

# DEWALT®



**POWERTOOLS AND ACCESSORIES CATALOGUE  
GUARANTEED TOUGH.®**

**2011**

# DEWALT<sup>®</sup>

## ENGINEERING EXCELLENCE

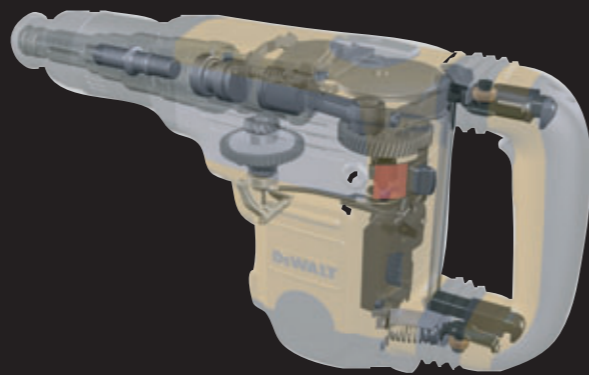

**30** Years of experience in engineering professional construction power tools at our in-house facility in Idstein, Germany



**50** Years of experience in designing and manufacturing world class drilling solutions for the construction industry at our in-house facility in Buchberg, Germany

- Simulation software developed in partnership with the automotive industry
- Industry leading application-based testing facilities
- Cutting edge drilling accessories manufacture
- Award winning design



**In-house design and manufacture ensures that the quality of DEWALT drilling solutions exceeds the requirements of the most demanding professional applications**



### END USER RESEARCH

- On average, we speak to 20,000 users every year as part of the product development process
- A comprehensive understanding of the real applications that our users perform enables us to generate product features that are a genuine benefit to our users



### INNOVATIVE PRODUCTS

- To support our users and drive our industry forward, DEWALT consistently develop truly innovative products, across multiple categories
- This technical strength is regularly recognised by international design awards



### COMPLETE PROFESSIONAL QUALITY PRODUCT RANGE

- DEWALT is a full range power tool and accessories supplier for the building contractor and professional tradesman

### USER LOYALTY

- The cast-iron DEWALT guarantee and premium service network ensure that our users have faith in the quality of our products. First-time buyers will become loyal DEWALT users
- DEWALT is heavily involved in end-user events across Europe - building our brand reputation, and generating huge excitement around our diverse product portfolio



<b>FEATURES QUICK REFERENCE</b>	<b>4</b>
<b>PRODUCT QUICK REFERENCE</b>	<b>5</b>
<b>PRODUCT INNOVATIONS</b>	
Heavy Duty Cordless	6
Compact Cordless	8
The 10.8 Volt System	10
Construction Instruments	12
Heavy Duty Construction	14
Dust And Vibration Management	16
Mitre Saws	18
Portable Woodworking	20
Jobsite Saws	22
<b>WARRANTY AND SERVICE</b>	<b>24</b>

## POWER TOOLS & ATTACHMENTS

### CORDLESS

The 36 Volt System	26
24 Volt SDS-Hammers	28
The 18 Volt System	28
The 14.4 Volt System	37
The 12 Volt System	41
The 7.2 Volt System	44
The 3.6 Volt System	45
Area Light, Radio and Vacuum	45
The 10.8 Volt System	46
Battery and Charger Systems	47

### CONSTRUCTION INSTRUMENTS

Laser Level Kit, Self Levelling Lasers	48
Laser Pointer & Plumb Bob, Distance Measurer & Auto Level Package	49
Tile Laser, Laser Level Attachments	50

### SCREWDRIVERS

Drywall Screwdrivers	51
Versaclutch Screwdrivers	51
Screwdrivers for Self Drilling Screws	52
Impact Wrenches	52

### DRILLS

Drill/ Mixers	53
Percussion Drills	53
Rotary Drills	55
Magnetic Drill Press	57

### DIAMOND DRILLS

Diamond Drilling System	58
Diamond Drills	60
Drilling Stands for Diamond Drills	60
Wet Tile Saw	61
Diamond Drill Attachments	61

### HAMMERS

Rotary & Combination Hammers	62
Dust Extraction	63
Chipping & Demolition Hammers	65

### METAL WORKING

Small Angle Grinders	67
Medium Angle Grinders	70
Large Angle Grinders	71
Die Grinders	74
Chop Saws	75
Sander	75
Polisher	75

### NAILERS

Staplers	76
Roofing Nailers	76
Framing Nailers	76
Palm Nailer	77
Finish Nailers	77
Cordless Nailers	78

### WOODWORKING

Routers	79
Dovetail Jigs	80
Router Attachments	81
Trimmers	83
Jointers	83
Planers	84
Orbital Sanders	85
Detail Sanders	85
Random Orbital Sanders	86
Belt Sanders	86
Linishing/ Grinding Machines	87
Heatgun	87

### SAWING

Plunge Saw	88
Jigsaws	89
Circular Saws	90
Reciprocating Saws	91
Alligator® Saws	92

### MITRE SAWS

Crosscut Mitre Saws	93
Compound Mitre Saws	93
Slide Compound Mitre Saws	94
Mitre Saw Attachments	95
Table Top Mitre Saws	96

### MACHINERY

Table Saws	97
Rolling Stand	97
Jobsite Saws	98
Radial Arm Saws	100
Bandsaws	100
Thicknessers	101
Dust Extraction	102

### BRUSH PAIRS

**103**

### ACCESSORIES

#### MASONRY DRILLING

EXTREME DeWALT® Masonry Drill Bits	105
Masonry Drill Bits	105
Multi-Material Drill Bits	106
SDS-Plus EXTREME DeWALT® 2 Drill Bits	106
EXTREME DeWALT® XLR Full Head Carbide Drill Bits	109
SDS-Plus 4-Cutter Drill Bits	110
SDS-Max Hammer Drill Bits	110
SDS-Plus Chisels	111
EXTREME DeWALT® Chisels	111
SDS-Max Chisels	112
19mm Hexagon Chisels	112
Pavement Breaker Chisels	112
Light Duty SDS-Plus Core Drills	113
Heavy Duty SDS-Max Core Drills	113
Single Piece Cores	113
Through Drilling Bits	114
Drive Adaptors & Adaptor - SDS-Plus	114

### METAL DRILLING

HSS-CO EXTREME DeWALT® Cobalt Metal Drill Bits	115
EXTREME DeWALT® 2 Metal Drill Bits	116
HSS-G DIN 338 Jobber Metal Drill Bits	117
HSS-G DIN 340 Long Series Metal Drill Bits	118
EXTREME DeWALT® Impact Step Bits	119
Step Drills	119
EXTREME DeWALT® Impact Drill Bits	120

### WOOD DRILLING

Brad Point Wood Drill Bits	120
Frame Drill Bits	121
TCT Hinge Boring Bits	121
Wood Auger Drill Bits	121
Self Feed Drill Bits	122
EXTREME DeWALT® Flat Wood Drill Bits	122
EXTREME DeWALT® Long Flat Wood Drill Bits	122
Flatwood Drill Bits	123

### HOLESAWS

EXTREME DeWALT® Impact Holesaws	124
Bi-Metal Deep Cut Holesaws	124
Bi-Metal Holesaw Sets	125
Carbide Grit Holesaws	125
Carbide Grit Holesaw Sets	125
EXTREME DeWALT® Quick Change Mandrels	126
Holesaw Mandrels and Accessories	126

### DRILLING ACCESSORIES

Mixer Tools	126
Chucks & Keys	127

### SCREWDRIVING

Screwdriving Accessories	128
EXTREME DeWALT® Impact Sets	130
DeWALT 'Flip & Drive' Units	131
EXTREME DeWALT® Impact Rated Socket Sets	131

### DRILLING & SCREWDRIVING SETS

Drilling Accessory Sets	132
Mag Box Magnetic Sets	133
Tough Case Storage	133
Modular Accessory Cases	134
Mini Mac Case Sets	134

### CIRCULAR SAW BLADES

EXTREME DeWALT® Stationary Circular Saw Blades	135
Stationary Circular Saw Blade Guide	137
EXTREME DeWALT® Portable Circular Saw Blades	138
Cordless Circular Saw Blades	139
Portable Circular Saw Blades	139
Portable Circular Saw Blade Guide	140
Insert Rings	142

### JIGSAW BLADES

XPC Wood Cutting Blades	143
Wood Cutting Blades	144
EXTREME DeWALT® Bi-Metal Cutting Blades T-Shank	145
Metal Cutting Blades	145
Wood & Metal Cutting Blades	146
EXTREME DeWALT® Special Material Blades	146
Wood & Metal Cutting Blade Kits	146

### RECIPROCATING SAW BLADES

Wood Cutting Blades	147
Metal Cutting Blades	147
General Purpose Blades	148
Demolition Blades	148
Reciprocating Blade Sets	148
Specialist Blades	149

### ALLIGATOR® SAW BLADES

**149**

### SPECIALIST WOODWORKING ACCESSORIES

Bandsaw Blades	150
Planer Blades & Jointer Accessories	150

### ROUTER BITS

**151**

### COATED ABRASIVES

Full Sheet	153
Hand Sanding Block	153
Half Sheet	154
Third Sheet	154
Quarter Sheet	155
Detail	156
Rolls	156
Belts	157
Grinding Belts	158
Honing Belts	158
Nylon Loop Discs	159
Extreme DeWALT® Fibre Discs	160
Flap Discs	160

### PADS & BONNETS

'Quick Fit' Platens	161
Backing Pads & Bonnets	161
Angle Grinder Polishing Bonnets	161

### BONDED ABRASIVES

Metal Cutting & Grinding Discs	162
Chop Saw Wheel	162
Stainless Steel & Thin Metal Cutting & Grinding Discs	163
Aluminium Cutting Discs	163
High Speed Stone Cutting Discs	163
Stone Cutting & Grinding Discs	164
Grinding Wheels & Honing Wheels	164
Grinding Cups	164
Wire Brushes	165

### DIAMOND DISCS

Diamond Disc Guide	166
High Performance Diamond Discs	167
Dry Diamond Discs	168
Wet & Dry Diamond Tile Saw Blade	168

### DIAMOND DRILLS

Dry Diamond Core Drills & Dosensenker	169
Wet Diamond Core Bits	170
Adaptors, Extension Rods & Pilot Bits	171
Diamond Tile Drill Bits	171



















### NAILER ACCESSORIES

















Nails	172
Staples	173

### DeWALT SERVICE

5 Star Service	174
Service Agent Network	175

The icons under each tool indicate the product features. Check details for information.

-  **DRILLING/CHISELLING MODES**  
Single mode for chiselling only
-  **TWO MODE**  
For rotary and hammer drilling
-  **THREE MODE**  
For rotary, hammer drilling and chiselling
-  **IMPACT MECHANISM**  
Uses rotary impacts to generate extremely high torque
-  **TWO AND THREE SPEED SELECTOR**  
Many DeWALT tools are available with multiple speeds to offer greater control in a variety of applications
-  **XRP®**  
The range of XRP® cordless powertools have extreme run-time and power
-  **CONSTANT SPEED**  
A constant speed is maintained under operational load
-  **ELECTRONIC VARIABLE SPEED CONTROL**  
The speed can be adjusted from low to high giving greater control in each application
-  **SOFT START**  
Electronic soft start to limit start-up current and reduce kick reaction which could misalign the accessory
-  **LOW VIBRATION SIDE HANDLE**  
Low-Vibration side handle with a damped mechanism
-  **ANTI-MASS**  
Anti-Mass Counter-balance system helps reduce vibration
-  **SUSPENDED HANDLES**  
Suspended handles dramatically reduce vibration, increasing productivity and end user comfort
-  **ANTI-VIBRATION FLOATING HANDLE**  
No matter where it is pressed, the whole handle is completely damped from top to bottom reducing the vibration to the user
-  **WET & DRY**  
Tool is designed to work with water feed
-  **3-POSITION KEYLESS SHOE**  
To maximise blade life
-  **4-POSITION KEYLESS BLADE CLAMP**  
Allows quick blade change, flush cutting and versatility
-  **PLUNGE ACTION**  
Parallel plunge action for accuracy and cut finish
-  **GUIDE RAIL COMPATIBLE**  
Tool can be used with DeWALT guide rail system

-  **COMPLETE TORQUE CONTROL**  
The Complete Torque Control offers a patented two step clutch system. On the pre-set lowest torque the user can complete 80% of his applications in a safer way. The highest torque setting is perfect for core drilling and big diameter applications with solid bits
-  **CLUTCH**  
Clutch protects the operator against kick back and the tool against overload should the accessory jam
-  **TOOL FREE ADJUSTMENT**  
The accessory in use, guard or shoe of the tool can be changed or adjusted without the need of a screwdriver, key or spanner
-  **KEYLESS CHUCK**
-  **QUICK CHANGE CHUCK**  
Ideal solution to change easily between SDS and 3 jaw chuck systems
-  **SPINDLE LOCK**  
Spindle is locked by pushing a button allowing quick and easy change of accessories
-  **FORWARD AND REVERSE**  
Forward and reverse action for screwdriving applications
-  **PENDULUM BLADE ACTION**  
Adjustable pendulum blade action provides improved cutting performance in comparison to a conventional blade action
-  **DUST EXTRACTION**  
Dust Extraction into either a dust bag on the tool or through an attachment to a dust extraction unit
-  **EASILY ACCESSIBLE BRUSHES**  
Brushes accessible for easy servicing reducing down time
-  **ELECTRONIC BRUSH WEAR INDICATOR**  
Service light in the tool handle indicates when the brushes require changing.
-  **DUST EJECTION SYSTEM**  
Rejects the majority of dust sucked into a grinder leaving clean air only to pass over the motor, resulting in increased durability
-  **HOOK & LOOP**  
Hook & Loop bases allow easy attachment of sand paper
-  **PALM GRIP**  
Tool designed for single-handed operation
-  **BATTERIES**  
Cordless tools (with the exception of bare units) come with either one or two batteries as standard equipment. The battery chemistry can be Nickel Cadmium (NiCd), Nickel Metal Hydride (NiMH) or Lithium-Ion (Li-Ion). Please refer to individual tool specifications for clarification of which battery or batteries come with your selected tool
-  **COMPACT BATTERY**  
Compact batteries are smaller and lighter than standard batteries, and require less charging time
-  **CORDED/CORDLESS**  
Tool can be powered by mains electricity source, or by DeWALT batteries
-  **CARRYING CASE**  
Supplied with heavy duty carrying case

Cat. No.	Page	Cat. No.	Page	Cat. No.	Page	Cat. No.	Page	Cat. No.	Page
D21160	57	D26500/ D26500K	84	DC235KL	26	DC840KB	43	DW630	75
D21441	56	D26501K	84	DC300KL/ DC300KN	27	DC845KB	43	DW650/ DW650E	86
D21510	53	D27107/ D27107V	98	DC305KL/ DC305KN	27	DC901KL/ DC901KN	26	DW670	83
D21520	53	D27111/ D27112	96	DC308KL/ DC308KN	27	DCD710S2	46	DW677	84
D21570K	55	D27300/ D27300T	101	DC330KB/ DC330KA/		DCD920B2	30	DW680/ DW680K	84
D21580K	60	D27900	102	DC330N	35	DCD920L2	30	DW682K	83
D215821	60	D27901	102	DC330KL	34	DCD925B2	29	DW685K	83
D21582K	60	D27902	129	DC352KBR/ DC352KN	35	DCD925L2	29	DW711	96
D215831	61	D28065	70	DC385KB/ DC385N	34	DCD930B2	38	DW712/ DW712N	93
D21583K	60	D28111	67	DC385KL	34	DCD930L2	38	DW713XPS/ DW713	93
D21585	60	D28113/ D28113K	67	DC390KB/ DC390KA/		DCD935B2	37	DW716EXPS/ DW716	94
D215851	61	D28116	67	DC390N	35	DCD935L2	37	DW717XPS	94
D21620K	57	D28117	67	DC390KL	35	DCD940B2	42	DW718XPS/ DW718	94
D21717K/ D21716/		D28130	68	DC411KB/ DC411KA/		DCD945B2	41	DW721KN/ DW722KN	100
D21716K	53	D28132C	68	DC411N	34	DCF610S2	46	DW728KN/ DW729KN	100
D21721K/ D21720K/	54	D28133	69	DC411KL	34	DCF815S2	46	DW733	102
D21720		D28134	68	DC415KL/ DC415KN	27	DKC210S2	47	DW738	100
D21805/ D21805K/		D28135/ D28135K	69	DC500	45	DKC211S2	47	DW739	101
D21805KS	54	D28136	69	DC509	27	DCL510N	46	DW743N	99
D23550	90	D28137	69	DC515N	36	DE7400	97	DW744XP	97
D23551	90	D28139	68	DC520KA/ DC520N	32	DW030P	49	DW745	97
D23620/ D23620K	90	D28141	70	DC527N	36	DW059K2H/ DW059K2	32	DW753	87
D23650K	90	D28142	68	DC528N	44	DW060K	50	DW754	87
D23651K	90	D28400	72	DC540K/ DC540	44	DW074K	48	DW755	87
D23700	91	D28401	72	DC542K/ DC542	43	DW075PK	48	DW777/ DW771	93
D24000S	61	D28413	71	DC547K/ DC547	36	DW079KH	48	DW831	70
D25012K/ D25012N	62	D28414	73	DC600KA	45	DW079PKH	48	DW840	70
D25013K/ D25013C/		D28415	74	DC602KB	43, 78	DW082K	49	DW849	75
D25013N	62	D28421	73	DC608KB	33, 78	DW084K	49	DW872	75
D25123K	62	D28422	71	DC616KB	33, 78	DW087K	49	DW876	101
D25124K	62	D28423	73	DC618KB/ DC618KN	33, 78	DW096PK	49	DW882	74
D25223K	62	D28432C	73	DC721KB/ DC721KA/		DW152	53	DW904	44
D25301D	63	D28490	72	DC720KA	31	DW217	56	DW906	41
D25302DH	26	D28491	71	DC722C2	30	DW221	56	DW908	36
D25323K	63	D28492/ D28492K	72	DC722KL/ DC722N	30	DW236I	56	DW915	44
D25324K	63	D28493	71	DC725KB/ DC725KA	30	DW246	57	DW918	41
D25325K	63	D28495	71	DC727C2	29	DW263K	52	DW919	36
D25330K	65	D28498	74	DC727KL/ DC727N	29	DW264K	52	DW920K	44
D25404K	64	D28700	75	DC731KB/ DC731KA/		DW268K	51	DW934K2H/	
D25405K	64	D28715	75	DC730KA	38	DW269K	51	DW934K2/ DW934	35
D25501K	64	D28750	73	DC732C2	38	DW274K/ DW274KN	51	DW941K	41
D25601K	64	D28885	74	DC732KL/ DC732N	38	DW275K/ DW275KN	51	DW960	31
D25602K	64	D51180	77	DC733C2	39	DW292	52	DW965K	42
D25711K	65	D51238K	77	DC733K2/ DC733KB/		DW294	52	DW966K	40
D25712K	65	D51257K	77	DC733KA/ DC733KN	39	DW304PK	91	DW979K2	43
D25762K	65	D51276K	78	DC733KL	39	DW310K	91	DWC410	61
D25831K	65	D51321	76	DC735KB/ DC735KA	37	DW311K	91	DWD014/ DWD014S	55
D25870K	66	D51430	76	DC737C2	37	DW331K	89	DWD024/ DWD024K/	
D25899K	66	D51431	76	DC737KL/ DC737KN	37	DW333K	89	DWD024S/ DWD024KS	53
D25901K	66	D51825	76	DC740KA/ DC740K2	42	DW341K	89	DWD112/ DWD112S	55
D25941K	66	D51850	76	DC743KB/ DC742KA	42	DW343K	89	DWD115KS	56
D25980/ D25980K	66	D51855	77	DC745KB/ DC745KA	42	DW390/ DW391	92	DWD221	57
D26200	79	D51856	77	DC800KL/ DC800KN	26	DW392	92	DWD522KS	54
D26203	79	DC013	45	DC820KB	32	DW393	92	DWD524KS	54
D26204K	79	DC019	45	DC822KL/ DC822N	32	DW394	92	DWD525KS	55
D26410	86	DC020	45	DC825KB	32	DW432/ DW433	86	DWD530KS	55
D26411	87	DC212KA/ DC212N	29	DC827C2	31	DW443	86	DW5520K	88
D26420/ D26421	85	DC213KB	28	DC827KL/ DC827N	31	DW609	83	DW5520KR	88
D26422/ D26423	85	DC213KL	28	DC830KB	41	DW615	79		
D26430	85	DC222KA	28	DC832KL/ DC832N	40	DW621K/ DW621	79		
D26441	85	DC223KA	28	DC835KB	40	DW624	80		
D26453	86	DC224KA/ DC224KB	28	DC837C2	40	DW625EK/ DW625E	80		
D26480	85	DC234KL	26	DC837KL/ DC837N	40	DW626	80		

**DEWALT heavy duty cordless products offer SPEED, POWER & PRODUCTIVITY - what else do you need?**

**4 reasons to buy DEWALT XRP**



**ALL NEW** 



DCD925L2

- **DURABILITY** - Robust all metal transmission provides reliability and longer tool life
- **APPLICATION SPEED** - DEWALT innovative 3 speed gear box provides optimal torque to speed ratio for the most common jobsite applications
- **EFFICIENCY** - Exclusive self-tightening chuck prevents bit slippage and is easy to apply
- **POWERFUL** - Frameless Motor and efficient power delivery system ensure tasks are completed easily and quickly

**18V PLATFORM**

DEWALT long life lithium ion batteries provide up to 2X the number of recharges of NiCd and NiMH

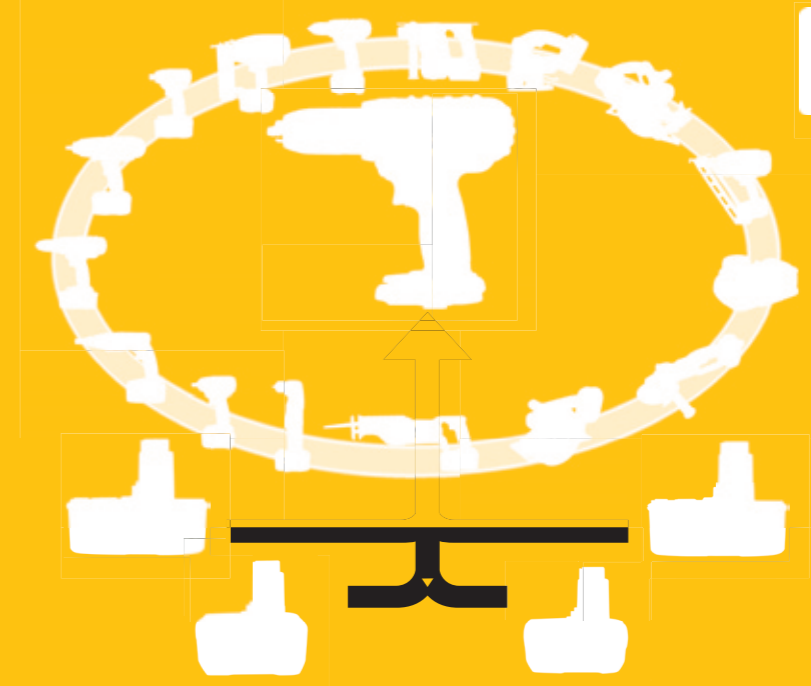

All DEWALT Lithium Ion powertools have been designed to maximise your productivity - perfectly combining POWER and USER COMFORT

**➤ Other heavy duty cordless products from DEWALT**



DC213KL - 18V 3 MODE SDS-PLUS



DC390KL - 18V 165MM CIRC SAW



DC305KL - 36V RECIP SAW



DC020 - 12V-18V AREA LIGHT

**DEWALT compact cordless products offer superior task efficiency for repetitive applications and better access to confined work spaces**

**4 reasons to buy DEWALT Compact Impact Tools**



DC837KL

- **POWER VS SIZE** - DEWALT Impact Drivers deliver incredible power, whilst retaining an extremely compact profile
- **CONTROL** - Ergonomic design, full variable speed switch and electronic motor brake for complete control
- **DURABILITY** - Rugged Aluminium front housing provides greater heat dispersion for longer tool life
- **DO MORE WITH 1 TOOL** - DEWALT has the most comprehensive range of Impact Accessories on the market, including:

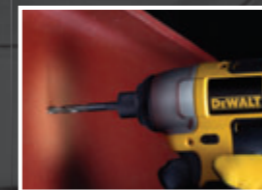

Extreme Impact Drill Bits



Extreme Impact Screwdriver bits



Extreme Impact Holesaws



Extreme Impact Sockets

**MAXIMISE YOUR EFFICIENCY!**

Now Available - DEWALT COMPACT Lithium Ion Batteries

**COMPACT**  
**LITHIUM ION**



- **SMALLER** - more versatile
- **LIGHTER** - less user fatigue
- **FASTER** - less charge time

**BACKWARDS COMPATIBLE IN OVER 40 TOOLS**



➤ **Other compact cordless products from DEWALT**



DC822KL - 18V IMPACT WRENCH



DC727KL - 18V 2SP COMBI



DW965K - 12V RIGHT ANGLE DRILL



DC500 - 18V CORDLESS VAC

**10.8V range delivers total control optimising user efficiency**

**4 reasons to buy DEWALT 10.8V Screwdriver**



DCF610S2

- **ERGONOMICS** - Designed for comfort, the soft grip fits perfectly into the palm of your hand - pick up the tool and try for yourself!
- **DELIVERY OF POWER** - Optimized control and power over full range of jobsite applications
- **BIT RETENTION** - Innovative chuck holds 25mm hex bits securely, without the need for a holder and allows for single-handed operation
- **BALANCE** - The tool foot design and slide pack battery system mean that the tool will stand upright, so the user can always keep it close to hand

**Coming in 2011...**

**10.8V INFRA RED THERMOMETER**

Measures the temperature of an object from a distance!



DCT414S1

- Find leaks / hot spots
- Evaluate sealing / insulation
- Confirm water / pipe temperatures
- Inspect equipment

- User adjustable colour change indicator for hot/cold spots
- Adjustable emissivity - precise temperature measurement for different materials
- -30°C - 500°C temperature range



**➤ Other 10.8V Cordless products from DEWALT**



DCD710S2 - 10.8V DRILL DRIVER



DCF815 - 10.8V IMPACT DRIVER



DCL510 - 10.8V TORCH



DT7965 - MAG BOX

The result of thousands of hours of user research - **DEWALT Lasers** are exactly what you asked us to build

**4** reasons to buy the **DEWALT Cross-Line Laser**



DW087

- **INDUSTRY BENCHMARK** - The DEWALT Cross-Line Laser is trusted on over 100,000 jobsites across Europe\*
- **EASE OF USE** - Each button performs 1 function, DEWALT removes all unnecessary complexity
- **VERSATILITY** - Built in pivot mechanism, can be easily mounted on any common work surface
- **DURABILITY** - Designed specifically to maintain accuracy and withstand tough jobsite conditions (internal shock-absorbing mechanism/ full rubber over-mould)

**HAVE YOU ALSO TRIED ...**



**DEWALT Laser Distance Measure**

Designed specifically to withstand tough construction site conditions

- **Accurate**
- **Easy to Use**
- **Jobsite tough**



➤ **Other laser products from DEWALT**



DW079KH - SELF LEVELLING LASER



DW084 - 4 BEAM LASER POINTER



DW096 - X26 AUTO LEVEL



DW060 - TILE LASER

\*estimate based on DEWALT annual sales figures and product lifespan



**DEWALT SDS-MAX commercial construction hammers offer both performance and protection. No Compromise**

**4 reasons to buy DEWALT 40-45mm Combination Hammer**



D25602K



➤ **COMFORT** - Shock absorbing rear and side handles for increased user comfort

➤ **DURABLE** - Heat resistant mechanism due to oil filled gearbox. Chain driven gearbox for longer tool life

➤ **Performance** - Oversized mechanism mechanism for more impact energy. Variable speed for optimal control



➤ **TECHNOLOGY** - Complete Torque Control system offers the user a low setting for standard applications, but a higher 'overdrive' setting for heavier tasks such as core drilling and large diameter bits



**SPEED**  
4 Flute Helix maximises mill removal for fast drilling and clear holes

**SPEED**  
Long Helix length with optimised free space for faster debris removal

**DURABILITY/SPEED**  
Maximised Central Core = Durability/Speed

**LIFE/SPEED**  
Open head design for fast debris removal

➤ **Other Heavy Duty Construction products from DEWALT**



D25980 - 30KG BREAKER



D25762K - 9KG SDS-MAX HAMMER



D28498 - 9 INCH GRINDER

[www.DEWALT.eu/vibrationcalculator](http://www.DEWALT.eu/vibrationcalculator)

**GUARANTEED TOUGH.**

**DEWALT has developed efficient dust and vibration management products for improved user safety and comfort**

**4 reasons to buy DEWALT 26mm Low Vibration L-Shape Hammer**



D25324



- **ACTIVE VIBRATION CONTROL SYSTEM** - AVC system and **FULLY FLOATING** rear handle dramatically reduce vibration, while the working end of the tool delivers the full force of the hammer to ensure maximum productivity
- **IMPROVED ERGONOMIC DESIGN** - Combined with AVC means the user can work for longer without tiring, and with reduced exposure to vibration
- **TOOL LIFE** - Optimised seals and robust design prevent dust ingress and prolong the life of the tool in a tough jobsite conditions
- **USER HEALTH** - Optional dust extraction system protects the user from harmful dust and supports a safe working environment

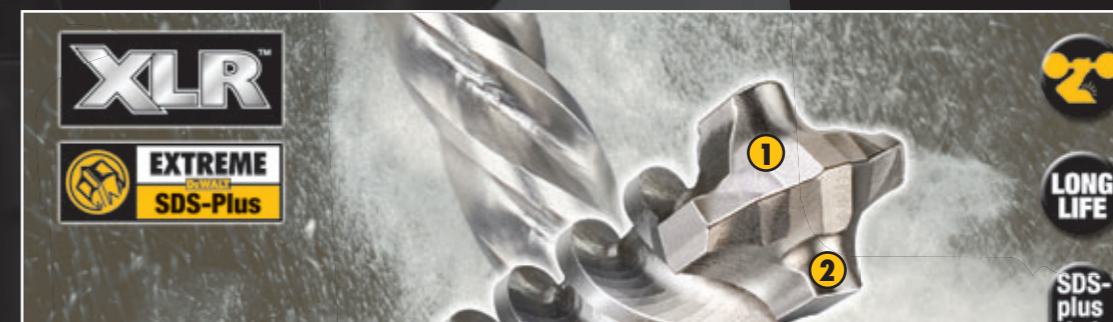

- 1** 2x more carbide than SDS-Plus 2-cutters for long life & extreme durability
- 2** Unique tip geometry for cleaner, concentric holes
- 3** Four flute spiral design for optimum debris removal and fast drilling

**➤ Other construction products from DEWALT**



D25124K - HEAVY DUTY 3 MODE SDS-PLUS



D25223 - LOW VIBRATION 3 MODE SDS-PLUS



D25013 - TRADESMAN 3 MODE SDS-PLUS



D28113 - 115MM GRINDER

[www.DEWALT.eu/vibrationcalculator](http://www.DEWALT.eu/vibrationcalculator)

**GUARANTEED TOUGH.**

**DEWALT manufactures precision engineered mitre saws which offer accuracy, performance and durability**

**4**

**reasons to buy DW717XPS**



DW717XPS

**XPS**  
CROSS CUT POSITIONING SYSTEM



**THE NEW SHADOW CUT-LINE SYSTEM**



- **REPEATABLE ACCURACY** - Impressive specification, outstanding build quality and exclusive precision mitre and bevel adjustment system
- **BUILT FOR DURABILITY AND LONG-LIFE** - Powerful 1675 Watt motor delivers extended power and durability. Superior design ensures DeWALT mitre saws are tough enough to withstand the jobsite environment
- **XPS CUT-LINE** - Unlike lasers, the XPS system requires no adjustment, the shadow of the blade shows exactly where the cut will be
- **GREATER PRODUCTIVITY** - Illuminated work surface and fast accurate alignment

**DEWALT's best selling compact mitre saw**

- Ultra-compact
- Easy to carry
- Reliable
- Repeatable accuracy
- Easy to slide



DW777

**➤ Other mitre saws from DEWALT**



DW712 - 216MM SLIDE MITRE SAW



DW713XPS - 250MM MITRE SAW



DW716XPS - 305MM MITRE SAW



DW718XPS - 305MM SLIDE MITRE SAW

**DEWALT manufacture class leading wood working tools to provide professional tradesmen and craftsmen with a full range of high quality products**

**4 reasons to buy the DEWALT Plunge Saw**



DWS520KR



- **ACCURACY** - Superior tooth design and excellent rail system with fixed rail adjusters to eliminate deflection during a cut
- **QUALITY OF FINISH**
  - 48 tooth blade gives fine finish and very little breakout in laminates
  - DEWALT guide rail system offers anti-splinter strips on both sides of the rail
- **SPEED AND PRODUCTIVITY** - Rapid adjustment and fast, accurate cuts
- **SAFETY** - Anti kickback function stops the saw from moving backwards along the rail

**The DEWALT Guide Rail System**



SPEED

PRODUCTIVITY

ACCURACY

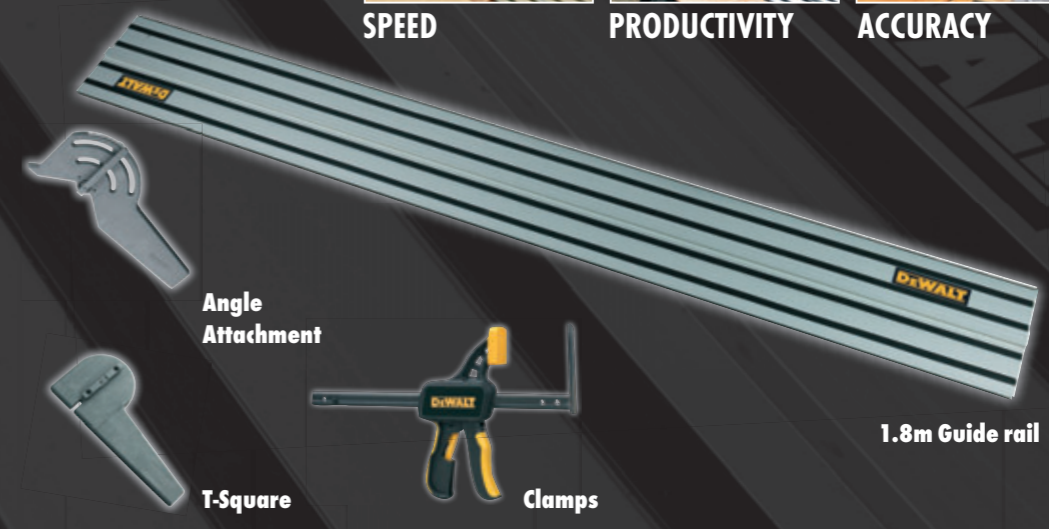

**➤ Other portable wood working products from DEWALT**



DW625EK - 2000 WATT 1/2" ROUTER



DW331K - 701 WATT JIGSAW



D26453 - 125MM RANDOM ORBIT SANDER



D26501K - 4MM PLANER

**DEWALT Jobsite Saws are designed for durability and provide class-leading functionality - without compromising on accuracy**

**4**

**reasons to buy DEWALT Combination Saws**



D27107



- **ACCURACY** - Workshop accuracy - this machine has been designed for the needs of kitchen fitters to roofers. Ideal for cutting anything from cornice to roof joists - Giving you quality cuts every time
- **VERSATILITY** - Large accurate mitre saw combined with an accurate table saw in a mobile compact design - improving productivity
- **POWER** - Outstanding power to meet the most demanding site & workshop applications - Designed for tough environments
- **CAPACITY** - 305mm Blade delivers a capacity to suit the vast majority of applications with 81mm depth of cut and a cross cut of 205mm. You only need one machine which saves space, time and money

**Outstanding Portability**

**Purpose built rolling stand dedicated to DW745 and DW744 table saws**

- **Lightweight**
- **Robust**
- **Easy set-up**



**➤ Other jobsite saws from DEWALT**



D23620K - 62MM CIRC SAW



DW311K - 1200 WATT RECIP SAW



D27111 - TABLE TOP MITRE SAW



DW745 - 250MM TABLE SAW

**DEWALT**

**30** DAY NO RISK SATISFACTION GUARANTEE

**1** YEAR FREE SERVICE CONTRACT

**1** YEAR WARRANTY

**GUARANTEED TOUGH**

# DEWALT offers an outstanding guarantee for professional users of our products



**DEWALT**

**TOTAL SERVICE**

**PROVIDING EXTRA PEACE OF MIND**

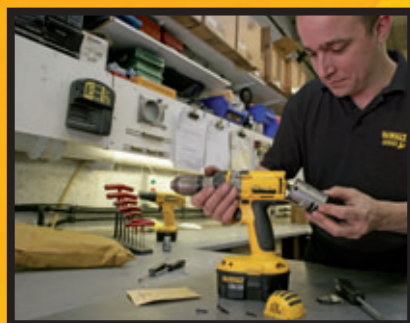

**30 DAY NO RISK SATISFACTION GUARANTEE**

If you are not completely satisfied with the performance of your DeWALT product, simply return it to the point of purchase within 30 days for a full refund or exchange. Product must be complete as purchased and proof of purchase must be produced. Spare parts and Accessories are excluded unless failed under warranty.



**1 YEAR FREE SERVICE CONTRACT**

If you require maintenance or service for your DeWALT product within 12 months of purchase, you are entitled to one service free of charge, undertaken at an authorised DeWALT repair agent. Proof of purchase must be produced. Includes labour. Spare parts and Accessories are excluded, unless failed under warranty.



**1 YEAR FULL WARRANTY**

In the unlikely event that your DeWALT product becomes defective due to faulty materials or workmanship within 12 months of purchase, DeWALT guarantees to replace all defective parts free of charge or - at our discretion - replace the unit free of charge.

This is provided that:

- The product has not been misused
- The product has been subject to fair wear and tear
- Repairs have not been attempted by unauthorised persons
- Proof of purchase is produced

In order to make a claim, you will need to submit proof of purchase to the vendor or an authorised repair agent.



This guarantee statement is in addition to and in no way prejudices your contractual rights as a professional user or your statutory rights as a private non-professional user. The guarantee is valid within the territories of the Member States of the European Union and the European Free Trade Area. A list of authorised DeWALT repair agents and full details of our after-sales service and contacts are available online at:

[www.DEWALT.eu](http://www.DEWALT.eu)

**TOTAL SERVICE IS THE HAMMER PROTECTION PLAN THAT OFFERS COMPLETE PEACE OF MIND WITH NO UNEXPECTED SERVICE COSTS**

If your hammer drill breaks down simply deliver it to any authorised DeWALT repair agent, and it will be repaired and returned to you quickly and efficiently.



**WHAT DOES TOTAL SERVICE COVER?**

- Wear & Tear
- Manufacturing defects
- Brush Change
- DeWALT Parts & retest



**PLUS**

- Transportation of hammer, to and from site.



**WHERE CAN I BUY A TOTAL SERVICE PLAN?**

DeWALT Total Service is not available at all DeWALT distributors. Please ask your DeWALT representative.

AVAILABLE AS EITHER

**2 OR 4**  
YEAR PLAN

You can also find a full list of the Terms & Conditions on the website.

[www.DEWALT.eu](http://www.DEWALT.eu)

**YOUR BENEFITS**

- LOWER ANNUAL RUNNING COSTS FOR YOUR TOOL
- BETTER FINANCIAL PLANNING - GUARANTEED FIXED COSTS
- LESS DOWN TIME - FAST SERVICE TURNAROUND
- CONVENIENCE
- COMPLETE PEACE OF MIND



**36 Volt Dedicated Cordless Hammer with Integrated Dust Extraction System DC235KL**



Ideal for drilling anchors and fixing holes into concrete, brick and masonry from 4 mm to 26 mm, with Dust Extraction System up to 16 mm in diameter. Rotation stop for light chiseling applications in plaster, tiles and render. Internal mechanism connected to external housings via spring dampeners meaning significantly lower vibration, reduced user fatigue allowing longer operating periods. Includes D25302DH Dust Extraction System with quick-fit system for easy tool free assembly and release.

**Standard Equipment:** Integrated D25302DH dust extraction system with Hepa filter, 1 hour charger, 2 batteries Li-Ion, Side handle with dust extraction adaptation, Quick release SDS-Plus toolholder, Quick release 13mm 3 jaw chuck, Grease, Heavy duty carrying case

Battery Capacity	Li-Ion 2.2 Ah
Power Output	450 Watts
No Load Speed	0-1150 rpm
Impact Energy	2.5 J
Blows per Minute	0-4300 bpm
Tool Holder	SDS-Plus
Max. Drilling Capacity [Wood]	30 mm
Max. Drilling Capacity [Metal]	13 mm
Max. Drilling Capacity [Concrete]	26 mm
Weight	5.6 kg
Length	502 mm



**36 Volt Heavy Duty 3 Mode Quick Change Chuck Dedicated Cordless Hammer DC234KL**



Ideal for drilling anchors and fixing holes into concrete, brick and masonry from 4 mm to 26 mm. Rotation stop for light chiselling applications in tiles and plaster and impact stop mode for rotary drilling only in wood and steel. Internal mechanism connected to external housings via spring dampeners meaning significantly lower vibration, reduced user fatigue allowing longer operating periods. Quick Release SDS-Plus Toolholder and 3 jaw chuck supplied for easy switching between hammer/rotary hammer and rotary only applications.

**Standard Equipment:** 1 hour charger, 2 batteries, Multi-position side handle, 13 mm diameter 3 jaw keyless quick change chuck, Grease, Heavy duty carrying case

Battery Capacity	Li-Ion 2.2 Ah
Power Output	450 Watts
No Load Speed	0-1150 rpm
Impact Energy	2.5 J
Blows per Minute	0-4300 bpm
Tool Holder	SDS-Plus
Max. Drilling Capacity [Wood]	30 mm
Max. Drilling Capacity [Metal]	13 mm
Max. Drilling Capacity [Concrete]	26 mm
Weight	3.8 kg
Length x Height	320 x 230 mm



**Cordless Dust Extraction System D25302DH**



Ideal for dust free drilling up to 16 mm in diameter with any DeWALT 28V or 36V SDS-Plus hammer. Powered by an independent motor maintaining maximum hammer performance with no decrease in durability. High quality washable HEPA filter capable of achieving 99.5% efficiency with dust particles as small as 0.3 microns. Quick-fit system for easy tool free assembly and release.

**Standard Equipment:** Cordless dust extraction system, Side handle with dust extraction adaptation, Telescope, extraction head and depth rod, Connector pipe, Large kit box

Fits	Any DeWALT 28V or 36V SDS-Plus Hammer
Collar Diameter	54 mm
Max. Drill Bit Diameter	16 mm
Max. Drill Bit Length	210 mm
Max. Drilling Depth	150 mm
Hose Length	215 mm
Hose Diameter	32 mm
Weight	1.8 kg
Length x Height	502 x 360 mm



**36 Volt 13 mm Heavy Duty Hammer Drill DC901KL / DC901KN\***



Powerful 36 Volt combination tool for heavy duty hammer drilling and screwdriving applications. Three speed settings for optimum performance in high torque, normal use and high speed applications. 22 position adjustable torque control for uniform results and optimised precision when screwdriving.

**Standard Equipment:** 1 hour charger, 2 batteries, Multi position side handle, Heavy duty carrying case

Battery Capacity	Li-Ion 2.2 Ah
Chuck Capacity	1.5-13 mm
Power Output	750 Watts
No Load Speed	0-400 / 0-1200 / 0-1600 rpm
Beats per Minute	0-6800 / 0-20400 / 0-27200 bpm
Max Torque	42 Nm
Max. Drilling Capacity [Wood]	65 mm
Max. Drilling Capacity [Metal]	13 mm
Max. Drilling Capacity [Masonry]	16 mm
Weight	3 kg
Length x Height	267 x 260 mm

\*N version sold as bare unit



**36 Volt Heavy Duty High Torque Impact Wrench DC800KL / DC800KN**



Powerful fan cooled motor delivers up to 440 Nm of max torque and up to 2500 impacts per minute for heavy duty fastening applications. All metal gearing for efficient power transmission and long tool life. Aluminium front housing for better weight and balance. Modular component design for easy access and fast service.

**Standard Equipment:** 1 hour charger, 2 batteries, Heavy duty carrying case

Battery Capacity	Li-Ion 2.2 Ah
Bit Holder	1/2"
Power Output	800 Watts
No Load Speed	1400 rpm
Impacts per Minute	2500 ipm
Max. Torque	440 Nm
Max. Bolt Diameter	M20
Weight	3.4 kg
Length x Height	273 x 275 mm



**36 Volt Heavy Duty Cordless Finishing Grinder DC415KL / DC415KN**



Powerful DeWALT fan cooled motor delivers maximum power and durability. 6,500 rpm provides high power for cutting and grinding applications. Battery pack produces 36 Volt power at equivalent weight to 18 Volt NiCd/NiMH pack weight.

**Standard Equipment:** 1 hour charger, 2 batteries, Keyless protective guard, 2 position anti vibration side handle, Wrench, Heavy duty carrying case

Battery Capacity	Li-Ion 2.2 Ah
Max. Disc Diameter	125 mm
Power Output	815 Watts
No Load Speed	6500 rpm
Spindle Thread	M14
Weight	3.5 kg
Length x Height	340 x 150 mm

\*N version sold as bare unit



**36 Volt Heavy Duty Cordless Reciprocating Saw DC305KL / DC305KN**



Powerful DeWALT fan cooled motor with replaceable brushes and variable speed delivers fast cutting action up to 3000 strokes per minute and 29 mm stroke length. 4-position keyless blade clamp allows quick blade change, flush cutting, and versatility. Battery pack produces 36 Volt power at equivalent weight to 18 Volt NiCd/NiMH pack weight.

**Standard Equipment:** 1 hour charger, 2 batteries, Wood cutting blade, Heavy duty carrying case

Battery Capacity	Li-Ion 2.2 Ah
Power Output	710 Watts
No Load Stroke Rate	0-3000 spm
Stroke Length	29 mm
Weight	3.81 kg
Length x Height	440 x 200 mm

\*N version sold as bare unit



**36 Volt Heavy Duty Cordless Circular Saw DC300KL / DC300KN**



184 mm, 24 tooth carbide tipped blade allows for efficient run-time and fast, smooth cut finish at maximum 62 mm depth of cut. 0-50° bevel capacity with lever-action detents at 22.5° and 45° allows for aggressive bevel cuts while allowing users to locate common angles quickly. Battery pack produces 36 Volt power at equivalent weight to 18 Volt NiCd/NiMH pack weight.

**Standard Equipment:** 1 hour charger, 2 batteries, 184 mm 24 tooth carbide blade, Rip fence, Heavy duty carrying case

Battery Capacity	Li-Ion 2.2 Ah
Blade Diameter	184 mm
Power Output	940 Watts
No Load Speed	4000 rpm
Bevel Capacity	50°
Weight	4.49 kg
Length x Height	406 x 255 mm

\*N version sold as bare unit



**36 Volt Heavy Duty Cordless Jigsaw DC308KL / DC308KN**



Powerful DeWALT fan cooled motor with replaceable brushes and variable speed delivers fast cutting action up to 2,700 strokes per minute. Dust blower keeps line of cut clear of chips. Battery pack produces 36 Volt power at equivalent weight to 18 Volt NiCd/NiMH pack weight.

**Standard Equipment:** 1 hour charger, 2 batteries, Anti-splinter shoe insert, Anti-scratch shoe cover, Dust extraction adaptor, 4 blades, Heavy duty carrying case

Battery Capacity	Li-Ion 2.2 Ah
Power Output	550 Watts
No Load Stroke Rate	0-2700 spm
Stroke Length	26 mm
Bevel Capacity	45°
Max. Depth of Cut [Wood]	130 mm
Max. Depth of Cut [Metal]	10 mm
Weight	3.4 kg
Length x Height	300 x 215 mm

\*N version sold as bare unit



**36V Heavy Duty Flashlight DC509**



Lockable head clip offers versatility and convenience of a lantern. Flashlight with flexible neck for multi-directional hands-free lighting. Compact, lightweight design with impact resistant housing. 8 hours continuous run time with the 36V Li-Ion battery pack.

Bulb Type	Xenon
Battery Type	Li-Ion 36 V
Weight	0.52 kg
Length x Height	200 x 130 mm

\*Batteries and charger sold separately



**24 Volt Heavy Duty SDS-Plus 3 Mode Quick Change Chuck Dedicated Cordless Hammer** DC224KA/ DC224KB\*



Ideal for drilling anchors and fixing holes into concrete, brick and masonry from 4 mm to 22 mm  
 Rotation stop for light chiselling applications in plaster, tiles and render and Impact stop mode for rotary drilling only in wood and steel  
 Internal mechanism connected to external housings via spring dampeners meaning significantly lower vibration, reduced user fatigue allowing longer operating periods  
 Quick Release SDS-Plus Toolholder and 3 Jaw Chuck supplied for easy switching between hammer/rotary hammer and rotary only applications

**Standard Equipment:** 1 hour charger, 2 batteries, Multi-position side handle, 13 mm diameter 3 jaw keyless quick change chuck, Grease, Heavy duty carrying case

Battery Capacity	NiCd 2.0 Ah
Power Output	300 Watts
No Load Speed	0-1100 rpm
Impact Energy	2.1 J
Blows per Minute	0-4200 bpm
Tool Holder	SDS-Plus
Max. Drilling Capacity [Wood]	30 mm
Max. Drilling Capacity [Metal]	13 mm
Max. Drilling Capacity [Concrete]	22 mm
Weight	4.0 kg
Length x Height	310 x 240 mm

\*Available with 3.0 NiMH batteries as B-version



**24 Volt Heavy Duty SDS-Plus 3 Mode Dedicated Cordless Hammer** DC223KA



Ideal for drilling anchors and fixing holes into concrete, brick and masonry from 4 mm to 22 mm  
 Rotation stop for light chiselling applications in plaster, tiles and render and Impact stop mode for rotary drilling only in wood and steel  
 Internal mechanism connected to external housings via spring dampeners meaning significantly lower vibration, reduced user fatigue allowing longer operating periods  
 Large 19 mm optimised hammer mechanism delivers corded drilling performance

**Standard Equipment:** 1 hour charger, 2 batteries, Multi-position side handle, Grease, Heavy duty carrying case

Battery Capacity	NiCd 2.0 Ah
Power Output	300 Watts
No Load Speed	0-1100 rpm
Impact Energy	2.1 J
Blows per Minute	0-4200 bpm
Tool Holder	SDS-Plus
Max. Drilling Capacity [Wood]	30 mm
Max. Drilling Capacity [Metal]	13 mm
Max. Drilling Capacity [Concrete]	22 mm
Weight	3.9 kg
Length x Height	290 x 240 mm



**24 Volt Heavy Duty SDS-Plus 2 Mode Dedicated Cordless Hammer** DC222KA



Ideal for drilling anchors and fixing holes into concrete, brick and masonry from 4 mm to 22 mm  
 Impact stop mode for rotary drilling only in wood, ceramic, steel  
 Internal mechanism connected to external housings via spring dampeners meaning significantly lower vibration, reduced user fatigue allowing longer operating periods  
 Large 19 mm optimised mechanism delivers corded drilling performance

**Standard Equipment:** 1 hour charger, 2 batteries, Multi-position side handle, Grease, Heavy duty carrying case

Battery Capacity	NiCd 2.0 Ah
Power Output	300 Watts
No Load Speed	0-1100 rpm
Impact Energy	2.1 J
Blows per Minute	4200 bpm
Tool Holder	SDS-Plus
Max. Drilling Capacity [Wood]	30 mm
Max. Drilling Capacity [Metal]	13 mm
Max. Drilling Capacity [Concrete]	22 mm
Weight	3.8 kg
Length x Height	290 x 240 mm



**18 Volt Heavy Duty SDS-Plus 3 Mode Dedicated Cordless Hammer** DC213KL



Ideal for drilling anchors and fixing holes into concrete, brick and masonry from 4 mm to 20 mm  
 Rotation stop for light chiselling applications in plaster, tiles and render and Impact stop mode for rotary drilling only in wood and steel  
 Internal mechanism connected to external housings via spring dampeners meaning significantly lower vibration, reduced user fatigue allowing longer operating periods

New 2.0Ah 18 Volt Lithium Ion battery, delivers higher performance and durability with 25 percent smaller battery and 200grams lighter. Overall unit weight less than 3kg

**Standard Equipment:** 40 minute charger, 2 batteries, Multi-position side handle, Grease, Heavy duty carrying case

Battery Capacity	2.0 Li-Ion Ah
Power Output	300 Watts
No Load Speed	0-1100 rpm
Impact Energy	2.1 J
Blows per Minute	0-4200 bpm
Tool Holder	SDS-Plus
Max. Drilling Capacity [Wood]	26 mm
Max. Drilling Capacity [Metal]	13 mm
Max. Drilling Capacity [Concrete]	20 mm
Weight	2.9 kg
Length x Height	270 x 192 mm



**18 Volt Heavy Duty SDS-Plus 3 Mode Dedicated Cordless Hammer** DC213KB



Ideal for drilling anchors and fixing holes into concrete, brick and masonry from 4 mm to 20 mm  
 Rotation stop for light chiselling applications in plaster, tiles and render and Impact stop mode for rotary drilling only in wood and steel  
 Internal mechanism connected to external housings via spring dampeners meaning significantly lower vibration, reduced user fatigue allowing longer operating periods  
 Large 19 mm optimised hammer mechanism delivers corded drilling performance

**Standard Equipment:** 40 minute charger, 2 batteries, Multi-position side handle, Grease, Heavy duty carrying case

Battery Capacity	NiMH 2.6 Ah
Power Output	300 Watts
No Load Speed	0-1100 rpm
Impact Energy	2.1 J
Blows per Minute	0-4200 bpm
Tool Holder	SDS-Plus
Max. Drilling Capacity [Wood]	26 mm
Max. Drilling Capacity [Metal]	13 mm
Max. Drilling Capacity [Concrete]	20 mm
Weight	3.1 kg
Length x Height	295 x 192 mm



**18 Volt SDS-Plus 2 Mode Dedicated Hammer** DC212KA/ DC212N\*



Ideal for drilling anchors and fixing holes into concrete, brick and masonry from 4 mm to 20 mm  
 Large 19 mm optimised hammer mechanism delivers corded drilling performance  
 Efficient and compact gearbox for longer runtime and lighter weight  
 Extremely compact design and rear mounted battery for excellent balance and optimum comfort

**Standard Equipment:** 1 hour charger, 2 batteries, Multi-position side handle, Grease tube, Heavy duty carrying case

Battery Capacity	NiCd 2.0 Ah
Power Output	300 Watts
No Load Speed	0-1100 rpm
Impact Energy	2.1 J
Blows per Minute	0-4200 bpm
Tool Holder	SDS-Plus
Max. Drilling Capacity [Wood]	26 mm
Max. Drilling Capacity [Metal]	13 mm
Max. Drilling Capacity [Concrete]	20 mm
Weight	3.1 kg
Length x Height	295 x 195 mm

\*Available as bare unit, without batteries and charger as N-version



**18 Volt 13 mm XRP Li-Ion Heavy Duty Hammer Drill** DCD925L2



Powerful 18 Volt XRP combination tool for heavy duty drilling and screwdriving applications  
 DeWALT built frameless motor reduces size and increases efficiency producing excellent runtime  
 22 position adjustable torque control for uniform results and optimised precision when screwdriving

**Standard Equipment:** 40 minute charger, 2 batteries, Multi position side handle, Heavy duty carrying case

Battery Capacity	Li-Ion 2.0 Ah
Chuck Capacity	1.5-13 mm
Power Output	450 Watts
No Load Speed	0-500/0-1250/0-2000 rpm
Beats per Minute	0-8500/0-21250/0-34000 bpm
Max Torque	55 Nm
Max. Drilling Capacity [Wood]	50 mm
Max. Drilling Capacity [Metal]	13 mm
Max. Drilling Capacity [Masonry]	16 mm
Weight	2.5 kg
Length x Height	247 x 252 mm



**18 Volt 13 mm XRP Heavy Duty Hammer Drill** DCD925B2



Powerful 18 Volt XRP Combi tool for heavy duty drilling and screwdriving applications  
 DeWALT built frameless motor reduces size and increases efficiency producing excellent runtime  
 Ultra smooth 3 speed selector for optimum performance in high torque, normal use and high speed applications.  
 22 position adjustable torque control for uniform results and optimised precision when screwdriving

**Standard Equipment:** 40 min multi chemistry charger, 2 batteries, Multi position side handle, Heavy duty carrying case

Battery Capacity	2.6 NiMH Ah
Chuck Capacity	1.5-13 mm
Power Output	450 Watts
No Load Speed	0-500/0-1250/0-2000 rpm
Beats per Minute	0-8500/0-21250/0-34000 bpm
Max Torque	55 Nm
Max. Drilling Capacity [Wood]	50 mm
Max. Drilling Capacity [Metal]	13 mm
Max. Drilling Capacity [Masonry]	16 mm
Weight	2.9 kg
Length x Height	247 x 248 mm



**18 Volt 13 mm Compact Hammer Drill** DC727KL/ DC727N\*



Powerful 18 Volt combination tool for hammer drilling and screwdriving applications  
 17 position adjustable torque control for consistent screwdriving into a variety of materials with different screw sizes  
 13 mm single sleeve keyless chuck with automatic spindle lock for quick and easy bit change with one hand

**Standard Equipment:** 40 minute charger, 2 batteries, Heavy duty carrying case

Battery Capacity	Li-Ion 2.0 Ah
Chuck Capacity	1.5-13 mm
Power Output	375 Watts
No Load Speed	0-500 / 0-1700 rpm
Beats per Minute	0-8500/0-29000 bpm
Max Torque	41 Nm
Max. Drilling Capacity [Wood]	38 mm
Max. Drilling Capacity [Metal]	13 mm
Max. Drilling Capacity [Masonry]	13 mm
Weight	2.2 kg
Length x Height	225 x 239 mm



\*Available as bare unit, without batteries and charger as N-version

**18 Volt 13mm Compact Hammer Drill** DC727C2



Powerful 18 Volt combination tool for hammer drilling and screwdriving applications  
 13 mm single sleeve keyless chuck with automatic spindle lock for quick and easy bit change with one hand  
 17 position adjustable torque control for consistent screwdriving into a variety of materials with different screw sizes  
 Provided with Compact Li-Ion battery

**Standard Equipment:** 40 minute charger, 2 x 1.1Ah Compact Lithium batteries, Heavy duty carrying case

Battery Capacity	Li-Ion 1.1 Ah
Chuck Capacity	1.5-13 mm
Power Output	350 Watts
No Load Speed	0-500 / 0-1700 rpm
Beats per Minute	0-8500/0-29000 bpm
Max Torque	41 Nm
Max. Drilling Capacity [Wood]	38 mm
Max. Drilling Capacity [Metal]	13 mm
Max. Drilling Capacity [Masonry]	13 mm
Weight	1.84 kg
Length x Height	225 x 225 mm





18 Volt 13mm Compact Hammer Drill

DC725KB/ DC725KA\*



Powerful 18 Volt combination tool for hammer drilling and screwdriving applications  
13 mm single sleeve keyless chuck with automatic spindle lock for quick and easy bit change with one hand  
17 position adjustable torque control for consistent screwdriving into a variety of materials with different screw sizes  
All metal gearing for efficient power transmission and longer tool life

**Standard Equipment:** 1 hour charger, 2 batteries, Heavy duty carrying case

Battery Capacity	NiMH 2.6 Ah
Chuck Capacity	1.5-13 mm
Power Output	400 Watts
No Load Speed	0-500/ 0-1700 rpm
Beats per Minute	0-8500/ 0-29000 bpm
Max Torque	44 Nm
Max. Drilling Capacity [Wood]	38 mm
Max. Drilling Capacity [Metal]	13 mm
Max. Drilling Capacity [Masonry]	13 mm
Weight	2.4 kg
Length x Height	225 x 239 mm

\*Available as bare unit, without batteries and charger as N-version



18 Volt 13 mm XRP Li-Ion Heavy Duty Cordless Drill Driver

DCD920L2



Powerful 18 Volt drill driver for heavy duty drilling and screwing applications  
DEWALT built frameless motor reduces size and increases efficiency producing excellent runtime.  
22 position adjustable torque control for uniform results and optimised precision when screwdriving

**Standard Equipment:** 40 Minute Charger, 2 batteries, Multi position side handle, Heavy duty carry case

Battery	2.0 Li-Ion
Chuck Capacity	1.5-13 mm
Power Output	450 Watts
No Load Speed	0-500/0-1250/0-2000 rpm
Max. Torque	55 Nm
Max. Drilling Capacity [Wood]	50 mm
Max. Drilling Capacity [Metal]	13 mm
Weight	2.4 kg
Length x Height	240 x 252 mm



18 Volt 13 mm XRP Heavy Duty Drill Driver

DCD920B2



Powerful 18 Volt XRP Drill Driver for heavy duty drilling and screwdriving applications  
DEWALT built frameless motor reduces size and increases efficiency producing excellent runtime  
Ultra smooth 3 speed selector for optimum performance in high torque, normal use and high speed applications.  
22 position adjustable torque control for uniform results and optimised precision when screwdriving

**Standard Equipment:** 40 min multi chemistry charger, 2 batteries, Multi position side handle, Heavy duty carrying case

Battery	NiMH 2.6 Ah
Chuck Capacity	1.5-13 mm
Power Output	450 Watts
No Load Speed	0-500/0-1250/0-2000 rpm
Max. Torque	55 Nm
Max. Drilling Capacity [Wood]	50 mm
Max. Drilling Capacity [Metal]	13 mm
Weight	2.8 kg
Length x Height	240 x 248 mm



18 Volt 13 mm Compact Drill Driver

DC722KL/ DC722N\*



Powerful 18 Volt drill driver for drilling and screwdriving applications  
13mm single sleeve keyless chuck with automatic spindle lock for quick and easy bit change with one hand  
Battery pack produces 18 Volt power at less than 12 Volt NiCd/NiMH pack weight providing the ultimate ergonomic solution

**Standard Equipment:** 40 minute charger, 2 batteries, Heavy duty carrying case

Battery Capacity	2.0 Li-Ion Ah
Chuck Capacity	1.5-13 mm
Power Output	375 Watts
No Load Speed	0-500 / 0-1700 rpm
Max Torque	41 Nm
Max. Drilling Capacity [Wood]	38 mm
Max. Drilling Capacity [Metal]	13 mm
Weight	2.1 kg
Length x Height	210 x 239 mm

\*Available as bare unit, without batteries and charger as N-version



18 Volt 13mm Compact Drill Driver

DC722C2



Powerful 18 Volt drill driver for drilling and screwdriving applications  
13mm single sleeve keyless chuck with automatic spindle lock for quick and easy bit change with one hand  
17 position adjustable torque control for consistent screwdriving into a variety of materials with different screw sizes  
Compatible with all DEWALT 18V battery packs

**Standard Equipment:** 40 minute charger, 2 x 1.1Ah Compact Lithium batteries, Heavy duty carrying case

Battery Capacity	1.1 Li-Ion Ah
Chuck Capacity	1.5-13 mm
Power Output	350 Watts
No Load Speed	0-500 / 0-1700 rpm
Max Torque	41 Nm
Max. Drilling Capacity [Wood]	38 mm
Max. Drilling Capacity [Metal]	13 mm
Weight	1.74 kg
Length x Height	210 x 225 mm



18 Volt 13 mm Compact Drill Driver

DC721KB/ DC721KA/ DC720KA



Powerful 18 Volt drill driver for drilling and screwdriving applications  
13mm single sleeve keyless chuck with automatic spindle lock for quick and easy bit change with one hand  
17 position adjustable torque control for consistent screwdriving into a variety of materials with different screw sizes  
All metal gearing for efficient power transmission and longer tool life

**Standard Equipment:** 1 hour charger, 2 batteries, Heavy duty carrying case

Battery Capacity	NiMH 2.6 Ah
Chuck Capacity	1.5-13 mm
Power Output	400 Watts
No Load Speed	0-500 / 0-1700 rpm
Max Torque	44 Nm
Max. Drilling Capacity [Wood]	38 mm
Max. Drilling Capacity [Metal]	13 mm
Weight	2.3 kg
Length x Height	210 x 239 mm



18 Volt 10mm Right Angle Drill - Bare Unit

DW960



Powerful fan cooled motor delivers up to 33 Nm of sustained torque for turning large drill bits and fasteners  
2 speed ranges 0-475/0-1500 rpm for increased user flexibility to achieve a wide range of applications  
Forward, reverse, variable speed and electronic motor brake for total control  
Durable, right angle transmission with sealed ball bearings and cut-steel gears for a longer tool life

Battery Capacity	fits 2.0, 2.4, 2.6, 3.0 Ah
Chuck Capacity	1.0-10 mm
Power Output	300 Watts
No Load Speed	0-475 / 0-1500 rpm
Max Torque	33 Nm
Max. Drilling Capacity [Wood]	28 mm
Max. Drilling Capacity [Metal]	10 mm
Weight	1.2 (2.2) kg
Length x Height	323 x 125 mm



18 Volt Compact Impact Driver

DC827KL/ DC827N



Durable frameless high speed motor delivers up to 150 Nm of torque  
All metal gearing for efficient power transmission and long tool life  
Aluminium front housing provides greater heat dispersion increasing motor life  
Improved variable speed switch and electronic motor brake for complete control for both setting and removing fasteners

**Standard Equipment:** 40 minute charger, 2 batteries, Heavy duty carrying case

Battery Capacity	2.0 Li-Ion Ah
Bit Holder	1/4"
Power Output	250 Watts
No Load Speed	0-2400 rpm
Impacts per Minute	0-2700 ipm
Max Torque	150 Nm
Max. Bolt Diameter	M12
Weight	1.7 kg
Length x Height	146 x 231 mm



18 Volt Compact Impact Driver

DC827C2



Durable frameless high speed motor delivers up to 150 Nm of torque  
All metal gearing for efficient power transmission and long tool life  
Aluminium front housing provides greater heat dispersion increasing motor life  
Improved variable speed switch and electronic motor brake for complete control for both setting and removing fasteners

**Standard Equipment:** 40 minute charger, 2 x 1.1Ah Compact Lithium batteries, Heavy duty carrying case

Battery Capacity	1.1 Li-Ion Ah
Bit Holder	1/4"
Power Output	250 Watts
No Load Speed	0-2400 rpm
Impacts per Minute	0-2700 ipm
Max Torque	150 Nm
Max. Bolt Diameter	M12
Weight	1.4 kg
Length x Height	146 x 230 mm



DEWALT IMPACT DRILLING AND SCREWDRIVING

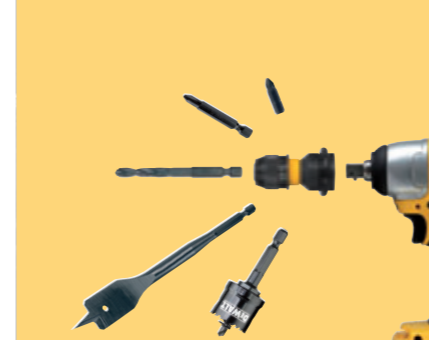

The DeWALT EXTREME Impact range allows the user to perform more applications using the same tool.

DeWALT supplies Impact Rated:

- Screw-driving bits
- Drill bits
- Hole-saws
- Flat-wood Bits

All these fastening and drilling bits have been designed to withstand the high torque generated by DeWALT Impact drivers.

For the complete range of IMPACT drilling and screwdriving accessories see pages 119, 120, 122, 123, 128

18 Volt Compact Impact Driver

DC825KB



Durable frameless high speed motor delivers up to 150 Nm of torque  
All metal gearing for efficient power transmission and long tool life  
Aluminium front housing provides greater heat dispersion increasing motor life  
Improved variable speed switch and electronic motor brake for complete control for both setting and removing fasteners

**Standard Equipment:** 40 minute charger, 2 batteries, Heavy duty carrying case

Battery Capacity	NiMH 2.6 Ah
Bit Holder	1/4"
Power Output	250 Watts
No Load Speed	0-2400 rpm
Impacts per Minute	0-2700 ipm
Max Torque	150 Nm
Max. Bolt Diameter	M12
Weight	2.0 kg
Length x Height	146 x 231 mm



18 Volt High Torque Impact Wrench

DW059K2H/ DW059K2



Powerful fan cooled motor delivers up to 418 Nm of sustained torque and up to 2600 impacts per minute for heavy duty fastening applications  
All metal gearing for efficient power transmission and long tool life  
Magnesium front housing for better weight and balance  
Modular component design for easy access and fast service

**Standard Equipment:** 1 hour charger, 2 batteries, Heavy duty carrying case

Battery Capacity	NiMH, 2.6 Ah
Bit Holder	1/2"
Power Output	365 Watts
No Load Speed	1650 rpm
Impacts per Minute	2600 ipm
Max. Torque	418 Nm
Max. Bolt Diameter	M20
Weight	3.4 kg
Length x Height	264 x 260 mm



18 Volt Compact Impact Wrench

DC822KL/ DC822N



Durable Frameless high speed motor delivers up to 195 Nm of torque  
All metal gearing for efficient power transmission and long tool life  
Aluminium front housing provides greater heat dispersion increasing motor life  
Improved variable speed switch and electronic motor brake for complete control for both setting and removing fasteners

**Standard Equipment:** 40 minute charger, 2 batteries, Heavy duty carrying case

Battery Capacity	2.0 Li-Ion Ah
Bit Holder	1/2"
Power Output	250 Watts
No Load Speed	0-2400 rpm
Impacts per Minute	0-2700 ipm
Max. Torque	195 Nm
Max. Bolt Diameter	M16
Weight	1.7 kg
Length x Height	146 x 231 mm

LITHIUM ION

18 Volt Compact Impact Wrench

DC820KB



Durable frameless high speed motor delivers up to 195 Nm of torque  
All metal gearing for efficient power transmission and long tool life  
Aluminium front housing provides greater heat dispersion increasing motor life  
Improved variable speed switch and electronic motor brake for complete control for both setting and removing fasteners

**Standard Equipment:** 40 minute charger, 2 batteries, Heavy duty carrying case

Battery Capacity	NiMH, 2.6 Ah
Bit Holder	1/2"
Power Output	250 Watts
No Load Speed	0-2400 rpm
Impacts per Minute	0-2700 ipm
Max. Torque	195 Nm
Max. Bolt Diameter	M16
Weight	2.0 kg
Length x Height	146 x 231 mm



18 Volt Drywall Screwdriver

DC520KA/ DC520N



Removable depth sensitive "set and forget" nosepiece for consistent fastener depth  
Two speed settings, variable speed and reverse switch for maximum user control  
Up to 20 Nm of sustainable torque for maximum performance  
High performance fan cooled motor with replaceable brushes for maximum power and durability

**Standard Equipment:** 1 hour charger, 2 batteries, Magnetic bit holder, Screwdriver bit, Drywall nosepiece, Heavy duty carrying case

Battery Capacity	NiCd 2.0 Ah
Tool Holder	(Hex) 6.35 mm
Power Output	360 Watts
No Load Speed	0-900/0-2900 rpm
Max Torque	20 Nm
Weight	2.2 kg
Length x Height	307 x 231 mm



18 Volt Heavy Duty 16 Gauge Cordless Nail Gun

DC618KB/ DC618KN



Versatility in the loading and unloading of fasteners - 20 degree angled magazine 120 nail capacity  
The tool works as fast as you do with consistent nail penetration  
The sequential operating mode allows for precision placement and the bump operating mode provides the user with production speed  
Depths can be easily referenced utilising numbered dial and user does not sacrifice performance when changing depths

**Standard Equipment:** 1 hour charger, 2 batteries, DeWALT safety glasses, Reversible belt hook, No-mark tip, Heavy duty carrying case

Nail Diameter	1.6 mm
Battery Capacity	NiMH 2.6 Ah
Magazine angle	20 °
Nail Length	32-63 mm
Magazine capacity	Up to 120 Nails
Magazine loading	Rear - load
Operating pressure range	NA Bar
Air consumption per shot @6.9 Bar	NA l
Firing mode	Bump & Sequential
Height x Length	320 x 330 mm
Weight	3.9 kg
Nailer Operating Mode	Selective
Integrated Belt Hook	Yes
Jam Clearing	Yes
Features	LED Headlights



18 Volt 18 Gauge Cordless Nailer

DC608KB



The tool works as fast as you do with consistent nail penetration  
The sequential operating mode allows for precision placement and the bump operating mode provides the user with production speed  
Depths can be easily referenced utilising numbered dial and user does not sacrifice performance when changing depths  
Provides easy access to the nosepiece for the simple removal of a jammed fastener without the use of screwdrivers or tool wrenches

**Standard Equipment:** 1 hour charger, 2 batteries, Heavy duty carrying case

Nail Diameter	1.2 mm
Battery Capacity	NiMH 2.6 Ah
Magazine angle	0 °
Nail Length	16-50 mm
Magazine capacity	110 Nails
Magazine loading	Side Load
Operating pressure range	NA Bar
Air consumption per shot @6.9 Bar	NA l
Firing mode	Bump & Sequential
Length x Height	295 x 290 mm
Weight	3.4 kg
Nailer Operating Mode	Selective
Integrated Belt Hook	Yes
Jam Clearing	Yes



18 Volt Heavy Duty 16 Gauge Straight Cordless Nailer

DC616KB



Versatility in the loading and unloading of fasteners - straight magazine 110 nail capacity  
The tool works as fast as you do with consistent nail penetration  
The sequential operating mode allows for precision placement and the bump operating mode provides the user with production speed  
Depths can be easily referenced utilising numbered dial and user does not sacrifice performance when changing depths

**Standard Equipment:** 1 hour charger, 2 batteries, DeWALT safety glasses, Reversible belt hook, No-mark tip, Heavy duty carrying case

Nail Diameter	1.6 mm
Battery Capacity	NiMH 2.6 Ah
Magazine angle	0 °
Nail Length	32-63 mm
Magazine capacity	110 Nails
Magazine loading	Rear - load
Operating pressure range	NA Bar
Air consumption per shot @6.9 Bar	NA l
Firing mode	Bump & Sequential
Length x Height	330 x 320 mm
Weight	3.9 kg
Nailer Operating Mode	Selective
Integrated Belt Hook	Yes
Jam Clearing	Yes
Features	LED indicators



**18 Volt Finishing Grinder DC411KL**



Powerful DEWALT fan cooled motor delivers maximum power and durability 6,500 rpm provides high power for cutting and grinding applications Battery pack produces 18 Volt power at less than 12 Volt NiCd / NiMH pack weight providing the ultimate ergonomic solution

**Standard Equipment:** 40 Min Charger, 2 batteries, Keyless protective guard, 2 position side handle, Heavy duty carrying case

Battery Capacity	Li-Ion 2.0 Ah
Max. Disc Diameter	125 mm
Power Output	405 Watts
No Load Speed	6500 rpm
Spindle Thread	M14
Weight	2.9 kg
Length x Height	375 x 147 mm



**18 Volt Finishing Grinder DC411KB / DC411KA / DC411N**



Powerful DEWALT fan-cooled motor delivers maximum power and durability 6,500 rpm provides high power for cutting and grinding applications Steel cut spiral bevel gears provide highest level of durability and low vibration increasing user productivity Convenient trigger switch with lock-off button for easier gripping

**Standard Equipment:** 1 hour charger, 2 batteries, Keyless protective guard, 2 position side handle, Heavy duty carrying case

Battery Capacity	NiMH 2.6 Ah
Max. Disc Diameter	125 mm
Power Output	405 Watts
No Load Speed	6500 rpm
Spindle Thread	M14
Weight	3.2 kg
Length x Height	375 x 147 mm



**18 Volt Heavy Duty Reciprocating Saw DC385KL**



Powerful DEWALT fan cooled motor with replaceable brushes and variable speed delivers fast cutting action up to 3,000 strokes per minute and 28.6 mm stroke length Four-position blade clamp allows for flush cutting and increased versatility Battery pack produces 18 Volt power at less than 12 Volt NiCd / NiMH battery pack weight providing the ultimate ergonomic solution

**Standard Equipment:** 40 Min Charger, 2 batteries, Wood and metal blade, Heavy duty carrying case

Battery Capacity	Li-Ion 2.0 Ah
Power Output	390 Watts
No Load Stroke Rate	0-3000 spm
Stroke Length	28.6 mm
Weight	3.4 kg
Length x Height	435 x 188 mm



**18 Volt Heavy Duty Reciprocating Saw DC385KB / DC385N**



Powerful DEWALT fan cooled motor with replaceable brushes and variable speed delivers fast cutting action up to 3,000 strokes per minute and 28.6 mm stroke length 4-position blade clamp allows for flush cutting and increased versatility Lever-action keyless blade clamp for quick and easy blade changes Variable speed trigger, lock-off switch and electronic motor brake for quick controlled cuts and enhanced work safety

**Standard Equipment:** 40 Min Charger, 2 batteries, Wood and metal blade, Heavy duty carrying case

Battery Capacity	2.6 NiMH Ah
Power Output	390 Watts
No Load Stroke Rate	0-3000 spm
Stroke Length	28.6 mm
Weight	3.70 kg
Length x Height	435 x 188 mm



**18 Volt Heavy Duty Jigsaw DC330KL**



Powerful DEWALT fan-cooled motor with replaceable brushes and variable speed. Fast cutting action up to 3000 strokes per minute Dust blower keeps line of cut clear of dust and debris Battery pack produces 18 Volt power at less than 12 Volt NiCd / NiMH battery pack weight providing the ultimate ergonomic solution

**Standard Equipment:** 40 minute charger, 2 batteries, Anti-scratch shoe cover, 1 XPC Wood blade, Heavy duty carrying case

Battery Capacity	Li-Ion 2.0 Ah
Power Output	400 Watts
No Load Stroke Rate	0-3000 spm
Stroke Length	26 mm
Bevel Capacity	45 °
Max. Depth of Cut [Wood]	135 mm
Max. Depth of Cut [Metal]	10 mm
Weight	3.1 kg
Length x Height	285 x 213 mm



**18 Volt Heavy Duty Jigsaw DC330KB / DC330KA / DC330N**



Powerful DEWALT fan cooled motor with replaceable brushes and variable speed delivers fast cutting action up to 3000 strokes per minute Dust blower keeps line of cut clear of chips Tool free adjustable shoe with anti-scratch cover bevels 45 degrees in both directions Quick and easy patented keyless blade change system accepts t-shank blades

**Standard Equipment:** 1 hour charger, 2 batteries, Anti-scratch shoe cover, 1 XPC Wood blade, Heavy duty carrying case

Battery Capacity	NiMH 2.6 Ah
Power Output	400 Watts
No Load Stroke Rate	0-3000 spm
Stroke Length	26 mm
Bevel Capacity	45 °
Max. Depth of Cut [Wood]	135 mm
Max. Depth of Cut [Metal]	10 mm
Weight	3.4 kg
Length x Height	285 x 213 mm



**18 Volt Heavy Duty Circular Saw DC390KL**



Ultra thin kerf 165 mm, 24 tooth carbide-tipped blade allows for efficient run time and fast, smooth cut finish at maximum 55 mm depth of cut Powerful DEWALT fan cooled motor with replaceable brushes delivers up to 3700 rotation per minute for fast cutting action Battery pack produces 18 Volt power at less than 12 Volt NiCd / NiMH pack weight providing the ultimate ergonomic solution

**Standard Equipment:** 40 Min Charger, 2 batteries, 165 mm carbide blade, Rip fence, Hex key, Heavy duty carrying case

Battery Capacity	Li-Ion 2.0 Ah
Blade Diameter	165 mm
Power Output	390 Watts
No Load Speed	3700 rpm
Bevel Capacity	50 °
Weight	3.9 kg
Length x Height	406 x 259 mm



**18 Volt Heavy Duty Circular Saw DC390KB / DC390KA / DC390N**



Ultra thin kerf 165 mm, 24 tooth carbide tipped blade allows for efficient run-time and fast, smooth cut finish at maximum 55 mm depth of cut Powerful DEWALT fan cooled motor with replaceable brushes delivers up to 3700 rotation per minute for fast cutting action Keyless bevel angle and depth of cut adjustment with easy to read scale for maximum cordless versatility Extremely durable design offering a cast magnesium shoe and full metal guarding to withstand rough job site conditions

**Standard Equipment:** 1 hour charger, 2 batteries, 165 mm carbide blade, Rip fence, Hex key, Heavy duty carrying case

Battery Capacity	NiMH 2.6 Ah
Blade Diameter	165 mm
Power Output	390 Watts
No Load Speed	3700 rpm
Bevel Capacity	50 °
Weight	4.2 kg
Length x Height	406 x 259 mm



**18 Volt Heavy Duty Plunge Saw with 1.5m Rail DC352KBR / DC352KN\***



Parallel plunge allows the user to maintain a smooth and constant hand position while cutting A 24 tooth blade gives a fine and accurate cut and maximises runtime and power Rail adjustment allows the saw to be adjusted to accurately move along the rail The anti kickback function stops the saw from moving backwards along the rail and helps stop the saw climbing out of the work piece when making plunge cuts

**Standard Equipment:** 1 hour charger, 2 batteries, 24 tooth precision circular saw blade, Heavy duty carrying case, 1.5m rail

Battery Capacity	NiMH 2.6 Ah
Power Output	390 Watts
No Load Speed	3200 rpm
Blade Diameter	165 mm
Blade Bore	20 mm
Bevel Capacity	47 °
Max. Depth of Cut at 90° [with guide rails]	55 mm
Max. Depth of Cut at 45° [with guide rails]	40 mm
Weight	5.6 kg
Length x Height	349 x 264 mm

\*N version sold as bare unit and does not include guide rail



**18 Volt Heavy Duty Metal Cutting Circular Saw DW934K2H / DW934K2 / DW934\***



Robust cool-running 173mm, 40 tooth tungsten carbide tipped blade for burr-free cuts at constant 61 mm cutting depth throughout the life of the blade Powerful DEWALT fan cooled motor with replaceable brushes and new transmission design Left side blade design, the new gun-sight line of cut indicator and the unique chemically treated glass window for enhanced line of cut visibility Extremely durable design offering an anti-magnetic stainless shoe and full metal guarding to withstand rough job site conditions

**Standard Equipment:** 1 hour charger, 2 batteries, 173mm tungsten carbide blade, Hex key, Heavy duty carrying case

Battery Capacity	NiMH 2.6 Ah
Blade Diameter	173 mm
Power Output	315 Watts
No Load Speed	3100 rpm
Bevel Capacity	NA °
Weight	3.8 kg
Length x Height	365 x 195 mm

\*DW934 version sold as bare unit



**18 Volt 600 ml Satchet and 310 ml Cartridge Sealant Gun** **DCS47K/ DC547\***



2900 N push force suitable for high viscosity urethanes and adhesives  
Variable speed control dial for pre-selection of dispensing speed  
Electronic trigger with variable speed and automatic overload protection  
Ergonomic T-handle design with rubber grip for extra comfort

**Standard Equipment:** 1 hour charger, 1 battery, Cartridge holder, Satchet barrel, Conversion kit

Battery Capacity	NiMH 2.6 Ah
Carrier Size	310-600 ml
Applicator	Cartridge & Satchet
Push Force	2900 N (295Kg)
Push Speed	635 mm/min
Weight	3.3/2.3* kg
Length x Height	734 x 322 mm

\*DC547 sold as bare unit



**18 Volt Handheld Wet/Dry Vacuum - Bare Unit** **DC515N**



Runs off current 18 Volt battery platform allowing quick and easy change between different tools with a single battery  
High efficiency filter traps 99.7% of dust as small as drywall and cement dust  
1.9 Litre tank capacity allows for the cleaning up of larger amounts of material  
The rubber hose is extendable to 1 metre for added flexibility for a wide range of applications

**Standard Equipment:** No batteries included, 1 metre heavy duty rubber hose, Crevice tool, Wide nozzle

Voltage	18 V
Battery	Not included
Power Input	180 Watts
Max. Airflow	15.9 l/sec
Tank volume	1.9 l
Power Source	DC
Hose Nozzle Outside Diameter	32 mm
Blower	No
Weight	1.2 (2.2) kg
Length x Height	460 x 200 mm

**18 Volt Fluorescent Light - Bare Unit** **DC527N\***



Compact, lightweight design with impact resistant housing  
Battery and charger sold separately  
Rubber overmold for increased durability  
4 prong bulb for added bulb stability

Bulb Type	Fluorescent
Battery Type	18 V
Weight	0.5 kg
Length x Height	155 x 0 mm

\*Spare bulb available - DE5273

**18 Volt Heavy Duty Flexible Flashlight - Bare Unit** **DW919\***



Wide angle beam with metal reflector and Xenon bulbs for greater brightness  
Lockable head clip offers versatility and convenience of a lantern.  
Flashlight with flexible neck for multi-directional hands-free lighting  
Compact, lightweight design with impact resistant housing

Bulb Type	Xenon
Battery Type	18 V V
Weight	0.45 kg
Length x Height	130 x 180 mm

\*Spare bulb available - DE9083

**18 Volt Flashlight - Bare Unit** **DW908\***



Wide angle beam with metal reflector and Xenon bulbs for greater brightness  
Flashlight with 90 degree pivoting head and 5 set positions for multi directional lighting (including horizontal and vertical lighting)  
Compact, lightweight design with impact resistant housing  
On board spare bulb storage

Bulb Type	Xenon
Battery Type	18 V V
Weight	0.34 kg
Length x Height	85 x 240 mm

\*Spare bulb available - DE9083

**14.4 Volt 13 mm XRP Li-Ion Heavy Duty Hammer Drill** **DCD935L2**



Powerful 14.4 Volt XRP combination tool for heavy duty drilling and screwdriving applications  
DeWALT built frameless motor reduces size and increases efficiency producing excellent runtime  
22 position adjustable torque control for uniform results and optimised precision when screwdriving

**Standard Equipment:** 40 min multi chemistry charger, 2 batteries, Multi position side handle, Heavy duty carrying case

Battery Capacity	Li-Ion 2.0 Ah
Chuck Capacity	1.5-13 mm
Power Output	325 Watts
No Load Speed	0-425/0-1200/0-1800 rpm
Beats per Minute	0-7225/0-20400/0-30600 bpm
Max Torque	50 Nm
Max. Drilling Capacity [Wood]	45 mm
Max. Drilling Capacity [Metal]	13 mm
Max. Drilling Capacity [Masonry]	14 mm
Weight	2.4 kg
Length x Height	247 x 252 mm



**14.4 Volt 13mm XRP Heavy Duty Hammer Drill** **DCD935B2**



Powerful 14.4 Volt XRP Combi tool for heavy duty drilling and screwdriving applications  
DeWALT built frameless motor reduces size and increases efficiency producing excellent runtime  
22 position adjustable torque control for uniform results and optimised precision when screwdriving  
Dual Collar design for quick and easy changing between hammer, drill and screw modes

**Standard Equipment:** 40 minute multi chemistry charger, 2 batteries, Multi position side handle, Heavy duty carrying case

Battery Capacity	NiMH 2.6 Ah
Chuck Capacity	1.5-13 mm
Power Output	325 Watts
No Load Speed	0-425/0-1200/0-1800 rpm
Beats per Minute	0-7225/0-20400/0-30600 bpm
Max Torque	50 Nm
Max. Drilling Capacity [Wood]	45 mm
Max. Drilling Capacity [Metal]	13 mm
Max. Drilling Capacity [Masonry]	14 mm
Weight	2.7 kg
Length x Height	247 x 248 mm



**14.4 Volt 13mm Compact Hammer Drill** **DC737KL/ DC737KN**



Powerful 14.4 Volt combination tool for hammer-drilling and screw-driving applications  
Compact, lightweight design  
17 position adjustable torque control for consistent screwdriving into a variety of materials with different screw sizes  
Two speed settings, variable speed and reverse switch for controllable use

**Standard Equipment:** 40 minute charger, 2 batteries, Heavy duty carrying case

Battery Capacity	Li-Ion 2.0 Ah
Chuck Capacity	1.5-13 mm
Power Output	270 Watts
No Load Speed	0-400 / 0-1450 rpm
Beats per Minute	0-6,800/ 0-25,000 bpm
Max Torque	37 Nm
Max. Drilling Capacity [Wood]	35 mm
Max. Drilling Capacity [Metal]	13 mm
Max. Drilling Capacity [Masonry]	13 mm
Weight	2.1 kg
Length x Height	225 x 239 mm



**14.4 Volt 13mm Compact Hammer Drill** **DC737C2**



Powerful 14.4 Volt combination tool for hammer-drilling and screw-driving applications  
Compact, lightweight design  
17 position adjustable torque control for consistent screwdriving into a variety of materials with different screw sizes  
Two speed settings, variable speed and reverse switch for controllable use

**Standard Equipment:** 40 minute charger, 2 x 1.1Ah Compact Lithium batteries, Heavy duty carrying case

Battery Capacity	Li-Ion 1.1 Ah
Chuck Capacity	1.5-13 mm
Power Output	250 Watts
No Load Speed	0-400 / 0-1450 rpm
Beats per Minute	0-6,800/ 0-25,000 bpm
Max Torque	37 Nm
Max. Drilling Capacity [Wood]	35 mm
Max. Drilling Capacity [Metal]	13 mm
Max. Drilling Capacity [Masonry]	13 mm
Weight	1.7 kg
Length x Height	225 x 240 mm



**14.4 Volt 13mm Compact Hammer Drill** **DC735KB/ DC735KA**



Powerful 14.4 Volt combination tool for hammer drilling and screwdriving applications  
13 mm single sleeve keyless chuck with automatic spindle lock for quick and easy bit change with one hand  
17 position adjustable torque control for consistent screwdriving into a variety of materials with different screw sizes  
All metal gearing for efficient power transmission and longer tool life

**Standard Equipment:** 1 hour charger, 2 batteries, Heavy duty carrying case

Battery Capacity	NiMH 2.6 Ah
Chuck Capacity	1.5-13 mm
Power Output	295 Watts
No Load Speed	0-400/ 0-1450 rpm
Beats per Minute	0-6800/ 0-25000 bpm
Max Torque	40 Nm
Max. Drilling Capacity [Wood]	35 mm
Max. Drilling Capacity [Metal]	13 mm
Max. Drilling Capacity [Masonry]	13 mm
Weight	2.2 kg
Length x Height	225 x 239 mm



14.4 Volt 13mm XRP Li-Ion Heavy Duty Drill Driver

DCD930L2



Powerful 14.4 Volt XRP drill driver for heavy duty drilling and screwdriving applications  
 DEWALT built frameless motor reduces size and increases efficiency producing excellent runtime  
 Ultra smooth 3 speed selector for optimum performance in high torque, normal use and high speed applications

**Standard Equipment:** 40 min multi chemistry charger, 2 batteries, Heavy duty carry case, Multi position side handle

Battery	2.0 Li-Ion
Chuck Capacity	1.5-13 mm
Power Output	325 Watts
No Load Speed	0-425/0-1200/0-1800 rpm
Max. Torque	50 Nm
Max. Drilling Capacity [Wood]	45 mm
Max. Drilling Capacity [Metal]	13 mm
Weight	2.3 kg
Length x Height	240 x 252 mm

XRP LITHIUM ION

14.4 Volt 13mm XRP Heavy Duty Drill Driver

DCD930B2



Powerful 14.4 Volt XRP drill driver for heavy duty drilling and screwdriving applications  
 DEWALT built frameless motor reduces size and increases efficiency producing excellent runtime  
 Ultra smooth 3 speed selector for optimum performance in high torque, normal use and high speed applications.  
 22 position adjustable torque control for uniform results and optimised precision when screwdriving

**Standard Equipment:** 40 minute multi chemistry charger, 2 batteries, Multi position side handle, Heavy duty carrying case

Battery	NiMH 2.6 Ah
Chuck Capacity	1.5-13 mm
Power Output	325 Watts
No Load Speed	0-425/0-1200/0-1800 rpm
Max. Torque	50 Nm
Max. Drilling Capacity [Wood]	45 mm
Max. Drilling Capacity [Metal]	13 mm
Weight	2.6 kg
Length x Height	240 x 248 mm

XRP

14.4 Volt 13mm Compact Drill Driver

DC732KL/ DC732N



Powerful 14.4 Volt drill driver for drilling and screwdriving applications  
 13mm single sleeve keyless chuck with automatic spindle lock for quick and easy bit change with one hand  
 Battery pack produces 14.4 Volt power at less than 9.6 Volt NiCd/NiMH pack weight providing the ultimate ergonomic solution

**Standard Equipment:** 40 minute charger, 2 batteries, Heavy duty carrying case

Battery Capacity	2.0 Li-Ion Ah
Chuck Capacity	1.5-13 mm
Power Output	270 Watts
No Load Speed	0-400 / 0-1450 rpm
Max. Torque	37 Nm
Max. Drilling Capacity [Wood]	35 mm
Max. Drilling Capacity [Metal]	13 mm
Weight	2 kg
Length x Height	210 x 239 mm

LITHIUM ION

14.4V 13mm Compact Drill Driver

DC732C2



Powerful 14.4 Volt drill driver for drilling and screwdriving applications  
 Compact, lightweight design  
 17 position adjustable torque control for consistent screwdriving into a variety of materials with different screw sizes  
 Two speed settings, variable speed and reverse switch for controllable use

**Standard Equipment:** 40 minute charger, 2 x 1.1Ah Compact Lithium batteries, Heavy duty carrying case

Battery Capacity	1.1 Li-Ion Ah
Chuck Capacity	1.5-13 mm
Power Output	250 Watts
No Load Speed	0-400 / 0-1450 rpm
Max. Torque	37 Nm
Max. Drilling Capacity [Wood]	35 mm
Max. Drilling Capacity [Metal]	13 mm
Weight	1.7 kg
Length x Height	210 x 240 mm

COMPACT LITHIUM ION

14.4 Volt 13mm Compact Drill Driver

DC731KB/ DC731KA/ DC730KA\*



Powerful 14.4 Volt drill driver for drilling and screwdriving applications  
 13mm single sleeve keyless chuck with automatic spindle lock for quick and easy bit change with one hand  
 17 position adjustable torque control for consistent screwdriving into a variety of materials with different screw sizes  
 All metal gearing for efficient power transmission and longer tool life

**Standard Equipment:** 1 hour charger, 2 x 2.6Ah NiMH batteries, Heavy duty carrying case

Battery Capacity	NiMH 2.6 Ah
Chuck Capacity	1.5-13 mm
Power Output	295 Watts
No Load Speed	0-400 / 0-1450 rpm
Max. Torque	40 Nm
Max. Drilling Capacity [Wood]	35 mm
Max. Drilling Capacity [Metal]	13 mm
Weight	2.1 kg
Length x Height	210 x 239 mm

\*DC730KA has 10mm chuck, DC731KA

COMPACT LITHIUM ION

14.4V 10mm Cordless Li-Ion Drill Driver

DC733KL



Powerful 14.4 Volt drill driver for drilling and screwdriving applications  
 10 mm single sleeve chuck and spindle lock for quick and easy bit change with one hand  
 Two speed settings, variable speed and reverse switch for maximum control  
 14 position adjustable torque control for consistent screwdriving into a variety of materials with different screw sizes

**Standard Equipment:** 40min Multi Chemistry Charger, 2 x 2.0Ah Li-Ion batteries, Heavy duty carrying case

Battery Capacity	Li-Ion 2.0 Ah
Chuck Capacity	1-10mm mm
Power Output	195 Watts
No Load Speed	0-400 / 0-1300 rpm
Max. Torque	30 Nm
Max. Drilling Capacity [Wood]	30 mm
Max. Drilling Capacity [Metal]	10 mm
Weight	1.8 kg
Length x Height	220 x 240 mm

LITHIUM ION

14.4 Volt 10mm Drill Driver

DC733K2/ DC733KB/ DC733KA/ DC733KN



Powerful 14.4 Volt drill driver for drilling and screwdriving applications  
 10 mm single sleeve chuck and spindle lock for quick and easy bit change with one hand  
 Two speed settings, variable speed and reverse switch for maximum control  
 14 Position adjustable torque control for consistent screwdriving into a variety of materials with different screw sizes

**Standard Equipment:** 1 hour charger, 2 batteries, heavy duty carrying case

Battery Capacity	NiCd 2.0 Ah
Chuck Capacity	1-10 mm
Power Output	195 Watts
No Load Speed	0-400/0-1300 rpm
Max. Torque	30 Nm
Max. Drilling Capacity [Wood]	30 mm
Max. Drilling Capacity [Metal]	10 mm
Weight	2.0 kg
Length x Height	220 x 235 mm

COMPACT LITHIUM ION

14.4 Volt 10mm Compact Drill Driver

DC733C2



Powerful 14.4 Volt drill driver for drilling and screwdriving applications  
 10 mm single sleeve chuck and spindle lock for quick and easy bit change with one hand  
 Two speed settings, variable speed and reverse switch for maximum control  
 14 position adjustable torque control for consistent screwdriving into a variety of materials with different screw sizes

**Standard Equipment:** 40min Multi Chemistry Charger, 2 x 1.1Ah Compact Li-Ion batteries, Heavy duty carrying case

Battery Capacity	Li-Ion 1.1 Ah
Chuck Capacity	1-10mm mm
Power Output	195 Watts
No Load Speed	0-400 / 0-1300 rpm
Max. Torque	30 Nm
Max. Drilling Capacity [Wood]	30 mm
Max. Drilling Capacity [Metal]	10 mm
Weight	1.5 kg
Length x Height	220 x 220 mm

COMPACT LITHIUM ION

DEWALT EXTREME 2 METAL™



DEWALT Extreme 2 Metal drill bits are ideal for fast, accurate, burr-free drilling.

- Up to 4x faster than standard HHS-R bits, and up to 50% stronger
- The DEWALT twin tip design eliminates 'walking' allowing for accurate hole positioning and more efficient drilling
- Gold Ferrous Oxide coating prevents over-heating for longer bit life

For the complete range of EXTREME 2 METAL drill bits see page 116

14.4 Volt 10mm Compact Right Angle Drill DW966K



Powerful fan cooled motor delivers up to 24 Nm of sustained torque for turning large drill bits and fasteners  
2 speed ranges 0-400/0-1,250 rpm for increased user flexibility to achieve a wide range of applications  
Forward, reverse, variable speed and electronic motor brake for total control  
Multi-grip trigger provides comfort and convenience by allowing the user to get into tighter spaces while still having access to the trigger

**Standard Equipment:** 1 hour charger, 1 battery, Heavy duty carrying case

Battery Capacity	NiCd 2.0 Ah
Chuck Capacity	1.0-10 mm
Power Output	220 Watts
No Load Speed	0-400/0-1,250 rpm
Max Torque	24 Nm
Max. Drilling Capacity [Wood]	28 mm
Max. Drilling Capacity [Metal]	10 mm
Weight	2.1 kg
Length x Height	323 x 125 mm



14.4 Volt Compact Impact Driver DC837KL/ DC837N



Durable frameless high speed motor delivers up to 140 Nm of torque  
All metal gearing for efficient power transmission and long tool life  
Aluminium front housing provides greater heat dispersion increasing motor life  
Improved variable speed switch and electronic motor brake for complete control for both setting and removing fasteners

**Standard Equipment:** 40 minute fast charger, 2 batteries, Heavy duty carrying case.

Battery Capacity	Li-Ion, 2.0 Ah
Bit Holder	1/4"
Power Output	240 Watts
No Load Speed	0-2400 rpm
Impacts per Minute	0-2700 ipm
Max Torque	140 Nm
Max. Bolt Diameter	M12
Weight	1.6 kg
Length x Height	146 x 231 mm



14.4 Volt Compact Impact Driver DC837C2



Durable frameless high speed motor delivers up to 140 Nm of torque  
All metal gearing for efficient power transmission and long tool life  
Aluminium front housing provides greater heat dispersion increasing motor life  
Improved variable speed switch and electronic motor brake for complete control for both setting and removing fasteners

**Standard Equipment:** 40 minute fast charger, 2 x 1.1Ah Compact Lithium batteries, Heavy duty carrying case.

Battery Capacity	Li-Ion, 1.1 Ah
Bit Holder	1/4"
Power Output	240 Watts
No Load Speed	0-2400 rpm
Impacts per Minute	0-2700 ipm
Max Torque	140 Nm
Max. Bolt Diameter	M12
Weight	1.4 kg
Length x Height	146 x 230 mm



14.4 Volt Compact Impact Driver DC835KB



Durable frameless high speed motor delivers up to 140 Nm of torque  
All metal gearing for efficient power transmission and long tool life  
Aluminium front housing provides greater heat dispersion increasing motor life  
Improved variable speed switch and electronic motor brake for complete control for both setting and removing fasteners

**Standard Equipment:** 40 minute fast charger, 2 batteries, Heavy duty carrying case

Battery Capacity	NiMH 2.6 Ah
Bit Holder	1/4"
Power Output	240 Watts
No Load Speed	0-2400 rpm
Impacts per Minute	0-2700 ipm
Max Torque	140 Nm
Max. Bolt Diameter	M12
Weight	1.8 kg
Length x Height	146 x 231 mm



14.4 Volt Compact Impact Wrench DC832KL/ DC832N



Durable frameless high speed motor delivers up to 180 Nm of torque  
All metal gearing for efficient power transmission and increased tool life  
Aluminium front housing provides greater heat dispersion increasing motor life  
Improved variable speed switch and electronic motor brake for complete control for both setting and removing fasteners

**Standard Equipment:** 40 minute fast charger, 2 batteries, Heavy duty carrying case.

Battery Capacity	Li-Ion, 2.0 Ah
Bit Holder	1/2"
Power Output	240 Watts
No Load Speed	0-2400 rpm
Impacts per Minute	0-2700 ipm
Max. Torque	180 Nm
Max. Bolt Diameter	M16
Weight	1.6 kg
Length x Height	146 x 231 mm



14.4 Volt Compact Impact Wrench DC830KB



Durable frameless high speed motor delivers up to 180 Nm of torque  
All metal gearing for efficient power transmission and long tool life  
Aluminium front housing provides greater heat dispersion increasing motor life  
Improved variable speed switch and electronic motor brake for complete control for both setting and removing fasteners

**Standard Equipment:** 40 minute fast charger, 2 batteries, Heavy duty carrying case

Battery Capacity	NiMH 2.6 Ah
Bit Holder	1/2"
Power Output	240 Watts
No Load Speed	0-2400 rpm
Impacts per Minute	0-2700 ipm
Max. Torque	180 Nm
Max. Bolt Diameter	M16
Weight	1.8 kg
Length x Height	146 x 231 mm



14.4 Volt Shear DW941K



Powerful DeWALT fan cooled motor with replaceable brushes delivers high speed cutting in 1.2 mm sheet metal at 4.4 m/min  
Head swivels 360° which allows user to access tight quarters while maintaining comfort  
Variable speed and electronic brake for greater control and user safety  
42.7 m maximum length of cut per charge in 1.2 mm sheet metal

**Standard Equipment:** 1 hour charger, 1 battery, Allen key, Heavy duty carrying case

Battery Capacity	NiCd 2.0 Ah
Power Output	295 Watts
No Load Stroke Rate	0-2300 spm
Max. Depth of Cut [Metal]	1.2 mm
Weight	2.4 kg
Length x Height	336 x 230 mm



14.4 Volt Heavy Duty Flexible Flashlight - Bare Unit DW918



Wide angle beam with metal reflector and Xenon bulbs for greater brightness  
Flashlight with flexible neck for multi-directional, hands free lighting  
Lockable head clip offers versatility and convenience of a lantern.  
Compact, lightweight design with impact resistant housing

Bulb Type	Xenon
Battery Type	14.4 V V
Weight	0.45 kg
Length x Height	130 x 180 mm

\*Spare bulb available - DE9043

14.4 Volt Flashlight - Bare Unit DW906



Wide angle beam with metal reflector and Xenon bulbs for greater brightness  
Flashlight with 90 degree pivoting head and 5 set positions for multi directional lighting (including horizontal and vertical lighting)  
Compact, lightweight design with impact resistant housing  
On board spare bulb storage

Bulb Type	Xenon
Battery Type	14.4 V V
Weight	0.34 kg
Length x Height	85 x 240 mm

\*Spare bulb available - DE9043

12 Volt 13mm XRP Heavy Duty Hammer Drill DCD945B2



Powerful 12 Volt XRP Combi tool for heavy duty drilling and screwdriving applications  
DeWALT built frameless motor reduces size and increases efficiency producing excellent runtime  
Ultra smooth 3 speed selector for optimum performance in high torque, normal use and high speed applications.  
22 position adjustable torque control for uniform results and optimised precision when screwdriving

**Standard Equipment:** 40 min multi chemistry charger, 2 batteries, Multi position side handle, Heavy duty carrying case

Battery Capacity	NiMH 2.6 Ah
Chuck Capacity	1.5-13 mm
Power Output	285 Watts
No Load Speed	0-425/0-1200/0-1800 rpm
Beats per Minute	0-7225/0-20400/0-30600 bpm
Max Torque	44 Nm
Max. Drilling Capacity [Wood]	38 mm
Max. Drilling Capacity [Metal]	13 mm
Max. Drilling Capacity [Masonry]	13 mm
Weight	2.5 kg
Length x Height	247 x 248 mm



12 Volt 13mm Compact Hammer Drill

DC745KB/ DC745KA



Powerful 12 Volt combination tool for hammer drilling and screwdriving applications  
13 mm single sleeve keyless chuck with automatic spindle lock for quick and easy bit change with one hand  
17 position adjustable torque control for consistent screwdriving into a variety of materials with different screw sizes  
All metal gearing for efficient power transmission and longer tool life

**Standard Equipment:** 1 hour charger, 2 batteries, Heavy duty carrying case

Battery Capacity	NiMH 2.6 Ah
Chuck Capacity	1.5mm-13 mm
Power Output	240 Watts
No Load Speed	0-400/ 0-1450 rpm
Beats per Minute	0-6800/ 0-25000 bpm
Max Torque	35 Nm
Max. Drilling Capacity [Wood]	28 mm
Max. Drilling Capacity [Metal]	13 mm
Max. Drilling Capacity [Masonry]	13 mm
Weight	2.1 kg
Length x Height	225 x 239 mm



12 Volt 13mm XRP Heavy Duty Drill Driver

DCD940B2



Powerful 12 Volt XRP Drill Driver for heavy duty drilling and screwdriving applications  
DEWALT built frameless motor reduces size and increases efficiency producing excellent runtime  
Ultra smooth 3 speed selector for optimum performance in high torque, normal use and high speed applications.  
22 position adjustable torque control for uniform results and optimised precision when screwdriving

**Standard Equipment:** 40 minute multi chemistry charger, 2 batteries, Multi position side handle, Heavy duty carrying case

Battery	NiMH 2.6 Ah
Chuck Capacity	1.5-13 mm
Power Output	285 Watts
No Load Speed	0-425/0-1200/0-1800 rpm
Max. Torque	44 Nm
Max. Drilling Capacity [Wood]	38 mm
Max. Drilling Capacity [Metal]	13 mm
Weight	2.4 kg
Length x Height	240 x 248 mm



12 Volt 13mm Compact Drill Driver

DC743KB/ DC742KA\*



Powerful 12.0 Volt drill driver for drilling and screwdriving applications  
13mm single sleeve keyless chuck with automatic spindle lock for quick and easy bit change with one hand  
17 position adjustable torque control for consistent screwdriving into a variety of materials with different screw sizes  
All metal gearing for efficient power transmission and longer tool life

**Standard Equipment:** 1 hour charger, 2 x 2.6Ah NiMH batteries, Heavy duty carrying case

Battery Capacity	NiMH 2.6 Ah
Chuck Capacity	1.5-13 mm
Power Output	240 Watts
No Load Speed	0-400 / 0-1450 rpm
Max Torque	35 Nm
Max. Drilling Capacity [Wood]	28 mm
Max. Drilling Capacity [Metal]	13 mm
Weight	2.0 kg
Length x Height	210 x 239 mm

\*DC742KA has 10mm chuck



12 Volt 10mm Drill Driver

DC740KA/ DC740K2



Powerful 12 Volt drill driver for drilling and screwdriving applications  
10 mm single sleeve chuck and spindle lock for quick and easy bit change with one hand  
14 position adjustable torque control for consistent screwdriving into a variety of materials with different screw sizes  
Removable Belt Clip

**Standard Equipment:** 1 hour charger, 2 batteries, Heavy duty carrying case

Battery Capacity	NiCd 1.3 Ah
Chuck Capacity	1-10 mm
Power Output	190 Watts
No Load Speed	0-350/0-1200 rpm
Max Torque	26 Nm
Max. Drilling Capacity [Wood]	25 mm
Max. Drilling Capacity [Metal]	10 mm
Weight	1.7 kg
Length x Height	220 x 225 mm



12 Volt 10mm Compact Right Angle Drill

DW965K



Powerful fan cooled motor delivers up to 20 Nm of sustained torque for turning large bits and fasteners  
2 speed ranges 0-400/0-1200 rpm for increased user flexibility providing a wide range of applications  
Multi-grip trigger provides comfort and convenience by allowing the user to get into tighter spaces while still having access to the trigger  
Forward, reverse, variable speed and electronic motor brake for total control

**Standard Equipment:** 1 hour charger, 1 battery, Heavy duty carrying case

Battery Capacity	NiCd 2.0 Ah
Chuck Capacity	1.0-10 mm
Power Output	190 Watts
No Load Speed	0-400 / 0-1200 rpm
Max Torque	20 Nm
Max. Drilling Capacity [Wood]	25 mm
Max. Drilling Capacity [Metal]	10 mm
Weight	2.0 kg
Length x Height	323 x 125 mm



12 Volt Compact Impact Driver

DC845KB



Durable frameless high speed motor delivers up to 130 Nm of torque  
All metal gearing for efficient power transmission and long tool life  
Aluminium front housing provides greater heat dispersion increasing motor life  
Improved variable speed switch and electronic motor brake for complete control for both setting and removing fasteners

**Standard Equipment:** 40 minute charger, 2 batteries, Heavy duty carrying case

Battery Capacity	NiMH 2.6 Ah
Bit Holder	1/4"
Power Output	220 Watts
No Load Speed	0-2400 rpm
Impacts per Minute	0-2700 ipm
Max Torque	130 Nm
Max. Bolt Diameter	M12
Weight	1.7 kg
Length x Height	146 x 231 mm



12 Volt Compact Impact Wrench

DC840KB



Durable frameless high speed motor delivers up to 160 Nm of torque  
All metal gearing for efficient power transmission and long tool life  
Aluminium front housing provides greater heat dispersion increasing motor life  
Improved variable speed switch and electronic motor brake for complete control for both setting and removing fasteners

**Standard Equipment:** 40 minute charger, 2 batteries, Heavy duty carrying case

Battery Capacity	NiMH 2.6 Ah
Bit Holder	1/2"
Power Output	220 Watts
No Load Speed	0-2400 rpm
Impacts per Minute	0-2700 ipm
Max. Torque	160 Nm
Max. Bolt Diameter	M16
Weight	1.7 kg
Length x Height	146 x 231 mm



12 Volt Drywall Screwdriver

DW979K2



Removable depth sensitive "set and forget" nosepiece for consistent fastener depth  
6.35 mm hex shank magnetic tool holder  
Up to 8.5 Nm of sustainable torque for maximum performance  
Two speed settings, variable speed and reverse switch for maximum control

**Standard Equipment:** 1 hour charger, 2 batteries, Magnetic bit holder, Screwdriver bit, Heavy duty carrying case

Battery Capacity	NiCd 2.0 Ah
Tool Holder	(Hex) 6.35 mm
Power Output	220 Watts
No Load Speed	0-800 / 0-2300 rpm
Max Torque	8.5 Nm
Weight	1.9 kg
Length x Height	307 x 231 mm



12 Volt 18 Gauge Cordless Nailer

DC602KB



The tool works as fast as you do with consistent nail penetration  
The sequential operating mode allows for precision placement and the bump operating mode provides the user with production speed  
Depths can be easily referenced utilising numbered dial and user does not sacrifice performance when changing depths  
Provides easy access to the nosepiece for the simple removal of a jammed fastener without the use of screwdrivers or tool wrenches

**Standard Equipment:** 30 minute charger, 2 batteries, Heavy duty carrying case

Nail Diameter	1.2 mm
Battery Capacity	NiMH 2.6 Ah
Magazine angle	0 °
Nail Length	16-50 mm
Magazine capacity	110 Nails
Magazine loading	Side Load
Operating pressure range	NA Bar
Air consumption per shot @6.9 Bar	NA l
Firing mode	Bump & Sequential
Length x Width x Height	295 x 95 x 290 mm
Weight	3.0 kg
Nailer Operating Mode	Selective
Integrated Belt Hook	Yes
Jam Clearing	Yes



12 Volt 600 ml Satchet and 310 ml Cartridge Cordless Sealant Gun

DC542K/ DC542\*



2900 N push force suitable for high viscosity urethanes and adhesives  
Variable speed control dial for pre-selection of dispensing speed  
Electronic trigger with variable speed & automatic overload protection  
Ergonomic T-handle design with rubber grip for extra comfort

**Standard Equipment:** 1 hour charger, 1 battery, Satchet barrel, Cartridge holder, Conversion kit

Battery Capacity	2.6 Ah
Carrier Size	310-600 ml
Applicator	Cartridge & Satchet
Push Force	2900 N (295Kg)
Push Speed	584 mm/min
Weight	3.1/2.4* kg
Length x Height	734 x 322 mm

\*DC542 sold as bare unit



12 Volt 310 ml Cartridge Sealant Gun

DC540K/ DC540



2900 N push force suitable for high viscosity urethanes and adhesives  
Variable speed control dial for pre-selection of dispensing speed  
Electronic trigger with variable speed & automatic overload protection  
Ergonomic T-handle design with rubber grip for extra comfort

**Standard Equipment:** 1 hour charger, 1 battery, Cartridge holder

Battery Capacity	2.6 Ah
Carrier Size	310 ml
Applicator	Cartridge
Push Force	2900 N (295Kg)
Push Speed	584 mm/min
Weight	2.8/2.1 kg
Length x Height	472 x 322 mm



12 Volt Heavy Duty Flexible Flashlight - Bare Unit

DW915



Wide angle beam with metal reflector and Xenon bulbs for greater brightness  
Spare extra-bright xenon bulb inside lens cover so a replacement is always on-hand.  
Flashlight with flexible neck for multi-directional hands-free lighting  
Lockable head clip offers versatility and convenience of a lantern

Bulb Type	Xenon
Battery Type	12 V V
Weight	0.45 kg
Length x Height	130 x 180 mm

\*Spare bulb available - DE9043

12 Volt Flashlight - Bare Unit

DW904



Wide angle beam with metal reflector and Xenon bulbs for greater brightness  
Flashlight with 90 degree pivoting head and 5 set positions for multi directional lighting (including horizontal and vertical lighting)  
Compact, lightweight design with impact resistant housing  
On board spare bulb storage

Bulb Type	Xenon
Battery Type	12 V V
Weight	0.34 kg
Length x Height	85 x 240 mm

\*Spare bulb available - DE9043

12 / 14.4 Volt Fluorescent Light - Bare Unit

DC528N



Compact, lightweight design with impact resistant housing  
Battery and charger sold separately  
Rubber overmold for increased durability  
4 prong bulb for added bulb stability

Bulb Type	Fluorescent
Battery Type	12 / 14.4 V
Weight	0.5 kg
Length x Height	155 x 370 mm

\*Spare bulb available - DE5273

7.2 Volt Two Position Screwdriver

DW920K



Hinged handle with position lock for two grip positions (in-line and pistol grip)  
15 position adjustable torque control for consistent screwdriving into a variety of materials with different screw sizes  
Variable speed and reverse switch for added versatility  
Electronic motor brake for better control

**Standard Equipment:** 1 hour charger, 1 battery, Heavy duty carrying case

Battery Capacity	NiCd 1.3 Ah
Tool Holder	(Hex) 6.35 mm
Power Output	125 Watts
No Load Speed	0-500 rpm
Max Torque	10 Nm
Weight	1 kg
Length x Height	355 x NA mm



3.6 Volt Compact 3 Position Screwdriver

DC600KA



A 3 position locking pivot operated from left or right and a gearbox diameter of only 40 mm for easy access to the tightest of working spaces with maximum user control  
Two speed control and 8 torque settings ideal for screwdriving applications and pilot drilling  
Pistol grip, soft grip handle and a rapid actuation switch for superior ergonomics and maximum user control in any working position  
Quick release 6.35 mm magnetic collet for ease of use and convenience

**Standard Equipment:** 1 hour charger, 2 batteries, Screwdriver bit, Heavy duty carrying case

Battery Capacity	NiCd 1.2 Ah
Tool Holder	(Hex) 6.35 mm
Power Output	n/a Watts
No Load Speed	200/600 rpm
Max Torque	6 Nm
Weight	0.7 kg
Length x Height	300 x 65 mm



Multi Chemistry Corded/Cordless Radio Charger

DC013



Runs off mains and 7.2 Volt to 18 Volt Li-ION/NiCd/NiMH batteries  
Blow molded protective roll cage with 6 impact resistance points for maximum job site durability  
Charges DEWALT 7.2 Volt to 18 Volt Li-ION/NiCd/NiMH batteries  
High efficiency weather resistant speakers with bass ports and bass boost for maximum job site listening experience

**Standard Equipment:** No batteries included

Battery	Li-ION/NiMH/NiCd
Radio Power Source	AC - DC
Radio Frequencies	AM- FM Stereo
Charging Time	30-70 min
Length x Height	490 x 290 mm
Weight	6.7 kg

LITHIUM ION NiMH NiCd

Cordless or Corded Wet/Dry Vacuum

DC500



Runs off of 12-18 Volt DeWALT battery packs or mains supply  
High efficiency filter traps 99.7% of dust as fine as 0.3 Microns  
Vacuums Wet or Dry without the need to change the filter  
Heavy Duty Washable Filter

**Standard Equipment:** No batteries included, 2 metre heavy duty rubber hose, Crevice tool, Wide nozzle, Dust extraction adaptor

Voltage	12-18 V
Battery	Not included
Power Input	300 Watts
Max. Airflow	15.9 l/sec
Tank volume	7.5 l
Power Source	AC/DC
Hose Nozzle Outside Diameter	32 mm
Blower	Yes
Length x Height	390 x 360 mm
Weight	4.6 kg

LITHIUM ION NiMH NiCd

Cordless / Corded Area Flashlight

DC019



Runs off mains and 12 Volt to 18 Volt DeWALT Li-ion / NiCd / NiMH batteries  
Compact and lightweight design provides quick and easy transport and storage  
Spring-loaded battery holder keeps battery in place when transporting from place to place

**Standard Equipment:** No batteries included

Power Source	12 - 18 V DC - AC
Voltage	12- 18 V
Battery	Not included
Bulb Type	Fluorescent
Brightness	2700 Lumens
Charge time	NA hr
Weight	2.2 kg
Length x Height	165 x 159 mm

LITHIUM ION NiMH NiCd

Cordless / Corded Area Light

DC020\*



Runs off of mains and 12 Volt to 18 Volt DeWALT Li-Ion / NiCd / NiMH battery packs  
2 power outlets offer more versatility for jobsite power  
Compact, lightweight design provides quick and easy fold up, transport and storage  
Spring loaded battery hold down keeps batteries in place when transporting around the jobsite

**Standard Equipment:** No batteries included

Power Source	12 - 18V DC - AC
Voltage	12- 18 V
Battery	Not included
Bulb Type	Fluorescent
Brightness	2700 Lumens
Charge time	NA hr
Weight	2.4 kg
Length x Height	165 x 159 mm

LITHIUM ION NiMH NiCd

\* Battery and charger sold separately



10.8 Volt 10mm Compact Drill Driver

DCD710S2



Powerful 10.8V drill driver for drilling and screwdriving applications  
 15 Position adjustable torque control for consistent screwdriving into a variety of materials with different screw sizes  
 Ergonomic handle and rubber overmold to provide ultimate end user comfort  
 Parabolic switch profile allowing for greater control over speed of application

Standard Equipment: 40 min charger, 2 Batteries, Kit box

Battery Capacity	1.3 Ah
Chuck Capacity	1.5 - 10 mm
Power Output	180 (MWO) Watts
No Load Speed	0-400/0-1500 rpm
Max Torque	25 Nm
Max. Drilling Capacity [Wood]	19 mm
Max. Drilling Capacity [Metal]	10 mm
Weight	1.1 kg
Length x Height	185 x 195 mm



10.8 Volt Screwdriver

DCF610S2



Powerful 10.8V Screwdriver for screwdriving & drilling applications  
 15 Position adjustable torque control for consistent screwdriving into a variety of materials with different screw sizes  
 6.35mm 'drop in' keyless hex driver allows for quick, one handed fitment  
 3 LED 'Halo' ring provides maximum illumination to work piece

Standard Equipment: 40 min charger, 2 x 10.8V 1.3Ah Li-Ion batteries, Kit box

Battery Capacity	1.3 Ah
Bit Holder	6.35mm
Power Output	154 Watts
No Load Speed	0-1050 rpm
Max Torque	8 Nm
Weight	0.96 kg
Length x Height	158 x 190 mm



10.8 Volt Compact Impact Driver

DCF815S2



Compact, durable design delivers 107Nm of torque  
 Parabolic switch profile allowing for greater control over speed  
 6.35mm 'drop in' keyless hex driver allows for quick, one handed fitment  
 3 LED 'Halo' ring provides maximum illumination to work piece

Standard Equipment: 40 min charger, 2 Batteries, Kit Box

Battery Capacity	1.3 Ah
Bit Holder	1/4" (6.35mm)
Power Output	147 Watts
No Load Speed	0-2450 rpm
Impacts per Minute	3400 ipm
Max Torque	107 Nm
Max. Bolt Diameter	6mm
Weight	1.04 kg
Length x Height	158 x 195 mm



10.8 Volt Compact LED Flashlight - Bare Unit

DCL510N



Compact, lightweight design with impact resistant housing  
 Flashlight head can rotate 180 degrees horizontally  
 Flashlight head also rotates 180 degrees vertically with ratchet lock  
 Flashlight has belt clip, magnetic mount or can be free standing,

Bulb Type	LED
Battery chemistry	Li-Ion
Height x Length	123 x 52 mm
Weight	0.15 kg
Battery Type	10.8 V



\*Battery and charger sold separately

10.8 Volt Compact Impact Driver/Screwdriver Twin Pack

DCK210S2



DCF815 10.8V Impact driver delivering 107Nm torque, 2450 RPM with 3400 BPM.  
 DCF610 10.8V Screwdriver delivering 0 - 1050 rpm.  
 Both tools feature 6.35mm 'drop in' hex retention, allowing 25mm bits to be inserted directly.  
 3 LED 'Halo' ring provides maximum illumination to work piece

Standard Equipment: 1 x DCF815 10.8V Compact Cordless Impact Driver, 1 x DCF610 10.8V Compact Cordless Screwdriver, 2 x 10.8V 1.3Ah Li-Ion batteries, 1 x 10.8V 40min charger, 1 x Heavy Duty Kit Bag

Voltage	10.8 V
Battery Capacity	1.3 Ah



10.8 Volt Compact Drill Driver/Impact Driver Twin Pack

DCK211S2



DCF815 10.8V Impact driver delivering 107Nm torque, 0-2450 RPM with 3400 BPM.  
 DCD710 10.8V Drill driver with 10mm chuck and 0-450/1500 RPM  
 DCD710 features 15+1 position adjustable torque control  
 DCF815 features 3 LED 'Halo' ring, providing maximum illumination to work piece.

Standard Equipment: 1 x DCD710 10.8V 10mm Compact cordless drill driver, 1 x DCF815 10.8V Compact Cordless Impact Driver, 2 x 10.8V 1.3Ah Li-Ion batteries, 1 x 10.8V 40min charger, 1 x Heavy Duty Kit Bag

Voltage	10.8 V
Battery Capacity	1.3 Ah



DEWALT Cordless Battery System

		Amp Hours		1 hour	1 hour	40 minutes	1 hour	1 hour	1 hour	1 hour	1 hour	40 minutes
				DE9000	DE0246	DE9135	DE9136	DC013	DE9116	DE9216	DCB100	
 NiCd	 DE9096	7.2V DE9057 1.3 Ah				✓	✓	✓	✓	✓		
		9.6V DE9062 1.3 Ah				✓	✓	✓	✓	✓		
		12V DE9074 1.3 Ah				✓	✓	✓	✓	✓		
		14.4V DE9094 1.3 Ah				✓	✓	✓	✓	✓		
		18V DE9098 1.3 Ah				✓	✓	✓	✓	✓		
		24V DE0243 2.0 Ah		✓								
 NiMH	 DE9503	12V DE9501 2.6 Ah				✓	✓	✓	✓	✓		
		14.4V DE9502 2.6 Ah				✓	✓	✓	✓	✓		
		18V DE9503 2.6 Ah				✓	✓	✓	✓	✓		
		24V DE0241 3.0Ah		✓								
 Compact Li-Ion	 DE9181	14.4V DE9141 1.1Ah				✓	✓	✓				
		18V DE9181 1.1Ah				✓	✓	✓				
 Heavy Duty Li-Ion	 DE9180 DE9360	18V DE9180 2.0 Ah				✓	✓	✓				
		14V DE9140 2.0Ah				✓	✓	✓				
		28V DE9280 2.2Ah		✓								
		36V DE9360 2.2Ah		✓								
 10.8V Li-Ion	 DCB121	10.8V DCB121 1.3 Ah									✓	

Horizontal and Vertical Rotary Laser Kit

DW079PKH



Fully self-levelling horizontal and vertical rotary laser for internal and external applications  
 Levelling accuracy of 0.1 mm/m combined with DeWALT durability  
 Built in beam-splitting prism allows easy 90° lay out and plumb up applications  
 The remote control features a manual button to allow the user to tilt the laser plane in the X and Y axis

**Standard Equipment:** DW079KH, Digital Detector (DE0772-XJ), Combi grade rod (DE0737-XJ), Heavy duty telescopic tripod (DE0735-XJ), Gradient bracket (DE0738-XJ), Wireless (IR) remote control, 18 Volt 2.6Ah NiMH battery, 1 hour charger, Laser target card, Wall mount, Laser enhancement glasses, Heavy duty carrying case

Laser class	3R, <5mW
Levelling accuracy	+/- 0.1 mm/m
Self-levelling range	+/- 5°
Indoor visibility range	30 m
Max. Working Range with Receiver	300 m
Rotation speed	0, 10, 50, 200, 600 rpm
Sloping range in X and Y axis	+/- 5°
Power Source	9.6V - 18V, NiCd/NiMH/Li-ion DeWALT batteries
Tripod connection	5/8"
Weight	2.0 kg
Length x Height	305 x 190 mm



Horizontal and Vertical Self-Levelling Rotary Laser

DW079KH



Fully self-levelling horizontal and vertical rotary laser for internal and external applications  
 Levelling accuracy of 0.1 mm/m combined with DeWALT durability  
 Built in beam-splitting prism allows easy squaring and plumb bob applications  
 The remote control features a manual button to allow the user to tilt the laser plane in both X and Y axis

**Standard Equipment:** Wireless (IR) remote control, 18 Volt 2.6Ah NiMH battery, 1 hour charger, Wall mount, Laser target card, Laser enhancement glasses, Digital detector (DE0772-XJ), Heavy duty carrying case

Laser class	3R, <5mW
Levelling accuracy	+/- 0.1 mm/m
Self-levelling range	+/- 5°
Indoor visibility range	30 m
Max. Working Range with Receiver	300 m
Rotation speed	0, 10, 50, 200, 600 rpm
Sloping range in X and Y axis	+/- 5°
Power Source	9.6V - 18V, NiCd/NiMH/Li-ion DeWALT batteries
Tripod connection	5/8"
Weight	2.0 kg
Length x Height	305 x 190 mm



Self-Levelling Horizontal and Vertical Rotary Laser Kit

DW075PK



Fully automatic horizontal and vertical rotary laser  
 Levelling accuracy of 0.2mm/m  
 Wireless (IR) remote control operated scan mode generates a line between two points for an extremely bright beam over long distances which can then be moved by the user leaving hands free  
 Built in beam splitting prism allows easy squaring applications

**Standard Equipment:** DW075 transmitter, Laser Detector, Wall mount, Laser target card, Laser enhancement glasses, Heavy duty carrying case, Construction grade rod, Construction tripod

Laser class	3R, <5mW
Levelling accuracy	+/- 0.2 mm/m
Self-levelling range	+/- 5°
Indoor visibility range	15 m
Max. Working Range with Receiver	100 m
Rotation speed	0, 60, 600 rpm
Power Source	2 x D
Tripod connection	5/8"



Self-Levelling Horizontal Rotary Laser

DW074K



Fully automatic horizontal laser  
 Vertical manual levelling via easy to operate adjustment buttons, no dials for faster set up  
 Levelling accuracy of 0.2mm/m  
 Protected rotary head and weather proof design deliver class-leading exterior jobsite durability

**Standard Equipment:** DW074 transmitter, Laser Detector, Wall mount, Laser target card, Laser enhancement glasses, Heavy duty carrying case

Laser class	3R, <5mW
Levelling accuracy	+/- 0.2 mm/m
Self-levelling range	+/- 5°
Indoor visibility range	15 m
Max. Working Range with Receiver	100 m
Rotation speed	0, 60, 600 rpm
Power Source	2 x D
Tripod connection	5/8"



Laser Plumb Bob

DW082K



Self-Levelling plumb bob is accurate to ± 0.2 mm/m  
 Self-Levelling up to 4 degrees surface angle, finds plumb in seconds - no vials or knobs to adjust  
 One button operation is fast and easy to use  
 Focused laser beam keeps dot small even over long distances for improved accuracy and visibility

**Standard Equipment:** 4 x AA size alkaline batteries, Heavy duty carrying case

Laser class	2, <1mW
Levelling Accuracy	+/- 0.2 mm/m
Self-levelling range	+/- 4°
Number of beams	2
Direction of beams	up/down
Indoor visibility range	15 m
Power Source	6V - 4x AA
Tripod connection	1/4"
Weight	0.46 kg
Length x Height	108 x 125 mm



Self Levelling Plumb, Level and Square 4 Beam Laser Pointer

DW084K



Self levelling 4 beam laser is accurate to ±0.2 mm/m  
 Self levelling up to 4 degrees surface angle, finds plumb in seconds - no vials or knobs to adjust  
 One button operation is fast and easy to use  
 Focused laser beam keeps dots small even over long distances for improved accuracy and visibility

**Standard Equipment:** 4 x AA size alkaline batteries, Heavy duty carrying case

Laser class	2, <1mW
Levelling Accuracy	+/- 0.2 mm/m
Self-levelling range	+/- 4°
Number of beams	4
Direction of beams	up/down/level/square
Indoor visibility range	25 m
Power Source	6V - 4x AA
Tripod connection	1/4"
Weight	0.55 kg
Length x Height	128 x 100 mm



Laser Distance Measurer

DW030P



Laser distance measurer (LDM) manufactured to withstand the inevitable drops, falls and knocks on the Job site  
 It has a range of up to 30m and at this distance the unit will have an accuracy variance no greater than 3mm  
 The unit has raised, oversized buttons to avoid miss measures  
 'One button, one function' when selecting the unit to give linear meter readings, square meter calculations and cubic metre calculations. It will add or subtract readings and calculate distance in Metric and Imperial.

**Standard Equipment:** 2 x 1.5v dc LR03 (AAA-size) batteries, Horizontal Belt Pouch, Wrist Lanyard

Laser class	Class 2
Levelling Accuracy	3mm @ 30m
Number of beams	1
Indoor visibility range	30m m
Power Source	2 x 1.5v dc LR03 (AAA-size) batteries
Weight	0.15 with batteries kg
Length x Height	115mm x 26mm mm

26 x Auto Level Package

DW096PK



26 x magnification for 100 m+ range  
 360° horizontal circle for precise measuring of horizontal angles  
 Vial set-up with final 1° self levelling capability for extra ease of use  
 Magnetically dampened compensator that maintains compensation over product life and for easy setup with optimum range and accuracy

**Standard Equipment:** Heavy duty 2.44 m aluminum grade rod, Aluminium construction tripod, String plumb bob, Heavy duty carrying case

Levelling Type	Auto
Magnification	26x
Accuracy	2 mm
Range	100 m
Stadia Ratio	1:100
Horizontal Circle Type	Continuous Drive
Weight	1.72 kg
Length x Height	207 x 145 mm



Self-Levelling Line Laser (Horizontal and Vertical)

DW087K



Self-levelling cross line laser is accurate to ±0.3 mm/m in levelling applications  
 Self-Levelling up to 4 degrees surface angle with automatic out of level indication, marks a levelled line in seconds  
 2 button operation and low battery indication for ease of use  
 Built in magnetic pivot bracket mounts easily on metal surfaces

**Standard Equipment:** 3 x AA size alkaline batteries, Wall mount bracket, Heavy duty carrying case

Laser class	2, <1mW
Accuracy	+/- 0.3 mm/m
Number of beams	2
Direction of beams	vertical/level
Indoor visibility range	15 m
Self-Levelling Range	+/- 4°
Power Supply	4.5V - 3x AA
Tripod connection	1/4"
Weight	0.46 kg
Length x Height	112 x 113 mm



**Tile Laser DW060K**

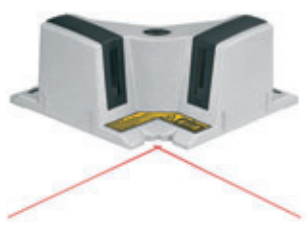

Beams cross at 90 degrees for precision set out.  
Thin narrow beams aid alignment and increase accuracy.  
One button operation for easy of use.  
Cast Aluminium Body for increased accuracy and job site durability.

**Standard Equipment:** 2 x C-size alkaline batteries, Target card, Heavy duty carrying case

Laser class	2, <1mW
Accuracy	+/- 0.2 mm/m
Number of beams	2
Direction of beams	Forward
Indoor visibility range	15 m
Power Supply	3v - 2 x C
Tripod connection	No
Weight	1.26 kg
Length x Height	285 x 95 mm

**Laser Level Attachments**



Cat. No.	Description
DE0730	Laser Target Card
DE0734	Aluminium Construction Grade Rod
DE0735	Elevated Laser Construction Tripod
DE0736	Aluminium Construction Tripod
DE0737	2.4m Construction Grade Rod
DE0738	Gradient Setting Bracket
DE0772	Waterproof Digital Laser Detector with Clamp
DE0841	Lightweight 1/4 inch Mini Tripod
DE0842	Floor to Ceiling 1/4 inch Laser Pole
DE0731	5/8" to 1/4" tripod adaptor

**Drywall Screwdriver DW274K/ DW274KN\***



Ideal for fastening drywall and panels to wooden or metal studs  
Removable depth sensitive "set and forget" nosepiece for consistent fastener depth  
Lightweight and compact design to reduce user fatigue and increase productivity  
Soft grip surface on handle and switch to reduce vibration and enhance user comfort

**Standard Equipment:** Depth sensitive nose, Screwdriver bit holder & Ph2 screwdriver bit, Belt clip, Heavy duty carrying case

Max Torque	10 Nm
Power Input	540 Watts
Power Output	295 Watts
No Load Speed	0-4000 rpm
Max. Screw Diameter	4.8 mm
Tool Holder	(Hex) 6.35 mm
Weight	1.3 kg
Length x Height	306 x 186 mm

**High Speed Drywall Screwdriver DW275K/ DW275KN\***



Ideal for fastening drywall and panels to wooden or metal studs  
Removable depth sensitive "set and forget" nosepiece for consistent fastener depth  
High speed for increased productivity  
Lightweight and compact design to reduce user fatigue and increase productivity

**Standard Equipment:** Depth sensitive nose, Screwdriver bit holder & Ph2 screwdriver bit, Belt clip, Heavy duty carrying case

Max Torque	10 Nm
Power Input	540 Watts
Power Output	295 Watts
No Load Speed	0-5300 rpm
Max. Screw Diameter	4.8 mm
Tool Holder	(Hex) 6.35 mm
Weight	1.3 kg
Length x Height	306 x 186 mm

**Versadutch Screwdriver DW268K**



Ideal for screwdriving applications in wood, plastic and metal  
Versatile tool with torque control up to 26 Nm  
Unique Versa Clutch Torque Control System allows a torque level to be set whilst maintaining an override capability for driving screws into material of inconsistent density such as wood  
Lightweight and compact design to reduce user fatigue and increase productivity

**Standard Equipment:** Heavy duty carrying case

Max Torque	4.26 Nm
Power Input	540 Watts
Power Output	295 Watts
No Load Speed	0-2500 rpm
Max. Screw Diameter	6.3 mm
Tool Holder	(Hex) 6.35 mm
Weight	1.3 kg
Length x Height	301 x 187 mm

**High Torque Versadutch Screwdriver DW269K**



Ideal for screwdriving applications in wood, plastic and metal  
Versatile tool with torque control up to 42 Nm  
Unique Versa Clutch Torque Control System allows a torque level to be set whilst maintaining an override capability for driving screws into material of inconsistent density such as wood  
Lightweight and compact design to reduce user fatigue and increase productivity

**Standard Equipment:** Heavy duty carrying case

Max Torque	4.42 Nm
Power Input	540 Watts
Power Output	295 Watts
No Load Speed	0-1000 rpm
Max. Screw Diameter	6.3 mm
Tool Holder	(Hex) 6.35 mm
Weight	1.3 kg
Length x Height	301 x 187 mm

Screwdriver for Self Drilling Screws

DW263K



Ideal for fascia, cladding and roofing applications  
Specially designed for working with self-drilling screws  
Removable depth sensitive "set and forget" nosepiece for consistent fastener depth  
Lightweight and compact design to reduce user fatigue and increase productivity

**Standard Equipment:** 8 mm magnetic bit holder for self drilling screws, nose adaptors (13 mm, 15 mm), Depth sensitive nose, Heavy duty carrying case

Max Torque	14.5 Nm
Power Input	540 Watts
Power Output	295 Watts
No Load Speed	0-2500 rpm
Max. Screw Diameter	6.3 mm
Tool Holder	(Hex) 6.35 mm
Weight	1.3 kg
Length x Height	301 x 186 mm



High Torque Screwdriver for Self Drilling Screws

DW264K



Ideal for fascia, cladding and roofing applications  
Specially designed for working with self-drilling screws  
Removable depth sensitive "set and forget" nosepiece for consistent fastener depth  
Lightweight and compact design to reduce user fatigue and increase productivity

**Standard Equipment:** 8 mm magnetic bit holder for self drilling screws, nose adaptors (13 mm, 15 mm), Depth sensitive nose, Heavy duty carrying case

Max Torque	18 Nm
Power Input	540 Watts
Power Output	295 Watts
No Load Speed	0-2000 rpm
Max. Screw Diameter	6.3 mm
Tool Holder	(Hex) 6.35 mm
Weight	1.3 kg
Length x Height	301 x 186 mm



Heavy Duty Impact Wrench 1/2"

DW292



440 Nm of deliverable torque in forward and reverse  
Higher torque and faster speed increased productivity  
Soft grip handle to reduce vibrations and to enhance user comfort  
Robust design for increased durability

**Standard Equipment:** 1/2 inch ring retainer

Max Torque	440 Nm
Power Input	710 Watts
Power Output	370 Watts
No Load Speed	2200 rpm
Impacts per Minute	2700 ipm
Max. Bolt Diameter	M20
Bit Holder	1/2"
Weight	3.2 kg
Length x Height	292 x 216 mm



Heavy Duty Impact Wrench 3/4"

DW294



440 Nm of deliverable torque in forward and reverse  
Robust 3/4" anvil  
Compact and light weight to reduce user fatigue  
Soft grip handle to reduce vibrations and to enhance user comfort

**Standard Equipment:** 3/4 inch ring retainer

Max Torque	440 Nm
Power Input	710 Watts
Power Output	370 Watts
No Load Speed	2200 rpm
Impacts per Minute	2700 ipm
Max. Bolt Diameter	M20
Bit Holder	3/4"
Weight	3.2 kg
Length x Height	292 x 216 mm



IMPACT SOCKETS



**DEWALT Extreme Impact Rated sockets provide maximum durability.**

- Manufactured to the highest standards to ensure long life and durability
- Clear, laser etched diameter markings on each socket
- Designed for use with 1/2" drive wrenches, but also comes with 1/4" to 1/2" adaptor

For the complete range of Impact Sockets see page 131

13 mm Mixer and Rotary Drill

D21520



Variable speed reversing switch offers greater control for a wider range of applications  
550 RPM provides increased torque for heavy duty drilling and mixing  
Robust design and metal gear case for greater durability  
2-position rear spade handle and 3-position side handle gives greater control

**Standard Equipment:** 3-position side handle, 2-position rear handle, Chuck key with holder

Chuck Capacity	2.0-13 mm
Spindle Thread	5/8" x 16 U.N.F.
Tool Holder	Keyed Chuck
Power Input	710 Watts
Power Output	560 Watts
Max Torque	50 Nm
No Load Speed	0-550 rpm
Max. Capacity	160 mm
Weight	3.4 kg
Length x Height	400 x 215 mm



Mixer with M14 Fitment

D21510



Ideal for mixing viscous materials like paints, mortar, drywall compound, etc.  
Forward operation only  
550 RPM provides increased torque for heavy duty mixing  
Uses mixer baskets up to 160mm (M14 thread)

**Standard Equipment:** 3-position side handle, 2-position rear handle, M14 connector

Spindle Thread	5/8" x 16 U.N.F.
Tool Holder	M14
Power Input	710 Watts
Power Output	560 Watts
Max Torque	50 Nm
No Load Speed	0-550 rpm
Max. Capacity	160 mm
Weight	3.0 kg
Length x Height	420 x 215 mm



Heavy Duty Morse Taper (No 2) Mixer and Rotary Drill

DW152



Drilling large holes up to 23 mm diameter in metal  
Two speed and high torque for continuous drilling even through hard materials  
Ergonomic breast plate and two side handles for adjustment of the working position  
No.2 Morse Taper tool holder for heavy duty applications

**Standard Equipment:** 2 side handles, Breast plate, Morse taper-M14 adaptor, Drift key

Tool Holder	No. 2 morse taper
Power Input	1050 Watts
Power Output	680 Watts
Max Torque	118/58 Nm
No Load Speed	400/800 rpm
Max. Capacity	53 mm
Weight	7.5 kg
Length x Height	435 x 605 mm



650W 13mm Percussion Drill

DWD024/ DWD024K/ DWD024S/ DWD024KS\*



Low weight ensures the drill is easy to use and it reduces user fatigue  
Compact design enables comfortable use and allows access to tight spaces  
An excellent power to size ratio results in a powerful, durable drill in a compact size  
Trigger sensitive variable speed switch allows a user to drill slowly for precision accuracy when starting to drill a hole

**Standard Equipment:** Chuck key, Multi-position side handle, Depth stop

Chuck Capacity	1.5-13 mm
Power Input	650 Watts
Power Output	302 Watts
Max Torque	8.6 Nm
No Load Speed	0-2800 rpm
Blows per Minute	47600 bpm
Max. Drilling Capacity [Wood]	25 mm
Max. Drilling Capacity [Steel]	13 mm
Max. Drilling Capacity [Concrete]	16 mm
Spindle Thread	1/2" x 20 U.N.F.
Weight	1.82 kg
Length x Height	255 x 180 mm

\*Available with heavy duty carrying case as K version and with keyless chuck as S version

701 Watt single speed Percussion Drill

D21717K/ D21716/ D21716K\*



More powerful for heavy duty applications  
Soft grip to enhance user comfort  
Jampot construction design for added durability and ease of service  
Variable speed control with forward and reverse mode to suit different materials

**Standard Equipment:** keyless chuck, multi-position side handle, depth stop, kitbox

Chuck Capacity	1.5-13 mm
Power Input	701 Watts
Power Output	360 Watts
Max Torque	12 Nm
No Load Speed	0-2600 rpm
Blows per Minute	0-44200 bpm
Max. Drilling Capacity [Wood]	30 mm
Max. Drilling Capacity [Steel]	13 mm
Max. Drilling Capacity [Concrete]	16 mm
Spindle Thread	1/2" x 20 U.N.F.
Weight	1.8 kg
Length x Height	280 x 185 mm

\*Available with heavy duty carrying case as K version and with keyless chuck as D21716



650 W - 2 Speed Percussion Drill

D21721K / D21720K / D21720\*



Very compact and lightweight to enhance user comfort  
Two speed gearbox for increased torque and more versatility  
Variable speed control with forward and reverse mode to suit different materials  
Dust sealed switch for added durability

**Standard Equipment:** Keyless Chuck, kitbox, multi position side-handle, depth stop

Chuck Capacity	1.5-13 mm
Power Input	650 Watts
Power Output	325W Watts
Max Torque	30/12 Nm
No Load Speed	0-1100 / 0-2600 rpm
Blows per Minute	0-19000 / 0-44200 bpm
Max. Drilling Capacity [Wood]	40/25 mm
Max. Drilling Capacity [Steel]	13 mm
Max. Drilling Capacity [Concrete]	16 mm
Spindle Thread	1/2" x20 U.N.F.
Weight	2.1 kg
Length x Height	330 x 199 mm

\*Available with heavy duty carrying case as K version and with keyed chuck as D21720



770 W - 2 Speed Percussion Drill

D21805 / D21805K / D21805KS\*



Two speed gearbox for increased torque  
Improved drilling performance due to new motor wind  
Improved ergonomics with new polymer gear case  
New gear design to give improved life

**Standard Equipment:** Keyed chuck, Chuck key, Multi-position side handle, Depth stop

Chuck Capacity	1.5-13 mm
Power Input	770 Watts
Power Output	425 Watts
Max Torque	40/20 Nm
No Load Speed	0-1100 / 0-2700 rpm
Blows per Minute	0-18700 / 0-45900 bpm
Max. Drilling Capacity [Wood]	35 mm
Max. Drilling Capacity [Steel]	13 mm
Max. Drilling Capacity [Concrete]	20 mm
Spindle Thread	1/2" X 20 U.N.F.
Weight	2.3 kg
Length x Height	352 x 199 mm

\*Available with heavy duty carrying case as K version and with keyless chuck as S version



950 W - 2 Speed Percussion Drill

DWD522KS



Improved drilling performance from powerful new motor gives improved performance in heavy duty applications  
Innovative mode selection collar allows intuitive control for optimal performance  
Two speed gearbox for increased versatility  
Mechanical clutch increases user control and protection

**Standard Equipment:** multi-position side handle, depth stop, Heavy Duty Carrying Case.

Chuck Capacity	1.5-13 mm
Power Input	950 Watts
Power Output	415 Watts
Max Torque	40/20 Nm
No Load Speed	0-1250 0-3500 rpm
Blows per Minute	0-56000 bpm
Max. Drilling Capacity [Wood]	40 mm
Max. Drilling Capacity [Steel]	13 mm
Max. Drilling Capacity [Concrete]	20 mm
Spindle Thread	1/2" X 20 U.N.F.
Weight	2.8 kg
Length x Height	370 x 210 mm



1100 W - 2 Speed Pistol Percussion Drill

DWD524KS



Improved drilling performance from powerful new motor gives improved performance in heavy duty applications  
Innovative mode selection collar allows intuitive control for optimal performance  
Two speed gearbox for increased versatility  
Mechanical clutch increases user control and protection

**Standard Equipment:** multi-position side handle, depth stop, Heavy Duty Carrying Case.

Chuck Capacity	1.5-13 mm
Power Input	1100 Watts
Power Output	540 Watts
Max Torque	40/20 Nm
No Load Speed	0-1200 0-3500 rpm
Blows per Minute	0-5600 bpm
Max. Drilling Capacity [Wood]	40 mm
Max. Drilling Capacity [Steel]	13 mm
Max. Drilling Capacity [Concrete]	20 mm
Spindle Thread	1/2" X 20 U.N.F.
Weight	2.8 kg
Length x Height	370 x 210 mm



EXTREME MASONRY DRILL BITS



**Extreme DEWALT Masonry Drill Bits offer class-leading percussion drilling performance:**

- Last up to 2x longer than a standard masonry bit
- Optimum carbide grade maximizes durability
- Ideal for drilling for anchors, plastic fixings, and pipe-work clearance holes

For the complete range of EXTREME Masonry drill bits see page 105

1100 W - 2 Speed Mid-Handle Percussion Drill

DWD525KS



Improved drilling performance from powerful new motor gives improved performance in heavy duty applications  
Two speed gearbox for increased versatility  
Mechanical clutch increases user control and protection  
Innovative mode selection collar allows intuitive control for optimal performance

**Standard Equipment:** multi-position side handle, depth stop, Heavy Duty Carrying Case.

Chuck Capacity	1.5-13 mm
Power Input	1100 Watts
Power Output	540 Watts
Max Torque	40/20 Nm
No Load Speed	0-1250 0-3500 rpm
Blows per Minute	0-56000 bpm
Max. Drilling Capacity [Wood]	40 mm
Max. Drilling Capacity [Steel]	13 mm
Max. Drilling Capacity [Concrete]	20 mm
Spindle Thread	1/2" X 20 U.N.F.
Weight	2.8 kg
Length x Height	345 x 225 mm



1300 W - 2 Speed Percussion Drill

DWD530KS



Improved drilling performance from powerful new motor gives improved performance in heavy duty applications  
Two speed gearbox for increased versatility  
Electro-Mechanical clutch increases user control and protection  
Innovative mode selection collar allows intuitive control for optimal performance

**Standard Equipment:** multi-position side handle, depth stop, Heavy Duty Carrying Case.

Chuck Capacity	1.5-13 mm
Power Input	1300 Watts
Power Output	680 Watts
Max Torque	40/20 Nm
No Load Speed	0-1100 0-2700 rpm
Blows per Minute	0-56000 bpm
Max. Drilling Capacity [Wood]	40 mm
Max. Drilling Capacity [Steel]	13 mm
Max. Drilling Capacity [Concrete]	20 mm
Spindle Thread	1/2" X 20 U.N.F.
Weight	2.8 kg
Length x Height	370 x 215 mm



2 Speed Dry Diamond Drill with 16mm Keyed Chuck

D21570K



New motor gives improved performance in applications with dry core bits up to 127 mm in bricks or soft masonry  
Two speed gearbox for increased versatility when drilling in wood, metal and concrete with standard drill bits  
Heavy duty 16mm keyless steel chuck allows quick bit change whilst offering excellent bit retention  
Innovative mode selection collar allows intuitive control for optimal performance

**Standard Equipment:** Multi-Position side handle, Depth Stop, Heavy Duty Carrying Case

Spindle Thread	1/2" X 20 U.N.F.
Power Input	1300 Watts
Power Output	680 Watts
No Load Speed	0-1100 0-2700 rpm
Max. Drilling Capacity [Masonry]	100 mm
Weight	2.4 kg
Length x Height	352 x 215 mm



10mm 0-2800rpm Rotary Drill

DWD014 / DWD014S\*



Compact design enables comfortable one handed use and allows access to tight spaces  
Low weight ensures the drill is easy to use and it reduces user fatigue  
Variable speed dial switch ensures control to suit different hole sizes in different materials  
Trigger sensitive variable speed switch allows a user to drill slowly for precision accuracy when starting to drill a hole

**Standard Equipment:** Chuck key

Chuck Capacity	1.0-10 mm
Power Input	550 Watts
Power Output	269 Watts
Max Torque	7.9 Nm
No Load Speed	0-2800 rpm
Max. Drilling Capacity [Wood]	25 mm
Max. Drilling Capacity [Steel]	10 mm
Spindle Thread	1/2" X 20 U.N.F.
Weight	1.34 kg
Length x Height	225 x 170 mm

\*Available with keyless chuck as S version



10 mm Rotary Drill with Keyed Chuck

DWD 112 / DWD 112S\*



Rubber grip gives maximum comfort to the user while drilling  
Ideal for use in a woodworking or light metal fabrication workshop to drill small holes into wood or sheet metal  
Size, balance and weight designed for one handed operation  
Variable speed switch control to suit different materials

Chuck Capacity	1.0-10 mm
Power Input	701 Watts
Power Output	358 Watts
Max Torque	10.9 Nm
No Load Speed	0-2500 rpm
Max. Drilling Capacity [Wood]	25 mm
Max. Drilling Capacity [Steel]	10 mm
Spindle Thread	1/2" X 20 U.N.F.
Weight	1.8 kg
Length x Height	230 x 190 mm

\*Available with keyless chuck as S version

10 mm Mid-Handle Rotary Drill DWD115KS



Rubber grip gives maximum comfort to the user while drilling  
Ideal for use in a woodworking or light metal-fabrication workshop to drill small holes into wood or sheet metal  
All metal 10 mm keyless chuck for quick and easy bit change  
Well balanced mid-handle design similar to a cordless drill

**Standard Equipment:** Kitbox

Chuck Capacity	1.0-10 mm
Power Input	701 Watts
Power Output	358 Watts
Max Torque	10.9 Nm
No Load Speed	0-2500 rpm
Max. Drilling Capacity [Wood]	25 mm
Max. Drilling Capacity [Steel]	10 mm
Spindle Thread	1/2" x 20 U.N.F
Weight	1.9 kg
Length x Height	230 x 190 mm



High Speed Rotary Drill DW217



Ideal for high speed drilling of small, precise holes in metal or wood  
High overload capacity motor prevents failure in heavy duty applications  
10 mm keyless chuck for quick and easy bit change with one hand to aid productivity  
Heavy duty metal gear box for added durability

**Standard Equipment:** None

Chuck Capacity	0.5-10 mm
Power Input	675 Watts
Power Output	340 Watts
Max Torque	8.2 Nm
No Load Speed	0-4000 rpm
Max. Drilling Capacity [Wood]	20 mm
Max. Drilling Capacity [Steel]	8 mm
Spindle Thread	3/8" x 24 U.N.F
Weight	1.2 kg
Length x Height	247 x 177 mm



Rotary Drill DW221



Ideal for drilling applications in wood, aluminium, soft steel and alloys  
High overload capacity motor prevents failure in heavy duty applications  
10 mm keyless chuck with innovative spindle lock system for quick and easy bit change with one hand to aid productivity  
Heavy duty metal gear box for added durability

**Standard Equipment:** None

Chuck Capacity	1.5-10 mm
Power Input	701 Watts
Power Output	385 Watts
Max Torque	13.8 Nm
No Load Speed	0-2500 rpm
Max. Drilling Capacity [Wood]	25 mm
Max. Drilling Capacity [Steel]	10 mm
Spindle Thread	1/2" x 20 U.N.F
Weight	1.3 kg
Length x Height	275 x 190 mm



Rotary Drill for Stainless Steel DW236i



Ideal for drilling large holes in stainless steel  
High overload capacity motor prevents failure in heavy duty applications  
13 mm keyless chuck with innovative spindle lock system for quick and easy bit change with one hand to aid productivity  
Heavy duty metal gear box for added durability

**Standard Equipment:** Multi-position side handle, 6 piece cobalt drill bit set

Chuck Capacity	1.5-13 mm
Power Input	701 Watts
Power Output	385 Watts
Max Torque	35.8 Nm
No Load Speed	0-850 rpm
Max. Drilling Capacity [Wood]	30 mm
Max. Drilling Capacity [Steel]	13 mm
Spindle Thread	1/2" x 20 U.N.F
Weight	1.6 kg
Length x Height	295 x 198 mm



770 W - 2 Speed Rotary Drill with Clutch D21441



Ideal for use in heavy steel fabrication  
Two speed gearbox for increased torque  
Improved drilling performance due to new motor wind  
New patented ball clutch to give greater user control

**Standard Equipment:** Multi-position side handle, Depth stop

Chuck Capacity	1.5-13 mm
Power Input	770 Watts
Power Output	425 Watts
Max Torque	40/20 Nm
No Load Speed	0-1100 / 0-2700 rpm
Max. Drilling Capacity [Wood]	35 mm
Max. Drilling Capacity [Steel]	13 mm
Spindle Thread	1/2" x 20 U.N.F
Weight	2.2 kg
Length x Height	352 x 199 mm



High Torque Rotary Drill DW246



Ideal for use in steel fabrication and construction industry  
High overload capacity motor prevents failure in heavy duty applications  
13 mm keyless chuck with innovative spindle lock system for quick and easy bit change with one hand to aid productivity  
High torque for easy conversion to light duty mixer supported by a triple gear reduction

**Standard Equipment:** Multi-position side handle

Chuck Capacity	1.5-13 mm
Power Input	701 Watts
Power Output	385 Watts
Max Torque	57.3 Nm
No Load Speed	0-600 rpm
Max. Drilling Capacity [Wood]	35 mm
Max. Drilling Capacity [Steel]	13 mm
Spindle Thread	1/2" x 20 U.N.F
Weight	1.6 kg
Length x Height	310 x 195 mm



Low Speed Electronic Rotary Drill DWD221



Ideal for use in steel fabrication and construction industry  
High overload capacity motor prevents failure in heavy duty applications  
13 mm keyless chuck with innovative spindle lock system for quick and easy bit change with one hand to aid productivity  
e-clutch feature automatically switches off the unit in case of jammed drill bits to prevent motor overload and increase user protection

**Standard Equipment:** Multi-position side handle

Chuck Capacity	1.5-13 mm
Power Input	800 Watts
Power Output	385 Watts
Max Torque	57.3 Nm
No Load Speed	0-650 rpm
Max. Drilling Capacity [Wood]	38 mm
Max. Drilling Capacity [Steel]	13 mm
Spindle Thread	1/2" x 20 U.N.F
Weight	2.3 kg
Length x Height	310 x 215 mm



10 mm Right Angle Rotary Drill D21160\*



Ideal for working in tight or narrow spaces  
Compact and lightweight design for easy handling  
The full body paddle switch supports the natural shape of your hand and ensures less user fatigue for prolonged use  
High torque to enable larger diameter hole drilling

**Standard Equipment:** Chuck keys

Chuck Capacity	1.0-10 mm
Power Input	350 Watts
Power Output	180 Watts
Max Torque	9.2 Nm
No Load Speed	0-1200 rpm
Max. Drilling Capacity [Wood]	20 mm
Max. Drilling Capacity [Steel]	10 mm
Spindle Thread	3/8" x 24 U.N.F
Weight	1.7 kg
Length x Height	262 x 50 mm

\*230V only

2 Speed Magnetic Drill Press - 50 mm D21620K



Delivers high level of performance for fast, clean and accurate drilling into steel  
Compact and light weight unit which is both easy to transport and easy to position for drilling.  
The universal quick release cutter holder is quick and easy to operate : no Allen key needed. It accepts any annular cutter with 19 mm round shank (Weldon) with one or more flats.  
No volt switch prevents inadvertent restart after power failure

**Standard Equipment:** Quick release cutter holder, Gravity fed cutting fluid tank, Reversible press handle, Drilling guard, Safety strap, Heavy duty carrying case

Power Input	1150 Watts
Spindle Thread	1/2" x 20 UNF
No Load Speed	350/650 rpm
Cutter holder	19mm Weldon shank (3/4")
Max cutting depth with cutters	50 mm
Max cutting diameter with cutters	50 mm
Drill point pressure	317 Kg
Clamping force	10000 N
Length of drill stroke	147 mm
Weight	13 kg
Magnetic base dimensions	180 x 84 mm



**HSS-G JOBBER METAL DRILL BITS**

**DEWALT HSS-G Jobber Metal Drill Bits offer rapid drilling, long life and excellent hole concentricity.**

- Precision ground from solid stock to 118 degree point angle
- Diameter tolerance to h8
- Suitable for portable or stationary drilling in steel cast steel, alloyed and non-alloyed, grey cast iron etc... up to 900N/mm<sup>2</sup>

For the complete range of HSS-G JOBBER metal drill bits see pages 117/118

**DRY**

Do you drill only into soft materials such as bricks, Poroton blocks, light breezeblock or limestone?

You need a Dry Drilling System

NO  
See below

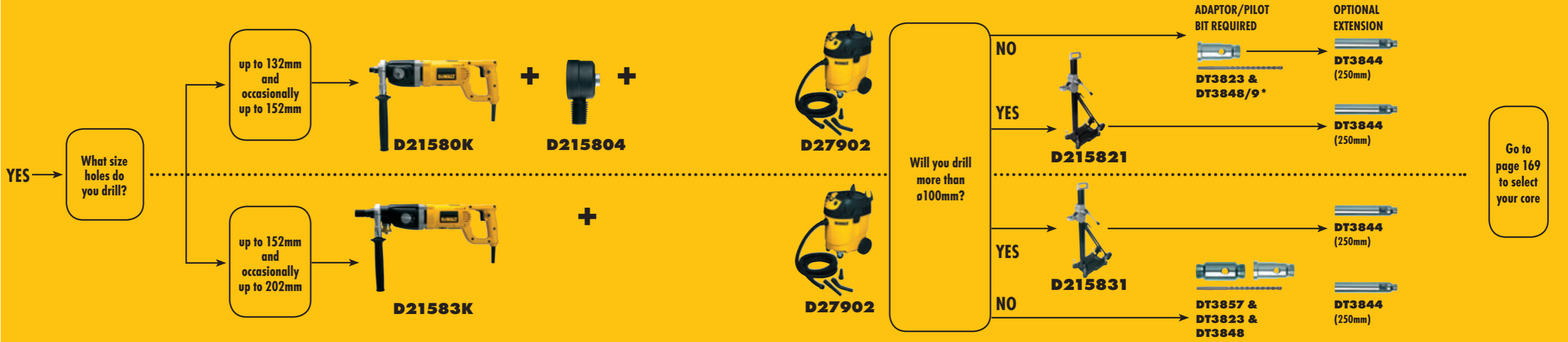

\*Longer pilot drill bit (DT3849) required when using D215804 dust extraction adaptor

Go to page 169 to select your core

Go to 1/2" BSP fitment cores on page 170

This drill will accept either 1/2" BSP or 1/4" UNC cores please go to page 170

Go to 1/4" UNC fitment cores on page 170

**WET**

Do you drill into hard materials such as reinforced concrete, natural stones or engineering bricks?

You need a Wet Drilling System

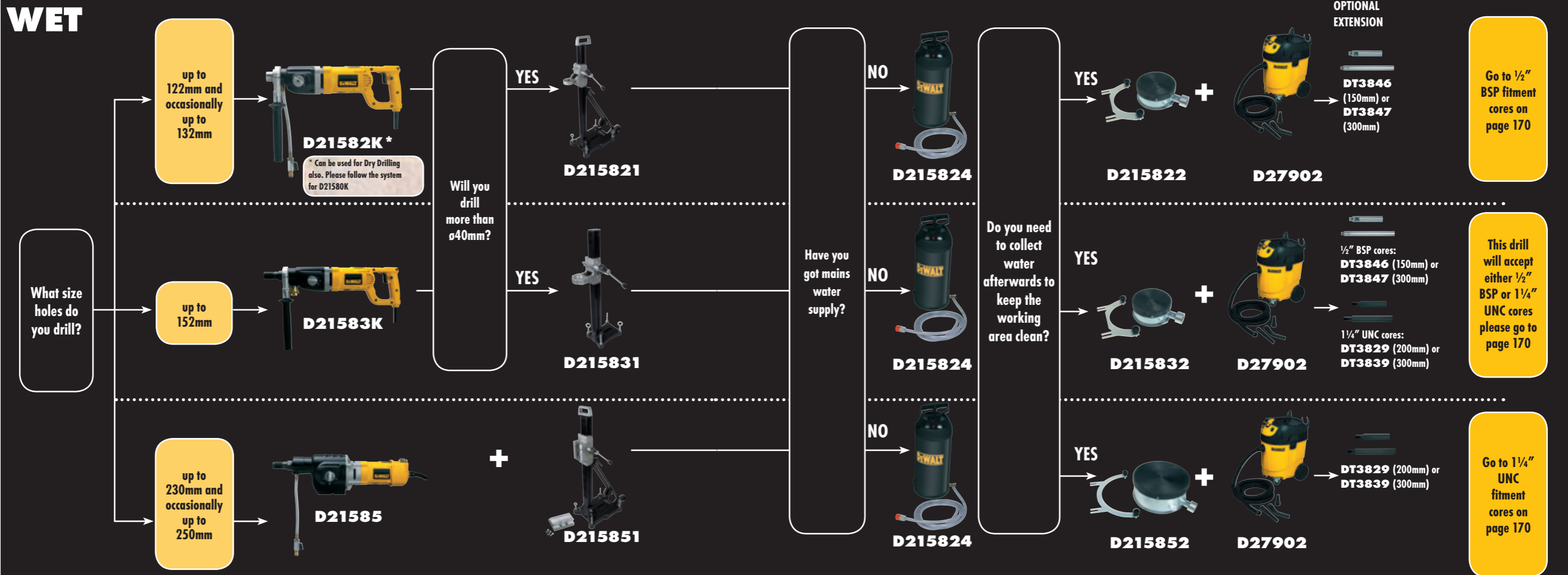

**1705 W - 2 Speed Dry Diamond Drill** **D21580K**



Ideal tool for electrical, plumbing or HVAC applications when drilling only into masonry and bricks  
Quick and accurate core drilling into brick and masonry up to 152 mm  
Increased power makes the job easier and faster  
Overload and thermal protection increase the life of the tool

**Standard Equipment:** Multi-position side handle, Heavy duty carrying case

Spindle Thread	1/2" Male BSP
Power Input	1705 Watts
Power Output	1150 Watts
No Load Speed	0-1100/0-2350 rpm
Max. Drilling Capacity [Masonry]	152 mm
Collar Diameter	53 mm
Weight	5.4 kg
Length x Height	480 x 165 mm



**1705 W - 2 Speed Wet & Dry Diamond Drill** **D21582K\***



Ideal tool for electrical, plumbing or HVAC applications when drilling into masonry and concrete  
Quick and accurate dry drilling into bricks and masonry up to 152 mm  
Integrated water swivel for core drilling into harder material up to 132 mm such as natural stone, concrete, engineering bricks and reinforced concrete  
Increased power makes the job easier and faster

**Standard Equipment:** Multi-Position side handle, PRCD (in-line circuit breaker), Water supply hose with integrated tap, Heavy duty carrying case

Spindle Thread	1/2" Female BSP
Power Input	1705 Watts
Power Output	1150 Watts
No Load Speed	0-1100 / 0-2350 rpm
Max. Drilling Capacity [Concrete]	132 mm
Max. Drilling Capacity [Masonry]	152 mm
Collar Diameter	53 mm
Weight	5.9 kg
Length x Height	480 x 165 mm

\*110V only



**1910 W - Heavy Duty 3 Speed Wet & Dry Diamond Drill** **D21583K\***



Ideal tool for heavy duty electrical, plumbing or HVAC applications when drilling predominantly into concrete  
Integrated water swivel for core drilling into the hardest material up to 152 mm such as natural stone, concrete, engineering brick and reinforced concrete  
Quick and accurate core drilling into brick and masonry up to 202 mm  
When dry drilling, a dust extractor can be plugged directly onto the drill to increase drilling performance

**Standard Equipment:** Multi-position side handle, PRCD (in-line circuit breaker), Connector for water supply, Connector for dust extraction, Heavy duty carrying case

Spindle Thread	1 1/4" Male UNC & 1/2" Female BSP
Power Input	1910 Watts
Power Output	1300 Watts
No Load Speed	0-1000 / 0-2400 / 0-4600 rpm
Max. Drilling Capacity [Concrete]	152 mm
Max. Drilling Capacity [Masonry]	202 mm
Collar Diameter	60 mm
Weight	6.4 kg
Length x Height	550 x 165 mm

\*110V only



**2500 W - Heavy Duty 3 Speed Wet Diamond Drilling Motor** **D21585**



Ideal tool for heavy duty electrical, plumbing, HVAC or general construction applications when drilling into concrete  
Integrated water swivel for core drilling into any material up to 250 mm  
High powered motor delivers best in class performance for frequent Heavy duty drilling  
3 Mechanical speeds deliver optimum drilling speed

**Standard Equipment:** PRCD (in-line circuit breaker), Water supply hose with integrated tap

Spindle Thread	1 1/4" Male UNC
Power Input	2500 Watts
Power Output	1500 Watts
No Load Speed	500 / 1200 / 2000 rpm
Max. Drilling Capacity [Concrete]	250 mm
Max. Drilling Capacity [Masonry]	300 mm
Collar Diameter	N/A mm
Weight	11.2 kg
Length x Height	570 x 160 mm



**Small Drilling Stand - 53 mm Collar** **D215821**



Ideal for occasional drilling of large holes into concrete or masonry  
Small and compact for easy transport to the job site  
Smooth sliding carriage delivers best in class drilling accuracy  
Reversible press handle offers tool-free handle set-up

Column Length	680 mm
Collar Diameter	53 mm
Max Drilling Diameter with Water Collector	102 mm
Max Drilling Diameter without Water Collector	152 mm
Weight	7 kg

**Medium Drilling Stand with integrated vacuum base - 60 mm Collar** **D215831**



For heavy duty drilling into masonry and concrete  
Quick release tool holder allows a quick set up on the jobsite  
Support brackets increase the rigidity of the column  
Integrated vacuum base for an even quicker set up (vacuum pump required)

Column Length	995 mm
Collar Diameter	60 mm
Max Drilling Diameter with Water Collector	152 mm
Max Drilling Diameter without Water Collector	172 mm
Inclinable	45 °
Weight	16 kg

**Stand for Drilling Motor (D21585)** **D215851**



For heavy duty drilling into masonry and concrete with D21585 drilling motor  
Large base delivers higher stability and improved drilling accuracy  
Integrated vacuum base for an even quicker set up (vacuum pump required)  
Support brackets increase the rigidity of the column

Column Length	995 mm
Collar Diameter	N/A mm
Max Drilling Diameter with Water Collector	250 mm
Max Drilling Diameter without Water Collector	300 mm
Inclinable	45 °
Weight	22 kg

**250mm Slide Table Wet Tile Saw & Leg Stand** **D240005**



Stainless steel rail system is intergrated into the tile saw frame, ensuring accurate cuts  
Cantilevering rail / cart system allows for 610 mm ripping capacity  
Low weight allows one person to transport and set up saw  
Plunge feature allows the user to make quick plunge cuts for electrical outlets together with an intergrated 45 / 22.5 degree feature for quick angle cuts

**Standard Equipment:** D240001 leg stand, DT3734 cutting disc, Extension table, Side and rear water collector, Hex key

Power Input	1600 Watts
Wheel Diameter	250 mm
No Load Speed	4200 rpm
Depth of cut	95 mm
Width x Length	690 x 860 mm
Weight	32 kg



**110 mm Hand Held Wet Tile Saw** **DWC410\***



1300 W motor delivers the cutting power to cut through granite, porcelain, concrete and other stone materials  
Premium 110 mm diameter continuous rim blade allows the user to cut a variety of different materials from ceramics to concrete up to 34 mm deep - wet or dry

Water line and adjustable nozzle feeds water to the blade decreasing dust and increasing blade performance and life  
Bevels to 45 degrees for quick angled cuts

**Standard Equipment:** 110 mm wet / dry continuous rim diamond blade, Water feed line, Tools for blade change

Power Input	1300 Watts
Power Output	800 Watts
Wheel Diameter	110 mm
No Load Speed	13000 rpm
Depth of cut	34 mm
Length x Height	252 x 166 mm
Weight	3.0 kg



\*For information on Diamond Blades - see page 168

**Mechanical Anchoring for Diamond Drill Stands** **Vacuum Pump and Attachments for Diamond Drills** **Diamond Drill Attachments**



D215826		D215825
Cat. No.	Description	Fits
D215825	Fastening set for concrete	D215821 / D215831 / D215851
D215826	Fastening set for masonry	D215821 / D215831 / D215851
D215827	10 x spare dowels for concrete	D215825
D215828	Spare dowel for masonry	D215826



D215837		D215839
Cat. No.	Description	Fits
D215837	Vacuum pump	D215831 / D215851
D215838	Spare 3 m vacuum hose	D215837
D215839	Vacuum set (seal and valve)	D215831
D215859	Vacuum set (seal and valve)	D215851



D215834		D215854
Cat. No.	Description	Fits
D215834	Reduction ring 60 to 53 mm collar	D215831
D215835	Quick action bracing bracket	D215821 / D215831 / D215851
D215854	5 Copper ring for 1 1/4" core bits	D21583K / D21585



22 mm SDS-Plus Rotary Hammer

D25012K/ D25012N



Drilling 4-22mm diameter anchor holes into concrete and masonry  
Impact stop for drilling in wood, steel, plastic and screwdriving applications  
Variable speed switch and full power in forward and reverse for total control  
Very compact design and low weight

**Standard Equipment:** Multi-position side handle, Depth stop, Heavy duty carrying case

Power Input	650 Watts
Power Output	300 Watts
No Load Speed	0-1550 rpm
Blows per Minute	0-4150 bpm
Impact Energy	0-2.4 J
Tool Holder	SDS-Plus
Max. Drilling Capacity [Wood]	30 mm
Max. Drilling Capacity [Metal]	13 mm
Max. Drilling Capacity [Concrete]	22 mm
Max. Drilling Capacity [Core bit]	50 mm
Weight	2.3 kg
Length x Height	325 x 210 mm



22 mm SDS-Plus Combination Hammer

D25013K/ D25013C/ D25013N\*



Drilling 4-22mm diameter anchor holes into concrete and masonry...  
Impact stop for drilling in wood, steel, plastic and screwdriving applications  
Rotation stop for light chiselling in concrete and masonry  
Variable speed switch and full power in forward and reverse for total control

**Standard Equipment:** Multi-position side handle, Depth stop, Heavy duty carrying case

Power Input	650 Watts
Power Output	300 Watts
No Load Speed	0-1550 rpm
Blows per Minute	0-4550 bpm
Impact Energy	0-2.4 J
Tool Holder	SDS-Plus
Max. Drilling Capacity [Wood]	30 mm
Max. Drilling Capacity [Metal]	13 mm
Max. Drilling Capacity [Concrete]	22 mm
Max. Drilling Capacity [Core bit]	50 mm
Weight	2.3 kg
Length x Height	325 x 210 mm

\*Available with 3 jaws keyed chuck and SDS-Plus adaptor as C version



26mm Heavy Duty SDS-Plus Combination Hammer

D25123K



Ideal for drilling anchor and fixing holes into concrete and masonry from 4 to 26 mm in diameter  
Impact-stop for drilling in wood, steel, ceramic and screwdriving applications  
Rotation-stop for light chiselling applications in brick, soft masonry and occasionally concrete  
Large 22 mm hammer mechanism delivers high performance with low stress to the critical components resulting in better durability

**Standard Equipment:** Multi position side handle, Depth stop, Heavy duty carrying case

Power Input	800 Watts
Power Output	395 Watts
No Load Speed	0-1150 rpm
Blows per Minute	0-4300 bpm
Impact Energy	0-3.4 J
Tool Holder	SDS-Plus
Max. Drilling Capacity [Wood]	30 mm
Max. Drilling Capacity [Metal]	13 mm
Max. Drilling Capacity [Concrete]	26 mm
Max. Drilling Capacity [Core bit]	65 mm
Weight	2.9 kg
Length x Height	352 x 200 mm



26mm Heavy Duty SDS-Plus Combination Hammer with Quick Change Chuck

D25124K



Ideal for drilling anchor and fixing holes into concrete and masonry from 4 to 26 mm in diameter  
Rotation-stop for light chiselling applications in brick, soft masonry and occasionally concrete  
Impact-stop and Quick Change Removable Chuck for drilling in wood, steel, ceramic and screwdriving applications  
Large 22 mm hammer mechanism delivers high performance with low stress to the critical components resulting in better durability

**Standard Equipment:** "Quick Change" 13 mm 3-jaw keyless chuck, Multi-Position side handle, Depth stop, Heavy duty carrying case

Power Input	800 Watts
Power Output	395 Watts
No Load Speed	0-1150 rpm
Blows per Minute	0-4300 bpm
Impact Energy	0-3.4 J
Tool Holder	SDS-Plus
Max. Drilling Capacity [Wood]	30 mm
Max. Drilling Capacity [Metal]	13 mm
Max. Drilling Capacity [Concrete]	26 mm
Max. Drilling Capacity [Core bit]	65 mm
Weight	2.9 kg
Length x Height	352 x 200 mm



26mm SDS-Plus Combination Hammer D-Handle Low Vibration

D25223K



Ideal for drilling holes and fixing anchors into concrete and masonry from 4 to 26 mm in diameter  
The "D-handle" design makes it particularly suitable for vertical down drilling  
Active Vibration Control system with floating handle delivers extremely low vibration and more comfort  
Rotation-stop for light chiselling applications in soft masonry and occasionally concrete and impact-stop for drilling in wood, steel and screwdriving applications

**Standard Equipment:** Multi-position side handle, Depth stop, Heavy duty carrying case

Power Input	800 Watts
Power Output	395 Watts
No Load Speed	0-1150 rpm
Blows per Minute	0-4300 bpm
Tool Holder	SDS-Plus
Max. Drilling Capacity [Wood]	30 mm
Max. Drilling Capacity [Metal]	13 mm
Max. Drilling Capacity [Concrete]	26 mm
Max. Drilling Capacity [Core bit]	65 mm
Weight	3.2 kg
Length x Height	450 x 200 mm



For more information on vibration and to calculate the vibration exposure from your power tool visit: [www.DEWALT.co.uk/safety/vibration/calculator](http://www.DEWALT.co.uk/safety/vibration/calculator)

26mm L-Shape SDS-Plus Combination Hammer Low Vibration

D25323K



Ideal for drilling holes and fixing anchors into concrete and masonry from 4 to 26 mm in diameter  
Active Vibration Control system with floating handle delivers extremely low vibration and more comfort  
Rotation-stop for light chiselling applications in soft masonry and occasionally concrete and impact-stop for drilling in wood, steel and screwdriving applications  
Large 22 mm hammer mechanism delivers high performance with low stress to the critical components

**Standard Equipment:** Multi-position side handle, Depth stop, Heavy duty carrying case

Power Input	800 Watts
Power Output	395 Watts
No Load Speed	0-1150 rpm
Blows per Minute	0-4300 bpm
Impact Energy	0-3.4 J
Tool Holder	SDS-Plus
Max. Drilling Capacity [Wood]	30 mm
Max. Drilling Capacity [Metal]	13 mm
Max. Drilling Capacity [Concrete]	26 mm
Max. Drilling Capacity [Core bit]	65 mm
Weight	3.4 kg
Length x Height	314 x 225 mm



26mm L-Shape SDS-Plus Combination Hammer with 3 jaw Quick Change Chuck Low Vibration

D25324K



Ideal for drilling holes and fixing anchors into concrete and masonry from 4 to 26 mm in diameter  
Active Vibration Control system with floating handle delivers extremely low vibration and more comfort  
Rotation-stop for light chiselling applications in soft masonry and occasionally concrete  
Impact stop and Quick Change Removable Chuck for precise drilling in wood and steel and screwdriving applications

**Standard Equipment:** Multi position side handle, Quick Adjustment depth stop, Quick Change 13 mm 3 Jaw Keyless Chuck for rotary drilling, Heavy duty carrying case

Power Input	800 Watts
Power Output	395 Watts
No Load Speed	0-1150 rpm
Blows per Minute	0-4300 bpm
Impact Energy	0-3.4 J
Tool Holder	SDS-Plus
Max. Drilling Capacity [Wood]	30 mm
Max. Drilling Capacity [Metal]	13 mm
Max. Drilling Capacity [Concrete]	26 mm
Max. Drilling Capacity [Core bit]	65 mm
Weight	3.5 kg
Length x Height	329 x 225 mm



26mm L-Shape SDS-Plus Combination Hammer Integrated Dust Extraction Low Vibration

D25325K



Ideal for drilling holes and fixing anchors into concrete and masonry from 4 to 26 mm in diameter, and up to 16 mm with Dust Extraction System  
Rotation-stop for light chiselling in soft masonry and occasionally concrete and Impact-stop with Quick Change Removal Chuck for precise drilling in wood, steel and screwdriving applications  
Active Vibration Control system with floating handle delivers extremely low vibration  
Hepa filter improves dust filtering ensuring minimum dust levels emitted into atmosphere

**Standard Equipment:** Integrated dust extraction system with Hepa filter, Multi position side handle, Quick adjustment depth stop, Quick change 13 mm 3 jaw keyless chuck for rotary drilling, Heavy duty carrying case

Power Input	800 Watts
Power Output	395 Watts
No Load Speed	0-1150 rpm
Blows per Minute	0-4300 bpm
Impact Energy	0-3.4 J
Tool Holder	SDS-Plus
Max. Drilling Capacity [Wood]	30 mm
Max. Drilling Capacity [Metal]	13 mm
Max. Drilling Capacity [Concrete]	26 mm
Max. Drilling Capacity [Core bit]	65 mm
Weight	5.1 kg
Length x Height	462 x 291 mm



SDS-Plus Dust Extraction Telescope

D25301D\*



For use with DEWALT corded and cordless SDS-Plus hammers  
Ideal for dust free drilling up to 16 mm in diameter  
Quick-fit system for easy tool free assembly and release  
Tough and versatile to meet the needs of the most demanding applications with a compact design to maintain visibility and extremely light weight to minimise user fatigue

**Standard Equipment:** Side handle with dust extraction adaptation, Telescope and extraction head, Rubber hose, 43mm adaptor, Carton box

Fits	Corded and Cordless SDS-Plus
Collar Diameter	43 / 54 mm
Max. Drill Bit Diameter	16 mm
Max. Drill Bit Length	224 mm
Max. Drilling Depth	150 mm
Hose Length	1500 mm
Hose Diameter	35 mm
Weight	1.2 kg

\*For dust extraction vacuums see page 102

XLR ACCESSORIES



Our ultimate SDS-Plus Concrete drilling solution

- SOLID CARBIDE head provides long life and extreme durability
- 4 cutter tip geometry provides cleaner, more concentric holes for supreme fixing retention
- 4 flute spiral gives optimum debris removal - for the hardest hitting hammers

For the complete range of XLR drill bits see page 109

For more information on vibration and to calculate the vibration exposure from your power tool visit: [www.DEWALT.co.uk/safety/vibration/calculator](http://www.DEWALT.co.uk/safety/vibration/calculator)

**32 mm Heavy Duty SDS-Plus Combination Hammer D25404K**



Ideal for drilling large anchor, fixing and through holes in concrete and masonry from 6 to 32 mm in diameter  
 Rotation-stop for light chiselling applications, render and tile removal  
 Impact-stop for drilling in wood, ceramic, steel and screwdriving applications  
 Large hammer mechanism construction guarantees longer tool life and superior performance

**Standard Equipment:** Quick release removable tool holder, Multi-position side handle, Heavy duty carrying case

Power Input	900 Watts
Power Output	550 Watts
No Load Speed	0-730 rpm
Blows per Minute	0-4100 bpm
Impact Energy	0-4.8 J
Tool Holder	SDS-Plus
Max. Drilling Capacity [Wood]	40 mm
Max. Drilling Capacity [Metal]	16 mm
Max. Drilling Capacity [Concrete]	6-32 mm
Max. Drilling Capacity [Core bit]	90 mm
Weight	4.9 kg
Length x Height	385 x 230 mm



**32mm Heavy Duty SDS-Plus Combination Hammer QCC and Accessory Pack D25405K**



Ideal for drilling large anchor, fixing and through holes in concrete and masonry from 6 to 32mm in diameter  
 Rotation-stop for light chiselling applications, render and tile removal  
 Impact-stop for drilling in wood, ceramic, steel and screwdriving application  
 Large hammer mechanism construction guarantees longer tool life and superior performance

**Standard Equipment:** heavy duty carrying case, multi-position side handle, quick release removable tool holder, quick change 3 jaw chuck, 2 x SDS-Plus drill bits, 20mm flat SDS-Plus chisel, 4 x HSS drill bits, 4 x brad point wood drill bits, 20mm flatwood drill bit, 25mm flatwood drill bit, toughcase accessory organiser, safety glasses, workgloves

Power Input	900 Watts
Power Output	550 Watts
No Load Speed	0-730 rpm
Blows per Minute	0-4100 bpm
Impact Energy	0-4.8 J
Tool Holder	SDS-Plus
Max. Drilling Capacity [Wood]	40 mm
Max. Drilling Capacity [Metal]	16 mm
Max. Drilling Capacity [Concrete]	6-32 mm
Max. Drilling Capacity [Core bit]	90 mm
Weight	4.9 kg
Length x Height	385 x . mm



**40 mm SDS-Max Combination Hammer D25501K**



Ideal for drilling anchor fixing and through holes in concrete and masonry from 12 to 40 mm in diameter. Core drilling up to 90 mm  
 Chain drive improves durability and increases efficiency together with an oil filled gearbox to ensure total component lubrication and superior heat dissipation  
 Ergonomic, compact and slim line design maximises control and offers easy access to confined spaces  
 Excellent power to weight ratio: 11 Joules of impact energy delivered by a 6 kg hammer

**Standard Equipment:** Multi-position side handle with depth stop, Heavy duty carrying case

Power Input	1100 Watts
Power Output	500 Watts
Load Speed	400 rpm
Blows per Minute	2740 bpm
Impact Energy	11 J
Tool Holder	SDS-Max
Max. Drilling Capacity [Concrete]	40 mm
Max. Drilling Capacity [Breakthrough bit]	55 mm
Max. Drilling Capacity [Core bit]	90 mm
Weight	6.15 kg
Length x Height	457 x 245 mm



**45mm SDS-Max Combination Hammer D25601K**



Ideal for drilling anchor fixing and through holes in concrete and masonry from 12 to 45 mm in diameter. Core drilling up to 100 mm  
 Chain drive improves durability and increases efficiency together with an oil filled gearbox to ensure total component lubrication and superior heat dissipation  
 Ergonomic, compact and slim line design maximises control and offers easy access to confined spaces  
 Active Vibration Control system incorporating a floating rear handle and damped side handle to reduce vibration

**Standard Equipment:** Multi-position anti-vibration side handle with depth stop, Heavy duty carrying case

Power Input	1250 Watts
Power Output	615 Watts
Load Speed	210-415 rpm
Blows per Minute	1430-2840 bpm
Impact Energy	2-12 J
Tool Holder	SDS-Max
Max. Drilling Capacity [Concrete]	45 mm
Max. Drilling Capacity [Breakthrough bit]	65 mm
Max. Drilling Capacity [Core bit]	100 mm
Weight	6.8 kg
Length x Height	477 x 245 mm



**45 mm SDS-Max Combination Hammer D25602K**



Ideal for drilling anchor fixing and through holes in concrete and masonry from 12 to 45 mm in diameter. Core drilling up to 100 mm  
 Chain drive improves durability and increases efficiency together with an oil filled gearbox to ensure total component lubrication and superior heat dissipation  
 Active Vibration Control system incorporating a floating rear handle and damped side handle to reduce vibration  
 Complete Torque Control. A patented 2 step clutch allows the user to select one of two settings for different diameter drill and core bits providing the maximum level of protection in all drilling applications

**Standard Equipment:** Multi-position anti-vibration side handle with depth stop, Heavy duty carrying case

Power Input	1250 Watts
Power Output	615 Watts
Load Speed	210-415 rpm
Blows per Minute	1430-2840 bpm
Impact Energy	2-12 J
Tool Holder	SDS-Max
Max. Drilling Capacity [Concrete]	45 mm
Max. Drilling Capacity [Breakthrough bit]	65 mm
Max. Drilling Capacity [Core bit]	100 mm
Weight	6.9 kg
Length x Height	477 x 245 mm



For more information on vibration and to calculate the vibration exposure from your power tool visit: [www.DEWALT.co.uk/safety/vibration/calculator](http://www.DEWALT.co.uk/safety/vibration/calculator)

**48 mm SDS-Max Combination Hammer D25711K**



Ideal for drilling anchor fixing and through holes in concrete and masonry from 12 to 48 mm in diameter. Core drilling up to 115 mm  
 Active Vibration Control system incorporating a floating handle delivers extremely low vibration  
 Electronic variable speed and impact energy control  
 Lock-on switch for chipping

**Standard Equipment:** Multi-position side handle, Heavy duty carrying case

Power Input	1250 Watts
Power Output	840 Watts
Load Speed	132-265 rpm
Blows per Minute	1225-2450 bpm
Impact Energy	1.5-13 J
Tool Holder	SDS-Max
Max. Drilling Capacity [Concrete]	48 mm
Max. Drilling Capacity [Breakthrough bit]	80 mm
Max. Drilling Capacity [Core bit]	115 mm
Weight	8.7 kg
Length x Height	528 x 268 mm



**48 mm SDS-Max Combination Hammer D25712K**



Ideal for drilling anchor fixing and through holes in concrete and masonry from 12 to 48 mm in diameter. Core drilling up to 125 mm  
 Active Vibration Control system incorporating a counterbalance mass and floating handle delivers extremely low vibration  
 Complete Torque Control. A patented 2 step clutch allows the user to select one of two settings for different diameter drill and core bits providing the maximum level of protection in all drilling applications  
 Electronic variable speed and impact energy control

**Standard Equipment:** Multi-position side handle, Heavy duty carrying case

Power Input	1300 Watts
Power Output	840 Watts
Load Speed	137-275 rpm
Blows per Minute	1260-2520 bpm
Impact Energy	2-14 J
Tool Holder	SDS-Max
Max. Drilling Capacity [Concrete]	48 mm
Max. Drilling Capacity [Breakthrough bit]	80 mm
Max. Drilling Capacity [Core bit]	125 mm
Weight	9.1 kg
Length x Height	528 x 268 mm



**52 mm SDS-Max Combination Hammer D25762K**



Ideal for drilling anchor fixing and through holes in concrete and masonry from 12 to 52 mm in diameter. Core drilling up to 150 mm  
 Active Vibration Control system incorporating a counterbalance mass and floating handle delivers extremely low vibration  
 Electronic variable speed and impact energy control  
 Complete Torque Control. A patented 2 step clutch allows the user to select one of two settings for different diameter drill and core bits providing the maximum level of protection in all drilling applications

**Standard Equipment:** Multi-position side handle, Heavy duty carrying case

Power Input	1500 Watts
Power Output	980 Watts
Load Speed	125-250 rpm
Blows per Minute	1150-2300 bpm
Impact Energy	3-18 J
Tool Holder	SDS-Max
Max. Drilling Capacity [Concrete]	52 mm
Max. Drilling Capacity [Breakthrough bit]	80 mm
Max. Drilling Capacity [Core bit]	150 mm
Weight	9.9 kg
Length x Height	561 x 272 mm



**3 kg Heavy Duty SDS-Plus L-Shaped Dedicated Chipping Hammer D25330K**



Ideal for light chiselling applications in brick, light masonry and occasionally concrete  
 Quick change chisel adjustment allows fast orientation of the chisel through 12 preset positions  
 Large 22 mm hammer mechanism delivers high performance with low stress to the critical components  
 Improved sealing for maximum protection from dust ingress ensuring long tool life

**Standard Equipment:** Multi position side handle, Heavy duty carrying case

Power Input	650 Watts
Power Output	400 Watts
Blows per Minute	0-4100 bpm
Impact Energy	0-3.1 J
Tool Holder	SDS-Plus
Weight	3.0 kg
Length x Height	296 x 225 mm



**SDS-Max Dedicated Chipping Hammer D25831K**



Ideal for light demolition, surface preparation or chiseling grooves and channel openings in brick, masonry and light concrete  
 Chain drive improves durability and increases efficiency together with an oil filled gearbox to ensure total component lubrication and superior heat dissipation  
 Ergonomic, compact and slim line design maximises control and offers easy access to confined spaces  
 Electronic variable speed and impact energy control

**Standard Equipment:** Multi-position side handle, Heavy duty carrying case

Power Input	1250 Watts
Power Output	615 Watts
Blows per Minute	1430-2840 bpm
Impact Energy	2-12 J
Tool Holder	SDS-Max
Weight	6.1 kg
Length x Height	477 x 245 mm



For more information on vibration and to calculate the vibration exposure from your power tool visit: [www.DEWALT.co.uk/safety/vibration/calculator](http://www.DEWALT.co.uk/safety/vibration/calculator)

SDS-Max Dedicated Demolition Hammer

D25870K



Ideal for demolition and surface preparation in brick, masonry and concrete  
Active Vibration Control system incorporating a counterbalance mass and floating handle delivers extremely low vibration  
Variable chisel locking at 24 positions to provide the perfect approach for all applications  
Electronic variable impact energy/speed for total control

**Standard Equipment:** Multi-position side handle, 1 point chisel, Heavy duty carrying case

Power Input	1300 Watts
Power Output	840 Watts
Blows per Minute	1260-2520 bpm
Impact Energy	2-14 J
Tool Holder	SDS-Max
Weight	8.0 kg
Length x Height	528 x 268 mm



10 kg Demolition Hammer

D25899K



Powerful and durable 1500 Watt motor delivers outstanding concrete breaking performance  
In line design for better handling and quick change chisel adjustment allows fast orientation of the chisel through 12 preset positions  
Magnesium housings ensure maximum durability and minimum weight  
Compact, streamlined design allows access in confined areas

**Standard Equipment:** Multi position side handle, Heavy duty carrying case

Power Input	1500 Watts
Power Output	750 Watts
Blows per Minute	2040 bpm
Impact Energy	25 J
Tool Holder	SDS-Max
Weight	9.6 kg
Length x Height	650 x 250 mm



10 kg Demolition Hammer

D25901K



Powerful and durable 1500 Watt motor delivers outstanding concrete breaking performance  
Active Vibration Control system incorporating a counterbalance mass and floating handle delivers extremely low vibration  
In line design for better handling and quick change chisel adjustment allows fast orientation of the chisel through 12 preset positions  
Magnesium housings ensure maximum durability and minimum weight

**Standard Equipment:** Multi position side handle, Chisel, Grease, Cloth, Heavy duty carrying case

Power Input	1500 Watts
Power Output	750 Watts
Blows per Minute	1020-2040 bpm
Impact Energy	5-25 J
Tool Holder	SDS-Max
Weight	10.6 kg
Length x Height	690 x 250 mm



12 kg Demolition Hammer

D25941K



Powerful and durable 1600 Watt motor delivers outstanding concrete breaking performance  
Active Vibration Control system incorporating a counterbalance mass and floating handle delivers extremely low vibration  
In line design for better handling and quick change chisel adjustment allows fast orientation of the chisel through 12 preset positions  
Magnesium housings ensure maximum durability and minimum weight

**Standard Equipment:** Multi position side handle, Pointed chisel, Grease, Cloth, Heavy duty carrying case

Power Input	1600 Watts
Power Output	790 Watts
Blows per Minute	1620 bpm
Impact Energy	30.6 J
Tool Holder	19mm Hex
Weight	13.1 kg
Length x Height	750 x 250 mm



30 kg Pavement Breaker

D25980/ D25980K\*



Large oversize mechanism delivers extreme durability and excellent breaking performance  
2000 Watt motor delivers outstanding efficiency and durability  
Active Vibration Control offers safer, more comfortable use and more productivity  
Suspended Handle System absorbs the rebound and, working with the AVC, delivers the lowest vibration on the market

Power Input	2000 Watts
Power Output	986 Watts
Blows per Minute	870 bpm
Impact Energy	68 J
Tool Holder	28 mm Hex
Weight	31 kg
Length x Height	780 x 620 mm



\*K version comes with trolley (D259801)

For more information on vibration and to calculate the vibration exposure from your power tool visit: [www.DEWALT.co.uk/safety/vibration/calculator](http://www.DEWALT.co.uk/safety/vibration/calculator)

900 W - 115 mm Small Angle Grinder

D28113/ D28113K



Dust ejection system removes majority of debris from the air which passes over the motor, preventing abrasion and tracking  
Small girth allow comfortable gripping resulting in superior ergonomics  
The low profile gear case allows access in confined areas  
Anti vibration side handle to improve user comfort

**Standard Equipment:** Protective keyless guard, Multi-position anti vibration side handle, Inner and outer disc flange, Spanner

Power Input	900 Watts
No Load Speed	10000 rpm
Max. Disc Diameter	115 mm
Spindle Thread	M14
Weight	2.1 kg
Length x Height	285 x 80 mm



850 W - 115 mm Small Angle Grinder

D28111



Small girth allows comfortable gripping resulting in superior ergonomics  
The low profile gear case allows access in confined areas  
Abrasion protected motor for increased durability  
Anti lock flange prevents flanges from permanently locking up and locking the disc on

**Standard Equipment:** Protective guard, Multi-position side handle, Inner and outer disc flange, Spanner

Power Input	850 Watts
No Load Speed	10000 rpm
Max. Disc Diameter	115 mm
Spindle Thread	M14
Weight	2.1 kg
Length x Height	270 x 80 mm



1100 W - 115 mm Variable Speed Small Angle Grinder

D28116



The electronic variable speed control offers added tool control and enables the tool to be used at optimum conditions to suit the accessory and material  
Electro-mechanical clutch reduces the "kickback" transmitted to the operator if the cutting disc jams

No volt release switch will prevent the unit starting when plugged in, even if the switch is in the on position. Switch must be consciously reset before power is delivered

Overload protection will prevent the unit over heating by shutting the unit off until the unit has cooled down

**Standard Equipment:** Protective keyless guard, Multi-position anti vibration side handle, Inner and outer disc flanges, Spanner

Power Input	1100 Watts
No Load Speed	2800 - 10000 rpm
Max. Disc Diameter	115 mm
Spindle Thread	M14
Weight	2.3 kg
Length x Height	315 x 80 mm



1100 W - 115 mm Variable Speed Autobalancer Small Angle Grinder

D28117



Autobalancer reduces vibration resulting in greater comfort

The electronic variable speed control offers added tool control and enables the tool to be used at optimum conditions to suit the accessory and material  
Electro-mechanical clutch reduces the "kickback" transmitted to the operator if the cutting disc jams

No volt release switch will prevent the unit starting when plugged in, even if the switch is in the on position. Switch must be consciously reset before power is delivered

**Standard Equipment:** Protective keyless guard, Multi position anti vibration side handle, Inner and outer disc flanges, Spanner

Power Input	1100 Watts
No Load Speed	2800 - 10000 rpm
Max. Disc Diameter	115 mm
Spindle Thread	M14
Weight	2.5 kg
Length x Height	315 x 90 mm



850 W - 125 mm Small Angle Grinder D28139



Small girth allows comfortable gripping resulting in superior ergonomics  
The low profile gear case allows access in confined areas  
Abrasion protected motor for increased durability  
Anti lock flange prevents flanges from permanently locking up and locking the disc on

**Standard Equipment:** Protective guard, Multi-position side handle, Inner and outer disc flange, Spanner

Power Input	850 Watts
No Load Speed	10000 rpm
Max. Disc Diameter	125 mm
Spindle Thread	M14
Weight	2.1 kg
Length x Height	270 x 80 mm

900 W - 125 mm Small Angle Grinder D28130



Dust ejection system removes majority of debris from the air which passes over the motor, preventing abrasion and tracking  
Small girth allow comfortable gripping resulting in superior ergonomics  
The low profile gear case allows access in confined areas  
Anti vibration side handle to improve user comfort

**Standard Equipment:** Protective guard, Multi-position anti vibration side handle, Inner and outer disc flange, Spanner

Power Input	900 Watts
No Load Speed	10000 rpm
Max. Disc Diameter	125 mm
Spindle Thread	M14
Weight	2.2 kg
Length x Height	285 x 80 mm

1100 W - 125 mm Small Angle Grinder D28134



Dust ejection system removes majority of debris from the air which passes over the motor, preventing abrasion and tracking  
Small girth allow comfortable gripping resulting in superior ergonomics  
The low profile gear case allows access in confined areas  
New guard design allows guard fitment, adjustment or removal without the use of tools, for increased flexibility

**Standard Equipment:** Protective keyless guard, Multi-position side handle, Inner and outer disc flange, Spanner

Power Input	1100 Watts
No Load Speed	10000 rpm
Max. Disc Diameter	125 mm
Spindle Thread	M14
Weight	2.2 kg
Length x Height	285 x 80 mm

125mm / 115mm Paddle Switch Grinder D28142



A non locking paddle switch ensures the grinder switches off automatically when the unit is released  
Dust ejection system removes majority of debris from the air which passes over the motor, preventing abrasion and tracking  
Small girth allows user to maintain a comfortable grip, resulting in superior ergonomics  
Anti-vibration side handle to improve user comfort

**Standard Equipment:** 115mm Protective guard, 125mm Protective guard, Inner and outer disc flange, Spanner, Multi positioned anti vibration side handle

Power Input	1100 Watts
No Load Speed	10000 rpm
Max. Disc Diameter	125 / 115 mm
Spindle Thread	M14
Weight	2.2 kg
Length x Height	285 x 80 mm

1200 W - 125 mm Small Angle Grinder D28132C



Dust ejection system removes majority of debris from the air which passes over the motor, preventing abrasion and tracking  
Anti lock flange prevents flanges from permanently locking up  
Abrasion protected motor for increased durability  
New guard design allows guard fitment, adjustment or removal without the use of tools, for increased flexibility

**Standard Equipment:** Protective keyless guard, Multi-position anti vibration side handle, Inner and outer disc flange, Spanner

Power Input	1200 Watts
No Load Speed	10000 rpm
Max. Disc Diameter	125 mm
Spindle Thread	M14
Weight	2.5 kg
Length x Height	300 x 80 mm

1500 W - 125 mm Variable Speed Small Angle Grinder D28136



The electronic variable speed control offers added tool control and enables the tool to be used at optimum conditions to suit the accessory and material  
Electro-mechanical clutch reduces the "kickback" transmitted to the operator if the cutting disc jams  
No volt release switch will prevent the unit starting when plugged in, even if the switch is in the on position. Switch must be consciously reset before power is delivered  
Overload protection will prevent the unit over heating by shutting the unit off until the unit has cooled down

**Standard Equipment:** Protective keyless guard, Multi position anti vibration side handle, Inner and outer disc flanges, Spanner

Power Input	1500 Watts
No Load Speed	2800 - 10000 rpm
Max. Disc Diameter	125 mm
Spindle Thread	M14
Weight	2.6 kg
Length x Height	315 x 90 mm

1100 W - 125 mm Electronic Small Angle Grinder D28133



Electro-mechanical clutch reduces the "kickback" transmitted to the operator if the cutting disc jams  
No volt release switch will prevent the unit starting when plugged in, even if the switch is in the on position. Switch must be consciously reset before power is delivered

Overload protection will prevent the unit over heating by shutting the unit off until the unit has cooled down

Dust ejection system removes majority of debris from the air which passes over the motor, preventing abrasion and tracking

**Standard Equipment:** Protective keyless guard, Multi position anti vibration side handle, Inner and outer disc flanges, Spanner

Power Input	1100 Watts
No Load Speed	10000 rpm
Max. Disc Diameter	125 mm
Spindle Thread	M14
Weight	2.3 kg
Length x Height	315 x 80 mm

1400 W - 125 mm Small Angle Grinder D28135 / D28135K\*



Dust ejection system removes majority of debris from the air which passes over the motor, preventing abrasion and tracking  
Anti lock flange prevents flanges from permanently locking up and locking the disc on

Abrasion protected motor for increased durability  
New guard design allows guard fitment, adjustment or removal without the use of tools, for increased flexibility

**Standard Equipment:** Protective keyless guard, Multi-position anti vibration side handle, Inner and outer disc flanges, Spanner

Power Input	1400 Watts
No Load Speed	10000 rpm
Max. Disc Diameter	125 mm
Spindle Thread	M14
Weight	2.5 kg
Length x Height	300 x 80 mm

\*K version comes with kitbox

1500 W - 125 mm Variable Speed Autobalancer Small Angle Grinder D28137



Autobalancer reduces vibration resulting in greater comfort  
The electronic variable speed control offers added tool control and enables the tool to be used at optimum conditions to suit the accessory and material  
Electro-mechanical clutch reduces the "kickback" transmitted to the operator if the cutting disc jams  
No volt release switch will prevent the unit starting when plugged in, even if the switch is in the on position. Switch must be consciously reset before power is delivered

**Standard Equipment:** Protective keyless guard, Multi positioned anti vibration side handle, Inner and outer disc flanges, Spanner

Power Input	1500 Watts
No Load Speed	2800 - 10000 rpm
Max. Disc Diameter	125 mm
Spindle Thread	M14
Weight	2.7 kg
Length x Height	315 x 90 mm



**1400 W - 125 mm Medium Angle Grinder DW831**



Large diameter high power motor for superior performance  
High temperature resin coated field for increased durability  
Special air channels designed into field case to optimise motor cooling  
Spindle lock for quick wheel changes

**Standard Equipment:** Protective guard, Side handle, Inner and outer disc flanges, Spanner

Power Input	1400 Watts
Power Output	900 Watts
No Load Speed	10000 rpm
Max. Disc Diameter	125 mm
Spindle Thread	M14
Weight	3.1 kg
Length x Height	385 x 115 mm

**1250 W - 125 mm Small Angle Grinder D28065**



Dust ejection system removes majority of debris from the air which passes over the motor, preventing abrasion and tracking  
Ergonomic main handle with rubber grip allows for maximum comfort when grinding for long periods of time  
Abrasion protected motor for increased durability  
New guard design allows guard fitment, adjustment or removal without the use of tools, for increased flexibility

**Standard Equipment:** Protective keyless guard, Multi-position anti vibration side handle, Inner and outer disc flanges, Spanner

Power Input	1250 Watts
Power Output	680 Watts
No Load Speed	9000 rpm
Max. Disc Diameter	125 mm
Spindle Thread	M14
Weight	2.6 kg
Length x Height	385 x 110 mm

**1400 W - 150 mm Small Angle Grinder D28141**



Dust ejection system removes majority of debris from the air which passes over the motor, preventing abrasion and tracking  
Anti lock flange prevents flanges from permanently locking up and locking the disc on  
Abrasion protected motor for increased durability  
New guard design allows guard fitment, adjustment or removal without the use of tools, for increased flexibility

**Standard Equipment:** Protective keyless guard, Multi-position anti vibration side handle, Inner and outer disc flanges, Spanner

Power Input	1400W Watts
No Load Speed	9000 rpm
Max. Disc Diameter	150 mm
Spindle Thread	M14
Weight	2.6 kg
Length x Height	300 x 80 mm

**1800 W - 180 mm Angle Grinder DW840**



High temperature resin coated field for increased durability  
Large diameter high power motor for excellent performance  
Maximum power to weight ratio and superior tool balance  
Special air channels designed into field case to optimise motor cooling

**Standard Equipment:** Protective guard, Side handle, Inner and outer disc flanges, Spanner

Power Input	1800 Watts
Power Output	1180 Watts
No Load Speed	8000 rpm
Max. Disc Diameter	180 mm
Spindle Thread	M14
Weight	4.0 kg
Length x Height	405 x 120 mm

**DEWALT DIAMOND BLADES**



**The DEWALT Laser range of Diamond Blades is designed to offer the right blade for the right task.**

- Diamond blades containing a high concentration of top quality diamonds for excellent cutting performance in extremely hard materials
- Segments Laser Welded to the core for use in tougher applications
- High quality, low carbon steel core reduces core distortion at high temperatures

For the complete range of diamond blades see page 166-168

**2000 W - 180 mm Angle Grinder D28491**



Abrasion protected motor for increased durability  
Two position side handle allows the user to optimise handle position to give maximum comfort.  
Spindle lock for quick wheel changes  
Brush window allows quick brush replacement

**Standard Equipment:** Protective guard, Side handle, Inner and outer disc flanges, Spanner

Power Input	2000 Watts
Power Output	1054 Watts
No Load Speed	8500 rpm
Max. Disc Diameter	180 mm
Spindle Thread	M14
Weight	5.5 kg
Length x Height	490 x 151 mm

**2200 W - 180 mm Angle Grinder D28493**



Abrasion protected motor for increased durability  
Two position side handle allows the user to optimise handle position to give maximum comfort  
Spindle lock for quick wheel changes  
Brush window allows quick brush replacement

**Standard Equipment:** Protective guard, Side handle, Inner and outer disc flanges, Spanner

Power Input	2200 Watts
Power Output	1246 Watts
No Load Speed	8500 rpm
Max. Disc Diameter	180 mm
Spindle Thread	M14
Weight	5.5 kg
Length x Height	490 x 151 mm

**2200 W - 180 mm Heavy Duty Angle Grinder D28413**



Soft start to limit start up current and reduce kick back  
Anti vibration side handle  
Quick adjustment tool free guard  
Abrasion protected high power motor for increased motor durability

**Standard Equipment:** Protective tool free guard, Anti vibration side handle, Inner and outer flange set, Spanner

Power Input	2200 Watts
Power Output	1540 Watts
No Load Speed	8500 rpm
Max. Disc Diameter	180 mm
Spindle Thread	M14
Weight	5.9 kg
Length x Height	450 x 145 mm

**2400 W - 180 mm Heavy Duty Angle Grinder D28422**



Soft start to limit start up current and reduce kick back  
Anti vibration side handle  
Quick adjustment tool free guard  
Abrasion protected high power motor for increased motor durability

**Standard Equipment:** Protective tool free guard, Anti vibration side handle, Inner and outer flange set, Spanner

Power Input	2400 Watts
Power Output	1680 Watts
No Load Speed	8500 rpm
Max. Disc Diameter	180 mm
Spindle Thread	M14
Weight	6.5 kg
Length x Height	470 x 145 mm

**2400 W - 180 mm Heavy Duty Angle Grinder with No Volt Release Switch D28495**



No volt release switch prevents the unit starting when plugged in, even if the switch is lock on. Switch must consciously reset before power is delivered  
Torque limiting clutch reduces the maximum torque reaction transmitted to the operator if the disc jams  
Overload protection will prevent the motor overheating by shutting off the unit until the unit cools down  
Soft start to limit start-up current and reduce kick back

**Standard Equipment:** Protective keyless guard, Anti vibration side handle, Inner and outer disc flanges, Spanner

Power Input	2400 Watts
Power Output	1246 Watts
No Load Speed	8500 rpm
Max. Disc Diameter	180 mm
Spindle Thread	M14
Weight	5.5 kg
Length x Height	490 x 151 mm

2200 W - 230 mm Angle Grinder

D28492/ D28492K

Abrasion protected motor for increased durability  
Two position side handle allows the user to optimise handle position to give maximum comfort  
Spindle lock for quick wheel changes  
Brush window allows quick brush replacement

**Standard Equipment:** Protective guard, Side handle, Inner and outer disc flanges, Spanner

Power Input	2200 Watts
Power Output	1246 Watts
No Load Speed	6500 rpm
Max. Disc Diameter	230 mm
Spindle Thread	M14
Weight	5.5 kg
Length x Height	490 x 151 mm



2000 W - 230 mm Angle Grinder

D28490

Abrasion protected motor for increased durability  
Two position side handle allows the user to optimise handle position to give maximum comfort  
Spindle lock for quick wheel changes  
Brush window allows quick brush replacement

**Standard Equipment:** Protective guard, Side handle, Inner and outer disc flanges, Spanner

Power Input	2000 Watts
Power Output	1054 Watts
No Load Speed	6500 rpm
Max. Disc Diameter	230 mm
Spindle Thread	M14
Weight	5.5 kg
Length x Height	490 x 151 mm



2000 W - 230 mm Heavy Duty Angle Grinder

D28401

Quick adjustment tool free guard  
Abrasion protected high power motor for increased motor durability  
Five position side handle for improved balance in cutting and grinding applications  
Cut off brushes to prolong motor life

**Standard Equipment:** Protective tool free guard, Side handle, Inner and outer flange set, Spanner

Power Input	2000 Watts
Power Output	1400 Watts
No Load Speed	6500 rpm
Max. Disc Diameter	230 mm
Spindle Thread	M14
Weight	5.8 kg
Length x Height	450 x 145 mm



2000 W - 230 mm Heavy Duty Angle Grinder

D28400

Soft start to limit start-up current and reduce kick back  
Quick Adjustment tool free guard  
Abrasion protected high power motor for increased motor durability  
Five position side handle for improved balance in cutting and grinding applications

**Standard Equipment:** Protective tool free guard, Side handle, Inner and outer flange set, Spanner

Power Input	2000 Watts
Power Output	1400 Watts
No Load Speed	6500 rpm
Max. Disc Diameter	230 mm
Spindle Thread	M14
Weight	5.9 kg
Length x Height	450 x 145 mm



2200 W - 230 mm Heavy Duty Angle Grinder

D28414

Soft start to limit start-up current and reduce kick back  
Anti vibration side handle  
Quick adjustment tool free guard  
Abrasion protected high power motor for increased motor durability

**Standard Equipment:** Protective tool free guard, Anti vibration side handle, Inner and outer flange set, Spanner

Power Input	2200 Watts
Power Output	1540 Watts
No Load Speed	6500 rpm
Max. Disc Diameter	230 mm
Spindle Thread	M14
Weight	6.0 kg
Length x Height	450 x 145 mm



2300 W - 230 mm Heavy Duty Angle Grinder

D28421

Anti vibration side handle  
Quick adjustment tool free guard  
Abrasion protected high power motor for increased motor durability  
Five position side handle for improved balance in cutting and grinding applications

**Standard Equipment:** Protective tool free guard, Anti vibration side handle, Inner and outer flange set, Spanner

Power Input	2300 Watts
Power Output	1610 Watts
No Load Speed	6500 rpm
Max. Disc Diameter	230 mm
Spindle Thread	M14
Weight	6.6 kg
Length x Height	470 x 145 mm



2400 W - 230 mm Heavy Duty Angle Grinder

D28423

Soft start to limit start-up current and reduce kick back  
Anti vibration side handle  
Seven position rotating back handle  
Quick adjustment tool free guard

**Standard Equipment:** Protective tool free guard, Anti vibration side handle, Inner and outer flange set, Spanner

Power Input	2400 Watts
Power Output	1680 Watts
No Load Speed	6500 rpm
Max. Disc Diameter	230 mm
Spindle Thread	M14
Weight	6.6 kg
Length x Height	490 x 145 mm



2600 W - 230 mm Heavy Duty Angle Grinder

D28432C

Soft start to limit start-up current and reduce kick back  
Anti vibration side handle  
Seven position rotating back handle  
Quick adjustment tool free guard

**Standard Equipment:** Protective tool free guard, Anti vibration side handle, Inner and outer flange set, Spanner

Power Input	2600 Watts
Power Output	1820 Watts
No Load Speed	6500 rpm
Max. Disc Diameter	230 mm
Spindle Thread	M14
Weight	6.6 kg
Length x Height	490 x 145 mm



2400 W - 230 mm Heavy Duty Angle Grinder

D28750

Soft start to limit start-up current and reduce kick back  
Anti vibration side handle  
Seven position rotating back handle  
Quick adjustment tool free guard

**Standard Equipment:** Protective tool free guard, Anti vibration side handle, Inner and outer flange set, Spanner

Power Input	2400 Watts
Power Output	1680 Watts
No Load Speed	5000 rpm
Max. Disc Diameter	230 mm
Spindle Thread	M14
Weight	6.6 kg
Length x Height	490 x 145 mm



2200 W - 230 mm Low Vibration Heavy Duty Angle Grinder D28415



Autobalancer gives low vibration (4.1m/s<sup>2</sup> triaxially) resulting in greater end user comfort  
Soft start to limit start-up current and reduce kick back  
Anti vibration side handle  
Quick adjustment tool free guard

**Standard Equipment:** Protective tool free guard, Anti vibration side handle, Inner and outer flange set, Spanner

Power Input	2200 Watts
Power Output	1540 Watts
No Load Speed	6500 rpm
Max. Disc Diameter	230 mm
Spindle Thread	M14
Weight	6.1 kg
Length x Height	450 x 145 mm



230mm No volt release switch LAG D28498



No volt release switch prevents the unit starting when plugged in, even if the switch is lock on. Switch must consciously reset before power is delivered  
Torque limiting clutch reduces the maximum torque reaction transmitted to the operator if the disc jams  
Overload protection will prevent the motor overheating by shutting off the unit until the unit cools down  
Soft start to limit start-up current and reduce kick back

**Standard Equipment:** Protective keyless guard, Anti vibration side handle, Inner and outer disc flanges, Spanner

Power Input	2400 Watts
Power Output	1246 Watts
No Load Speed	6500 rpm
Max. Disc Diameter	230 mm
Spindle Thread	M14
Weight	5.5 kg
Length x Height	490 x 151 mm



1800 W - 150 mm Straight Angle Grinder DW882



Abrasion protected high power motor for increased durability  
Rubberized front grip for better control  
Brush access window for better serviceability  
Cut-off brushes to prolong motor life

**Standard Equipment:** Protective guard, Inner and outer disc flanges, Abrasive 150 mm disc, Spanner

Power Input	1800 Watts
Power Output	1200 Watts
No Load Speed	5600 rpm
Max. Disc Diameter	150 mm
Spindle Thread	M16
Weight	6.7 kg
Length x Height	650 x 155 mm



500 W - Single Speed Die Grinder D28885



Short body allows access when grinding in confined spaces  
Hardened, precision-ground collet ensures that all attachments run perfectly true and concentrically  
Cut-off brushes to prolong motor life  
Ergonomic design results in user comfort allowing strain free grinding

**Standard Equipment:** 6 mm collet, Spanner

Power Input	500 Watts
Power Output	300 Watts
No Load Speed	27000 rpm
Collet Size	6 mm
Weight	1.4 kg
Length x Height	250 x 70 mm
Spindle lock	No



Collets



Cat. No.	Description
D288861	3 mm Collet
D288862	1/8" Collet
D288863	6 mm Collet
D288864	1/4" Collet
D288865	8 mm Collet

2200 Watt 355 mm Abrasive Chop Saw D28700



Horizontal handle for superior ergonomics and less user fatigue  
Quick release clamp results in less time in changing the work piece  
High power abrasion protected motor delivers high overload capabilities for greater durability  
Spindle lock for quick and easy wheel change

**Standard Equipment:** Metal cutting disc, Hex key

Power Input	2200 Watts
Power Output	1350 Watts
No Load Speed	3800 rpm
Wheel Diameter	355 mm
Max. Cutting Capacity at 90° [Square Profile]	119 x 119 mm
Max. Cutting Capacity at 90° [Rectangular Profile]	115 x 130 mm
Max. Cutting Capacity at 90° [L-Shape Profile]	137 x 137 mm
Max. Cutting Capacity at 90° [Rounded Profile]	115 mm
Max. Cutting Capacity at 45° [Square Profile]	98 x 98 mm
Max. Cutting Capacity at 45° [Rectangular Profile]	115 x 98 mm
Max. Cutting Capacity at 45° [L-Shape Profile]	98 x 98 mm
Max. Cutting Capacity at 45° [Rounded Profile]	98 mm
Weight	16 kg
Length x Height	486 x 378 mm



2200 Watt 355 mm High Performance Chopsaw D28715



Keyless blade clamp allows quick, hassle free blade change  
Electronic soft start to limit start-up current and kick back reaction  
High power abrasion protected motor delivers high overload capabilities for greater durability  
Keyless mitre adjustments for quick and simple operations

**Standard Equipment:** Metal cutting disc, Hex key, Keyless blade clamp

Power Input	2200 Watts
Power Output	1350 Watts
No Load Speed	4000 rpm
Wheel Diameter	355 x 2.5 mm
Max. Cutting Capacity at 90° [Square Profile]	120 x 120 mm
Max. Cutting Capacity at 90° [Rectangular Profile]	100 x 200 mm
Max. Cutting Capacity at 90° [L-Shape Profile]	140 x 140 mm
Max. Cutting Capacity at 90° [Rounded Profile]	130 mm
Max. Cutting Capacity at 45° [Square Profile]	113 x 113 mm
Max. Cutting Capacity at 45° [Rectangular Profile]	100 x 140 mm
Max. Cutting Capacity at 45° [L-Shape Profile]	120 x 120 mm
Max. Cutting Capacity at 45° [Rounded Profile]	130 mm
Weight	18 kg
Length x Height	520 x 435 mm



2200 Watt 355 mm Tungsten Carbide Tipped Metal Cutting Chopsaw DW872



Burr-free cuts at constant cutting depth throughout the life of the blade  
High power 2200 Watt motor with electronic soft start for metal cutting  
Robust cool-running 355 mm, 70 tooth tungsten carbide tipped blade  
Extra wide steel base for larger working area and increased stability

**Standard Equipment:** 355 mm metal carbide blade, Hex key, Auxiliary clamp

Power Input	2200 Watts
Power Output	1350 Watts
No Load Speed	1300 rpm
Wheel Diameter	355 mm
Max. Cutting Capacity at 90° [Square Profile]	100 x 100 mm
Max. Cutting Capacity at 90° [Rectangular Profile]	75 x 130 mm
Max. Cutting Capacity at 90° [L-Shape Profile]	92 x 92 mm
Max. Cutting Capacity at 90° [Rounded Profile]	130 mm
Max. Cutting Capacity at 45° [Square Profile]	79 x 79 mm
Max. Cutting Capacity at 45° [Rectangular Profile]	79 x 123 mm
Max. Cutting Capacity at 45° [L-Shape Profile]	56 x 56 mm
Max. Cutting Capacity at 45° [Rounded Profile]	79 mm
Weight	22.5 kg
Length x Height	525 x 430 mm



1200 W - 178 mm Sander DW630



Abrasion protected motor for increased durability  
Dust sealed bearings for long product life  
Precision heat treated gears for smooth power transmission  
Spindle lock for ease of disc changing

**Standard Equipment:** Rubber backing pad, Threaded flange, Two pin spanner, Side handle & guard

Power Input	1200 Watts
Power Output	700 Watts
No Load Speed	5000 rpm
Max. Disc Diameter	178 mm
Spindle Thread	M14
Weight	3.2 kg
Length x Height	410 x 140 mm



1150 W - 178 mm Variable Speed Right Angle Polisher DW849



Full power variable speed electronics with constant speed control  
Abrasion protected high power motor for increased durability  
Heat treated precision gears for smooth power transmission  
Top rubber bumper to protect from scratching the work piece

**Standard Equipment:** Rubber backing pad, Polishing bonnet, Outer flange, Side handle

Power Input	1150 Watts
Power Output	670 Watts
No Load Speed	0-3000 rpm
Max. Disc Diameter	178 mm
Spindle Thread	M14
Weight	3.8 kg
Length x Height	455 x 135 mm



Medium Crown Stapler 11.1 mm D51430



5-position indexed depth setting is lockable and repeatable, which enables the user to find the perfect depth, saving time and materials  
The rear load magazine is fast and easy to load and unload with a 160 staples capacity  
Open contact tip allows for better visibility and durability  
Tool-free jam clearing feature eliminates down-time from bent nails caught in the nose piece

**Standard Equipment:** Safety glasses, 28 ml bottle of pneumatic tool oil, Replacement sequential trigger

Staple diameter	1.6 mm (16 gauge)
Magazine angle	0 °
Staple length capacity	25-51 mm
Staple width	11.1 mm
Magazine Capacity	160 Staples
Magazine loading	Rear load
Operating pressure range	4.8 - 8.3 Bar
Air consumption per shot @6.9 Bar	1.1 l
Firing mode	Bump trigger installed
Length x Height	290 x 370 mm
Weight	2.1 kg



Medium Crown Stapler 12.7 mm D51431



5-position indexed depth setting is lockable and repeatable, which enables the user to find the perfect depth, saving time and materials  
The rear load magazine is fast and easy to load and unload with a 160 staples capacity  
Open contact tip allows for better visibility and durability  
Tool-free jam clearing feature eliminates down-time from bent nails caught in the nose piece

**Standard Equipment:** Safety glasses, 28 ml bottle of pneumatic tool oil, Replacement sequential trigger

Staple diameter	1.6 mm (16 gauge)
Magazine angle	0 °
Staple length capacity	25-51 mm
Staple width	12.7 mm
Magazine Capacity	160 Staples
Magazine loading	Rear load
Operating pressure range	4.8 - 8.3 Bar
Air consumption per shot @6.9 Bar	1.1 l
Firing mode	Bump trigger installed
Length x Height	290 x 370 mm
Weight	2.1 kg



Coil Roofing Nailer D51321



2.2 kg magnesium housing and magazine aid to provide lightweight nailer  
Tool-free adjustable depth setting allows for quick and easy depth of drive setting  
Titanium exhaust cap protects tool from impacts to the cap  
Quick release jam clearing feature eliminates down-time removing bent nails caught in nosepiece

**Standard Equipment:** Safety glasses, 34 ml bottle of pneumatic tool oil, Replacement sequential trigger

Nail Style	Full round head
Magazine angle	15 °
Nail Length	19-45 mm
Nail diameter range	2.9 - 3.8 mm
Magazine capacity	120 Nails
Energy @ 6.9 Bar	70 Nm
Operating pressure range	4.8 - 8.3 Bar
Air consumption per shot @6.9 Bar	1.18 l
Length x Height	290 x 265 mm
Weight	2.2 kg



Full Head Framing Nailer D51850



Optimised design, generates power for the toughest applications using less air consumption  
Unique motor design generates power to bury nails in both standard framing timber and engineered timber with minimal recoil  
Tool-free adjustable depth allows for quick and easy depth of drive setting  
Dry fire lockout extends bumper life by preventing tool from firing when magazine is empty

**Standard Equipment:** Replacement sequential trigger

Nail Style	Full round head
Magazine angle	20 °
Nail Length	50 - 90 mm
Nail diameter range	2.9 - 3.8 mm
Magazine capacity	65 Nails
Energy @ 6.9 Bar	101.7 Nm
Operating pressure range	4.8 - 8.3 Bar
Air consumption per shot @6.9 Bar	2.04 l
Length x Height	482 x 362 mm
Weight	3.7 kg



Clipped Head Framing Nailer D51825



Optimised design generates power for the toughest applications and using less air consumption  
Tool-free adjustable depth allows for quick and easy depth of drive setting  
Driver piston catch allows for a consistent drive each time  
Unique motor design generates power to bury nails in both standard framing timber and engineered timber with minimal recoil

**Standard Equipment:** Replacement sequential trigger

Nail Style	Clipped head
Magazine angle	31-34 °
Nail Length	50 - 90 mm
Nail diameter range	2.9 - 3.3 mm
Magazine capacity	80 Nails
Energy @ 6.9 Bar	101.7 Nm
Operating pressure range	4.8 - 8.3 Bar
Air consumption per shot @6.9 Bar	2.04 l
Length x Height	482 x 362 mm
Weight	3.70 kg



Palm Nailer D51180



Lightweight - Compact Design  
Jobsite versatility - Will drive most 19-83 mm jobsite nails  
Durability - Full metal housing to withstand jobsite abuse  
Magnetic Tip - For easy nail placement

**Standard Equipment:** Bottle of oil, Leather comfort grip, Safety Glasses

Nail Style	Bulk
Nail Length	19-89 mm
Nail diameter range	10 mm
Operating pressure range	5.0 - 8.5 Bar
Air consumption per shot @6.9 Bar	0.4 l
Length x Height	105 x 125 mm
Weight	1.2 kg

100 mm Framing Nailer D51856



Fires nails up to 100 mm  
Tool-free adjustable depth allows for quick and easy depth of drive setting  
Dry fire lockout extends bumper life and prevents tool from firing when magazine is empty  
Bump and sequential trigger allows rapid change for varying applications

Nail Style	Clipped head
Magazine angle	34 °
Nail Length	57-100 mm
Nail diameter range	2.8-3.3 mm
Magazine capacity	90 Nails
Energy @ 6.9 Bar	100 Nm
Operating pressure range	4.8-8.3 Bar
Air consumption per shot @6.9 Bar	2.5 l
Length x Height	507 x 373 mm
Weight	3.8 kg



Coil framing Nailer D51855



Optimized power design, generates power for the toughest applications and delivers less air consumption  
Unique engine design generates power to bury nails in both standard framing lumber and engineered lumber with minimal recoil  
Tool-free adjustable depth allows for quick and easy depth of drive setting  
Dry fire lockout extends bumper life by preventing tool from actuating when magazine is empty

**Standard Equipment:** Bump fire trigger (optional)

Nail Style	Full Head Coil
Magazine angle	15 °
Nail Length	38-90 mm
Nail diameter range	2.5-3.3 mm
Magazine capacity	300 Nails
Energy @ 6.9 Bar	102 Nm
Operating pressure range	4.8-8.3 Bar
Air consumption per shot @6.9 Bar	2.04 l
Length x Height	370 x 320 mm
Weight	3.7 kg



18 Gauge Brad Nailer Kit D51238K



16-50 mm nail capacity provides a complete range for trim carpenters and woodworkers  
4-position indexed depth setting is lockable and repeatable, which enables the user to find the perfect depth, saving time and materials  
Top and side low nail indicator windows to allow the user to quickly and easily see when it is time to reload - before they punch empty holes into their wood  
Tool-free jam clearing feature eliminates down-time from bent nails caught in the nose piece

**Standard Equipment:** Safety glasses, 28 ml bottle of pneumatic tool oil, Allen wrench, Replacement sequential trigger, Heavy duty carrying case

Magazine angle	0 °
Nail Diameter	1.2 mm (18 gauge)
Nail Length	16 - 50 mm
Magazine capacity	110 Nails
Magazine loading	Side load
Operating pressure range	4.8 - 8.3 Bar
Air consumption per shot @6.9 Bar	1.0 l
Firing mode	Bump trigger installed
Length x Height	216 x 222 mm
Weight	1.27 kg



16 Gauge Finish Nailer D51257K



5-position indexed depth setting is lockable and repeatable, enabling the user to set the depth and save time and materials  
Sealed lube dual-tech motor works as an oil free and oil lube unit  
Tool-free features: adjustable belt hook, nail depth adjustment, jam clearing, 360 degree exhaust meaning less down-time for adjustment  
For maximum convenience, this tool uses a patented dual-load magazine that can be loaded by either load & lock or lock & load

**Standard Equipment:** Replacement sequential trigger, Heavy-duty carrying case

Magazine angle	0 °
Nail Diameter	1.6 mm (16 gauge)
Nail Length	32 - 63 mm
Magazine capacity	100 Nails
Magazine loading	Rear load, dual load
Operating pressure range	4.8 - 8.3 Bar
Air consumption per shot @6.9 Bar	1.27 l
Firing mode	Bump trigger installed
Length x Height	299 x 269 mm
Weight	1.75 kg





15 Gauge Angled Finish Nailer

D51276K



5-position indexed depth setting is lockable and repeatable, enabling the user to set the depth and save time and materials  
 Sealed Lube Dual Tech: motor works as an oil free and oil lube unit.  
 Tool-free features: adjustable belt hook, nail depth adjustment, jam clearing, 360 degree exhaust meaning less down-time for adjustment  
 Low profile no-mark pad gives the user greater visibility whilst protecting surfaces from being damaged

**Standard Equipment:** Replacement sequential trigger, Heavy duty carrying case

Magazine angle	34 °
Nail Diameter	1.8 (15Ga) mm
Nail Length	25-63 mm
Magazine capacity	100 Nails
Magazine loading	Rear Load, Load & Lock / Lock & Load
Operating pressure range	4.8-8.3 Bar
Air consumption per shot @6.9 Bar	1.9 l
Firing mode	Sequential, with optional bump trigger
Length x Height	330 x 292 mm
Weight	1.75 kg



18 Volt Heavy Duty 16 Gauge Cordless Nail Gun

DC618KB



Versatility in the loading and unloading of fasteners - 20 degree angled magazine 120 nail capacity  
 The tool works as fast as you do with consistent nail penetration  
 The sequential operating mode allows for precision placement and the bump operating mode provides the user with production speed  
 Depths can be easily referenced utilising numbered dial and user does not sacrifice performance when changing depths

**Standard Equipment:** 1 Hour Charger, 2 batteries, DeWALT safety glasses, Reversible belt hook, No-mark tip, Heavy duty carrying case

Nail Diameter	1.6 mm
Battery Capacity	NiMH 2.6 Ah
Magazine angle	20 °
Nail Length	32-63 mm
Magazine capacity	Up to 120 Nails
Magazine loading	Rear - load
Operating pressure range	NA Bar
Air consumption per shot @6.9 Bar	NA l
Firing mode	Bump & Sequential
Length x Height	330 x 320 mm
Weight	3.9 kg
Nailer Operating Mode	Selective
Integrated Belt Hook	Yes
Jam Clearing	Yes
Features	LED Headlights



18 Volt 18 Gauge Cordless Nailer

DC608KB



The tool works as fast as you do with consistent nail penetration  
 The sequential operating mode allows for precision placement and the bump operating mode provides the user with production speed  
 Depths can be easily referenced utilising numbered dial and user does not sacrifice performance when changing depths  
 Provides easy access to the nosepiece for the simple removal of a jammed fastener without the use of screwdrivers or tool wrenches

**Standard Equipment:** 1 Hour Charger, 2 batteries, Heavy duty carrying case

Nail Diameter	1.2 mm
Battery Capacity	NiMH 2.6 Ah
Magazine angle	0 °
Nail Length	16-50 mm
Magazine capacity	110 Nails
Magazine loading	Side Load
Operating pressure range	NA Bar
Air consumption per shot @6.9 Bar	NA l
Firing mode	Bump & Sequential
Length x Height	295 x 290 mm
Weight	3.4 kg
Nailer Operating Mode	Selective
Integrated Belt Hook	Yes
Jam Clearing	Yes



18 Volt Heavy Duty 16 Gauge Straight Cordless Nailer

DC616KB



Versatility in the loading and unloading of fasteners - straight magazine 110 nail capacity  
 The tool works as fast as you do with consistent nail penetration  
 The sequential operating mode allows for precision placement and the bump operating mode provides the user with production speed  
 Depths can be easily referenced utilising numbered dial and user does not sacrifice performance when changing depths

**Standard Equipment:** 1 Hour Charger, 2 batteries, DeWALT safety glasses, Reversible belt hook, No-mark tip, Heavy duty carrying case

Nail Diameter	1.6 mm
Battery Capacity	NiMH 2.6 Ah
Magazine angle	0 °
Nail Length	32-63 mm
Magazine capacity	110 Nails
Magazine loading	Rear - load
Operating pressure range	NA Bar
Air consumption per shot @6.9 Bar	NA l
Firing mode	Bump & Sequential
Length x Height	330 x 320 mm
Weight	3.9 kg
Nailer Operating Mode	Selective
Integrated Belt Hook	Yes
Jam Clearing	Yes
Features	LED indicators



12 Volt 18 Gauge Cordless Nailer

DC602KB



The tool works as fast as you do with consistent nail penetration  
 The sequential operating mode allows for precision placement and the bump operating mode provides the user with production speed  
 Depths can be easily referenced utilising numbered dial and user does not sacrifice performance when changing depths  
 Provides easy access to the nosepiece for the simple removal of a jammed fastener without the use of screwdrivers or tool wrenches

**Standard Equipment:** 1 Hour Charger, 2 batteries, Heavy duty carrying case

Nail Diameter	1.2 mm
Battery Capacity	NiMH 2.6 Ah
Magazine angle	0 °
Nail Length	16-50 mm
Magazine capacity	110 Nails
Magazine loading	Side Load
Operating pressure range	NA Bar
Air consumption per shot @6.9 Bar	NA l
Firing mode	Bump & Sequential
Length x Height	295 x 290 mm
Weight	3.0 kg
Nailer Operating Mode	Selective
Integrated Belt Hook	Yes
Jam Clearing	Yes



900W 8mm (1/4") Premium Plunge & Fixed Base Router Combination

D26204K



Full wave electronic speed control with feedback ensures the selected speed is maintained under any load for a consistent finish in all grades of timber, aluminium and plastics  
 Variable speed control 16,000 to 27,000 which enables the router bit to be optimised for application  
 Compact, light weight design that increase ease of use and user comfort  
 Aluminium motor housing can be transitioned quickly to a fixed base attachment increasing the versatility of the machine

**Standard Equipment:** 2 x Parallel fences, 2 x Dust extraction adaptor, 8 mm collet (1/4" GB), 17 mm spanner, 17 mm guide bush, Plunge and Fixed base, Centering cone, Tough Kit Box

Power Input	900 Watts
Power Output	620 Watts
No Load Speed	16000-27000 rpm
Plunge Stroke/Movement	55 mm
Collet Size	6-8 mm
Max. Cutter Diameter	36 mm
Weight	2.9 kg
Length x Height	110 x 270 mm



900W 8mm (1/4") Fixed Base Router

D26200



Full wave electronic speed control with feedback ensures the selected speed is maintained under any load for a consistent finish in all grades of timber, aluminium and plastics  
 Variable speed control 16,000 to 27,000 enables router bit to be optimised for application  
 Depth ring and clamping mechanism combine to ensure motor remains accurate  
 Aluminium motor housing and base construction provides long term durability

**Standard Equipment:** Parallel fence, Dust extraction adaptor, 8 mm collet (1/4" GB), 17 mm spanner, Also available as accessories - Plunge base, Round base with guide bush application - Guide rail attachment

Power Input	900 Watts
Power Output	620 Watts
No Load Speed	16000-27000 rpm
Plunge Stroke/Movement	55 mm
Collet Size	6-8 mm
Max. Cutter Diameter	36 mm
Weight	1.9 kg
Length x Height	120 x 200 mm



900W 8mm (1/4") Variable Speed Plunge Router

D26203



Full wave electronic speed control with feedback ensures the selected speed is maintained under any load for a consistent finish in all grades of timber, aluminium and plastics  
 Variable speed control 16,000 to 27,000 which enables the router bit to be optimised for application  
 Compact, light weight design that increase ease of use and user comfort  
 Aluminium motor housing can be transitioned quickly to a fixed base attachment (not included) increasing the versatility of the machine

**Standard Equipment:** Parallel fence, Dust extraction adaptor, 8 mm collet (1/4" GB), 17 mm spanner, 17 mm guide bush, Centering Cone

Power Input	900W Watts
Power Output	620W Watts
No Load Speed	16000-27000 rpm
Plunge Stroke/Movement	55 mm
Collet Size	6-8 mm
Max. Cutter Diameter	36 mm
Weight	2.9 kg
Length x Height	110 x 270 mm



900 W - 1/4" (6-8 mm) Variable Speed Plunge Router

DW615



Soft start to eliminate any small initial movement that might misalign the cutter  
 Lightweight and compact design increases ease of use as the cutter remains visible at all times for error free routing  
 Two column precision guide for plunging accuracy in a high quality aluminium housing with phosphor bronze bushing so that carefully controlled plunge cuts can be made  
 Electronic speed control ensures that a consistent finish is achieved in all grades of timber, aluminium and plastics since the full wave electronic control ensures the selected speed is maintained under any load

**Standard Equipment:** Parallel fence & 2 guide rods, 17 mm guide bush, Dust extraction adaptor, 17/13 mm & 8 mm spanners, 8 mm collet (1/4" GB)

Power Input	900 Watts
Power Output	590 Watts
No Load Speed	8000-24000 rpm
Plunge Stroke/Movement	55 mm
Collet Size	6-8 mm
Max. Cutter Diameter	36 mm
Weight	2.9 kg
Length x Height	110 x 260 mm



1100 Watt 1/4" (6-8mm) Variable Speed Plunge Router

DW621K/ DW621\*



Unique through the column dust extraction for excellent cutter visibility - no adaptor or hose which restrict visibility is required  
 Full wave electronic speed control with feedback ensures the selected speed is maintained under any load for a consistent finish in all grades of timber, aluminium and plastics  
 Two column precision guide with phosphor bronze bushing - the extra broad column provides superior rigidity for the greatest accuracy in this size of router  
 Power switch located in the handle for ease of use features lock off and lock on actions

**Standard Equipment:** Parallel fence with fine adjustment, Dust extraction adaptor and cap, 8mm collet (1/4" GB), 17/10mm spanner, 24 mm guide bush, Heavy duty carrying case, Also available in a 1400W 12mm (1/2") version

Power Input	1100 Watts
Power Output	620 Watts
No Load Speed	8000-24000 rpm
Plunge Stroke/Movement	55 mm
Collet Size	6-8 mm
Max. Cutter Diameter	36 mm
Weight	4.1 kg
Length x Height	165 x 325 mm



\*Jan 2011 - DW622 - 1400 Watt (8-12mm) variable speed plunge router

2000 Watt 1/2" (12mm) Variable Speed Plunge Router

DW625EK / DW625E



Soft start to eliminate small initial movements that might misalign the cutter, especially important with such a powerful router  
Two column precision guide with large phosphor bronze bushes for plunging accuracy in a high quality die cast aluminium housing so that carefully controlled plunge cuts can be made  
Electronic speed control ensures that the same fine finish is achieved in all grades of timber, aluminium and plastics since the full wave electronic control ensures the selected speed is maintained under any load  
Large comfortable handles with the on/off switch and plunge lock at your finger tips for excellent control

**Standard Equipment:** Parallel fence with fine adjustment, Dust extraction adaptor, 30mm guide bush, 12mm collet (1/2" UK), 22mm spanner, Heavy duty carrying case

Power Input	2000 Watts
Power Output	1400 Watts
No Load Speed	8000-20000 rpm
Plunge Stroke/Movement	80 mm
Collet Size	6-12.7 mm
Max. Cutter Diameter	50 mm
Weight	5.1 kg
Length x Height	290 x 295 mm



2300 W - 1/2" (12 mm) Variable Speed Plunge Router

DW626



Powerful 2300 Watt motor with massive overload reserves to deal with the most demanding of applications in freehand, template or inverted table operations  
Soft start to eliminate any small initial movement that might misalign the cutter, especially important with such a powerful router  
Two column precision guide with large phosphor bronze bushes for plunging accuracy in a high quality die cast aluminium housing so that carefully controlled plunge cuts can be made  
Electronic speed control ensures that the same fine finish is achieved in all grades of timber, aluminium and plastics since the full wave electronic control ensures the selected speed is maintained under any load

**Standard Equipment:** Parallel fence with fine adjustment, Dust extraction adaptor (factory fitted), 30 mm guide bush, 8 mm & 12 mm collet (1/2" GB), 22 mm spanner, Heavy duty carrying case

Power Input	2300 Watts
Power Output	1560 Watts
No Load Speed	8000-21000 rpm
Plunge Stroke/Movement	70 mm
Collet Size	8-12 mm
Max. Cutter Diameter	50 mm
Weight	7 kg
Length x Height	290 x 320 mm



1600 W - 1/2" (12 mm) Plunge Router

DW624



1600 Watt of power make this unit ideal for heavy duty use where a single speed is sufficient  
Routing depth setting with fine adjustment and magnified scale for simple setting  
Two column precision guide with large phosphor bronze bushes for plunging accuracy in a high quality die cast aluminium housing so that carefully controlled plunge cuts can be made  
Large comfortable handles with the on/off switch and plunge lock at your finger tips for excellent control

**Standard Equipment:** Parallel fence with fine adjustment, Dust extraction adaptor, 30 mm guide bush, 22 mm spanner, 12 mm collet (1/2" GB)

Power Input	1600 Watts
Power Output	960 Watts
No Load Speed	20000 rpm
Plunge Stroke/Movement	62 mm
Collet Size	6-12.7 mm
Max. Cutter Diameter	40 mm
Weight	5.1 kg
Length x Height	290 x 295 mm



Dovetail Jigs



- Cuts through, half-blind, rebated half-blind and sliding dovetail joints as well as finger joints
- Fully adjustable combs and offset stops ensure perfect joints
- Patented adjustable cutter depth stops give extremely accurate, repeatable joint size and tightness
- Patented alignment lines for quick, accurate jig set-up
- Twin dual-cam clamps with pre-mounted abrasive pads firmly grip the whole width of the wood
- Heavy-duty steel base with chamfered front panel for maximum rigidity and durability
- Setup instructions mounted on jig for ease of use
- Detachable combs give infinite joint lengths
- DE6215 miniature dovetail template available separately for miniature half-blind, through and finger joints

Cat. No.	Description	Standard Equipment	Capacity	Pitch
DE6212	Multi-Functional Dovetail Jig	8mm shank dovetail & straight cutters (1/4" GB); Guide bushes; 3 base adaptors; 2 templates; Offset guides	305 x 30 mm	25.4 mm
DE6215	Miniature Dovetail Comb for DE6212	8mm dovetail & straight cutters (1/4" GB); Guide bushes; Offset guides	305 x 35 mm	12.7 mm

Collets

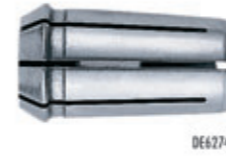

DE6274



DE6259

Cat. No.	Description	D26200	D26203	DW609	DW614	DW615	DW621/K	DW622/K	DW624	DW625E/EK	DW626	DW629	DW670
DE6257	12.7 mm Collet												
DE6258	12 mm Collet												
DE6259	10 mm Collet												
DE6260	8 mm Collet												
DE6261	6.35 mm (1/4") Collet												
DE6262	6 mm Collet												
DE6272	6 mm Collet												
DE6273	6.35 mm (1/4") Collet												
DE6274	8 mm Collet												
DE6275	9.52 mm (3/8") Collet												
DE6276	10 mm Collet												
DE6277	12 mm Collet												
DE6278	12.7 mm (1/2") Collet												
DE6950	6 mm Collet												
DE6951	6.35 mm (1/4") Collet												
DE6952	8 mm Collet												

Guide Bushes

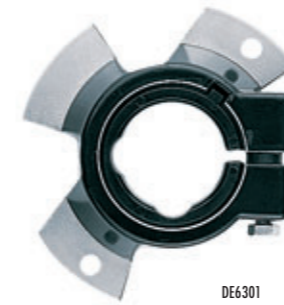

DE6301



DE6960



DE6991

Cat. No.	Description	D26200	D26203	DW609	DW614	DW615	DW621/K	DW622/K	DW624	DW625E/EK	DW626	DW629	DW670
DE6301	Guide bush system												
DE6310	10 mm guide bush - use with DE6301												
DE6324	24 mm guide bush - use with DE6301												
DE6327	27 mm guide bush - use with DE6301												
DE6330	30 mm guide bush - use with DE6301												
DE6340	40 mm guide bush - use with DE6301												
DE6427	27 mm guide bush - fixes to base												
DE6430	30 mm guide bush - fixes to base												
DE6440	40 mm guide bush - fixes to base												
DE6910	10.8 mm guide bush - fixes to base												
DE6914	14 mm guide bush - fixes to base												
DE6916	16 mm guide bush - fixes to base												
DE6917	17 mm guide bush - fixes to base												
DE6918	18 mm guide bush - fixes to base												
DE6920	20 mm guide bush - fixes to base												
DE6924	24 mm guide bush - fixes to base												
DE6926	26 mm guide bush - fixes to base												
DE6927	27 mm guide bush - fixes to base												
DE6930	30 mm guide bush - fixes to base												
DE6940	40 mm guide bush - fixes to base												
DE6960	Complete set of 12 base-fixing guide bushes (10-40 mm)												
DE6961	10 mm guide bush - fixes to base												
DE6989	17 mm guide bush - fixes to base												
DE6990	24 mm guide bush - fixes to base												
DE6991	27 mm guide bush - fixes to base												
DE6992	30 mm guide bush - fixes to base												

Dust Extraction



Cat. No.	Description	D26200	D26203	DW609	DW614	DW615	DW621/K	DW622/K	DW624	DW625E/EK	DW626	DW629	DW670
DE6211	Fits post-1999 models of DW624/5/6/9								•	•	•	•	
DE6269	Fits pre-1999 models of DW624/5/6/9								•	•	•		

Thread Adaptors



Cat. No.	Description	D26200	D26203	DW609	DW614	DW615	DW621/K	DW622/K	DW624	DW625E/EK	DW626	DW629	DW670
DE6281	M12 thread collet conversion / spindle extension kit. For use with DE6282 or DE6283								•	•	•	•	
DE6282	12.7 mm (1/2") shank - M12 adaptor								•	•	•		
DE6283	12 mm shank - M12 adaptor								•	•	•		

Fine Height Adjusters



Cat. No.	Description	D26200	D26203	DW609	DW614	DW615	DW621/K	DW622/K	DW624	DW625E/EK	DW626	DW629	DW670
DE6956	Fits DW621/20/15/14/13				•	•	•						
DE6966	Fits DW624/5/6/9								•	•	•	•	

Fences, Bars, Bases & Copy Follower



Cat. No.	Description	D26200	D26203	DW609	DW614	DW615	DW621/K	DW622/K	DW624	DW625E/EK	DW626	DW629	DW670
DE6263	Fence holder with fine adjustment. Compatible with DE6265 copy follower				•	•	•		•	•	•	•	
DE6913	Universal micro adjustable fence with dust extraction port				•	•	•		•	•	•	•	
DE6265	Micro adjustment roller follower. Compatible with DE6263				•	•	•		•	•	•	•	
DE6905	Trammel bar for cutting circles				•	•	•				•		
DE6284	Circular Sub Base								•	•		•	

600 W - (6-8 mm) Laminate Trimmer

DW670



Especially for small radius, chamfers and shaping edges  
Light weight makes it ideal for one hand use and accurate work  
Copy follower system with 19 mm ball bearing for long life, comfort and precision  
Spindle lock mechanism for quick and easy cutter changes with a single spanner

**Standard Equipment:** Square base, 8 mm, 6 mm and 1/4" collets, Copy follower and fence, 17/19 mm spanner, Dust extraction adaptor

Power Input	600 Watts
Power Output	340 Watts
No Load Speed	30000 rpm
Plunge Stroke/Movement	22 mm
Collet Size	6 - 8 mm
Max. Cutter Diameter	28 mm
Weight	1.9 kg
Length x Height	90 x 230 mm



600 W - Laminate Trimmer

DW609\*



Ideal for laminate trimming and general edge work, especially intensive production work  
Large base plate for good balance and control on the edge of the work piece  
Pistol grip design with built in on/off switch for greater control and safety  
Accurate edge trimming through the copy follower and built in fine height and edge adjusters

**Standard Equipment:** 8 mm collet (1/4" GB), Self aligning guide with slider, Following roller, 13/17 mm & 11/13 mm spanners

Power Input	600 Watts
Power Output	400 Watts
No Load Speed	24000 rpm
Collet Size	8 mm
Max. Cutter Diameter	32 mm
Weight	3.3 kg
Length x Height	230 x 240 mm

\*240V only

600 W - Biscuit Jointer

DW682K



Rack and pinion control provides precise vertical adjustment and fence alignment  
Pre-set cutting depths for 0, 10 and 20 biscuit sizes with additional fine adjustment for ultimate accuracy  
Grooving setting with up to 20 mm depth of cut gives increased versatility  
Anti slide grippers, eight guiding notches and fence window to aid accurate cuts

**Standard Equipment:** Tungsten carbide tipped grooving cutter, Shavings bag, Spanner, 35 mm Dust extraction spout, Heavy duty carrying case

Power Input	600 Watts
Power Output	335 Watts
No Load Speed	10000 rpm
Max. Cutter Diameter	100 mm
Max. Cutting Depth	20 mm
Fence adjustment	0-90 °
Joint Groover Setting	4 mm
Weight	3.0 kg
Length x Height	320 x 150 mm



600 W - Flat Dowel Jointer and Groover

DW685K\*



This tool combines a flat dowel jointer with a groover making this one of our most versatile tools  
Guiding notches on base and fine adjustment screws for extremely accurate operation  
45° corner joints are extremely easy to make with the special bevel fence  
Smooth pivot action for precise control, especially important for the start and end of a groove

**Standard Equipment:** Tungsten carbide tipped grooving cutter (105 mm), Parallel fence, Single-position side handle, Heavy duty carrying case

Power Input	600 Watts
Power Output	360 Watts
No Load Speed	7500 rpm
Max. Cutter Diameter	100/105 mm
Max. Cutting Depth	24 mm
Fence adjustment	45 °
Joint Groover Setting	9.5-18 mm
Weight	2.8 kg
Length x Height	360 x 145 mm

\*240V only

Replacement Inserts



Cat. No.	Fits
DE6853	DW685K

Dust Extraction Adaptors



Cat. No.	Fits
DE6852	DW685K

**4 mm Electronic Planer D26501K**



A powerful planer that copes effortlessly with hard woods, even at maximum depth of cut, giving a smooth, consistent finish  
Electronic brake stops the blades in 2 seconds for safety  
Front handle depth control in clearly marked 0.1 mm steps for accurate setting with positive indexing  
3 chamfering grooves in the front shoe simplify precision fitting jobs

**Standard Equipment:** Tungsten carbide tipped reversible blades, Parallel fence, Rebate depth guide, Dust extraction spout, Chip ejector, Chip deflector and high capacity collapsible collection container, Heavy duty carrying case

Power Input	1150 Watts
Power Output	680 Watts
No Load Speed	11500 rpm
Maximum Depth of Cut	4 mm
Rebating Depth	25 mm
Planer Width	82 mm
Shoe Length	320 mm
Drum Diameter	64 mm
Weight	4.0 kg
Length x Height	320 x 180 mm



**4 mm Planer D26500/ D26500K\***



A powerful planer that copes effortlessly with hard woods, even at maximum depth of cut, giving a smooth, consistent finish  
Left and right chip ejection for convenience  
Front handle depth control in clearly marked 0.1 mm steps for accurate setting with positive indexing  
3 chamfering grooves in the front shoe simplify precision fitting jobs

**Standard Equipment:** Tungsten carbide tipped reversible blades, Parallel fence, Rebate depth guide, Dust extraction spout, Chip ejector

Power Input	1050 Watts
Power Output	620 Watts
No Load Speed	13500 rpm
Maximum Depth of Cut	4 mm
Rebating Depth	25 mm
Planer Width	82 mm
Shoe Length	320 mm
Drum Diameter	64 mm
Weight	4.0 kg
Length x Height	320 x 180 mm



\*K version available with kitbox

**2.5 mm Planer DW680/ DW680K\***



Low weight and perfect balance make this planer ideal for single handed use in awkward applications  
Front handle depth control in clearly marked 0.1 mm steps for accurate setting with a positive stop position  
High power motor for smooth results, even in hard woods  
3 different size chamfering grooves in the front shoe simplify precision fitting jobs

**Standard Equipment:** Tungsten carbide tipped reversible blades, Parallel fence, Dust extraction adaptor

Power Input	600 Watts
Power Output	350 Watts
No Load Speed	15000 rpm
Maximum Depth of Cut	2.5 mm
Rebating Depth	12 mm
Planer Width	82 mm
Shoe Length	290 mm
Drum Diameter	54 mm
Weight	3.2 kg
Length x Height	290 x 170 mm



\*K version available with kitbox

**1.5 mm Planer DW677**



Low weight and perfect balance make this planer ideal for single handed use in awkward applications  
Front handle depth control in clearly marked 0.1 mm steps for accurate setting with a positive stop position.  
A large planer blade drum rotating at high speed provides an excellent finish  
3 different size chamfering grooves in the front shoe simplify precision fitting jobs

**Standard Equipment:** Tungsten carbide tipped reversible blades, Parallel fence, Dust extraction spout

Power Input	600 Watts
Power Output	350 Watts
No Load Speed	15000 rpm
Maximum Depth of Cut	1.5 mm
Rebating Depth	12 mm
Planer Width	82 mm
Shoe Length	290 mm
Drum Diameter	54 mm
Weight	2.8 kg
Length x Height	290 x 170 mm



**Dust Extraction Adaptor**



Cat. No.	Fits
DE2651	D26500, D26501
DE6775	DW677, DW680

**Chip Containers**



Cat. No.	Fits
DE2650	D26500(K) D26501K
DE6784	DW677 DW680 DW678K DW678EK

**1/4 Sheet Orbital Palm Grip Sander D26441**



230 Watt motor sands at 14,000 orbits per minute, providing a superior finish  
Sealed 100% ball-bearing construction provides longer life  
Dual plane counter-balance low-vibration design reduces user fatigue  
Textured anti-slip top and body grip provides ultimate comfort and control during prolonged use

**Standard Equipment:** Sanding sheets, Paper punch, Dust bag with built-in extractor connection

Power Input	230 Watts
Power Output	120 Watts
Rotation speed	14000 rpm
Orbits Per Minute	28000 opm
Orbit Size	1.4 mm
Paper Size	140x115 mm
Pad Size	108x115 mm
Weight	1.4 kg
Length x Height	130 x 160 mm



**1/3 Sheet Electronic Orbital Sander D26422/ D26423**



High performance motor with aluminium bearing seats for continuous use and a long life  
Small orbit size for a smooth finish  
Efficient dust collection using integrated dustbag or external dust extractor for a better sanding performance and sheet life  
Optional hook and loop base pad included to enable fast sanding sheet changes

**Standard Equipment:** Fabric and paper dust bags with built-in extractor connection and support tray, Nylon hook & loop sanding pad, Hook & loop sanding sheet

Power Input	350 Watts
Power Output	190 Watts
Rotation speed	12000-22000 rpm
Orbits Per Minute	24000-44000 opm
Orbit Size	2.5 mm
Paper Size	93 x 230 mm
Pad Size	92 x 190 mm
Weight	2.6 kg
Length x Height	270 x 190 mm



**1/2 Sheet Electronic Orbital Sander D26420/ D26421\***



High performance motor with aluminium bearing seats for continuous use and a long life  
Small orbit size for a smooth finish  
Efficient dust collection using integrated dustbag or external dust extractor for a better sanding performance and sheet life  
Optional hook and loop base pad included to enable fast sanding sheet changes

**Standard Equipment:** Fabric and paper dust bags with built-in extractor connection and support tray, Nylon hook & loop sanding pad, Hook & loop sanding sheet

Power Input	350 Watts
Power Output	190 Watts
Rotation speed	12000-22000 rpm
Orbits Per Minute	24000-44000 opm
Orbit Size	2.5 mm
Paper Size	113 x 280 mm
Pad Size	112 x 236 mm
Weight	2.8 kg
Length x Height	270 x 190 mm

\*D26421 - non-electronic version (22.000 opm)



**Detail Sander D26430\***



High performance motor for extended life  
Large orbit size for high stock removal  
Dust collection using integrated extraction or external dust extractor for a better sanding performance and sheet life  
Interchangeable quick fit sanding pad, with optional scraper blade or louver attachments

**Standard Equipment:** Dust Cartridge, Hook & Loop sanding sheet

Power Input	300 Watts
Power Output	130 Watts
Rotation speed	14000-22000 rpm
Orbits Per Minute	28000-44000 opm
Orbit Size	1.8 mm
Paper Size	93 x 93 x 93 mm
Pad Size	93 x 93 x 93 mm
Weight	1.3 kg
Length x Height	305 x 100 mm



\*240V only

**500 W - Compact Belt Sander D26480**



Ergonomic palm grip design with soft grip maximises user comfort and control in all applications  
Lightweight configuration increases ease of use  
Flush sided design allows sanding right up to an edge or vertical surface  
Dust sealed construction maximises unit life

**Standard Equipment:** Belt Pack, Dust Extraction Port, Secondary Handle

Power Input	500 Watts
Power Output	350 Watts
Belt Speed	365 m/min
Belt Size	64 x 356 mm
Sanding Size	64 x 80 mm
Weight	2.4 kg
Length x Height	200 x 120 mm



125 mm Random Orbit Palm Grip Sander D26453\*



Controlled finishing system controls pad speed and minimises gouging during start up  
 Compact palm grip design  
 Sealed 100% ball-bearing construction provides longer life  
 Dust-sealed switch prevents contamination

**Standard Equipment:** Sanding sheet, Fabric dust bag with built-in extractor ports

Power Input	280 Watts
Power Output	120 Watts
Rotation speed	7000-12000 rpm
Orbits Per Minute	14000-24000 opm
Orbit Size	2.4 mm
Paper Size	125 mm
Weight	1.6 kg
Length x Height	130 x 160 mm



\*240V only

150 mm Pistol Grip Dual-Orbit Random Orbit Sander D26410



Two orbit size settings: a 3 mm orbit for fine finishing and a 6 mm orbit for fast material removal  
 Controlled finishing system eliminates start-up scratching by keeping the sanding pad at a controlled speed  
 Variable speed for heat sensitive sanding, polishing and superior finishing  
 Dust sealed switch and bearings for a long life

**Standard Equipment:** Sanding sheet, Fabric and paper dust bags with built-in extractor connection and support tray

Power Input	400 Watts
Power Output	250 Watts
Rotation speed	4000 - 10000 rpm
Orbits Per Minute	8000-20000 opm
Orbit Size	3.0 & 6.0 mm
Paper Size	150 mm
Weight	2.7 kg
Length x Height	129 x 200 mm



150 mm Body Grip Random Orbit Sander DW443\*



Controlled finishing system eliminates start-up scratching by keeping the sanding pad at a controlled speed  
 Variable speed for heat sensitive sanding, polishing and superior finishing  
 Right angle design and side handle make this sander ideal for extended use especially when sanding large surfaces, such as boat hulls, walls, doors and tables  
 Dust sealed switch and bearings for a long life

**Standard Equipment:** Sanding sheets, Multi-position side handle, Dust bag

Power Input	530 Watts
Power Output	295 Watts
Rotation speed	4,200 - 7,600 rpm
Orbits Per Minute	8,400-15,200 opm
Orbit Size	5.0 mm
Paper Size	150 mm
Weight	2.7 kg
Length x Height	320 x 125 mm



\*240V only

800 W - 75 mm Belt Sander DW432/ DW433



Automatic tracking, with manual override provides precise belt running to the users requirements  
 Efficient dust collection using integrated dust container or external dust extractor for a better sanding performance and belt life  
 Three wheel design increases contact area of sanding belt giving improved sanding performance  
 Two handle arrangement for good balance and control, can be used single handed.

**Standard Equipment:** Sanding belt, Dust container

Power Input	800 Watts
Power Output	360 Watts
Belt Speed	427 m/min
Belt Size	75 x 533 mm
Sanding Size	75 x 140 mm
Weight	5.6 kg
Length x Height	280 x 150 mm



1010 W - Heavy Duty Belt Sander DW650/ DW650E\*



Robust construction using aluminium and dust sealed bearings for extended life  
 High performance motor to minimise slow down in use  
 2 central handles arranged for good balance and control, especially when flush sanding  
 Efficient dust collection using integrated dustbag or external dust extractor for a better sanding performance and sheet life

**Standard Equipment:** Sanding belt, Dust bag

Power Input	1010 Watts
Power Output	560 Watts
Belt Speed	350 m/min
Belt Size	100 x 560 mm
Sanding Size	100 x 110 mm
Weight	6.3 kg
Length x Height	340 x 210 mm

\*E version is variable speed

415 W - 150/40 mm Linishing/Grinding Machine DW753



Quiet and vibration free high torque induction motor  
 Grinding wheel with workpiece clamp for exact grinding and sharpening  
 Leather honing belt with adjustable support for concave/convex shapes  
 Robust lightweight aluminium base

**Standard Equipment:** Grinding wheel, 2 x Honing belts, Clamping and tool sharpening attachments, Spark guard, Spanner

Power Input	415 Watts
Power Output	300 Watts
No Load Speed	2750 rpm
Wheel Diameter	150 mm
Wheel Width	25 mm
Bore Size	20 mm
Belt Size	577x40 mm
Weight	9.3 kg
Length x Height	310 x 215 mm

415 W - 125 mm Dual Honing/Grinding Machine DW754



Quiet and vibration free high torque induction motor  
 Grinding wheel with workpiece clamp for exact grinding and sharpening  
 Honing wheel with machining support  
 Robust lightweight aluminium base

**Standard Equipment:** Grinding wheel, Honing wheel, Clamping and tool sharpening attachments, Spark guards, Spanner

Power Input	415 Watts
Power Output	300 Watts
No Load Speed	2750 rpm
Wheel Diameter	125 mm
Wheel Width	25 mm
Bore Size	20 mm
Belt Size	None mm
Weight	9.3 kg
Length x Height	310 x 215 mm

415 W - 125/45 mm Wet Linishing/Grinding Machine DW755



Water supply for an optimal finish on the cutting edge  
 Quiet and vibration free high torque induction motor  
 Grinding wheel with workpiece clamp for exact grinding and sharpening  
 Leather honing belt with adjustable support for concave/convex shapes

**Standard Equipment:** Grinding wheel, Clamping and tool sharpening attachments, Top and reservoir, Spark guard, Spanner

Power Input	415 Watts
Power Output	300 Watts
No Load Speed	2750 rpm
Wheel Diameter	125 mm
Wheel Width	20 mm
Bore Size	20 mm
Belt Size	715x45 mm
Weight	9.5 kg
Length x Height	310 x 320 mm

1800W Standard Heatgun D26411



Durable design with added protection for the heating element  
 Light weight ergonomics and compact design for increased comfort and application use  
 Two air flows to maximise control in most applications  
 Large stable support stand to ensure safety in stationary applications

**Standard Equipment:** Cone nozzle, Fish tail surface nozzle

Power Input	1800 Watts
Operating Temperature	50-400 / 50-600 °C
Air Flow	250 / 450 l/min
Weight	0.80 kg
Length x Height	253 x 210 mm

Specialist Platens & Backing Pads, Dust Extraction Adaptors, Dust Filters & Bags



Cat. No.	Description	Fits
D264301	Louvre attachment	D26430
D264302	Replacement hook & loop pad liner	D26430
D264303	Replacement foam sanding pad	D26430
D264306	50 mm Scraper Blade	D26430
D264411	1/4 Sheet Hook & Loop Platen	D26441, DW411
D264412	1/4 Sheet Foam Backed Platen	D26441, DW411
DE2639	150 mm 6 & 8-hole pattern	D26410, DW443
DE2643	150 mm medium-hard hook and loop platen	D26410
DE2644	150 mm soft hook and loop platen	D26410
DE2645	160 mm sponge backed disc for sanding curved surfaces	D26410, DW443
DE2646	160 mm Polishing Sponge	D26410, DW433
DE2647	160 mm Lambswool Buffing Disc	D26410, DW443
DE2648	160 mm felt disc for fine finishing	D26410, DW443
DE2649	150 mm nylon coarse polishing / oxide removal disc	D26410, DW443



Cat. No.	Fits
D264304	D26430
DE4050	DW432, DW433
DE6502	DW650, DW650E



Cat. No.	Fits	Description	Pack Qty
D264305	D26430	Dust filters	10
DE2642	D26410, D26420, D26421, D26422, D26423	Pack of 5 disposable dust bags	5



55mm Depth of Cut Heavy Duty Plunge Saw + 1.5m Guide Rail DWSS20KR



55mm depth of cut allows the trimming and sizing of most common door sizes  
 Parallel plunge allows the user to maintain a smooth and constant hand position while cutting  
 The anti kickback function stops the saw from moving backwards along the rail and helps stop the saw from climbing out of the work piece when making plunge cuts  
 A 48 tooth blade gives a fine and accurate finish with very little breakout in laminates

**Standard Equipment:** 48 tooth precision circular saw blade, Heavy duty carrying case

Power Input	1300 Watts
Power Output	690 Watts
No Load Speed	1750 - 4000 rpm
Blade Diameter	165 mm
Blade Bore	20 mm
Bevel Capacity	47 °
Max. Depth of Cut at 90°[with guide rails]	55 mm
Max. Depth of Cut at 45°[with guide rails]	40 mm
Weight	5.1 kg
Length x Height	303 x 265 mm



55 mm Depth of Cut Heavy Duty Plunge Saw DWSS20K



55mm depth of cut allows the trimming and sizing of most common door sizes  
 Parallel plunge allows the user to maintain a smooth and constant hand position while cutting  
 The anti kickback function stops the saw from moving backwards along the rail and helps stop the saw from climbing out of the work piece when making plunge cuts  
 A 48 tooth blade gives a fine and accurate finish with very little breakout in laminates

**Standard Equipment:** 48 tooth precision circular saw blade, Heavy duty carrying case

Power Input	1300 Watts
Power Output	690 Watts
No Load Speed	1750 - 4000 rpm
Blade Diameter	165 mm
Blade Bore	20 mm
Bevel Capacity	47 °
Max. Depth of Cut at 90°[with guide rails]	55 mm
Max. Depth of Cut at 45°[with guide rails]	40 mm
Weight	5.1 kg
Length x Height	303 x 265 mm



Guide Rails

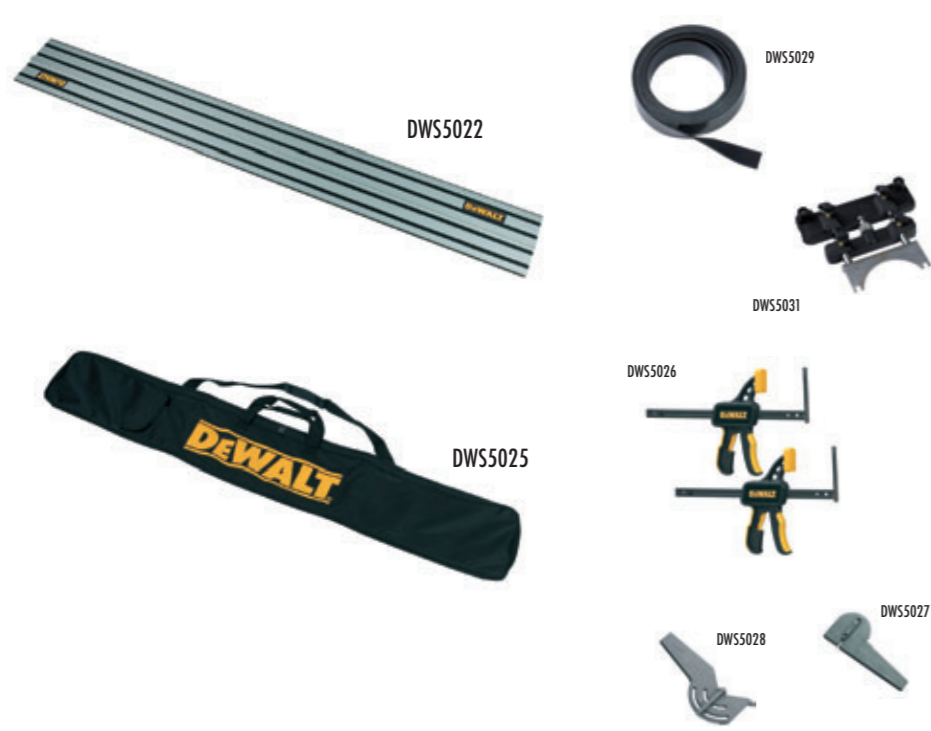

Cat. No.	Description
DWS5021	1 m guide rail
DWS5022	1.5 m guide rail
DWS5023	2.6 m guide rail
DWS5025	Bag - for use with 1 m and 1.5 m DEWALT guide rails
DWS5026	Clamps for use with DEWALT guide rails
DWS5027	'T' square attachment for guide rails
DWS5028	Angle attachment for guide rails
DWS5029	Replacement edge strip
DWS5030	Replacement 'Teflon' strip
DWS5031	Router attachment for guide rail

701 W - Heavy Duty Top Handle Jigsaw DW331K



Quick and easy patented keyless blade change system accepts T - shank blades  
 Powerful 701 Watt motor with variable speed delivers fast cutting action up to 3100 strokes per minute  
 Patented anti-vibration counterbalance mechanism and rubber grip provide smooth operation  
 4-position pendulum action controls the aggressiveness or smoothness of cuts

**Standard Equipment:** Blade, Anti-scratch cover, Anti-splinter insert, Dust extraction adaptor, Heavy duty carrying case

Power Input	701 Watts
Power Output	445 Watts
No Load Stroke Rate	0-3100 spm
Stroke Length	26 mm
Bevel Capacity	45 °
Max. Cutting Capacity [Wood]	135 mm
Max. Cutting Capacity [Steel]	12 mm
Max. Cutting Capacity [Non Ferrous Metal]	30 mm
Weight	2.8 kg
Length x Height	250 x 210 mm



701 W - Heavy Duty Body Grip Jigsaw DW333K



Quick and easy patented keyless blade system accepts T - shank blades  
 Powerful 701 Watt motor with variable speed delivers fast cutting action up to 3100 strokes per minute  
 Patented anti-vibration counter-balance mechanism and rubber grip provide smooth operation  
 4-position pendulum action controls the aggressiveness or smoothness of cuts

**Standard Equipment:** Blade, Anti-scratch cover, Anti-splinter insert, Dust extraction adaptor, Heavy duty carrying case

Power Input	701 Watts
Power Output	445 Watts
No Load Stroke Rate	800-3100 spm
Stroke Length	26 mm
Bevel Capacity	45 °
Max. Cutting Capacity [Wood]	135 mm
Max. Cutting Capacity [Steel]	12 mm
Max. Cutting Capacity [Non Ferrous Metal]	30 mm
Weight	2.8 kg
Length x Height	265 x 210 mm



550 W - Top Handle Compact Jigsaw DW341K



Keyless blade change with patented anti-deflection clamp design for ease of use and accuracy  
 Compact, ergonomic, design gives user comfort and versatility in use  
 Variable speed dial and trigger allows controlled cutting in all materials  
 Adjustable pendulum action gives increased cutting performance and longer saw blade life

**Standard Equipment:** Blade, Allen key, Anti-scratch shoe cover, Dust extraction shield, Vacuum adaptor, Heavy duty carrying case

Power Input	550 Watts
Power Output	350 Watts
No Load Stroke Rate	0-3100 spm
Stroke Length	20 mm
Bevel Capacity	45 °
Max. Cutting Capacity [Wood]	85 mm
Max. Cutting Capacity [Steel]	10 mm
Max. Cutting Capacity [Non Ferrous Metal]	20 mm
Weight	2.0 kg
Length x Height	230 x 200 mm



550 W - Body Grip Compact Jigsaw DW343K



Keyless blade change with patented anti-deflection clamp design for ease of use and accuracy  
 Compact, ergonomic, design gives user comfort and versatility in use  
 Variable speed dial allows controlled cutting in all materials  
 Adjustable pendulum action gives increased cutting performance and longer saw blade life

**Standard Equipment:** Blade, Allen key, Anti-scratch shoe cover, Vacuum adaptor, Dust extraction shield, Heavy duty carrying case

Power Input	550 Watts
Power Output	350 Watts
No Load Stroke Rate	650-3100 spm
Stroke Length	20 mm
Bevel Capacity	45 °
Max. Cutting Capacity [Wood]	85 mm
Max. Cutting Capacity [Steel]	10 mm
Max. Cutting Capacity [Non Ferrous Metal]	20 mm
Weight	2.0 kg
Length x Height	250 x 185 mm



**JIGSAW BLADES**

**XPC**

**XPC - DEWALT's ultimate jigsaw blade solution for control and accuracy of cut**

- Premium steel for maximum durability and thicker body for easy control and ultimate accuracy
- Optimised tooth geometry for longer life and reduced breakout
- Increased speed - large deep gullets for easy chip removal
- Plunge point tip design for easy plunge cut

For the complete range of jigsaw blades see page 143

55 mm Depth of Cut Heavy Duty Circular Saw D23550



Compact, well balanced and easy to use circular saw with 55 mm cutting depth  
Quick and easy depth and angle adjustment  
High torque motor for durability and power for cutting job site and joinery materials  
Aluminium shoe for accuracy and durability

**Standard Equipment:** Precision 12 tooth saw blade, Rip fence, Blade spanner

Power Input	1050 Watts
Power Output	570 Watts
No Load Speed	5000 rpm
Blade Diameter	165 mm
Blade Bore	20 mm
Bevel Capacity	45 °
Max. Depth of Cut at 90°[with guide rails]	51 mm
Max. Depth of Cut at 45°[with guide rails]	37 mm
Weight	4.1 kg
Length x Height	270 x 215 mm

52mm Depth of Cut Circular Saw D23551



Compact, well balanced and easy to use circular saw with 52 mm cutting depth  
Quick and easy depth and angle adjustment  
High torque motor for durability and power for cutting job site and joinery materials  
Guide rail compatible for quick and easy use with the DeWALT guide rail system

**Standard Equipment:** Precision 12 tooth saw blade, Rip fence, Blade spanner

Power Input	1050 Watts
Power Output	570 Watts
No Load Speed	5000 rpm
Blade Diameter	165 mm
Blade Bore	20 mm
Bevel Capacity	45 °
Max. Depth of Cut at 90°[with guide rails]	47 mm
Max. Depth of Cut at 45°[with guide rails]	32 mm
Weight	4.4 kg
Length x Height	270 x 215 mm

65 mm Depth of Cut Precision Circular Saw D23650K



Scale for precise cutting depth setting to 65 mm  
General purpose ripping, cross-cutting and bevelling circular saw for wood and other construction materials  
High torque motor for durability and power for cutting job site and joinery materials  
Stable block construction for low vibration running and long service life

**Standard Equipment:** Precision 18 tooth saw blade, Rip Fence, Blade Spanner, Heavy duty carrying case

Power Input	1350 Watts
Power Output	800 Watts
No Load Speed	5000 rpm
Blade Diameter	190 mm
Blade Bore	30 mm
Bevel Capacity	55 °
Max. Depth of Cut at 90°[with guide rails]	61 mm
Max. Depth of Cut at 45°[with guide rails]	41 mm
Weight	5.4 kg
Length x Height	355 x 245 mm

62mm Depth of Cut Heavy Duty Circular Saw D23651K



Scale for precise cutting depth setting to 62 mm  
General purpose ripping, cross-cutting and bevelling circular saw for wood and other construction materials  
High torque motor for durability and power for cutting job site and joinery materials  
Guide rail compatible for quick and easy use with the DeWALT guide rail system

**Standard Equipment:** Precision 18 tooth saw blade, Rip Fence, Blade Spanner, Heavy duty carrying case

Power Input	1350 Watts
Power Output	800 Watts
No Load Speed	5000 rpm
Blade Diameter	190 mm
Blade Bore	30 mm
Bevel Capacity	55 °
Max. Depth of Cut at 90°[with guide rails]	57 mm
Max. Depth of Cut at 45°[with guide rails]	44 mm
Weight	6.0 kg
Length x Height	355 x 245 mm

65 mm Depth of Cut Tradesman Circular Saw D23620/ D23620K\*



Compact, well balanced and easy to use circular saw with 65 mm depth of cut  
High torque motor gives durability and power for cutting job site and joinery materials  
Efficient dust extraction port to minimize airborne dust particles when connected to an extractor unit  
Gears and drive spindle mounted in a durable cast aluminium housing

**Standard Equipment:** 18 tooth saw blade, Rip fence, Blade spanner

Power Input	1150 Watts
Power Output	570 Watts
No Load Speed	5000 rpm
Blade Diameter	184 mm
Blade Bore	16 mm
Bevel Capacity	50 °
Weight	5.1 kg
Length x Height	315 x 250 mm

\*K version comes with kitbox

86mm Depth of Cut Circular Saw D23700



High power, durable motor delivers excellent power even at maximum depth of cut  
Stable block construction for low vibration running and long service life  
Spindle lock for ease of blade change  
Optimum balance for fatigue-free operation

**Standard Equipment:** 24 tooth Precision saw blade, Rip fence, Blade spanner

Power Input	1750 Watts
Power Output	960 Watts
No Load Speed	4700 rpm
Blade Diameter	235 mm
Blade Bore	30 mm
Bevel Capacity	45 °
Weight	8.2 kg
Length x Height	430 x 290 mm

1200 Watt Heavy Duty Reciprocating Saw DW311K



1200 Watt motor delivers increased power for heavy duty applications  
Orbital action delivers fast cutting in wood applications  
0-2,600 SPM and 28 mm stroke length for fast and efficient cutting  
Keyless adjustable shoe easily adjusts depth of cut and extends the blade life

**Standard Equipment:** 1 professional bi-metal blade, Heavy duty carrying case

Power Input	1200 Watts
Power Output	630 Watts
No Load Stroke Rate	0-2600 spm
Stroke Length	28 mm
Max. Cutting Capacity [Wood]	300 mm
Max. Cutting Capacity [Steel Sections & Pipes]	130 mm
Max. Cutting Capacity [PVC]	160 mm
Weight	4.0 kg
Length x Height	460 x 60 mm

1200 Watt Heavy Duty Reciprocating Saw DW310K\*



1200 Watt motor delivers increased power for heavy duty applications  
0 - 2,600 SPM and 28 mm stroke length for fast and efficient cutting  
Keyless adjustable shoe easily adjusts the depth of cut and extends the blade life  
Variable speed trigger provides control and versatility

**Standard Equipment:** 1 professional bi-metal blade, Heavy duty carrying case

Power Input	1200 Watts
Power Output	630 Watts
No Load Stroke Rate	0-2600 spm
Stroke Length	28 mm
Max. Cutting Capacity [Wood]	300 mm
Max. Cutting Capacity [Steel Sections & Pipes]	130 mm
Max. Cutting Capacity [PVC]	160 mm
Weight	4.0 kg
Length x Height	460 x 60 mm

\*240V only

1050 Watt - Reciprocating Saw DW304PK\*



1050 Watt motor designed for heavy duty applications  
4 position blade clamp allows for flush cutting and increased versatility  
With a 29 mm stroke length, the DW304PK delivers excellent cutting performance  
Lever-action keyless blade clamp for quick and easy blade changing

**Standard Equipment:** 1 professional bi-metal blade, Heavy duty carrying case

Power Input	1050 Watts
Power Output	525 Watts
No Load Stroke Rate	0-2800 spm
Stroke Length	29 mm
Max. Cutting Capacity [Wood]	280 mm
Max. Cutting Capacity [Steel Sections & Pipes]	100 mm
Max. Cutting Capacity [PVC]	130 mm
Weight	3.5 kg
Length x Height	435 x 178 mm

\*240V only

**PROFESSIONAL SAW BLADES**

**DEWALT High Performance Professional Saw Blades**

- Deliver outstanding performance across a wide variety of wood, composite materials and non-ferrous metals
- Excellent surface finish ensured by laser-cut expansion slots that also reduce noise and vibration
- Longer intervals between re-sharpening through use of large micro-grain carbide teeth
- Consistently precise cutting from a balanced and tensioned laser-cut plate

For the complete range of saw blades see page 135-142

275 mm ALLIGATOR® Power Saw

DW390/ DW391



Blades available for cutting wood, drywall, plastic and poroton blocks  
 Long life, low vibration double blade system with blade break of less than 3 secs  
 Ergonomic design and rubberised handles for superior handling and less fatigue  
 Two saw blades running in opposite directions so the material will not move while cutting

**Standard Equipment:** Hard metal blade, Saw blade protection guard, Hex key

Power Input	1350 Watts
Power Output	700 Watts
No Load Stroke Rate	3300 spm
Stroke Length	38 mm
Blade Length	275 mm
Blade Stop	3 s
Weight	4.0 kg
Length x Height	345 x 210 mm



425 mm ALLIGATOR® Power Saw For Cutting Bricks

DW392



Ideal for cutting aerated concrete (gasbeton) and drywall  
 Constant speed for optimal cutting capabilities  
 Powerful motor to meet all application needs  
 Two long life and durable saw blades running in opposite directions so the material will not move while cutting

**Standard Equipment:** Hard metal set of blades (yellow) for breeze block, drywall, Saw blade protection guard, Hex key

Power Input	1350 Watts
Power Output	700 Watts
No Load Stroke Rate	3300 spm
Stroke Length	38 mm
Blade Length	425 mm
Blade Stop	3 s
Weight	4.3 kg
Length x Height	490 x 210 mm



425 mm ALLIGATOR® Power Saw for cutting Poroton Bricks

DW393



Ideal for cutting Class 20 thermal bricks (Poroton brick/ Porotherm brick)  
 Constant speed for optimal cutting capabilities  
 Powerful motor to meet all application needs  
 Two long life and durable saw blades running in opposite directions so the material will not move while cutting

**Standard Equipment:** Hard metal set of blades (black) for porosite brick, Saw blade protection guard, Hex key

Power Input	1350 Watts
Power Output	700 Watts
No Load Stroke Rate	3300 spm
Stroke Length	38 mm
Blade Length	425 mm
Blade Stop	3 s
Weight	4.3 kg
Length x Height	490 x 210 mm



425mm ALLIGATOR® Power Saw

DW394



Two 39 tooth Tungsten carbide tipped blades enable the user to cut class 20 Poroton bricks  
 Constant speed for optimal cutting capabilities  
 Powerful motor to meet all application needs  
 Two long life and durable saw blades running in opposite directions so the material will not move while cutting

**Standard Equipment:** Hard metal set of blades (black) for porosite brick, Saw blade protection guard, Hex key

Power Input	1350 Watts
Power Output	700 Watts
No Load Stroke Rate	3300 spm
Stroke Length	38 mm
Blade Length	425 mm
Blade Stop	3 s
Weight	4.3 kg
Length x Height	490 x 210 mm

ALLIGATOR BLADES



**DEWALT ALLIGATOR® Saw Blades are essential to optimise the performance of your Alligator saw**

Ideal for fast and easy cutting in:

- Building blocks
- Wood
- Plywood
- Chipboard
- Drywall

For the complete range of Alligator Saw Blades see page 149

216 mm Crosscut Mitre Saw

DW777/ DW771\*



**Cut Capacities**

90°/90°	270x60 mm	265 x 62 mm
45°/90°	190 x 60 mm	189 x 62 mm
90°/45°	270 x 48 mm	173 x 62 mm
45°/45°	190 x 48 mm	190 x 48 mm

The classic pull saw design improved and updated for the modern user  
 New 1800 Watt motor for powerful cutting in all materials  
 The base and fence have been machined to meet the accuracy requirements of the most demanding applications  
 Compact internal rail design for huge cutting capacity in a highly transportable format

**Standard Equipment:** 24 tooth saw blade, 2 bench mounting bolts, Blade spanner

	DW777	DW771
Power Input	1800 Watts	1600 Watts
Power Output	1100 Watts	1100 Watts
Blade Speed	6300 rpm	2600 - 5200 rpm
Blade Diameter	216 mm	216 mm
Blade Bore	30 mm	30 mm
Bevel Capacity	48 °	48 °
Mitre Capacity [right/left]	50/50 °	50/50 °
Weight	14.0 kg	14.0 kg
Depth	550 mm	550 mm
Length x Height	490 x 590 mm	490 x 590 mm



\*DW771 is electronic

216 mm Slide Compound Mitre Saw

DW712/ DW712N



**Cut Capacities**

90°/90°	300 x 70 mm
45°/90°	215 x 70 mm
90°/45°	300 x 50 mm
45°/45°	212 x 50 mm

New mitre angle adjustment system provides accurate and consistent setting of mitre angles between 0 and 60° right and 0 and 50° left  
 The innovative grooving stop allows adjustment of the cutting depth for grooving and rebating applications  
 The large dual sliding fence mechanism gives maximum support in large material cuts at any angle or combination of angles  
 The aluminium base construction provides stability to the saw while still retaining its portability

**Standard Equipment:** 24 tooth saw blade, On-board blade spanner

Power Input	1600 Watts
Power Output	930 Watts
Blade Speed	3700-4600 rpm
Blade Diameter	216 mm
Blade Bore	30 mm
Bevel Capacity	48/2 °
Mitre Capacity [right/left]	60/50 °
Weight	19.5 kg
Depth	457 mm
Length x Height	580 x 480 mm



250mm Compound Mitre Saw

DW713XPS/ DW713\*



**Cut Capacities**

90°/90°	162 x 41 mm	95 x 89 mm
45°/90°	114 x 41 mm	67 x 89 mm
90°/45°	162 x 25 mm	95 x 61 mm
45°/45°	114 x 25 mm	114 x 25 mm

Powerful universal motor delivers plenty of cutting power in high torque cutting applications  
 Ultra smooth head actuation for safe precise cuts at any angle or compound angle  
 Extremely light unit weight with rugged construction for maximum jobsite versatility  
 XPS Shadow line cut indicator provides fast accurate alignment of the blade while illuminating the work piece for increased productivity

**Standard Equipment:** 24 tooth precision saw blade, Blade spanner, Dust bag

Power Input	1600 Watts
Power Output	1000 Watts
Blade Speed	5000 rpm
Blade Diameter	250 mm
Blade Bore	30 mm
Bevel Capacity	48/3 °
Mitre Capacity [right/left]	50/50 °
Weight	13.6 kg
Depth	485 mm
Length x Height	600 x 425 mm

\*DW713 version does not have XPS



250 mm Slide Compound Mitre Saw

DW717XPS



**Cut Capacities**

90°/90°	320 x 76 mm	302 x 88 mm
45°/90°	226 x 76 mm	213 x 88 mm
90°/45°	320 x 50 mm	302 x 58 mm
45°/45°	226 x 50 mm	226 x 50 mm

Maximum rear fence vertical cut capacity 152mm

XPS Shadow line cut indicator provides fast accurate alignment of the blade while illuminating the work piece for increased productivity  
Compact and lightweight design characteristics deliver a saw with enormous capacity which is easy to transport around the jobsite  
Linear horizontal rails utilise bronze guides to provide maximum precision when cutting materials up to 320 mm wide  
The large dual sliding fence gives maximum support in large material cuts at any angle or combination of angles. This provides maximum stability and accuracy.

**Standard Equipment:** 60 tooth blade, Blade spanner, Dust bag

Power Input	1675 Watts
Power Output	750 Watts
Blade Speed	4000 rpm
Blade Diameter	250 mm
Blade Bore	30 mm
Bevel Capacity	48/48 °
Mitre Capacity (right/left)	50/60 °
Weight	23 kg
Depth	541 mm
Length x Height	718 x 442 mm

305mm Double Bevel Mitre Saw

DW716EXPS/ DW716



**Cut Capacities**

90°/90°	190 x 85 mm	203 x 72 mm
45°/90°	134 x 85 mm	142 x 72 mm
90°/45°	190 x 56 mm	203 x 47 mm
45°/45°	134 x 56 mm	142 x 47 mm

XPS Shadow line cut indicator provides fast accurate alignment of the blade while illuminating the work piece for increased productivity  
Powerful 95mm universal motor provides superior power in high torque cutting applications  
Solid aluminium base and fence machined to exacting tolerances delivers precision cuts in the largest materials.  
Stainless steel detent system has been designed to maintain accuracy for the life of the machine.

**Standard Equipment:** 80 tooth TCG blade, Blade and guard spanner

Power Input	1600 Watts
Blade Speed	1900-3600 rpm
Blade Diameter	305 mm
Blade Bore	30 mm
Bevel Capacity	50/50 °
Mitre Capacity (right/left)	50/50 °
Weight	18 kg
Depth	680 mm
Length x Height	620 x 690 mm

305mm Compound Slide Mitre Saw + XPS

DW718XPS/ DW718



**Cut Capacities**

90°/90°	345 x 71 mm	50 x 163 mm	327 x 90 mm
45°/90°	241 x 71 mm	35 x 163 mm	231 x 90 mm
90°/45°	345 x 48 mm	50 x 114 mm	327 x 58 mm
45°/45°	242 x 52 mm	35 x 114 mm	242 x 52 mm

XPS Shadow line cut indicator provides fast accurate alignment of the blade while illuminating the work piece for increased productivity  
Compact and lightweight design characteristics deliver a saw with enormous capacity which is easy to transport around the jobsite  
Electronic speed control for adjusting cutting speed when cutting materials other than wood  
Linear horizontal rails utilise bronze guides to provide maximum precision when cutting materials up to 345 mm wide

**Standard Equipment:** 60 tooth blade, Blade spanner, Dust bag

Power Input	1600 Watts
Power Output	960 Watts
Blade Speed	1900 - 3400 rpm
Blade Diameter	305 mm
Blade Bore	30 mm
Bevel Capacity	48/48 °
Mitre Capacity (right/left)	50/60 °
Weight	24.8 kg
Depth	470 mm
Length x Height	770 x 396 mm

For DW702 / 713 / 706 / 706E / 708 / 017 / 712 / 716 / 716E / 717 / 718 / D27111 / D27112



Cat. No.	Item	Description
DE7080	1	Extension kit
DE7051	2	Length stop
DE7082	3	Vertical clamp
DE7088	Illustrated	Dust extraction adaptor. For DW708 only
DE7053	Not illustrated	Dust bag
DE7084	Not illustrated	Crown stops

For DW700 / 701 / 707 / 711 / 771 / 777



Cat. No.	Item	Description
DE3490	1	Table end plate
DE3491	2	Pair of guide rods, 500 mm length
DE3492	3	Length stop for short work pieces
DE3462	4	Swivel stop
DE3493	5	Leg stand
DE3494	6	Pair of guide rods, 1000 mm length
DE3495	7	Material support plate
DE3477	8	Adjustable support stand 740 mm
DE3499	Illustrated	Workpiece clamp
DE7777	Illustrated	Dust extraction kit 100 mm connection port
DE7778	Illustrated	Dust extraction kit 35 mm connection port

Mitre Saw Workstation



- Accommodates all DEWALT mitre saws
- Lightweight aluminium construction provides portability in and around the jobsite
- 1.7 metre beam extends to support up to 3.9 metres for use with large workpieces
- The beam can support up to 182 kg providing maximum flexibility and capacity
- Work stops can be converted into end stops for repetitive cutting to length
- Integral folding legs avoids unnecessary assembly
- Integrated carry handle provides ease of transportation
- Cutting to length
- Roofing timbers
- All material support requirements
- Large workpiece support

Cat. No.	Fits	Description
DE7023	All DEWALT mitre saws	Heavy Duty Mitre Saw Workstation

For DE7023



Cat. No.	Item	Description
DE7024	1	Work support
DE7025	2	Mounting bracket
DE7027	3	Roller work support
DE7028	4	Extension arm support
DE7029	5	Increased width work support
DE7030	6	Increased length mitre brackets
DE7031	7	Heavy duty extension arm support
DE7026	Not illustrated	Carry strap

260 mm Table Top Mitre Saw

DW711



**Cut Capacities**

90°/90°	125 x 55 mm	140 x 40 mm
45°/90°	90 x 55 mm	100 x 40 mm
90°/45°	125 x 50 mm	140 x 20 mm
45°/45°	90 x 50 mm	100 x 20 mm

50mm 175mm

Powerful dust protected 1300 Watt induction motor, provides years of maintenance free service  
Integrated blade brake, for active user protection and additional machine safety  
Precision cast aluminium machined base and table top, guarantees high quality precision cuts in both cutting modes  
High and stable back fence increases accuracy in all mitering applications

**Standard Equipment:** 260 mm 24 tooth tungsten carbide tipped saw blade, Top guard with extraction, Blade spanner, Hex key, Push stick

Power Input	1300 Watts
Power Output	900 Watts
Blade Speed	2750 rpm
Blade Diameter	260 mm
Blade Bore	30 mm
Bevel Capacity	48 °
Mitre Capacity [right/left]	50 °
Max. Cutting Capacity [Sawbench position 90°/90°]	50 mm
Weight	20.0 kg
Depth	590 mm
Length x Height	490 x 620 mm
Max. Cutting Capacity at 90°/90°	96 mm
Max. Ripping Capacity [right]	175 mm
Max. Ripping Capacity [left]	60 mm

305 mm Slide Table Top Mitre Saw

D27112



**Cut Capacities**

90°/90°	285 x 90 mm
45°/90°	200 x 90 mm
90°/45°	285 x 62 mm
45°/45°	200 x 62 mm

51mm 200mm

Lightweight, powerful 1600 Watt universal motor for demanding applications  
Combination saw with crosscut and ripping capabilities  
Slide mechanism incorporated to increase cross cut capacity  
Precision cast aluminium base and table top guarantees high precision cuts in both cutting modes

**Standard Equipment:** Saw blade, Push Stick, Blade Wrench, Rip Fence, Table Saw Blade Guard, Allen Key

Power Input	1600 Watts
Power Output	1370 Watts
Blade Speed	3650 rpm
Blade Diameter	305 mm
Blade Bore	30 mm
Bevel Capacity	45 °
Mitre Capacity [right/left]	60/50 °
Max. Cutting Capacity [Sawbench position 90°/90°]	51 mm
Weight	23.0 kg
Depth	980 mm
Length x Height	580 x 710 mm
Max. Cutting Capacity at 90°/90°	285 x 90 mm
Max. Ripping Capacity [right]	200 mm
Max. Ripping Capacity [left]	220 mm

305 mm Slide Table Top Mitre Saw

D27111



**Cut Capacities**

90°/90°	220 x 90 mm
45°/90°	155 x 90 mm
90°/45°	220 x 62 mm
45°/45°	155 x 62 mm

51mm 200mm

Combination saw with crosscut and ripping capabilities  
Powerful 1500 Watt induction motor to meet the needs of the most demanding applications  
Precision cast aluminium base and table top guarantees high precision cuts in both cutting modes  
Slide mechanism incorporated to increase cross cut capacity

**Standard Equipment:** Saw blade, Push Stick, Blade Wrench, Rip Fence, Table Saw Blade Guard, Allen Key

Power Input	1500 Watts
Power Output	1100 Watts
Blade Speed	3000 rpm
Blade Diameter	305 mm
Blade Bore	30 mm
Bevel Capacity	45 °
Mitre Capacity [right/left]	60/50 °
Max. Cutting Capacity [Sawbench position 90°/90°]	51 mm
Weight	26.5 kg
Depth	800 mm
Length x Height	580 x 710 mm
Max. Cutting Capacity at 90°/90°	220x90 mm
Max. Ripping Capacity [right]	200 mm
Max. Ripping Capacity [left]	220 mm

Heavy Duty Electronic Portable Table Saw

DW744XP



77mm 57mm 625mm

Powerful 2000 Watt motor for high performance in all applications  
Telescoping fence rails provide over 610 mm of rip capacity in a portable design for cutting large sheet materials to size  
Cast aluminium table top design ensures accuracy and precision  
Soft start electronics increases accuracy and motor durability

**Standard Equipment:** 24 tooth SERIES 40° saw blade, Mitre fence, 2 blade spanners, Parallel fence, Dust port reducer, Push stick

Power Input	2000 Watts
Power Output	1600 Watts
Blade Speed	3000 rpm
Blade Diameter	250 mm
Blade Bore	30 mm
Bevel Capacity	-3 to 48 °
Max. Ripping Capacity [right]	625 mm
Max. Ripping Capacity [left]	342 mm
Table Size	627 x 678 mm
Weight	35 kg
Depth	740 mm
Length x Height	680 x 465 mm



Heavy Duty Lightweight Table Saw

DW745



77mm 57mm 410mm

22 kg unit weight and optimised footprint make this the most portable saw in its class  
Fence system provides 410 mm of rip capacity in a portable design for cutting large sheet materials to size  
Steel roll cage protects saw against jobsite drops and impacts  
Powerful 1700 Watt motor for high performance in all applications

**Standard Equipment:** 24 tooth SERIES 30° saw blade, Mitre fence, 2 blade spanners, Parallel fence, Dust port reducer, Push stick

Power Input	1700 Watts
Power Output	1100 Watts
Blade Speed	3800 rpm
Blade Diameter	250 mm
Blade Bore	30 mm
Bevel Capacity	-3 to 48 °
Max. Ripping Capacity [right]	410 mm
Max. Ripping Capacity [left]	315 mm
Table Size	630 x 570 mm
Weight	22 kg
Depth	742 mm
Length x Height	577 x 425 mm



Heavy Duty Rolling Saw Workstation

DE7400



Large Heavy-Duty wheels designed to easily roll over steps, kerbs, and jobsite debris  
Folding legs with quick release levers which retract under the stand in a few seconds for easy and quick transport  
Lightweight aluminium construction which improves the portability  
Heavy-Duty kick stand allows the stand to balance upright for mobility and storage

**Standard Equipment:** Universal Brackets to attach most Table saws

305 mm Combination Saw

D27107 / D27107V



**Cut Capacities**

90°/90°	50 x 155 mm	205 x 63 mm
45°/90°	45 x 155 mm	160 x 63 mm
90°/45°	60 x 110 mm	205 x 50 mm
45°/45°	60 x 100 mm	—

81 mm 56 mm

The next generation of TGS combination saw combines the accuracy of modern mitre saws with the power and capacity of dedicated table saws  
 Electronic pack provides massive overload protection and constant cutting speed for optimal cutting performance  
 305 mm head provides an massive 155 mm depth of cut  
 New mitre and bevel adjustment systems ensure high accuracy and simple adjustment  
**Standard Equipment:** 48 tooth saw blade, Parallel fence, Riving knife, Push stick, Mitre dust collector, Table saw guard, Assembly wrench

Power Input	2000 Watts
Power Output	1400 Watts
Blade Speed	4000 rpm
Blade Diameter	305 mm
Blade Bore	30 mm
Bevel Capacity	48 °
Mitre Capacity [right/left]	48/48 °
Max. Cutting Capacity [Sawbench position 90°/90°]	0 - 81 mm
Max. Cutting Capacity [Sawbench position 90°/45°]	0 - 56 mm
Weight	40 kg
Depth	800 mm
Length x Height	720 x 770 mm



For D27107 / D27105



Cat. No.	Item	Description
D271055	1	Sliding table for D27105/7 TGS
D271057	2	Replacement table saw guard for D27105/7 TGS
D271058	3	Right extension table for D27105/7 TGS
DE3460	4	Length stop for short workpieces
DE3462	5	Swivel stop
DE3474	6	Adjustable support stand
DE3491	7	Pair of guide rods, 500 mm length
DE3494	8	Pair of guide rods, 1000 mm length
DE3495	9	Material support plate
D271051	Illustrated	Clamp assembly
D271052	Illustrated	Mitre gauge for D27105/7 TGS
D271053	Illustrated	Crown stop for D27105/7 TGS
D271054	Illustrated	Dust extraction kit for D27105/7 TGS
D271059	Illustrated	Laser site line attachment



250 mm Combination Saw

DW743N



**Cut Capacities**

90°/90°	140 x 68 mm	180 x 20 mm
45°/90°	95 x 70 mm	120 x 46 mm
90°/45°	70 x 95 mm	150 x 20 mm

70mm 52mm

The classic TGS flip-over bevelling saw  
 Rapid tool free transformation from a saw bench to a mitre saw provides flexibility in a range of site and workshop applications  
 New high output heavy duty high torque induction motor provides years of maintenance free use, suitable for workshop applications where low noise characteristics are desirable  
 Updated design for maximum cutting capacity across the range of mitre and bevel angles

**Standard Equipment:** 30 tooth saw blade, Parallel fence, Push stick, 4 detachable legs, Saw blade guard, Assembly tool

Power Input	2000 Watts
Power Output	1550 Watts
Blade Speed	2850 rpm
Blade Diameter	250 mm
Blade Bore	30 mm
Bevel Capacity	45 °
Mitre Capacity [right/left]	45 / 45 °
Max. Cutting Capacity [Sawbench position 90°/90°]	0 - 70 mm
Max. Cutting Capacity [Sawbench position 90°/45°]	0 - 32 mm
Weight	37 kg
Depth	670 mm
Length x Height	700 x 750 mm



For DW743N



Cat. No.	Item	Description
DE3491	1	Pair of guide rods, 500 mm length
DE3460	2	Length stop for short workpieces
DE3474	3	Adjustable support stand
DE3494	4	Pair of guide rods, 1000 mm length
DE3462	5	Swivel stop
DE3495	6	Material support plate
DE3454	Illustrated	2 x push sticks
DE3472	Illustrated	Right side extension table
DE3489	Illustrated	Roller support
DE3496	Illustrated	Replacement mitre fence for use in bench saw mode
DE3497	Illustrated	Roller support table
DE3500	Illustrated	Shaving extraction kit
DE3461	Not Illustrated	Clamp assembly
DE3471	Not Illustrated	Single sliding table
DE3473	Not Illustrated	Ripping/parallel fence
DE3488	Not Illustrated	Replacement table saw guard



DE3497

DE3496

DE3472

DE3454

300mm RADIAL ARM SAW

DW721KN / DW722KN

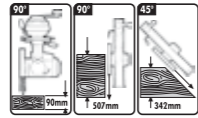

Free standing radial arm saw with 507mm of crosscut capacity and 90 mm depth of cut  
Solid cast iron arm and four roller bearings in the motor head assembly ensure high accuracy and durability  
Quiet maintenance free induction motor delivers high power even at the maximum cutting capacities of the machine. Also available in three phase voltage as a DW722KN  
Simple yet positive controls and adjustment scales enable the width, depth and angle of cut to be set with accuracy in seconds

**Standard Equipment:** 32 tooth saw blade, Assembly tools, Automatic safety return, Blade brake, Legstand

	DW721KN	DW722KN
Power Input	2000 Watts	3000 Watts
Power Output	1580 Watts	2280 Watts
Blade Speed	3000 rpm	3000 rpm
Blade Diameter	300 mm	300 mm
Blade Bore	30 mm	30 mm
Max. Cutting Speed	36 m/sec	36 m/sec
Weight	115 kg	115 kg
Depth	1200 mm	1200 mm
Length x Height	1490 x 1470 mm	1490 x 1470 mm

350mm Radial Arm Saw

DW728KN / DW729KN\*

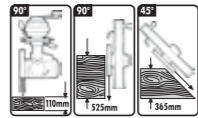

The industrial radial arm saw performs accurate crosscuts time after time. Unrivalled reputation in the professional woodworking industry  
Solid cast iron arm machined to provide arm tracks with no inserts, increasing accuracy and life  
Simple yet positive controls and adjustment scales enable the width, depth and angle of cut to be set with accuracy in seconds  
Quiet maintenance free induction motor delivers high power even at the maximum cutting capacities of the machine. Also available in three phase voltage as DW729K

**Standard Equipment:** 32 tooth saw blade, Assembly tools, Automatic safety return, Blade brake, Legstand

	DW728KN	DW729KN
Power Input	2200 Watts	4000 Watts
Power Output	1820 Watts	3300 Watts
Blade Speed	2800 rpm	2780 rpm
Blade Diameter	350 mm	350 mm
Blade Bore	30 mm	30 mm
Max. Cutting Speed	53 m/sec	53 m/sec
Weight	149 kg	149 kg
Depth	1380 mm	11380 mm
Length x Height	1800 x 1450 mm	1800 x 1450 mm

\*DW729K is a 3-phase unit

155 mm 2 Speed Bandsaw

DW738\*



High quality, rigid, cast aluminium construction suitable for wood, non-ferrous metal, foam, composites and plastics applications  
Two speed control for multiple applications  
Large balanced aluminium band wheels with rubber linings ensure smooth quiet operation  
Large aluminium saw table with high quality, wear resistant coating and replaceable insert

**Standard Equipment:** Saw blade, Rip fence

Power Input	749 Watts
Power Output	550 Watts
Max. Cutting Height	155 mm
Max. Cutting Width	310 mm
Cutting Speed	330/800 m/min
Table Size	380 x 380 mm
Weight	23.0 kg
Depth	520 mm
Length x Height	660 x 1550 mm

\*240V only

155 mm Variable Speed Bandsaw

DW739\*



High quality, rigid, cast aluminium construction suitable for wood, non-ferrous metal, foam, composites and plastics applications  
Adjustable blade speed from 300 to 800 m/min increases control in delicate operations  
Large aluminium saw table with high quality, wear resistant coating and replaceable insert  
Bevel adjustment from 0° to 45°

**Standard Equipment:** Saw blade, Rip fence

Power Input	749 Watts
Power Output	550 Watts
Max. Cutting Height	155 mm
Max. Cutting Width	310 mm
Cutting Speed	330-800 m/min
Table Size	380 x 380 mm
Weight	23.0 kg
Depth	520 mm
Length x Height	660 x 1550 mm

\*240V only



200 mm 2 Speed Bandsaw

DW876\*



All steel welded construction provides extreme rigidity and accuracy even at maximum depths of cut  
500 x 500 mm aluminium extruded table provides a large support area built for flatness and accuracy  
Easy to adjust blade tensioning with integrated tension indicator for different blade types and applications  
Micro switch incorporated in door to prevent accidental starting while open

**Standard Equipment:** Diamond ground steel blade, No volt release switch, Legstand, Mitre and rip fence

Power Input	1000 Watts
Power Output	750 Watts
Max. Cutting Height	200 mm
Max. Cutting Width	310 mm
Cutting Speed	380/880 m/min
Table Size	500x500 mm
Weight	54.0 kg
Depth	650 mm
Length x Height	770 x 1590 mm

\*240V only



Machinery Planer Thicknesser

D27300\*



Large aluminium fence for accurate bevel angles in the surface planing mode  
Large, extruded aluminium top planing table for high accuracy and ease of use  
Integrated motor design to save space and improve transportation  
New control design to improve ease of use and accuracy of adjustment

**Standard Equipment:** HSS knives, Adjustable fence, Allen keys, Spanner, Blade setting gauge, Dust extraction mouthpiece, Push stick, Legset

Power Input	2100 Watts
Power Output	1600 Watts
No Load Speed	6200 rpm
Max. Capacity	260 mm
Max. Depth of Cut	4 mm
Max. Planing Depth	3 mm
Planer Table Size	1000 x 260 mm
Thicknesser Table Size	500 x 250 mm
Max. Thicknesser Capacity	160 mm
Feed Rate	5 m/min
Weight	53 kg
Depth	700 mm
Length x Height	1050 x 950 mm

\*240V only



317 mm Portable Thicknesser

DW733



4 post column design allows the cutter head to move up and down smoothly and accurately  
 Large infeed and outfeed tables provide added material support when cutting large materials to improve the surface finish  
 Powerful 1800 Watt motor makes large surface planing easy  
 Designed for portability on the job site and in small workshops

**Standard Equipment:** Dust shroud and adaptor, Allen key, Blade spanner, Blade changing guides

Power Input	1800 Watts
Power Output	1000 Watts
No Load Speed	10000 rpm
Max. Capacity	317 mm
Max. Planing Depth	2 mm
Max. Thicknesser Capacity	152 mm
Feed Rate	8 m/min
Weight	33.6 kg
Depth	310 mm
Length x Height	520 x 445 mm



27 Litre Dust Extractor

D27900\*



Wet and dry pick up with separate motor cooling system for extended operating times in workshop or site environment  
 Powerful motor generating 208 mbar of vacuum pressure  
 Built-in power take off socket allows power tool connection for automatic switching of the vacuum system  
 Light and powerful, this machine is easily transportable with the carrying handle or transport wheels

**Standard Equipment:** 4 m x 35 mm extraction hose, 35 mm stepped adaptor, Crevice tool, Dust bag

Power Input	1200 Watts
Power Take Off Rating: UK & Ireland	N/A Watts
Power Take Off Rating: Switzerland	N/A Watts
Power Take Off Rating: Europe	N/A Watts
Max. Airflow	4020 l/min
Capacity	27 ltr
Wet/Dry Capacity	14 ltr
Weight	7.5 kg
Length x Height	420 x 525 mm

\*240V only



45 Litre Dust Extractor

D27901\*



Wet and dry pick up with a large 45 litre capacity  
 Automatic start and stop control when the power tool is operated, machine continues to run for 15 seconds to allow all dust to be cleared from system  
 Built-in power take off socket allows power tool connection for automatic switching of the vacuum system  
 Light and powerful, this machine is easily transportable with the carrying handle or transport wheels

**Standard Equipment:** 4 m x 35 mm extraction hose, Crevice tool, Universal hose adaptor, Dust bag

Power Input	1200 Watts
Power Take Off Rating: UK & Ireland	1800 Watts
Power Take Off Rating: Switzerland	1100 Watts
Power Take Off Rating: Europe	2200 Watts
Max. Airflow	3420 l/min
Capacity	45 ltr
Wet/Dry Capacity	45 ltr
Weight	11.0 kg
Length x Height	505 x 640 mm

\*240V only



45 Litre Dust Extractor with Constant Automatic Filter Cleaning

D27902\*



Wet and dry pick up with variable suction control allows for the reduction of suction power if required  
 Constant suction power even with the finest concrete and wood dust  
 The filter is automatically cleaned every 15 seconds reducing filter clogging and delivering constant air flow

**Standard Equipment:** 4 m x 35 mm extraction hose, Crevice tool, Universal hose adaptor, Dust bag

Power Input	1380 Watts
Power Take Off Rating	2200 Watts
Max. Airflow	3660 l/min
Capacity	45 ltr
Wet/Dry Capacity	45 ltr
Weight	13.5 kg
Length x Height	520 x 695 mm

\*110V only



BRUSH PAIRS



Fits	Pair Number	Voltage	Fits	Pair Number	Voltage
D21101 (T1 + 2)	578393-02	230V	D28132	1003860-00	230V
D21441 (T1 + 2)	578393-02	230V	D28132C	1003857-00	230V
D21620K (T1)	596825-00	115V-230V	D28133	1003860-00	230V
D21710 (T1 + 2 + 3 + 5)	578393-02	230V	D28134	1003860-00	230V
D21711 (T1 + 2 + 3 + 5)	578393-02	230V	D28135	1003857-00	230V
D21716 (T1 + 2)	578393-02	230V	D28136	1003857-00	230V
D21717 (T1 + 2)	578393-02	230V	D28137	1003857-00	230V
D21720 (T1 + 2 + 3 + 4 + 5)	578393-02	230V	D28139	1003860-00	230V
D21721 (T1 + 2 + 4)	578393-02	230V	D28141	1003857-00	230V
D21805 (T1)	578393-02	230V	D28151	1003859-00	230V
D21810 (T1)	578393-02	230V	D28152	1003859-00	230V
D21815 (T1)	578393-02	230V	D28153	1003861-00	230V
D25011K (T1)	N032831	230V	D28154	1003861-00	230V
D25012K (T1)	N032831	230V	D28155	1003861-00	230V
D25013K (T1)	N032831	230V	D28156	1003859-00	230V
D25101K (T1 + 2 + 3)	585475-00	230V	D28157	1003861-00	230V
D25102K (T1 + 2 + 3)	585475-00	230V	D28187	1003861-00	230V
D25103K (T1 + 2 + 3 + 4)	585475-00	230V	D28400 (T1 + 2)	585041-00	230V
D25104K (T1 + 2 + 3)	585475-00	230V	D28401 (T1 + 2)	585041-00	230V
D25112K (T1)	585475-00	230V	D28410 (T1 + 2)	585041-00	230V
D25113K (T1)	585475-00	230V	D28411 (T1 + 2)	585041-00	230V
D25114K (T1)	585475-00	230V	D28413 (T1 + 2)	585041-00	230V
D25201K (T1 + 2 + 3)	585475-00	230V	D28414 (T1 + 2)	585041-00	230V
D25203K (T1 + 2 + 3)	585475-00	230V	D28415 (T1 + 2)	585041-00	230V
D25213K (T1)	585475-00	230V	D28420 (T1)	585041-00	230V
D25223K (T1)	585475-00	230V	D28421 (T1 + 2)	585041-00	230V
D25303K (T1 + 2 + 3)	584429-00	230V	D28422 (T1 + 2)	585041-00	230V
D25304K (T1 + 2 + 3)	584429-00	230V	D28423 (T1 + 2)	585041-00	230V
D25313K (T1)	584429-00	230V	D28430 (T1)	585041-00	230V
D25314K (T1)	584429-00	230V	D28432C (T1 + 2)	585041-00	230V
D25323K (T1)	584429-00	230V	D28490 (T1)	585041-00	230V
D25324K (T1)	584429-00	230V	D28491 (T1)	585041-00	230V
D25330K (T1 + 2)	584429-00	230V	DC210K (T1)	493511-00	N/A
D25404K (T2)	487131-00	230V	DC212K (T1)	493511-00	N/A
D25405K (T2)	487131-00	230V	DC213 (T1)	493511-00	N/A
D25500K (T1 + 2)	582621-00	230V	DC213KL (T1)	493511-00	N/A
D25600K (T1 + 2)	327148-01	230V	DC222K (T1)	493511-00	N/A
D25700K (T1)	489256-00	230V	DC223K (T1)	493511-00	N/A
D25701K (T1 + 2)	489256-00	230V	DC224K (T1)	493511-00	N/A
D25730K (T1 + 2)	489256-00	230V	DC330 (T1)	493511-00	N/A
D25830K (T1 + 2)	327148-01	230V	DC520K (T1)	493511-00	N/A
D25840K (T1)	489256-00	230V	DC920K (T10)	493511-00	N/A
D25890K (T1)	489256-00	230V	DC925K (T10)	493511-00	N/A
D25899 (T1)	1005550-02	230V	DC930K (T10)	493511-00	N/A
D25900K (T1 + 2)	588698-00	230V	DC935K (T10)	493511-00	N/A
D25901K (T1)	1005550-02	230V	DC940K (T10)	493511-00	N/A
D25940K (T1 + 2)	588698-00	230V	DC945K (T10)	493511-00	N/A
D25941K (T1)	1005550-02	230V	DC980K (T10)	493511-00	N/A
D25980 (T1 + 2)	1005550-02	230V	DC981K (T10)	493511-00	N/A
D26410 (T1)	589016-00	230V	DC984K (T1)	493511-00	N/A
D26410 (T1)	596106-00	230V	DC984K (T1)	493511-00	N/A
D26420 (T1)	589016-00	230V	DW205 (T1 + 2)	578393-02	230V
D26420 (T1)	596106-00	230V	DW223K (T3)	578393-02	230V
D26421 (T1)	589016-00	230V	DW241	578393-02	230V
D26421 (T1)	596106-00	230V	DW268 (T5)	N023113	230V
D26422 (T1)	589016-00	230V	DW331 (T1)	589016-00	230V
D26422 (T1)	596106-00	230V	DW333 (T1)	589016-00	230V
D26423 (T1)	589016-00	230V	DW341 (T1 + 2)	494040-00	230V
D26423 (T1)	596106-00	230V	DW341K (T1 + 2)	494043-00	230V
D26441 (T1 + 2)	1006269-00	230V	DW343 (T2)	494040-00	230V
D26451 (T1)	1006269-00	230V	DW343K (T1 + 2)	494043-00	230V
D26453 (T1)	1006269-00	230V	DW448	1003859-00	230V
D26500	575963-00	230V	DW451 (T1 + 2)	1003859-00	230V
D26501 (T1)	575963-03	230V	DW456 (T1 + 2)	1003861-00	230V
D27900 (T1)	597226-00	230V	DW625E (T6)	869368-00	230V
D27901 (T1)	597093-00	230V	DW626 (T1)	585443-00	230V
D28108	1003859-00	230V	DW678 (T1 + 2 + 3 + 4)	575963-00	230V
D28111	1003860-00	230V	DW678E (T1 + 2 + 4)	575963-03	230V
D28113	1003860-00	230V	DW770 (T1)	659512-00	115V-230V
D28116	1003860-00	230V	DW770 (T1)	659513-00	115V-230V
D28117	1003860-00	230V	DW771 (T1 + 2)	659512-00	115V-230V
D28127	1003859-00	230V	DW771 (T1 + 2)	659513-00	115V-230V
D28128	1003859-00	230V	DW777 (T1 + 2)	659512-00	115V-230V
D28129	1003859-00	230V	DW777 (T1 + 2)	659513-00	115V-230V
D28130	1003860-00	230V	DW5520 (T1)	1007368-00	230V

- Spare parts such as brush pairs can only be purchased by a DeWalt Service Agent. To find your nearest Service Agent, visit our service web site: [www.2helpU.com](http://www.2helpU.com)
- Repairs on power tools should be carried out by an authorised technician
- Any attempt by anyone other than an authorised service repair agent to service a tool during the warranty period will invalidate the warranty for said tool.
- To have the most recent data on spare parts: technical features and the tools they fit, visit our service web site: [www.2helpU.com](http://www.2helpU.com)



# ACCESSORIES SECTION

**YOUR PREMIUM DEWALT TOOLS DESERVE THE RIGHT ACCESSORY**

**USING PROFESSIONAL QUALITY ACCESSORIES WILL IMPROVE THE PERFORMANCE OF YOUR TOOL**



## ICON REFERENCE

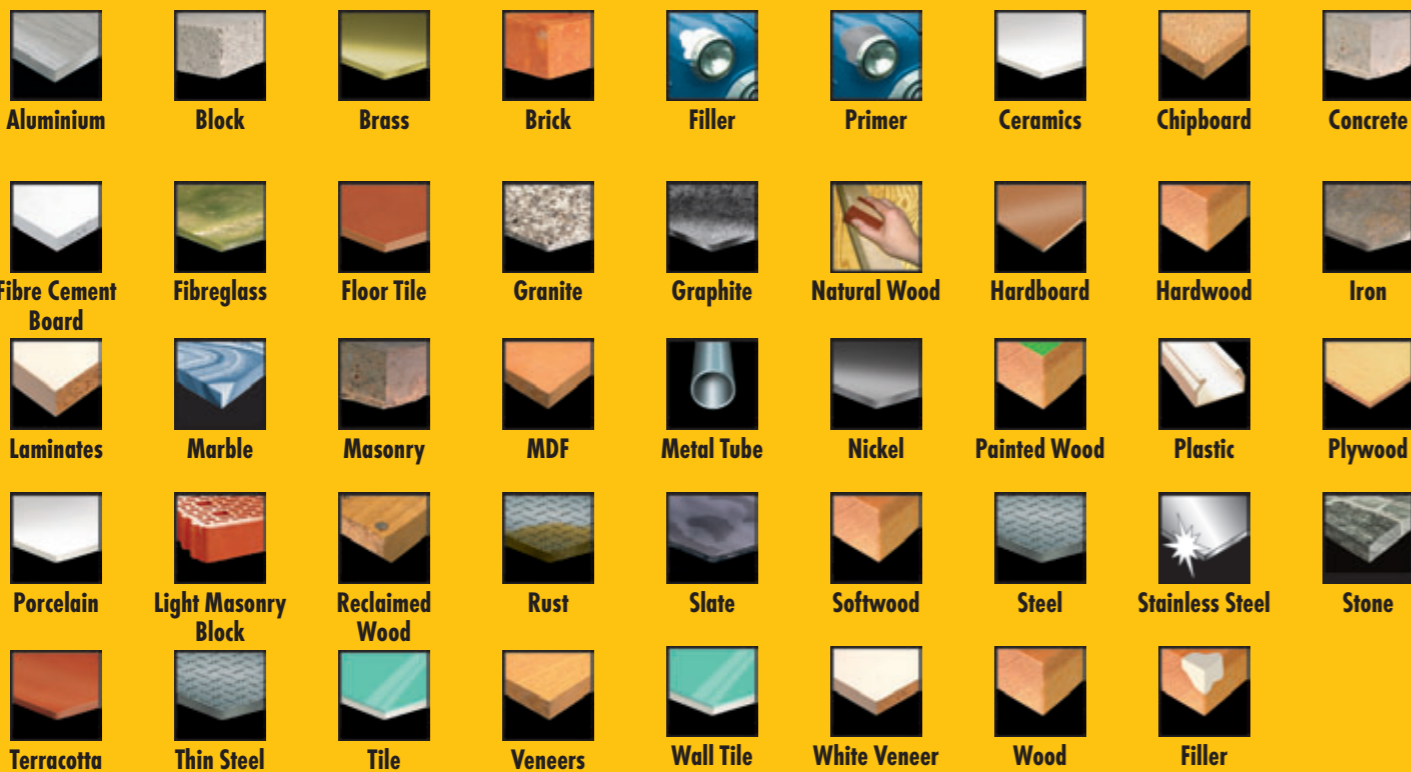

## EXTREME DEWALT® MASONRY DRILL BITS



### APPLICATIONS

- Typically used for drilling anchor, plastic plug, fixing or pipework clearance holes.
- Suitable for masonry, brick, stone, tiles and light concrete.

### FEATURES

- Lasts up to 2x longer and delivers up to 50% more holes per charge than a standard masonry bit.
- Unique Carbide Grade - optimum grade maximises durability.

### SINGLE PACKS

Cat. No.	Diameter mm	Length mm	Working Length mm	Pack Qty.	M.O.Q.	Barcode
DT6695-QZ	3	110	70	1	1	5035048061879
DT6699-QZ	3.5	110	70	1	1	5035048014028
DT6696-QZ	4	110	70	1	1	5035048061886
DT6671-QZ	4	75	50	1	1	5035048060568
DT6672-QZ	5	85	50	1	1	5035048060575
DT6673-QZ	5	150	100	1	1	5035048060582
DT6674-QZ	5.5	85	50	1	1	5035048060599
DT6675-QZ	6	100	60	1	1	5035048060605
DT6676-QZ	6	150	100	1	1	5035048060612
DT6677-QZ	6	200	150	1	1	5035048060629
DT6678-QZ	6.5	100	60	1	1	5035048060636
DT6679-QZ	6.5	150	100	1	1	5035048060643
DT6680-QZ	7	100	60	1	1	5035048060650
DT6681-QZ	7	150	100	1	1	5035048060667
DT6682-QZ	8	120	80	1	1	5035048060674
DT6683-QZ	8	200	150	1	1	5035048060681
DT6684-QZ	9	120	80	1	1	5035048060698
DT6685-QZ	10	120	80	1	1	5035048060704
DT6686-QZ	10	200	150	1	1	5035048060711
DT6687-QZ	12	150	100	1	1	5035048060728
DT6688-QZ	12	200	150	1	1	5035048060735
DT6689-QZ	13	150	100	1	1	5035048060742
DT6690-QZ	14	150	100	1	1	5035048060759
DT6691-QZ	14	200	150	1	1	5035048060766
DT6692-QZ	16	150	100	1	1	5035048060773
DT6693-QZ	16	200	150	1	1	5035048060780



### EXTREME DEWALT® MASONRY DRILL BIT SETS

Cat. No.	Description	Diameter mm	Pack Qty.	M.O.Q.	Barcode
DT6956-QZ	5 piece set in plastic cassette.	4, 5, 6, 8, 10	5	1	5035048060797
DT79288-QZ	Small tough case in blister with EXTREME DEWALT® Masonry drill bits. Ph2x4, Pz2x4, Ph2x50mm, Pz2x50mm, Slotted 5.5x50mm, Magnetic holder, Magnetic drive guide.	4, 5, 5.5, 6, 7, 8	19	1	5035048072219

## MASONRY DRILL BITS



### APPLICATIONS

- Typically used for drilling anchor, plastic plug, fixing or pipework clearance holes.
- Suitable for masonry, brick/blockwork, stone.

### FEATURES

- Rotary/percussion masonry drill bit 130° Douglas form carbide tip.
- Shank diameter of drill bits 10-13 mm is reduced to 9.5 mm.
- Shank diameter of drill bits larger than 13 mm is reduced to 12.7 mm.

### SINGLE PACKS

Cat. No.	Diameter mm	Length mm	Working Length mm	Pack Qty.	M.O.Q.	Barcode
DT6500-QZ	3	60	28	1	1	5011402382309
DT6504-QZ	4	75	38	1	1	5011402372379
DT6505-QZ	5	85	44	1	1	5011402372416
DT6502-QZ	5.5	85	44	1	1	5011402372454
DT6552-QZ	5.5	150	82	1	1	5011402372478
DT6506-QZ	6	100	54	1	1	5011402372492
DT6556-QZ	6	150	82	1	1	5011402372515
DT6606-QZ	6	200	135	1	1	5011402372539
DT6503-QZ	6.5	100	54	1	1	5011402372553
DT6507-QZ	7	100	54	1	1	5011402372614
DT6557-QZ	7	150	82	1	1	5011402372638
DT6508-QZ	8	120	67	1	1	5011402372676
DT6558-QZ	8	150	82	1	1	5011402372690
DT6608-QZ	8	200	135	1	1	5011402372713
DT6708-QZ	8	400	230	1	1	5011402372737
DT6509-QZ	9	120	67	1	1	5011402372751
DT6510-QZ	10	120	67	1	1	5011402372836
DT6560-QZ	10	150	82	1	1	5011402372850
DT6610-QZ	10	200	135	1	1	5011402372874
DT6710-QZ	10	400	230	1	1	5011402372898
DT6732-QZ	10	600	400	1	1	5011402382361
DT6562-QZ	12	150	82	1	1	5011402372935
DT6612-QZ	12	200	135	1	1	5011402372959
DT6712-QZ	12	400	230	1	1	5011402372973
DT6733-QZ	12	600	400	1	1	5011402382378
DT6563-QZ	13	150	82	1	1	5011402372997
DT6564-QZ	14	150	82	1	1	5011402373055
DT6714-QZ	14	400	230	1	1	5011402373093
DT6734-QZ	14	600	400	1	1	5011402382385
DT6566-QZ	16	150	82	1	1	5011402373130
DT6716-QZ	16	400	230	1	1	5011402373154
DT6735-QZ	16	600	400	1	1	5011402382392
DT6718-QZ	18	400	230	1	1	5011402373192
DT6720-QZ	20	400	230	1	1	5011402373239



MASONRY DRILL BITS



MASONRY DRILL BIT SETS

Cat. No.	Description	Diameter mm	Pack Qty.	M.O.Q.	Barcode
DT6952-QZ	5 piece set in plastic cassette	4, 5, 6, 8, 10	5	1	5011402373413

MULTI MATERIAL DRILL BITS



MULTI MATERIAL DRILL BITS

Cat. No.	Diameter mm	Length mm	Working Length mm	Pack Qty.	M.O.Q.	Barcode
DT6515-QZ	3	113	83	1	1	5035048066010
DT6516-QZ	3.5	113	83	1	1	5035048066027
DT6517-QZ	4	103	73	1	1	5035048066034
DT6518-QZ	5	113	83	1	1	5035048066041
DT6527-QZ	5.5	113	83	1	1	5035048077504
DT6528-QZ	5.5	200	170	1	1	5035048077511
DT6519-QZ	6	123	93	1	1	5035048066058
DT6529-QZ	6	200	170	1	1	5035048077528
DT6520-QZ	6.5	123	93	1	1	5035048066065
DT6530-QZ	6.5	200	170	1	1	5035048077535
DT6521-QZ	7	123	93	1	1	5035048066072
DT6522-QZ	8	134	104	1	1	5035048066089
DT6531-QZ	8	200	170	1	1	5035048077542
DT6523-QZ	9	134	104	1	1	5035048066096
DT6524-QZ	10	134	104	1	1	5035048066102
DT6533-QZ	10	200	170	1	1	5035048077559
DT6525-QZ	12	153	123	1	1	5035048066119
DT6526-QZ	13	160	130	1	1	5035048066126

APPLICATIONS

- Suitable for wood, plastics, mild steel and non ferrous metals and masonry.
- For use in rotary or percussion drilling modes.

FEATURES

- Unique 120° tip grind for maximum sharpness.
- Fully supported carbide head gives faster drilling and extended life.
- Non slip shank ensures better retention in chuck.

SDS-Plus EXTREME DeWALT® 2 DRILL BITS



SINGLE PACKS

Cat. No.	Diameter mm	Length mm	Working Length mm	Pack Qty.	M.O.Q.	Barcode
DT9625-QZ	3	135	75	1	1	5035048014011
DT9500-QZ	3.5	110	50	1	1	5035048054758
DT9502-QZ	4	110	50	1	1	5035048054772
DT9503-QZ	4	160	100	1	1	5035048054789
DT9504-QZ	5	110	50	1	1	5035048054796
DT9505-QZ	5	160	100	1	1	5035048054802
DT9506-QZ	5	210	150	1	1	5035048054819
DT9507-QZ	5	310	250	1	1	5035048054826
DT9620-QZ	5	460	400	1	1	5035048061855
DT9508-QZ	5.5	110	50	1	1	5035048054833
DT9509-QZ	5.5	160	100	1	1	5035048054840
DT9510-QZ	5.5	210	150	1	1	5035048054857
DT9511-QZ	5.5	260	200	1	1	5035048054864
DT9512-QZ	5.5	310	250	1	1	5035048054871
DT9513-QZ	5.5	460	400	1	1	5035048054888
DT9514-QZ	6	110	50	1	1	5035048054895
DT9515-QZ	6	160	100	1	1	5035048054901
DT9516-QZ	6	210	150	1	1	5035048054918
DT9517-QZ	6	260	200	1	1	5035048054925
DT9621-QZ	6	310	250	1	1	5035048061862
DT9518-QZ	6	460	400	1	1	5035048054932
DT9519-QZ	6.5	110	50	1	1	5035048054949
DT9520-QZ	6.5	160	100	1	1	5035048054956
DT9521-QZ	6.5	210	150	1	1	5035048054963
DT9522-QZ	6.5	260	200	1	1	5035048054970
DT9523-QZ	6.5	310	250	1	1	5035048054987
DT9524-QZ	7	110	50	1	1	5035048054994
DT9525-QZ	7	160	100	1	1	5035048055007
DT9526-QZ	7	210	150	1	1	5035048055014
DT9527-QZ	7	260	200	1	1	5035048055021
DT9528-QZ	8	110	50	1	1	5035048055038
DT9529-QZ	8	160	100	1	1	5035048055045

APPLICATIONS

- Suitable for fast drilling of plug, anchor or clearance holes in masonry, stone, concrete and brick/block work.

FEATURES

- The innovative EXTREME DeWALT® 2 SDS-Plus drill bit is amongst the very best in terms of its durability drilling life and speed.
- The Superior carbide grade ensures a tip with outstanding durability which gives consistent drilling life.
- The NEW 4 FLUTE SPIRAL incorporates a maximized central core for increased durability and energy transmission.
- The 140° tip design ensures better bit penetration and longer life.
- Hardened Steel body for extra strength and reduced breakage.

SDS-Plus EXTREME DeWALT® 2 DRILL BITS



SINGLE PACKS

Cat. No.	Diameter mm	Length mm	Working Length mm	Pack Qty.	M.O.Q.	Barcode
DT9530-QZ	8	210	150	1	1	5035048055052
DT9531-QZ	8	260	200	1	1	5035048055069
DT9532-QZ	8	310	250	1	1	5035048055076
DT9533-QZ	8	410	350	1	1	5035048055083
DT9534-QZ	8	460	400	1	1	5035048055090
DT9535-QZ	8	600	540	1	1	5035048055106
DT9536-QZ	9	160	100	1	1	5035048055113
DT9537-QZ	9	210	150	1	1	5035048055120
DT9539-QZ	10	110	50	1	1	5035048055144
DT9540-QZ	10	160	100	1	1	5035048055151
DT9541-QZ	10	210	150	1	1	5035048055168
DT9542-QZ	10	260	200	1	1	5035048055175
DT9543-QZ	10	310	250	1	1	5035048055182
DT9544-QZ	10	350	300	1	1	5035048055199
DT9545-QZ	10	460	400	1	1	5035048055205
DT9546-QZ	10	600	550	1	1	5035048055212
DT9547-QZ	10	1000	950	1	1	5035048055229
DT9548-QZ	11	160	100	1	1	5035048055236
DT9549-QZ	11	210	150	1	1	5035048055243
DT9550-QZ	11	260	200	1	1	5035048055250
DT9551-QZ	11	310	250	1	1	5035048055267
DT9552-QZ	12	160	100	1	1	5035048055274
DT9553-QZ	12	200	150	1	1	5035048055281
DT9554-QZ	12	260	200	1	1	5035048055298
DT9555-QZ	12	300	250	1	1	5035048055304
DT9556-QZ	12	350	300	1	1	5035048055311
DT9557-QZ	12	450	400	1	1	5035048055328
DT9558-QZ	12	600	550	1	1	5035048055335
DT9559-QZ	12	1000	950	1	1	5035048055342
DT9560-QZ	13	160	100	1	1	5035048055359
DT9561-QZ	13	200	150	1	1	5035048055366
DT9562-QZ	13	260	200	1	1	5035048055373
DT9563-QZ	13	300	250	1	1	5035048055380
DT9565-QZ	13	450	400	1	1	5035048055403
DT9566-QZ	14	160	100	1	1	5035048055410
DT9567-QZ	14	200	150	1	1	5035048055427
DT9568-QZ	14	260	200	1	1	5035048055434
DT9569-QZ	14	300	250	1	1	5035048055441
DT9570-QZ	14	450	400	1	1	5035048055458
DT9571-QZ	14	600	550	1	1	5035048055465
DT9572-QZ	14	1000	950	1	1	5035048055472
DT9573-QZ	15	160	100	1	1	5035048055489
DT9574-QZ	15	200	150	1	1	5035048055496
DT9575-QZ	15	260	200	1	1	5035048055502
DT9576-QZ	15	300	250	1	1	5035048055519
DT9577-QZ	15	450	400	1	1	5035048055526
DT9578-QZ	16	160	100	1	1	5035048055533
DT9579-QZ	16	200	150	1	1	5035048055540
DT9580-QZ	16	260	200	1	1	5035048055557
DT9581-QZ	16	300	250	1	1	5035048055564
DT9582-QZ	16	450	400	1	1	5035048055571
DT9583-QZ	16	600	550	1	1	5035048055588
DT9584-QZ	16	800	750	1	1	5035048055595
DT9585-QZ	16	1000	950	1	1	5035048055601
DT9586-QZ	17	200	150	1	1	5035048055618
DT9587-QZ	18	200	150	1	1	5035048055625
DT9588-QZ	18	250	200	1	1	5035048055632
DT9589-QZ	18	300	250	1	1	5035048055649
DT9590-QZ	18	450	400	1	1	5035048055656
DT9591-QZ	18	600	550	1	1	5035048055663
DT9592-QZ	18	800	750	1	1	5035048055670
DT9593-QZ	18	1000	950	1	1	5035048055687
DT9596-QZ	19	450	400	1	1	5035048055717
DT9597-QZ	20	200	150	1	1	5035048055724
DT9598-QZ	20	300	250	1	1	5035048055731
DT9599-QZ	20	450	400	1	1	5035048055748
DT9600-QZ	20	600	550	1	1	5035048055755
DT9601-QZ	20	1000	950	1	1	5035048055762
DT9602-QZ	22	250	200	1	1	5035048055779
DT9603-QZ	22	300	250	1	1	5035048055786
DT9604-QZ	22	450	400	1	1	5035048055793
DT9605-QZ	22	600	550	1	1	5035048055809
DT9606-QZ	22	800	750	1	1	5035048055816
DT9607-QZ	22	1000	950	1	1	5035048055823
DT9609-QZ	24	250	200	1	1	5035048055847
DT9610-QZ	24	450	400	1	1	5035048055854
DT9611-QZ	25	250	200	1	1	5035048055861
DT9612-QZ	25	300	250	1	1	5035048055878
DT9613-QZ	25	450	400	1	1	5035048055885
DT9614-QZ	25	1000	950	1	1	5035048055892
DT9615-QZ	26	250	200	1	1	5035048055908
DT9616-QZ	26	450	400	1	1	5035048055915
DT9617-QZ	26	800	750	1	1	5035048055922
DT9618-QZ	30	250	200	1	1	5035048055939
DT9619-QZ	30	450	400	1	1	5035048055946

APPLICATIONS

- Suitable for fast drilling of plug, anchor or clearance holes in masonry, stone, concrete and brick/block work.

FEATURES

- The innovative EXTREME DeWALT® 2 SDS-Plus drill bit is amongst the very best in terms of its durability drilling life and speed.
- The Superior carbide grade ensures a tip with outstanding durability which gives consistent drilling life.
- The NEW 4 FLUTE SPIRAL incorporates a maximized central core for increased durability and energy transmission.
- The 140° tip design ensures better bit penetration and longer life.
- Hardened Steel body for extra strength and reduced breakage.



SDS-Plus EXTREME DeWALT® 2 DRILL BITS



APPLICATIONS

- Suitable for fast drilling of plug, anchor or clearance holes in masonry, stone, concrete and brick/block work.

FEATURES

- The innovative EXTREME DeWALT® 2 SDS-Plus drill bit is amongst the very best in terms of its durability drilling life and speed.
- The Superior carbide grade ensures a tip with outstanding durability which gives consistent drilling life.
- The NEW 4 FLUTE SPIRAL incorporates a maximized central core for increased durability and energy transmission.
- The 140° tip design ensures better bit penetration and longer life.
- Hardened Steel body for extra strength and reduced breakage.

BULK PACKS

Cat. No.	Diameter mm	Length mm	Working Length mm	Pack Qty.	M.O.Q.	Barcode
DT9800-QZ	5	110	50	10	1	5035048055953
DT9803-QZ	5	160	100	10	1	5035048055984
DT9806-QZ	5.5	110	50	10	1	5035048056011
DT9809-QZ	5.5	160	100	10	1	5035048056042
DT9812-QZ	6	110	50	10	1	5035048056073
DT9814-QZ	6	110	50	100	1	5035048056097
DT9815-QZ	6	160	100	10	1	5035048056103
DT9816-QZ	6	160	100	50	1	5035048056110
DT9817-QZ	6	160	100	100	1	5035048056127
DT9818-QZ	6	210	150	10	1	5035048056134
DT9848-QZ	6	210	150	50	1	5035048013977
DT9820-QZ	6.5	160	100	10	1	5035048056158
DT9846-QZ	6.5	210	150	10	1	5035048013953
DT9847-QZ	6.5	210	150	50	1	5035048013960
DT9823-QZ	7	160	100	10	1	5035048056189
DT9826-QZ	8	110	50	10	1	5035048056219
DT9827-QZ	8	160	100	10	1	5035048056226
DT9828-QZ	8	160	100	50	1	5035048056233
DT9829-QZ	8	160	100	100	1	5035048056240
DT9830-QZ	8	210	150	10	1	5035048056257
DT9831-QZ	8	260	200	10	1	5035048056264
DT9833-QZ	10	110	50	10	1	5035048056288
DT9834-QZ	10	160	100	10	1	5035048056295
DT9835-QZ	10	160	100	50	1	5035048056301
DT9837-QZ	10	210	150	10	1	5035048056325
DT9838-QZ	10	260	200	10	1	5035048056332
DT9839-QZ	12	160	100	10	1	5035048056349
DT9840-QZ	12	160	100	50	1	5035048056356
DT9841-QZ	12	200	150	10	1	5035048056363
DT9842-QZ	12	260	200	10	1	5035048056370
DT9843-QZ	14	160	100	10	1	5035048056387
DT9844-QZ	14	200	150	10	1	5035048056394

SDS-Plus EXTREME DeWALT® 2 DRILL BIT SETS

Cat. No.	Description	Diameter mm	Pack Qty.	M.O.Q.	Barcode
DT9700-QZ	4 piece set in plastic cassette.	5,6,8,10	4	1	5035048056400
DT9701-QZ	7 piece set in metal cassette.	5,6x2,8x2,10,12	7	1	5035048056417
DT9702-QZ	4 piece set in plastic cassette.	5,5,7,8,10	4	1	5035048056424

EXTREME DeWALT® XLR FULL HEAD CARBIDE DRILL BITS



APPLICATIONS

- Suitable for drilling plug & anchor holes in masonry, all types of stone and concrete.

FEATURES

- New solid carbide drill tip with optimised 4 cutter geometry offers the highest levels of drill bit life and durability from DeWALT to date.
- 4 cutter geometry drills a more concentric hole to offer the best fixing retention.
- 4 flute spiral aids consistent drilling speed and efficient debris removal.
- Unique bonding system joins the solid carbide head to the 4 flute spiral as one to ensure the highest standards available in DeWALT® SDS-Plus drilling to date.



SINGLE PACKS

Cat. No.	Diameter mm	Length mm	Working Length mm	Pack Qty.	M.O.Q.	Barcode
DT8907-QZ	5	110	50	1	1	5035048077689
DT8908-QZ	5	160	100	1	1	5035048077696
DT8909-QZ	5	210	150	1	1	5035048077702
DT8910-QZ	5.5	110	50	1	1	5035048077719
DT8911-QZ	5.5	160	100	1	1	5035048077726
DT8912-QZ	6	110	50	1	1	5035048077733
DT8913-QZ	6	160	100	1	1	5035048077740
DT8914-QZ	6	210	150	1	1	5035048077757
DT8915-QZ	6	260	200	1	1	5035048077764
DT8916-QZ	6.5	160	100	1	1	5035048077771
DT8917-QZ	6.5	210	150	1	1	5035048077788
DT8918-QZ	6.5	260	200	1	1	5035048077795
DT8919-QZ	6.5	310	250	1	1	5035048077801
DT8920-QZ	7	160	100	1	1	5035048077818
DT8921-QZ	7	210	150	1	1	5035048077825
DT8922-QZ	8	110	50	1	1	5035048077832
DT8923-QZ	8	160	100	1	1	5035048077849
DT8924-QZ	8	210	150	1	1	5035048077856
DT8925-QZ	8	260	200	1	1	5035048077863
DT8926-QZ	8	310	250	1	1	5035048077870
DT8927-QZ	8	460	400	1	1	5035048077887
DT8928-QZ	10	160	100	1	1	5035048077894
DT8929-QZ	10	210	150	1	1	5035048077901
DT8930-QZ	10	260	200	1	1	5035048077917
DT8931-QZ	10	310	250	1	1	5035048077924
DT8932-QZ	10	460	400	1	1	5035048077931
DT8933-QZ	12	160	100	1	1	5035048077948
DT8934-QZ	12	200	150	1	1	5035048077955
DT8935-QZ	12	260	200	1	1	5035048077962
DT8936-QZ	12	310	260	1	1	5035048077979
DT8937-QZ	12	460	410	1	1	5035048077986
DT8938-QZ	14	160	100	1	1	5035048077993
DT8939-QZ	14	200	150	1	1	5035048078000
DT8940-QZ	14	260	200	1	1	5035048078013
DT8941-QZ	14	310	250	1	1	5035048078020
DT8942-QZ	14	460	400	1	1	5035048078037

BULK PACKS

Cat. No.	Diameter mm	Length mm	Working Length mm	Pack Qty.	M.O.Q.	Barcode
DT8950-QZ	5	110	50	10	1	5035048078105
DT8951-QZ	5	160	100	10	1	5035048078112
DT8952-QZ	5	210	150	10	1	5035048078129
DT8953-QZ	5.5	110	50	10	1	5035048078136
DT8954-QZ	5.5	160	100	10	1	5035048078143
DT8955-QZ	6	110	50	10	1	5035048078150
DT8956-QZ	6	160	100	10	1	5035048078167
DT8957-QZ	6	210	150	10	1	5035048078174
DT8958-QZ	6	260	200	10	1	5035048078181
DT8959-QZ	6.5	160	100	10	1	5035048078198
DT8960-QZ	6.5	210	150	10	1	5035048078204
DT8961-QZ	6.5	260	200	10	1	5035048078211
DT8962-QZ	7	160	100	10	1	5035048078228
DT8963-QZ	7	260	150	10	1	5035048078235
DT8964-QZ	8	110	50	10	1	5035048078242
DT8965-QZ	8	160	100	10	1	5035048078259
DT8966-QZ	8	210	150	10	1	5035048078266
DT8967-QZ	10	160	100	10	1	5035048078273
DT8968-QZ	10	210	150	10	1	5035048078280
DT8969-QZ	10	260	200	10	1	5035048078297
DT8970-QZ	10	310	260	10	1	5035048078303
DT8971-QZ	12	160	100	10	1	5035048078310
DT8972-QZ	12	200	150	10	1	5035048078327
DT8973-QZ	14	200	150	10	1	5035048078334

EXTREME DeWALT® FULL HEAD CARBIDE DRILL BIT SETS

Cat. No.	Description	Diameter mm	Pack Qty.	M.O.Q.	Barcode
DT8976-QZ	7 piece set in metal cassette	5, 6x2, 8x2, 10,12	7	1	5035048078341
DT8977-QZ	Medium Tough Case with SDS-Plus XLR Full Head Carbide drill bits	5, 6x2, 8x2, 10,12	10	1	5035048078358





SDS-Plus 4-CUTTER DRILL BITS



SINGLE PACKS

Cat. No.	Diameter mm	Length mm	Working Length mm	Pack Qty.	M.O.Q.	Barcode
DT9680-QZ	16	250	200	1	1	5035048066133
DT9681-QZ	16	450	400	1	1	5035048066140
DT9682-QZ	18	250	200	1	1	5035048066157
DT9683-QZ	18	450	400	1	1	5035048066164
DT9684-QZ	20	250	200	1	1	5035048066171
DT9685-QZ	20	450	400	1	1	5035048066188
DT9686-QZ	22	250	200	1	1	5035048066195
DT9687-QZ	22	450	400	1	1	5035048066201
DT9688-QZ	24	250	200	1	1	5035048066218
DT9689-QZ	24	450	400	1	1	5035048066225
DT9690-QZ	25	250	200	1	1	5035048066232
DT9691-QZ	25	450	400	1	1	5035048066249
DT9692-QZ	26	450	400	1	1	5035048066256
DT9693-QZ	28	250	200	1	1	5035048066263
DT9694-QZ	28	450	400	1	1	5035048066270
DT9695-QZ	30	250	200	1	1	5035048066287
DT9696-QZ	30	450	400	1	1	5035048066294

APPLICATIONS

- For fixing holes and through holes 16mm - 30mm.

FEATURES

- 4 flute spiral with maximum flute entry enables faster debris removal.
- Maximised central core enables more efficient energy transmission to the drill bit head.
- Fully supported carbide head gives longer life and cleaner, more concentric holes for better fixing retention.
- Open head design ensures faster drilling.

SDS-MAX HAMMER DRILL BITS



SINGLE PACKS

Cat. No.	Diameter mm	Length mm	Working Length mm	Cutters	Pack Qty.	M.O.Q.	Barcode
DT9400-QZ	12	340	200	2	1	1	5035048059678
DT9401-QZ	12	540	400	2	1	1	5035048059685
DT9402-QZ	12	670	550	2	1	1	5035048059692
DT9403-QZ	13	340	200	2	1	1	5035048059708
DT9404-QZ	13	540	400	2	1	1	5035048059715
DT9405-QZ	14	340	200	2	1	1	5035048059722
DT9406-QZ	14	540	400	2	1	1	5035048059739
DT9407-QZ	15	340	200	2	1	1	5035048059746
DT9408-QZ	15	540	400	2	1	1	5035048059753
DT9409-QZ	16	340	200	4	1	1	5035048059760
DT9410-QZ	16	540	400	4	1	1	5035048059777
DT9411-QZ	18	340	200	4	1	1	5035048059784
DT9412-QZ	18	540	400	4	1	1	5035048059791
DT9413-QZ	19	340	200	4	1	1	5035048059807
DT9414-QZ	19	540	400	4	1	1	5035048059814
DT9415-QZ	19	670	550	4	1	1	5035048059821
DT9416-QZ	20	340	200	4	1	1	5035048059838
DT9417-QZ	20	540	400	4	1	1	5035048059845
DT9418-QZ	20	920	800	4	1	1	5035048059852
DT9419-QZ	22	340	200	4	1	1	5035048059869
DT9420-QZ	22	540	400	4	1	1	5035048059876
DT9421-QZ	22	920	800	4	1	1	5035048059883
DT9422-QZ	24	340	200	4	1	1	5035048059890
DT9423-QZ	24	540	400	4	1	1	5035048059906
DT9424-QZ	25	340	200	4	1	1	5035048059913
DT9425-QZ	25	540	400	4	1	1	5035048059920
DT9426-QZ	25	920	800	4	1	1	5035048059937
DT9427-QZ	26	340	200	4	1	1	5035048059944
DT9428-QZ	26	540	400	4	1	1	5035048059951
DT9429-QZ	28	380	250	4	1	1	5035048059968
DT9430-QZ	28	570	450	4	1	1	5035048059975
DT9431-QZ	28	670	550	4	1	1	5035048059982
DT9432-QZ	30	380	250	4	1	1	5035048059999
DT9433-QZ	30	570	450	4	1	1	5035048060001
DT9434-QZ	32	380	250	4	1	1	5035048060018
DT9435-QZ	32	570	450	4	1	1	5035048060025
DT9436-QZ	32	920	800	4	1	1	5035048060032
DT9437-QZ	35	380	250	4	1	1	5035048060049
DT9438-QZ	35	570	450	4	1	1	5035048060056
DT9439-QZ	35	670	550	4	1	1	5035048060063
DT9440-QZ	36	570	450	4	1	1	5035048060070
DT9441-QZ	38	380	250	4	1	1	5035048060087
DT9442-QZ	38	570	450	4	1	1	5035048060094
DT9443-QZ	38	670	550	4	1	1	5035048060100
DT9444-QZ	40	380	250	4	1	1	5035048060117
DT9445-QZ	40	570	450	4	1	1	5035048060124
DT9446-QZ	40	920	800	4	1	1	5035048060131
DT9447-QZ	42	570	450	4	1	1	5035048060148
DT9448-QZ	45	570	450	4	1	1	5035048060155
DT9449-QZ	50	570	450	4	1	1	5035048060162
DT9450-QZ	52	570	450	4	1	1	5035048060179

APPLICATIONS

- For use with SDS-Max drive hammer drills (Hilti type F,G or Y) for anchor, fixing or clearance holes in masonry concrete, brick or block work.

FEATURES

- 4 flute spiral with maximum flute entry enables faster debris removal.
- Maximised central core enables more efficient energy transmission to the drill bit head.
- Fully supported carbide head gives longer life and cleaner, more concentric holes for better fixing retention.
- Open head design ensures faster drilling.



SDS-Plus CHISELS



SINGLE PACKS

Cat. No.	Description	Width mm	Length mm	Pack Qty.	M.O.Q.	Barcode
DT6801-QZ	Pointed	-	250	1	1	5011402371426
DT6802-QZ	Flat	20	250	1	1	5011402371433
DT6803-QZ	Flat	40	200	1	1	5011402371440
DT6804-QZ	Sliding Chasing	22	250	1	1	5011402371457
DT6805-QZ	Hollow/Gouge	22	240	1	1	5011402371464
DT6806-QZ	Tile Chisel	40	200	1	1	5011402371471
DT6807-QZ	TCT Comb	32	130	1	1	5011402371488
DT6810-QZ	TCT Comb	32	200	1	1	5035048014301

APPLICATIONS

- For light chipping and chiselling of tile, mortar, glazing compounds and other masonry products with hammers with a rotation stop feature.

EXTREME DeWALT CHISELS

Coming soon in 2011



APPLICATIONS

- For heavy duty chiselling, channelling and demolition tasks in concrete/rebar and hard stone.
- The new EXTREME chisels combined with DeWalt demolition hammers are ideal for even the toughest requirements.

FEATURES

- High grade toughened steel shank designed for optimum durability in heavy duty tasks.
- Fully hardened steel for high wear resistance and increased service life.
- Innovative cutting geometry and aggressive angles for improved material removal over complete life of chisel



EXTREME DeWALT SDS-MAX CHISELS

Cat. No.	Description	Width mm	Length mm	Pack Qty.	M.O.Q.	Barcode
DT6888-QZ	300mm pointed chisel SDS-Max	-	300	1	1	5035048082393
DT6889-QZ	400mm pointed chisel SDS-Max	-	400	1	1	5035048082409
DT6890-QZ	600mm pointed chisel SDS-Max	-	600	1	1	5035048082416
DT6811-QZ	300mm x 25mm flat chisel SDS-Max	25	300	1	1	5035048082423
DT6812-QZ	400mm x 25mm flat chisel SDS-Max	25	400	1	1	5035048082430
DT6810-QZ	360mm x 50mm flat chisel SDS-Max	50	360	1	1	5035048082447

EXTREME DeWALT 19MM CHISELS

Cat. No.	Description	Width mm	Length mm	Pack Qty.	M.O.Q.	Barcode
DT6953-QZ	400mm pointed chisel 19mm hex	-	400	1	1	5035048082461
DT6954-QZ	600mm pointed chisel 19mm hex	-	600	1	1	5035048082478
DT6958-QZ	400mm x 25mm flat chisel 19mm hex	25	400	1	1	5035048082485
DT6959-QZ	600mm x 25mm flat chisel 19mm hex	25	600	1	1	5035048082492

EXTREME DeWALT 28MM CHISELS

Cat. No.	Description	Width mm	Length mm	Pack Qty.	M.O.Q.	Barcode
DT6971-QZ	520mm pointed chisel 28mm hex	-	520	1	1	5035048082508
DT6972-QZ	520mm x 36mm flat chisel 28mm hex	28	520	1	1	5035048082515

EXTREME DeWALT 30MM CHISELS

Cat. No.	Description	Width mm	Length mm	Pack Qty.	M.O.Q.	Barcode
DT6808-QZ	520mm pointed chisel 30mm hex	-	520	1	1	5035048083246
DT6809-QZ	520mm x 36mm flat chisel 30mm hex	36	520	1	1	5035048083253

SDS-MAX CHISELS

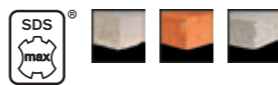

SINGLE PACKS

Cat. No.	Description	Width mm	Length mm	Pack Qty.	M.O.Q.	Barcode
DT6820-QZ	Pointed	-	300	1	1	5011402378067
DT6821-QZ	Pointed	-	400	1	1	5011402378104
DT8087-QZ	Pointed	-	600	1	1	5035048061411
DT6822-QZ	Flat	25	300	1	1	5011402378074
DT6823-QZ	Flat	25	400	1	1	5011402378111
DT6824-QZ	Flat	50	360	1	1	5011402378128
DT6825-QZ	Flat	80	300	1	1	5011402378081
DT8088-QZ	Flat	25	600	1	1	5035048061428
DT6826-QZ	Hollow/Gouge	26	300	1	1	5011402378098
DT6832-QZ	Sliding Chasing	32	300	1	1	5035048034217
DT6833-QZ	Sliding Chasing	35	380	1	1	5035048034224
DT6834-QZ	Tile Chisel	80	300	1	1	5035048034231
DT6837-QZ	TCT Comb Chisel	38	280	1	1	5035048034248
DT8090-QZ	Clay Spade	110	400	1	1	5035048034514
DT8091-QZ	Asphalt Cutter	90	400	1	1	5035048034521
DT8092-QZ	Earth Rod Driver	13	260	1	1	5035048034538
DT8093-QZ	Earth Rod Driver	16.5	260	1	1	5035048034545

APPLICATIONS

- For heavy duty chiselling, channelling, and demolition tasks in concrete, stone (medium hardness), floor and wall tiles, general masonry and mortar.

FEATURES

- DeWALT has a wide range of chisels covering most common applications. Specially toughened steel and micro-processor controlled heat treatment ensures consistent tough bits with long life.

19MM HEXAGON CHISELS



SINGLE PACKS

Cat. No.	Description	Width mm	Length mm	Pack Qty.	M.O.Q.	Barcode
DT6940-QZ	Pointed	-	400	1	1	5035048025031
DT6941-QZ	Pointed	-	600	1	1	5035048025048
DT6942-QZ	Flat	25	400	1	1	5035048025055
DT6943-QZ	Flat	25	600	1	1	5035048025062
DT6944-QZ	Flat	60	300	1	1	5035048025079
DT6945-QZ	Flat	60	450	1	1	5035048025086
DT6946-QZ	Flat wide	140	350	1	1	5035048025093
DT6947-QZ	Clay Spade	115	400	1	1	5035048058893
DT6948-QZ	Asphalt Cutter	90	400	1	1	5035048058909

APPLICATIONS

- For heavy duty chiselling, channelling, and demolition tasks in concrete, stone (medium hardness), floor and wall tiles, general masonry and mortar.

PAVEMENT BREAKER CHISELS



28MM PAVEMENT BREAKER CHISELS

Cat. No.	Description	Width mm	Length mm	Pack Qty.	M.O.Q.	Barcode
DT6927-QZ	Bull point	-	500	1	1	5035048070505
DT6928-QZ	Clay Spade	140	540	1	1	5035048070512
DT6929-QZ	Cold Chisel	32	500	1	1	5035048070529
DT6932-QZ	Scaling Tool	75	500	1	1	5035048070536
DT6933-QZ	Ground Rod Driver	-	400	1	1	5035048070543
DT6934-QZ	Asphalt Cutter	115	430	1	1	5035048070550
DT6935-QZ	Tamper Shank	-	400	1	1	5035048070567
DT6936-QZ	Tamping Plate	150	150	1	1	5035048070574

APPLICATIONS

- Heavy duty breaking of concrete, asphalt & stone. Heavy duty tamping tasks and earth rod driving.

30MM PAVEMENT BREAKER CHISELS

Cat. No.	Description	Width mm	Length mm	Pack Qty.	M.O.Q.	Barcode
DT6827-QZ	Scaling Tool	75	500	1	1	5035048083260
DT6828-QZ	Clay Spade	140	540	1	1	5035048083277
DT6839-QZ	Asphalt Cutter	115	430	1	1	5035048083284

LIGHT DUTY SDS-Plus CORE DRILLS

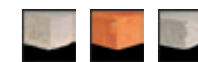

LIGHT DUTY SDS-Plus CORE DRILLS

Cat. No.	Diameter mm	Length mm	Pack Qty.	M.O.Q.	Barcode
DT6740-QZ	30	72	1	1	5035048013595
DT6741-QZ	35	72	1	1	5035048013601
DT6742-QZ	40	72	1	1	5035048013618
DT6743-QZ	45	72	1	1	5035048013625
DT6744-QZ	50	72	1	1	5035048013632
DT6745-QZ	68	72	1	1	5035048013649
DT6746-QZ	72	72	1	1	5035048013656
DT6747-QZ	80	72	1	1	5035048013663
DT6748-QZ	90	72	1	1	5035048013670

APPLICATIONS

- For fitting drainage and water pipes, heating pipes, switches, junction & distribution boxes.

- To be used with light duty SDS-Plus core drills - must be used with a pilot bit.

LIGHT DUTY CORE ADAPTORS

Cat. No.	Description	Length mm	Pack Qty.	M.O.Q.	Barcode
DT6750-QZ	SDS-Plus adaptor	110	1	1	5035048013687
DT6751-QZ	SDS-Plus adaptor	300	1	1	5035048013694
DT6752-QZ	Hex adaptor	110	1	1	5035048013700
DT6753-QZ	Pilot drill	120	1	1	5035048013717

HEAVY DUTY SDS-MAX CORE DRILLS

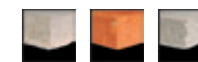

HEAVY DUTY SDS-MAX CORE DRILLS

Cat. No.	Diameter mm	Length mm	Pack Qty.	M.O.Q.	Barcode
DT6760-QZ	40	107	1	1	5035048013724
DT6761-QZ	50	107	1	1	5035048013731
DT6762-QZ	68	107	1	1	5035048013748
DT6763-QZ	80	107	1	1	5035048013755
DT6764-QZ	90	107	1	1	5035048013762
DT6765-QZ	100	107	1	1	5035048013779
DT6766-QZ	125	107	1	1	5035048013786

APPLICATIONS

- For clean round holes in blocks, bricks and light concrete.

- To be used with Heavy duty SDS-Max Core drills in conjunction with a pilot bit.

HEAVY DUTY CORE ADAPTORS

Cat. No.	Description	Length mm	Pack Qty.	M.O.Q.	Barcode
DT6770-QZ	SDS-Max Adaptor	180	1	1	5035048013793
DT6771-QZ	SDS-Max Adaptor	400	1	1	5035048013809
DT6772-QZ	Pilot bit	155	1	1	5035048013816
DT6773-QZ	Extension Piece	280	1	1	5035048013823

SINGLE PIECE CORES



SINGLE PIECE CORES

Cat. No.	Description	Diameter mm	Length mm	Pack Qty.	M.O.Q.	Barcode
DT6780-QZ	SDS-Max core	50	300	1	1	5035048013830
DT6783-QZ	SDS-Max core	68	300	1	1	5035048013847
DT6784-QZ	SDS-Max core	80	300	1	1	5035048013854
DT6785-QZ	Pilot bit	-	185	1	1	5035048013908

- For SDS-Max hammer drills - for drilling holes in concrete or masonry from 50 to 80mm diameter.

THROUGH DRILLING BITS



• For drilling through holes (55 to 80mm diameter) up to 550mm depth in concrete and masonry.

THROUGH DRILLING BITS

Cat. No.	Description	Diameter mm	Length mm	Pack Qty.	M.O.Q.	Barcode
DT6790-QZ	SDS-Max through drilling bit	55	550	1	1	5035048013861
DT6791-QZ	SDS-Max through drilling bit	65	550	1	1	5035048013878
DT6792-QZ	SDS-Max through drilling bit	80	550	1	1	5035048013885
DT6793-QZ	Pilot bit	-	88	1	1	5035048013892

ADAPTOR - SDS-Plus



• Allows use of round shank drill bits in SDS-Plus fitment hammers. USE IN ROTARY MODE ONLY.

ADAPTOR - SDS-Plus

Cat. No.	Description	Pack Qty.	M.O.Q.	Barcode
DT7030-QZ	SDS-Plus - 1/2" x 20 UNF (Chuck adaptor)	1	1	5011402371419
DT6829-QZ	SDS-Plus - 1/2" x 20 UNF chuck adaptor / screwdriver bit holder	1	1	5035048034170

DRIVE ADAPTORS



• Allows interchangeability between tool & hammer bit fitments.

DRIVE ADAPTORS

Cat. No.	Description	Pack Qty.	M.O.Q.	Barcode
DT6830-QZ	SDS-Max to SDS-Plus	1	1	5011402378135



HSS-CO EXTREME DeWALT® COBALT DRILL BITS

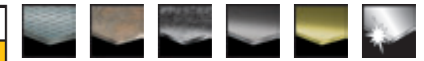

APPLICATIONS

• Suitable for portable or stationary drilling of high alloy content steels and metals with a tensile strength up to 1100N/mm<sup>2</sup> e.g. heat and acid proof steel, cast iron, bronze, welded seams, stainless and chrome nickel steels.

FEATURES

- Faster drilling - up to 4x faster than standard HSS-R drill bits.
- Increased durability - up to 50% stronger than standard HSS-R drill bits.
- Cleaner, more accurate, burr-free holes due to recessed cutting wings.
- Innovative tapered web greatly reduces breakage.
- No-Slip shank with 3 flats eliminates slipping in the chuck (diameters 5.0mm and above only).
- Gold Ferrous Oxide coating prevents overheating for longer bit life.
- 5% cobalt alloyed High Speed Steel for stability at high temperatures when drilling tough materials.



SINGLE PACKS

Cat. No.	Diameter mm	Length mm	Working Length mm	Pack Qty.	M.O.Q.	Barcode
DT5403-QZ	2	49	24	2	1	5011402375912
DT5630-QZ	1.0	34	12	2	1	5035048076958
DT5631-QZ	1.5	40	18	2	1	5035048076965
DT5632-QZ	1.6	43	20	2	1	5035048076972
DT5404-QZ	2.5	57	30	2	1	5011402375936
DT5405-QZ	3	61	33	2	1	5011402375950
DT5633-QZ	3.1	65	36	2	1	5035048076989
DT5634-QZ	3.3	65	36	2	1	5035048076996
DT5408-QZ	3.5	70	39	2	1	5011402375974
DT5409-QZ	4	75	43	2	1	5011402375998
DT5635-QZ	4.1	75	43	1	1	5035048077009
DT5636-QZ	4.2	75	43	1	1	5035048077016
DT5412-QZ	4.5	80	47	1	1	5011402376018
DT5637-QZ	4.9	86	46	1	1	5035048077023
DT5414-QZ	5	86	52	1	1	5011402376032
DT5638-QZ	5.1	86	46	1	1	5035048077030
DT5415-QZ	5.5	93	57	1	1	5011402376056
DT5416-QZ	6	93	57	1	1	5011402376070
DT5639-QZ	6.1	101	58	1	1	5035048077047
DT5417-QZ	6.5	101	63	1	1	5011402376094
DT5640-QZ	6.8	109	66	1	1	5035048077054
DT5418-QZ	7	109	69	1	1	5011402376117
DT5641-QZ	7.5	109	66	1	1	5035048077061
DT5642-QZ	7.8	117	75	1	1	5035048077078
DT5643-QZ	7.9	117	75	1	1	5035048077085
DT5419-QZ	8	117	75	1	1	5011402376131
DT5644-QZ	8.5	117	72	1	1	5035048077092
DT5421-QZ	9	125	81	1	1	5011402376155
DT5645-QZ	9.5	125	78	1	1	5035048077108
DT5422-QZ	10	133	87	1	1	5011402376179
DT5646-QZ	10.2	133	84	1	1	5035048077115
DT5647-QZ	10.5	133	84	1	1	5035048077122
DT5424-QZ	11	142	94	1	1	5011402376193
DT5648-QZ	11.5	142	91	1	1	5035048077139
DT5426-QZ	12	151	101	1	1	5011402376216
DT5649-QZ	12.2	151	98	1	1	5035048077146
DT5650-QZ	12.5	151	98	1	1	5035048077153
DT5427-QZ	13	151	101	1	1	5011402376230

BULK PACKS

Cat. No.	Diameter mm	Length mm	Working Length mm	Pack Qty.	M.O.Q.	Barcode
DT5442-QZ	2	49	24	10	1	5011402384518
DT5660-QZ	1.5	40	18	10	1	5035048077160
DT5661-QZ	1.6	43	20	10	1	5035048077177
DT5443-QZ	2.5	57	30	10	1	5011402384525
DT5444-QZ	3	61	33	10	1	5011402384532
DT5662-QZ	3.1	65	36	10	1	5035048077184
DT5446-QZ	3.2	65	36	10	1	5011402384549
DT5447-QZ	3.3	65	36	10	1	5011402384608
DT5448-QZ	3.5	70	39	10	1	5011402384563
DT5449-QZ	4	75	43	10	1	5011402384570
DT5450-QZ	4.1	75	43	10	1	5011402384587
DT5451-QZ	4.2	75	43	10	1	5011402384594
DT5452-QZ	4.5	80	47	10	1	5011402384600
DT5453-QZ	4.8	86	52	10	1	5011402384617
DT5663-QZ	4.9	86	46	10	1	5035048077191
DT5454-QZ	5	86	52	10	1	5011402384624
DT5455-QZ	5.1	86	52	10	1	5011402384631
DT5456-QZ	5.2	86	52	10	1	5011402384648
DT5457-QZ	5.5	93	57	10	1	5011402384655
DT5458-QZ	6	93	57	10	1	5011402384662
DT5664-QZ	6.1	101	58	10	1	5035048077207
DT5459-QZ	6.5	101	63	10	1	5011402384679
DT5460-QZ	6.8	109	69	10	1	5011402384686
DT5461-QZ	7	109	69	10	1	5011402384693
DT5462-QZ	7.5	109	69	10	1	5011402384709
DT5665-QZ	7.8	117	75	10	1	5035048077214
DT5666-QZ	7.9	117	75	10	1	5035048077221
DT5463-QZ	8	117	75	10	1	5011402384716
DT5464-QZ	8.5	117	75	10	1	5011402384723
DT5465-QZ	9	125	81	10	1	5011402384730
DT5466-QZ	9.5	125	81	10	1	5011402384747
DT5467-QZ	10	133	87	10	1	5011402384754
DT5468-QZ	10.2	133	87	10	1	5011402384761
DT5667-QZ	10.5	133	84	5	1	5035048077238
DT5469-QZ	11	142	94	5	1	5011402384778
DT5668-QZ	11.5	142	91	5	1	5035048077245
DT5470-QZ	12	151	101	5	1	5011402384785
DT5669-QZ	12.2	151	98	5	1	5035048077252
DT5670-QZ	12.5	151	98	5	1	5035048077269
DT5471-QZ	13	151	101	5	1	5011402384792

EXTREME DeWALT® 2 METAL DRILL BITS

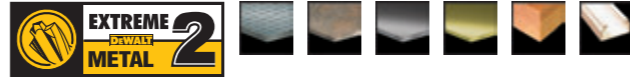

APPLICATIONS

- Suitable for portable drilling of steel, alloyed and non-alloyed up to 900 N/mm<sup>2</sup>.
- For drilling sheet or thin materials (suitable for use in wood and plastics).

FEATURES

- Faster drilling - up to 4x faster than standard HSS-R drill bits.
- Increased durability - up to 50% stronger than standard HSS-R drill bits.
- Cleaner, more accurate, burr-free holes due to recessed cutting wings.
- Innovative tapered web greatly reduces breakage.
- No-Slip shank with 3 flats eliminates slipping in the chuck (diameters 5.0mm and above only).
- Gold Ferrus Oxide coating prevents overheating for longer bit life.



For drilling sets see page 134

SINGLE PACKS

Cat. No.	Diameter mm	Length mm	Working Length mm	Pack Qty.	M.O.Q.	Barcode
DT5034-QZ	1	34	12	2	1	5035048034767
DT5035-QZ	1.5	40	18	2	1	5035048034774
DT5600-QZ	1.6	43	20	2	1	5035048076811
DT5036-QZ	2	49	24	2	1	5035048034781
DT5037-QZ	2.5	57	30	2	1	5035048034798
DT5038-QZ	3	61	33	2	1	5035048034804
DT5601-QZ	3.1	65	36	2	1	5035048076828
DT5039-QZ	3.2	65	36	2	1	5035048034811
DT5040-QZ	3.3	65	36	2	1	5035048034828
DT5041-QZ	3.5	70	39	2	1	5035048034835
DT5042-QZ	4	75	43	2	1	5035048034842
DT5063-QZ	4.1	75	43	1	1	5035048052648
DT5043-QZ	4.2	75	43	1	1	5035048034859
DT5044-QZ	4.5	80	46	1	1	5035048034866
DT5045-QZ	4.8	86	46	1	1	5035048034873
DT5046-QZ	5	86	46	1	1	5035048034880
DT5064-QZ	5.1	86	46	1	1	5035048052655
DT5065-QZ	5.2	86	46	1	1	5035048052662
DT5066-QZ	5.4	93	52	1	1	5035048052679
DT5047-QZ	5.5	93	57	1	1	5035048034897
DT5048-QZ	6	93	57	1	1	5035048034903
DT5603-QZ	6.1	101	58	1	1	5035048076842
DT5049-QZ	6.5	101	58	1	1	5035048034910
DT5067-QZ	6.8	109	66	1	1	5035048052686
DT5050-QZ	7	109	66	1	1	5035048034927
DT5051-QZ	7.5	109	66	1	1	5035048034934
DT5604-QZ	7.8	117	75	1	1	5035048076859
DT5605-QZ	7.9	117	75	1	1	5035048076866
DT5052-QZ	8	117	72	1	1	5035048034941
DT5053-QZ	8.5	117	72	1	1	5035048034958
DT5054-QZ	9	125	78	1	1	5035048034965
DT5055-QZ	9.5	125	78	1	1	5035048034972
DT5056-QZ	10	133	84	1	1	5035048034989
DT5606-QZ	10.2	133	84	1	1	5035048076873
DT5057-QZ	10.5	133	84	1	1	5035048034996
DT5058-QZ	11	142	91	1	1	5035048052006
DT5059-QZ	11.5	142	91	1	1	5035048052013
DT5060-QZ	12	151	98	1	1	5035048052020
DT5061-QZ	12.5	151	98	1	1	5035048052037
DT5062-QZ	13	151	98	1	1	5035048052044

BULK PACKS

Cat. No.	Diameter mm	Length mm	Working Length mm	Pack Qty.	M.O.Q.	Barcode
DT5535-QZ	1	34	12	10	1	5035048052051
DT5536-QZ	1.5	40	18	10	1	5035048052068
DT5615-QZ	1.6	43	20	10	1	5035048076880
DT5537-QZ	2	49	24	10	1	5035048052075
DT5538-QZ	2.5	57	30	10	1	5035048052082
DT5539-QZ	3	61	33	10	1	5035048052099
DT5616-QZ	3.1	65	36	10	1	5035048076897
DT5540-QZ	3.2	65	36	10	1	5035048052105
DT5541-QZ	3.3	65	36	10	1	5035048052112
DT5542-QZ	3.5	70	39	10	1	5035048052129
DT5543-QZ	4	75	43	10	1	5035048052136
DT5544-QZ	4.2	75	43	10	1	5035048052143
DT5545-QZ	4.5	80	46	10	1	5035048052150
DT5546-QZ	4.8	86	46	10	1	5035048052167
DT5617-QZ	4.9	86	46	10	1	5035048076903
DT5547-QZ	5	86	46	10	1	5035048052174
DT5567-QZ	5.1	86	46	10	1	5035048052716
DT5568-QZ	5.2	86	46	10	1	5035048052723
DT5548-QZ	5.5	93	57	10	1	5035048052181
DT5549-QZ	6	93	57	10	1	5035048052198
DT5618-QZ	6.1	101	58	10	1	5035048076910
DT5550-QZ	6.5	101	58	10	1	5035048052204
DT5551-QZ	7	109	66	10	1	5035048052211
DT5552-QZ	7.5	109	66	10	1	5035048052228
DT5619-QZ	7.8	117	75	10	1	5035048076927
DT5620-QZ	7.9	117	75	10	1	5035048076934
DT5553-QZ	8	117	72	10	1	5035048052235
DT5554-QZ	8.5	117	72	10	1	5035048052242
DT5555-QZ	9	125	78	10	1	5035048052259
DT5556-QZ	9.5	125	78	10	1	5035048052266
DT5557-QZ	10	133	84	10	1	5035048052273
DT5621-QZ	10.2	133	84	10	1	5035048076941
DT5558-QZ	10.5	133	84	10	1	5035048052280
DT5559-QZ	11	142	91	10	1	5035048052297
DT5560-QZ	11.5	142	91	10	1	5035048052303
DT5561-QZ	12	151	98	10	1	5035048052310
DT5562-QZ	12.5	151	98	10	1	5035048052327
DT5563-QZ	13	151	98	10	1	5035048052334

HSS-G DIN 338 JOBBER METAL DRILL BITS

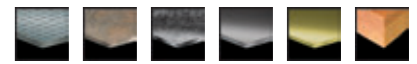

APPLICATIONS

- Suitable for portable or stationary drilling in steel cast steel, alloyed and non-alloyed material, grey cast-iron, spherical-graphite cast iron, sintered iron, nickel, brass, etc up to 900N/mm<sup>2</sup>.

FEATURES

- Precision ground twist drill bit for rapid drilling, long life and excellent concentricity.
- Ground from solid stock right hand cutting, type N flute, precision ground at 118° point angle.
- Diameter tolerance to h8.
- Drills above 13mm (1/2") have a shank reduced to 12.7mm.



SINGLE PACKS

Cat. No.	Diameter mm	Length mm	Working Length mm	Pack Qty.	M.O.Q.	Barcode
DT5201-QZ	1	34	12	2	1	5011402373437
DT5200-QZ	1.1	36	14	2	1	5035048080481
DT5207-QZ	1.2	38	16	2	1	5035048080498
DT5210-QZ	1.3	38	16	2	1	5035048080504
DT5223-QZ	1.4	40	18	2	1	5035048080511
DT5202-QZ	1.5	40	18	2	1	5011402373451
DT5225-QZ	1.6	43	20	2	1	5035048080528
DT5231-QZ	1.7	43	20	2	1	5035048080535
DT5236-QZ	1.8	46	22	2	1	5035048080542
DT5237-QZ	1.9	46	22	2	1	5035048080559
DT5203-QZ	2	49	24	2	1	5011402373475
DT5238-QZ	2.1	49	24	2	1	5035048080566
DT5239-QZ	2.2	53	27	2	1	5035048080573
DT5240-QZ	2.3	53	27	2	1	5035048080580
DT5241-QZ	2.4	57	30	2	1	5035048080597
DT5204-QZ	2.5	57	30	2	1	5011402373499
DT5242-QZ	2.6	57	30	2	1	5035048080603
DT5243-QZ	2.7	61	33	2	1	5035048080610
DT5244-QZ	2.8	61	33	2	1	5035048080627
DT5245-QZ	2.9	61	33	2	1	5035048080634
DT5205-QZ	3	61	33	2	1	5011402373512
DT5246-QZ	3.1	65	36	2	1	5035048080641
DT5206-QZ	3.2	65	36	2	1	5011402373536
DT5247-QZ	3.3	65	36	2	1	5035048080658
DT5248-QZ	3.4	70	39	2	1	5035048080665
DT5208-QZ	3.5	70	39	2	1	5011402373574
DT5249-QZ	3.6	70	39	2	1	5035048080672
DT5250-QZ	3.7	70	39	2	1	5035048080689
DT5251-QZ	3.8	75	43	2	1	5035048080696
DT5252-QZ	3.9	75	43	2	1	5035048080702
DT5209-QZ	4	75	43	2	1	5011402373598
DT5253-QZ	4.1	75	43	1	1	5035048080719
DT5211-QZ	4.2	75	43	1	1	5011402373635
DT5254-QZ	4.3	80	47	1	1	5035048080726
DT5269-QZ	4.4	80	47	1	1	5035048076477
DT5212-QZ	4.5	80	47	1	1	5011402373659
DT5270-QZ	4.6	80	47	1	1	5035048076484
DT5271-QZ	4.7	80	47	1	1	5035048076491
DT5213-QZ	4.8	86	52	1	1	5011402373673
DT5272-QZ	4.9	86	52	1	1	5035048076507
DT5214-QZ	5	86	52	1	1	5011402373697
DT5273-QZ	5.1	86	52	1	1	5035048076514
DT5274-QZ	5.2	86	52	1	1	5035048076521
DT5275-QZ	5.3	86	52	1	1	5035048076538
DT5276-QZ	5.4	93	57	1	1	5035048076545
DT5215-QZ	5.5	93	57	1	1	5011402373710
DT5277-QZ	5.6	93	57	1	1	5035048076552
DT5278-QZ	5.7	93	57	1	1	5035048076569
DT5279-QZ	5.8	93	57	1	1	5035048076576
DT5280-QZ	5.9	93	57	1	1	5035048076583
DT5216-QZ	6	101	63	1	1	5011402373734
DT5281-QZ	6.1	101	63	1	1	5035048076590
DT5282-QZ	6.2	101	63	1	1	5035048076606
DT5283-QZ	6.3	101	63	1	1	5035048076613
DT5284-QZ	6.4	101	63	1	1	5035048076620
DT5217-QZ	6.5	101	63	1	1	5011402373758
DT5285-QZ	6.6	101	63	1	1	5035048076637
DT5255-QZ	6.7	101	63	1	1	5035048080733
DT5256-QZ	6.8	109	69	1	1	5035048080740
DT5257-QZ	6.9	109	69	1	1	5035048080757
DT5218-QZ	7	109	69	1	1	5011402373772
DT5258-QZ	7.1	109	69	1	1	5035048080764
DT5259-QZ	7.2	109	69	1	1	5035048080771
DT5286-QZ	7.3	109	69	1	1	5035048080788
DT5287-QZ	7.4	109	69	1	1	5035048080795
DT5288-QZ	7.6	117	75	1	1	5035048080801
DT5289-QZ	7.7	117	75	1	1	5035048080818
DT5290-QZ	7.8	117	75	1	1	5035048080825
DT5291-QZ	7.9	117	75	1	1	5035048080832
DT5219-QZ	8	117	75	1	1	5011402373796
DT5292-QZ	8.1	117	75	1	1	5035048080849
DT5293-QZ	8.2	117	75	1	1	5035048080856
DT5294-QZ	8.3	117	75	1	1	5035048080863
DT5295-QZ	8.4	117	75	1	1	5035048080870
DT5220-QZ	8.5	117	75	1	1	5011402373819
DT5296-QZ	8.6	125	81	1	1	

HSS-G DIN 338 JOBBER METAL DRILL BITS

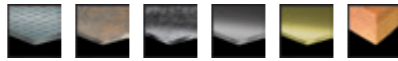

APPLICATIONS

- Suitable for portable or stationary drilling in steel cast steel, alloyed and non-alloyed material, grey cast-iron, spherical-graphite cast iron, sintered iron, nickel, brass, etc up to 900N/mm<sup>2</sup>.

FEATURES

- Precision ground twist drill bit for rapid drilling, long life and excellent concentricity.
- Ground from solid stock right hand cutting, type N flute, precision ground at 118° point angle.
- Diameter tolerance to h8.
- Drills above 13mm (1/2") have a shank reduced to 12.7mm.

SINGLE PACKS

Cat. No.	Diameter mm	Length mm	Working Length mm	Pack Qty.	M.O.Q.	Barcode
DTS420-QZ	9.9	133	87	1	1	5035048081006
DTS222-QZ	10	133	87	1	1	5011402373857
DTS423-QZ	10.2	133	87	1	1	5035048081013
DTS425-QZ	10.5	133	87	1	1	5035048081020
DTS224-QZ	11	142	94	1	1	5011402373895
DTS428-QZ	11.5	142	94	1	1	5035048081037
DTS226-QZ	12	151	101	1	1	5011402373932
DTS429-QZ	12.5	151	101	1	1	5035048081044
DTS227-QZ	13	151	101	1	1	5011402373956
DTS430-QZ	13.5	151	101	1	1	5035048081051
DTS228-QZ	14	160	108	1	1	5011402373970
DTS431-QZ	14.5	160	108	1	1	5035048081068
DTS229-QZ	15	169	114	1	1	5011402373994
DTS432-QZ	15.5	169	114	1	1	5035048081075
DTS230-QZ	16	178	120	1	1	5011402374014
DTS433-QZ	16.5	178	120	1	1	5035048081082
DTS434-QZ	17	178	120	1	1	5035048081099
DTS435-QZ	17.5	178	120	1	1	5035048081105
DTS436-QZ	18	191	130	1	1	5035048081112
DTS437-QZ	18.5	191	130	1	1	5035048081129
DTS438-QZ	19	198	135	1	1	5035048081136
DTS439-QZ	19.5	198	135	1	1	5035048081143
DTS472-QZ	20	205	140	1	1	5035048081150

BULK PACKS

Cat. No.	Diameter mm	Length mm	Working Length mm	Pack Qty.	M.O.Q.	Barcode
DTS301-QZ	1	34	12	10	1	5011402383504
DTS311-QZ	2	49	24	10	1	5011402383603
DTS321-QZ	3	61	33	10	1	5011402383702
DTS332-QZ	4	75	43	10	1	5011402383818
DTS342-QZ	5	86	52	10	1	5011402383917
DTS352-QZ	6	93	57	10	1	5011402384013
DTS362-QZ	7	109	69	10	1	5011402384112
DTS372-QZ	8	117	75	10	1	5011402384211
DTS382-QZ	9	125	81	10	1	5011402384310
DTS392-QZ	10	133	87	10	1	5011402384419
DTS473-QZ	10.2	133	87	5	1	5035048081167
DTS393-QZ	10.5	133	87	5	1	5011402384426
DTS394-QZ	11	142	94	5	1	5011402384433
DTS395-QZ	11.5	142	94	5	1	5011402384440
DTS396-QZ	12	151	101	5	1	5011402384457
DTS398-QZ	13	151	101	5	1	5011402384471

HSS-G DIN 338 JOBBER METAL DRILL BIT SETS

Cat. No.	Description	Diameter mm	Pack Qty.	M.O.Q.	Barcode
DTS921-QZ	10 piece set in plastic cassette.	1, 2, 3, 4, 5, 6, 7, 8, 9, 10	10	1	5011402374137
DTS922-QZ	13 piece set in plastic cassette.	1.5, 2, 2.5, 3, 3.5, 4, 4.5, 5 (x2), 5.5, 6, 6.5	13	1	5011402374151
DTS923-QZ	19 piece set in metal cassette.	1, 1.5, 2, 2.5, 3, 3.5, 4, 4.5, 5, 5.5, 6, 6.5, 7, 7.5, 8, 8.5, 9, 9.5, 10	19	1	5011402374175
DTS929-QZ	29 piece set in metal case	1, 1.5, 2, 2.5, 3, 3.2, 3.3, 3.5, 4, 4.5, 5, 5.5, 6, 6.5, 7, 7.5, 8, 8.5, 9, 9.5, 10, 10.5, 11, 11.5, 12, 12.5, 13	29	1	5035048077429



HSS-G DIN 340 LONG SERIES METAL DRILL BITS

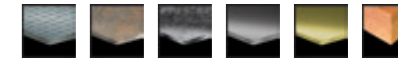

APPLICATIONS

- Used either portable or stationary for drilling of deep holes in steel cast steel, alloyed and non-alloyed material, grey cast-iron, spherical-graphite cast iron, sintered iron, nickel, brass, etc up to 900N/mm<sup>2</sup>.

BULK PACKS

Cat. No.	Diameter mm	Length mm	Working Length mm	Pack Qty.	M.O.Q.	Barcode
DTS776-QZ	1.56	85	55	10	1	5035048081174
DTS707-QZ	3	100	66	10	1	5011402385331
DTS777-QZ	3.1	100	66	10	1	5035048081181
DTS709-QZ	3.2	106	69	10	1	5011402385348
DTS778-QZ	3.3	106	69	10	1	5035048081198
DTS712-QZ	3.5	112	73	10	1	5011402385355
DTS717-QZ	4	119	78	10	1	5011402385379
DTS719-QZ	4.2	119	78	10	1	5011402385393
DTS722-QZ	4.5	126	82	10	1	5011402385409
DTS725-QZ	4.8	132	87	10	1	5011402385416
DTS779-QZ	4.9	132	87	10	1	5035048081204
DTS726-QZ	5	132	87	10	1	5011402385423
DTS731-QZ	5.5	139	91	10	1	5011402385447
DTS736-QZ	6	139	91	10	1	5011402385454
DTS780-QZ	6.1	139	91	10	1	5035048081211
DTS741-QZ	6.5	148	97	10	1	5011402385461
DTS781-QZ	6.8	148	97	10	1	5035048081228
DTS746-QZ	7	156	102	10	1	5011402385478
DTS748-QZ	7.5	156	102	10	1	5011402385485
DTS782-QZ	7.8	156	102	10	1	5035048081235
DTS783-QZ	7.9	156	102	10	1	5035048081242
DTS749-QZ	8	165	109	10	1	5011402385492
DTS784-QZ	8.5	165	109	10	1	5035048081259
DTS785-QZ	9.5	175	115	10	1	5035048081266
DTS753-QZ	10	184	121	10	1	5011402385515
DTS786-QZ	10.2	184	121	5	1	5035048081273
DTS787-QZ	10.5	184	121	5	1	5035048081280
DTS755-QZ	11	195	128	5	1	5011402385522
DTS788-QZ	11.5	195	128	5	1	5035048081297
DTS757-QZ	12	200	134	5	1	5011402385539
DTS789-QZ	12.5	200	134	5	1	5035048081303
DTS759-QZ	13	205	134	5	1	5011402385546

EXTREME DEWALT IMPACT STEP BITS



Coming soon in 2011

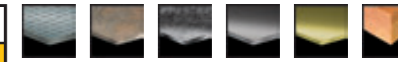

APPLICATIONS

- For drilling and enlarging existing holes from 4mm to 34mm

FEATURES

- Durable hex shank designed to fit all impact drivers

STEP DRILLS

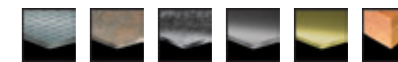

FEATURES

- For drilling and enlarging existing holes from 14mm up to 34mm

SINGLE PACKS

Cat. No.	Description	Pack Qty.	M.O.Q.	Barcode
DTS026-QZ	4-12mm Step Drill	1	1	5035048077276
DTS027-QZ	6-18mm Step Drill	1	1	5035048077283
DTS030-QZ	14-25mm Step Drill	1	1	5035048077290
DTS031-QZ	20-34mm Step Drill	1	1	5035048077306

EXTREME DeWALT IMPACT DRILL BITS

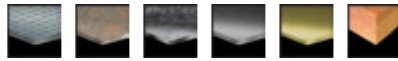

FEATURES

- Full range of metal drill bits designed and optimised for use in an impact driver.
- Unique tip design eliminates walking and increases drilling speed.
- Single piece design, optimised flute angle and hardening process deliver extreme life in impact driver applications.

SINGLE PACKS

Cat. No.	Diameter mm	Length mm	Working Length mm	Pack Qty.	M.O.Q.	Barcode
DT50600-QZ	3	64	26	1	1	5035048081723
DT50601-QZ	3.2	67	29	1	1	5035048081730
DT50602-QZ	3.5	70	29	1	1	5035048081747
DT50603-QZ	4	71	30	1	1	5035048081754
DT50604-QZ	4.2	71	31	1	1	5035048081761
DT50605-QZ	4.5	75	31	1	1	5035048081778
DT50606-QZ	4.8	76	32	1	1	5035048081785
DT50607-QZ	5	78	33	1	1	5035048081792
DT50608-QZ	5.5	78	35	1	1	5035048081808
DT50609-QZ	6	80	37	1	1	5035048081815
DT50610-QZ	6.5	81	38	1	1	5035048081822
DT50611-QZ	7	89	45	1	1	5035048081839
DT50612-QZ	7.5	95	50	1	1	5035048081846
DT50613-QZ	8	102	50	1	1	5035048081853
DT50614-QZ	8.5	102	50	1	1	5035048081860
DT50615-QZ	9	102	50	1	1	5035048081877
DT50616-QZ	10	102	50	1	1	5035048081884
DT50617-QZ	11	102	50	1	1	5035048081891
DT50618-QZ	12	102	50	1	1	5035048081907
DT50619-QZ	13	102	50	1	1	5035048081914

SETS

Cat. No.	Description	Diameter mm	Pack Qty.	M.O.Q.	Barcode
DT705008-QZ	10 piece set	3, 3.2, 3.5, 4, 4.5, 5, 6, 8, 10, 12	10	1	5035048081921



BRAD POINT WOOD DRILL BITS



APPLICATIONS

- Suitable for drilling hardboard, plywood, chipboard and all natural hard and softwood.
- Typically used for doweling applications or wood screw clearance holes.

FEATURES

- Manufactured from chrome vanadium alloyed steel.
- Centre location point and outer cutting spurs for clean accurate holes.

SINGLE PACKS

Cat. No.	Diameter mm	Length mm	Working Length mm	Pack Qty.	M.O.Q.	Barcode
DT4503-QZ	3	70	46	1	1	5011402385553
DT4504-QZ	4	80	52	1	1	5011402385560
DT4505-QZ	5	90	60	1	1	5011402385577
DT4506-QZ	6	100	66	1	1	5011402385584
DT4507-QZ	7	110	72	1	1	5011402385591
DT4508-QZ	8	120	80	1	1	5011402385607
DT4509-QZ	9	130	84	1	1	5011402385614
DT4510-QZ	10	133	90	1	1	5011402385621
DT4511-QZ	11	150	100	1	1	5011402385638
DT4512-QZ	12	155	102	1	1	5011402385645
DT4513-QZ	13	155	102	1	1	5011402385652
DT4514-QZ	14	160	107	1	1	5011402385669
DT4516-QZ	16	165	112	1	1	5011402385683
DT4518-QZ	18	200	130	1	1	5011402385690
DT4520-QZ	20	200	130	1	1	5011402385706

SETS

Cat. No.	Description	Diameter mm	Pack Qty.	M.O.Q.	Barcode
DT4535-QZ	5 piece set in plastic cassette	4, 5, 6, 8, 10	5	1	5011402385713



FRAME DRILL BITS



APPLICATIONS

- For very rapid and accurate drilling of clean holes in hard/softwoods and laminates.

SINGLE PACKS

Cat. No.	Diameter mm	Length mm	Pack Qty.	M.O.Q.	Barcode
DT4870-QZ	7	600	1	1	5035048014035
DT4871-QZ	8	600	1	1	5035048014042
DT4872-QZ	10	600	1	1	5035048014059
DT4873-QZ	12	600	1	1	5035048014066
DT4874-QZ	16	600	1	1	5035048014073
DT4875-QZ	18	600	1	1	5035048014080
DT4876-QZ	20	600	1	1	5035048014097
DT4877-QZ	22	600	1	1	5035048014103

TCT HINGE BORING BITS



APPLICATIONS

- Typically used to fit cantilever hinges.

FEATURES

- Tungsten carbide tipped wood boring tool for clean accurate flat bottom recess holes.
- Hexagonal shank facilitates a firm chuck grip.

SINGLE PACKS

Cat. No.	Diameter mm	Length mm	Pack Qty.	M.O.Q.	Barcode
DT4541-QZ	26	65	1	1	5011402386161
DT4542-QZ	30	65	1	1	5011402386178
DT4543-QZ	35	65	1	1	5011402386185

WOOD AUGER DRILL BITS



APPLICATIONS

- Typically used for boring clean precise holes through beams, joists, doors etc.

FEATURES

- Threaded centre point to aid accurate drilling.
- Outer cutting spur provides clean holes with less splintering.
- Special "Lewis" spiral flute allows for fast removal of debris and rapid drilling.

SINGLE PACKS

Cat. No.	Diameter mm	Length mm	Working Length mm	Pack Qty.	M.O.Q.	Barcode
DT4600-QZ	6	200	100	1	1	5011402385720
DT4602-QZ	8	200	100	1	1	5011402385737
DT4604-QZ	10	200	100	1	1	5011402385744
DT4606-QZ	12	200	100	1	1	5011402385751
DT4608-QZ	14	200	100	1	1	5011402385768
DT4610-QZ	16	200	100	1	1	5011402385775
DT4612-QZ	18	200	100	1	1	5011402385782
DT4614-QZ	20	200	100	1	1	5011402385799
DT4615-QZ	22	200	100	1	1	5011402385805
DT4616-QZ	24	200	100	1	1	5011402385812
DT4618-QZ	26	200	100	1	1	5011402385829
DT4619-QZ	28	200	100	1	1	5011402385836
DT4620-QZ	30	200	100	1	1	5011402385843
DT4621-QZ	32	200	100	1	1	5011402385850
DT4632-QZ	8	380	280	1	1	5011402385867
DT4634-QZ	10	380	280	1	1	5011402385874
DT4636-QZ	12	380	280	1	1	5011402385881
DT4638-QZ	14	380	280	1	1	5011402385898
DT4640-QZ	16	380	280	1	1	5011402385904
DT4642-QZ	18	380	280	1	1	5011402385911
DT4644-QZ	20	380	280	1	1	5011402385928
DT4645-QZ	22	380	280	1	1	5011402385935
DT4646-QZ	24	380	280	1	1	5011402385942
DT4648-QZ	26	380	280	1	1	5011402385959
DT4649-QZ	28	380	280	1	1	5011402385966
DT4650-QZ	30	380	280	1	1	5011402385973
DT4651-QZ	32	380	280	1	1	5011402385980



SELF FEED DRILL BITS

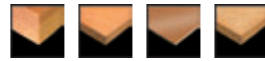

APPLICATIONS

- For rapid drilling of clean large diameter holes in wood.

FEATURES

- 2 x sharp cutting edges for extremely fast drilling in woods with reduced risk of binding.
- Aggressive 'Self feed' spur for rapid penetration into material.
- Non slip shank gives better bit retention in chuck.

SINGLE PACKS

Cat. No.	Diameter mm	Pack Qty.	M.O.Q.	Barcode
DT4575-QZ	25	1	1	5035048072004
DT4576-QZ	28	1	1	5035048072011
DT4577-QZ	32	1	1	5035048072028
DT4578-QZ	35	1	1	5035048072035
DT4579-QZ	38	1	1	5035048072042
DT4580-QZ	41	1	1	5035048072059
DT4581-QZ	45	1	1	5035048072066
DT4582-QZ	51	1	1	5035048072073
DT4583-QZ	54	1	1	5035048072080
DT4584-QZ	57	1	1	5035048072097
DT4585-QZ	65	1	1	5035048072103
DT4586-QZ	68	1	1	5035048072110
DT4587-QZ	74	1	1	5035048072127
DT4588-QZ	76	1	1	5035048072134
DT4589-QZ	92	1	1	5035048072141
DT4590-QZ	117	1	1	5035048072158
DT4591-QZ	Self Feed Set - 5 pce (35mm, 38mm, 54mm, 65mm plus extension bar 140mm)	1	1	5035048072165
DT4592-QZ	Self Feed Extension piece 140mm	1	1	5035048072172

EXTREME DeWALT® FLATWOOD DRILL BITS

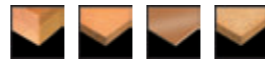

APPLICATIONS

- For the rapid drilling of holes in wood.
- Suitable for natural hard and soft wood, chipboard and other man made materials.
- Ideal for door locks, mortising, electrical and plumbing work.

FEATURES

- Extra thick robust steel shank for outstanding durability and bit life.
- Chamfered outer cutting spurs for clean, very fast drilling and extended drilling life.
- Precision ground central point with optimised design for faster material penetration and increased drilling speed.

SINGLE PACKS

Cat. No.	Diameter mm	Length mm	Pack Qty.	M.O.Q.	Barcode
DT4762-QZ	10	152	1	1	5035048072950
DT4763-QZ	12	152	1	1	5035048072967
DT4764-QZ	13	152	1	1	5035048072974
DT4765-QZ	14	152	1	1	5035048072981
DT4766-QZ	16	152	1	1	5035048072998
DT4767-QZ	18	152	1	1	5035048073001
DT4768-QZ	20	152	1	1	5035048073018
DT4769-QZ	22	152	1	1	5035048073025
DT4770-QZ	24	152	1	1	5035048073032
DT4771-QZ	25	152	1	1	5035048073049
DT4772-QZ	26	152	1	1	5035048073056
DT4773-QZ	28	152	1	1	5035048073063
DT4774-QZ	30	152	1	1	5035048073070
DT4775-QZ	32	152	1	1	5035048073087
DT4776-QZ	35	152	1	1	5035048073094
DT4777-QZ	38	152	1	1	5035048073100
DT4778-QZ	40	152	1	1	5035048073117
DT79438-QZ	8 piece set (12, 16, 18, 20, 22, 25, 28, 32)	152	1	1	5035048073292

EXTREME DeWALT® LONG FLATWOOD DRILL BITS

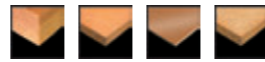

APPLICATIONS

- For the rapid drilling of holes in wood.
- Suitable for natural hard and soft wood, chipboard and other man made materials.
- Ideal for door locks, mortising, electrical and plumbing work.

FEATURES

- Extra thick robust steel shank for outstanding durability and bit life.
- Chamfered outer cutting spurs for clean, very fast drilling and extended drilling life.
- Precision ground central point with optimised design for faster material penetration and increased drilling speed.

SINGLE PACKS

Cat. No.	Diameter mm	Length mm	Pack Qty.	M.O.Q.	Barcode
DT4780-QZ	10	406	1	1	5035048073124
DT4781-QZ	12	406	1	1	5035048073131
DT4783-QZ	14	406	1	1	5035048073155
DT4784-QZ	16	406	1	1	5035048073162
DT4785-QZ	20	406	1	1	5035048073179
DT4786-QZ	22	406	1	1	5035048073186
DT4787-QZ	24	406	1	1	5035048073193
DT4788-QZ	25	406	1	1	5035048073209
DT4789-QZ	26	406	1	1	5035048073216
DT4791-QZ	30	406	1	1	5035048073230
DT4792-QZ	32	406	1	1	5035048073247
DT4793-QZ	35	406	1	1	5035048073254

FLATWOOD DRILL BITS

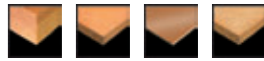

APPLICATIONS

- For the rapid drilling of holes in wood.
- Suitable for natural hard and soft wood, chipboard and other man made materials.
- Ideal for door locks, mortising, electrical and plumbing work.

FEATURES

- High quality chrome vanadium flat drill bit.
- Ground central point and cutting edges for accurate location and clean cutting.
- Ground chip breaker to reduce splintering providing relatively clean holes and improved drilling efficiency.

SINGLE PACKS

Cat. No.	Diameter mm	Length mm	Pack Qty.	M.O.Q.	Barcode
DT4810-QZ	10	150	1	1	5011402385997
DT4812-QZ	12	150	1	1	5011402386000
DT4813-QZ	13	150	1	1	5011402386017
DT4814-QZ	14	150	1	1	5011402386024
DT4816-QZ	16	150	1	1	5011402386031
DT4818-QZ	18	150	1	1	5011402386048
DT4820-QZ	20	150	1	1	5011402386055
DT4822-QZ	22	150	1	1	5011402386062
DT4824-QZ	24	150	1	1	5011402386079
DT4825-QZ	25	150	1	1	5011402386086
DT4826-QZ	26	150	1	1	5011402386093
DT4828-QZ	28	150	1	1	5011402386109
DT4830-QZ	30	150	1	1	5011402386116
DT4832-QZ	32	150	1	1	5011402386123
DT4835-QZ	35	150	1	1	5011402386130
DT4838-QZ	38	150	1	1	5011402386147

FLATWOOD DRILL BIT EXTENSION

Cat. No.	Length mm	Pack Qty.	M.O.Q.	Barcode
DT4849-QZ	300 x 1/4"	1	1	5035048058923



EXTREME IMPACT HOLESAWS



APPLICATIONS

- Ideal for cutting holes in thin metals, plastics and fibreglass board
- For use with all Impact drivers and wrenches

FEATURES

- Optimised tooth design for faster drilling and more holes per charge
- Thin walled design for optimum efficiency in cutting thin materials
- Durable hex shank designed to fit all impact drivers
- Ejection spring for easy plug removal
- Single piece design to avoid lock up on mandrel

SINGLE PACKS

Cat. No.	Diameter mm	Depth of Cut mm	Pack Qty.	M.O.Q.	Barcode
DT8253-QZ	19	5	1	1	5035048079959
DT8254-QZ	22	5	1	1	5035048079966
DT8255-QZ	25	5	1	1	5035048079973
DT8256-QZ	29	5	1	1	5035048079980
DT8257-QZ	32	5	1	1	5035048079997
DT8258-QZ	35	5	1	1	5035048080009
DT8259-QZ	38	5	1	1	5035048080016

BI-METAL DEEP CUT HOLESAWS

APPLICATIONS

- Ideal for cutting holes in steel, stainless steel, brass, copper, aluminium, wood, plastic and other composites.

FEATURES

- Industrial, rugged hole saws designed for heavy duty cutting in standard or deep cut applications.
- Extra hard variable pitch high speed steel teeth.
- M3 Steel cutting edge providing extended holesaw life.
- 12.5 mm deeper cut than standard bi-metal hole saw.
- Increased depth of cutting edge providing extended holesaw cutting life.

SINGLE PACKS

Cat. No.	Diameter mm	Depth of Cut mm	Pack Qty.	M.O.Q.	Barcode
DT8116-QZ	16	38	1	1	5011402370290
DT8119-QZ	19	38	1	1	5011402370306
DT8120-QZ	20	38	1	1	5011402370313
DT8121-QZ	21	38	1	1	5035048061145
DT8122-QZ	22	38	1	1	5011402370320
DT8124-QZ	24	38	1	1	5035048061152
DT8125-QZ	25	38	1	1	5011402370337
DT8127-QZ	27	38	1	1	5035048061169
DT8129-QZ	29	38	1	1	5011402370344
DT8130-QZ	30	38	1	1	5035048061176
DT8132-QZ	32	38	1	1	5011402370351
DT8133-QZ	33	38	1	1	5035048061183
DT8135-QZ	35	38	1	1	5011402370368
DT8138-QZ	38	40	1	1	5011402370375
DT8141-QZ	40	40	1	1	5035048061206
DT8140-QZ	41	40	1	1	5011402370382
DT8143-QZ	43	40	1	1	5035048061213
DT8145-QZ	44	40	1	1	5011402370399
DT8146-QZ	46	40	1	1	5035048061220
DT8148-QZ	48	40	1	1	5035048053683
DT8151-QZ	51	40	1	1	5011402370405
DT8152-QZ	52	40	1	1	5035048061237
DT8154-QZ	54	40	1	1	5035048053690
DT8157-QZ	57	40	1	1	5011402370412
DT8160-QZ	60	40	1	1	5035048053706
DT8164-QZ	64	40	1	1	5011402370429
DT8165-QZ	65	40	1	1	5035048061244
DT8167-QZ	67	40	1	1	5011402370436
DT8168-QZ	68	40	1	1	5035048061251
DT8170-QZ	70	40	1	1	5035048053713
DT8173-QZ	73	40	1	1	5011402370443
DT8176-QZ	76	40	1	1	5035048053720
DT8179-QZ	79	40	1	1	5035048053737
DT8183-QZ	83	40	1	1	5011402370450
DT8186-QZ	86	40	1	1	5035048053744
DT8189-QZ	89	40	1	1	5035048061268
DT8192-QZ	92	40	1	1	5035048053751
DT8195-QZ	95	40	1	1	5011402370467
DT8202-QZ	102	40	1	1	5035048053799
DT8205-QZ	105	40	1	1	5035048053805
DT8208-QZ	108	40	1	1	5035048053812
DT8265-QZ	111	40	1	1	5035048014271
DT8214-QZ	114	40	1	1	5035048053829
DT8221-QZ	121	40	1	1	5035048053836
DT8227-QZ	127	40	1	1	5035048053843
DT8240-QZ	140	40	1	1	5035048053850
DT8252-QZ	152	40	1	1	5035048053867
DT8260-QZ	160	40	1	1	5035048061282
DT8266-QZ	177	40	1	1	5035048014288
DT8267-QZ	210	40	1	1	5035048014295



BI-METAL HOLESAW SETS

FEATURES

- Sets designed specifically for plumbers, electricians and general purpose users.
- All sets supplied in durable plastic boxes for easy transportation and storage



BI-METAL HOLESAW SETS

Cat. No.	Description	Pack Qty.	Barcode
DT8104-XJ	General purpose set in plastic kitbox, 2x hex shank mandrels, 2x pilot drill bits, 9 hole saws ø 16, 19, 25, 32, 38, 44, 48, 51, 64mm.	13 pieces	5035048053768
DT8105-XJ	Electrician's set in plastic kitbox, 2x hex shank mandrels, 2x pilot drill bits, 7 hole saws ø 22, 29, 35, 38, 44, 51, 64mm.	11 pieces	5035048053775
DT8106-XJ	Plumber's set in plastic kitbox, 2x hex shank mandrels, 2x pilot drill bits, 9 hole saws ø 19, 22, 29, 35, 38, 44, 57, 64, 76mm.	13 pieces	5035048053782
DT8110-XJ	Electrician's set in plastic kitbox, 2x hex shank mandrels, 2x pilot drill bits, 7 hole saws ø 16, 20, 25, 32, 40, 51, 64mm.	11 pieces	5035048061336
DT8111-XJ	Electrician's set in plastic kitbox, 2x hex shank mandrels, 2x pilot drill bits, 7 hole saws ø 20, 25, 35, 32, 40, 51, 64mm.	11 pieces	5035048061343

EXTREME DEWALT HOLESAW SETS

Cat. No.	Description	Pack Qty.	M.O.Q.	Barcode
DT8270-QZ	EXTREME DEWALT® EXTREME 11 piece set in plastic kit box - 1x small quick change mandrel, 1x large quick change mandrel, 2x EXTREME pilot drill bits, 7 hole saws ø 22, 29, 35, 44, 51, 64, 68 mm	11	1	5035048073414
DT8269-QZ	EXTREME DEWALT® 11 piece Plumbers Kit - 1x small quick change mandrel, 1x large quick change mandrel, 2x EXTREME pilot drill bits, 7 hole saws ø 19, 22, 29, 38, 44, 51, 57mm	11	1	5035048073995
DT8273-QZ	EXTREME DEWALT® 11 piece Electricians Kit - 1x small quick change mandrel, 1x large quick change mandrel, 2x EXTREME pilot drill bits, 7 hole saws ø 16, 20, 25, 32, 35, 51,64mm	11	1	5035048074008

CARBIDE GRIT HOLESAWS

APPLICATIONS

- Ideal for cutting holes in masonry, light concrete, fibre glass and other abrasive composites.

FEATURES

- Nickel alloy brazed carbide grit edge (Hrcc 85) ensures long life, 'go anywhere' performance.
- Dual directional cut ensures smooth cutting action with no 'kickback'.
- Wear resistant grit ensures longer life when working with abrasive materials such as masonry/concrete.



CARBIDE GRIT HOLESAWS

Cat. No.	Diameter mm	Depth of Cut mm	Pack Qty.	M.O.Q.	Barcode
DT8118-QZ	16	40	1	1	5035048012345
DT8123-QZ	19	40	1	1	5035048012116
DT8126-QZ	20	40	1	1	5035048012123
DT8128-QZ	22	40	1	1	5035048012130
DT8131-QZ	25	40	1	1	5035048012147
DT8134-QZ	29	40	1	1	5035048012154
DT8136-QZ	32	40	1	1	5035048012161
DT8139-QZ	35	40	1	1	5035048012178
DT8142-QZ	38	40	1	1	5035048012185
DT8144-QZ	40	40	1	1	5035048012192
DT8147-QZ	44	40	1	1	5035048012208
DT8149-QZ	48	40	1	1	5035048012215
DT8150-QZ	51	40	1	1	5035048012352
DT8155-QZ	54	40	1	1	5035048012369
DT8156-QZ	57	40	1	1	5035048012222
DT8163-QZ	64	40	1	1	5035048012239
DT8172-QZ	76	40	1	1	5035048012246
DT8174-QZ	68	40	1	1	5035048072875
DT8175-QZ	83	40	1	1	5035048072882
DT8177-QZ	102	40	1	1	5035048072899

CARBIDE GRIT HOLESAW SETS

FEATURES

- Sets designed specifically for plumbers, electricians and general purpose users.
- All sets supplied in durable plastic boxes for easy transportation and storage.



CARBIDE GRIT HOLESAW SETS

Cat. No.	Description	Pack Qty.	M.O.Q.	Barcode
DT8275-QZ	Electrician's set in plastic kitbox, 2 x hex shank mandrels, 2 x pilot drill bits, 7 holesaws ø 16, 20, 25, 32, 40, 51, 64	11	1	5035048012307
DT8276-QZ	Electrician's set in plastic kitbox, 2 x hex shank mandrels, 2 x pilot drill bits, 7 holesaws ø 20, 25, 32, 38, 44, 51, 64	11	1	5035048012314
DT8277-QZ	General purpose set in plastic kitbox, 2 x hex shank mandrels, 2 x pilot drill bits, 9 holesaws ø 16, 19, 25, 32, 38, 44, 48, 51, 64	13	1	5035048012321
DT8278-QZ	Plumber's set in plastic kitbox, 2 x hex shank mandrels, 2 x pilot drill bits, 9 holesaws ø 19, 22, 29, 35, 38, 44, 57, 64, 76	13	1	5035048012338



EXTREME DeWALT QUICK CHANGE MANDRELS



FEATURES

- Fast, tool free changeovers.
- Quick release collar to prevent hole saw lock up
- Available as single units and in sets

FOR USE WITH BI-METAL HOLESAWS

Cat. No.	Description	Pack Qty.	M.O.Q.	Barcode
DT8286-QZ	EXTREME Small Quick Change Mandrel (No drive pins) ø 14mm - 30mm	1	1	5035048073377
DT8288-QZ	EXTREME DeWALT™ Large Quick Change Mandrel (Drive pins) ø 32mm - 210mm	1	1	5035048073391
DT8289-QZ	EXTREME DeWALT™ EXTREME Replacement pilot drill (6.3mm diameter)	1	1	5035048073407

HOLESAW MANDRELS AND ACCESSORIES



FEATURES

- Quick release mandrel prevents lock up of the holesaw on the mandrel enabling easy removal.

FOR USE WITH BI-METAL HOLESAWS

Cat. No.	Description	Pack Qty.	M.O.Q.	Barcode
DT8101-QZ	Mandrel for 14 - 29 mm diameter hole saws. For 10 mm capacity chuck or larger.	1	1	5011402370474
DT8102-QZ	Quick release mandrel for 32 - 210mm diameter hole saws. For 13 mm capacity chuck or larger.	1	1	5011402370481
DT8103-QZ	Replacement pilot drill bit (6.3 mm diameter).	1	1	5011402370498
DT8290-QZ	Extension Rod 300mm. For use with holesaw mandrel DT8102	1	1	5035048061299
DT8295-QZ	Plug Ejection Spring	1	1	5035048061312
DT8107-QZ	Quick release mandrel - SDS+ fitment - for 14-30mm diameter holesaws	1	1	5035048053935
DT8108-QZ	Quick release mandrel - SDS+ fitment - for 32-210mm diameter holesaws	1	1	5035048061329

HOLESAW MANDRELS AND ACCESSORIES



FOR USE WITH CARBIDE GRIT HOLESAWS

Cat. No.	Description	Pack Qty.	M.O.Q.	Barcode
DT8280-QZ	Pilot bit masonry - long	1	1	5035048012253
DT8285-QZ	Pilot bit masonry - small	1	1	5035048013939
DT8281-QZ	Small mandrel & masonry bit	1	1	5035048012260
DT8282-QZ	Large mandrel & masonry bit	1	1	5035048012277
DT8283-QZ	SDS & small mandrel & pilot bit	1	1	5035048012284
DT8284-QZ	SDS & large mandrel & pilot bit	1	1	5035048012291

MIXER TOOLS



MIXER TOOLS

APPLICATIONS

- For wallpaper paste, gloss paint, emulsion, mortar and plaster.

FEATURES

- Universal stirring/mixing tool for hand-held drills with a 13mm chuck. Mixing effect from bottom to top.
- Suitable for DW130.
- M14 version also available.

Cat. No.	Diameter mm	Length mm	Pack Qty.	Shank	M.O.Q.	Barcode
DT4950-QZ	100	600	1	Hex	1	5035048027202
DT4951-QZ	120	600	1	Hex	1	5035048027219
DT4952-QZ	120	600	1	M14	1	5035048011300

CHUCKS AND KEYS



APPLICATIONS

- Professional heavy duty chucks & keys.
- For use with DeWALT and other makes of drills.

FEATURES

- Choose from metal or plastic body.
- Single or twin sleeved.
- Carbide jaws for extra grip.

KEYLESS CHUCKS 10MM/13MM

Cat. No.	Chuck Capacity mm	Fitment	Sleeves	Metal/ Plastic	Pack Qty.	M.O.Q.	Barcode
DT7001-QZ	10	1/2" x 20 UNF	2	Plastic	1	1	5011402371358
DT7040-QZ	10	3/8" x 24 UNF	2	Plastic	1	1	5035048060209
DT7041-QZ	10	1/2" x 20 UNF	2	Metal	1	1	5035048060216
DT7042-QZ	10	1/2" x 20 UNF	1	Metal	1	1	5035048060223
DT7002-QZ	13	1/2" x 20 UNF	2	Plastic	1	1	5011402371365
DT7043-QZ	13	1/2" x 20 UNF	2	Metal	1	1	5035048060230
DT7044-QZ	13	1/2" x 20 UNF	2	Metal/carbide	1	1	5035048060247
DT7045-QZ	13	1/2" x 20 UNF	1	Metal	1	1	5035048060254
DT7046-QZ	13	1/2" x 20 UNF	1	Metal/carbide	1	1	5035048060261
DT7025-QZ	13	1/2" x 20 UNF	2	Plastic/Metal	1	5	5035048061718

KEYED CHUCKS 10MM/13MM

Cat. No.	Chuck Capacity mm	Fitment	Pack Qty.	M.O.Q.	Barcode
DT7013-QZ	10	3/8" x 24 UNF	1	1	5035048060186
DT7011-QZ	10	1/2" x 20 UNF	1	1	5011402371372
DT7012-QZ	13	1/2" x 20 UNF	1	1	5011402371389
DT7014-QZ	13	5/8" x 16 UNF	1	1	5035048060193

CHUCK KEYS

Cat. No.	Chuck Capacity mm	Pack Qty.	M.O.Q.	Barcode
DT7021-QZ	Fits 10 mm and 13 mm chucks (S2).	1	1	5011402371396
DT7022-QZ	Fits 5/8" x 16 UNF keyed chucks (S9).	1	1	5035048060506

SPECIAL CHUCKS/ADAPTORS

Cat. No.	Chuck Capacity mm	Fitment	Pack Qty.	M.O.Q.	Barcode
DT7005-QZ	13	1/2" x 20 UNF keyed chuck with SDS adaptor.	1	1	5035048060278
DT7030-QZ	-	SDS-Plus - 1/2" x 20 UNF (Chuck adaptor).	1	1	5011402371419
DT6829-QZ	-	SDS-Plus - 1/2" x 20 UNF Chuck adaptor / screwdriver bit holder.	1	1	5035048034170
DT7017-QZ	13	2 Sleeve plastic chuck for 2.8kg quick change hammers (eg. D25104K)	1	1	5035048061695
DT7018-QZ	13	2 Sleeve metal chuck for 2.8kg quick change hammers (eg. D25104K)	1	1	5035048061701



SCREWDRIVING ACCESSORIES



APPLICATIONS

- For all heavy duty screwdriving applications

FEATURES

- Durable hex shank designed to fit all impact drivers
- Full hex body design for increased strength and life
- Optimised tip design for reduced cam out
- Heat treated body for increased durability

EXTREME DEWALT IMPACT BITS FOR POZIDRIV SCREWS

Cat. No.	Size	Description	Pack Qty.	M.O.Q.	Barcode
DT7386-QZ	Pz1	25mm Impact bit	5	1	5035048082201
DT7387-QZ	Pz2	25mm Impact bit	5	1	5035048082218
DT7388-QZ	Pz3	25mm Impact bit	5	1	5035048082225
DT7390-QZ	Pz1	50mm Impact bit	5	1	5035048082249
DT7391-QZ	Pz2	50mm Impact bit	5	1	5035048082256
DT7392-QZ	Pz3	50mm Impact bit	5	1	5035048082263

EXTREME DEWALT IMPACT BITS FOR PHILLIPS SCREWS

Cat. No.	Size	Description	Pack Qty.	M.O.Q.	Barcode
DT7993-QZ	Ph1	25mm Impact bit	5	1	5035048082270
DT7994-QZ	Ph2	25mm Impact bit	5	1	5035048082287
DT7995-QZ	Ph3	25mm Impact bit	5	1	5035048082294
DT7997-QZ	Ph1	50mm Impact bit	5	1	5035048082317
DT7998-QZ	Ph2	50mm Impact bit	5	1	5035048082324
DT7999-QZ	Ph3	50mm Impact bit	5	1	5035048082331

EXTREME IMPACT BITS FOR TORX® SCREWS

Cat. No.	Size	Description	Pack Qty.	M.O.Q.	Barcode
DT7379-QZ	T10	25mm Impact bit	5	1	5035048082133
DT7380-QZ	T15	25mm Impact bit	5	1	5035048082140
DT7381-QZ	T20	25mm Impact bit	5	1	5035048082157
DT7382-QZ	T25	25mm Impact bit	5	1	5035048082164
DT7383-QZ	T27	25mm Impact bit	5	1	5035048082171
DT7384-QZ	T30	25mm Impact bit	5	1	5035048082188
DT7385-QZ	T40	25mm Impact bit	5	1	5035048082195
DT7393-QZ	T10	50mm Impact bit	5	1	5035048082843
DT7394-QZ	T15	50mm Impact bit	5	1	5035048082850
DT7395-QZ	T20	50mm Impact bit	5	1	5035048082867
DT7396-QZ	T25	50mm Impact bit	5	1	5035048082874
DT7397-QZ	T27	50mm Impact bit	5	1	5035048082881
DT7398-QZ	T30	50mm Impact bit	5	1	5035048082898
DT7399-QZ	T40	50mm Impact bit	5	1	5035048082904

SCREWDRIVING ACCESSORIES

APPLICATIONS

- For all screwdriving applications.

FEATURES

- High quality professional screwdriver bits.
- Flexible Torsion Zone absorbs torque peaks and reduces breakage.
- All bits are provided in sturdy plastic re-useable storage containers.

SLOTTED BITS

Cat. No.	Size	Description	Pack Qty.	M.O.Q.	Barcode
DT7105-QZ	4.5mm	25mm Torsion bit Slotted	5	1	5035048012437
DT7106-QZ	5.5mm	25mm Torsion bit Slotted	5	1	5035048012444
DT7116-QZ	5.5mm	25mm Torsion bit Slotted	20	1	5035048012475
DT7107-QZ	6.5mm	25mm Torsion bit Slotted	5	1	5035048012451
DT7117-QZ	6.5mm	25mm Torsion bit Slotted	20	1	5035048012482

TORSION BITS FOR POZIDRIV SCREWS

Cat. No.	Size	Description	Pack Qty.	M.O.Q.	Barcode
DT7210-QZ	Pz0	25mm Torsion bit	5	1	5035048012499
DT7211-QZ	Pz1	25mm Torsion bit	5	1	5035048012505
DT7217-QZ	Pz1	25mm Torsion bit	20	1	5035048012512
DT7212-QZ	Pz2	25mm Torsion bit	5	1	5035048012529
DT7218-QZ	Pz2	25mm Torsion bit	20	1	5035048012536
DT7213-QZ	Pz3	25mm Torsion bit	5	1	5035048012543
DT7219-QZ	Pz3	25mm Torsion bit	20	1	5035048012550
DT7214-QZ	Pz4	32mm Torsion bit	5	1	5035048012567
DT7225-QZ	Pz1	50mm bit with "extra grip" ribs	5	1	5035048013083
DT7226-QZ	Pz2	50mm bit with "extra grip" ribs	5	1	5035048013090
DT7227-QZ	Pz3	50mm bit with "extra grip" ribs	5	1	5035048013106

SCREWDRIVING ACCESSORIES

APPLICATIONS

- For all screwdriving applications.

FEATURES

- High quality professional screwdriver bits.
- Flexible Torsion Zone absorbs torque peaks and reduces breakage.
- All bits are provided in sturdy plastic re-useable storage containers.

TORSION BITS FOR PHILLIPS SCREWS

Cat. No.	Size	Description	Pack Qty.	M.O.Q.	Barcode
DT7230-QZ	Ph0	25mm Torsion bit	5	1	5035048012574
DT7231-QZ	Ph1	25mm Torsion bit	5	1	5035048012581
DT7237-QZ	Ph1	25mm Torsion bit	20	1	5035048012598
DT7232-QZ	Ph2	25mm Torsion bit	5	1	5035048012604
DT7238-QZ	Ph2	25mm Torsion bit	20	1	5035048012611
DT7233-QZ	Ph3	25mm Torsion bit	5	1	5035048012628
DT7234-QZ	Ph4	32mm Torsion bit	5	1	5035048012642
DT7235-QZ	Ph2	25mm Reduced tip	5	1	5035048066430
DT7236-QZ	Ph2	25mm Reduced tip	20	1	5035048066423
DT7245-QZ	Ph1	50mm bit with "extra grip" ribs	5	1	5035048013113
DT7246-QZ	Ph2	50mm bit with "extra grip" ribs	5	1	5035048013120
DT7247-QZ	Ph3	50mm bit with "extra grip" ribs	5	1	5035048013137

HEX BITS

Cat. No.	Size	Description	Pack Qty.	M.O.Q.	Barcode
DT7165-QZ	4	25mm Hex bit	5	1	5035048012659
DT7166-QZ	5	25mm Hex bit	5	1	5035048012666
DT7167-QZ	6	25mm Hex bit	5	1	5035048012673
DT7168-QZ	8	25mm Hex bit	5	1	5035048012680

SQUARE BITS

Cat. No.	Size	Description	Pack Qty.	M.O.Q.	Barcode
DT7170-QZ	1	25mm Square bit	5	1	5035048013564
DT7171-QZ	2	25mm Square bit	5	1	5035048013571
DT7172-QZ	3	25mm Square bit	5	1	5035048013588

SCREWDRIVER BITS FOR TORX® SCREWS

Cat. No.	Size	Description	Pack Qty.	M.O.Q.	Barcode
DT7251-QZ	T8	25mm bit for Torx	5	1	5035048012703
DT7252-QZ	T9	25mm bit for Torx	5	1	5035048012710
DT7253-QZ	T10	25mm bit for Torx	5	1	5035048012727
DT7254-QZ	T15	25mm bit for Torx	5	1	5035048012734
DT7265-QZ	T15	25mm bit for Torx	20	1	5035048012741
DT7255-QZ	T20	25mm bit for Torx	5	1	5035048012758
DT7266-QZ	T20	25mm bit for Torx	20	1	5035048012765
DT7270-QZ	T20	25mm bit for Torx	50	1	5035048012772
DT7256-QZ	T25	25mm bit for Torx	5	1	5035048012789
DT7267-QZ	T25	25mm bit for Torx	20	1	5035048012796
DT7271-QZ	T25	25mm bit for Torx	50	1	5035048012802
DT7257-QZ	T27	25mm bit for Torx	5	1	5035048012819
DT7258-QZ	T30	25mm bit for Torx	5	1	5035048012826
DT7268-QZ	T30	25mm bit for Torx	20	1	5035048012833
DT7272-QZ	T30	25mm bit for Torx	50	1	5035048012840
DT7259-QZ	T40	25mm bit for Torx	5	1	5035048012857
DT7290-QZ	T10	70mm bit for Torx	5	1	5035048013182
DT7291-QZ	T15	70mm bit for Torx	5	1	5035048013199
DT7292-QZ	T20	70mm bit for Torx	5	1	5035048013205
DT7293-QZ	T25	70mm bit for Torx	5	1	5035048013212
DT7294-QZ	T27	70mm bit for Torx	5	1	5035048013229
DT7295-QZ	T30	70mm bit for Torx	5	1	5035048013236
DT7296-QZ	T40	70mm bit for Torx	5	1	5035048013243

60 MM DOUBLE ENDED BITS

Cat. No.	Size	Description	Pack Qty.	M.O.Q.	Barcode
DT7304-QZ	Pz1	60mm double ended bits	5	1	5035048013144
DT7305-QZ	Pz2	60mm double ended bits	5	1	5035048013151
DT7315-QZ	Ph2	60mm double ended bits	5	1	5035048013175

110 MM POWER BITS

Cat. No.	Size	Description	Pack Qty.	M.O.Q.	Barcode
DT7203-QZ	Pz2	110mm bit	5	1	5035048013250
DT7204-QZ	Ph2	110mm bit	5	1	5035048013267



SCREWDRIVING ACCESSORIES

APPLICATIONS

- For all screwdriving applications.

PILOT BITS, DRIVE GUIDES & HOLDERS



Cat. No.	Length mm	Description	Pack Qty.	M.O.Q.	Barcode
DT7501-QZ	57	Non-magnetic	1	1	5011402371327
DT7500-QZ	60	Magnetic	1	1	5011402371310
DT7511-QZ	60	Quick change bit holder	1	1	5035048078365
DT7515-QZ	60	Quick connector	1	1	5035048013274
DT7516-QZ	60	Rapidfix holder	1	1	5035048013281
DT7615-QZ	38	Hex Shank Pilot bit 3mm	3	1	5035048013298
DT7616-QZ	43	Hex Shank Pilot bit 4mm	2	1	5035048013304
DT7617-QZ	48	Hex Shank Pilot bit 6mm	2	1	5035048013311
DT7701-QZ	80	DeWALT Screw drive guide 9.5mm diameter	1	1	5035048031995
DT7702-QZ	120	DeWALT Screw drive guide 12mm diameter	1	1	5035048032008
DT7508-QZ		1/2" SQ to 1/4" Hex Impact Wrench Adaptor	1	1	5035048082034
DT7512-QZ		1/4" hex to 1/2" square adaptor	1	1	5035048083055

SCREWDRIVING SETS



APPLICATIONS

- For all screwdriving applications.

FEATURES

- High quality professional screwdriver bits.
- Flexible Torsion Zone absorbs torque peaks and reduces breakage.
- All bits are provided in sturdy plastic re-useable storage containers.

SCREWDRIVING SETS

Cat. No.	Pieces	Description	Pack Qty.	M.O.Q.	Barcode
DT7917-QZ	11	TORX® 7, 8, 9, 10, 15, 20, 25, 27, 30, 40, Magnetic bit holder.	1	1	5035048060445
DT7944-QZ	31	31 Piece Set with 1x2, Pz2x3, Pz3x1, Ph1x2, Ph2x2, Ph3x1, S14.5x1, S15.5x1, S16.5x1, T10x2, T15x2, T20x2, T25x2, T30x2, T40x2, H3x1, H4x2, H5x1 & Quick Connector	1	1	5035048078372
DT7945-QZ	11	TORX® Quick Connector set (T7,8,9,10,15,20,25,27,30,40)	1	1	5035048013328
DT7946-QZ	11	Torx/Pazi Quick Connector set (T15,20,25,30,40Pz1,2x2,2x3)	1	1	5035048013335
DT7915-QZ	11	Torsion with "Extra Grip" ribs, Incl Pz 1,2,3 Ph 1,2,3 Slotted 4.5, 5.5,6.5,8 Magnetic bit holder	1	1	5035048060421
DT7916-QZ	11	Torsion with "Extra Grip" ribs, Incl Pz 1, 2, 3 Ph 1, 2, 3, T10, 15, 20, 25 Magnetic bit holder	1	1	5035048060438
DT7947-QZ	11	Torsion Pz/Ph Quick Connector set (Pz1,2x2,2x3,Ph1,2x2,2x3)	1	1	5035048013342
DT7948-QZ	11	Torsion Pz/Ph/Sl Quick Connector set (Pz1,2x2,3,Ph1,2x2,3 Sl 5.5,6.5)	1	1	5035048013359

EXTREME DeWALT IMPACT SETS



APPLICATIONS

- For all heavy duty screwdriving applications

FEATURES

- Durable hex shank designed to fit all impact drivers
- Full hex body design for increased strength and life
- Optimised tip design for reduced cam out
- Heat treated body for increased durability

EXTREME DeWALT IMPACT SETS

Cat. No.	Description	Pack Qty.	M.O.Q.	Barcode
DT705018-QZ	29pc Impact Screwdriving set	29	1	5035048082591
DT705028-QZ	26pc Impact Drill Drive set - PH/PZ	29	1	5035048082607
DT705038-QZ	26pc Impact Drill Drive set - T	29	1	5035048082614



DeWALT 'FLIP & DRIVE' SYSTEM

APPLICATIONS

- For use in hard and soft wood, composite board and MDF.
- Ideal for cabinet making, furniture assembly, remodelling and shop fitting.

FEATURES

- Complete drill drive accessory system for drilling countersink & pilot holes in one action and screwdriving.
- One-handed connector release with push forward collar for easily changing between drilling and screwdriving applications.
- 5/16" (8mm) shank for added durability.

'FLIP & DRIVE' UNITS



Cat. No.	Size	Description	Pack Qty.	Barcode
DT7600-XJ	No.6	Connector, countersink, pilot drill bit & Pz2 screw driver bit.	1	5035048052365
DT7601-XJ	No.8	Connector, countersink, pilot drill bit & Pz2 screw driver bit.	1	5035048052372
DT7602-XJ	No.10	Connector, countersink, pilot drill bit & Pz2 screw driver bit.	1	5035048052389
DT7603-XJ	No.12	Connector, countersink, pilot drill bit & Pz2 screw driver bit.	1	5035048052396

PILOT BITS



Cat. No.	Size	Description	Pack Qty.	Barcode
DT7608-XJ	No.6	Pilot drill bit	3	5035048031773
DT7609-XJ	No.8	Pilot drill bit	3	5035048031780
DT7610-XJ	No.10	Pilot drill bit	3	5035048031797

COUNTERSINK & PILOT



Cat. No.	Size	Description	Pack Qty.	Barcode
DT7604-XJ	No.6	Pilot drill bit & 4 cutter countersink.	1	5035048052402
DT7605-XJ	No.8	Pilot drill bit & 4 cutter countersink.	1	5035048052419
DT7606-XJ	No.10	Pilot drill bit & 4 cutter countersink.	1	5035048031759
DT7607-XJ	No.12	Pilot drill bit & 4 cutter countersink.	1	5035048031766

DeWALT 'FLIP & DRIVE' SETS

Cat. No.	Size	Description	Pack Qty.	Barcode
DT7612-XJ	No.6, 8,10, 12	Case containing No.6 connector, countersink, pilot bit & Pz 2, No.8, 10, 12 countersink & pilot bits, Pz2 x2, Ph2 x2.	1	5035048031810



DeWALT IMPACT RATED SOCKET SETS



DeWALT IMPACT RATED SOCKET SETS

Cat. No.	Description	M.O.Q.	Barcode
DT7506-QZ	17 Pce Impact Socket Set (6,8,10,11,12,13,14,16,17,18,19,20,21,22,24,27mm & 1/4" to 1/2" Adaptor)	1	5035048078624
DT7507-QZ	9 Pce Impact Socket Set (10,13,15,17,19,22,24,27mm) 1/4" to 1/2" Adaptor	1	5035048078631
DT7512-QZ	1/4" to 1/2" Impact Driver Adaptor	1	5035048083055

HEXAGONAL SOCKET DRIVERS - 50 MM



SINGLE PACKS

Cat. No.	Size	Description	Pack Qty.	M.O.Q.	Barcode
DT7415-QZ	6	Magnetic	1	1	5035048061473
DT7416-QZ	6.35	Magnetic	1	1	5035048061480
DT7401-QZ	7	Magnetic	1	1	5011402371181
DT7402-QZ	8	Magnetic	1	1	5011402371198
DT7403-QZ	10	Magnetic	1	1	5011402371204
DT7422-QZ	11	Magnetic	1	1	5035048077580
DT7423-QZ	11	12 Point Magnetic	1	1	5035048077597
DT7404-QZ	13	Magnetic	1	1	5011402371211
DT7424-QZ	17	Magnetic	1	1	5035048077603

DRILLING ACCESSORY SETS - MASONRY



MASONRY DRILL BIT SETS

Cat. No.	Description	Diameter mm	Pack Qty.	M.O.Q.	Barcode
DT6952-QZ	5 piece set in plastic cassette	4, 5, 6, 8, 10	5	1	5011402373413



EXTREME DeWALT® MASONRY DRILL BIT SETS

Cat. No.	Description	Diameter mm	Pack Qty.	M.O.Q.	Barcode
DT6956-QZ	5 piece set in plastic cassette.	4,5,6,8,10	5	1	5035048060797
DT7928-QZ	Small tough case in blister with EXTREME DeWALT® Masonry drill bits. Ph2x4, Pz2x4, Ph2x50mm, Pz2x50mm, Slotted 5.5x50mm, Magnetic holder, Magnetic drive guide.	4, 5, 5.5, 6, 7, 8	19	1	5035048072219



SDS-PLUS EXTREME DeWALT® 2 DRILL BIT SETS

Cat. No.	Description	Diameter mm	Pack Qty.	M.O.Q.	Barcode
DT9700-QZ	4 piece set in plastic cassette.	5,6,8,10	4	1	5035048056400
DT9701-QZ	7 piece set in metal cassette.	5,6x2,8x2,10,12	7	1	5035048056417
DT9702-QZ	4 piece set in plastic cassette.	5,5,7,8,10	4	1	5035048056424

DRILLING ACCESSORY SETS - METAL



EXTREME DeWALT® 2 METAL DRILL BIT SETS

Cat. No.	Description	Pack Qty.	M.O.Q.	Barcode
DT7920B-QZ	Small tough case in blister with EXTREME DeWALT® 2 Metal drill bits 1.5, 2, 2.5, 3, 3.2, 3.5, 4, 4.5, 5, 5.5, 6, 6.5, 7.	13	1	5035048072189
DT7921B-QZ	Small tough case in blister with EXTREME DeWALT® 2 Metal drill bits 1.5, 2, 2.5, 3, 3.2, 3.5, 4, 4.5, 5, 5.5, 6, 6.5, 7.	13	1	5035048072196
DT7926-XJ	Large tough case with EXTREME DeWALT® 2 Metal drill bits 1,1.5, 2, 2.5, 3, 3.2, 3.3, 3.5, 4, 4.2, 4.5, 4.8, 5, 5.5, 6, 6.5, 7, 7.5, 8, 8.5, 9, 9.5, 10, 10.5, 11, 11.5, 12, 12.5, 13 mm.	29	1	5035048052341

HSS-R DIN 338 JOBBER METAL DRILL BIT SETS

Cat. No.	Description	Diameter mm	Pack Qty.	M.O.Q.	Barcode
DT5911-QZ	10 piece set in plastic cassette.	1, 2, 3, 4, 5, 6, 7, 8, 9, 10	10	1	5011402383191
DT5912-QZ	13 piece set in plastic cassette.	1.5, 2, 2.5, 3, 3.2, 3.5, 4, 4.5, 5(x2), 5.5, 6, 6.5	13	1	5011402383207
DT5913-QZ	19 piece set in metal cassette.	1, 1.5, 2, 2.5, 3, 3.5, 4, 4.5, 5, 5.5, 6, 6.5, 7, 7.5, 8, 8.5, 9, 9.5, 10	19	1	5011402383214
DT5930-QZ	29 piece set in metal case.	1,1.5, 2, 2.5, 3, 3.2, 3.3, 3.5, 4, 4.2, 4.5, 4.8, 5, 5.5, 6, 6.5, 7, 7.5, 8, 8.5, 9, 9.5, 10, 10.5, 11, 11.5, 12, 12.5, 13	29	1	5035048077436

HSS-G DIN 338 JOBBER METAL DRILL BIT SETS

Cat. No.	Description	Diameter mm	Pack Qty.	M.O.Q.	Barcode
DT5921-QZ	10 piece set in plastic cassette.	1, 2, 3, 4, 5, 6, 7, 8, 9, 10	10	1	5011402374137
DT5922-QZ	13 piece set in plastic cassette.	1.5, 2, 2.5, 3, 3.2, 3.3, 3.5, 4, 4.5, 5 (x2), 5.5, 6, 6.5	13	1	5011402374151
DT5923-QZ	19 piece set in metal cassette.	1, 1.5, 2, 2.5, 3, 3.5, 4, 4.5, 5, 5.5, 6, 6.5, 7, 7.5, 8, 8.5, 9, 9.5, 10	19	1	5011402374175
DT5929-QZ	29 piece set in metal case	1,1.5, 2, 2.5, 3, 3.2,3.3,3.5, 4, 4.2, 4.5, 4.8, 5, 5.5, 6, 6.5, 7, 7.5, 8, 8.5, 9, 9.5, 10,10.5, 11,11.5, 12, 12.5, 13	29	1	5035048077429



HSS-CO EXTREME DeWALT® COBALT DRILL BIT SETS

Cat. No.	Description	Diameter mm	Pack Qty.	M.O.Q.	Barcode
DT5940-QZ	6 piece set in plastic cassette	2, 3, 4, 5, 6, 8	6	1	5011402376254
DT5928-QZ	29 piece Cobalt set in plastic case	1,1.5, 2, 2.5, 3, 3.2, 3.3, 3.5, 4, 4.2, 4.5, 4.8, 5, 5.5, 6, 6.5, 7, 7.5, 8, 8.5, 9, 9.5, 10,10.5, 11, 11.5, 12, 12.5, 13 mm.	29	1	5035048077412

DRILLING ACCESSORY SETS - WOOD



WOOD DRILL BIT SETS

Cat. No.	Description	Diameter mm	Pack Qty.	M.O.Q.	Barcode
DT4535-QZ	5 piece set in plastic cassette	4, 5, 6, 8, 10	5	1	5011402385713
DT4591-QZ	5 piece self feed bit set.	35, 38, 54, 65 plus Extension bar 140mm	5	1	5035048072165

MAG BOX MAGNETIC SETS



APPLICATIONS

- Flexible storage solution fits most common accessories

FEATURES

- Compact design for easy storage and portability
- High impact materials for optimum durability
- High strength magnets and built in hooks for increased functionality

MAG BOX MAGNETIC SETS

Cat. No.	Description	Pack Qty.	M.O.Q.	Barcode
DT7918-QZ	Magnetic Set - Ph1, Ph2, Ph3, PZ1, PZ2 x 2, PZ3, T20, T25, 50mm Ph2, 50mm Ph3, Magnetic holder, 7mm, 8mm, 10mm socket drivers	15	1	5035048082553
DT7919-QZ	Magnetic Impact Set - Ph1, Ph2, Ph3, PZ1, PZ2 x 2, PZ3, T20, T25, 50mm Ph2, 50mm Ph3, Magnetic holder, 7mm, 8mm, 10mm socket drivers	15	1	5035048082560
DT7965-QZ	Magnetic Impact Set - 3mm, 4mm Impact drills, Ph1, Ph2, Ph3, PZ1, PZ2 x 2, PZ3, T20, T25, 50mm Ph2, 50mm Ph3, Magnetic holder, 7mm, 8mm, 10mm socket drivers	20	1	5035048083208

TOUGH CASE STORAGE



SMALL TOUGH CASE SETS

Cat. No.	Description	Pack Qty.	M.O.Q.	Barcode
DT7928B-QZ	Small tough case in blister with 6 piece EXTREME DeWALT® Masonry drill bits 4, 5, 5.5, 6, 7, 8. Ph2x4, Pz2x4, Ph2x50mm, Pz2x50mm, Slotted 5.5x50mm, Magnetic holder, Magnetic drive guide.	19	1	5035048072219
DT7920B-QZ	Small tough case in blister with EXTREME DeWALT® 2 Metal drill bits 1.5, 2, 2.5, 3, 3.2, 3.5, 4, 4.5, 5, 5.5, 6, 6.5, 7.	13	1	5035048072189
DT7921B-QZ	Small tough case in blister with EXTREME DeWALT® 2 Metal drill bits 1.5, 2, 2.5, 3, 3.2, 3.5, 4, 4.5, 5, 5.5, 6, 6.5, 7.	13	1	5035048072196
DT7922B-QZ	Small tough in blister case with Ph1, 2x6, 3, Pz1, 2x6, 3, T10, 15, 20, 25, 30, 40, Slotted 5.5, 8, Ph2x50mm, Pz2x50mm, Slotted 5.5x50mm, Magnetic holder, Magnetic drive guide.	29	1	5035048072202
DT7942-QZ	Small tough case with EXTREME DeWALT® Cobalt bits 4, 1.5, 2, 2.5, 3, 3.2, 4, 4.5, 5, 5.5, 6, 6.5, 7	13	1	5035048066003
DT70500B-QZ	10 piece Impact metal drilling set 3, 3.2, 3.5, 4, 4.5, 5, 6, 8, 10, 12	10	1	5035048081921
DT70501B-QZ	29pc Impact Screwdriving set	29	1	5035048082591
DT70502B-QZ	26pc Impact Drill Drive set - PH/PZ	29	1	5035048082607
DT70503B-QZ	26pc Impact Drill Drive set - T	29	1	5035048082614

MEDIUM TOUGH CASE SETS

Cat. No.	Description	Pack Qty.	M.O.Q.	Barcode
DT7933B-QZ	Medium tough case set in blister with 45 screwdriving bits. (Pz2x10, Ph2x10, Sl6x5, Sl4x5, T10x5, T15x3, T25x3) screwguide, bit holder and nutdrivers (x2).	45	1	5035048072233
DT7934B-QZ	Medium tough case 42 piece Hex shank set in blister with Screwdriver bits - Pz2x10, Ph2x10, Sl6x5, Pz2x2(50mm), Ph2x2(50mm), Hex shank pilot drill bits - 1.5mmx2, 2mmx2, 3mmx2, 4mmx1, 5mmx1, 6mmx1, Screwguide, bit holder and nutdrivers(x2).	42	1	5035048072240
DT7935B-QZ	Medium tough case in blister with SDS Plus EXTREME DeWALT® 2 drill bits 5, 6x2(110mm), 6x2, 7, 8, 9, 10, 12, 160mm	10	1	5035048072257
DT7937B-QZ	Medium tough case in blister with SDS Plus EXTREME DeWALT® 2 drill bits 5, 6, 6.5, 7, 8, Extreme® Masonry drill bits 4, 5, 2x6, 7, 2x8, Pz1x2, Pz2x2, Pz3, Ph1, Ph2x2, Ph3 25mm bits	21	1	5035048072271
DT7939-QZ	Medium tough case with SDS Plus EXTREME DeWALT® 2 drill bits 5, 5.5, 6, 7, 8, Pz1x2, Pz2x2, Pz3, Ph1, Ph2x2, Ph3 25mm bits, T10, T15, T20, T25, T30, T40 25mm bits, Sl4.5mm, Sl5.5mm, Sl6.5mm 25mm bits, Pz1x2, Pz2x2, Pz3, Ph1x2, Ph2x2, Ph3 50mm bits, T20, T25, T30 70mm bits, Magnetic bit holder, 7mm, 8mm socket drivers	39	1	5035048011386
DT7936B-QZ	Medium tough case in blister with SDS EXTREME DeWALT® Plus 2 drill bits 5, 6, 6.5, 8, 10, Pz1x2, Pz2x2, Pz3, Ph1, Ph2x2, Ph3 25mm bits, T10, T15, T20, T25, T30, T40 25mm bits, Sl4.5mm, Sl5.5mm, Sl6.5mm 25mm bits, Pz1x2, Pz2x2, Pz3, Ph1x2, Ph2x2, Ph3 50mm bits, T20, T25, T30 70mm bits, Magnetic bit holder, 7mm socket driver, 8mm socket drive	39	1	5035048072264
DT7938B-QZ	Medium tough case set in blister with EXTREME DeWALT® 2 Metal drill bits 1, 1.5, 2, 2.5, 3, 3.2, 3.3, 3.5, 4, 4.2, 4.5, 4.8, 5, 5.5, 6, 6.5, 7, 7.5, 8, 10, 12, Pz1, Pz2x2, Pz3, Ph1, Ph2, Ph3, T20, T25 25mm bits, Magnetic drive guide, Magnetic bit holder, T20, T25 70mm, Pz2 bits, Ph2 50mm bits	36	1	5035048072288

LARGE TOUGH CASE SETS

Cat. No.	Description	Pack Qty.	M.O.Q.	Barcode
DT7926-XJ	Large tough case with EXTREME DeWALT® 2 Metal drill bits 1,1.5, 2, 2.5, 3, 3.2, 3.3, 3.5, 4, 4.2, 4.5, 4.8, 5, 5.5, 6, 6.5, 7, 7.5, 8, 8.5, 9, 9.5, 10, 10.5, 11, 11.5, 12, 12.5, 13 mm.	29	1	5035048052341
DT5928-QZ	Cobalt 29 piece set with Plastic Tough Case 1,1.5, 2, 2.5, 3, 3.2, 3.3, 3.5, 4, 4.2, 4.5, 4.8, 5, 5.5, 6, 6.5, 7, 7.5, 8, 8.5, 9, 9.5, 10, 10.5, 11, 11.5, 12, 12.5, 13 mm.	29	1	5035048077412
DT5929-QZ	HSS-G 29 piece set with Metal Case 1,1.5, 2, 2.5, 3, 3.2, 3.3, 3.5, 4, 4.2, 4.5, 4.8, 5, 5.5, 6, 6.5, 7, 7.5, 8, 8.5, 9, 9.5, 10, 10.5, 11, 11.5, 12, 12.5, 13 mm.	29	1	5035048077429
DT5930-QZ	HSS-R 29 piece set with Metal Case 1,1.5, 2, 2.5, 3, 3.2, 3.3, 3.5, 4, 4.2, 4.5, 4.8, 5, 5.5, 6, 6.5, 7, 7.5, 8, 8.5, 9, 9.5, 10, 10.5, 11, 11.5, 12, 12.5, 13 mm.	29	1	5035048077436



MODULAR ACCESSORY CASES



Made from tough, heavy-duty plastic, the full size modular accessory case can carry a very large selection of accessory items as well as providing plenty of storage space for other consumables such as plugs and fixings.

MODULAR ACCESSORY CASES

Cat. No.	Description	M.O.Q.	Barcode
DT9289-QZ	90 piece set	1	5035048082041
DT9290-QZ	106 piece set	1	5035048082058
DT9291-QZ	95 piece set including EXTREME DeWALT® Masonry, Extreme DeWALT® 2 Metal, Flatwood, SDS Plus, Torx, Pz, Ph & pilot bits	1	5035048012376
DT9292-QZ	100 piece set including EXTREME DeWALT® Masonry, Extreme DeWALT® 2 Metal, Flatwood, SDS Plus, Torx, Slotted, Pz, Ph, 50mm bits & pilot bits	1	5035048012383
DT9293-QZ	100 piece set including EXTREME DeWALT® Masonry, Extreme DeWALT® 2 Metal, Flatwood, Bradpoint, Torx, Slotted, Pz, Ph, 50mm bits & pilot bits	1	5035048012390
DT9294-QZ	100 piece set including EXTREME DeWALT® Masonry, Extreme DeWALT® 2 Metal, Flatwood, Bradpoint, Torx, Slotted, Pz, Ph, 50mm bits & pilot bits	1	5035048012406
DT9296-QZ	90 piece set	1	5035048061626
DT9298-QZ	106 piece set	1	5035048245385
DT9299-QZ	100 piece set	1	5035048245392

MINI MAC CASE SETS



Offering excellent value, the more compact 'Mini' modular accessory case provides the same robustness and job-site durability as well as being easy to store away in situations where space is at a premium.

MINI MAC CASE SETS

Cat. No.	Description	M.O.Q.	Barcode
DT9281-QZ	63 piece set with EXTREME DeWALT® Masonry (4,5,6x2,8x2 mm), EXTREME DeWALT® 2 Metal (1,5,2,2,5,3,3,5,4,4,5,5,5,5,6,6,5,7mm). Screwdriver bits: 50mm Pz2, Ph2, SlS.5, Sl6.5, 25mm Ph1, Ph2x3, Ph3, Pz1, Pz2x23, Pz3, T15, T20x2, T25x3, T30, T40, Magnetic bit holder and drive guide	1	5035048073308
DT9282-QZ	57 piece set with Brad Point (3,4,5,6,8,10,12mm), EXTREME DeWALT® Flatwood (12,14,16,20,22,25mm). Screwdriver bits: 50mm Pz2, Ph2, SlS.5, Sl6.5, 25mm Ph1, Ph2x2, Ph3, Pz1, Pz2x3, Pz3, T15, T20x22, T25x3, T30, T40, Magnetic bit holder and drive guide	1	5035048073315
DT9283-QZ	69 piece set with EXTREME DeWALT® SDS-Plus (6x110,6x160x2,8x160x2,10x160), EXTREME DeWALT® 2 Metal (1,5,2,2,5,3,3,5,4,4,5,5,5,5,6,6,5,7mm), EXTREME DeWALT® Masonry (4,5,6x2,8x2 mm). Screwdriver bits: 50mm Pz2, Ph2, SlS.5, Sl6.5, 25mm Ph1, Ph2x2, Ph3, Pz1, Pz2x3, Pz3, T15, T20x22, T25x3, T30, T40, Magnetic bit holder and drive guide	1	5035048073322
DT9284-QZ	77 piece set with EXTREME DeWALT® Cobalt (1,5,2,2,5,3,3,5,4,4,5,5,5,5,6,6,5,7mm), EXTREME DeWALT® 2 Metal (1,1,5,2,2,5,3,3,2,3,3,3,5,4,4,2,4,5,4,8,5,5,5,6,6,5,7,7,5,8,10,12mm) Screwdriver bits: 50mm Pz2, Ph2, SlS.5, Sl6.5, 25mm Ph1, Ph2x3, Ph3, Pz1, Pz2x23, Pz3, T15, T20x2, T25x3, T30, T40, Magnetic bit holder and drive guide	1	5035048073339
DT9285-QZ	65 piece set with HSS-G (1,1,5,2,2,5,3,3,2,3,3,3,5,4,4,2,4,5,4,8,5,5,5,6,6,5,7,7,5,8,10,12mm). Screwdriver bits: 50mm Pz2, Ph2, SlS.5, Sl6.5, 25mm Ph1, Ph2x3, Ph3, Pz1, Pz2x23, Pz3, T15, T20x2, T25x3, T30, T40, Magnetic bit holder and drive guide	1	5035048073346
DT9286-QZ	72 piece set with Masonry Bits (4,5,6x2,8x2 mm), HSS-G (1,1,5,2,2,5,3,3,2,3,3,3,5,4,4,2,4,5,4,8,5,5,5,6,6,5,7,7,5,8,10,12mm). Screwdriver bits: 50mm Pz2, Ph2, SlS.5, Sl6.5, 25mm Ph1, Ph2x2, Ph3, Pz1, Pz2x3, Pz3, T15, T20x22, T25x3, T30, T40, Magnetic bit holder and drive guide	1	5035048073353
DT9287-QZ	85 piece set with HSS-G (1,1,5,2,2,5,3,3,2,3,3,3,5,4,4,2,4,5,4,8,5,5,5,6,6,5,7,7,5,8,10,12mm). Screwdriver bits: 50mm Pz2, Ph2, SlS.5, Sl6.5, 25mm Ph1, Ph2x23, Ph3, Pz1, Pz2x23, Pz3, T15, T20x2, T25x3, T30, T40, Magnetic bit holder and drive guide	1	5035048073445

EXTREME DeWALT® STATIONARY CIRCULAR SAW BLADES



• See individual blades for machine fitment, material suitability and finish.

- Teeth remain sharp for longer through use of extra-large sub micrograin carbide teeth.
- Exceptional surface finish due to unique anti-vibration slots that minimise blade vibration.
- Extended cutting life in difficult materials such as tropical hardwoods and MDF through use of corrosion resistant carbide teeth.
- Excellent blade to spindle fitting is provided by honed arbor holes.

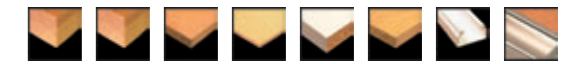

EXTREME DeWALT® STATIONARY CIRCULAR SAW BLADES

Cat. No.	Diameter /Bore	Plate / Kerf	Teeth	Grind	Rake	Fast Rip	General Purpose	Fine Finish	Extra Fine Finish	Aluminium	Barcode
DT4211-QZ	210/30	1.8/2.6	18	ATB	25°	•					5035048057360
DT4221-QZ	210/30	1.8/2.6	24	ATB	-5°		•				5035048057421
DT4250-QZ	210/30	1.8/2.6	40	ATB	10°			•			5035048057520
DT4252-QZ	210/30	1.8/2.6	48	ATB	-5°			•			5035048057544
DT4253-QZ	210/30	1.8/2.6	56	TCG	-5°			•			5035048057551
DT4285-QZ	210/30	1.8/2.6	80	TCG	-5°				•	•	5035048057698
DT4254-QZ	215/30	1.8/2.6	60	TCG	-5°			•			5035048057568
DT4310-QZ	216/30	1.8/2.6	24	ATB	-5°	•					5035048057827
DT4320-QZ	216/30	1.8/2.6	48	ATB	-5°		•				5035048057902
DT4350-QZ	216/30	1.8/2.6	60	ATB	-5°			•			5035048058107
DT4370-QZ	216/30	1.8/2.6	60	TCG	-5°				•		5035048058220
DT4286-QZ	216/30	1.8/2.6	80	TCG	-5°					•	5035048057704
DT4213-QZ	250/30	2.2/3.0	24	ATB	-5°	•					5035048057384
DT4311-QZ	250/30	2.2/3.0	24	FT	10°	•					5035048057834
DT4321-QZ	250/30	2.2/3.0	30	ATB	10°		•				5035048057919
DT4226-QZ	250/30	2.2/3.0	30	ATB	20°		•				5035048057476
DT4322-QZ	250/30	2.2/3.0	40	ATB	10°		•				5035048057926
DT4323-QZ	250/30	2.2/3.0	48	ATB	20°		•				5035048057933
DT4351-QZ	250/30	2.2/3.0	60	ATB	10°			•			5035048058114
DT4352-QZ	250/30	2.2/3.0	60	TCG	-5°			•			5035048058121
DT4353-QZ	250/30	2.2/3.0	80	ATB	10°			•			5035048058138
DT4354-QZ	250/30	2.2/3.0	80	ATB	-5°			•			5035048058145
DT4287-QZ	250/30	2.2/3.0	80	TCG	-5°				•	•	5035048057711
DT4373-QZ	250/30	2.2/3.0	80	TCG	10°				•		5035048058251
DT4282-QZ	250/30	2.2/3.0	96	TCG	-5°				•	•	5035048057667
DT4214-QZ	260/30	1.8/2.6	24	ATB	15°	•					5035048057391
DT4312-QZ	260/30	1.8/2.6	24	ATB	15°	•					5035048057841
DT4324-QZ	260/30	1.8/2.6	48	ATB	10°		•				5035048057940
DT4280-QZ	260/30	1.8/2.6	80	TCG	-5°				•	•	5035048057643
DT4314-QZ	300/30	2.2/3.0	30	ATB	10°	•					5035048057865
DT4327-QZ	300/30	2.2/3.0	48	ATB	10°		•				5035048057971
DT4328-QZ	300/30	2.2/3.0	60	ATB	10°		•				5035048057988
DT4329-QZ	300/30	2.2/3.0	60	TCG	10°			•			5035048057995
DT4357-QZ	300/30	2.2/3.0	72	TCG	10°			•			5035048058176
DT4281-QZ	300/30	2.2/3.0	80	TCG	-5°				•	•	5035048057650
DT4376-QZ	300/30	2.2/3.0	96	TCG	10°				•		5035048058299
DT4378-QZ	300/30	2.2/3.0	96	TCG	-5°					•	5035048058305
DT4210-QZ	305/30	1.8/2.6	32	ATB	-5°	•					5035048057353
DT4330-QZ	305/30	2.2/3.0	36	ATB	-5°		•				5035048058008
DT4340-QZ	305/30	2.2/3.0	48	ATB	10°		•				5035048061909
DT4260-QZ	305/30	1.8/2.6	60	ATB	-5°			•			5035048057629
DT4331-QZ	305/30	2.2/3.0	60	ATB	-5°			•			5035048058015
DT4283-QZ	305/30	1.8/2.6	80	TCG	-5°				•		5035048057674
DT4288-QZ	305/30	2.2/3.0	80	TCG	-5°				•	•	5035048057728
DT4290-QZ	305/30	2.2/3.0	96	TCG	-5°				•	•	5035048057742
DT4215-QZ	315/30	2.2/3.0	24	ATB	10°	•					5035048057407
DT4332-QZ	315/30	2.2/3.0	48	ATB	10°		•				5035048058022
DT4358-QZ	315/30	2.2/3.0	72	ATB	10°			•			5035048058183
DT4289-QZ	315/30	2.2/3.0	80	TCG	-5°				•	•	5035048057735
DT4333-QZ	350/30	2.2/3.0	42	ATB	10°		•				5035048058039
DT4334-QZ	350/30	2.2/3.0	54	ATB	10°		•				5035048058046
DT4359-QZ	350/30	2.2/3.0	80	TCG	-5°			•			5035048058190
DT4360-QZ	350/30	2.2/3.0	84	ATB	10°			•			5035048058206
DT4291-QZ	350/30	2.2/3.0	96	TCG	-5°				•	•	5035048057759
DT4317-QZ	400/30	2.5/3.0	36	ATB	10°		•				5035048057896
DT4338-QZ	400/30	2.5/3.5	60	ATB	10°		•				5035048058084



FLAT TOP GRIND (FT)

Teeth ground flat across top with 0 degree bevel. Best for ripping and general purpose, where quality of finish is less important than cut force.



ALTERNATE TOP BEVEL (ATB)

Teeth where the top bevel alternates from left to right, with bevel angle ranging 10 to 25 degrees. Ideal for cross cutting in hard and softwoods and general purpose woodcutting.



TRIPLE CHIP GRIND (TCG)

Flat top teeth alternate with slightly trapezoidal teeth that make a narrower cut, to prevent chipping brittle materials such as laminates.



HOLLOW GRIND (HG)

Very sharp edges designed to leave a chip-free finish - top and bottom. Ideal for cutting double sided composite board, eg. melamine.



EXTREME DeWALT® PORTABLE CIRCULAR SAW BLADES



- See individual blades for machine fitment, material suitability and finish.

- Excellent surface finish ensured by laser-cut expansion slots that reduce vibration and noise.
- Consistently precise cutting from a balanced and tensioned laser-cut plate.
- Longer intervals between re-sharpenings through use of large micrograin carbide teeth.

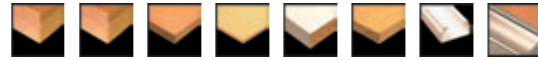

EXTREME DeWALT® PORTABLE CIRCULAR SAW BLADES

Cat. No.	Diameter / Bore	Plate / Kerf	Teeth	Grind	Rake	Fast Rip	General Purpose	Fine Finish	Extra Fine Finish	Aluminium	Barcode
DT4053-QZ	150/20	1.8/2.6	30	ATB	10°						5035048056943
DT4081-QZ	150/20	1.8/2.6	40	TCG	-5°						5035048057124
DT4004-QZ	152/20	1.8/2.6	12	ATB	25°	•					5035048056592
DT4022-QZ	152/20	1.8/2.6	18	ATB	25°		•				5035048056745
DT4055-QZ	152/20	1.8/2.6	30	ATB	10°			•			5035048056967
DT4005-QZ	160/16	1.8/2.6	24	ATB	25°		•				5035048056608
DT4056-QZ	160/16	1.8/2.6	36	ATB	10°			•			5035048056974
DT4083-QZ	160/16	1.8/2.6	48	TCG	-5°						5035048057148
DT4006-QZ	160/20	1.8/2.6	12	ATB	25°	•					5035048056615
DT4023-QZ	160/20	1.8/2.6	24	ATB	25°		•				5035048056752
DT4057-QZ	160/20	1.8/2.6	36	ATB	10°			•			5035048056981
DT4084-QZ	160/20	1.8/2.6	48	TCG	-5°						5035048057155
DT4024-QZ	160/30	1.8/2.6	24	ATB	25°		•				5035048056769
DT4085-QZ	160/30	1.8/2.6	48	TCG	-5°						5035048057162
DT4025-QZ	165/16	1.8/2.6	24	ATB	25°		•				5035048056776
DT4026-QZ	165/20	1.8/2.6	24	ATB	25°		•				5035048056783
DT4087-QZ	165/20	1.8/2.6	48	TCG	-5°						5035048057186
DT4007-QZ	165/30	1.8/2.6	12	ATB	25°	•					5035048056622
DT4027-QZ	165/30	1.8/2.6	24	ATB	25°		•				5035048056790
DT4088-QZ	165/30	1.8/2.6	48	TCG	-5°						5035048057193
DT4058-QZ	170/30	1.8/2.6	30	ATB	10°			•			5035048056998
DT4059-QZ	180/30	1.8/2.6	30	ATB	10°			•			5035048057001
DT4091-QZ	180/30	1.8/2.6	48	TCG	-5°						5035048057223
DT4012-QZ	184/16	1.8/2.6	12	ATB	25°	•					5035048056677
DT4011-QZ	184/16	1.8/2.6	16	ATB	25°	•					5035048056660
DT4031-QZ	184/16	1.8/2.6	28	ATB	25°		•				5035048056837
DT4063-QZ	184/16	1.4/2.6	40	ATB	10°			•			5035048057049
DT4092-QZ	184/16	1.8/2.6	48	TCG	-5°						5035048057230
DT4032-QZ	184/20	1.8/2.6	28	ATB	25°		•				5035048056844
DT4062-QZ	184/20	1.8/2.6	40	ATB	10°			•			5035048057032
DT4034-QZ	190/20	1.8/2.6	28	ATB	10°		•				5035048056868
DT4065-QZ	190/20	1.8/2.6	40	ATB	10°			•			5035048057063
DT4095-QZ	190/20	1.8/2.6	48	TCG	-5°						5035048057261
DT4013-QZ	190/30	1.8/2.6	16	ATB	25°	•					5035048056684
DT4033-QZ	190/30	1.8/2.6	28	ATB	10°		•				5035048056851
DT4064-QZ	190/30	1.8/2.6	40	ATB	10°			•			5035048057056
DT4094-QZ	190/30	1.8/2.6	48	TCG	-5°						5035048057254
DT4096-QZ	200/30	1.8/2.6	56	TCG	-5°						5035048057278
DT4224-QZ	230/30	2.2/3.0	28	ATB	25°		•				5035048057452
DT4225-QZ	230/30	2.2/3.0	40	ATB	10°			•			5035048057469
DT4256-QZ	230/30	2.2/3.0	56	TCG	-5°						5035048057582
DT4037-QZ	235/25.4	2.2/3.0	28	ATB	25°		•				5035048056889
DT4068-QZ	235/25.4	2.2/3.0	40	ATB	10°			•			5035048057094
DT4098-QZ	235/25.4	2.2/3.0	56	TCG	-5°						5035048057292
DT4015-QZ	235/30	2.2/3.0	18	ATB	25°	•					5035048056707
DT4036-QZ	235/30	2.2/3.0	28	ATB	25°		•				5035048056882
DT4067-QZ	235/30	2.2/3.0	40	ATB	10°			•			5035048057087
DT4097-QZ	235/30	2.2/3.0	56	TCG	-5°						5035048057285
DT4016-QZ	240/30	2.2/3.0	18	ATB	20°	•					5035048056714
DT4038-QZ	240/30	2.2/3.0	28	ATB	20°		•				5035048056905
DT4069-QZ	240/30	2.2/3.0	40	ATB	20°			•			5035048057100
DT4099-QZ	240/30	2.2/3.0	56	TCG	-5°						5035048057308

CORDLESS CIRCULAR SAW BLADES



- Heavy duty tungsten carbide tips maintain cutting edge for longer blade life.
- Thin kerf blade design - yields more cuts per charge by minimising battery drain.
- Triple action sharpening process which grinds the tip to a razor sharp edge for a smooth finish.
- Specifically designed for use with DEWALT Cordless Trimsaws. The range comprises of blades for cutting wood and for cutting plastic & non-ferrous metals.

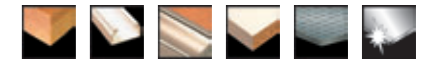

CORDLESS CIRCULAR SAW BLADES

Cat. No.	Diameter / Bore	Plate / Kerf	Teeth	Grind	Rake	Fast Rip	General Purpose	Fine Finish	Extra Fine Finish	Aluminium	Stainless Steel	Barcode
DT1200-QZ	136/10	1.5	16	ATB	+20°	•						5011402378159
DT1201-QZ	136/10	1.5	24	ATB	+20°		•					5011402370160
DT1202-QZ	136/10	1.5	30	FT	+3°			•	•			5011402378173
DT1203-QZ	165/10	1.5	18	ATB	+20°	•						5035048031056
DT1204-QZ	165/10	1.5	24	ATB	+20°		•					5035048031063
DT1205-QZ	165/10	1.5	36	FT	+3°			•	•			5035048031186
DT1208-QZ	165/20	1.5	16	ATB	+20°	•						5035048060490
DT1207-QZ	165/20	1.5	24	ATB	+20°		•					5035048060483
DT1206-QZ	165/20	1.5	36	FT	+3°			•	•			5035048060476
DT1210-XJ	173/20	2.2	50	TCG	0°					•		5035048056431
DT1266-QZ	173/20	1.8	40	MTCG	0°						•	5035048080429
DT1211-QZ	184/20	1.8	24	ATB	+18°		•					5035048061992

PORTABLE CIRCULAR SAW BLADES



- See individual blades for machine fitment, material suitability and finish.

- Precision ground cutting angles for excellent blade sharpness and faster cutting.
- "K20" extra robust carbide and unique wedge shoulder design for greater durability.
- Thick steel plate hard body for professional quality.



FOR CONSTRUCTION MATERIALS

Cat. No.	Diameter / Bore	Plate / Kerf	Teeth	Grind	Rake	Additional Insert Rings	Fast Rip	General Purpose	Barcode
DT1164-QZ	150/20	1.5/2.4	12	ATB	+20°		•		5035048011263
DT1140-QZ	152/20	1.5/2.4	12	ATB	+20°		•		5035048011010
DT1141-QZ	152/20	1.5/2.4	24	ATB	+10°			•	5035048011027
DT1142-QZ	160/20	1.5/2.4	18	ATB	+20°	16		•	5035048011034
DT1143-QZ	160/20	1.5/2.4	30	ATB	+10°	16		•	5035048011041
DT1166-QZ	165/20	1.5/2.4	18	ATB	+20°		•		5035048080290
DT1167-QZ	165/20	1.5/2.4	30	ATB	+10°			•	5035048080306
DT1144-QZ	165/30	1.5/2.4	18	ATB	+20°	16, 20		•	5035048011058
DT1145-QZ	165/30	1.5/2.4	30	ATB	+10°	16, 20		•	5035048011065
DT1146-QZ	170/30	1.5/2.4	18	ATB	+20°		•		5035048011072
DT1147-QZ	170/30	1.5/2.4	30	ATB	+10°			•	5035048011089
DT1149-QZ	184/16	1.7/2.6	18	ATB	+20°		•		5035048011102
DT1151-QZ	184/16	1.7/2.6	30	ATB	+10°			•	5035048011126
DT1148-QZ	184/30	1.7/2.6	18	ATB	+20°	20		•	5035048011096
DT1150-QZ	184/30	1.7/2.6	30	ATB	+10°	20		•	5035048011119
DT1165-QZ	190/16	1.7/2.6	18	ATB	+20°		•		5035048014318
DT1152-QZ	190/30	1.7/2.6	18	ATB	+20°	20		•	5035048011133
DT1153-QZ	190/30	1.7/2.6	40	ATB	+10°	16, 20		•	5035048011140
DT1175-QZ	230/30	1.7/2.6	24	ATB	+20°		•		5035048080313
DT1176-QZ	230/30	1.7/2.6	40	ATB	+10°			•	5035048080320
DT1156-QZ	235/30	1.7/2.6	24	ATB	+20°	25.4	•		5035048011171
DT1157-QZ	235/30	1.7/2.6	40	ATB	+10°	25.4		•	5035048011188



- FAST RIP**
- Blades designed for fast rip of soft and hard natural wood
  - Ideal for pre-sizing applications
  - ATB grind geometry, low tooth count and aggressive rake angles



- GENERAL PURPOSE & CROSS CUT**
- For all purpose rip and cross cutting in natural wood, plywood, laminates and particle board
  - ATB grind geometry, medium tooth count and positive rake angles allow the blades to cut at higher feed speeds



- FINE FINISH & CROSS CUT**
- For smooth cross cuts in plywood, softwood, and all hardwoods
  - ATB grind geometry, high tooth count and tuned grinding angles give excellent surface finish



- EXTRA FINE FINISH**
- Blades designed for EXTRA fine cuts in plywood, veneers, laminates and plastics
  - Blades are tuned to avoid breakout on laminate materials
  - TCG grind geometry gives excellent surface finish on workpiece



- ALUMINIUM CUTTING**
- Blades optimised for cutting in Aluminium
  - TCG grind geometry gives clean and accurate finish on workpiece

PORTABLE CIRCULAR SAW BLADES 150mm TO 240mm



- STEP 1: SELECT TOOL FITMENT & BLADE SIZE
- STEP 2: SELECT MATERIAL TO BE CUT
- STEP 3: SELECT FINISH REQUIRED

1.		Diameter Ø mm Bore Ø mm			150 20	152 20	160 16	160 20	160 30	165 16	165 20		165 30	170 30	180 30	184 16	184 20	184 30	190 16	190 20	190 30	200 30	230 30	235 25.4	235 30	240 30		
2. Material	3. Cut	Teeth	Geometry	Angle																								
Plywood Natural Wood MDF	Fast Rip	12	ATB	25		DT4004		DT4006																				
		16	ATB	25																								
		18	ATB	25																							DT4015	DT4016
	General Purpose	18	ATB	25		DT4022																						
		24	ATB	25			DT4005	DT4023	DT4024	DT4025	DT4026		DT4027															
		28	ATB	10																	DT4034	DT4033						
		28	ATB	20																							DT4038	
		28	ATB	25													DT4031	DT4032						DT4224	DT4037	DT4036		
	Fine Finish	30	ATB	10		DT4053	DT4055								DT4058	DT4059												
		36	ATB	10				DT4056	DT4057																			
		40	ATB	10													DT4063	DT4062			DT4065	DT4064		DT4225	DT4068	DT4067	DT4069	
		40	ATB	20																								
		48	ATB	5									DT1090															
	Veneers Laminates Plastics Aluminium	Extra Fine Finish	40	TCG	-5	DT4081																						
			48	TCG	-5				DT4084	DT4085		DT4087		DT4088		DT4091	DT4092					DT4095	DT4094					
56			TCG	-5																			DT4096	DT4256	DT4098	DT4097	DT4099	
Construction Materials Softwood Reclaimed wood Wood with nails	Fast Rip	12	ATB	20	DT1164	DT1140																						
		18	ATB	20				DT1142			DT1166		DT1144	DT1146		DT1149		DT1148	DT1165		DT1152							
		24	ATB	20																							DT1156	
	General Purpose	24	ATB	20		DT1141																						
		30	ATB	20				DT1143			DT1167		DT1145	DT1147		DT1151		DT1150										
		40	ATB	20																	DT1153				DT1157			

For geometry details refer to page 135



EXTREME DeWALT® PORTABLE CIRCULAR SAW BLADES



• Blades designed specifically for use with plunge saws. See individual blades for details.



FOR PLUNGE SAWS

Cat. No.	Diameter / Bore	Plate / Kerf	Teeth	Grind	Rake	Fast Rip	General Purpose	Fine Finish	Extra Fine Finish	Aluminium	Barcode
DT1089-QZ	165/20	1.6/2	18	ATB		•					5035048083383
DT1091-QZ	165/20	1.6/2	40	ATB			•				5035048072677
DT1090-QZ	165/20	1.6/2	48	ATB				•			5035048066416
DT1086-QZ	165/20	1.6/2	48	TCG					•		5035048083352
DT1087-QZ	165/20	1.6/2	54	MTCG					•		5035048083369
DT1088-QZ	165/20	1.6/2	54	TCG					•	•	5035048083376

BLADE FOR CORDLESS MITRE SAW



Specially for use with DW017 24V Mitre Saw



BLADE FOR CORDLESS MITRE SAW

Cat. No.	Blade Diameter	Bore Size mm	Plate Thickness mm	Kerf Thickness mm	Tooth Count	Grind Geometry	Rake Angle	Barcode
DT1700-QZ	216	30	1.6	2.4	24	ATB	0°	5035048056448

INSERT RINGS



INSERT RINGS

Cat. No.	Outside diameter mm	Inside diameter mm	Thickness mm	Pack Qty.	M.O.Q.	Barcode
DT1094-QZ	30	16	1.8	10	10	5011402382071
DT1095-QZ	30	20	1.8	10	10	5011402382088
DT1096-QZ	30	25	1.8	10	10	5011402382095
DT1099-QZ	30	25	2.2	10	10	5011402382101

XPC WOOD CUTTING BLADES



FEATURES

- Unique jigsaw blade solution for ultimate control and accuracy of cut, even on the tightest of corners
- New optimised tooth angle provides long life and clean tear-free cuts at high speed in all wood materials
- Plunge Point tip design for easy plunge cutting with no 'kick-back' in all wood materials
- Extra long life bi-metal blades provide up to twice the number of cuts of standard HCS blades

T SHANK & U-SHANK

Cat. No.	Applications	Overall Length mm	Working Length mm	Tooth Pitch mm	Max DOC mm	Equivalent Bosch Reference	Pack Qty.	Barcode
DT2205-QZ	For clean and fast accurate cutting in wood, chipboard, plywood, laminates and plastic up to 30mm thick.	100	75	2.5	30	T101B	5	5035048074978
DT2206-QZ	For clean and fast accurate cutting in wood, chipboard, plywood, laminates and plastic up to 30mm thick.	100	75	2.5	30	T101B	20	5035048074985
DT2207-QZ	Downcutter blade for clean, splinter free cutting in laminates and wood up to 40mm thick.	100	75	2.5	40	T101BR	5	5035048074992
DT2209-QZ	For clean and fast accurate cutting in wood, chipboard, plywood, laminates and plastic up to 60mm thick.	100	75	4.2	60	T101D	5	5035048074992
DT2210-QZ	For clean and fast accurate cutting in wood, chipboard, plywood, laminates and plastic up to 60mm thick.	100	75	4.2	60	T101D	20	5035048074992
DT2211-QZ	For coarse accurate cutting in wood, chipboard, plywood, laminates and plastic up to 60mm thick.	100	75	3.1	60	T111C	5	5035048074992
DT2212-QZ	For coarse accurate cutting in wood, chipboard, plywood, laminates and plastic up to 60mm thick.	100	75	3.1	60	T111C	20	5035048074992
DT2213-QZ	For fast accurate cutting in wood, chipboard, plywood, laminates and plastic up to 60mm thick.	100	75	4.2	60	T144D	5	5035048074992
DT2214-QZ	For fast accurate cutting in wood, chipboard, plywood, laminates and plastic up to 60mm thick.	100	75	4.2	60	T144D	20	5035048074992
DT2216-QZ	Scroller blade for fast accurate curve cutting in wood, chipboard and plywood up to 15mm thick. NOT suitable for plunge cutting	82	54	2.0	15	T119B0	5	5035048074992
DT2217-QZ	Bi-metal blade for extra long life. For clean and fast accurate cutting in wood, chipboard, plywood, laminates and plastic up to 30mm thick	100	75	2.5	30	T101BF	3	5035048074992
DT2218-QZ	Bi-metal blade for extra long life. For clean and fast accurate cutting in wood, chipboard, plywood, laminates and plastic up to 60mm thick	100	75	4.0	60	T1101DF	3	5035048074992
DT2219-QZ	Bi-metal blade for extra long life. Downcutter blade for clean, splinter free cutting in laminates and wood up to 40mm thick	100	75	2.5	40	T101BRF	3	5035048074992
DT2220-QZ	Bi-metal blade for extra long life. For fast accurate cutting in wood, chipboard, plywood, laminates and plastic up to 60mm thick	100	75	4.0	60	T144DF	3	5035048074992
DT2221-QZ	Bi-metal blade for extra long life. For fast accurate cutting in aluminium up to 15mm and plastics up to 30mm	100	75	3.0	30	T127DF	3	5035048074992
DT2208-QZ	For clean and fast accurate cutting in wood, chipboard, plywood, laminates and plastic up to 30mm thick. U shank blade	94	75	2.5	30	U101B	5	5035048074992
DT2215-QZ	For fast accurate cutting in wood, chipboard, plywood, laminates and plastic up to 60mm thick. U shank blade	94	75	4.0	60	U144D	5	5035048074992

BLADE KITS

Cat. No.	Description	Contents	Barcode
DT2296-QZ	10 piece jigsaw kit	DT2209 x2, DT2205 x2, DT2213 x2, DT2216, DT2218, DT2217, DT2220	5035048065142
DT2298-QZ	14 piece jigsaw kit	DT2209 x3, DT2205 x3, DT2213 x3, DT2216 x2, DT2218, DT2217, DT2220	5035048065159

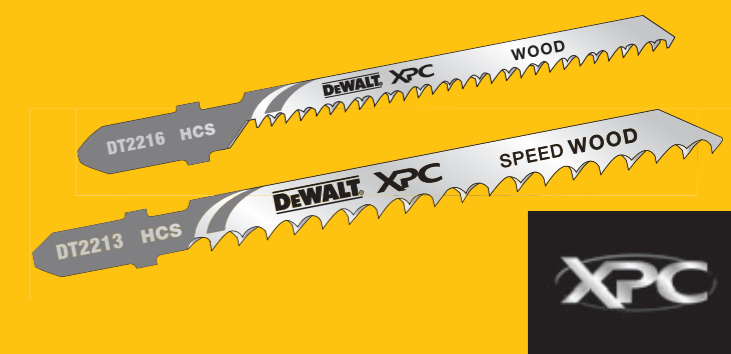

WOOD CUTTING BLADES



FEATURES

- DEWALT HCS jigsaw blades are engineered to deliver a quality cut in a variety of materials, including wood, laminates and plastics.
- Made from high carbon steel.
- For use in soft materials such as wood, laminates, plywood, chipboard and plastics.



T SHANK

Cat. No.	Applications	Overall Length mm	Working Length mm	Tooth Pitch mm	Max DOC mm	Equivalent Bosch Reference	Pack Qty.	Barcode
DT2177-QZ	For coarse, straight cuts in wood & plastic up to 60mm thick.	100	72	3	60	T111C	20	5035048033210
DT2187-QZ	For coarse, straight cuts in wood & plastic up to 60mm thick.	100	72	3	60	T111C	100	5035048033227
DT2050-QZ	Scroller blade - for softwoods, plywood & chipboard - basic cutting up to 15mm thick.	76	48	2	15	T119B0	5	5035048060896
DT2052-QZ	Wood, chip & fibreboard - fast/clean cutting up to 60mm thick.	116	87	3	65	T301CD	5	5035048060919
DT2053-QZ	For wood & laminates - downcutter for 'splinter free' cuts.	100	73	2.5	40	T101BR	5	5035048060926
DT2164-QZ	For fast, straight cuts in wood, chipboard, plywood, laminated chipboard & plastic up to 60mm thick.	100	68	4	60	T101D	5	5035048033128
DT2174-QZ	For fast, straight cuts in wood, chipboard, plywood, laminated chipboard & plastic up to 60mm thick.	100	68	4	60	T101D	20	5035048033159
DT2184-QZ	For fast, straight cuts in wood and chipboard up to 60mm thick.	100	68	4	60	T101D	100	5035048033203
DT2165-QZ	For straight, fine cuts in wood, chipboard, plywood, laminated chipboard & plastic up to 30mm thick.	100	73	2.5	30	T101B	5	5035048033135
DT2175-QZ	For straight, fine cuts in wood, chipboard, plywood, laminated chipboard & plastic up to 30mm thick.	100	73	2.5	30	T101B	20	5035048033166
DT2185-QZ	For straight, fine cuts in wood, chipboard, plywood, laminated chipboard & plastic up to 30mm thick.	100	73	2.5	30	T101B	100	5035048033197
DT2168-QZ	For fine, curve cutting in wood, chipboard, plywood, laminated chipboard & plastic up to 30mm thick.	76	47	1.4	30	T101AO	5	5035048033234
DT2049-QZ	For clean extra straight cutting in wood and chipboard up to 60mm thick. (Extra thick blade).	100	68	4	60	T101DP	5	5035048060889
DT2051-QZ	Wood & plywood, chip & fibreboard - fast/rough cutting up to 85mm thick.	132	100	4	85	T301DL	5	5035048060902
DT2077-QZ	Scroller blade - for wood & chipboard - fast curve cutting up to 60mm thick.	100	70	4	60	T244D	5	5035048060858
DT2166-QZ	For fast, straight cuts in wood and chipboard up to 60mm thick.	100	68	4	60	T144D	5	5035048033142
DT2176-QZ	For fast, straight cuts in wood and chipboard up to 60mm thick.	100	68	4	60	T144D	20	5035048033173
DT2186-QZ	For fast straight cuts in wood, chipboard, plywood, laminated chipboard & plastic up to 60mm thick.	100	68	4	60	T144D	100	5035048033180
DT2169-QZ	For fast, straight cuts in wood & chipboard up to 100mm thick.	152	116	4	100	T344D	5	5035048033241
DT2048-QZ	For clean cuts in wood, chipboard, plywood & laminates up to 65mm thick.	116	87	2.5	65	T301BCP	5	5035048060872
DT2074-QZ	For straight fine cuts in wood - cuts flush to surface 180°.	112	74	2.3	65	T142HB	1	5035048060827
DT2075-QZ	For fast extra straight cutting in wood and chipboard up to 60mm thick. (Extra thick blade).	100	68	4	60	T144DP	5	5035048060834
DT2076-QZ	For fast extra straight cutting in wood and chipboard up to 100mm thick. (Extra thick blade).	152	116	4	100	T344DP	5	5035048060841
DT2057-QZ	For wood, chipboard & fibreboards up to 65mm thick. Progressor blade for fast cutting in different material thicknesses.	116	91	2-3	65	T234X	5	5035048060964
DT2167-QZ	For fast, rough cuts in thick construction timber up to 120mm thick.	180	155	4	120	T744D	5	5035048014455

U SHANK

Cat. No.	Applications	Overall Length mm	Working Length mm	Tooth Pitch mm	Max DOC mm	Equivalent Bosch Reference	Pack Qty.	Barcode
DT2062-QZ	For basic cuts in wood & chipboard up to 60mm thick.	91	70	2.5	60	U111D	5	5035048061015
DT2060-QZ	For straight fine cuts in wood, chipboard, plywood, laminates & plastic up to 30mm thick.	100	78	2.5	30	U101B	5	5035048060995
DT2061-QZ	For fast straight cuts in wood & chipboard up to 60mm thick.	100	76	4	60	U144D	5	5035048061008

EXTREME DEWALT® BI-METAL METAL CUTTING BLADES



FEATURES

- DEWALT HSS jigsaw blades are engineered to deliver a quality cut in a variety of ferrous and non-ferrous materials.
- EXTREME DEWALT® bi-metal blades are designed for long life and extra durability in ferrous and non-ferrous materials
- Fully hardened high speed steel for increased durability.
- For use in aluminium, ferrous and non-ferrous materials.

T SHANK

Cat. No.	Applications	Overall Length mm	Working Length mm	Tooth Pitch mm	Max DOC mm	Equivalent Bosch Reference	Pack Qty.	Barcode
DT2150-QZ	For fast cuts in steel to 3mm thick. Also for aluminium, copper, brass and other soft metals to 3mm thick.	86	61	1	3	T118AF	3	5035048059425
DT2154-QZ	For fast cuts in steel to 6mm thick. Also for aluminium, copper, brass and other soft metals from 3-5mm thick.	76	51	1.8	6	T118BF	3	5035048059432
DT2156-QZ	For fast cuts in sheet metal to 2.5mm thick.	76	51	0.8	2.5	T118GF	3	5035048059449
DT2054-QZ	Bi-Metal - scroller blade for mainly metal - curve cutting & thin sheet metal from 1.5-4mm thick.	82	55	1.5	4	T118EOF	5	5035048060933

METAL CUTTING BLADES



FEATURES

- DEWALT HSS jigsaw blades are engineered to deliver a quality cut in a variety of ferrous and non-ferrous materials.
- Fully hardened high speed steel for increased durability.
- For use in aluminium, ferrous and non-ferrous materials.

T SHANK

Cat. No.	Applications	Overall Length mm	Working Length mm	Tooth Pitch mm	Max DOC mm	Equivalent Bosch Reference	Pack Qty.	Barcode
DT2160-QZ	For straight cuts in thin metal, non-ferrous metal, aluminium & sheet metal from 1.5-4mm thick.	76	50	1.2	4	T118A	5	5035048033050
DT2170-QZ	For straight cuts in thin metal, non-ferrous metal, aluminium & sheet metal from 1.5-4mm thick.	76	50	1.2	4	T118A	20	5035048033098
DT2190-QZ	For straight cuts in thin metal, non-ferrous metal, aluminium & sheet metal from 1.5-4mm thick.	76	50	1.2	4	T118A	100	5035048034057
DT2161-QZ	For straight cuts in thick metal, non-ferrous metal & aluminium from 2.5-6mm thick.	76	50	2	6	T118B	5	5035048033067
DT2171-QZ	For straight cuts in thick metal, non-ferrous metal & aluminium from 2.5-6mm thick.	76	50	2	6	T118B	20	5035048033104
DT2191-QZ	For straight cuts in thick metal, non-ferrous metal & aluminium from 2.5-6mm thick.	76	50	2	6	T118B	100	5035048034064
DT2162-QZ	For straight cuts in very thin metal, non-ferrous metal & aluminium from 0.8-2mm thick.	76	50	0.7	2	T118G	5	5035048033074
DT2172-QZ	For straight cuts in very thin metal, non-ferrous metal, sheet metal & aluminium from 0.8-2mm thick.	76	50	0.7	2	T118G	20	5035048033111
DT2085-QZ	For straight cuts in thin metal, non-ferrous metal (1.5-3mm) and aluminium up to 65mm thick.	132	108	1.2	3	T318A	5	5035048070581
DT2163-QZ	For fast, straight cuts in aluminium 4-15mm; metal & non-ferrous metal 4-6mm & plastic up to 30mm thick.	100	72	3		Aluminium 15, Metal 6, Plastic 30	5	5035048033081
DT2058-QZ	For metal plate - thick & thin pipes & profiles, aluminium for thicknesses of 1.5-10mm. Progressor blade for fast cutting in different material thicknesses.	100	74	1.2-2.6	10	T123X	5	5035048060971

METAL CUTTING BLADES

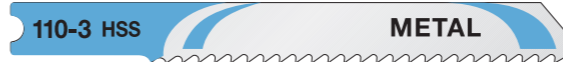

FEATURES

- DEWALT HSS jigsaw blades are engineered to deliver a quality cut in a variety of ferrous and non-ferrous materials.
- Fully hardened high speed steel for increased durability.
- For use in aluminium, ferrous and non-ferrous materials.

U SHANK

Cat. No.	Applications	Overall Length mm	Working Length mm	Tooth Pitch mm	Max DOC mm	Equivalent Bosch Reference	Pack Qty.	Barcode
DT2063-QZ	Metal cutting blade - medium sheet steel 2.5-6mm thick.	70	50	2	6	U118B	5	5035048061022

**WOOD & METAL CUTTING BLADES**



**T SHANK**

Cat. No.	Overall Length mm	Working Length mm	Tooth Pitch mm	Max DOC mm	Equivalent Bosch Reference	Pack Qty.	Barcode
DT2059-QZ	132	101	2.4 - 5	Wood 65, Metal 10	T345XF	5	503504806988

**APPLICATIONS:**

- BIM - for wood up to 65mm thick & metals, pipes and profiles 3 - 10mm thick.
- Progressor blade for fast cutting in different material thicknesses.

**EXTREME DeWALT® SPECIAL MATERIAL BLADES**

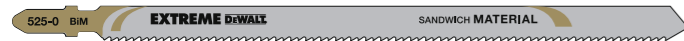

**T SHANK**

Cat. No.	Applications	Overall Length mm	Working Length mm	Tooth Pitch mm	Max DOC mm	Equivalent Bosch Reference	Pack Qty.	Barcode
DT2080-QZ	For clean and straight cuts in all laminates up to 15mm thick.	82	59	1.7	15	T101BIF	5	5035048014400
DT2081-QZ	For clean and curved cuts in all laminates up to 15mm thick.	82	59	1.4	15	T101AOF	3	5035048014417
DT2055-QZ	Tungsten Carbide Tipped blade (ICT) for stainless steel sheet metal (inox) from 1.5 - 5mm thick.	82	55	1.4	5	T118EHM	1	5035048060940
DT2101-QZ	Tungsten carbide for stainless steel, sheet & mild steel 1.2 - 3mm.	76	47	1	3	T118AHM	1	5035048059340
DT2082-QZ	For thin Metal and inox cutting - new technology up to 2mm thick.	82	59	0.8	1-2	T118GFS	1	5035048014424
DT2083-QZ	For medium Metal and inox cutting - new technology up to 4mm thick.	82	59	1.4	1.5 - 4	T118EFS	1	5035048014431
DT2056-QZ	Tungsten Carbide Tipped blade (ICT) for fibreglass, plastics & corian up to 65mm thick.	132	100	4.3	65	T341HM	1	5035048060957
DT2103-QZ	Tungsten carbide tipped blade for ceramic tiles, fibreglass & reinforced plastic to 20mm thick.	100	69	4.3	20	T141HM	1	5035048059364
DT2102-QZ	Tungsten carbide grit blade for ceramic tiles, fibreglass & reinforced plastic to 10mm thick.	76	50	-	10	T130RF	1	5035048059357
DT2201-QZ	Knife blade for soft materials, rubber, foam & polystyrene up to 100mm thick.	152	125	-	100	T313AW	5	5011402370764
DT2084-QZ	For straight and curved cuts in Sandwich materials and medium thick sheet metal up to 120mm thick.	180	148	2	120	T718BF	5	5035048014448

**APPLICATIONS**

- Specialist blades for cutting a wide variety of materials
- See individual blades for details



**WOOD & METAL CUTTING BLADE KITS**



**WOOD & METAL CUTTING BLADE KITS**

Cat. No.	Description	Contents	Barcode
DT2290-QZ	10 piece jigsaw kit - wood cutting	DT2165 x 2, DT2050 x 1, DT2168 x 1, DT2177 x 2, DT2166 x 2, DT2075 x 2 (Bosch equivalent T101B, T11980, T101AQ, T111C, T144D, T144DP)	5035048061077
DT2292-QZ	10 piece jigsaw kit - metal cutting	DT2160 x 3, DT2172 x 2, DT2054 x 1, DT2161 x 2, DT2163 x 2 (Bosch equivalent T118A, T118G, T118E0F, T118B, T127D)	5035048061084
DT2294-QZ	10 piece jigsaw kit - wood/metal cutting	DT2165 x 2, DT2050 x 2, DT2163 x 2, DT2177 x 2, DT2160 x 2 (Bosch equivalent T101B, T11980, T127D, T111C, T118A)	5035048061091



**WOOD CUTTING BLADES**



**APPLICATIONS**

- Blades available for almost all materials and applications

**FEATURES**

- Bi-metal construction combining HCS and HSS for increased flexibility and durability.
- Tough cutting edge made from M2 High Speed Steel.
- Raker tooth pitch to maximise blade durability.
- Universal 1/2" (13mm) shank suitable for DeWALT, Bosch, Hitachi, Flex, Makita, Metabo, Skil.
- New "Plunge Point" tip for fast and accurate plunge cutting into all wood materials

**APPLICATIONS**

- For fast cuts in wood and plastics.

**FEATURES**

- High Carbon Steel construction.
- For use in wood, plywood, laminates and plastics.
- Universal 1/2" (13mm) shank suitable for DeWALT, Bosch, Hitachi, Flex, Makita, Metabo, Skil.



**METAL CUTTING BLADES**



**APPLICATIONS**

- Blades available for almost all materials and applications

**FEATURES**

- Bi-metal construction combining HCS and HSS for increased flexibility and durability.
- Tough cutting edge made from M2 High Speed Steel.
- Raker tooth pitch to maximise blade durability.
- Universal 1/2" (13mm) shank suitable for DeWALT, Bosch, Hitachi, Flex, Makita, Metabo, Skil.

**BI-METAL**

Cat. No.	Applications	Length mm	Pitch mm	Equivalent Bosch Reference	Pack Qty.	Barcode
DT2351-QZ	Fine, fast cuts, specially for curve cutting in wood and plastic.	152	4.2	S611DF	5	5035048033319
DT2359-QZ	Fast cuts in wood with nails and tough plastics. New "Plunge Point" tip for fast and accurate plunge cutting into all wood materials.	152	4.2	S611VF	5	5035048034583
DT2349-QZ	Fast cuts in wood with nails and tough plastics. New "Plunge Point" tip for fast and accurate plunge cutting into all wood materials.	228	4.2	S1111VF	5	5035048034590
DT2320-QZ	Fast cuts in wood with nails and tough plastics. New "Plunge Point" tip for fast and accurate plunge cutting into all wood materials.	228	4.2	S111VF	100	5035048034071
DT2350-QZ	Fast cuts in wood with nails and tough plastics. New "Plunge Point" tip for fast and accurate plunge cutting into all wood materials.	305	4.2	S1411VF	5	5035048033302
DT2344-QZ	Fine, fast cuts, specially for curve cutting in wood and plastic. Ideal for use with cordless reciprocating saws.	152	3.6 - 5.1	S711VF	5	5035048034668

**HCS**

Cat. No.	Applications	Length mm	Pitch mm	Equivalent Bosch Reference	Pack Qty.	Barcode
DT2362-QZ	Fine fast and curved cuts in wood and plastic.	152	4.2	S611D	5	5035048033272
DT2363-QZ	Fine fast cuts and curve cuts in wood and plastic.	228	4.2	S1544D	5	5035048033289
DT2364-QZ	Fine fast cuts and curve cuts in wood and plastic.	305	4.2	S1344D	5	5035048033296
DT2402-QZ	Progressor blade for different material thicknesses. Construction timber (6 - 150mm), chipboard and MDF (6-60mm), plywood, plastic (6 - 150mm), wooden panels (to 175mm).	203	2.4 - 4	S2345X	5	5035048072691
DT2410-QZ	Progressor blade for different material thicknesses. Construction timber (6 - 150mm), chipboard and MDF (6-60mm), plywood, plastic (6 - 150mm), wooden panels (to 175mm). Ideal for use with cordless recip saws.	203	2.5 - 4	SA2345X	5	5035048072721
DT2430-QZ	Coarse wood with no nails (20-100mm), living wood and pruning (to 100mm). Ideal for plunge and curve cutting.	152	8.5	S617K	5	5035048072806
DT2352-QZ	Coarse, fast cuts in wood (logs and pruning).	240	5 - 6.5	S1531L	5	5035048033326
DT2432-QZ	Coarse wood with no nails (20-250mm), living wood and pruning (to 250mm).	305	8.5	S1617K	5	5035048072813

**BI-METAL**

Cat. No.	Applications	Length mm	Pitch mm	Equivalent Bosch Reference	Pack Qty.	Barcode
DT2385-QZ	Fine cuts in metal, sheet material, pipes and profiles up to 1.5mm thick.	152	1.1	S922AF	5	5035048034620
DT2384-QZ	Cuts in metal, sheet metal, pipes and profiles up to 3mm thick.	152	1.4	S922EF	5	5035048034613
DT2354-QZ	Cuts in metal, sheet metal, pipes and profiles up to 3mm thick.	203	1.4	S1022EF	5	5035048033340
DT2361-QZ	Fast cuts in ferrous and non-ferrous metal, sheet metal, pipes and profiles from 3-8mm thick.	152	1.8	S922BF	5	5035048034606
DT2353-QZ	Fast cuts in ferrous and non-ferrous metal, sheet metal, pipes and profiles from 3-8mm thick.	203	1.8	S1022BF	5	5035048033333
DT2323-QZ	Fast cuts in ferrous and non-ferrous metal, sheet metal, pipes and profiles from 3-8mm thick.	203	1.8	S1022BF	100	5035048034101
DT2346-QZ	Ferrous and non-ferrous metals up to 3mm thick. Ideal for use with cordless reciprocating saws.	152	1.4	S922EF	5	5035048034682
DT2404-QZ	Progressor blade for different material thicknesses. Thin to thick sheet metal (1 - 8mm), thin to thick metal profiles (5 - 100mm).	150	1.4 - 3.35	S123XF	5	5035048072707

**HARD METAL**

Cat. No.	Applications	Length mm	Pitch mm	Barcode
DT2407-QZ	152mm hard metal cutting blade	152	4.2	5035048083321
DT2408-QZ	152mm hard metal cutting blade	152	2.5	5035048083338
DT2409-QZ	152mm hard metal cutting blade	152	2	5035048083345

GENERAL PURPOSE BLADES



APPLICATIONS

- Blades available for almost all materials and applications

FEATURES

- Bi-metal construction combining HCS and HSS for increased flexibility and durability.
- Tough cutting edge made from M2 High Speed Steel.
- Raker tooth pitch to maximise blade durability.
- Universal 1/2" (13mm) shank suitable for DeWALT, Bosch, Hitachi, Flex, Makita, Metabo, Skil.

BI-METAL

Cat. No.	Applications	Length mm	Pitch mm	Equivalent Bosch Reference	Pack Qty.	Barcode
DT2348-QZ	For use in tough plastics, sandwich material and pipes from 3-12mm thick.	152	1.8-2.5	S922VF	5	5035048034637
DT2387-QZ	For use in tough plastics, sandwich material and pipes from 3-12mm thick.	203	1.8-2.5	S1122VF	5	5035048034644
DT2355-QZ	For use in heavy gauge metal, rubber, fibreglass and angle iron.	305	1.8-2.5	S1222VF	5	5035048033357
DT2345-QZ	General purpose for wood, wood with nails, aluminium and fibreglass. Ideal for use with cordless reciprocating saws.	152	2.5	S922VF	5	5035048034675
DT2406-QZ	Progressor blade for different material thicknesses. Wood with nails/metal, chipboard (5 - 150mm), sheet metal, aluminium profiles (3 - 18mm), plastic, fibre glass, reinforced plastic profiles (5 - 150mm).	203	2.4 - 4.6	S3456XF	5	5035048072714

DEMOLITION BLADES



APPLICATIONS

- Ideal or extreme applications and demolition tasks.
- For cutting hard and soft wood including wood with nails.
- Range also includes metal and plastic cutting (sheet metals, profiles and tubes).

FEATURES

- Wider blade body gives greater stability during cutting.
- Thicker blade ensures greater strength.
- Bi-metal construction gives strong, flexible blade and hardened teeth.
- Deeper tooth strip ensures longer cutting life.
- New "Plunge Point" tip for fast and accurate plunge cutting into all wood materials

BI-METAL

Cat. No.	Applications	Length mm	Pitch mm	Equivalent Bosch Reference	Pack Qty.	Barcode
DT2300-QZ	For fast/rough cutting of hard & soft woods. New "Plunge Point" tip for fast and accurate plunge cutting into all wood materials.	152	4.2	S610VF	5	5035048059500
DT2307-QZ	For fast/rough cutting of hard & soft woods. New "Plunge Point" tip for fast and accurate plunge cutting into all wood materials.	228	4.2	S1110DF	5	5035048059555
DT2314-QZ	For fast/rough cutting of hard & soft wood. New "Plunge Point" tip for fast and accurate plunge cutting into all wood materials.	305	4.2	S1210DF	5	5035048059609
DT2303-QZ	For fast cutting of metals - sheet, profiles & tube	152	1.8	S923BEF	5	5035048059531
DT2304-QZ	For fast cutting of metals - sheet, profiles & tubes	152	1.8	S923BEF	100	5035048059548
DT2310-QZ	For fast cutting of metals - sheet, profiles & tubes	228	1.8	S1125VF	5	5035048059586
DT2301-QZ	For fast cutting of metals, plastics & sandwich materials.	152	2.5	S920CF	5	5035048059517
DT2302-QZ	For fast cutting of metals, plastics & sandwich materials.	152	2.5	S920CF	100	5035048059524
DT2308-QZ	For fast cutting of metals, plastics & 'sandwich materials'	228	2.5	S1120CF	5	5035048059562
DT2309-QZ	For fast cutting of metals, plastics & 'sandwich materials'	228	2.5	S1120CF	100	5035048059579

RECIPROCATING BLADE SETS



RECIPROCATING BLADE SETS

Cat. No.	Description	Contents	Barcode
DT2440-QZ	6 piece set and storage case	DT2307 x 2, DT2349 x 2, DT2353 x 2	5035048072912
DT2441-QZ	12 piece set and storage case	DT2307 x 1, DT2349 x 3, DT2359 x 2, DT2353 x 3, DT2361 x 3	5035048072929

SPECIALIST MATERIAL BLADES

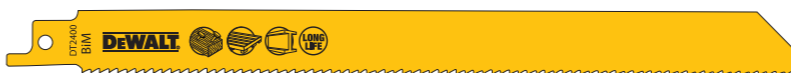

APPLICATIONS

- Specialist blades for cutting a wide variety of materials
- See individual blades for details

SPECIALIST MATERIAL BLADES

Cat. No.	Applications	Length mm	Pitch mm	Equivalent Bosch Reference	Pack Qty.	Barcode
DT2356-QZ	Bi metal construction blade for splinter free cuts in plaster.	152	1.8	S628DF	5	5035048033364
DT2332-QZ	Wear resistant carbide grit edged blade for cutting light masonry blocks, bricks, abrasive materials, ceramics, fibreglass, mild steel and wood with nails.	152	2	-	1	5035048011287
DT2333-QZ	Wear resistant carbide grit edged blade for cutting light masonry blocks, bricks, abrasive materials, ceramics, fibreglass, mild steel and wood with nails.	228	2	S1130Riff	1	5035048011294
DT2335-QZ	Tungsten carbide toothed blade for cutting light masonry blocks, bricks, abrasive materials.	235	1	-	1	5035048014264
DT2400-QZ	Bi-metal construction blade for pallet repair, wood with nails (5 - 175mm), sheet metal pipes, aluminium profiles (3 - 12mm). Ideal for flexible flush cutting.	225	2.5	S1122HF	100	5035048072684
DT2401-QZ	Bi-metal construction blade for pallet repair, wood with nails (5 - 175mm), sheet metal pipes, aluminium profiles (3 - 12mm). Ideal for flexible flush cutting.	200	1.8-2.5	S1122HF	100	5035048082577
DT2420-QZ	Tungsten carbide tipped blade for cutting aerated Concrete, red brick and fibre cement to 150mm.	240	12.7	S1543HM	1	5035048072752
DT2421-QZ	Tungsten carbide tipped blade for cutting aerated Concrete, red brick and fibre cement to 250mm.	305	12.7	S1243HM	1	5035048072769
DT2422-QZ	Tungsten carbide tipped blade for cutting aerated Concrete, red brick and fibre cement to 400mm.	457	12.7	S2243HM	1	5035048072776
DT2423-QZ	Tungsten carbide tipped blade for aerated Concrete, red brick and fibre cement, reinforced plastics (6 - 100mm). Ideal for abrasive materials.	152	4.3	S641HM	1	5035048072783
DT2426-QZ	Tungsten carbide tipped blade for stainless steel plates (2 - 4mm), stainless steel profiles (2 - 80mm), fibre glass, reinforced plastics (2 - 15mm).	150	1.4	S922EHM	2	5035048072790

ALLIGATOR® SAW BLADES

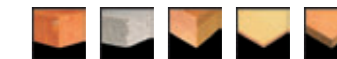

ALLIGATOR® SAW BLADES

Cat. No.	Applications	Overall Length mm	Working Length mm	Tip Material	Pack Qty.	M.O.Q.	Barcode
DT2960-QZ	Drywall, Board.	360	275	HSS	1	1	5035048025390
DT2961-QZ	Hardwood, Softwood, Plywood.	360	275	HSS	1	1	5035048025406
DT2962-QZ	Plywood, Chipboard and MDF.	360	275	TCT	1	1	5035048025413
DT2963-QZ	Building Block, Class 12 Paroton.	360	275	TCT	1	1	5035048025420
DT2964-QZ	Building Block, Class 12 Paroton.	528	425	TCT	1	1	5035048033258
DT2965-QZ	Building Block, gas beton.	528	425	TCT	1	1	5035048033265
DT2966-QZ	Building Block, Class 20 Paroton.	528	425	TCT	1	1	5035048058855

APPLICATIONS

- Ideal for fast and easy cutting in building blocks, wood, plywood, chipboard and drywall. See individual blades for details.

FEATURES

- Blades designed with HSS or TCT teeth to optimise the performance of the DeWALT Alligator® Power Saw.



BANDSAW BLADES



FEATURES

- High Grade Steel.
- Sharp ground teeth slice through the workpiece, producing a fine finish. (Wood cutting blades only).

FEATURES

- High Grade Steel.
- Sharp ground teeth slice through the workpiece, producing a fine finish. (Wood cutting blades only).

APPLICATIONS

- Range for most wood and some steel applications.

FEATURES

- Premium Grade Steel.
- Ultra sharp diamond ground teeth slice cleanly through the work piece producing a sandpaper fine finish (woodcutting blades only).
- Edge hardened teeth maintain ultra sharp edge.

FOR USE WITH DW738 AND DW739

Cat. No.	Primary Application	Overall Length mm	Width mm	Thickness mm	Pitch mm	Pack Qty.	Barcode
DT8480-QZ	Wood-Fretsaw Blade.	2095	3	0.6	4.2	1	5035048025543
DT8481-QZ	General Purpose Blade.	2095	12	0.6	4.2	1	5035048025550
DT8482-QZ	Wood - thick cuts.	2095	16	0.6	6.4	1	5035048025567
DT8483-QZ	Wood - contour.	2095	6	0.6	3.2	1	5035048025574
DT8484-QZ	Non-ferrous Metal - Thin cuts.	2095	6	0.6	1.8	1	5035048025581
DT8485-QZ	Non-ferrous Metal - Thick cuts.	2095	12	0.6	3.2	1	5035048025598
DT8486-QZ	Wood, Formica and Laminates.	2095	10	0.6	3.2	1	5035048025604

FOR USE WITH DW876

Cat. No.	Primary Application	Overall Length mm	Width mm	Thickness mm	Pitch mm	Pack Qty.	Barcode
DT8470-QZ	Wood - Fretsaw Blade.	2215	4	0.6	1.8	1	5011402380978
DT8471-QZ	Wood - contour / scroll.	2215	6	0.4	4.2	1	5011402380985
DT8472-QZ	Wood - Rip & Cross cut.	2215	10	0.4	4.2	1	5011402380992
DT8473-QZ	Wood - Fast rip cut, medium composites.	2215	16	0.6	6.4	1	5011402381005
DT8474-QZ	Wood - Fast rip cut, thick wood.	2215	20	0.6	6.4	1	5011402381012
DT8475-QZ	Metal - Non-ferrous - thin steel.	2215	6	0.6	1.4	1	5011402381029
DT8476-QZ	Metal - Non-ferrous - thick steel.	2215	12	0.6	1.8	1	5011402381036

PLANER BLADES



FOR USE WITH DW676K

Cat. No.	Description	Pack Qty.	M.O.Q.	Barcode
DT3901-QZ	80mm TCT reversible planer blades.	1 pair	1	5035048059456

FOR USE WITH DW677, DW678K, DW678EK AND DW680K

Cat. No.	Description	Pack Qty.	M.O.Q.	Barcode
DT3905-QZ	82mm HSS reversible planer blades.	1 pair	1	5011402381852
DT3906-QZ	82mm TCT reversible planer blades.	1 pair	1	5011402381869

JOINTER ACCESSORIES



BISCUIT JOINTER BLADES

Cat. No.	Blade Diameter	Blade Thickness mm	Bore Size mm	Tooth Count	M.O.Q.	Barcode
DT1306-QZ	102	3.9	22	12	1	5011432382118
DT1307-QZ	105	2.4	22	30	1	5011402382125

BISCUITS

Cat. No.	Size	Description	Pack Qty.	M.O.Q.	Barcode
DT3930-QZ	0	6 - 12 mm board	1000	1	5035048025369
DT3931-QZ	10	13-18 mm board	1000	1	5035048025376
DT3932-QZ	20	>19 mm board	1000	1	5035048025383

Straight Cutters



APPLICATIONS

- For general cutting of straight edges, slots, grooves and straight rebates in hard woods, MDF, HDF, plywood and chipboard
- Can be used for straight trimming of laminates

FEATURES

- Single flute cutters available for fast cutting.
- Two flute cutters available for superior finish
- Long reach bits for deep grooving and mortising. Include carbide bottom plate for easier plunge cutting and long life in abrasive materials
- Straight cutter with bearing for following a template
- Available with 8mm and 12mm shanks (also available in 1/4" & 1/2" shanks for UK and Eire only)

Straight Cutters

Cat. No.	Description	Shank mm (A)	Cut Diameter mm (B)	Working Length mm (C)	Total Length mm	Barcode
DR1002-XC	Straight Cutter - 1 Flute	8	4	10	48	7392585010011
DR1003-XC	Straight Cutter - 2 Flutes	8	5	12	50	7392585010028
DR1004-XC	Straight Cutter - 2 Flutes	8	6	19	55	7392585010035
DR1005-XC	Straight Cutter - 2 Flutes	8	8	20	55	7392585010042
DR1006-XC	Straight Cutter - 2 Flutes	8	10	20	52	7392585010059
DR1007-XC	Straight Cutter - 2 Flutes	8	12	20	52	7392585010066
DR1008-XC	Straight Cutter - 2 Flutes	8	14	20	52	7392585010073
DR1009-XC	Straight Cutter - 2 Flutes	8	15	20	52	7392585010080
DR1010-XC	Straight Cutter - 2 Flutes	8	16	20	52	7392585010097
DR1011-XC	Straight Cutter - 2 Flutes	8	18	20	52	7392585010103
DR1012-XC	Straight Cutter - 2 Flutes	8	20	20	52	7392585010110
DR1013-XC	Straight Cutter - 2 Flutes	8	22	20	52	7392585010127
DR1014-XC	Straight Cutter - 2 Flutes	8	24	20	52	7392585010134
DR1015-XC	Straight Cutter - 2 Flutes	8	25	20	52	7392585010141
DR6011-XC	Straight Cutter - 2 Flutes	12	25	30	70	7392585010257
DR1020-QZ	Straight Cutter - 2 Flutes	8	12	30	90	5035048073490
DR1022-QZ	Straight Cutter - 2 Flutes	8	16	30	90	5035048073513
DR1023-QZ	Long Reach Straight Cutters	12	12	50	94	5035048073520
DR1024-QZ	Long Reach Straight Cutters	12	16	50	90	5035048073537
DR1101-XC	Straight Cutter with bearing	8	12	25	-	7392585010264

Profiles For Grooving / Moulding



APPLICATIONS

- For hard woods, MDF and plywood
- For grooving and moulding various profiles

FEATURES

- Two cutting flutes for superior finish

Profiles For Grooving / Moulding

Cat. No.	Description	Shank mm (A)	Cut Diameter mm (B)	Working Length mm (C)	Radius mm (D)	Barcode
DR1402-XC	Straight Cutter - 2 Flutes	8	8	8	4	7392585010325
DR1403-XC	Straight Cutter - 2 Flutes	8	12	9.5	6	7392585010332
DR1302-XC	Straight Cutter - 2 Flutes	8	12.7	12.7	90	7392585010295
DR1301-XC	Straight Cutter - 2 Flutes	8	12.7	15.9	60	7392585010288

Edge Trimmers / Cutters



APPLICATIONS

- For cutting, trimming and bevelling soft woods, hard woods, MDF and laminates

Edge Trimmers / Cutters

Cat. No.	Description	Shank mm (A)	Cut Diameter mm (B)	Working Length mm (C)	Radius mm (D)	Barcode
DR2201-XC	Trimming Cutter Triple Flute	8	12.7	25.4	68	7392585010523
DR4401-XC	Straight Cutter - 2 Flutes	8	31.8	12.7	-	7392585011162
DR2502-XC	3 Wing Slotting Cutter	-	8	47.6	3	7392585010608
DR2503-XC	3 Wing Slotting Cutter	-	8	47.6	4	7392585010615
DR2504-XC	3 Wing Slotting Cutter	-	8	47.6	5	7392585010622
DR2701-XC	Arbor with Bearing	8	8	-	-	7392585010646
DR2603-XC	2 Wing Flat Bottom Slotter	8	40	4	10.5	7392585011476
DR2604-XC	2 Wing Flat Bottom Slotter	8	40	5	10.5	7392585011483

Edge Profiling and Moulding

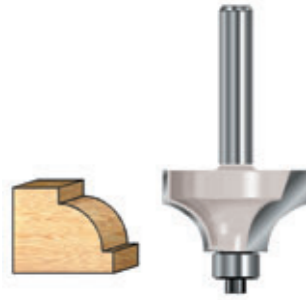

APPLICATIONS

- For creating decorative edges on worktops, furniture, cabinet doors, window sills and picture frames
- For soft wood, hardwood, MDF and plywood

FEATURES

- Two cutting flutes for superior finish
- Available with replacement ball bearing where applicable

Edge Profiling and Moulding

Cat. No.	Description	Shank mm (A)	Cut Diameter mm (B)	Working Length mm (C)	Radius mm (D)	Barcode
DR3102-XC	Cove Cutter with Bearing	8	19.5	9.5	5	7392585010851
DR3103-XC	Cove Cutter with Bearing	8	22.2	12.7	6.35	7392585010868
DR3104-XC	Cove Cutter with Bearing	8	28.6	12.7	9.5	7392585010875
DR6701-XC	Chamfer with Bearing	12	44.5	15.9	45	7392585010585
DR2402-XC	Bevel Trimmer with Bearing	8	28	11.2	45	7392585010578
DR3801-XC	Covetto Cutter with Bearing	8	25.4	12.7	4.8	7392585011025
DR2802-XC	Rounding Over Cutter	8	18.7	9.5	3	7392585010660
DR2803-XC	Rounding Over Cutter	8	22.7	9.5	5	7392585010667
DR2804-XC	Rounding Over Cutter	8	25.4	12.7	6.35	7392585010684
DR2805-XC	Rounding Over Cutter	8	28.6	12.7	8	7392585010691
DR2806-XC	Rounding Over Cutter	8	31.8	15.9	9.5	7392585010707
DR2807-XC	Rounding Over Cutter	8	38.1	19	12.7	7392585010714
DR2903-XC	Beading Cutter	8	25.4	12.7	6.35	7392585010769
DR2905-XC	Beading Cutter	8	31.8	15.9	9.5	7392585010783
DR3301-XC	Ogee Cutter	8	31.8	12.7	4.8	7392585010905
DR3401-XC	Roman Ogee Cutter	8	27	11.9	4	7392585010929
DR3501-XC	Ogee Fillet Cutter	8	34.9	14.3	4.8	7392585010943
DR3602-XC	Classic Ogee Cutter	8	31.8	14.3	4.8	7392585010967
DR3702-XC	Classic Roman Ogee Cutter	8	31.8	15.9	4.8	7392585010998

Dovetail & Glue Jointing



APPLICATIONS

- For soft woods, hard woods, MDF, Plywood and Chipboard

FEATURES

- Two cutting flutes for superior finish
- Replacement ball bearings available where applicable

Dovetail & Glue Jointing

Cat. No.	Description	Shank mm (A)	External Diameter mm (B1)	Internal Diameter mm (B2)	Angle °	Barcode
DR4201-XC	Dovetail Cutter	8	14.3	12.7	13.5	7392585011131
DR1028-QZ	Dovetail Cutter	8	14.3	N/A	13.5	5035048073575
DR5301-XC	Router Hinge Bit	8	35	-	-	7392585011346
DR4701-XC	Tongue & Groove Set	8	41	6.35	9.5	7392585011230
DR4301-XC	Off Set Tongue & Groove Cutter	8	30.2	25.4	-	7392585011148
DR4801-XC	Rail & Stile - Roman Ogee	8	41	23.8	4.76	7392585011254
DR4901-XC	Rail & Stile - Classical	8	41	23.8	2.38	7392585011278

Replacement Ball Bearings

Cat. No.	Description	External Diameter mm (B1)	Internal Diameter mm (B2)	Range	Barcode
DR9907-XC	Replacement Bearing	15.9	6.35	4.76	7392585011421

Router Bit Sets



Router Bit Sets

Cat. No.	Description	Barcode
DR9992-XC	12 Piece Router bit set - Straight bit x3, Trimming cutter with BB, Rounding over bit with BB x2, Core box, Dovetail cutter, V-groove bit, Cove bit with BB, Roman ogee with BB, Chamfer bit with BB	5035048940211
DR9994-QZ	22 Piece Router bit set - Straight bit x6, Trimming cutter with BB, Rounding over bit with BB x2, Core box x2, Dovetail cutter, V-groove bit x2, Cove bit with BB x2, Roman ogee with BB, Chamfer bit with BB, Beading nit, New traditional beading bit of Freud, Bevel trim cutter with BB, Rebate cutter with BB	5035048905630

FULL SHEET 230mm x 280mm



APPLICATIONS

- Wood and paint preparation and finish.

FEATURES

- High quality aluminium oxide grain gives superior finish.
- Strong & flexible D/C weight backing.
- Stearate coating helps reduce clogging (80g and above).



ALUMINIUM OXIDE PAPER

Cat. No.	Description	Grit Size	Pack Qty.	M.O.Q.	Barcode
DT3230-QZ	Multi Purpose Wood/paint-dry	40	1	10	5035048073612
DT3231-QZ	Multi Purpose Wood/paint-dry	60	1	10	5035048073629
DT3232-QZ	Multi Purpose Wood/paint-dry	80	1	10	5035048073636
DT3233-QZ	Multi Purpose Wood/paint-dry	120	1	10	5035048073643
DT3234-QZ	Multi Purpose Wood/paint-dry	180	1	10	5035048073650
DT3235-QZ	Multi Purpose Wood/paint-dry	240	1	10	5035048073667
DT3236-QZ	Multi Purpose Wood/paint-dry	320	1	10	5035048073674
DT3238-QZ	Multi Purpose Wood/paint-dry	60	1	50	5035048073698
DT3239-QZ	Multi Purpose Wood/paint-dry	80	1	50	5035048073704
DT3240-QZ	Multi Purpose Wood/paint-dry	120	1	50	5035048073711
DT3241-QZ	Multi Purpose Wood/paint-dry	180	1	50	5035048073728
DT3242-QZ	Multi Purpose Wood/paint-dry	240	1	50	5035048073735

APPLICATIONS

- Fine sanding of primers and fillers.

FEATURES

- Flexible waterproof latex paper backing enables easier sanding on contoured surfaces and finishing applications.
- High quality sharp aluminium oxide grain provides excellent finish.
- High water resistance - no paper curl.



WATERPROOF PAPER

Cat. No.	Description	Grit Size	Pack Qty.	M.O.Q.	Barcode
DT3244-QZ	Multi Purpose Wet & Dry	180	1	10	5035048073759
DT3245-QZ	Multi Purpose Wet & Dry	240	1	10	5035048073766
DT3246-QZ	Multi Purpose Wet & Dry	320	1	10	5035048073773
DT3247-QZ	Multi Purpose Wet & Dry	400	1	10	5035048073780
DT3248-QZ	Multi Purpose Wet & Dry	1000	1	10	5035048073797
DT3249-QZ	Multi Purpose Wet & Dry	1200	1	10	5035048073803

APPLICATIONS

- Rust removal, surface grinding deburring and final finish.

FEATURES

- Heavyweight 'J' Cloth backing - tough durable sanding on metals.
- Industrial grade Aluminium oxide grain - fast aggressive stripping/sanding.

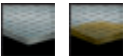

METALWORKING CLOTH

Cat. No.	Description	Grit Size	Pack Qty.	M.O.Q.	Barcode
DT3281-QZ	Steel, Stainless Steel, Non-Ferrous Metal	80	1	10	5035048073872
DT3282-QZ	Steel, Stainless Steel, Non-Ferrous Metal	120	1	10	5035048073889
DT3283-QZ	Steel, Stainless Steel, Non-Ferrous Metal	180	1	10	5035048073896
DT3284-QZ	Steel, Stainless Steel, Non-Ferrous Metal	240	1	10	5035048073902
DT3285-QZ	Steel, Stainless Steel, Non-Ferrous Metal	320	1	10	5035048073919

HAND SANDING BLOCK

Cat. No.	Description	Pack Qty.	M.O.Q.	Barcode
DT3199-QZ	Hand Sanding Block	1	1	5035048082829



**HALF SHEET 115mm x 280mm**



**APPLICATIONS**

- For all sanding and finishing tasks on wood, painted surfaces and fillers.

**FEATURES**

- Industrial grade abrasive paper for all stripping, sanding and finishing tasks on wood, paint and fillers.
- High quality aluminium oxide grain gives superior finish.
- Resin bonding provides excellent grain adhesion and heat resistance for powered sanding.
- Tough, durable "E" weight backing ensures longer life and performance.

PRE-PUNCHED Fits: DeWALT, Bosch, Festool, Makita, Metabo, Hitachi, Peugeot, Ryobi



Cat. No.	Description	Grit Size	Pack Qty.	M.O.Q.	Barcode
DT8570-QZ	Multi Purpose Wood/paint-dry	40	10	1	5035048070598
DT8510-QZ	Multi Purpose Wood/paint-dry	60	10	1	5035048069202
DT8511-QZ	Multi Purpose Wood/paint-dry	80	10	1	5035048069219
DT8512-QZ	Multi Purpose Wood/paint-dry	120	10	1	5035048069226
DT8513-QZ	Multi Purpose Wood/paint-dry	180	10	1	5035048069233
DT8514-QZ	Multi Purpose Wood/paint-dry	220	10	1	5035048069240

**HALF SHEET 'QUICK FIT' 115mm x 228mm**



**APPLICATIONS**

- For all sanding and finishing tasks on wood, painted surfaces and fillers.

**FEATURES**

- Industrial grade abrasive paper for all stripping, sanding and finishing tasks on wood, paint and fillers.
- High quality aluminium oxide grain gives superior finish.
- Resin bonding provides excellent grain adhesion and heat resistance for powered sanding.
- Tough, durable "E" weight backing ensures longer life and performance.

PRE-PUNCHED Fits: DeWALT, Bosch, Festool, Makita, Metabo, Hitachi, Peugeot, Ryobi



Cat. No.	Description	Grit Size	Pack Qty.	M.O.Q.	Barcode
DT8574-QZ	Multi Purpose Wood/paint-dry	40	10	1	5035048070635
DT8550-QZ	Multi Purpose Wood/paint-dry	60	10	1	5035048069608
DT8551-QZ	Multi Purpose Wood/paint-dry	80	10	1	5035048069615
DT8552-QZ	Multi Purpose Wood/paint-dry	120	10	1	5035048069622
DT8553-QZ	Multi Purpose Wood/paint-dry	180	10	1	5035048069639

**THIRD SHEET 93mm x 230mm**



**APPLICATIONS**

- For all sanding and finishing tasks on wood, painted surfaces and fillers.

**FEATURES**

- Industrial grade abrasive paper for all stripping, sanding and finishing tasks on wood, paint and fillers.
- High quality aluminium oxide grain gives superior finish.
- Resin bonding provides excellent grain adhesion and heat resistance for powered sanding.
- Tough, durable "E" weight backing ensures longer life and performance.

PRE-PUNCHED Fits: DeWALT, Bosch, Festool, Makita, Metabo, Ryobi, Skil, AEG



Cat. No.	Description	Grit Size	Pack Qty.	M.O.Q.	Barcode
DT8590-QZ	Multi Purpose Wood/paint-dry	60	10	1	5035048069905
DT8591-QZ	Multi Purpose Wood/paint-dry	80	10	1	5035048069912
DT8592-QZ	Multi Purpose Wood/paint-dry	120	10	1	5035048069929
DT8488-QZ	Multi Purpose Wood/paint-dry	40	25	1	5035048070727
DT8595-QZ	Multi Purpose Wood/paint-dry	60	25	1	5035048069950
DT8596-QZ	Multi Purpose Wood/paint-dry	80	25	1	5035048069967
DT8597-QZ	Multi Purpose Wood/paint-dry	120	25	1	5035048069974
DT8598-QZ	Multi Purpose Wood/paint-dry	180	25	1	5035048069981

**THIRD SHEET 'QUICK FIT' 93mm x 190mm**



**APPLICATIONS**

- For all sanding and finishing tasks on wood, painted surfaces and fillers.

**FEATURES**

- Industrial grade abrasive paper for all stripping, sanding and finishing tasks on wood, paint and fillers.

PRE-PUNCHED Fits: DeWALT, AEG, Bosch, Casals, Einhell, Festool, Hitachi, Makita, Metabo, Peugeot, Skil



Cat. No.	Description	Grit Size	Pack Qty.	M.O.Q.	Barcode
DT8620-QZ	Multi Purpose Wood/paint-dry	60	10	1	5035048070208
DT8621-QZ	Multi Purpose Wood/paint-dry	80	10	1	5035048070215
DT8622-QZ	Multi Purpose Wood/paint-dry	120	10	1	5035048070222
DT8623-QZ	Multi Purpose Wood/paint-dry	180	10	1	5035048070239
DT8624-QZ	Multi Purpose Wood/paint-dry	240	10	1	5035048070246

**QUARTER SHEET**

**APPLICATIONS**

- For all sanding and finishing tasks on wood, painted surfaces and fillers.

**FEATURES**

- Industrial grade abrasive paper for all stripping, sanding and finishing tasks on wood, paint and fillers.
- High quality aluminium oxide grain gives superior finish.
- Resin bonding provides excellent grain adhesion and heat resistance for powered sanding.
- Tough, durable "E" weight backing ensures longer life and performance.

QUARTER SHEET 115mm x 140mm Fits: DeWALT, Bosch, Makita, Ryobi, Skil



Cat. No.	Description	Grit Size	Pack Qty.	M.O.Q.	Barcode
DT3001-QZ	Multi Purpose Wood/paint-dry	40	10	1	5035048066546
DT3002-QZ	Multi Purpose Wood/paint-dry	60	10	1	5035048066553
DT3004-QZ	Multi Purpose Wood/paint-dry	100	10	1	5035048066560
DT3005-QZ	Multi Purpose Wood/paint-dry	150	10	1	5035048066577
DT3007-QZ	Multi Purpose Wood/paint-dry	220	10	1	5035048066584
DT3011-QZ	Multi Purpose Wood/paint-dry	40	25	1	5035048058947
DT3012-QZ	Multi Purpose Wood/paint-dry	60	25	1	5035048058954
DT3014-QZ	Multi Purpose Wood/paint-dry	100	25	1	5035048058961
DT3015-QZ	Multi Purpose Wood/paint-dry	150	25	1	5035048058978
DT3017-QZ	Multi Purpose Wood/paint-dry	220	25	1	5035048058985

QUARTER SHEET 'QUICK FIT' 115mm x 115mm Fits: DeWALT, Bosch, Makita, Hitachi, Metabo

Cat. No.	Description	Grit Size	Pack Qty.	M.O.Q.	Barcode
DT3020-QZ	Multi Purpose Wood/paint-dry	40	10	1	5035048014462
DT3021-QZ	Multi Purpose Wood/paint-dry	60	10	1	5035048014486
DT3022-QZ	Multi Purpose Wood/paint-dry	80	10	1	5035048014509
DT3023-QZ	Multi Purpose Wood/paint-dry	120	10	1	5035048014523
DT3024-QZ	Multi Purpose Wood/paint-dry	180	10	1	5035048014547
DT3025-QZ	Multi Purpose Wood/paint-dry	240	10	1	5035048014561
DT3026-QZ	Multi Purpose Wood/paint-dry	320	10	1	5035048071953
DT3030-QZ	Multi Purpose Wood/paint-dry	40	25	1	5035048014479
DT3031-QZ	Multi Purpose Wood/paint-dry	60	25	1	5035048014493
DT3032-QZ	Multi Purpose Wood/paint-dry	80	25	1	5035048014516
DT3033-QZ	Multi Purpose Wood/paint-dry	120	25	1	5035048014530
DT3034-QZ	Multi Purpose Wood/paint-dry	180	25	1	5035048014554
DT3035-QZ	Multi Purpose Wood/paint-dry	240	25	1	5035048014578
DT3036-QZ	Multi Purpose Wood/paint-dry	320	25	1	5035048070819

QUARTER SHEET 'QUICK FIT' 80mm x 133mm Fits: Festool

Cat. No.	Description	Grit Size	Pack Qty.	M.O.Q.	Barcode
DT3100-QZ	Multi Purpose Wood/paint-dry	40	25	1	5035048082638
DT3104-QZ	Multi Purpose Wood/paint-dry	60	25	1	5035048082645
DT3109-QZ	Multi Purpose Wood/paint-dry	80	25	1	5035048082652
DT3110-QZ	Multi Purpose Wood/paint-dry	120	25	1	5035048082669
DT3114-QZ	Multi Purpose Wood/paint-dry	180	25	1	5035048082676

DETAIL SANDING SHEETS



APPLICATIONS

- For all sanding and finishing tasks on wood, painted surfaces and fillers.

FEATURES

- Industrial grade abrasive paper for all stripping, sanding and finishing tasks on wood, paint and fillers.
- High quality aluminium oxide grain gives superior finish.
- Resin bonding provides excellent grain adhesion and heat resistance for powered sanding.
- Tough, durable "E" weight backing ensures longer life and performance.



PRE-PUNCHED 93mm x 93mm Fits: DeWALT, Bosch, AEG, Makita, Metabo, Skil, Kress

Cat. No.	Description	Grit Size	Pack Qty.	M.O.Q.	Barcode
DT3090-QZ	Detail Sanding Sheet	40	10	1	5035048061770
DT3091-QZ	Detail Sanding Sheet	60	10	1	5035048061787
DT3092-QZ	Detail Sanding Sheet	80	10	1	5035048061794
DT3093-QZ	Detail Sanding Sheet	120	10	1	5035048061800
DT3094-QZ	Detail Sanding Sheet	180	10	1	5035048061817
DT3095-QZ	Detail Sanding Sheet	240	10	1	5035048061824

PRE-PUNCHED 94mm x 94mm Fits: Festool

Cat. No.	Description	Grit Size	Pack Qty.	M.O.Q.	Barcode
DT3560-QZ	Detail Sanding Sheet	40	10	1	5035048067338
DT3561-QZ	Detail Sanding Sheet	60	10	1	5035048067345
DT3562-QZ	Detail Sanding Sheet	80	10	1	5035048067352
DT3563-QZ	Detail Sanding Sheet	120	10	1	5035048067369
DT3564-QZ	Detail Sanding Sheet	180	10	1	5035048067376

ROLLS



APPLICATIONS

- For all sanding and finishing tasks on wood, painted surfaces and fillers.

FEATURES

- Industrial grade abrasive paper for all stripping, sanding and finishing tasks on wood, paint and fillers.
- High quality aluminium oxide grain gives superior finish.
- Resin bonding provides excellent grain adhesion and heat resistance for powered sanding.
- Tough, durable "E" weight backing ensures longer life and performance.



ROLLS - HALF SHEET & QUARTER SHEET

Cat. No.	Description	Grit Size	Size (Length x Width)	Pack Qty.	M.O.Q.	Barcode
DT3580-QZ	Multi Purpose Wood/paint-dry	60	5m x 115mm	1	1	5035048067079
DT3581-QZ	Multi Purpose Wood/paint-dry	80	5m x 115mm	1	1	5035048067086
DT3582-QZ	Multi Purpose Wood/paint-dry	120	5m x 115mm	1	1	5035048067093
DT3583-QZ	Multi Purpose Wood/paint-dry	180	5m x 115mm	1	1	5035048067109
DT3584-QZ	Multi Purpose Wood/paint-dry	220	5m x 115mm	1	1	5035048067116

ROLLS - THIRD SHEET

Cat. No.	Description	Grit Size	Size (Length x Width)	Pack Qty.	M.O.Q.	Barcode
DT3154-QZ	Multi Purpose Wood/paint-dry	40	5m x 93mm	1	1	5035048082942
DT3590-QZ	Multi Purpose Wood/paint-dry	60	5m x 93mm	1	1	5035048067178
DT3591-QZ	Multi Purpose Wood/paint-dry	80	5m x 93mm	1	1	5035048067185
DT3592-QZ	Multi Purpose Wood/paint-dry	120	5m x 93mm	1	1	5035048067192
DT3593-QZ	Multi Purpose Wood/paint-dry	180	5m x 93mm	1	1	5035048067208
DT3594-QZ	Multi Purpose Wood/paint-dry	220	5m x 93mm	1	1	5035048067215
DT3579-QZ	Multi Purpose Wood/paint-dry	40	25m x 93mm	1	1	5035048070871
DT3595-QZ	Multi Purpose Wood/paint-dry	60	25m x 93mm	1	1	5035048067222
DT3596-QZ	Multi Purpose Wood/paint-dry	80	25m x 93mm	1	1	5035048067239
DT3597-QZ	Multi Purpose Wood/paint-dry	120	25m x 93mm	1	1	5035048067246
DT3598-QZ	Multi Purpose Wood/paint-dry	180	25m x 93mm	1	1	5035048067253
DT3599-QZ	Multi Purpose Wood/paint-dry	220	25m x 93mm	1	1	5035048067260

BELTS



APPLICATIONS

- For all stripping sanding and finishing tasks on wood, metal and painted surfaces.

FEATURES

- Heavy duty "X" weight backing cloth.
- Heat resistant resin bonding.
- High quality Aluminium Oxide grain for fast, aggressive stock removal and fine finishing on wood, metal or painted surfaces.
- EXTREME belts (grits up to 120) have an 'Anti Static' resin bonding - reduces clogging and ensures more efficient dust extraction - Longer belt sanding life.



100mm x 610mm Fits: Hitachi, Makita, Ryobi

Cat. No.	Description	Grit Size	Pack Qty.	M.O.Q.	Barcode
DT3320-QZ	Multi Purpose Wood/paint-belt	40	3	1	5035048068151
DT3321-QZ	Multi Purpose Wood/paint-belt	60	3	1	5035048068168
DT3322-QZ	Multi Purpose Wood/paint-belt	80	3	1	5035048068175
DT3323-QZ	Multi Purpose Wood/paint-belt	100	3	1	5035048068182
DT3324-QZ	Multi Purpose Wood/paint-belt	150	3	1	5035048068199
DT3670-QZ	Multi Purpose Wood/paint-belt	40	10	1	5035048068205
DT3671-QZ	Multi Purpose Wood/paint-belt	60	10	1	5035048068212
DT3672-QZ	Multi Purpose Wood/paint-belt	80	10	1	5035048068229
DT3673-QZ	Multi Purpose Wood/paint-belt	100	10	1	5035048068236
DT3674-QZ	Multi Purpose Wood/paint-belt	150	10	1	5035048068243

100mm x 560mm Fits: DeWALT, AEG, Ryobi

Cat. No.	Description	Grit Size	Pack Qty.	M.O.Q.	Barcode
DT3312-QZ	Multi Purpose Wood/paint-belt	40	3	1	5035048025642
DT3314-QZ	Multi Purpose Wood/paint-belt	60	3	1	5035048025659
DT3315-QZ	Multi Purpose Wood/paint-belt	80	3	1	5035048025666
DT3316-QZ	Multi Purpose Wood/paint-belt	100	3	1	5035048025673
DT3362-QZ	Multi Purpose Wood/paint-belt	120	3	1	5035048034484
DT3318-QZ	Multi Purpose Wood/paint-belt	150	3	1	5035048025680
DT3685-QZ	Multi Purpose Wood/paint-belt	40	10	1	5035048068458
DT3686-QZ	Multi Purpose Wood/paint-belt	60	10	1	5035048068465
DT3687-QZ	Multi Purpose Wood/paint-belt	80	10	1	5035048068472
DT3626-QZ	Multi Purpose Wood/paint-belt	100	10	1	5035048070826
DT3688-QZ	Multi Purpose Wood/paint-belt	120	10	1	5035048068489



75mm x 533mm Fits: DeWALT, Bosch, Hitachi, Atlas Copco, Holz-Her, Makita, Metabo, Peugeot, Ryobi, Skil

Cat. No.	Description	Grit Size	Pack Qty.	M.O.Q.	Barcode
DT3376-QZ	Multi Purpose Wood/paint-belt	60	3	1	5035048068717
DT3377-QZ	Multi Purpose Wood/paint-belt	80	3	1	5035048068724
DT3628-QZ	Multi Purpose Wood/paint-belt	100	3	1	5035048070840
DT3301-QZ	Multi Purpose Wood/paint-belt	40	10	1	5011402375172
DT3302-QZ	Multi Purpose Wood/paint-belt	60	10	1	5011402375189
DT3303-QZ	Multi Purpose Wood/paint-belt	80	10	1	5011402375196
DT3304-QZ	Multi Purpose Wood/paint-belt	100	10	1	5011402375202
DT3629-QZ	Multi Purpose Wood/paint-belt	120	10	1	5035048070857
DT3305-QZ	Multi Purpose Wood/paint-belt	150	10	1	5011402375219
DT3307-QZ	Multi Purpose Wood/paint-belt	220	10	1	5011402375226

75mm x 480mm Fits: Elu

Cat. No.	Description	Grit Size	Pack Qty.	M.O.Q.	Barcode
DT3364-QZ	Multi Purpose Wood/paint-belt	40	3	1	5035048053942
DT3365-QZ	Multi Purpose Wood/paint-belt	60	3	1	5035048053959
DT3366-QZ	Multi Purpose Wood/paint-belt	80	3	1	5035048053966
DT3367-QZ	Multi Purpose Wood/paint-belt	100	3	1	4024048053973
DT3368-QZ	Multi Purpose Wood/paint-belt	120	3	1	5035048053980
DT3369-QZ	Multi Purpose Wood/paint-belt	150	3	1	5035048053997

75mm x 457mm Fits: Makita, Metabo, Peugeot, Skil

Cat. No.	Description	Grit Size	Pack Qty.	M.O.Q.	Barcode
DT3640-QZ	Multi Purpose Wood/paint-belt	40	3	1	5035048068809
DT3641-QZ	Multi Purpose Wood/paint-belt	60	3	1	5035048068816
DT3642-QZ	Multi Purpose Wood/paint-belt	80	3	1	5035048068823
DT3643-QZ	Multi Purpose Wood/paint-belt	100	3	1	5035048068830
DT3644-QZ	Multi Purpose Wood/paint-belt	150	3	1	5035048068847



BELTS



APPLICATIONS

- For all stripping, sanding and finishing tasks on wood, metal and painted surfaces.

FEATURES

- Flexible J weight backing cloth.
- Heat resistant resin bonding.
- High quality Aluminium Oxide grain for fast, accurate stock removal and fine finishing on wood, metal or painted surfaces.



64mm x 356mm (MINI BELT SANDER)

Cat. No.	Description	Grit Size	Pack Qty.	M.O.Q.	Barcode
DT3661-QZ	Multi Purpose Wood/paint-belt	60	3	1	5035048069011
DT3662-QZ	Multi Purpose Wood/paint-belt	80	3	1	5035048069028
DT3663-QZ	Multi Purpose Wood/paint-belt	100	3	1	5035048069035
DT3664-QZ	Multi Purpose Wood/paint-belt	150	3	1	5035048069042
DT3299-QZ	Multi Purpose Wood/paint-belt	220	3	1	5035048071960
DT3666-QZ	Multi Purpose Wood/paint-belt	60	10	1	5035048069066
DT3667-QZ	Multi Purpose Wood/paint-belt	80	10	1	5035048069073
DT3668-QZ	Multi Purpose Wood/paint-belt	100	10	1	5035048069080
DT3669-QZ	Multi Purpose Wood/paint-belt	150	10	1	5035048069097

GRINDING BELTS



APPLICATIONS

- For use with bench grinder.
- Coarse grits or shaping metal, wood and ceramics.

FEATURES

- High performance 'X' weight backing cloth.
- Heat resistant resin bonding.
- High quality aluminium oxide grain.



40mm x 577mm

Cat. No.	Description	Grit Size	Pack Qty.	M.O.Q.	Barcode
DT3340-QZ	Grinding belt	40	3	1	5035048034262
DT3341-QZ	Grinding belt	60	3	1	5035048034279
DT3342-QZ	Grinding belt	80	3	1	5035048034286
DT3343-QZ	Grinding belt	100	3	1	5035048034293
DT3344-QZ	Grinding belt	120	3	1	5035048034309
DT3345-QZ	Grinding belt	150	3	1	5035048034316
DT3346-QZ	Grinding belt	240	3	1	5035048034323
DT3347-QZ	Grinding belt	320	3	1	5035048034330

45mm x 715mm

Cat. No.	Description	Grit Size	Pack Qty.	M.O.Q.	Barcode
DT3349-QZ	Grinding belt	40	3	1	5035048034354
DT3350-QZ	Grinding belt	60	3	1	5035048034361
DT3351-QZ	Grinding belt	80	3	1	5035048034378
DT3352-QZ	Grinding belt	100	3	1	5035048034385
DT3353-QZ	Grinding belt	120	3	1	5035048034392
DT3354-QZ	Grinding belt	150	3	1	5035048034408
DT3355-QZ	Grinding belt	240	3	1	5035048034415
DT3356-QZ	Grinding belt	320	3	1	5035048034422

HONING BELTS



FEATURES

- Use after regrinding tools to bring them to a very sharp edge.
- Use in conjunction with DeWALT honing paste.

40mm X 577mm

Cat. No.	Description	Pack Qty.	M.O.Q.	Barcode
DT3395-QZ	Leather honing belt	1	1	5035048054017

45mm X 715mm

Cat. No.	Description	Pack Qty.	M.O.Q.	Barcode
DT3396-QZ	Leather honing belt	1	1	5035048054024

HONING PASTE

Cat. No.	Description	Pack Qty.	M.O.Q.	Barcode
DT3398-QZ	Honing Paste	1	1	5035048054031

'QUICK FIT NYLON' LOOP DISCS



APPLICATIONS

- For all stripping sanding and finishing tasks on wood, metal and painted surfaces.

FEATURES

- Heat resistant resin adhesive bond, ideal for power sanding.
- Tough, durable paper backing ensures longer disc life and performance.
- Stearate coating reduces clogging, excellent for softwoods & painted surfaces (grits 80 or greater).
- Quick Fit nylon loop backing allows fast and easy disc changeover.



8 HOLES PUNCHED Ø125mm Fits: DeWALT, AEG, Bosch, Atlas Copco, Festool, Elu, Fein, Hitachi, Kress, Makita, Metabo, Skil

Cat. No.	Description	Grit Size	Pack Qty.	M.O.Q.	Barcode
DT3101-QZ	Multi Purpose Wood/paint-dry	40	10	1	5035048058992
DT3102-QZ	Multi Purpose Wood/paint-dry	60	10	1	5035048059005
DT3103-QZ	Multi Purpose Wood/paint-dry	80	10	1	5035048059012
DT3105-QZ	Multi Purpose Wood/paint-dry	120	10	1	5035048059029
DT3106-QZ	Multi Purpose Wood/paint-dry	180	10	1	5035048059036
DT3107-QZ	Multi Purpose Wood/paint-dry	240	10	1	5035048059043
DT3108-QZ	Multi Purpose Wood/paint-dry	320	10	1	5035048059050
DT3111-QZ	Multi Purpose Wood/paint-dry	40	25	1	5035048059067
DT3112-QZ	Multi Purpose Wood/paint-dry	60	25	1	5035048059074
DT3113-QZ	Multi Purpose Wood/paint-dry	80	25	1	5035048059081
DT3115-QZ	Multi Purpose Wood/paint-dry	120	25	1	5035048059098
DT3116-QZ	Multi Purpose Wood/paint-dry	180	25	1	5035048059104
DT3117-QZ	Multi Purpose Wood/paint-dry	240	25	1	5035048059111
DT3118-QZ	Multi Purpose Wood/paint-dry	320	25	1	5035048059128

8 HOLES PUNCHED Ø125mm Fits: Festool

Cat. No.	Description	Grit Size	Pack Qty.	M.O.Q.	Barcode
DT3119-QZ	Multi Purpose Wood/paint-dry	40	25	1	5035048082683
DT3120-QZ	Multi Purpose Wood/paint-dry	60	25	1	5035048082690
DT3124-QZ	Multi Purpose Wood/paint-dry	80	25	1	5035048082706
DT3129-QZ	Multi Purpose Wood/paint-dry	120	25	1	5035048082713
DT3130-QZ	Multi Purpose Wood/paint-dry	180	25	1	5035048082720
DT3139-QZ	Multi Purpose Wood/paint-dry	240	25	1	5035048082911

6 HOLES PUNCHED Ø150mm Fits: DeWALT, Bosch, Hitachi, Metabo, Peugeot

Cat. No.	Description	Grit Size	Pack Qty.	M.O.Q.	Barcode
DT3121-QZ	Multi Purpose Wood/paint-dry	40	10	1	5035048059135
DT3122-QZ	Multi Purpose Wood/paint-dry	60	10	1	5035048059142
DT3123-QZ	Multi Purpose Wood/paint-dry	80	10	1	5035048059159
DT3125-QZ	Multi Purpose Wood/paint-dry	120	10	1	5035048059166
DT3126-QZ	Multi Purpose Wood/paint-dry	180	10	1	5035048059173
DT3127-QZ	Multi Purpose Wood/paint-dry	240	10	1	5035048059180
DT3128-QZ	Multi Purpose Wood/paint-dry	320	10	1	5035048059197
DT3131-QZ	Multi Purpose Wood/paint-dry	40	25	1	5035048059203
DT3132-QZ	Multi Purpose Wood/paint-dry	60	25	1	5035048059210
DT3133-QZ	Multi Purpose Wood/paint-dry	80	25	1	5035048059227
DT3135-QZ	Multi Purpose Wood/paint-dry	120	25	1	5035048059234
DT3136-QZ	Multi Purpose Wood/paint-dry	180	25	1	5035048059241
DT3137-QZ	Multi Purpose Wood/paint-dry	240	25	1	5035048059463
DT3138-QZ	Multi Purpose Wood/paint-dry	320	25	1	5035048059258

9 HOLES PUNCHED Ø150mm Fits: Festool

Cat. No.	Description	Grit Size	Pack Qty.	M.O.Q.	Barcode
DT3151-QZ	Multi Purpose Wood/paint-dry	40	25	1	5035048068083
DT3152-QZ	Multi Purpose Wood/paint-dry	60	25	1	5035048068090
DT3153-QZ	Multi Purpose Wood/paint-dry	80	25	1	5035048068106
DT3155-QZ	Multi Purpose Wood/paint-dry	120	25	1	5035048068113
DT3156-QZ	Multi Purpose Wood/paint-dry	180	25	1	5035048068120

9 HOLES PUNCHED Ø225mm Fits: Festool, Flex

Cat. No.	Description	Grit Size	Pack Qty.	M.O.Q.	Barcode
DT3164-QZ	Multi Purpose Wood/paint-dry	60	10	1	5035048082782
DT3169-QZ	Multi Purpose Wood/paint-dry	80	10	1	5035048082799
DT3179-QZ	Multi Purpose Wood/paint-dry	100	10	1	5035048082928
DT3170-QZ	Multi Purpose Wood/paint-dry	120	10	1	5035048082805



EXTREME DeWALT FIBRE DISCS



APPLICATIONS

- Stock removal /stripping tasks on metal and derusting.

FEATURES

- Extra tough Vulcanised fibre backing for aggressive fast sanding.
- Extremely durable hard Zirconia grain for fast aggressive stock removal on metals.
- Heat resistant resin bond keeps the abrasive grain in place for longer ensuring longer disc life.
- Cool cut for low discolouration of metal.

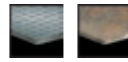

115mm Ø

Cat. No.	Description	Grit Size	Pack Qty.	M.O.Q.	Barcode
DT3201-QZ	Fibre Disc	40	25	1	5011402375257
DT3202-QZ	Fibre Disc	60	25	1	5011402375271
DT3203-QZ	Fibre Disc	80	25	1	5011402375295
DT3205-QZ	Fibre Disc	100	25	1	5035048067277
DT3206-QZ	Fibre Disc	120	25	1	5035048067284

125mm Ø

Cat. No.	Description	Grit Size	Pack Qty.	M.O.Q.	Barcode
DT3211-QZ	Fibre Disc	40	25	1	5011402375356
DT3212-QZ	Fibre Disc	60	25	1	5011402375370
DT3213-QZ	Fibre Disc	80	25	1	5011402375394
DT3215-QZ	Fibre Disc	100	25	1	5035048067291
DT3216-QZ	Fibre Disc	120	25	1	5035048067307

FLAP DISCS



APPLICATIONS

- For rust removal, grinding and cleaning metal.

FEATURES

- Tough durable zirconia grain.
- Very strong with very high removal rate.
- Low noise.
- Cool grinding.

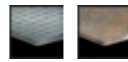

FLAP DISCS

Cat. No.	Description	Diameter mm	Grit Size	Pack Qty.	M.O.Q.	Barcode
DT3269-QZ	Type 29 Angled	100mm	60	10	1	5035048077344
DT3274-QZ	Type 29 Angled	100mm	80	10	1	5035048077351
DT3255-QZ	Type 29 Angled	115mm	36	10	1	5035048075166
DT3256-QZ	Type 29 Angled	115mm	60	10	1	5035048075173
DT3257-QZ	Type 29 Angled	115mm	80	10	1	5035048075180
DT3258-QZ	Type 29 Angled	115mm	120	10	1	5035048075197
DT3265-QZ	Type 29 Angled	125mm	36	10	1	5035048075203
DT3266-QZ	Type 29 Angled	125mm	60	10	1	5035048075210
DT3267-QZ	Type 29 Angled	125mm	80	10	1	5035048075227
DT3268-QZ	Type 29 Angled	125mm	120	10	1	5035048075234
DT3208-QZ	Type 27 Flat	100mm	36	10	1	5035048077375
DT3209-QZ	Type 27 Flat	100mm	60	10	1	5035048077382
DT3218-QZ	Type 27 Flat	100mm	80	10	1	5035048077399
DT3219-QZ	Type 27 Flat	100mm	120	10	1	5035048077405
DT3292-QZ	Type 27 Flat	115mm	36	10	1	5035048075241
DT3293-QZ	Type 27 Flat	115mm	60	10	1	5035048075258
DT3294-QZ	Type 27 Flat	115mm	80	10	1	5035048075265
DT3295-QZ	Type 27 Flat	115mm	120	10	1	5035048075272
DT3308-QZ	Type 27 Flat	125mm	36	10	1	5035048075289
DT3309-QZ	Type 27 Flat	125mm	60	10	1	5035048075296
DT3310-QZ	Type 27 Flat	125mm	80	10	1	5035048075302

'QUICK FIT' PLATENS

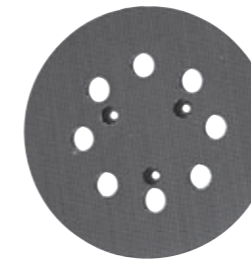

FEATURES

- Quick Fit replacement platens for DeWALT Random Orbit Sanders. Hardness grade - medium.

'QUICK FIT' PLATENS

Cat. No.	Description	Diameter mm	Pack Qty.	M.O.Q.	Barcode
DT3600-QZ	Quick Fit Platen	125	1	1	5035048059265
DT3601-QZ	Quick Fit Platen	150	1	1	5035048059272
DE2639-XJ	150MM 6 & 8 HOLE BACKING PAD	150	1	1	5035048136553

BACKING PADS & BONNETS



APPLICATIONS

- For use with angle grinder fibre discs and polishing bonnets.

FEATURES

- Thermoplastic backing pad supplied with flange locking nut.

BACKING PADS & BONNETS

Cat. No.	Diameter mm	Max Speed	Bore Size mm	Pack Qty.	M.O.Q.	Barcode
DT3610-QZ	115	13000 rpm	M 14	1	1	5035048059289
DT3611-QZ	125	15000 rpm	M 14	1	1	5035048059296
DT3612-QZ	178	8500 rpm	M 14	1	1	5035048059302

ANGLE GRINDER POLISHING BONNETS



APPLICATIONS

- High Speed polishing on a wide variety of surfaces (e.g.) unpainted metals and stone.

FEATURES

- Lambswool pile polishing bonnets.

ANGLE GRINDER POLISHING BONNETS

Cat. No.	Diameter mm	Pack Qty.	M.O.Q.	Barcode
DT3620-QZ	115	1	1	5035048059319
DT3621-QZ	125	1	1	5035048059326
DT3622-QZ	178	1	1	5035048059333
DT3557-QZ	125	1	1	5035048083031
DT3558-QZ	150	1	1	5035048083048

POLISHING FOAMS

Cat. No.	Diameter mm	Pack Qty.	M.O.Q.	Barcode
DT3555-QZ	115	1	1	5035048083017
DT3558-QZ	150	1	1	5035048083048

CLEANING FLEECES

Cat. No.	Diameter mm	Pack Qty.	M.O.Q.	Barcode
DT3550-QZ	115	1	1	5035048082980

**METAL CUTTING DISCS**



**APPLICATIONS**

- Cutting ferrous metals such as steel, iron, rebar and welds.

**FEATURES**

- Professional grade aluminium oxide.
- Premium resin bond.
- Reinforced fibre glass.

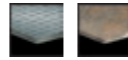

**FLAT**

Cat. No.	Diameter mm	Material	Thickness mm	Bore Size mm	Pack Qty.	M.O.Q.	Barcode
DT3405-QZ	115	A46TBF	1.6	22.2	1	25	5035048014592
DT3400-QZ	115	A30TBF	2.5	22.2	1	25	5011402375646
DT3409-QZ	125	A46TBF	1.6	22.2	1	25	5035048014608
DT3410-QZ	125	A30TBF	2.5	22.2	1	25	5011402365677
DT3415-QZ	150	A30TBF	2.5	22.2	1	25	5035048059470
DT3420-QZ	180	A30TBF	3	22.2	1	25	5011402375707
DT3430-QZ	230	A30TBF	3	22.2	1	25	5011402375738
DT3481-QZ*	115	A46TBF	1.7	22.2	1	25	5035048077443
DT3482-QZ*	125	A46TBF	1.7	22.2	1	25	5035048077450
DT3483-QZ*	180	A46TBF	1.7	22.2	1	25	5035048077467
DT3484-QZ*	230	A46TBF	1.8	22.2	1	25	5035048077474
DT3487-QZ*	230	A30TBF	3.1	22.2	1	25	5035048078396

\*EXTREME DEWALT

**DEPRESSED CENTRE**

Cat. No.	Diameter mm	Material	Thickness mm	Bore Size mm	Pack Qty.	M.O.Q.	Barcode
DT3406-QZ	115	A30TBF	2.5	22.2	1	25	5035048014615
DT3413-QZ	125	A30TBF	2.5	22.2	1	25	5035048014622
DT3423-QZ	180	A30TBF	3.0	22.2	1	25	5035048014639
DT3433-QZ	230	A30TBF	3.0	22.2	1	25	5035048014646

**METAL GRINDING DISCS**



**APPLICATIONS**

- For general metal grinding applications on ferrous and non-ferrous metals, including weld and surface preparation.

**FEATURES**

- Professional grade aluminium oxide.
- Reinforced fibre glass.
- Premium resin bond.

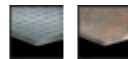

**DEPRESSED CENTRE**

Cat. No.	Diameter mm	Material	Thickness mm	Bore Size mm	Pack Qty.	M.O.Q.	Barcode
DT3458-QZ	115	A24TBF	4.5	22.2	1	25	5035048014806
DT3402-QZ	115	A24TBF	6.0	22.2	1	25	5011402375660
DT3412-QZ	125	A24TBF	6.0	22.2	1	25	5011402375691
DT3416-QZ	150	A24TBF	6.0	22.2	1	10	5035048059487
DT3422-QZ	180	A24TBF	6.0	22.2	1	25	5011402375721
DT3432-QZ	230	A24TBF	7	22.2	1	25	5011402375752

**CHOP SAW WHEEL – FOR METAL**



**APPLICATIONS**

- Cutting ferrous metals such as steel, iron, rebar and welds.

**FEATURES**

- Professional grade aluminium oxide.
- Premium resin bond.
- Reinforced fibre glass.

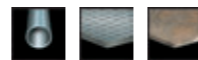

**CHOP SAW WHEEL – FOR METAL**

Cat. No.	Diameter mm	Material	Thickness mm	Bore Size mm	Pack Qty.	M.O.Q.	Barcode
DT3450-QZ	355	A30TBF	3	25.4	1	10	5011402375769

**STAINLESS STEEL AND THIN METAL CUTTING DISCS**



**APPLICATIONS**

- For cutting all types of steel.

**FEATURES**

- Professional grade aluminium oxide formulation for high durability, aggressive cutting action and long life.

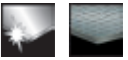

**FLAT**

Cat. No.	Diameter mm	Material	Thickness mm	Bore Size mm	Pack Qty.	M.O.Q.	Barcode
DT3440-QZ	100	A60TBF	1.0	16.0	1	25	5035048014707
DT3442-QZ	115	A60TBF	1.0	22.2	1	25	5035048014714
DT3445-QZ	125	A60TBF	1.0	22.2	1	25	5035048014738
DT3485-QZ	115	A60SBF	1.0	22.2	1	25	5035048077481
DT3486-QZ	125	A60SBF	1.0	22.2	1	25	5035048077498
DT3443-QZ*	115	A/ WA30T BF	2.5	22.2	1	25	5035048014721
DT3446-QZ*	125	A/ WA30T BF	2.5	22.2	1	25	5035048014745
DT3447-QZ*	180	A/ WA30T BF	2.8	22.2	1	25	5035048014752
DT3449-QZ*	230	A/ WA30T BF	2.8	22.2	1	25	5035048014769

\*EXTREME DEWALT

**STAINLESS STEEL GRINDING DISCS**



**APPLICATIONS**

- For cutting all types of steel.

**FEATURES**

- Professional grade aluminium oxide formulation for high durability, aggressive cutting action and long life.

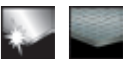

**DEPRESSED CENTRE**

Cat. No.	Diameter mm	Material	Thickness mm	Bore Size mm	Pack Qty.	M.O.Q.	Barcode
DT3467-QZ	115	A/ WA24T BF	4.5	22.2	1	25	5035048014851
DT3468-QZ	125	A/ WA24T BF	4.5	22.2	1	25	5035048014868

**ALUMINIUM CUTTING DISCS**



**APPLICATIONS**

- Fast cutting and long life in aluminium.

**FEATURES**

- Professional grade aluminium oxide and silicone carbide.
- Premium resin bond.
- Reinforced fibre glass.



**FLAT**

Cat. No.	Diameter mm	Material	Thickness mm	Bore Size mm	Pack Qty.	M.O.Q.	Barcode
DT3453-QZ	115	AC46TBF	1.6	22.2	1	25	5035048014776
DT3454-QZ	125	AC46TBF	1.6	22.2	1	25	5035048014783

**HIGH SPEED STONE CUTTING DISCS**



**APPLICATIONS**

- For cutting natural stone, concrete, brick.

**FEATURES**

- Professional grade silicon carbide for aggressive cutting action and long life.



**HIGH SPEED STONE CUTTING DISCS**

Cat. No.	Diameter mm	Material	Thickness mm	Bore Size mm	Pack Qty.	M.O.Q.	Barcode
DT3476-QZ	300	C24RBF	3.5	20.0	1	10	5035048074916
DT3477-QZ	300	C24RBF	3.5	25.4	1	10	5035048074923

STONE CUTTING DISCS



APPLICATIONS

- For cutting general masonry products including concrete, stone and aggregate.

FEATURES

- Professional grade silicon carbide.
- Premium resin bond.
- Fibre glass reinforcements.



FLAT

Cat. No.	Diameter mm	Material	Thickness mm	Bore Size mm	Pack Qty.	M.O.Q.	Barcode
DT3401-QZ	115	C30TBF	2.5	22.2	1	25	5011402375653
DT3411-QZ	125	C30TBF	2.5	22.2	1	25	5011402375684
DT3421-QZ	180	C30TBF	3	22.2	1	25	5011402375714
DT3431-QZ	230	C30TBF	3	22.2	1	25	5011402375745

DEPRESSED CENTRE

Cat. No.	Diameter mm	Material	Thickness mm	Bore Size mm	Pack Qty.	M.O.Q.	Barcode
DT3407-QZ	115	C30TBF	2.5	22.2	1	25	5035048014660
DT3414-QZ	125	C30TBF	2.5	22.2	1	25	5035048014677
DT3424-QZ	180	C30TBF	3.0	22.2	1	25	5035048014684
DT3434-QZ	230	C30TBF	3.0	22.2	1	25	5038048014691

STONE GRINDING DISCS



APPLICATIONS

- For cutting general masonry products including concrete, stone and aggregate.

FEATURES

- Professional grade silicon carbide.
- Premium resin bond.
- Fibre glass reinforcements.



DEPRESSED CENTRE

Cat. No.	Diameter mm	Material	Thickness mm	Bore Size mm	Pack Qty.	M.O.Q.	Barcode
DT3461-QZ	115	C24TBF	7.0	22.2	1	25	5035048014813
DT3462-QZ	125	C24TBF	7.0	22.2	1	25	5035048014820
DT3464-QZ	230	C24TBF	7.0	22.2	1	25	5038048014844

GRINDING AND HONING WHEELS

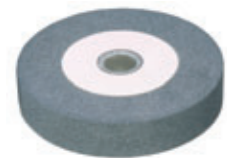

GRINDING AND HONING WHEELS

Cat. No.	Grit Size	Material	Diameter mm	Width mm	Bore Size mm	M.O.Q.	Barcode
DT3384-QZ	60	Blue Aluminium Oxide	125	25	20	1	5035048054093
DT3385-QZ	80	White Aluminium Oxide	125	25	20	1	5035048054116
DT3386-QZ	80	Silicon Carbide	125	25	20	1	5035048054130
DT3389-QZ	60	White Aluminium Oxide	150	20	20	1	5035048054161
DT3380-QZ	400	Silicon Carbide	125	25	20	1	5035048054048
DT3381-QZ	800	Silicon Carbide	125	12	20	1	5035048054055



GRINDING CUPS



APPLICATIONS

- For manual grinding large surface areas of natural and synthetic stones.

FEATURES

- Professional grade silicon carbide for high removal rate.
- Available in coarse and medium.



GRINDING CUPS

Cat. No.	Diameter mm	Material	Thickness mm	Bore Size mm	Pack Qty.	M.O.Q.	Barcode
DT3551-QZ	110	C16	55	22.2	1	1	5035048082997
DT3552-QZ	110	C24	55	22.2	1	1	5035048083000

WIRE BRUSHES

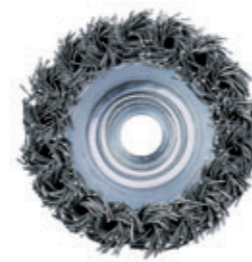

APPLICATIONS

- Aggressive twist knot wire wheel and cup brushes for heavy duty cleaning work, derusting and deburring
- Crimped wire wheel and cup brushes for medium duty cleaning
- Wire wheel and cup brushes for multi purpose cleaning applications in hard to reach areas

FEATURES

- Highly specified wire grades for optimum material removal
- High wire content for extra brush durability

WIRE WHEEL BRUSHES FOR DRILLS For: Cleaning Work eg Paint, Rust, Scale, Burr and Rust Removal

Cat. No.	Diameter mm	Wire Length mm	Bore Size mm	Pack Qty.	M.O.Q.	Barcode
DT3496-QZ	40	8	6	1	1	5035048079423
DT3494-QZ	50	8	6	1	1	5035048079430
DT3408-QZ	60	10	6	1	1	5035048079447
DT3418-QZ	75	10	6	1	1	5035048078454
DT3419-QZ	100	10	6	1	1	5035048079461
DT3425-QZ	75	10	6	1	1	5035048079478
DT3426-QZ	75	10	6	1	1	5035048079485

WIRE CUP BRUSHES FOR DRILLS For: Medium duty work on surfaces eg paint removal, de-rusting, cleaning, deburring, descaling

Cat. No.	Diameter mm	Wire Length mm	Bore Size mm	Pack Qty.	M.O.Q.	Barcode
DT3427-QZ	17	25	6	1	1	5035048079492
DT3428-QZ	25	25	6	1	1	5035048079508
DT3429-QZ	30	30	6	1	1	5035048079515
DT3435-QZ	40	17	6	1	1	5035048079522
DT3436-QZ	50	16	6	1	1	5035048079539
DT3437-QZ	60	18	6	1	1	5035048079546
DT3439-QZ	75	19	6	1	1	5035048079560
DT3441-QZ	50	16	6	1	1	5035048079577
DT3495-QZ	50	16	6	1	1	5035048079584

CRIMPED WIRE WHEEL BRUSHES FOR BENCH GRINDERS For: Light and medium cleaning jobs

Cat. No.	Diameter mm	Wire Length mm	Bore Size mm	Pack Qty.	M.O.Q.	Barcode
DT3451-QZ	100	20	20	1	1	5035048079607
DT3455-QZ	115	20	20	1	1	5035048079621
DT3448-QZ	125	20	20	1	1	5035048079591
DT3456-QZ	150	25	32	1	1	5035048079638
DT3459-QZ	200	25	32	1	1	5035048079645

TWIST KNOT WIRE WHEEL BRUSHES FOR ANGLE GRINDERS For: Heavy duty cleaning work eg deburring, paint stripping, rust removal

Cat. No.	Diameter mm	Wire Length mm	Bore Size mm	Pack Qty.	M.O.Q.	Barcode
DT3460-QZ	100	22	16	1	1	5035048079652
DT3466-QZ	115	22	22.2	1	1	5035048079676
DT3502-QZ	115	22	22.2	1	1	5011402375790
DT3452-QZ	150	22	22.2	1	1	5035048079614
DT3470-QZ	180	40	22.2	1	1	5035048079683

CRIMPED WIRE CUP BRUSHES FOR ANGLE GRINDERS For: Medium duty work on surfaces eg paint removal, de-rusting, cleaning, deburring

Cat. No.	Diameter mm	Wire Length mm	Bore Size mm	Pack Qty.	M.O.Q.	Barcode
DT3475-QZ	65	19	M10	1	1	5035048079690
DT3480-QZ	65	19	M14	1	1	5035048079706
DT3488-QZ	75	23	M14	1	1	5035048079713
DT3489-QZ	100	26	M14	1	1	5035048079720
DT3490-QZ	100	26	5/8"	1	1	5035048079737
DT3465-QZ	125	26	M14	1	1	5035048079669

TWIST KNOT WIRE CUP BRUSHES FOR ANGLE GRINDERS For: Heavy duty cleaning work

Cat. No.	Diameter mm	Wire Length mm	Bore Size mm	Pack Qty.	M.O.Q.	Barcode
DT3491-QZ	60	18	M10	1	1	5035048079744
DT3500-QZ	65	18	M14	1	1	5011402375776
DT3492-QZ	75	22	M14	1	1	5035048079751
DT3501-QZ	100	24	M14	1	1	5011402375783
DT3493-QZ	100	24	5/8"	1	1	5035048079768

SELECT THE BLADE FOR THE MATERIAL



	Professional High Performance					Professional Sintered		
	Building materials/ Concrete	Abrasive Materials/ Concrete	Hard Concrete/ Granite	Tile	Asphalt	Building materials/ Concrete	Turbo-Building Materials/Concrete	Tile
VERY ABRASIVE AND NOT COMPACT								
ASPHALT					●			
GREEN CONCRETE					●			
LIGHT EXPANDED CLAY BLOCK (Argex, Syporex, Poroton)	○	●			●			
SILICA BASED ABRASIVE REFRACTORY (Brick)	○	●			●			
BREEZE BLOCK	●	●			●			
MEDIUM-ABRASIVE AND COMPACT								
MARBLE CEMENT BLOCK (Granito, Terrazo)	●	●		○	○	○	○	○
FIBROUS CONCRETE (Eternit roof tile)	●	●		○	○	○	○	○
CELLULAR CONCRETE	●	●		○	○	○	○	○
FIRED CLAY (Brick, roof tile)	●	●		○	○	○	○	○
GYPSUM PLASTER	●	●		○	○	●	○	○
NATURAL SOFT STONES (Limestone, Sandstone)	●	●		○	○	●	○	○
SOFT REFRACTORY (Hand made bricks, abrasive concrete)	●	●	○	○	○	●	○	○
CONCRETE ROOF TILE	●	●	○	○	○	●	○	○
KALKSANDSTEIN (KSS)	●	●	○			●	●	
ABRASIVE AND VERY COMPACT								
SOFT AGGREGATES CONCRETE (Industrial floors)	●	●	○			●	●	
MEDIUM-HARD SANDSTONE	●	●	○			●	●	
ABRASIVE MARBLE (Crystalline)	●	●	○			●	●	
MEDIUM-HARD REFRACTORY (Facing bricks, Limestone concrete)	●	●	○			●	●	
FIRED CLAY, EARTHENWARE PIPE	●	●	○			●	●	
MEDIUM-HARD AND COMPACT								
NATURAL SLATE, SCHIST	●	○	○			○	○	
CONCRETE (Kerb, Paving block, Driveway blocks)	●	●	○			○	○	
LIGHT REINFORCED CONCRETE	●	●				○	○	
MEDIUM-HARD AGGREGATES CONCRETE (Industrial floors)	●	●	○			○	○	
CURED CONCRETE, MEDIUM-HARD AGGREGATES	●	●	○			○	○	
HARD NATURAL SANDSTONE	●	●	○			○	○	
HARD AND COMPACT								
HARD MARBLE	○		●			○		
REINFORCED CONCRETE (Lintels)	○		●			○		
CURED CONCRETE, HARD AGGREGATES, FLINT	○		●					
FACING BRICK	○		●					
QUARTZITE			●					
HARD REFRACTORY (Hard bricks, Medium concrete)			●					
SOFT GRANITE (Black)			●					
VERY HARD								
LIGHT REINFORCED CONCRETE, FLINT AGGREGATES			●					
COLOURED GRANITE			●					
SILICON CARBIDE REFRACTORIES (Bricks)			●					
OTHERS								
SOFT TILE (Terracotta, Ceramic)				○			○	●
HARD TILE (Gräs)				●				
STONEWARE (Porcelain tiles)				●				
MORTAR (Joints)				●				

● Recommended Material ○ Suitable Material

HIGH PERFORMANCE DIAMOND DISCS



APPLICATIONS

- For use in standard construction materials including concrete, brick, tiles and paving slabs.

FEATURES

- The best choice of diamond blade for fast, aggressive cuts in most standard construction materials.
- Segments laser welded to the core for use in tougher applications.
- High quality, low carbon steel core reduces core distortion at high temperatures, giving better cutting performance and longer life.

LASER: BUILDING MATERIALS/ CONCRETE

Cat. No.	Diameter mm	Bore Size mm	Segment Height mm	Segment Width mm	Pack Qty.	M.O.Q.	Barcode
DT3740-XJ	115	22.2	7.5	2	1	1	5035048058374
DT3741-XJ	125	22.2	7.5	2	1	1	5035048058381
DT3742-XJ	180	22.2	8.5	2.4	1	1	5035048058398
DT3743-XJ	230	22.2	8.5	2.4	1	1	5035048058404
DT3744-XJ	300	20	8.5	2.8	1	1	5035048058411
DT3747-XJ	350	20	8.5	2.8	1	1	5035048058442
DT3749-XJ	350	25.4	8.5	2.8	1	1	5035048058466

APPLICATIONS

- For use in abrasive materials including sandstone, concrete, concrete roof tiles, brick and breeze blocks.

FEATURES

- High performance diamond blade providing a balanced combination of cut speed and durability in abrasive materials.
- Segments laser welded to the core for use in tougher applications.
- High quality, low carbon steel core gives better cutting performance and longer life.

LASER: ABRASIVE MATERIALS/ CONCRETE

Cat. No.	Diameter mm	Bore Size mm	Segment Height mm	Segment Width mm	Pack Qty.	M.O.Q.	Barcode
DT3770-XJ	115	22.2	7.5	2	1	1	5035048058572
DT3771-XJ	125	22.2	7.5	2	1	1	5035048058589
DT3772-XJ	180	22.2	7.5	2.4	1	1	5035048058596
DT3773-XJ	230	22.2	7.5	2.4	1	1	5035048058602
DT3774-XJ	300	20	7.5	2.8	1	1	5035048058619
DT3777-XJ	350	20	7.5	2.8	1	1	5035048058640
DT3779-XJ	350	25.4	7.5	2.8	1	1	5035048058664

APPLICATIONS

- These blades achieve optimum speed of cut in granite, reinforced concrete and most construction materials.

FEATURES

- Manufactured using 'Advanced Bond Technology' which increases blade productivity and operating life.
- A layer of pre-alloyed metal encloses the diamond creating a pellet that is held more securely and distributed better within the segment.
- Segments laser welded to the core for use in tougher applications.
- High quality, low carbon steel core gives better cutting performance and longer life.

LASER: HARD MATERIALS/ GRANITE

Cat. No.	Diameter mm	Bore Size mm	Segment Height mm	Segment Width mm	Pack Qty.	M.O.Q.	Barcode
DT3760-XJ	115	22.2	7.5	2	1	1	5035048058473
DT3761-XJ	125	22.2	7.5	2	1	1	5035048058480
DT3762-XJ	180	22.2	8.5	2.4	1	1	5035048058497
DT3763-XJ	230	22.2	8.5	2.8	1	1	5035048058503
DT3766-XJ	230	22.2	10	2.8	1	1	5035048058534
DT3764-XJ	300	20	8.5	2.8	1	1	5035048058510
DT3767-XJ	350	20	8.5	2.8	1	1	5035048058541
DT3769-XJ	350	25.4	8.5	2.8	1	1	5035048058565

APPLICATIONS

- For porcelain tiles, floor and wall tiles, slate, concrete tiles, bricks, terracotta etc.
- Not recommended for use on wet tile saws.

FEATURES

- Diamond blade containing a high concentration of top quality diamonds with excellent cutting performance in extremely hard materials.
- Continuous rim sintered blade for fine finish and minimal chipping in tiles and ceramics.
- High quality, low carbon steel core reduces core distortion at high temperatures, giving better cutting performance and longer life.

SINTERED: TILES

Cat. No.	Diameter mm	Bore Size mm	Segment Height mm	Segment Width mm	Pack Qty.	M.O.Q.	Barcode
DT3735-XJ	115	22.2	7	1.6	1	1	5035048058732
DT3736-XJ	125	22.2	7	1.6	1	1	5035048058749
DT3737-XJ	180	22.2	7	2.1	1	1	5035048058756
DT3738-XJ	230	22.2	7	2.1	1	1	5035048058763

APPLICATIONS

- Ideal for use in very abrasive materials such as asphalt and green concrete, these blades can be used in wet or dry applications.

FEATURES

- Featuring a hard bond coupled with a high concentration of diamonds, giving optimum speed and a long service life.
- Designed to be used on petrol saws, utilised hand held / placed on a cart or on lightweight floor saws.
- Segments laser welded to the core for use in tougher applications.
- High quality, low carbon steel core gives better cutting performance and longer life.

LASER: ASPHALT

Cat. No.	Diameter mm	Bore Size mm	Segment Height mm	Segment Width mm	Pack Qty.	M.O.Q.	Barcode
DT3780-XJ	300	20	7.5	2.8	1	1	5035048058671
DT3783-XJ	350	20	7.5	3.2	1	1	5035048058701
DT3785-XJ	350	25.4	7.5	3.2	1	1	5035048058725

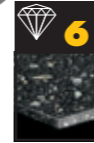
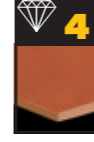

DRY DIAMOND DISCS

APPLICATIONS

- Fast, dry cutting of general masonry construction materials eg. building bricks/blocks, tiles, paving blocks, medium concrete.

FEATURES

- Segmented rim design allows fast cutting.
- Sintered diamond wheel for dry cutting general masonry materials.
- All wheels up to 230 mm diameter have 22.2 mm bore.
- 300 mm wheel has a 20 mm bore for petrol saws.

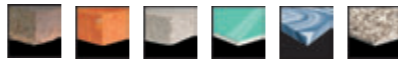

DRY DIAMOND SEGMENTED RIM WHEELS

Cat. No.	Diameter mm	Bore Size mm	Segment Height mm	Segment Width mm	Pack Qty.	M.O.Q.	Barcode
DT3701-QZ	115	22.2	7	1.75	1	1	5035048025895
DT3711-QZ	125	22.2	7	1.8	1	1	5035048025901
DT3721-QZ	180	22.2	7	2.1	1	1	5035048025918
DT3731-QZ	230	22.2	7	2.3	1	1	5035048025925
DT3751-QZ	300	20	7	2.8	1	1	5035048025932

APPLICATIONS

- Cool clean cutting of masonry construction materials particularly suitable for marble, granite and natural stone.

FEATURES

- Sintered diamond wheel for dry cutting general masonry materials.
- Turbo rim design provides cooler, cleaner cutting of harder materials.
- All wheels have 22.2 mm bore.

TURBO DRY DIAMOND CUTTING WHEELS

Cat. No.	Diameter mm	Bore Size mm	Segment Height mm	Segment Width mm	Pack Qty.	M.O.Q.	Barcode
DT3702-QZ	115	22.2	7	2.1	1	1	5035048025970
DT3712-QZ	125	22.2	7	2.2	1	1	5035048025987
DT3722-QZ	180	22.2	7	2.4	1	1	5035048025994
DT3732-QZ	230	22.2	7	2.6	1	1	5035048026007

APPLICATIONS

- Fine finish cutting tiles, ceramics etc.

FEATURES

- Continuous rim design for fine finish in hard materials.
- Sintered dry cutting wheel with 22.2mm bore.

DRY DIAMOND CONTINUOUS RIM WHEELS

Cat. No.	Diameter mm	Bore Size mm	Segment Height mm	Segment Width mm	Pack Qty.	M.O.Q.	Barcode
DT3703-QZ	115	22.2	5	1.6	1	1	5035048025956
DT3713-QZ	125	22.2	5	1.6	1	1	5035048025963

WET DIAMOND TILE SAW

APPLICATIONS

- Fine finish cutting tiles, ceramics etc.

FEATURES

- Continuous rim design for fine finish in hard materials.
- Sintered dry cutting wheel with 25.4mm bore.
- Music slots for hard materials eg. stone and granite (DT3734XJ).



WET DIAMOND TILE SAW

Cat. No.	Diameter mm	Bore Size mm	Segment Height mm	Segment Width mm	Pack Qty.	M.O.Q.	Barcode
DT3733-XJ	250	25.4	5	1.6	1	1	5035048012413
DT3734-XJ	250	25.4	8	1.6	1	1	5035048012420

WET & DRY TILE SAW



APPLICATIONS

- For manual wet and dry cutting of tiles.

FEATURES

- Continuous rim design for fine finish in all tile materials
- DT3715-QZ designed for extra fine finish in porcelain, marble and granite tiles.



WET & DRY TILE SAW

Cat. No.	Diameter mm	Bore Size mm	Segment Height mm	Segment Width mm	Pack Qty.	M.O.Q.	Barcode
DT3714-QZ	110	20	5	1.6	1	1	5035048083109
DT3715-QZ	110	20	8	1.6	1	1	5035048083116



DRY DIAMOND CORE DRILLS



APPLICATIONS

- Standard 1/2" BSP female fitment to allow usage with DeWalt and other diamond drill brands (use in conjunction with adaptor for machines with different threads).
- For dry drilling clean large diameter holes in masonry and stone.

FEATURES

- Optimised diamond segment design for high speed drilling and long life in a wide range of building materials.
- Laser welding to prevent segment loss when dry drilling
- Solid core body for optimum dust extraction performance.



FITMENT 1/2" BSP (FEMALE) UNIVERSAL

Cat. No.	Diameter mm	Length mm	Number of Segments	Pack Qty.	M.O.Q.	Barcode
DT3876-QZ	28	300	1	1	1	5035048070918
DT3877-QZ	32	300	1	1	1	5035048070925
DT3885-QZ	38	150	3	1	1	5035048070932
DT3886-QZ	48	150	4	1	1	5035048070949
DT3887-QZ	52	150	3	1	1	5035048070956
DT3888-QZ	60	150	3	1	1	5035048070963
DT3889-QZ	65	150	3	1	1	5035048070970
DT3890-QZ	72	150	4	1	1	5035048070987
DT3891-QZ	78	150	4	1	1	5035048070994
DT3892-QZ	82	150	4	1	1	5035048071007
DT3893-QZ	91	150	4	1	1	5035048071014
DT3894-QZ	107	150	4	1	1	5035048071021
DT3895-QZ	117	150	5	1	1	5035048071038
DT3896-QZ	127	150	5	1	1	5035048071045
DT3897-QZ	132	150	5	1	1	5035048071052
DT3898-QZ	152	150	6	1	1	5035048071069

DOSENSEKER

APPLICATIONS

- User length of 62mm, M16 fitment.
- Used for electrical installations e.g wall sockets or boxes etc.

DOSENSEKER

Cat. No.	Diameter mm	Length mm	Thread	Number of Segments	Pack Qty.	M.O.Q.	Barcode
DT3865-QZ	68	62	M16F	3	1	1	5035048071076
DT3866-QZ	82	62	M16F	4	1	1	5035048071083

ACCESSORIES FOR DOSENSEKER

Cat. No.	Thread Conversion from	Thread Conversion to	Range	Pack Qty.	M.O.Q.	Barcode
DT3864-QZ	1/2" BSP F	M16M	Dry	1	1	5035048072349
DT3868-QZ	3 Jaw Chuck	M16M	Dry	1	1	5035048072356
DT3869-QZ	SDS Plus	M16M	Dry	1	1	5035048072363
DT3873-QZ	120mm A Taper pilot drill		Dry	1	1	5035048066607

ADAPTORS DRY

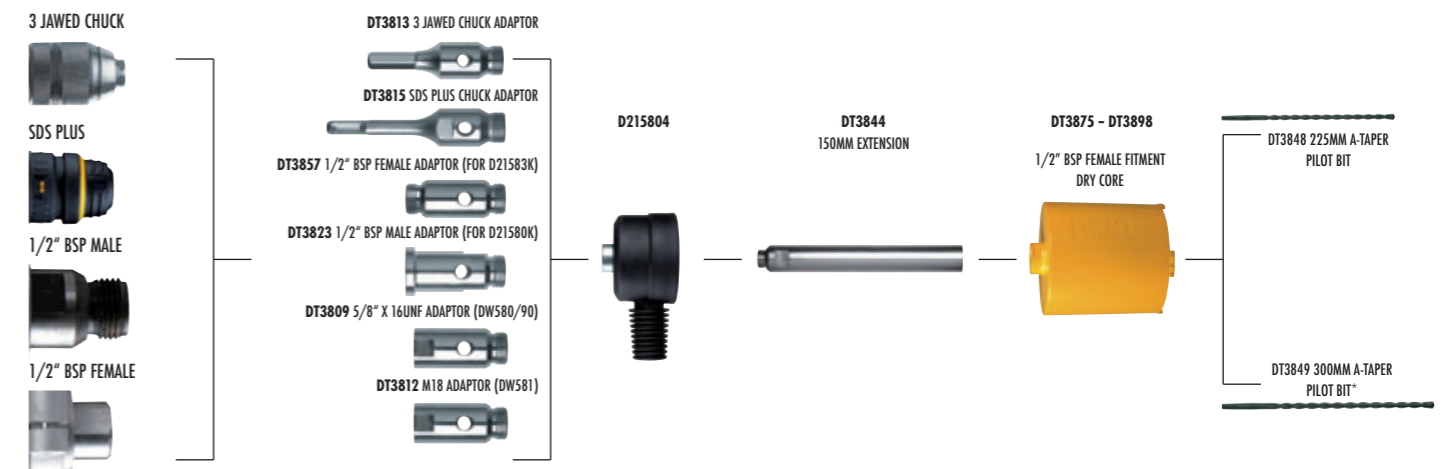

\* 300mm Pilot bit required when dust extraction system is used.

WET DIAMOND CORE BITS



APPLICATIONS

- Standard 1/2 BSP male fitment to allow usage with DeWalt and other diamond drill brands (use in conjunction with adaptor for machines with different threads).

FEATURES

- Optimised diamond segment design for high speed drilling and long life in a wide range of building materials.
- Laser welding to prevent segment loss when wet drilling.
- Available in 2 performance grades for fast cutting and long life in both standard and hard materials.



FITMENT 1/2" BSP (MALE) UNIVERSAL

Cat. No.	Diameter mm	Length mm	Number of Segments	Pack Qty.	M.O.Q.	Barcode
DT9710-QZ	25	350	1	1	1	5035048071274
DT9712-QZ	30	350	1	1	1	5035048071298
DT9714-QZ	37	350	4	1	1	5035048071311
DT9715-QZ	40	350	4	1	1	5035048071328
DT9716-QZ	45	350	5	1	1	5035048071335
DT9717-QZ	52	350	5	1	1	5035048071342
DT9718-QZ	60	350	6	1	1	5035048071359
DT9719-QZ	65	350	7	1	1	5035048071366
DT9720-QZ	72	350	7	1	1	5035048071373
DT9721-QZ	78	350	8	1	1	5035048071380
DT9722-QZ	82	350	8	1	1	5035048071397
DT9724-QZ	102	350	9	1	1	5035048071410
DT9726-QZ	112	350	10	1	1	5035048071434
DT9727-QZ	122	350	11	1	1	5035048071441
DT9728-QZ	127	350	11	1	1	5035048071458
DT9729-QZ	132	350	12	1	1	5035048071465
DT9730-QZ	152	350	13	1	1	5035048071472



APPLICATIONS

- Standard 1/2 BSP male fitment to allow usage with DeWalt and other diamond drill brands (use in conjunction with adaptor for machines with different threads).

FEATURES

- Optimised diamond segment design for use with hard materials.
- Laser welding to prevent segment loss when wet drilling.



FITMENT 1/2" BSP (MALE) HARD MATERIALS

Cat. No.	Diameter mm	Length mm	Number of Segments	Pack Qty.	M.O.Q.	Barcode
DT9735-QZ	25	350	1	1	1	5035048071489
DT9736-QZ	28	350	1	1	1	5035048071496
DT9737-QZ	30	350	1	1	1	5035048071502
DT9738-QZ	32	350	1	1	1	5035048071519
DT9740-QZ	40	350	4	1	1	5035048071533
DT9742-QZ	52	350	5	1	1	5035048074557
DT9743-QZ	60	350	6	1	1	5035048071564
DT9744-QZ	65	350	7	1	1	5035048071571
DT9746-QZ	78	350	8	1	1	5035048071595
DT9747-QZ	82	350	8	1	1	5035048071601
DT9748-QZ	91	350	9	1	1	5035048071618
DT9749-QZ	102	350	9	1	1	5035048071625
DT9751-QZ	112	350	10	1	1	5035048071649
DT9752-QZ	122	350	11	1	1	5035048071656
DT9753-QZ	127	350	11	1	1	5035048071663
DT9754-QZ	132	350	12	1	1	5035048071670
DT9755-QZ	152	350	13	1	1	5035048071687

APPLICATIONS

- Standard 1 1/4" UNC female fitment to allow usage with DeWalt and other diamond drill brands (use in conjunction with adaptor for machines with different threads).

FEATURES

- Optimised diamond segment design for high speed drilling and long life in a wide range of building materials.
- Available in 2 performance grades for fast cutting and long life in both standard and hard materials.



FITMENT 1 1/4" UNC (FEMALE) UNIVERSAL

Cat. No.	Diameter mm	Length mm	Number of Segments	Pack Qty.	M.O.Q.	Barcode
DT9760-QZ	52	400	5	1	1	5035048071694
DT9761-QZ	60	400	6	1	1	5035048071700
DT9762-QZ	65	400	7	1	1	5035048071717
DT9763-QZ	72	400	7	1	1	5035048071724
DT9764-QZ	78	400	8	1	1	5035048071731
DT9765-QZ	82	400	8	1	1	5035048071748
DT9766-QZ	91	400	9	1	1	5035048071755
DT9767-QZ	102	400	9	1	1	5035048071762
DT9768-QZ	107	400	10	1	1	5035048071779
DT9769-QZ	112	400	10	1	1	5035048071786
DT9770-QZ	122	400	11	1	1	5035048071793
DT9771-QZ	127	400	11	1	1	5035048071809
DT9772-QZ	132	400	12	1	1	5035048071816
DT9773-QZ	152	400	13	1	1	5035048071823
DT9774-QZ	162	400	13	1	1	5035048071830
DT9775-QZ	178	400	14	1	1	5035048071847
DT9776-QZ	187	400	15	1	1	5035048071854
DT9777-QZ	200	400	16	1	1	5035048071861
DT9778-QZ	212	400	16	1	1	5035048071878
DT9779-QZ	225	400	17	1	1	5035048071885
DT9780-QZ	250	400	17	1	1	5035048071892
DT9781-QZ	300	400	22	1	1	5035048071908

ACCESSORIES



ADAPTORS

Cat. No.	Thread Conversion from	Thread Conversion to	Applications	Pack Qty.	M.O.Q.	Barcode
DT3800-QZ	1/2" BSP M	1 1/4" UNC M	Wet	1	1	5035048071106
DT3801-QZ	Hilti DCM1/DD80	1/2" BSP F	Wet	1	1	5035048071113
DT3803-QZ	Hilti DCM1.5, DD1160, DCM2, DD250	1 1/4" UNC M	Wet	1	1	5035048071120
DT3809-QZ	5/8" x 16UNF	1/2" BSP M	Dry	1	1	5035048071137
DT3812-QZ	M18	1/2" BSP M	Dry	1	1	5035048071144
DT3813-QZ	3 jaw chuck	1/2" BSP M	Dry	1	1	5035048071151
DT3815-QZ	SDS Plus	1/2" BSP M	Dry	1	1	5035048071168
DT3823-QZ	1/2" BSP F	1/2" BSP M	Dry	1	1	5035048071182
DT3857-QZ	1/2" BSP M	1/2" BSP M	Wet to Dry	1	1	5035048071946
DT3858-QZ	1 1/4" UNC F	1/2" BSP F	Wet	1	1	5035048072325



EXTENSION RODS

Cat. No.	Thread Conversion from	Thread Conversion to	Length mm	Applications	Pack Qty.	M.O.Q.	Barcode
DT3829-QZ	1 1/4" UNC F	1 1/4" UNC M	150	Wet	1	1	5035048071199
DT3839-QZ	1 1/4" UNC F	1 1/4" UNC M	300	Wet	1	1	5035048071205
DT3846-QZ	1/2" BSP M	1/2" BSP F	150	Wet	1	1	5035048071236
DT3844-QZ	1/2" BSP F	1/2" BSP M	150	Dry	1	1	5035048071212
DT3847-QZ	1/2" BSP M	1/2" BSP F	300	Wet	1	1	5035048071243



PILOT BITS

Cat. No.	Length mm	Applications	Pack Qty.	M.O.Q.	Barcode
DT3848-QZ	225	Dry	1	1	5035048071250
DT3849-QZ	300	Dry	1	1	5035048071267

ADAPTORS WET

1 1/4" UNC MALE



DT3800 1/2" BSP FEMALE TO 1 1/4" UNC MALE



DT3829 150mm 1 1/4" UNC



DT3839 300mm 1 1/4" UNC



DT3803 HILTI TO 1 1/4" UNC



1/2" BSP FEMALE



DT3801 HILTI TO 1/2" BSP FEMALE



DT3846 150mm 1/2" BSP



DT3847 300mm 1/2" BSP



1 1/4" UNC WET CORES



1/2" BSP MALE GENERAL MATERIAL WET CORE



1/2" BSP MALE HARD MATERIAL WET CORE



1/2" BSP MALE HARD MATERIAL WET CORE

DIAMOND TILE DRILL BITS



APPLICATIONS

- Diamond grit edged head - tough & hard wearing - enables 'easy start' drilling at 45° into material and copes with almost any hardness of tile.
- Open head design helps more effective cooling with water.
- Ejection slot enables easy removal of material 'core' after drilling in deeper tiles.

FEATURES

- Clean concentric holes in all wall and floor tiles (up to and including Class 5 hardness), porcelain, marble, granite and slate. Ideal for installing fixtures and fittings in bathrooms and kitchens.

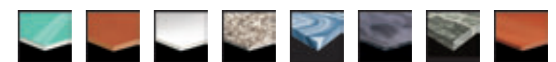

Cat. No.	Diameter mm	Description	Pack Qty.	M.O.Q.	Barcode
DT6037-QZ	5	Diamond Tile Drill	1	1	5035048066300
DT6038-QZ	6	Diamond Tile Drill	1	1	5035048066317
DT6039-QZ	7	Diamond Tile Drill	1	1	5035048066324
DT6040-QZ	8	Diamond Tile Drill	1	1	5035048066331
DT6041-QZ	10	Diamond Tile Drill	1	1	5035048066348
DT6042-QZ	12	Diamond Tile Drill	1	1	5035048066355
DT6043-QZ	15	Diamond Tile Drill	1	1	5035048066362
DT6044-QZ	20	Diamond Tile Drill	1	1	5035048066379
DT6045-QZ	25	Diamond Tile Drill	1	1	5035048066386
DT6046-QZ	-	Mixed Pack Diamond Tile Drill	1	1	5035048066393

NAILS

NAILS FOR CORDLESS FINISHING NAILERS (16 GAUGE 20°)



DC618

Cat. No.	Description	Type	Diameter mm	Length mm	Pack Qty.	M.O.Q.	Barcode
DT9900-QZ	Galvanised	Angled 20°	1.39 x 1.61	32	2500	1	5035048061640
DT9901-QZ	Galvanised	Angled 20°	1.39 x 1.61	38	2500	1	5035048061657
DT9902-QZ	Galvanised	Angled 20°	1.39 x 1.61	44	2500	1	5035048061664
DT9903-QZ	Galvanised	Angled 20°	1.39 x 1.61	50	2500	1	5035048061671
DT9904-QZ	Galvanised	Angled 20°	1.39 x 1.61	63	2500	1	5035048061688
DT9910-QZ	Stainless Steel	Angled 20°	1.39 x 1.61	32	2500	1	5035048011461
DT9911-QZ	Stainless Steel	Angled 20°	1.39 x 1.61	38	2500	1	5035048011478
DT9912-QZ	Stainless Steel	Angled 20°	1.39 x 1.61	44	2500	1	5035048011485
DT9913-QZ	Stainless Steel	Angled 20°	1.39 x 1.61	50	2500	1	5035048011492
DT9914-QZ	Stainless Steel	Angled 20°	1.39 x 1.61	63	2500	1	5035048011508

NAILS FOR ANGLED FINISHING NAILERS (15 GAUGE 34°)



DS1276

Cat. No.	Description	Type	Diameter mm	Length mm	Pack Qty.	M.O.Q.	Barcode
DT9920-QZ	Galvanised	Angled 34°	1.75 x 1.75	32	4000	1	5035048011515
DT9921-QZ	Galvanised	Angled 34°	1.75 x 1.75	38	4000	1	5035048011522
DT9922-QZ	Galvanised	Angled 34°	1.75 x 1.75	44	4000	1	5035048011539
DT9923-QZ	Galvanised	Angled 34°	1.75 x 1.75	50	4000	1	5035048011546
DT9924-QZ	Galvanised	Angled 34°	1.75 x 1.75	63	4000	1	5035048011553
DT9986-QZ	Inox	Angled 34°	1.75 x 1.75	32	4000	1	5035048079287
DT9987-QZ	Inox	Angled 34°	1.75 x 1.75	38	4000	1	5035048079294
DT9988-QZ	Inox	Angled 34°	1.75 x 1.75	44	4000	1	5035048079300
DT9989-QZ	Inox	Angled 34°	1.75 x 1.75	50	4000	1	5035048079317
DT9995-QZ	Inox	Angled 34°	1.75 x 1.75	63	4000	1	5035048079324

NAILS FOR STRAIGHT FINISHING NAILERS (16 GAUGE)



DS1257

Cat. No.	Description	Type	Diameter mm	Length mm	Pack Qty.	M.O.Q.	Barcode
DT9930-QZ	Galvanised	Straight	1.38 x 1.64	35	5000	1	5035048011560
DT9931-QZ	Galvanised	Straight	1.38 x 1.64	38	5000	1	5035048011577
DT9932-QZ	Galvanised	Straight	1.38 x 1.64	44	5000	1	5035048011584
DT9934-QZ	Galvanised	Straight	1.38 x 1.64	50	5000	1	5035048011591
DT9935-QZ	Galvanised	Straight	1.38 x 1.64	63	5000	1	5035048011607

NAILS FOR STRAIGHT FINISHING NAILERS (18 GAUGE)



DS1238

Cat. No.	Description	Type	Diameter mm	Length mm	Pack Qty.	M.O.Q.	Barcode
DT9940-QZ	Galvanised	Straight	1.00 x 1.25	16	5000	1	5035048011614
DT9941-QZ	Galvanised	Straight	1.00 x 1.25	20	5000	1	5035048011621
DT9942-QZ	Galvanised	Straight	1.00 x 1.25	25	5000	1	5035048011638
DT9943-QZ	Galvanised	Straight	1.00 x 1.25	30	5000	1	5035048011645
DT9944-QZ	Galvanised	Straight	1.00 x 1.25	35	5000	1	5035048011652
DT9945-QZ	Galvanised	Straight	1.00 x 1.25	40	5000	1	5035048011669
DT9946-QZ	Galvanised	Straight	1.00 x 1.25	44	5000	1	5035048011676
DT9947-QZ	Galvanised	Straight	1.00 x 1.25	50	5000	1	5035048011683
DT9927-QZ	Inox	Straight	1.00 x 1.25	20	5000	1	5035048079355
DT9928-QZ	Inox	Straight	1.00 x 1.25	25	5000	1	5035048079362
DT9929-QZ	Inox	Straight	1.00 x 1.25	30	5000	1	5035048079379
DT9936-QZ	Inox	Straight	1.00 x 1.25	35	5000	1	5035048079386
DT9937-QZ	Inox	Straight	1.00 x 1.25	40	5000	1	5035048079393
DT9938-QZ	Inox	Straight	1.00 x 1.25	44	5000	1	5035048079409
DT9939-QZ	Inox	Straight	1.00 x 1.25	50	5000	1	5035048079416

NAILS

NAILS FOR CLIPPED-HEAD FRAMERS (34°)



DS1825

Cat. No.	Description	Type	Diameter mm	Length mm	Pack Qty.	M.O.Q.	Barcode
DT9955-QZ	Hot Dipped Galvanised	Angled 34°	2.85	50	2500	1	5035048013410
DT9956-QZ	Hot Dipped Galvanised	Angled 34°	3.05	63	2500	1	5035048013427
DT9959-QZ	Hot Dipped Galvanised	Angled 34°	2.90	75	2500	1	5035048072370
DT9996-QZ	Hot Dipped Galvanised	Angled 34°	3.10	90	2500	1	5035048072387

NAILS FOR FULL ROUND-HEAD FRAMERS (20°)



DS1850

Cat. No.	Description	Type	Diameter mm	Length mm	Pack Qty.	M.O.Q.	Barcode
DT9965-QZ	Hot Dipped Galvanised	Angled 20°	2.87	50	4000	1	5035048013458
DT9966-QZ	Hot Dipped Galvanised	Angled 20°	3.05	63	4000	1	5035048013465
DT9969-QZ	Hot Dipped Galvanised	Angled 20°	2.90	75	2500	1	5035048072394
DT9998-QZ	Hot Dipped Galvanised	Angled 20°	3.10	90	2500	1	5035048072400

NAILS FOR COIL ROOFING NAILERS (15°)



DS1321

Cat. No.	Description	Type	Diameter mm	Length mm	Pack Qty.	M.O.Q.	Barcode
DT9976-QZ	Hot Dipped Galvanised	Angled 15°	3.10	25	7000	1	5035048013502
DT9977-QZ	Hot Dipped Galvanised	Angled 15°	3.10	32	7000	1	5035048013519
DT9978-QZ	Hot Dipped Galvanised	Angled 15°	3.10	38	7000	1	5035048013526

NAILS FOR COIL FRAMING NAILERS (15°)

Cat. No.	Description	Type	Diameter mm	Length mm	Pack Qty.	M.O.Q.	Barcode
DT9916-QZ	Hot Dipped Galvanised	Angled 15°	2.90	63	4500	1	5035048079249
DT9917-QZ	Hot Dipped Galvanised	Angled 15°	3.10	75	4500	1	5035048079256
DT9918-QZ	Hot Dipped Galvanised	Angled 15°	3.10	90	4500	1	5035048079263

STAPLES

STAPLES FOR 11.1MM MEDIUM CROWN STAPLERS (16 GAUGE)



DS1430

Cat. No.	Description	Type	Diameter mm	Length mm	Pack Qty.	M.O.Q.	Barcode
DT9980-QZ	Staples	Crown 11.1mm	1.33 x 1.60	25	5000	1	5035048011829
DT9981-QZ	Staples	Crown 11.1mm	1.33 x 1.60	32	5000	1	5035048011836
DT9982-QZ	Staples	Crown 11.1mm	1.33 x 1.60	38	5000	1	5035048011843
DT9983-QZ	Staples	Crown 11.1mm	1.33 x 1.60	44	5000	1	5035048011850
DT9984-QZ	Staples	Crown 11.1mm	1.33 x 1.60	50	5000	1	5035048011867

STAPLES FOR 12.7MM MEDIUM CROWN STAPLERS (16 GAUGE)



DS1431

Cat. No.	Description	Type	Diameter mm	Length mm	Pack Qty.	M.O.Q.	Barcode
DT9990-QZ	Staples	Crown 12.7mm	1.33 x 1.60	25	5000	1	5035048011874
DT9991-QZ	Staples	Crown 12.7mm	1.33 x 1.60	32	5000	1	5035048011881
DT9992-QZ	Staples	Crown 12.7mm	1.33 x 1.60	38	5000	1	5035048011898
DT9993-QZ	Staples	Crown 12.7mm	1.33 x 1.60	44	5000	1	5035048011904
DT9994-QZ	Staples	Crown 12.7mm	1.33 x 1.60	50	5000	1	5035048011911







**DEWALT®**

**SERVICE** 

★ ★ ★ ★ ★  
**OUR PROMISE OF 5-STAR SERVICE QUALITY, CONVENIENCE AND SPEED**

**DEWALT 5-STAR SERVICE STARTS WITH CONVENIENCE**

At the heart of DeWALT's 5 star service promise are its 5 star service agents which are conveniently located throughout the country, with specialists always available to answer any questions whether you are on or off the jobsite.

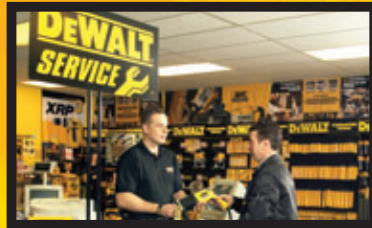

**SPEED OF REPAIR**

Having your tools back in action in the fastest time possible is our prime objective. Subject to parts availability, most repairs should not take more than 48 hours in the workshop and for those smaller urgent repairs we provide a "while-u-wait" service.



**HIGHEST QUALITY**

Highest Quality is assured with DeWALT factory trained technicians carrying out all repairs with all work being backed by our 90 day warranty. Each DeWALT repair comes with our personal "satisfaction tag" listing all the work done and a DeWALT contact telephone number should you be less than 100% happy with the repair.

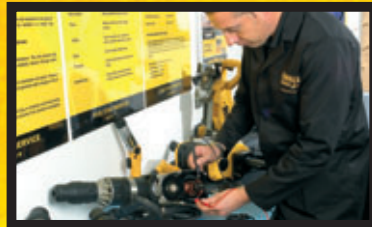

**WARRANTY REPAIRS**

All 5 star service agents carry out warranty repairs. If the tool is covered by its original DeWALT 1 year Warranty, all repairs are free, including parts and labour. Proof of purchase must be produced.

**DEWALT GENUINE FACTORY PARTS**

All parts used in repairs are original, ensuring both the highest quality and a perfect fit every time.

**ALL BACKED UP BY THE DEWALT ON-LINE SERVICE**

Instantly accessed via the internet providing information on our wide range of products and services, including dealer and service locations, spare parts and technical support.



**TO LOCATE YOUR NEAREST 5 STAR AGENT PLEASE VISIT:**

**[www.DEWALT.eu](http://www.DEWALT.eu)**

Not all DeWALT service agents are 5 star rated. Those that are not may not be able to provide all services available above but will display in-store a detailed list of their selected services.



**DEWALT**  
**SERVICE** 



## IN STORE MERCHANDISING AND DISPLAY SYSTEM

- **FLEXIBLE, MODULAR SYSTEM**
- **CLEAR PRODUCT DIFFERENTIATION AND COMMUNICATION**
- **STRONG DEWALT BRANDING**

Products sold as per dealer's valid price list. Please refer to price list for stock availability.

All products shown are in compliance with the appropriate European regulations.

DeWALT is a member of EPTA

Dual voltage - all DeWALT power tools are supplied in both 230 Volts and 115 Volts options unless otherwise stated. Please contact your local dealer for availability.

DeWALT reserves the right to revise product specifications at any time without notice.

All measurements are in millimetres (mm) unless otherwise stated.

WARNING: all warranties are country/region specific. Tools purchased e.g. in the USA or via the internet, and imported into Europe, which are not CE approved, not only violate EU legislation, but will not be supported/serviced in Europe by DeWALT as a result.

Only European tools are covered by a European warranty.

GUARANTEED TOUGH, ROBUSTESSE GARANTIE, DeWALT EXTREME, DeWALT, EXTREME DeWALT, DeWALT EXTREME IMPACT, DeWALT GUARANTEED TOUGH, SERIES 20, SERIES 30, SERIES 40, SERIES 60, AVC, XRP, XPC, XLR, and ALLIGATOR are registered trademarks of The Black and Decker Corporation. The yellow and black colour scheme is used on DeWALT power tools and accessories as a trademark.

GORE Wet/Dry Filter is a trademark of W.L Gore & Associates Inc.



Registered Trade Marks of Robert Bosch GmbH. Torx® is a Registered Trade Mark of Acument Intellectual Properties, LLC.

# DEWALT®

**POWERTOOLS &  
ACCESSORIES  
CATALOGUE 2011**

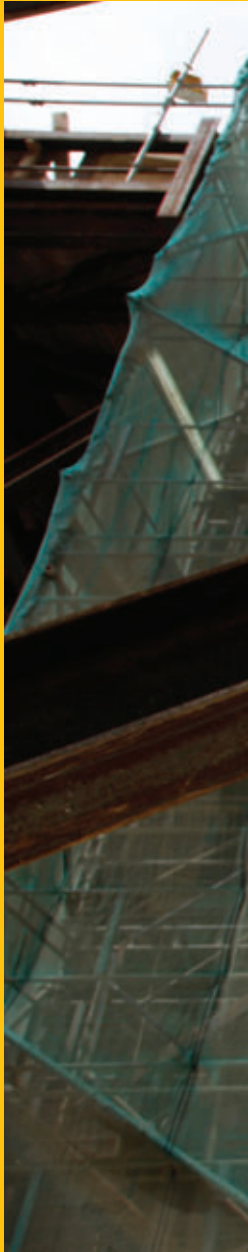

**[www.DEWALT.eu](http://www.DEWALT.eu)**

MP09603-GB40