

DATA SHEET SPECIAL: POPULAR MEMORIES

electronics today

NOVEMBER 1977

INTERNATIONAL

\$1.25*
NZ \$1.50

INSIDE:
Dick Smith
8-PAGE
XMAS
LIFTOUT

WHITE LINE FOLLOWER

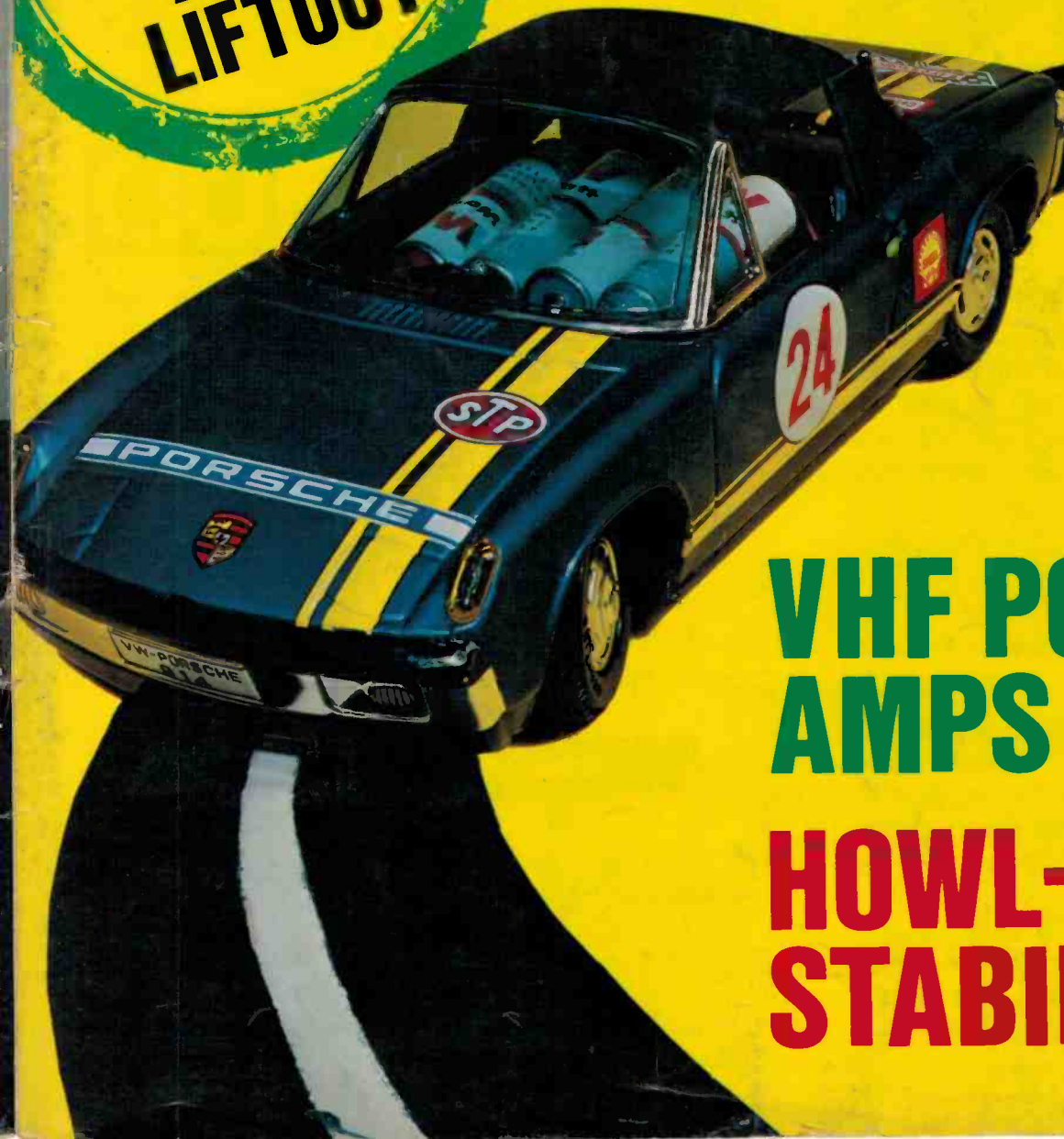

VHF POWER AMPS

HOWL-ROUND STABILIZER

WHY YOUR NEXT CASSETTE SHOULD BE A MAXELL UD



3 THE SHELL — Even the best tape can get mangled in a poorly constructed shell. That's why Maxell protects its tape with a precisely constructed shell, made of lasting heavy-duty plastic.

No fixed guide posts are used. Instead Maxell uses nylon rollers on stainless steel pins thus eliminating the major cause of skipping, jumping and unwinding.

A tough teflon (not waxed paper) slip sheet keeps the tape pack tight and flat. No more bent or nicked tape to ruin your recording.

Maxell doesn't use a welded seal, but puts the cassette together with precision screws. Result — Maxell doesn't jam.



1 THE RESEARCH — More than twenty years ago, Maxell produced their first reel of magnetic tape. At that time, Maxell made a commitment to produce and sell only the finest magnetic products their technology could create.

That commitment still stands today.

2 THE TAPE — This continuous research has led to the development of the Maxell UD (ultra dynamic) cassette. A tape that has a coating of super-fine PX gamma ferric oxide particles with an extra smooth mirror-finish surface.

All of this adds up to high output, low noise, distortion free performance and a dynamic range equaling that of open reel tapes.

4 THE LEADER — A-leader tape that has a four function purpose.

- a) Non-abrasive head cleaning leader (cleans recording head for 5 secs.).
- b) 5 second cueing line (recording function starts 5 seconds after the line appears).
- c) Arrows indicating direction of tape travel.
- d) A/B side mark (indicates which side is ready for play).

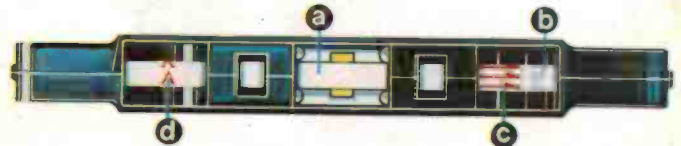

Now you know why your next cassette should be a Maxell UD (ultra dynamic).

maxell®

The sound expert's cassette. UD available in C60, C90 and C120. Distributed by Hagemeyer (Australasia) B.V. Branches in all States.

electronics today

INTERNATIONAL

Editorial: Les Bell
 Publisher: Collyn Rivers

SPECIAL FEATURE NEXT MONTH—

INSIDE STAR WARS

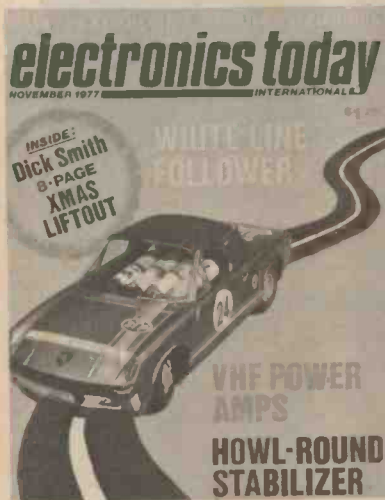

Cover: Wouldn't we all like to drive a Porsche? On page 50, we tell how to convert this \$8 Woolworths toy into a fascinating electronic car. Photo: George Hofsteters.

PROJECTS

VHF Power Amps 29
If they don't work, blame it on Roger Harrison...

White Line Follower 50
Formula One?

Howl-Round Stabilizer 57
No more screech, whine

Theatrical Lighting Controller, Pt. 1 75
Who turned the lights out?

PCBs 108
Still experimenting...

FEATURES

Radioactivity: A History 13
Tick, tick, tick, tick...

Sound 21
The importance of phase.

Batteries 38
Dry cells, wet cells...

Data Sheet Special: Memories 65
Thanks for the...

TI Programmable 59 Review 81
Lots and lots of...

High Technology CB 93
What? A CB with a...

Print Out 105
Nothing to do with...

Sinclair Software 120
To put in your...

Test Probe Offer 19
Ideal for that meter

Win a CB 64
Let Stalk Strine

NEWS & INFORMATION

News Digest5

Calculator Contest9

Sound Briefs25

CB News89

Print Out News 100

Ideas for Experimenters ... 123

Reader Services 130

Index to Advertisers 130



A Modern Magazines Publication
 * Recommended retail price only.

HEATSINKS

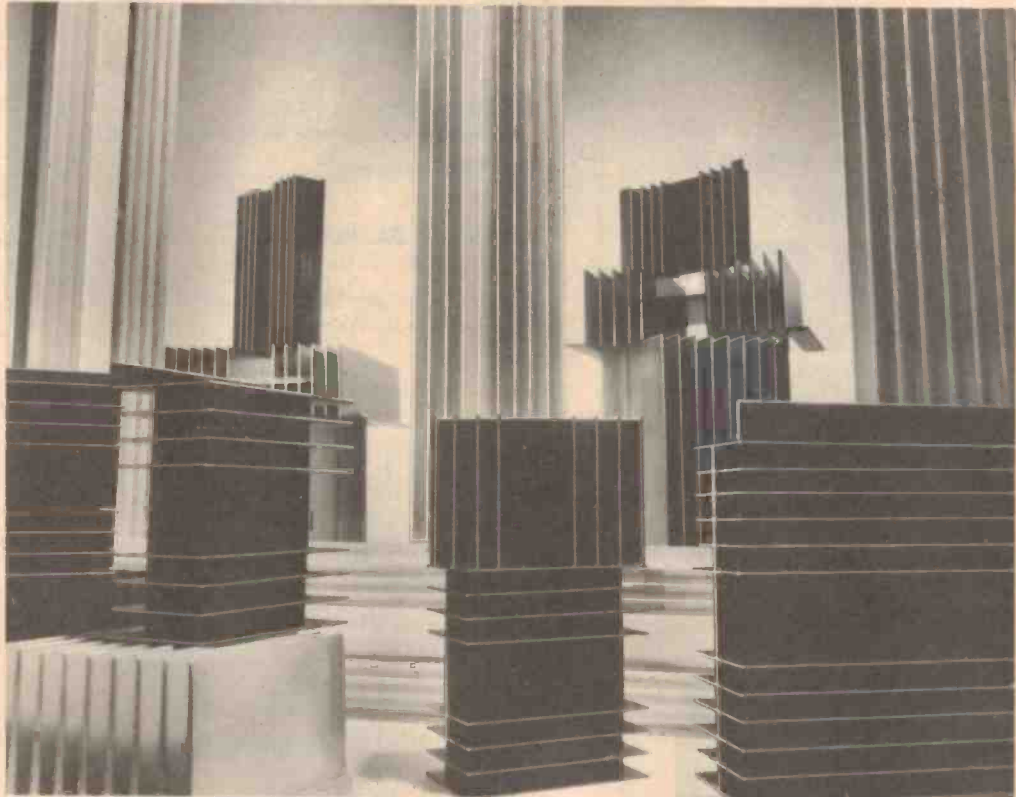

Australian Made Extrusions For Every Purpose

These extrusions offer design engineers heatsinks "off the shelf" for most applications. They can be used in conjunction with: —

- Power Transistors
 - Thyristors
 - Silicon Diodes
- } Some under high peak current conditions

Standard Lengths (ins)

TYPE	2	3	4	6	8	36	72
35D	*	*	*	*	—	*	*
40D	—	*	*	*	—	*	*
45D	—	*	*	*	—	*	*
55D	*	—	*	*	*	*	*
65D	—	—	*	*	*	*	*

All 36 inch and 72 inch bulk lengths are supplied in mill finish as is the total 65D range. The remainder are supplied in a black anodised finish.

Philips Electronic Components & Materials

Sydney _____ 427 0888
 Melbourne _____ 699 0300
 Brisbane _____ 277 3332
 Adelaide _____ 223 4022
 Perth _____ 65 4199

Philips Electronic Components & Materials
 P.O. Box 50, Lane Cove, N.S.W. 2066

I am interested in Heatsinks Type _____

Please send me further information
 arrange for a representative to call

Name _____

PLEASE CLIP TO YOUR LETTERHEAD



Electronic Components and Materials

PHILIPS

153.0183

News Digest

Single 3½ Digit Panel Meter

A new addition to the National Semiconductor data conversion line is the "ADD3701", a single CMOS integrated circuit which requires only a display, an external voltage reference and a digit driver to form a complete 3½ digit DVM (digital voltmeter) that reads up to 3.999 units.

Manufactured using standard CMOS technology, the ADD3701 is an extended-range version of National's "ADD3501" 3½ digit DVM introduced earlier this year, with readings up to 1.999. The additional range of the new DVM chip expands the applications of the device into areas where a reading of 1.999 isn't high enough, such as weight measurement on bathroom scales, measurement of degrees of rotation, and of temperature.

The ADD3701 utilizes a single five-volt supply to drive a multiplexed seven-segment output directly, and features differential input protection to 200 volts. Overrange condition is displayed by "+OFL" or "-OFL" indication, depending upon whether the input voltage is positive or negative.

The 3701 also features auto polarity and an on-chip clock that eliminates the need for an external signal timing circuit. This internal oscillator can be set by an external RC network, or the oscillator can be driven from an external frequency source.

A pulse modulation analog-to-digital conversion method is used, requiring no external precision components. The seven-segment outputs are capable of delivering up to 40 milliamperes per segment, making the ADD3701 ideally suited to drive 0.5-inch and 0.7-inch common-cathode LED displays. The price of the model "ADD3701CCN" is \$11.95 when purchased in lots of 100.

For further information contact your nearest National franchised Distributor or telephone Melbourne 729 6333; Sydney 93 0481; Adelaide 46 3929; Perth 25 5722; Brisbane 36 5061; Hobart 44 1337.

National Slim-Line Calculators

Two new hand-held slim-line calculators are being introduced to National Semiconductor's slim line array, according to Jack Rutherford, Managing Director of N.S. Electronics, National's Australian Division.

"The new hand-helds are models NS/200 and NS/200R", he said. "Both are the size of a slender cigar carrying case and fit into any shirt pocket with ease."

The model NS/200 will carry a suggested retail price of \$18.99 while

the model NS/200R with rechargeable battery and charger base will have a suggested retail price of \$28.99.

"The charger base doubles as an excellent stand for the NS/200R and provides the user with a desktop capability", Rutherford said.

Both the NS/200 and NS/200R will feature a vacuum fluorescent display which will offer bright green, 8-digit read-outs easily observable in any lighting condition.

Both are full-function calculators with 4-key accumulating memory, square root, "live" percent, change sign and memory exchange key. Cosmetically, both will be cased in brushed aluminium housings to assure long life and hardy resistance to damage, Rutherford said.

Emergency sets donated

PHILIPS announced at the NCRA National Convention that they would donate a number of UHF transceivers to CREST to try out for their emergency service monitors.

The sets were recently drawn out of commercial service and would be modified to meet the UHF CB technical specifications.

TI CB

Texas Instruments have delayed application for FCC type acceptance of that much-vaunted microprocessor-controlled CB. The reason they give is the need to make minor design changes to improve the sets' 'manufacturability'. The word we have, though, is that TI

plan to put the sets on their calculator assembly lines and produce them at a ridiculously low price, thus cracking the CB market.

AC/DC Colour 'Sportable'

National has just unveiled a new addition to the Quintrix range — the TC 3000, Australia's first 31 cm AC/DC colour portable.

Called the "Sportable", the set operates from either 240v mains or 12v battery power and delivers the same sharp, clear picture as the other sets in the Quintrix range.

The rugged construction of the set makes it ideal for campers, caravanners, four-wheel-drive and boating enthusiasts. Providing the station signal is of sufficient strength, off-roaders can get a lounge room quality colour reception in the wilds of the Australian bush.

Weekend sailors who connect the "Sportable" to their boat batteries will be able to view their favourite shows while they laze in the sun or dangle a fishing line over the side.

The "Sportable" features the latest flat screen Quintrix picture tube as well as National's popular Magic Line fine tuning system.

The set is also equipped with a battery check lamp to guard against flattening the car or boat battery. If the battery output falls below 11.5v, the "Sportable" automatically shuts off and the battery warning lamp lights up.

Sounds like a great way to spend a weekend. They've sold me — I'll buy the boat!



INCREDIBLE OFFER!

**2 new revolutionary, portable electronic games!
No TV set needed!**

FUTURETRONICS HAVE DONE IT AGAIN. THE PEOPLE WHO BROUGHT TO YOU THE WORLDS FIRST MICROPROCESSOR BASED CHESS GAME NOW BRING YOU THE ULTIMATE IN PERSONAL ENJOYMENT AND RELAXATION. TWO NEW PORTABLE HAND HELD ELECTRONIC GAMES FULLY ASSEMBLED, WITH L.E.D. DISPLAY, PRECISION LENS, SOLID STATE CIRCUITRY AND REALISTIC SOUND EFFECTS. USES STANDARD 9 VOLT BATTERY (NOT INCLUDED). IT'S YOU AGAINST THE COMPUTER FOR A WHOLE NEW KIND OF EXCITEMENT, FUN AND CHALLENGE.

MISSILE ATTACK

ICBM alert! Computer-controlled missiles attacking! You command anti-missile missiles! Push the fire button. Intercept. Save "Your City"! (Lose and you'll hear part of "Taps".)

Game features automatic digital scoring, launch and guidance controls, and realistic sounds.



AUTO RACE

The race is on! Computer-controlled cars coming straight at you. Steer! Shift! Avoid a collision and beat the clock! (Hear the sound of victory!).

Game features automatic digital timer, steering and gear shift controls, plus realistic race sounds.



To order or for information
contact:

**Future
tronics** pty. ltd.

527 TODORONGA ROAD, MAWTHORN EAST, VICTORIA, AUSTRALIA. TELEPHONE (03) 82-3732

PLEASE SEND AUTO RACE I ENCLOSE \$49.65
 PLEASE SEND MISSILE ATTACK I ENCLOSE \$49.65

NAME:

ADDRESS:

STATE . . . P/CODE . . .

PLEASE SEND
BOTH GAMES
I ENCLOSE \$89.90

PHONE 823732

News Digest

Signetics Data Handbooks

Because of the increasing size of the Signetics Data Handbook and the need to include even more information for the customer, Philips have divided the single volume into four parts.

These sections will be:

Signetics MOS and Bipolar Memories 1977. 352 pages — \$3.50. Ex stock Lane Cove.

Signetics Analog Data & Applications 1977. Approx. 700 pages — \$7.00. Available December, 1977.

Signetics MOS and Bipolar Micro-processors 1978 Data and Applications. Approx. 400 pages — \$4.00. Available Feb, 1978.

Signetics Logic and Interface Products 1978. Approx. 800 pages — \$8.00. Available March, 1978.

Orders should be placed now to ensure that customers receive their copies promptly. Subscriptions similar to Philips Data Handbooks can be made to obtain regular update when new editions are published in 1978/9. Philips P.O. Box 50, Lane Cove, NSW. 2066.

Zilog S10

Zilog are now pushing the peripherals market with their latest offering — a two channel serial I/O controller designated the S10. The controller was originally designed to work with the Z-80, but it will interface with almost any other 8-bit micro. The design is unusual in that it does not use the 'micro-programmed' structure of conventional I/O chips; instead it is primarily random logic and consequently is around 10 to 15 times faster than any similar device at present available. The S10 can handle asynchronous or synchronous data with 5 to 8 bits per character plus parity (even or odd), and in a 4 MHz system runs at 800 kilobits/s.

Portable 30 MHz Counter

The B & K Model 1827 Frequency Counter, available from Parameters Pty. Ltd., is intended for general service use and covers frequencies to 30 MHz (guaranteed) and 50 MHz (typical).

Not much larger than a pocket calculator, the 1827 is ideal for CB radio checking since it covers the whole 27 MHz band with a 6 digit display and 1 Hz resolution.

No skill is needed to operate the counter. Full autoranging provides direct frequency read-out of the 6 most significant digits with automatic decimal point and illuminated kHz and MHz indicators.

A battery-saving feature blanks the display (apart from a decimal point 'pilot lamp') until the display button is pressed. The display remains alight for

15 seconds after the button is released. Input sensitivity is 100 mV into 10 k with a maximum input of 200 V up to 500 Hz.

Accuracy is ± 1 count with 1 ppm resolution. The 1827 will run for approximately 8 hours from 6 AA type batteries or optional rechargeable cells. An optional antenna is available for making "wireless" measurements from nearby transmitters.

Further information on the B & K 1827 Frequency Counter is available from *Parameters Pty. Ltd, 68 Alexander Street, Crows Nest, 2065.*



No. 7 for Dicky

Dick Smith has opened his seventh "Electronics for the Enthusiast" store, at Parramatta in Sydney's outer Western Suburbs.

The Store, at 30 Grose Street, is the most spacious and well laid out of his stores to date. He has extended the 'serve yourself' concept and supplemented it with a comprehensive Book Bar, Hi Fi Section and CB Radio Section.

Dick Smith Electronics Pty. Ltd. have announced that they enjoyed a successful trading year in 1976-77.

Mr. Ike Bain the General Manager said that their turnover had increased from 3.5 to 7 million dollars from 1975-1975-76 to 1976-77, which represents a tremendous growth.

"CB Radio obviously contributed to this increase but our traditional hobbyist electronic lines were still responsible for the majority of our turnover. Due to the current economic climate this year may bring difficulties but we are confident that our expansion programme will yield positive results" commented Mr. Bain.

Dick now has 7 "Electronics for the Enthusiast" Stores, 160 dealers and plans to open 5 more stores before the end of the year.

Quick Tester

A simple device to detect most common electrical hazards in power points and extension cords has been developed by a Melbourne based electronics manufacturing company.

Called the Power Point Safety Tester, the relatively inexpensive unit instantly checks if the power is on and diagnoses incorrect wiring in power points and extension cords, with the exception of two rare conditions requiring highly complex and expensive testing equipment.

The Power Point Safety Tester is compact, durable and virtually indestructible. Three colored lights (red, green and amber) on the face of the unit indicate whether the power point is correctly wired.

Only the red and green lights should illuminate together. If any other combination appears the power point could be unsafe and should be examined. However, the manufacturer points out that only a licensed electrician should attempt to effect any repairs.

Ideal for checking new installations and outlets in older premises, the Power Point Safety Tester is available from Swann Electronics Pty. Ltd, Mount Waverley, Victoria.

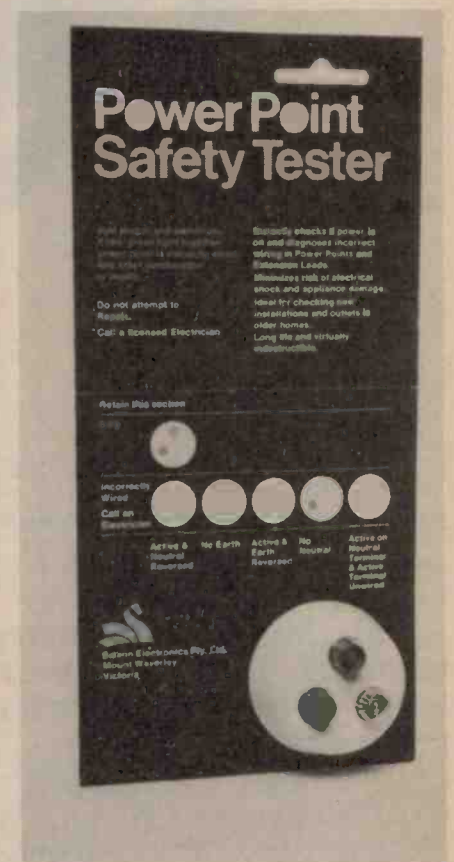

A cassette deck to break Mr Nakamichi's heart.

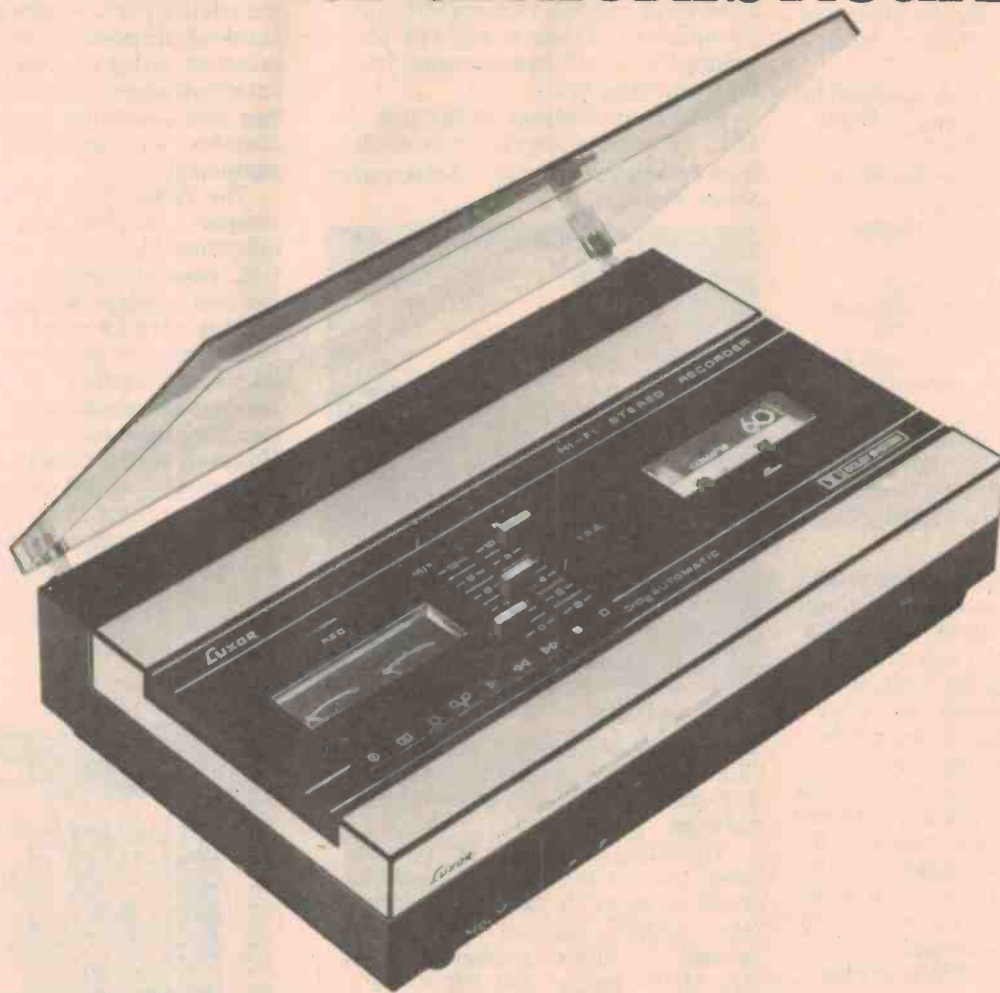

Make Model	S/N dB				Wow and flutter % DIN weighted	Signal levels mV			Fast winding sec. C60 cassette	Meter	Built-in mixer	Deviation from nominal tape speed	Automatic Fe/CrO ₂ switching	FeCr capability	Noise-reduction System		Output volume control	Tape memory	B = illuminated cassette	Signal Connectors
	NR out		NR in			Mic	OUT								DNL	Dolby				
	Fe	Cr	Fe	Cr			Line	Line												
Luxor 9255	52	55	59	61	0,045	0,20	9	610	37	VU	Yes	±0	Yes	Yes	No	Yes	No	No	B	DIN
Nakamichi 600	52	55	60	61	0,07	—	65	750	111	P	No	+1,2	No	No	No	Yes	Yes	Yes	—	DIN + Phono

Mr. Nakamichi has the reputation of making one of the best cassette decks in the world. Like Mr. Dolby, he is one of the all time greats.

But times have changed.
We've caught up.
Our Luxor 9255 is as good as Mr. Nakamichi's, if not better.

(from Stereo HiFi No. 5, 1976)
Have a look at the specifications.
And have a look at the price.
Ours will break Mr. Nakamichi's heart.
Please write to us for free brochure.

LUXOR Electronics.
Swedish quality at its best.

News Digest

Northern Territory Communications Convention

A communications convention will be held at the Darwin Community College, Darwin over the weekend of 3 and 4 December, 1977. It promises to be the only convention of its type ever held in Australia with attendance of representatives from a wide cross section of radio spectrum users.

A series of lectures will be presented by the Darwin Community College in conjunction with Telecom Australia, Department of Posts and Telecommunications, the Defense Forces, the Australian Broadcasting Commission and other Government departments.

In parallel with the main stream of the convention, a major display of communications equipment is to be staged encompassing local and interstate business houses.

The convention, which is open to the general public, is being organised through the joint effort of the National Citizen's Radio Association, Northern Territory Division, and the Darwin Amateur Radio Club. Parties interested in participating by way of display, lectures or field demonstration of communications equipment should contact Mr. John Tate, Director of the National Citizen's Radio Association, Northern Territory Division, or Mr. Doug Haig, President of the Darwin Amateur Radio Club on (089) 85 2016.

What Shall We Do . . .

Last month we published a puzzle entitled 'Puzzle of the Drunken Sailor'. To satisfy those readers who gave it up as impossible, here's the solution.

First assign the numbers 1 to 12 to the sockets as shown in the diagram. Note that the numbers refer to sockets not to the lamps in those sockets.

Next, make moves as follows. (The two numbers in any move mean "Move the lamp which is in the socket with the first number to the vacant socket with the second number".)

Move Number	1:	11 to 7
	2:	3 to 11
	3:	2 to 8
	4:	7 to 2
	5:	8 to 7
	6:	11 to 3
	7:	10 to 5
	8:	7 to 10
	9:	5 to 7
	10:	3 to 11
	11:	4 to 8
	12:	7 to 4
	13:	8 to 3
	14:	11 to 5
	15:	12 to 7
	16:	5 to 12
	17:	3 to 11
	18:	7 to 3

19	11 to 7
20	10 to 5
21	9 to 6
22	12 to 9
23	6 to 12
24	7 to 10
25	12 to 7
26	5 to 12
27	3 to 11
28	2 to 8
29	1 to 6
30	4 to 1
31	6 to 4
32	8 to 2
33	4 to 8
34	7 to 4
35	8 to 7
36	11 to 3
37	7 to 11

If you can devise a solution with fewer moves, let's hear of it.



The 7L5 from Tektronix is a microprocessor-based spectrum analyser that achieves exceptional frequency accuracy (two parts in 10^6) through a unique combination of synthesiser and digital technology. The inherent stability of the synthesiser method used, coupled with digital tuning techniques, means that the centre frequency can be set with 6-digit accuracy immediately after turn-on with no need to fine-tune the displayed signal.

Enquiries to: Tektronix Aust. Pty. Ltd. 80 Waterloo Rd. Nth Ryde, NSW 2113.

ETI/Unitrex Calculator Contest

Well, the September problem really caught you, didn't it? Only one person found the correct answer, Mr. K. Loane, of East Devonport, Tasmania. The problem, as you will recall, concerned an astronaut circling Ganymede in a buggy with limited range.

The correct solution is that the journey requires 23 tanks of fuel. To explain this, we divide the circumference into 20 equal parts of 5 units each, hence 100 parts in total.

1. In five trips, five containers are moved to point 10 and the buggy returns to base. This consumes five tanks.

2. Take one container to point 15

and return to point 10 (one tank).

3. Take one container to point 20, return to point 10 (one tank).

4. Take one container to point 20, return to point 15, pick up tank and take it to point 20 (one tank).

5. Take one tank to point 30 and return to point 20 (one tank).

6. Return to base, take a tank to point 95 and return to base (1½ tanks).

7. Take four containers to point 90 and return to base (four trips, four tanks).

8. Take one container to point 90, return to point 95, pick up the tank there and move it to point 90 (one tank).

9. Move two containers to point 80 (two trips, two tanks).

10. Take one container to point 75, return to point 80 (one tank).

11. Take one container to point 70, return to point 75, pick up the container there and take it to point 70 (one tank).

12. Continue round to point 30 (two tanks).

13. Pick up fuel and continue to point 10 (one tank).

14. Refuel once more and home to base! (half a tank).

Adding up the fuel consumption, we see that the trip has used 23 tanks of fuel.

It is possible to improve on this result marginally, but no-one managed to beat our winning entry by Mr. K. Loane, who will receive a Unitrex calculator. And so to this month's problem...

Back in the 18th century there lived a typical urban nut-case called Peter Pelican (don't ask me, it gets even sillier...). Peter liked to experiment with mathematical problems, just like ETI readers. This particular problem came from his first, and only, edition of puzzles called Peter Pelican's Puzzled Paperback (can still be found in many waiting-rooms).

One of the last (and best) entries in his book reads like this: Enter an orange-grove which has three gates, and a man at each one — collect a number of oranges, give the first man half the oranges and half an orange. To the second man give half of what is left and half an orange, and finally give the last man half of what remains and half an orange — yet not one orange is to be cut.

What is the smallest number of oranges the reader could use and still fulfill these conditions?

Seal an empty envelope, write your answer on the back of it with your name and address, and send it to: Unitrex Calculator Contest (November), ETI Magazine, 15 Boundary Street, Rushcutters Bay, NSW 2011. Closing date is 23rd December.

PROMARAMA

Think
Signetics
 Think
PHILIPS

DESIGNER'S CHOICE

When choosing PROMS, Signetics gives you so much more. Check for yourself.

MORE TYPES

- 21 STANDARD TYPES
- 13 MILITARY TYPES
- ONGOING DEVELOPMENT
- PLASTIC AND CERAMIC PACKAGES

MORE FEATURES

- PNP (100 μ A) INPUTS (82S types)
- FAST - COMPARE THEM
- BETTER SPEED-POWER PRODUCT
- FULLY COMPATIBLE ROMS (MOST TYPES)
- ALL OUTPUTS AT 'O' AS SUPPLIED

MORE CONFIDENCE

- EASIER PROGRAMMING (NICHROME F/L)
- GUARANTEED HIGH YIELDS
- PROVEN RELIABILITY

MORE SUPPORT

- DATA I/O PROGRAMMING EQUIPMENT
- APPLICATION ENGINEERS
- AUSTRALIA'S LARGEST INTEGRATED CIRCUIT PLANT - PHILIPS HENDON WORKS

MORE VALUE

- COMPETITIVE PRICES
- GENERIC FAMILIES FOR EXPANSION
- ALTERNATIVE ORGANISATIONS

SIGNETICS BIPOLAR FUSIBLE LINK PROMS

DEVICE	MEMORY SIZE	ORGANISATION	OUTPUTS	PINS	MAX ACCESS TIME	FULLY COMPATIBLE ROM
82S23/123	256	32 x 8	OC/TS	16	50	82S224/223
10139	256	32 x 8	OE	16	20	
82S27	1024	256 x 4	OC	16	40	
82S126/129	1024	256 x 4	OC/TS	16	50	82S226/229
10149	1024	256 x 4	OE	16	17	
82S114 ¹⁾	2048	256 x 8	TS	24	60	82S214
82S130/131	2048	512 x 4	OC/TS	16	50	82S230/231
82S115 ¹⁾	4096	512 x 8	TS	24	60	82S215
82S140/141	4096	512 x 8	OC/TS	24	60	82S240/241
82S136/137	4096	1024 x 4	OC/TS	18	60	82S286/237
82S180/181*	8192	1024 x 8	OC/TS	24	100	82S280/281
82S184/185	8192	2048 x 4	OC/TS	18	100	82S284/285
82S190/191*	16384	2048 x 8	OC/TS	24	125	82S290/291

SIGNETICS ERASABLE MOS PROMS

1702A	2048	256 x 8	PMOS	24	650	
2704*	4096	512 x 8	NMOS	24	450	
2708*	8192	1024 x 8	NMOS	24	450	2607

¹⁾ With Latch * Available Soon

You get all this plus a comprehensive prototyping and production programming service. Signetics PROMS are available from all Philips-Signetics IC stockists. But make sure when you ask for PROMS that you get Signetics PROMS.

Philips Electronic Components and Materials
 P.O. Box 50, LANE COVE. 2066. N.S.W.
 Sydney 427 0888, Melbourne 699 0300, Brisbane 277 3332,
 Adelaide 223 4022, Perth 65 4199



Electronic
 Components
 and Materials

PHILIPS

Thorens Transcription turntables: the professionals choice.

These are the turntables which other manufacturers use to evaluate the standard of their own product. Sold and serviced nationally by Rank Australia.

Here are 2 top selling models from our wide range.

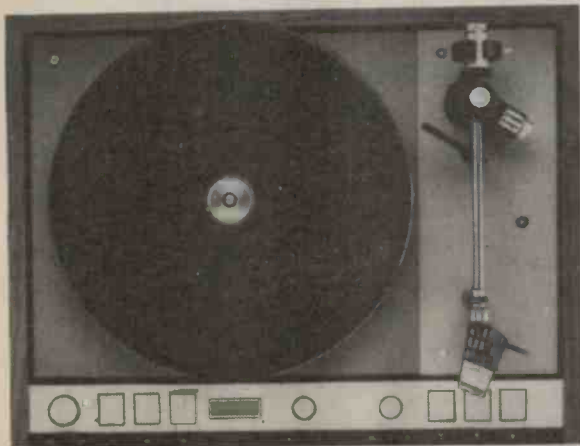

TD126 MKII. Electronically controlled top-of-range model for sophisticated home music systems or semi-professional use. Drive motor supplied by electronic two-phase generator for even-high speed consistency and better rumble figures.

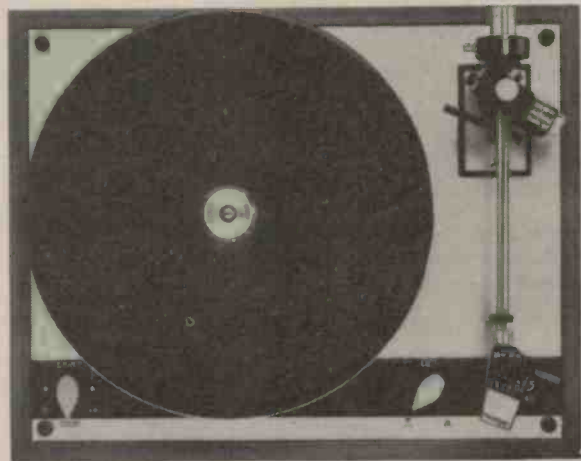

TD145 MKII. 1 step belt drive with 16 pole two phase synchronous motor. Special Isotrack tone arm is dynamically balanced to prevent external shocks and acoustic feedback. Auto-stop feature. Excellent performance for a modest price.

THORENS

Watts: The record care people.

Watts Dust Bug. Automatically removes static charges and dust as record plays. Fits all turntables Easy to connect.

Watts Disc Preener. Keeps new records like new. Ideal for recordings which have had no previous static treatment. Essential where playing weights are less than 3 grams.

Watts 'Manual Parastat'. Dual purpose record cleaner. Treat older records with the manual Parastat when using a new lighter weight pick-up. You'll notice the difference where playing weights are less than 1½ grams. Also keeps new records like new.



Watts Disc Preener.

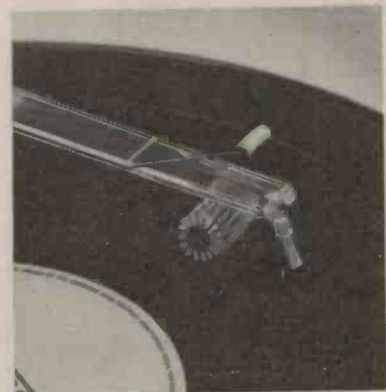

Watts Dust Bug.



Distributed Nationally
By Rank Australia



We Keep Performing

**RANK
AUSTRALIA**

This is the safest place in the world to play your records.

We believe you should have as little as possible to do with the ADC Accutrac 4000.

So once you've placed your record on the turntable, and pressed a few buttons, you can leave the rest to the world's first computerised turntable.

The human errors that do a lot of damage to records are a thing of the past.

You get more out of it, because we put less into it.

It's a fact that when you compare the ADC Accutrac to other expensive turntables, the rest are made to look clumsy, complex and old-fashioned.

Truly superb sound reproduction can now be achieved in a much simpler way.

The turntable with a memory.

We started by replacing a lot of noisy mechanics with a neat little computer.

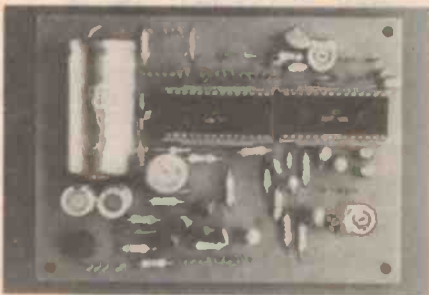

Out came standard components.

In went the latest breakthrough in MOS computer circuitry.

So all Accutrac's operations are controlled and programmed far more quickly and efficiently than any other automatic turntable.

The control panel is designed for you to select up to 13 tracks in any order you want to hear them, and a 24 selection memory bank allows for programmed repeats.

The motor that keeps an eye on itself.

We replaced the conventional belts, wheels and pulleys with an electronically controlled direct drive system that keeps wow and flutter to a completely inaudible .03% and rumble at -70dB.

The motor contains electronic speed-sensing circuits, which keep a constant eye on the accuracy of the massive 12 inch diecast turntable's speed, and instantly corrects any error.

There's also a speed tuning circuit that lets you vary the speed over 5%.

A glance through the stroboscope provides a reliable speed check.

The tonearm you never touch.

We did some more eliminating.

Out went the noisy linkages that power automatic arms from the main turntable drive



motor.

Out went velocity-sensing mechanical arm-trip mechanisms.

Out went all the clumsy cams and gears.

Instead, Accutrac's tonearm is moved by its own electro-optically controlled servo-motor. It responds instantly and silently to your programme in the turntable's memory bank. Tracking error is minimised by the arm's 9 1/3 inch (237mm) effective length, and horizontal and vertical bearing friction has been reduced to the negligible level of 5-7mg, due to Accutrac's new ball race and pivot system.

From the instant the stylus touches the record, the arm is totally decoupled from the servo-motor and controls, so it always tracks the groove with perfect freedom.

The cartridge that knows where it's going. Accutrac has the most advanced cartridge in the world.

The ADC LMA-1.

It scans the surface of the record with a tiny beam of light from a solid-state infra-red generator.

When the beam is focused on the record, closely spaced grooves scatter the light, while the smooth surface between the tracks reflects the light back to a detector which triggers the arm mechanism.

This system ensures that the tonearm selects the right track quickly and smoothly, while accurately gauging where it begins and ends. The low mass cartridge with its elliptical stylus, features the *Induced Magnet* system on which ADC built its enviable reputation.

It combines a strong, accurate, signal output with a 3/4 to 1 1/2 gram tracking ability.

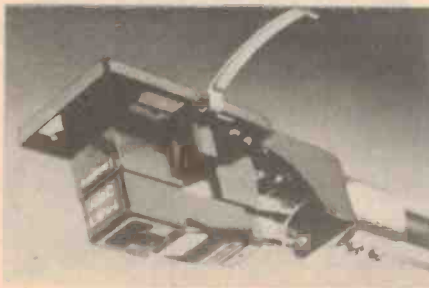

The integrated design of the tonearm and cartridge results in minimal arm mass and an ideal tonearm resonance between 8-10Hz.

It's all at your command.

As you see, Accutrac has some very intriguing features, quite apart from the turntable.



What looks like a pocket calculator is actually a

cordless command module.

So you have remote control.

The sculptured space-age object is the receiver for the turntable's memory bank. It's 'winking eye' tells you that your commands have been received.

Then you just sit back and enjoy what we hope you'll agree is the main attraction: the sheer excellence of the sound reproduction.

ADC

Distributed by
BSR (A'asia) Pty. Ltd.,
Anne Street, St. Mary's,
NSW 2760
Phone 623 0375, 623 5410

Accutrac 4000

Guaranteed for 2 years.

RADIOACTIVITY - a history

RADIOACTIVITY was first detected about eighty years ago and its discovery has led to some spectacular advances. From the study of radiation scientists have been able to explain many of physical science's fundamental principles.

Radioactivity occurs in nature, and can also be man-made. The natural sources are all around us in the form of radioactive elements dispersed throughout the soil and vegetation. Areas of high background radioactivity are usually associated with concentrations of naturally occurring radioactive elements, particularly uranium and thorium.

Another natural source is constant radiation from outer space. Fortunately the earth's atmosphere filters out most of it, but some of the more intense types of cosmic rays penetrate the atmosphere and are more detectable at sea level.

Man-made radiation takes many forms and can be generated in large particle accelerators, through the release of energy in an atomic explosion, in a nuclear reactor, or x-ray tube.

THE DISCOVERY OF RADIOACTIVITY

The nineteenth century was a period of intense scientific activity. The mediaeval attitudes that had fettered



The operator uses long tongs to keep his body away from the radioactive material in the container, whilst the monitor continuously checks the radiation level. (Courtesy Nuclear Enterprises Ltd.)

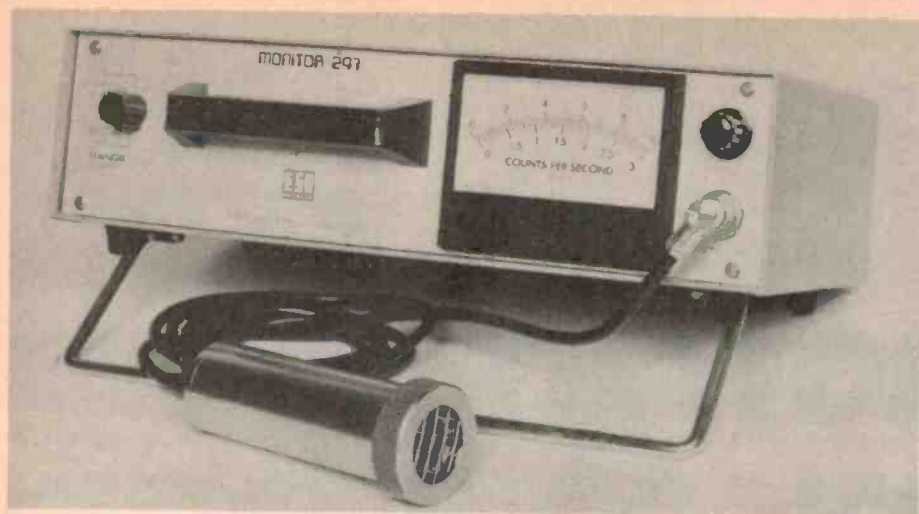

Simple radioactivity measuring equipment. The end-window Geiger tube is shown at the front. The meter indicates the counting rate. (Courtesy: ESI Nuclear Ltd.)

scientists were disappearing, and the age of the true experimenter had come. Scientists throughout the world were tackling problems on a broad front, laying the groundwork for the fundamental principles of modern science. By the middle of the century Coulomb, Volta, Oersted, Faraday, and many others had evolved the laws of electricity and associated phenomena which hold to this day.

The electric spark had always been a

source of interest to investigators, and with the development of the induction coil, high voltage sparks could be produced. As a further interest, their behaviour in a vacuum was investigated. A glass tube, with two electrodes fused into the glass at each end was made, and the tube was then evacuated with a vacuum pump. The two end electrodes were connected to the output of an induction coil and the effects observed.

The result was unexpected, and became the subject of intense investigation.

One of the investigators was German physicist Julius Pflucker. He observed that, as the air in a discharge tube is gradually pumped out and a high voltage applied to the tube, when the pressure is low enough, long thin streamers of light pass down the tube. As the pressure decreases further, these streamers expand out until the whole tube is filled with a glow. Still further reduction of pressure (towards a near vacuum) causes the glow to first become striated with dark areas then gradually increasing till the glow almost disappears, but with the glass walls glowing a yellowish-green colour in the region opposite the cathode.

It was obvious to Pflucker that this fluorescence in the glass was caused by some unknown invisible rays hitting the glass. Since these rays appeared to come in straight lines from the cathode he called them *cathode rays*.

From this time events began to move fast, and there was a growing excitement among scientists as several investigators performed experiments to determine the nature of these rays.

In 1895 a German physicist, Wilhelm Roentgen was experimenting with a discharge tube at very low pressure. He became particularly interested in the fluorescence (visible light) produced in a nearby zinc-sulphide screen by radiation coming from the tube. The fluorescence continued when the discharge tube was covered with black paper. Not knowing the nature of this radiation, he called it the unknown 'X'. Roentgen rays are now commonly known as X-rays.

The stage was set for the discovery of radioactivity.

Henri Becquerel, who was greatly interested in the phenomenon of fluorescence, had set up a similar apparatus to Roentgen's and used it to "excite" chemical compounds to observe whether they fluoresce or not. Among the compounds tested were some uranium salts.

From these observations two facts came to light. One was that some uranium compounds would fluoresce, when exposed to X-rays. (That is they emitted visible light). Second, while X-rays were not visible to the human eye, they exposed photographic plates, even when wrapped inside black, light-tight paper.

He then conducted an experiment to see if the reverse reaction could be brought about. He supposed that if he exposed the uranium salt to visible light, then the salt should be excited

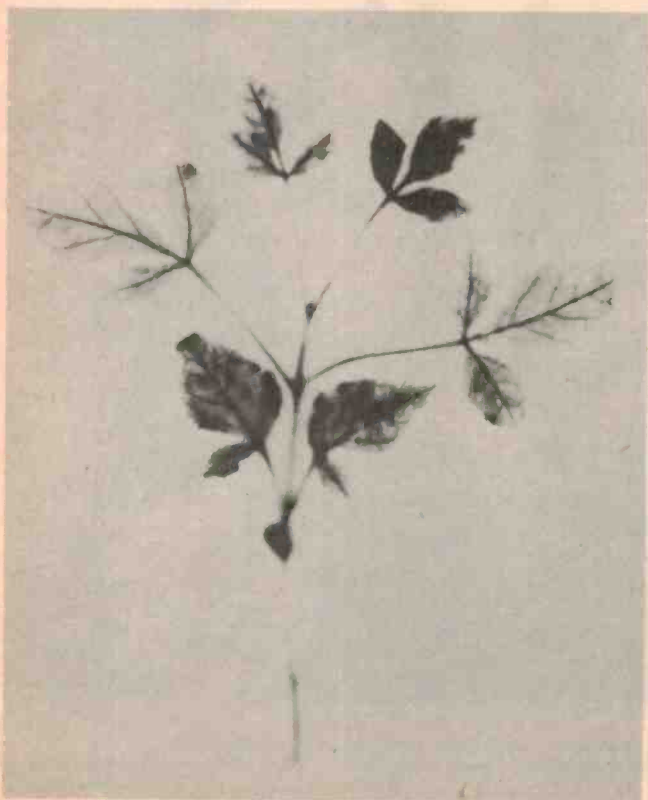

Radiograph of a plant which was placed in phosphorus-32 for a time and then pressed against x-ray film which was subsequently developed. The young rapidly growing leaves absorb more phosphate than the older leaves and therefore appear darker. (Courtesy: Kodak Ltd.)



Monitor for checking the contamination of personnel working with radioactive materials. It comprises a vertical array of 11 beta/gamma Geiger detectors with an additional detector for monitoring the soles of shoes. An alarm bell is included in this equipment, whilst the tone chimes sound when there is no contamination. (Courtesy: Nuclear Enterprises Ltd.)

to give off X-rays, which could be detected by photographic film. The results of his experiment seemed to be confirmed when he developed the photographic plate on which the uranium salt had been placed. The plate was exposed. It seemed the experiment had worked in reverse. However, Becquerel found that the plate was also darkened when the crystals were *not* exposed to light. He then prepared some crystals of the uranium compound under conditions of total darkness, without exposing them to light at any stage, and repeated the experiment. Again the plates were exposed. Further tests showed that all uranium compounds, including those that did not fluoresce, gave the same effect.

He now proceeded to investigate this new radiation and found that it could penetrate materials in a similar fashion



The patient has been given an injection of a radioactive material which is rapidly excreted by the kidneys. The two detectors, one behind each kidney, drive the pen recorder above the patient's head which produces a chart containing kidney function information. (Courtesy: U.K.A.E.A.).

as X-rays — seemingly unending production of energy by the uranium apparently contradicted the law of the conservation of energy.

Thus was ushered in our present atomic or nuclear age, for Becquerel had discovered radioactivity.

Madame Curie, as a young post-graduate student in Paris, investigated minerals which she found in her school's extensive collection of mineral samples. Many of these contained uranium and thorium. Many considered her efforts a waste of time. However, this "waste of time" brought a surprising result. Observations on the uranium-bearing minerals pitchblende and chalcocite showed that they have a radiation four times as strong as an equivalent amount of pure uranium. Repeated tests yielded the same results. Marie Curie concluded that the mineral pitchblende emits radiation four times as strongly as it should do. Therefore, in addition to uranium it must contain small amounts of an unknown element that is so radioactive that even a small admixture increases the radioactivity of the uranium mineral fourfold. In the subsequent search, Pierre and Marie Curie refined several tons of ore over four years, finally isolating 100 milligrams of pure radium chloride. In the intermediate stages they also discovered another radioactive element, Polonium.

By 1900 Max Planck had

revolutionised physics with his theory of quanta, or discontinuous emission of energy. Following work by F. Soddy and W. Ramsay in Montreal, demonstrating that radium disintegrates with the emission of helium, their mentor Ernest Rutherford demonstrated in 1907 that the alpha particle is a nucleus of ionised helium.

A few years later Rutherford and Niels Bohr proposed the "planetary system" models of the atom. In 1919 the first artificial nuclear disintegration was produced by Rutherford. He succeeded in transmitting one element into another (nitrogen into oxygen), a thing that alchemists had been trying to do for centuries.

Meanwhile, just one year later, regular radio broadcasting began in the U.S. An offshoot of the early vacuum tube demonstrating the Edison effect had been perfected by de Forest. It had ushered in the electronics era.

By 1932 two British scientists, J. D. Cockroft and E. T. S. Walton, achieved atomic disintegration by bombarding lithium with accelerated protons. This resulted in the lithium atom splitting up into two alpha particles.

Then came an announcement that meant little to the man in the street of the politician, and which received little publicity in the press.

Otto Hahn and Fritz Strassman announced that they had succeeded in

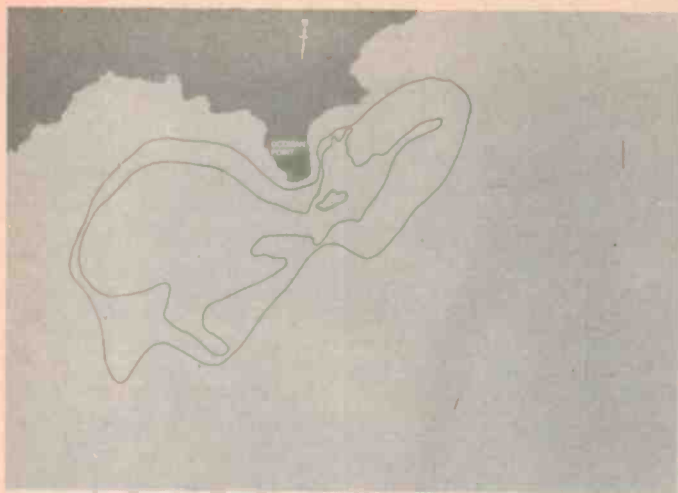

Radioactive clay was mixed with the sea bed off Dodman Point, Cornwall. The contours show how the radioisotope has spread 10-12 days after it was added. Such charts can be used to estimate the movement of the sea bed. (Courtesy: U.K.A.E.A.).

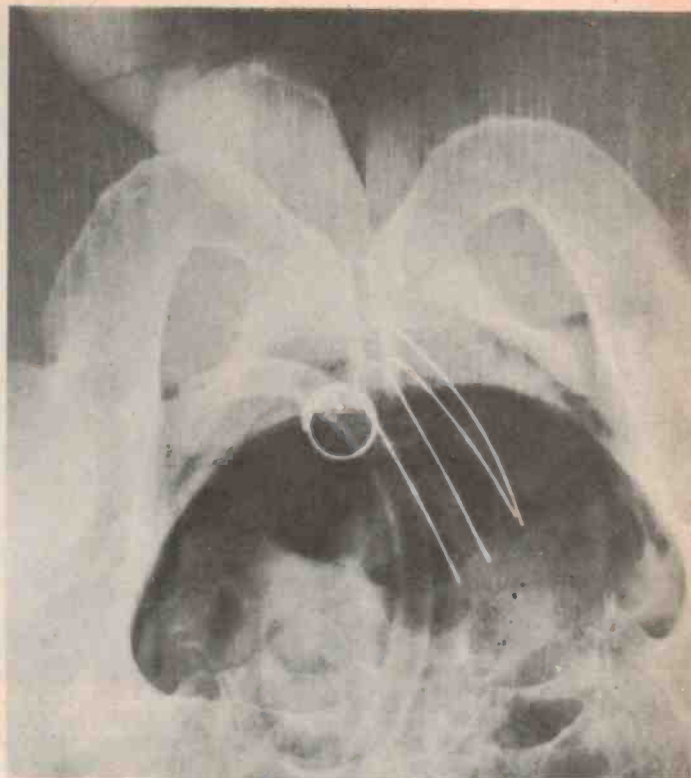

X-ray photography showing tantalum wire 'hairpins' implanted in the bladder. The radioactive wire contains the isotope tantalum-182 which irradiates a tumour. (Courtesy: Royal Marsden Hospital and U.K.A.E.A.).

splitting the uranium nucleus by neutron bombardment. They considered the possibility of a chain reaction. The energy released with their small sample was equivalent to 25 million kilowatts per kilogram of uranium.

NUCLEAR FISSION

Hahn and Strassman had induced nuclear fission (splitting the nuclei of uranium atoms into two parts) by neutron bombardment. However they found it hard to understand how this had taken place, and did not at first believe their results.

But Hahn and Strassman's doubts were soon resolved by two scientists working at the Bohr Institute in Copenhagen. Lise Meitner and Otto Frisch who performed further experiments, concluded that Hahn and Strassman were correct. They coined the phrase "nuclear-fission".

On January 16th, 1939, exactly ten days after Hahn's announcement, two short notes about the Copenhagen findings were sent to the English publication *Nature*.

Two days later, Niels Bohr travelled to the USA for a hurried conference with physicists in Washington. He presented Meitner and Frisch's results to an astonished audience, even before they had appeared in print. Enrico Fermi, already in the USA as a refugee from Italy was also present. The

conference at Washington continued with heated discussions well into the night. Many new possibilities came to light. Most notable was that fragments of the split uranium nucleus contain a large surplus of neutrons and there was the possibility that these free neutrons would in turn split further atoms of uranium.

This was the first time that the notion of a chain reaction cropped up. The question arose as to what becomes of the free neutrons that the uranium fission fragments must contain in abundance.

The answer came in March at the Paris Academy when Frederick Joliot and colleagues Dode, von Halban and Kowarski presented their results. They had confirmed that free neutrons are produced, and surmised that these induced the fission of further uranium nuclei, so producing more neutrons and so on, like an ever-swelling avalanche.

It was in this report that the words "reaction a chaine" were used. The words were to gain currency as "Nuclear Chain Reaction". Visions were conjured up of mighty machines fed by uranium, which could supply whole countries' energy needs, running on a handful of uranium fuel. However, at the time a more grim vision overshadowed this; one that mocked the achievements of human culture; the atomic bomb.

THE RACE FOR THE "BOMB"

The sweeping advance towards the practical use of radioactive elements came at a time of acute political tension.

In March 1939, Hitler's troops were marching in to Prague and occupying the "Protectorate of Bohemia and Moravia". It was not unnoticed that Czechoslovakia was the major source of pitchblende in Europe. This was the same ore from which Pierre and Marie Curie had extracted uranium and radium many years earlier. On September 1 Hitler's troops entered Poland, and World War II had begun.

During that first *Blitzkrieg* a group of eminent physicists met at the Kaiser Wilhelm Institute of Physics. Present were Hahn, Geiger, Bothe, Heisenberg, von Weizsaker. They met to consider the practical applications of atomic energy. However, a substantial number of others such as Lise Meitner, Otto Frisch, Enrico Fermi and Albert Einstein had fled the Nazi Axis and were now serving the "other side".

The German war ministry was alarmed by the news from America. Leading physicists were said to have been working with the armed forces for months, preparing for the military use of atomic energy.

Meanwhile in the USA, less was being done than the Germans imagined, but this changed and one of the greatest

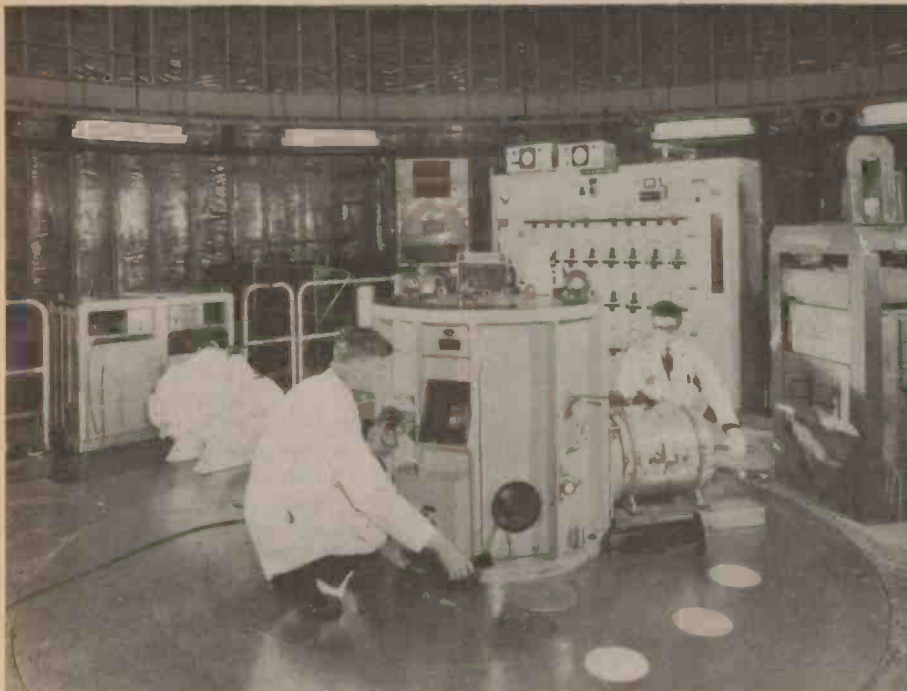

A radioactive isotope being removed from the nuclear reactor 'PLUTO' at Harwell. The reactor is situated beneath the centre of the photograph. (Courtesy: U.K.A.E.A.).

avalanches of research the world had seen was soon underway.

When Niels Bohr had reported the news from Europe, Enrico Fermi, by then a professor of Columbia University, began lobbying for increased nuclear research, and an attack on the problems of developing the atomic bomb. His campaign against the fatal dangers of delay was unheeded till he gained the support of Albert Einstein.

In July, Bohr and Einstein eventually reached the President, warning that war was imminent (the USA was still then a non-combatant) and that "the Nazis will construct an atom bomb and will not hesitate to use it". Bohr and Einstein thus became the driving forces in atomic research. President Roosevelt realised what was at stake, and he appointed an advisory commission of physicists and army and navy representatives. Their momentous decision was to make an atomic bomb. The first grant in 1940 was a mere \$6000. By November a further \$40 000 had been advanced. The sums increased like a landslide until by 1945 the sum of two billion dollars had been spent. Adjusted to present-day values this represents about ten billion dollars.

The problem facing both the Germans and the Americans was the same. Natural uranium will not make a bomb. The isotope uranium-235

undergoes nuclear fission, while the major isotope, uranium-238, is a hindrance. Uranium-235 is only 0.7% of natural uranium, and it must be separated out and concentrated. This is extremely difficult, and expensive,

since it must be done using physical means, as the two isotopes have identical chemical properties. However, it is a direct method of making a bomb. When sufficient pure uranium-235 has been separated out, a bomb can be made. Two subcritical masses of uranium-235 are brought together extremely rapidly, and an uncontrolled chain-reaction results in explosion.

No detonator was required, as once a "critical mass" is reached, the material goes off spontaneously, to release the energy equivalent of 20 000 tonnes of TNT.

Meanwhile the Germans had occupied Norway, thus ensuring themselves a supply of heavy water from the Norsk hydro-plant at Rjukan in the mountains, where hydro-electric power was plentiful and cheap. With the ready supply of pitchblende from Czechoslovakia and heavy water from Norway everything was in favour of German success in constructing a nuclear reactor.

While German scientists did have some success in building a reactor, which could have led to development of nuclear weapons, they appeared to avoid the acquisition of the technology to do this.

On June 6, 1942, a group of scientists met in the great hall of Harnack House in Berlin. Also present were the men behind the German war

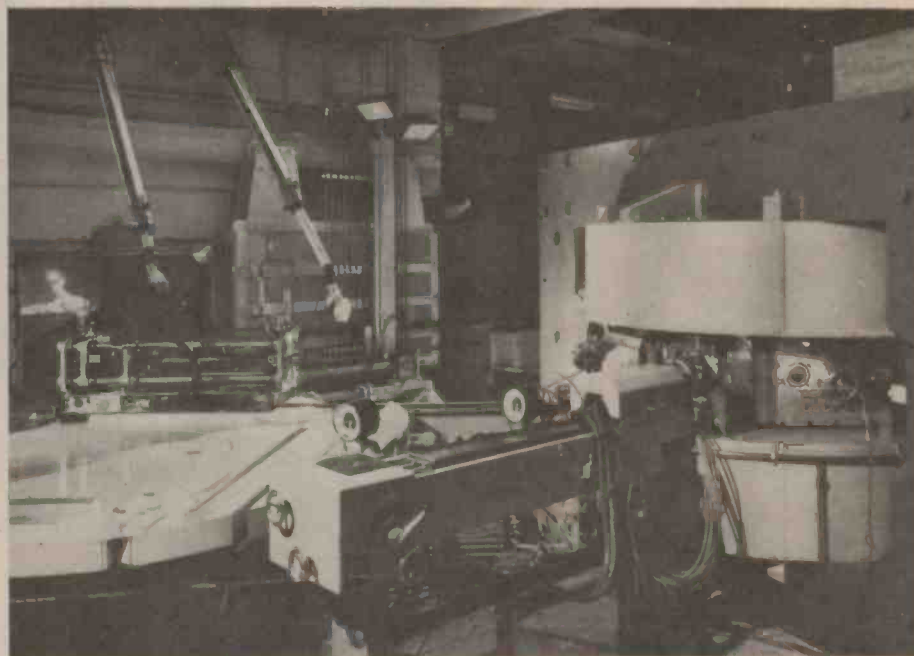

The cyclotron at the Radiochemical Centre, Amersham, Bucks, which is used for making radioisotopes which the Centre markets. The magnet can be seen on the right hand side. The remote handling equipment on the upper left hand side is being used to fix the target head to the rotating target. (Courtesy: U.K.A.E.A.).



Calibration of the reference flow meters at the Gas Council's Engineering Research Station at Killingworth. Ethyl bromide containing the radioactive isotope bromine-82 is employed. (Courtesy: Gas Council and U.K.A.E.A.).

machine, including their chief, Albert Speer. Progress towards the use of atomic energy was reported. They reported some progress towards harnessing nuclear energy in an atomic pile, but did not give a positive report on the possibilities of developing nuclear weapons. Initial efforts to separate out uranium-235 had failed, and it would take an enormous expenditure to even find a way to do it. In addition, they did not have any expertise in particle accelerators, and were therefore not able to research many of the fundamental processes of nuclear physics. Since the economy was already hard-pressed by the war, the decision was taken to scrap ideas of producing an atomic bomb.

On the other side of the Atlantic, the American research project developed quickly. At the commencement of the war some twelve particle accelerators of varying power were either in operation or in various stages of construction. These were the experimental tools that enabled the scientists to understand the mechanisms of transmutations and nuclear reactions. Using accelerators such as the Berkeley cyclotron, American scientists MacMillan and Seaborg bombarded ordinary uranium with high energy deuterons. They succeeded in producing new elements. Among these were minute quantities of neptunium and plutonium.

The discovery of plutonium-239 in 1941 added a new dimension. Like uranium-235 it is fissile. That is, it will undergo nuclear fission and can take

part in a chain reaction, and if purified can be used in an atomic bomb instead of uranium.

Of particular importance is the fact that it is produced in significant amounts in a nuclear reactor, or atomic pile, using natural uranium (often enriched in uranium-235). Then

the plutonium can be separated from the uranium fuel using chemical methods, since plutonium has different chemical properties from uranium. This separation is much easier than the task of concentrating uranium-235 out of natural uranium.

There were then three ways of releasing atomic energy. The direct way is to separate uranium-235 from natural uranium, and use it in a bomb. Second, natural uranium, possibly enriched in fissile materials, is used in an atomic pile in controlled energy release, and simultaneous production of plutonium. Third, the plutonium from the reactor fuel can be separated and used in a bomb. The Americans pushed ahead with all three aspects. They were co-ordinated under the name 'Manhattan Project'.

The direct method needed uranium-235. Ernest Lawrence, inventor of the cyclotron, had an idea. In a mass spectrograph, charged atoms (ions) were separated according to their mass. This was done by sending them through a magnetic field. The atoms were deflected variably according to their weight by the field.

Lawrence had at his disposal the then most powerful magnetic fields on earth. They were generated by the 940 mm electromagnet of the Berkeley cyclotron.



Measurement of lung contamination by plutonium-239. Apart from alpha particles, this isotope emits low energy gamma rays which penetrate the chest wall and are detected. (Courtesy: U.K.A.E.A.).

Lawrence's research group converted the cyclotron using the giant magnet as the basic component into a kind of gargantuan mass spectrograph. They called the new apparatus the "calutron" (California University Cyclotron).

By the end of 1941 this machine was capable of separating one microgram of U235 per hour. Whilst this was nowhere near the many kilograms that were required it was not a futile enterprise. It provided the basis of future technology for separating uranium-235 on a larger scale.

The indirect method, of manufacturing a bomb with plutonium produced in an atomic pile, also had enormous problems. There was then no operating pile, and a chemical plant had to be built to separate the fissile material from the uranium fuel by the time the atomic piles were ready to deliver it.

To make a chemical plant, the chemistry of plutonium would have to be known. At this time it had not yet been produced in observable quantities. A measurable quantity was needed urgently.

Every available accelerator was brought into service and hundreds of

kilograms of uranium were bombarded with neutrons for months until about a milligram of plutonium was made and separated. On this tiny amount, chemists used ultra-micro techniques to study its chemistry and design a method for separating it from uranium. By the time the atomic reactors were able to deliver large quantities of uranium fuel containing plutonium, a huge chemical plant was ready to extract it.

Meanwhile, Fermi and Allison had continued their constructions of experimental piles in Chicago. On the ninth attempt a multiplication factor of 1.0007 was achieved, signifying a self-sustaining chain reaction.

Fermi now concentrated on manufacturing a pile in which a chain reaction could be sustained and controlled. To prevent the system going out of control, a series of cadmium rods were inserted into the graphite/uranium pellet structure. The purpose of the rods was to absorb as many neutrons as possible thus inhibiting their action when necessary. A sustained reaction was achieved in December 1942. Power was kept to a mere half watt whilst measurements were taken. This was increased to 200

watts ten days later. Outputs of one megawatt were being produced two years later.

The bomb could be made.

The centre for developing the bomb was at Los Alamos some 50 kms from Santa Fe, the state capital of New Mexico. To this place came physicists from all over the United States and other Allied countries, assembled by the eminent physicist Robert Oppenheimer.

The first atomic bomb was exploded from a tower at Alamogordo in the New Mexican desert at 5.30 am on July 16, 1945 at the height of a thunderstorm.

The successful result of the first test presented US President Truman with a very difficult decision. This was whether to defeat Japan by orthodox means — with estimated Allied casualties of 300 000 or whether to use the atomic bomb against Japan's civilian population and by such overwhelming evidence of power force Japan to surrender.

Three weeks after the first test, the city of Hiroshima was destroyed with a uranium-235 atomic bomb. A plutonium bomb fell later on Nagasaki.

**E-Z-HOOK
OFFER...**

This pack of E-Z-Hooks is ideal for your test probe needs! It includes 1 red XPL Probe (above right), 1 black XP Probe (left), six assorted colour X-100W Mini hooks (above left), six assorted banana plugs, three 2-metre lengths of flexible hook-up wire and an E-Z-Hook catalogue. The Reader Offer price of \$16.15 includes sales tax, postage and packing.

Please forward. . . . E-Z-Hook Packs at \$16.15 each.

Name

Address

Postcode

Please make cheques payable to E-Z-Hook Offer.

Send to:

ETI/E-Z-Hook Offer,
ETI Magazine,
15 Boundary Street,
Rushcutters Bay,
NSW 2011.

Leak 3000 Series: Computer designed for superior audio accuracy.

From the originators of high fidelity speaker design – the Leak 3000 Series.

A fully imported range of loudspeakers computer designed to reproduce your sound with authentic accuracy and the utmost clarity.

The 3000 Series is the result of an intensive research programme to evaluate and correct various

audible distortions in such key areas as intermodulation, doppler and delayed resonance.

Now the Leak 3000

Series can deliver:

- Design control to compensate for time delay.
- Bass/mid range driver

with no audible doppler distortion.

- Special compensating crossover network for improved treble performance.
- Treble unit with range up to 22kHz.
- Superb stereo imagery.

Hear the difference now at your leading Hi-Fi Specialist. Leak loudspeakers have never looked better, never sounded so accurate.



 **LEAK**

**NEW. FULLY
IMPORTED.**

We Keep Performing



**RANK
AUSTRALIA**

CU151/77

SOUNDS

IS PHASE JUST A CRAZE?

Attempts to reproduce the sound of an original event as accurately as possible have brought about constant and consistent improvement in techniques and results since recorded sound first became a practical proposition.

A most important contribution to realism is stereophony, whereby some illusion of the apparent sound sources is provided, and it is becoming increasingly obvious that the relation of musical sounds to their acoustic surroundings must be reproduced to give believable results.

To do this, we must first observe exactly how the ears hear and resolve the original complex combinations of sounds to reproduce the subjective impression characterising that event. This involves studying the dynamics of the sound — the various sonic components in terms of frequency and amplitude, and their phase characteristics.

For the purposes of this discussion, any deviation of the reproduced result from the original in respect of these parameters will be referred to as distortion and in this instance should not be confused with the various types of distortion (i.e. harmonic, intermodulation or transient) often used to describe deficiencies in audio equipment.

For example, should the amplitude of a component in the reproduced sound differ relatively to others from its original amplitude, then the result will be a distortion of the original. If a component so distorted happened to be a fundamental or harmonic of a particular complex sound, then, unless the deviation were very small indeed, the result would sound different from the original.

Just how small a deviation can go undetected is still a matter for investigation but there is evidence to suggest that surprisingly small deviations of this sort can have a clearly audible influence — the result will sound different from the original, even though that result will be recognisable as a re-creation (or an attempt at re-creation) of the original.

This sort of distortion of amplitude would appear to be most significant if only a few (of the many) sound components are affected. Should all components be affected equally, then of course the audible effect is merely one of changed overall volume level, the total sound retaining correspondence with the original. Even so, there is evidence that true realism depends on overall levels being similar to those at the original event.

Alterations in the frequency of sounds will obviously have an audible effect, although very rarely is this significant unless such deviations are cyclically variable, as with wow and flutter — the latter being a far more serious phenomenon, affecting dynamics in addition to pitch. Wow has far less influence on dynamics as such, but the characteristic 'sour' sound completely destroys realism of sustained sounds. It is very rare to encounter a modification of frequency of one individual component when the remainder stay correct, recording/reproduction techniques making this virtually impossible.

This brings us to the vexed question of phase.

Phase relationships of complex sounds are under careful

scrutiny at present, for although it has been demonstrated that incorrect phase relationships between components of different frequency and amplitude in complex sounds have no audible effect in a continuous sound provided amplitude and frequency characteristics are correctly preserved, there is evidence that an initial transient can be audibly degraded if, for example, a phase shift occurs across the frequency range. If, for example, a high frequency component of a complex sound is shifted in respect to time relative to a low frequency component, there will obviously be a modification of amplitude in the overall complex waveform, and, depending on the direction of shift, the initial transient peak could be either too great or too small. Thus while it can be argued that phase shift is of no consequence during reproduction of *continuous* sounds, it cannot be argued that incorrect phase relationships will have no audible effect on the quality of reproduction overall. Fig. 1 illustrates why this is so.

Preservation of correct phase characteristics has been an aim of a number of loudspeaker manufacturers in the past few

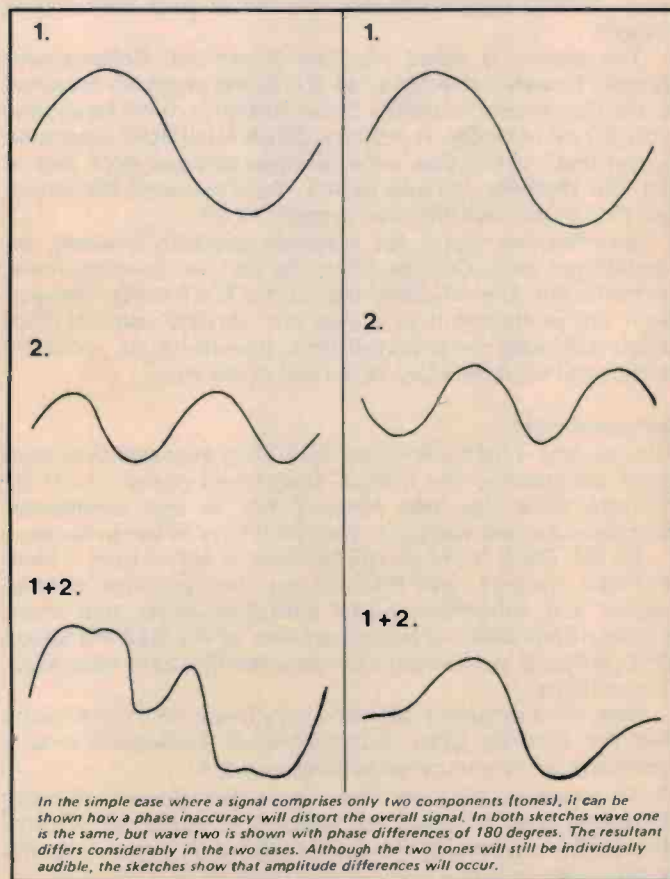

PHASE CRAZE?

years. Models such as B & W's DM6, Dahlquist's DQ10, the forthcoming KEF reference 105 and a number of the Technics range, amongst others, have been designed to give far better phase 'coherency' than more conventionally designed systems. The attempt has been to ensure that sounds of different frequency arrive at the listeners' ears in correct relative phase, the intention being to give better homogeneity of sound — so that the results sound less 'reproduced' and more 'live'.

In our experience, speakers designed for better phase coherence sound somewhat bland, with a less spectacular but more natural result. The one speaker we have had the opportunity to audition very critically (Dahlquist's DQ10) epitomises this sound and at first listening sounded quite different from most other speakers. However, when the pair was correctly set up and optimally positioned relative to the listener (and this is essential) they provided the same kind of effortless, almost muted musical quality experienced at a live performance. As a drawback, of course, it exposed mercilessly the degrading effects of some recording techniques, notably

multi-miking. However recordings made via a cheap pair of dynamic microphones (Shure Unispheres) in classic crossed pair configuration, using a Revox tape recorder and solo guitarist as accompaniment to the instrumentalist's voice displayed a very convincing sense of realism despite certain restrictions of the record/replay system, notably restricted frequency response of the microphones, less than optimum signal-to-noise ratio and a tape recorder badly in need of overhaul.

The Dahlquists provided a fine sense of ease and naturalness which is definitely missing from many speakers. This and other experiences causes us to believe that preservation of correct phase relationships contributes very strongly to that nebulous 'musicality' which is really the essence of convincing sound reproduction.

These comments are intended primarily for further experiment and thought. We believe that perfect sound reproduction will only be achieved when the fundamental characteristics of soundwaves — frequency, amplitude and phase — are correctly preserved throughout the record/reproduction chain, in such a way that the waveforms incident on the eardrums are identical in every way with the waveforms which would have been present at the original performance.

This makes a mockery of the assertions that this that and the other forms of distortion (in the broad sense) can be inaudible or imperceptible.

MORE QUAD

IT WOULD appear that four channel sound might not be quite the flock of dead ducks we took it for. Over in the USA a new (1974!) system of enhancing matrix quad is causing no little stir.

The system is called the Tate Directional Enhancement System, hereafter referred to as TDES, and originally launched at the Consumer Electronics Show (USA) in 1974 for dealing with SQ more kindly. It promises 30 dB MINIMUM separation — and that's better than most pick-ups between ANY two of the four channels you care to pick. Total harmonic distortions less than 0.05% and S/N ratio exceeds 70 dB.

Specifications won't get a system adopted, however, no matter how good. Compatibility and cost, on the other hand, certainly will. One big advantage of the TDES is that National Semi are producing it as a chip set, LM1852 and LM1853, which will make the cost realistic to manufacturers, recording studios and we Australians at the end of the chain.

Using their loaf

The two and a half years since TDES first appeared have been spent compressing the original breadboard design of 2ft by 3ft into these nice little National ICs, so that commercial companies can sell you a box you don't have to live in to use.

To get TDES to do its stuff a signal is fed in from a basic *non-logic* decoder, and the chip set then provides volume, balance and dimension control with four power amp feeds. A ready built board is being marketed in the USA for about \$200, although prices must inevitably fall if volume sales begin to materialise.

National themselves estimate they'll sell 25 million units over the next five years. Either someone somewhere is very optimistic, or they know something we don't!

Tate's inventors naturally look upon their system as being the saving grace of quad, but whether or not it can perform this almost divine act of resurrection will depend on the public — us.

Certainly the TDES is streets ahead of any of the present methods of getting four channels of sound from a stereo compatible disc or FM broadcast. It is relatively cheap, and leaves the present logic enhancement systems standing. With those the only way to get 30 dB separation was to play the speakers in four different rooms using four different pieces of music! And non-matrix quad i.e. CD4 requires special cartridges and suffers from greater distortion and surface noise susceptibility. In fact TDES's inventor, one Wesley Ruggles, gets most upset at attempts to compare his baby with CD4.

For all this, it looks like too little, too late. I hope we're wrong and the best of luck to Tate, but first let's get an industry standard, if it's Tate SQ — fine. So long as the vinyl starts to appear for us to use our new toy with, I think the uncommitted masses won't care which system it is, they'll just be glad to get off that fence safe in the knowledge that the clever orientals aren't going to invent something better tomorrow.

Below: Schematic diagram of the Tate Directional Enhancement System.

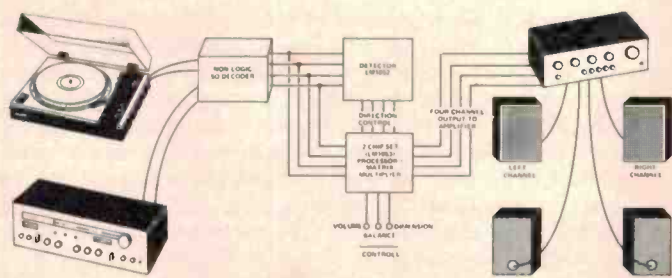

TECHNICS PRESENTS ITS CREDENTIALS.

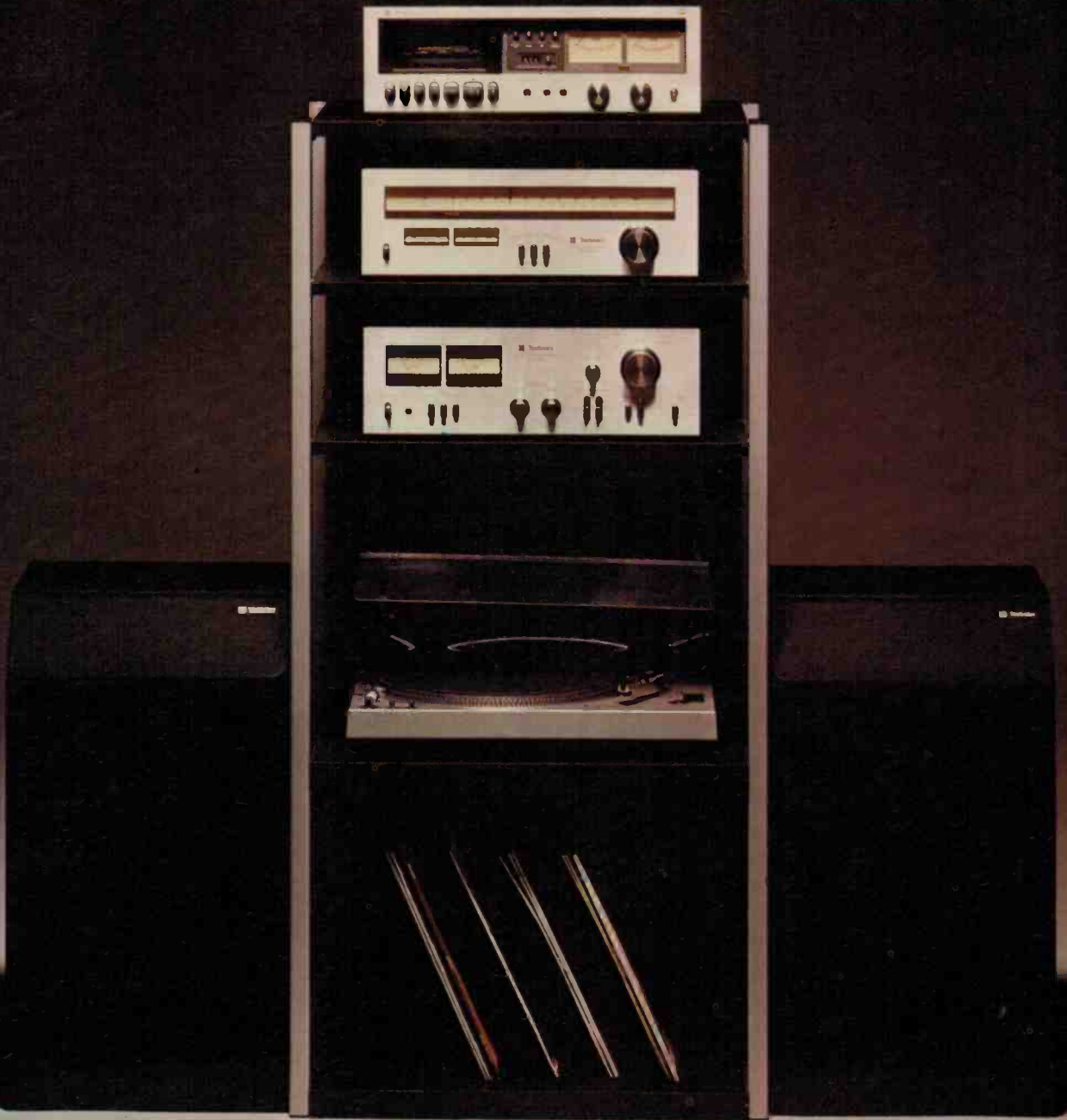

Technics present 'the professional look' . . . vertically racked components that make up one of the finest hi-fi systems available. Each component has been matched both in design and specifications, making it all so easy for you to enjoy optimum stereo performance.

This system comprises Technics 1977 components—

SU7300 stereo integrated amplifier (43 watts per channel, RMS at 1 kHz, 8 ohms); ST7300 AM/FM tuner; SL1700 direct-drive semi-automatic turntable (wow and flutter 0.025% WRMS); RS630AUS front-loading cassette deck with Dolby* noise reduction; and the SB4500 linear-phase speaker system. All components are housed in a Technics rack for the total professional look.

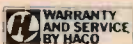

For a National Technics catalogue please write to:
National Technics Advisory Service, P.O. Box 49, Kensington, N.S.W. 2033

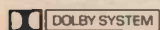

*Under licence from Dolby Laboratories Inc.



Technics

hi-fi

THE SALE OF THE DECADE

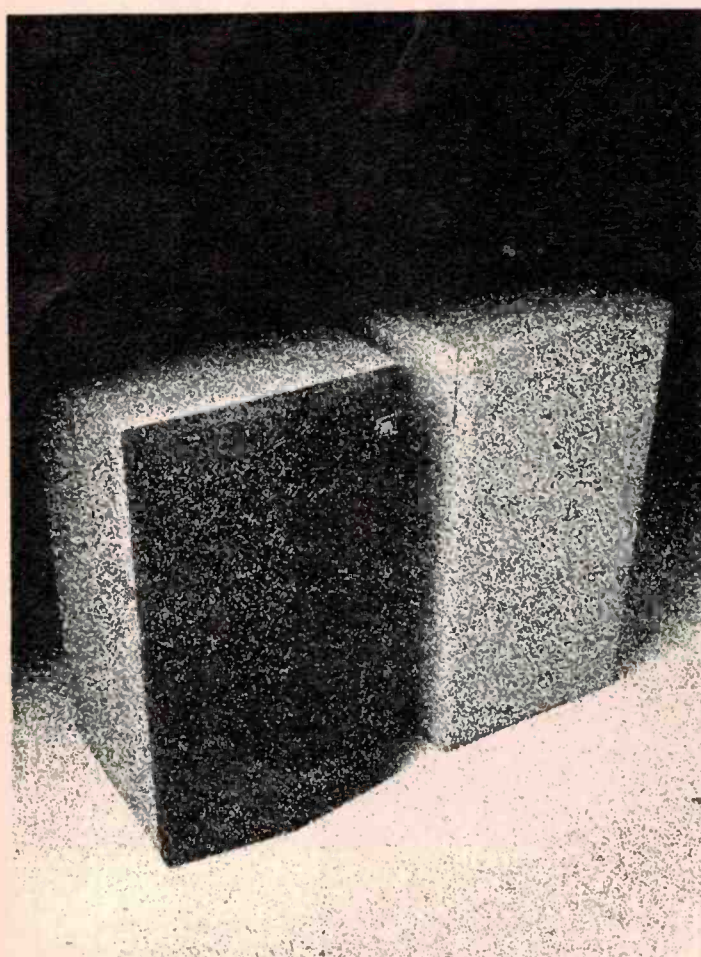

It's official: From NOW until December 31st, or until stocks are sold, a *limited* number of JBL L26 and L36 Decades will be available from your JBL Audio Specialist Dealer . . . at a *Reduced Price!*

With every pair of Decades purchased during the Sale, you will receive **Free**, a pair of JBL Speaker Stands.



Available at your JBL Dealer . . . **NOW!**

Distributed by—
HARMAN AUSTRALIA PTY. LTD.,
P.O. Box 6, BROOKVALE, N.S.W. 2100
Telephone: (02) 939 2922



Available Now!
From these



audio
specialist dealers.

- **A.C.T.:**
Pacific Stereo
Manuka, A.C.T. 2603. Ph. 95-0695
- **N.S.W.:**
Albury Audio Centre
Lavington, N.S.W. 2461. Ph. 25-1712
Byron Bay TV
Byron Bay, N.S.W. 2481. Ph. 85-6762
Car Radio & Hi Fi Centre
Wagga Wagga, N.S.W. 2650. Ph. 21-4618
Convoy International Pty. Ltd.
Woolloomooloo, N.S.W. 2011. Ph. 357-2444
Convoy International Pty. Ltd.
Sydney, N.S.W. 2000. Ph. 29-1354
Eastern Hi-Fi
Newcastle, N.S.W. 2300. Ph. 2-5623
Electronic Enterprises Ltd.
Hornsby, N.S.W. 2077. Ph. 476-5372
Hi Fi Hut
Gladesville, N.S.W. 2111. Ph. 89-3571
Insound
Crows Nest, N.S.W. 2065. Ph. 92-1498
Instrol Hi Fi
Sydney, N.S.W. 2000. Ph. 231-3816
Lismore Hi Fi
Lismore, N.S.W. 2480. Ph. 21-5193
Milversons Sound Centre
Chatswood, N.S.W. 2067. Ph. 412-2122
Miranda Hi Fi Centre
Miranda, N.S.W. 2228. Ph. 525-6745
Miranda Hi Fi Centre
Roselands, N.S.W. 2195. Ph. 750-7311
Miranda Hi Fi Centre
Taren Point, N.S.W. 2229. Ph. 525-7166
Nitronics
Coffs Harbour, N.S.W. 2450. Ph. 52-4343
Park Street Hi Fi
Sydney, N.S.W. 2000. Ph. 26-2798
Riverina Hi Fi
Brookvale, N.S.W. 2100. Ph. 938-2663-4
Russin Electronics
Ashfield, N.S.W. 2131. Ph. 799-2421
Taree Photographics
Taree, N.S.W. 2430. Ph. 52-1488
Warringah Hi Fi
Mona Vale, N.S.W. 2103. Ph. 997-5313
- **NORTHERN TERRITORY:**
Sound Spectrum (N.T.) Pty. Ltd.
Casuarina, N.T. 5792. Ph. 85-1979
- **QUEENSLAND:**
Alvin Communications
Townsville, Qld. 4810. Ph. 79-3455
Audio Laboratories
Milton, Qld. 4064. Ph. 36-0080
Bob Wilsons
Bundaberg, Qld. 4670. Ph. 71-3864
Keller Electronics
Maryborough, Qld. 4650. Ph. 21-4559
Mackay Audio Centre
Mackay, Qld. 4740. Ph. 57-5035
Premier Sound
Rockhampton North, Qld. 4701. Ph. 28-2701
Russ Adams Hi Fi
Townsville, Qld. 4810. Ph. 71-5618
Southport Hi Fi Centre
Southport, Qld. 4215. Ph. 32-4687
Townsville Hi Fi
Townsville, Qld. 4180. Ph. 71-4367
- **SOUTH AUSTRALIA:**
Aslins Hi Fi
Mt. Gambier, S.A. 5290. Ph. 25-3277
Revolver Hi Fi
Goodwood, S.A. 5034. Ph. 272-5686
- **TASMANIA:**
James Loughran & Sons
Burnie, Tas. 7230. Ph. 31-1533
Opus One
Hobart, Tas. 7000. Ph. 34-8881
- **VICTORIA:**
Allans Music
Melbourne, Vic. 3000. Ph. 63-0451
Allans Music
Bendigo, Vic. 3550. Ph. 43-4744
Contemporary Sound Centre
Hawthorn, Vic. 3123. Ph. 81-5585
Instrol Hi Fi
Frankston, Vic. 3199.
Instrol Hi Fi
Melbourne, Vic. 3000. 67-5831
Shepparton Hi Fi
Shepparton, Vic. 3630. Ph. 21-9006
A. G. Smith & Co.
Warrnambool, Vic. 3180. Ph. 62-3056
The Soundcraftsman
North Caulfield, Vic. 3161. Ph. 509-2444
R.B. Television
Moe, Vic. 3825. Ph. 27-2357
E. & B. Wholesale Pty. Ltd.
Geelong, Vic. 3220. Ph. 9-6616
- **WESTERN AUSTRALIA:**
Alberts Hi Fi
Tuart Hill, W.A. 6060. Ph. 349-1055
Alberts Hi Fi
Perth, W.A. 6000. Ph. 22-4409
Alberts TV & Hi Fi
Victoria Park, W.A. 6100. Ph. 62-1188
Alberts TV & Hi Fi
Perth, W.A. 6000. Ph. 25-2699
Leslie Leonard Hi Fi
Perth, W.A. 6000. Ph. 22-4304

SOUND BRIEFS

SYDNEY CES

This year's Consumer Electronics Show was an outstanding success. So many people attended that three out of the four lifts at the Sydney Hilton broke down due to overloading. The organisers, Riddell Exhibitions, tell us that the '78 show will be held at the Sydney Showground.

350 WATTS CLASS A!

Technics have just sent us details of what must be the amp of the year! Would you believe 350 watts per channel in class A? There's no less than eight power supply stages with four 100,000 μ F (0.1 F) electrolytics. Total harmonic distortion is 0.003%. Weight is almost exactly 1 cwt.

Presumably one provides written notice to the Electricity Authority before switching on.

NEW SYDNEY RETAIL STORE

Despite the current depressed state of the hi-fi retail market, Andrew Golfinch, genial ex-Convoy retail showroom manager, has opened his new **Leisuresound store** in Chatswood at 871, Pacific Highway. The showroom is based on the 'small room' concept and we will describe this in greater detail in the near future. Andrew has a wide selection of leading lines and will welcome personal callers or phone enquiries on (02) 411 4944.

DIGITAL RECORDS

Sony has already developed a digital PCM disc record system which is a working proposition. Playback from the disc — similar to a conventional analogue record — is to be by laser and it seems likely the system will be marketable on a competitive basis compared with conventional equipment in the fairly near future.

TWO SPEEDS FOR LINN

Allen Wright, engineer responsible for the new Audiolab amplifier, will shortly introduce an attachment for the Linn-Sondek LP12 enabling it to be used at 45 rpm as well as 33.3. The device is a frequency generator and the 45 rpm speed will be obtained simply by increasing power supply frequency to increase rotational speed of the Linn synchronous motor.

AND NOW LINN SPEAKERS

Linn Products has recently announced a speaker system — the **Isobarik** — and although details are not yet to hand, it seems likely the new transducer will reflect the same attention to performance detail which has made the LP12 a world leader in turntables.

B & W DM7

Latest from B & W of England is the DM7, designed to give new standards of linear amplitude response and minimal distortion due to diffraction. No local release date is yet available but we imagine supplies will be reaching Australia within the next couple of months.

IS BASS DIRECTIONAL?

Using a pair of compact model 149 speakers, JR, a young company headed by Jim Rogers, the man responsible for the famous Rogers line of components, fooled visitors to the JR exhibit at England's recent Harrogate audio exhibition into believing that extreme bass was emerging from a dummy bass-bin between the compact enclosures. This bin was in fact a dummy: bass information actually emerged from another bass-bin concealed behind the audience and to one side of the room.

GARRARD IMPULSE NOISE REDUCTION UNIT

Garrard is soon to launch an impulse noise reduction unit, apparently similar in performance and operation to the recently-introduced SAE 5000 unit which has already received considerable acclaim from audiophiles.



De-soldering problems?

The new Weller power vacuum desoldering station for printed circuit board repair. Famous Weller closed loop temperature control protects sensitive components while soldering or desoldering. See-through solder collector is easy to clean or replace. Non-burnable cord sets afford safety and longer life. Low voltage tool inputs give added safety margins. High impact resistant tool handles and stainless steel barrels mean longer tool usage.

Also there's now cordless soldering from Weller - (see right). Soldering was never easier than with the Weller cordless kit, consisting of iron charger, solder, 4 different tips and a handy screwdriver. Other products from The Cooper Group include Crescent, top quality electronic pliers; Lufkin, measuring equipment; Nicholson, precision files; Xcelite, professional hand tools and Wiss shears and scissors. Whatever your requirements, you can choose Cooper products with confidence.



The Cooper Group

CRESCENT · LUFKIN · NICHOLSON · WELLER · WISS · XCELITE

The Cooper Tool Group Limited,

P.O. Box 366, Nurigong Street, Albury NSW 2640, Australia. Telephone: 215511 Telex: 56995





The new



Sound Reinforcement Components

distributed exclusively throughout Australia by
AUDIO ENGINEERS Pty. Limited

Stones' Rolling Studio.



A complete recording studio in a van? For Mick Jagger, it's almost a necessity. Mick and the Stones can be inspired to produce their next hit anytime; but when they're on tour or vacationing, the best recording studios aren't always around the corner. For these moments of midnight inspiration, the Stones rely on their Shure-equipped mobile studio for the unmatched recording perfection they insist upon. Whether in a recording session or on stage, the Stones' Shure SM53, SM58, SM5C, SM33, and SM54 microphones are their assurance of consistent quality and natural sound.

Three more new Microphones from the Shure range.



Model PE52 Vagabond Close-Talking Microphone

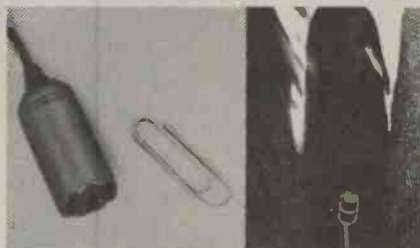

Shure SM11 Dynamic Element Lavalier Microphone



PE5EQ. The first Equalizer Microphone.

ALSO A RANGE OF SHURE SPEAKER COLUMNS, AMPLIFIERS, ELECTRONIC CROSSOVERS & ACCESSORIES.

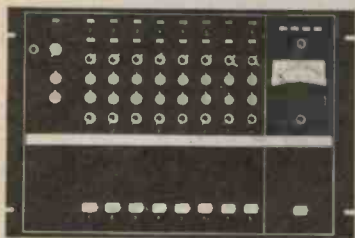

SR101 AUDIO CONSOLE



SR105 POWER AMPLIFIER

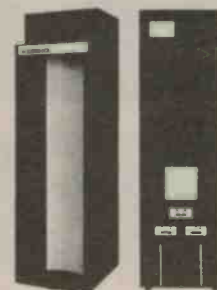

SR108 EXTENDED RANGE SPEAKER SYSTEM

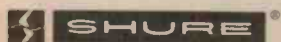

AUDIO ENGINEERS P/L **AUDIO ENGINEERS (Vic.)** **AUDIO ENGINEERS (Qld)** **P/L. ATHOL M. HILL P/L**
342 Kent Street, 2A Hill Street, 51a Castlemaine St 33 Wittenoom Street,
SYDNEY 2000 N.S.W. THORNBURY 3071 Vic. Milton 4064. Qld. EAST PERTH 6000 W.A.

Sansui Stereo Integrated Amplifier: The Super Power Package.

From Sansui, the Stereo Integrated Amplifier AU20000, a super power package that pushes out 170 watts per channel. We call it integrated because it is a combination of the Definition BA-3000 power and CA-3000 preamplifier within the one unit.

That means the AU20000 is more compact to handle and is available at a price to please every true audiophile.

Specifications

Power Output: Min. RMS, both channels driven, from 20 to 20,000Hz, with no more than 0.05% total harmonic distortion 170 watts per channel into 4 and 8 ohms.

Power Bandwidth: 20 to 20,000Hz at or below rated min. RMS power output and total harmonic distortion.

Total Harmonic Distortion: Overall (from AUX) less than 0.05% at or below rated min. RMS power output.

Intermodulation Distortion: (70Hz:7,000Hz = 4:1 SMPTE method). Overall (from AUX) less than 0.05%.
Frequency Response (at 1 watt):

Overall (AUX to power output)
10 to 50,000Hz + 0dB, -1.0dB
Power Amplifier Only

10 to 70,000Hz + 0dB, -1.0dB

Damping Factor: approximately 80 to 8 ohm load

Channel Separation at rated output 1,000Hz:

Phono 1—better than 55dB
(at 3mV sensitivity)

Phono 2—better than 55dB
(at 3mV sensitivity)

Tuner—better than 60dB

Aux—better than 60dB

Tape Monitor—1,2,3 better than 60dB

Power Amplifier—better than 65dB

Available from all leading Hi-Fi specialists



Sansui

Sold and serviced nationally
by Rank Australia.
Sydney (02) 406 5666
Melbourne (03) 62 0031
Brisbane (07) 44 2851
Adelaide (08) 212 2555
Perth (092) 28 3933



We Keep Performing.

**RANK
AUSTRALIA**

VHF POWER AMPLIFIERS

Range of designs share common PCB, simple construction.
By Roger Harrison, VK2ZTB and Phil Wait, VK2ZZQ.

A WIDE RANGE of amateur VHF transceivers is now available at prices many amateurs seem able to afford. They are manufactured for portable, mobile or home station operation having power outputs to suit the application. Hand-held transceivers are also popular.

Typical of the very popular FM hand-held rigs for the two metre band are the Ken KP202 and a similar unit made by Standard. There must be legions of these popular little rigs around, even though power output is only about 1-2 watts. They are cheap and convenient.

These days, SSB portables are also quite popular. The Icom IC 502 and IC202, for six and two metres respectively, push out around 2-3 watts PEP and seem to be an inexpensive way of getting amongst the action on sideband on the popular VHF bands.

Most six and two metre FM mobile rigs, like the popular series from Yaesu, Icom, Kenwood et al, run about 10 watts output while the multimode home station transceivers have about 10-15 watts output on FM or PEP on sideband. The still-popular FT620 six metre transceiver and the more recent Kenwood TS700 are pretty representative of the latter rigs.

Boosting the power output of any of these transceivers to a more useful level, using a suitable RF power transistor is a project attempted by quite a few owners. Doubtless though, for many others — that's a 'someday when I can find a circuit' project. Perhaps we can herewith oblige!

We first attempted such a project some two years ago. The result was the ETI-710 — a 45 W, 2m booster amplifier. Much RF has passed into the ether since that project was published in April 1976. Project 710 has undoubtedly passed into legend as one of the 'standards' used on two metres, not only in Australia but in Britain as

well! It's still a popular kit in Britain. Many constructors have gained by the experience of playing with a real live, solid state RF power amplifier. So have the authors.

Following voluminous correspondence, innumerable on-air questions and uncountable 'requests' at club meetings for more 'booster' amp circuits to suit the above-mentioned range of transceivers available for VHF operators, we have succumbed. And we haven't forgotten the hardy home-brew hermits who hanker after more power than their hundreds of milliwatts.

Bless all your little soldering irons gentlemen — now get cracking because this is where the story really starts. The six projects in this series are:—

ETI-715A	25W amp,	52-54 MHz
ETI-715B	60W amp,	52-54 MHz
ETI-715C	10W amp,	144-148 MHz
ETI-715D	3W amp,	144-148 MHz
ETI-715E	12W amp,	144-148 MHz
ETI-716	45W amp,	144-148 MHz

The second article, next month, will describe state-of-the-art, wideband high power amplifiers employing stripline input/output matching circuitry. One will be the ETI-716 project. Two others will be described that cover the 140-180 MHz range. One is a three stage amplifier to produce 40 W output from 200 mW to 500 mW drive, the other can provide up to 160 W output from 20-30 W drive. What your appetite?

The two amplifiers for six metres provide outputs of 25 watts and 50 watts. The first, ETI-715A, requires only 2-3 watts drive and is suited to homebrewers and IC502 owners etc. The second, ETI-715B, delivers around 50-65 watts from 6-10 watts drive. This is designed for the mobile and multimode home station transceiver owner.

The first of the 2m amplifiers ETI-715C, might seem like a bit of a ring-in at first glance. It is intended for the legions of hand-held FM rig

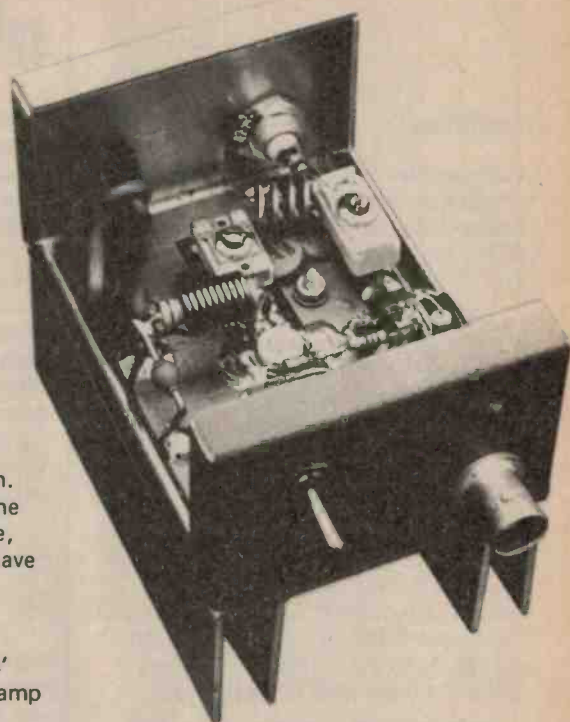

The 25 W six metre amp, ETI-715A mounted in a box with home-made heatsink and SSB/FM bias switch. External relay changeover switching was used for this model. LED indicates linear mode.

owners. It is designed to deliver around 10 W output from 1 W drive. This amplifier uses a Motorola transistor that is readily available locally and is suited to the lower powered hand-held transceivers.

The last three amplifiers are a complementary set in that the lowest powered amp is suited to driving the next etc. A three stage power amp going from around 250 mW up to 40 W can be made employing ETI-715D, 715E and ETI-716. The first mentioned provides 3 watts output from as little as 100 mW drive, and up to 5 W with more drive. The second, ETI-715E, is suited to both FM hand-helds and the SSB portables. It will deliver 12-15 watts output from a drive level around 1.5-2.5 watts. This level of power is more than adequate to drive the ETI-716 which will provide 40-50 watts output. The ETI-716 is a more modern, and improved, version of the ETI-710 described in April 1976 ETI. Rather than 'lumped' circuit elements it uses stripline input and output matching networks for improved efficiency, less critical adjustment and better matching to the transistor.

The ETI-716 is designed to suit the range of 10 W FM mobiles and the multimode home station transceivers. It will deliver quite a 'respectable' signal on the band.

The Care & Feeding of RF Power Transistors

Transistors

Two families of transistors from the ranges manufactured by the Communications Transistor Corporation (CTC) are used in five of the amplifiers. The 'ring-in' uses a Motorola device.

The two 6m amps use a couple of the CTC A-series devices. These are designated as "50 MHz, 12 volt land mobile . . ." transistors. The A25-12, used in ETI-715A, features a typical gain of between 10 and 12 dB around 52-54 MHz, a collector efficiency of 60% and a typical power output of 30 W with 3 W drive and up to 36 W with 5 W drive. The ETI-715B employs an A50-12. This device features a typical gain of 9-10 dB on six metres, a collector efficiency of 60% and will deliver about 52 W from 6 W drive, rising to 65 watts at 10 watts drive.

Both of these transistors are rated to withstand infinite VSWR at all phase angles when operated at rated power and supply voltage. Now what more could you ask?

The first of the 2m amplifiers, the ETI-715C uses a Motorola MRF603. This device is designed for operation from a 12.5 V supply as a power amp up to 300 MHz. It features a minimum gain of 10 dB, output power of 10 W and a collector efficiency of 50%.

The other three 2m amps use devices from the CTC B-series. These are "175 MHz, 12 Volt land mobile . . ." transistors. The 715D employs a B3-12 which features a typical power gain of 12 dB on two metres, a collector efficiency of 60% and a power output of 4.5 watts with 500 mW drive, or 3 watts output for around 200 mW drive. The 715-E employs a B12-12. It features a typical power gain of 8-9 dB on two metres, a collector efficiency of 60% and a power output between 12 and 15 watts for around 3 watts drive.

The ETI-716 amplifier puts a B40-12 to work. This popular device seems to have overshadowed the 2N6084 recently. And no wonder; it features a typical power gain of around 6-7 dB on two metres, a collector efficiency of 60% and will deliver between 40 and 45 watts for 10 watts drive, rising to 50 watts for 15 watts drive. Very attractive.

The B-series transistors, like the A-series, have the ability to withstand infinite VSWR to all phase angles when operated at rated power and supply voltage. More zip, less zap!

THIS SHOULD BE subtitled 'learn construction you ham-fisted bar stewards'. The abortions we have seen committed upon poor innocent little RF power transistors struggling to do their appointed job (if lucky enough to survive that far!) under mountains of surplus solder, abuses with blunt instruments, having their nuts grawnched with gas pliers — after all, you wouldn't want the same treatment yourself, would you? Tch, Tch and shame on you. It doesn't have to be perfect, just take a little care. Read before soldering.

The transistors used in this series are manufactured in what is termed a 'Stripline-Opposed-Emitter' (SOE) package, illustrated in Figure 1.

The body of the package is made from a Beryllium Oxide (BeO) disc, chosen for its high thermal conductivity. Attached beneath the disc is a copper stud, having an integral threaded bolt, for the purpose of heat transfer and mechanical mounting. The leads are attached to a metallized pattern on the top surface of the BeO disc. There are variations between different package styles, some having the leads entering straight into the package, others being tapered where they enter the package. See Figure 1. A ceramic cap is attached to the top of the disc over the leads and transistor chip as a protective covering.

The collector lead is always chamfered at the end and this serves to identify the base and emitter leads as well, as can be seen from Figure 1.

The leads on some RF power transistors are made from springy, gold-plated beryllium-copper whereas other types have leads of gold-plated copper. The latter are quite ductile and will readily 'crinkle' if handled too much. Both types of lead are subject to being broken where they enter the package. Always handle the transistors with care. Do not place any undue twisting force on the leads or any upward force. Twisting causes the leads to fracture at the junction of the package and an upward force can cause the ceramic cap to pop off. The latter event is not entirely a disaster as it can be glued back on carefully with one of the instant 'super' glues without apparent ill-effect (I can see all the engineers wincing!), unless some other damage has occurred.

Always exercise care when bolting a transistor to its heatsink. It is possible to snap the stud from the BeO disc. It is

also possible to strip the thread on the stud bolt.

To properly secure the transistor to the heatsink following assembly of an amplifier, first thread the stud nut on the bolt so that it is finger-tight only against the heatsink.

Grasp the stud wrench-flat with a small adjustable wrench or light pair of pliers and then with another wrench or pair of pliers, carefully give the nut about a 1/4 to 1/3 turn.

If using a torque-wrench, it is not recommended that the 'one time maximum' torque is used as it may be necessary to disassemble the amplifier at some stage.

Always take extreme care, when handling RF power transistors, not to chip or abrade the Beryllium Oxide disc. This substance is quite poisonous. A dead RF power transistor should be carefully enshrined in your shack for all time or returned to the manufacturer for disposal.

Do's and Don'ts

Don't apply drive without collector voltage present.

Don't apply drive without a DC return for the base — you'll almost certainly destroy the base-emitter junction.

Tune-up with care. If your hand slips and the screwdriver-tuning tool shorts the capacitor you're adjusting it could spell disaster for a number of components.

Tin the underside of transistor leads and then sweat-solder them to the printed circuit board.

Do not exceed rated maximum collector current or recommended maximum supply voltage.

Take care with transistor leads, they are fragile.

Ensure that the transistor is being mounted with the correct orientation — the two emitter leads to the board ground plane and the base and collector leads to the correct matching circuit components. Note that the collector will have the +ve supply connected to it via a hefty RF choke. A 90° turn and the input will be connected to the output via the emitter leads — the base-emitter junction will be reverse biased when supply voltage is applied, resulting in the inevitable destruction of the transistor. A 180° turn of the transistor and the base and collector will be transposed, with a similar disaster!

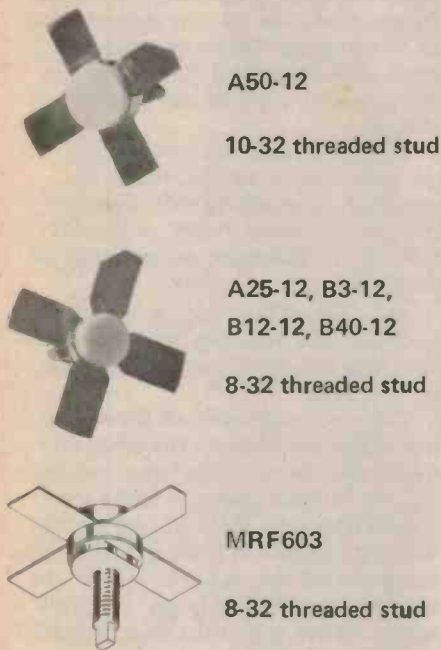

A50-12

10-32 threaded stud

A25-12, B3-12,
B12-12, B40-12

8-32 threaded stud

MRF603

8-32 threaded stud

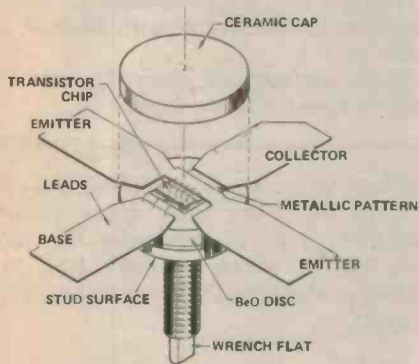

	8-32 threads	10-32 threads
One time assembly	.73 N-m, 6.5 lb-in.	1.24 N-m, 11 lb-in.
Repeated assembly	.57 N-m, 5 lb-in.	.96 N-m, 8.5 lb-in.

Fig. 1. The transistors used in the amplifiers described here are constructed in a 'strip-line-opposed-emitter' package (SOE) which has a number of variations. (Courtesy Motorola).



The 12 W two metre amp, ETI-715E.

Fig. 2. General circuit for VHF power amplifiers ETI-715 models A, B, C, D and E. The diode switching circuit is not used in linear operation. Bias for linear operation is fed in via RFC1, refer to Fig. 3. The coils may be wound using either tinned copper wire (t.c.w.) or enamelled wire. A gauge either side of that specified may be used and SWG wire may be substituted for %S.

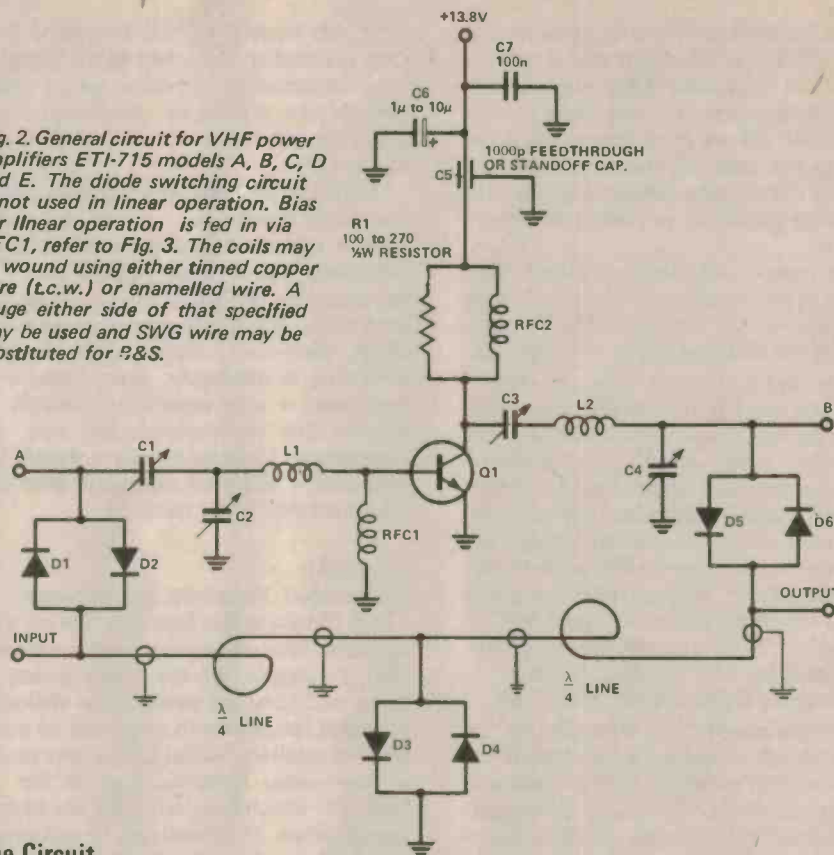

The Circuit

The general circuit of the ETI-715 power amplifier models A, B, C, D and E is given in figure 2.

Each of the individual amplifiers requires different component values and varying component types for the input and output matching circuits and the RF chokes. These are discussed in the specific construction information on each amplifier.

The input employs a T-match network as this provides workable component values and reasonable "Q's" with the sort of input impedances encountered amongst the transistors used in this series. The input capacitors, C1 and C2, are trimmer capacitors to enable individual matching adjustment. In practice, they are adjusted for maximum collector current — RF power output and then C1 is adjusted for minimum SWR between the driver and the amplifier input, if necessary.

The output matching is an 'L' network which was also found to provide workable component values and Q's with the range of transistor output impedances encountered. The output tuning capacitors, C3 and C4, allow individual adjustment of the output matching. They are simply peaked for maximum output.

In practice, the four trimmers C1, 2, 3 and 4, may be comprised of a fixed capacitor in parallel with a trimmer of adequate capacitance range to cover the

expected variation in transistor input and output impedance parameters, assuming drive and load impedances to be resistive and within 20% of the design of 50 ohms.

The base and collector are shunt-fed via RFC1 and RFC2 respectively. The base choke, RFC1, varies from model to model and is a complex component rather than the simple RFC shown in the circuit — reduced here to its basic representation for the sake of simplicity.

Details of how RFC1 is made up is given with the individual construction information for each model.

The collector choke, RFC2, is quite straightforward, and requires no further comment.

The collector feed bypass capacitor, C5, requires a low self-inductance capacitor and thus a 500 to 1900 pF feedthrough or standoff capacitor is necessary. Capacitors C6 and C7 are low-frequency bypass capacitors to prevent feedback and possible instability at frequencies well below the signal frequency. The electrolytic, C6, should be a tantalum type with a value between 1 μF and 10 μF. Capacitor C7 should be a ceramic (disc or multilayer) or polyfilm type. Short lead lengths are essential when mounting C6 and C7.

The diode switching network has been described in our April 1976 article and several other journals and only a minimal explanation is necessary here.

Project 715

On transmit, all the diodes conduct. Diodes D3 and D4 shunt the quarter-wave lines to ground reflecting an open circuit at the ends opposite these diodes. As D1 and D2 are conducting, the drive goes to the input of the amplifier. As D5 and D6 are also conducting, the RF from the amplifier is passed to the output.

On receive, no diodes conduct. The two quarter-wave lines form a half-wave line between the input and the output — passing the received signal without loss.

This system works fine provided there is a low SWR on the transmission line. The two quarter-wave lines and the amplifier input/output connections must be carefully terminated to avoid any impedance 'bumps' at that point in the transmission line system. Otherwise, a voltage node, representing a relatively high impedance, may be reflected across any of the diode pairs and signal may be shunted off by the capacitive mismatch presented by the diodes' junction capacitance, small though it may be.

Complaints of "two S-points loss" in diode switching networks are inevitably traced to this problem. Many modern S-meters are often excessively generous! Loss would rarely reach 12 dB unless the RF stage of a receiver was unstable and the noise figure were adversely affected by mismatch as well.

It can work the other way too! In fact, it actually happened to us. Signals were measurably improved when one particularly prototype diode-switched amplifier was inserted in the feedline to Phil's IC22!

Better to do it the right way in the first place though.

The diode switching network is definitely not suitable for use when the amplifier is operated in linear service with SSB. The input diodes cause too much distortion. Relay changeover switching is necessary. Some people have used it with what they claim is success but we certainly do not recommend it. Suitable relays should be obtained — ordinary miniature cradle relays are definitely out.

Heatsinks

Single-sided heatsinks are necessary. These have one flat face and fins on the opposite face. Redpoint make a line that is suitable for the lower power amps and they are available in various standard lengths from a number of component retailers. Allied Capacitors make a single-sided heatsink (but in 6m lengths!) which is suitable for the high power amps. It is available in suitable lengths from Amateur Communications Advancements.

For the ETI-715C, D and E models,

which dissipate less than 10 watts from the transistor collector, a 75 mm length of 60 mm wide single-sided Redpoint heatsink is eminently suitable. Alternatively, an 80 mm square of 16 or 18 gauge aluminium or brass may be used, with two edges bent up as fins. The size and angle of the bend is not critical.

The heatsink of any of the amps may get quite warm to the touch in operation, particularly with those operating in the linear mode where the collector is dissipating some power all the time.

For the ETI-715A, a suitable commercially available single-sided heatsink may be used or one can be made up as follows:

Cut two rectangles of aluminium, one 80mm by 110mm; the other 80 mm by 95 mm. Bend up the larger rectangle 30 mm in from opposite edges along the 80 mm side. Bend up the smaller rectangle 28 mm in from opposite edges along the 80 mm side also. 'Nest' the smaller piece in the larger and drill appropriately to suit the transistor stud and board mounting bolts.

You will then have a heatsink 80 mm long, 50 mm wide overall with 30 mm deep fins.

Spray the heatsink assembly matt black or have it black anodised.

Class AB service bias

Two circuits suitable for providing bias to operate the amplifiers in class AB linear service are given in figure 3. Circuit A employs a silicon power diode of 1 amp rating or more. It is forward biased via R1 and R2, the voltage drop across the diode junction provides base bias for the RF power transistor via RFC1.

The 'grounded' end of RFC1 is terminated on a 500-1000 pF feedthrough or button type bypass capacitor providing a low inductance RF ground return. A low impedance DC return for the base-emitter circuit is provided via D1 and R2.

This circuit is simple and straightforward. Collector current of the RF power transistor can be optimised by varying R1 by the 'cut and try' method. No real thermal compensation is provided but this has not proved a problem in most circumstances to date.

Circuit B is taken from a circuit by C.P. Bartram which appeared in the 'Circuit Ideas' section of Wireless World some years ago. Transistor Q1 is used as an amplified diode variable voltage

source. Transistor Q2 is an emitter follower which lowers the bias supply output impedance.

If Q1 is in contact with either the RF power transistor heatsink, or the transistor cap, then excellent thermal

stabilization is achieved. It can be glued on using one of the 'super' glues or a small bead of five-minute epoxy. Ensure good thermal contact is made by holding or clamping Q1 down while the glue sets.

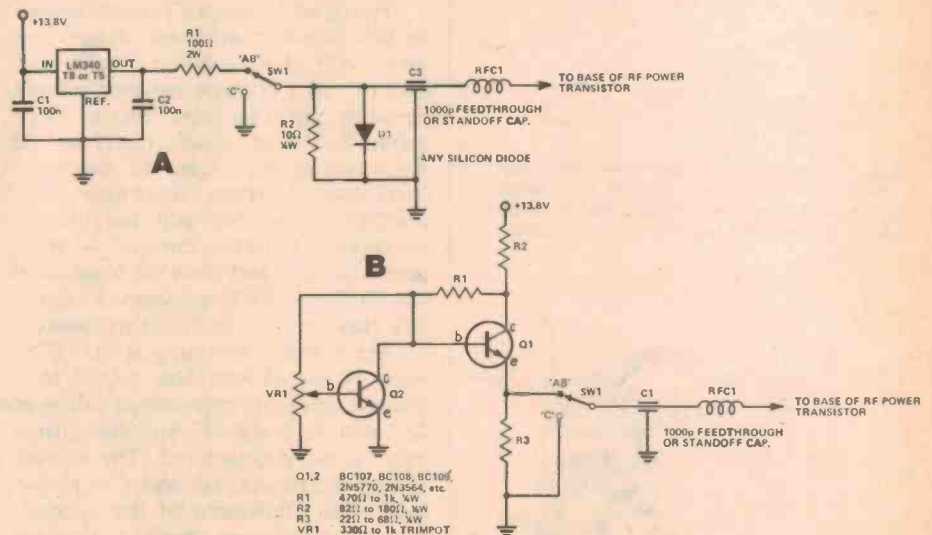

Fig. 3. Suggested bias circuits for class AB linear operation of the VHF power amplifier series. The LM340 in circuit A should have a metal tab heatsink or be bolted to the chassis/heatsink on which the amplifier is mounted. The transistor Q2 in circuit B may be thermally connected to the transistor or heatsink to provide thermal compensation.

Circuit B has a very low output impedance (in the order of one ohm or less) and the bias voltage will remain within 2% for a ± 2 V change in the supply voltage. It is recommended for use with ETI-715B and ETI-716 in linear service.

General Construction

The first five amplifiers, ETI-715 A, B, C, D and E, are constructed on the same PC board — ETI-715. The board layout is given in figure 4. This is sort of a 'universal' RF power amplifier board. It can be used with a variety of matching circuits and SOE transistors and includes provision for diode and stub changeover switching.

Before mounting any components on the board the chassis/heatsink to be used should be drilled out to take the PC board assembly. Use the blank PC board as a marking template. Drill clearance holes for the transistor stud and board mounting bolts. Take care with the alignment of the holes to avoid placing stress on the board or transistor when assembled other than the downward securing force. The PC board ground plane is grounded to the chassis via the board mounting bolts.

The amplifier components are all mounted on the *copper side* of the board, contrary to the usual practice with other printed circuit assemblies. This is apparent from the individual layout drawings.

The transistor should always be mounted on the board first. Bend up the end of each lead for 3 - 4 mm and tin the *underside* of each, then sweat-solder the transistor in place on the board. Only use a minimum of solder and make sure the stud bolt is as near as possible at right angles to the plane of the board. Remember the cautions necessary concerning the transistor leads.

At this stage, the board could be temporarily assembled onto the chassis/heatsink to check the alignment of the

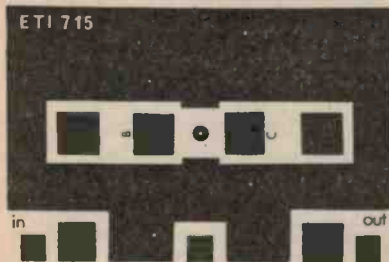

Fig. 4. General view of the ETI-715 PCB with the drilling points marked in. The central hole should be drilled out to 10 mm diameter, or 13 mm dia. for the ETI-715B amp. The four other holes should be drilled 4 mm dia. This board can be 'universally' used for RF power amps. Full size PCB pattern on p. 108.

stud bolt and bolt holes holding the board down. Experiment with packing the board up between the chassis/heatsink and the underside of the board so that there is no tension, or only *slight* downward tension placed on the leads. A little downward tension is permissible, improving contact between the stud and chassis/heatsink, when the two bolts holding the board down are tightened. See figure 5. A flat washer may be used under the studnut but is not entirely necessary. The board should not be mounted flat on the chassis/heatsink.

If feedthrough type capacitors are used for the collector supply and base-bias bypass capacitors, a clearance hole

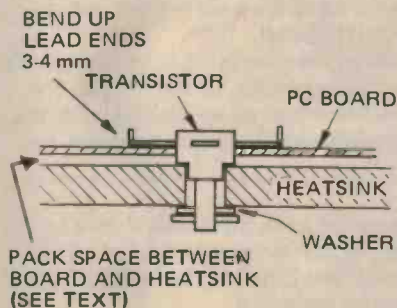

Fig. 5. Mounting transistor and board to chassis/heatsink.

may need to be drilled beneath their locations as illustrated in figure 6.

Once the transistor is mounted on the board and you are satisfied that the assembly can be mounted without stress, then you can proceed to mount the other components according to the individual amplifier construction details.

Regarding the diode and stub changeover switching, cut the coax stubs as shown in figure 7. Lengths are given for both the six and two metre bands. There is a 5 - 6 mm tolerance on the six metre stub lengths and a 3 - 4 mm tolerance on the two metre stubs. The best coax to use is RG174 as it is only about 4 mm overall diameter and can be conveniently coiled and tucked away into quite a small space.

The best method for terminating the

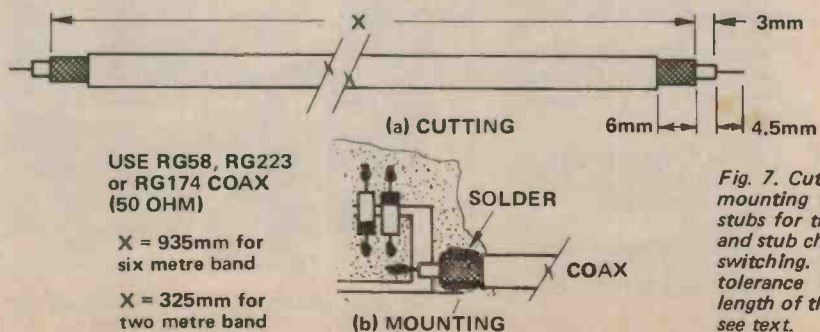

Fig. 7. Cutting and mounting the coax stubs for the diode and stub changeover switching. There is a tolerance on the length of the stubs—see text.

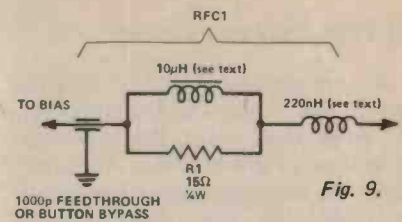

Fig. 9.

stubs is also illustrated in figure 6. The braid at the stub end should be flared out slightly and tinned before soldering to the board. Do the job quickly with a small tip at a high temperature. Tin the board first where the braid is to be soldered down.

The four tuning capacitors, C1, C2, C3, C4, can be made up of fixed capacitors in parallel with a suitable trimmer, where large capacitance values are required, to provide 'trimming' coverage across the expected value as listed in the individual amplifier construction details. Several alternatives are suggested. Otherwise, trimmers having a maximum value of 40 pF or 60 pF are used. These are commonly available and certainly cheaper than high maximum capacitance trimmers.

Trimmers that can cope with the RF currents at the input powers required can be of the miniature plastic film type (such as marketed by Philips) or ceramic types (such as those from Stetna). Mica compression trimmers are recommended for output tuning circuits at powers of 25 watts and above. Plastic film or ceramic types may be used below this power level.

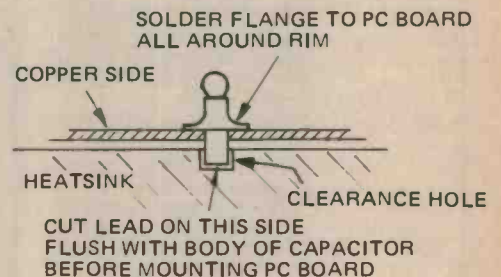

Fig. 6. Mounting feedthrough type bypass capacitor. A clearance hole may be necessary in the chassis/heatsink under the capacitor (see text).

Project 715

ETI-715A, 25W on six metres

The component layout is shown in figure 8, accompanied by the component list. Note that, since the widest application of this amplifier will be with SSB — the commonest mode on 6m — the diode and stub changeover components have been omitted.

Once the transistor has been mounted according to the general construction details, the rest of the construction can proceed as follows.

First mount the capacitors that go in parallel with the trimmers. These are soldered between the appropriate lands on the board. Place them flat on the board so that the minimum lead length is obtained. Next mount all the trimmers. Wind L1 and L2, next and solder them in place, followed by RFC2.

The base choke, RFC1, is made up as shown in figure 9 on page 33. Refer also to the layout in figure 8 and the photograph. Both the 0.22 μ H and the 10 μ H chokes may be moulded RF types such as the 'microchoke' series made and marketed by Philips. Alternatively, the 0.22 μ H choke can be made by winding 15 turns of 34 B & S enamelled wire on any low value $\frac{1}{4}$ W resistor. The 10 μ H choke can be made by winding 10 turns of 34 B & S

ETI-715A, 25 W on six metres PARTS LIST

Q1	A25-12 (CTC)
C1	(85 pF) 115 pF mica compression trimmer (Elmenco A4006/OX) or 60pF (A4004/OX) and 33 to 56 pF ceramic or mica cap.
C2	(275 pF) Elmenco A4004/OX 60 pF mica compression trimmer and 220 pF ceramic or mica capacitor.
C3	(260 pF) as for C2 but use mica dipped parallel cap.
C4	(205 pF) Elmenco 4004/OX 60 pF mica compression trimmer and 150 pF or 180 pF mica dipped cap.
L1	2 turns, 18 B&S tinned copper wire, wound on 6 mm mandrel, 6 mm long.
L2	4 turns, 18 B&S t.c.w., 6 mm dia. by 12 mm long.
RFC1	see fig. 19.
RFC2	8 turns, 18 B&S enamelled wire, close wound 6 mm dia. mounted with $\frac{1}{2}$ W resistor inside it.
C5, C6, C7	as per fig. 2.
D1 - D6	1N914, 1N916, BAX13 or BAV10. Do not use diode switching for linear operation.
NB	Note that various trimmer and parallel combinations can be used for C1 - C4; see text.

ETI-715B - 60 W on six metres

The component layout is shown in figure 10, together with the component list. As with the ETI-715A, this is primarily intended as a linear amp and the diode and stub changeover components are omitted. If you operate FM then these can be added as described in figure 7. Note that four BAV10 diodes should be used on the output (D5/D6) to handle the RF current, if diode switching is employed in this application.

Mount the transistor according to the general instructions. As the A50-12 has a larger diameter stud than the A25-12, the hole in the centre of the PC board should be drilled or reamed out to 13mm diameter.

Once the transistor is mounted, the next components to mount are the capacitors that go in parallel with the trimmers. Solder them between the

enamelled wire through a 4 mm long F14 ferrite suppression bead. This component is not all that critical, but it must be included!

The other components can now be mounted on the board. The completed assembly can then be mounted on the chassis/heatsink and secured by the two mounting bolts. Smear a small quantity of silicone grease (such as Bevaloid GS13) on the chassis/heatsink to improve thermal conductivity where the transistor stud will make contact.

Leads from the board input and output pads should be no longer than 10mm, otherwise use a short run of coax, grounding the braid to the connector at one end and the board at the other.

ETI-715A Performance

A maximum saturated output in class C of 30 watts was obtained with the

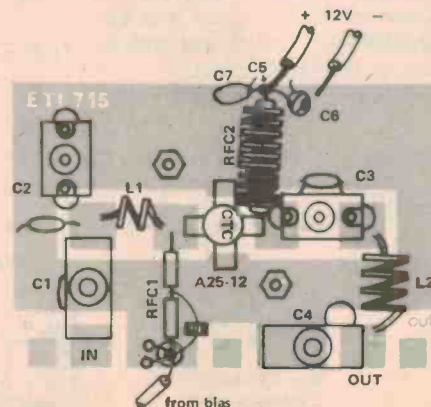

Fig. 8. Construction and component layout of the ETI-715A 25W six metre amp.

appropriate lands on the board using absolute minimum lead length and laying the capacitor body flat on the board.

Next mount all the trimmers. Make up L1 according to the diagram with the board layout and mount it. Then wind and mount L2, followed by RFC2.

The base choke, RFC1, is made up as for the 25W amp and is illustrated in figure 9. Refer to the layout in figure 10 to see how the components are mounted. Refer to the text on the ETI-715A for the base choke components.

All the other components can now be mounted on the board. The completed assembly can then be mounted on the chassis/heatsink and secured by the two mounting bolts. First smear a little silicone grease on the chassis/heatsink where the transistor stud contacts.

prototype. In class AB (linear), about 25 watts PEP can be achieved before significant 'flat-topping' distortion is noticeable. Performance of the prototype was as follows:—

Peak Power

Output = 25 watts (class AB)
gain = 11 dB
efficiency = 55% (improves with supply above 12.5 volts)

Collector current = 3.6 A at 12.5 V supply and 3 A at 13.8 V.
Max I_c = 5 A
Max V_s = 36 V

Collector dissipation = 21 watts (at full carrier)

Maximum recommended voltage = 16 volts.

The no-signal collector current should be around 100-150 mA. Adjust it if necessary — see section on bias circuits.

The actual value will depend somewhat on the individual device and may be as high as 200 mA. The continuous dissipation may be around two to three watts. Considerable leeway is allowable in the quiescent collector current with good linearity being maintained.

Many IC502 transceivers will likely be able to overdrive the ETI-715A as they produce around 3 watts PEP output. Keep the drive down or insert a one or two dB pad between the IC502 and the linear. This can be made using ordinary 1W resistors.

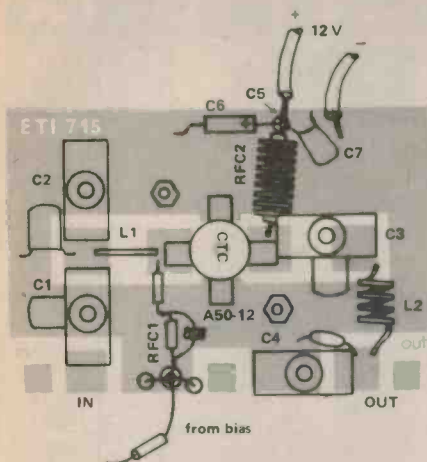

Leads from the board input and output pads should be of a heavy gauge — preferably 18 B & S t.c.w. or heavier — and as short as possible. No longer than 10mm, otherwise use a short run of coax as described before.

ETI-715B Performance

A maximum output in class C of 60 watts was delivered by the prototype! In class AB (Linear), around 45–50 watts PEP can be obtained before flat-topping is noticeable.

Performance of the prototype was as follows:—

Peak Power Output = 45–50 watts (class AB)
gain = 10 dB
efficiency = 68%

Collector current = 5.9 amps @ 12.5 volts supply (max. $I_c = 10A$)
5.4 amps @ 13.8 volts supply (max. $V_s = 36V$)
Collector dissipation = 28 watts (at full character)
Maximum recommended voltage = 16 volts

The quiescent collector current in linear service will likely fall between 100 mA and 300 mA. There is considerable latitude. Most devices will require around 150-200 mA quiescent collector current for good linear operation.

An IC502 will drive this linear to around 30 watts output. An FT620 will definitely overdrive it! Knock back the drive or put a 3–4 dB pad between the FT620 and the ETI-715B.

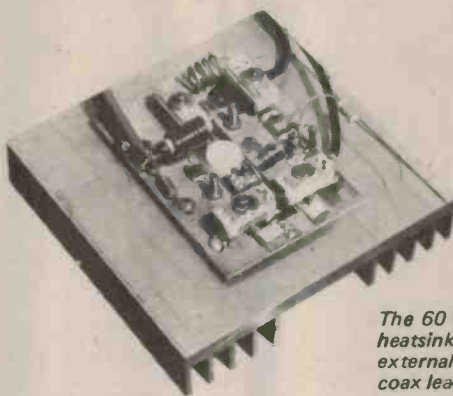

The 60 W six metre amp, ETI-715B and its heatsink. The floating resistor goes to an external bias supply. The input and output coax leads can be seen to the right of the PCB.

PARTS LIST

Q1	A50-12 (CTC)
C1	(350pF) Elmenco A4006/OX 115 pF mica compression trimmer plus 270 pF ceramic or mica capacitor.
C2	As C1.
C3	(180 pF) A4006/OX 115 pF mica compression trimmer and 82 pF dipped mica cap.
C4	(325 pF) A4006/OX 115 pF mica compression trimmer and 220 pF dipped mica cap.
L1	16 or 18 B&S t.c.w., wound around 10 mm drill shank.
	
L2	4 turns 18 B&S t.c.w. 6 mm dia. 12 mm long.
RFC1	See fig. 9.
RFC2	10 turns, 18 B&S enamel wire close wound 6 mm dia. with 1/2 W resistor mounted inside.
C5, C6, C7	as per fig. 2.
D1 – D6	use four diodes on output: 1N914, 1N916, BAX13 are DK for D1 – D4. Use BAV10's on output. Do not use diode switching for linear operation.
NB	Note that various trimmer and parallel capacitor combinations can be used for C1 – C4; see text.

ETI-715C – 10W on two metres

Two-metre handhelds such as the KEN KP-202, put out around 1–1.5 watts. This amp will put your handheld transceiver on a par with the 10 watt mobiles — providing they're not all using the 40 watt ETI-716 or something similar!

The component layout is shown in figure 11, together with the list of components. Note that there is a 150 pF metal-clad mica capacitor installed between base and ground plane. This component is essential. The only substitution that could be made here would be a 'ceramic-chip' capacitor of the same value, installed in the same place. Follow the layout scrupulously.

Once the transistor is mounted according to the general construction details, proceed by mounting the 150 pF metal-clad mica capacitor. Sweat-solder the capacitor body to the ground-plane, adjacent to the transistor emitter lead.

Next, mount RFC1. Note from figure 11 that this consists of a 6-hole F14 ferrite bead with a length of 22 or 24 gauge tinned copper wire passed through five holes. A 1.5 ohm, 1/4 W resistor is connected in series with the 'cold' end of the ferrite choke. The

Fig. 11.

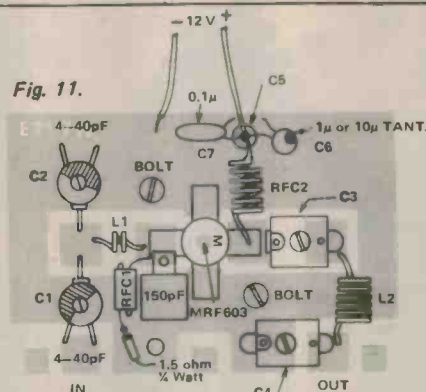

Q1	MRF603 (Motorola)
C1	40 pF film trimmer or mica compression type.
C2	As C1.
C3	60 pF film trimmer of mica compression type.
C4	115 pF Elmenco A4006/OX or greater value mica compression trimmer.
L1	2 turns 20 B&S t.c.w. wound on 3 mm dia. mandrel 3 mm long.
L2	6 turns 20 B&S t.c.w. wound on 6 mm dia. mandrel 10 mm long.
RFC1	See text.
RFC2	6 turns 20 B&S t.c.w. wound on 6 mm mandrel 12 mm long with 1/2 W resistor inside.
C5, C6, C7	As per fig. 2.
D1 – D6	1N914, 1N916, BAX13 or BAV10.

RFC1 assembly is mounted above the metal-clad mica capacitor.

Mount all the trimmers next. Then wind L1 and L2 and mount them. Complete construction by mounting all the other components.

The completed assembly can then be mounted on the chassis/heatsink to be used. Don't forget to smear silicone grease on the chassis/heatsink where the transistor stud will make contact.

Leads from the board input and output pads should be short and direct, certainly no longer than 10 mm. Use short lengths of coax if any longer. However, the coax should only have the braid grounded at the groundplane adjacent to the appropriate pads, contrary to what was advised for the six metre amps.

The diode stubs should be cut and mounted last. These have been omitted from the layout drawing in figure 11 for clarity. Refer to figure 7 also.

ETI-715C Performance

A power output of 12.5 watts was obtained from the prototype.

It is possible to use this amp in linear service in lieu of the ETI-715E, by applying bias to the base in the

Continued on page 118...

NOW YOU CAN CHANGE TEMPERATURES WITHOUT CHANGING TIPS.

THE NEW SCOPE TEMPERATURE CONTROLLED 60W IRON.

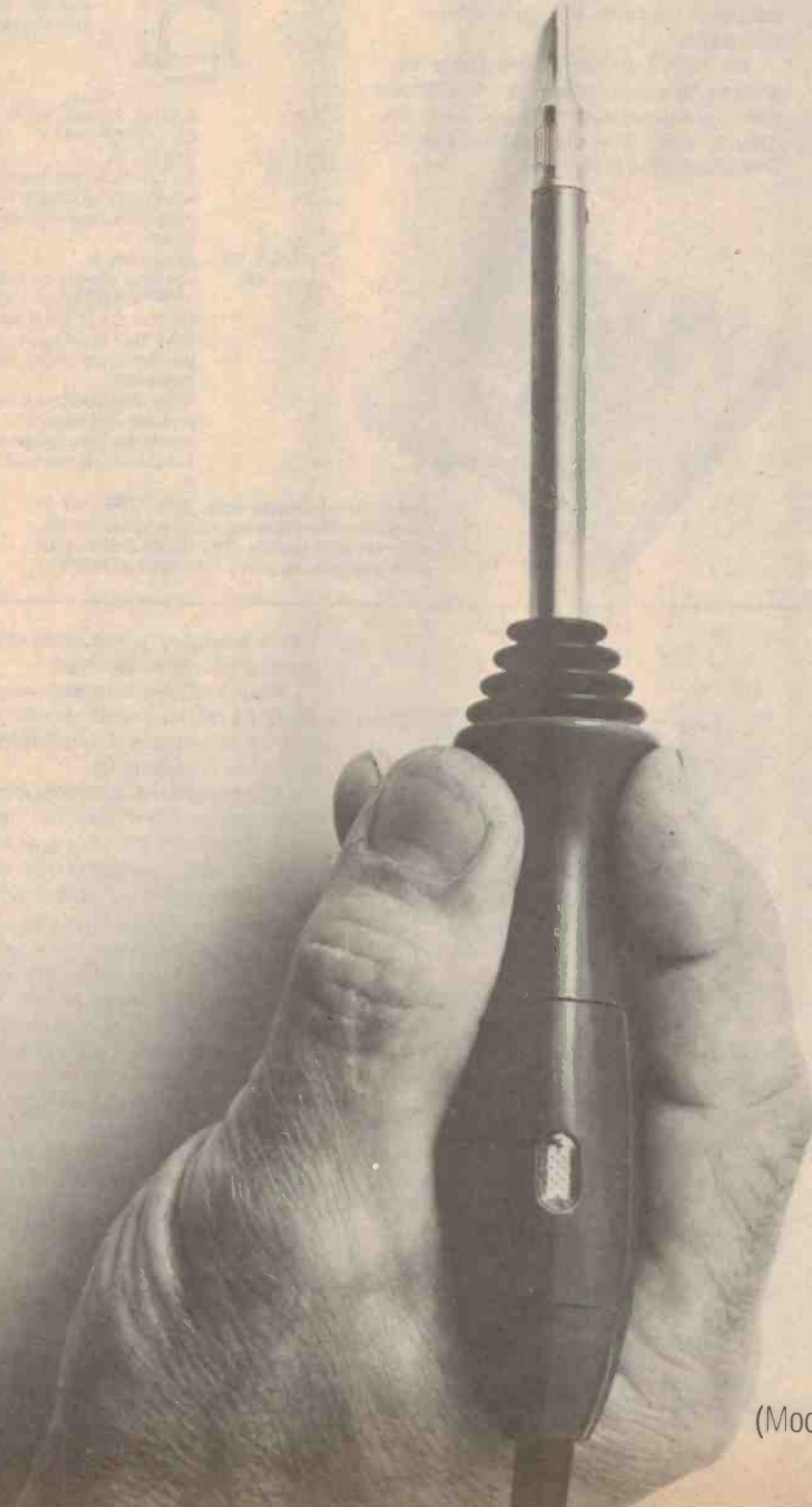

(Model TC60 240v 60w actual size).

The new Scope temperature controlled iron introduces new convenience to high reliability soldering.

1. Faster temperature selection.

You can select any temperature with the control key without the delay of unscrewing a hot tip and then heating up a cold one. This also saves the cost of buying tips for various temperatures.

2. Change temperature while soldering. Then hold $\pm 2\%$.

The operator can change temperatures between 200° and 400°C whilst soldering. This convenience makes it more likely that the operator will solder at the correct temperature for any job. Selected temperature will always be within 2% accuracy.

3. No separate control box.

The temperature control selector is in the handle of the iron. This saves money and space.

4. 60 watt element.

This ensures more stable temperature control with heavy soldering jobs.

The Scope temperature controlled iron explained.

1. Tips need only be changed to alter weights or shapes. Thirteen different tips are available. See chart.

2. Earth leakage currents are kept below 6 μ A. Design checked by an independent consulting engineer.

3. 60 watt element is about 3 times the heat required. Greater temperature stability and faster recovery on heavy joints.

4. Heat is kept away from handle by using low conductivity s.s. barrel alloy, plus black aluminium heat sink. Removable hook provided.

5. Handle shaped for easy, light control. Whole iron weighs only 70 gms.

6. Temperature sensing probe extends to front of barrel. Ensures prompt response to heat drain.

7. Removable temperature setting key. Supervisor can set precise soldering conditions without changing tips. And, can then take key away to ensure conditions are not altered.

8. Neon indicator indicates when iron is heating and reduces risk of being left on.

9. Plugs direct into mains. Other voltages available: 24V, 50V.



Accessories:

Safety stand. Model STS. Designed for bench top use when operator is seated. Comes with sponge pad for tip cleaning.



Desoldering tool. Model SR3A. Comes with plunger safety guard and replaceable temperature resistant Teflon tip.

Long life tips for Scope TC60 iron.

TYPE	SINGLE FLAT	WIDTH	TYPE	DOUBLE FLAT	WIDTH
LL/SF/16		1/16" = 1.6mm	LL/DF/08		1/32" = 0.8mm
LL/SF/24		3/32" = 2.4mm	LL/DF/16		1/16" = 1.6mm
*LL/SF/32		1/8" = 3.2mm	LL/DF/24		3/32" = 2.4mm
LL/SF/48		3/16" = 4.8mm	LL/DF/32		1/8" = 3.2mm
LL/SF/64		1/4" = 6.4mm	LL/DF/48		3/16" = 4.8mm
LL/CONCORDE		23mm	LL/DF/64		1/4" = 6.4mm
* THIS TIP IS FITTED AS STANDARD			LL/DF/SPECIAL		2.6mm

Other Scope products.

(A) Scope Cordless. 60W.

Designed for working where no power is available or during temporary failure. It's powered by two rechargeable Nicad cells with the capacity to solder between 100 and 200 typical electronic connections before overnight recharging.



(B) Scope 12V Hobby Iron. This versatile iron is designed to work within 6 metres of your car battery.

(C) Scope Vibroscope. This electric pencil allows for permanent writing on all metals. Valuable in an engineering store identifying metal tools, dating and naming parts, inscribing trophies.

(D) Scope Superspeed Iron. Extreme soldering versatility. 20-150 watts of manually controlled heat output. Heats in 5 seconds

(E) Scope Mini Iron. Similar benefits of soldering versatility, speed and safety as for Superspeed but 20-75 watt controlled output.



For enquiries and further information on the Scope range of products contact: Sydney, Ampec Engineering Co. 747 2731. Hobart, W. P. Martin Pty. Ltd. 34 2811. Adelaide, Protronics. 51 4713. Brisbane, K. H. Dore & Sons. 221 1933. Perth, Simon Holman & Co. Pty. Ltd. 81 4155. Melbourne, Scope Laboratories. 338 1566.

SCOPE

THE RIGHT IRON FOR THE RIGHT JOB.

BATTERIES

Batteries must be the least understood and most abused of all electronic components. Some knowledge of which battery is most effective in a particular application—and of what alternatives may be used—is invaluable. This article in our on-going components series assists you in making the right choice.

BATTERIES may be divided into two general classes; primary batteries and secondary batteries.

A primary battery or cell (strictly speaking, a battery is a group of cells connected together, but the term battery is commonly used for either form), only has a single working life. In general, once discharged, their capacity to provide useful power ceases and they must be discarded. A primary cell can provide power as soon as it is assembled and requires no initial charging current.

Five types of primary cell are currently available. These are:—

- Leclanche (or carbon-zinc) cell
- Mercury cell
- Alkaline cell
- Zinc-Air cell
- Weston Cadmium cell

SECONDARY BATTERIES

Secondary batteries or cells require an initial charging current before they can be used, in the opposite polarity (or direction) to their discharge current. They can go through many charge-discharge cycles throughout their useful life, and can be stored for considerable periods in a discharged condition without deteriorating. Secondary batteries are sometimes also called storage batteries. Two types of secondary battery are in common use:—

- Lead-Acid battery
- Nickel-Cadmium battery (familarly called the Nicad).

THE LECLANCHE CELL

The construction and composition of this type of cell is shown in Fig. 1. The zinc container is the negative electrode and the carbon rod the positive one. The carbon rod is surrounded by a mixture of manganese dioxide and powdered carbon in a porous sack. This is called the 'depolariser'. The rest of the cell is filled with a paste of ammonium chloride — the 'electrolyte'. The Leclanche or carbon-zinc cell, is also known as a dry cell.

These cells, commonly known as 'dry cells', have a no-load terminal voltage of 1.5 to 1.6 volts. The energy that they can supply is related to their size. Under

load the terminal voltage of dry cells gradually decreases and internal resistance rises. When the load is removed terminal voltage rises again, but not to the original value. Over a number of discharge-rest periods, the no-load terminal voltage will gradually decrease as will the amp-hour capacity of the cell (Fig. 2).

Once the no-load voltage drops to 1 volt or so the cell has come to the end of its useful life and should be given a decent burial. Leclanche cells are best suited to applications that require intermittent use or low-drain use for long periods.

Heavy duty dry cells are available that will provide much higher discharge currents. These will supply several hundred milliamps for four to five hours at a time, whereas the ordinary cell will

typically provide 100 mA or less for similar periods. They cost more than ordinary dry cells.

The heavy duty dry cell deteriorates

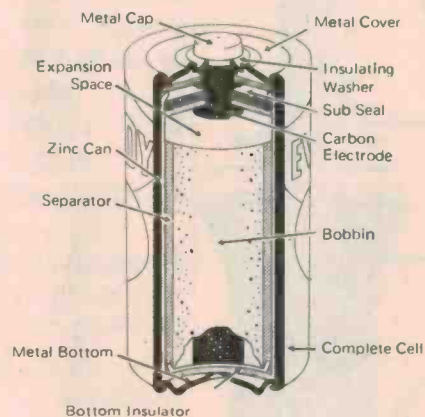

Metal Cover. Closes the cell tightly at the top, making it safe against bulging and breakage.

Carbon Electrode. Collects the current from the bobbin, conducting it to the metal cap. It is composed of powdered carbon particles bonded together and baked at a very high temperature.

Bobbin. The depolarizing "mix", this contains manganese dioxide to combine with hydrogen as it accumulates, plus carbon to provide conductivity. It also contains some of the sal ammoniac and zinc chloride.

Complete Cell. Contained in a jacket bearing a decorative label design.

Metal Cap. Specially formed with projecting tip to ensure perfect electrical contact between cells.

Expansion Space. For expansion of cell contents during use.

Zinc Can. Negative electrode and at the same time the container for the cell. When electricity is generated, some of the zinc is consumed by the electrolyte chemicals.

Separator. Layer of electrolyte paste, made of wheat flour and cornstarch, and containing sal ammoniac and zinc chloride. This layer of paste physically separates the mix bobbin from the zinc can but permits electrochemical action to go on between the two.

Insulating Washer. Insulates metal cap from the metal cover.

Sub Seal. Seals internal cell materials from the outside air.

Metal Bottom. Seals the cell tightly at the bottom.

Bottom Insulator. Insulates carbon electrode from zinc can.

Fig. 1. Left: Leclanche (or carbon-zinc) cell—mechanical construction. Above: cell details.

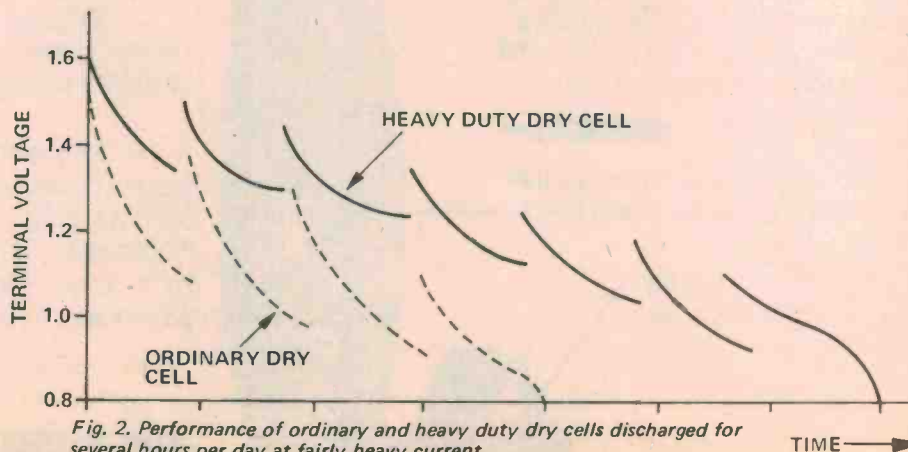

Fig. 2. Performance of ordinary and heavy duty dry cells discharged for several hours per day at fairly heavy current.

more slowly than conventional cells and will undergo more discharge-rest cycles before requiring replacement. They are sometimes marketed as 'Longer-Life' batteries. Conventional and heavy duty dry cells are compared in Fig. 2.

Size is not the only factor which governs the life of a dry cell. The ratio of the period of use to the rest period is an important factor. The old door-bell batteries which were about the size of a drink can would last for years. They could supply up to one amp but their rest-to-use ratio was very high. Temperature also affects the performance of dry cells. Optimum is between 20°C and 27°C. Terminal voltage and capacity is drastically reduced below 15°C, and utterly useless below 5°C. Leclanche cells deteriorate when stored for long periods. Generally, the larger the cell, the less the deterioration.

Leclanche cells have a serious drawback. When left for long periods in a discharged condition the outer zinc container is gradually eaten away by the electrolyte which then finds its way to the outside, corroding surrounding equipment. Leakresistant versions are available, but these should not be left too long discharged either.

For applications requiring six volts or more at low currents, the layer battery has been developed. These are made up of square or rectangular layer cells, their shape enabling them to be grouped together with minimum waste of space. The common 9 V transistor radio battery is of this type. They suffer less deterioration than the round style dry cell. They are relatively low current devices. Round cells are better where fairly heavy consumption for fair periods is required.

The internal resistance of a Leclanche cell rises steeply as it discharges. This can give rise to low frequency instability ('motorboating') in amplifiers. A large value electrolytic (1000 μ F +) across the supply rail will often eliminate this problem, and will often dramatically improve the sound reproduction from a transistor radio.

THE MERCURY CELL

The mercury cell was invented in World War II by Dr. Samuel Ruben. It has an anode of high purity amalgamated zinc and a cathode of compressed mercuric oxide-graphite separated from the anode by an ion-permeable barrier. The cathode is in contact with a steel container which provides the terminal connection. The electrolyte is a solution of alkaline hydroxide, the ions of which act as carriers for the cell's chemical action.

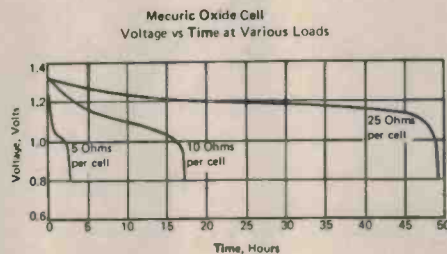

Fig. 4. Discharge characteristics of a typical mercury cell (Gould type 502R). Curves show voltage vs time at various loads.

The electrolyte is not consumed during discharge. The cell containers are nickel plated steel and thus do not corrode.

Mercury cells are produced in a variety of forms, the two most common are shown in Fig. 3.

The no-load terminal voltage of mercury batteries is 1.35 volts. This drops about 0.05 to 0.1 volt under load but unlike Leclanche cells remains very steady throughout the greater part of its life. At the end of its life the terminal voltage falls away with increasing rapidity to less than 1.0 volt. Typical discharge curves are shown in Fig. 4.

Mercury batteries may be stored for up to three years with only slight deterioration in terminal voltage and amp-hour capacity. Maximum storage temperature is 30°C, optimum is 21°C.

The characteristics of these batteries are little affected by extremes in temperature. They work well down to -20°C and some as high as 100°C, or more.

Mercury cells are capable of discharge rates much greater than equivalent Leclanche cells, the internal resistance being maintained until near the end of

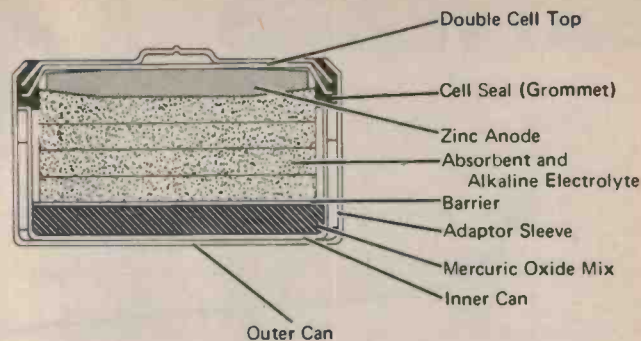
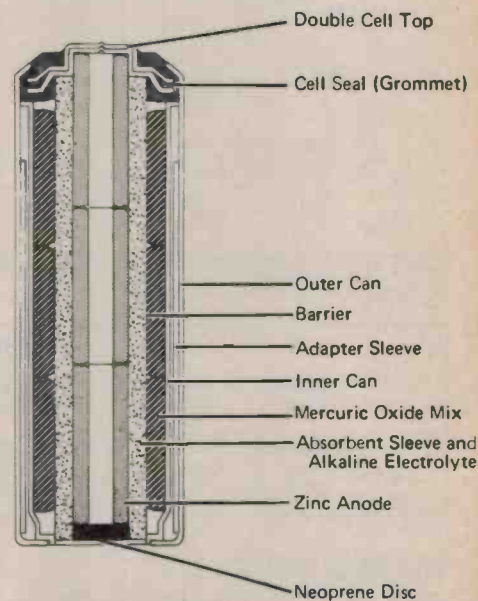

Fig. 3. Two types of mercury cell—flat pellet (button) cell, and the cylindrical cell.



their working life. Mercury cells do not leak if left for long periods. However, their price is several times that of equivalent sized Leclanche cells.

A range of voltages is available, typically 1.35, 2.5, 4 & 8 volts, in different sized packages.

A new cell may be used as a voltage reference with an accuracy of 0.02 V or better. Mercury batteries should always be used within the recommended discharge rate for which they are intended — they cannot be recharged.

Mercury batteries are used where voltage stability and long life are required. Their small size and high capacity are also advantageous in some applications.

BATTERIES

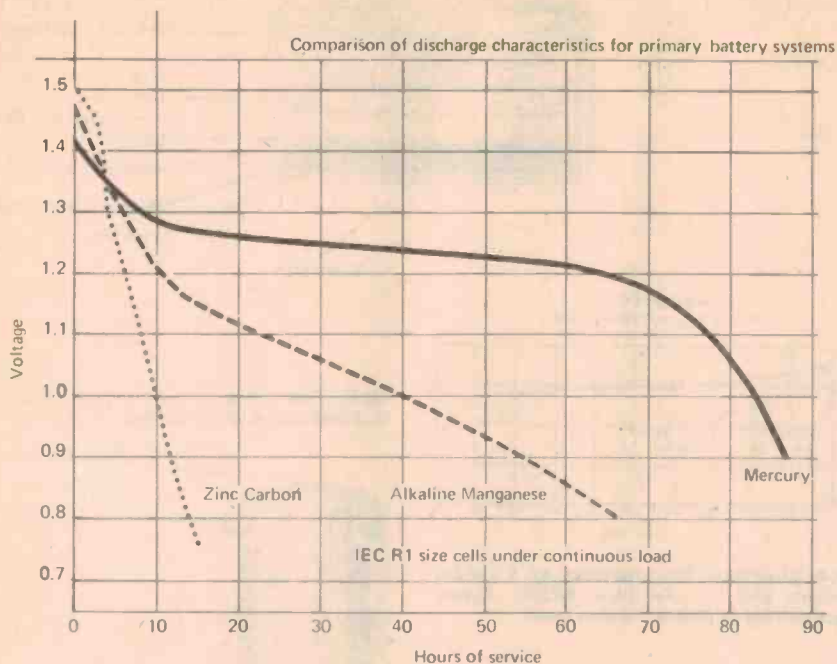

Fig. 6. Graph shows discharge performance of zinc-carbon, alkaline manganese and mercury batteries.

Battery Type	Nominal Voltage	Storage to 80% Capacity (months)	Watt-hours per kilogram	Watt-hours per cm ³
Mercury	1.35-1.4	30	101	98.3
Alkaline	1.5	30	77	57.4
Leclanche	1.5	6-12	48	32.8

THE ALKALINE CELL

The alkaline-manganese cell is constructed similarly to mercury cells, and have similar characteristics in that their terminal voltage is much more constant than Leclanche cells and they are largely unaffected by temperature extremes. Their energy capacity is also similar to mercury batteries.

The construction of a typical alkaline cell is shown in Fig. 5. It features a steel container which also forms the positive contact. This is in contact with the cathode which is a mixture of manganese dioxide and graphite compressed into cylinders that fit around the anode. The electrolyte is potassium hydroxide; the anode consists of zinc pellets.

No-load terminal voltage of alkaline batteries is nominally 1.5 V. They cost more than conventional carbon-zinc cells but less than mercury cells. Table 1 compares alkaline, mercury and Leclanche cells on the basis of storage capacity and energy capacity for size and weight. The discharge characteristics of these three types of battery are illustrated in Fig. 6.

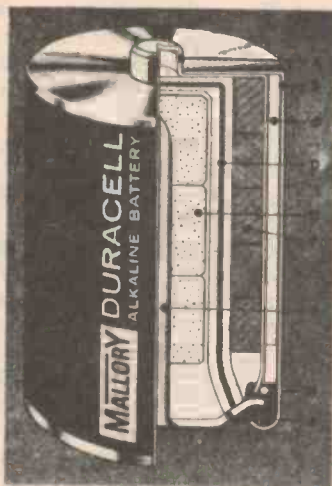

- A Inner Can
- B Outer Can
- C Adaptor Sleeve
- D Electrolyte in Absorbent
- E Zinc Anode Pellets
- F Depolariser Pellets
- G Collector
- H Plastic Sealing Grommet
- J Top

Fig. 5. Cutaway view of alkaline-manganese cell.

THE ZINC-AIR CELL

Zinc-air cells are an outgrowth of research into fuel cells. They were invented by Leosona Moos laboratories in the USA and are now manufactured under license by various US and Japanese companies. Figure 7 shows the basic construction. The anode is amalgamated zinc powder and incorporates the negative terminal. The electrolyte, a concentrated solution of potassium hydroxide, is in contact with the anode. This construction allows large discharge currents without serious polarisation of the anode occurring. The anode structure is held in a tough plastic case.

The cathode is constructed in several layers, held in a plastic frame. The outermost layer is a micro-porous PTFE plastic film. This allows atmospheric oxygen to come in contact with the electrolyte. The PTFE will allow air into the cell but will prevent the electrolyte escaping. Thus, the battery may be used in any position. On the inner face of the PTFE is a layer of catalyst. This is also in contact with the electrolyte and aids the chemical action of the cell without itself being consumed. The catalyst used provides a high current density at the cathode.

A metal mesh collects the current generated by the cell and is the positive terminal connection. A permeable separator allows free passage of ions within the cell but prevents direct electrical contact between anode and cathode.

Zinc air cells find most use in applications requiring continuous or semi-continuous service at high currents. They have high energy to weight and volume ratios and have higher current output and amp-hour capacities than equivalent size alkaline or mercury cells.

The maximum current capability of zinc-air primary cells is dependant on cathode area. Their amp-hour capacity is dependant on the volume of the zinc anode. The cathode will operate continuously provided its surface has sufficient access to the air.

Depending on the application, a zinc-air cell may produce six to eight times the output of an equivalent high power carbon-zinc cell or a weight

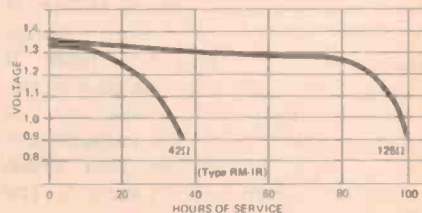

Fig. 6. Characteristics of Mallory Mercury system; discharged continuously at $\pm 20^{\circ}C$

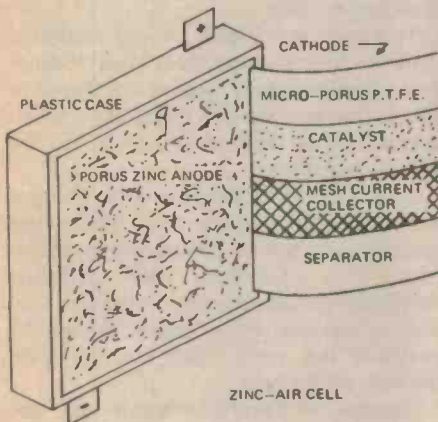

Fig. 7. Section of rectangular zinc-air cell.

saving of the same order for equivalent power outputs. (Leclanche cells are not of course capable of the high discharge rates of the zinc-air cells).

Zinc-air cells can deliver high currents continuously at a voltage which remains nearly constant throughout the discharge system. A comparison of the discharge characteristics of various cells and zinc-air batteries of equivalent size is given in Fig. 8.

Zinc-air cells have a nominal terminal voltage of 1.4 on no-load dropping to 1.2 - 1.1 under load with an end point voltage of 0.9 volts (discharged). Very small cells (AA size) can provide continuous discharge currents of 250 mA and up to 500 mA peak. This size cell would typically have a capacity of 2.5 amp-hours after three months storage. Leclanche cells of equivalent size have a capacity measured in milliamp-hours. Zinc-air cells can provide 185 watt-hours per kilogram - compare this with the other primary cells in Table 1.

Their main drawbacks are cost and availability.

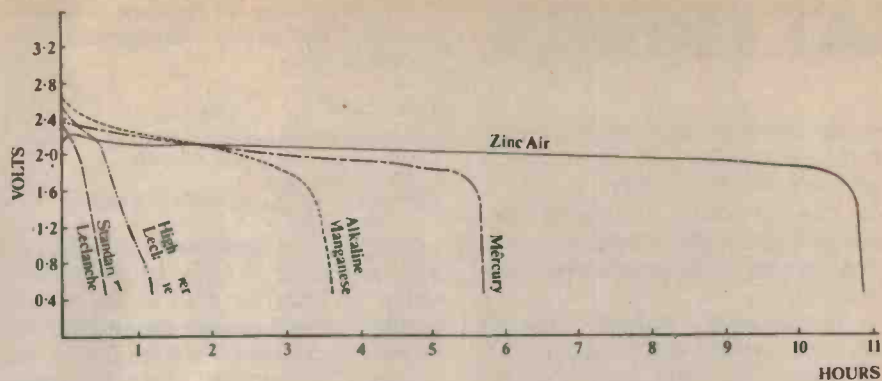

Fig. 8. Discharge curves of various types of cell compared to a zinc-air battery of the same physical size.

THE WESTON CADMIUM CELL

This cell is used *only* as a primary voltage standard or reference. It is unable to supply useful current - in fact a discharge current greater than about one milliamp will ruin it. The terminal voltage of a Weston Cadmium cell is 1.01864 volts at 20°C. It's not what you would call a handy figure to work with (especially using it in calculations!), its advantage lies in the fact that it can be quoted within plus or minus ten microvolts. A diagram is given

in Fig. 9.

The cathode (+ve) is mercury and mercurous sulphate paste. The anode (-ve) is an amalgam of cadmium and mercury in saturated cadmium sulphate.

The cell is usually contained in an H-shaped glass vessel as illustrated in Fig. 9. To maintain the accuracy of the output voltage, the cell is usually constructed in a temperature regulated container.

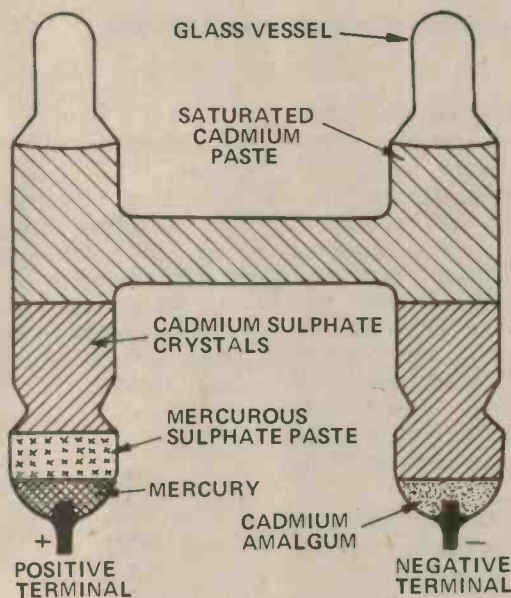

Fig. 9. The Weston Cadmium cell.

THE LEAD-ACID BATTERY

The lead-acid battery has a long and honourable history. The car battery is probably the most familiar example. High current capabilities, long life and relatively low cost are attractive advantages. A forty amp-hour capacity car battery can supply several hundred amps for periods of a few seconds (i.e.: for a car starter motor).

The lead-acid cell consists of a lead

and litharge (lead oxide) anode and a lead and red-lead cathode immersed in a liquid electrolyte of dilute sulphuric acid. This is contained in a hard rubber or polypropylene case. A filler cap for the electrolyte is provided and a vent hole for the release of gas during charging. For this reason, conventional lead-acid batteries can only be used in the upright position.

Lead-acid batteries are obtainable in a wide variety of sizes and amp-hour

BATTERIES

capacities. Some are designed for heavy duty service while others are designed for light or intermittent duty.

They are of course produced for innumerable applications other than the starting, lighting and automobile ignition applications.

The fully-charged, no-load terminal voltage of a lead-acid cell is between 2.3 - 2.4 volts. This drops under load to about 2.0 - 2.2 volts. When discharged, the cell voltage is typically 1.85 volts. The amp-hour capacity is determined

1,275, depending on the type of service for which the battery was intended. For example:—

S.G.

1.210 emergency lighting, low duty.

1.245 light and intermittent duty.

1.260 car batteries.

1.275 heavy discharge, truck and tractor batteries.

USE

Charging is a fairly simple operation. The unfiltered output of a rectifier (dirty dc) may be used or any power supply that will provide the appropriate current at a voltage a little above the battery's fully charged terminal voltage. Some means of varying the charging current is necessary. High wattage, low voltage lamps in series with the battery

charging current should be reduced to somewhere between 4-8 amps per 100 AH until charging is complete. Check the specific gravity at half-hourly intervals. At the end of charging, cell voltage may rise to about 2.6 volts or more but this decreases slowly after the charger is removed, the terminal voltage then usually reading around 2.4 volts per cell (Fig. 11).

Slower charging rates can be used, the battery taking longer to recharge. A continuous low-rate charge can be used ('trickle charging'). A constant current charger is best in this application, providing between 100 mA and 300 mA per 100 AH capacity.

During charging, the electrolyte temperature should not be allowed to rise above 38°C (100°F). If the battery is hot and gassing rapidly, reduce the charging current.

Hydrogen is released during charging. This is highly explosive. Keep flames and cigarettes away and avoid electrical sparks by turning off the charger when connecting or disconnecting leads to the battery terminals.

Lead-acid batteries should be charged in an open area where small electrolyte spillages and fumes cannot affect nearby materials. Cotton and synthetic materials are attacked by sulphuric acid and mysterious holes appear where the material has come into contact with battery electrolyte.

The level of the electrolyte in each cell of a battery must be kept above the tops of the plates. The loss of water by evaporation and decomposition during charging should be made up with distilled water. Do not use tap water as it usually contains minerals and traces of chemicals that contaminate the electrolyte. Distilled water is best added when the cells are gassing to ensure thorough mixing.

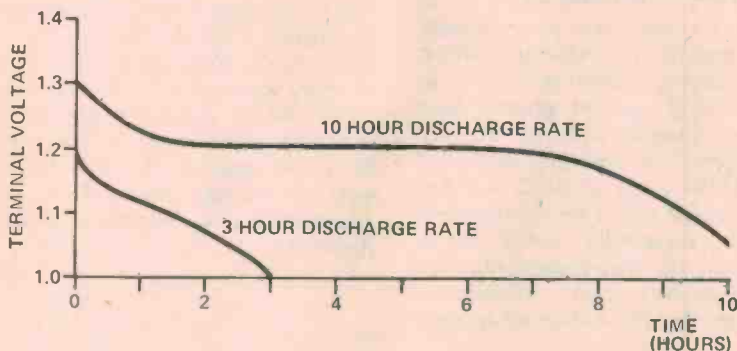

Fig. 10. Discharge characteristics of Lead-Acid cells.

from a 10 hour discharge rate. The current required to discharge the battery to its end-point voltage of 1.85 V/cell is multiplied by this time. e.g. a 40 AH battery will provide 4 amps for 10 hours before requiring recharge. Note however that the amp-hour capacity varies with the discharge current. The same battery discharged at a rate of 10 amps will not last four hours, on the other hand if it is discharged at 1 amp it will last somewhat longer than 40 hours. The discharge characteristics are shown in Fig. 10.

Lead acid batteries may be operated over a wide range of temperatures, from -20°C to +35°C. At low temperature, amp-hour capacity and discharge current are reduced and there is the possibility of the electrolyte freezing, depending on the specific gravity of the electrolyte. Preferred operating temperature is about +20°C to about +25°C.

A direct indication of the state of charge in a lead-acid battery is the specific gravity of the electrolyte. This is measured with a hydrometer. These can be obtained calibrated specifically for use with lead-acid batteries. The hydrometer reading for full charge will lie somewhere between 1.210 and

are suitable for the dirty dc type of charger.

The initial charging current for the fully discharged battery (cell voltage under 2.0 V), should be about 20 amps per 100 amp-hours of capacity (i.e.: 8 amps for a 40 AH battery). Once the electrolyte begins to gas rapidly, the cell voltage will be around 2.3 volts and rising rapidly. At this point, the

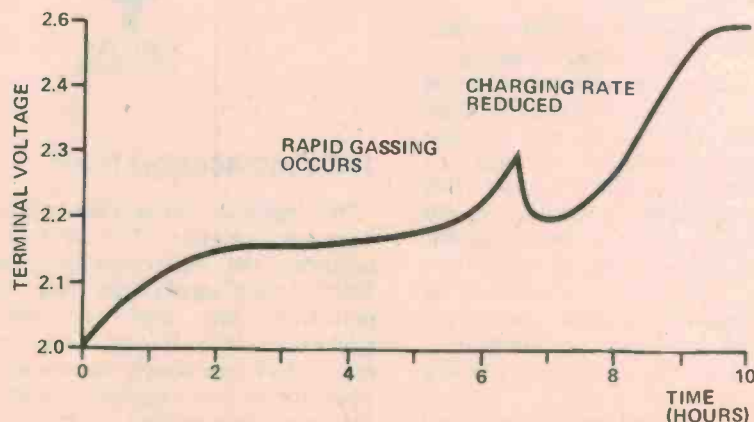

Fig. 11. Charging characteristics of Lead-Acid cells.

BATTERIES

If a lead-acid battery is used at relatively light duty then it should be periodically discharged through a dummy load, at its normal rate, and then immediately recharged.

Lead-acid batteries should not be overcharged at high current as this causes the plates to buckle and slake (which may result in a short circuit). Neither should they be left in a discharged state as the lead sulphide produced during discharge may undergo a generally irreversible physical change resulting in reduced battery capacity. Batteries in this condition are referred to as 'sulphated'. This condition may sometimes be remedied, at least partially, by trickle charging for a considerable period. Eventually, sulphated cells self-discharge.

In normal operation, lead-acid batteries should be overcharged from time to time, at about half the normal rate, until half-hourly readings of the terminal voltage and electrolyte specific gravity show no further increase. This action removes sulphate and restores the plates to their normal condition.

Spilled electrolyte should be neutralized with an alkaline solution. This is simply made up by dissolving 4-6 tablespoons of common baking soda (sodium bicarbonate— per litre of water, using as much water as necessary. When applied to spilled electrolyte, foaming occurs. When the foaming has stopped the residue should be washed away with clean water. If washing down the top of a battery with this solution, do not let any into the cells!

THE NICKEL-CADMIUM CELL (Nicad)

Nicad cells use a potassium hydroxide electrolyte. In a typical unit the positive and negative plates are both perforated steel. The positive plate is filled with nickel hydroxide, the negative plate with finely divided cadmium mixed with a little iron to prevent it flaking and losing porosity. The electrolyte has a specific gravity of 1.15-1.2, depending on the type of service, it does not undergo any chemical change during discharge. Very little electrolyte is needed and the positive and negative plates are very closely spaced.

Nicad batteries are made in a wide variety of sizes and amp-hour capacities, miniature ones for use in cameras, calculators etc up to large heavy duty types similar to car batteries. They may be operated over a wide temperature range — similar to that of lead-acid

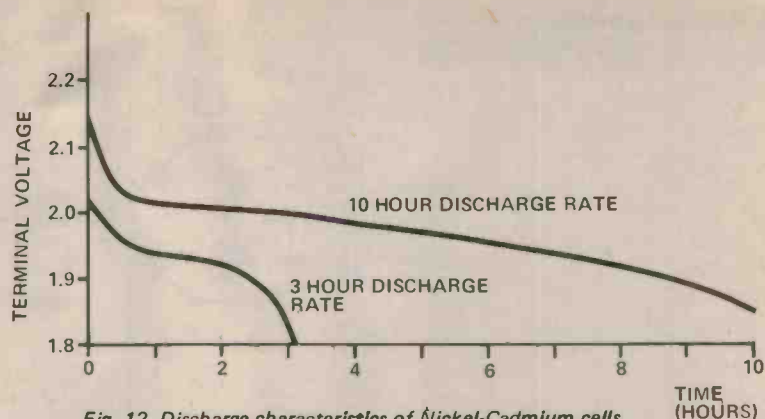

Fig. 12. Discharge characteristics of Nickel-Cadmium cells.

batteries. At low temperatures, the amp-hour capacity does not diminish as much as with lead-acid batteries. However, the electrolyte may freeze.

As Nicad batteries may be sealed, they can be used in any position. The no-load terminal voltage of a nickel-cadmium cell is typically 1.3-1.4 volts. This drops to about 1.2 volts under load, and to about 1.1 volts when discharged. As the electrolyte does not change during discharge (as it does in lead-acid batteries), the number of amp-hours obtained from a Nicad battery is much less affected by the discharge rate than are lead-acid batteries (Fig. 12).

As Nicad batteries can be made quite small, and can be recharged, they are

eminently suitable for use in portable electronic equipment such as calculators, tape recorders, hand-held transceivers, camera flash units etc. They can withstand considerable vibration, are free from sulphating or similar problems, and can be left in any state of charge without ill effect.

Charging should be done with a constant-current charger. The charging rate for the quickest charge should be no more than 1.5 times the 10 hour discharge rate. Most manufacturers recommend a charge rate and a trickle or 'float' charge rate and this is best adhered to. Charging characteristics are shown in Fig. 13.

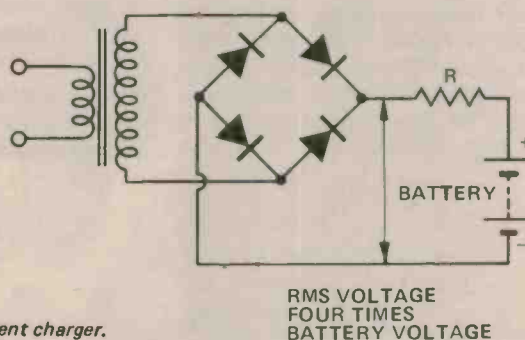

Fig. 14. Simple constant current charger.

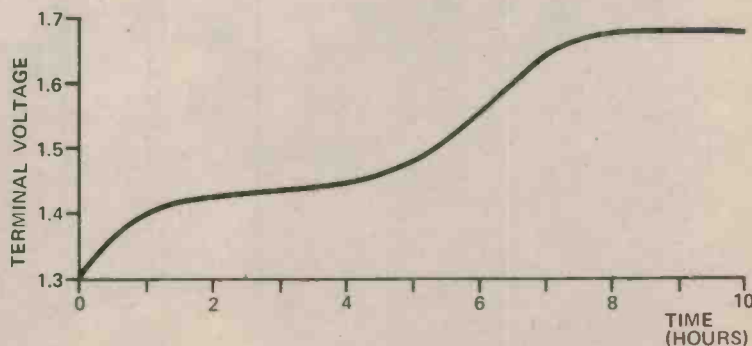

Fig. 13. Charging characteristics of Nickel-Cadmium cells.

BATTERIES

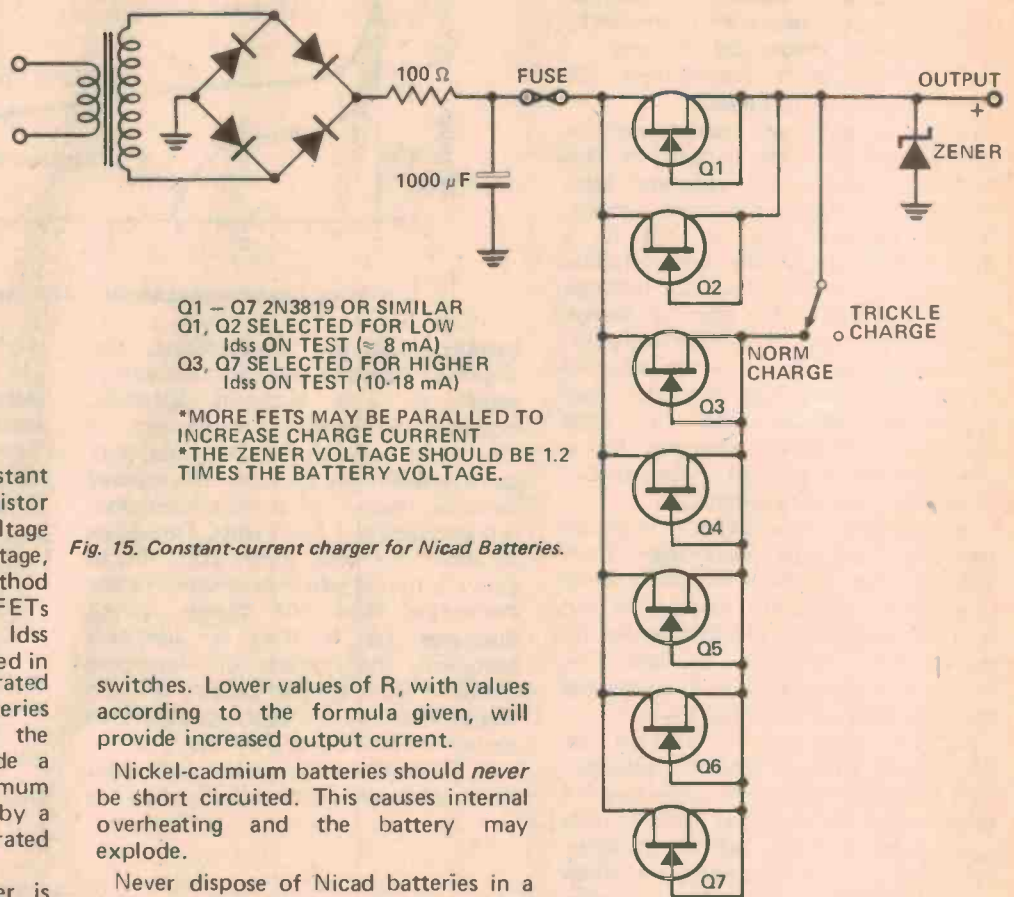

Fig. 15. Constant-current charger for Nicad Batteries.

One method of producing a constant current charger is to place a resistor in series with a supply having a voltage three or four times the battery voltage, as shown in Fig. 14. A better method is shown in Fig. 15. Junction FETs are selected on test for similar I_{dss} currents and a number are connected in parallel as shown to supply the rated charge current. The FETs are in series with the rectifier output and the drain-source characteristics provide a constant current output. The maximum output voltage should be limited by a zener diode to about 1.2 times the rated battery voltage.

Another constant-current charger is shown in Fig. 16. This will charge batteries up to 12 V at currents up to 10A with a suitably rated transformer and rectifiers. The output current is selected by closing one or more

switches. Lower values of R, with values according to the formula given, will provide increased output current.

Nickel-cadmium batteries should *never* be short circuited. This causes internal overheating and the battery may explode.

Never dispose of Nicad batteries in a fire or incinerator. This too will cause them to explode!

The nickel-iron battery is an earlier counterpart of the Nicad and has similar characteristics.

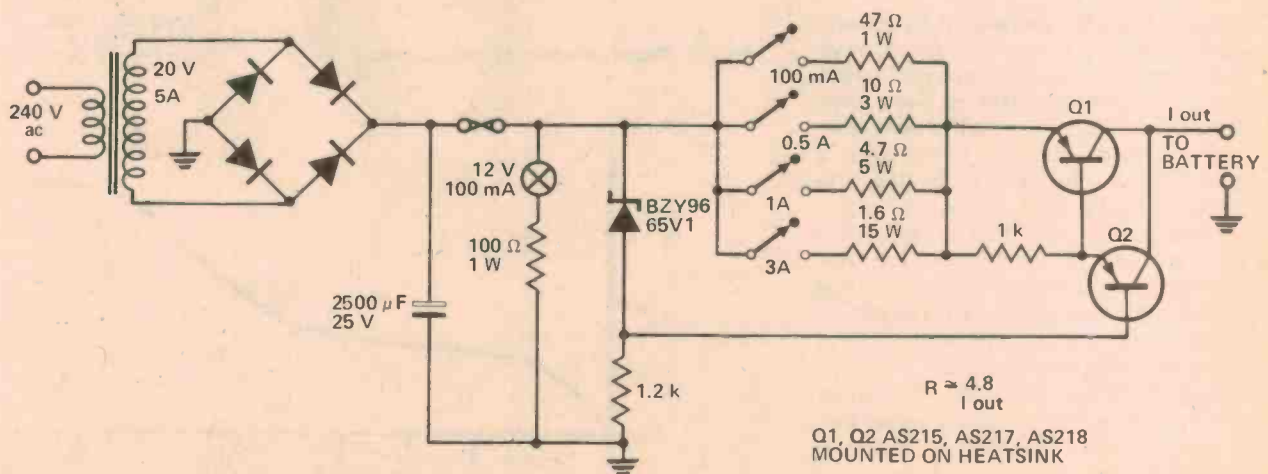

Fig. 16. Constant-Current charger for batteries up to 12V, and currents up to 10A. (max. output current shown is 4.6A).

RECHARGING DRY BATTERIES

ARTICLES are written from time to time explaining how dry cells may be rejuvenated by a simple 'recharging' procedure. Home battery chargers have in fact been specifically made and sold for this purpose.

Whilst limited recharging can be carried out successfully it is a potentially hazardous procedure and most battery manufacturers advise against it.

If you do wish to try it yourself follow the advice reproduced here — courtesy Union Carbide.

The primary battery may be recharged for a limited number of cycles under certain conditions. Briefly these are:—

1. The operating voltage on discharge should not be below 1.0 volt per cell when battery is removed from service for charging.
2. The battery should be placed on charge very soon after removal from service.
3. The ampere-hours of recharge should be 120-180% of the discharge.
4. Charging rates should be low enough to distribute recharge over 12-16 hours.
5. Cells must be put into service soon after charging as the recharged cells have poor shelf life.

Some manufacturers of home battery chargers produce laboratory test data to show recharging 15 times or more following the above conditions, and some of the equipment is designed to ensure the meeting of requirements numbered 3 and 4 above, if directions are carefully followed. However, very few owners of battery-powered lights, radios, cordless equipment, etc. will know when batteries drop below 1.0 volt per cell. Further, with no planned system, discharged batteries may not be placed back into service until their replacements have worn down, by which time the recharging will have been to no avail.

Recharging cells of any chemical system which are not specifically designed for charging can be dangerous.

Excessive amounts of gassing which may result from too high a value of charging current, may cause a tightly sealed cell to rupture, resulting in personal injury or damage to equipment.

If new unused alkaline-manganese dioxide primary cells are subjected to charging currents, there is a possibility of rupture, due to the generation of hydrogen with resultant pressure build-up. If partially used cells are charged or overcharged, the cell seal may break, causing leakage and fast cell deterioration. Similarly, if one attempts to charge mercuric oxide or silver oxide primary batteries, the possibility exists of violent rupture or at least leakage. This is particularly true if cells are overcharged.

Apart from the active use of chargers, inadvertent charging of primary batteries in an appliance can also occur by:

- (a) One of a group of batteries being reversed in an appliance.
- (b) Use of a faulty appliance which has allowed the set of batteries to be charged while the appliance is operated from an external power source.
- (c) Use in an appliance for which rechargeable batteries were intended (e.g. some portable car radios or some electronic calculators).

In respect of (a) above, many appliances which use four or more batteries will continue to operate the appliance. If used under any of the above conditions, the resultant gas pressures can cause a sudden rupturing of the seal, sometimes even after it is removed from the appliance.

The Federal Trade Commission in the U.S.A. has instructed manufacturers of charging equipment to warn against attempting to recharge primary batteries and has insisted on the redesign of some mains/battery operated equipment which originally allowed the primary batteries to receive a charging current when the appliance was being mains operated.

BRIGHT STAR CRYSTALS

ESTABLISHED FOR THE
PAST 35 YEARS FOR
ALL YOUR REQUIREMENTS



STILL ON TOP
ELECTRONIC UNITS

● DECADE COUNTING UNITS TO 1 Hz ● WIDE BAND AMPLIFIER FOR your counter 1 MV sensitivity, band width 1-250 MHz.

DEVOTED EXCLUSIVELY TO
THE MANUFACTURE OF
PIEZO ELECTRIC
CRYSTALS

Contractors to Federal & State
Government Departments.



"All Types of Mountings"

REPRESENTATIVES —

NSW	Hose & Equipment Co. Pty Ltd, 11 Salisbury St., Botany, 2019 Phone 666-8144
S.A.	Rogers Electronics P.O. Box 3, Modbury North, S.A. Phone: 42-6666
QLD	Fred Hoe & Sons Pty Ltd, 246 Evans Road, Salisbury North, Brisbane, Phone: 47-4311
W.A.	Communication Systems, 32 Rudlock Road, Morley 6062 Phone 76-2566
TAS.	Dilmond Instruments, P.O. Box 219, Bellerive, Hobart, Tas. Phone: 479-077.

Send stamped addressed
envelope for new catalogue or
quote for your requirements.

BRIGHT STAR CRYSTALS P/L.
35 EILEEN ROAD, CLAYTON,
VICTORIA, 546-5076

Dont take chances...

Is a life worth

4.49

Most electrocutions are caused by 'experts' wiring their own cords & power points.

Now there is a way to check your wiring and make sure you have not created a hazard — this great little power point & cord tester. Plug it in — observe the light pattern. You know straight away if it is ok or not.

YOU COULD SAVE A LIFE — MAYBE. EVEN YOUR OWN!
Cat P-5300

Cheap cheap

NO, WE HAVEN'T GONE INTO THE CANARY BUSINESS (though Dick once sold white mice...)

Look at these 'prized' IC's for extra special value...

CT7001 Clock Chip: Long valued by experimenters — has prov. for date, alarm, snooze — circuits are available on request. Save now. Cat Z-6821 .. was \$8.90 ..

A BARGAIN AT \$6.50

2112 Memory chip: Suits Miniscamp. Incredible special for logic experiments. Cat Z-9304. \$4.00 **SAVE MONEY — BUY NOW!!!!**

NEW

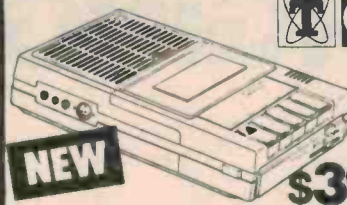

TEMPEST

Cassette Recorder

Wow! AC AND DC portable cassette recorder with beaut new styling — comes complete with in-built condenser microphone and carry strap. Even has a DIN socket for all the Volkswagen drivers! At our price it's a great buy. Cat A-4092 \$39.95

CMOS: 25c

That's right! 74C02 CMOS ICs are just 25c each! Who'd of thought it possible! Get you 74C02's from Dick while they last! But quickly! Cat Z-5412 25c!!

IMPROVED noise cancel microphone

Dick's done it again! The new model of his famous noise cancelling microphone looks the same as before, but is better! Instead of two inserts, the new model uses a single insert which is acoustically balanced to really stamp out noise! Ideal for all CB, amateur or PA applications.

same low 99c price
C-1105

scamp: save \$12!

Dick feels generous at Christmas — and Christmas is almost here. Save now on the Scamp microprocessor kit. Learn all about logic electronics. Cat Z-9200 \$82.90

NEW...

Here is the ideal gift for all budding CBers!

'10-4, Good Buddy' is a 12 inch L.P. record describing all aspects of CB radio, including codes and jargon. The ideal complement to Dick's own CB book (see below).

\$6.99 THAT'S A BIG 10-4!!
D - 9200



Hey! How about this:

79.50 save \$35.50



D - 1433

This is unbelievable value!!! Last month we introduced the new Hi-gain II AM set — at \$115.00. That was fantastic value for such a fine rig. The demand took us completely by surprise, so we air-lifted in another shipment to satisfy the need. And the best part: these are actually cheaper than the last shipment. Dick's quantity buying has paid off again — and you get the benefits.

While they last, these incredible Hi-gain II AM rigs are only \$79.50 But be warned — we cannot guarantee this price once this shipment is sold out. Better be quick!

SAVESAVESAVESAVESAVESAVESAVESAVESAVESAVESAVE

NEW

It's Dick Smith's Handbook of Australian CB Radio...

The only CB book written for the Australian CB scene. All you want to know about CB radio in this country. Even has the latest in CB rigs. Codes, channels, jargon, and much more. Foreword by Mr CB — C.W. McCall!

IDEAL CHRISTMAS PRESENT!
Cat B-2325

3.95

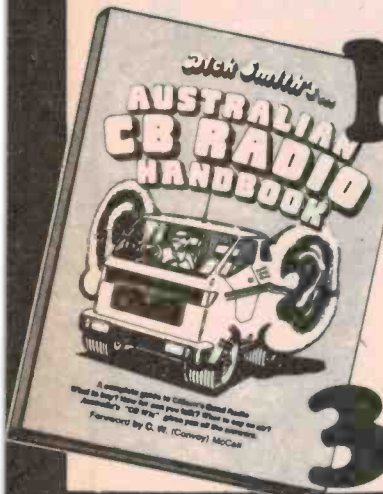

Dick Smith products are available from all these dealers — right across Australia. Dealer prices may, in some cases, be slightly higher to cover transport costs. The Dick Smith warranty and parts back-up applies to all products bought from authorized dealers. **LOOK FOR THIS SIGN:**



- DICK SMITH DEALERS:** Armidale 72 1895, Griffith 62 1577, Newcastle 69 1222, Orange 62 6491, Tamworth 66 1363, Bendigo 43 1977, Geelong 94 408, Palm Beach 34 1248, Maryborough 21 4559, Elizabeth St. 255 2249, Port Adelaide 47 3688, Prospect 44 5835, Perth 328 1599, Devonport 24 4216, Hobart 34 8232, Wivenhoe 31 2560, Alice Springs 52 1713, Darwin 81 3491, Canberra 80 4307, Mt. Gambier 256404
- DICK SMITH CB DEALERS:** Adelong 46 4258, Albury 21 3888, Ballina 86 2669, Bateman's Bay 72 4555, Bathurst 31 1200, Bega 22 090, Bourke 72 2129, Bowral 61 1861, Cootamundra 42 1682, Dubbo 82 3793, Dulibo 82 2377, Finlay 83 1611, Forbes 52 2300, Forster 561, Glen Innes 1219, Gloucester 571 1152, Gosford 24 4644, Goulburn 21 5440, Grenfell 43 1733, Gunnedah 42 0222, Inverell 22 2443, Jindabyne 62 112, Kurri Kurri 37 2141, Laurieton 599 060, Lavington 21 6058, Leeton 53 2081, Lismore 21 3741, Lismore 21 3189, Lithgow 51 2563, Milparinka 4, Mudgee 72 1413, Nowra 23 628, Peak Hill 31, Rylstone 77, Shell Harbour 95 1175, Sth. Grafton 42 3400, Sydney 31 0673, Taree 52 1488, Tullamore 75, Wagga 21 2125, Walgett 243, Wellington 1002, West Gosford 24 1768, West Wyalong 424, Wollongong 29 2254, Wollongong 29 5876, Drouin 25 1342, Horsham 82 3724, Mildura 23 2438, Mildura 23 4432, Sale 44 2677, Shepparton 21 9006, Wangaratta 21 5907, Warrnambool 62 4070, Biloela 26 126, Bundaberg 724263, Cairns 54 1035, Dalby 62 2389, Edmonton 55 4235, Gladstone 72 3949, Gympie 82 1327, Lota 396 9010, Margate 284 2341, Mackay 511 211, Miles 118, Nambour 411 100, Proserpine 45 1071, Rockhampton 27 4004, Toowoomba 32 3766, Townsville 79 8844, Victoria Pt 207 7308, Adelaide 223 6539, Cleve 99, Narrung 11, Peterborough 307, Port Lincoln 82 1981, Renmark 86 6682, Wallaroo 211 017, Whyalla-Norrie 455766, Yorketown 29, Bunbury 212 777, Carnarvon 411 362, Claremont 862 433, Kalgoorlie 21 1906, Paraburdoo 895200 x 368, Port Headland 732 504, Sth Fremantle 355 875, Tom Price RMDodson, Waroona 331 595, Avoca 842 166, Launceston 31 5688, Launceston 31 5815, New Norfolk 612 553, Traralgon 57 3135, Darwin 81 5411,

Books

MAKE GREAT CHRISTMAS PRESENTS...



COURSE IN RADIO FUNDAMENTALS. Want to progress up to amateur radio? Learn how your CB works? Find out with this valuable reference. Cat B-2202 .. \$5.50

HINTS & KINKS Great for ideas! Amateur, Cber or experimenter. Save time & money. Cat B-2206 . \$3.75



HAM RADIO OPERATING GUIDE. Another value text. Ideal for novices or old hands! Everything you need. Cat B-2208 .. \$6.90

NEW! 1977 AMATEUR RADIO CALL BOOK. Official listing from P&T gives all calls plus lots of info. Cat B-2259 ..\$2.85



FOREIGN CALL BOOK Into DX? find out who you're talking to. A must for QSL addresses. Cat B-2262 .. \$18.00



US CALL BOOK All the names & calls the other (foreign) book misses out on! Talk to the W's & K's. Cat B-2260 .. \$18.00



WORLD RADIO TV H'BOOK Here's one for the SWL. All stations around the world. Most authoritative available. Cat B-2080 .. \$12.90



TEST EQUIPMENT FOR THE RADIO AMATEUR. You might know theory, but do you know your test gear. RSGB publication. Cat B-2048 .. \$6.50



GETTING INTO MICRO-PROCESSORS. New from Electronics Australia. Examine this fascinating new science. Cat B-2350 .. \$4.50

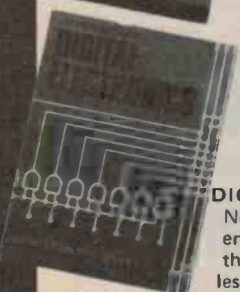

DIGITAL ELECTRONICS. New from EA - up-dated and enlarged. Features modern IC theory, starts at first principles. Cat B-3622 \$3.00

NOW HERE'S A SWITCH...



Come home to a warm bed... turn the lights on... make a cuppa before you wake up...

You can with this great little time switch! Lets you turn an appliance or circuit on and off

twice a day. You can easily change the times, too. Fully self contained, portable. Handles up to 2400 watts (3-bar radiator).

The Autoset is made by Smith's (now there's a familiar name) so you know it's quality.

Save money - don't waste electricity when it's not needed. Let the Autoset turn the wasteful appliance off until you want it on again.

\$44⁹⁵

Cat X-1118

DON'T FORGET OUR INCREDIBLE RANGE OF ELECTRONICS AND HOBBYIST'S TOOLS... THEY MAKE IDEAL XMAS PRESENTS!!!

NOW IN! EASY ELECTRONICS VOL 2. Cat B-3630 .. \$2.50

HAVE YOU SEEN THEM YET

<p>BUMBLEBEE 18 CH. AM</p>		<p>THE SSB HORNET Australia's best value SSB!</p>
<p>WASP Economy CB with all the big rig features! IDEAL FIRST RIG! Cat D-1510</p>	<p>99⁵⁰</p>	<p>NEW 18 CHANNEL</p>
<p>DE-LUXE The greatest little AM set around! For the serious Cber. Cat D-1520</p>	<p>149⁵⁰</p>	<p>259⁵⁰ The very latest technology with the very latest styling. Cat D: 1720</p>
<p>SSB BASE Mains & 12V base with a real sting! Superb in looks as well as performance. Cat D-1740</p>	<p>299⁵⁰</p>	<p>SCORPION!</p>

* **OPENING SOON IN MELBOURNE CITY -** *
* **399 LONSDALE ST - NEAR MYERS** *

DICK SMITH ELECTRONICS GROUP
THE AUSTRALIAN COMPANY

SYDNEY - 125 York St. Ph: 29 1126.
GORE HILL - 162 Pacific Hwy. Ph: 439 5311.
BANKSTOWN - 361 Hume Hwy. Ph: 709 6600.
PARRAMATTA - 30 Grose St. Ph: 683 1133.
MELBOURNE - 656 Bridge Rd. Richmond. Ph: 42 1614.
BRISBANE - 166 Logan Rd. Buranda. Ph: 391 6233.
MAIL ORDERS: PO. Box 747, Crows Nest. NSW. 2065. Ph: 439 5311.



Postage & packing extra.

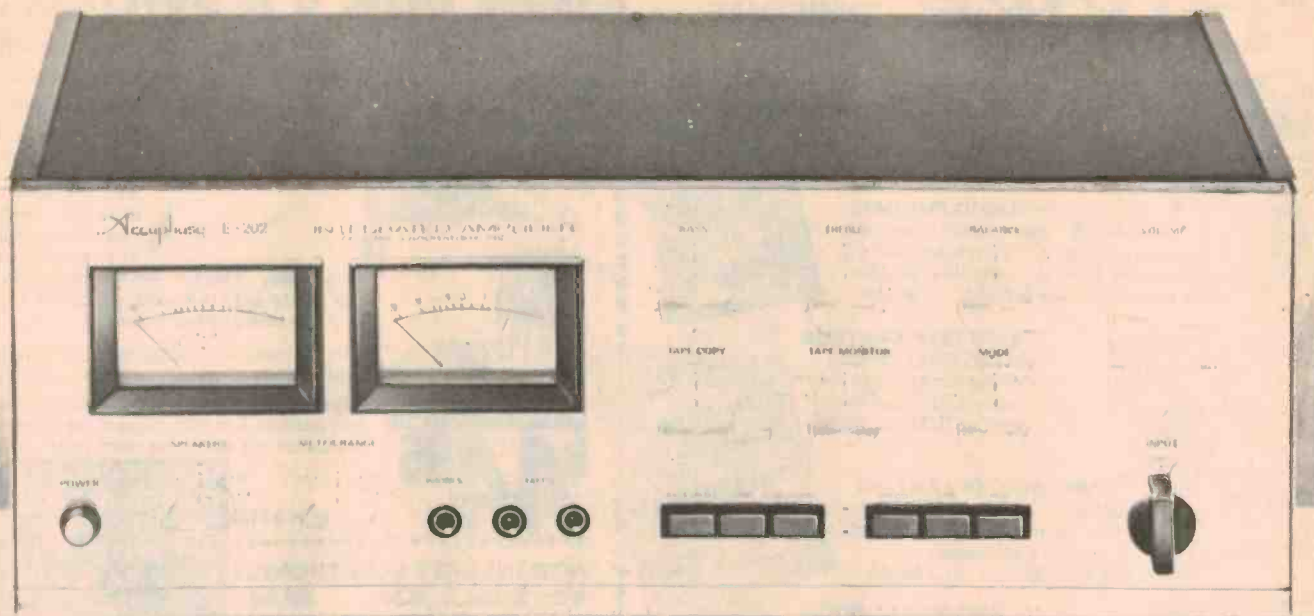

When you're ready for the finest Hi-Fi in the world... you're ready for Accuphase

In reviewing Accuphase audio equipment both Hi Fi News & Record Review and Stereo Review magazines acclaimed Accuphase as "The Rolls Royce" of high fidelity equipment.

The design philosophy behind Accuphase goes beyond building equipment that ranks with the world's finest state of the art music systems. Accuphase produces a smoother sound at all listening levels. Its total application and flexibility is exceptional. For example, the E202, can drive 3 pairs of speakers and at the same time accept 4 ac output facilities. Switchable VU meters, separate level and impedance controls and an exceptional quality of design and engineering make Accuphase the standard of how close the world has come to perfection in sound reproduction.

E.202 Power Amplifier:

Rated power 2 x 100 watt RMS stereo output with less than 0.15% THD. The E.202's specifications are outstanding and its ability to reproduce precisely the softest to the loudest musical passage is without parallel.

T.100 AM/FM Tuner:

The finest AM sound reproduction yet developed with exceptional FM reproduction capacity. Signal to Noise ratio is an exceptional 76DB with an IM distortion figure of less than 0.02%.

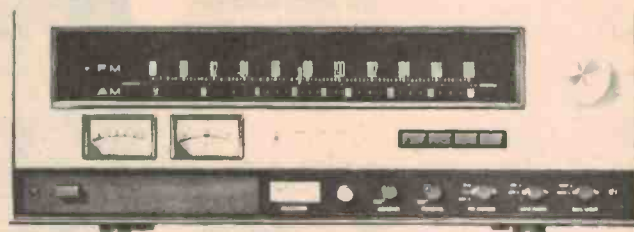

Ask for a demonstration at your nearest Accuphase Hi Fi specialist.

- SYDNEY:** Instrol Hi Fi.
Convoy International.
- MELBOURNE:** Instrol Hi Fi.
- BRISBANE:** J. Gipps Stereo
- ADELAIDE:** Blackwood Sound Centre.
- PERTH:** Alberts Hi Fi.
Leslie Lenoard Hi. Fi.

Sole Australian Agents

ARENA
DISTRIBUTORS

Areha Distributors Australasia Pty. Ltd.
"Romney Building" 273 Hay Street East,
PERTH, W.A. 6000. TELEPHONE: 25 9993.

Get into hi-fi photography. Get onto Minolta.



Your favourite photographic subject matter can move pretty fast. And if the camera you're using can't move fast with it, the chances are you won't get the shot you want.

One of the very best answers to that problem is a Minolta single lens reflex, the same as the pro's use. Because Minolta make a range to match almost any budget. All have contrast light control. (Other cameras don't.)

All have genuine Rokkor lenses. As you progress, add a telephoto, or a close-up, a fish-eye, a zoom. Plus all kinds of accessories that deliver professional results.

If you want sharp pictures, better ask for a Minolta.

Minolta

DEPEND ON IT IT'S FROM PHOTIMPORT

For free colour brochures, write, enclosing two 18 cent stamps to Photimport (Australia) Pty Ltd, 69 Nicholson St, East Brunswick, Vic 3057.

WHITE LINE FOLLOWER

This toy car will follow a track around — but there's always the danger of spinning off!

THE IDEA OF A SLOT CAR that doesn't need a slot is not new — in fact, sophisticated systems based on inductive loops have been used in large factories for some years. This project is at the other end of the complexity scale, and uses a simple light/photocell combination to follow a white line. The electronics involved make up a simple feedback control system — as soon as one photocell sees more light than the other, the differential amplifier applies a correcting voltage to the steering servomotor and so the model steers itself back on to the line.

We are not sure whether to class this project as a toy or as a serious experimental project. Certainly, the basic project makes a great toy, but there is tremendous scope for experimenting and 'tuning' the control circuitry. Like all control systems, this one displays a characteristic called 'damping' — if the system is overdamped, the car will steer sluggishly and will have difficulty following anything except the smoothest curves. If the control circuitry is underdamped, the car will oscillate from side to side on curves — this may also be set off by small deviations on the straights.

The ideal situation is to have a 'critically damped' system, which has just the right combination of characteristics to respond quickly on curves without oversteering. This can be achieved by theoretical analysis, using techniques like Nyquist's Criterion, but

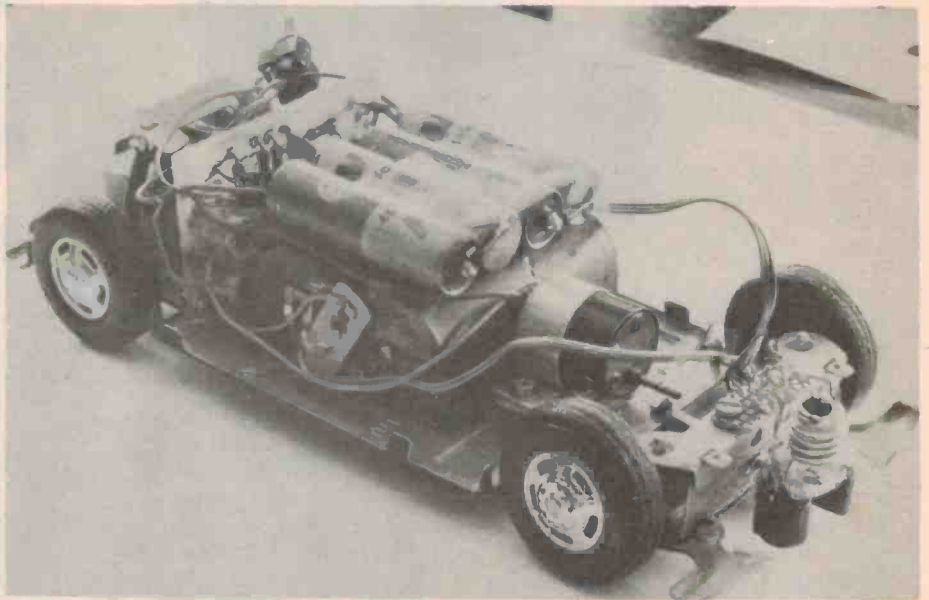

it's more fun to tune by trial and error. The damping is a factor of the photocell spacing, the amplifier gain and the servomotor characteristics.

You can have a lot of fun racing these cars, especially since there is quite a bit of scope for tinkering and tuning them. The layout of your race track should include both smooth and tight curves — you may have problems with figure-8's that cross at anything but right angles. And of course you can time races with your ETI stopwatch!

Construction

Construction of the mechanical side we must leave to the individual reader. The car we used was purchased from Woolworth's and already had steerable front wheels, which saved a lot of work in designing and building, although for the enthusiast a plastic kit would be a good start.

The motor for the steering should operate on 1.5 V reliably and has to be geared down. The motor we used had an internal 15:1 gearbox and the steering

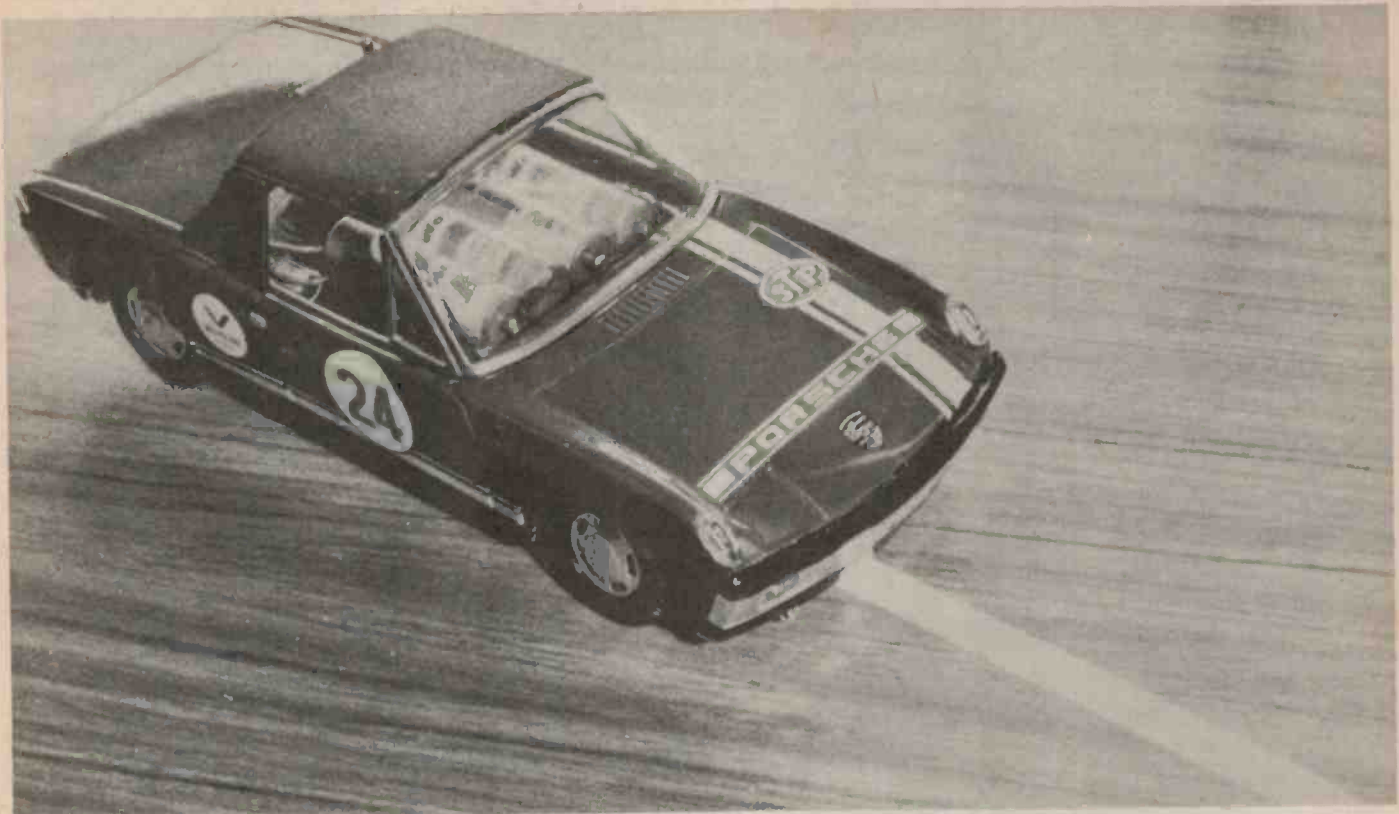

arms were driven by a piece of fishing line wrapped around the shaft (see photo). This is only one possible method — we leave the final choice to you.

The sensors should be mounted in front of the wheels and should move with them so that when the wheels turn to the right, the sensor also moves to the right and vice versa.

The LDRs were housed in short lengths (about 10 mm) of cardboard tube to act as a shield and were spaced about 15 mm apart (we used a 12 mm wide line) with the globe mounted between them.

Electrically the components can be built onto the PC board described which can be mounted somewhere in the car. We used separate batteries for the electronics and ran the globe off the main batteries, to keep the electronics supply more constant.

Experimenting

Using different motors/gear ratios some changes to the electronics will probably be found necessary. These would mainly involve C1, R1 and R10. Increasing R10 or reducing R1 increases the DC gain, while increasing C1 increases the dynamic damping to reduce overshoot. Track width may also be experimented with as well as LDR spacing.

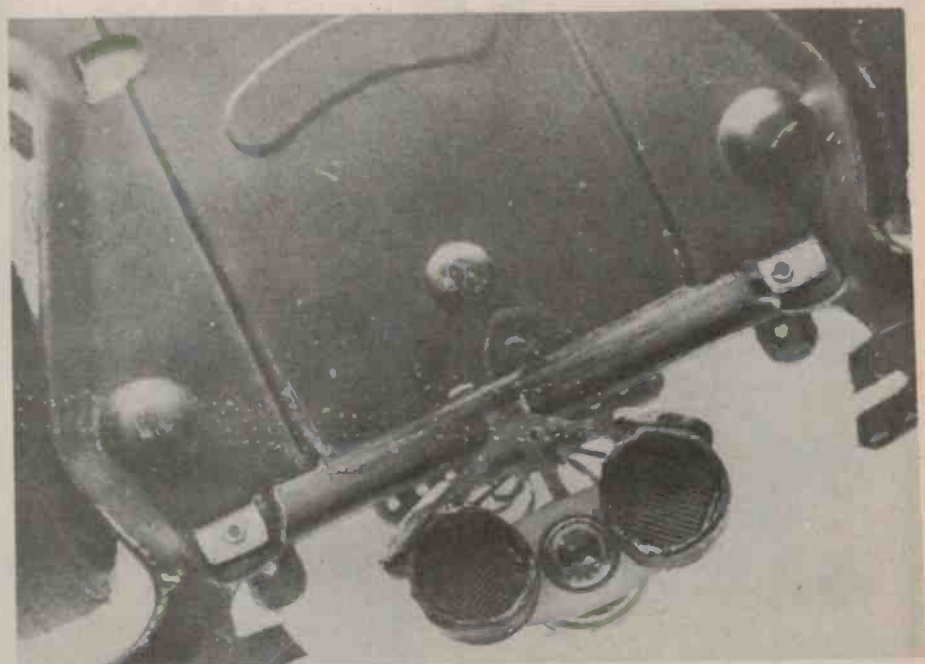

Underneath view of the photo resistors and the light globe.

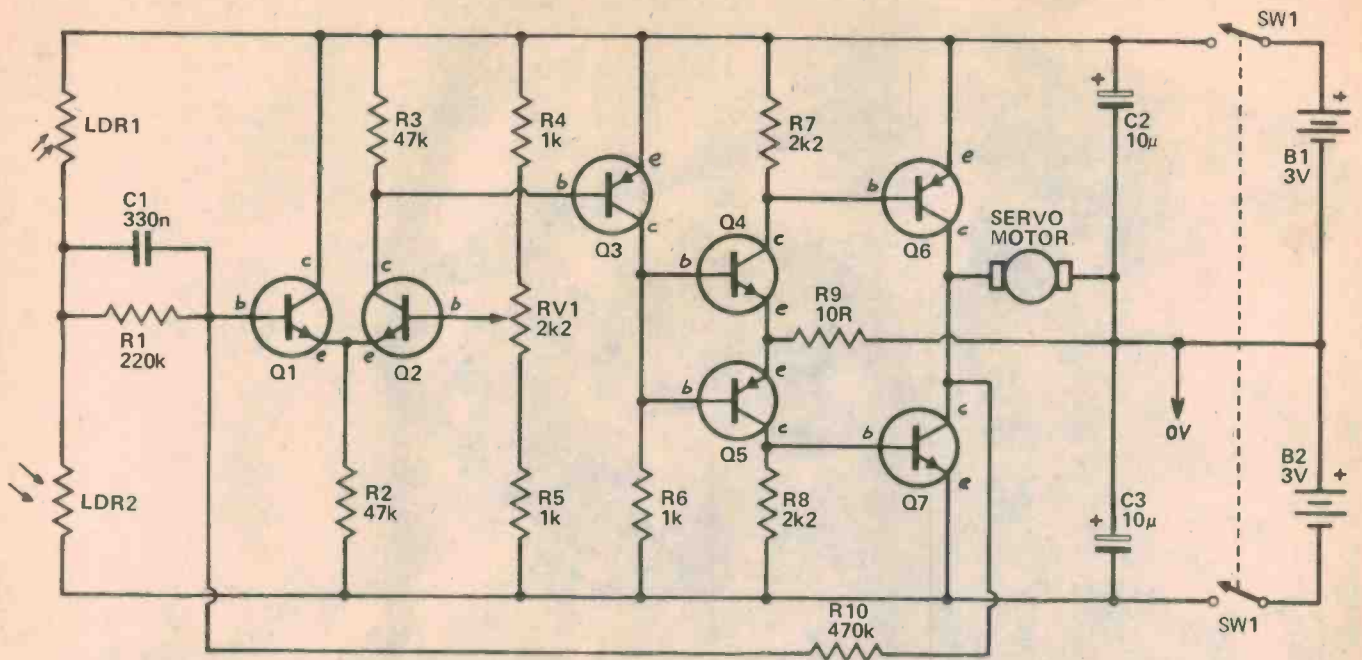
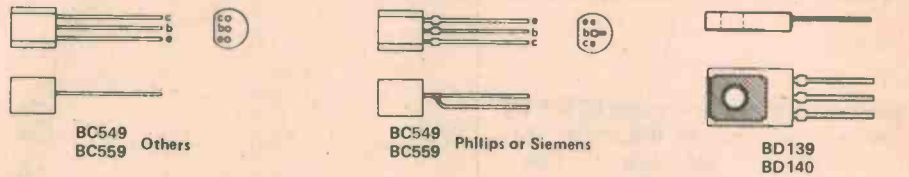

Fig. 1. The circuit diagram of the electronics.

The printed circuit layout for this project is on page 108.



We just couldn't resist this neat piece of graffiti by ETI resident wlt John Gerrie. With apologies to W. Von Beckerath (the artist), and Johannes Brahms (the subject).

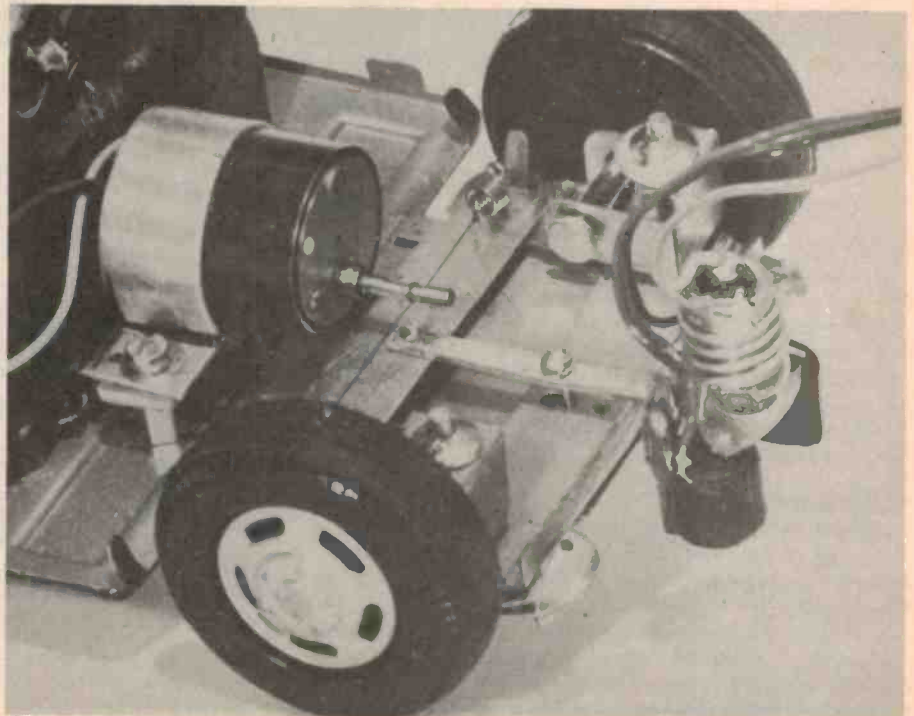

Photo showing the mechanical side of the project.

HOW IT WORKS - ETI 245

The sensor used to look for the white line is a pair of light dependent resistors (LDRs) which are aimed at either side of the line so that each sees half white half dark. The line is illuminated by a globe to ensure that the LDRs have a relatively low resistance. If the car is moved off the centre line one LDR will see more 'white' and its resistance will fall. The two LDRs are connected in series across the supply voltage and so the voltage at the junction will vary as the car moves in relation to the line.

This voltage is compared with that set on RV1 by Q1 and Q2, the error signal driving the servo motor in the correct direction to try to eliminate the error. Negative feedback is provided by R10 to reduce the 'open loop gain', and dynamic feedback is provided by C1 which is used to reduce overshoot.

When designing the mechanical side of the car's steering mechanism, provision should be made to somehow move the sensors with the front wheels to provide additional negative feedback.

The motor used in the prototype was an expensive one (about \$40) with an internal 15:1 gearbox. While a motor of this quality is probably not justified a reasonably good motor and reduction gear is necessary as the cheap (50c) motor we tried didn't seem to like starting on 1.5 V.

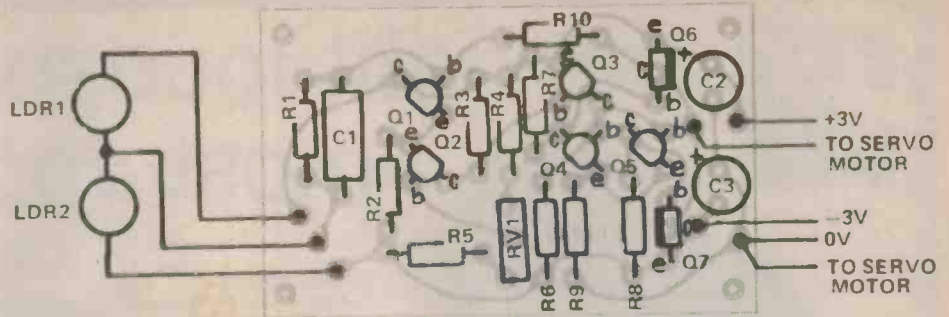

Fig. 2. Component overlay.

PARTS LIST - ETI 245

Resistors all 1/4W, 5%

R1	220k
R2,3	47k
R4-R6	1k
R7,8	2k2
R9	10R
R10	470k

Light dependent resistors

LDR1,2	Philips 2322 600 94001 or similar
--------	-----------------------------------

Potentiometer

RV1	2k2 Trim
-----	----------

Capacitors

* C1	330n polyester
C2,3	10µ 10V electro

Semiconductors

Q1,2	BC549
Q3	BC559
Q4	BC549
Q5	BC559
Q6	BD140
Q7	BD139

Miscellaneous

PC Board ETI 245
3V globe
* servo motor and gears
toy car
2 pole toggle switch
* see text

—PTY LTD—
DELSOUND

BRISBANE 1 Wickham Terrace, Brisbane. 229-6155
Also 35 Logan Road, Woollongabba
Queensland Distributors for Swann Electronics (ex Murdo)

I.C. TEST CLIPS

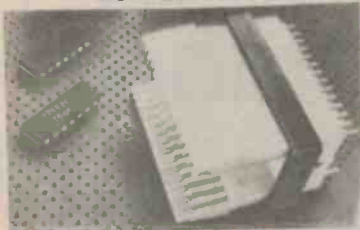

14/16 PIN	\$4.60
28 PIN	\$9.50
40 PIN	\$11.90

JACK PLUGS

P2, MONO 6.3mm TOUGH MOULDED COVER	50c
ASSORTED COLOURS	
P5, MONO METAL 3.5mm	40c
SEP3 MONO METAL COVER	95c

JACK SOCKETS (Nylon)

S1—MONO, CHASSIS INSULATED	35c
S3—STEREO, CHASSIS INSULATED	57c
S5—MONO, CHASSIS METAL FACIA NUT	60c

INSULATED TERMINALS

TP1 & TP2	45c
-----------	-----

SPECIAL AM/CB RADIO \$15.50

TERMINAL PLUGS

P12 (2mm) THROUGH PLUG	15c
P14 (4mm) TOP BANANA PLUG	22c

PRICE LIST FOR CLIFF KNOBS

CONTROL KNOBS. SCREW FIX

K1 Black/Grey	28c
K1 Black/Grey Chrome Top	34c
K1 Black/Grey Coloured Anodised Top	34c
K2 Black/Grey Chrome Top	40c
K2 Black/Grey Plain	29c
K2 Black/Grey Coloured Anodised Top	48c
K3 Black/Grey	28c
K4 Black/Grey	29c
K5 Black/Grey	49c
K5 Black/Grey Marker Line	54c
K6 Black/Grey	54c
K6 Black/Grey Marker Dot	56c
K6 Black/Grey Skirt 0-10	76c
K7 Black/Grey	54c
K7 Black/Grey Marker Line	56c
K8 Black/Grey	48c

MAIL ORDERS & TRADE ENQUIRIES WELCOME

STOCKS AS OF 1/10/77
ALL PRICES PLUS 10% POST & PACK
CBs & ACCESSORIES

AUDITEC

Pre assembled and Guaranteed Modules Using Only High Quality Comp.

POWER AMPLIFIER BOARDS

001 55 Watts RMS 4/ohms \$23.00. 018 60 Watts RMS 4/ohms \$23.00. 35 Watts RMS 8/ohms 1 percent T.H.D. \$38.00. 009 120 Watts RMS 4/ohms 70 Watts RMS 8/ohms 1 percent T.H.D. \$61.00. 027 250 Watts RMS 8/ohms 2 percent T.H.D. \$114.00. 033 VERY HIGH QUALITY 100 Watts RMS 4/ohms. 70 Watts RMS 8/ohms. Intermodulation Distortion .01 percent. Total Harmonic Distortion .005 percent. \$75.50.

All Auditec power amps require 1 volt RMS input for full rated output and are short and open circuit protected.

PREAMPS

1-015 Hi Z or Lo Z Mic., Guitar, Music or Programme Inputs 25 mV or IV RMS Output Volume, Bass and Treble ± 15 dB. Controls on Board. \$18.00.

2-015 2 x 1-015 On One Board Side By Side \$31.50
029 015 With No Tone Controls \$11.00

025 Magnetic Cart Preamp (Stereo) High Overload 2 mV Input 25 mV or IV RMS Output RIAA ± 1 dB \$20.50

1-036 Stereo Preamp. Performance Matches That of 033 Complete Assembly with Controls and Switches Wired with Mag., Tape in/out, Volume, Bass, Treble, Balance, Selector, Mode and Loudness. \$89.00

016 12 Channel Mixer Module 12 x 25 mV Input 1 x IV RMS Output \$11.00

022 Bass and Treble ± 15 dB Control for Mixer Module \$11.50

ALL PREAMPS CAN BE POWERED DIRECT FROM SUPPLIES TO AUDITEC POWER AMPS (035 Regulated Supply Recommended for 1-036).

POWER SUPPLIES TO SUIT

027	\$64.60
033, 009	\$32.50
001, 018	\$20.50
1-036 Preamp	\$10.50

AUSTRALIAN DISTRIBUTORS



the right loudspeaker for most applications

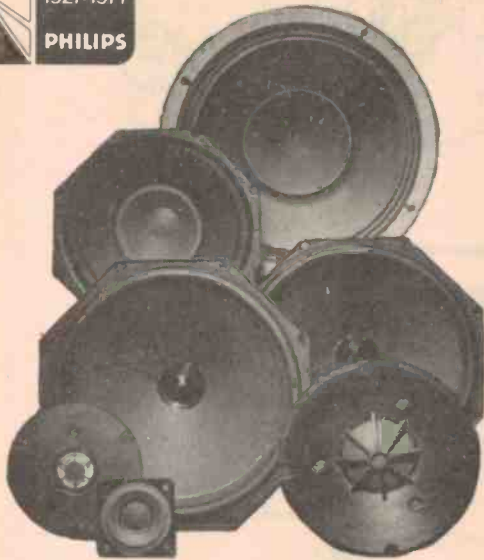

HIGH POWER

High power loudspeakers are available as woofer, mid-range and tweeter units for high-fidelity applications. They have power capacities from 10 to 60 W, and are designed to be used in special combinations with appropriate cross-over filters and enclosures, and conform to the European high-fidelity standard DIN 45 500.

Additionally, high power loudspeakers are available in full-range versions, specially suitable for musical instruments, monitoring and public address systems.

MEDIUM POWER

Medium power loudspeakers, covering the full frequency range. They have power capacities from 2 to 10 W, and are mainly used in radios, televisions and audio products.

LOW POWER

With power capacities of up to 2 W, the low power types are mainly used in products like portable televisions and intercoms.

Our experts are always available to give you the benefit of their know-how and experience in all types of loudspeaker applications.

For further details contact:

ELECTRONIC COMPONENTS AND MATERIALS, 67 Mars Road, LANE COVE, N.S.W. 2066. Tel: 427 0888
Melbourne: 699 0300 • Brisbane: 277 3332 • Adelaide: 223 4022 • Perth: 65 4199



Electronic Components
and Materials

PHILIPS

DIRECT FROM USA



MOTOROLA 'PIEZO' SUPER HORN has all the features!

Needs no cross-over network. Frequency response 4.000-30.000 Hz \pm 3 dB patented momentum drive principle. No voice coils or magnets. High internal Impedance. Adapts to any system. High acoustic output. Many can be connected in series to form an array-increased output. Power handling capacity 25 volts RMS.

4 OHMS 100 WATTS

Trade Enquiries Invited

*As used by many major musical equipment manufacturers.
Available through your local Hi-Fi, Electronic
component or Music shop or direct*

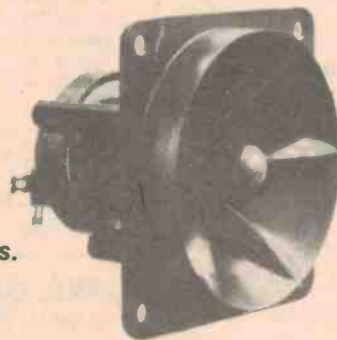

SIZE: 3³/₈ x 3³/₈ x 2¹/₂

Retail price
\$16.00 * P&P \$1.00.

Victorian Distributor:
ZEPHYR PRODUCTS
70 Batesford Road
Chadstone VIC 3148
Tel. 568-2922

Sole Australian Importer

FREEDMAN ELECTRONICS PTY LTD.

89-91A Liverpool Road, Summer Hill, NSW 2130. Tel: 797-9941 — 797-0986

South Australian Distributor:
BOB'S SOUND SYSTEMS
37 Angas Street
Adelaide, SA
Tel. 87-3933

BULK Electronic Warehouse

NEW PRODUCTS FOR MICROPROCESSOR USERS NUMERIC KEYBOARD KITS



Ideal for keyless entry systems, burglar alarms, micro processors etc. Keys 0 to 9, blue with white lettering and CLR key, red with white lettering. Giant key-top 18 x 18mm, long life (10-6 guaranteed operations), made in Germany by Rafi, PC mounting, very low profile. \$5.90 Full Kit or 75c per key. 10 kits \$5 ea 25 kits \$4 ea.

DOLLAR STRETCHERS \$1 PACS

- 99 2 PVC Transistor Tuning Gangs 20mm x 20mm, 200pf as in most radios.
- 1 20 Yds Hookup wire.
- 3 Multi-stranded in assorted colours.
- 9 Phillips Asst. VDR's.
- For servicemen, experimenters, c.w. data.
- 200 Asst. Screws, Nuts.
- 129 60 Asst. Self-Tapping Screws.
- 130 120 Asst. Steel Washers.
- 131 120 Asst. High Grade Nuts.
- 132 100 Asst. Screws.
- 124 12 Pot. Nuts, Washers.
- 11 20Ft. Plastic Spaghettil Tubing in various colours.
- 17 10 Volume Controls Some with switch, ganged.
- 18 10 Preset pots. Tab mtg. TV types.
- 2 50Ft. Speaker Cable — colour coded.
- 170 4-14 Pin DIL Sockets — gold pins.
- 171 3-16 Pin DIL " " " "
- 24 3-UM3X4 Battery Holders.
- 25 10 — No. 216 Battery clips.
- 27 3 Magnetic 8 ohm Earpieces — 3.5mm plugs.
- 29 15 Fuses 3AG 1 1/2" x 1/4"
- Choose 1/4A, 1A, 2A, 3A, 5A, 10A.
- 39 5 Core 16G Solder — 60-40 multicore, 10Ft.
- 5 15Ft Twin Core Shielded Fig. 8 cable.
- 96 5-5K ohm Volume Controls. Miniature for trans. radios — c.w. knobs.
- 76 Mono crystal cartridge, Gen. purpose
- 87 3 3/8" x 8" long round ferrite rods.
- 134 3 Suppressor Resistors — HT Lead.
- 110 3 Computer Boards, loaded with trans, diodes, res, caps, approx 150 asst. parts.
- 111 2 Car Cigarette Lighter Plugs Useful for all car accessories.
- 112 2 Neon Indicator Bezels — 250v. AC Red.
- 136 3 Asst. Neon Bezels 250VAC.
- 113 2-6V Indicator Bezels, Chromed, choose red, green, amber.
- 119 5-2 Pin Plug Sockets Sets. Polarised with covers.
- 120 8-3AG Plastic In-line Fuseholders.
- 123 10 ASST. Potentiometers. New, incl. preset, gang, switched etc. 25ft. Dial Cord — plus 5 springs.
- 14 26 Tuning Dial Kit. Incl. spindle, 3 pulleys, pointer, drum, cord, spring and instructions.
- 121 Handspan Radio Dial Kit, round dial, all states dial scale, bush etc. suit most PVC tuning gangs.
- 2 RCA to RCA audio leads.
- 133 15 Radio Knob Assortment.
- 95 2 Push button switch, 6P2T ea.
- 151 2 Panel Fuseholders — std 3AG.
- 30 2 Panel Fuseholders — std 3AG.
- 152 6 Mini-Slide Switches, 3P2T, PCB mtg.

JUMBO BAGS \$3ea.

- 400 1/4W Asst. Resistors
- 500 1/4W " " "
- 300 1W " " "
- 100 Asst. Semiconductors
- 100 Asst. Poly Caps 160-630V
- 150 Asst. various caps
- 60 Asst. Electrolytics
- 160 ASST. BULK PARTS Inc. res, caps, semis etc. We don't have time to sort out!

BONANZA JACKPOTS

For experimenters and constructors, a large assortment of new, high quality parts — samples, specials, end-of-line components incl. semiconductors.

JACKPOT No. 1
A 500gm (approx) Lucky-dip offer, all useable parts. Up to \$25 worth for only \$5.

JACKPOT No. 2
A 2Kg (approx) assortment in a 315 x 270 x 160mm box includes relays, edge connectors, pots, switches, semis and many others too numerous to mention ONLY \$10.

10W STEREO AMP

Sounds great, many features — bass/treble controls, 5 pin din rec/play & h'phone sockets, loudness, rumble and scratch switch ceramic cart, input, 35V 1.2A req, transformer, extra \$4.00.

Few only Available

\$19



5" B & W SHARP TV TUBE

Brand new, sealed in manufacturers carton. Ideal for servicemen, amateurs, experimenters etc. Were selling at \$11.95, now only \$5.95; sorry no yokes avail.



DOLLAR STRETCHERS \$1 PACS

- 337 10 Asst. Mini Preset Pots.
- 338 2 Bourns 2K Cermet Trimpots
- 234 4 DPDT Medium Slide Switches
- 235 6 DPDT Mini Slide Switches
- 232 5 T05 Black Finned Heatsinks
- 220 100 Asst. 1/2W RESISTORS. 5/, 10/ mixed carbon composition.
- 169 5-16 PIN DIL PLUGS. Gold Pins, suit 16 Pin IC Sockets
- 170 5-14 PIN DIL PLUGS.
- 167 10-IN914 Silicon Diodes.
- 166 3-6V 1W Zener Diodes.
- 163 1 Valve Output Transformer G.P.
- 148 1-1 Watt Audio IC Amplifier-with circuit diagram
- 142 10-0.0022 Feedthrough Capacitors
- 87 3 FERRITE RODS 3/8" diam x 8" long
- 306 15-0.22uF 160V Polyester Capacitors.
- 307 15-0.0047uF 400V Polyester Capacitors.
- 308 10-0.1uF 400V Polyester Capacitors.
- 309 15-100uF 10V Pigtail Electros
- 310 12-22uF 63V Pigtail Electros
- 311 10-470uF 16V Pigtail Electros
- 312 5-1000uF 10V Pigtail Electros
- 3-3300uF 6.3V Pigtail Electros
- 313 15 Asst. Lamps-low voltage 6-50V.
- 314 3 Sub-min Painton Preset Pots 1K.
- 315 3 Sub-min Painton Preset Pots 2.2K
- 316 2-90mfd 300VW Can Electros
- 317 1-200mfd 1/2 100mfd 200VW Can Electros
- 138 2-12 Pin PCB Connectors.

DOLLAR STRETCHERS \$2 PACS

- 137 30 Asst. ELECTROLYTICS. All good quality low voltage.
- 180 5 WAFER SWITCHES MSP rotary, std. mtg. 1/4" diam. shaft, 1to4 bank, various positions, all new.
- 319 MSP. CAR SPEAKER 5" x 4" — 150hms.
- 320 8 ohm TWEETER 75mm-8 ohms.
- 321 3 Edge Connectors, 46 way, double sided 0.156" pitch, Plessey.
- 300 1-12V MINI RELAY — PCB intg, 2A c/O contacts, 200ohm coil.
- 217 10-TIC44 SCR's -40V 600mA rating, mini T092 plastic pkg.
- 181 1-SUPER SENSITIVE MICROPHONE. Hearing aid type by Shure, 1" diam. x 3/4" high, low imp. Ex. Govt. use.
- 318 15 Neons, 60-90V pigtail.
- 231 2-10 Amp Microswitches.
- 193 10 Asst. Switches:- Toggle, slide, rotary, all new, useful.
- 266 2-2SB337 Germ. Power Transistors.
- 198 50 TO-18 Asst. TRANSISTORS PNP&NPN, tested OK, marked.
- 218 250 Mixed Bulk RESISTORS:- 1/8W, 1/4W, 1/2W, up to 10W.
- 156 10-200pf TRIMMER CAPS. Air-spaced, mini, cer. base.
- 154 4-100pf CERAMIC TRIMMERS. High Quality Air-Spaced, PC or chassis mtg., communications specs.

"SUPA" SPECIALS for DEC.

- 322 MOTOR SPEED CONTROL KIT. Suits most electric motors. 240V 750W max \$4.50
- 323 TRANSISTOR RADIO REPAIR KIT Gang, speaker, semis, caps, pots etc \$4.50
- 324 5" B&W SHARP TV TUBE New, ideal servicemen, experimenters, \$5.95
- 199 600V 25A SILICON RECTIFIERS. International Rectifier 10 for \$6.50, 25 for \$15.00 ea. 75
- 205 VHF Trans. TV TUNER. Miniature Sharp. 12 channels. 9 with biscuits, new. 2 for \$11.00. \$6.00 ea
- 219 100 ASST. 1W RESISTORS. 5/, 10/ mixed carbon composition. \$1.50.
- 331 30 A 400 PIV SILICON RECTIFIERS. Heavy duty, STC RS640 stud mounted. \$1.50.
- 332 CATHODRAY CONO. 0.5mld 2KV Stud mtg. hi qual. special purpose. \$1.00 ea.
- 249 HP 5082-7300 LED DISPLAY. 7 Segment 4x7 dot matrix, m built decoder-driver and memory. L.H. decimal pt 0-9 Readout. buy 4 for \$26.00 \$7.00 ea.
- 9 BONANZA JACKPOT A 500 gm (approx) lucky-dip offer, all useable parts, samples, specials, end-of-line components incl. semis \$5.00 ea.
- 333 3 PIN MINI PLUG & SOCKET 60pr.
- 334 7 PIN MINI PLUG & SOCKET 1.00pr
- 335 14 PIN MINI PLUG & SOCKET 1.20pr
- 336 37 PIN MINI PLUG & SOCKET 1.80pr

Electronic Agencies

Trading Hours — 12.00 — 6 pm Mon-Fri. 8.30 — 1 pm Sat.
Mall Orders — P.O. Box 1005 Burwood North 2134.
Post & Pack — Add 15 per cent up to \$25 order value. 10 per cent over.
Minimum Order Value — \$5.00 C.O.D.'s Send \$3.00 pre-paid
Prices and availability — as at 25/10/77

115-117 Parramatta Road, CONCORD, N.S.W. Telephone (02) 741 0177

Write your Name, Address, P/Code here and send your order to P.O. Box 1005, Burwood Nth. 2134.

HOWL-ROUND STABILIZER

Feedback problem in halls can be corrected by the use of this clever gadget.

ANYONE WHO HAS USED a microphone in public address work has come across problems with feedback. These are caused by the level of sound reaching the microphone from the speaker approaching or exceeding that from the person originating the sound. As the reflected sound approaches the level of the original signal, the sound becomes distorted or 'coloured', then audible ringing occurs and finally complete oscillation or howl-round occurs as the reflected sound exceeds the level of the original signal.

The most effective method of eliminating this problem in most cases is to use the correct location for the speakers and the correct choice of microphone. Also the use of the microphone is important so if you are in charge of a sound system don't be afraid to tell the singer or speaker how to use the microphone as a good performer will take advice.

However in certain environments the most effective use and selection of microphone/speakers does not help the problem of feedback. These are the halls and rooms which have little sound-absorbing material on the walls and are very 'live'. If a frequency response curve is drawn for such a room it will be found that there are many peaks and troughs, normally only 4 or 5 Hz apart, along with perhaps major resonances.

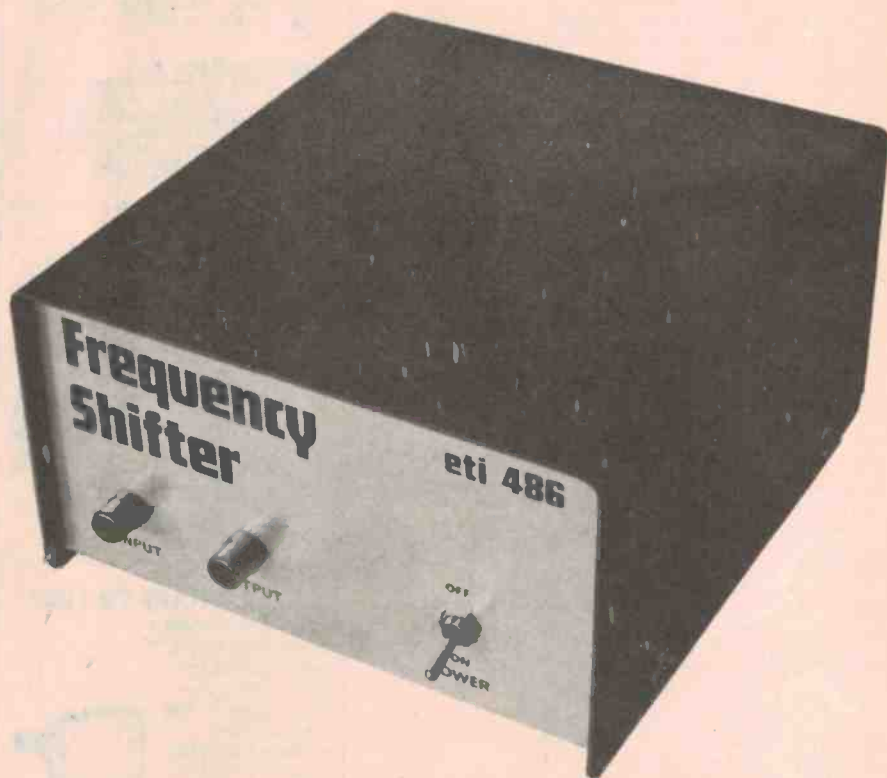

The printed circuit layout for this project is on page 108.

Solutions

There are various electronic devices which have been developed to deal with this problem, the main ones being the graphic equalizer, the variable notch filter and the frequency shifter. The first two (especially the notch filter) are ideal for eliminating major resonances. These however also alter the frequency response of the original sound. They can also help if the offending 'echo' is actually a direct path and not dependent on the room (i.e. if the speakers are behind the microphone). The other method, frequency shifting, is described here.

With a frequency shifter the echo signal is of slightly different frequency on each path round the loop and cannot directly reinforce itself so that while on the first echo it may strike a room resonance the second time it will probably be in a null. This tends to even out the frequency response of the room and allows 5 to 8 dB higher levels to be used in the average room. Also the onset of howl-round is not as dramatic as with the conventional system and the distortion which normally occurs below the howl-round level is not as noticeable. The system does not however do a great deal for howl-round not associated with room resonances.

Only a small shift is normally required and it does not matter if it is an increase or a decrease. We chose to increase the frequency by about 5 Hz as it is easier to tell if a vocalist is flat rather than sharp. As the frequency response of the unit is good it is suitable for vocal work as well as general public address use. The frequency shift and the slight amplitude modulation cannot be detected by most people.

Alignment

Equipment needed — a sensitive AC voltmeter (100 mV or less) or preferably an oscilloscope and an audio oscillator.

1. Check the output of the 5 Hz oscillator and adjust RV1 until it stops. If it cannot be completely stopped, try a link across C9.
2. Apply a signal of about 1 — 2 V amplitude at about 1 kHz to the input and measure the output of IC3 at pin 2. (If your meter does not reject DC, measure at the junction of C17 and R36). Adjust RV3 to give the minimum output.
3. Measure the output of IC4, pin 2 (or the junction of C18 and R37) and adjust RV5 for minimum output.
4. Measure the output of the 5 Hz oscillator on pin 6 of IC1 and adjust RV1 until it starts, then adjust to give about 1.25 V RMS.

5. With no input signal, measure the output of IC3 (or the junction...) and adjust RV2 for minimum output.
6. Measure the output of IC4 (or...) and adjust RV4 for minimum output.
7. If an oscilloscope is available, monitor

the output with a 1 — 2 V input signal and adjust RV6 to give the minimum amplitude modulation. Alternatively, by using an amplifier and speaker, RV5 can be adjusted by ear. The unit is now set up.

SPECIFICATION — ETI 486

Frequency shift	5kHz upwards
Maximum input voltage	3V
Frequency response +½ dB, -3dB	30Hz — 20kHz
Signal to noise ration re 3V output	70 dB
Distortion @ 1kHz, 2V out	0.25%
Amplitude modulation	100Hz — 10kHz < 1dB
Phase shift network 50Hz — 20kHz	90° ± 5°

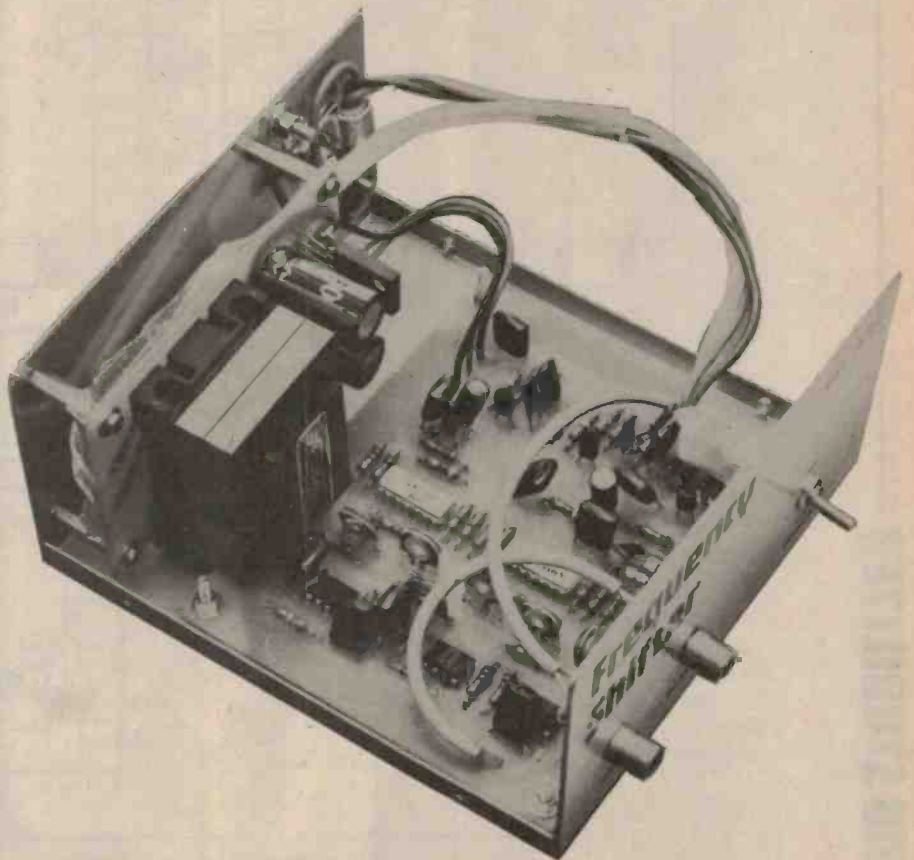

HOWL-ROUND STABILIZER

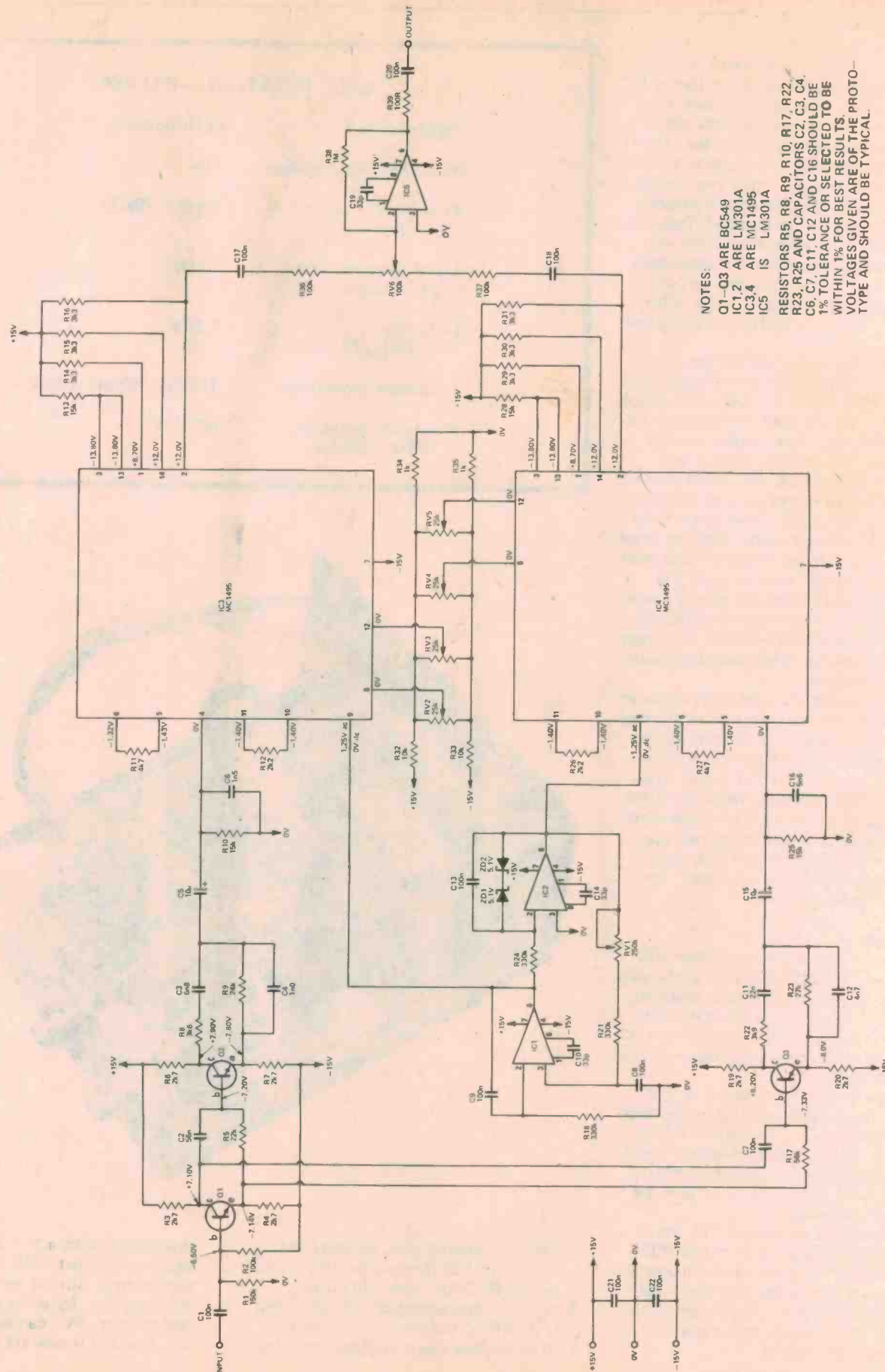

Fig. 1. The circuit diagram of the phase shifter. For the power supply see project ETI 581

HOW IT WORKS — ETI 486

There are numerous methods of generating a frequency shift in an audio signal. Most however require coils and precise tuning which rules them out for a project. With this method only resistors and capacitors have to be accurate, yet it gives a result adequate for the purpose.

The audio input is split into two circuits which provide a frequency-related phase shift as shown in Fig. 4. The amplitude however remains constant. Due to the different component values in the two networks the phase shifts are not the same but differ by 90° at all frequencies (50 Hz $- 20$ kHz $\pm 5^\circ$).

IC1 and IC2 form a quadrature sine wave oscillator with the frequency set by R18, R21, R24, C8, C9 and C13. Amplitude stability is provided by ZD1 and ZD2 along with RV1 (see adjustment section). The outputs from these two op amps are the same amplitude but 90° phase shifted.

We now multiply (the MC1495 is a four-quadrant multiplier) one of the audio signals by one of the 5 Hz outputs and the second audio input by the second 5 Hz signal. When we multiply two waveforms together the output consists of the sum of the two frequencies and their difference. This means that if the audio signal is 100 Hz the output will contain a 95 Hz signal and a 105 Hz signal. These will beat with each other to produce a 10 Hz beat note as shown in Fig. 2. Due to the phase shift between the inputs of the multipliers the 105 Hz components of the outputs are in phase, while the 95 Hz components are 180° out of phase. Therefore by adding the outputs of the two multipliers in IC5 the 95 Hz components cancel out, leaving only the 105 Hz signal. Provided the multiplier inputs have the 90° phase relationship there will always be a 5 Hz shift, independent of frequency.

Due to the inability to maintain exactly the 90° phase relationship, the 95 Hz, or lower sideband, will not completely cancel and the result is a slight beat giving rise to an amplitude modulation effect (we had about 1 dB). This is not normally noticeable on speech or music.

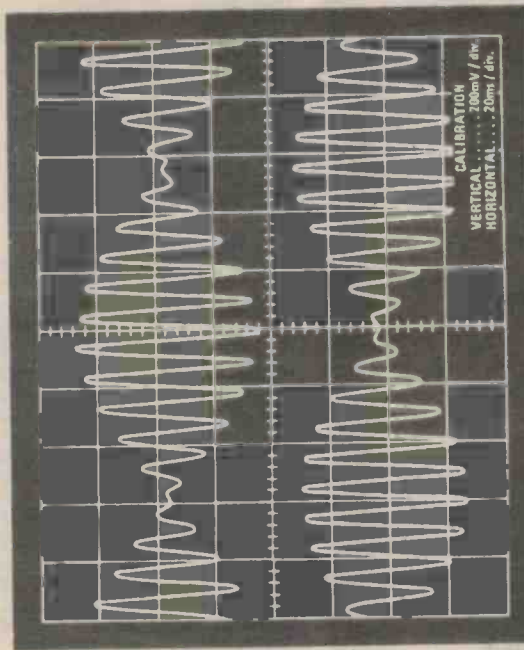

Fig. 2. The output of IC3 (top) and IC4 (lower) with a 100 Hz input signal. Note the phase difference.

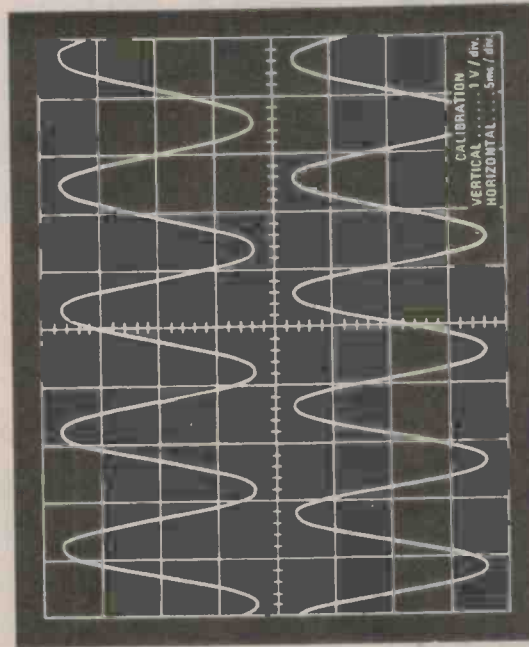

Fig. 3. The input signal (top) and the output (lower). Note the difference in frequency.

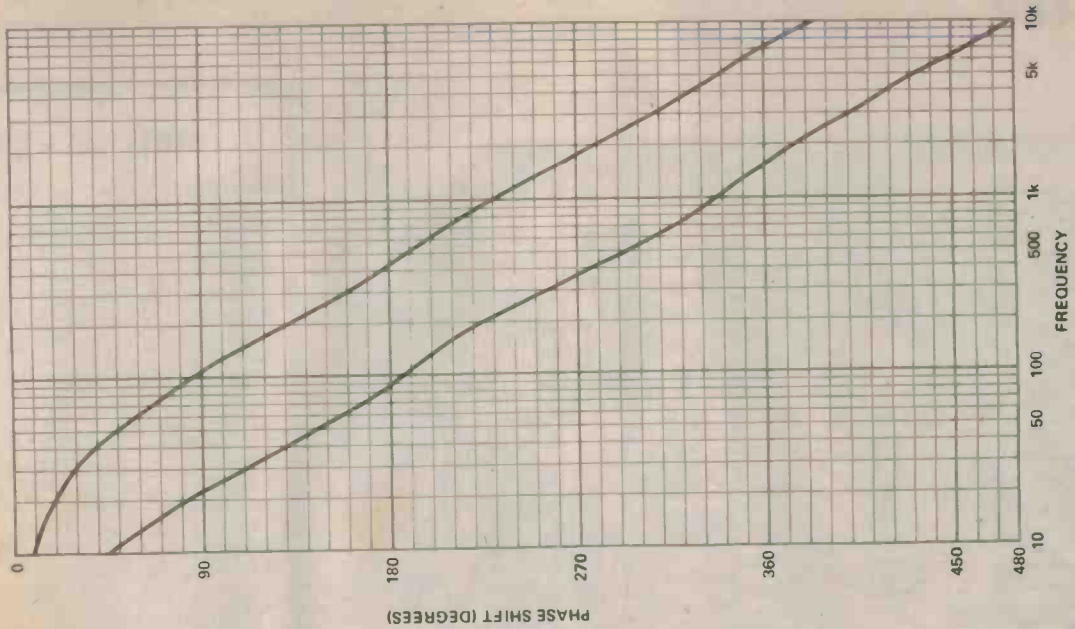

Fig. 4. The phase response of the two filters.

Project 486

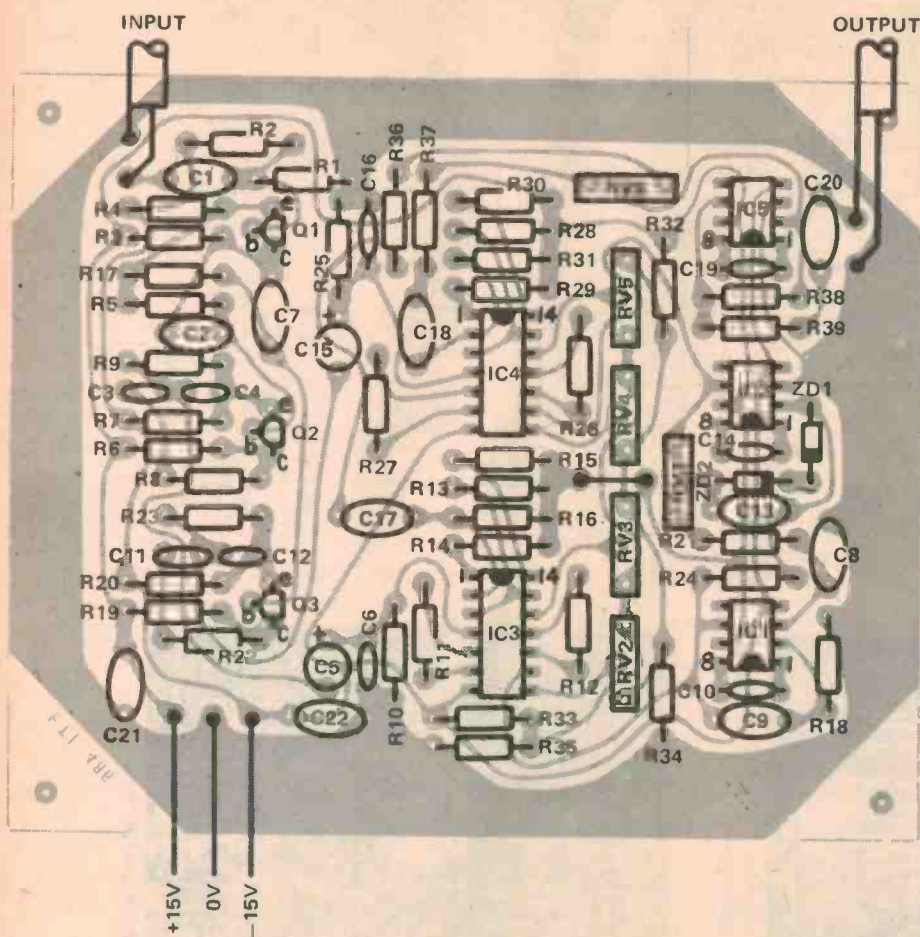

Fig. 5. The component overlay.

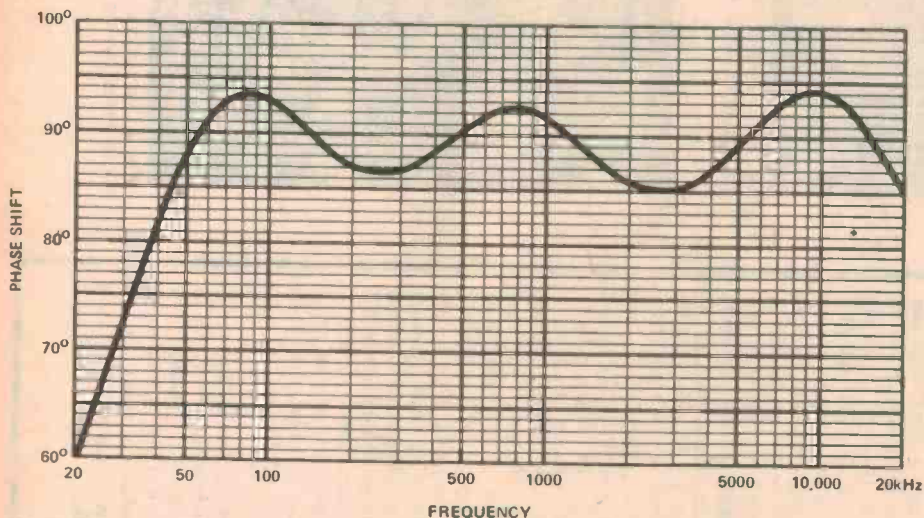

Fig. 6. The phase difference between the two filter networks.

PARTS LIST - ETI 486

Resistors all 1/2 W 5%

R1	150k
R2	100k
R3,4	2k7
*R5	22k
R6,7	2k7
*R8	3k6
*R9	24k
*R10	15k
R11	4k7
R12	2k2
R13	15k
R14-R16	3k3
*R17	56k
R18	330k
R19,20	2k7
R21	330k
*R22	3k9
*R23	27k
R24	330k
*R25	15k
R26	2k2
R27	4k7
R28	15k
R29-R31	3k3
R32,33	10k
R34,35	1k
R36,37	100k
R38	1M
R39	100R

Potentiometers

RV1	250k trim
RV2-RV5	25k trim
RV6	100k trim

Capacitors

C1	100n polyester
*C2	56n polyester
*C3	6n8 polyester
*C4	1n0 polyester
C5	10μ 25V electro
*C6	1n5 polyester
*C7	100n polyester
C8,9	100n polyester
C10	33p ceramic
*C11	22n polyester
*C12	4n7 polyester
C13	100n polyester
C14	33p ceramic
C15	10μ 25V electro
*C16	5n6 polyester
C17,18	100n polyester
C19	33p ceramic
C20-C22	100n polyester

Semiconductors

IC1,2	LM301A
IC3,4	MC1495
IC5	LM301A
Q1-Q3	BC549
ZD1,2	5.1V 300mW

Miscellaneous

PC board ETI 486
Power supply ± 15V 40mA (ETI 581)

* For best results the components should be as accurate as possible, preferably 1% tolerance or selected to be within 1%.

ECLIPSE

AUSTRALIA'S MOST HELPFUL PROFESSIONAL SUPPLIER OF
SPECIAL EFFECT LIGHTING CONTROLLERS, PROJECTION &
DISCO EQUIPMENT CONSOLES

THE PULSAR MODULATOR - The Ultimate in Lighting control!
One of the many products from Europe's largest manufacturer of lighting controllers

The Modulator gives a high degree of flexibility to a lighting installation so that the whole atmosphere may be changed by altering the settings on the control unit. The most exciting sound to light effects can be created, or alternatively, a soothing atmosphere of slowly fading colours, simply by adjusting the controls.

Each channel is fitted with a Brightness and a Contrast control and this is the basis of the Modulator's flexibility. Gentle background effects are obtained at low contrast settings or very dramatic effects at high contrast levels. Each channel may be operated in sound to light mode or alternatively to automatic cycling at variable speed.

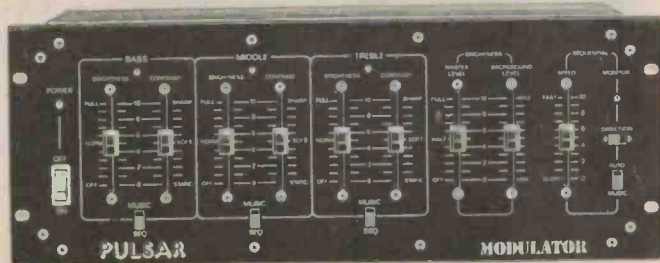

In addition the Modulator has a music-based sequential system together with a reverse switch. Two master dimmer controls are provided — one to set the maximum brightness level and the other to set a minimum brightness level if background lighting is required. Considerable attention has been paid

to the power-handling characteristics of the Modulator so that the unit is suitable for use in large clubs and discotheques where high reliability and high power-handling are called for. The unit itself handles three channels of 2kW (total 6kW) and if greater power-handling capability is required the unit is fitted with remote control sockets to run PULSAR Slave Units.

Largest Range of 3" Effects cassettes and 6" Effects wheels in Australia

Disco Consoles, Jingle Machines, Fog & Bubble Blowers, Strobes, Dimmer Racks, Chasers
Solar, Tutor & Aquarius effects Projectors & Accessories

OFFICES & SHOWROOM — 100 PENSHURST ST. WILLOUGHBY, N.S.W., 2068. Ph 95 4212.
TRADE & DISTRIBUTOR ENQUIRIES INVITED



T.T.L.

I.C. No.	Price	I.C. No.	Price
SN7400N	.44	SN7473N	.85
SN7401N	.44	SN7474N	.90
SN7402N	.44	SN7475N	1.10
SN7403N	.44	SN7476N	1.10
SN7404N	.44	SN7483AN	1.65
SN7405N	.44	SN7486N	.75
SN7407N	.75	SN7490AN	.90
SN7408N	.44	SN7492AN	.85
SN7410N	.44	SN7493AN	.85
SN7412N	.44	SN7495AN	1.50
SN7413N	.90	SN7496N	1.90
SN7420N	.44	SN74107N	.75
SN7430N	.44	SN74121N	.79
SN7432N	.65	SN74122N	.95
SN7437N	.75	SN74123N	1.10
SN7442N	1.10	SN74141N	2.88
SN7447AN	1.65	SN74145N	1.95
SN7448AN	1.55	SN74154N	2.10
SN7454N	.44	SN74192N	2.10
SN7460N	.44	SN74193N	2.10
SN7472N	.75	SN74199N	3.75

C./M.O.S.

I.C. No.	Price	I.C. No.	Price
TP4001AN	.44	TP4024AN	1.25
TP4007AN	.44	TP4027AN	1.16
TP4011AN	.44	TP4028AN	1.85
TP4012AN	.44	TP4043AN	1.95
TP4013AN	1.16	TP4049AN	1.10
TP4015AN	1.95	TP4050AN	1m10
TP4016AN	1.16	TP4051AN	1.85
TP4017AN	2.10	TP4304AN	1.65
TP4018AN	2.65	TP4306AN	1.65
TP4022AN	1.99	TP4581AN	5.50
TP4023AN	.44	TP4582AN	1.95

Audio Amplifiers

I.C. No.	Price	I.C. No.	Price
SN76001N	1.42	SN76023N	2.65
SN76005N	2.25	UPC1025H	2.50

Clock Chips

I.C. No.	Price	I.C. No.	Price
MM5314	5.80	TMS3834	8.75

Linear

I.C. No.	Price	I.C. No.	Price
LM381	3.48	SN72723L	1.20
SN72301AP	.99	SN72723N	1.20
SN72555P	.95	SN72741L	.60
SN72709L	.99	SN72741P	.60
SN72709P	.95	SN72747N	.95
SN72710	1.17	SN72748N	.80

Misc. and C.T.V.

I.C. No.	Price	I.C. No.	Price
HA1125	3.20	TBA550Q	6.33
LM2917M	2.50	TBA560	7.20
SN76226D	2.20	TBA560C	7.20
SN76227N-07	2.58	TBA720A	4.75
SN76231N	2.10	TBA730	4.50
SN76533N	3.85	TBA750A	4.50
SN76570N	2.35	TBA750BQ	4.50
SN76666N	1.41	TBA760	4.25
TA7070P	4.50	TBA900	5.25
TA7074P	5.35	TBA920	5.75
TA7173P	9.10	TCA2705	5.20
TAA300	4.50	TDA2620	6.50
TAA570	5.50	TDA2630	10.50
TAA630S	4.50	TMS6011NC	9.77
TBA240B	4.50	UPC30C	1.50
TBA520	4.75	UPC574J	1.30
TBA530	4.25		

Mail Order Instructions

Minimum P + P \$1.00
Orders over \$9.99 must include additional postal charges (see right).

PLASTIC CASE SPECIAL

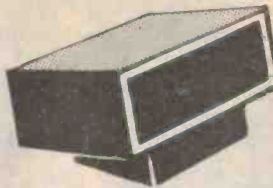

As used in many clock projects. Has sold at double this price before. You'll have to be in quick for this one.

\$3.75

BUILD-IT YOURSELF Slide Rule Calculator Electrokit 45



\$9.50

6 functions plus 4 key memory, with 8 digit Red LED display. Operates off 9 volt battery. Great value for kitset builders. Features square root, %, facilities plus the four basic functions.

Plugs and Sockets

CB



PL259 ONLY \$1.29



SO239 ONLY \$1.30



1 metre **\$4.50**
Patch Cord **PC258**

Dip Switch

16 pin dual in-line switch. Fits into 16 pin DIL socket.

\$2.25

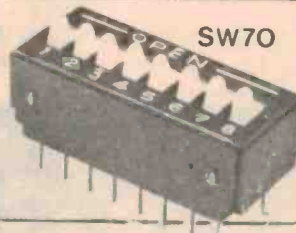

SW70



I.C.1. Instrument Case

House those projects in a professional-looking cabinet

Attractively finished Instrument Case ideal for power supplies, bench test instruments etc.

Size: 130 mm wide, 70 mm high, 175 mm deep

\$3.50

ADDITIONAL POSTAL CHARGES

Order value	Charge
\$5 — \$9.99	Nil
\$10 — \$24.99	\$0.50
\$25 — \$49.99	\$1.50
\$50 — \$99.99	\$2.50
\$100 or more	\$4.00

SWITCHES

SW24	SPST Toggle	65c
SW18	DPDT Slide	35c
SW45	SPST Min. Toggle	\$1.10
SW50	SPST Sub Min. Toggle	75c
SAS-1	Proximity Switch	\$1.90
Complete with magnet		
SW16	Min. Push-on	35c
SW55	Push-on Irrid. end	70c

BATTERY SPECIAL

Japanese 006P (equiv. 216). Here's value and quality **65c**

Japanese AAA **30c ea.** (zinc)

Rechargeable Batteries

Top brand Ni-Cad for radios, tape recorders, and all other projects.

	1-9	10 up
UM3	Penlight	\$1.65 \$1.45
UM2	C size	\$3.50 \$3.20
UM1-3500	D size	\$7.25 \$7.00
NTU-1200		
mA.H	D size	\$3.25 \$3.00

CHARGING UNITS

At last charging units for all sizes of Ni-Cads. for +ve and -ve polarity and regulated charge 6V supply required.

NC1 (fits UM3 batteries)	\$3.40
NC2 (fits UM2 batteries)	\$4.25
NC3 (fits UM1 batteries)	\$4.59

PLUGS AND SOCKETS

P85	Auto Cigar Plugs	60c
P7	3 pin moulded Plug	25c
S7	3 pin moulded Socket	20c
P14	3 pin Din Plug	48c
P15	5 pin Din Plug	55c
S15	5 pin Din Socket	35c
P27	Insulated Phono Plug	25c
P33	2 pin AC Adpt. Plug	35c
S33	2 pin AC Adpt. Socket	70c
P37	2.1 mm DC Adpt. Plug	30c
P38	2.5 mm DC Adpt. Plug	30c
P45	6.5 mm std. Jack Plug	55c
P51	Std. Stereo Jack Plug	55c
P62	3.5 mm Min. Phone Plug	30c

Insulated Battery Clips



CL4

These won't last long. 10 mm wide jaws. black PVC cover only. **Only 12c ea.**

Plastic Mini-Box

Tough little black box ideal for TV games controls, small projects. 40 x 29 x 15 mm. **PB1 LOOK only 18c ea.**

Mylar 50 volt

.01 mfd **SPECIAL 10c** each

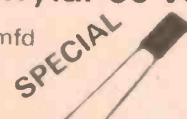

DAVRED ELECTRONICS PTY. LTD.

104-106 King Street Newtown Sydney Australia P.O. Box 317 Newtown, N.S.W. 2042.

THE NEW BREED IN ELECTRONICS SERVICE

Telephone 516-3544

Extractor Tool

P150 D.I.P.

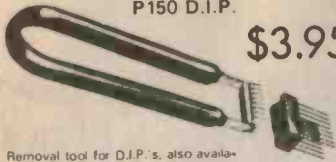

\$3.95

Removal tool for D.I.P.'s, also available, assures easy pull-out of D.I.P.'s without bending leads

Vernier Dial

T502-0-100

Fully calibrated 0-100 dial with 3.75:1 reduction. Ideal for fine adjustments on pots, tuning condensers, etc.

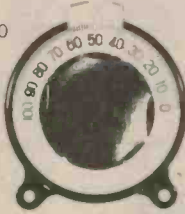

\$4.50

AUTO SPEAKER SELECTOR SWITCH



SW37E

Ideal for use with Kit 60. Play any radio and tape from the same pair of speakers. Suitable for stereo. Includes all instructions.

\$1.95

Quality ALUMINIUM KNOBS now available in a matching set of differing sizes to add a professional appearance to front panels.

ALL 21mm HIGH



KA1
17.5 mm diameter

95c

KA2
20 mm diameter

95c

KA3
23 mm diameter

\$1.10

KA4
26 mm diameter

\$1.15

LOGIC PROBE LP-1

Compact self-powered probe

The Logic Probe LP-1 is a compact, enormously versatile design and test tool for digital applications. By simply connecting the clip leads to the circuit's power supply, setting the logic family switch to the proper position (TTL/DTL or CMOS) and touching the probe tip to the node you're investigating, the LP-1 will give you an instant picture of circuit conditions. Two level detector LED's - H (logic '1') and L (logic '0') and a blinking PULSE detector LED display the signal activity at the node under test. That's all there is to it!

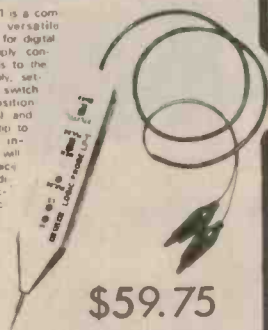

\$59.75

Spun-Aluminium Knobs KE3



Only 80c

Kitset PA Amplifier

Electrokit 38

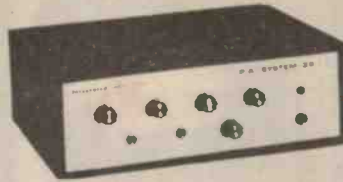

This series of electronic Kitsets are designed to produce a fully operational Public Address (PA) Sound System. Provisions are available for inputs for two dynamic microphones, crystal pickup and auxiliary for radio or tape reproduction, and also an output socket for recording into a tape recorder. Full mixing facilities are provided between all inputs with minimum inter-reaction between the four level controls. An overall tone control is also provided.

INPUT SENSITIVITIES

Channels 1 and 2	5 millivolt	Dynamic	10 50K ohms
Channel 3	250 millivolts	Crystal	1 meg ohm
Channel 4	50 millivolts	Auxiliary	100K ohms

The power amplifier section utilises a single Hybrid Audio Power Amplifier Module for simplicity of construction and highly reliable performance, which enables the PA amplifier to be used for a wide variety of applications including social functions, disco's, outdoor activities, etc.

Four power options are available (into 8 ohm speaker or speaker combinations).

Kit 38A	10 watts utilising SI1010G amplifier module	\$85.50
Kit 38B	20 watts utilising SI1020G amplifier module	\$99.50
Kit 38C	30 watts utilising SI1030G amplifier module	\$109.50
Kit 38D	50 watts utilising SI1050G amplifier module	\$135.75

Approximate sizes: 375 mm wide, 300 mm deep, and 115 mm high

Thank you very much
for the tremendous response

Thanks to the customers who have written in advising that they would not be without their 'New Davred Electronics Catalogue' and how they are amazed at the service they have received from our 'mail Order Department'. They also advise that they are continually using the semi-conductor specification pages, electronic symbol guides, and component technical information scattered throughout.

Not only is it the most up-to-date electronic catalogue of its kind, but also it has one of the largest ranges of 'build your own kitsets' and electronic components, at the most competitive prices in Australia.

Even though 'Electronics Today International' printed more copies of the issue containing the 'Davred Catalogue' you may have found they were sold out, so we suggest that you write now using the coupon below to receive your copy as stocks will definitely not last long.

Opto-electronics

7-SEG LED

.3 in 7 seg. L.E.D. Red.
Common Anode TIL 312P

NOV.-DEC.

ONLY \$1.55

Tantalum — Dipped ± 20%

Miniature bead-type. Resin dipped, dry, solid tantalum capacitors.

Reverse voltage:

0.3 volts max. for wkg. volts up to 6.3 volts
0.5 volts max. for wkg. volts over 6.3 volts

1 mfd 35V	40c	35c	
15 mfd 35 volt	40c	35c	
22 mfd 35 volt	40c	35c	
33 mfd 35 volt	40c	35c	
63 mfd 35 volt	40c	35c	
47 mfd 35 volt	40c	35c	
63 mfd 35 volt	40c	35c	
1 mfd 35 volt	40c	35c	
1.5 mfd 35 volt	40c	35c	
2.2 mfd 35 volt	40c	35c	
3.3 mfd 35 volt	40c	35c	
4.7 mfd 35 volt	40c	35c	
6.8 mfd 35 volt	40c	35c	
10 mfd 25 volt	40c	35c	
15 mfd 25 volt	40c	35c	
22 mfd 20 volt	40c	35c	
33 mfd 16 volt	40c	35c	
47 mfd 6.3 volt	40c	35c	
68 mfd 6.3 volt	65c	60c	
100 mfd 3.15 volt	65c	60c	

New Arrivals!



Vinyl Insulated Staples

Just arrived. New pat.. overseas type.

1/2" 65c per box of 100
3/8" 70c per box of 100

Get Switched On!



Try our new SW60. It will really dress up these projects and kitsets. As used on many of the latest Japanese amplifiers.

\$2.25

Davred Electronics Pty. Ltd
P.O. Box 317, Newtown, Sydney, Australia 2042

I enclose 50c to cover postage. Please send the 1977/8 Electronic Catalogue.

TO: Name

Address

Postcode

DAVRED ELECTRONICS PTY. LTD.

104-106 King Street Newtown Sydney Australia P.O. Box 317 Newtown, N.S.W. 2042.

THE NEW BREED IN ELECTRONICS SERVICE

Telephone 516-3544



**For
transistors
you can
depend
on**

General purpose
Switching
RF
FET's
Power
Photo
Transmitting

**Think
Philips**

153 0191



Electronic
Components
and
Materials

PHILIPS

In conjunction with.....

CB AUSTRALIA

we present

The Great CB Oz 'Let Stalk Strine' contest

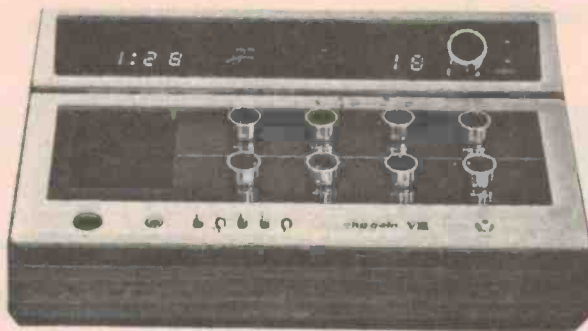

**WIN A
MIGHTY
HY-GAIN
RIG!**

**FIRST PRIZE
VALUE \$358!**
Hy-gain VIII AM/SSB base
station plus a model 560
antenna from OBC
International.

HERE AT CB'Oz, like you'd expect, we spend quite a bit of time on the band, and it's nice to hear people having so much fun. But strike me pink, what's this? It sounds like a bunch of septic tanks* on there! 'Negatory' or 'That's a big 10-4, good buddy!' are just the kind of thing we mean. Why are we trying so hard to sound like Stateside CB'ers? We've even heard phrases like 'Tijuana Taxi' and 'Kojak with a Kodak' recently. Whatever happened to the beaut slang for which we're famous? It's enough to make an ocker's beer flat!

So, we decided to do something about it — the Great CB Oz 'Let Stalk Strine' Contest. This month, in conjunction with OBC International, we're offering a first prize of a Hy-gain VIII base station plus antenna (worth over \$350) for the best original (or unoriginal) example of Ozzie CB slang. The runner-up will receive a Hy-gain V and mobile antenna.

HOW TO ENTER

You can submit as many words or phrases as you like, but please explain them. (It's not that we're thick...) Then add about thirty words or so, telling us what you like about CB and finally, don't forget your name and address. Stuff it all in an envelope and send it to: *Let Stalk Strine Contest, CB Australia, 15 Boundary Street, Rushcutters Bay, NSW 2011.*

The winning entry will be decided on humour and brevity, and will be uniquely Australian.

So get yer pencils and yer wits sharpened! We wanna hear from all youse out there beyond the Black Stump! But most of all, on channel 6, we wanna hear you stalk Strine!

*No offence meant, sport.



**SECOND PRIZE
VALUE \$285!**
Hy-gain V plus Hellcat I antenna

Contest Rules

The contest is open to all persons normally resident in Australia, with the exception of members of the staff (and their relatives) of Modern Magazines (Holdings) Ltd., Gordon and Gotch, Pty Ltd., Rotor Press, OBC International and associated companies. The contest will be judged by the Editor and Publisher of CB Australia. Their decisions will be final and no correspondence will be entered into regarding their decisions. The winners will be advised by telegram

as soon as possible after the contest results have been decided. The names of the winners, together with the winning entries will be published as soon as possible in CB Australia. All entries become the property of CB Australia and may be published in a future issue. The closing date for the contest is December 20th 1977. Entries received within seven days after that date will be accepted provided they are postmarked December 20th or earlier.

**PRIZES DONATED BY
OBC INTERNATIONAL**

ETI data sheet

2102 1K STATIC RAM

THE ELECTRONICS PRESS is full of articles high-lighting the latest advances in memory technology, and we must plead guilty to this ourselves; it's quite fascinating. But we discovered that a lot of hobbyists who are using memories don't have access to good information on the devices available, and are consequently running into problems while trying to get their systems up and running.

Here we attempt to give some real nitty-gritty down-to-earth useful information on memories. The data sheets are not complete by any means, but we hope they contain the most important information. If you require more specs, then check out our list of references. Bear in mind that distributors deal (in the main) with commercial organisations, and cannot possibly afford to supply hobbyists with heaps of expensive books, brochures and data sheets. If you request information from a manufacturer or distributor, please make life easy for them by enclosing a large stamped addressed envelope and payment, if any is required.

The 2102 is, without doubt, the commonest RAM in use today. It is a static 1024-bit (1K x 1) memory and is exceptionally easy to use, as many hobbyists will testify.

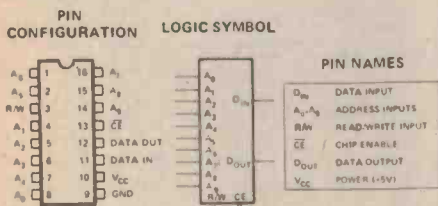

TRUTH TABLE

CE	R/W	D _{IN}	D _{OUT}	MODE
H	X	X	HIGH Z	NOT SELECTED
L	L	L	L	WRITE "0"
L	L	H	H	WRITE "1"
L	H	X	D _{OUT}	READ

BLOCK DIAGRAM

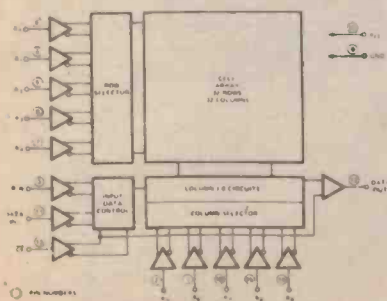

P/N	Standby Pwr. (mW)	Operating Pwr. (mW)	Access (ns)
2102AL-4	35	174	450
2102AL	35	174	350
2102AL-2	42	342	250
2102A-2	---	342	250
2102A	---	289	350
2102A-4	---	289	450
2102A-6	---	289	650

D. C. and Operating Characteristics

T_A = 0°C to 70°C. V_{CC} = 5V ±5% unless otherwise specified.

Symbol	Parameter	2102A, 2102A-4 2102AL, 2102AL-4 Limits			2102A-2, 2102AL-2 Limits			2102A-6 Limits			Unit	Test Conditions
		Min.	Typ. (1)	Max.	Min.	Typ. (1)	Max.	Min.	Typ. (1)	Max.		
I _{LI}	Input Load Current		1	10		1	10		1	10	μA	V _{IN} = 0 to 5.25V
I _{LOH}	Output Leakage Current		1	5		1	5		1	5	μA	CE = 2.0V, V _{OUT} = V _{OH}
I _{LOL}	Output Leakage Current		-1	-10		-1	-10		-1	-10	μA	CE = 2.0V, V _{OUT} = 0.4V
I _{CC}	Power Supply Current		33	Note 2		45	65		33	55	mA	All Inputs = 5.25V, Data Out Open, T _A = 0°C
V _{IL}	Input Low Voltage	-0.5		0.8	-0.5		0.8	-0.5		0.65	V	
V _{IH}	Input High Voltage	2.0		V _{CC}	2.0		V _{CC}	2.2		V _{CC}	V	
V _{OL}	Output Low Voltage			0.4			0.4			0.45	V	I _{OL} = 2.1mA
V _{OH}	Output High Voltage		2.4		2.4			2.2			V	I _{OH} = -100μA

Notes: 1. Typical values are for T_A = 25°C and nominal supply voltage.

2. The maximum I_{CC} value is 55mA for the 2102A and 2102A-4, and 33mA for the 2102AL and 2102AL-4.

A. C. Characteristics T_A = 0°C to 70°C, V_{CC} = 5V ±5% unless otherwise specified

READ CYCLE

Symbol	Parameter	2102A-2, 2102AL-2 Limits (ns)		2102A, 2102AL Limits (ns)		2102A-4, 2102AL-4 Limits (ns)		2102A-6 Limits (ns)	
		Min.	Max.	Min.	Max.	Min.	Max.	Min.	Max.
t _{RC}	Read Cycle	250		350		450		650	
t _A	Access Time		250		350		450		650
t _{CO}	Chip Enable to Output Time		130		180		230		400
t _{OH1}	Previous Read Data Valid with Respect to Address	40		40		40		50	
t _{OH2}	Previous Read Data Valid with Respect to Chip Enable	0		0		0		0	

WRITE CYCLE

t _{WC}	Write Cycle	250		350		450		650	
t _{AW}	Address to Write Setup Time	20		20		20		200	
t _{WP}	Write Pulse Width	180		250		300		400	
t _{WR}	Write Recovery Time	0		0		0		50	
t _{OW}	Data Setup Time	180		250		300		450	
t _{DH}	Data Hold Time	0		0		0		20	
t _{CW}	Chip Enable to Write Setup Time	180		250		300		550	

READ CYCLE

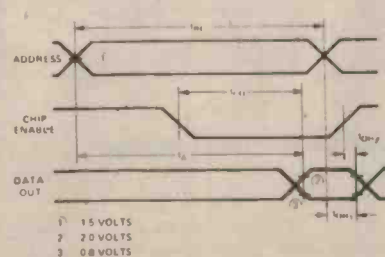

WRITE CYCLE

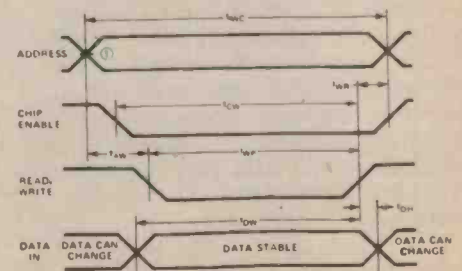

NOTES: 1. Typical values are for T_A = 25°C and nominal supply voltage.
2. This parameter is periodically sampled and is not 100% tested.

ETI data sheet

2107A DYNAMIC RAM

WHEREAS STATIC RAMS basically consist of flip-flops and will retain data for as long as power is applied, with dynamic RAMs, life wasn't meant to be easy. The basic storage element in a dynamic RAM is a capacitor which is subject to leakage and requires data to be read from a cell, amplified and written back again in order to avoid total decay of the data.

Because the memory cell in a dynamic RAM is one transistor and a capacitor as against the six transistors of the static type, the density of dynamic RAMs is around four times higher. Thus, we now have 16 K dynamics, and 64 K types are rumoured to exist in research labs around the world! Anyway, enough of this contemplation of the wonders of LSI, let's get down to brass tacks.

The innards of dynamic RAMs, like statics, are organised into rows and columns, 64 rows x 64 columns for a 4 K RAM, to be precise. All the cells in a single row are refreshed at the same time, and so to fully refresh a 4 K RAM, one need only cycle through all combinations of the low-order six address bits within 2 ms.

The discussion here will be limited to 4 K dynamic RAMs. Although 16 K types are available, they are still fairly expensive and 4 K types are a much more viable proposition for the amateur user. In particular, we shall address our remarks to the 2107B type of RAM, as its cousin the 2104A is slightly more awkward to use. The 2104 is a 16 pin (I) 4 K RAM, and to get all the address lines into the package, the 12 bits are split into two groups of six and then multiplexed over six pins using the RAS (Row Address Strobe) and CAS (Column Address Strobe) pins to tell the chip what's coming in. This makes fairly critical demands on timing, and so poses a few problems for the hobbyist. Whilst single chip refresh controllers are available, which take on the job of multiplexing the address bits, and also include an on-chip refresh counter which cycles through the addresses to be refreshed, these still do not do all the work. There are some tricky design problems associated with using dynamic RAMs, and if you're doing it as a hobby there's no need to make your life difficult.

For these reasons, most hobbyists (and not a few professional designers) will concentrate on the 2107B. This

PIN CONFIGURATION

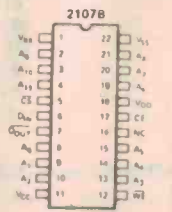

LOGIC SYMBOL

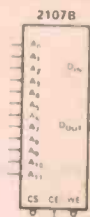

BLOCK DIAGRAM

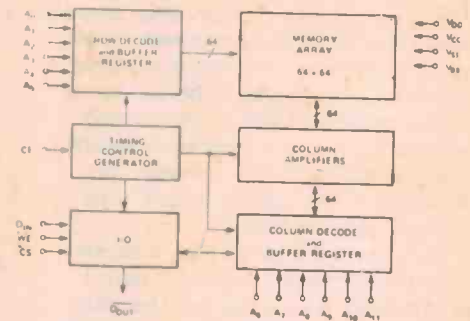

PIN NAMES

A ₀ -A ₁₁	ADDRESS INPUTS*	V _{BB}	POWER (-5V)
CE	CHIP ENABLE	V _{CC}	POWER (+5V)
CS	CHIP SELECT	V _{DD}	POWER (+12V)
D _{IN}	DATA INPUT	V _{SS}	GROUND
D _{OUT}	DATA OUTPUT	WE	WRITE ENABLE
NC	NOT CONNECTED		

*Refresh Address A₀-A₅.

A.C. Characteristics T_A = 0°C to 70°C, V_{DD} = 12V ± 5%, V_{CC} = 5V ± 10%, V_{BB} = -5V ± 5%,

READ, WRITE, AND READ MODIFY/WRITE CYCLE V_{SS} = 0V, unless otherwise noted.

Symbol	Parameter	2107B		2107B-4		2107B-5		Units
		Min.	Max.	Min.	Max.	Min.	Max.	
t _{REF}	Time Between Refresh		2		2		1	ms
t _{AC}	Address to CE Set Up Time	0		0		10		ns
t _{AH}	Address Hold Time	100		100		100		ns
t _{CC}	CE Off Time	130		130		200		ns

READ CYCLE

Symbol	Parameter	2107B		2107B-4		2107B-5		Units
		Min.	Max.	Min.	Max.	Min.	Max.	
t _{CY}	Cycle Time	400		470		590		ns
t _{CE}	CE On Time	230	4000	300	4000	350	3000	ns
t _{CO}	CE Output Delay		180		250		280	ns
t _{ACC}	Address to Output Access		200		270		300	ns

WRITE CYCLE

Symbol	Parameter	2107B		2107B-4		2107B-5		Units
		Min.	Max.	Min.	Max.	Min.	Max.	
t _{CY}	Cycle Time	400		470		590		ns
t _{CE}	CE On Time	230	4000	300	4000	350	3000	ns
t _{WP}	WE Pulse Width		50		50		75	ns
t _{WW}	WE Delay		75		75		75	ns

D.C. and Operating Characteristics

T_A = 0°C to 70°C, V_{DD} = +12V ± 5%, V_{CC} = +5V ± 10%, V_{BB}⁽¹⁾ = -5V ± 5%, V_{SS} = 0V, unless otherwise noted.

Symbol	Parameter	Limits			Unit	Conditions
		Min.	Typ. (2)	Max.		
V _{IL}	Input Low Voltage	-1.0		0.6	V	t _T = 20ns, V _{ILC} = +1.0V
V _{IH}	Input High Voltage	2.4		V _{CC} +1	V	t _T = 20ns
V _{ILC}	CE Input Low Voltage	-1.0		+1.0	V	
V _{IHC}	CE Input High Voltage	V _{DD} -1		V _{DD} +1	V	
V _{OL}	Output Low Voltage	0.0		0.45	V	I _{OL} = 2.0mA
V _{OH}	Output High Voltage	2.4		V _{CC}	V	I _{OH} = -2.0mA

Absolute Maximum Ratings*

Temperature Under Bias	0°C to 70°C
Storage Temperature	-65°C to +150°C
All Input or Output Voltages with Respect to the most Negative Supply Voltage, V _{BB}	+25V to -0.3V
Supply Voltages V _{DD} , V _{CC} , and V _{SS} with Respect to V _{BB}	+20V to -0.3V
Power Dissipation	1.25W

chip is in a 22 pin package, so you can't get so many of them into the same space compared with the 2104A, but because it uses less interface and control circuitry, the real estate difference is not that great, and the timing problems aren't so critical.

The first problem with these chips is that they are not fully TTL-compatible as is the 2102, for example. The chip enable input of the 2107B requires a high-level signal of at least 11 V to operate, but this can easily be got from a special driver chip, the Intel 3245, which also provides some selection logic.

Given a 3245 and a handful of external logic, it looks as though the 2107B would be a good choice for hobbyists using the Z-80. The 2107 does not require address strobing, and consequently could run directly off the data bus, with the Z-80 supplying the refresh logic (the Z-80 has an internal refresh counter which is output while the processor decodes instructions).

If you are designing your own memory system, and your processor is not a Z-80, you will have to decide on one of three refresh schemes: Asynchronous, which insists on refresh occurring, even if this interrupts the processor; Synchronous, which runs 'in phase' with the processor, supplying refresh at times when the processor is not accessing memory; and Semi-synchronous, which is a combination of these schemes. Your decision will be dependent upon the circuit complexity, processor speed and overhead, and a number of other considerations.

NORMALLY, LOGIC GATE outputs have two states, 1 and 0, (in TTL, +5 V and 0 V). Three-state logic devices, such as some memories and buffers, have an input which can be used to force the output to a high impedance condition, effectively disconnecting the device so that it does not interfere with the operation of other devices connected to that point.

The idea of three-state control (TSC) is central to systems which use a single data bus to connect the processor to several memory chips. When the processor reads from a memory location, only the memory concerned is enabled and outputs data onto the bus; all other memories and devices on the bus should be in the high-impedance state.

Care should be taken to avoid situations where two or more chip outputs are enabled at the same time; this could happen in worst-case system timing errors or just plain wrongly-

Read and Refresh Cycle ^[1]

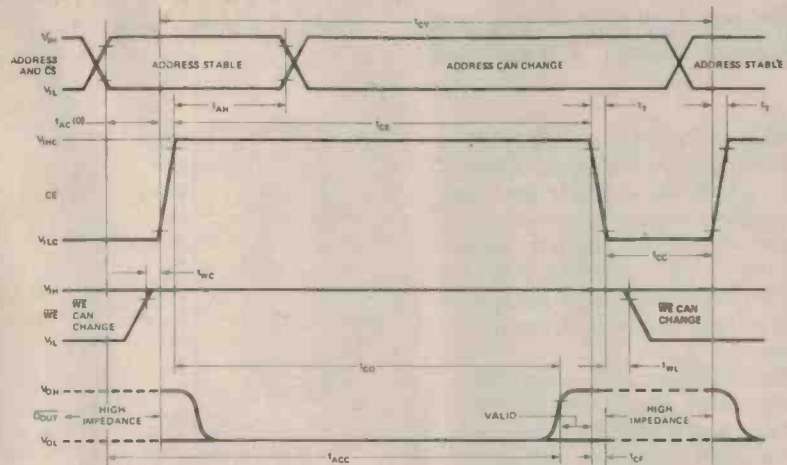

The second problem you will face in using dynamic RAMs is getting your memory system to work. It is a good idea to have some static RAM in the system so that the processor can be checked out without having to worry too much about the memory. Once this is done, attention can be turned to the dynamic memories. In general, dynamic memory is a good choice for expanding your memory size, but not for starting a system.

There is obviously much more we could say about dynamic RAMs that we just haven't got the space to cover here. If you are in the market for large amounts of memory, then check out some of the references for further information. Alternatively, dynamic RAM kits are starting to appear, such as the new Econoram II's, if you don't want to design from scratch.

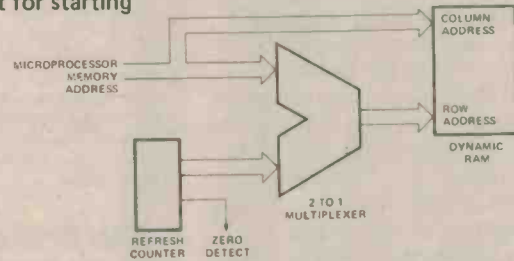

designed logic. The output buffers of a typical MOS memory chip are shown in Fig. 1. Should device 1 and device 2 both be enabled at the same time and be outputting different data (e.g. Q1 and

Q4 both on) it can be seen that this virtually puts a short across the supply. At best this is likely to cause an incorrect read, and may possibly destroy one or both devices.

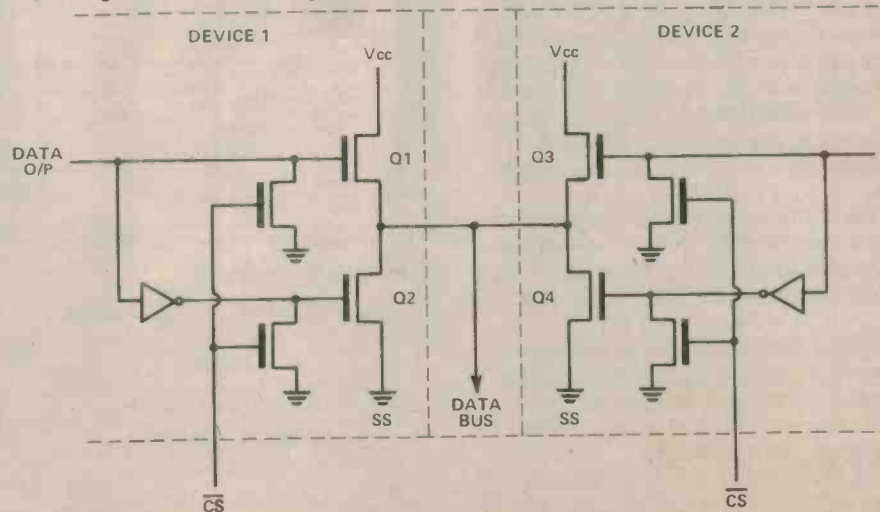

ETI data sheet

2708 EPROM

The 2708 is a static 1K x 8 EPROM (Erasable Programmable Read Only Memory), which has a quartz window on top to allow erasure under ultraviolet light. The 2708 requires three supplies, +5 V, -5 V and +12 V in normal operation, and a 26 V pulse on the Program pin is required during programming.

The Data I/O pins (O1 - O8) are three-state; when pin 20, the CS/WE pin is at V_{IL} (0 V), the chip is selected for normal read operation but when pin 20 is at V_{IH} (3 V min) the data outputs are in the high impedance state. The CS/WE pin has a third function - when it is at V_{IH} the device is Write Enabled and ready for programming.

As this is a 1 Kbyte device it has 10 address pins (A0 - A9). For full address decoding, this leaves six bits to be utilised for the CS input, a requirement that is easily met by the use of (say) a 74LS154.

Programming the 2708 is straightforward, but not easy. Commercial users get round this by buying a sophisticated PROM programmer (such as those made by Data I/O) or by having their distributor supply the EPROMs pre-programmed - many distributors now offer this service. This doesn't help most hobbyists, who are unable to supply paper tape in the correct format to enable an EPROM to be blown.

To program a 2708, a circuit is required to do the following: put +12 V on CS/WE (pin 20), apply data and address to the 2708 and then, once the address and data lines have stabilized, pulse the PROGRAM pin to 26 V for between 0.1 ms and 1.0 ms. The address input can then be incremented, the data associated with that location presented and the PROGRAM pin pulsed. The sequence is repeated for all 1024 addresses; this is defined as one program loop.

This entire sequence is then repeated at least one hundred times. The number of program loops, N , is a function of the program pulse width T_{PW} , such that:

$$N \times T_{PW} \geq 100 \text{ ms}$$

It is not permitted to apply N program pulses to an address and then change to the next address and apply N program pulses. There must be N successive loops through all 1024 addresses.

Fig. 3 illustrates a circuit recommended by Intel for a typical program

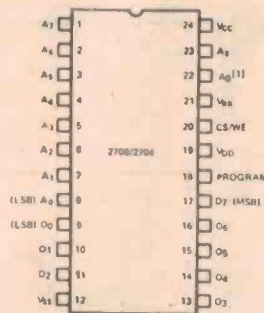

PIN NAMES

A ₀ -A ₉	ADDRESS INPUTS
O ₁ -O ₇	DATA OUTPUTS/INPUTS
CS/WE	CHIP SELECT/WRITE ENABLE INPUT

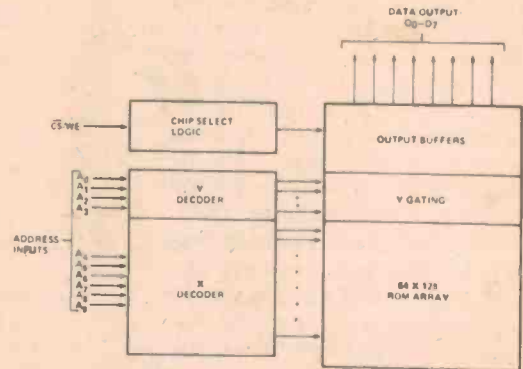

PIN CONNECTION DURING READ OR PROGRAM

MODE	PIN NUMBER									
	DATA I/O		ADDRESS INPUTS		V _{SS}	PROGRAM	V _{DD}	CS/WE	V _{BB}	V _{CC}
READ	O ₁ -O ₇	I ₁ -I ₇	A ₀ -A ₉	A ₀ -A ₉	12	20	19	21	24	
DESELECT	HIGH IMPEDANCE	HIGH IMPEDANCE	DON'T CARE	DON'T CARE		GND	GND	+12	V _{SS}	
PROGRAM	O ₁ -O ₇	I ₁ -I ₇	A ₀ -A ₉	A ₀ -A ₉		GND	PULSED 26V	+12	V _{BB}	

Absolute Maximum Ratings

Temperature Under Bias	-25°C to +85°C
Storage Temperature	-65°C to +125°C
V _{DD} With Respect to V _{BB}	+20V to -0.3V
V _{CC} and V _{SS} With Respect to V _{BB}	+15V to -0.3V
All Input or Output Voltages With Respect to V _{BB} During Read	+15V to -0.3V
CS/WE Input With Respect to V _{BB} During Programming	+20V to -0.3V
Program Input With Respect to V _{BB}	+35V to -0.3V
Power Dissipation	1.5W

READ OPERATION

D.C. and Operating Characteristics

$T_A = 0^\circ\text{C}$ to 70°C , $V_{CC} = +5V \pm 5\%$, $V_{DD} = +12V \pm 5\%$, $V_{BB}^{(1)} = -5V \pm 5\%$, $V_{SS} = 0V$, unless otherwise noted.

Symbol	Parameter	Min.	Typ. ^[2]	Max.	Unit	Conditions
I_{LI}	Address and Chip Select Input Sink Current		1	10	μA	$V_{IN} = 5.25V$ or $V_{IN} = V_{IL}$
I_{LO}	Output Leakage Current		1	10	μA	$V_{OUT} = 5.5V$, CS/WE = 5V
$I_{DD}^{[3]}$	V _{DD} Supply Current		50	65	mA	Worst Case Supply Currents:
$I_{CC}^{[3]}$	V _{CC} Supply Current		6	10	mA	All Inputs High
$I_{BB}^{[3]}$	V _{BB} Supply Current		30	45	mA	CS/WE = 5V; $T_A = 0^\circ\text{C}$
V_{IL}	Input Low Voltage	V_{SS}		0.65	V	
V_{IH}	Input High Voltage	3.0		$V_{CC} + 1$	V	
V_{OL}	Output Low Voltage			0.45	V	$I_{OL} = 1.6\text{mA}$
V_{OH1}	Output High Voltage	3.7			V	$I_{OH} = -100\mu\text{A}$
V_{OH2}	Output High Voltage	2.4			V	$I_{OH} = -1\text{mA}$
P_D	Power Dissipation			800	mW	$T_A = 70^\circ\text{C}$

NOTES: 1. V_{BB} must be applied prior to V_{CC} and V_{DD}. V_{BB} must also be the last power supply switched off.

A. C. Characteristics

$T_A = 0^\circ\text{C}$ to 70°C , $V_{CC} = +5V \pm 5\%$, $V_{DD} = +12V \pm 5\%$, $V_{BB} = -5V \pm 5\%$, $V_{SS} = 0V$, unless otherwise noted.

Symbol	Parameter	2708-1 Limits			2708 Limits			Units
		Min.	Typ.	Max.	Min.	Typ.	Max.	
t_{ACC}	Address to Output Delay		280	350		280	450	ns
t_{CO}	Chip Select to Output Delay		60	120		60	120	ns
t_{DF}	Chip Deselect to Output Float	0		120	0		120	ns
t_{OH}	Address to Output Hold	0			0			ns

pulse driver. Beware! A single transistor from the +26 V line with an emitter pull-down resistor will not work, as it cannot get the output down to within 1 V of V_{SS} .

To erase the 2708, it should be exposed to ultra-violet light of a wavelength shorter than approximately 4000 Angstroms. Warning: sunlight and certain types of fluorescent lighting have wavelengths in the range 3000 - 4000 Angstroms. Intel's data shows that continuous exposure to room level fluorescent lighting could erase a typical 2708 in approximately 3 years, while direct sunlight will take approximately 1 week to do the job. While this may be one way of erasing your 2708s, you generally don't want it to happen, and so an opaque label should be stuck over the quartz window.

The best, and recommended, way of erasing a 2708 is to expose it to short-wave ultra-violet light which has a wavelength of 2537 Angstroms. The integrated dose (i.e. UV intensity x exposure time) for erasure should be a minimum of 15 W-sec/cm². The erasure time with this dosage is approximately 15 to 20 minutes using an ultra-violet lamp with a 12000 μ W/cm² power rating. The 2708 should be placed within 1 inch of the lamp during erasure. If you are already using a UV lamp to process Scotchcal, then you're well equipped to handle 2708's. If you're not, then it's time you got a UV lamp anyway - it's good for the skin, you know!

CAPACITANCE⁽¹⁾ $T_A = 25^\circ\text{C}$, $f = 1\text{ MHz}$

Symbol	Parameter	Typ.	Max.	Unlt.	Conditions
C _{IN}	Input Capacitance	4	6	pF	V _{IN} = 0V
C _{OUT}	Output Capacitance	8	12	pF	V _{OUT} = 0V

Note: 1. This parameter is periodically sampled and is not 100% tested.

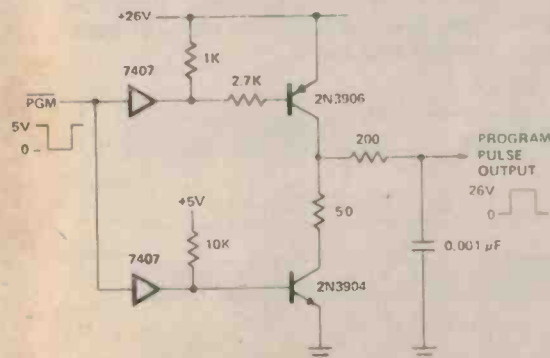

Waveforms

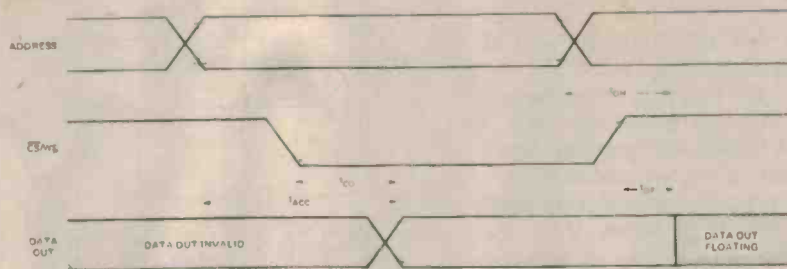

PROGRAM CHARACTERISTICS

$T_A = 25^\circ\text{C}$, $V_{CC} = 5\text{V} \pm 5\%$, $V_{DD} = +12\text{V} \pm 5\%$, $V_{BB} = -5\text{V} \pm 5\%$, $V_{SS} = 0\text{V}$, Unless Otherwise Noted.

D.C. Programming Characteristics

Symbol	Parameter	Min.	Typ.	Max.	Units	Test Conditions
I _{LI}	Address and CS/WE Input Sink Current			10	μA	V _{IN} = 5.25V
I _{IPL}	Program Pulse Source Current			3	mA	
I _{IPH}	Program Pulse Sink Current			20	mA	
I _{DD}	V _{DD} Supply Current		50	65	mA	Worst Case Supply Currents: All Inputs High CS/WE = 5V; T _A = 0°C
I _{CC}	V _{CC} Supply Current		6	10	mA	
I _{BB}	V _{BB} Supply Current		30	45	mA	
V _{IL}	Input Low Level (except Program)	V _{SS}		0.65	V	
V _{IH}	Input High Level for all Addresses and Data	3.0		V _{CC} + 1	V	
V _{IHW}	CS/WE Input High Level	11.4		12.6	V	Referenced to V _{SS}
V _{IHP}	Program Pulse High Level	25		27	V	Referenced to V _{SS}
V _{IPL}	Program Pulse Low Level	V _{SS}		1	V	V _{IHP} - V _{IPL} = 25V min.

A.C. Programming Characteristics

Symbol	Parameter	Min.	Typ.	Max.	Units
t _{AS}	Address Setup Time	10			μs
t _{CS}	CS/WE Setup Time	10			μs
t _{DS}	Data Setup Time	10			μs
t _{AH}	Address Hold Time	1			μs
t _{CH}	CS/WE Hold Time	5			μs
t _{DH}	Data Hold Time	1			μs

Programming Waveforms

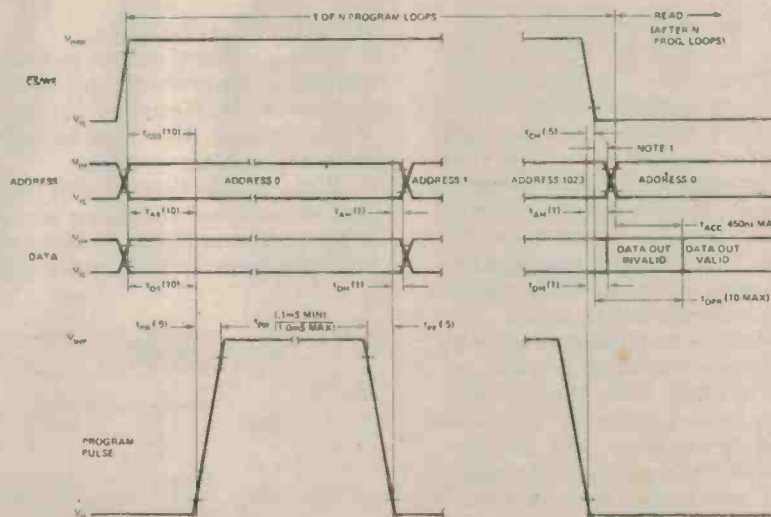

NOTE 1: THE CS/WE TRANSITION MUST OCCUR AFTER THE PROGRAM PULSE TRANSITION AND BEFORE THE ADDRESS TRANSITION.
NOTE 2: NUMBERS IN () INDICATE MINIMUM TIMING IN μs UNLESS OTHERWISE SPECIFIED.

ETI data sheet

DECODING

PROBABLY THE COMMONEST size of memory chip in use today is 1 K x 1, or in ROM, 1 K x 8. The 2102, for example, is exceptionally easy to use from the point of view of address decoding. Ten bits of the address bus are decoded by the chip itself, leaving only six bits from which to derive the CE signal.

If full address decoding is not required, for example, in small dedicated systems, then it is possible to invert the individual high order bits of the address bus and use them directly as chip selects. This will allow the use of up to 6 K of 2102s or a combination of RAM/ROM (less if you use memory-mapped I/O).

Beware! This method can lead to bus contentions. For example, when a 6800 restarts, it looks for its restart vector in locations FFFE and FFFF, thus setting all those high-order address bits high simultaneously. This will enable all of your RAM simultaneously, leading to all kinds of nasties; see the section on three-state control.

From the hobbyist's point of view, and in any general-purpose or large system, it is better to fully decode the address bus. As we have said, the 2102 and the 2708 decode 10 bits, leaving six to be decoded by external circuitry. The most common, and probably the easiest way of doing this is to use the 74154 (or 74LS154) 4-line-to-16-line decoder.

SPEED

OFTEN IN ADVERTISEMENTS, memories are described as 'prime, high speed, low power'. The advantages of low power consumption are obvious — less expensive and bulky power supplies, cooler on-card regulators, etc. But the advantages of using high speed memories are not quite so evident — bear in mind that most hobby computers operate at speeds far in excess of human reaction times, making increases in speed of only marginal, indeed dubious, value.

Let's look at what happens when an 8080-type microprocessor reads a memory location. First, the processor issues the memory address on the address bus. This settles down, and around 100 ns later the memory read strobe (MEMR) goes active, requesting the selected memory location to place its contents on the data bus. Roughly 350 ns after that, the processor accepts

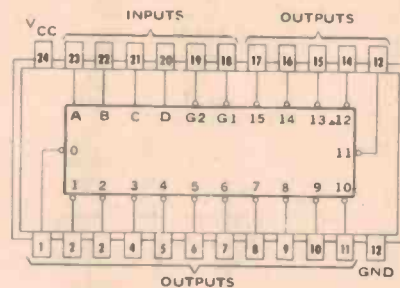

Fig. 1. The 74(LS)154 pinout.

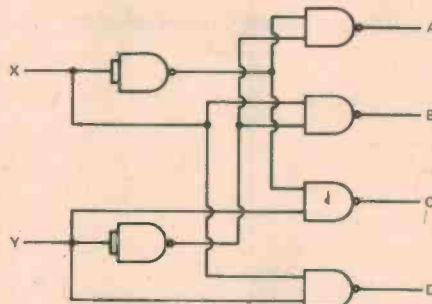

Fig. 3. This circuit can be used to decode two bits to one of four.

The 74154 will decode a 4-bit input to one of 16 mutually exclusive outputs. The outputs are normally high and go low when selected, thus matching the CE and CS inputs of most memories. For example, if the input code is 1010, output 10 will go low.

We have said that the '154 decodes 4 bits; how do you cope with the re-

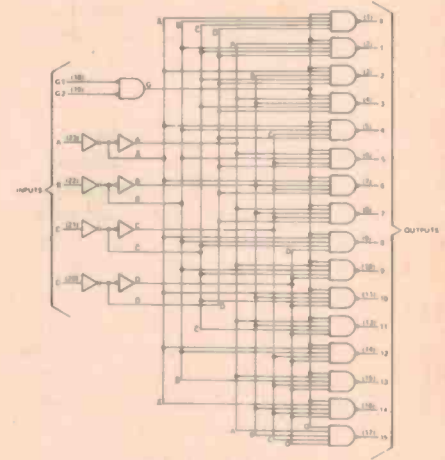

Fig. 2. The internal circuit of the '154.

maining two? Well, the '154 has two enable inputs, G1 and G2, which can be used, in conjunction with a couple of NAND gates, to decode A14 and A15. By slightly increasing the complexity of this bit of circuitry, it is possible to decode the read and write strobe signals of your computer to ensure correct timing in operation.

the data that is on the bus.

If the memory cannot respond in that time, the processor can be forced to enter a WAIT state by pulling its READY input. As long as READY is false, the processor will wait.

It can be seen that the time between the address lines stabilizing and the processor accepting data is the maximum time the memory system (including

external decoding and buffering) has to respond. The important parameter of a memory from this point of view is the access time, t_A , which is the time between a stable address being presented to the memory and data being available at the output. This time, plus any delays due to decoding/buffering, should be less than the processor required read access time t_{ACA} .

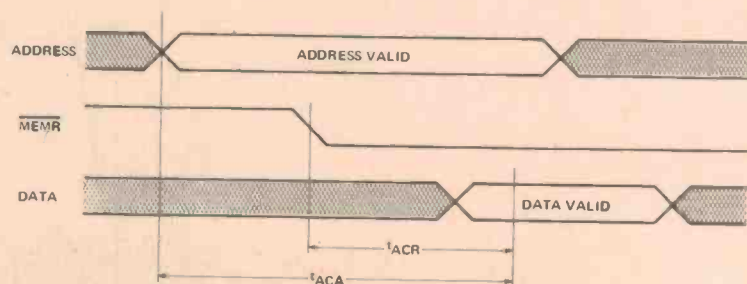



naim audio suggest

L.O.I.

a new amplifier measurement?

“L.o.I. or, Loss of Information mechanisms in amplifier circuits seem to account for most variations between one audio amplifier and another. To improve the quality of the sound it is necessary not only to try to eliminate the causes of L.o.I. but also to ensure that where L.o.I. does occur (e.g. clipping) it is limited to the shortest possible time.”

— J. VEREKER of Naim Audio

DESIGN CRITERIA OF NAIM POWER AMPLIFIERS

The purpose of an audio amplifier is to drive loudspeakers without loss of musical information. In our view many commonly accepted parameters have little to do with loss of information and in some instances, such as the pursuit of large bandwidths or low distortion, unqualified acceptance of them can actually lead to the creation of mechanisms that cause loss of information. Dynamic output impedance, open loop bandwidth, slew rate, propagation delay and stability margins are only some of the many other factors to which we attach importance, and which must all be brought into positive balance.

To this end our amplifiers not only achieve low harmonic distortion, low noise and wide power bandwidth, but also have a constant dynamic output impedance over the whole audio bandwidth. They are able to drive reactive loads with phase angles of -90° to $+90^{\circ}$ without any appreciable change in distortion, and are not sensitive to the absolute impedance of the load.



NAP-160 & 250

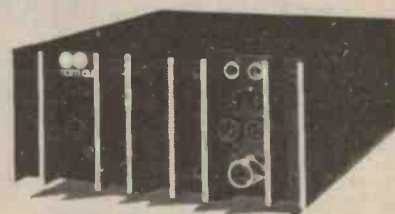

NAP-120



NAC-32



NAC-22

DESIGN CRITERIA ON NAIM CONTROL UNITS

We consider the most important circuit in a pre-amplifier to be the phono input stage. This must be designed to accept the output from a pick-up cartridge without loss of information. To achieve this it is necessary to consider the total output of the cartridge and also the effect of its impedance on the circuit. In our pre-amplifiers we have employed a new concept. The initial pre-amplifier stage is linear with a small gain, equalisation being divided into two parts. Complete theoretical and practical stability is attained, with a much wider open loop bandwidth than is normally possible. The resultant overload capability is maintained over the whole audio bandwidth.

Our experience has shown that tone controls and filters do not improve the musical performance with a system of this calibre, even when playing old and dirty records, due partly to the excellent stability and overload margin of the pre-amplifier and partly to its outstanding transient handling capability.

All Naim Audio equipment has a frequency response to within 1 dB between 20Hz and 20kHz.

All distortions of whatever type including noise, at any audio frequency and at any power level, up to rated levels, will remain below one thousandth part of the required signal.

Now you've read Naim's philosophy on their approach to amplifier design, but you're really no better off. Right?!

The only way to really decide if in fact Naim does lose less information than any other amplifier and does sound more life-like, is to hear it yourself.

Write to us for a personal invitation to one of our carefully selected dealers in your state. He sells Naim because he, like us, uses only one reference point when judging reproduction of music, that is, its resemblance to live music, and isn't that what it's really all about?

Sole Australian Agents

arena

DISTRIBUTORS

Australasia Pty. Limited
273 Hay St. East, Perth 6000.
25 9993 Telex 93299.

SUPER CLOCK FROM TECHNIPARTS

New from National



MA1010A

- ★ Same as Popular MA1002B except with .84" Digits
- ★ 50/60HZ Operation
- ★ Price \$23.50 Post Free
- ★ Transformer JT197 \$6.50 Post Free

TECHNIPARTS LOW COST CRYSTAL TIMEBASE KIT

- ★ Using National MM5369 3.58 MHZ to 60HZ Divider
- ★ Includes PCB, Crystal, Divider, Trimmer etc.
- ★ PCB has allowance for $\frac{1}{6}$ and $\frac{1}{10}$ Counters also TTL buffered output = 3 IC'S.
- ★ Great to use with Clock Modules, Timers etc.
- ★ Power Supply 3-15VDC

PRICE: \$6.75 Post Free
1HZ + 10HZ + TTL Out Option \$3.20 extra

NATIONAL MA1003 CAR CLOCK MODULE

- ★ 12VDC operation
- ★ Maintains Timekeeping Down to 5VDC
- ★ Display Blanking with Ignition off Draws 5MA.
- ★ Draws 100MA with Ignition on.
- ★ Just add 3 switches + DC 12V.
- ★ On board 2MHZ crystal.

PRICE \$32.00 Post Free.



Woolworths Arcade,
95 Latrobe Terrace,
PADDINGTON. 4066
P.O. Box 118,
PADDINGTON. 4064

Ph: Brisbane (07) 36 1474
Trading Hours (8.30am - 5.00pm
Mon - Fri., 8.00am - 11.15am Sat.)

ELECTROMART

P.O. BOX 36, HIGHBURY S.A. 5089

RESISTORS

	1 up	100 up
¼W 10 ohms — 10M	4c	3c
½W 2.2 ohms 4M7	4c	3.5c
5w .33 ohms 4K7	37c	

	1up	10up
BC 107, 108, 109	26	23
BC 177, 178, 179	33	29
BD 139, 140	95	90
2N3055		
(includes mounting kit)	1.50	1.20
MJ2955	2.40	2.10
2N2905	1.00	90
2N2906	60	55
2N2222 (switching trans)	75	70
C106DI (400v 4A S C R)	1.65	

DIODES

	1up	10 up
IN914	12	10
OA91	24	19
1N4002	15	12
1N4004	20	15
1N4007	30	25

INTEGRATED CIRCUITS

	1up	10up
LM555CN	85	80
LM741CN	60	55
LM301 AN	75	70
LM 3909	1.50	1.40
LM 340-T (state voltage)	2.25	2.00

BRIDGES

	1up
200 V 1.5A W02	1.03
400 V 1.5A W04	1.07
100V 10A	4.54
100V 30A	6.65

LIGHT EMITTING DIODES

	1up
RED 24 MCD	2.15
GREEN 30MCD	1.07
RED 6 MCD	1.95
YELLOW 7 MCD	.75

TRIMPOTS

	1up
100,220,470 ohm, 1 k	
2k2, 10k, 22k, 47k 100k	
220k,470k, 1M	
Carbon 1w Hor or Vert	25
Cermet hor only	67

POTENTIOMETER

VCU (single)	70
VGU (ranged)	1.50

CAPACITORS poly. 100 V

1000 pF — .033	15
.039 — .056	17
.068 — .1	22
.12 — .18	25
.22 — .33	36
.39 — .56	48
.68 — 1.0	90
1.2 — 1.8	1.35
2.2 — 3.3	2.00

CERAMIC PHILIPS 100V

1.8 — 47pF NPO	10
56 — 120pF NPO	13
150 — 330pF N750	14
390 — 1800pF H1 K	09
2200 — 4700pF H1 K	14
1000 — 10000pF 40v H1 K	09

NICADS

	PROFESSIONAL GRADE
AA 450m AH	2.99
C 1.5 AH	6.50
D 3 S AH	8.50
Button 225 m AH	2.21
Button 500 m AH	2.88

CASSETTES

PROFESSIONAL GRADE	
C90 Low noise	only 2.60

POST & PACKING - 60c

SEND S.A.E FOR QUALITY PRICES OR COMPLETE CATALOGUE

DIGGERMAN ELECTRONICS

P.O. Box 33, Coramba, N.S.W. 2466

Keep electronics a hobby and not a luxury, compare our prices and buy from us. Same day turnaround service. Quality assured.

ELECTROCAPS

CAP	16V	25V	50V
.47 uF	5c	6c	7c
1 uF	5c	6c	8c
2.2 uF	5c	6c	8c
3.3 uF	6c	6c	8c
4.7 uF	6c	6c	8c
10 uF	6c	7c	8c
22 uF	7c	7c	8c
33 uF	8c	9c	9c
47 uF	9c	10c	10c
100 uF	10c	12c	14c
220 uF	11c	13c	—
470 uF	16c	22c	—
1000 uF	22c	35c	—

Axials price list SAE

T03 KITS MOUNTING

10 for \$1 or \$4 box of 50
Generic kit includes mica, screws, nuts, washers, tag, nylon bushes.
LEDs: 28c ea. big red & clip.
Clip alone 3c
Zeners: 15c ea.
400mW 5%
E24. 3V to 33V

POLYESTER FILM CAPS

E12 10% 100V
All values .001 to .01 — 7c ea.
.01 — 7c .1 — 13c
.012 — 8c .12 — 14c
.015 — 8c .15 — 14c
.018 — 8c .18 — 14c
.022 — 8c .22 — 16c
.027 — 8c .27 — 16c
.033 — 8c .33 — 18c
.039 — 9c .39 — 19c
.047 — 9c .47 — 19c
.056 — 9c All values
.068 — 10c values
.082 — 10c in uF

Specials: Economy LEDs — big red with clip — 20c ea. \$1.80/10, \$15/100.

Electrospecial: Axial 1000uF/16V — 20c ea. plus 2c ea. extra postage.

Resistors: 2c ea. ¼W carb film 5% E12 values 1 Ohm to 1M \$1.80/100 same. Also ½W: 3c ea. metal glaze 5% E12 2.2 Ohm to 470K only. \$2.50/100 same.

SCR'S

0.8A 30V C103Y — 35c	2A 400V ESP240 — 65c	DIODES:
0.8A 200V C103B — 60c	2A 400V SC141D — \$1.30	1N4001 — 7c (1A 50V)
4A 30V C106V1 — 40c	10A 400V SC146D — \$1.50	1N4002 — 8c (1A 100V)
4A 400V C106D1 — 75c	25A 400V SC260D — \$2.50	1N4004 — 9c (1A 400V)
8A 400V C122D — \$1.05	DIAC ST2 — 35c	1N4007 — 12c (1A 1000V)
8A 500V C122E — \$1.20	Chart to identify leads	6c. \$4.50/100
25A 400V C37D — \$2.50	plus trigger info. — 15c	\$38/1000

Potentiometers: 50c ea. rotary carbon sing. gang — log or lin: 1K, 5K, 10K, 25K, 50K, 100K, 250K, 500K, 1M, 2M (metal shafts).
Trim Pots: 17c ea. — 10 mm .1W horz. or vert: 100 Ohm, 250 Ohm, 500 Ohm, 1K, 2K, 5K, 10K, 25K, 50K, 100K, 250K, 500K, 1M, 2M

All goods top quality & new. No minimum order. One P/P charge of 40c regardless of quantity. Advert current 3 months for benefit of late readers. Our prices a standard by which to judge others — if you are paying more you are supporting profiteers.

SENCORE

+199.9

A NEW BREED OF
DIGITAL MULTIMETERS

With exclusive features backed by 25 years of all American craftsmanship!

SPECIFICATION:

DC VOLTAGE		DC/AC CURRENT	
Range	0 to $\pm 2,20,200,1000V$	Range	0 to 2,20,200,2000mA (Total avg sum DC \pm AC)
Accuracy	0.5% ± 1 digit	Accuracy	DC: 1% ± 1 digit AC: 1.5% ± 2 digit
Input Impedance	15 Megohm/60pF		
AC VOLTAGE		HI-LO POWER OHMS	
Range	0 to 2,20,200,1000V	Range	0 to 200, 2K, 20K (Lo) 200K, 2000K, 20M (Hi)
Accuracy	1.0% ± 2 digits	Accuracy	1% ± 2 digit
Input Impedance	15 Megohm/60pF	Max Test Voltage	Lo: 200m Hi: 2V
Frequency Response	40Hz-1 KHz (± 1 dB)		
SPECIAL FEATURES		GENERAL	
<ul style="list-style-type: none"> DCV x 2 button in probe extends DCV range to 2000V "PUSH ON" button in probe to turn unit on only during measurement Automatic negative sign. Decimal. Overrange. 		<ul style="list-style-type: none"> 3 1/2 digit 0.3" L.E.D. 1000V (DC + peak) any range Cyclocac case; tilt stand 6" x 4" x 1 1/4"; 1.1 lb. Six 1 1/2V "AA" cells or with PA202 for AC/rechargeable operation 	
		Mechanical	
		Size (HWD) Weight	
		Power	



DVM 36

LAB ACCURATE
POCKET
PORTABLE

3 1/2 DIGIT
DIRECT READOUT
.5% DCV ACCURACY
POCKET PORTABLE
DIGITAL MULTIMETER

THAT FITS
EVERY BUDGET

\$149* (P & P \$3.00)

* Add Sales Tax
if applicable

Available from:

Room 208, 661 George St., Sydney - C.B.C. Bank Bldg., Haymarket,

EMONA ENTERPRISES, Ph 212 4815 (A.H. 399 9061) Mail Orders: Box 188, COOGEE, N.S.W. 2034.

NEW MODEL, 3-30 MHz BI-LINEAR AMPLIFIER

HF-3-100L2

Frequency Range 3-30 MHz

Input Power: 10W Nom, 5-20 W PEP range

Output Power: 100W Nom $\pm 1/2$ dB across band 200-250W PEP output

Input Impedance: 50 Ω nom, adjustable to match exciter range under 2:1 across band

Output Impedance: 50 Ω nom, up to 3:1 VSWR acceptable with little degradation

Current Drain: 16A nom. 20 A supply recommended at 13.6 VDC

Power Supply: 13.6 VDC recommended for best results, 11.14 VDC acceptable positive or negative ground

Pre-amp: 18 dB nom. gain across entire HF band, 15 dB typ at 50 MHz, 3-4 dB NF

Size: 19.1 x 16.5 x 8.9 cm wt 1 1/2 Kg



DEALERS ENQUIRIES WELCOME

SOLE AUSTRALIAN DISTRIBUTORS FOR SCS LINE OF LINEAR AMPLIFIERS



EMONA electronics

PHONE 2124815

P.O. BOX K21,

HAYMARKET, N.S.W. 2000

7 DIGIT FREQUENCY METER KIT



COMPLETE KITS:
20 MHz \$82.00
200 MHz \$89.50

Prices include sales tax, postage extra.

'Electronics Australia' March 1977 design High Stability Crystal (30 P.P.M. -10°C to +60°C) in cold-welded HC18/U holder.

ALL high quality components (National, Fairchild, etc.) Fibreglass P.C. Boards with component overlay 'Polaroid' front panel, L.E.D. readouts, 'BNC' socket standard - 'UHF' socket optional. Pre-drilled aluminium chassis with black 'Marvplate' cover.

240 volt operation - provision for 12 Volt operation. Instructions included.

Assembled units available - \$40 extra. Postage N.S.W. \$2. Interstate \$4. Registration \$2, "Comet" - Sydney \$2 insured. 'T.N.T.' Air-road courier, insured - Separate components (post free) \$6 anywhere in Australia. Crystal \$8, 95H90 prescaler \$9.50.

J.R. COMPONENTS

P.O. Box 128, Eastwood, N.S.W. 2122 Ph: (02) 853976.



The leading TV channels use
Tektronix instruments to help
maintain a quality picture . . .

NOW, FROM
TEKTRONIX . . .

TELEQUIPMENT
MODEL D61A

low cost oscilloscope

for TV servicing, audio, general
electronics, lab or classroom

Probably the most popular low cost general purpose oscilloscope on the market. Thoroughly reliable, light-weight design. Simple to use. It has performance high enough to tackle the most meticulous of pulse analyzing jobs on the bench and rugged construction with solid state circuiting so you can take it out on the job with confidence.

Features include:

10MHZ, 8 x 10 cm display. Can be used in Single Trace, Dual Trace and X - Y modes. Automatically selects for chopped or alternate modes. Automatically selects for TV line or frame displays.

Contact Tektronix for a demonstration or specification literature.



TEKTRONIX®

committed to
technical excellence

Sydney 888 7066 Brisbane 31 2896
Melbourne 818 0594 Perth 21 7885
Adelaide 223 2811

From 1st January 1978
**ELECTRONIC ENTHUSIASTS
EMPORIUM**
becomes

ELECTRONIC DISTRIBUTORS

**DISTRIBUTORS OF COMPONENTS
AND EQUIPMENT TO TRADE
AND INDUSTRY**

- Widest range of Stock
- Off the shelf availability
- A.W.A.
- Ferguson Transformers
- Instant component service
- I.R.H.
- Motorola
- Philips
- Plessey
- R.C.A.
- Soanar
- Swann
- Technico

Call into our shop from January 3rd and
check out our Super Sale of items no
longer required for stocking.

Closed Dec 25 — Jan 3rd

ELECTRONIC (DISTRIBUTORS)

SHOPS 2 & 3 P.O. Arcade Joyce St.
Pendle Hill NSW 2145 (P.O. Box 33)
C fflce 636-6222 — Orders only 636-6052
Telex No. A23343

THEATRICAL LIGHTING CONTROLLER

6052

Pt.1 Introduction to Techniques

First part of a series describing a high quality dimming system suitable for schools or the theatre. Modules with ratings of 10 amps (2.5 kW) and 20 amps (5 kW) will be available along with a comprehensive control desk.

SINCE THE EARLY DAYS of the theatre the need for lighting has been all-important. Just as important has been the need for control of that lighting. This ranges from very crude initially to very sophisticated today, often with a computer doing the controlling in the creation of special moods and effects.

The first types of dimmer used, of which there are still some examples in older theatres, was a variable resistance type which used either a variable or switched power resistor in series with the load. With small loads a wire wound resistor or a carbon pile was used while larger loads used a tank of saline solution with a central electrode which was raised or lowered in the liquid, effectively changing the resistance. This type of dimming, while reasonably effective, dissipated a lot of power which made life uncomfortably hot for the operator, since to minimise mechanical linkages the dimmers themselves were often in the control room.

Electronics

With the advent of electronics, life was a little bit easier. The use of phase controlled dimming using thyratrons and later SCRs and Triacs reduced the heat dissipation dramatically (if you'll excuse the pun) and also allows the control to be physically separate from the dimmer. Besides being easier for the

operator performances were greatly enhanced by the much better control available.

Today the use of phase control is almost universal as it is simple, reliable and cheap. Another method in use today is by magnetics; this type has the advantage of generating no RFI but unfortunately is expensive.

The problem of RFI is common to all phase control circuits, but can usually be reduced to acceptable levels by the use of a choke and several capacitors. For RFI the choke need not be very large, but one other effect of phase control is the audible rattling of the lamp filament (especially with the larger globes) which is due to the sudden application of power, and the magnetic field so produced, each half cycle. This can be cured by reducing the rate of rise of current by using a larger choke.

Type casting

We have given some schematic diagrams of types of dimmers which have been used previously. Fig. 1 is the oldest type comprising simply a variable resistor in series with the load. The second (Fig. 2), probably the most common type in use today (mainly in homes) is very simple but lacks the versatility needed for theatrical work.

The third type (Fig. 3) is in common use and while still very simple does have

many good features. These include having the control potentiometer isolated from the mains voltage and also a modified control curve to give a better input-output voltage relationship. Synchronization is referred to the zero crossing of the mains voltage, making the unit more suitable for driving inductive (fluorescent) loads; this also eliminates hysteresis which occurs with the simple dimmers.

One problem which has arisen in recent years is caused by the control tones used by councils to turn on and off the hot water units in homes. These are usually around 1050 Hz (it varies from council to council) and 15 V or so in amplitude on top of the 240 V 50 Hz mains voltage. This causes synchronization problems when using a simple

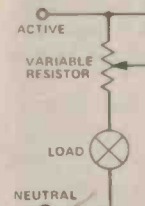

Fig. 1.

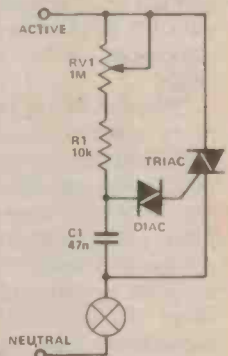

Fig. 2.

Theatrical Lighting Controller eti 588

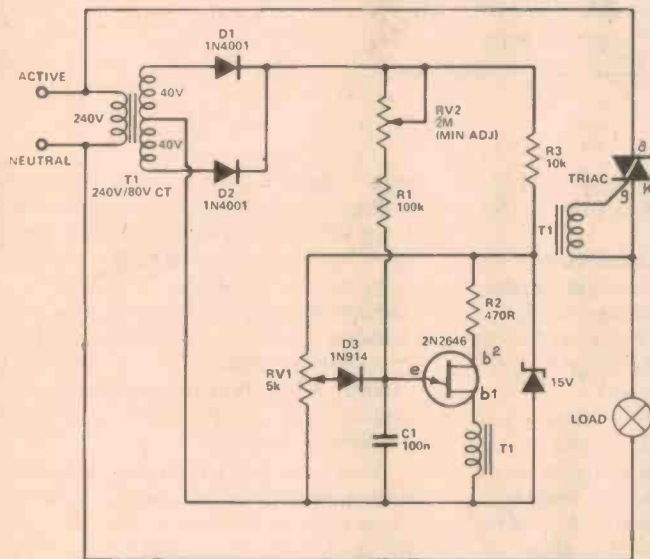
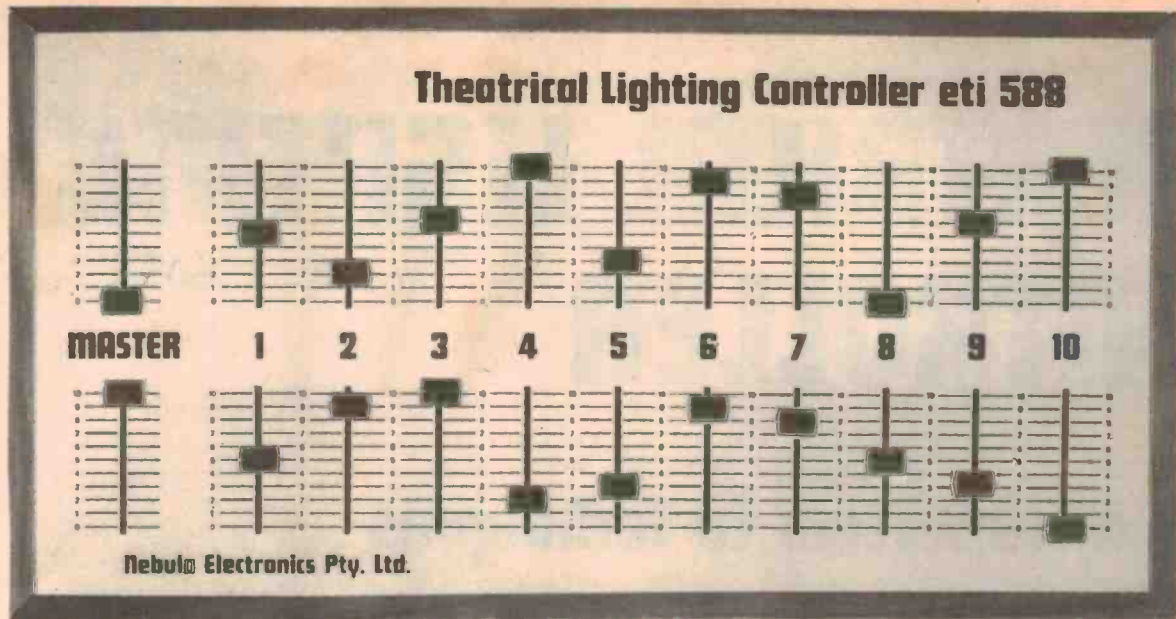

Fig. 3.

zero crossing technique especially as the tone is not phase-locked to the mains. The effect of this tone is a slight rise and fall in light level as the tone beats with the 50 Hz mains. This is especially noticeable on fluorescent loads at low levels.

The dimmer to be described here is more complex than most previously described but a great deal of effort has been taken to ensure that all these problems have been solved. A low pass filter, with phase correction, is used to remove the control tones and ensure accurate synchronization. The control curve is also modified to give a subjectively more linear response and it

has the ability to drive a fluorescent load without requiring a ballast resistor. Both the maximum and minimum light levels are adjustable without interaction giving reliable and predictable output. This is especially necessary if a dimmer fails for some reason and is replaced by a spare unit.

The dimmer as described is a modular system with units plugged into a standard 19" rack. This unfortunately pushes up the price, however the increased convenience makes it worthwhile especially in situations where a fairly large number of units is used. What we will be describing is a high quality professional dimming system at a lower

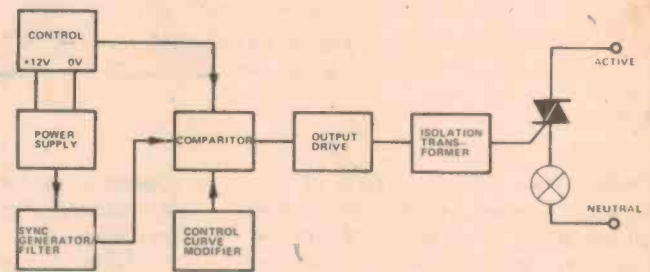

Fig. 4. Block diagram of the dimmer module.

cost than currently available units.

The Protection Racket

The protection of SCRs and Triacs, especially Triacs, is usually difficult as they tend to fuse faster than the fuse purportedly protecting them. The use of a cheap Triac which requires an expensive fuse to protect it is false economy. We have used a large rugged Triac (40 A device for the 20 A dimmer) which allows economical fuses to be used, especially for the 10 A version.

On the control side we will be describing a panel with two sets of long sliders per dimmer with two master controls which allow the next scene to be set up then faded in when required. A digital memory which can 'pre-record' scenes and recall them on demand may be published later.

Next month we will commence the constructional details of the dimmers and control desk.

DENON

The Professional Audio Brand

providing a direct drive system with the following features:—

- HIGH ROTATIONAL ACCURACY
- LARGE DIAMETER TURNTABLE
- EQUIPPED WITH STROBOSCOPE
- RUBBER & FELT INSULATORS
- INDEPENDENT CUEING LEVER
- HIGH SENSITIVITY TONE ARM
- WOW AND FLUTTER OF LESS THAN 0.04 PER CENT (WRMS) at 33-1/3 rpm

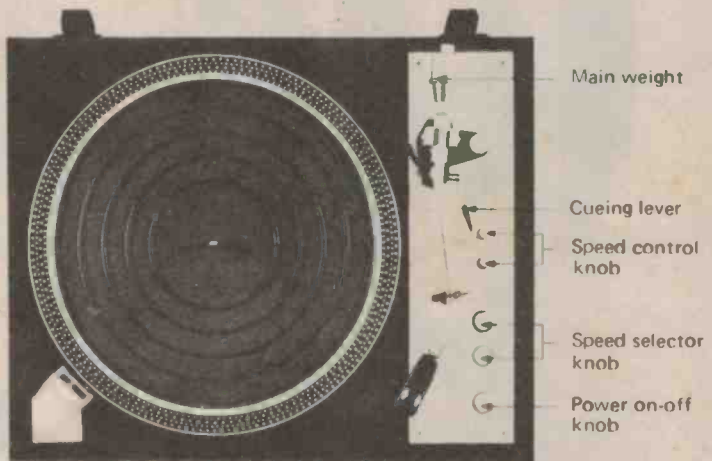

In other words, the

SL-7D Direct Drive Turntable

MOVING MAGNET CARTRIDGE

DL-107



Output voltage: 2.0 mV (1 kHz
50 mm/sec)
Frequency response: 20 ~ 30,000 Hz
Tracking force: 2.0 ± 0.3 gr
Compliance: 8×10^{-6} cm/dyne
Weight: 8 gr

INTEGRATED STEREO AMPLIFIER



SA-3300

- Wide power band (5Hz-55kHz/-3 dB at rated output).
- Audio muting switch.

Rated output 30W 30W
Dimensions 390 (W) x 145 (H) x 258 (D) mm.

MOVING MAGNET CARTRIDGE

DL-109D



Output voltage: 3 mV (1 kHz
50 mm/sec)
Frequency response: 20 ~ 50,000 Hz
Tracking force: 1.8 ± 0.3 gr
Compliance: 9×10^{-6} cm/dyne
Weight: 7.5 gr

AM/FM STEREO TUNER

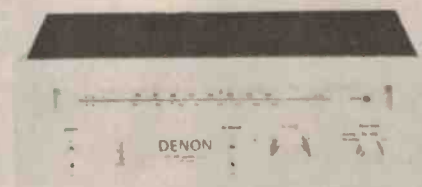

ST-3300

- High performance MPX circuit uses phase lock loop circuit.

For further information please contact:

Automatic muting circuit and high blend switch.



Hi-Fi Audio Equipment

554 Parramatta Rd., Ashfield. NSW. 2131 Telephone: 797-5757

AMALGAMATED WIRELESS (AUSTRALASIA) LIMITED

CANBERRA 953431 NEWCASTLE 25166 MELBOURNE 5604533 BRISBANE 441631 TOWNSVILLE 796155 ADELAIDE 2722366 PERTH 710888 HOBART 345266 LAUNCESTON 445155

AD A4

25 MHz Bandwidth



● 5mV Sensitivity

● 30MHz Triggering

Dual Trace Oscilloscope

at a price you expect to pay for half this performance.

The new BWD 539D is superb for CB Radio, μ Processors, Video recorders, Colour TV, Audio systems, Video games or any application where waveform fidelity and measurement accuracy is essential.

Break through the performance barrier.
Ask for your BWD 539D data sheet today.

BWD

ELECTRONICS PTY. LTD.
Miles Street, Mulgrave, Victoria, 3170.
P.O. Box 325 Springvale, 3171.
Telephone 561 2888 Telex 35115

N.S.W. Amalgamated Wireless (A'asia) Ltd., Sydney, Ph. 888 8111
QLD. Warburton Franki (Brisbane) Pty. Ltd., Phone 52 7255
S.A. Protronics Pty. Ltd., Adelaide, Phone 51 4713
Rogers Electronics, Adelaide, Phone 42 6666
W.A. Cairns Instrument Services, Perth, Phone 25 3144
TAS. Associated Agencies Pty. Ltd., Hobart, Phone 23 1843

W10

CMOS 4000 .39 4001 .39 4002 .39 4006 2.35 4007 .39 4008 2.10 4009 1.20 4010 1.20 4011 .35 4012 .45 4013 1.00 4014 2.50 4015 2.20 4016 1.00 4017 2.20 4018 2.50 4019 1.35 4020 2.60 4021 2.60 4022 2.40 4024 1.90 4025 .45 4027 1.20 4028 2.00 4029 2.40 4030 1.10 4035 2.50 4040 2.65 4043 1.65 4044 1.65	Transistors BC547 .25 BC548 .25 BC549 .27 BC557 .33 BC558 .33 BC559 .30 BD137 .95 BD138 .95 BD139 .95 MPF102 .60 2N5457 .60 2N5458 .60 2N5459 .60 2N5485 .65	Greencaps capacitors .001 mfd. .16 .0015 .16 .0022 .16 .0033 .16 .0039 .16 .0047 .16 .0056 .16 .0068 .16 .0082 .16 .01 .16 .015 .16 .022 .16 .033 .17 .039 .17 .047 .17 .056 .17 .068 .20 .082 .20 .1 .20 .15 .20 .22 .20 .27 .25 .33 .25 .39 .30 .47 .35 1.0 1.10 2.2 2.00 3.3 2.00	ETI 583 Gas alarm kit price \$33.00 plus P&P Printed circuit for ETI 583 \$3.00 plus P&P TGS gas sensors 202 and 308 each \$7.50 plus P&P 812 and 813 each \$9.78 plus P&P	High frequency fittings for CB installations to 200 MHz. PL259 HF plug \$1.30 PL259 HF plug with 28U cord outlet \$1.30 PL259 quick connect HF plug \$1.40 SO239 panel socket with flange \$1.30 SO239A panel socket. . . \$1.10 PL258 double female connector jolner \$1.30 M258 double male connector jolner \$1.70 M358T type connector double female & male \$4.15 M359 right angle connector male to female \$2.80 MP4 4 pin microphone plug \$3.10
	Resistors 1/4 watt 1 ohm to 10 megohm 4c each 1/2 watt 1 ohm to 10 megohm 4c each 1 watt 1 ohm to 10 megohm 7c each 1 watt 1.2 megohm to 10 megohm 10c each	Hitachi cassettes 60 LN \$1.33 90 LN \$1.82 90 UD \$2.53 90 UDR \$3.09 Postage & Packing order value charge \$5 — \$9.99 \$1.00 \$10 — \$24.99 \$2.00 \$25 — \$49.99 \$3.00 \$50 — \$99.99 \$4.00	Tokumi Headphones TE1025 Volume control stereo mono selector switch. Frequency response 20—16000Hz. Matching impedance 4—16 ohms. Price \$17.85 plus P&P. TE2025 Volume control only. Frequency response 20—20000Hz. Matching impedance 4—16 ohms. Price \$30.90 plus P&P. TE8750 Volume control, stereo mono selection switch. Frequency response 20—20000Hz Matching impedance 4—16 ohms. Price \$25.25 plus P&P.	



MODE ELECTRONICS CO

44 TREVELYAN ST. BOTANY 2019 666 6324
MAIL ORDERS P.O. BOX 365, MASCOT 2020

SHERIDAN

ELECTRONICS PTY. LTD.

THE GREAT NAME FOR ELECTRONIC COMPONENTS IN AUSTRALIA

164-166 REDFERN ST., REDFERN, P.O. BOX 156 REDFERN, N.S.W. 2016 TEL: 69-5922 or 69-6912

TRADING HOURS

MON-TUES-WED & FRI: 9am-5.30pm.
THURS: 9am-7pm. SAT: 9am-12 noon.
C.O.D.'s: Please add \$2.40 to posting fee. NO ORDERS UNDER \$5.00 accepted. For replies please send S.A.E. Post and Packing \$1.00 where not included in price. PLEASE PRINT YOUR NAME AND ADDRESS ON ALL ORDERS AND CORRESPONDENCE.

FROM MARCH '78
699-5922 or 699-6912

NEW A LEGITIMATE AMATEUR PRODUCT

Finally a true 80-10M linear amplifier really designed for amateur use, not a cheap class-C biased "CB" unit. The HF-150 is a true, band switching, class-B linear amplifier. Perfect for use with many of the low-powered HF transceivers now on the market.

INSTRUMENT QUALITY

The HF-150 is designed and built by Communications Power, Inc., a company well established in the manufacture of industrial power amplifiers and ferrite RF components. Thus, the HF-150 has such quality features as -50db minimum harmonic suppression on all bands, with built-in switchable harmonic filters. 10 times better than current FCC and ITU regulations.

- In addition there is absolute stability into all phase angles of a 3:1 VSWR mismatch, plus a built-in 20db gain, low noise receiver pre-amplifier.
- 200W PEP input power
- Typical RF output at 30 MHz: 100 W AM-4W drive, 160 W PEP SSB-12W PEP drive, 13.6 VDC: 150 W CW-10W drive
- positive or negative ground
- SSB-AM-CW operation
- The built in 20db gain, 2db noise figure broadband receiver rf preamplifier operates independently of the power amplifier and is just the thing to perk up a "dead" receiver.
- Compact size: 6.55 "W-2" H-7.75" D
- Provisions for simple plug-in installation of C.P.I.'s RC-1 remote control head.

Note: Illegal for use on the Citizens Band



\$239
P&P \$5.00
INCL. INS.

"PLAYMEC" KEYBOARD SWITCHES

An Indispensable necessary component in developing handy electronic calculators and microprocessors. Can also be adapted for electronic games. Ultra thin, ultra compact.



Current Cap. 20 mA, 24 VDC. Contact resist 1 max. Insul. res.: 100 m MIN & 24 VDC. Chattering time 2m SEC MIN. Size 60 mm x 80 mm. Complete with mounting bracket set at 160 deg. approx.

ONLY \$13.95
P & P \$1.00

Heavy Duty Control Key Switch

Rigidly constructed for industrial use. ON-OFF-ON Change-over. Supplied with 2 keys. For 240V 10 amp. All new & cartoned. LIMITED QUANTITIES ONLY.



NEW P & P \$1.00

\$4.95

EXCLUSIVE TO US RECHARGEABLE GEL BATTERIES

USE THESE FOR YOUR CB

6 Volt 1.8 AMP HOUR
SIZE: 'A' 75mm x 'B' 52mm x 'C' 50mm

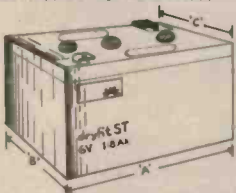

PRECISION GERMAN MADE
S.E.'s Price Only \$8.75.
WORTH DOUBLE P & P \$1.25

A.M. TUNER MODULE

Beautifully constructed with high grade components . . . Fully wired and ready for operating. Complete with data and connecting diagram.

Specifications:
Frequency Range . . . 535 to 1605 kHz.
Intermediate Frequency . . . 455 kHz.
Antenna . . . Ferrite Rod.
Sensitivity . . . 80 Microvolts.
Signal to Noise . . . 20 dB at 80uV.
Image rejection . . . 40 dB at 1 MHz.
Power Supply . . . 4 mA at 9V.

MADE TO SELL
AT \$19.50

OUR PRICE ONLY

\$12 POST FREE



CAR RADIO FRONT PANEL & KNOB KIT

Will fit most car radio & cassette players. Size of panel: 195mm x 60mm. Dist. between holes: 145mm. Size of aperture: 113mm x 50mm.

LOOK AT THIS — Completely crazy!!

ONLY 95c
P&P 50c



TV GAMES

GAME CHIP AY-3-8550

with two joy stick controls, this advanced unit comes complete with joy sticks — all games (6) and scoring etc are the same as game chip AY-3-8500 BUT the bats not only move up and down but forward and backward too. Complete with data sheet. Yours for a value packed \$24.00

\$24

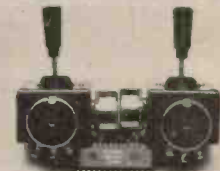

GAME CHIP AY-3-8500

6 selectable games. Tennis, soccer, squash, practise and rifle shoot. Auto score on screen 0 to 15. Selectable bat size, speed, angles, ball speed and sound. Complete with 7 pages of instructions to build game using easy to buy parts. BC108 etc. A gift at \$12.50.

P.C. BOARDS AVAILABLE IN LIMITED QUANTITY AT \$3.50 ea. for AY-3-8500 and AY-3-8550

NEW

7 TRANSISTOR 2 DIODE RADIO by BENDIX

Completely ready wired with volume control and switch. Large tuning dial

and complete with 3 1/2" 8 ohms 6 watt speaker. Battery container included. (Batteries not included) — Ready to go!! S.E.'s crazy price \$3.85 each or 2 for \$6.50. P&P \$1.50



SEALED NEON INDICATOR LAMP BEZELS

For 250VAC 1 amp Operation. Sturdily constructed, complete with Neons. For that Power Supply Equipment Power Indicator . . . Data-board on/off indicators and many other uses.

Type 'A' 65mm x 23 mm dia. RED or WHITE Lens (please indicate) ONLY 95c Post Free
Type 'B' 25mm x 20 mm dia. RED or ORANGE Lens (please indicate) ONLY 65c Post Free



BOTH MODELS IN ELEGANT CHROME BEZEL FINISH

Electronics is where it's all happening

...if you're into it you've got it made!

It's the world's fastest growing industry... with new discoveries... new products every day. And, every day, there are more jobs... bigger salaries... better opportunities... for people who are trained.

You can be part of this boom now by training with International Correspondence Schools. Learn to design, build, install, test, control and maintain modern electronic equipment... from your own colour TV or hi-fi set to a digital computer.

Your career opportunities are limitless... in broadcasting, industry, the military, aerospace programs, medical science and communications. With your enthusiasm and ICS tuition, a well paid job and a secure future in electronics is well within your grasp.

How do I get into it? ICS have put together a FREE Electronics Career Folder. It tells you all about the many courses open to you including Communications and Broadcasting, Industrial Electronics, Computer Servicing and Audio/Radio Servicing... courses endorsed by the Television and Electronics Technicians Institute of Australia. Post the coupon and the career folder will be on its way to you without obligation. Don't wait another minute... progress won't. The big developments in electronics are happening now and the demand for skilled people is growing all the time.

Special Colour TV repair course. Colour TV is booming all over Australia, beyond the expectations of all the manufacturers, resulting in a shortage of qualified people to fill the service gap.

You could make a successful career in this growing field with the help of the ICS School of TV Servicing. You can benefit by this course - all you need is the enthusiasm to learn and enjoy rewarding work.

Your ICS course could be a start of an exciting new career or you can use your new-found knowledge to earn extra money in your spare time.

This special course is endorsed by the Television and Electronics Technicians Institute of Australia.

Send the coupon today. It could be the first step in an exciting new future for you.

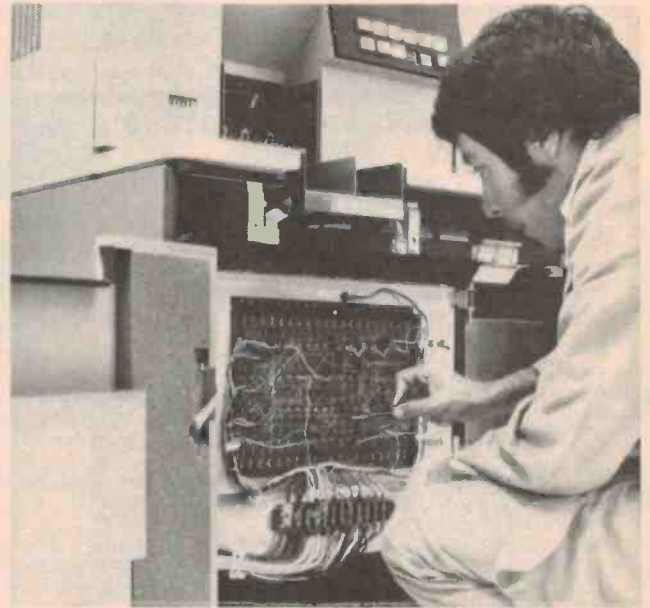

Find out how you can be where it's all happening - in Electronics. Fill in the coupon and post today!

ICS Home Study ...your passport to success in life!

Your invitation to join the thousands of successful ICS graduates.

To: International Correspondence Schools
400 Pacific Highway, Crows Nest, NSW. 2065
18-20 Collins Street, Melbourne VIC. 3000
182 Wakefield Street, Wellington, N.Z.

YES!

Please send me, entirely without obligation, a copy of the:

- ICS Electronics Career Guidance Kit
- ICS Colour TV Servicing Career Guidance Kit.

MR/MRS/MISS _____

ADDRESS _____

POST CODE _____

PRESENT OCCUPATION _____

AGE _____

Take the first step - 276500

Fill in and mail this coupon today!

ICS

PKB54430

Texas Instruments TI 59 Programmable

Les Bell takes a look at the new super-calculators from Texas Instruments, weighs them in the balance, and finds them not to be wanting.

AS TECHNOLOGY PROGRESSES by leaps and bounds, we can see very small machines getting bigger and big machines getting smaller; calculators become more powerful and computers become more stupid. The gap in the middle is getting smaller and smaller, until, eventually, one machine must close that gap.

Way back on January 14, 1974, Hewlett-Packard introduced the HP65, the first Pocket Programmable Calculator (PPC). This machine set the trend for PPCs to follow, in having a program memory which could store sequences of keystrokes, conditional and unconditional GO TO instructions, user definable keys and a magnetic card reader. This combination of features has been followed and built upon by what I shall call the 'heavyweight' engineering calculators — the SR52, SR56, HP67, HP97, HP25, HP19. There are other PPCs made by Casio, Sinclair, Commodore and others but (although I know this is hard to justify) the big league, the 'big guns', are still the Texas Instruments and Hewlett-Packard models.

Anyway, dear reader, the reason you and I are here today is to take a look at the new TI model, the Programmable 59, with a fairly critical eye, and sort out, between us, its place in the scheme of things. And let me state, right here and now, that I know you'll decide the same as I did. The P59 sits, by virtue of its sheer power, fair and square on top of the pile.



Fig. 1. The Texas Instruments Programmable 59.

Programmable TI 59

The P59 is the most powerful PPC yet made (see note). At this point, it is important to distinguish between calculator features made possible by advances in technology, and those which are the product of ingenuity and good design in using that technology. The P59 holds its position primarily because of Texas Instruments' expertise in semiconductor technology, specifically in high density semiconductor memory technology.

The major difference between the P59 and previous PPCs is its use of 'Solid State Software'. If you flip the calculator over and slide out the panel in its base, you will find a 0.85" x 0.7" x 0.35" block of plastic labelled 'Master Library Module'. This is, in fact, a read only memory containing anything up to 5000 steps of program, which in the case of the Master Module provide 25 programs designed to solve a variety of problems.

The Master Library Module can be changed easily for different modules in the fields of Surveying, Business, Navigation, Aviation and Statistics (no Mathematics or Electrical Engineering modules as yet). A spare module can be carried in the wallet supplied along with 40 magnetic cards.

Programs are called up from the Module by the keystroke sequence '2nd Pgm nn', where nn is the program number, and the user-definable keys can then be used to run the programs. In addition, Module programs can be called as subroutines from user programs by the same sequence of keystrokes since the Module programs do not occupy the same address space as the read/write memory in which the user's program runs. The Solid State Software can also be downloaded into the RAM section for examination or modification, using the keystroke sequence '2nd Pgm nn 2nd Op 09'. The calculator can then be put into the 'Learn' mode and the program modified.

User Memory

This leads us naturally into a discussion of the block of memory available to the user in the P59. Here again TI's semi-

Note: National Semiconductor's NS-7100 has broadly similar capabilities to the P58 including interchangeable ROM plus an I/O port for interfacing to printer or microcomputer. Where it sits in the power stakes we don't yet know.

conductor memory expertise has come to the fore; the P59 is, in terms of memory, way ahead of its competition, with a possible 960 steps of program memory.

Why 'possible'? Well, the P59 has inherited an organizational hangover (if that's the word!) from its predecessor, the SR52. In that calculator, program memory and data memory are physically the same, and, as many owners discovered, spare program space can be used for data storage. The P59 employs a similar scheme, but now TI openly admit to it, and partitioned memory has become what PPC owners call a 'supported feature'. Another SR52 unsupported feature which has turned up respectably in the P59 is the ability to store data on magnetic cards.

When initially turned on, the P59 has 480 steps of program memory and 60 data registers. However, the user can repartition memory, trading off 80 program steps for every 10 data registers, so that one may have 780 steps/20 data registers or 320 steps/80 registers or one of several other combinations.

The P59 has a kid brother, the P58, which has identical features, including the Solid State Software, but less memory (240 steps/30 registers on switch-on) and no magnetic card capability. Except where memory size or magnetic cards are concerned, all my remarks apply equally to both PPCs.

Printing

The third main area of advance is in the incorporation of printing facilities in the P59. Like the SR52, the P59 is designed

to operate with the PC100A print cradle. The important difference between this and previous PPCs is that the P59/PC100A combination can print alphanumeric. The PC100A can print 20 characters wide, and this can be divided up into 5-character quarters, with each character being represented by a two digit code, e.g. A is 13 and (is 55. Five characters therefore fill a 10-digit display, and four such displays are successively loaded into a print buffer, which is then completely printed. Alternatively, the current answer can be printed along with four characters on the right to identify it.

This opens up tremendous scope for PPC users. Firstly, alphanumeric printing may be used to prompt untrained operators when using a program — with 960 steps of program memory there is surely some going spare for this! Secondly, complex programs can provide identification of results for the skilled user. Thirdly, error messages can be printed if a program detects errors in data. Fourthly, games programs can be livened up with messages — I could go on and on.

But the printing capabilities of the P59 don't stop there — you can also plot graphs! Admittedly, this is a fairly crude sort of graphical output, but it works, and graphically presented data is much easier to use than tables of results when you're looking for trends or experimental relationships. It works like this: since the PC100A has 20 columns, the command '2nd Op 07' will print an * in the column specified by the display. So if you've produced a result which is



Fig. 2. The PC100A allows printing of results, headings, prompts...

SINE CURVE PLOT
SAMPLED EVERY 18 DEG

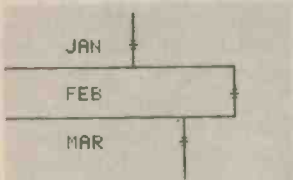

Fig. 3. ...and even plotting!

a percentage, say 60%, you divide it by 5 (to scale it) giving 12 and then '2nd Op 07' will print an * in the right column (the 12th, in this example).

The printer can also be used to produce a listing of the labels in your program, a listing of the program itself, results (obviously), and, in the trace mode, all intermediate results and the instructions that generate them as a program executes.

Functions

From the technological advances of the P59, we move on now to the design of the machine, the way it operates, and its ease of use — all functions not of the technology, but of the time, effort and ingenuity/insight of the design team.

The appearance and construction of the P59 are pretty well standard, as you can see from the photographs. The keys have a good 'tactile feedback' feel, and are spaced at what is probably the minimum spacing for convenient, fast and accurate operation. This brings me to the only bugbear I found with the calculator — the visibility angle of the display. A PPC, by the nature of the beast, spends a lot of its time on a desk-

top, but I discovered that working with a notepad on the desk in front of me and the P59 to the right of that (say, 7" from dead centre), I had to constantly lean over to read the display. Now that's bad — are you listening, TI? Mind you, with the P59, I could learn to live with it!

As a manual calculator, the P59 performs very nicely indeed, although the keyboard is perhaps a little crowded for occasional heavy sessions of key-bashing; but if you use it a lot, you'll get to know it like the back of your hand and if you use it a little, the busyness won't bother you. I've experienced no difficulties in finding my way around the keyboard, but some colour-coding might have helped.

RPN or AOS?

The big debate raging in the literature produced by the 'Big Two' PPC manufacturers is between the number crunching 'languages' they each favour. Hewlett-Packard calculators use Reverse Polish Notation or Lukasiewicz Notation — RPN for short. Using RPN an expression like $(4+5) \times (6+2)$ would be entered as '4 1 5 + 6 1 2 + x'. Once 4×5 is calculated, it sits in the stack above the subsequent calculation of $6 + 2$ until the x key completes the calculation by adding the two intermediate results.

The P59 uses TI's 'Algebraic Operating System' which makes use of parentheses to over-ride the rules of algebraic hierarchy, and enables you to enter calculations as they are written. In the above example, you would key in

$(4 + 5) \times (6 + 2) =$, and the correct result, 72, would appear. $(4 + 5)$ gives 9 in the display, then the x key is pressed, but when the next (is keyed this postpones the multiplication operation till the equals key is pressed. $(6 + 2)$ gives 8, and the equals key completes the pending multiplication.

Now, I expect you're waiting with bated breath for a point-by-point comparison of the two systems, but I'm afraid I'm going to disappoint you. After having used both systems, I'd say it's a fruitless exercise as both systems actually get the job done. As a long time RPN user, I must confess to being pleasantly surprised by the ease with which AOS would solve quite complex problems; yet, if confronted with a real toughie, I would reach for my HP, simply because I'm more accomplished with RPN. So really, it boils down to: 'you pays yer money and you takes yer choice', and it doesn't really matter which you choose as long as you take a little time to become familiar with it.

The P59 sports a tremendous array of functions, including all the usual trig, exponential and scientific functions. In addition, there are also two-variable mean and standard deviation, and although there is no sign of it on the keyboard, the statistical capability is further extended by variance, slope and intercept, correlation coefficient, y' for a given x and x' for a given y. All these functions are examples of special control operations, and are accessed by the key sequence '2nd Op nn', where nn is a two-digit code assigned to each

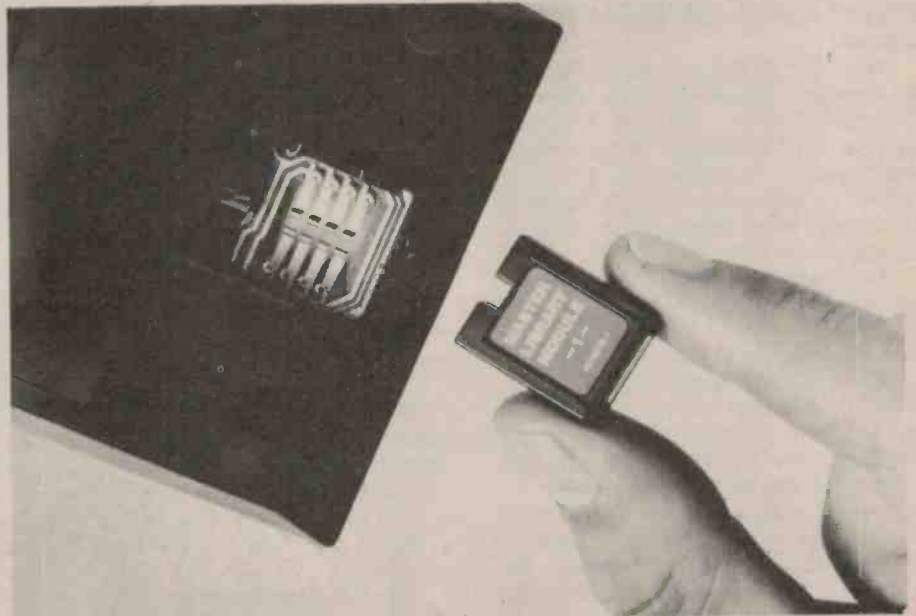

Fig. 4. The Library Module clips into the base of the calculator.

Programmable TI 59

function. Other special operations include the print functions, library program downloading, the signum function, memory partitioning, error flagging and a set of operations which can increment or decrement data registers.

While this scheme is slightly awkward to use manually, it does give an additional 40 infrequently used functions without cluttering the keyboard. And of course, most of these functions will be used almost exclusively from programs, so their ease of use is not very important. A list of special operations on the back of the calculator would have been handy, though.

Programming

As a programmable calculator, the P59 performs extremely well. Program entry is extremely easy, and simple programs can be made up as they are entered. For longer programs, it is, of course, advisable to at least sketch out a program on paper before commencing entry.

Programs consist basically of the same set of keystrokes as you would use to solve the problem manually. However, in order to let a program run without the need for human intervention, PPCs have a number of instructions not found on conventional calculators, such as go to (GTO), label (Lbl), and conditional branches ($x = t$, $x \geq t$, etc.). These instructions are used to structure the program and transfer control between sections.

The P59 allows the use of 72 labels to identify program sections: these are the usual 'Lbl A', 'Lbl 2nd A' type as well as others created using virtually any other key as a label, e.g. 'Lbl CLR', 'Lbl x^2 '. This permits the creation of extremely large programs in sections, each with a specific function.

There are four different tests which can be made in order to decide program branching ($x = t$, $x \neq t$, $x \geq t$, $x < t$), which are fairly standard on PPCs. In addition, a Decrement and Skip on Zero (DSZ) instruction can be implemented on registers 0-9 to control program looping, as well as the inverse function, Decrement and Skip on Non-Zero.

The power of most memory referencing instructions can be multiplied by the use of Indirect addressing. For instance, it is possible to branch indirectly, to store and recall data indirectly, to call Library Module programs indirectly, to set flags indirectly, all

manner of tricks. A good example is the instruction 'If flg Ind 02 Ind 22', which will recall register 2, and on finding the value 5 there will test flag 5. If that flag is set, it will recall register 22, giving the value 64 and will then jump to step 64. If flag 5 is not set, the program will continue normally. As you can see, instructions of this type pack real programming power, but only 'STO Ind' and 'RCL Ind' are used often.

Programs can be written as subroutines, so that they can be called by other programs, simply by avoiding the use of = (which completes all pending operations) and terminating the program with a subroutine return, 'INV SBR'. If this technique is used, you can have up to six levels of subroutines, which is probably enough to process three-dimensional arrays in quite complex fashions. (I haven't tried it yet though!)

Editing a program is very easy, as you can over-write, insert or delete steps and can single-step, backstep or jump about in your examination of the program. If you use the PC100A printer, then its trace mode will let you see what is happening as each instruction is executed, as well as providing complete program listings (it can't be easy to write down 960 steps!).

The Card Reader

Since there are 960 steps of program memory in total (regardless of whether they contain program or data) it is just not possible to put the whole memory onto one magnetic card. To get round this, the memory is divided into four banks, each of which may be separately written onto one side of a magnetic card. The bank number should be in the display, and the key sequence '2nd Write' will then record that bank onto a card. Each card has two sides, consequently two cards are required to store the whole memory.

If the bank number in the display is negative, when the program is subsequently reloaded, it will be found impossible to list it, or to enter the 'learn' mode to examine or modify it. This provides a means of protecting software from accidental (or deliberate) modification, and ensures security of confidential data.

The calculator records the bank number onto the card, and will subsequently read the card into the correct bank, unless it is forced to read into a particular bank. Cards can be read under program control, enabling large amounts of data to be entered for processing.

The card reader is not 'smart' in the sense of prompting the user, but it is certainly versatile. No over-write protection is provided, but it is much more

difficult to accidentally erase a program than with HP's W/PRGM-RUN switch scheme.

Documentation

The most incredible calculator ever devised would be of dubious value without the knowledge of how to use it, which is the result of experience and a long session with the owner's manual. The P59 manual is called 'Personal Programming' and is an A4 format book almost $\frac{3}{4}$ " thick. This provides plenty of examples to explain both the operation of the various calculator functions, and the rudiments of programming.

With a PPC of this complexity, there is just no way you can sit down and start writing programs — even display control takes two pages of explanation. The only way to do it is to sit down with the manual and start at the beginning, working through every example. Programming is a skill you learn by doing, not by reading, and 'Personal Programming' is well organised for this. In short, the manual doesn't let the machine down.

Also supplied is a programming pad, and a guide to the programs in the Master Library Module. This guides the user through the keystroke sequences needed to enter data and run the programs, as well as explaining the program operation and providing necessary information on registers used, parentheses levels etc. Again familiarity breeds ease of use: you have to sit down and play with the machine to learn how to really use it.

Summing Up

The Programmable 59 incorporates several major advances over previous PPCs, specifically in terms of memory. The basic calculator has a more than adequate range of functions, but the addition of the 'Solid State Software' modules converts it into a general- or special-purpose calculator of extraordinary power.

Probably the greatest compliment I could pay the P59 is to say that as a long time HP and RPN user, I would never have contemplated any other kind of calculator. I'll probably still use my HPs (I don't need another calculator), but if I was a first time PPC buyer, the TI Programmable 59 would be top of my list.

Both calculators are available from Texas Instruments retailers around Australia. The Programmable 58 retails for \$141.83 inc. tax and the P59 is \$328.41 inc. tax. These are recommended retail prices — discount prices may be considerably lower. The PC100A is yours for only \$278.25 and extra Library Modules are \$35.26 each.

NEW-NEW-NEW

National

RJX SERIES

For every hobby there is an "ultimate" unit. For the sports car enthusiast it's the Ferrari. For the amateur photographer, it's the Hasselblad. For the amateur radio operator it's the National RJX1011.



RJX-51011

RJX-1011

RJX-V1011

A Unique New SSB/CW Transceiver For Amateur Communications

There is no substitute for quality, performance, or the satisfaction of owning the very best. Hence, the incomparable National RJX-1011 amateur transceiver. The RJX-1011 covers all amateur bands 1.8-30 MHz (160-10 metres). It utilizes advanced Phase-Lock-Loop circuitry with dual gate MOS FETs at all critical RF amplifier and mixer stages. There's a rotating dial for easy band-scanning and an electronic frequency counter with digital readout and a memory display that remembers frequencies at the flip of a switch. And that's just the beginning.

Matching speaker unit RJX-S1011 and complete external VFO RJX-V1011 also available. For further information and specifications write, phone or call in!

DISTRIBUTED BY:



EMONA electronics

ROOM 208/661 GEORGE STREET, SYDNEY, NSW PHONE: 212 4815
A.H.: 398 6378 — 399 9061

P.O. BOX K21, HAYMARKET, NSW, 2000, AUSTRALIA

INCOMPARABLE NEW TRANSCEIVER

INCOMPARABLE NEW TRANSCEIVER

SEMCON MICROCOMPUTERS PTY. LTD.

ATTENTION MOTOROLA D2 OWNERS!



If you want a functional, expandable system, you need:

8K BYTE, STATIC MEMORY CARD

Australian Designed and Built

- Fast Access 350 ns Chips (2102LF)
- Low Current - 1.3 Amps
- Motorola Bus Compatible
- Write Protect
- Parity Generation/Checking available
- Professional Finish
- Plated through Holes
- \$275 assembled board
- \$219 in kit form
- 298 Assembled with Parity
- Built Boards Guaranteed 12 months

CARD CAGE/BACKPLANE:

- Designed for Motorola Cards
- Anodised Aluminium chassis
- Sturdy Construction
- Tin Plated Backplane
- Accommodates 8 cards

\$74.00

EDGE CONNECTORS —

43 x 2 x 0.156" \$8.50 each
Eight for \$59.00

\$100 Connectors \$8.50



TOTAL SYSTEM: D2 KIT with Hex Keyboard, and cassette interface, Buffers for expansion, 81c Byte Memory and Cage, Back Plane, Power Supply

THE SEMCON CATALOGUE is a must for the Professional and Hobbyist interested in **COMPUTERS INDUSTRIAL GRADE COMPONENTS AT COMPETITIVE PRICES.**

IT INCLUDES:

- 1 ● Pricing on our extensive range of ● TTL ● CMOS ● Lower power schottky ● Regulators ● Analog ● Memories ● Microprocessors ● Optoelectronics ● Linear ● Diodes ● Capacitors ● Sockets ● Resistors ● Cable
- 2 ● Details on the Semcon System.
- 3 ● Evaluation and Developments Modules Using ● Texas 9900 — 16 b $\frac{1}{2}$ CPU o Fairchild CPU ● Intersil 6100 — 12b $\frac{1}{2}$ CMOS PDP8 compatible CPU ● Mostek SBD80 280/16 keyboard ● AMD 2900

Please send fifty cent stamp for a copy.

AMD 9511 — HIGH SPEED ARITHMETIC PROCESSOR

Application Notes \$1.50

Features: Fixed and Floating Point Maths, Binary Data Format, Add, Subtract, Multiply, Divide, Trig, Inverse Trig, Square Root, Logs, Exponentiation. This 24 pin package performs these functions an order of magnitude faster than by conventional software. APPLICATION NOTES \$1.50

LOW POWER SCHOTTKY

2708
\$19.50

Z-80
4MHZ
\$38.00

2102 LFPC
\$1.90

8080
\$15.90

SOCKETS

Voltage RGG
1 Amp all Val-
ves
\$1.60

Rectangular
Leds
\$0.99

Solder		Wire Wrap	
8	22	8	24
14	24	14	40
16	28	16	
18	40	18	

SHOWROOM: 1 Chivvers Road, THORNLEIGH. 2120
MAIL ORDER: P.O. Box 61, Pennant Hills. 2120
PHONE: 848-0389 or 848-0800 Add 15 percent Sales Tax P & P \$1.50

RAINBOW AUDIO VISUAL ELECTRONICS

Importers of fine electronic products.

LIGHTING

Dimmer Racks
Dimmer Control Desks
Par Can 1000 Watt
sealed beams
Patt 23-23N
Auto Faders
Sound to Light Units
Colour Filters
Mirror Balls
Effects Projectors

DISCO EQUIPMENT

Professional Disco
units
Jingle machines
Microphones
Mic Stands
Slave Amps
Mixers
Speakers
Bubble Machines
Fog Machines



'Phone Write or Call:

Berkeley Arcade,
2388 Gold Coast Highway
MERMAID BEACH. QUEENSLAND 42
Phone (075) 383331

Showroom open 9.30 am till 6 pm. Monday to Friday
10.00 am till 3.30 pm Sat & Sunday.

RADIO DESPATCH SERVICE

869 George Street, Sydney, N.S.W. 200

Near Harris Street)

Ph. 211-0816 211-0191

"Dolphin" 108AW Lanterns Assorted colours
"Stadium" 12 v Battery powered fluorescent trouble lights
"Letco" Speaker cable 20ft and 50ft rolls.
12 volt battery chargers Ferguson and A&R
ACV 27 CB Antenna Converter. Use your existing car aerial
HL-2 CB Hot-line filter.
Heavy duty type 12 volt. dc
5" Horn type speakers 8 ohm impedance
CC-2 CB microphone curly-cords
YW-1 SWR-Power-F.S.
Meter Ideal for CB use
"Hansen" FS-5 Power-F.S.
Meter Suitable for CB base station, etc.

N.S. MA 1003B 12 volt digital display car clock module units.
"Coral" 10 SA-1 3-way 3 speaker kits Music power — 50 watts 8 ohms impedance
"Coral" 12 SA-1 3-way 4 speaker kits Music power 60 watts 8 ohm impedance.
"Ralmar" AM/FM Mpx Stereo Tuner Model 222.
Texas Instruments and Novus Calculators, Printers and Accessories. Wide range in stock.
ETI and EA printed circuit project boards.
T.V. aerials, accessories and installation kits. Suitable for black & white and colour T.Vs.

OPEN Mon. — Fri.

8.00 am — 5.30 pm Sat. 8.00 am — 11.45 a.m.

Each B & W speaker comes with its own written proof of superb performance:

B&W's reputation is based on producing clean natural sound without distortion, even at low volume. Each B&W speaker is tested in an Anechoic Chamber and issued with its own individual pen graph. You know exactly the performance of the speaker you are buying



B&W DM6 Monitor
A brand new design. A high powered dynamic loud-speaker with low colouration and very high transient performance.



B&W DM2A Monitor
A more conventional design, utilising B&W research into acoustic line rear loading.. Brilliant clarity and lack of distortion.



B&W DM4 Monitor
A speaker with large B&W Monitor characteristics; its performance surpasses speakers of much greater size.



B&W DM5
A speaker for small living areas. It has above average performance at moderate cost.

Hear B & W Speakers at:

N.S.W.: CONVOY SOUND WOOLLOOMOOLOO SHOWROOM 357 244; CONVOY SOUND CITY SHOWROOM 29 1364; (EASTWOOD) 85 2726; MILVERSON PTY. LTD. (CHATSWOOD) 412 2122 (PARRAMATTA) 635 3588; RIVERINA HI-FI 938 2663/4; UNITED RADIO DISTRIBUTORS PTY. LTD. 232 3718; ARROW ELECTRONICS 29 8580; RUSSIN HI-FI 799 2421; PITMAN'S RADIO & T.V. (WAGGA) 25 2155; ALBURY AUDIO CENTRE 25 1712; WROTH CENTRE HI-FI (BATHURST) 31 2088; LEISURE SOUND (CHATSWOOD) 411 4944; BYRON BAY T.V. & SOUND CENTRE 85 6762; SINGLETON HI FIDELITY CONSULTANTS 72 2270. A.C.T. DURATONE 82 1388; VICTORIA: ALLANS MUSIC (CITY) LTD. 63 0451; ENCEL ELECTRONICS PTY. LTD. 42 3761; SOUTHERN SOUND (CITY) 67 7869 (MOORABBIN) 97 7245; TIVOLI HI-FI 81 2872; THE SOUND CRAFTSMAN 509 2444; BUY RITE ELECTRIX 42 6200; OMNISOUND 24 2428; QUEENSLAND: JOHN GIPPS SOUND 36 0080; PREMIER SOUND (INTH. ROCKHAMPTON) 27 4004; TARGA ELECTRONICS (CAIRNS) 53 2715; RUSS ADAM (TOWNSVILLE) 71 5618. TASMANIA: BEL CANTO (HOBART) 34 2008. WEST AUSTRALIA: TECHNICAL SERVICES PTY. LTD. 31 5455. SOUTH AUSTRALIA: BLACKWOOD SOUND CENTRE 278 1281; ALLANS MUSIC (AUST) PTY. LTD. 223 5533; SOUND SPECTRUM 223 2181.



Sole Australian Agents

Convoy International Pty. Ltd.

4 Dowling Street, Woolloomooloo, 2011

Sydney, N.S.W. Tel: (02) 357-2444

387 George Street, Sydney, NSW.

Tel: (02) 29-1364

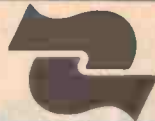

EDGE ELECTRIX

31 BURWOOD RD., BURWOOD, SYDNEY, 2134. Tel: 747 2931

THE SPEAKER KIT SPECIALIST

AWA CORAL

- 12SA1 30W RMS
- 10SA1 25W RMS
- 8SA1 18W RMS
- 6SA1 15W RMS
- 12SA5 30W RMS
- 10SA5 Improved 25W RMS
- 8 SA5 18W RMS
- 12SA7 40W RMS
- 10SA7 Dome Series 30W RMS
- 8 SA7 20W RMS

PLESSEY FOSTER

- 3016 12" 3way 40W RMS
- 3003 12" 3way 40W RMS
- 2503 10" 3way 40W RMS
- 2510 10" 3way 30W RMS
- 2010 8" 3way 20W RMS
- 2006 8" 2way 12W RMS

PHILIPS

- 07 12" 3way 40W RMS
- 06 10" 3way 40W RMS
- 04 8" 3way 40W RMS
- 14 12" 3way Dome Series 40W RMS
- AD12K12 12" 3 way Incl. Cabinets 40W RMS
- AD8K40 8" 2 way Incl. Cabinets 40W RMS

KEF

- SK3 Concerto Kit 50 WRMS

WRITE OR RING TODAY! (02) 747 2931.

MAIL ORDER BY BANKCARD

JUST QUOTE NUMBER

CORAL (FROM AWA) * SPECIAL *

10" 3 WAY SPEAKER KIT INCLUDING QUALITY CABINET.

This magnificent kit includes very good looking dark walnut finished cabinets in knock down form with acoustic foam fronts. (Note: Freight on via carrier).

25 cm (10") 3-way 3-speaker SYSTEM KITS (One pair) 10SA-1

● Speaker: Two 25 cm (10") woofers, two 12.5 cm (5") cone squawkers, two 6.5 cm (2 1/2") cone tweeters ● Impedance: 8Ω Cross-over frequency: 2,000Hz, 6,000Hz Output sound pressure level: 93dB Program source input: 50W ● Frequency response: 4020,000Hz (381 Air-tight enclosure)



NOW ONLY **\$129** (OFFER CLOSES END NOVEMBER)

- * OVER 25 DIFFERENT SPEAKER KITS STOCKED!
- * 100's OF TYPES OF INDIVIDUAL SPEAKERS INCLUDING X'OVERS, CABINETS & ACCESSORIES.

MORE BARGAINS FROM KITSETS

330pf. Disc Ceramic Capacitors
10 for only 50c

390pf. Disc Ceramic Capacitors
10 for only 50c

47uf 50V R.T. Electro's
10 for \$1.00

47uf 50V R.T. Electro's
5 for \$1.00

220uf 50V R.T. Electro's
Just 40c ea.

.033uf Greencap Capacitors
10 for 70c

.39uf Greencap Capacitors
5 for \$1.50

100 ONLY A&R 9129 TRANSFORMER 240V Primary, Secondary 30V tapped at 15V at 1 AMP. **ONLY \$6.55 ea.**

CLIP-ON HEATSINK FOR TO-5 TRANSISTORS
10 for only \$1.00

MANY, MANY MORE CAPACITORS, RESISTOR PACKS ETC. AT GREAT PRICES. POP OVER AND SEE US AT DEE WHY SOON.

KITSETS

657 Pittwater Road,
Dee Why. 982 7500

293 St. Pauls Terrace
Brisbane 528 391

THIS MONTH'S SPEAKER SPECIAL

PLESSEY FOSTER
BASS DRIVER

NORMALLY \$21.07
NOW \$17.00

COMBINE THIS WITH THE FOSTER TWEETER AND A 2-WAY CROSSOVER TO GIVE YOU A 10" 2 WAY SYSTEM (LESS CABINETS)

FOR ONLY \$66.00 a PAIR

UNBELIEVABLE.

CB NEWS

Aust-built rig

The Black Knight CB transceiver — the first 27 MHz, 18-channel rig to be designed and built in Australia, is set to start a revolution.

A product of a relatively new Australian company, Cadet Research, the Black Knight offers a host of unique features.

The rig is a mobile SSB/AM 18-channel, 27 MHz CB transceiver designed to meet the Australian specification RB249.

It is a modified version of their Microcom commercial SSB/AM transceiver.

The first rig in the world to use a microprocessor, it is housed in an innocuous-looking matte black cabinet only 180 mm wide by 65 mm high and 220 mm deep.

The three features that first strike you are the digital S-meter, the digital mode/channel display and the push-button controls on the front panel.

Only the usual basic three control knobs are included — volume, squelch and clarifier.

Instead of a panel meter, from which you 'guesstimate' the readings, the Black Knight has a big, bright digital readout on the upper left of the front panel which indicates the signal strength of stations being received and the power output when you are transmitting!

Now you can give 'real' signal reports!

The mode of operation is selected by successively pushing the MD button near the clarifier control.

With each press the mode will change from AM to upper sideband then lower sideband.

The mode is indicated on the left of the channel display as A, U and L respectively.

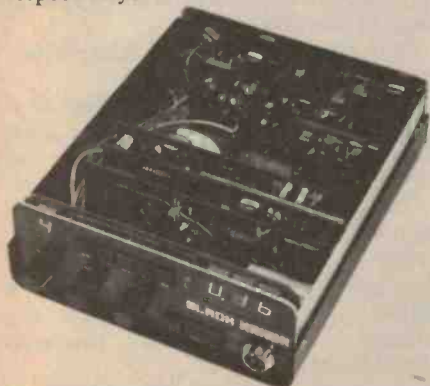

Above, the guts of the Black Knight showing the plug-in type printed circuit boards for quick servicing.

The channel is changed by depressing either the DN button to go down or the UP button to go up.

A single push increments the channel by one.

Holding down the appropriate button causes the rig to step through the channels at the rate of about two per second.

the Black Knight has two special 'scan' facilities.

The receiver can be scanned through all 18 channels or only five selected channels, the channel numbers of which can be stored in a 'memory'.

This enables the operator to look for busy or clear channels across the whole band or only among selected favorite channels at channels at the push of a button!

When the AS button is depressed, the receiver will scan all 18 channels.

Selected channels are stored in the transceiver's memory by dialling up the required channel(s) and pressing the MW (memory write) button.

If you want to check or change the channels at any time the MR (memory read) button is pressed and the channels in the memory will be displayed and can be changed simply by going over the memory write procedure.

The receiver incorporates an automatic gain control circuit that does away with the need for an RF gain control.

Many CB transceivers include an RF gain control so that the operator can reduce the strength of nearby stations to prevent overload and improve reception clarity.

The transmitter includes a built-in speech processor that prevents splatter while maintaining 'talk power' when transmitting.

The mic connector is conveniently placed on the right-hand side of the front panel as the transceiver is designed to be installed in right-hand drive vehicles.

Cadet Research look like cleaning up in CB market 'jousts' with their Black Knight.

Mickey mic and Smithy!

DICK Smith recently added two new base microphones to his catalogue.

Number C1112 is a modern style amplified mic featuring press-to-talk bar with a slide locking feature that is useful when delivering long monologues.

A control is included to allow level adjustment of the built-in amplifier.

A slide switch is located beneath the base of the mic to allow for either electronic or relay switching.

This unit will be available from all Dick Smith stores for about \$45.

The second mic is a great chrome-

plated metal monster reminiscent of the microphones of the 1930s.

A large press-talk bar dominates the tubular stem — a great feature for passionate mic-holders!

A heavy, grey enamelled base ensures stability and the coiled mic cord enters the base via a protective coil spring.

Catalogue number is C1114, designated model 95-328, it is available in all Dick Smith stores for \$39.50.

For any further details contact Dick Smith Electronics, 24 Carlotta St., Artarmon, 2065, NSW, (439-5311).



Above Dicks' amp mic with slide locking press-to-talk bar.

Right, 'a great chrome-plated monster' with that beautiful 1930s style.

Das CB Bleepen-blooper

Blaupunkte-Werke GmbH, in West Germany reckon they've come up with a great scheme to increase the effectiveness of CB in emergencies. Their idea is that if you can't raise anyone on channel 9 (5), then you trigger the transmission of beep tones on all CB channels, thus alerting other CB'ers to listen on channel 9. They don't seem to have considered the absolute chaos this type of device could cause in the hands of an idiot with a linear!

CB Expansion

The EIA's 1973 proposal to expand the US CB band to 224-225 MHz has finally been considered and rejected by the FCC. By this time, it was obsolete anyway...

CB NEWS

Exciting new ground plane

LOCAL manufacturer Electrocraft have just released details of their new CB base station antenna.

The quarterwave, spiral-tuned groundplane has not been seen on the local market before and Electrocraft expect lots of interest in their antenna.

The sturdy construction features a heavy gauge, plated mounting bracket and U-bolt designed to fit a range of pipe-mast diameters.

The four quarterwave radials and the vertical radiator are all telescopic to facilitate optimum adjustment.

A strong plastic base insulator supports the vertical element and a standard SO-239 socket is provided.

Retail price will be under \$40 which should give most of the competition base antennas a run for their money.

Availability may be limited while Electrocraft seek agents in all States.

Customer and trade enquiries welcome, contact Electrocraft at 106A Hampden Road, Artarmon 2064 (411-2989 or ring 411-3772).

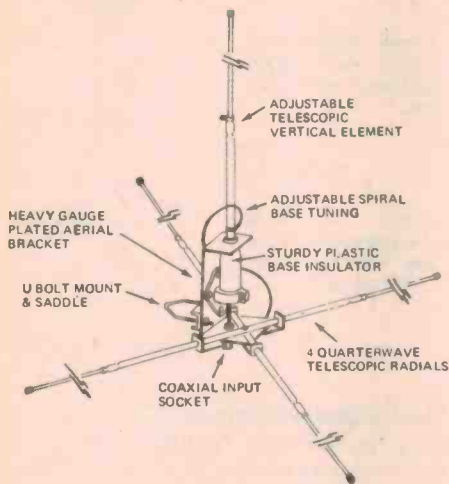

The new groundplane antenna from Electrocraft features fully adjustable elements and adjustable spiral tuning.

Extended cut-off for 23ch. gear

THE Federal Communications Commission (FCC) has been asked by the US National Appliance and Radio-Electronics Dealers Association (NARDA) to extend the cut-off date for sales of 23-channel CB equipment from January 1 to March 1, 1978.

NARDA told the FCC that many of its members were carrying huge inventories of 23 channel equipment and asked that the deadline be extended

so that they could dispose of the equipment.

Chief of the FCC's Technical Standards Branch, Frank Rose, said: "It is 50/50 which way it will go."

He added that the deadline was notified way back in August 1976, noting that many firms "depended on our pronouncement to get rid of their stocks early and in doing so incurred some type of economic adversity."

The proposed deadline will probably be considered by the FCC early in November.

Similar petitions for extensions had been filed with the FCC by Dynascan, Fannon/Courier, Pathcom, Royce Electronics and various retailers and distributors along with the National Association of Retail Dealers representing general merchandisers and chains of leisure equipment stores.

Low-Cost CB Mics

Audio Telex Communications has introduced two new CB hand microphones incorporating an "Electret" element which the company says represents a "significant breakthrough" in CB mic design.

Called the "Procom I" and "Procom II" in the Telex Professional Communications Series, the mics are claimed to offer excellent sound quality, sensitivity, and immunity to RF interference.

The ProComs are built to the same quality standards as aviation communications equipment of which Telex is the world's leading producer.

During his recent visit to Australia, the Chief Product Manager for Telex CB products, Mr. Norman Hansen introduced the new "Procom" range to Telex dealers throughout Australia.

"The new electret design for CB power mics is a real breakthrough" said Mr. Hansen. "Procom offers a frequency response acoustically shaped for CB radio transmission with outstanding crispness and intelligibility."

The Procom I has a fixed level

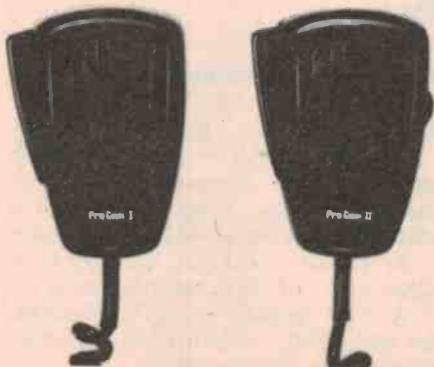

Two mics from Audio Telex Communications. Left: Procom I, Right: Procom II (power mic with variable gain).

output, gain of approx. 16 dB and a list price of \$31.05. The Procom II is a power mic equipped with a variable gain preamplifier, approx. 42 dB gain and list price is \$44.99.

Further information from Audio Telex Communications, 54 Alfred Street, Milson's Point, NSW, 2061.

Thief beater . . .

THE Hy-Gain model 2679A 'Hide & Speak' is a 23-channel remote mounting style AM transceiver designed to foil would-be thieves.

The 2679A is divided into two modules.

The actual transceiver is packaged in a low-profile module designed to be mounted in a car boot, under a seat or any other secure location.

This puts it out of sight, hidden away from potential thieves.

The handset module is a complete control unit.

It contains the mic, push-to-talk bar, receive and transmit LED indicators, channel selector, LED digital channel readout plus squelch and volume control.

All controls can be operated with one finger.

The handset/control module fits easily in the hand and hangs from the dashboard when not in use.

It can be detached and stored in the glove box when you leave the car.

A 1.6 metre long cable links the transceiver module to the control module socket at the dashboard.

All controls and indications are at the driver's hand — literally — so the 2679A would be one of the safest rigs to operate while driving.

There is no straining to read or reach under the dash.

Whips in summer colours

MOBILE One have released their popular series of helical whips in a new range of summer colors.

The protective heat-sink plastic sleeving covering the whip is available now in four fluorescent colors — green, blue, yellow and red.

The standard black and white whips are also available.

All five whips in the Mobile One range — the Skipwhip, Heliwhip, LSD, Thunderstick and Superhelical — can be obtained in the new color range.

Now you can play mix-and-match with your mobile whip and duco color!

All whips are now available also with the new 'locking snap-down' mount which allows you to lay down the antenna to clear low overhead obstructions.

Enquiries to Mobile One, 17 Sloane St., Marrickville, or write PO Box 166, Randwick, NSW, 2031 (516-4500).

Get your Xmas goodies before the rush



cb corner

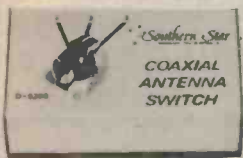

co-ax switch
1175

New design antenna switch. Allows you to swap between antennas for best DX! Suits PL-259 plugs.
Cat D-5206 \$11.75

Filter
\$1050

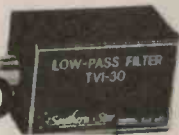

Cure your TVI troubles. As Cbers, TV interference can put you off air. Ensure your signals are clean with a low pass filter. Cheap insurance!
Cat D-7082 \$10.50

car stereo



auto reverse **\$115**

That's right! An automatic reversing car cassette for only \$130.00! Incredible value, high fidelity machine will really do your cassettes proud! You can select the program by pressing a button, or let it get to the end of the tape and the unit does it for you!
Cat. A-6486 \$115.00 (speakers not included)

SEE DICK SMITH FOR ALL YOUR CHRISTMAS GIFT IDEAS - EVERYTHING FOR THE HOBBYIST FROM COMPONENTS TO COMPUTERS, FROM TAGSTRIPS TO TOOLS - ALL AT EXTRA VALUE PRICES!

How about a bit of 'light' reading?



What do you give someone who wants to know more about a subject: A good book, of course. Here's a really authoritative book: An introduction to microcomputers. A whopping 1207 pages crammed with the good oil!
Cat B-2342

1950

1207 pages!

Here's the first volume of the above book. Real value for the novice computer brain!
Cat B-2340 . . . \$12.50

1250

Fantastic Xmas Video Game Bargains...

Greatest Kit value ever
The ETI 408 Video Game Kit is now being supplied with the fantastic AY-38550 IC which allows up & down as well as back & forth movement of bats!

This, plus the special price, makes the ETI 408 video game kit an ideal christmas gift. Keep the family amused over the long holidays ahead!

Has ON-SCREEN SCORING & SOUND!
NEVER BEFORE AT THIS PRICE!

Cat K-3432

47⁵⁰

Chips

We still have a few AY-38500 ICs in stock, at a VERY SPECIAL PRICE! They were \$19.75 each - NOW ONLY

Fish

Sorry - sold out.

15⁷⁵



FREE: Full details for converting your old video game to two-way bat control. Just ask!

Convert your TV game to full TWO-WAY BAT CONTROL!!!!

First the bad news - your old TV game is out of date. New advances in IC technology have meant that TV games now have two-way bat control for more realism.

Now the good news - you can easily convert your old TV game to two way bat control simply by replacing the IC with a new type. Pin-for-pin substitution - no more soldering or new components. Add a joystick pot to allow two-way movement and the job's finished!

THE PARTS YOU NEED:

AY-38550 IC Direct substitution for the old AY-38500.
Cat Z-6850 \$17.75

(Normally \$19.75 - save \$2.00 until Christmas)

JOY STICK POTS: Gives two-way action in an ingenious mechanical combination of two conventional pots.

Cat R-1976 \$4.75

PRINTED CIRCUIT BOARD: (only necessary if you've damaged the old one - or wish to experiment!)

Cat H-8605 \$3.50

DICK SMITH ELECTRONICS GROUP

SYDNEY - 125 York St. Ph: 29 1126.
GORE HILL - 162 Pacific Hwy. Ph: 439 5311.
BANKSTOWN - 361 Hume Hwy. Ph: 709 6600.
PARRAMATTA - 30 Grose St. Ph: 683 1133.
MELBOURNE - 656 Bridge Rd. Richmond. Ph: 42 1614.
399 Lonsdale St., City. Ph 67-9834
BRISBANE - 166 Logan Rd. Buranda. Ph: 391 6233.

THE AUSTRALIAN COMPANY.



Mail Orders: Box 747, Crows Nest, NSW.
Postage and packing is extra!
We have a network of dealers across Australia.



TL081 · TL071 · TL061

Low cost · Low noise · Low power

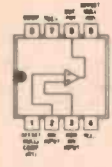
From the leader in BIFET op amps, Texas Instruments.

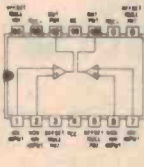
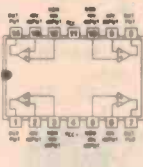
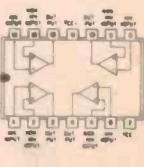
 <p>TL080 Uncompensated with offset control. Pin equivalents: LM301A, LM308, μA748</p>	 <p>TL061 TL071 TL081 Compensated with offset control. Pin equivalents: μA741, LF355, CA3140</p>	 <p>TL062 TL072 TL082 Compensated with no offset control. Pin equivalents: MC1458, RC4558</p>	 <p>TL043 Compensated with offset control. Pin equivalents: μA747</p>	 <p>TL064 TL074 TL084 Compensated with LM324 pinout</p>	 <p>TL075 Compensated with RC4136 pinout</p>
---	---	---	---	---	--

Now there are three BIFET op amp families to serve virtually all of your operational amplifier requirements. The new TL061 and TL071 families join the TL081 family to offer you the most comprehensive line of BIFET op amps available. Each family has its own identical specifications so you can standardize your requirements regardless of application.

You'll find low-cost general purpose BIFET op amps priced to replace bipolars. Low noise audio devices with low harmonic distortion. And a totally new concept, a BIFET op amp with low power consumption and low supply current. Four singles, four duals and four quads. Six pinouts in three series plus a whole lot more.

Check the prices and specifications. You'll find them more than competitive. But more

important, you'll find all twelve BIFET op amps available off the shelf from TI and your local authorized TI distributor.

TL081 General Purpose Series

Five general purpose devices with identical specifications that allow you to standardize your op amp requirements in one family to replace such widely used bipolars as μ A741, MC1458, LM308, LM324, μ A747, RC4558 and RC4136.

TL071 Low Noise Series

Low noise and low harmonic distortion make the TL071 series ideal for high fidelity and audio pre-amp applications. Equivalent input noise voltage is typically $18\text{nV}/\sqrt{\text{Hz}}$ with a low harmonic distortion of .01%.

TL061 Low Power Series

A totally new BIFET op amp series ideally suited for battery-powered and similar applications requiring a minimum of power consumption. Now you can get BIFET dc specs and ac specs better than μ A741 and MC1458 bipolar op amps at less than one tenth the power—0.25 mA max I_{CC} per amplifier.

**TEXAS
INSTRUMENTS**
AUSTRALIA LIMITED

UNIT 1A, 5 BYFIELD STREET
P.O. BOX 106
NORTH RYDE N.S.W. 2113
TELEPHONE: 887 1122
TELEX: 25685



For further information, please contact your nearest Texas Instruments Distributor, as listed below:—

BIFET op amp specifications.	TL081	TL071	TL061
I_{IB} Input bias current (nA max)	0.4	0.2	0.4
V_{IO} Input offset voltage (mV max)*	15	10	15
B_1 Unity gain bandwidth (MHz)	3	3	1
SR Slew rate (V/ μ s)	13	13	3.5
V_n Equivalent input noise voltage (nV/ $\sqrt{\text{Hz}}$ max)	47	18	—
I_{CC} Supply current (mA max)	2.8	2.5	0.25

* A & B versions available with 6 mV and 3 mV respectively for all three families.

INSTANT COMPONENT SERVICE,
16 Gertrude Street, ARNCLIFFE. 2205.
Phone: 597-1444
147 Ward Street, NORTH ADELAIDE. 5006.
Phone: 267-2393
Wickham Road, MOORABBIN. 3189.
Phone: 95-1566
CEMA ELECTRONICS,
21 Chandos Street, ST. LEONARDS. 2065.
Phone: 439-4655
208 Whitehorse Road, BLACKBURN. 3130.
Phone: 877-5311.

Assuring you of our complete support.

TEXAS INSTRUMENTS
INCORPORATED

PROCESSOR-CONTROLLED SSB/AM CB TRANSCEIVER

EARLIER THIS YEAR, Texas Instruments announced that they had developed the world's most advanced CB transceiver which incorporated two microprocessors in the circuitry along with a number of unique, and sophisticated, features.

As Texas Instruments are bound to start something of a revolution in both ergonomic and electronic design with their transceivers, we thought you might like to have a look at what they're doing.

Two transceivers will be produced, using much the same circuitry but differently packaged. The mobile model, designated SM-172, will be a remote-control type having a transceiver section about the size of a hard-cover book that can be mounted anywhere out of sight.

The base model, the SB-173, will be quite unlike most bases.

Both models will be 40 channel SSB/AM transceivers to meet current FCC specifications. So far as we know, Texas Instruments have no plans to export them to Australia. They would have to be modified to comply with the 18 channel Australian specifications but the technology employed in these transceivers should make them easy to convert.

The SM-172 appears to be the world's first remote-controlled SSB/AM transceiver. This type of transceiver has been AM only to date, and a number of manufacturers, like Hy-Gain, Johnson and Bowman, have been marketing remote rigs for some time.

The big, and revolutionary, feature of the TI rigs is the handset. It looks like an electronic calculator but contains all the controls and indications usually encountered on a CB transceiver — and then some!

A microprocessor in the handset sees to all the handset functions and 'communicates' with another in the transceiver which commands all the transceiver functions.

Memory storage facilities are available for a variety of unique functions designed into the TI transceivers.

The design of these transceivers and the incorporation of the microprocessors heralds the advance of push-button ('computerised') communications on CB removing the necessity for dial twisting, constant control adjustments

and the distraction of checking dials and indicators.

A unique feature of these TI rigs is the 'automatic clarifier'. Manual fine tuning is a thing of the past! This is of paramount importance on SSB where the clarifier on ordinary rigs is probably the single, most-used control.

When communicating between two TI rigs, clarifier adjustment is instant and automatic — you don't touch a thing, the transceivers do it all themselves. When using a TI rig and communicating with a conventional SSB rig, clarifier adjustment is available at the push of a button!

A selective calling system is provided in both transceiver models. Preselected channels can be monitored in complete silence until a call from a particular TI transceiver is received. Calls between the two units can then proceed.

The selective calling code and channel number can be entered into the transceiver's 'memory' via the handset keyboard pads. Up to 100,000 combinations can be stored for any of the channels giving the transceivers an enormous versatility.

This unique digital selective calling system of the TI transceivers virtually allows 'direct dialling' between rigs using the pre-selected codes. When in the selective calling mode, the receiver will remain silent until someone with another TI rig, with the appropriate code stored, calls on the channel.

The odds are millions to one against someone with the same combination calling within an operator's geographical range!

The five most-used call codes can be programmed into the processor memory so that they can be selected by pressing only one keyboard pad.

Both the mode of operation and the channel number can be incorporated in the call code.

Facilities to find a clear channel and a busy channel are also incorporated. The first allows rapid search for a clear channel when you want to QSY from a call channel. The busy channel facility allows you to find a contact already in progress that you can 'break'.

Transmit Features

The transmitter features an automatic level control (ALC) on SSB that provides 16 dB of RF compression to prevent



flattopping and maintain a high average-to-peak power level. This makes for a really punch SSB signal.

On AM, 20 dB of audio compression is provided to maintain high average modulation level with varying voice level.

A unique frequency-lock digital synthesizer is used to select channels. This is controlled by the transceiver microprocessor and incorporates the addition of an 'automatic clarifier'. We'll discuss this in detail later in the article.

In conjunction with the automatic clarifier, the receiver incorporates a digital-tunable charge-coupled device (CCD) filter that markedly improves reception and reduces adjacent channel rejection. More on this feature later too!

The Handset

The handset for the SM-172 and SB-173 contains all the operational controls, plus a five-digit LED channel and mode readout together with the microphone! No more peering under the dash to fiddle with the knobs or see what channel you're on.

Styling is very similar to a small, hand-sized pocket calculator as it has twenty key pads for function selection and digital control and two rocker switches for volume and squelch operation.

A conventional bar on the side provides press-to-talk operation of the transmitter.

Looking at the handset in our illustration, the three LED displays on the left hand side of the readout indicate channel and mode. In this case it is channel 40 and the U stands for upper

sideband (USB). To the right, the two LED displays function as would the panel meter on a conventional CB. Signal strength and SWR can be displayed on this part of the readout.

The squelch can be decreased in incremental steps by depressing the left hand end of the squelch rocker switch. It is increased by pressing the right hand end.

Similarly, the volume can be increased or decreased in increments by depressing the left or right hand ends of the volume rocker switch respectively.

Mode Selection

Four keypads along the top of the keyboard on the handset operate various functions. The two on the left are marked LB and UB. These select the SSB operating modes of upper sideband and lower sideband respectively. The two pads on the right increment the clarifier when communicating with non-TI transceivers.

Ten pads marked 0 to 9, as on a calculator keyboard, are used to enter channel numbers and selective call codes. To the right of these are a row of pads for the selection of other functions.

The one marked AM is obviously used to select the AM mode of operation.

Busy and Clear Channels

The CC and BC pads are to initiate the receiver to search for a clear channel (CC) or a busy channel (BC).

Their operation is as follows:

Say you've raised a station on the call channel and you're about to QSY (change channel). To find the nearest clear channel the CC key is held down. The receiver then scans until a clear channel is found. The digital readout indicates which channel it is. When the CC key is released, the receiver returns automatically to the channel you were on and you can then tell your contact which channel to QSY to.

Say you've broken down on the highway and can't raise a station on the emergency channel. What you need to do is break in on an existing QSO. The busy channel is found holding down the BC key. The receiver then scans until the nearest busy channel is found, the digital readout indicating the channel number. When you release the BC key the receiver returns to the channel you were on and you can then punch in the number of the busy channel on the numerical key pads and the transceiver will then move to that channel.

SWR Monitor

The SWR is monitored by the micro-processor in the transceiver and protection is provided in the event of a high SWR occurring on the feedline. This

TEXAS INSTRUMENT'S SM-172 MOBILE & SB-173 BASE STATION 27 MHz CB TRANSCEIVERS

SPECIFICATIONS

General:	
Frequency Range	26.965 – 27.405 MHz (40 channels)
Frequency Stability	± .002%
Supply Voltage	13.8 V pos. or neg. ground (reverse polarity protected)
Transceiver Protection	Dual fusing and automatic SWR protection
Transmitter:	
RF power output	4 watts (carrier), AM mode 12 watts PEP, SSB
Harmonic & Spurious suppression	greater than 60 dB
SSB Carrier suppression	40 dB
Audio Frequency response	300-2500 Hz @ -6dB
Audio Distortion	less than 5% at 1 kHz with 80% modulation
Modulation limiting	AM—20 dB audio compression SSB—16 dB RF ALC
Output impedance	50 ohms
Emission modes	AM, USB, LSB
Receiver:	
Input impedance	50 ohms
Sensitivity	0.6 μ V, AM for 1kHz & 30% mod 0.4 μ V SSB . . . both for 10 dB (S + N)/N ratio
Squelch threshold	4 μ V min., 1000 μ V max
Adjacent channel rejection	greater than 80 dB
Image rejection	greater than 60 dB
Crossmodulation rejection	75 dB at +50 kHz
AGC performance	less than 6dB change for greater than 100 dB change in input level
Audio output	3 watts (RMS) at less than 5% distortion, into 3 ohms
Noise blanker	separate receiver antenna sampler and IF gate

prevents transmitter damage that could be caused by severe antenna mismatch, broken cables, connections or damaged antenna.

Each time the PTT is pressed when you take an 'over', the SWR is instantly checked. If the SWR is above a

certain value the transmitter is deactivated automatically and the processor alerts the operator by flashing "AAA AA" on the LED readout.

The SWR can be read at any time by pressing the SWR key. The SWR is then displayed on the LED readout.

Selective Call

The selective call numbers consist of the channel number and mode followed by five digits.

Selective calling works like this:

A particular channel and mode is selected and a five digit number. These are entered into the transceiver processor memory via the keyboard, on each transceiver.

For example, say channel 16 upper sideband is the desired channel and mode. The number 16 is punched up on the numeral keys followed by the UB key. Any random five digit number is then entered on the numeral keys — say, 74291.

If this combination is used in a base-mobile situation, the code is keyed into both transceivers. The base will monitor the selected channel (16) in silence, on USB. When the mobile wishes to call base the operator enters the code on the keyboard, presses the PTT, and calls. The base receiver squelch will open and the call will be heard.

Similarly, the base can call the mobile. If any other stations use the channel while both base and mobile are only monitoring, the calls will not be heard, and the operators will not be distracted by having to listen for calls not intended for their stations.

Up to five most-used codes can be entered into the transceiver processor's memory and recalled at the press of a single key. This saves having to punch out the complete code each time a call is made.

With the five digit numeral code used in the selective call feature, up to 100,000 combinations are possible *per channel, per mode!* That's 1.2×10^7 combinations!

You're in trouble if you forget the code! That's why the code memory facility is provided.

Inside the Transceivers

The transceivers apparently use two microprocessors from the TMS1000 series made by Texas Instrument's solid state manufacturing division.

They are four-bit, single chip microcomputers currently used in calculator, microwave oven and burglar alarm applications.

It is believed that Motorola are making a CMOS version of these microprocessors, thus making possible handheld and portable CBs incorporating the sophistication of the SM-172 and SB-173 transceivers.

Automatic Clarifier and IF filter

The frequency synthesizer uses a unique frequency-lock system to effect automatic clarifier operation in the SSB

Fig.2. Comparison of conventional clarifier and T.I. system automatic clarifier and IF tuning.

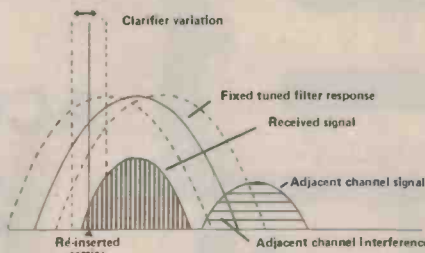

(A) conventional clarifier and IF filter. Clarifier manually tunes Rx local oscillator to centre passband and re-inserted carrier on signal.

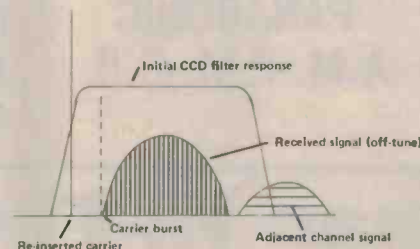

(B) T.I. system IF and clarifier. Carrier burst is detected and compared with re-inserted carrier. IF filter is 'wide' initially.

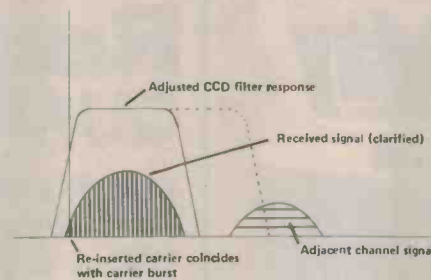

(C) Carrier burst locked with re-inserted carrier and filter adjusted. Adjacent channel interference reduced.

mode. Working along with this is a special CCD 3rd-stage IF filter that is adjusted by the microprocessor once the signal is clarified to reduce the bandwidth, providing optimum signal tuning and greatly reducing adjacent channel signals.

The automatic clarifier works between two TI transceivers. When the PTT is pressed, a carrier-burst is transmitted just prior to when the operator speaks. The receiver of the other station detects the carrier-burst and computes the difference between the suppressed carrier of the transmission being received

and the re-inserted carrier provided the receiver for resolving the SSB sign

The processor then shifts the synthesizer frequency slightly, centering the signal in the receiver IF passband. The re-inserted carrier is then virtually 'locked' to the suppressed carrier of the received transmission.

The receiver is a triple-conversion type, the third IF stage using a charge-coupled device filter (CCD).

The CCD filter is a Fairchild invention developed for imaging, signal processing and memory applications in airborne radar. It is used in Texas Instrument's sophisticated airborne radars for computer tuned and controlled signal processing to enhance signal-to-noise ratios for optimum radar target detection systems.

The CCD filter in the 3rd IF of the TI CB receivers can be frequency and bandwidth tuned by the on-board microprocessor, to optimise signal-to-noise ratios and adjacent channel rejection on received signals.

The action of the automatic clarifier and the digital tunable CCD IF filter are illustrated in figure 2, compared with a conventional clarifier. Over 80 dB of rejection of adjacent channel signals is provided by the steep 'skirts' of the CCD filter. This compares very favourably with conventional CBs which generally have around 45-60 dB adjacent channel rejection only.

In a fraction of a second before voice communications commences, the signal is automatically clarified and the receiver bandwidth adjusted to provide optimum reception.

Pretty nifty, eh?

When are they going to make amateur band transceivers with these features?

Noise Blanker

The noise blanker used in the TI CBs employs an antenna-sampling receiver. This is virtually a separate wideband receiver that is always connected to the antenna. Any noise pulses, car ignition, static etc, received are turned into a 'gating' pulse. This pulse operates a 'gate' in the receiver IF system that literally turns the receiver off for the duration of the noise pulse. The small 'hole' in the received signal goes unnoticed and no manual switching of the noise blanker system is necessary. It is equally effective on both AM and SSB.

This type of noise blanker is one of the most effective available.

The Future?

If that's the sort of high technology sophistication that's setting the pace in CB transceiver design — what does the future hold?

C.B.

TRANSCEIVERS AND ACCESSORIES

S.S.B.
COBRA
JOHNSON VIKING
HY-GAIN
X-TAL
COURIER
PANTHER

A.M.
COBRA 21
COBRA 26
SIDEWINDER 111
PANASONIC
A.M.-F.M.-C.B.

**ALSO AVAILABLE
 FULL RANGE OF
 ANTENNAS S.W.R.
 METERS. PLUGS,
 SOCKETS AND
 CABLE.
 FROM THE NORTH'S
 LARGEST SUPPLIER
 OF C.B. EQUIPMENT**

Ron Chapman Hi-Fi Centre pty Ltd.,

880 Hunter Street, Newcastle West.2302. Phone 69-2733 - 69-2796

electronics today

INTERNATIONAL

BINDERS
HOLDS 12
COPIES OF

eti



Protect and file your back issues of Electronics Today with these attractive binders. Price: \$4.50 plus postage and packing (80c NSW. \$1.70 other states).

SUBSCRIPTION DEPARTMENT

ELECTRONICS TODAY INTERNATIONAL
MODERN MAGAZINES (HOLDINGS) LTD.,
15 BOUNDARY ST., RUSHCUTTERS BAY, 2011

Realtime QUARTZ

1/100 OF A SECOND ACCURACY
CHRONOGRAPH — LAP
TIME — LCD DIGITAL
WATCH



- Display-Hour, Minute, Second/Date, Month, Day
- Start, Stop, Reset, Lap time, Instant time freeze, Memory recall
- Accuracy 5 sec/month, 30 sec discrepancy can be corrected easily by push-button
- Back light enables time reading in dark
- 2-battery system — time keeping and light
- Four-year calendar
- Module thickness: 5 mm
- One-year guarantee

\$99

postage included

Trade enquiries welcome

CHAN MERCHANDISING CO P/L

111 Reservoir St, Surry Hills
Tel (02) 211-4660
906 Casson Ave, Mt Hutton
(049) 48-9676 (Sat & Sunday)



EMONA
enterprises

**FOR PROMPT MAIL
ORDER SERVICE!**



EMONA
electronics

SALES: Room 208, 661 George St., Sydney. Phone: 212-4815 — C.B.C. Bank Bldg., Haymarket.
REG. OFFICE: 21 Judge St., Randwick. Phone: 399-9061.

**OUR NEW RANGE OF NATIONAL
SEMICONDUCTORS CALCULATORS**



NS 100 NS 4640 NS 201

● NS 4640 — Scientific/Engineering/Statistical/Business calculator. National Semiconductors Model 4640 (see August ETI for details) only \$49.95. ● NS 201 — Scientific — \$19.40.

Plus 15% S. Tax (P&P Int. \$3.00, NSW \$2.00).

● Elcon SC-44F, Scientific — \$32.50. (Recharg. battery & charger), plus 15% S. Tax. (P&P Int. \$3.00, NSW \$2.00)

- NS 100 — Ultralim Pocket (7.5mm thin) Billfold style, \$22.50
- NS 202 — Full Financier, Billfold style, \$22.50
- NS 201 — Full Scientific, Billfold style, \$19.50



CJ1YW DAB5WB KEK5WS

NATIONAL SEMICONDUCTOR QUARTZ DIGITAL LCD WATCHES

MENS: * CJ1YW CHRONOGRAPH, \$85.00

In the timekeeping mode: Continuous Read Display of Hours, Minutes, Seconds Counter; Day of Week Indicator; Month/Date Calendar and Night Viewing Light. In the stopwatch mode: Continuous Counting Six Digit Display of Minutes, Seconds and HUNDREDTHS of a Second, plus Lap and Split Timing.

* DAB5WB — Stainless steel case & band — \$47.00

* DAB5YB — Gold plated case & band — \$55.00

FEATURES: Continuous Read Display * Display of Hours, Minutes, Seconds Counter * Month/Date Calendar * Night Viewing Light * Dust Resistant * Anti-Magnetic * Quartz Crystal Accuracy

LADIES: * KED5WS — Stainless steel case & black leather band \$44.00

* KEK5YS — Gold plated case & brown leather band — \$49.00

* KED5WB — Stainless steel case & band — \$53.00 * KEK5YB — Gold plated case & band — \$58.50.

FEATURES: Fashionably-Styled Cases * Continuous Read Display of Hours, Minutes, Seconds Counter * Month/Date Calendar * Night Viewing Light * Dust Resistant * Anti-Magnetic * Quartz Crystal Accuracy.

WARRANTY: FULL 12 MONTHS

P & P \$2.00

DIGITAL CLOCK RADIOS:

● EMONA E-4 stereo FM/AM 24 HOUR DIG. CLOCK RADIO, \$79.00 (p/p Int. \$4.50, NSW \$3.50). ● EMONA E-2, All solid state AM/FM 24 HOUR DIG. CLOCK RADIO, \$49.00 (P&P Int. \$4.00, NSW \$2.50). Unique design. ● CR-102, AM/FM 12 & 24 HOUR DIG. CLOCK RADIO, Sliding brightness, volume & tone controls. \$45.00 (P&P Int. \$4.00; NSW \$2.50.)

**DENTRON ANTENNA TUNER
80-10 SKYMATCHER**



500W PEP.

\$89

Here's an antenna tuner for 80 through 10 meters, matches your 52 ohm transceiver to a random wire antenna. ● Continuous tuning 3.2 - 30 mc ● "L" network. ● Ceramic 12 position rotary switch. ● SO-239 receptonal to transmitter. ● Random wire tuner. ● 3000 volt capacitor spacing. ● Tapped inductor. ● Ceramic antenna feed thru. ● 7" W. 5" H. 8" D., Weight: 5lbs.

DENTRON SUPER TUNER



1 KW PEP

\$179

160-10 Meters Balanced Line, Coax, Random or Long Wire Maximum Power Transfer, Xmitter to Antenna.

CB — FREQUENCY COUNTER, BC-275 \$89 P&P Int. \$3.50, NSW \$2.50

AMATEUR RADIO EQUIPMENT!



● YAESU FRG-7
GENERAL COVERAGE
RECEIVER-WADLEY
LOOP SYSTEM
— \$295

TRANSCEIVERS:

- YAESU FT-101E AC-DC TRANSCEIVER — \$799
- YAESU FT-301 TRANSCEIVER — \$910
- YAESU FT-301D TRANSCEIVER — \$1050
- YAESU FT-301SD TRANSCEIVER — \$839
- TRIO KENWOOD TS 520S
- TRIO KENWOOD TS 820
- TRIO KENWOOD TS 600
- TRIO KENWOOD TR 7400A
- PRICE ON ALL KENWOOD EQUIPMENT TO BE ANNOUNCED

LINEAR AMPLIFIERS:

- YAESU FL 2100B — \$505
- DENTRON MLA 2500 — \$899.50
- DENTROL MLA 1200 — \$489
- DENTRON 160-10L/572 — \$755
- SCS HF3-100L2 — \$219



NEW!
MEDIUM SIZED HAM ANTENNA
ROTATOR — FU400.
CONSTRUCTED FOR LONG
TROUBLE-FREE OPERATION,
200KG VERTICAL WEIGHT
CAPACITY. EXTRA HEAVY
DUTY DISC BRAKE THAT PRE-
VENTS WIND-MILLING! \$105

ANTENNA TUNERS:

- DENTRON MT-3000A — \$399
- DENTRON 160-10AT — \$179
- DENTRON 80-10AT — \$89
- A15 S FOR BCL — \$34
- RF PREAMPLIFIER SX1 — \$49
- RF PREAMPLIFIER SX59 — \$79



ANTENNAS:

HUSTLER 4 BTV ALL BAND VERT. TRAP ANTENNA
HUSTLER ALL BAND MOBILE ANTENNA.

FREQUENCY COUNTERS:

MODEL C-401BS, HIGH QUALITY FREQ. COUNTER,
1Hz to 67MHz, 670 MHz with UHF SCALER BA-6.

NEW MODEL DX-555P COUNTER-GENERATOR



NEW Counter-Generator
Two vital pieces of test
equipment in one

Counter: 5 digit display, 7 digit readout capability. 10 Hz to over 30 MHz (250MHz with prescaler) input level 20m Vrms to 5 Vrms (Prescaler 200m Vrms to 2 Vrms). Base oscillator beats directly against WWV.

Generator: 440 KHz to 30 MHz in 3 ranges. Output displayed on counter and available at Jack on rear panel 600 Hz modulation for AM receivers.

General: VAC fuseo supply Size (In.) 2.3H x 6.3W x 8.5D Weight (lbs) 4.4

\$198.00

CB RANGE:

- SEIKI, HA-23 CHANNEL, AM TRANSCEIVER — \$ 59.00
- MECAO, BCB-6, 23 CHANNEL, AM TRANSCEIVER — \$ 59.00
- SBE — SIDEBANDERIV, AM/SSB TRANSCEIVERS — \$199.00
- KRACO, MOBILE, AM/SSB TRANSCEIVER — \$199.00
- IN-LINE DIGITAL FREQ. COUNTER FOR CB — \$ 79.00
- CB MOBILE HELICAL WHIP ANTENNAS — \$ 27.50

ALL AMATEUR RADIO EQUIPMENT IS AVAILABLE ON 10 PERCENT DEP. TO APPROVED BUYERS!

2650 HOME COMPUTER SELECTION GAME

DO YOU WANT TO BUILD A POWERFUL, LOW COST HOME COMPUTER

START HERE

SELECT A BASIC SYSTEM

A. EA BABY 2650 \$75.00
 B. KT 9500 COMPLETE \$199.00
 C. EA 2650/KT9500 CONVERSION \$142.00

LOW COST TV TERMINAL

A MUST TO GET THE MOST OUT OF YOUR SYSTEM - INCLUDES AUTOMATIC SCROLLING, CURSOR, FULL EDIT FACILITIES

ETI 632 VDU PLUG IN VERSION \$180.00
 632 ECONOMY VERSION \$135.00

POWER SUPPLY DECISION

+5, -12V

A. 1A LCPS KIT \$15.00
 B. AT 512 ASSEMBLED UNIT -12 \$27.50
 C. AT 1250 HI-CURRENT \$47.50

CASSETTE INTERFACE *LIMITED QUANTITY ONLY*

For Low Cost Bulk Storage

CT750 (Assembled) \$37.50
 Radio Electronics low cost kit with test tape and instructions \$22.50

SOFTWARE GAMES PACK

TAPE WITH LISTINGS \$12.50

ASTRO TREK, HANGMAN, NIM, POKER MACHINE, MASTERMIND ETC

MEMORY

4K STATIC RAM KIT \$100.00
 1K RAM STICKS \$ 25.50

2650 USERS GROUP

INITIAL MEMBERSHIP INCLUDES PROFESSIONAL DOCUMENTATION PACKAGE CONTAINING A MOST COMPREHENSIVE SOFTWARE LISTINGS INCLUDING

TEXT EDITOR
 ASSEMBLER
 BLOCK MOVE
 ASTRO TREK
 BAUDOT ROUTINES
 VARIOUS GAMES
 SORTING ROUTINES
 MATHEMATICS PACKAGES ETC, ETC \$40.00

ALSO INCLUDES UP DATE SERVICE

★ YOU WIN !! ★

YOU NOW HAVE A MOST COST EFFECTIVE HOME COMPUTER SYSTEM

2650 HOME STUDY PROGRAMMING COURSE

CASSETTES AND WORKSHOP NOTES

Available soon

NEED MORE INFO send \$1.00 and return address for full details



APPLIED TECHNOLOGY P/L
 109-111 Hunter St., Hornsby 2077.
 Phone: 476 4758, 476 3759
 Hours: Mon - Fri. 9 - 5, Sat All Day.

END OF YEAR

SEMI-CONDUCTOR CLEARANCE SALE

*Offer expires 7/1/78 unless stock sold beforehand.

CMOS

4000	.29	4043	1.24
4001	.29	4044	1.24
4002	.29	4046	2.76
4006	1.92	4049	.84
4007	.32	4050	.84
4008	1.96	4051	1.56
4009	.92	4060	2.24
4010	.96	4066	1.20
4011	.29	4068	.32
4012	.32	4069	.32
4013	.68	4070	.32
4014	1.96	4071	.32
4015	1.64	4081	.32
4016	.72	4082	.32
4017	1.62	4416	1.32
4018	1.84	4426	3.56
4019	.60	4449	.29
4020	2.56	4511	2.32
4021	2.24	4510	2.76
4022	1.56	4518	2.00
4023	.32	4520	2.00
4024	1.12	4528	1.52
4025	.32	4556	2.20
4026	3.64	74C00	.44
4027	.92	74C04	.44
4028	1.48	74C08	.44
4029	1.84	74C10	.44
4030	.40	74C14	2.16
4035	3.76	74C75	1.12
4040	2.48	74C192	2.96
		74C193	2.96

LINEAR IC'S

301	.64	556	1.96
307	.88	565	1.96
308	1.24	566	1.96
311	1.24	567	2.24
324	1.40	709	.64
339	1.40	741	.58
349	2.25	3900	1.22
379	6.96	3089	2.80
380	2.04	1310	2.44
381	2.04	TCA220	2.00
382	1.66	SAK140	1.86
386	1.92	UAA170	2.82
555	.58	UAA180	2.82
		50242	12.48

TTL STANDARD

7400	.32	7470	.48
7401	.32	7472	.48
7402	.32	7473	.68
7403	.32	7474	.60
7004	.32	7475	.88
7405	.32	7476	.60
7406	.36	7480	.88
7407	.48	7482	1.48
7408	.32	7483	1.32
7409	.32	7485	1.64
7410	.32	7486	.60
7411	.48	7489	3.64
7413	.32	7490	.68
7414	1.44	7491	1.12
7416	.64	7492	.60
7417	.64	7493	.60
7420	.32	7494	1.48
7426	.56	7495	1.04
7427	.44	74100	1.84
7430	.32	74107	.56
7432	.44	74121	.56
7437	.48	74123	.76
7438	.48	74150	1.84
7440	.32	74151	1.36
7441	1.10	74153	1.24
7442	1.56	74154	1.62
7447	1.24	74157	1.36
7448	1.24	74160	1.36
7450	.32	74164	1.48
7451	.32	74165	1.84
7453	.32	74173	2.64
7454	.32	74192	1.52
7460	.32	74193	1.52
		74221	2.86

VOLTAGE REGULATORS

309	2.00	7824	1.95
317	3.50	78L05	.72
323	6.95	78L12	.72
325	3.75	78L15	.72
7805	1.95	79L05	.88
7806	1.95	79L12	.88
7808	1.95	79L15	.88
7812	1.95	723	.85
7815	1.95	7905	2.56
7818	1.95	7912	2.56
		7915	2.56

TTL-LOW SCHOTTKY

74LS00	.39	74LS78	.56
74LS02	.39	74LS86	.62
74LS03	.39	74LS90	1.48
74LS04	.39	74LS92	1.48
74LS05	.42	74LS93	1.48
74LS08	.42	74LS109	.66
74LS09	.42	74LS113	.70
74LS10	.42	74LS114	.70
74LS11	.42	74LS154	2.48
74LS12	.42	74LS157	2.20
74LS14	2.15	74LS163	2.54
74LS20	.42	74LS164	2.15
74LS21	.42	74LS174	2.15
74LS27	.46	74LS175	2.15
74LS28	.46	74LS191	2.55
74LS30	.42	74LS192	2.55
74LS32	.46	74LS193	2.55
74LS37	.46	74LS194	2.14
74LS38	.46	74LS195	2.14
74LS40	.46	74LS196	2.14
74LS42	1.64	74LS221	2.00
74LS73	.53	74LS253	2.00
74LS74	.56	74LS367	1.56
74LS75	.92	74LS368	1.56

OPTO

Red Led (6 mm)	.18	NSN71	1.86
Green Led (6 mm)	.20	NSN73	1.86
Orange Led (6 mm)	.35	NSN61	2.04
4N26 isolator	1.72	FND500	1.92
		MEL12	1.58

DIODES

OA91	Germanium	.12	
IN914	Silicon	.09	
1N4004	1A/400V	.10	
A7579	5A/100V	.76	
MD3502	35A/200V bridge	3.80	
MD3504	35A/400V bridge	4.80	
400mW zenr diodes (all values to 20V)			.22

TRANSISTORS

8C547	.18	2N6577	2.18
8C548	.18	2N3442	2.68
8C549	.18	40411	3.20
8C557	.18	2N3638	.38
8C558	.18	PN3643	.38
8C559	.18	2N3644	.38
8D137	.62	µPF102	.62
8D138	.62	2N5457	.62
8D139	.84	2N5459	.64
8D140	.84	2N5461	.74
MJ2955	1.96	2N5485	.78
2M3055	.98	2N6027	1.32
µE340	1.30	2N4626	1.54
		µPF131	1.08

THE
ELECTRONIC
MAILBOX

P. O. BOX 355,
HORNSBY N.S.W. 2077

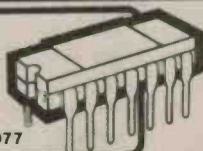

(a division of Applied Technology)

Showroom 109-111 Hunter St., TERMS: Min order \$5.00

Hornsby.

Please add \$1 post & pack.

Open Mon-Fri 9-5

All day Saturday

SORRY NO TAX EXEMPT SALES

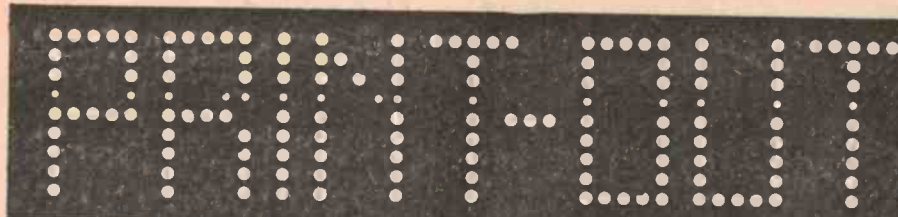

ETI's COMPUTER SECTION



New Zilog Bits

Following hot on the heels of the Z-8 announcement, here's the latest rumour from Zilog's Cupertino HQ: the 16-bit Z-8000 microprocessor will virtually be a miniprocessor, with hardware multiply and divide and powerful memory management. Word is that the Z-8000 is in the same league as DEC's PDP11/70, and that is a totally different ball-park from the micros we're used to. Also coming from Zilog in the next couple of months are COBOL and FORTRAN for the Z-80. Still don't know what the Z-800 will be like, though...

Memory Contention

Highest sales of 16K RAMs this year are by Mostek, who sold 800,000 of the beasties. Also leading the pack are Intel and Fujitsu, who sold 800,000 between them. Demand is presently outstripping supply, so prices are still holding up...

Hobart Club

Okay, all you Hobart and Tassie computer hackers, we know you're out there. If you'd all like to get together and form a club, then contact: *Clive Myers at 19 Esplanade St., Midway Point, Hobart, Tasmania 7171.* If you're in a hurry to get started, you could ring him on (002) 65 2252.

Pace Disk Operating System

A new disk-operating system (DOS) for the PACE microprocessor Development System substantially reduces the time to assemble, edit and execute microprocessor and microcomputer operating and application programs. Designated the IPC-16P/840 by the Microcomputer Systems group of National Semiconductor Corporation, the system includes a dual-floppy disk drive in a stand-alone enclosure, an interface circuit subsystem card, a read-only memory (ROM) card containing firmware and complete operating software on a diskette.

The PACE DOS includes a comprehensive file management capability, support for assembly programs, Editors, Linking Loaders, Utility Programs and Diagnostics. The system may be installed on any IPC-16P PACE Microprocessor Development System with 12K words of Random-access memory (RAM) and heavy-duty power supply.

The PACE DOS software and firmware combines an effective Monitor, a comprehensive File Manager, and a convenient File I/O Subsystem. With the combination, users reduce development time, speed debug procedures and simplify program testing.

Upon naming source and destination files, the PACE Assembler automatically performs the assembly operation. The DOS EDITOR speeds generation of new source-statement text and aids modification of existing text in preparation for assembly. It can all be used to edit non-assembler-formatted source such as lists, tables, and directories.

The DOS Linkage Editor (LINKEDIT) relocates and links one or more load modules produced by the assemblers into a main program. LINKEDIT is command driven, accepting commands from the console and from paper tape, punched cards, or the diskette itself.

The PACE DOS, IPC 16P/840 is priced at \$4500 which includes the dual-floppy disk with complete electronics and power supply, the PROM card for firmware routines, the DISK/CRT interface card and cables. Delivery is 30 days ARO, and a retrofitting service is available in the Melbourne Microprocessors Applications Laboratory for existing systems.

For further information contact your nearest NS Electronics office on Melbourne 729-6333; Sydney 93-0481; Adelaide 46-3929; Perth 25-5722; Brisbane 36-5061; Hobart 44-1337.

Motorola Clock

The tricky clock requirements of the 6800 have long been a bit of a problem for hobbyists, but fortunately Motorola have at last come up with a solution, in the form of the MC6875. This chip utilises either a crystal or an LC circuit to generate buffered two-phase outputs, and also provides DMA logic, clock-stretching circuitry for slow memories and a Schmitt trigger for power-on reset.

More news on page 105.

COMPUTER CLUB DIRECTORY

Sydney: Microcomputer Enthusiasts Group, P.O. Box 3, St. Leonards, 2065. Meets at WIA Hall, 14 Atchison St., St. Leonards on the 1st and 3rd Mondays of the month.

Melbourne: Microcomputer Club of Melbourne, meets at the Model Railways Hall, opposite Glen Iris Railway Station on the third Saturday of the month at 2 p.m.

Newcastle: contact Peter Moylan, Dept. of Electrical Engineering, University of Newcastle, NSW 2308. (049) 68-5256 (work), (049) 52-3267 (home).

Brisbane: contact Norman Wilson, VK4NP, P.O. Box 81, Albion, Queensland, 4010. Tel. 262 1351.

New England: New England Computer Club, c/- Union, University of New England, Armidale, NSW 2351. (New club; not restricted to students)

Computer clubs are an excellent way of meeting people with the same interests and discovering the kind of problems they've encountered in getting systems 'on the air'. In addition, some clubs run hardware and software courses, and may own some equipment for the use of members. Try one - you'll like it!

If your club is not listed here, please drop us a line, and we'll list you. The same applies if you are interested in starting a club in your area. Also, if established clubs know their programme of forthcoming events, we can publicise them.

ELECTRONICS TODAY

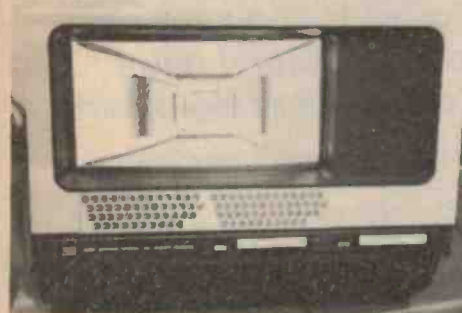

A few candid shots of the ACS/CAE Seminar (mentioned last month) as seen through the lens of Dr. Bill Caelli, Conference Convenor.

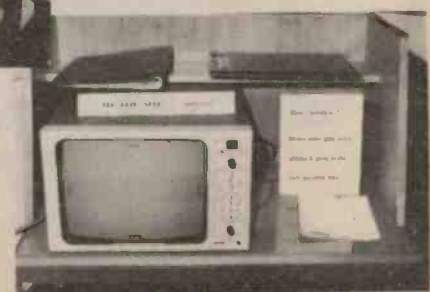

CASHMORE'S FABULOUS "SOUNDOUT" DISCOTHEQUE PACKAGE DEAL OFFER UNTIL DECEMBER 1977

Soundout equipment used by

- Donnie Sutherland
 - Stagalee (Lidcombe Dancers)
 - Bardwell Park RSL
 - Penrith Leagues Club
 - Castle Hill RSL
 - Bombaderry RSL Nowra
 - 2ST Radio (Nowra)
 - Mariners Lodge
 - Jolly Frog Windsor
 - Monterey Hotel Mosman
 - D.B. Disco
 - Wauchope Country Club
 - Pennant Hills Bowling Club
 - Eltoro's (Orange)
 - Liverpool Hotel
 - Cronulla Hotel
 - Launceston
 - Townsville (ABC)
- and so many more all over Australia

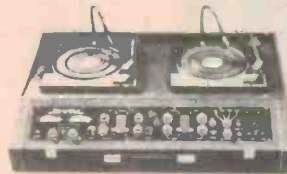

SERIES III MONO



DL6 CABINETS



6 Channel MXR with or without 200 watt power amp.

**NORMALLY \$1960
SPECIAL COST \$1790**

- Package includes Series III mono (170 watt) inbuilt Amp.
- 2 DL6 cabinets, vinyl covered with 2 x 12" full range speakers, ported cabinet
- Special Boom arm clips onto back of disco
- Microphone
- Headsets



NEW FROM SOUNDOUT. 200 watts per channel stereo switchable to 400 watts mono

CASHMORE SOUND SYSTEMS PTY LTD — SUPPLIERS — RETAILERS — IMPORTERS — INSTALLERS — HIRERS OF QUALITY SOUND — DISCOTHEQUE LIGHTING — EFFECTS LIGHTING — TO CLUBS — HOTELS — SCHOOLS — DISCOTHEQUES — FOR BROCHURES OF OUR CONCERT SOUND — LIGHTING RIGS PLEASE CONTACT OUR OFFICE — FOR DEMONSTRATIONS VISIT OUR SHOWROOM AT 149-151 GEORGES RIVER ROAD, CROYDON PARK, SYDNEY. WE HAVE A FEW OF OUR DISCOTHEQUE PACKAGE DEALS USED FOR HIRING. FULLY GUARANTEED — FOR SALE AT \$1400 798-6782 — 798-5647

2102L2

\$1.50 EACH

- 1024 BIT STATIC RAM
- 650 NS ACCESS TIME / LOW POWER 130MW
- FULLY TESTED AND GUARANTEED

Q.E.D. Sales

P.O. Box 165, Epping 2121.

Tel. 866 337

P&P FREE

Owners of Altair, Imsai, Vector Graphic, Parasitic Engineering, Cromemco Z-2, TDL and other S-100 bus computers take heart!

Subsystem B offers a choice of three memory modules — 4KRA, 8KRA or 16KRA — with four, eight or sixteen thousand bytes of memory for programs and data. The VDM-1 module interfaces the computer with a tv monitor. The CUTS (the Computer Users Tape System) module interfaces with a cassette recorder for program loading and mass storage of up to 200,000 characters per C-60 cassette. For all other communication to the outside world — keyboard, teletype, printers and so forth — 3P+S provides three ports for data input or output.

The General Purpose Memory (GPM) is a single piece of hardware/software which integrates the functions of all the other modules. The software is preprogrammed onto IC chips and provides instructions to operate the interfaces as well as set up elementary operating commands for the system as a whole which can be entered through a keyboard.

COMPUTER BITS

A DIVISION OF AUTOMATION STATHAM PTY. LTD.
47 Birch Street, Phone (02) 709 4144

BANKSTOWN N.S.W. 2200

Telex AA26770



silicon valley MICROPROCESSOR STORES

Build your own computer with components from Silicon Valley.

Silicon Valley are professional microprocessor stores carrying microprocessor kits from Motorola, Texas Instruments, AMI, Intel, National Semiconductor and Synertek; displays and monitors from Motorola, Burroughs and Elcoma; magazines which include Byte, Interface, Kilobaud and Dobbs, etc. Components such as ROMs, PROMs, EROMs, RAMs, UARTs, Registers, Multiplacers, OP Amps, LEDS, CMOS, S/TTLs and LS/TTLs. All this complemented by supporting software and in-store programming.

Quality products backed by Cema experience.
Cema, one of Australia's

leading suppliers of industrial microprocessor components, have backed Silicon Valley stores with experience and quality products normally available only to industrial buyers. Silicon Valley stores are stocked with necessary literature, books and a complete line of accessories.

Professional assistance and guidance.

Silicon Valley stores have a team of technical experts ready to assist you with any microprocessor problem. Beginners are welcome and kits are available to get you started on building your own micro-computer. Expert guidance is available on advanced projects, peripherals and software. Silicon Valley is the one shop for all your microprocessor needs.

Magazines

Current issues: Byte, Kilobaud and Interface all \$4.00 ea. Plus extensive range of handbooks, manuals, and microprocessor data.

Microprocessor Kits

Motorola	6800D2
Intel	SDK85
National	SC/MP
Signetics	2650

Supported by at least 2,500 line items of semiconductors, from Motorola, Texas Instruments, Solid State Scientific, Harris, Unitrode, Signetics, Philips, American Microsystems, Precision Monolithic, Synertek and Litronix.

YOUR ONE STOP MICROPROCESSOR STORE



SYDNEY:

23 Chandos Street, St. Leonards, Tel: 439 2965

MELBOURNE:

380 Bridge Road, Richmond. Tel: 429 4780

AUCKLAND N.Z.

7-9 Kirk Street, Grey Lynn. Tel: 76 0019

ELECTRONIC KITS

Ideal Xmas present for beginners — no soldering.

Morse Code Trainer — audio/visual	
2 Transistor Radio — 8 years up	\$5.95
10 Projects — ideal starter kit	\$7.95
16 Projects — block modules	\$10.50
20 Projects — varied, interesting	\$11.60
25 Projects — most popular kit	\$13.50
30 Projects — full instructions	\$14.75
	\$14.95

XMAS SPECIAL!



240V to 6V DC Adaptor
High Current (300 MA)
rating, with lead and DC
plug.
\$3.95 each or 2 for
\$7.00.

KITS FOR THE HOBBYIST!

500w Light Dimmer C/W wall mtg plate	\$6.95
Motor Speed Control suits most motors, fans, etc.	\$5.00
9 transistor car radio-push-button, 12V-neg grid	\$18.00
Philips tuned RF front-end, last few only	
P/M 145 8 Input Mixer — also 4 input stereo, C/W	\$115.00
base, treble, vol, master vol, VU's, etc	\$11.50
2 Transistor Radio — for beginners, works well,	
FM Radio Antenna — dipole gives up to 6dB gain	\$4.50
only	\$2.95
Dual LED Flasher — burglar deterrent for cars, etc.	\$9.00
Mag. Pre-Amp — stereo, for mag. cart. 300 mV out	\$49.00
Temperature Meter ETI 113 — 0 to 200°C in 3 ranges	\$115.00
Experimenters Workshop ETI — tools, parts, IC's etc	

SEMICONDUCTOR SPECIALS

8C107	15c
8C108	15c
8C109	15c
TT800	75c
TT801	75c
2N3643	30c
1N914	10c
OA91	12c
EM401-4	10c
A14A 2.5A	20c
5023 RED LED	25c
5023 GRN LED	50c
MAN7 display	\$1.75
6.8V 5W zener	50c
2N3055 80V	\$1.00
7400	20c
7441	\$1.00
7473	70c
7490	70c
600PIV 25A rect.	75c

Originals or equivalents supplied!

HI-FI SPEAKER KITS

Special "Xmas only" prices on
CORAL famous name speakers.
(all prices are per PAIR or 2 KITS).



- 6SA-1 6" 2 way 20w SPEAKERS**\$42.00
(Includes 6", 2 1/2" spkrs crossover terminals, screws, wire) — 15W RMS each, 50Hz — 20 kHz P&P \$6.00
- 8SA-1 8" 3 way 35W SPEAKERS**\$45.00
(Includes 8", 4", 2 1/2" spkrs, crossover, terminals, screws, wire) — 17.5W RMS each, 70Hz-20 kHz P&P \$7.00
- 8SA-5A 8" 2 way 35W SPEAKERS**\$53.00
(Includes 8", 2 1/2" spkrs, de-luxe crossover, terminals, screws, wire) — 17.5W RMW each, 50Hz—20 kHz 7 \$7.00
- 10SA-1 10" 3 way 50W SPEAKERS**\$72.00
(includes 10", 5", 2 1/2" spkrs, crossover terminals, screws, wire) — 25W RMS each, 40Hz—20 kHz P&P \$9.00
- 10SA-5A 10" 3 way 50W SPEAKERS**\$90.00
(Includes 10", 5", 2 1/2" spkrs, de-luxe crossover, terminals, screws, wire) -25W RMS each, 40Hz—25 kHz 7 \$10.00
- 12SA-1 12" 3 way 60W SPEAKERS**\$101.00
(Includes 12", 5", 2 1/2"x2 spkrs, crossover, terminals, screws, wire) — 30W RMS each, 30Hz — 20 kHz 8 \$12.00
- 12SA-5A 12" 3 way 50W SPEAKERS**\$116.00
(Includes 12", 5", 2 1/2"x2 spkrs, de-luxe crossover, terminals, screws, wire) — 25W RMS each, 35Hz — 20 kHz P&P \$19.00
- DE-LUXE HORNY SPEAKER**\$27.50
Fully waterproof A beautiful white rectangular horn speaker for PA, CB, marine, outdoor extension speaker etc. 8 ohms 15 watts.

SPEAKER KITS

Partly assembled universal speaker box kits, below normal price, beautifully made by our cabinet factory. With "continental-look" WOOD GRILLE FRONTS; you mount speakers, front, back and wire up etc — It's so easy to DO IT YOURSELF. You'll have a really professional job and you'll save \$\$\$.

SPK-15 \$22 ea.
Size 570 x 330 x 230 mm. Suits all 10" and smaller speakers

SPK-10 \$20 ea
Suits all 8" and smaller speakers

SPK-5 \$16 ea.
Size 435 x 275 x 230 mm. Suits all 8" and smaller speakers.

SPECIALS

Large ferric chloride pack \$1, 52 pin plug/socket set (gold pins) \$2.50, 4 computer boards (over 150 high quality parts — diodes, trans, res, caps etc.) \$2.

500 1/2w resistors \$3.00; 100 1w resistors \$1.00; 40 5w, 10w resistors \$3.00; 50 hi-stab 1/2 per cent, 1 per cent, 2 per cent asst. resistors \$1.50; 100 asst capacitors, cer, poly, mica 100-630V \$2.00; 20 new, quality asst potentiometers \$2.00; 50 asst tagstrips \$2.00; 10 asst switches, toggle, DPDT, rotary, slide etc \$2.00; 200 asst nuts, bolts etc \$100 25 TTL asst, ICs, new \$4.50; 50 asst RTLIC's, new \$5.00; 100 asst RTLIC's, new \$9.00; 30 PVC insulated mains terminal blocks \$1.00; 10 alligator clip jumper leads asst colours \$2.00; 30 lengths 6" x asst sizes and colours spaghetti \$1.50; 80 way PC edge connector, you cut to own size \$1.00; Heat sensor cut-out switch, for transformers, heatsinks etc 50c; 10 pces PCB cutouts, some fibreglass, 2-sided etc \$2.00.

A full range of amateur and professional PA and SOUND GEAR.

- FM WIRELESS MIC LM-72 \$25.00
- Electret condenser, 88-106 MHz, with windscreen.
- FM WIRELESS MIC LM-75 \$34.80
- Electret condenser, cardioid, 88-106 MHz
- PROFESSIONAL DYNAMIC MIC DM-15000 \$87.50
- Dual Imp, 600/20K ohms, uni-directional, 50-17000 HZ, with Cannon connector.
- ELECTRET CONDENSER MIC Y8-10 \$16.90
- Omn-directional, low imped (600 ohms), 50-13000 Hz
- MINIATURE TIE-CLIP MIC EM-84 \$18.50
- Electret condenser, 40-16000HZ, 1K imped, uni-directional.
- CASSETTE STOP-START MIC \$8.65
- Electret condenser, omni-directional, 600 ohms, with remote stop-start switch.
- DE-LUXE FOLDING MIC STAND \$32.50
- Chrome finish, approx. 3' 5" high, folding legs.
- MIC BOOM ASSEMBLY \$30.00
- Fully adjustable, suit all stands, quality chrome.
- TWIN MIC ATTACHMENT \$21.00
- Use 2 mics on 1 stand, professional finish.

- GUITAR MIC ATTACHMENT \$21.00
- Clamps to mic stand, 9" gooseneck incl.
- CLIP MIC HOLDER \$4.10
- Large spring-clip suits all mics, all stands.
- 12" GOOSENECK — quality chrome \$7.75
- HEAVY DUTY MIC CABLE — single shield per M. 30c
- HEAVY DUTY MIC CABLE — twin shield per M 55c

"HARD-TO-GET" AND MISCELLANEOUS ITEMS

- | | | | |
|------------------------------|------------|-----------------------|------------|
| PCB etch resist pans | \$1.50 | 75-300 ohm balun | \$2.00 |
| NIXIE tubes, 0-9, GR111 | \$1.00 ea | 300-75 ohm balun | \$2.00 |
| NE-2 neons 60V oper. | 10c | 4XUM-3 batt holder | 30c |
| To-3 mtg ins. bushes | 50 for 50c | 3/8" ferrite rods | 25c |
| 1.5uF 35V tantalums | 15c | Car aerials | \$2.50 |
| PVC-2 tuning gangs | 50c | ON-OFF toggle switch | 40c |
| 3.5mm earphone plugs | 10c | DPDT toggle switch | 65c |
| 3.5mm sockets | 15c | DPDT rotary switch | 30c |
| Fuseholders, in-line 3AG | 35c | DPDT slide switch | 60c |
| 5K Trans vol. controls | 10c | 3PDT rocker switch | 35c |
| Knobs to suit, 33mm diam | 30c | HT suppressors 15K | \$12.00 |
| Mag. earpieces, 3.5mm plug | 30c | MA1002B NS clock | \$6.00 |
| Cigar lighter plugs | 50c | Transformer to suit | 30c |
| 240 neon bezels | 5c | 5 pin dir plug | 10 for 30c |
| Car aerial sockets | 10c | 9 lug dir plug | \$1.00 |
| Alligator clips | 15c | 16 way plug/socket | 50c |
| TK-64 white knobs | 15c | 50 ohm 2W WW pots | \$1.00 |
| TK-55 brown knobs | 15c | Permeability tuners | \$1.00 |
| TK-29 black knobs | 30c | Mono cartridges | \$3.00 |
| TK-816 alum. oval splr 8 ohm | \$1.55 | Stereo cartridges C-1 | \$2.00 |
| 70 x 45mm oval splr 25 ohm | \$1.20 | 6" x 4" speakers | \$2.00 |
| 58mm diam. splr 25 ohm | \$1.20 | UM-3 Ni-cad batts | \$1.65 |
| 8 track cartridges | \$1.20 | | |
- Originals or equivalents supplied.

SPEAKERS, ETC.

2" round 15 ohms \$1.20; 2 1/4" round 25 ohms \$1.50; 2 1/2" round 47 ohms \$1.90; 3" round 33 ohms \$2.30; 3 1/2" round 40 ohms \$2.50; 3" round 150 ohms \$4.50; 4" round 15 ohms \$3.00; 5" round 33 ohms \$4.90; 5" x 3" ellipt 27 ohms \$3.30; 5" x 4" ellipt 15 ohms \$3.00; 6" x 2 1/4" ellipt 50 ohms \$2.75; 6" x 4" ellipt 15 ohms \$3.50; 6" x 4" ellipt 100 ohms \$4.50; 7" x 3" ellipt 15 ohms \$4.50; 7" x 3" ellipt 50 ohms \$4.90; 7" x 3" ellipt 100 ohms \$5.30; 8" x 4" ellipt 15 ohms \$5.90; 10" x 3" ellipt 15 ohms \$7.40

De-luxe HORNY SPEAKER

\$27.50

PRE-PAK electronics

Head Office — 718 Parramatta Rd., Croydon NSW 2132
Mail Orders — P.O. Box 43 CROYDON NSW 2132
OPEN 7 DAYS Mon-Sun: 9.00am — 5.30pm
Telephone (02) 797 6144

Please send my order ASAP to —

Name..... Date.....

Address.....

..... Code.....

TEAR OUT THIS PAGE AND SEND WITH REMITTANCE TO OUR MAIL ORDER DEPT.

How the Other Half Lives

Hewlett-Packard's latest desk-top computer is a regular Rolls-Royce of microcomputing. Although priced a little beyond the amateur, we can expect some of its features to appear on low-end micros. In any case, it's interesting to see how the other half lives!

The new Series 9800 System 45 is claimed to have the most powerful central processor and the largest built-in mass storage system ever offered in a desktop computer. It also features a 12-inch CRT display, BASIC interpretive language conforming to the new ANSI standard, applications software, and an optional graphics package with high-speed hard-copy output. The system is all contained within a single compact package.

"We feel that our System 45 desktop computer represents a major step forward in computer systems integration," said John Young, Executive Vice-President, Hewlett-Packard Company. "It bridges the gap between console-based minicomputers and desktop calculating systems — offering the power and flexibility of larger computers with the ease of use and physical size of desktop programmable calculators."

Said Young, "The System 45 is designed to solve the problems most often encountered by technical users. As a result, solutions often can be found more quickly and conveniently with the System 45 than with larger computers."

Applications Software

System 45 users are able to select from growing software library, both from HP and from other sources. Already available from Hewlett-Packard are programs in scientific computation and data analysis, data acquisition and control, management science, business development are programs for materials management, medicine and engineering design.

Because the System 45's language is based on ANSI BASIC, existing software complying with this standard will operate directly with the new computer.

In addition to compiling with the new ANSI BASIC standard, the system's enhanced BASIC language makes available to users such features as subprograms, multicharacter identifiers, line labels, powerful array operations and flexible output formatting. The computer's standard keyboard with separate groupings of keys for program control and editing, CRT control and 32 user-definable functions simplifies the use of the enhanced language.

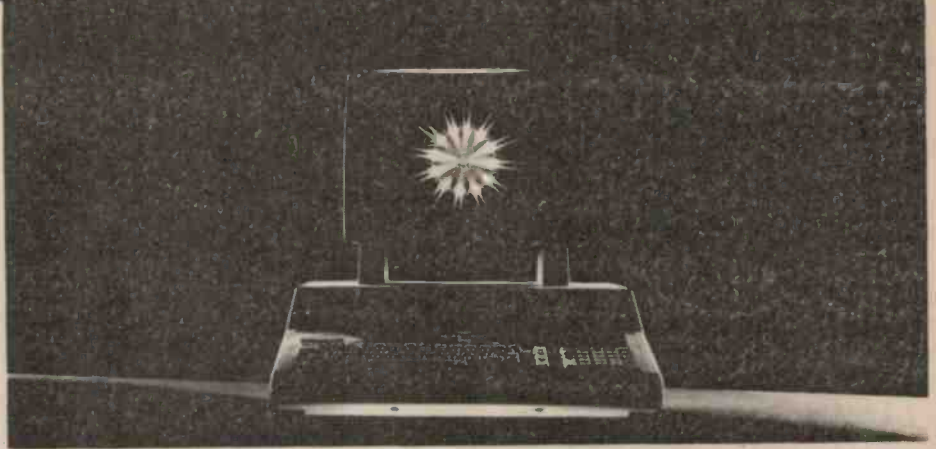

CRT

Hewlett-Packard's implementation of CRT technology provides both quality graphics and an alphanumeric display with superior editing features. The graphics mode provides a 560 X 455 dot matrix with high visual resolution and no perceptible flicker. The alphanumeric mode offers a full 80-character wide, 24-line deep screen. In this mode the screen is split for user convenience, with the top 20 lines dedicated to output in the bottom four lines for prompting and diagnostic signals. Other important features of the CRT components include adjustable screen brightness; high-lighting functions such as inverse video, blinking and underline; full keyboard-character display; and optional foreign character sets.

A built-in thermal line printer may be ordered as an option. The printer can produce 80-character lines at 480 lines per minute and transfer graphical images from the CRT in seconds. It uses either continuous blue-printing paper or perforated black-printing paper that enables top-of-page sensing for page control.

Mass Storage

The System 45 allows data and program storage using commands that are device independent. Aside from changing the address of the storage device, no program modification is necessary to access any of the available storage devices. These include a built-in 210 kbyte tape cartridge system, an external 460 kbyte flexible disc drive, and a



choice of external hard disc drives with capacities of 15 to 50 megabytes. A second built-in 210 kbyte tape cartridge system can be added for increased storage flexibility and high speed duplication.

The basic System 45 has 16 Kbytes of RAM with 13,498 bytes available to the user. The RAM can be expanded to 64 Kbytes, with 62,650 bytes available to the user.

Multiple interface ports and the capability to use four standard interface types — Bit-Serial, BCD, Bit-Parallel and HP-IB (in accordance with IEEE specification 488-1975) — make the System 45 HP's most powerful desktop computer/controller. System 45 is equipped with four input/output ports to hold a wide range of optional interface cards, enabling the user to add multiple 15 Mbyte or 50 Mbyte discs and control or acquire data from as many as 20 instruments.

The Hewlett-Packard Series 9800 System 45 is 18.5 in. high, 19 in. wide and 26¼ in. deep, and weighs 75 lbs (34.1 kg), making it well-suited for applications requiring portability, such as use in different areas within a large company. The basic system, with built-in keyboard, 16 kbytes of read/write memory, CRT and one tape transport, costs about \$15,000 plus tax. Delivery is 16 weeks. More details from your local Hewlett-Packard office.

Tandy Computer Stores

The Stateside Tandy Corp., now that it has launched its TRS-80 microcomputer, has started opening a chain of Tandy Computer Stores. As well as selling the TRS-80, the stores will sell Imsai computers, iCom floppies, and a whole bunch of other computers, peripherals and processors, but the real crunch is Tandy's contract with Computer Automation to sell CA's Naked Mini single-board computers — starting with the LSI 4/10, which has four I/O channels and 4K of RAM on the board.

Flat-screen CRT

Texas Instruments' research labs in Dallas, Texas, have come up with a 6" by 8" CRT which is 2" thick. The tube uses a matrix of wires which function as cathodes and can be selected to generate a 24 row by 80 character array of 5 x 9 dot matrix characters.

ComputerLand

No, it's not a mythical land in the next world where all good computer hobbyists go as a reward for a life of resisting the temptations of software piracy. ComputerLand is not mythical, and it's completely in this world, not the next. But certainly computer freaks would find a visit to be a rewarding experience!

ComputerLand is a chain of 200 stores in the States, whose adverts can be seen in publications like *Byte*, *Interface Age*, etc., and whose headquarters just happen to be situated around the corner from a well-known San Leandro microcomputer manufacturer whose product just happens to be one of their major lines.

ComputerLand is a big operation, by personal computing standards — it's a bit like Kentucky Fried Chicken in operation, with all the stores decorated in the same bright orange and white colour scheme and graphics on the walls.

ComputerLand has now spread across the Pacific and is alive and well and living at 55 Clarence St., in Sydney, under the guiding hand of Rudi Hoess, who is no stranger to the Australian high technology scene.

Of course, this is what ComputerLand is really selling — high technology as a commodity, not computers. All of a sudden, technology is becoming, well, not fashionable, but certainly more acceptable. Rudi talks of the tremendous difference 'Star Wars' is making in people's attitudes. Technology really can be fun!

ComputerLand has a room within a room, a games room, where all kinds of computer games are on display, where you can play *Star Trek*, plot your biorhythm, and generally play with the computers. But if you're seriously into computers, and many of our readers are, then you'll be more concerned with what bits and boards you can get there. IMSAI, Apple, Cromemco, Polymorphic, TDL, Vector Graphic, DEC, Lear Siegler, Diablo and Persci are amongst the major names at ComputerLand. In addition, there's a whole lot of support in the form of books, tools and of course, the staff, who are the key part of any computer store. The store is based on an open-plan floor scheme, and there are several demonstration systems up and running.

As well as the games room, there is also a classroom — tutorials will be available on both hardware and software so you can work out how to use the darn thing after you've bought it!

If you're not in Sydney, don't despair. ComputerLand stores will be opening in Melbourne and Canberra early next year, if all goes according to plan. We hope it does — it's good to have a comprehensive supply of all the good gear that's available in the States.

Chip of the Month

The major advantage which microprocessors offer over random logic is the number-crunching capability thrown in as a bonus. This is usually of a fairly rudimentary nature, i.e. 8-bit add and subtract plus often a decimal accumulator adjust instruction to ease BCD arithmetic, but is enough for many applications such as crude temperature control.

Eight-bit arithmetic permits a precision of only 1 part in 256, which is not very good when compared with the sort of performance we expect from even the crudest pocket calculators. However, with most microprocessors, we are not limited to 8 bits, but can instead use the carry bit of the condition code or flag register to carry from one 8-bit addition to the next. Using this technique, we can extend the precision of our arithmetic in 8-bit jumps, but only at the expense of speed.

The 8080 can perform 16-bit arithmetic on the HL register pair and the Z-80 can also perform arithmetic on its index registers. This is in fact the way most Tiny BASICs do their arithmetic, which is why you can only have integer values in the range -32768 to 32767. Larger versions of BASIC use the same scheme for line numbering, but it just isn't adequate for serious number-crunching.

16-bit processors are a bit better off in this regard, as double precision arithmetic on a 16-bit processor gives 32-bit precision without too much overhead. This gives an accuracy of about 1 part in 4×10^9 , which is a much better proposition. In addition (if you'll pardon the pun), because of their enhanced instruction set, some 16-bit micros, like the TMS9900 and the LSI-11 have multiply and divide instructions.



Multiplication and division can be added to a micro's capabilities by writing the appropriate subroutines — multiplication is simply a matter of repeated shifting and addition, while division is slightly more complicated. In fact, we could fill this entire magazine with a treatise on the different ways of doing arithmetic!

Big Numbers

But so far, we still have not found a way of working with extremely large numbers or fractions, as we can only represent integers with this scheme, the decimal (binary?) point always being to the immediate right of the least significant bit. This format is referred to as fixed point and is often used for number representation in business systems, where only simple arithmetic procedures are involved.

For scientific calculations a different technique is employed. Here, instead of using 32 bits to represent a two's complement number, we use 24 bits to represent a number in unsigned form as a mantissa. The remaining eight bits contain the exponent, exponent sign bit and mantissa sign bit. Now we have a binary number in a kind of scientific notation, similar to the display on a scientific calculator. Use of this floating point format means that we can now deal with very large and very small

numbers, but at the expense of precision. There is now some uncertainty involved, as our mantissa is a truncated representation of the correct value and hence is only an approximation. Arithmetical operations on floating point numbers are considerably more complex than on fixed point numbers, and consequently run more slowly.

Floating point routines are quite tricky to write, but examples are available for the 8080 and 6800 in Scelbi's 'Cookbooks'. The Lawrence Livermore Labs' 8080 BASIC also contains a floating point package.

But these routines take quite some time to run, and may not be fast enough for your task. Or perhaps you require trig or exponential functions. What options do you have?

Fortunately, two manufacturers have come to the rescue with some rather interesting chips. National Semiconductor offer the MM57109 'number cruncher', which is basically a reorganised calculator chip and handles BCD data in exactly the same format as an RPN scientific calculator. The 57109 can in fact be used as a stand-alone calculator chip, and offers a full range of scientific functions.

However, since it is organised as a calculator, the 57109 is not particularly elegant in the way it interfaces to a micro, and it is fairly slow. A new

device which has been specifically designed for use with 8-bit micros has been released, and promises to turn your 6800 or 8080 into an IBM370 (well, all right, perhaps not quite, but there are similarities...)

The AMD Am9511 Arithmetic Processing Unit is a single chip which performs all the functions of the optional floating-point arithmetic hardware which is available for many mini-computers. It can execute fixed point single and double precision (16 and 32 bit) arithmetic (+, -, *, /), and can perform the same operations on 32-bit floating point variables. Several floating point trigonometric and logarithmic operations are also provided, as well as format conversion and stack control instructions.

The Am9511 is packaged in a 24 pin package, and two versions with 2 MHz and 4 MHz maximum clock speeds are available, as well as a military temperature spec. 2 MHz device. Running at 4 MHz, (250 ns clock cycle), it can complete a floating point multiply in 168 cycles, or 42 μ s. This excludes the time taken to load the 9511's stack and then pull off the result. All these transfers take place over the processor's 8-bit bidirectional data bus, and the internal data stack automatically configures itself to 16-bit or 32-bit word lengths.

Numbering the data bits from 0 (LSB) to 31, bit 31 is the mantissa sign, bit 30 is the exponent sign, and the next six bits are the exponent value, thus forming a 7-bit two's complement value for the exponent. The remaining bits (23-0) are the mantissa value. This is very similar to the floating point format of the IBM 370, the only difference being that the 370 expresses the exponent as an excess-64 value, so the exponent sign bit is always the complement of the 9511 format.

The 9511 is built using similar architecture to AMD's 2900 bipolar bit-slice, only in depletion-mode MOS. On the 200 mil x 200 mil chip there are a 16-bit arithmetic and logic unit, a microprogram sequence controller, an 8-level operand stack register, 10-level working-register stack, command and control registers and a control ROM to make it all work.

We have, as yet, no details of pricing on the Am9511, but we know it won't be cheap — at least as much as a top-line 8-bit micro. But it's still an awful lot of number-cruncher for the money...

PCB's

ONCE AGAIN, there's a page of blue in Print Out, and we've published the PCBs on a page by themselves. We are continuing last month's experiment with PCB making directly from the page, and are glad to report that, provisionally at least, the experiment is successful. It

is possible to make PCB negatives in Scotchcal 8007 by exposing it directly through the page to UV light. Actinic blue fluorescent bulbs are ideal for this: around 20 minutes exposure at 3-4" will produce a good negative.

We haven't yet tried this process using direct exposure of a negative

photo resist; this is a matter for further experimentation.

Commercial organisations are reminded that ETI PCB patterns are copyright and reproduction for commercial use is expressly forbidden. Readers are free to make individual copies for their own use.

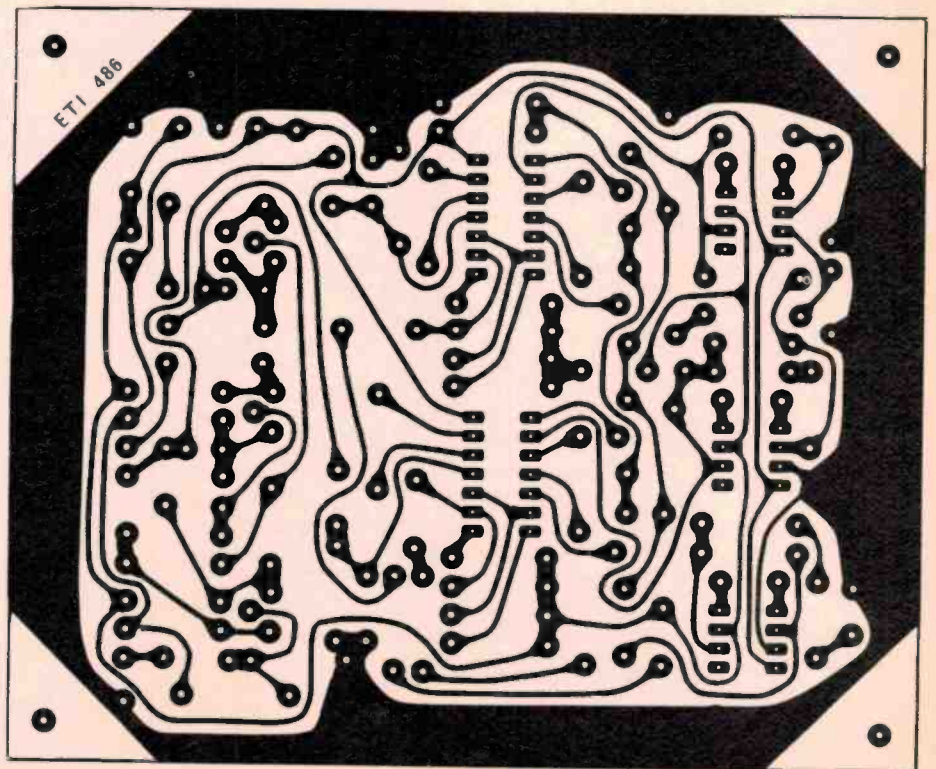
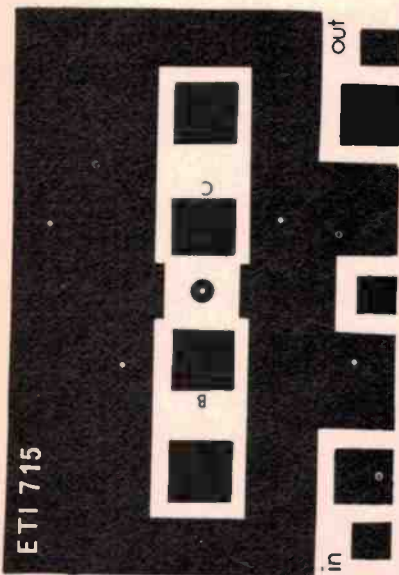
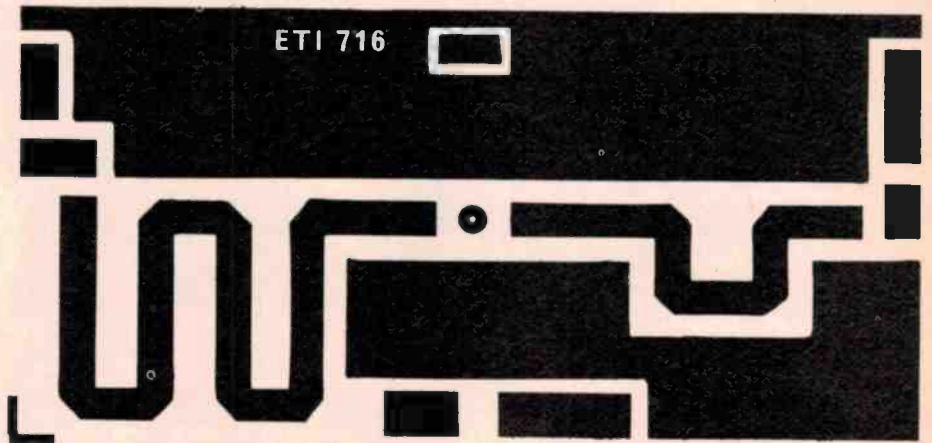
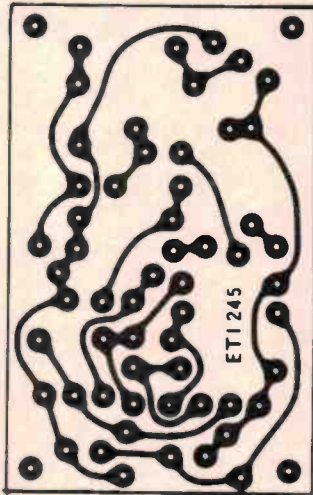

VU METER 1.60



DUE TO A HUGE PURCHASE AND LARGE SALES WE ARE ABLE TO OFFER THIS METER AT A FURTHER BETTER PRICE. METER IS FOUR CENTIMETRE SQUARE WITH A BLACK FACE AND WHITE AND RED LETTERING. BACK LIGHTING IS POSSIBLE. 200uA MOVEMENT.

CHASER DRIVER

CHASER LIGHT DRIVER, AUTO OR MUSIC CONTROLLED FOUR 240 VOLT THREE PIN OUTLETS DRIVING UP TO 1000 WATT EACH. A VARIETY OF SPECIAL CHASING EFFECTS AVAILABLE. VERSATILE AND EYE-CATCHING DISPLAYS CAN BE ASSEMBLED USING THIS DRIVER.

85.00

COLOR DRIVER



MUSICOLOR DRIVER, FOUR CHANNEL MUSIC TO LIGHT CONVERTER, FREQUENCY SELECTIVE, 1000 WATT PER CHANNEL. WATCH THE BEAT IN YOUR MUSIC. IDEAL FOR CHRISTMAS DECORATION.

85.00

60 Hz TIME BASE

THIS IS A 60 HZ TIME BASE BECAUSE THE ROTATIONAL PERIOD OF THE MOTOR IS 1/60 OF A SECOND. IT IS AVAILABLE IN TWO SIZES. THE 1/2" SIZE IS MORE ACCURATE AND THE 1/4" SIZE IS MORE CONVENIENT FOR PORTABLE USE. THE 1/4" SIZE IS MORE ACCURATE AND THE 1/2" SIZE IS MORE CONVENIENT FOR PORTABLE USE.

85.00

CRYSTAL

4.95



MM 5369

KIT

3.90

REVERBERATION

REVERBERATION SPRINGS FOR THIS RIDICULOUS LOW PRICE ARE BOUND TO SELL QUICKLY GET YOURS NOW SPECIALLY BUILT MODULE AVAILABLE TO SUIT THIS HIGH QUALITY PLESSEY SPRING. LIMITED QUANTITY AVAILABLE.

SPRING

4.70

MODULE

12.30

METAL BOXES

METAL BOXES IN TWO SIZES, FOLDED FROM STEEL THESE BOXES ARE STRONG AND PROVIDE EXCELLENT SHIELDING FOR THOSE SPECIAL PROJECTS. PAINTED THEY PROVIDE A GOOD SOLID FINISH. AVAILABLE IN 4" x 4" x 2" AND 8" x 4" x 2".

2.00 3.00

CROSSOVERS

SPEAKER CROSSOVER SYSTEMS. TWO WAY CROSSOVER AT 3000HZ WITH 6dB SLOPE PER OCTAVE. THREE WAY CROSSOVERS AT 800HZ AND 3200HZ WITH SLOPE OF 6dB PER OCTAVE.

TWO WAY

4.80

THREE WAY

8.70

COILS

CROSSOVER COILS
 .18mH to .75mH \$2.00
 .76mH to 1.5mH \$2.50
 1.6mH to 2.6mH \$3.00
 2.7mH to 3.7mH \$3.50

CAPACITORS

CROSSOVER CAPACITORS
 1uF AND 1.5uF 80c
 22uF BIPOLAR 60c

ROTARY POTS

DEFINITELY THE LAST TIME TO BE OFFERED AT THIS PRICE. NOT \$1.10 OR HIGHER AS ADVERTISED MANY TIMES BY OUR COMPETITORS, BUT ONLY 45c EACH!!! AVAILABLE ONLY IN THE FOLLOWING VALUES.....
 DOUBLE GANG LINEAR... 25K, 47K, 100K, 470K.
 DOUBLE GANG LOG..... 47K WITH REP.
 MIXED QUANTITIES OF THE ABOVE POTS 100 FOR \$40

SLIDE POTS

IF YOU THINK THE ROTARY POTS ARE A STEAL, LOOK AT THE PRICES ON THE FOLLOWING 45mm SLIDE POTS AVAILABLE IN THE FOLLOWING VALUES.....
 DOUBLE GANG LINEAR... 250K, 5K
 DOUBLE GANG LOG... 250K, 100K
 SINGLE GANG LINEAR... 1K

THE FOLLOWING VALUES AVAILABLE IN 30mm.....
 SINGLE GANG LINEAR... 1K, 20K
 SINGLE GANG LOG... 500K, 1M
 MIXED QUANTITIES OF THESE SLIDE POTS 50 FOR \$10

ZENERS

400uW ZENERS IN THE FOLLOWING VALUES:
 8.2V, 12V, 22V, 24V, 27V, 30V,
 18c EACH OR 7 FOR \$ 1.00
 500uW ZENERS, MOTOROLA BRAND:
 8.2V, 12V, 30V, 100 FOR \$10.00

HARDWARE

PS1 ROCKER SWITCH SPST 30c 4 for \$1.00
 RN1 240V NEON PUSH FIT 30c 4 for \$1.00
 B21 6.3V BEZEL, RED & GREEN 30c 4 for \$1.00
 MS1 MICROSWITCH SPDT 50c 3 for \$1.00
 A10 ASSORTED PLASTIC KNOBS 25c 10 for \$2.00
 DS2 2PIN DIN SOCKETS 35c 10 for \$2.00
 DP2 2PIN DIN PLUGS 25c 10 for \$2.00
 RCA5 5 WAY RCA SOCKETS 60c 2 for \$1.00
 RCA6 6WAY RCA SOCKETS 60c 2 for \$1.00
 PN216 9V BATTERY SNAP 12c 10 for \$1.00
 PM1 3AG PANEL FISHERIDER 60c 10 for \$5.00
 ALS 240V JA SPST AL TOGGLE 35c 3 for \$1.00
 PPT PMC TOGGLE 4PDT MOM. 30c 4 for \$1.00
 TC120 12-120PF TRIMMER 25c 5 for \$1.00

PLASTIC BOXES

USEFULL PLASTIC BOXES WITH ALUMINIUM LID. FIVE SIZES. IDEAL FOR PROJECTS REQUIRING ATTRACTIVE PRESENTATION.

UB1.... 6" x 4" x 2" \$ 2.45
 UB2.... 8" x 4 1/2" x 2 1/2" \$ 3.95
 UB3.... 8" x 2 1/2" x 1 1/2" \$ 2.15
 UB4.... 4" x 2" x 1 1/2" \$ 1.55
 UB5.... 3" x 2" x 1" \$ 1.45

PC I

\$4.95



POPULAR PLASTIC CASES. IMPACT RESISTANT. THIS IS ONE OF THE MOST POPULAR INSTRUMENT CASES. AVAILABLE IN A VARIETY OF COLOURS. GREY, BLUE AND RED THE MOST POPULAR.

ETI KITS

ETI 704 CROSS WATCH AND DOT GENERATOR \$17.50
 ETI 129 RF SIGNAL GENERATOR \$29.50
 ETI 706 MARKER GENERATOR \$29.50
 ETI 120 LOGIC PROBE \$13.50
 ETI 121 LOGIC PULSER \$11.50
 ETI 122 LOGIC TESTER \$59.50
 ETI549 INDUCTION BALANCE DETECTOR \$ 29.50
 ETI549A BOARD \$ 1.60
 ETI548 PHOTOGRAPHIC STROBE Enquire
 ETI548 BOARD \$ 1.50
 ETI316 TRANSISTOR ASSISTED IGNITION \$ 16.50
 ETI316 BOARD \$ 1.30
 ETI481PS 12V to 40V 100WATT CONVERTER \$ 29.50
 ETI481PS BOARD \$ 2.00
 ETI444 FIVE WATT STEREO \$ 19.50
 ETI444 NEW BOARD \$ 2.00
 LM382 \$ 2.95
 LM3795 \$ 8.50
 ETI 581 DUAL POWER SUPPLY \$17.50
 ETI 581 BOARD \$1.40
 PL30 - 5VA \$ 8.75
 7815 IC \$ 2.35
 7915 IC \$ 2.55
 ETI 547 TELEPHONE BELL EXTENDER \$16.50
 ETI 547 BOARD \$ 1.60
 CA 3130 IC \$ 2.25
 NE 555 IC 70c
 CB POWER SUPPLY \$29.50
 ETI 712 BOARD \$ 1.60
 PL30 - 60VA \$15.00
 ETI 481 HIGH POWER PA/GUITAR AMP
 ETI 480 BOARD \$ 1.60
 ETI 480PS BOARD \$ 1.60
 ETI 481M BOARD \$ 1.60
 ETI 445 BOARD \$ 1.20
 ETI 446 BOARD \$ 1.40
 ETI 449 BOARD \$ 1.20
 ETI 438 BOARD \$ 1.60
 ETI 480 /50W KIT \$14.50
 ETI 480 /100W KIT \$18.50
 ETI 480PS KIT \$16.50
 PF 3577 for above \$19.50
 ETI 481 KIT \$12.50
 ETI 445 KIT \$ 4.95
 ETI 446 KIT \$ 7.95
 ETI 449 KIT \$ 4.95
 ETI 438 KIT \$13.50
 ETI134 TRUE RMS VOLT/METER Enquire
 CA3140 \$ 1.95
 ETI134 BOARD \$ 1.70
 ETI603 SEQUENCER (No case included) \$ 49.50
 CA3140 \$ 1.60
 ETI603 BOARD \$ 1.80
 ETI484 COMPRESSOR EXPANDER \$ 49.50
 ETI484 BOARD \$ 2.00
 NE571 \$ 13.95
 ETI317 REV MONITOR, COUNTER \$ 12.50
 ETI317 BOARD \$ 1.50
 METER (Not included in kit) \$ 8.50
 ETI582 HOUSE ALARM (A AND B) \$ 79.50
 ETI582A \$ 2.70
 ETI582B \$ 1.50

DIGITAL FREQUENCY COUNTER



DFC1

89.50

THIS UNIT HAS THREE RANGES, 1MHz., 10MHz., AND 100MHz., WITH SIX HALF INCH READOUTS AND THREE SCALE LEDS. MEASUREMENT IS MADE APPROXIMATELY EVERY 1.1 SECONDS. BUILT IN A GREY IMPACT RESISTANT PLASTIC CASE APPROXIMATELY FIVE BY FIVE BY THREE. POWER SUPPLY REQUIRED IS 12 VOLTS DC OR A 9 VOLT AC PLUGPACK ADAPTER. SUITABLE FOR TECHNICIANS, HOBBYISTS AND SCHOOLS., AT THIS PRICE EVERYONE SHOULD HAVE ONE- WHAT A CHRISTMAS GIFT.

DFC2

119.50

THIS UNIT IS SIMILAR TO THE ABOVE BUT WITH AN EXTRA RANGE. INPUT ON THE TOP RANGE IS TYPICALLY 650MHz. WITH A SUITABLE INPUT LEVEL OPERATION CAN EXCEED THIS. IDEAL FOR THOSE WHO REQUIRE THE EXTENDED RESPONSE BUT STILL CANNOT AFFORD HIGH PRICES USUALLY ASKED.

GAS ANALYSER

DON'T LET YOUR PROPERTY TURN INTO A BOMB. USE THIS DETECTOR KIT TO DETERMINE IF FUMES, GAS PRESENT. FEATURED IN ELECTRONICS AUSTRALIA 77 MAY ISSUE.....

GAS ANALYSER MARINE KIT \$27.50
 AUTO KIT \$27.50
 PORTABLE KIT \$17.50
 812 TGS \$10.50
 813 TGS \$10.50

ROTARY SWITCHES

GET SWITCHED ON WITH THESE ROTARY SWITCHES. AT THESE PRICES THERE'S NO COMPETITION. AVAILABLE IN ONE, TWO AND THREE SECTION.

ONE SECTION... 1 POLE 12 POSITION
 2 POLE 5 POSITION 1.20
 3 POLE 4 POSITION
 4 POLE 3 POSITION
 TWO SECTION... 1 POLE 12 POSITION 2.20
 2 POLE 5 POSITION
 3 POLE 4 POSITION
 THREE SECTION. 2 POLE 5 POSITION 3.20
 3 POLE 4 POSITION

PC BOARD

BOARDS FOR ALL PROJECTS ARE AVAILABLE. PRICES AS FOLLOWS FOR EACH BOARD:
 SINGLE LAMINATE : 90c + 6c PER SQUARE INCH
 SINGLE FIBREGLASS : \$1.20 + 8c PER SQUARE INCH
 DOUBLE FIBREGLASS : \$1.80 + 12c PER SQUARE INCH

BOARDS TO YOUR OWN POSITIVE OR NEGATIVE ARTWORK AVAILABLE AT THE SAME COST PROVIDED ARTWORK IS SUITABLE FOR PHOTOGRAPHY.

PLUG PACKS

PLUGPACK POWER SUPPLY. 9 VOLTS AC AT 500mA NO PROBLEMS WIRING TO 240 VOLTS. VERSATILE SINCE NOT RECTIFIED, MANY DIFFERENT USES, ELIMINATE MAINS WIRING FROM SMALL TEST EQUIPMENT.



5.95

REED RELAYS

THESE REED RELAYS WORK FROM SIX VOLTS TO 20 V. EACH RELAY HAS TWO SPST NORMALLY OPEN CONTACTS PC BOARD MOUNTING, 6.5 cm. x 2 cm. x 1.25 cm. LIMITED QUANTITY ONLY, BUY EARLY. 1.95

VALVES

GR110 Small nixie tube, long leads 45c
 GR111 Large nixie tube, long leads 45c
 ZM100 Nixie tube, PC board mount 50c
 12A07 40c

SPECIAL IC'S

LOOK AT THIS SELECTION OF DIGITAL AND LINEAR INTEGRATED CIRCUITS. EXOTIC DEVICES AND SOME OF THE COMMON BUT HARD TO GET.....

MS30395 SIX DECADE COUNTER, LATCH, DECODER, PRESETTABLE, UP-DOWN, INTERNAL SET REGISTER AND COMPARATOR, LEADING ZERO BLANKING. DATA SUPPLIED. 19.60
 MS330 FOUR AND HALF DIGIT DIGITAL VOLT METER INTEGRATED CIRCUIT, DUAL RAMP AUTOMATIC ZERO, AUTOMATIC POLARITY DATA SUPPLIED. 12.60
 MS3369 SEVENTEEN STAGE OSCILLATOR DIVIDER WHEN USED WITH 3.579MHz CRYSTAL IT GIVES 60Hz OUTPUT. CRYSTAL \$4.95 3.90
 CA3130T RCA FET OF AMP
 CA3140T RCA FET OF AMP 1.90
 AY3-8550 NEW GAMES CHIP REPLACES 3-8500 IN CIRCUIT WITH NO CHANGES. ADDITION OF A FEW EXTRA COMPONENTS AND PAN POTS ALLOWS VERTICAL & HORIZONTAL MOVEMENT OF BATS. PRICE INCLUDES TWO PAN POTS. 23.40

PROJECTS

PROJECT ELECTRONICS FROM ETI. (With P&P) \$ 5.00

ETI 041 CONTINUITY TESTER \$ 4.95
 ETI 042 SOIL MOISTURE INDICATOR \$ 2.95
 ETI 043 HEADS OR TAILS \$ 3.95
 ETI 044 TWO TONE DOORBELL \$ 6.95
 ETI 045 500 SECOND TIMER \$ 5.95
 ETI 047 MORSE PRACTICE SET \$ 7.95
 ETI 511 BATTERY SAVER \$ 3.95
 ETI 048 BUZZ BOARD \$ 5.95
 ETI 061 BASIC AMPLIFIER \$ 8.95
 ETI 062 SIMPLE AM TUNER \$ 9.95
 ETI 063 ELECTRONIC BONGOS \$ 4.95
 ETI 064 SIMPLE INTERCOM \$ 4.95
 (ONE SPEAKER, MOMENTARY TOGGLE SUPPLIED)
 ETI 066 TEMPERATURE ALARM \$ 6.95
 ETI 067 SINGING MOISTURE - METER \$ 5.95
 ETI 071 TAPE NOIS LIMITER \$ 3.95
 ETI 072 TWO - OCTAVE ORGAN \$ 5.95
 ETI 068 LED DICE \$ 6.95
 ETI 081 TACHO \$ 9.95
 ETI 085 OVER - REV ALARM \$ 5.95
 ETI 528 INTRUDER ALARM \$ 9.95
 ETI 084 CAR ALARM \$ 8.95
 ETI 083 TRAIN CONTROLLER \$17.95
 ETI 086 FM ANTENNA \$
 ETI 087 OVER LED \$ 3.95
 ETI 065 ELECTRONIC SIREN \$12.95

POSTAL ADDRESS :

BKX ELECTRONIC SUPPLY SERVICE, PO BOX 787, POTTS POINT, SYDNEY, 2011.

MAIL ORDER MINIMUM.....\$8.00
 P&P.....FREE IN AUSTRALIA.
 TEL.....02.....358 2420

WE REGRET THAT IT IS SOMETIMES NECESSARY TO CHANGE PRICES WITHOUT NOTICE

BKX Electronics Supply Service



179 VICTORIA ST., KINGS CROSS N.S.W. 2011 358-2420.

BKX ELECTRONIC SUPPLY SERVICE
 PLEASE DEBIT MY BANKCARD ACCOUNT
 NUMBER.....
 SIGNATURE.....
 NAME.....
 ADDRESS.....

DISTRIBUTORS

for the Electronic Industry

ARE YOU AWARE??

THAT WE HAVE PROBABLY THE LARGEST RANGE IN AUSTRALIA OF TOP-BRAND, QUALITY PRODUCTS AT CURRENT MARKET PRICES WITH OFF-THE-SHELF AVAILABILITY.

Semi-Conductors

Delco
E.D.I.
General Electric
Intermetall
I.T.T.
National Semiconductor
N.E.C.
Philips
Sanyo
Signetics
Solitron
Texas Instruments
A.M.D.
Intersil
Monolithic Memories

Passive Components

Bournes
Elna
Erie
I.T.T. Capacitors
I.T.T. Thermistors
Philips (Elcoma)
R.C.A.
Soanar
Sprague

Electro-Mechanical and Hardware

Alco
Cannon
Delco Heatsinks
I.T.T. Diecast Boxes
I.T.T. Fans & Blowers
Dica I.C. Accessories
I.E.E.
I.T.T. Relays
Jean Renaud
J.A.E.
National Relays
Pomona Accessories
Rotron Fans
Switchcraft Connectors
Thermalloy Heatsinks
T.I. I.C. Accessories
Weller Soldering Irons
G.E. Rechargeable Batteries

Trade enquiries to:

Instant Component Service

Instant Component Service

DISTRIBUTORS:-

NORTH.

J. A. SEVERN

P.O. Box 47
Epping 2121
869-1058

SOUTH.

**BRYAN CATT
INDUSTRIES.**

105 Miranda Road South,
(Near Motor Registry)
Miranda.

Phone: 524-4425
Telex AA27266

EAST.

**RADIO DESPATCH
SERVICE.**

869 George Street,
Sydney, N.S.W. 2000
Phone: 211-0191

WEST.

**ELECTRONIC
(DISTRIBUTORS)**

(A Division of Electronic
Enthusiasts Emporium).
2-3 Post Office Arcade,
Joyce St., Pendle Hill,
N.S.W. 2145. Phone
636-5222

**NEWCASTLE:
DIGITRONICS**

186 Parry Street,
Newcastle West, 2302
Phone: (049) 614991

QUEENSLAND:

**FRED HOE &
SONS PTY LTD.,**

246 Evans Road,
Salisbury Nth., 4107
Phone: (07) 2774311

FERGUSON

"DEVELOPMENTS"

DIRECT CURRENT OUTPUT
POWER POINT ADAPTORS TYPE
"PPA"

- For connecting to 240V 50Hz mains supply.
- Manufactured to comply with Australian Standard C 126.
- Electricity Authority Approved.

PLUGS DIRECTLY INTO A POWER POINT

This range has been designed to provide filtered, unregulated D.C. suitable as battery replacements for small solid state equipment such as radio receivers, tape players, calculators, etc. with a power requirement not exceeding 3 V.A. (i.e. volts multiplied by amps). The type numbers designate the voltage output at 300 mA. However, the characteristics illustrated by the graph should permit the optimum selection to be made up to 500 mA and 14 Volts within the above power limits.

MADE IN AUSTRALIA MADE IN AUSTRALIA MADE IN AUSTRALIA MADE IN AUSTRALIA MADE IN AUSTRALIA MADE IN AUSTRALIA MADE IN AUSTRALIA MADE IN AUSTRALIA MADE IN AUSTRALIA MADE IN AUSTRALIA



HEIGHT 40mm
WIDTH 45mm
LENGTH 65mm
WEIGHT 0.3kg

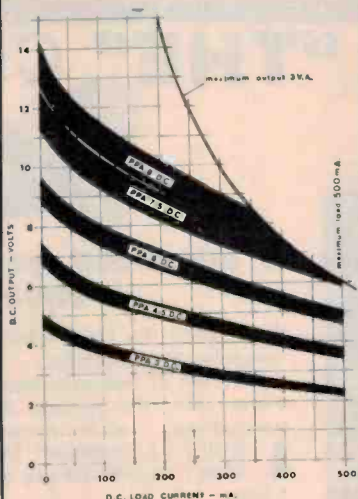

- No Mains Lead
- No Selector Switches
- Choose the correct "PPA" and forget batteries, alternatively choose a "PPA" and recharge your batteries.

AVAILABLE FROM
ELECTRICAL WHOLESALERS

Manufactured by:

FERGUSON TRANSFORMERS

P/L

Head Office: 331 High Street,
Chatswood, NSW 2067.

Phone (02) 407-0261 — Telex: AA25728.

Not a special offer...

...just our price

TDK

**CASSETTE
TAPES**

ED-C90min.

\$3.99

ED-C60 \$2.99

SD-C60 \$1.99

SD-C90 \$2.99

PLUS \$1.00 POST & PACK.

**Dindy Marketing (Aust.)
Ltd. P.O. Box 555 Tweed
Heads. N.S.W. 2485**

20 OR MORE
AND RECEIVE
A FREE 6 RACK
BUY IN UNITS OF 10
MINIMUM ORDER 10 CASSETTES
I Enclose cheque, P/Order or Card No.
to the value of \$

ED-C90

SD-C60

ED-C60

SD-C90

Name _____

Address _____

P/C _____ R _____

A LEGITIMATE AMATEUR PRODUCT

Finally a true 80-10M linear amplifier *really* designed for amateur use, not a cheap class-C biased "CB" unit. The HF-150 is a true, band switching, class-B linear amplifier. Perfect for use with many of the low-powered HF transceivers now on the market.

INSTRUMENT QUALITY

The HF-150 is designed and built by Communications Power, Inc., a company well established in the manufacture of industrial power amplifiers and ferrite RF components.

- Thus, the HF-150 has such quality features as —50db minimum harmonic suppression on **all** bands, with built-in switchable harmonic filters, 10 times better than current FCC and ITU regulations.
- In addition there is absolute stability into **all** phase angles of a 3:1 VSWR mismatch, plus a built-in 20db gain, low noise receiver pre-amplifier.
- 200W PEP input power
- Typical RF output

at 30 MHz	100 W AM-4W drive
13.6 VDC :	160 W PEP SSB-12W PEP drive
	150 W CW-10W drive
- positive or negative ground
- SSB-AM-CW operation
- The built-in 20db gain, 2db noise figure broadband receiver rf preamplifier operates independently of the power amplifier and is just the thing to perk up a "dead" receiver.
- Compact size: 6.5"W-2"H-7.75"D
- Provisions for simple plug-in installation of C.P.I.'s RC-1 remote control head.



Note: Illegal for use on the Citizens Band

CP300 "THE" CB RADIO

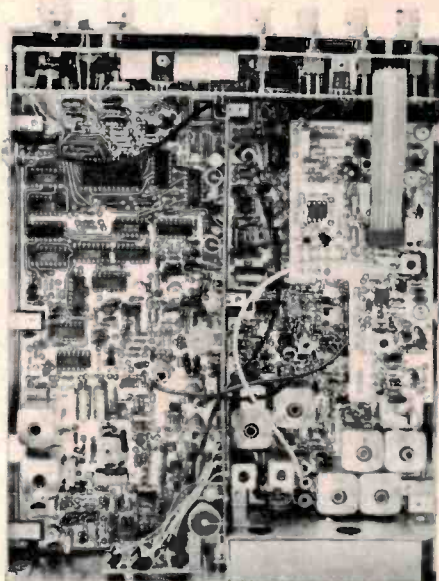

so advanced, years could pass before its equal comes along

We believe the C.P.I. AM/SSB CB transceiver to be the finest, most versatile set you can buy . . . today . . . or a year from now. Please reflect on the list of features, bearing in mind that these are highlights that merely skim the surface. Even so, compare them with any other CB transceiver . . . at any price, then make your own judgement.

- BUILT-IN, 7-element TVI filter.
- BUILT-IN JFET RF pre-selector with extremely low noise figure (only 1.5db)
- BUILT-IN, highly effective, non-distorting RF noise BLANKER, not a LIMITER, Strictly commercial quality with its own noise-sampling receiver section.
- BUILT-IN, logarithmic speech compressor for vital, bang-through increase in AVERAGE AM and SSB TALK POWER without overmodulation.
- BUILT-IN 8-pole crystal lattice filter, gives —80db selectivity both on SSB and AM. C.P.I. is probably the only CB receiver with this high selectivity on both modes.
- Superior quality U.S. made Turner power microphone.
- Comes standard with key lock anti-theft mounting bracket.

ANYTHING LESS IS CHILDS PLAY

MADE IN THE U.S.A. BY

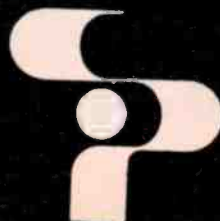

**COMMUNICATIONS
POWER, INC.**

Distributed exclusively
in Australia by

COMMUNICATIONS POWER INC AUST P/L
P.O. Box 246,
DOUBLE BAY 2028
Phone 363703

(ADVERTISEMENT)

AUSTRALIA'S OWN AUDIO MONTHLY

NOVEMBER 1977 \$1.40*

hi-fi

Naim 250
Naim NAC 32
Luxman 3600
Luxman CL 32
Dynavector DV 3000
Dynavector DV 8250

REVIEW



**VALVE
AMPS
are they
really
better?**

**ON SALE NOW
AT ALL NEWSAGENTS**

hi-fi

REVIEW

Vol. 3, No. 11

EDITOR:

Peter Scott

MUSIC EDITOR:

John Clare

EQUIPMENT REVIEWS:

Richard Timmins

EQUIPMENT MEASUREMENTS:

Louis A. Challis & Associates

Main Features

- 4 **COMMENT**
Ideas, views and happenings
- 9 **YOUR SOUND**
You describe your system
- 14 **VALVE AMPLIFIERS**
Do they really sound different?
- 20 **LUXMAN CL 32 PRE-AMP**
Unique linear equaliser
- LUXMAN 3600 POWER AMP**
Character and individuality
- 27 **DYNAVECTOR DV 3000 PRE-AMP**
\$2998.
- DYNAVECTOR DV 8250 POWER AMP**
\$2500 — both worth it.
- 35 **AUDIOLAB PREAMP.**
Australia leads the way
- 43 **NAIM NAC 32 PRE-AMP**
Musical results
- NAIM 250**
A very fine amplifier indeed
- 47 **HI-FI FAULTS**
Brilliant 8-page feature
- 59 **PIRATE RECORDINGS**
Exploding records next?

Music Features

- 64 **JAZZ REVIEW**
- 72 **FLEETWOOD MAC (Pt 1)**
- 79 **CLASSICAL REVIEWS**
- 91 **ROCK REVIEWS**



Cover: Despite a decade and a half of transistor development, many hi-fi enthusiasts have remained faithful to valve amplifiers. Now it seems they could be right.

Pix — courtesy Interdyn Pty. Ltd.

Published by MODERN MAGAZINES (HOLDINGS) LIMITED, 15 Boundary St., Rushcutters Bay, NSW 2011. Phone 33-4282. Sydney Telex AA27243 (Modmags). Managing Director: Arnold Quick. Secretary: Charles O'Leary. Publisher: Collyn Rivers. Editor Peter Scott. Music Editor: John Clare. Layout: Jim Hattersley. Assembly: Linda Spain. Production Manager: Roy Leight. Advertising: Bob Taylor and Geoff Patschler. INTERSTATE ADVERTISING: Melbourne: Poppe Davis (51-9836). Adelaide: Admedia Group, 37 Fullerton Rd., Kenttown 5067. Phone (08) 42-4858. Brisbane: Geoff Horne, 378-8273. West Australia: Aubrey Barker and Associates, 38 Mounts Bay Rd., Perth, 6000. Phone 322-3814. OVERSEAS ADVERTISING: UK: Modern Magazines, 25-27 Oxford St., London W1R 2NT. Phone (01) 434-1782-3. USA: ACP, Room 2102, 44 Madison Square Avenue, New York, 10022. Japan: Genzo Uchida of Bancho Media Service, 15 Sanyocho, Shinjuku, Tokyo 160. Printed in 1977 by ADM Paramac, Sydney. Distributors Gordon and Gotch. Circulation and subscription enquiries to John Oxenford, Sydney (02) 33-4282. (Recommended and maximum price only). Copyright.

Registered for posting as a publication — Category B.

Valve Amplifiers

-do they really sound different?

Despite a decade and a half of transistor development many hi-fi engineers and enthusiasts are turning back to valve amplifiers. Worldwide, leading hi-fi equipment manufacturers are having a second hard look at this once all-but-discarded technology. And often the results are surprising!

The November issue of Hi-Fi Review discusses this phenomenon in depth.

The issue includes in-depth subjective reviews of three of the world's best valve units and tells how they stack up against a really top quality transistor combination.

Also in Hi-Fi Review's November issue is an eight-page colour flow chart feature explaining step-by-step how to fix those troublesome hi-fi faults.

Each month Hi-Fi Review contains such up-to-the-minute authoritative and often controversial material. That's why it's the hi-fi magazine that the trade themselves read and trust!

Hi-Fi Review is produced by the same editorial and production team that produces Electronics Today International.

**READ HI-FI REVIEW EVERY MONTH
AND KEEP UP TO DATE!**

hi-fi
REVIEW

ON SALE NOW!

AUSTRALIA'S OWN AUDIO MONTHLY

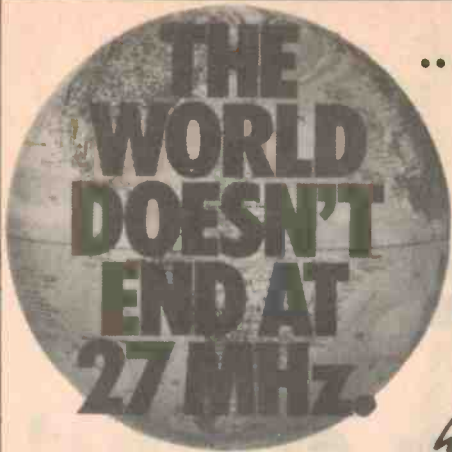

... It's just the beginning.

At VICOM we provide a whole World of communications products including CB, Military and Amateur Radio, our speciality. VICOM didn't reach the top without providing Amateurs in Australia with the technical back-up and support demanded in marketing specialised sophisticated commercial equipment. Come and see our wide range of transceivers and accessories and receive some of that friendly personalised service for which VICOM has become famous!



Yaesu FT101E transceiver 160-10m including speech processor, VICOM 90 day warranty. Price \$839.

KENWOOD



The TS820S from VICOM is the rig that is the talk of the Ham bands. Too many built-in features to list here! What a rig and only \$990 complete with digital display! Many accessories available to increase your operating pleasure and station versatility.



ATLAS 350-XL

The ATLAS 350-XL from VICOM is the new, all solid state sbs transceiver, 350w pep input with coverage 160 thru 10 metres. Plug in options include digital display, auxiliary VFO and auxiliary oscillator. Superb selectivity for which ATLAS have become famous.

ROTATORS

- ART3000C Heavy Duty with 240v con. box \$199
- ART9000 Super Heavy Duty 240v con. box \$478
- CDE CD44 medium duty 240v control box \$192
- CDE AR22XL light duty 240v control box \$109
- 8 core cable per meter \$1.40

...TOPS FOR HAM GEAR

DISTRIBUTORS OF QUALITY ICOM PRODUCTS



IC22S 2m fm synthesised with programmable matrix. ICOM quality with back-up technical support. Price \$279.



ICOM IC-245

VICOM brings the VFO revolution to you with the IC245 mobile 144 thru 148MHz transceiver. The IC245 features accurate tuning over 50 detent steps, digital display in 5KHz steps, modes: fm, ssb (with optional adapter only) and cw. Carrier suppression better than 40dB. TX output 10w fm. Comes complete with mic, bracket, manual and VICOM 90 day warranty.



WARNING: The law requires that a licence be held for all transmitting equipment. Purchasers may be asked to produce a licence when buying equipment.

HANDY ICOM PORTABLES

- IC202 2m ssb/cw \$199
- IC502 6m ssb/cw \$219
- IC215 2m fm \$199
- 8C-20 nicad pack \$67
- IC50L 10w linear 6m \$98
- IC20L 10w linear 2m \$98
- Rubber Ducky for IC215 \$13



VICOM IC211 2m fm transceiver

The new IC211 from VICOM is the last word in digital 2m, all-mode transceivers. Fully synthesised in 100Hz or 5KHz steps, has dual tracking, optically coupled VFOs with 7 digit LED readout. One knob controls all frequencies. Modes fm, usb, lsb, cw. Internal 240vac and 13.8vdc power supply. Comes complete with VICOM 90 day warranty, freight and insurance.

UNIDEN the best value



The fabulous UNIDEN 2020 p11 transceiver offers separate usb, 1sb and cw 8-pole filters as STANDARD and 6146Bs in the final with screen grid voltage stabilisation for minimum distortion products. Features pcbs and even the front panel can be swung out for easy servicing! A comprehensive range of spare parts is available together with back-up service support. Overseas this rig sells for at least \$65 more than the FT101E! Compare the features of the UNIDEN 2020 with other HF transceivers and you'll quickly be convinced that it offers the best value!

Popular VC2 swr/power meter operates 3-150 MHz with power measurement 12/120 watts. Will handle up to 1000 watts. 50 ohms impedance, twin meters. A bargain!



VC2 SWR \$38

ANTENNAS

BASE & MOBILE

- Space 2m 1/2 wave model 42S, complete with assembly \$14
- Space 2m 5/8 wave model 82D, complete with assembly \$26
- Lindenow 5/8 wave quality 2m (incl base) \$26
- Ringo Ranger ARX-2 for 2m \$45

VHF/UHF BEAM ANTENNAS

- JAYBEAM 5Y/2M 2m 5el 7.8dBd gain \$29
- BY/2M 2m 8el 9.5dBd gain \$85
- 10Y/2M 10el 11.4dBd gain \$59
- 10XY/2M crossed yagi 11.3dBd \$68
- DB/70cm twin 8el 12.3dBd \$48
- PBM18/70cm 18el 70cm 14.9dBd \$69
- MBM88/70cm 88el 70cm 18.5dBd \$75
- MBM48/70cm 48el 70cm 14.5dBd \$59



Why take the gamble? All rigs sold by VICOM are given a thorough pre-delivery check-out supported by technical expertise and well equipped workshops. Spare parts are available too!

PARABOLIC DISH ANTENNA

For 430 and 1296MHz \$349

NOISE BRIDGES

Te7-01 up to 100 MHz \$39
Te7-02 up to 300 MHz \$49

MORSE KEYS

- Economy model KH708 \$19
- Operator model HK706 \$20
- Deluxe model HK702 \$35
- Electronic Keyer EK103 \$159
- Manipulator MK701 \$38

RECEIVERS

- Yaesu-Musen FRG-7 \$325
- Barlow-Wadley with FM \$339
- NRD-505 Professional \$2499

TRAP DIPOLES

- AL48DXN 40/80 metres \$49
- AL24DXN 20/40 metres \$47
- MIDY VN 80 thru 10m \$65

BALUNS

- AS-8L (Asahi) for beams \$30
- BN-86 (Hy-Grain) for beams \$30
- BL50A 50 ohms, 4kW model \$24
- BL70A 70 ohms, 4kW model \$24



The FL2100B linear uses two rugged 572B carbon plate tubes in class B grounded grid-circuit with individually tuned input coils for each band. Covers 80 thru 10 metres at 1200W pep input. Price \$524.

FL-2100B linear amplifier



TS520S the transceiver that has made the Kenwood name near and dear to amateur operators around the World. Reliability is the name of the rig in capital letters! 160 metres thru 10 metres with many built-in features.



The new HAL KSR3000 send/receive RTTY terminal including keyboard and video display, features scrolling, continuous, word or line transmission and firmware for word wrap-around and blankfill. Handles Baudot and ASC11 (8-level) with a screen size up to 1152 chs. List price \$1499. Write (including SAE) for complete specifications.

A whole world of communications products.



Head Office & Mail orders—

139 AUBURN RD. AUBURN, VIC. 3123
Phone: (03) 82.5398, (03) 813.2355 Telex: AA30566
Adelaide (437981) Brisbane (3844480)
Canberra (823581) Perth (4633232)

Director: Russell J. Kelly VK3NT
Peter D. Williams VK3IZ

ELECTROCRAFT PTY. LTD.

Distributors of Belling Lee, Channel Master, Ecrafft, Hills, HI.Q, Lab Gear, Kingray, Matchmaster. Largest Television range of aerial equipment in Sydney.

106A Hampden Rd.
Artarmon, 2064
Phone 411-2989

TELEVISION AERIALS, DISTRIBUTION AMPLIFIERS, EQUIPMENT AND ACCESSORIES WHOLESALE, TRADE AND RETAIL SUPPLIED.

NEW FROM ECRAFT A range of Medium & High gain R.F. DISTRIBUTION Amplifiers, suitable for all TV & FM Radio transmissions within the VHF & UHF Bands 1 to V.

APPLICATION Suitable for small home unit, showroom or household type installations. D16 & D25 amplifiers have good signal to noise ratio. As such this makes them suitable as a booster in semi-fringe or fringe areas.

1.75 D16 16 dB gain \$45.90 1.75 D25 25 dB gain \$53.55

All type coaxial cables in stock from 30c per yd. 50 ohm—75 ohm.

HILLS	ANTENNA'S	CH's	\$
CA16	High gain phased array	Multi	45.94
215/2710	8 EL	Multi	25.29
2010/2710	Airways	Multi	58.26
E.F.C. 1	75 ohm for colour	Multi	36.00
E.F.C. 2	75 ohm for colour	Multi	50.96
E.F.C. 3/24	75 ohm for colour	Multi	75.50
E.F.C. 4/24	75 ohm for colour	Multi	82.00
207/45A		3 & 4 & 5A	40.71

HILLS FM	ANTENNA'S		
FM.1	300 ohm		9.35
FM.3	75 ohm		26.11

CHANNEL MASTER		CH's	\$
3110	2 EL Coloray	0 to 11	27.96
3111	6 EL Super Coloray	Multi	41.98
315	2 EL City Vee	D to 11	15.68
3615A	9 EL Crossfire	Multi	43.64
3614A	13 EL Crossfire	Multi	54.97
3613A	17 EL Crossfire	Multi	68.17
3612A	21 EL Crossfire	Multi	78.54
3610A	24 EL Crossfire	Multi	99.84
3617A	28 EL Crossfire	Multi	134.98

CHANNEL MASTER FM			
700 FM	8 EL 300 ohm		19.68
FM	2 EL 300 ohm		8.31

MATCHMASTER FM ANTENNA'S			
FMG.	300 ohm		19.68
FMG/2	300 ohm		18.30
FMG/6	Fringe area 300 ohm		40.93

For the best in CB performance, there's single sideband. And for the best in mobile single sideband, there's Grant. It has unsurpassed sensitivity, and has a powerful 12 watt PEP transmitter. Features include a variable mike gain control, a true RF noise blanker with manual override, a huge S/RF meter, and an easy-to-read and use upper and lower sideband selector/indicator.



A big voice in a small package. The Cobra 19M \$110.00.

If you've ever heard a Cobra 26, you'll know it's hard to believe all that talk-power is legal. Cobra found the way to make their radios really talk and still obey the rules. Now you can talk just as loud and far with a smaller package. Cobra 19M is thin and narrow enough to mount conveniently in any car, even the latest subcompacts. And the 19M has other features you'd expect from a Cobra, such as a plug-in dynamic mike, external speaker jack, and now, even an illuminated RF/signals metre. The Cobra 19M has the same receiver sensitivity and selectivity as its big brother, Cobra 26. It has an efficient automatic noise limiter too, you'll hear clearly in the heart of heavy traffic. Dimensions: 1 1/2" H x 5 1/2" W x 8" D. Power Output: Factory adjusted to 4 watts legal maximum. Modulation: 100%. Sensitivity: Less than 1.0uV for 10dB (S+N)/N. Selectivity: dB—6dB at 4kHz, 40dB at 20kHz. Image Rejection—30dB. IF Rejection—80dB. Audio Output: 2.5 watts into 8 ohms.

CB AERIALS		
Belling Lee:	5ft Fibreglass vertical helical whip aerial with base (Guard Mount) complete with 12ft cable & plug.	\$24.00.
	5ft Helical home base aerial for mast mounting	\$33.
	CB2600 Gutter Clamp aerial complete with lead & plug.	\$20.70.
ALL TYPES OF	HARDWARE IN STOCK Wall Brackets, Chimney Mounts, J Brackets, Guy Rings & Guy Wire. Masts from 8ft to 50ft. ETC.	

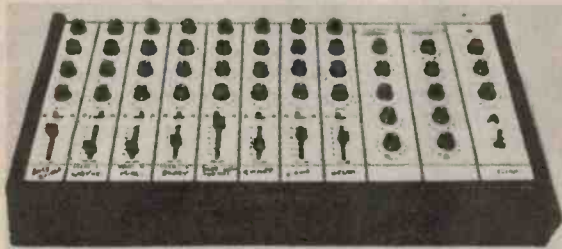

414 8 CHANNEL AUDIO MIXER

- 8 input channels each with linear fader, input attenuation switch, bass, treble, echo send and pan controls. High and low impedance PMG inputs.
 - 2 output channels with 5 stage equalisation on each channel, VU meters, overload led, master pan, echo and volume controls.
 - Black anodised front panel with yellow lettering. Vinyl covered cabinet.
- COMPLETE KIT \$254.00 plus \$5.00 Freight.**

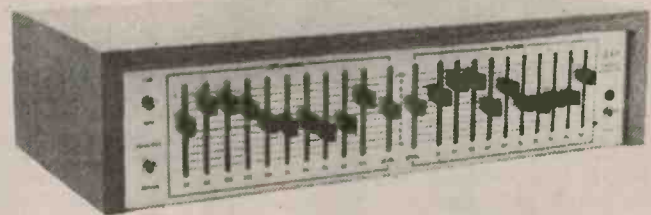

485 STEREO GRAPHIC EQUALISER

- This superb equaliser offers 10 octave-centred 11ear controls for each channel; level match control, in-out switch and tape monitor switch.
- The performance of this unit is equal to some of the best available.

COMPLETE KIT \$98.50 plus \$2.50 Freight.

jaycar PTY LTD. P.O. Box K39 Haymarket 2000,
405 Sussex Street, SYDNEY.
Tel: 2115077.

Project 715 Continued from page 35 . . .

manner described. Lower PEP output is obtained though.

Measured performance of the prototype was as follows:—
Power Output = 12.5 watts (12.5 volt supply)

gain = approx. 10 dB
efficiency - 50%

Collector current = 2 amps @ 12.5 volts supply (max. $I_c = 2A$) (max. $V_s = 36V$)
Collector dissipation = 12.5 watts @ full output
Maximum recommended voltage = 15 volts (watch I_c !)

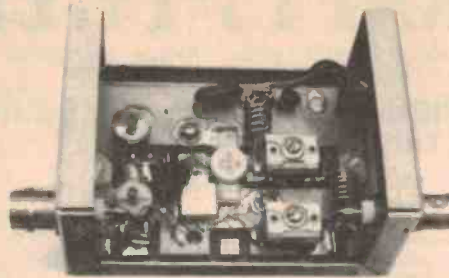

The ETI-715C prototype 10 W two metre amp for hand-held transceivers, etc. The diode and stub switching has been omitted for clarity.

ETI-715E 12 W on two metres

Fig. 13. Construction and component layout of the ETI-715E 12W two metre power amp.

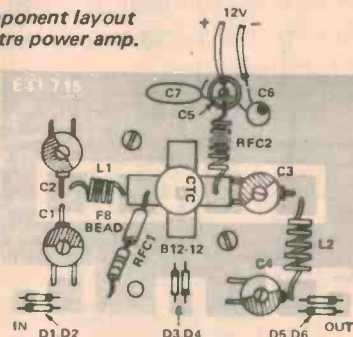

- | | | | |
|------------|--|---------|---|
| L2 | 5 turns 20 B&S t.c.w. wound on 6 mm mandrel 12 mm long. | Q1 | B12-12 (CTC) |
| RFC1 | See text. Use a 220 μ H moulded choke with a Neosid 159 x 059 x 375/F8 bead slipped over the 'hot' lead. | C1 | 40 pF film or mica compression trimmer. |
| RFC2 | 6 turns 20 B&S t.c.w. wound on 3 mm dia. mandrel 11 mm long. | L1 | 4 turns, 20 B&S t.c.w. wound on 6 mm mandrel 5 mm long. |
| C2, C3, C4 | As C1. | D1 - D6 | 1N914, 1N916, BAX13 or BAV10. |
| C5, C6, C7 | As per fig. 2. | | |

This model is intended for the IC202 owners and homebrewers who have got to the 715D stage.

Components and layout are given in figure 13. Good luck!

Mount the transistor first according to the details given earlier — like, carefully. The usual construction order then follows. Refer to figure 13 and make up RFC1. This consists of a 0.22 μ H moulded choke with an F8 ferrite bead slipped over the base end. The 0.22 μ H choke may be wound up on a low value resistor as described in the 715D.

All the other components may then be mounted in the usual order — trimmers first, coils next, followed by the rest of the components.

The diode and stub switching network should be mounted last. It can be left until after the assembly is mounted in/on the chassis/heatsink used.

The assembly should be mounted as per the previous descriptions — don't forget the silicone grease on the chassis/heatsink under the transistor stud.

Leads from the board should be

short, 10mm or less, otherwise use coax and only ground the braid at the ground plane.

ETI-715E Performance

This little beauty delivers around 12–15 watts saturated power output in class C and around 10–12 watts PEP in class AB. The diode and stub network is not used in linear operation. Bias is applied via the 'cold' end of RFC1, as described.

Prototype performance as follows:—

Peak Power output = 10–12 watts PEP (class AB) 12–15 watts (class C)
gain = 8–10 dB
efficiency = 68.5% (class C)
Collector current = 1.4 amps @ 12.5 volt supply 1.7 amps @ 13.8 volt supply
Collector dissipation = 6 watts (class C, full carrier).
Bandwidth = 4 MHz (– 3 dB points).

In linear operation, the quiescent collector current should be around 50–80 mA. It may be as high as 100 mA in some devices, but generally it will be towards the bottom end of this range. Continuous collector dissipation will be 1 watt or less.

General Tune-Up Procedures

First check all components and connections. Make sure that there are no shorts anywhere. Check that the adjusting screws of the mica compression type trimmers do not short to the ground plane or any of the pads.

Insert an appropriately rated fuse in series with the positive supply lead. For example, a 750 mA fuse is recommended for the ETI-715D, and a 2A fuse for the ETI-715E.

Connect an ammeter of appropriate range in series with the positive lead also.

A power supply of between 12 and 14 volts will be necessary for testing and tune up having sufficient current rating to handle the expected peak current.

Either an in-line RF power meter and a dummy load, calibrated for the frequency, or a dummy load/wattmeter of suitable rating, should be used for measuring the output.

A reasonable SWR meter is also handy for setting the amplifiers' input SWR. It should have sufficient sensitivity and accuracy, up to 150 MHz at least, to work effectively with the low drive powers.

Commence by connecting the dummy load and wattmeter to the output. Make no connections to the input. Connect the power supply and check the quiescent collector current if the amp is to be used as a linear. Adjust the bias if necessary, as described in the bias circuit details, to put the quiescent current into the range quoted.

Apply a low drive level, about 1/4 to 1/2 that required and tune C1 and C2 for a peak in the collector current. Then tune C3 and C4 for a peak in RF output. Tune C1 and C2 again for a peak in RF output this time.

Then, if all is well, increase the drive to full power and tune C1, 2, 3 and 4 for maximum power output. Monitor the supply current while doing this. Make sure that it doesn't approach the maximum rating. If it does it is most likely that the transistor is oscillating at a low frequency. Adjusting RFC1 or RFC2 will get rid of this problem. We have only had this 'evil' occur in a few cases, and the design has been changed to prevent low frequency instability.

All the amplifiers should be quite stable.

Transistors, printed circuit boards and kits of the ETI-715 series of six and two metre amplifiers are available from Amateur Communications Advancements, P.O. Box 57, Rozelle, 2039, and also through Daicom Electronics of 29 Colbee Court, Phillip 2606, in Canberra.

CONTINUED NEXT MONTH

SOVEREIGN CITY ELECTRONICS

Ballarat



TTL Specials

7403	17	7430	19
7404	21	7440	19
7410	19	7474	33
7414	1.25	7493	48

DTL Specials

932 DC (Dual 4 input buffer)	21	950 DC (AC coupled RS FF)	1.47	1.47
937 DC (NEX Inverter)	22	951 DC (Monostable Multivibrator)	1.47	
944 DC (Dual 4 input ex buffer)	22	961 DM (Dual 4 input gate/ex)	76	
946 DC (Quad 2 input gate)	21	963 DM (Triple 3 input gate)	76	
949 DC (Quad 2 input gate)	21	961 DC (Dual 4 input gate/ex)	71	

(Data Supplied)

Signetics TTL Low Schottky

74LS00	36	74LS42	1.42	74LS85	1.99
74LS02	36	74LS51	36	74LS86	56
74LS04	38	74LS55	36	74LS90	1.73
74LS10	36	74LS73	47	74LS93	1.23
74LS20	36	74LS74	49	74LS95A	1.70
74LS30	36	74LS78	47	74LS164	1.76

Regulators

		GENERAL ELECTRIC	SCR'S ETC.	
LM309A	2.36	C10501	1.19	512 33
LM340T	2.10	C122D	2.11	514 50
LM723	.65	C122E	2.54	D1311 1.68
UA7803	2.10	SC1410	1.95	D1312 1.18
UA7808 13.8 V	2.97	SC1510	1.37	

Signetics Linear

LM301	36	UA741	56
LM309	1.43	LM381	3.03
NE555	54	LM382	2.69
NE556	1.43		

Phillips Locmos

HEF 4000	30	4013	50	4024	99
4001	30	4014	1.28	4027	57
4002	30	4016	52	4028	99
4006	1.28	4017	1.24	4030	52
4007AB	30	4018	1.28		
4008	1.24	4021	1.28		
4011	30	4022	1.22		
4012	30	4023	30		

Gold Rush Specials:

HOOK UP WIRE

\$2.76
100yd



14/0076

7/0076 - 5/0076

Pin for Pin Sub etc.

(P&P semiconductors only 60c. Orders including Cable etc. \$2.80)

2500uF CAN ELECTRO'S

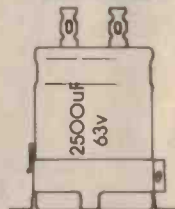

\$1.68ea

P.O. Box 623

Ballarat Victoria

3350

Convert your CB into a base station



Power your rig direct from mains electricity with an SEC approved power supply. These small portable units provide a factory-set 13.8V DC regulated output for maximum transmitting power.

High performance integrated circuitry guarantees clean, hum-free reception. Quick-connect terminals facilitate rapid changeover from static-mobile-static operation.

ARLEC CB radio power supplies



ELECTROPAK PS352

For CB Radios up to 5 Watts Rating

1.8 Amp peak capability. Automatic overload protection. 1.0 Amp continuous output. Size: 140 x 80 x 133mm



SIDE BAND 4 PS353

For CB Radios up to 15 Watts Rating

4 Amp peak capability. Automatic overload protection. 2 Amp continuous output. Size: 140 x 80 x 133mm

See them at your local CB Store or write to A&R Electronic Equipment Co. Pty. Ltd. for further details

A+R ELECTRONIC EQUIPMENT CO. PTY. LTD.

A MEMBER OF THE A+R-SOANAR ELECTRONICS GROUP

SALES OFFICES VICTORIA 89 0661

N.S.W. 78 0281

S. AUSTR. 51 6981

QUEENSLAND 52 5421

W. AUSTR. 81 5500

30 Lexton Road, Box Hill, Vic., 3128 Australia. Telex: 32286



SINCLAIR

AS PROMISED, here are a few programs for the Sinclair Cambridge Programmable Calculator which we featured in a special offer a few months ago. We haven't fully checked these out, only keyed them in and ensured they didn't do anything nasty or nonsensical, so as with Ideas for Experimenters we are unable to accept responsibility for the accuracy of these programs or the results they produce. If you have developed an interesting program, send it in, all programs used will be paid for.

555 TIMER

C. Wares

This program calculates the frequency of operation of a 555 connected as an astable multi-vibrator.

Solves $f = 1.44 / (R_a + 2R_b)C$

Execution sequence:

Rb/RUN/Ra/RUN/C/RUN/(f)

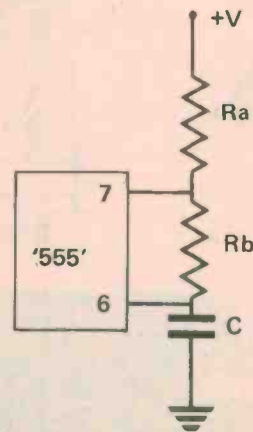

+	E	00
=	-	01
sto	2	02
(6	03
stop	0	04
+	E	05
rcl	5	06
)	6	07
x	.	08
stop	0	09
=	-	10
sto	2	11
#	3	12
1	1	13
.	A	14
4	4	15
4	4	16
÷	G	17
rcl	5	18
=	-	19
stop	0	20
▼	A	21
go to	2	22
0	0	23
0	0	24
		25
		26
		27
		28
		29
		30
		31
		32
		33
		34
		35

Software

GOLF GAME

B. Bland

This program simulates a golf game on the Sinclair Cambridge Programmable.

Execution Sequence:

Distance to hole/RUN/
Shot/RUN/(result)

For distances ≥ 500 , shot should be 1 to 29.

To tell whether you are in the hole or not, the display should show 1-2 or less, with the objective being E0.

stop	0	00
sto	2	01
=	-	02
stop	0	03
x	.	04
#	3	05
7	7	06
-	F	07
#	3	08
6	6	09
-	F	10
rcl	5	11
=	-	12
=	-	13
▼	A	14
gin	1	15
2	2	16
0	0	17
-	F	18
=	-	19
-	F	20
=	-	21
sto	2	22
lnx	4	23
-	F	24
rcl	5	25
=	-	26
-	F	27
=	-	28
▼	A	29
go to	2	30
0	0	31
3	3	32
▼	A	33
go to	2	34
0	0	35

NUMBER GUESSING GAME

G. Haggard

This game illustrates the conditional branching capability of the Sinclair calculator.

Player A enters N into memory and clears display.
Player B's first guess:
x1/RUN/RUN
successive guesses:
x2/RUN

When entering negative numbers use

x/▲▼/▲▼/ +/- /RUN

stop	0	00
-	F	01
rcl	5	02
=	-	03
▼	A	04
gin	1	05
1	1	06
8	8	07
-	F	08
=	-	09
▼	A	10
gin	1	11
2	2	12
5	5	13
▼	A	14
go to	2	15
3	3	16
2	2	17
#	3	18
1	1	19
=	-	20
▼	A	21
go to	2	22
0	0	23
0	0	24
#	3	25
3	3	26
=	-	27
▼	A	28
go to	2	29
0	0	30
0	0	31
#	3	32
2	2	33
=	-	34
stop	0	35

CITIZENS BAND ANTENNAS

Made in Australia by **SCALAR Industries**, suppliers of communication antennas to Government, Industry and Commerce.

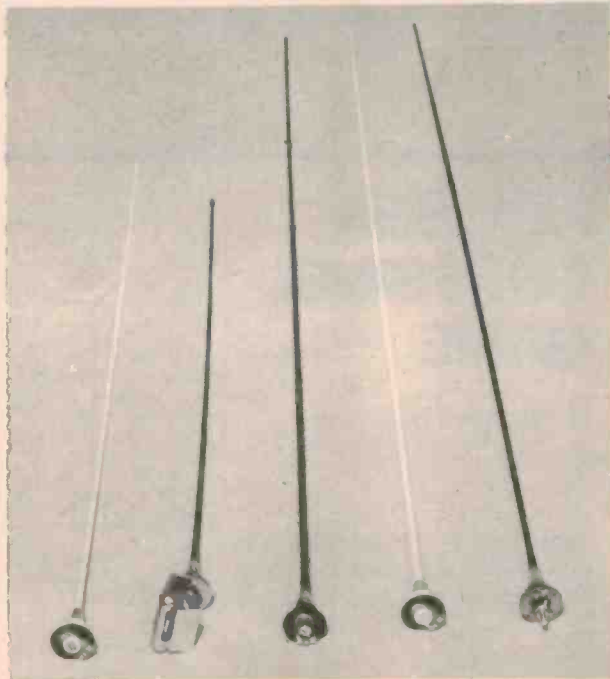

CB 1220 CB 1120 CB 1420 CB 1520 CB 1320

CB 1220	42" centre loaded
CB 1120	30" centre loaded
CB 1420	60" helical
CB 1520	60" helical/sector/top loaded
CB 1320	60" centre loaded

SCALAR Citizen Band antennas are designed to provide efficient performance with reduced length. Either helical, centre or top loading on fibreglass rods, many thousands are already efficiently in use throughout Australia in vehicle, marine and base installations.

Dipole Simulator meets the need of installations of 27 MHz antennas where a ground plane is not available. It can be used with any **SCALAR** 27 MHz whip top and is particularly useful in installations on fibreglass and wooden boats and vehicles having fibreglass cabins. The helipole converts the whip into a 1/2 wave centrefed dipole, assuring a very stable and efficient antenna system.



Modified CB accessories, for use with any **SCALAR** mobile whip top: GUTTER GRIPS
 SLOPE ADJUSTERS
 MARINE KNOCK DOWN
 VEHICLE KNOCK DOWN



Available from leading retailers and distributors throughout Australia.
 Trade enquiries to:
SCALAR Industries Pty Ltd.
 18 Shelley Ave, Kilsyth, Vic. 3137.
 Tel: (03) 725 9677. Telex: AA 34341. Cables: Welkin.
 NSW: 20 The Strand, Penhurst, 2222.
 Tel: (02) 570 1392
 QLD: (07) 371 5677; WA: (092) 57 1555; SA: (08) 42 6666

ROD RIVING ELECTRONICS

P.O. BOX 135 NORTHCOTE VIC. 3070

OPTO		REGULATORS	
FND 357 .375" cc display	\$.140	uA7805uC 5U1A	1.30
FND 500 .5" cc display	\$.150	uA7808uC 8U1A	1.20
FLU 117 Red LED Pis clip	.25c	uA7812uC 12U1A	1.30
FPT 100 photo transistor	.90c	uA7815uC 15U1A	1.30
FLU 315 green LED	.40c	uA7818uC 18U1A	1.30
FLU 450 yellow LED	.40c	uA7824uC 24U1A	1.20

LINEARS:		T.T.L.	
uA555	.50c	7400	25c
10 for	\$4.50	7401	25c
uA741	.40c	7402	25c
10 for	\$3.50	7403	25c
uA723	.50c	7447	\$1.15
LM 380	\$.130	7490	65c

TRANSISTORS		DIODES	
BC 107-8-9	.18c	IN4002	.7c
BD 139-140	.60c	IN4004	.8c
2N3055	.85c	0A91	16c
FT3055 (TIP)	.80c	IN4148	.5c
BC 547-8-9	.20c	IN5625 400c SA	50c
TIP 31B, TIP 32B	.75c	SC1410 6A 400V TRIAC	\$1.29

CMOS		MEMORIES	
4001	.28c	2708 EPROM	\$22.50
4002	.28c	2102	\$2.30
4011	.28c	8 for	\$17.00
4012	.28c	35382DC 256 x 4 bit	
4023A	.28c	ST-RAM	\$4.90
4049	.60c		

ZENERS
 400mW 5 percent E24 valves 3V to 33V 16c

RESISTORS
 I.R.H. Metal glaze G.L.P. G.L. 1/2 watt 2.2 OHM to 1 MEG 2.5 cents each for 2 cents for 100 plus

FAIRCHILD CB REGULATOR
 uA 78CB 13.8V at 2 amp\$2.75

CAPACITORS
 GREEN CAP 100V .001, .0012, .0015, .0018, .0022, .0027, .0033, .00398c
 .0047, .0056, .0068, .0068, .0082, .018c
 .012, .015, .018, .022, .027, .03310c
 .037, .047, .05612c
 .068, .1, .12, .1515c

POTENTIOMETERS:
 .25 Watt rotary carbon single gang. Log or Line IK, 5K, 10K, 25K, 50K, 100K, 250K, 500K, 1M 45c each.

TRIM POTS:
 0.1 Watt 10mm. 100, 250, 500, 1K, 2K, 5K, 10K, 25K, 50K, 100K, 250K, 500K, 1M 15c each.

CERAMICS TH 630V
 10pF, 12pF, 15pF, 18pF, 22pF5c
 27pF, 33pF, 39pF, 47pF, 56pF5c
 68pF, 82pF, 100pF6c
 120pF, 150pF, 180pF, 220pF, 270pF6
 330pF, 390pF, 470pF, 560pF, 680pF6c
 820pF, .001uF, .0012uF, .0015uF7c

OPTO COUPLERS
 FCO 820A (TIL111) . . . 1500 Volt\$1.50
 4N25 2500 volt\$1.75
 30 amp 400V Bridge rectifier\$4.75
 2500uF 50V Electrolytic\$1.85

30 AMP 400V BRIDGE RECT \$4.75 2500 uF 50V ELECTROLYTIC \$1.85

Weller cordless soldering iron kit model WC100DKW includes batteries, solder 4 interchangeable tips, battery charger, plus instructions for only \$26.50. All goods new and guaranteed. Price list enclosed with each order. Postage and packing charge 50c per order

Ideas for experimenters

TONE BURST GENERATOR

The circuit in Fig 1. generates the waveform shown in Fig. 2. The output is basically oscillations at a certain frequency outputed in small pulses. This type of waveform has varied uses ranging from a beat for an organ or synthesizer to audio or radio frequency testing.

The variable parameters of the

waveform are shown in Fig. 3:—
VR1 alters the time between pulses.
C1 alters the length of the pulse.
VR2 alters the amplitude of the waveform.

Cx alters the frequency of the waveform within a pulse. This ranges from .0005 giving RF, to 5 giving AF. (microfarads).

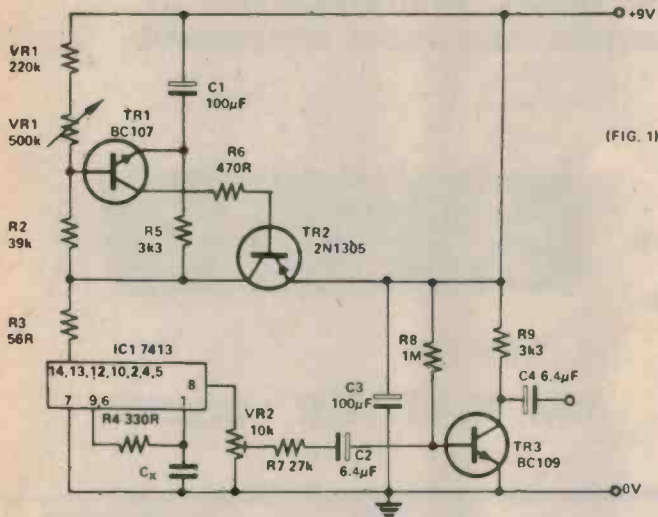

(FIG. 1)

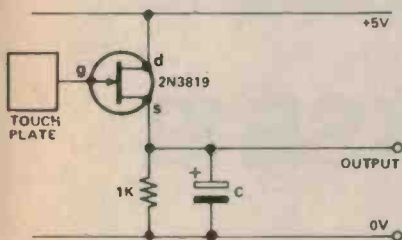
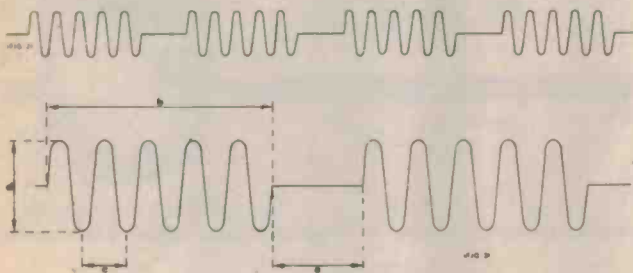

TOUCH-SWITCH FOR LOGIC

An n-channel field-effect transistor is the basis of this simple trigger. In its quiescent state the voltage at the output is about 3V. When the plate is

briefly touched with a finger, the minute currents between the body and the plate alter the electric field at the gate of the transistor. The effect is to cause a drop in output voltage. It falls almost to zero and can be used to trigger a TTL flip-flop. This can be constructed in the usual way, using two NAND gates from a 7400 IC. If several triggering circuits are required, it is more convenient to use the 74118 sextuple bistable latch.

The value of the capacitor is not critical, but 10uF is convenient. The touch-plate can be an area of copper etched on a circuit-board, a square of aluminium foil or simply a thumb-tack pressed into an insulating support.

INTRODUCING OUR GREAT NEW BOLVAR 125.

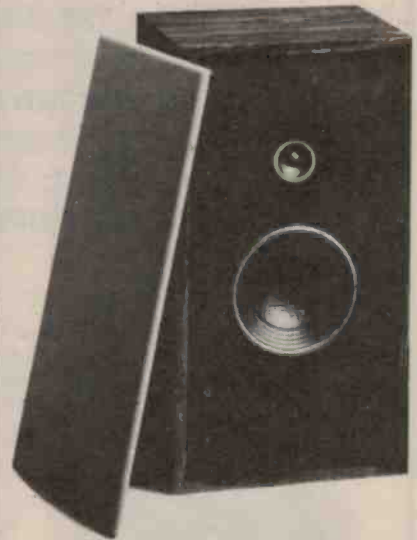

Model 125 has the same woofer as does the Model 18 and therefore the same enclosure, and therefore the same incredible bass response. It has the same tweeter, too. And therefore the same lucid shimmer on higher frequencies.

Most of all, it allows you to make another choice within the class of great — for the price of good.



Bolívar Speaker Works
GREAT FOR THE PRICE OF GOOD.

HARMAN AUSTRALIA PTY. LTD.,
P.O. BOX 6, BROOKVALE, N.S.W. 2100
PH. (02) 939-2922. TLX. 24873.

18 CHANNEL IS HERE!

From 1st September, 1977, only 16 channels on a 23-channel rig can be used legally.

Karina introduces the KSB18, the most advanced CB on the Australian market today, manufactured by Cybernet, the world's largest and most respected manufacturer of CB.

Power input-output 5W-3W,
output impedance 50 amps,
synthesized frequency control,
Dynamic microphone.
Dimensions: 150mm x 130mm
x 40mm.



18 channel
A.M. RAIDER #30500



PLL synthesized frequency, maximum
output 12W-p.e.p. S.S.B, LED channel
indicator, negative earth chassis.
Dimensions: 245mm x 184mm x 62mm.

18 channel
Karina KSB18

Sole importers:

Karina Sales Pty. Ltd.

QLD.
24 Light Street,
Bowen Hills,
Brisbane, 4006.
Ph: 52 7916.

N.S.W.
13-15 Newton Street,
Auburn,
Sydney, 2144.
Ph: 648 4966

VIC. & TAS.
198 Burnley Street,
Richmond,
Melbourne, 3121.
Ph: 429 1999

S.A. & N.T.
91-93 King William St.,
Kent Town,
Adelaide, 5067.
Ph: 42-5626

W.A.
Unit 2, 4 Burgay Ct.,
Osborne Park,
Perth, 6017.
Ph: 446-9111.

STOCKS AVAILABLE SHORTLY FROM LEADING RETAILERS THROUGHOUT AUSTRALIA

TRADE ENQUIRIES ONLY TO YOUR NEAREST KARINNA STATE BRANCH

Ideas for experimenters

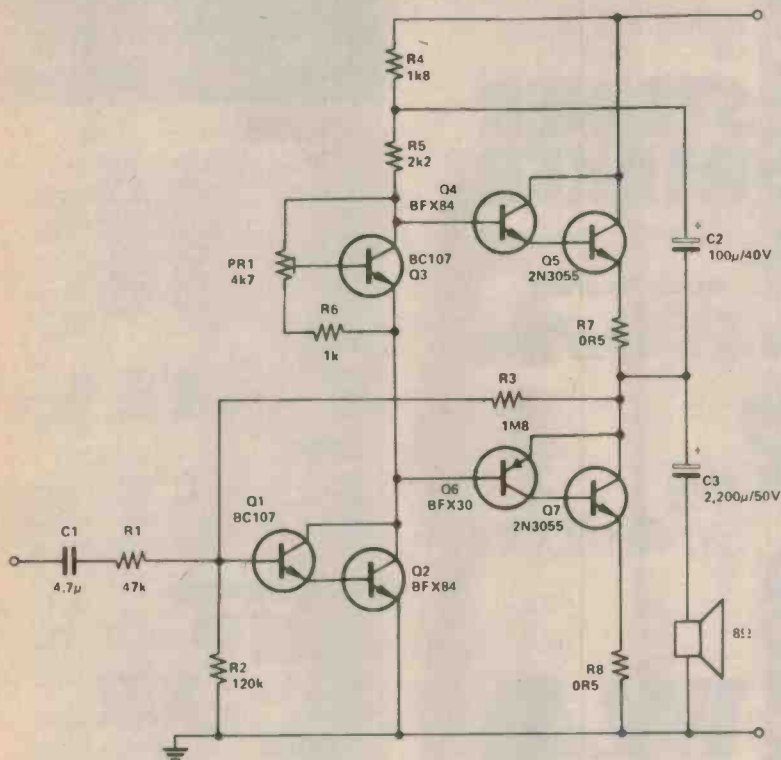

20W SLAVE AMP

This amplifier is very simple to build and most of the parts will probably be available from the constructor's 'junk' box. The circuit consists of a Darlington pre-driver, Q1 and Q2, a V_{BE} multiplier Q3 and a quasi-complementary output stage Q4-7.

Overall shunt feedback is applied from the collector of Q7 to Q1's base via R3 which, in conjunction with R2, also provides DC feedback and input bias. The voltage gain, and hence the

sensitivity of the amplifier, is set at 33 and 370mV by the ratio of R3 to R1.

Quiescent current through Q5 and Q7 should be set at 30mA by PR1.

The collector load of the Darlington, R4 and R5, is bootstrapped by C2 to provide a current drive for the output stage.

Although simple, the amplifier is capable of good quality reproduction and will operate quite happily into a 4, 8 or 16R load.

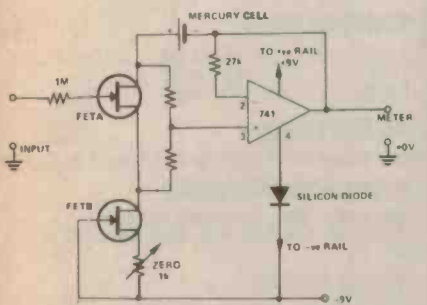

100,000 MEGOHM DC PROBE!

The input current of a junction FET, usually less than 1nA, flows out of the gate, and is constant at a particular temperature, provided the voltage across the device is constant. By making the gate positive to the source this leakage current can be made to flow back into

the device, reducing the input current almost to zero.

FET A should be a low loss, low V_p device (ideally V_p should be about 0.5V). FET B must be somewhat higher but is less critical, the bargain pack is usually a good source of such devices. Forward bias should be about 150mV and current through the FETs about 400mA.

The mercury cell holds the voltage across the input FET constant at 1.5V (1.35V plus 150mV) and the silicon diode in the op amp's negative lead prevents the cell from discharging when the power is off.

By adjusting values in the potential divider it is possible to achieve input currents within a few picoamps either way and to measure the voltage on a small capacitor without changing it.

NOW HEAR THIS!

Our new magnetic cartridge, the Ortofon M 20 Super, will almost certainly be found among the best in every review and test report you are likely to see.

But if you feel weighed down by curves and diagrams, maybe you should skip the reading for a change and concentrate on listening.

When you agree that no other cartridge sounds better than our new M 20 Super—go ahead and buy it.

You can always ask for the literature afterwards. Just to prove that your ears told you the truth and nothing but the truth.

ortofon
accuracy in sound

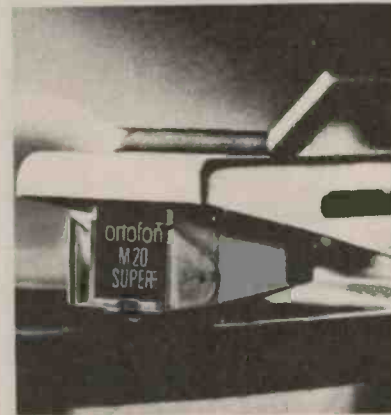

Latest from Ortofon is the M 20 Super—a unique magnetic stereo cartridge, based on our exclusive world-patented Variable Magnetic Shunt (VMS) principle.

Harman Australia Pty. Ltd.
P.O. Box 6, Brookvale, NSW 2100
Telephone: (02) 939 2922. Tlx: 24873



**For
transistors
you can
depend
on**

General purpose
Switching
RF
FET's
Power
Photo
Transmitting

**Think
Philips**

153 0191

PHILIPS Electronic Components and Materials

PHILIPS

FARRELL KEYBOARDS

IMPORTERS
OF

**STEINER
PARKER**

POLYPHONIC

Orchestron

THE
SYNTHACON

WLA

ALSO AVAILABLE
SYNTHESIZERS
LEADS
AMPLIFIERS

ALSO AVAILABLE

Synapse MAGAZINE

CONTEMPORARY
KEYBOARD

FOR

FARRELL KEYBOARDS

SEND COUPON TO
FARRELL KEYBOARDS

505 Pittwater Road
Brookvale • NSW 2100
Telephone • 939 1785



Please send me a copy of

FARRELL KEYBOARDS

Name

Address

Postcode

**ELEKTROMART
FOR
HOBBYIST COMPONENTS**

LINEARS

LM301A.....50c	LM723.....75c
LM307.....90c	LM741.....40c
LM324.....1.25	LM3900.....1.15
LM339.....1.15	LM3909.....1.40
LM340.....1.60	LM78L12.....50c
LM382.....2.30	uA304.....3.20
LM555.....65c	uA709.....65c
LM556.....1.20	uA753.....1.60
LM710.....1.00	uA7805.....1.60

TTL's

7400.....40c	7490.....70c
7404.....60c	7492.....70c
7447.....1.30	7493.....70c

CMOS

4001.....40c	4024.....1.50
4011.....40c	4030.....85c
4015.....1.65	4040.....1.70
4016.....1.10	4050.....6.50
4017.....1.50	4068.....50c

TRANSISTORS

BC107, BC108, BC109.....30c	
BC177, BC178, BC179.....40c	
BD139, BD140.....70c	
2N2222.....55c	2N2906.....50c
2N2646.....1.50	2N3054.....1.30
2N2905.....80c	2N3055.....1.20

DIODES

EM410.....25c	1N4002.....13
1N914.....10c	1N4004.....16
OA91.....17	1N5405.....40c

ELECTROLYTIC CAPACITORS

Value	Voltage	Axial	Upright
2.2uF	25V	9	7
3.3		9	7
4.7		9	7
10		9	7
25		11	8
47		12	9
100		16	11
220		18	15
470		34	22
1000		54	48
33	16V	10	8

CERAMICS

100pF, 150pF, 220pF, 270pF, 330pF, 470pF, 680pF, 820pF, 1000pF; 6c ea. (10 up: 5c ea.)

TANTALUMS

1.0pF.....12c	3.3pF.....17c
1.5pF.....13c	4.7pF.....17c
2.2pF.....17c	10pF.....17c

RESISTORS

All preferred values, 1/2W: 3c ea. (10 up: 2.5c ea.)

POTENTIOMETERS

1/4W, rotary, carb., single gang, log or lin.
1K, 5K, 10K, 25K, 50K, 100K, 250K, 500K, 1M: 47c ea.

TRIM POTS

0.1W; 100 ohm, 250 ohm, 500 ohm, 1K, 2K, 5K, 10K, 25K, 50K, 100K, 500K, 1M: 15c ea.

Mail Orders to:

ELEKTROMART

P.O. BOX 30
MELTON SOUTH, VIC.
3338.

Ideas for experimenters

LOW FREQUENCY EXTENDER

In circuits which have a variable frequency input, e.g. optical tachometers, vibration measuring equipment etc., the low frequency response can leave a lot to be desired. The circuit shown brought the lower 3 dB point of a measuring instrument down to 0.5 Hz when placed in circuit between the transducer and the instrument.

Being of small size, the circuit may be fixed inside the case of the instrument it is to serve.

The gain of the circuit may be altered by means of the feedback capacitor to give a level response compatible with the instrument to which it

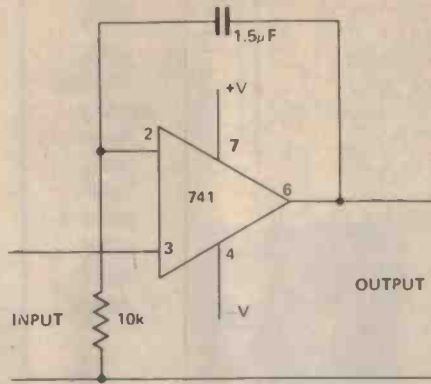

is connected, i.e. a higher value will give a lower gain and vice-versa.

The 741 IC will operate at voltages between ± 5 and ± 15 V.

IMPROVED MULTIVIBRATOR

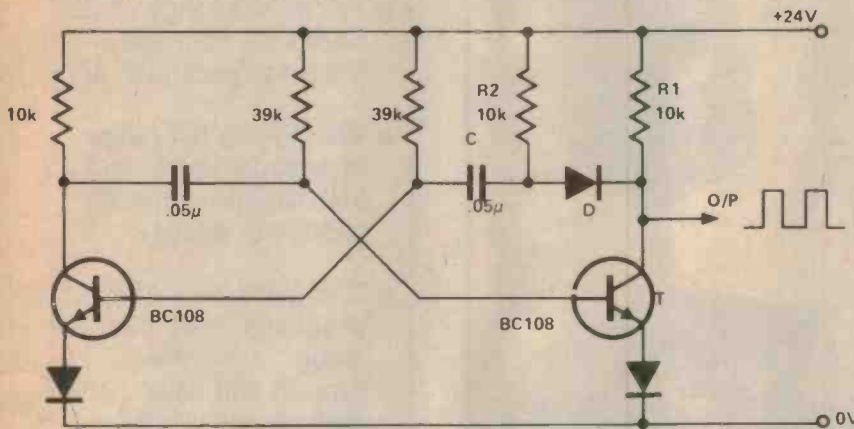

Conventional astable multivibrators suffer from the disadvantage that they do not produce a good square-wave output; the leading edge of the wave-form has a very slow rise since the collector resistor R1 is tied to a slowly charging capacitor C when the transistor T turns off.

This circuit prevents this effect and

thus generates a clean square-wave with 400 nS rise-times and 100 nS full-times. This is because diode D turns off when the output begins to rise in voltage, and a fast rise is then possible. C is charged by a separate resistor R2, and apart from this multivibrator action is normal. The components shown give an operating frequency of about 700 Hz.

WATER LEVEL INDICATOR

This simple circuit provides an audible warning of the level of liquid in a tank. Alternatively it may be used as a touch or rain alarm.

When any liquid is present between the probes a current is allowed to flow, limited by R1, which triggers the thyristor on. The current drawn by the warning device WD1 is above the holding current of the thyristor alarm and so the alarm continues to sound. R1 should be chosen to suit the thyristor used, D1 provides protection

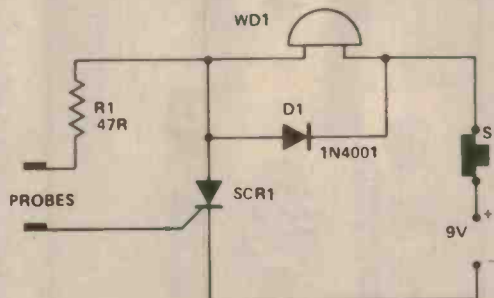

from current surges. The circuit may be reset by pressing S1 which is a push break type, SCR1 should be a 25 V low current type.

TOCORD ULTIMATE AUDIO CABLES

Can you hear your speaker cables?

Recent research has confirmed that listening to a quality HI-FI music system which utilises standard figure eight speaker cable may be compared with viewing a colour slide out of focus!

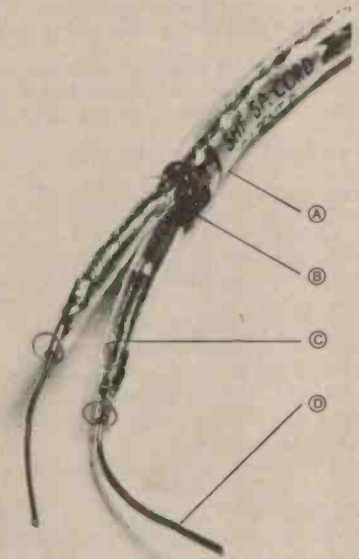

- Ⓐ Clear P.V.C. outer sheath.
- Ⓑ Braided conductors to cancel linear inductance.
- Ⓒ 144 individually insulated conductors per side.
- Ⓓ Tinned copper ends on 20 ft lengths.

Specifications:

D.C. Resistance	.0105 Ω /m
Impedance	9.15 Ω (constant)
Inductance	0.15 μ H/m

HARMAN AUSTRALIA PTY. LTD.,
P.O. BOX 6, BROOKVALE,
N.S.W. 2100
PH. (02) 939-2922.
TLX. 24873.

Send coupon for your detailed literature and your free sample of TOCORD SHF speaker cable.

NAME _____ ADDRESS _____ POSTCODE _____

ELECTRONIC DISPOSALS

297 Little Lonsdale St.,
Melbourne, 3000
Phone 663-1785

AWA Solid State TV Tuners \$7.50 ea.
AWA Thorn Valve TV Tuners \$5.00 ea.
EHT Stick Rectifiers 75c ea.
13KV, 18KV, 20KV
Plessey 8" 10W 8Ω or 15Ω \$6.50 ea;
4" 8Ω \$1.50 ea. Many other types in stock.
12V DC 5 Ω Solenoids \$2.00 ea.
12V AC Min. Relays 5 Amp. \$1.50 ea.
Slide Pots. 20K to 3meg. Singles 35c ea. Dual 60c ea.
Resistors. Most values ¼ to 1 Watt. 3c ea.
Carbon Pots. Most values 30c ea. Duals 60c ea.
Skeleton Preset Pots 100Ω to 3 meg. 8c ea.
Green Caps .001 to .022uF 5c ea.
.033 to .022uF 15c ea. .47 to .68uF 20c ea.
Polystyrene Capacitors. Many Types 5c ea.
Disc Ceramics. Large Range. 5c ea.
Polyester Capacitors. Large Range. Up to 1.5uF 250V 10c to 25c ea.
New Desk Telephones - Grey. \$15.00 ea.
Polyester Capacitors 6.8uF and 3.3uF 60c ea. 2.2uF 40c ea. Tantalum Capacitors. Good range 15c ea.
BC. 107 Transistors 10c ea.
OA636 600V 2A Fast Recovery Silicon Diodes - TV Type 25c ea.
Dual 100 Ω 3W Wire Wound Pots. \$1.25 ea.
S.C.R. BT100A 300V 2AMP 60c ea.
Triacs. 2AMP 400V 60c ea.
2N3055, 90c ea. AD149, \$1.00 ea.
AY8110, 80c ea. OC912, \$1.00 ea.
AY8139 and 9139, 45c ea. IN914 diodes 10c ea.
5 amp AC panel meters \$3.50 ea.
2500 uF 35V P/T electrolytics, 60c ea.
2200 uF 25V P/T electrolytics, 40c ea.
Aluminium and plastic instrument boxes and ARLEC multimeters NOW IN STOCK.
Spkrs MAGNAVOX 5"x3" 8ohm \$1.50 ea.
Belt drive T/T kits 240V AC motor with speed change. 12" cast alloy platter, rubber mat, bearing, spindle and belt, \$25.00 ea.
CTS 10" woofers Mod10W14P 8 ohm 50W continuous power, 30-2000Hz. Air suspension foam cone surround, 15oz ALNICO V magnet. \$19.50 ea.
Silicon bridge rectifiers 400V, 1.5A, 85c ea.
Balance meters 35Mm x 15Mm, \$2.00 ea.
A&R 240V ac primary, 115V secondary at 95Vamps, \$7.50 ea.
Phone enquiries and personal shopping only.
Also in stock - large range of electrolytic capacitors - wire wound resistors - switches - panel meters - transistors - diodes - plugs - sockets - edge connectors - vero board - transformers - chokes. We could go on and on, so call in and browse around and check our low, low prices.

redpoint heatsinks

TV-3 Powerfin

Description
This design uses total metal
content of size length to radiate.
Specification
Thermal rating 9 = 7.2°C/Watt
Size 38 x 42 x 25mm high



P-Type

Height 1.34"-34mm
Width 4.62"-118mm

2P	2"-51mm
3P	3"-76mm
4P	4"-102mm
6P	6"-152mm

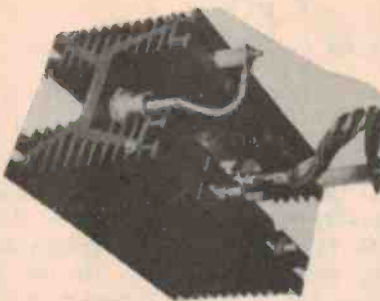

TV-Type

Extended section for robust power handling
4 tie-slots and 4 tiebar slots allow easy
fitting stacking and electrical connections

Height 4.72"-120mm
Width 4.72"-120mm

4NV	4"-102mm
6NV	6"-152mm
9NV	9"-229mm

99 ALEXANDER ST., CROWS NEST
TELEPHONE 439 2488
Adelaide 42 6655
Brisbane 277 4311
Newcastle 69 1222
Canberra 95 9138
82 3581
Melbourne 598 9207
Newcastle 69 1222
Perth 25 5722



EX STOCK

UNIQUE ELECTRONICS SECURITY CO. P/L. 682-3325

- A new shop catering for the hobbyist, CB'er and for the trade.
- We specialise in: Components Kits Technical Books Burglar alarm equip. CB Club needs.
- We have a range of data books for your use — or purchase your own copy.
- We stock a full range of security equipment Installation companies check our prices.
- If you are having technical problems with your equipment drop in and have a chat, perhaps we can help you.
- If you don't see what you want displayed, please ask us, we can probably obtain it for you.
- MAIL ORDERS WELCOME SEND YOUR ORDER TO P.O. BOX 402, PARRAMATTA, 2150
- TRADE SALES WELCOME

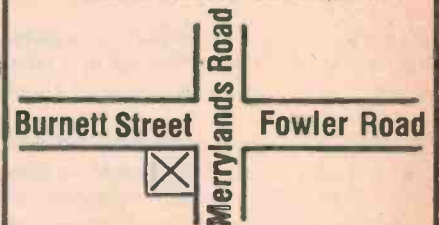

383 MERRYLANDS ROAD,
(CNR. BURNETT STREET)
MERRYLANDS, N.S.W. 2160
682-3325

INTERNATIONAL ELECTRONICS UNLIMITED

10% OFF WITH \$25 ORDER
15% OFF WITH \$100 ORDER

THESE DISCOUNTS APPLY TO TOTAL OF ORDER - SPECIALS INCLUDED

UNIVERSAL BREADBOARD
 Silver plated copper circuit board
 1.5" x 5.1" x .2" rows of 27
 holes for DIP IC's - space for
 transistors, resistors & capacitors
 Versatile and simple for bread-
 boarding IC circuits \$1.80 ea.

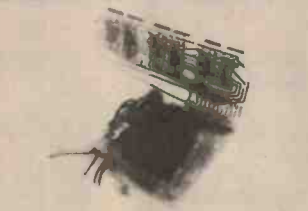

6 Digit Clock Kit
 MM5314 with 6 NS71 .27" displays 2 P.C.
 boards - Display board may be remote.
 Internal or wall transformer can be used.
 50-60 Hz, 12-24 hour. Includes all necessary
 transistors, resistors, capacitors, diodes, 3
 switches and complete assembly Instruc-
 tions.

CK6-3 \$14.95

UART
 AYS1013A \$6.95

IC SOCKETS
 Solder Tail - low profile
 8 pin \$.17 24 pin .42
 14 pin .20 28 pin .59
 16 pin .22 40 pin .69
 18 pin .29

SPECIAL DEVICES

372	AF-IF Strip Detector DIP	2.93
546	AM Radio Receiver Subsystem DIP	.75
1310	FM Stereo Demodulator DIP	2.90
1496	Balanced Modulator-Demodulator	.99
1800	Stereo Multiplexer DIP	2.48
ULN2208	FM Gain Block 34db (typ) mDIP	1.18
ULN2209	FM Gain Block 48db (typ) mDIP	1.35
2513	Character Generator 64ks5 DIP-24	10.20
3046	Transistor Array DIP-14	.73

LINEAR CIRCUITS

100	\$.71	373	2.42	723	.62
101	.29	376	.68	33	.89
302	.53	180	1.30	739	1.07
304	.80	180-8	1.25	741	.32
305	.71	181	1.75	747	.71
307	.26	382	1.75	748	.35
308	.89	511	2.95	1458	.62
109K	1.35	540	2.95	1800	2.48
310	1.07	550	.79	3900	.49
311	.95	555	.45	7524	.71
319	1.13	556A	1.19	7525	.90
1201	1.39	556A	1.19	8038	4.25
320K	1.39	560	3.39	8864	2.25
844	1.70	562	3.39	75150	1.75
324	1.52	565	1.18	75451	.35
339	1.38	566	1.95	75452	.35
340R	1.69	709	.26	75453	.35
340T	1.44	710	.35	75491	.71
372	2.93	711	.26	75492	.80

DISCRETE LED's

ME4	INFRARED CLEAR DOME .170"	EACH .29
MV10B	CLEAR DOME .170"	.25
MV50	CLEAR - AXIAL .09"	.12
MV50	RED - AXIAL .09"	.12
NSL100	RED .19"	.12
RL209	RED DIFF. SUBMINIATURE .12"	.12
RLT-T1-03	WHITE DIFF. SUBMINIATURE NO FLANGE .12"	.15
RLC-200	RED DIFF. CURRENT REG. .190" CONST. BRIGHTNESS 4.5-12.5V	.25
RLC-201	RED DIFF. CURRENT REG. .190" CONST. BRIGHTNESS 4.5-190V	.25
RL-4403	RED DIFF. FULL HOOD .190"	.15
GREEN	SPOT .190"	.18
GREEN	POINT .190"	.15

LED S

DL10A	RED CA .27" LHD	\$1.89
DL 707	RED CA .30" RHD	1.49
DL 507	RED CA .50" RHD	1.49
FND 359	RED CC .375" RHD	.89
DL 702	RED CC .30" LHD	1.39
NSN 74R	RED CC .30" RHD	1.49
DL 500	RED CC .50" RHD	1.49
MAN5	GREEN CA .27" LHD	1.39
MAN8	YELLOW CA .27" LHD	1.39
MANB2	YELLOW CA .3" LHD	1.89
MAN66	RED CA .6" LHD	2.19
DL747	RED CA .6" LHD	2.39

TTL

7400	.13	7451	.17	74153	.89
7401	.16	7452	.17	74154	1.20
7402	.15	7454	.17	74155	.97
7403	.15	7460	.17	74156	.97
7404	.16	7464	.35	74157	.99
7405	.19	7465	.35	74158	1.79
7406	.20	7470	.30	74160	1.23
7407	.28	7472	.30	74161	.97
7408	.18	7473	.35	74162	1.39
7409	.19	7474	.28	74163	1.09
7410	.16	7475	.49	74164	.99
7411	.25	7476	.30	74165	.99
7413	.43	7483	.68	74166	1.25
7414	.65	7485	.88	74170	2.10
7416	.35	7486	.40	74173	1.49
7417	.35	7489	2.25	74174	1.23
7420	.16	7490	.43	74175	.97
7422	.30	7491	.75	74176	.89
7423	.29	7492	.48	74177	.84
7425	.27	7493	.48	74180	.90
7426	.26	7494	.78	74181	2.45
7427	.29	7495	.79	74182	.79
7430	.20	7496	.79	74184	1.90
7432	.23	74100	.98	74185	2.20
7437	.25	74105	.44	74187	5.75
7438	.25	74107	.37	74190	1.15
7440	.15	74121	.38	74191	1.25
7441	.89	74122	.38	74192	.95
7442	.59	74123	.65	74193	.85
7443	.73	74125	.54	74194	1.25
7444	.73	74126	.58	74195	.74
7445	.73	74132	.89	74196	1.25
7446	.81	74141	1.04	74197	.73
7447	.79	74145	1.04	74198	1.73
7448	.79	74150	.97	74199	1.69
7450	.17	74151	.79	74200	5.45

LOW POWER

74L00	.29	74L51	.29	74L90	1.40
74L02	.29	74L55	.29	74L91	1.20
74L03	.23	74L71	.29	74L93	1.50
74L04	.29	74L72	.45	74L95	1.50
74L06	.29	74L73	.56	74L98	2.25
74L10	.29	74L74	.56	74L164	2.25
74L20	.29	74L78	.75	74L165	2.30
74L30	.29	74L85	1.09		
74L42	1.39	74L86	.65		

LOW POWER SCHOTTKY

74LS00	.36	74LS32	.48	74LS95	2.09
74LS02	.36	74LS40	.45	74LS107	.59
74LS04	.36	74LS42	1.40	74LS164	2.20
74LS08	.38	74LS74	.59	74LS193	2.20
74LS10	.36	74LS90	1.30	74LS197	2.20
74LS20	.36	74LS93	1.30		

HIGH SPEED

74H00	.25	74H22	.25	74H61	.25
74H01	.25	74H30	.25	74H62	.25
74H02	.25	74H40	.25	74H78	.39
74H04	.25	74H50	.25	74H101	.58
74H08	.25	74H52	.25	74H102	.58
74H10	.25	74H53	.25	74H103	.60
74H11	.25	74H55	.25	74H106	.72
74H20	.25	74H55	.25	74H106	.72
74H21	.25	74H60	.25	74H108	.72

CMOS

4000A	.26	4018A	1.39	4066A	.89
4001A	.25	4020A	1.72	4068A	.44
4002A	.25	4021A	1.18	4069A	.44
4006A	1.35	4022A	.98	4071A	.26
4007A	.26	4023A	.25	4072A	.35
4008A	1.52	4024A	.89	4073A	.39
4009A	.57	4025A	.25	4075A	.39
4010A	.54	4027A	.59	4078A	.39
4011A	.29	4028A	.98	4082A	.35
4012A	.25	4030A	.44	4518A	1.56
4013A	.45	4035A	1.27	4528A	1.56
4014A	1.27	4040A	1.39	4585A	2.10
4015A	1.27	4042A	1.47		
4016A	.48	4049A	.59		
4017A	1.01	4050A	.59		

74C00	.19	74C74	1.04	74C162	2.49
74C02	.26	74C76	1.34	74C163	2.66
74C04	.64	74C107	1.13	74C164	2.66
74C08	.68	74C151	2.62	74C173	2.22
74C10	.35	74C154	3.15	74C195	2.26
74C20	.35	74C157	1.76	80C95	1.15
74C42	1.61	74C160	2.48	80C97	.96
74C73	1.04	74C161	2.49		

CALCULATOR CHIPS

CT5002	12 digit, 4 function fixed decimal battery operation - 40 pin	1.95
CT5005	12 digit, 4 function plus memory, fixed decimal - 20 pin	2.49
MM5725	8 digit, 4 function, floating decimal 18 pin	1.98
MM5736	6 digit, 4 function, 9V battery operation - 18 pin	2.95
MM5738	8 digit, 5 function plus memory and constant floating decimal, 9V battery operation - 24 pin	3.95
MM5739	9 digit, 4 function, 9V battery operation - 22 pin	3.95

SPECIALS

MAN 72 .99 FND 359 .59
 DL702 .99 MVI0B 6/\$1.00
 NSN 74R .99 RL 209 12/\$1.00

7410 Triple 3 input NAND gate .12
 7438 Quad 2 input NAND buffer (n.c.) .17
 7442 BCD to decimal decoder .39
 7453 Exp. AND-OR-INVERT gate .14
 7474 Dual D flip-flop .19
 7493 4 Bit binary counter .35
 74121 One shot .29
 74153 Dual four-input multiplexer .69

733
 DIFFERENTIAL VIDEO \$.59
 AMPLIFIER

CALCULATOR DISPLAY
 9 MAN 3 M ON PC BOARD
 99¢

SP-425-09 9 digit .25" neon direct interface with MOS/LSI, 180 VDC, 7 seg. 1.79

MM5369 Divider mDIP 2.49
 Crystal 3.58 MHZ color TV 1.75
 Crystal 2.010 MHZ 3.95

IC BREADBOARD
 Accommodates 5 16 pin IC's with additional interconnection holes. 1/16" phenolic with silver plated copper circuits. 2 1/2" x 6 9/16" \$1.60 ea.

KEYBOARD
 20 KEYS
 2 SLIDE SW
 3" x 3" \$1.49

EDGE CONNECTOR
 ELCO MODULAR UNIT 6/99¢
 6 PIN 3 POSITION
 WIRE WRAP, GOLD PLATE

CLOCK CHIPS

MM5314	6 digit multiplexed 12-24 Hr, 50-60 Hz 24 pin	4.45
MM5316	4 digit, 12-24 Hr, 50-60 Hz, alarm 40 pin	4.95
5375AA	4-6 digit, 12 hour, 60 Hz snooze alarm brightness control capability, alarm tone output - 24 pin	4.95
CT7001	6 digit, 12-24 Hr, 50-60 Hz, alarm, timer and date circuits - 28 pin	6.95

SHIFT REGISTERS

2502	1024 bit MULT DYN 16 pin	\$2.95
2504	1024 bit MULT DYN 8 pin	2.95
2511	Tri-State Dual 50-100-200 bit STATIC 14 pin	2.95
2518	Hex 32-bit STATIC 16 pin	2.95
2519	Hex 40-bit STATIC 16 pin	2.95
2527	Dual 256 bit STATIC 8 pin	2.95
2532	Quad 80 bit STATIC 16 pin	3.95
5013	1024 bit accum. Dynamic 8 pin	1.75
5016	500/512 bit Dynamic 8 pin	1.59

OPTO ISOLATORS

MC D2	Opto isolator diode	\$1.19
MC T2	Opto isolator transistor	.79

Date sheets on request. Add 30¢ each if item is priced below \$1.00 each.

2708 \$16.95
 1 x 8K EROM

82S23
 256 bit PROM Schottky 16 pin
\$2.50

5314 \$2.95
 CLOCK CHIP

2102
 1024 bit static RAM 16 pin
\$1.49

CENTRAL PROCESSING UNIT
8008 \$16.95
8080A \$16.95

MEMORIES

1101	\$.69	74S200	3.25
1103	.69	7489	1.75
1702A	5.95	82S23	2.75
5262	.99	93410	1.39

MINIATURE SOLID STATE ELECTRONIC BUZZER

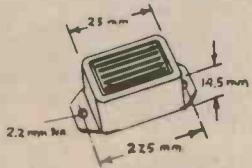

LONG LIFE - HIGH RELIABILITY
 LOW CURRENT DRAIN
 NO MOVING CONTACTS
 78 dB min AT 1 FT. - 450 Hz EA
 EB-106 6V 15mA 4-9 VDC \$1.99
 EB-112 12V 15mA 8-20 VDC 1.99

CARBON FILM RESISTORS ±5% ALL STANDARD VALUES
 1/4 OR 1/2 WATT

QTY.	PRICE (each)	PRICE (Minimum 10 per value)
0-10	\$.10 ea	
10-100	\$.10 ea	\$.05 ea
100-1000		\$.04 ea

METAL FILM RESISTORS ALL STANDARD VALUES ±1% 1/4 WATT

QTY	PRICE EACH	PRICE MINIMUM 10 PER VALUE	PRICE MINIMUM 100 PER VALUE
0 - 10	\$.20		
10 - 100	.20	\$.15	
100 - 1000		.10	\$.09
1000 -		.10	.08

TANTALUM CAPACITORS Solid dipped +20%

.1 mid	35V	\$.25	10 mid	16V	\$.40
.33 mid	35V	.25	10 mid	25V	.45
1 mid	35V	.25	15 mid	10V	.40
2.2 mid	20V	.25	15 mid	20V	.45
2.2 mid	35V	.30	22 mid	16V	.45
3.3 mid	35V	.30	33 mid	10V	.40
4.7 mid	16V	.30	47 mid	6V	.40
6.8 mid	6V	.30	56 mid	6V	.45
6.8 mid	50V	.40	150 mid	15V	.50

FREE CATALOG AVAILABLE ON REQUEST

Satisfaction guaranteed. Shipment will be made within 3 days from receipt of order.
 Prices are in Australian \$. Payment may be made with personal check, international money order (include receipt), charge card (include no. & expiration date) or bank cheque made payable in U.S. \$

All items are shipped via air-prepaid unless otherwise indicated.
 Add \$1.00 service charge for orders less than \$10.00

INTERNATIONAL ELECTRONICS UNLIMITED

READERS' LETTERS

No charge for replies but a foolscap-size stamped addressed envelope must be enclosed. Project queries can only be answered if related to item as published. We cannot assist if project is modified nor if components are otherwise than specified. We regret we cannot answer readers' enquiries by telephone.

SUBSCRIPTIONS AND BACK ISSUES

ETI subscriptions cost \$17.00 per year (inc. postage) within Australia. Cost elsewhere is \$17.65 (inc. postage — surface mail). Airmail rates on application.

Back Issues cost \$1.25 (Sept onwards) each plus post & packing.

We can supply only the following issues.

1975: April, Nov., Dec.

1976: May, Nov., Dec.

1977: All issues except Jan, Feb, March.

Photostats are available of any article ever published in ETI. We charge a flat \$1.00 regardless of page quantity from any one issue of ETI. Thus if the article is in three issues the cost is \$3.00. Send orders to address below.

Binders \$4.50 plus 80c post NSW, \$1.70 other states.

COPYRIGHT

The contents of Electronics Today International and associated publications is fully protected by the Commonwealth Copyright Act (1968).

Copyright extends to all written material, photographs, drawings, circuit diagrams and printed circuit boards. Although any form of reproduction is a breach of copyright, we are not concerned about individuals constructing projects for their own private use, nor by pop groups (for example) constructing one or more items for use in connection with their performances.

Commercial organisations should note that no project or part project described in Electronics Today International or associated publications may be offered for sale, or sold, in substantially or fully assembled form, unless a licence has been specifically obtained so to do from the publishers, Modern Magazines (Holdings) Ltd or from the copyright holders.

LIABILITY

Whilst every effort has been made to ensure that all constructional projects referred to in this edition will operate as indicated efficiently and properly and that all necessary components to manufacture the same will be available, no responsibility whatsoever is accepted in respect of the failure for any reason at all of the project to operate effectively or at all whether due to any fault in design or otherwise and no responsibility is accepted for the failure to obtain any component parts in respect of any such project. Further no responsibility is accepted in respect of any injury or damage caused by any fault in the design of any such project as aforesaid.

A MODERN MAGAZINES PUBLICATION

Managing Director:

Secretary:

Publisher:

Arnold Quick

Charles O'Leary

Collyn Rivers

PRODUCTION

Art Director:

Artist:

Production Manager:

Subscriptions & Circulation:

Project Design:

Acoustical Consultants:

Jim Hattersley

Maree Stanley

Roy Leight

John Oxenford

Nebula Electronics

Louis A Challis & Assoc.

ADVERTISING

Sydney: Bob Taylor (Manager), Geoff Petschler (NSW Manager), 15 Boundary St, Rushcutters Bay 2011. Tel: 33-4282.

Melbourne: Tom Bray (Manager), Poppe Davis, Suite 24, 553 St. Kilda Rd, Melbourne. Tel: 51-9836.

Brisbane: Geoff Home, 199 Jesmond Rd, Indooroopilly, Brisbane, 4068. Tel: 378-3273.

Adelaide: Ad Media Group of SA,

37 Fullarton Rd, Kent Town 5067. Tel: 42-4858.

Perth: Aubrey Barker, 38 Mounts Bay Rd, Perth. Tel: 322-3184

Hobart: H.W. Lincolne Advance Publicity, 281 Elizabeth St, Nth Hobart 7000.

Tokyo: Genzo Uchida, Bancho Media Service, 15 Sanyeicho, Shintuku-Ku, Tokyo 160.

London: Electronics Today International, 25-27 Oxford St, London W1R2NT. Tel: 01 434-1781/2.

Electronics Today International is published by Modern Magazines (Holdings Ltd, 15 Boundary St, Rushcutters Bay NSW 2011. It is printed (in 1977) by Wilke & Co, Browns Rd, Clayton, Victoria and distributed by Australian Consolidated Press.

ADVERTISERS INDEX

A & R Sonar	119
AWA	77
AMI	OBC
Arena	48, 71
Audio Engineers	27
Applied Technology	98, 99
Auto Statham	102
BWD	78
Chapman	96
Chan Merch	96
Cashmore Sound	86
Cooper Tool Co.	26
CPI	112
BKX	109
BSR	12
CEMA	103
Convoy	87
Davred	62, 63
Delsound	53
Diggerman	72
Dindy	111
Dick Smith	46, 47, 91
E.E.E.	74
Electromart	72, 126
Electronic Disposals	128
Edge Electrix	88
Elect Agencies	55, 104
Electrocraft	117
Emona	73, 85, 97
Farrell Keyboards	126
Freedman	54
Ferguson	111
Futuretronics	6
General Electric Serv.	128
Haco	23
Hagemeyer	IFC, IBC
Harmon	25, 123, 125, 127
Hi-Fi Review	113, 114, 115
Inst. Comp. Service	110, 111
Int. Corresp. Schools	80
Inter. Elec. Unlimited	129
J.R. Components	73
Jaycar	117
Karrina	124
Kitsets	88
Mode	78
OBC Imports	8
Philips	4, 10, 54, 64, 126
Photimport	49
Radio Dispatch	86
Rainbow Audio Visual	86
Rank	11, 20, 28
Rod Irving	122
Sovereign City	119
Semcon Microcomputers	107
Sheridan Electronics	79
Scalar	122
Scope	36, 37
Techtronix	74
Techniparts	72
Texas Inst.	92
Unique Securities	128
Vicom	116

Well stacked in front



The new range of JVC front-loading cassettes is here. And if you think that's the only change, you're highly mistaken. Because, as usual, JVC brings in the range with a few unique additions which are going to make you think twice about any other brand.

For a start, the JVC ANRS sound reduction system is incorporated throughout, to make hi fi recording and playback as free of hiss as possible. And in some cases, even improving the dynamic range of normal cassettes.

Another exclusive is the JVC Sen-alloy head, and believe it or not, it offers you the clearest sound and longest wearing lifespan of any head available; originally designed solely for

professional use, this head is now incorporated in JVC cassette decks CD-S200 and CD-1970.

And yet another first: JVC is the only manufacturer to provide decks with 5 LED peak-level indicators so that your recordings are perfect at all times. These are featured on models CD-1920 and CD-S200.

Loading is, of course, simplified. The special compartment is air-damped and removable for uncramped head maintenance.

The JVC famous range of top-loaders is still available, offering you the very highest quality. All things considered, there is no other consideration.

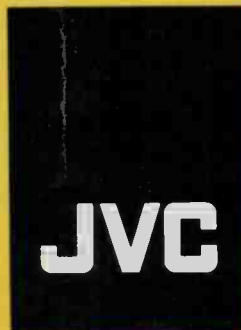

the right choice

For details on JVC Hi Fi Equipment, write to: JVC Advisory Service, P.O. Box 49, Kensington, N.S.W. 2033.



Dynamic TEAC performance is now available to everyone.

Buying an inexpensive deck doesn't mean you need to scrimp on features or quality.

Not with the TEAC A-100. For a very reasonable investment, it offers features normally reserved for more expensive equipment. Like the FG servo controlled DC motor and Dolby* noise reduction circuitry. You'll also get expanded scale VU meters, separate two-stage Bias and EQ switching, timer control capability and a guaranteed wow and flutter specification of 0.07%.

If you think only a few can afford an expensive name like TEAC, look at the dynamic A-100.

TEAC A-100

TEAC

AUSTRALIAN DISTRIBUTORS

Australian Musical Industries Pty. Ltd., 155 Gladstone Street, South Melbourne, VIC. 3205. Ph: 699 6455

INTERSTATE AGENTS

BTS Sales, 55 Dickson Avenue, Artarmon, N.S.W. 2064. Ph: 439 6262

BTS Sales, 51 Norma Road, Myaree, W.A. 6154. Ph: 30 1255

BTS Sales, 53 Robertson Road, Fortitude Valley, QLD. 4006. Ph: 52 8900

P.G.A. Associates Pty. Ltd., 62 Hindmarsh Square, Adelaide, S.A. 5000. Ph: 223 3024

RETAILERS

VIC: Brashs, Allans, Douglas Hi-Fi. QLD: Jeff's Stereo Shop, Stereo Supplies.

N.S.W. Autel Systems, Douglas Hi-Fi, Miranda Hi-Fi, Grace Bros, David Jones, S.A. Truscott Electronics.

W.A. Albert's Hi-Fi, Audio Centre, A. D. Urquhart.

NOW AT
CHRISTMAS
PARTY
PRICES.