

# Audio

\$1.25

HEYSER  
TESTS KEF'S 104

THE AUTHORITATIVE MAGAZINE ABOUT HIGH FIDELITY • DECEMBER 1979

47425 

**CHRISTMAS  
BUYING  
GUIDE:  
AUDIOPHILE  
RECORDS**

**THE INS  
AND OUTS  
OF TOROIDAL  
TRANSFORMERS**



NONE DO.



PIONEER Quartz-PLL  
ELECTRONIC FULL-AUTOMATIC PL-12

**UNDER LABORATORY CONDITIONS,  
FEW HIGH PRICED TURNTABLES  
SOUND AS GOOD AS THIS ONE.**



# UNDER REAL CONDITIONS,

For years, people have been selecting turntables based on specs obtained in a lab, without knowing what kind of sound they'll obtain in their homes.

And while a few turntables today look as good as Pioneer's PL-630 on paper, you'd be hard pressed to find one that sounds as good in your living room.

## A SUSPENSION SYSTEM THAT ELIMINATES SHAKE, RATTLE & ROLL.

In your home, simply walking across the floor can cause the stylus to skate across your records.

And acoustic feedback can make even the most lively piece of music sound dull and lifeless.

Pioneer's PL-630, however, has a free floating suspension system that isolates the platter and tone arm from the rest of the turntable. So that while the base may vibrate, the platter and tone arm won't. Which means you don't have to tip-toe across the floor just to prevent vibration. And you can turn your music up loud enough to rattle the walls without fear of rattling the turntable.

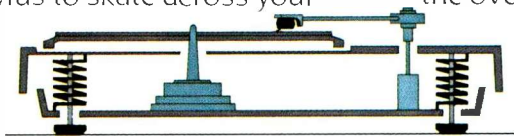

When the base of the PL-630 vibrates, the platter and tone arm don't.

## A DIRECT DRIVE MOTOR THAT WON'T DETERIORATE WITH OLD AGE.

All DC direct drive motors start out to be incredibly accurate.

Unfortunately, they don't always stay that way.

After a while, the quality of sound could deteriorate because the motor is left exposed and free to collect dust and foreign objects.

This is not the case with the PL-630. Unlike most of the competition, its motor is totally enclosed. Which means that the incredible wow and flutter figure of 0.025% will still be an incredible 0.025% years from now. And so will the 0.002% speed accuracy.

What's more, the electronic circuitry of this Quartz PLL Hall element system constantly monitors itself. When it senses the slightest deviation in speed, it corrects itself. By just switching the quartz "lock" on, you lock onto the correct speed, so you're assured of accurate platter speed at all times and under all conditions.

And because of its extremely high torque, the PL-630 reaches full platter speed in a mere third of a revolution.

But more importantly, it stops almost as quickly as it starts. Reverse current is fed into the drive system eliminating both excessive wear on the turntable and the need for a brake.

Spring loaded tone arm pivots help improve sensitivity.

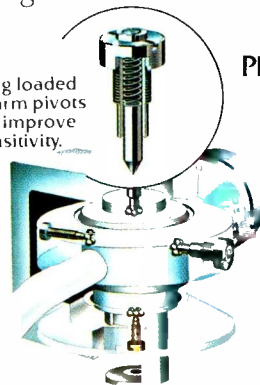

The electronic brain of the PL-630.

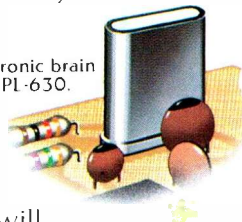

## ONLY ONE THING COMES THROUGH THE TONE ARM. MUSIC.

The tone arm of the PL-630 rests on a massive die-cast aluminum base.

And while other tone arms may rest on a similar base few, if any, are mounted to it in a similar manner. Instead of piano wire or cheap plastic casings that vibrate, the PL-630's tone arm is gimbaled on spring mounted pivot bearings. This not only reduces tracking error due to tone arm pivot wear, but increases the overall performance of the turntable.

Which brings us to the magnesium headshell. It has far better acoustical properties than the headshell you'll find on most turntables. This new construction reduces the chances of hearing any howling or distortion.

## FEATURES OUR COMPETITORS PRETEND THEY'VE NEVER HEARD OF.

Our platter mat is concave so that even if your records are slightly warped, they'll sound like they aren't.

Our spindle is only 0.8 microns larger than most, but it can make a big difference in keeping your records perfectly centered.

And our massive platter is less vulnerable to fluctuations in speed than smaller platters that come with most turntables.

Even the way the platter is coupled to the motor is unique. It doesn't have bearings. It's precision machined to a tapered fit so that it's less likely to wobble.

And while you'll find a strobe on most direct drive turntables, you won't find one on the PL-630. Simply because there's no need for one. Instead, there's a pitch display that gives you visual confirmation of accurate speed.

You'll also find super sensitive controls that even shut off the power automatically when the tone arm comes to rest.

If you're beginning to get the idea that Pioneer's PL-630 would sound great in your home, we suggest you go to your nearest Pioneer dealer.

After all, you may not live in a sound room, but it doesn't mean your living room can't sound like one.

 **PIONEER**<sup>®</sup>  
We bring it back alive.



## THE PL-630.

Enter No. 39 on Reader Service Card

# WHAT PRODUCT

1. Prevents "record chatter" on your turntable?
2. Looks unimpressive?
3. Is very thin and gray?
4. Is more anti-static than similar products\*?

\*according to tests by the Swedish National Test Institute.

## ANSWER

### D'STAT<sup>®</sup>-II by Discwasher<sup>®</sup>

(A turntable mat for overlay or replacement on your existing equipment.)

D'STAT-II works; costs only \$7.95; and never wears out.

Give D'STAT-II a spin.



### D'STAT-II

At Discwasher dealers nationwide.

 discwasher, inc.  
1407 N. Providence Rd.  
Columbia, Missouri 65201

December 1979

Vol. 63, No. 12

# Audio

"Successor to **RADIO**, Est. 1917"

## Feature Articles

The Ins and Outs of Toroidal Transformers	38	John I. Brown
Christmas Buyers Guide: Audiophile Records	52	Gary Stock
Digital Recording: State of the Market	70	Gary Stock

## Equipment Profiles

TEAC Model C-1 Cassette Deck	78	George W. Tillett
TDK Test Tapes	82	Howard A. Roberson
ADC 1700DD Semi-Automatic Turntable	84	George W. Tillett
KEF 104aB Loudspeaker System	88	Richard C. Heyser

## Record Reviews

European Records	99	John S. Wright
The Column	102	Michael Tearson & Jon Tiven
Jazz & Blues	110	
Folkgab	116	
Top of the Pile	120	
Classical	123	Edward Tatnall Canby

## Audio in General

Tape Guide	6	Herman Burstein
Behind the Scenes	8	Bert Whyte
Audio ETC	20	Edward Tatnall Canby
What's New in Audio	28	
Dear Editor	32	
Audioclinic	36	Joseph Giovanelli
Picking at the Congress	44	Peter W. Mitchell
Classified Advertising	124	
Free Information Service	138	
Annual Index	146	

**About the Cover:** After making your list, and checking it twice, turn to our Christmas Buying Guide to Audiophile Records on page 52, compiled by Gary Stock. Photo: Photographic Illustrations, Philadelphia. Models: Robyn Hoch and Sam Kressin.



Audio Publishing, Editorial, Subscription, and Advertising Production offices, North American Building, 401 No. Broad St., Philadelphia, Penna. 19108. Telephone: 215/574-9600.  
Postmaster: Send Form 3579 to above address.

# EXPENSIVE SOUND... INEXPENSIVELY

the new  
OA-5A  
from  
Pickering



© 1979 PICKERING & CO. INC.

With the introduction of the OA-5A Pickering adds a new dimension to an already great line of headphones. The OA-5A combines the dynamic performance of low mass, high energy samarium cobalt drivers found in our top-of-the-line stereophones, with the benefits of open-audio design, assuring an acoustically perfect listening environment and the ultimate in listening comfort... without isolating you from your surroundings. And the OA-5A delivers full range frequency response everywhere you go, because Pickering includes a special adapter plug for portables. Suggested retail for the Pickering OA-5A headphone is \$60. For further information write to Pickering and Co., 101 Sunnyside Blvd., Plainview, N.Y. 11803.



OA-3A

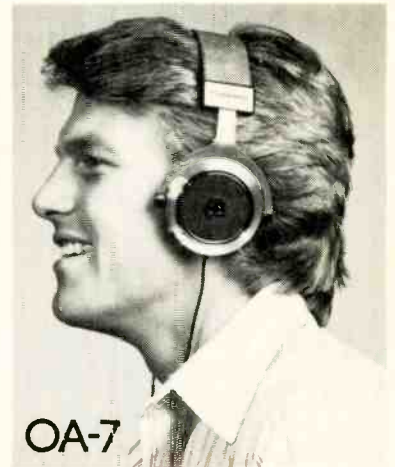

OA-7

 **PICKERING**

"for those who can hear the difference"

Above left is the Pickering OA-3A, an advanced headphone that delivers impressive sound quality. With adapter plug. Suggested retail \$45. Our finest example of open-audio design and engineering, the OA-7 has superb listening characteristics and featherlight wearing comfort. Suggested retail \$70.

Enter No. 38 on Reader Service Card

# The Legend Continues.



The New Dynaco A150 & A250 priced from \$150.

Dynaco helped create stereo hi-fi 25 years ago. We built a reputation based on rigorous yet simple designs that produced more sound than the industry had ever seen.

Now we've come back to do it again. With two new speakers that are far and away the best we've ever built. Each of these systems continues the Dynaco legend of simplicity and performance at a

modest cost. Each in its own way will make you part of a listening experience that for 25 years has meant only Dynaco.

To sample that experience, take your favorite record album to your Dynaco dealer. Lean back and listen. You'll hear that Dynaco sounds better than ever. And the legend will continue. We have many new and exciting products coming your way.

# **dynaco**

We build them like we used to.

110 Shawmut Road • Canton, Mass. 02021 • (617) 828-7858

Enter No. 59 on Reader Service Card

## Audio

**Editor**  
Eugene Pitts III

**Assistant Editor**  
Kay Blumenthal

**Design**  
Frank Moore

**Design Assistants**  
Barbara D'Aprile, Mark Collins

**Production Manager**  
Margaret Zibelman

**Associate Editors:**  
Edward Tatnall Canby, Bert Whyte

**Senior Editors:**  
Richard C. Heyser, B. V. Pisha  
Howard A. Roberson

**Contributing Editors/Artists:**  
Tom Bingham, Herman Burstein,  
Ted Costa, John Diliberto,  
Leonard Feldman, Joseph Giovanelli,  
Edward M. Long, C. G. McProud,  
Gary Roseman, Jon Sank,  
Donaid Spoto, Gary Stock,  
Michael Tearson, George W. Tillett,  
Jon Tiven

**Vice President/Publisher**  
Jay L. Butler



**AUDIO** is published monthly by North American Publishing Company. Irvin J. Borowsky, Founder and President  
Frank L. Nemeyer, Vice President/General Manager  
Joseph Florentine, Chief Financial Officer  
R. Kenneth Baxter, Vice President/Manufacturing  
Vijay Chowdhry, Production Director  
Jack Maxson, Promotion Director  
Betty Brodsky, Subscription Promotion Director  
S. O. (Shap) Shapiro, Circulation Consultant  
Jean Davis, Circulation Manager  
Dorothy Yockey, Subscription Fulfillment Manager

### ADVERTISING SALES

Jay Butler, Vice President/Publisher,  
545 Madison Ave., New York, NY 10022  
Telephone (212) 371-4100

**East Coast Sales Office:** Laurel Carr, Eastern Regional Manager, 545 Madison Ave., New York, NY 10022. Telephone (212) 371-4100

**West Coast Sales Office:** Jay Martin, 17000 Ventura Blvd., Encino, CA 91316. Telephone (213) 788-9900.

**Classified Advertising:** Carolynn Sumner, 401 North Broad St., Philadelphia, Pa 19108. Telephone (215) 574-9600

**Continental European Representative:** V. B. Sanders, International Publishers Advertising Service, Raadhuisstraat 24, P.O. Box 25, Graft-De Ryp, Holland. Telephone, 02997-1303

**England:** The Paul Singer-Lawrence Media Group, 54 Burton Court, London SW 3 5Y4, England. Phone, 01-730-3592

©1979, North American Publishing Co. Established 1917. ALL RIGHTS RESERVED.

World Library Congress Number ISSN0004-752X  
Dewey Decimal Number 621.381 or 778.5

Editorial Contributions are welcomed but should be accompanied by return postage. Submissions will be handled with reasonable care, but the publisher assumes no responsibility for return or safety of manuscripts, photographs, or artwork.

Printed in U.S.A. at Columbus, Ohio. Second-class postage paid at Philadelphia, PA and additional mailing offices. USPS Number 036-960

U.S. Subscription Rates: 1 year \$12.00, 2 years \$22.00, 3 years \$30.00.

Other Countries: 1 year \$18.00, 2 years \$34.00, 3 years \$49.00.

Back issues, when available, \$5.00 postpaid.

Audio Publishing, Editorial, Subscription, and Advertising Production offices, North American Building, 401 North Broad St., Philadelphia, PA 19108.

Telephone: (215) 574-9600.

Postmaster: Send Form 3579 to above address.



# For \$450\*, you deserve more than just a switch.

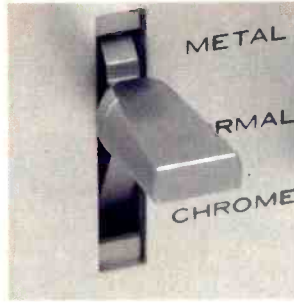

There are other cassette decks at this price that can handle metal tape.

But only the new Kenwood KX-1060 can get the most out of every metal tape. And every other kind of tape as well. The reason is our simplified adjustable bias control with built-in oscillator that allows you to calibrate the deck to a specific tape for optimum results. It's one more "hands on" feature that really lets you get the most out of your deck.

And when it comes to performance, you'll appreciate the KX-1060 even more. The three ferrite heads have been designed for better playback sensitivity and remarkable frequency response (30-18,000 Hz  $\pm$ 3dB with chrome or metal tape).

To eliminate a common problem on other manufacturers' three head decks, we've increased our tape-to-head contact. This maintains constant output and high frequency response. At .045% (WRMS), wow and flutter has practically been engineered out. Signal-to-noise is an outstanding 65dB. Not to mention Kenwood's Double Dolby\*\* for true monitoring right off the tape for extreme accuracy in recording.

At Kenwood, we think that metal tape is the future of ultimate-quality recordings. With the KX-1060, you can take full advantage of any metal tape and get the very best performance possible.

See your Kenwood dealer and get your hands on one soon.

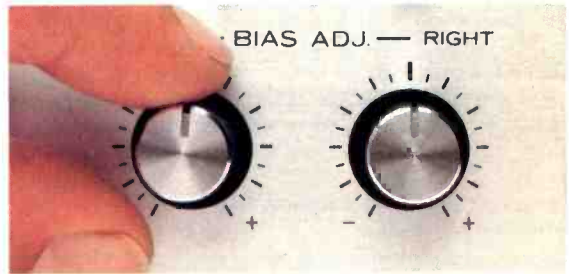

Simplified adjustable bias control with built-in oscillator lets you get optimum results with any kind or brand of tape.

 **KENWOOD®**

For the Kenwood dealer nearest you, see your Yellow Pages, or write Kenwood, P.O. Box 6213, Carson, CA 90749.

In Canada: Magnasonic Canada, Ltd.

\*Nationally advertised value.

Actual prices are established by Kenwood dealers.

\*\*Dolby is a trademark of Dolby Laboratories, Inc.



# Tape guide

Herman Burstein

## Tape Guide Policy

*Q. I am considering the purchase of brand X, brand Y, or brand Z tape deck. Please help me decide which one is best for my needs.—John Q. Public, Main St., U.S.A.*

*Q. I have about \$600 to spend on a tape deck. Please advise me which one is the best for the money.—Jane Q. Public, Elm St., U.S.A.*

A. It is again necessary for me to issue my periodic reminder that the policy of *Audio* prohibits The Tape Guide column from recommending specific brands and models of audio equipment (except in unusual cases where there is only one of a kind on the market).

The first step in making a purchase decision is to make oneself knowledgeable about the subject matter. One way to do so is by reading the equipment reviews of tape decks that appear in *Audio* and other periodicals. Consult the tape deck directory that appears annually in *Audio's* October issue to become familiar with the comparative features and specifications of the decks you are considering. Check with your audio store or library for a readable book on the subject of tape recording. LISTEN to the decks you are considering. Using a phono disc of good quality, notice how faithful a copy each of the tape decks can make and how faithfully they can reproduce inter-station FM noise. See what parts and service warranties come with the decks; find out how far it is to the nearest authorized service agency. Try to find out which tape decks come in least frequently for service relative to the number sold.

Armed with all this information, determine your priorities regarding specifications and special features. Consider the amount of money you can afford to spend and also *where* to spend it — i.e., look around for a store whose reputation you can trust and whose personnel seem both knowledgeable and helpful. Then decide which brand and model offers you the most value.

## Taping Multiple Turntables

*Q. I am looking for an uncomplicated method of connecting two turntables so that both are "live" simulta-*

*neously. The purpose is to be able to cross-fade stereo albums and record them with a tape deck. My aim is to imitate actual broadcast techniques, especially those of the "top forty" AM radio stations, and record the result on stereo tape. If I wanted to add microphones for the purpose of disc jockeying, to what component would they be properly connected?—Steven Cohen, Philadelphia, Penna.*

A. I think you are looking for a mixer that will, accept two turntables and several microphones. The output of the mixer would be fed to your tape deck. I suggest that you visit local audio dealers to find a mixer suitable for your needs.

## Erase Fader

*Q. Enclosed is a photocopy of the schematic for my tape deck. I want to install a potentiometer into the erase circuit to fade the erase head in or out. As I am not able to determine the necessary circuit for this modification, I wonder if you might be able to suggest such a circuit. I suspect that some form of L-pad or T-pad might be the answer, but I just don't know what values to use. — Ron Streicher, Elk Grove, Cal.*

A. I am sorry, but I cannot give you a specific answer because this would involve more time — to design and check out the required circuitry — than the Tape Guide is able to devote to one question. You might try putting a variable resistor in the path between the bias oscillator and the erase head. As a very rough guess, it should have a power rating of at least two watts, and its resistance should be in the area of 100 ohms. Keep in mind that as you diminish the amount of bias current taken by the erase head, you increase the bias current supplied to the record head, with a consequent decline in amount of treble signal recorded on the tape. Hence, as your letter recognizes, an L-pad arrangement would be better to present a constant load to the bias supply. Unless the pad presents a perfectly uniform impedance in conjunction with the erase head, you may still be changing the amount of bias going to the record head, although less than before. I do not know what value of L-pad to use. Check your ser-

vice manual regarding the impedance of your erase head at the bias frequency, and try an L-pad (if available) with the corresponding ohmic value. If the service manual does not give the impedance, consult the manufacturer.

All the above may be academic, however. For fade in and fade out the loss and/or gain in treble may be inconsequential, provided that bias to the record head is ultimately correct when erasing full strength. Hence, you might find a simple variable resistance quite satisfactory.

## Buzzing Tape

*Q. I have a problem with my tape deck. At 1 7/8 ips there is a sound resembling speaker buzzing on transients. This appears on the tape itself, and I am sure it is not the fault of my speakers.— Kenneth Karasek, Maple Heights, Ohio.*

A. The buzzing may be due to overloading the tape, i.e., excessive signal applied to the tape. At 1 7/8 ips there is a good deal of treble boost in the record amplifier (in order to overcome the great magnetic losses of high frequencies on the tape); this increases the tendency toward overloading. Try recording at a lower level.

## Effects of Power Supply Fluctuations

*Q. I am stationed at a remote Air Force radar installation. Our power supply fluctuates between 59 and 63 Hz. Does this have any adverse effects on a Dual 1219, ReVox A-77, or Heathkit AR1500?—Anders Bastman, APO Seattle, Wash.*

A. The ReVox A-77 maintains correct speed independently of changes in line frequency. I doubt that changes of the magnitude you describe would have any significant effect on the Heathkit's performance. If the turntable has a synchronous motor, its speed would change with variations in line frequency.

---

If you have a problem or question on tape recording, write to Mr. Herman Burstein at AUDIO, 401 N. Broad Street, Philadelphia, PA 19108. All letters are answered. Please enclose a stamped, self-addressed envelope.

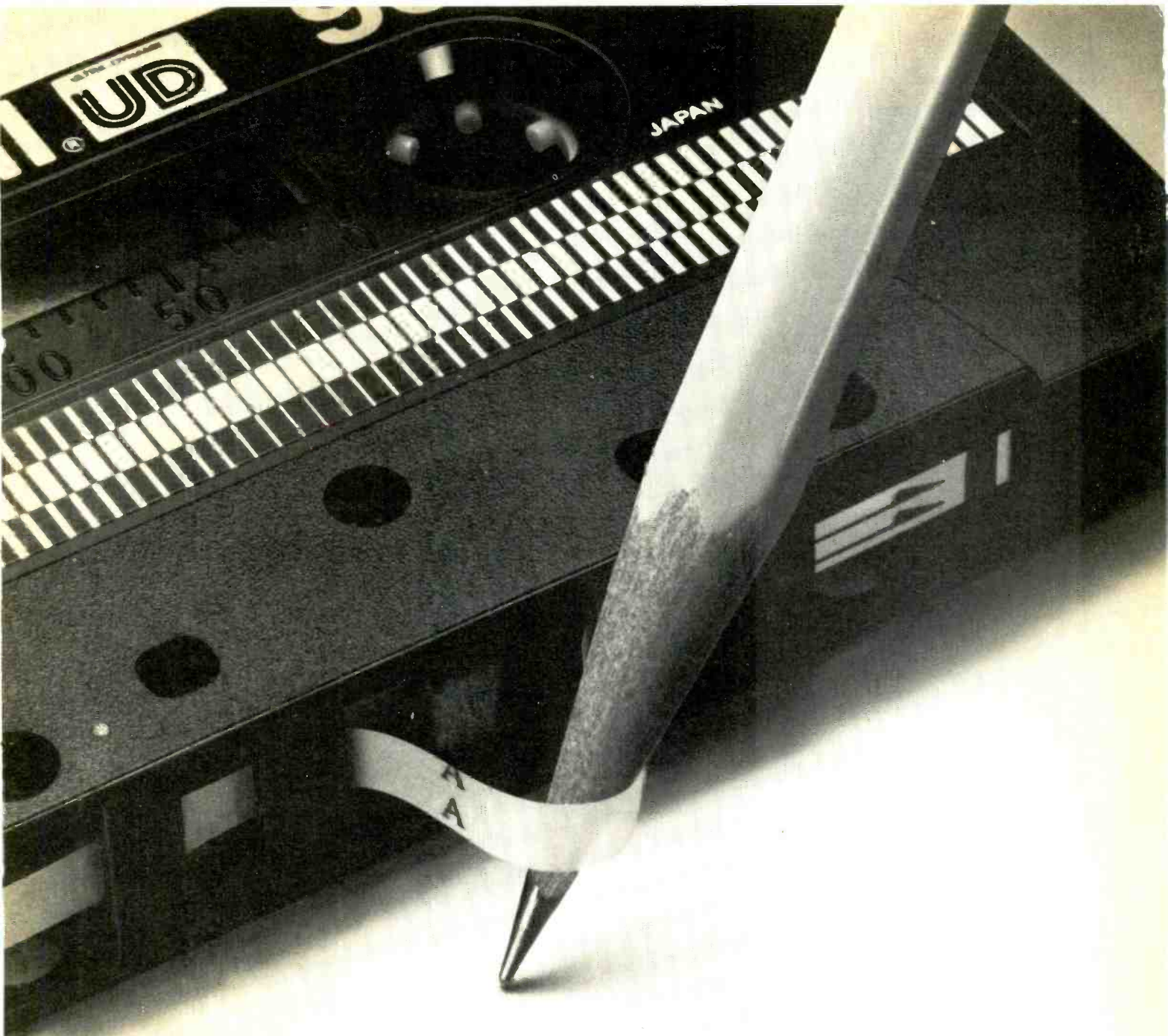

# We put more thought into our leader than most manufacturers put into their tape.

One of the reasons Maxell has such a great following is because of our leader.

It has a built-in non-abrasive head cleaner designed to remove the oxide residue other tapes leave behind, without damaging your tape heads.

It also points out what side of the tape you're on (A or B) as well as which direction the tape is traveling. So it's almost impossible to make a mistake.

It even gives you a five second cueing mark, so you can set your recording

levels without wasting tape. Or time.

Obviously, all the thought that went into our leader was designed to help you get more out of our tape.

So if you think our leader sounds impressive, wait till you hear what follows it.

**maxell**



Maxell Corporation of America, 561 Oxford Drive, Moonachie, N.J. 07074

Enter No. 25 on Reader Service Card

# Behind the scenes

Bert Whyte

Among the spate of technical papers presented at the 63rd convention of the Audio Engineering Society in Los Angeles was a provocative essay by Prof. J. Robert Ashley of the Univ. of Colorado at Denver entitled "On the Degradation of Symphonic Music Phonograph Recordings" (AES preprint 1513, A-2). Professor Ashley is no stranger to the pages of *Audio*, and his involvement with loudspeaker research has led to consultancy and design work in this area with the Koss Corp.

The essence of Prof. Ashley's paper is that he finds the majority of current phonograph recordings of symphonic music deplorably lacking in many of the sonic virtues that characterized the great recordings of yesteryear. He particularly criticizes the use of the newer concert halls for recording and the acoustic perspective presented through the recording technique of multi-track tape machines and multiple microphones. He points out that the mix-down of the multi-track tape to a two-channel master adds an extra quotient of distortion. He condemns the typical studio speaker used for

monitoring on the recording sessions, as well as the use of cutting amplifiers with excessive amounts of transient intermodulation distortion. He feels that unless these current recording techniques are reversed or modified, they will negate many of the virtues of the impending digital recorders.

Prof. Ashley's solution to all this is, first and foremost, to record the symphony orchestra in a great concert hall, use simple microphone techniques, eschew equalization and all other doctoring of the music signal, and use cutting amplifiers with no audible TIM. He singles out Carnegie Hall, Boston Symphony Hall, and some nineteenth century European halls as great recording halls, and ruefully he notes that "there are only a dozen or so of these great halls in the world." The professor has high regard for the early 1950s mono recordings of Toscanini in Carnegie Hall, and, in fact, he is particularly enamored of Carnegie Hall and its virtues as a recording hall.

Professor Ashley's observations are very timely, and in general I wholeheartedly agree with what he has to say. However, with all due respect, the

recording of symphonic music is far more complex, especially in the choice of recording venue, and the implementation of some of his ideas would be much more difficult than he may realize. Speaking as a recording engineer and producer of symphonic (more properly "classical") recordings, I want to particularly comment on recording halls and certain other aspects of recording technique.

It is not, however, my intention to throw brickbats at recording engineers who use multi-track/multi-mike techniques for classical recordings. I don't like this technique, and I prefer to use microphones and a microphone methodology employing the least number of microphones which will ensure a true stereophonic recording. Many of the engineers using the multi-mike approach are well aware of the compromises and shortcomings of this technique but are obliged to use it because of rigid company policy. I vividly remember the well-known director of a major record company telling me that he personally "prefers the simpler stereo microphoning techniques, but they are not commercial enough!"



# WHICH HIGH BIAS TAPE WINS WITH MAHLER'S FOURTH SYMPHONY?



Original manuscript sketch for the first movement of Gustav Mahler's Fourth Symphony. Courtesy of The Newberry Library, Chicago.

Choose eight measures of Mahler's Fourth that are really rich in the high frequencies. The type of passage that high bias tapes are designed for.

Record it on your favorite high bias cassette, using the Chrome/CrO<sub>2</sub> setting. Then again on MEMOREX HIGH BIAS.

Now play back the tapes.

We're convinced you'll have a new favorite.

MEMOREX HIGH BIAS is made with an exclusive ferrite crystal oxide formulation. No high bias tape delivers greater high frequency fidelity with less noise, plus truer response across the entire frequency range.

In short, you can't find a high bias cassette that gives you truer reproduction.

**MEMOREX**

Recording Tape and Accessories  
Is it live... or is it Memorex?



# Why JVC's new metal decks knock out your ears and not your wallet.



## Free tape.

Even though we knocked out the hi-fi world last year with the world's first true metal-compatible deck, we're not the only company that sells them now. So we've decided to stay one jump ahead by offering you SIX metal compatible models from \$299 to \$749.\* Each packed with a free Metafine C-46 metal particle cassette.

One reason we're doing this is because our metal-compatible, KD-Series decks perform so well with conventional tape, you might never get around to buying a metal tape!

But pop the Metafine cassette in and you'll hear the difference. Suddenly you've gained 6dB output level, 10dB signal-to-noise and at least 3000 Hz of high end. Even more with our computerized KD-A8!

## Features like Sen-Alloy™ and Super-ANRS even at \$299\*

Our key to metal tape performance is all in our heads. Super-hard, low-distortion Sen-Alloy heads different from any other manufacturer's. When we toss in our unique Super-ANRS noise reduction system that adds 10dB S/N at 5kHz and our

famous Multi-Peak recording indicators, you get a knock-out sound.

And all in decks starting at less than \$300.\*

## T-shirts and posters at your JVC dealers.

The arrival of a whole line of decks this good for prices this reasonable is worth celebrating. So we've outfitted participating



dealers with free posters and even some limited edition T-shirts, all with our knock-out Technical Knockout graphic.

Just walk in and ask to hear a comparison of conventional oxide performance versus metal

particle tape in a JVC KD-A3, A5, A6, or A8. (The three-head KD-A77 and two-color fluorescent meter A7 will be in the stores by December.)

Where do you go to hear for yourself just how much better metal sounds than oxide?

## Call 800-221-7502 and get knocked out.

That's the toll-free number that tells you where you'll find your nearest participating JVC dealer. (In New York, call 212-476-8300.) Drop in to see and hear the technical knock-outs, including the top-of-the-line KD-A8. It features B.E.S.T., the computerized bias/equalization/sensitivity tuning system that fine-tunes the deck to any tape ± 1/2dB, special "X-cut" heads that add another octave of bass (flat all the way down to 25Hz!), solenoid operation, Multi-Peak recording indicators, and a host of other audiophilia. All for just \$799.\*

Stop in and take advantage of the free metal tape with each deck, and free posters and T-shirts, while supplies last.

But stunning as JVC's new metal decks are, free offers like these won't last for long.

**Now you're ready for JVC.**



**JVC**  
US JVC CORP.

KD-A8 with B.E.S.T., KD-A3, KD-A5

Shown: KD-A8 with B.E.S.T., KD-A5, KD-A3.  
\*Suggested Retail Price.

Enter No. 18 on Reader Service Card

Get  
ready  
for a

TECHNICAL

KNOCKOUT



How does a poor engineer cope with that?

### Prime Acoustics

To me, the prime consideration in a classical music recording is the concert hall acoustics. Ideally, the hall should be large enough for the full expression of the most fortissimo music passages without overloading the hall, but not so large as to excite resonant and reflective modes that produce slap-back, flutter echo, and other acoustic anomalies. The reverberation period should fall within 1.7 to 2.2 S, and the decay should be smooth with no "shelving." The acoustics should lend warmth, airiness, and sonority to the instruments

of the orchestra, but not so much that inner detail is obscured. Orchestral balances should be such that one section does not overwhelm another . . . for example, trumpets and trombones should not acoustically "swamp" the first violins into inaudibility. Contrabassi and low percussion should have good projection, with solidity and weight, yet maintain good articulation. There are very few concert halls, indeed, that can meet such demanding criteria as I have just described. A limited amount of correction can be accomplished by microphone techniques in halls with acoustic anomalies, but frankly, I'd rather not undertake the recording if the hall is not first

rate. Since there are so few really good concert halls in existence, many engineers, including myself, make a sort of hobby of ferreting out good recording locales in the various cities we visit.

I should hasten to also point out that a great concert hall is not necessarily a great recording hall. Especially with older halls, the prime goal of the architects was an attractive edifice where a considerable number of people could enjoy listening to a concert in relative comfort. Recording was virtually unknown, and, for that matter, so was the science of acoustics. A good concert hall was a matter of happenstance. Naturally, a given hall gained a reputation as a good concert hall when the sound of the orchestra pleased the large number of people seated in the audience. Of course, the acoustic response of a hall changes when it is empty, and some of the old great halls become too reverberant for recording when they are empty. In the best of all possible worlds, no one could fault Professor Ashley's formula for the successful recording of symphonic music. But in the harsh realities of real-life symphonic recording, the recording engineer must cope with acoustic anomalies, which exist even in so-called good halls or, in many cases, admit the problems are insoluble, or worst of all . . . make a good recording of an inferior hall.

### Lore of Halls

Herewith, some lore about concert halls and symphonic recording locales that Prof. Ashley and you, dear reader, may find interesting:

Carnegie Hall, so beloved of Prof. Ashley, has been intermittently used for symphonic recording for many years, but has been on a steady decline for this purpose for some time now. It has all the desirable qualities previously noted. When empty, the reverberation period is about 1.7 S, and the decay is quite smooth. Why then the decline? For one thing, the hall is incredibly busy, in use almost every day. If you are going to record there, it will have to be after midnight when you start or very early in the daylight hours. Since few symphonic recordings can be accomplished in one day, you would have to dismantle your recording setup every day to make way for an evening concert, and reset the next day. The hall is also expensive in terms of rental and high fees for union stagehands who must move your recording equipment in and out of the hall, plus handle setup and breakdown of the orchestra. The major problem, however, is that Carnegie

**sweet  
sixteen**

U.S.A.  
**Martin**

You ordinarily see Martin speakers advertised one at a time. But there are 16 superb, sweet-sounding Martin speaker models, manufactured in one or more of our four production facilities in the USA, France, Spain or Norway — ranging in price from \$99 to \$750.

We make only one kind of product . . . fine loudspeakers. They are meticulously crafted one by one for a discerning audience which demands the Sound of Perfection.

Martin Speaker Div.  
Eastman Sound Mfg. Co., Inc.  
Mickleton, N.J. 08056  
609/423-0100

Enter No. 12 on Reader Service Card



AD-6700



AD-6900MK II

# Put metal tape where it will do the most good.

Again AIWA leads the way toward the ultimate in cassette technology—with three of the most sophisticated metal-capacity decks you can buy: the AIWA AD-6900MK II, AD-6700 and AD-L40.

Performance is simply unparalleled.

At -20 dB recording, AIWA's state-of-the-art AD-6900MK II boasts a frequency response of 20~20,000 Hz with metal tape. Even at 0 dB, frequency response is an exceptionally broad 25~12,500 Hz  $\pm 3$  dB.

This superb performance is maximized by AIWA's extremely durable Ferrite Combination V-Cut (CVC) playback/record head. With the best possible gap widths of 5 microns for recording and 1 micron for playback.

The AD-6900MK II's unique 3-head design not only lets you compare source with tape during recording—it also permits the most precise bias adjustment available today for FeCr, CrO<sub>2</sub> and all other LH/Normal tapes: AIWA's exclusive FLAT RESPONSE TUNING SYSTEM.

And only AIWA's AD-6900MK II and AD-6700 offer advanced feather-touch logic controls including Cue & Review—plus exclusive full-function wireless remote con-

trol from across the room. Both decks also feature AIWA's exclusive Double Needle Meters for simultaneous monitoring of Peak and VU.

AIWA's newest AD-6700 and AD-L40 are just as sophisticated.

The AD-6700 offers 2-head design, convenient Auto/Repeat with Memory Switch, full-function wireless remote control and an amazingly accurate 9-point LED peak power display in three dramatic colors.

AIWA's ultra-modern AD-L40 offers the only 20-point LED horizontal peak power bar graph you can buy—for instant three-color warning of distortion.

All three decks were designed with a special Ferrite double-gap erase head and high-power erase circuitry.

So if you're ready for metal tape, put it where it will do the most good. Inside AIWA's incredibly advanced AD-6900MK II, AD-6700 or AD-L40.



Upgrade to **AIWA**

Distributed in the U.S. by AIWA AMERICA INC.,  
35 Oxford Drive, Moonachie, New Jersey 07074.  
Distributed in Canada by SHIRYO (CANADA) LTD.

Enter No. 2 on Reader Service Card

TAPE SPEED

1 7/8 3 3/4



INPUT LEVEL

65

70

75

80

85

90

95

FeC

Fe<sub>2</sub>O<sub>3</sub>

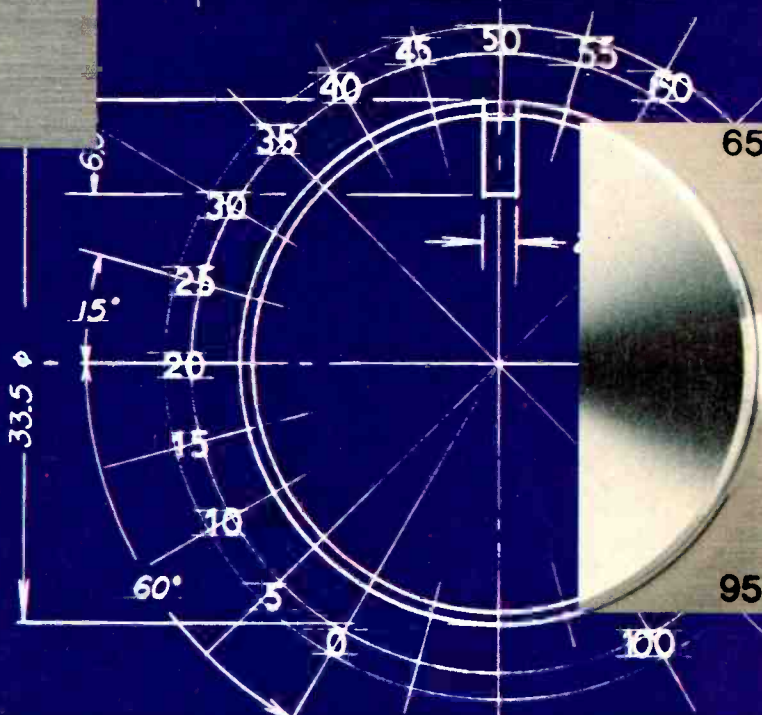

THIS REMARKABLE  
CASSETTE DECK  
COULD ONLY  
COME FROM  
THE NEW FISHER.

Recent developments have revolutionized tape technology. The new Fisher CR4029 cassette deck, with an array of features you thought were still in the future, can now make recordings in your home that rival the product of professional studios. Equally important, the CR4029 offers a wide range of choices that, until now, were unavailable. Some of the new cassette decks offer one or two of these technological innovations—Fisher offers them all in one integrated package.

**TWO SPEED OPERATION.**

You can use the CR4029 at the standard 1 7/8 ips speed and you'll have outstanding recordings. But that's just the beginning. Switch to the new high-speed 3 3/4 ips and the CR4029 delivers an incredible 30Hz-20kHz ± 3 dB frequency response (using normal tape). What's more, recording at high speed drastically reduces wow and flutter and tape dropout. Off-the-air and off-the-disc recordings will astound you, and even surprise your friends who own reel to reel recorders. (Since a C90 cassette will record a full album at 3 3/4 ips, high speed recording is still economical.) But—there's more.

**METAL TAPE.** Another of the marvelous innovations is metal tape. Why has it become so important? Our chart shows why. Metal tape demonstrably improves frequency response. Combine it with the new high speed and you'll get a hard-to-believe 30Hz-25kHz ± 3 dB frequency response with virtual freedom from distortion. You'll also be able to record at higher levels. (With normal tape and standard speed, you have to record at lower levels to prevent tape saturation and consequent distortion.)

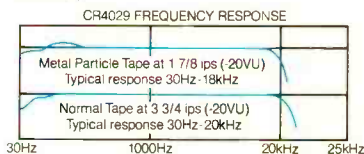

**THREE VHT/SENDUST HEADS WITH DUAL PROCESS DOLBY.** All this new technology requires new recording, playback and erase heads. So Fisher engineers came up with our new VHT heads. Made of a special micro-fine, high density particle formulation, they bring out the best potential of metal tape and high speed. Because the

BIAS TAPE SELECT EQUALIZE TAPE LIMITER INPUT MONITOR

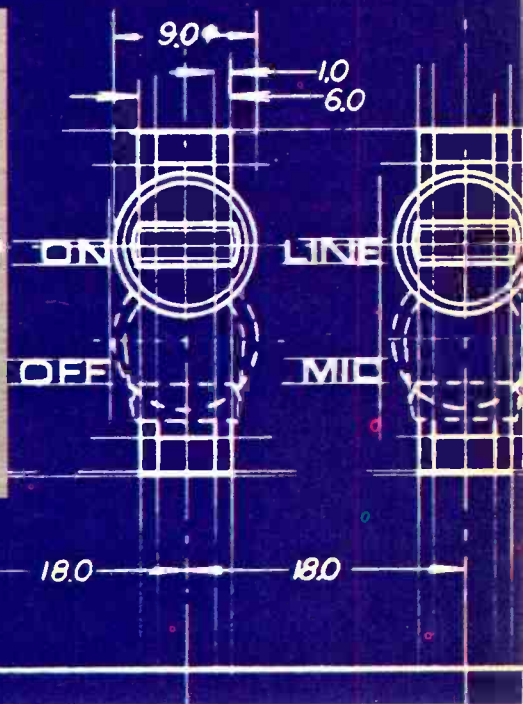

THREE HEAD SYSTEM WITH DUAL PROCESS DOLBY



CR4029 is a three-head design, each head can be optimized for a specific function. There's a wide 4  $\mu\text{m}$  gap VHT record head for the best possible signal-to-noise ratio. A narrow 1  $\mu\text{m}$  gap VHT playback head improves frequency response. And a Sendust alloy erase head overcomes the problem of hard-to-erase metal tape. The separate record and playback heads allow you to monitor as you record—an absolute must for serious record-

VHT RECORD AND PLAYBACK HEADS

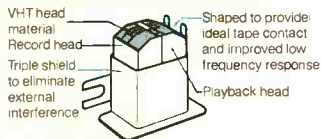

ing. And Dual Process Dolby gives you the advantage of Dolby noise reduction in both the record/playback and off-the-tape monitoring mode.

**THE CR4029 HAS ALL THE OPTIONS.**

Why have only part of the new tape technology when you can have all of it? Using the CR4029 three head system you can use metal tape at the standard 1 7/8 ips speed, combining high performance with long play. Or use normal tape at the new 3 3/4 ips speed for both economy and superior performance. Or choose the ultimate: metal tape at high speed 3 3/4 ips, and exceed the expectations of the most critical enthusiasts.

**IT'S WHAT YOU'D EXPECT FROM THE NEW FISHER.** We invented High Fidelity over 40 years ago. We've never stopped moving ahead. The CR4029 is a perfect example. Part of the new Fisher. Where the only thing about us that's old is our tradition of quality and craftsmanship. See the new CR4029 at your Fisher dealer. Everything you'd want in a technologically advanced cassette deck, and at an under \$500 price.

New guide for buying high fidelity equipment. Send \$2.00 with name and address for Fisher Handbook to: Fisher Corporation, Department H, 21314 Lassen Street, Chatsworth, California 91311.

© Fisher Corp. 1979.



**SPECIFICATIONS:**

Motor	(1) DC-Servo	Frequency Response 1 7/8 ips
Drive System	(1) Capstan	FeCr Tape (± 3dB) 30Hz-16kHz
Number of Heads	3	Metal Tape (± 3dB) 30Hz-18kHz
Head Material	VHT/Sendust	Frequency Response 3 3/4 ips
Wow and Flutter		Normal Tape (± 3dB) 30Hz-20kHz
1 7/8 ips	0.06% WRMS	CrO <sub>2</sub> Tape (± 3dB) 30Hz-22kHz
3 3/4 ips	0.05% WRMS	FeCr Tape (± 3dB) 30Hz-22kHz
Signal-to-Noise Ratio (CCIR Weighted)		Metal Tape (± 3dB) 30Hz-25kHz
(Dolby Off)	52dB	Total Harmonic Distortion at OVU
(Dolby On)	62dB	1 7/8 ips 1.5%
Frequency Response 1 7/8 ips		3 3/4 ips 1.2%
Normal Tape (± 3dB)	30Hz-14kHz	Tape Selector Switch Norm., CrO <sub>2</sub> , FeCr, Metal
CrO <sub>2</sub> Tape (± 3dB)	30Hz-16kHz	Bias Fine Adjustment ± 20%

Dolby is a registered trademark of Dolby Laboratories

the New  **FISHER**  
The first name in high fidelity.®

Hall is noisy in terms of room rumble caused by the vibrations from heavy New York traffic and, worst of all, low and subsonic vibrations generated by the subway trains which pass underneath! Needless to say, many kinds of filters have been tried to cope with this noise, but most remove some of the extreme low-frequency content of the music as well, and this discourages their use. I well remember that just after the 1956 Hungarian uprising, maestro Antal Dorati conducted the refugee Philharmonica Hungarica orchestra in an evening concert in Carnegie Hall, and at midnight Bob Fine (of Mercury Records' "Olympian Series"

fame) and I began to record the orchestra. We were armed with a subway train schedule furnished by the city, and at that hour the trains ran 24 minutes apart. We stopped recording altogether during the passage of the trains, and this was some help in the rumble problem.

### Changes and Improvements

One of the best recording venues in the United States once was Orchestra Hall in Chicago. This is where Fine made the first of the Mercury "Olympian Series" recordings with the Chicago Symphony, and he was the first to use the Telefunken U-47 microphone

for this type of recording. While he was recording the orchestra monophonically, I was simultaneously making experimental stereo recordings of the group with a pair of U-47s in the omni pattern. Orchestra Hall was simply luscious for recording, with a reverberation time of about 1.9 S when empty. In 1965, a wealthy patron of the Chicago Symphony gave money to remodel the hall, and, in addition to new seats and other improvements, they modified the curved proscenium that swept from the ceiling down to the back of the stage. In the original configuration, the stage did not form a "room within a room" as in most halls, but was open and largely responsible for the great recording acoustics. The remodeling caused a disastrous reduction in the reverberation time of the hall, to a much too dry 0.9 S. Because of this, all the companies that recorded the Chicago Symphony began to record them in the nearby Shriners' Medinah Temple. This is a largish hall with a very deep stage, and, depending on the engineers involved, some quite fine recordings have been made there. Some years later, Orchestra Hall was further modified, and the reverberation time rose to 1.4 S... better, but still lacking. Now, it is well known that symphony orchestra players generally like to perform in their "home" hall and, if at all possible, record in it as well. Just recently, Deutsche Grammophon, who regularly record in the Chicago Symphony, tried a unique experiment. Wanting to satisfy the Chicago musicians, they spread heavy-gauge vinyl sheeting over all the seats in the hall. The seats, because of their upholstery, represented a considerable amount of acoustic absorption, and the vinyl sheeting reflected sufficient sound to lower the absorption in the hall and raise the reverberation time. Thus, the musicians were able to record in Orchestra Hall once more, and although I understand they do not always use this setup, it is a step in the right direction.

After having told this encouraging story about trying to cope with marginal recording acoustics, here is the other side of the coin... A well-known record company, which records in a famous concert hall, uses multi-mike, close-up recording (up to 32 mikes!) to the extent that they swamp the natural acoustics of the hall and, in fact, are forced to add artificial reverb!

So it takes all kinds, Prof. Ashley. Your recording utopia will probably never be realized in the real world, but let us both hope the clinically revealing sound of digital recording may change all that!



# SUPER DISCS

Quality Music, Quality Pressings, Quality Sound

Nautilus Half-Speed Mastered Series

STEREO



Nautilus Recordings premieres The Half-Speed Master Series. These high quality discs are produced from the original master tapes, mastered at half-speed to insure maximum fidelity and then pressed on 100% virgin vinyl to bring you all the music.

Coming soon, The Doobie Bros., America, Pablo Cruise, Joan Baez, John Klemmer and Tim Weisberg. Expect more from Nautilus Recordings.

Nautilus Recordings  
761 Shell Beach Rd.  
Pismo Beach, CA 93449  
(805) 773-1848  
Dealer Inquiries invited



Produced by Mike Flicker

# THE PHASE 8000 IS AS CLOSE TO PERFECT AS YOU CAN GET.

**SIGNAL/NOISE: -78dB.**  
**WOW & FLUTTER: 0.015%.**  
**TRACKING ERROR 0.**  
**SKATING FORCE 0.**

No other turntable can match the Phase 8000, because no other turntable has such advanced motors. You can't buy a quieter turntable.

Or one with as low wow & flutter.

Or one that tracks better.

The Phase 8000's tangential tracking tone arm keeps the stylus in perfect 90° tangent with the grooves. It's the same way the master disc was cut, so the motion of your stylus is identical to the cutterhead stylus. There's absolutely no tracking distortion. No crosstalk.

No skating force that can actually re-cut your grooves.

## NEW LINEAR MOTOR ELIMINATES MECHANICAL LINKAGE

Other manufacturers have tried to move tangential tone arms with worm gears.

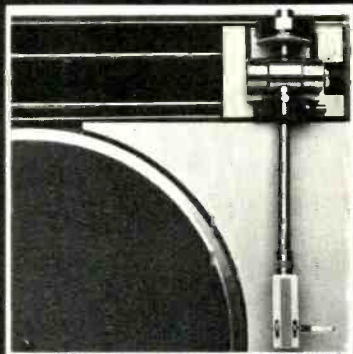

Belts. Rollers. All with the same sad result: Mechanical connectors pass on the noise and vibration of the motor.

The Phase 8000 solves this problem with an ingenious Linear Motor. The tone arm base is a permanently magnetized armature that glides along guide bars above electro-magnetic coils. The arm moves by direct induction — not mechanical connection. So there's virtually no noise.

Inside the tone arm, an opto-electronic detector cell senses the slightest tracking error, and instantly sends correcting signals to keep the arm on track.

## NEW QUARTZ-PLL DIRECT DRIVE

Our new slotless, coreless Stable Hanging Rotor DC motor virtually eliminates "platter wobble." Quick start/stop. Speed deviation is lower than 0.002%.

If you want to hear all these technical advantages translated into musical improvements, contact your Phase Linear audio dealer.



Phase Linear Corporation, 20121 42nd Ave. W., Lynnwood, WA 98036

*Phase Linear*®

Enter No. 36 on Reader Service Card

# Audio etc.

Edward Tatnall Canby

NO NOISE! That's what we want today, speaking negatively. Noise is bugging us. We're spoiled by the digital system, which in both tape and disc brings us extremely close to TOTAL SILENCE in the absence of signal. That's what we want! But we can't get it — yet. At least not on discs. We are still living with the LP in our own consumer systems, as we are living with analog tape. We will for many a year, maybe. Ten years? That's Philips' casual estimate. *Ten years of LP noise?* How can we ever stand it?

Well, dbx says it has the answer. (And we can use it, as never before.) The dbx "noiseless" encoded disc! It's here — or rather, it is back and better. This system was launched once before, quite awhile ago, and nobody noticed very much. Wrong moment. This time is better and we will probably notice — we almost have to. For if you can't yet get noiseless audio via digital, the very next best way just has to be via electronic-type noise reduction. You reduce the noise without affecting the signal itself.

Or do you affect it? That's the vital question.

Well, this new dbx disc is astonishing. I can say that because I've heard it. Here you have no more than a plain old LP (specially cut and pressed) with the same dbx II circuit for coding that you already know from recent dbx consumer products (and compatible with them) — and it sounds, really, truly, almost like digital. SILENCE!

I'm wary of the word "total" in respect to any kind of silence — let's call this *audible* silence, palpable silence, the kind you almost feel, that makes you think the system is switched off. You hear — nothing. Except signal, when & if. We get this sort of silence out of the best component and pro equipment (and leave it turned on for

days by mistake). We have heard it, unbelievably, in demo after demo of the new prototype digital discs and the digital tape systems. All digital audio has it because silence is inherent in the system itself, which does not read noise. (Well, hardly ever.)

But do we get it in our new LP superdiscs, d-to-d or digital-derived? Nope. Not even on the best and/or most expensive. It may have been there in the original signal but the good old phono pickup and the LP surface convert that silence very efficiently into, at best, low noise.



There's only one way to achieve minimal noise on standard LP and that's via a scarce commodity called "TLC." Tender Loving Care. But folks, we really can't depend on TLC for our mini-noise! It's inhuman. It isn't fair. If the natural end state for milk is to be sour, then the natural tendency for the LP record is to be noisy. More Murphy subsets. We aren't in the dairy biz and we'll never, NEVER get *predictably* quiet LP discs via any sort of regulation, supervision or inspection, or even with TLC. Well, again, hardly ever. But that's not enough.

## Surface Silence

So let's examine the dbx offering and see what it might do to help — short of digital. Dbx is ready. The company is now a subsidiary of BSR (USA) Ltd., and it has a dynamic new boss-

man, Jerome E. Ruzicka, who is far from noise-free. He recently was with the Bose Corp. and now will talk your ear off with enthusiasm for the dbx "noiseless" disc, which is very much his baby. He was so excited at his press conference that he fairly sputtered, and a good many of us went right along with him. When, after his speech, that vaunted SILENCE finally hit our ears, it was indeed extraordinary. This was definitely the first time I had heard an LP pressing, played through a standard pickup, that actually compared for the ear with digital.

Especially in comparison with the same recording in an uncoded pressing.

Let's put it into figures, unofficial. I quote Bert Whyte and others to the effect that the limit in S/N for the LP (uncoded) is around 60 dB. Normal, smooth LP surfaces average very roughly around 45 dB below a hypothetical center point, the standard 0 dB level, if I read it correctly. But these

last numbers, even with engineering precision, are quite arbitrary because of the huge plus-or-minus factor. In practice, I would suggest, what with the usual swishes, rumbles, ticks, pops, mini-explosions (says my suffering ear), a better everyday average might be -30 dB with occasional violent peaks (say no more!) up to +15. "Noise louder than signal?" Of course. You hear it every day.

If I am right, the coded dbx LP disc plays back with an S/N that gets down into the -70 dB range. Extraordinary if true, and it surely accounts for what my ears did not hear. This does indeed compare favorably with digital specs. Philips says the S/N figure for its compact digital disc is -85 dB, and digital tape goes down astronomically beyond -90. No—not quite totally silent. But might as well be. If you stick your ear right into the speaker on silent pas-

# Yamaha decks the competition.



**TC-720.**  
The 3-head deck  
for the creative  
recordingist.

If you like to get involved with your tape recording this is the deck for you. The bias rotary control and built-in pink noise generator allow you to fine-adjust the deck's high frequency response to best suit the particular tape you are using. The REC LEVEL ADJ controls and REC CAL switch allow you to further adjust the recording sensitivity for proper Dolby® NR tracking, resulting in very high signal-to-noise ratio and exceptionally clean sound. The TC-720 also has a unique built-in "rec time" echo facility. You can use this to add new dimensions of studio realism to tapes

recorded for playback in both your car and your home. All these front panel features (and more) are backed by reliable, advanced electronics. The Closed-Loop Dual Capstan Drive keeps the tape at an ideal tension for smooth head contact. An advanced Frequency Generator servomotor transports the tape at a constant, accurate speed with very high torque. High-performance, low-noise amplifying circuits are used for the mic and line inputs. All this superior performance is wrapped in a beautiful simulated ebony cabinet.

\*Dolby is a trade mark of Dolby Laboratories.



**TC-920B.**  
Matching the Industry's finest  
separates in appearance as well as performance.

For unparalleled performance, the TC-920B starts with the heads. Yamaha's unique Pure Plasma Process results in Sendust heads of unparalleled purity, resulting in high permeability of the core for better sensitivity and playback efficiency, excellent S/N ratio, and greatly reduced tape/head wear.

The 920B has a vast array of audiophile features. Like the unique FOCUS switch. In the "SOFT" position, you will attain a more relaxing, mellow quality to the overall listening effect. In the "SHARP" position, you get a more crisply punctuated high frequency sound quality. There's also a fine bias adjust control to match the deck's characteristics to those of the actual tape in use.

A switchable subsonic filter cuts out subsonic interference due to warped records, line hum, etc., and also safeguards your speakers during playback without altering

sound quality. The bar-graph peak level meters have a fast/slow switch to adjust the recovery time of the meters for maximum control over the material you are recording.

The 920B's sleek black cabinetry enhances the high-performance look of this studio quality deck. For maximum convenience an ingenious hinged panel conceals the less often used controls. Everything was done with striking esthetics and total performance in mind.

The TC-720 and the TC-920B will bring the competition to its knees, and will bring you to your feet, cheering. For the full story, visit your local Yamaha Audio Specialty Dealer listed in the Yellow Pages. Or write us: Yamaha, Audio Division, P.O. Box 6600, Buena Park, CA 90622.

From Yamaha, naturally.



sages (at your own risk), you just might hear something but you probably wouldn't. So in terms of achieved S/N via the LP record, dbx provides us with exactly what we want in the most negative abundance. This might very well hold us until the digital disc gets around, maybe within that 10 years or so. That could be important.

### Pay the Piper?

If dbx is this good, there must be a catch, a price to pay, whatever its value. That price is in the compression-expansion cycle, a treatment of the whole signal through some pretty fan-

cy circuit work. And right there I see a lot of leery faces and eyes looking askance. That sort of thing? "No-no! We hate noise but we want our audio pure and lovely, untouched by human hands. Or extra electronic circuits, thank you. We will even listen to all that NOISE (gritting our teeth) in order to preserve signal pristinity."

Or will we? It all depends.

The dbx system uses the long-familiar two-step type of noise reduction, via a pair of mirror-image circuits that code the signal before recording and then decode it in the playing, back to where it started, at the same time tak-

ing any subsequently added noise (uncoded) — say LP surfaces or tape hiss — right down along with it to far below "normal." Ideal result: Signal unchanged, noise reduced. It's a nice concept once you've got it straight in the mind (which isn't always easy, I've found). And there are many ways to design the double circuitry. The idea is, of course, best known today in the popular "Dolbyized" cassette as well as in Dolby professional equipment. Indeed the two systems, Dolby and dbx, fill very similar rival niches in audio usage, both professional and consumer. As we know, dbx even designed a plug-in replacement for Dolby A pro equipment—they are that close in type of function. Either one does its noise reducing very well when the two mirror-image circuits work as intended. But, of course, one system will not decode the other. There are profound differences.

Those differences are technical and do not belong here in detail. Yet the two systems' basic principles are important if we are to evaluate the "fi" of any sort of noise-reduced LP disc.

### History into Future

There could be a Dolby disc—there may be?—parallel to the familiar Dolby cassette. That would involve "Dolbyizing" the disc itself and playing it back through conventional Dolby B decode. Now there is, in fact, a dbx disc (let's not speak of "dbx-ing") and it works the same. The record is dbx II encoded in the production process and decoded in the playback through reverse dbx circuitry, added to your system in one form or another according to need. As simple as the cassette. Right here the Dolby/dbx similarity ends. And the differences begin.

I think I can see why there could be a dbx disc in our future and not a Dolby disc, though both are possible. The most profound difference between these systems is historical, which explains a lot.

Dbx is newer, goes further (-30 dB to Dolby's approximate -10 dB) and takes bigger risks, at least in theory, by boldly treating the whole signal. Dbx depends on the incredible accuracy of modern electronic design. Dolby, designed in an earlier time, most ingeniously avoids that risk, and that is why Dolby is still with us. A very neat and interesting comparison.

Dolby's circuit came out of the early 1960s in its original launching, which is a very long while ago in audio terms. To my mind Ray Dolby's thinking at that time had the real quality of genius, safety-pin type. It was simple, unerring, and to the point. Nobody

## The New ADS L810-II "radical improvements wouldn't have been possible..."\*

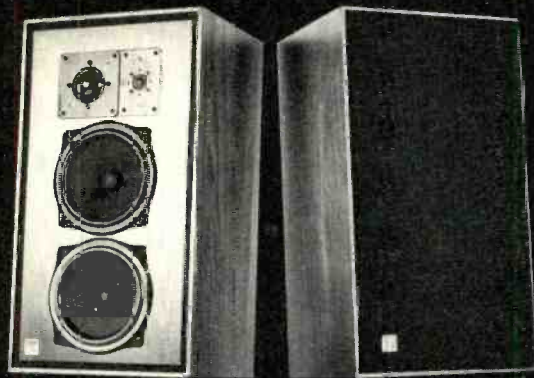

(ADS #10s shown with optional stands #80C)

"ADS' Series II speakers are subtly improved over the original versions — radical improvements wouldn't have been possible considering the high quality of the originals. The 810 was highly respected for its extreme clarity, and for the natural, tight bass response it exhibited. The Series II continues to offer these attributes, will handle more power, and have better high end dispersion. A fine speaker has been made better, and we recommend it highly."\*

\*As quoted from the May 1979 Complete Buyer's Guide To Stereo Hi-Fi Equipment.

ADS has indeed spared nothing in the quest for perfection. Less than \$375 apiece the ADS 810 is accurate enough for the professional recording engineer and affordable enough for the lover of good music at home. Discover the best today. Discover the ADS L810-II.

There is a selected ADS dealer near you.

For more information and complete reviews, write ADS, Dept. AU9, or call 1-800-824-7888 (California 1-800-852-7777) toll free and ask for Operator 483.



Where technology serves music

Analog & Digital Systems, Inc., One Progress Way, Wilmington, MA 01387 (617) 653-5400



# The standard bearers.



## The high bias standard.

In the past few years, these fine deck manufacturers have helped to push the cassette medium ever closer to the ultimate boundaries of high fidelity. Today, their best decks can produce results that are virtually indistinguishable from those of the best reel-to-reel machines.

Through all of their technical breakthroughs, they've had one thing in common. They all use TDK SA as their reference tape for the high bias position. These manufacturers wanted a tape that could extract every last drop of performance from their decks and they chose SA.



And to make sure that kind of performance is duplicated by each and every deck that comes off the assembly line, these manufacturers use SA to align their decks before they leave the factory.

Enter No. 57 on Reader Service Card

Which makes SA the logical choice for home use; the best way to be sure you get all the sound you've paid for.

But sound isn't the only reason SA is the high bias standard. Its super-precision mechanism is the most advanced and reliable TDK has ever made—and we've been backing our cassettes with a full lifetime warranty\* longer than anyone else in hi fi—more than 10 years.

So if you would like to raise your own recording standards, simply switch to the tape that's become a recording legend—TDK SA. TDK Electronics Corp., Garden City, NY 11530.

**TDK**  
The machine for your machine.

\*In the unlikely event that any TDK cassette ever fails to perform due to a defect in materials or workmanship, simply return it to your local dealer or to TDK for a free replacement.

else thought of it. Dolby A, the original, and Dolby B, for consumers, each remain the same today in their operating parameters as they always have been—and interchangeable right down the line, old and new. The Dolby system is hellishly clever—it “solved” the problem of signal purity by simply leaving the signal untouched. All but a tiny fraction in the very low-level area. The ear’s masking ability, ignoring noise in the presence of louder signal, had been used before but this was an ingenious application. For most of the signal, Dolby was a non-circuit. And it gave

us that 10 dB. Not surprising that the pros went along in force! The idea still holds—*don’t tamper with my signal*. Not any more than you have to. So Dolby lives on.

But dbx can give us much more noise reduction via the two-stage approach—IF we accept treatment of the whole signal, complete. That’s the rub. Heads still shake at the thought. Signal purity! We like it better than ever. And dbx boldly grabs your entire audio signal, not only compresses it 2:1 across the board, 100-dB wide in the dynamics, but even adds pre-emphasis up at the top and de-emphasis in the

playback. That’s tampering, if you feel that way. But look at the results. Not merely all that noise reduction. A grandly widened range in the replaying, a full 100 dB instead of the safe average 50 dB or so of the usual LP. Dbx puts no more than 50 dB on the record, cuts narrower grooves closer together (thanks to much lower maximum excursion in the lows), and overall cuts out nearer the edge for cleaner inner-groove sound in the same playing time. That makes for new flexibility. The mechanical strains on the LP-groove system itself are neatly transferred to the more capable electronic area.

Dbx even goes back to the master tapes (or wide-dynamics d-to-d cutting) to find its 100 dB of dynamic range, often reduced for the standard LP cutting. Remastering. It’s a whole new version of the recording, maximized to take advantage of every favorable break provided by this code-decode procedure. Pretty good, eh? Solid thinking. But how about the signal quality?

I’ll give no specs, but the argument is straightforward. Since the mid-Sixties there have been enormous advances in audio electronics. We have learned to “treat” our audio signals, in whatever way, in many ways, with incredible precision and lack of distortion even in systems of great complexity. Our signals go in clean, travel through a million or so modifiers—and come out clean. Just compare amplifier specs of 20 years back and today. Look inside our audio gadgetry, already in wide hi-fi use. Study Peter Scheiber. It’s a new electronic world.

And thanks to transistors and then circuit boards and ICs, we can build enormously sophisticated circuits that still manage to be practical and reasonably cheap to produce. We know how to make them work not only with low distortion but with uncanny precision. Enough said.

### New-Era Cleanliness

So now, maybe, we can indeed grab the whole of a signal, put it through compression and re-expansion and more, and come out clean? Maybe not quite 100 percent. But close. Without any specs at all, that is the argument.

Dbx, you understand, comes straight out of this new era and has had the time to become highly knowledgeable in noise-related compression/expansion techniques. If I am right, then, the dbx II circuitry is a very sophisticated product of recent advanced thinking. It has to be. I think maybe I’d trust my best audio to it. Would you? You’ll have to decide.

# MAXELL MAKES A RECORD OFFER WORTH LISTENING TO.



Get one of these albums free when you buy 3 Maxell UD-XL cassettes.

Anyone who appreciates great music is sure to appreciate these special recordings.

Each contains selected cuts performed by some of the world’s greatest jazz, rock and classical musicians. And each has been specially selected under our supervision to bring out the

most in your equipment.

All you have to do to get one free is buy 3 UD-XL I 90 or 3 UD-XL II 90 cassettes.

That way, you’ll not only be getting some great tape, you’ll also be getting some great

music to listen to. Offer good at participating dealers while supplies last.



Maxell Corporation of America, 60 Oxford Drive, Moonachie, N.J. 07074.

Enter No. 26 on Reader Service Card

# INTRODUCING THE B&W 801. THE END OF THE BEGINNING.



**S**peaker design, as any engineer will tell you, traditionally involves compromises and trade-offs. Visions of perfection sacrificed to practical considerations.

But does it have to be this way?

B&W doesn't think so and they've designed the loudspeaker to prove it, the B&W 801.

## **No more compromises.**

With the 801, B&W engineers have broken with conventional design practices, not to mention conventional technology, to create a loudspeaker that surpasses, in every audible respect, the finest currently available.

The outstanding performance of the B&W 801 is directly traceable to a massive investment in research and development. From the computer models employed in its design to the laser interferometry used to measure

the behavior of its individual components, this landmark in loudspeaker technology represents an uncompromising commitment to excellence.

Critically matched drive units using new materials and fabrication techniques are employed throughout. A computer optimized, 4th-order crossover network maintains uniform sound pressure/frequency response and correct phase characteristics. In addition, a unique electronic overload protection device continually senses the voltage applied to each driver and if safe values are exceeded, cuts off the signal. A convenient reset button restores operation.

The striking two-part enclosure has been precisely matched to the individual drive units with a staggered, in-line driver configuration insuring wide horizontal dispersion and the time arrival correction needed to yield a coherent wavefront. Finally, the enclosure has been contoured to minimize secondary diffraction effects.

## **For the discerning few.**

To be sure, the 801 isn't for everyone. Both price and limited production effectively preclude widespread use. However, if you are unwilling to settle for anything less than a supremely accurate loudspeaker fully capable of recreating every nuance of the original performance, the B&W 801 is for you.

A visit to your B&W audio specialist will prove conclusively that the B&W 801 represents a quantum leap in loudspeaker technology—a singular end to the beginning.

For additional information write: Anglo American Audio Co., Inc., P.O. Box 653, Buffalo, N.Y. 14240. In Canada: Remcron Electronics Ltd.

## **B&W Loudspeakers. The next step up.**

# If you can find a receiver that does more.

DC configuration OCL power amplifier    Relay protection with LED    18 LED logarithmic power display    Logarithmic volume attenuator    2 phono inputs

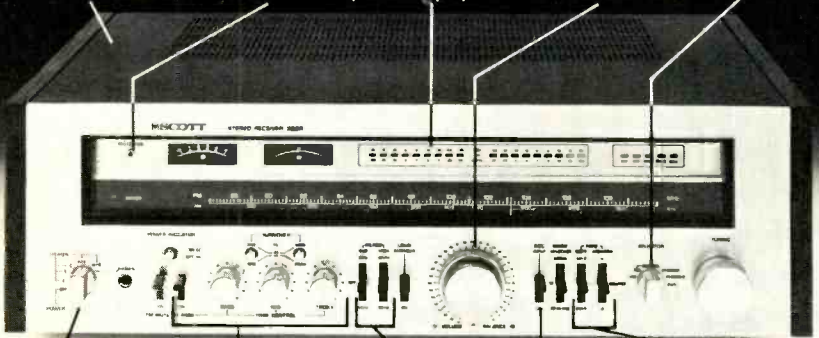

Connections for 3 pair of speakers    Bass/midrange/treble tone controls with variable turn-over frequencies and by-pass    Twin position active subsonic and high filters    Front panel accessory switch    2 tape monitors with full tape copy capability

## Buy it.

Scott's new 390R is perhaps the most complete receiver ever made.

A professional control center for your entire sound system, the 390R delivers a full 120 watts per channel min. RMS, at 8 ohms from 20-20,000 Hz with no more than 0.03% THD. And it offers more options, features and flexibility than you'll find on most separates.

Compare the Scott 390R with any other receiver on the market today. If you can find one that does more... buy it.

For specifications on our complete line of audio components, contact your nearest Scott dealer, or write H.H. Scott, Inc., 20 Commerce Way, Dept. J.R., Woburn, MA 01801.

**SCOTT**  
The Name to listen to.  
Makers of high quality high fidelity equipment since 1947.

Enter No. 46 on Reader Service Card

## THE CELESTION DITTON 332. ITS RANGE-ABILITY HITS YOU RIGHT BETWEEN THE EARS.

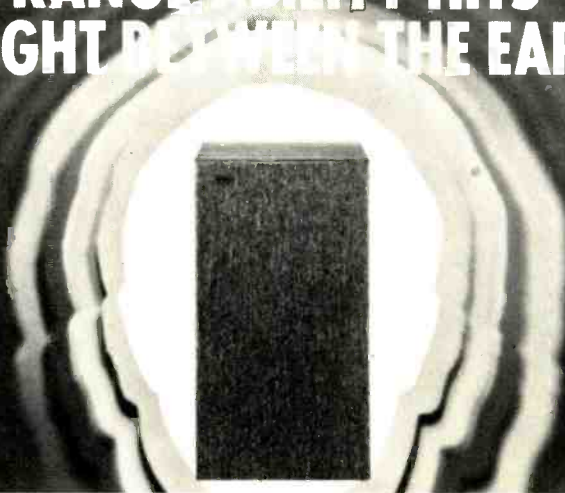

From the incredible bravura of a diva's high C to the seemingly subliminal low E of a string bass. From the explosion of a faraway cannon to the fragile ting of a triangle floating across the room.

That's Range-ability<sup>®</sup> in the Celestion Ditton 332.

Celestion's Range-ability is also pure pronunciation at any volume—from a level barely perceptible to an overpowering 107dB. Through it all, the Ditton 332 maintains exceptional linearity, imaging, dynamic range and high efficiency.

Celestion manufactures each com-

ponent for its speakers. The result is an integrated acoustic suspension system of superbly efficient elements backed by over 55 years of speaker manufacturing craftsmanship.

Your pair of Ditton 332 cabinets will look as good as they sound. Finishes of oiled American walnut or elm are available.

Range-ability. Finally, listening becomes an experience.

celestion  
international 

Enter No. 8 on Reader Service Card

Of course, there are a few minor ancillary problems before this dbx disc can get through to us in the millions and save our noiseless souls. No new recording system will succeed without a very substantial software immediately available. By itself, the system is nothing. We know what Philips has in store for us in its digital baby disc—the best of Europe and the world. Do you remember the stacks of ready LPs that came from Columbia right at the beginning? What can a smallish outfit like dbx, not a record company at all, do on its own?

Well, quite a lot, it seems. Bossman Ruzicka understands the crucial aspect of available software and he is going to strenuous lengths. Dbx isn't about to buy out RCA or Columbia, but they're not going to toss you only a few tiny labels, take it or leave it. Instead, they are setting up an emergency ad hoc processing and distribution department at dbx that will do everything, almost anything, that might help a record label to get started and avoid the ominous problem of wasteful double inventory—a separate disc for each type, dbx and standard. There will be no double inventory. Dbx takes on the coded version, does the vital remastering from early-generation originals; dbx in effect buys the records from the label and distributes them. A big strain on the resources, but that seems to be the way they'll do it, for the present. It is a brilliant, brave, and positive approach. It may well work. Anything, anything that gets this product out on the market in quantity is good.

Needless to say, the decoding end of the process is right in dbx's alley. Most of the recent dbx components already can decode the new record, and there is a new Model 21, just for disc. Other decoding configurations, built into phono equipment, should follow according to need as with the Dolby cassette.

Now don't laugh. As of the first press conference some months ago, dbx had exactly 19 releases on its list of coded LPs and a few more under the hat. Not exactly a Schwann catalogful. But that very day they announced that Vanguard was on board and they have Vox-Turnabout, two important labels for a good start. Also smaller labels, plus their own audiophile specialty line, beginning with the work of Mark Levinson. The big companies are another story—they will act reluctant, you can bet. Even so, we should look carefully and listen with care to the dbx sound. It just might rescue us from LP noise for some years to come. Lovely idea. 

AUDIO • December 1979

# Same looks. More guts.



The speaker on the left is the best selling, most popular car stereo speaker ever. The Jensen Triaxial® 3-way speaker system.

The speaker on the right is the one that's replacing it. The new Jensen Series I Triax®. The one with even higher efficiency. More power. More guts.

Sure, they look alike. But the similarity ends there.

## Higher power handling.

Believe it. The new 6" x 9" Series I Triax is rated at 50 watts continuous average power, compared to 30 watts for the old Triaxial. Which means it'll take more power—more heat—and more abuse from high power car stereo units, without sacrificing musical accuracy at the expense of high volume levels.

Why can it take more power? Because of its new, larger oven-cured one inch voice coil. It offers 66% greater power handling for superior durability. And because the special piezoelectric solid state tweeter is virtually indestructible, yet sensitive to every musical nuance.

## The efficiency expert.

Like all of the new Jensen Series I speakers, the Triax is more efficient than ever, thanks to our special high compliance cones with Flexair® rim suspension, 4 Ohm impedance and new, more efficient motor structures. Which translates to very high efficiency that lets

## More improvements.

The Series I Triax features an improved, 20-ounce ceramic magnet structure for deep, well-defined bass. Also a new, rugged gasket for a tight acoustic seal. Black zinc chromate plating insures corrosion resistance.

We also designed it to be easier to install than the old Triaxial with the stud-mounted grille.

## Some things don't change.

There are some things we just couldn't improve. Like the idea of an individual woofer, tweeter and midrange balanced for accurate sound reproduction.

We also haven't changed our commitment to quality. And to back it up, we steadfastly support our full line of Jensen Series I speakers with an excellent one year limited warranty.

## "But they still look the same..."

You say you still can't see any difference between the old Triaxial on the left and the new Series I Triaxial on the right. Maybe not. But you sure will be able to hear the difference. And after all, that's the guts of the matter.

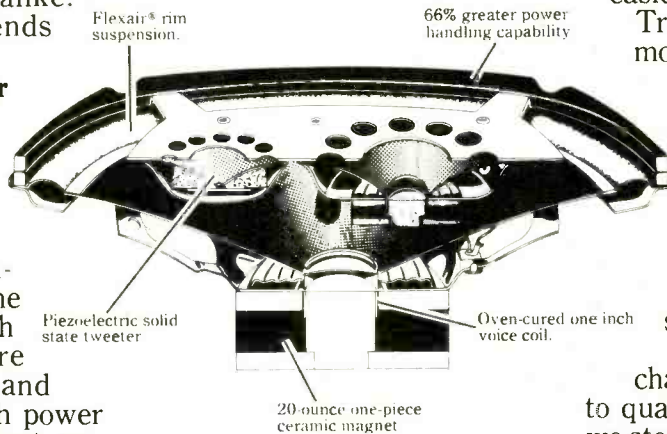

Jensen Series I speakers play louder with less power for smoother, distortion-free music in your car.

# JENSEN

## The thrill of being there.

4136 N. United Parkway  
Schiller Park, Illinois 60176

"Triaxial" and "Triax" are the registered trademarks identifying the patented 3-way speaker systems of Jensen Sound Laboratories. (U.S. Patent No. 4,122,315)

Enter No. 58 on Reader Service Card

# What's new

## Threshold Preamp

Model SL-10 has direct-coupled cascode, Class-A circuitry featuring switchable capacitance and impedance phono-cartridge loading and a pre-preamp stage for moving-coil or ribbon phono cartridges. Input facilities are included for three high-level sources, and there is input-monitor switching for a single recorder. The

low-level signal processing circuits are powered from a separate power supply module and operate with a total of 20,000  $\mu\text{F}$  of regulation. The two-unit

modular design makes use of Dale and Corning metal-film resistors; gold-plated connectors, circuit paths, and switch contacts; a Waters conductive-plastic, environmentally sealed dual pot, and individually curve-traced, high-gain, 200-MHz semiconductors. Price: \$943.00.

Enter No. 100 on Reader Service Card

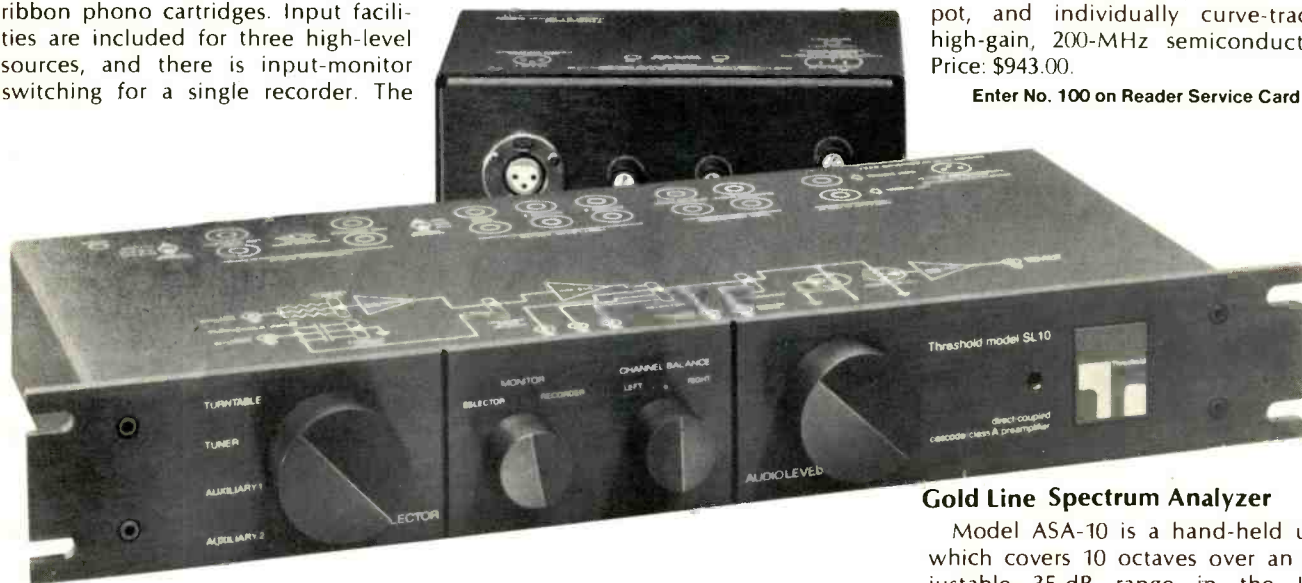

## Gold Line Spectrum Analyzer

Model ASA-10 is a hand-held unit which covers 10 octaves over an adjustable 35-dB range in the LED readout display. Three response modes include fast, slow, and hold for easier analysis. Optional accessories include the PN-2 pink-noise generator, 45-PWN 45-rpm pink- and white-noise recording, and an adjustable mount. Prices: Kit, \$139.95; wired, \$199.95.

Enter No. 102 on Reader Service Card



## Sony Headphones

Model DR-6M folding stereo headphones have 50-cm diameter cone-type drivers with a specified sensitivity of 110 dB/mW and a frequency response of 20 Hz to 20 kHz. Rated output is 10 mW, with a maximum of 100 mW. The 12.35-ounce headphones are suited for monitoring while recording live performances or off-the-air. Price: \$58.00.

Enter No. 101 on Reader Service Card



### SAE Two Receiver

Model R9 is a 90-watt unit featuring digital FM and AM frequency readout, digitally synthesized quartz-locked tuning, and four-function fluorescent metering, which show AM signal strength, FM signal strength and multi-path, power output, and output level



at the tape-cut jacks. Other features include an external processor loop for noise-reduction or equalizer accessories, a varactor touch tuning control, an automatic scanning capability,

headphone output, three tone controls, and two-way tape dubbing. Price: \$800.00.

Enter No. 103 on Reader Service Card



### Bang & Olufsen Turntable

The Beogram 3400 features touch control buttons on a slanting front panel located outside the dustcover for greater convenience. An automatic sensor assures that the belt-driven turntable will operate only when a

record is on the platter. Because of its patented suspension system, playing will not be affected even if the dustcover is slammed. The unit includes a low-mass tonearm and matched cartridge with elliptical naked diamond stylus. A special coating on the platter helps dissipate static electricity to prevent dust collection on records. Price: \$425.00.

Enter No. 105 on Reader Service Card

### Niles Audio Patchbox

Model CPM-31 Universal Component Patching Matrix is a 5x5 input vs. output patch bay which provides almost any combination of switching, patching, dubbing, mixing, monitoring, and signal processing the user might ever require. Price: \$169.95.

Enter No. 104 on Reader Service Card

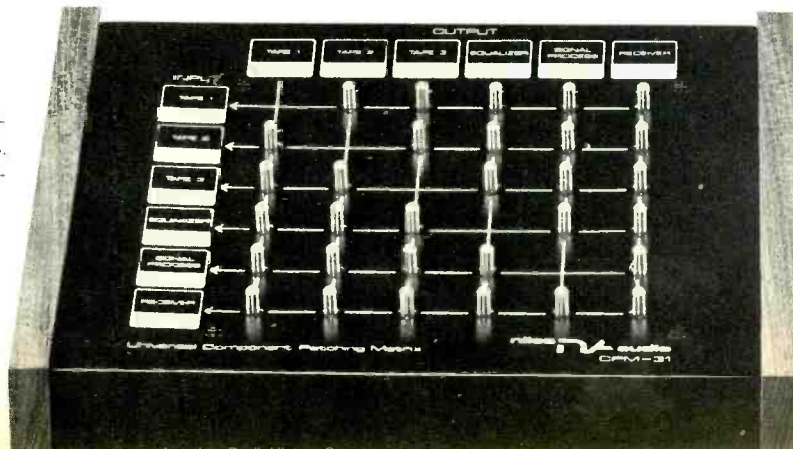

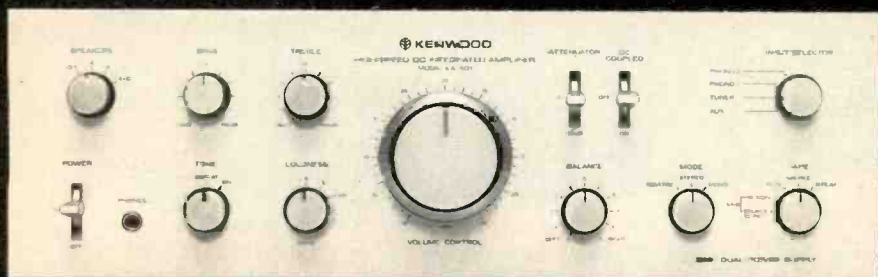

### Kenwood Amplifier

Model KA-60 is a high-speed d.c. integrated amplifier said to react instantaneously to transient signals without a time lag that causes spuri-

ous distortion or TIM. In addition, dual power supplies eliminate crosstalk on transients. It delivers 60 W rms/channel, both channels driven

into 8 ohms, from 20 Hz to 20 kHz, with THD less than 0.02 percent. Price: \$399.00.

Enter No. 63 on Reader Service Card

### Phase Linear Turntable

Model 8000 Series Two has a linear tracking tonearm that traces a record's grooves in the same way that the grooves are cut. This eliminates tracking error, prevents harmonic distortion, and lowers crosstalk and IM distortion. The linear motor, which drives

the tonearm directly, and an optical no-contact servo shut-off system enhance S/N to better than 78 dB. The platter drive system incorporates a Hall effect direct-drive motor with a Quartz PLL system. The motor's speed

precision is stated to be 0.002 percent, with wow and flutter less than 0.013 percent W rms. Price: \$749.95.

Enter No. 67 on Reader Service Card



### Marantz Cassette Deck

Model SD9000 Compudeck, with metal tape capability, offers a choice of two memory functions that allow the user to program up to 19 selections. Features include three Sandust alloy heads, two d.c. motors, a double-Dolby system, and two-speed operation. At 3 1/4 ips, wow and flutter is specified at 0.33 percent rms; frequency response is 25 Hz to 20 kHz, ±3 dB, for normal tapes. Price: \$775.00.

Enter No. 108 on Reader Service Card





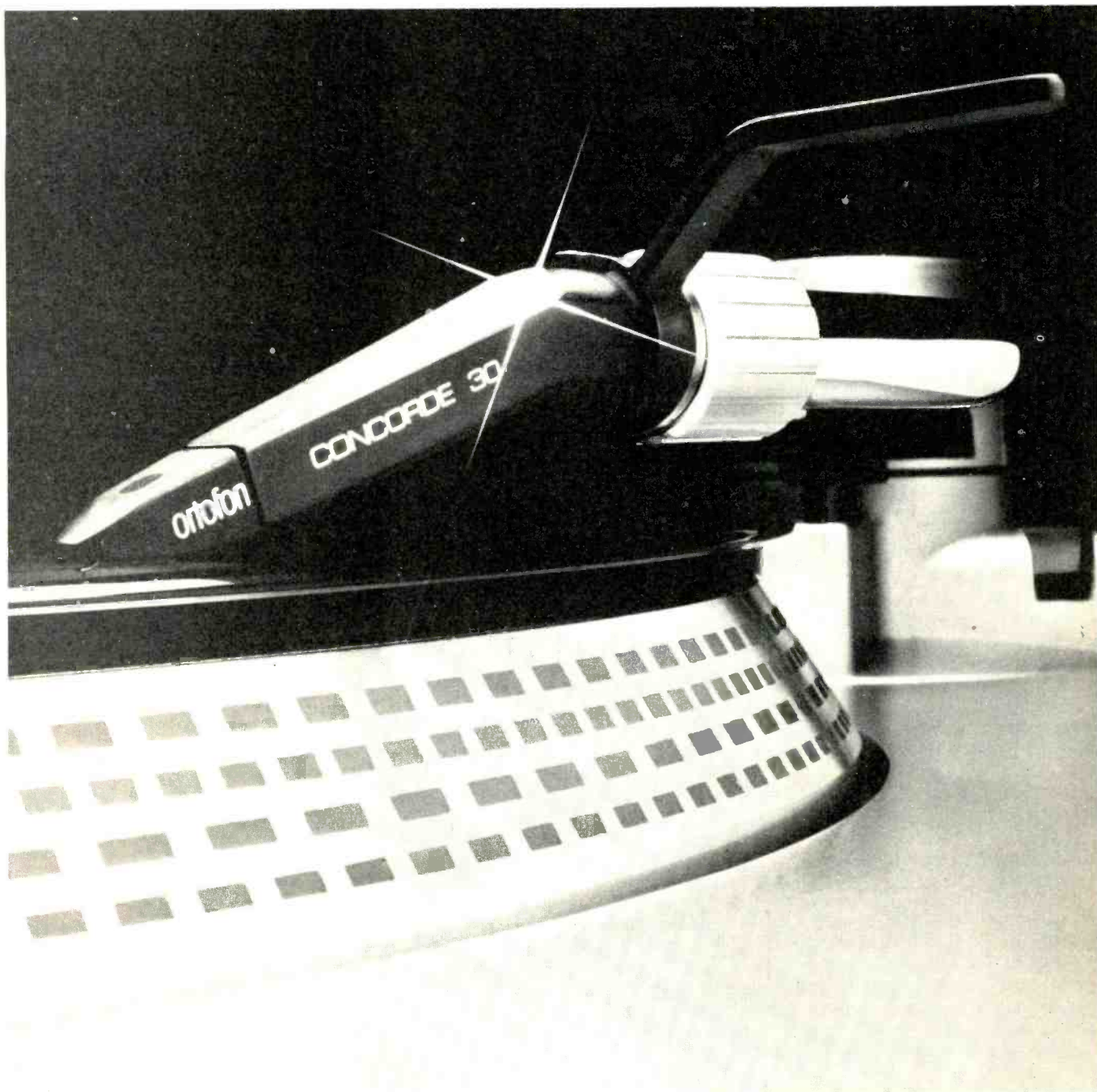

31

## LAUNCHING A NEW ERA IN THE REPRODUCTION OF MUSIC FROM RECORDS.

A strong claim, but true. The Concorde combines a cartridge and headshell in a single form, but weighs less than most headshells alone. The reduction in record wear and distortion, and the ability to track accurately despite warpage, pay incalculable dividends to music lovers.

Ortofon dealers are now ready to demonstrate the Concorde. It's worth a visit just to see and hear this remarkable cartridge that stands at the very frontier of music reproduction technology. For complete information write: Ortofon, 122 Dupont Street, Plainview, New York 11803.

Enter No. 34 on Reader Service Card

ortofon 

# Dear editor

## Twanks

Dear Editor:

Bob Gary's "Tweaking Your Turntable" has saved me money and extended the life of my ten-year-old turntable.

After reading his article in the May issue, I removed about three grams of excess trim, stylus guard and fingerlift from the pickup shell of my turntable. The results were immediately audible. For the first time, my Shure V-15 Type III cartridge tracked "ffff" passages flawlessly. I had been told that I shouldn't be using a high-compliance cartridge in a relatively high-mass arm. Now, with the help of Mr. Gary, I feel that I have alleviated that problem, and I am again more than happy with my equipment.

Incidentally, during the installation of my V-15 Type III cartridge, I broke the stylus shank. Thinking the unused diamond might still be of some value, I called Shure Brothers. They immediately replaced the damaged assembly free of charge. Shure Brothers not only makes a great product — they care about their customers.

Joseph Reese  
Chicago, Ill.

## Wideband Woodpecker

Dear Editor:

In the July, 1979, issue of *Audio*, Mr. Curtiss R. Schafer makes reference to a particular source of interference on the short-wave bands, and in the editorial reply you state that it "would be interesting" to receive comments from others regarding the interference.

As an active radio amateur (as well

as audiophile), I am quite familiar with the interference to which Mr. Schafer refers. For the past year-and-a-half or so, our friend the "Russian Woodpecker" has frequented the 20-meter ham band with his characteristic pulse-modulated signal which has earned him this nickname.

Contrary to what Mr. Schafer's friends' direction-finding equipment may indicate, however, the source of the interference is not within the U.S., but in the eastern part of the USSR. Believe me, if it were in Bremerton, Washington, as Mr. Schafer's friends indicate, I would know it; I live there.

According to intelligence reports, the offender is an "over-the-horizon" radar prototype which operates in the vicinity of 14 MHz. The pulsed waveform, however, is rich in harmonics, and the total radiated energy from the installation is so great that whenever the Woodpecker comes on the air, the whole world knows it.

Our State Department is aware of the Woodpecker and the trouble he is causing, but appears at this time to be powerless. The Soviets have not denied the existence of the Woodpecker, but have taken no steps to eliminate him, nor to move his frequency to one less likely to interfere with other communications.

Be assured, Mr. Schafer (and others concerned): If the U.S.A. or any other country wished to cause interference to programming in the international shortwave spectrum (3 to 30 MHz), they would do it selectively, not with a broad signal like that of the Woodpecker. It stands to reason that you

wouldn't interfere with your own signal (Voice of America, etc.) knowingly, but the Woodpecker not only clobbers VOA, but renders Radio Moscow unintelligible as well.

Patrick H. Bailey, K7KBN  
Bremerton, Wash.

## Somewhere, Over The Horizon...

In reference to Mr. Schafer's letter in your July '79 column, the "noise" he describes as staccato-like is generally accepted as sounding like machine-gun fire, and has been unofficially named "Ivan The Terrible." The "noise" usually occurs between 9 and 15 MHz with a bandwidth of 300 to 500 kHz wide (sometimes 1 MHz wide), but is not confined to the above parameters.

In December of 1976, the defense departments of Scandinavian countries found what the "noise" was. They called the U.S. Intelligence Agency and had their suspicions confirmed.

It was a Russian over-the-horizon radar system. The radar systems watch over the Canadian and U.S. missile bases, and also the attack paths to the Soviet Union. The system is still in the testing stages, with four powerful transmitters in the Kiev area.

The "noises" that Mr. Schafer's direction-finding friends found are the American over-the-horizon radar stations. What stage of use or building they are in I don't know, but one station is on the West Coast and the other the East Coast.

So Mr. Schafer can be assured that the FCC is not trying to block signals from European and Canadian stations

Howard T. Souther, retired Senior Vice President of Engineering/Manufacturing for the Koss Corp., died of a heart attack on September 11 at his home in Milwaukee, Wisconsin.

Mr. Souther, who was 69, received his degree in electrical engineering from the Univ. of Arizona. During a long association with the motion picture industry, he was a significant contributor to the improvement of sound quality. As a market director from 1949 to 1959, Souther helped make Electro-Voice a household name in the hi-fi field.



He had been employed by the Koss Corp. since 1967 and was responsible for the development of the world's first self-energized electrostatic stereo-telephone in 1968. His efforts in acoustics formed the basic groundwork for stereo-telephone test measurement, and in 1970 his electro-acoustical research led to the first dynamic element designed exclusively for use in stereo-phones.

Mr. Souther had remained active with Koss as a consultant since his 1975 retirement, and he developed a facility for the manufacture of transducers at Koss/Ireland in 1976.

The SP-15 has two things our best turntable doesn't have: Quartz-locked pitch control and a lower price.

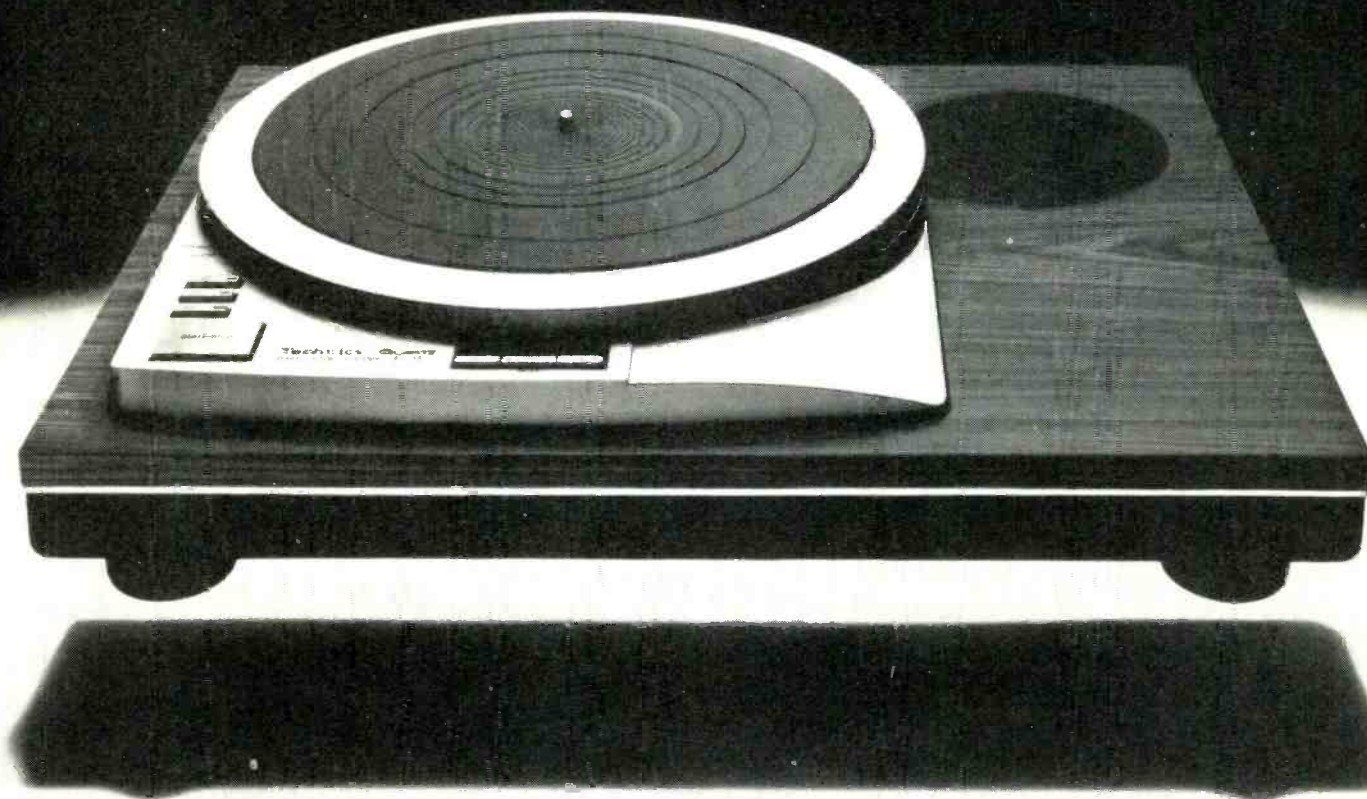

You know what made the SP-10 MK2 our best turntable, and why so many radio stations use it: Wow and Flutter of 0.025% WRMS. Rumble of -78dB (DIN B). Speed accuracy within an astonishing 0.002%. And amazingly high torque for a start-up time of 0.25 second.

Yet for \$300 less,\* the SP-15 has exactly the same high degree of speed accuracy, the same wow and flutter and the same rumble as the SP-10 MK2 while delivering an incredible start-up time of 0.4 second.

Technics quartz-locked pitch control is pretty incredible, too. Unlike the pitch control in many other turntables, it lets you vary the speed with the unvarying accuracy of quartz. In precise 0.1% steps above or below any of the three standard speeds up to a maximum of  $\pm 9.9\%$ . What's more, the exact speed variation you choose is shown right up front in bright digital display. And with Technics you can lock the pitch at the pitch you choose.

Another reason you'll choose the Technics SP-15 is durability. It has an electronic brake that can stop the platter in 0.4 second, even though a tracking force of

2.2 lbs. (or the weight of 250 tonearms tracking at 2 grams) can't begin to slow the platter down. And to help minimize acoustic feedback, it has a heavy-duty aluminum diecast chassis plus a double-damped platter. And when you add the optional SH-15B2 base (shown with SP-15) you'll get the extra protection needed to cope with high volume levels.

There's also Technics SP-25, a two-speed version. With the same accuracy, quartz-locked pitch control ( $\pm 6\%$ ) and many of the great features of the SP-15.

The SP-15 with quartz-locked pitch control. It has the same phenomenal performance as the Technics turntables many FM stations use and discos abuse: MOTOR: Quartz-locked DC direct drive. SPEED:  $33\frac{1}{3}$ , 45 and 78 RPM. STARTING TORQUE: 3.0 kg-cm. START-UP TIME: 0.4 sec. (90° rotation at  $33\frac{1}{3}$  RPM). WOW AND FLUTTER: 0.025% WRMS. RUMBLE: -78dB (DIN B). PITCH ADJUSTMENT RANGE:  $\pm 9.9\%$ .

The SP-15. We added quartz-locked pitch control, we subtracted from the price.

\*Based on Technics recommended price for SP-10 MK2 and SP-15 (excluding bases).

**Technics**  
Professional Series

Enter No. 54 on Reader Service Card

# The weakest link in your hi-fi system isn't in your system.

You could spend thousands of dollars on your stereo system and still not hear its full musical potential. That's because all hi fi systems, even the most sophisticated, have one weak link — *the music source itself.*

Dynamic range (the difference between the loudest and quietest music passages) is one of the primary elements that creates the power and excitement of a live performance. Records (even digital and direct-to-disc), pre-recorded tapes and radio broadcasts sound lifeless in comparison because they're missing more than 1/3 of this vital dynamic range. But add a dbx Dynamic Range Expander to any system, large or small, and the missing dynamics are amazingly restored.

dbx offers three state-of-the-art expanders that let every

stereo system flex its musical muscles. The 1BX, 2BX, 3BX Dynamic Range Expanders provide as much as a 50% improvement in dynamic range, with the additional benefit of up to 20dB reduction of background noise. Any model will let you enjoy *all the music you never heard from your record and tape library.*

Don't let the weak link make your investment in a good stereo system worthless. Visit your nearest dbx dealer for a demonstration of the dbx dynamic range expander that best fits your budget. Experience all the emotional impact and realism that was missing from your music. Records, tapes and radio broadcasts never sounded so good.

dbx, Incorporated,  
71 Chapel St., Newton, MA 02459  
(617) 964-3210.

# dbx

## Making Good Sound Better



dbx is a registered trademark of dbx®, Inc.

Enter No. 11 on Reader Service Card

(they still come in strong as ever).

The information cited here was obtained from a report by the Spanish foreign radio service and a paper by Juan Sanches Belgan entitled "QRM of Ivan the Terrible." I have a taped copy of the program and am willing to share it with readers who would care to send me a blank tape and return postage.

Dan Wilczek  
27 Grant St.  
Auburn, N.Y. 13021

### Ivan, The Woodpecker

Dear Editor:

I suppose that every editor has to print a silly letter once in a while if only to help keep reader interest, but it has been a long time since I have read such stuff as the letter from Curtis R. Schafer in your July issue.

The "staccato-like" interference he mentions is known to amateur and other radio operators, to listeners, and to governments worldwide as the "Russian Woodpecker." It is believed to be a long-range radar system. It constantly moves about in frequency during operation, pausing usually for about 10 S at a time on any given center frequency.

There is no evidence whatever that it originates anywhere but within the USSR. Mr. Schafer can test this for himself by noting that the "loudspeaker" can be heard only when European BC stations (Careful! Not their overseas relays!) can be heard. And then usually near the highest frequency at which they are heard.

Rather than write to *Audio*, Mr. Schafer should write to the FCC, to his Congressman and Senators, and possibly to the State Department. His friends should take up another hobby than direction finding.

Clair J. Robinson  
Minneapolis, Minn.

### Recordists Wanted

Dear Editor:

I would like to hear from readers who are interested in forming a club specializing in recording the neglected, lesser-known, and in some cases unknown classical music repertoire. Operating expenses would be covered by members' subscriptions prior to recording sessions.

The Opera Rara Record Club of England functions in this manner, although they specialize in opera. It should be possible to carry over their success to symphonic music provided enough classical music lovers respond to this idea.

Alex F. Soave  
192 Central Park Rd.  
Plainview, N.Y. 11803

AUDIO • December 1979

All the features you'd expect from  
a 2-channel parametric equalizer.  
At a price you don't.



A radical departure in circuit principles, Technics SH-9010 universal frequency equalizer offers the experienced technician and demanding audiophile the flexibility of a 2-channel parametric equalizer with five bands per channel.

Each band has a center frequency that's continuously variable. By turning the control knob below each slide pot, the center frequency can be varied up or down by as much as 1.6 octaves. So, unlike conventional equalizers with a fixed-center frequency, the SH-9010 has no frequency "blind spots." What's more, each band of the SH-9010 can adjust to overlap the adjacent band to further boost or attenuate a selected frequency width.

Incredible for the price? You're right. But what's even more incredible is that variable center frequency is just one of the SH-9010's advantages. Variable "Q" or bandwidth is another. With it you can broaden or narrow any frequency band,

independently or both at the same time. Which means you can balance an entire string section or eliminate an annoying little hum.

Technics SH-9010. Compare specifications and prices. And you'll agree there's no comparison.

THD: 0.02%. FREQUENCY RESPONSE: 10 Hz—20 kHz (+0, -0.2 dB), 10 Hz—70 kHz (+0, -3 dB). GAIN:  $0 \pm 1$  dB. SN: 90 dB. BAND LEVEL CONTROL: +12 dB to -12 dB (5 elements x 2). CENTER FREQUENCY CONTROL: +1.6 oct. to -1.6 oct. BANDWIDTH (Q) CONTROL: 0.7 to 7.0. CENTER FREQUENCIES: 60 Hz (Variable 20 Hz ~ 180 Hz), 240 Hz (Variable 80 Hz ~ 720 Hz), 1 kHz (Variable 333 Hz ~ 3 kHz), 4 kHz (Variable 1.3 kHz ~ 12 kHz) and 16 kHz (Variable 5.3 kHz ~ 48 kHz). SUGGESTED RETAIL PRICE: \$560.00.\*

Technics SH-9010. A rare combination of audio technology. A rare standard of audio excellence.

\*Technics recommended price, but actual retail price will be set by dealers.

**Technics**  
Professional Series

Enter No. 55 on Reader Service Card

# Audioclinic

Joseph Giovanelli

## Anti-Skating

*Q. As a collector of fine records, who wishes to keep them in excellent condition, I am concerned about reducing wear caused by the cartridge/stylus. Although my tracking force is set for one gram, and I have the anti-skating compensation set per the manufacturer's recommendations, I have read and heard many conflicting articles and stories about anti-skating. Please advise me how anti-skating can be set correctly with no uncertainties.—Name withheld.*

A. Anti-skating compensation can never be set with certainty. The exact amount of compensation required changes from instant to instant, depending on the modulation level on the disc at that given instant. Turntable speed has some influence, plus friction of the stylus as it travels in the grooves. Groove depth plays some part in the amount of friction. I use a system which is at least reasonable. I set the tracking force as prescribed and then take a recording blank, which has no grooves, and place it on the turntable. I place the tonearm on this disc, with the table turning, and next adjust the anti-skating force so that the arm does not move inward or outward. This will achieve the minimum setting. You may need to strike a compromise with some tonearms by making adjustments so that, at one point, the arm drifts in an outward direction. At other parts of the disc, such an arm may drift in an inward direction.

If you cannot obtain a recording blank, use the blank side of one of those plastic sheet Eva-Tone recordings which are often used as promotional materials. Place a standard blank under the thin, plastic sheet so that the tonearm will be at its proper height.

If you have a good test record and an oscilloscope, you can sometimes fine-tune your adjustment just a bit by adjusting the anti-skating compensation for symmetrical distortion on each channel.

## FM Reception Problems

*Q. I recently tried to replace my FM antenna with a TV/FM antenna, given to me by a friend. The idea was to gain outdoor reception for my television*

*set. The result was both terrible FM reception and a poor TV picture.*

*The FM antenna system includes a rotator. My tuner includes a switch which enables the user to hear multipath distortion. Turning the TV antenna did little for signal strength and nothing at all for the distortion.*

*I replaced the coaxial cable and 300-ohm matching transformers and double-checked my work. No change. I spent a lot for parts, including a signal splitter and coupler.*

*Could I have damaged the tuner? I fed the lead-in into a coupler; one output from the coupler fed a band splitter for the TV set, and the other coupler output fed the tuner.*

*The FM signal is now affected by foot traffic in the room where the tuner is housed, and sometimes I lose the station completely. I had none of these problems before this installation. Whom should I call, the repairman or an exorcist? —Bob Breeden, Forestville, Md.*

A. The fact that people moving about your listening room makes a difference to FM reception has to mean that the antenna is not feeding into the set.

The only antenna that you have right now is the piece of twin lead between the coupler and the tuner. The reason that signals come and go as people move around the room is that they absorb or add to the amount of signal reaching this small piece of cable.

Directly connect the lead-in 300-ohm cable (after the matching transformer) to your tuner—without using the coupler. If reception is still poor, I must suspect that one or both of your matching transformers is no good. If reception does become what you expect it should be, the coupler is probably defective. I say this because both the TV set and the tuner are affected, and the coupler is common to both.

These couplers usually work by virtue of the twin lead's being cut by the holding screws. If you fail to tighten these screws firmly, the cutting arrangement will not penetrate the insulation of the twin lead, and no contact will be made. This, in turn, will result in loss of signal.

There is always the possibility of strands of the coaxial cable shorting

out the signal. If the cable was soldered to the transformer terminals, it is possible that excessive heat melted the jacket of the center conductor, causing a short to the shield.

## Sound Quality Of "Picture Discs"

*Q. I have noticed that the sound quality of "picture discs" is not as good as the same music released on conventional discs. Why would the sound quality be poor just because it is a picture disc? —Bob Hoffman, Worth, Ill.*

A. The sound quality on a "picture disc" will not change just because there is a picture printed on it. What tends to change, however, is the amount of background noise which the disc will possess. The use of truly virgin vinyl material will yield a transparent record—not black. The black disc is made by adding lamp black to the vinyl mix before the disc is pressed. By being careful not to add too much lamp black, it is possible to maintain a reasonably good noise figure during pressing.

The process by which a picture is printed onto a disc, however, adds more impurities. These impurities will produce increased background noise. The sound quality, per se, will not change. Of course, if the background noise is high enough, some of the subtleties of high-frequency sound will be masked by this noise.

## Phono Cartridge Channel Balance

*Q. What is meant by "channel balance" in phono cartridges? —T.P.S. Filho, Rio De Janeiro, Brazil.*

A. By "channel balance" in a phono cartridge, we mean that we are discussing the difference in output from one channel of the cartridge to the other. The output voltage with an equal signal should be the same for each channel. Where there is a difference in output from one channel to the other, this difference is expressed in dB.

---

If you have a problem or question about audio, write to Mr. Joseph Giovanelli at AUDIO Magazine, 401 North Broad Street, Philadelphia, PA 19108. All letters are answered. Please enclose a stamped, self-addressed envelope.



An acknowledged world leader in loudspeaker design and engineering, KEF has developed a monitor-standard speaker system that is both small — only ¼-cubic foot in size—and truly “high” fidelity. While these objectives are not new, the Reference Series Model 101 speaker system represents the first time that both are available in one product.

The Model 101 is, therefore, ideal for use in locations where an accurate small speaker is required in keeping with the rest of a high quality audio system.

### System Design

Despite all the ingenious ideas that have been proposed by various speaker manufacturers over the years, the three basic parameters of Enclosure Volume, Bass Response and Efficiency are still related by unchanged physical laws. What is different is the thorough manner in which KEF engineers have, with the use of advanced technology, optimized the relationships between these parameters.

Starting with the premise that prospective Model 101 users will have substantial amplification available, KEF engineers achieved a response from this small enclosure of 90Hz–30kHz  $\pm$ 2dB (–10dB at 47Hz).

KEF's leadership in computer-aided digital analysis techniques enabled them to optimize the design of the drivers, crossover network and enclosure to achieve a Target Acoustic Response without repetitious trial and error experimentation. Much of this technology, which did not previously exist, has been applied to the design and production of a small high fidelity speaker system for the first time in the Model 101.

Once the desired prototype was completed, KEF applied the same unique computer-aided techniques developed for the production of the critically acclaimed Model 105, so that the sound quality originally achieved in the laboratory prototype will be available to every user.

In addition, the high standards of the computer-aided production and assembly procedures enable precision-matched pairs of stereo loudspeakers to now be offered. For example: every Model 101 driver is tested and matched to tolerances of better than 0.5dB, and crossover networks to tolerances of 0.1dB; each pair of drive units is matched not only to each other, but to the other components in the system as well.

### Loudspeaker Protection

The major problem with small, relatively less efficient loudspeakers is thermal overloading of the voice coils. KEF engineers have developed a unique self-powered electronic overload protection circuit, S-STOP (Steady State and Transient Overload Protector).

Musical peaks are generally of short duration, so tweeters can handle far in excess of their normal program rating. A similar situation exists with low frequencies and their effect on the bass unit. Consequently any form of fuse protection can reasonably limit the instantaneous peak handling ability of the system, yet fail to protect the system against a very high average power level. KEF's solution is to incorporate a protection circuit which takes into account the instantaneous power applied to each drive unit and also computes the length of time the signal is applied. The law under which it operates resembles very closely the temperature rise within the voice coil. A potentially damaging signal is immediately attenuated by about 30dB, and the full signal is automatically reconnected when it is safe to do so.

As a result, the Model 101, although only ¼-cubic foot in size, is fully protected against fault conditions when used with amplifiers of up to 100 watts per channel.

The Model 101 is obviously not your average “miniature” speaker system where the quality of sound or power handling capacity is compromised by the small size of the enclosure. Nor is it inexpensive. If you require a speaker system that is both small and truly high fidelity, visit your authorized KEF dealer for a thorough demonstration. For his name, write: KEF Electronics, Ltd., c/o Intratec, P.O. Box 17414, Dulles International Airport, Washington, DC 20041.



# KEF Reference Series Model 101:

## Accurate, Small, Protected.

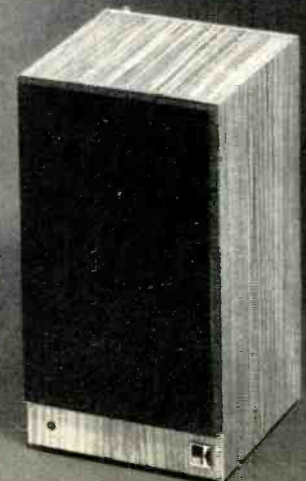

Enter No. 20 on Reader Service Card

# The Ins and Outs of Toroidal Transformers

John L. Brown\*

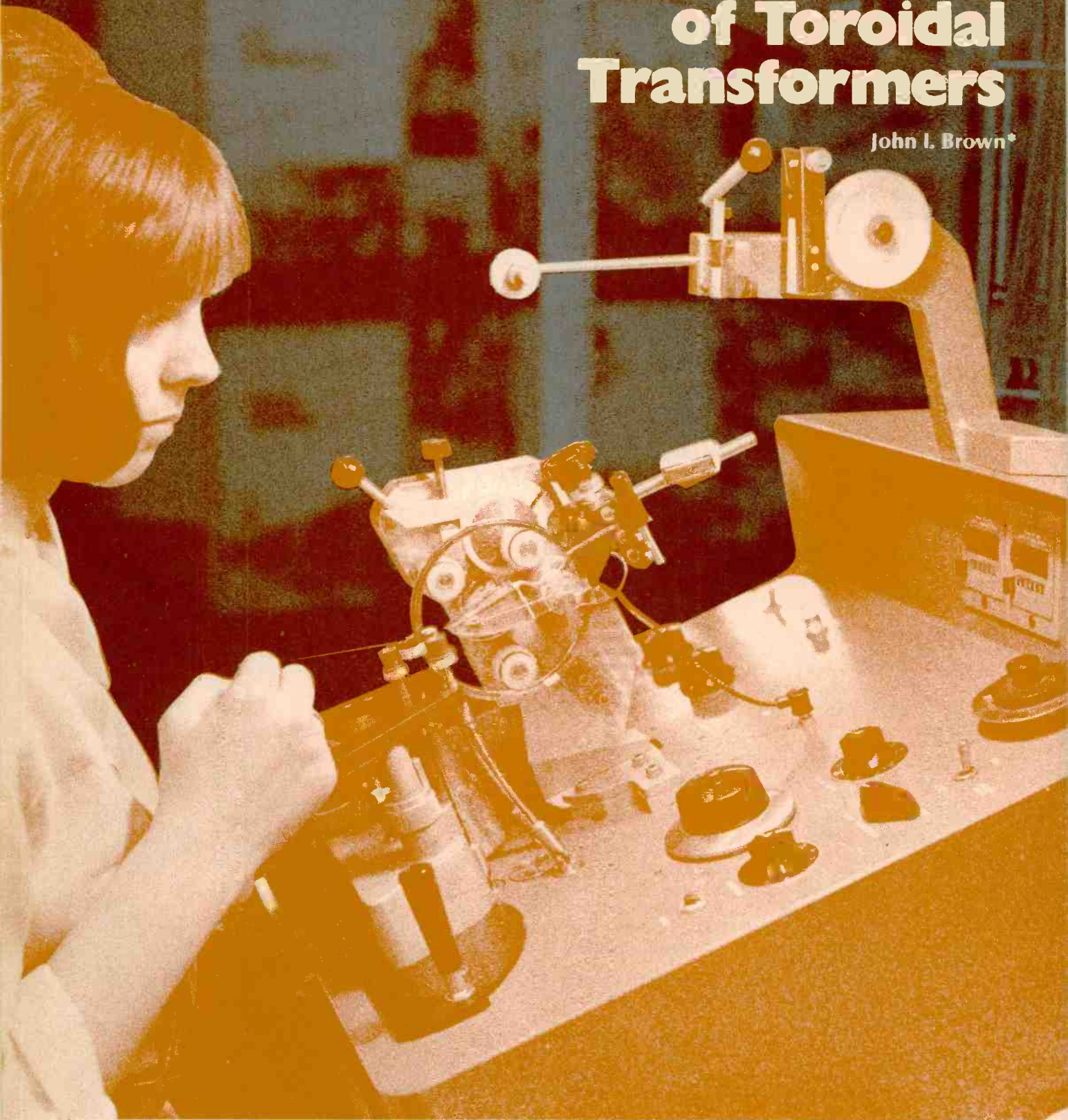



A problem common to all branches of electronics is the hum, both electrical and acoustic, which is generated by power transformers. Electrical hum is caused by stray magnetic flux leaking from the core and windings, and interacting with nearby conductors and components. Acoustic noise is caused by the laminations in the core literally being "flexed" by the magnetostrictive effect of the currents passing through the windings. An accident of design, because its inventor never had hum in mind, gives the toroidal transformer very considerable inherent advantages over other types of transformers when it comes to the suppression of hum despite the influences on audio design which seem to conspire to create a hum problem.

The introduction of veneer type laminates, synthetic surfaces, and constant changes in home furnishing fashions have meant that the industrial designer involved in the audio field had to produce equipment with less "battleship" and more "furniture" if his product was to be readily accepted as an integral part of the home. A typical example is the "slimline" trend where the height of the case has been considerably reduced, and trim good looks have become a marketing necessity. Any physical limitation, imposed by dimensional constraints, makes it that much more difficult for the designer to select a transformer and choose a site where it will not interfere with other circuits. The user has also demanded higher power from stereo amplifiers, with negligible noise, of course, and user requirements have also led to reduction in loudspeaker size with consequent lowering of efficiency so that higher power input is now needed to produce an equivalent sound level. This in turn requires a higher output from the amplifiers. The introduction of solid-state rectifier technology has also caused problems, as has the higher component packaging density brought about by component miniaturization and printed circuit techniques. The circuit engineer therefore faces a mounting difficulty, sooner or later, of what to do about the power transformer—that well-known generator of unwanted hum.

### Hum and Leaking Flux

The trouble with a transformer is, simply, that it depends on the creation and decay of an alternating magnetic flux field through its windings to perform its function in life. Any stray flux, leaking from the transformer, will in-

roduce an emf in any adjacent wiring or susceptible components and will cause hum at the a.c. line frequency. High-gain, high-impedance, low-signal-level circuitry is at greatest risk, which is why the old unwritten law of keeping the input circuitry as far away as possible from the power supply components always made good sense. In the days of tubes, if trouble from power transformer hum developed, then mu-metal screens (which attenuate magnetic flux), twisted pairs, screened leads, and hum-bucking windings could be employed if the transformer couldn't physically be moved to a position where it stopped being a nuisance. The smaller the equipment, though, the more difficult it becomes to find a satisfactory position. In certain instances, it is also necessary to use multiple mu-metal screens, which adds to the cost of the unit.

### The Gap

In the traditional wound-bobbin transformer, with E and I laminations stacked together to form a core, it is the air gap at the junction of the I across the three legs of the E that causes most of the trouble. The air in the gap has a high reluctance, or magnetic resistance, compared with the metal and the concentration of flux which results and radiates out into its surroundings.

The same effect, though to a lesser extent, occurs if the laminations have mounting holes or notches punched through them, because this imposes a localized concentration of the magnetic field and causes some of the flux to be spilled out. The answer to this problem is, obviously, "get rid of the air gap," and to this end, the C core type of construction is a definite improvement. However, even with the butting faces lapped, ground, and polished, a residual air gap remains, and so does some unwanted stray flux.

### Torus Concept

Theoretically, the ideal answer would appear to be to have a magnetic circuit without an air gap, and this can be achieved in practice using a ring or torus, wound from strip steel material rather like a tightly wound clockspring. Granted, with this system you can only wind one toroid at a time whereas you can multiple-wind bobbins, but a fair trade-off can be achieved, however, because you have to assemble the conventional core stack by hand from separate lamina-

tions. The mechanical construction of the toroidal core also has the inherent advantage that once it is wound, its magnetic properties can be measured before the windings are applied in the knowledge that they will remain constant throughout all subsequent operations. The windings are put on the core, using high speed machines, across the three outside faces and through the hole in the center so that they encompass the core. Impregnation, potting, and packaging in thermoplastic cases provide good protection from environmental hazards.

### Electrically Induced Hum

The pulsing magnetic field developed by an unscreened stacked-lamination type transformer can generate a flux leakage which extends completely through the entire spatial volume of a typical modern 100-watt amplifier. Where multiple channel amplifiers are involved, there is an additional problem of unequal demands for current which affect the regulation characteristics as the currents in the secondaries vary in sympathy with the different demands of each channel on the power supply. The use of separate secondary windings and rectifiers for each channel is desirable and, for the purist, two completely separate toroids can be mounted on top of each other and still be lower than a single stacked-lamination type.

The hum problem is not limited to low-level, high-gain stages, however, because it can also make itself a nuisance in the negative-feedback circuits of power amplifier stages. The combination of a "gapless" continuous magnetic circuit and the natural screening effect of the copper windings, which completely enclose the core of a toroid, give an 8:1 reduction in radiated field when compared with a stacked-lamination type as shown in the polar diagram (Fig. 1).

Where radiated magnetic fields are a problem, then the toroidal transformer is more likely to provide a solution without resorting to expensive mu-metal screening or completely reorganizing the circuit layout. Changing a layout might not have presented too many difficulties in a unit constructed with tagboards and discrete wiring because it was a relatively simple matter to reroute a couple of wires or move

•Chief Development Engineer,  
Avel-Lindberg Ltd.,  
South Kendon, Essex,  
England

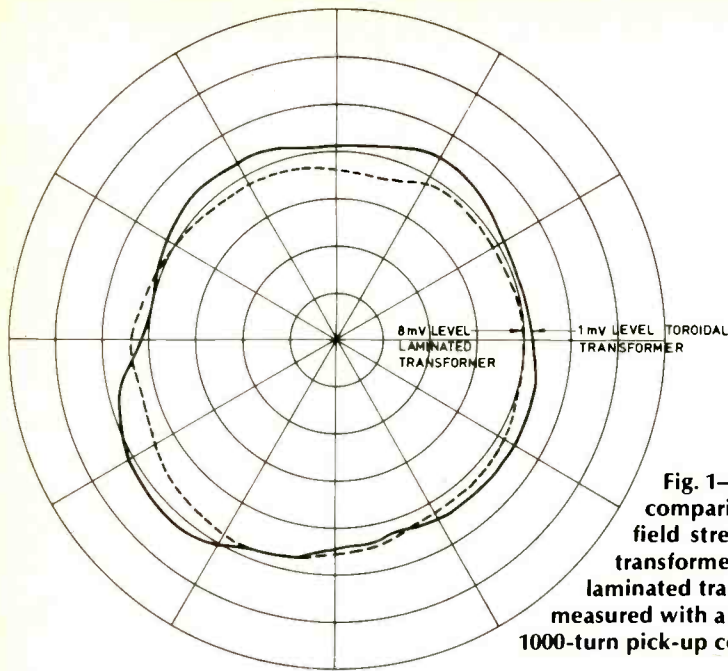

Fig. 1—A polar diagram comparing the radiated field strengths of a toroidal transformer (at 1 mV) and a laminated transformer (at 8 mV) measured with a standard 1000-turn pick-up coil.

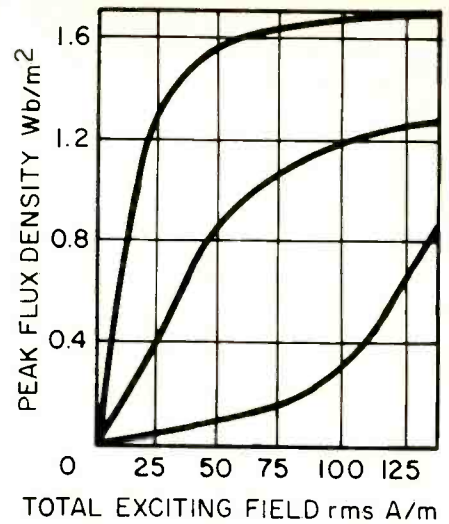
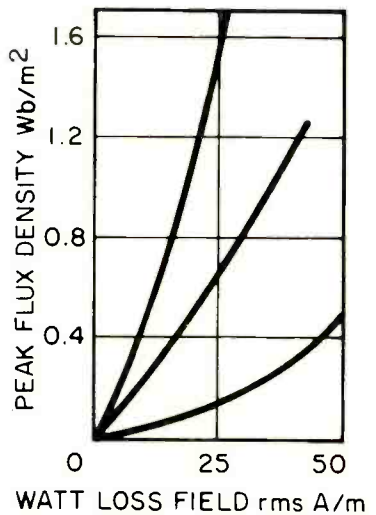

Fig. 3—Magnetic performance of grain-oriented steels is very dependent on grain direction.



some components around. If the circuitry is based on a printed circuit board, however, and hum is only detected at a late stage in the design, it can be an expensive business to modify a complex board layout. In this situation, toroids have often been used as a "last resort," before calling for radical design changes, and have proved entirely satisfactory.

### Acoustic Noise

The best known example of the noise generated by magnetostriction is probably the characteristic "ping" sent out from sonar devices used aboard ships for detecting submarines, fish shoals, or the depth of the sea bed. The current through the transducer causes the laminations to move and displace the medium in which it is mounted — water in the sonar example and air in the transformer example. In sonar it is a necessity; in audio equipment, however, it's the last thing you want from a transformer.

Advances or changes in circuit technology sometimes aggravate the problem of noise while trying to improve other features, e.g. high-voltage, low-current tube circuits with low-value filter capacitors (8 to 16  $\mu$ F) and high-resistance, high-tension windings operated at very low peak currents. The advent of low-voltage, high-current transistor circuitry, however, meant that very much larger (1,000  $\mu$ F) filter capacitors were needed for ripple reduction (smoothing), and these capacitors caused high peak currents to be developed. The general use of low-impedance silicon rectifiers, with large filter capacitors to smooth their d.c. supplies, resulted in the transformer current being in the form of large

Fig. 2—The physical advantages of toroid transformers are demonstrated in this photograph of a 90-VA toroid transformer compared with a similarly rated conventional transformer. The toroidal transformer is 1.8 in. H and 4.2 in. diameter, with a weight of 3 lbs.; the conventional transformer is 3½ in. H x 3½ in. L x 3½ in. W.



pulses with steep edges lasting only a fraction of each half-cycle of the a.c. supply. Typically, the secondary winding feeding the rectifiers of a power supply for a 100-watt audio amplifier delivers pulses in the order of 15-A peak and 2-mS duration at a pulse rate frequency of twice the supply frequency. The harmonics resulting from the sharp pulses begin in and extend well up into the audio range. In the case of a stacked and laminated transformer, the core can be clamped (but, of course, screw holes distort the field), and heavy impregnation helps a little to damp down the noise. The toroidal transformer, however, has a much higher core packing density and is almost a solid ring to start with because it is wound from strip under constant tension. It is capillary impregnated and then the copper windings are wound round the circumference, which in itself is a clamping operation, and also has a damping effect on any sound that is generated.

### Core Material

As a general rule the toroidal transformer is smaller and lighter than a stacked laminated type — of equivalent VA rating and function — mainly because the core material is used more effectively (Fig. 2). The strip is manufactured from grain-oriented silicon

steel (GOSS) and wound so that all the molecules in the metal point in the same direction as the flux. Any molecules out of this alignment increase the reluctance (magnetic resistance) and therefore progressively degrade the performance until, at 90 degrees out of phase, they reduce the effectiveness to that of ordinary mild steel. With a stacked-lamination core, it is possible that at least 40 percent of the total core area will be at 90 degrees to the required grain direction and another 40 percent will be effective only as a return flux path. A smaller transformer — and the savings can be in the region of 50 percent in volume and weight — means greater flexibility in the choice of mounting position and a greater probability of being able to site the transformer where it will not cause interference.

### Core Geometry

The use of strip steel as the core medium enables the transformer designer to produce a large number of variations in core sizes from a single strip width, and this gives more flexibility to the circuit designer who may require a different width-to-height geometry from the optimum two to one. If there is plenty of room for diameter and little height, then a three-to-one ratio could be used, and if space is at a premium then a ratio of 1.5 to 1 could be supplied. In the slimline-styled equipment, the toroid has the obvious

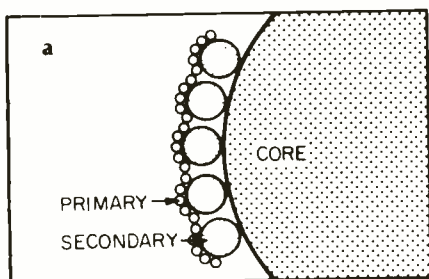
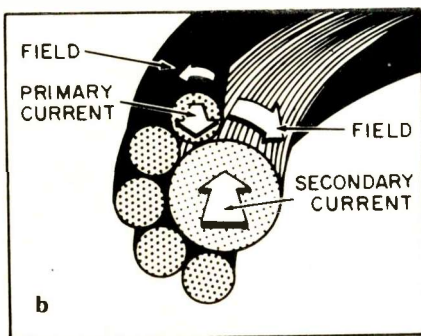

Fig. 4—Even distribution of the primary over the secondary in, a, ensures that the magnetic fields generated in the windings cancel, b.



Nominal Rating	20	20	130	130
Transformer Type	Toroid	Laminated	Toroid	Laminated
Radiated Field (mV) at 7.5 cm from center of transformer	1	7	—	—
Radiated Field (mV) at 11 cm from center of transformer	—	—	1	8
Radiated Field (mV) at contact with transformer	3	10	20	40
Magnetizing Current (mA)	3	36	10	110
Off-load Power Consumption (VA)	0.72	8.64	2.4	26
Iron Loss (W)	0.4	3	1.8	7.5
Copper Loss (W)	2	3	10	9
Total Losses (W)	2.4	6	11.8	16.5
Regulation (%)	10	10	8	7
Temp. Rise (°C)	40	40	45	45
Weight (g)	400	660	1500	3000
Length (mm)	70	70	95	84
Depth (mm)	70	50	95	90
Height (mm)	30	58	50	98

Table I—Comparison of Two Toroid vs. Two Laminated Transformers.

advantage of presenting a very low profile compared with a stacked type, but this is not the only area where the toroid scores because, in any equipment, single point fixing, coupled with low weight and a low center of gravity, helps the engineering.

### Efficiency

With full advantage being taken of all the grain orientation being in the preferred direction and having no air gap, the toroidal core can be operated at a flux density of 1.6 Tesla (16,000 Gauss) to 1.8 Tesla (18,000 Gauss), while a stacked-lamination transformer would be limited to the 1.2 Tesla (12,000 Gauss) to 1.4 Tesla (14,000 Gauss). This higher efficiency means that the alternatives of using less magnetic material or fewer turns are available to the designer. The iron losses are much less significant in a toroid because the reluctance is so low, and therefore it is often the required physical size that determines the core material, not the losses. The higher efficiency also means that there is less heat generated, and a value of 0.4 watts per square inch of surface area is a reasonable midrange target. The toroidal transformer designer can therefore trade off size against efficiency.

The toroid also saves power, and comparison between the low magnetizing current (which is being drawn the whole time the transformer is connected to the power supply, no matter if secondary current is being drawn or not) of a toroid and that of a laminated transformer amply demonstrates this point. Comparison between the other losses, which also consume power to no good effect, make quite interesting reading (see Table I).

### Mounting

The toroid might well have been designed originally with printed circuits in mind because the center hole fixing, the low center of gravity, and the PC

Fig. 5—Mounting methods for toroidal transformers.

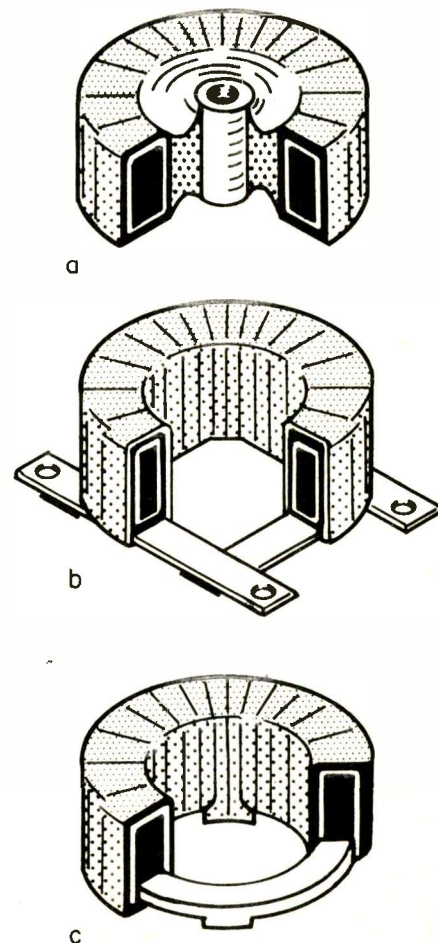



**fact:**  
**it's easy to upgrade  
 your M95 cartridge  
 and gain dramatic  
 freedom from  
 distortion**

One of the critically acclaimed advances introduced in Shure's incomparable V15 Type IV phono cartridge is its revolutionary and unique distortion-reducing Hyperelliptical diamond stylus.

The Hyperelliptical stylus contacts the groove in a "footprint" that is narrower than both the Biradial (Elliptical) and the long-contact shapes such as the Hyperbolic. The performance features of this new tip geometry are now available to owners of M95ED or M95G cartridges by simply upgrading either with a Model N95HE Hyperelliptical stylus.

You'll find the cost extraordinarily low—but the difference in sound will be immediately apparent. The new stylus takes only seconds to install with a simple, no-tools procedure.

The Hyperelliptical stylus is also available in a brand new, ultra-flat frequency response, high trackability cartridge: the M95HE. Write for free brochure (AL600).

**N95HE  
 Improvement Stylus**



Shure Brothers Inc.  
 222 Hartrey Ave., Evanston, IL 60204  
 In Canada:  
 A. C. Simmonds & Sons Limited

MANUFACTURERS OF  
 HIGH FIDELITY COMPONENTS,  
 MICROPHONES, SOUND SYSTEMS AND  
 RELATED CIRCUITRY.

Enter No. 51 on Reader Service Card

**Fig. 6—Comparison between toroid core and laminated E and I core showing differences in grain direction.**

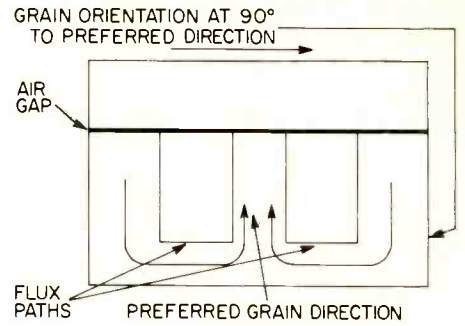
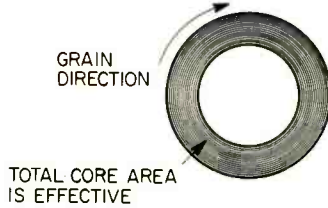

board compatible pins enable it to be mounted at the same time as the other major components and flow-soldered using standard production techniques. The availability of a library of entirely "standard" designs also gives the circuit designer the facility of having the "standard range" dimensions — pin layout, fixing drilling ordinates, and track constraints stored as macros in PC board computer-aided drafting systems. In this way the transformer details can be laid down simply by pressing a single key; the computer can also be programmed to take into account the various constraints regarding track widths and spacings to take the current involved.

**Summary**

When presenting a summary of the technical advantages of toroidal transformers, there is a danger of establishing a credibility gap by overkill. There is a tendency for the uninitiated circuit designer to speculate "if they are that good, they must be expen-

sive." The simple fact is that it is harder to make a comeback than to start from scratch.

The eight-to-one lower radiated field has been demonstrated, and the acoustic quietness is self-evident when the method of construction is investigated. A working flux density of 1.7 Tesla (17,000 Gauss) for the all-in-line grain-oriented toroid, as against 1.3 Tesla (13,000 Gauss) for a conventional transformer, is inherent in the design; as are iron losses of typically only 0.46 W/lb. (Fe) as against 1.25 W/lb. (Fe). The absence of the air gap means the toroid only requires a magnetizing current of one-tenth of that needed by a transformer with a gap. Center-hole, single-point mounting, coupled with the ability to mount the toroid directly onto a PC board, make the production engineer's life easier. The typically 50 percent lower weight and volume, with the lower height profile, must also contribute to easing the designer's ulcer when space is at a premium in high-component density equipment.

The toroid is certainly the oldest type of transformer; in fact, Faraday wound the first ever. But modern winding techniques coupled with advances in wire technology, especially in insulation, have enabled its manufacturers to produce a product of considerable benefit to contemporary circuit designers. The advantages, which stem largely from characteristics inherent in the toroidal construction, will commend the toroid to designers with transformer problems, and in their next project they are likely to specify a toroid as the prime choice as a matter of course. In the past, the toroid has suffered from its own negative feedback effect, where small quantity production kept costs up and the small numbers in use meant that the toroid did not warrant a very prominent place in the educational syllabus for electronic engineers. This educational gap meant that only the "enlightened" specified toroids and, because of the cost penalty, only when any other type would not do the job.

**Fig. 7—The winding process.**

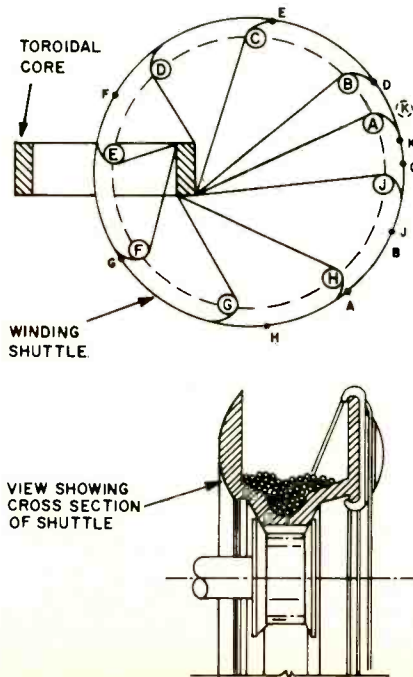

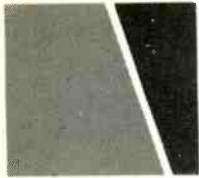

# fact: professional studio technology comes to home hi-fi!



There is a new phono cartridge line that is the talk of the recording and broadcasting industries: the Shure SC39 Series. It is the first professionally optimized combination of true high fidelity performance, superb trackability, resistance to stylus damage under grueling conditions, and prolonged record life. These unique features make the SC39 ideal for high quality home applications as well.

## if you transfer discs to tape

Use the cartridge developed for professional recording studios. The SC39 Series has a special strengthened internal stylus-support wire and elastomer bearing to improve stability when professional backcuing and slip-cuing techniques are employed.

In addition, the SC39 offers a unique stylus tip *not available on any other cartridge*: the MĀSAR™ tip, designed for playing even delicate lacquer masters, without objectionable noise buildup or "cue-burn" damage. It even helps when playing discs with high surface noise, or 45 rpm records made from reprocessed, substandard vinyl or polystyrene.



## if youngsters have access to your hi-fi



This cartridge also comes close to being "butterfinger-proof." Most stylus damage is caused either by dropping the cartridge or by pushing the stylus sideways against the edge of a record. To protect against this, the SC39 is equipped with two remarkable features. The first is the *Lever-Operated Stylus Guard*, which locks the stylus guard in safety position when not in use. With the flip of a thumb, the guard snaps up and the operating lever turns into a handy cueing aid.

In addition, the *SIDE-GUARD Stylus Deflector* protects the stylus shank from damage by withdrawing it safely into the cartridge body in response to sideways impacts.

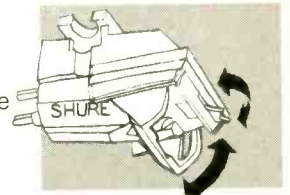

Lever-Operated Stylus Guard

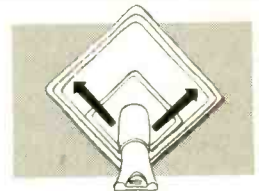

SIDE-GUARD Stylus Deflector

## if you prefer professional response

The transparent sound of the SC39 Series is due to its optimized professional response which is virtually flat through the upper mid-range, with a smooth and gentle rolloff at the highest frequencies. It is especially pleasant when used with loudspeakers that tend to exaggerate the high frequencies.

There are three models in the SC39 Series: SC39ED—Biradial (Elliptical) stylus for ¾ to 1½ gram tracking; SC39EJ—Biradial (Elliptical) stylus for 1½ to 3 gram tracking; and SC39B—Spherical stylus for 1½ to 3 gram tracking.

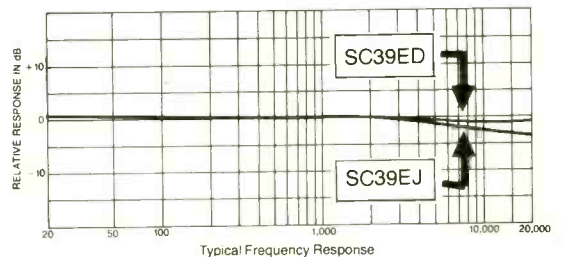

Send for brochure AL620.

# SC39 series professional phono cartridges... by



Shure Brothers Inc., 222 Hartrey Ave., Evanston, IL 60204

In Canada: A. C. Simmonds & Sons Limited

Outside the U.S. or Canada, write to Shure Brothers Inc., Attn: Dept. J6 for information on your local Shure distributor. Manufacturers of high fidelity components, microphones, sound systems and related circuitry.

Enter No. 52 on Reader Service Card

# Picking at the Congress

Peter W. Mitchell

Americans buy about a billion dollars' worth of hi-fi components each year, and much of that hardware comes from the large manufacturers whose names everyone knows — Pioneer, Bose, Kenwood, Advent, etc. But one of the major trends in the audio industry is the proliferation of independent small companies, manufacturing a small number of products each of which represents a particularly thorough and thoughtful design effort by just one engineer or a small staff.

In the October and November issues of *Audio*, Bert Whyte described many of the exotic and innovative new products on display at last summer's CES, including some of the most advanced designs seen (and heard) at the Pick Congress. But there are so many companies designing new products these days, with so many exhibits both in the Pick and other hotels as well, that even the highly peripatetic Mr. Whyte was not able to cover them all, even in two months' worth of columns. So in the following paragraphs we will look at a few more of the provocative products seen last summer at the Pick; given the usual delays in starting up production of new designs, some of these components will just be arriving in retail stores when this issue gets to you. Being a dollar-conscious New England Yankee myself, I will concentrate mainly on products with non-exotic price tags, if only to show that a thoughtful and innovative design needn't cost as much as a new car. And rather than providing a laundry list of new products, I will focus on the ideas and concepts which stand behind them — new ideas worth knowing about and a few old ideas which deserve another look.

## Amplifiers

Discussions of new amplifiers often revolve around exotic technology — FETs, ring-emitter transistors, floating-bias output circuits, slew rates measured in hundreds of volts per microsecond, etc. But there is another school of amplifier design which suggests that while these improvements may be audible under idealized conditions, much larger differences in amplifier performance arise under typical

operating conditions which are not considered in the design lab. By rigorously analyzing amplifier misbehavior modes and thoughtfully applying non-exotic technology, a surprisingly clean and musical amplifier can be produced at reasonable cost.

As a trivial example, an "ideal" amplifier might have vanishingly small levels of transient intermodulation or slew-induced distortions (TIM and SID), obtained by making the amplifier have very fast response from d.c. to television frequencies. But in typical real-world audio systems, all of the signal energy found at infrasonic and ultrasonic frequencies consists of distortion and interference whose amplification and delivery to the speaker yields no benefit and may produce audible intermodulation products *within* the audible range. By designing and placing a minimum-phase, audio-bandpass filter ahead of the output stage, the designer can prevent a common real-world problem, eliminating a cause of unclear sound. At the same time this provides a gentle limit to the rise times in the input signal, thus ensuring that the output stage can never be driven beyond its slew-rate capability. The result is an amp which is free of TIM or SID without exotic and costly ultra-high-speed output devices.

A more serious set of real-world problems arises because amplifiers are *designed* to drive 8-ohm test resistors but are *used* to drive loudspeakers whose minimum impedance is usually lower than specified, partly reactive, and may become increasingly nonlinear at high volume levels. In a simple experiment to measure the current flowing through loudspeakers while they were reproducing music, I have observed current peaks of plus and minus eight amperes (i.e. 16 amps peak-to-peak) in simple drumbeats played by America's best-selling "8-ohm" loudspeaker. With "4-ohm" speakers, or two 8-ohm speakers wired in parallel, this current requirement might have doubled. Very few of today's amplifiers, regardless of their exotic technology, are designed to provide such output currents to the speakers. Furthermore the impedance of a typical loudspeaker is partly reac-

tive, i.e. inductive and capacitive as well as resistive, so currents and voltages tend not to be in phase. As a result, it is not uncommon to find an amplifier's protection circuit producing audible distortion at output levels lower than the amp's rated power. VI (voltage-current) limiters commonly work by feedback, altering the input signal in an attempt to keep the output within the prescribed "safe-area" bounds prescribed for the output transistors.

The object of this prelude is to suggest that audible differences among amplifiers under typical operating conditions often depend as much on the amplifier's interface with the loudspeaker as on conventional performance parameters such as the distortion and slew rate measured when driving a resistor on the test bench. By minimizing or eliminating the influence of protection circuits on the amplifier's sound, a remarkably high level of performance may be obtained from an amplifier with non-exotic specifications. It is possible, for example, that the notably fine sound of the MOS-FET power amplifiers which have been introduced by Hitachi and Hafler is not due only to the high speed of the MOS-FET; it probably is also due to the MOS-FET's negative thermal coefficient and consequent resistance to self-destruction, leading to circuit designs which require unusually little VI limiting for protection.

Two new amplifiers seen at the Pick Congress exemplify this design approach but use "conventional" bipolar transistors. One of these is from NAD, an international company which has a headquarters in London. NAD decides what products it wants to create and farms out their actual manufacture to specialized independent factories around the world (e.g., NAD amplifiers and tuners are assembled in Taiwan, their turntables are from England, and a moving-coil cartridge comes from Japan). They had the most incongruous display at the show: A simple-looking little \$175.00, 20-watt Model 3020 integrated amplifier driving the big Acoustic Research AR-9s. It didn't reach disco volume levels, of course, but its sound was clean, trans-

# At last a moving coil cartridge you can recommend to your best friend!



Model AT30E: \$125.00

## New AT30E Stereo Phono Cartridge with Vector-Aligned™ Dual Moving MicroCoils™ and user-replaceable Stylus

The subtle, yet unique characteristics of moving coil cartridges have had their admirers for years. A top-quality moving coil cartridge exhibits remarkable sonic clarity and transparency. This performance can be attributed to the very low mass, and low inductance of the tiny coils used to sense the stylus motion.

But until now, moving coil cartridge popularity has been limited by three major problems which seemed almost inherent to moving coil designs.

1) It seemed impossible to make a user-replaceable stylus assembly without compromising performance; 2) most moving coil cartridges exhibited relatively low tracking ability due to rather stiff cantilever mounting systems; and 3) output of the cartridge was below the level needed for commonly available amplifier inputs.



Introducing the new Audio-Technica AT30E and the end to all three problems! Our design approach is simple and

direct. Rather than locate the coils in the cartridge body, they are integral with the stylus assembly. If the stylus becomes worn or damaged, the *entire* moving system, coils and all, is simply unplugged and replaced, just like a moving magnet cartridge. Large, gold-plated connectors insure loss-free connections so vital at the low voltages generated by a good moving coil cartridge. The result is easy field replacement with no penalty in terms of performance.



Careful research indicated that good tracking and moving coil design were not incompatible. By controlling effective mass and utilizing a radial damping system similar to our famed Dual Magnet™ cartridges, we have achieved

excellent tracking ability throughout the audio range. Compliance is individually controlled during manufacture of each assembly to optimize performance. This extra step, impossible with most other designs, coupled with our unique radial damping ring, insures excellent tracking of the high-energy modulation found in many of the top-quality recordings now available.

Each coil is located in the ideal geometric relationship to reproduce "its" side of the record groove. This Vector-Aligned™ design assures excellent stereo separation, minimum moving mass, and the highest possible efficiency. It's a design concept which is exclusive to Audio-Technica, and a major contributor to the outstanding performance of the AT30E.

We can't take credit for solving the low output problem. The AT30E output is similar to many other fine moving coil cartridges. But an increasing number of amplifiers and receivers are featuring built-in "pre-amplifiers" or "head amplifiers" to accommodate moving coil cartridges directly. Thus the new systems buyer can make a cartridge choice based on sonic characteristics rather than on input compatibility.

In addition, Audio-Technica offers the Model AT630 Transformer for matching to conventional amplifier inputs.

The new Audio-Technica AT30E Dual Moving MicroCoil Stereo Phono Cartridge. With the introduction of this remarkable new design, every important barrier to full enjoyment of the moving coil listening experience has been removed. Progress in sound reproduction from Audio-Technica... a leader in advanced technology.



parent, and detailed at levels substantially higher than what we usually expect from a low-cost budget amp. I am reminded that Paul Klipsch used to remark that what the world needs is a good five-watt amplifier (to drive his high-efficiency Klipschorns); in our pursuit of the state of the art, we often neglect the needs of people whose bank accounts won't accommodate kilowatt amplifiers and whose neighbors won't tolerate wall-rattling volume levels. Stereo systems which produce only a modest quantity of sound need not be equally limited in quality. The NAD 3020's sonic performance probably can be credited to several factors — the use of large output transistors normally seen in 60-watt amplifiers, with voltage and current ratings sufficiently conservative that VI limiting never occurs in use; enough output current to drive even 2-ohm loads; a phono preamp which is unusually elaborate for a budget amp; a "soft clipping" circuit which minimizes power-supply buzz and even-order

maintain a large dynamic headroom with load impedances of 8-16 ohms, or set it to provide the lower voltages and larger currents required for high peak output into 2- to 4-ohm loads. Since listeners usually don't know the true impedance of their speakers, a VI comparator monitors the output voltage and current flow and activates a front-panel light to tell the user which way to set the transformer switch.

Apt also displayed a mockup of their Model 2 amplifier, a more exotic design which will be released next spring. It employs MOS-FETs (in multiples for large current capacity) and a Class-D switching power supply which eliminates the usual bulk of a large power transformer and filter capacitors. The Model 2, like the Model 1, is about the size of the Apt preamp and has a rated output of 200 watts/channel continuous and 800 watts/channel for transients! Normally MOS-FETs require a lot of heat-sinking because of their quiescent power dissipation (high idle current combined with the

## Loudspeakers

My attention was drawn to the H/H amplifiers by the speakers that they were driving at the Pick: The Dayton-Wright XG-10 full-range electrostatics. It is risky to judge loudspeakers on the basis of first impressions in a hotel-room show; any conclusions must perforce be tentative. But while the earlier Dayton-Wrights had generally struck me as sounding a bit hard, my first impression was that the reproduction of both vocals and instrumentals through the XG-10 was startlingly realistic and uncanned. Such quality doesn't come cheap of course, \$2,900.00 for a pair. But that doesn't seem exorbitant by the standards of today's exotic loudspeakers.

Having delivered my disclaimer about trusting first impressions at shows, I must now echo Bert Whyte's enthusiastic comments about the remarkably uncolored, wide-range sound of the Bowers & Wilkins 801 (\$2,500.00 per pair). In the carnival-like atmosphere of the show, the B & W rooms were a model of thoughtful attention to program material, room acoustics, and the aesthetic values of music. At any show one can always count on Allison Acoustics, too, for a similarly relaxed and civilized atmosphere with well-chosen music.

The principal trend visible in current speaker designs is the attention being paid to the control of reflected sounds that can bounce off the speaker's own cabinet or off nearby surfaces such as walls and floor. A decade ago at AR, Allison and Berkovitz discovered the irregular response that arises from the woofer's boundary reflections, and Allison Acoustics pioneered the increasingly popular column design with the woofer placed at the floor/wall intersection. But so far other manufacturers have not applied the same principles to smaller bookshelf speakers — in which the woofer ends up on the top or side of the cabinet, next to the wall, with the tweeter on the front. The new Allison Six is a particularly compact implementation of this approach, in the form of an 11-in. cube. Its spacious stereo sound field was not surprising, but its clean, deep bass output was — particularly when the Allison Electronic Subwoofer was used to dig into the recording and bring its bottom-octave bass up to audible levels.

There's a new speaker company formed every week or so, and one of the more promising is Boston Acoustics, founded by Andrew Petite and Frank Reed after they left Advent. Their first speaker, the A200, is quite un-Adventish in appearance and

---

## The products of independent designers are worth examining because in some cases they will turn out to be the harbingers of new trends.

---

harmonics when the amplifier clips, and a high IHF dynamic headroom factor.

The second amplifier which exemplifies these ideas is the Model 1 power amp designed by Tomlinson Holman and his colleagues at Apt Corp. It uses newly developed bipolar output transistors with an exceptional combination of ruggedness and speed, yielding high slew rates and very high peak output currents without the limitations imposed by VI limiting. This power amp is nearly the same size as the well-known Apt/Holman preamp and is rated at 100 watts/channel; with a dynamic headroom of 3 dB, it actually exceeds 200 watts/channel on musical transients into either 8- or 4-ohm load impedances and maintains strong output down to 2 ohms. Its power transformer has two sets of secondary taps which are selected by a rear panel switch; depending on the true impedance of his loudspeakers, the listener can set the transformer to supply the large voltage swings required to

high power-supply voltages required for large rated power output), which would make the compact size of the Apt 2 impossible. So the Model 2 doesn't use fixed power-supply voltages; instead an active "smart" supply is used, producing supply voltages which vary over a broad range to track the audio signal. The compact size of the celebrated Carver "magnetic" amplifier is based on a similar principle — forcing a supply voltage to track the audio input so that the quiescent dissipation is low at normal levels while a large voltage swing is generated on demand to accommodate loud passages and transients.

Currently all of the MOS-FET amps announced so far have names beginning with H: Hitachi, Hafler, Holman (Apt), and H/H Electric of Cambridge, England. H/H has developed a line of amps employing fewer or more of the devices to yield rated outputs of 60, 150, or 200 watts/channel, with the option of bridged mono operation to yield 250, 500, or 800 W respectively.



# Perfection for the Professional

Drawing upon their unequalled 30 year leadership in magnetic recording technology, Tandberg's TD 20A open reel tape recorder extends their traditionally superior level of performance to even further limits—to even beyond the present capabilities of today's magnetic recording tape! This is due to Tandberg's exclusive ACTILINEAR Recording System, which not only provides up to 20 dB headroom margin over existing tape, but is specifically designed to be used with the new high coercivity tapes that will appear in the market in the near future—including the soon-to-be-available metal particle tapes. No other quality open reel tape recorder can make this obsolescent-proof claim today.

The ACTILINEAR Recording System's extremely linear frequency response ("ruler flat" according to some test reviewers) not only makes the TD 20A essentially immune to slow-rate limiting and transient intermodulation distortion (TIM), but also means better transient response and lower distortion overall.

Adding to the TD 20A's superior level of quality & performance is its unique PROM computer-controlled four-motor transport, as well as its many standard operating features that permit a degree of performance and control flexibility that you would expect only from Tandberg—the world leader in tape recorders.

Visit your authorized Tandberg dealer for a demonstration of the TD 20A. Check our *guaranteed minimum specifications* and rate them against any other manufacturer. Combined with the unsurpassed ease of operation & control, the TD 20A is probably more tape deck than you actually need. Isn't it the way things should be?

For your nearest dealer write:  
Tandberg of America, Inc.  
Labriola Court  
Armonk, N.Y. 10504

**TANDBERG**

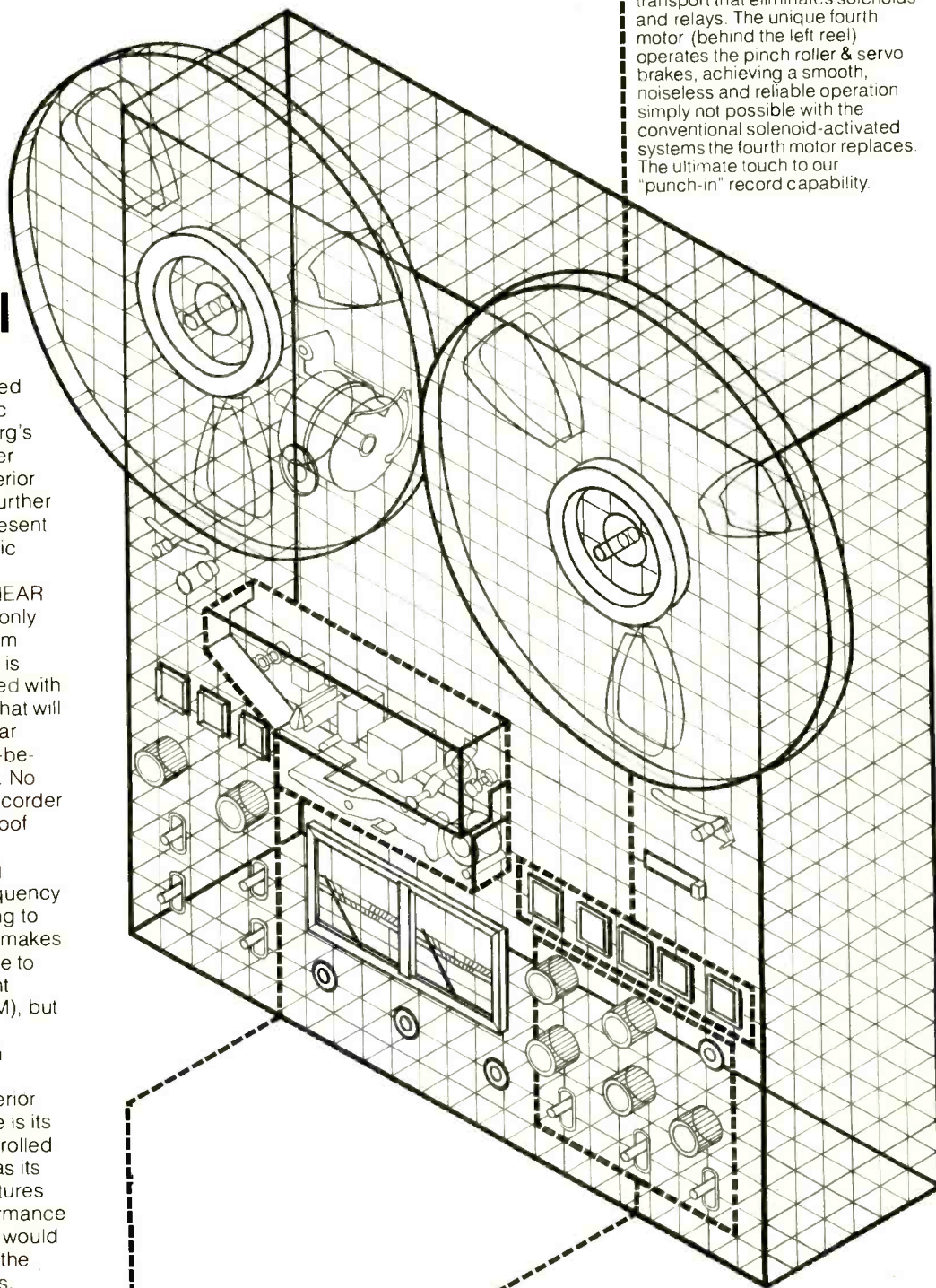

Tandberg's exclusive PROM computer-controlled four-motor transport that eliminates solenoids and relays. The unique fourth motor (behind the left reel) operates the pinch roller & servo brakes, achieving a smooth, noiseless and reliable operation simply not possible with the conventional solenoid-activated systems the fourth motor replaces. The ultimate touch to our "punch-in" record capability.

Tandberg's unique ACTILINEAR Recording System, offering up to 20 dB headroom margin over existing tape. And easily adjustable for use with the new high coercivity tapes to come, so your TD 20A is obsolescent-proof!

Still more features: Four line input mixer + Master gain control with pre-set, Self adjusting input amplifier, Front-panel bias adjustment, Mic sensitivity switch, Channel Sync & Sound-on-Sound, "Free" mode & Edit/Cue facilities, Infrared-controlled motion sensing device, Professional scrape-flutter filter, Separate power supplies for operational functions & audio functions, and Peak-reading equalized meters that have been graphically redesigned for easier reading.

Optional PCM infrared wireless remote control for an ease of operation that doesn't tie you down to the length of a cable. Plus automatic start & stop via a timer switch (optional).



Enter No. 53 on Reader Service Card

sound; in fact, it doesn't look like any of the more traditional Cambridge bookshelf speakers. It's a floor-standing unit, only a few inches thick, 1½ ft. wide and 3½ ft. tall, with its 10-in. woofer near the bottom behaving as if it were mounted at the floor/wall intersection and radiating uniformly into that 90-degree solid angle with all boundary reflections in phase with the woofer's direct output. The midrange and tweeter, flush-mounted in a very large front-panel area and more than a half-wavelength away from any cabinet edges, radiate rather uniformly into a 180-degree solid angle. As a result the speakers have a remarkably uniform tonal quality over a large listening area.

A couple of really small speakers drew a lot of attention at the Pick: The KEF 101 minis mounted in midair on slim poles (like microphone stands), and the Cizek KA-1 minis beautifully finished in Hawaiian koa wood with a companion common-bass subwoofer also finished in the same wood — a striking solution to the perennial problem of integrating hi-fi technology into a gracefully appointed living room.

#### Phono Cartridges

Historically there have been numerous obstacles to widespread accept-

ance of moving-coil pickups by American audiophiles — low output voltage (requiring the addition of a preamp or transformer), a typically massive cartridge body (implying low compliance and mediocre low-frequency tracking), a tipped-up high end with undamped ultrasonic ringing, styli that were not user-replaceable, and a retail price substantially higher than the better moving-magnet designs. Happily these obstacles are gradually becoming overcome, though not all in any one model. For example, new MC pickups from Adcom and NAD have joined the family of high-output-voltage models from Satin and Dynavector, feeding directly into the standard RIAA phono input without any step-up device (though, for the benefit of listeners who have already made that investment, the Adcoms are optionally available in low-voltage versions as well). Adcom's head, Newton Chanin, was previously an Ortofon executive, and the Adcom Crosscoils (so called because their coils are symmetrically wound on an X-shaped armature), will retail for around \$200.00. Adcom personnel conducted a showdown at the Pick, an on-the-spot comparison versus many of the best-known MC pickups from Fidelity Research, Denon, etc.

The Adcom and NAD pickups are made in Japan, in part because a high-output MC cartridge requires a large number of turns of extremely fine wire to form each coil — involving specialized techniques and equipment not widely available. The NAD 9000 costs only \$160.00 and has a total weight of 6 grams, less in both respects than some of today's moving-magnet pickups. The NAD has an internal electrical damping network which eliminates ultrasonic ringing and yields an unusually flat response. Meanwhile Satin has announced a new model in its popular 117 series, an MC pickup whose stylus assembly is user replaceable.

Yamaha and JVC have taken another approach to the problem of winding consistently good coils; instead of wire they employ tiny bits of IC substrate on which a delicate spiral conductive pattern has been photo-etched. One more aspect of cartridge design is receiving fresh attention: The cantilever bar which carries the stylus vibration up to the coil/magnet assembly. New MC pickups from Sony and Onkyo employ carbon fiber, Yamaha's MC-1 employs a beryllium rod, and Dynavector's Karat 100R has a solid ruby cantilever and a proportionally exotic price. A

## The Dry System by Audio Groome

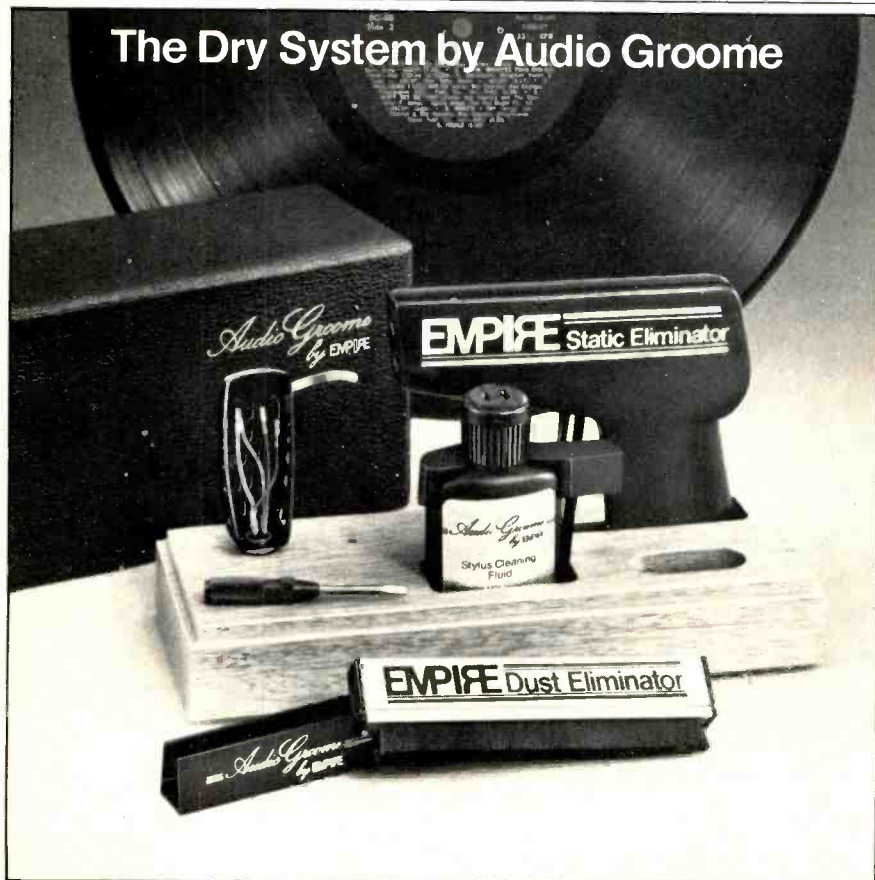

## Record care that leaves behind clean sound, not chemicals.

Housed in a solid mahogany base with removable leatherette cover, the Dry System is a combination of Audio Groome products designed to prolong the life of your record collection. The position of each item within the package has been carefully considered so that when placed next to your turntable, the most frequently used are the most accessible.

1. Empire Static Eliminator: Millions of positive and negative ions are released to effectively neutralize the entire surface of the record. It stops dust before it starts.
2. Empire Dust Eliminator: Microbristles reach deep down into record grooves to lift dirt out with thousands of electrically conductive carbon fibres which neutralize the static charges that attract dust.
3. Empire Stylus Cleaning Kit: Built-up dirt on the stylus can disfigure the record grooves and ruin the stylus. Our special formula fluid and brush keeps your stylus free of dirt, helping to prolong record life.
4. Empire Universal Headshell: Many of today's audiophiles use more than one phono cartridge. This additional lightweight aluminum shell allows switching cartridges without constant remounting.
5. Empire Audiophile Screwdriver: The perfect tool for minor adjustments.

For complete information on Audio Groome accessories write to:  
Empire Scientific Corp., Dept. AG, Garden City, NY 11530.

EMPIRE EMPIRE EMPIRE EMPIRE EMPIRE EMPIRE EMPIRE EMPIRE EMPIRE EMPIRE EMPIRE EMPIRE

Enter No. 14 on Reader Service Card

*Audio Groome by* EMPIRE

ADC has four Sound Shaper<sup>®</sup> frequency equalizers that will improve your sound system. No matter how good it is. And at a cost that's lots less than trading in your components.

ADC Sound Shapers will improve your speakers. By extending the true bass response, including the critical mid bass.

ADC Sound Shapers will improve the relationship between your cartridge and speakers. From one of partial incompatibility to total compatibility.

They'll also eliminate rumble (low frequency overload), tape hiss and record scratches.

And that only scratches the surface of what ADC Sound Shapers can do. For instance, the walls, carpeting and furniture of your listening room physically bounce sound around so that some spots have less sound than other spots.

Lots less. ADC Sound Shapers will bring these "dead" spots to life.

Perhaps best of all, though, is a Sound Shaper's ability to let you re-equalize what a recording engineer mixed. If a horn section is overwhelming a piccolo, for example, you just slide the appropriate frequency lever. Presto, more piccolo. You can also vanquish a voice. Or boost a tuba.

Sound Shapers segment the entire spectrum of sound. To let you re-shape a sound track to your personal musical preferences. It's all the control you've ever dreamed of but never dreamed possible.

To get into equalizers, start with our Sound Shaper One which operates in five frequency ranges. Or our Sound Shaper One Ten which gives you greater control by operating in ten frequency ranges.

For more professional equalizers, there's our Sound Shaper

Two Mk II which functions in twelve frequency ranges with a two-channel LED meter. And there's our new Sound Shaper Three *Paragraphic*<sup>™</sup> Equalizer.

It combines all the advantages of a graphic equalizer with all the advantages of a parametric equalizer. Twelve primary frequency controls per channel. Plus twenty-four ancillary control positions per channel. The Sound Shaper Three is the ultimate in controlling and creating with your stereo system.

Take the ultimate step up in sound, without trading in a thing.

ADC Professional Products, a division of BSR Consumer Products Group, Route 303, Blauvelt, NY 10913. Distributed in Canada by BSR (Canada) Ltd., Ontario. <sup>®</sup>Sound Shaper is a registered trademark of Audio Dynamics Corporation.

# HOW TO TRADE UP YOUR RECEIVER, TUNER, AMP, TURNTABLE, CARTRIDGE AND SPEAKERS WITHOUT TRADING IN A THING.



**ADC** **SOUND SHAPER<sup>®</sup>**  
A BSR COMPANY **FREQUENCY EQUALIZERS**

Enter No. 6 on Reader Service Card

## Consider what it would be like to own the new Dual 839 cassette deck.

The new Dual 839 is so different from all other cassette decks that, rather than list its many features, we'll guide you through them as if the 839 were in front of you.

First, the 839 is bi-directional. In record and playback, the tape reverses automatically and stops at the end of the second side. This doubles the length of every cassette. (Reversing can also continue indefinitely if desired.)

You'll notice there's no door between you and the cassette compartment. Just a shield over the tape heads that swivels away when you switch on. Insert a cassette and it will lock in precise alignment. That's Dual's Direct Load and Lock system. (A subtle but important touch: any slack in the tape is immediately taken up.)

Follow us carefully on this next one. Even when the tape is in motion, you can pull it out and replace it with another... and the previous mode resumes automatically. Useful? Well, if you're recording off the air and the tape nears the end at a crucial moment, you can have a new tape in place without missing a beat.

The 839 is just as innovative in playback. If a tape made on another deck is too sharp or too flat, or if you need to match pitch to a live instrument, no problem. Playback pitch can be varied over an eight percent range.

And previously recorded tapes with clicks, pops and disc jockey interruptions can be cleaned up electronically—smoothly and permanently. Dual's fade/edit control lets you do that with complete confidence, because it functions in playback.

Back to recording. The peak-level LED indicators react faster than any other metering system. And more accurately, because they're equalized. They read the full processed signal—including the high frequency boost other decks add but only Dual reads. No more risk of overloading a tape into distortion.

There's still more. Much more. Full metal record and playback. 6-way bias/equalization. Computer logic solenoid-activated controls. Switchable multiplex filter. Switchable limiter. Line and mic mixing. Two-way memory stop with automatic replay. Headphone level controls. And operation by external timer or optional wireless remote control.

Among the features you can't see are the two-motor, twin-capstan drive system and the electronic tape-tension sensor that guards against jams and spills.

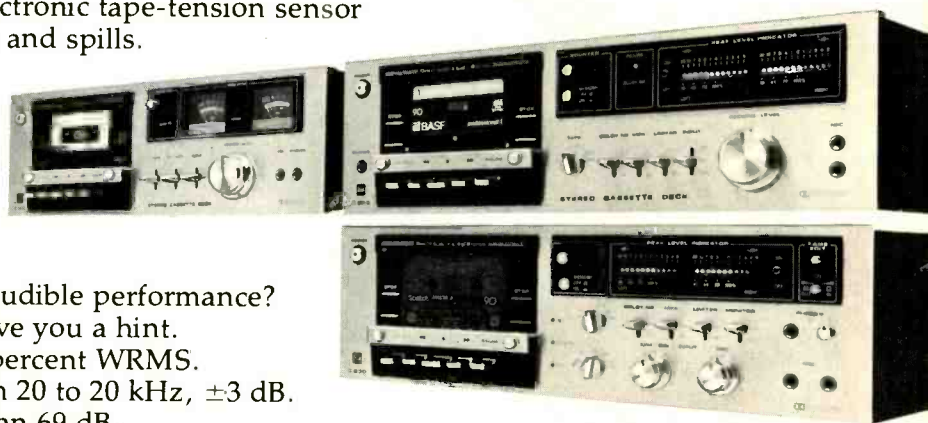

What about the 839's audible performance? The specifications can give you a hint. Wow and flutter  $\pm 0.03$  percent WRMS. Frequency response from 20 to 20 kHz,  $\pm 3$  dB. Signal-to-noise better than 69 dB.

Of course, there's a price for all the 839 offers: \$850. If that seems to be more deck than you really need, there are three other new Dual cassette decks. They start at \$330, and they all feature the Direct Load and Lock system, DC servo motors, twin-belt drive systems, tape-motion sensor/protectors and equalized meters.

For complete details on all four Dual cassette decks, please write to us directly. United Audio, 120 So. Columbus Ave., Mt. Vernon, NY, 10553.

**Dual**®



CHRISTMAS BUYING GUIDE:

# AUDIOPHILE RECORDS

Gary Stock



Concerned about finding the perfect Christmas gift for your audiophile relative or friend? Confused and intimidated by that mass of knobs, switches, and wires? And you don't want to spend an arm and a leg on some exotic piece of gear and then find out that your friend already has two of them in his system? Quite a quandary, isn't it?

Well, there's an easy way out; buy your friend an audiophile record, like the ones we've been reviewing in our "Top of the Pile" column. That's where such records stay, you know, at the top of the pile—because they get played more than most others. And all you need to know, or find out, is a bit about your audiophile friend's musical taste, then read our Christmas Buying Guide to Audiophile Records, which follows, and buy that record your friend has been thinking about getting for himself.

Over the past 10 years, the audiophile record field has expanded from a handful of

gimmick-laden sound-effects discs to a new and respected position within the music industry. As a browse through the specialty section of any large record dealer will prove, many audiophile labels, despite their relatively modest size, are attracting world-class performing artists, top-flight production and technical talent, and the degree of technical backing necessary to acquire the finest equipment and ensure the highest level of manufacturing quality. Even more significant, all of this has occurred during a period when most observers agree that mainstream record sales have leveled off and creative energies at major commercial labels fallen to a low ebb. Clearly, the audiophile disc is fulfilling some keenly felt need—the need for a new generation of technically and musically sophisticated recordings comparable in sonic performance to the music systems on which they will be played.

In recognition of the specialty

disc's growing importance to the serious music listener, this Christmas Buying Guide to the audiophile record field has been assembled. It covers more than 50 record labels and nearly 700 recordings in a broad range of musical styles and recorded using a variety of methods.

Each of the company listings contains a brief description of the firm's offerings, recording techniques, and philosophy, as well as recommendations on one or more musical selections that will help prospective buyers "get a handle" on the company's musical and sonic tastes. Further information in the form of a flyer or catalog is available from virtually all of the companies through the addresses listed; except where noted, all will sell recordings via direct mail to customers in areas without a local dealer. In most cases, however, recordings are sold primarily through audio and record stores and should be purchased through such retail outlets.



*American Gramophone* (Precision Sound Marketing), 24310 2nd Place, Bothell, Wash. 98011.

American Gramophone is an Omaha, Nebraska, based company known for the popular **Fresh Aire** series, three discs featuring music in the jazz-rock vein composed by coproducer Chip Davis and performed by a group of Omaha musicians called Mannheim Steamroller. They've also recently released a direct-to-disc recording of classical piano pieces (**Sunken Cathedral**, American Gramophone AG 361) as played by the group's pianist, Jackson Berkey, bringing the total catalog to four selections. Both the members of the group and the producers are involved in commercial and industrial recording in the Omaha area.

The **Fresh Aire** albums use fairly conventional recording techniques, with an emphasis on slow, careful assembly of each piece using multi-track techniques. Each track is laid down using an electronically synthesized "click track" as its rhythmic basis (the click track is not dubbed onto the master tape, and hence is not heard on the record); recording a single album takes several months.

American Gramophone's discs are pressed by the American Wakefield company, on virgin vinyl, using an exceptionally slow cycling time and individual observation of each press.

**Recommended Selections:** "Chocolate Fudge" from **Fresh Aire I** (American Gramophone AG 355), "The Cricket" and "Toccatà" from **Fresh Aire III** (American Gramophone AG 365). In lieu of a click track, "The Cricket" uses a live, and very well-modulated, cricket, as a click track. The cricket's voice, however, remains on the final recording.

**Prices:** **Fresh Aire** series, \$13.95 per disc; **Sunken Cathedral**, \$14.95.



*Angel Records*, 1370 Ave. of the Americas, New York, N.Y. 10019.

Angel has entered the audiophile disc market in an unusual way, through the introduction of 45 rpm versions of about 30 classical recordings from their standard catalog, mastered at half-speed and pressed by Wakefield. These "Sonic Series" albums, as Angel calls them, were made from original master tapes recorded by Angel's affiliate EMI in Europe. On the average, the discs run only 12 to 13 minutes on a side, but the improvement in sound quality, in the view of most listeners, is marked enough to justify the inconvenience. Angel notes that EMI has begun to record in Europe using digital equipment and that future releases on the Sonic Series label may therefore be digitally mastered.

**Recommended Selections:** "The Great Gate of Kiev" from **Pictures at an Exhibition**, Philadelphia Orchestra, conducted by Riccardo Muti (Angel SS-45004), "Stars and Stripes Forever" from **U.S.A. — Olympic March**, Concert Arts Symphonic Band, conducted by Felix Slatkin (Angel SS-45016), side 2 of **The Pines of Rome**, London Symphony Orchestra conducted by Lamberto Gardelli (Angel SS-45005).

**Prices:** \$8.98 per disc.



*Audio Directions*, 1035 Draughon Ave., Nashville, Tenn. 37204.

Audio Directions is a fairly new company which thus far has two releases, a direct-to-disc album in the pop/country vein, **Doin' It My Way**, by Tracy Nelson, and a jazz album by Farrell Morris, **Bits of Percussion and Jazz**, which features performances by jazz notables Stan Getz and Ron Carter. The Morris disc was recorded digitally using the Sony PCM-1600 digital processor and industrial videocassette recorder combination.

Engineer Tom Semmes notes "there is no right or wrong way to make a given song" and adds that the recording philosophies of the two albums differed considerably. The Nelson disc was recorded with 15 to 20 microphones placed close to the instruments, while the Morris album used a

smaller number of mikes in a fairly open, live acoustic environment.

The company makes a point of using aged (two or three years old) master lacquers to prevent groove relaxation after cuttings; discs are pressed in the United States by Music Hall, on an imported virgin vinyl.

*Recommended Selections:* "Rosalinda" and "Some Day My Prince Will Come" from **Bits of Jazz and Percussion**, Farrell Morris (Audio Directions AD-102), "I Could Have Been Your Best Friend" from **Doin' It My Way**, Tracy Nelson (Audio Directions AD-101).

Prices: \$13.95 per disc.



Audio Source, 1185 Chess Dr., Foster City, Calif. 94404.

Known primarily as the importer for Monitor Audio speakers and various audio accessories, Audio Source has recently expanded into the specialty record business as well, bringing in about 250 albums, most in the classical and jazz veins, from various other countries. Included in their catalog are:

*Proprius* and *Lyricon* (Sweden) classical albums recorded by conventional means using simple microphone arrays,

*Three Blind Mice* (Japan) jazz selections conventionally recorded using high speed recorders and close microphone placement with minimal mix-down,

*Philips/Direct Cut* (Japan) jazz records made using classic direct-to-disc techniques,

*Audio Lab* (Japan) classical and jazz discs recorded by conventional means on-location in concert halls and clubs,

*Sarastro* (France) classical recordings made using microphones placed in an artificial head, combined with 45 rpm mastering speed, and dbx encoding on some discs (see section on dbx),

*Mercury Audio Check Series* (Japan) jazz and classical recordings made at 33 and 45 rpm on special vinyl mixes,

*East Wind* (Japan) jazz recordings made direct-to-disc at 45 rpm,

*Merlin* (England) classical and pop recordings made by conventional means with exceptionally rigorous standards of pressing quality,

## The Three Recording Methods

*Direct-to-disc* (also called direct-cut, direct-disc, direct-mastered) recordings route the musical signal (derived from the microphones, or sometimes from electronic instruments) almost directly to the cutting lathe which inscribes the master lacquer, without any form of tape recording interposed between the two. The process has the virtue of avoiding the signal degradation introduced by several generations of tape copies. However, each side of the disc, often including the short spaces between successive selections, must be recorded in one single extended "live" take, without any possibility of editing or overdubbing. This may bring a sense of excitement and immediacy to many recordings, but in some cases it also introduces an element of caution to the musical performances that would not be present if they were alterable.

Because there is no way of recopying the master lacquer after it has been cut using the direct-to-disc approach, only a limited number of discs (somewhere in the range of 20,000 to 100,000) can be made from any given performance. This has the effect of rendering many direct-to-disc albums "limited editions," with some degree of collector value.

*Digital* (also called PCM or direct-to-digital) recordings are made on a tape recorder, but a recorder that differs radically from older, conventional analog studio recorders, in that it operates by sampling and storing the musical signals in the form of binary-encoded numbers, the same "bits" — composed essentially of either pulses or silent spaces — that are the language of computers. Because the music is therefore recorded as an "on" or "off" signal, rather than as a magnetic pattern of continuously varying level, a digital recorder largely avoids the problems of tape noise, print-through, tape saturation, and wow-and-flutter that afflict conventional recorders. In fact, most digital recorders have specifications comparable to those of an am-

plifier or preamplifier, far superior to those of a conventional analog tape recorder.

Digital recordings offer the musicians and the producer the opportunity to overdub, edit, and complete a recording in several separate sessions, just as conventional tape recordings do. They also permit an infinite number of identical master lacquers and therefore records to be made from a given performance. And, depending on the particular model of digital recorder in use, they allow the master lacquer to be "half-speed" mastered — a process in which the master disc is cut while rotating at half of the intended playback speed and the musical signal fed to it lowered by an octave. This process, when done correctly, extends the bandwidth and reduces the distortion of the final recording.

*High-performance analog* (also called high-technology) recordings use conventional tape recorders, but depart in one of several ways from normal recording practice in order to

improve the sonic quality of the end product. Some eliminate all unnecessary intermediate stages — noise-reduction devices, equalizers, mixers, and dynamic-range compressors — from the recording chain; others operate the tape recorder at very high transport speeds in order to reduce distortion and extend bandwidth. The common factor linking these various measures is a desire on the part of the producer and engineer to maintain the sonic integrity of the musical signal to a greater degree than typical recording practice allows.

One other form of high-performance analog recording is the *remastered* recording, for which the original master tape of a disc in circulation is reprocessed and recut using exceptional care. The resulting master lacquer and final record, which is often produced using special vinyls and manufacturing processes, is usually markedly superior to the commercial version, although it is derived from the same master tape and contains the same performance.

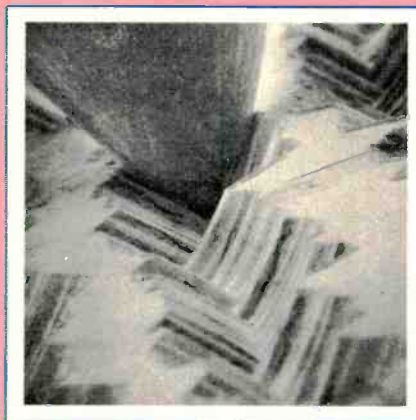

Diamond stylus in a record groove, 1000X magnification.  
Photo: John L. Brown.



# SAE gives you more pre-amp:

If you're looking at pre-amps, you're looking at three things: performance, flexibility and construction.

You're trying to get the most of all three. It's as simple as that.

Why look at SAE? It's as simple as this:

**Two-stage phono circuit.** (All models.) By dividing amplification into two stages, we are able to utilize passive high-frequency equalization.

This dramatically reduces high-frequency feedback, by 20dB in fact, as well as the resulting transient intermodulation distortion (TIM). The audible effect is a greater definition of sound, increased clarity.

**Tape facilities.** (All models.) Take the unique Tape EQ: Now you can modify the recorded sound to suit your personal tastes by switching parametric or tone control circuits between selected input (phono, tape, aux.) and recorder circuits.

**Parametric equalizers.** Providing virtually complete control over bandwidth, center frequency and cut or boost, our parametrics provide greater flexibility and a wider variety of effects than any conventional system has ever offered. (2100 and 2900 models.)

**"Superchip."** We took the integrated circuit out of instrumentation and into audio. Even at full output, our state-of-the-art superchip provides super-low distortion (<0.005%), super-high slew rate (>V/ $\mu$  sec) and excellent transient response. (2100 and 2100L models.)

We make our pre-amps exactly the same way we make our amps, tuners, equalizers, everything. By hand. With the finest materials money can buy and the greatest care money can't buy.

But the most important feature in every SAE pre-amp is sound. It's the only reason we do everything we do. It has greater clarity, finer accuracy, and a more vivid sense of dimensionality.

It had better. It has one other very important feature to live up to: Its name: SAE.

# SAE gives you more pre-amps:



2100 parametric pre-amplifier.  
0.005% THD and IM. \$950\*



2100 pre-amplifier with LED display.  
0.005% THD and IM. \$800\*



2900 parametric pre-amplifier.  
0.01% THD and IM. \$500\*



3000 pre-amplifier with  
3-band tone control.  
0.02% THD and IM. \$300\*

## Write for more.

Name \_\_\_\_\_  
Address \_\_\_\_\_  
City \_\_\_\_\_ State \_\_\_\_\_ Zip \_\_\_\_\_

Send To: SAE, P.O. Box 60271, Terminal Annex,  
Los Angeles, California 90060

# SAE

Scientific Audio Electronics, Inc.

\*Nationally advertised value,  
actual retail prices are  
established by SAE Dealers.

Enter No. 42 on Reader Service Card

# "SONICALLY BREATH-TAKING" DIGITAL AND DIRECT-TO-DISC M&K RealTime Records

Don't take our word for it. Here's what some of the critics have said already:

"Performance: Exquisite. Recording: Superior . . . I advise you to get your copy fast." (For Duke) **STEREO REVIEW**

"Dynamic range unheard of in traditional recordings." **AUDIO**

"So they caught a big one direct-to-disc." (Fatha) **JAZZ JOURNAL INTERNATIONAL**

"For Duke is technically the most perfect jazz disc I have seen or heard." **JAZZ MAGAZINE**

The RealTime Recording Process eliminates compression, limiting, transformers and audio analog tapes. Out go tape hiss, wow, flutter, and distortion. Live sound passes unscathed through specially modified transformerless condenser microphones and state-of-the-art D.C. coupled electronics and finally to M&K's 600-watt per channel disc cutter driving stage. The lacquer masters are flown directly to West Germany for plating and pressing on the finest pure virgin vinyl.

The results are recordings with all their dynamic range, detail, and steep transients preserved on ultra-quiet surfaces.

## SIX NEW DIGITAL RECORDINGS NOW IN FINAL PRESSING

The following compositions will be featured. Call your record or audio dealer for availability.

**Tchaikovsky**, Romeo and Juliet, The Nutcracker Suite; **Liszt**, Les Preludes; **Brahms**, Hungarian Dance No. 5; **Dvorak**, Slavonic Dance Op. 46 No. 8; **Smetana**, Moldau (My Fatherland); **Bizet**, Carmen (Toreador March); **Rimsky-Korsakov**, Procession of the Nobles; **Berlioz**, Rakoczy March; **Rossini**, William Tell Overture, The Barber of Seville Overture, La Gazza Ladra (The Thieving Magpie); **Bach**, Air from B Minor Suite; **Pachelbel**, Canon; **Handel**, Water Music Suite, Aria from Concerto Grosso No. 12; **Dukas**, Sorcerer's Apprentice; **Debussy**, "Fetes" from The 3 Nocturnes, Prelude to the Afternoon of a Faun; **Chabrier**, Espana Rhapsody; **Ginastera**, Panambi Suite.

Just recorded in West Germany with the Philharmonia Hungarica Symphony Orchestra, winner of many "Grand Prix du Disque" and other major European recording awards. Orchestra conducted by Zoltan Rosznyai, its founding conductor.

Also soon to be available will be an album by the Original Biblical Gospel Singers.

## DIRECT-TO-DISC ALBUMS NOW AVAILABLE

**For Duke**, The ultimate in Ellingtonian Jazz; **The Magnificent Basso**, Operatic arias, Carl Loewe ballads by Michael Li-Paz; "**Fatha**", Earl "Fatha" Hines shows he's still at his piano-playing best; **Hot Stix**, "Fatha's" drummer Ed Graham performs dazzling pyrotechnics; **Flamenco Fever**, Flamenco music right from the night club floor; **Encore**, The Roger Wagner Chorale recorded live in concert; **Golden Themes**, Some of your favorite songs and movie themes; **Ode to Joy**, The complete Fourth Movement from Beethoven's Ninth Symphony; **The Power and the Glory, Volumes I and II**, One of the world's largest pipe organs thunderously captured direct-to-disc; **Yeti Chasers**, the "joy and happiness" jazz of the 1930's.

M&K RealTime Records, A Division of:



MILLER & KREISEL SOUND CORPORATION

10391 Jefferson Boulevard, Culver City, CA 90230 USA 213 204-2854

Get your \$5.00 Super Sampler and other M&K RealTime Direct-to-Disc and Digital Records at these dealers:

**ALABAMA**  
Audition  
Birmingham  
Ingram Audio  
Florence  
Stereo Components  
Birmingham

**ARIZONA**  
HiFi Sales  
Mesa

**CALIFORNIA**  
Audio Dimensions  
San Diego  
Audio Torium  
Stockton  
Henry Radio  
Los Angeles  
Hi Fidelity Shoppe  
Walnut Creek  
Jonas Miller Sound  
Beverly Hills

**Serra Stereo**  
Colma  
Walnut Creek  
**Stereo HiFi Center**  
Gardena  
**Stereo Unlimited**  
La Mesa  
**Tower Records**  
Los Angeles  
**CONNECTICUT**  
HiFi Stereo House, Inc.  
Newington  
**J. Robert Barry**  
Manchester  
**Take 5 Audio**  
New Haven  
**FLORIDA**  
Sound Advice  
Tampa  
**GEORGIA**  
Audio Outlet  
Savannah

**HiFi Buys**  
Atlanta  
**Hi Fidelity SSS**  
Atlanta  
Turtles  
Atlanta  
**HAWAII**  
Audio Center, Ltd.  
Honolulu  
**Lakeside Audio**  
Honolulu  
**Warehouse Sound**  
Honolulu  
**INDIANA**  
Sound Room  
South Bend  
**ILLINOIS**  
Columbia HiFi  
Highland Park  
**Rose Records**  
Chicago

**Victors Stereo**  
Chicago  
Morton Grove  
**KANSAS**  
Stereo Odyssey  
Merriam  
**KENTUCKY**  
Hi Fidelity Inc.  
Louisville  
**LOUISIANA**  
Unlimited Sounds  
Lafayette  
**MARYLAND**  
Audio Associates  
Bethesda  
**House of Sound**  
Baltimore  
**McGuire's Audio Shop**  
Rockville  
**Soundscape**  
Baltimore

**MASSACHUSETTS**  
Natural Sound  
Framingham  
**MICHIGAN**  
Absolute Sound  
Detroit  
**Almas HiFi**  
Dearborn  
**Audio Dimensions**  
Birmingham  
**Audio House**  
Flint  
**Audio Threshold**  
Mt. Clemens  
**Gramophone**  
Birmingham  
**Mark I Audio**  
Midland  
**Pecar's**  
Detroit  
**Sound Room**  
Benton Harbor  
Grand Rapids  
Kalamazoo

**Stereo Center**  
Flint  
**Stereoland**  
Detroit  
**MINNESOTA**  
HiFi Sound Electronics  
Minneapolis  
**T & T Dist. Co.**  
Rochester  
**NEW JERSEY**  
Armands Sound  
Odyssey  
Cherry Hill  
**HiFi Haven**  
New Brunswick  
**NEW YORK**  
Alltronics  
Amherst  
**Audio Audio Inc.**  
Staten Island  
**Crazy Eddie**  
Bronx

# SUPER SAMPLER

One exciting cut from each of our 11 RealTime Direct-to-Disc albums

**SUPER SAMPLER ALBUM OFFER!!**  
You can hear a selection from each of our direct-to-disc records.  
Get your copy for just \$5.00 from any participating RealTime dealer.

**CAN'T DECIDE?**

Try one of RealTime's

**\$5 Super Samplers**

Made from ultra-high fidelity back-up analog master tapes.



**Eardrum Stereo**  
Nanuet  
**Electronic Workshop**  
New York City  
**Gordon Electronics**  
Syracuse  
**Harrison Radio Corp.**  
Farmingdale  
**Harvey Sound**  
New York City  
**Innovative Audio**  
Brooklyn Hts.  
**King Karol Records**  
NYC - all locations  
**Liberty Music**  
New York City  
**Listening Room**  
Scarsdale  
**Lytic HiFi**  
New York City  
White Plains  
**Metro Electronics**  
New York City

**Park Avenue Audio**  
New York City  
**Sam Goody**  
NYC - all locations  
**Sound By Singer**  
New York City  
**Sound Image**  
Rochester  
**Sound Odyssey**  
Wappinger Falls  
**Stereo Chamber**  
Orchard Park  
**NORTH CAROLINA**  
**Audio Advice**  
Raleigh  
**Audio Works**  
Chapel Hill  
Raleigh  
**Pair Electronics**  
Greenville  
**Southern Sight & Sound**  
S. Charlotte

**Stereo Station**  
Hi Point  
**Stereo Village**  
Burlington  
**Woofers & Tweeters**  
Carrboro  
**OKLAHOMA**  
**Maguires**  
Oklahoma City  
**PENNSYLVANIA**  
**Audio Clinic**  
York  
**David Mann**  
Philadelphia  
**Sound Plus**  
Jenkintown  
**SOUTH CAROLINA**  
**Read Brothers**  
Charleston  
**TENNESSEE**  
**Nicholson's HiFi**  
Nashville

**Sound Concept**  
Bristol  
Johnson City  
Kings Port  
**Underground Sound**  
Memphis  
**Watkins Stereo**  
Kings Port  
**TEXAS**  
**Audio Concepts**  
Austin  
**Audio Craft**  
Houston  
**Audio Trend**  
Houston  
**Audio Visions**  
Dallas  
**Bjorns Stereo**  
San Antonio  
**Bunkley's Sound**  
Systems  
Abilene

**Electronic Svc. Ctr.**  
Odessa  
**Hi Fidelity**  
Lubbock  
**Hillcrest Hi Fidelity**  
Dallas  
**UTAH**  
**Bobs Audio**  
Salt Lake City  
**VIRGINIA**  
**Audio Associates**  
Richmond  
**Lakeside Audio**  
Lynchburg  
**Needle In A Haystack**  
Springfield, VA  
Rockville, MD  
Washington, DC  
**WASHINGTON**  
**Tower Records**  
Lynwood  
Seattle  
University District

**WISCONSIN**  
**Audio Emporium**  
Milwaukee  
**Audio Systems**  
Kenosha  
**EME Audio Systems**  
Menomonie  
**CANADA**  
**Bay Bloom**  
Toronto  
**Dave McDonald Audio**  
Cambridge  
**Dino's**  
Niagara Falls  
**K & W Audio**  
Calgary  
**London Audio**  
London  
**Millers Sound**  
Vancouver  
**Opus Audio**  
Montreal

**Rotac**  
St. Foy  
**Sam The**  
Record Man  
Ontario  
**Sonoclub**  
Montreal  
**Sound Lovers**  
Winnipeg  
**Stereo City**  
Edmonton  
33/45 Inc.  
Quebec  
**INTERNATIONAL**  
**DISTRIBUTORS**  
**Audio International**  
Frankfurt  
**Korbon Trading**  
Toronto  
**M.R. Acoustics**  
Brisbane  
**United Bearings**  
Singapore 8

Enter No. 22 on Reader Service Card

# For those who appreciate simple virtuosity

## The 480 Series

With the 480 Series, Nakamichi again offers a more affordable cassette recorder—a deck that is simpler to operate, but that sacrifices neither Nakamichi sound nor Nakamichi excellence. The secret is simple. The Asymmetrical, Diffused-Resonance Transport—shared by all three models and closely akin to that of the highly acclaimed 582—is a 3-motor, dual-capstan drive so unique in its simplicity and elegance that it can be manufactured with virtually zero defects. Each 480-Series deck is factory calibrated to yield optimum performance with three types of tape—ferric, chrome-equivalent, and metal. Use products of equivalent quality, and you can experience Nakamichi sound and Nakamichi specifications—response to 20 kHz—in your home.



### 480

The 2-Head Model 480—fully metal-compatible thanks to our special, narrow-gap, Sendust R/P head and exclusive Direct-Flux erase head. Wide-range, peak-responding meters, professional sliding record-level controls, Dolby, and defeatable MPX filter, of course! Even an optional remote control.



### Nakamichi 481 Discrete Head Cassette Deck



### 481

Step up to the 481, a 3-Head deck utilizing Nakamichi's exclusive "Crystalloy" cores and "Discrete-Head" technology. All the features of the 480 plus the greater dynamic range of a discrete 3-Head format.

### 482

For those who demand "off-tape monitoring," the 482—a 3-Head deck similar to the 481 but with two complete sets of electronics and Double-Dolby so you can hear exactly what has been recorded as it is being recorded.

### Nakamichi 482 Discrete Head Cassette Deck

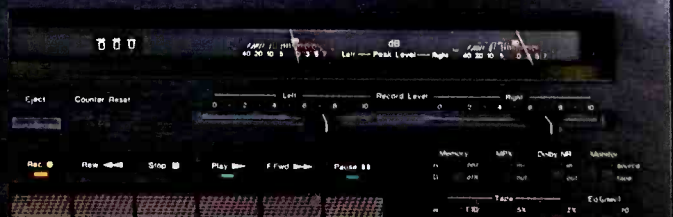

The 480-Series starts at under \$500. For more information, write to Nakamichi U.S.A. Corp., 1101 Colorado Avenue, Santa Monica, CA 90401.

Enter No. 30 on Reader Service Card

RCA Direct Mastering Series (Japan) two direct-to-disc 45 rpm recordings, one jazz and one classical, and

Additional recordings from *Opus 3* (Sweden) and *Nimbus* and *Accent* (Belgium).

All Audio Source imports are pressed on virgin vinyl and are said to reflect the traditionally high quality of European and Japanese production techniques. An unusually detailed catalog is available from Audio Source.

**Recommended Selections:** "Chopin Fantasia Impromptu" from **Music from Ingmar Bergman**, Kabi Lareti, pianist (Proprius 7829), "Moanin'" from **Night in Tunisia**, Art Blakey and the Jazz Messengers (Philips/Direct Cut RJD-4).

Prices: \$11.95 to \$17.50 per disc.

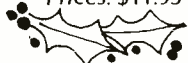

**Audio-Technica U.S.**, 33 Shiawassee Ave., Fairlawn, Ohio 44313.

Audio-Technica is a major importer of phono cartridges and audio accessories, but they have also undertaken a large-scale audiophile disc distribution program, which is credited with having done much to bring the specialty disc out of the shadows and into the public view. Through their Standardisc division, the company now distributes four labels for a total of about 55 titles. The labels are:

**Telarc (U.S.A.)**, which has produced eight highly acclaimed classical and jazz recordings. One, *The Great Organ at Methuen* with organist Michael Murray (Telarc 5036), was made using the direct-to-disc process. Seven others have been recorded using the Soundstream digital system, including **The Cleveland Symphonic Winds**, with Frederick Fennell conducting, playing selections from Holst, Handel and Bach (Telarc 5038), Malcolm Frager playing Chopin piano works (**Malcolm Frager-Chopin Piano Program**, Telarc 10040), and Mel Lewis and The Jazz Orchestra performing Thad Lewis selections (**Mel Lewis and The Jazz Orchestra-Thad Lewis Program**, Telarc 10044). Telarc's most recent release, **Tchaikovsky: 1812 Overture/Capriccio Italien**, performed by the Cincinnati Orchestra under Erich Kunzel (Telarc 10041), features actual cannon blasts having high-level fundamentals at frequencies well below 30 Hz. The album jacket comes with several warnings to the effect that the disc should initially be played at moderate volume in order to define a safe playback level.

RCA Japan has 16 recordings available in this country, most in the mainstream jazz vein. All have been recorded direct-to-disc, and most are at 45 rpm. Among them are two albums

featuring Lew Tabackin: **Trackin'** (RCA RDC-3) and **Vintage Tenor**, by Lew and the New Herd (RCA RDC-11), a well-received Vivaldi **Seasons** (RCA RDC-501/2), and a recording of Ikuyo Kamiya playing the Beethoven *Appassionata* on a Bosendorfer Imperial piano (RCA RDC-4).

**Umbrella Records (Canada)** recorded one of the earliest direct-to-disc rock albums, the hard-driving **Rough Trade: Live!** (Umbrella DD1); they now have a total of eight recordings, including the Toronto Chamber Orchestra performing selections of Mozart (Umbrella DD6) and Bach (Umbrella DD9), an album of ragtime music by an ensemble called Nexus (Umbrella DD2), and a brass recording by the Canadian Brass (Umbrella DD5). All of Umbrella's releases are direct-to-disc.

**Toshiba/EMI's** 22-album catalog is composed predominantly of large jazz groups recorded by the direct-to-disc process, and includes such titles as **Take the "A" Train** by the Big Band Jazz Ensemble (Toshiba EMI LF-95011) and **30 Years in 30 Minutes** by Eiji Katamura and the All Stars (Toshiba EMI LF-95012). Also available, however, are a number of rock recordings, three albums in the Latin vein, and an exceptionally transparent recording of the Chopin Nocturne in E Flat Major (**Jun Fukamachi at the Steinway**, Toshiba EMI LF-95001), among others.

**Recommended Selections:** "Spirit Levels" from **Acoustic Guitar**, Stefan Grossman with John Renbourn (Toshiba EMI EWLF-98001), "Just Friends" from **Big Band Jazz, Volume 1**, Rob McConnell and the Boss Brass (Umbrella DD4), "Finale" from **Chopin, Scherzo No. 2 and Piano Sonata No. 3**, Edward Auer (RCA RDC-7), "Polovetsian Dances" from **Stravinsky: The Firebird and Borodin: Overture and Polovetsian Dances**, Atlanta Symphony Orchestra and Chorus, Robert Shaw conducting (Telarc 10039).

Prices: \$15.95 to \$17.95 for single discs, \$23.95 to \$27.95 for double-record album sets.



**Century Records**, 6550 Sunset Blvd., Hollywood, Calif. 90028.

Two points immediately evident from an examination of Century's 17-disc catalog are the number of big band and jazz recording artists gathered under one roof and the diversity of recording techniques used. Featured artists include Benny Goodman, Buddy Rich, The Glenn Miller Orchestra, Woody Herman, and Les Brown and his Band of Renown. Ten of the discs, including 45-rpm disco singles

by Denise McCann and Tuxedo Junction, have been recorded direct-to-disc, four by conventional analog methods, and one — *Anita Kerr Performs Wonders* (Century CRD-1160), an album of Stevie Wonder songs — using Sony's PCM-1600 digital recording system.

Century frequently records on-location, using simple MS style microphone arrays when possible. A number of their direct-mastered recordings also employ a process called Direct Disc Phase II in which some vocal lines are transferred to the final lacquer master from previously recorded tapes. The company believes in rapid plating of the master lacquer (within six hours), and in a fairly thick, heavy disc (130 grams) made of virgin vinyl. Century's recordings are pressed in West Germany by Teldec.

**Recommended Selections:** "Sunrise" from **Fusion Is** by Barry Miles (Century CRDD-1070), "Birdland" from **Buddy Rich/Class of '78** (Century CRDD-1030), "Berceuse" and "Piece Heroique" from **Robert Candide at the Mormon Tabernacle Organ** (Century CRDD-1040).

Prices: Conventionally recorded albums, \$7.95; direct-to-disc and digital albums, \$14.95.



**Crystal Clear Records**, 648 Mission St., San Francisco, Calif. 94105.

Crystal Clear's catalog consists of about 25 records, all recorded direct-to-disc, featuring music in several genres — rock, classical, jazz, and easy listening. A number of well-known artists, including Virgil Fox, Peter Nero, Carlos Montoya, and Cal Tjader have recorded on the label, which also encompasses such unusual items as a direct-to-disc disco album (**Direct Disco**, Gino Dente, Crystal Clear CCS-5002) and a direct-to-disc Boston Pops album (**Capriccio Italien/Capriccio Espagnol**, Crystal Clear CCS-7003).

The company uses simple microphone arrays, often consisting of only two microphones, for many recordings. They are also among the first companies to have produced a live concert direct-to-disc, a recording by blues/folk guitarist Taj Mahal called **Live and Direct** (Crystal Clear CCX-5011). Their discs are pressed on white or transparent vinyl by Teldec of West Germany, and are exceptionally heavy (160 grams); the company feels that the carbon black used to color most records can increase surface noise. Crystal Clear is one of several companies interviewed for this article which expressed dissatisfaction with the sonic quality of current digital recordings,

noting an upper midrange harshness and lack of depth.

**Recommended Selections:** "Fanfare for the Common Man" from **Sonic Fireworks, Volume 1** by Richard Morris and the Atlanta Brass Ensemble (Crystal Clear CCS-7010), opening theme from "Also Sprach Zarathustra" from **Sonic Fireworks, Volume II**, by Richard Morris and the Atlanta Brass Ensemble (Crystal Clear CCS-7011).

Prices: \$16.98 per disc.



dbx, 71 Chapel St., Newton, Mass. 02195.

Dbx has adopted an unusual and ingenious approach to specialty record manufacture, one reliant on electronic rather than mechanical or chemical technology. They are distributing a catalog of about 20 discs (with more to be added soon) taken from a number of other labels — Desmar, Desto, Vox, Sine Qua Non, Chalfont, and Varese Sarabande among them — and remastering the discs on the dbx label in a dynamically compressed encoded format, in much the same way that a tape or broadcast might be dbx or Dolby encoded. A decoder, either the Model 21 (\$109) or any dbx Series II dynamic range expander, is then used to re-expand the dynamic range of the recorded signal after it has been preamplified by the phono-stage electronics. Effectively, therefore, both the disc and the first stages of the preamplifier are incorporated into a compression-expansion loop, which is said to reduce noise by as much as 30 dB. The concept was developed by dbx in the late Sixties, shelved for several years, and has now been put into production. The technique has several benefits aside from the dramatic reduction in disc surface noise; the level of pops and ticks is greatly reduced, as are the influences of turntable rumble and phono-stage hum and noise. In addition, since the peak recording level put on the disc is reduced, cartridge mistracking and phono-stage overload are virtually eliminated. Dbx has rapidly acquired backing for the encoded disc concept, as it is called, from a broad spectrum of other disc manufacturers, many of which will independently distribute dbx-encoded recordings. Direct-Disk Labs has already announced the availability of their entire catalog in the format, and Vanguard, Nautilus, Sarastro, and Musical Heritage Society all plan to offer releases using the approach. Encoded discs will display a gold dbx sticker on the album jacket.

The preliminary catalog of recordings to be distributed by dbx dealers

runs heavily to classical orchestral and instrumental releases, with a few light orchestral albums, and a jazz disc that is the first of several to be recorded to demonstrate the virtues of the encoded disc concept, **Mark Levinson Presents** (dbx RTS-1).

**Recommended Selections:** "The Pizzicato Polka" from **A Strauss Family Gala**, Johann Strauss Orchestra (dbx SS-3003), side one of **American Brass Band Journal Revisited**, Empire Brass Quartet and Friends, Frederick Fennell conducting (dbx SS-3004), "Rodeo" from **Aaron Copland: Billy the Kid; Rodeo; Fanfare for the Common Man**, Dallas Symphony Orchestra, Donald Johanos conducting (dbx SS-3007).

Prices: Silver Series (SS), \$8.00 per disc; Gold Series (GS), \$12.00 per disc.



Decibel Records, Post Box 631, Lexington, Mass. 02173.

Richard Burwen, a noted New England engineer and founder of Decibel, has coined the term "Indirect Disc" to describe the four recordings available from the firm. All of them were made using conventional analog recording equipment modified by Mr. Burwen and supplemented by his professional noise-reduction system and microphones and cutting-lathe electronics of his own design. The result, according to Burwen, is an analog master tape with a dynamic range of 110 dB.

The four discs cover a wide musical range as well. Included are a jazz piano recording, **This is the One**, by Dick Wellstood (Audiophile AP-120); an album of Dixieland jazz, **The East Bay City Jazz Band** (Celia BL-2A); a pipe-organ recording done in the enormous castle/home of an eccentric inventor, **The Hammond Castle Pipe Organ**, with Douglas Marshall (Decibel DB 4000), and a pop recording, **Misty**, by the Petty Trio.

**Recommended Selections:** "Pastorale in E Major" from **The Hammond Castle Pipe Organ**, Douglas Marshall, organist (Decibel DB 4000; this piece contains a sustained, accurately recorded 19-Hz pedal note), "Rose of Washington Square" and "Blues My Naughty Sweetie Gives to Me" from **The East Bay City Jazz Band** (Celia BL-2A).

Prices: \$15.00 per disc, order direct from address above.



Delos Records (Supersounds Ltd.), 2210 Wilshire Blvd., Santa Monica, Calif. 90403.

Delos is an American label that recently entered the audiophile disc

field with six digitally recorded albums, all in the classical genre; this is in addition to their existent catalog of 50 or so classical and film soundtrack albums, all recorded by conventional analog methods.

The digital releases were recorded with the Soundstream system, using a three-microphone array of Bruel and Kjaer instrumentation mikes and custom-built electronics. The discs were mastered at full speed by the JVC Cutting Center and are pressed by JVC in Japan, using an exceptionally hard virgin vinyl compound originally developed for CD-4 use. Among these first releases are three albums of impressionistic music performed on brass instruments and a sonically superb recording of various Liszt, Ravel, Debussy, and Griffiths works performed on a Bosendorfer Imperial Grand piano by Carol Rosenberger (**Water Music of the Impressionists**, Delos D/DMS3006). This disc contains several passages of 16-Hz fundamental. Delos is planning several additional recordings in Europe and the United States over the next year, again using digital equipment.

**Recommended Selections:** "Haydn Trumpet Concerto in E Flat Major" from **The Classic Trumpet Concerti of Haydn/Hummel**, Gerard Schwarz, trumpet (Delos D/DMS3001), side B of **The American Brass Quintet Plays Renaissance, Elizabethan, and Baroque Music** (Delos D/DMS3003).

Prices: \$17.98 per disc.



Direct-Disk Labs, 16 Music Circle So., Nashville, Tenn. 37203.

Despite the name, Direct-Disk Labs is involved in all three types of contemporary recording, with a catalog of 17 albums, five recorded using the Soundstream digital system and about 15 direct-to-disc (several are available in both formats). They have also recently begun a program to offer high-quality remastered versions of well-known commercial albums and will be introducing about 25 discs of this type over the next year, including albums by Jackson Browne, Van Morrison, and Tower of Power. Their catalog of direct-to-disc and digital recordings includes jazz, country, bluegrass, and big band releases, many made using a proprietary microphone type called a pressure zone mike, which consists of a very small instrumentation microphone constructed with an integral reflective device, intended to achieve a high degree of sonic focus and balance. The company owns its own mastering facilities, plating equipment and pressing plant, and uses a virgin

# LUX SS SERIES

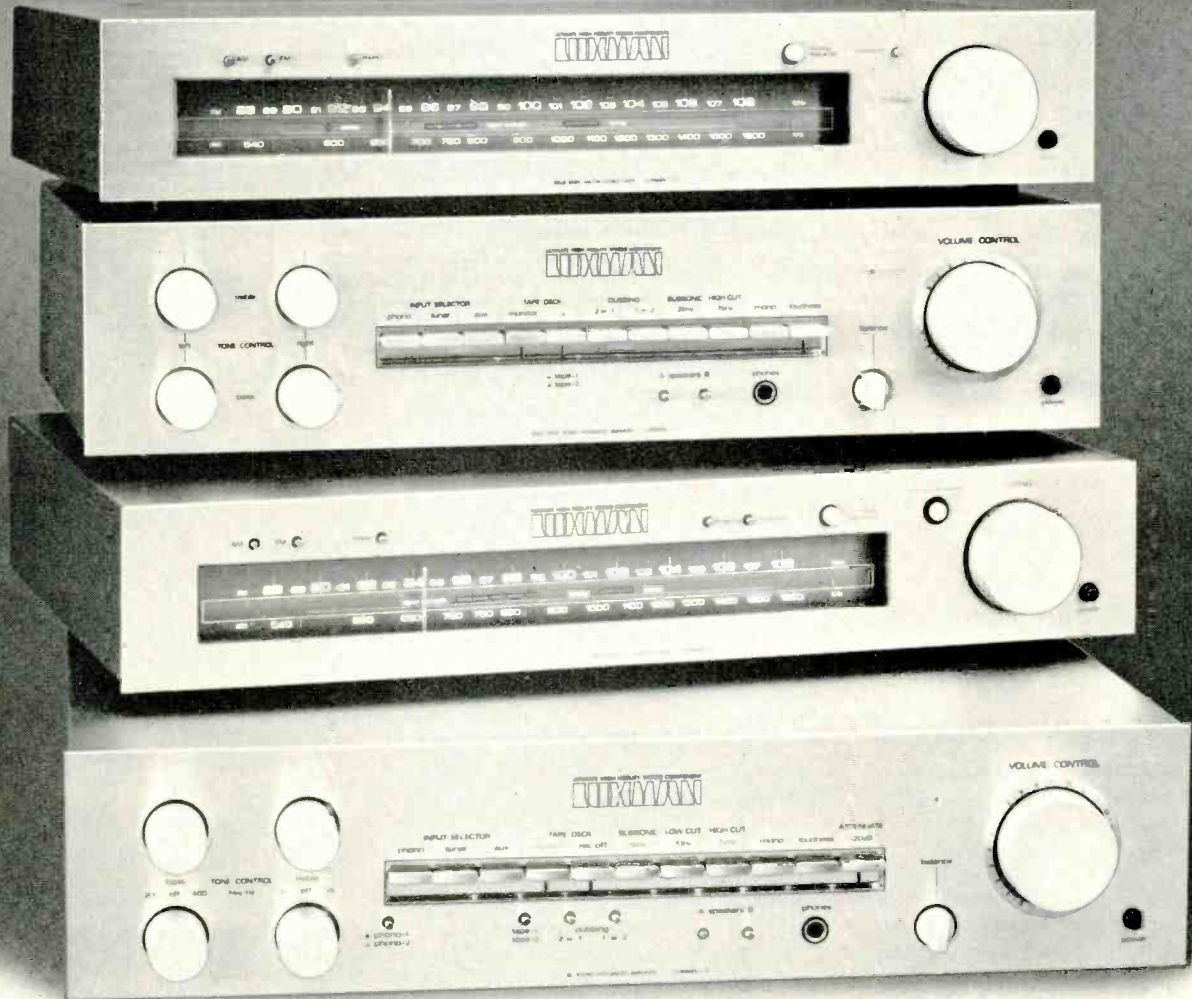

## UPGRADING THE STATE OF THE ART

Lux's audiophile engineers know that true advances in the audio art come about only through innovative circuit engineering and the constant development of improved semiconductors. Lux excels in both areas. Their engineering application teams are intimately involved with the designers of tomorrow's semiconductor marvels. The four products in the Lux SS Series represent what Lux has learned in more than 50 years of inspired audio engineering.

The T-4 and lower priced T-2 tuners differ in their ultimate performance specifications and features, but the Lux attention to detail and concentration on tonal quality is expressed in both products. For example, accurate FM tuning is critical to achieving low distortion and for Lux even today's quartz synthesizer circuits are not quite good enough. In the T-4

tuner, you'll find a Closed-Loop Locked circuit that precisely adjusts and locks in *all* the tuned stages. . . not just the front end. . . to the precise center of the tuned channel. And the Closed-Loop tuning system controls Lux's proprietary Accu-touch tuning mechanism that actually injects a mechanical detent in the tuning knob at the optimum tuning point.

Equivalent innovative approaches are found in the matching L-5 and L-3 integrated amplifiers. Intensive use is made of recently developed and vastly improved semiconductors. Lux's real-time processed DC amplifier sections employ the superior response of these superb devices to provide previously unattainable performance.

The Lux SS Series: Tomorrow's State of the Art.

LUX AUDIO OF AMERICA, LTD.  
160 Dupont Street, Plainview, NY 11803  
In Canada: LUX AUDIO OF CANADA, LTD., Ontario

**A SPECIAL OFFER: Buy the sound system you've waited for, and Lux will return part of the cost. In cash. Get Lux quality and inflation-fighting economy. Check your local Lux dealer for details.**

vinyl and temperature-controlled spring water for its pressing operations. Direct Disk's experiments indicate that very close tolerances for the pressing dies and a long cycle time are necessary to achieve and maintain consistent quality.

All Direct-Disk albums in the current catalog and all future releases, including those mastered direct-to-disc, are also available in dbx encoded format (see section on dbx). Direct-Disk will not sell albums by mail but will refer enquirers to their nearest dealer.

**Recommended Selections:** "Take Five" and "Blue Rondo" from **A Cut Above**, The New Dave Brubeck Quartet (Direct-Disk DD 106), "Foggy Mountain Breakdown" from **Neophonic String Band** (Direct-Disk DD 105), "You Needed Me" from **Lenny Breau with Chet Atkins** (Direct-Disk DD 112).

Prices: \$15.00 per disc.



Discwasher Records, 1407 No. Providence Rd., Columbia, Mo. 65201.

Discwasher is a large Missouri manufacturer of record care products which also imports, through their American Audioport subsidiary, the Stax and Denon lines of electronics, record-playing components, and stereophones. The close relationship between Denon and Discwasher grew out of an early agreement by which Discwasher imported and continues to import Denon's series of PCM (digitally recorded) discs. Denon was among the very first companies in the world to manufacture a digital recorder and begin offering commercial recordings using it. The present Discwasher catalog of Denon recordings lists about 100 albums, all produced using the system and some recorded with it as long ago as 1972. The discs, which are elaborately packaged with antistatic inner sleeves and beautifully photographed jacket illustrations, cover a broad musical range, from traditional jazz, as in **The 24th Street Band Jazz Fusion Rock** (Denon YX 7547), to chamber music (**Vivaldi: Six Sonatas for Flute and Harpsichord**, Denon OX 7005), to a recording of Beethoven's Ninth Symphony by the Czech Philharmonic Orch. (Denon OB 7333-4).

Discwasher is also the distributor for five digitally recorded discs, all made using the Soundstream system, on the Chalfont and Varese Sarabande labels, and three rock and jazz direct-to-disc recordings from the Canadian Kiras label. Discwasher has become directly involved in the audiophile-disc pro-

duction field, too, through their release on the Discwasher label of six recordings, all in the jazz or rock vein; three were recorded digitally using the Soundstream system, three direct-to-disc.

**Recommended Selections:** "I Hadn't Anyone Until You" from **The Good Life**, Paul Smith Quartet (Discwasher DR004-D), "Prague" (Symphony No. 38) from **W. A. Mozart, Symphony No. 38; Symphony No. 36**, NHK Symphony Orchestra conducted by Otmar Suitner (Denon OX 7156), "Sambandrea Swing" from **Note Smoking**, Louie Bellson & Explosion (Discwasher DR002-D).

Prices: \$15.00 per disc.



Mark Levinson Recordings, 55 Circular Dr., Hamden, Conn. 06514.

Mark Levinson is a New England manufacturer of esoteric electronics, tape recorders and speaker systems, but Mr. Levinson has also made seven recordings using the equipment manufactured by his firm, along with Bruel & Kjaer instrumentation microphones, and a decidedly "purist" recording philosophy. Levinson recordings use only two mikes, placed to maintain a natural-sounding stereo perspective, and are recorded at 30 ips without gain riding, noise reduction, compression, or equalization. The catalog includes a four-record set of organ recordings, **The Art of the Fugue** (Mark Levinson 5), a live jazz recording with an excellent sense of club ambience, **Jazz at Long Wharf** (Mark Levinson 7), and a rather avant-garde piece of percussion music, **A Life** (Mark Levinson 3).

**Recommended Selections:** "Chorale Preludes: Schubler Chorales" from **Choral** by The Battell Chapel Choir (Mark Levinson 1).

Prices: \$15.00 per disc.



Mobile Fidelity Sound Lab, Post Box 919, Chatsworth, Calif. 91311.

Mobile Fidelity's stock-in-trade is the remastering of well-known pop and jazz recordings into super-fidelity versions they call "Original Master Recordings." The discs in the Mobile Fidelity catalog hold precisely the same musical performances found in the major-label release (and the same jacket art with the MFSL logo superimposed), produced without any of the manufacturing shortcuts that often limit the quality of commercial discs.

Basically, the company selects well-recorded master tapes through an arrangement with the original label, cuts

new master lacquers at half speed, and then presses the disc with exceptional care on virgin vinyl. Other points of significance include special sleeves, jackets, stiffening boards and wrapping plastic, all designed to reduce the incidence of record warp and static formation. The approach offers the listener the musical sophistication of major popular and jazz performers, combined with a level of technical quality approaching that found on direct-to-disc and digitally recorded albums from less familiar artists.

Hence, Mobile Fidelity's catalog includes a number of pop "blockbusters" — Gordon Lightfoot's **Sundown** (Mobile Fidelity MFSL 1-018), George Benson's **Breezin'** (Mobile Fidelity MFSL 1-011), Al Stewart's **Year of the Cat** (Mobile Fidelity MFSL 1-009), the Grateful Dead's **American Beauty** (Mobile Fidelity MFSL 1-014) and others, for a total of about 20 titles. Recently remastered, and scheduled to become available before Christmas, are **Fly Like An Eagle**, by The Steve Miller Band (Mobile Fidelity MFSL 1-021) and **Manhattan Transfer Live** (Mobile Fidelity MFSL 1-022).

**Recommended Selections:** "Touch" from **Touch**, John Klemmer (Mobile Fidelity MFSL 1-006), "Rhiannon" from **Fleetwood Mac** (Mobile Fidelity MFSL 1-012), "Eclipse" and "Speak to Me" from **Dark Side of the Moon**, Pink Floyd (Mobile Fidelity MFSL 1-017).

Prices: \$14.95 for single discs.



Oneiric Records, P.O. Box 4576, Santa Barbara, Calif. 93103.

Oneiric's sole release to date, **Live One on the Wire**, by Jeff Campbell, has the distinction of being the first digitally recorded rock album, as well as one of the first examples of a "roll your own" digital production. Oneiric used Sony's consumer PCM-1 adaptor/videocassette recorder combination to record the album, mixing it down to two channels through a 24-channel console without overdubbing or editing. The disc was then mastered and processed by the JVC Cutting Center and pressed on virgin vinyl. Notable also on many tracks is the use of what are referred to as "rare guitars," collector's instruments from the early days of electric guitar manufacture. The album has a very clean, unstrained sound, proving that even a digital recording is not beyond the capabilities of a determined group.

**Recommended Selection:** "Live One on the Wire" from **Live One on the Wire**, Jeff Campbell (Oneiric 1).

Price: \$9.98, order direct from manufacturer.



# ONE-OF-A-KIND QUALITY CONTROL RAISES THE NIKKO NR-1219 ABOVE ORDINARY RECEIVERS.

You compare specs and features of different brands before you buy a new receiver. But how about quality?

That's why you should know about Nikko's "200% Quality Control" program. It provides continuous custom inspection of each and every receiver before it leaves our production line. Then, just to make sure, we start all over again. Each unit is thoroughly rechecked before it's delivered to your Nikko dealer. That way you can be certain you're getting all of the outstanding performance and reliability that Nikko builds in.

Nikko's NR-1219 AM/FM stereo receiver is the perfect result of our "200% Quality Control" program combined with state-of-the-art tech-

nology and advanced features. This superb DC amplified receiver delivers a hefty 700 watts per channel, minimum RMS, at 8 ohms, from 20 to 20,000 Hz, with no more than 0.03% total harmonic distortion. And because it's designed with a direct-coupled DC amplifier that uses no input or output capacitors—nothing comes between you and the music. You hear it all!

You can monitor both channels of the NR-1219's power output in watts and decibels with a 12-LED display. FM tuning is precise with dual tuning meters, plus Nikko's T-Lock, which zeros in dead center on the FM signal, for minimum distortion. Recording buffs will especially appreciate the two-way tape dubbing; while record fans will find the subsonic filter gives them better sound from warped discs.

The NR-1219 also features a 25-microsecond FM Dolby\* deemphasis switch, 20dB audio muting, and the insurance of an electronic protection circuit for speakers. It's the

finest receiver Nikko has ever produced.

You can buy the NR-1219 with complete confidence because Nikko's one-of-a-kind quality control is never under someone else's control. That's why we offer a three-year limited warranty on parts and labor.

Call toll-free 800-523-2994 for your nearest Nikko dealer. Nikko Electric Corp. of America, 16270 Raymer St., Van Nuys, Calif. 91406 (213) 988-0105/320 Oser Ave., Hauppauge, N.Y. 11787 (516) 231-8181.

\*Dolby is the trademark of Dolby Laboratories, Inc.

## Nikko Audio

© 1979 Nikko Audio

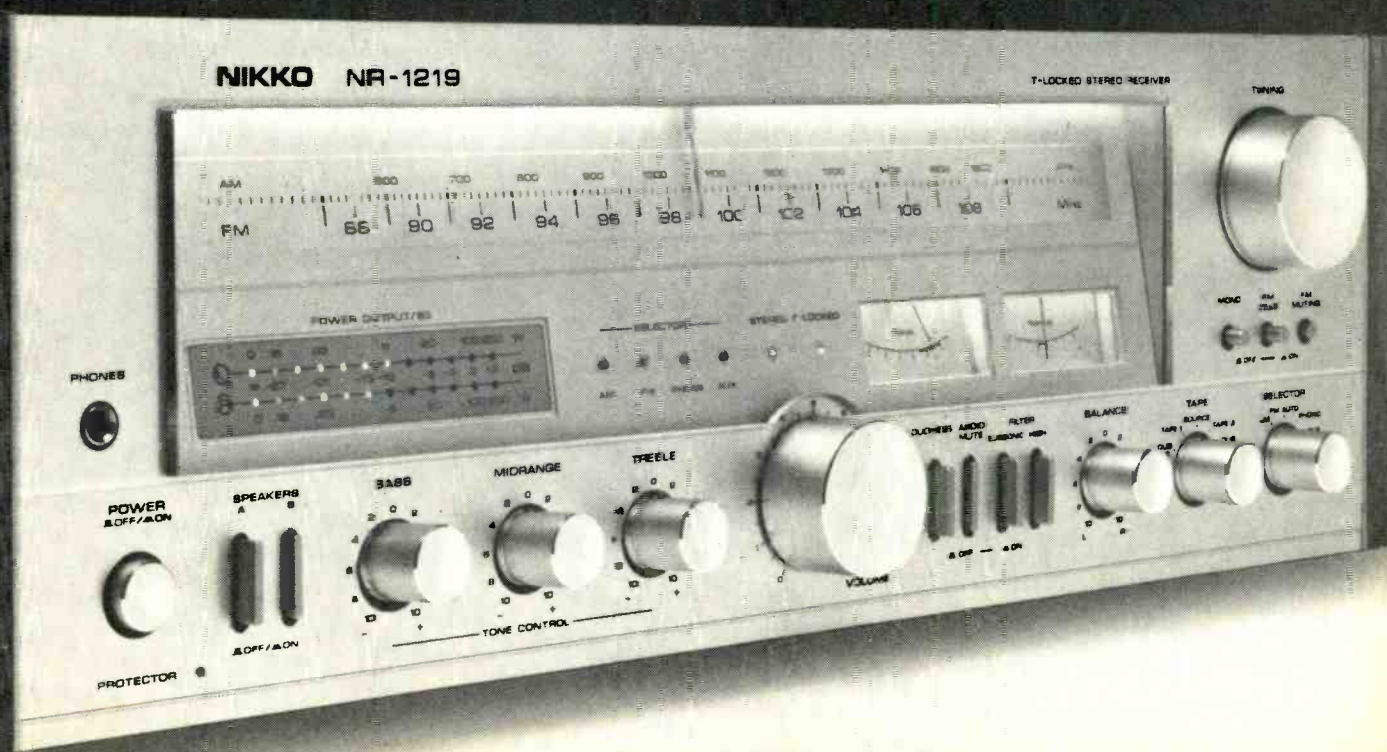

Enter No. 31 on Reader Service Card

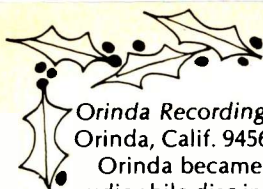

Orinda Recording Corp., Post Box 808, Orinda, Calif. 94563.

Orinda became a major factor in the audiophile disc industry overnight, following the acclaim received by their first digital recording, **A Tribute to Ethel Waters**, with Diahann Carroll and the Duke Ellington Orchestra. The disc, which Orinda notes was the first digital pop album ever released in the United States, was well reviewed by numerous publications and went on to win a Grammy nomination.

Orinda has now released two additional digitally recorded discs, both made, like the Ethel Waters album, using the Soundstream system. They are **The Bee Gees Music**, a group of orchestral renditions of Bee Gees pop hits performed by the Glendale Symphony Orchestra, and a 12-in., 45-rpm single with two tracks from that album, **Staying Alive/Nights on Broadway**. The two newest recordings are among the first to be mixed down in digital form and to use overdubbing with a digital recorder. Orinda also has a direct-to-disc pop recording, **You're Something Special**, by Robert Goulet, and a conventionally recorded 7-in. disco single by Cynthia Black.

Producer Michael Phillips comments that multi-microphone techniques are used for most of Orinda's recordings; the company's digital discs have been half-speed mastered and processed by the JVC Cutting Center and are pressed by Award Records, an American firm, using a particularly hard formulation of virgin vinyl. Orinda does not have any direct-mail sales program, but will refer enquirers to their nearest dealer.

**Recommended Selections:** "After You've Gone" from **A Tribute to Ethel Waters**, Diahann Carroll and the Duke Ellington Orchestra (Orinda ORC-400), "Shadow Dancing" from **The Bee Gees Music**, The Glendale Symphony Orchestra and Sabu, conducted by Carmen Dragon (Orinda ORC-500).

Prices: \$8.98 per disc.



**Orion Marketing** (Nautilus Recordings), 761 Shell Beach Rd., Pismo Beach, Calif. 93449.

Orion Marketing acts as the national distributor for several independent audiophile disc labels, as well as its own Nautilus label. Included in the Orion catalog are:

**Coherent Sound** (U.S.A.) with one direct-to-disc jazz recording, **In My Pocket** by Victor Feldman (Coherent CSR-1001),

**JVC** (Japan) with three direct-to-disc jazz recordings, all featuring guitarist Lee Ritenour,

**East Wind** (Japan) with five direct-to-disc jazz recordings, including three of the jazz group The LA4 with guitarist Laurindo Almeida,

**Romar** (U.S.A.) with one folk recording, **Window Panes**, by Karen Gibbs (Romar R107), recorded conventionally and transferred to the Soundstream digital system for mastering as well as editing,

**Flying Disc** (Japan) with a single direct-to-disc jazz recording, **String Band**, featuring Ron Carter and Hank Jones (Flying Disc FD601),

**ASI** (U.S.A.), a known and established jazz label with one direct-to-disc jazz recording, **Natural Life** (ASI 5001),

**Trend** (U.S.A.) with three direct-to-disc jazz recordings, including the only existent direct-mastered album of oud music (the oud is a lute-like ancient Persian instrument usually played with an eagle feather), **The Art of the Oud**, John Bilezikjian (Trend TR-513), and

**Nautilus** (U.S.A.) with one direct-to-disc folk/rock recording, **First in Line**, by Randy Sharp (Nautilus NR1) and one digital folk recording, the well-received **Aspen Gold**, by the Kingston Trio (Nautilus NR2), as well as a conventionally recorded music-system test record (Nautilus NTR). Nautilus albums by John Klemmer and Tim Weisberg are expected to be available early in 1980.

The company is also preparing to introduce a series of half-speed remastered versions of popular rock and jazz recordings. The first disc in the series will be Heart's **Steamboat Annie**; albums by the Doobie Brothers and America may also be issued as part of the series, which will be expanded to about ten titles over the next year.

**Recommended Selections:** "Corcovado" from **The LA4 Volume 1: Pavane for Une Infante Defunte** (East Wind E10003), "Satin Doll" from **The Great Jazz Trio Direct from L.A.** (East Wind E10005), "Lovin' Arms" from **Window Panes**, Karen Gibbs (Romar R107), "Womanizer" and "For Old Times Sake" from **First in Line**, Randy Sharp (Nautilus NR1).

Prices: \$12.95 to \$16.50 per disc.



**Realtime Records**, 10391 Jefferson Blvd., Culver City, Calif. 90230.

Realtime Records is a California label in the interesting position of being associated with both M&K Sound Corp., a subwoofer manufacturer, and Jonas Miller Sound, a Beverly Hills retail dealership. The company can therefore lay claim to being one of the few high-fidelity firms involved with the entire audio chain of reproduction

— from studio microphone to home speaker output.

Realtime has a catalog of 13 discs; eleven, mostly in the jazz vein, were recorded direct-to-disc, and two used conventional analog techniques for a low-frequency demonstration record and a sampler of material from their direct-mastered products. An additional five or six albums, made using the Sony PCM-1600 professional digital recording system, are expected to be released by the end of this year. These were recorded in Europe this past Fall, and feature the Hungarica Philharmonica performing **The Nutcracker Suite**, **Romeo and Juliet**, and other works.

Realtime favors simple microphone setups placed close to the instruments being recorded, with mixing done passively to prevent low-frequency roll-off (the mixing consoles are flat to 1 or 2 Hz). Mastering is done with aged lacquers, which are then flown by courier to Teldec in West Germany for processing and pressing. The company plans additional digital recordings in the near future.

**Recommended Selections:** "Llorona" from **Flamenco Fever**, Felipe de la Rosa (Realtime RT-107), Fourth Movement of Beethoven's Ninth Symphony from **Ode to Joy**, The Los Angeles Camerata Orchestra and Chorus (Realtime RT-112).

Prices: \$15.00 per disc.



**Reference and Ambience Records** (Sumiko, Inc.), 3000 College Ave., Berkeley, Calif., 94705.

Sumiko is best known as the U.S. importer of Supex and Grace phono cartridges and Lustre tonearms. They also have a catalog of six recordings, primarily in the contemporary and dixieland jazz vein. All were made using conventional analog methods, and the majority with special PRP microphones developed by E. M. Long, Contributing Editor of this magazine who also served as co-recording engineer on several of the albums. The PRP microphones are said to provide the most natural-sounding stereo perspective for recordings made using distant two-microphone arrays, combined with the musical detail of closely spaced microphone setups. A two-channel Nagra recorder was used for most of the discs, which were mastered at half-speed, plated within 15 minutes of cutting, and pressed on virgin vinyl by the (American) Record Technology plant.

**Recommended Selection:** "Dinah" from **Sweet and Hot** (Ambience 70301).

Prices: \$13.00 per disc.

# In recent years over 500,000 music lovers chose a Realistic® receiver over Kenwood®, Pioneer® and Technics® ...



## Why?

**We make it easy for you.** Radio Shack is a retailer as well as a manufacturer. When the store is also the factory, you're apt to get less fiction and more fact. Also, Radio Shack has more company-owned and operated service stations than anyone we know of in the audio business (54 to be specific).

**We've stood the test of time.** Could it be we sell so much Realistic because we've been around since 1921 — long before those other brands were even a twinkle in daddy's eye? Although hi-fi is typically a younger person's product, maybe the kids prefer to bet their hard-earned bucks on the outfit with the grayest hair.

**We have the edge on technology.** Then there's this to consider: The same company that puts Realistic out front also builds and markets the world's most popular personal computer, the TRS-80™. It seems to us that a company smart enough to design

equipment as innovative and complex as a computer is a logical one to choose to build your stereo receiver!

**We're close to you.** Need another good reason to buy Realistic? Let's take availability. Instead of tens or hundreds of places to find it, we offer over 7,300 — wherever you go in the USA or Canada — and a surprising number of overseas locations as well. Being more available doesn't necessarily make us more lovable. But it goes a long way towards assuring you of being able to get in touch with us when you need advice on adding a tape deck or replacing a lost instruction manual.

**We've challenged the rest and won your trust.** Incidentally, we're not picking on Kenwood, Pioneer and Technics. The same half-million-plus folks who chose Realistic also probably had a crack at buying Sansui, Marantz® and Fisher®. The important thing is ... they didn't!

**Radio Shack**®  
The Nationwide Supermarket of Sound®

A DIVISION OF TANDY CORPORATION  
FORT WORTH, TEXAS 76102

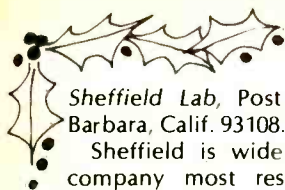

Sheffield Lab, Post Box 5332, Santa Barbara, Calif. 93108.

Sheffield is widely viewed as the company most responsible for the popularization of the audiophile record, and especially the contemporary direct-to-disc recording. Two of the company's principals, Doug Sax and Lincoln Mayorga, had carried on experiments in this field from 1961 onward, and in 1968 they released the first modern direct-to-disc album, the now historic **Lincoln Mayorga and Distinguished Colleagues, Volume I** (mint copies are currently selling for \$500 to \$1,500).

The present catalog is composed of 10 titles in a variety of genres, all made using the direct-to-disc process. Included are two recordings of the Los Angeles Philharmonic Orchestra performing Prokofiev (**Prokofiev: Excerpts from Romeo and Juliet Ballet**, Sheffield Lab 8) and Wagner (**Wagner: Excerpts**, Sheffield Lab 7), an album of classical piano pieces (**Lincoln Mayorga: Pianist**, Sheffield Lab 4), three recordings of Harry James and his Big Band (**The King James Version**, Sheffield Lab 3, **Harry James. . . Comin' From a Good Place**, Sheffield Lab 6, and **Still Harry After All These Years**, Sheffield Lab 11), and several other jazz and pop albums. Sheffield will issue an eleventh album, **Now is the Time**, by Don Randi and Quest, a jazz sextet, (Sheffield Lab 12) by the end of this year. They also anticipate increasing the number of releases to four or five per year within the next several months as a result of expanded studio facilities.

Sheffield tends to favor simple microphone arrays, and even a single stereo microphone on some occasions, for most recordings. All of their later albums are recorded using cutting lathes, microphones, and cutting head amplifiers of their own design. Plating of master discs is done within one half-hour of cutting; discs are pressed on virgin vinyl, using an unusually long cycle time. Sheffield has no plans to become involved with digital recording. Doug Sax is candid in his dissatisfaction with current digital recordings, noting an absence of ambience in the high frequencies. "In its present form," he commented, "it is definitely something we will avoid."

**Recommended Selections:** "America" from **Lincoln Mayorga and Distinguished Colleagues, Volume III** (Sheffield Lab 1), "Cherokee" from **The King James Version**, Harry James and His Big Band (Sheffield Lab 3), "I've Got the Music in Me" from **I've Got the Music in Me: Thelma Houston and**

### Pressure Cooker (Sheffield Lab 2).

Prices: \$15.00 per disc.



Sonic Technology Corp., 3 Westchester Plaza, Elmsford, N.Y. 10523.

Sonic Technology is the originator of a record manufacturing technique called "direct pressing," which shortens the sequence of intermediate processing steps between the original tape and the final disc. The process employs two elements that differ from those used in conventional record-manufacturing operations. In the first step, the multi-channel master tape for a direct-pressed disc is not mixed down and transferred to a two-channel tape; rather, the mixdown levels and equalization are controlled by a computer as the multi-track tape feeds the cutting lathe directly. In the second step, the master lacquer is plated and processed conventionally and then used to press the final vinyl discs directly, rather than being used to make a metal mother and then a metal stamper. When it begins to degrade, after about 1,000 pressings, it is replaced by another metal master derived from another lacquer. The direct pressing process thereby avoids one tape-transfer stage and two metal-mold transfer stages (which Sonic Technology states add 3 to 5 dB of noise each). The end result, according to the company, is a sense of immediacy and aliveness very much like that of a direct-to-disc recording without the need for "one-shot only" caution on the part of the performers.

Thus far, there are two records in the Sonic Technology series, both direct-pressed. One is a jazz-rock version of Vivaldi's "The Seasons" and the other a group of Copland pieces, including selections from the ballets "Rodeo" and "Billy the Kid," and "Fanfare for the Common Man."

**Recommended Selection:** "Hoe-down" from **Rodeo, Fanfare for the Common Man, Billy the Kid**, The Dallas Symphony Orchestra (Sonic Technology STC-200).

Prices: \$15.00 per disc.



Sound 80 Records, 2709 East 25th St., Minneapolis, Minn. 55406.

Sound 80 is a large Minneapolis recording studio that participated in the "shakedown cruise" for 3M's 2-track and 24-track digital recording systems, and was therefore one of the first studios to have use of the equipment. They've recorded two albums using the 3M 2-track machine—an acclaimed performance by the St. Paul

Chamber Orchestra of Copland's "Appalachian Spring" and Ives' "Three Places in New England," and a jazz album by a Minneapolis jazz ensemble called **Flim and the B.B.s**. The third album on the Sound 80 label, **Schubert's Symphony No. 5 in B Flat Major**, performed again by the St. Paul Chamber Orchestra (Sound 80 DTD-102), was made via the direct-to-disc process.

All three discs were mastered in-house by Sound 80 using a Scully cutting lathe, then plated within 48 hours, and pressed on virgin vinyl by the Wakefield organization.

**Recommended Selections:** "View from Seventh Heaven" from **Flim and the B.B.s** (Sound 80 DLR-102), "Appalachian Spring" from **Aaron Copland: Appalachian Spring/Charles Ives: Three Places in New England**, The St. Paul Chamber Orchestra, Dennis Russell Davies conducting (Sound 80 DLR-101).

Prices: \$10.95 per disc (\$12.50 post-paid if sold direct).



2000 B.C. Records, 15313 Via de las Olas, Pacific Palisades, Calif. 90272.

**California Smoker**, 2000 B.C.'s sole release to date, was among the first rock albums made using the Soundstream digital recording system. The album features a group of Los Angeles session musicians playing in an intriguingly eclectic style, recorded in a single studio take using multiple microphones. It is half-speed mastered and pressed on a white virgin vinyl.

**Recommended Selection:** "Fantasy" from **California Smoker**, various musicians (2000 B.C. D2D Chapter 1).

Price: \$13.95.



Xanadu Records, 3242 Irwin Ave., Kingsbridge, N.Y. 10463.

Xanadu specializes in contemporary and historical jazz recordings, usually involving acoustic instruments; as such the label has attracted some noted jazz performers — Al Cohn, Barry Harris and Sam Most among them — and amassed a catalog of about 75 titles. Xanadu has recently ventured into direct-to-disc recording with an album of flute music by jazz flutists Sam Most and Joe Farrell called **Flute Talk**. The album, which was made with several microphones in a rather "live" acoustic environment, is almost entirely improvisational and was recorded without rehearsal.

**Recommended Selections:** "Kim" and "Samba to Remember You By" from **Flute Talk**, Sam Most and Joe Farrell (Xandau X 3001).

Prices: \$12.00 per disc.



# Why we created our own total system.

We simply had to. Because no chain is stronger than its weakest link. And no music system is better than the distortion or noise coming from any of its components.

We wanted to make sure that when you choose one Revox you get all that it has to offer.

The total Revox system delivers virtually distortion-free music from every source and in any mode—music reproduction so true that it is unmatched by any other system available today.



Revox  
Audio-Rack

All the components in the Revox system are designed to meet the professional quality standards that have been set by the Revox B77 open reel recorder with its ingenious logic control system. The B750 integrated amplifier, for example, is renowned for its fast transient response to all musical signals and for its low TIM. It is paired with the incredible B760 digital synthesizer FM tuner with the unusual capability of programming 15 stations which you can recall at the push of a button. The B790 direct drive, quartz controlled turntable reduces tracking distortion to an absolute minimum using a revolutionary new system called Linatrack.

For an unmatched musical experience, listen to our matched components at your franchised Revox dealer.  
Or write to us for details.

## REVOX

STUDER REVOX America, Inc.  
1819 Broadway, Nashville, TN 37203 615 329-9576 / In Canada: Studer Revox Canada, Ltd.

# TEAC TODAY:

You're looking at four new machines that have more in common with data recorders than audio recorders.

Together they are called the X-Series. And they bring a totally new kind of technology to the open reel format.

Each X-Series transport is an instrumentation mechanism. For 15 years, this TEAC design has stood the grueling test of time in computer installations where dependability is worth millions.

The basic configuration is closed-loop dual capstan. It's extraordinarily quiet, stable and precise. Wow & flutter is very low. Speed accuracy very high.

Three DC motors drive the tape. They're used to keep changes in motor temperature to a minimum under different loads so constant torque is maintained.

Our Magnefloat flywheel assembly, a completely new concept, uses magnetics rather than mechanics to eliminate problem-causing

springs and pressure plates. Axial variations between the tape and capstans are prevented so proper tracking is assured. The result is highly accurate audio reproduction even after years of hard use.

The X-Series transport maintains ideal tape-to-head contact. Audible drop-outs, level and frequency losses are absolutely minimized. Frequency response is wide and flat. And signal articulation is unusually clear.

The brain behind the transport is our LSI control chip. It eliminates the need for mechanical relays so transport control is faster, more positive and reliable. The LSI also lets us provide full motion-sensing in the X-10 and X-10R.

Within the X-Series, machines have been specifically designed for bi-directional record and playback. Perfectly symmetrical head stacks (6 heads in all) assure top performance in

both directions. There's automatic reverse and repeat. And two-way cue monitoring.

New audio electronics accompany this new transport technology. Record and playback amplifiers are quieter and completely free of audible distortion. The sound is cleaner, more faithful to the source. The fidelity is unsurpassed.

An option previously available only on our professional recorders can now be added to any X-Series machine. Called dbx I,\* this noise elimination system adds 30dB to the already high S/N and over 10dB of headroom to give you master-quality recordings.

If your audio perception is critical, your listening standards high, audition an X-Series recorder. The performance is flawless. The sound peerless.

## TEAC®



\*dbx is a trademark of dbx, Inc.

# THE X-SERIES.

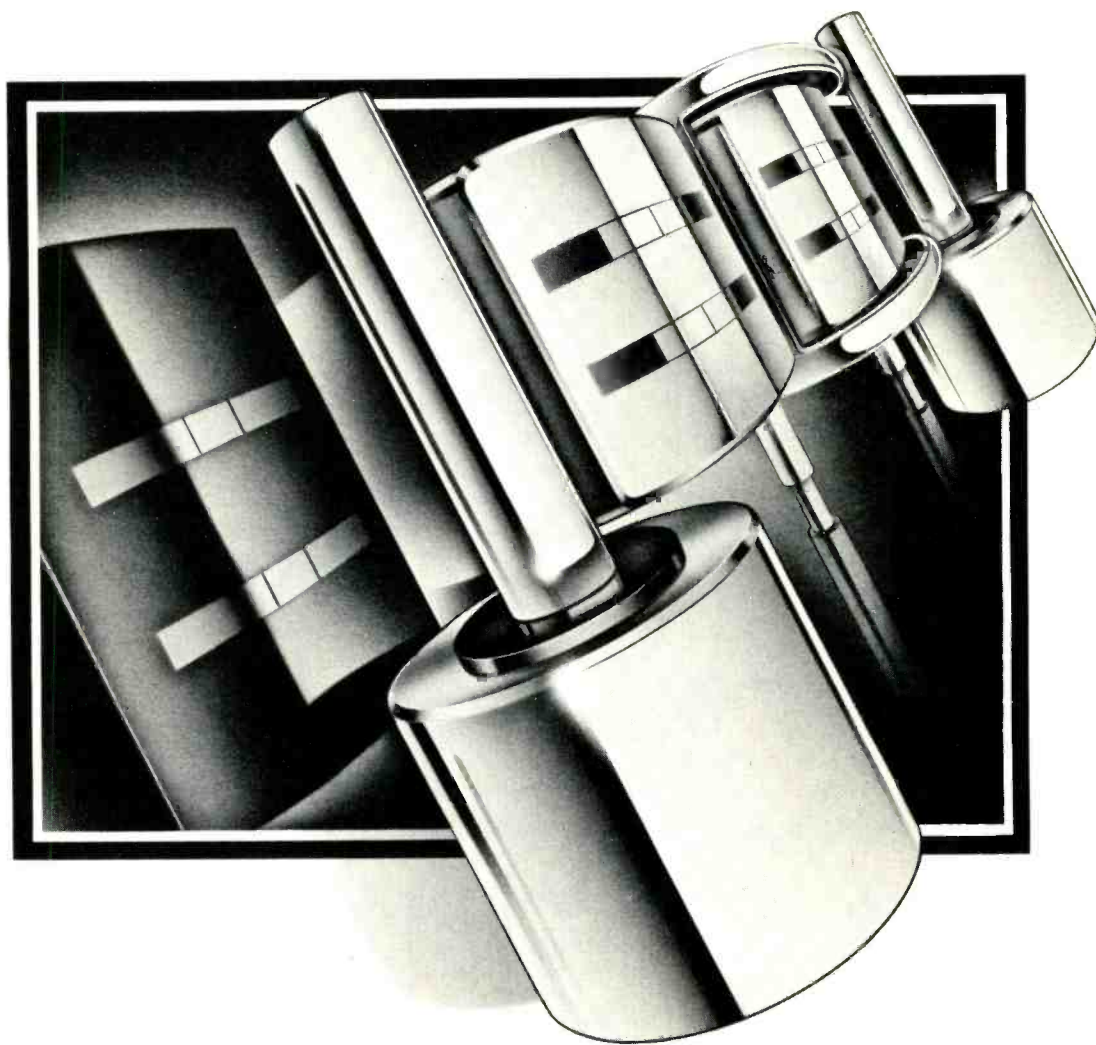

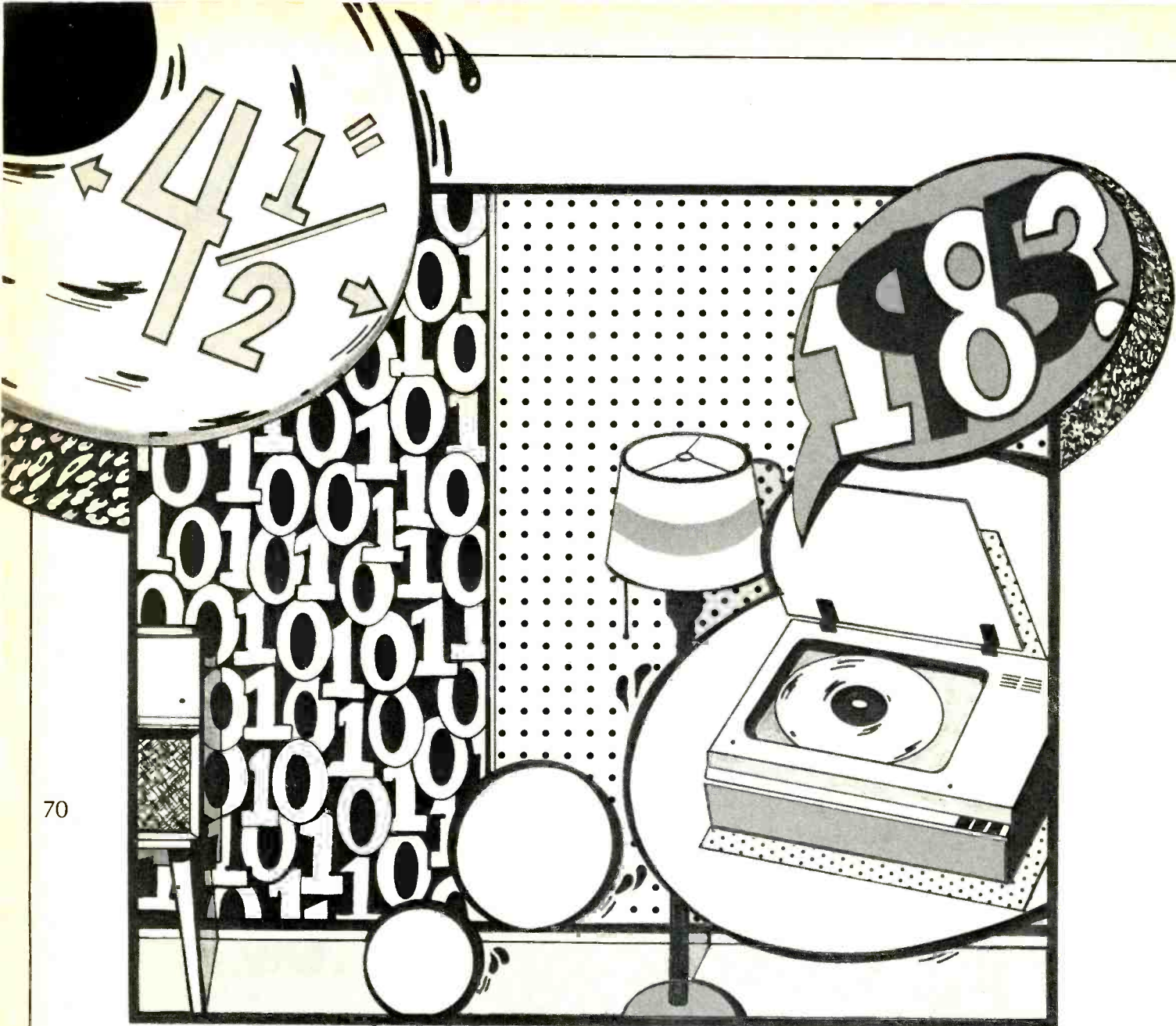

70

# DIGITAL RECORDING: STATE

Allow me to prophesy an event in your future, if I may be so presumptuous. If you are genuinely interested in the reproduction of music, and living in any population center larger than 500 people, there will be a very special and unquestionably memorable day in your life in the next few years. Some time between now and 1985, you will walk into an audio salon and ask to hear a digital audio disc system. The salesman will oblige; he will show you a disc player that may be as small as a cigar box or as large as a transcription turntable. In it, or perhaps on it, he will place a disc. The disc will probably be either an odd matte black or a rainbow-splashed opalescent silver. It may be as small as 4½ in. or as large as 12.

Those details are not important, except to those who have designed the equipment.

What is important is that this first audition of a digital disc system will change forever your perception of the home music system's capacity to recreate reality. It will transport you to a new world of sonic excellence and demonstrate an immediacy, vibrance, and aliveness that no conventional long-playing record could ever truly match. By comparison with the vivid, sharply defined tonal colors of the digital disc, even the direct-to-disc and digitally mastered LP records, which have recently set the recording industry on its ear, will seem slightly pallid and drawn.

I have not sold my soul to Mephistopheles in exchange for the gift of prescience. I'm able to predict this sort of event with a fair amount of confidence because I've seen the products in question — the players, the discs — and heard the superb sound quality they produce. These devices exist now. The units the press has heard are prototypes, but all are technical *faits accomplis*. Only the decision to initiate their manufacture stands between them and the showroom shelf.

## PCM Basic Theory

The extraordinary sound quality of the digital disc players is a result of their use of the pulse code modulation (PCM) encoding system, an informa-



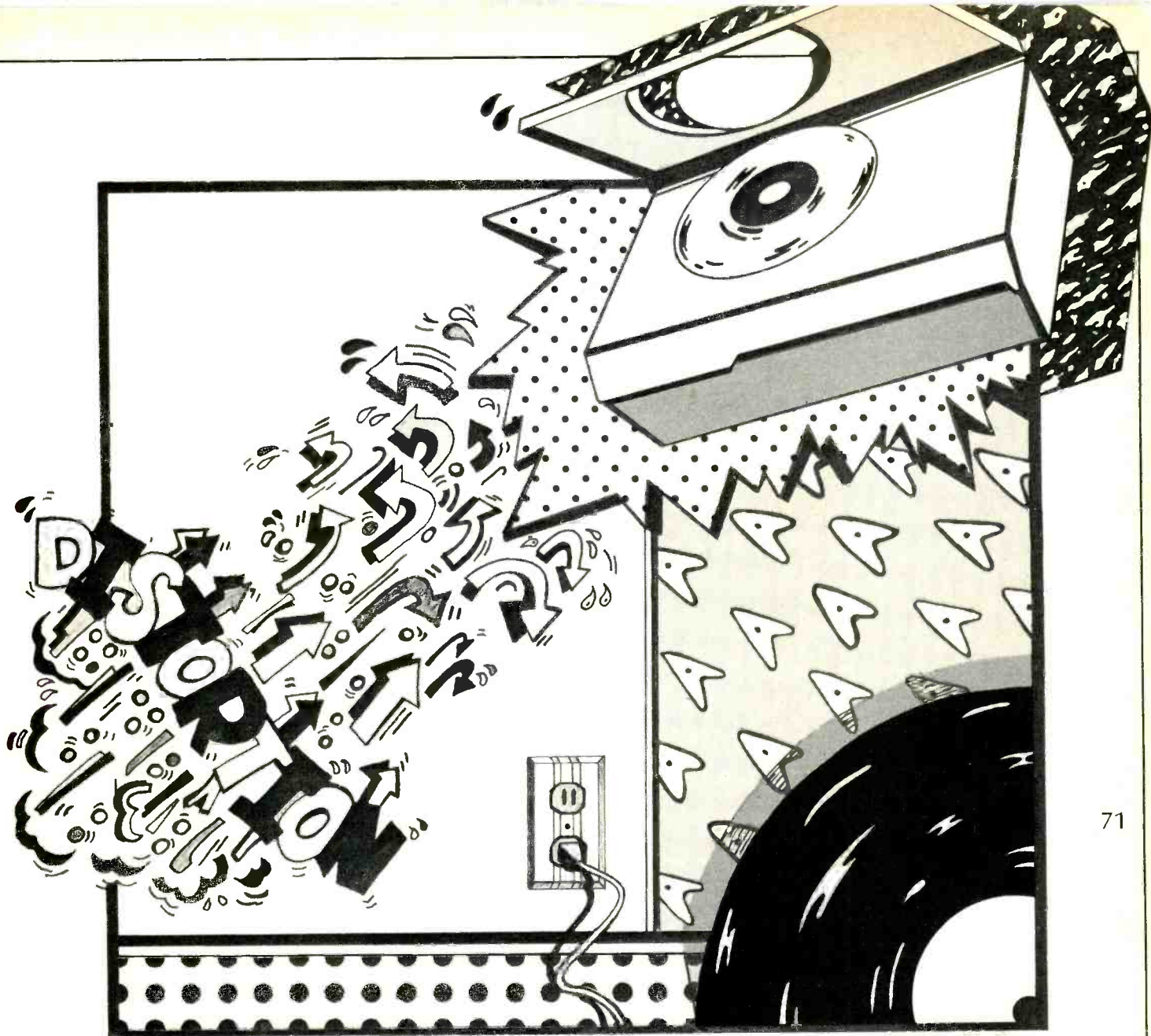

WAYNE BRESSLER

# OF THE MARKET

Gary Stock

tion storage method in which musical signals are handled and stored in the form of long groups of numbers. In a PCM device, such as a digital tape recorder or a digital disc system, the conventional audio signal has been converted into a string of binary numbers — "0"s and "1"s, as it were. This is done by sampling the musical waveform at frequent intervals (usually in the range of 40,000 to 55,000 times per second), measuring the level of each of these samples, converting that level to a binary number — the "0"s and "1"s, and storing that number as pulses and silent spaces on tape or indirectly on the surface of a disc. In order to reconstruct the original music, therefore, one need only be able to

distinguish between pulses and silent spots, and know how frequently the original signal was sampled (the sampling rate). This rate is controlled by a highly accurate electronic "clock" in both the recording and playback phases, so small variations in, say, the digital recorder's transport mechanism or the disc player's platter speed have no effect on the precise rate at which the tape or disc's digital signal is reassembled into a conventional analog output, and therefore have no effect on the music. The musical signal is also immune to most other sources of incidental noise and distortion in the recording and playback chain, since only pulses and silent sections of fixed amplitude are being stored and recalled.

The wow-and-flutter specifications of the prototype digital disc systems are therefore unmeasurably low, and the theoretical distortion, dynamic range, and bandwidth specifications significantly better than could be achieved by any analog method.

A short list of the requirements for a practical digital disc is a sobering document to contemplate, however. In order to fall within the price range necessary to ensure accessibility to the general public, the disc cannot cost very much more than a conventional LP record. It must be able to be mastered and manufactured at high speed and be fabricated of an inexpensive material. It must be durable, resistant to our increasingly noxious

Fig. 1—Matsushita/  
Panasonic Visc-o-Pac  
player and discs.



atmosphere, and fairly simple to use and to store. A little basic arithmetic tells us that with 50,000 binary numbers per second of playing time, an hour of recorded music will require the disc to store some 180 million separate groups of numbers, an information density far higher than that of a conventional record.

Surprisingly, despite these stringent requirements, three separate methods of putting a PCM-encoded signal on a disc (and getting it off again) have been developed. All meet the basic criteria we have set, in their own individual ways. They are:

#### The Mechanical Approach: Visc-o-Pac

Matsushita, parent company of Panasonic, has developed the player system closest in principle to the classic stylus and groove of the phonograph record. Their Visc-o-Pac system uses a minute diamond stylus tip, bonded directly to a piezo-ceramic "chip," to play an extremely narrow groove in a 9-in. vinyl disc. The groove is vertically modulated, i.e. it has hills and valleys over which the stylus rides. Tracking these grooves with a stylus force of only a few milligrams, the stylus transmits variations in pressure caused by the pattern of hills and dales to the piezo-electric element, which generates an output voltage proportional to the vertical modula-

tion of the groove. The hills and valleys, in effect, represent the "0"s and "1"s of our binary number groups.

Visc-o-Pac is much more complex than any conventional turntable, despite its straightforward theory of operation. Its "tonearm," if it can be called that, tracks radially from the innermost grooves outward, moving at a constant velocity. The arm is driven by a servomechanism, since no free-pivoting arm could track such a narrow, shallow groove at such low pressures unassisted. The disc revolves at a speed varying from 300 to 700 rpm, depending on the position of the stylus, the objective being to maintain a constant relative speed even though the radius being touched by the stylus changes.

The disc itself is enclosed in a two-sided plastic case that is automatically removed from the surface to be played when the disc is put in the player. It has a playing time of two hours (one hour per side), and a life of at least 1,000 plays. The stylus assembly, like the stylus of a normal phono cartridge, is replaced by the user at intervals of 1,000 hours or so. Much of the Visc-o-Pac technology is derived from Matsushita's efforts in the consumer videodisc field. In fact, the Visc-o-Pac player is primarily intended for videodisc playback, with digital audio to be a secondary function. Matsushita has committed to this simple system, one

reliant upon proven technology, in an effort to keep the price of the basic player within the reach of the non-audiophile videodisc customer. A retail price under \$500.00, with discs costing about 50 percent more than contemporary LPs, is projected by company spokesmen. The projected price of the PCM adaptor is \$250.00.

#### The Capacitive Approach: VHD/AHD

As its name suggests, JVC's prototype Video High Density/Audio High Density (VHD/AHD) digital disc player is fundamentally a videodisc player that may be equipped, via an out-board PCM adaptor, to play audio-only discs. VHD/AHD uses a stylus (of sorts) in contact with the surface of a 12-in. disc, but the stylus is used as an electrode, rather than a mechanical sensing element. The broad pentagonal "footprint" of the stylus tracks along rows of wide, oval-shaped depressions called "signal pits" that are molded into the disc surface; the arm is guided by servomechanisms that monitor the stylus' position using dual rows of slender tracking pits that run at right angles to the signal pits. The JVC disc is made of a vinyl-based plastic that is electrically conductive. The electrode/stylus moving over the surface of the disc acts as one plate of a capacitor, the disc surface itself as the other plate. The pits therefore continuously modulate this capacitance, causing a carrier tone to be frequency modulated. Once demodulated, this modulation signal comprises the digital information that contains the music. Due to the broad stylus "footprint," VHD/AHD discs have a lifespan of at least 54,000 plays; stylus life is 2,000 hours or so. The discs turn at 900 rpm and have a playing time of two hours, one hour per side. They are enclosed in a dust-tight sleeve. Sliding the sleeve into the player's front panel extracts the disc for play; inserting it again removes the disc.

72

Fig. 2—JVC Video High Density/Audio High Density player.

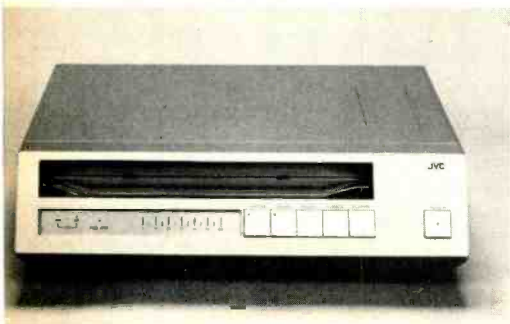

Fig. 3—Philips Compact-Disc player.



Fig. 4—Sony DAD-1X player.



You expect to be really impressed by a new cartridge. Otherwise you wouldn't even consider it. What you don't expect is to get the same impressive performance thousands of plays later. But consider this: after 1000 playing hours the new ADC Improved Series cartridges show no audible change in performance! Amazing? You're right. But what's even more

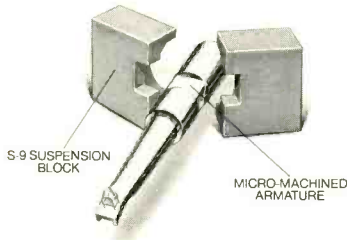

amazing is the new Omni-Pivot System™ that did it. It's a major advance in

micro technology. There are no unpredictable armature governors, wires or adhesives. Instead each armature is micro-machined to perfectly lock into our exclusive new S-9 high definition suspension block. We think it's a real breakthrough. But you should be the judge.

Look at both the frequency response and stereo separation of a new ADC ZLM Improved cartridge. They're incredible. The new ADC ZLM accurately reproduces even the most complex musical passages with absolute neutrality.

Now compare the same cartridge after 1000 playing hours. See any difference? The ADC ZLM Improved cartridge shows less than a 1dB change in performance. That means you won't hear any difference.

Now the good news gets even better. The Omni-Pivot

System™ comes in a wide range of new ADC Improved Series cartridges. The ZLM, XLM MKIII and MKII, and QLM-36 MKIII. All featuring new snap-down stylus protectors.

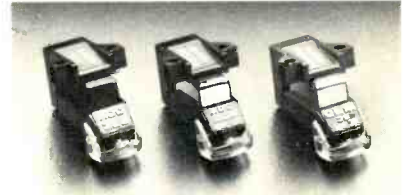

If you already own a fine ADC cartridge, the Omni-Pivot System™ is yours for just the price of a replacement stylus.

Listen to any new ADC Improved cartridge. After you've heard us, we'd like to hear from you. Write Audio Dynamics Corporation, Pickett District Rd., New Milford, Ct., 06776, or call our toll-free number (800) 243-9544.

# BEFORE YOU BUY A NEW CARTRIDGE TAKE A LOOK AT A GOOD USED ONE.

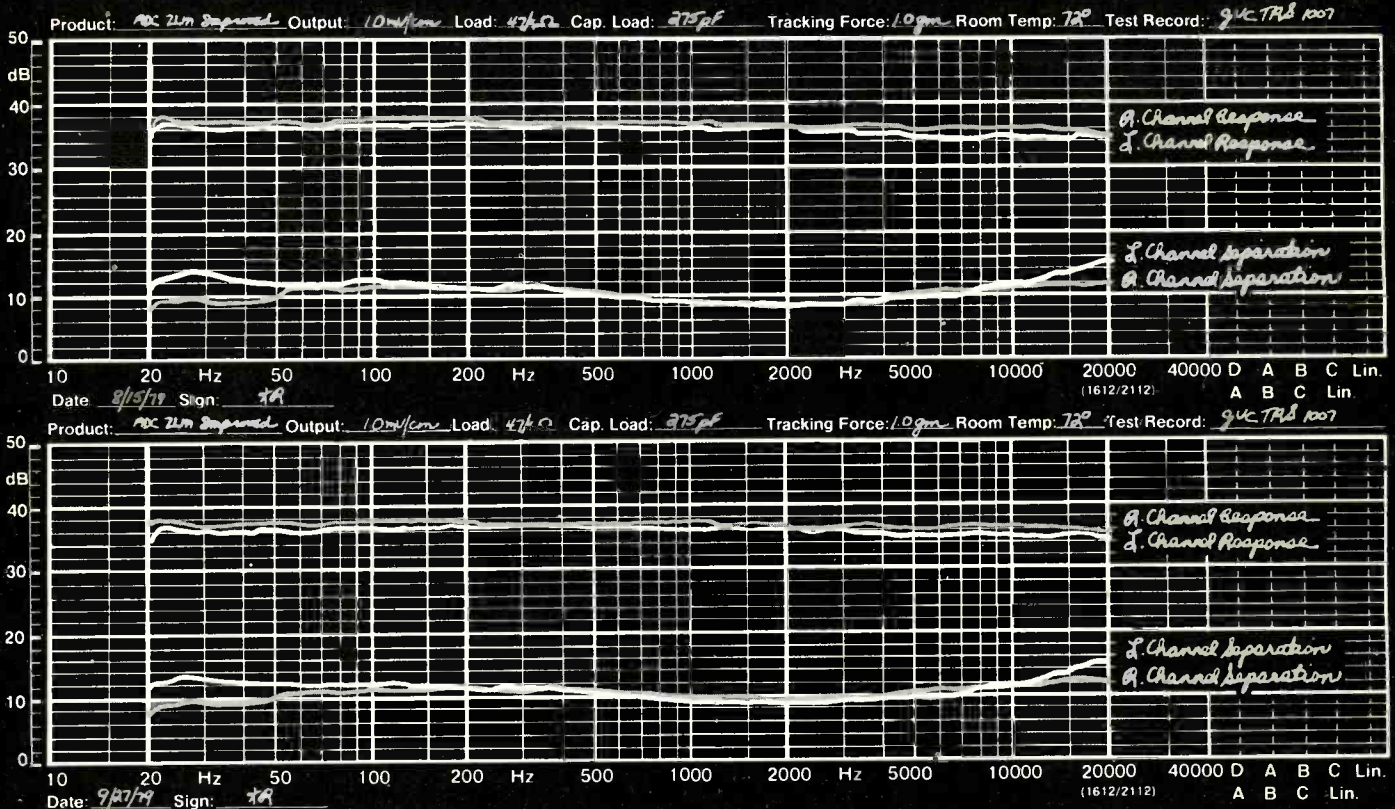

A BSR COMPANY

Enter No. 1 on Reader Service Card

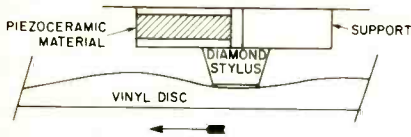

**Fig. 5—Visc-o-Pac stylus assembly and disc surface. The stylus reacts to vertical modulation of the record surface, applying pressure to piezoceramic element. Support member acts as a fulcrum.**

**Fig. 6—JVC VHD/AHD stylus and disc surface. Note the wide signal pits and long, slender tracking pits.**

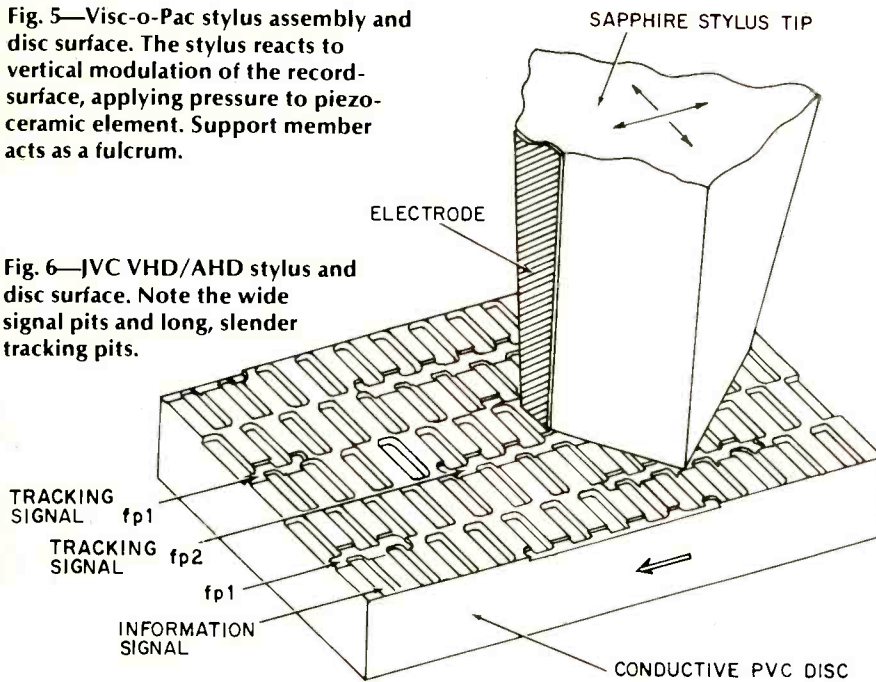

JVC also endeavors to offer their basic player at a moderate price — perhaps under \$600.00, although the optional PCM adaptor will add considerably to that sum. Other options include a random access unit for rapid access to any point on the disc and a video-oriented "Trick-play Unit" for such picture special effects as stop-frame and slow motion.

### The Optical Approach: Compact Disc and DAD-1X

The third and most complex approach to storage of PCM information in disc form is the laser-read optical system, represented here by two prototype players — the Philips Compact Disc and the Sony DAD-1X — whose

operating characteristics have been described publicly in some detail.

The Compact Disc is by far the smallest of the digital disc players demonstrated thus far. The dimensions of the player are approximately 10x7x3 ins., about the size of a portable cassette recorder (the dimensions have not been formally released; what I've indicated is derived from my examination of the unit at its demonstration). The discs are a brilliant silver, and only 4½-in. in diameter, smaller than a doughnut 45-rpm record.

**Fig. 7—Visc-o-Pac protective cover. Cover is automatically removed after insertion into player.**

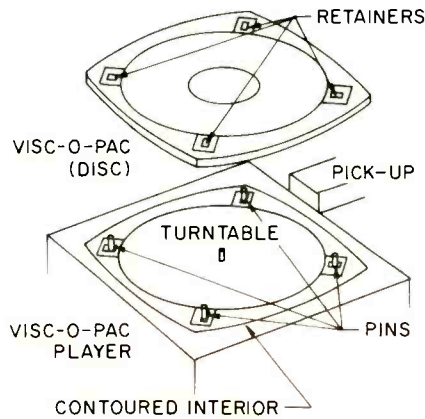
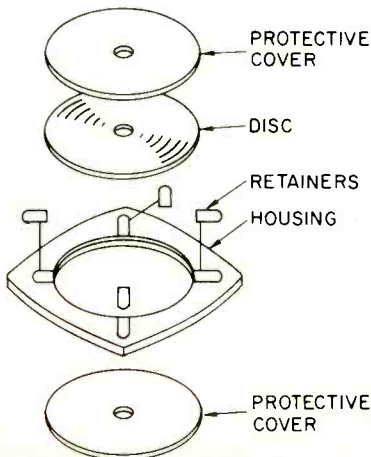

The Compact Disc's scanning element is a byproduct of Philips' videodisc research. It is a miniature, low-power laser element that reads the disc radially from below, the laser moving from inner radius to outer. The focus and lateral position of the laser are maintained by multiple servomechanisms. The beam of the laser is focused in a tiny spot on the disc's reflective, aluminum-plated center layer, which is impressed with a spiral track composed of millions of tiny pits. The light beam from the laser is reflected by the aluminum surface and its brightness continuously modulated by the pattern of the pits. This reflected light beam passes through a series of mirrors and prisms to a photodiode that converts the light into a modulated electrical signal, which in turn is decoded into the PCM audio signal, as well as tracking information to control the laser elements' servomechanisms and program-indexing information that can be displayed on the front panel as letters or numbers on an alphanumeric display. In the Philips system, a black space on the disc represents a binary "0," while a pit represents a binary "1."

There is no physical contact between the disc and the laser; both, therefore, are theoretically wear-free. Also, since the laser beam is focused on the center layer of the disc rather than its surface, dust and imperfections on the surface are out of focus and should not substantially affect the scanning process. The disc speed changes from 500 to 215 rpm as the laser element moves outward; the intent, as with the Visc-o-Pac, being a constant relative speed over the entire radius of the disc. Playing time is one hour, with one side only recorded, although recording on both sides is technically feasible.

Philips projects a cost for the Compact Disc system "comparable to the cost of a good conventional record-player," in their terms, and most observers interpret this to mean a price under \$500.00 for the player.

Sony's DAD-1X also uses a beam from a low-power laser, focused from beneath on the reflective center layer of a pitted plastic disc. As with the Philips, in the DAD-1X the modulated light reflected from the disc is carried through an arrangement of mirrors and prisms to an optical detector system, which converts the modulations into a PCM-encoded musical signal. But the disc itself is different. Unlike Philips, Sony may well offer a single player as a combined videodisc and digital audio disc player, and since video recordings require even higher infor-

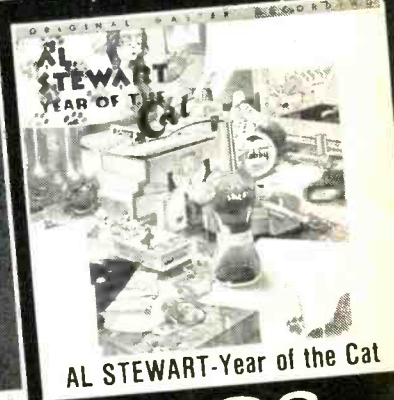
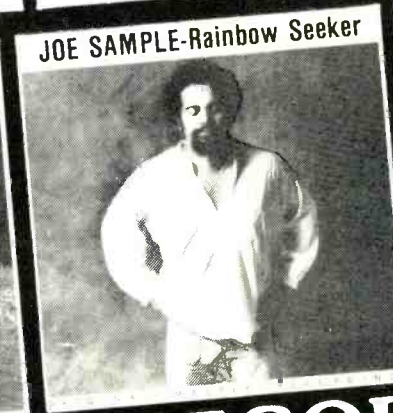
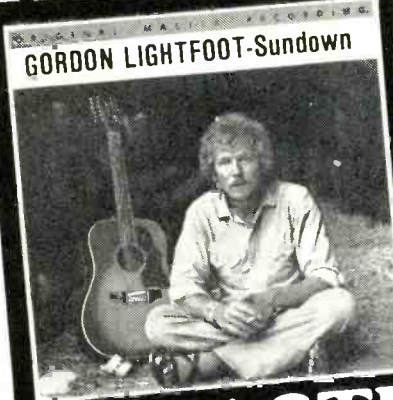
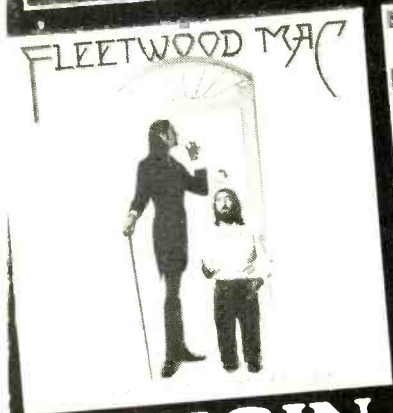
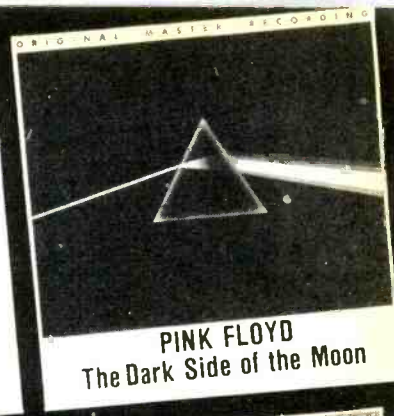
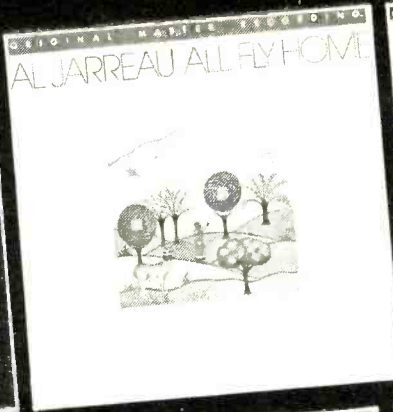

# ORIGINAL MASTER RECORDINGS™ The State Of The Art.

The key high fidelity component guaranteed to improve your stereo system. **Super High Fidelity** is achieved by total quality control, using **only Original Stereo Master Tapes!** Our exclusive **Half-Speed Mastering** technique insures natural musical clarity and impact; our high definition **Super Vinyl** disc is custom pressed overseas. Each pressing is protected by a **Static Free Inner Sleeve** and placed in a **Special Heavy Duty Protective Package.** The result is your favorite music by your favorite artists on the highest quality, **Limited Edition** pressings. Your stereo system will **come alive** with the sounds of the original performance!

## Available from select audio and record stores coast to coast.

The following titles are  
**SOLD OUT!**  
However, your MFSL Dealer  
may have some copies in stock.

- STEELY DAN  
"Katy Lied"
- ZUBIN MEHTA & LAPO  
"Suites From Star Wars" and  
"Close Encounters Of  
The Third Kind"
- THE CRUSADERS  
"Chain Reaction"
- THE MYSTIC MOODS ORCHESTRA  
"Emotions" and "Cosmic Force"

### ALSO AVAILABALE...

- THE MANHATTAN TRANSFER
- STEVE MILLER BAND
- THE MYSTIC MOODS ORCHESTRA
- JOHN KLEMMER
- STEELY DAN
- THE CRUSADERS
- L.A. PHILHARMONIC ORCHESTRA
- GEORGE BENSON
- LITTLE FEAT
- GRATEFUL DEAD
- EMMYLOU HARRIS



P.O. BOX 919 • CHATSWORTH, CA 91311 • (213) 993-4945

Enter No. 28 on Reader Service Card



Fig. 8—Cross-section of the laser element and disc surface of Philips Compact Disc system. The Sony laser element is fairly similar.

mation density than digital audio recordings, the 12-in. disc diameter Sony has adopted provides 2½ hours of playing time on one side of the disc, as against one hour of video playing time. Intriguingly, Sony says that it is technically feasible to encode both sides of their disc, which would yield a total of five hours of playing time from

a single double-sided disc! A reference signal is recorded between selections on the Sony disc, and the player has the capacity to automatically locate a particular program. As with the Philips (and all other optical systems demonstrated thus far), the DAD-1X's laser element and disc surface are non-contacting and therefore not subject to wear.

Sony has announced no projected price for their player or discs, and no target introduction date. They describe the unit as a prototype, demonstrated primarily to solicit commentary on the optimal design for final production.

### The Compatibility Question

The manufacturers of most systems demonstrated (which also include Pioneer and Mitsubishi with optical disc systems and RCA with a possible capacitive system) make at least a pretense of saying that they will market a proprietary system in the early '80s. Most everyone agrees, though, that the simultaneous introduction of several incompatible digital disc systems, each in limited quantity and with a limited software catalog, would probably result in a marketing catastrophe at least on the scale of the quadrasonic

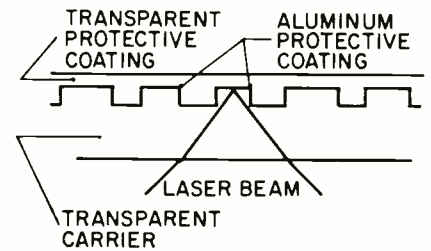

Fig. 9—Cross-section of Philips compact-disc, showing pits and transparent surface layer. Sony's disc is similar.

disaster of the early '70s. The Japanese government has requested that a common standard be set for digital audio discs, and about 30 manufacturers have taken part in standards committee meetings seeking to compromise on a single disc system. No one in Japan or outside of it is legally bound to a doctrine of one unified system, but most observers feel that some degree of consensus will be reached, at least among the Japanese manufacturers, in the next few years.

The whole story of the corporate politics surrounding the videodisc and digital audio disc standards questions is an extremely involved one, both volatile and complex. The important point to bear in mind is that the products we have examined are all in the prototype stage, and most likely substantial changes will take place in many cases before they reach the market. It is possible that some of the companies in question will abandon one technical format in favor of another, so as to share the costs of software development and licensing with other companies, acquire greater marketing strength through alliance, and thereby improve the chances of a given system being accepted by the public. Probably more than one system will reach the market; whether two or more can coexist is another question. Unlike the LP versus 45 struggle of the '50s, no armistice-style compromise wherein a single player can be used with two different disc formats seems likely or even practical.

It is also not likely that you will throw away your record collection and turntable on the same day you buy your digital disc player. It will take many years for the catalog of available digital programs to near the size of the immense analog library we now enjoy. Philips, for instance, forecasts a 10-year period of parallel use of analog and digital systems. The quaint, fussy device we call the phonograph will be around for quite a while. But even though its period will not soon end, the era of the digital disc will soon begin. **A**

Table 1 — Comparative Specifications of Four Prototype Digital Audio Disc Systems.

Disc System	Matsushita (Panasonic) Visc-o-Pac	JVC Video High Density/Audio High Density	Philips Compact Disc	Sony DAD-1X
Scanning Format	Mechanical	Capacitive	Optical	Optical
Playing Time	2 hours (1 hour per side)	2 hours (1 hour per side)	1 hour (recorded one side only)	2½ hours (recorded one side only)
Disc Diameter	9 inch (225 mm)	12 inch (305 mm)	4½ inch (115 mm)	12-inch (305 mm)
Number of Channels	2	2	2 to 4 <sup>2</sup>	2
Frequency Response	20 to 20 kHz ±1 dB	1 to 20 kHz ±0.5 dB	20 to 20 kHz	2 to 20 kHz ±0.25 dB
Dynamic Range	>85 dB	>90 dB	≥85 dB	>95 dB
Distortion	<0.1 percent	<0.05 percent	<0.05 percent	<0.03 percent
Disc Lifespan	>1,000 plays	>54,000 plays	Infinite	Infinite
Stylus Lifespan	>1,000 hours	>2,000 hours	Infinite (no stylus)	Infinite (no stylus)
Revolving Speed	300 to 700 rpm <sup>1</sup>	900 rpm	215 to 500 rpm <sup>1</sup>	450 rpm
Bit Format	14 bit	14 bit	14 bit	16 bit
Track Pitch (Spacing)	2.3 μM (micrometers)	1.4 μM	1.66 μM	1.3 μM

Notes: <sup>1</sup>Speed varies dependent upon position of scanning element.

<sup>2</sup>Playing time 45 minutes in four-channel mode.

# The Universal Expander

Dynamic range limiting during the production of records (and of FM broadcasts) has long been a source of irritation for music lovers. As playback equipment improves, the limitations of most program material become more and more obvious. The vast majority of records are produced with the lowest common denominator in mind—a system that is restricted in its ability to recreate natural dynamic range.

With the introduction of the Dynamic Expander, MXR's Consumer Products Group has achieved its goal of providing a signal expansion technique for all types of music compatible with the finest audiophile equipment available.

**Enter the typical dynamic range expander:** While dynamics are restored, a series of disturbing side effects becomes apparent. Because typical expanders cannot distinguish scratches, ticks, pops, and rumble from music, these noises trigger the expansion circuitry. More importantly, because most existing expanders have a fixed value release time, they seem to 'pump' with some music, and hiss or 'breathe' with other kinds of music.

In most cases these drawbacks have outweighed the advantages of expansion for the critical listener.

**Enter MXR's Dynamic Expander:** a linear signal processor with up to 8 dB upward expansion (restoring musical peaks) and as much as 21 dB downward expansion (reducing noise). MXR has solved the problem of 'breathing and pumping' by providing a variable release-time control that tailors the response characteristics of the expander to the program material.

A sophisticated level detection circuit discriminates between music and unwanted information such as

rumble and scratches. To monitor gain changes, a unique LED display accurately indicates the expander's effect on the signal whether in or out of the circuit. A level control adjusts the detector's sensitivity to optimize the expansion for varying signal levels, and additional controls provide in/out bypass switching and versatile taping facilities.

The MXR Dynamic Expander preserves the bandwidth, stereo image, and spectral balance of the original signal even after processing. Dynamic range expansion that is musically natural will restore the excitement and nuance that makes live music so emotionally satisfying, and will let you rediscover your cherished recordings.

Harnessing innovative technology and sophisticated production techniques, MXR continues its commitment to the music lover.

**The expanding universe** of signal-enhancing equipment from MXR's Consumer Products Group gives demanding music listeners maximum performance from their playback systems regardless of room acoustics or program deficiencies. The MXR Comander allows you to maintain the dynamic range of source material through open reel or cassette tape decks. Environmental equalization is easily achieved with your choice of stereo 10 band (full octave), stereo 15 band (two-third octave) or professional one-third octave equalizers all built to the exacting performance specs for which MXR is famous. See your MXR dealer.

**MXR Innovations, Inc.**, 247 N. Goodman Street, Rochester, New York 14607, (716) 442-5320

**MXR** Consumer Products Group

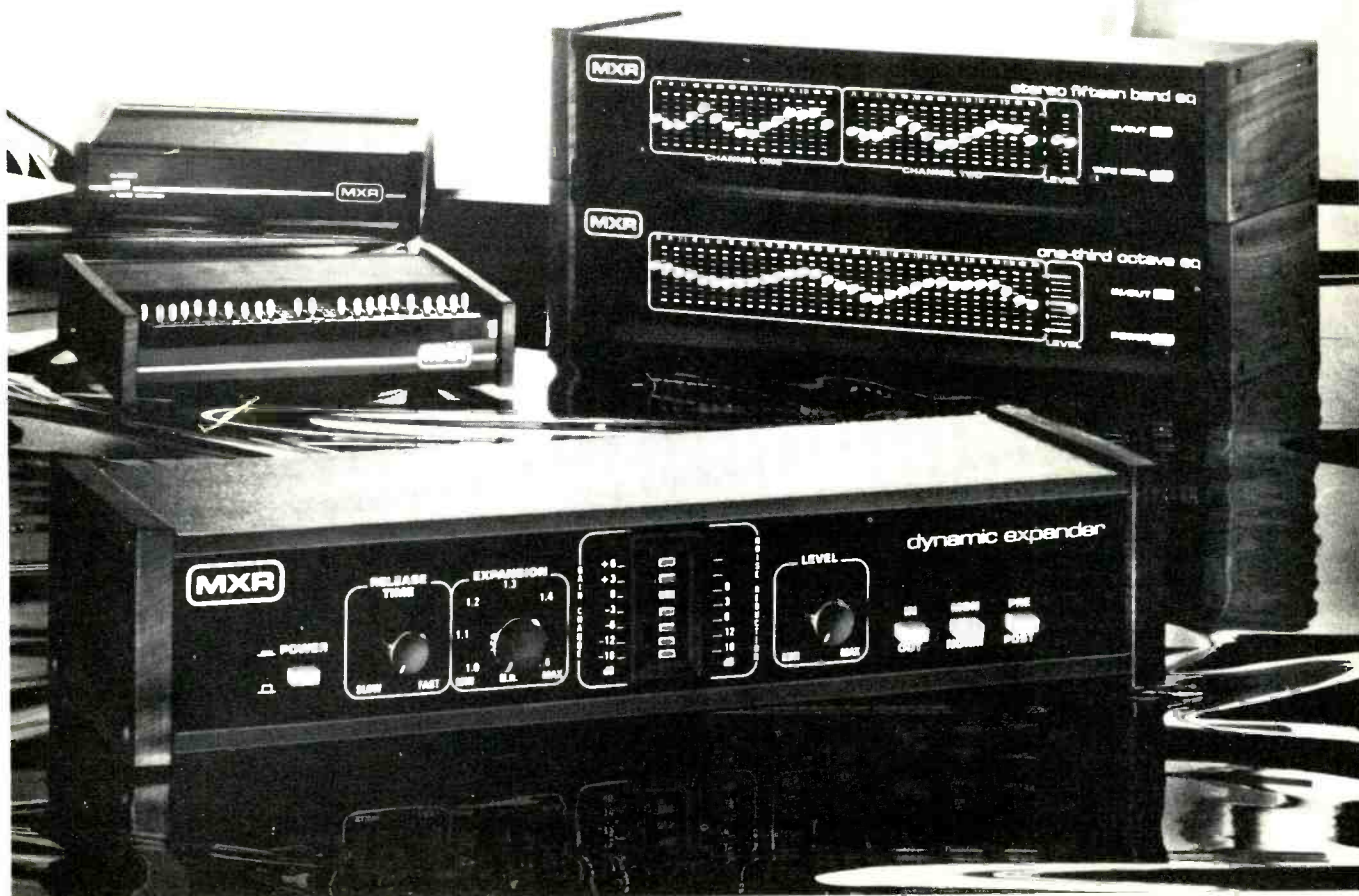

Enter No. 22 on Reader Service Card

# Equipment profiles

## TEAC Model C-1 Cassette Deck



### Manufacturer's Specifications

**Motors:** 3; 1 PLL d.c. servo-controlled dual capstan, 2 d.c. coreless reel.

**Heads:** 3.

**Wow and Flutter:** 0.04 percent.

**Frequency Response:** 30 to 18,000 Hz,  $\pm 3$  dB, with CrO<sub>2</sub> and FeCr; 30 to

16,000 Hz,  $\pm 3$  dB, with FeO.

**Signal-to-Noise Ratio:** 60 dB with FeCr (without Dolby).

**Inputs:** 2 lines, 50 kilohms; 2 mikes, 600 ohms.

**Output:** 0.3 V at 50 kilohms line, 1 mW at 8 ohms for phones.

**Features:** Jacks for external dbx encoder-decoder, 2 bias-equalization plug-in cards.

**Dimensions:** 19 in. (48.26 cm) x 6½ in. (16.51 cm) x 13¾ in. (35.24 cm).

**Weight:** 32 lbs. (70.4 kg).

**Price:** \$1,350.00.

There is no official or even commonly accepted set of standards for a professional cassette deck. However, most engineers would stipulate variable bias, equalization and speed, with provision for azimuth head adjustment, off-tape monitoring plus the state-of-the-art parameters in respect to frequency response, signal-to-noise ratio, and so on. TEAC's impressive-looking Model C-1 does not have facilities for external head adjustment, but it certainly has some outstanding features with an excellent overall performance and should at least qualify as "nearly professional." Bias and equalization adjustments are provided on plug-in cards and, normally, two are included: One for cobalt and the other for CrO<sub>2</sub>.

Other tapes — ferric and FeCr — are handled by a pair of three-position bias and equalization switches.

The deck is rather larger than average, measuring just under 14 in. deep, 6½ in. high, and 19 in. wide (yes, it can be rack-mounted). The front panel has the usual satin-silver finish, contrasting with a neat black sub-panel containing the cassette compartment and the associated tape-transport controls. A complex LSI logic system is employed with three motors and two capstans — the drive motor being servo-controlled. The *On-Off* switch, timer button, headphone jack, and variable speed control are located on the left of the cassette compartment. To the right, under the VU meters, are three rotary controls. Number one and number two are the input controls for left and right channels which, although ganged together, can be moved independently if desired. The third control governs the output. On the extreme right is a vertical row of six three-position slide switches. At the top is the source-monitor switch, the center position bypassing the aforementioned output control. Number two switches in the Dolby system or connects an external dbx system, and number three is the mike-line selector with a 20-dB attenuation position. The next switch, number four, works in con-

Fig. 1 — Playback response from standard test tape.

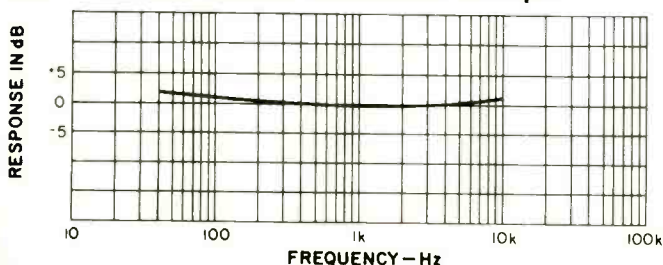



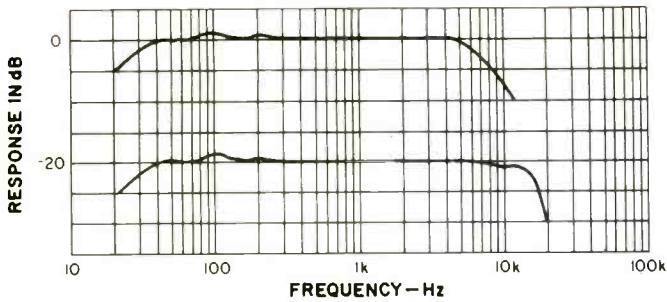

Fig. 2 — Record-replay response with BASF Studio tape.

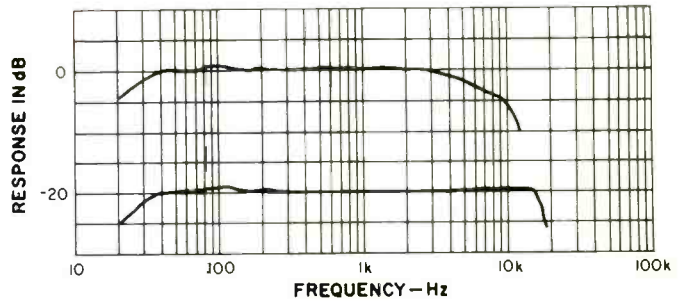

Fig. 3 — Record-replay response with Maxell UD XL-II tape.

junction with the digital tape counter to initiate automatic rewind when the tape reaches the end — either in the play or record modes. Switches five and six are the bias and equalization selectors mentioned earlier, and they are marked *Normal*, *FeCr*, and *CrO<sub>2</sub>/Option* — which last refers to the plug-in board. The two VU meters are calibrated for peak readings with the 0 VU indicating a flux density of 200 nWb/m, the Dolby level. I ought to mention that one of the controls on the sub-panel is the *Record Muting* switch which discon-

nects the recording input signal from the heads, leaving the erase head functioning to clean the tape. Input and output sockets — including a pair of microphone jacks (standard 1/4-in. types) — are at the rear.

### Measurements

Figure 1 shows the playback response from a standard test tape, and Fig. 2 shows the record-playback response with BASF Studio tape which has a “normal” 120- $\mu$ S equaliza-

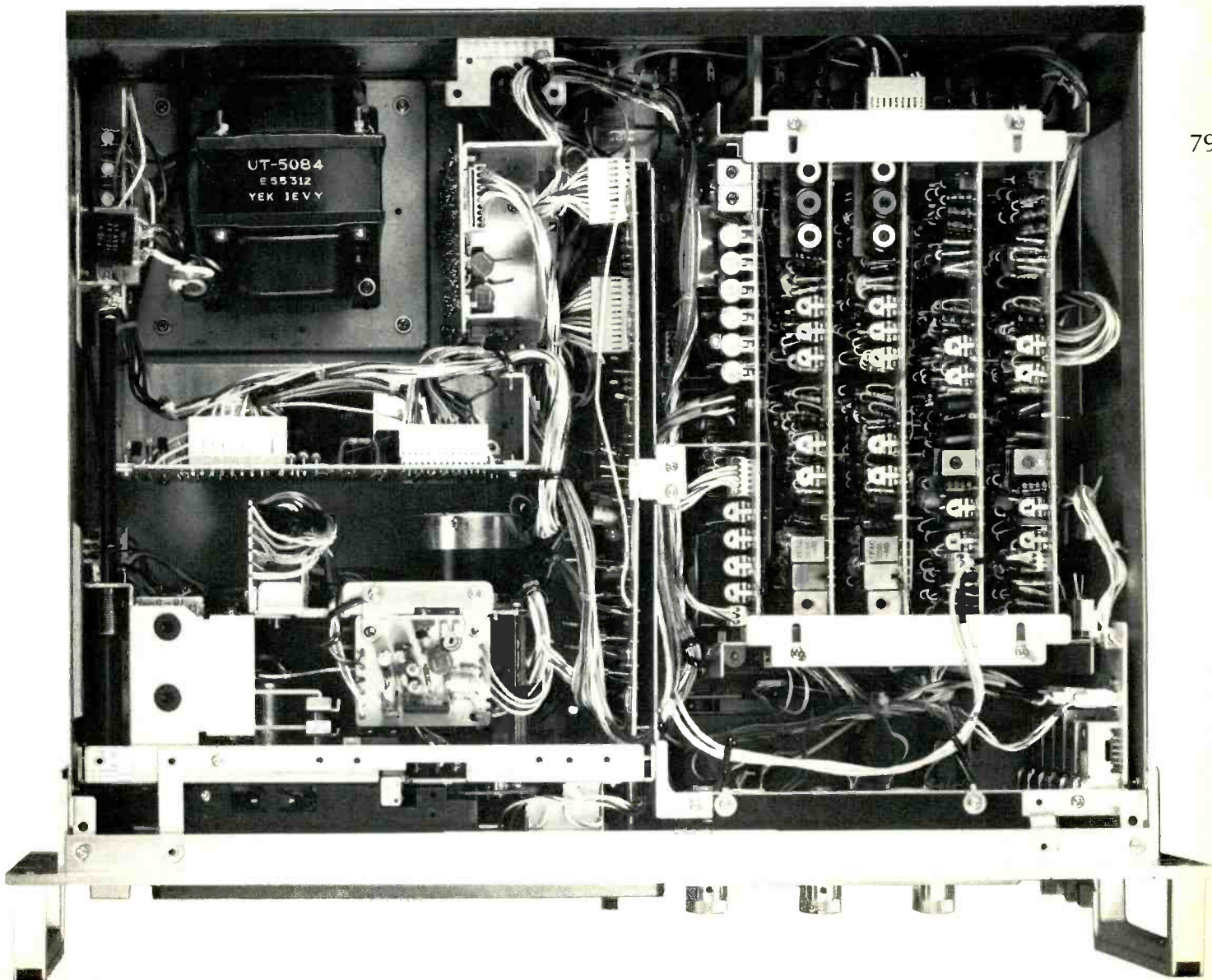

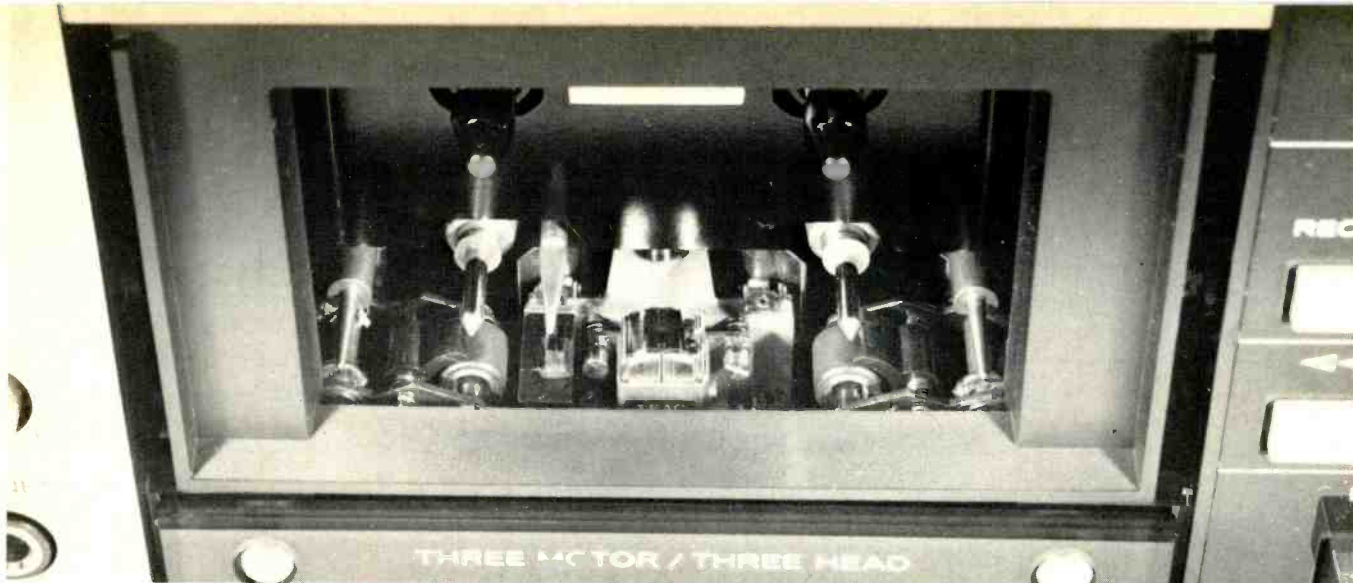

tion. The upper -3 dB point was at 16.8 kHz, with an extended low end free from "fringing." Next, a CrO<sub>2</sub> cassette was tested, a Maxell UD XL-II "chrome substitute." As can be seen in Fig. 3, the high-frequency response was extended to 18 kHz. While the plug-in card was switched in for this tape, it was possible to adjust the controls for the flattest response. The third tape to be checked out was a Sony FeCr-46 which (see Fig. 4) had the widest response with the -3 dB frequency point at an amazing 22 kHz!

Distortion at 1 kHz is shown in Fig. 5. Note that the ferric tape, the BASF Studio, has the greatest headroom at +7.6 dB, against +4.5 dB for the UD XL-II and +5.2 dB for the FeCr-46. Figure 6 shows distortion versus frequency, and here the differences are not so marked.

Signal to noise came out at 61 dB for the Studio and 60 dB for the FeCr-46 and UD XL-II (ref. 3 percent THD) with the Dolby system adding 8 to 10 dB. Input required for 0 VU was 72 mV, the output then being approximately 800 mV. Microphone sensitivity was 0.25 mV with a handling capacity of 50 mV, increasing to 500 mV with the attenuator switched in. With the input switch in the microphone position and the control in its maximum position, signal to noise decreased by some 11 dB. The Dolby system tracked down to -40 dB with an error of less than 1.5 dB.

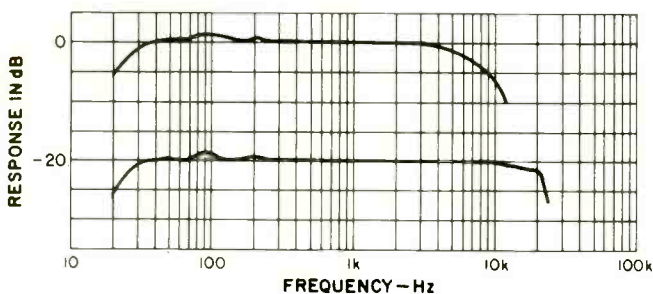

Fig. 4 — Record-replay response with Sony FeCr tape.

Fig. 5 — Distortion at 1 kHz with three tapes.

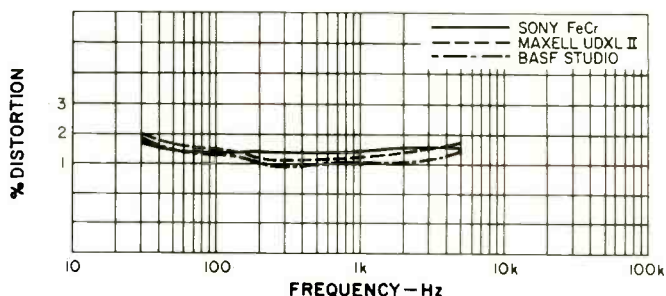
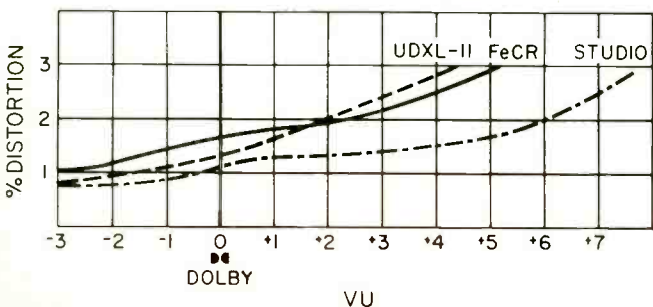

Fig. 6 — Distortion vs. frequency with three tapes.

Wow and flutter measured 0.04 percent (DIN 45 507), and the speed control gave a variation of +10 and -7 percent. Rewind time for a C-90 cassette was 75 S.

### Use and Listening Tests

Logic controls are really a delight to use, and those on the C-1 proved to be no exception. The VU meters with their fast rise time and peak indicator capability gave a more accurate reading than most, but I did miss the convenience of a peak limiter. The deck was used to make a number of recordings at the local college where a well-known soprano, Maria Niles, was rehearsing. As a matter of interest, the microphone used was a Sennheiser Profipower with a Nakamichi Model 1000 condenser type for the piano. I found the ganged input controls a mixed blessing; the piano levels remained more or less constant, but occasionally the soprano tended to get close to the microphone and the control had to be backed off a little — which meant using both hands on the controls! This dual arrangement, however, does permit instant fades, and, when you return to the correct level position for channel number 1, number 2 is also bound to be right!

The plug-in cards will appeal to both the professional user and discriminating audio enthusiast since they not only guarantee optimum performance from any current tape, but extra cards will presumably be available for new formulations. (I understand complete conversion kits can now be obtained to suit metal-particle tapes.) The outboard dbx noise-reduction unit mentioned earlier (TEAC Model RX-8) is recommended for the professional recordist; it can increase the dynamic range by adding 10 dB to the saturation point and 30 dB to the noise reduction. In other words, recordings can be made with a total range of 100 dB!

George W. Tillet

Enter No. 90 on Reader Service Card

# TAJ MAHAL...DIRECT TO DISC!

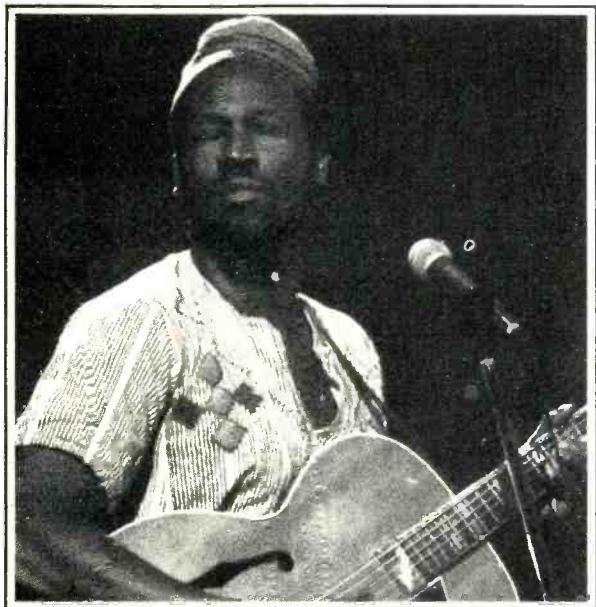

Taj Mahal — Live & Direct — CCX-5011 — Recorded before a live audience, Direct To Disc. Includes "Take a Giant Step", "Little Brown Dog", "Jorge Ben".

The Music You Asked For... But With Sound Quality You Never Dreamed Of!

Crystal Clear's Got It!

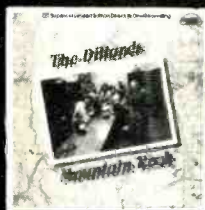

**The Dillards**  
CCS-5007 — Bluegrass and Country Rock. Includes "I've Just Seen A Face", "Somebody Touched Me", "Walkin' In Jerusalem", others.



**Musselwhite**  
CCS-5005 — Blues recorded night club style. Includes "Time's Gettin' Tougher Than Tough", "Big Leg Woman", "Nightclub", others.



**Jonas Nordwall**  
CCS-6003 — Space Themes performed on Theatre Organ. Star Wars, Close Encounters, Superman, Battlestar Galactica.



**Merl Saunders**  
CCS-5006 — R & B tunes including "Shining Star", "Long Train Runnin'", "Another Star", "Do I Move You", more.



**Stoneground**  
CCX-5009 — Straight-ahead rock and roll recorded with a live audience. Includes "Under My Thumb", "Rock 'N' Roll Prophet", "Blackjack City", more.



**Direct Disco**  
CCS-5002 — The hot sound of disco with the clarity and wide dynamics of direct to disc. Includes "Movin'", "Happy Music", "The Hustle", others.

**DIRECT TO DISC**



**THE SOUND IS CRYSTAL CLEAR**

Enter No. 9 on Reader Service Card

Available at leading Stereo and Record Stores, or you may order direct: To order call toll-free: 800-227-4259.

(Visa and Master Charge accepted). Retail price is \$15.98 per record. Orders shipped within two weeks. Fully guaranteed against defects. All records are premium quality pressed in West Germany. California residents add 6% sales tax.

Please send me the following:

- \_\_\_ CCS-5011 (Taj)
- \_\_\_ CCS-5007 (Dillards)
- \_\_\_ CCS-5005 (Musselwhite)
- \_\_\_ CCS-6003 (Nordwall)
- \_\_\_ CCS-5006 (Saunders)
- \_\_\_ CCX-5009 (Stoneground)
- \_\_\_ CCS-5002 (Direct Disco)

Mail to:

First Edition Club  
Crystal Clear Records  
648 Mission Street  
San Francisco, CA 94105

Enclosed is check or money order for \$ \_\_\_\_\_ for \_\_\_\_\_ records.

Send catalog only.

Name \_\_\_\_\_

Address \_\_\_\_\_

City \_\_\_\_\_

State \_\_\_\_\_

Zip \_\_\_\_\_

A129

Direct To Disc Records Make Excellent Christmas Gifts

**ADC  
Model 1700DD  
Semi-Automatic,  
Quartz-Lock Turntable**



**Manufacturer's Specifications**

**Type:** Two speed.

**Motor Type:** Quartz-reference, phase-locked loop, direct drive.

**Variable Pitch:** Six percent range.

**Wow and Flutter:** Less than 0.03 W rms.

**Rumble:** -70 dB DIN "B."

**Drift:** 0 percent.

**Tracking Error:** Less than 0.5 degrees per inch.

**Dimensions:** 18.5 in. (47 cm) W  
x 15 in. (38.1 cm) D x 6 in. (15.24 cm) H  
including dust cover.

**Price:** \$279.95.

The ADC 1700DD is an attractively priced, quartz-lock turntable with some features usually reserved for more expensive models. For instance, the tonearm is a straight, aluminum, low-mass type with a tiny plug-in headshell made of carbon fiber. The bearings are highly polished instrument types, with a cradle suspension similar to that used on the sophisticated and expensive ADC LMF-1 which costs almost as much as this turntable! The connector pins are silver plated, and the shell is locked firmly to the arm by a screw.

Length of the arm is just under 9½ inches from pivot to stylus — rather longer than average. A calibrated counterweight is at the rear, and the tracking force adjustment range is from 0 to 3.5 grams. The arm is mounted on a plate which is suspended from the top panel, and further acoustic isolation is provided by the four large, spring-loaded feet at the base of the unit. This base, by the way, has neat rounded corners and is molded from a high-density plastic material — a design feature which is becoming more common these days. On the left-hand side is a variable speed control, and just behind it is a strobe plus a push-button switch for disconnecting the quartz lock (unlocking it — if you prefer). To the right of the speed control are two windows which display the speed (33 or 45 rpm). When the lock is on, the words "quartz lock" are also shown; when the lock is off and the variable control is operative, only the numbers 33 or 45 are visible. It must be emphasized that there is no continuous digital readout.

Over on the right-hand side, there is a light indicating that the power is switched on, and at the extreme right there is a three-position switch for Off, 33, and 45 rpm. A long cue lever is mounted near the arm base, and in front of it, next to the arm rest, is the anti-skating dial. The motor is servo-controlled, and the die-cast aluminum platter is dynamically balanced. It weighs 2.3 lbs, and its soft rubber mat is treated with an anti-static material.

**Laboratory and Use Tests**

For test purposes, a Stanton 881S phono cartridge was mounted in the shell, and tracking force set to 1 gram with the anti-skating dial set at 1.25. The first test was for wow and flutter, and the combined figure came out at 0.045 percent using the DIN 45-507 standard. Rumble measured -63 dB (ARLL), somewhat better than the -70 dB DIN B figure claimed (as a rule, DIN B is roughly equivalent to the ARLL figure plus 9 dB). Tracking error was significantly better than 0.5 degrees per inch, and the tracking force calibration error was negligible. The anti-skating dial matched the tracking force quite well, and optimum results were obtained when the anti-skating dial was set about 20 percent higher than the tracking force.

Both lateral and vertical bearing friction was insignificant (the figures quoted are 5 and 7 milligrams). Arm resonance with the 881S was at 10 Hz with a rise of 4.5 Hz with the cartridge brush lifted so it was well clear of the record. With

FROM PICKERING

# *The New Shape of Sound*

## THE STEREOHEDRON<sup>®</sup> SERIES

From one of the oldest names in sound development comes the latest sound innovation... the Stereohedron Stylus tip... with expanded contact area for truest fidelity. And now it's available from Pickering in three great cartridges.

The critically acclaimed XSV/3000, the new XSV/4000 with expanded frequency response range, and the ultimate in lightweight compliance, the Pickering XSV/5000 which captures all the high frequency information contained in today's finest recordings... creating a whole new experience in recorded sound.

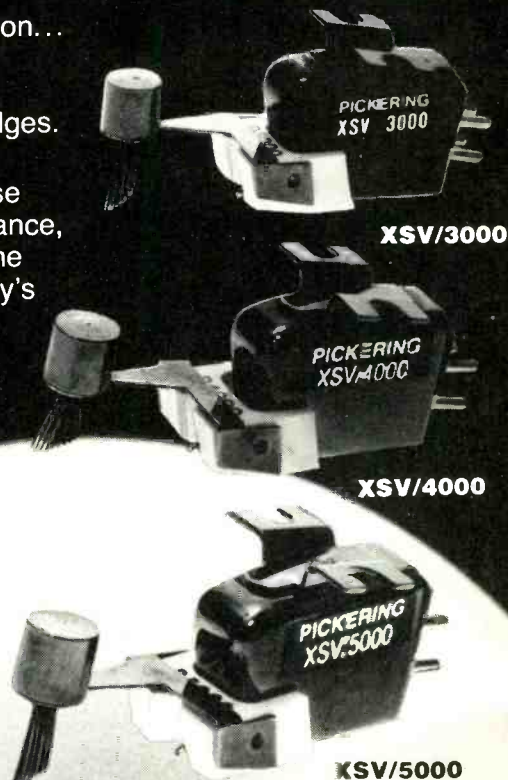

© 1973 PICKERING & CO. INC.



**PICKERING** "for those who can hear the difference"

101 Sunnyside Blvd., Plainview, N.Y. 11803

Enter No. 40 on Reader Service Card

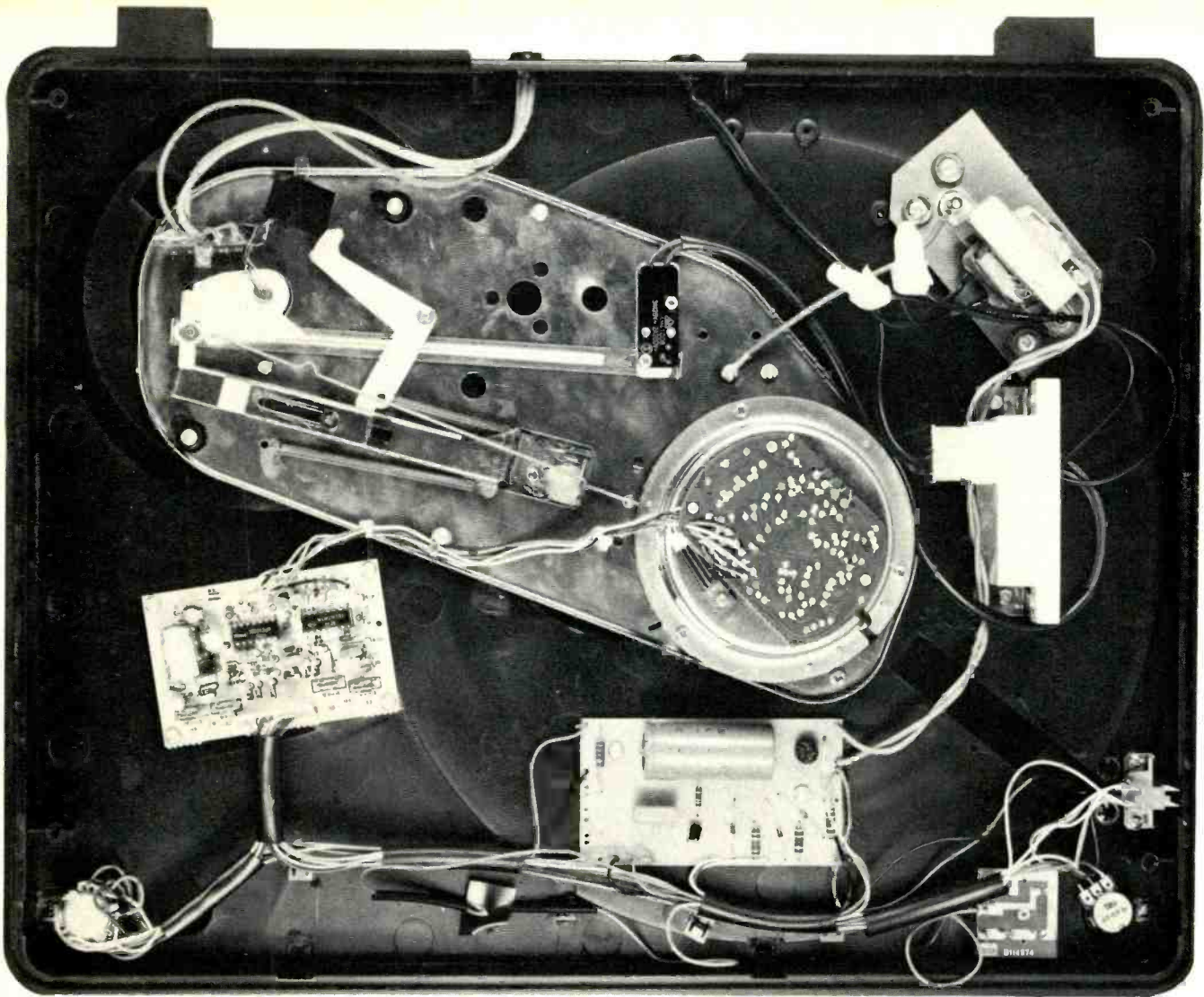

the brush down, the rise was reduced by 2 dB and, in any case, 10 Hz is outside the "warp zone." As claimed, the time taken to reach full speed was two-thirds of a revolution, while the arm return cycle took approximately 4 seconds. The speed control had a range of +7 percent and -4.8 percent which is more than adequate.

As the arm is moved to the record, the turntable starts automatically, and the cue lever can then be used to lower the cartridge. If the right-hand control (the one labelled 33, 45, and Off) is in the Off position, the stylus can be placed in

the desired position before switching the motor on. At the end of the record, the arm is returned to its rest. The cue control is nicely damped, and I was pleased to note that there is the minimum of backlash. Although the tracking force was set to 1 gram, I must confess I initially thought this was a little optimistic. This was not the case at all, and I found that the 881S tracked all bands of the Shure Era III "torture test" record with ease. All-in-all, the ADC is a nicely styled, well-made turntable with a good performance. At today's prices, it is a bargain!

George W. Tillett

Enter No. 92 on Reader Service Card



# How to get an honest 30Hz from a 1.25 cubic foot speaker system.

The story behind the new KLH Computer Controlled Loudspeakers.™

With the introduction of acoustic suspension more than 20 years ago, the loudspeaker industry took an impressive step forward. This technology allowed speaker manufacturers to achieve full-range frequency response in a cabinet substantially smaller than any previous full-range loudspeaker.

Since then, breakthroughs have come and gone in the industry. But none that has significantly reduced the size of a true, full-range system.

The reason is actually quite simple. Accurate bass reproduction requires a woofer to displace a large volume of air. In a small system with a small woofer, the woofer cone must therefore travel a long way to reproduce the lower frequencies.

Although a small woofer is perfectly adequate most of the time, occasional high level, low frequency signals can drive the cone well beyond its intended excursion, causing severe overload distortion.

To avoid this, it has been necessary to attenuate lower frequencies in smaller systems. Which is why small speakers have always had compromised bass.

## The KLH Analog Bass Computer.™\*

To solve this problem, we developed a completely new approach — computer control.

We designed a separate component, the KLH Analog Bass Computer, as an integral part of the entire speaker system. This component sits next to the receiver or amplifier and constantly monitors its output. The computer derives an electronic analog of cone motion, and controls the woofer at the precise instant at which overload distortion would otherwise occur.

With this kind of accurate, reliable control, our designers were free to extract the optimum theoretical performance for any given cabinet size. And develop a line of loudspeakers that can deliver extended bass response in cabi-

nets that are substantially smaller than ever before possible.

The KLH-1 is one example. From a 1.25 cubic foot cabinet, it delivers bass to 30 Hz (-3dB) at 105 dB s.p.l. with absolutely no possibility of overload distortion.

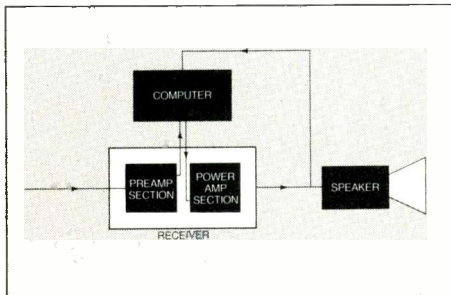

## Beyond the Computer.

Since the Analog Bass Computer and the speakers must be designed as a single, integrated system, we started from scratch with the objective of optimizing our new technology.

To achieve the widest possible

bandwidth with acceptable efficiency, we employed sixth-order equalized systems. Combined with the Analog Bass Computer, these systems provide a -3dB point equal to conventional acoustic suspension systems of at least four times their volume.

In keeping with our objectives, we also refused to compromise other elements of the design.

For our cones, we selected polypropylene, a material first developed for use in studio monitors by BBC engineers. The movement of polypropylene reflects the electrical signal more faithfully than either paper or bextrene. The result is a remarkably clear, transparent, uncolored midrange.

For our speaker baskets, we used die-cast aluminum rather than stamped steel.

And we used massive magnet assemblies, optimized for the sixth-order design.

## Three Applications.

Finally, we applied all we had learned to accomplish three distinct objectives.

Our first objective was to produce a speaker that raises the absolute level of low-frequency response in a cabinet that is still practical for the home environment. The new KLH-1 does exactly that. It delivers flat bass to 30 Hz (-3dB) from a floor standing unit just 11" x 30½" x 10¼". At a price per pair of \$1100\*\* including Analog Bass Computer.

Our second objective was to provide the best possible combination of price and performance. Our solution is the KLH-2. At \$660\*\* per pair with computer, the KLH-2 can deliver flat bass to 38 Hz (-3dB) at 102 dB s.p.l.

from a cabinet that measures 10¼" x 21" x 8½".

Our third and final objective was to design a moderately priced speaker with performance equal to or better than anything near the cost, in a cabinet one fourth the size. This is the KLH-3. It measures 8½" x 12½" x 6", delivers bass to 40 Hz (-3dB) at 95 dB s.p.l. and costs \$450\*\* per pair including computer.

The new line of KLH Computer Controlled Loudspeakers.



Listen to them.

For more information, call toll-free 800-225-6042 (in Mass. 1-800-532-9566). Or write KLH Research and Development Corp., 145 University Avenue, Westwood, MA 02090. In Canada: The Pringle Group, Ontario.

# KLH

\*Patent applied for.

\*\*Manufacturer's suggested retail price.

Enter No. 21 on Reader Service Card

## KEF 104aB Loudspeaker System



### Manufacturer's Specifications

**Frequency Range:** 30 to 40,000 Hz.

**Nominal Impedance:** 8 ohms.

**Dividing Frequencies:** 45 Hz, acoustically coupled; 3,000 Hz, electrical cut-off slope 18 dB per octave.

**Acoustic Contour Control:** Three position  $\pm 2$  dB, centered on 1,500 Hz.

**Sensitivity:** 12.5 watts into nominal 8 ohms produces 96 dB at one meter and 400 Hz in anechoic conditions.

**Continuous Power Rating:** 20 volts (50 watts) from 100 Hz to 2,500 Hz, reducing to 8 volts (8 watts) above 3,000 Hz.

**Dimensions:** 63 cm (24.8 in.) x 33 cm (13 in.) x 26 cm (10.2 in.).

**Weight:** 15.8 kg (35 lbs.).

**Price:** \$425.00 each.

It is probably fair to say that most loudspeaker manufacturers now have access to computers or at least know what a computer can do. It is also fair to say that most loudspeaker manufacturers now know something about phase response and have at least a passing acquaintance with the phrase "time domain." But there had to be someone who was first; there had to be a manufacturer who, without prior advertising hoopla or pressure from their competition, borrowed an expensive computer to analyze the time domain and phase performance of their product, then laid out good money to buy a computer to assist in further design improvements on that product. KEF Electronics Ltd. in Kent, England was that company. However, KEF never blew horns or beat drums over what they did, so most persons not on the inside of this business are not aware of the mild revolution KEF started.

One of the first of KEF's commercial loudspeaker systems to benefit from computer analysis was their Model 104, which was introduced in 1973. KEF now has a number of computer-assisted-design loudspeaker systems in their inventory, but they recently upgraded the 104 with a new crossover design (using digital analysis techniques, of

course). The system utilizes a new crossover circuit which KEF calls an acoustic Butterworth (aB) filter network, and the system is accordingly identified as the Model 104 aB.

The 104 aB uses two active drivers and a passive radiator. A 330-mm by 229-mm (13x9 in.) passive radiator is acoustically coupled with a 203-mm (8-in.) driver at frequencies below 45 Hz. The 203-mm driver crosses over at 3 kHz to a tweeter which carries the top end up to beyond 20 kHz.

The crossover network is unusual in two respects: (1) it is a third-order network with an asymptotic 18-dB-per-octave attenuation rate, and (2) it incorporates the driver-reflected impedances in its design. It does not, in other words, draw values from some handbook under the presumption that the loudspeaker which is to be connected to the network is a pure resistor.

The system is relatively small, measuring 630 x 330 x 260 mm (24.8 x 13 x 10.2 in.) and can be shelf mounted. But at a weight of 15.8 kg (35 lbs.), this system should have a sturdy shelf. To avoid overemphasis of the lower frequencies, KEF advises raising the cabinet by at least 200 mm (7.9 in.) above the floor.





# MADE FOR EACH OTHER.

Earphones are made for ears. Yours. That's why the Beyer DT 440 has sound so natural and is so light and comfortable you don't even know it's there, even after many hours.

At 9.6 ounces, it is one of the lightest headphones available. And its weight is evenly distributed among the sponge-padded ear-cups and air-filled headband.

There's no great weight suspended from your head, and your ears never get squeezed.

Some people complain about the isolation of headphones that close them off from the world. So we built the DT 440 with a high velocity open design, to allow a natural mixture of recorded music and environmental sound.

How does it sound? Most

people say "spectacular." A great combination of impact and intimacy. The overall sound is wonderfully smooth and transparent. With clean, rich bass response. Powerful, lifelike midrange. Crystal-clear, undistorted highs. And perfect stereo imaging.

For sound — and for comfort — nothing beats a Beyer. We'd like to make one for you.

DT 220

DT 302

DT 441

ET 1000 / N 1000

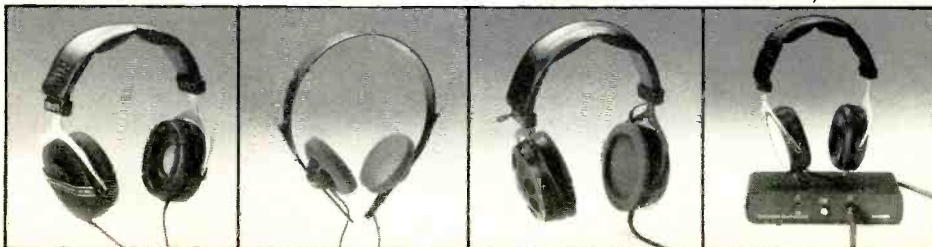

**Beyer**   
**Dynamic**

**BURNS AUDIOTRONICS, INC.**  
5-05 Burns Avenue, Hicksville, NY 11801  
(516) 935-8000 • In Canada, H. Roy Gray, Ltd.

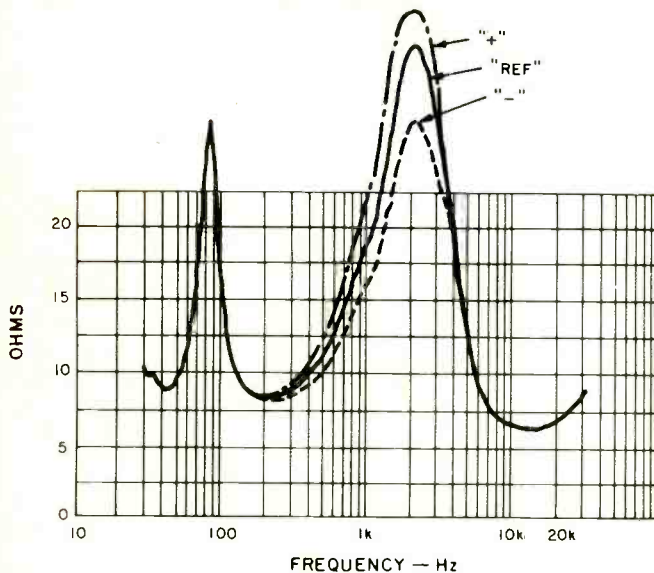

Fig. 1—Magnitude of impedance for each of the three equalizer settings.

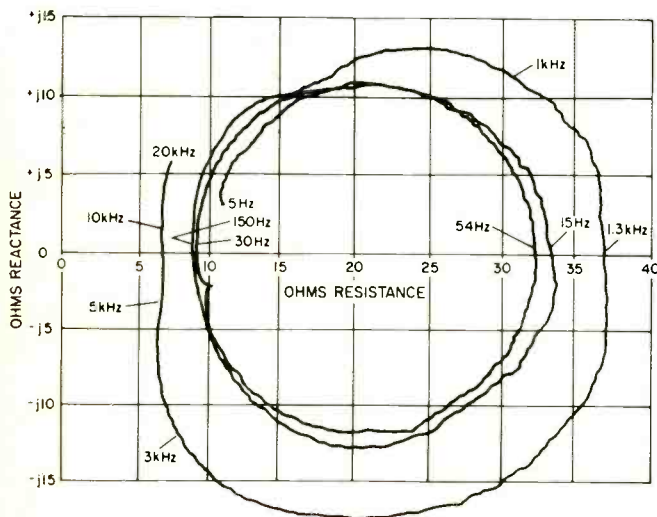

Fig. 2—Complex impedance plot for reference equalizer setting.

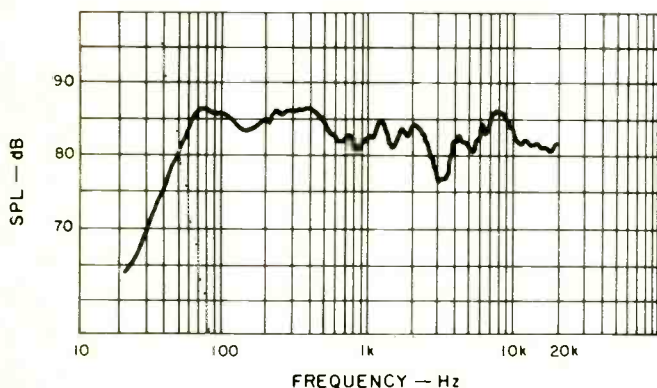

Fig. 3—One-meter axial anechoic frequency amplitude response for a constant voltage drive level corresponding to one average watt into 8 ohms.

Electrical connection to the system is made either by a two-pin DIN connector, using the cable supplied with each speaker, or via 4-mm sockets. Since most American power amplifiers will not accept the connector which is attached to the cable, it is necessary to use the 4-mm sockets. Unfortunately it is not possible to make good electrical contact without the aid of plugs, known commonly as "banana plugs." And since the spacing between these sockets is 35 mm, rather than the more conventional 20-mm spacing of American plugs, it will require the purchase and connection of additional connectors. Terminal polarity is indicated by small positive and negative symbols molded in the plastic receptacle holding the sockets, and the choice of basic black-on-black renders the sockets extremely difficult to identify. This appears quite out of keeping with the rest of the KEF design philosophy, particularly since the same receptacle holds a high-contrast label which tells the user that he has a KEF 104aB, the impedance, and the serial number, and I feel that the installer, perhaps crawling around on hands and knees with a flashlight in his teeth, would much rather see the polarity identification in high contrast, particularly if he's concerned with true acoustic polarity.

The foam grille is readily removed (and replaced) to reveal a three-position acoustic equalizer switch and the protective fuse for the high-frequency driver. The manufacturer thoughtfully provides spare fuses, which are a variety somewhat smaller in physical size than conventional fuses used in domestic loudspeakers.

KEF supplies a very thorough user's manual with each loudspeaker. Other than the possible difficulty with electrical connection to which I referred, even a totally nontechnical user should be able to follow the instructions to get proper performance from this loudspeaker system.

### Technical Measurements

The magnitude of terminal impedance for each of the three equalizer settings is shown in Fig. 1. The lowest value of impedance occurs around 10 kHz and measures slightly over 6 ohms, while the highest value of impedance measures nearly 37 ohms and occurs around 1.3 kHz. While this impedance excursion is of little or no concern for the quality of sound from the KEF 104aB when driven from a low-impedance source, it does suggest that care should be taken in choosing speaker connecting wire so that the line drop will not influence tonal balance. Too small a speaker wire, such as 22 gauge, would cause a frequency response boost at 1.3 kHz relative to 10 kHz. For example, eight meters of 22 gauge cause a 1 dB response variation. Larger size wire should be used for the KEF 104aB.

The low-frequency resonance impedance rise at 54 Hz seems reasonable, while the amplitude measurement, which only extends down to 20 Hz, shows a minimum around 30 Hz with an indication of rising impedance at frequencies below 20 Hz. Figure 2 is the complex impedance plot of the KEF 104aB for the reference equalizer position and for a frequency range from 5 Hz to 20 kHz. The reason for the lower frequency impedance rise is now evident; there are two bass resonance impedance peaks, one at 15 Hz and the other at 54 Hz.

The 15-Hz resonance peak is the cause of an unfortunate difficulty in the listening test (which is always performed prior to laboratory measurements). This lower frequency resonance peak, associated with the passive radiator acoustic design of this system, lies in the region of resonance for many phonograph cartridge and arm combinations. Certain types of record warp can excite this resonance, with the result that the KEF woofer will literally drive itself wild on frequencies which it cannot reproduce. The result is an unacceptable distortion when the program content consists of strong low-



**Why have millions of  
Americans bought  
Sanyo car stereo?**

**Just listen.**

**AUDIO  
SPEC**  
**SANYO**

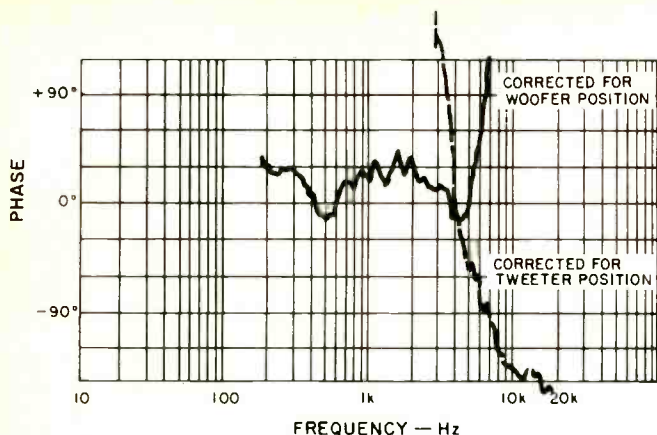

Fig. 4—One-meter axial phase response corrected for acoustic position of woofer and tweeter.

frequency tones plus record warp. The bass response literally turns to pure mud with increasing playback sound levels. The problem is the interaction of program content, record warp, arm-cartridge combination, and KEF subsonic resonance. The solution which I used to eliminate this problem is discussed in the listening test.

Another potential impedance problem is associated with the substantial phase angle at around 3 kHz. With a phase angle nearly 60 degrees lagging, the KEF 104aB can place a reactive drive-angle demand on amplifiers which are driven near their peak power capability on strong upper register material, such as female vocal or brass. Only the better quality amplifiers should be used with this speaker to get the response it is capable of delivering at high sound levels.

The axial one-meter anechoic amplitude response is shown in Fig. 3 for a drive level corresponding to one average watt into 8 ohms resistance. The reference equalizer position is used for this measurement. Low frequency response extends down to about 60 Hz and then falls off at a slope of around 15 dB per octave below this frequency. The response is generally smooth through most of the range with a mild dip around 3 kHz and an overall fall-off of about 3 dB per decade with increasing frequency. The top end goes right on out to the 20-kHz limit of this test with no sign of cutoff, indicating a good, crisp response.

The measured anechoic phase response is shown in Fig. 4. Since the signals from the woofer and tweeter do not arrive simultaneously at the one-meter microphone location, the phase measurement is shown for the corrected arrival time of these components. The woofer is essentially in phase with the electrical drive. This means that a positive-going voltage applied to the positive-marked speaker terminal produces a positive sound pressure at the listening location when the air-path time delay is taken into account. The tweeter has an

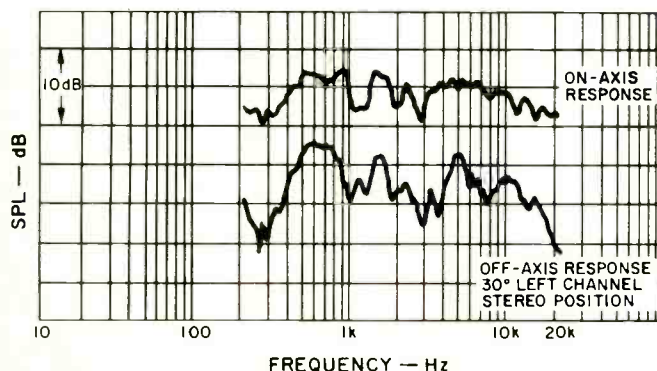

Fig. 5—Three-meter room response.

opposing polarity; positive voltage produces a pressure decrease. The actual phase crossover occurs around 7 kHz.

The three-meter room response is shown in Fig. 5. In this measurement the speaker is placed against a back wall and raised 400 mm off a carpeted floor. The microphone is positioned in a conventional listening location, three meters in front of the speaker and one meter above the floor. Figure 5 is the frequency spectrum of the first 13 milliseconds of sound which arrives at the listener's location. The measurement shows two listening positions relative to the speaker, directly in front of the speaker (upper curve) and with the speaker in a left-channel stereo position (lower curve). The responses are separated by 10 dB for clarity of presentation. With the exception of a response dip near 300 Hz, the KEF 104aB measures almost as well in this room response as it does under anechoic conditions.

In the earlier listening test I definitely preferred the equalizer on the KEF 104aB set to its "plus" position, rather than the "reference" position. I also preferred the KEF being rotated toward the listening position (as KEF recommends), for clarity of response and balance. In addition, I conducted my listening evaluation with experimental setups placing the KEFs in front of heavy drapes which could be opened to reveal an acoustically hard back wall or closed to give a moderate acoustic damping. I preferred the balance when the KEF's were placed 400 mm (15.75 in.) off the floor and against the acoustically absorbing back wall. Figure 6 is the response for the left-stereo channel speaker as measured directly where I sat during most of the listening tests. This even includes the effect of the chair in which I sat, but does not include myself as an acoustically intruding body. All three equalizer responses are shown in Fig. 6, and the comparison

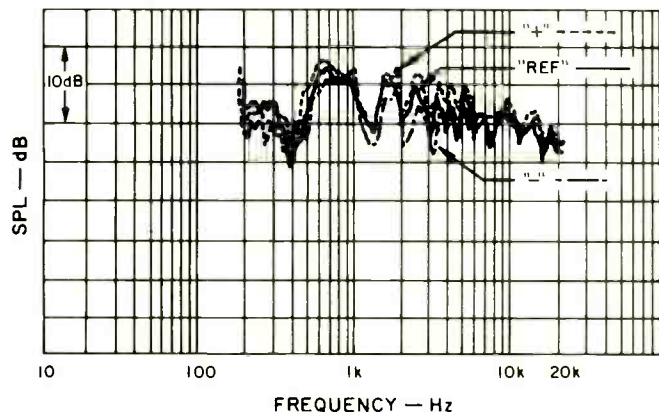

Fig. 6—Measured three-meter response in the actual stereo-left channel listening position for each of the three KEF equalizer settings.

with Fig. 5 is interesting. The 300-Hz dip is gone when drapes are used as absorbing material, and the positive equalizer position definitely gives the best overall response. In most other respects, there is general agreement in these two three-meter room tests.

I concluded from these measurements and the listening test that the KEF 104aB has an excellent response for early sound if placed against an acoustically dead wall and rotated toward the listening area.

The overall horizontal and vertical directivity patterns of the KEF are indicated in the polar energy responses of Figs. 7 and 8 respectively. All frequencies from 20 Hz to 20 kHz are uniformly weighted, and the net sound energy for this whole range is plotted as a function of listening position relative to the frontal axis of the speaker. Little can be said of the polar energy responses of this system other than that they are darn

**The one and only computer-locked, digital drive changer-turntable.** B-I-C introduces the 80 Z. With a brain equal to room-size computers of just 10 years ago. A microprocessor that instructs a system intelligent enough to actually read and adjust platter speed (not simply motor speed). A unique digital drive system that's capable of unequalled nominal speed accuracy (to within .01 rpm). With a digital read-out that's over 300% more accurate than any strobe. The state-of-the-art 80Z is one of six new belt drive, straight tone arm B-I-C models. For complete details write B-I-C|AVNET, Dept. Z, Westbury, N.Y. 11590. **The new 80Z Changer-Turntable.**



93

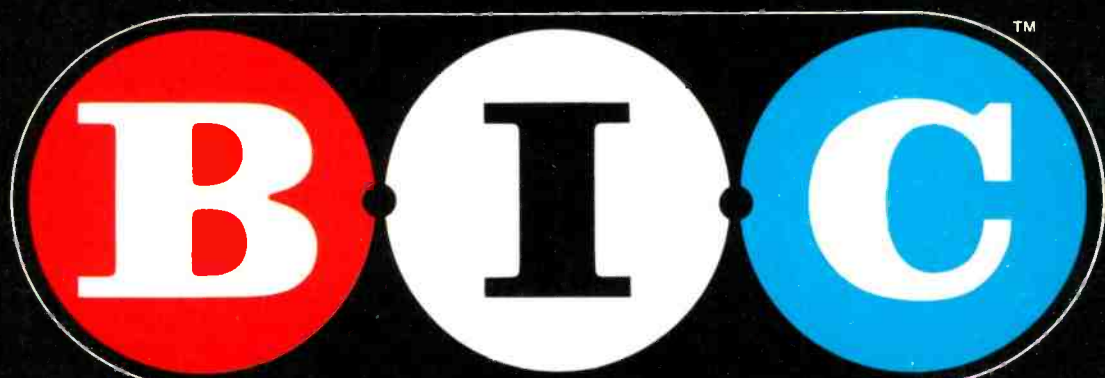

Say "Bee-Eye-Cee". Think "Best-In-Components."

Series Z Changer-Turntables | Cassette Decks | SoundSpan™ Speaker Systems | The Beam Box.®  
Enter No. 7 on Reader Service Card

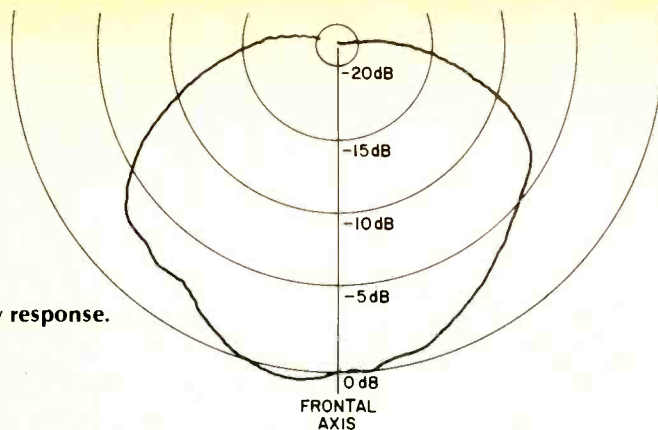

Fig. 7—Horizontal polar energy response.

good. There is enough energy radiated to the sides and upward that this speaker should not be placed adjacent to objects which could scatter sound back into the listening area, such as lamps or overhanging shelves.

Harmonic distortion for the tones  $E_1$  (41.2 Hz),  $A_2$  (110 Hz), and  $A_4$  (440 Hz) is shown in Fig. 9. Low-frequency power handling, as with 41.2 Hz, is definitely a tough job for the KEF 104, as it cannot handle truly high-energy, low-frequency signals. However, 440 Hz is handled like a champ, with residual distortion well below that of many of the best speakers I have tested. In addition, 110 Hz is also quite good, with the KEF running out of steam at about 30 watts average with distortion products still below one percent.

The intermodulation on 440 Hz caused by simultaneous excitation by 41.2 Hz is plotted in Fig. 10, and this intermodulation test is startlingly good. Up to 10 average watts, the intermodulation on 440 Hz is almost purely amplitude modulation, with phase modulation appearing above 30 average watts. The substantial difference between the IM and 41.2-Hz harmonic distortion implies that the passive radiator may be the culprit and that the active woofer is a very clean driver. In any case, the modulation of upper musical material by kickdrum and percussive bass is quite low. This implies that

Fig. 9—Harmonic distortion for the tones  $E_1$  (41.2 Hz),  $A_2$  (110 Hz), and  $A_4$  (440 Hz).

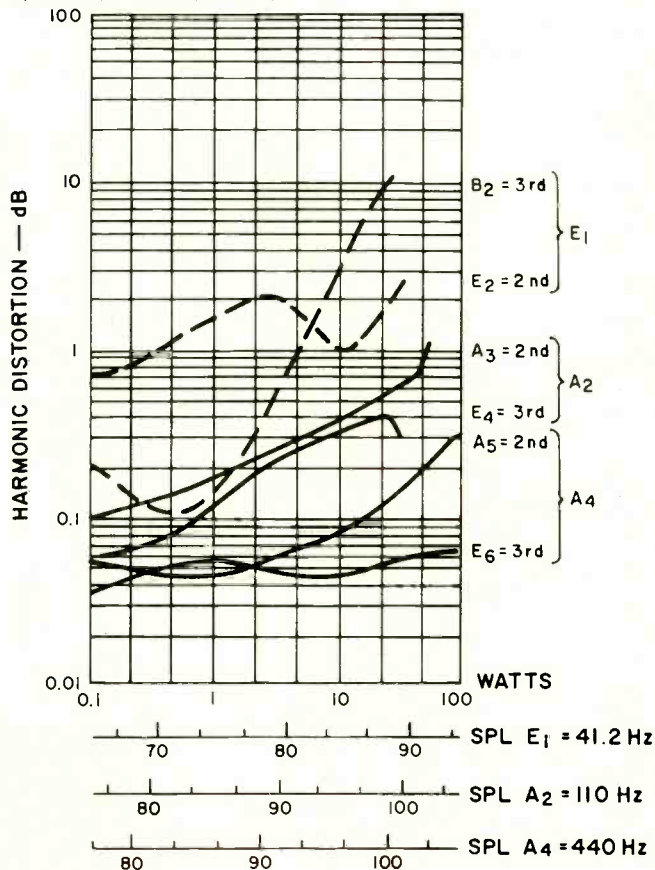
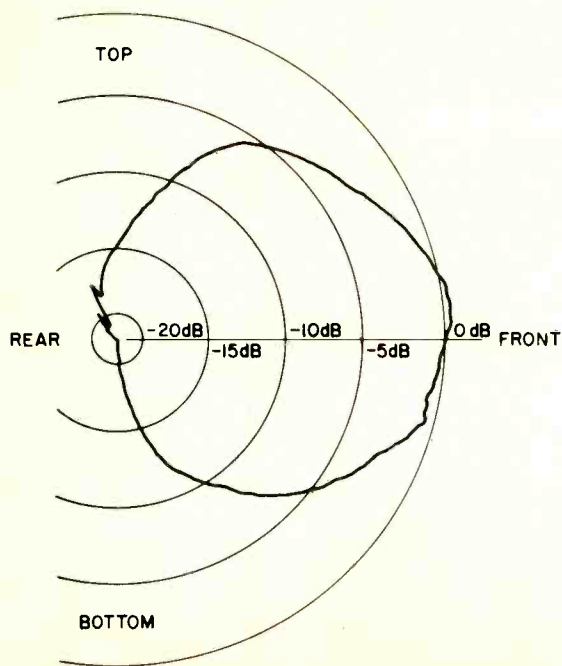

Fig. 8—Vertical polar energy response.



stereo imaging should not jump around with changes in low-frequency content.

The acoustic transfer gain of the KEF 104aB remains uniform at low average powers and begins to decrease above 10 average watts for pure tones of 262 Hz (middle C) and 110 Hz ( $A_2$ ). This implies that stereo lateralization of solo instruments should remain independent of sound intensity for all levels below about 96 dB SPL, but begin migrating toward center stage for higher sound levels. The timbre of solo instruments should also remain essentially independent of sound intensity up to this sound level.

The crescendo test, where low-level single musical tones are checked for change in sound level when wide-band incoherent noise is suddenly superimposed, shows that the KEF hangs in there pretty well up to combined peak levels of around 105 dB. This implies that the stereo location of woodwinds, for example, will not jump kangaroo fashion when the brass lets go triple forte. This 105 dB, by the way, is the instantaneous peak, which can be readily achieved when

# THE ONKYO TX-MKII RECEIVERS... COMMITTED TO QUALITY



95



Most manufacturers play "take away" when they design a product line. With every cost reduction, there's a quality loss. Onkyo takes a different approach. Each of the five models in the TX-MKII series of receivers represents an exceptional value for price. And vital performance features such as Onkyo's exclusive distortion-free, quartz or servo-locked FM tuning are built into each of the receivers, as is the sophisticated HTS™ (Human Touch Sensor) control. HTS™ senses your touch on the tuning knob and "unlocks" the station. You rough tune to another station, release the knob, and the HTS™ analog comparator circuits automatically find and precisely lock into the most distortion-free station setting.

And aside from the excellent signal-to-noise ratios at all inputs, the Onkyo TX-MKII series provides excellent value-to-

dollar ratios at all power levels, starting with the top-of-the-line digital-readout TX-8500MKII rated at 160 watts per channel, with 0.05% total harmonic distortion, both channels driven into 8 ohms from 20 Hz to 20 kHz, to the modest TX-1500MKII at 17 watts per channel and 0.03% THD under the same conditions.

Don't step down in quality. Step up to Onkyo.

Artistry in Sound

## ONKYO

Eastern Office: 42-07 20th Avenue, Long Island City, NY 11105 (212) 728-4639  
Midwest Office: 935 Siverd Drive, Wood Dale, IL 60191 (312) 595-2970  
West Coast Distribution Center: Damark Industries, Inc.  
20600 Nordhoff Street, Chatsworth, CA 91311 (213) 998-6501  
Canada: Sole Distributor: Tri-Tel Associates, Ltd., Ontario, Canada

Enter No. 32 on Reader Service Card

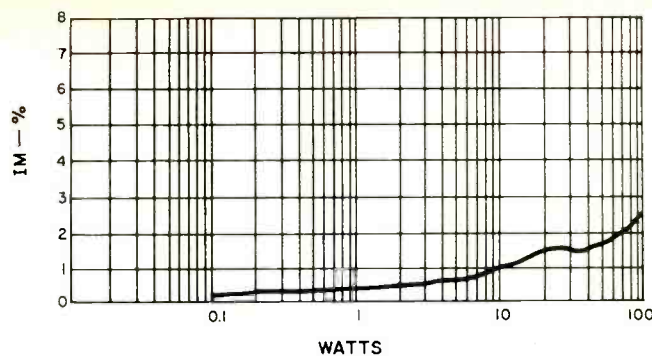

Fig. 10—Intermodulation distortion of  $A_1(440 \text{ Hz})$  by  $E_1(41.2 \text{ Hz})$  mixed one to one.

listening to a clean direct-to-disc recording at brisk but not window-shattering levels. While the KEF is good, a high intensity studio monitor it is not.

The one-meter axial energy-time curve is shown in Fig. 11. This is the envelope of the response of the speaker to a perfect band-limited impulse. The first sound at 2.84 milliseconds is due to the tweeter, with the woofer signal arriving at 3.15 milliseconds. The exponential die-off from 2.84 to around 3.25 milliseconds is due to the tweeter. After some small diffraction bumps, the residual tail of the impulse response stays more than 30 dB below the peak tweeter signal. This is quite a good transient response.

### Listening Test

After considerable experimentation with placement of the speakers, I decided that the most realistic sound, to my ears, was obtained with the speakers placed against a heavily draped wall and angled toward the listening area. These speakers need to be raised off the floor to minimize bass dominance, and I chose to mount them on cloth-covered cinder blocks which elevated them 400 mm. I also preferred the positive equalizer setting on the KEF 104 for more natural realism of most program material.

The KEF 104aB does not have super-low-frequency response and could benefit from the services of a subwoofer. At the beginning of the listening test I found a curious effect on certain organ and strong kickdrum recordings that I knew from experience were clean. As the sound level was raised on playback, a stage would be reached where the bass turned to pure mud. But this did not happen on all such records. When I removed the grille on the speakers I found that the offending records were causing the woofer and passive radiator to undergo violent low-frequency excursions. The problem was record pinch warps which created 10 to 15 Hz damped oscillations in the tonearm-cartridge combination and which in turn excited the loudspeaker excursions. I had not run into

Fig. 11—One-meter axial energy-time response.

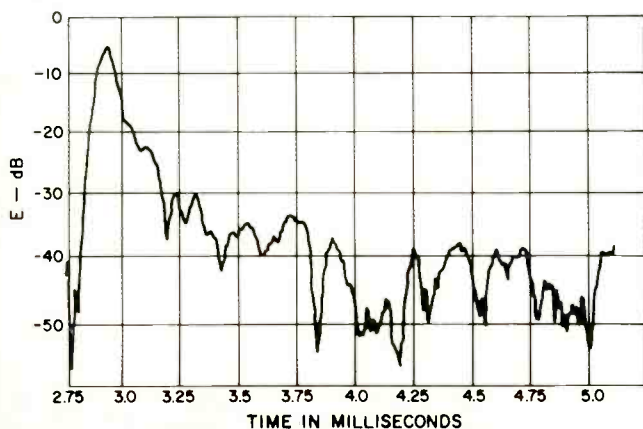

this problem before, even on vented loudspeaker systems, and it appeared to be associated with the 15-Hz resonance in the KEF. Switching in the rumble filter will eliminate this problem, but I do not like what most rumble filters do to low-frequency program content. I commented on this problem to our Kindly Editor at homebase, who sent me a DiscTraker for evaluation to see if it would help. The DiscTraker solved the problem completely and most impressively. This little gadget, made by Discwasher, Inc. of Columbia, Missouri, is a small dashpot which attaches to the cartridge and damps vertical cartridge motion. The results were startling, both to the visual motion of the woofer and the audible effect. I have several records with pretty bad warps which I use to test loudspeakers for susceptibility to warp. One of these was totally unplayable at any level on the KEF 104aB without the damper and completely acceptable (except for pitch wobble) when the DiscTraker was installed.

The KEF 104aB is not a highly efficient loudspeaker and takes a moderate amount of amplifier power to reproduce sound at a brisk level. But what it lacks in efficiency, it makes up in clean sound. The KEF 104aB took the full peak capability of a Marantz 510 amplifier on drum snaps on the M&K Ed Graham *Hot Sticks* record (RT-106) without evidencing any audible strain. The only time I was able to run out of loudspeaker was on super-low bass from the famous E flat drum on Telarc's Fennell and the Cleveland Symphonic Winds version of Holst's *Suite No. 1* (5038).

The KEF 104aB is one of the few loudspeakers which can reproduce a piano reasonably well. It still won't fool you into believing a real piano is being played in the room, but this speaker, in my opinion, does one of the best jobs around. It also does an excellent job in reproducing solo male and female vocals. Piano and vocals are, I believe, the very toughest items to reproduce.

Massed choral groups, for some reason, did not fare as well with this speaker. In fact, the female voices on a clean Beethoven 9th recording (M&K RT-112) sounded screechy to me. I also found some difficulty with stereo depth on some program material, although lateralization was usually excellent on all material.

The 104aB has good spectral balance from the lower mid-range to the extreme top end. It is an accurate reproducer that intrudes very little on the sound. If you have a heavily draped or extremely large listening room, the KEF 104aB may not be able to provide the high intensity sound which some listeners like, but for most situations and listeners, I suspect that this system is quite adequate. The KEF 104aB is not a disco speaker and cannot provide heavy driving bass, nor would pipe organ aficionados fall in love with its performance.

However, and despite whatever negative comments I have made, the KEF 104aB is a speaker I can definitely recommend for accurate reproduction at moderate sound levels.

Richard C. Heyser

Enter No. 93 on Reader Service Card



# INSIDE EVERY RECEIVER OWNER IS A SPECTRO ACOUSTICS BUYER



What do you do when the old receiver's lost its zip? When your ear's improved, but the sound still hasn't? When you've outgrown the basic bass, treble and occasional mid? What do you do when hifi's lost its high?

Well, if you really want to put the fun back in your system, you'll take a good, hard look and listen at Spectro Acoustics.

Here's a line of high quality stereo components that's built for enjoyment—and priced that way too. Fact is, you can get a complete Spectro Acoustics component system for about the same price as that receiver you were thinking of.

And you'll get a lot more for your money. Such as a dramatic-looking FM stereo tuner—newest addition to the Spectro line—featuring digital readout of station frequency, our exclusive new pinpoint tuning system and astonishing sensitivity.

You'll also have a power amp—we make 4 of them, at two different wattage levels—built to deliver dependable performance with plenty of reserve power. A straight-line preamp featuring adjustable cartridge loading. And a graphic equalizer—choose from 2—that gives you 10 divisions of frequency control per channel, instead of a receiver's 2 or 3.

In short, you'll get more versatility, flexibility and control over your system than any receiver can provide.

You'll also get peace-of-mind with Spectro Acoustics. We build all of our components almost 100% by hand, and subject every one of them to continuous quality control.

We don't hurry through production, so our components don't hurry into the repair shop. That's why Spectro Acoustics owners keep coming back when it's time to add on or trade up. Our careful, limited production means you may have to look a little harder, or wait a little longer for Spectro Acoustics components. But when you do get yours, you can bet they're good ones.

**SPECTRO ACOUSTICS**   
Built for enjoyment™

All Spectro Acoustics components are manufactured in the U.S.A.  
4500 150th Avenue, N.E.  
Redmond, Washington 98052



Enter No. 49 on Reader Service Card

# Wharfedale. First and everlasting.



98

The Wharfedale E's are the newest speakers in an unequalled tradition of excellence that goes back to the early days of music reproduction.

In those days, our speakers — like the unique sand-filled designs of Gilbert Briggs — were received with wide acclaim despite the limited technical resources of that era. Today's Wharfedale E's benefit from our space-age technology, and hold a special position of leadership in acoustic engineering.

The design goal for America's Wharfedale E's was to achieve that elusive combination of crystal-like clarity, strong bass and extremely high efficiency. We met this objective

using computer optimization and holographic research, developing speakers with extremely wide dynamic range and no coloration. They've won the praise of lovers of every kind of music. And seem destined to keep that praise for years to come.

A Wharfedale E can fill a room with just a couple of watts. Or handle hundreds for unusually large areas. At any level, with any music, you won't detect any of the harshness or roughness inherent in lesser speakers.

Each Wharfedale E goes through a stringent Quality Control procedure that rejects all but the most perfect speakers. Those that pass represent

the highest attainable audio technology, enhanced by the skills of old-world craftsmen who make each pair of perfectly matched hand-rubbed, fine wood veneer cabinets.

Many speaker makers have come and gone in the nearly 50 years since the first Wharfedale was made. And when you listen to the E's you'll know why Wharfedale lasts.

The new E90 measures 45-3/8" H x 15-3/16" W x 14-3/4" D and has a typical frequency response of 30-18,000Hz  $\pm$ 3dB. The E70 is 32" x 13-1/2" x 14" with frequency response from 35-18,000Hz  $\pm$ 3dB. The E50 measures 25" x 13-1/2" x 13-1/2" with a frequency response of 40-18,000Hz  $\pm$ 3dB. The new E30 is 22-3/4" x 13-3/16" x 10-5/16" with a 45-18,000Hz  $\pm$ 3dB frequency response. Efficiency is 94dB at 1 watt and 1 meter for the E30, and 95dB for the other models.



RANK HI FI Inc., 20 Bushes Lane, Elmwood Park, New Jersey 07407 (201) 791-7888

Enter No. 41 on Reader Service Card

**W**<sup>®</sup>  
WHARFEDALE

# European records

John S. Wright

I concluded my last record column in the June issue by promising to update on the advent of digital recordings. Of course, in this I refer to records that are in fact analog but derived from digital master tapes. Among the advantages claimed over normal tape-recording practices are more linear frequency response and improved signal-to-noise ratio and reduced distortion, all without need of separate noise reduction. How successful this new development proves is considerably influenced by the number of "bits" and the "sampling rate"—technical matters adequately explained in other pages of this journal and not a matter for investigation here. Nevertheless, beside the difficulty of editing digital tapes, which has to be differently handled, it is the considered opinion of many experts that both sampling rates and bits (for which yet there are no firm standards) need to be increased over that of first-generation equipment if the full advantages of this medium are to be realized. At best, digital master tapes are claimed to enable conventional records to be manufactured with the quality of direct-to-disc.

The very first digital record to be released in England was a recording of Willi Boskovsky's **New Year's Day Concert in Vienna** on the Decca label (D 147D2). This live recording of the frivolous waltzes, polkas, marches, etc. by Johann Strauss and the like is very much a counterpart of the earlier analog recording issued in 1976 (SXL 6740), over which I enthused in the Christmas issue of that year. Not surprisingly, therefore, the musical content is most similar, as is the audience participation in the spirit of the occasion. The disc-pressing quality is excellent and leads to speculation as to whether special care had been taken for this dual historic occasion, being the first digital recording from Decca and the Silver Anniversary for the Concert. Orchestral presentation is exceptionally well detailed, especially in the clarity of the bass, but the string tone is edgy sometimes to the point of being uncomfortable. More so than in the earlier disc, a contrast of acoustics presents itself between those of the orchestra and the audience, as though they were recorded at different locations. Without direct comparison to a version derived identically but using

analog tape, it is impossible to say whether these minor reservations are due to the specific microphone techniques employed or whether it is that digital recording reveals not only all that is best in the engineering.

Two other releases swiftly follow in Decca's digital format, the first a selection of music by Mendelssohn including his *Italian Symphony*, *Fingal's Cave*, and the overture *Calm Sea and Prosperous Voyage* (SXDL 7500). Again, this is an altogether clear and clean presentation, though not overwhelmingly different from any of the best from Decca. The third release, Mahler's *Symphony No. 4* (SXDL 7501), contains the finest attributes of the other digital recordings and to my taste has the best balance of them all. Conducted by Zubin Mehta, the Israel Philharmonic Orchestra gives the work a freshness considerably enhanced by the clarity of the recording.

EMI has not in the meantime been complacent over the possible advantages of digital recording and has entered into a licensing agreement under which MCI will manufacture digital tape-recording equipment based upon technology developed by EMI's Central Research Laboratories. Future joint projects under the licensing agreement will include the manufacture of an editing system as well as multi-channel digital tape recorders. Obviously, the editing of digital tapes is still a problem, one which Decca seems to have solved. We await with interest releases by EMI of digitally originated material.

At this writing I understand they are about to issue a popular music record, 12 in. in diameter but revolving at 45 rpm (12 DIG 1001). So, yet again, we will have another potential improvement in the chain which will further the difficulty of differentiating when improvements are attributable to digital technology. Certainly it superficially appears that in digital form, recording techniques are more ruthlessly exposed, and this in itself should motivate companies to achieve more convincing results.

Not to be left out, the independents have also entered the field of digital work. Bob Auger (an independent re-

99



Zubin Mehta

ording engineer) undertook the mastering of Reinhold Gliere's *Symphony No. 3* which was sent to Nimbus Records (an independent recording company) which cut and pressed the discs (PCM 500/1) for Unicorn Records (independent record producers). While I have not yet had the opportunity to hear this, reactions from colleagues have been favorable—although it seems a pity that Unicorn could not select a more significant musical item for their first digital release.

### Standard Discs

Without any apparent need for such new technology, Philips continues to dependably provide unparalleled recordings, especially of chamber music. Without any doubt the best discs to be mentioned here come under this category, and not the least is the boxed set of Chopin *Nocturnes* played by Claudio Arrau (6747 485). With the piano set in a spacious and ambient acoustic and against a virtually silent background, the soloist savors every inner detail of the music, rather than merely concentrating upon the melody line. Christoph Eschenbach, however, takes a far more aggressive approach in his rendition of Beethoven's *Sonatas*, the *Moonlight* and *Pathétique* (EMI ASD 3695). Whether this suits the works or not must be a matter of personal preference, but the recording amply complements this approach by being clinically clear yet with sufficient bloom.

Some years ago, Paul Tortelier recorded the Bach *Cello Suites* for EMI. They are still available on SLS 798 (three discs) and are fresh, inspiring, and as fine a recording as we have ever had on this label. I recall at the time some music critic damning the set as being "over-resonant." What rubbish! However, if he did not like the Tortelier on those grounds, he is going to hate the new Maurice Gendron recording issued on Philips (6770 005), since this could perhaps be so described. For myself, I love this type of presentation where the recording environment becomes as important a part of the musical experience as does the performance proper. I have heard it said that Philips engineers sometimes enhance this effect by dubbing in the additional acoustic of a local church. Whether this is so or not, and whether it applies to this recording, is immaterial to the results, which I applaud. Gendron's playing is more sober than Tortelier's, especially in the dance movements where Tortelier can become almost jaunty. Of the two recordings, I would choose both.

Staying with Bach, the Decca team, in association with Sun Life, makes sensible use of the stereo stage in a new recording—sung in English—of the *St. Matthew Passion* (D 139D 4). Sir David Willcocks conducts the Bach Choir and Thames Chamber Orchestra in a full-scale production, in contrast to the more intimate performances so currently fashionable. The soloist lineup includes Robert Tear, John Shirley-Quirk, and Felicity Lott. That having been stated, the musical standards are set, and it remains a matter of contention as to whether such music is translatable from the German to the more grandiose style. The separation between orchestra sections and orchestra to choir is not overtly exaggerated, but as one might expect of Decca, the soloists are comparatively close.

The distinctive voice of Dame Janet Baker heralds a selection of late seventeenth and eighteenth century music in a selection named *Arie Amorose* on Philips (9500 557). Such popular items as *Plaisir d'amour* are sung with a fully scored accompaniment played by the Academy of St. Martin-in-the-Fields, as opposed to the more traditional parlor piano. The equally distinctive voice of Victoria de Los Angeles is accompanied by the equally revered Gerald Moore in a live concert recording from the Festival Hall on EMI (ASD 3656). One side is devoted to a selection of Spanish songs for which she is so justifiably famous, and the audience warms to the occasion. This memorable recording bears a natural stage setting, only marred by evidence of coloration in the applause.

Also recorded live on tour is a double album of Julian Bream and John Williams playing a varied but popular selection (also including Spanish music) on RCA (RL 25198). Considering the practical difficulties of such a venture where two locations were involved, it is remarkable that without placing the microphones too close, the balance remains constant. Perhaps,

though, this is just another way of saying that the original acoustic was masked? Julian Bream, this time playing lute music of the *Dances of Dowland*, appears as a reissue from RCA (BL 12610). Despite a very close recording, where no correct volume setting can be found, at least not one that resembles a lute, the music still lives through the ages.

Two recordings appear in rapid succession of Smetana's *Ma Vlast* (*My Country*). The Paavo Berglund version on HMV SLS 5151 is smooth, warm and deliberate; not an impressive sound with a tendency towards sourness in the treble. The alternative, however, is a good Decca sound with Walter Weller conducting the Israel Philharmonic Orchestra (D 108D 2). This reading is more onward-going with the recording rich yet detailed and suiting the music.

Two recordings of Elgar's *Enigma Variations* are also worth noting. I have come to expect excellent results when Brian Couzens records the Scottish National Orchestra conducted by Sir Alexander Gibson for RCA. This latest release (RL 25206), though, is a disappointment. I fear some fault in the processing, for the review sample was undercut — presenting a poor signal-to-noise ratio with a somewhat screaming top. The Philips version (7300 642) with Neville Marriner conducting the Concertgebouw Orchestra is coupled with *Pomp & Circumstance Marches Nos. 1, 2 and 4*. All this is excellent, full-blooded, and exciting, and the usual air and ambience associated with the Concertgebouw are tailor-made for the *Enigma Variations*.

Fans of the Philip Jones Brass Ensemble should not miss their latest release entitled *Baroque Brass* (ZRG 898). Up to the usual exceptionally high standards, the music is not as

Paul Tortelier



stodgy as its title may suggest. Also referring back to Paul Tortelier, his recording of the Dvorak *Cello Concerto* (HMV ASD 3652) is super, except for the fact that as soloist he not only dominates musically, but the engineers have also placed him too far forward. Equally luscious but unfussy is another recording of Zubin Mehta with the Israel Philharmonic playing Schubert's *Symphonies Nos. 1 and 2* on Decca (SXL 6892). The warmth of platform resonances makes this a pleasurable and untiring experience.

Tchaikovsky symphonies again deserve new interpretations. Riccardo Muti conducts the Philharmonia Orchestra in a version of the *Fifth*, on EMI (ASD 3717). It is an immediate if not profound rendition, exhilarating with forward brass but, for me, not on par with the Haitink version. Conducting the Concertgebouw, however, Bernard Haitink gives of his best on the Philips release of *Symphony No. 2 (Little Russian)* (9500 444). The expected spacious sound is accompanied by extraordinary bass impact.

Turning exclusively to chamber music, four recordings require special mention. The little-known Tchaikovsky *Piano Trio in A minor Op. 50* is played by the Yuval Trio in a most endearing manner with a close "in-the-room" format (CBS 76698). The Quartetto Italiano yet again provides exemplary performances of Schubert *Quartets Nos. 10 and 13* with the professional polish always provided for them by Philips (9500 078).

Alfred Brendel provides a truly outstanding recording with members of the Cleveland Quartet of Schubert's most popular quintet *The Trout*, also on Philips (7300 648). A rather close recording but excellent nevertheless; a high cutting level does not make this too easy to track. Having more than the usual Philips recording distance, the Beaux Arts Trio provides Haydn's *Trios in C, D and F minor; No. 36 in E Flat* (9500 472). None should be missed!

Continuing with Haydn and the parallel series running between Marriner and the Academy, versus Colin Davis and the Concertgebouw; the former have released *No. 31 (Horn Signal)* and *No. 73 (The Hunt)* as 7300 674 from Philips, while the Davis contribution is *No. 100 (Military)* and *No. 104 (London)* on 9500 510. Both are in the vein of their series, with the Marriner lighter textured. I am glad that I do not have to opt for one series or the other, being both different yet inseparable in my collection.

Dukas' *Sorcerer's Apprentice* is always a good seller, and David Zinman

conducting the Rotterdam Philharmonic has coupled this to some of the few other orchestral works of that composer (7300 677). It is not the blockbuster of a recording that we had from Walter Weller but nevertheless is intrinsically well-detailed with very deep bass in places. Weller has, though, concurrently conducted the incidental music to Grieg's *Peer Gynt* in a recording that I very much liked for its openness and impact — Decca SXL 6901.

As though everything should happen in pairs, there are also two recent releases of Holst's *The Planets*. The HMV recording (ASD 3649) is intended to commemorate Sir Adrian Boult's 90th birthday with his conducting the London Philharmonic Orchestra. Sir Adrian conducted the first performance of this work in 1918 and received a copy of the score inscribed: "This copy is the property of Adrian Boult who first caused the Planets to shine in public and thereby earned the gratitude of Gustav Holst." Unfortunately a 24-Hz signal seems implanted throughout the end of the second side. It is claimed that the organ at the Kingsway Hall emits a steady drone while it is activated, and presumably the tone was not switched off or filtered out.

Nevertheless, rumor has it that EMI also took this down on digital tape, although editing facilities were not available in time for its issue; so perhaps we shall have cause to refer to it more properly in future. An alternative issue arrived from Decca with Sir Georg Solti giving a full-impact, fast interpretation (SET 628). The sleeve shows Sir Georg conducting pointedly with a "they went that-way" gesture, which coincidentally illustrates the interpretation. The recording is more than adequate with more than apparent dynamic range; it is impressive yet without undue closeness.

Space does not allow for the full review the last recording deserves. Benjamin Britten's opera *Peter Grimes* is arguably the single most significant item he wrote and is certainly one of the few masterpieces of modern English music (Philips 7699 089). For those who know nothing of the work, it is pointless commencing a dissertation here. For those who do, I can only recommend this as the best "staged" rather than "contrived" presentation I can imagine given the confines of conventional two-channel stereo. The depth of feeling contained in the music is transmitted to the listener in a manner which is spectacular without his realizing it. Surely this is the epitome of success? A

# Interface: C

Series II

**It sounds like music.**

Interface: C Series II is the fulfillment of our six-year association with optimally vented speakers based on the theories of A.N. Thiele — speaker designs first introduced by Electro-Voice in 1973. The Interface: C offers you a unique combination of high efficiency and high power capacity — the only way to accurately reproduce the 120+ dB peak sound pressure levels found in some types of live music.

The SuperDome™ tweeter, an E-V exclusive, and the VMR™ vented midrange driver, the first to apply optimally vented design to mid frequencies, ensure your music is reproduced without the coloration normally found in other high-efficiency drivers. An honest 30 Hz low end totally eliminates the need for expensive subwoofer assemblies.

When you spend \$1,000 for a speaker system, get your money's worth. Audition the Interface: C Series II at your nearest Interface dealer. If you want a speaker that sounds like music, the Interface: C Series II is the one you'll buy.

**EV** ElectroVoice®  
a gulton company

600 Cecil Street, Buchanan, Michigan 49107



Enter No. 13 on Reader Service Card

Jon Tiven

Michael Tearson

# The column

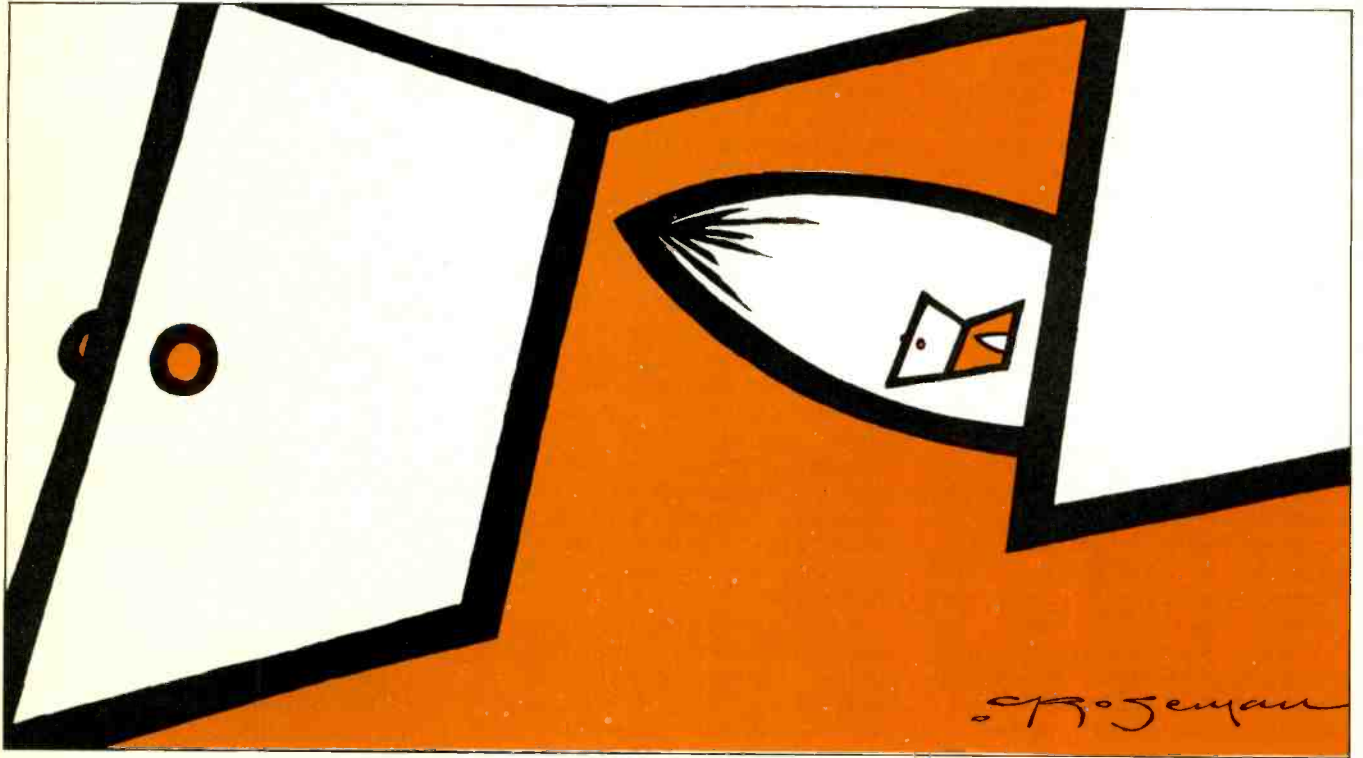

**In Through the Out Door:** Led Zeppelin

Swan Song SS 16002, stereo, \$8.98.

As time stretched out between Led Zeppelin albums, at one point speculation was rife that when their album came, it would be a double. Yet the album Zep did put out has two such cohesive yet different sides that they could almost have come from completely different albums.

Here's a thought. How many double albums have received the criticism that with editing they would have been brilliant single albums? This is one of the latter.

Side one is the snappy song side, side two is the "progressive," more stretched-out side. Both are purest Zeppelin. And each is somewhat of a surprise and for different reasons.

The most important element of Led Zeppelin's albums is always their BIG sound. Cavernous. When the material is up to the size of the sound, the results can be immortal — *Dazed and Confused*, *Stairway to Heaven*, *Kashmir*. When the song isn't up to it, it can feel leaden and even confused, but

still BIG. Much of **Presence**, the previous studio album, felt that way.

Side one of **In Through the Out Door** is just the most accessible album side that Zep has put together, at least since **Physical Graffiti** and maybe longer. It contains four songs, and I emphasize songs. Perhaps it is enlightening that although they ultimately did not play the gig, Led Zeppelin offered to play at the memorial concert for Lowell George of Little Feat. There is a genuine hint of his influence in these songs' quirky rhythms and sometimes goofy lyrics, things the late, lamented Feat was especially known for.

It all opens very ponderously with moody mellotrons before *In the Evening* erupts into a smashing rocker with a minor-key melody that gives the song some of the Middle Eastern drive of a *Kashmir*. Going from that riff into the chorus' major key is a thrill each time around. A little Richard piano line kicks off *South Bound Saurez*, a flat-out rock and roll song. *Fool in the Rain* is the unexpected one. As it starts, it has a loping, circular tune that

is catchy as hell. Robert Plant gets a real chance to sing here, what with an uncommonly uncluttered arrangement for Zeppelin and his voice mixed unusually forward. Abruptly with the blast of a police whistle, it takes off into a jam that for all the world sounds most like the old Pigpen-era Grateful Dead wailing on the riff of *Turn On Your Lovelight* so long ago. Then finally it's back to the opening theme. The first time I heard it on the radio I had to pull over to the side of the New Jersey road. Then, of all things, the side closes with *Hot Dog*, a hot rockabilly number. Four great songs in a row. A revelation.

The prevalence of the keyboards of John Paul Jones throughout the first side is a big surprise that will continue through the second. It is as unexpected and as strong in its way as the sudden adoption of sweeping keys was for The Who on **Who's Next**, another giant.

Side two opens with the album's big, sprawling epic-length piece, *Carouselambra*. I find it a mighty driver, but diffuse and lacking focus.

Plant's voice is buried so far beneath the keys that what he is singing is totally indecipherable, and for me the song suffers because of it. One of my best friends, one with uncommonly sharp ears, has told me that just lately he has to hear the next one, the near-ballad *All My Love*, at least once a day. It has a lovely melody for a Zeppelin tune, and Plant gives it his best Al Green/Otis Redding pleading shot.

The finale, *I'm Gonna Crawl*, opens with a movie theme sweep thing before it evolves into a slow, nightclubby 12-bar blues that actually does crawl for about a minute and a half too long.

Yes, I much prefer side one.

**Out Door** does have the BIG Led Zeppelin sound, and it requires loud volume to hear it right. The sonic relationships just don't properly gel at low volume — there is that much dimension in the sound. Yet the sound of the album is not what makes it come alive. The magic moments aren't magical because the record sounds great, but because the song carries you on out.

Now some of the fans are saying that this Zeppelin album doesn't rock like Zep is supposed to. Hooey! **In Through the Out Door** is a real smart album to enter the '80s with. It really tries to reach out to people on the song level and meet them somewhere in the middle. Unlike **Presence**, it does not project stubbornness at all.

Some of these songs are going to be radio staples for at least the next 10 years or more. And I for one don't think they are going to get tired. Quite to the contrary, I expect **Out Door** to wear very well with time. M.T.

Sound: B+

Performance: A-

**In Through the Out Door:** Led Zeppelin

**Swan Song SS 16002**, stereo, \$8.98.

Without question this is THE brilliant rock album of the Seventies, easily the most powerful music Zeppelin's put down since their second album, and demonstrates most ably that you don't have to sound like anybody else in order to make your mark in the music industry. Each member of this group has his own personal stamp impressed firmly upon each groove, making an unmistakable sound that has yet to be duplicated. Certainly no drummer could be mistaken for John Bonham, who proves time and again that strength and steadiness in good measure are 75 percent of what it takes. John Paul Jones, who was content merely to play bass on **Presence**, fully earns his keep as a keyboardist/arranger this time around, using tricks he's kept in the bag since he was The

Stones' conductor on **Satanic Majesty's Request**. And speaking of **Satanic Majesty**, the good old demonologist himself, Mr. Jimmy Page, turns in some fine performances himself on **Out Door**, whether he is conducting the band through bizarre timings (a la *Achilles Last Stand*) or strictly playing the session guitarist (most notably on *I'm Gonna Crawl*). Robert Plant is his own inimitable self, the screaming mimi of heavy metal who, this time around, gets a heavy dose of delay to soup up the pipes and whose remarkable range is hardly affected by the passage of time. Where their last album, **Presence**, sounded like a deliberate attempt to be abrasive and uncharming, **In Through the Out Door** is Led Zeppelin's most soothing document without any power loss.

Unable to use Jimmy Page's computerized home studio since it was still being debugged, the foursome journeyed to Stockholm's Polar Music, most famed for Abba's use of the place. The sonic transformation of the band is immediately evident in Jones' keyboards, which are used much more than rhythm guitars on the album. Although nothing could really alter the sound of Bonzo's drums, Plant's vocals aren't quite so shrill as usual, gravitating towards an almost mellow quality (particularly on the new *Stairway to Heaven* entitled *All My Love*). Page's approach to guitar on this album is nothing short of ear-bending; on the first track and several others he demonstrates a new technique of playing distortion-free the sloppiest leads known to man. On *Hot Dog* Pagey lets loose with a solo that is so off-time in places one wonders how he let it slip by, particularly when the *Hello Mary Lou Gubye Heart* progression isn't a difficult bunch of changes to grope with. Yet throughout the album, his layers of guitar create a structure that no other guitarist has ever duplicated or even attempted to work toward. Perhaps he isn't anymore the solo virtuoso that the first two Zeppelin albums showed him to be, but his approach to guitar is far more challenging than practically anyone else in rock—he leaves the show-off stuff to Jeff Beck and Ritchie Blackmore.

But **In Through the Out Door** isn't just a handbook for guitarists: There are plenty of lessons in song structure, and besides there are a few fine tunes that you can sing along to. But beware, this isn't a simple record at all—it's a very imposing album to listen to, and that's about as strong a recommendation as any. J.T.

Sound: A+

Performance: A+

**In Style:** David Johansen  
**Blue Sky JZ 36082**, stereo, \$7.98.

This dude cannot sing. I mean, as long as he's on a track that's rocking fast he can scream and bluff his way through a tune like *She*, but as soon as the pace slows the Jaggeresque trappings of his voice fall away and The King of Staten Island takes over. Some of his slower tunes are okay, but they just blow the David Jo facade — you'd swear he was lisping when he sings "I luv you" in *Big City*. But the guy simply has a very limited voice, like a five-note range and a patented delivery that only works in very few situations, and unfortunately there aren't enough hard rockers here to keep his silliness in check.

On the more positive side, there's a tune called *Melody* which sounds like

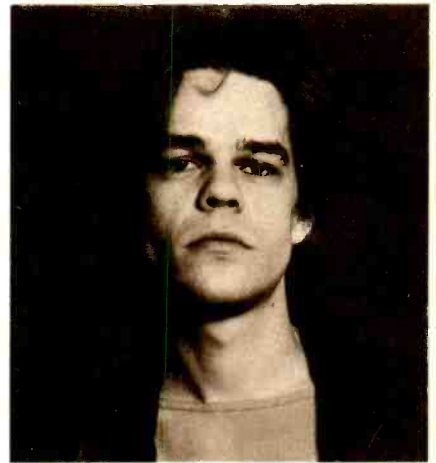

a rewrite of The Four Tops' *Bernadette* where David's voice skirts the edge of his vocal precipice but manages to carry the tune. I'd love to hear a real black voice work with the tune, but you can't have everything — at least he's found a second milieu in which he can work.

The first album by David Johansen had a pretty horrible sound to it, while this one is far more listenable on a strictly sonic basis, as he's got a real band behind him and Mick Ronson handling production chores. Ronson does a fine job with the strings on *Melody*, and the disco cut, *Swaheto Woman*, doesn't ever bother me. The title cut is the best rocker, mainly because back-up vocals help mask David Jo's delivery — it's just tiring to here his voice so naked, so upfront on a whole album. In The New York Dolls at least there were other personalities in the group, David wasn't so far out front, and there was an abundance of humor....I think the humor is what I miss more than anything. J.T.

Sound: B+

Performance: B

**Repeat When Necessary:** Dave Edmunds

**Swan Song SS 8507**, stereo, \$7.98.

Dave Edmunds' third Swan Song album is an end-to-end rocker. When the artist is not much of a songwriter like Dave, selection of material is that much more crucial, and he's gathered some dandy tunes together here, none very well known at all before. There is *Girls Talk*, a wonderful Elvis Costello song that has already been a runaway hit in England. *Crawling through the Wreckage* is a Graham Parker thing never recorded before. From there out, it is obscure city. "B. Murray" wrote or co-wrote several, including *Creature from the Black Lagoon*. "H. DeVito" (from Emmylou Harris' Hot Band?) wrote two, *Sweet Little Lisa* on which Albert Lee plays hot guest country lead guitar and *Queen of Hearts* complete with an Everly Brothers feel.

The band is the redoubtable Rockpile with Edmunds on guitars and piano, Nick Lowe on bass, guitarist Terry Williams, and drummer Billy Bremner.

**Repeat When Necessary**, a rock & roll album with lots of style. Great fun.

M.T.

Sound: B+

Performance: B+

**The Long Run:** The Eagles  
**Asylum 5E-508**, stereo, \$8.98.

The cover makes it look like the album should have been called **The Last Run**, with its hearse-like frontispiece and casket shots on the inside, and let me assure you that the music isn't much more uplifting. The single, *Heartache Tonight*, a basic blues shuffle that needed collaborators such as Bob Seger and J. D. Souther, is fairly decent but totally unspectacular, and one wonders whether each co-author supplied one chord. It's probably the best track on the album.

One must give credit to Joe Walsh for integrity. While Don Henley and Glenn Frey spent the entire album rewriting their past hits, Joe Walsh maintains his roots by simply recutting *In the City*, a track off his last solo album, rather than trying to disguise it as something new. What I'd really like to hear is an album of Neil Young and Jackson Browne songs by Don Henley and Glenn Frey, respectively, which undoubtedly would be indistinguishable from the originals.

Of course, one must not neglect The Eagles' fine choice of subject matter, the casting couch (*King of Hollywood*), footwear (*Those Shoes*), and social commentary (*The Disco Strangler*). These fellows must be intellectuals,



probably why they're so contemptuous of society. They even satirize/attack "New Wave" music on *The Greeks Don't Want No Freaks*, a thinly veiled rewrite of *Big Boy Pete*.

**The Long Run** has been touted as The Eagles' return to "real rock 'n' roll." I think The Rolling Stones, Dave Edmunds, and Chuck Berry need not worry about being dethroned, although Chicago and Three Dog Night might have some trouble maintaining their reputations.

J.T.

Sound: B

Performance: F+

**Get The Knack:** The Knack  
**Capitol SO-11948**, stereo, \$7.98.

This year's winner. By now it is no surprise that The Knack has absolutely conquered America as an instantaneous out-of-the-box smasher. And small wonder why.

Their cover stares at you, four black-and-white faces chisled out of pictures of the mod era of the '60s. Are they British? American? Can't tell from the cover. On the back the pose is even more Beatlesque, black trousers, white shirts, thin black ties, all matching. Black on white and in color. Perfect, deft packaging.

The music backs it up. Twelve compact pop songs bulging with the fish-hooks to pull you in. *My Sharona* is the natural lead cut, and it's already a #1 single. There is a cover of Buddy Holly's *Heartbeat*, a good one, too, and 10 more originals. *Good Girls Don't (But I Do)* is irresistible. *Let Me Out*, *Frustrated*, and *She's So Selfish* are all bashers with plenty of style.

*Your Number or Your Name* shows exquisite song sense. And that's only a few.

The group's centerpiece is Doug Feiger who is their singer/guitarist/songwriter-lyricist (sometimes collaborating with lead guitarist Berton Avarre). Feiger is also photographically a ringer for the younger Pete Townshend. Bruce Gary and Prescott Niles, the rhythm section, complete the group. By the way, they are American.

The Knack had the exquisite fortune to employ Mike Chapman as producer. Chapman, currently hot with several artists, most notably Blondie, reportedly brought in the completed album for \$18,000 recording cost. Conservatively, \$100,000 is a reasonable average cost for an album these days with some superstars going to many times that figure. What this means is that the band had the songs down cold before they even got to the studio. No expensive rehearsing in the studio here. Clearly the album employs a minimum of overdubbing and assorted studio wizardry. The punch comes from solid performance and material combined with a no-nonsense producer who loves to bash out the songs real quick, one after another.

Thus, The Knack is a perfect blend of talent, production and marketing. Add just enough luck to cover appearing at the perfect moment, just in the knick of time, and you have a phenomenon called The Knack, this year's surprise smash hit band.

Do they have another album this good in them? Tune in again next year when . . .

M.T.

Sound: B+

Performance: A

**Clout**  
**Epic 35617**, stereo, \$7.98.

What we have is a brunette Abba sounding so much like their Swedish counterparts my only surprise is that they haven't had a hit in America yet. The first tune on the album, *Substitute*, is as close to a perfect hit single as groups get these days. If Clout's version doesn't go Top Twenty by the end of this year, somebody will make a hit of it—it's that good. The rest of the album isn't quite so inspiring but *Feel My Need* and that overworked Russ Ballard tune, *Since You Been Gone*, get a good treatment. Chances are that FM will ignore this completely, so in case *Substitute* doesn't make it, be sure you pick up a copy of the single or album of said tune because it surely should be.

J.T.

Sound: B+

Performance: B





# Bone Fone<sup>TM</sup>

*A new concept in sound technology may revolutionize the way we listen to stereo music.*

*The Bone Fone surrounds your entire body with a sound almost impossible to imagine.*

You're standing in an open field. Suddenly there's music from all directions. Your bones resonate as if you're listening to beautiful stereo music in front of a powerful home stereo system.

But there's no radio in sight and nobody else hears what you do. It's an unbelievable experience that will send chills through your body when you first hear it.

#### AROUND YOU

And nobody will know you're listening to a stereo. The entire sound system is actually draped around you like a scarf and can be hidden under a jacket or worn over clothes.

The Bone Fone is actually an AM/FM stereo multiplex radio with its speakers located near your ears. When you tune in a stereo station, you get the same stereo separation you'd expect from earphones but without the bulk and inconvenience. And you also get something you won't expect.

#### INNER EAR BONES

The sound will also resonate through your bones—all the way to the sensitive bones of your inner ear. It's like feeling the vibrations of a powerful stereo system or sitting in the first row listening to a symphony orchestra—it's breathtaking.

Now you can listen to beautiful stereo music everywhere—not just in your living room. Imagine walking your dog to beautiful stereo music or roller skating to a strong disco beat.

You can ride a bicycle or motorcycle, jog and even do headstands—the Bone Fone stays on no matter what the activity. The Bone Fone stereo brings beautiful music and convenience to every indoor and outdoor activity without disturbing those around you and without anything covering your ear.

#### SKI INVENTION

The Bone Fone was invented by an engineer who liked to ski. Every time he took a long lift ride, he noticed other skiers carrying transistor radios and cassette players and wondered if there was a better way to keep your hands free and listen to stereo music.

So he invented the Bone Fone stereo. When he put it around his neck, he couldn't believe his ears. He was not only hearing the music

and stereo separation, but the sound was resonating through his bones giving him the sensation of standing in front of a powerful stereo system.

#### AWARDED PATENT

The inventor took his invention to a friend who also tried it on. His friend couldn't believe what he heard and at first thought someone was playing a trick on him.

The inventor was awarded a patent for his idea and brought it to JS&A. We took the idea and our engineers produced a very sensitive yet powerful AM/FM multiplex radio called the Bone Fone.

The entire battery-powered system is self-contained and uses four integrated circuits and two ceramic filters for high station selectivity. The Bone Fone weighs only 15 ounces, so when worn over your shoulders, the weight is not even a factor.

#### BUILT TO TAKE IT

The Bone Fone was built to take abuse. The large 70 millimeter speakers are protected in flexible water and crush resistant cases. The case that houses the radio itself is made of rugged ABS plastic with a special reinforcement system. We knew that the Bone Fone stereo may take a great deal of abuse so we designed it with the quality needed to withstand the worst treatment.

The Bone Fone stereo is covered with a sleeve made of Lycra Spandex—the same material used to make expensive swim suits, so it's easily washable. You simply remove the sleeve, dip it in soapy water, rinse and let the sleeve dry. It's just that easy. The entire system is also protected against damage from moisture and sweat making it ideal for jogging or bicycling.

The sleeve comes in brilliant Bone Fone blue—a color designed especially for the system. An optional set of four sleeves in orange, red, green and black is also available for \$10. You can design your own sleeve using the pattern supplied free with the optional kit.

#### YOUR OWN SPACE

Several people could be in a car, each tuned to his own program or bring the Bone Fone to a ball game for the play by play. Cyclists,

joggers, roller skaters, sports fans, golfers, housewives, executives—everybody can find a use for the Bone Fone. It's the perfect gift.

Why not order one on our free trial program and let your entire family try it out? Use it outdoors, while you drive, at ball games or while you golf, jog or walk the dog. But most important—compare the Bone Fone with your expensive home stereo system. Only then will you fully appreciate the major breakthrough this product represents.

#### GET ONE SOON

To order your Bone Fone, simply send your check or money order for **\$69.95** plus \$2.50 postage and handling to the address shown below. (Illinois residents add 5% sales tax.) Credit card buyers may call our toll-free number below. Add \$10 if you wish to also receive the accessory pack of four additional sleeves.

We'll send you the entire Bone Fone stereo complete with four AA cell batteries, instructions, and 90-day limited warranty including our prompt service-by-mail address.

When you receive your unit, use it for two weeks. Take it with you to work, or wear it in your car. Take walks with it, ride your bicycle or roller skate with it. Let your friends try it out. If after our two-week free trial, you do not feel that the Bone Fone is the incredible stereo experience we've described, return it for a prompt and courteous refund, including your \$2.50 postage and handling. You can't lose and you'll be the first to discover the greatest new space-age audio product of the year.

Discover the freedom, enjoyment, and quality of the first major breakthrough in portable entertainment since the transistor radio. Order a Bone Fone stereo at no obligation, today.

\*Pending FCC approval.

**JS&A** PRODUCTS  
THAT THINK<sup>®</sup>

Dept. AV One JS&A Plaza  
Northbrook, Ill. 60062 (312) 564-7000  
Call TOLL-FREE ..... 800 323-6400  
In Illinois Call ..... (312) 564-7000

© JS&A Group, Inc., 1979

Enter No. 19 on Reader Service Card

Empire's revolutionary cleaning method peels off every trace of dirt, dust and oil from deep down in your record's grooves.



Write for your free brochure on all fine record care products by Audio Groome. Empire Scientific Corp., Dept AG, Garden City, NY 11530

EMPIRE EMPIRE Audio Groome by EMPIRE

Enter No. 15 on Reader Service Card

**Bread and Roses:** Various artists. **Fantasy F-79009**, stereo, two discs, \$13.98.

The performances on this double album come from a three-day 1977 festival held to raise funds to stage concerts for "people in limited environments" such as hospitals, mental health facilities, convalescent homes for the elderly, and prisons. So, too, go proceeds from the recording.

The album is a magnificent collection of musical snapshots. Twenty artists are represented, each in a superb performance of a signature song. Buffy Sainte-Marie offers *The Universal Soldier*, Dave van Ronk has *Swinging on a Star*, the late Malvina Reynolds sings *Little Boxes*, followed by Pete Seeger with *Sailing Down My Golden River*. The John Herald Band's own *Ramblin' Jack Elliott* is followed by Jack himself doing *San Francisco Bay Blues*. Tom Paxton's classic *Last Thing on My Mind* is a treat, as is Joan Baez singing a new Phil Ochs' *There But for Fortune*. Jackson Browne in duet with David Lindley is a magical combination, and the performance of *For Everyman* is all it could be. Some of the others well represented are Jesse Colin Young, Richie Havens, Mickey Newbury, Dan Hicks, and Hoyt Axton (the only one inexplicably represented with two songs).

It must have been an amazing weekend; the intensity of the performances attests to that. As I've hinted above, the sequencing of the album is superb, thoughtful, caring, the technical aspects excellent.

**Bread and Roses** is a wonderful album. True, it seems somehow anachronistic, a frozen amber image of some simpler time, of the "heyday of the golden folkies." What an embarrassing way to say that I love the album. M.T.

Sound: A- Performance/Presentation: A

**Priority:** The Pointer Sisters **Planet P-9003**, stereo, \$7.98.

Remember the theory about the strictest parents breeding the most rebellious kids? Well, it might be just because the Rev. Pointer banned all but gospel music in his household that his daughters' new album, **Priority**, makes such an attempt to rock with a vengeance. The choice of cover tunes includes such modern classics as Graham Parker's *Turned Up Too Late*, a Bob Seger song called *All Your Love*, Ian Hunter's *Who Do You Love*, The Stones' *Happy*, *The Shape I'm In* by Robbie Robertson, and Springsteen's *The Fever*.

Following their commercial success with *Fire*, the last selection would seem like a sure bet, but this version is a real sleeper. The vocal isn't gruff enough nor the instruments particularly noticeable, and there are no rough edges or rhythmic jolts that could make this song happen. *Who Do You Love* is a more likely candidate with a powerful lead vocal by June and a strong instrumental track, especially in its drum sound. June delivers the most effective tunes on this LP, performing *The Shape I'm In* in a spunky version identical to The Band's, and a nearly note-for-note recreation of Parker's *Turned Up Too Late* which substitutes only her smooth delivery for his anguished tone.



The arrangements of the songs on this album remain virtually unchanged from the original versions, and the girls don't employ much of their usual unison singing, formerly their personal stamp. The change from harmonic to individual singing leads me to believe that solo careers are in the near future for the three Pointers who haven't yet followed in the footsteps of their independent (and now hit-making) sister Bonnie. For a producer known for his lush concoctions (such as Nilsson's *Without You*), Richard Perry does a pretty good job making The Pointers a Real Rock LP. I only wish they hadn't chosen to cover *Happy*, a tune whose original version was a sloppy masterpiece, which loses some of its messiness, and thereby its impact, in this incarnation. Sally Young

Sound: B+ Performance: A

AUDIO • December 1979

# When you share interests in High Fidelity, Audio is the gift to give.

**MORE THAN 33 1/3% SAVINGS\* OFF COVER PRICE**

Give Gift Subscriptions to all those on your list and save \$2 on the subscription price. (List additional names on separate sheet.)

## Here's Audio's gift to you:

when you order gift subscriptions you will receive the audiophile fix-it tool of jewel-like practicality!

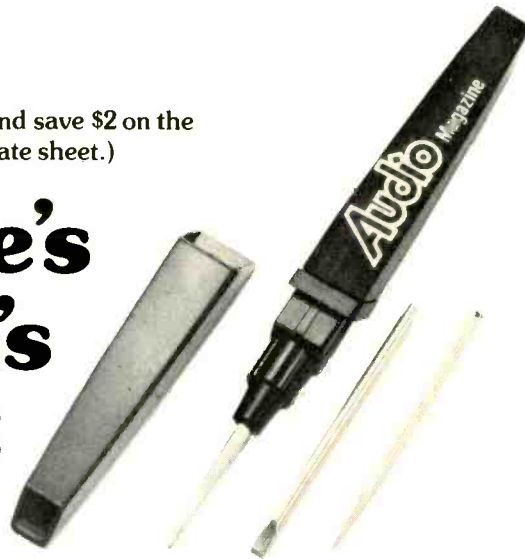

107

**YES** send gift subscriptions at special rate of \$10 each (\*\$5.50 saving on newsstand price) with a gift card from me to the following list:

<p><b>1</b> Name _____</p> <p>Address _____</p> <p>City/State/Zip _____</p>	<p><b>3</b> Name _____</p> <p>Address _____</p> <p>City/State/Zip _____</p>
<p><b>2</b> Name _____</p> <p>Address _____</p> <p>City/State/Zip _____</p>	<p><b>4</b> Name _____</p> <p>Address _____</p> <p>City/State/Zip _____</p>

**PLEASE BILL MY:**

AMERICAN EXPRESS     VISA

MASTERCARGE         DINERS CLUB

ACCT. NO. \_\_\_\_\_

Exp. Date \_\_\_\_\_

Signature \_\_\_\_\_

**MY CHECK IS ENCLOSED**

**Rush this order to:**

**AUDIO GIFT MANAGER**  
 North American Building  
 401 North Broad Street  
 Philadelphia, PA 19108

12/79



**Euclid Beach Band**

**Cleveland/Epic JE 35619, stereo, \$7.98.**

About a year ago I heard a great Beach Boys sendup on the radio called *No Surf in Cleveland*. It had every production trademark of the Wilson Brothers down to a "T" but actually was *good*, as opposed to something like Billy Falcon doing Bruce Springsteen or Tim Curry impersonating David Bowie. Anyhow, many moons later

the group whose satire I had enjoyed so much has released an album which, I'm afraid, does them a grave injustice. They would have been better off living in obscurity with a mysterious reputation than foisting a recording of this quality on the public. The group, which essentially is vocalist Pete Hewlett and guitarist/songwriter Richard Reising, isn't what you'd call talented songwriters or arrangers, so the rest of the album resembles a meek parody of their producer, Eric Carmen, set to the most mundane arrangements imaginable. Eric throws them a few of his discarded tunes, but even those can't save this bunch from sounding like an AM radio programmer's nightmare. Being able to turn a cliché is a talent, but direction is also important. I hope they will retire gracefully until they write another song that is at least as amusing as *No Surf in Cleveland*, which should not be that difficult. *J. T.*

Sound: C Performance: D+

**Hammer: Jan Hammer Group  
Asylum 6E-232, stereo, \$7.98.**

Aside from an astoundingly tacky t & a cover, Jan Hammer's umpteenth album finds him moving in an exciting

direction with a combo that seems intent on making the listener forget he's a jazzier at heart. With an ex-member of the "Beatlemania" cast, Glenn Burt-nick, fronting the band as lead singer and rhythm guitarist, Hammer's latest direction is what might be called your basic Foreigner/Yes progressive rock format. The interesting thing is that the lead instrument is Hammer's synthesizer, which more often than not plays what sound like guitar lines rather than your typical keyboard runs — the months he spent on the road duetting with Jeff Beck finally paid off. With a little work, Hammer could be to the Eighties what Cream was to the Seventies, or something like that, but there are some basic mistakes.

First off, Jan shouldn't sing — he's a mediocre croaker if there ever was one, and Burtnick's got not only a fine range but a pleasing tone. Second, he either needs to dump his rhythm section or get a producer to make them sound more "rock" if he's going to continue in this direction, because they're not heavy when they need to be. Thirdly, lame covers of tunes like *Oh Pretty Woman* are ill-advised when they don't suit Burtnick's pipes, and besides, it's not exactly an obscure song.

# OVER \$80. AND UNDERPRICED.



You probably know that our headphones are among the world's most highly-praised. You may know that our company doesn't introduce new models frequently. Yet, here we are, introducing two new headphone models. And telling you that as good as our other headphones are, these are better. It's no exaggeration. Hear what we mean at your Sennheiser dealer.

**SENNHEISER**  
ELECTRONIC CORPORATION  
10 West 37th Street, New York 10018 (212) 239-0190  
Manufacturing Plant: Bissendorf/Hannover, West Germany  
© 1978 Sennheiser Electronic Corporation (N.Y.)



**Rockit:** Chuck Berry  
**Atco SD 38-118**, stereo, \$7.98.

Although it is rumored that Chuck Berry is in jail charged with tax evasion, the truth of the matter is that he's in the slammer for grand fraud—he's been posing as himself for years when any fool can tell that the Chuck Berry they've been passing off as The Real Thang isn't the same man who cut *Thirty Days* however many years ago. The records released under the name of Chuck Berry for the past 10 years have all been horrendous impeachments of Chuck Berry's legendary status, and **Rockit** is only a slight—very slight—improvement over its predecessors. Originally it was to have been produced by Dave Edmunds, then Keith Richard, but finally the project was laid in the hands of this same self-impostor, Chuck Berry. The result is a fairly dull album with one track that stands out, *Oh What A Thrill*, which is redeemed by a hot piano by Johnny Johnson. Whoever heard of a Chuck Berry album whose only value lay in a piano track—this can't be the real Chuck Berry! Maybe when he gets out of the can, he'll be able to come across with something more interesting. J.T.

Overall, Hammer as a group shows a lot of promise if they can refine what they do a little more because there really isn't anybody attempting this sort of thing. With a slightly more streamlined approach, they could actually

blaze new trails in rock music. They have to open up the group a bit more, but the writing and performing talent are there. J.T.

Sound: C-                      Performance: B

Sound: C+                      Performance: D+

## The Watts Parastat



**In 15 seconds your records are clean, dry and ready to play.**

With some systems you pour liquid on your records (and rub it into the grooves), while with others you brush the dirt around (and rub it into the grooves). The Watts Parastat is neither of these.

By placing a plush velvet pad on either side of a soft nylon brush and adding a drop or two of Parastatik<sup>®</sup> fluid, a

remarkably efficient system is created.

The brush bristles lift the rubbish to the surface. The pads collect and remove it. And the Parastatik<sup>®</sup> fluid supplies just the right degree of humidity to relax dust collecting static without leaving any kind of film or deposit behind.

No other system does so much for

your records in so little time.

So when you want the best, ask for the original. The Parastat, by Cecil Watts.

Watts products are distributed exclusively in the U.S. by: Empire Scientific Corp., Garden City, NY 11530.

*Cecil & Watts Ltd*

EMPIRE EMPIRE EMPIRE EMPIRE EMPIRE EMPIRE EMPIRE EMPIRE EMPIRE EMPIRE

Enter No. 16 on Reader Service Card

# Jazz & blues

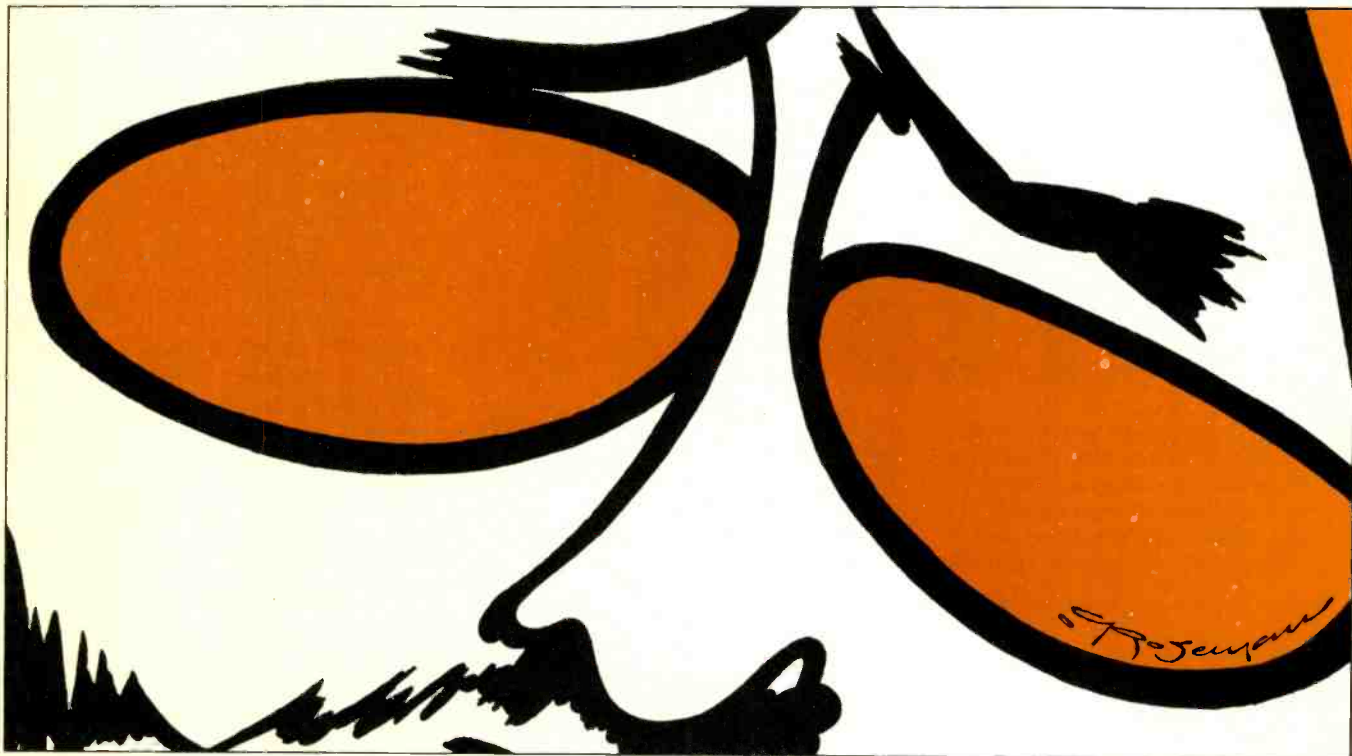

**Barney Kessel Plays Kessel**  
Concord CJ-9, stereo, \$7.98.

**Poor Butterfly:** Barney Kessel, Herb Ellis

Concord CJ-34, stereo, \$7.98.

**Soaring:** Barney Kessel

Concord CJ-33, stereo, \$7.98.

Concord is a mainstream, independent jazz label that turns out albums of consistent quality; its artist roster is made up of a coterie of swing-oriented West Coast musicians who came of age in the modern jazz era — musicians such as the highly regarded guitarist Barney Kessel. Kessel, considered one of the master technicians on contemporary jazz guitar, absorbed the teachings of the late Charlie Christian, and plays an extroverted, happy kind of modern/mainstream jazz in an entirely natural manner. Although he is seldom heard functioning only as a rhythm guitarist today, it should not be forgotten that he first came to the attention of the jazz world in the rhythm section of the Charlie Parker Dial sessions in 1947 (along with Doda Marmorosa, Red Callender, and Don

Lamond), feeding chords at the most telling points behind the soloists on such bop classics as *Carvin' the Bird*, *Stupendous*, and *Relaxin' at Camarillo*.

Kessel was first recorded with his own groups by Contemporary in the '50s and is now being sensitively recorded by Carl Jefferson's Concord engineers (the clarity of reproduction on the Concord releases is first rate). The result is a group of fine Kessel releases that this reviewer has just discovered. The three albums covered here should be of interest to aspiring guitarists as well as to the lay lover of jazz guitar. The **Barney Plays Kessel** LP, devoted to original Kessel compositions, gains considerably from the presence of ex-Woody Herman tenorman Herbie Steward, vibist Vic Feldman, and pianist Jimmy Rowles. Not only do these musicians spark Kessel into some particularly alert and adroit playing, but they also lend depth and variety to the harmonic textures, as well as permitting opportunities for creative exploration and close-knit group interplay. Steward solos in a forceful and buoy-

ant manner; Feldman spins out sinuous melodic lines, while drummer Jake Hanna, with bassist Chuck Domanico and Milt Holland on piano, provides a firm underpinning.

The Kessel-Herb Ellis set is not as consistently compelling. The playing, though faultless, is more predictable. With only a rhythmic accompaniment (Hanna again on drums; Monty Budwig, bass), there is less harmonic scope. Both guitarists are in excellent form, however; their contrasting styles are showcased on a beautifully executed *Poor Butterfly*, and a downhome *Blueberry Hill* shows their funky side. Kessel's cascading solo-line technique, vivid imagination, and splendid sense of swing are to the fore on the **Soaring** LP. Again teamed with Hanna and Budwig, the trio's sense of musical kinship is strongly evident as they rework a fine group of standards including *You Go to My Head*, *Get Out of Town*, and *Star Eyes*. The frequent duets of the guitarist with bassist Budwig are particularly empathetic, and sometimes drummer Hanna adds a third

voice, as well as rhythmic counterpoint. As mentioned before, the Concord releases are well recorded and well balanced.

John Lissner

**Plays Kessel**

Sound: A+ Performance: A

**Kessel/Ellis**

Sound: A+ Performance: A-

**Soaring**

Sound: A+ Performance: A+

**I Wanna Play For You:** Stanley Clarke  
Columbia KZ235680, two discs, stereo,  
\$11.98.

Stanley Clarke doesn't want to play for you, he wants to posture for you, make funny sounds for you, pander to you and make lots of money from you. Clarke's latest is a two-record assemblage of live and studio tracks that sound like justifiably discarded outtakes. Unfortunately, lower instincts prevailed. **I Wanna Play . . .** is an inconsistent pastiche of tunes that tries to please everybody. He covers rock with *Rock 'n' Roll Jelly*, undanceable disco in the title tune and *Just a Feeling*, and some perfunctory fusion in live performances of *School Days* and *Quiet Afternoons*. His *Blues for Mingus* is an embarrassingly unconscious parody, and *The Streets of Philadelphia* will go down as another joke on that city. Clarke's corny sentimentality would make his most puerile fan blush.



Stanley Clarke's writing has rarely been memorable, but here even his playing can't pull him through. In his shameless attempts at crowd-pleasing, he goes for the "big" effect. His playing consists of aimless flurries, bending slides, synthesized vocals, and those same safe trebly runs we've all come to expect. He leads his sidemen through pointless exchanges, and in

AUDIO • December 1979

return they offer him no support. Whether he's playing with all-star sidemen like Jeff Beck, George Duke, Stan Getz and Freddie Hubbard, or with his faceless performing unit, it all sounds like they're just putting in time.

The lack of concern that permeates Clarke's music also extends into his production. The clear definition and brilliance that have marked his previous efforts are absent here. In its place is a thin and brittle recording lacking bottom and presence. Clarke may have the greatest collections of Alembic basses in the world, but it doesn't mean a thing if you don't play them.

John Diliberto

Sound: C- Performance: F

**The Legendary Hoagy Carmichael:**  
Hoagy Carmichael and others.

RCA CPL 1-3370 (e), electronic stereo,  
\$8.98.

I've been anticipating a Hoagy Carmichael retrospective anthology for some years now, and this is a good start.

The album is split nearly evenly between Carmichael singing his own songs and interpretations by others. Hoagy never had the world's greatest voice, but he has a wonderful way with phrasing. He knows well how to make the words work for him.

Ultimately it is the songs which make the set important, and Hoagy Carmichael's are great examples of American song. There is still lots more that deserves reconsideration and anthologizing.

Carmichael, the songwriter, is a master of telling the story from a perspective not his own. His songs are not necessarily autobiographical. As example take *Lazy Bones*, represented here by a 1958 Kay Starr recording that is not nearly as sensational as the song itself.

Some highlights are the two versions each of *Star Dust* and *Georgia on My Mind*. *Star Dust* is included with the immortal 1940 Tommy Dorsey Orchestra version with Frank Sinatra and a delightful 1933 Carmichael solo recording. For *Georgia*, there is the terrific 1939 Ethel Waters version and Carmichael's own 1930 recording featuring the great Bix Beiderbecke. The album would have been incomplete without the 1932 Mildred Bailey *Rockin' Chair*.

The album's sound is somewhat noisier than I expected it would be, even with the age of the recordings, the oldest of which dates from 1927 with most from the '30s. That (e) in the album's serial number indicates the dread specter of electronic rechannel-

# ALLISON™: leaders in acoustic research

In 1954 Edgar Villchur, by means of his revolutionary acoustic suspension design, demonstrated the advantages of treating the woofer and its enclosure as a system rather than as separate components. Today, nearly all loudspeakers embody this concept. Roy Allison (a professional associate of Mr. Villchur for many years) has now extended the "system" one logical step further, to include the listening room itself. The result is

an improvement by one order of magnitude in the accuracy of the reproduced sound field.

Allison Acoustics manufactures six models of Room Matched loudspeaker systems priced from \$125 to \$441 each. Visit your Allison dealer or contact us directly for literature which includes complete specifications.



ALLISON: FIVE \$160/168  
price varies with shipping distance

ALLISON ACOUSTICS INC. 7 Tech Circle, Natick, Massachusetts 01760

ing, but there is no indication of what was rechanneled.

The enclosed booklet has lots of photos and Richard M. Sudhalter's notes. I wish Mr. Sudhalter had said a bit more about the selections contained, but his essay does shed considerable light on the character of Hoagy Carmichael.

The album is a welcome and long overdue reintroduction to a premier songman. *Michael Tearson*

Sound: C-

Packaging: B

**Lenox Avenue Breakdown:** Arthur Blythe

**Columbia JC 35638**, stereo, \$7.98.

Until recently, Arthur Blythe's alto was only known to followers of New York's loft jazz scene and the avant-garde, where he is still called Black Arthur by a few. He's played in the bands of Horace Tapscott, Chico Hamilton, and Gil Evans, in addition to almost everyone else on the scene. **Lenox Avenue Breakdown** is his first record for a major after two releases on India Navigation and Adelphi.

In spite of having a major label contract, Blythe has not gone the route of selling out to commercial tastes. At the same time, he's made one of the most uplifting and danceable albums of the year. **Lenox Avenue Breakdown** abounds with a rhythmic earthiness that comes from the beat of life and not some prefabricated orgasmic ritual. The bottom is a fluid dance orchestrated by Jack DeJohnette's multi-accented drumming and the melodic bass of Cecil McBee. Coloration and texture is added by percussionist Guilermo Franco, tuba player Bob Stewart, and the jagged guitar chordings of James "Blood" Ulmer.

But the highlights of the album are found in the playing of Arthur Blythe and flautist James Newton. Blythe has composed a highly melodic album from which his improvisations expand. He glides and bounces over the shifting changes of DeJohnette with lyrical deftness. James Newton is a kindred spirit. His solos grow out of Blythe's. On the title track Blythe concludes a furious run with a long, sustained note that he stretches to its hardest and softest limits. Newton's subsequent solo seems to materialize right out of this sustain, as if Blythe gave birth to it.

From the funk of *Down San Diego Way* to the Middle Eastern mystery of *Odessa*, Blythe and his unit create music that is spontaneous and joyful, creative and accessible. The crisp and buoyant recording highlights the balanced arranging that Blythe has put into **Lenox Avenue Breakdown**.

*John Diliberto*

Sound: B+

Performance: A-

**Central Avenue:** Wardell Gray

**Prestige P-24062**, mono, two discs, \$8.98.

Wardell Gray is one of the forgotten men of the be-bop movement, a tenor saxophonist who blended influences of both Lester Young and Charlie Parker. Indeed, as one can hear on this Prestige double-set, he sounded like a more robust version of Young. Gray served an apprenticeship in the reed section of Earl Hines' band from 1943-45, then settled in Los Angeles, becoming an active figure on the West Coast bop jazz scene, playing in clubs along Central Avenue in the Watts black ghetto, hitting the road intermittently with Benny Goodman (1948-49) and with Count Basie (1948; 1950-51). Gray died in 1955 while playing a gig in Las Vegas. His body was found on the desert, apparently tossed out of a car; the cause of his death was never determined.

# THE FUJI CHALLENGE

## Try the others. Then try ours.

When it comes to choosing the best tape, a minute of *listening* will tell you more than hours of specs. Because the best tape for *you* depends solely on the sound *you* like and the response of *your* deck.

At Fuji, we make the most advanced magnetic tape in the world — for video as well as audio. We'll match our specs against anyone else's, but we respectfully suggest you stop reading and start *listening*. Once you compare Fuji FX-I or II to any other premium tape, there's nothing more to say. We have confidence in your ears.

# FUJI

Magnetic Tape Division  
of Fuji Photo Film U.S.A., Inc.  
350 Fifth Avenue,  
New York, New York 10001





The Prestige re-issue covers small-group recordings he made while touring with Goodman and Basie, a recording of a live date in a Los Angeles club; two other sessions are studio dates from later years, one as a leader of a group of West Coast musicians and the other as a sideman with vibist Teddy Charles. The high point of the album, a 1949 session with the Charlie Parker rhythm section — Al Haig piano, Tommy Potter bass, and Roy Haynes drums — is notable for performances of a blues titled *Twisted*, a swinging *Southside*, and a ballad performance of Billie Holiday's *Easy Living*. Another fine ballad from the session, *Sweet Lorraine*, displays Gray's immaculate tone to great advantage. The four items from the Teddy Charles date, recorded in Detroit with a local rhythm section, lack some of the fire of the Haig-Potter-Haynes pieces, yet Gray rides through numbers like *A Sinner Kissed an Angel*, *Greyhound* (another blues), *Treadin'*, and *Blue Gray*, confidently and authoritatively.

As can be heard on his work in this collection, Wardell Gray possessed all the qualities that should have ranked him with the top players of the modern jazz era, a rich melodic conception, a full and consistent tone, an unrivalled sense of swing, and a seamless continuity of expression. Yet despite these assets, he was repeatedly passed over by a jazz public seeking more sensational and superficially exciting performers.

Of the remaining selections in the Gray double-set, the most notable is the live August 27, 1950 blowing session from the Hula Hut in Los Angeles which features trumpeter Clark Terry, Gray's associate in the Basie band of the time; tenor man Dexter Gordon, and altoist Sonny Criss. The session evolves into some broiling, hard-swinging choruses on Parker's *Scraple from the Apple* and Denzil Best's *Move*. The taped session has a reasonable sound, considering the vintage of the recording, the noisy audience, and the number of players on one mike. The mono sound quality of the re-issued studio sessions ranges from good to adequate.

John Lissner

Sound: C- Performance: A-

**A Tribute to Cannonball:** Don Byas and Bud Powell  
Columbia JC-35755, stereo, \$7.98.

Columbia's Contemporary Jazz Masters series is starting to unearth a number of previously unreleased sessions; the exceptional performances on this release, recorded in Paris in 1961, co-

AUDIO • December 1979

# Instant Link to Better Sound

AudioSource High Definition Speaker Cable allows electrical energy to be transferred to your speaker from your amplifier with significantly reduced self-inductance and DC resistance.

Eight individually insulated wires for

each lead provides a greater surface area and more efficient signal transfer to your speakers. The end result is more sound and better sound.

If you're looking for optimum performance, audibly improved high frequency response and freedom from distortion, hook your speakers up to a pair of AudioSource High Definition Speaker Cables.

Available at finer audio stores.

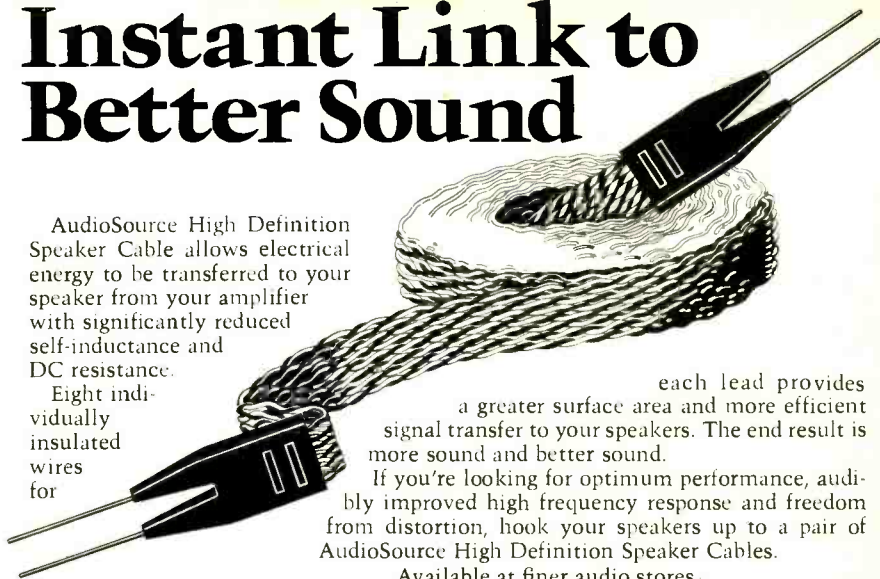

**AudioSource**

1185 Chess Drive, Foster City, CA 94404  
Phone: (415) 574-7585

Please send \_\_\_\_\_ pairs of FHD 5 (16 foot) speaker cables at \$17.50 per pair. Total \_\_\_\_\_  
Please send \_\_\_\_\_ pairs of FHD 7.5 (25 foot) speaker cables at \$25.00 per pair. \_\_\_\_\_  
Add postage and handling of \$1.50 (each). \$1.50  
(California Residents add 6% sales tax.) TOTAL \_\_\_\_\_  
I enclose check \_\_\_\_\_ or money order \_\_\_\_\_  
Charge my BankAmericard/Visa \_\_\_\_\_ Master Charge \_\_\_\_\_  
Account No. \_\_\_\_\_ Expires \_\_\_\_\_  
Signed \_\_\_\_\_  
Mail Speaker Cables to: \_\_\_\_\_  
Name \_\_\_\_\_  
Address \_\_\_\_\_  
City \_\_\_\_\_ State \_\_\_\_\_ Zip \_\_\_\_\_

Please place this coupon in an envelope along with your remittance and mail to AudioSource, 1185 Chess Drive, Foster City, Calif. 94404. Orders received will be processed immediately, however, please allow three to four weeks for delivery.

Enter No. 4 on Reader Service Card

## HELP!

Anytime you have a question about your Audio subscription, please include a mailing label to insure prompt service on your inquiry.

AFFIX LABEL HERE

### CHANGE OF ADDRESS

If you're about to move, please let us know approximately four weeks before the move comes about. Or, if there is anything wrong with your current mailing label, please let us know on this form also. Simply affix your present label here, and carefully print the updated information below.

### PLEASE HELP US TO SERVE YOU BETTER

AUDIO MAGAZINE

401 N. Broad Street • Phila., Pa. 19108

Name \_\_\_\_\_ (Please Print)  
Company \_\_\_\_\_  
Address \_\_\_\_\_  
City \_\_\_\_\_ State \_\_\_\_\_ Zip \_\_\_\_\_

AU/11/78

## BIGGEST SAVINGS— SAME DAY DELIVERY

Call TOLL FREE 800-638-8806 or, if busy, 301-488-9600



- We have more of the components and manufacturers you are looking for.
- Our prices are the lowest you'll find anywhere.
- Your phone order is shipped the same day you call.
- In most cases you'll enjoy your equipment within 72 hours.
- We stand behind everything we sell with a "No Lemon" guarantee and a trained customer service department.
- Our Audio Advisors will help you select the right equipment at the best prices for the quickest delivery.

Call TOLL FREE 800-638-8806, or, if busy, 301-488-9600 for information on equipment, prices and ordering, or send for free brochure, tips on buying hi-fi equipment by mail, test reports and a \$2.00 merchandise certificate.



**International Hi-Fi Distributors**  
Moravia Center  
Industrial Park, Dept. A12  
Baltimore, Maryland 21206

Enter No. 17 on Reader Service Card

## YOU CAN TAKE IT WITH YOU!

Quality Sound takes  
to the road . . . the sky . . .  
and the ocean!



## DIMENSION LAB SERIES

We wrote the book on miniature speakers, from Design to Production! Our five models speak for themselves in total performance, styling, and features that are found in no other speakers . . . such as, Solid Walnut Cabinetry, full 12 db cross-over network, a specially designed cone with our exclusive rubber surround, and a deep throw speaker basket. These are just a few of the reasons why our Bass is unequalled in the industry. "Dimension Minis" are Proven best by listening test."

Come in for a demonstration and judge for yourself.

See and Hear the New Dimension in Sound at  
Your Local Stereo Dealer.

**DIMENSION**

819 S. Kraemer • Placentia, CA 92670  
(714) 630-5440

Representative and Dealer Inquiries Welcome



114

Enter No. 10 on Reader Service Card

AT LAST, A Line Of Records Good  
Enough To Be Played On  
The Very Best Hi Fi Systems. . .

INTRODUCING . . .  
mobile fidelity's  
ORIGINAL MASTER RECORDINGS

featuring  
*Supertramp, Fleetwood Mac  
Pink Floyd, Poco & others*

The key high fidelity component guaranteed to improve your stereo system. Super High Fidelity is achieved by total quality control, using Original Stereo Master Tapes. They use Half-Speed Mastering to capture natural musical impact, the highest quality Super Vinyl is custom pressed overseas and the final disc is protected by a Static free Inner Sleeve and placed in a Special Heavy Duty Package. The result is your favorite music by your favorite artists on top quality, Limited Edition discs. Your stereo system will come alive with the sounds of the original performance.

Send Me A Free Catalog

Name \_\_\_\_\_

Address \_\_\_\_\_

Software & Such, Inc.  
#1 IN THE U.S.A.  
5816 Lankershim Blvd.  
N. Hollywood, CA 91601

Enter No. 48 on Reader Service Card

## INTRODUCING THE SUPEREX MULTI-DECK TAPE SWITCHER

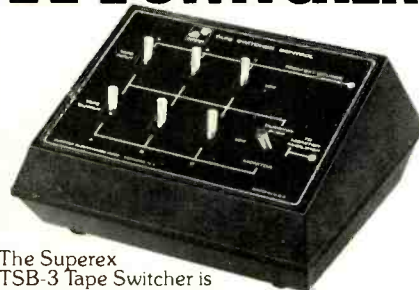

The Superex TSB-3 Tape Switcher is the obvious creative answer to the audiophile who has more than one tape deck. You can finally duplicate recordings or broadcasts on up to three decks with this "passive" switching console. Mixing music sources and adding voice-over to create a final recording is just one of the professional engineering features.

The Superex TSB-3 provides access to and from external equipment through identified phone jacks. Along with full tape monitoring, the switcher allows flexibility not normally found in many of today's amplifiers.

Write for more details, or see your Superex dealer. Made in USA.

**SUPEREX**

151 Ludlow Street, Yonkers, NY 10705 • (914) 965-6906

Enter No. 50 on Reader Service Card

feature Byas, one of the major figures on tenor sax, and Powell, the genius of bop piano; accompanists are trumpeter Idrees Sulieman, drummer Kenny Clarke, and the excellent French bassist Pierre Michelot. Byas, admired by swing men and modernists alike, was an early expatriate jazz musician, arriving in Paris in 1946; Powell went to Paris in 1959. Byas found himself the patriarch of the large, Paris-based American jazz community and organized many dates, including this one. On this album, Byas and Powell offer us consummate musicianship, prodigious technical displays, and impressive rapport.

On uptempo tunes like *Cherokee*, *Good Bait* and *Jeannine*, Byas reveals his big, forceful sound, unlimited ideas, and his adaption of modern jazz techniques to what is a basically swing style. The slow ballads like *Jackie*, *My Little Cat* and a particularly lyrical *All the Things You Are* showcase the scope of Byas' virtuosity — his melodic inventiveness and keen harmonic sense. Powell, apparently fully recovered from various and lengthy sieges in mental hospitals, is in top form, ripping through the fast tunes with an energetic and compulsive attack. Slowed down and supporting Byas on Benny Golson's haunting *I Remember Clifford*, the pianist and saxophonist offer sensitive, delicate music, with Byas' long solo, a shimmering, legato line of breathtaking beauty.

John Lissner

Sound: A-

Performance: A+

### Divine Love: Leo Smith

ECM ECM-1-1143, stereo, \$8.98.

Leo Smith is one of the more cerebral musicians from the Association for the Advancement of Creative Musicians (AACM), but he has never gone in for the humor or screaming anger that characterizes much of the AACM work. Instead, with people like Anthony Braxton and with his own group, New Dalti Ahkri, he journeys in an area of spatial improvisation in which silence is as important as the sounds it envelops. Dissonance is not unheard of in his music; more often he'll be probing inside a soft and ethereal tonal palette. This is an area of gentle warmth and subtle mysticism.

The side-long *Divine Love* opens with ritualistic percussion and Dwight Andrews' arid alto flute playing across the gentle shimmerings of vibraphonist Bobby Naughton. The piece evolves through several phases in a dreamlike state of movement. The musicians seem to pass through each other in their interplay. Long, sustained lines

are pierced by Smith's muted trumpet while Naughton and Andrews undulate about each other. When it is over, there's a feeling of having been someplace new and peaceful.

*Spirituals: The Language of Love* follows the same improvisational concepts. Here the textures are darker due to the addition of Charlie Haden's bass and the use of bass clarinet and tenor sax by Andrews. Where *Divine Love* was light and airy, *Spirituals* is an ominously stalking tune. Haden's bass is an irregular pulse accompanied by a skittering of trumpet and vibes and a rumbling bass-clarinet and tenor. Naughton's marimba sounds as if it comes from a voodoo nightmare.

The remaining piece, *Tastalun*, employs a scoring concept that Smith calls "Ahkreation." This translates into the only emotionally unsatisfying piece on the album. Smith scores it for the muted trumpets of Lester Bowie, Kenny Wheeler, and himself. He fabricates a convoluted surface of suspended phrases between bubbling rivulets of sound, which makes for some nice sonics, but never seems to get beyond their initial premise.

*Divine Love* is an entrancing album that furthers ECM Records' commitment to the more cerebral aspects of the avant-garde. There is a transparency and openness of sound that allow Smith's performances to take a natural shape once they enter your sound system. And that shape is an uncharted world of mysterious sounds.

John Diliberto

Sound: A Performance: A-

### Gonna Be a Live One in Here Tonight!

Luther Allison  
Rumble RR 1001, stereo, \$8.98.

At times it's seemed that the greatest obstacle bluesman Luther Allison faced on the road to recognition was his own startling versatility. Record producers were all too quick to seize on the Arkansas-born guitarist's ease at adapting to different genres, and the result was a series of uneven albums on Gordy before he dropped out of public view. Rumble, a new label, has avoided questionable production concepts by questioning Luther in performance in a small Illinois club, a solution obvious to anyone who's seen this young blues master in concert.

*Gonna Be a Live One in Here Tonight!* is the Luther Allison album for which his fans have been waiting. This set reaffirms Luther's status as one of Chicago's finest blues guitarists, a dazzling technician with a lyrical touch and the surest grasp of dynamics since B.B. King, who's been a major  
AUDIO • December 1979

influence on his work. In fact, Luther covers two of B.B.'s standards, but with more gusto and abandon than the veteran bluesman usually brings to the stage these days.

The album's only flaw, and a minor one at that, is a shortage of original material. Of Luther's own songs on this disc (*You're Gonna Need Me* is credited to him, but Albert King claimed its authorship when he cut it over ten years ago), *Movin' On Up* is a remake of his old One-derful 45, and *Strokes* is nothing more than a warm-up instrumental. The remaining original, *Cat Blues* (as in Caterpillar Tractor

Co., which has a major plant near the club), is perhaps the album's strongest track. A revealing look at the pressures on a musician to get a "regular" job, this slow blues features some blistering guitar work and draws an enthusiastic response from an audience that must contain a number of Caterpillar employees.

The extremely satisfying record is well worth the effort of tracking down. If you can't find it locally, write to Rumble Records at P.O. Box 84, Peoria, Ill. 61650.

Roy Greenberg

Sound: B- Performance: A-

## Transform your home into a nightclub, concert hall or cathedral.



- Even the finest stereo cannot create the illusion of "being there" in the same acoustic space as the musicians.

Now you can experience the impact of hearing sound in three dimensions with the ADS 10 Acoustic Dimension Synthesizer. The ADS 10 uses sophisticated digital time delay techniques to recreate the ambient sound field which surrounds the listener in any real acoustic space.

*Stereo Review*\* on the ADS 10 experience: "... a totally unobtrusive, natural ambience can be achieved — and once you've experienced it, it's very difficult to give up."

*The Complete Buyer's Guide to Stereo/Hi-Fi Equipment*\* put it this way "... If you have a good stereo system and ask yourself, 'Is there anything I could do for under \$1200 that would do so much to improve the realism of music reproduction in my home as the ADS 10?', the answer is certain to be 'no'. It's that good."

For more information, write ADS, Dept. AU9, or call 1-800-824-7888 (California 1-800-852-7777) toll free and ask for Operator 483. Or better yet, take your favorite records to your ADS dealer and let him demonstrate how the ADS 10 can recreate the live musical experience in your home.

\* Quoted by permission, *Stereo Review*, April 1979, and *The Complete Buyer's Guide to Stereo/Hi-Fi Equipment*, November 1978.



Where technology serves music

Analog & Digital Systems, Inc., One Progress Way, Wilmington, MA 01887 (617) 658-5100

# Folk bag

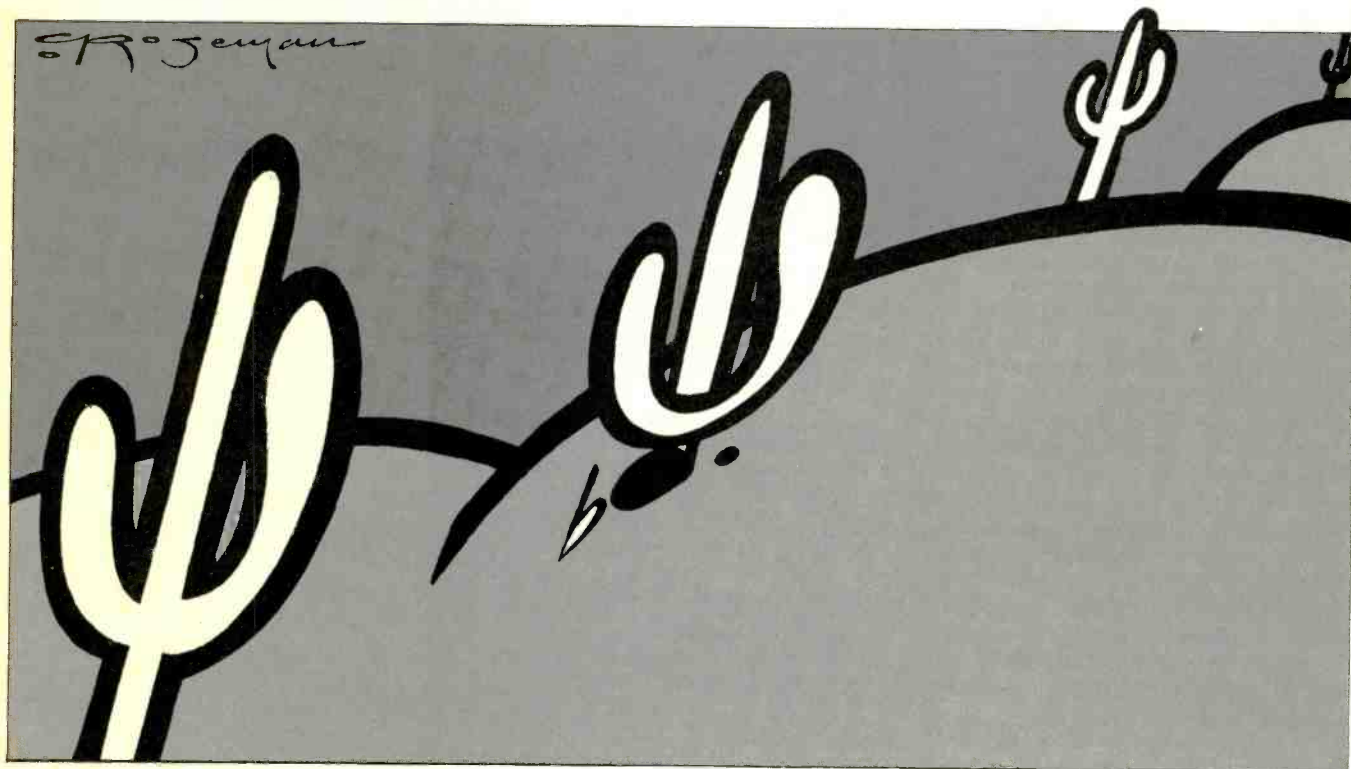

116

**You Gotta Let All the Girls Know You're a Cowboy:** Jim Silvers  
CMH 6228, stereo, \$7.98.

While Nashville continues its push toward commercial-pop respectability and Austin bumps around aimlessly in search of a new savior, along comes a California-based singer-songwriter to breathe some fresh air into the stagnant country-music scene.

Jim Silvers establishes his musical credentials in the opening, *Cannonball Yodel*, an Elton Britt specialty in which Silvers just rears back and lets go over a bluegrass-with-synthesized-orchestra backdrop. He also proves himself adept at rockabilly (*My, My, My*) and "straight" country (*Each Season Changes You*—a tearful duet with Rebecca Burns—and Ernest Tubb's *Waltz Across Texas*), sung with authority and flair.

But Silvers' original compositions are, more than anything else, what set him apart from country music's popballadeers and progressives alike. If it's possible to judge a man by his lyrics,

Jim Silvers must be a bit on the demented side. *Paul's Saloon* outlines the temptations, pleasures, and wages of sin in humorously graphic detail. The title cut is a tongue-in-cheek lesson in how to convince people you're an outlaw. *I Wanna See Las Vegas* (with sturdy fiddling by Brantley Kearns) is unquestionably the first bluegrass song ever to mention Wayne Newton, Mitzi Gaynor, and Shecky Greene! On the other hand, a novelty called *Goodbye California (Hello Illinois)*—with good Dobro by veteran San Francisco multi-instrumentalist Fred Sokolow plus Roger Bush's inimitable slapping bass—has the earmarks of a bluegrass standard. But the album's big barroom crowd-pleaser should prove to be *Old Faithful* (preceded by *Katy Daly*, which is listed neither on the cover nor the label), a catchy singalong ditty which is *not* about the famous geyser.

Though the music is hardly slick, it would have had more immediacy with slicker production, specifically a more

spatial mix with brighter sound. (CMH Records, Inc., P. O. Box 39439, Los Angeles, Cal. 90039.) *Tom Bingham*

Sound: C+

Performance: A-

**Travelin' Lady Rides Again:** Rosalie Sorrels  
Philo PH 1049, stereo, \$7.98.

Sometimes a Rosalie Sorrels album soars. Sometimes it only hovers. This one soars.

Ever one of the most personal of singers and one of the most difficult to pin down, on *Travelin' Lady Rides Again* she's almost a country Lady Day singing blues. Surely Rosalie's voice is the bluest it has ever sounded on record.

The album opens with a wrenching remake of the lady's theme song *Travelin' Lady*. Then it's Mayne Smith's wacky *I Like It*, Susannah Clark's sad *We Were Kinda Crazy Then*, Sylvia Tyson's *Trucker's Cafe* which is purest prototype, and the inevitable Bruce

Phillips song *Going Away* as a low-down blues.

The other side opens with a diverse pair of Phillips songs, then Peter Rowan's tender storysong *Feather Ben*, the traditional *Bad Girl's Lament* done a cappella and a sure show-stopper after all these years, and finally another remake, one of Rosalie's most remarkable songs, *Postcard from India*.

The sidemen are all exemplary with special nods to Madcat Ruth for harmonica, Winnie Winston again for steel guitars, and Jeff Gutcheon again for piano.

Rosalie Sorrels is one of the toughest ladies I know and nobody sings like her. She sings extra well when she gets pushed like her musicians do here. As I said at the top, this is one of the really great Rosalie Sorrels albums. The last words on the album, the words at the close of *Postcard from India*, say it: "Keep on rocking!/It's a beautiful boat."

Michael Tearson

Sound: B Performance: A

**Wind in the Mountains:** Raintree  
**Green Mountain GMS 1071**, stereo, \$5.50.

Raintree is yet another highly promising eclectic-bluegrass band from New England (Amherst, Mass., to be exact). Like the majority of Northern bands, their picking abilities exceed their vocal talents, though their singing is, for the most part, unobjectionable. Husky-voiced Debbie Fish is their strongest lead, and she also has a fine ear for harmony (note Reno and Smiley's *Country Boy Rock and Roll*, among others). Nick Plakias sounds more comfortable on the folk-styled title cut (which he also wrote) than on the straight bluegrass material. Bob Green's singing is not only shaky and perceptibly off-key, but awkwardly phrased; fortunately, he's only featured on two songs.

In any case, the album is well worth recommending for the band's energetic picking alone. Bob Green is an uncommonly versatile mandolinist, whose mastery of a number of styles—among them Jesse McReynolds-style cross-picking (*On the Ocean*), old-fashioned chord tremolos (title tune), dexterous adaptations of fiddle tunes (*Medley #1*), and a progressivist leaning toward Sam Bush (*I Miss You*)—is matched by his infectious enthusiasm. Nick Plakias' flatpicking is clean, supple, and intelligent. Jim Heffernan, who is split between Dobro and banjo chores, is especially creative on the former instrument (hear *The Cuckoo* and *Medley #1*). In order to keep pickers this spirited from flying off the

handle, a firm, steady bottom line providing both uncluttered harmonic support and a rhythmic lift is needed; Debbie Fish's fat-toned bass supplies just that.

*Bud's Bounce/Panhandle Rag* doesn't swing as flexibly as the band undoubtedly intended. Otherwise, Raintree impresses as a talented instrumental quartet which, with more work on their singing, should make a substantial impact on the Northern bluegrass scene.

It would have been nice to be able to hear Plakias' rhythm guitar under the vocals, while Fish's bass should also have been brought up somewhat. (Green Mountain Records, Inc., Garvey Hill, Northfield, Vt. 05663.)

Tom Bingham

Sound: B- Performance: B

**Fiddlin' Arthur Smith & His Dixieliners, Vols. 1 and 2**  
**County 546, 547**, mono, \$5.98 each.

The late Arthur Smith (not to be confused with the veteran guitarist/multi-instrumentalist/producer of the same name) was the fiddle superstar of the 1930s. Almost single-handedly, he provided the bridge between the old-time breakdown styles which dominated country music in the '20s and today's bluegrass and country fiddling.

A good deal of Smith's renown came from his amazing agility at a rapid clip; note *Goin' to Town*, *Straw Breakdown*, and *Lost Train Blues* on Volume 1, plus *Indian Creek*, *Fiddler's Dream*, and *Smith's Rag* on Volume 2. More influential, though, was his smoothing out of the various rough edges which characterized the many local and regional Southeastern fiddle styles prevalent up to that time. Yet, while he transcended old-time fiddling, he was clearly rooted in it, altering it through the incorporation of raggy blues, an occasional dollop of swing fiddling, and a great deal of his own personal innovation.

His bowing had a remarkably even flow, while his fingering was worthy of the reverence his peers showered upon him. (This is not to say he was always so awesomely perfect as some observers have claimed; the man *did* make mistakes, just very few of them.) His variations were far more adventurous than those of virtually any country fiddler before him. He was also a very emotional musician, with a vehemence to his playing that sounded as if he were trying to rid himself of some personal demon.

The guitar backing by the Delmore Brothers (occasionally spelled by members of Bill Monroe's or Herald

# McIntosh

## "A Technological Masterpiece ..."



McIntosh C 32

### "More Than a Preamplifier"

McIntosh has received peerless acclaim from prominent product testing laboratories and outstanding international recognition! You can learn why the "more than a preamplifier" C 32 has been selected for these unique honors.

Send us your name and address and we'll send you the complete product reviews and data on all McIntosh products, copies of the international awards, and a North American FM directory. You will understand why McIntosh product research and development always has the appearance and technological look to the future.

Keep up to date.  
Send now - - -

McIntosh Laboratory Inc.  
Box 96 East Side Station  
Binghamton, NY 13904

Name \_\_\_\_\_

Address \_\_\_\_\_

City \_\_\_\_\_ State \_\_\_\_\_ Zip \_\_\_\_\_

If you are in a hurry for your catalog please send the coupon to McIntosh. For non-rush service send the Reader Service Card to the magazine.

Enter No. 29 on Reader Service Card

# The pre-eminent pick-up arm

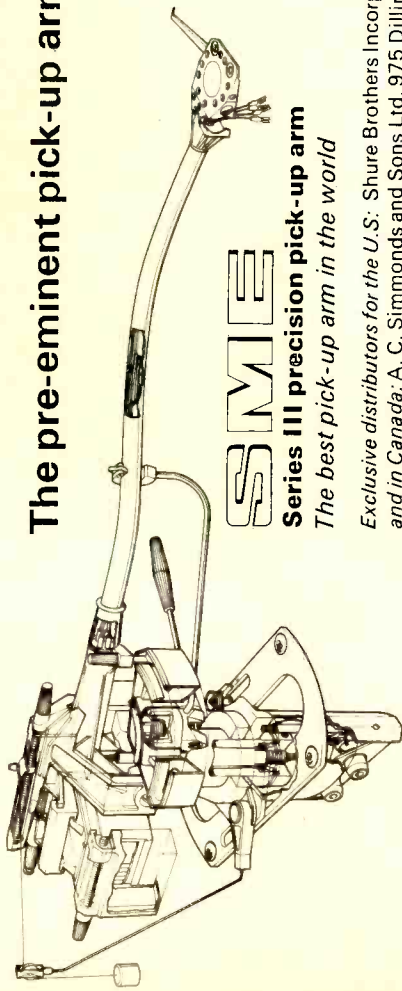

**SME**

**Series III precision pick-up arm**  
The best pick-up arm in the world

Exclusive distributors for the U.S.: Shure Brothers Incorporated, 222 Hartrey Avenue, Evanston, Illinois 60204 and in Canada: A. C. Simmonds and Sons Ltd, 975 Dillingham Road, Pickering, Ontario, L1W 3B2

Whilst able to explore the best of the present, the Series III precision pick-up arm anticipates the greater engineering elegance of impending miniature cartridges which may weigh as little as one and a half grammes.

Its unique patented balance system minimises mass and inertia, presenting optimum conditions for even the most delicate transducer.

No other pick-up arm is as versatile, a reason why the Series

III is already playing its part in the development of tomorrow's cartridges.

Choose it for your listening pleasure today with confidence in the future.

\*Another accolade for SME: the Series III precision pick-up arm was one of the Design and Engineering Awards at the 1979 U.S. Summer Consumer Electronics Show, the only pick-up arm to be acknowledged in this way.

Write to Dept 1457, SME Limited, Steyning, Sussex, BN4 3GY, England

Goodman's bands) added a jumping, propulsive drive. Several samples of Smith's likable vocal style are included, as well as a tantalizing glimpse of his unusual clawhammer banjo picking (*I'm Bound to Ride*, on Volume 1).

Both volumes are essential items for fiddle fans. Volume 1 may have a slight edge, though Smith's most famous tune, *Blackberry Blossom*, appears on Volume 2. You can't go wrong with either. (Country Records, P.O. Box 191, Floyd, Va. 24091.)

Tom Bingham

Performance: A

**For Foul Day and Fair:** Cilla Fisher & Artie Trezise

**Folk-Legacy FSS-69**, stereo, \$7.98.

Cilla Fisher and Artie Trezise are the sister and brother-in-law of the great Scottish singer-writer Archie Fisher. One often expects more than is justified from relatives of the renowned, but the Trezises succeed admirably on their own merit.

Their repertoire consists largely of traditional Scots folk songs, given just enough contemporary flavor to communicate with the "general" folk audience without alienating hard-core traditionalists. Several of the songs—including *The Bothy Lads*, *Billy Taylor* (a sea ballad with a familiar plot but an unexpected ending), and *The Maid Gaed Tae the Mill* (a bawdy narrative with a tune similar to *When Johnny Comes Marching Home*)—have the potential to become perennial favorites on this side of the Atlantic. To be sure, they require a few words of explanation to cut through some substantial cultural and language difficulties. On the other hand, Fisher and Trezise's clear, unaffected Scottish accents only add to the authentic charm of their material.

Both Fisher and Trezise have distinctive vocal personalities. Fisher has a hearty middle-range voice, spiked with an expressive quaver. She's especially effective on jaunty, dance-rhythmed tunes, among them *The Jolly Beggar*, *Laird O' the Dainty Doonby*, and *The Shepherd Lad*. She can also sing a convincing love ballad, as *False Lover Won Back* illustrates. Trezise has an instantly identifiable voice, which might be described as a tenacious tenor. His leads on the duets (such as *Rhynie and The First Time*) are as sensitive as they are vigorous. His guitar backing is uncomplicated, stylish, and complementary.

Ironically, the one cut which doesn't live up to the rest is Cilla's rendering

of her brother Archie's *The Final Trawl*. Somehow, she fails to capture the empathic perceptiveness of Ed Trickett's interpretation (on Bok, Muir, and Trickett's *The Ways of Man*, Folk-Legacy FSL-68). But this is the only blemish to an otherwise exquisite record, which is certain to please anyone who loves Scottish ballad singing.

As with many other Folk-Legacy recordings, the voices ring loud and true while the accompaniment is, as a rule, relegated well into the background. I don't doubt this is an aesthetic decision by producer Sandy Paton, rather than a faulty mix. There are, however, occasional mildly disturbing distortions on Trezise's vocal track. (Folk-Legacy Records, Inc., Sharon, Conn. 06069.)

Tom Bingham

Sound: B-

Performance: A-

**Bend In the River:** McPeak Brothers County 771, stereo, \$7.98.

While most of the attention in the bluegrass world, over the past several years, has been given to virtuoso instrumentalists, the McPeak Brothers have been quietly carving their niche as bluegrass' finest vocal trio. Dewey McPeak handles most of the leads in a voice steeped in traditional bluegrass, yet polished with enough soft-edged understatement to appeal to the newgrass audience as well. Larry McPeak's resourceful tenor vocals are adroitly sung, while Mike McPeak's baritone tastefully rounds out the harmonies. Listen, for example, to *Shelly's Winter Love* and *Barbara Allen*, which contain some of the finest bluegrass trio singing in recent memory. Dewey is also a nimble Scruggs picker, though the bulk of the album's considerable instrumental interest (hear the title track and *Steel Rails*) comes from fiddler Jim Buchanan, mandolinist/fiddler Ricky Simpkins, and dobro ace Jerry Douglas. Though the choice of material isn't quite as consistent as on the brothers' last album (*McPeak Brothers*, County 764), *Bend In the River* should please anyone who loves good bluegrass harmony. (County Records, P.O. Box 191, Floyd, VA 24091.)

Tom Bingham

Sound: B

Performance: A-

**40 Polkas and Waltzes:** Frankie Yankovic

**Polka City 381**, rechanneled stereo, two discs, \$6.99.

One of the benefits of growing up in a multi-ethnic, three-generation,

working-class household was exposure to a marvelous variety of music at an early age. From my accordion-playing Polish grandfather came a love for polka music, which I later disowned as a Beatle-era teenager, only to return to it when I realized I was exploring everyone's ethnic culture but my own.

Back in the days of my original pre-teen polka enthusiasm, Frank Yankovic was unquestionably the number one polka star in the nation, and he's managed to retain a great deal of his popularity to this day. The son of Slovenian immigrant parents, Yankovic developed a highly personal sound intended to reach across ethnic boundaries. Thus, he was able to extend his artistry beyond Cleveland's sizable Slovenian community to appeal to European-Americans from all backgrounds.

Part of his popularity lay in the range of his repertoire, as illustrated on this reissue of some of his early material (no years are given, but it probably dates back to the late '40s and early '50s). Alongside such Yankovic staples as *Just Because*, *Blue Skirt Waltz*, and *Tick Tock Polka* (all of which crossed over onto the pop charts, a feat virtually unheard of in American ethnic music today), this set includes traditional-style Slovenian polkas (*The Page Polka*, *Ohio Polka*, and *Shandy Polka*), several more polkas in a less strictly ethnic vein, sentimental and sometimes downright schmaltzy waltzes, vocal novelties which sound unbearably corny today, and even a few Italian tunes. They're all performed using Yankovic's distinctive blend of two accordions, two Solovoxes (an outmoded keyboard instrument capable of only one note at a time; the two are played in harmony), piano, bass, and four-string rhythm banjo, a tonal combination which has never been successfully duplicated.

The 40 tracks in this collection are by no means of equal musical value. Indeed, at times the album swings rather wildly between the classic and the wholly forgettable. But the best tracks are choice stuff, and the majority are listenable at the very least. Frankie Yankovic was at his peak when these sides were made. While he's still a first-rate live entertainer, there's a freshness to much of this early music that his recordings of the past several years simply can't begin to match.

The "stereo" consists of separating the bass line from the rest of the ensemble. The sound as a whole is quite constricted, mostly due to the original recordings, I don't doubt, though there was probably some extra

compression to fit 10 tracks on a side. (Polka City, 7625 Bush Lake Road, Edina, Minn. 55435.) *Tom Bingham*

Sound: C- Performance: C to A-

#### Buell Kazee

**June Appal JA 009**, mono, \$7.98.

Buell Kazee was one of the well-known rural recording artists of the 1920s whose influence proved to be especially crucial to the "folk boom" of the early '60s. His repertoire and vocal approach—Kazee sang archaic modal ballads in a polished voice which showed his formal training, yet without ever losing sight of his authentic Kentucky mountain origins—greatly affected Joan Baez and countless lesser balladeers, while his rapid, intricate banjo frailing inspired many urban musicians during the revival.

Unlike many early blues and country giants who were "rediscovered" in the '50s and '60s, Kazee remained in possession of his musical faculties almost until his death in 1976, at age 76. This album, compiled from private and concert tapes recorded primarily between 1965 and 1972, is more than merely an overdue tribute to an artist whose reputation among folk cognoscenti far outstripped his familiarity to the public at large. It is, more significantly, a peerless example of authentic traditional Appalachian music at its very finest.

Kazee's sure, precise singing is virtually unmatched on both mountain variants of classic British ballads (*The Lady Gay*, *Black Jack Davy*) and such purely American ballads as *The Roving Cowboy* and *The Orphan Girl*. The listener's overall impression is that of a serious, dignified artist well aware of his role as a preserver and transmitter of an invaluable, yet disappearing tradition. Still, he was no self-conscious academician, faithfully noting down every semiquaver, flatted note, and deviation from printed texts. This music was originally meant to be entertainment, and Kazee was as much, perhaps even more, an entertainer as he was a performing folklorist.

Thus, the material on this album encompasses the full range of traditional mountain entertainment music, including humorous songs (*Sporting Bachelors*), white blues (*Look Up, Look Down That Lonesome Road*), railroad songs (*Steel A-Going Down*), hymns (*O, Thou in Whose Presence*), and an instrumental (*Banjo Medley*). His performances on all these are of the same high quality he brought to his ballads. Special attention should

also be given to the full-voiced, melismatic drama of Rev. Kazee's *a cappella* hymn-singing.

Sound varies depending on the circumstances of recording, but it is never less than acceptable. (June Appal Recordings, Box 743, Whitesburg, Ky. 41858.) *Tom Bingham*

Sound: C to B Performance: A



## A NEW WEAPON FOR THE WORLD OF SOUND!

### Electret Condenser Microphone

# Model PC-20



Model PC-20 has been exhaustively researched for frequency response, directivity and transmission characteristics for direct sound collection of string instruments in a concert hall. Clip it to any string instrument.

**FEATURES**

- Supercardioid characteristic and wide frequency response specially designed to match the directivity pattern of string instruments provide a sound quality boasting excellent reverberation of the middle and low regions.
- Microphone employs a clip type mounting system with freely adjustable angle. Can be mounted to the instrument with one touch. All mounting parts have a soft construction to prevent damaging precious instruments.

**RATINGS**

<ul style="list-style-type: none"> <li>• Sensitivity: -74 dB ± 2 dB</li> <li>• Directivity: Supercardioid characteristic</li> <li>• Output impedance: 250 Ω</li> <li>• Frequency response: 50 to 20,000 Hz</li> <li>• Noise: 22 dB SPL or less</li> <li>• Maximum input sound pressure: 120 dB SPL or greater</li> </ul>	<ul style="list-style-type: none"> <li>• Power requirement: 1.5 V (UM-5) and 48 V phantom</li> <li>• Battery life: 2 months or more of continuous use</li> <li>• Output connector: XLR-3-12C equivalent</li> <li>• Cable: 3 m</li> <li>• Weight: Microphone 25 g, power supply 160 g</li> </ul>
--	---

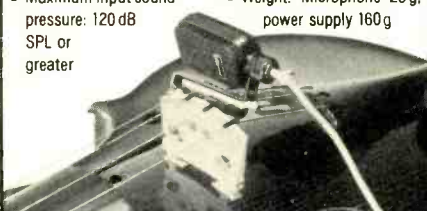

• For more information write or call us today.

**PRIMO MICROPHONES, INC.**  
2468 DELTA LANE, ELK GROVE VILLAGE,  
ILLINOIS 60007, U.S.A. TEL: 312-595-1022  
TELEX: 28-3474 PRIMO MUS ELGR

**PRIMO MICROPHONES SINGAPORE (PTE) LTD.**  
24B-27B BLOCK 3, KALLANG WAY, SINGAPORE 13  
TEL: 803586 TELEX: 26131

**PRIMO COMPANY LIMITED TOKYO, JAPAN**  
6-25-1 MURE, MITAKA-SHI, TOKYO, JAPAN  
TEL: 0422-43-3121-9 TELEX: 2822-326 PRIMO J.

# Top of the pile

**Sonic Fireworks, Vols. I & II.** Music for organ, brass and percussion. Richard Morris and the Atlanta Brass Ensemble. **Crystal Clear CCS-7010/7011**, stereo, \$16.98 each.

During the 1979 Summer Consumer Electronics Show, advance copies of **Sonic Fireworks** were to be heard in the demo rooms of those manufacturers intent on showing off bass response and overall cleanliness of sound. Since the show, final European pressings have arrived for review.

We have come to expect of Crystal Clear unyielding attention to sonic details, and these albums of organ and brass music are no exception. Richard Morris plays the Ruffatti instrument in the Cathedral of Christ the King in Atlanta and is supported by the twelve-man Atlanta Brass Ensemble. You will recall that the instrument played by Virgil Fox in the two Crystal Clear records issued two years ago was also a Ruffatti. While the Fox recordings presented a close-in pickup of the organ in a relatively absorptive environment, the present recordings present the bright Ruffatti sound at a greater distance in a far more reverberant environment. The main problem faced by the Crystal Clear engineers in these recordings was to establish a proper musical balance between the organ, the brass ensemble, and the room itself — with only a pair of microphones. They have succeeded admirably, capturing both wide-frequency and dynamic ranges in a detailed stereophonic panorama. There is absolutely no trace of rough edge on even the loudest brass passages, a common failing in recordings of this kind. The direct-to-disc process, along with Crystal Clear's attention to low-distortion electronics and sensible disc recording levels, no doubt contributes to this.

Four sides of organ and brass is a lot of one genre of music. Some of the selections are gratuitous, such as the first 45 seconds or so of *Also Sprach Zarathustra* (the well-worn 2001 part) and the Mouret *Fanfare* music from the "Masterpiece Theater" episodes

on public television. The works which come off best are those that draw naturally on the sonorities of these special musical resources, such as those of the French organists Widor, Dupre, and Gigout, who understood so well the interaction between the acoustics of large churches and musical structure itself.

The playing is accurate and competent but tends to be a bit studied. In many ways, the performances of similar works by E. Power Biggs, even with the usual excesses of Columbia's engineering, come across with more musical verve and flair. In terms of sound, however, there is no contest; these discs take all honors in the organ-and-brass category.

Now for the complaints. With the careful attention given the discs themselves, it is a pity that Crystal Clear gives us album liners containing so little information. Records such as these deserve double-fold albums with competent program notes and thorough technical information. Instead, we are provided with only minimal information about the recording activities themselves, along with some of the most amateurish and inaccurate program notes I've come across. (Examples: St. Bartholomew's Church is on New York's Park Avenue, not Fifth Avenue; Copland's *Fanfare for the Common Man* was incorporated into his *Third Symphony*, not his second; Sir Arthur Bliss died in 1975, but the notes indicate he is still alive.) There is no reason why these records, or any other first-class audiophile product, should not consistently meet the highest industry standards in all aspects of production. These minor points aside, the discs are thoroughly recommended for their sonic values.

*John M. Eargle*

**Times Gettin' Tougher Than Tough:** Charlie Musselwhite  
**Crystal Clear CCS 5005**, stereo, direct-to-disc, \$16.99.

A new Charlie Musselwhite album is usually ample justification for blues

fans to dance in the streets. Musselwhite is a blues harp player of breathtaking inventiveness, and each of his albums has documented his growing success at extending the limitations of the instrument by building upon innovations pioneered by the legendary Little Walter Jacobs.

**Times Gettin' Tougher Than Tough** is his first album in several years, but is



**Charlie Musselwhite**

unfortunately disappointing. His harp work is still flowing and lyrical, as always, but at times here, it's, well, feeble. Not only are his solos unadventurous, but they lack the customary verve and joyful exuberance that are his trademarks. He seems to be blowing his instrument with unusual restraint, perhaps because he felt there were difficulties in capturing the wide-



# Only The Audio Critic would dare.

Can you imagine any audio publication, either commercial or underground, telling you that a new integrated amplifier under \$200 sounds unquestionably superior to many highly venerated preamp-power-amp combinations costing \$2000 and more?

Only The Audio Critic would have the integrity and self-confidence to take that credibility risk. Read all about it in the forthcoming Volume 2, Number 2 (the eighth issue since the start).

At the other end of the spectrum, a fairly simple new speaker system for \$3500 the pair is hailed in the same issue as the reference standard replacing The Audio Critic's previous "hybrid" reference speaker costing incomparably more.

As the audio community has come to appreciate, The Audio Critic is the only totally noncommercial, ad-free, consumer-oriented audio review with a decently equipped laboratory, merciless ears and an editorial mind unconfused about the laws of physics. You should probably start your subscription retroactively, with the sixth issue (Vol. 1, No. 6), which is a cumulative reference work with over 150 reviews.

Send \$30 for 6 consecutive issues by first-class mail (no Canadian dollars, \$6 extra for overseas airmail) to The Audio Critic, Box 392, Bronxville, NY 10708.

121



**John Simonton's time-proven design provides two envelope generators VCA, VCO & VCF in a low cost, easy to use package.**

Use alone with its built-in ribbon controller or modify to use with guitar, electronic piano, polytonic keyboards, etc.

The perfect introduction to electronic music and best of all, the Gnome is only \$59.95 in easy to assemble kit form. Is it any wonder why we've sold thousands?

Send GNOME MICRO-SYNTHESIZER Kit (\$59.95 plus \$2.00 postage)

GNOME MICRO-SYNTHESIZER (Fully Assembled) \$100.00 plus \$2 postage

Send FREE CATALOG

name: \_\_\_\_\_

address: \_\_\_\_\_

city: \_\_\_\_\_ state: \_\_\_\_\_ zip: \_\_\_\_\_

BAC/VISA  MC  card no. \_\_\_\_\_

**FREE SHIPPING WHEN ORDERED WITH THIS COUPON**

**DEPT. 11-A**  
1020 W. WILSHIRE, OKLAHOMA CITY, OK 73116

Enter No. 35 on Reader Service Card

ly varying dynamics of amplified blues harp in the direct-to-disc process.

Blues is typically a music of improvisation, thereby ensuring a measure of emotional conviction on the part of performing bluesmen. While some of this quality is inevitably lost in the studio, a sense of involvement and spontaneity is crucial for the music to retain its integrity and impact. Compared to such earlier Musselwhite albums as **Takin' My Time** on Arhoolie or **Leave the Blues to Us** on Capitol, that boasted supercharged arrangements which provided a launching pad for exploratory soloing and group interplay, this set seems stiff and unconvincing. I suspect that part of the problem can be traced to repeatedly rehearsing the material in order to efficiently utilize the direct-to-disc format, which calls for cutting an entire album side in one sitting without a chance to overdub or erase at a later time.

Musselwhite has cut 3 of the 6 tunes on this album before (*Sloppy Drunk* is a disguised remake of *Skinny Woman*) all to better effect. His band of San Francisco Bay area musicians is larger than in past outings, and with sidemen lining up to take a break, the ostensible band leader plays less harp than usual. He's consequently thrust into the role of featured vocalist, and since he is at best a merely adequate singer, he tends to get overwhelmed by his band's brass section.

On the plus side, this is the best recorded album yet by Musselwhite and for that matter sets a standard for fidelity unprecedented in blues recording, a field notorious for the production of poorly recorded albums. The disc has a clarity that allows for each instrument to be heard separately and distinctly, due to the state-of-the-art approach to recording. There's also a striking absence of ambient noise. If, however, like most blues fans, you subscribe to the Southside Johnny Lyon school of audio fidelity ("It ain't how the grooves sound, but what's in 'em"), then this probably seems like a dubious achievement.

True Musselwhite fans will want this one regardless of any negative comments; others are sternly advised to first hear his albums for Arhoolie, Capitol, and Cherry Red. *Roy Greenberg*

Recording: A Performance: B- Pressing: A

**Rachmaninoff** (C-4001, 2, 3, 4): Piano Concertos Nos. 1-4 and other works; Jean-Philippe Collard, piano; Orch. du Capitole de Toulouse, Michel Plasson, cond.

**Liszt** (C-4005): Organ Works; Lionel Rogg.

**Bartok** (C-4006): Sonata, Out of Doors, Roumanian Folk Dances, Hungarian Peasant Dances, Six Dances in Bulgarian Rhythms; Michel Beroff, piano.

**Chopin** (C-4007): Barcarolle in F#, Etude in C#, Ballade No. 1 in G, Five Mazurkas; Ivan Moravec, piano.

**Roussel** (C-4008): Psalm 80, Bacchus et Ariane Suite No. 2; John Mitchinson, tenor; Chorus of Stephen Caillat; Orch. de Paris, Serge Baudo, cond.

**Honegger** (C-4011): Pacific 231, Rugby, A Christmas Cantata; Chorus and Orch. National de l'O.R.T.F., Jean Martinon, cond.

**Debussy and Ravel** (C-4013): Various Works; Ivan Moravec, piano.

**In-Sync Laboratories**, chromium-dioxide cassettes, Dolby B N-R, \$10.98. (390 West End Ave., New York, N.Y. 10024.)

Audiophiles now have another source of high-quality audio material besides direct discs, digital discs, and Barclay-Crocker open-reel tapes. This new source is in the form of the Super Chrome Cassette series from In-Sync Laboratories. "Pre-recorded cassettes?" That's what I said. I must admit I was a bit skeptical when these cassettes arrived for review but after sampling a few selections I quickly changed my opinion. These cassettes have a frequency response, dynamic range, distortion, and noise levels that are superior to most commercial discs and nearly equal to that of the best direct-disc and digital recordings. The credit for this technical excellence belongs to Mr. Julius Konins, President of Cassette Productions, Inc., where these cassettes were duplicated. Mr. Konins was an early pioneer in the field of high-speed duplication and in recent years has concentrated his efforts on cassette duplication.

Mr. Konins attributes the improvement over previously available cassettes to the following factors:

1. The duplication master is copied directly from the original tape whenever possible. This eliminates any noise or distortion that would be caused by using an intermediary copy. When the duplication copy wears out, a new copy will be made from the original tape.

2. The duplication copy is made at 15 ips, instead of the usual 7.5 ips. This proved to be the most significant factor in reducing audible distortion.

3. The exclusive use of second-generation chromium-dioxide tape (either DuPont or BASF Crolyn II). First-generation CrO<sub>2</sub>, while having improved frequency response capability, also had about twice as much distortion as ferric oxide tapes. Crolyn II, however, has

distortion levels equal to the best ferrics.

4. The use of Dolby B and 70 $\mu$ S equalization.

5. A great deal of Tender Loving Care and careful quality control. All the duplicating equipment is carefully maintained and kept to a 1-dB tolerance. All cassettes are given an audio check before being shipped, an expensive and time consuming procedure that is reflected in the price of the In-Sync cassettes.

I had the opportunity to visit Mr. Konins' production facilities in Upper Saddle River, N.J., where I was very im-

pressed by the conscientious staff and the custom-made duplicating equipment. While there, I was allowed to compare randomly selected production samples directly with the 15-ips duplication master. In most cases, there was virtually no difference, and when a difference was heard, it was mostly due to a slight change in tonal balance rather than any increase in noise or distortion.

Getting down to specifics, I found the best sounding tapes to be those featuring solo piano works as performed by Ivan Moravec (C-4007, C-4013). I attribute this to the fact that the

duplication masters were copied directly from the Connoisseur Society original tapes. Ivan Moravec is also one of the finest pianists of our time, and these classic recordings, made in the late 1960s, have long been praised for their sonic qualities in their disc form. The remainder of the tapes reviewed, licensed from EMI/Pathe, do not have the transparency of the Moravec recordings, which is most likely the result of the extra copying process involved in the licensing agreement. Of the EMI/Pathe tapes, the best was that which featured music of Roussel (C-4008). It had a spectacular sound with wide dynamic range and featured music not often heard in the U.S.

The Rachmaninoff Piano Concerti (C4001-C4004), while featuring brilliant pianistic pyrotechnics by Jean-Philippe Collard and excellent piano sound, also have the somewhat coarse-textured playing of the Toulouse Orchestra.

A word of caution: These cassettes should not be played back on an ordinary cassette deck. To do so would be like playing the finest direct or digital disc with a \$1.98 crystal cartridge. The flux levels are so high they will overload the heads and/or electronics of the average machine as well as the early versions of a highly touted, expensive Japanese cassette deck. For this review, I used a Technics RS-M85 deck which proved more than equal to the challenge presented by these cassettes. This deck features a new Sendust head capable of withstanding high flux levels without saturation, low-noise electronics, and a special Quartz-locked drive mechanism that produces super-low wow and flutter. The unit also features peak-reading meters that allowed me to read flux levels 8 dB above 0 VU, and these In-Sync cassettes had them bouncing at their maximum a good part of the time.

The last thing I did before writing this review was to listen to several current Advent, DGG, London, and Philips cassettes. These cassettes were all made on equipment that represented a breakthrough in technology several years ago. They all sounded fine, but the In-Sync cassettes were better, with wider dynamic range and lower noise. Only the Advent cassettes use chrome tape and 70 $\mu$ S equalization, but their average signal level was 3 to 5 dB lower than the In-Sync cassettes.

Finally, as good as new cassettes are now, Mr. Konics assures me that even better cassettes will be possible in the future when metal-particle tape becomes available in duplicator quantities. I can hardly wait. *Charles P. Repka*

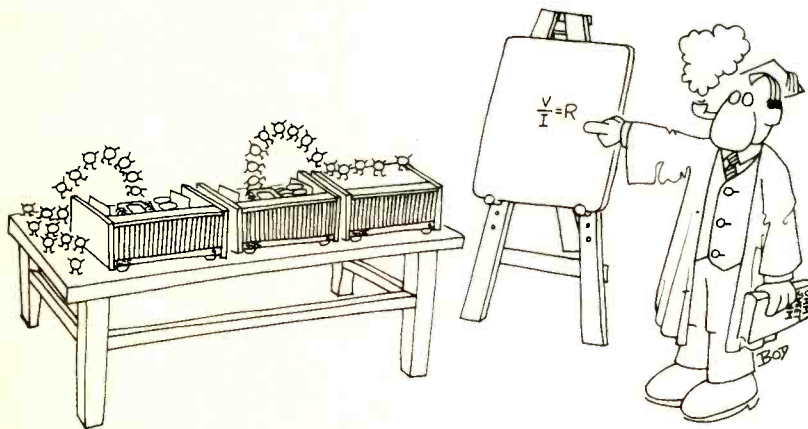

## Ohms Law Rules O.K.

It is fashionable in avant-garde hi-fi circles to abandon the precepts of science and to endow equipment with personality.

Fortunately the electrons which whiz through the circuitry of your equipment are not conversant with fashion: if they were they'd probably die laughing and we would have H.I.D. (hysteria induced distortion) to add to T.I.D., T.P.D., B.L.T., and sundry other initial ailments which supposedly afflict your equipment. As it is, they behave predictably whatever others might wish to believe.

At Quad we apply the rules, rigorously, which largely explains why our products withstand the test of time.

For further details on the full range of QUAD products write to

The Acoustical Manufacturing Co. Ltd.,  
Huntingdon, Cambs. PE18 7DB, England  
Telephone: (0480) 52561

# QUAD

for the closest approach to the original sound

QUAD is a registered Trade Mark.



# Classical reviews

Edward Tatnall Canby



**Beethoven: Sonatas for Violin and Piano.** Itzhak Perlman, Vladimir Ashkenazy. **London CS 7012**, stereo, \$7.98.

The somewhat intimidating close-up faces of these two young jet-star performers is almost enough to drive you away, unless (as London must figure) you like your macho! What happens in the living room when players like these, accustomed to "projecting" to large audiences, play music at you from a few feet?

It's OK, though sometimes a bit jarring. Beethoven, after all, is often a bit jarring himself. The ensemble is good but not as good as it can be among those who habitually play together over a lifetime. One senses two strong personalities, as well as that third power, Beethoven the composer. All this is common to most "celebrity" records and you may judge your own reaction accordingly.

The violin, Perlman, has a curiously nasal tone, a bit of cold in the head, and his vibrato is faster than the norm. I didn't too much like the resulting slightly whining effect. The piano is the leading element, as Beethoven surely intended, and the "ash can" dishes it out beautifully, with a very

slight touch of a rock beat, vital but not entirely elegant. Again—why not? It's Beethoven. All in all, these two will not leave you bored. Much too strong for that! Two musical powerhouses.

Sound: B Recording: A- Surfaces: B+

**Handel: The Sonatas for Flute (complete).** Paula Robison; Kenneth Cooper, harpsichord, Timothy Eddy, cello continuo. **Vanguard VSD 71229/30**, 2 discs, stereo, \$15.96.

This is surely the richest, creamiest performance of these noble sonatas in all recent time; perhaps it is just as well that most audio people will enjoy the sound without having to worry about the prolific added ornamentation, played by both flute and harpsichord (the cello just plays the harmonic bass line as written). To this day, most performers merely perform the printed notes and many will be bewildered by all this extra elaboration. But definitely, it was Handel's idea — ad lib, and no two performances alike. The ornamentation is like the enamel on a well-built piece of "kit" furniture. Paint to taste, tastefully.

It just so happens that both of these two performers, Paula Robison and Kenneth Cooper, have the ability to improvise, quite easily, in the Handelian manner. (Too many contemporary players are rigidly stuck to the printed notes and can never add a thing of their own devising.) So a collaboration was inevitable and it works like a charm, both players favoring a rather lush and complex — but quite proper — style. They are indeed a team and the music is an excellent cooperation, nor should we denigrate the excellent and steady accompanying cello foundation from Timothy Eddy that helps keep the whole together.

There is only one anachronism, and few will object — the flute is decidedly a modern one, with that gorgeous, big sound-of-the-angels that we admire so widely in virtuosi such as Jean-Paul Rampaal. The old flute, to match the harpsichord, would have only finger holes and a simple key or two and its sound would be more breathy and hissy, with less volume, especially on the low notes.

Sound: B+ Recording: A Surfaces: B+

# Classified

## FOR SALE

### CLASSIFIED ADVERTISING RATES

**BUSINESS ADS-** For Sale. Help Wanted. Services. Business Opportunities. Tape Recordings, etc. etc. \$5.25 per line. First line set in bold face type at no extra charge. Extra lines \$9.60 per line. One point ruled box, extra charge \$8.00. Full payment must accompany order.

**NON BUSINESS ADS-** Situations Wanted, used equipment for sale by private individuals \$3.50 per line. First line set in bold face type at no extra charge. Extra lines set in bold face type \$7.00 per line. Full payment must accompany order.

**FREQUENCY DISCOUNT-** 3 times, less 10%. 6 times, less 15%. 12 times, less 20%. (line copy ads only)

**DEADLINE-** 1st of two preceding months. (Dec. 1 for Feb. issue).

**BLIND ADS-** Box numbers may be used at \$5.00 extra for handling and postage.

#### MAIL ORDER AND DISPLAY CLASSIFIED RATE

1 col x 1"	\$150
1 col x 2"	\$225
1 col x 3"	\$300
2 col x 1"	\$225
2 col x 2"	\$395

Advertiser must supply complete film negative ready for printing for display ads.

Carolynn F. Sumner  
Classified Advertising Manager

AUDIO Magazine  
401 North Broad Street  
Philadelphia, Penna 19108

## FOR SALE

### HOW TO ANSWER BOX NUMBER ADS

When replying to an Audio Box Number Ad, please use this address Box No. — c/o Audio, 401 No. Broad Street, Philadelphia, Pa. 19108

### ABATE THE HIGH COST OF YOUR NEXT AUDIO PURCHASE!

DIRECT DISCOUNTS LTD. offers many of the finest lines of audio gear from budget equipment to typically non-discounted components and cartridges. But more important is our concerned attitude that your next audio purchase be best suited for your individual needs. Whether you're a novice or seasoned audiophile, we believe that our wide selection, low prices and helpful advice could make us your one-stop audio bargain place. As an added service to our customers we also offer top-notch camera equipment, TV's, video recorders, and many interesting gift items including the new wireless extension telephone from ATE. Just call us at 212-254-3125 for prices and information, or send \$2.00 for our current brochure to Direct Discounts Ltd., P.O. Box 841, Cooper Station, NY 10003. Shop with us by phone with your M/C or VISA. We ship worldwide! Foreign inquiries invited.

### ACCURATE, QUALITY AUDIO EQUIPMENT DISCOUNTED!

Low prices on quality Car and Home gear. Send SASE, call for quotes and prices. Denco Audio, P.O. Box 6104-U, El Monte, CA 91734. (213) 444-9978 eves and wknds. 1-0

**ADDICTED TO DYNAKITS?** Phone for quotes on hard-to-find Dynaco components/accessories. (216) 452-6332. 1-0

**ADIRONDACK AUDIOPHILES** Northern New York State House of Hi-Fi is now open with Hegeman, Conrad Johnson, Fidelity Research, Marcof, Grafyx, Hafler, D.C. Time Windows, Ampzilla (G.A.S.) Polk Audio Monitors, KEF, Harmon Kardon ST8, Sleeping Beauty, Audionics, N.A.D., Mayware formula 4 tonearm, Signet moving coils, AKG cartridges, Toshiba, Sony, and Aiwa. For info. call 518-793-6639 Mon. to Fri. 11-9 Sat. 10-6. House of Hi-Fi, 50 Miller Rd. (Rt. 9), Glen Falls, NY 12801.

### AFFORDABLE ESOTERICA

Central N.Y. State  
Audionics Apt-Holman Dahlquist Denon  
Spectro-Acoustics Crystal Clear  
Citation Grace Ortofon Cizek  
B&O McIntosh Crown KEF  
**STELLAR STEREO**  
384 Elmira Rd. Ithaca N.Y. 14850 607 272 2644

### AGFA — THE BEST OPEN REEL TAPE! CASSETTES:

ASF (C66 & C96) and DIRECT TYPE II (C96) are the best available! Direct-to-tape Recordings offer the finest sound available only on reels, cassettes, & cartridges. Ampex video cassettes also available. WRITE for FREE brochure & current special offers. Direct-to-Tape Recording Co., 14 Station Ave., Haddon Heights, NJ 08035. 2-0

## FOR SALE

### A GALAXY OF FINE AUDIO & VIDEO EQUIPMENT

at guaranteed lowest prices! 160+ brands. Esoteric! Pro! "No-lemon" warranty! Mail to: Stellar Sound, 13906 Ventura Blvd., Suite 193, Sherman Oaks, CA 91423. (213) 766-9790 M.Th, 6-9.

**A Jonas Miller Original.** At this moment, there are 25 speaker manufacturers busily reproducing their version of the "David and Goliath" system (little speakers for mid's and highs, and one big one for lows). Five years ago, there was just one company — the one upstairs of Jonas Miller Sound.

M&K Sound is all "grewed up" now — it has its own spacious facility in Culver City. And the five years of research and development have yielded a "David and Goliath" system that is more than just "cute."

The S-1/Volkswoofers system by M&K is priced competitively with the imitators — but leaves them all in the dust the moment sound comes out. No "David and Goliath" combination produces as much dynamic range as the S-1/VW System; while adjusting to every acoustical environment; while imaging precisely; while preserving transient information; while handling 400+ watt peaks.

There isn't a 3-way box system OR planar system OR "David and Goliath" system this side of \$1500 that isn't playing catch-up to the M&K S-1/VW.

The S-1/VW system is sold for \$835. It can always be auditioned at Jonas Miller Sound, 8719 Wilshire Bl., Beverly Hills CA 90211, Hours: 10-6 Mon-Thurs & Sat, 10-9 Fri; Phone (213) 659-1707.

### AMBIENCE DECODER FOR REAR CHANNELS, \$149.95.

Literature 50c. Huntington Electronics, Box 2009-A, Huntington, Conn. 06484

### AMPEX TAPE—NEW 1800 on 7" reel 12 for \$18 POST-PAID, 1200 12 for \$13 POSTPAID—free list—WIDE RESPONSE, 6114A, SANTA MONICA BLVD., HOLLYWOOD, CA 90038

TF

### ANALYZE/EQUALIZE with the AUDIO CONTROL C101

Now available — the amazing model C101 combination octave-band spectrum analyzer, matching octave-band equalizer, pink noise generator, and calibration microphone all in one handsome stereo component. An extremely versatile tool for room, speaker, and component analysis and correction. (And a dazzling light show on the hundred-LED analyzer grid.) All for \$550 postpaid. To order or for information call or write. (617) 874-0706, mon-fri, 6-8 pm (ask for Dick.) AUDIO CALIBRATION, Box 250, Westminster, MASS 01473.

### ANNOUNCING — HAFLER HDQTRS IN ARIZONA

Amps and preamps in stock for prompt shipping anywhere. Supex, Grace, Marcof, Conrad-johnson, Denon, Goldring, Connoisseur, etc. only at THE LISTENING POST (602) 967-1250 by appt.

### ANOTHER AUDIOPHILE PUBLICATION?

AUDIO UPDATE is published ON TIME. This bi-monthly includes modifications construction projects, improvement methods, data available nowhere else. It's provocative, informative, and a MUST if you enjoy audio. Annual: \$12.00 USA/Canada, \$14.00 elsewhere. MasterCharge/Visa welcome. AUDIO DIMENSIONS, 8888 Clairmont Mesa Blvd., San Diego, CA 92123. (714) 278-3310. TF

# AUDIO HORIZONS

P.O. BOX 10973  
St. Louis, MO 63135

Issue #3 is now available. It contains reviews of the AUDIO STANDARDS MX-10A pre-amplifier, the DENNESEN Soundtractor, the DENON PCC 1000 phono crosstalk canceller, the JML protractor, and the THETA preamplifier. Issue #3 also features reviews of the BREUER SC, DENON DA-307, DYNAVECTOR DV-505, FIDELITY RESEARCH FR-64s, GRACE G-707MKII, G-704 and G-714, HADCOCK GH-228 Super INFINITY "Black Widow" GF, JH Audio Labs, LUSTRE GST-1 and GST-801, MAYWARE Formula IV Series IIMICRO MA-505X, MISSION 774, SME 3009 Series III, STAX UA-7cf-m, SYRINX PU1, WOODLESS LURNE WLP-1, and ULTRACRAFT AC-3000MC pickup arms, plus reviews of the DENON DL-303, FIDELITY RESEARCH FR-1 MK3F, FULTON RS, GRADO Signature III, KOETSU MC-ONE, LINN ASAK DC-2100K, MISSION 773, ORTOFON MC-30, PRECISION FIDELITY, SUMO II, SUPEX SD-900 Super II and SDX-1000, WIN LABS SDT-10 Type IIC, and YAMAHA MC-1S phono cartridges.

Subscription rates to AUDIO HORIZONS™ for six issues are: U.S. - \$18, Canada and Mexico - \$20, and outside North America - \$26 (AIR MAIL). Please remit in U.S. funds only. Sample copies of all issues of AUDIO HORIZONS are available for \$4.50 each (U.S., Canada, and Mexico), and \$6.00 each (outside North America).

**Audio Video**  
Professional Quality

**CASSETTES**

TDK • 3M • AGFA

Call/write for free cassette catalog

**Polyline** 312/297-0955

1233 RAND RD. • DES PLAINES, IL 60016

## FOR SALE

**ANOTHER NEW YORK CITY HIGH END AUDIO STORE?**  
Not really. Instead of rush A/B comparisons, electronics B.S., flashy switching systems, or high pressure salesmanship, we offer honest advice, audiophile to audiophile, and an open invitation to audition, at your leisure the finest components available in a comfortable setting on Manhattan's east side.

Rapport Electronics, Snell Acoustics, Dynavector, KEF loudspeakers, Adcom, Linn-Sondek, Linn Isobarik, Naim, Marcof PPA-I, Meridian, Michaelson & Austin TVA-I, Spendor, Fried, Mordaunt-Short, Precedent Audio, Spatial Coherence, Van Alstine, Strelloff Systems, STD, Connoisseur, Rega Planar, Grace, Supex, Signet, Micro-Acoustics, NAD, AGI, Hadcock, CPU Micro-Tuner, Bering FT-10 and many others.

**SOUND BY SINGER AN ALTERNATIVE**

For information call or write: Sound by Singer, 227 Lexington Ave., New York, NY 10016. (212) 683-0925. (10:00 AM-10:00 PM) We ship anywhere. 11-0

**ANTI-SKATING for AR TURNTABLES!!** Proven counter-weight design of nickels steel & aluminum construction. Install yourself in minutes. \$7.95 postpaid. (Dealer inquiries invited.) **AUDIO INNOVATIONAL PRODUCTS**, P.O. Box 1607, Portsmouth, N.H. 03801.

**ARC D-350**, \$1695; **ARC SP6A**, \$999; **EMT**, \$225; **Dynavector 505**, \$295; or **B/O**. All mint. (216) 481-6229. 12-9

**ARC SP-5 \$495**. D51N mint \$495. 803-785-4547.

### ARIZONA AUDIOPHILES

Dahlquist, S.A.E., Revox, Rabco, Nakamichi, Yamaha, Crown, Grace, Stax, Tandberg, Sonab, Supex, Gale, Klipsch, Phase Linear, Uher, Burwen, J.B.L., Harmon-Kardon Citation, A.D.S., Spectro Acoustics, Beveridge, Sennheiser, Teac, Thorens, Stanton, Aiwa, Stax, Micro-Seiki, Fidelity-Research, Genesis, Optonica, R.T.R., B&W, Toshiba, DBX, Signet, Mitsubishi and Mitsubishi V.S.S.

### JERRY'S AUDIO EXCHANGE

**PHOENIX**—334 E. Camelback Rd. (602) 263-9410

**TEMPE**—130 E. University Dr. (602) 968-3491

**TUCSON**—5750 E. Broadway. (602) 622-7407

**MAIL ORDER HOT LINE**—MR. WOZ (602) 265-7841

TF

**AT CUSTOM SOUND**, we've spent more than two years developing the very best designed cabinet for housing stereo components. Before you invest in a rack or cabinet send 25c (stamps O.K.) for our color brochure. Custom Sound, 8460 Marsh Road, Algonac, Mich. 48001.

### AUDIOWORKS

**AUDIOWORKS ASSUMES THERE IS MUCH, MUCH MORE TO SOUND REPRODUCTION THAN IMPRESSIVE, BUT MEANINGLESS SPECS, GEE-WHIZ TECHNOLOGY, AND VIRTUOSO SALES HYPES. THERE IS THE MUSIC.**

RAPPAPORT, SYMDEX, SNELL ACOUSTICS, FIDELITY-RESEARCH, DENON, SPENDOR, CONRAD-JOHNSON, AUDIONICS, BRYSTON, VANDERSTEEN, TANGENT, GRACE, AMBIENT, Z-MOD CARTRIDGE, DECCA, PLATTER PAD, THE TA, NAD, SAEC, MOGAMI CABLE. Authentic high-resolution sound at **AUDIOWORKS**, Box 4314, Harrisburg, PA 17111. Tel. 717-652-6996.

### Bob Heenan Sells Great Used Equipment

Tel: 617-734-2727  
Sound Advice  
Box 782  
Brookline Village  
MA 02147

AR	Mark Levinson	GAS
dbx	Magneplanar	SME
KLH	QUAD ESL	Denon
Bose	Rappaport	Dynaco
B & W	Bryston	Thorens
Advent	I.S3/5A	Dahlquist
APT/Holman	Hafler	Nakamichi
Bang & Olufsen	JBI	Marantz (tubes)
Audio Research	DB	and much more

**Equipment bought, sold,  
traded & brokered  
Money Back Guarantee**

## FOR SALE

**AUDIO ALTERNATIVE: A unique specialty audio shop** featuring Grado, Promethean, Signet, Sumo, Supex, Denon, SMA, Hadcock, Ultra Craft, Fidelity Research, Ariston, Mitchell, Thorens, Micro-Seiki, Cotter, Hafler, Audionics, Sumo, Conrad-Johnson, TVA-1, Marcof, NAD, Harmon-Kardon, Rogers, J-R, Mordaunt-Short, Infinity, Vandersteen, Theil, Sigma, Snell, Swallow. Advantageous pricing/Pre-Paid shipping cont. USA/Mastercharge-Visa.

Mail inquiries and orders promptly and courteously answered. 1124 East Elizabeth Street, Fort Collins, Colorado 80524.

12-9

**Audio and TV tubes** factory boxed, speakers, semiconductors—low prices, free price list. Transisleteronic Inc., 1365-39th St. Brooklyn, N.Y. 11218 212-633-2800 TF

## FOR SALE

### ATTENTION SOUTHERN AUDIOPHILES

Yamaha	Great American Sound
Dahlquist	Ortofon
Polk Audio	Denon
Bang & Olufsen	Klipsch
Advent	Technics
M & K	Visonik
Aiwa	Sonus
Philips	Maxell

### Available at Sound Advice

Village Plaza Ruston LA. 71270 (3181 255-8000). 9-9

**AUDIO AT WHOLESALE** prices call or write for quote on high end and popular equipment. Brian Keller, 1244 Leland Ave., Bronx, NY 10472 (212) 792-1844. 12-9

## "MERIDIAN NOW AVAILABLE IN U.S.A."

"If sonic excellence is more important to you than 19" racks, meters, and L.E.D.S. then you owe it to yourself to find out why the British press has been writing rave reviews on the Boothroyd Stuart Meridian high fidelity equipment.

For further information and the name of a dealer in your area write:

Anglo American Audio  
P.O. Box 653  
290 Larkin Street  
Buffalo, NY 14240."

125

GET IT TOGETHER...

with a

# SEAS

Speaker Kit



Dealer Inquiries Invited

SEAS SPEAKER KITS use the finest Scandinavian drivers in computer optimized three-way designs, from \$59.00. For literature and information on SEAS Speaker Kits, raw drivers, and crossover networks, send \$1.00 (refundable upon purchase) to:

### THE SPEAKER WORKS

Box 303  
Canaan, N.H. 03741  
(603-523-7389)

**FOR SALE**

**ATTENTION DCM TIME WINDOW OWNERS**

We now offer a convenient and attractive way to improve the sound of your speakers. The DCM Time Window, when raised 9 inches off the ground, has an arier and tighter sound: the image is raised and standing waves reduced.

THE DCM TIME WINDOW PEDESTALS are made of heavy duty wrought iron and suit the shape and appearance of the Time Window perfectly. They sell for \$65. per pair. If there is no dealer nearby, order postpaid (Master Charge & Visa accepted) from

**R. S. PARK AUDIO ASSOCIATES**

5 SUNRISE PLAZA, VALLEY STREAM, NY 11581

**(516) 561-7555**

DEALER INQUIRIES INVITED

**FOR SALE**

**AUDIO DEN AND POLK AUDIO**

The Audio Den is proud to have on display and demonstration the amazing Polk Audio Monitor Series. Our customers say "Fantastic! Compares with the finest loudspeakers I have heard. Probably the best value in the history of Audio!!!" Audiogram®, from the Audio Advisor said, "We were so impressed that we could not believe the prices . . . Other \$200 speakers simply do not come close to the standards set by the Model 10 . . . And at their price, they are simply a steal." Come in for an audition or write us for information on Polk or our other state-of-the-art products. Polk is shipped free in the continental U.S. Audio Den Ltd. 1320-34 Stony Brook Rd., Stony Brook L.I., N.Y. 11790, 516-751-3350. TF

**AUDIO BARGAINS — FREE LIST.** Closeout/bankruptcy specials. SCC, Box 8014 (A-79), Canton, Ohio 44711. TF

**AUDIOPHILE RECORDS FOR BARGAIN-PHILES!!!**

Save 20% to 40% on the 50 top titles we keep in stock. Free catalog - write: Super Sound Record Service; P.O. Box 411237, Chicago, IL 60641. Fast, personal service. 1-0

**FOR SALE**

**ATTENTION AUDIOPHILES:**

**SPECIAL OFFERING OF VERION PRODUCTS**

General Resistance, Inc., the ONLY manufacturer of Verion MK1 Stereo Pickup Transformers, Triaxial Audio Cables, and GS1 Ground Strips has been authorized by Stipulation to sell the remaining inventory of those products:

MK1 Stereo Pickup Transformers (specify pickup impedance): \$350 each.

Triaxial Audio Cable pairs: \$30 per one meter, plus \$5 for each ½ meter added to the pair. All Triaxial cables have RCA-type connectors, at one end, and either bare leads, RCA-type connectors, or male or female DIN connectors at the other. Be sure to specify length and choice of connector.

GS1 silver-plated 12" solid copper Ground Strips with hardware and grounding pig tail: \$20 each.

All above carry 5-year manufacturer's warranty. Quantities are limited since there will be no further production.

Send official bank check or postal money order immediately to avoid disappointment. Orders shipped prepaid UPS in the USA. Others add shipping. No telephone orders accepted.

**GENERAL RESISTANCE, INC.**

130 S. Columbus Ave.  
Mt. Vernon, NY 10553

**AT PARAGON OF SOUND:** New and superb Conrad-Johnson tube amp and Bering FT10 tube-transistor and the Precision Fidelity C-4 preamps. In speakers: the new Snell Acoustic, the MZ MOD3, Rogers LS3/5A, and Acoustic Concept AC-24; M & K and Fundamental Research Subwoofers. Armstrong 624 FM Tuner; Bering Stereo 20 amp. S.T.D. Turntable, Hadcock tonearm, Denon, Grace, Supex, and Dynavector products. Call 301-229-2676 (Bethesda, MD) or write P.O. Box 189, Cabin John, MD. 20731 7-9

**ACCURATE**



**The only expander to accurately invert both compression and peak limiting.**

For information write: RG Dynamics  
4448 W. Howard St., Skokie, IL 60076

**THE RG PRO-20W DYNAMIC PROCESSOR**

**The Original Short Story**

"Some moving coil manufacturers move in mysterious ways. At Dynavector, we like to think we are constantly (and relentlessly) moving forward to recreate the excitement of the original musical performance.

**Shorter is better.**

"Dynavector has uncovered the real truth. By using micro-miniaturization of internal components and a cantilever of only 2.5mm in length, the realization of tremendous transient attack—coupled with exceptional trackability—is finally at hand.

"With this short cantilever (2/3 the size of traditional cartridges), the resonant frequency in our DV/Karat series is greater than 50kHz.

**How we did it.**

"The resultant effect of such a high resonant frequency made possible the elimination of all rubber used in its most traditional sense—as a damper.

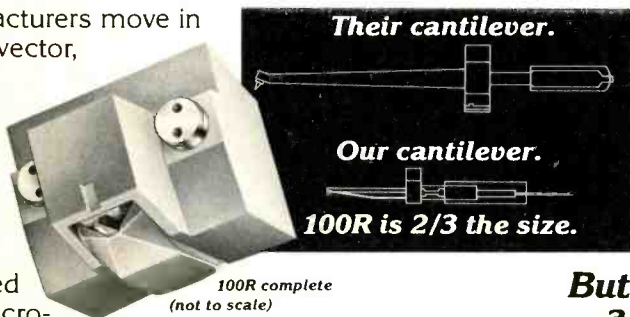

"Rubber, as used in this sense, has two major faults: it is subject to temperature change as well as deterioration with age. Thus, our cartridges are not at the mercy of 'the creeping time effect of rubber.'

**But in the final analysis...**

"...The truth is always in the listening. Please ask your dealer for details on the new generation Dynavector MC cartridges—the new 100 Ruby, 100 Diamond and the 20A and 20B Mark 2 series. And, ask about our DV 505 tone arm and two great transformers.

"For a great ending to your next component purchase, make it Dynavector. Wouldn't it be just a little criminal to buy anything else?"

Dynavector Systems USA, Inc., 30708 Lakefront Drive, Agoura, CA 91301 (213) 991-5010.

**Dynavector**  
**The soft touch**

## FOR SALE

### AUDIO DEN LTD.

Long Island's leading audio store has on demonstration

THE STATE OF THE ART  
AUDIO RESEARCH ELECTRONICS  
THE NEW SP6 TUBE PREAMP  
THE NEW D79 TUBE AMPLIFIER  
THE NEW SCHEIBER 4 CHANNEL DECODER  
THE NEW ACOUSTAT MONITOR III'S  
THE NAKAMICHI 680  
CONRAD-JOHNSON ELECTRONICS  
GRADO SIGNATURE CARTRIDGE  
FULTON CARTRIDGE AND TRANSFORMER  
LINN-SONDEK

(AUDIO CRAFT) ULTRA CRAFT UNI-PIVOT TONEARM

We also have the following lines, Connoisseur, Denon, Grace, Luxman, Magneplanar, Magnepan, Polk, Quad, Rogers, Sherwood, Sonus, Thorens, Yamaha, the largest selection of Audiophile Recordings on Long Island.

FREE "SET UP" IN NY AREA

UTILIZING IVE SPECTRUM ANALYZER

COME IN WITH 2 RECORDS AND WE WILL DEMONSTRATE THE WORLDS FINEST RECORD CLEANING MACHINE BY KEITH MONKS.

AUDIO DEN LTD.  
1320-34 Stony Brook Road  
Stony Brook, New York 11790  
516-751-3350

10-0

### AUDIO FOUR PAGE REPORT

on

Stan White, Rohrenverstärker

HI FI Exklusiv (Germany 5/79) reports on Stan White, Inventor of the GLASSCONE™ speaker: "Stanley White der Konstrukteur des vorliegenden Veteranen, zählt neben Paul Klipsch, Saul Marantz and Avery Fisher zu den Wegbereitern der High Fidelity. Er baute neben einer Reihe von Vorund Endverstärkern den ersten Motional Feedback Hochtoner und einige zu ihrer Zeit unter Audiophilen hochgeschätzte Lautsprecher wie den Mach I und den 4000 Mark teuren 4-D." Write TACHYON, P.O. Box 204, Bloomingdale, IL 60108.

10-0

### AUDIO HOUSE — FLINT MICHIGAN

Mordaunt - Short	Sound Concepts	Watson Labs
Audionics	Rogers	Symmetry
Linn Sondek	Conrad-Johnson	Theta
Bryston	Marcof	M & K

Keith Monks Record Sleeves 100 for \$20. Sample \$1.00.  
4304 Brayon Dr., Swartz Creek, Michigan 48473 313-655-8639 by Appointment. TF

Audionics CC-2 \$310. (304) 798-5975.

INTRODUCING THE AFFORDABLE ALTERNATIVE

## AUDIRE

### • The LEGATO

A simple yet flexible preamp. Quiet, open and airy.

### • The CRESCENDO

A 60 watt power amplifier. High slew rate, solid power supply, smooth, authoritative dynamic range, LED power indicators. These along with our other fine audio products at:

## AMERICAN AUDIOPHILE

716 Madison Ave., New York, NY 10021  
(212) 751-9733

5 Sunrise Plaza, Valley Stream, NY 11581  
(516) 561-7114

ALL SHIPMENTS PREPAID AND INSURED  
FREE THROUGHOUT CONTINENTAL U.S.  
MASTER CHARGE & VISA ACCEPTED

## FOR SALE

### AUDIONICS-BERNING

We have in stock the CC-2, the NEW IMPROVED BT-2 and the incredible BERNING BA-150. Free shipping in USA. Worldwide shipping. Visa & M.C. honored. By appt. OXFORD AUDIO CONSULTANTS, Box 145, Oxford, OH 45056, 513-523-3895.

**AUDIOPHILES!** Direct-Disc, Digital, Mobil Fidelity All labels-Low Prices Fast Service. Write for free catalog. Direct Discounters, 2245 New Hope Church Rd., Raleigh, NC 27604. 9-9

### AUDIO REPORT

STAN WHITE Glasscone™ Speaker

AUDIO Magazine (Germany 2/78) reports on Stan White SHOTGLASS loudspeaker. "Er klingt so als ob ein im Halbdunkel spielendes Orchester plötzlich von starken SCHEINWERFERN beleuchtet wurde, so dass jeder Mann mit seinem Instrument plötzlich sichtbar wird." For further information write TACHYON, P.O. Box 204, Bloomingdale, Ill. 60109 Sole U.S.A. distributor. 312-529-9468.

## FOR SALE

AUDIO RESEARCH D-52B, \$850. FUTTERMAN H3A, \$500. (213) 473-9813. 12-9

AUDIO RESEARCH EC4A \$275, SP3A1 Marantz 8 \$265, 10b \$700, McIntosh MC60's \$425. (319) 323-6567.

Audio Research Corp. D-51 (tubes), Linn Sondek Lp-12 with or without Grace 707 Mk II, Denon 103C with transformer (new). 919-929-3037.

AUDIO RESEARCH SP-6A \$900, D-110 AMP \$1900, SAE 2800 EQ \$400, QUAD ELECTROSTATICS \$600, TOM 216-524-1185.

"A-1 SOLUTION TO MC CART./PREAMP INTERFACE consider the MGT-1, a passive device with twin transformers in mu-metal containers. bandwidth, 0, -1db 10 to OOKH 25, to 22.5 volts out. \$299 Amer. \$340 Can. RWR Audio Ltd., Box 3080, Station D, Ottawa, Canada K1P 6H6 Or send for literature.

# SPATIAL



Exclusive patented circuitry optimizes stereo image.

For information write: RG Dynamics  
4448 W. Howard St., Skokie, IL 60076

THE RG PRO-16B DYNAMIC PROCESSOR

127

## F.M. MULTIPATH PROBLEMS ?

Finally Intrelex brings you the classic solution: MAGANTENNA. A space age answer to the commonest FM reception problems. An antenna which responds only to the direct transmission from the FM station.

MAGANTENNA is an electronically tuned indoor F.M. antenna which provides crystal clear reception in problem areas.

- Dramatically reduces multipath effects and distortions.
- No more proximity effect from people walking about the room and from planes flying overhead.
- Increases receiver image rejection to pull in weak stations.
- Increases receiver selectivity to allow hearing a weak station close to a strong one.
- Simply connect to receiver antenna terminals.

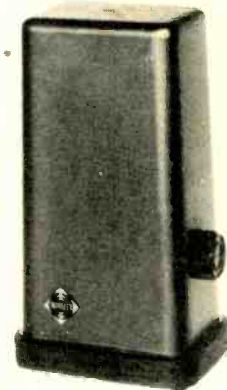

MK I \$49.95 postpaid  
MK II DX Version (Twice the range) \$99.95 postpaid

Send certified check, money order or Master Charge/Visa number with order.

Factory direct, 10-day money back guarantee.



## INTRELEX CORP

1268 MAIN STREET  
WALTHAM, MASS. 02154  
617-891-1785



MASTER CHARGE & VISA ACCEPTED

## FOR SALE

AUDIO RESEARCH SP-5 PREAMP \$475. 316-685-6564.

AUDIO RESEARCH D100-A 214-783-0661. 1-0

**BEAUTIFUL SOLID WOOD CUSTOM BUILT CABINETS** for individual components. Made to your specifications & design from wormy chestnut, walnut, cherry, oak and others by North Carolina Craftsman. \$100 up. Audio Salon, Dept. SWCC, 2227 Greenway Ave., Charlotte, NC 28204 (704) 377-6590. 12-9

### BERNING-BEVERIDGE

AUDIONICS BA150 Computer controlled hybrid amplifier, designed for best possible sound and, offering the most intelligent use of advanced solid state, vacuum tube, and digital circuit technology yet. And the incomparable BEVERIDGE electrostatic Lens Speaker System 3.

The AUDIONICS BA150 and BEVERIDGE SYSTEM 3  
The world's best amplifier speaker system?

Hear them at The Sound Environment  
Lincoln Omaha Minneapolis  
(402) 423-8733 (402) 391-3842 (612) 926-7674

**BIG, SAFE, TWISTED #12 GAUGE SPEAKER WIRE** 40c per FT. COD O.K. Free Shipping 100 Ft. or more. Keith Monks Record Sleeves 100 for \$20. Samples \$1.00. Audio House, 4304 Brayan Dr., Swartz Creek, Mich. 48473 313-655-86394670. TF

**B & O USES "ANY" CARTRIDGE** with standard mounting centers after our modification kit or at factory. Effective mass 2.5 grams. Adjustable silicone damping. \$199.00 with money back guarantee. JML Company, 39,000 Highway 128, Cloverdale, CA 95425. TF

## FOR SALE

**Braun TG 1000** reel-to-reel deck, very fine machine in excellent cond. \$450 including collection of 30 tapes and 8 blank reels 207 call: 901-683-5355. 12-9

**BRAUN 1020 SPEAKERS \$700 PR., QUAD 405 \$400, VERION TRNSFMR \$250.** GRACE 704 \$150. 503-641-5937.

**BRITISH AMERICAN SOUND — SOUTH CAROLINA'S** only high-end store: Threshold, Rappaport, Qysonic, Snell, Symdex, Acoustat, Linn-Sondek, GAS, KA, Spondor, B&W, Rega. Precedent, Audio, Sonus, Hafler, Grace, Supex, JR, and others. Special prices on components used for demonstration and on selected new equipment; e.g. NEW Mitch Cotter transformer + Sleeping Beauty Shitaba \$550. P.O. Box 1247; Charleston, SC 29402 (803) 723-6025.

**BRITISH AND EUROPEAN EQUIPMENT DIRECT TO YOU.** Most quality makes of equipment available at advantageous prices. For price list and price quotes send international Reply Coupon. Audio T, Dept. B, 190 West End Lane, London NW6 1SQ, England. Phone 01-794-7848. Visitors welcome. 4-0

**BURWEN TNE-7000A**, \$200. Mint. 316-684-2416. 12-9

**CAMPUS REPS FOR ESOTERIC EQUIPMENT**  
We need campus reps immediately to sell esoteric as well as a vast selection of major brands. We have an unusually high selection of high end equipment, excellent prices, and unique advertising program.

AUDIO SYSTEMS II  
200 WEST 57th STREET, Suite 1004  
New York, N.Y. 10019

9-0

### CARTRIDGES UP TO 70% OFF!

DIRECT DISCOUNTS LTD. is now fully stocked with top-rated phono cartridges at unbelievable prices. We feature ACUTEX, ADC, DYNAVECTOR, EMPIRE, GRADO, MICRO ACOUSTICS, ORTOFON, PICKERING, SHURE, SONUS, STANTON, et al. Specials this month include: ADC XLM Mk. III-49.95; DYNAVECTOR 10X-89.95; GRADO F3E-27.95; SONUS BLUE (gold) -89.95. All fact. fresh w/manuf. warranty. We also handle several esoteric pick-ups at competitive prices. Please call us at 212-254-3125 for more information or write to: DIRECT DISCOUNTS LTD., P.O. Box 841, COOPER STATION, NY 10003. TF

**CASH IN ON DISCO: BEAT INFLATION START YOUR OWN BUSINESS NOW! CONVERT AN OLD BAR/RESTAURANT INTO A DISCO. SEND \$12.50 FOR COMPLETE, INDEPTH MANUAL EXPLAINING DISCO SOUND AND LIGHTING SYSTEMS TO L'AVENTURE DISCOTHEQUE, UNION STATION, P.O. BOX 702, DEPT. A1, ENDICOTT, NY 13760. tf**

## SpeakerGuts.

The absolute latest in advanced speaker technology. *Wave Aperture™ Drivers, the Patented Nastrovic Woofer System™*, raw speaker components selected for their excellence. Horns, crossovers, subwoofers, woofers, midranges, horn and dome tweeters. Over 30 in all. Build your own speaker system and we'll provide top quality speakers and design information. Send for FREE 48 page color catalog from the largest, most experienced speaker kit manufacturer in the world. **DON'T DELAY. Write today!**



**Speakerlab**  
Dept. A-AD, 735 N. Northlake Way  
Seattle, Washington 98103

## FOR SALE

### CHARLOTTE, NC

Audio Salon demonstrates selected audio products by appointment only 3-9 pm daily.

Fried	Hafler
PS Audio	Thorens
SME	Grace
Decca	Supex
AUDIO SALON 2227 Greenway Avenue 28204	
Prompt quotes & pre-paid shipping US & Canada	9-0

### COMMONWEALTH LOUDSPEAKERS

Fine quality loudspeakers also drive units, walnut veneer cabinets, air core inductors, mylar capacitors, crossover networks. Choose from famous manufacturers like: Decca, Coles, Dalesford, Richard Allan, Jordan, Schackman, Radford, and more. Send \$3.00 for design, reprints, plans and catalog (refundable with first purchase.) COMMONWEALTH ELECTRONICS, 300 N. Allen, Pasadena, CA 91106, (213) 793-5184. 11-0

**CONNECTICUT: A.D.S., Advent, A.P.T. Holman Audio Pulse, B&O, B.I.C., Carver, Citation, Dahlquist, D.C.M. Time Windows Epicure, Hafler Harman/Kardon, J.B.L., Mitsubishi, Nakamichi, Ortofon, Phase Linear, Micro-Acoustics, N.A.D., Stax, Tandberg, Yamaha, Cizek, Sonus, Will ship prepaid. Sounds Incredible. 39 Federal Road, Brookfield, CT, 06804. (203) 775-1122—phone quotes only. TF**

**CONNOISSEUR BD1 TURNTABLE** Belt Drive, 37 logged hours, w/mtg hole for Grace 707. \$75 408-279-1425. 259-9648.

### CONRAD-JOHNSON

Tube Preamp (revised version) and Tube Power Amp are available for your listening pleasure. Moderate price, exceptional tube performance. At G-B Electronics (201) 427-8885 for Appointment in Northern New Jersey. 1-0

### DAVID HAFLER IS BACK!

The man behind the original Dynakit is back with his own company and a new state-of-the-art preamplifier at a bargain price! Available as a KIT or CUSTOM ASSEMBLED by expertly trained wireners — each performance certified. For further details write or call AUDIOKIT—260 Old Country Road, Hicksville, N.Y. 11801 (516) 822-5749

### DAVID HAFLER PREAMP

Now available at Audio Ltd.  
115 N. Walnut, Champaign, IL 61820 (217) 359-3774

4-9

### DEALERS! AUDIOPHILES!

KINETIC AUDIO LTD. SPEAKERS IN NEW YORK AND NEW JERSEY.

State-of-the-art no compromise speaker systems utilizing advanced synthetic transducers arranged in a patented configuration, phase corrected crossovers, transmission line loaded and designer crafted cabinetry. Audiophile acclaimed sound and beauty. CALL (716) 461-3000 and ask for JIM GALA.

**Denon AU-320 Cartridge Transformer and DL-103S Stereo Cartridge (Re-conditioned).** \$125.00. Guaranteed A-1 condition. Contact: Fred Marconi, 6502 Outer Loop, Louisville, Kentucky 40228. (502) 966-4148. 12-9

### DESIGN ACOUSTICS DEMONSTRATED NEW YORK AND NEW JERSEY

All Models in Stock  
Phone your "MUSIC MAN" for demo appointment  
212-463-1208 OR 516-621-2126  
Custom Audio Systems Designed and Installed

128

## A Switch-in Line Saves Time!



Just one of a complete line of top quality audio accessories and switching units. Superbly designed and manufactured in England by Q.E.D.

Sole U.S. Importer and Distributor:—  
**F. & R. AUDIO IMPORTS INC.,**  
P.O. BOX 212,  
SOMERSET N.J. 08873  
201-828-8075

Dealer and Rep. inquiries invited:—

**GED AUDIO PRODUCTS LIMITED**  
Sunbury-on-Thames, ENGLAND.

## Connecticut's Progressive Audio Store

Over 350 Titles of Direct-Disc  
• Keith Monks Record Cleaning • 5 Listening Rooms

M-W 10-7, TH-F 10-8, S 10-5  
All shipments pre-paid & insured.  
Master Charge/Visa/American Express

**TAKE 5 AUDIO**

Acoustat • Apt Holman • Audionics • Bryston  
Cizek • Cotter • Cybele • DAC • DCM Time Window • Denon • Grace • Grado • Hafler • JR • Levitation • KMAL • LS-3/5A • M&K • NAD • Pyramid • Quatre • Rappaport • Signet  
• Sounds Concepts • Supex • Symdex • Tangent  
• Yamaha • Audiophile Accessories.

105 Whitney Ave., New Haven, CT 06511 (203) 777-1750



## FOR SALE

**DENON DP-1200M Semi-Auto Turntable.** Mint condition. 3 years left on warranty. \$239. Evenings (314) 474-8146.

**DIAMOND NEEDLES** and Stereo Cartridges at Discount prices for Shure, Pickering, Stanton, Empire, Grado, Audio Technica and ADC. Send for free catalog. **LYLE CARTRIDGES**, Dept. A, Box 69, Kensington Station, Brooklyn New York 11218. For fast service call toll free 800-221-0906. TF

**DOLBY DECODER NOW ASSEMBLED FOR \$100.** Encode/decode also as kit or assembled. Complete reviews. **AN INTEGREGX**, Box 747, Havertown, PA 19083. 12-9

**DTR CHALLENGER II'S & Design Speakers:** 201-595-9223. 12-9

**DYNACO COMPONENTS/ACCESSORIES** — ST-416/A, \$639; SCA-50/A, \$109; C-100/A \$179; A-25 II speakers, @\$77; ST-150/K, \$169. Call for quotes on other Dyna models. Add 5% shipping. COD's welcomed! Ohio residents: 4% tax. SCC, Box 8014 (1179A), Canton, OH 44711 — (216) 452-6332. 1-0

**DYNACO/DYNAKIT:** SCA-80Q/K, \$97; PAT 5/A, \$177; ST-80/K, \$67; PAT 4/K, \$64. POSTPAID (U.S. only). Certified check/mo. SCC, Box 8014, Canton, Ohio 44711. TF

**DYNACO QD-1** ambience recovery unit (Hafler designed). Amazing special realism without extra amplifier! Perfect gift. \$19.95 (kit); \$24.95 (wired). Postpaid SCC, Box 8014 (1179A), Canton, OH 44711. 1-0

**DYNACO WALNUT CABINETS** dramatically improve appearance of Dynakits! Single, \$19.95; Double \$24.95. Postpaid. (Please specify models.) SCC, Box 8014 (1179A), Canton, OH 44711. 1-0

**D.B. SYSTEMS DB 1A and DB 2.** Preamp and Power Supply Now \$399.00. Ship Anywhere in States Prepaid. Send certified check or money order to Campus Hi-Fi, 106 Market St., Manchester, NH 03101. 1-0

**ELECTRONIC CROSSOVERS — ALL TYPES** Updated definitive booklet describes applications, how to improve speaker systems; \$5.00 postpaid, credited to first purchase. Huntington Electronics, Box 2009-A Huntington, Conn. 06484.

**END YOUR SEARCH.** The new **FULTON PREMIERE** speaker system . . . compares only to live, unamplified, music. For a definitive, in depth, written evaluation contact **MEDWIN AUDIO**, 11400 Rochester Ave., West Los Angeles, CA 90025. (213) 477-8871. 12-9

### FERROGRAPH

**AUDIO EQUIPMENT/RECORDER TEST SETS. FERROGRAPH QUALITY DESIGNED FOR O.E.M.'S & SERVICE SHOPS. COMBO UNIT MEASURES . . . DISTORTION, FREQ. RESPONSE, SIG/NOISE RATIO, CROSS TALK, WOW & FLUTTER, DRIFT, ERASURE, I/P SENSITIVITY, OUTPUT POWER, GAIN (LOADED & UNLOADED), IMP. MATCHING (BAL & UNBAL), WEIGHTING, ETC. RTS-2/ATU-1 COMBO UNIT AT \$1319.00 F.O.B. N.Y. (N.Y. RESIDENTS ADD APPROPRIATE SALES TAX) DETAILS FROM HAMMOND INDUSTRIES INC., P.O. BOX 6028, HUNTSVILLE, AL 35806. (205) 772-0251.**

**FORMULA 4 ALIGNMENT PROTRACTOR** devised by Percy Wilson M.A. enables correct setting up all tonearm/cartridge assemblies, measures tracking accuracy over entire disc. \$10 Bills only. Includes reviews etc. Mayware Ltd., P.O. Box 58, Edgware, Middx. HA8 9UH England. 4-0

## FOR SALE

**FORMULA 4 MC-2C MOVING COIL CARTRIDGE** The best transducer only \$85 incl. Airmail. Literature \$1 Bill. Dealer Enquiries invited. Mayware Ltd., 15 Heather Walk, Edgware, Middx. England. 2-0

**FRANK VAN ALSTINE HAS DONE IT AGAIN.** All new **ZERO SLEW INDUCED DISTORTION** modifications for **DYNACO** and other equipment. Walt Jung is right of course, but he overlooks a few things we have not, such as the small signal effects of RFI and the low frequency analogy to S. I. D., which relates to the time constant ratio between low frequency cut-off and power supply stiffness after regulation (we can prove that DC coupled inputs guarantee high distortion at low frequencies) Our new mods guarantee zero T. I. M. and until you hear an amp or preamp achieving this, you haven't heard anything yet. For example our all new **SUPERPAS** mod will outplay any other vacuum tube preamp and its only our fourth best preamp design. Write for our detailed explanation that may shake the world of high end audio.

**JENSENS STEREO SHOP 2202 RIVER HILLS DRIVE BURNSVILLE, MINN 55337 612-890-3517 1-0**

**FULTON J MODULAR SPEAKER SYSTEM** with electrostats. \$1395. (913) 648-3750. 12-9

### G-B ELECTRONICS

On demonstration: Snell Acoustics Loudspeaker, Spondor, Symdex, Chartwell, J.R., Rogers LS3-5A, Richard Allen, Threshold, Conrad-Johnson, Precedent Audio-Berning Preamp, Hapi, Leach, Linn-Sondek, STD, Connoisseur, Denon, Supex, Promethean, Grace, Hadcock, Decca, Platter Pad, Spectra Mat, Monster Cable, K. Monks Record Cleaning and others. G-B Electronics, P.O. Box 385, Hawthorne, NJ 07506 (201) 427-8885 for appointment. Serving Northern New Jersey Since 1945. 1-0

**GET ACQUAINTED WITH TRANSCENDENTAL AUDIO'S** line of exciting advanced raw speakers, many used in systems by Tangent, Plasmatronics, Symdex, DAC etc.. Bextrene cone models in 5" to 10" most w/magnet, voice coil layer & lgh. options. Very neutral SD tweeters plus a fascinating new driver w/1.3 gms moving mass that "traces" signal detail like the best electrostatic headphones, will definitely spoil you. Design & application assistance from our lab available to help you realize the dream system you are planning from mini monitors, satellites, car systems to sub woofers, X' over designs & parts including Mylar caps up to 10uf. Your inquiries & orders receive our prompt attention. send \$1.00 for literature. **Transcendental Audio**, 6550 Indiana Street, Golden, CO 80401. Innovative components & designs in high-end audio. Polydax (Audax), Decca, E.J. Jordan, Dalesford. 303/420/7356.



**GOLDEN gramophone**

Audio Res ch	Grace	Platter Pad
Advent	Grado Sig.	Poik Audio
ADS	Hafler	Quatre
Denon	Hiroka Mat	Rega
Dynavector	Kenwood	Revox
Electro Res'ch	LinnSondek	Rogers
E.M.T.	Magneplanar	Setton
FMI (Fulton)	Mitch Cotter	Shure/SME
G.A.S.	Nakamichi	Signet
		Sonus
		Stax
		Technics
		Ultracraft
		Wintec

2856 W. Market St., Akron, Ohio 44313 Phone (216) 864-4411

## FOR SALE

**GAS** Thoebe preamp, mint, warranty. \$295. (208) 529-0093. 12-9

**GOLD PLATED** phono jacks \$1.00, plugs 85¢ ea., \$1.00 handling. Reference Audio, Box 368, Rindge, NH 03461. 2-0

### GRAPHIC EQUALIZER KIT—ONLY \$100 PPD.

Twelve bands/channel, 100dB S/N. Free info or send \$2.50 for instruction manual with Len Feldman's review and copy of May 1978 Radio-Electronics cover story. (Refundable with purchase.) Symmetric Sound Systems, Dept. A, 912 Knobcone Place, Loveland, CO 80537. 4-0

### GREAT GRACE & SUPER SUPLEX

We have in stock the **Grace 707MKII**, 704, F-8L, F-9L, Linn Mods for the **707MKII**, the **Supex SD-900E+** Improved & **SD-900MKII**. Free shipping, Visa & M.C. honored. By appt. **OXFORD AUDIO CONSULTANTS**, Box 145, Oxford, OH 45056, 513-523-3895.

### COMPONENTS FOR THE CONNOISSEUR

**ACOUSTAT • AGI • AUDIO PRO • AUDIO TECHNICA • BEDINI CLASS A • BEVERIDGE • BEARD • DRACO LABS • DUNLOP SYS—TEMDEK • FIDELITY RESEARCH • GRADO • HADCOCK • HEGEMAN • JANIS • JR 149's & 150's • MORDAUNT-SHORT • MARCOF • MXR • NAD • POLK • QUATRE • RAPPAPORT • SEQUERRA PYRAMID • SME • SNELL • SONUS • STD • SYMMETRY • THETA • WIN LABS**

**PAUL HEATH AUDIO**  
3047 W. Henrietta Rd.  
Rochester, N.Y. 14623  
(716) 424-4916

## GRAPHIC EQUALIZER KIT only \$100



- 12 bands per channel
- Only 10" W x 3-3/16" H x 4-3/8" D
- Can be wired for 100 dB S/N
- Only .02% THD
- Solid walnut end-panels
- "Offers equalization capabilities of more expensive commercially built units at just a fraction of the cost" — Len Feldman in the May 1978 Radio-Electronics cover story
- Schematic, review and assembly manual \$2.50, refundable with order.

FREE INFORMATION:



**SYMMETRIC SOUND SYSTEMS**

Dept. C  
912 Knobcone Place, Loveland, CO 80537

## Houston and the Gulf Coast

Mark Levinson/Threshold/G.A.S./Apt/Holman/Hafler/Advent/Nakamichi/Dahlquist/Magneplanar/KEF/Acoustat/KM Systems/DCM Time Window/Cizek/Snell/Denon/Klipsch/Fidelity Research/Grace/Signet/Cotter/Ivie Analyzers

**Audio Concepts**

2200 SW Freeway at Greenbriar Houston, Texas 77098 713/527-0774

Credit Cards Accepted Freight Prepaid in Continental USA

## FOR SALE

**GET INTO BROADCASTING!** Learn how to receive free records, tapes, get an FCC broadcast license, start your own station. Free details. "Broadcasting", Box 130-N5, Paradise, CA 95969.

### HAFLER: AMP AND PREAMP

Audio Ltd 115 N. Walnut Champaign Il 61820 217-359-3774.  
11-0

### HAFLER DH-101 PREAMP

We expect to be in stock on this exciting new preamp by Dec. 12th. Kit price is \$199.95. Custom wired and tested, \$299.95. Immediate prepaid shipment via UPS. THE AUDIBLE DIFFERENCE, 435 Tasso, Palo Alto, California 94301. (415) 328-1081. TF

### HAFLER DOES IT AGAIN!

The Hafler DH200 state of the art Amp, 101 preamp, and 102 head amp are now available at:

Personalized Audio  
723 Bound Brook Rd. Dunellen NJ 08812  
(201) 752-3883

1-0

## ACTIVE ELECTRONIC CROSSOVERS

Plug-in Butterworth (maximally flat) filters in 6 db., 12 db., or 18 db., per octave attenuation, any frequency specified. Filters flat beyond 100 KHz.

Complete crossover in attractive metal cabinet with all terminations and regulated power supply;

### STEREO BI-AMP \$139

Tri-amp, quad-amp, and monaural types available at comparable prices. Other available features: Summer for "single woofer" systems, Subsonic noise elimination filters supplied with or without bass boost, level controls.

### FOR OEM'S AND HOME ASSEMBLERS

500 Series dual filters and/or plug-in filters, regulated power supplies.

**FREE CATALOG & PRICE SHEET**  
Write to:

**DeCoursey ENGINEERING LABORATORY**  
11828 Jefferson Bl., Culver City, CA 90230  
Phone: (213) 397-9668

## FOR SALE

**HAFLER HEADQUARTERS IN CANTON, OHIO** - The Listening Room, 1807 Cleveland Ave. NW. (216) 452-6332. TF

### HAFLER IN THE SOUTH!

In stock, the superb Hafler DH-101 preamp. Kit \$199, factory assembled \$299. New: DH-200 amp. Immediate free shipping. Also Fried, Audionics, more. READ BROS. STEREO, 593 King St., Charleston, S.C. 29403 (803) 723-7276. 7-9

**HAFLER PREAMP CABINETS.** Literature. GEOMETRIX, Box 612, Mexico, MO 65265 7-9

### HAFLER PREAMP, HEAD AMP, AMP & ACCESSORIES

We have in stock the DH-101K \$199.95, DH-101A \$299.95, DH-102 head amp \$74.95, DH-101A/DH-102 \$399.95, DH-103 black knobs \$19.95, DH-104 rack mount \$24.95, DH-105 preamp cabinet \$24.95, DH-106 mod kit for 101 \$19.95, DH-200K \$299.95, DH-200A \$399.95, DH-201 rack panel \$24.95, DH-202 bridging kit \$24.95. Worldwide shipping. Free shipping in USA. Visa & M.C. honored. By appt. OXFORD AUDIO CONSULTANTS, Box 145, Oxford, OH 45056. 513-523-3895.

**HARMON/KARDON CITATION 15 TUNER, WALNUT CABINET.** BEAUTIFUL CONDITION. \$175.00 614-464-0810. 12-9

## HAVE AN AFFAIR

Listen to the PRECISION FIDELITY C7 tube preamplifier with innovative cascode circuitry. The real David against all the Goliaths. Let your ears as well as your pocketbook relax. State of the art affair at \$499.

PRECISION FIDELITY, 1169 E. CHESS DR.,  
FOSTER CITY, CA, 94404 6-0

**HAVING TROUBLE FINDING DIRECT-TO-DISC AND SOTA RECORDINGS? WE HAVE THEM ALL. SEND FOR FREE CATALOGUE. KNOT SO CHEAP RECORDS, 705 BIG BEND, DEPT. AM12, WEBSTER GROVES, MO 63119.**

**HEATHKIT TV CABINET, GRA-602-25 for GR-2000 or 2001 TV's.** \$150. NO SCRATCHES. 408-279-1425 day. 408-259-9648, eves.

**HI-FI ENTHUSIASTS WANTED!!!** Earn more than just spare money in your spare time. We need campus representatives to sell name brand stereo components at discount prices in your area. No investment required. Serious inquiries only please. Contact: Mail Order Dept., K&L Sound Services Co., 75 N. Beacon St., Watertown, Mass. 02172 TF

**HIGH-END AUDIO AT LOW LOW PRICES!** Aiwa, Allison, Audio Pulse, Bose, DBX, Cizek, ESS, Luxman, Micro Seiki, SAE, Technics Pro and many more! All factory fresh with full warranty. For discount price call 212-254-3125. Or send \$2.00 for our catalogue and price list to DIRECT DISCOUNTS LTD, P. O. Box 841, Cooper Station, NY 10003.

## FOR SALE

**HIGHEST QUALITY USED EQUIPMENT:** Nakamichi 700 II, \$625; Luxman 4000 amp, \$1000; Yamaha C2 Preamp, \$450; IMF Monitor mk III, \$700 ea; McIntosh C28, \$400; McIntosh C26, \$250; McIntosh XR5 spkrs, \$300 ea; Yamaha CR3020, \$1000; McIntosh MA 6100, \$450; Audio Research SP-3, \$360; Quad 303 preamp, \$175; Genesis III spkrs, \$360 pr; Luxman L100 amp, \$550; Harmon/Kardon Citation 11, \$200; Marantz 3600 preamp, \$270; Luxman PD 272 tt, \$250; B&O 300 tt, \$180; SAE mk 1M preamp, \$285; B&O 4002 tt, \$550; Harmon/Kardon Citation 17S, \$285; Harmon/Kardon ST8 tt, \$285; Nakamichi 580 deck, \$520. All used equipment guaranteed 90 days parts and labor. Audio Consultants, 1014 Davis Street, Evanston, IL 60201, (312) 864-9565. 12-9

**H/K Cit. 16 (2), Cit. 17 AS NEW, WARRANTY, \$400 ea.** 615-339-2745. 12-9

**How is it that the inefficient, noisy, distortion prone, archaic vacuum tube can retain any acceptance among serious audiophiles? Why do manufacturers, large & small still expend enormous creative energy in designing and making tube equipment? Who cares? We do . . . MR. AUDIO'S BIMONTHLY** expounds the gospel of tube equipment but not at the exclusion of all else. We concede to permit solid state MC head amps, covers, bass amps & the like in a music system. The tenacity with which tubes cling in spite of advanced solid state technology is a mystery to some — but not to us. MR. AUDIO'S BIMONTHLY — 6 issues 1st class \$15. Overseas \$18 — P.O. Box 3022, Monterey, Ca. 93940.

### IMPEDANCE MISMATCH DIFFICULTIES??

Pede-Match (Bilateral Impedance Transverter) is a new circuit designed to eliminate the impedance mismatch found between preamp-power amp combinations. Improves definition and stereo imaging. Tested and guaranteed \$79.95. Nick's Audio, 529 N Grant, Westmont, IL 60559.

**INFINITY SERVO-1** \$850, Audio Research D-51 with fan base \$25. (804) 595-4509, 5:00-9:00 PM EST only. 12-9

### INFRA-SONIC COMPENSATOR - MODEL A

Reduce Power Wasting Distortion - Increase Clarity and Solidify Bass. Steep Cut-Off, Self Contained, A/C Powered Active Filter Removes Harmful Sub-Sonic Energy from your Component Stereo System. -55DB (Minimum) at 4 CPS. Only \$54.95 Postpaid. AUDIO SPECTRICALS, P.O. Box 4223, Yuma, AZ 85364. 1-0

**In Illinois:** Audionics, Conrad-Johnson, Polk, Sendor, Rogers JR 149, Precedent, Rotel, Connoisseur, JSH, Hadcock, Linn-Sondek. SYSTEMATIC SOUND, 512 Bridge St., Rockton, Ill. 61072 (815) 624-4902. 1-0

**INVISIBLE HANGERS FOR ADS, Braun, Visonik/David** speakers. Pair \$12.00, \$1.00 postage. Plexiforms, 1016 1/2 Gilbert Court, Iowa City, IA. 52240

**IVE ELECTRONICS REAL TIME ANALYZERS,** etc. Some very slightly used demonstrators at discount. Full factory warranty. Money-back guarantee. JML Company, 39,000 Highway 128, Cloverdale, CA 95425.

**JBL PARAGON STEREO SPEAKER SYSTEM,** oiled walnut, new, perfect; \$3900.00. Call 203-929-5255 or write Box 2009 Huntington, CT 06484.

## GA GARLAND AUDIO, INC.

**WHERE ONLY THE FINEST IS GOOD ENOUGH**

AUDIO RESEARCH  
MAGNEPAN  
LUXMAN  
DENON  
GALE  
F.M.I.

B & W  
ROGERS  
NAKAMICHI  
MITCH COTTER  
FIDELITY RESEARCH  
R.H. LABORATORY

MARK LEVINSON  
SEQUERRA  
QUATRE  
GRACE  
QUAD  
G.A.S.

Call or write for a FREE subscription to our quarterly newsletter!

**GARLAND AUDIO**  
2960 Stevens Creek Blvd. • San Jose • (408) 244-6724

Tues/Thurs, 11-8 — Wed/Fri, 11-6 — Sat, 10-5 — and by appointment —

**get with the Audio Pros**  
select from top quality brands  
Franchised Dealers For: AR, BOSE, ONYX, MICRO LINEAR, TANDBERG, DBX, WIN LABS, PULSE, VISONIK STAX, DENON, HAFNER, G.A.S., QYSONIC, SAE, ESS, CONNOISSEUR, OTHERS.  
**AUDIO CONCEPTS**  
(213) 445-3663  
(800) 423-4170  
1127 W. HUNTINGTON  
ARCADA, CA 95008

## FOR SALE

### INCREDIBLE

In Just about every way the SONIC DEVELOPMENTS D235 stereo amplifier is incredible.

**PERFORMANCE:** Superb transients, clear extended highs, solid bass down through the entire audible range, and trouble free reliable cool operation.

**PRICE:** Only \$310 plus shipping.

**GUARANTEE:** In addition to a standard 2 yr. parts/labor warranty, a MONEY BACK SATISFACTION guarantee. If for any reason you are not satisfied, return your D235 within 7 days and your purchase price of \$310 will be refunded.

The D235 is a modest powered (35w RMS minimum per channel, both channels driven) solid state amp of the highest quality. Because of its superior power supply the D235 is comparable on music reproduction to amps rated at 75w per channel and higher and selling for hundreds of dollars more. It is the ideal choice for use with small "monitor" type speakers (LS3/5A, JR149, etc.), Quad ELS (truly incredible), mid-range/treble units of multi amp set-ups, larger speakers in small to moderate size rooms, and recording studios. The D235 measures 17" w x 10" d x 4" h behind a 3/16" thick brushed aluminum face plate 19" w x 4 1/2" h. It is suitable for shelf mounting in rack systems.

Here then is your opportunity to PERSONALLY JUDGE the incredible sonic performance of this MONEY SAVING amp under ideal conditions. Compare the D235 with your current amp or any amp you are considering buying in YOUR OWN SYSTEM AND IN YOUR OWN HOME for up to 7 days. You risk nothing and could save hundreds of dollars. Send your check\* or COD approval to:

SONIC DEVELOPMENTS  
134 CLAREWILL AVENUE  
UPPER MONTCLAIR, NJ 07043

\*Include non-refundable shipping charges of \$5 east coast, \$7 mid west and central, \$8 west coast. New Jersey residents include 5% sales tax.

**JBL PARAGON**, walnut with 80 watt matching energizer \$1950.00. (414) 483-6261. 12-9

**LAUGH AND THINK.** The Hi-Fi Game: A board game of fun and thought. \$11.95 from Penjon Games, Box 2129, Martinez, CA 94553. Dealer inquiries welcome, too.

### LINN SONDEK — NAIM — LINN MODIFICATIONS

We offer the remarkable Linn Sondek LP12, the superb Naim head amp, the detailed Linn Asak MC cartridge, the giant killing Naim NAC42/NAP110 preamp/amp, 45 rpm adapter, friction hinged dust cover & Linn mods for the Grace 707MKII. By appt. Free shipping in the USA. OXFORD AUDIO CONSULTANTS, Box 145, Oxford, OH 45056, 513-523-3895.

**LOWEST DISCOUNT PRICES ANYWHERE** on audio equipment. All major brands discounted. Write for quotes. K&L Sound Services, 75 N. Beacon St., Watertown, Mass. 02172. TF

**LOWEST PRICES ON STEREO-ESOTERIC COMPONENTS & Tapes.** Over 150 brands. Send #10 SASE for quotes. Audio Unlimited, 401 Reynolds Circle, San Jose, CA 95112 (408) 289-8875 1-6 Monday thru Thursday.

**LWE — Ill in unity cabinets w/CM-662 feedback/coupler w/ extra cables, midranges reconed.** Best Offer. Dave (315) 337-7050.

## Buy with confidence

**fact: the IV does more!**

Send for Quotes & Price List on Shure & Over 100 Other Famous Brands



**SHURE**  
V15 Type IV  
**SUPER TRACK IV**  
Stereo Dynamic Phono Cartridge

Consistent record tracking has always been challenged by such ever-present factors as warp, static, lint and dust—especially when these factors combine with today's "hot" recordings.

**CARSTON**  
STEREO  
DISCOUNT CENTER

**146 OLD BROOKFIELD RD**  
Dembury, Conn. 06810  
(203) 744-6421 (212) 369-6212

MON., TUE WED., FRI. 9:00-5:30  
THUR. 9:00-8:00 P.M. SAT. 9:00-4:30

## FOR SALE

"LOWEST PRICES: BOSE, SAE, DBX, HAFLER, GRADO, ADVENT, TANDBERG, AND MORE. DYNAMIC SOUND, BOX 168, STARKVILLE, MS 39759. (601) 323-0750." 1p.m.-9p.m. 4-0

**Low Prices:** Immaculate (Sealed Container) Dual 939 Cassette Deck \$425. New Quad 405. 33, FM 3 \$650. Available Separately. Also M&K Woofer \$75. Call Mark 716-631-0758. 1-0

### LUXMAN

L85V - \$556.00 T88V - \$229.00  
C1010 - \$448.00 T110 - \$309.00  
L110 - \$529.00  
Nakamichi 630 - \$495.00 ESS Stereo Preamp Demo - \$259.00  
1 pair FM180 - \$140.00 a pair  
All Brand New. Call Rony (915) 565-1405 or write Audio Consultants, 3824 Montana Ave., El Paso, TX 79903. 12-9

### L.A. — SOUTHERN CALIFORNIA

**LINN ASAK CARTRIDGE:** The makers of the finest turntable have brought us the finest cartridge. This moving coil tracks excellently in most fixed pivot tonearms. The cartridge does the same thing as the table, less trash and hash, more music. \$350

**SERIES 20 PA1000:** This incredible tonearm is the perfect match for the Linn cartridge or any other cartridge regardless of compliance (1 or 2 exceptions). \$150

**MUSIC FIDELITY BB1:** This battery powered preamp is the clearest, tightest, most natural available. Its only competition is a certain transformer (causes some smearing compared to the BB1) at twice the price. \$225

**MICHAELSON & AUSTIN:** All three pieces from this company are among the finest values ever offered in audio. The TVP-1 preamp at \$750 is a tube unit with resolution and a 50/50 watt tube amp with high resolution and detail you probably never heard before. The TVA-10 is the big brute, at 75 lbs. this amp has the muscle to fill the room with the largest and yet most detailed sound stage.

**WE CARRY:** Linn Sondek, Denon, Michaelson & Austin, Series 20, Professional Systems Engineering (PSE), Rogers, Tangent, Koss ESL, Satterberg, Spatial, Theta, Peterson, Hafler, Lentek, Stax, SAEC, Audionics, Decca and Osawa.

### EXECUTIVE AUDIO

BY APPOINTMENT ONLY (213)394-6463  
2210 Wilshire # 207 Santa Monica, CA 90403

**MARANTZ CLASSIC EQUIPMENT FOR THE COLLECTOR:** Model 7T Preamplifier & Model 15 Power Amplifier, both in flawless condition with special-order black faceplates. \$400 buys both of these fine examples of MARANTZ' first solid-state equipment. J. CHOREN 414/242-4953.

## FOR SALE

**Marantz 18** near mint \$300, Audio/Pulse One \$475. (513) 793-8050. 12-9

**Marantz:** (2) 10-B's, (1) Model 15, (1) Marantz-made rack mount assembly for 10-B. All excellent condition, (201) 744-1758.

**MARANTZ 33 PREAMPS (2)** \$195. ea. MARANTZ 16B Amp 100 W/Channel \$225. Marantz 250 Amp. \$325. Garrard Music Recovery Module, New \$90. All items perfect condition. Ctns. Pvt. 609 455-6627.

**MARANTZ 7C, 9, McIntOSH C22, MC275, MC240.** J. Fong, 1238 Green St., San Fran., CA 94109. (415) 885-0596. 7-0

**Marantz "B" Mint \$275.00.** Citation "19" 6 mos. old Excel. \$345.00. Scott "233" tube Int. Amp. \$75.00. 203-875-1765.

**MARK LEVINSON ML-2 CLASS A AMPLIFIERS IN MINT CONDITION.** GARLAND AUDIO (408) 244-6724. 2-0

**MARK LEVINSON PREAMP AND CARTRIDGE JC1AC PREAMP** \$800.00 for both, 2 Fulton Mono Tube Amps \$750.00 for pair, ARC D-76 Amp \$650.00, Phase Linear 700A Amp Mint \$525.00, RTR Rhombus subwoofers New \$950.00 pair, 4-AKG 224 Mikes Mint \$600.00, Ampex 10 1/2 407 Tape Full Case 12 Reels Brand New \$100.00, Atlas M-25's And B-36's Mike Stands. 203-739-0565. 12-9

## "STATE OF THE ART" IN STOCK ALWAYS!

## SHIPPED PREPAID ANYWHERE IN U.S.

Credit Cards Accepted,  
Trade Ins Welcomed.

<p><b>Apt/Holman</b> <b>Audionics</b> <b>Audio Research</b> Burmast Denon Globe Magnepan</p>	<p><b>Mitsubishi</b> <b>M&amp;M</b> <b>N.A.I.</b> <b>Nakamichi</b> B&amp;K Audio Quad R.T.L. Labs Yamaha</p>
--	--

**HAWTHORNE** 1-503-292-4401  
**STEREO**  
8680SWCanyonRd Portland,OR97225

## SPECTRUM ANALYSIS SYSTEM

The ASA-10 is a true professional quality analyzer that offers:

- A 10-Octave Spectrum Analyzer covering the full audio range
- Built-in flat response microphone
- Adjustable dynamic range display up to 35dB
- Selectable detector response times for either pink noise or signal monitoring
- A Hold Mode for easier analysis

P.O. Box 115 · West Redding, CT 06896  
203-938-2588

## GOLD LINE



**Analyzer ASA-10** . . . . . \$199.95  
**Pink/White Noise Generator** . . 49.95  
**DEALER INQUIRY INVITED**

## FOR SALE

### MARCOF, HAFLE, OTHER STATE OF THE ART!

All at Reasonable Prices. Send SASE to Q/LC Audio, 1006 Berkshire Rd., Dayton, Ohio 45419 or Call (513) 293-7287. 12-9

**McINTOSH C-28 - MIMT** - \$400. Davis-Brinton Phono Pre-amp \$110. Call Ron eves. (217) 426-6374. 12-9

**McINTOSH C-28 PREAMPLIFIER**, MINT CONDITION, 5 years old, \$475. CT. Call (203) 735-6500, eves., wknds. 12-9

**METAL FILM RESISTORS**, RN55, 0.35 watt, 107 values from 10 ohms to 1 Meg., 25' ea., 10 per value/\$1.80, 50 per value/\$7.50. Send stamped self addressed envelopes for list of values and order form. Gold plated shielded RCA type phono plugs, \$1.25 ea. Gold plated panel mount phono jacks, \$1.00 ea. Nylon panel insulators for jacks, 10/\$1.50. Minimum order, \$10. Component Systems, 5556 Personality Court, Indianapolis, Indiana 46227. 12-9

### MICHIGAN AUDIOPHILES

Apt Holman	Hafler	Revox
Bryston	Hitachi	Sumo
Cabasse	Linn Sondek	Sherwood
Denon	M & K	Sonus
Dahlquist	NAD	Snell
DB Systems	Nakamichi	Spendor
Grace	Onkyo	Soundcraftsmen
Grado Signature	Polk	Stax
GAS	Pyramid	Threshold
Gratix	Rega	Visonik

### ABSOLUTE SOUND

"Michigan's High Accuracy Audio Dealer"

Detroit, 12400 Mbrang Ave. (313) 527-2244  
Royal Oak, 4354 N. Woodward (313) 549-7550  
Ann Arbor, 312 S. State St. (313) 662-2026  
Shipping Prepaid

## FOR SALE

**McIntosh MA 230:** Tube amp, solid state preamp, stereo: 415-376-9172. 12-9

**MCINTOSH TUNER — MR77 — \$390.00, PREAMP C28 \$390.00; BOTH \$750.00.** A. Beck, 3 Gilchrist St., Thomaston, ME 04861.

### METRO-NEW YORK CITY

G.A.S., FR, Dahlquist, B&O, Lux, Linn Sondek, AVID, Janis, Baure & Wilkens, Grace, Tangent, R.H. Labs, Direct Discs, Grado, many others. All issues of Absolute Sound.  
UNIVERSITY STEREO-Ridgewood, N.J.,  
57 E. Ridgewood Ave (201) 447-5700  
20 minutes from G.W. Bridge 12-9

**MILWAUKEE!** — The Audio Emporium: Audio Perfection Cables, Audiopulse, Audio Research, B&O, Connoisseur, Dahlquist, Denon, Genesis, Grace, Grado, GAS, Hafler, Linn, Lux, Magneplan, Marcof, New Acoustic Dimension, Polk Audio, RH Labs, Revox, Rogers, Snell Acoustics, Sonus, Sumo, Technics and Threshold. Over 100 direct discs and the Keith Monks record cleaning machine. 6900 W. Brown Deer Rd. Open Tues. Wed. Fri. Sat. 10-6, Thurs. 10-8. Closed Sun. & Mon. (414) 354-5082.

### MILWAUKEE & WISCONSIN'S ONLY TRUE AUDIOPHILE DEALER

Specialists in components by: G.A.S., Yamaha, KEF, Tandberg, Dahlquist, DCM, Fried, Quatre, Stax, SAE, Connoisseur, Transcriptors, Grace, Nakamichi, Infinity, Dynaco, Crown, Ortofon, Sonus, ADC, Hafler, DBX, Akai, Teac, Revox, MXR, Technics and many many more. Featuring a very unique switching system for instant component comparisons. Also, one of the largest tape recorder displays in the country, with over 130 machines on display. WACK ELECTRONICS, INC. 5722 W. NORTH AVE. MILWAUKEE, WI. 53208. PHONE: 414-442-3441 TF

**MIXER** made especially for tape duplication. Will produce enhanced high quality second generation tapes. KUHN ELECTRONICS, 1801 Mills Ave., Norwood, OH 45212. TF

**MULTI-TRACK AND SEMI-PROFESSIONAL AUDIO EQUIPMENT: BEST PRICES!** Prompt Delivery! DBX, TEAC/Tascam, Sound Workshop, AKG, Delta-Lab, Phase-Linear, Uni-Sync, Others. Dept. AD, WDI, P.O. Box 340, Cary, NC 27511. 919-467-8122.

**Must Sell** — Dokorder & head Auto-Reverse Reel-to-Reel and 13 Ampex brand Master tapes plus extras. \$415. Louis (205) 928-2062. Leave message and phone =. 12-9

**Nakamichi 1000 MKII** \$1100, Audio Research SP-4A Preamplifier with optional Head Amp MCP-1 \$795. Harry Lawson, 3801 Hogue Rd., Evansville, IN 47712. (812) 422-5851. 2-0

**NAKAMICHI 610/B Preamp** — \$475.00 will trade for NAKAMICHI 600/B TAPE DECK. (212) 825-0738. 12-9

## FOR SALE

**NAKAMICHI 700 USED LESS THAN 20 HOURS SINCE COMPLETE CALIBRATION AND HEAD INSTALLATION BY NAKAMICHI.** \$750 (212) 222-2584 EVENINGS. 12-9

**NAKAMICHI 700 # cassette deck \$750, NAKAMICHI 600 deck \$460.** Why pay the high price of metal tape? (218) 326-1992.

**NEW AMPEX MASTERING TAPE 406 (7") 2.25, 407 (7") 3.25 New Scotch or Ampex LN-HO 1200x7 1.50, 1800x7 2.25, 4000x10 5.00 min. 20 pp. all boxed. New type 10" metal Reels Boxed \$4 min. 10 pp. other tapes Avail. Large SASE for Details. MJS, 2514 Seaboard Ave., SJ, CA 95131 408-262-8793.**

**New or Used Elecsets.** State type, Number and Price. After 5 — 919-876-0645.

### NORTHERN CALIFORNIANS

It is our goal to make the joy of music possible for everyone. At any price we offer solid value, superior performance, and traditional service.

We operate on the theory that you as our customer will achieve the greatest long term satisfaction only through a careful analysis of your audio requirements. We strive to offer sober, highly cost effective solutions to meet your specific needs. Please stop in for a refreshing experience with music.

### OUR SELECTION INCLUDES:

Magneplan	Audiocis	Dahlquist
Tandberg	Threshold	Chartwell
Onkyo	Audire	B&W
JVC	Hafler	Cizek
AKG	P.S.E.	AVID
Denon	Lux	Stanton
Micro	Grado Sig.	AIWA
Connoisseur	Sonus	M&K
Soundcraftsmen	Grace	Rogers

### HIGH FIDELITY SHOPPE

1511 North Main Street  
Walnut Creek, Calif. 94596  
(415) 932-2242

"WE BUILD BETTER SYSTEMS FOR YOU"

**Northern N.J.'s finest store—Lux, Mod DQ-10, Grace, B&W, G.A.S. Sleeping Beauty, FR, B&O, Linn, Sondek, Janis, Tangent, R.H. Labs, Grado, AVID and more.** University Stereo, 57 E. Ridgewood Ave., Ridgewood, N.J. 07450. 20 minutes from the G.W. Bridge. 201-447-5700. TF

**OVERSTOCKED, MUST GO** Phase Linear 400 II Power Amp \$395, 4000 Pre-amp, \$399, 5000 II Tuner \$399, Pioneer Spec 2 Power Amp \$539, RT 1011 10" Open Reel \$399, CTF 1000 Cassette Deck \$399, TEAC A 3340SX \$849, A2340 \$499, AR 1011 Speakers \$279 ea. Acoustat X 1495 Pr. ALL NEW FACTORY WARRANTY. Used SAE MK I Pre-Amp \$249, MK II Power Amp \$299. OTHER GOOD DEALS, WRITE OR CALL: STEREO CLEARANCE HOUSE, 1029 Jacoby St., Johnstown, PA 15902. (814) 536-1611. 1-0

## Western Pennsylvania's Quality Audio Dealer

Threshold	Watson Labs
Bryston	M&K Systems
Apt Holman	Magneplanar
Nikko	Polk
Sony	DCM Speakers
Hafler	Rogers LS3 5A
Duntech	Infinity
Linn Sondek	Altec Lansing
Grado	Janis
Denon	Thorens
Fidelity Research	ADC
Supex	SAE
Ariston	Visonik
Grace	Blaupunkt
Scheiber Decoder	Grundig
Cotter	AIWA
Marcoff	Sony
Symmetry	Technics Pro

plus much more...

Direct To-Disc Recordings

SHIPPED PREPAID & INSURED

## OVATION AUDIO

6019 Broad St. Mall

Pittsburgh, Pa. 15206

(412) 441-4550

# DISCLAIMER™

- Greatly enhances bass & mid transients
- Eliminates 80% of disc warp problems
- Vastly improves imaging
- All the benefits of platter weights without the weight
- Great holiday gift for the HI FI owner



\$14.00 plus \$1.00 postage and handling • Check or Money Order

Name \_\_\_\_\_

Address \_\_\_\_\_

Oysonian Import Company, 920 S. Placentia, Placentia, Calif.

## FOR SALE

**NORTHWEST!** The Tin Ear: Audio Research, Audionics, B&W, Grado, LUX, Magnepan, Polk Audio, RH Labs, Rogers, Supex, Technics, Yamaha and Audiophile recordings. 704 Symons, Richland, WA 99352, 509-946-4459. 9-0

### PERFECTIONISTS PREFER DYNAKITS

Before Purchase You Owe Yourself Our Quote Mainline Ila, 971 Fronheiser, Johnstown, PA 15902 TF

**PHILA. AREA** — Bryston Amp. 4B-\$1100. Gale Speakers (chrome) w/chr. stands-\$950. Verion Transformer Mk.Iw/De-non "S" cart.-\$325. CALL (215) 677-5929 Bob, Equ. new, boxed. 12-9

**POLYDAX (AUDAX)** Bextrenes, soft domes etc., Decca Rib-bon tweeters Leach Amplifiers. Catalog: TA Box 97A, W. Cornwall CT. 06796. Postage now 40¢, please help with stamps. 9-8

**PROPER TONEARM GEOMETRY!!** Optimum offset angle, overhang, vertical pivot height and angle. Resonance damp-ing construction. Jewelled pivots. Height adjustable while playing records. Effective mass 2.5 grams. Damped cueing. Anti-skate bias. TA-3A with silicone damping, \$249.00. "Universal" nylon hardware, \$1.00; alignment protractor, \$3.00. Prices include postage and money-back guarantee. JML Company, 39,000 Highway 128, Cloverdale, CA 95425 TF

**PROTECT YOUR LPs. POLY SLEEVES FOR JACKET 10", ROUND BOTTOM INNER SLEEVES 9", SQUARE BOTTOMS 6", POLY LINED PAPER SLEEVES 15", white jackets 35", POSTAGE \$1.50. HOUSE OF RECORDS, HILLBURN, NEW YORK, 10931. TF**

### PS AUDIO

PSII & model One Amp available. Audio Salon, 2227 Green-way Ave., Charlotte, NC 28204 (704) 377-6590. Shipped pre-paid US, Canada & Europe. 12-9

**QUAD ELECTROSTAT, ONLY ONE, BUY OR SELL \$150.00** QUAD C-22 Tube Preamp \$75.00 QUAD II Power Amp \$50.00 SERIES 20 M-22 Amp \$625.00. G. Sanford, 45 Anso-nia Dr., Woodbridge, CT 06525, (203) 389-5148. 10-9

**QUAD ELECTROSTATIC SPEAKERS & 33-303 electronics,** \$970.00; Kenwood 500 turntable w/Grace 707 arm, \$250.00 (318) 322-7686.

**QUICKEST AIRMAIL DIRECT FROM TOKYO:** All brands of Cartridges & Arms of Japan. Ask for latest Quotations with \$1 for postage. JAPAN AUDIO TRADING CO., LTD. Saikaen Bldg., 4-33-21, Kamimeguro, Meguro-Ku, Tokyo 153 Japan. 2-0

Rabco ST-7 turntable excellent condition \$225 or best offer. 302-762-0347.

**RAPPAPORT PRE-1** \$475, Citation 16 \$410, AR-5 spkrs. & MA-1 twtrs. \$225. 302-368-9854. 2-0

## FOR SALE

**RABCO OWNERS S.O.T.A.** modification features a tonearm whose sound has been described as "magnificent," "superb." Details and photos \$1.00

WHEATON MUSIC  
2503 ENNALS AVE.  
WHEATON, MD 20902  
301-949-1145 12-9

**RECORDS/TAPES.** Major labels, top names at distributor prices. All categories. Complete set of catalogs \$1.00 (re-fundable) Box 1111, Chatsworth, Calif. 91311.

**REINFORCEMENT, RECORDING DISCO** equipment featur-ing Electro-Voice, Tapco, Numark, Whirlwind, etc. Competi-tive prices with fast competent mail order service is our spe-cialty. Write or call SONIX CO., Dept. A, Box 58, Indian Head, MD 20640, (301) 753-6432. 10-0

**RENOUCE ROTTEN RECORDINGS!** Read selected British reviews in the bi-monthly EURO-DISC GAZETTE, then order these European discs judged the finest in technical and musi-cal excellence. Selections mainly classical. Send for free sam-ple issue. No obligation. EURO-DISC GAZETTE, PO Box 337-A, Peterborough, NH 03458. TF

**RG-16B Processor,** \$230. 212-853-1478.

### ROGERS REFERENCE MONITOR SYSTEM

This is a biamped system designed by Rogers using the in-credible LS3/5a's. Hear this system as well as the Rogers Monitor II's, Compact Monitor's, A100 amp and T75 tuner. By appt. Free shipping. Visa & M.C. honored. OXFORD AUDIO CONSULTANTS, Box 145, Oxford, OH 45056, 513-523-3895

## SALE!!!!

**TWO FOR LESS THAN THE PRICE OF ONE.** Now you can buy two fine RCA (Japan) direct to disc records, Beethoven's ap-passionata and Lew Tabackin quartet's trackin' for only \$11.95 including postage. That's right. Two records for \$11.95! Rated as reference recordings in the Absolute Sound & Stereophile, these records retail for \$30 for both. Hurry, supply limited. Send check or money order to: Specs Corp., 130 Fallen Leaf Drive, Hillsborough, Calif. 94010 CA resi-dents add Sales tax. 2-0

### SAVE UP TO 40% ON DIRECT DISCS

Select from over 250 different direct discs, PCM, and Japa-nese Audiophile records. Over 30 labels to choose from. Send \$1 for complete list and prices. (\$2 outside U.S.) Dynamic Discs, P.O. Box 0, Tarzana, CA 91356. 1-0

**SAVE UP TO 69% ON OVER 100 TOP BRAND AUDIO COM-PO-NENTS FROM CARSTON STUDIOS.** NEW ENGLAND'S AU-DIO SUPERMARKET ONE OF THE OLDEST MAIL ORDER FIRMS (EST 1952) AND CERTAINLY ONE OF THE MOST RELIABLE. ALL ORDERS SHIPPED FROM STOCKED WARE-HOUSE. SEND FOR PRICE QUOTE AND PRICE LIST. CAR-STON STUDIOS, OLD BROOKFIELD ROAD, DANBURY, CONN. 06810. TF

## FOR SALE

**SEAS SPEAKER COMPONENTS.** Raw Drivers, crossover networks, speaker kits and more! Drivers and plans for mini kit and subwoofer kit. For information and literature send \$1 refundable upon purchase to:

The Speaker Works  
Dept A  
Box 303  
Canaan, NH

03741

**SIEMENS, TELEFUNKEN, GENALEX AND AMPEREX** and other top quality audio tubes available at very competitive prices. Contact Jim Wallace at 1203 Success St., Pittsburg, PA 15212 or (412) 322-4706 TF

### SNELL ACOUSTIC LOUDSPEAKER

We have on demonstration this superb full-range speaker sys-tem now bi-amped with the Snell Active Crossover and the extraordinary Threshold electronics. A marvelous listening ex-perience awaits you. At G-B Electronics (201) 427-8885 for appointment in Northern New Jersey. 1-0

**SONY V-FET INTEGRATED AMP. MODEL 8650. 80 WATTS PER CHANNEL. MINT \$500.00.** (614-464-0810).

**SOUTH CAROLINA'S ONLY HIGH-END STORE** the finest audiophile equipment: British American Sound, P.O. Box 1247 186 King Street, Charleston, SC 29402 TF

## PASSIVE BUT POWERFUL

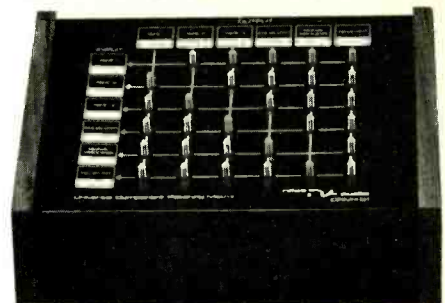

The CPM-31 Universal Component Patching Matrix combines tape decks, equalizers and signal processors in nearly limitless combinations. • It simplifies the tasks of recording, dubbing, equalization, mixing, monitoring and signal processing. • It eliminates the "patch-cord headache." • And the CPM-31 adds no hum, noise or distortion. For more information, write to:

**Niles Audio Corporation**  
P.O. Box 160818  
Miami, FL. 33116

niles  audio

Dealer Inquiries encouraged.

## AT SOUND COMPONENTS, INC. WE'VE GOT IT ALL . . . . .

Audionics . . . . Bang & Olufsen . . . . Beveridge Cylindrical . . . . Bryston  
. . . . DCM . . . Denon . . . Dynavector . . . Fidelity Research . . . Fulton . . .  
Grace . . . Great American Sound . . . Hafler . . . H.Q.D. Reference System  
. . . Janis . . . KEF . . . Kenwood Purist . . . Linn Sondek . . . Magnepan . . .  
Mark Levinson . . . Paragon . . . Pyramid Metronome . . . Quad . . . Rega  
. . . Rogers . . . Sonex . . . Spondor . . . Stax . . . Verion . . . Yamaha . . .

Master Charge & Visa accepted

We ship prepaid within U.S.

**SOUND COMPONENTS, INC.**  
2710 Ponce de Leon Blvd., Coral Gables, Fla. 33134  
(305) 446-1659

Simply The Best...

**MOVING COIL CARTRIDGE  
STEP-UP TRANSFORMER**

MODEL  
CST-80

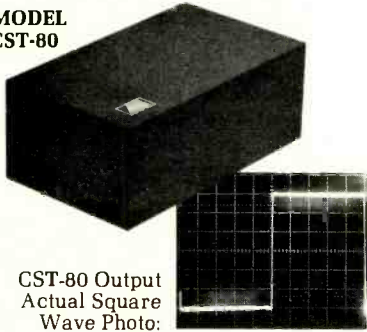

CST-80 Output  
Actual Square  
Wave Photo:  
(50 uS/div. hor., 50 mV/div. vert.)

Provides the necessary gain and impedance matching for connection of any moving coil cartridge to a typical preamplifier phono input. The unit utilizes a pair of ultra-high fidelity transformers exclusively made for us by JENSEN TRANSFORMERS. Suggested retail price, \$300.

Please write for complete specifications.  
(Dealer Inquiries Invited)

**AUDIO  
INTERFACE**  
INCORPORATED

P.O. Box 7369/Van Nuys, CA 91409  
Phone (213) 998-1082

134

**FOR SALE**

**SOUND ADVICE AND POLK AUDIO LOUDSPEAKERS** We have the incredible Polk Audio Monitor Series loudspeakers in stock. The Polk's are definitely the best performance per dollar value ever offered in a truly accurated inexpensive loudspeaker. State of the art sound is now available from less than \$200 per pair. We ship freight prepaid anywhere in the U.S. within 24 hours upon receipt of order. Write or call for information on the Polk Audio Monitor Loudspeakers.

SOUND ADVICE  
Village Plaza Ruston, LA 71270  
(318) 255-8000 9.9

**STAN WHITE**

Latest thoughts on loudspeaker enclosure Geometry OR 'Demise of the Theory of Relativity' Send \$1.00 to: Tachyon® P.O. Box 204 Bloomingdale, IL 60108.

**REDISCOVER YOUR  
RECORD COLLECTION**

WITH THE

**AUDIONICS  
TATE**

**SPACE and IMAGE  
COMPOSER**

IN STOCK AT

**AMERICAN AUDIOPHILE**

5 Sunnise Plaza Valley Stream, NY 11581  
(516) 561-7114

716 Madison Ave. New York, NY 10021  
(212) 751-9733

ALL SHIPMENTS PREPAID AND INSURED  
FREE THROUGHOUT CONTINENTAL U.S.  
MASTER CHARGE & VISA ACCEPTED

**FOR SALE**

**SOUND COMPONENTS INC.**  
EXCLUSIVE SOUTHEAST  
DEALER FOR THE  
INCOMPARABLE  
MARK LEVINSON H.Q.D.  
REFERENCE SYSTEM

The H.Q.D. reference playback system consists of the following components:

- 2 Hartley 24 in sub-woofers
- 4 Quad ESL loudspeakers
- 2 Decca ribbon tweeters (modified)
- 2 Levinson LNC-2 Crossovers (100 Hz & 7 KHz)
- 1 Levinson ML-1 (LEMO) preamp
- 6 Levinson ML 2 amplifiers
- 1pr. Hand-crafted oak or ash trestle stands (for Quads & Decca)

THE H.Q.D. SYSTEM WITH GOOD SOURCE MATERIAL, WILL REPRODUCE A MUSICAL EVENT BETTER THAN ANY SYSTEM WE KNOW OF.

For more information, please write or call:  
SOUND COMPONENTS  
2710 Ponce de Leon Boulevard  
Coral Gables, Florida, 33134  
305-446-1659

TWX 812-848-7627

ff

**STATE-OF-THE-ART RIP-OFF?** Some people charge \$300/\$500. We ask \$150 T-24 Universal MC Transformer No Better Exists. Similarly our \$85 Formula 4 MC-2C moving coil cartridge equals \$200/\$300 ones. Literature \$1 Bill. May-ware Ltd., P.O. Box 58, Edgware, Middx. HA8 9UH England.

1.0

**STEREO REPRESENTATIVES NEEDED!!!**

Sell 100 brands!! Lowest Possible Prices!! Krasco—REP DEPT. —998 Orange Ave. West Haven, Conn. 06516TFFILE

**SUMO "THE POWER" AMPLIFIER, "THE MOAT" BRIDGE.** NEW IN BOX — MAKE OFFER. ALSO USED ARC D-100 \$700. ARC D-100A \$850, Levinson ML-2 \$1425. (408) 244-6724 GARLAND AUDIO. 2.0

**SUPEX - ORTOFON - DENON - OTHER MOVING-COIL CARTRIDGE OWNERS** Send 50¢ for literature on our Micro-Preamp. Superb Performance at \$129.95. Huntington Electronics, Box 2009-A, Huntington, Conn. 06484.

**MONTANA AUDIOPHILES**

DISCOVER ROCKY MOUNTAIN HI FI

DAHLQUIST	NAKAMICHI	MAGNEPLANAR
ACOUSTAT	GAS/AMPZILLA	SONUS
BEVERIDGE	AUDIONICS	GRACE
DCM TIME WINDOW	SONY	HEGEMAN
FULTON/FMI	STAX	POLK
R. H. LABS	N.A.D.	B&W

812 Central Ave., Great Falls, Montana 59401  
Phone (406) 761-8683

**PAUL HEATH AUDIO**

Offers the following new or mint-condition used equipment at sacrifice prices:

Beveridge 2SW1 System (latest), Acoustat Monitors, Sequerra Pyramids, Harbeth Monitors, Koss Electrostatics, Rogers Export Monitors, Dahlquist Woofer & electronic crossover, Janis Subwoofer, Obelisk loudspeakers, RH Labs Subwoofer, Bose 901's.

Rappaport PRE-14 preamp, Theta preamp, Quatre GC 500 and DG 250C gain cells and preamp, GAS "Grandson", Bedini/Strelloff 200/200, M-A T.V.A.-1 tube amplifier, AEA Analogue 520 preamplifier and 620 stereo amplifier, HAPI preamplifier, STD turntable, Ariston turntable... and numerous others. Please Inquire.

PAUL HEATH AUDIO  
3047 W. Henrietta Rd.  
Rochester, N.Y. 14623  
(716) 424-4916

**You can pay \$5.00 for an advanced  
state-of-the-art 60 minute cassette.**

**Why? Larksong will sell you  
one for \$1.30 or less.\***

- \* Pure Micro-Acicular Ferric Oxide
- \* Fully Bias and Equalization Compatible
- \* Five Screw Case
- \* Outstanding Signal to Noise Ratio
- \* Lifetime Guaranteed

Treat your hungry power-packed tape machine to a Larksong cassette and get a lot more entertainment for your money. No longer does its thirst for quality cassettes need to be limited by your lean budget.

Now you afford the best — Larksong. One top line of exceptional cassettes available in two styles of boxes. ★ Dollar Special — Your first Larksong C-60 cassette with complete tape specifications and postage-free order blank for only \$1. Limit one per customer. Larksong puts it all together so you get more music out. Larksong, Dept. IC, 10 Scott St., Point Arena, CA 95468.



WHOLESALE INQUIRIES INVITED

**The Real tape breakthrough you've waited for.**

## FOR SALE

### STATE OF THE ART IN N. CALIFORNIA

is now on demonstration at The Audible Difference. Hear the superb Threshold NS-10 preamp/400A power amp through Dick Sequerra's stunning Metronome loudspeakers. Audition Peter Snell's superb Snell Acoustics Type A loudspeaker system with Threshold's new medium power CAS-1 amplifier. For the ultimate in high-power amplification, audition the Threshold 8000A mono amplifiers. Hear how good a bi-amp system can be with John Curl's new transient perfect crossover from Symmetry, the ACS-1, plus Paragon's 125 watt solid state bass amp. Experience the beautiful new Paragon 12A preamp, plus Thaedra II from G.A.S.

Hear the ultimate direct drive turntable, the Denon DP-6000, plus the audiophile reference Linn Sondek with Linn-modified Grace 707 tonearm. Examine the precisely machined bearing of the new glass platter, belt drive Planar tables from Rega Research. Hear the ultra-musical Paragon System E preamp, plus the new high performance, moderate cost Thalia/grandson combination from G.A.S. Audition a new generation of compact high performance loudspeakers from Polk and Cizek, plus BBC minimonitors from Sendor and Rogers. For the music listener who demands the best, we offer the Breuer Dynamic Tonearm, plus the EMT cartridge with Verion transformer.

For that extra measure of sonic purity so important to the critical audiophile, we recommend and stock Polk Sound Cables; Mogami wire; the anti-resonant Platter Pad, \$24.95; Audio Perfection audio interconnect low capacitance cables, \$15/p.; plus the Stylift at \$19.95 and a wide selection of audiophile quality recordings including Gale Maximum, Fidelity and Denon PCM.

We ship all products prepaid throughout the United States.

**THE AUDIBLE DIFFERENCE**  
435 Tasso, Palo Alto, CA 94301  
(415) 328-1081

TF

### TAMPA BAY AREA AUDIOPHILES

Hear the incomparable Theta preamp, Fried speakers and Win Cartridge/turntable. Also J.H., Marcof, etc. Friendly, knowledgeable service. Call for appointment.

DAJG Audio: 1-813-937-4147

1-0

## FOR SALE

Tandberg TD 20A: 10 1/2" Reel Tape Deck, 3/4 27 1/2 IPS., Lined Mixing Controls & Designed for both Oxide & Metal Tape: 8 mos. old w/8 Maxell 35-180 Tapes - \$1,250. (216) 855-4356 1-0

TAPCO and ELECTRO-VOICE, mixers, equalizers, amps, mics, and raw loudspeakers. Write for low mail order prices. Sonix Co., P.O. Box 58, Indian Head, MD 20640 8-9

THE AUDIOGRAM®, a pithy independent newsletter now in its third year, provides timely, money saving reports on the latest products and techniques. Our critical integrity and realistic sense of proportion fill the gap between the commercial magazines and the neurotic underground press. Our latest issue of number 12 contains reviews of:

- The best moving magnet cartridge
- The best headamps
- The best turntable mat
- The best tube preamp
- Ultracraft AC300 Mark II

A review of tonearms by Paul Messenger.

\$10/4 issues/1 year. AUDIOGRAM, Box 27406, St. Louis, MO 63141.

### Build Your Own Speakers!

Save 50% or More...



Acusta Craft®

- FREE KIT BROCHURE — Send me your free 8-page brochure.
- \$1.00 CATALOG/COMPREHENSIVE MANUAL — Send me all the details for your entire line of speaker kits and basic components with "How-to-do-it" article by W.J.J. Hoge.

Dept. AU9 Box 12030 • Shawnee Mission, Ka. 66212

## H&H INTERNATIONAL NEWSLETTER

### New Products from H&H

#### JR 150 LOUDSPEAKERS

The long awaited JR 150 loudspeaker is now available and is receiving an excellent response both here and abroad. It will play approximately twice as loud as the JR 149 or the LS 3/5A and is much more efficient. The workmanship and design are impeccable. The speakers will retail for \$825.00 per pair. Attractive chrome or black stands are available.

#### DUNLOP SYSTEMDEK 2 SPEED TRANSCRIPTION TURNTABLE

The SYSTEMDEK is designed with advanced acoustic and engineering innovations that make it, quite simply, one of the best platforms for disc reproduction yet devised.

The plinth incorporates six highly damped acoustic barriers, which are specially designed to eliminate the effects of vibration and acoustic interference.

The turntable is finished in an attractive black and aluminum "Pagoda" styling.

A unique bush bearing that pumps oil and eliminates metal contact, thus eliminating friction and rumble, is part of the DUNLOP design philosophy. The precision 10mm stainless steel spindle is recessed to accept an 8mm ball thrust bearing which is seated in a self lubricating PTFE cup. The 10 1/2 lb. (4.7 Kg) aluminum platter is individually balanced and is belt driven from 24 pole synchronous motor.

Another unique feature is that all adjustments can be made from above.

Mr. Peter Dunlop designed the original Ariston turntable. He has spent considerable time developing the SYSTEMDEK and feels, as do we, that it easily competes with or surpasses the older Fons, Linn, or STD designs.

Tables will be available momentarily and will sell for approximately \$650.00.

#### BAS, BEARD SOUND AMPLIFIERS

The BAS tube amplifiers and preamplifiers have quickly become the standard of reference in England and Europe. The amplifier features a dual power supply and a floating bias (no adjustments ever needed). All metal work is executed by computerized machinery and the design, parts and workmanship is of such extraordinary quality that no amplifier has ever failed.

#### PROFILE ACOUSTICS

The Profile loudspeaker is of large bookshelf configuration, and uses three very special drivers. The materials employed in the cabinet construction are unique. The workmanship is the finest we have ever seen. Needless to say, we feel that the sonic quality is most pleasing along with a superb bass response. The Profile loudspeaker will retail for over \$1000.00 a pair.

Please contact me for further information. Dealer inquiries welcome.

Best regards,

Paul Heath

**H&H INTERNATIONAL**  
3047 W. HENRIETTA RD.  
ROCHESTER, NEW YORK 14623  
(716) 424-4827

135

# WOW.

## A \$1000 Deck for \$299.



**TEAC • ELCASSET FORMAT • AL-700** Frequency Resp. 25-22,000 Hz (±3db) • Signal-to-Noise (Type III Tape, Dolby\*) 62db • WOW & Flutter (NAB Weighted) .04% • 3 Heads • 3 Motors • Full Logic • Closed Loop Drive • Automatic Dolby\* • Auto Tape Type Bias Set • Dual VU Meters with Peak LED's • Auto Rewind and Index • 2 C-60 Low Noise Sony ELCASSETS Included. *Shipping East of Mississippi Add \$10, West of Mississippi Add \$15*

Save On **SONY ELCASSET Tape**

Type 1 Low Noise LC-60	\$5.88	<b>Special 6 or More</b>
Type 1 Low Noise LC-90	\$7.88	
		\$5.50 ea.
		\$7.50 ea.
Shipping \$1.25 ea. or \$2.00 in quantities of 6		

from the audio departments of

# Citizens

## JEWELRY

**249 Peachtree Street, N.E. Atlanta, Georgia 30303 (404) 522-2150**  
Visa, Master Charge, American Express

\* Dolby is registered trademark of Dolby Laboratories, Inc.

**A SINGER'S DREAM!**



**REMOVES VOCAL FROM MOST STEREO DISCS**  
The Thompson Vocal Eliminator can actually remove most or virtually all of a solo vocalist from a standard stereo record and yet leave most of the background music untouched! Not an equalizer! We can prove it works over the phone. Write for a brochure and demo record below. COST: \$249.00

**YOU SHOULD SEE US**

For:

- Delay and Ambience
- Studio Echo/Reverb
- Tape Noise Reduction
- Parametric Equalization
- Electronic Crossovers
- Comp/Limiters
- Mic Preamp/Mixers
- Patch Bays



We manufacture a full line of high quality audio and recording equipment. You will probably have to pay twice as much elsewhere to obtain comparable quality. Only Direct Sales make our prices and quality possible. Send \$1 for a 20 page brochure and 20 minute demonstration record.  
Write to: **LT Sound**, Dept. AU, P.O. Box 729, Decatur, GA 30031, (404) 284-5155

**FOR SALE**

TECHNICS 676 Stereo Cassette Deck with remote control and 10 year warranty on HPF heads. (213) 392-3957.

**SPICA**

The new, highly affordable mini loudspeaker that sets a new standard of performance for others to follow. Audition the SC-50 loudspeaker at

**AMERICAN AUDIOPHILE**

5 Sunrise Plaza, Valley Stream, NY 11561  
(516) 561-7114

716 Madison Ave., New York, NY 10021  
(212) 751-9733

ALL SHIPMENTS PREPAID AND INSURED  
FREE THROUGHOUT CONTINENTAL U.S.  
MASTER CHARGE & VISA ACCEPTED

**FOR SALE**

**TAPE HEAD REFINISHING** - Precision method full frequency response. \$15.00 ea. One day service. E. Maher, 5 Evans Place, Orinda, CA 94563.

**TECHNICS PRO. BOTH NEW. EQUALIZER SH-9010 \$350. AMPLIFIER SE-9060 \$300. BOTH \$600.** A. Beck, 3 Gilchrist St., Thomaston, ME 04861. 12-9

**THE AUDIO JOURNAL™**, in its upcoming third issue, reviews the Threshold S1-10 preamp, the Audioetc/Rabco straight line tracking tonearm, the Dayton-Wright XG-10 electrostatic speaker system, the Magnepan MG-2A planar speakers, the Threshold 4000 amplifier, the Orotofon MC-30 cartridge, the Theta tube preamp, and several others as well. The recordings section boasts articles about contemporary composers and recordings of their music. The Audio Journal is fast becoming the leading publication for audio enthusiasts and music lovers everywhere. Subscription rates for four issues: USA — \$18 (first class), Canada — \$22 (first class), Outside North America — \$24 (Air mail). Send a check or money order today to: The Audio Journal, P.O. Box 4205, Macon, Georgia 31208. Foreign subscribers please remit in US funds only. 1-0

The Listening Room Loves

**POLK AUDIO MONITORS**

The golden ear of Marcel Wittman has established the Listening Room as one of the nation's premier audio salons. Not only do we have the finest esoteric audio equipment costing well into the five figures price range, we have the Polk Audio Monitor Series Loudspeakers beginning at just \$99.95 each, and easily worth many times their price in sound value. Come in to listen, write them for full literature, or give us a call. Shipped free anywhere in the U.S.

Listening Room  
590 Central Park Avenue  
Scarsdale, N.Y. 10583  
(914) 472-4558

9-9

**THE LISTENING ROOM INC.**

590 Central Park Avenue  
Scarsdale, N.Y. 10583  
(914) 472-4558

Cordially invites you to audition our fine line of equipment. THRESHOLD · BRYSTON · SPATIAL · PYRAMID METRONOME 2+2 · PLASMATRONIC · SPEAKER · DAYTON WRIGHT ESL · QUAD ESL · SNELL ACOUSTICS · DAHLQUIST · KEF 105 · DYNAVECTOR · DENON · YAMAHA · TANDBERG · POLK AUDIO · GRACE · NAKAMICHI · STAX · R.H. LAB · S3/5A BBC MINI MONITOR BY CHARTWELL · KEITH MONK · SEQUERRA · HAFLE · JANIS · FONTEK HEADPHONES · AUDIO PUSLE · LINN SONDEK · OASIS · GREAT AMERICAN SOUND · EMT · HADCOCK · SRATHCLYDE · PSE · OBEUSK · MARCOFF · ULTRACRAFT TONE ARM · AUDIO STANDARD · GRADO SIGNATURE III · IMPULSE · FIDELITY RESEARCH · TANGENT · DIRECT TO DISK RECORDS.

Visit our private studios. We ship free anywhere in the Continental U.S. We invite inquiries. TF

**THE MONITOR SERIES FROM POLK AUDIO**

**AUDIO BREAKTHROUGHS** now has on demonstration the remarkable new Polk loudspeakers priced from less than \$200 per pair. Compare them to the finest loudspeakers in the world. All Polk Audio Monitors utilize high definition polymer laminate bass-midrange drivers, wide dispersion soft dome tweeters and fluid coupled sub-bass radiators. They are capable of reproducing a highly defined phase accurate three dimensional sonic image which rivals the thousand dollar super speakers. They sound great with a small receiver, yet reveal the fine subtleties of state of the art electronics. Shipped free in U.S. Send for free brochures on Polk or our other fine lines. **AUDIO BREAKTHROUGHS**, 1534 Northern Blvd., Manhasset, LI, NY 11030 (516) 627-7333 TF

**THOUSANDS OF LIKE NEW LP's** and prerecorded tapes. Catalogue—\$2.00. House of Records, Hillburn, New York 10931. TF

**LEGENDS MOVE AND GROW.**

Chestnut Hill Audio has moved and grown. We now represent Audionics, Bowers & Wilkins, Bryston, Cotter, DCM, Denon, Fidelity Research, Grace, Grado, Hafler, Hegeman, Impulse, Janis, JR149, Linn Sondek, Levinson, Marcof, Precedent, Quad, Rappaport, Revox, Rogers, Sequerra, Snell Acoustics, Sony/Pro, Spondor, Symdex, Symmetry, TVA, Tandberg, Tangent, Technics/Pro, Theta, Threshold and Vandersteen. All of these legends at 311 Cherry Street, Philadelphia, Pa. 19106. (215) 923-3035.

**CHESTNUT HILL AUDIO LTD.**

**CHARTWELL** THE SPEAKERS THAT LOOK AS GOOD AS THEY SOUND

Introducing the **FIRST** full range of Monitor Speakers Featuring Polypropylene cones.

**ADVANTAGES OF THESE CONES:**

- Less Coloration
- Less Distortion
- Smoother Frequency Response
- Lower Mass - Improving Transients
- More Efficient
- Consistent Acoustic Performance

Add all these benefits together with careful design and the result is . . . Pure Music

Don't take our word for it, hear the full range yourself, from the mini to the professional studio monitor.

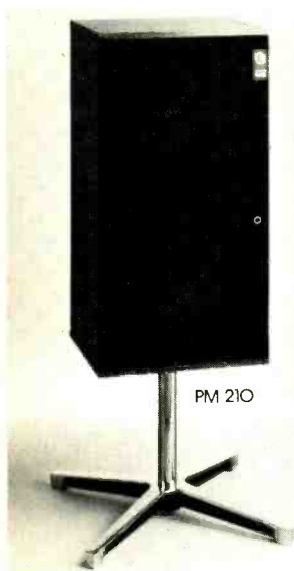

Reference Monitor Int. Inc., 2380 "C" Camino Vida Roble, Carlsbad, CA 92008



## FOR SALE

**THE MOST EXPENSIVE CARTRIDGE IN THE WORLD,** the Linn Asak Signature Moving-Coil. \$3,500 delivered to your door by Ivor Tiefenbrun, president of Linn Products. (Or, save the cost of Ivor's plane fare, buy one from your Linn dealer and sign it yourself, it will cost you about \$400.) Write for specifications and the name of your nearest dealer. **AUDIOPHILE SYSTEMS, 5750 RYMARK COURT, INDIANAPOLIS, IN 46250.**

### THE SOUNDING BOARD, INC.

75 Franklin Ave.  
Ridgewood, NJ  
(201) 445-5006

Come to listen at northern N.J.'s brand new audio salon. We carry quality products such as:

DAHLQUIST, D.B. SYSTEMS, VAN ALSTINE, I.M.F., OBELISK, SERIES 20

LINN SONDEK, CIZEK, TANDBERG, MITSUBISHI, QYSONIC, AVID, WINTEK, DUAL, CONNOISSEUR, GRADO SIGNATURE, GRADO DECCA, STAX, and more.

## Three Phase Audio

104 Lafayette Drive (318) 981-4951  
Lafayette, LA 70503(318) 981-4952

Ariston	Mitsubishi Auto
Audio Technica	Mobile Fidelity
Becker	MXR
Berning	Osawa
B&W	Plasmatronics
BGW	Precedent Audio
Dual	PS Audio
Fuji	Quatre
Fulton	Revox
Hartley	Shure
Kenwood	Sonax
Keith Monks	Sony
Marcof	Ultracraft
Meridian	

### THRESHOLD

The Class A Power Amps and Preamps are on display for your auditioning. State of the Art performance and meticulous craftsmanship. At G-B Electronics (201) 427-8885 for appointment in Northern New Jersey. 1-0

**TONERMS-CARTRIDGES-TURNABLES** at lowest prices. Most brands available, including MC. Send #10 SASE for quotes. Audio Unlimited, 401 Reynolds Circle, San Jose, CA 95112.

### TOP-RATED CARTRIDGES UP TO 70% OFF!!

We feature just about all of the finest phono cartridges on the market at the lowest possible prices. Our selection includes cartridges that are normally sold for the full retail price! Our most popular lines include Acutex, ADC, Crado, Nagatron, Ortofon, Shure, Sonus, Stanton and many others that we can't even mention by name. Just call us at 212-254-3125 for more information or write to Direct Discounts Ltd., P.O. Box 841, Cooper Station, NY 10003. We accept phone orders with your M/C or VISA.

**TOURING SOUND SYSTEMS, 2, 4 and 8 Track Studios.** Disco Sound, Cerwin Vega B&W, Altec, Shure, AKG, Tapco, Dyna, Revox, EV, Beyer, Cetec, etc. K & L Sound Service, 75 North Beacon At., Watertown, Mass. 02172. (617) 787-4072. Att: Ken Berger. TF

### TRADE UP to the MICRO CPU 100 fm tuner

It may have been out of the question at \$2000, but the new retail is \$995. Subtract even more for your trade-in and this magnificent tuner can be yours at a surprisingly low price. We offer very generous trade-in allowances on your old tuner or other audio equipment. A rare chance to own the best at a reasonable price (see Audio. Nov. '77). Write us for a quote, or better yet, phone after business hours and we can discuss your trade-in: (617) 874-0706, mon.-fri., 6-8 pm. (ask for Dick)

**AUDIO CALIBRATION, box 250, Westminster, MASS 01473.** TF

## FOR SALE

**USED AND DEMO SALE:** Mark Levinson ML 1, \$1325; Spatial TVA 1, \$750; Luxman CL-35 Mk III, \$425; Threshold NS 10, \$800; Paragon 12A, \$550; G.A.S. Thadra II, \$750; Kenwood L-07-M, \$495 pr.; Audio Research D100A, \$775; Luxman M-2000, \$600; Threshold 4000, \$1600; Ariston RD 11s, \$225. **GOLDEN GRAMOPHONE, 2858 W. Market St., Akron, Ohio 44313 (216) 864-4411.** 2-0

**HORNS-WOOFERS-MIDS-TWEETERS** at tremendous OEM savings. Altec, CTS, Electro-Voice, Pioneer, Panasonic, Peerless, Phillips, Polydax and many others. Dozens of hard to find items used in major manufacturers most expensive systems. Huge selection of crossover network components, automobile systems, and musical instrument loudspeakers. Send \$1.00 for catalog. **SRC Audio Dept. AD, 3238 Towerwood Dr., Dallas, TX 75234.**

## STEREO COMPONENT Video Tape Equipment

**AKAI • B•I•C • Harman Kardon  
Phase Linear • ALTEC • Kenwood •  
TEAC • Marantz • Sony • Technics •  
Sanyo • JVC • JBL • Pioneer • Dual •  
RCA** Photographic Equipment Too!  
**TO ORDER CALL TOLL FREE  
(800) 421-8537**



516 W. 8th St. Downtown L.A., Ca. 90014 Tel. 488-0341

**Now in Fort Lauderdale...**  
**State of the art components for the  
audio perfectionist and serious listener.**

Audio Research • Acoustat • Denon • B & W • Armstrong • Chartwell • Lux  
Tangent • Polk • GAS • Conrad Johnson • Audire • Ariston • Connoisseur  
ADC • Grace • Supex • Grado • Goldring • DB Systems • Quatre • Stax  
Theta • Plasmatronics • Transcriptors • Dynavector • Vandersteen  
*Complete selection of direct to disc recordings.*

### AUDIO INSIGHT

The Promenade at Bay Colony

6286 N. Federal Hwy., Ft. Lauderdale, FL 33308 • 305/491-7677



# Closer To The Source

**Musicality. Liquidity.  
Harmonic integrity.**  
**Design qualities we are  
committed to in getting closer  
to the source.**  
**Write for information on our  
Vacuum Tube Preamp and  
Power Amplifier.**



**conrad-johnson design, inc.**  
1474 Pathfinder Lane • McLean, Virginia 22101  
**(703) 528-8650**

# Free information service

## To AUDIO readers . . . from AUDIO advertisers

- Look over the below list of advertisers and select those from whom you want more product information.
- Write the numbers on the Reader Inquiry Card and fill in all the information. We will rush your request to each company.

Advertiser	Page	Advertiser	Page	Advertiser	Page
ADC Cartridges <b>Enter No. 1 on Reader Service Card</b>	73	Barclay Electronics Hi-Fi Components <b>Write Direct to Advertiser</b>	144	Fuji Tapes <b>Write Direct to Advertiser</b>	112
ADS 1810 Speakers <b>Write Direct to Advertiser</b> ADS 10 Acoustic Dimension Synthesizer <b>Write Direct to Advertiser</b>	22, 115	Burns Audiotechnics Hi-Fi Equipment <b>Write Direct to Advertiser</b>	89	Garland Audio Audio Store <b>Write Direct to Advertiser</b>	130
AIWA Hi-Fi Equipment <b>Enter No. 2 on Reader Service Card</b>	15	Carston Studios Stereo Receiver <b>Write Direct to Advertiser</b>	131	Golden Gramophone Audio Store <b>Write Direct to Advertiser</b>	129
Acoustical Manufacturing Quad Hi-Fi Equipment <b>Enter No. 5 on Reader Service Card</b>	122	Celestion Ditton 332 Speakers <b>Enter No. 8 on Reader Service Card</b>	26	Goldline Analyzer/Noise Generator <b>Write Direct to Advertiser</b>	131
Acusta Craft Speaker Kits <b>Write Direct to Advertiser</b>	135	Chestnut Hill Audio Audio Store <b>Write Direct to Advertiser</b>	136	Christopher Hansen, Ltd. Hi-Fi Components <b>Write Direct to Advertiser</b>	142
Allison Acoustics Allison Five Speakers <b>Enter No. 3 on Reader Service Card</b>	111	Citizens Jewelry Elecaset Tape <b>Write Direct to Advertiser</b>	135	Havens & Hardesty Audio Components <b>Write Direct to Advertiser</b>	144
American Audiophile Stereo Store <b>Write Direct to Advertiser</b>	142	Conrad-Johnson Hi-Fi Equipment <b>Write Direct to Advertiser</b>	137	Henry's Camera Shop Hi-Fi Components <b>Write Direct to Advertiser</b>	137
Audiocom Audio Store <b>Write Direct to Advertiser</b>	142	Crystal Clear Direct to Disc Recordings <b>Enter No. 9 on Reader Service Card</b>	81	Hawthorne Stereo Audio Store <b>Write Direct to Advertiser</b>	131
Audio Concepts Hi-Fi Components <b>Write Direct to Advertiser</b>	129, 130	Custom Craft Dimension Miniature Speakers <b>Enter No. 10 on Reader Service Card</b>	114	International Hi-Fi Hi-Fi Equipment <b>Enter No. 17 on Reader Service Card</b>	113
Audio Critic Publication <b>Write Direct to Advertiser</b>	121	dbx Hi-Fi Equipment <b>Enter No. 11 on Reader Service Card</b>	34	Intrelex Corporation Magantenna <b>Write Direct to Advertiser</b>	127
Audio Excellence Hi-Fi Components <b>Write Direct to Advertiser</b>	145	DeCoursey Engineering Electronic Crossovers <b>Write Direct to Advertiser</b>	130	Itone Audio Speakers <b>Write Direct to Advertiser</b>	143
Audio Horizons Publication <b>Write Direct to Advertiser</b>	124	Discwasher D'Stat II Turntable Mat <b>Write Direct to Advertiser</b>	2	JVC Cassette Decks <b>Enter No. 18 on Reader Service Card</b>	12, 13
Audio Insight Audio Equipment <b>Write Direct to Advertiser</b>	137	Dynaco Hi-Fi Equipment <b>Enter No. 59 on Reader Service Card</b>	4	JS&A Bone Fone <b>Enter No. 19 on Reader Service Card</b>	105
Audio Source High Definition Speaker Cable <b>Enter No. 4 on Reader Service Card</b>	113	Eastman Martin Speakers <b>Enter No. 12 on Reader Service Card</b>	14	Jensen Car Stereo Equipment <b>Enter No. 58 on Reader Service Card</b>	27
Audio Technica Moving Coil Cartridge <b>Write Direct to Advertiser</b>	45	Electro Voice Series II Speakers <b>Enter No. 13 on Reader Service Card</b>	101	KEF Reference Series Model 101 Speakers <b>Enter No. 20 on Reader Service Card</b>	37
BIC 80 Z Changer Turntable <b>Enter No. 7 on Reader Service Card</b>	93	Empire Audio Groome Record Care Products <b>Enter No. 14 on Reader Service Card</b> Discofilm Record Cleaner <b>Enter No. 15 on Reader Service Card</b> Watts Parastat <b>Enter No. 16 on Reader Service Card</b>	48, 105, 109	KLH Hi-Fi Equipment <b>Enter No. 21 on Reader Service Card</b>	87
BSR Hi-Fi Equipment <b>Enter No. 6 on Reader Service Card</b>	49	F&R Imports Switching Units <b>Write Direct to Advertiser</b>	128	Kenwood KX-1060 Cassette Deck <b>Write Direct to Advertiser</b>	5
B&W 801 Loudspeakers <b>Write Direct to Advertiser</b>	25	Fisher Cassette Deck <b>Write Direct to Advertiser</b>	16, 17	Larksong Stereo Components <b>Write Direct to Advertiser</b>	134
				L.T. Sound Hi-Fi Components <b>Write Direct to Advertiser</b>	136

# Free information service

## To AUDIO readers . . . from AUDIO advertisers

- Look over the below list of advertisers and select those from whom you want more product information.
- Write the numbers on the Reader Inquiry Card and fill in all the information. We will rush your request to each company.

Advertiser	Page	Advertiser	Page	Advertiser	Page
Lux SS Tuner Series <b>Write Direct to Advertiser</b>	61	Pickering Hi-Fi Equipment <b>Enter No. 38 on Reader Service Card</b> Hi-Fi Equipment <b>Enter No. 40 on Reader Service Card</b>	3, 85	Softwear & Such Hi-Fi Equipment <b>Enter No. 48 on Reader Service Card</b>	114
MXR Dynamic Expander <b>Enter No. 22 on Reader Service Card</b>	77	Pioneer PL-630 Turntable <b>Enter No. 39 on Reader Service Card</b>	Cover II, 1	Sonikit Speaker Kits <b>Write Direct to Advertiser</b>	134
M&K Direct-to-Disc Records <b>Enter No. 22 on Reader Service Card</b>	56, 57	Qysonic Import Company Disclamp <b>Write Direct to Advertiser</b>	132	Sound Components Hi-Fi Components <b>Write Direct to Advertiser</b>	133
Maxell Tapes <b>Enter No. 25 on Reader Service Card</b> Record Offer <b>Enter No. 26 on Reader Service Card</b>	7, 24	Radio Shack Realistic Receivers <b>Write Direct to Advertiser</b>	65	Sounder Electronics Hi-Fi Equipment <b>Write Direct to Advertiser</b>	124
McIntosh C 32 Preamplifier <b>Enter No. 29 on Reader Service Card</b>	117	Rank Wharfedale E Speakers <b>Enter No. 41 on Reader Service Card</b>	98	Speakerlab Speaker Kits <b>Write Direct to Advertiser</b>	128
Memorex Tapes <b>Enter No. 27 on Reader Service Card</b>	11	R. G. Dynamics Dynamic Processor <b>Write Direct to Advertiser</b>	126, 127	The Speaker Works Speaker Kits <b>Write Direct to Advertiser</b>	125
Mobile Fidelity Hi-Fi Equipment <b>Enter No. 28 on Reader Service Card</b>	75	Reference Monitor International Speakers <b>Write Direct to Advertiser</b>	136	Spectro Acoustics Receivers <b>Enter No. 49 on Reader Service Card</b>	97
Nakamichi 480 Series Cassette Decks <b>Enter No. 30 on Reader Service Card</b>	58	SAE Hi-Fi Equipment <b>Enter No. 42 on Reader Service Card</b>	55	Stereo Corporation of America Audio Equipment <b>Write Direct to Advertiser</b>	144
Nautilus Recording Hi-Fi Products <b>Enter No. 33 on Reader Service Card</b>	18	SME Series III Pick-Up Arm <b>Enter No. 43 on Reader Service Card</b>	118	Studer ReVox Matched Components <b>Write Direct to Advertiser</b>	67
Nikko NR-1219 Receiver <b>Enter No. 31 on Reader Service Card</b>	63	Sansui Turntable <b>Enter No. 44 on Reader Service Card</b>	Cover III	Superex Multi-Deck-Tape-Switcher <b>Enter No. 50 on Reader Service Card</b>	114
Niles Audio Corporation Audio Equipment <b>Write Direct to Advertiser</b>	133	Sanyo Car Stereo <b>Enter No. 45 on Reader Service Card</b>	91	TDK Tapes <b>Enter No. 57 on Reader Service Card</b>	23
Onkyo Hi-Fi Equipment <b>Enter No. 32 on Reader Service Card</b>	95	Saxitone Tapes & Tape Recordings <b>Write Direct to Advertiser</b>	144	TEAC Hi-Fi Equipment <b>Write Direct to Advertiser</b>	68, 69
Ortofon Concorde Cartridge <b>Enter No. 34 on Reader Service Card</b>	31	Scott Hi-Fi Equipment <b>Enter No. 46 on Reader Service Card</b>	26	Take 5 Audio Audio Store <b>Write Direct to Advertiser</b>	128
Ovation Audio Audio Components <b>Write Direct to Advertiser</b>	132	Sennheiser Headphones <b>Write Direct to Advertiser</b>	108	Tandberg Hi-Fi Equipment <b>Enter No. 53 on Reader Service Card</b>	47
Paia Hi-Fi Equipment <b>Enter No. 35 on Reader Service Card</b>	121	The Sensible Sound Publication <b>Write Direct to Advertiser</b>	145	Tape World Blank Tapes, etc. <b>Write Direct to Advertiser</b>	144
Phase Linear Phase 8000 Turntable <b>Enter No. 36 on Reader Service Card</b>	19	Shure Stylus <b>Enter No. 51 on Reader Service Card</b> Hi-Fi Equipment <b>Enter No. 52 on Reader Service Card</b>	42, 43	Technics Hi-Fi Equipment <b>Enter No. 54 on Reader Service Card</b> Hi-Fi Equipment <b>Enter No. 55 on Reader Service Card</b> Hi-Fi Equipment <b>Enter No. 56 on Reader Service Card</b>	33, 35, Cover IV
Polyline Corporation Hi-Fi Equipment <b>Write Direct to Advertiser</b>	124	Yamaha Hi-Fi Equipment <b>Write Direct to Advertiser</b>	21		

# christopher hansen td

Mark Levinson/Sales & Service  
in the West

On Display: The entire Mark Levinson line, including the HQD Reference System; Koetsu, Fidelity Research, Rega, Linn Products, Rogers LS3/5A, Pyramid Metronome

Showroom Open: Saturday 11 to 5  
By Appointment: Tues. - Fri. 10 to 5

9014 Burton Way  
Beverly Hills, CA 90211  
213-858-8112

We ship prepaid within the U.S.

## FOR SALE

**UP TO 50% OFF ON NEW, USED AND DEMO**  
AUDIO RESEARCH-DYNAVECTOR-DENON-EMT-JR  
ARC includes current models plus D150, SP3A, etc.  
JR149 Satellite and Subwoofer systems including  
stands and low pass amplifiers  
Denon DP2500, DP2800, DP6700 and others  
Dynavector arms and cartridges  
The Sound Environment 5421 South 84th Street  
Lincoln, NE 68516 (402) 423-8733 Ask for John

**U.S. AUDIOPHILES REJOICE!** The KOETSU moving coil cartridge is now available. For more information write: Sumiko, Inc., P.O. Box 5046 Berkeley, CA 94705. 12-9

**VACUUM TUBES**, tube-peculiar parts. All kits/parts for circuitries described in our 230+ page Modification Manual. Write for list to AUDIO DIMENSIONS, 8888 Clairemont Mesa Blvd., San Diego, CA 92123. (714) 278-3310. 9-0

**Wisconsin Has:** Audionics, Denon, Luxman, Hafler, Polk, Mayware, STAX, Micro-Acoustics, Connoisseur, Nagatronics, Aiwa, Hitachi, Kenwood, Lit. and prices on request: The Sound Seller, 1706 Main St., Marinette, WI 54143 715-735-9002.

## FOR SALE

**WORLD AUDIO WESTCHESTER, INC.**  
Westchester's finest audio sales and service dealer is proud to announce the addition of:

Fried Loudspeakers to the already fine lines of AR, AKG, ADC, Pro-Accutrac, Quanta, CM Labs, Celestion, Decca, Dir.-to-Disc, Discwasher, J.V.C., J.V.C. Pro., Kos, Lux, L.S.S., Maxell, Panasonite, Pickering, Qysonic Array, Rotel, Scott, Sennheiser, Soundcraftsman, Sound Source, Stanton, Supex, Thoren, Tandberg, TDK. Shipping is free in continental U.S.

WORLD AUDIO WESTCHESTER, INC.

211 North Avenue  
New Rochelle, NY 10801  
914-576-3230

2-0

**YAMAHA CA 400 AMP \$175, ONKYO T4055 TUNER \$145, (2) SONAB 0011 SPKRS. \$125 EA. OR "THE WORKS" FR 499! ALL MINT W/BOXES. BOOKS 817 292-9096.**

**YAMAHA - C2, B1 150 watts Classa. Ws 690 II Speakers. NAK. 700 II, Transcripator w/tonerarm. 8 months old. \$2400 or sell sep. (501) 895-2851. 12-9**

## RECORDS

**AUDIOPHILES!** Direct-Disc, Digital, Mobil Fidelity-All labels-Low Prices Fast Service. Write for free catalog. Direct Disc Discounters, 2245 New Hope Church Rd., Raleigh, NC 27604. 9-9

**DIRECT TO DISC AND DIGITAL RECORDINGS:** All labels at low prices. Telearc, Discwasher, Audio-Technica, Sheffield, Denon PCM, Crystal Clear, Mobile Fidelity Labs. . . WE HAVE THEM ALL!! (and more!!) Send for FREE price list and Newsletter or \$2.00 for descriptive cataloge DISConnection. P.O. Box 10705 Tampa FL 33679.

**FREE SOUNDTRACKS & CASTS CATALOG!** Personalities! ST/OC Valuebook: \$4. RTSA 711 W. 17th G-1 Costa Mesa, CA 92627. TF

142



## Audiocom High Technology Audio

ADS, Allison, Apt, Audio Pulse, Audionics, B&W, Bruer, Burwen, Cotter, Dahlquist, DCM, Denon, Draco, EMT, EV, Eumig, FR, GAS, Grace, Grado, Janis, JR, KEF, Mitsubishi, MK, NAD, Nakamichi, Ortofon, RH Labs, Revox, Rogers, Snell, Spectro, Stax, Symmetry, Tandberg, VA Systems

Major credit cards honored. Phone orders shipped promptly.

177 Sound Beach Avenue, Old Greenwich, CT Phone: (203) 637-3621

# American Audiophile

recreates the performance  
in your home through the  
finest audio components  
available.

MOVE ONE STEP CLOSER  
TO THE CONCERT HALL

5 Sunrise Plaza  
Valley Stream, NY 11580

516/561-7114

716 Madison Ave.  
New York, NY 10021

212/751-9733

- *FINEST STATE OF THE ART AUDIO COMPONENTS*
- *PRIVATE DEMONSTRATIONS*
- *INTIMATE ATMOSPHERE*
- *CONSTANT PROOF THAT THERE IS NO REASON TO MORTGAGE YOUR HOME TO GET FINE SONIC PERFORMANCE*

### WE FEATURE:

AUDIONICS  
AUDIO INNOVATIONS  
AUDIO STANDARDS  
AUDIO TECHNOLOGY  
AUDIRE  
AXIOM  
CIZEK  
DCM  
DECCA  
DENON  
HADCOCK  
HAFLER  
H.A.P.I.  
IMPULSE  
IVIE  
JANIS  
LUSTRE

MARCOF  
NAD  
NEXUS  
PRECISION FIDELITY  
PREMIER  
RAPPAPORT  
SERIES 20  
SHURE  
SIGNET  
SME  
SPICA  
STAX  
STD  
SUPEX  
VANDERSTEEN  
VPI  
WIN LABORATORIES

REFERENCE AUDIOPHILE RECORDINGS



ALL SHIPMENTS PREPAID AND INSURED  
FREE THROUGHOUT CONTINENTAL U.S.

MASTER CHARGE & VISA ACCEPTED



## RECORDS

**FREE CATALOG OF LP's** \$2.50 to \$4.00 factory sealed. Modern Design, 1731 NE 51st St., Pompano, FL 33064. 12-9

**HOTTEST PICKIN' ON RECORD** Roy Smeck, Eddie Lang, Harry Reser and many more. Send for a free catalog to: Zoo Records, 245 Waverly Place, New York, NY 10014. 12-9

**Jonas Believes in Records.** A frequent complaint we used to hear went something like, "I've spent all this money, and have all this great equipment — now, if I could only find a good record to play. . .!"

Since we started to actively seek out the finest recordings, we haven't had this gripe. Jonas Miller now offers the best in direct-to-disc, digital, and analog records. One hundred fifty of the newest selections are available under one roof.

We recommend records by Audio Labs, Century, Crystal Clear, Mobile Fidelity, Proprius, RealTime, Sheffield, and Telarc.

If it's not busy we'd be glad to demonstrate a record for you — on a really great playback system.

And while you're at Jonas Miller's, be sure to check out our direct-to-disc/digital recording facility. Jonas Miller Sound, 8719 Wilshire Bl. Beverly Hills, CA 90211 Hours: 10-6 Mon-Thurs & Sat. 10-9 Fri: Phone (213) 659-1707.

**MILWAUKEE! The Audio Emporium:** we have over 100 direct discs and other high quality LPs, most labels and constantly new releases. We also have the Keith Monks record cleaning machine. 6900 W. Brown Deer Rd. Open Tues. thru Sat. 10-6, (414) 354-5082. TF

**RARE OUT-OF-PRINT LP's.** Factory Sealed — 99c to \$3.99 ea. Over 25,000 in stock. List — \$1.00 Record Warehouse, Box 4617, Dept. AO, Rochester, New York 14613.

**RECORD HOUND,** Box 88A, Eagleville, PA 19408. Fills want list? Doggone right!!! 33 1/3 specialist. Fast, friendly service. 10-0

**"RECORD JACKETS.** Replace old, torn, LP jackets with clean, glossy, pure white or black jackets. Plastic lined inner sleeves, 78 sleeves, opera boxes. Free catalog. CABCO A6, Box 8212, Columbus, Ohio 43201." TF

**RECORDSAVERS, POLY-LINED INNER SLEEVES** TEN CENTS EACH, POSTPAID, MINIMUM 100. DEO, INC., BOX 452D, GLENVIEW, IL 60025. 6-0

### RECORDS, RECORDS, RECORDS

Old, New & Direct Disc too! Send \$1. for Complete Info. S.E.O.J., 519 Wheat, Johnstown, PA 15902. 4-9

**SOUSA RECORDS.** Free catalog upon request. Stanford, Box 36163, Grosse Pointe, Mich. 48236. 1-0

## SPEAKERS

**VENEER SPEAKER CABINETS** Hardwood Walnut Speaker Cabinets with grill. Routed or unrouted, front baffles, or complete **SPEAKER KITS.** Send self-addressed stamped envelope for complete brochure. **KUSTOMIZED SPEAKER SYSTEMS, 260-A GLENN CIRCLE, POWELL, TN 37849.**

**NEW ENGLAND AUDIOPHILES** Goodwin's Inc. is unique in the audio field, offering a few select products which are acknowledged to be the finest. These products are properly set-up, and may be auditioned in a comfortable, relaxed, living room environment.

Our reference is the Mark Levinson HQD system, with 30ips master tapes played on a Mark Levinson Studer A-80. The degree to which this system approaches the sound of live music is literally breathtaking.

Goodwin's represents: Mark Levinson, Quad, Linn Souddek, Syrinx, Verion, Draco, Symdex, Precedent Audio, Fidelity Research, Pedersen Acoustics, and Win Labs.

If you would like to avoid the planned obsolescence of most stereo components, and are interested in the finest music reproduction, please call Goodwin's for an appointment.

Goodwin's Inc.  
(617) 266-0608

33 Newbury St.  
Boston, MA 02116

## WANTED TO BUY OR TRADE

**CROWN TAPE DECK WANTED.** "Broadcaster" series model BX 822 or BX 824. Condition unimportant. Phone collect A.M.'s Jeff (213) 550-3217. 11-9

**FISHER 125-A, ALSO LITERATURE & SCHEME FOR ABOVE.** RANDY CAIL, 2902 SANTA MONICA, DECATUR, GA 30032. 12-9

**JBL HARTS-FIELD** 1 or Pr. 313-229-7378. 2-9

**Manufacturer Seeking Inventions.** Advantek, 1100 17th NW, Washington, DC 20036. 10-0

**McINTOSH C22 & 275 and Marantz 7c & model 9's.** Exc. to mint. 713-729-1658, Texas. 1-0

**McINTOSH MC-275, MC-3500, C-22; MARANTZ 7C, 9 and 2. WESTERN ELECTRIC AMPS and SPEAKERS:** mint pairs of JBL HARTSFIELD, ELECTRO VOICE PATRICIANS and TANNINOY AUTOGRAPH PROFESSIONALS. Also QUAD ESL's old, unworking-cheap only. CALL COLLECT 617-969-2727.

**McINTOSH OR MARANTZ any kind of tube amps:** Pay top dollar (213) 278-3430. 8633 Airdrome St., LA, Calif. 90035.

**McIntosh 3500 and Marantz 240 or 250 US** urgently needed. Pay the best price. (514) 482-9372 call collect. 3-0

**OPEN REEL** pre-recorded tapes. Rock, folk, jazz, classical stereo, quad (8-track quad also). A few of each for sale too. SASE. Ray, 1293 French Ave., Lakewood, Ohio 44107. 11-9

## WANTED TO BUY OR TRADE

**WANTED:** Recording gear of all ages and variety. Microphones, outboard gear, etc. Dan Alexander, 6026 Bernhard, Richmond, CA 94805, (415) 232-7933.

**WANTED: FISHER SA-1000** (Vacuum Tube) Power Amplifier. State Condition and Price. (516) 546-2345, Scott M. Kunen, 402 Pennsylvania Ave., Freeport, New York 11520.

**WANTED - Instruction booklet** for Kenwood 5066 Tape Recorder. (or Copy) Henry S. Taylor - 10170 Huguenot Rd., Richmond, VA 23235. 1-0

**WANTED: MARANTZ & McINTOSH TUBE EQUIPMENT.** Sam Aberst, P.O. Box 480436, L.A., Calif. 90048 (213) 276-6727. 9-9

**WANTED TO BUY, OR WILL PAY TO HAVE RE-PHOTOGRAPHED:** AIWA DEALERS AD POSTER OF NUDE GIRL, SITTING, WEARING EARPHONES (FROM APPROX. TWO YEARS AGO). D. MEVIS, 8302 BASHAN LK., S.D., CA 92119. 12-9

## PLANS & KITS

**TAPE-SLIDE SYNCHRONIZER,** multiprojector lap-dissolve plans, \$5.50. With mixer, compressor, preamp schematics, \$8.50. The Millers, 1896 Maywood, S. Euclid, OH 44121. TF

**UNCONVENTIONAL REPLACEMENT KIT** for single-play turntable mat. Greatly reduces dust contact. \$3.50 postpaid. AUDIO PLEASURE, P.O. Box 498, Croton-on-Hudson, NY 10520. 2-0

## LOWER LOUDSPEAKER DISTORTION, SMALLER



The VMPS MiniTower II, shown without grill, \$389ea (kit \$249ea)

The VMPS MiniTower II offers many of the features and most of the performance of the larger floor-standing VMPS systems in a compact (35" x 15" x 15"), lower cost format.

THD with 1W input remains below 1.5% from 28Hz-20kHz, about one-third less distortion than competitors of other manufacture regardless of size or cost.

Efficiency (100dB/1W/1m), power handling (200W rms), maximum undistorted output (122dB/1m) and dynamic range are excellent.

Included in its complement of five drivers are a bottom-firing, slot-loaded 12" subwoofer and front-firing 12" lowbass driver which provide clean, high levels of bass to 28Hz (-3dB). Accuracy and linearity are the equal of the finest audiophile monitors—without their restrictions on bass response and output level, and with even lower distortion. Output is minimum phase over the entire musical range.

The MiniTower II costs \$389ea fully assembled (optional with dealer), or \$249ea in easy-to-assemble kit form. Kit includes assembled and veneered cabinet.

Audiophiles on a budget should find the MiniTower II to be the loudspeaker they've been waiting for.

There are nine VMPS Minimum Phase Response loudspeaker systems priced from \$72ea (model 101b) to \$1499ea (the fabulous 7ft-tall Super Tower II in finishes). Kit prices plus shipping.

Dealer and rep inquiries invited.

VMPS AUDIO PRODUCTS, div. Itone Audio  
7301 Rockway, El Cerrito, California 94530 • (415) 526-7084

## BUSINESS OPPORTUNITIES

**CABLE FM BROADCAST STATION.** Unique no investment/experience business makes money! Others work for you! Free Details "CAF.M," Box 130-N4, Paradise, CA 95969

**CAMPUS REPS** - High Performance Loudspeakers, Box 18009, Seattle, WN 98118 TF

**Order Toll Free!**  
Except N.Y. Alas. Hawaii

**SCA 800-221-0974**

**FOR ORDERS ONLY!**  
Mon & Thurs 9AM-7PM Tues, Wed, Fri, Sat 9AM-5PM EST

# STEREO HOT-LINE

**AKAI Technics**



**CHECK US OUT!**

- ✓ Our prices are the lowest.
- ✓ Discounts on over 60 major brands.
- ✓ Reliability: one of the oldest audio mail-order houses in the U.S.A.
- ✓ Rated #1: by a leading trade publication.
- ✓ Large inventory: we buy in volume getting the best deals from the manufacturers you get the best deal from us.

**GIVE US THE OPPORTUNITY TO BEAT THE BEST DEAL YOU'VE BEEN ABLE TO FIND.**

**— QUOTES AND INFORMATION —**  
(212) 253-8888. 9AM-5PM, MON., SAT., N.Y. TIME

Write or Call us now for the lowest price quotes and a Free price flyer.

## STEREO CORPORATION OF AMERICA

AU-1629 Flatbush Ave.  
Brooklyn, New York 11210

## BUSINESS OPPORTUNITIES

**Want money? Hate hard work? Lazy way to big money.** Cleaver plan \$2.00 (Refundable) Noble, Box 10033, Houston, TX. 77206.

**\$500/THOUSAND** Stuffing envelopes. Send stamped addressed envelope. Messerer Enterprise, Rt. 2A, Hawkeye, Iowa 52147. 1-0

## HELP WANTED

**AUSTRALIA—NEW ZEALAND WANT YOU!!** 50,000 Jobs! Big Pay! Reports \$2.00. AUSTCO, Box 2069-K, La Puente, CA 91746 1-0

**RADIO-TV Jobs...** Stations hiring nationwide! Free details: "Job Leads," 1680-PH Vine Hollywood, CA 90028

## TAPE RECORDINGS

**CHRISTMAS CAROLS CASSETTE** ... 60 minutes ... \$2.95 plus 50c postage ... EKR Classics, GPO Box 1977A0, New York City, 10001. 10-0

### BLANK TAPE SALE

TDK SA-C90	3 05	AMPEX GRANDMASTER II-90	2 69
TDK AD-C90	2 45	AMPEX GRANDMASTER II-90	3 09
TDK D-C90	1 59	Scotch 212 78-1800	3 99
TDK SA-C90	2 15	Soundguard, Record Pres. Kit	4 59
BASF PRO I C-90	2 79	TDK L-1800	5 13
BASF PRO II or III C-90	2 89	TDK LB-1800	6 31
BASF Studio I or II C-90	2 59	AMPEX Grandmaster 1800 H Reel	5 95
SCOTCH Master II or III C-90	3 15	SCOTCH 207-78-1800	5 09
SCOTCH Master IC-90	2 69	BASF Studio 1800 H Reel	6 49

All tapes can be assorted. No minimum order. Shipping 3.00 per order. Or write for free catalog of over 250 products, including lowest prices on all Maxell products. All tapes 100% guaranteed. Free gift with every order. 412-283-8621. M-Th 9-5

TAPE WORLD, 220 Spring St. Butler, PA 16001

**SAVE up to 80% BY MAIL on:** SCOTCH, TDK, BASF, MAXELL, MEMOREX, CAPITOL MUSIC TAPE, CERTRON (over 180 different reel & cassette tapes to choose from); top brand recorders; America's largest collection of taping accessories; too. Same day service. **FREE catalog.**

America's Recording Tape Specialists

## SAXITONE TAPE SALES

1776 a Columbia Rd., Washington, D.C. 20009  
(202) 462-0800

## TAPE RECORDINGS

**ON OPEN REEL** from master tapes. Argo, Telefunken, Vanguard, Unicorn, MHS. Catalogue \$1.00. Barclay-Crocker, Room 1470-A, 11 Broadway, NYC. 10004. TF

**OPEN REEL TAPES.** 7½ips. Dolbyized releases from RCA, London, DG, Warner and others. Airline tapes. quad. Catalog and updates, \$1. THE REEL SOCIETY, P.O. Box 55099-A, Valencia, CA 91355. 9-9

## MUSICAL INSTRUMENTS

**ELECTRONIC MUSIC** and home recording in Polyphony magazine. Advanced applications, interviews, projects, computer music. Sample, \$1.50. Subscription (6 issues), \$8 US/\$10 foreign. POLYPHONY, Box AM20305, Okla. City, OK 73156. 5-0

**GIBSON LES PAUL, OVATION, GUILD, MARTIN GUITARS:** 41% OFF, LOWEST PRICES. FREE CATALOG. MANDOLIN BROS., 629 FOREST, S.I., NY 10310. (212) 981-3226. 1-0

## RADIO PROGRAMS

**CATALOGS.** Broadcasts, soundtracks, Personalities of Thirties, Forties. Box 225, New York, N.Y. 10028. TF

**GOLDEN AGE RADIO.** Your best source for radio tapes, reels or cassettes. Box 25215-D, Portland, Oregon 97225. 9-0

**RENT RADIO SHOWS:** Make your own copies or just listen. Great way to build your collection reasonably. Catalog \$1 refundable. OTR Rental, Box 1146, Livermore, Ca. 94550 TF

**YESTERDAYS RADIO ON TAPE.** Reels-Cassettes. Quality Sound. Reliable Service. Giant catalog \$1.00 refundable with first order. ADVENTURES, Box 4822-A, Inglewood, California 90302. TF

**1930-1962 RADIO PROGRAMS.** Beats television!! Tapes. \$1.00 hour! Established esteemed dealer, informative 200 page catalog \$1.25. Cassette samples \$2.00. AM Treasures, Box 192AU, Babylon, N.Y. 11702 TF

## INSTRUCTION & EDUCATION

**CERTIFIED AUDIO CONSULTANTS** home study Hi Fi course available. Send \$5.00 for information. Includes AUDIO TECHNICAL YEARBOOK with 29 sample lessons and applications for membership in Society of Audio Consultants. Write SAC, P.O. Box 552 Department A, Beverly Hills, Calif. 90213.

**FREE EDUCATIONAL ELECTRONICS CATALOG.** Edukits Workshop, Department 508K, Hewlett, New York 11557.

**"PASS FCC EXAM"** over 1200 questions, answers, discussions, illustrations. 3rd, 2nd, 1st, phone, radar, broadcast, endorsements. \$14.95. SPECIFIC SKILLS INTERNATIONAL Inc., P.O. Box 1233, Cocoa, Florida 32922. Mastercharge/VISA. 2-0

## TAPE AND TAPE RECORDERS

**ACTION SALE! TDK AUDIO TAPE (Lots of 10 only)**  
Dc-60 \$1.19 each, DC-90 \$1.49 each, SAC-60 \$2.10 each, SAC-90 \$2.90 each. TDK VIDEO TAPE (No minimum order) T120 4HR. VHS \$16.95, L500 2HR. BETA \$13.95. Add \$3.00 shipping per order. N.Y.S. residents add 8% sales tax. Empire Action Audio/Visual, P.O. Box 248, Dept. A, Howard Beach, New York, 11414. 1-0

**NAME-BRAND RECORDING TAPE,** custom loaded. Available in cassettes, reels, cartridges. Huge savings from manufacturer. Also low everyday prices on Maxell, TDK, Ampex, Scotch, BASF, etc. New catalogue now available. MJS, 2514 Seaboard Ave., San Jose, CA 95131. (408) 262-8793.

**SCOTCH RECORDING TAPE,** lowest prices TAPE CENTER Box 4305B Washington, D.C. 20012. USA, APO, FPO 5-9

**TDK, MAXELL, MEMOREX, BASF,** cassettes, reels 8-tracks. Lowest prices. New, Guaranteed. FREE CATALOG. S & S Audio, P.O. Box 94485, Schaumburg, IL 60194 TF

**SUPERIOR AUDIO COMPONENTS:** Audio Pulse; Audio Research SP-6 tube preamp and D-110 amp; Badap 1; Celestion; Cizek; Crown Distinction Series DL-2, SA-2, and EQ-2; Dayton Wright; dbx; Decca; Denon; Dynavector; EMT; Formula 4; Grace; Haffler kits; KEF; Kenwood Purist; Lux LRS; Magneplanar; Mitsubishi; Mobile Fidelity records; Nakamichi; Plasmatronics; Polk; RTR; Verion; Watson speakers.



233 East Lancaster Avenue, Wynnewood, Pa. 19096.  
(215) 667-3048 or 649-2965.

In today's ever changing field of audio there exists a storm of hype and confusion. By adhering to certain guidelines we have clearly found our calm in the eye of the storm. Honesty, integrity, and expertise have helped us to create a unique audio environment that is indeed professional in the true sense of the word. The lines we represent speak for themselves

Audio Research	B & W	Pyramid	Nakamichi
Vandersteen	KEF	Promethean	Luxman
Linn Sondek	Dayton Wright	GAS	Bang & Olufsen
Theta	Denon	Dynavector	RH Labs
Dahlquist	Grace	EMT	Yamaha
Audire	Grade Signatures	Marcol	Advent

**HALENG & HALENG**  
AUDIO SYSTEMS

We ship prepaid throughout the U.S. (714) 897-0166  
15102 Bolsa Chica Suite A Huntington Beach, CA 92649  
Store Hours - Mon. thru Fri. 1:00-9:00 Sat. 10:30-5:00 Sun. 12:30-5:00

## SERVICES

**CUSTOM RECORDING SERVICE.** Tapes, discs, and cassettes. Stereo and mono. Live and copies. Editing. Masters and pressings. High quality at reasonable rates. Joseph Giovanelli, Audio-Tech Laboratories, 2819 Newkirk Ave., Brooklyn, N.Y. IN9-7134 TF

**JBL AND GAUSS SPEAKER WARRANTY CENTER.** Full lines stocked. Instant Recone Service, compression driver DIAPHRAGMS FOR IMMEDIATE SHIPMENT. Newcome Sound, 4684 Indianola Avenue, Columbus, Ohio 43214, (614) 268-5605.

**JBL SPEAKER WARRANTY STATION- RCI,** 8550 2nd Avenue, Silver Spring, Md. 20910. Mail orders Welcome.

**NASHVILLE RECORD PRODUCTIONS WILL PRESS HIGH QUALITY PURE VINYL RECORDS FROM YOUR TAPES. SEND FOR SAMPLE RECORD AND PRICE LIST. ALSO FINEST DISC MASTERING.** 469 CHESTNUT ST., NASHVILLE TENNESSEE 37203 TF

**!!!QUAD LIVES!!!** For all the latest happenings on the surround-sound scene, tune into 4 QUAD/EVOLUTION. THE newsletter for the disc-criminating Quadraphile! Discounts on hard and software!!! 4 QUAD/EVOLUTION, 23757 Canzonet St., Woodland Hills, CA 91367. 2-0

## JEWELRY

**GEM STONES, INVESTMENT.** Direct from importer, save. Send \$50 check, specify Aquamarine, Sapphire. Approximately two carat size. Monthly investment plan available. Candlelight Jewelry, Box 15024, Nashville, TN 37215. 1-0

## HIGH FIDELITY

**UNZOO OBFUSCATION OF SALON AUDIO.** STATE-OF-THE-ART: PHASELIN-EAR II, ANALOG, TECHNICS, PRO, NAKAMICHI, KENWOOD PURIST, PSE, NIKKO, PRO DENON, RTR, MARK LEVINSON, VAN ALSTINE, DYNA, TANDBERG, KIRKSAETER, LECSON, OTHERS: ADS, BOSE, B & O, MCINTOSH, KLIPSCH, AUDIO PULSE, BRYSTON, THRESHOLD, DAHLQUIST, KEF, SAE, YAMAHA, LUX, AND OVER 141 MORE. INCREDIBLE DISCOUNTS. PROFESSIONAL ENGINEER AVAILABLE TO GIVE FREE, NO B.S. ADVICE AND INFORMATION. SEND \$5.00 FOR NEW 36 PAGE CATALOG CONTAINING 2,500 HIGH-END AUDIO ITEMS; EVALUATED:G.E.A./E., Drawer 33 (DEPT: A.), Blackhawk COLORADO, 80452, OR CALL: (303) 582-5200, 1:00 p.m. until 9:00 p.m. (MST) GOLDEN EAR AUDIO/ELECTRONICS ACCEPTS: MC, VISA, BANK, CHECKS, TRADE-INS AND HOME TRIALS.

**Audio Threshold's**  
Sensible Sound System  
Vandersteen II Loudspeakers  
Electrocompaniet Amp Class A  
Electro Preamp Built in M.P.  
Incredible!

Plus ESS Transar  
Grado, Phillips, S.M.E.  
Direct to Disc Records  
36633 Gratiot, Mt. Clemens, MI 48043  
(313) 791-1400

## SpeakerGuts.



The absolute latest in advanced speaker technology, Wave Aperature™ Drivers, the Patented Netrovic Woofer System™, raw speaker components selected for their excellence. Horns, crossovers, subwoofers, woofers, midranges, horn and dome tweeters. Over 30 in all. Build your own speaker system and we'll provide top quality speakers and design information. Send for FREE 48 page color catalog from the largest, most experienced speaker kit manufacturer in the world. **DON'T DELAY. Write today!**

**Speakerlab®**  
Dept. A-AD, 735 N. Northlake Way  
Seattle, Washington 98103

## PUBLICATIONS

**TERRIFIC SWAP OFFERS NATIONWIDE**  
Rcvrs., amps, TTs, Audio, Ham Gear, Etc. 5 issues \$2! "Electronic Trader," Box 73-A, Folly Beach, SC 29439. T.F.

**YELLOW PAGES OF AUDIO—\$3.95**  
Sourcebook to 1,100 periodicals, 250 books, 7,500 products! Future Publications, 137 Valley Park S., Bethlehem, PA 18018 1-0

## ANNOUNCEMENTS

**Free Promotional Albums, Concert Tickets, Stereos, Etc.** Information: Barry Publications, 477 82nd Street, Brooklyn, NY 11209.

## EMPLOYMENT INFORMATION

**JOURNEYMAN CREDENTIALS GRANTED LEGITIMATE!**  
Write: National Craftsman Union, 210 Fifth Avenue, Suite 1102, New York, NY 10010. 10-0

## MISCELLANEOUS

**COLLEGE STUDENTS!** Improve your grades. Send \$1.00 for 356-page, collegiate research papers catalog. 10,250 available. RESEARCH ASSISTANCE, Box 25918AD, Los Angeles, California, 90025. (213) 477-8226. 9-0

**HOW INTELLIGENT are you?** Self-scoring test reveals I.Q. in 45 minutes! Send \$3 today — guaranteed!! Tests, 405 West Culton, Dept. 2AM, Warrensburg, MO 64093. 12-9

**16mm Films, Videotapes.** SAVINGS on reels, equipment. Big list. Urbanski, 8142 Kenneth, Chicago, IL 60652. 10-9

## FOR SALE



The gooseneck lamp you've been looking for! Great for turntables . . . pre-amps . . . keyboards . . . amps . . . music stands . . . lecterns . . . anywhere you need a little light.

**Littlite-1:** Detachable 12" lamp, bulb, base with dimmer, wall-plug-in power supply, storage clips and mounting hardware. **\$44.95**

**Littlite-2:** Same as Littlite-1, but with fixed lamp and high-low switch. **\$34.95**

Add \$1 per order, shipping  
**30 day money back guarantee.**

Send check or money order to:  
Custom Audio Electronics  
Dept A1279 2828 Stommel Road  
Ypsilanti, Michigan 48197

**Send for our FREE catalog!**

## THE SENSIBLE SOUND

## NEW ISSUE #8

403 DARWIN, SNYDER, NY 14226  
REQUIRED READING BEFORE  
MAKING ANY PURCHASE

**POWER AMP COMPARISON TEST:** Hafler DH-200, Nikko Alpha III, GAS Grandson, Hitachi HMA-7500, Audionics CCP2, Spectro Acoustics 500R, Threshold 400A, Series 20 M-22, Bryston 2B, Audire M-2, Mitsubishi DA-A10DC. **SPEAKERS:** Qysonic Array, Tangent RS-4, Thiel 03, KA Imp, DEA Cobra, Symdex Sigma, M-S Festival, Cizek II, Infinity Quantum 3, Acoustat 3 & 4, ESS Transar, Boston Acoustics A-200, Pyramid Metronome 3, Great white Whale Point 3 & 4. **CARTRIDGES:** Denon 103 & 103D, Onkyo MC-100, Satin M-18X, Supex SD-900E Super +, Dynavector 10X, B&O MMC 20CL, Sonus Gold/Blue, AKG P8ES, Empire .9, Signet TK7SU. **PREAMPS:** Levinson ML-1, Rappaport Pre-1, Threshold NS-10, Spatial. **MISC:** BIC T-1 & T-2, Harman Kardon 3500, Philips AH-673, Spectra mat, Statibrush, NAD 3020 integrated, EAR plugs, ADC LMG-1, BIB accessories. **ARTICLES:** Speaker Wire, The Hype Abounds, The Conical Stylus-Fact & Fancy, Metal Tape, Should You Buy Now?, The Listening Room & How To Improve Yours, The Smashed Groove Caper. PLEASE JOIN US—\$15 (4 issues), \$19 Foreign air mail—VERY SENSIBLE.

# Audio Excellence

A UNIQUE STEREO SHOWROOM DEDICATED TO THE PERFECTIONIST

Presenting Components from the Prestigious Companies of

THRESHOLD	ROGERS	MAGNEPAN	KOETSU
AUDIONICS	SNELL	PYRAMID	SIGNET
WIN LABS	DENON	OBELISK	HAFLER
BEVERIDGE	AXIOM	SYMDEX	BRYSTON
LINN SONDEK	DCM	MARCOF	SPATIAL
M.A. COTTER	PSE	SUPEX	SYMMETRY
PLASMATRONICS	LUX	TVA	FID. RES.

SHIPPED PREPAID THROUGHOUT THE U.S.

584 Washington Street, San Francisco 94111 415-433-1335

# ANNUAL

## Subject Index

146

### Addenda

AKG P8ES Phono Cartridge (Equipment Profile, Dec. 1978, 96), Feb., 12.  
Satin M-18BX Moving-Coil Phono Cartridge (Equipment Profile, Dec. 1978, 106), Feb., 12.

### Amps & Preamps

*Build an Amplifier Strapping Circuit*, W. Marshall Leach, Feb., 40.  
*Build a Microphone Preamp*, W. J. J. Hoge, Feb., 50.  
*Build a Headphone Amp*, Walter G. Jung, May, 56.  
*Quick-Build a Speaker Impedance Checker*, M. J. Salvati, Aug., 32.  
*The Ins and Outs of Toroidal Transformers*, John I. Brown, Dec., 38.

### Antennas

*Antennas — Part V: Special Antenna Techniques*, M. J. Salvati, Jan., 42.

### Book Reviews

*Honkers and Shouters: The Golden Years of Rhythm and Blues*, Jan., 28.  
*Walk Away René*, Jan., 29.  
*Music, Speech & High Fidelity*, Feb., 34.  
*Active-Filter Cookbook*, Feb., 34.  
*IC Timer Cookbook*, March, 99.  
*Handbook of Noise Assessment*, March, 99.  
*Audio IC Op-Amp Applications*, Sept., 74.  
*Noise Reduction Techniques in Electronic Systems*, Sept., 74.  
*Grounding and Shielding Techniques in Instrumentation*, Sept., 74.  
*The Complete Handbook of Public Address Systems*, Sept., 78.  
*The Face of Rock & Roll*, Sept., 78.  
*Dictionary of Scientific and Technical Terms, 2nd Edition*, Nov., 110.  
*The History of Radio*, Nov., 110.  
*TV Antennas and Signal Distribution Systems*, Nov., 110.

### Car Stereo

*Tips from a Pro — Car Speaker Installation*, July, 52.  
*Car Stereo Manufacturers Directory*, July, 54.

*Car Stereo Directory — Radios/Tape Players*, July, 56.

*Car Stereo Directory — Speakers*, July, 64.

*Car Stereo Directory — Amps/Equalizers*, July, 73.

### Cassettes

*Tape-to-Deck Matching for Best Dolby Tracking*, Howard A. Roberson, Sept., 44.  
*Up in the Air About Metal Tape?*, Howard A. Roberson, Sept., 50.  
*Metal Cassette Tests*, Howard A. Roberson, Sept., 54.

### Construction

*Build an Amplifier Strapping Circuit*, W. Marshall Leach, Feb., 40.  
*Build a Stepped Volume Control*, W. Marshall Leach, Feb., 44.  
*Build a Microphone Preamp*, W. J. J. Hoge, Feb., 50.  
*Magnetic Shielding*, Herman Burstein, April, 46.  
*Build a Tape Deck Switching Box*, John T. Peer, April, 50.



*Line Surge and Hash Protection for Hi-Fi Equipment*, F. J. Stifter, May, 38.

*Build a Headphone Amp*, Walter G. Jung, May, 56.

*Quick-Build a Speaker Impedance Checker*, M. J. Salvati, Aug., 32.

*The Ins and Outs of Toroidal Transformers*, John I. Brown, Dec., 38.

### Directories

*Car Stereo Directory*, July.  
*Directory of Manufacturers*, 54;  
*Radios/Tape Players*, 56; *Speakers*, 64;  
*Amps/Equalizers*, 73.

*Annual Equipment Directory*, Oct.

*Directory of Manufacturers*, 34;  
*Amplifiers*, 46; *Preamplifiers*, 60;  
*Tuners*, 66; *Receivers*, 70; *Turntables*, 76;  
*Phono Cartridges*, 85; *Tonearms*, 100;  
*Cassette & 8-Track Tape Decks*, 102;  
*Open-Reel Tape Decks*, 112; *Equalizers*, 114;  
*Headphones*, 116; *Loudspeakers*, 120;  
*Microphones*, 148.

*Directory II*, Nov.

*Blank Tape*, 54; *Directory of Manufacturers*, 66;  
*Ambience and Time-Delay Units*, 68;  
*Noise-Reduction and Filter Systems*, 70;  
*Compressors-Expanders*, 72; *Record Care Accessories*, 74.

*1978 Equipment Directory Addenda II*, Jan., 30.

### Distortion Theory

*A View Through Different Windows*, Richard C. Heyser, Feb., 56.

*Catastrophe Theory and Its Effect on Audio*, Richard C. Heyser, *Part I*, March, 52; *Part II*, April, 36; *Part III*, May, 42.

*Phase, Time, Ears & Tape*, William A. Manly, April, 52.

*An Overview of SID and TIM*, Walter G. Jung, Mark L. Stephens, and Craig C. Todd; *Part I*, June, 59; *Part II*, July, 38; *Part III*, Aug., 42.

### Dolby

*Tape-to-Deck Matching for Best Dolby Tracking*, Howard A. Roberson, Sept., 44.

### Equipment Profiles

*ADC Model LMF-2 Tonearm & ZLM Phono Cartridge*, Jan., 92.



# INDEX

ADC Model 1700DD Semi-Automatic Turntable, Dec., 84.  
ADS Model 10 Digital Time Delay System, June, 98.  
Acoustic Research AR90 Loudspeaker, Nov., 88.  
Advent 500 SoundSpace Control, May, 70.  
Akai GX 267D Open-Reel Tape Deck, June, 106.  
Audio Technology 510 Peak Responding Delay, May, 68.  
Bauman Research Pro-400 Preamplifier, Nov., 102.  
Berkshire Audio Products Match-Maker, March, 93.  
Berkshire Audio Products CCM Capacitance Meter, March, 94.  
Cotter MK-2 Transformer, March, 94.  
Crown DL-2 Digilogic Control Center, March, 89.  
db Systems DBP-6 Phono Equalization Kit, March, 93.  
Decca London International Tonearm & Mk VI Gold Elliptical Phono Cartridge, Aug., 72.  
Empire Disco Film Record Cleaner, April, 75.  
Empire EDR.9 Magnetic Phono Cartridge, Sept., 66.  
Infinity Black Widow Tonearm, March, 76.  
Jensen R-430 Car Stereo Cassette/Receiver, Jan., 70.  
KEF 104aB Loudspeaker System, Dec., 88.  
KLH/Burwen Research TNE7000 Transient Noise Eliminator, Jan., 105.  
Kenwood KR-7050 Receiver, July, 76.  
Lirpa 1 Showermike, April, 70.  
McKay Dymek DR-33 All-Wave Receiver, Sept., 70.  
Nagatronics HV9100 Ribbon (Velocity) Magnetic Phono Cartridge, May, 66.  
Nakamichi 582 Cassette Deck, Aug., 82.  
Nikko Gamma I Tuner, May, 64.  
Onkyo TX-2500-II Receiver, Feb., 74.  
Ortofon MC-30 Moving-Coil Phono Cartridge & T-30 Transformer, Nov., 98.  
PS Audio Model PS-II Phono Preamplifier, Feb., 80.  
Phase Linear 3000 Series II Preamplifier, Jan., 76.  
Pioneer TX-9800 Tuner, Nov., 80.  
Professional Systems Engineering (PSE) Studio One Preamplifier and Studio Two Power Amplifier, April, 72.  
Quad (Acoustical Mfg., Ltd.) 405 Power Amplifier, April, 77.

Realistic SCT-30 Cassette Deck, June, 94.  
ReVox Model B 790 Turntable, June, 92.  
Rotel RT-2100 Tuner, Sept., 58.  
SAE Model 2922 Integrated Amplifier, March, 84.  
Sansui SR-838 Direct-Drive Turntable, Feb., 70.  
Sanyo RD5350 Cassette Deck, Feb., 87.  
H. H. Scott 390R Receiver, Aug., 60.  
Sencore PR50 Audio Prescaler, April, 76.  
Shure V15 Type IV Phono Cartridge, Feb., 68.  
Sonus Gold Series II Blue Label Phono Cartridge, July, 81.  
Sony ECM-56F Electret Condenser Microphone, Jan., 103.  
Soundcraftsmen RP2215-R Stereo Equalizer, July, 83.  
Stanton Permostat Anti-Static Record Treatment, May, 60.  
TDK HD-01 Head Demagnetizer, March, 96.  
TDK Test Tapes, Dec., 82.  
TEAC Model C-1 Cassette Deck, Dec., 78.  
Tandberg TD 20A Open-Reel Tape Deck, March, 64.  
Technics RS-616 Cassette Deck, Feb., 84.  
Technics RS-M85 Cassette Deck, June, 87.  
Visonik DD-8200 Turntable, May, 76.  
Warp Out Record Weight, Sept., 64.  
Yamaha NS-1000 Loudspeaker System, Jan., 82.  
Yamaha CR-2040 Receiver, June, 74.

## The Forum

*AM Clear-Channel Proposal*, Lawrence D. Swift, May, 6.  
*Polarity Convention*, Richard C. Heyser, Aug., 18.  
*Omitted Factors in Audio Design*, John J. Curl, Aug., 20.

## History

*Scott—The Stradivarius of Radio*, J. W. F. Puett, Feb., 36.

## Loudspeakers

*Quick-Build a Speaker Impedance Checker*, M.J. Salvati, Aug., 32.  
*Influence of Listening Rooms on Loudspeaker Systems*, Roy F. Allison, Aug., 36.  
*The Importance of Speaker Directivity*, Dan Queen, Sept., 37.

## Measurements

*TDS—A Progress Report*, Don and Carolyn Davis, Jan., 58.  
*Metal Cassette Tests*, Howard A. Roberson, Sept., 54.

## Obituaries

Clarence C. Moore, May, 28.  
Benjamin B. Bauer, July, 51.  
Howard T. Souther, Dec., 32.

## Personalities

*Scott—The Stradivarius of Radio*, J.W.F. Puett, Feb., 36.  
*Interview/Jim Metzner/Sound Image*, Tom Bingham, Nov., 44.

## Phono Cartridges

*Understanding Phono Cartridges*, S.K. Pramanik, March, 33.

## Records & Recording

*Acoustic Rosetta Stone*, Richard C. Heyser, Jan., 66.  
*Aphex Aural Exciter—New Tool of Hit Record Makers*, Paul Laurence and George Pontis, June, 46.  
*Interview/Jim Metzner/Sound Image*, Tom Bingham, Nov., 44.  
*Christmas Buying Guide: Audiophile Recordings*, Gary Stock, Dec., 52.  
*Digital Recording: State of the Market*, Gary Stock, Dec., 70.

## Tape

*Phase, Time, Ears & Tape*, William A. Manly, April, 52.  
*Tape-to-Deck Matching for Best Dolby Tracking*, Howard A. Roberson, Sept., 44.  
*Up in the Air About Metal Tape?*, Howard A. Roberson, Sept., 50.  
*Metal Cassette Tests*, Howard A. Roberson, Sept., 54.

## Tuners

*Rimo FM Tuner Filters*, Richard Modafferri, Jan., 32.  
*SCA & Stereo FM*, Stephen R. Waldee, Jan., 50.

## Turntables

*Do Turntable Mats Work? You Bet!*, Robert Stockton, June, 42.  
*The Fine Art of Tweaking Your Turntable*, Bob Gary, June, 52.

## Workbench Profiles

Hewlett-Packard 339A Distortion Analyzer/Oscillator, July, 48.  
Crown RTA-2 Real-Time Analyzer, Nov., 106.

# Author Index

**Allison, Roy F.**, *Influence of Listening Rooms on Loudspeaker Systems*, Aug., 36.

**Bingham, Tom**, *Interview/Jim Metzner/Sound Image*, Nov., 44.

**Brown, John I.**, *The Ins and Outs of Toroidal Transformers*, Dec., 38.

**Burstein, Herman**, *Magnetic Shielding*, April, 46.

**Curl, John J.**, *Omitted Factors in Audio Design*, Aug., 20.

**Davis, Don and Carolyn**, *TDS—A Progress Report*, Jan., 58.

**Gary, Bob**, *The Fine Art of Tweaking Your Turntable*, June, 52.

**Heyser, Richard C.**, *Acoustic Rosetta Stone*, Jan., 66; *A View Through Different Windows*, Feb., 56; *Catastrophe Theory and Its Effect on Audio, Part I*, March, 52; *Part II*, April, 36, and *Part III*, May, 42; *Polarity Convention*, Aug., 18.

**Hoge, W. J. J.**, *Build a Microphone Preamp*, Feb., 50.

**Jung, Walter G.**, *Build a Headphone Amp*, May, 56. With Mark L. Stephens and Craig C. Todd, *An Overview of SID and TIM, Part I*, June, 59; *Part II*, July, 38; *Part III*, Aug., 42.

**Laurence, Paul and George Pontis**, *Aphex Aural Exciter—New Tool of Hit Record Makers*, June, 46.

**Leach, W. Marshall**, *Build an Amplifier Strapping Circuit*, Feb., 40; *Build a Stepped Volume Control*, Feb., 44.

**Manly, William A.**, *Phase, Time, Ears & Tape*, April, 52.

**Modaferrri, Richard**, *Rimo FM Tuner Filters*, Jan., 32.

**Peer, John, T.**, *Build a Tape Deck Switching Box*, April, 50.

**Pontis, George and Paul Laurence**, *Aphex Aural Exciter—New Tool of Hit Record Makers*, June, 46.

**Pramanik, S. K.**, *Understanding Phono Cartridges*, March, 33.

**Puett, J. W. F.**, *Scott—The Stradivarius of Radio*, Feb., 36.

**Queen, Dan**, *The Importance of Speaker Directivity*, Sept., 37.

**Roberson, Howard A.**, *Tape-to-Deck Matching for Best Dolby Tracking*, Sept., 44; *Up in the Air About Metal Tape?*, Sept., 50; *Metal Cassette Tests*, Sept., 54.

**Salvati, M. J.**, *Antennas—Part V: Special Antenna Techniques*, Jan., 42; *Quick-Build a Speaker Impedance Checker*, Aug., 32.

**Stephens, Mark L.**, *Walter G. Jung, and Craig C. Todd, An Overview of SID and TIM, Part I*, June, 59; *Part II*, July, 38; *Part III*, Aug., 42.

**Stifter, F. J.**, *Line Surge and Hash Protection for Hi-Fi Equipment*, May, 38.

**Stock, Gary**, *Christmas Buying Guide: Audiophile Recordings*, Dec., 52; *Digital Recording: State of the Market*, Dec., 70.

**Stockton, Robert**, *Do Turntable Mats Work? You Bet!*, June, 42.

**Swift, Lawrence, D.**, *AM Clear-Channel Proposal*, May, 6.

**Todd, Craig C.**, *Walter G. Jung, and Mark L. Stephens, An Overview of SID and TIM, Part I*, June, 59; *Part II*, July, 38; *Part III*, Aug., 42.

**Waldee, Stephen R.**, *SCA & Stereo FM*, Jan., 50. A

## Statement of Ownership, Management, and Circulation

[Required by 39 U.S.C. 3685.]

1. Title of Publication: *Audio*.
- 1A. Publication Number: 0004752X.
2. Date of Filing: September 19, 1979.
3. Frequency of Issue: Monthly.
- 3A. Number of Issues Published Annually: 12.
- 3B. Annual Subscription Price: \$12.00.
4. Location of Known Office of Publication: 401 No. Broad St., Philadelphia, Penna. 19108.
5. Location of Headquarters or General Business Offices of the Publishers: 401 No. Broad St., Philadelphia, Penna. 19108.
6. Names and Complete Addresses of Publisher, Editor, and Managing Editor: Publisher, Jay L. Butler, 401 No. Broad St., Philadelphia, Penna. 19108; Editor, Eugene Pitts III, 401 No. Broad St., Philadelphia, Penna. 19108; Managing Editor, None.
7. Owner: North American Publishing Co., 401 No. Broad St., Philadelphia, Penna. 19108; I.J. Borowsky, 401 No. Broad St., Philadelphia, Penna. 19108.
8. Known Bondholders, Mortgagees, and Other Security Holders Owning or Holding One Percent or More of Total Amount of Bonds, Mortgages, or Other Securities: None.
9. For Completion by Nonprofit Organizations Authorized to Mail at Special Rates: Does Not Apply.
10. Extent and Nature of Circulation:

	Average No. Copies Each Issue During Preceding 12 Months	Actual No. Copies of Single Issue Published Nearest to Filing Date
A. Total No. Copies Printed [Net Press Run]:	147,299	153,442
B. Paid Circulation		
1. Sales Through Dealers and Carriers, Street Vendors, and Counter Sales:	33,879	41,461
2. Mail Subscriptions:	87,395	83,292
C. Total Paid Circulation:	121,274	124,753
D. Free Distribution by Mail, Carrier or Other Means; Samples, Complimentary, and Other Free Copies:	2,192	2,152
E. Total Distribution:	123,466	126,905
F. Copies Not Distributed		
1. Office Use, Left Over, Unaccounted, Spoiled after Printing:	1,324	1,787
2. Returns From News Agents:	22,509	24,750
G. Total:	147,299	153,442

11. I certify that the statements made by me above are correct and complete.

Jay L. Butler, Publisher

# We found the optimum pivot point before the others even knew it was missing.

Most manufacturers are content to determine tonearm pivot points by trial-and-error. And many tonearms are so susceptible to external vibrations that you have to tiptoe around the turntable.

With Sansui's Dyna-Optimum Balanced (DOB) tonearms, based on our Optimum Pivot Point principle, the transmission of vibrations is dramatically reduced to give you more freedom to enjoy your music. It's used in our new, fully automatic direct-drive FR-D4 and FR-Q5.

Here's how the DOE works: Put a pencil on a table. Wiggle one end back-and-forth. The other end will move; but a certain point will not. This is the Optimum Pivot Point.

In our new DOB tonearm the arm is pivoted at it is highly stable point. With no relative motion between the point and the arm support, effects from external forces are minimized. Friction is almost non-existent, so the stylus is

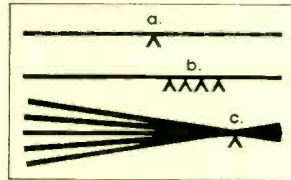

**a.** Center of Mass. Starting point for conventional tonearm designs.

**b.** Typical trial-and-error pivot points, usually placed close to **a.**, so that counterweight is not too heavy, tonearm not too long.

**c.** Sansui's Optimum Pivot Point. Calculated mathematically as a function of length and mass. The most stable point.

free to trace every part of the groove. We also added a special decoupling device and a unique counterweight for optimum tracking.

A patent is pending on Sansui's brushless DC motor used in the FR-D4 and FR-Q5. And with the Quartz-PLL system of the FR-Q5 and the special speed-error detection/correction system of the FR-D4, wow and flutter, speed accuracy and signal-to-noise specifications are outstanding. All operations are computer-controlled using the latest LSIC technology. The computer even knows to shut off the motor if you forget to unlock the tonearm clip.

To make the FR-D4, FR-Q5, as well as the budget-priced direct-drive FR-D3 even more convenient, we put all the controls up-front, outside the dustcover.

Ask an authorized Sansui dealer to demonstrate our new turntables. Listen closely and you'll hear what the others are missing.

## SANSUI ELECTRONICS CORP.

Lynhurst, New Jersey 07071 • Gardena, Ca. 90247  
 Sansui Electric Co., Ltd., Tokyo, Japan  
 Sansui Audio Europe S.A., Antwerp, Belgium  
 In Canada, Electronic Distributors



Enter No. 44 on Reader Service Card

