

# Audio

Rock 'n' Roadies

DECEMBER 1984 • \$2.00

## JVC R-X500B RECEIVER

TRUE STATE OF THE ART  
UNQUALIFIED APPROVAL

THE UNTOLD STORY  
BEHIND THE BOSE-CU CASE



TE  
OI  
(  
NA

MC 2000  
GE  
TUNER



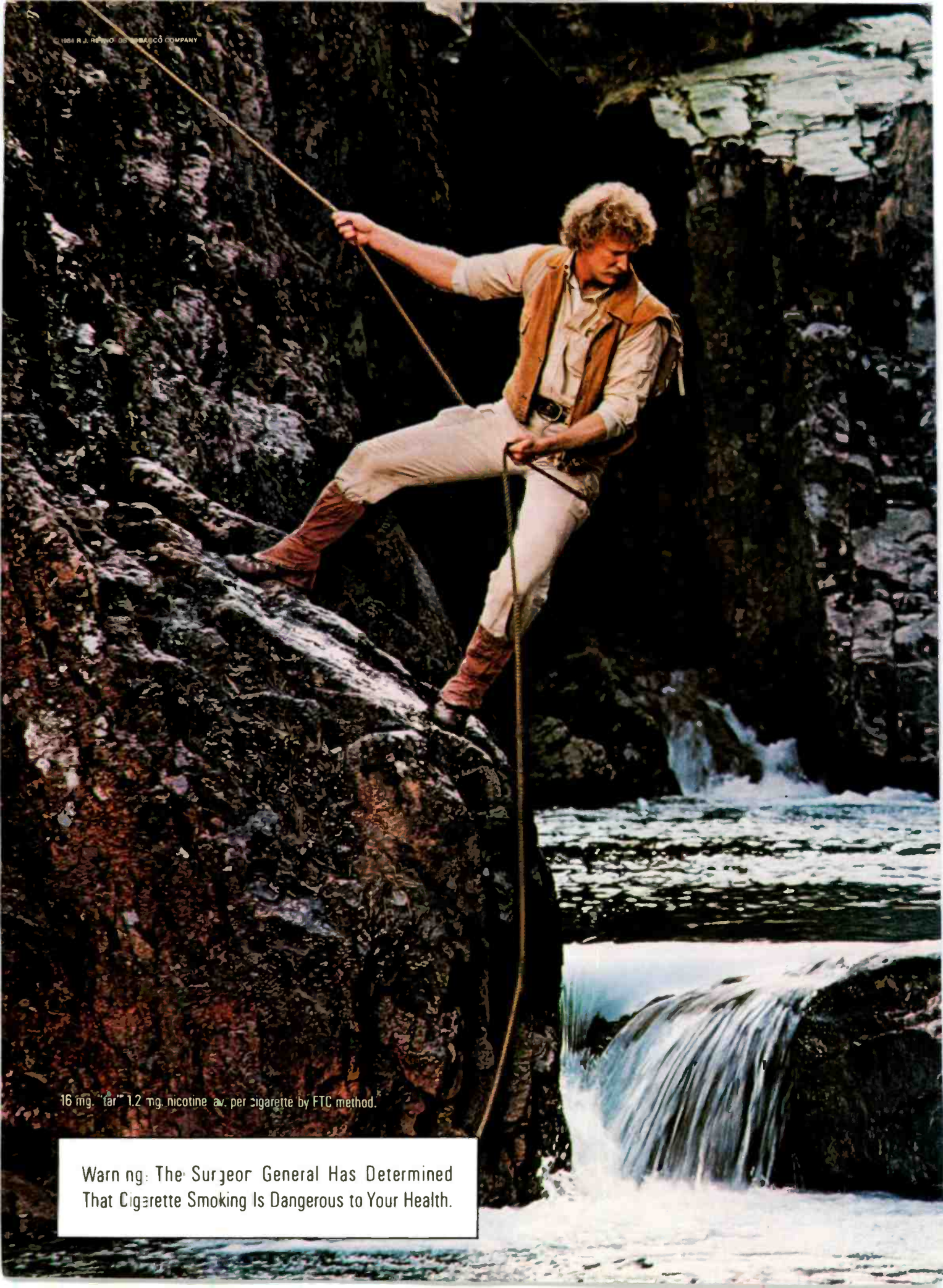

16 mg. "tar" 1.2 mg. nicotine av. per cigarette by FTC method.

Warning: The Surgeon General Has Determined  
That Cigarette Smoking Is Dangerous to Your Health.

# CAMEL FILTERS

It's a whole new world.



Today's  
Camel Filters,  
surprisingly smooth.

# Audio

DECEMBER 1984

VOL. 68, NO. 12



See page 32.

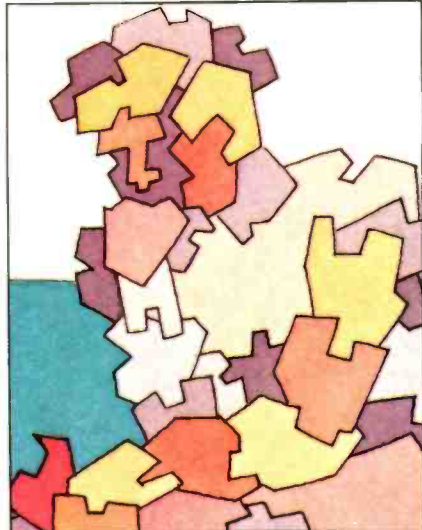

See page 20.

## FEATURES

<b>ROCK 'N' ROADIES:</b>		
TRAVELING WITH JOURNEY	Pam Alloway	32
<b>THE UNTOLD STORY</b>		
BEHIND THE BOSE-CU CASE	David Lander	42
<b>HOME STUDIO: DO IT THE</b>		
PRO WAY, PART II	Jon & Sally Tiven	46
1984 ANNUAL INDEX		143

## EQUIPMENT PROFILES

JVC R-X500B RECEIVER	Leonard Feldman	50
SAE R102 RECEIVER	Leonard Feldman	58
<b>ACOUSTICAL PHYSICS LABS</b>		
ACOUSTIC IMAGE II SPEAKER	David L. Clark	65
NAD 4155 TUNER	Leonard Feldman	75
<b>ORTOFON MC 2000 CARTRIDGE</b>		
AND T 2000 TRANSFORMER	B. V. Pisha	83
<b>AURICLE: DENNESEN POLARIS</b>		
INDOOR FM ANTENNA	Leonard Feldman	91
<b>AURICLE: PROTON 300</b>		
TABLE RADIO AND		
MODEL 301 SPEAKER SYSTEM	Ivan Berger	94



See page 46.

## MUSIC REVIEWS

COMPACT DISCS		98
CLASSICAL RECORDINGS	Edward Tatnall Canby	106
ROCK/POP RECORDINGS	Michael Tearson, Jon & Sally Tiven	112

## DEPARTMENTS

SIGNALS & NOISE/ERRATUM		5
WHAT'S NEW		6
BEHIND THE SCENES	Bert Whyte	10
AUDIO ETC	Edward Tatnall Canby	16
DIGITAL DOMAIN	Ken Pohlmann	20
TAPE GUIDE	Herman Burstein	27
AUDIOCLINIC	Joseph Giovanelli	29
SPECTRUM	Ivan Berger	120

The Cover Equipment: JVC R-X500B receiver.  
The Cover Photographer: Carl Zapp.

Audio Publishing, Editorial and Advertising Production Offices,  
1515 Broadway, New York, N.Y. 10036.

Subscription Inquiries, (800) 525-9511; in Colorado (303) 447-9330.

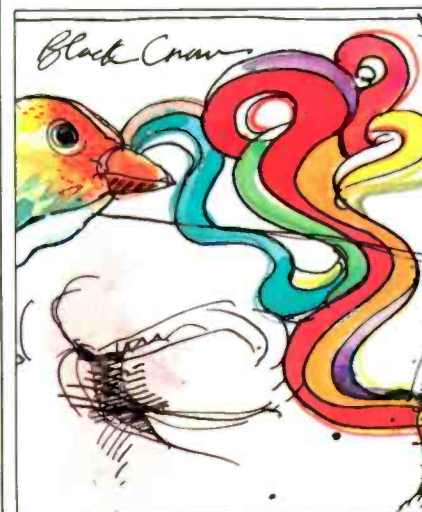

See page 16.

# Speaker Tweaker from TDK

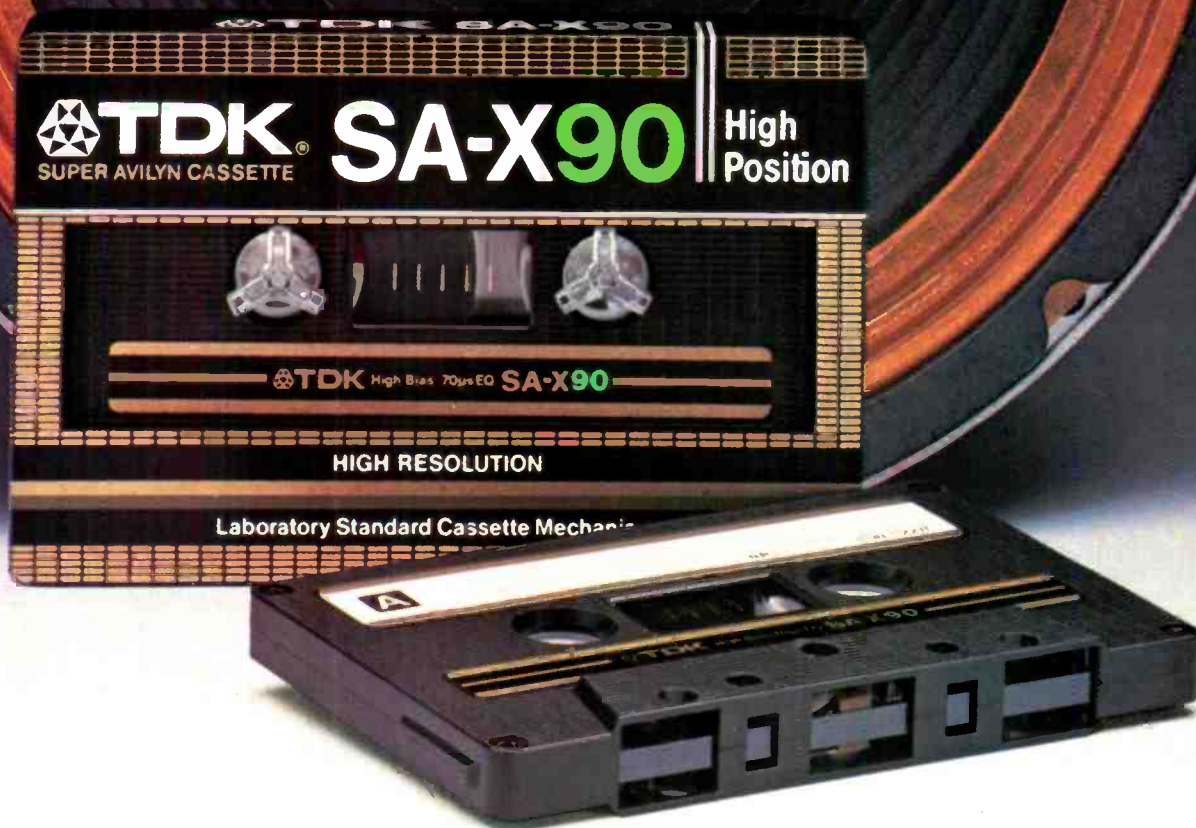

You bought a high-powered, quality audio system with speakers to match for only one purpose. Total performance. To maximize its potential, you need the ultimate high-bias audio cassette. TDK SA-X.

It's one of our Pro Reference cassettes designed to deliver unmatched performance.

Surpassing all other conventional cassettes in its class, SA-X delivers a level of sound quality, clarity and fidelity that you have never obtained before. Unless, of course, you're already using it.

SA-X's exclusive dual coating of Super Avilyn magnetic particles pro-

vides optimum performance at all frequency ranges. You get crisp, clean highs and rich, solid lows. With pure sonic pleasure in between.

SA-X will also handle high signal levels without distortion or saturation, thanks to its super-wide dynamic range and higher MOL.

And we make sure SA-X keeps on tweaking without squeaking (as some other cassettes do). Our specially-engineered Laboratory Standard Mechanism provides a smoother tape transport to assure total reliability and trouble-free performance.

It should also come as no surprise that you'll get incredible perform-

ances from two other TDK Pro Reference cassettes: MA-R metal and AD-X Avilyn-based normal bias cassettes.

Each is designed to deliver pure performance pleasure and long-time reliability...each backed by our Lifetime Warranty.

So maximize the performance of your equipment. Pick up TDK Pro Reference audio cassettes today. We've never met a speaker we couldn't tweak!

 **TDK**<sup>®</sup>  
THE MACHINE FOR YOUR MACHINE.

# REDEFINITION.

**THE CARVER RECEIVER:** Redefines your expectations of receiver performance with the power you need for Digital Audio Discs plus virtually noise-free stereo FM reception. A receiver with astonishing performance incorporating two highly significant technological breakthroughs: Bob Carver's Magnetic Field Power Amplifier and his Asymmetrical Charge Coupled FM Detector.

**ESSENTIAL POWER:** Your system needs an abundance of power to reproduce, without distortion, the dynamic range of music on Digital Audio Discs and fine analog recordings.

The Magnetic Field Amplifier in the CARVER Receiver gives you 130 watts per channel\* of pure, clean power with superbly defined, high fidelity reproduction.

The Magnetic Field Amplifier produces large amounts of power (absolutely necessary for the accurate reproduction of music at realistic listening levels) without the need for heavy heat sinks, massive transformers, and enormous power capacitors required by conventional amplifier design.

Unlike conventional amplifiers which produce a constant, high voltage level at all times, irrespective of the demands of the ever-changing audio signal (Even when there is no audio signal in the circuit at all!), the Magnetic Field Amplifier's power supply is signal responsive. Highly efficient, it produces *exactly and only* the power needed to carry the signal with complete accuracy and fidelity.

The 130 watts-per-channel\* CARVER Receiver is about the same size and weight of conventional receivers having merely 30 watts per channel!

**NOISE-FREE RECEPTION:** The AM-FM CARVER Receiver gives you FM stereo performance unmatched by that of any other receiver.

As it is transmitted from the station, the stereo FM signal is extremely vulnerable to distortion, noise, hiss and multipath interference.

However, when you engage CARVER's Asymmetrical Charge Coupled FM Detector circuit, the stereo signal arrives at your ears virtually noise-free. You hear fully separated stereo with space, depth and ambience!

"This receiver combines the best elements of Carver's separate tuner and amplifier... The Carver Receiver is, without question, one of the finest products of its kind I have ever tested and used. Bob Carver is definitely an audio and r.f. genius." *Leonard Feldman, Audio Magazine, June 1984*

"I consider the Carver Receiver to be the "most" receiver I have yet tested in terms of the quantitative and qualitative superiority of almost all its basic functions." *Julian D. Hirsch, Stereo Review, April 1984*

The CARVER Receiver has been designed for fidelity, accuracy and musicality. You will want to visit your CARVER dealer for a personal audition of this remarkable instrument.

**\*130 watts per channel RMS into 8 ohms, 20 Hz to 20 kHz with no more than 0.05% total harmonic distortion.**



## CARVER

POWERFUL

CORPORATION PO. Box 1237 Lynnwood, WA 98036

MUSICAL

ACCURATE

Distributed in Canada by Evolution Audio, Ltd.

# Audio

Eugene Pitts III  
Editor

Art Director: Cathy Cacchione  
Assistant Art Director: Linda Zerella

Technical Editor: Ivan Berger  
Managing Editor: Kay Blumenthal  
Assistant Editor: Andrea Lynne Hecker

Associate Editors:  
Edward Tatnall Canby, Bert Whyte, B. V. Pisha

Senior Editors:  
Leonard Feldman, Richard C. Heyser,  
Howard A. Roberson  
Editor-At-Large: David Lander

Contributing Editors/Artist:  
Herman Burslein, David L. Clark,  
Anthony H. Cordesman, Ted Costa, John Diliberto,  
John M. Eargle, Joseph Giovinelli,  
Laurence L. Greenhill, Bascom H. King,  
Edward M. Long, C. G. McProud,  
Peter W. Mitchell, Jon Sank, Donald Spoto,  
Michael Tearson, Jon & Sally Tiven, Paulette Weiss

General Manager: Mary Anne Holley  
Production Manager: Patti Burns  
Special Projects Coordinator: Phyllis K. Brady  
Ad Coordinator: Ruth M. Linehan

Roman Beyer  
Publisher

### ADVERTISING

Advertising Director: Stephen Goldberg  
(212) 719-6335

Eastern Ad Manager: Stephen W. Witthoft  
(212) 719-6337

Account Managers: Susan L. Newkirk  
(212) 719-6346  
Lesla Rader  
(212) 719-6291

Western Ad Manager: William J. Curtis  
Regional Ad Manager: Joy Aronson  
(213) 827-8655

Classified Ad Manager: Laura J. LoVecchio  
(212) 719-6338

### OPERATIONS

Circulation Director: Leon Rosenfield  
Production Director: David Rose  
Research Director: Lester Abberbock

### CBS MAGAZINES EXECUTIVE STAFF

President: Peter G. Diamandis  
Sr. V.P./Adv.: Michael J. O'Neill  
V.P., Finance & Admin.: Robert J. Granata  
V.P., Circulation: Robert F. Spillane  
V.P., Mfg. & Distribution: Murray Romer

**AUDIO** (ISSN 0004-752X, Dewey Decimal Number 621.381 or 778.5) is published monthly by CBS Magazines, A Division of CBS Inc., at 1515 Broadway, New York, N.Y. 10036. Printed in U.S.A. at Nashville, Tenn. Distributed by CBS Magazine Marketing. Second class postage paid at New York, N.Y. 10001 and additional mailing offices. Subscriptions in the U.S., \$15.94 for one year, \$27.94 for two years, \$37.94 for three years; other countries, add \$6.00 per year.

**AUDIO** is a registered trademark of CBS Inc. ©1984, CBS Magazines, A Division of CBS Inc. All rights reserved.

Editorial contributions are welcomed but should be accompanied by return postage. Submissions will be handled with reasonable care, but the Editor assumes no responsibility for safety or return of manuscripts, photographs, or artwork. The Publisher, in his sole discretion, reserves the right to reject any ad copy he deems inappropriate.

**AUDIO** Publishing, Editorial and Advertising Production offices, 1515 Broadway, New York, N.Y. 10036. Subscription offices, P.O. Box 5318, 1255 Portland Place, Boulder, Colo. 80322; (800) 525-9511, (303) 447-9330 in Colorado. Postmaster: Send change of address to P.O. Box 5316, 1255 Portland Place, Boulder, Colo. 80322.

## Tube Bias

Dear Editor:

Recently, I have been concerned about a slight but noticeable tendency, in *Audio*, towards bias in favor of tube equipment. For example, Bert Whyte's June column cites "devotees of the [tube] technology" on "the 'smoothness' of the sound, the absence of 'graininess' and 'overbright, tizzy' top end," illustrating how tube devotees feel about transistor equipment.

While I am a proud owner of fine transistor equipment, my quarrel is not with tube design but with tube-design devotees. I have seldom heard an owner of transistor equipment downgrade tube equipment. I agree that tube equipment sounds excellent, maybe different, but definitely not better than transistor equipment.

When I read reports on transistor amplifiers, I get the impression that comments were not as positive as they would have been if the equipment had been of tube design. If their systems are designed around tube equipment, how can your writers formulate unbiased reports on transistor equipment? I realize that all listening comments are the opinions of the writers, but it is to these biased comments that thousands of readers respond.

The reports of Leonard Feldman are quite unbiased. He reports on high-quality transistor equipment (among other things). But his tests do not specify the system components used with the piece being tested. Tube-equipment reports, on the other hand, include information on the cartridge, speaker cable, weather conditions and altitude. I feel this information is necessary for a complete analysis, but I only see it in regard to tube equipment. Is this another underlying bias of your writers, that high quality deserves more attention but transistor equipment is not of high quality?

Another example of product bias was in the new column, "Auricle." The idea of having a high-end gear column without all the technical measurements is great, but the idea was "high-end gear," and hopefully the comments will not come only from high-end tube gear devotees. I refer to Anthony Cordesman's statement on the Innovative Techniques speaker, where he writes: "The equalizer is comparatively neutral, although it will add a slight transistor quality to the sound if you are using tube equipment." I can almost bear this sort of statement. He then adds: "This is reflected in a slight drying out of the sound and minor loss of life." I find this statement quite derogatory and unnecessary since it will lead the readers towards a negative opinion of transistor equipment.

I hope I have made my point clear. There have been other examples of this sort of bias which detracts from the overall reviews. (Why not design a system around transistor equipment to test tube equipment?) I will surely be amused to see the review that says: "The Zeta amp will add a slight tube sound if using transistor equipment, and its sound is characterized by the inherent distortion qualities which will mask and smooth out flaws of analog recordings."

Richard D. Kelly  
Davis, Cal.

## New Discoveries

Dear Editor,

Your review in the April issue of the Lirpa Compact Dish Player was most enlightening. This product is certainly a masterpiece of technology, and its portent for the future of audio is indeed awesome.

One thing you failed to include was a discography of selections available for playback on the Lirpa. I have some old Bavarian dishes, but I wonder if

they might not be too heavy for the Lirpa, consisting as they do of compositions by Wagner, Mahler and Bruckner. I have some Delft dishes which might be more suitable, but there isn't a very large repertoire of Dutch music, except old street barrel organs in Amsterdam. Wedgwood has some lovely British salon music available, but the mood is a little on the blue side. I did, however, come across a popular dish made by The Platters with some good old hits on it.

You also omitted any mention of dishcocheque music. Could it be that the Lirpa is deficient in the area of deep water bass?

As to choice of detergents, Dawn dishwashing liquid did a nice job of cleaning up my copy of the soundtrack from *Grease*, and, by applying a dab of brilliantine to the brush, *Hair* becomes quite a glossy production. Overall, Cascade left a sheen on the music that was hard to resist.

Perhaps at some future date, Professor Lirpa could add a tuner with FM and TV frequencies so that listeners could derive the ultimate pleasure from their soap operas.

I shall anxiously await the arrival of a Lirpa Si-O<sub>2</sub> Compact Dish player at my dealer's showroom. In the meantime, when you see him again, please thank the good professor and tell him to keep up the good work.

Don Charles  
North Plainfield, N.J.

*Editor's Note:* This letter was passed on to Dr. Lirpa, who wishes to remark he considers it a Joy.

## Erratum

In "Cassette Test Update: 12 Formulations" which appeared in the September 1984 issue, the data for Type II tapes in Table I should have been as shown below:

BRAND	DESIGNATION	TYPE	MAXIMUM RECORD LEVEL dB re: 400-Hz Dolby Level						S/N RATIO dBA	RESPONSE AT -3 dB (kHz)		MOD NOISE dB	BIAS dB	SENS dB
			HDL <sub>3</sub> = 3%				TTIM = 3%			0 dB Level	-20 dB Level			
			100	400	1k	2k	5k	10k						
Konica	GM-II	II	-4.3	-5.9	-6.7	-3.5	-4.5	-10.6	60.9	9.8	22.6	-49.2	-0.3	-1.0
Rea-istic	Supertape Hi Bias	II	-4.4	-5.4	-5.7	-2.1	-5.1	-10.4	59.7	9.6	23.4	-47.1	-0.2	+0.8
Swire	Laser UHDII	II	-0.6	-1.9	-3.0	-2.1	-6.2	-1.1	57.0	9.3	23.9	-51.4	-0.1	-0.1
TDK	HX-S	II	-7.8	-8.7	-8.9	-7.0	-1.7	-6.4	60.6	12.0	25.8	-47.4	0.0	-3.5

## Ohm Walsh Loudspeakers

The Ohm Walsh 1 is the least expensive speaker using the Walsh, upended-cone driver for its woofer. The two-way system has a vented enclosure and uses a cone tweeter. Its cabinet is finished in walnut veneer, and this speaker is recommended for use with amplifiers from 20 to 90 watts per channel. Price: \$595.00 per pair. For literature, circle No. 100

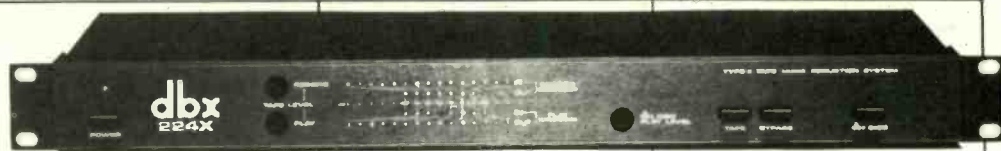
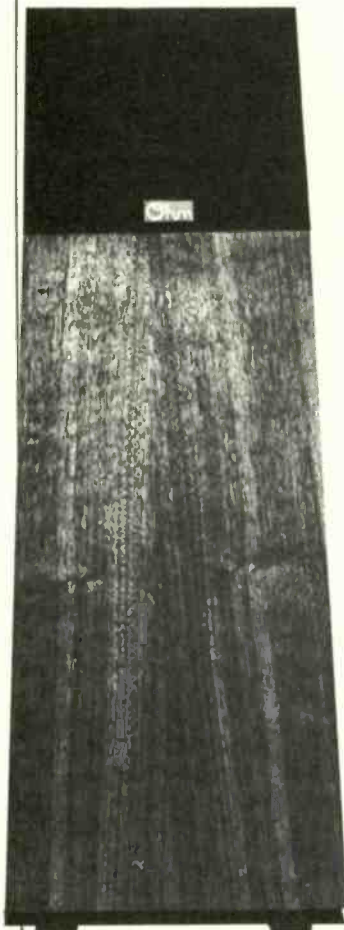

## dbx NR System

This dbx noise-reduction unit provides full monitoring with three-head tape decks, but can also be used with two-head models. The dbx 224X is similar to the earlier

224, but with front-panel, thumb-button level adjustments in place of the earlier, rear-panel screwdriver adjustments. It has a four-tier display showing both input and

output dynamics and is rated as providing a 40-dB increase in usable dynamic range. Price: \$249.00.

For literature, circle No. 101



## ADS Cassette Deck

The Atelier C3 cassette deck records and plays at both the standard 1 7/8 ips and at 3 3/4 ips. The latter speed is intended for such demanding uses as

dubbing from CDs. The deck also features three heads, Dolby B and C NR, and an illuminated loading drawer. The bias/EQ and Dolby B/C NR selectors, normally reset only when changing tapes, are in the

tape drawer. Other features include line/mike mixing and a music finder. The C3 is ready for remote operation with an additional module yet to come. Price: \$799.00.

For literature, circle No. 102



## Bose Amplifier/Speaker System

A new, lower-cost car amplifier/speaker system from Bose continues the

company's tradition of combining full-range, single-cone drivers with equalized amplification. The 1201 Mobile system includes a stereo amplifier delivering 25 watts per channel into 0.45 ohm at less than 0.2%. The amplifier is remotely switched, and has adjustable input sensitivity to match either speaker or preamplifier outputs. The speakers can be either 4 1/2-inch door-mount or 6 x 9 inch rear-deck-mount units. Price: \$299.00 with 4 1/2-inch speakers; \$349.00 with 6 x 9 inch speakers.

For literature, circle No. 103



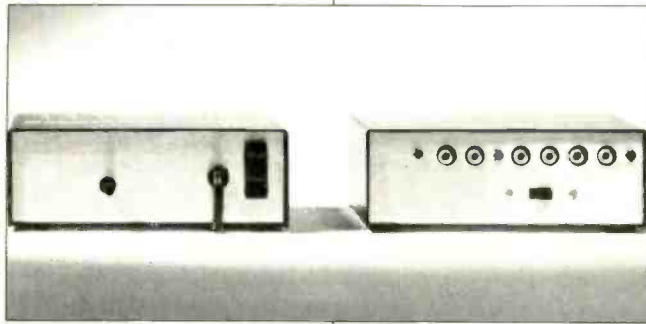

**Ace Subwoofer Crossover**

The Ace Audio 5000-SF crossover can be used with one or two subwoofers in a mono connection, and it includes a bridging circuit and a level control which

provides up to 10 dB of boost. The slope is 18 dB/octave, and the crossover frequency is normally 100 Hz, with other frequencies optional. Price: \$186.00. For literature, circle No. 105

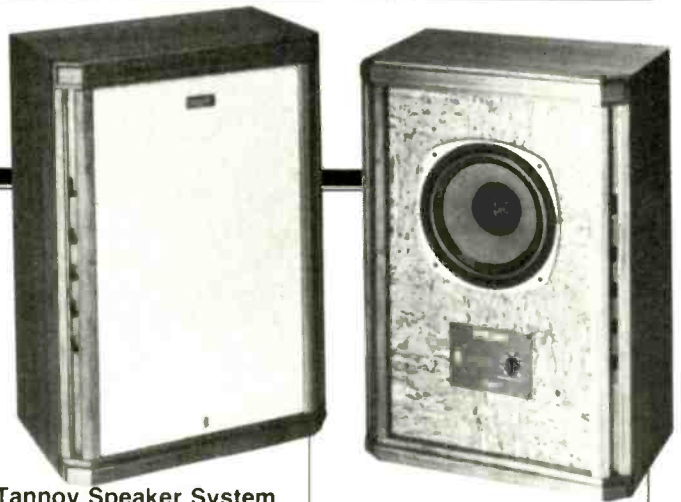

**Tannoy Speaker System**

The Tannoy Stirling loudspeaker uses a 10-inch dual-concentric driver and a "SyncSource" time-compensated crossover network, for a "single-point" sound source. Its enclosure has two ducted ports, one on each side of the cabinet, which can be closed by shutters to change the system from a ported to an acoustic-

suspension design, controlling bass (25 to 100 Hz) output. (Opening the ports gives full bass response, while closing them reduces it.) A control behind the grille sets levels above 1.2 kHz. Response is rated at 35 Hz to 20 kHz, and maximum sound pressure output is 114 dB. Price: \$2,358.80 per pair. For literature, circle No. 106

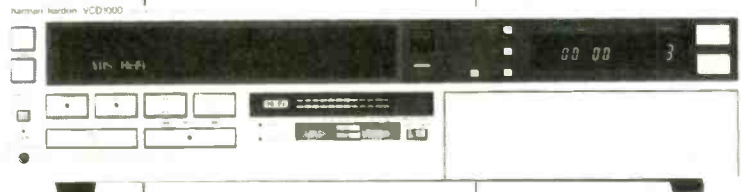

**Harman/Kardon VHS Hi-Fi VCR**

Harman/Kardon's first VCR, the VHS Hi-Fi VCD-1000, is also one of the first VCRs equipped to receive and decode stereo TV

broadcasts. The audio section uses all-discrete, fully complementary circuits, with low negative feedback. Features include a 4-program/14-day timer, still-frame, forward and

reverse picture search, a 105-channel, cable-ready tuner, plus a wireless remote control with preset buttons for 16 stations. Price: \$1,250.00. For literature, circle No. 107

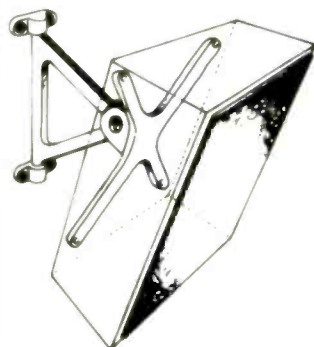

**Pivotelli Speaker Brackets**

The Pivotelli brackets allow flexible wall-mounting for speakers, turntables, television sets or other devices. Versions are available in several sizes, with a choice of screw-on or clamp attachments for the devices to be mounted. Price Range: From \$49.95 to \$199.95. For literature, circle No. 104

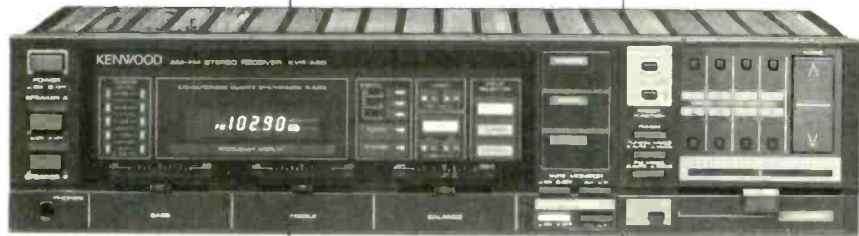

**Kenwood AM/FM Receiver**

The KVR-A50 is one of the growing number of audio receivers with built-in video switching. Inputs are provided for two video

sources with stereo sound, as well as for two audio tape decks, MM phono, a CD player or other line source, and the built-in tuner. The latter has

presets for 8 AM and 8 FM stations, plus manual and automatic tuning. Power is 45 watts per channel. Price: \$305.00. For literature, circle No. 108

## FOR A DEMONSTRATION OF SOUNDCRAFTSMEN PRODUCTS VISIT NEAREST DEALER LISTED BELOW

However, many additional Dealers—too numerous to list here—are located thruout the U.S. with many models on display. If no dealer is shown near you, or you encounter any difficulty, please phone us at 714-556-6191, ask for our "Dealer Locator Operator."

### **ARIZONA**

Tucson  
B & A ELECTRONICS  
Yuma  
WAREHOUSE STEREO

### **NO. CALIFORNIA**

Berkeley  
HONKERS SOUND CO.  
Concord  
SOUND DISTINCTION  
Davis  
WORLD ELECTRONICS

Palo Alto  
WESTERN AUDIO

Sacramento  
NEAL'S SPEAKERS  
WORLD ELECTRONICS

San Francisco  
LISTENING POST

### **SO. CALIFORNIA**

Phone 714-556-6191, ask for  
"Dealer Locator Operator."  
(Insufficient space to list  
all Dealers in this area)

### **COLORADO**

U.S. STEREO STORES

Englewood  
GOLD SOUND

Colorado Springs  
THE SOUND SHOP

### **CONNECTICUT**

Danbury  
CARSTON STUDIOS

Newington  
SOUNDS GREAT

Stamford  
COUNTY AUDIO

### **DELAWARE**

Dover  
SOUND STUDIO

Newark  
SOUND STUDIO

Wilmington  
SOUND STUDIO

### **FLORIDA**

Boca Raton  
CAPTAIN VIDEO

Fort Lauderdale  
CAPTAIN VIDEO

Fort Walton Beach  
AUDIO INTERNATIONAL

Merritt Island  
AUDIO MART ELECTRONICS

Miami  
CAPTAIN VIDEO  
LAS FABRICAS

Orlando  
AUDIO MART ELECTRONICS

Tampa  
MAURICE STEREO

### **GEORGIA**

Atlanta  
AUDIO UNLIMITED  
STEREO DESIGNS

Columbus  
WORLD-WIDE ELECTRONICS

### **HAWAII**

Hilo  
YAFUSO T.V. APPLIANCE

Honolulu  
HARRY'S AUDIO  
VIDEO LIFE

Lihue, Kauai  
JACK WADA ELECTRONICS

Wailuku, Maui  
ADRIAN'S ELECTRONICS

### **IDAHO**

Idaho Falls  
PHASE 4 STEREO

### **ILLINOIS**

Chicago  
MUSICRAFT

Dekalb  
AUDIO PLUS

Evergreen Park  
MUSICRAFT

Gurnee  
OPUS EQUIPMENT

Homewood  
MUSICRAFT

Lombard  
MUSICRAFT

Morton Grove  
MUSICRAFT

Oak Park  
MUSICRAFT

Palatine  
MUSICRAFT

Peoria  
ELECTRONICS DIVERSIFIED

Rockford  
AUDIO ACCENT

### **INDIANA**

Anderson  
ANDERSON ELECTRONICS

Evansville  
TED FINK AUDIO

Goshen  
McKIBBINS SOUND

Indianapolis  
SOUND DECISION

New Haven  
HJS SOUND

South Bend  
SIGHTS & SOUNDS

Valparaiso  
WAYNE ELECTRONICS

West Lafayette  
VON'S AUDIO

### **KANSAS**

Overland Park  
AUDIO ELECTRONICS

Salina  
DEL'S TV

Wichita  
AUDIO PLUS

### **KENTUCKY**

Louisville  
HI-FIDELITY, INC

### **LOUISIANA**

Baton Rouge  
NEW GENERATION

Lafayette  
NEW GENERATION

Metairie  
SOUND TREK

### **MARYLAND**

Annapolis  
SPACEWAYS SOUND

Baltimore  
STANSBURY STEREO

Hagerstown  
HUNT AUDIO

Lutherville  
GRAMOPHONE, LTD.

Salisbury  
SOUND STUDIO, INC.

### **MASSACHUSETTS**

Brockton  
AUDIO VISION

N. Dartmouth  
CREATIVE SOUND SYSTEMS

Sunderland  
SCIENTIFIC STEREO

### **MICHIGAN**

Marquette  
AMERICAN TV

Saginaw  
LISTENING ROOM

Mississippi  
TIPPIT'S MUSIC

### **NEBRASKA**

Lincoln  
LIGHT & SOUNDS FABTASTIC

### **NEVADA**

Las Vegas  
UNIVERSITY PRO AUDIO

New Jersey, So.  
Wildwood  
SEASHORE STEREO

### **NEW YORK CITY,**

### **NORTHERN N.J.**

Phone 201-947-9300, ask for  
"Dealer Locator Operator"

(Insufficient space to list  
all Dealers in this area)

### **NEW YORK—UPSTATE**

Albany  
SOUNDS GREAT

Buffalo  
PURCHASE RADIO

Poughkeepsie  
DUTCHESS AUDIO

Rochester  
SOUNDS GREAT

Syracuse  
SUPERIOR SOUND

### **NORTH CAROLINA**

Charlotte  
AUDIO SALON

Greensboro,  
High Point,  
Winston-Salem,  
AUDIO-VIDEO CONCEPTS

Hickory  
MC LAUGHLIN'S TV

Raleigh  
CREATIVE ACOUSTICS

### **NORTH DAKOTA**

Fargo  
WATTS-MORE

### **OHIO**

Akron  
OHIO SOUND

Canton  
OHIO SOUND

Cleveland  
B&B APPLIANCE  
OHIO SOUND

Columbus  
PALMER ELECTRONICS

Defiance  
ZELLER'S SOUND STORE

Lima  
HART AUDIO

Mayfield Hts.  
HOME ENTERTAINMENT

Middleburg Hts.  
B&B APPLIANCE

North Olmstead  
HOME ENTERTAINMENT

Toledo  
AUDIO CENTRE

Warren  
CUSTOM SOUND CO.

Youngstown  
CUSTOM SOUND CO.

**OKLAHOMA**

Oklahoma City  
JOHNSON TV & SOUND

### **OREGON**

Coos Bay  
PENNINGTON'S AUDIO

Eugene  
BRADFORD'S HI FIDELITY

Klamath Falls  
HIGH COUNTRY RECORDS

Medford  
SOUNDTRACK ELECTRONIC

Portland  
HAWTHORNE STEREO

### **PENNSYLVANIA**

Chambersburg  
SUNRISE ELECTRONICS

Hermitage  
CUSTOM SOUND CO.

Lebanon  
MARTY'S MUSIC

McKeesport  
HI FI CENTER

Natrona Heights  
GOOD HOUSEKEEPING

New Brighton  
TV PARTS

### **PENNSYLVANIA**

Philadelphia  
RADIO 437  
SOUND OF MARKET STREET  
SOUND SERVICE

Pittsburgh  
AUDIO JUNCTION

Pittsburgh  
WORLD WIDE STEREO

Reading,  
Shillington  
PHOENIX HI FI

Willow Grove  
SOUNDEX

### **PUERTO RICO**

Puerto Nuevo  
LASER SOUND

### **SOUTH CAROLINA**

Charleston  
STEREO DEN

Columbia  
NORTON STEREO

Greenville  
DON JONES STEREO

### **SOUTH DAKOTA**

Sioux Falls  
GOURLEY DISTRIBUTING  
PRO AUDIO

### **TENNESSEE**

Chattanooga  
COLLEGE HI FI

### **TEXAS**

Arlington  
SOUND IDEA

Beaumont  
BROCK AUDIO

Houston  
HOME ENTERTAINMENT

Midland  
FOLGER'S ENTERTAINMENT

### **UTAH**

Ogden  
INKLEY'S

St. George  
ARROW AUDIO

Salt Lake City  
INKLEY'S

### **VIRGIN ISLANDS**

St. Thomas  
ELECTRONICS UNLIMITED

### **VIRGINIA**

Richmond  
GARY'S

### **WASHINGTON**

Bremerton  
EVERGREEN AUDIO

Olympia  
DESCO ELECTRONICS

### **WEST VIRGINIA**

Morgantown  
THE SOUND POST

Princeton  
THE SOUND POST

### **WISCONSIN**

Appleton  
AMERICAN TV

Madison  
SPECIALIZED SOUND  
AMERICAN TV

Milwaukee  
PORT OF SOUND

Oshkosh  
AUDIO PLUS

Waukesha  
AMERICAN TV

Racine  
BRANDT'S

# Soundcraftsmen presents...

## The New DC4415 Third-Octave Equalizer

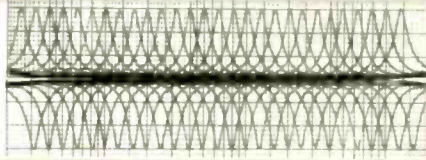

Conventional sharp Q designs provide extremely narrow bandwidth that can result in severe phase shift.

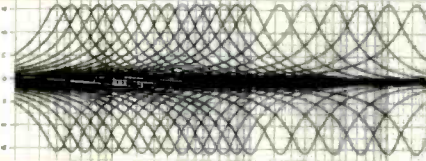

Soundcraftsmen Smooth-Q design prevents harshness by eliminating excessive phase shift of conventional "sharp" Q.

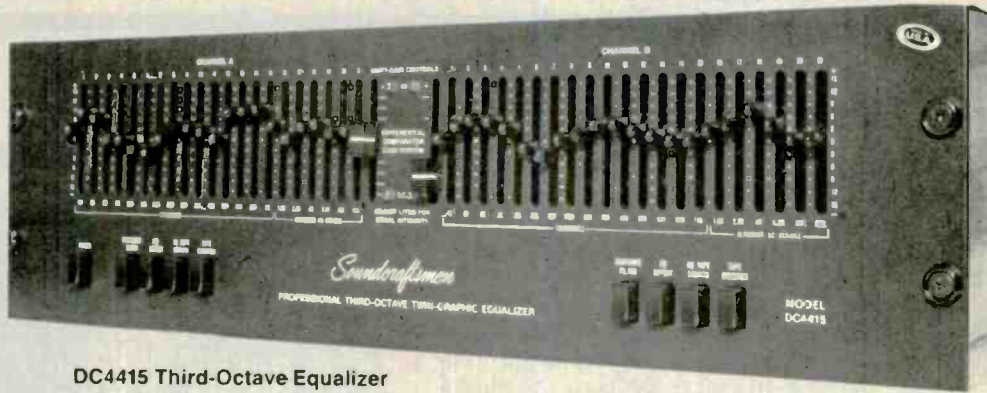

DC4415 Third-Octave Equalizer

The New DC4415 is a Stereo Graphic Equalizer designed especially for the advanced requirements of the new digital source material and its increased dynamic range. This increased dynamic range makes *accurate in-out signal level balancing vital and critical*. The Soundcraftsmen 0.1 dB Differential Comparator<sup>®</sup> balancing system assures *this accuracy*, thus eliminating completely any limitation on the increased dynamic range capabilities of the Compact Discs' digital content... The filters are divided into 1/3-Octave center frequencies from 40Hz through 1kHz. From 1kHz through 16kHz, center frequencies are at alternate 1/3-Octave intervals. All center frequencies correspond with Standard ISO Center Frequencies. This arrangement provides maximum flexibility in the critical low and mid frequencies while permitting reductions in both size and cost in the less critical higher frequencies.

The DC4415 is unique in another important aspect. Unlike conventional 1/3-Octave Equalizers, it does not utilize an ultra-sharp filter "Q" design. The "Q" of the specially designed filter circuits is a fairly low 2.2, combined with a 3 dB per octave slope, to provide especially smooth equalizing characteristics across the full frequency spectrum. By avoiding the conventional extremely narrow bandwidth-filters, we eliminate the harsh sonic characteristics often associated with higher "Q" design, which create sharp dips, peaks, and excessive phase shift. The result is a sonically smooth EQ curve with superb musical characteristics... Soundcraftsmen manufactures a full line of Hi Fi and Professional 10-Octave Equalizers. Prices start at only \$189.00, including a specially-narrated EQ-Analyzer 12" Test Record, instant reset Computone Charts, and connecting cables.

# Soundcraftsmen



AMERICA'S PERFORMANCE/VALUE LEADER  
IN ADVANCED AUDIO TECHNOLOGY...

### DIGITAL QUARTZ AM-FM-FM STEREO TUNER...

AM-FM-FM Stereo Tuner with 7 AM, 7 FM Station Presets, Automatic or Manual Scanning, Active High Blend Circuitry... \$299.

### WORLD'S MOST VERSATILE PREAMPLIFIERS...

Featuring -97dB Phone S/N, Adjustable Phono Capacitance and Impedance, Moving Coil Inputs, Phono Input Level Controls, Exclusive AutoBridge<sup>®</sup> circuit for Mono Operation of Stereo Amplifiers @ TRIPLE POWER OUTPUT, Push-Button Patch Bay with Two External Processor Loops, Digital and Video/Audio Inputs, 10-octave EQ, Precision Passive Coil EQ Circuitry and Differential/Comparator<sup>®</sup> for Highest Gain, Lowest Distortion and No "Clipping" of Wide Dynamic-Range Material. 12" LP Analyzer Test Record and Charts with EQ's... from \$399.

### REAL-TIME SCAN-ANALYZER/EQUALIZERS AND EQUALIZERS, ACCURACY TO 0.1dB...

REVOLUTIONARY Differential/Comparator<sup>®</sup> circuitry makes possible Accuracy to 0.1dB! Automatic or Manual Octave Scanning for Fast, Accurate Analyzing and Equalizing. Precision Passive Coil Filters for Highest Gain, Lowest Distortion, Scan-Analyzer Models. With and Without Built-in Equalizers. No Calibrated Microphone necessary. 12" LP Analyzer Test Record and Charts with EQ's... from \$189.

### REVOLUTIONARY CLASS "H" AND MOSFET AMPLIFIERS, 125 TO 555 WATTS P/C...

The most advanced Stereo and Professional Amplifier Models, featuring Class H Dual Signal-Tracking Power Supply, Auto-Buffer<sup>®</sup> for Continuous 2-Ohm Operation, No Current-Limiting, Power MOSFET circuitry for Highest Reliability, Calibrated LED meters, A, B, and AB Speaker Switching... from \$449.

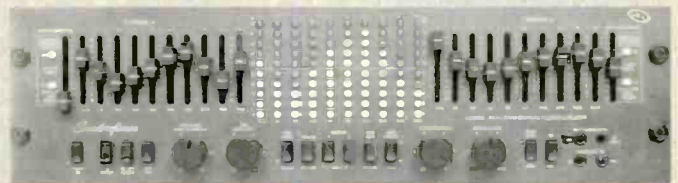
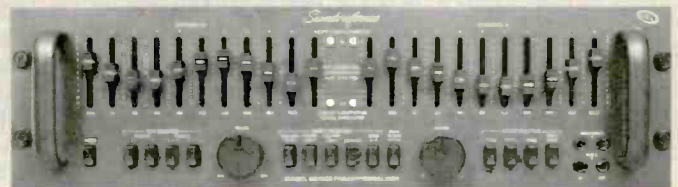

# FREE!

16-PAGE FULL-COLOR BROCHURE, \$19.95 EQ-EVALUATION KIT, includes 1-12" LP Frequency Spectrum Analysis Test Record, 2-sets of Computone Charts, 1-Connector Cable for comparison test, 1-instruction folder for use with your present stereo system, JUST WRITE TO US OR CIRCLE READER SERVICE CARD # 30 for FREE SPECIAL OFFER DETAILS.

2200 So. Richey, Santa Ana, California 92705. U.S.A./Telephone (714) 556-6190/U.S. Telex/TWX 910-595-2524 • International Telex 910-595-2524/Answer back Code SDCRFTSMN SNA

Enter No. 30 on Reader Service Card

# BEHIND THE SCENES

BERT WHYTE

## A/B CD

According to the October issue's Annual Equipment Directory, there are now some 50+ consumer models of CD players on the market, with prices ranging from \$399 to \$1,600. Most people considering the purchase of a CD player usually audition a number of units, listening to them under extremely variable conditions of room acoustics and associated playback equipment. Many people also seek guidance by reading magazine reviews, and most are aware of price differentials between CD players due to the inclusion of "bells and whistles" features and conveniences in various models. The more knowledgeable also know that CD players employ either the 16-bit/44.1-kHz sampling rate system espoused by Sony or the 176.4-kHz oversampling and noise-shaping system favored by Philips.

The burning questions from potential CD buyers are, "Do some CD players sound better than others?" or "Do higher priced CD players sound better?" or "Which CD player sounds best?" Much confusion attends these questions, because while some golden-eared audiophiles state that sonic differences between CD players are easily perceived, there are writers and reviewers who contend that most CD players sound alike. They state that if any audible differences between players exist, they are so slight as to be inconsequential. Although this is certainly not a very satisfactory answer, there is a germ of truth in such allegations. In a casual listening test of the kind usually performed in a typical sound room of an audio dealer, CD players do tend to sound alike.

It occurred to me that a more satisfactory resolution to an appreciation of the sonic differences between players could be realized through the inherent characteristics of the CD medium itself. Consider that a CD is an absolutely uniform, invariable and infinitely repeatable sound source that will never wear out! One does not have to elaborate on the multiple variables involved in the playback of a vinyl record—but to make the point, these are the matters of pressing flaws, surface noises, and improper arm and cartridge geometry resulting in poor groove/stylus interface and resonance problems. Then there are rumble overlays, incre-

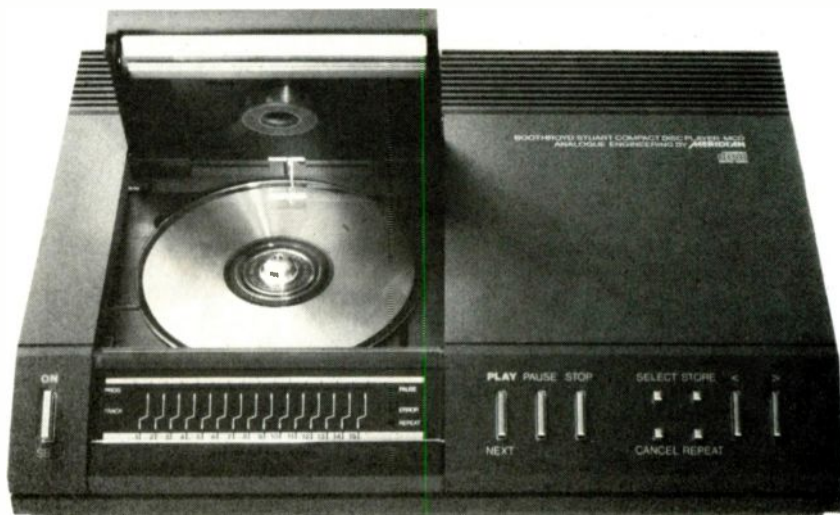

mental wear that ultimately destroys high frequencies and increases distortion. One could go on and on, and when considering all these things, the fact that we can get good sound (for a while) from vinyl records seems well-nigh miraculous.

Because a CD has the qualities I have just enumerated, it is, in fact, the best sound source for A/B testing, an invaluable tool for the evaluation of preamplifiers, amplifiers, loudspeakers—and, of course, Compact Disc players. The ability to quickly and accurately repeat a desired passage of music for the testing of a particular component parameter is the exclusive province of the CD player. The time saving is tremendous, and, of course, there are no concerns about vinyl groove fatigue and wear.

Evaluating CD players for sonic differences is simplicity itself. Required are two identical CDs (the choice of music is a matter of taste, but as a general rule, classical music affords greater dynamic range and a more useful instrumental complement) and a preamplifier with at least two high-level inputs. CD player X is fed into one input, CD player Y into another. It is necessary to have both CD units begin playing the first selection on the disc. Because different players have differ-

ent start-up times after their play buttons are pushed, a stopwatch is essential. If the start time on unit X is 5 S and 7 S on unit Y, Y will then have to be started 2 S earlier. Synchronizing two players is usually easy to achieve by using the fast forward or reverse controls. Once in step, it is easy to simply switch between the inputs on the preamplifier for A/B comparisons; this should not be too much of a hassle for a good audio dealer. If the customer can't hear any differences between players, the purchasing decision can devolve into a matter of bells and whistles and/or styling or price.

You may recall that in the September issue, I reported on the new Meridian CD player. The Meridian people in England made an OEM deal with Philips for their pioneering CD-100 player and then specially modified this unit, attempting to achieve higher performance. It had been postulated by a number of engineers that, quite apart from the problems inherent in digital anti-aliasing filters, almost any CD player could be improved with upgraded analog circuitry. Bob Stuart of Meridian holds similar views, plus a few other ideas about how to improve CD playback. More credit to him for taking the plunge and actually producing such a player.



S-X1130 Audio/Video/Stereo Receiver

# *Introducing one brilliant idea on top of another.*

Unmatched FM Stereo/AM Stereo reception and video control makes them fantastic. X-Balanced circuitry makes them phenomenal. Sansui's 130 watt S-X1130 and 100 watt S-X1100 Quartz PLL Audio/Video receivers are so far advanced, they even have a special decoder that lets you receive broadcasts of all AM stereo systems. What's more, their unique X-Balanced circuitry cancels out external distortion and decisively eliminates IHM, for the purest all-around listening pleasure.

But the advantages don't stop there. Both receivers are complete Audio/Video control centers that are radically different—and significantly more versatile—than any others on the market. The S-X1130 delivers all the highly advanced audio and video performance of the S-X1100, with the added bonus of sharpness and fader controls for enhanced video art functions. And both units offer additional audio dexterity with "multidimension" for expanded stereo or simulated stereo, plus sound mixing capabilities.

For more brilliant, innovative ideas, check out our full line of superior receivers. You'll know why we're first, the second you hear us.

There's more worth hearing and seeing from Sansui. Write: Consumer Service Dept., Sansui Electronics Corp., Lyndhurst, NJ 07071; Carson, CA 90746; Sansui Electric Co., Ltd., Tokyo, Japan.



*Putting More Pleasure in Sound.*



## Chrysler Laser XE. We never forget the competition is always on our tail. We intend to keep them there.

We built the new '85 Laser XE to outperform the competition: Camaro Z28, Trans Am, Mustang SVO, Toyota Supra, Nissan 300 ZX.\* Laser XE does it when you equip it with turbo and European

handling suspension with nitrogen-charged shocks.

In over 500 test runs by the United States Auto Club front-wheel drive Laser dominates the competition.



First in the slalom. Shortest distance in braking with new, bigger Eagle GT radials. And with more turbo-power for '85, Laser does 0 to 50 in 5.6 seconds leaving Z28, Trans Am, Supra and 300 ZX in its wake. Inside Laser XE's fitted cockpit, the performance continues.

A 19-feature electronic monitor thinks with you. Your driver's seat responds with pneumatic thigh and lumbar supports that adjust to

fit your form. You can choose Mark Cross leather and the Ultimate Sound Stereo that remembers what you like to hear and plays it through six premium speakers. Chrysler knows: to be first a sports car must last. So Laser's engine, its 5-speed and even its turbo are backed by a five-year or 50,000-mile Protection Plan.<sup>†</sup> No other sports car gives you that. Not even Porsche. Buckle up for safety.



Chrysler. Best built, best backed American cars.<sup>‡</sup>

\*Based on overall results of USAC tests vs. standard equipped 1984 models. †Whichever comes first. Limited warranties on powertrain and outer body rust-through. Deductible applies. Excludes fleet/leases. Dealer has details. ‡Lowest percent of NHTSA safety recalls for '82 and '83 models designed and built in North America. Best backed based on warranty comparison of competitive vehicles.

**"THE COMPETITION IS GOOD. WE HAD TO BE BETTER."**

CHRYSLER  
**LASER**

The Meridian CD player offered a markedly superior retrieval and presentation of ambience than the Philips player I used for my A/B comparison.

I recently conducted A/B tests of the Meridian MCD and Philips CD-100 players and also performed very comprehensive, straightforward listening tests using a broad spectrum of music. I can state right now that the initial impressions I had of the Meridian CD player at the Summer Consumer Electronics Show have now been completely confirmed. In fact, its performance parameters are beyond my expectations. As you read my comments, keep in mind that while the Meridian CD player was most extensively modified, it was being compared to the Philips player which has, at least, the same basic characteristics.

I fed the Meridian CD player into the auxiliary input, and the Philips player into the tape input, of the excellent Spectral DMC-10 Gamma preamplifier. Synchronization of the two units was easy, since their access time was the same: Simply pressing the play buttons simultaneously locked the two players into perfect sync.

By circumstance, I happened to have four CD recordings in duplicate. I first loaded the players with a Telarc disc (CD-80080). This is a collection of such pieces as the Pachelbel "Kanon," Vaughan Williams's "Greensleeves" and Tchaikovsky's "Serenade for Strings," all beautifully recorded and performed by Leonard Slatkin and the Saint Louis Symphony Orchestra.

The single most significant difference between these CD players is the markedly superior retrieval and presentation of ambience with the Meridian MCD. There is a spacious, open nature to the sound, with more air around the instruments. The Meridian has a cleaner, more well-defined sound, and instruments are more articulate. The music on the Telarc CD was scored for strings, and the sound of the violas and cellos in the upper bass/lower midrange region was more delineated and had better projection on the Meridian unit. This player also afforded a smoother sound to the higher strings.

The differences I perceived between these two units were clearly audible; it was not necessary to strain my ears.

As a change of pace, I loaded both players with the very fine, new Sheffield CD of Dave Grusin's *Discovered Again* (CD-5). Switching between the Philips and the Meridian once again verified the superior playback of the Meridian unit. The pop music in this highly detailed recording (typical of Sheffield) was reproduced with stunning clarity. Transients on the piano and percussion were utterly clean.

I went back to classical music, using Mahler's *Symphony No. 1* (CBS MK 37273) with Zubin Mehta conducting the New York Philharmonic. The repetitive nature of the scoring in the first movement made comparison infinitely easier. The differences between the players were striking, there being much more ambience presented by the Meridian. Here again, there was more air around instruments, particularly the woodwinds, and brass sounds



CD No. 38C38-7189

STEREO 38C38 7189  
PCM DIGITAL  
Interface

**NEW  
DENON CD  
RELEASE!**

**GOMEZ**  
featuring  
**CHICK COREA and STEVE GADD**

From the world's greatest jazz innovators comes an award-winning collaboration. Eddie Gomez, Chick Corea and Steve Gadd join their unique talents to create GOMEZ.

This unprecedented jazz recording received the "Gold Disc" Award from SWING JOURNAL, the pre-eminent jazz publication. This Reference Denon CD release was produced in Japan by Kiyoshi Ito using a 32-track digital recorder.

**DENON**

# ALPHASONIK<sup>TM</sup>

## A-2125 Auto Stereo Amplifier

CLASS  
**A**  
CIRCUIT

■ The A-2125 high power Class A auto stereo power amplifier provides a new level of clarity in auto sound, as pioneered in our highly acclaimed A-265 amplifier.

■ Delivers 125 watts per channel (into 2 or 4 ohms, both channels driven, 20Hz to 20kHz, with no more than 0.01% THD) bridgeable for an incredible 250 watts.

■ Full Complimentary Symmetry circuitry achieves a low negative feedback (30 dB) and high slew rate (30V/microseconds) for low TIM.

■ Pulse Width Modulation regulated power supply and exclusive Perma-Tect<sup>TM</sup> protection.

■ Ideally suited for use with Alphasonik P-1 pre-amp/4-band equalizer.

Alphasonik, Inc.  
701 Heinz Avenue  
Berkeley, CA 94710

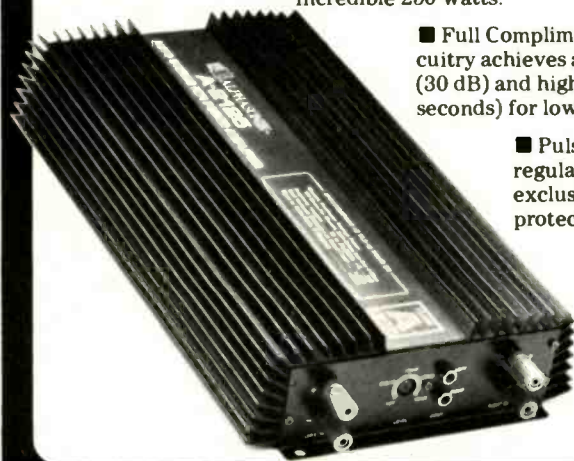

Enter No. 6 on Reader Service Card

Yes, Virginia, there are differences between Compact Disc players, and A/B testing with duplicate CDs can help you hear them.

were cleaner. Alas, the strident high strings that plague so many CDs, including this Mahler recording, were only marginally smoother and less edgy. I'm afraid the excesses of close-up multi-miking, with microphones that have a tizzy top end, are beyond sonic redemption—even with a superior CD player like the Meridian. Having said this, it must be noted that, nonetheless, the increased ambience and spatial presentation make the music more listenable on the MCD.

For my last comparison I used Telarc's blockbuster *Star Tracks* recording (CD-80094). This combines some opening and closing special sound effects with passages from the *Star Wars* trilogy, *Close Encounters of the Third Kind*, and *E.T.* This CD offers a glorious feast of brass fanfares, soaring strings, and percussion of awesome impact. Intelligent miking, using three spaced Schoeps omni mikes, brings a recording of outstanding quality—good by all standards with the Philips player, but absolutely stunning with the Meridian. All that I had come to expect from the MCD—the more realistic presentation of ambience, more air, better definition, and cleaner sound—was very apparent.

The Meridian MCD has the attractive styling of the original Philips CD-100 but is finished in a soft, nappy charcoal gray. All control lettering has been enlarged. As in Levinson equipment and some other components, the circuitry is designed to be constantly energized from the a.c. line, and fluorescent track indicators glow dimly as a reminder of this. When the power button of the Meridian player is pushed, it turns on the motor, which is verified by the track indicators becoming brighter.

The emphasis in the Meridian CD player is on quality, not frills. Best of all, because of the strength of the U.S. dollar in England, the selling price may decrease from its \$850 list price.

To return to the original question: Yes, Virginia, there are sonic differences between CD players, and the duplicate CD, A/B testing technique can help in hearing these qualities. To be sure, some of the differences will be quite subtle, and you may have to fight the ambient noise of the sound room. But it certainly beats choosing a CD player just for its looks!

A

## Retailers—put

# Audio<sup>®</sup>

on your  
counter...  
and welcome a  
great new  
sales partner!

We've got a plan to help build your sales... and ours.

You're invited to join AUDIO's Retailer Sales Plan. Simply offer everyone's favorite audiophile magazine in our handy display rack and you:

- chalk up 100% profit on every issue sold.



- build traffic as your customers come back for issue after issue of AUDIO.
- generate more interest in the accessories and equipment you carry.
- make more sales now!

For details, write to us on your letterhead.

Contact: Margaret Cole  
AUDIO

1515 Broadway, New York, NY 10036  
212-719-6568





# WHO WOULD HAVE THOUGHT IT COULD TRIGGER A REVOLUTION IN SOUND.

Remember when laser technology was the stuff that made for good science fiction?

Well, it isn't fiction anymore.

Because Pioneer has harnessed the same laser that used to blow space creatures away, to blow you away.

With the P-D70. A compact disc player that

reproduces music so realistically you'll think you were at the original recording session.

Since a sophisticated optical laser never makes contact with the disc, all surface noise from dust and scratches is eliminated.

And because the music is processed digitally distortion is essentially nonexistent, resulting in the drama of a live performance.

In addition, the P-D70 contains all the ultra-convenience features of a player so sophisticated and futuristic.

But of course, it's what you should expect from a compact disc player from Pioneer.

After all, we developed laser optics and digital electronic technology for our revolutionary LaserDisc™ brand video disc player.

And that was back when most people were of the opinion that lasers were more fiction than science.



 **PIONEER**  
Because the music matters.

© 1984 Pioneer Electronics (USA) Inc. For your nearest dealer call toll-free (800) 447-4700.

Enter No. 37 on Reader Service Card

EDWARD TATNALL CANBY

## A BIRD'S EAR VIEW

**I**f beauty is in the eye of the beholder, as one old geezer of an aesthetician said, then how about the ear? To be sure, he was right in a way. Beauty is, in effect, what you think is beautiful. Or what somebody tells you is beautiful. But, how about the ear of the listener? That seems rather important to us in audio.

Prejudice in favor of the eyes, that's what we find. It's an eye world, and here we are plugging away with the ears alone, and nothing at all to look at. Except, of course, all that pretty equipment. I'm tempted to say we're up to our ears in it.

Another pundit chose a different sense. Not the ears, of course. He announced that one man's meat is another man's poison. Right! Good man. My prime rib is your emetic. But still—no ears. He's talking about taste buds.

It has been an eye world for a long time. Sound has always been with us, as have the sonic arts of various kinds, but the eyes have had the play as the most important sense—from sheer sales figures to learned definitions of art. Just take a gander at any college course in aesthetics. It's all eye stuff. Beauty for the ear? See cross-reference: *Music*. Different department. The musicians are left to take care of their own beauty.

Now, I have been worried about this for a long time, because I am, first of all, an ear man, even with perfectly good 20-20 vision in stereo. I hear and see, but it's the sound that I notice first. In surprisingly small ways. Since we are all into audio of some sort, you will sympathize with me. Most people are eye people, just as most people are right-handed. (I'm left-handed.) We all have the two senses, except, of course, the deaf and blind; we all share an admirable coordination between them, as we do between our two hands; nevertheless, there are eye people and ear people and it's not only the musicians who are ear-orientated.

Take little things. Bird songs, for instance. I've known many an ardent birdologist (as I call them), and there is no more persistent enthusiast than a bird chaser. If a bird is a bird is a bird, to you, the birdologist will drive you nuts. Shades of Roger Tory P.!

Well, a bird is color, sometimes, and I like color. So, I like cardinals and

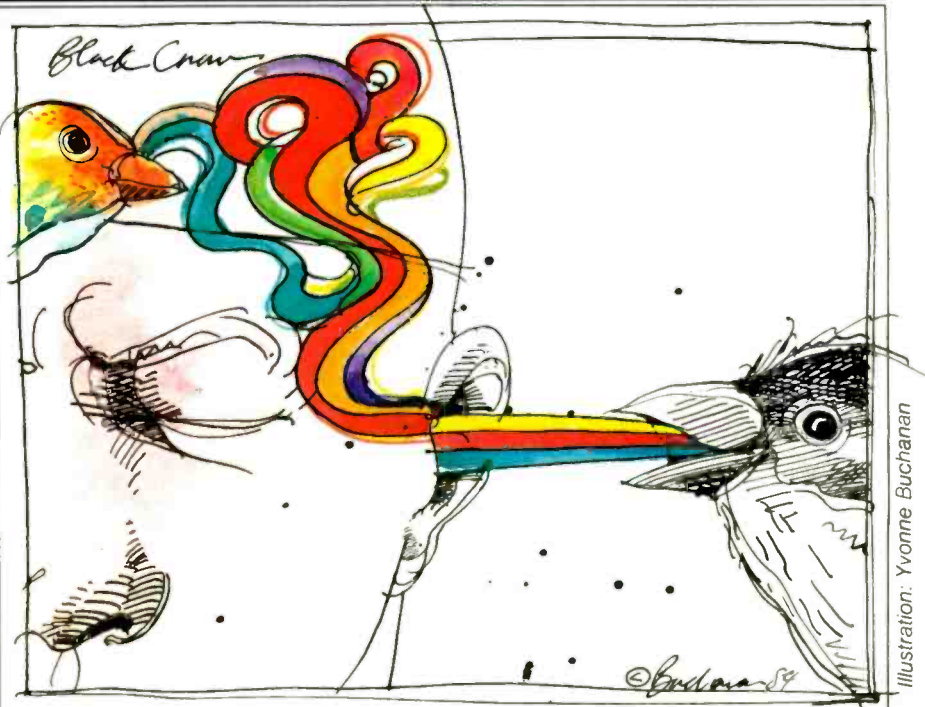

Illustration: Yvonne Buchanan

goldfinches and bluebirds. But all those nasty little warblers that migrate in the spring! Bird people go nuts with their field glasses trying to identify the brand name, feather by feather. This is a typical eye world. I find most birds very dull to look at, especially robins, catbirds and mockingbirds. Gray, mud color or speckled, that sums it up. Even a crow or raven is just a jet-black silhouette.

But the sounds! Such incredible variety, out of such tiny equipment! I can never tire of bird sounds. I even get to know individual birds—by song, not sight. Mostly I never see them at all, nor wish to. I have long conversations with cardinals, who will come right up to you if you challenge them in their own parlance. Also with catbirds, charming conversationalists, or so it seems as you listen. And a mockingbird, that gray thing with the long tail, is an absolute sonic miracle in a miniature package. I have never even seen that serene, distant songster who sings chords, transposing the pitch up and down and supersonic, the hermit thrush. I guarantee you, he's nothing to look at, even through field glasses.

Just try your birdologist friends on a bird song—and watch them reach for their glasses. And Roger Tory P.

Let's move on to bigger and more important things—people. To be sure, I am always happiest when I can reconcile my two primary senses, sight and hearing. Just as when my left hand works smoothly with my right. People are to see and also to hear. In the flesh these are inseparable. But when people depart, or grow up, we have to remember them as they were. How?

Eye stuff again. Billions and billions of pictures—what else? There were portraits, painted and drawn, long before daguerreotypes, and now we have instant. Again, we are sight-orientated. It is by their pictures that we remember our kids as kids, and recall our parents, some long since gone. But *can you hear their voices?*

As for me, though my eyes go along, my ear again comes first and often to the astonishment of others. I can actually *hear* my favorite uncle, an early childhood role model as they now would say, to the very timbre and pitch of his voice. He died suddenly, of a heart attack, in 1934. I think I hear him more accurately than I can see him in my mind. My father and mother, long since dead, are entirely familiar to me when I imagine their voices, or listen to a few odd recordings I still have around. I can make either of them talk

# When the Hollywood Bowl wanted music in the round they chose B.E.S. speakers.

in my head, precisely as if it were the live sound. Photos—of course! I take them for granted, as do most people.

You can understand, then, why I waxed so enthusiastic a year ago (*Audio*, January 1984) concerning my very recent editing of a wedding recording, made on an uneditable 78-rpm disc in 1940. Everybody has wedding pictures, but how many of us have sound pictures of our wedding guests? Especially from a half-century ago. Those recorded voices are so startlingly familiar to me now that I can hardly believe it has been so long.

Have you noticed that though people's figures and faces (and hairdos and clothes) change radically over the years until they are often unrecognizable, their voices remain remarkably constant, from late teenage right through the years of maturity? This confirms my own rare feeling that the sound of people is far more characteristic of them than the sight. The sound describes them best, not the photographs, not the painted portraits nor the (silent) home movies.

And so we in audio and hi-fi live in an eye world. People are eye-trained, not ear-trained. Sounds in the large tend to be background—unfortunate for musicians and for music listeners who hear their music in the foreground, like me. Music itself is changing. More and more, the sound goes along with the sight, with something to look at. Concerts of Baroque dance music—with dancers. Michael Jackson, the sound and the sight. The two go together wherever you look—and listen. In all formats, right and left, but particularly in those which are reproduced. That is the key.

It's not hard to see [sic] the why and the wherefore of this, as Gilbert and Sullivan would have put it. The key is indeed reproduction in our current, nonsexual sense.

In the purely live state, sound and sight went together inseparably as nature intended and as man very well understood. It has always been extremely difficult to separate them, and it still is in the live original. Our ears and eyes, too, have worked together for so many millennia that we are full of subtle, built-in connections and interactions in our system of perception. These belonged to the most ancient of

Conventional speakers that use cones, horns, and boxy enclosures have distortion built in.

When the Hollywood Bowl wanted the world's most advanced sound system, the choice was B.E.S. speakers, with their light-weight computer-designed planar diaphragms. They respond instantly to every shading and mood in the music, and deliver a three-dimensional stereo image wherever you sit.

That's music in the round, the special talent of B.E.S. speakers. Performing now at the Hollywood Bowl—and available now for your living room.

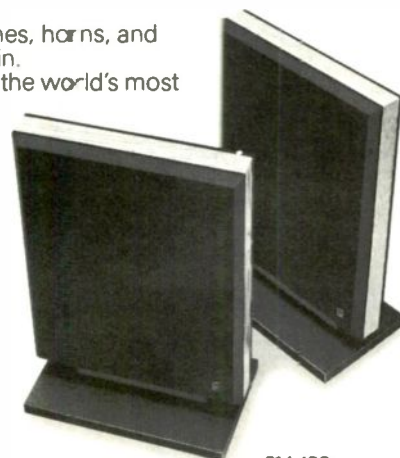

SM 10C

**B.E.S.**  
Music in the round.™

c 1984 by B.E.S., 345 Fischer Street, Costa Mesa, Ca 92626 • (714) 549 3833

Enter No. 10 on Reader Service Card

## Shift to high performance car audio with the KICKER II™

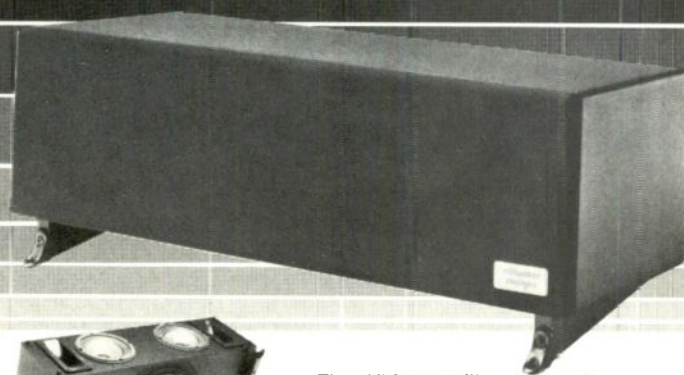

The KICKER II™... massive sound, full of definition and clarity, in a self-contained stereo speaker system designed to fit in the rear of your fastback or hatchback.

- 100 watts/channel maximum amplifier power
- Beautifully-detailed cabinet installs with just two screws.

Available nationwide at better car audio specialists. Suggested list price \$250.00



stillwater designs..

Stillwater Designs 1212 South Main Stillwater, OK 74074 (405) 624-0451

## SONEX looks as good as it sounds.

SONEX traps sound four times better than rich, thick carpeting, so just a few squares can tune your room like recording engineers tune their studios. It's easy to hang, and it looks good. Write for our color brochure, or try a box today. Four 24" squares per box.

Send \$39.95 plus \$3 shipping/handling to: 3800 Washington Ave. No., Minneapolis, MN 55412.

**illbruck**



## Try Audio's Classifieds

The marketplace for Hi-Fi gear!

# BRYSTON



### Bryston announces . . .

a substantial advancement to the technology of audio power amplification.

Bryston has been researching the science and the art of amplification for over ten years. Recently, a breakthrough of sorts at Bryston in the application of complementary Bipolar power-delivery systems has almost perfectly optimized the output transfer-function, resulting in an amplifier more linear, less sensitive to loading, with smaller amounts of upper-order harmonic content than previously possible without class-A biasing, or other special compensation techniques.

We feel that another veil has been lifted from the amplifier's contribution to the overall audio picture. We believe you will think so too. Write to Bryston at the appropriate address (below) for a technical paper on Bryston's newest advancement on the state of the art, and a list of dealers where you can listen to the optimal amplifier (and, of course, our matching preamplifier).

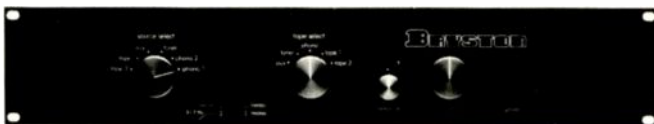

IN THE UNITED STATES

**BRYSTON VERMONT**  
RFD #4, Berlin, Montpelier, Vermont 05602

IN CANADA

**BRYSTON MARKETING LTD**  
57 Westmore Dr., Rexdale, Ontario, Canada M9V 3Y6

Enter No. 12 on Reader Service Card

We are sight-orientated. It is by their pictures that we remember our kids as kids, and recall our parents, some long since gone.

civilizations and to pre-civilized tribes exactly as they do to us today within our living, internal circuitry. It probably served first for human survival, but by a very close second it served for every sort of human entertainment.

But civilization is basically, as they say, a matter of record. We'd call it recording. Accurate duplication—reproduction—of all sorts of things, shapes, documents, artifacts, a sort of visible fi. It was slow in coming, and there was no sound hi-fi at all. Visible hi-fi began when molds turned out identical castings, ring seals made multiple impressions, when movable type brought printing, while etching and lithography reproduced eye stuff with genuine, repeatable accuracy.

Is it any wonder, then, that products designed for the eyes to perceive still have a magisterial eminence in our world, including the sanction of law? Our brief instant of sonic reproduced glory is still much too short to have overtaken what has long endured. The eyes still have it.

The rest is simple. We are increasingly, as I say, in the age of reproduction, to the point where many of us aren't really sure what the word "live" means, as in "live on tape." And thus nature is reversed.

Where in the natural, live state, sound and sight are inseparable, reproduced sound and sight are the opposite. The technologies are much easier if kept apart. Suddenly, it was extremely difficult to put these elements together—in the new reproduced form. So we developed them separately. Eye stuff. Ear stuff. And we found we could do wonders, first with visuals, then, later, with the sonic. Typically, we invented whole new kinds of softgear, as I like to call it, appropriate to each medium. Did we! The silent film. Radio. Records. These things made a new kind of sense, single-sense, and plenty of money too.

But all that is now about over. We are into the Great Merger, sound and sight reproduced together in all formats. It is, as you can see, no more than a return to mother nature, the natural state of things, after a brief interlude. To me, this makes the whole business that much more exciting. We have a lot to look forward to, even including those dollars, if we do it right.

**A**



**THE EXPERTS SAID THEY HEARD EXCELLENT FREQUENCY RESPONSE,  
A HIGHER MOL, AND GREATER DYNAMIC RANGE.**

**BUT NOT IN THOSE WORDS.**

Wicked lows. Manic highs. Nasty passages.  
It all translates the same.

Music sounds better when it's recorded  
on Maxell XL-S cassettes.

That's because we've improved our crys-  
tallization process. So we can now produce  
magnetic particles that are both smaller  
in size and more uniform in shape. Which  
allows us to pack more of these particles  
on the tape's surface, in turn, making it  
possible to record more information within  
a given area of tape.

AC bias noise is reduced by 1dB. And maximum output levels are  
increased by 1.5dB on XLI-S and 2dB on XLII-S.

As a result, XL-S delivers a signifi-  
cantly expanded dynamic range. A  
noticeably improved signal to noise ratio.  
And a fuller impact of dynamic transients.

So if you want to hear your music the  
way it was meant to be heard, put it on  
Maxell XL-S.

Because recording tapes just don't  
get any better.

Or any badder.



**IT'S WORTH IT.**

© 1984 Maxell Corporation of America, 60 O'ford Drive, Monticello, N.J. 07074

Enter No. 32 on Reader Service Card

## SYSTEMATIC THINKING

**F**or the last several months we have examined the various theoretical underpinnings of digital audio. Topics such as sampling and quantization and the way their limitations dictate digital design are critically important, but man does not live by conceptualization alone; he also needs hardware. This month I would like to jump into that particular domain with a look at a complete digitization system, focusing on a PCM hardware design.

A classic stereo PCM digitization scheme is shown in Fig. 1. The recording section consists of input amplifiers, a dither generator, input low-pass filters, sample-and-hold circuits, analog-to-digital converters, a multiplexer, digital processing and modulation circuits, and, of course, a storage medium such as digital tape. On the output side are demodulation and processing circuits, a demultiplexer, digital-to-analog converters, aperture circuits, output low-pass filters, and output amplifiers. This hardware collection is thus the realization of our previous conceptual mathematical theorems. As we have discussed, the whole point here is that of digital storage and the tremendous advantages it presents. Thus, an audio digitization system is really nothing more than a kind of transducer which processes the audio for digital storage, then processes it again for reproduction. While that sounds simple, the hardware must be carefully engineered, for success in accomplishing its task (and the resulting quality of the reproduced audio) depends entirely on the quality of the system's design. Whoever said that all digital audio products sound alike nev-

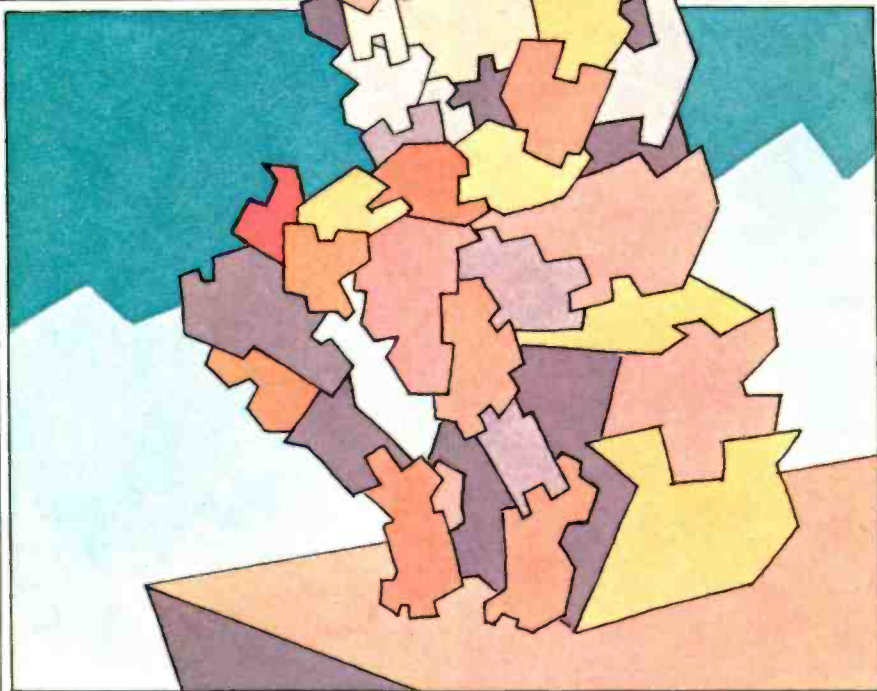

Illustration: Michael A. Donato

er designed one or tried to manufacture it competitively. . . .

Aside from the requirement of absolute quality, so as to not compromise the fidelity of the ensuing digital system, there is nothing interesting about the input amplifier. The dither generator, as discussed last month, is a controlled noise circuit typically outputting white noise. Our first engineering challenge occurs with the input filter. The analog signal is low-pass filtered by this very sharp cutoff filter to band-limit the signal and its entire harmonic content to frequencies below half the sampling frequency. On a professional re-

coder with a sampling rate of 48 kHz, the filter's cutoff will be set around 22 kHz to allow for maximum attenuation at the half-sampling point. A number of analog filter designs may be employed for this purpose, such as types corresponding to Bessel, Butterworth, or Chebychev polynomials. All of these designs offer a flat pass-band, sharp cutoff, and a low stop band. Thus, our band-limited signal passes to the sample-and-hold circuit.

The input sampler samples discrete values of the input signal at a fixed periodic rate, and it holds each analog value while the analog-to-digital conversion takes place. This is required because a varying input to the A/D converter could result in error. A sample-and-hold circuit is essentially a capacitor and a switch. The circuit tracks the signal until the sample commands cause the switch to isolate the capacitor from the signal; the capacitor holds that analog voltage during conversion. The timing of the sample command must be carefully regulated to prevent jitter, the phenomenon of incorrectly varying sample times. Furthermore, the capacitor must be carefully chosen and isolated to prevent any loss of voltage, known as droop.

Our signal now appears as a stair-

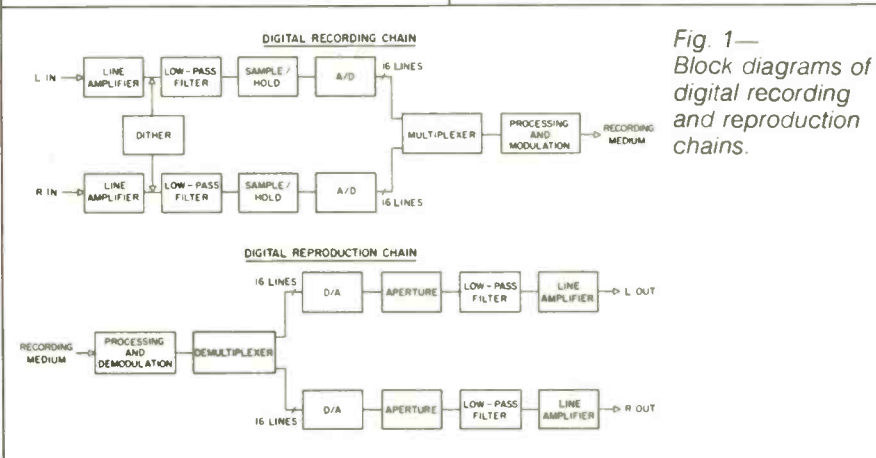

# "It's made by who?!"

And then there's "The name's familiar, but I just can't place the face." Most people aren't aware that Magnavox makes anything as technologically advanced as the Total Audio Component System. Yet it's one of the most sophisticated, complete music systems ever assembled. It's even equipped with total remote control.

Here's how these exquisitely compatible components stack up: *Compact Disc*. From a recording sealed in an almost indestructible 5" disc, a laser beam transmits the purest, most accurate sound ever. With no background or surface noise, music takes on the emotional intensity of a live performance. *Turntable*. Microcomputer controlled, fully automatic with linear tracking. *Tuner*. Digital synthesized with 8AM and 8FM random presets. *Cassette Tape Deck*. Full record, playback features, including auto reverse. *Amplifier*. Delivers 100 watts per channel at .05% THD, 20Hz-20kHz at 8 ohms. *Speakers*. Two 12" woofers, two 5" mid range, two 3" tweeters.

Well, now that you know us better, maybe next time you run into a Magnavox, instead of saying "who?" you'll say "hello."



**MAGNAVOX**  
America's best kept secret.

# TO CREATE A BETTER DISC PLAYER, WE TURNED TO A HIGHER INTELLIGENCE.

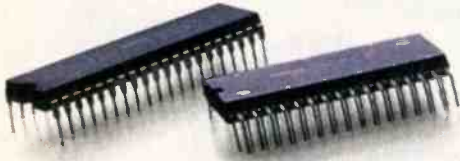

Yamaha's proprietary LSI technology provides audibly superior playback and added programming power.

Introducing the CD-2 compact disc player. And the brains that set it

above all other compact disc players.

We're referring, of course, to our proprietary LSIs (Large Scale Integrated circuits). And the approach they use to process digital signals.

Most CD players convert the digitized signals at a standard sampling rate of 44.1kHz. So they are forced to use a very sharp 50db/octave analog filter to cut off the unwanted frequencies above 20kHz generated by the 44.1kHz carrier signal.

This process creates phase anomalies which degrade the harmonic structure of your music. You hear this as a loss of dimensionality.

So we came up with an intelligent solution. Our YM-2201 LSI. It doubles the sampling rate to 88.2kHz and uses an on-chip digital filter.

This over-sampling eliminates phase distortion and



Cordless infra-red remote control is standard equipment.

maintains the harmonic integrity of your source. With no loss of dimensionality. You can actually hear a more natural, spacious sound from your discs.

A related benefit of our proprietary LSI technology is user convenience. You can choose from three different playback modes. Program the random-access memory system in moments. And search for selections (or individual passages within a selection) at the touch of a button.

You also get wireless infra-red remote control. Our 3-beam laser with LSI-based servo-control for extraordinary tracking accuracy. And a sleek, component-sized package.

What's more, if you don't require the CD-2's random access programming, or a remote, you can enjoy all this sound-improving technology in the CD-X1. At an even lower price. (CD-2, \$599\*; CD-X1, \$499\*)

So visit your Yamaha dealer today. And hear for yourself why our CD-2 is the most intelligent way there is to listen to compact discs.



To match your decor and other components, the CD-2 is available in silver and black (both standard component size).

\*Suggested U.S.A. retail prices



Yamaha Electronics Corporation, USA, P.O. Box 6660, Buena Park, CA 90622





The success of digital hardware depends entirely on the quality of the system's design.

case, a hybrid analog signal ready for conversion. The analog-to-digital converter is the most critical and costly component in a digitization system. Consider: This circuit must transform the analog signal into as many as 65,536 steps, and it must accomplish that task in 10 or 20  $\mu$ S. Fortunately, several circuits are available for this operation. A successive-approximation converter contains a digital-to-analog converter; it tries a digital word, converts it and compares the analog result to the original input, then corrects its approximation until the proper digital word has been determined and output. Integrated A/D converters offer another design approach, a timing circuit. A capacitor stores the input analog voltage, and then the timer counts as the voltage is discharged. The number of counts in that timing becomes the output digital value. Whichever method is used, we have accomplished our initial goal of digitizing the analog signal.

Now that we are in the digital domain, software becomes king and the fun begins. The output of the A/D converter is raw binary data ready to be processed as the designers see fit. However, a number of operations must occur. First, the A/D output is parallel data and our storage devices permit only serial data. Thus, the data is multiplexed; that is, parallel data is converted to serial. Secondly, a data code must be structured to identify the original data words in the resulting bit stream. Perhaps the most intriguing operation takes place at this point. In analog recording, an error is an error, and that's that. In digital we may provide for error detection and correction. The data stream, therefore, is provided with parity bits and redundancy checks, extra data created from the original data to help detect errors. In addition, data is redundantly written for error correction. Finally, the data is modulated and formatted prior to recording on tape. This latter step is hotly debated among manufacturers, as formats and standards are always wont to be.

The storage medium itself can be fixed- or rotating-head tape recorders commonly found in the professional studio. Many recording engineers prefer fixed head designs because of

ease of editing and historical familiarity; however, rotary-head video recorders are more efficient. But no matter what happens in the studio, the data is eventually transferred to the Compact Disc for consumer playback. Both the CD player and the professional's recorder follow the reproduction side of our digitization chain.

The reproduction circuits take care of many housekeeping functions, such as demultiplexing. In this process, the data stream is recovered from the modulation scheme and is again put into parallel form. Our foresight in placing error-detection and correction safeguards in the digital signal prior to storage pays off here. Any errors intro-

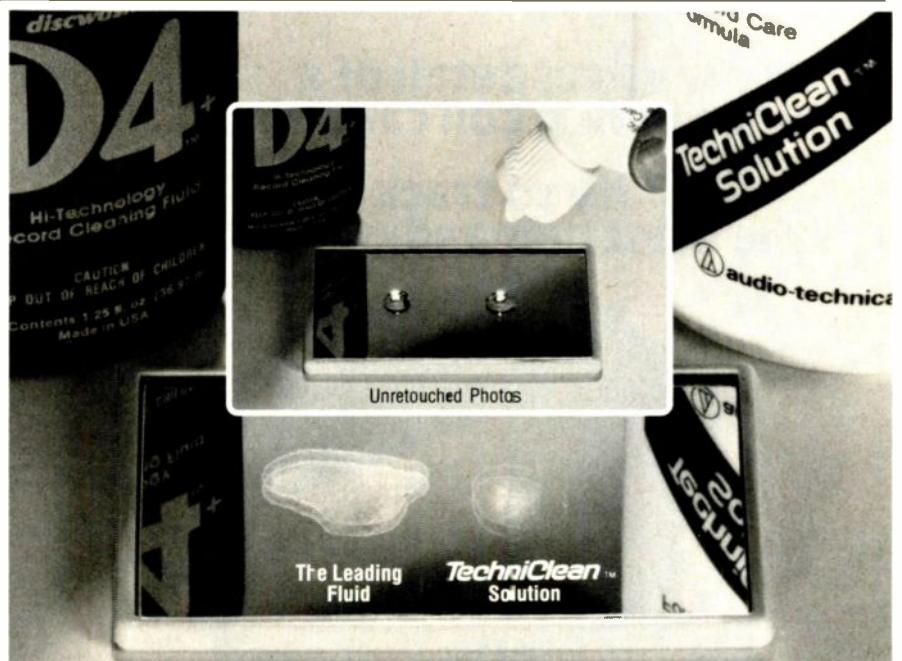

## Hold up a mirror to your record cleaner!

It's hard to see what's happening in the record groove when you use a record cleaning fluid. You can't tell what's left behind by the fluid, though it's a vital factor in the protection of your records.

So we placed a drop of the leading fluid on a mirror, and a drop of AT613 TechniClean Solution beside it. And let both drops dry. You can see for yourself what happened.

Clearly visible residue on their side, almost nothing to see on ours. The Audio-Technica TechniClean Solution makes short work of fingerprints

and oily, waxy debris and dirt. Leaving *less than half* the dry weight residue of the leading fluid. That's clean!

Our TechniClean Solution works with any good record cleaning pad. But it works best as part of the complete TechniClean System. Unlike the leading brand, our system *reduces* static as it cleans. Put the full power of the TechniClean System to work caring for your records today.



Model AT6015 TechniClean  
\$22.95



audio-technica, 1221 Commerce Dr., Stow, OH 44224

Enter No. 8 on Reader Service Card

Beware of claims implying that oversampling doubles the sampling rate and the audio high-frequency limit; nothing of the kind occurs.

duced by the tape or disc are detected and corrected or concealed. This includes mechanical errors such as transport wow and flutter; our data is output at a constant speed referenced by a crystal clock.

The digital-to-analog converter's task is the reverse of the analog-to-digital converter's, but simpler. It is in-

herently easier to accomplish a digital-to-analog conversion because of the nature of the circuit's design. Many D/A converter types are used, but the most common type is the weighted-resistance D/A. Each of the input bits (usually 16) is converted to a current according to its weighting; for example, the most significant bit would

yield a larger current than the second most significant bit, and so on, with each bit value changing twofold. The currents are added and converted to a voltage which corresponds to the original voltage prior to the A/D conversion. For economy's sake, sometimes one D/A converter is shared between channels.

An aperture circuit essentially consists of a switch which is timed to wait for the D/A conversion. When the D/A output voltage is stable, the switch passes the voltage. This removes unstable values and improves the frequency characteristics of the pulse amplitude signal (PAM) present at this point. It is gated as a function of the original sampling frequency; the aperture circuit acts as an output sample-and-hold circuit to accomplish this.

The output low-pass filter is substantially identical to the input low-pass filter and performs the same cutoff function. The staircase function is smoothed, removing all the high-frequency components of those sharp edges, and the original waveform is recovered. Either an analog filter or an oversampling (digital-filter) technique, as found on some CD players, may be used. With oversampling, the sampling frequency is multiplied, and thus extended, and a more gentle cutoff filter may be employed. Theoretically, less phase shift occurs, but perhaps the best reason for selecting the oversampling technique is that a 14-bit D/A converter may be used instead of a 16-bit. Beware of claims by manufacturers which imply that oversampling doubles or quadruples the sampling rate as well as the audio high-frequency limit. Nothing of the kind occurs; oversampling is merely a very ingenious method of output filtering. The final part of our digitization system is the analog amplifier, again hopefully designed with care (by analog designers, not digital specialists).

That's about the size of it. A complete digital audio system isn't really all that difficult, at least in block-diagram form. And even in actuality it isn't an impossible situation. When taken block by block, each part may be thoroughly understood in detail. In later columns, we'll be looking into that. You'll be building your own Compact Disc player in no time. 

## The musical detail of a fine moving coil cartridge . . .

## The ability to track the most demanding records . . .

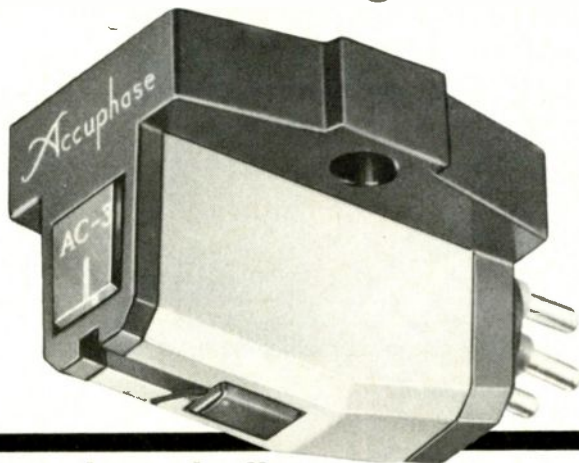

You can have both . . .

# Accuphase AC-3

The AC-3 features a tubular boron cantilever that is reinforced with a beryllium rod. This unique cantilever provides nearly the stiffness of sapphire but with significantly lower mass. Combined with the newly developed microtrack stylus, the moving elements of the AC-3 bring new levels of tracking ability to the performance of moving coil cartridges.

#### Accuphase AC-3

Frequency response	20 Hz to 20 kHz $\pm$ 1 dB
Output voltage at 1 kHz, 5cm/sec	0.2 mV
Recommend tracking force	1.7 grams
Net weight	7.5 grams

Exclusive U.S. Distributor:

**MADRIGAL**  
LTD.

P.O. Box 781, Middletown, CT 06457

# A THOUGHTFUL GIFT FOR A FRIEND WHO ENJOYS GOOD SOUND AS MUCH AS YOU DO

Thoughtful gifts don't have to cost a lot to be appreciated. One of the best gift values you can find for fellow audiophiles is in your hands right now. With this holiday offer, you can give a one-year gift subscription for *half* the regular subscription price—only \$7.97 for 12 months of AUDIO excitement!

(That means you save \$7.97 off the regular subscription price—and over \$16 off the newsstand cost.)

What's more, we'll send a gift announcement card to each person you name and see that the subscriptions begin with the January issue.

Just fill in the postage paid card bound into this issue, and then drop it in the mail. Do it today!

For your convenience, call our toll free number: 1-800-228-4420  
In Nebraska call: 1-800-642-9900



# Audio®

## SAVE 50%

Off the Regular  
Subscription Price

The **Only** Amplifiers and Receivers  
with Wide Dynamic Range  
**And** Low Impedance Drive Capability.

## The Onkyo Delta Power Supply



In order to properly reproduce the dynamic range of today's music, your amplifier must be capable of similar dynamic range. For example, the Compact Disc has a dynamic range of over 90 db, and this can place severe demands on your amplifier. By the same token, the impedance of your speaker system is constantly changing from one moment to the next (as the dynamics of the music change), so your amplifier must also be capable of driving a wide impedance range.

Onkyo's patented Delta Power Supply is the only answer to all of these critical requirements. First, our oversize power transformers provide additional power for substantial headroom. The ultra quiet background essential for noise-free reproduction is provided by the Delta circuitry, and substantial Low Impedance Drive Capability means that Onkyo amplifiers will comfortably handle low impedance speaker loads. In fact, our latest series of amplifiers and receivers are IHF Dynamic Power rated

into 8, 4, and 2 ohms, further evidence of the outstanding power capabilities of the Delta Power Supply.

Because the Delta Power Supply effectively satisfies these critical power supply requirements, true high fidelity is possible with any source material, and choice of loudspeaker. As the name Integra suggests, Onkyo components equipped with the Delta Power Supply give the listener a sound as close as possible to the original, with all of the integrity of the live performance retained.

*Shown is our new Integra TX-85 receiver. In addition to incorporating the Delta Power Supply, the TX-85 features dbx Type II Noise Reduction (Encode/Decode), APR Automatic Precision Reception, Dynamic Bass Expansion, Computer Controlled Logic Input Selection.*

dbx is a registered trademark of dbx Inc.

**ONKYO**  
Artistry in Sound  
200 Williams Drive, Ramsey, NJ 07446  
(201) 825-7950

**Which-Way Dubbing**

*Q. I own a Pioneer CT-4 cassette deck and an Aiwa AD-F330. When recording from tape to tape, which deck should I use for recording and which for playing the tape?—Andy Dresdner, Summit, N.J.*

A. Generally, you should play the original tape on the quieter deck—that is, the one with the greater signal-to-noise ratio in playback. I don't know which of your two decks is the quieter.

On the other hand, for best frequency response (including Dolby tracking, if you use Dolby NR), it may be advantageous to play the original tape on the deck that recorded it. Thus, tapes recorded on the Pioneer would be played on the Pioneer even if the Aiwa were somewhat quieter in playback (which is not to say that the Aiwa is quieter).

Your best course is to experiment. Use one deck in the playback role and the other in the record role, and then swap them, checking the results of both trials by ear. Quite possibly you will find there is no prominent difference between the roles you assign to each deck.

**Bass Bumps**

*Q. My cassette deck has a slight but noticeable emphasis in the range of 60 to 100 Hz. For instance, when playing back a recording of a jazz group, the string bass will be slightly more pronounced on the tape than on the record from which I made the tape. I recently acquired a speaker system that has a frequency response "hump" of about 2 or 3 dB at 60 Hz, which makes the tape deck's bass boost even more noticeable. Is there a way to eliminate this bass boost?—Robert P. Bottman, Olympia, Wash.*

A. Tape decks typically display irregularities in playback response at the low end of the audio spectrum, consisting of a series of "bumps" below about 100 Hz or so. This is due to the tendency of the entire head, rather than the gap alone, to respond to the magnetic flux emanating from the tape when the head is no longer much larger than the recorded wavelength. Wavelengths are long at bass frequencies, with wavelength equal to tape speed divided by frequency.

However, this irregularity can be

minimized by proper head shape and approach of the tape to the head. Therefore, some decks show less irregularity than do others.

Your low-end emphasis may be due to one or more of the bumps. It may also be due to the equalization employed in recording, which sometimes supplies a mild amount of bass boost. There is probably little that you yourself can do about this, although a qualified technician could adjust either the record or playback equalization; this might involve a fair amount of effort and cost.

Whether the record or playback equalization should be adjusted depends on where the fault lies. If your deck has exaggerated bass when playing standard frequency-response test tapes, then the playback is at fault and its EQ should be corrected. If the exaggerated bass is heard only from tapes made on your recorder (especially if the same problem is heard when playing those tapes on other decks), then the record equalization needs adjustment.

You might try reducing the bass in playback, either by your bass control (which may not be very satisfactory) or by a graphic equalizer (if you have one), which can usually provide quite satisfactory results.

**Balancing Channels**

*Q. What is the best way to set the individual record-level controls so that the original source's channel balance is preserved? My open-reel deck has separate level controls for each channel, while my cassette deck has individual channel controls as well as a master level control. My preamp's stereo/mono switch does not affect the signal going to the recorder, so setting the levels on the basis of a monophonic signal is not possible.—Brian K. Howard, Centerville, Ohio*

A. This is a good question and a tough one. After all, what is the "original source's channel balance"? The relative levels of the two channels can be affected by several factors, among them the judgment of the recording engineer and the channel balance of the signal source you are using, such as a phono cartridge (output of the two channels can differ by 1 dB or more). In general, it appears the best course

is to adjust the record level of each channel independently so that program peaks register at maximum permissible recording level. If necessary, then alter the relative levels of the two channels in playback via your deck or audio system controls.

**Adding Dolby HX Pro**

*Q. I wish to know if the Dolby HX Professional circuit can be installed in existing cassette decks.—Steve Mably, Willowdale, Ont., Canada*

A. To install HX Pro in an existing deck would require very considerable technical know-how and skill, so that is virtually ruled out. The circuitry is sophisticated, using the high-frequency content of the program material to meet part of the bias requirement in recording. That is, as the high-frequency content increases, the bias current is correspondingly decreased because the high frequencies tend to have the same biasing effect on low frequencies as the bias current does. Thus, overbiasing is prevented and better high-frequency response is obtained, inasmuch as treble response drops as bias increases.

**Fading Highs**

*Q. I have a home tape deck which I use to record tapes with Dolby C NR, and I play them back without Dolby (on a car or another home player). I find that the highs fade in and out, but, when I play back with Dolby C, the fading goes away. Is this a normal occurrence, or is the cassette deck that I use for recording defective?—Werner Apel, Lincoln Park, N.J.*

A. Your deck appears to be operating normally. The Dolby NR system applies variable treble boost in recording; the lower the signal level, the more the boost. With Dolby off in playback, one might hear this variable boost as a fading effect. But when Dolby is on in playback, there is complementary variable treble cut, which restores flat frequency response.

The amount of treble boost and cut employed by Dolby B NR is substan-

**If you have a problem or question on tape recording, write to Mr. Herman Burstein at AUDIO, 1515 Broadway, New York, N.Y. 10036. All letters are answered. Please enclose a stamped, self-addressed envelope.**

Broadcasters use tape cartridges for their convenience, but there's a sonic benefit, too.

do its damage. Merely turning things off, even en masse, obviously was not enough protection.

My solution was to "single up" all of my equipment's a.c. power connections to a group of four, heavy-duty sockets and a 3-foot heavy-duty cord to a single plug, from which another heavy-duty wire and plug went to the wall outlet. Now I can, and invariably do, unplug all the vulnerable instruments at once by pulling out one plug. I call it my "lightning plug." When it is pulled, gravity takes it more than 20 inches away from its wall outlet, a substantial "airbreak" for any high-voltage spike.

That one entry of wild thunderstorm voltage cost me \$80 for repairs, and I was lucky to get away with so little. Since the "lightning plug" installation, I have had no further damage.—Will Hoskins, Jacksonville, Fla.

#### More on Broadcast Tape Cartridges

The following material is drawn from three letters which were sent to me in response to the May 1984 "Audio-clinic" item on broadcast cartridges. I thank these people, who took time from their busy schedules in broadcasting and advertising to shed more light on this interesting subject.

The primary tone which precedes the beginning of program material is rarely, if ever, used for anything except stopping and appropriately "cueing" the cartridge.

This stop/cue (or recueing) tone is not added manually, but is automatically inserted at the time a tape "cart" is started in the record mode, which eliminates any concern about its placement.

If it is desired to start another source, near or at the end of the current program, a secondary tone, of different frequency, is recorded on the cue track. This permits the next source to begin, say, during the fade of a song to create an overlap, or "segue." The cartridge continues to run until it encounters the primary (stop) tone. Using this system, the cartridge need not be the exact length of the program, as you said. Indeed, cartridges are commonly sold in increments of 30 S and thus exceed the program length by (usually) 10 S or more. "Recue time" (the time between the program's

end and its beginning) is minimized by selecting a cartridge length which exceeds the program time by the minimum amount.

A tertiary tone, also different in frequency, may also be used for special purposes, such as starting a tape to "voice-over" the intro of a song.

Broadcast cartridges are similar in design to the largely extinct four-track type, but the broadcast version does not have a built-in pinch roller.—Dennis J. Martin, Banning, Cal.

You're quite right that broadcast tape cartridges are used primarily for convenience, but there is a significant sonic benefit from transferring music from vinyl disc to tape cartridge for on-air playback. The radio-station control room environment is hostile to a vinyl disc's surface. With the frequent playback encountered in most radio formats, normal wear and careless handling reduce an LP to tattered vinyl in very short order. Transferring the music to tape cart preserves the integrity of the disc and allows repeatable, high-quality playback under these operating conditions.

The quality of many broadcast tape cartridge machines is very high, and companding noise reduction is often used with high-output tape for excellent sonic performance. Although transferring the music to cart does introduce another generation of tape, the net result is improved long-term audio quality for radio listeners.—Christopher B. Downing, Merriam, Kans.

Broadcasters do not use tapes containing multiple selections but, rather, play each song on its own, separate cartridge. To most consumers, this would be no different from playing 45s on a single-play turntable.

The cartridges are not interchangeable with the eight-track format.

In terms of the application of this equipment by consumers, the cost is virtually prohibitive in every area. As in most professional situations, the customer pays for the specialized engineering of a product sold to a limited market. Even though prices vary, depending on models and features, play-only cart machines sell from about \$600 up to \$2,000. A unit which can also record will cost about twice that much.—Walt Pinto, Woodbridge, Conn. A

## Finally, compact discs at a compact price. \$7.99.

Sony® brings you a compact disc offer that's music to your ears and an ode to joy for your wallet. Compact discs for no more than you'd pay for an ordinary LP or cassette tape. Just \$7.99\* each.

For a limited time only, Sony in cooperation with CBS is offering 30 of the most popular titles at a great low price. If you purchase any Sony home, car, or portable Compact Disc Player between Nov. 1, 1984 and Feb. 28, 1985, you can choose any or all of these great CBS titles:

ARTIST	TITLE
Bruce Springsteen	Born in the U.S.A.
The Jacksons	Victory
Scandal	Warrior
Cyndi Lauper	She's So Unusual
Footloose	Soundtrack
Billy Joel	Innocent Man
Willie Nelson	Always on My Mind
Journey	Escape
Kenny Loggins	High Adventure
Miles Davis	Decoy
Jeff Beck	Wired
Meatloaf	Bat out of Hell
Bruce Springsteen	Darkness on the Edge of Town
Dan Fogelberg	Phoenix
ELO	Discovery
Billy Joel	Glass Houses
Toto	Turn Back
Men at Work	Business as Usual
The Jacksons	Triumph
John Williams	Rodrigo: Concierto de Aranjuez
Yo-Yo Ma/ Lorin Maazel	Lalo: Cello Concerto
Pinchas Zukerman	Mozart: Violin Concerti Nos. 3&5
Zubin Mehta	R. Strauss: Ein Heldenleben
Leonard Bernstein	Prokofiev: Symphony No. 5
Placido Domingo	Perhaps Love
Glenn Gould	Bach: Goldberg Variations
Wynton Marsalis	Haydn: Trumpet Concerto
Stevie Ray Vaughan	Couldn't Stand the Weather
Elvis Costello	My Aim Is True
Bob James & Earl Klugh	One on One

To take advantage of this great offer, just return a copy of your sales receipt and owner's registration card along with the special order form available only at a participating Sony CD Dealer. Payment must be made by check, money order, MasterCard or Visa before April 30, 1985.

## SONY

THE LEADER IN DIGITAL AUDIO™

\*Plus postage and handling. See your participating dealer for details. © 1984 Sony Corp. of America. Sony is a reg. trademark of the Sony Corp., 1 Sony Dr. Park Ridge, NJ 07656. "CBS" is a trademark of CBS, Inc., 1984, CBS, Inc.



# Please accept Sony's sincerest apology for making all car stereos obsolete.

## SONY INTRODUCES THE WORLD'S FIRST CAR COMPACT DISC PLAYER.

To state it bluntly, the difference in sound quality between the new Sony Car Compact Disc Player and everything else is like the difference in performance between a Ferrari and a Model T.

One noted audio critic at *High Fidelity* magazine said, "In all my road testing to date, I've never heard it so good... It can stand comparison against the best home CD players we've tested... The new Sony Car Compact Disc Player is the real thing in every sense."

And not only are wow and flutter unmeasurable, but its phenomenal 90dB dynamic range will sound that way forever. Because Compact Discs are played by a laser beam. Not a tape head. So you can't wear them out.

To test-drive the Sony Car CD Player, visit your nearest authorized Sony autostereo dealer.

And once again, accept our regrets for rendering your present system an antique.

**SONY.**

THE LEADER IN DIGITAL AUDIO.

# Rock 'n' ROADIES

## Traveling with Journey

Leaning back against a wall, he props his feet on a numbered crate. His face is drawn and his eyelids droop as the vibrations of heavy rock music and 12,500 fans bounce off the walls.

After helping unload the trucks of over 40 tons of amplifiers, speakers and other musical and video equipment and completing the myriad tasks for which he is responsible, he nods off to sleep for a couple of hours during the show.

He works and lives with rock stars, but his job is not as glamorous as those of his counterparts on the stage. Yet without him and an estimated 5,000 members of road crews who work with bands which pack the nation's larger stadiums and concert halls, there would be neither stages nor concerts.

And the equipment and techniques that are the backbone of those concerts are becoming more and more sophisticated, changing the most basic techniques of the music world.

In the past the only qualifications needed to work on a road crew were muscle and a nomadic spirit. Today "roadies" are highly specialized technicians responsible for the smooth operation of multimillion-dollar concerts.

This involves not only audio but video and other electronic (and nonelectronic) technology. Take Journey, for example. The top concert group of the 1983 summer concert series, Journey performed before 1.5 million people in 27 cities, taking their own video system with them. That system's 15-by-20 foot screen enabled even the most unlucky ticket-holders, in nose-bleed corner seats, to see in colorful detail the intricate guitar licks of Neal Schon and the sweat on lead vocalist Steve Perry's face.





**by Pam Alloway**  
**Photography by Patricia Foster**

*Journey's lead vocalist,  
Steve Perry, and guitarist  
Neal Schon.*  
*Inset photo: The final result—  
Journey on stage, with all  
equipment going.*

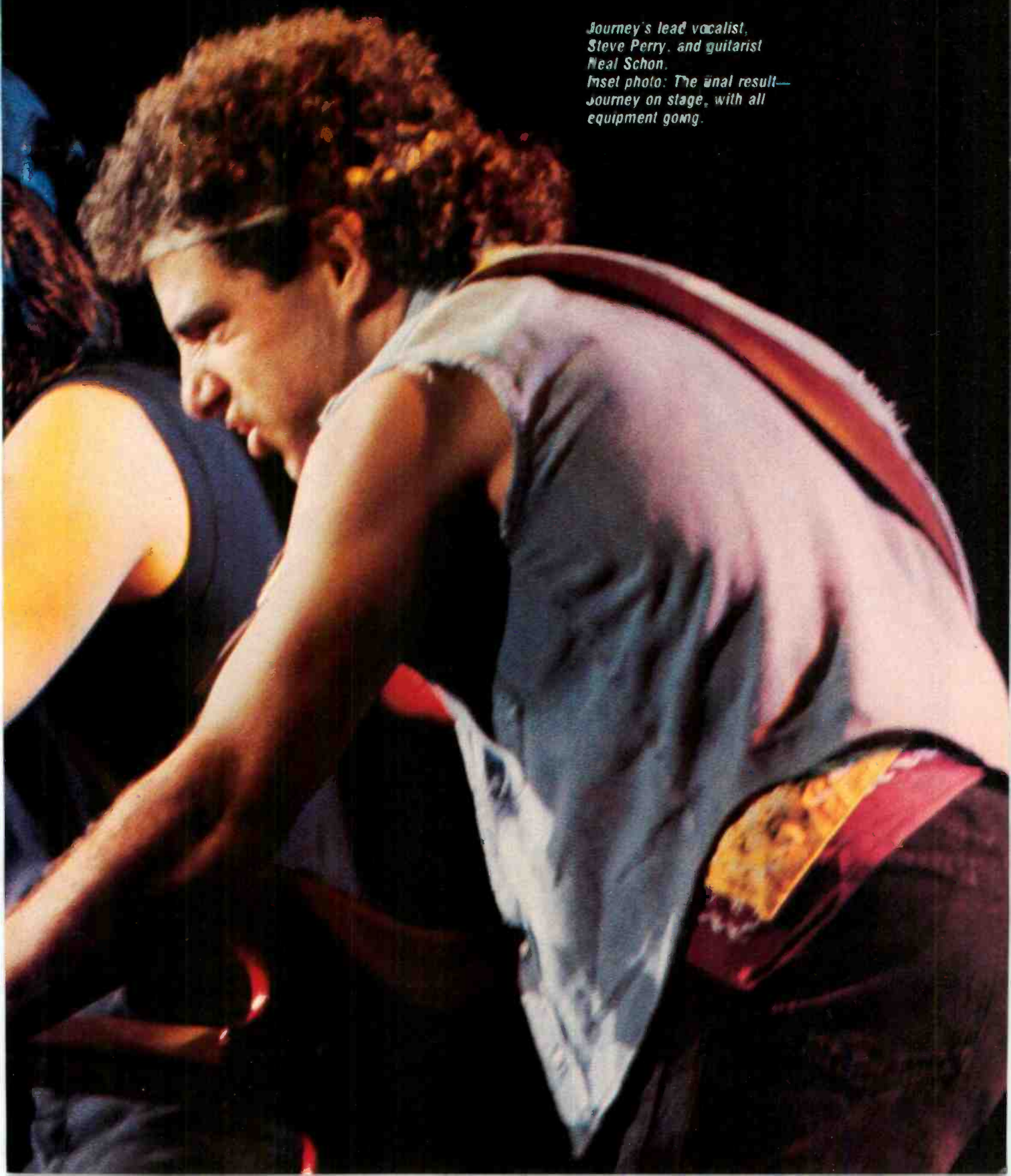



**To the road crew, every new hall is a new challenge. And when the group performs outside, that's a whole, new ball game.**

Journey has a long-standing romance with video of all kinds. There's even a Journey video game (the object is to collect all five of the band members' instruments so they can play a concert). But it's the innovative indoor video show that has captured the public's attention and sent fans' jaws jabbering and their hands moving toward their wallets to find \$12 to \$15 for a ticket.

Journey's management company, Nightmare, Inc., says the inclusion of the video show initially was prompted by sluggish attendance at concerts, competitive concert seasons with more and more artists on the road, and a more refined, discriminating audience.

"Take the man who, for years and years, has been seated in the back of the house," says Journey's production manager, Benny Collins. "All he's seen is a bunch of little heads running around. That no longer happens at a Journey show. There are no bad seats. The video system is designed to give our fans an optimum view."

Collins is a beefy man with a hoarse, gravelly voice and a cigarette ever present between his fingers. Interviewed while Journey was setting up for an appearance at the Kansas Coliseum in Wichita, Collins sent orders and people flying as he strode around the set or, in a makeshift office backstage, listened to two

**Opposite: Cameraman Bob Loney takes aim during a performance.**

**Below: Hazards of the trade—pyrotechnician John Watkins shows the scars from an explosives accident.**

**Bottom: Russell Lynn, of the sound crew, talks about his work.**

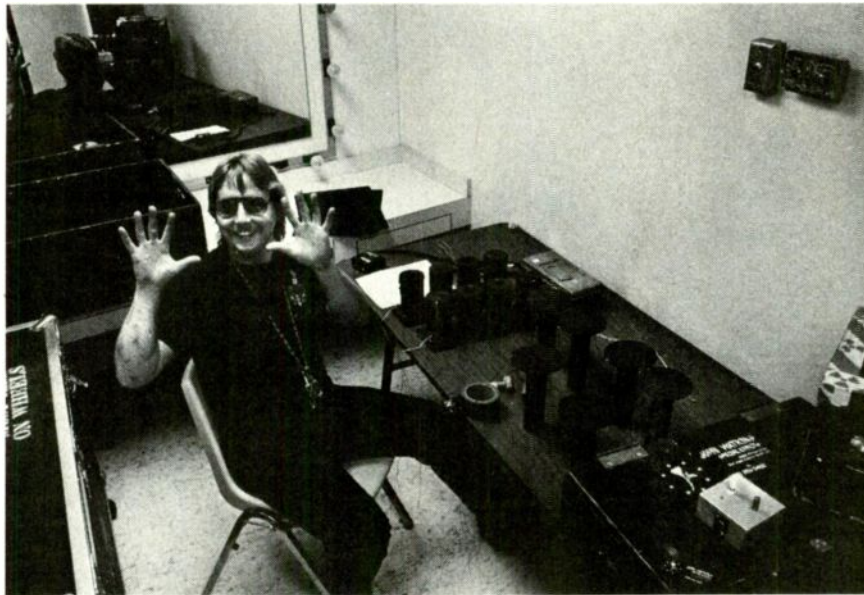

certainly glad to see it. It means security for me."

Loney is a self-described "transplanted keyboard and guitar/synthesizer technician." After working for various electronic musical companies in the United States and Japan, in 1978 Loney became the technician for a one-man band, then moved into positions on sound and lighting crews, and worked two years as a keyboard technician for Devo, a group known for its heavily synthesized sound, before joining Journey on its 1983 tour.

Video is nothing new to the music scene, but musicians have been somewhat reluctant to use it until lately. Now bands are scrambling head over heels in the mad rush to outdo one another in the video race. And Loney says this is not just a passing fad. Video has become a vital part of the music business.

"I don't think bands are scared of being exploited by video like they once were, as much as they are trying to keep up with the technology that is caught up with it," Loney said. "A popular comparison would be public address systems. We didn't used to have PAs and now we can't do without them."

The ultimate winners in this revolution that has bred video

conversations at once, with phones held to either ear.

For the past five years the 35-year-old grandfather has climbed the rungs of the road-crew management ladder, starting as the drum roadie. He then became the drum roadie/stage manager and now is the production manager. Collins also holds a master's degree in applied behavioral science which, he admits, frequently comes in handy when trying to ride herd on his crew of 24 and the additional 16 stagehands hired in each city to help out.

The addition of video to the group's show took some getting used to, says Collins. But enthusiastic receptions by the public and good reviews of the show with its new addition have relieved any misgivings other crew members might have had.

"We didn't get into [live video projection] before, because we were still trying to understand the medium," said Collins. "Other bands used live video outdoors but until recently it had never been tried inside."

Bob Loney, 33, in charge of the four-man video crew, refers with almost parental pride to the equipment that makes Journey's indoor video projection possible. The projector Journey uses bounced out onto the market in the summer of 1982, and because of its compactness and minimal distortion

was welcomed with open arms. Previous projectors required full rigging crews to unload them and were far too bulky to lug around. The refrigerator-sized units, weighing in at a modest 140 pounds each, required only two men to move, making it feasible to use the projectors on a daily basis. But there also were new problems, slowing the projector's acceptance into the band's equipment line.

By careful control of the screen's modulating light level, as well as use of a high-quality lens, such problems as excessively fuzzy pictures and unacceptable distortions were corrected so that a semi-sharp image could be projected onto the screen that hangs on top of the PA system, some 33 feet off the ground.

"The light during a concert is very low and indirect," Loney explained. This does not affect the projection screen— if anything, it helps—but it does cause problems for the video cameras. "You have to be careful of images bleeding into each other."

Problems or not, what began with a slow start took off with lightning speed.

"Video meets rock 'n' roll," said Loney. "Journey's 1983 summer tour was the first video projection show to happen day after day. But the use of video projection has really exploded since then. It's very sellable, and I'm

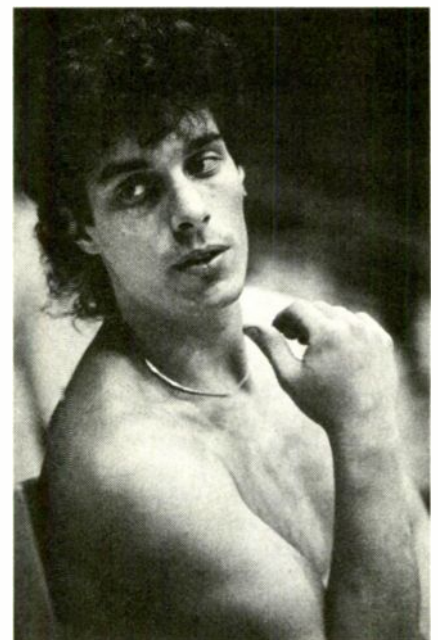

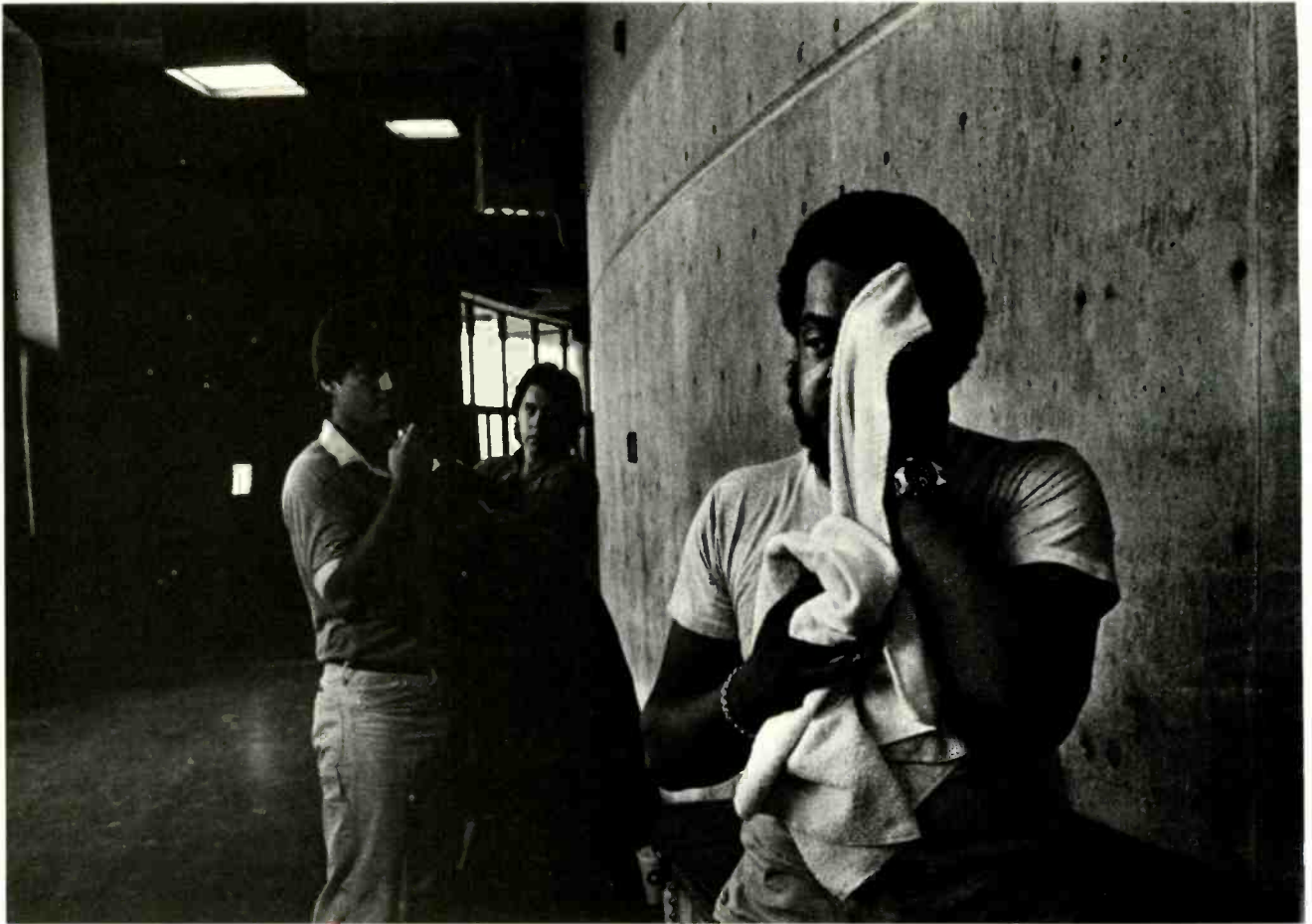

**Once, muscle and a nomadic spirit were all it took to work on a road crew. Today, roadies are specialized technicians.**

projection are, of course, the fans—particularly those small-statured fans who in the past have had to strain to see performers. Loney, who stands just slightly over 5 feet, can readily identify with them.

"I think video projection is great. I know I really got tired of looking at the back of people's knees every time I went to a concert," Loney says.

As a member of the video crew, Loney spends much of his time behind a camera. From a cameraman's point of view, keeping up with the frantic jumping, running and gyrations of five active young

men is not as easy as it might look.

"Seems like I look at Neal Schon's back a lot of the time," said Loney. "But the shows are pretty much the same every night and the musicians usually will be in the same place every night. For instance, when Neal gets ready to do his fast guitar work, you can feel it coming and you just gradually zoom in."

The Journey tour also uses technology that booms—very loudly—instead of zooming. That's John Watkins's department. To find Watkins in his equipment room backstage, one opens a door plastered with brightly colored signs that warn "No Smoking" and "Danger—Explosives." Watkins is Journey's pyrotechnician, the man in charge of the show's special effects, which includes explosives.

"The idea is to take a band that is very musical and performance-orientated and accentuate them without taking away from the music," says the 29-year-old Watkins. "The bands have the talent. The purpose here is to complement."

In Journey's 1983 show Watkins had two opportunities to complement the band. For one he used low-level explosives to simulate a "line of fire,"

the sound of a handgun barrage. The show concluded with six 70-foot salutes—bright, golden fireworks headed skyward (or in this case, ceilingward). These salutes, called "Gold Mines," are each made from 25 grams of gunpowder and a substance called "Super Flutter Flash," packed into a black cylinder tooled from solid steel.

Watkins, who holds a college degree in psychology, has worked for seven years as a professional pyrotechnician, and among his responsibilities at each show is acting as a tour guide for the local fire marshal. The fire marshal checks out Watkins's equipment and surveys the stage to ensure a safe distance between the special effects and the area where exuberant fans will stand. The local fire officials also look at Watkins's licenses to make sure they are current and authorized. Watkins has two federal licenses plus separate licenses for New York and Maryland; the licenses give him authority to work with low-yield explosives in controlled areas.

Caution is the uppermost thought in Watkins's mind as he readies his materials for the show. Not only must he be concerned about the fans

*Opposite: Production manager Benny Collins switches a second to wipe his sweat-beaded face.*

*This page: David Berger, of Journey's lighting crew, checks out stage lights.*

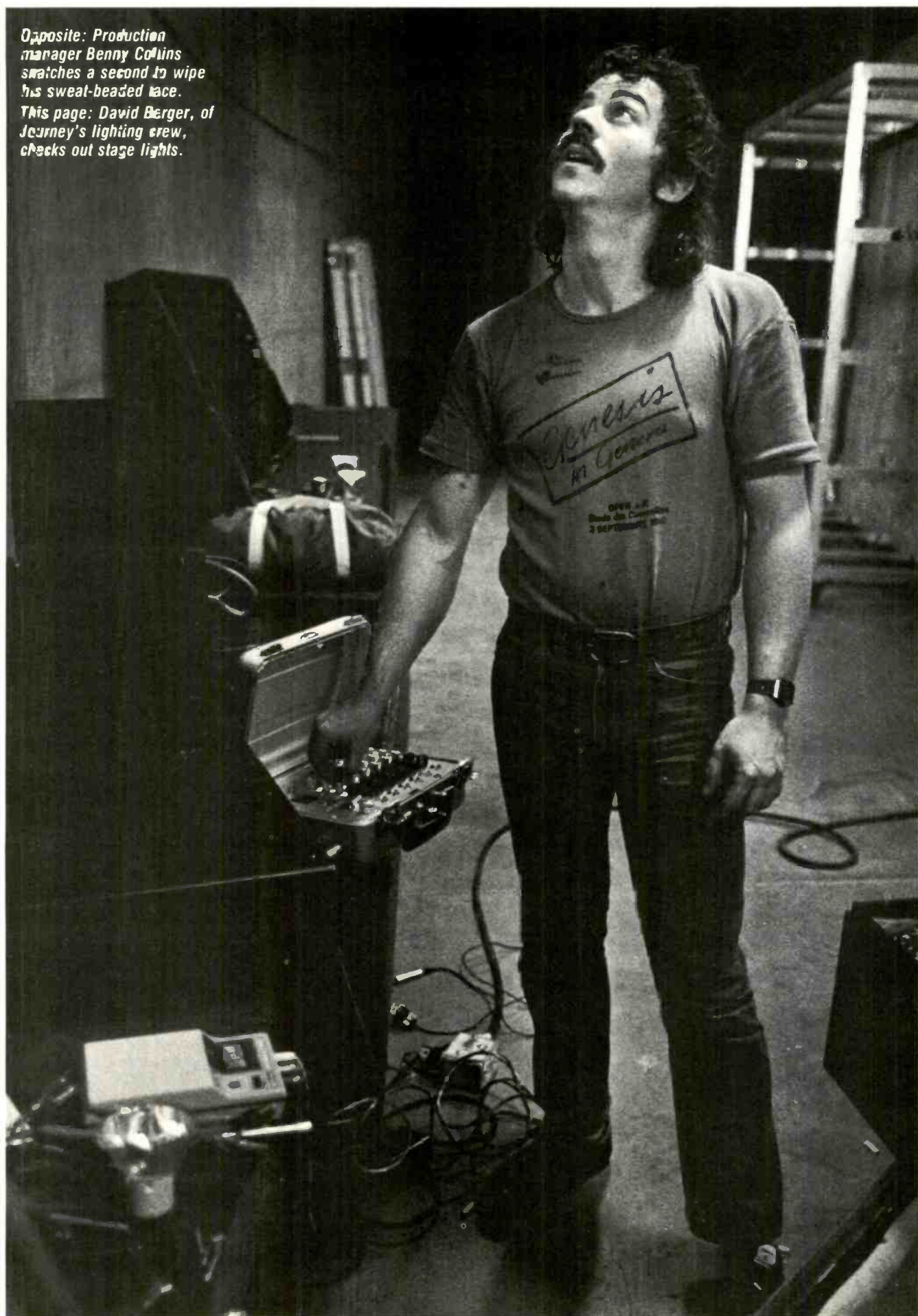

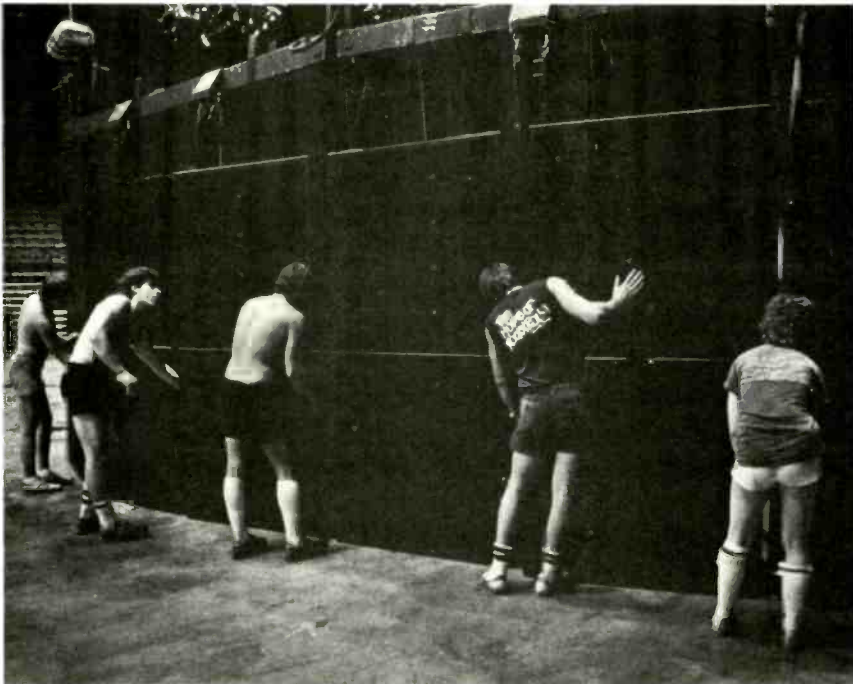

**Top:** Not your average bookshelf speaker, this speaker bank is about to be hoisted high above the stage by the sound crew.  
**Above:** Roadies taking a rare break on the cramped crew bus.

**Opposite:** Stage manager Chris Tervit grabbing a quick lunch.

wedged against barricades set up in front of the stage, he also must be concerned about the rock stars on the stage.

"They [the special effects] go off about 99% of the time, and even though everyone usually clears away from the area where the effects are set up about 3 to 4 minutes before anything goes off, there's no such thing as being too careful," said Watkins.

His recently burned arms bear evidence, however, that mistakes can and do happen. The splotchy burns were the result of an effect that didn't go off—until the moment Watkins approached it.

Perhaps, he said, he should expand his basic words of advice, "Keep your powder dry and don't smoke," to include two additional cautions: Against being too anxious to find out what's wrong when an effect doesn't go off as planned, and to be especially wary when approaching live explosives.

Danger commands high pay, and the pyrotechnician is one of the highest-paid members of the road crew. The other is the rigger, whose work above the stage gives him less cause to worry about blowing up than falling down.

Riggers earn their keep (sometimes \$1,000 a week or more) climbing across catwalks and onto beams to hang heavy cables and equipment. Journey's rigger on this tour was Bob Grenier, 28, the owner of a rigging company which leases out riggers—himself included—and rigging equipment to bands.

Bob most frequently can be found among the building beams, raising some 40,000 pounds of lighting and sound equipment with chain hoists and anchoring it to the beams.

Among the mass of equipment Grenier is responsible for hoisting up and attaching to the trusses is a unique effect used by Journey and one relatively new to concertgoers, Vari-Lights. Multi-colored showers of sparkling lights, the Vari-Lights come under the watchful eye of David Berger, one of a four-man lighting crew.

"In these Vari-Lights there are 60 different colors and seven different beam sizes," said Berger, fixing a

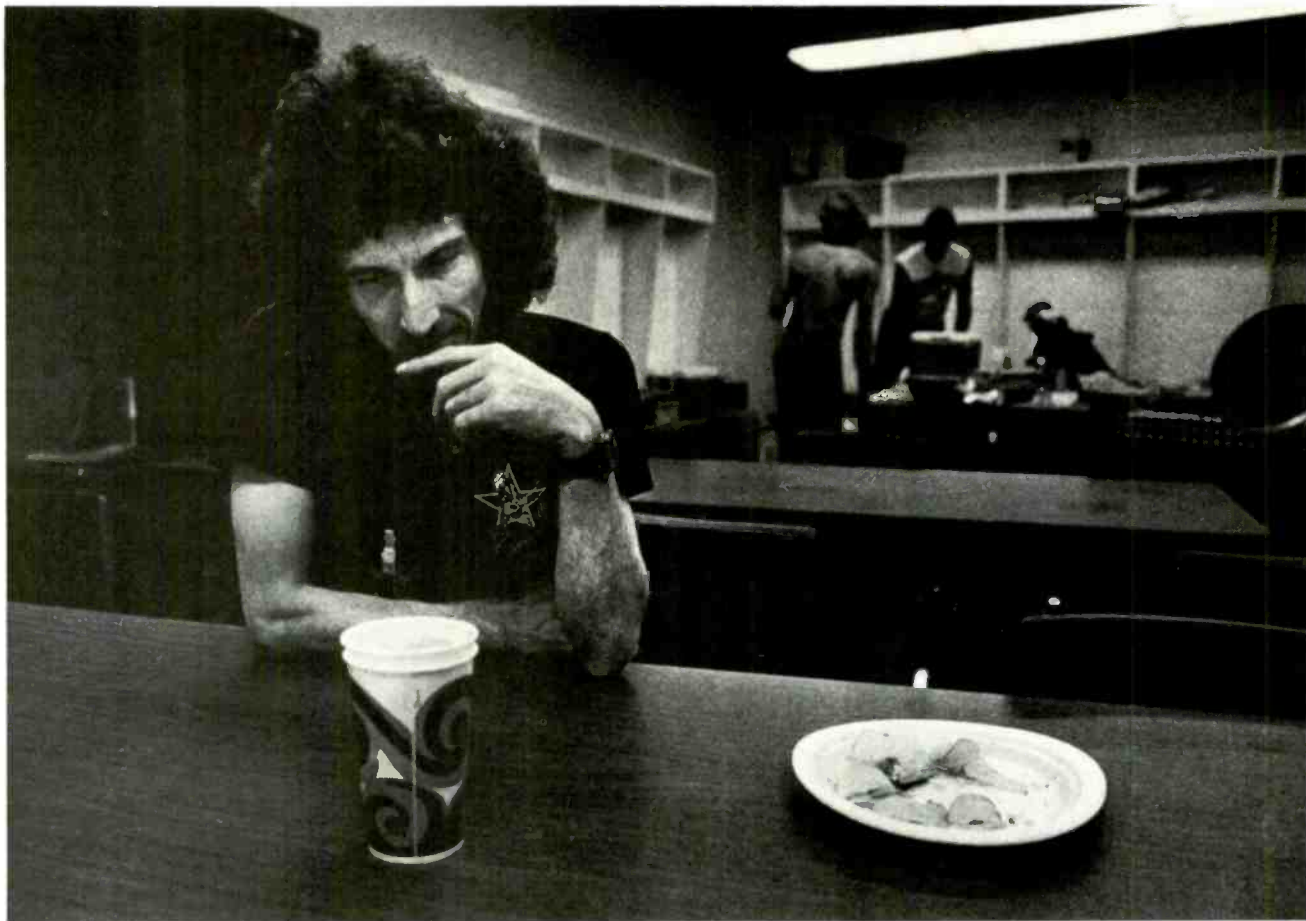

loose connection on a circuit board as he talked. "We have a computer that preprograms each light."

A former microwave and antenna specialist, Berger said that he "fell in love with these little toys" and began working on lighting crews about a year ago. His "little toys" are 14-inch steel cylinders mounted on yokes which, in turn, are mounted on large light boxes. The contraptions, called tungsten arcs, are operated by Berger from the risers during the show.

In his spare time Berger can be found tinkering with the master lighting boxes that brim over with colorful spaghetti-like wires. Russell Lynn, one of Journey's four-man sound crew, also fiddles with job-related outside projects during his off hours.

A 10-year sound-crew veteran, Lynn, 27, started his own business not long ago and now does sound work for various studio musicians in and around New York. Traveling on the road with Journey as one of the group's sound men for several months had not given him much time for outside interests. But it did leave plenty of time to pass during the hours when the equipment had been

set up and the show hadn't started. Having worked with such acts as Earth, Wind and Fire, Molly Hatchet and Billy Squier, Lynn said he had noticed a metamorphosis in the industry lately.

"The business of rock 'n' roll has changed about 100% in the last few years," he said, shaking his dark hair as he spoke. "There was no such thing as a monitor 10 years ago. Now we have 44 main speakers, with monitor speakers under the stage and house speakers flown above, as well as wireless mikes."

Like the military, there's a lot of hurrying up and waiting involved in setting up a show of this magnitude. The sound crew must wait for the riggers to hang cables and lay out equipment, followed by the lighting crew who carefully adjusts and readjusts the array of lighting equipment. Then it's the sound crew's turn to move in and string their thick cables across the stage and onto trusses. Cables across the stage are methodically tucked away under heavy canvas, enabling Lynn to boast about the clean stage.

Chris Tervit knows every bit of that "clean stage" by heart, having spent a considerable amount of time

## The road crew lives and works with rock stars, but their jobs are not as glamorous as their counterparts on stage.

building it. With an occasional hint of Scottish burr creeping into his speech, Tervit recounted how he was recruited into the band's ranks from his home town of Glasgow, Scotland.

"I was drafted in here for a lack of anything better to do," he said in the Coliseum's makeshift lunch room (which usually serves as visiting athletic teams' locker room). "I was a welder and always liked music, so I went to school and got an electronics degree," Tervit continued.

The degree initiated him into the music world and he eventually went on the road with Molly Hatchet, Judas

**Roadies live in a set-it-up, tear-it-down, move-it-on world, where time is measured by cities; the object is a flawless performance.**

Priest and then Journey. As stage manager, he works closely with local musician and theater unions to hire stage hands and also secures the equipment needed to unload the trucks.

"It's very good for me," Tervit said. "It's taught me patience. And no, I could never go back to a 'normal' job. I like music and I'm very fortunate to work for an organization that has its shit together."

For inside shows, each building must be carefully eyed so that the amps can be hung just right. And when the group performs outside—

"well, that's a whole new ball game," Tervit commented. "An outside show is more difficult," he said. "There are the elements to deal with, the stage, other groups and twice as much sound. It's generally a bigger production, so there are bigger problems."

The man who checks up on those problems—and many others—is Steve Clark, the group's road manager. Clark, 35, was the production manager of Molly Hatchet until January of 1982 when he became Journey's road manager. He filled the gap left when the road manager at that time, Pat Morrow,

*Road crew removing equipment after Journey's appearance at the Kansas Coliseum in Wichita.*





was promoted to vice president of Nocturne Productions Co., the company which handles Journey, along with various other artists.

Nicknamed "The Rhino" because of his brusque personality, the burly Morrow was Journey's road manager for six of the 11 years he traveled the highway working as a member of various road crews. Now he spends most of his time in the company's home office in San Francisco, while Clark crisscrosses the country with the band and its crew.

"My job is to see that things run as smoothly as possible and to act as a

liaison between the band and the outside world," said a weary looking Clark during the stop in Wichita.

Clark's first duty after arriving at the Coliseum was the production room, where he conferred with production manager Collins on the day's progress and hurriedly ironed out details for upcoming shows. A sound check was due to start late that afternoon and everything had to be ready when the band arrived.

The show went smoothly. Afterward, as clusters of die-hard groupies loitered outside waiting for a glimpse of band members, the road crew

inside scurried to load up the equipment and pack it in the waiting semi-trailers.

Roadies live in a set-it-up, tear-it-down and move-it-on world where time is measured by cities: the object of the game is a master performance with no technical flaws.

Working long after the house lights go up, the road crew finally tears the stage down to bare floor and packs the last trunk onto the truck. The auditorium is empty, and the hour very late.

Time to move on to another town, another gig, another load-out. **A**

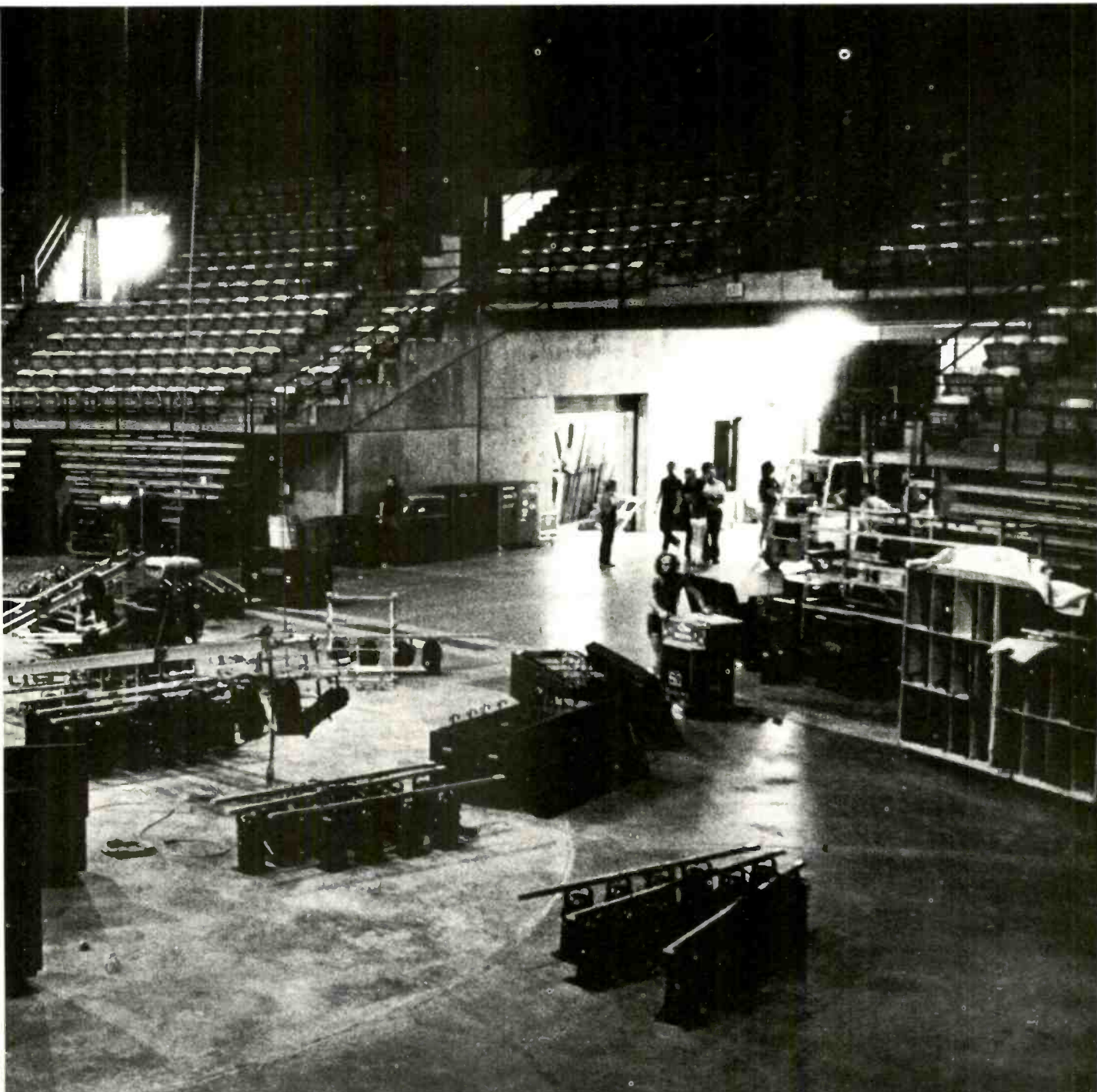

# The Untold Story Behind The Bose-CU Case

BY DAVID LANDER

**O**n the last day of April, the Supreme Court of the United States handed down a ruling that caused sighs of relief to emanate from pressrooms and editorial offices around the nation. The opinion upheld an appellate court decision that exonerated Consumers Union (the nonprofit group which publishes *Consumer Reports* magazine) after a lower court had ruled they had libeled Bose Corporation.

The decision put an end to a bitter 14-year-old battle between CU and the Bose Corporation, now almost certainly America's most successful high-fidelity manufacturer. Bose, objecting to derogatory comments about its Model 901 loudspeaker that appeared in *Consumer Reports*, sued the organization and won the initial firefight, becoming the first manufacturer ever to beat CU in the courtroom. When an appeals court reversed the decision, Bose appealed to the U.S. Supreme Court which, to the surprise of many following the case, agreed to hear it.

The press was not only shocked, but appalled and frightened. A court case involving a critical report on a high-fidelity loudspeaker system seemed of little importance, and many legal experts suspected that one or more conservative Justices saw *Bose v. CU* as

an opportunity to restrict appellate review in libel cases, a protection that dates back two decades and has proven highly important to defendants in such suits.

It was therefore not surprising when the press rallied to CU's defense. A friend-of-the-court brief submitted to the Supreme Court in CU's behalf carried the names of eight major communications companies (including CBS, NBC, the New York Times Co., Newsweek and Dow Jones, publishers of the *Wall Street Journal*) and argued that a decision against Consumers Union would imperil the press by imposing "standards of verbal accuracy that are as impossible to articulate as they are to meet." An editorial in the *Washington Post* called the case "preposterous," and *New York Times* columnist Anthony Lewis fumed over "facts that were outrageous in their very triviality." "After all," he wrote, "here was a magazine that had been embroiled in litigation for 13 years over what finally amounted to a three-word phrase."

Because Bose's charges were, in fact, distilled to a case that ultimately hung on three little words, and because the ramifications were potentially so large, it may have been easier for the press to ignore the speaker maker's side of the issue and indulge its penchant for probing elsewhere. As an example of a media establishment biased in its own favor, Charles Hieken, attorney for Bose Corporation, points a finger at Timesman Lewis, "a special student law school classmate of mine [who] saw me at lunch in the Supreme Court before the oral argument and . . . did not even contact me before writing his . . . column."

There is, in fact, much more to *Bose v. CU* than has met the media's eye. And had the case not been so threatening to the press, that panning orb might have reflected at least a closeup or two of the aloof testing organization in Mount Vernon, N.Y. and the brilliant

scientist/businessman who devoted years and untold tens of thousands of dollars to kicking the pedestal out from under it.

Amar Bose—founder, chairman, technical director and majority stockholder of Bose Corporation—presides over his audio empire from an office in a modern factory building perched on a Framingham, Mass. hilltop known as The Mountain. While loudspeaker designers run the gamut from the self-taught garage variety to graduate engineers with sterling credentials, Bose, with an earned doctorate from MIT and the status of full professor at that esteemed institution, epitomizes the latter group. His 901 loudspeaker system, a recent introduction at the time *Consumer Reports* chose to review it in May 1970, was the product of countless hours of research dating back nearly 15 years. In an attempt to emulate what one hears in a concert hall, which Bose contends is mainly sonic energy reflected off room surfaces, the 901 aims eight of its nine component loudspeakers at the wall behind the unit. Dr. Bose calls the resulting phenomenon "direct/reflected" sound.

CU used the editorial hook of its "relatively new design" to include the 901 in a speaker review that, for the most part, focused on models in the area of \$160 to \$300 a pair. Two 901s and the equalizer that completes the system then sold for \$476 (\$30 higher on the West Coast), considerably more. The magazine made a number of negative comments about the 901. After lauding its sound as "spacious," "reverberant," and "dramatic," the report went on as follows:

"But after listening to a number of recordings, it became apparent that the panelists could pinpoint the location of various instruments much more easily with a standard speaker system than with the Bose system. Worse, individual instruments heard through the Bose system seemed to grow to gigantic proportions and tended to wander about the room. For instance, a violin appeared to be 10 feet wide and a piano stretched from wall to wall."

"As for sound quality," the author of the unsigned piece, a CU engineer named Larry Seligson, stated, "if the Bose 901 had been rated with the main group of tested speakers, it would have fallen between the high and medium-accuracy groups." Moreover, the 901 was said to require "a rather gigantic amount of power"; "50 watts per channel for the deepest bass response" was recommended. Summarized the writer, "We think the Bose

Amar  
Bose

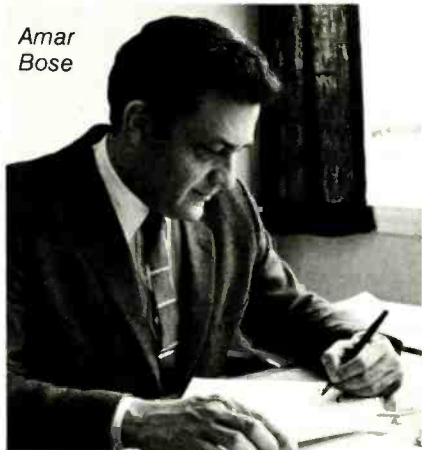

system is so unusual that a prospective buyer must listen to it and judge it for himself. We would suggest delaying so big an investment until you were sure the system would please you after the novelty value had worn off."

The review caused Bose to bristle. For one thing, he notes, the power claim was far from correct, and the 901 was actually more efficient than any speaker tested for the article. As for the instruments tending to wander "about the room," this was called nothing less than scientifically impossible.

Early one June morning, shortly after the evaluation appeared in print, Bose and Frank Ferguson (then president of Bose Corporation) drove to Mount Vernon, N.Y. for a meeting at CU headquarters. For Bose, the get-together was a long-awaited one. He had first become interested in CU's testing procedures more than a decade earlier, when *Consumer Reports* gave a \$27.50 add-on electrostatic tweeter from Radio Shack a better rating than one designed by Arthur Janszen, a pioneer in electrostatics, that cost several times that amount. Bose felt Radio Shack's product was vastly inferior, yet its sales are said to have soared following the review's publication.

It may have been the teacher in him—possibly the evangelist—but even before he had a speaker to sell, Amar Bose was inviting CU personnel to hear him speak at meetings and seminars. All attempts at contact prior to his request for this post-publication powwow had been met with silence, however, and according to Frank Ferguson, Bose had thought he'd use the opportunity to expose what he believed was Seligson's "shoddy science" to concerned superiors. Instead, the pair found, the Mount Vernon group had something other than rating products on their minds—namely, the circulation of *Consumer Reports*.

"It was soooo staggering it was beyond anything we had ever anticipated," a wide-eyed Amar Bose recalls. "The attitude was beyond belief." Dr. Bose remembers Monte Florman, then associate technical director, asking, "What do you think people read our magazine for?" I said, after a pause, "Product information." Sandbach [Walker Sandbach, then the group's executive director], who was to my left, pounded on the table and said, "No, Dr. Bose, you're wrong. People read our magazine for entertainment."

The speaker maker goes on to recall that Colston Warne, then board chairman of CU and an Amherst professor of economics, confirmed this, citing a

survey and commenting that people "love to read about vermin hair in canned soup." Sandbach, he alleges, added that, if the "sarcasm and spice" were removed from the magazine it would be more factual but circulation would drop to less than a quarter of its figure. To make matters worse, the CU officials refused to repeat the demonstration of the 901s that allegedly resulted in wandering instruments. (Florman later testified he made this decision because Bose's demeanor at the meeting gave it a "rancorous quality"; Bose claims he came in "quite courteously," and Ferguson supports this.) Nor would CU produce the recordings used for the test—crucial, since a speaker's imaging is invariably affected by program material. Had it not been for this meeting, Bose reflects, he probably would not have hauled out the heavy guns and opened fire.

The battle that followed was long and bloody. When the case finally came up for trial before a U.S. district judge in 1980, it went on for 19 days. Of the original charges leveled, Judge

Anthony Julian upheld only one, that of product disparagement, a form of libel. His decision hinged on the three-word phrase that described the instruments as wandering "about the room."

Julian rejected Bose's contention that Seligson's motivation in demeaning the 901 was his hope for commercializing a loudspeaker system based on a patent he and Robert S. Lanier, a former CU writer, had been granted not long before the review appeared. To support his case, Bose cited an agreement that Lanier and Seligson struck with a certain Bertram Menden, who gave them \$2,000 in exchange for their promise to develop a working model (which, it turned out, they were never able to do).

In fact, Menden was a private detective in the employ of Bose Corporation. According to Dr. Bose, he was hired after the review appeared, to determine whether the Arnold L. Seligson whose name appears on the patent along with Lanier's was in fact the Larry Seligson of CU and, if so, who stood to gain if the patent was com-



Illustration: Philip Anderson

mercialized. Masquerading as the representative of an anonymous West Coast manufacturer interested in entering the audio business, Menden initially contacted Lanier, although who first raised the issue of money is a disputed point.

As for instruments wandering "about the room" rather than along the wall between the speakers, a normal effect in stereo, Seligson stuck to his position that what he heard was what he described. But Judge Julian reasoned that, given the engineer's grasp of the English language, he must have known that what he wrote "did not accurately describe the effects that he had heard." Therefore, Julian held, Bose Corporation had sustained its burden under law, which stipulates in such cases that the plaintiff must offer "clear and convincing" proof, not only that a

false statement had been made, but that it had been made with malice, legally defined in this context to mean with the knowledge that it was false or with reckless disregard of its truth or falsity. After a separate trial to consider the issue of damages, Bose was awarded a total of more than \$210,000.

Then, after an appellate court turned Judge Julian's decision on its ear, the case went as high as it possibly could, to the Supreme Court of the United States.

In an attempt to get the appellate court's decision reversed, attorney Hieken argued for Bose that the court had overstepped its bounds, that Julian's finding of malice was a fact and the higher court was bound by law to accept "findings of fact" made by the trial court unless they were "clearly erroneous." Moreover, Hieken main-

tained, the appellate court relied on the testimony of CU's Monte Florman, which the district judge had decided was "wholly untrustworthy and . . . not credible."

On the other hand, Michael N. Pollet, an attorney for CU, maintained that the appellate court judges were well within their right when they refused to accept Judge Julian's finding of malice and held that CU was merely "guilty of using imprecise language." In effect, maintained Pollet, the appellate court in this case did no more than what the Supreme Court mandated in the landmark 1964 case, *New York Times v. Sullivan*, which "heightened" appellate courts' right of review in libel suits.

Had the Supreme Court reversed the appellate decision in the Bose case, Pollet felt the result might have proven "a tutorial to unsympathetic trial judges

## Editing, Testing, and Libel

As you will see from David Land-er's accompanying story, the Bose versus Consumers Union case is very complicated. Yet, there are still aspects and issues which, I feel, have not been brought out adequately. I am not much given to the writing of editorials, as I generally feel they are a sign of egotism, but I am so strongly interested a bystander that I hope I will be pardoned a small amount of personal journalism in turning over and explaining some further parts of this puzzle. Too, you should be interested because the case strongly affects what *Audio* and other magazines can say in product reviews.

First of all, as David explains, *Bose v. CU* was a libel suit, about the review of the Bose Model 901 speaker, but for the life of me, I cannot—and this country's body of law to the contrary—see how an object can be libeled. People, not things, are libeled. *Bose v. CU* seems to me to be a case of product *discrimination*, not of product *disparagement*, and it is that act of discrimination, in print, for which CU was sued. To an editor whose business is essentially the same, it is a frightening thing to see such a case brought at all, let alone get all the way to the Supreme Court. It is also somewhat ironically deflating to suddenly find that a certain amount of inaccurate language is acceptable in "robust First Amendment debate."

This does not seem, to me, to be a First Amendment case either, since

the First Amendment has to do with Congress making no laws abridging freedom of the press. Such censorship may be reserved to the States by the 10th Amendment. But, specifically, this is not a case where Congress has forbidden someone, e.g., members of a religious or political group, the right to publish. Indeed, the Congress was *not* involved. Certainly, both Bose and CU could say things in print, though Bose would have to publish in places other than *Consumer Reports*, which does not take advertising. It is simply not, on the face of it, a First Amendment case.

Speaking of advertising, let me lay one more romantic myth to rest. Acceptance of advertising by a magazine does not prevent that magazine from publishing the truth. Further, non-acceptance of advertising does not help a magazine publish the truth.

As might be obvious to long-time readers of hi-fi publications, the various magazines, both little and large, have quite different techniques and standards relative to dealing with reviews and with manufacturers. Some let the manufacturers see what's to be printed and encourage a spicy reply; this method has always seemed to me to produce more tantrums than truth. Other magazines say relatively little about the products. Some makers don't care whether they see the reviews prior to publication because they see such things as a product of their public-relations

effort. Other firms care strongly for exactly the same reason.

The question really isn't whether an editor shows a manufacturer a review prior to publication, but what the editor is prepared to do in the wake of the maker's response. Getting facts right, like price and color of face-plate, justify showing *some* of the review; getting things like circuit details right is not an easy exercise. At this stage of publication, a maker's tactful help can produce a review that is better for all four parties—reader, publication, reviewer, and maker. While an editor must, obviously, stand fast before a fire-breathing manufacturer intent on securing assistance in the marketplace for a mediocre product, this same editor must similarly be wary of a reviewer who's simply gotten up on the wrong side of the bed that day. Most desirable are reviewers who test and write for a living; using some firm's chief engineer usually produces accurate numbers along with an unacceptably high potential for conflict of interest.

In attempting to tie up the loose ends of this story, David and I went to The Mountain and talked with Dr. Bose. He wasn't particularly interested in the inanimate libel question, but he did recall for us, rather vividly, the trepidation he felt about the effect of the review on his company. More extreme examples of this we term the "Don't kick my baby" syndrome. The power of the press is great, and CU's is greater, by far, than *Audio's*. The only general admonition I've ever made to our reviewers, beyond being right about measurement data, is that they be gentlemanly and fair, for we

or juries as to how to immunize anti-press decisions and make them almost impervious to reversal. Quite often these issues of freedom of the press in a libel context come up in very highly charged, emotionalized circumstances," he elaborated, "and there is concern that there is anti-press feeling and that unsympathetic judges and juries who do not understand these constitutional issues involved will hold against the press for wrong reasons and that those wrong reasons cannot then be fairly looked at by appellate courts."

It is undeniable that the powers of appellate review threatened by this case were significant in more than an academic sense. Libel defendants now lose more than 80% of all such cases tried, and about 80% of the adverse decisions later examined by ap-

are not in the business of putting companies out of business or of making a product successful. While we very often find that we know aspects of a piece of gear as well as the maker, it is never our position that we know the whole better; to say otherwise would be hubris.

The loudspeaker is probably the most difficult portion of the audio chain to test, witness the rigor of Mr. Clark's review of the Acoustical Physics speaker in this issue. Despite the fact that *Bose v. CU* was decided on a First Amendment argument, testing methods lay at the center of the controversy. As David points out, Dr. Bose has some strong ideas about testing and sound, though when I asked him to discuss how a magazine ought to test, he replied that he preferred to keep his proprietary methods secret than to give away too much to his competitors. There were similar holes, to my mind, in CU's explanation of how they tested speakers, even after reading their "How We Test ..." mail-out brochure. This is fair enough, though probably as frustrating to the reader as it was to me, but it is to be emphasized that basic research on how people hear is still going on. Hearing and speaker testing are such difficult and diverse fields that it seems unlikely that one could be familiar with all the literature and all the techniques. For the present, then, I think that we who test ought to do so with greater accuracy than we believe the ear-brain can muster. And for those of us who write about the testing, I commend a little charity.

—Eugene Pitts, Editor

pellate courts are reversed or modified at that level.

Yet Amar Bose maintains that trimming of First Amendment liberties is "just the opposite" of what he wanted. "The issue with CU itself is not their freedom to print something," the MIT professor asserts. "They're doing nothing more, as I see it, than writing a report on their so-called research. And we're asking that they do that research accurately."

Bose has been known to make that same request—some would call it demand—of publishers other than Consumers Union. In 1974, a magazine called *Physician's Life Style* ran a test report slamming the 901, and attorney Hieken responded with a 10-page letter charging them with making "false and disparaging statements about Bose and its loudspeaker systems." The letter contrasted the review in question with complimentary statements made by a number of other magazines and ended with a list of demands that included a retraction on the cover of "the earliest possible" future issue. Hieken and his client settled for the publication of a Bose Corporation-prepared article stating their point of view.

At least two overseas publishers have been summoned to court on similar occasions. In 1976, an English periodical called *Hi-Fi Choice*, which appears irregularly, was set to publish a collection of speaker reviews by audio writer Angus McKenzie. Though the events remain somewhat blurred by time, someone from Bose or its wholly owned U.K. subsidiary apparently saw a prepublication copy and resented the review given the 901. McKenzie, contacted by phone at his London home recently, confirmed that a temporary injunction was granted against Aquarius Press, which then published *Hi-Fi Choice*, while the publisher prepared his case. Aquarius did so in a matter of days, says McKenzie, and the suit was thrown out of court.

Still in litigation is a Dutch case between Bose's Netherlands subsidiary and that nation's Consumers Union (not connected with CU here). That organization was sued over an article published in 1978, which gave the Bose 301 loudspeaker a low rating.

While Bose denies personally knowing of the English incident until recently and comments that the action was taken by a U.K. management team since departed, he admits that the Dutch litigation was instituted with his knowledge, albeit by overseas managers. Still, he defends the right of reviewers



Bose Model 901 Series V Loudspeakers

to state opinions, however negative, under their bylines. Like the CU piece, neither the one in *Physician's Life Style* nor the Dutch magazine, *Consumenten-tengids*, is signed. According to Hieken, testing for the former was said to be the work of an unidentified "non-commercial professional." The Dutch article, according to a translation supplied by Bose Corporation, refers to a "panel" that consisted of "approximately" eight men whom it calls "professional sound-recording specialists, sound technicians, and other experts." Dr. Bose claims the same tests resulted in much different conclusions in an English article (the tests were conducted jointly by consumer groups from Holland, England and Belgium) and that the Dutch group would not reveal its testing methods.

Though some may view Dr. Bose as overly aggressive in guarding the reputation of his company's products, there is no question that his long-running combat with CU began in pursuit of a victory more substantial than one which, in attorney Pollet's words to the Supreme court, hinged on "the alleged slip of a single preposition." And even the appeals court which sanitized that so-called slip made a point of saying they "would refrain from describing CU's loudspeaker article as exemplifying the very highest order of responsible journalism." Why, for example, does the piece repeatedly refer to listening "panels" and "panelists" when at least one such body consisted solely of Seligson and his assistant?

Charles Hieken, in response to critics who consider his client's argument with CU trivial, argues that the publisher wields sufficient power to damage, even destroy, corporations. "None of the people who are making those comments experienced the apprehension Bose Corporation experienced when that article first came out," he declares. "It was a small company." A

# HOME STUDIO: DO IT THE PRO WAY

PART II BY JON & SALLY TIVEN

Since the first installment of this article in September 1983, there have again been major technological developments. Musical instrument manufacturers have found that only about a third of the money previously spent on musical instruments is still going into their pockets; the rest is going into—you guessed it—equipment for the home studio. Everyone and his grandmother is now making outboard gear, home multi-track units, and easy-to-operate synthesizers. As a result, great technological strides allow prices to drop on equipment that only yesterday was out of the range of most home studios' budgets.

For instance, LinnDrums' legendary drum machine emerged only three years ago as the definitive "drummer replacement," but it carried a hefty price tag of over \$3,000. Now Oberheim makes the DX, a very similar unit which offers many of the same options, for only about a third of that price. Digital reverb machines were in the \$5,000+ range when Lexicon first brought them out, and now Yamaha



makes a cheaper version that sells for under \$800. Granted, there are advantages to the higher priced spread—but for the home recordist, these less expensive versions offer the opportunity to make quantum leaps in the world of home demos without having to put the house up for a second mortgage. Now that Fostex has the X15 portable four-track cassette recorder on the market, a whole new crew of recordists has gotten the feel of multi-tracking without making the major move buying a machine of this nature used to entail.

### Multi-Trackers: Present and Future

In the last episode of the continuing saga of home recording, the war between the manufacturers was just heating up. A company called Fostex was formed to meet the public demand for bigger and better home multi-track systems, and these folks began doing a good job of putting the rest of the field to shame. Their four-track cassette systems (including the X15, which sells for about half what any of the others cost), as well as quarter-

inch eight-track recorders and half-inch 16-track systems, are all competitively priced. Yamaha got into the act with a four-track cassette unit, and its success has prompted the company to move further into home recording. Chances are there will be more companies springing up with versions of the four-, eight- and 16-track formats, but whether they all will last is something else again.

The logical item for these companies to make—albeit an expensive one—would be a home digital multi-track recorder. The problems of tape wear, narrow bandwidth, and S/N ratios could be minimized if the industry's emphasis were placed on home digital units. Since the home recording field seems to be expanding quickly and home digital stereo units are just getting off the ground, the sooner these parallel lines become one the more everyone will benefit. With all the digitized instruments being created, it becomes even more imperative that the home recordist be able to capture all the sound that he is able to create.

More records which started as home demos are hitting the charts than ever before. New artists like The Eurythmics are able to come up with a Top Ten single ("Sweet Dreams") that was almost completely made in a home studio, and established hitmakers like Hall & Oates get a head start on studio work at home. As the thin line between a demo and a master tape all but disappears, fidelity becomes the crucial priority.

The result of all this increased flexibility at the home studio level is the emergence of a new breed of music enthusiast, the self-made producer. Where once a producer was only a geezer who came up with the money to pay for a session (whether or not he knew how to set up a microphone), one can groom oneself for the producer's chair *at home*. The first step is to get to know technology and what its limits are.

### Digital Keyboards

Although most of these gadgets are still in the primitive stages, the cost of digital instruments is becoming less prohibitive. The Fairlight and the Synclavier were the original machines which digitally synthesized and/or sampled, but price tags of over \$20,000 kept them out of the home studios (as well as many professional recording studios). However, the recent prices on similar units are falling as the technology develops.

E-mu Systems has developed a keyboard called the Emulator which samples digitally and costs in the neighborhood of 5 or 6 grand. Before you hit the ceiling, realize that this little wonder can mimic virtually any sound that the user cares to either record himself or call up from a floppy disk. In other words, if you want to play the drums and sound just like John Bonham but you can't play and don't own a kit, you just pull out the John Bonham floppy disk (which assigns a different voice to each key on the keyboard) and press lightly on the keys. The frequency response on the unit isn't that great—it only records up to 10k (with a little tuning trickery, you can squeeze it up to 20k)—but the Emulator is a pretty exciting device. Yamaha's DX-7 digital synth, which has full frequency range but doesn't sample, runs under 2 grand and is selling like crazy.

All of this is more indicative of what's to come than what's here, as the proliferation of these devices will increase dramatically through the use of digital chips. It might be wise to wait a bit until the dust settles, as the MIDI interfaces





No matter how highfalutin technology gets, someone will always be able to make a dream come alive by creating a little magic in a home studio.

and guitar adaptability are only now starting to appear as standard features. And remember, the more you spend on a synth, the greater the dollar depreciation. You can get units for under a grand today, the equivalent of which would have run about \$4,000 only a year and a half ago.

### Drum Computers

Given the advanced degree of logic involved in the current crop of automatic percussion units, we tend to call them drum computers. These digitized drummers are amazingly versatile, sound remarkably like a real kit, and have become so integrated into today's music that, whether you know it or not, at least 30% of all records made in 1984 use them. Most home studios are built in places which aren't particularly suited to recording a full kit. Without the benefit of proper soundproofing, miking techniques or a drummer, any session can have a professional drum sound, combining years of apparent experience of playing and recording drums, a metronomic sense of rhythm, and the flexibility of instant tuning. All this is packaged in a box that runs anywhere between \$900 and \$2,500. The ramifications are of great importance to the home recordist—and make most drummers want to run out and sell their kits.

The first guys on the market were the boys at Linn, whose digital machines run on the high end, price-wise, but deliver quiet a bit for the money. Although frequency response does not come close to the harmonic range of a real kit, with some decent outboard equipment (particularly a reverb) the Linndrum machine can become an adequate substitute for a real drummer. It does have a flaw, in that the initial chips supplied with the unit have three snares of different volumes when three completely different snares would have been of much greater value. But the chips are replaceable, and Linn has already come up with a library of sounds that allows you to simulate Simmons drums (electronic percussion), Latin sounds, or even record your own sounds. (Linn will even burn the chips for you for a modest sum as long as you let them add the chips to their library if they so choose.)

Oberheim's DX and DMX machines

are more reasonably priced and take a slightly different approach: Their sounds are more produced and, in some cases, a little better thought-out. Instead of having fixed tuning on claps, bass drum and cabasa, all of the voices are tunable. Both companies have their eye on the replaceable sound department, but Oberheim allows you to purchase all the sounds for a particular kit at once via cards (rather than Linn's chip-by-chip method). The common way of programming is by establishing patterns for each section of a song and then linking them together in the order one chooses. Both have the ability to edit, much in the way a writer edits text on a word processor.

Oberheim's less expensive DX is an incredible machine for the money, but until quite recently it did not sync to tape like the more expensive DMX and Linn. The sync-to-tape feature allows the recordist to record just a sync tone and a mono mix when initiating the track and then use the "live" machine sounds when mixing. Alternatively, the recordist can change the entire drum track at any point in the recording process with a minimum of effort. These two features can be crucial in the effort to get the best-sounding final product, and the flexibility of the drum track is increased so much by having this sync-to-tape feature—especially when one has an eight-track machine—that this item alone is almost indispensable in any drum computer.

Roland used to dominate this genre with their Dr. Rhythm, Drumatix and Rhythm Composer, but they have yet to come up with a digital drum machine. The updated version of their 808, the 909, features mostly analog signals which have a greater frequency response. All too often however, it sounds more like white noise than drums. Surely this company will eventually heed the call, but they've been outdistanced by their progeny.

Sequential Circuits, best known for the Prophet Synthesizer, has recently come out with a digital drum machine called Drumtracks. Sad to say, it is a bit of a disappointment for a variety of reasons. It's more difficult to program than the competition and is virtually incomplete without its own six-channel mixer. Yet even with a good six-track mixer, stereo panning isn't easily

achieved because of the arrangement of the outputs on the back. In addition, the volume control unit per drum is quite limited, and tuning isn't that easily accessible (occurring in increments rather than being fully adjustable). This machine also tends to heat up dramatically and rather quickly; we sensed that using it for hours might end as a scary project.

It must be said that this digital age is not without its share of headaches. Most of these machines are easily capable of pulling tantrums, such that when you start to fill their memories up to the brim you are rewarded with freak-outs where all your information is lost. From talking to several owners of these machines, we get the feeling that whoever is in the business of repairing the digital drum computers is keeping busy. So make sure whichever machine you purchase carries a substantial warranty because you may well have to use it.

There's obviously a lot more to this story than can be told in a few magazine pages, not to mention the tendency of equipment manufacturers to continually come up with new products, making any primer obsolete. Things are changing so quickly at the home studio level that professional studio owners literally have to stay on top of the semi-pro market just to make sure they really are sufficiently equipped for their clients' needs. In fact, it could be said that greater progress is being made now to upgrade semi-pro equipment than to improve the high-tech studios which too often charge \$100 per hour and more for their time.

Just remember: Regardless of how great a major studio can make your music sound, it also produces as great a percentage of commercial duds as the average hole-in-the-wall. Every year some band makes a Top Ten record with just a couple of microphones and a four-figure (or smaller) budget, but with a whole lot of music on its side. No matter how highfalutin the technology gets, someone will always be able to make their dream come alive by creating something in a home studio that brings a little magic into everyone's life. More than all the toys that money can buy, this fact is what keeps the home recordist striving to make his studio special. A



# Music just met its Master.



Home audio from Proton, the "Best Picture" video people. Pure black, purely superb home audio components that deliver a richness in performance unequalled in audio today.

Performance is Proton-engineered into these separates with features like the exclusive Schotz Tuner/Noise Reduction System in the digital Proton 440 Stereo FM/AM Tuner.

The Proton 520 Integrated Amplifier also features High Current capability, Video Select, and Dual Phono Preamps for both moving coil and moving magnet cartridges. The Proton 720 Stereo Cassette Deck offers both Dolby® B and Dolby® C Noise Reduction Systems and Metal/Normal/CrO<sub>2</sub> tape capabilities.

Proton Audio components reproduce the full spectrum of music with great beauty and depth, perfectly matching Proton Video components in styling, size and performance. They're definitely in a class of their own.

**PROTON**  
*Audio*

© 1984 Proton Corporation. 737 West Artesia Boulevard  
Compton, California 90220. 213-638-5151.

Dolby® B and Dolby® C are registered trademarks of Dolby Laboratories, Inc.

Enter No. 39 on Reader Service Card

# 1

## JVC R-X500B RECEIVER

### Manufacturer's Specifications FM Tuner Section

**Usable Sensitivity:** Mono, 10.3 dBf.

**50-dB Quieting Sensitivity:** Mono, 14.8 dBf; stereo, 38.3 dBf.

**S/N Ratio:** Mono, 82 dB; stereo, 73 dB.

**THD (At 1 kHz):** Mono, 0.08%; stereo, 0.1%.

**Frequency Response:** 30 Hz to 15 kHz, +0.5, -0.8 dB.

**Capture Ratio:** 1.5 dB.

**Alternate-Channel Selectivity:** 75 dB.

**Image Rejection:** 80 dB.

**I.f. Rejection:** 100 dB.

**Stereo Separation (At 1 kHz):** 50 dB.

### AM Tuner Section

**Sensitivity:** 250  $\mu$ V/m; 30  $\mu$ V, external antenna.

**S/N Ratio:** 50 dB at 100 mV/m.

**Selectivity:** 38 dB.

**Image Rejection:** 40 dB.

**I.f. Rejection:** 55 dB.

**THD (At 1 kHz):** 0.5%.

### Amplifier and Preamp Section

**Power Output:** 100 watts per channel, continuous, 8-ohm loads, 20 Hz to 20 kHz.

**Rated THD:** 0.007%.

**Damping Factor:** 45 at 8 ohms, 1 kHz.

**Input Sensitivity:** MM phono, 2.5

mV; MC phono, 250  $\mu$ V; high level and tape, 240 mV.

**Frequency Response:** Phono, RIAA  $\pm$ 0.5 dB; high-level inputs, 5 Hz to 50 kHz, +0, -1.0 dB.

**Graphic Equalizer Control Range:**  $\pm$ 10 dB at 63 Hz, 160 Hz, 400 Hz, 1 kHz, 2.5 kHz, 6.3 kHz and 16 kHz.

**Loudness Control Action (At -30 dB Volume Control Setting):** +6 dB at 100 Hz, +4 dB at 10 kHz.

**S/N Ratio:** MM phono, 80 dB; high-level inputs, 77 dB.

### General Specifications

**Power Requirements:** 120 V, 60 Hz, 350 watts (450 VA).

**Dimensions:** 17 $\frac{1}{8}$  in. (43.5 cm) W  $\times$  4 $\frac{7}{8}$  in. (11.7 cm) H  $\times$  14-9/16 in. (37 cm) D.

**Weight:** 20 $\frac{1}{2}$  lbs. (9.3 kg).

**Price:** \$650.00.

**Company Address:** 41 Slater Dr., Elmwood Park, N.J. 07407.

For literature, circle No. 90



I can remember when a stereo receiver was a relatively simple piece of audio equipment; there was a simple tuner section with a slide-rule dial, a couple of tone-control knobs, volume and balance controls, a program selector switch, and a power amplifier section. How times have changed! JVC's new R-X500B receiver has the most elaborate looking front panel I have ever seen. The display section leaves nothing to your imagination; it tells you just about everything that's happening inside (and outside) the receiver. Normally, I would be critical of such a flashy video-graphics-like display, but this one truly clarifies and enhances the near-countless useful features this receiver sports. I'll try to enumerate all of the unusual features found in this, JVC's top receiver for 1985, but if I miss any, it's only because there are so very many.

A microcomputer controls the digital quartz-synthesizer AM and FM tuner sections of the receiver. You can preset up to 15 AM and 15 FM stations for one-touch pushbutton recall. Using what JVC calls "Preset Scan," you can sample all of those preset stations, one at a time, for about 5 S each, to decide which one you'd like to "lock in." If the input signal during FM stereo reception is relatively weak, a "QSC" (Quieting Slope Control) circuit automatically reduces noise. It's actually a rather nice blend circuit, which reduces or cancels noise, while separation stays at still-acceptable levels. Instead of a conventional signal-strength meter or bank of LEDs, the R-X500B has a digital readout of actual signal strength, shown in dB above 1  $\mu$ V.

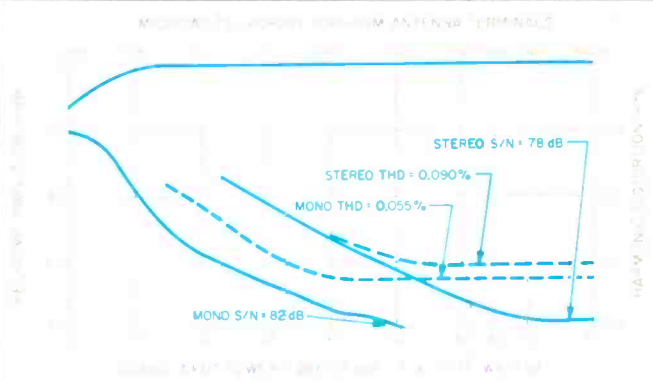

Fig. 1—Mono and stereo quieting and distortion characteristics, FM section.

Instead of conventional tone controls, the JVC R-X500B features an electronically controlled, seven-band graphic equalizer (which they insist upon calling an "SEA"—for Sound Effects Amplifier). JVC and other receiver manufacturers have featured five- and seven-band equalizers in their products before, but this is the first receiver I know of that alters band setting *electronically*, at the touch of an "Up" or "Down" button (no slider controls). It's certainly the first receiver to allow you to memorize and store five specific equalizer responses (plus their inverse curves) for instant recall. The selected response is shown in a special section of the elaborate display, and the same special display section works as a sort of real-time spectrum analyzer during normal use!

A wireless remote-control unit (supplied) allows you to adjust such parameters as channel balance, volume, and program source selection. You can also call up preselected AM or FM stations remotely and even adjust the graphic equalizer or select any of its memorized response settings.

The display area, occupying nearly two-thirds of the upper half of the front panel, is divided into three major sections. At the left are the seven columns of indicators corresponding to the seven bands of the graphic equalizer. This display shows either the response curve set or selected or the spectral content (in each of its seven bands) of music being played through the receiver. Five tiny pushbuttons further to the left select any of the five memorized response curves. The middle display section tells you such things as program source selected (using symbols as well as words), volume-control setting, status of the tape monitor and dubbing switches, and whether or not the loudness circuit has been activated. The right-most display section is devoted to the tuner and, besides indicating tuned-to frequency, shows which station-preset button has been chosen, the condition of the received signal, and which tuning mode (manual or automatic) has been selected. The station-frequency indicator doubles as a digital indicator of actual signal strength (in dB) when an appropriate button is pushed. If the "QSC" (blend) circuit comes on automatically because of weak stereo-signal reception, that is also indicated in this display



# CAN YOU SEE THE MUSIC?

B&W's newest star is in the spotlight.

To celebrate the marriage of Audio and Video, B&W of England commissioned its world renowned research team to design a loudspeaker dedicated to the audio/video environment. A new star was born!

Until recently, TV was meant to capture the eye rather than the ear, a one-experience medium. But now, with the availability of Beta and VHS Hi Fi and the advent of Stereo TV, it has become a two-experience medium. Yes, you can expect theatre quality sound in your own living room. B&W video acoustic monitors reproduce the whole eight octaves of sound, an astounding improvement over the four to five octaves reproduced by ordinary TV speakers.

The television picture tube and associated components are seriously affected by stray magnetic fields. The magnets employed in TV loudspeakers are shielded to prevent magnetic interference but if large magnets required to produce true high fidelity are used, then shielding is only partially effective.

B&W goes one step beyond. B&W has totally redesigned the magnet circuits and motor system by producing nickel-cobalt centre pole magnets. B&W has produced ZMF speakers, giving virtually a Zero Magnetic Field. This revolutionary new approach actually enhances the performance of the loudspeaker system beyond anything achievable with simple screening; B&W ZMF speakers can be placed immediately adjacent to the television monitor without creating any adverse effect.

Behind the successful development of these video acoustic monitors lies B&W's world leadership in loudspeaker technology and design. B&W's Model 801 has been selected by famous recording companies, orchestras and conductors worldwide as their classical music monitor. For both the professional recording artists and the critical music lover, B&W has dedicated itself to the pursuit of perfection in the recreation of live sound.

More than a contribution to viewing pleasure, B&W ZMF loudspeakers provide all that has been missing from the complete audio video experience. LISTEN AND YOU'LL SEE!



## B&W

Enter No. 13 on Reader Service Card

VIDEO ACOUSTIC MONITORS

### SUPERB SOUND WITHOUT PICTURE DISTORTION OR MOVEMENT

Anglo American Audio P.O. Box 653, Buffalo, NY 14240 (416) 297-0595

Equalizers in receivers aren't new, but this is the first receiver I know of that alters the band setting electronically.

area, as are a few other items relating to tuning mode and auto scan mode of the tuner section.

To the right of the display area are 15 numbered buttons plus a "Preset Scan" button, which is used to quickly audition the 15 preset stations. To the right of these keys are touch pads used to select program sources and tape monitoring and dubbing functions. Separate high-level inputs are provided for "AUX" and "DAD" (Digital Audio Disc or CD player) program sources. Two tape-monitor loops are available in this receiver.

About two-thirds of the way down the panel are several horizontally oriented, slim touch buttons. These are used to turn power on or off, to select either or both pairs of speakers, to switch the graphic-equalizer display from showing response curves to serving as a real-time spectrum analyzer, and to memorize graphic equalizer settings. Also present at this level are several buttons associated with the tuner section, such as a manual "Tuning" bar, a "Memory" button for storing preset frequencies, an "Auto Memory" switch which lets you scan usable signals and store them in memory at the same time, a switch labelled "CH/dB" which selects whether one of the displays will show station-preset numbers or incoming signal strength in dB, an FM mute button, and a button which selects the signal-strength level to which the auto-scan tuning will respond.

Along the lower edge of the panel, below the equalizer display area, are small pairs of touch buttons, each assigned to a specific equalizer frequency band. Touching the upper button boosts response at the designated center frequency, while pushing the lower button cuts response at that center frequency. A covered stereo headphone jack is located to the left of these equalizer adjustment buttons, while to their right are four additional controls associated with the graphic equalizer. The first of these is used to restore flat response. The next gives the inverse of the response curve (boost becomes cut, cut becomes boost), and the third and fourth select whether the equalized response should be applied to the program source or to the tape-recorder outputs.

The seven buttons remaining, at the bottom right, select MM or MC phono input, switch the loudness compensation on and off, adjust left/right balance, set volume, and switch the audio muting on and off.

The entire front panel is finished in black, while the displayed graphics and lettering range in color from yellow, through orange, to brown. JVC has another, lower-powered model (70 watts per channel), known as the R-X400, whose front panel is finished in silver and black. This model resembles the higher powered R-X500B in all respects except that it does not come with a remote-control unit, nor does it have a moving-coil (MC) phono input.

The rear panel is equipped with the usual array of input and output jacks, antenna terminals (for 75- and 300-ohm FM antenna lines as well as for an external AM antenna), twin sets of speaker output terminals, an AM and FM channel spacing switch (for the U.S., 10 kHz on AM, 100 kHz on FM; for Europe and other areas, 9 kHz and 50 kHz, respectively), a pair of a.c. convenience outlets, a fuse-holder, a chassis ground terminal, and a DIN-type connector for one of the tape-monitor loops. A separate AM loop antenna is

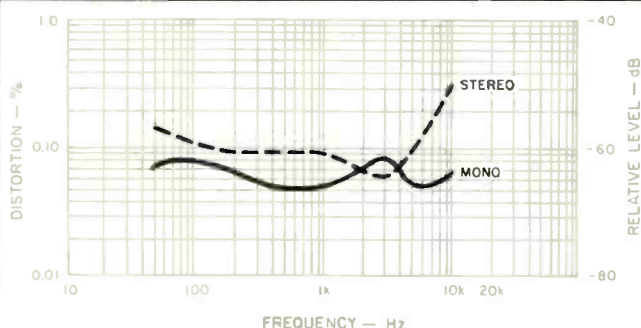

Fig. 2—THD vs. modulating frequency.

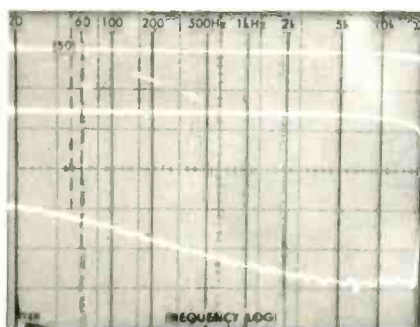

Fig. 3—Frequency response (upper trace) and stereo separation with QSC (middle trace) and without QSC (bottom trace).

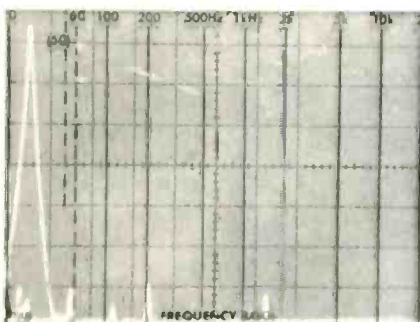

Fig. 4—Crosstalk and distortion products at the unmodulated channel's output, with a 5-kHz, 100% modulating signal applied to the opposite channel. Sweep is linear from 0 Hz to 50 kHz.

packed with the receiver and is installed at the rear panel so that it can be pivoted away from the chassis for best AM reception.

The amplifier section of the R-X500B utilizes JVC's Dynamic Super-A power amplifier circuitry. According to JVC, this circuit combines the positive attributes of both Class-A and Class-B circuitry. Because output transistors are never switched off, no switching distortion is generated. On the other hand, in terms of efficiency, the circuit behaves much like a conventional Class-B amplifier. Other circuit innovations built into this section are said to improve overall linearity and reduce open-loop (before application of feedback) distortion. Another new circuit, which JVC calls a Gm Driver (it has nothing to do with the Detroit Proving Grounds), is said to improve performance by driving the power stage at

Performance was excellent. The tuner picked up all my 50 favorite FM stations, strong or weak, and the amp sounded great at loud and soft levels.

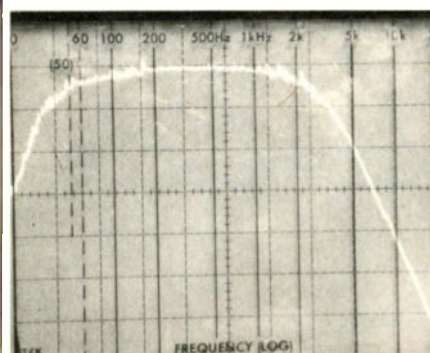

Fig. 5—  
Frequency response, AM tuner section.

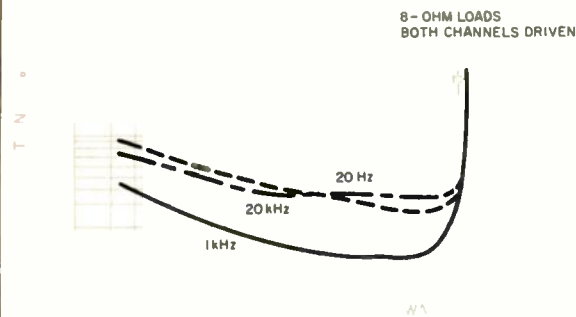

Fig. 6—Power output vs. THD.

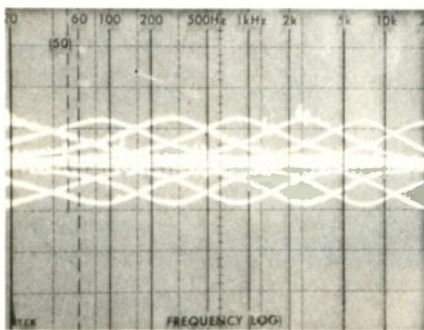

Fig. 7—  
Control characteristics of seven-band SEA equalizer.

constant voltage, to reduce output impedance and achieve flat frequency response. This circuit is intended to negate the effects of counter EMF generated by the speaker load, while at the same time reducing distortion caused by the inherent nonlinearity of power transistors.

#### Tuner Measurements

Figure 1 shows signal-to-noise and distortion characteristics as a function of input signal strength for the receiver's FM tuner section. I measured excellent signal-to-noise ratios of 82 dB in mono and 78 dB in stereo for strong-signal inputs. Distortion in mono, for a 1-kHz modulating signal, decreased to a low value of 0.055%: in stereo, the same signal was reproduced with total harmonic distortion levels of only 0.09%. Fifty-dB quieting was reached with a signal

strength of only 14.5 dBf in mono and 37 dBf in stereo. The stereo switching threshold (which corresponds to the muting threshold as well) measured 24 dBf. A plot of harmonic distortion versus audio modulating frequency is shown in Fig. 2 for mono and stereo reception. At 6 kHz, THD in stereo was still relatively low, at 0.15%.

Frequency response and channel separation for the FM tuner section are depicted in the 'scope photo of Fig. 3. The upper trace shows frequency response in stereo. Response was flat to within 0.5 dB all the way out to the highest broadcast frequency of 15 kHz. The lower curve represents crosstalk in the unmodulated channel's output. Separation was 55 dB at 1 kHz, decreasing to 40 dB at 100 Hz and 46 dB at 10 kHz. The middle curve in Fig. 3 shows what happens to separation when the QSC circuit operates (in the presence of weak signals). Essentially, separation is reduced to around 15 dB across the entire audio band, with attendant reduction in background noise.

Figure 4 illustrates the relative levels of crosstalk, separation and distortion components for a 5-kHz modulating signal applied to one channel. In this spectrum-analyzer 'scope photo, the sweep is linear from 0 Hz to 50 kHz. The two spikes at left are the desired 5-kHz signal (taller spike) and the undesired 5-kHz crosstalk showing up at the opposite channel's output. Other components in the output of the unmodulated channel, seen further to the right, are harmonics of 5 kHz and any 19- or 38-kHz subcarrier components that might be present. If you have been following my tuner and receiver reports over the last few years, you will recognize, as I did, that this tuner section is one of the best I have ever measured in terms of crosstalk and distortion products in the stereo mode. All of the unwanted components in the unmodulated channel's output are better than 65 dB below the level of the 5-kHz signal appearing in the modulated channel's output!

Capture ratio measured exactly 1.5 dB, as claimed, while alternate-channel selectivity measured 75 dB. Image rejection was 82 dB, as against the 80 dB claimed by JVC, and i.f. rejection was in excess of the 100 dB claimed. AM rejection, not specified, measured a very high 65 dB.

Figure 5 is a plot of frequency response for the AM tuner section. Although audio fidelity of this section was not much better than that typically found in most receivers, usable sensitivity was very good, measuring a very low 10  $\mu$ V as against 15  $\mu$ V claimed. Signal-to-noise ratio in AM was also quite satisfactory, with readings in excess of 50 dB. Distortion, for a mid-frequency signal, was 0.4%, or slightly under the 0.5% specified by JVC.

#### Amp and Preamp Measurements

The power amplifier section of the R-X500B receiver delivered nearly 110 watts per channel into 8-ohm loads before there was evidence of clipping. At its rated output (100 watts per channel), THD for a 1-kHz signal was an almost unmeasurable 0.002%. In fact, to measure the THD for this amplifier I found it necessary to use my spectrum analyzer in a special setup (in combination with the "Distortion Output" of my distortion analyzer) which provides me with a useful dynamic reading range of more than 120 dB for any reference level. In this case, the reference level was 100

# SOLID

Introducing the Canton CT 2000 floor standing speaker - our first using proprietary vent technology. The result is sound reproduction so fast, natural and free of coloration you must hear it to appreciate the acoustic achievement it represents.

Engineered to meet the most exacting demands of digital technology, the CT 2000's superior dynamic range, resolution and transient response stem from Canton's solid technical expertise.

And, like the entire Canton product line, every element of the new CT 2000 is designed, engineered and manufactured within Canton's factory...this gives us the solid quality for which we are known worldwide.

Solid detailing goes into every Canton speaker as well. That's why we offer our speakers in a variety of fine finishes, like walnut and oak veneers, rich black,

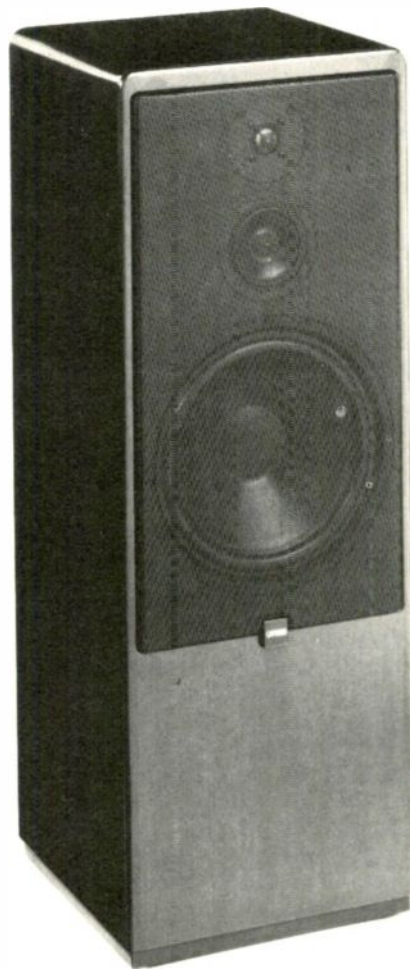

bronze and white lacquers and now a premium finish, gloss mahogany. For at Canton, we believe speakers should look as good as they sound.

And what about the CT 2000's technical specs? We think you'll find these solid as well:

Efficiency:

92dB (1 meter/1 watt)

Frequency Response:

18-30KHz

Power Handling:

300 Watts (music spectrum)

Distortion:

0.1% (DIN Standard)

Dimensions (WxHxD):

14" x 38" x 14"

Solid acoustic technology & design principles, solid detailing & quality. For you it means a solid investment. Visit your local Canton dealer today.

Canton

North America, Inc.  
254 First Avenue North  
Minneapolis, MN 55401

**CANTON**  
Die reine Musik

I have no hesitation in giving my unqualified approval and recommendation to this true bargain receiver.

watts of output, and the THD components showed up some 95 dB below that reference. Figure 6 is a plot of harmonic distortion versus power output for frequencies of 1 kHz, 20 Hz and 20 kHz. At rated output, THD for a 20-kHz test signal measured only 0.0045%, while for a 20-Hz signal it was 0.005%.

I measured a much higher damping factor for the receiver than was specified by JVC. My reading was an even 100, as against the claimed 45. The difference may well be caused by the fact that JVC specified damping factor for a 1-kHz signal, whereas the EIA Measurement Standard for amplifiers calls for the test to be made at a frequency of 50 Hz. Dynamic headroom was a modest 0.83 dB. CCIF-IM distortion was extremely low, at 0.0039%, and IHF-IM distortion was below my limit of measurement, which is 0.03%.

Phono input sensitivity, referenced to 1-watt output, measured 0.25 mV for the moving-magnet (MM) inputs, 0.025 mV for the moving-coil (MC) inputs. A 24-mV signal at any high-level input produced an output of 1 watt with the volume control set to maximum. Phono overload measured 110 mV for the MM phono inputs and 20 mV for the MC inputs. RIAA equalization was slightly off at the low-frequency end, measuring +0.4 dB (relative to the ideal RIAA response characteristic) at 30 Hz. At the high end of the playback curve, the deviation was -0.5 dB at 15 kHz. Overall frequency response via the high-level inputs was flat from 7 Hz to 45 kHz for the -1 dB roll-off point, and from 3.5 Hz to 90 kHz for the -3 dB cutoff limits.

The complete control range of the seven bands of the graphic equalizer is illustrated in the composite spectrum-analyzer 'scope photo of Fig. 7. The perfect spacing of the filter's center frequencies is as accurate as any I have encountered during tests of separate, dedicated graphic equalizers.

Signal-to-noise ratio in phono, referred to a 5-mV input signal applied to the MM inputs and to a 1-watt output at the speaker terminals, measured a very outstanding 84 dB. For the MC inputs, using a referenced input signal of 0.5 mV, the S/N ratio was 69 dB. With the standard 0.5 V applied to the high-level inputs, S/N was 89 dB when referenced to 1-watt output. If you hooked up a CD player to this unit and then drove the R-X500B to within 3 dB of rated output during peaks in program material, the system would provide a total dynamic range of 106 dB—89 dB with respect to 1 watt, plus 17 dB to get to the 50-watt peak level (3 dB below rated output). That's more than enough dynamic range to handle any program on a Compact Disc or from any other digital audio source.

#### Use and Listening Tests

Admittedly, the JVC R-X500B is a receiver that takes a bit of getting used to—there are so many buttons to push and so many unusual features to learn about. Of course, the elaborate visual displays help greatly, and the more I played with this receiver and its many circuits, the more fascinated I became with what is now possible in a compact receiver. I can remember when the first microprocessor-controlled graphic equalizer with response storage memory was introduced as a separate component: It cost more than \$2,000! And now here is that facility incorporated as just one of

many features in an integrated receiver. The first frequency-synthesized tuner with preset facilities I ever tested was able to memorize no more than five favorite stations, as I recall, and it cost around \$2,000. Now here is quartz-synthesized tuning with memories for 30 AM and FM stations in the tuner section of a \$650 receiver.

I wish I had more time (and space) to detail all the other marvelous features of the R-X500B, such as its auto-scan and auto-tuning modes, its automatic switchover to stereo-blend for noise reduction, its ability to deliver five different user-made response curves and their inverse at the touch of a button, and its multi-purpose graphic spectrum-analyzer display and FM signal-strength indications. Suffice it to say that I had a ball playing with this receiver, and I suspect that anyone who buys it will have as much fun with it as I did.

As for how it performed as a tuner and as an amplifier, I can only say that it was excellent. The tuner was sensitive enough and selective enough to enable me to pick up all my favorite strong and weak signals (over 50 of them) in FM. I did find one little annoying quirk in the QSC feature. When you tune to a weak FM stereo signal, the QSC circuit goes on, just as it's supposed to, and its light glows to indicate that noise has been reduced at the expense of separation. But QSC does not shut off if the station's strength increases again, and there's no direct way to defeat it. The only way to disable the circuit and restore full separation is to tune away and then tune back.

Aside from that minor complaint I could find nothing to criticize about the R-X500B in terms of features, layout, or sound quality. The amplifier sounded great at loud listening levels. Perhaps even more important, during very soft passages (such as those likely to be encountered with program sources of wide dynamic range) sound was as clean as could be, with no residual noise or distortion to distract me.

I think perhaps many of us who come across a lot of new audio equipment tend to take some of the more recent design innovations for granted. We shouldn't! The JVC R-X500B is true state-of-the-art, if I may use that shopworn phrase once again. The engineering is superb in every sense. The uses to which the built-in microprocessor has been put are practical and not superfluous frosting on the cake. "Computerized" and "computer-controlled" are much overused terms these days in the audio industry. In this receiver, JVC can be forgiven for perhaps using these terms a bit loosely. The fact is that, whether you are controlling the R-X500B remotely from the comfort of your listening chair or via its front panel light-touch buttons, the unit responds as quickly and as surely as a computer, while providing sound that is not the least bit computerized or artificial-sounding. If I were confronted with just an FM/AM tuner that sold for the same price as this whole receiver and performed as well as the R-X500B's tuner section, I would have absolutely no hesitation in recommending it. If I found an integrated amplifier with a built-in, seven-band, electronically controlled graphic equalizer that performed as well as the preamplifier and amplifier section of the R-X500B and sold for the same price as this entire receiver, I would not hesitate to recommend it. That ought to give you some idea of my unqualified approval and recommendation of this true bargain receiver from JVC.

*Leonard Feldman*



LIGHTS: 10 mg. "tar", 0.8 mg. nicotine, KING: 17 mg. "tar",  
1.0 mg. nicotine, av. per cigarette by FTC method.

© 1984 R. J. REYNOLDS TOBACCO CO.

*You've got what it takes.*

# **Salem Spirit**

*Share the spirit.  
Share the refreshment.*

Warning: The Surgeon General Has Determined  
That Cigarette Smoking Is Dangerous to Your Health.



## 2

SAE R102  
RECEIVERManufacturer's Specifications  
FM Tuner Section

**Usable Sensitivity:** Mono, 11.2 dBf; stereo, 17.2 dBf.

**50-dB Quieting Sensitivity:** Mono, 14.4 dBf; stereo, 35.8 dBf.

**S/N:** Mono, 75 dB; stereo, 70 dB.  
**THD (At 1 kHz):** Mono, 0.10%; stereo, 0.15%.  
**Selectivity:** 30 dB.  
**Capture Ratio:** 1.7 dB.  
**Image Rejection:** 78 dB.  
**I.f. Rejection:** 88 dB.  
**Spurious Rejection:** 88 dB.  
**AM Suppression:** 55 dB.  
**Separation:** 50 dB at 1 kHz; 40 dB from 100 Hz to 10 kHz.  
**Frequency Response:** 40 Hz to 15 kHz,  $\pm 1.5$  dB.

## AM Tuner Section

**Usable Sensitivity:** 15  $\mu$ V.  
**S/N:** 50 dB.  
**Selectivity:** 32 dB.  
**THD:** 0.5%.  
**I.f. Rejection:** 40 dB.  
**Image Rejection:** 45 dB.

## Amplifier Section

**Power Output:** 50 watts per channel, 8 ohms, 20 Hz to 20 kHz.

**THD:** 0.025%.

**SMPTE-IM Distortion:** 0.035%.

**Dynamic Headroom:** 0.2 dB.

**Damping Factor:** 30.

**Input Sensitivity:** Phono, 2.5 mV; high level, 150 mV (for rated power).

**Frequency Response:** Phono, RIAA  $\pm 0.25$  dB; high level, 10 Hz to 100 kHz, +0, -2.5 dB.

**S/N:** Phono (re: 2.5-mV input), 82 dB; high level (re: 1-watt output), 77 dB.

**Tone Control Range:** Bass,  $\pm 10$  dB at 100 Hz; treble,  $\pm 10$  dB at 10 kHz.

## General Specifications

**Dimensions:** 19 in. (48.3 cm) W  $\times$  3.5 in. (8.9 cm) H  $\times$  14 in. (35.6 cm) D.

**Weight:** 22 lbs. (11 kg).

**Price:** \$499.00.

**Company Address:** 1734 Gage St., Montebello, Cal. 90640.

For literature, circle No. 91



The trend towards knobless audio products continues. SAE's new R102 integrated receiver sports not a single rotary knob on its front panel, and the result, in my opinion, is a clean-looking, easy-to-operate unit that would fit nicely into any mid-priced home audio system. This is partially made possible by a design concept which SAE calls Direct-Line Audio. It uses an on-board microprocessor/computer

to make front-panel layout independent of the audio circuits' locations in the chassis. As SAE puts it, "This approach frees both the audio engineer and the front-panel designer to optimize their respective areas."

In the R102, almost all controls have been grouped according to their function, with alphanumeric or digital readouts for each group. Input selectors cluster around an



**WE SOLD ONLY  
3,000,000 OF THESE  
HEADPHONES.**



**SO WE  
MADE THEM  
BETTER.**

Ah, our legendary HD 414's. They've become the standard of recording and broadcast studios. The favorite of critics and music lovers everywhere. And they're even used by NASA.

Which explains, in part, why they've outsold every other headphone.

So why tamper with success?

Because as good as the transient response and dynamic range of the HD 414 were, we found ways to make them even better. And as comfortable as the HD 414's Open-Aire® design was, we were able to improve it with larger cushions and lower headband pressure.

The result: Our new, improved HD 414 SL. Audibly superior with analog records, tapes and broadcasts. And incredible with digital.

Audition them—as well as our more modestly-priced 410 SL—at your Sennheiser dealer. And hear what happens when the world's leading headphone innovator won't leave well enough alone.

 **SENNHEISER®**  
Sennheiser Electronic Corporation (N.Y.)  
48 West 38th Street • New York, NY 10018 • (212) 944-9440

The clean front panel of SAE's R102 receiver starts with an on-board microprocessor/computer for control of functions.

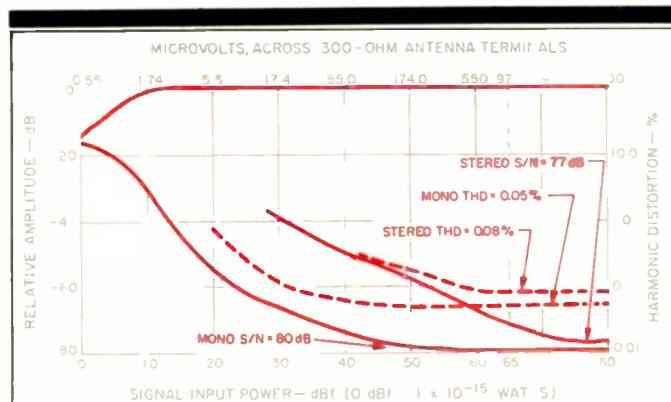

Fig. 1—Mono and stereo FM quieting and distortion characteristics.

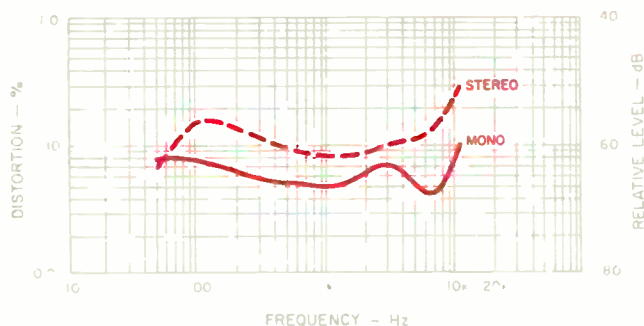

Fig. 2—Distortion vs. frequency, FM section.

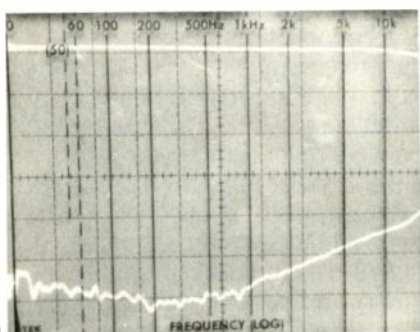

Fig. 3—Response (top trace) and stereo separation vs. frequency, FM section.

alphanumeric display showing which signal source (and, in tuner mode, which station memory) is selected. Tone functions (including a memory selector that lets you return to either of two favorite bass and treble settings instantly) line up beneath a digital display which shows the degree of bass and treble cut or boost. Most tuning controls lie just under the digital tuning display (the exception, a rocker which scans up or down through the eight-station memory on each radio band, is grouped with the input selectors). And a digital display showing volume settings for each channel sits above the buttons and switches for all volume-related functions. All controls whose action is not shown in the main displays have indicator LEDs, so control settings can be taken in at a glance.

My overall impression of the front panel's layout is that it may be too "computerized" for those who belong to the inveterate knob-twirler school of audio appreciation. On the other hand, those whose interest is primarily in listening to good music will appreciate the ease with which this receiver's controls perform. Many people will love it; a few will feel it takes some of the fun out of using the equipment.

### Control Layout

A detailed description of the front-panel control layout will show you what I mean. Six touch pads and a double-width rocker pad are found at the left end. Four of these light-touch buttons or pads are used to select program input sources ("Phono," "AUX/CD," "AM" or "FM"). According to SAE, changing input selections makes the receiver's microprocessor ramp the volume first down, then up again, for a fast cross-fade effect, visible on the volume display across the panel. I didn't notice this, probably because the owner's manual hadn't alerted me to look for it.

Below the input selectors come the switches which select main or remote speaker output. Separating these input and output functions is a double-width "Memory Scan" rocker, which accesses the eight station memories. A single touch of the appropriate end of the bar retunes to the next or previous memory; holding down the bar continues the scan to more distant memory numbers.

There are a total of four displays arranged in pairs across the upper section of the panel. The display closest to the controls just described shows which program source has been selected ("F" for FM, "A" for AM, "AU" for AUX and "PH" for phono), and, when the memory scan bar is depressed, it shows which of the eight memorized frequencies has been called up (e.g., "F2," "A6," etc.). Below this display are "Tape 1" and "Tape 2" touch bars (for selecting either of the tape monitor loops), a tape 1-to-2 or tape 2-to-1 "Tape Copy" rocker switch pad, and another rocker pad which programs the tuner and tone memories. Pressing this pad starts an LED flashing; calling up the appropriate memory (and, for station memory, pressing "Program" again) makes the memory entry and extinguishes the LED.

To the right of this cluster, and below the second display area, are treble and bass rocker touch bars and a bar labeled "Tone Memory." Pressing either end of this bar after pressing the "Program" bar memorizes control settings, while pressing the memory bar alone recalls the memorized tone setting. (Memory 1 comes factory-programmed for

# A FACE THAT ONLY AN AUDIO BUFF COULD LOVE.

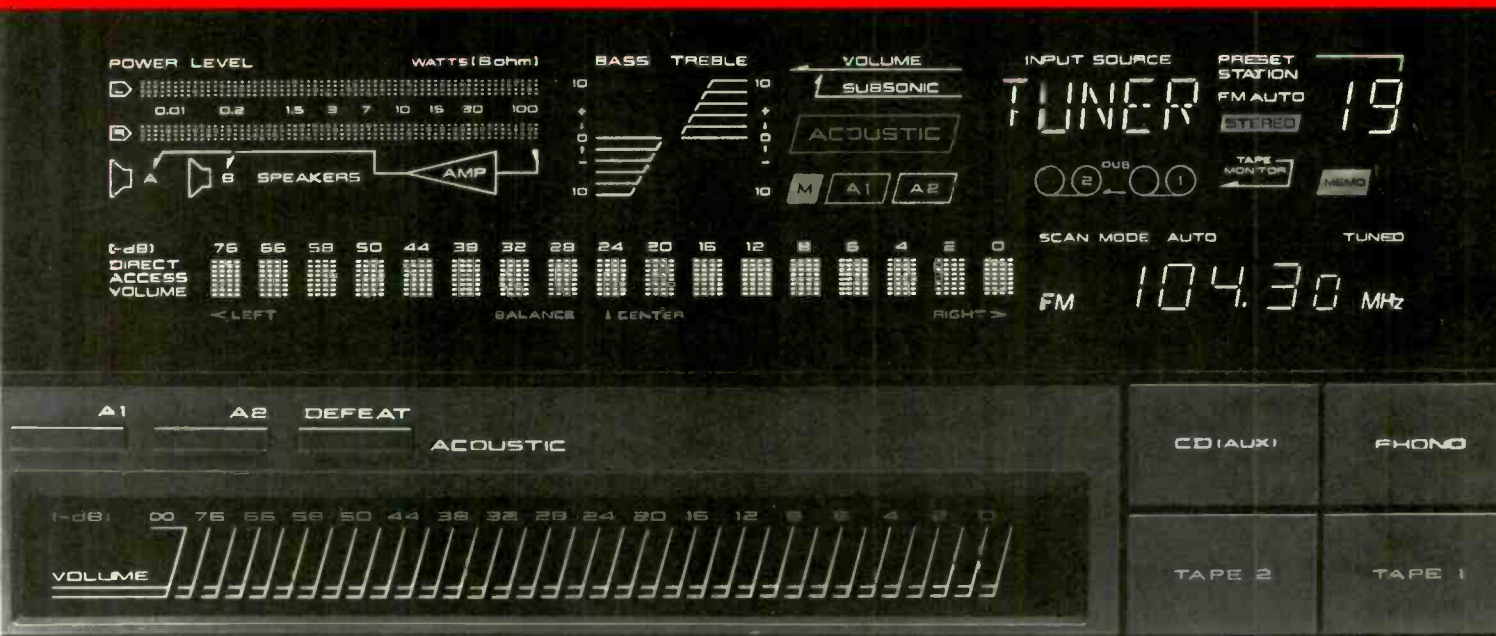

This isn't just another pretty face. It's a masterpiece of electronic sophistication and technical wizardry.

One look at its dazzling FL display gives you instant verification of station frequency, memory program number, output and input source, Acoustic Memory settings and virtually every other AA-A45 receiver operating function.

You'll find AKAI innovations like Direct Access Volume Control. Just one of many computer-controlled functions, it responds with instantaneous volume settings at the touch of a bar. A special safety circuit automatically prevents

abrupt volume increases and resulting performance problems.

Tuning is also at your fingertips, thanks to 20 Station Random Pre-Set Memory. An advanced tuner section that incorporates quartz frequency synthesis for continuous, drift-free reception.

There's even a Zero-Drive circuit that eliminates distortion and negative feedback. A Dual Pole DC Servo Circuit for greater signal resolution and musical fidelity. And an MC head amp with Moving Coil Cartridge compatibility.

But the thing you'll really love about the AA-A45 is its reasonable price.

Because while a lot of companies can design a receiver that an audio buff would love, AKAI's also designed one that you can afford.

For more information on AKAI's full line of receivers, write to AKAI America, Ltd., P.O. Box 6010, Compton, CA 90024.

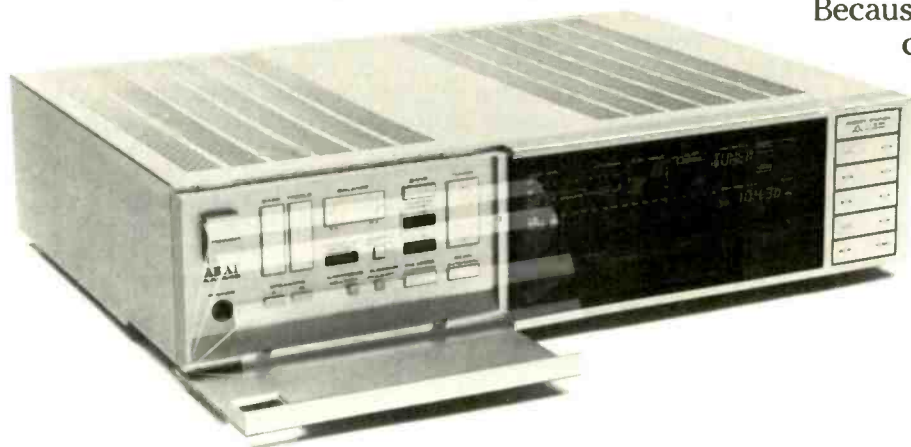

**AKAI**

The tuner section's most outstanding qualities are low distortion in mono and stereo, high S/N ratios, and wide separation.

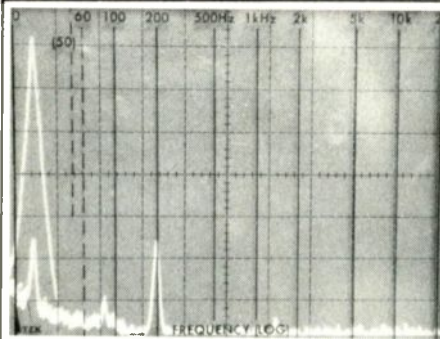

**Fig. 4—**  
Analysis of 5-kHz  
crosstalk and  
distortion  
products,  
FM section.

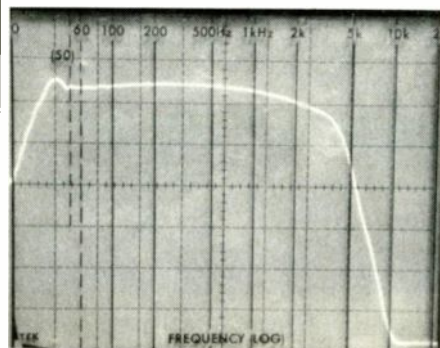

**Fig. 5—**  
AM frequency  
response.

loudness compensation at a fixed level.) The display above the control bars shows the settings of the Baxandall tone-control circuits, in 2-dB steps of boost or cut (e.g., "06:04" means 6 dB of bass and 4 dB of treble boost or cut—the display doesn't tell you which).

The next display, further to the right near the top edge of the panel, shows AM or FM tuner frequencies. Below this readout are a "Tuning" rocker bar, a "Manual" touch bar (which overrides the automatic tuning mode to allow tuning in single-frequency steps), a mono/stereo touch bar (which, in mono, also defeats FM muting), and, near the lower edge of the panel, two sets of level-indicating LEDs calibrated in 6-dB increments from "0 dB" to "-24 dB." The "0 dB" LED corresponds approximately to full power output and is red to warn of approaching amplifier overload or clipping.

The display on the far right shows output-level settings for each channel in dB. Unequal readings (such as "54:56") indicate that the balance control is not centered. Beneath the display are the "Volume" and "Balance" rocker bars, which adjust listening levels in 2-dB increments for each touch, or in 4-dB increments if held continuously.

At the bottom are switch pads for audio "Mute" and "Standby." The muting function decreases volume by the usual 20 dB—but volume can only be decreased, not increased, while the muting is on. This prevents sudden ear-blasting, speaker-blowing jolts of sound when it is switched off again. The "Standby" switch turns off all audio circuits and controls but leaves the microprocessors and associated memories alive until the unit is turned on again.

The rear panel of the R102 is equipped with the usual 75- and 300-ohm FM, and external AM, antenna terminals. An AM loop antenna, located at the center of the rear panel,

can be detached and mounted remotely to further improve reception. "Phono," "AUX," "Tape 1" and "Tape 2" jacks as well as a ground terminal are provided, as are two sets of polarity-identified loudspeaker terminals, two switched a.c. convenience outlets, and a 5-ampere line fuse.

SAE's owner's manual, though succinctly adequate thanks to its use of graphics and illustrations, tells us little about the R102's circuitry. A brief press release concerning this receiver informs that the audio circuits "utilize SAE's latest technology, including the Phono Power Amp, and High Current main power amplifier." So much for circuit details . . .

### Tuner Measurements

The most outstanding characteristics of the R102's FM tuner section, considering its relatively modest price, are its low distortion in both mono and stereo, its high signal-to-noise ratios, and its excellent stereo separation characteristics. Somewhat less impressive are such secondary, but important, characteristics as AM suppression and alternate-channel selectivity.

Figure 1 shows FM quieting and THD (at a 1-kHz modulating frequency) in both mono and stereo modes. Best quieting with strong signals measured 80 dB in mono and 77 dB in stereo, both figures well above SAE's conservatively stated claims. Harmonic distortion in mono measured only 0.05% at 1 kHz, increasing to a still insignificant 0.08% in stereo. Usable sensitivity in mono was 12.0 dBf, while in stereo I measured a least usable sensitivity of 20 dBf. The switchover point from mono to stereo occurs at an even lower input level of 15 dBf, but, of course, the signal is then quite noisy and unusable. Fifty-dB quieting for mono measured 15 dBf; for stereo, the 50-dB quieting point was reached with an input signal strength of 35 dBf.

Figure 2 is a plot of THD versus modulating frequency for both mono and stereo operation. Unlike many inferior stereo decoding circuits, the multiplex decoder section of this FM tuner circuit did not produce high levels of "beats" when high audio frequencies modulated the carrier. This is evidenced by the low reading of THD at 10 kHz in the stereo mode.

Figure 3 is a plot of FM tuner-section frequency response (in stereo) and separation. Frequency response was flat within 0.5 dB from 30 Hz to 10 kHz, but it was down about -2.0 dB at the upper FM broadcast limit of 15 kHz. At the three key test frequencies of 1 kHz, 100 Hz and 10 kHz, I measured separations of 51.5, 50 and 40 dB, respectively.

Figure 4 illustrates the excellent crosstalk characteristics of the multiplex decoder section. The tall spike at the left of this spectrum-analyzer 'scope photo represents the desired left-channel output of a 5-kHz, 100%-modulated stereo signal, while the shorter spike contained within it represents the amplitude of 5-kHz output from the unmodulated right channel. More important, while there is evidence of 19-kHz output, there are virtually no visible crosstalk or distortion products seen at the unmodulated channel's output.

Alternate-channel selectivity measured 45 dB, and capture ratio measured 2.0 dB. Spurious and i.f. rejection were both around 90 dB, with image rejection measuring close to 80 dB. AM suppression was exactly 55 dB, as specified.

The amplifier section delivers more than its rated 50 watts across the band, but the stiff power supply limits headroom.

The AM tuner section performed pretty much as claimed. Frequency response for AM, shown in the spectrum-analyzer 'scope photo of Fig. 5, turned out to be better than most. Although amplitude begins to roll off above 2 or 3 kHz, there is still a fair amount of output at and above 5 kHz; the bass end of the response curve is relatively flat to below 50 Hz.

### Amplifier Measurements

The power amplifier of the R102 was able to deliver 56.7 watts per channel, at 1 kHz with both channels driven into 8-ohm loads, at the rated harmonic distortion level of 0.025%. At 20 kHz, maximum power output for that THD level was 53.5 watts; at 20 Hz, it was 51.8 watts. At rated output (50 watts per channel), THD for a 1-kHz test signal measured 0.01%. SMPTE IM at rated output measured 0.02% (as claimed), CCIF (twin-tone) IM measured a very low 0.0022%, and IHF IM was below my test equipment's ability to read it (well under 0.03%). Figure 6 is a graph of power output versus harmonic distortion for three key test-signal frequencies. I also operated the amplifier section with 4-ohm loads, and at that lower load impedance, the amplifier was able to produce 70 watts of power per channel at mid-frequencies and 65 watts per channel at the audio-frequency extremes for a distortion level of 0.025%. SAE might well have quoted power output for this impedance in their FTC disclosure, since the amp has plenty of current supply capability for this and for even lower impedances. SMPTE-IM distortion at 50 watts equivalent output using the 4-ohm loads measured 0.02%, the same as for 8 ohms.

Damping factor, using a 50-Hz signal and 8-ohm loads, measured 47 as against only 30 claimed by SAE; perhaps SAE used a different reference frequency in their measurement of this parameter. The amplifier has very little dynamic headroom, approximately 0.3 dB by my measurement method as against SAE's claim of an even lower 0.2 dB. This indicates a stiff power-supply configuration, not a design flaw, and it merely means that under music program conditions you should not expect to obtain much more than the 50 watts of power that is measured with continuous test signals. It also means that if you are going to use any of the wide-dynamic-range program sources now available (CD player, Beta Hi-Fi VCR, VHS Hi-Fi VCR, or even some digitally mastered phonograph records), you will want to link the R102 up to a pair of fairly high-efficiency speakers.

Figure 7 is a multiple-sweep logarithmic frequency plot (from 20 Hz to 20 kHz) showing the maximum boost and cut range of the bass and treble tone controls. These nicely configured circuits leave the mid-frequencies pretty much intact even when maximum bass and treble cut or boost is applied to the audio frequency extremes, just the way a good set of tone controls should operate.

Input sensitivity for the phono inputs was 0.4 mV for 1-watt output, with volume control set at maximum. Under the same test conditions, 20 mV was required at the high-level inputs to produce 1 watt of power into 8-ohm loads. Phono overload measured a surprisingly low 70 mV. SAE offers no published specification for these important characteristics, but my test results suggest that you had better go for a relatively low-output moving-magnet phono cartridge if you are going to use this receiver. Otherwise, some of the newer

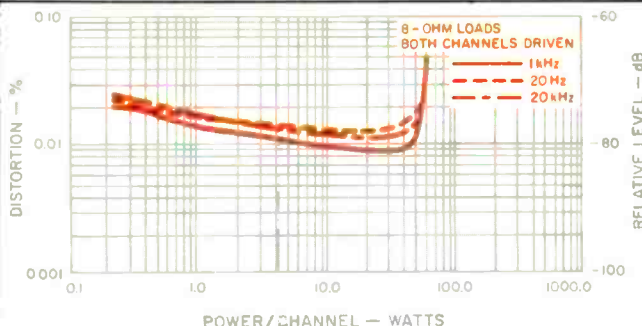
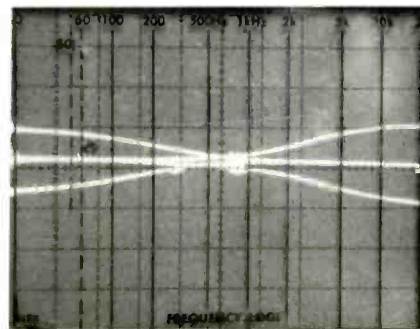

Fig. 6—Harmonic distortion vs. power.

Fig. 7—Range of bass and treble tone controls.



digitally mastered or direct-to-disc LPs in your collection may well overdrive the phono preamp stages during musical peaks.

Maximum deviation from precise RIAA equalization was about +0.4 dB over the bass region and -0.5 dB at 15 kHz. Phono S/N measured a very high 85 dB, referred to 5-mV input and 1-watt output; for the high-level inputs, S/N measured 81 dB with reference to a 0.5-V input and 1-watt output. At minimum volume, residual hum and noise was 99 dB below 1-watt output or, if referred to rated output, it was -116 dB!

Overall frequency response from a high-level (AUX) input to speaker outputs was flat from 5 Hz to 40 kHz, +0, -1.0 dB; for a -3 dB cutoff point, response extended from 3 Hz to 100 kHz. The receiver consumes around 135 watts when idling and a maximum of 300 watts with both channels delivering full power.

### Use and Listening Tests

My concern regarding the power output and dynamic headroom capabilities of this small receiver were reinforced when I began my listening tests. Hoping at first to listen via my usual reference speakers (a pair of KEF 105.2 units), I soon abandoned that idea. Those speakers were adequate for listening to FM and most of the preferred LPs in my record collection. However, when I attempted to listen to some of my newest and best CDs, the R102 ran out of steam and I could see the red LEDs on the receiver's front panel flashing repeatedly as I tried to achieve the kind of lifelike levels I enjoy. To be sure, the overload only occurred during musical crescendos, but it was sufficiently audible to make me switch to my alternate reference speakers, B & W Model

Revox B225

For those who waited.  
And those who wish  
they had.



All Compact Disc players are *not* created equal. This much, at least, has emerged from all the hype and hoopla.

Some CD players are built better than others. Some have more sophisticated programming features. Some are easier to use. And, yes, some *do* sound significantly better than others.

The new B225, from Revox of Switzerland, excels on all counts. For those who have postponed their purchase, patience has been rewarded. For those who didn't wait, the B225 is the logical upgrading route.

First, the B225 is designed for unexcelled CD reproduction. By using oversampling (176.4 kHz) in conjunction with digital filtering, the B225 guarantees optimum sound resolution and true phase response.

For your convenience, the B225 offers programming of nearly every conceivable combination of start, stop, pause, and loop functions, in any sequence, and using mixed combinations of track numbers and times. Cueing time is always less than 3 seconds, and a single infrared remote transmitter (optional) operates the B225 as well as all other components in the Revox 200 audio system.

Finally, the B225 is a product of refined Swiss design and meticulous craftsmanship. Behind its faceplate of functional elegance, you'll find the B225 is an audio component built in quiet defiance of planned obsolescence.

Without question, the definitive CD player has now arrived. For those who waited (and those who didn't), now is the time to see an authorized Revox dealer.

**STUDER REVOX**

1425 Elm Hill Pike, Nashville, TN 37210/(615) 254-5651

The engineering excellence  
has been kept inside, under  
the control of an elegant  
computer program and a  
microprocessor.

3000 units, which are several dB more sensitive than the admittedly low-efficiency KEFs. That difference was enough to keep the amplifier section of the R102 from going into clipping on peaks at the same listening levels as before.

I don't want to overemphasize this problem. There are any number of speakers available which, when teamed with an honest 50 watts per channel of amplifier power, will deliver all the sound pressure anyone could possibly want in a home environment. I merely want to make it clear that, these days, 50 watts per channel is not as much as it was once thought to be, especially when the product design philosophy calls for a stiff, highly regulated power supply, as is the case with the SAE R102.

As I mentioned earlier, the controls are so simplified that familiarization took only a few minutes. Memorization of favorite station frequencies is actually simpler with this receiver than it is on many tuners and receivers which sport more knobs and switches on their front panels. The idea of using a single rocker-bar type of touch switch to perform double functions is a good one and cuts down on the number of switches needed, thereby improving appearance and simplifying operation.

It's simpler for the designer, too, since he doesn't have to think about the physical constraints quite so much. With rotary controls, for instance, the engineer has to worry about the length of the shaft, and there are always limits on how many positions and contacts can be placed on such a control. It's also easier to handle things like getting the r.f.i.-sensitive phono stage away from the power supply, and despite this "put it where you want to" approach, SAE claims that they've been able to cut circuit path length by more than 50%. The firm also says they are experiencing less unit-to-unit variation than with other techniques.

I found FM tuner performance to be adequate, though the somewhat lower than usual alternate-channel selectivity was evident in my crowded FM environment just outside of New York City; it won't bother most of the country. Still, the broadband i.f. system which is responsible for the lower selectivity also accounts for the ultra-low distortion that this tuner section exhibits, and that is a plus in its favor. If you do run into some alternate-channel interference, your solution will be to employ a directional antenna, with which you can usually block out the offending signal. This is especially true if the nearby signal originates from a different direction than the desired signal. Stereo FM sound was exceptionally clean and noise-free with the R102's tuner section, separation wide, and sensitivity very good.

If you like to get past the knobs and switches and just concentrate on the music, this SAE receiver may be just what you are looking for. The engineering, amplifier and tuner excellence have been kept inside and are under the control of an elegant computer program and a microprocessor. All you have to do is press a few light-touch bars, sit back, read the displays, and enjoy the music. If, on the other hand, you like to be in "total control" of all the bells and whistles of an audio product, you may miss some of the familiar joys of knob-twirling and fine-tuning that have been omitted in this receiver. But I suspect that most knob-twirlers will actually prefer the SAE approach once they've become familiar with it.

*Leonard Feldman*



## 3

## ACOUSTICAL PHYSICS LABS ACOUSTIC IMAGE II LOUDSPEAKER

### Manufacturer's Specifications

**System Type:** Two-way, sealed box.

**Frequency Response:** 28 Hz to 22 kHz,  $\pm 2$  dB.

**Drivers:** 10-in. (25-cm), polypropylene cone woofer and 1-in. (25-mm), soft-dome tweeter.

**Crossover Frequency:** 3.5 kHz, gradual slope.

**Impedance:** 8 ohms.

**Recommended Amplifier Power:** 40 to 150 watts per channel.

**Sensitivity:** 85 dB SPL, 1 watt/meter.

**Dimensions:** 34½ in. (87.6 cm) H x 13 in. (33 cm) W x 13¾ in. (34.9 cm) D.



**Weight:** 45 lbs. (20.4 kg).

**Prices:** Assembled, \$600.00 per pair; Basic Kit, \$225.00 per pair; Complete Kit, \$400.00 per pair.

**Company Address:** 3877 Foxford Dr., Doraville, Ga. 30340.  
For literature, circle No. 92

The most unusual feature of the Acoustic Image Model II from Acoustical Physics Laboratories is its combination of size and price. The highly competitive \$400-per-pair speaker market is dominated by diminutive bookshelf systems. The Model II, however, stands 37¾ inches off the floor on casters. "Do it yourself" is the key to the low price, although, at \$600, a factory-assembled pair still appears to be a bargain. The Complete Kit requires only that the constructor screw crossover, drivers and casters to the finished cabinet and plug together four push-on terminals. The Basic Kit contains drivers, crossovers and hardware, but the constructor must build the enclosure from scratch. All versions can only be purchased directly from the manufacturer, with a 30-day money-back return policy. The factory-assembled version is reviewed here.

The Model II is a two-way system utilizing a 10-inch, polypropylene-cone woofer in a sealed box, crossing over to a 1-inch soft-dome tweeter at 3.5 kHz. The woofer cabinet is constructed of ¾-inch, walnut-veneer particleboard and has the proportions of an elongated bookshelf system. Audiophiles frequently place their "bookshelf" speakers on floor stands to elevate them and get them away from nearby reflecting surfaces. With the Model II, the "floor stand" is

built in as additional cabinet volume. The larger volume gives the potential for extended low-frequency response and higher efficiency. Alignment of the acoustic centers of woofer and tweeter is accomplished by mounting the tweeter in a free-standing bracket on top of the main cabinet. Removable frame and stretch-fabric grilles cover the entire front and top. The overall appearance is well-finished and classy.

Four smoothly operating casters allow the speaker to be placed against a wall for storage or casual listening; it can then be pulled away from reflecting surfaces for more critical listening. Acoustical Physics Laboratories also recommends removing the upper grille frame and applying thin pieces of felt or fiberglass to the top of the cabinet near the tweeter to further reduce reflections. The speaker systems have no fuses, level controls or other adjustments. Connection is made via high-quality five-way binding posts which accept the convenient double-banana plugs.

The instruction/specification sheet supplied has all the high-tech buzzwords—polypropylene cone, tight bass, time-domain accuracy, fast response, and the like—but contains little setup information. Power requirements and fusing recommendations, for instance, would be useful.

The Acoustic Image II speaker demands owner involvement, but rewards it with impressive performance at low cost.

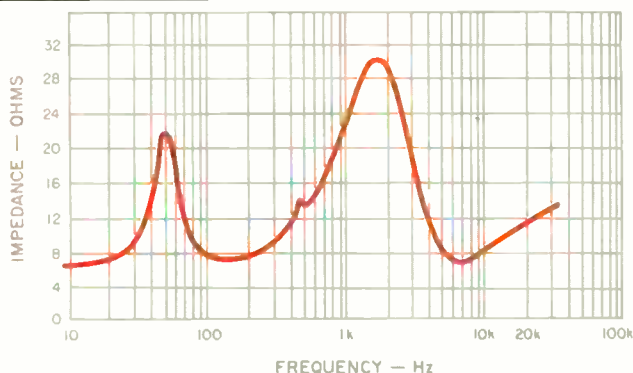

Fig. 1—Impedance magnitude vs. frequency.

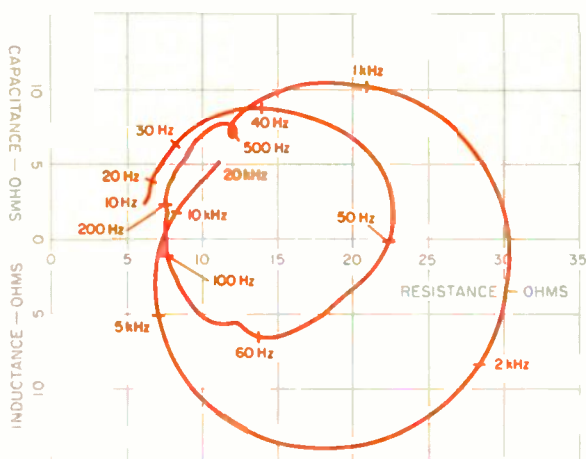

Fig. 2—Complex impedance.

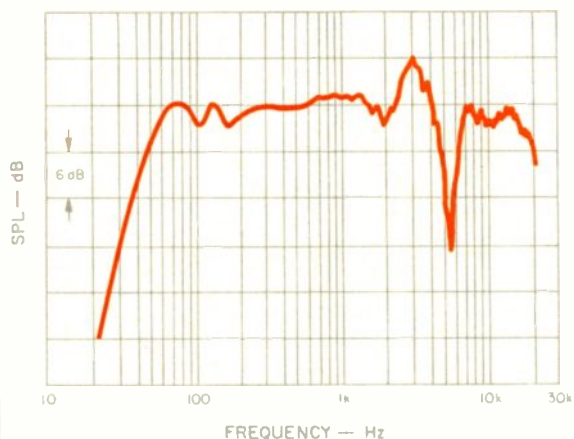

Fig. 3—Anechoic frequency response measured at 1-meter

distance, perpendicular to the center of the front panel.

Suggested speaker placement and orientation, items that I found to be critical, are not covered.

My initial listening tests of the Model IIs were not favorable. The bass was weak, and the mids were hard, with a plastic coloration (not too surprising, when you consider that a sizable plastic cone is being forced to accelerate many thousands of times per second). The upper mids were suppressed, giving a dull and pinched quality, particularly in the brasses. As the measurements proceeded, I began to see the causes of many of these defects. Some problems could be minimized by careful aiming and positioning of the cabinets; others would require minor modifications to the kit assembly. One modification was rather drastic but still required no new parts. Normally I would not consider making such changes to a commercial product, but the kit format and apparently untapped potential of this speaker system invited tinkering. More on this later.

### Measurements

Audio's speaker testing for the past 10 years has all been done by Senior Editor Richard C. Heyser, using time-delay spectrometry techniques which he invented. The Tecron division of Crown International recently introduced a dedicated time-delay spectrometry system based on Richard Heyser's work. This unit, at a price of under \$16,000, is combined with other general-purpose and custom instrumentation to form my speaker-testing laboratory. The Tecron analyzer can collect and display vast amounts of data with great accuracy. The graphs accompanying this review are composed of over 60,000 individual data points, each stored with six-digit resolution on the system's floppy disks. The three-dimensional display format is particularly useful in showing patterns of this data at a glance.

Impedance versus frequency for the Acoustic Image Model II is plotted in Fig. 1. The single bass peak, characteristic of sealed-box designs, occurs at 50 Hz, and the anechoic frequency response can be expected to fall off at 12 dB per octave below this frequency. The minimum impedance is 6.5 ohms. By replotting the data in the impedance curve, more information about the loading of the speaker system on the amplifier is obtained, but frequency resolution is lost. In Fig. 2, the complex impedance plot, resistance is represented by the horizontal component and reactance by the vertical component. Reactance, either up or down from center scale, means that energy is stored in the speaker system and must be both supplied and removed during each cycle. At major impedance-peak frequencies, such as at 50 Hz and 1.7 kHz, stored energy is transferred between two forms within the system (for instance, between suspension displacement and cone velocity), so there is none to be absorbed by the amplifier. Note the loop at 500 Hz: It is a result of energy storage in the displacement and velocity of the heavy rubber surround superimposed on a major impedance peak. There are no frequencies where the Model IIs should prove an undue challenge for an amplifier rated for 8-ohm loads.

All frequency response measurements were made with both grille frames removed but without any felt added around the tweeter. The standard 1-meter anechoic response curve, Fig. 3, is made with the microphone placed

FLY WITH THE EAGLES

EAGLE VR50

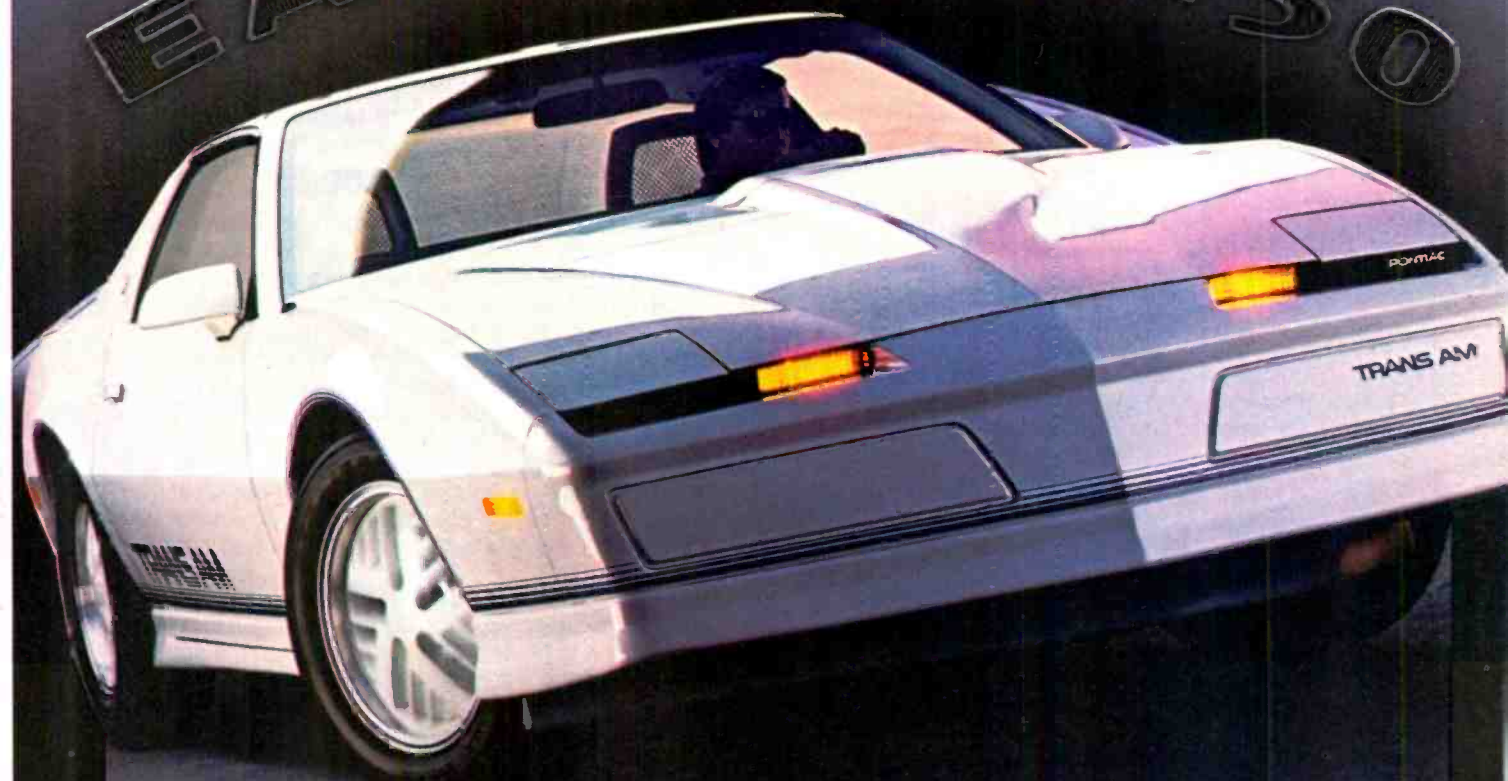

## THIS YEAR'S FASTEST PONTIAC HAS ONLY ONE TIRE —EAGLE VR.

Ask a group of car experts what's the best performance tire in the world.

Chances are, one name will dominate the conversation—Eagle VR.

Now that tire—the tire that has helped the new Corvette achieve "...absolutely astonishing limits of grip..." according to *Road & Track*—has



been selected sole original equipment tire on Pontiac's 1984 Anniversary Trans Am.

And no other high-performance radial combines Eagle VR's unidirectional tread pattern, long tread wear, steel-belted toughness and smooth ride with VR (30 MPH) speed rating.

It seems that more

and more, the builders of the world's finest performance cars are using our new Eagle VR's.

And that suits us just fine.

The Goodyear Eagle VR radial. In the Eagles' Nest at your Goodyear retailer.

For a free copy of the detailed product specification book *Fly With The Eagle*, write to: The Goodyear Tire & Rubber Company, Box 9125, Dept. 17M Akron, Ohio 44305.

**GOODYEAR**

"Do it yourself" is the key to the low price, but even the assembled version appears to be a bargain at \$600 per pair.

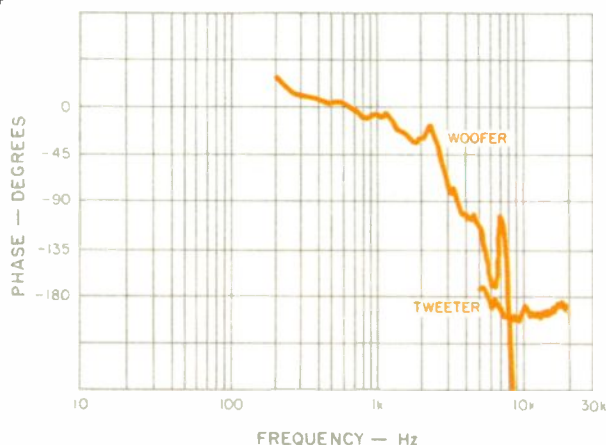

**Fig. 4—One-meter on-axis anechoic phase response corrected for woofer time delay of 3.026 mS and tweeter time delay of 3.309 mS.**

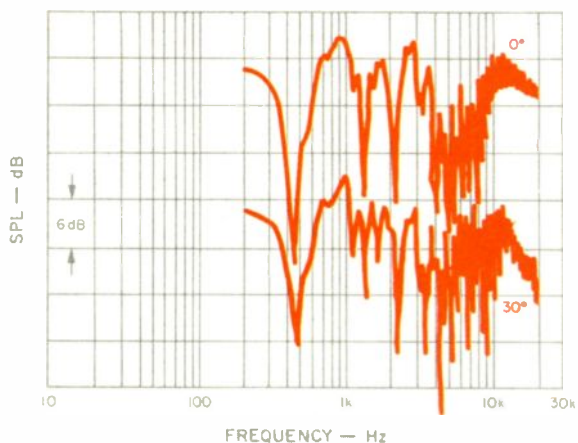

**Fig. 5—Three-meter room-test plots, separated 15 dB for clarity.**

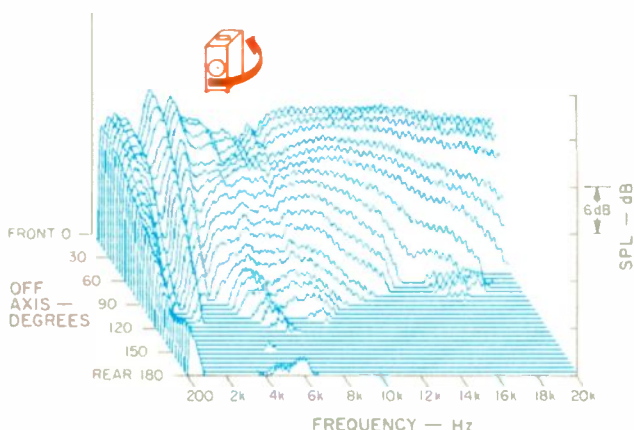

**Fig. 6—Horizontal off-axis frequency response plots from front to rear of system.**

perpendicular to the geometric center of the front panel. For this floor-standing speaker, the standard microphone placement means that both woofer and tweeter are measured at an angle considerably below the normal listening axis. The differing path lengths from woofer and tweeter to microphone produce a deep cancellation notch at 5 kHz. The rise at 3 kHz and the droop at 20 kHz are due to the microphone being on the woofer axis and off the tweeter axis. Radiation of frequencies near the upper operating range of a driver are usually quite directional. The low end does roll off below 50 Hz, as expected.

Anechoic phase is shown for woofer and tweeter separately in Fig. 4. For the standard microphone position, the tweeter is about 100 mm farther away than the woofer. This is corrected for in this measurement. The overall trend of a shift from 0° to -180° through the crossover frequency is characteristic of an ordinary second-order crossover network. Double-blind tests I have conducted indicate that this amount and rate of change of phase shift are inaudible in music. Of course, the phase shifts in the two stereo channels must track each other closely. Ideally, woofer and tweeter would have no relative phase shift near crossover even though the system phase is changing. This would avoid a tilting of the loudspeaker's polar pattern near the crossover frequency.

If only one measurement were relied upon to tell us how a speaker sounds, it would be the 3-meter room test, Fig. 5. The microphone is placed 3 meters away from the speaker and 1 meter off the floor—similar to the ear position of a seated listener. In the case of the Acoustic Image Model II, the speaker was placed 1 meter away from the side and rear walls, a position found to be optimum earlier, during music listening. A time window in the measurement allows only the first 10 mS of sound arrival to influence the plot. This time period allows reflections from floor, ceiling, rear and side walls as well as cabinet diffraction to be included in the measurement, and it approximates the ears' integration time for assessing timbre or coloration. A period of 10 mS is too short to allow room reverberation to affect the measurements, so this curve should apply to this speaker in most listening environments. Deep floor- and ceiling-reflection interference notches occur, starting at 400 Hz. Having a thicker carpet than the one on my floor would help here. The major hole around 6 kHz is due to interference between woofer and tweeter radiation. This woofer has surprisingly strong on-axis output to one octave above the crossover frequency. The factory alignment of the Model II's tweeter on the top of the cabinet results in cancellations both for the downward angle of the 1-meter on-axis test and at the listening location.

I also noticed, during the earlier listening tests, that the sound was brighter when I stood than when I sat. A check of vertical polar response in the 6-kHz region revealed that interference notches occurred at roughly 20° intervals. One of these notches happened to be aimed at the normal seated listening location! This design error should never have reached production. My first modification was to change the tweeter's front-to-back location to aim the first interference notches above and below my seated listening position, thereby restoring proper brightness to the sound.

The original kit design has some untapped potential which can reward the tinkerer with truly impressive performance.

Figure 6 is a composite of 31 frequency response curves, taken at 6° increments from on-axis (rear plot) around the side to the back of the cabinet (front plot). The linear scale expands the high-frequency range and allows easy recognition of interference patterns by their regular "comb" appearance. As always, dispersion is wide and uniform at the lowest frequencies. The woofer becomes increasingly directional near the upper end of its range (1 to 4 kHz). At about 4 kHz, the tweeter becomes active and the 1-inch dome reintroduces wide dispersion, which again narrows as frequency goes up to 20 kHz. Speaker designers may argue about the merits of wide versus narrow dispersion patterns, but a drastic mid-band change such as this must be considered a deficiency.

Figure 7 is a similar composite of 31 response measurements, this time taken from directly below the cabinet, up the front to directly above the cabinet. Since woofer and tweeter are vertically displaced, each angle results in a different measurement distance from woofer and tweeter and produces a unique set of peaks and dips in the 2- to 7-kHz crossover range. The overall trend of wide to narrow dispersion with increasing frequency for both woofer and tweeter can still be seen. At frequencies where dispersion is restricted both horizontally and vertically, less energy is injected into the room to return to the listener as reverberation. Without the mellowing effect of room reflections, a speaker with very uniform, anechoic on-axis response can still sound harsh. By listening slightly off-axis, the ratio of direct-to-reflected sound can be reduced and made somewhat more uniform with frequency. For the Acoustic Image Model IIs, a relatively small optimum listening window is dictated by vertical interference effects and by the need to be slightly off-axis horizontally.

Figures 8, 9 and 10 show harmonic distortion components of test signals of 41.2, 110, and 440 Hz respectively. The fundamental is not shown, but it is the reference at 0.0 dB or 100% for all curves. The front-to-back dimension of this three-dimensional plot is increasing power from 0.1 to 100 watts. Distortion components through the fifth harmonic are plotted at each power level. The distortion is not particularly low, even at low power levels, but it consists primarily of low-order harmonics (i.e., second and third) which are not as annoying as the "buzz" associated with higher harmonics. Generally, low-order harmonic distortion products at levels of 3% or 4% are not audible in music, so the Model II may be considered clean at typical listening levels.

Intermodulation distortion is plotted in Fig. 11. The cyclic amplitude compression and phase shift of 440 Hz by 41.2 Hz, mixed at the same level, is rather high for a 10-inch driver in this size enclosure. On most program material, however, a 300 watt-per-channel amplifier would clip on peaks before the average distortion level would exceed a few percent.

In the crescendo test, a 630-Hz tone of 0.1-watt input was compressed 1.0 dB by the addition of 10 watts of wide-band pink noise. Peaks in the noise test signal reached 100 watts, so this compression should not be considered very much of a problem.

Overall, the harmonic, intermodulation and crescendo tests indicate that amplifiers rated up to 200 watts would be

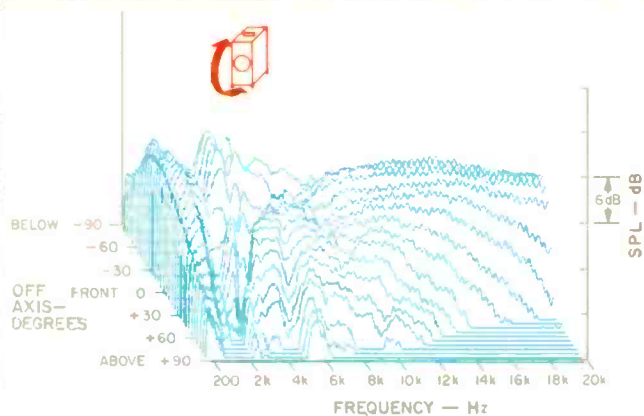

Fig. 7—Vertical off-axis frequency response plots from below to above system.

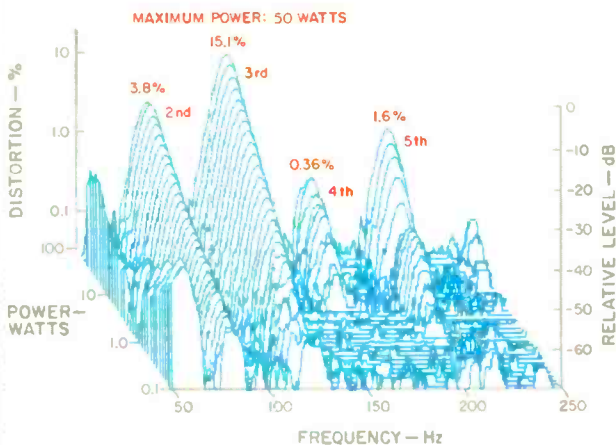

Fig. 8—Harmonic distortion products of the tone E<sub>1</sub> (41.2 Hz).

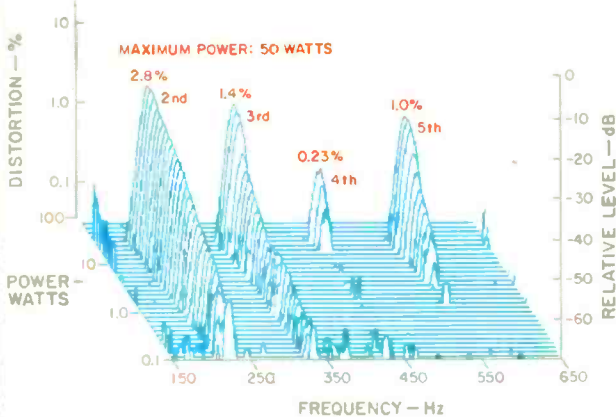

Fig. 9—Harmonic distortion products of the tone A<sub>2</sub> (110 Hz).

Tests of harmonic distortion result in low-order products, so that the "buzziness" of high harmonics is avoided.

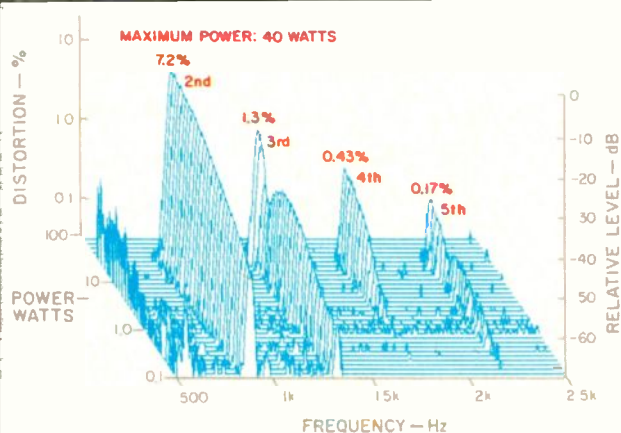

Fig. 10—Harmonic distortion products of the tone  $A_4$  (440 Hz).

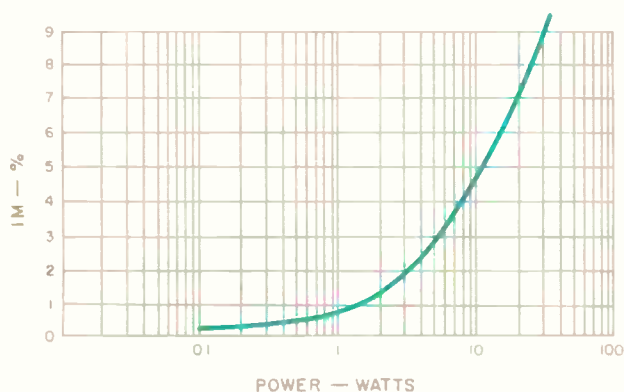

Fig. 11—IM distortion on  $A_4$  (440 Hz) caused by  $E_1$  (41.2 Hz), mixed one to one to one.

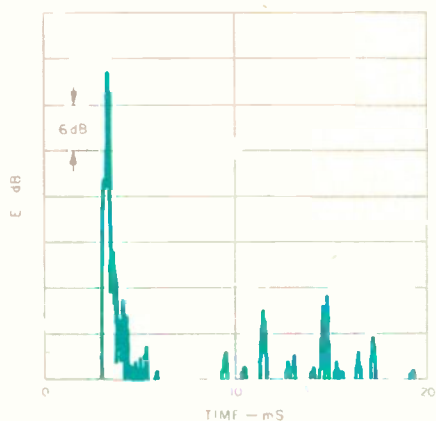

Fig. 12—One-meter on-axis energy vs. time response. (Traces beginning at 8 mS are room reflections.)

beneficial—provided that the average power fed to these speakers did not exceed about 30 watts. Considering their reasonable efficiency, the Model IIs can produce a satisfying level at 3 meters in a typical listening room.

The time response curve shown in Fig. 12 is dominated by tweeter output, because the tweeter covers three-quarters of the 20 Hz to 20 kHz bandwidth of this test. The woofer output, 15 dB below the maximum level, begins slightly before the tweeter because of the low microphone position of the standard test setup. The response dies quickly, indicating a lack of resonant energy storage or cabinet diffraction.

### Use and Listening Tests

As I said earlier, the out-of-the-box Model IIs did not impress me favorably during the initial listening test, even considering their modest price. The bass was weak, though it did not have the objectionable thump of vented designs tuned to a relatively high frequency. Upper bass had a discernibly nasal character. Midrange had the colorations mentioned earlier, with the upper mids suppressed. Only the high end escaped criticism because of its smooth and extended sound.

The speakers were auditioned in two different rooms, using various placements and cabinet orientations. With the 6-kHz hole not yet remedied, every position seemed to be a compromise. Corner positioning solidified the bass response, but the stereo image developed a hole in the middle. A fairly wide spacing, away from the walls and with toe-in, seemed to be the best overall. A thick rug or a piece of foam sound-absorbing material on the floor, placed midway between listener and speaker, also helped. Acoustic guitar was one of the few music sources that the stock Model IIs reproduced well.

After discovering there was a tweeter-position problem, I figured out an easy way to optimize it for a given listening height, even without the aid of instruments: Simply tune in some interstation FM noise and have an assistant slide the tweeter forward to tune for maximum high-frequency output. Use the same physical offset for the other speaker. A movement of less than 1 inch can transform the system's spectral balance; I settled on mounting the front edge of the bracket  $1\frac{3}{4}$  inches back from the front edge of the cabinet.

I had a suspicion that the nasal character might be due to internal cabinet resonances, so I removed the woofer to add about 4 square feet of 2-inch thick fiberglass to the inside of the cabinet, behind and above the woofer. Sure enough, when A/B tested against the unmodified unit in mono, there was an audible improvement. Not trusting my "constructor's ear," I asked other people to listen in a blind test and they also preferred the modified unit.

The Acoustic Research AR-1W introduced 30 years ago was the first acoustic-suspension woofer. It was slightly smaller than the Acoustic Image Model II's woofer and had much better low-end performance. It was also much more expensive, but, in theory, frequency response optimization, at low power levels, need not be cost-constrained. I decided to measure the Thiele-Small parameters of the Model II's low-frequency driver to check the design against theory. The driver's suspension proved to be rather stiff, requiring

## WHO CAN MAKE A MORE DIGITAL-READY TAPE THAN THE COMPANY THAT INVENTED PCM RECORDING IN THE FIRST PLACE?

When other companies talk about being "digital-ready," remember that Denon is the Company that also builds professional digital studio tape recorders and is credited for having *invented* the PCM recording process in 1972. Denon has recorded more

digital material than *any* Company in the world. It is only natural that Denon simultaneously developed the cassette formulation most suitable for making digital-to-analog recordings. The formulation is Denon DX-8. The ultimate non-metal cassette tape.



# DENON

D E S I G N I N T E G R I T Y

Nippon Columbia Co., Ltd., No. 13-14-4-Chome, Akasaka, Minato-Ku, Tokyo 107, Japan

Denon America, Inc., 27 Law Drive, Fairfield, N.J., 07006 201-575-7811  
 Quebec Imports, 2950 Griffith St., Montreal, Quebec H4E 1A7, Canada 514-735-433E

Enter No. 20 on Reader Service Card

While the midrange is surpassed by some other low-priced speakers, I'd gladly sacrifice this for the Model II's remarkable bass potential.

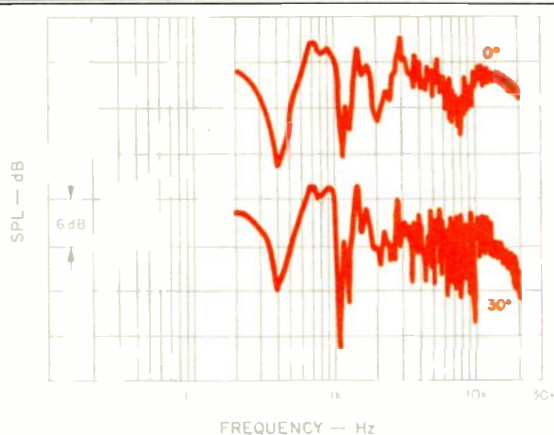

**Fig. 13—Three-meter room-test plots of modified unit, on-axis and 30° off-axis. (Plots separated by 15 dB for clarity.)**

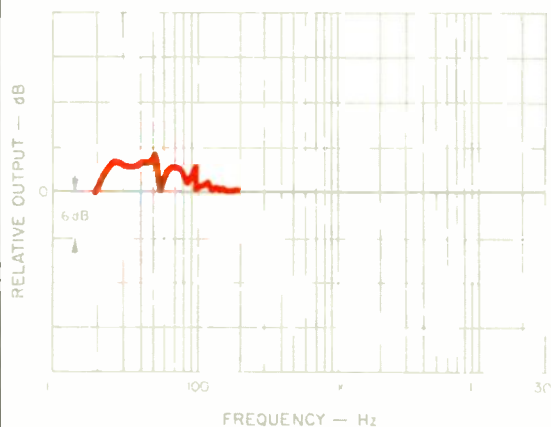

**Fig. 14—Additional in-room bass response of modified unit relative to stock unit. (Stock unit is shown as 0 reference.)**

the enclosure to be rather large (2.2 cubic feet) in order to keep the system resonance low enough in frequency. The Acoustic Research approach used a combination of small cabinet and ultra-compliant suspension to achieve the proper system resonance.

Using vented-box design equations similar to those published in *Audio* in August 1978, I found that the Model II's woofer/cabinet combination might work as a nearly optimum vented system. With a port tuning the cabinet to 27 Hz, the response should be nearly flat to 30 Hz. The frequency of maximum cone excursion should be 18 Hz, well above record-warp and arm/cartridge resonance frequencies. It looked like a winner, so I did it. I mounted a 6-inch long piece of 3-inch diameter PVC pipe facing downward in the bottom panel of the enclosure, which is raised off the floor by the casters.

After quickly comparing the modified unit to the original unit, I modified the second unit as well. I then began the listening tests all over. The additional clean bass response gave a solid, balanced quality to the sound, even with the

speakers well away from the walls. The Model IIs still had a little harshness and coloration in the midrange, audible mainly on recordings of choir and massed strings. This problem was reduced by listening about 10° off-axis. With the speakers facing parallel to the side walls, the harshness and most of the coloration were gone, because the centered listener was about 15° off-axis. This angle also dulled the midrange slightly, giving a nice distant quality, but lateral imaging was very sensitive to the listener's side-to-side location. An extreme, "cross-eyed" toe-in of about 45° was then tried. The depth imaging and ambience retrieval became very good, with an even left-center-right soundstage perceptible over a reasonably wide listening area. The modified Model IIs were often preferred to the much more expensive reference speakers by a variety of listeners (including me) in one listening room but not in the other.

Figures 13 and 14 show changes resulting from my modifications. Besides the tweeter repositioning, the 3-meter room curve of the modified speaker benefits from a piece of sound-absorbing material placed on the floor midway to the microphone. This reduces the floor-bounce cancellation notches. The big improvement, however, is that the 6-kHz hole is nearly gone. The difference resulting from venting the enclosure is shown in Fig. 14. This curve includes all room effects for modified and unmodified systems. The nearly 4-dB increase in low-end output is due, in part, to the excellent coupling of the vent radiation to the floor.

The Acoustic Image Model IIs have a unique position in the speaker market: They demand owner involvement, and reward it with impressive performance at low cost. Even the purchaser of factory-assembled units is expected to remove the grilles and reposition the cabinets before listening. I suggest that any owner go beyond this level of involvement and try the modifications suggested in this review—they are all reversible. Naturalness of midrange timbre of the modified speakers is surpassed by a number of other low-priced two-way systems employing 6- or 8-inch woofers, but I would gladly make the slight sacrifice in this important quality to get the remarkable bass performance of the large, vented 10-inch Model IIs.

*David L. Clark*

**Manufacturer's Comment:** We have reviewed and tested the Model II modifications suggested by David Clark. Our own listening tests, as well as swept warble and impulse FFT measurements, indicate significant improvements do result from the suggested modifications. As a result, our instructions for the Model II now specify tweeter displacement of 1.75 inches from the front of the enclosure, specify additional fiberglass damping within the enclosure, and recommend, as an option, the 27-Hz downward venting of the enclosure. The factory-assembled Model II incorporates these modifications with the vented enclosure as an option.

As a manufacturer of speaker systems, we applaud *Audio*'s comprehensive TDS acoustical tests as meaningful representations of speaker performance. We would like to comment that 1-meter, on-axis measurements of the Model II do not represent a real listener's position and emphasize that measurements at the 3-meter distance, at a 1-meter height, are more representative of the loudspeaker's performance as viewed by a listener.—*William Morrison*



# Hearing is believing -

Hearing Cabasse loudspeakers for the first time can be a revelation. Fine details of dynamic contrast are revealed in a way that is common in the concert hall but very rare in home reproduction. Due to their attention to accuracy in the time domain, Cabasse loudspeakers produce an image that is as wide and deep as the recording engineer intended, without exaggeration or diminution. Move about the room and the sonic image from Cabasse speakers does not have the irritating shifts and tonal changes of many otherwise fine loudspeakers because of Cabasse's smooth dispersion even at high frequencies. With their exceptional efficiency and power handling capacity for speakers of this sonic refinement, Cabasse loudspeakers bring to your listening room the life-like excitement of percussive transients from cymbals, guitars, pianos and drums.

Listen for yourself and you will want to see more.



# Seeing is believing -

Seeing Cabasse loudspeakers for the first time can also be a revelation. The workmanship on the cabinets is of a quality that can only be achieved by a company like Cabasse that produces woodwork with the same loving care as an artisan producing a fine violin or guitar. Behind the acoustically transparent grill are the famous Cabasse drivers, designed in Cabasse's own research facility and manufactured in their own plant so that they do not have to rely on an outside source for

precision and consistency. Of special interest is the *honeycomb dome* material used for the speaker cones. Developed and produced exclusively by and for Cabasse loudspeakers, this unique substance is extremely rigid yet low in mass. It has a high resonance frequency that is naturally damped, making it a nearly perfect reproducer of mid and low frequencies.

Take a close look at a Cabasse loudspeaker and you will want to hear more.



The premier French audiophile speaker company is pleased to announce the appointment of Madrigal LTD as its exclusive United States Distributor.

**MADRIGAL**  
LTD.

Post Office Box 781, Middletown, Ct 06457 (203) 346-0896

# "Spectacular" "Astounding"

*Stereo Review Magazine*

*High Fidelity Magazine*

The Nation's Top Audio Experts Agree:  
Polk's Revolutionary True Stereo SDAs  
Always Sound Better Than Conventional Speakers



SDA-CR3  
\$395.

SCA-2  
\$670.

SDA-1A  
\$850.

In Baltimore at Seascope  
406 West Coldspring Lane.

**"The result is always better than would be achieved by conventional speakers."**

*Stereo Review Magazine*

**"They truly represent a breakthrough."**

*Rolling Stone Magazine*

Polk's AudioVideo® Grand Prix Award winning SDA technology has been called the most important fundamental advance in loudspeaker design in the last 25 years. In fact, Polk's remarkable SDAs are the world's first and only True Stereo loudspeakers.

**Hear the Remarkable Sonic Benefits Now!**

Polk's exclusive True Stereo SCA technology results in spectacularly lifelike, three-dimensional sound. *Stereo Review* said, "Literally a new dimension in sound." *High Fidelity* said, "Astounding... Mind-boggling... Flabbergasting... An amazing experience... You owe it to yourself to audition them."

Polk Audio, Inc., 1915 Annapolis Rd., Baltimore, MD 21230. For nearest dealer call: 1-800-843-3300

Digital Disc Ready

**polk audio**  
The Speaker Specialists®

Enter No. 38 on Reader Service Card

4

## NAD 4155 TUNER

### Manufacturer's Specifications

#### FM Tuner Section

**Usable Sensitivity:** Mono, 9.8 dBf  
(1.7  $\mu$ V, 300 ohms).

**50-dB Quieting Sensitivity:** Mono, 13.2 dBf (2.5  $\mu$ V, 300 ohms); stereo, 32 dBf (22  $\mu$ V, 300 ohms).

**S/N:** Mono, 82 dB; stereo, 75 dB (80 dB at 75 dBf).

**THD:** Mono, 0.09% at 1 kHz (0.2%, 100 Hz to 6 kHz); stereo, 0.09% at 1 kHz (0.3%, 100 Hz to 6 kHz).

**Frequency Response:** 30 Hz to 15 kHz,  $\pm$ 0.5 dB.

**Alternate Channel Selectivity:** 70 dB.

**Capture Ratio:** Less than 1.5 dB.

**Image Rejection:** 85 dB.

**I.f. Rejection:** 90 dB.

**AM Rejection:** Greater than 65 dB.

**Stereo Separation:** 50 dB at 1 kHz, 40 dB from 30 Hz to 10 kHz (Dynamic Separation off).

**SCA Rejection:** 70 dB.

**Subcarrier Suppression:** 60 dB.

#### AM Tuner Section

**Usable Sensitivity:** 300  $\mu$ V/meter.

**Selectivity:** 35 dB.

**Image Rejection:** 50 dB.

**I.f. Rejection:** 50 dB.

#### General Specifications

**Power Consumption:** 12 watts.

**Dimensions:** 16½ in. (41.9 cm) W x 3 in. (7.6 cm) H x 11 in. (27.9 cm) D.

**Weight:** 8½ lbs. (3.9 kg).

**Price:** \$348.00.

**Company Address:** 675 Canton St., Norwood, Mass. 02062.

For literature, circle No. 93



The name Larry Schotz has been associated with FM tuner products produced and sold by NAD ever since that company delivered its outstanding 4150 tuner some two years ago. The new NAD 4155 incorporates a new concept developed by Mr. Schotz, which NAD calls Dynamic Separation. Basically, this circuit reduces noise normally heard during weak-signal stereo FM reception by blending the highs during quiet moments or pauses in the music (when background noise would be most obvious and obtrusive)

and restoring wider separation when there is more significant stereo information in the signal, or when the signal is stronger. In all other respects, the 4155 follows the traditional, no-nonsense design approach characteristic of NAD products: There are no superfluous controls or gimmicks. Front-panel layout is simple and clean. The basic black finish of both the panel and the metal enclosure retains the NAD look, free of gaudiness and meaningless gloss, of bells and whistles.

Unlike other auto-blend circuits, NAD's Dynamic Separation stops blending when the treble content is enough to mask the noise.

### The Dynamic Separation Circuit

While the overall performance of the NAD 4155 was excellent, what particularly interested me was the Dynamic Separation circuit. In conventional, manual high-blend circuits (Fig. 1), high frequencies are crossed between channels, cancelling the out-of-phase components of the high-frequency noise that occurs when signals are weak. With this blend, however, a moderate amount of midrange separation (about 10 dB at 1 kHz) is retained.

Although this lowers noise for weak-signal stereo reception, the result does not sound as open nor is stereo imaging as precise as it would be if full stereo separation were retained. For this reason, many tuners have automatic high-blend circuits, which blend only under weak-signal conditions. Dynamic Separation varies the blend effect not only according to r.f. signal strength but also according to the audio signal's high-frequency content, on the premise that

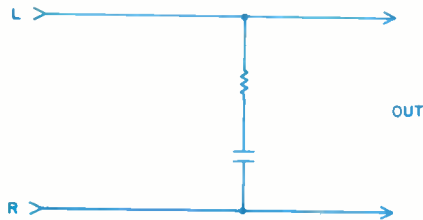

Fig. 1—  
Basic high-blend  
circuit.

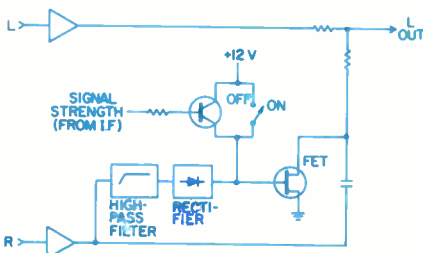

Fig. 2—Dynamic  
Separation circuit  
used in  
NAD 4155 tuner  
(see text).

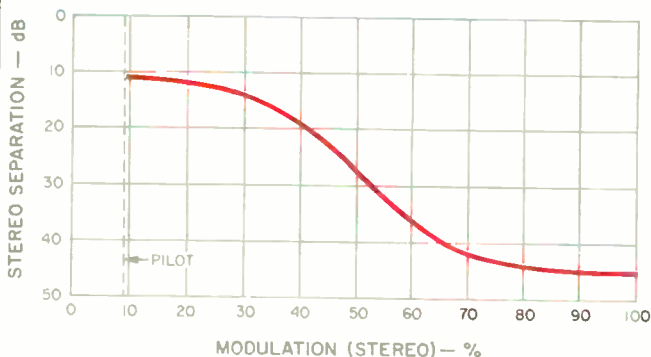

Fig. 3—Dynamic Separation circuit varies interchannel separation (shown here at 1 kHz) according to modulation level of mid/high-frequency program content.

high blend is desirable during quiet pauses in the music but increased separation is wanted whenever the musical signal is loud enough and rich enough in high frequencies to "mask" the background hiss and noise. Figure 2 shows how the Dynamic Separation circuit controls the crossfeed from the right channel into the left; a similar circuit (not shown) controls the crossfeed from the left channel to the right. As long as the FET remains turned off (offering a high-impedance path to ground), the full crossfeed signal reaches the opposite channel and maximum high blend occurs. When a positive gate voltage turns the FET on, its low resistance short-circuits the crossfeed to ground and full, wide stereo separation is thus restored. Such positive gate voltages reach the FET gate from three sources:

- (1) From the "Dyn Sep" switch on the front panel;
- (2) From the a.g.c. line from the i.f. stage (which is, of course, proportional to signal strength and is calibrated so that the high-blend turns off for signal strengths greater than about 150  $\mu$ V, at which time stereo signal-to-noise is greater than 60 dB), and

- (3) From the Dynamic Separation controller, which consists of a high-pass filter and a rectifier. When there is little or no modulation, full high blend occurs. With significant modulation levels at mid- or high frequencies, the filter and rectifier produce a control voltage at the FET gate, progressively shorting out the high blend again and restoring wider separation. Figure 3 shows how separation at 1 kHz varies from around 10 dB at low modulation levels to around 45 dB at full modulation.

### Control Layout

A "Power" switch is located at the lower left of the front panel of this tuner. Nearby are three more pushbuttons for mono/stereo selection, engaging "FM Mute," and turning Dynamic Separation on or off. A display window just to the left of the panel's center shows station frequencies, AM or FM mode, and relative signal strength (a row of LEDs light progressively with increasing signal strength). Tuning is in 10-kHz increments for AM and 100-kHz increments for FM. A separate stereo indicator light is just to the right of the display window.

Seven pushbuttons, arranged horizontally, are located along the right section of the panel. The first five are numbered and are used as preset buttons for memorizing five favorite AM station frequencies plus five FM station frequencies. The sixth button, colored tan to stand out from the others, is used for entering the selected frequencies into memory, while the seventh button in this cluster selects AM or FM reception.

A rocker switch at the upper right corner tunes up or down the frequency scale. A pushbutton, below the rocker, switches tuning from normal frequency-incrementing mode to the "Search" mode. When in search, touching the rocker causes the tuner to go up or down in frequency until the next usable signal is found.

On the rear panel are a pivoting AM loopstick antenna and AM and FM antenna terminals. These are similar to many speaker terminals: You simply insert the stripped wire end of your antenna cable into a small hole and flip down a locking lever to keep the wire firmly in place and in contact

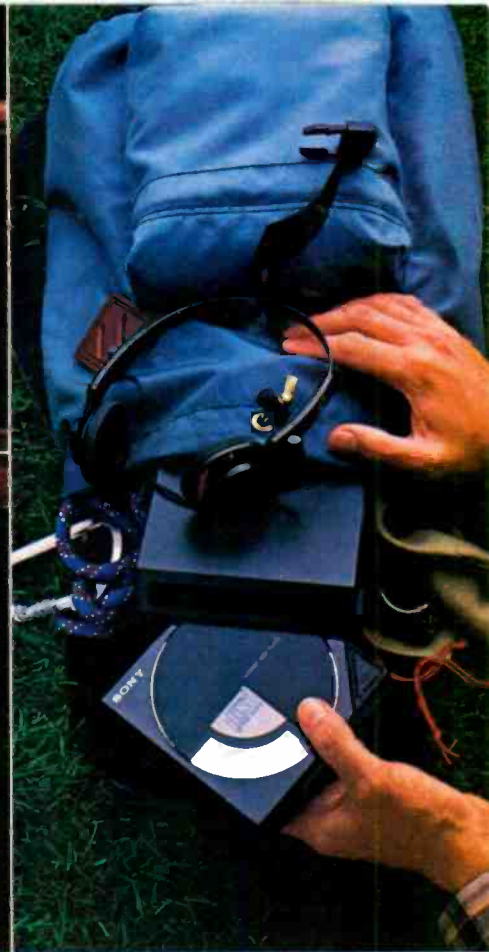

# Sony revolutionizes the compact disc revolution.

If there are still a few among you who have any lingering doubts as to who the leader in digital audio really is, consider the following:

On October 1, 1982, Sony\* set the music industry on its ear with the creation of the world's first compact digital audio disc player.

Today, with over 30 companies joining the revolution, Sony is starting two others. The Car Compact Disc Player and the Portable Compact Disc Player.\*

Combine that with the fact that the CDP-111, shown above, represents another addition to the world's largest family of

home compact disc players, and one thing should become abundantly clear:

While other companies are claiming advanced circuits, Sony has taken a somewhat different course.

Advanced products.

**SONY.**  
THE LEADER IN DIGITAL AUDIO.™

\*Initial supplies may be limited. © 1984 Sony Corp. of America. Sony is a registered trademark of the Sony Corporation, 1 Sony Drive, Park Ridge, NJ 07656. †Optical headphones and battery pack case may vary where purchased.

Enter No. 46 on Reader Service Card

# The Sound of Nakamichi



Never before has so much technology been concentrated in one modestly priced cassette deck.

No other recorder in its class can claim to possess the three essential ingredients of sonic perfection—the legendary Nakamichi Discrete 3-Head approach to recording, the unique Direct-Drive Asymmetrical Dual-Capstan Diffused-Resonance transport, and the most sophisticated wide-range low-distortion electronics in the industry.

*Its name—The Nakamichi BX-300.*

*Its heritage—Nakamichi.*

*Its destiny—Legendary.*

See it...Hear it... You can afford

The Sound of Nakamichi.

 **Nakamichi**

Nakamichi U.S.A. Corporation 19701 South Vermont Ave., Torrance, CA 90502 (213) 538-8150  
In Canada: W. Carsen Co., Ltd., 25 Scarsdale Road, Don Mills, Ontario M3B 3G7

I am constantly amazed at how NAD comes up with reasonably priced products that often outperform more expensive competitors.

with the input circuits. Two of these terminals are used for 300-ohm transmission lines; the other two for external AM antenna and ground connections. A 75-ohm coaxial connector is also provided for those using coaxial shielded transmission lines from outdoor antenna to tuner input. Signal levels at the left and right output jacks are controlled by an output-level control also located on the rear panel.

### Measurements

Usable sensitivity in mono measured 10.8 dBf (1.9  $\mu$ V, 300 ohms), while usable sensitivity in stereo was governed by the point at which the tuner switches over from mono to stereo. This occurs at an input signal level of 23 dBf (7.8  $\mu$ V, 300 ohms). Fifty-dB quieting in mono was obtained with signal strengths of 14 dBf (2.8  $\mu$ V); for stereo, with the Dynamic Separation circuit defeated, 34 dBf of signal was required. Turning on the Dynamic Separation circuit improved the 50-dB quieting figure to 32 dBf. Best signal-to-noise ratio in mono (with strong-signal inputs) measured 84 dB and a remarkably high 81 dB in stereo. Total harmonic distortion for a 1-kHz mono signal at full modulation was 0.055%; in stereo, THD for a modulating signal at the same frequency was even lower, at 0.05%. Quieting and mid-frequency distortion as a function of input-signal strength are plotted in Fig. 4. Note that with the Dynamic Separation circuit activated, an improvement in stereo quieting (for any given signal strength) of around 3 dB is evident. This may seem like a minimal improvement, but remember that these curves are derived from 100%-modulated signals and that the major action of the Dynamic Separation circuit occurs at lower modulation levels.

Figure 5 shows harmonic distortion versus frequency for mono and stereo operation. In mono, THD figures were 0.08% at 100 Hz and 0.14% at 6 kHz. In stereo, THD measured 0.06% at 100 Hz and only 0.19% at 6 kHz. This last result is quite remarkable: Distortion in stereo usually tends to rise at higher frequencies because of pilot-carrier related "beats" and other spurious signals generated in the multiplex decoder section. No such problems were noted with the 4155.

Figure 6 is a 'scope photo of a logarithmic frequency sweep made with my spectrum analyzer, from 20 Hz to 20 kHz, without activation of the Dynamic Separation circuit. The upper trace represents frequency response at the output of the fully modulated left channel, while the lower trace shows crosstalk, or separation, as measured at the output of the opposite channel. Separation under these test conditions measured nearly 60 dB at 100 Hz, 52 dB at 1 kHz, and 47 dB at 10 kHz.

Figures 7A and 7B illustrate the action of the Dynamic Separation circuitry. For Fig. 7A, I used a medium-strength signal and, with pre-emphasis in the signal generator turned on, swept from 20 Hz to 20 kHz. Full separation (bottom trace) is again obtained with the Dynamic Separation circuit off. The unusual crosstalk curve (middle trace) that occurs when the sweep is repeated and the Dynamic Separation circuitry is activated results from the fact that at low frequencies, modulation levels were low (owing to the way my generator works when pre-emphasis is turned on). As higher frequencies are reached, however, modulation levels

approach 100%, and less high blend (greater separation) results. Figure 7B shows what happens when signal strengths are so weak that signal strength becomes the dominating factor in the operation of the Dynamic Separation circuits. Now, even at full modulation levels (in the high-frequency region of the sweep), high blend remains fully in force, and noise is substantially reduced at the expense of good high-frequency separation.

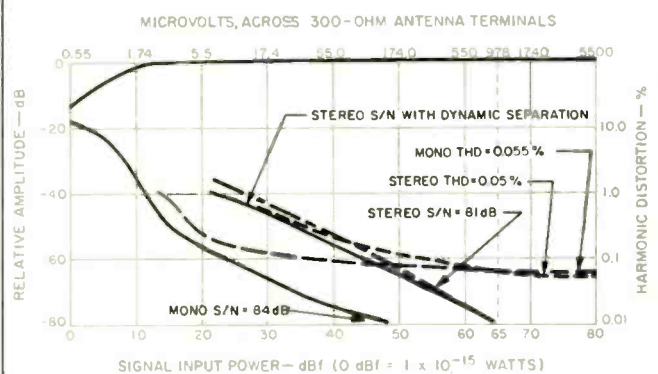

Fig. 4—Mono and stereo FM quieting and distortion characteristics.

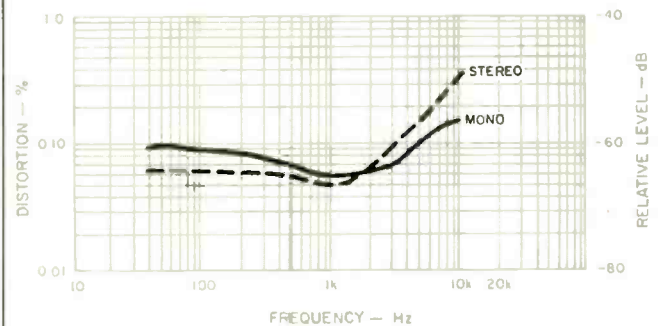

Fig. 5—THD vs. modulating frequency.

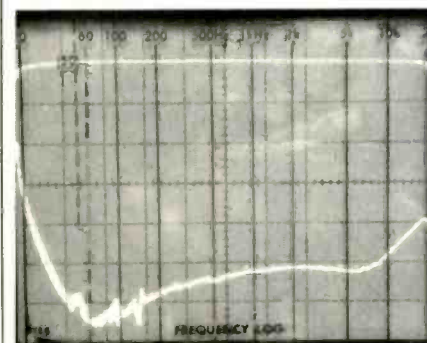
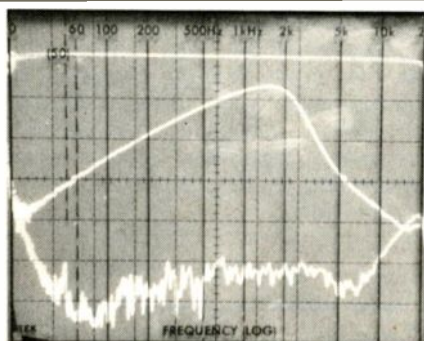
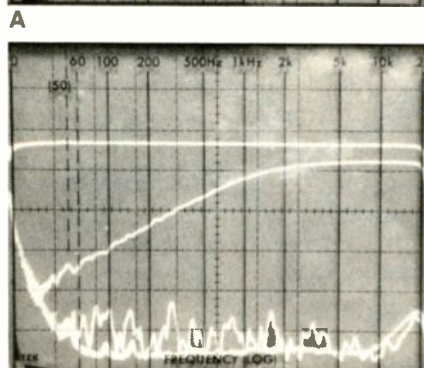

Fig. 6—Frequency response (upper trace) and separation vs. frequency, with Dynamic Separation off.

There is no doubt that the Dynamic Separation does what it claims to. This circuit simply wiped away 15 to 20 dB of high-frequency noise.



**Fig. 7—**  
**Action of Dynamic Separation circuits. With medium-strength signal, blend (middle trace) is regulated by frequency content of pre-emphasized signal (A). With weak signals, blend increases with frequency, regardless of program content (B).**



B

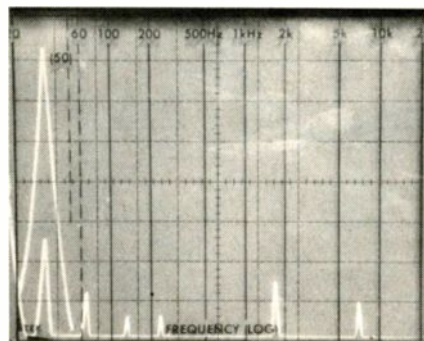

**Fig. 8—**  
**Crosstalk, subcarrier and distortion products at unmodulated channel's output, with opposite channel modulated 100% by 5-kHz signal. Sweep is linear from 0 Hz to 50 kHz.**

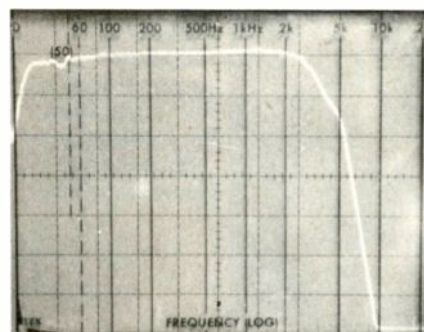

**Fig. 9—**  
**Frequency response, AM tuner section.**

Figure 8 shows what happened when I applied a 5-kHz modulating signal to one channel of the FM generator at full modulation levels. The tall spike at left represents the desired output. Sweep is linear this time, extending from 0 Hz to 50 kHz. A second sweep was made while observing the unmodulated channel. The lower spike contained within the tall one therefore represents true separation at 5 kHz, while other components appearing in the unmodulated channel (such as harmonic distortion and the 19- and 38-kHz sub-carrier components) are visible further to the right.

Capture ratio for the 4155 measured exactly 1.5 dB, as claimed. Selectivity was somewhat better than claimed, measuring 72 dB. Image rejection was 85 dB and i.f. rejection 92 dB. Spurious rejection, not quoted in NAD's specification sheet, measured a very comfortable 93 dB.

Figure 9 shows frequency response for the AM tuner section. The sweep is logarithmic this time, extending from 20 Hz to 20 kHz. Note the care with which NAD's designers have managed to extend AM frequency response at least to 4 or 5 kHz, while at the same time insuring that there is almost infinite attenuation at 10 kHz to prevent audible whistles and "birdies."

#### Use and Listening Tests

After satisfying myself that the tuner, without Dynamic Separation circuitry, was up to the standards I have come to expect from NAD (it was), I spent most of my listening time playing with the special "Dyn Sep" switch on the front panel. There is no doubt in my mind that this innovative circuit does what is claimed for it. When I tuned to weaker FM stereo signals, pressing that switch simply wiped away a good 15 to 20 dB of high-frequency hiss and noise. For most types of programs to which I listen, the loss of separation, as such, was hardly noticeable. In one or two instances, however, I did sense a slight wavering in the stereo imaging as music alternated between soft and loud, but to notice this effect I had to concentrate on the music intently and to remain centered exactly between my loudspeakers. During more casual listening there was no evidence of wavering stereo image—only reduced noise when the circuit was activated.

As for my more basic impressions of this moderately priced tuner, they are pretty much the same as those I had when testing its predecessor, the 4150, some time ago. I am constantly amazed by NAD's ability to come up with components at reasonable cost that perform as well as (and often outperform) competing products costing much, much more. As NAD says in one of their technical papers, "With ICs and a few other off-the-shelf building blocks, designing an FM tuner has become almost a routine exercise. Since these parts are manufactured in large quantities at only a few dollars each, a mid-priced tuner can now be audibly indistinguishable from a costly super-tuner under typical listening conditions." Still, we all know that there are differences between tuners—in every price class. Obviously, this company has done more than just assemble some off-the-shelf integrated circuits and other parts to create such a fine tuner. As in earlier products, NAD seems to be able to put things together in a way that provides excellent performance at a price that never ceases to amaze me—and those who buy their products.

*Leonard Feldman*



# “Sherwood products offer excellent performance at very reasonable prices.”

Leonard Feldman, *Audio Magazine*

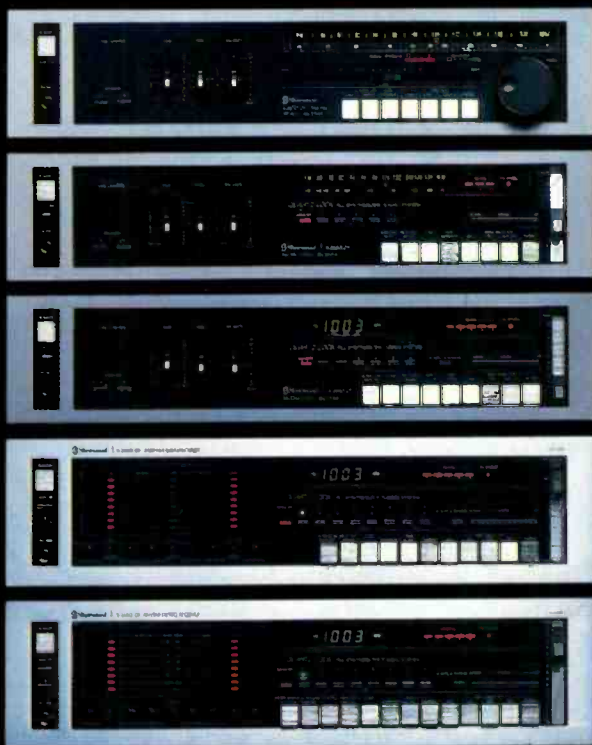

The occasion of Mr. Feldman's comment was his review of our S2680-CP top-of-the-line receiver. His statement was sparked by the fact that, while quite affordable, the S2680-CP, like all Sherwood receivers, is designed and built with the care, precision and innovation which have become Sherwood trademarks.

**A tradition of affordable quality.** More than three decades ago Sherwood was founded on this philosophy: Through innovation, make quality audio equipment more affordable. That philosophy has been nurtured throughout Sherwood's history and is the foundation of our newest line of receivers.

**We never cut corners on sound.** All five Sherwood receivers deliver true high-fidelity performance. Even our budget-priced S2619-CP sounds better than many separate components. And the entire group is laced with features that can make significant differences in your listening enjoyment. Ultra-low-bass EQ, multi-deck dubbing, auto-scan digital tuning and discrete phono preamp circuitry are standard on several

Sherwood models, yet missing from many other brands, regardless of price.

**Certified Performance.** Sherwood is the only manufacturer to test and certify the performance of each individual receiver. On the outside of every carton you will find a certificate showing the measurement details of the power amp, phono preamp and FM tuner sections of each receiver. These are not just the rated specs; these are the actual measured performance data of the individual unit, so you know exactly what you're buying.

**Find out what the experts say.** Get the whole story on why Sherwood receivers—in Mr. Feldman's words—"...offer excellent performance at very reasonable prices."

To get your own copy of his review of the S2680-CP and to find out just how much quality and innovation you can afford, visit your nearest Sherwood audio specialist today. To find him, call (800) 841-1412 during west coast business hours.

 **Sherwood**  
Quality and Innovation You Can Afford.

13845 Artesia Blvd., Cerritos, CA 90701 In Canada: The Pringle Group, Don Mills, Ontario

Enter No. 44 on Reader Service Card

# A to B in 0.2 secs!

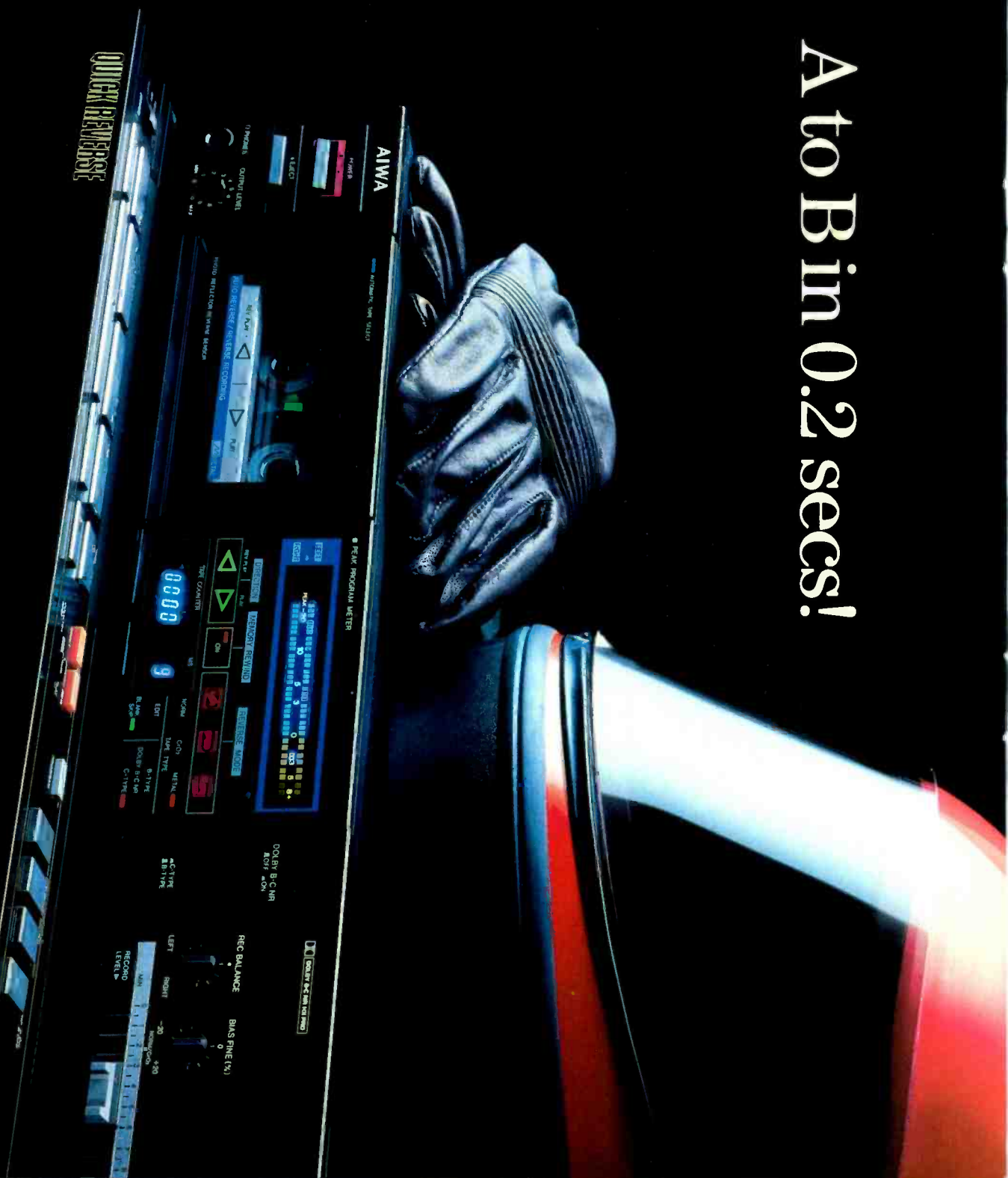

#### CONTINUOUS PLAYBACK AND RECORDING.

Auto-reverse was a great idea. Quick-Reverse is a better one. It not only changes tape sides, it does something even more miraculous. It eliminates interruption between sides!

Aiwa engineers achieved this remarkable feat two ways: First, Aiwa's AD-R550 does its changing act fast: just 0.2 of a second from one side to the other! That's just half the story.

Just before the tape leader reaches the heads, a photo-electric sensor activates Aiwa's Quick-Reverse mechanism. That way, instead of giving you 15 seconds of leader, Aiwa gives you something unheard of...continuous playback and recording!

#### DOLBY BX PROFESSIONAL

With Dolby® BX Professional, normal bias cassettes you record on the AD-R550 will actually outperform expensive chrome position tapes recorded on conventional decks! What's more, they can be played back on any deck, with the same superior results. UNPARALLELED PERFORMANCE MATCHED BY

#### UNEQUALLED CONVENIENCE.

Activate Aiwa's unique Blank Skip feature and the AD-R550 will automatically move into Fast Forward mode when it senses more than 12 seconds of blank tape. That way it skips any long pauses.

The Aiwa Quick-Reverse AD-R550. Catch it at your Aiwa dealer.

\*Dolby is a trademark of Dolby Labs.

# AIWA

## SIMPLY ADVANCED

36 Oxford Dr., Moonachie, N.J. 07074  
In Canada, Shrinjo (Canada) Ltd.

Quick-Reverse: Aiwa's latest innovation in digital-ready cassette decks.

Enter No. 4 on Reader Service Card

STEREO CASSETTE DECK **R550**

## 5

## ORTOFON MC 2000 PHONO CARTRIDGE AND T 2000 TRANSFORMER

### Manufacturer's Specifications MC 2000 Cartridge

**Type:** Moving coil.

**Stylus Type:** Symmetrical Contact Line.

**Frequency Response:** 5 Hz to 90 kHz (5 Hz to 50 kHz, +5, -1 dB).

**FIM Distortion:** Less than 1% at recommended force, per DIN 45 542.

**Tracking Ability:** Greater than 100  $\mu$ m at 315 Hz at recommended tracking force.

**Dynamic Compliance:** Vertical/lateral, 20/20  $\mu$ m/mN.

**Output Voltage:** 0.050 mV at 1 kHz, 5 cm/S.

**Channel Balance:** Within 1 dB at 1 kHz.

**Channel Separation:** Greater than 25 dB at 1 kHz, greater than 18 dB at 20 kHz.

**Equivalent Stylus Tip Mass:** 0.27 mg.

**Recommended Tracking Force:** 1.5 grams,  $\pm$ 0.3 gram.

**Recommended Load Impedance:** 20 to 100 ohms.

**Internal Impedance (D.c. Resistance):** 3 ohms.

**Vertical Tracking Angle:** 20°.

**Headshell Supplied:** Magnesium, universal-arm type, with 5-mm overhang adjustment; weight, 10 grams.

**Cartridge Weight:** 11 grams.

**Price:** \$1,000.00.

### T 2000 Transformer

**Type:** Toroidal.

**Shielding:** Permalloy plus soft iron.

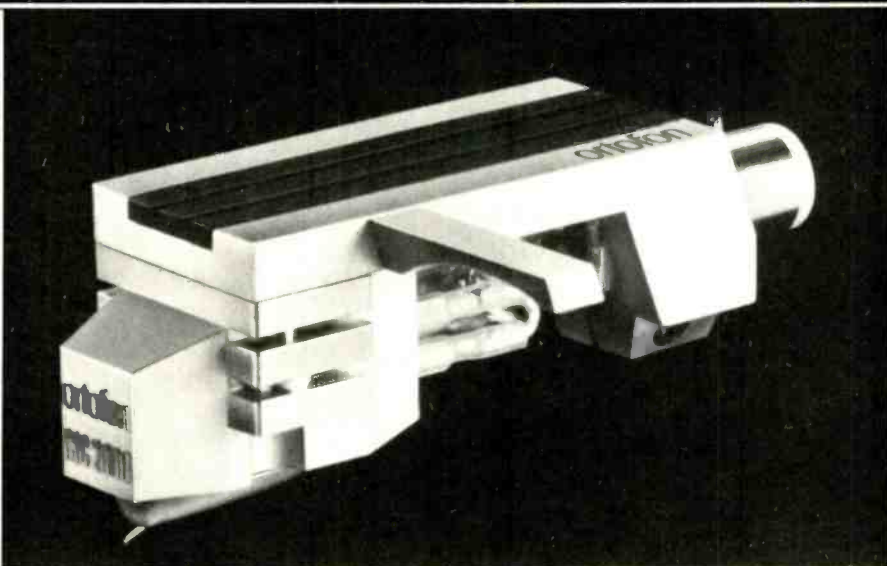

**Input Loading:** 3 ohms,  $\pm$  1 ohm.  
**Recommended Output Load:** 47 kilohms, 100 pF.

**Frequency Response:** 8 Hz to 100 kHz, +0.5, -1 dB; 4 Hz to 150 kHz, +0.5, -3 dB.

**Phase Linearity:**  $\pm$  10°, 10 Hz to 20 kHz.

**Square-Wave Rise-Time:** Less than 3  $\mu$ s.

**Gain:** 35 dB (3 ohms in, 47 kilohms out).

**Channel Balance:** Within 0.2 dB.

**Channel Separation:** Greater than 80 dB, 5 Hz to 50 kHz.

**Price:** \$1,000.00.

**Company Address:** 122 Dupont St., Plainview, N.Y. 11803.

For literature, circle No. 94

The moving-coil phono cartridge was invented by the late Arthur C. Keller of Bell Laboratories in 1929, but was not announced until 1980. In 1948, Ortofon introduced the first commercially available moving-coil phono cartridge, a mono unit, which matched the quality level of the moving-coil cutterhead they had introduced in 1945.

The moving-coil cartridge is actually a micro-miniature generator. When a coil moves in a magnetic field, a voltage (EMF) is generated in that coil. Thus, as the stylus tip traces the undulations of the record groove, its movements are transmitted through the cantilever to the coil. In turn, the coils are diverted from their neutral position, cutting through the lines of magnetic force between the poles of the magnet to create an electromagnetic force (voltage). These micro-voltages are an accurate replica of the signal present in the record groove. To be able to utilize such a minute electromagnetic force, a step-up transformer or preamplifier is needed so that the tiny signal can be amplified to the level

matching the sensitivity of the phono input stage of the receiver, integrated amplifier or preamp.

In their search for an explanation of the claimed sonic difference between the moving-coil designs and those of the moving-magnet and moving-iron types, Ortofon examined the amplitude and phase response characteristics of moving-coil cartridges ("Phase Testing in Phono Cartridges," *Audio*, March 1983). They found that phase shift occurs when there is a displacement in time between the signal at the input of a device and that signal when it appears at the output of the same device, and that this displacement may change with frequency. From this work, it was concluded that phase shift represents a distortion of the original signal. Ortofon calls this the Ortophase concept and has applied it to the MC 2000 moving-coil phono cartridge design. By optimizing their moving-coil design for both amplitude and phase response, using only a moderate amount of damping, and allowing a slightly rising characteristic (+2 or +3

Trackability at low frequencies was the best I have ever measured. It is truly unique for a moving-coil cartridge.

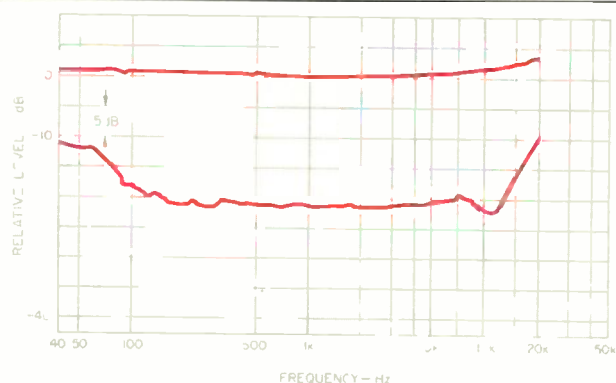

**Fig. 1—**  
Frequency response and separation from 40 Hz to 20 kHz using CBS STR-170 test record.

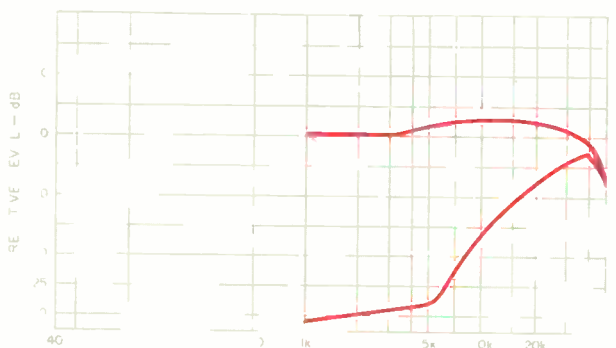

**Fig. 2—**  
Frequency response and separation from 1 to 50 kHz using JVC TRS-1005 test record.

dB) in the high-frequency amplitude response, they have improved the phase response characteristics in the audible bands.

Aside from the Ortofon concept, the MC 2000 includes Ortofon's well-known Wide Range Damping (WRD) system. The system comprises, as previously, two pieces of rubber separated by a tiny platinum disc. With the MC 2000's very low equivalent stylus tip mass, it has been possible to incorporate a finer suspension wire and softer rubber compounds for the bearings. These improvements have permitted a higher compliance value than in any previous Ortofon moving-coil cartridge. Further, the rear rubber bearing is asymmetrical, positioning the armature more precisely in the center of the magnetic field when the correct tracking force is applied.

The cartridge body has been milled out of a solid aluminum block, giving the cartridge a large amount of stiffness, resistance to torsion, and insensitivity to resonance so that high frequencies will not be fed back to the cantilever via the arm and headshell in a resonant loop. To further stiffen the

cartridge body, the magnetic circuit is mounted to a horizontal bar inside the body. The elements are held together, and the tension of the stylus suspension wire controlled, by a large screw atop the body. A ring, positioned between the screw and the cartridge body, distributes the pressure from the screw over as wide an area as possible. This also contributes to body stiffness which, in turn, is claimed to give the cartridge a neutral and well-defined bass reproduction, as there are no low-frequency resonances present in the cartridge body.

Other improvements include the new Symmetrical Contact Line (SCL) diamond stylus, one of the smallest ever used in a cartridge construction, with its slim profile and wide vertical contact surface. The cantilever is made from hard aluminum. It is extremely light and rigid, has a conical shape, and is 6.15 mm in length. The armature is made from aluminum and shaped as a cross, and the cross has hollow legs to further reduce mass. The coils are made of silver wire, with 24 turns per coil, while the magnet is made of samarium cobalt alloy.

The high compliance of the MC 2000 results in an exceptional tracking ability at low frequencies (greater than 100 microns), while the stylus tip's low equivalent mass allows superior tracking at high frequencies.

The MC 2000 is packaged in an outer cardboard box. Inside this box is a styrofoam packing, in which is housed a beautiful, hinged, plush-lined walnut presentation case with a hinged divider. The top of the divider contains a certificate for the enclosed cartridge, giving its serial number and the exact measured performance for channel separation at 1 kHz and 20 kHz, tracking ability at 315 Hz, and the temperature at which the measurements were made. Next to the certificate is the MC 2000 cartridge, with its removable stylus guard, and a special magnesium headshell that weighs 10 grams. Beneath the hinged divider is a frequency response curve for each channel (but without the separation curves), a screwdriver, a densely bristled stylus brush, a well-designed balance for setting the proper tracking force, and a container with the usual hardware (including four silver-wire interconnects). The manual is included in the outer cardboard box.

The T 2000 moving-coil transformer is also packaged in an outer cardboard box. Inside is a styrofoam container that houses the transformer and a pure silver cable. The T 2000 is designed specifically to match the electrical characteristics of the MC 2000 cartridge. Accordingly, the T 2000 transformer has a high gain (35 dB), which insures accurate and noiseless matching to the 47-kilohm phono inputs of most music systems. The transformer is usable with any moving-coil phono cartridge having an internal impedance in the 2 to 4 ohm range.

The unit consists of two identical, though completely independent, transformers, one for each channel, and each with its own double mu-metal shielding against hum. The two transformers are housed in a heavy metal case, which provides a further shield. The T 2000 uses two mu-metal ring cores, and a new method of winding the coils. The coil windings and wires are of pure silver throughout. The sockets are gold-plated and have been specially designed to give an immedi-



## Why didn't they sound like that in the showroom?

The effects of environment on speaker performance.

by John Carter

Chief Engineer



As an experienced audio enthusiast, you've spent numerous hours in hi-fi dealerships listening to speakers. But when someone asks "Which speakers sound best?" you're not always sure what to say. You have an opinion, but you know that speakers don't sound the same at home as they do in the showroom.

Two key factors contribute to this variation—room acoustics and speaker placement. As the accompanying graph shows, different environments significantly vary the frequency response of a speaker system. The largest variance typically occurs in the mid-bass region, as evident on the graph by the large discrepancy in response between 70 Hz and 200 Hz. This discrepancy is a direct result of the placement of the speaker relative to the wall behind it.

Variations in frequency response, combined with other complications, present a formidable problem to the speaker buyer. The logical question to ask is "What can be done to help simplify speaker evaluation in a showroom?"

To simplify evaluation, you must first limit the conditions under which speakers are compared. Have speakers which interest you placed in the same relative location you'll use at home. There's no sense auditioning a speaker on a showroom shelf if it's going to be used on your living room floor. Also, compare speakers at the same relative volume level. Otherwise, the louder (more efficient) speaker will sound better, even if it isn't. Finally,

set the tone controls on the demonstration amplifier to neutral. This will provide you with your most accurate comparison.

Once the conditions are set, you can begin to evaluate speakers. But as we've already seen, frequency response, a crite-

constant. Since FM noise covers a wide bandwidth, you can make a general determination of the sound distribution, without worrying about the effect of the showroom on a particular frequency.

**3. Lifelike Spaciousness.** This is not quite as subjective a judgment as it seems, if you make the evaluation with your eyes closed. While you'll be able to localize various instruments, a good system will make it hard for you to localize the enclosures. The music should seem to originate from an imaginary stage, much larger than the enclosures themselves.

All Bose® Direct/Reflecting® speaker systems are designed to meet these criteria. But since the criteria are derived from live performance, you can use them to evaluate any speakers. They'll help you select a system which delivers solid performance in the home, not just in the showroom.

For more information on Bose products and a list of authorized dealers, write: Dept AU, Bose Corporation, The Mountain, Framingham, MA 01701.

John Carter holds an M.S. in Electrical Engineering from M.I.T.

The Effects of Environment on Frequency Response

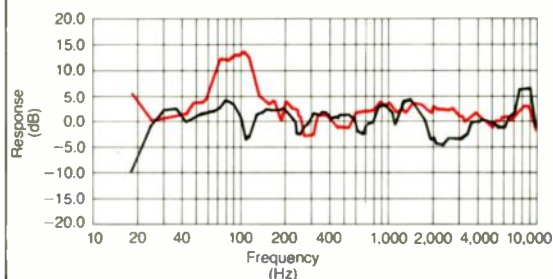

The two curves show the frequency response of the same speaker system in two different rooms. Key reasons for variations in response are room acoustics and speaker placement.

tion often used for evaluation, varies too widely from room to room to provide adequate information for comparison. This emphasizes the need for a set of audible criteria which indicate desired speaker performance, yet remain relatively constant between the showroom and the home. At Bose, we invested many years researching live performance, and as a result, have developed such a set of criteria:

**1. Stereo Throughout The Listening Room.** To test for this, stand in front of one enclosure, and try listening to the other one. If you only hear one speaker in the showroom, you'll probably only hear one at home.

**2. Even Sound Distribution.** To test for this, listen to interstation FM noise over a pair of speakers, and walk around the room. The level of noise should remain



You'd expect the 5.1-Hz arm-cartridge resonance would cause mistracking or distortion. But at no time did I hear any.

ate ground connection to prevent speaker overload during the mounting process. The low-capacitance cable supplied with the T 2000 is made from pure silver and has gold-plated plugs.

#### Measurements

Where applicable, laboratory measurements of the Ortofon MC 2000 were made using the T 2000 transformer. The frequency response of the transformer was measured and found to be flat from 10 Hz to 100 kHz and -7 dB at 200 kHz.

The Ortofon MC 2000 phono cartridge was mounted in its specially designed magnesium headshell and used with the Technics EPA-A250 (S-shaped) interchangeable tonearm unit attached to the Technics EPA-B500 tonearm base and mounted on a Technics SP-10 MkII turntable. With the weight of the cartridge being 11 grams, and the headshell weighing 10 grams, I was unable to use the combination in any tonearm available to me. To properly balance the tonearm, it was necessary to increase the mass of the counterweight at the end of the tonearm. The MC 2000 was oriented in the headshell and tonearm with the Dennesen Geometric Soundtracktor.

All laboratory tests were conducted at an ambient temperature of 70° F (21.11° C) and a relative humidity of 61%, ±3%. The tracking force for all reported tests was set at 1.5 grams, with an anti-skating force of 1.9 grams. The MC 2000 was connected to the input of the Ortofon T 2000 step-up transformer. As is my practice, measurements were made on both channels, but only the left channel is reported (unless there is a significant difference between the two channels, in which case both channels are reported for a given measurement).

The following test records were used in making the reported measurements: Columbia STR-100, STR-112, and STR-170; Shure TTR-103, TTR-109, TTR-110, TTR-115, and TTR-117; Deutsches HiFi No. 2; DIN 45 549; Nippon Columbia Audio Technical Record (PCM) XL-7004; B & K QR-2010; Ortofon 0002 and 0003, and JVC TRS-1005.

Frequency response and stereo separation were measured from 40 Hz to 50 kHz, using the CBS STR-170 test

record for the range from 40 Hz to 20 kHz (Fig. 1) and the JVC TRS-1005 test record for the range from 1 to 50 kHz (Fig. 2).

Using the CBS test record, I measured +3, -0 dB overall from 40 Hz to 20 kHz (+0.66 dB at 40 Hz, +0.33 dB at 100 Hz, +1 dB at 8 kHz, +1.8 dB at 10 kHz, +2 dB at 15 kHz, and +3 dB at 20 kHz). Separation was 22 dB at 1 kHz, 24 dB at 10 kHz, 17 dB at 15 kHz, and 12.5 dB at 20 kHz.

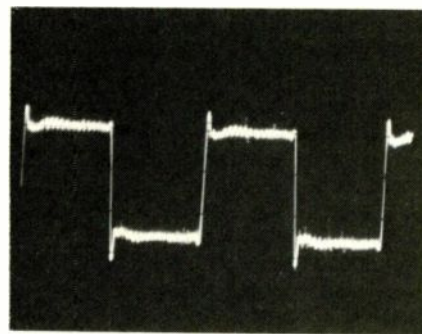

Fig. 3—Square-wave response, 1 kHz.

Using the JVC test record, frequency response was ±0 dB from 1 to 4 kHz, +1.8 dB at 10 and 20 kHz, +1 dB at 30 kHz, -1 dB at 40 kHz, and -9 dB at 50 kHz. Separation was 32 dB at 1 kHz, 20 dB at 10 kHz, 11 dB at 20 kHz, 5 dB at 30 kHz, 1 dB at 40 kHz, and 0 dB at 50 kHz.

The Ortofon MC 2000 is remarkably flat to about 8 kHz, and then it has the response rise beyond 10 kHz that is typical of most moving-coil cartridges. Separation through the same range is excellent. Frequency response and separation beyond 20 kHz are not remarkable, with response at 32 kHz being at 0 dB. The 1-kHz square wave (Fig. 3), using the Columbia STR-112 test record, is one of the flattest I have ever encountered, with minimal overshoot followed by very low-level ringing. From the square wave it is evident that the ultrasonic resonant frequency is at about 36 kHz.

The Technics EPA-A250 tonearm has a built-in anti-resonant device that is absolutely effective. Therefore, to measure the arm-cartridge low-frequency resonance, it is necessary to disable this device. The arm-cartridge low-frequency lateral resonance for either channel measured a surprisingly

low 5.1 Hz with a 1.5-dB rise. The vertical resonance was also at 5.1 Hz.

Using the Dynamic Sound Devices DMA-1 Dynamic Mass Analyzer, the arm-cartridge dynamic mass was measured at 31 grams, and the dynamic vertical compliance at  $30 \times 10^{-6}$  cm/dyne at the vertical resonant frequency of 5.1 Hz. The harmonic distortion components of the 1-kHz, 3.54-cm/S rms, 45° velocity signal from the Columbia STR-100 test record are: 1.68% second harmonic and 0.56% third harmonic, with less than 0.28% higher order terms. The vertical stylus angle measured 26° for each channel.

Other measured data are: Wt., 11 g. Opt. tracking force, 1.5 g. Opt. anti-skating force, 2.3 g. Output, 0.92 mV/cm/S with the T 2000 step-up transformer, and 6 μV/cm/S directly from the cartridge across a 3-ohm load. IM distortion (200/4000 Hz, 4-to-1): Lateral (+9 dB), 0.8%; vertical (+6 dB), 4.3%. Crosstalk (using Shure TTR-109): Left, -21.5 dB; right, -25 dB. Channel balance: With transformer, 0.3 dB; direct from cartridge, 0.2 dB. Trackability: High freq. (10.8-kHz, pulsed), 30 cm/S; mid-freq. (1000 and 1500 Hz, lat. cut), 31.5 cm/S; low freq. (400 and 4000 Hz, lat. cut), 24 cm/S. Deutsches HiFi No. 2, 300-Hz test band was tracked cleanly to 114 microns (0.0114 cm) lateral at 21.50 cm/S at +12.10 dB and to 55.4 microns (0.00554 cm) vertical at 10.32 cm/S at +5.86 dB. This is the best trackability I have ever measured at low frequency. It is truly unique for an MC cartridge.

The Ortofon MC 2000 encountered no difficulty in tracking all the test bands on the Shure Era III and Era IV Obstacle Course musical test records as well as level 6 of the Shure Era V trackability disc. It is a rare commercial analog record that has peak recorded velocities exceeding 15 cm/S, and thus the MC 2000 would be able to track any commercially available record, including the audiophile records issued by Sonic Arts, Telarc, Sheffield, Reference Recordings, RCA Point 5, or Mobile Fidelity.

#### Use and Listening Tests

Listening tests are performed both before and after laboratory measurements. All reported listening tests of the Ortofon MC 2000 were made with

# McINTOSH... POWERFUL PERFECTION

The magnificent music of the mighty organ demands *POWERFUL PERFECTION* from any power amplifier. The 500 watt per channel perfect voice of the McIntosh MC 2500 is *POWERFUL PERFECTION*. Proud craftspeople, here in the United States, assemble carefully selected technologically superior high quality components into a powerfully perfect power amplifier. In the MC 2500 you get performance . . . you get all the power necessary for perfect musical reproduction . . . you get complete response unaffected by distortion . . . and you get the pleasure of owning the best . . . you get *POWERFUL PERFECTION*.

Send for our 76 page catalog for more information.



For Detailed Information on McIntosh Products Write:  
McINTOSH LABORATORY INC.  
P.O. BOX 96 EAST SIDE STATION, A54  
BINGHAMTON, NY 13904-0096

Organ pipes photographed at Casadesus Recital Hall  
State University of New York at Binghamton, N.Y.

Enter No. 33 on Reader Service Card

# Speaker of the Year

## Quality, Innovation and Value Earned the Title for Ohm's Walsh 2 in 1982.

## Now the New Ohm Walsh 4 Wins for 1984.

HiFi retailers voted and leading audio critics reviewed the selections, the result is Audio Video International's HiFi Grand Prix Awards.

the room . . . this is a superb-sounding speaker—not inexpensive by any means, but worth every cent of its price." Ohm Walsh speakers start at less than \$595 per pair.

cabinetwork we aim for one thing, to make the best speakers. This means we engineered the unique, patented transducer for perfect phase alignment so the sound is crisply detailed and the stereo image unambiguous. And we make the speaker durable with protective grills and circuits, Ferro Fluid™ cooling of the drivers, and superb power handling (the Ohm Walsh 4 is rated to 500 watts rms). Then we hand oil the select oak or walnut veneers and you have a choice of rosewood and either black or white lacquer.

### Why These Speakers?

#### Value

It makes sense Ohm's Walsh speakers should receive acclaim for value. As Julian Hirsch said in Stereo Review, the Ohm Walsh 4 "is as smooth and natural sounding as its excellent frequency response measurement suggests . . . [It] is capable of generating distinct spatial images that are apparent from almost any position in

### Quality and Craftsmanship

From the very beginning of the design process to the hand finishing of the

### Innovative Design

If these speakers are anything it's innovative. Working from the Walsh Theory we created a transducer in the shape of a cone positioned with its point up. The sound radiates from the outside of the cone with perfect dispersion. And the result as Popular Mechanics said "meets the ultimate audio test: it makes you unaware of its presence. You feel there's nothing between you and the music." And the New York Times described it as "a spacious acoustic ambience with precise stereo imaging creating a 'reach-out-and-touch-it' realism that this listener has rarely experienced."



**1982**  
**Speaker of the Year**

**1984**  
**Speaker of the Year**

**Walsh<sub>2</sub>**

**Walsh<sub>4</sub>**



### What Next?

Get complete information about all the Ohm Walsh speakers and buying directly from Ohm. Call us today, toll free.

**1-(800)-221-6984**

**Ohm Acoustics Corp.**

241 Taaffe Place, Brooklyn, New York 11205



We make loudspeakers correctly.

© 1984 Ziff-Davis Publications, reprinted by permission  
© 1984 The New York Times  
© 1982 Popular Mechanics



Never before have I heard a moving-coil cartridge reproduce music so realistically, from nuances to blockbusters.

the Ortofon T 2000 step-up transformer. During the pre-measurement listening period, I was quite impressed with the MC 2000's sonic clarity and transparency of sound, as well as the well-defined and tight bass. However, when the arm-cartridge low-frequency lateral and vertical resonance measured 5.1 Hz, I was wholly surprised and rechecked my test procedure. I finally accepted the 5.1-Hz figure as correct when I got the same result with other test records. That I didn't hear any mistracking or distortion during the pre-test listening period, when the vacuum chuck on the turntable was not used, seemed unbelievable. Further checking, with the arm's anti-resonance device defeated, was no help until I found some badly warped records, and then I finally heard some mistracking and distortion. I've concluded that the Technics EPA-A250 tonearm is so truly excellent that when the super-efficient anti-resonance device is activated, there is no record that it can't play

even if the arm-cartridge resonance measures 5.1 Hz. At no time did I encounter any problem with mistracking or distortion during the many additional hours of listening I did with the MC 2000, despite textbook claims that such low resonance would cause these problems. This speaks very well for the Ortofon MC 2000 cartridge and T 2000 transformer.

**Warning:** The samarium-cobalt magnet in the MC 2000 is one of the most powerful magnets ever used in a moving-coil cartridge. It is absolutely imperative that *no ferrous materials*, such as screwdrivers, platforms for measuring resonant frequency, metal-backed mirrors, etc., be used near the MC 2000. This is particularly true of the small mirrors used to check stylus angle. The cartridge will magnetically snap up such items and, without a question, destroy the cantilever, if not the entire moving-coil assembly.

It has come to my attention that a few improperly cut diamond styli had

been polished and set into some MC 2000 phono cartridges. Should any reader find that his stylus has been sheared at the cantilever, he should return it to Ortofon for checking and replacing.

When all the measurements were completed, it was time for a serious and final musical evaluation of the MC 2000. Equipment used in the listening evaluation included the aforementioned Technics tonearm and turntable, an Audio-Technica AT666EX vacuum disc stabilizer, an Amber Model 17FF preamplifier, two VSP Labs Trans-MOS 150 amplifiers (each used in the 300-watt mono mode), speaker and interconnecting cables from Discrete Technology, a pair of B & W 801F loudspeakers, a Technics SL-P10 CD player, and an Electrocompaniet MC-2 pre-preamplifier.

I found no coloration present but did find excellent transient response and applause definition. As I had expected, the MC 2000 reproduced very

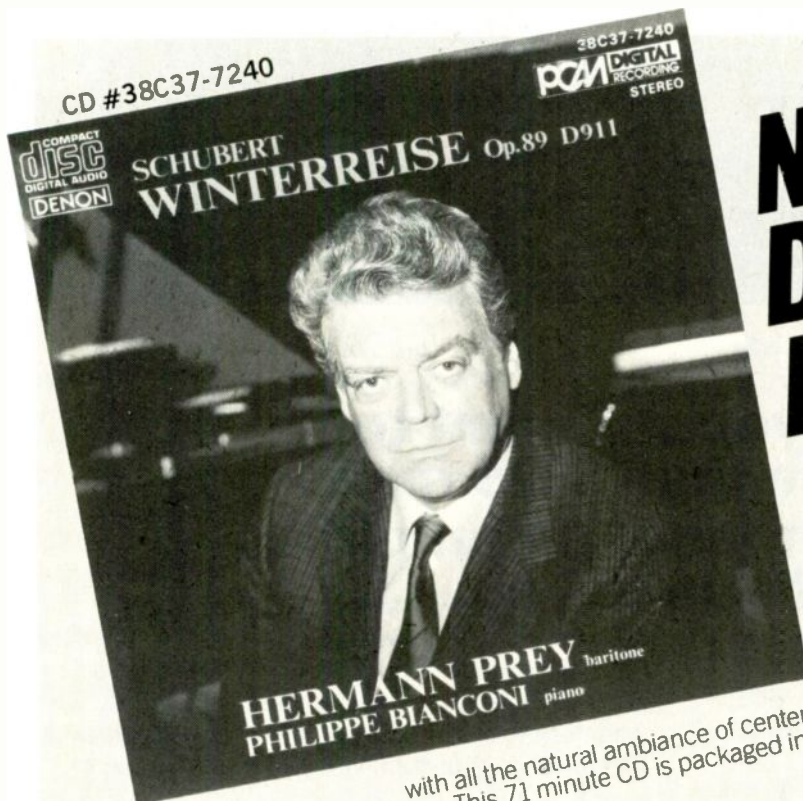

## NEW DENON CD RELEASE!

### HERMANN PREY/SCHUBERT WINTERREISE

From Germany's greatest baritone comes this glorious set of Schubert's Winterreise songs, the centerpiece of Mr. Prey's repertoire.

This Reference Denon Digital recording captures Mr. Prey's most expressive interpretation at the height of his singing career in the front of the Freidrich Ebert Halle.

with all the natural ambiance of center seats in an elegant presentation box with libretto.

# DENON

Without a doubt, the MC 2000 will elevate anyone's music system by at least an order of magnitude.

high-velocity cannon shots on a Telarc "1812" (Matrix 11) with no apparent difficulty. Both the human singing voice and the Bösendorfer piano were reproduced realistically. Occasionally, massed violins seemed to be a bit strident, but that could have been the recording I used. Also, there seemed to be some upper midrange thinness, but, again, that could have been my records. Both stereo imaging and depth were truly superb.

It is my practice to try various transformers and pre-amplifiers with any moving-coil cartridge I evaluate, and the MC 2000 was no exception. (Readers unfamiliar with transformers should be aware that they can all cause hum if not properly oriented.) However, I was at first unable to find either another transformer or a pre-amplifier that could equal the T 2000 transformer, which was specifically designed for use with the MC 2000. Even my reference pre-amplifier, the Audio Standards MX-10A, was easily bested. Dur-

ing this period, however, I received for evaluation Electrocompaniet's Model MC-2 pre-amplifier, a \$595 unit with 40 dB of gain. I tried the combination and found the MC-2 to be wholly superior to the T 2000, having improved the sonic quality of the music beyond belief. Subtle musical nuances were suddenly heard quite clearly. It became quite evident that the Ortofon MC 2000 coupled with the Electrocompaniet MC-2 would be hard to surpass.

During my listening evaluation, I also compared the phonograph record and CD versions of a digitally mastered recording. The music included "Wellington's Victory, Op. 91" by Beethoven and Liszt's "Battle of the Huns" and "Hungarian March to the Assault" (Cincinnati Symphony Orchestra, Kunzel, Telarc DG-10079 on LP and CD-80079 on Compact Disc). Although the MC 2000 reproduced the digital-analog recording very accurately, I feel that the sound of the high-energy cymbals and of the great organ chords was not

equal to that present on the Compact Disc.

Some of the other "super" recordings I used in evaluating the Ortofon MC 2000 were: *Recital*, Welch, organist (Wilson Audio W-278); Sutherland, Horne, Pavarotti, *Live from Lincoln Center* (NYC Opera Orchestra, Bonynge, London LDR 72009); *Reiner Conducts Wagner* (RCA Red Seal Point 5 ARP1-4738); *76 Pieces of Explosive Percussion* (Sonic Arts Symphonic Percussion Consortium, Sonic Arts Laboratory Series LS11); *James Newton Howard Quintet* (Sheffield Lab 23), and *The Tony Bennett/Bill Evans Album* (Mobile Fidelity MFSL 1-117).

Without a doubt, the Ortofon MC 2000 will elevate anyone's music system by at least an order of magnitude. Never before have I had, or heard, a moving-coil cartridge that reproduces recorded music so realistically, from the finest nuances to the blockbusters present in many music scores.

B. V. Pisha



“The construction of the GFP-1A is, to put it mildly, robust...The cabinet and chassis are made of steel... everything is on a single large circuit board, with an open, uncluttered parts layout and a minimum of point-to-point wiring. All of this indicates probable long-term reliability. Both on the test bench and as part of a hi-fi system, the Adcom GFP-1A left nothing to be desired. It has all the flexibility one could ever want combined with smooth, silent and bug-free operation. An excellent preamplifier at a very reasonable price.”

Julian Hirsch in *Stereo Review*

“The GFP-1A gives us just about everything—in features, technology, and performance—that we’ve ever really wanted in a preamplifier. That response and distortion measurements are beyond reproach goes without saying... and the feel and appearance of the controls further inspire confidence. Had we not been delighted by what we heard through the GFP-1A, we would have been astonished. But the only real surprise was the price... which was modest relative to some of the high-tech preamplifiers to which its performance invites comparison.”

High Fidelity

**Now, if you still want to pay more than \$375 for a high-performance preamplifier, that's up to you.**

**ADCOM®**

11 Elkins Road, East Brunswick, New Jersey 08816

## DENNESEN POLARIS INDOOR FM ANTENNA

**Company Address:** P.O. Box 51,  
Beverly, Mass. 01915.  
For literature, circle No. 95

The problem of what to do if you can't install a good outdoor FM antenna but still want reasonably good FM reception is an old one. From time to time, various inventors and experimenters have come up with solutions to this problem, some of them simple, some of them complex and expensive. An indoor FM antenna that I recently tested falls into the simple but highly effective category. Developed for and marketed by Dennesen Electrostatics, the Polaris indoor FM antenna, with a suggested retail price of \$40, is nothing more than a pair of monopole antenna elements, mounted at opposite ends of a 19-inch piece of wood (having a 1-inch cross-section). Each monopole element can be extended to a maximum length of around 39 inches, and each is terminated in a standard F-type coaxial connector. Actually, only one of these elements is intended to be an "active" antenna; the other element serves as a passive reflector.

The Polaris antenna was designed to be mounted on a wall at a height of about 6 or 7 feet, with its telescoping rods projecting into the room. Figure 1 shows two configurations that the manufacturer feels will give good results. In either, the rods can be oriented vertically or horizontally. With many FM stations now using circular polarization, vertical orientation usually works out best; it is also the easiest to implement in a typical listening room.

Obviously, the possible orientations are almost infinite, since each rod can be pivoted to any angle and the lengths of the active and passive elements can also be adjusted for optimum reception. The instructions say to keep the elements parallel to each other and perpendicular to the arriving signal. The passive, unconnected element should be nearer to the station and shorter than the active one connected to the tuner. To receive stations



from the opposite direction, the cable can be moved to the opposite element, and the lengths of both elements can be readjusted.

In my tests, however, I confined myself to four configurations, the horizontal and vertical versions of those shown in Fig. 1. The signal received from the Polaris was compared to that from a standard dipole antenna, with both antennas oriented for best reception of each station. The results are given in Table I. Measurements were made with a Blonder-Tongue FSM-2 field strength meter, which covers the entire

FM frequency band (as well as the VHF and UHF TV frequencies). The meter is calibrated directly in microvolts for its input impedance of 75 ohms. The Polaris also has a 75-ohm output, and most FM tuners and receivers have 75-ohm antenna inputs. (Matching transformers are available for tuners having only 300-ohm inputs.)

It is apparent from Table I that for almost every incoming FM signal to which I tuned, there was one available configuration of the Polaris which provided some gain, compared to the signal strength obtained using the stan-

**Table I—Signal strength ( $\mu$ V), Dennesen Polaris vs. standard dipole antenna.**

Frequency, MHz	Ref. Dipole	Polaris (Fig. 1A)		Polaris (Fig. 1B)		Best Gain, dB*
		Vert.	Horiz.	Vert.	Horiz.	
90.7	70	260	25	175	125	+11.4
91.5	100	175	225	185	225	+7.04
93.9	75	130	75	110	80	+4.78
94.7	30	80	60	55	50	+8.52
95.5	80	60	70	100	100	+1.94
96.3	**	80	125	100	100	**
97.1	125	100	125	110	110	0
98.7	110	110	90	100	100	0
99.5	150	170	120	120	65	+1.09
101.9	55	110	55	100	45	+6.02
102.7	85	60	60	75	15	-1.09
104.3	100	70	75	100	60	0
105.1	70	105	80	50	100	+3.52
106.7	55	110	60	60	100	+6.02

\*Best figure obtained for any orientation as compared with optimized dipole orientation.

\*\*Signal strength of this station could not be reliably read due to interference from other stations' signals nearby on the dial.

# Genius that goes beyond jazz.

Introducing two new classical works  
by two of jazz music's biggest stars.



On his second Masterworks album, Wynton Marsalis continues to astound the classical world with his trumpet virtuosity. Conducted by Raymond Leppard (who also accompanied Wynton on his Grammy-winning debut album), this new disc of Baroque music features a special appearance by soprano, Edita Gruberova.

On his classical debut album, jazz superstar Bob James uses the latest keyboard technology to add new perspective to the music of French composer, Jean-Philippe Rameau. The result is a delight: the perfect synthesis of Baroque music and electronic genius. A surprisingly "natural" sound that expresses Rameau's work as never before!

## On CBS Masterworks Records and Cassettes.

Experience the jazz sides of Wynton Marsalis and Bob James on their new Columbia albums: "Hot House Flowers" and "12."

FC 39530

FC 39580

"CBS," "Masterworks," and "Columbia" are trademarks of CBS Inc. © 1984 CBS Inc.

The Dennesen Polaris antenna is a simple but effective solution to FM reception problems.

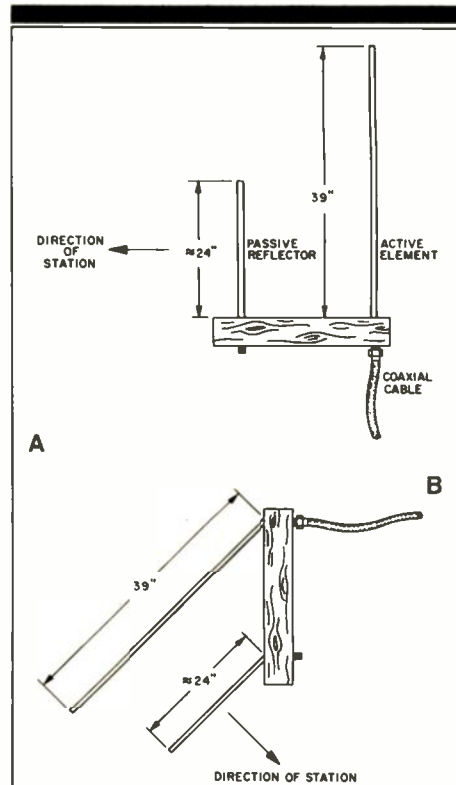

Fig. 1—Two of the possible orientations for the Dennesen Polaris; these can be used horizontally or vertically, depending on station polarization.

dard dipole. Over and above the mere gain exhibited by the Polaris antenna, I noted that proper positioning of the antenna resulted in considerably less multipath interference with some of the more troublesome stations in my area. In addition, there were at least two instances where, in the crowded FM band in which my tests were conducted, I was able to separate two stations that interfered with each other when I tried to tune to them using the standard dipole. On the basis of these results, I would conclude that, as simple as the Dennesen Polaris indoor FM antenna seems to be, it may well provide a solution for the many FM listeners who are having trouble with FM reception in their homes or apartments and who, for one reason or another, are unable to mount a good directional antenna on their rooftops.

Leonard Feldman



# A clear challenge from PDMagnetics to the readers of Audio.

**Introducing the 500 CROLYN® HG Audio Cassette. Clear sound, clear shell...clearly superior.**

The new 500 CROLYN® High Grade cassette will exceed even *your* high standards. We engineered it for you, the audiophile. We want to hear from you. We challenge you to compare it with the likes of XL-IIS and SA-X. Hear the difference genuine chromium dioxide tape makes versus cobalt-iron oxide imitations or other "chrome equivalent" tapes. Also, ask about 1100 Metal HG and Tri-Oxide Ferro HG.

Buy a 500 CROLYN® HG cassette. Use it—test it—under *your* standards. Send us your comments (plus outer wrapper and sales receipt). We'll send you a 500 CROLYN® HG Cassette FREE! We're betting you will agree with our results.\*

Only the people who invented the compact cassette (Philips, the "P" in our name), and chromium dioxide (Du Pont, the "D" in our name), could bring you a tape this great.

Rating vs. Leading Premium Cassettes

	500 CROLYN® HG
Tape Background Noise	SUPERIOR
S/N, Low Frequency	SUPERIOR
S/N High Frequency	EQUAL
Dynamic Range	SUPERIOR
Frequency Response	EQUAL
Shell Quality	EQUAL
Overall Listening Quality	SUPERIOR

Specific test results available on request. For free cassette offer, technical information or the PDMagnetics dealer serving your area, write us at address below.

## PDMagnetics

A legacy of quality from Philips and Du Pont.



\*Offer expires December 31, 1984

©1984 PDMagnetics 600 Heron Drive, Pureland Industrial Complex, Bridgeport, NJ 08014

Enter No. 36 on Reader Service Card

## PROTON 300 TABLE RADIO AND MODEL 301 SPEAKER SYSTEM

**Company Address:** 737 West Artesia Blvd., Compton, Cal. 90220.  
For literature, circle No. 96

Proton bills its Model 300 as "The Radio . . . unlike any other radio in history." Actually, it's a good bit like the old KLH and Advent radios in concept: A good tuner, amplifier and speaker system in one convenient, table-top package.

A closer look shows that the package actually has two parts: A biamplified, self-powered speaker system and a tuner/control module. The amp/speaker module includes a 20-watt bass and a 5-watt treble amplifier (at 0.03% THD), driving a 4½-inch woofer and a 1¾-inch tweeter, respectively. It has rear-panel controls for tweeter level and input level. For stereo, you add a second powered-speaker module (also sold for component TV use).

On the front of the tuner panel are an AM/FM/tape selector, a power switch, a large tuning knob, and smaller knobs for volume, treble and bass. On the rear are the AM rod antenna, switches for stereo/mono and muting on/off plus jacks for tape input and output, preamp output and a separate jack for

the second speaker. AM and FM antenna terminals are underneath the module.

The Proton's human engineering struck me as only fair. The flywheel tuning could have used a bit of extra damping; as it is, it has a slight tendency to store up just enough kinetic energy to nudge itself over a bit when you release the knob. Without the digital dial, you might never know this, as the difference is usually too small to be seen on an analog dial or heard. A more serious problem is that the volume knob (coded red, to distinguish it from the same-sized bass and treble) is a bit close to the tuning knob for comfort. I also would have welcomed having a balance control and having the stereo/mono switch up front.

Hooking the system up for stereo is easy. Just run a cable from the tuner's second-speaker outlet to the input on the second amp/speaker module, and set the tuner's rear switch to stereo.

The Radio tries to bridge the gap between table radios and components, and does a pretty good job of it. You can use it with a tape deck, as the foundation of a modest second system. You can't monitor off the tape—but the tape deck in such a system would probably be a two-head unit in any case, so that's no problem. The AM rod antenna can be swivelled around more freely than those on most component tuners, which definitely helped. Arrow LEDs pointed the way to correct tuning; an LED line told when it was correct.

However, some of its component aspects are those I don't like in components. Its AM performance seemed only a bit better than that of most component tuners' AM sections—that is to say, more prone to pick up interference than good portable AM radios. Again like a component tuner, it apparently has no built-in FM antenna to speak of. With a pair of rabbit ears, it worked fine—but I would have preferred the option of a true radio's plug-in-and-play convenience. With rabbit ears—or even a two-bit wire dipole—it easily handled the horrific multipath in my home. That's no surprise, as the tuner incorporates a version of the Schotz variable-bandwidth detector. Its specs include 1-μV sensitivity (for 3% THD + noise, at 75 ohms, in mono, which the spec sheet doesn't mention), a 1.5-dB capture ratio, 77 dB S/N in stereo, and greater than 60 dB of selectivity.

The sound had plenty of power, plenty of bass, excellent clarity and a pleasant tone. I found I rarely used the tone controls and had no need to reset the tweeter levels from their factory positions. Since each speaker system has its own amplifiers, one can add several pairs of additional speakers for use in other rooms, without straining the system; that would work better, though, if the speakers had front-panel volume controls.

Quality, alas, does not come cheap. The Proton 300 is \$280, and the Model 301 amp/speaker unit costs \$150.

*Ivan Berger*

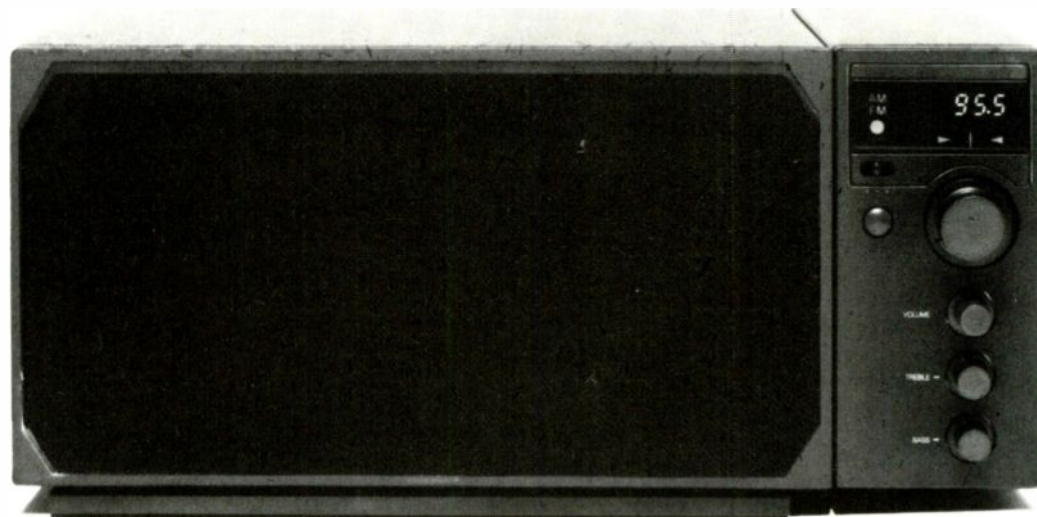

# T A N D B E R G

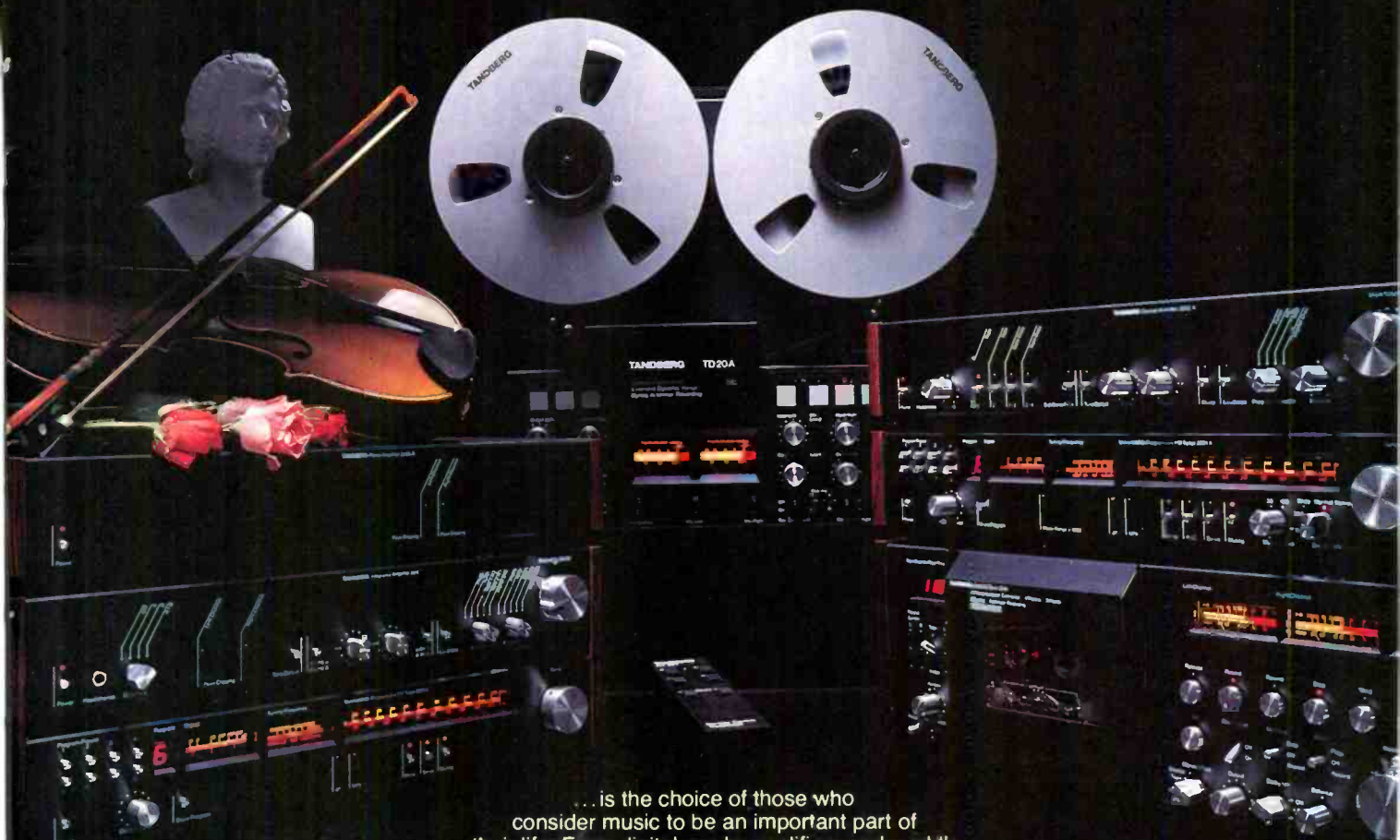

... is the choice of those who consider music to be an important part of their life. From digital-ready amplifiers and world's finest FM tuner, to the most sophisticated cassette & reel recorders, only Tandberg offers a complete family of the most respected music reproduction equipment. European-made... acclaimed world-wide. For a color poster (without advertising copy) and the name of your nearest dealer, send \$2 for postage & handling to: Tandberg of America, 1 Labriola Ct., Armonk, NY 10504. Enter No. 49 on Reader Service Card



# THE ULTIMATE MACHINE

**JVC'S NEW R-X500B RECEIVER IS A SUPERB EXAMPLE OF HOW FAR JVC WILL GO TO BRING YOU THE ULTIMATE IN SOUND.**

Some hi-fi equipment delivers slightly higher fidelity. Especially when it's designed by JVC®. In fact, JVC's entire line

remote equalization and unheard-of-refinements, it is virtually without equal.

**ADVANTAGE: A POWER AMP WITH INCREDIBLE**

## POWERS

The R-X500B boasts two of the highest refinements in power amp technology available today—Dynamic Super A and Gm Driver. Dynamic Super A improves

performance in two significant ways. One, it renders music reproduction silky and pure by eliminating offensive switching distortion. Two, it capably controls speaker motion by forming an ideal interface between the amplifier and the speaker.

of high fidelity components is known throughout the world for technological brilliance and painstaking craftsmanship. The R-X500B receiver is a case in point. With the technology of JVC's power amp, equalizer and tuner, plus

performance in two significant ways. One, it renders music reproduction silky and pure by eliminating offensive switching distortion. Two, it capably controls speaker motion by forming an ideal interface between the amplifier and the speaker.

**HIGH FIDELITY**







JVC's newest technology, Gm Driver, improves actual in-use performance at all listening levels, high and low, by driving the power stage at a constant voltage.

**ADVANTAGE: AN EQUALIZER WITH A GRAPHIC DIFFERENCE**

Since 1966, when JVC pioneered equalizers for home use, we have remained in the very forefront of equalizer technology.

The computer controlled graphic equalizer in the R-X500B is a superb example of engineering to achieve an end. It combines unequalled versatility with automatic capabilities, while maintaining sonic integrity.

Five equalized responses can be memorized for instant recall at a touch.



And an infrared wireless remote control makes it possible to adjust equalization from your armchair without sacrificing sound quality.

In a further refinement, JVC engineers opted for an LSI to handle electronic switching for both channels at seven different control frequencies. The result—electrical loss and tonal

degradation never enter the picture.

**ADVANTAGE: A TUNER AS SMART AS A COMPUTER**

**SPECIFICATIONS**

**AMPLIFIER SECTION**

Output Power

100 Watts per channel, min. RMS, both channels driven into 8 ohms, from 20Hz to 20kHz, with no more than 0.007% total harmonic distortion.

Signal-to-Noise Ratio ('66 IHF/DIN)

Phono—80dB/66dB  
Video/Aux/DAD/Tape—100dB/67dB

RIAA Phono Equalization

± 0.5dB (20Hz -20kHz)

**S.E.A. SECTION**

Centre Frequencies—63, 160, 400, 1k, 2.5k, 6.3k, 16kHz  
Control Range—± 10dB

**FM TUNER SECTION ('78 IHF)**

50dB Quieting Sensitivity

Mono—14.8dBf Stereo—38.3 dBf

Signal to Noise Ratio (IHF-A Weighted)

Mono/Stereo—82dB/73dB

The R-X500B puts an advanced microcomputer in charge of the digital synthesizer tuner and references it to the accuracy of a quartz oscillator, making it highly versatile and easy to use. The microcomputer lets you preset 15 AM and 15 FM frequencies, scan them all for 5 seconds each, read out aerial signal strength in 5dB increments, plus much more.

**ADVANTAGE: JVC**

It is the attention to engineering detail and craftsmanship evident in the R-X500B which separates every JVC hi-fi component from all others. JVC makes changes in design for the sake of improvement. Not just for the sake of change. And the result is the difference between excellent and average. See, and hear, this difference at your nearest JVC dealer.



# A New Monster Has Surfaced

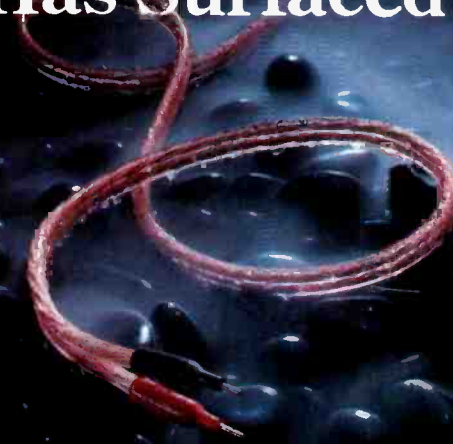

Monster speaker cable with its new winding for better sound.

Monster Cable never fails to impress. Great bass, extended highs, and increased dynamic range. It's rightfully become the standard of the audio industry, providing big sonic improvements for little money. Just ask a friend who has a pair. **Now introducing the New Monster . . .**

**Higher performance, same low cost.** Our latest research into the electromagnetic behavior of audio signals has led to an updated design of the original Monster. The results are impressive. Improved clarity, even better bass, and superb imaging that cannot be matched by

any competitor . . . at many times the price. If you currently own Monster Cable, we invite you to audition the New Monster. And if you do not yet have the Monster in your system, old or new . . . then you're in for a very pleasant sonic experience.

**MONSTER CABLE**®

Call or write for the Monster dealer nearest you.

Monster Cable® Products, Inc.  
101 Townsend, San Francisco, CA 94107  
4 5 777-1355 Telex: 47058- MCSYU1

Enter No. 55 on Reader Service Card

## Even this Infinity RS11 speaker

### has the soul of our \$32,000 Infinity Reference Standard

All our home and automotive speakers share technology developed for our no-compromise state-of-the-art systems.

And every Infinity achievement—from polypropylene cones and domes to our world-famous EMIT™ tweeter—shares the goal of greater musical accuracy. The way the musicians meant you to hear it.

**Infinity**®

We get you back to what it's all about. Music.

Enter No. 26 on Reader Service Card

*It's a Good Day* has a very up-front sound, with superb transient response and a great deal of presence.

gig at the Royal York Hotel, with Woody telling me how impressed he was with the arrangements of a young New Zealander, Alan Broadbent. Sitting at a ringside table later that evening, I was equally impressed with Broadbent's exciting, up-tempo, cleverly orchestrated arrangements. However, Broadbent's role here is a pianist, and he obviously is a talented performer in the jazz idiom.

*It's a Good Day* was recorded in Annex Studios in Hollywood. John Earle has provided an excellent multi-mike recording. His mixing is very deft, and he maintains a good balance between instruments, with all elements completely articulate. This is a very up-front sound having a great deal of presence. There is superb transient response and sparkling detail on percussion. Mavis Rivers's voice is well projected, just in front of the orchestra, in a somewhat detached acoustic perspective. John places the orchestra in a mildly reverberant field. I personally would have mixed in a bit more weight on bass and kick-drum, but these are minor quibbles about an otherwise superior jazz recording. *Bert Whyte*

### The Digital Domain: A Demonstration Elektra 9 60303-2.

This is a CD digital-demonstration recording, which, by its nature, cannot be issued in any format except CD (or digital tape). It has already gained a certain degree of notoriety, because if you do not heed the warning about volume-level settings enclosed in the CD package, you may wind up with blown speakers!

The recording is intended to demonstrate the various aspects and advantages of digital recording, most especially dynamic range. It begins with 15 seconds of silence (all bits set to zero). Then follows a pastoral setting with the sounds of gentle breezes, insects, and a distant babbling brook. In the background is the faint sound of a jet plane. Now, friends, if you turn up your volume control to hear the insects, brook, etc., in a trice this will be followed by a full-bore, maximum-thrust jet plane take-off, and the other zapping sound might be your speakers taking off! Another jet takes off, followed by a jet landing, including the monumental

# THIS MONTH'S BIG EVENTS ON CBS COMPACT DISCS

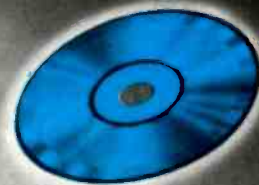

## DECEMBER

4

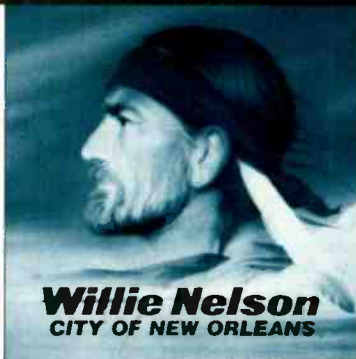

WYNTON MARSALIS



7

CLASSICAL BARBRA



100 BEL AIR PLACE



13

14

2 CDs

PUCCINI  
TURANDOT



19

JUST RELEASED!

WENDY CARLOS "Digital Moonscapes"  
BOB JAMES "Rameau"  
PHILIP GLASS "Glassworks"  
QUIET RICT "Condition Critical"  
BILLY JOEL "Piano Man"  
WINGS "Venus And Mars"  
BRUCE SPRINGSTEEN "Greetings From  
Asbury Park, N.J."

BOB JAMES  
TOUCHDOWN

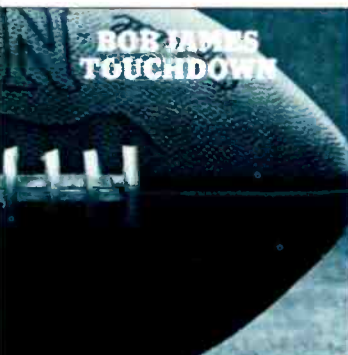

21

Enjoy today's revolution in sound with CBS Compact Discs. Our rapidly-growing catalog features hundreds of titles by superstar artists in all categories of music. Ask for a free copy wherever Compact Discs are sold.

COMPACT  
disc  
DIGITAL AUDIO

\*CBS\* is a trademark of CBS Inc. © 1984 CBS Inc.

Enter No. 17 on Reader Service Card

## WHEN BUYING COMPONENT FURNITURE YOU'D BETTER LOOK DOWN THE ROAD

Handcrafted in select oak or walnut hardwoods, CWD's modular furniture systems stand the test of time with craftsmanship befitting the finest audio, video and computer components.

And only CWD lets you add 'n stack matching units and accessories as you need them—down the road.

See why great Home Entertainment Centers begin with Custom Woodwork & Design. From \$199 (Manuf. sugg. retail) Call toll-free for the dealer nearest you.



**CWD**  
CUSTOM WOODWORK  
& DESIGN

TOLL-FREE: 1-800-323-2159  
IN ILLINOIS: 312-563-1745

In Natural Oak, Dark Oak  
or Natural American Walnut.

The Handel CD is distinguished by the finely wrought, deftly paced performance of conductor Christopher Hogwood.

bass thunder of the reverse thrusters. Before my protective circuits blew, I assure you, it shook my house to its foundations, with the jet sound so realistic it was nigh on to the real thing!

The rest of the recording features various sounds—natural, processed and digitally synthesized—followed by a digital test section. While fully acknowledging the complexity and the hard work it took to produce many of these sounds, quite frankly I found it all a bit boring. As a suggestion, I would like to have a CD recording that explores the dynamic compass of the various instruments in a symphony orchestra, and specific examples of music to demonstrate these qualities.

Having said all this, can you just imagine playing the jet plane sequence on some superstar rock group's stadium P.A. system with dozens of horn speakers and a zillion watts?

*Bert Whyte*

**Mozart: Sinfonie No. 36, "Linzer"; Sinfonie No. 38, "Prague."** Klasische Philharmonie Stuttgart, Karl Munchinger.

**Intercord 38CT-5.**

These familiar Mozart symphonies are given fine performances by veteran conductor Karl Munchinger. The recording is well done, with a nice balance between the orchestral definition and the fairly broad acoustics of the hall. The sound is reasonably clean, but I hear an edginess in the high strings, and there seems to be a peculiar hooty, resonant coloration in the woodwinds.

*Bert Whyte*

**Handel: Water Music Suite; Royal Fireworks Music.** The Academy of Ancient Music, Christopher Hogwood. **L'Oiseau-Lyre 400 059-2.**

This CD of Handel's "Water Music Suite" and "Music for the Royal Fireworks" comes from the same forces who performed the *Messiah Highlights* reviewed so favorably in the October issue. Like that memorable recording, it is distinguished by the superb playing of the Academy of Ancient Music and the finely wrought, deftly paced performance of conductor Christopher Hogwood.

This, too, is derived from an analog



*Christopher Hogwood*

recording of outstanding quality. The recording venue sounds just about the same as was used in the *Messiah* recording, which is to say, a large acoustic space that affords a luxuriant, warm ambience for the sound while never obscuring inner detail. The high strings are very smooth and natural-sounding, while woodwinds are nicely projected in the phantom center and exhibit a most ingratiatingly rich, natural tonality. The famous French horn passages in the "Water Music" are very clean and have a majestic yet brazen sonority. A most rewarding recording, sonically and musically. *Bert Whyte*

**The Best of The Alan Parsons Project:** Andrew Powell and the Philharmonia Orchestra

**Mobile Fidelity Sound Lab MFCD 806.**

It's Mantovani on steroids: Andrew Powell has taken the attractive but insubstantial basic melodies of The Alan Parsons Project and pumped them up into orchestral hulks with huge neck sizes who are impossible to buy good shirts for. On his own recordings, producer/engineer/keyboardist/songwriter Parsons, in partnership with Eric Woolfson, also dressed up these slight tunes in swirling layers of glittering synthesizer and orchestral cloth, but rarely did he approach the sheer massiveness of Powell's arrangement for the Philharmonia Orchestra.

The Alan Parsons Project is a loose collection of floating English session players who perform Parsons's and Woolfson's arty, electrified pop oeuvres assisted by orchestras of varying sizes. Powell has been an integral member of

# A M A S T E R P I E C E O F H I G H F I D E L I T Y

In a true masterpiece, subtle details combine with unique design to become the ideal. Harman Kardon has achieved this ideal with the introduction of the technologically advanced T65C Turntable.

An example of disc reproduction excellence, the T65C incorporates a sophisticated 3-point suspension system, counter-balanced to center the moving mass at the platter spindle. This keeps the platter, tonearm, and belt drive system isolated from vibration. The T65C's AC sine-wave driven motor is crafted to turn with pure harmonic motion, a dramatic improvement over conventional turntables that use a series of DC pulses, resulting in high frequency deviations in platter rotation.

The T65C's tonearm exemplifies Harman Kardon's technological know-how. A straight, tapered tube to suppress natural resonances, it features a weight and wire anti-skating mechanism for additional precision. Its high mass pivot assembly acts as a high frequency vibration filter, and a lateral balancer on the tonearm compensates for

unevel surfaces.

A carbon fiber headshell provides low resonance and vibration damping. The T65C's massive 3.3 pound platter, disc stabilizer, capacitance trim and optically-sensed auto-lift further illustrate Harman Kardon's commitment to the art of high fidelity. A commitment that is reflected in all Harman Kardon products.

Harman Kardon... Dedicated to mastering the fine art of high fidelity.

**SPECIFICATIONS:**  Wow & Flutter (WRMS): 0.025%  Rumble (DIN-B WTD): -70dB  Pitch Adjustable Range:  $\pm$  3%  Effective Tonearm Mass: 3.5 Grams  Stylus Overhang: 18mm  Offset Angle: 25.5%  Effective Tonearm Length: 216mm  Tracking Error:  $\pm$  2°  Phono Capacitance: 70/170/270  Tracking Force: 3-3 Grams

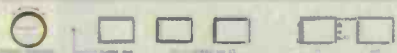

## harman/kardon

*The Best of the Alan Parsons Project* has digital sound that's accurate and *big*, but the music is inflated.

this group-in-flux since its birth, and this, his personal interpretation of The Project's best material, was his first solo recording effort, in 1983. It includes Parsons Project major hits, like "Eye in the Sky," and lesser ones, such as "Games People Play" and "Time."

Now, Mobile Fidelity Sound Lab has released its half-speed, remastered

version of the original EMI analog recording on CD, and it's *big*. Strictly from the aspect of accurate digital sound reproduction, this CD is a beauty. Its dynamic range is prodigious. Powell tests this aspect of digital recording mercilessly, slamming the volume up to the heavy decibel levels of a full orchestra and pulling out all stops

in great theatrical bursts of combined percussion, strings, horns, keyboards—the works—then dropping it down to the whisper-low levels of a passage where a bell chime tinkles faintly by itself or floats lightly over a wisp of strings. The CD handles this hefty workout admirably: There's no audible distortion, even at sudden, thunderous volume levels.

There is a superb sense of depth as well; fore-, mid-, and background are thoroughly occupied and defined. Left and right channels are well used for presencing the individual instruments of the rock band which accompanies the Philharmonia. Both channels are also well used for presenting the orchestra as an acoustically accurate, palpable block with specific instrumental sections of the orchestra in their correct aural positions. Textures are voluptuous, with layer on layer of meaty orchestration emerging relentlessly from the tiny, silvery disc that seems too small to hold it all. When the kettle drum comes rolling thunderously out of "Lucifer" like the huge stone that comes roaring out of the screen in *Raiders of the Lost Ark*, I found myself ducking involuntarily. In contrast, the fragile, plucked wash of a harp in "Pavane" is captured as delicately and precisely as is technically feasible. As I have said, a lovely recording.

Beautiful as the recorded sound is, the material is too much bombast for my blood. Too-often-repeated orchestral crescendos, heavily synthesized "eerie" passages, great choral moanings, and swirling, skirling violins and horn sections repeatedly building to great blaring peaks of ecstasy are all hung on tiny tunes that simply cannot bear the weight. Listen to this to be amazed at the Conan-like capacity of your little Compact Disc, but not for great pop entertainment.

*Paulette Weiss*

#### **James Newton Howard & Friends Sheffield Lab CD-23.**

This recording is something of a departure for Sheffield, inasmuch as the music is almost wholly derived—make that created—on digital synthesizers.

Three performers used Yamaha DX7, DX9, and GS1 digital synthesizers, and two other musicians played

The true audiophile judges components with his ears, not just his eyes. Amber's Series 50B Integrated Amplifier offers more than the "specs" you've been looking for. It offers the natural musicality you've been listening for . . . in a superbly engineered and remarkably affordable package. The 50B allows speakers to recreate music with the immediacy and clarity of a live performance. Yet for all its simplicity, the 50B can control even the most sophisticated system. Visit your Amber dealer. Hear the difference between mere components and fine, musical instruments.

## From the Amber Collection of Fine Musical Instruments: The Series 50B Integrated Amplifier



# Amber



P.O. BOX 2015 CHARLOTTESVILLE, VA 22902 TLX 901601 (804) 296-5696

# A MASTERPIECE OF HIGH FIDELITY

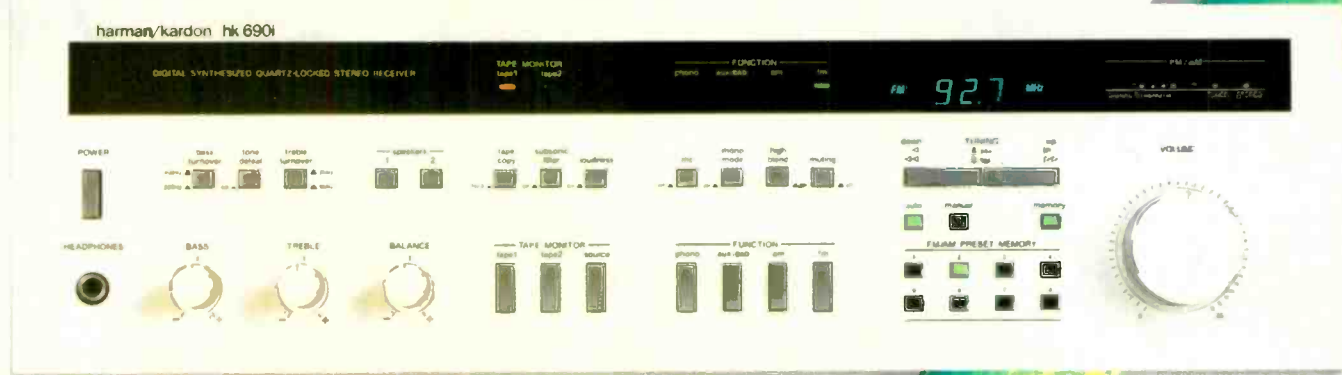

The hk690i is Harman Kardon's unique expression of ultimate artistry in high fidelity. In it are found the same control of technique, mastery of detail and creative excellence inherent in every great and enduring work of art.

The hk690i receiver is exemplary of the technological strokes of genius created and perfected by Harman Kardon throughout its more than 30 year history. 45 Amps of High Instantaneous Current Capability allows the hk690i to develop up to 150 Watts per channel into 2 Ohms under peak conditions. An Ultrawideband Frequency Response of 0.2Hz to 150kHz delivers extremely fast and accurate transient response. Low Negative Feedback results in the virtual elimination of TIM distortion. An exclusive Sample-And-Hold Multiplex Decoder decreases high frequency switching noise while eliminating the need for much of the filtering normally required in FM processing. And, the use of Discrete Components demonstrates Harman Kardon's inherent technical integrity.

With this dedication, Harman Kardon stands ready to deliver the ultimate in high fidelity listening pleasure with every model in their entire product line.

Harman Kardon... Dedicated to mastering the fine art of high fidelity.

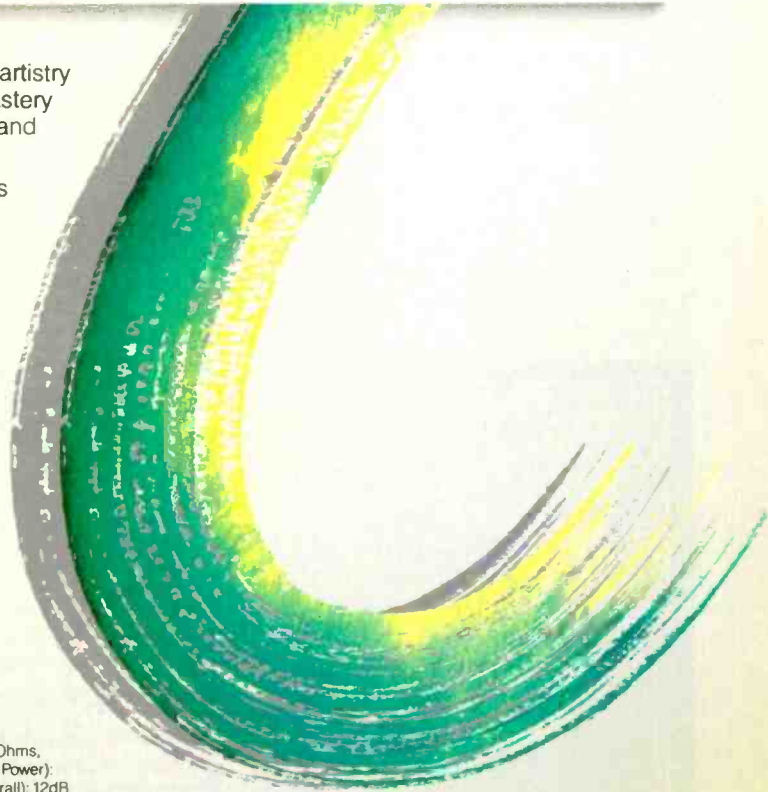

**SPECIFICATIONS**  Power Output, (FTC) RMS, per channel, both channels driven into 8 Ohms, 20-20,000Hz: 60 Watts per channel @ < .06% THD  4 Ohms, 1kHz, IHF Signal (Dynamic Power): 120 Watts  2 Ohms, 1kHz, IHF Signal (Dynamic Power): 150 Watts  Negative Feedback (overall): 12dB  HCC (High Instantaneous Current Capability): 45 Amps  Power Bandwidth, at half-rated output, 8 Ohms: <10Hz-100kHz  Frequency Response, at 1 Watt output, +0/-3dB: 0.2Hz-150kHz  TIM: Immeasurable  Slew Rate: 200V/μsec  Usable FM Sensitivity: mono (dBI/μV-75 Ohms): 10.8dBI/0.95μV  Stereo Separation: 1kHz, 65dB, 100% mod: 55dB  FM THD: mono 1kHz, 100% mod: 0.06%; stereo: 0.08%.

## harman/kardon

Art Pepper's charts are good and the sound is clean, although this CD still suffers from the dry, 1959 studio sound.

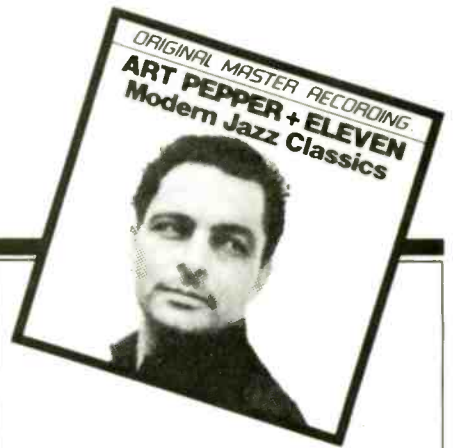

drums and percussion. The recording was made simultaneously direct to disc and on digital tape. The CD recording was made from the digital reference master. In the direct-to-disc version, this recording has become a hot demonstration disc; the CD version should earn similar recognition.

There is not much musical substance to this recording; it's more a matter of the innovative use of these versatile synthesizers in clever arrangements. The sound is the star here, and it is really spectacular. All the synthesized sounds are very clean and are combined with drums and percussion for some of the most explosive transients yet recorded. The synthesiz-

ers truly explore the entire audio spectrum, and in the last cut, "Amuseum," the low frequencies get down to the subbasement. An interesting collage of sounds, unquestionably of value in the testing of loudspeakers and other audio components. *Bert Whyte*

**Art Pepper & Eleven Modern Jazz Classics**  
**Mobile Fidelity Sound Lab MFCD-805.**

This is yet another successful transfer, by Mobile Fidelity, of an analog master to CD.

Art Pepper is, of course, a very well-known jazz musician, and on this recording he has assembled such top-rank players as Pete Candoli, Jack Sheldon, Bud Shank, Mel Lewis and others into a swingin', hard-driving, big band. The band plays such chestnuts as Dizzy Gillespie's "Groovin' High," "Shawnuff," and "Anthropology," as well as the "Four Brothers" made fa-

mous by Woody Herman and some numbers by Sonny Rollins and Charlie Parker.

The charts are good, the playing is very professional, and the sounds of trumpets, trombones, saxes, percussion and drums are very clean. It should be a winner and appeal to many people. However, it was recorded in 1959 in a studio environment with acoustics as dry as the Sahara Desert! It sounds so lifeless and compressed in its close-up perspective that, at least for me, its musical values are diminished. Surely the addition of some appropriate reverberation would have helped considerably, without offending the jazz purists who dote on authenticity. *Bert Whyte*



# Telarc CD's



**BEETHOVEN**  
 THE FIVE PIANO CONCERTOS

**RUDOLF SERKIN**

**SEIJI OZAWA**

**BOSTON SYMPHONY ORCHESTRA**

**BEETHOVEN: The Five Piano Concerti (CD-80061-5).** Serkin's dynamic reading of Beethoven's monumental exploration of the piano concerto. Completed over a period of five years, this magnificent achievement takes its place among the definitive recordings of the 20th Century.

**HANDEL: Messiah (CD-80093-2).** Robert Shaw's fresh and masterful account of this greatest of sacred oratorios. Talented young singers assist Shaw's disciplined chorus and orchestra in bringing Messiah to stunning recorded life.

**HANDEL: Favorite Messiah Selections (CD-80103).**

**THE MANY MOODS OF CHRISTMAS: Shaw/Atlanta Symphony & Chorus (CD-80087).** Four collections of the best-known and loved Yuletide hymns and carols.

**SIBELIUS: Symphony No. 2 in D; Finlandia (CD-80095).** Rising conductor Yoel Levi leads the Clevelanders in Sibelius' thrilling scores.

**JONGEN: Symphonie Concertante; FRANCK: Fantaisie & Pastorale (CD-80096).** First domestic and only digital recording of this organ masterpiece.

**MICHAEL MURRAY PREMIERE RECITAL RECORDING: Works of Bach, Duprè, Franck, Messiaen & Widor (CD-80097).** The debut of the new Ruffatti Organ in Davies Symphony Hall.



**COMPACT disc**  
 DIGITAL AUDIO



# A MASTERPIECE OF HIGH FIDELITY

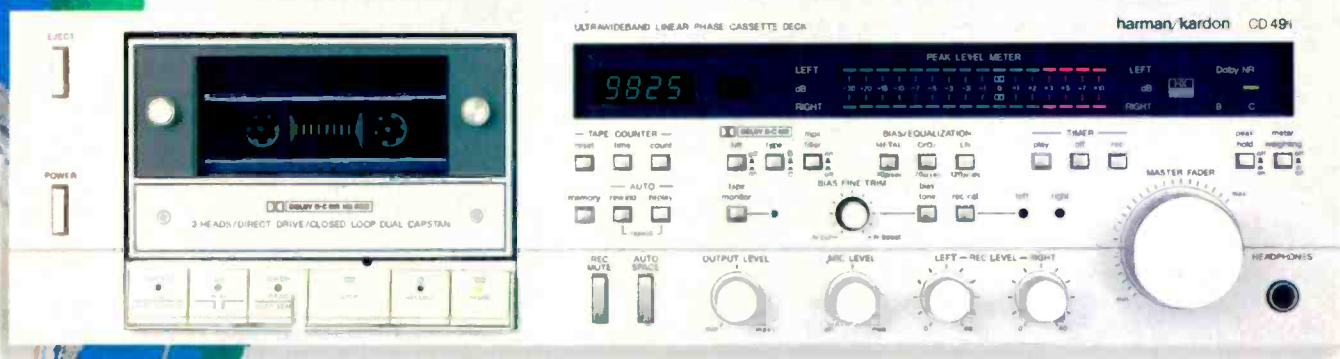

Of the many elements inherently necessary for the production of a lasting, true work of art, perhaps attention to design fundamentals is the most crucial. Time must be devoted and painstaking attention to detail must be asserted on every level for an authentic masterpiece to result. It is that commitment to precision that makes Harman Kardon's CD491 stand apart from other cassette decks.

An audiophile demands nothing less than the fine quality inherent in the CD491 — Harman Kardon's most advanced cassette deck and one of the few in the world that can equal the range of human hearing. With a frequency response of 20Hz to 24kHz ( $\pm 3\text{dB}$ ) with any tape formulation, the CD491 is a classic of technological excellence. Incorporated in the CD491 is Dolby HX Professional,\* a headroom expansion system that extends frequency response at high record levels while significantly reducing distortion. Added to this is a signal-to-noise ratio of 75dB. The dramatic result of this combination is the ability to accurately record more dynamic audio signals than was previously possible. This makes the CD491 a truly enduring technological triumph as more demanding forms of software, such as digital audio and hi-fi VCRs, emerge. Three heads improve performance and offer the convenience of monitoring while recording. A Sendust record head withstands high record levels without overload and a ferrite playback head assures high frequency response. Both heads are precisely aligned in one housing. The CD491 is such a unique expression of artistry that one shouldn't compare it to any other cassette deck, but rather to the source being recorded.

This strong commitment to achieving the ultimate in audio listening pleasure is reflected in the many fine products Harman Kardon makes.

Harman Kardon... Dedicated to mastering the fine art of high fidelity.

**SPECIFICATIONS:**  Frequency Response, -20dB (IFH std) All tape Formulations (No Ferrichrome position): 20Hz-24kHz  $\pm 3\text{dB}$ ; Metal: 20Hz-26kHz  $\pm 3\text{dB}$ .  
 Large Signal Response (0dB, with Dolby\* on, Metal Tape): 20Hz-20kHz  $\pm 3\text{dB}$ .  Wow-and-Flutter (NAB, WRMS): 0.025%.  Signal-to-Noise Ratio (Cr02) Dolby C\* on: 75dB.  Total Harmonic Distortion, 1kHz, metal tape, Dolby\* level: 0.9%.

\*Registered Trademark of Dolby Laboratories, Inc.

## harman/kardon

EDWARD TATNALL CANBY

## FLAUNTING THE FLUTE

### Bach: The Chamber Music for Flute.

Sandra Miller, flute; James Richman, harpsichord; Mary Springfels, viola da gamba.

**Titanic TI 47/48**, two-record set, \$20.00.

Just what led to this label's title I do not know—it hasn't sunk yet, after (I am now informed) 10 years. Curiously, it has an import label called Lusitana Musica—does this recall the Lusitania? Next, no doubt, will come the Morro Castle (sunk off New Jersey) followed by the Andrea Doria. I also must admire the label's bravado in pricing its LPs at \$10 instead of \$9.98. Must mean something, that.

Though these Bach works feature the flute—the “old” flute of Bach's time, a wooden instrument not unlike a recorder but cross-blown—there is a lot of variety in the musical formats, common in Bach's works even when, as here, they are not related as a published group. In fact, you have on these discs Bach's thinking on the major types of chamber ensemble in his day, from a work for solo flute to works with continuo accompaniment and for flute with the much more elaborate harpsichord obbligato written out by Bach in great detail. The recordings are capped by the “Trio Sonata” from Bach's late *Musical Offering* for Frederick the Great, in which the “King's Theme” is repeatedly heard. This work is by far the longest, being one breath short of 20 minutes. The other instruments are as Bach knew them, a second flute and the appropriate viola da gamba to play the bass line of the continuo accompaniments.

No doubt of the prowess of this flute player! We are used to the incredible fluency of present-day recorder virtuosi, who merely match what was common in Bach's own day (as the musical notes witness), but the old flute is only now challenging the familiar glittering metal tube with all the valve frostings on it which is “the” flute to most people and, for that matter, most professional musicians. Ms. Miller can play anything Bach wrote as easily as any player of the modern instrument, and with first-rate musicianship. Professional flute players should listen, I suggest, and look to their laurels, just as horn players should note the sounds of Ti-



Illustration: Rick Tulka

tanic's Jean Rife on the old valveless horns. It is astonishing how quickly we can reconstitute the whole professional technique of such old and supposedly dead instruments, once we have the motivation to do it.

Good recording techniques here, very knowledgeable. For the obbligato harpsichord we hear that instrument or an equality with the flute, as we should. On the other hand, in the music with continuo accompaniment, the harpsichord is properly subdued and blended in favor of the active solo and the bass line of the gamba. Of course, the harpsichordist also contributes, with a lighter and more blended sound—but a brash recording engineer can reverse that with a twist of the wrist or the push of a slider. All the more reason for a recording man to know his music as well as he knows his equipment.

These are decidedly modern-type performances, leaving behind all the Romantic pathos that so often went into Bach in the olde days, a few decades ago. These players tend strictly to business, playing quite fast but always clearly, letting the music speak for itself as, perhaps, Shakespeare speaks in a straightforward reading today. The effect is emphatically dead-

pan if you are used to the older virtuoso Bach playings, but we must admit that this is probably right. My only reservation is in the matter of phrasing: The solo flute and the harpsichord do not shape their common melodies in the same fashion, as if they had not come to an entire agreement in rehearsal. Miller is smooth and long-breathed; Richman tends to a more bouncy jogging.

A word on the notes. I had to laugh when the Partita for solo flute is described as puzzling—is it a transcription?—in that “there are no obvious places to breathe in the first movement.” Typical Bach, is all I can say! He was an organist and never worried about his air supply, so long as the boys at the air pumps kept going. In virtually every Bach choral work there are pages of sung notes without a place for a break for minutes at a time—you must leave out a few notes and gasp for air. And what about the “Suite in B Minor” for orchestra with solo flute? In the final “Badinerie” there is no place to breathe in the entire movement, not even at the repeats.

As for Sandra Miller, she has a built-in air pump. She never breathes. Just listen to her.

# HARMAN KARDON'S STATE-OF-THE-MIND TECHNOLOGY TAKES TO THE ROAD



harman/kardon CA260 High Fidelity Car Amplifier

With the introduction of the CA260 high fidelity car amplifier, Harman Kardon blazes new trails. The commitment to sonic superiority that's synonymous with Harman Kardon home audio equipment is now ready for those who demand the same quality on the road.

At Harman Kardon, we believed that there was a need for quality car audio components for the discerning listener. A car amplifier that would outperform any car amplifier on the market. Harman Kardon's thirty years of audio expertise is unleashed with the CA260.

The unrivaled design technologies that are embodied in the CA260 include: High Instantaneous Current Capability, Low Negative Feedback, Ultrawidebandwidth and Discrete Components. The CA260 goes beyond industry standards to set new ones.

Incorporated in the Harman Kardon CA260 is 30 amps of High Instantaneous Current Capability to provide 60 Watts of power into 4 Ohms, 90 Watts into 2 Ohms, and 180 Watts bridged mode into 4 Ohms. Two 10,000  $\mu$ F capacitors provide full power even at 20Hz.

The CA260 is rugged and reliable enough to perform under any environmental and automotive conditions. It has been designed to overcome extreme humidity, varying voltages in the car's electrical system, mechanical vibrations, intense temperatures and engine noise.

The CA260 is the debut of a line of superior and fundamentally advanced car stereo products from Harman Kardon.

Harman Kardon's state-of-the-mind technology. Unparalleled excellence in advanced audio equipment now journeys with you.

## harman/kardon

Our state-of-the-mind is tomorrow's state-of-the-art.



Four guitars is an unusual and attractive idea, and you'll scarcely believe mere guitars made all those sounds.

**Music of Praetorius, Bach, Stravinsky, Debussy and De Falla.** The Los Angeles Guitar Quartet.

**Orpharion OR 2501.** (Available from Orpharion, P.O. Box 91209, Long Beach, Cal. 90809.)

The LP format is not exactly dead yet. In fact, it would seem to be entering its most happy usefulness as a high-quality but relatively low-cost vehicle for the immense range of music we now expect on recordings.

Here is a new label, out of the teeming enthusiasm of the West Coast, offering a well-produced and sophisticated product. One of the promoters, who triples as producer and recording engineer, is also one of the guitarists, that is, a musician/engineer, a new breed who appears more and more in audio operations. The complete specs must be abridged: Nagra open-reel tape recorder with Nagra-master EQ on Agfa tape (to avoid print-through), two Schoeps omni mikes (i.e., old-fashioned, two-point stereo), pressing on Quiex II, same as Sheffield. Enough? The point is that one can start right out these days at the very top level of both knowledge and quality material when one goes into the highly developed LP area. That is not yet the case with digital and the CD, for evident reasons, and no reflection on their promoters.

Music? Four guitars is reasonably unusual and an attractive idea; a range of "classical" music such as this excites curiosity, too. And in 2 S you will know that this is no dull drudgery of performance, as entirely too many classical-guitar recordings are. Everything is, of course, transcribed—but from such a variety of originals! Some come over better than others, assuming you know the original music, but all are lively, again knowledgeable, impeccably played, with a fine sense of rhythm. And whales of technique.

The most unusual item is the complete Sixth Brandenburg of Bach, originally for low strings (bowed), gambas at the top, no violins, a work that has only now begun to make sense as the original instrumentation gets around our musical concert circles. (It used to

be played with masses of modern strings, violas replacing the gambas' wiry, edgy sound—it was a muddy disaster.) The Sixth Brandenburg is very listenable in the guitar transcription, and I only take exception to the flaccid shaping of the opening theme, recurring throughout a long movement: It should drive through the three repetitions to the third, then on down forcefully into the lower regions. Well—not an audio concern!

The trio of Stravinsky items are maybe too peppy—the old man tended towards deliberate heavy-handedness on occasion. These are pigmy elephants in his "Elephant Polka" for Barnum & Bailey et al. The Debussy, one of his more difficult "Spanish" pieces, somehow misses the atmospheric of the subtle piano original, which are anything but easy to reproduce in another form. All these, nevertheless, make unfailingly pleasant good fi. But the set piece of the whole recording is the last, the "Ritual Fire Dance" of De Falla, familiar to just about anyone. It is more "daemonic" than I've ever experienced it, with sounds that you can scarcely believe come from a mere guitar! Did I hear a huge grand piano at one point? And horns, strings, castenets, you name it? An astonishing and unique guitar item.

**Weinberger: Schwanda.** The Munich Radio Orchestra, Heinz Wallberg; The Bavarian Radio Chorus with Popp, Prey, Jerusalem et al.

**CBS M3 36926,** three-LP boxed set.

The music-listening world divides into opera and all the rest. A recording of this kind thus has to be judged two ways. Opera people listen to great voices singing great arias, doing the big opera scenes. The rest of us grade downwards from those who enjoy the same (but also enjoy a few other likely items, like symphonies or Baroque concerti), all the way to those who simply can't stand such singing and avoid it on records or wherever it rears its ugly vocal chords. But some opera recordings have compensations. Though this is not a first-rate performance, it has them.

There are opera voices here, big ones, leading names in current German opera performance. They are loud

because that's the way singers do it today, filling big halls (bigger than the originals) without a hint of a microphone. This requires musclemen and musclemwomen! That's how they are trained. Thus, opera lovers will be enchanted by the vocal power unleashed here, whereas other listeners may find it too much. The normal story.

The opera? A good old-fashioned Bohemian work (Czech), right in the familiar tradition of Smetana, Dvořák, even the later Janáček. One of the compensations for non-opera people is the orchestral music, a lot of it without voices at all, and the prevailing dance-like melody. This isn't "The Battered Bride" (as we used to call it), but it's in the same tradition.

There's an oddity here. You'd think *Schwanda* might be middle or late 19th century on casual listening. Modern dissonance—heavens no. Just a few mystery chords in the occasional serious moments. Yet the composer, surprisingly, died in Florida in 1967. His opera was written in 1927, spang in the middle of the high-jazz age, the Roaring Twenties. Weinberger, then, was one of many who simply sat out that period, carrying the old, elegant Romantic way of composing onwards with never a break. Very strange.

This is (it says) a first recording. I seem to have heard a good deal of the music somewhere before on records, and who doesn't know the familiar "Polka" and "Fugue" from *Schwanda*, one of the standard chestnuts of popular classic programs. At any rate, the opera is almost complete here (a few cuts). Performance? Not the best. It is a thoroughly Germanic version (sung in German), sort of Black Forest style, not very Czech. The singers are powerful beyond the needs of a folksy opera, the orchestra is sloppy and misses a lot of the ever-rhythmic, danceable verve that is in the score. There is blurred, out-of-tune playing, and singing too. Lack of rehearsal, for unfamiliar music? Maybe. *Schwanda der Dudelsackpfeifer!* The performance sounds exactly like the German title.

An all-Czech recording could be much lighter and altogether dancier. But there isn't any recording of *Švanda Dudák* (the original title), so this one will have to do. It's not *that* bad—just too, too Teutonic.

# DENON RECEIVERS DO NOT COMPROMISE FIDELITY FOR CONVENIENCE.

Most receivers are designed as if the person desiring a compact, convenient component obviously cares less about sound quality. The DRA-Series Receivers, like all Denon products, place sonic quality above all. Their power sections incorporate Non-Switching Class-A circuitry (with no negative feedback on the DRA-750) and heavy duty power supplies, temperature-controlled by liquid-cooled heat sinks. Infinitely variable loudness control now ensures

The tune section stores up to 16 AM or FM stations or any combination thereof (DRA-350: 5 AM/FM preset memory tuning). The DRA-750 incorporates Denon's exclusive Super Searcher tuning circuitry which eliminates the principle causes of distortion without sacrificing stereo separation.

Whether you choose a 70W/CH DRA-750, a 50W/CH DRA-550 or a 36W/CH DRA-350, its uncompromised performance will

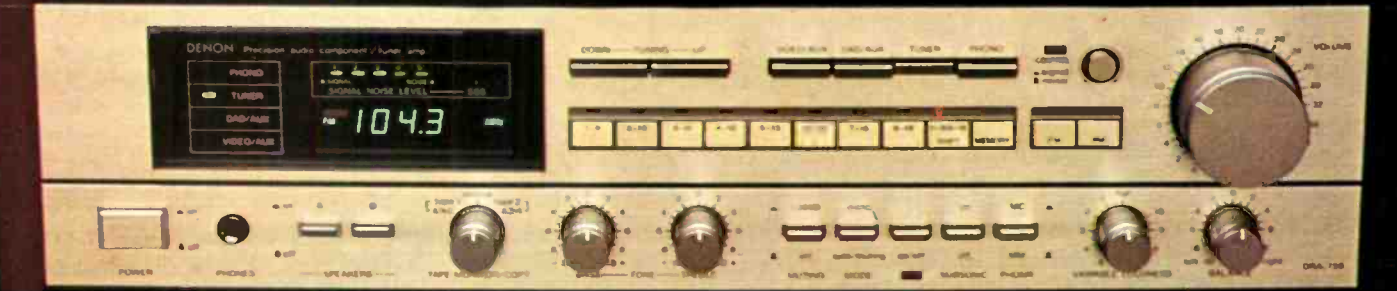

# DENON

D E S I G N I N T E G R I T Y

Side panels included on DRA-750 only.

Denon America, Inc., 27 Law Drive, Fairfield, N.J. 07006 (201) 575-7810

Enter No. 22 on Reader Service Card

MICHAEL TEARSON  
JON & SALLY TIVEN

## MUCH ADU ABOUT SOMETHING

### Diamond Life: Sade Epic 1002.

Sound: B+ Performance: A

The current toast of Great Britain is a group led by a visually and musically striking Nigerian woman, Sade Adu, who has a natural sound that I find to be reminiscent of Curtis Mayfield and Marvin Gaye in the early '70s. The front woman and focus of the band, Adu's musical persona is cool and sophisticated, but it's not a mere matter of striking poses: The woman is how she sounds, an exquisite beauty of exotic origins who just can't keep the class out of her act.

As British bands are wont to do, Sade has absorbed the music of Ray Charles, Billie Holiday and other American black originals, and their unique, immediate sound lays waste to other recent Brit soulboys. Sade writes, plays, and sings with an authenticity which cannot be faked—this group is the real thing. The band plays to complement Ms. Adu's vocals and comes across crisp and tasty, sacrificing solos for melodic lines. Snuggled somewhere in between R&B, pop and jazz, Sade has a sound of its own based on spacious arrangements of mid-tempo tunes lazily vocalized by Ms. Adu's husky pipes.

The separation of instruments in this recording is a joy to the ear. In this relatively quiet group, the percussion provides crucial underlining of rhythms and textures, and producer Robin Miller does right by paying much attention to this area. All in all, this is a superlative first effort, and we can understand, after hearing this record, exactly why Miller is now as sought after as Roy Thomas Baker once was; much as RTB was the master of overblown technology, Miller is the king of understatement.

From the first blast of "Your Love is King" to the refrain of "Cherry Pie," we sense Sade as a collective of extremely gifted songwriters blessed with a unique vision. Although the music the group makes is tough to pigeonhole, being rooted in obscure influences, we suspect Sade will find a wide following among discriminating vinyl-buyers in this country.

Jon & Sally Tiven

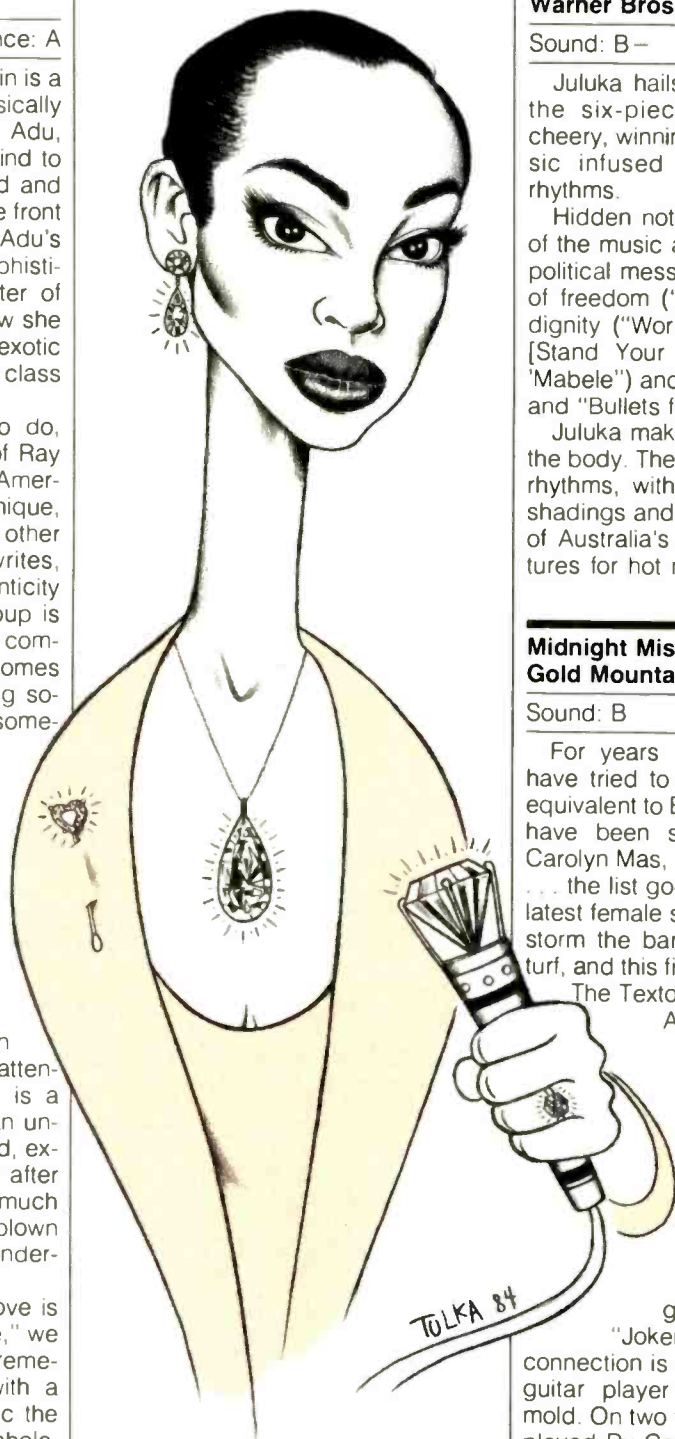

### Stand Your Ground: Juluka Warner Bros. 25155, \$8.98.

Sound: B- Performance: B

Juluka hails from South Africa, and the six-piece group's music is a cheery, winning brand of light pop music infused with bubbling African rhythms.

Hidden not far beneath the surface of the music are some highly charged political messages about the meaning of freedom ("Kilimanjaro"), pride and dignity ("Work for All," "Mana Lapho [Stand Your Ground]" and "Walima Mabele") and street violence ("Fever" and "Bullets for Bafazane").

Juluka makes heady music to move the body. Their sound uses clean poly-rhythms, with breezy flute and vocal shadings and syncopation reminiscent of Australia's Men At Work. Cool textures for hot music. *Michael Tearson*

### Midnight Mission: The Textones Gold Mountain GT 86010, \$8.98.

Sound: B Performance: B+

For years now, record companies have tried to come up with a female equivalent to Bruce Springsteen. There have been several notable failures, Carolyn Mas, Ellen Foley, Ellen Shipley... the list goes on. Carla Olson is the latest female singer/songwriter to try to storm the barriers of male-dominated turf, and this first album with her group, The Textones, is highly promising.

Although she comes off a little more like a female Tom Petty (who, oddly enough, she also resembles physically), she certainly has carved out some of the turf as her own.

You might have already seen Ms. Olson miming to Mick Taylor's guitar solo in Bob Dylan's "Jokerman" video. The Stones connection is no accident; she's a fine guitar player in the Keith Richards mold. On two tracks here, she has employed Ry Cooder to complement her playing with his distinctive slide guitar. Dylan also lent her a new song, "Clean Cut Kid," which she's recorded; a new Dylan tune is always welcome. We're

# Perfect bass...Perfect treble... Perfect sound...forever

**ROTEL** introduces a refreshing new range of audio equipment designed exclusively to appeal to hi fi enthusiasts. Its acceptance in the UK, where Rotel was designed and conceived, is overwhelming.

**HI FI TODAY** says "Rotel have engineered some outstanding products which offer amazing sound and remarkable value".

**NEW HI FI SOUND** says "The sound was open, lively, detailed and enjoyable to listen to, and as for the RA820B amplifier, well, it was a real gem".

**WHAT HI FI** says "The most obvious ability of Rotel is the way it allows music to live and breathe".

**HI FI CHOICE** says "The Rotel system stands out in its ability to play records properly. The stereo soundstage is well defined, and with a good cartridge there is clarity, precision, and evenness of reproduction that allows the music to sound lively and vivid...Quite clearly, its performance is something special".

Listen to Rotel yourself and let us hear what **YOU** have to say.

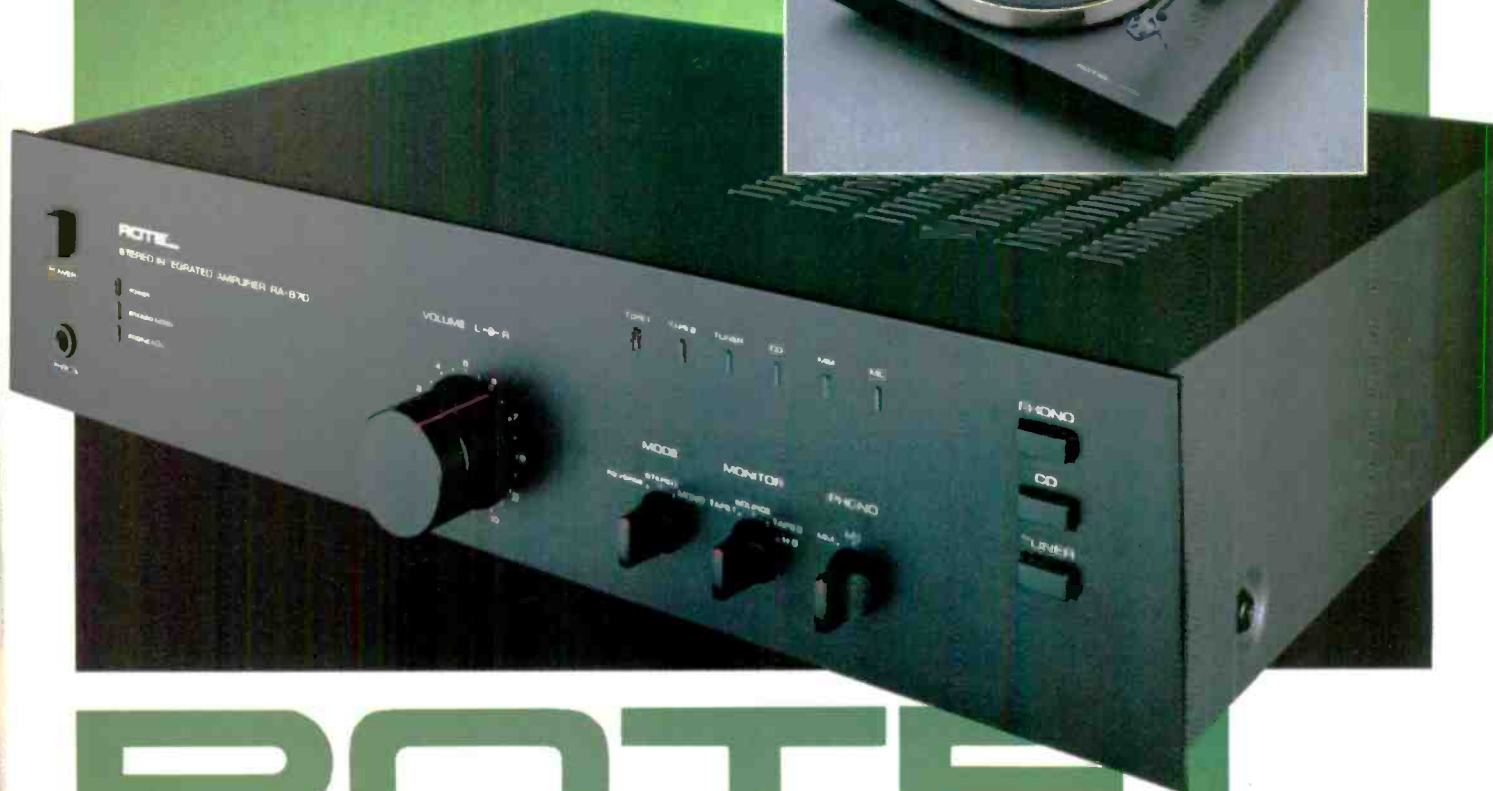

# ROTEL

P.O. Box 653, Buffalo N.Y. 14240 U.S.A. (416) 297-0599

Enter No. 41 on Reader Service Card

# For Accurate and Efficient Reproduction



Loudspeaker efficiency dictates how much power you need to reproduce music accurately at the desired volume. Because Scott speakers are highly efficient, your amplifier has more headroom to meet the demands of today's digital programs, to drive a second pair of speakers and to bring a large room alive with sound.

When compared with many other major brands, Scott speakers will deliver cleaner sound and optimum dynamic range while using substantially less power. It's an audible difference—maximum accuracy and efficiency—all at lower distortion. That's why Scott is consistently rated among the very best by leading consumer publications throughout the world.

Every Scott speaker is a product of over 35 years of outstanding technical achievement. They're designed and manufactured in our U.S. plants, and undergo demanding quality assurance testing to guarantee your satisfaction. And Scott speakers are reasonably priced to fit any budget. Scott—we're ears ahead of our time.

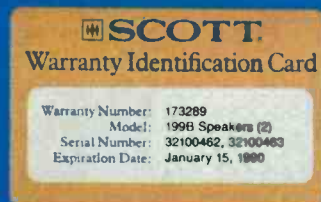

*Scott's unique Gold Warranty Card. Scott's fully transferable 5-year parts and labor limited warranty is your assurance of lasting pleasure.*

## **SCOTT**

Makers of high quality high fidelity equipment since 1947.

For the name of your nearest Authorized Dealer contact:

H.H. Scott, Inc., 20 Commerce Way, Woburn, MA 01888, (617) 933-8800, Telex: 949302, 200265.

Enter No. 23 on Reader Service Card



Only advanced paralysis could keep toes from tapping at Jools Holland's joyful boogie-mania.

not finished yet—the drummer and backing vocalist in The Textones is Phil Seymour, formerly of The Dwight Twilley Band, who helped out on the first two Tom Petty albums.

Now that all the names have been dropped, the question is: How is the music? Very good on the whole, with a fine collection of songs (mostly originals) well-sung and tastefully played. The record is a little on the light side—not exactly a feast for Motley Crue or Ratt fans here—in fact, a bit more grunge might have served nicely, but no matter. *Midnight Mission* is the kind of debut album that any band should be proud of, and it's reasonable to say that The Textones and Carla Olson will be heard from for some while.

Jon & Sally Tiven

**The Story of a Young Heart:** A Flock of Seagulls  
Jive/Arista JL8-8250, \$8.98.

Sound: C+ Performance: C+

They came charging out from the post with the single "I Ran" and their 1982 debut album. Then they faltered with a draggy follow-up in '83. This time around, A Flock of Seagulls sounds a bit confused and introspective.

There's no new "I Ran" here to leap out from the album to the singles chart.

Most of the material is at a loping, medium pace that

AFOS used some-

**All Kinds of Blues:** Memphis Slim  
Bluesville OBC-507, \$5.98.

Sound: B Performance: A-

It has been said that popular music is mostly attitude: One's recorded persona remains lodged in the public's memory long after melodies fade. If this statement is taken as fact, then Memphis Slim's records should be on the front racks of every record store in the country, not lying in the budget

section of a giant record chain which puts Billy Idol in the window. *All Kinds of Blues* is the kind of record you put on if you want to have some company, for

this Peter Chatman fills the room with his presence. If you weren't sure exactly how to define the blues before you heard this record, Memphis Slim clearly lays out the parameters here.

Although this album is several decades old, chances are most modern record companies would have insisted he censor his lyrics on the more sexually oriented tunes herein, but Bluesville let the lyrics slide on by on "If You See Kay" and "Churnin' Man Blues." The album is simply vocals and piano, but Chatman creates such textures with his counter melodies and multi-rhythmic playing that one needs nothing more. The annotation by poet/playwright LeRoi Jones (Imamu Amiri Baraka) is informative, and the price is right!

Jon & Sally Tiven

**Jools Holland Meets Rock 'A' Boogie Billie:** Jools Holland  
I.R.S. SP-70509, \$5.98.

Sound: C+ Performance: B

The title tells a lot here. Jools Holland has made an eight-song mini album with lots of boogie-woogie and heavy doses of rockabilly, swing, and good humor. The album makes a joyful date with boogie-mania strong enough that only advanced paralysis could keep the old toes from tapping.

Six of the eight songs are Holland originals, four of them cowritten with Chris Difford of Squeeze, a band Holland helped found. The other two are fine covers of "Morse Code" and "Flip, Flop and Fly," which was Big Joe Turner's follow-up to the original "Shake, Rattle and Roll."

Holland's frantic piano dominates the proceedings of some genuinely lively recording left (thankfully) ungim-micked to let the fun shine through.

Michael Tearson

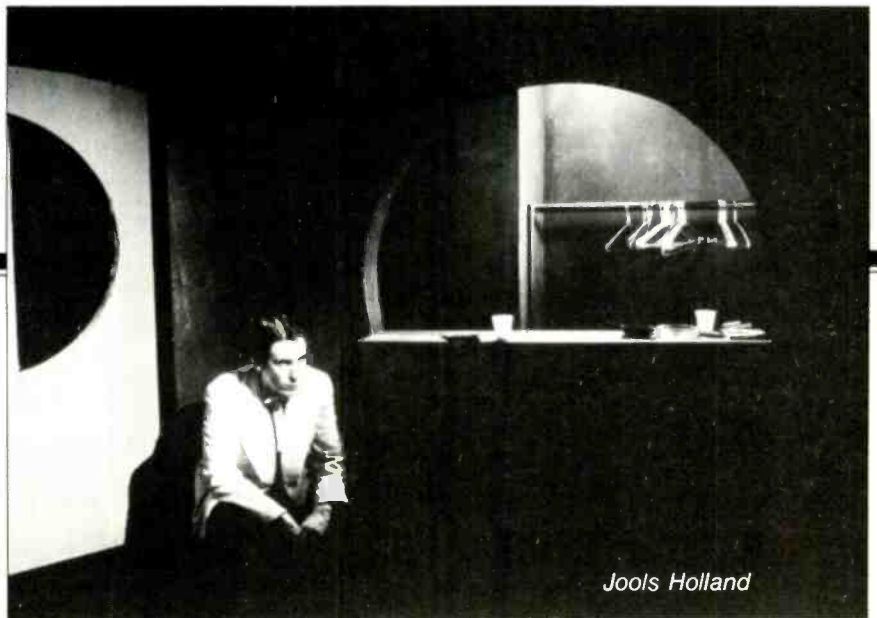

Jools Holland



A Flock of Seagulls

# audio-talk from audio-technica®

Number 10 in a Series

## Back to Basics!

When a disc recording is made, a cutting head, with its diamond cutting stylus, slowly spirals from the outside to the inside of the blank record surface. Inside the cutting head are two coils, similar to speaker coils, except they are both coupled to the cutting stylus instead of speaker cones. Each coil is mounted at a 45° angle to the surface of the record, and at 90° to the other. When the left coil is energized, the cutting stylus is moved from upper left to lower right, while the other coil moves the stylus from upper right to lower left.

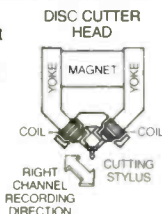

### One Groove...Two Signals

This geometry permits independent signals to be recorded on each face of the V-shaped groove. Signals intended only for the left speaker appear as undulations of only the left-hand groove side, while the other groove wall is smooth and unmodulated. A signal common to both channels results in horizontal motion of the cutting stylus if it is in phase, or vertical motion if out of phase, with both groove walls affected.

### Plain Geometry

If a single magnet in the phono cartridge is used to sense both planes of motion, its entire mass must be moved, no matter what signal is being reproduced. On the other hand, use of *TWO* Vector-Aligned™ magnets can reduce the effective mass of the moving magnets. While each magnet moves back and forth in response to "its" groove wall, it simply rotates in place when the other groove wall is modulated. This axial motion is virtually invisible to the stylus, lessening the apparent mass at the tip.

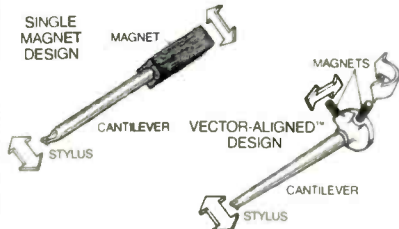

### Better Separation

By completely separating the two magnets and their two entire magnetic and electrical systems, Audio-Technica Vector-Aligned cartridges also ensure the highest possible separation of the differing signals, important in creating a coherent and stable stereo image. Other details of cartridge construction will be discussed in our next column.

Good listening,

*Jon R. Kelly*

Jon R. Kelly, President  
Audio-Technica U.S., Inc.  
1221 Commerce Dr., Stow, OH 44224



**audio-technica.**

The World's Favorite Phono Cartridge

If you've never encountered Bob Marley's considerable genius, this album is a good place to begin, a lovely addition to his legacy.

ognized worldwide as the leading proponent of reggae and the leading force in its emergence from Jamaica into the world.

There were so many great songs written by Bob Marley that *Legend* could easily have been a two-record set, but as a single album of 14 songs, adding up to nearly 55 minutes, it is still a very generous helping. The remastering has generally been nicely done. Five of the songs have been remixed by Eric Thorngren, not all of them to advantage, though the damage is minimal.

Bob Marley



If I might nitpick a bit, it would have been nice to see "Jah Live," a single that never appeared on a Wailers album, just to serve up something rare, but that omission is pardonable. One might pick further nits with the selections included and omitted, but the excellence throughout Marley's work illuminates the album.

If somehow you've never encountered the considerable genius of Bob Marley, *Legend* and the live album recorded in London are the places to begin. If you already are an aficionado, *Legend* makes a lovely addition to a legacy whose importance continues to grow.

Michael Tearson

**A Word to the Wise Guy:** The Mighty Wah!

**Beggar's Banquet BEGA 54, \$9.98**

Sound: B+

Performance: A

The *Mighty Wah!* is, for all intents and purposes, one Pete Wylie from Liverpool, England. Wylie's a wacky guy content to put out a single every year or so and, in the interim, to publicly bicker with whatever record company he's currently signed with. Recently he recorded a version of his new British hit, "Come Back," with altered lyrics about his hate/hate relationship with Warner Bros. which read (as if coming from the mouth of Warners): "We'll get t-shirts and videos/we'll bribe the charts and pay deejays 'cause money talks/we'll get you on the saucy shows . . . come back, it's been over a year/come back, well it is your career. . . ."

Get the picture? All this on top of a backing track as lush as any Phil Spector record using primarily acoustic guitars and synths. Wylie is a phenomenal talent, but the term "legend in his own mind" is most apropos. However, in this world of overprocessed pabulum, a true original is hard to find, and Wylie comes darn close time and again.

Let us not neglect the rest of the band (Washington on bass, Jay Naughton on piano, Chris Joyce on drums, Charlie Griffiths on synths) who make their own contribution to the sound of *The Mighty Wah!* Some may find fault with the record's consistency—"Come Back" is a track of such intensity and power that nothing on the album can match it—but there is a great deal of variety in the approaches Wylie uses from track to track, and on some levels the album fails to be more than a collection of disparate tracks. On the other hand, there is such a variety of genres on *A Word to the Wise Guy* that it wears well. A lyric book is enclosed, as is a special 12-inch version of "Learning the Ways of the World," which is more or less the theme behind the album's lyric content.

*A Word to the Wise Guy* is one of the few important records to come out of England this year, and to ignore it is to be ignorant. "Come Back" is the single of the year so far, and to miss out on it would be a crime for anyone who cares passionately about passionate music.

Jon & Sally Tiven

*The Sight and Sound of*  
**QUALITY**

**YOU CAN SEE AND HEAR**

When you're this good, you put your warranties where your mouth is. That's why, overall, Hitachi probably has the finest limited warranty protection ever offered in home electronics products. Products that perform so well, you may never get a chance to see how good our warranties really are.



**NEW SIGNAL TRACKER COMPONENT TV**

Backed by Hitachi's incomparable 10/2/1 limited warranty, this state-of-the-art 20" diagonal flat square tube receiver/monitor integrates all your home entertainment functions. VCR, VideoDisc Player, stereo system, video games, home computer and total TV reception. Enjoy more on-screen picture and less distortion. And only Hitachi has Signal Tracker control, our most advanced color control system ever. With the handy wireless remote control and wood cabinetry you get ease of operation, great sound and quality good looks.

Simulated TV picture.



**NEW COMPACT DIGITAL AUDIO DISC PLAYER**

Hitachi leads the way in compact disc performance with Laser Life, a two-year limited warranty twice as long as the competition. Introducing the DA-600. Three spot laser pick-up servo system; wireless remote control that reads, selects, repeats, skips and scans; memory programming for up to 15 selections; slim-line, front load design.

**NEW 5 + 2 HEAD HI-FI VCR**

With Adjustomatic, a limited warranty superior to industry standards, the exceptional VT-89A VCR from Hitachi has brought hi-fi technology to video sound. Sound finer than any turntable or conventional tape deck... far superior to ordinary VCRs, it's sound you have to see to believe. Five video heads, two audio heads, cable ready, with a computer brain that guides you through every program function. Each step is displayed on your TV screen.



**HITACHI**

401 W. Artesia Blvd., Compton, CA 90220. (213) 537-8383

## 100 NIP UPS AND COUNTING...



### Good Old Doggie

Fox terriers don't normally live a hundred years, but RCA is officially observing this one's 100th birthday. Nipper is at least as familiar a face as Rin-Tin-Tin or Lassie, since Francis Barraud's painting, "His Master's Voice," has been used as a trademark around the world by Victor (now RCA Victor) and its former affiliates and subsidiaries. One of these, the company which first purchased and used the painting, even changed their name, some decades back, from The Gramophone and Typewriter Company to His Master's Voice—HMV, for short.

### A Straight 25th, With Gain

Nineteen eighty-four marks the 25th anniversary of Harman/Kardon's Citation line. I'd thought it also marked the 25th anniversary of the phrase "a straight wire with gain," which I first encountered in a piece by Hans Fintel on the Citations.

The phrase, however, was not Hans's. He got it from Stew Hegeman, Citation's original designer—who, in turn, disclaims originating it. (He thinks it came from Bell Labs.) Can anyone come up with an earlier citation?

### Sense of Rhythm

In April '83, this column outlined some Lirpa-like suggestions from Joe Lesly, including the "Minus Maestro System," designed to let you conduct orchestras at home by adjusting the sound from the record during play, in response to your hand signals.

Fine. But adjusting the music's tempo to match the conductor's requires that the music's beat be sensed electronically. And how do you do that? The beat *may* be the loudest tone of each measure ("ONE, two, three, ONE, two, three . . ."). But it may also fall on a rest, or be followed by a louder tone. The beat is

frequently marked by the bass . . . but not always.

We can usually find the beat, especially in music which follows patterns that are familiar to us. But we house exceptionally sensitive and elaborate signal-processing computers between our ears. How could a less sensitive and elaborate, electronic computer sense the beat?

I still don't know the answer. But if it is known, the odds are that someone among *Audio's* readership knows it. If you know, or have an intelligent guess to share, write me and I'll pass your answer back to the rest of our readers.

### Indiana Discs

There is, at last, a Compact Disc plant in the U.S., in Terre Haute, Indiana. The Digital Audio Disc Corporation (DADC) is owned by CBS/Sony, which in turn is owned by . . . well, you can guess.

The plant is a complete CD operation, with facilities for editing and inserting track and timing codes into master tapes, cutting master discs by laser, pressing, labelling, and packaging. It's all highly automated, except for the packaging. That's done by hand to allow for "different packaging requirements in different areas" (and, I suspect, to



*The only major operation done by hand is the packaging of the discs, artwork, and liner notes.*



*Above, preparing encoded master tapes in one of the plant's editing rooms. Below, applying the aluminum reflective layer, after molding.*



allow a replacement of the current, plastic "jewel box").

Dignitaries at the September opening included Indiana's governor and lieutenant governor, the mayor of Terre Haute, and executives from the companies involved. Toshio Ozawa, chairman of CBS/Sony and president of DADC, told of explaining to a six-year-old neighbor in Japan that he was going to Indiana to meet the governor. "Oh," said the boy, "Is that Indiana Jones?"

The plant was actually in operation even before the dignitaries cut the ribbon. As proof, visitors received two CDs made there: One was *Born in the U.S.A.*; the other was a special collection of historic Edison-company releases in full, digital mono.

DADC will not just be pressing CBS recordings; we saw several other labels coming off the presses as we toured. Capacity will be 300,000 discs per month by the year's end, with an ultimate capacity of up to 1.2 million per month.

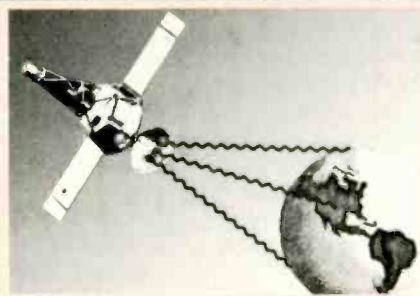

### "CD" by Satellite

The Germans have ambitious plans for their direct broadcasting TV satellite, TV-Sat, due on the air in late 1985. According to a story in *Electronic Engineering Times*, one TV channel on it will carry 16 high-quality audio channels. The 14-bit signals will have 32-kHz sampling frequencies, with no more than one audible error per hour. A German spokesman compared this performance to the Compact Disc, but he's a little off: With those parameters, TV-Sat's audio channels would have about the same 15-kHz top-end limit as today's stereo FM, though with much lower noise (theoretically, -84 dB).

### Timer, Timer, Glowing Bright . . .

Everyone whose tape deck has a "Timer Start" switch raise their hands. Now, every one of you who doesn't have a timer, clench your fists.

Timers are hard to find in this country (Japan makes many, exports few)—and they're never, ever, advertised, so you can't compare their features. In part, that's due to the nature of our FM broadcasting; most stations run the same sort of thing all day, and there's little in the way of "programs" at stated times to tape. Classical listeners may tape specific selections but rarely know when in the course of a program the piece they want will be played.

Still, it would be nice to have a timer as versatile as those on videocassette recorders, able to program a series of on-off times, days in advance, and maybe even to select FM stations for you. (Philips used to make a timer that would do the latter, with their tuner.) It would be even nicer if the timer had a Monday-through-Friday setting, instead of the every-day setting that most VCRs have. Few programs run at the same time for seven days a week.

Sometimes, I get my hi-fi wishes granted. Just as I finished writing this, Akai announced a timer with that Monday-through-Friday setting. Now if only it changed stations . . .



Illustrations: Marc Yankus

### Inconclusive Evidence

Three different companies manufacture Compact Discs for GRP Records: JVC masters and presses them for the Japanese market (where they are GRP's marketing and production licensee), while, to meet U.S. demand, more of the same discs are mastered by Sony and pressed by Sanyo. Was there a difference, GRP wondered, in the sound of CDs made from the same master tapes by these two sources? And how different were LPs from the same master tapes?

A select group of the hi-fi press was invited to hear level-matched comparisons between six versions of GRP's *In the Digital Mood*, recreations of Glenn Miller tunes from the original arrangements. The six versions were: The digital master tape (mixed down and equalized in analog from a digital original, then re-digitized), a JVC-made CD on a Sony player, a Sony/Sanyo CD (GRP-D-5902) on a Sony player, a Sony/Sanyo CD on a Technics player, the

equalized, analog master tape (with Dolby A NR) made from the digital master tape for cassette production, and a fresh copy of the LP version (GRP-A-1002). The object was to find what differences, if any, there were.

There were, it turned out, hardly any—at least, ones that we could hear in the hour or so at our disposal. I thought I heard a slight softening at the high end on the LP, and perhaps a slight extra touch of high end on the analog tape master, but I wasn't even sure of those, and I could hear no difference between the digital versions. Others present couldn't even hear the analog differences that I did, perhaps because the listeners were less directly on the speakers' axes, or perhaps because those differences weren't really there. Larry Rosen (co-owner, with Dave Grusin, of GRP) felt he could hear very subtle differences between the JVC and Sony/Sanyo CDs, but only after long listening—and he wouldn't say just what those differences were.

Even surface noise, usually the

obvious cue in an LP/CD comparison, was no help. The LP was factory-fresh, and the music was loud enough and rich enough in highs to mask any noise that might still have been there.

Conclusion? That the LP can stand up darn well against the CD, if it's carefully made (not all are) and hasn't been played much. Those who buy LPs and tape them at once for posterity have a point, at least as long as CDs cost more than the LP and a blank tape together.

I still think CD is the wave of the immediate future, because of its convenience and its ability to do justice to the still-rare material whose dynamic range or frequency content is too much for the LP. And I wonder what CD's influence will be on LP quality: Will LP makers get their act back together to meet this new competition, or will they simply abandon the quality market to CD and make their analog pressings junkier? The answer, I suspect, will depend on the recording company.

The classical announcer's lot is not a happy one, what with tongue-tangling thickets of unpronounceable foreign names.

### Classical Tongue-Twister

It's not enough for a classical music station like WFMT (subject of an article in our February 1983 issue) to get their music on the air. They also have to announce that music, which can get the announcer into tongue-tangling thickets of hard-to-pronounce foreign names. (I should know, having done it on my college station, WYBC-FM.) Other than that, though, classical announcing can be easy work—you only have to talk every 20 minutes or so, rather than every two or three as pop announcers do. If you think you'd like to be a classical announcer, try reading the following aloud; it's a test, reputedly created by Mike Nichols when he was a WFMT announcer. It was written years ago (before Nichols teamed up with Elaine May to form a sophisticated comedy duo, and long before he went on to his present career as a director of films and Broadway plays). Otherwise, I'm sure that Stanislaw

Skrowaczewski, Krzystof Penderecki and Ivan Moravec would have been included.

"The announcer's lot is not a happy one. In addition to uttering the sibilant, mellifluous cadences of such cacophonous sounds as Hans Schmidt-Isserstedt, Carl Schuricht, Nicanor Zabaleta, Hans Knappertsbusch and the Hammerklavier Sonata, he must thread his vocal way through the complications of L'Orchestre de la Suisse Romande, the Concertgebouw Orchestra of Amsterdam, the Leipzig Gewandhaus Orchestra and other complicated nomenclature.

"However, it must by no means be assumed that the ability to pronounce L'Orchestre de la Societe des Concerts du Conservatoire de Paris with fluidity and verve outweighs an ease, naturalness and friendliness of delivery when at the omnipresent microphone. For example, when delivering a diatribe concerning

Claudia Muzio, Beniamino Gigli, Hetty Plumacher, Giacinto Prandelli, Hilde Rössel-Majden and Lina Pagliughi, five out of six is good enough if the sixth one is mispronounced plausibly. Jessica Dragonette and Margaret Truman are taken for granted.

"Poets, although not such a constant annoyance as polysyllabically named singers, creep in now and then. Of course, Dylan Thomas and W. B. Yeats are no great worry.

"Composers occur almost incessantly, and they range all the way from Albeniz, Alfven and Auric through Wolf-Ferrari and Zeisl.

"Let us reiterate that a warm, simple tone of voice is desirable, even when introducing the Bach Cantata: 'Ich hatte viel Bekümmernis' or Monteverdi's opera 'L'Incoronazione de Poppea.

"Such, then, is the warp and woof of an announcer's existence 'in diesem heiligen hallen' [in these hallowed halls]."

## Outstanding

Designed by Dieter Rams, award-winning ADS Atelier components are rational, uncluttered audio equipment that emphasize both excellent real-

world performance, and human factors. For more reasons why you can't live without them call 800-824-7888 (in CA 800-852-7777) operator 483. Or write to

Chris Browder (our sales manager), ADS, 512 Progress Way, Wilmington, MA 01887. He'll send literature and the name of your nearby dealer.

### T2 Tuner

Digitally synthesized tuning includes unique fine-tuning capability. **1**

16 preset stations, AM or FM. **2**

Plus two other tuning modes; scan and manual. **3**

Excellent selectivity for exceptionally interference-free reception.

"...The T2 (tuner) sounds as good as it looks..."

Computers & Electronics



### A2 Amplifier

Separate inputs for moving magnet and moving coil cartridges.

Rail-switching power supply.

Separate listening and taping outputs. **4**

Audio inputs for VCR or VideoDisc player. **5**

"... (On the A2 amplifier) you find some options that many separates omit, including high-cut and infrasonic filters." *High Fidelity*

### C2 Cassette deck

Cassette drawer illuminated from within. **6**

Drawer slides out under its own power when you push button. **7**

Dolby B & C noise reduction controls placed logically inside cassette drawer. **8**

The musician's tapes ran slow, but logic showed which of his three decks was the culprit.

### Ultra-Compact Disc

CD players, so far, play only albums. Will there ever be a CD single? "Yes, someday," says Polygram's Wolfgang Munczinski. "But not till the demand is there," which puts it a few years down the road.

Meanwhile, the German magazine, *Stereo*, recently ran a picture of a 70-mm (2¾-inch) CD, capable of holding 15 minutes of music. Since CDs are played from the center out, the tiny disc should be playable on any CD unit that can load it. But only machines with accessible drive hubs (including most drawer-loaders but not most players with swing-down loading doors) could handle the mini disc. . . . And, it turned out, the whole thing was a gag: *Stereo's* editors had machined down a conventional CD to make it.

When CD singles do arrive, they'll be full-sized because of the loading problem. The price, says Munczinski, will be "reasonable."

### Armchair Detection

A musician I know recently dubbed some reel-to-reel tapes onto cassette to play in his car. On the car system, however, they sounded slow.

The change in tempo was something he could live with. But he has absolute pitch (the ability to recognize musical pitches by ear), and the resultant tonal change drove him crazy.

I suggested he have his cassette deck's speed checked. If it checked out okay, he should check out the car system. But before he had a chance to follow my advice, a few weeks rolled around and he came back to me, smiling, "The problem's cured itself." That puzzled me—even more so when he told me, two days later, that the trouble had returned again.

This time, I asked some searching questions. I soon discovered that the trouble had come only when he played the tapes he'd dubbed from open reel, and disappeared when he

played other tapes. The problem returned when he played his dubs again—so it wasn't in the car stereo but in the tapes.

Had he listened to the tapes while he was dubbing? No, he hadn't. That left open the question of whether his open-reel or cassette deck was at fault. If it had sounded okay when he was dubbing, the cassette deck would be the culprit, while if it had sounded slow back then, it would be the open-reel deck.

What about the tapes that sounded good—were they commercially recorded cassettes, or had he dubbed them from records or FM? When he said they, too, were dubbed, the problem was solved. His open-reel deck was running slow; the cassette deck was fine, thank you. The problem had been solved by pure logic, without my moving farther than my telephone. And my reputation as an armchair detective had advanced another millimeter.

**P2 Turntable**  
Suspension isolates platter and tone arm to eliminate feedback. Controls located outside dust cover. **11**  
Angled dust cover allows full opening under overhanging shelf. **12**  
Geometry of ultra low-mass tone arm reduces tracking error to theoretical limit. **13**  
"... we believe that (the P2 turntable's) straightforward design contributes to extremely high performance..."  
*Audiophile Buyer's Guide*

Repeat button instructs deck to rewind and replay automatically. **10**  
"The ADS C2 (cassette deck) provides excellent response, well-designed metering, low noise and distortion—all for a moderate price." *Audio*

Bias and Eq controls for all 4 tape types also placed in cassette drawer. **9**

© 1984 Analog & Digital Systems, Inc.

**ADS**

**ADS Atelier.**

## CLASSIFIED ADVERTISING RATES

**BUSINESS ADS**—\$1.40 per word, MINIMUM charge PER AD, PER INSERTION \$33.00. All centered or spaced lines \$11.00.

**NON BUSINESS ADS**—95¢ per word, MINIMUM charge PER AD, PER INSERTION \$17.00. All centered or spaced lines at \$9.00.

**ALL LINE ADS**—First line set in bold face type at no extra charge. Additional words set in bold face at \$1.65 extra per word. One point ruled box is \$12.00.

**CLASSIFIED LINE ADS ARE PAYABLE IN ADVANCE BY CHECK OR MONEY ORDER ONLY.** (Sorry, we cannot accept credit cards or bill for line advertising.) **ALL LINE ORDERS** should be mailed to:

AUDIO/CBS Magazines  
P.O. Box 9125  
Dept. 346V  
Stamford, CT 06925

**ORDERS WILL NOT BE PROCESSED WITHOUT ACCOMPANYING CHECK OR MONEY ORDER FOR FULL AMOUNT.**

**CLOSING DATE**—First of month two months preceding the cover date. If the first of the month falls on a weekend or holiday, the closing date is the last business day preceding the first. **ADS RECEIVED AFTER THE CLOSING DATE WILL BE HELD FOR THE NEXT ISSUE UNLESS OTHERWISE STATED.**

**FREQUENCY DISCOUNTS**—3 times less 5%, 6 times less 15%, 12 times less 20%. These discounts apply to line ads only. Ads submitted for a three time frequency are unchangeable. Frequency discounts not fulfilled will be short rated accordingly. Agency discounts do not apply to line advertising.

**BLIND ADS**—Audio box numbers may be used at \$6.00 extra for handling and postage.

**GENERAL INFORMATION**—Ad copy must be type-written or printed legibly. The publisher in his sole discretion reserves the right to reject any ad copy he deems inappropriate. **ALL ADVERTISERS MUST SUPPLY:** Complete name, Company name, Full street address (P.O. Box numbers are insufficient) and telephone number. Classified **LINE ADS** are not acknowledged and do not carry Reader Service Card Numbers. **AGENCY DISCOUNTS** do not apply to line advertising. **FREQUENCY DISCOUNTS** not fulfilled will be short rated accordingly. Only those advertisers who have prepaid for their entire contract time will be **RATE PROTECTED** for the duration of that contract, in the event of a rate increase.

### CLASSIFIED DISPLAY RATES

1 col x 1 inch	\$275.
1 col x 2 inches	\$435.
1 col x 3 inches	\$622.
2 cols. x 1 inch	\$495.
2 cols. x 2 inches	\$836.

One column width is 2 1/8". Two columns wide is 4 1/4". For larger display ad rates and 6, 12, 18 and 24 times frequency rates call (212) 719-6338.

**DISPLAY ADVERTISERS** should make space reservation on or before the closing date. Ad material (film or velox) may follow by the 10th. **DISPLAY ADVERTISERS MUST SUPPLY COMPLETE FILM NEGATIVE READY FOR PRINTING OR VELOX. PRODUCTION CHARGES WILL BE ASSESSED ON ANY AD REQUIRING ADDITIONAL PREPARATION.**

**ALL DISPLAY CORRESPONDENCE** should be sent to:

Laura J. Lo Vecchio  
AUDIO MAGAZINE  
1515 Broadway  
New York, NY 10036

**FOR ANY ADDITIONAL INFORMATION** contact Laura directly at (212) 719-6338

*Home of High End Values*  
Expert Repairs/Service  
Custom Installation, Liberal Trade-ins, Leasing  
Free Shipping • Accessories • Audiophile Records/CD's  
MC/VISA • Write for Brochure

**AUDIO VISION** 40 Mass. Ave., Lexington, MA 02173  
(617) 863-5221

### ATTENTION READERS:

Please note that only retailers who are authorized by manufacturers to sell their product lines are listed under the heading "AUTHORIZED DEALERS". This particular category is further subdivided into the geographic areas which these dealers serve.

Ads placed by private individuals, manufacturers and retailers can be found in specific categories, i.e., AMPS/PREAMPS. (The letters AD in bold face type at the end of an ad means **AUTHORIZED DEALER**.) We hope this will allow you to easily locate a specific product or service.

**Audiophile's Corner**  
**THE INCREDIBLE TRANSFORMATION**  
**Interlink Reference® from Monster Cable**  
Improves your sound system like no other component that you can add. Featuring Monster's "bandwidth balanced™" system of three "wire networks", Interlink Reference gets the maximum sound out of all your components. Available for audition at:  
**ESOTERIC AUDIO** 27861 Orchard Lake Rd.  
Farmington Hills, MI (313) 553-8240

### AUTHORIZED DEALERS

### NATIONAL

**ABBIE'S AUDIO OFFERS EXCEPTIONAL PRODUCTS,** Berning, Nova, B&K, Lazarus, Robertson, Creek, Watkins, Goetz System, JSE, Spica, M&K, VPI, AR Tables, Souther, Alphason, MMT Premier, Sumiko, Koetsu, Talisman, Audioquest, Monster Cable, Promethean Green, Music Link, Nitty Gritty, and others. Good used equipment and free newsletter. 302 E. High St. Waynesburg, PA 15370. (412) 852-1134.

**ATTENTION: BERNING, ALPHA, SOTA, AR TURNTABLE, DYNAVECTOR, STAX, FULTON, KOETSU, PETERSON, AUDIBLE ILLUSIONS, WALKER, MUSIC & SOUND, ZETA, ALPHASON, DENON CARTRIDGES, ELECTRO KINETICS, SHINON, GOETZ, BRB, OTHERS. CODS. MAURY CORB 713-7284343**

# IF YOU ARE OBSESSIVE ABOUT DIGITAL AUDIO, WELCOME TO THE CLUB.

It's the Sony Digital Audio Club. The world's first club dedicated to creating awareness and understanding of the remarkable technology behind compact disc players—from the company that's most qualified to provide it.

This year, to welcome you to the club, you'll receive special promotions on compact discs; discounts on digital accessories; the club's quarterly newsletter, "The Sony Pulse"; The Sony Book of Digital Audio Technology (with over 300 pages of facts and details); a 30" x 40" digital audio poster; a digitally-recorded compact disc; and extensive information about the latest advances in digital prod-



ucts from Sony—the leader in digital audio.

To become a member, simply mail the coupon below, along with a check or money order for \$15\* to Sony Digital Audio Club, Post Office Box 161, Lowell, Massachusetts 01852.\*\*

And join the thousands of people who are already well on their way to satisfying their obsessions.

**SONY**

THE LEADER IN DIGITAL AUDIO.™

Name \_\_\_\_\_  
Address \_\_\_\_\_  
City \_\_\_\_\_  
State \_\_\_\_\_ Zip \_\_\_\_\_

AM-12/84

\* \$3.00 additional for postage and handling outside the U.S. \*\* Please allow 4-6 weeks for delivery.



**AUTHORIZED DEALERS**

**NATIONAL**

**A BRAND NEW WONDER CAP!!**

A TOTALLY NEW DESIGN from IAR research. It's bigger, it's far better—and it costs LESS! How much better does it really sound, compared to our old Wonder Cap? Excited users have said: SPECTACULAR! UNBELIEVABLE! What will you say when you hear the NEW IAR Wonder Caps™ in your own electronics and speakers? Write for FREE application notes and order forms.

IAR/TRT  
VISTA, CA 92083 AD

**AUDIO ELITE IN WISCONSIN!!!**  
DENON TAPE DECK—FANTASTIC  
DENON TURNTABLES—SUPERB  
WHY DENON? SIMPLE THERE THE FINEST  
AUDIO ELITE, MENASHA, WI, 414-725-4431.

**ATTENTION DYNA, HAFLER, CROWN OWNERS**  
Frank Van Alstine and Associates engineer complete new Transcendence power mos-fet amplifier and precision fet preamp designs to interface with your existing chassis. Original circuits, and their problems, are discarded. Obtain superior performance without buying expensive new hardware. Learn why "underground" magazines claim our rebuilt Dyna 150 is a best buy, our MOS-FET 120B sounds like 150 watts, our FM-5 circuits sound best, and our preamps play music. Call or write for free catalogue and sample Audio Basics monthly newsletter. We ship worldwide. Jensens Stereo Shop, 2202 River Hills Drive, Burnsville, Minnesota 55337 (612) 890-3517.

**AUDIOPHILE START UP SYSTEM**

(\$700)

Turntable: NAD 5120  
Receiver: NAD 7125  
Speakers: AKROYD CONISTON

**SOUND BY SINGER**

165 E. 33rd Street  
New York, NY 10016  
(212) 683-0925

**CONRAD JOHNSON IN WISCONSIN!!!**  
AUDIO ELITE, MENASHA, WI, 414-725-4431.

**ELECTRACRAFT FEATURES** Aiwa, ADS, B&O, Dahlquist, DCM, Denon, Grado, Graco, Mitsubushi, NAD, NEC, Revox, Signet, Spica, Tandberg, Thiel. ELECTRACRAFT, 212 North First Ave., Sandpoint, Idaho 83864, (208) 263-9516.

**BEST DARN TRADES OFFERED.** Dealer for Accuphase, Acoustat, Alpha-1, Audioquest, Audio Research, AR turntables, Beard, Bedini, Belles, Berning, Classe, Counterpoint, Creek, Dual, Duntech, Dynavector, Electrocompaniet, Electro Research, ESB, Goetz, Goldbug, Grace, Grado, Gyro-dec, Hafler, Helius, JSE, Koetsu, MAS, Monster Cable, Music-Link, Oracle, Perreux, Pentagram, Pink Triangle, Premier, Precision Fidelity, PS AUDIO, Pyramid, Rauna, Robertson, Rogers, Snell, SOTA, Spondor, Spica, Souther, STAX, Sumiko, Symdex, Syrinx, VPI, Win-Labs, Nitty Gritty, and more. In the beautiful OZARKS, Audio Doctor, 1518 West Commercial, Box 390, Buffalo, Missouri, 65622. 417-345-7245 Newsletters.

**ACTIVE ELECTRONIC CROSSOVERS**  
NEW DESIGN! MODEL 120  
NOW AVAILABLE

Made to order in bi-amp, tri-amp, and quad-amp configurations with optional level controls, subsonic filters, or summers. Filters, regulated power supplies, equalizers, also available.

Free catalog and price sheet

**DeCoursey Eng. Lab.**

11828 Jefferson Bl. Culver City, CA 90230  
PHONE (213) 397-9668

**AUTHORIZED DEALERS**

**NATIONAL**

**AUDIO CONNECTION**

in Northern New Jersey

**TURNTABLES:** Goldmund, VPI, Heybrook, System-dek IIX

**TONEARMS:** Eminent Technology, Goldmund/Lume, Grado Signature LSTA, Souther

**CARTRIDGES:** Alpha, Decca Super Gold & Van den Hul, Grado & Signature, Promethean

**ELECTRONICS:** Tube—Audible Illusions, Berning, Quicksilver, Jadis 80 (France)  
Solid state—Electrocompaniet, Klyne, FM Acoustics, Leach, Magnum, PS Audio

**SPEAKERS:** Fuselier, Heybrook, Kindel, Rauna, Spondor, Spica, 3D, Vandersteen

**ACCESSORIES:** Goldmund mat/clamp, Last, Live-wire, Decca, Randall, Kimber, Tweek, VPI

201-239-1799  
615 Bloomfield Ave., Verona, NJ 07044

**Quality Tapes**

**BELOW WHOLESALE SPECIALS!**

TDM		SONY			
SA 90	1.85	AD 60	1.45	UCKS 90	2.25
SA 60	1.80	D 90	1.05	UCKX 90	1.99
SAX 90	2.49	D 60	.95	LNIX 90	1.85
SAX 60	2.49	LX 35-90	4.79	LNIX 60	.85
MA 90	4.19	LX 35-90B	5.05	L-500	4.99
MS-X 90/New	4.19	HD-01 D mag	13.49	L-750	5.99
MAR 90	5.99	T-120	5.49	L-750HG	7.95
MAR 60	4.79	T-120 Ex Hg	7.49	T-120	5.49
ADX 90	2.55	L-750	5.99		
AD 90	1.85	L-750 Ex Hg	7.95		
		<b>MAXELL</b>		<b>FUJII</b>	
UDXL H 90	2.09	LN 90	1.15	FR METAL 90	3.49
UDXL II 60	1.85	LN 60	1.85	FR II 90	2.19
XL II S 90	2.65	UD 35-90	4.89	<b>DISCWASHER</b>	
MX 90	4.69	XL 135-90B	6.39	SYSTEM	9.99
UD 90	1.95	T-120	5.49	DHSCSET	16.49
UD 60	1.85	T-120 MGX	7.49	16 oz. Fluid	9.99
		<b>MEMOREX T-120</b>	5.49	<b>MEMOREX METAL C-90</b>	2.39

**CALL NOW 718-434-3417 or order by mail**  
In Continental USA add \$3.50 for shipping on orders up to \$70. Over \$70 add 5% of total order. Elsewhere in USA add \$7 on orders up to \$70. Over \$70 add 10%. Outside USA write. MC/VISA add 3%.

**QUALITY TAPES**

864 East 7th Street, Dept. A12, Brooklyn, NY 11230

**MUSIC, NOT JUST SOUND.**

Our equipment is designed to reveal the full range of music. Hear it all at Chestnut Hill Audio Accuphase, Acoustic Electronics, Amber, Apature, Apogee, Audio Pro, Audioquest, B&K Components, Berning, CWD, Counterpoint, DB, Denon, Duntech, Dynavector, EMT, Entec, Euphonic, Fourier Grace Hafler, Janis, Koetsu, Kiseki, K'rell, LAST, Linn Sondek, Live Wire, Mark Levinson, J A Michell, Monster Cable, Music Reference, NAD, Naim, Oracle, Origin, Pioneer Video, Proton, Pyramid, Quad, RGR, Rogers, Signet, Sony, Souther, Spectral, Spondor, Symdex, Syrinx, Talisman Tandberg, Thorens, 3D Acoustics, VPI, VSP Labs, Vandersteen, Zeta. We are located at 311 Cherry Street, Philadelphia, Pa., 19106 (215) 923-3035

**CHESTNUT HILL AUDIO LTD.**

**Never Before has so Much Praise been Given to an Audio Cable**

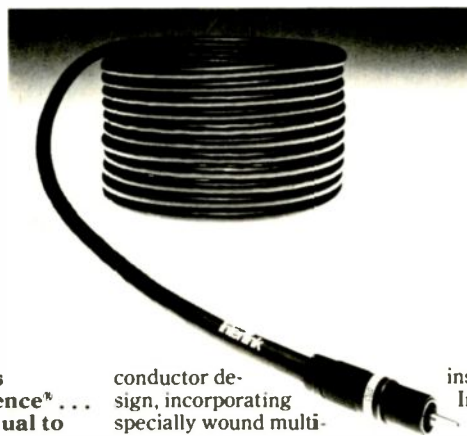

**Monster Cable's Interlink Reference\* . . . Performance equal to the world's finest audio components.**

"Pure harmonic integrity"  
Sound News Journal,  
"Effortlessly revealing"  
International Audio Review,  
"Stunning clarity"  
Stereophile.

It doesn't seem possible, but this is what you'll hear with Interlink Reference incorporating our new "Bandwidth Balanced"™ cable technology. Interlink Reference utilizes a special dual

conductor design, incorporating specially wound multiple gauged "wire networks" to critically align the music signals in both amplitude and phase for the best possible sound with the least distortion.

**The Result?**

Music reproduction so real that the only thing better is a front row seat. Greater dynamic range, lower distortion, and the uncanny ability to precisely place and localize each

instrument . . . make Interlink Reference an indispensable part of your sound system. See your Monster Cable dealer for a demonstration, and see why the critics are raving. Then take some home . . . you'll rediscover how good your entire sound system can really be.

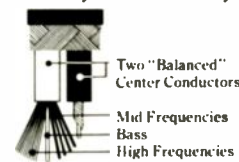

Interlink 4 and Interlink Special are available at less cost and still use the same "bandwidth balanced" design.

Monster Cable® Products, Inc.  
101 Townsend, San Francisco, CA 94107  
115 777-1355 Telex: 470584 MCSYUI

**Interlink® REFERENCE**

## LOWER LOUDSPEAKER DISTORTION

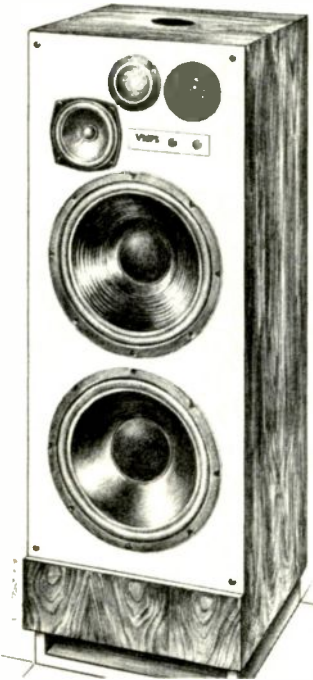

The VMPS Tower II GSO Series, \$419ea kit, \$599ea assem. 43 x 15 x 15-1/2" (HxWxD), 90lbs.

The VMPS Tower II is a six-way, low distortion, high output speaker system of outstanding linearity, bass response, and dynamic range at a most affordable price.

Ironically, many systems now proclaiming themselves "digital ready" do not even approach the Tower II's maximum undistorted output capacity (126dB/1m for 5% THD), high sensitivity (95dB/1W/1m), and low total harmonic distortion (no more than 0.7% from 22Hz to 30kHz/1W drive). In addition, its new quasi-second-order (GSO) crossover filters are the only such networks combining phase coherence and zero group delay with a higher order slope than 6dB/oct; the result is a tactile presence and localization of sound sources, and spaciousness of imagery, achieved without meretricious signal manipulations such as omnidirectional dispersion patterns or phase matrixing.

Hear the GSO Series of floor-standing VMPS speakers at the dealers below, or write us for brochures and test reports. Also available are: the **MiniTower II** (\$309ea kit, \$439ea assem); the **Super Tower/R** (\$679ea kit, \$969ea assem); the **Super Tower IIa/R** (\$999-1199ea kit, \$1499-1699ea assem), and the fabulous **Widerange Ribbon** (\$7500 in the Special Edition featuring all Wondercap crossovers and Discrete Technology wire). And don't forget our famous **Subwoofer** (\$250ea kit, \$375ea assem) and **Electronic Crossovers** (\$250/\$395ea). Kits include fully assembled cabinets and all prices include **free shipping** in USA.

### VMPS AUDIO PRODUCTS

div Itone Audio, 1016 Contra Costa Dr  
El Cerrito, Ca 94530  
(415) 526-7084

Hear VMPS At: The Listening Studio, Boston Ma, Stereotown, Brookings SD; Missoula Trumpet Sales, Missoula Mt; North American Sound, San Angelo Tx, Efficient Stereo, Torrance Ca; The Long Ear, Big Bear Lake Ca; Sounds Unique, San Jose Ca; A-Vidd Electronics Long Beach Ca; Cuomo's Salem NH, Itone Audio El Cerrito Ca, Leisure Electronics Chugiak Ak; Arthur Morgan (rep) Altamonte Springs Fl.

A new standard

## The MIT/Spectral MH-750 Speaker Interface Cable

Tonally Balanced  
Phase Coherent

MIT Dealer  
Inquiries Invited

Technical Paper  
Free on Request



Music  
Interface  
Technologies

1012 Morse Avenue, #1  
Sunnyvale, CA 94089 • (408) 745-0832

### AUTHORIZED DEALERS

#### NATIONAL

##### GOODWIN'S MUSIC SYSTEMS

In New England, Goodwin's is recognized as the leader in high performance audio. Along with the finest in components, we can provide the most sophisticated custom installation tailored to your individual needs. We offer:

Mark Levinson, Magneplanar, Apogee, Soundlab, Quad, Entec, Goldmund, Linn, Oracle, Tandberg, Nakamichi, Bryston, Hafler, Adcom, Celestion SL, Eminent Technology, Nitty Gritty, Walker, AR, Thorens, Infinity, H-K, NAD, Proton, B & W, Rega, Camber, Essence, Janis, Velodyne, Van den Hul, AudioQuest, Monster, Favorite, Kyocera, Stax, Astatic & Grace.

Goodwin's Music Systems, 16 Eliot St., Harvard Square, Cambridge, MA 02138 Tel. 617-492-1140

### AUTHORIZED DEALERS

#### NATIONAL

## AUDIO ONE

PRODUCT OF THE YEAR

Again, it is time to select the Audio One product of the year—the component that has made the most significant contribution to the art of accurate sound reproduction during the past year. For 1984, we are pleased to present the award to Eminent Technology, for their linear tracking, virtually frictionless, air bearing tonearm. Uniquely, this arm combines incredibly low friction (a mere fraction of conventional arms) with the largest and longest bearing surface area (for maximum coupling & rigidity) plus genuine straight line tracking—a feat that is physically impossible in conventional designs. The sonic improvement, particularly in bass definition/impact, vocal & instrumental air/space & localization, ambiance/depth and revelation of subtle harmonic textures is magnitudes greater than we previously believed possible from a tonearm. Equally important, is the \$600 price, making the arm affordable, even to low budget audiophiles. Congratulations Eminent Technology & designer Bruce Thigpen.

##### NEW & EXCITING COMPONENTS

Futtermann Moscode Amplifiers  
Superfon Preamplifier  
Fried Studio IV & MFM Speakers  
Merrill Audio Turntable  
Promethean Green Improved  
Monster Alpha 2 MC  
and

Randall Research Cable Systems  
Mavrick/Spatial preamplifier  
not new, just the very best!

For information and prices, phone:

## AUDIO ONE

8788 SUNSET BOULEVARD  
WEST HOLLYWOOD, CA 90069  
(213) 855-0500

# stereophile

SAVVY EQUIPMENT REPORTS AND SPIRITED EDITORIAL CONTENT

Send \$20 for 10 issues. Stereophile, 1107c Early Street, Santa Fe, NM 87501 or  
Call toll-free 800/821-3528

## NY METRO AREA

ADS AGI APT Astatic Audio Control Audio oncs. Audio Pro Audio Research Audio Technology Beyer Blaupunkt B&O Burwen B&W Carver CAT. Colter CWO Dahlquist DCM Denon Dynavektor Ev. Fidelity Research Grace Grado Hafler Jans KEF Koetsu Linn Sordex L-ve Wire Lustre Nakamichi Pyramid Quad Queen Labs Revox RG Dynamics RGR RH Labs Rogers Snell Stax Symmetry Tandberg 3D Acoustics VPI Yamaha

# Audiocom

high technology audio

SERVICE ON PREMISES • CUSTOM INSTALLATIONS  
THREE LISTENING ROOMS ON TWO LEVELS  
LARGE INVENTORY • PROMPT DELIVERY  
INFORMATION LINE 203-637-3621

177 Sound Beach Avenue, Old Greenwich, CT 06830  
Major credit cards honored. Open 10 AM-6 PM Mon-Sat.

## AUTHORIZED DEALERS

## NATIONAL

CALL TOLL FREE 1-800-826-0520 FOR ACOUSTAT, DAHLQUIST, NAD, MONSTER, HAFLER, DENON, dbx, THORENS, B&W, PROTON, TANDBERG, BELLES, 3D, GRACE, GRADO, PERREAUX, SNELL, VSP, ORACLE, M&K, SUMIKO, PYRAMID, NITTY GRITTY, TALISMAN, STAX, DYNAVECTOR, AUDIOQUEST, CWD, ASTATIC, DCM, SOTA. THE SOUND SELLER, 1706 MAIN ST., MARINETTE, WI 54143 (715) 735-9002.

**EXCEPTIONAL AUDIO REPRODUCTION SYSTEMS**  
REGA, HEYBROOK, LOGIC, THORENS, AR, DUAL turntables; ZETA, REGA, PREMIER, LOGIC, GRACE, LOGIC tonearms; ADCOM, ARCOM, AUDIRE, CREEK, KENWOOD BASIC, KYOCERA, ROTEL, SHERWOOD, VSP LABS electronics; FRIED, HEYBROOK, MORDAUNT-SHORT, MAS, REGA, WATKINS loudspeakers; TALISMAN, SUPEX, GRADO & SIGNATURE, PROMETHEAN, REGA, PREMIER, ARCOM cartridges; AUDIOQUEST, DECCA, NITTY GRITTY, THE PIG, LIVEWIRE and other accessories. EARS, P. O. BOX 658-U, W. COVINA, CA 91790. 818/961-6158 EVENINGS, WEEKENDS. MC/VISA. MANY MONTHLY SPECIALS! (SEND STAMP)

**FM ACOUSTICS**—Swiss made. Find out why music lovers throughout the world would own FMA only! Audio Connection, NJ, 201-239-1799.

### HAFLER—QUALITY AUDIO, MODEST PRICES

We stock all of the following components: DH-100K \$175.00, DH-100A \$225.00, DH-110K \$360.00, DH-110A \$440.00, DH-112 \$75.00, DH-160K \$275.00, DH-160A \$375.00, DH-220K \$400.00, DH-220KE \$410.00, DH-220A \$500.00, DH-220AE \$510.00, DH-330K \$385.00, DH-330A \$460.00, DH-500K \$675.00, DH-500KE \$695.00, DH-500A \$850.00, DH-500AE \$670.00. Accessories too! Three year warranty on assembled units. FREE SHIPPING to all fifty states, PR and APO-FPO. WORLDWIDE EXPORTING. Visa and MasterCard honored. OXFORD AUDIO CONSULTANTS, INC., Box 145, Oxford, OH 45056-0145, 513-523-3333, TLX427791.

## SOUND SERVICE CO.

We proudly represent:

AR Turntable	Futerman OTL	Naim Audio
Accuphase	Genesis	Nitty Gritty
Akroyd	Goldring	Proton
Amplifier	Grace-Supex	PS Audio
Audioquest	Grado	Rega Planar
Beyer	Infinite Slope	RH Labs
Bryston	JSE	Robertson
Burwen	Kenwood Basic	Rogers
Celestion	Kimber Kable	Sonographe
Creek Audio	Koetsu	Soundcraftsman
CJ Walker	Linn Isobank	Spectrum
Dynavector	Linn Sondek	Spica
Electrocompaniet	Livewire	Stax
ESB	Micro Seiki	Talisman
Fuselier	NAD	Thiel

### Sound Service Company

8010 Bustleton Ave. Philadelphia, PA. 19152  
(215) 725-1177-78 Bank Cards Accepted

## DALLAS

AR	Nitty Gritty
Acoustat	Onkyo
Audible Illusions	PS Audio
Audio Source	ProAc
Audioquest	Randall Research
Belles	Reference Recordings
CJ Walker	Robertson
Conrad-Johnson	Sheffield
Electrocompaniet	SOTA
Grace	Sonographe
Grado	Souther
Hairman-Kardon	Spica
Kimber Kable	Sumiko Products
Live Wire	Talisman
Magnepan	Thiel
MAS	Threshold
Monster Cable	VPI

### Omni Sound

4833 Keller Springs Rd.  
Dallas, Texas 75248  
(214) 931-6664

**Q. Can I get "digital" dynamic range from my existing records and tapes?**

**A. Yes,**

with any of the dbx dynamic-range expanders. They increase music dynamics of your present analog records and tapes by up to 50%, and also restore sonic impact that's lost in recording. The result is music realism that's more than just "digital"! Write for details. Better yet, visit your dbx dealer.

**dbx** ... High-Performance Options for Home Stereo Systems  
dbx Inc., Dept. ABXL, 71 Chapel St., Newton, Mass. 02195 Tel. 617-964-3210

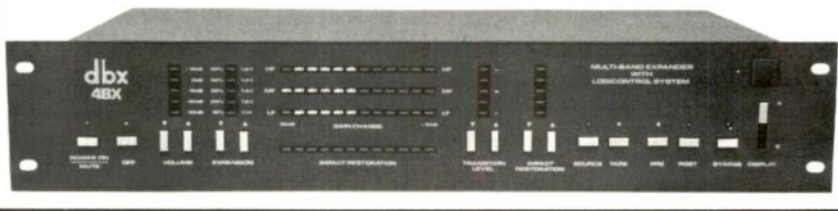

## AUTHORIZED DEALERS

## NATIONAL

**MAGNUM 105 FM**—for clean & strong FM reception. It works! Audio Connection 201-239-1799.

### PS AUDIO—SUPERB!

Free shipping! Fast service! Also Nakamichi, Thorens, Talisman, Proton, Hafler, Klipsch, Adcom, Mitsubishi, SAE, digital discs and players. READ BROTHERS STEREO, 593 King Street, Charleston, South Carolina 29403. (803) 723-7276. AD

## AUTHORIZED DEALERS

## NATIONAL

**NOTICE TO REVOX BUYERS:** Unauthorized dealers are selling Revox products not designated for sale in the USA. STUDER REVOX AMERICA CANNOT BE RESPONSIBLE FOR ANY WARRANTY SERVICING OF PRODUCTS SOLD BY THESE DEALERS. For the location of your nearest authorized Revox dealer, call or write: Studer Revox America, 1425 Elm Hill Pike, Nashville, TN 37210; (615) 254-5651.

## "A Revelation"

Sound News Journal

## "Flawless Reproduction"

Audio Magazine

## "Absolutely Superb Sound"

High Fidelity

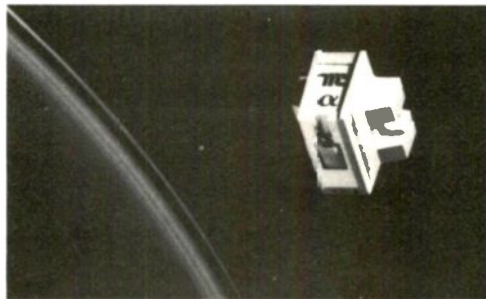

The Alpha 1™ moving coil by Monster Cable

Finally, A moving coil cartridge that all the experts agree on! It's no surprise that critics, manufacturers, and audiophiles alike have given unanimous critical acclaim to the Alpha 1. Our unique "magnetic feedback control" circuit reduces phase and intermodulation distortion for dramatically improved music reproduction that will keep you up nights re-

listening to your entire record collection.

The Alpha 1 recreates the original musical event with unprecedented realism. Hear every instrument clearly placed across the concert hall soundstage in the finale of Berlioz's "Symphonie Fantastique"; feel the gut shaking bass of the Sheffield "Tracks" album, or listen to just how delicate and natural an

instrument can sound in any of the Windham Hill recordings. You will agree with the experts. The Alpha 1 is an exceptional sounding cartridge with few peers.

So meet the digital challenge. Put new life into your analog records by adding the Monster Alpha 1 to your sound system.

*alpha 1*

Call us for the Monster Cable Alpha 1 dealer nearest you. Suggested retail \$175

Monster Cable® Products, Inc.  
101 Townsend, San Francisco, CA 94107  
415 777-1355 Telex: 470584 MCSYU1

## EXTRAORDINARY PRODUCTS

Triplanar Tonearm, Phoenix Preamplifier, SOTA & Oracle Power Supplies, Tiptoes, MacMod Tonearm Termination Box, MacMod Tonearm & Interconnect Cables, MacMod Regulated Power Supply, MacMod Crossover, MacMod Subwoofer.

## EXCEPTIONAL MODIFICATIONS

QUAD 405 amplifiers, Ittok, Premier MMT, Mission 774, Technics EPA-100 & SME tonearms, Belles & Spatial preamplifiers, QUAD 63 & Rogers LS3/5A speakers.

Request a complete catalog from The Mod Squad, 542 Coast Highway 101, Leucadia, CA 92024.

(619) 436-7666

*The Mod Squad*

## In New England...



The knowledge, creativity and dependability you expect from a dealer who represents these manufacturers.

Acoustar	Kiseki
ADS	Magnepan
Alpha	Mission
Audio Interface	NAD
Audio Pro	Nakamichi
Audioquest	Niles
Bang & Olufsen	Nitty Gntty
Boston Acoustics	Oracle
Bryston	Plexus
Carver	Proton
Counterpoint	Pyramid
C J Walker	Robertson
Dennessen	Signet
Denon	SOTA
Dynavector	Stax
Energy	Sumiko
ESB	Tandberg
Grace	Threshold
Hafler	Vandersteen
KEF	VPI
Keith Monks	Wooden Images

5 listening rooms... New England's largest Audiophile record dealer... Keith Monks record cleaning... In-store service... All shipments pre-paid and insured in the continental U.S.

**5 TAKE AUDIO**

105 Whitney Ave., New Haven, CT (203) 777-1750

Mon., Tue., Wed., Fri. 10-6, Thurs. 10-8, Sat. 10-5

**BENNETT SOUND CORPORATION**

*The first wholly new technology in loudspeaker systems in fifty years.*

P.O. BOX 565  
RESEDA, CA 91335  
(818) 345-1608

## AUTHORIZED DEALERS

### NATIONAL

#### OXFORD AUDIO CONSULTANTS, INC.

For nearly ten years, we have been serving the audio cognoscenti, from our pastoral setting here in Oxford, Ohio, with excellent services, superb products and succinct, expert advice. We reach customers not only in Ohio, Kentucky and Indiana but throughout the United States, Puerto Rico and in countries all over the world. OAC specializes in accurate high quality audio components. Our product lines include AKG, AR, Audionics, Dennessen, Grace, Hafler, Janis, Linn, Naim, Spondor, Talsman, Vandersteen and Walker. Demonstrations are given by appointment in our single speaker demonstration room. Most orders are shipped by the next business day. We pay for shipping and insurance on orders shipped to the fifty states, Puerto Rico and APO/FPO. Our extensive export facility ships worldwide. OXFORD AUDIO CONSULTANTS, INC., Box 145, Oxford, OH 45056-0145, 513-523-3333, TLX427791.

## AUTHORIZED DEALERS

### NEW ENGLAND

**CARSTON STEREO IS YOUR** subwoofer headquarters. We feature the JBL subwoofers for the best in bass. If you haven't heard the JBL subwoofers, you probably haven't heard what really good low frequency reproduction can do for a stereo system. The difference is amazing. Carston Stereo, Danbury CT (203) 744-6421.

**TRANSCENDENTAL AUDIO LTD.** offers you the best low frequency reproduction you're likely to hear—a JBL subwoofer. The JBL system is designed to reproduce the lowest octave, the one missing from most full-range systems. And the difference it makes is dramatic. Hear for yourself at Transcendental Audio, 773 Niagara Falls Blvd., Amherst, NY.

### MIDDLE ATLANTIC

**BRYCE AUDIO WANTS TO HELP** your stereo system reach new lows—with a JBL subwoofer. Not only will the JBL B380 or B460 give you the bottom octave that's missing from most full-range systems, it will improve midrange reproduction by relieving the full-range woofers of responsibility for the lowest frequencies. Hear what a JBL subwoofer can do for your system at Bryce Audio, 115 West 40th St., New York City. (212) 575-8600.

**EVER WONDER WHAT REALLY GOOD DEEP BASS SOUNDS LIKE?** Head on over to Cosmophonic Sound and wonder no more. We'll show you the remarkable JBL subwoofer, a speaker that reproduces the lowest octave with clarity and accuracy. Today's best sound sources have plenty of good deep bass, and only a JBL subwoofer will let you hear it the way it's intended to be heard. Cosmophonic Sound, 1614 2nd Avenue, New York City. (212) 734-0459.

## Three of the Best Kept Secrets in Audio: Straightwire II™ TransMos™ • Gold Edition

For five years VSP LABS has been quietly producing some of the finest audio products available. Now the secret is out. Engineered for excellence, designed for a long life, tested to the highest standards, VSP LABS is proud to produce such fine products. So proud, in fact, that we would like to share our secret with you. For literature and product reviews, please call or write to:

VSP Labs,  
670 Airport Blvd.,  
Ann Arbor, MI 48104



Only the music remains.

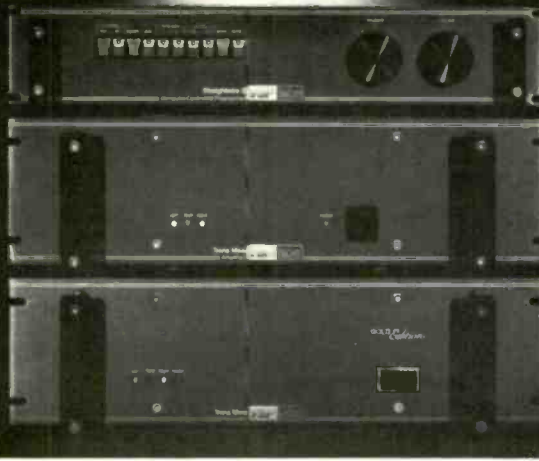

## AUTHORIZED DEALERS

### MIDDLE ATLANTIC

ADIRONDACK MUSIC can put the excitement back in your stereo system—with a JBL subwoofer. Even the best systems often can't deliver the bottom octave—but a JBL subwoofer gives it to you with the punch and power of the original performance. The improvement is little short of amazing. Adirondack Music, Commercial Drive in New Hartford, NY.

### SOUTHEAST

CUSTOM SOUND INVITES you to stop by and discover the missing octave—the truly deep bass that gives music its foundation. We feature JBL subwoofers—the world's best. JBL subwoofers restore that missing octave, and once you hear it you won't want to live without it. Custom Sound in Athens, GA (404) 549-4844; in Augusta (404) 738-8181; and in Montgomery, AL (205) 279-8940.

EVEN IF YOU HAVE exceptional full-range speakers, you're probably missing most of the lowest octave. It takes a JBL subwoofer to bring out the lowest notes in today's top recordings and let you hear them at proper volume levels. Hear what this remarkable JBL subwoofer can do—come to Mac's TV and Audio Showcase in Morganton, NC (704) 437-2494.

IF YOU DON'T HAVE a JBL subwoofer, you're missing your bottom octave. We didn't realize how much low frequency information is on today's top recordings until we hooked up our JBL subwoofer. This system made a tremendous difference, and once you've heard it, you won't live without it either. We have JBL on display at Todd's Stereo Center, Greenville, NC (919) 756-2257 or 756-2293.

LEE HARTMAN & SONS is the place to go when you want the best in bass. We have the JBL subwoofers, outstanding systems that reproduce the lowest octave with clarity and power. Even the best full-range systems can benefit—and the difference is dramatic. Hear for yourself at Lee Hartman & Sons, 3236 Cove Rd., Roanoke, VA.

ONCE YOU'VE HEARD a JBL subwoofer system, you won't want to live without it. A JBL B380 or B460 will let you hear the bottom octave, the octave missing from most full range speaker systems. And the sound is crisp and tight. Hear JBL subwoofers at Mellon's Pro Sound in Atlanta (404) 873-4484. Also in Doraville, GA.

## ASTOUNDING loudspeakers from

# EUPHONIC AUDIO

RR1 Box 246 New Egypt, N.J. 08533 801-929-2613

## RECORD CLEANING PERFECTED

Cheap record brushes, static guns, and ointments leave damaging garbage in your record grooves! Nitty Gritty leaves only a purified record and will save your precious record collection. In the long run it will save you \$ as well.

Six affordable models to choose from, starting at \$239.

## NITTY GRITTY

RECORD CLEANING SYSTEMS

4650 ARROW HWY #F4  
MONTCLAIR, CA 91763  
714/625-5525

**Q** Do I need to add a subwoofer to get the deep bass I feel at concerts?

**A** Not necessarily.

With the dbx 120X, you'll regain the deep bass lost in recording. For even further bass definition, the new 120X includes an active, phase-coherent crossover for use with any subwoofer. Write for details. Better yet, visit your dbx dealer.

**dbx** ... High-Performance Options for Home Stereo Systems  
dbx Inc., Dept. ASHL, 71 Chapel St., Newton, Mass. 02195 Tel. 617-964-3210



## AUTHORIZED DEALERS

### SOUTHWEST

HI-FI SALES OF MESA wants to introduce you to true low frequency reproduction, the kind you can't get from most full-range systems. But you can get it from a JBL subwoofer. The JBL B380 and B460 will let you hear the deep bass that's on today's top recordings, and hear it with clarity and accuracy. Hi-Fi Sales, 810 W. Main, Mesa, AZ.

## AUTHORIZED DEALERS

### SOUTHWEST

JERRY'S CONCEPTS in Home Entertainment Environments now brings you the ultimate in low frequency reproduction—the JBL subwoofer system. Yes, JBL makes the best subwoofers around—the only ones we know of that deliver clean, natural deep bass. Even the best systems can benefit. Jerry's Concepts in Phoenix (602) 263-9410.

## Introducing a Component for the Most Important Part of Your Sound System... Your Listening Room.

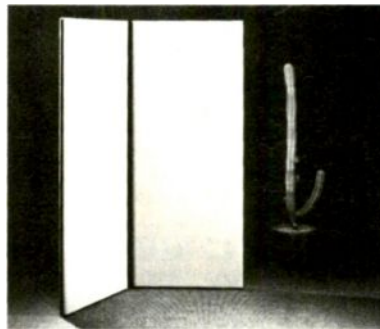

Soundex™ Acoustic Control Panels

Monster Cable presents a new concept in acoustic room control that will provide a new level of listening enjoyment.

Audio experts have told us for years that our listening room is critical to a proper sounding audio system. And indeed, it's true. The acoustics of your listening room can make or break the entire investment that you have in your sound system. But there was very little that we could do about

it... until now.

Introducing Soundex for effective, attractive control of room acoustics. Utilizing a special combination of acoustic materials, Soundex controls room reverberations and lets you enjoy the sound of your system without room coloration. And unlike other sound absorbing products, Soundex absorbs sound smoothly and evenly, without dips and peaks in the frequency response that will "color" the

sound. Covered in premium decorator fabric, Soundex is easy on the eyes as well as the ears.

Optimize your sound system... and your listening room with Soundex by Monster Cable.

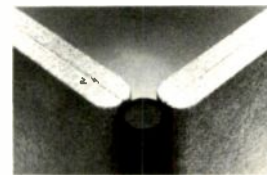

**SOUND**EX™

Send for our no charge brochure or call us for your nearest Monster Cable Soundex dealer.

Monster Cable® Products, Inc.  
101 Townsend, San Francisco, CA 94107  
415 777-1355 Telex: 470584 MCSYU1

# MUSIC TO YOUR EARS

**PREAMP AMP** Audio Research • Sony Esprit • SAE-X  
**SPEAKERS** Infinity RS-1B • B&W 808  
**TURNTABLE** Oracle Adelphi • Micro-Seiki BL-111  
**CARTRIDGE** Black Koetsu • Accuphase AC-2 • Alpha 2  
**CASSETTE DECK** Tandberg TCD-3014 • Nakamichi Dragon  
**TUNER** Tandberg TPT-3001A  
**VIDEO** Mitsubishi Monitors • Kloss Novabeam

## Avenue ParkAudio

425 Park Avenue South at 29th Street New York, N.Y. 10016 212 685-8101/3102

For accuracy, quality and reliability, we carry and demonstrate:  
 AUDIO RESEARCH • SONY ESPRIT • SONY ES SERIES • MCINTOSH •  
 NAKAMICHI • SAE-X • BLACK KOETSU • ACCUPHASE AC-2 • ORACLE •  
 B&W • QUAD • MERIDIAN • ESB • BANG & OLUFSEN • TANDBERG •  
 KIRKSAETER • SHAHINIAN ACOUSTICS • PIONEER LASER-VISION • DENON •  
 INFINITY • MITSUBISHI • LUXMAN • SIGNET • KLOSS NOVABEAM •  
 ADS • PROTON • MONSTER CABLE

### AUTHORIZED DEALERS

#### SOUTHWEST

##### GENE RUBIN AUDIO—LOS ANGELES

Linn Sondek	Naim Audio	Isobaniks
Thorens	Conrad-Johnson	Acoustat
C.J. Walker	Creek	Spendor
Acoustic Research	NAD	Celestion
Dual	Precision Fidelity	PS Audio

Pre-paid shipping, (818) 571-1299, (Pac. time)

##### LINN-NAIM TRI-AMPED SYSTEM

Experience this world renowned reference SYSTEM in Arizona exclusively at THE LISTENING POST (602) 967-1250 Tempe, since 1979.

#### MIDWEST

ANY STEREO SYSTEM, no matter how good, can benefit from a JBL subwoofer. These are the best subwoofers we've heard; they reproduce the lowest octave with clarity and depth. And the midrange of the stereo speakers is cleaner too. Hear how a JBL subwoofer will improve your system, at Meyer Television and Audio in Edwardsville, IL (618) 656-4620.

AUDIO EMPORIUM, representing hifi's best values. Free Catalog, 6914 W. Brown Deer Rd., Milwaukee, WI. 53223. 414-354-5082. **AD**

## SAEC TONEARMS

THE TONEARM OF CHOICE AMONG JAPANESE AUDIOPHILES

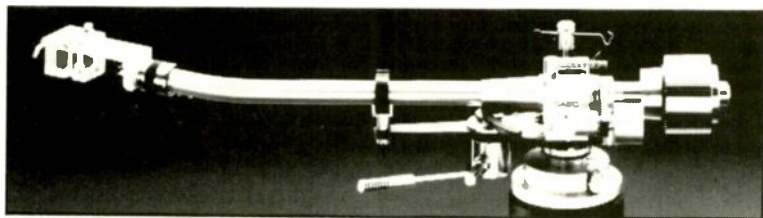

Announcing. Superb engineering, quality construction, and precision manufacturing in the U.S. we offer eight different tonearms, priced from \$250 to \$850. Each uses the SAEC patented Double Knife Edge Bearing for excellent sound reproduction.

FOR OUR FULL LINE BROCHURE AND DEALERS INQUIRIES, WRITE:  
 ANALOG EXCELLENCE, P.O. BOX 69A97, LOS ANGELES, CA 90069

## HIGH-PHONIC MC CARTRIDGES

CREATED BY AUDIO ENGINEERS FOR AUDIOPHILES

High-phonics pure moving-coil cartridges will track even the most difficult passages at just 1 gram — or less! Exceptional imaging and sound stage. Illustrated The MC-R5 Specifications Especially narrow ultra line contact stylus Response 10-75 000 Hz Channel separation 34 dB Channel Balance within 2 1000ths mV. for superb imaging in this superior to any other cartridge. Four MC cartridges priced at \$225 to \$1 200

FOR FULL DETAILS AND DEALERS INQUIRIES, WRITE:

ANALOG EXCELLENCE, P.O. BOX 69A97, LOS ANGELES, CA 90069

### AUTHORIZED DEALERS

#### MIDWEST

B&B APPLIANCE will HELP your stereo system reach new lows—with a JBL subwoofer. The JBL B460 and B380 will let you hear all the low bass that's in today's best recordings—and when you hear it, you won't want to live without it. Hear these remarkable JBL subwoofers at B&B Appliance in Middleburg Heights, OH (216) 842-5600, and in Cleveland (216) 261-5600.

DIGITAL SIGHTS AND SOUNDS features new lows in audio—the best subwoofers we've ever heard. And they're from JBL! The JBL subwoofers reach down and bring back the bottom octave that's missing in just about all full-range systems. You owe it to yourself to hear what we're talking about. Digital Sights & Sounds, 783 Bethel Rd., Olentangy Plaza, Columbus, OH.

GOURLEY PRO AUDIO now has the world's best subwoofers—from JBL! The JBL B380 and B460 bring you the bottom octave that's missing from most full-range systems. Today's best recordings really benefit from a JBL subwoofer—the difference is dramatic! Hear JBL at Gourley Pro Audio, 400 N. Main, Sioux Falls, SD.

IN BLOOMINGTON, THE PLACE TO GO to add new lows to your stereo system is American Audio-Video. We feature the best subwoofers you'll find—and they're from JBL! We think that only JBL can reproduce both the power and the subtlety of the low bass on today's best recordings. Come in and hear what we mean. American Audio-Video, Bloomington, IN. (812) 334-1905.

QUITE A CHALLENGE, but there is a way to add the lowest octave to your stereo system. Hear a JBL subwoofer, and you'll be amazed at the clarity and power it adds to even the best full-range systems. Since you hear it, you won't want to be without it. Come to Stereo Center, Flint, MI (313) 239-9474.

RED BARON'S INC. IS PROUD to feature JBL subwoofers, the very best. The JBL B460 and B380 reproduce the lowest octave with clarity and depth, and they reach the volume levels that make such bass stunning in its impact. After you hear what a JBL subwoofer can do for your favorite state-of-the-art recordings, you'll wonder how you lived without it. Red Baron's in Wichita, KS (316) 684-6572.

SO YOU THOUGHT SUBWOOFERS were only for reproducing cannon shots? When you hear the JBL subwoofers, you'll find out how much one of them can add to any good recording. In fact, when you hear what really good bass actually sounds like, you'll wonder how you ever got along without one... even if you don't like cannon. Sound World in Appleton, WI (414) 733-8539 and in Green Bay (414) 499-4519.

#### NORTHWEST

DEEP BASS THAT'S REALLY crisp and clean? You bet, when you have a JBL subwoofer. Audition the JBL B380 at the Sound Wave in Pocatello and you'll hear how much bass there really is in today's best recordings. Only JBL can give you the bottom octave with such clarity and power. Hear it at the Sound Wave, 416 S. 5th Ave., Pocatello, ID.

*Esoteric Audio*

Orchard-12 Plaza  
 27861 Orchard Lake Rd  
 Farmington Hills, MI 48018  
 (313) 553-8240

MICHIGAN'S FINEST SOUND SHOP

ELECTRONICS	AUDIBLE ILLUSIONS CONRAD JOHNSON, PS AUDIO ELECTROCOMPANET VSP LABS. HARMON KARDON JVC ARISTON V.P.L. PINK TRIANGLE, MICHELLE GYRODEC
TURNTABLES	SUMIKO PREMIER MMT SUMIKO TALISMAN ARM. SUMIKO MDC 800 THE ARM ZETA DYNAVECTOR
TONEARM	ALPHA I ALPHA II TALISMAN ALCHEMIST ORTOFON AUDIOQUEST
CARTRIDGE	SPICA THIEL, PROAC, KINDELL
LOUDSPEAKER	CELESTION SL6 & SL600 MONSTER, MIT CABLE SHEFFIELD REFERENCE RECORDINGS WILSON
ACCESSORIES	AUDIO-PLUS NITTY GRITTY LAST TWEAK VPI BRICKS GORNISE CABINETS

(313) 553-8240  
 ORCHARD-12 PLAZA, FARMINGTON HILLS 48018

## AUTHORIZED DEALERS

### NORTHWEST

**MARK'S CUSTOM STEREO** now features the world's best subwoofers—JBL! That's right—JBL! The JBL B460 and B380 restore the bottom octave that's missing from most stereo systems—and once you've heard true deep bass, you won't want to live without it. We wouldn't. Hear it all at Mark's Custom Stereo, Ontario, OR (503) 889-8855.

**ROCKY MOUNTAIN HI-FI WANTS** to help you find the missing octave in your stereo system—the lowest octave. Most full-range systems simply can't reach that low. But a JBL subwoofer can. These are the best subwoofers we've ever heard, and adding one to your system will make a dramatic difference. Rocky Mountain Hi-Fi in Great Falls, MT (406) 761-8683.

**THE SOUND TRACK NOW OFFERS** the world's best subwoofers—JBL! That's right, JBL. The B380 and B460 reproduce the lowest octave, the one missing from most systems. From thunderous crescendos to delicately played tympani, a JBL subwoofer brings out the best in your best recordings. The Sound Track, Boise, ID (208) 375-5530.

### WEST

**FIDELITY SOUND OF ORANGE** wants you to hear low frequency sound so good you won't believe it's from a speaker system. But it is—and from a JBL subwoofer system. There's really no other way we know of to get true deep bass. The JBL subwoofers are the best around. Hear them at Fidelity Sound, Orange, CA (714) 997-3030.

**GRAMOPHONE SHOP, INC.** now offers the world's best subwoofers—and they're from JBL! That's right—JBL's subwoofers deliver the truest low bass reproduction we've heard. Today's best recordings demand these systems, and so will you when you hear them. Come in now—the Gramophone Shop in Denver (303) 744-1283.

**KUSTOM HI-FI IN BURLINGAME** wants to introduce you to the best in low frequency reproduction—a JBL subwoofer. From cannon to contrabassoon, a JBL subwoofer gives you all the power—and the detail—that's present in the lowest octaves. We wouldn't live without it. And we think you'll feel the same way. Kustom Hi-Fi, 220 California Drive In Burlingame, CA.

**LISTEN UP BRINGS NEW LOWS** to the mile-high city—subwoofers from JBL! JBL makes the best low frequency loudspeakers around, and the B380 and B460 subwoofers are what you need to hear the bottom octave that's missing from just about all full-range systems. Hear what we're talking about at 685 S. Pearl St. in Denver.

**MATEO HI-FIDELITY** is now featuring the ultimate low in stereo sound—a JBL subwoofer system. JBL makes the best low frequency loudspeakers in the world, subwoofers that cleanly reproduce the bottom octave that's missing from most stereo systems. Today's best recordings demand equipment of this caliber. Mateo Hi-Fidelity, San Mateo, CA (415) 573-6506.

**NO QUALITY STEREO SYSTEM** should be without a JBL subwoofer. Come to Sunnyvale Electronics and hear what these spectacular speakers can do for you. With a JBL subwoofer, you'll hear the lowest octave, and hear it cleanly and crisply. Sunnyvale Electronics in Sunnyvale, CA (408) 736-1323.

Luxman  
Harmon Kardon  
Tandberg  
Boston Acoustics  
Audio Control  
Sherwood  
Hitachi  
Denon  
Revox  
Onkyo  
Ortofon  
Hafler  
Thorens

ADS  
AIWA  
Grace  
M&K  
B&O  
SME  
& Many More

# Get It Free!

We Deliver FREE  
Anywhere in the  
Continental USA!

**the SOUND Approach**  
6067 Jericho Tpke., Commack, NY 11725  
Charge It...Call 516-499-7680

## Q. Are dbx Program-Route Selectors really the best switchers I can get?

## A. Yes.

With the dbx 400X or 200X you can add up to three tape decks, three signal processors and a noise-reduction unit—and route them with push-button ease. What's more, they're affordable and attractive. Write for details. Better yet, visit your dbx dealer.

**dbx** ... High-Performance Options for Home Stereo Systems  
dbx Inc., Dept. ASWL, 71 Chapel St., Newton, Mass. 02195 Tel. 617-964-3210

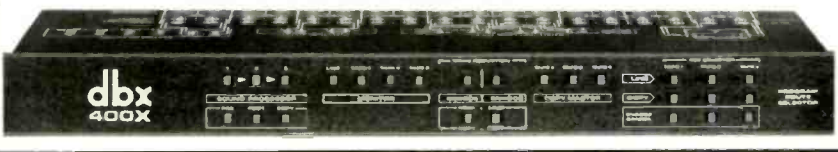

## AUTHORIZED DEALERS

### WEST

**PERFECTION** in audio reproduction is hard to find... but you should listen to a JBL subwoofer system. With today's fine signal sources, you'll hear the lowest octave the way it should be heard. A JBL subwoofer will improve any stereo system. Hear what it can do at Serra Stereo in Colma, CA (415) 992-5018.

**STEREO SHOWCASE NOW FEATURES** an indispensable part of the ultimate stereo system—a JBL subwoofer. JBL makes the best low frequency loudspeakers we know of, and you won't believe how good the sound is until you've heard one. The impact is stunning. Hear for yourself at Stereo Showcase in Vallejo, CA (707) 552-1515, and in Sacramento (916) 483-5141.

**THRIFTY ELECTRONICS CAN SHOW** you how to take your stereo system to new lows—with a JBL subwoofer. The JBL subwoofers will reproduce the bottom octave of music, the octave that's missing from even the best full-range systems. JBL brings it to you cleanly and powerfully. Hear JBL at Thrifty Electronics in Van Nuys, CA (818) 786-1610. (819) 873-2976.

**UNLESS YOU HAVE A JBL SUBWOOFER**, you're probably missing out on hearing the lowest octave. From cannon to contrabassoon, there is a lot of music down there, and it takes a JBL subwoofer to reproduce it with the clarity and power of the original performance. Hear JBL at Metro Stereo, Fresno, CA (209) 221-0500. Also in Visalia.

### Quotes From the letters page of **HI-FI SOUND MAGAZINE**

"One of the classiest, well-designed and informative audio magazines around"

"It is a breath of fresh air. Keep up the GREAT WORK (and sense of humor)!"

"I still can't believe what I'm looking at is a BS-free, garbage-free magazine. Only in Canada you say?"

"I recently picked up a copy of your magazine and was impressed. Ever since **Audie Critic** disappeared I've been lost!"

"I don't know who writes your copy but it's good."

"It took me all of five minutes to make up my mind about subscribing."

**For a one-year subscription (six issues) send \$18 (US funds) to HI-FI SOUND MAGAZINE  
Box 316, Station A  
LONGUEUIL, Que. Canada J4H 3Z2**

## VANDERSTEEN AUDIO DIMENSIONAL PURITY

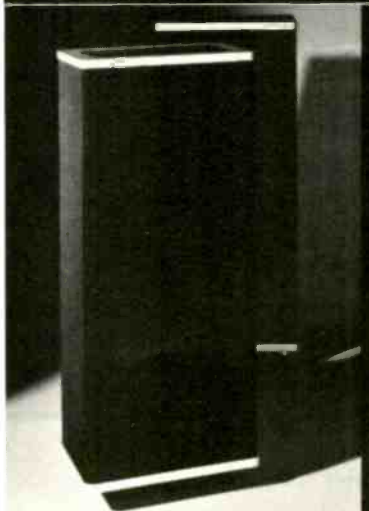

Vandersteen Audio was founded in 1977 with the commitment to offer always the finest in music reproduction for the dollar. Toward this goal there will always be a high degree of pride, love, and personal satisfaction involved in each piece before it leaves our facilities. Your Vandersteen dealer shares in this commitment, and has been carefully selected for his ability to deal with the complex task of assembling a musically satisfying system. Although sometimes hard to find, he is well worth seeking out.

Write or call for a brochure and the name of your nearest dealer.

**VANDERSTEEN AUDIO**  
116 WEST FOURTH STREET  
HANFORD, CALIFORNIA 93230 USA  
(209) 582-0324

# MOREL INTEGRA



MOREL'S "INTEGRA" AUTO FIDELITY loudspeakers provide the perfect solution to high-quality sound reproduction in the car. Morel's system differs from conventional coaxial systems which use two separate drivers that have to be mounted mechanically together. The "Integra" concept is based on a two-way coaxial system consisting of two magnets - one for the dome tweeter and one for the woofer - integrated on a single axis. Similar in their high power-handling and excellent sound to the Morel driver units for home loudspeakers, the Morel Integra auto fidelity loudspeakers are durable and rugged enough for use in any type of vehicle.

## INTEGRA - 1

Integrated 2-way 8" / Dome Tweeter (Adapted for bi-amp)

Power Handling Capacity	100 Watts RMS
Frequency Response	45-25000 Hz
Woofer Type	6" Dia., 3" Aluminum voice coil
Tweeter Type	Soft dome, Aluminum voice coil
Ferrofluid Cooling/Damping	Yes
Impedance	4 ohms
Sensitivity 1W/1M	91 db
Magnetic Structure Weight	2.3 lbs./1.05 Kgs.
Dimensions	160mm/8 1/4" Dia., 67mm/2 3/4" Depth
Mounting Depth	53mm/2 1/4"
Net Weight	2.85 lbs./1.3 Kgs.
Front Grill	Integral metal grill

## INTEGRA-2

Integrated 2-way 8" / Dome Tweeter (Adapted for bi-amp)

Power Handling Capacity	120 Watts RMS
Frequency Response	35-25000 Hz
Woofer Type	8" Dia., 3" Aluminum voice coil
Tweeter Type	Soft dome, Aluminum voice coil
Ferrofluid Cooling/Damping	Yes
Impedance	4 ohms
Sensitivity 1W/1M	92 db
Magnetic Structure Weight	2.3 lbs./1.05 Kgs.
Dimensions	220mm/8 3/4" Dia., 75mm/3" Depth
Mounting Depth	57mm/2 1/4"
Net Weight	3.3 lbs./1.5 Kgs.
Front Grill	Integral metal grill

Please write for details:



### morel acoustic usa

414 harvard street, brookline, mass. 02146  
u.s.a. tel. (617) 277-6663

### morel acoustic ltd

industrial area b, p.o.b. 140, ness ziona  
70 451 israel. tel. 08-470796, telex 361951

# Your Ears Will Smile!

"The new MC44 from Fidelity Research renders such a spectacular stereo image that, on a good system, you almost feel you can walk around the musicians."

"This cartridge delivers all the depth and detail of the original master tapes... better than anything I've ever heard!"

"Your ears will smile."

Gary Giorgi



**fidelity research  
of america**

a division of Giorgi.Com

P.O. Box 1079, Simi Valley, CA 93062

(805) 584-1445



## AUTHORIZED DEALERS

### WEST

WOODEN SHIP STEREO OF AUBURN wants to introduce you to the best low frequency reproduction you're likely to hear—a JBL subwoofer. That's right—JBL makes a superb subwoofer system that lets you hear the bottom octave that's missing from most setups. Hear what JBL can do for you at Wooden Ship Stereo in Auburn, CA (916) 823-1493.

YOU WON'T BELIEVE THE DIFFERENCE a JBL subwoofer can make in even the best stereo systems. For the first time, you'll hear the bottom octave the way it was intended to be heard. No boom, no mud, just clean, deep bass. Hear it at Speaker Works, 211 E. Katella in Orange, CA, or 16460 Whittier Blvd. in Whittier.

## AMPS/PREAMPS

A HIGH END PREAMP for \$495? The Counterpoint SA-7 is the audiophiles' choice. Hear it at Musical Images in Fresno. (209) 226-1770. **AD**

AUDIO PERFECTION IN MINNEAPOLIS presents Counterpoint. Hear what music sounds like without Solid State devices. (612) 866-0083. **AD**

AUDIO RESEARCH—AMP-D100B & PREAMP-SP4-\$1300. HAFLER AMP & PREAMP-NEW-450. PHONE 414-654-9108.

AUDIO RESEARCH D-160-D REVISED amplifier. Immaculate condition. \$1,995. Jerry (313) 353-4148.

AUDIO RESEARCH SP-6E, just checked and factory packed, three year factory warranty: \$1095. The best version of this classic preamp. ABSOLUTE AUDIO 714 547-4497

## AMPS/PREAMPS

BEST DEALS, EXPERT HELP! Conrad Johnson, Classe', Counterpoint, Robertson, PS. Audio, Audire, SUMO, NAD, SOTA, VPI, AR, Thorens, Spica, Fuselier, Vandersteen, Fried, Dahlquist, Etc. Crosby's Hobbs, N.M. 88240 (505) 393-3923.

## BIG TEN SYSTEM

(ABOUT \$10,000)

Turntable:	Linn Sondek Lp-12
Tonearm:	Syrinx PU-3
Cartridge:	Kiseiki Blue
Tuner:	Adcom GFT-1A
Preamp:	Krell PAM 3
Amp:	Krell KSA-100
Speakers:	Apogee Scintilla's

## SOUND BY SINGER

165 E. 33rd Street  
New York, NY 10016  
(212) 683-0925

## BRAND NEW TUBE AMP

**\$550**

BY QUICKSILVER AUDIO

Features 60 watts of power output (mono), completely hand wired—no circuit boards, no transistors. Chassis constructed of heavy duty carbon steel with textured black finish.

QUICKSILVER AUDIO  
5841 Columbus Avenue  
Van Nuys, CA 91401  
(818) 989-3329

# SYSTEMDEK

# IIX

The **SYSTEMDEK IIX** represents the ultimate value/performance combination in turntables available today. This is accomplished by including such features as; oil-pump bearing, glass platter, lamb's wool record mat, 24 pole synchronous motor, belt drive, interchangeable arm board, real-wood base built about a steel frame and a unique 3-point hung suspension which allows quick and easy adjustment, even while a record is playing! All this at a surprisingly affordable price.

The **SYSTEMDEK IIX** is available; without tonearm, fitted with a Profile II (as shown); or Profile IIS tonearm.

Please write for further information.



DISTRIBUTED BY:

**PRO-ACOUSTICS INC.**

IN CANADA:

16877 Hymus Blvd.  
Kirkland, Quebec  
H9H 3L4

IN USA:

Waterfront Plaza  
Newport, Vermont  
05855



## AMPS/PREAMPS

**BRB SYSTEMS**—delivers performance without the hype and high prices! Model 200 Power Amps 100w/ch \$395. Model 120's 60w/ch \$250. Full 3 year warranty, 30 day return policy, COD, checks or M.O.: P.O. Box 391202, Mt. View, CA 94039.

**DB SYSTEMS OFFERS PRECISION ELECTRONICS AND AUDIOPHILE ACCESSORIES.** Five year warranty. Write for our complete product list. DB SYSTEMS, Main Street, Rindge, NH 03461 (603) 899-5121.

### HAFLER IN THE SOUTH!

In stock, the superb Hafler pre-amps, amplifiers, tuner and equalizer. Immediate, FREE shipping. Also Adcom, Audire, Conrad-Johnson, Fried, Klipsch, Mirage, Nakamichi, PS, Proton, SAE, Talisman, Thorens, Vandersteen, digital discs and players. READ BROTHERS STEREO, 593 King Street, Charleston, South Carolina 29403. (803) 723-7276. AD

**HARMAN/KARDON, NAKAMICHI, TANDBERG, CROWN, REVOX, HAFLER, CARVER, NAD, DBX, ELECTRO-VOICE AND OTHER QUALITY COMPONENTS. BEST PRICES-PROFESSIONAL CONSULTATION. ALL PRODUCTS COVERED BY USA MANUFACTURER'S WARRANTY.** AMERISOUND SALES, INC., P.O. BOX 24009, JACKSONVILLE, FL 32241. EAST: (904) 262-4000; WEST: (818) 840-0878.

**JULIUS FUTTERMAN OTL\* AMPLIFIERS**—By eliminating the output transformer you may reach the full potential of a tube amplifier. With a bandwidth of 200,000 HZ and a slew rate of 33 volts per micro second any model for the five models of OTL\* amplifiers will demonstrate the superior performance of a tube amplifier that is not encumbered by an output transformer. Read all about the differences between transformer and OTL\* amplifiers in our 100 page book UNDERSTANDING TUBE ELECTRONICS, send \$3 domestic, \$5 foreign to New York Audio Laboratories, 33 N. Riverside Ave. Croton-on-Hudson, NY 10520

**MARANTZ 9S, 5S, 7C.** Garrard 301. Best offers. Vanderbilt 89 Bridgewater, Oceanport, NJ 07757 (201) 870-1642

**MARK LEVINSON IN PITTSBURGH, PA.** Hear these superb electronics now on display at BETTER SOUND CONCEPTS, 400 South Craig St., Pittsburgh, PA 15213. (412) 687-3737.

**MARK 9 POWER AMPLIFIERS,** 250 watt amp using six 6550A outputs tubes and a regulated power supply. \$795.00 kit - \$975.00 wired. Write for brochure. AUDIO CLASSICS/ATLANTA, PO BOX 690, ROSWELL GA 30077.

**MICHAELSON & AUSTIN M-100** dual mono tube amps. 100 w/ch, superb sound, 5 months old, demos. New: \$2200 sell for \$1300. Audio by A.J. Conti (603) 883-4504.

*Impact  
Definition  
Compact Size*

"Among mini-speakers in (its) price bracket, the Spectrum 108A stands alone..."

—Int'l. Audio Review—  
Hotline #35  
Berkeley, CA 94704

**THE SPECTRUM 108A, extremely affordable, high-resolution sound.**



MODEL 108A

For information or dealer inquiries, write:

**spectrum**   
P.O. BOX 774 TOLEDO, OHIO 43695 419-242-4448

## AMPS/PREAMPS

**MOSCODE™ TUBE AMPLIFIERS**—Julius Futterman's last project was an experiment on creating a tube amplifier that would be cost effective and deliver great power. We have finished his work. The MOSCODE™ 300 TUBE AMPLIFIER rated at 150 watts per channel costs \$899, the MOSCODE™ 600 rated at 300 watts per channel costs \$1,599—both are available in kit form. Complete technical discussion of this new MOSCODE™ TUBE CIRCUITRY is in our 100 page book UNDERSTANDING TUBE ELECTRONICS. Send \$3 domestic, \$5 foreign to New York Audio Laboratories, 33 N. Riverside Ave. Croton-on-Hudson, NY 10520

**MOSCODE™ MINUET PREAMP**—This tube preamp has a mosfet output stage 80 db of gain so that any moving coil cartridge can be used without headamp and an optional tube power supply. The MOSCODE™ MINUET is \$600 and the tube power supply is \$300. Both available in kit form. Read about the new MOSCODE™ TUBE CIRCUITRY in our 100 page book UNDERSTANDING TUBE ELECTRONICS send \$3 domestic, \$5 foreign to New York Audio Laboratories, 33 N. Riverside Ave. Croton-on-Hudson, NY 10520

**QUICKSILVER DUAL MONO AMPS; STATE OF THE ART** amplification, under \$1000. Audio by A.J. Conti, 38-A Gowing Rd., Hudson, NH 03051. (603) 883-4504.

## A SINGER'S DREAM!

### REMOVES VOCAL FROM MOST STEREO DISCS

Our VOCAL ELIMINATOR can remove most or virtually all of a solo vocalist from a standard stereo record and leave most of the background untouched! Not an equalizer! We can prove it works on the phone. Write or call for brochure and demo record.

## YOU SHOULD SEE US

For:

- Time Delay/Ambience
- Studio Echo/Reverb
- Tape Noise Reduction
- Parametric Equalization
- Electronic Crossovers
- Compressor/Expanders
- Mic Preamp/Mixers



We manufacture a full line of high quality audio and recording equipment. You will probably have to pay twice as much elsewhere to obtain comparable quality. Only Direct Sales make our prices and quality possible. Write or call for a 24 page brochure and demo record.

Write to: **LT Sound, Dept. AU, P.O. Box 338,**  
Stone Mountain, GA 30086, Phone (404) 493-1258  
**TOLL FREE: 1-800-241-3005 — Ext. 13**

## AudioVisions

The New Store That Features  
State Of The Art Technology,  
Combined With Truly Old-Fashioned Hospitality

### electronics

BELLES • BRYSTON • DENON • LUXMAN • S.A.E.

### loudspeakers

ALLISON • DESIGN ACOUSTICS • DUNTECH • I.T.C.  
MARIAH • M&K • SNELL • 3D "cube" • THIEL

### turntables, cartridges, tape decks

ACCUPHASE • ADCOM • AUDIOQUEST • DENON  
DYNARECTOR • F.R. • GRACE • GRADO • KOETSU  
ORACLE • SUMIKO • SYSTEMDEK • THORENS

### We Are Different 1...

Customers travel to visit us from as far away as Boston, Philadelphia, Albany. Why do these people travel so far to purchase their stereo components from AudioVisions? Visit us soon (please make AN APPOINTMENT in advance) and you, too, will decide that we are different.

### We Really Love Music — Do You?

Technological hardware should be only a means to an end. We believe that an audio system should exist for just ONE purpose: To reproduce MUSIC, correctly, accurately, convincingly. Our carefully matched systems of superior components will cause you, finally, to cease thinking about pieces of audio gear. At last, "only the music... nothing but the music" will matter.

### Careful matching

We go so far as to stock SIX different speaker cables, and we recommend specific cables for specific applications. Each component in our matched systems is recommended by us for a definite reason. Perhaps that's why our customers almost NEVER sell or trade the equipment they purchase from us.

### State Of The Art Technology

The very first presentation, anywhere, to consumers of the "superb" THIEL Cs3 loudspeakers took place at AudioVisions on June 25, 1983. The very first evaluation (and subsequent introduction), anywhere, of the new "revolutionary" ORACLE "Mark II" turntables took place at AudioVisions on April 26, 1984. Both of these products are now being raved about by reviewers around the country. AudioVisions customers had the benefit of being exposed to these products MONTHS before they appeared in other stores, and months before the reviews were published. The AudioVisions staff does not need to wait to read reviews before making decisions. Our competence and our dedication enable us, on our own, to make the best possible decisions for the benefit of our customers.

### A Wonderful Bargain!

The MARIAH LS-4 loudspeaker, honest, clean reproduction, excellent imaging, truly musical, easy to drive, handsome unusual appearance, at an amazing \$298 pair price. In complete "sound sense" systems from \$775.

• GIVE THE GIFT OF MUSIC —  
SPECIALS BEING OFFERED FOR THE HOLIDAYS •

1067 MONTAUK HIGHWAY, WEST BABYLON  
NEW YORK 11704 (516) 661-3355

## FOR THE SILENCE OF SPACE, THE THUNDER OF THE PLANETS...



Listen to the BPA-100B High Technology, High Definition Amplifiers. • Meets all the design criteria of Ottaia and Cherry. • Features nested multiple feedback loops, wide bandwidth and high slew rate with a dominant pole frequency of 15KHz, resulting in constant feedback and zero phaseshift from DC to 20 KHz. • A fully regulated power supply yields true DC coupling and incredibly solid bass. No protection circuitry within the signal path, yet fully protected. 100 w/ch. into 8 ohms, 175 w/ch. into 4 ohms and 350 w into 8 ohms in the built-in bridge-mono mode. • Coming soon: Model LCA-10 preamplifier. Spectrascan, Inc. 5923 N. Nevada Ave., Colorado Springs, Colorado 80907. (303) 599-9254 Dealer and representative inquiries invited.

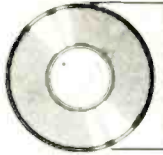

**New England Compact Disc Headquarters**  
Acoustic • AR • Boston Acoustics • B&W • Carver  
Celestion • Denon • Dual • Friedl • Hafler  
harmon/kardon • Onkyo • Integra • Ortofon  
Pyramid • Shure • Sony ES • Stanton • Thorens  
**Sound & Music**  
92 King St., Northampton, MA 413 584-9547



**regal**

**REGA turntables reflect a splendidly simple British design philosophy: use only what is necessary & make it of the highest quality. The result is a handsome source of beautiful music, at a proper price.**

**You are invited to hear your favorite recordings on a REGA. Please address consumer & dealer inquiries to:**

**import audio**

**3149 shenandoah, st. louis, mo. 63104 • 314-773-1211**

## AMPS/PREAMPS

**MUSICAL CONCEPTS NEW PRODUCTS:** LC-200, a pair of 26,000mfd/75V capacitors the same size as those in the Hafler DH-200/220 (also for Dynaco ST-150 and ST-400-410). LC-500, as above but 38,000mfd/100V (Hafler DH-500). A new technology makes these possible! TP-200 (7 amp toroid transformer), replaces 4 amp DH-200/220 transformer. LIPS, outstanding low impedance regulation circuit board for Hafler preamps. MC-1 dual mono preamplifier board replacement for Hafler DH-101, others. Write for our brochure and review packet. Musical Concepts, 1060 Fifth Plaza, Florissant, MO. 63031. 314-831-1822.

**MCINTOSH C-32 PREAMP,** 2205 pwramp and MR-78 tuner. New. \$6000. Will sell \$2700 or offer. Mint. (502) 774-4322.

## RECEIVERS

**HARMAN/KARDON, NAKAMICHI, TANDBERG, CROWN, REVOX, HAFLER, CARVER, NAD, DBX, ELECTRO-VOICE AND OTHER QUALITY COMPONENTS. BEST PRICES-PROFESSIONAL CONSULTATION. ALL PRODUCTS COVERED BY USA MANUFACTURER'S WARRANTY. AMERISOUND SALES, INC., P.O. BOX 24009; JACKSONVILLE, FL. 32241. EAST: (904) 262-4000; WEST: (818) 840-0878.**

**HEATH AR-15 RECEIVER.** Excellent condition with manual. \$200. (612) 763-4857.

## TUNERS

**HARMAN/KARDON, NAKAMICHI, TANDBERG, CROWN, REVOX, HAFLER, CARVER, NAD, DBX, ELECTRO-VOICE AND OTHER QUALITY COMPONENTS. BEST PRICES-PROFESSIONAL CONSULTATION. ALL PRODUCTS COVERED BY USA MANUFACTURER'S WARRANTY. AMERISOUND SALES, INC., P.O. BOX 24009; JACKSONVILLE, FL. 32241. EAST: (904) 262-4000; WEST: (818) 840-0878.**

**MICRO CPU 100FM TUNER** retail \$2000, will sacrifice for \$750. For information and laboratory test results, phone (219) 875-8123.

## LOUDSPEAKERS

**ALTEC-LANSING AND ELECTRO-VOICE** speaker systems. Most Altec in stock including the LF2 subwoofer system. E-V Interface, microphones, speaker components stocked. Low prices. Rick Marder (201) 561-8123.

**DAYTON WRIGHT S LCM-1 LOUDSPEAKER: WORLD'S FINEST** minimonitor. Audio Nexus, NJ. (201) 464-8238, (201) 730-2409.

## LOUDSPEAKERS

### AUDIO PRO POWERED SUBWOOFERS.

The most accurate powered subwoofer available today. The combination of deep and flat bass and high levels at low distortion is unique among moderately sized loudspeaker systems. Models are: B2-40, B2-50, B2-100, B4-200. Retail price is \$695-\$2750. They are available in Walnut or Black Ash. Call or write today for dealer nearest you. Sonic Research, Inc. 27 Sugar Hollow Rd., Danbury, Ct. 06810 203-792-8824.

**B&W 801F SPEAKERS,** new—\$2800. 202-337-1725. evenings and weekends.

**CONSTRUCT STATE-OF-THE-ART LOUDSPEAKERS** at far less cost than you've ever dreamed! Dynaudio, Strathern, Seas, Peerless, Morel etc. Capacitors, coils including IAR/WCB Ultracaps™. Acoustic foam for cost-effective room treatment, cabinet dampening. Shadow Electronic crossovers. Full line definitive, esoteric speaker kits. Beautiful oak, walnut cabinetry. Thousands of satisfied customers because of our products, informed assistance, fast service, and guaranteed lowest prices. Catalog \$2.00 refundable (608) 781-2110 MC/Visa AUDIO CONCEPTS, 1631 Caledonia St., LaCrosse, WI 54603.

**DIMENSIONS UNHEARD NC-1 LOUDSPEAKER** images so vividly it's almost unsettling. Time aligned. Phase coherent. Transient perfect. Hand-built polypropylene woofers coupled to European dome drivers by a FFT optimized crossover. Ten year warranty! RTRD, 2105 Claremont, Springfield, IL 62703 (217) 529-8793

**DUNTECH PCL-3 PLANAR SPEAKERS—PITTSBURGH,** gain magnificent sound without losing an inch of floor space—BETTER SOUND CONCEPTS, 400 S. Craig St., Pittsburgh, PA 15213. (412) 687-3737.

### FRIED SPEAKERS & KITS

State-of-the-art sound. Try our prices! Free shipping. Also Nakamichi, Hafler, SAE, Proton, Mitsubishi, Adcom, digital discs and players. READ BROTHERS STEREO, 593 King Street, Charleston, South Carolina 29403. (803) 723-7276.

AD

**HARMAN/KARDON, NAKAMICHI, TANDBERG, CROWN, REVOX, HAFLER, CARVER, NAD, DBX, ELECTRO-VOICE AND OTHER QUALITY COMPONENTS. BEST PRICES-PROFESSIONAL CONSULTATION. ALL PRODUCTS COVERED BY USA MANUFACTURER'S WARRANTY. AMERISOUND SALES, INC., P.O. BOX 24009; JACKSONVILLE, FL. 32241. EAST: (904) 262-4000; WEST: (818) 840-0878.**

**HIGH-END SPEAKERS! SAVE 40%** on esoteric speaker systems. Fast service. Visa MC. RTRD, 2105 Claremont, Springfield, IL 62703

**J. B. L. SPEAKERS AND COMPONENTS** used - bought, sold, and traded 1-313-229-5191 evens. aft. 7 EST

# MUSIC OR MAGIC . . . ?

When developing a new product many decisions must be made and many different parameters must be balanced. The best audio equipment is the result of someone listening very carefully and being very sensitive to the notion of musical intent vs information processing. There are no magical solutions, alchemy isn't the answer.

If we wanted to sound trendy we would call our approach "holistic".

The new AQ T-5 and AQ T-7 moving coil cartridges have a musical balance we are very proud of — a combination of superior tracking, smooth, clean, fast, neutral sound, high dynamic contrast and a minimum of tone arm sensitivity. AudioQuest has earned its strong reputation in the quality cartridge market

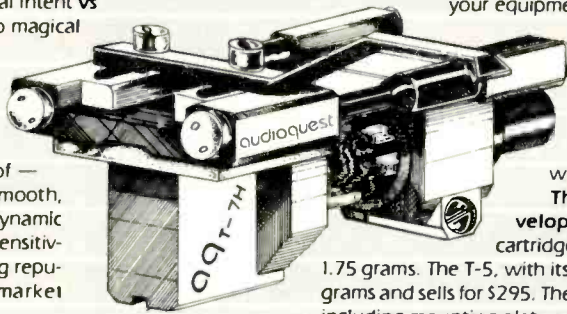

with its high output moving coils. Almost single-handedly, AQ has made most preamps and transformers obsolete. The AQ T-5 and T-7 are available in 3 output levels so you can choose the best one for your equipment. The T-5H and T-7H have an output

of 2.2mV for all normal phono inputs. The T-5M and T-7M are 1.1mV and are perfect for "high gain" preamps (which includes almost all current tube units). The T-5L and T-7L are .22mV and should be used when a top quality MC input is available.

The AQ T-5 and T-7 use a specially developed tapered titanium cantilever. Both cartridges have a compliance of 12 and track at 1.75 grams. The T-5, with its solid brass mounting plate, weighs 8.8 grams and sells for \$295. The T-7 has a solid sapphire support system including mounting plate, weighs 6.9 grams and sells for \$495. The AQ M-1 induced magnet cartridge at \$95 and the AQ MC-3 high output MC at \$145 also set value standards that can't be matched.

**aq audioquest**

AudioQuest brings your system to life!

412 N. Coast Highway, #B-360, Laguna Beach, California 92651 714/720-1995

## LOUDSPEAKERS

**JSE INFINITE SLOPE LOUDSPEAKERS** Hear your music at last! Now, unique and technologically advanced crossovers deliver unparalleled clarity, smoothness, dynamics. Call AUDIO NEXUS, NJ, (201) 464-8238. (201) 730-2409 for copies of Sensible Sound's rave reviews.

**LOUDSPEAKER COMPONENTS—KITS**, Audax, Dynaudio, Eclipse, Focal, Foster, Peerless, Morel, Vifa, SIARE, and more! New catalog, 50¢. Meniscus Systems, 3275W Gladiola, Wyoming, Michigan 49509

### MAGNEPAN IIB OWNERS TAKE NOTE

Now your Magnepan sound can be everything you've ever wished for. Unique new plug-in crossovers deliver the benefits of bi-amplification at significantly lower cost. Improved bass definition is only the start. Lower distortion and better dynamics combine to give you the detail and increased image depth you've been wanting. . . . Try it for 20 days. Installs in seconds. Money back guarantee. \$229.00. Visa or Mastercard accepted. DSA Marketing, 4448 W. Howard St., Skokie, IL 60076. (312) 673-7003.

**MAGNEPAN MG3 & B&W 801F**, like new. 215-567-4676 Eve.

**MATCHED KLIPSCHORNS AND CENTER LASCALA**. Really like new. \$2000. Alan Brown, 1916 Allyson Dr., Tupelo, Ms. 38801. 601-841-2150.

**ONE PAIR OHM LOUDSPEAKERS** model "H". Very good condition. \$400.00. 404-321-4299 after 5 p.m. EST.

**SPICA SPEAKERS & ARCICI STANDS—SIMPLY THE BEST**. Authorized dealer, personalized service, free shipping. Call for audition/prices. Mobile Recording Company, Carmel, IN. (317)-846-5308 5-10 PM. AD

## Randall Research Cable Systems ... the indispensable component

17925-A SKY PARK CIRCLE • IRVINE, CA 92714 • (714) 261-9141 • TELEX 382175

## LOUDSPEAKERS

### TWEETER OF THE MONTH CLUB!

High frequency masterpieces from all over the world, picked at the point of perfection and delivered to your door. A gift to delight the audio gourmet. **WHERE ELSE BUT . . . MADISOUND** Box 4283, Madison, Wisconsin 53711 608-767-2673.

## SPICA TC-50

These amazing speakers are available from:

**OPUS ONE**  
400 smithfield street  
pittsburgh, pa. 15222

OR  
357 north main street  
butler, pa 16001

Telephone orders, please call toll free 800-441-2327.

**FREE** shipping on all pre-paid orders within the 48 states. Visa, Mastercharge and American Express accepted

## DIAL Q FOR AUDIO!

COMPETITIVE LOW PRICES ON NEW AUDIO & VIDEO PRODUCTS

617-547-2727



BOB HEENAN

BUY SELL TRADE CONSIGN  
BROKER RENTAL NEW & USED

SONY	SOUND CONCEPTS	MONSTER CABLE
PIONEER	DESKTOP	STAR
TECHNICS	INNOTECH	SPENDOR
AI	VAMPIRE WIRE	SOUTHERN
EQUAL	KRELL	DYNAMICCORP
THORENS	KEYNE	APARTURE
MAGNAVOR	SUPER	CARTALIGN
PHILIPS	SUMMO	LAST
HAFER	CRAMOLIN	PREMIER
PS AUDIO	NAGAOKA	GRADO
KRELL	LEVITATION	GRACE
DBA	JANIS	DB SYSTEMS
PYRAMID	ACULSTAT	SONEA
FIBED	AUDIOFORCE	EUPHONIC AUDIO
NOTA	DIYRON	ADCOM

NEW CATALOG \$3.00

COMPACT DISCS	EQUALIZERS	TAPE DECKS
COMPACT DISC PLAYERS	CONSULTATIONS	PORTABLE STEREO
RECEIVERS	CUSTOM INSTALLATIONS	INTERCONNECT CABLES
BETA HI-FI VHS HI-FI	APPRAISALS	RECORD CLEANING PRODUCTS
LASER DISC PLAYERS	EXPORT IMPORT	AUDIOPHILE MAGAZINES
SPEAKERS	BROKERAGE	SPEAKER WIRE
AMPLIFIERS	CONSIGNMENT	NOISE REDUCTION SYSTEMS

THE FINEST SELECTION OF NEW/USED EQUIPMENT IN AMERICA

95 VASSAR ST.  
CAMBRIDGE, MA  
02139



MON-FRI 10-7  
SATURDAY 10-5

# SYNTHESIS™

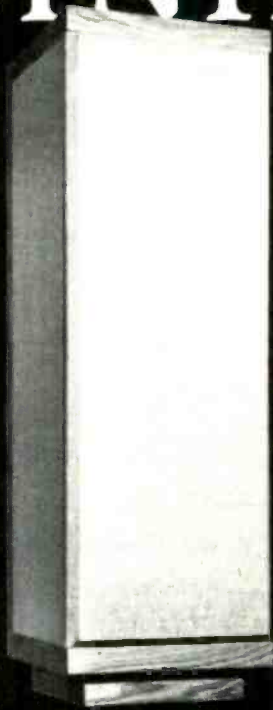

A Fusion of  
Art and  
Technology

Loudspeakers  
designed by  
William Conrad &  
Lewis Johnson

Synthesis, 2817M Dorr Avenue, Fairfax, Virginia 22031



**naiao**  
ELECTRONICS FURNITURE

BOX 1840 BRANTFORD  
ONTARIO CANADA  
N3T 5W4

BOX 1250 FALLS STA  
NIAGARA FALLS NY  
USA 14303-0260

# Fanfare FOR THE UNCOMMON MAN

This is the only loudspeaker available at under \$600 that has: true acoustical alignment of its drivers, phase coherent crossover, open air tweeter mount, imported polypropylene drivers, Wonder Caps, Livewire BC-1, and gold plated, 5-way binding posts. The result is MUSIC at a price the common man can afford. Write for literature and the location of the dealer nearest you.



4650 ARROW HWY #F4, MONTCLAIR, CA 91763 • 714/624-4020

## Eliminate Your "Patchcord Headaches"

If you have more components than places to hook them up, we have a switching system for you. For complete information on switch boxes for your tape decks, signal processors, and speakers, WRITE OR CALL TODAY.



**niles audio**

Dept. A, P.O. Box 160818  
Miami, Florida 33116 (305) 238-4373

## The Best Amplifier

- How different do the best modern amplifiers sound, one from another?
- How great is the difference between the best tube designs and the best solid-state?
- Which basic amplifier has the best dynamic contrasts? The most lifelike recreation of hall ambience, of the musical soundstage?
- Is there a best overall amplifier?
- How do the great amps rank?

In the Fall issue of *The Absolute Sound*, HP begins a comprehensive and lively look at the new breed of basic amplifiers.

**Also in the Fall issue of *The Absolute Sound*:**  
• Classic analogue Mercury recordings from the Golden Age of American sound (1956-1964); the story of Ewing D. Nunn, one of the forgotten greats in sound recording.

• Pertinent reviews of new generation High End audio equipment, with the emphasis on how well this gear reproduces the real thing, the sound of music itself. We report on 3 Compact Disk players, how each sounds different from the other and how none come close to digital master tapes. *The Absolute Sound* is the magazine that reports authoritatively on the High End of audio.

**Order today and find out the results.**

.....  
A year's subscription costs \$20 US, \$22 Canada, \$35 Overseas. If you would like to sample a single issue, send us \$7.50.

Name \_\_\_\_\_  
Address \_\_\_\_\_

City, State \_\_\_\_\_ Zip \_\_\_\_\_

Please send a check or US money order with return address to:

**the absolute sound**®

P.O. Box 1,

Sea Cliff, New York 11579

Visa, Mastercard and Am. Ex. accepted.

To order by phone, (516) 671-6342 9:30 am - 5:30 pm ET. Ask for Eden.

## LOUDSPEAKERS

SHAHINIAN OBELISK SPKRS, TWEAKED BY DICK. BOUGHT FROM FACTORY, UTTERLY UNUSED. COST \$1700, SELL \$950. 619-755-5213.

### VANDERSTEEN 2C

With the Orpheus SW12 subwoofer—an awesome combination! ORPHEUS AUDIO, Locust Valley, NY (516) 676-5082. AD

## TURNTABLES

### BEST SOUND PER DOLLAR SYSTEM

(UNDER \$2100)

Turntable: Rega Planar 3  
Cartridge: Rega R100  
Receiver: NAD 7155  
Speakers: Snell Type E II

### SOUND BY SINGER

165 E. 33rd Street  
New York, NY 10016  
(212) 683-0925

### MERRILL AR MODIFICATIONS

Sound quality upgrade for XA, XB, and XE. Allows replacement of original tonearm in XA and XB. Replacement Subchassis Kit (XA, XB) \$85.00—Subchassis Kit (XE) \$95.00. Following mods for all models: Platter Coating \$10.00. Replacement Spindle \$25.00. Spring Kit \$8.00. High Torque Motor \$45.00. Platter Balancing Service \$10.00. Replacement inner and outer platters. \$135.00. UNDERGROUND SOUND, 2125 Central Ave., Memphis, TN 38104. (901) 272-1275.

## TURNTABLES

HARMAN KARDON, NAKAMICHI, TANDBERG, CROWN, REVOX, HAFNER, CARVER, NAD, DBX, ELECTRO-VOICE AND OTHER QUALITY COMPONENTS. BEST PRICES-PROFESSIONAL CONSULTATION. ALL PRODUCTS COVERED BY USA MANUFACTURER'S WARRANTY. AMERISOUND SALES, INC.; P.O. BOX 24009; JACKSONVILLE, FL 32241. EAST: (904) 262-4000; WEST: (818) 840-0878.

### MERRILL TURNTABLE

Features: Beautiful solid oak base. A tunable, three-point Constant Resonance Suspension System. A subchassis designed to absorb tonearm release energy. Supplied with an inner weight clamp and outer periphery record clamp. Price: \$789. For more information contact UNDERGROUND SOUND, 2125 Central Ave., Memphis, TN 38104. (901) 272-1275.

### OPTIMIZE YOUR "NEW" AR TURNTABLE!!

Dramatically improve the transparency, detail, and smoothness of your AR Turntable with our aluminum tonearm mounting boards. We stock precision milled and pre-drilled 2024-T4 aluminum boards for the MMT and Linn arms. All others, please include your arm template. \$25 + \$3 mailing. Also, aluminum boards for the SOTA. \$45 + \$3. The Audio Advisor Inc., Box 6202, Grand Rapids MI 49506 (616) 451-3868

SOTA SAPPHIRE: EXQUISITE SOUND FROM THE CROWN JEWEL of turntables. Audio Nexus, NJ, (201) 464-8238, (201) 730-2409.

## MULTI COMPONENTS

ACCURATE AFFORDABLE AUDIOPHILE EQUIPMENT AT GREAT PRICES! WE CONCENTRATE ON COST-EFFECTIVE AUDIOPHILE PRODUCTS AND HOW TO GET THE MOST OUT OF THEM. GREAT SELECTION INCLUDING ACCESSORIES, CABLES, AND RECORD CARE PRODUCTS. SPECIALISTS IN TURNTABLES TONEARMS CARTRIDGES. GOOD HONEST ADVICE AVAILABLE. CALL OR WRITE FOR OUR FREE NEWSLETTER. HCM AUDIO, 1600BB MANGROVE, CHICO, CA 95926 (916) 345-1341

AT DESERT WAIL, music lives body and soul. We work hard to discover the musical truth. We don't just sell equipment we sell music. Just arrived, Proac EBT: extended bass tablette. Think about it. 535 Cordova Rd., #429, Santa Fe, NM 87501. (505) 983-2443.

AUDIBLE ILLUSION TUBE PREAMP \$379, Spica TC-50 \$359, Premiere MMT \$179, AR turntable \$259, Bedini preamp \$259, QLN speakers \$499, Prometheus Green \$149, VPI turntable \$649, Kevek speakers \$749, Monster. Eve/weekend (714) 861-4830.

AUDIO RESEARCH D-150 AMPLIFIER, excellent condition, \$1995. Dynaco PAS 3-X preamp, mint, \$135. Eico ST-96 FM-AM tuner with MX 99 multiplex autotuner, new tubes. \$135. Tom Layman, 9825 Upton Circle, Bloomington, MN 55431. Call 612-884-2604 after 10:00 weekdays.

## MICRO SEIKI TURNTABLES

SIMPLY THE BEST BELT DRIVE TURNTABLE SYSTEMS AVAILABLE

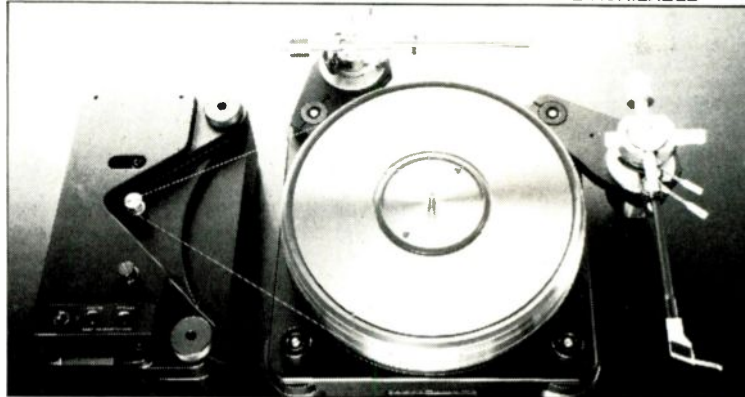

Illustrated the Micro Seiki RX-1500VG shown here mounted with two tonearms (four are possible) Platter 20 lb bronze platter Record hold-down light force vacuum system Frame massive 36 lb non-resonant metal alloy Motor outboard belt-drive DC servo Inertia moment 3 000 lb cm² Total system weight 100 lb U S list \$1 495 (without tonearm) Several other versions available, including an air bearing design where the bronze platter floats on a thin .03 mm layer of air

FOR COLOR BROCHURE AND DEALERS INQUIRIES, WRITE: ANALOG EXCELLENCE, P.O. BOX 69A97, LOS ANGELES, CA 90069

## MULTI COMPONENTS

AUDIO EQUIPMENT NEW AND USED, ACCOUSTAT III, II, TNT200 amplifier, TNP preamp; AUDIONICS PZ3 poweramp; GRACE 9E Ruby—\$200 New; MAGNEPAN Tympani IB—\$600; MCINTOSH 2120; ORACLE/Magnepan Dynavector Ruby; TANDBERG TCD3004 Cassette-Deck; TD20A; THORENS TD126/SME Grace 9E—\$695; Call Terry #402-391-3842

THE SOUND ENVIRONMENT  
120 Regency Parkway  
Omaha, NE 68114

AUDIO HOUSE—FLINT MICHIGAN: ROGERS, SOTA, CONRAD JOHNSON, ROBERTSON, NEC VIDEO, ONKYO, REVOX, AUDIO PRO, SPECTRUM, SOUTHER, GRADO, BELLES, GONZA Speaker wire 12 gauge 100ft. \$49. 4304 Brayan, Swartz Creek Michigan, 313-655-8639 by appointment.

AUDIO RESEARCH SP-6B \$795, D-110 \$1595 & 2 D-79 \$1895 ea. \$1595, Yamaha CT-7000 Tuner \$500, Nakamichi ZXL-1000, \$2600, Oracle Delphi TT \$700, Magnepan Arm \$225, Infinity RS-1 Speakers \$3500, Infinity/Magnepan QRS 1D Speakers with ARC xover (a la TAS) \$3500. Call 503-254-9802.

## LUCKY 16 SYSTEM

(ABOUT \$1650)

Turntable: Rega Planar 2  
Cartridge: Adcom HC/E II  
Receiver: NAD 7155  
Speakers: Snell Type J II

## SOUND BY SINGER

165 E. 33rd Street  
New York, NY 10016  
(212) 683-0925

HARMAN/KARDON, NAKAMICHI, TANDBERG, CROWN, REVOX, HAFLER, CARVER, NAD, DBX, ELECTRO-VOICE AND OTHER QUALITY COMPONENTS. BEST PRICES—PROFESSIONAL CONSULTATION. ALL PRODUCTS COVERED BY USA MANUFACTURER'S WARRANTY. AMERISOUND SALES, INC.; P.O. BOX 24009; JACKSONVILLE, FL. 32241. EAST: (904) 262-4000; WEST: (818) 840-0878.

HCM AUDIO 1-916-345-1341 "VALUE LIVES" AUDIO-QUEST ★ B & W ★ GRACE ★ GRADO ★ HAFLER ★ LIVEWIRE ★ MONSTER CABLE ★ NITTY GRITTY ★ PREMIER ★ PYRAMID ★ SOTA ★ STAX ★ TALISMAN ★ THORENS ★ SUMIKO ★ AND MUCH MORE ALL AT REASONABLE PRICES! FREE NEWSLETTER & EXPERT ADVICE. HCM AUDIO, 1600BB MANGROVE, CHICO, CA 95926

## MULTI COMPONENTS

KHL NINES, TWO PAIR, among last made, excellent condition, and two late Futterman power amplifiers, 250 watts/channel into the Nines, \$3250. Beveridge Twos, \$3750. Luxman 35 Mark III tube preamp, \$450. Dynaco Stereo 70, PAS3X, FM3, \$225. ARXA turntable, \$60. Moving to Europe! 212-222-8818.

AUDIO RESEARCH SP-6B, D-120A; Tympani I-D; Thorens TD-126 w Ruby; Marantz 110; B/O. 1100 Salisbury II, Lincoln NE 68505.

ESOTERIC SOUND-STONY BROOK, LI NY invites you to hear this superb, musically accurate system unsurpassed in fidelity, craftsmanship and aesthetics! The Hartley Reference Speaker with the famous 24" bass driver. Counterpoint Electronics- SA-2, SA-4, SA-5, Michell GyroDec, Zeta, Goldbug Brnr, Spectacular dynamics, outstanding definition, lightning fast transients, awesome bass and breathtaking realism are the hallmarks of this system. Also available: Hartley raw drivers, SPL-1 and "H" series. Electrocompanion, Eidolon Research, Amber Electronics. Call (516) 689-7444 for an appointment.

MITCHELL GYRODEC \$800, HAFLER DH-101 \$150, DBX 21 \$65, MCINTOSH C27 \$475, SNELL ELECTRONIC X-OVER \$275, ADS 1530's \$1600pr. STAX SRX-III w/SRB-7 \$200, THRESHOLD FET TWO \$700, ARC SP-8 \$1100, CROWN PL-2 \$400, MITSUBISHI DA-F30 TUNER \$275, DYNACO ST-70 mint \$150, MITSUBISHI LT-5V vertical turntable \$275, THRESHOLD SERIES II S-300 \$1500, DYNAVECTOR DV-6Z \$90, TEAC T2-650 dustcover \$20, TECHNICS SP-10 w SME 3009 Mint \$300, GLI 1000 \$115, NEW JBL FOAM GRILLS \$30, OTARI S050-8 \$3500, REVOX B-77 \$1100, REVOX B-77 MK II 1 2 track \$1300, TAPCO 2200 \$150, TAPCO 3300-2T \$450, TAPCO 4400 \$225, TASCAM MODEL 5 \$900, KENWOOD 700C preamp \$200. Call Jeff 913-842-0304.

## MORE WITH FOUR SYSTEM

(UNDER \$4300)

Turntable: Linn Sondek Lp-12  
Tonearm: Linn Basik LV-X  
Cartridge: Audioquest 404  
Tuner: Adcom GFT1-A  
Preamp: Counterpoint SA-7  
Amplifier: Robertson 4010  
Speakers: Fuselier 3.3

## SOUND BY SINGER

165 E. 33rd Street  
New York, NY 10016  
(212) 683-0925

AD

## KIMBER KABLE

HIGH PERFORMANCE  
SPEAKER WIRE

Strong in the West, headin' East.

## ASK YOUR DEALER

Manufactured by:

RKB Industrial, Inc.  
2058 Harrison Blvd.  
Ogden, Utah 84401  
(801) 621-5530

## GREENFIELD EQUIPMENT

Audio systems dedicated to the presentation of the art form.

### THE MUSIC.

ACCUPHASE • ADCOM • ARISTON • AUDIO INTER-FACE • BEVERIDGE • BERNING • CLASSE' AUDIO • COUNTERPOINT • DISTECH • DYNAVECTOR • EAR ELECTROCOMPANET • ELECTRONKINETICS • ENTEC • GRACE • GRADO • HAFLER • ITC • JSE • KISEKI • KIMBER KABLE • KLYNE • KOETSU • NEC • ORSONIC • PRECISION FIDELITY • PROFILE • REGA • SPECTRUM • SIDEREAL AKUSTIC • SOUTHER • SPICA • STAX • SUPLEX • THORENS • TRIAD • VPI • VSP LABS • VAN DEN HUL

Auditions by appointment • Shipping and export facilities

7805 Greenfield Street • River Forest, Illinois 60305

312/771-4660

## LISTEN TO A LEGEND



For more than a decade Rogers has earned a reputation for producing musically articulate loudspeakers.

If you take the time for a serious demonstration, Rogers performance will become self evident.

For the name of your nearest authorized dealer, please write:

## Rogers

BRITISH HIGH-FIDELITY

U.S.A.  
Naiad Products Inc  
Box 1250 Falls Sta.  
Niagara Falls, N.Y.  
14303-0260

CANADA  
Naiad Products Inc  
Box 1840  
Brantford, Ont.  
N3T 5W4

## Resign from the Cartridge-of-the-Month Club

The Talisman cartridges, which were considered revolutionary when they were released, quickly became the standard by which moving coil cartridges are judged. Now the Talisman Alchemist IIIS establishes a new standard. We call it *Alchemist* because our quest to create a no-compromise moving coil with 2mV output seemed as impossible as the would-be wizard's quest to turn lead into gold. The difference is that we succeeded.

Don't compare the Alchemist IIIS to other high-output moving coils. Compare it to the most highly rated combination of low-output moving coils and step-up devices. And let your ears decide.

Resign from the Cartridge-of-the-Month Club because you've found the cartridge that



will put smiles on your face for years—the Talisman Alchemist IIIS.

Alchemist IIIS—nothing stands between you and the music.



Sumiko, Inc. P.O. Box 5046, Berkeley CA 94705

# AURA

The Experience Awaits You

**EMF Research**  
Ask your dealer

## plateau<sup>®</sup> SPEAKER STANDS

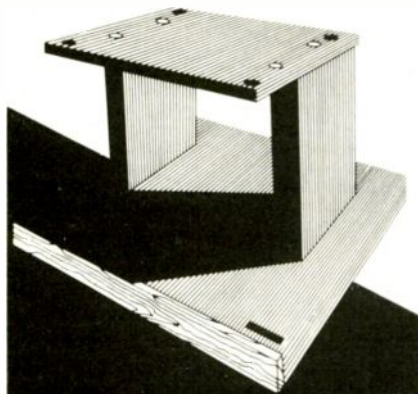

Plateau speaker stands provide an easy and inexpensive way to dramatically improve the performance of your audio system. Designed to acoustically decouple and position the speaker, Plateau provides tighter bass, more focused mid-range and precise stereo imaging. For more information and the name of your nearest Plateau dealer, please write:

Canada: Naiad Products Inc, Box 1840, Brantford, Ontario N3T 5W4  
United States: Naiad Products Inc, Box 1250 Falls Sta., Niagara Falls, N.Y. 14303-0260

### MULTI COMPONENTS

## START WITH SEPARATES SYSTEM 1 (UNDER \$2700)

Turntable: Rega Planar 3  
Cartridge: Adcom XC/LT II  
Preamp: Adcom GFP-1A  
Tuner: Adcom GFT1-A  
Amplifier: Adcom GFA-2  
Speakers: Snell Type E II

## SOUND BY SINGER

165 E. 33rd Street  
New York, NY 10016  
(212) 683-0925

AD

**THORENS REFERENCE!** Serial No. 55 with SME 3009 series III, TSD 15 professional pick-up at EMT 9'-arm: \$25,000. Revox A700 1/2-track with 8 new tapes (Maxell UDXL 35-180B): \$2200. All prices basis of negotiation. W Wanzke, Zugspitzstrabe 1, 8081 Althegnenberg West-Germany.

### TRADE-INS WELCOME

Nakamichi, Conrad Johnson, Gold Aero tubes, Acoustal, Grado Signature, Carver, harman kardon, Sonographe VSP mosfet, VPI turntable and lots more! Carver PM 1.5 pro amp has 450 watts ch! Used specials—M&K Rabcc mint. \$400; Macintosh MR-78 mint, \$699. THRESHOLD AUDIO 409 S. 22nd St., Heath, Ohio 43056, 614-522-3520

**USED MAC, MARANTZ, A.R.C., LEVINSON, C.J.,** Beverage, and all other hi-end and collectables bought,—traded. I'll meet your audio needs with my shamefully small markup, paying more and selling low. If you're selling or want to save on expensive equip. Call soon. Dealers note: I'll buy one piece or your whole used inventory. N.Y. Sound Investments. (718) 377-7282. Noon to 3PM only.

VSP LABS TRANSMOS amp (newest version) \$630, Kenwood KT-1000 Purist tuner \$240. Mint condition. 313-769-8544.

### MULTI COMPONENTS

**21ST CENTURY AUDIO LTD** For all of your high end audio needs at reasonable prices. Top brands such as Argent, Belles, C-J, DCM, Eagle, Grado, Pentagram, Perreux, Pyramid, SOTA, Spica, Stax, VPI and much more. Plus Computer and video items too many to mention. Call or write to 5041-Rising Sun Ave. Phila., Pa. 19120. (215) 324-4457. MC, VISA, Diners Club, & Carte Blanche welcomed.

### TAPE RECORDERS

**FOR SALE: REVOX A-700 2TR.** Stereo recorder exc. cond. Write S.L. Alekman, One Macintosh Ct.—E. Brunswick, NJ 08816.

**HARMAN/KARDON, NAKAMICHI, TANDBERG, CROWN, REVOX, HAFLE, CARVER, NAD, DBX, ELECTRO-VOICE AND OTHER QUALITY COMPONENTS. BEST PRICES-PROFESSIONAL CONSULTATION. ALL PRODUCTS COVERED BY USA MANUFACTURER'S WARRANTY. AMERISOUND SALES, INC., P.O. BOX 24009; JACKSONVILLE, FL. 32241. EAST: (904) 262-4000; WEST: (818) 840-0878.**

### CARTRIDGES/TONEARMS

**AMERICAS ONLY HAND BUILT ESOTERIC PHONO CARTRIDGE**—The product of seven years of exhaustive research is the **PROMETHEAN GREEN**—the most accurate pick-up available for under \$400! No gimmicks, no tricks, just solid engineering for the most cost-effective listening possible! 3.5mv output, 5 grams weight. \$175. The Audio Advisor Inc., Box 6202, Grand Rapids MI 49506. 616-451-3868 VISA MC AMEX.

**DIAMOND NEEDLES and STEREO CARTRIDGES at DISCOUNT PRICES** for SHURE, PICKERING, STANTON, EMPIRE, GRADO, AUDIO TECHNICA, ORTOFON, MICRO-ACOUSTICS, SONUS, ADC and LAST, send S.A.S.E free catalog. LYLE CARTRIDGES, Dept. A., Box 69, Brooklyn, NY 11218. For fast COD service Toll Free 800-221-0906. N.Y. State (718) 871-3303, 9AM - 8PM except Sunday. VISA MC AD

### SONUS SUPER BLUE BY SONIC RESEARCH.

Now the world's most phase coherent cartridge. The exclusive lambda stylus shape and cantilever design insure a single transmission path and are major contributors to the clarity of sound. Suggest Retail \$195.00. Call or write for the dealer nearest you. Sonic Research, Inc. 27 Sugar Hollow Rd. Danbury, Ct. 06810, 203-792-8824.

### TUBE EQUIPMENT

**DYNACO OWNERS:** 60,000-lb buyout of Dyna's remaining inventory! Tubes, transistors, circuit boards, sheet metal, manuals... more. **FREE BARGAIN CATALOG.** SCC, Box 551(AM), Dublin, OH 43017. (614) 889-2117. VISA MC COD.

Prompt Insured Shipments

## GUARANTEED SAVINGS

"Why Settle For Less When You Can Own The Best"

- Professional Advice • FREE Delivery & Set Up
- Relaxed "NO RUSH" Showroom • Financing Available
- Trade-ins Accepted • Custom Installation & Repairs

### FEATURING OVER 60 BRANDS INCLUDING:

- ADS • Advent • Aiwa • AKG • Alpine • Amber • AR • Audio Control • Audio Source • Blaupunkt • Bose • Celestion • Concord • DBX • Denon • Dual • Dynavector • Energy Loudspeaker • Grace • Grado • Harman/Kardon • JBL • Kyocera • Mitsubishi • Onkyo • Ortofon • Pyramid • Robertson Audio • Scott • Sherwood • Signet • SoundCraftsmen • Sony • Sound Dynamics • Systemdek • Tandberg • Thorens • Warfedale/Diamond • C.J. Walker • And More...

### CAR STEREO

- ADS • Alpine • Alphasonik • Altac • Blaupunkt • Clarion/Audio • Concord • JVC • AFS/KRIKET • Phillips • Sherwood • Sony • Ungobox • And More...

Call or Write Harold Minto, Proprietor

## performance audio/video

365 South Bayview Ave. (Corner Atlantic Ave.) • Freeport, Long Island, New York 11520

Tel (516) 378-4389

Just 35 min. from Manhattan by car or railroad.

Showroom Hours: Mon.-Fri. 12 noon to 7 p.m. Sat. 11 a.m. to 6 p.m.

MC  
VISA  
AMEX

Retail Mailorder Export

### TAPE WORLD TOLL FREE 1-800-245-6000

TDK	MAXELL	TDK	TDK	SCOTCH	TDK
MA-90 6:05	MR-90 4:78	TDK 1120 L750	5:75	SCOTCH T120 L750	6:49
MA-90 4:25	UL180 2:78	TDK 1120 L750H	7:89	ZUC T120	6:49
SAR 90 2:85	UDXL802 15	MAXELL 1120 L750	5:75	POLAROID T120 L750	6:49
ADX 90 2:59	UDJL801 99	MAXELL 1120 L750HGX	7:89	QUASAR T120	5:99
SA-90 1:85	UD80 1:99	KODAK 1120 L750	6:38	RCA T120	6:49
SA-80 1:89	UD60 1:89	FUJI 1120 L750	5:75	TDK HES-90	4:19
AD-90 1:89	LN60 1:19	SONY 1120 L750	6:49	FUJI METAL 90	2:75
AD-80 1:49	LN60 1:05	SONY UCX5 90	2:29	SCOTCH X511C80	2:29
D-90 1:07	EL360 6:49	SONY HF90	1:19	BASE PRO 1180	2:29
D-80 99	UD3090 4:99	FUJI FR1190	2:29	MEMOREX HMBIA80	2:29

WE WILL BEAT ANY COMPETITOR'S PRICE OF THE TOTAL ORDER INCLUDING ALL SHIPPING AND HANDLING CHARGES BY 1%.

3-75 Shipping only size order in US. VISA MC no extra charge. COD Add 1.6% Minimum COD order 40.00. PA add Sales Tax. All orders shipped within 48 hours. M-F 9:30-5:00.

222 Brown Avenue, Box 361, Butler, PA 16001, 412-763-9831

### THE SOUTHER SLA-3

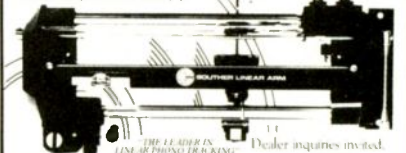

DEALER INQUIRIES INVITED  
SOUTHER ENGINEERING CORPORATION  
429 A York Street, Canton, Massachusetts 02021  
(617) 828-5050

**ANNOUNCING VERITAS**  
THE NEW INTERNATIONAL SOUTHER-SUCHY  
INTEGRATED CARTRIDGE/TONEARM

## TUBE EQUIPMENT

**COUNTERPOINT: A NAME YOU SHOULD KNOW.** Experience the finest tube preamplifiers, preamplifiers, power amplifiers at **AUDIO NEXUS**, New Jersey's highend Mecca. (201) 464-8238, (201) 730-2409.

**MARANTZ MODEL 9, MCINTOSH MC75**, or Dynaco other tube amps of 100 watts or more wanted by enthusiast. Eric Brill (314) 225-8340 (St. Louis).

**MCINTOSH SOLID STATE**—bought, sold, and traded. 1-313-229-5191 alt. 7 EST

**TUBE SPECIALS!** Premium quality Tunggram 12AX7, \$2.99 each; Amperex (British) EL34 6CA7 (tall slender style), \$19.95 matched pair. Complete kits: Dyna Mk4 40W mono power amp, \$199.00; Dyna PAS-3X stereo preamp, \$149.00. **FREE BARGAIN CATALOG.** SCC, Box 551(AM), Dublin, OH 43017. (614) 889-2117. VISA MC COD.

**TUBE TWEAKS, AUDIOPHILES**—We speak your language. Top quality tubes & audiophile products at competitive prices. Large selection, imports & exotics. Specialty tubes can be your cheapest sonic improvement. Call for recommendations prices. Dealer manufacturer inquiries invited. Douglas Kent Smith Audio Consulting, 1792 Perrysville Ave., Pittsburgh, PA 15212. (412) 322-1693

### UNDERSTANDING TUBE ELECTRONICS

This 100 page book is an education in the theory and operation of tube circuits and a controversial explanation of why tubes are superior to transistors in audio circuits. A combination of essays and technical articles will permit everyone to understand why tubes are dominating state of the art. Send \$3 domestic, \$5 foreign, to New York Audio Laboratories, 33 N. Riverside Ave, Croton-on-Hudson, NY 10520

**WANTED: MCINTOSH, MARANTZ, ARC, QUAD, DYNA-CO, LEAK, CJ, WESTERN ELECTRIC, LEVINSON, KRELL, TANNY, ALTEC, JBL, (SOLID STATE & TUBE), AMPS, SPEAKERS.** 713-7284343. MAURY CORB, 11122 ATWELL, HOUSTON TX. 77096

**WHOEVER SAID THAT TUBE ELECTRONICS** had to be ugly or unreliable hasn't seen Counterpoint! The Audio Doctor, Buffalo, MO. (417) 345-7245 **AD**

## PARTS/ACCESSORIES

**ATTENTION: MARANTZ 108 OWNERS!** I have dial glasses; both inner and outer. Guaranteed perfect. \$35 a pair, \$20 individually. Dave Miller, 7927 E. 77th Pl. Tulsa, Okla. 74133 918-252-9052.

**DBP-SC SOUTHER CLEVER CLAMP.** Ultra-light, clear poly-carbonate record clamp. One piece design, simple to use. \$10.00 plus \$2.50 handling. **DB SYSTEMS**, Main St., Rindge, NH 03461 (603) 899-5121.

**DCM TIME WINDOWS.** New & untouched in SEALED CARTONS. Retail: \$797; \$400 takes them both. Call Jeff G. M-F 11:00-5:00 (215) 628-2000.

**ELECTRONIC CROSSOVERS:** 6, 12, 18dB octave. Kits from \$106.50. Transient-Perfect Crossover, \$175. Free folder. **ACE AUDIO CO.**, 532-5th St., E. Northport, NY 11731-2399. (516) 757-8990.

**ESOTEK SWX-12DB MULTIPLE BI-AMP X-OVER:** Outputs for up to four bi-amp sub-woofer systems. 12DB OCT design, six x-over freq. available. \$119.00. Info write: **ESOTEK Inc.** 1412 SW 102nd #175A Seattle, WA 98146.

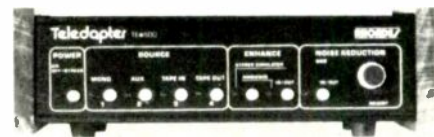

- Noise Reduction
- Stereo Synthesizer
- Ambience
- Four Input Stereo Switcher

Bring new life to TV or FM Audio with this fabulous product! Order yours today — comes complete with all cables, instruction, two-year warranty - 30 day money back guarantee. Send check M.O., Visa, or MC # to below address or call for free literature. Also available at better dealers. The TE-600 Teledapter \$149.95 4 Needed Features in One Audio Processor.

**RHOADES**  
NATIONAL CORPORATION

Toll Free 1-800-251-8608  
P.O. Box 1316, Dept. 122  
Columbia, TN 38402

## PARTS/ACCESSORIES

**GOLD LION, "INDIA", TELEFUNKEN TUBES.** Cramolin, Furman Sound, Hartley, Kimber Kable, LAST, Precision Fidelity, Sheffield, SONEX, VPI, VECTOR ELECTRONICS, 2030 NW Marshall #104, Portland, OR 97209. 503-227-5641. VISA MASTERCARD, AMERICAN EXPRESS.

**LOW DCR AIR CORE INDUCTORS** ARE OUR ONLY PRODUCT! Wide selection of coils wound with twelve and sixteen gauge wire! Custom orders welcome! Lowest prices! Rush C.O.D. orders accommodated! Free Information! Wilsonics, 2111-M 30th street, Suite 1138, Boulder, Colorado 80301. (303) 530-1067 evenings

Noted audio critic Peter Moncreff says

**"IF YOU'VE EVER HAD A YEARNING TO MAKE YOUR SYSTEM MORE DYNAMIC, THIS IS THE COMPONENT TO DO IT WITH."**

"So free of unwanted side effects, it is virtually impossible to misadjust it. It also lowers the noise on analog discs. The **RG SIGNATURE ONE** . . . by far the best device that's ever come along for restoring the pure sound of music's true dynamics."

For a complete copy of this review (IAR #33) and more information contact **RG DYNAMICS**, 4448 W. Howard St., Skokie, IL 60076, 312-673-7003.

**PETERSON PRESENTS EMERALD™**—a new, air-dielectric, symmetrical, twinaxial Interconnect and Tonearm Cable System of incomparable transparency and musicality. No price increase. Peterson Interconnects have been setting performance and quality standards since 1979, and EMERALD™ continues that tradition. Find out what experience and established competence bring to this complex technology. See your dealer or contact us for information and no-risk trial terms. **PETERSON AUDIO**, Dept. AM, 13665 SW Garrett Court, Tigard, OR 97223. (503) 639-2401. Dealer inquiries invited.

**SUBSONIC FILTERS.** 18 or 24dB/octave (from \$98.50) remove unwanted noise/thumps from passband. Free flyer w reviews. **ACE AUDIO CO.**, #532-5th St., East Northport, NY 11731-2399. (516) 757-8990.

**THE BEST ESOTERIC CABLE?** We sell Randall Research, Straight Wire and Discrete Technology. We have studied each cable and know the differences. Call for details. **Audio Advisor, Inc.** 616-451-3868. Box 6202, Grand Rapids MI. 49506.

## CD PLAYERS

**SONY CDP-101 OWNERS:** Perfectionist modification of analog section (D-A converter onward with power supplies) updates sonic performance many generations! Details (514) 842-1693 evenings.

## APOGEEACOUSTICS

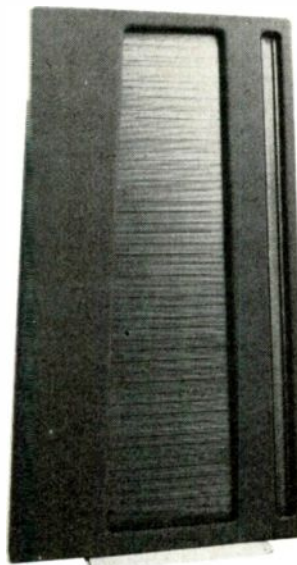

Designers and manufacturers of the world's first full range ribbon speaker system bring you the

### SCINTILLA

The full impact and quality of ribbon technology in a mid-size speaker.

Contact your high end dealer or write:

**APOGEEACOUSTICS, INC**  
920 PROVIDENCE HWY · NORWOOD, MA 02062

## COMPACT DISCS AND ACCESSORIES

7 DAYS A WEEK — FREE CATALOG  
CALL TOLL FREE  
**1-800-ALL DISC**  
IN CONN CALL 1-452-0203  
**ALL DISC MUSIC, INC.**  
133 WHEELER RD, MONROE, CT 06468

COMPACT  
disc  
DIGITAL AUDIO

## A JANIS BASS SYSTEM

FOR MANY YEARS A  
REFERENCE STANDARD FOR SUBWOOFER PERFORMANCE  
ITS THE CHOICE WHEN ONLY THE BEST WILL DO

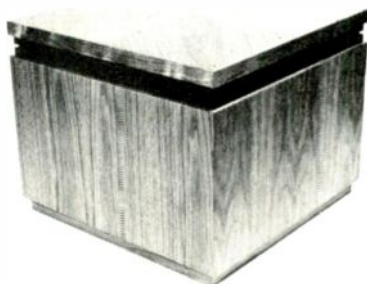

ASK FOR OUR COMPLETE LITERATURE THE JANIS BASS SYSTEM

**JOHN MAROVSKIS AUDIO SYSTEMS, INC.**  
7389 Roebling Avenue, Bronx New York 10461 (212) 892-7419

## CD PLAYERS

### COMPACT DIGITAL DISCS AND PLAYERS!

In stock! Many titles. Fast, FREE shipping. Also: Mitsubishi, Klipsch, Nakamichi, more (see our Hafler ad.) READ BROTHERS STEREO 593 King Street, Charleston, South Carolina 29403. (803) 723-7276. AD

**HARMAN/KARDON, NAKAMICHI, TANDBERG, CROWN, REVOX, HAFLER, CARVER, NAD, DBX, ELECTRO-VOICE AND OTHER QUALITY COMPONENTS. BEST PRICES-PROFESSIONAL CONSULTATION. ALL PRODUCTS COVERED BY USA MANUFACTURER'S WARRANTY. AMERISOUND SALES, INC., P.O. BOX 24009; JACKSONVILLE, FL. 32241. EAST: (904) 262-4000; WEST: (818) 840-0878.**

## BLANK TAPE

**OPEN REEL TAPE** Mostly Ampex 641 used once, 7 in. 1800's 50 REELS Unboxed \$70 with box \$84 Shipping Included. (ALSO VIDEO PRODUCTS) R.M.T.C., Box 1733, San Leandro, Ca. 94577, (415) 895-9992

**TEAC REEL-TO-REEL BLANK CASSETTES** make great gifts and great recordings! Professional Look and Quality. Write: For the Record . . . , Box 21201-C, Columbus, Ohio 43221

## COMPACT DISCS

**COMPACT DIGITAL DISCS** exclusively—from stock—classical, opera, jazz, film—catalog \$1.00, refundable with order—Ethel Enterprises, P.O. Box 3301, Dept. A, Falls Church, VA 22043

**COMPACT DISCS—MOST TITLES \$11.99—\$13.99.** 1,200 plus titles in stock. Free catalog plus monthly updates. Oz Records, 5246A Memorial Drive, Stone Mountain, GA 30083, (404) 292-5452.

**COMPACT DISCS—2,000 TITLES—LISTED NOW!** Immediate delivery! Classics—Pop—Jazz!—FREE Catalog available. Phone or mail orders—Master Card & Visa. LAURY'S RECORDS, 9800 North Milwaukee, Des Plaines, IL, 60016 (312) 296-0420

## COMPACT DISCS

**LOWEST COMPACT DISC PRICES ANYWHERE.** Low as \$9.99. London-DG-Philips \$12.99 per disc. All labels sharply discounted. Order by label, number. Send M.O., check, MC/Visa. Add \$2.25 UPS 1st disc, 50c each additional. Or send \$2.00 for greatest CD catalog and discount coupons. Classic Diversions, P.O. #1923, Evanston, Ill. 60204. (312) 475-4010

**NEW FULL-HOUR DELOS DIGITAL JAZZ CDs:** Joe Williams—Nothin' But The Blues—with Red Holloway's Blues All-Stars; Mavis Rivers—It's A Good Day—16 great standards; Bobby Shew Chuck Findley—Trumpets No End. Each \$15.98 postpaid. RJAI, POB 5565A, Santa Monica, CA 90405-0565.

**NEW TELARC CD'S!** "Moods of Christmas," 2-disc Handel's "Messiah"; "Messiah Highlights"; "Star Tracks #2"; "Straussfest"; "Sibelius" "Symphony #2"; "Michael Murray's "Solo Recital," "Encores," "Jongen & Franck;" each \$14.95 (doubles, \$22.95). FREE CATALOG! For The Record . . . Box 21201-CCD, Columbus, Ohio 43221.

**COMPACT DISCS**  
Get All Your Compact Discs  
From ONE Source At LOW  
**DISCOUNT PRICES**  
All Labels Available  
Send \$2.00 for 58 page catalogue  
with over 900 titles & growing!  
OMNI DISTRIBUTORS

Mail to  
**869 S. Lynnhaven Rd., Va. Beach, VA 23452**

**WE SPECIALIZE** in audiophile and imported compact discs. Special for December: Complete Beethoven Symphonies from Denon—\$79. For our 40 page catalog, send \$1 to: SUPERSOUND, P.O. box 7082-A, Forest Park, Il. 60130. Phone (312) 366-1300 1-5 pm.

## PRERECORDED TAPE

**AFFORDABLE PRICES:** All ratings, VHS, Beta. Large selection of sports, children's and vintage movies. Send \$5.00 for catalogs! Renault Sound Video, P.O. Box 7098, Dept A, Mpls, MN 55407. (612)721-7772. We sell albums too!

**QUADRAPHONIC OPEN REEL TAPES, RECORDS** (whole collections), select equipment. Michael Robin, 120 Atlanta Place, Pittsburgh, Pennsylvania, 15228. (412) 341-1686.

**OPERAS & CONCERTS LIVE ON TAPE.** Cassette/video reel-reel. Visa-M.C.-Amx. Free catalog: Tardoin, P.O. Box 210255, San Francisco, Ca. 94121-0255.

## RECORDS

**FREE ISSUE OF GOLDMINE,** world's largest record collector's publication! Thousands of records of all types, eras for sale. Plus articles on recording stars, past and present. Rock 'n' roll, jazz, country, folk, blues. Every two weeks! 13 issues, \$22. GOLDMINE, Circulation Department AJY, 700 E. State St., Iola, WI 54990.

**OUT OF PRINT, SEALED "KATY LIED"**—Copies by Mobile Fidelity. Call 516-889-7276 leave message.

## RECORDS

**LOWEST PRICES** anywhere on Mobile Fidelity's "Rolling Stone Collection" and Fresh Aire's "Christmas Album". Over 5,000 Japanese imports on sale for \$11.50. Free Newsletter. Supersound Record Service, P.O. Box 7082, Forest Park, Il. 60130. (312) 366-1300 (1-5 pm)

### PIXOFF BY SONIC RESEARCH

Dry clean your records the new, safe, easy way. Hear and see the difference. No messy liquids. Call or write for the dealer nearest you. Sonic Research, Inc. 27 Sugar Hollow Rd. Danbury, CT 06810, 203-792-8824. Retail \$20.00

### SGT. PEPPER'S UHQ'S

Former MFSL employee offering SEALED BEATLES albums. Perfect Christmas or Hanaukka gift. Free shipping in USA. Call BOB (818) 845-9236 Evenings PST

**THELMA HOUSTON PRESSURE COOKER,** Sheffield Lab, originally sealed for sale. Best offer. Day 212 754 9402, Evening 212 744 2196

**UHQ SGT. PEPPER \$298, PINK FLOYD Master,** Crusaders-Chain Reaction, Beatles Magical Mystery, Abbey Road \$39. Sheffield Lab D-D Thelma Houston \$39. Grusin \$59. Beatles Set \$895. All records factory sealed. William Wegner (517) 793-4218 or 793-1777 days.

**WE BUY AND SELL LIKE NEW LPS,** Prerecorded reel tapes and cassettes. Thousands in stock. Catalog \$2.50. Protect your Lps Poly, Paper, Cardboard jackets Low Prices, Free Catalog, House Of Records, Hillburn, New York 10931.

## VIDEO EQUIPMENT

**SUPERB AUDIO AND VIDEO PRODUCTS**—best values to best performance. We specialize in A-V systems. Brands include Sony, PS Audio, Duntech . . . Hawkeye Electronics, 515-472-7712.

## AUDIOPHILE RECORDS

**AUDIOPHILE RECORDINGS AT AFFORDABLE PRICES.** Mobile Fidelity \$15, Telarc \$12, Sheffield \$14, Denon (CD's) \$13.95, compact discs and more. Send \$2.00 (refundable w/first purchase) for complete catalog. Satisfaction Sounds, Inc., 2888 Bluff St., Suite 381C, Boulder, CO 80301. Charge customers call toll free 1-800-443-0100 ext. 588C.

### REFERENCE RECORDINGS

The wait is over! Respighi's "CHURCH WINDOWS," one of the great demonstration pieces of early hi-fi, has finally been given the Prof. Johnson treatment. Scored for pipe organ and full symphony orchestra, "Church Windows" contains the mightiest gong crash ever recorded! Hear Keith Clark and The Pacific Symphony tear into this sonic showpiece on RR-15, 45 rpm premium pressing, \$16.98. Also new this month from RR, the first recording of the CHICAGO PRO MUSICA—players from the renowned Chicago Symphony Orchestra—in a suite from Walton's sassy "Facade" and more. Recorded in Medinah Temple, the imaging and acoustic ambience of this recording is uncanny: RR-16, 45 rpm premium pressing, \$16.98. Visa/MC welcome. Reference Recordings Ltd., Box 77225X, San Francisco, CA 94107. Call free: 800-621-0854, ext. 107 (or 408-745-7159). Dealer inquiries invited.



**Tools for Discriminating Listening**

Enjoying a tasty album over Stax "carspeakers" is an exquisite experience. Their original design lets the music's detail come through. Stax electret and electrostatic "carspeakers" start under \$100. They can be auditioned at our Stax display.

**STAX**

**Soundfield One** is the architecture of a brilliant new speaker design. After years of psychoacoustic research, DBX delivers a speaker system with optimum stereo imaging throughout your listening area. At SOUND STAGE audition them with your favorite electronics and a personal music selection.

**dbx**

**NAD**

NAD 7140 The newest receiver and it's their best value yet. It's typically twice as FM sensitive as other receivers, has Soft Clipping\*, and 3 db of dynamic headroom. Priced at under \$500.

Call for a personal appointment or just stop in.  
212 961-9888  
Sorry, no mail orders accepted.

ADS ALPINE DENON KLOSS THE UNGO BOX  
FAS GRACE FOSTEX PROTON 3D ACOUSTICS  
BES GRADO HITACHI CLIFFORD AUDIOCONTROL  
MEC AMBER LUXMAN TALISMAN BANG & OLUFSEN  
DCM ADCOM ALLISON CJ WALKER DBX SOUNDFIELD  
STAX SIGNET PYRAMID AUDIO-PRO BOSTON ACOUSTICS  
(Not all brands in both stores.)

Please visit our stores at:

178 Broadway  
New York City, NY 10007  
(Northwest corner of Brown & Cortland)  
One flight up. Entrance on Cortland.

OR

194-10 Horace Harding Express  
Fresh Meadows, NY 11365  
East 25 L.I.E., Upper Plaza  
(Three blocks from Bloomingdale's)



# THE NEW TECHNOLOGY

## Tube Quality— Transistor Prices

New from Kinergetics.  
**The KBA-100 Amplifier \$795.00.**  
**The KPA-1 Preamplifier \$775.00.**

Hear them now at selected audio dealers.



UNDER LICENSE BY



6029 Reseda Boulevard • Tarzana, California 91356 • (818) 345-2851



## AUDIOPHILE RECORDS

**NEW! FRESH AIRE CHRISTMAS ALBUM.** Specially priced, \$11.98. Telarc 3-record Handel's "Messiah," \$34.98; "Messiah" Highlights or Telarc Christmas Album, \$11.98. FREE CATALOG of Audiophile Albums, CD's, Accessories: For The Record . . . Box 21201-B, Columbus, Ohio 43221.

**SAVE-SAVE-SAVE:** Audiophile records, compact discs, imports, M.F.S.L. Stones Collection, and Last cleaners at **HUGE** savings. Free catalog: **CLASS-A-UNDERGROUND**, 35 North Greenbush Road, West Nyack, NY 10994 or call (914) 638-4089. Visa and Mastercards accepted.

**BIG REWARD !!** All Mac equip., JBL spkrs. and electronics, Altec Acousta-voicette, MXR ETC 31 band equalizers, Thorens TD 125, SME 3009-3, JBL speaker cabinet blueprints. 1-313-229-5191 aft. 7 EST

**MCINTOSH, MARANTZ TUBE COMPONENTS,** Western Electric, Hartfields, Patricians. John Conrad 1178 Blackbird El Cajon, Ca. 92020 (619) 449-9155

**MCINTOSH, MARANTZ, QUAD, FISHER, TUBE EQUIPMENT.** Old Tannoy Speakers. Thorens TD-124, Garrard 301, JBL Amps. Drivers, Tweeters, Speakers, Western Electric Equip. (including Tubes) Tel: 818 576-2642. David Yo. POB 832, Monterey Park, Ca. 91754.

**NAKAMICHI 680ZX, SONY PT-77, CARVER C-4000, SONY PCM-701ES, JVC D-M3, BAKER, 8 VALLEYVIEW, NEWTOWN SQUARE, PA 19073.**

**WANTED: KLH TABLE RADIO.** Prompt payment for either FM or AM FM model in good condition. (415) 397-2718 or (415) 458-3940.

## PLANS & KITS

**GET MORE SPATIAL REALISM** with these kits. The KIR-1 at \$97 expands stereo sound to fill your room. The KVSP-1 at \$95 creates full stereo from mono and patches your TV to your audio system. Plans alone \$1 ea. Prices include UPS to 48 states. Send check, VISA or M.C. to SOUND CONCEPTS, BOX 135, Brookline, MA 02146.

**POSH DECOSOUND**—music with perfect balance and control, in every room in your home, using your stereo equipment. Write: Posh Systems, 6100 SW Taylors Ferry, Portland, Oregon, 97219.

## SERVICES

**AUDIO PULSE SERVICE.** Factory trained technicians. Write us about Model One update kits. White Labs, 10528 Lower Azusa Rd., Suite 192A, El Monte, CA 91731. (818) 446-5346.

**AUDIO PULSE SPECIALISTS.** Repairs—Modifications—Updates—Sales. WALT'S AUDIO SERVICE, 111 East Rialto Ave., Rialto, Calif. 92376. (714) 875-0776.

## RADIO PROGRAMS

**OLDTIME RADIO . . .** Classic broadcasts on high quality tapes. Free catalogue. Carl A. Froelich, 2 Heritage Farm, New Freedom, PA 71349.

**OLD TIME RADIO**—Original broadcasts on quality tapes. For free catalog send SASE to: Triple Trivia Studios, PO Box 29073A, Chicago, IL 60629.

## BUSINESS OPPORTUNITIES

**DEALER AND STUDENT REPRESENTATIVES NEEDED** For Denon And Nakamichi Cassette Decks And Turntables. Serious Inquires Only. AudioWorkShop, Box 18009, Seattle, WA 98118, 1-206-323-4987. Established 1967

*Electrified*  
*Discounters*

**203-937-0106**

**Lowest Possible Prices !!**

MOST MAJOR AUDIO BRANDS!!

CD'S — HI-END AUDIO — CAR PRODUCT  
COMPUTERS — (HARDWARE-SOFTWARE) — VIDEO

FULL WARRANTY — FAST DELIVERY

SEND FOR OUR CATALOGS!!



996 ORANGE AVE.  
WEST HAVEN, CT. 06516



## THE PEOPLE TO LISTEN TO:

knowledge, individual attention plus the names you want most in audio/video.

•ACOUSTAT•ACOUSTIC ELECTRONICS•AUDIO RESEARCH•B&O•DENON  
•Boston Acoustics•ADS•COUNTERPOINT•CARVER•DUNTECH•HAFLER  
•Discrete Technology•KYOCERA•JENSEN VIDEO•PS AUDIO•Alphason  
•Koetsu•Dahlquist•GRADO•LINN SONDEK•PRAC•SONOGRAPHIE  
•REGA•NAD•Signet•THIEL•Naim•Koetsu•Grace

**CSA**  
**AUDIO/VIDEO**  
**201/744-0600**  
upper montclair, n.j.

AUTHORIZED DEALER

## PUBLICATIONS

**ARE YOU INTERESTED IN QUALITY, USED STEREO EQUIPMENT?** Send for the **PLAY IT AGAIN SAM** newsletter—hundreds of listings—items for sale—items sought—published 6 times per year. \$8. 1-year subscription. Send today to **PLAY IT AGAIN SAM**, 12611 Madison Avenue, Lakewood, Ohio 44107. (216) 228-0040. Master Charge and Visa accepted.

## MISCELLANEOUS

**ABARGAIN: STAX SIGMA \$209, LAMBDA \$159, SRX MK3 \$129, SRD-7 \$68, SRE15 \$25, PROF LAMBDA AMP \$509, GRACE F9E \$99, F9E STYLUS \$58, RUBY STYLUS, \$105, F9E RUBY \$155, 707III(B) \$130, 747 \$149; ACCUPHASE AC-2 \$255, AC-3 \$229; TECHNICS EPC205CIII \$85, EPC205CIV \$155, EPA500 \$245, TECHNICS STYLUS GAUGE \$49; DENON 103D \$165, 103C \$110, 303 \$198; DYNAVECTOR 23RS, DV-501 BOTH \$349, 17DII \$139, 17DS \$349, 20BII \$145, 10X4 \$85; KOETSU BLACK \$445; FR64FX \$265; AUDIO-TECHNICA AT-1100 (SIGNET SK-50) \$198; ORSONIC SHELL \$22; INTERCONN: BENISEI 3' \$35, 6' \$49, HITACHI; CD DISC \$12 P.P.; ALL UNUSED: FULL MFG WARRANTY; MFG STYLUS REPLACED; WANTED M.C. BODIES; BOX 273179, BOCA RATON, FL. 33427 (305) 487-1048; BOX 6312, L.I.C. N.Y. 11106 (212) 784-2939.**

**CLOCKS:** The absolute finest ships bell and mantel clocks. Discounted "high-end" send \$3 for catalog. San Joaquin Clockworks P.O. Box 60322 Dept.-A, Bakersfield, CA 93386

## MISCELLANEOUS

**INVENTIONS, IDEAS, NEW PRODUCTS WANTED!** Industry presentation/national exposition. 1-800-528-6050. X831.



*You've been reading a lot about the superiority of tube amplification lately. Isn't it time you checked into it? The unique design of the Counterpoint SA-3 Preamplifier offers the sonic verity of tubes in a gorgeous slimline chassis. You owe it to yourself to audition the Counterpoint SA-3 and our other fine products at your dealer.*

**COUNTERPOINT**

(619) 453-9090

P.O. Box 12294, La Jolla, CA 92037

## The \$500 esoteric speaker

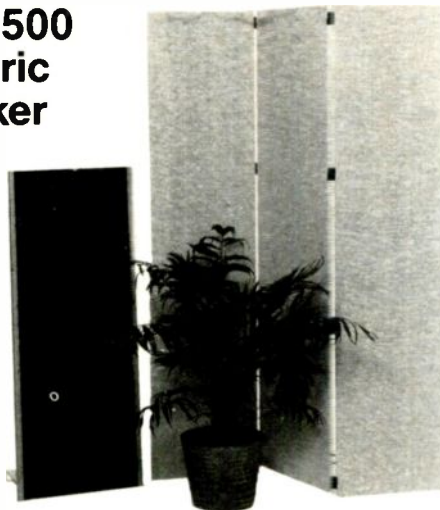

Since 1971, Magnepan has manufactured large, screen-type speakers for the uncompromising audiophile. In spite of the size and expense of these boxless, coneless speakers, over 50,000 pairs have been sold to those that simply must have the best.

In the normal evolution of things, products based on poor engineering or gimmicks eventually die out, whereas those based on sound principles become better and more affordable—for example, calculators and digital watches.

Enter the Magneplanar® SMGa at \$500.00 per pair—the same uncompromising design and construction in a much smaller package with clarity and dynamics you will find hard to believe—all from a 1" thick panel.

Audition the Magneplanar SMGa at your Magnepan dealer for an excellent example of technological evolution.

**MAGNEPAN** 1645 9th Street, White Bear Lake, MN 55110

NAKAMICHI • KOETSU • ACCUPHASE • LUX • MICRO SEIKI • GRACE • EUREKA

## ALL JAPANESE HIGH-END DISCOUNTED

### America's Largest Selection

OVER 100 CARTRIDGES, 50 TONEARMS, 30 TURNTABLES, 100 ACCESSORIES, & MORE

52 PAGE CATALOG - \$3.00

## JAPANESE STEREO

930 N. La Cienega Blvd., Los Angeles, CA 90069 • (213) 659-8550

BAEC • HIGHPHONIC • SONY ES • ESPRIT • ENTRÉ • STAX • DENON • ORSONIC

**1-800-431-3232**  
specializing in...  
cartridges - stylus - mics - headphones

**audiofon**

B&O • audio-technica • AKG • Ototon  
Dynavector • Grace • PICKERING • Stanton  
ADC • SIGNET • SHURE • Sennheiser

We quote pro advice + lowest price  
24 Hr. Shipment on all our equipment  
COD's are Okay. call us. don't delay

P.O. Box 37, Brooklyn, NY 11204 (212) 436-6400

### MISCELLANEOUS

DENNESEN PRD \$125, sumo "nine" amplifier \$285, Sony CDP-101 compact disc player \$285, Phase Linear 1000 2 autocalibrator \$110, (717) 421-2884.

**AUDIO DISCOUNTS OFFERS THE FINEST** lines of audio components (INCLUDING THE ESOTERIC) at DISCOUNT PRICES. If you're in the market for speakers, receivers, cassette decks, to the best in separate components including amps, pre-amps, turntables, cartridges etc. or a new CAR STEREO our knowledgeable sales staff will be glad to assist you. For more information Monday thru Saturday PLEASE CALL 301-593-8833 or write to AUDIO DISCOUNTS, 1026 McConey Avenue, Silver Spring, MD 20901. We honor VISA-MC and COD for your convenience. AD

MC INTOSH, MARANTZ, LEVINSON, ARC, ACOUSTAT, and all other hi-end and collectible components, bought and traded. Let me try to satisfy your audio needs with my shamefully small mark-up. I usually pay more and sell for less. I handle only used gear sold in perfect condition and will handle some consignments. If you like saving money on expensive equipment, call soon. I'm making up my longest inventory clearance list now. N.Y. SOUND INVESTMENTS, 212-377-7282 noon to 3PM ONLY.

### MISCELLANEOUS

HARMAN KARDON, NAKAMICHI, TANDBERG, CROWN, REVOX, HAFNER, CARVER, NAD, DBX, ELECTRO-VOICE AND OTHER QUALITY COMPONENTS. BEST PRICES-PROFESSIONAL CONSULTATION. ALL PRODUCTS COVERED BY USA MANUFACTURER'S WARRANTY. AMERISOUND SALES, INC.; P.O. BOX 24009; JACKSONVILLE, FL 32241. EAST: (904) 262-4000; WEST: (818) 840-0878.

**A BETTER SYSTEM?** People who know stereo buy their sound direct. Now you can buy the finest in high fidelity components, including esoterics and autotune, at unheard of prices. DIRECT SOUND MARKETING provides sensible expert advice, in-house service facilities, and factory fresh components on an in-stock basis. Discover America's best kept audio secret. Send \$1.00 for our informative catalogue to DIRECT SOUND MARKETING, Dept. A, 3095 Bolling Way N.E., Atlanta GA 30305 or call 404-233-9500. MC/VISA and AMEX accepted.

**DISCO-STAGELIGHTING-EFFECTS** at wholesale prices lasers to foggers. New and used P.A. equipment. Send \$1.00 TO H M Lighting, P.O. Box 20395, Bowling Green, KY 42101.

**NAKAMICHI NAKAMICHI SHAMEFULLY LOW PRICES:** Products Designed Especially For USA And Overseas Use. The More Information You Have The Better You Can Make Your Decision. Extremely Long Insured USA Warranties. Service Available Nationwide. Thousands of Satisfied Customers Worldwide. AudioWorkShop 1-206-323-4987.

**THEY DON'T DISCOUNT IT? WE DO!** Get LOW PRICES on ALL types of audio equipment—including high-end and even esoteric products not normally discounted! Now we can save you money on the equipment you REALLY WANT. Extensive selection—no need to settle for second choice. Thousands of satisfied customers nationwide. Call us for price quotes or friendly, expert advice. Catalog \$1. 616-451-3866. VISA/MC/AMEX. THE AUDIO ADVISOR INC., BOX 6202, GRAND RAPIDS, MI 49506.

**WALKMAN® STYLE HEADPHONES \$7.00.** Piezo Super Tweeters, range to 40,000hz. 2 for \$15.00. James Figielski, P.O. Box 42, Florham Park, N.J. 07932. No checks.

20% TO 40% SAVINGS: NAKAMICHI, B&W, KOETSU, Denon, Tascam, NAD, Etc. VISA/MC. COD. AudioWorkShop 1-206-323-4987.

CALL TOLL FREE **800-221-8180**  
IN NEW YORK CALL (212) 937-0600

23 PARK ROW, NEW YORK CITY, NEW YORK 10038

## J&R MUSIC WORLD

### SPECIALS OF THE MONTH

RECEIVERS HEADPHONES

TECHNICS SA450 50w ch. DUAL \$219.95  
TECHNICS SA150 50w ch. DUAL \$119.95  
TECHNICS SA330 70w AM/FM \$179.95  
AKAI AA45 50w ch. Digital \$119.95  
AKAI AA45 50w ch. Digital \$119.95  
SANSUI SA1090 50w ch. 5-BAND DIGI \$249.95  
SANSUI SA1070 50w ch. 5-BAND DIGI \$249.95  
MARANTZ SA90 50w ch. 5-BAND DIGI \$249.95

COMPACT DISC PLAYERS

TECHNICS SA21 50w ch. DUAL \$119.95  
TECHNICS SA21 50w ch. DUAL \$119.95  
SHERWOOD COPPO 50w ch. DUAL \$119.95

TURNTABLES

TECHNICS SA11 50w ch. DUAL \$119.95  
TECHNICS SA11 50w ch. DUAL \$119.95  
TECHNICS SA11 50w ch. DUAL \$119.95  
TECHNICS SA11 50w ch. DUAL \$119.95

CARTRIDGES

SHURE V15 TYPE V-AMR MICRO \$149.95  
SHURE V15 TYPE V-AMR MICRO \$149.95  
AUDIO TECHNICA AT122P \$149.95  
AUDIO TECHNICA AT122P \$149.95  
AUDIO TECHNICA AT122P \$149.95  
AUDIO TECHNICA AT122P \$149.95

CASSETTE DECKS

TRAC VP0818 4-B B CDS \$149.95  
TRAC VP0818 4-B B CDS \$149.95  
TRAC VP0818 4-B B CDS \$149.95  
TRAC VP0818 4-B B CDS \$149.95

STEREO-TO-GO

SONY WH60 50w ch. DUAL \$149.95  
SONY WH60 50w ch. DUAL \$149.95  
SONY WH60 50w ch. DUAL \$149.95  
SONY WH60 50w ch. DUAL \$149.95

SOUND ENHANCERS

AUDIO CONTROL C101 100 \$149.95  
AUDIO SOURCE B01 100 \$149.95  
ADC 55115 100 \$149.95  
ADC 55115 100 \$149.95  
HUMARU K1010 100 \$149.95  
HUMARU K1010 100 \$149.95  
TECHNICS SP055 100 \$149.95  
TECHNICS SP055 100 \$149.95

23 PARK ROW, DEPT. A12, NYC, N.Y. 10038

HOW TO ORDER BY MAIL: FOR PROMPT AND CERTAIN SHIPMENT, SEND MONEY ORDER CERTIFIED CHECK, CASHIER'S CHECK, MASTERCARD VISA (INCLUDE NUMBER), OR MONEY ORDER. NO EXPIRATION DATE AND VALIDITY. DO NOT SEND CASH, PERSONAL AND STOP PAY CHECKS. MUST CLEAR OUR BANK BEFORE PROCESSING. \$33 MINIMUM ORDER. SHIPPING, CARRIER'S INSURANCE CHARGE 9.5% OF ORDER WITH \$5.95 MINIMUM. WE SHIP TO CONTINENTAL U.S., ALASKA, HAWAII, PUERTO RICO, AND CANADA. ONLY CANADIAN ORDERS ADD 15% SHIPPING. WITH A \$10.00 NEW YORK RESIDENTS (L.I.C.D. BY AP. PLEASE INCLUDE STREET ADDRESS, PHONE NO. E.O. 13176. NEW YORK RESIDENTS ONLY. ADD SALES TAX. ALL MERCHANDISE SHIPPED BRAND NEW, FACTORY FRESH, AND 100% GUARANTEED. WE ARE NOT RESPONSIBLE FOR ANY TYPOGRAPHICAL ERRORS.

FOR FREE QUANT CATALOGS: CALL TOLL FREE 800-221-8180  
150 PAGE RECORD AND CASSETTE CATALOG 140 PAGE VIDEO HOME CATALOG

For America's best brands  
at America's lowest prices . . .

CALL S.C.A. TOLL-FREE!

## 800-221-0974

(In N.Y. State Call (718) 253-8888)

Save hundreds on top-name brands like Bose, A.R., Sansui, Aiwa, Shure, JVC, Technics & more. Call us today. Orders accepted by phone using your Visa or Mastercard. All merchandise is brand new & fully warranted. Free catalog by request.

## STEREO CORPORATION OF AMERICA

Dept. AM, 1629 Flatbush Avenue  
Brooklyn, N.Y. 11210

Firm (Reader Service No.)	Page
3D Acoustics (1)	117
Accuphase (54)	24
Adcom (2)	90
ADS (3)	122 & 123
Aiwa (4)	82
Akai (5)	61
Alphasonic (6)	14
Amber (7)	104
Audio-Technica (8, 9)	23, 118
BES (10)	17
Bose (11)	85
Brystonvermont (12)	18
B & W (13)	52
Camel	Cover II & 1
Canton (14)	55
Carver (15)	4
CBS (16, 17)	92, 101
Celestion (18)	Cover III
Chrysler	12
Custom Woodwork	102
Denon (19, 20, 21, 22)	13, 71, 89, 111
Goodyear	67
Harman/Kardon	103, 105, 107, 109
H. H. Scott (23)	114
Hitachi (24)	119
Illbruck (25)	18
Infinity (26)	100
Intraclean (27)	14
JVC (28)	96 & 97
Madrigal (29)	73
Magnavox (31)	21
Maxell (32)	19
McIntosh (33)	87
Monster Cable (55)	100
Nakamichi	78
Ohm (34)	88
Onkyo (35)	26
PDMagnetics (36)	93
Pioneer (37)	15
Polk (38)	74
Proton (39)	49
RCA (40)	28
Rotel (41)	113
Salem	57
Sansui (42)	11
Sennheiser (43)	59
Sherwood (44)	81
Sony (45, 46)	30 & 31, 77
Soundcraftsmen (30)	8 & 9
Stillwater (47)	17
Studer Revox (48)	64
Tandberg (49)	95
TDK (50)	3
Technics (51)	Cover IV
Telarc (52)	106
Yamaha	22

## SUBJECT INDEX

**Addenda**

*Drive Your Walkman 'Round the Block*, Richard Boryczewski (July 1983, 70), Jan., 9.

*Build a Center-Woofer Crossover*, M. J. Salvati (Aug. 1983, 65), Jan., 9.

*Boston Acoustics MC-1vdH Phono Cartridge* (Equipment Profile, Feb. 1984, 61), March, 6.

*Error Correction in the Compact Disc System*, Dr. Toshi T. Doi (April 1984, 24), July, 8.

*Akai CD-D1 CD Player* (Equipment Profile, June 1984, 76), July, 8.

*Cassette Test Update: 12 Formulations*, Howard A. Roberson (Sept. 1984, 47), Nov., 15; Dec., 5.

**Book Reviews**

*'Scuse Me While I Kiss the Sky*, Oct., 41.

*Handbook of Noise Control, Second Edition*, Oct., 41.

*The Yardbirds*, Oct., 41.

**Car Stereo**

*10th Annual Car Stereo Directory*, May, 39.

*Sony Car CD Player: On the Road Ahead*, Leonard Feldman, July, 26.

**Construction**

*Performance-Check Your Amp and Preamp*, M. J. Salvati, *Part I*, Feb., 42; *Part II*, March, 42.

**Digital Sound & Equipment**

*The Audio Interview: Sheffield's Doug Sax and Lincoln Mayorga*, David Lander, Jan., 62.

*Error Correction in the Compact Disc System*, Dr. Toshi T. Doi, April, 24; *Addenda*, July, 8.

*Philips Oversampling System for Compact Disc Decoding*, Wayne Schott, April, 32.

*What Makes a CD Player Professional?*, Leonard Feldman, April, 36.

*Sony Car CD Player: On the Road Ahead*, Leonard Feldman, July, 26.

*The Audio Interview: Jack Renner*, David Lander, July, 30.

*Phase Filter for Digital*, Richard J. Kaufman, July, 34; *On the Testbench*, Richard C. Heyser, July, 37.

**Directories**

*Car Stereo Directory*, May

Radios/Tape Players, 39; Amps/Equalizers/Crossovers, 45; Speakers, 53; Company Addresses, 64.

*Annual Equipment Directory*, Oct.

Introduction, 181; Digital Recorders/Processors, 182; Compact Disc Players,

184; Preamplifiers, 190; Amplifiers, 202; Tuners, 212; Receivers, 215; Turntables, 222; Tonearms, 228; Phono Cartridges, 230; Open-Reel Tape Decks, 236; Blank Tape, 238; Noise-Reduction Units, 240; Cassette Decks, 242; Microphones, 248; Headphones, 256; Equalizers, 261; Loudspeakers, 264; Company Addresses, 352.

**Equipment Profiles**

Accuphase C-280 Preamp and P-600 Amp, Aug., 42.

Acoustical Physics Labs Acoustic Image II Loudspeaker, Dec., 65.

Acoustic Research Turntable, July, 38.

Akai CD-D1 Compact Disc Player, June 76; *Addenda*, July, 8.

Allsop 3 Cassette Deck Cleaning System, May, 80.

Alphasonik A-265 Car Stereo Amplifier, July, 57.

Alpine 7347 Car Stereo, March, 60.

ASC AS-6004/S Open-Reel Recorder, Jan., 82.

Audible Illusions Modulus Preamplifier, Nov., 62.

Audio Research SP-10 Preamplifier and D-70 Amplifier, June, 84.

Audio-Technica AT160ML Cartridge, Sept., 72.

Boston Acoustics MC-1vdH Phono Cartridge, Feb., 61; *Addenda*, March, 6.

Brüel & Kjaer Type 4003 and Type 4007 Microphones, Nov., 78.

The Carver Receiver, June, 52.

conrad-johnson PV-5 Preamp, Aug., 68.

dbx 48X Dynamic-Range Expander, Feb., 50.

Dennesen Polaris Indoor FM Antenna, Dec., 91.

Denon DN-3000F Compact Disc Player, April, 36.

Discwasher D'Mag Cassette Deck Demagnetizer, May, 82.

Haller DH-220 Power Amplifier, Feb., 54.

Harman/Kardon CD491 Cassette Deck, March, 50.

Heybrook TT2 Turntable and Tonearm, Nov., 95.

Hitachi DA-800 Compact Disc Player, May, 76.

Innovative Techniques ITC-1 Speaker, June, 97.

JVC R-X500B Receiver, Dec., 50.

Linn Asak Cartridge and Ittok LVII Tonearm, March, 76.

Lirpa Si-O<sub>2</sub> Compact Disc Player, April, 40.

Luxman KX-102 Cassette Deck, March, 76.

Luxman DX-103 Compact Disc Player, Nov., 69.

Marantz CD-73 Compact Disc Player, Feb., 66.

Micro-Acoustics 630 Phono Cartridge, March, 67.

Micro Seiki CD-M1 Compact Disc Player, June, 70.

Monster Cable Alpha-1 Phono Cartridge, Jan., 94.

NAD 5120 Turntable, Feb., 58.

NAD 4\*55 Tuner, Dec., 75.

Nakamichi RX-505 Cassette Deck, July, 50.

Nakamichi TD-800 Car Stereo, Sept., 64.

Nakamichi BX-300 Cassette Deck, Nov., 56.

Nitty Gritty 1.0 and VPI HW-16 Record Cleaners, Nov., 100.

Ortofon MC 2000 Phono Cartridge and T 2000 Transformer, Dec., 83.

Perreux SM2 Preamp, July, 60.

Pioneer F-90 Tuner, Jan., 98.

Proton 300 Table Radio and Model 301 Speaker System, Dec., 94.

Revox B225 Compact Disc Player, Sept., 50.

SAE R102 Receiver, Dec., 58.

Sansui PC-X1 PCM Digital Processor, Jan., 76.

Sanyo DAD 8 Compact Disc Player, April, 64.

Sears 564.97500350 Compact Disc Player, April 56.

Sherwood S-2680CP Receiver, June, 62.

Shure V15 Type V Cartridge with Souther SLA-3 Tonearm, May, 70.

Sony CDP-610ES Compact Disc Player, Nov., 88.

Soundcraftsmen PCR800 Amplifier, Aug., 55.

Souther SLA-3 Tonearm with Shure V15 Type V Cartridge, May, 70.

Spectrascan BPA-100B Amplifier, July, 66.

Tandberg TCD 3014 Cassette Deck, Sept., 58.

Teac Z-7000 Cassette Deck, May, 84.

Technics SH-8055 Graphic EQ/RTA, March, 54.

Technics SL-P8 and SL-P7 Compact Disc Players, April, 48.

van den Hul Type I Phono Cartridge, July, 43.

van den Hul Type III Phono Cartridge, July, 71.

VPI HW-16 and Nitty Gritty 1.0 Record Cleaners, Nov., 100.

Yamaha M-70 Power Amplifier, Jan., 90.

Yamaha CD-X1 Compact Disc Player, Aug., 60.

Yamaha NS-2000 Loudspeaker, Sept., 78.

**History of Hi-Fi**

*Olde-Tyme High-Tech Electronic Cylinder System*, Fred Petras, May, 66.

*History of Magnetic Recording*, Robert Angus, *Part I*, Aug., 27 (includes Sound-sheet); *Part II*, Sept., 33.

*The Untold Story Behind the Bose-CU Case*, David Lander, Dec., 42.

# ANNUAL INDEX

## Interviews

- Sheffield's Doug Sax and Lincoln Mayorga*, David Lander, Jan., 62.  
*Jack Renner*, David Lander, July, 30.

## Loudspeakers

- Polk's SDA Speakers: Designed-In Stereo*, Matthew Polk, June, 32.  
*Speaker Impedance: More Complex Than One Number*, Richard C. Heyser, June, 42.

## Music Performance & Recording

- The Audio Interview: Sheffield's Doug Sax and Lincoln Mayorga*, David Lander, Jan., 62.  
*Sound Reinforcement for the Amateur*, Glen Ballou, March, 36.  
*The Audio Interview: Jack Renner*, David Lander, July, 30.  
*History of Magnetic Recording*, Robert Angus, Part I, Aug., 27 (includes Sound-sheet); Part II, Sept., 33.  
*Dynamic Bias Control with HX Professional*, J. Selmer Jensen and S. K. Pramanik, Aug., 34.  
*Rock 'n' Roadies: Traveling with Journey*, Pam Alloway, Dec., 32.  
*Home Studio: Do It the Pro Way, Part II*, Jon & Sally Tiven, Dec., 46.  
*Olde-Tyme High-Tech Electronic Cylinder System*, Fred Petras, May, 66.

## Phono Cartridges

- Bringing Trackability Home*, Robert Kita, Jan., 68.

## Psychoacoustics

- Polk's SDA Speakers: Designed-In Stereo*, Matthew Polk, June, 32.  
*Speaker Impedance: More Complex Than One Number*, Richard C. Heyser, June, 42.

## Tape & Tape Recorders

- History of Magnetic Recording*, Robert Angus, Part I, Aug., 27 (includes Sound-sheet); Part II, Sept., 33.  
*Dynamic Bias Control with HX Professional*, J. Selmer Jensen and S. K. Pramanik, Aug., 34.  
*How Important Is Tape Azimuth?*, Herman Burstein, Sept., 40.  
*Cassette Test Update: 12 Formulations*, Howard A. Roberson, Sept., 47; Addenda, Nov., 15; Dec., 5.

## Tonearms & Turntables

- NAD's Floppy Tonearm*, B.-E. Edvardsen, P. W. Mitchell, and J. Janda, Feb., 34.

## Video Sound

- At Last—Stereo TV*, Leonard Feldman, June, 47.  
*VHS Hi-Fi: Five Units Tested*, Leonard Feldman, Nov., 42.

# AUTHOR INDEX

- Alloway, Pam**, *Rock 'n' Roadies: Traveling with Journey*, Dec., 32.  
**Angus, Robert**, *History of Magnetic Recording, Part I*, Aug., 27 (includes Sound-sheet); *Part II*, Sept., 33.  
**Ballou, Glen**, *Sound Reinforcement for the Amateur*, March, 36.  
**Burstein, Herman**, *How Important Is Tape Azimuth?*, Sept., 40.  
**Doi, Dr. Toshi T.**, *Error Correction in the Compact Disc System*, April, 24; Addenda, July, 8.  
**Edvardsen, B.-E.**, P. W. Mitchell, and J. Janda, *NAD's Floppy Tonearm*, Feb., 34.  
**Feldman, Leonard**, *What Makes a CD Player Professional?*, April, 36; *At Last—Stereo TV*, June, 47; *Sony Car CD Player: On the Road Ahead*, July, 26; *VHS Hi-Fi: Five Units Tested*, Nov., 42.  
**Heyser, Richard C.**, *Speaker Impedance: More Complex Than One Number*, June, 42; *Phase Filter for Digital: On the Testbench*, July, 37.  
**Janda, J.**, B.-E. Edvardsen, and P. W. Mitchell, *NAD's Floppy Tonearm*, Feb., 34.  
**Jensen, J. Selmer** and S. K. Pramanik, *Dynamic Bias Control with HX Professional*, Aug., 34.  
**Kaufman, Richard J.**, *Phase Filter for Digital*, July, 34.  
**Kita, Robert**, *Bringing Trackability Home*, Jan., 68.  
**Lander, David**, *The Audio Interview: Sheffield's Doug Sax and Lincoln Mayorga*, Jan., 62; *The Audio Interview: Jack Renner*, July, 30; *The Untold Story Behind the Bose-CU Case*, Dec., 42.  
**Mitchell, P. W.**, B.-E. Edvardsen, and J. Janda, *NAD's Floppy Tonearm*, Feb., 34.  
**Petras, Fred**, *Olde-Tyme High-Tech Electronic Cylinder System*, May, 66.  
**Polk, Matthew**, *Polk's SDA Speakers: Designed-In Stereo*, June, 32.  
**Pramanik, S. K.** and J. Selmer Jensen, *Dynamic Bias Control with HX Professional*, Aug., 34.  
**Roberson, Howard A.**, *Cassette Test Update: 12 Formulations*, Sept., 47; Addenda, Nov., 15; Dec., 5.  
**Salvati, M. J.**, *Performance-Check Your Amp and Preamp, Part I*, Feb., 42; *Part II*, March, 42.  
**Schott, Wayne**, *Philips Oversampling System for Compact Disc Decoding*, April, 32.  
**Tiven, Jon & Sally**, *Home Studio: Do It the Pro Way, Part II*, Dec., 46.

## CELESTION DEALERS

- ALABAMA. Brewton  
 McDowell Electronics  
 CALIFORNIA. Anaheim  
 Henry Radio  
 CALIFORNIA. Berkeley  
 DB Audio  
 CALIFORNIA. Carmichael/Sacramento  
 Pinkerton Audio  
 CALIFORNIA. Fairfield  
 C & M Stereo Unltd.  
 CALIFORNIA. Hollywood  
 Ametron  
 CALIFORNIA. Los Angeles  
 Christopher Hansen Ltd.  
 CALIFORNIA. Los Angeles  
 Bel Air Camera & Hifi  
 CALIFORNIA. Los Angeles  
 Paul Seydor Audio  
 CALIFORNIA. Mill Valley  
 World of Sound  
 CALIFORNIA. Monterey Park  
 Gene Rubin Audio  
 CALIFORNIA. San Diego  
 Stereo Unlimited  
 CALIFORNIA. San Francisco  
 World of Sound  
 CALIFORNIA. Santa Monica  
 Shelley's Stereo  
 COLORADO. Fort Collins  
 U.S. Stereo  
 FLORIDA. Coral Gables  
 Sound Components  
 FLORIDA. Ft. Lauderdale  
 Sound Components  
 FLORIDA. Jacksonville  
 House of Stereo  
 GEORGIA. Atlanta  
 Back Door Stereo  
 GEORGIA. Smyrna  
 Back Door Stereo  
 ILLINOIS. Chicago  
 Paul Heath Audio Ltd.  
 ILLINOIS. Evanston  
 Audio Consultants  
 ILLINOIS. Hinsdale  
 Audio Consultants  
 ILLINOIS. Naperville  
 Quintessence Audio Ltd.  
 KENTUCKY. Lexington  
 Custom Electronics  
 MASSACHUSETTS. Cambridge  
 Goodwins  
 MASSACHUSETTS. Marlboro  
 Hi Fi Listening  
 MASSACHUSETTS. Northhampton  
 Sound & Music Audio  
 MASSACHUSETTS. Sudbury  
 Electric Gramophone  
 MICHIGAN. Farmington Hills  
 Esoteric Audio  
 NEW JERSEY. Woodbridge  
 Woodbridge Stereo  
 NEW YORK. Manhattan  
 Audio Salon  
 NEW YORK. Manhattan  
 Lyric Hi Fi  
 NEW YORK. Manhattan  
 Music Masters  
 NEW YORK. Manhattan  
 Stereo Exchange  
 NEW YORK. Mount Kisco  
 Homestyle Appliance  
 NEW YORK. Rochester  
 Sound Concept  
 OKLAHOMA. Norman  
 Thomson Sound  
 OKLAHOMA. Oklahoma City  
 Thomson Sound  
 OREGON. Medford  
 Sound Track  
 OREGON. Milwaukie  
 Brownell Sound  
 PENNSYLVANIA. Philadelphia  
 Nathan Muchnick  
 TEXAS. Dallas  
 Omni Sound  
 TEXAS. Fort Worth  
 Power Base Electronics  
 TEXAS. Laredo  
 Audio Systems  
 TEXAS. Lubbock  
 Hi Fidelity of Lubbock  
 TEXAS. San Antonio  
 Bill Case Sound  
 UTAH. Salt Lake City  
 Discriminator Music  
 VIRGINIA. Alexandria  
 Excalibur Audio/Video  
 VIRGINIA. Virginia Beach  
 Digital Sound  
 WASHINGTON. Seattle  
 Definitive Audio

**14½" x 8" x 10" x incredible.**



**SL6**  
BY CELESTION

**are**

**"It is, quite simply, probably the best loudspeaker they have ever made, and one of the finest produced anywhere."**

Peter Herring, Practical Hi Fi

**celestion  speakers**

Celestion Industries, Inc., 521 Kuniholm Drive, Holliston, MA 01746 • 1-800-235-7757  
In Canada, Rocelco, Toronto

Enter No. 18 on Reader Service Card



## Technics Digital Compact Disc Players. Lasers and computers give you the one experience your conventional audio system never could: Reality.

Reality: The duplication of a live musical performance. The most elusive goal of all. Yet reality is precisely what you hear with Technics digital Compact Disc players.

How? Technics revolutionary Compact Disc players have a laser instead of a conventional stylus. Because instead of conventional record grooves, digital Compact Discs have a computer code. The laser "reads" this code. And a computer instantaneously translates it into music.

What you hear is not just a reproduction of the music, but a re-creation of it: Reality.

And nothing touches the Compact Disc except the laser beam. That means there is no wear. No noise. And no distortion. All of which can plague conventional records.

All this Technics digital technology comes together in the latest generation of Technics Compact Disc players. The remarkable SL-P8 and SL-P7.

You can program the SL-P8 up to 32 different

ways. Play any selection you want. In any order you want. Repeat the selections you like. Even skip ones you don't.

Auto Music Scan automatically lets you hear the first 10 seconds of every selection. So finding the selection you want is easy.

The fluorescent display shows you precisely where the laser is on the disc. So you can even find the exact notes you want to hear.

And to let you do all this from across the room, the SL-P8 even has an infrared remote control.

Experience the full range of Technics digital technology. Including the SL-P8 and the affordable SL-P7.

The digital revolution continues at Technics.

**Technics**  
The science of sound

**Get a Technics CD Starter Kit\* — 3 Free Discs: The Jacksons' "Victory," "Flashdance," "Classical Sampler." Plus a Free CD Cleaning System & CD Club Membership Including 1 Free Disc. Total Suggested Retail Value Over \$85.**

\*with purchase of any Technics CD Player from September 1 to December 31, 1984. See participating Technics dealers for details.

Enter No. 51 on Reader Service Card