

Stereo Review

JULY 1973 • 75 CENTS

CALENDAR OF CLASSICAL COMPOSERS

<p>H.W. Henze  1 JULY</p>	<p>C. WILLIBALD GLUCK </p>	<p>3 Leoš Janáček Meyer Kupferman Ruth Crawford Seeger</p>	<p>Wm. Byrd 4  STEPHEN FOSTER L. Armstrong</p>	<p>5 Wanda Landowska Paul Ben-Haim George Rochberg</p>	<p>6 Charles Whittenberg Joseph Holbrooke  G. MAHLER</p>
<p>G. Antheil 8  P. Granger</p>	<p>9  Ottorino Respighi</p>	<p> Carl Orff</p>	<p>11 J. S.  Lekmann</p>	<p>12 Evaristo dall'Abaco J. J. Quantz Clara L. Kellogg Karl Barth Van Cliburn O. Hammerstein Geo. Butterworth</p>	<p>13  Gerald Finzi</p>
<p>15  Julian Bream</p>	<p>16 Fanny Bloomfield Leislere Eugene Ysaïe</p>	<p> PETER SCHICKELE</p>	<p>18 Bononcini Hugo Riemann Pauline Viardot-Garcia</p>	<p>19 Klaus Egge</p>	<p>De Seval 21  St. Filippo NERI Irving Scherke J.C. Pepusch</p>
<p>Julius 22 Stockhausen</p>	<p>Ben Weber  LEO</p>	<p>24 Benedetto Marcello E. Bloch</p>	<p>25 </p>	<p>26 John Field Mick Jagger</p>	<p> Rudy Vallee 28 E. Granados E.v. Dohnányi </p>
<p>29 DIAMOND</p>	<p>30 man Del Nar</p>	<p>31  angois aveart</p>	<p> 7</p>	<p> 15</p>	<p> 22</p>
					<p> 29</p>

42936 BCH HAZELG93 SEPT3 7 1J
D EUCHEMAN
HAZEL GREEN ACAD
HAZEL GREEN
KY 41332 SCF



Power Bandwidth. 15-50
KHz -0.9% dist.

FM Sensitivity [IHF]: 1.9 uv [-30
dB noise & dist.].

Capture Ratio: 2.8 dB.

Distortion: 0.5% @ 100% mod.

Alternate-channel selectivity: 50 dB

What
you
don't
see
see



is what you get

SHERWOOD | S-7100A



TUNING

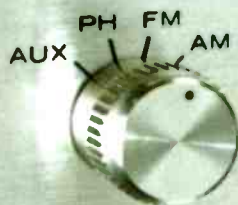
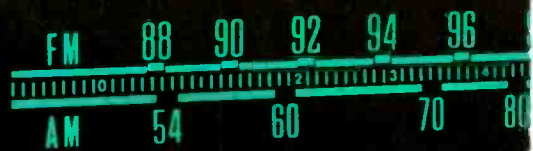

SELECTOR

TAPE MON
OUT

MODE
STEREO

FM HUSH
OUT

LOUDN
DN



IN



MONO



IN



OFF

Power Output—RMS, both channels driven.

27 watts × 2 @ 4 ohms, 1 KHz.

22 watts × 2 @ 8 ohms, 1 KHz.

14 watts × 2 @ 8 ohms,

20–20,000 Hz.

18 watts × 2 @ 8 ohms, 1/3

40–20,000 Hz.

Harmonic Distortion: 0.9% @ 8 ohms rated output, 0.20% @ 10 watts

Walnut case, included in the price.

You won't see Sherwood advertised on television.

Manufacturers are constantly faced with an agonizing choice: How much do you spend on the product and how much do you spend advertising it?

With products like receivers, which require a great deal of handcrafting, whatever is spent on advertising must literally come out of the product itself.

It must be obvious to you that Sherwood is not exactly a household word.

At the same time you see other manufacturers spending a great deal of money to advertise in very expensive places: The Johnny Carson Show, The Today Show, in Playboy, Penthouse, Time, etc.

Advertising dollars must come right out of the product.

Example: one of the two top hi-fi component manufacturers [and advertisers] in this field boasts that their \$200 receiver puts out 10 + 10 watts RMS power @ 8 ohms from 40-16,000 Hz. The walnut case is extra.

Compare that to our S7100A spec: 18 + 18 watts from 40-20,000 Hz. And we include the walnut case. For only \$219.95.

Another major manufacturer gives you 17 + 17 watts RMS [@ 1KHz] and charges \$260. Our S7100A offers 22 + 22 watts for \$40 less.

Spec for spec, dollar for dollar, we'll match our receivers with any other manufacturer.

We put our marketing dollar into

improving the receiver and rely on the equipment to speak for itself.

And that, obviously, is what has been happening. Sherwood receivers have been consistently getting "Best Buy" ratings from consumer testing publications.

For a recent review of the S7100A see **Stereo & HiFi Times**, Spring issue. Or write to us for a complete reprint: Sherwood Electronic Laboratories, Inc., 4300 North California Avenue, Chicago, Illinois 60618.

Who knows, we might be starting a trend:

Television programs with fewer commercial interruptions.

Goodnight, Johnny



Sherwood

The word is getting around.

IMPROVE YOUR HEARING FOR \$200.

Sometimes high fidelity people lose sight of what it's all about: Sound.

The ultimate test of any piece of high fidelity equipment is what you hear.

That's why, of all the statements made by equipment reviewers about our Garrard Zero 100, the most significant were these:

"Using identical virgin records, and virgin styli in identical good cartridges, the Zero 100 on occasion sounded markedly 'crisper' than other turntables." *Rolling Stone*.

"A listening test proves to bring new life to many records, noticeably reducing distortion on the inner grooves." *Radio Electronics*.

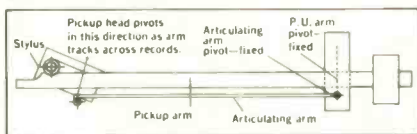

"From about 7 in. diameter to runout, the Zero 100 delivers considerably less distortion and greater definition than with the same pickup mounted in a standard arm. The improvement in sound quality is notably impressive."

Elementary Electronics.

"The articulated arm of the Zero 100 produced less distortion, and therefore greater definition, on high-level, musically complex passages, from the inner grooves."

Hi-Fi Stereo Buyers' Guide.

That's what reviewers actually

heard when they tested the first automatic turntable with Zero Tracking Error. This is, to our knowledge, the first time a turntable has been given credit for making records sound better.

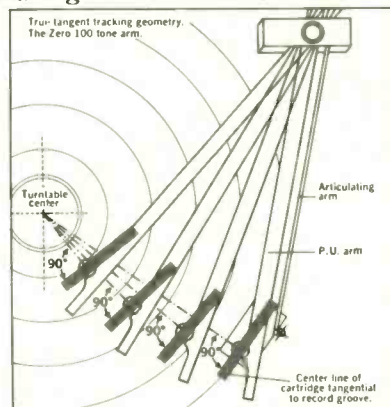

Cartridges and other components, yes. But never a turntable — until the Zero 100.

By this time you probably know how we achieve Zero Tracking Error. The principle of the articulating arm, continually adjusting the angle of the cartridge so it is always at a 90° tangent to the grooves, is a simple one. But the ingenious engineering and the development of the precision pivots to make the principle work, took several years.

But enough from us. Let's go back to what the reviewers say about the Zero 100.

"It probably is the best arm yet

offered as an integral part of an automatic player." *High Fidelity*.

"All of these features combined into one automatic turntable make news, even though some are found on other units. Only in the Zero 100 are they all put together." *Audio*.

When *Audio* talks about "all of these features" they're referring to such things as our magnetic anti-skating, variable speed control, illuminated strobe, viscous-damped cueing, 15° vertical tracking adjustment, patented Garrard Synchro-Lab synchronous motor and our exclusive two-point record support in automatic play.

But all of this gets back to our original point. It is the sound that makes the difference. After all, a \$200 record player should give you a really meaningful difference. And the high fidelity experts agree that people who own a Zero 100 will hear better than people who don't.

If you'd like to read the reviews in full detail, we'll send them to you along with a complete brochure on the Zero 100 and the Garrard line. Write to: British Industries Company, Dept. G33, Westbury, N.Y. 11590.

GARRARD ZERO 100

The only automatic turntable with Zero Tracking Error.

Dist. by British Industries Company/Div. of Avnet, Inc.
Mfg. by Plessey Ltd.



Stereo Review

JULY 1973 • VOLUME 31 • NUMBER 1

THE MUSIC

THE BASIC REPERTOIRE

Bartók's Music for Strings, Percussion, and Celesta MARTIN BOOKSPAN 46

CALENDAR OF CLASSICAL COMPOSERS

Music history in capsule: a three-page foldout in color JAMES GOODFRIEND 50

THE MUSICAL STYLES OF THE ROMANTIC PERIOD

A guide to the significant features of a landscape we still live in ERIC SALZMAN 54

STOP! IN THE NAME OF LOVE!

Contemporary song lyrics are running a little short on tenderness J MARKS 70

RICK NELSON

The continuing saga of a pop singer with a high survival quotient TODD EVERETT 72

IGGY (POP) AND THE STOOGES

The pain and terror of growing up—set to music LESTER BANGS 86

A LITTLE SONDHEIM

Two new albums provide assurance that all is not lost on Broadway REX REED 94

THE NEW CARMEN

Deutsche Grammophon's recording is better than the Met original ERIC SALZMAN 100

THE FAIRY QUEEN

Peter Pears ornaments two new versions of the Purcell "semi-opera" IGOR KIPNIS 115

THE EQUIPMENT

NEW PRODUCTS

A roundup of the latest in high-fidelity equipment 12

AUDIO QUESTIONS AND ANSWERS

Advice on readers' technical problems LARRY KLEIN 16

AUDIO BASICS

Glossary of Technical Terms RALPH HODGES 20

TECHNICAL TALK

Speaking of Acoustics; Hirsch-Houck Laboratory reports on the ESS amt 1 speaker system, BSR-Metrotec FEW-1 frequency equalizer, Technics SL-1100A record player, and Shure V-15 Type III phono cartridge JULIAN D. HIRSCH 33

INSTALLATION OF THE MONTH

Total Stereo SUSAN LARABEE 63

PHONO CARTRIDGES

Their manufacturers are challenged by an ever-advancing disc technology .. JULIAN D. HIRSCH 64

TAPE HORIZONS

Cassettes: The Next Step Up CRAIG STARK 116

THE REVIEWS

BEST RECORDINGS OF THE MONTH 75

POPULAR DISCS AND TAPES 81

CLASSICAL DISCS AND TAPES 97

THE REGULARS

EDITORIALLY SPEAKING WILLIAM ANDERSON 6

LETTERS TO THE EDITOR 8

GOING ON RECORD JAMES GOODFRIEND 27

ADVERTISERS' INDEX 116

COVER: Design by Borys Patchowsky; photo by Bruce Pendleton

2



4



PHONES ONLY

MAIN

REMOTE

MAIN
RE

MAIN

REMOTE

MAIN +
REMOTE

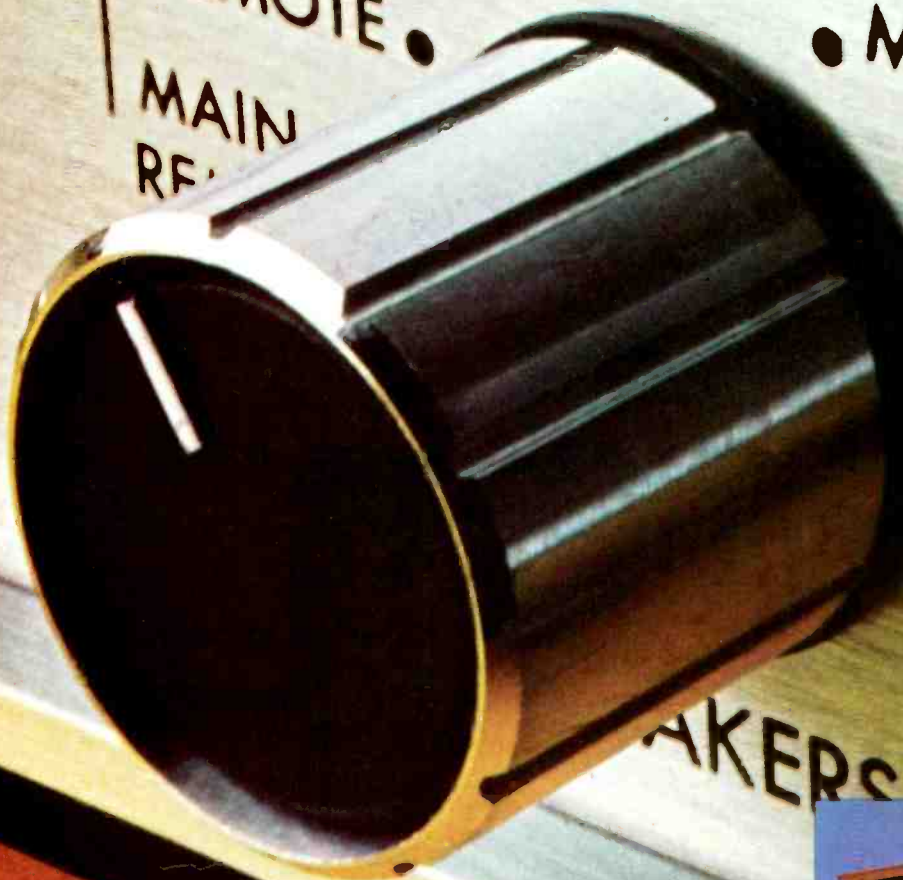

MAKERS



NO MORE UNEMPLOYED WATTS.

Until now, 4-channel receivers could deliver their full power only into four speakers.

Playing regular stereo through two speakers meant leaving two channels idle. Half of those expensive watts were unemployed.

Fisher has changed all that with the new Studio-Standard 4-channel receivers. Each has a 2/4-channel front-panel switch, like the one shown here.

In the "2" position, the four amplifiers are "strapped" together in pairs to drive two speakers with their *combined* power. No unemployed watts! In the "4" position, the four amplifiers are separated for 4-channel operation with four speakers.

The Fisher 504, at \$599.95* is the most advanced of the Studio-Standard receivers. (See specifications.) Two others are available for considerably less, with minimal changes in features and performance.

Write us for detailed literature. The "strapping" feature is just the beginning of the Studio-Standard story.

Fisher Radio, Dept. SR-7, 11-40 45th Road, Long Island City, N.Y. 11101.

FISHER
Studio-Standard

Fisher 504 Studio-Standard 4-Channel Receiver

Continuous sine-wave power, 20 Hz to 20 kHz (not just IIF music power!)	40/40/40/40 watts at 4 ohms 32/32/32/32 watts at 8 ohms
4-channel matrix decoder	SQ
FM sensitivity (IIF standard)	1.8 μ V
Capture ratio (IIF at 1 mV)	1.2 dB
FM front end	Dual-gate MOSFET with AGC
FM input	Up to 3,000,000 μ V (3 V)
MPX decoder	PLL (phase-locked loop)

*Fair trade prices where applicable.
Prices slightly higher in the Far West and Southwest.

Stereo Review

PUBLISHER
EDGAR W. HOPPER

EDITOR
WILLIAM ANDERSON

MANAGING EDITOR
WILLIAM LIVINGSTONE

MUSIC EDITOR
JAMES GOODFRIEND

TECHNICAL EDITOR
LARRY KLEIN

ART DIRECTOR
BORYS PATCHOWSKY

COPY EDITOR
LOUISE GOOCH BOUNDAS

ASSOCIATE TECHNICAL EDITOR
RALPH HODGES

POPULAR MUSIC EDITOR
STEVE SIMELS

ASSISTANT MUSIC EDITOR
VIVIENNE WINTERRY GOODMAN

PRODUCTION EDITOR
PAULETTE WEISS

CONTRIBUTING EDITORS

CHRIS ALBERTSON
MARTIN BOOKSPAN
ROBERT S. CLARK

NOEL COPPAGE
DAVID HALL
JULIAN D. HIRSCH

BERNARD JACOBSON
GEORGE JELLINEK
IGOR KIPNIS

PAUL KRESH
REX REED
PETER REILLY

STEPHEN E. RUBIN
ERIC SALZMAN
CRAIG STARK

LESTER TRIMBLE
JOEL VANCE
ROBERT WINDELER

LONDON EDITOR
HENRY PLEASANTS

ADVERTISING MANAGER
JAMES J. SULLIVAN

ADVERTISING SERVICE MANAGER
MADELEINE LITTMAN

GROUP VICE PRESIDENT
ELECTRONICS & PHOTOGRAPHIC
FURMAN HEBB

ASSOCIATE PUBLISHER
STANLEY NEUFELD

Editorial and Executive Offices
Ziff-Davis Publishing Company
One Park Avenue, New York, New York 10016
212 679-7200

Eastern Advertising Manager: Richard J. Halpern

Midwestern Office: The Pattia Group
4761 West Touhy Ave., Lincolnwood, Ill. 60046
312-679-1100

Arnold S. Hoffman

Western Office
9025 Wilshire Boulevard
Beverly Hills, California 90211
213 273-8050; 272-1161

Western Advertising Manager: Bud Dean

Japan: James Yagi
Oji Palace Aoyama, 6-25, Minami Aoyama
6-Chome, Minato-ku, Tokyo, Japan
Telephone: 407-1930/6821

Circulation Office
P.O. Box 2771, Boulder, Colorado 80302

EDITORIAL CONTRIBUTIONS must be accompanied by return postage and will be handled with reasonable care, however, publisher assumes no responsibility for return or safety of art work, photography or manuscript.

Member Audit Bureau of Circulations



ZIFF-DAVIS PUBLISHING COMPANY
William Ziff, President
W. Bradford Briggs, Executive Vice President
Hershel B. Sarbin, Senior Vice President and Secretary
Philip Sine, Financial Vice President and Treasurer
Phillip T. Heffernan, Vice President, Marketing
Frank Romorantz, Vice President, Creative Services
Arthur W. Butzow, Vice President, Production
Edward D. Muhfeld, Vice President, Aviation Division
Irwin Robinson, Vice President, Travel Division
George Morrissey, Vice President
Sydney H. Rogers, Vice President
Sidney Holtz, Vice President
Lawrence Sporn, Vice President, Circulation



EDITORIALLY SPEAKING

By WILLIAM ANDERSON

POPSICAL MUSIC (SECOND VERSE)

A PAIR of peremptory interruptions—space limitation and printing deadline—combined to yank me off this little stage last month before I had quite finished my number on the subject of classical *versus* (or classical *and/or*) popular music. So, to resume: perhaps I have already made it clear that although I stand with those who believe there are substantial, if hard to pin down, differences between classical and popular music in both production and consumption, I also believe that both have their natural, occasionally overlapping, places somewhere on the grander continuum we call Music and—particularly—that both *ought* to have their places in all our lives as well. The differences are not only elusive in themselves; they are also obscured and confounded by a fog of extra-musical concerns—social, moral, and even political—that add more subjective heat than objective light to the discussion.

But there is one difference, it seems to me, that is hard to deny either subjectively or objectively, and that is the position each of these kinds of music occupies in time. Popular music, to put it metaphorically, is like a daily newspaper, chronicling in closely observed detail the almost moment-to-moment happenings, the thoughts, ideas, and concerns of the present tense. This is not to say it simply sets headlines to music, but that it has an almost eerie knack for communicating the feel, the aura, the very essence of comparatively brief moments in time. This is a great and useful gift, but it has its price, and that price is transiency: in general, popular music has all the permanence of a May fly, a hemline—or yesterday's newspaper. Its very completeness is both virtue and fault: the picture is perfect, but it is unfortunately too specific. Classical music, in the terms of our metaphor, is a history book. It does not deal in particulars, as popular music does, but in generalities—the bigger picture, the larger movement, the universal theme; it is the celestial as opposed to the terrestrial telescope. Without being wholly independent of time, it nonetheless manages to live simultaneously in past, present, and future, to deliver its messages almost miraculously intact over the span of centuries. In order to do this, its musical means must be abstract, mythical, learned—and difficult. Its gifts are, though different, as great and useful as those of popular music, and the price—the sacrifice of the broader audience—may be even higher.

Now, distinctions of this kind are always far from clear-cut, and since pettifogging exception has always been the sworn enemy of your fine, ringing generality, let me knock at least one of them down right here. What about the staying power of folk music? Well, (a) there is a whole body of Norwegian folk songs so old and decayed that no one knows what it means any more; (b) folk song may be persistent, but it is not universal and cannot communicate from one language or culture to another unless (c) it has been transmuted by a *classical* operator named Brahms, Schubert, Chopin, Dvořák, Bartók, Sibelius, Canteloube, or John Jacob Niles.

Ars longa, vita brevis est. If I may be permitted one more twist of that flexible Senecan aphorism, I would like to point out that it may have something to say about the fact that popular music, brief candle that it is, is performer-oriented (*vita brevis*) and that perdurable classical music is composer-oriented (*ars longa*). When great popular performers fade away, their music fades with them; when great classical performers retire, the music remains. Parting shot: in this issue you will find Music Editor James Goodfriend's *Calendar of Classical Composers*, a capsule compendium of 142 classical composers from the year 1400 to the present. Every one of these 142 is represented in the current recordings catalog—certainly some kind of tribute to the timelessness of their music. Can anyone even envision working up a similar calendar for popular composers? The question is rhetorical and is not meant to denigrate popular music in any way. But can we at least agree that there is here a *difference*, and that that difference may be significant?

Can you live without a 400 watt amplifier?

Maybe. If you're content to listen to music at a less than realistic level. Or if you don't mind the loss of quality caused by clipping during the more dramatic passages in your favorite records. On the other hand, if you want to listen at a real-life level without distortion, you need at least 400 watts of amplifier power. Other things being equal, the more power you have to drive those fine speakers, the more faithful the sound. Julian Hirsch put it this way: "Anyone using a low-efficiency speaker . . . with an amplifier in the 30 to 50 watt class cannot approach realistic listening levels without severe clipping." And *Audio*, after listening to the Phase Linear 400, said, ". . . many people do not realize just how much power is necessary to handle peaks without clipping . . ." *Stereo Review* summed up: "A superb amplifier, furnishing the essential qualities of the

(Phase Linear) Model 700 at a much lower price (almost a bargain in today's market)."



Advanced design heat sink provides protective cooling.

At \$499.00 why live with anything less than the Phase Linear 400? Ask your dealer for an audition.

Phase Linear 400

THE POWERFUL DIFFERENCE

PHASE LINEAR CORPORATION
P.O. BOX 549
EDMONDS, WASHINGTON 98020

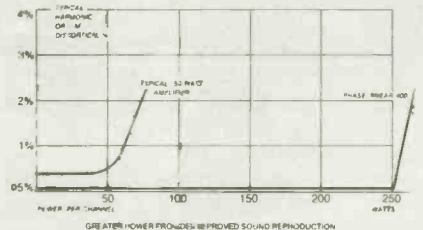

Phase Linear 400

400 watts RMS direct coupled solid state stereo power amplifier.

POWER: Greater than 200 watts/channel RMS both channels driven into 8 ohms. Power at clipping typically 250 watts/channel into 8 ohms and 400 watts/channel RMS into 4 ohms. **HARMONIC OR I.M. DISTORTION:** Less than .25%; typically less than .05%.

PROTECTION: Patented protection circuit monitors energy, shuts down amplifier if safe operating levels are exceeded. **HUM AND NOISE:**

Better than 100 db below 200 watts.

STABILITY: Absolutely stable with all speaker loads including electrostatic units.

WARRANTY: Three years, parts and labor.

FFICE: \$499.00

WALNUT CABINET: \$37.00.





LETTERS TO THE EDITOR

Rachmaninoviana

● I was extremely interested in the tribute to the great Sergei Rachmaninoff by Victor Seroff in the May STEREO REVIEW. However, as a collector of Rachmaninoviana both substantial and trivial, I must question one of Mr. Seroff's observations: "... I cannot even imagine him having a hamburger and a cup of coffee at a drugstore lunch counter." It may be that by 1943 Rachmaninoff had indeed abandoned all frivolity in his personal life, yet as late as 1937 he had not, if at least one source of information is to be trusted. I offer this paragraph:

"Waiting his turn at a soda bar a couple of years ago where he had come for a double orange juice, he heard a girl ordering a cherry malted milk float. He watched, fascinated, as the soda jerker put together this mysterious beverage. He asked for one. It tasted fine. He got the recipe and carefully memorized, 'Cherry syrup, malt, milk, a scoop of ice cream.' The sight of a fancy soda counter evokes in him an immediate desire for the drink. If he happens to be in a one-arm joint where the soda jerk has never graduated beyond an ordinary malted milk, Rachmaninoff patiently instructs him in the mysteries of his drink."

This trivial observation was made in the course of an article entitled "Musical Triple-Threat" by Howard Taubman, in the December 16, 1939 issue of *Collier's* magazine.

In more substantial aspects, however, Mr. Seroff's article is enormously valuable, and not the least reason for this is the sense of immediacy conveyed by the author, making his interview appear to have been conducted yesterday, instead of over thirty years ago! Lovers of Rachmaninoff as pianist and composer are deeply in his debt.

THOMAS L. DIXON
Sodus, N. Y.

● Your May issue purportedly contained a centennial celebration of Sergei Rachmaninoff. What was actually published was (1) Victor Seroff's "Sergei Rachmaninoff as I Knew Him," a revealing personal memoir, interesting and informative, appropriate to a centennial appreciation of the great musician's birth, and (2) Eric Salzman's "Rachmaninoff Da" and "Rachmaninoff Nyet," an unprincipled attack on the composer's best musical virtues in the guise of a pro-and-con appraisal.

Mr. Salzman's articles are not worth rebut-

tal, but why, in a centennial memoir, when one would expect above all to find an affirmative appraisal of the man's music, did STEREO REVIEW instead print this vitriolic attack? Was there nowhere to be found a rational discussion of the music's merits? Why, if you couldn't get a writer who appreciated the music, did you substitute such a shameful insult?

CATHERINE MONROE
Washington, D. C.

● "Will history be kind to Rachmaninoff?" asks Eric Salzman in the May issue ("Rachmaninoff Nyet"). He doubts it. I doubt it, too. Any culture without the courage to say that the emperor has no clothes when hearing today's music will allow itself to be bullied out of anything, no matter how estimable.

Think of Rachmaninoff. What comes to mind—his music? Probably not—that comes second. One thinks of a very somber, serious face, and feels the air of mysterious, secretive privacy: this is what critics confuse with his music when they write their clever reviews.

If a listener is ever going to discover the composer who, more than any other so far, spoke for free, unfettered joy, exultation, and serenity (called self-pity, bathos, or melancholia by critics in whom these latter emotions come closest to being the former), then he can't be intimidated by such rot as critic Salzman's "Rachmaninoff Nyet" or the even more intimidating approach in Mr. Salzman's "Rachmaninoff Da." When Beethoven, Brahms, Verdi, and Wagner become "campy," only then will the definition be twisted enough to fit Rachmaninoff.

BRUCE S. BROCKWAY
ST. PAUL, MINN.

● In his "Rachmaninoff Da" and "Rachmaninoff Nyet" pieces (May), Eric Salzman has pulled off a performance of "dialectical personality opposition" (nowadays we call it schizophrenia) all his own. Re the Salzman negations: Rachmaninoff did not conceive of his music as "a kind of background for day-dreaming—music to stupefy the listener, to stroke his emotions. . . ." Refusing to broadcast, he said quite specifically that "the listener is too comfortable. Music is not a bath. It is a passion and a problem, like poetry." His best work, the last six songs, the great *cappella Vsnenochnaya*, the second book of *Etudes-Tableaux*, the *Trois Chansons Russes*, the Third Symphony, in addition

to the pieces Mr. Salzman mentions, demands the concentrated attention that all great art does, and "tells us" everything.

On another level, it is disheartening to see Robert S. Clark in "Beyond the Basic Repertoire" in the same issue refer to John Culshaw's "admirable monograph" on Rachmaninoff. This is a book—ineptly written, condescending, error-infested—for all serious students of the composer to avoid. As a corrective, one longs for a reprint of William Flanagan's *Sergei Rachmaninoff: Twentieth-Century Composer* (in the British publication *Tempo*, 1952).

NOEL FARRAND
New York, N. Y.

Mr. Salzman replies: In a schizophrenic society, schizophrenia is a very fashionable disease, so I guess I'll accept gracefully Mr. Farrand's diagnosis of my "dialectical personality opposition" concerning Rachmaninoff. Of course, on a personal and emotional level—obviously the most valid approach for the individual—the question is only "like" and "dislike." But artistic questions are, in the cultural sense, more than just personal preference polls and the case of Rachmaninoff—so adored and so hated—is such a fascinating one that it deserves serious thought; that is what I hoped I had given it. I am of two minds about Rachmaninoff. His music seems to be the apotheosis of the ancien regime and, whatever the composer's intention, the result is emotional escapism. On the other hand, I really have very little sympathy with the modernist and quite elitist attacks on his music and I agree with Mr. Farrand that his music gains enormously by being taken seriously. Perhaps I could sum up the point of "Rachmaninoff Da" and "Rachmaninoff Nyet" by saying Rachmaninoff's music has great intrinsic value, that its artistic anachronisms matter less and less as time goes on, but that it nonetheless represents a kind of decadent cultural situation (Kultur, Concerto, Carnegie Hall, Great Artiste) which is now coming back (did it ever leave?) to plague our "classical" musical life and prevent its further growth. No art, no matter what its "intrinsic" worth, can be judged entirely on either a personal or abstract level, but Rachmaninoff, however great or small as an artist, is frankly a monkey on our backs. Like it or not, that is our problem and, increasingly, our passion.

McCormack's Rachmaninoff

● The John McCormack-Fritz Kreisler performance of *O cease thy singing, maiden fair* that Robert S. Clark describes as being "in limbo" ("Beyond the Basic Repertoire," May) is still (or perhaps again) available on RCA LM 6099, the two-disc Kreisler set. I recall reading several years ago that, though listed in Schwann, the album was actually unobtainable, but I bought it by mail just a few weeks ago from Chesterfield, a dealer in New York. I was attracted by the incredibly beautiful interweaving of voice and violin on that particular song as much as by any of the other items on the album.

DAVID PIERCE
Vero Beach, Fla.

Latin Lovers

● As a long-time reader of STEREO REVIEW, I find it necessary and quite surprising to point out several obvious defects in Joel Vance's article "The Latin Connection" (Continued on page 10)

IF OUR \$1000 SPEAKER DOESN'T GET YOU, MAYBE OUR \$55 ONE WILL.

People who hear about the Linear Sound of EPI invariably ask, "How much?"

To which we respond: "It depends."

If money is no object, we're only too happy to recommend our Model 1000. "The Tower," we call it.

This is a \$1000 item (each), and it is the absolute epitome of EPI's Linear Sound. (The Tower is *The Stereophile's* most recent addition to its select list of five Class A speakers.)

On a frequency response graph, the Tower will record a virtually straight line from the lowest bass to the highest treble. Meaning that what you hear is a pure, uncolored, natural sound from bottom to top. With no artificial boosting of the bass to impress the innocent. And all the nuances and overtones at the treble end that, on ordinary speakers, just fade away.

In short, what you hear is something rather sensational. (At \$1000 a crack, you might say it *ought* to be sensational. It is.)

But since, for most people, money is an object, you'll be happy to know our

Model 1000 is just one of eight Linear Sound speakers from EPI.

In the middle of the line, for example, you'll find our Model 400, "The Mini Tower," at \$389. Of this speaker, *Stereo Review* said, "The airy, open quality... in our view earns it a place in the select group of superb speaker systems."

Then, for the budget-minded, is our Model 50 at an attractive \$55 each.

Don't let the price fool you.

The EPI Model 50 produces a true linear sound. It has the same 1" air spring tweeter you'll find in the Tower and the same 6" long-throw woofer you'll find in the Mini Tower.

When *Audio Magazine* reviewed the Model 50, it recorded a response that "extended from 45 to 16,000 Hz ± 3 db, and dispersion was excellent." When *Audio* tested 14 small speakers for dispersion, our Model 50 beat the pack of them.

So, getting back to the question of the cost of EPI's Linear Sound:

How much did you want to spend?

(You can reach us at Epicure Products Inc., Newburyport, Mass. 01950.)

**THE LINEAR SOUND
OF EPI.** 



(May). Although I did not agree with several observations made by Mr. Vance, his greatest error seems to be in what he did *not* write. How anyone can fail to mention Tito Rodriguez or Machito in an article on Latin music is an oversight for which there is no possible excuse.

AMELIO PAOLUCCI
New York, N. Y.

Mr. Vance replies: Please reread page seventy-nine of my article, where I state "The following list does not pretend to be complete, but the records are all both representative and tasty. So, if you like the taste, remember that there's much, much more to be had."

● I read the article on Latin music by William Livingstone with great pleasure and hope you will do a follow-up at some time in the near future. My record collection has been immeasurably improved as a result.

I would like to bring to Mr. Livingstone's attention a singer he may have overlooked, María Dolores Pradera. She is a singer of considerable scope and greatness. She is well known and very popular in Spain, and her records are available in the States.

PHYLLIS STEVENS MANGRAVITE
New York, N. Y.

● Re "The Latin Connection" by Joel Vance and "A Latin Postscript" by William Livingstone in the May issue of STEREO REVIEW: How could any serious list of Latin greats have possibly excluded the late Tito Rodriguez? Along with Tito Puente, he did more to promote the soul of Latin music here than most of the "Hollywood Latins" mentioned in the articles. Over the past twenty-five years or more, whose voice has caressed a lyric more beautifully than his? I, for one, will always miss him and cherish the many recordings still available.

R. SOUTHWERTH
Brooklyn, N. Y.

Managing Editor William Livingstone replies: On page eighty-two of my article, Mr. Southwerth will find the following: "My list is a very personal sampling, with no attempt at chronological or geographical completeness. I've had to leave out many of my own favorites, so please don't blame me if I've neglected some of yours."

Pure Korn or Solid Gold?

● After reading Paul Kresh's review of Erich Wolfgang Korngold's "The Sea Hawk" in the May issue, I can only conclude that his pseudo-chic remarks prove his genuine lack of understanding of both Korngold and the movies of romantic and swashbuckling cinema. I wonder if Mr. Kresh has ever seen the pictures Korngold wrote his music for. If he has not, I can understand his caustic attitude. To appreciate Korngold one must understand more than just his music.

Korngold, a composer who *will* someday be honored for his real achievements in music (*Die Tote Stadt* and the Violin Concerto in D, among others), was writing emotional grist for the movie mills. As such, this music should be taken for what it is: tone poetry of the greatest universality. Who can fail to feel the wind in the sails and the roll of the ship as Captain Thorpe (Erroll Flynn) sets out to sea ahawking? Korngold's musical setting created emotional climaxes that perhaps would not have been the same otherwise.

It is indeed unfortunate that critics these days tend to berate the old swashbuckling romantic movies as banal and trivial. This might be the "in" thing, critically speaking, but it is a result of lack of identity, or an absence of the ability to feel. For example, *The Sea Hawk* as a movie was horrendous Tudor history, but what great escapist fare it was! How it and the other Korngold scores enlivened a whole generation and more, washing away some of the tears of everyday reality. Eyewash? Yes indeed.

HARVEY MARGOLIS
Cranford, N. J.

Mr. Kresh replies: Whenever a Hollywood composer is described in terms that might not meet the requirements of his studio publicity department, the kitch-lovers of the world unite and send up a plaintive howl. Their cry: all reviews of movie music must be unqualified raves! The difficulty is not that I am unfamiliar with Mr. Korngold's music, nor with the movies for which he wrote it, but that I grew up with both, know them all too well, and apparently have committed the unpardonable sin of outgrowing them. Let's face it—I prefer to obtain my movie popcorn from the popcorn machine.

The Late István Kertész

● It was difficult for me to open the May issue of STEREO REVIEW when I received it, for I knew that it contained a feature article by Stephen E. Rubin on my long-time friend and client István Kertész. Destiny ordained that Maestro Kertész was never to see the article, for he drowned tragically in a swimming accident in Tel Aviv, Israel, on April 17 of this year. Thus a brilliant career ended with shocking abruptness. Maestro Kertész did, however, leave two legacies—first, the remembrance of a series of incredibly distinguished performances on four continents; and second, an outstanding catalog of more than fifty London recordings.

It was sad to read his own words quoted in your interview: "I never felt in my life that I am a man of whom writers must later write a book. I am a simple musician. As a simple musician who enjoys music, and in the same way tries to enjoy life, I have completed my life. Whatever comes after is a gift."

AUDREY MICHAELS
New York, N. Y.

Give a Guy a Break

● The two songs Noel Coppage deems the high points of Jerry Jeff Walker's new album (May), *That Old Time Feeling* and *L.A. Freeway*, are credited to Jerry Jeff's prolific pen. These songs (as Mr. Walker makes clear in his liner notes) were written by one of the finest guitarist-singer-songwriters in the country, Guy Clark. A Texan now moved to Nashville, Guy deserves all the recognition that is rightfully his. Maybe one day we'll have an album of Guy doing his own material for Mr. Coppage to review. This is not meant to take any glory from Jerry Jeff Walker, who continues to create songs with the wonderful insight and humor that are his alone.

DAVID HARGIS
Houston, Tex.

Friml Fans

● Fie, fie on thee, STEREO REVIEW, for assigning to Paul Kresh the review of the Rudolf Friml "Music for the Theater" disc (May). It would appear that Mr. Kresh is much more

suited to reviewing current popular music offerings than albums of the type in question. Evidently he had an unhappy childhood, or is one of the oft-seen types with long grey hair trying in a pathetic but unsuccessful way to be one of the "in" crowd.

A hearty bravo to Monmouth-Evergreen for releases such as this, and may they continue to reissue them! I hope that, should Mr. Kresh be subjected to the reviewing of a similar album, he will run into the middle of a very busy street rather than being diverted by a rock group playing a medley of old songs.

J. DAVID WHITE
Jamaica, N. Y.

● Paul Kresh said in your May issue: "The archeological branch of the record industry is ever ferreting out old artifacts—and some of them I only wish could be put back in their mummy cases and kept there. The music of Rudolf Friml is the sort of thing my mother used to sing to herself during the Depression to keep her spirits up when it was time to start pawning the furniture. I have waited patiently for it to go away . . . no restaurant is safe from some Muzak resurrection of one medley or another."

What an awful thing to really say about poor Rudolf Friml. Do you honestly believe your readers could place an iota of confidence in any man you would hire to review musical comedy who is against it from the start, let alone buy a record you assign him to review, whether favorable or otherwise? We might say the same for any category of music, be it opera, the classics, or music by Paul McCartney, Led Zeppelin, Glenn Campbell, or whatever. Who's really to blame for such irresponsibility—STEREO REVIEW or your assigned reviewer?

FRANK FLANAGAN
New York, N. Y.

The Editor replies: What would really be irresponsible would be to indulge in the kind of pre-censorship Mr. Flanagan seems to be endorsing, to assign a record only on the basis that we were sure ahead of time that the reviewer would like it. The result would be a pollyanna world from which all dissent was absent by prearrangement, one in which even Mr. Flanagan's letter would fail to see print. The world being instead the richly various place it is, I am sure that reviewer Kresh's low tolerance for Friml music is shared by at least a few others. But even if it were not, and he stood quite alone in his opinion, that is hardly sufficient reason to shut him up. On the contrary, such rare, unusual, maverick eccentricity ought to be preserved and encouraged for the good of the species.

A Good Move

● Many thanks to Greg Shaw for his excellent account of the Move (April), even though, in my opinion, it was a retrospective long overdue rather than one "well timed." He is the only writer, save for Lillian Roxon, to make mention of the group's first single, *Night of Fear*, which I remember all too fondly, having heard it upon its release in 1966. Some of the early singles by the Move mentioned in Mr. Shaw's article (*Blackberry Way* and *Curly*, as well as a few minor masterpieces such as *Wild Tiger Woman* and *Omnibus*) are available on the "Best of the Move," an import LP on the Fly label.

JOHN W. INGRAM
Trenton, N. J.

STEREO REVIEW

The most frequently asked question about loudspeakers:

Does the sound of a speaker depend upon the method by which the air is moved?

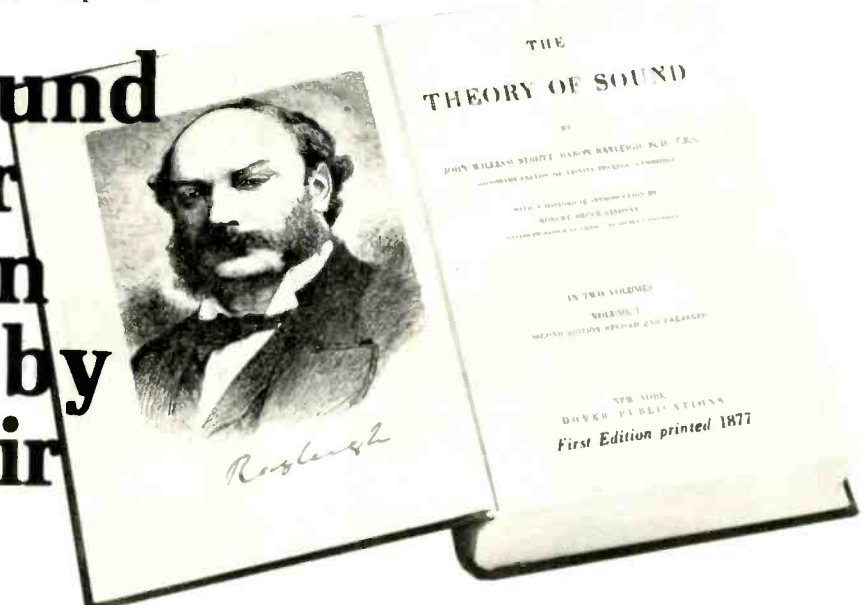

All speakers sound different from each other and when you hear a difference between two speakers that employ different principles of moving the air, it is only natural to wonder whether the variance in sounds is a consequence of the principles involved. After all, moving the air is what produces the sound.

Back in the 1950's, when electrostatic speakers reached a peak of popularity, some people thought that they might have a fundamental advantage because of the lower mass of the moving element compared to that of a cone speaker. Then, in the 1960's, ionic speakers were developed with no moving parts at all, and therefore, zero moving mass. Today, in the 1970's, a wide variety of transducers exists using principles ranging from piezoelectric to magnetostrictive, which either push the air with a diaphragm or squeeze the air out between moving surfaces.

Indeed, some of the principles of moving the air do have advantages over others in terms of size, weight, efficiency, and cost. But there is absolutely no advantage of any particular method of moving the air in terms of the potential quality of the sound that can be produced.

Let's see why this is so. We experience sound through the medium of acoustic waves traveling in air. It has long been known¹ that once the air is set into motion, it moves by the laws of acoustic wave propagation which are totally independent of the method by which the air was set into motion.

Therefore, a source (speaker) influences the sound field only through the amount of air it moves at each frequency and through the directions that the speaker moves the air. The method of moving the air in no way affects the sound that you hear.

In a basic experiment presented at a meeting of the I.E.E.E. professional group on Electroacoustics in 1964, it was demonstrated² that a multiplicity of full-range cone speakers can produce music that is subjectively identical to that produced (with the aid of computer simulation) by an ideal massless membrane free of all resonances and distortion. While this very basic result was proved only for full-range cone type speakers, the above discussion indicates that the same result could be obtained by the use of other types of full-range speakers as well. Thus, the secret of excellent performance doesn't lie in the type of speaker used (i.e. the way the air is moved). It lies in the use of a multiplicity of full-range speakers in one enclosure, in the exact proportioning of the ratio and the directions of direct and reflected sound radiated by the total enclosure, in the precise equalization of the speakers to radiate the correct balance of frequencies, and in extreme quality control measures that select and match all the speakers in the enclosure.

To fully appreciate the effect of a multiplicity of full-range speakers, with precise equalization and the optimum combination of direct and reflected sound, simply A-B the BOSE 901 Direct/Reflecting® speaker with any other speaker. Hear why the BOSE 901 is the most highly reviewed speaker regardless of size, price, or type of speakers.



References

1. The Theory of Sound, Vol. 1, By J.W.S. Rayleigh, 1877.
2. The results are documented in the Audio Engineering Society Paper, ON THE DESIGN, MEASUREMENT AND EVALUATION OF LOUSPEAKERS, by Dr. A. G. Bose. Copies are available from the Bose Corporation for fifty cents.

For complimentary copies of the reviews, circle your reader service card or write Dept. RS.

You can hear the difference now.

BOSE®

The Mountain, Framingham Mass.

NEW PRODUCTS

THE LATEST IN
HIGH-FIDELITY
EQUIPMENT

Poly-Planar DS60 Sound Panels



● THE Magitran Company, which manufactures the extremely thin Poly-Planar

speakers with rectangular expanded-polystyrene diaphragms, has taken the logical step of installing them in picture frames with decorative grilles to create the Poly-Planar Sound Panels. Each solid walnut-finish wood frame, approximately 29³/₄ x 23³/₄ inches, holds two identical Poly-Planar drivers, wired in parallel for a nominal impedance of 4 to

8 ohms. The grille-cloth assemblies, held on with snap fasteners, are available in thirteen interchangeable designs and colors. Overall depth with the grille in place is 2¹/₄ inches. The speakers can be driven with as little as 5 watts of amplifier power. Price: \$79.95. Additional grilles are \$14.95 each.

Circle 115 on reader service card

Stanton Sixty Five Four C Four-Channel Headphones



● STANTON's latest offering in the Dynaphase series of stereo headphones is the Sixty Five Four C, a four-channel model with a switch control that con-

nects the two drivers in each earpiece for conventional stereo listening. The phones are of the acoustically isolating type, with foam-filled vinyl ear cushions and a thickly padded length-adjustable headband. Internally, the headset employs a total of four dynamic drivers with 1¹/₂-inch diaphragms. Frequency response is specified as 20 to 20,000 Hz, and distortion is under 0.5 per cent for a sound-pressure level of 110 dB. At 1,000 Hz, an input of 0.1 volt produces a

100-dB sound-pressure level; continuous power-handling capability is 1.25 volts, with provision for transient peaks that exceed that level by as much as 10 dB. Nominal impedance is 15 ohms \pm 20 per cent. The headphones have an 11-foot coiled cable that terminates in two color-coded stereo phone plugs for the front and rear channels. The switch control is integral with the cable. The unit weighs 1 pound, 3 ounces. Price: \$64.95.

Circle 116 on reader service card

Sony PS-2251 Direct-Drive Manual Turntable



● SONY's finest turntable, the new Model PS-2251, is a direct-drive manual

design with a pitch control that permits a \pm 4 per cent adjustment around the two motor speeds of 33¹/₃ and 45 rpm. The motor, which is integral with the 12¹/₄-inch turntable platter itself, is servo-controlled by a motion-sensing system that detects and electronically corrects any deviation from true speed. A built-in illuminated stroboscope indicates on-speed operation. The cast-aluminum alloy platter weighs 3 pounds, 5 ounces. Wow and flutter are 0.07 per cent (DIN), and rumble is lower than -67 dB (weighted, DIN). The arm that comes

with the PS-2251 is a statically balanced tubular design with an adjustable counterweight for initial balancing, and includes anti-skating and stylus-force adjustments calibrated from 0 to 3 grams. Lateral tracking-angle error does not exceed 2¹/₄ degrees for any record radius. A lever-operated cueing control, viscous-damped, is integral with the tone arm. The PS-2251 comes with a wood base and hinged, removable dust cover. The dimensions are approximately 19¹/₄ x 15¹/₂ x 7¹/₄ inches. Price: \$299.50.

Circle 117 on reader service card

Empire Jupiter 6500 Speaker System

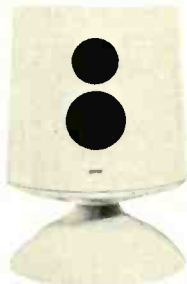

● EMPIRE's new weatherproof indoor/outdoor speaker system, the Jupiter 6500, is a floor- (or patio-) standing three-way design employing a vented enclosure of unusual shape. The system's woofer, a downward-facing 12-inch unit, crosses over to a forward-facing 6-inch direct-radiating mid-range at 450 Hz. The 2-inch dome-type tweeter mounted just above handles the frequencies from 2,500 Hz up. The round enclosure is made of Uniroyal Rubicast, an abrasion-resistant material unaffected by moisture

and direct sunlight; it is integral with a molded pedestal base. Specifications for the Jupiter 6500 include a frequency response of 30 to 20,000 Hz, power-handling capability of 75 watts program material, and a nominal impedance of 8 ohms. The system is 17¹/₄ inches in diameter at its widest point, has a flat top, and stands 25¹/₂ inches high. Weight of the unit is 40 pounds. Price: \$139.95. The Jupiter 6500 speaker system is available in glossy white only.

Circle 118 on reader service card

Pioneer TX-9100 AM/Stereo FM Tuner

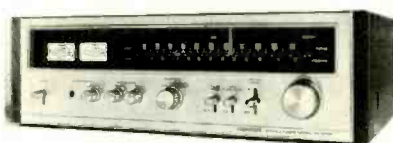

● PIONEER's finest and most elaborate tuner, the Model TX-9100, has several unusual features. The front panel has three output-level controls: one for FM, one for AM, and the third for the front-panel headphone jack (which is usable with 8-ohm phones). The interstation-noise muting function is switchable between two different threshold levels or

can be deactivated entirely. The tuner also has a switchable "pulse-noise suppression" circuit said to be effective in eliminating electrical-equipment noise interference from sources such as automotive ignition systems, fluorescent lights, and other appliances. The TX-9100's more conventional facilities in-

(Continued on page 14)



The sound you buy now
is the sound you'll hear
three years from now.
Hitachi guarantees it.

Hitachi guarantees that nothing will go wrong with our Maxi-Fi® tuners, amplifiers, receivers or loudspeakers for three years after you buy them.

If anything does, bring it in and we'll fix it free. Parts and labor.

Three years is a lot longer than most manufacturers give you. And we go even further on the transistors. We guarantee them for five.

For a very good reason.

Practically everything that goes into a Hitachi is made by Hitachi. Our own transistors. Our own IC's.

Many stereo companies make few, if any, parts of their own.

Hitachi believes in realistic sound. Nothing to get in the way of pure, natural sound.

Like distortion or coloration.

Those transistors we were talking about, for instance. We developed a new type called LTP (for Low Temperature Passivity). They reduce amplifier noise to practically nil. And increase FM tuner sensitivity at the same time.

We also did away with input and output transformers on many of our models in favor of ITL-OTL circuitry. Doing away with one of the major causes of frequency distortion and deterioration.

Our patented gathered-edge woofers are more flexible than conventional bellows-type suspension speakers. And our damped bass reflex enclosure, with a special ducted port, produces a deep, rich sound without that "boxed-in" effect familiar to so many bookshelf speaker systems.

For more about Hitachi Maxi-Fi components, write for our brochure. Dept. SR-5, Hitachi Sales Corp. of America, 48-50 34th Street, Long Island City, N.Y. 11101.

Quality always comes first at
HITACHI



NEW PRODUCTS

THE LATEST IN
HIGH-FIDELITY
EQUIPMENT

clude tuning meters for signal strength and channel center, a switchable multiplex noise filter, and a function selector with positions for AM, FM auto, and FM mono. The large tuning dial has linear calibrations. Specifications: IHF sensitivity, 1.5 microvolts; capture ratio,

1 dB; alternate-channel selectivity, 90 dB; image, i.f., and spurious-response rejection, all better than 110 dB; AM suppression, 65 dB. Frequency response is 20 to 15,000 Hz ± 0.2 , -2 dB, and stereo separation exceeds 30 dB from 50 to 10,000 Hz. Harmonic distortion levels

are under 0.2 per cent for mono reception and 0.3 per cent for stereo. The multiplex stereo decoder section employs phase-lock-loop circuitry. The TX-9100 measures approximately $5\frac{1}{2} \times 13\frac{1}{2} \times 17$ inches overall. Price: \$299.95.

Circle 119 on reader service card

Sansui Model SF-1 Speaker System

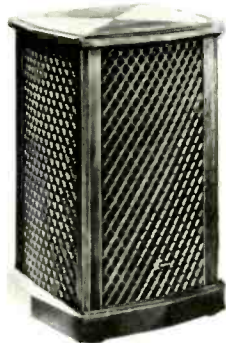

● THE second and smaller design in Sansui's series of omnidirectional speaker systems is the SF-1, also a floor-standing model, with fretwork grille panels on all four vertical sides and walnut-finish top, bottom, and upright supports. The SF-1's drivers are conventional (two $6\frac{1}{2}$ -inch woofers and one $2\frac{1}{4}$ -inch cone tweeter), but they are mounted with one woofer facing down, the other two drivers up. All the drivers radiate into cone-shaped deflector elements that disperse the sound over 360 degrees horizontally. The two woofers share a

common internal enclosure with a circular ducted port. The tweeter is mounted above the upper woofer within a small sub-enclosure that serves as the woofer's deflector. Sansui rates the frequency response of the SF-1 as 55 to 20,000 Hz, with a nominal impedance of 8 ohms and a power-handling capability of 45 watts on program peaks. The crossover frequency is 2,000 Hz. The SF-1 has four $14\frac{1}{2}$ -inch sides, is approximately $22\frac{1}{4}$ inches high, and weighs 26 $\frac{1}{2}$ pounds. Price: \$139.95.

Circle 120 on reader service card

Ampex 20/20+ Cassettes



● AMPEX is using a new magnetic-oxide coating originally developed for profes-

sional mastering tape in a recently introduced line of blank cassettes designated the 20/20+ series. Besides providing a very smooth coating surface that reduces dropouts and improves tape-to-head contact, the new oxide affords increases in sensitivity and output, resulting in a 1.5-dB bettering of overall signal-to-noise ratio and a 3-dB improve-

ment in output at 10,000 Hz. Like other Ampex cassettes, the 20/20+ series employs screw-fastened cassette shells. The cassettes are packaged in flip-open plastic containers. Playing lengths and prices available are: 42 minutes (\$2.60), 60 minutes (\$2.80), 90 minutes (\$4.20), and 120 minutes (\$5.95).

Circle 121 on reader service card

National Tel-Tronics Speaker Cabinet Kit

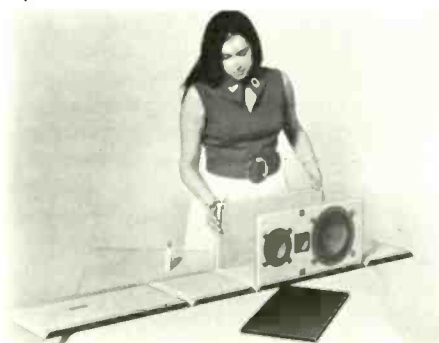

● FOR those interested in the satisfactions and economies of assembling their own speaker systems, National Tel-

Tronics has fashioned several air-suspension speaker kits, available in two- or three-way versions, that go together with a minimum of time and effort. All panels are pre-cut and finished, and ready for gluing with the adhesive supplied. The four side panels, which come attached end-to-end by vinyl covering, have slots that mate with the edges of the speaker-mounting board and the rear panel. After acoustical padding has been inserted and the driver units and crossover have been wired and bolted in place, Velcro fasteners are used to attach the grille cloth, which completes assembly. All enclosure panels are $\frac{3}{4}$ -inch thick, and the speaker-mounting panels are pre-cut for the appropriate drivers. The kits come

complete with drivers manufactured by Peerless. The two-way system includes an 8-inch woofer and a $2\frac{1}{4}$ -inch cone tweeter, with a crossover network that acts at 2,500 Hz. The three-way kit adds a 5-inch mid-range and crossover components that operate at 750 and 6,000 Hz. Both systems have a nominal impedance of 8 ohms, and both use enclosures of approximately $20 \times 10\frac{1}{4} \times 9\frac{1}{2}$ inches. Prices: two-way kit (CK20-2), \$99.95 per pair; three way kit (CK20-3), \$119.95 per pair. National Tel-Tronics is also introducing a smaller two-way kit employing a $6\frac{1}{2}$ -inch woofer (\$59.95 per pair) and a four-way kit with a 10-inch woofer (\$179.95 per pair).

Circle 122 on reader service card

TDK Guide to Cassettes

● A 48-page booklet, packed with useful information on home tape recording methods and equipment, is available at no charge from TDK Electronics Corporation. The well-illustrated pocket-size booklet offers a wealth of facts and tips on tape recording techniques. In effect, it

offers a short course in tape recording terminology and technology for the layman, including an explanation of the various types of tape formats, their relative merits, and applications.

Emphasis is on cassettes, with sections on how to obtain the best results when recording, how to care for cassettes, how to perform routine mainte-

nance on recording equipment, the importance of internal mechanical design features and construction details, and even how to make minor repairs.

Free copies of the TDK *Guide to Cassettes* are available from TDK dealers or by writing to TDK Electronics Corporation, Dept. SR, 23-73 48th Street, Long Island City, N.Y. 11103.



SONY® PS 2251: a declaration of independence.

Independence of belts, pulleys, idler wheels and all the other paraphernalia that can cause wow, flutter and rumble. Independence from fluctuations in power line voltage that can effect the precise speed of the turntable. And independence of acoustical feedback. The new, direct-drive Sony PS-2251 has declared itself independent of all these potential intruders upon the enjoyment of your records.

Most turntables use belts, pulleys, idler wheels to make their turntables spin at the record's speed, instead of the motor's. Look underneath Sony's new PS-2251 and all you'll see is the motor. We don't need all those extras, because our motor's speed is precisely the same as the record's.

Eliminating all those parts also eliminates the wow and flutter and rumble they can cause. So, our rumble figure is a remarkable -58dB (NAB).

And because our motor turns so much slower than conventional ones, the rumble frequency is lowered too, making the rumble even less audible than that -58dB figure indicates.

To maintain precise speed accuracy at slow speeds, we use an AC servo system (superior to a DC servo system because of its uniform magnetic field strength). Its precise speed is not affected by variations in line voltage or in line frequency. But its speed can be varied $\pm 4\%$ by the built-in pitch control and returned to a precise $33\text{-}1/3$ or 45 rpm , with the built-in self-illuminated strobe.

Then we matched it with a statically-balanced tonearm that tracks records as precisely and faithfully as our turntable turns them. We added viscous-damped cueing and effective anti-skating. And we mounted the PS-2251 on a handsome wood base using an independent spring suspension system to completely isolate

it from externally caused vibrations. At \$349.50 (suggested retail) including arm, wood base and hinged dust cover, the PS-2251 is today's most advanced turntable.

We also offer a moderately priced, single-play component turntable with the convenience of automatic operation, the PS-5520. The complete system: turntable, arm, walnut base and hinged dust cover, \$159.50 (suggested retail) Sony Corporation of America, 47-47 Van Dam St., Long Island City, N.Y. 11101.



"AN EVENING WITH MANTOVANI."

A new album by the man who has made good music a part of all our lives. Including some of today's finest music... "Cabaret," "The Candy Man," "The Good Life," "Amazing Grace"... exquisitely interpreted.

An Evening with Mantovani

An Evening with Mantovani
Amazing Grace
The Candy Man
The Good Life
With You from the film "The Sandlot"
London

What a way to spend an evening.



AUDIO QUESTIONS and ANSWERS

By LARRY KLEIN *Technical Editor*



Headphone/Tape Feed

Q. Is it usually safe to feed a tape recorder from the headphone jack of a low-power, solid-state amplifier when the amplifier lacks a tape or preamp output and the headphone jack is designed to cut out the speakers when used?

PAUL F. BOHNET
Queens Village, N. Y.

A. I don't think you'll run into problems if you use the following approach. Assemble the adapter plug as shown below. Note that one of the two shielded leads does *not* have its shield soldered to the phone plug. Also make sure that none of the bare wires from the

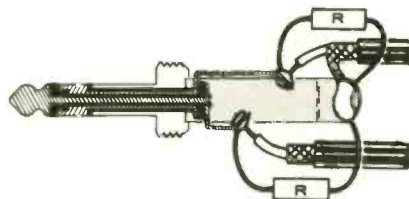

two resistors (R) or the shielded cables touch anything they should not. Insulate the various wires from each other with plastic electrical tape and then wrap the entire rear section of the plug with tape. The other ends of the two shielded leads terminate in standard phono plugs—or whatever type of plug the AUX, RADIO, or LINE inputs of your tape recorder accept. When taping from the amplifier, simultaneously adjust the amplifier's volume control and the recorder's input-level control for the least hum and most freedom from overload. If the recorder's input-level control has to be set very low and is touchy, reduce the volume-control setting on the amplifier. The values of the resistors (R) can be anywhere from 20 to 50 ohms, 1/4 or 1/2 watt.

Several Quadraphonic Standards?

Q. Recently I've seen printed statements by the proponents of several competing four-channel disc techniques, each claiming that his technique

is recognized as a standard by the Electronic Industries Association of Japan. Can you clarify this for me?

JAMES CONNER
Chicago, Ill.

A. Some confusion has come about because of the way in which the Japanese used the word "standard." For most people, "standard" connotes a single specific "approved" technique or unit to which everything is referenced. However, in the case of four-channel discs, the Japanese intend the word "standard" to mean simply an agreed-upon set of parameters and techniques. This allows them to have an SQ matrix "standard," an RM/QS matrix "standard," and a CD-4 discrete-disc "standard." The implication is that if a manufacturer produces equipment incorporating one or more of these systems, it should follow the particular agreed-upon "standard" parameters for the systems used. It is confusing, however, and I only recently suggested to the Electronic Industries Association of Japan (EIA-J) that the use of the term "standardized" would be less misleading for Americans than "standard."

Super-Amplifier Clipping

Q. In writing about super-power amplifiers in the April 1972 issue, Julian Hirsch claimed that musical material with a compressed dynamic range clipped with average levels of 50 to 100 watts. He then claimed that music with a wide dynamic range clipped at perhaps 20 to 30 watts. He adds that the Phase Linear 700 clipped regularly. Am I to understand from this that this amplifier will clip at such low power?

BRUCE GEORGE
Great Neck, N. Y.

A. Apparently, no matter how carefully something is phrased, someone, somewhere, is going to miss—or misinterpret—the point. If Mr. George will re-read the Listening Tests section (Continued on page 18)

The Quadraflex Model 55

\$99.95

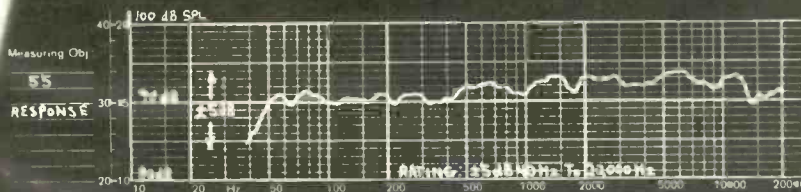

Need we say more?

Quadraflex

1301 65th Street, Emeryville, California 94608

the sound is great! by Jupiter...

Geared to modern living, Empire's Jupiter 6500 speaker will fit any decor or blend with any setting. The virtually indestructible enclosure is made of Uniroyal Rubicast, a new space-age acoustic material that can withstand wind, rain, and sun.

Jupiter's perfect three-way system, completely weatherproofed for indoor or outdoor use, uses Empire's heavy 12-inch downward facing woofer for powerful mid-range for crisp, clear alto and voice tones, and a lightweight ultrasonic tweeter with wide angle dispersion.

The power of the Jupiter 6500 speaker is awesome either indoors or out - it can deliver a full 75 watts of music power without overload, burnout, or strain.

Empire's new Jupiter 6500 speaker. Available at better hi-fi dealers for \$129.95.

EMPIRE Scientific Corp.
World Famous Speaker Systems-Mfd. U.S.A.
Garden City, New York 11530



CIRCLE NO. 90 ON READER SERVICE CARD



Dokorder 9100
A MINIATURE RECORDING STUDIO

Unique in its electronic/solenoid operation. Unique in its design.
Unique in its professional features. Appealingly priced.
For information write...

Dokorder Inc. 11264 Playa Court, Culver City, Ca. 90230

CIRCLE NO. 12 ON READER SERVICE CARD

of the report he will see that Mr. Hirsch wrote that music with a wide dynamic range, played at "live" levels, had an average output of perhaps 20 to 30 watts. However, on sonic peaks, the power demand on the amplifier hit 450 to 500 watts per channel—and higher! This being the situation, the amplifier "clipped regularly." An equally good amplifier, but with less power reserve, would clip more often, and an amplifier with greater power reserve would clip less often. The point that Mr. Hirsch tried to make was that even a 700-watt super-amplifier, when feeding normal low-efficiency speakers with certain types of common program material, can be driven into frequent clipping. He was not saying that the particular amplifier used was unusually prone to clipping.

Quadraphonic Decoder Installation

Q. All the instructions for quadraphonic matrix decoder/adapters I have seen (except the Dynaco passive unit) require that they be installed between the tape-monitoring output/input jacks of the equipment. Like a large number of audiophiles, I have a separate preamp and power amplifiers. Is there any reason why I can't install my decoder between the preamp outputs and power-amp inputs?

CHARLES ROBERTS
Orange, N. J.

A. I can think of two reasons why it might not be the best thing to do. There's a possibility that under certain conditions the signal levels coming out of your preamp's output jacks may be high enough to overload the decoder's input circuits. As a rule, no such risk is run when the decoder is connected via the tape-monitoring input/output jacks.

A second possible problem has to do with phase shift. Since the correct decoding of the directional information in a matrix-encoded disc depends upon the proper phase relationships being preserved, the additional stages—including the tone controls—that the encoded signal must pass through before being decoded could result in improper decoding. By tapping off the encoded signal early in the preamplifier (at the tape-output jacks, that is), potential phase problems are avoided. However, aside from theoretical considerations, it may be that the convenience of installing the decoder at the preamp's main outputs will be more significant than the possible confusion of directionality. In any case, it seems to me you have nothing to lose by trying it both ways.

Because the number of questions we receive each month is greater than we can reply to individually, only those questions selected for this column can be answered. Sorry!

When you build the Heathkit deck with Dolby circuit, you get pride of accomplishment plus features you won't find on others



If you have built a kit, you know the kind of pride we are talking about. Now imagine the satisfaction of assembling a stereo cassette deck with Dolby circuitry. One that is equal, or superior, to the finest components on the market today.

Moreover, you can't miss on this kit. Ask the man who has built a Heathkit component. He can tell you how service outlets in every major metropolitan area, plus a technical correspondence group at the Heath Headquarters, simply won't let you fail.

Actually, the fact that it is a kit gives the Heathkit AD-1530 two of its completely unique features. The built-in test circuit, using VU meters, 2-tone audio oscillator and test cassette supplied, allows you to set up bias and Dolby level for the cassettes you will be using, also permits you to do your own periodic recalibration or reset the levels for any new types of tape in the future. Secondly, the assembly manual contains all the troubleshooting and maintenance information you should ever need for self-service. These two items alone make the AD-1530 one of the most economical cassette decks you can buy. The AD-1530 also has switch

selection of either high-level or mike inputs. That lets you record the family band the same way you record Blood, Sweat & Tears — without an additional microphone amplifier.

Other features include automatic shutoff; lever switches for stereo or mono input, Dolby on/off and tape type (conventional tape or CrO₂ tape); two record level controls with separate VU meters; large three-digit resettable counter. You can build the Heathkit AD-1530 in about five spare evenings. The tape transport mechanism comes pre-assembled to make the job even easier.

- Kit AD-1530, 20 lbs. 249.95*
- ADA-1530-1, dust cover, 1 lb. 4.95*

AD-1530 SPECIFICATIONS: Frequency Response: Regular (iron oxide) tape; ±3 dB from 40 Hz to 12 kHz typical. CrO₂ (chromium dioxide) tape; ±3 dB from 40 Hz to 14 kHz typical. Distortion: Tape dependent; electronics less than 0.2%. Hum and Noise: Dolby Switch OFF, -48 dB. Dolby Switch ON-Provides Additional Noise Reduction as Follows: -10 dB @ 4000 Hz and up. -9 dB @ 2400 Hz -6 dB @ 1200 Hz -3 dB @ 600 Hz. Wow and Flutter: Less than 0.25% RMS. Inputs: Microphone: Lo-Z, 0.2 mV to 10 mV. Auxiliary: Hi-Z, 50 mV to 10V. Bias Oscillator Frequency: Approximately 100 kHz. Tape: Any good quality iron oxide or chromium dioxide tape cassette may be used. Tape Speed: 1 7/8 in/s or 4.76 cm/s. Fast Forward/Rewind Time: Approximately 45 sec. for C-60 cassette. Solid State Devices: 37 transistors and 2 JFET's. Output: Greater than 0.5 volts from low impedance source. Dimensions: 5 1/2" H x 9 1/2" D x 14" W. Power Requirements: 120 volts, 60 Hz, 15 W.

HEATHKIT ELECTRONIC CENTERS — ARIZ.: Phoenix; CALIF.: Anaheim, El Cerrito, Los Angeles, Pomona, Redwood City, San Diego (La Mesa), Woodland Hills; COLO.: Denver; CONN.: Hartford (Avon); FLA.: Miami (Hialeah); GA.: Atlanta; ILL.: Chicago, Downers Grove; IND.: Indianapolis; KANSAS: Kansas City (Mission); MD.: Baltimore, Rockville; MASS.: Boston (Wellesley); MICH.: Detroit; MINN.: Minneapolis (Hopkins); MO.: St. Louis; N.J.: Fair Lawn; N.Y.: Buffalo (Amherst), New York City, Jericho; L.I.: Rochester; OHIO: Cincinnati (Woodlawn), Cleveland; PA.: Philadelphia, Pittsburgh; R.I.: Providence (Warwick); TEXAS: Dallas, Houston; WASH.: Seattle; WIS.: Milwaukee.



World's largest selection of electronic kits SEND FOR FREE CATALOG

HEATH
Schlumberger

HEATH COMPANY, Dept. 40-7
Benton Harbor, Michigan 49022

Please send FREE Heathkit Catalog.

Enclosed is \$_____ plus shipping.
Please send model AD-1530.

Name _____

Address _____

City _____ State _____ Zip _____

*Mail order prices; F.O.B. factory. HF-274

SAVE!

MONEY • TIME • FREIGHT

- ♪ QUALITY STEREO EQUIPMENT AT LOWEST PRICES.
- ♪ YOUR REQUEST FOR QUOTATION RETURNED SAME DAY.
- ♪ FACTORY SEALED CARTONS—GUARANTEED AND INSURED.
- ♪ SAVE ON NAME BRANDS LIKE:
A.D.C. KLH
A.R. SHURE
DYNACO KOSS
SONY FISHER

AND MORE THAN 50 OTHERS
BUY THE MODERN WAY
BY MAIL—FROM

ia illinois audio

Department 217S
12 East Delaware
Chicago, Illinois 60611
312-664-0020

CIRCLE NO. 18 ON READER SERVICE CARD

WRITE FOR QUOTATION

FACTORY SEALED CARTONS
FRANCHISED DISTRIBUTOR
QUICK SHIPMENT

WE GIVE DISCOUNTS ON HI-FI COMPONENTS

SOUND REPRODUCTION, INC.

460 CENTRAL AVENUE
East Orange, New Jersey 07018
(201) 673-0600

CIRCLE NO. 48 ON READER SERVICE CARD



AUDIO BASICS

By RALPH HODGES

GLOSSARY OF TECHNICAL TERMS

LIKE other technical subjects, audio has its own technical and semi-technical jargon that may be comfortable territory for the initiate, but often puts off and confuses the beginner. In fact, if our daily mail is any indication, for every would-be audiophile who is merely hampered by this language problem there are two or three who are frightened away entirely. And so we've decided to turn this column for a while into a sort of audio dictionary, to be delivered until complete in easy monthly installments. The terms and expressions covered, which will appear in alphabetical order, will be those appearing most frequently in test reports and manufacturers' advertising and literature. Undoubtedly we'll miss a few along the way. When we do, I hope you'll write in to point out our oversights, so that we can work them in at a later time.

● **A.C.** (alternating current) is an electrical current that regularly reverses direction (polarity) and flows back and forth through its conductor (a wire, for example) instead of traveling in one fixed direction as *direct current* (see d.c.) does. You could get a rather rough kind of alternating current by rapidly interchanging the contacts to the terminals of a dry-cell or storage battery, which supplies only direct current when it is used conventionally.

Most electric generators in use today produce alternating current. For instance, the giant mechanism that supplies your house current alternates (reverses polarity) at a constant rate or frequency of 60 cycles per second (Hz). Your audio system's magnetic phono cartridge, which converts stylus movement to an a.c. audio signal, could also be considered an electric generator.

● **Acoustic feedback** is a phenomenon that occurs when the sound output from the loudspeaker—in the form of either acoustical or physical vibrations—travels back to the microphone or phono cartridge, where it is then picked up, re-amplified, and sent on again through to the speakers. When the feedback is not severe, the result is a slight tonal blur, "hangover," or a rumbling noise accompanying the music. At their worst, the re-amplified vibrations build up through the feedback process to a self-sustaining roar or howl. Feedback problems can be minimized by physically and/or acoustically isolating the speakers from the in-

put elements of an audio system so as to interrupt the feedback path.

● **Acoustic suspension** (also called "air suspension") is the popular term for a speaker system in which the movement of the speaker's cone is partially controlled by the springiness (compression properties) of the volume of air confined within its sealed enclosure. Speaker cones require some kind of spring to exert a restoring or "centering" force and regulate the in-and-out drive impulses provided by the magnet and voice coil. This spring can be entirely mechanical, acting at the points where the cone is attached to its supporting structure. In an acoustic-suspension system, however, there is a mechanical spring plus a carefully calculated quantity of air (for the desired resonant frequency), that acts as a cushion against which the cone pushes and pulls. (An acoustic-suspension system can be defined as one in which the trapped air provides about two-thirds of the restoring force.) The air "spring" permits larger and more linear in-and-out cone motions (excursions) than can be achieved by any practical mechanical spring alone. These, in turn, provide the potential for greater low-frequency acoustical output with lower distortion than can easily be obtained from a driver unassisted by an elaborate enclosure. Because the acoustic-suspension design generally requires a relatively compact sealed enclosure, the principle is used in many bookshelf-size speaker systems.

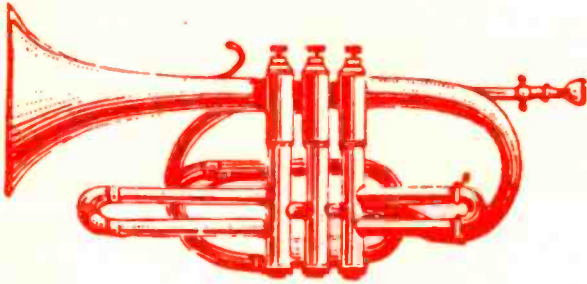

FREE INFORMATION SERVICE

- a** Here's an easy and convenient way for you to get additional information about products advertised or mentioned editorially in this issue. Just follow the directions below ...and the literature will be sent to you promptly and free of charge.
- b** Tear out one of the perforated postage-free cards. Please print or type your name and address where indicated.
- c** Circle the number on the card that corresponds to the key number at the bottom of the advertisement or editorial mention that interests you. (Key numbers for advertised products also appear in the Advertisers' Index.)
- d** Simply mail the card. No postage is required.
- e** This address is for our "Free Information Service" only. All other inquiries are to be directed to, Stereo Review, One Park Ave., New York, N.Y. 10016.



1	2	3	4	5	6	7	8	9	10	11	12	13	14	15
16	17	18	19	20	21	22	23	24	25	26	27	28	29	30
31	32	33	34	35	36	37	38	39	40	41	42	43	44	45
46	47	48	49	50	51	52	53	54	55	56	57	58	59	60
61	62	63	64	65	66	67	68	69	70	71	72	73	74	75
76	77	78	79	80	81	82	83	84	85	86	87	88	89	90
91	92	93	94	95	96	97	98	99	100	101	102	103	104	105
106	107	108	109	110	111	112	113	114	115	116	117	118	119	120
121	122	123	124	125	126	127	128	129	130	131	132	133	134	135
136	137	138	139	140	141	142	143	144	145	146	147	148	149	150

SR7733

NAME _____
PLEASE PRINT

ADDRESS _____

CITY _____ STATE _____ ZIP CODE _____
(Zip Code must be included to insure delivery) (Void after Sept. 30, 1973)

1	2	3	4	5	6	7	8	9	10	11	12	13	14	15
16	17	18	19	20	21	22	23	24	25	26	27	28	29	30
31	32	33	34	35	36	37	38	39	40	41	42	43	44	45
46	47	48	49	50	51	52	53	54	55	56	57	58	59	60
61	62	63	64	65	66	67	68	69	70	71	72	73	74	75
76	77	78	79	80	81	82	83	84	85	86	87	88	89	90
91	92	93	94	95	96	97	98	99	100	101	102	103	104	105
106	107	108	109	110	111	112	113	114	115	116	117	118	119	120
121	122	123	124	125	126	127	128	129	130	131	132	133	134	135
136	137	138	139	140	141	142	143	144	145	146	147	148	149	150

SR7732

NAME _____
PLEASE PRINT

ADDRESS _____

CITY _____ STATE _____ ZIP CODE _____
(Zip Code must be included to insure delivery) (Void after Sept. 30, 1973)

1	2	3	4	5	6	7	8	9	10	11	12	13	14	15
16	17	18	19	20	21	22	23	24	25	26	27	28	29	30
31	32	33	34	35	36	37	38	39	40	41	42	43	44	45
46	47	48	49	50	51	52	53	54	55	56	57	58	59	60
61	62	63	64	65	66	67	68	69	70	71	72	73	74	75
76	77	78	79	80	81	82	83	84	85	86	87	88	89	90
91	92	93	94	95	96	97	98	99	100	101	102	103	104	105
106	107	108	109	110	111	112	113	114	115	116	117	118	119	120
121	122	123	124	125	126	127	128	129	130	131	132	133	134	135
136	137	138	139	140	141	142	143	144	145	146	147	148	149	150

SR7731

NAME _____
PLEASE PRINT

ADDRESS _____

CITY _____ STATE _____ ZIP CODE _____
(Zip Code must be included to insure delivery) (Void after Sept. 30, 1973)

FREE INFORMATION SERVICE

(SEE REVERSE SIDE)

FIRST CLASS

PERMIT NO. 217
CLINTON, IOWA

BUSINESS REPLY MAIL

NO POSTAGE NECESSARY IF MAILED IN THE UNITED STATES

POSTAGE WILL BE PAID BY—

Stereo Review

P.O. BOX 2908
CLINTON, IOWA 52732

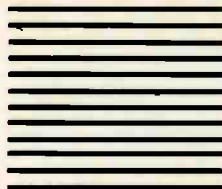

FIRST CLASS

PERMIT NO. 217
CLINTON, IOWA

BUSINESS REPLY MAIL

NO POSTAGE NECESSARY IF MAILED IN THE UNITED STATES

POSTAGE WILL BE PAID BY—

Stereo Review

P.O. BOX 2908
CLINTON, IOWA 52732

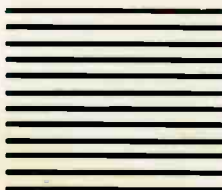

FIRST CLASS

PERMIT NO. 217
CLINTON, IOWA

BUSINESS REPLY MAIL

NO POSTAGE NECESSARY IF MAILED IN THE UNITED STATES

POSTAGE WILL BE PAID BY—

Stereo Review

P.O. BOX 2908
CLINTON, IOWA 52732

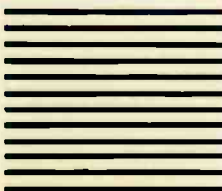

a
remarkable
listening
experience



for
stereo
headphone
owners!

*The phenomenal realism of binaural sound recording
is demonstrated by Stereo Review's*

AMAZING NEW BINAURAL DEMONSTRATION RECORD

*Created specifically for playback through
stereo headphones, this unique record presents
the listener with sound of unsurpassed realism.
It recreates at each of the listener's ears the
precise sound that each ear would have heard—
independently—at the original scene.*

Binaural recording re-creates the directions, distances, and even the elevations of sounds better than any other recording method. The super-realism of binaural recording is accomplished by recording the acoustical input for each ear separately, and then playing it back through stereo headphones. Thus the sound intended for the left ear cannot mix with the sound for the right ear, and vice versa.

Binaural recording offers the listener the identical acoustical perspective and instrument spread of the original. The sound reaching *each ear* is exactly the same as would have been heard at the live scene.

"MAX"—GENIE OF BINAURAL RECORDING. "Max," a specially constructed dummy head, cast in silicone rubber, duplicates the role of the human head as an acoustical absorber and reflector of sound. Super-precision capacitor microphones were installed in Max's ears so that each microphone would pick up exactly what each human ear would hear. The result is a demonstration of phenomenal recorded sound.

STARTLING REALITY. The Binaural Demonstration Record offers 45 minutes of sound and music of startling reality. You'll marvel at the eerie accuracy with which direction and elevation are re-created as you embark on a street tour in binaural sound—Sounds Of The City . . . Trains, Planes & Ships . . . a Basketball Game, a Street Parade, a Street Fabrication Plant, The Bird House at the Zoo—all demonstrating the incredible realism of binaural sound reproduction.

MUSIC IN BINAURAL. The musical performances presented on the Binaural Demonstration Record transport you to the concert hall for a demonstration of a wide variety of music. Selections total 23 minutes, and include examples of jazz, organ, and chamber music.

Although headphones are necessary to appreciate the near-total realism of binaural recording, the record can also be played and enjoyed on conventional stereo systems.

Only \$5.98

HERE'S HOW TO ORDER YOUR BINAURAL DEMONSTRATION RECORD

CASH: Mail your order along with your name, address and remittance in the amount of \$5.98, postpaid.

CHARGE: Your American Express or BankAmericard account! Mail your order, name, address and credit card number. You will be billed at \$5.98, postpaid.

**MAIL ALL ORDERS TO: RECORDS,
ZIFF-DAVIS SERVICE DIVISION,
595 BROADWAY, NEW YORK, N.Y. 10012.
OUTSIDE U.S.A. RECORDS ARE \$8.00 POSTPAID.**



The Memorex Cassette just got better.

NEW MRX₂ OXIDE

Superior fidelity to any
low noise or high energy
cassette designed for
all equipment.

New Memorex is the best ferric oxide cassette you can buy.

The reason? MRX₂ Oxide.

MRX₂ particles are smoother and more uniform than low noise or "energized" particles. So more of them can be packed on our tape surface.

That's why new Memorex picks up and plays back more sound than the competition.

And that's the way we plan to keep it.

MEMOREX Recording Tape



© 1973 Memorex Corporation, Santa Clara, California 95052

A concept that focuses the research, experience and skill of an electronics giant on the creation, design and production of components. A total commitment to audio componentry without peer.

The research has already produced over 23,000 patents. Firsts like: direct drive motors, Hot Pressed Ferrite heads, HiZNR resistors, automatic reversing micromotors, Exicon X-Ray television and new kinds of miniature fiber optics.

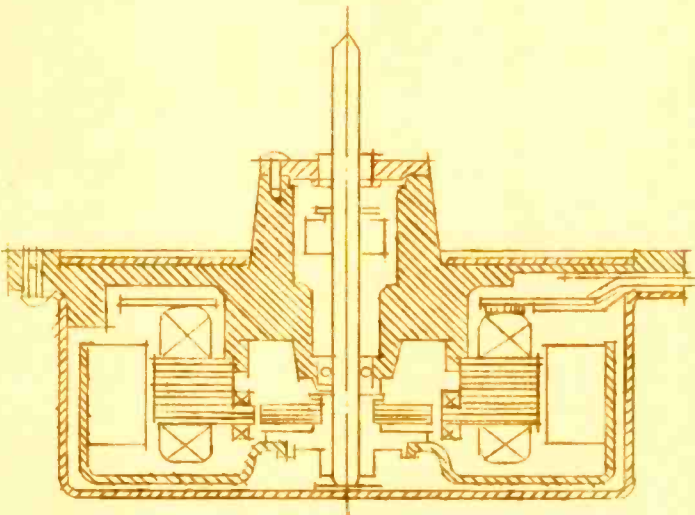

CROSS SECTION OF DIRECT DRIVE MOTOR



Experience has taught us to be extra finicky about the parts we use. So we design and make virtually every part of every component ourselves. From the newest type of monolithic I.C.'s to our own exclusive four-pole MOS FET. From the epoxy resin coils in our multiplex sections. To the precision controls on the front panel.

We have learned the virtue of being totally unmerciful in test procedures. All designs are put through tortures like baking, freezing, drenching, shock, extreme stresses and prolonged humidity. Because any unit that can survive that kind of

punishment is capable of years of faithful service under normal conditions.

We also know that there is no substitute for all-out quality control. Each subassembly is checked visually and electronically as it is put

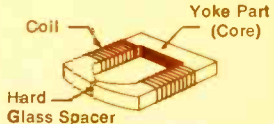
COMPARISON OF PERMALLOY AND HPF HEAD

	Permalloy Head	HPF Head
Material	Alloy of Ni, Mo and Fe	Powder of MnO ₂ , ZnO and Fe ₂ O ₃
Manufacturing Method	Punching by a press	Slating at a high temperature under high pressure
Core	Piles of metals	Precision made block, produced by cutting, grinding and polishing.
Shape		
Finished Gap	 Gap Spacer (BeCu) Thickness of Spacer < Effective Gap Effective Gap	 Gap Spacer (Hard Glass) Thickness of Spacer = Effective Gap Effective Gap
Electric Loss	Big	Small (1/2 of the permalloy)
Hardness	130 ~ 140 HV	630 ~ 700 HV (5 times harder)
Life	about 1,000 hours	about 200,000 hours

together. And checked again as it joins the main assembly. Every complete unit undergoes 50 performance checks, involving 170 different test points and measuring things like IHF sensitivity and power output. Sixty additional tests assure perfect appearance and proper operation.

All our units have earned the coveted listing for safety of Underwriters Laboratories®.

The Technics concept has already taken shape. In a line of discrete 4-channel receivers. Direct drive turntables. Dolbyized™ cassette decks. And reel-to-reel recorders. That are ready for delivery today.

So, now that we've been formally introduced, why don't we get to know each other.

™Dolby is a trademark of Dolby Laboratories Inc.

Technics

by Panasonic

Can you spot the Camel Filters smoker?



© 1973 R. J. Reynolds Tobacco Co.

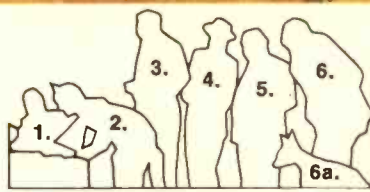

At class reunions almost everybody has a gimmick. Try picking the one who doesn't go along.

1. Nope. He's Don Wand. Won school essay contest with "The Art of Pre-Marital Dancing." Gimmick: 200 mm holder to balance his 100 mm cigarette.

2. No. It's Rah-Rah Mendelson, ex-cheerleader. Gimmick: He's wearing it. Smokes whatever he finds in his pouch.

3. No.

He's Moe Mentum, alias "Stone Hands" for dropping passes. Just dropped statue of school mascot.

4. T. Deious, school bore. Gimmick: His voice, off-key contralto. Smokes oval cigarettes (he sat on his soft-pack and liked it).

5. Curley Gilroy. His hair was voted "Most Likely to Recede." Gimmick: Staples toupee on. Also staples his roll-your-owns.

6. Right. He's still his own man. Likes his cigarette honest, no-nonsense, too. Camel Filters. Easy and good tasting.

6a. Kicky VIII, mascot. Has eyes only for Mendelson (see 2 above).

Camel Filters.
They're not for everybody
(but they could be for you).

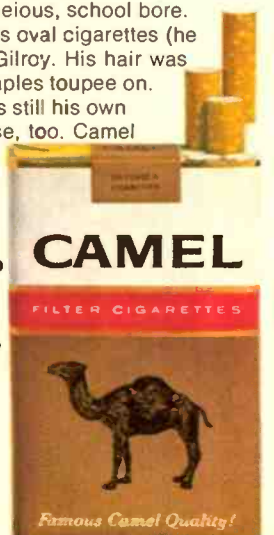

Warning: The Surgeon General Has Determined That Cigarette Smoking Is Dangerous to Your Health.

20 mg. "tar," 1.3 mg. nicotine av. per cigarette, FTC Report FEB. '73.

GOING ON RECORD

By JAMES GOODFRIEND
Music Editor



SONGS MY DAUGHTER TAUGHT ME

MY daughter Sari is two years old and has begun to teach me a few things about music. Sari, not yet having lived long enough to develop many prejudices, comes to music without the accompaniment of a carload of preconceptions, and handles things very straightforwardly, on the basis of what she hears rather than what she knows. The first classical music she heard was the Brahms Sonata in G Major for Violin and Piano, Op. 78, when she was a couple of weeks old, but it doesn't seem to have made much of an impression on her. It's not only that she doesn't remember the themes, but that hearing the music again, even after being scolded, does not seem to involve her in any Proust-like associations and recollections of earlier, happier times. Ah, youth!

Sari divides all music into two sorts: singing-and-playing music and listening-and-dancing music. She allows an occasional crossover, but, in general, she finds singing along with a record (even if she knows the tune) to be almost as preposterous as *not* singing or playing the piano when somebody in her presence is. She thus makes a distinction between live music and recorded that would never have occurred to me. Live music to her is live in all respects. When it is in progress she runs to the piano and pushes her way onto the bench, grabbing whatever notes on the keyboard haven't yet been appropriated, at the same time singing *her* choice of song and "shushing" the competition.

A record for Sari is a very different sort of thing. She has quite a few years to go before she can physically reach the turntable, so putting a record on to play is an action she relegates to others. But once the record is on, her critical faculties are aroused, and she is sure to let you know what she thinks. If she dislikes it she may simply go to some other part of the house. Since she has been told that she may do so, she sometimes goes to her own room and closes the door. This can be a trenchant criti-

cism. More often, she just tells me her opinion. "Daddy, I don't like that record," was her comment on Maurizio Pollini's new recording of the Chopin Études. I agree with her, though I worry about why and she doesn't.

When Sari likes a record she will sometimes sit very still and listen to it or else play quietly with a toy until the side is over. She astonished me the other day, when I thought she hadn't been paying the least attention, by telling me that she liked the music that had just been playing. It was the recent Seraphim release of William Walton conducting his own film score for *Henry V*.

When Sari *really* likes a record, though, she will get out of her chair, stand in the middle of the floor, and, with arms held out in front of her, shoulder height, the fingers curved down toward the floor, proceed to turn gravely in a counterclockwise direction while adding a little up-and-down movement of the arms. It is her own private dance, and the music to which she performs it has received a very high compliment indeed. At the moment, probably her favorite record is one of Renaissance duets for the lute (L'Oiseau-Lyre S 325). The modal tunes and harmonies do not seem to offend her ear at all, and the rhythms she finds just conducive to dancing. But that is not to say she finds such rhythms *vital*. A dance for her is a form of approbation and a pleasurable movement of expression, and she has also danced to Ivan Moravec playing Debussy's *Feux d'Artifice* (Connoisseur Society S1866). I defy any adult to do that.

Sari has recently discovered marches, through the medium of a particularly appealing record entitled "Little Marches by Great Masters" (Philips 659 9172). While I had some intellectual doubts about the "greatness" of some of the composers represented (Vránický? Rossini? Michael Haydn?), my daughter did not trouble her head over the matter and

(Continued on page 31)

DISCOUNTS HI-FI SYSTEMS COMPONENTS

KITS • COMPACTS
TUNERS • AMPLIFIERS
RECEIVERS • TURNTABLES
SPEAKERS • TAPE RECORDERS

- Franchised Distributors for over 70 mfrs.
- Largest selection in the country
- Full manufacturers warranty protection
- Only brand new, factory sealed components
- Fast, fully insured shipments
- Double-boxed cartons where possible
- Same day reply to your inquiry
- Extra savings on complete systems
- Lowest possible prices

WRITE FOR OUR QUOTE AND SPECIALS BULLETIN
VISIT OUR NEW MODERN WAREHOUSE
FREE AMPLE PARKING AT PREMISES

CARSTON *Stores*
146 OLD BROOKFIELD RD. (NORTH)
DANBURY, CT. 06810
DANBURY, CT. (203) 744-6421
N. Y. CITY (212) 369-6212

CIRCLE NO. 9 ON READER SERVICE CARD

DIXIE SAVES YOU MORE BY MAIL!

ON NATIONALLY ADVERTISED
BRANDS • HI-FI COMPONENTS!

 Master Charge / BankAmericard Honored on Mail Orders.			
	FISHER		SHURE
	SONY		GARRARD
	DYNACO		

Write Today for Our FREE Wholesale Audio Catalog

Dixie Hi-Fi really sells name-brand stereo gear at Wholesale prices. Prices even LOWER than the "discounters". Call or write for our newest Wholesale Catalog. Write for quotes too. Choose from the tops in stereo systems & components. Your orders filled promptly and shipped factory sealed and guaranteed.

DIXIE HI-FI WHOLESALERS
10140 Bacon Drive • Beltsville, Md. 20705

DIXIE HI-FI WHOLESALERS
10140 Bacon Drive • Beltsville, Md. 20705
Please rush me FREE Wholesale Audio Catalog and complete information. I understand there is no obligation

Name _____
Address _____
City _____ State _____ Zip _____
Phone: 1-301-937-3090 SR-7

CIRCLE NO. 11 ON READER SERVICE CARD

The ESS Heil amt 1

a revolutionary advance
a revelation in sound reproduction

see and hear the exciting ESS amt 1 at any of these ESS franchised dealers.
for an up-to-the-minute listing of dealers in your area, write ESS, sacramento.

ESS dealers for southern California

AUDIO VISION santa ana, california
BARKERSFIELD AUDIO bakerfield, california
BEVERLY ELECTRONICS
los angeles, orange, california
BIB PILOT'S STEREO CENTER santa monica, california
DIMENSIONS IN STEREO orange, california
DYNAMIC CITY san diego, el Cajon, california
HENRY RADIO anaheim, california
HIGH FIDELITY HOUSE pasadena, san diego, california
HIFIMATIC CO. culver city, california
JONAS MILLER STEREO Beverly Hills, california
KIERA CAMERA edenridge beach, california
RIGERSOUND LABORATORIES
south hollywood, california
SCOTT AUDIO long beach, california
SHELLEY'S STEREO CENTER los angeles, california
SOUND CENTER beverly hills, california
SOUND MART pasadena, arroyo, tarzana, california
WOODLAND STEREO woodland hills, california

ESS dealers for northern California

AUDIO ARTS livermore, california
AUDIO CENTER san jose, california
AUDIO SALES fresno, california
BOYC-WONN HI-FI valley, california
BURNON'S carmel, california
CAL HI FI berkeley, mountain view, oakland,
san francisco, san jose, california
CENTURY MUSIC san jose, california
DEANS TV AND STEREO Fremont, california
GOLDEN EAR san rose, chico, california
GRANAPONES & HI-FI MCS mcclintock, salinas, california
HERMARY'S san carlos, california
HI FI STEREO CENTER colma, california
HOUSE OF MUSIC san francisco, california
JACK HANNA MUSIC stockton, california
KLETON HI FI burlingame, california
LAKESHORE HI FI san francisco, california
MUSIC MACHINE davis, sacramento, california
SQUIDIA STEREO arcata, california
SUNNER, HIRSCH & KAY san francisco, california
STEREO SHOWCASE sacramento, california
SUN STEREO, INC. Fresno, santa cruz, california
WORLD OF SOUND, san francisco, california

ESS dealer for Nevada

INTERIOR SYSTEMS las vegas, Nevada

ESS dealers for Arizona

JERRY'S AUDIO EXCHANGE tempe, Tucson, Arizona
PACIFIC STEREO phoenix, Scottsdale, Arizona

ESS dealer for Hawaii

AUDIO CENTER Honolulu, Hawaii

ESS dealers for the northwest

COLUMBIA TYPEWRITER/RECORDEF CO.
portland, Oregon
ELECTROCRRAFT STEREO CENTER Seattle, Washington
FRED'S SOUND OF MUSIC portland, Oregon
MAC'S TV AND STEREO albany, Eugene, Oregon
MAGNOLIA HI FI Seattle, Washington
PAULSON'S INC. Tacoma, Washington
STEREO CRAFT ellensburg, Pullman, Washington

ESS dealers for the midwest

ALAN AUDIO Bloomington, Indiana
AUDIO COMPONENTS, LTD. Madison, Wisconsin
AUDIO DESIGNS, LTD. Wayzata, Minnesota
AUDIO FIDELITY Gary, Indiana
AUDIO KING Minneapolis, Minnesota
AUDIO LABS Des Moines, Iowa
AUDIO MART Kansas City, Missouri
BEST SOUND COMPANY St. Louis, Missouri
CONTEMPORARY SOUNDS And, Oklahoma
CUSTOM ELECTRONICS Omaha, Nebraska
DAVID BEATTY STEREO Kansas City, Missouri
DIENER STEREO, Champaign, Carbondale, Illinois
ELECTRONICS UNLIMITED Lincoln, Nebraska
FLANNER & HAZWOOD Milwaukee, Wisconsin
J. C. GERDON COMPANY St. Louis, Missouri
K M AUDIO, INC. Chicago, Illinois
PACIFIC STEREO Denver, Colorado
RMS ELECTRONICS Lawrence, Kansas
RISLEY ELECTRONICS Evansville, Indiana
SOUND PRODUCTIONS Lafayette, Indiana
SOUND UNLIMITED Tulsa, Oklahoma
SOUNDABOUT, INC. Chicago, Illinois
STEREO SHOP Owa City, Iowa
THE AUDIOPHILE Chicago, Illinois
THOMSON SOUND SYSTEMS Norman, Oklahoma
UNITED AUDIO Chicago, Illinois
WACK HI FI Milwaukee, Wisconsin

ESS dealers for the Texas area

AUDIO AND ACOUSTIC El Paso, Texas
AUDIO CONCEPTS Austin, Texas
B & M ELECTRONICS Houston, Texas
BILL CASE SOUND San Antonio, Texas
HILLCREST HI FI Dallas, Texas
HOME ENTERTAINMENT Houston, Texas

ESS dealers for the south

BLOCKDOOR STEREO Atlanta, Georgia
DON JONES CUSTOM STEREO Greenville,
Spartanburg, South Carolina
HOUSE OF SOUND AND SIGHT West Palm Beach,
Boca Raton, Florida
INTERIORS PLUS SOUND Ft. Lauderdale, Florida
NORTHWOOD STEREO CENTER Tallahassee, Florida
SONIC STEREO Savannah, Athens, Georgia
SOUND HAUS Euham, Chapel Hill, Raleigh, North Carolina
SOUTHEASTERN STEREO Knoxville, Tennessee
STUBBERS Memphis, Tennessee
SUNLIGHT, INC. Charleston, South Carolina
W. R. GIBSON AUDIO New Orleans, Louisiana

ESS dealers for the east

A. M. S. HI FI STEREO, INC. Dearborn, Michigan
AUDIO ASSOCIATES Bethesda, Hagerstown, Maryland,
Springfield, Vienna, Virginia, Washington, D.C.
AUDIO ELECTRONICS Cincinnati, Ohio
AUDIO CRAFT Cleveland, Akron, Ohio
AUDIO HALL Akron, Ohio
CARLIN AUDIO Dayton, Ohio
COURTESY STEREO, INC. New York, New York
CUSTOM STEREO ELECTRONICS Columbus, Ohio
DESIGNATION Takoville, Long Island, New York
Emanuel, Long Island, New York
ELECTRONIC WORKSHOP New York, New York
FEEL LOCK STEREO, INC. Avon, New Haven,
West Hartford, Connecticut
FRACOM SOUND STAGE Flushing, New York
HARMONY HOUSE New York, New York
HIGH FIDELITY CENTER Huntington, West Virginia
HOFFMAN HOUSE OF STEREO Brookpark, Ohio
HOUSE OF SOUND, Baltimore, Maryland
MUSIC HI FI New York, New York
NEVER-ENOUGH Washington, D.C.
MULTI-MAN RADIO Cambridge, Massachusetts
PARAGON SOUND Toledo, Ohio
PAUL HEATH AUDIO Ithaca, New York
RISH & SOUND LTD. Bel Air, Maryland
STEREO CENTER New Hartford, New York
STEREO DESIGN Hampton, Virginia
STEREO SOUND Wayne, New Jersey, Manet
Tonkers, New York
STEREO THREE Wayne, Philadelphia, Springfield
Pennsylvania, Newark, Delaware
STUART'S AUDIO Westfield, Raritan, New Jersey
THE STEREO SHOP McKees Rock, Pennsylvania
TERRY HI FI Randolph, Massachusetts
TRANSCENDENTAL AUDIO Buffalo, New York
UNITED ELECTRONICS Niles, Ohio
UNITED RADIO Cincinnati, Ohio

ESS products distributed in Canada

light
the
way

ESSTM
HEIL
amt 1

SOUND AS CLEAR AS LIGHT



I bought a Marantz 4 channel receiver because I refuse to be stuck with an electronic antique.



Not one to tolerate obsolescence (planned or unplanned), I considered the stereo vs. 4-channel question carefully, then purchased a Marantz receiver for three compelling reasons.

One. Marantz has Dual Power. This means you get full power of four discrete amplifiers working all the time. When you're listening to regular 2-channel tapes and records you can combine the power of all four channels into the front speakers. This means even if you're not ready to commit yourself to a complete 4-channel system, you can buy Marantz now and when you get the other two speakers just flip a switch. You have 4-channel. Meanwhile, you're not compromising 2-channel because you're getting more than twice the power for super stereo.

Reason number two. Marantz receivers feature the exclusive snap-in snap-out adaptability to any 4-channel matrix decoder. This means that your Marantz stereo will never be made obsolete by any future 4-channel technology because the Marantz snap-in SQ[®] module is designed to keep up with the changing state of the art. What's more, Marantz receivers have Vari-Matrix—a built-in circuit that will synthesize 4-channel sound from any stereo source (including your stereo records and tapes) and will also decode any matrix encoded 4-channel disc or FM broadcast.

Reason number three. Marantz receivers, from the Model 4230 up, feature built-in Dolby[®] noise reduction to bring you the quietest FM reception ever. And you can switch the built-in Dolby into your tape deck for noise-free, no-hiss recording from any source. A real Marantz exclusive.

I chose the Marantz Model 4270 because it suits my needs perfectly. It delivers 140 watts continuous power with under 0.3% distortion. And it's literally loaded with features. However, your requirements may be more modest than mine. In which case you can own the Marantz Model 4220 which delivers 40 watts with Dual Power. Or you can go all the way and get the Marantz Model 4300 with 200 watts. It is the very best. Choose from five Marantz 4-channel receivers from \$299 to \$799.95.

The point to remember is this—whichever model Marantz 4-channel receiver you do buy, you can buy it today without worrying about its being obsolete tomorrow. Look over the Marantz line of superb quality receivers, components and speaker systems at your Marantz dealer. You'll find him listed in the Yellow Pages. Think forward. Think Marantz.

marantz.
We sound better.

*SQ is a trademark of CBS Labs, Inc.
**TM Dolby Labs, Inc.



© 1973 Marantz Co., Inc., a subsidiary of Superscope Inc., P.O. Box 99A, Sun Valley, Calif. 91352. In Europe: Superscope Europe, S.A., Brussels, Belgium. Available in Canada. Prices and models subject to change without notice. Consult the Yellow Pages for your nearest Marantz dealer. Send for free catalog.

CIRCLE NO. 43 ON READER SERVICE CARD

almost immediately selected the Beethoven and Josef Haydn examples as her favorites. She has correctly diagnosed the march as a special form of dance, and the step she uses for it is closer to a conventional march step than to her semi-balletic pirouette. She still, however, does not find it necessary to put her feet down in accordance with the beat of the music; that there is a beat and that her feet do move seem to be sufficient.

She was also recently exposed to waltzes, and I must say the result was a disappointment, recalling for me Charles Ives' musical question: "Why doesn't one-two-three appeal to a Yankee as much as one-two?" (that's the whole text of Ives' song). Sari, on her mother's side, is half Yankee.

Sari sings quite well—for a two-year-old. She does not have perfect pitch, but her intonation is almost true. She has a repertoire of fifty or sixty songs, mostly classics (if not classical) of their type: *Over the River and Through the Woods*; *Cobbler, Cobbler*; *Frère Jacques*; the theme song from *Sesame Street*; and so forth. Her espousal of *Do You Know the Muffin Man?* taught Daddy that its tune forms the basis of Frederick Delius' Second Aquarelle. She knows *Twinkle Twinkle Little Star*, but she also knows the Haydn version of it as it appears in Symphony No. 94, and she infinitely prefers the melodic intricacies of the Haydn version to the simpler nursery rhyme.

As a creative musician Sari shows the same freedom from learned restraints that is evident in her dancing, in contrast to her efforts at accuracy in singing. When she is at the piano, her improvisations bear no resemblance to the song she is ostensibly playing or even to the one she is actually singing. The dissonances between vocal line and her free accompaniment bother her not at all: in fact, she seems to relish some of them, and they don't usually throw off her pitch.

Heard from a distance, where the voice tends to get covered by the piano, Sari's musical creations bear a striking resemblance to her artistic creations with pencil, finger paints, and the like. In short, they are quite free of rules (like perspective or tonal harmony), and chaotic overall, but they have presumably accidental moments of real and original beauty. She has already discovered the logic of a rising or falling stepwise series of tones, but she does not limit herself to such passages. Rather, she mixes them in with accidental (?) harmonies, at times nearly as luscious as Ravel's, at times as laconic as Webern's.

In too few years it will be time to give her some real lessons in music. She will lose a lot in learning, I'm sure, but she has found music to be so natural a part of life that I don't think she will ever lose her joy in it or turn her back upon it.

The great new vocal records
are as always on

LONDON[®]
RECORDS

THRILLING NEW RELEASES:

Puccini

LA BOHEME

with

LUCIANO PAVAROTTI

MIRELLA FRENI

NICOLAI GHIAUROV

THE BERLIN PHILHARMONIC ORCHESTRA

conducted by

HERBERT VON KARAJAN

OSA-1299

RICHARD TUCKER
AND ROBERT MERRILL
AT CARNEGIE HALL
January 7, 1973

The historic occasion of their great
Carnegie Hall appearance preserved by
London as a special bonus pack

BP-26351/2

The ADC-XLM "...in a class by itself."



That's the way Stereo Review described our XLM. High Fidelity headlined their review, "Superb new pickup from ADC" and went on to say, "...must be counted among the state of the art contenders." And Audio echoed them with, "The ADC-XLM appears to be state of the art."

With the critics so lavish in their praise of the XLM, there's hardly any necessity to add anything. Far better to let the experts continue to speak for us.

Frequency response The CBS STR-100 test record showed less than ± 1.5 dB variation up to 20,000Hz. *Stereo Review*
...response is within ± 2 dB over the entire range. *Audio*
Frequency response is exceptionally flat. *High Fidelity*

Tracking This is the only cartridge we have seen that is really capable of tracking almost all stereo discs at 0.4 grams. *Stereo Review*
The XLM went through the usual torture test at 0.4 grams (some top models require more than a gram). *High Fidelity*
The XLM is capable of reproducing anything found on a phonograph record. *Audio*

Distortion Distortion readings... are almost without exception better than those for any other model we've tested. *High Fidelity*

The XLM has remarkably low distortion in comparison with others. *Audio*
At 0.6 grams the distortion was low (under 1.5 per cent). *Stereo Review*

Hum and noise The XLM could be instrumental in lowering the input noise from the first stage of a modern transistor amplifier. *Audio*
The cartridge had very good shielding against induced hum. *Stereo Review*

Price This would be a very hard cartridge to surpass at any price. *Stereo Review*
We found it impossible to attribute superior sound to costlier competing models. *High Fidelity*
Priced as it is, it is a real bargain in cartridges. *Audio*

The Pritchard *High Definition*
ADC-XLM \$50.



TECHNICAL TALK

By JULIAN D. HIRSCH

● **SPEAKING OF ACOUSTICS:** Loudspeaker evaluation, by both objective and subjective means, is a perennial hot topic among audiophiles, and it was the subject of the Seventh Annual Midwest Acoustics Conference held in April at Northwestern University. The size and enthusiasm of the audience testified to the wisdom of the program-planners' choice. The opening speech by speaker manufacturer Paul Klipsch, reviewing the history of loudspeaker development and the levels of performance achieved at various stages, set the tone for the following papers. It would be hard to find a man better qualified than Mr. Klipsch to provide such a historical perspective, for he has an encyclopedic knowledge of the work done by himself and other pioneers in the field and a seemingly total recall of references to technical publications spanning a period of several decades. It was from this background that Mr. Klipsch reminded his auditors, as he has on numerous other occasions, that most "new" loudspeaker designs are really extensions of long-recognized principles. Few in the audience disagreed.

Although our ultimate concern as listeners is with the loudspeaker system *performance*, the speaker designer must know many specifics relating to the drivers that make up the system. The interrelationships of the magnetic, electrical, and physical parameters of a conventional cone driver, and the basis for their calculation from a limited number of measurements, was ably presented by Prof. Robert Ashley of the University of Colorado. Even with the aid of a large time-shared computer, this is far from a simple matter, as evidenced by the final print-out of a long list of parameters for a single 8-inch cone speaker used as an example for Prof. Ashley's paper.

Measurements in two very different environments—free-field (or anechoic) and reverberant-field—were described in some detail by Ed Long of Quadraflex Industries and Daniel Queen of Daniel

Queen Associates. Both men are well-known speaker designers, having been responsible for the creation of some highly regarded speakers during their extensive professional experience.

It was apparent from the information supplied by Mr. Long and Mr. Queen that a thorough, objective measurement of a speaker's performance is a very complex process, requiring a substantial investment in equipment, facilities, and time. Equally apparent was the absence of any solid correlation between these measurements and the sonic qualities of the speaker in its normal listening environment (although that was really outside the scope of their papers). This was further emphasized by George Augspurger, of Perception, Inc., who discussed the effects of room size and acoustic treatment, as well as the placement of the speaker and the listener, on the overall performance of the system.

The last three panelists spoke about the subjective side of speaker evaluation. Dr. Raymond Carhart, Chairman of the Department of Audiology at Northwestern University, spoke from the viewpoint of the psychoacoustician.

A number of little-appreciated effects, such as the distortion generated within the ear by a perceived sound, the effect of ambient noise on auditory perception, and the masking of certain sounds by others arriving both earlier and later, were

brought to the audience's attention by Dr. Carhart.

Finally, C. G. McProud, founder and longtime editor and publisher of *Audio* magazine, and I together discussed the more subjective evaluative processes. Mr. McProud offered suggestions for the use of selected music recordings to assist the layman in judging the quality of speakers, and emphasized frequent exposure to live music as a means of providing a frame of reference. It was (and is) my view that the myriad test procedures described by the various lecturers, vital though they certainly are to the *total* analysis of a speaker's performance (and

TESTED THIS MONTH

●
ESS amt 1 Speaker System
BSR-Metrotec FEW-1
Frequency Equalizer
Technics SL-1100A Record Player
Shure V-15 Type III Cartridge

to the art of the speaker designer), provide only partial clues to how it actually sounds. An expert in the field can probably classify a speaker in general terms by studying a complete set of measurement data, but to outsiders the data would be all but meaningless, and under no circumstances would they convey a sense of the overall sound quality of the speaker.

After reviewing some early attempts to compare a live program source directly with its reproduction through loudspeakers, I described our simulation of that technique, in which a complete high-fidelity system, whose sound has been accurately recorded under anechoic conditions while playing selected program material, serves as the "live" source. As I took pains to point out, this technique has certain limitations, and is by no means a total test, even subjectively, of a speaker's sound. Nevertheless, since its information is supplied in an audible form readily interpretable by any listener, I feel it goes more directly to the heart of the matter than all the instrumented measurements that have been devised for that purpose. Its major strength—as a "subjective" test—is that its results are quite independent of the listener's preferences in music or, for that matter, in loudspeaker sound.

The day was concluded with a lively give-and-take between the panelists and the audience. There was general agreement that tone-burst tests, as generally performed, are not precise enough to yield much useful information on the strengths or weaknesses of a speaker, unless these are formidable in themselves. In that case, any trained listener can

reach the same conclusions without benefit of an expensive tone-burst generator, microphone, and oscilloscope. Another point on which the panelists concurred was the amount of acoustic power necessary for realistic reproduction of music in the home—approximately 0.5 acoustic watt. In other words, a speaker with 1 per cent efficiency requires a 50-watt amplifier, while a speaker that is 10 per cent efficient will produce the same output with only 5 watts input.

There was less unanimity on the importance of modulation distortion in speakers. This term includes various forms of intermodulation distortion and the frequency-modulation (Doppler) distortion caused by the simultaneous presence of low and high frequencies in the same driver. There is no argument as to the physical reality of these effects, which are measurable. Mr. Klipsch and Prof. Ashley consider modulation distortion to be a serious fault of many, if not all, conventional loudspeakers. I expressed some doubts on this, never having heard a clear demonstration of the benefits claimed for a system having very low modulation distortion, or indeed of the severe degradation of quality claimed to result from its presence.

Recalling a recent experience in which severe amplifier crossover distortion was totally masked by the normal program content (STEREO REVIEW, May 1973), I suggested that similar masking effects might hide the subjective results of modulation distortion. However, no one's views seemed to have been altered by the arguments presented on either side, so the question remains open.

EQUIPMENT TEST REPORTS

By Hirsch-Houck Laboratories

ESS amt 1 Speaker System



● THE Electrostatic Sound Systems loudspeaker system called the "amt 1" features a new type of high-frequency driver, the Heil "air-motion transformer." Built under exclusive license from its inventor, Dr. Oskar Heil, the

air-motion transformer is both interesting and radical enough to justify a more extensive technical description than we normally supply in test reports—see the box on the facing page.

In the amt 1 system, the Heil driver operates at middle and high frequencies, beginning at about 600 Hz. Lower frequencies are handled by a conventional 10-inch cone driver in a ported enclosure. The mouth of the ducted port is underneath the enclosure and radiates through a rectangular opening to the rear. The input terminals, a three-position (BRIGHT, NORMAL, SOFT) high-frequency level switch, and a protective fuse are also located under the enclosure.

The Heil driver, mounted on top of the woofer enclosure, is covered by an acoustically transparent grille that permits its nearly 360 degrees of horizontal dispersion to be used effectively. Since its vertical dispersion is relatively narrow, the air-motion transformer is angled slightly upward for best projection of high frequencies into the

THE HEIL DRIVER

THE diaphragm of the Heil driver is a rectangular polyethylene membrane, 0.5 mil in thickness, with a grid of parallel conducting strips covering both sides of the plastic film. To form the moving element, the diaphragm is gathered into parallel pleats (resembling the folds in window draperies) and installed in a plastic frame approximately 5 inches high and 2 inches wide. In this configuration the diaphragm has extremely low moving mass and no resonances within its operating frequency range—both highly desirable qualities for a high-frequency driver.

The assembled element is inserted between two large magnetic pole pieces that immerse it in a magnetic field developed by six pounds of ceramic magnetic material. When an electrical audio signal passes through the conducting strips, they move in such a way as to vary the spacings between the folds of the pleated diaphragm. Alternate pairs of pleats move closer together, expelling the air from the folds between them, while the intervening spaces become larger and, in effect, "inhale" air from the opposite side of the

element. This motion generates one half-cycle of the audio waveform. To produce the second half, the pleats reverse their motion so that the closed folds open and the open folds close, and air is moved in the opposite direction as shown below.

This action, admittedly somewhat difficult to visualize without inspection of the element itself, produces a large air movement with a very small motion of the conducting strips. In other words, it is quite efficient—on the order of 3 to 4 per cent, according to ESS. Also, the mode of operation promotes effective circulation of cooling air at the diaphragm surface, so that power-handling capability is high. (However, ESS advises against prolonged application of steady-state high-power signals at very high audio frequencies.) The combination of high efficiency and power handling, extremely low mass, and an essentially non-resonant moving system results in a nearly ideal sound transducer.

For correct operation, the magnetic pole pieces must produce a field over the entire area of the diaphragm, both front and rear. Therefore, to permit unobstructed sound radiation, the poles form an open grid of parallel strips, so that sound can be emitted

from both sides of the driver assembly. The pole pieces also serve as a dipolar acoustic lens, producing exceptionally wide horizontal dispersion at both the front and rear of the driver.

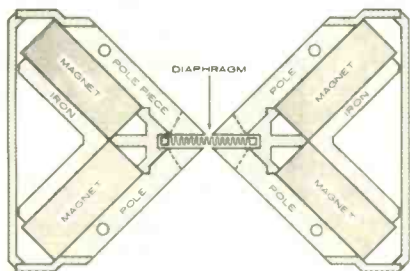
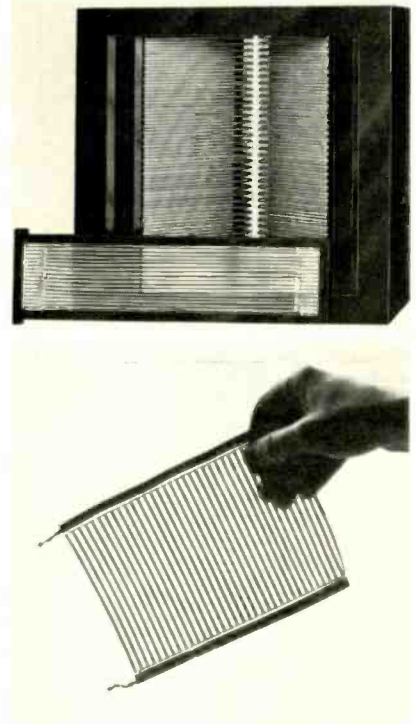

Schematic drawing (left) shows the Heil driver in horizontal cross-section. There are two separate magnetic circuits, each consisting of two pole pieces, two ceramic magnets, and an angle iron. The diaphragm assembly is shown at upper right in front of the assembled driver. Just below is the light, transparent unfolded diaphragm; the "stripes" are the continuous-foil maze that makes up the new unit's "voice coil."

listening area from the speaker's intended floor location.

The ESS amt 1 is 14½ inches square at its base, tapering to 13 inches square at the top. It is 31 inches high and weighs about 45 pounds. Price: \$299. An original-owner warranty covering parts and labor protects the amt 1 woofer for five years and the Heil transducer for life.

● **Laboratory Measurements.** Our averaged live-room frequency-response measurement, using two speaker locations and a distantly placed microphone, produced one of the flattest curves we have ever measured on a loudspeaker. The low-frequency output, with the port radiation adding to the direct output of the cone at frequencies below about 70 Hz, showed a gentle rise below 150 Hz, to +5 dB at 70 Hz. From 150 to 20,000 Hz, the output varied only ± 1 dB. If the low-frequency response is included, it was within ± 5 dB from 40 to 20,000 Hz. It was interesting to observe that the curve taken in our test room closely matched a free-field (anechoic-chamber) response curve published by ESS. In fact, our measurement did not differ from theirs by more than 3 dB at any

frequency from 20 to 20,000 Hz! The high-frequency level switch, in its BRIGHT position, increased the output by about 2 dB above 1,500 Hz. The SOFT setting reduced the output by 2 to 4 dB above 600 Hz. The measurements quoted previously were made with the NORMAL setting, which we also found best for listening.

The low-frequency distortion (measured in front of the woofer) was typically less than 2 per cent down to about 60 Hz under all of our test conditions. At a 1-watt input, it rose to 5 per cent at 42 Hz and 6.5 per cent between 30 and 40 Hz. Increasing the drive to 10 watts produced 5 per cent distortion at 54 Hz, 10 per cent at 49 Hz, and a maximum of 18 per cent at 40 Hz. Possibly because of the radiation from the port, which predominates at very low frequencies, the distortion dropped to 12 per cent at 30 Hz. With the speaker maintaining a constant output of 90 dB sound-pressure level (SPL) measured 3 feet from the front, distortion was 5 per cent at 44 Hz, 10 per cent at 39 Hz, and 26 per cent at 30 Hz. Tone bursts were reproduced well throughout the frequency range of the system, although we noted a single cycle of overshoot at 100

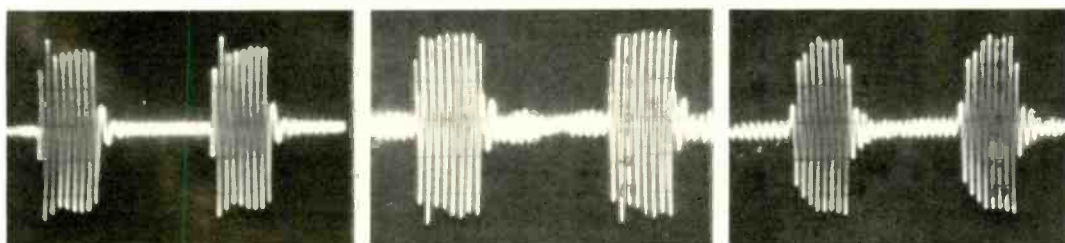

The response of the amt 1 to tone-burst signals was very good throughout its range. Frequencies shown are (left to right) 100, 1,500, and 10,000 Hz.

Despite its unusual appearance, the enclosure of the amt 1 is a conventional ducted-port design with a 10-inch woofer. The Heil driver (visible when the acoustically transparent grille top is removed) radiates over almost a full 360 degrees in the horizontal plane.



Hz. There was also a "build-up" time of four cycles at 10,000 Hz. However, since we rarely have occasion to measure tone-burst response at such a high frequency (or with a speaker that exhibits a virtually omnidirectional dispersion pattern at such frequencies, as the amt 1 does), we cannot be sure to what degree the test conditions may have been responsible for this. Certainly such an effect would not be audible under any conditions.

The instructions accompanying the amt 1 describe it as a 4-ohm system. Its measured impedance was 4 ohms at the minimum point (between 90 and 150 Hz), and remained between 4 and 5 ohms over most of the audio range. The low-frequency resonance was at 60 Hz, with a rise to 15 ohms. The ESS amt 1 is moderately efficient compared with acoustic-suspension systems, requiring about 1 watt at mid-frequencies for a 90-dB SPL. This efficiency is essentially determined by the woofer: the Heil driver is far more efficient, and is padded down to match the woofer characteristics. There was no indication, either in listening or in our measurements, of the crossover action.

● *Comment.* Even if we had never listened to the ESS amt 1, its measured frequency response alone would invite the use of superlatives. This is one of the few speakers we have tested, in a normally "live" room, whose overall frequency response and smoothness are comparable to those of a good high-fidelity amplifier—and that is

no small achievement! We were glad—though hardly surprised—to note that the amt 1 sounded as good as its measurements indicated.

Although there was a distinct vertical "beaming" of the high frequencies close to the speaker, this effect became negligible at the more usual listening distances of 10 to 15 feet. Horizontally, the dispersion was excellent: in fact, it could be considered as essentially omnidirectional over the operating frequency range of the Heil driver. Although the Heil air-motion transformer bears a superficial resemblance to a ribbon speaker, it has none of the ribbon speaker's fragility. ESS states that it can be used (with care) with amplifiers capable of delivering up to 300 watts per channel to 8-ohm loads, or 500 watts to 4-ohm loads. We drove it with an amplifier capable of well over 300 watts per channel at 4 ohms—at peak powers near that amplifier's maximum capability—without damage or objectionable distortion until a high-frequency transient blew the speaker's protective fuse. Even this deliberate abuse did not damage the speaker in any way.

With a pair of speakers in a free-standing position about 3 feet from the nearest wall, there was a moderate but noticeable emphasis of the low and mid bass, evidently corresponding to the measured rise of output in the 70-Hz region. In many cases, the slight additional heaviness could be considered a benefit; in any event, it would be modified by the listening-room dimensions and speaker placement. Overall, the amt 1's transparency, definition, and overall clarity were "state-of-the-art" in every respect. Perhaps the best way to convey our total impression is to say that the amt 1 has just the listening qualities one would expect from a speaker system with a ± 1 -dB response over practically the entire range of musical frequencies. Needless to say, it earned a solid "A" rating in our simulated live-vs.-recorded listening test.

From time to time, "new" principles in speaker design make their appearance. Most are more accurately described as variations of established techniques. To the best of our knowledge, the Heil air-motion transformer truly qualifies as a "new" principle. It works, apparently as claimed, and we look forward to further developments of this promising concept. ESS has indicated that a Heil air-motion transformer for low frequencies is under development—a mind-boggling prospect!

For more information, circle 105 on reader service card

BSR-Metrotec FEW-1 Stereo Frequency Equalizer



● THE bass and treble tone controls of the better high-fidelity amplifiers and receivers can boost or attenuate the output at the extremes of the audio-frequency range with little or no effect on the mid-range response. This enables the user to "touch up" the minor deficiencies at the highest and lowest frequencies that recordings (and speaker systems) frequently exhibit without altering the overall

sonic balance. Unfortunately, when the need to make *major* changes in the reproduced sound arises, conventional tone controls are usually useless.

The best solution to the limitations of conventional tone controls is a multi-band equalizer that permits more or less independent adjustment at a number of specific frequencies throughout the audio range. Although the more elaborate equalizers may act at twenty or more frequencies, often spaced at intervals of one-third of an octave, their high cost and the difficulty of adjusting them without special instruments usually limit them to commercial applications. However, a very effective and practical equalizer can be made with only five bands. It can be sold at a reasonable price, is only a little more difficult to adjust than ordinary tone controls, and is considerably more useful in home music systems. Several manufacturers have built such devices into their receivers and ampli-

(Continued on page 38)

Realistic 4-Channel with the Luxury of Wireless Remote Control!

"Leave it to Radio Shack to make a 4-channel receiver with a remote control that's really useful! Pre-set your 6 favorite stations, control tuning and volume from your easy chair. And it's wireless, too!"

Arthur Fiedler

Conductor of the Boston Pops



Introducing the Realistic QTA-790 280-Watt AM/FM 4-Channel Receiver



Palm Size Remote Control. Selects 6 Pre-Set FM Stations and Adjusts Volume

The most powerful, most innovative receiver in our 50-year history. Accepts every kind of source, reproduces every kind of sound. Has the power and outputs for eight speakers—enough for 4-channel anywhere you want it. Accu-Balance™ sliding controls balance left, right, front and rear just the way you like. Perfect Loudness™ adds the right amount of bass at any volume. Jacks for stereo or 4-channel headphones. Bass, treble and midrange controls, hi and lo filters, FM muting, more. Our wireless remote controller is a "miracle" you can put in your pocket. Try it out at any of our 2000 stores in all 50 states.

598⁰⁰

- Plays SQ Matrixed Records, FM and Tapes
- Synthesizes 4-Channel from 2-Channel
- Has Separate Input with Volume Control For Q-8 Discrete 4-Channel Tapes
- Complete 2-Channel Tape Facilities Including Monitoring and Dubbing
- Plays Two Separate Stereo Programs In Two Different Rooms At Once

FREE CATALOG

214

Values in Home Entertainment, Audio, Parts, Kits, Communications, More!

At your nearby store or mail to address at right.

Name _____ Apt. # _____

Street _____

City _____ State _____ Zip _____

REALISTIC[®]
by
Radio Shack[®]

and ALLIED RADIO STORES

A TANDY CORPORATION COMPANY

2617 W. 7th St., Fort Worth, Texas 76107

fiers. The idea of the BSR-Metrotec FEW-1 Graphic Stereo Frequency Equalizer (to give it its full name) is to provide add-on multi-band equalization facilities for existing audio systems that lack them.

The FEW-1 varies the response in each of its five bands with a vertical slider control that affords up to ± 12 dB of adjustment range, with flat response at the mid-point of travel. The center frequency of each control is marked on the panel above the slider: 60, 240, 1,000, 3,500, and 10,000 Hz. Each slider acts on both channels. The FEW-1 is designed to be connected in the tape-monitoring path of an amplifier or receiver, and it has its own tape-monitor switch and jacks to replace the amplifier facilities its installation takes up. Alternatively, for use with a separate preamplifier and power amplifier or an integrated amplifier with PREAMP OUT/MAIN IN jacks, the FEW-1 can be connected between the preamplifier outputs and the power-amplifier inputs. This leaves the normal tape-monitoring circuit undisturbed, and also affords the option—when a recorder is connected to the FEW-1—of modifying the signal to be recorded with the preamplifier's tone controls and filters.

The BSR-Metrotec FEW-1 has impressive performance specifications, including a frequency response of 5 to 100,000 Hz ± 1 dB, distortion less than 0.05 per cent at 2 volts output (and typically less than 0.007 per cent at 1 volt), a maximum output of 9 volts, and a noise level of 80 dB below 1 volt. The FEW-1 is $8\frac{3}{8}$ inches wide, $4\frac{5}{8}$ inches high, and $5\frac{1}{2}$ inches deep; it comes in a metal cabinet with walnut side panels. It carries a two-year guarantee. Price: \$99.95. It is also available in kit form, as the FEK-1, for \$79.95.

● **Laboratory Measurements.** The BSR-Metrotec FEW-1 introduced a 3-dB loss in the signal path, with all sliders centered. There was no output clipping on input signals up to 10 volts (which provided an output of about 7 volts). The output noise level was less than 1 millivolt (unweighted), and consisted largely of subsonic frequencies. When we applied an ANSI "A" weighting curve approximately corresponding to the ear's frequency sensitivity, the noise was below our measurement limit of 100 microvolts, or 80 dB below 1 volt.

As claimed, the FEW-1 is a virtually distortionless device. The distortion at low-level outputs (0.1 volts) was unmeasurable, being less than the very low noise level. At a 1-volt output, the distortion was 0.007 per cent or less across the full audio band (it was masked at 20 Hz by the inaudible subsonic "bounce"). At 5 volts output—beyond the maximum that would ever be required in practice—the distortion was under 0.035 per

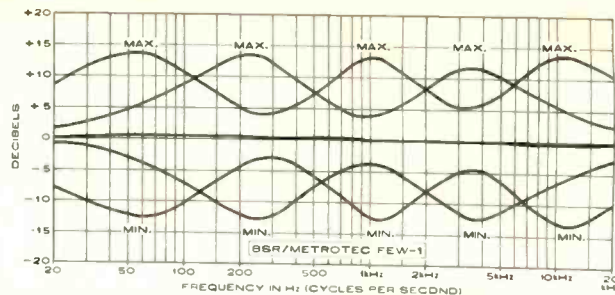

The curve lying along the 0-dB line shows the frequency response of the FEW-1 with all its sliders centered. The four other curves were obtained by setting alternate sliders at their maximum or minimum positions, leaving the controls in between at center.

cent at all frequencies, and at 10 volts it was still under 0.25 per cent.

With the sliders centered, the FEW-1's frequency response was ± 0.5 dB from 20 to 20,000 Hz. The individual bands had an adjustment range of at least ± 12 dB, and center frequencies were correct. When we applied a square-wave signal, its shape was modified by the equalizer in accordance with theoretical expectations, with peaking, rounding, or tilting of the waveform depending on the control settings. Under no conditions was there any trace of ringing or other transient instability. With the controls set flat, a 100,000-Hz square wave was passed with only slight rounding, which would indicate a frequency response extending to nearly one million Hz!

● **Comment.** The BSR-Metrotec FEW-1 was a fascinating unit to experiment with. We have rarely found conventional tone controls useful in compensating for any but the most minor frequency-response irregularities. With the FEW-1, however, it was possible to minimize a peaky mid-range or bass response from a loudspeaker, tame or brighten the extreme highs, or lift the low bass, with a minimum of side effects. We also put the device to good use when dubbing tape recordings that were originally of less-than-distinguished quality. Although it could not perform the sonic equivalent of converting a sow's ear into a silk purse, it certainly made poor recordings tolerable and fair recordings quite good.

We can heartily recommend the BSR-Metrotec FEW-1 to anyone plagued by annoying system response irregularities that are not amenable to correction by ordinary tone controls. In addition to its effective operation, it is reassuring to know that this little box has far less distortion than almost any amplifier one is likely to use with it.

For more information, circle 106 on reader service card

Technics SL-1100A Record Player



● PANASONIC's sophisticated new Technics line of components includes the SL-1100A record player, an elec-

tronically controlled direct-drive turntable with a new tone arm, mounted on an unusual cast-aluminum base. Four resilient feet support the entire assembly, providing acoustic isolation. The feet are individually adjustable for leveling the unit.

The motor armature of the SL-1100A turns at $33\frac{1}{3}$ or 45 rpm, and the 4.4-pound cast-aluminum platter with its ribbed rubber mat rests directly on the rotor (the motor shaft is the record spindle). The twenty-pole d.c. motor is controlled by an electronic feedback system that maintains the proper speed over a wide range of line voltages
(Continued on page 40)

Lend us your ears and we'll give you a **TDK C-60SD Super Dynamic Hi Output Cassette Tape FREE!**

You've been reading a lot about cassette noise reduction systems lately. At JVC, we think we've developed the finest, most advanced system available — ANRS (Automatic Noise Reduction System).

It's the ultimate answer to crisp, clean "reel-to-reel" reproduction. Listen to the JVC 1667 cassette deck. Look at these outstanding features: 2 studio-type VU meters, accurate enough to be used for studio recording . . . 3 digit counter with a memory . . . tape selector switch, for either chrome or normal tapes . . . long life cronios heads . . . hysteresis synchronous motor to insure accurate rotation, reducing wow & flutter to 0.13% RMS . . . an automatic eject system with photoelectric cell . . . automatic eject . . . 100% solid state construction . . . precision slide controls . . . push button function control panel . . . frequency response of 30-19,000 Hz . . . and more!

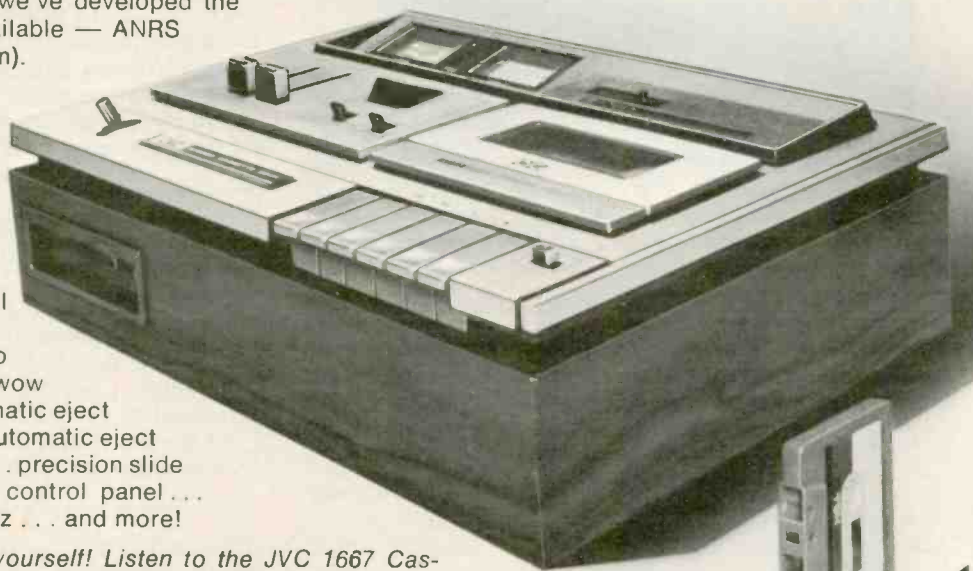

Hearing is believing! Prove it to yourself! Listen to the JVC 1667 Cassette Deck . . . and just for that we'll give you a FREE TDK C-60SD Super Dynamic Hi Output Tape. For the name and address of your nearest participating JVC Dealer, call this toll free number, 800-243-6000. In Connecticut call 1-(800) 862-6500, or write JVC America, Inc., 50-35B 56th Road, Maspeth, N.Y. 11378.

1013-C

JVC Hi-Fi

To receive a FREE TDK C-60SD Super Dynamic Hi Output Cassette Tape, fill out this coupon (no reproduction) and present it to a participating JVC Dealer. (Offer limited to 18 year olds and over, and to the available supply of tapes.)

Name _____ Age _____
Address _____
City _____ State _____ Zip _____
Dealer _____

Call today.
Offer ends
July 15th.

and has exceptionally low wow, flutter, and rumble. Vernier speed adjustments on the motorboard vary each speed over a nominal ± 5 per cent range.

The effective turntable diameter is $11\frac{7}{8}$ inches, but a stroboscope ring with raised "dots," which is part of the platter, gives it an overall diameter of almost 14 inches. Separate markings are provided for 50- and 60-Hz power sources (the turntable speed is independent of line frequency as well as voltage). A neon stroboscope lamp plugs into a receptacle next to the turntable, and pressing a button on it allows the stroboscope pattern to be viewed while adjusting the speed. The power switch of the SL-1100A is a short lever that also selects the operating speed. A small red light glows when power is applied, but the turntable does not rotate until a separate feather-touch snap-action START button is touched. A similar button stops the turntable. The tone arm is mounted on a removable metal plate so that other arms can be installed if desired. The arm counterweight is adjusted by a knob on its side. When the arm is balanced, the knob is pulled out slightly, which causes the tracking-force scale (also operated by the counterweight knob) to snap to a zero

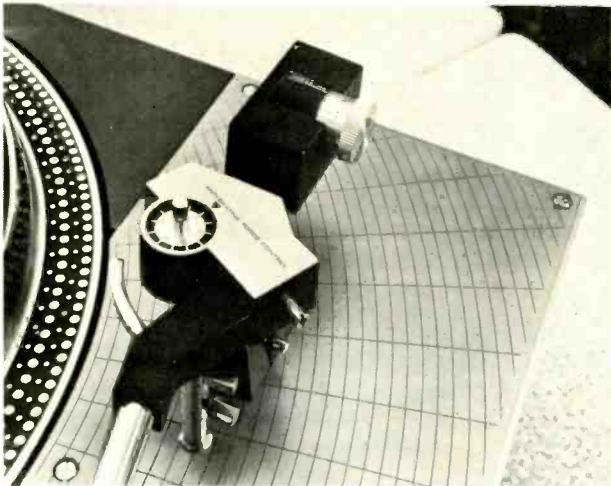

The tone arm of the SL-1100A, mounted on a removable metal plate, has a very solid-looking pivot assembly with the stylus-force and skating compensation adjustments in convenient view.

reading. The desired tracking force is then dialed in, with the scale reading from 0 to 5 grams in 0.5-gram intervals.

Above the arm pivots is a small anti-skating dial, calibrated to match the tracking-force dial. A damped cueing platform under the arm raises and lowers it smoothly under the control of a lever at the front right of the motorboard. In the rear of the base are the two phono-output jacks and two ground binding posts (for the chassis and arm wiring), as well as an a.c. convenience outlet. A $4\frac{1}{2}$ -foot low-capacitance output cable is supplied; other lengths can be used if desired.

The SL-1100A measures about 20 inches wide, $15\frac{3}{8}$ inches deep, and $7\frac{3}{4}$ inches high; it weighs just under 29 pounds including its plastic cover. The SL-1100A record player, with dust cover, is \$329.95. An optional walnut wood skirt (Model SH-11-B-1) is available for \$19.95.

● **Laboratory Measurements.** The only obvious difference between the turntable of the SL-1100A and the SP-10 turntable tested in September 1971 is the former's slightly lighter platter. The measured performance of the two was almost identical and places both among the elite of turntables. The SL-1100A's unweighted rumble was -43 dB (lateral plus vertical), and -44 dB in the lateral plane. With RRL weighting for relative audibility, the rumble was -58 dB, which is the lowest, by a small mar-

gin, we have measured to date. The wow and flutter were 0.03 and 0.04 per cent at $33\frac{1}{3}$ rpm, and each was 0.04 per cent at 45 rpm.

The range of speed adjustment was $+7.4$, -5.3 per cent at $33\frac{1}{3}$ rpm, and $+6.3$, -4.6 per cent at 45 rpm. A line-voltage change from 100 to 135 volts produced no measurable speed change, and a drop to 95 volts increased the speed by a negligible 0.4 per cent. When starting, the turntable platter reached its full speed in about one second, or one-half revolution.

The arm, which was quite easy to balance, had a very accurate stylus-force dial whose error did not exceed 0.1 gram at any setting from 0.5 to 5 grams. The $9\frac{1}{4}$ -inch arm length (about an inch longer than the arms of most top-quality automatic turntables) resulted in an almost unmeasurable lateral tracking-angle error, which did not, in any case, exceed 0.33 degree per inch for record radii from 2 to 6 inches.

The settings of the anti-skating dial appeared to be correct, whether judged by the criterion of equal distortion in both channels (the correct way) or by the simpler and more common method of adjusting for stationary arm position when the pickup is placed on a rotating blank disc. Since the extra-long tone arm of the Technics SL-1100A requires a relatively small offset angle, skating forces are somewhat lower than those found on most record-playing systems. This makes the setting of the proper corrective force on this particular machine an essentially noncritical procedure.

The cueing lift action was quite slow, requiring three seconds to lift the pickup from the record and two seconds to lower it. However, intermediate positions of the cueing lever could be used to just clear the record and then lower the pickup with a minimum of delay. There was no outward drift of the pickup during descent.

The SL-1100A was designed with the requirements of the quadraphonic CD-4 discrete-disc system in mind. CD-4 cartridges require very low cable capacitance to maintain their response to beyond 40,000 Hz, and most record-player and arm cables have excessive capacitance for this application. The $4\frac{1}{2}$ -foot cable of the SL-1100A

ADDENDUM: KLH MODEL 52 AM/FM RECEIVER

● In our test report on the KLH Model 52 receiver (May, 1973), we commented that this fine unit had a somewhat greater than usual temperature rise on its rear panel. Since KLH claimed that this was *not* normal behavior, we obtained another sample for test. We were pleased to find that the second unit maintained the excellent measurements of the first sample and its temperature rise was well within normal limits.

had only 52 picofarads (pF) capacitance (values of 20 to 30 pF per foot are common), and the cable capacitance of the entire unit, including the internal arm wiring, was only 165 pF.

● **Comment.** The SL-1100A is one of the most beautifully finished audio products we have seen. It has an aura of precision workmanship that is more than skin deep. Except for its rather leisurely arm lift and descent, we found absolutely nothing to criticize in its performance.

The plastic cover is not hinged, but simply rests on the turntable top and must be lifted off to use the machine. The relatively firm mounting feet complement the considerable mass of the SL-1100A, so that its arm seems to be immune not only to acoustic feedback, but to all normal handling and control operations. This represents an im-

(Continued on page 42)

control your own four channel destiny

Now you can create your own 4-channel world with the incomparable Sansui vario matrix QRX series of 4-channel receivers. Sansui's sound controls enable you to mix your own 4-channel sound according to your own musical preference in ways you have never experienced before.

Deliver for collar, ear for ear, the vario matrix QRX series gives you greater power, better separation and superior, truly musical 4-channel reproduction from all sound sources: records, tapes, FM, 3-track cartridges or cassettes. The unique Sansui QS vario matrix gives you richer, wider 4-channel sound from QS (Regular Matrix) as well as EQ (Phase Matrix) sources, plus 2-4 discrete demodulated sources. And with its superior QS synthesizing section, it creates thrilling 4-channel sound from conventional stereo. Get a demonstration today from a branch or Sansui dealer—anywhere.

*Sansui QRX Vario Matrix Series: QRX-6500, QRX-3500, QRX-3000



QS
REGULAR MATRIX

Sansui

SANSUI ELECTRONICS CORP.

Woodside, New York 11377 • Gardena, California 90247

ELECTRONIC DISTRIBUTORS (Canada) Vancouver 9, B.C.

SANSUI ELECTRIC CO., LTD., Tokyo, Japan • Sansui Audio Europe S. A., Antwerp, Belgium

provement over the SP-10, whose soft mounts called for some delicacy in operating the controls to avoid any jarring of the arm.

The SL-1100A, complete with tone arm, sells for considerably less than the original SP-10 turntable alone,

with absolutely no sacrifice of performance. Although the unit is by no means inexpensive, the price of this handsome instrument is certainly justified by its rare combination of performance and styling.

For more information, circle 107 on reader service card

Shure V-15 Type III Phono Cartridge



● THE introduction some years ago of the Shure V-15 phono cartridge represented a distinct advance in the then-current state of the art. Subsequently, a series of further improvements resulted in the redesigned V-15 Type II, followed by the V-15 Type II (Improved). This evolutionary process, which is almost inevitable when the initial concept and execution of a product design are fundamentally sound, can continue almost indefinitely. And thus we have Shure's new top-of-the-line phono cartridge, the recently announced V-15 Type III.

Unlike its predecessor, whose improved stylus assembly could be installed in the older V-15 Type II cartridge body to make it an "Improved" version, the V-15 Type III is an all-new design. Externally, it closely resembles the earlier V-15 models, including the swing-away stylus guard and black-on-chrome body. There have been two major areas of improvement: "trackability" (the ability to play very high recorded velocities at a low tracking force over the full frequency range of modern recordings), and a virtually flat frequency response.

Shure has long emphasized the importance of tracking ability (they coined the term "trackability," in fact). The V-15 Type II was rivaled in that respect by few cartridges and surpassed by none. Nevertheless, a study by Shure of a number of commercial recordings indicated that their maximum velocities, particularly at the higher frequencies, exceeded the capabilities of the Type II, especially at its minimum tracking force of 0.75 gram. To improve this situation, the effective stylus mass of the Type III was reduced about 25 per cent, from 0.45 to 0.33 milligram. This raised the high-frequency resonance from 20,000 to 23,000 Hz, thereby significantly reducing tracking problems in the upper audio range. At 0.75 gram, the rated tracking ability of the Type III is about 2 dB better than that of the Type II at middle and high frequencies, and at its maximum force the improvement is more than 3 dB.

The stylus compliance of the Type III was unchanged, so that its low-frequency resonance (when installed in one of the better tone arms) remains in the "safe" region of 7 to 15 Hz. Low-frequency tracking is therefore essentially the same as that of the previous V-15, which is to say more than adequate for virtually any recording. If the new lower-mass stylus assembly had been fitted to the body of the previous V-15, output voltage would have been reduced. Therefore, a new magnetic signal-generating system was developed, using laminated pole pieces for higher conversion efficiency. The output of the Type III is consequently identical to that of the Type II: its rated tracking force is from 0.75 to 1.25 grams.

The frequency-response curve of the V-15 Type III (Improved) typically had a slight "saddle" shape, with a reduction in output of about 2 dB in the 7,000 to 12,000-Hz range. Although this was hardly objectionable in view of the other virtues of the cartridge, Shure set about to eliminate it in the new model, whose response is rated nearly as flat as that of a good amplifier—within ± 1 dB from 30 to 8,000 Hz, and overall an excellent ± 3 dB from 20 to 20,000 Hz.

The price of the V-15 Type III with a 0.2 x 0.7-mil elliptical stylus is \$72.50. It is also available as the V-15 Type III-G, with a 0.6-mil conical stylus. For those with 78-rpm record collections, the VN78E stylus, with a 2.5 x 5-mil elliptical diamond that tracks from 1.5 to 3 grams, is also available. The Shure V-15 Type III is supplied with a soft brush for cleaning the stylus.

● **Laboratory Measurements.** The Shure V-15 Type III tracked our Cook 60 (low-frequency) and Fairchild 101 (middle-frequency) test records at its minimum rated force of 0.75 gram in an Empire 990 arm. Like other
(Continued on page 44)

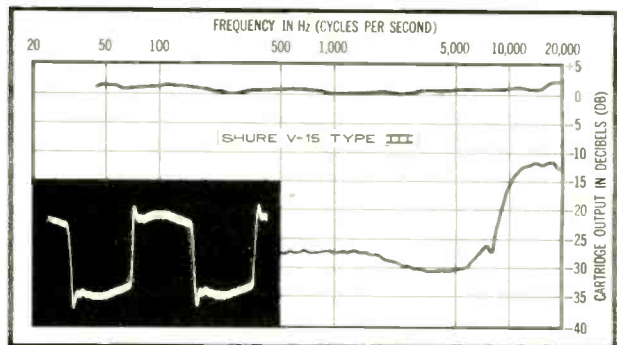

The upper curve represents the averaged frequency response of the cartridge's right and left channels. The distance (calibrated in decibels) between the two curves represents the separation between channels. The oscilloscope photograph of the cartridge's response to a 1,000-Hz square wave is an indication of a cartridge's high- and low-frequency response and resonances. Most program material on discs has velocities well below 15 cm/sec, and it only rarely reaches 25 to 30 cm/sec. Distortion figures shown are therefore not directly comparable with figures obtained on other audio components, but are useful in comparing different cartridges. The curve labeled RCA 12-5-39 was made with the RCA intermodulation-distortion test record used in all recent cartridge tests. The two TTR-103 curves show the distortion measured while playing the 10.8-kHz tone bursts on the Shure test record.



Belle
Klipsch®
Loudspeaker

Wallflower Sister of the Klipschorn®

But she's no wallflower when it comes to speaking out. Totally horn loaded like the KLIPSCHORN corner horn loudspeaker, the BELLE KLIPSCH is a wall type speaker with the same flat response, the same quality of reproduction, and the same freedom from distortion. Its three horns, because of their high efficiency, can take in their stride anything from a murmur to the loudest rock or classical crescendo. They don't have to labor or churn the air to achieve full range.

Basically, the BELLE KLIPSCH is a domesticated version of Klipsch theater speakers installed in Radio

City Music Hall. Only it's finished for home use.

Use it as a primary speaker or in conjunction with other Klipsch speakers in multi-speaker systems. They are all compatible. This coupon will bring you valuable information about Klipsch loudspeakers.



Klipsch and Associates, Inc.
P.O. Box 280 H-6
Hope, Arkansas 71801

Please send me your latest brochure and list of dealers.

Name _____

Address _____

City _____ State _____ Zip _____

Shure cartridges, it produced an essentially undistorted waveform from the 30 centimeters per second (cm/sec), 1,000-Hz tones of the latter record. Most other cartridges, if they are able to track it at all, produce a clipped output from this disc. The output voltage was 3.8 millivolts at 3.54 cm/sec from the CBS STR 100 record. Hum shielding was better than average, and the 1,000-Hz square-wave response showed only a single moderate overshoot in the waveform.

Like its predecessors, the V-15 Type III should be used with a relatively high capacitive load (as provided by the connecting cables and preamplifier input) for flattest response. However, the cartridge is less sensitive to capacitive loading than the Type II (Improved). We checked it with loads of 350 and 600 picofarads (pF), and the latter increased the output by about 1 dB between 4,000 and 9,000 Hz, and reduced it by 2 to 3 dB above 10,000 Hz. Flattest overall response was measured with a 600-pF load, with no more than a ± 1.25 -dB variation (including the recorded response variation of the STR 100 record) up to 20,000 Hz. Channel separation was notably uniform, exceeding 30 dB at all frequencies from 500 to almost 8,000 Hz, and falling to a still excellent 15 dB between 10,000 and 20,000 Hz. We measured the distortion of the Type III with the Shure TTR-103 test record, which provides separate tests for tracking ability in the lower-, mid-, and high-frequency ranges, at velocities up to 30 or 40 cm/sec. Allowing for variations in test equipment and records, our results were comparable to those claimed by Shure. A quick recheck of a couple of other top-quality cartridges confirmed that the Type III can claim top honors in tracking ability.

We also checked the IM (intermodulation) distortion with our older 78-rpm RCA 12-5-39 test record. It measured under 2 per cent (typically about 1 per cent) up to

15 cm/sec, but warp and eccentricity in the test disc prevented measurement at higher velocities when using the 0.75-gram minimum tracking force. On the other hand, with the 1.25-gram maximum recommended force, the IM was far lower over the full range of the record than anything we have previously measured with any cartridge. Typically only about 0.5 per cent, it was still a very low 1.5 per cent at the maximum velocity of 27.1 cm/sec. The chances are that if you hear distortion from your records with the V-15 Type III, it is coming from the record itself. As Shure puts it, "anything II could do, III can do better."

We have been using the Shure "Audio Obstacle Course" record as a useful though imprecise measure of tracking ability for some time. Since the Type III can hurdle its obstacles with ease, Shure has issued a new test disc called "Audio Obstacle Course—Era III," which is an even more severe test of tracking ability. A copy of the disc is available at no charge to each purchaser of a V-15 Type III.

Operating at 0.75 gram, the V-15 Type III played the "Era III" record without strain except on the highest level of the vocal-sibilant test band. We heard a trace of "sandpaper" quality on this that was not eliminated even at a 1.25-gram force. It may have actually been in the record, but, at any rate, no other cartridge we tried would play it either.

● *Comment.* As might be supposed, it takes an extraordinary record to reveal the full potential of this cartridge. Having played our most demanding discs with it, we can confirm that the Type III has no difficulty tracking any of them at a 0.75-gram force, and that its sound is as neutral and uncolored as can be desired.

For more information, circle 108 on reader service card

IF
CHARLIE PARKER
 HAD BEEN ABLE TO PLAY
 FIVE SAXOPHONES
 AT ONCE, IN HARMONY,
 HE MIGHT HAVE BEEN
 KNOWN AS SUPERSAX.



SUPERSAX PLAYS BIRD

An Exciting New Album Concept

"Supersax Plays Bird, as much as any album I have heard in recent years, is a thoroughgoing labor of love."

—Leonard Feather
 (Author of From Satchmo to Miles,
 Stein & Day)

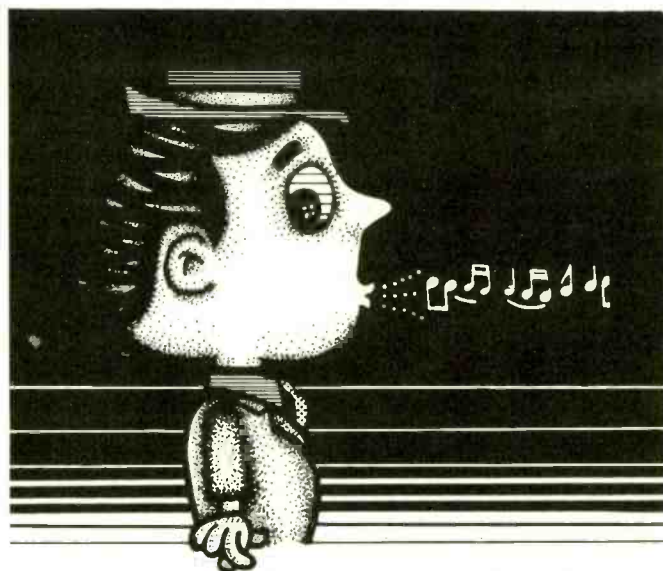

you're whistling in the dark.

If you think that heart attack and stroke hit only the other fellow's family.

Help your Heart... Help your Heart Fund 

Rhapsody in Budgetry

by KENWOOD

KENWOOD brings the luxury of audiophile sound within range of the most modest budget with this pair of handsome components. Newly engineered to incorporate the most advanced circuitry, tough new materials and remarkable new features, this high-performing pair is available together or individually.

KT-4005 AM/FM-STEREO TUNER:

Excellent broadcast quality and especially exciting FM-Stereo characterize the KT-4005. With KENWOOD's exclusive DSD Circuitry and a newly designed block filter, stereo separation is effectively improved (35 dB @ 100-8k Hz). High-grade silicon transistors insure maximum sensitivity (1.9 μ V); and the excellent FM IF Stage delivers better than 60 dB selectivity and a capture ratio of 2.0 dB, enabling clear reception of FM stations without interference from adjacent frequencies.

KA-4004 DIRECT COUPLING, 95-WATT (IHF) STEREO AMPLIFIER:

Ample power, sophisticated controls, and high-performance characteristics make the KA-4004 an excellent choice for the heart of any stereo system. Direct coupling circuitry assures flat frequency response, low distortion and high damping throughout the audible spectrum. An exclusive KENWOOD dual protection circuit prevents damage to speakers or transistors from transient power surges; and advanced new PNP can-type transistors assure low-noise performance and circuit reliability. Terminals for two PHONO'S, two AUTO-TAPE DECKS, TUNER and two sets of SPEAKERS offer tremendous flexibility.

SPECIFICATIONS: Continuous Power Output, 18 watts/channel, both channels driven into 8 ohms at any frequency from 50-20k Hz
■ Frequency Response, 20-40k Hz
■ Power Bandwidth, 10-50k Hz

For complete specifications write . . .

the world approach to quality
KENWOOD

1577 So. Broadway, Gardena, Calif. 90248
72-02 Fifty-first Ave., Woodside, N.Y. 11377

CIRCLE NO. 23 ON READER SERVICE CARD



Bartók's Music for Strings, Percussion, and Celesta

THE years between 1926 and 1931 were very active ones for Béla Bartók, for it was during that period that he composed the First and Second Piano Concertos, the two Rhapsodies for Violin and Orchestra, the Third and Fourth String Quartets, the Piano Sonata, and the start of his didactic *Mikrokosmos*, books of graded pieces for piano solo. But, with the notable exception of the Fifth String Quartet of 1934, Bartók composed very little of consequence during the next five years. Then, in 1936, a commission from the Swiss conductor Paul Sacher started Bartók on another, longer creative period. From then until his death in New York nine years later, the composer produced one masterly score after another, even in the very last years when his body was ravaged by the leukemia that ultimately killed him. It is the music of these final nine years, by and large, that has made Bartók one of the most frequently performed of all twentieth-century composers.

Certainly one of the cornerstones of the Bartók catalog is the Music for Strings, Percussion, and Celesta, the work that resulted from the 1936 Sacher commission. Bartók used the cumbersome designation as a working title while he was writing; when the score was completed, and it came time to put a name to it, he decided to let it stand. Sacher conducted its first performance in January 1937 in Basel, and before the year was out it was introduced in this country by the New York Philharmonic-Symphony Orchestra conducted by John Barbirolli.

In the score, Bartók directs that there be two groups of strings, deployed to the left and right of the conductor, with the percussion players ranged in two clusters between them and the double basses strung out along the rear of the stage. The two string bodies are merged in the first movement, but thereafter they are most often treated as separate but complementary units. In his invaluable book, *The Life and Music of Béla Bartók* (1953), Halsey Stevens characterizes Bartók's Music for Strings, Percussion, and Celesta as "one of the most intensively organized of all his compositions; the subject of its opening fugue generates the entire work, and yet it is at the same time so spontaneous and so communicative that only the rare listener is likely to be aware

of its complexities." The first movement, *Andante tranquillo*, is a questioning, mysterious section that rises to an impassioned climax and then subsides again into mystery. The second movement, *Allegro*, is a rhythmically vigorous and energetic section; the third movement, *Adagio*, is hushed and atmospheric "night music"; and the last movement, *Allegro molto*, is a headlong, Hungarian-flavored rondo with variations.

AMONG the baker's dozen recordings of the music currently available, four seem to me to be unusually satisfying: Bernstein's (Columbia MS 6956), Boulez's (Columbia MS 7206), Kubelik's (included in Mercury MG 3-4501, a three-disc mono set), and Reiner's (RCA Victrola VICS 1620). As might be expected, Bernstein's is the most passionate of the lot; there are some moments of less than perfect ensemble in the playing, but the force and excitement of his conducting are irresistible to me. The Boulez recording is one of that conductor's most consistently satisfying performances of anything in his repertoire; to the well-known Boulez virtues of clarity and precision are added a lively dynamism and spontaneity—and his recording team also makes most imaginative use of the stereo effects built into the score. Kubelik's marvelously impulsive reading goes back to his very first recording sessions as conductor of the Chicago Symphony Orchestra; its sound was a miracle of recording technology in 1951, and it is still remarkably vivid today in this remastered re-release. And Reiner's recording, also with the Chicago Symphony Orchestra, presents a superbly lucid and organized performance with sonics from the early stereo days that are still quite impressive. Moreover, Reiner's version is now available on the budget-price RCA Victrola label.

Unfortunately, none of these four versions exists in either the reel-to-reel or cassette medium. Tape and cassette collectors will have to content themselves with the Haitink-Amsterdam Concertgebouw Orchestra performance (Philips 5015, reel-to-reel; 7300 017, cassette), which is, I am afraid, a rather prim and proper approach to a score that calls for fiery abandon.

* Mr. Bookspan's 1972 UPDATING OF THE BASIC REPERTOIRE is now available in pamphlet form. *
Send 25¢ to Susan Larabee, Stereo Review, 1 Park Avenue, New York, N.Y. 10016 for your copy.

COMPOSERS



1750 1800 1825 1850 1875 1900 1925 1950

○ Mikhail Glinka (1804-1857)

○ Felix Mendelssohn (1809-1847)

○ Frédéric Chopin (1810-1849)

○ Robert Schumann (1810-1856)

○ Franz Liszt (1811-1886)

○ Giuseppe Verdi (1813-1901)

○ Richard Wagner (1813-1883)

○ Charles Gounod (1818-1893)

○ Jacques Offenbach (1819-1880)

○ César Franck (1822-1890)

○ Anton Bruckner (1824-1896)

○ Bedřich Smetana (1824-1884)

○ Johann Strauss, Jr. (1825-1899)

○ Alexander Borodin (1833-1887)

○ Johannes Brahms (1833-1897)

○ Camille Saint-Saëns (1835-1921)

○ Georges Bizet (1835-1875)

○ Max Bruch (1838-1920)

○ Modest Moussorgsky (1839-1881)

○ Peter Ilyitch Tchaikovsky (1840-1893)

○ Emmanuel Chabrier (1841-1894)

○ Antonín Dvořák (1841-1904)

○ Jules Massenet (1842-1912)

○ Edvard Grieg (1843-1907)

○ Nikolai Rimsky-Korsakov (1844-1908)

○ Gabriel Fauré (1845-1924)

○ Henri Duparc (1848-1933)

○ Leoš Janáček (1854-1928)

○ Ernest Chausson (1855-1899)

○ Edward Elgar (1857-1934)

○ Ruggiero Leoncavallo (1858-1919)

○ Giacomo Puccini (1858-1924)

○ Isaac Albéniz (1860-1909)

○ Gustav Mahler (1860-1911)

○ Hugo Wolf (1860-1903)

○ Edward MacDowell (1861-1908)

* Claude Debussy (1862-1918)

○ * Frederick Delius (1862-1934)

○ Richard Strauss (1864-1949)

○ Paul Dukas (1865-1935)

○ Carl Nielsen (1865-1931)

○ Jean Sibelius (1865-1957)

○ Erik Satie (1866-1925)

* Δ Albert Roussel (1869-1937)

○ Alexander Scriabin (1872-1915)

* ◇ Ralph Vaughan Williams (1872-1958)

○ Sergei Rachmaninoff (1873-1943)

Δ Max Reger (1873-1916)

○ Gustav Holst (1874-1934)

◇ Charles Ives (1874-1954)

○ Arnold Schoenberg (1874-1951)

* Maurice Ravel (1875-1937)

○ Manuel de Falla (1876-1946)

◇ Carl Ruggles (1876-1972)

○ Ernest Bloch (1880-1959)

◇ Béla Bartók (1881-1945)

○ Zoltán Kodály (1882-1967)

Δ ◇ Igor Stravinsky (1882-1971)

◇ Anton Webern (1883-1945)

* Charles Griffes (1884-1920)

◇ Edgard Varèse (1885-1965)

○ Alban Berg (1885-1935)

◇ Heitor Villa-Lobos (1887-1959)

Δ ◇ Serge Prokofiev (1891-1953)

◇ Arthur Honegger (1892-1955)

◇ Darius Milhaud (1892-1974)

Δ ◇ Paul Hindemith (1895-1962)

◇ Roger Sessions (1896-)

◇ Henry Cowell (1897-1965)

◇ George Gershwin (1898-1937)

◇ Roy Harris (1898-)

◇ Francis Poulenc (1899-1963)

◇ Aaron Copland (1900-)

◇ Kurt Weill (1900-1950)

◇ William Walton (1902-)

○ Aram Khachaturian (1903-)

○ Dmitri Shostakovich (1906-)

◇ Elliott Carter (1908-)

◇ Olivier Messiaen (1908-)

○ Samuel Barber (1910-)

◇ John Cage (1912-)

◇ Benjamin Britten (1913-)

◇ Luigi Nono (1924-)

◇ Luciano Berio (1925-)

◇ Pierre Boulez (1926-)

◇ Hans Werner Henze (1926-)

◇ Karlheinz Stockhausen (1928-)

ROMANTIC

LATE ROMANTIC

IMPRESSIONISTIC

MODERN

CLASSIC

Neo-Classical

Incredible as it may seem, six years ago only the most avid followers of authentic sound reproduction were familiar with the Pioneer name. Yet, Pioneer's reputation for quality craftsmanship has been 35 years in the making. And it's continually being enhanced with each new component introduced. Case in point. Pioneer's outstanding AM-FM stereo receivers. They're the superb result of everything we've learned about sound and quality sound reproduction.

Reliability through exhaustive quality control.

Pioneer builds each receiver as though it was one-of-a-kind. To begin with, we produce virtually every part that goes into our receivers on our own production lines. So we know we're putting in the best there is. Until it's a completed unit, each receiver is continuously checked and inspected every step along the way. (A receiver in production travels on the average of twice the length of a football field. You can imagine how many quality checks it undergoes.) Still, that's not where our quality control stops. Because each receiver is then subjected to another rigid round of inspection before it's shipped to your Pioneer dealer. As a result, the Pioneer receiver that ends up in your home is as trouble-free as a receiver can be. To top it off, Pioneer backs it up with a full two-year warranty on parts and labor.

All the versatility you need — plus.

Pioneer designers are people-oriented. You'll appreciate this when you see that each receiver has more than a full complement of connections

for every music source available: records, tape, FM, microphone, and 4-channel. You can do your own tape-to-tape duplicating and even make listening tests of different phono cartridges and speaker systems.

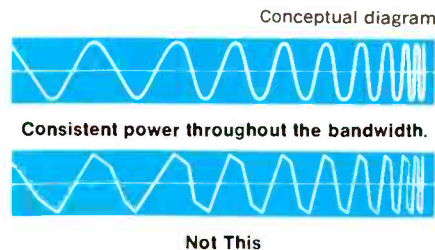

Consistent power to spare.

Merely comparing the power capabilities of different brands of receivers does not tell you what's behind the power. Not only do these Pioneer receivers provide more comparable watts for your high fidelity dollar, they also deliver consistent power throughout the most vital listening area — the 20 — 20,000 Hz bandwidth. This is important. It means you get better bass response plus greater across-the-board frequency response with absolute minimum distortion.

Great specs + top sound = outstanding performance.

To many hi-fi buffs top performance means great specifications and impeccable waveforms. However, most people listen first and check the specs later. Whatever your modus operandi, you'll be more than delighted with Pioneer's outstanding performance.

Here's a mini spec list:

SPECIFICATIONS	SX-828	SX-727	SX-626	SX-525
IHF Music Power 4 ohms	270 watts	195 watts	110 watts	72 watts
RMS @ 8 ohms. Both channels driven @ 1KHz	60+60 watts	40+40 watts	27+27 watts	17+17 watts
FM Sensitivity (IHF) (the lower the better)	1.7uV	1.8uV	2.0uV	2.2uV
Selectivity (The higher the better)	+75dB	+70dB	+70dB	+45dB
Capture Ratio (the lower the better)	1.5dB	2.0dB	2.5dB	3.0dB
Power Bandwidth	All exceed by a wide margin the usable sound frequency spectrum			
INPUTS:				
Tape monitor	2	2	2	2
Phono	2	2	2	Phono/Mic.
Auxiliary	1	1	1	1
Microphone	2	1	1	Phono./Mic. (as above)
OUTPUTS:				
Speakers	3	3	3	2
Headsets	2	1	1	1
Tape Rec.	2	2	2	2

Easy-to-use features increase listening enjoyment.

All four receivers share many basic features for simplified operation, such as loudness contour, FM muting, click-stop tone controls, mode lights, signal strength meters, and a super wide FM dial scale. With Pioneer's wide variety of models to choose from, you're bound to find just what you're looking for in the way of sophistication and refinements.

Unanimous acclaim from the experts.

Stereo Review: "Pioneer's moderately priced SX-727 has a degree of operating flexibility and electrical performance previously found only in some of the most expensive receivers . . . The array of operating features is impressive . . . In its flexibility and in many areas of its measured performance it is somewhat better than much of the competition at its price level."

Audio: "We find the SX-727 to be a rugged, reliable instrument that certainly represents state-of-the-art receiver technology in its design and performance."

Hi-Fi Stereo Buyers' Guide: "This (SX-828) excellent performer features full power output at all frequencies . . . excellent reception of weak FM signals . . . selectivity was excellent."

High Fidelity: ". . . Solid quality . . . Pioneer has avoided a make-do approach in the SX-626; we wish we could say the same for all under \$300 receivers."

Stereo Review: "... We were especially impressed by the solidity and precise 'feel' of the SX-626's controls. Clearly, nothing has been skimped in the mechanical design and construction of this receiver. It is a joy to use, a very good value in every respect."

A Pioneer receiver costs less than you'd imagined.

Normally you'd expect to pay a lot more for such quality, performance and features. But not at Pioneer. We believe sensible pricing goes hand in hand with craftsmanship. Let your capable Pioneer hi-fi dealer give you a complete comparison demonstration. It's the only way to find the best in high fidelity and the best high fidelity for you.

SX-828 — \$469.95; SX-727 — \$399.95
 SX-626 — \$329.95; SX-525 — \$259.95.
 Prices include walnut cabinet.
 U.S. Pioneer Electronics Corp.
 178 Commerce Rd., Carlstadt,
 New Jersey 07072.



DAR OF CLASSICAL COM

575} {1600} {1625} {1650} {1675} {1700} {1725} {1750} {1775}

- ☆ RENAISSANCE
- △ CLASSIC
- ⊙ LATE ROMANTIC
- BAROQUE
- ROMANTIC
- * IMPRESSIONISTIC
- ◻ ROCOCO
- △ NEO-CLASSIC
- ◇ MODERN

E

- 1525-1594)
 - 1623)
 - 1546-1618)
 - Victoria (c. 1549-1611) □ Pier Francesco Cavalli (1602-1676)
 - Corley (1557-1602) □ Jean-Baptiste Lully (1632-1687)
 - Gabrieli (1557-1612) □ Marc-Antoine Charpentier (1634-1701)
 - Peterszoon Sweelinck (1562-1621) □ Dietrich Buxtehude (c. 1637-1707)
 - Studio Monteverdi (1567-1643) □ Heinrich von Biber (1644-1703)
 - Girolamo Frescobaldi (1583-1643) □ Arcangelo Corelli (1653-1713)
 - Heinrich Schütz (1585-1672) □ Henry Purcell (c. 1659-1695)
 - André Campra (1660-1744)
 - Alessandro Scarlatti (1660-1725)
 - Johann Joseph Fux (1660-1741)
 - François Couperin (1668-1733)
 - Antonio Vivaldi (1678-1741)
 - Georg Philipp Telemann (1681-1767)
 - Jean Philippe Rameau (1683-1764)
 - Johann Sebastian Bach (1685-1750)
 - George Frideric Handel (1685-1759)
 - Domenico Scarlatti (1685-1757)
 - Giuseppe Tartini (1692-1770)
 - William Boyce (1710-1779)
 - Giovanni Battista Pergolesi (1710-1736)
 - Carl Philipp Emanuel Bach (1714-1788)
 - △ Christoph Willibald von Gluck (1714-1787)
 - △ Franz Josef Haydn (1732-1809)
 - Johann Christian Bach (1735-1782)
 - △ Luigi Boccherini (1743-1800)
 - △ Wolfgang Amadeus Mozart (1756-1791)
 - △ Ludwig van Beethoven (1770-1827)
 - △ Frédéric Chopin (1810-1849)
 - △ Franz Liszt (1811-1871)
 - △ Robert Schumann (1810-1856)
 - △ Johannes Brahms (1830-1897)
 - △ Felix Mendelssohn (1805-1847)
 - △ Hector Berlioz (1803-1869)
 - △ Franz Schubert (1797-1828)
 - △ Ludwig Spohler (1784-1845)
 - △ Franz Anton Hoffmann (1766-1842)
 - △ Carl Maria von Weber (1766-1826)
 - △ Wolfgang Amadeus Mozart (1756-1791)
 - △ Franz Joseph Haydn (1732-1809)
 - △ Johann Christian Bach (1735-1782)
 - △ Luigi Boccherini (1743-1800)
 - △ Wolfgang Amadeus Mozart (1756-1791)
 - △ Ludwig van Beethoven (1770-1827)
 - △ Frédéric Chopin (1810-1849)
 - △ Franz Liszt (1811-1871)
 - △ Robert Schumann (1810-1856)
 - △ Johannes Brahms (1830-1897)
 - △ Felix Mendelssohn (1805-1847)
 - △ Hector Berlioz (1803-1869)
 - △ Franz Schubert (1797-1828)
 - △ Ludwig Spohler (1784-1845)
 - △ Franz Anton Hoffmann (1766-1842)
 - △ Carl Maria von Weber (1766-1826)

1582 GREGORIAN CALENDAR INTRODUCED 1665-66 LONDON PLAGUE AND FIRE 1728 JOHN GAY'S BEGGAR'S OPERA PRODUCED
 1601 SHAKESPEARE'S HAMLET PRODUCED 1682 WILLIAM PENN FOUNDS PHILADELPHIA 1769 WATERGATE SCANDAL
 QUEEN OF ENGLAND 1626 MANHATTAN ISLAND BOUGHT BY PETER MINUIT 1709 FIRST PIANOFORTE BUILT 1776 AMERICAN REVOLUTION

SX-525

SX-727

Che

- CRAFTSMANSHIP ■ RELIABILITY
- VERSATILITY ■ VALUE
- CRITICS' REVIEWS ■ SPECIFICATIONS
- WARRANTY ■ SERVICE
- DEALER RECOMMENDATIONS

and you'll
the inevitable

in high fidelity the



SX-626

SX-828

ck

- ABILITY ■ PERFORMANCE
- FEATURES ■ POWER
- IFICATIONS ■ REPUTATION
- MUSIC REPRODUCTION
- NS ■ PIONEER OWNERS

ll reach
conclusion...

the best is Pioneer.



CALEN

—{1400}— —{1425}— —{1450}— —{1475}— —{1500}— —{1525}— —{1550}— —{1575}— —{1600}—

☆ John Dunstable (c. 1370-1453)

☆ Giles Binchois (c. 1400-1460)

☆ Guillaume Dufay (c. 1400-1474)

☆ Johannes Ockeghem (c. 1425-1495)

☆ Heinrich Isaac (c. 1450-1517)

☆ Josquin des Prez (c. 1450-1521)

R E N A

☆ Jacob Obrecht (1452-1507)

☆ Clement Janequin (c. 1475-c. 1560)

☆ Thomas Tallis (c. 1505-1585)

☆ Giovanni Pierluigi da Palestrina (c. 1525-1594)

☆ Orlandus Lassus (1532-1594)

☆ William Byrd (1543-1634)

☆ □ Giulio Caccini (c. 1550-1601)

☆ Tomás Luis de Victoria (1586-1641)

☆ Thomas Mottley (c. 1600-1670)

☆ □ Giovanni Gabrieli (c. 1550-1612)

☆ □ Jan Pieter Sweelinck (c. 1580-1621)

☆ □ Claudio Monteverdi (1590-1643)

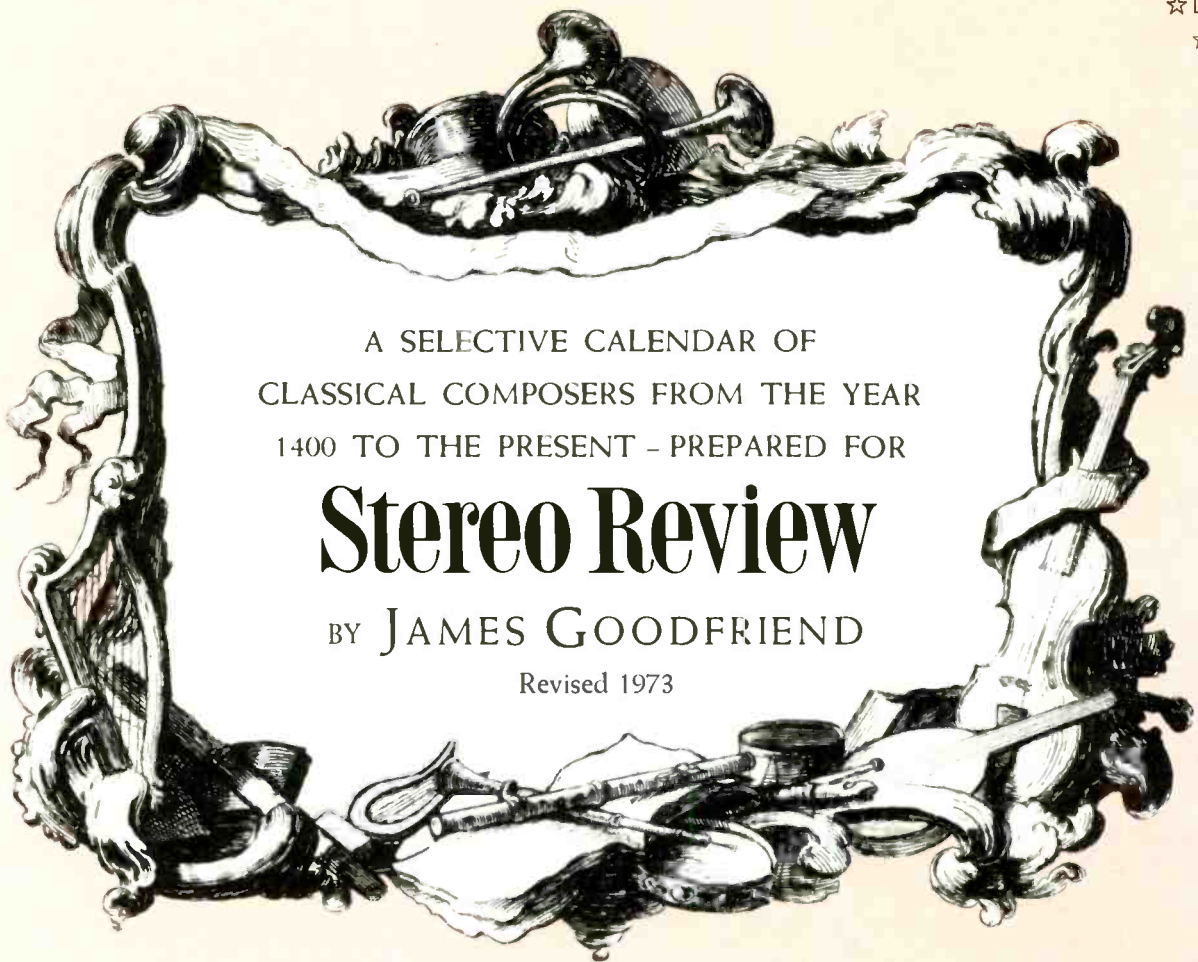

A SELECTIVE CALENDAR OF
CLASSICAL COMPOSERS FROM THE YEAR
1400 TO THE PRESENT - PREPARED FOR

Stereo Review

BY JAMES GOODFRIEND

Revised 1973

1415 BATTLE OF AGINCOURT

1431 EXECUTION OF JOAN OF ARC

1454 GUTENBERG INVENTS MOVABLE TYPE

1492 COLUMBUS DISCOVERS AMERICA

1517 MARTIN LUTHER'S NINETY-FIVE THESES

1558 ELIZABETH I

Guide: Introduction to the Musical Calendar

MUSIC being what it is, its history cannot be reduced to a conveniently arranged, equally spaced series of pigeonholes, each stuffed with the appropriate materials. Directions, trends, and classifications exist in music only after the fact; no trumpet blows to signify the beginning of a period or the end of one. And composers compose; they do not arrange themselves in history.

The Calendar of Classical Composers on the facing page begins with the year 1400. Of course, certain composers *have* to be included. But there were great and important composers who lived before that date and therefore are not, and there were others living after it who also are not. Their names are absent purely for reasons of space limitation; their styles are represented by other composers, and the space they might have occupied has been usurped by other perhaps less accomplished men who personify a style less rich in exemplars. Any compendium of this kind is necessarily personal, subjective, and arbitrary. One may deal coolly and scientifically with mathematical theorems or chemical hypotheses, but when it comes to the artistic productions of man, every prejudice, guilt, and hidden love in one's system creeps to the surface and subtly modifies all efforts to be objective.

Nonetheless, allowing that the calendar is not a substitute for *Grove's Dictionary of Music and Musicians*, nor for a college course in music history, it has a number of very practical uses. It facilitates comparisons—of composers and their styles with one another, with the historical periods in which they worked, and with certain historical events outside the field of music—and in so doing offers an overall perspective useful to any explorer of music. Second, it shows (by overlapping colors) that periods blend into one another more or less gradually, that individual composers may anticipate a style or an aesthetic view, or may lag behind one, that change may come to one country earlier than to another (Italy, for centuries, was years in advance of the remainder of Europe), or may not come at all (Impressionism never took hold in Germanic countries).

The Calendar, then, offers to the beginner a simplified guide to the intricacies of music history, to the intermediate an opportunity to place his knowledge in perspective, and to the knowledgeable a handy tool for reference and even, perhaps, a few factual surprises. As an adjunct, the major stylistic periods are briefly—and simply—defined below.

—James Goodfriend
Music Editor

- The RENAISSANCE was, above all, the great age of polyphonic vocal music. Religious music was dominant, but there existed a large amount of secular dance and processional music, together with a continuing tradition of secular vocal music, that amounted, by the end of the period, to an important body of work. Voices and instruments were used comparatively interchangeably, though there were the beginnings of a separate, purely instrumental music. Music printing was invented. The principal forms of the period included the motet, mass, madrigal, chanson, and later the Lutheran chorale in vocal music; dance forms like the pavane and galliard; and such non-dance forms as the *ricercar* and *canzona* in instrumental music.

- The BAROQUE period evolved from the Renaissance by slow degrees, the most sudden development being the invention of opera. Solo vocal music developed to a high degree, and much music was written for specific instruments in purely instrumental musical forms. Major and minor keys and well-tempered tuning all but completely replaced the old church modes, and the typical melodic line was a highly ornamented one. Orchestras began to assume a relatively standard make-up. Principal vocal forms of the period were opera, oratorio, cantata, recitative and aria, and song; principal instrumental forms and styles were fugue, *passacaglia*, theme and variations, dance suite, church and chamber sonatas, chorale prelude, concerto grosso and solo concerto, the French overture, and the Italian *sinfonia*.

- The ROCOCO began as a revulsion against the Baroque while continuing certain of its ideals. Polyphony and the "learned forms" of composition virtually disappeared and were replaced by a new concentration on expressivity, clarity, and lyricism, resulting in both light, elegant, and somewhat superficial music, and heavy, Sturm und Drang romanticism. The period saw the development of the symphony and the replacement of the concerto grosso with the solo concerto, and the refinement of orchestral techniques including full orchestral crescendos and diminuendos. Comic opera and operetta began, and the piano replaced the harpsichord and organ as the dominant keyboard instrument. Principal forms were the symphony, concerto, solo sonata, and song.

- The CLASSIC period was the first to exhibit a true dominance of instrumental music. The establishment of the sonata principle governed the development of the symphony, solo sonata, and chamber music forms. Chamber music itself rose to a new position of importance, while the solo concerto achieved its classical form. In most countries (some, like England, had achieved it earlier) music moved away from noble patronage to publicly supported concerts. The single most important instrument was the piano. Principal musical forms were Italian opera and German operetta, the four-movement symphony and chamber music forms, and the three-movement concerto and solo sonata forms, plus the lighter *divertimento* and *serenade*.

- ROMANTICISM embraced many separate movements and had many different aspects. To varying degrees composers placed their emphases on expressive content rather than an formal elegance, leading first to an unprecedented emphasis on the development section of sonata form, and later to the quest for simpler and freer forms altogether. A new predilection for pure melody arose at the same time that harmonies became far more daring. Music grew both larger and smaller as the size of orchestras and of orchestral works increased and the musical miniature began a life of its own. The lied became a dominant form. Nationalism brought new sounds into serious music, and instrumentally it was the age of the virtuoso as a public hero. German opera turned serious and built toward the Wagnerian music drama, and Italian opera became more concerned with the dramatic. The principal forms, besides opera and music drama, were the symphony, the virtuoso solo concerto, the symphonic poem, the song, and an abundance of more or less free forms that

went under the name of *impromptu*, nocturne, prelude, fantasy, *étude*, ballade, and the like, or under no formal name at all. The art of orchestration came into its own.

- The division between the Romantic and the LATE ROMANTIC or Post-Romantic is a purely artificial one. One either sets an arbitrary line between the two or, more honestly, if more confusingly, regards each composer individually, ignoring comparative dates. Late Romanticism has few characteristics of its own, but rather continues and in some cases carries further the trends of its predecessor. Musical nationalism still arises today, and music is produced today that has far more in common with Brahms than with Stravinsky. Late Romanticism is with us still. The increasing emphasis on expressivity led, among Late Romantics, to greater and greater degrees of chromaticism, and finally, in 1908, to the doors of one of the most powerful of Modern movements: dodecaphony, or twelve-tone composition. Performing forces grew to mammoth size and works to enormous length.

- IMPRESSIONISM is getting to be a bad word, and it must be taken today—even more than the word "Baroque"—apart from its literal meaning. Impressionism was a basically French movement that found echoes in other lands. It was characterized by an approach to form very different from that of Western music of the preceding few centuries, by a use of harmonies for and in themselves rather than as elements in a progression, and by an intense interest in the temporally and geographically exotic: Gregorian chant and the old church modes, folk music, the music of the Orient, to a certain extent early jazz. Rather than specific forms, certain harmonies and harmonic usages are taken to be hallmarks of Impressionist style.

- One adopts the word "MODERN" as a convenient term for a quandary. So many styles exist or have existed since 1900 (and in a few cases far earlier) that are decidedly not a part of something else that one could hardly find space to list them, much less describe them. In very general terms, there have been two major movements, plus a grab-bag entitled "Modern Nationalism" that might include such disparate composers as Bartok, Janacek, Ives, Vaughan Williams, and several dozen others. The two major movements are that stemming from Schoenberg on the one hand (largely the twelve-tone composers and serialists), and that arising from Debussy and Stravinsky on the other. Quite recently the two have met, but the arch formed by their meeting subsumes composers so different from one another in sheer sound, and related to special elements of past and present by such varying degrees, that classification is as yet impractical. A new schism has developed between serialists, tending toward greater control of every aspect of their music (including performance), and the aleatoric or "chance" composers. Other techniques and styles of the time include *Gebrauchsmusik*, jazz and jazz-influenced music, polytonality, atonality, machine music, electronic music, *musique concrete*, primitivism, satirical music, a scientific approach to folk music, and music as political propaganda.

- NEO-CLASSICISM, a modern movement distinct enough to be seen as an entity, is not, as its name might imply, a reactionary return to the music of the past, nor is it bound up with the music of the Classic period. It is rather a reaction to the excesses of Late Romanticism in the form of an objective rather than expressive approach to composition and an emphasis on clarity of texture. As part of this approach, Neo-Classicism emphasizes a contrapuntal texture, limits orchestral size and color, divorces music from programmatic associations, and has adopted certain forms and styles of earlier music (*tocatta*, fugue, concerto grosso, *passacaglia*, and dance suite), using them in conjunction with purely twentieth-century melodic, rhythmic, and harmonic language. The primary eighteenth-century influence has been Johann Sebastian Bach.

THE MUSICAL STYLES OF THE ROMANTIC PERIOD

A persistent and pervasive duality may or may not be the natural climate of the human psyche, but the concept was brought to its intellectual apogee in the arts (including music) of the Romantic era, and it continues to affect our thinking and responses today

By Eric Salzman



THIS IS the fifth in a continuing series of articles on the historical styles of music from the Renaissance to the present day. The series began with Igor Kipnis' analysis of Music of the Baroque (December 1966), and continued with Music of the Rococo (November 1967) and the Viennese Classical Era (July 1968), both by H. C. Robbins Landon, and "Modern" Music: the First Half-Century (October 1970) by Eric Salzman. The present article explores the styles of the Romantic period proper—distinguishing it from the late- or post-Romantic, which will be covered in a separate article—placing it, as well, in the context of the larger musical movement that embraced both Classical and Romantic styles.

These articles have been designed to expand upon the necessarily limited information offered by our Calendar of Classical Composers, which was originally published in the April 1966 issue. We are republishing the Calendar in this issue because, although it has long been out of print, we still get many requests for it. Too, we realize that we have acquired many new friends in the interim who might find the Calendar useful. And finally, it gives us an opportunity to make this handy reference tool available again to those readers who may have worn out their copies of the old one. Additional copies of the Calendar (tube-rolled and suitable for framing) are also available. Send 25c in coin to: Classical Calendar, Stereo Review, 1 Park Avenue, New York, N. Y. 10016.

—James Goodfriend, Music Editor

THE MUSICAL AGE in which we live is a late phase, possibly transitional, of the period that began at the end of the eighteenth century. Romantic art, in the larger sense, is the first "modern" art, the first art of "our" time.

This should not be, upon reflection, as surprising as it at first may sound. Books on "modern" history and "modern" art always used to begin with the French Revolution and the painter David. This is also the period of what is still the standard musical repertoire: nearly all of our basic musical institu-

tions, forms, and media—the concert, the recital, the symphony orchestra, grand opera, chamber music—came into being at this time and, in spite of radio, recordings, and the impact of pop, these are still the touchstones of musical performance. The modern sense of the terms sonata, rondo, symphony, and concerto also dates from this period. Our instruments came into common use or achieved their definitive modern format at this time. Key systems were developed for the winds and even the old string instruments were extensively remodeled. The codification of music theory took place as well, along with the establishment of the modern conservatory. The piano became the dominant social instrument, and art music became an adornment of the rising middle class.

The notion of "art for art's sake" became widespread, and music came to be regarded as the highest and purest of the arts, the central form of expression of the age; yet, paradoxically, composers tried to make music more literary, more visual, more dramatic. Music became separated from the court, municipal, church, and even theatrical functions with which it had always been firmly connected, and the work of art came to be prized for its own sake; yet, ironically, the composer's score, more and more precise in all its details, came to be regarded as the work of art itself, a Platonic ideal of which actual realizations in sound were only approximations. The "liberation" of music meant the "liberation" of the artist and his elevation to the status of a culture hero; it also meant poverty and alienation for the composer who had no marketable merchandise. The virtuoso performer and the virtuoso composer thus appeared, and so did the virtuoso listener. Aesthetics, musicology, and music

appreciation took their modern form. Musical "culture" came to depend on the knowledgeable listener, on the creation of a music public and a musical world dedicated to the sustenance of a rather rarefied art addressed to adepts, to an elite inner circle. Music, in part cut off from its roots, therefore had to flourish as a free entity, the purest and most perfect of the arts and the one best fitted to express its age.

Now, all of this is *still* our legacy and, though we may be in the middle of a transition to something new, there can be little doubt that the institutions and attitudes of Romanticism are still very much with us. Much of the way we compose, perform, hear, and even think about music today is based on assumptions that, far from being great universal truths, are direct ideological inheritances, now of arguable utility, from the period between the French Revolution and the revolutions of 1848.

Note that I have chosen *political* landmarks and that I have said nothing about musical "style" in the usual sense. Note too that a generous chunk of what we call "Classicism" is also included in this definition of "Romanticism." The inhabitants of the world of music are only too apt to regard the history of music as an insulated, self-contained succession of "styles"—the notion itself comes from the nineteenth century—and end up trapped in their own pigeonholes.

AFTER the French Revolution and Napoleon, the old aristocracy was replaced by a new and powerful bourgeoisie whose wealth was based not on

social status and landholdings, but on commerce and industry. The cities, centers of trade and of the financial institutions, inevitably became the culture centers as well. Instead of assuming the diffused pattern of earlier culture, the major movements of fashion and style spread out from the big centers. Industrial development, spurred by the new availability of investment capital, got up a full head of steam and had a tremendous effect on music. Perfected, standardized instruments, such as the piano and those of the "modern" orchestra, became uniform from place to place; composers were thus able to write for a European market with reasonable expectations of standardization. At the same time, specialization, originally a development of industrial technology, spread throughout the society and also had great influence on the arts. The role of the composer became more and more distinct from that of the performer, and composers even became specialists in piano or symphonic music, in songs or in opera. Similarly, the notion of individual and national "styles" became important. The nation-state, with some measure of parliamentary or public participation, became the basic political unit, and national consciousness was evoked and awakened. Ideas of individuality and freedom and a new hierarchy of wealth and talent spread all over Europe in the wake of the French Revolution and Napoleon. The return of the old regimes after Napoleon's downfall really marked the consolidation of the position and power of the new middle class.

In a real sense, Romantic art is schizophrenic: it springs from a number of dualities. "Two souls

The lied was a creation of the Romantic era, as was the intimate circumstance of its performance. The famous drawing by Moritz von Schwind depicts a musical soirée at the home of Joseph von Spaun; Johann Vogl is the singer, and Schubert is at the piano.

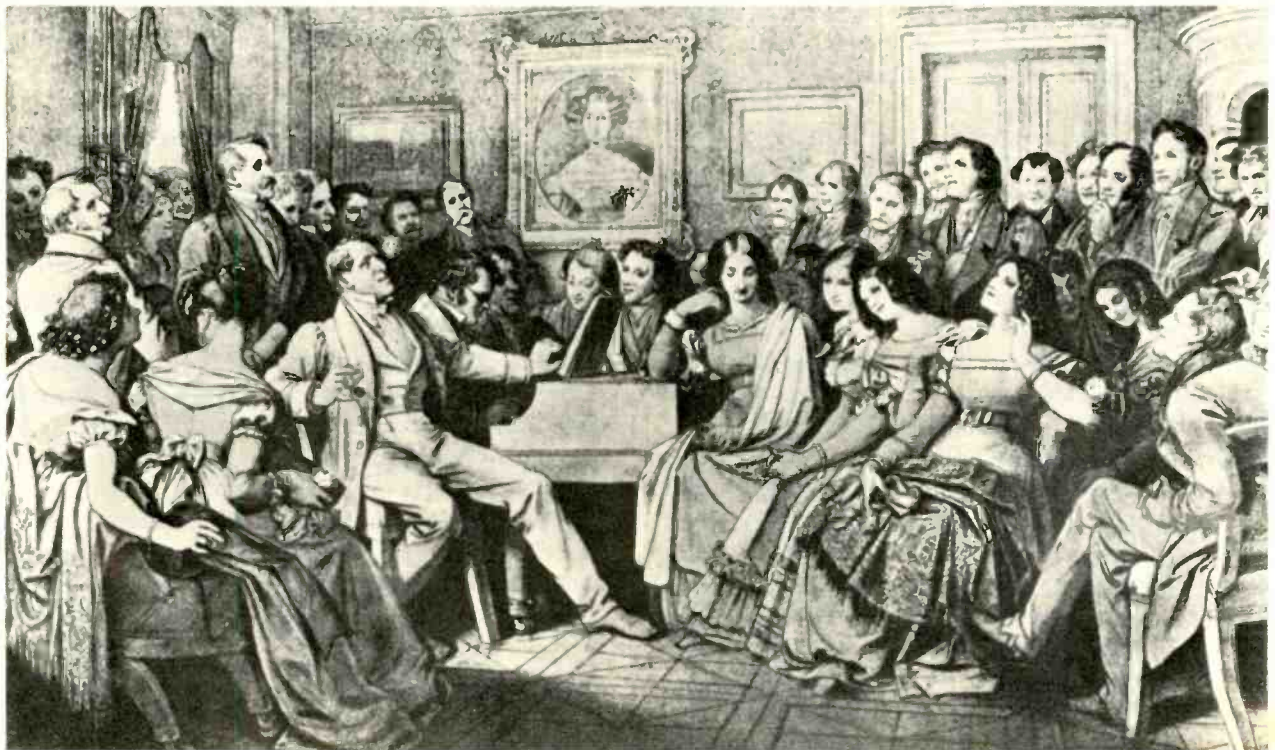

dwelt within my breast," says Goethe's Faust, and the age is surely full of paradoxes, contradictions, and oppositions. Even great historical philosophies like those of Hegel and Marx were based on such dualities. Composers too, for the first time, divided their efforts and artistic personalities. Beethoven wrote virtuoso public music and also intimate, private pieces. Schumann consciously divided his personality into two, which he named Eusebius and Florestan. These dualities take a number of forms: public-private, heart-head, intellect-emotion, Classicism-Romanticism, and others. Classicism or neo-Classicism (we are talking about the *original* meaning of these terms borrowed from the visual arts and not their rather misleading musical application) can even be usefully considered as a phase of Romanticism—and not always an antecedent phase. It is not really helpful to argue whether Goethe or Ingres or Beethoven or Schubert were Classicists or Romantics; they were clearly both, and, given the paradoxes of Romantic style, there is no contradiction in this at all. In architecture the same designer often turned out neo-Classical and Gothic Revival buildings; both were, in effect, *Romantic* interpretations of historical styles. There are many pertinent musical examples. Mendelssohn was more strict about his use of sonata form than Haydn, and both Schumann and Mendelssohn parade their Baroque contrapuntal skills, at times almost in defiance of the very expressivity they are supposed to be espousing. This is a musical *neo*-Classicism.

THE true dividing line is between the Enlightenment and the Rococo on the one side and neo-Classicism/Romanticism on the other. The difference is one of intent; the early eighteenth century prized naturalness, directness of expression, "imitation" of reality, faithfulness to "Nature"—in reality, a highly artful and stylized simplicity. This is the art of Rousseau, Watteau, Pergolesi, Voltaire, Gluck, Scarlatti, Boccherini, Haydn. Mozart is almost a transitional figure: his contemporaries thought him overly introverted, complex, and "Germanic," while the early Romantics adored him. The late eighteenth century accepted the theories of naturalism and imitation but interpreted them in an entirely different way: as the expression of feeling. The late-Classical/early-Romantic period prized individuality and sensibility, and from this grew the new awareness of individual style as a touchstone. The earlier artist assumed a community of interest and strove to express it simply and artfully. The later artist expressed his inner self. He assumed not one public but several. *Don Giovanni* was written for the connoisseurs, the Italian opera buffs; *The Mag-*

ic Flute is an operetta or musical comedy in the vernacular. The fatal rift between *Kultur* and Pop had already begun. Schumann consciously identified the Philistines—the very term is his—and excluded them from his *Davidsbündler*; his difficult, poetic works are for the knowing, the rare few who can understand and feel.

One important aspect of the new stylistic consciousness was the rediscovery of the past. Music, in spite of its reputation, is, in general, the *least* universal of the arts and the one with the shortest memory—or at least it was before the invention of recording. Although eventually the Romantics were able to extend their grasp as far back as the late Renaissance (the rediscovery of Palestrina took place during the nineteenth century), the musical past that had real meaning for the period was the high Baroque. Through the good works of a Viennese manuscript collector, Haydn and Mozart came to know Bach Sr. and Handel. Beethoven knew at least the "Forty-eight," and, of course, Mendelssohn revived the *St. Matthew* Passion and with it the gospel according to St. Johann. For these composers, the discovery of the high Baroque was equivalent to the rediscovery of Gothic and early Renaissance art in the visual arts (the misleading coupling of Bach with Gothic cathedrals, still prevalent, dates from this time!). One specific technical result was the reintroduction of counterpoint and voice-leading as a major principle in German Romantic music. Another was the use of expressive chromaticism, dissonance, and secondary harmony. Baroque music shares with the Romantic a certain care for specificity and expression. In the canons of the eighteenth century, Art must imitate Nature. Music, the one art that has limited external potential for imitation, must therefore mirror the internal world of the soul.

THE typically Romantic notions of freedom, individuality, and the liberation of art emanate from France, the home of the Enlightenment and the French Revolution. On the other hand, sensibility, inwardness, and soul, difficulty, alienation, and the divisibility of the public are Germanic (and Anglo-Saxon) motives rather alien to the Latin temperament and contrary to the spirit of the French Revolution. Throughout much of the period, French music was dominated by the populism pioneered by Rousseau—his opera *Le Devin du Village* remained genuinely popular throughout the period—and carried forward in the works of composers like Gossec, Grétry, Méhul, and Le Sueur. The Napoleonic period brought an official neo-Classicism or "Empire" style largely created by the resident Ital-



Quite as much a part of Romanticism as the intimate musical soirée was the sort of demonic instrumental virtuosity exemplified by Liszt. "Le Galop Chromatique, exécuté par le diable de l'harmonie," reads the inscription on this drawing of 1843. Liszt actually wrote a Grand Galop Chromatique, in 1838, for piano.

ians Cherubini and Spontini. Cherubini, with official state backing, founded and organized the French Conservatoire and formulated the classical conservatory education, still the basis for traditional musical training in Western civilization. Spontini helped spread the Napoleonic style throughout Europe when he moved to Berlin, a city that actually fostered early Romanticism and turned to neo-Classicism only later! Spontini, like his arch-rival Weber, also experimented with fairy tales and exoticism in his later work.

Musically speaking, the vocabulary of the "Classical," the Empire or neo-Classical, and the early Romantic periods is the same. The driving force of the great tonal system, brought to perfection twice by the high Baroque and the late Rococo/Classical periods, had lost none of its power. The cadence was still the milestone, all the rhythmic, melodic, and harmonic patterns continued to move away from and back toward set goals, and meter, rhythm, phrase, period, and larger form took shape around this very definite sense of musical motion. Thus, out of the simplest tonic-dominant-tonic cadence, grew—in the simplest, most natural, and logical way—all the glories of sonata form and symphony.

All this was accepted without question by post-Classical composers: indeed, they were, as we have noted, sometimes stricter formalists than their predecessors. What changed was the attitude toward the expression of musical ideas. The formulas, the stan-

dard transitions, even the progressions themselves could no longer be taken for granted; they had to be constantly re-created. Invention within defined limits was highly prized. Subsidiary chords and inflections took on a new weight. Chromatic or dissonant melodic notes and harmonic patterns appeared not merely as developments but as basic ideas to be used together or separately in order to highlight expressive ideas. Similarly, the subsidiary parts of the forms—transitions, developments, and codas—assumed a new importance, and *all* the parts became more interconnected. Instead of discrete scenes in aesthetic balance, the *process* of getting from place to place became important. Symphonies and sonatas, even when not at all programmatic, took on the character of picaresque narratives in the Hoffmannesque or Byronesque manner.

Church and symphonic music, no longer bread-and-butter work for composers, receded in importance. Choral works and symphonies were basically prestige forms and were used largely as public display pieces. On the other hand, chamber music held its own, and keyboard music, for both public and private use, became central. The characteristic piano piece and the art song with piano accompaniment came into their own as the appropriate music of the rising middle class and as the perfect vehicles for the expression of sentiment. Music strove toward the condition of poetry just as poetry strove toward the condition of music. Sentiment and feel-

ing were the hallmarks of a noble and poetic nature, and the upper middle class was encouraged to strive for noble sentiment, artistic appreciation, and patronage. The newly liberated artist became dependent on the support of the middle class, and both the best and the worst music of the day was created for the home and the salon.

Nearly all of these elements can be quite clearly identified in the works of both Beethoven and Schubert. Both were concerned with an elevated style, invention, the spinning out of ideas, and even a certain formalism and giant scale; sentiment in the later sense rarely enters in. Both composers—but particularly Beethoven—display a certain individuality, even eccentricity, with sudden shifts and contrasts of light and shade within a bigger flow and unity, plus an infusion of humanistic content. Certain of Beethoven's slow movements, the several sets of piano bagatelles, some of his work with folk material, *An die Ferne Geliebte*, the first movement of the Ninth Symphony, and many striking and expressive details here and there—though perhaps out of the main tonal flow—relate Beethoven's music more specifically to that of the composers who followed him than to those who preceded him or who were his contemporaries. This is even more true in the case of Schubert, whose very isolation from the larger musical world makes his individuality and proto-Romanticism all the more striking. Schubert's piano music and lieder are in the mainstream of the nineteenth century.

THE Empire style outlived the Napoleonic era, but it was no longer a real force. Neo-Classicism was, in itself, a dead end, and it had only one immediate result: the late works of Beethoven, music that is unquestionably of its time but almost without direct influence. Though Berlioz sometimes sounds like Beethoven (and so, surprisingly, does late Verdi), his direct influence is extraordinarily small. Weber was far more influential in the immediate evolution of Romantic music than either Beethoven or Schubert, and it is in the work of the second-rank composers of the period that the transition from Empire to true Romanticism can best be observed. Hummel, who studied with Mozart, anticipates Chopin. Spohr, who made an opera out of Goethe's *Faust*, wrote a "Historical Symphony" (Symphony No. 6, Op. 116) with successive movements in the Baroque, Classical, Empire, and Romantic styles!

As instrumental music gained ground, the larger abstract forms became more and more the means for the expression of will and personality, the more or less arbitrary manifestation of the composer's new God-like role of "genius." Thus "content" was

poured back into the old abstract forms and the old idea of illustrative music was revived in a new guise: the program symphony. The model was, of course, Beethoven's "Pastoral," and all the modern refinements of melodic expression, harmonic color, and orchestral timbre were brought to bear on its expression. The first master of this musical type was Berlioz; his *Symphonie Fantastique* and *Harold in Italy* remained influential throughout the century. Infusing symphonic form with literary content did not at first imply a major break with the traditional formal restraints. The program works of the early Romantics followed Beethoven's dictum "more an expression of feeling than painting," and kept to Classical forms to a surprising degree; only later did content begin to alter form.

Many of Mendelssohn's works carry titles, and the musical directions are full of terms such as *con fuoco* or *appassionato*. But the poetic impulse is always lyric, and the fire and the passion are always restrained, exquisite, and modulated to elegant and tender bourgeois sensibilities. All these same tendencies are present in Schumann, but they are enriched and intensified far beyond the genteel salon Romanticism of Mendelssohn; sentiment is replaced by deep feeling and passion, elegant figuration turns to passionate coloration, graceful voicing becomes an almost Baroque counterpoint, Classical form is intensified and concentrated by motivic unity and cyclical return.

Both Mendelssohn and Schumann wrote important larger works, including showpiece symphonies, learned sonatas and quartets, concertos, chamber works, and large choral works. But the key expressive media for both composers—and, indeed, for the entire early Romantic period—were the characteristic piano piece and the art song with piano accompaniment. Ironically, the piano is a very good example of the influence of industry on art; it is, in fact, a kind of "art machine" that could be produced in large and standardized quantity, easy to play a little, effective to play a lot. Like the modern phonograph, it was used for musical study, to provide music for dances and soirées, for entertainment in the home, and for musical communication across barriers of distance and culture. It is not the best of melodic instruments, but it is capable of representing the full harmonic dimensions of a piece of music, and it surpasses most of the other chordal instruments in strength and expressive variety.

The piano played apparently contradictory roles in the Romantic period. On the one hand it was the public display instrument *par excellence*, the showcase of the new Romantic virtuosity that began with Paganini but quickly became the province of the

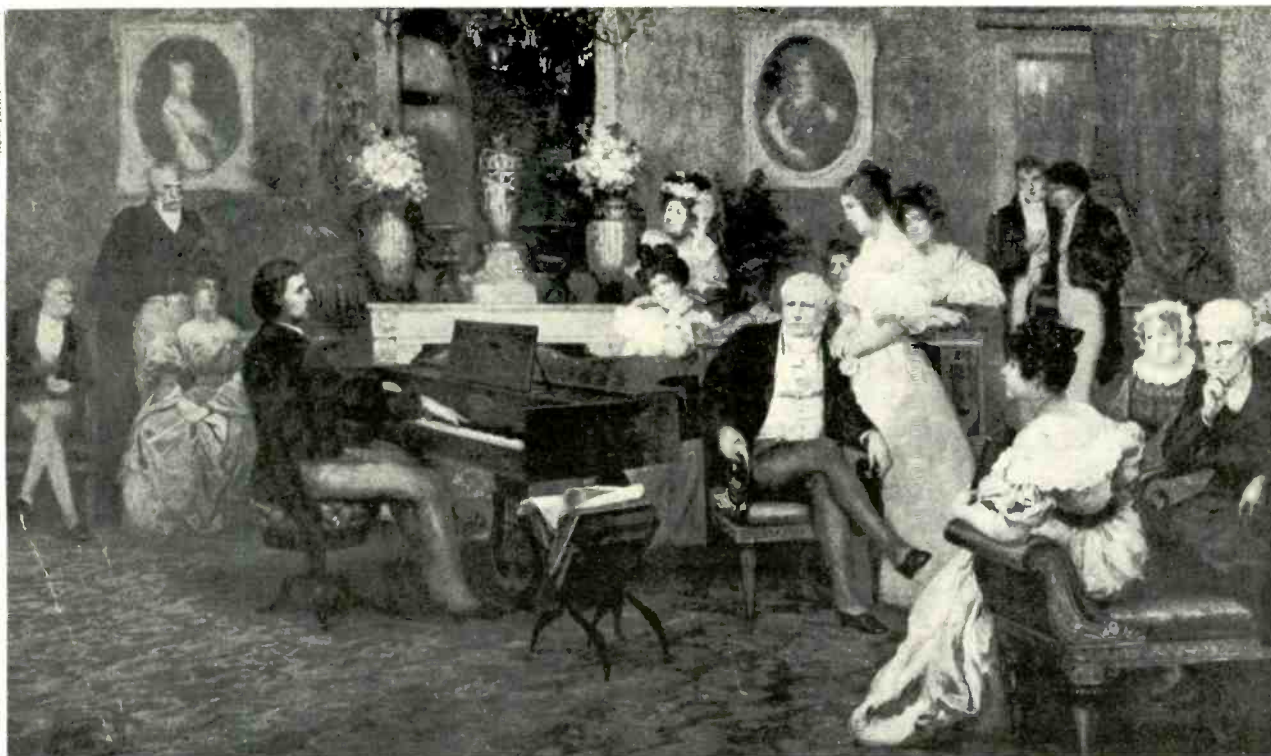

The intimate side of Romanticism again comes to the fore in this some-time-after-the-fact representation of Chopin performing at the home of Prince Radziwill in 1829. Much of Chopin's music was meant for such surroundings rather than for the concert hall.

keyboard showmen—Hummel, Moscheles, Czerny, Cramer, Kalkbrenner, and their progeny—études, variations, fantasias, caprices brillantes, and showy concertos without end. On the other hand, it was the medium of the most intimate kind of lyric expression. This genre, prefigured by the eighteenth-century fantasias of C. P. E. Bach and Mozart, the bagatelles of Beethoven, the nocturnes of John Field, and the impromptus and *Moments Musicaux* of Schubert, became the most characteristic Romantic type. These genres were not always mutually exclusive. Weber, Mendelssohn, and Chopin wrote both kinds of piano music, and Liszt had both a private and a public style almost his whole life. Schumann, while he opposed virtuoso display for its own sake, still composed several big, showy piano pieces, but whereas Mendelssohn's showy pieces are merely showy and his *Songs Without Words* are simple, accessible, lyric-sentimental, melody-and-accompaniment pieces, Schumann brought the whole array of keyboard figuration, color, dynamics, articulation, and counterpoint together with lyricism and deep feeling into a poetic unity. Motives, ornaments, counterpoints, figured harmonies with anticipations and suspensions—creating dissonance not always resolved—chromaticisms, syncopation, and cross-rhythms are all placed at the service of a rich and powerful expression that leaps from the contemplative to the passionate with great force. If one had to find the epicenter of early Romantic music, one might best look for it in the works Robert Schumann wrote from

1830 to 1840, his Opp. 1 to 23, and piano music all.

Unlike most of the instrumental forms, the high-art lied cannot really be traced back much before Schubert, and he had few worthy followers. The many popular songs of his period have not worn well and, except for some of the ballads of Karl Loewe, almost nothing survives. Schumann turned directly from piano music to lieder and in 1840 wrote more than one hundred songs. His songs, the most important after Schubert's, are an almost perfect fusion of piano style with vocal expression. They are the most highly colored of his works, filled with lyricism, folklore, pathos, exoticism, intense feeling, and humor. The harmonic vocabulary, enriched with passing tones, more dissonant chordal structures, and secondary chords, is mature and always used with the greatest subtlety. Schumann rarely failed to find a balance between the melodic sense of the words, the expression of feeling, dramatic or lyric propulsion, and the formal balance of the work. His influence on the lied can be felt from the songs of Robert Franz right through Brahms and on into the twentieth century.

The larger vocal and choral forms played an important part in the development of Romantic style but, beginning with Beethoven, they lost their religious functions and became concert display pieces. Mendelssohn's oratorios are still sometimes performed—and Schumann's ought to be. But the most important non-operatic vocal pieces of the period are by Berlioz. All of his works in this manner—from the Requiem to the pseudo-oratorio *L'Enfance*

du Christ to the dramatic symphonies—really constitute a new genre of dramatic concert music.

Except for the somewhat special institution of the concert hall—a gathering place of connoisseurs and still a somewhat rare thing—most public musical life in the early Romantic era centered on the theater. We have already mentioned Cherubini and Spontini in their roles as founders of *grand opéra*. Paris was the center of this new kind of spectacle with its full machinery of acts, choruses, settings, historical or exotic subjects, grand choruses, ballets and marches, big orchestrations, bigger opera houses, massive baritone arias, dramatic sopranos, vibrato tone production and projection, colorful costumes, pageants, ensembles, and grand scenes. Oddly enough, almost nothing survives today from this heyday of *grand opéra*. The overture to Hérold's *Zampa* occasionally turns up at a pop concert and Halévy's *La Juive* still occasionally shows signs of life in concert versions. Auber, who set *Little Red Riding Hood*, Scott's *Kenilworth*, and *La Muette di Portici* (probably the only opera ever to spark a revolution) to music, is today mostly a name in the history books. The dominant figure was Giacomo Meyerbeer, a fellow pupil and friend of Weber and a theatrical genius in the Cecil B. De Mille sense. The typical Meyerbeer opera is a conflation of historical subject matter from the libretto factory of Eugène Scribe, the composer's gift for the telling stroke and the catchy tune, and his genius for managing mass spectacle, chorus, ballet, and all. *Grand opéra* was the dominant high art form of the day, and both Verdi and Wagner had to surmount it to achieve what they achieved.

But there is *another* operatic history, one that comes from the *opera buffa*, *opéra-comique*, and *Singspiel* of the late eighteenth century. The simple, vernacular operetta with spoken dialogue is often based on the Rousseauian motifs "know thyself," "be natural," and these works are, in their way, criticisms of the decadent, over-civilized West. However, behind this quite apparent moralism lies the simple taste for exotic subjects that characterizes early Romanticism and influences even *grand opéra*. There were Oriental operettas, fairy tales, medieval settings, and Northern mythology even before 1800. Grétry wrote an Arabian-Nights operetta, another based on the *Aucassin and Nicolette* story, a *Bluebeard*, and a *Richard, the Lion-Hearted*. Mozart's *Abduction* and *Magic Flute* belong here, as does the rather aberrant "romantic realism" of Beethoven's *Fidelio*. And in 1815 the Romantic writer and sometime composer E. T. A. Hoffmann (later himself the subject of an opera, of course) brought out a romantic fairy opera on the

subject of *Undine*. A year later Spohr presented the first of many musical treatments of Goethe's *Faust*. But the key work in this genre is Weber's *Freischütz*, composed between 1817 and 1820, the first full expression of German folklore on the stage. Curiously enough, folklore appears here as still *another* kind of exoticism.

Most of these works are not full-scale operas but *opéras-comiques*, or *Singspielen*. Whereas in France the split between the grand and the popular form was, despite the later attempts of Offenbach and Bizet, eventually fatal, Weber was able to reconcile artistic ideals and popular forms. Mystery and magic, the countryside, and the supernatural are all evoked in these works with the most telling strokes, and the drama is built up in closely knit scenes, not merely dialogues, recitatives, and arias. The spate of German opera in the first half of the century flows from these works. Heinrich August Marschner, who wrote *The Vampire*, *Hans Heiling* (a forerunner of *Lohengrin*), and a version of Scott's *Ivanhoe*, was a popular figure, and Gustav Albert Lortzing's bourgeois comedies are still performed in Germany. However, German opera could not escape the growing split between high and popular art. By the middle of the century Spohr and Schumann (in his beautiful *Genoveva*) had produced through-composed dramatic music; Wagner had passed through Parisian *grand opéra*, and in *Tannhäuser* and *Lohengrin* had created the prototypes of the new German grand opera or music drama.

THE split between art and pop did not take place in Italy, however, and the Italians remained apart from the Romantic movement to a great extent as well. Italy was neither unified nor industrialized, and it had only a very small middle class. Northern Romanticism did not suit the Italian temperament, and opera, the traditional and still popular form, continued to dominate the country, eventually to the exclusion of every other kind of music. Stylistically, Rossini can be classified with the Empire or neo-Classical composers, particularly in his *opere serie*. But unlike the sculptor Canova, whose art is highly intellectualized in the service of ideal beauty, or the architect and etcher Piranesi, whose nostalgia for antiquity and ruins carries us from Empire straight into proto-Romanticism, Rossini created for a *popular* audience, not for connoisseurs with advanced tastes. In his hands, *The Barber of Seville*, an Enlightenment subject with real social significance, became merely a chance to make fun of the aristocracy, *Cinderella* was transcribed in purely human terms, the fairy tale qualities totally

removed. Toward the end of his career, Rossini did turn to Romantic subjects, and in *William Tell*, written for Paris, he actually created a highly successful *grand opéra*. He spent most of the rest of his life in Paris composing charming salon pieces and vocal music in a fully nineteenth-century style, but, cut off from his popular roots, he never wrote for the stage again.

Donizetti is Romantic principally in his choice of subjects and in his nineteenth-century thud-and-blunder theatricality. In other respects his very direct melody-and-accompaniment style is an outcome of the eighteenth-century aesthetic of simplicity and "natural" expression. Bellini, although in the same tradition, appeared to his contemporaries as a typically Romantic figure. Many of his works have historical and sentimental subjects, and *Norma*, although nominally Classical, has a tone of languid melancholy whose influence reached even Chopin. Bellini's genius lay almost entirely in his long, long melodic lines, which float over the simplest of harmonic figurations. The spinning out of long melodies is a Romantic trait, but it is not the whole thing. It is only with the appearance of Verdi toward mid-century that we find a really distinctive and fully developed form of Italian Romanticism—theatrical, intensely humanistic, utterly without the mystical trappings of the North.

It is possible to say that the center of early Romanticism moved at one point from Vienna to Germany. However, there are three important composers, already mentioned, whose work belongs somewhat outside the "mainstream" and

whose innovative ideas point toward later developments: the Frenchman Berlioz, the Polish-Parisian Chopin, and the cosmopolite Liszt. Berlioz, an extravagant genius with mercurial temperament, was (and remains) the very prototype of the volcanic, wild-eyed, Romantic artist, throwing himself into the sea, charging at the Academy, marshalling his Herculean forces against the Philistines; there is nothing of the Northern mystic about him. He was, judged by German standards, not a very good melodist or harmonist, but his long, aperiodic melodies are quite typically French, and his harmonic sense is justified by the orchestral voicing. He "invented" the modern art of orchestration and made it an integral part of musical expression. He introduced the demonic into Romantic music, and perfected the high-Romantic orchestral concept as well as the new form of symphonic program music. He was also the most literary of the Romantics, the most concerned with precise expression. His theater music was symphonic, his symphonic music theatrical. At his best he fused the two media in a synthesis that was to be excelled only later by Wagner. He stands apart from the Germanic Romantics because his passions, no matter how intense, are Southern and outdoorsy, at once naïve and stagey, full of temperament, *bizarrerie*, and originality. Above all, Berlioz was the most alienated of the Romantics, the most anti-bourgeois, and the most defeated by an uncomprehending middle-class public. France, unlike Germany, never developed a large enlightened middle-class audience for the non-literary arts; the intellectual elite was not large

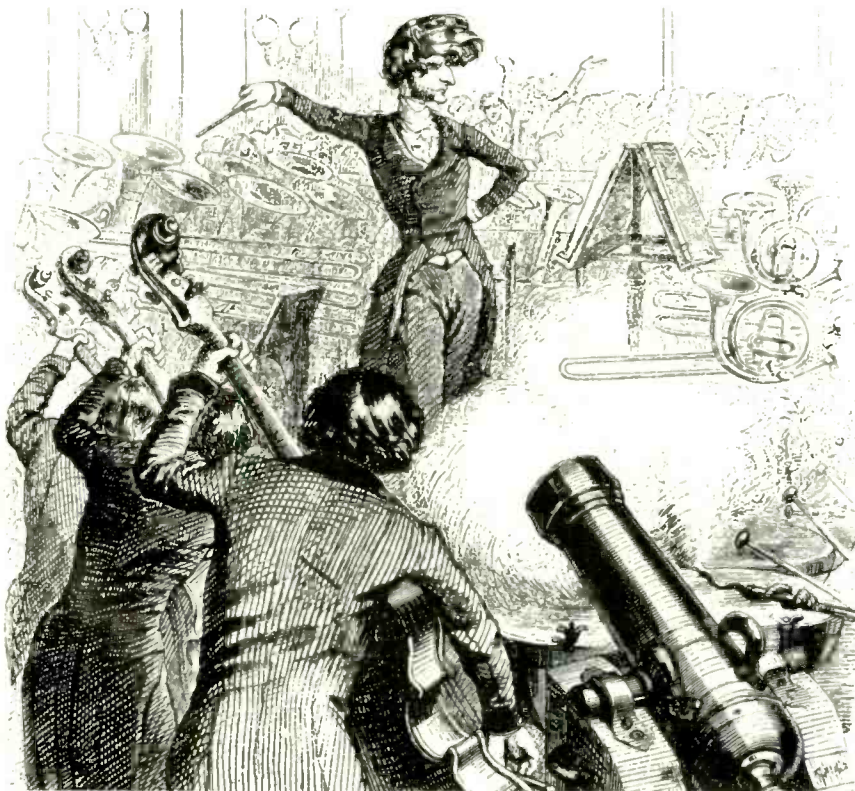

Things got bigger in the Romantic era as well as smaller, and Berlioz's compositions for huge performing forces were an apt subject for caricature. The admission of a cannon to the orchestra was not all that farfetched a step, though Berlioz didn't quite dare it.

enough or interested enough to support a musician like Berlioz—or, indeed, to encourage the appearance of any successors.

Berlioz's instrument was the orchestra, Chopin's the piano; Berlioz was a master of the grandiose, Chopin of the miniature. Berlioz was an extrovert, a fighter, an exponent of the sublime; Chopin was an introvert, a "small" master, a lyric poet. Like Berlioz, Chopin provides us with a Romantic image: a short but intense life, nationalism and alienation, personal suffering. Unlike Berlioz, Chopin did not attach specific programs to his works, but the poetic nature of the music is always clear. Chopin's origins lie in early Romantic salon music, but he has so transcended these origins that he appears to us as one of the most original composers who ever lived. Except for an acknowledged debt to Bach, his music seems to stand alone, quite outside the developmental tradition of the Central European style. The sound of the keyboard became with him a fundamental part of the language of the music and not merely ornamental; with Chopin the notion of keyboard "style" comes into its own. There is also an attractive element of aperiodicity in his lines and phrases, and he was an extraordinarily daring harmonist. His innovations, always highly expressive, are never crude or eccentric but are managed with the greatest finesse, subtlety, grace, and conviction. Modal, Slavic, and folkloric elements are introduced into the music, and the overall variety of types is remarkable. Each type, each genre—ballade, nocturne, mazurka, sonata, étude, waltz—has its own stylistic requirements, and Chopin moves easily from a bravura style to salon music to lyric poetry to Slavic melancholy. Everything, apparently, that Romantic sensibility had to express could be said within the narrow confines of a single instrument—the least romantic, to all appearances, and yet the one that spoke most typically for its age.

IN their use of timbre as a fundamental element, in their tendencies toward concision and intimacy on the one hand and expansion and rhetoric on the other, in their use of music to evoke states of feeling, in the appearance of the demonic and the elements of darkness and irrationality, in the absorption of styles and forms to new expressive ends, both Berlioz and Chopin introduced new notes into Romantic music and prefigured the developments of the second half of the century. The individual who carried these ideas from one end of the century to the other was, of course, Franz Liszt. Born in Hungary in 1811 and taken to Paris at the age of twelve, Liszt toured all of Europe as a great virtuoso and later lived, in rather flamboyant retirement,

in Germany and Italy. As a pianist and keyboard composer he stems from the violinistic model of Paganini rather than from any of the fashionable Biedermeier piano virtuosos. A great deal of his earlier music was material for his own use, a dazzling series of transcriptions, études, and variations exploiting and inventing new keyboard resources and new forms of virtuoso showmanship. Alongside these works, many of them not without musical merit, there are a series of poetic "impressions"—a kind of highly personal musical diary. Later, the personal style and the public personality were reconciled in large-scale works of symphonic scope now definitively outside of the bounds of Classical form. Liszt did not so much create a new form—the "symphonic poem"—as propose a situation in which each work, by its nature, demands new and appropriate formal treatment. Form now follows (or at least is reconciled with) literary and expressive content. In a sense, *everything* is development and therefore everything is unified. The scope of possible development is thus enormously enlarged; all of the keys, even the most remote, are now available, and a whole new arsenal of rich secondary chords, dissonance, and chromaticism is brought into play; the equality of the twelve tempered tones and their major and minor keys is firmly established. Timbre—orchestration, figuration, articulation, tone-color—is a means of expression almost equal to melody and harmony. Motivic interweaving and dynamic intensity are building blocks, and these expressive ideas in turn spring from literary and imaginative sources. The independent figure of the artist and the magic, transforming quality of his art are removed from the mundane level of everyday life to the highest intellectual and spiritual planes.

Liszt, for all his worldly success, did not write his "serious" music for a large audience; these works were intended for the cultivated, the initiated who can understand the deeper meanings and feelings, the mixture of the demonic and the divine, the extremes of despair and ecstasy. The worldly and the unworldly, the carnal and the spiritual, external display and inner feeling, lyric poetry and bravura virtuosity, Classical restraint and Romantic ecstasy, musical form and literary expression—all are mixed in equal quantities. The figure and the personality of Liszt himself, at once artist and showman, intellectual and publicist, womanizer and abbé, a keyboard athlete and spiritual poet, charlatan and genius, reflect the contradictions and dualities of the age. The Schubert-Schumann tradition of early Romanticism continued in the work of Brahms and some others. But it was the new dynasty of Berlioz, Chopin, and Liszt that opened the way to late Romanticism.



INSTALLATION OF THE MONTH

TOTAL STEREO

A PROJECT that began as a "lark" with research into technical books and magazines in the public library resulted in this "total" stereo installation two and a half years later. Robert Letterman, a member of the St. Louis Police Department, confesses that he had no technical or electronic experience before undertaking the design and building of the unit.

The housings and storage cabinets (lower portion of photo) are constructed of plywood with Plexiglas

and black and orange Formica veneer with aluminum trim. Across the top of the unit are several light displays. The line drawing will simplify identification of the components: (1) Kenwood KA-6000 amplifier; (2) Pioneer SR-202 reverberation amplifier; (3) Pioneer TX-500 tuner; (4) Bell & Howell 2433 tape deck; (5) Sony 352D tape deck; (6) Ampex Micro 52 cassette deck; (7) Craig 3207 eight-track tape deck; (8) Garrard SL95B automatic turntable; (9) BSR 610X automatic turntable; and (10) a frequency equalizer built by Mr. Letterman. The two cartridges are the Pickering models V-15/AME and V-15/ATE. Each of the two speaker enclosures contains ten speakers (one 15-inch woofer, one 12-inch woofer, one 8-inch mid-range, one 6-inch mid-range, one 10-inch horn mid-range, three horn tweeters, and two dome tweeters).

Mr. Letterman's system, he claims, still has great potential for growth, and several additions are already in the planning stages. These are indicated by the number 11, and will include a miniature digital computer which will operate some of the equipment via relay switches. Several electronic games are also housed in the console. Mr. Letterman enjoys listening to everything from folk to classical music.

—Susan Larabee

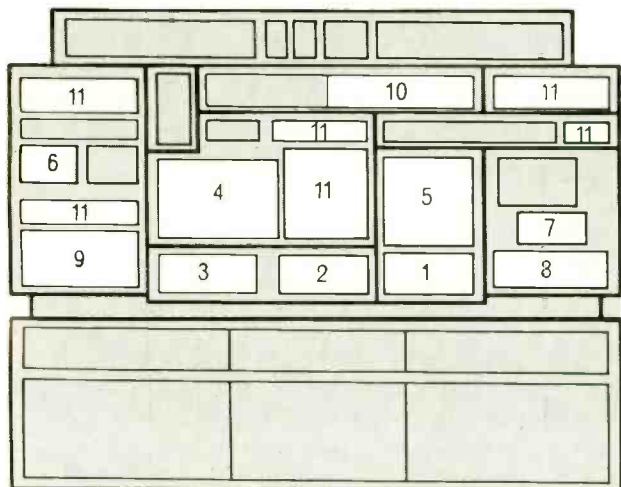

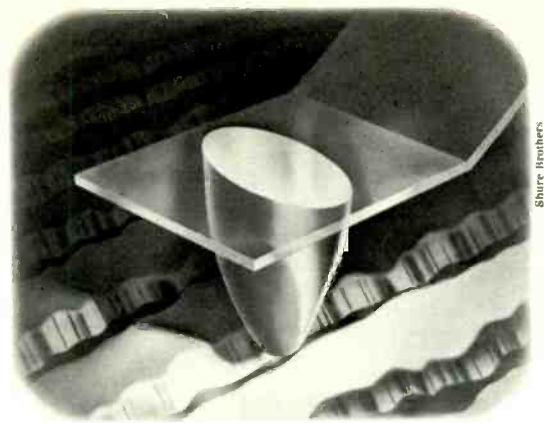

Shure Brothers

Julian Hirsch discusses some of the new challenges a continually advancing record-playing technology is posing for the makers of

PHONO CARTRIDGES

THE smallest audio component is the phono cartridge. It is so small, indeed, that it is normally partly concealed within a record player's tone arm. But it is the cartridge's big, important task to translate the highly complex and literally microscopic undulations of the record-groove walls into an electrical audio signal. To do this, the jewel tip of the cartridge's stylus must accurately follow the record-groove modulations, ideally without ever losing contact with the groove walls or significantly altering their physical shape. The stylus tip must therefore be able to reverse its direction at rates up to about 15,000 times per second (and now as high as 45,000 times per second if it is to play CD-4 four-channel stereo records). The amplitude of the stylus movement is less than 0.002 inch (2 mils)—usually much less—and in the inner, close-to-the-label grooves of a record rotating at $33\frac{1}{3}$ rpm it may have to trace as many as 2,000 "wiggles" in each inch of the groove walls moving past it.

Although the stylus typically exerts a force of only 1 to 3 grams on the vinyl material, the stylus' actual contact area on the groove walls is a circle or ellipse that is much smaller than the already minute tip of the jewel, whose radius of curvature is less than 0.001 inch. Thus, the pressure on the record is surprisingly high—as much as hundreds or even thousands of pounds per square inch. Combined with the high temperatures generated in the contact area by friction, this can cause erosion of the vinyl record material, and eventually even of the diamond stylus. Although much effort has gone into devising ways to eliminate the need for physical contact

between the pickup and the record (there has been some success recently in using laser beams to "play" video disc recordings), all current record-playing systems depend on mechanical tracing of the groove walls by a stylus.

A variety of means have been used to convert the motion imposed on the stylus by the record groove into an electrical signal. These fall into two basic categories: amplitude-responding and velocity-responding systems. The output of a cartridge that responds to *amplitude* is proportional to the magnitude of its stylus' displacement. Ideally, its output is independent of the frequency of the recorded signals. Amplitude-responding cartridges include piezoelectric types (in which a crystal or ceramic element is bent or twisted by the stylus motion to generate a voltage), strain-gauge types (in which the resistance of the semiconductor elements is varied by the stylus movement), capacitance pickups (in which the spacing between capacitor plates is varied by the movement of the stylus), and light-beam modulation pickups (in which the stylus movement is coupled to a vane that controls the amount of light reaching a pair of photocells).

CARTRIDGES that respond to the *velocity* of stylus motion—and these include the majority of those found in component systems—use some variation of the magnetic-transduction principle. This type of cartridge requires no external power source to operate; it is a miniature electric generator, creating electrical energy from record-groove motion the way a hydroelectric generator creates electricity from the rush of water through a turbine. Stylus

motion acts in such a way as to vary the number of magnetic-flux lines impinging on the turns of the coils built into the cartridge. A voltage is thereby generated in the coils that is proportional to the velocity of the stylus movement. And since the stylus velocity is itself proportional to the mathematical product of the recorded frequency and amplitude, if the amplitude is held constant, then the cartridge's output voltage will increase linearly as the signal frequency increases. It is therefore easy (!) to see why these are called velocity-responding cartridges.

Magnetic cartridges can be—and are—constructed in many ways. The stylus motion can be used to shift or rotate tiny coils in a stationary magnetic field (moving-coil cartridges), to move a tiny armature of ferrous material to vary the distribution of flux from a fixed magnet to stationary coils embedded in the cartridge body (variable-reluctance or moving-iron cartridges), to move a small ferrous element that carries the flux from an external magnet to the poles of the coils, or to actually move a very small magnet.

The question of which type of cartridge transduction system is *theoretically* best is difficult to resolve for several reasons. Our experience has been that, given the rapidly advancing state of the art, the quality of a cartridge seems to depend upon how well a particular design concept is realized rather than the specific design concept itself. Or, to look at it from another point of view, it is possible for two different cartridges to use the *same* transduction principle, yet one will be a fine performer and the other quite mediocre. This is not to say that there aren't some designs that have inherent minor or major disadvantages from the purely practical point of view. For example, given two cartridges that perform equally well, the one that does not require an external power supply, or have a very low output voltage, or need to be returned to the manufacturer to have its stylus replaced, is the preferred unit.

Each wall of the stereo record groove carries one

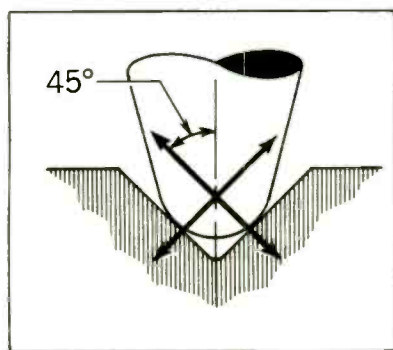

Fig. 1. Modulations in each groove wall produce stylus motion at an angle of 45° to the disc surface. Since both channels are usually modulated, stylus movement is not limited to the 45° angle, but can gyrate over a complete lateral and vertical range.

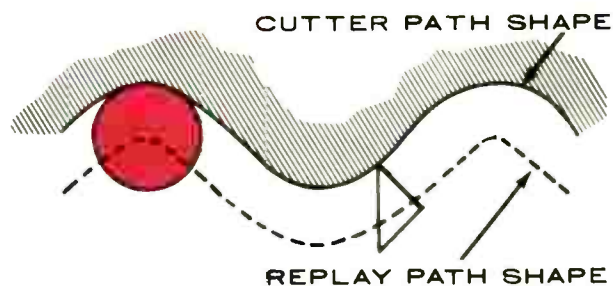

Fig. 2. One wall of the groove path cut by the sharp-edged cutting stylus is shown from above in simplified form. A spherical stylus cannot follow the smooth undulations of the groove accurately when they are close together—i.e., on high frequencies.

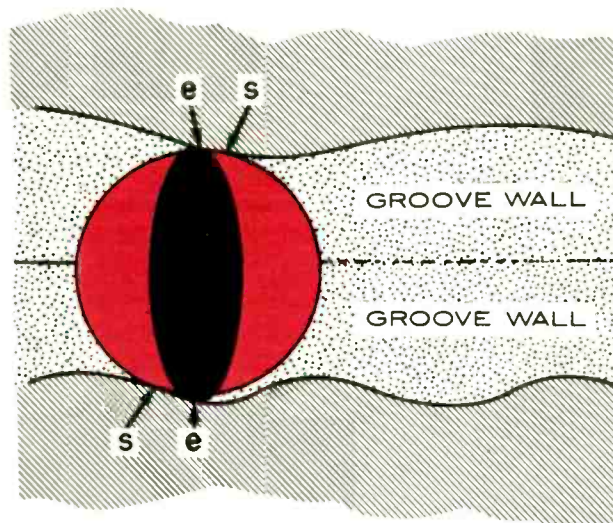

Fig. 3. The contact "points" (e) of an elliptical stylus—like those of the cutting stylus—are always parallel to the record radius. Depending on the shape encountered, a spherical stylus' contact points (s) respond to different parts of the groove wall.

sound channel, and it is responsible for moving the stylus at right angles to itself, or 45 degrees to the record surface. Two separate generating systems within the cartridge—one per stereo channel—respond individually to the stylus motions along its two orthogonal (right-angle) axes. (See Figure 1.) Of course, stylus motion is not *limited* to the left- and right-channel axes, and it gyrates freely between those limits, depending on the degree of stereo-channel blending. The isolation of each output channel from the other (the stereo "separation" spec) is mostly a function of the geometry of the moving and fixed elements in the cartridge. In most cases, a single magnet supplies all the flux, which is channeled, via the system of pole pieces, to the coils. In the case of at least one cartridge model, separate magnets are used for each of the two stereo channels.

As mentioned just above, design problems, and most of the notable advances in performance, relate less to the operating principle employed than to the specific mechanical parameters of the moving parts

of the system. There are two distinctly different aspects to the interface between stylus and record—*tracing* and *tracking*—that are often confused because of their similar names. *Tracing* refers to the geometrical relationship between the stylus and the groove modulation. The acetate master record is engraved with a special “V”-shaped ruby stylus that is able to produce very sharply defined contour changes in the groove. The playback stylus, on the other hand, has a rounded tip with a radius of curvature much larger than that of the cutting stylus. Obviously, it cannot follow the precise path traced by the cutting stylus. As a result, there are inevitable *tracing* distortions during playback, as illustrated in Figures 2 and 3.

To minimize tracing distortion, a conical stylus of smaller tip radius, such as 0.5 mil instead of the normal 0.7 mil, was once tried, because it was better able to follow the finer details of the groove modulation. However, the resulting increase in pressure per unit of contact area further accelerated wear of both record and stylus, and in some cases the stylus rode too far down between the groove walls and hit the groove bottom, adding noise or distortion to the signal. A more acceptable alternative, now almost universal in high-quality cartridges, is the use of a stylus with a bi-radial, or elliptical, cross-section. The groove wall is contacted by an edge radius as small as 0.2 mil, yet the radius of the stylus at right angles to the direction of record motion (across the groove, that is) is 0.7 to 0.9 mil, keeping the tip safely above the groove bottom.

Tracking refers simply to the ability of the playback stylus to remain in positive contact with the groove walls at all times. Tracking is actually a two-part problem for the designer, involving both the moving mass and the compliance of the stylus assembly. As the vertical tracking force is reduced in an effort to achieve less record and stylus wear, the stylus system must be made more compliant, so that the stylus yields more easily to the vertical movement of the groove. The stiffness of a noncompliant stylus would cause the entire arm to be moved by the groove, with resultant groove damage and loss of bass response. High compliance (the ability of a stylus to be deflected by a very small force) is necessary to track high-level, low-frequency signals, which can cause a pickup with insufficient compliance to actually jump from the groove.

However, *too much* compliance can lead to difficulties as well, and these arise from interaction with the tone-arm mass. The compliance of the stylus and the effective mass of the tone-arm-plus-cartridge system produce a low-frequency resonance—that is, a “preferred” frequency at which the whole

tone-arm/phono-cartridge assembly tends to vibrate. If the resonant frequency is at 20 Hz or higher, tracking of low-frequency program material will be affected and acoustic feedback problems may be accentuated. If it is too low (below 5 or 6 Hz), normal record warp can cause mistracking or even groove jumping in severe cases. The optimum frequency for the low-frequency resonance is generally considered to be between 7 and 15 Hz, and the arm/cartridge mass and cartridge stylus compliance should be so arranged as to achieve this condition. If you have doubts as to the practicality of any particular record player/tone arm and cartridge combination, check with the units’ manufacturers.

The second requirement for good tracking has to do with higher frequencies, where the amplitude of the groove undulations may be low but the velocities (and accelerations) can be very high. In this frequency range the critical factor is the effective moving mass of the stylus system, which is typically a milligram or less for good cartridges. The acceleration of even such a small mass, as it reverses direction thousands of times each second, requires that the record groove exert a large dynamic force on

RECORDED VELOCITY

● *Recorded velocity* should not be confused with *linear groove velocity*, which is really no more than the speed at which the spinning record surface passes beneath the stationary cartridge, and is a function of the rotational speed of the record and the record circumference at the point where the stylus is playing. *Recorded velocity*, on the other hand, is the speed at which the stylus must move—at right angles to the groove direction—in tracing the recorded program. This velocity is proportional to the product of the amount or amplitude (in centimeters) of the groove displacement from center and the recorded frequency in hertz, and is expressed in centimeters per second (cm/sec).

Although typical recorded velocities found on commercially available phonograph records average about 5 cm/sec, short-term values well in excess of 30 cm/sec have been measured, particularly at the higher audio frequencies. These, when present, would severely tax if not overwhelm the high-frequency tracking ability of any phono cartridge presently available.

Since stylus motion is actually a back-and-forth (or up-and-down) oscillation, its velocity is of course not a constant, straight-line quantity, but a series of starts, stops, accelerations, and decelerations. Therefore, when recorded velocity is specified, the figure given is usually the peak velocity—the highest rate of speed the stylus achieves in tracing a recorded waveform, even if that rate is reached only for an instant as it follows the undulations of the record grooves.

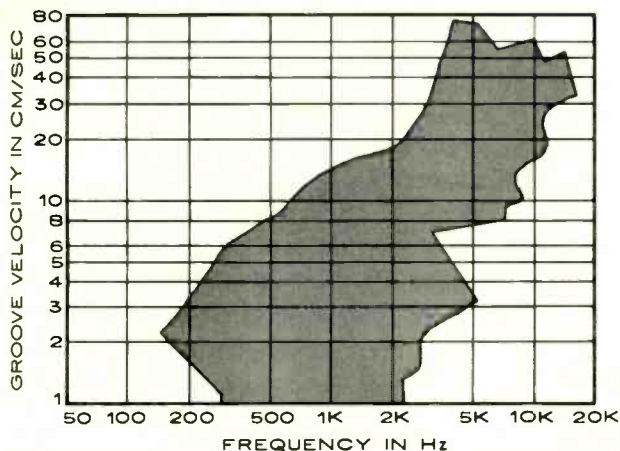

Fig. 4. The range of frequencies and velocities encountered in an assortment of difficult-to-track commercial records is indicated by the dark area. Shure Brothers engineers made the measurements to determine the tracking ability required for playback.

the stylus. As with low frequencies, there is a potential resonance problem, this time between the cartridge's moving mass and the elasticity of the vinyl record material. When the high-frequency resonance occurs in the upper audio range (10,000 to 15,000 Hz), it causes several undesirable effects. Transient response is degraded, stereo separation is often affected, and the groove walls can be permanently damaged by the mistracking stylus. Also, the cartridge's frequency response will drop off rapidly above the resonance point.

Since neither the cartridge designer nor user can control the properties of the record material, it is up to the phono-cartridge designer to keep the stylus-assembly/vinyl resonance above the audio range. The record companies are working to develop some "stiffer" record plastics, and there may be some significant announcements on that in the coming months. But until that happy event is upon us, the phono-cartridge designer must try to keep the stylus mass as low as possible by mounting a very small diamond in the lightest possible supporting structure. Not only is this an expensive procedure (because of the special materials and tolerances involved), but the low-mass moving systems used in the top-of-the-line cartridges tend to be relatively fragile compared with the rugged assemblies used in cartridges that have been designed for 3-gram and higher forces.

The "trackability" of a stylus can be expressed in terms of the maximum recorded velocity, in centimeters per second (cm/sec), that it will track at a given vertical force as a function of frequency. Maximizing the tracking ability at either end of the frequency spectrum involves some sacrifice at the other end: an optimum design must take into account the actual range of velocities and ampli-

tudes—at all frequencies—likely to be encountered on commercial records. Shure Brothers' engineers have done extensive research on the problem, and Figure 4 illustrates the velocities encountered on a large sampling of commercial discs.

In a real sense, the cartridge, when confronted by a recorded velocity that exceeds its tracking capability, is overloaded—or overdriven—in the same way that an amplifier or speaker is driven into distortion by an excessively strong signal. However, unlike the situation with an amplifier or speaker, the distortion produced by an overdriven phono cartridge cannot be reduced simply by turning down a volume control. The cartridge must be able to cope with whatever range of velocities may be engraved in the grooves of the disc, and in many cases these exceed the tracking ability of even a very good cartridge. We have all heard mistracking in the form of spitting or shattering vocal sibilants, bells, or harpsichord sounds, to mention but a few of the most audibly obvious cases. If you want a fast sonic demonstration of mistracking, all you need do is reduce your tracking force a half gram or so below the manufacturer's rated minimum force. The breakup and shattering on high-velocity recorded material will come through loud and clear. Conversely, the tracking ability of a cartridge can often be improved somewhat by using more tracking force, but eventually the stylus, because of its vertical compliance, will be forced back into the cartridge body. If the mistracking persists at the highest tracking force that can be used, the only recourse is to change to another cartridge with improved tracking ability.

ANOTHER aspect of stylus/groove geometry is the vertical tracking angle. As shown in Figure 5, this is the angle formed by the perpendicular line A-B and line C-D, which lies along the path the cutting stylus actually takes when inscribing vertical modulations on a master disc. According to the stated recording industry standard, this angle is 15 degrees. The arc the playback stylus describes in tracing these vertical modulations (curved line E-D) should coincide as closely as possible with the 15-degree cutting angle, or some distortion of the playback signal will theoretically result. In practice, however, this is of limited importance, since deviations (errors) of several degrees from the 15-degree standard are quite common with good modern phono cartridges and record-cutting equipment alike, and yet significant audible distortion does not seem to be produced. (According to industry sources, the German industrial association DIN is likely to adopt a standard of 20 degrees for vertical tracking angle shortly, and other countries may follow suit.)

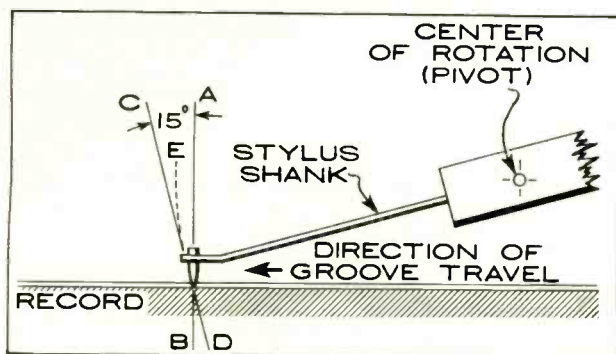

Fig. 5. The "vertical tracking angle" describes the movement of a stylus in following the vertical groove modulations. The 15° line C-D represents the current standard angle for disc cutters; the dotted line E-D is set by the location of the stylus pivot.

A related potential problem, especially with a cartridge having a very compliant stylus assembly, is the possibility of contact between the cartridge body and the record surface, especially when playing a warped disc. This is a function of the cartridge body shape, the angle of the stylus cantilever, and the arm design; if it occurs, it can usually be corrected (with some sacrifice of vertical-tracking-angle accuracy) by placing a small wedge between the front of the cartridge body and the inside of the cartridge shell, tilting the entire cartridge sufficiently to provide more clearance.

Although we have concentrated up to this point on the mechanical aspects of cartridge design and performance, the purely electrical properties cannot be ignored. For instance, the coils of a magnetic cartridge have considerable inductance and resistance. Together with the capacitance of the connecting cables and the amplifier input circuits, they form a resonant circuit that has a significant effect on the cartridge's frequency response. This electrical resonance is usually at a frequency at or above the cartridge's mechanical high-frequency resonance (as discussed earlier), and it can be used to extend and/or flatten the overall frequency response of the cartridge. Excessive capacitance, originating in the preamplifier input circuit or in long connecting cables from the player, will lower the resonance frequency. In some cases, this can result in a response peak in the 10,000 to 12,000-Hz region, which may be heard as an overly "bright" sound or as accentuated record hiss and distortion. Since the cartridge output falls off rapidly above resonance, the subjective effect of excessive cable capacitance can be either an increase or a reduction in apparent high-frequency response. Neither condition is desirable, as a rule. Some cartridges, however, require a higher-than-normal load capacitance for optimum frequency response. In other words, there is no single "right" load capacitance for every case. There-

fore, the manufacturer's recommendations should be followed.

Susceptibility to capacitive loading can be minimized in the design by reducing the inductance of the cartridge coils. This means fewer turns of wire—and hence a lower output voltage for a given magnetic flux. But in order to minimize the moving mass that must be driven by the stylus, most high-performance cartridge designs already use a minimum of magnetic material, and this also operates to reduce the available output. To keep the cartridge output voltage in the vicinity of 3 to 6 millivolts (at a standard 3.54-cm/sec reference groove velocity), the cartridge designer has relatively little latitude in his choice of coil design. Nevertheless, there are significant differences in inductance between different makes and models of cartridges.

At the opposite extreme, cartridges that have very high output voltages can overload some preamplifiers when playing at high recorded velocities. For example, a cartridge whose output is 2 millivolts at a 1 cm/sec groove velocity (typical of many low- and medium-priced cartridges) will produce a 50-millivolt output from a 25-cm/sec recorded signal (not an uncommon level for many recorded transients on commercial discs). Most good preamplifiers can handle 50 millivolts without distortion, but some will overload and "clip" at levels as low as 35 to 40 millivolts. The result of such an unfortunate pairing of a high-output cartridge and a preamplifier susceptible to being overdriven would be intolerable distortion, which could be eliminated by changing either the cartridge or the preamplifier.

THERE has been some confusion over special cartridge requirements for playing four-channel records. The majority of such discs are matrixed recordings, which appear to the cartridge exactly like any other normal stereo record, except that there tends to be slightly more vertical modulation in the groove. The velocities and frequency-response characteristics of matrixed records are essentially identical to those used for any normal stereo recording. True, excessive phase shift or channel imbalance in the cartridge, particularly at high frequencies, could alter the directional properties of the decoded four-channel program. But in general there are no special cartridge requirements for playing matrixed four-channel records, regardless of the matrix system employed.

Quite the opposite is true for the so-called "discrete" four-channel records cut with the CD-4 system. The frequency range of these recordings extends to 45,000 Hz—well beyond the useful upper

limit of conventional stereo cartridges. High-frequency tracking ability must be maintained, even though the levels of these ultrasonic signals are rather low. And performance of the two cartridge channels should be carefully controlled over the full frequency range for successful demodulation of the 30,000-Hz carrier and its FM sidebands, and for their subsequent recombination with the base-band audio signals to produce four separate program channels. The CD-4 demodulator must be adjusted and matched to the specific characteristics of the playback cartridge and stylus, so that even a change of stylus requires "retuning" the demodulator.

Earlier, we pointed out the advantage an elliptical stylus has in its ability to trace very short recorded wavelengths without excessive record wear. An extension of this concept to the CD-4 record's unique frequency-response requirements involves a specially shaped stylus jewel (Figure 6), called the "Shibata" after its inventor. The Shibata stylus jewel is shaped so as to contact the groove wall along a line, rather than the usual circle or ellipse. Since the line contact is narrower than the edge of an elliptical stylus, it is better able to trace the highest recorded frequencies. Because of its length, the contact area is reasonably large, and record wear is not a problem even at the 1.5- to 2-gram tracking forces needed by the cartridges presently available. The Shibata stylus is used in all the cartridges we have seen that were designed specifically for CD-4 service, and it seems to do what is claimed for it. Many cartridge designers, particularly in the United States, have expressed reservations about its practicality, since it requires exceptional care in manufacture and must be positioned on the stylus shank with great precision. Although Shibata styli have been a Japanese product up to now, some U. S. companies are reported ready (technologically, at

least) to begin manufacturing them. And both Pickering and Stanton have a U. S.-made stylus of a new shape intended to provide the same benefits as the Shibata configuration.

Magnetic cartridges for the CD-4 system are designed with low-inductance coils and have a correspondingly low output voltage. They must be operated with the lowest possible cable capacitance to avoid high-frequency losses, and special low-capacitance cables are usually supplied with the CD-4 demodulators.

It is very difficult for the layman to interpret cartridge specifications in any way that will relate to how a particular cartridge will perform in his own system. As we have seen, high compliance and low moving mass, both of which are necessary qualities of a good cartridge and much sought after by many audiophiles, must not be carried to excess.

As we have stated on other occasions, the best guide to the overall quality of a cartridge is the range of recommended tracking forces assigned to it by its manufacturer, with lower forces indicating, in theory, a better cartridge. Bear in mind, however, that the minimum rated force is at times an unrealistically optimistic figure, and one should normally use a force slightly above the center value in the suggested range. In the final analysis, the best—if not always most practical—way to select a cartridge is to play your most "difficult" record, using various cartridge candidates, and hear for yourself which one produces the least distortion. Otherwise, you'll have to depend on test reports, and perhaps on the recommendations of record-player manufacturers, when available.

If it seems that we have neglected frequency response, the oversight was intentional. Almost any cartridge worthy of consideration for a reasonably good system has a frequency response adequate for any commercial record. Such listening differences as do exist because of frequency-response aberrations generally are *not* inherent in the cartridge but arise mostly because of some mismatch at the preamplifier input. And even those frequency-response dips and peaks that *are* built into the cartridge have far less audible significance than the other distortion-producing characteristics discussed above.

I remember attending an engineering lecture once at which a guest speaker expressed awe at the amount of "information" that could be crammed into a record groove. I find it no less awesome that today's phono cartridges can mechanically *extract* that same information from the record groove with so little alteration of either the content of the signal or the groove itself.

Fig. 6. These head-on views of elliptical (left) and Shibata styli show how the Shibata "spade" shape offsets possible wear-producing effects of a narrow groove-tracing edge by extending the contact area vertically along the walls of the record groove.

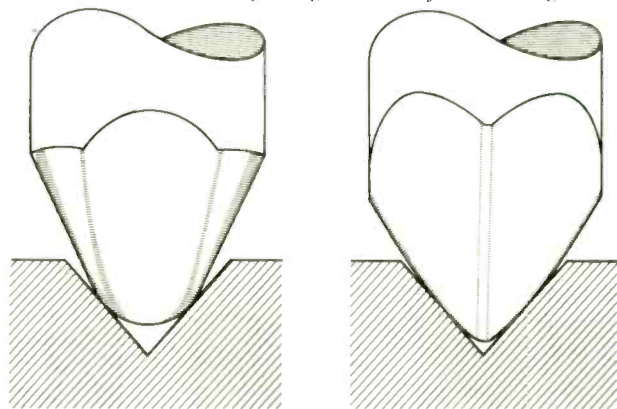

STOP! IN THE NAME OF LOVE!

A mercifully brief catalog of some
of the odd turns song lyrics
have been taking lately

By J Marks

REMEMBER 1967, when everything was coming up records, and Phyllis Diller was the only person on earth who wasn't part of the Love Generation? Remember? Back when the Beatles made a fortune telling us in two dozen different songs that "All you need is love, love, love is all you need"?

Well, you can kiss musical humanitarianism goodbye, because today's songwriters are busy telling people off. Even love songs have taken on a decidedly nonromantic mood, as for example in *Mirror* by the Batteau brothers (Columbia KC 32063), which has a line that goes "I can swim; I'm a sperm, on my night sea journey turn." A duet, doubtlessly, for Masters and Johnson. And those writers who aren't talking about biology constitute a whole school of composers dedicated to the latest form of that old serenade: "I'll be glad when you're dead, you rascal you!"



● Of course, as I write this, the most potent several minutes of loathing you can currently hear on AM and FM radio is CARLY SIMON's *You're So Vain*. It's clearly a song of retribution for all those horrible tunes guys have been writing about unfaithful and vain ladies for centuries. It has been rumored that the tune is addressed to one of several famous gentlemen of rock: Mick Jagger, some say—though it's Mick's voice that you hear singing harmony on the choruses, which sort of excludes him automatically—or, others insist, Warren Beatty. But whoever the unlucky egomaniac is, the lyrics work him over so thoroughly as an s.o.b. that I'm certain he'd very much like to remain comfortably anonymous.

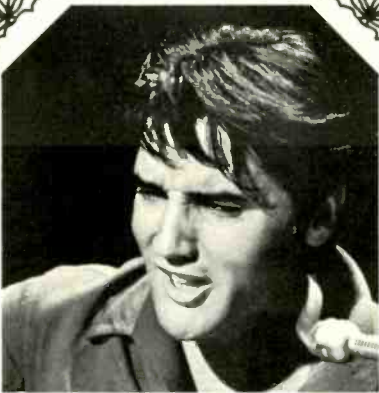

● But Carly didn't invent the song that says "drop dead!" in fluent rock-and-roll. Way back in 1956, a Mississippi country boy named ELVIS PRESLEY did a song by Jerry Leiber and Mike Stoller called *Hound Dog* that was as thoroughly contemptuous (if far less urban) than just about anything in the world of modern musical put-downs. Presley rode the tune to the top of the charts, and like Carly he made a fortune on the strength of tuneful invective. "When you said you was high classed," Elvis sang, "well, that was just a lie." What's more, the Pelvis admonished, "you ain't never caught a rabbit, and you ain't no friend of mine!" So git, mongrel! "You ain't nothin' but a Hound Dog!"



● A very special category of hate song is the declaration of self-contempt, otherwise known as a *Schwangesang*, or suicide song. There are many more contenders in this peculiar and rather bizarre genre than one might imagine, but probably the most dreary is the *Dress Rehearsal Rag* by LEONARD COHEN (popularized by Judy Collins in "In My Life," Elektra Records EKS 74027). Mr. Cohen, a Canadian poet-novelist-singer-songwriter, is noted for his dearth of *Sturm* and abundance of *Drang*, and he is probably the most afflicted songwriter of the English language—a veritable Job of pop music. The song, at least on one level, concerns the drugged decline of a superstar who, overtaken by ennui while shaving, is about to cut his throat. Some treat.

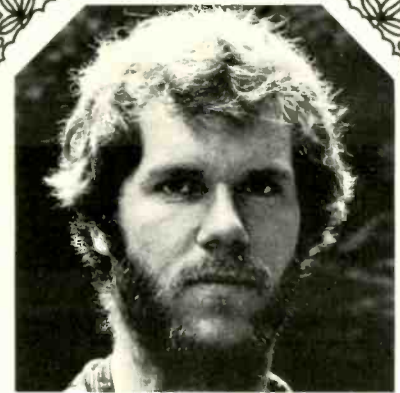

● Another popular suicide song was penned by the obscurantist Mr. LOUDON WAINWRIGHT III ("Album II," Atlantic Records SD 8291). Typically, Loudon deploys his disturbingly melancholy voice to depict a slightly over-ripe emotional state with a fair dose of self-mockery: "When you get the blues," he sings, "and want to shoot yourself in the head . . . go ahead." Furthermore, he advises, "Do the Monkey. Do the Pony. Do the Sloop. Do the Boogaloo. Twist—cut your throat, cut your wrist!" Turning philosophical, Wainwright suggests "When you tire of worldly toil, shuffle off this mortal coil. Turning your body back to soil. It's OK." And finally, "When you get hung up, hang yourself up by the neck," he sighs. "What the heck!"



● There's always been a question as to whether BOB DYLAN or Mick Jagger wrote more contemptuous lyrics about women. Among feminists who are enamored of rock, it's something of an embarrassment to scrutinize the lyrics of these pop giants. And lots of very elaborate schemes have been devised to vindicate the male chauvinist heroes. But Dylan's *Positively 4th Street* ("Highway 61 Revisited," Columbia CS 9189) still comes down as one of the most anti-female proclamations since Bluebeard. "You got a lotta nerve to say you are my friend" is, I'd say, a pretty rotten first line for any kind of song, but Bob goes on to explain that when he was down his friend "just stood there grinning." Dunno just what it means, but the song evidently got to a lot of people.



● Though Dylan undoubtedly has a nasty streak in him, he doesn't leave MICK JAGGER too far behind when it comes to a capacity for contempt. *Stupid Girl* ("Aftermath," London PS 476) by Jagger and Keith Richard is a most ferocious example of a type of song known as stay-out-of-my-life-you-dumb-broad. In this particular tune, Mick sizes up the lady from top to bottom—her terrible clothes, the dreadful way she combs her hair, the way she powders her nose. "Her vanity shows, and it shows. . . ." He condemns the way she digs for gold, the way she grabs and holds, the way she talks about someone else. "She's the sickest thing in this world." And, Mick concludes, "She bitches about things that she's never seen. Just look at that Stupid Girl!"



● Contempt is not limited to the new love songs. It's also the fashion in the current boom in songs with "religious" themes. Besides David Peel's notorious "The Pope Smokes Dope" (Apple Records SW 3399), there's a show-stopping vaudevillian diatribe in "Jesus Christ Superstar" (Decca DXSA 7206) in which an *haute couture* hermaphroditic Herod (above) sings a nasty tune to Jesus: "So," Herod hisses, "you are the Christ, you're the great Jesus Christ! Prove to me that you're no fool! Walk across my swimming pool! If you do that for me, then I'll let you go free. C'mon King of the Jews!" But then the disappointed Herod huffs, Bette-Davis-style, "You are nothing but a fraud! Get out, you King of the Jews! Get out of my life!"



● LOU REED, in the song *Vicious* ("Transformer," RCA LSP 4807), hits a person of indefinite gender with his purse. (It's rumored that all three photos on the album cover, the guy on the front with eye make-up, plus the 1940's tough and the 1950's cutie in black satin on the back cover, are all portraits of the artist.) "Vicious," Lou sings, "you're so vicious! You hit me with a flower. You do it every hour!" "You're the kind of person," he says, "that I don't want to meet." He further suggests, "Hey! Why don't you swallow razor blades . . . you must think I'm some kind of gay blade." Not exactly felicitous, but, all in all, you do get the impression that Lou doesn't like the party in question.



● With the disbanding of the Beatles a whole avalanche of contrariness crashed through the traditionally loving lyrics of the Fab Four. JOHN LENNON unleashed a tide of resentment he had felt for years for his ego-tripping collaborator Paul McCartney. In *How Do You Sleep?* ("Imagine," Apple Records SW 3379), John levels his former buddy: "Those freaks was right," he says (referring to the rumor that Paul had died and been replaced by a double), "when they said you was dead!" As for McCartney's contribution to the musical world of the Beatles, "The only thing you done was *Yesterday*." And, Lennon concludes, "The sound you make is Muzak to my ears; you must have learned something in all those years. How do you sleep at night?"



● HARRY NILSSON has always had a facility for being quietly outrageous. But he really outdid himself with a song called *You're Breaking My Heart*, which unquestionably puts the finishing touch on the whole repertoire of derogatory tunes. In a completely un-broadcastable diatribe from his excellent "Son of Schmilsson" (RCA LSP 4717), Harry proceeds to draw and quarter his Lady. She wants, he complains, to drive his car. What's more, she wants to buy a whole lot of stuff. She wants to boogaloo. But Harry's had enough. "You stepped on my ass, you're breakin' my glasses too! You're breaking my heart!" he admonishes sternly, as he heads for the killer line of romantic music: "You're tearin' it apart . . . so f'k you!" It is quite certainly a first in the literature of love.

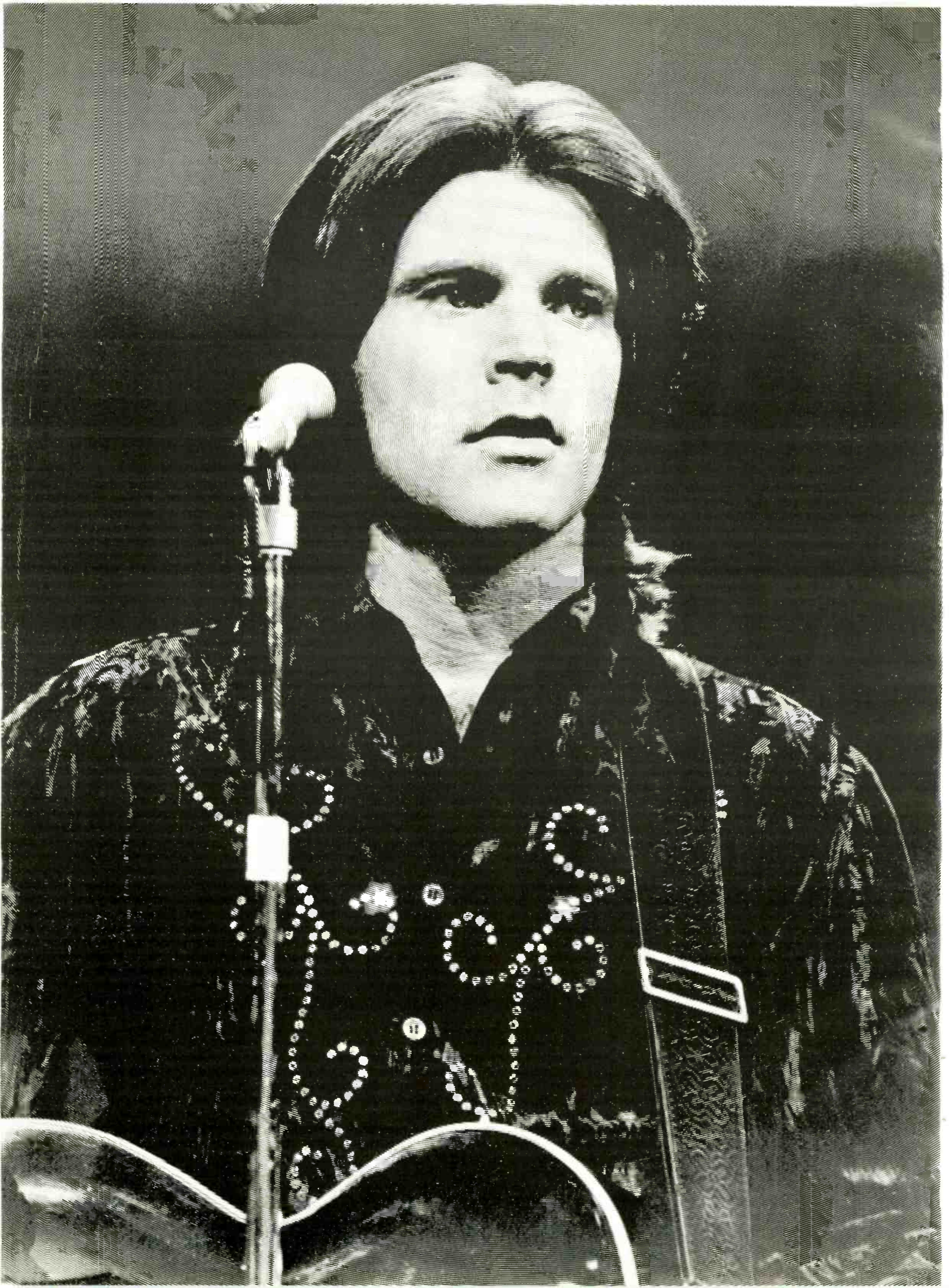

RICK NELSON

Light years away from *Ozzie and Harriet* and still moving

By TODD EVERETT

RICK NELSON. Eric Hilliard Nelson, actually. He's a singer, songwriter, guitarist, and bandleader, though not necessarily in that order. He's also an actor, having spent more time on radio and TV than just about anybody else has, and having appeared in a couple of movies as well. He's a husband and a father. He's an artist, and, as such, he's always just a bit ahead of his time—recording country music before it was fashionable, recording Randy Newman songs before *they* were fashionable. The guy who plays lead guitar with Elvis today was doing the same for Rick fifteen years ago. Johnny Cash wrote a song especially for him *ten* years ago. What other credentials do you need?

Rick was born thirty-three years ago—though he doesn't look it—in Teaneck, New Jersey. His parents, Ozzie and Harriet Nelson, were already well-known entertainers—he as bandleader and musical director for the Joe Penner and Red Skelton radio shows, and she, Harriet Hilliard, as band vocalist. Later, they began their own situation-comedy radio series, *The Adventures of Ozzie and Harriet*. In the early years of the radio show, the roles of Ricky and older brother David were played by young actors. When the real Ricky and David entered their teens, though, they started playing their own roles. The program made a highly successful transition into television, where it ran for fourteen years and can still be seen nationwide in reruns.

Although Rick's first film appearance was in *Here Come the Nelsons* in the early Fifties, he later made an impressive mark in Howard Hawks' *Rio Bravo*, with John Wayne and Dean Martin. Johnny Cash wrote the song *Restless Kid* for that film, incidentally, but the performance wound up on the cutting-room floor.

Not all of Rick's youth was spent acting. He attended school, and his friends were, for the most part, other entertainers. Some of them formed a group, which was later to gain national prominence as the Four Preps with songs like *26 Miles and Big Man*. "My first public appearance as a singer was with them," Rick recently recalled in the game room of his spacious Hollywood Canyon home. "They were going across town to perform at a high school assembly. I went along with them, just for fun. They performed and then asked me to come onstage. The kids knew me from television, and there was a minor riot. I couldn't believe it!" Rick and the group faked through an Elvis tune they all knew, *My Baby Left Me*. The youngsters chased Rick and the Preps into the parking lot, the performers barely escaping with their clothes intact.

It was not too much later that Rick told a girl friend he

was going to make a record. The story was, he says now, *just a story*, intended to impress her, but she called his bluff, so Rick asked his father to arrange for a recording session. Ozzie complied, and three sides were cut. Rick premiered one, a version of the Fats Domino hit *I'm Walkin'*, on the family TV show. As a singer, he was literally an overnight success.

Rock-and-roll purists of the time, if they bothered to think of him at all, tended to dismiss Rick and his singing since it was chiefly the more teen-oriented of his material (*Poor Little Fool*, *Waitin' in School*, and the like) that sold, and Elvis was still the king of rock. In retrospect (a view most conveniently provided through the United Artists "Ricky Nelson" Legendary Masters album, UAS 9960), Rick proves really to have been a lot hipper than he was generally given credit for. He produced all his own records (still in his middle-to-late teens and early twenties, remember) and claims to have made a very conscious attempt to emulate the Sun Records sound pioneered by such artists as Johnny Cash, Elvis Presley, and Carl Perkins.

NELSON's recording success lasted for close to six years, from 1957 until about 1963 or so. He survived (barely) a change in record labels in 1963, leaving Imperial when his father, a shrewd businessman, negotiated a twenty-year contract with Decca (now MCA). Rick's first few Decca singles did well enough; subsequent releases registered less and less on the national consciousness. By 1965, he was a virtual has-been.

"I'd been doing pretty much the same kind of thing for several years. I was getting tired of it, and obviously the audience was not as receptive as they had been. I went into a long period of feeling around, trying to get a style that fit me comfortably. Fortunately, I had that twenty-year contract with the label. All I had to do was come up with a certain number of records each year. I tried several styles, and used some outside producers. Some of the music was pretty good, but none of it really caught on."

It was a frustrating period for Rick. Financially, he didn't need to worry, thanks to past record royalties and residuals from his television shows. But he knew that he was capable of something artistically worthwhile, and he was faced with the inability, for a time, to isolate that capability and turn it into reality. During this period he became familiar with the work of such writers as Randy Newman, Tim Hardin, and Bob Dylan, with which he had had minimal previous contact. And he released a total of eleven albums, starting with "For Your Sweet

Love," and embracing a variety of styles, types of material, and instrumental backgrounds. Two of the most successful, artistically if not commercially, were "Bright Lights and Country Music" and "Country Fever." As the titles indicate, both had more to do with Rick's Carl Perkins influences than with any attempt to play on teenage female heartstrings.

By 1969, Rick had made the decision that would bring him back to the top. The concept was essentially simple: he went right back to what he had been doing at first. "When I was originally recording, through all my hits, I had been working with my own band. We used the same musicians on all my sessions, and got what was a very basic sound to our records. Later I tried everything, but none of the other styles was as comfortable for me. So I formed the Stone Canyon Band."

The group was made up of Los Angeles-based musicians, largely unknown but all very good. Probably the best-known Stone Canyon picker at the time was Tom Brumley, who had retired a year earlier from a long stint with Buck Owens' country band. Brumley (whose uncle, incidentally, wrote the sacred favorite *I'll Fly Away*) gave Rick and his group solid roots and a credibility that would otherwise be hard to come by with a large segment of his potential audience. Another early member of the Stone Canyon Band was Randy Meisner, one of the founders of Poco and now an Eagle.

Rick's first single with the Stone Canyon Band was a Dylan song that had already become a standard of sorts, *She Belongs to Me*. The combination of singer, song, and band proved fortuitous: it was Rick's first hit in more than four years. The band immediately cut a live album at L.A.'s Troubadour ("Rick Nelson in Concert," Decca DL 75162). The performance set the style of Rick's future format: a couple of Nelson oldies, a couple of contemporary pieces, and a couple of originals. Rick had, through the years, developed into a capable songwriter, and a later album, "Rick Sings Nelson" (Decca DL 75236), was a well-received testament to that talent.

WHAT really brought Rick Nelson back to the center of events, though, was *Garden Party*. A story-song in the best troubadour tradition, done in Rick's by-then standard easygoing country-rock style, the tune for some reason communicated to a larger audience than anyone expected. (The album "Garden Party," Decca 75391, contains the title song and its follow-up, *Palace Guard*.) The "plot," as almost everybody knows by now, concerns a performance Rick gave at a Richard Nader "Rock 'n' Roll Spectacular" held at Madison Square Garden a year ago last November. Rick had had an aversion to that type of show, he says, though "I've never tried to run away from the past. I feel that it's the other person's problem if he insists on living that kind of nostalgia. The audience at those concerts is a strange mixture of people. It's like they're true Fifties people who wear their saddle shoes and sweaters and really believe. I think that a lot of them are people who would like to be thought of as bikers—sort of like the kind of people who will wear suits to work and put on a long-hair wig for the weekends, only these are from another era altogether. For myself, I'm glad that I was around during that time, but it's not anything that I feel any need to go back and recapture.

"Now, if they're put in the right perspective, I think that the old songs are fine. We do some of our old numbers in the regular act, even though a lot of the time we're

playing to audiences, like college kids, who have never heard the originals. It would be dishonest of me not to do some of them. People expect it. I'd hate to see Tim Hardin and not have him do *If I Were a Carpenter*. But I don't do a *show* of old songs. It's a sign of people stopping. I think that people like Chuck Berry owe more to their audience than just doing hits from fifteen years ago at revivals."

Nevertheless, Rick was persuaded to attend this one particular "garden party." "I kind of went against my original reaction. I talked myself into it by saying that it would be good to be seen by that many people, and that I could always sneak in some new material.

"We really tried to get into the spirit of things as much as possible. We opened with *Be-bop Baby*, which I haven't done in years. The response was O.K., I guess, but there seemed to be a bit of uneasiness. It was probably because we dressed the way we do now, and didn't wear Fifties outfits like a lot of the acts and a great deal of the audience. I don't know. Anyway, the only thing that could be considered 'new material' that we wound up doing was *Honky Tonk Woman*. The audience got quite hostile, and started booing. We just forgot about doing anything else any more recent than *Lonesome Town*.

THE reason I'm so happy that *Garden Party* is the one that made it is because it's such a personal thing. I guess I'm saying more than just what happened that particular evening; it applies to any sort of putting too much emphasis on the past. You can't take something out of that era and compare it to what's going on now, except that that music is the basis of today's.

"The musicianship is so much better now, for one thing, and so are the studio techniques. All of my early songs were recorded on one track. We did *Garden Party* on twenty-four. Of course, back in the Fifties everybody was an innovator, because rock-and-roll was totally new. I said earlier that a lot of people at the Garden were trying to recapture the past. Well, I think also that a lot of people were there who missed out on it when it was all happening. There were a lot of people who spent all their time putting it down and who wouldn't listen to anything but straight-ahead jazz at the time. Now they're trying to recapture something that just can't be brought back—and shouldn't be.

"The song is basically a story of that one evening and that one show. But there is another thought involved—that if you can't please everybody, you've got to please yourself. I came to that conclusion three years ago, when I founded the Stone Canyon Band. For a while, nobody knew what I was doing—not even I did. With the formation of the band, I've gone back to what was the beginning for me. Before then, I was trying everybody else's ideas, because my ideas weren't really working. The big-production-type records that were becoming hits for other singers just weren't my style.

"For three years, it was like starting all over again. We began in small clubs, and got going slowly, got sort of a following going from people who had become familiar with us and what we were doing. Now, after *Garden Party*, we're able to play the kind of places we want to. People know us, and accept us for what we're doing today. It's much more rewarding to me now than it was when I started fifteen years ago. No, I can't really say that. It was a *different* thing, then. But it is more substantial now."

STEREO REVIEW'S SELECTION OF RECORDINGS OF SPECIAL MERIT BEST OF THE MONTH



CLASSICAL

BRAHMS' STRING QUARTETS COMPLETE: A MAGNIFICENT SET

Glorious Romantic freedom characterizes the Cleveland Quartet's performances for RCA

YOUNG American string quartets seem to be springing up these days like mushrooms—or maybe sometimes more like toadstools. Before going any further, perhaps I'd better lay my own stylistic preferences out for all to see: I have never been able to understand, for example, why so much fuss has been made about the Guarneri Quartet, a group that seems to me so surly and nerveless in manner, so devoid of real musical sap, that I have on occasion walked out of its concerts at intermission rather than suffer through any more devitalizations of great works. Far more to my taste is the utterly committed playing of the newer Vermeer Quartet, the as yet unrecorded artists-in-residence at Northern Illinois University (their corporate strength is threatened at the moment by the third personnel change they've had in as many years of existence).

Just now, however, with a magnificent set of the complete Brahms string quartets recorded for RCA, the Cleveland Quartet at one stroke establishes its position in the very forefront of American quartet playing. Formed at Marlboro in 1969, the quartet takes its name from the late Victor Babin's Cleveland Institute of Music, though it has since moved on to the University of Buffalo. Its members are violinists Donald Weilerstein and Peter Salaff, violist Martha Strongin Katz, and her husband, cellist Paul Katz.

I am all the more delighted to

be able to greet this recording with almost unqualified enthusiasm because I was sharply disappointed by the Cleveland when I first heard it at the University of Chicago a season ago. What I had heard of Weilerstein at Marlboro several years back, and what I knew of the Katzes' playing, had led me to expect great things. Instead, I found an ensemble sound that didn't quite cohere and a curious sense of tentativeness in the interpretations.

That must simply have been a bad night, for there is no trace of such weaknesses in these extraordinarily mature and skillful performances. The group could hardly have chosen a better vehicle for its debut recording. The three quartets are masterly expressions of Brahms' fundamentally polyphonic

cast of mind, and the unusually democratic balance of artistic power among the Cleveland's four instruments makes it ideally suited to be the medium of the composer's richly detailed textures. If the cellist and, even more, the violist make the most immediate impression here, that, I think, is only a natural consequence of the solicitude with which Brahms treats the middle and lower parts. The two violinists make just as good use of their opportunities, but they do not try to monopolize the limelight in an un-Brahmsian manner.

What is most exciting about these readings is their glorious sense of uninhibited Romantic warmth. The players' technical command and rhythmic zest



JOHANNES BRAHMS

A fundamentally polyphonic cast of mind

ensure that the music's broader lines are always kept firm and lucid. But they are also not averse to a whopping bit of *portamento* when the expressive context justifies it. The cello's juicy downward swoop at measure 161 in the finale of the C Minor, and the viola's passionately projected solo in the third movement of Opus 67, are excellent examples of a rhetorical freedom that reflects the Serkin-Marlboro tradition at its best.

I have only two reservations. I think the Cleveland will one day come to play the radiant major passage near the end of the C Minor Quartet with a more rarefied tone than it manages here. And I wish—this is a much more substantial gripe—that the exposition repeats in all three first movements had been observed: in Opus 67, particularly, the omission of the repeat seriously obscures the structure of the movement, with its complex, subtle interrelationship of $\frac{9}{8}$ and $\frac{2}{4}$ meters.

Yet even here the unbridled recklessness of tempo and articulation comes close to carrying the day. These are performances fit to stand with the best you will ever hear, recorded with thrilling immediacy, and my quibbles should be read in that context.

Bernard Jacobson

BRAHMS: *The Complete String Quartets: No. 1, in C Minor, Op. 51, No. 1; No. 2, in A Minor, Op. 51, No. 2; No. 3, in B-flat Major, Op. 67.* Cleveland Quartet. RCA VCS 7102 two discs \$13.96.

DONIZETTI'S ANNA BOLENA: ANOTHER SILLS TRIUMPH

Her interpretation lends quiet dignity to the romanticized story of Elizabeth's mother

GAETANO DONIZETTI's opera *Anna Bolena*, introduced in 1830, was his first real success. More than thirty stage works had preceded it in the composer's prodigious output, but the operas which sustain his fame today all came after *Anna Bolena*, among them *Maria Stuarda* (1833) and *Roberto Devereux* (1837). All three of these operas about famous queens of England, long dormant as stage works but now restored to circulation, are available in recorded performances built around the unique gifts of soprano Beverly Sills. I will therefore waste no further time in coming to the point: her portrayal of the hapless Anne Boleyn in the just-released ABC recording is another major triumph for her.

The character of Anne Boleyn has been idealized



BEVERLY SILLS: a rich and varied interpretation

but by no means dehumanized in Felice Romani's historically fast-and-loose but otherwise effective and credible libretto. As played by Miss Sills, she is a woman of quiet dignity who gains our sympathy at the outset because the singer skillfully stresses her vulnerability and her sense of impending doom. In scene after scene, Miss Sills manages to sustain, through her tremulous and fragile tone, an illusion of repressed tears. But there are other colors in her palette as well, making this a rich and varied interpretation that rests on a secure technique and (this time around) an avoidance of over-ornamentation.

As is well known by now, Miss Sills' is one of those voices that are not always under total control, and there are therefore moments when intonation suffers (the long duet with Percy on side four and the final "*Coppia iniqua*" are two examples of this)—but then the important opening aria comes off splendidly despite its taxing tessitura. She also sings her part of the first-act Sextet exquisitely and invests the melancholy pages of the great final scene, particularly "*Cielo a' miei lunghi spasimi,*" with heartbreaking poignancy.

Anna Bolena is a long opera about arresting personalities who suffer with dignity, connive nefariously, commit stupid blunders, and make noble sacrifices. All this is done to music that is both effective and vocally demanding; happily, Beverly Sills is not alone in standing up to these demands.



SHIRLEY VERRETT: a brilliant upper register

Shirley Verrett as Jane Seymour (she has also been quite effectively ennobled in the gallant Romani treatment) is responsible for some of the showiest—and most secure—singing of the production. Always compelling dramatically, particularly in the significant confrontations with the King (these scenes are among the musical highlights of this well-constructed opera), she is most effective in music that engages her brilliant upper register.

Although Enrico (Henry VIII) has no arias as such, his ominous presence casts a shadow over every scene. The young American basso Paul Plishka brings to the role both strong dramatic projection and impressive sonority. And though tenor Stuart Burrows is somewhat overmatched by the fiendish tessitura of his Prison Scene aria "*Vivi tu*," his singing is elsewhere distinguished by ingratiating tone and elegant phrasing. Patricia Kern is a very fine Smeton and Robert Lloyd a satisfactory Rochefort, but Robert Tear is weak in the role of Sir Hervey, the bearer of ominous tidings.

Julius Rudel's leadership combines firm control, sensible pacing, and consideration for the singers. The New York City Opera plans to add *Anna Bolena* to its repertoire in the near future. Given a cast of a strength comparable to this one, the presence of Sills and Rudel offers a comfortable guarantee of an exciting production.

A comparison with the first complete recording of

this opera, released two years ago on London OSA 1436, must begin with the admission that its frequently exciting but vocally rather wayward Anna (Elena Souliotis) has definitely been surpassed by Beverly Sills' portrayal here. Otherwise, the two sets are closely matched. The London album offers fine leadership by Silvio Varviso and good to excellent singing by principals Marilyn Horne (Seymour), John Alexander (Percy), and Nicolai Ghiaurov (Enrico).

George Jellinek

DONIZETTI: *Anna Bolena*. Beverly Sills (soprano), Anna; Shirley Verrett (mezzo-soprano), Jane Seymour; Stuart Burrows (tenor), Lord Percy; Paul Plishka (bass), Henry VIII; Patricia Kern (mezzo-soprano), Smeton; Robert Lloyd (bass), Lord Rochefort; Robert Tear (tenor), Sir Hervey; John Aldis Chorus; London Symphony Orchestra, Julius Rudel cond. ABC/ATS 20015/4 four discs \$23.94.

POPULAR

PAUL JEFFREY'S "FAMILY" ALBUM

Forty minutes of solid, unadulterated contemporary jazz in a new Mainstream release

TWO YEARS with Thelonious Monk's group—a group that has been sadly unproductive in recent years—earned saxophonist Paul Jeffrey a comfortable reputation within the limits of the jazz world. But now he has leaped over the monastery wall, and if he keeps making albums like his new Mainstream-label "Family," that reputation should quickly grow to the outer limits of the jazz scene and beyond.

Under the tasteful supervision of Ernie Wilkins, Jeffrey and a fine band of largely unknown musicians (including Monk's son) treat us to forty minutes of solid, unadulterated drive and beauty, effectively combining old and new elements of Afro-American music. There are no electronic instruments here, no precious tinkles of Eastern thumb bells, no chants in Lenox Avenue Swahili, no tambourine-dressed material from the pop scene, and no attempts at political statement. The message is clear and simple: outstanding contemporary music does not need such accessories. That is not to say that I question the validity of electronic jazz; much of it (Miles and Mahavishnu, for example) is excellent. But the majority of it is just so much pretentious extra-musical nonsense; I, for one, would rather get high on music than have to get high to appreciate it. Nor are political statements neces-

sarily out of place in music (Brecht and Weill, Big Bill Broonzy, Bob Dylan, and others have effectively fused the two), but our ears are lately too often assaulted by anti-this and -that inanities carelessly tacked on to something that only barely passes for music.

Paul Jeffrey's "Family" is, appropriately, very much "together." As jacket annotator Valerie Wilmer puts it, these are "straight ahead, timeless sounds," and the total lack of pretension with which they are presented will, I predict, give them the longevity they deserve. Afro-American music, like any good music, needs no costumes; its naked beauty is quite sufficiently breathtaking. Give us more Paul Jeffreys (the country abounds with them), and jazz, now often adulterated beyond recognition, will once again attract large audiences with its exquisite, original bouquet.

Chris Albertson

PAUL JEFFREY: a total lack of pretension



ROY BUCHANAN: a veteran picker with a distinctive sound

PAUL JEFFREY: *Family*. Paul Jeffrey (tenor saxophone); Joe Gardner (trumpet and flugelhorn); Stuart Butterfield (French horn); J. C. Williams (bass clarinet); Hamiet "Bunny" Bluiett (baritone saxophone and flute); George Cables (piano); Stan Clarke and Wilbur Ware (bass); Bob Stewart (tuba); Thelonious Monk, Jr. (drums). *F. U.: Immigration; Motor Drive; Ina; Kim; Rodan; Bianca*. MAINSTREAM 376 \$5.98, © M 8376 \$6.98, © M 5376 \$6.98.

'WAY OUT THERE WITH ROY BUCHANAN

His blues-based second album is an a-to-z of dazzling electric-guitar technique

ROY BUCHANAN'S "Second Album" for Polydor brings the electric guitar up to date, so to speak, with the veteran picker doing everything from lilting pastoral tinkles to Murderous Michigan Macho-Rauch and never once coming close to losing touch with his distinctive sound. The things he does in *After Hours* alone would amount to a satisfactory career for a better-than-average electric guitarist. Such praise, I know, suggests showboating, which is supposed to be offensive, but here it doesn't come out that way. Buchanan's work calls for its own definition of good taste — what I'm trying to say, I guess, is that he has his own unique brand of soul.

The selection of material this time out isn't as wildly unpredictable as it was in Roy's first album, and he's coaxed five of the tunes out of his own skull besides—two facts that are no doubt related. Blues is the backbone of this one, and given that circumstance, the melodies are adequate—all you really need is a key and a rough idea. The band is much better balanced here than before, with Dick Heintze playing a particularly good blues piano. The sound is hardly what you'd call integrated, and though the guitar may be said to dominate, it does so gracefully.

If you are a musician—even an amateur one, you'll know what I mean when I ask if you've ever had that Schlitz grab-for-the-gusto soaring feeling, as if you'd just sailed off the edge of the fixed world with that last note and you haven't the vaguest idea where the next one is coming from or how you'll make it . . . but even though you'll have to do it a split second from now, you *aren't worried* about it. Roy Buchanan is frequently out there in that state. And if you have some inkling of what that's like, you'll cherish this album all the more.

Noel Coppage

ROY BUCHANAN: *Second Album*. Roy Buchanan (guitar, vocals); Dick Heintze (keyboards); Teddy Irwin (rhythm guitar); Jerry Mercer (drums); Don Payne (bass); other musicians. *Filthy Teddy; After Hours; Five String Blues; Thank You Lord; Treat Her Right; I Won't Tell You No Lies; Tribute to Elmore James; She Once Lived Here*. POLYDOR PD 5046 \$4.98.

A NEW, DOWNRIGHT RABELAISIAN DONOVAN

Epic's "Cosmic Wheels" features some candid explorations beyond the borders of wonderland

REVIEWERS, to the really gifted creators and performers, must often seem to be among the most tiresome people in the world. Our options, supposedly, are to like or to dislike what they have done and to explain our reactions. Our problems, when we have any, usually spring from the realization that the artist knows where he is going, that we don't, and that we just have to tag tiresomely along behind and try to describe as best we can what is to us unfamiliar territory.

If Donovan will pardon me, then, I will say that I find his new album for Epic, "Cosmic Wheels," to be the work of a poet who has broken out of his accustomed pastel wonderland with a roar—two of



DONOVAN: the aplomb of the absolutely self-assured

the songs here are downright Rabelaisian. *The Intergalactic Laxative* is a bit of scatological musing, paradoxically sung in an elegant drawing-room folk style, that could have taken its inspiration from a men's room scrawl by, say, Brendan Behan. And *Wild Witch Lady*, earthy to a fault, is about a girl who just might be taken for Linda Lovelace. But then, with the aplomb of the absolutely self-assured, Donovan offers two lovely, romantic, and shimmeringly graceful songs called *Sleep* and *Maria Magenta*, and some keen-edged and amusing social commentary in *Appearances* and *The Music Makers*. His guitar playing continues to have its usual magical quality, and the orchestrations—especially for Pat Halling's lead violin—are superb.

"Cosmic Wheels" is, I think, a definite step forward for this poet/composer. Some may find the verbal candor a bit hard to take, though it is really no more than you get from *Carmina Burana*—but then I guess you can say anything as long as it's in Latin. Included in the elaborate package is a semi-nude photo of Donovan. This may by now have become mandatory, but it's where I draw the line: he looks scroungier than his scroungiest lyrics. Otherwise, no complaint, just praise and rejoicing.

Peter Reilly

DONOVAN: *Cosmic Wheels*. Donovan Leitch (vocals and guitar); orchestra. *Cosmic Wheels; Earth Sign Man; Sleep; Maria Magenta; Wild Witch Lady; The Music Makers; The Intergalactic Laxative; I Like You; Only the Blues; Appearances*. EPIC KE 32156 \$5.98. Ⓟ EA 32156 \$6.98. Ⓞ ET 32156 \$6.98.

The 400 millisecond miracle.



Most people seem to take for granted the smooth, effortless way in which a Revox works.

And that is as it should be.

For a great deal of time, effort and sophisticated engineering have gone into translating extremely complex function into lightning quick, responsive operation.

For example, when you press the play button of a Revox, you set in motion a sequence of events that take place with the precision of a rocket launching.

It begins with a gold plated contact strip that moves to close two sections of the transport control circuit board.

Instantaneously, the logic is checked for permissibility. If acceptable, a relay is activated.

Within 15 milliseconds, power is supplied to the pinch roller solenoid, the brake solenoid, the back tension motor, a second relay and, at the same time, the photocell is checked for the presence of tape. If present, Relay One self-holds.

Elapsed time, 25 milliseconds.

At 30 milliseconds, Relay Two closes and puts accelerating tension

on the take-up motor.

The logic checks are now complete and power is available to actuate all necessary functions.

From 30 milliseconds to 300 milliseconds, mechanical inertia is being overcome and the motors and solenoids are settling down.

By 300 milliseconds, the brakes have been released, the pinch roller is in contact with the capstan shaft, the tape lifter retracted, the playback muting removed and the motors have come up to operating speed.

At 350 milliseconds power is cut off from Relay Two, which changes over to another set of contacts, releasing the accelerating tension on the take-up motor and completing a circuit through Relay One that, in turn, restores normal tension to the take-up motor.

Total elapsed time, 400 milliseconds. The Revox is now in the play mode.

And it's all happened in a fraction of the time it takes to read this sentence.

The 400 millisecond miracle. **More proof that Revox delivers what all the rest only promise.**



Revox Corporation 155 Michael Drive, Syosset, N.Y. 11791, Calif.: 3637 Cahuenga Blvd. West, Hollywood 90068
England: C.E. Hammond & Co., Ltd., Lamb House, Chiswick, London W4 ZPB. Available in Canada.

CIRCLE NO. 40 ON READER SERVICE CARD



POPULAR DISCS AND TAPES

Reviewed by CHRIS ALBERTSON • NOEL COPPAGE • PAUL KRESH • PETER REILLY • JOEL VANCE

RECORDING OF SPECIAL MERIT

COLIN BLUNSTONE: *Ennismore*. Colin Blunstone (vocals and instrumentals); other musicians. *I Don't Believe in Miracles; Exclusively for Me; A Sign from Me to You; Every Sound I Heard; How Wrong Can One Man Be; I Want Some More;* and five others. Epic KE 31994 \$5.98, ⓑ EA 31994 \$6.98.

Performance: **Lovely**
Recording: **Ditto**

Blunstone, late of the Zombies, has one of the most haunting and original voices in rock-and-roll, and on this, his second solo outing, he has begun to create a music that approaches, both in style and in quality, his mid-Sixties work with that lamented ensemble. This is especially gratifying because much of his instrumental backing and material is provided here by the other ex-Zombies now known collectively as Argent, who, on their own, have been rather dire.

At any rate, this is probably the prettiest album I've heard in some months, but for those of you who understandably equate prettiness with vapidty (*à la* Joan Baez or Cat Stevens, for instance) let me add that Blunstone has a sly sense of humor, an engaging sexiness, and a rocker's instincts. In other words, despite his predilection for wistful romantic balladry, and despite a vocal instrument so sweetly feminine as to make Smokey Robinson sound like Captain Beefheart by comparison, the boy has funk.

So does the album, which is gorgeously produced to boot. Highly recommended.

Steve Simels

ROY BUCHANAN: *Second Album* (see Best of the Month, page 78)



COLIN BLUNSTONE

Haunting voice and a rocker's instincts

PETULA CLARK: *Now*. Petula Clark (vocals); instrumental accompaniment. *Wedding Song; Solitaire; Don't Hide Your Love; Shelter; Mother of Us All;* and six others. MGM SE 4859 \$5.98.

Performance: **For retarded teenagers**
Recording: **Very good**

When Petula Clark arrived on the pop music scene along with the Beatles, around 1964, hers was a refreshing voice to hear. It still retains its freshness, but the audience she is catering to nowadays seems to be in the puberty department, and I would like to think she has outgrown such things. Songs like *Solitaire* (a cautionary tale about a lonely man doomed to a life-long game of emotional solitaire) and *Don't Hide Your Love* ("You never give yourself completely—it's just that you've been hurt before") dispense such fatuous

dime-store sentiments that it's hard to believe so talented a girl is wasting herself on such shoddy goods. She redeems herself with the bouncy *It's a Musical World*, but *Mother of Us All* bears about as much resemblance to the opera by Gertrude Stein and Virgil Thomson as five-cent fudge does to a fine soufflé. It is a pallid charm Miss Clark displays on this occasion. I wish she would tackle some grown-up subject matter.

P.K.

DEEP PURPLE: *Who Do We Think We Are!* Deep Purple (vocals and instrumentals). *Woman from Tokyo; Mary Long; Super Trooper; Smooth Dancer; Rat Bat Blue; Place in Line; Our Lady.* WARNER BROS. BS 2678 \$5.98.

Performance: **Powerful**
Recording: **Very good**

Deep Purple was always a good thumping group, reliable rock-and-rollers with a minimum of nonsense or pretension. The title of this album, as the montage of press clippings on the inner sleeve reveals, is a confident appraisal of their own worth and prowess. It was said of Jelly Roll Morton that "he bragged like hell but he could always back it up." So can Deep Purple. *Woman from Tokyo* and *Mary Long* are the best cuts, but all the songs here are played with the group's typical dexterity and energy. An honest rock-and-roll album is good for the soul (also the brain and the glands). For me, listening to Deep Purple was like a tonic. Just wait 'til next summer when those beach bullies try to kick sand in my face.

J.V.

DEREK AND THE DOMINOS: *In Concert*. Eric Clapton (guitar, vocals); Jim Gordon (drums); Carl Radle (bass); Bobby Whitlock (keyboards, vocals). *Why Does Love Got to Be So Sad; Got to Get Better in a Little While; Let It Rain; Presence of the Lord; Tell the Truth; Bottle of Red Wine; Roll It Over; Blues Power/Have You Ever Loved a Woman.* RSO SO 2-8800 two discs \$9.97, ⓑ TP2 8800 \$9.97, © CS2 8800 \$9.97.

Performance: **Master at work**
Recording: **Very good**

(Continued overleaf)

Explanation of symbols:

- Ⓜ = reel-to-reel stereo tape
- ⓑ = eight-track stereo cartridge
- Ⓒ = stereo cassette
- Ⓢ = quadraphonic disc
- Ⓜ = reel-to-reel quadraphonic tape
- ⓑ = eight-track quadraphonic tape
- Ⓒ = quadraphonic cassette

Monophonic recordings are indicated by the symbol Ⓜ

The first listing is the one reviewed; other formats, if available, follow it.

Eric Clapton is the finest living rock guitarist; only Jimi Hendrix was capable of matching his technical mastery of the instrument and his ability to wield it as an expression of personality, to "translate" the inner voice of the musician into musical statements. But although this two-record set, recorded live at the departed Fillmore East, contains hunks of Clapton's amazing guitar work, it is ultimately disappointing. Most of the material has been recorded before by Clapton, alone or with Cream, Delaney and Bonnie, or Blind Faith. It is interesting to hear the difference between live performances and studio recordings, but live gigs have a built-in deficiency when they are recorded. A band playing a number on stage, reacting to the presence of the audience (especially a friendly audience), tends to stretch things out, to get caught up in the thrill of immediate experience, to run a riff for thirty-six or forty-eight bars when they would ordinarily run it for eight. And, unless you were there, and can supply elements of the live performance from memory, what was natural on stage tends to be boring on record. This is not *always* true: the Bangla Desh concert album was thrilling and intimate, whether the listener attended the concert or not. But this album is basically a re-run, or at the most an "alternate take"—interesting to the Clapton fan (and the band is mostly Clapton) but not really satisfying.

There is another deficiency about the album for which imbecile fate is responsible: Duane Allman is not there. Allman's guitar, perfectly complementing Clapton's, is what made the Dominos' studio work (the "Layla" album) so rich—with strong support from Messrs. Whitlock, Gordon, and Radle. Contractual obligations might have prevented him from appearing even were he alive, but "Layla" is one of the most important rock albums of the last five years, apparently difficult for Clapton to match in subsequent performances.

There is also the Robert Stigwood Organization, Clapton's management, who have formed their own label, on which this album appears. RSO are businessmen: with a marketable commodity like Clapton they would probably insist on *some* Clapton product being issued. They couldn't care less whether the material recorded is familiar; their attitude, partially correct, is that it has been a relatively long time since "Layla" appeared. Yes, it has. Yes, an artist like Clapton can't be expected to dash off a masterpiece every other month. But yes, this album—despite the excellent performances of all concerned—is merely an expedient stopgap. So the huzzah I would ordinarily raise is, in this case, *sotto voce*. J.V.

DONOVAN: *Cosmic Wheels* (see Best of the Month, page 79)

RECORDING OF SPECIAL MERIT

ISLEY BROTHERS: *The Isleys Live*. Ronnie Rudolph, and Kelly Isley (vocals); instrumental accompaniment. *Love the One You're With; It's Your Thing; Pop That Thang; Lay Lady Lay*; and four others. T-NECK TNS 3010-2 two discs \$6.98.

Performance: **Thrilling**
Recording: **Very good**

This album comes under the heading of Rare Good Fortune. The Isley Brothers make too few personal appearances these days—perhaps they are weary and leery of the endless

tours and one-nighters they played in the late Fifties and middle Sixties. But they are at their best in front of a live audience; their enormous power throbs and shakes and blows the house down.

Though they have recorded all of the material here in studio versions, with rare exceptions these live performances are superior. Their adaptation of Neil Young's *Ohio*, in a medley with Jimi Hendrix's *Machine Gun*, is an Isley masterpiece; nobody else, not even Young, can convey the horror and the ghastly stupidity of the awful Kent State incident so well. Listening to the Isleys' live performance, which takes up a whole side of this two-record set, is to be left limp and exhilarated at the same time.

Ronnie Isley is one of the most distinctive stylists in American music—like Little Richard and the late Otis Redding, he is unmistakable. What he is able to do technically in this contemporary idiom becomes even more amazing when you consider that he is (sorry,



BERT JANSCH
Weaves a glowing musical tapestry

kids) pushing forty, as are his brothers Rudolph and Kelly. They have been professional musicians for more than twenty years, yet they still sound fresh and exuberant.

Their artistry—now at its peak after many hot, cold, and lukewarm years—has been enhanced by their decision to switch from doing their own material exclusively to mixing in other people's. Thus their version of Carole King's *It's Too Late* becomes a little Isley concerto, with their excellent band (the Isleys have near-infallible taste in selecting their backup men) playing what I can only describe as a "foreplay" mood mixture of beat and rhythm. And their own material has improved, as witness the delightful and sprightly *Work to Do* and the audaciously conceived *Lay Away*.

All hail the brothers Isley! This album is a treasure. J.V.

LORI JACOBS: *Free*. Lori Jacobs (vocals); instrumental and vocal accompaniment. *Crack of Dawn; I've Never Been a Fool like This Before; Heavy Thinking; Wouldn't It Be Something; Constant Disappointment*; and five others. CAPITOL ST 11134 \$5.98.

Performance: **Dreary diary**
Recording: **Good**

Lori Jacobs is a former schoolteacher and housewife who gave up both of those careers to hang out nights as a singer at the Ann Arbor (Michigan) Road House, where you can find her, if you really want to, singing her own "autobiographical" songs. Her models in the word department seem to be the kind of verses you find on greeting cards, turned upside down so the effect will be dismal instead of cheery: "Don't ask me why I'm leaving you/I once had a reason why/But now the time is drawing near/I sure hate to say goodbye." Ms. Jacobs, apparently on her way to join all those sullen lads on the cluttered road to Phoenix, admits at the end of *Crack of Dawn* that "There ain't no special reason/For me to move along" but she goes anyhow. Later, she gets mixed up with some new friend ("I've never been a fool like this before") and as her "autobiography" in song continues, does some "heavy thinking" about life; searches for "a full-time man"; decides she's going to "live the life that's best for me"; cooks and cleans for still another "lovin' man"; spurns pursuers who would look at her soul "as a toy"; tells her parents and her own child that love must not be "a blanket to protect you"; and finally becomes "what I've wanted to be . . . free," just like Joan Crawford in one of those old movies before anybody had ever heard of Gloria Steinem. If Lori Jacobs' lyrics are a little on the fundamental side, the tunes to which they are set are practically nonexistent. The pseudo-funky way she drones them may lure you out to the Ann Arbor Road House, but I don't think I'll be waiting to join you there. P.K.

RECORDING OF SPECIAL MERIT

BERT JANSCH: *Moonshine*. Bert Jansch (vocals, guitar); Dave Mattacks (drums); Danny Thompson (bass); Ali Bain (fiddle); Ralph McTell (harmonica); other musicians. *Yarrow; Brought with the Rain; The January Man; Night Time Blues; Moonshine; The First Time Ever I Saw Your Face; Ramble-away; Twa Corbies; Oh My Father*. REPRISE MS 2129 \$5.98, Ⓜ 82129 \$6.98, Ⓞ M 52129 \$6.98.

Performance: **Excellent**
Recording: **Excellent**

Bert Jansch, anchor man of the Pentangle, has the kind of taste that overcomes major hurdles. He has to overcome a nasal honker of a working-class voice that is just *barely* capable of sounding pleasant if nobody moves and everybody holds his mouth right. He has to overcome a not-muscular-but-wiry muse with an overweening affinity for third-rate ideas. Being one of the very best of acoustic guitarists helps, of course, but even there taste holds sway. Jansch's guitar is never flashy. He weaves it into the arrangements with the anonymous dignified efficiency of a butler. It's natural and integrated, like the gold thread in a tapestry. Just hearing him blend the guitar with a beautiful array of woodwinds in *Yarrow* puts a picture of Harvard Square in the old days on my studio wall.

Jansch's treatment of olde ballades about maidens is in some unique, in-between (or off-to-the-side) place, thanks again to taste. He approaches neither from the purist-traditional angle nor from the bowdlerization-cum-indulgence modern folk-rock angle. He somehow conveys an unillusioned fondness for the old songs that we're lucky to encounter nowa-

(Continued on page 84)

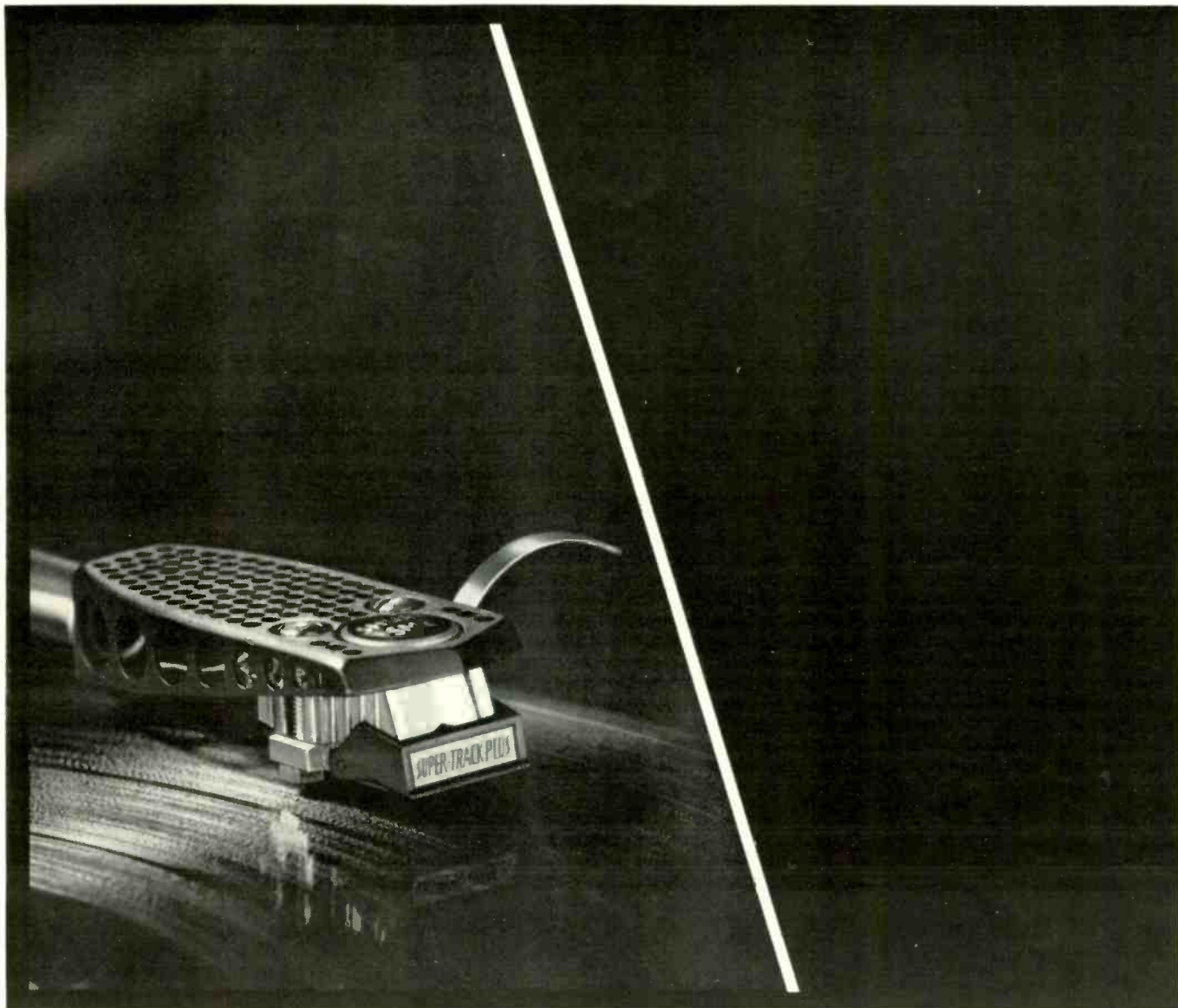

anything II could do III can do better!

Several years ago, we decided that our next challenge would be to go beyond the best there was. Our computers told us we had taken the existing cartridge structure and stylus assembly of the V-15 Type II Improved as far as we could, and that hereafter, any improvement in one performance parameter would be at the expense of performance in some other parameter.

Therefore, over the past several years, a wholly new *laminated* cartridge structure has been developed, as was an entirely new stylus assembly with a 25% reduction in effec-

tive stylus mass! These developments have resulted in optimum trackability at light tracking forces ($\frac{3}{4}$ - $1\frac{1}{4}$ grams), a truly flat, unaccented frequency response, and more extended dynamic range than was possible even with the Type II Improved, without sacrificing output level!

If you like its sound today, you will like it even more as time goes on. In fact, to go back to any other cartridge after living with the Type III for a short while is simply unthinkable, so notable is its neutral, uncolored sound. You must hear it. \$72.50.

INTRODUCING THE NEW

 **SHURE** V-15 TYPE III
Super-Track "Plus" Phono Cartridge

Shure Brothers Inc. • 222 Hartrey Ave. • Evanston, Ill. 60204
In Canada: A. C. Simmonds & Sons Ltd.,

CIRCLE NO. 46 ON READER SERVICE CARD

days. Of his own songs here, only *Moonshine* really cuts through the skim. *Night Time Blues* is listless and endless, and *Oh My Father*, with its electric guitar accompaniment, generation-gap clichés, and dum-de-dum-de-dum melody, is not exactly a sell-out, but it may be some sort of lend-lease deal. *Moonshine* is a simple song, but it has some changes that sound awkward when Jansch sings them. This is somehow fitting; and those changes provide an absolutely chilling take-off for a figure improvised by the little backing ensemble of guitar, violin, flute, clarinet, and cello. That, *Yarrow* and the other traditionals, and a striking arrangement of *The First Time Ever I Saw Your Face*, with Mary Hopkin on answering vocal (this being mistaken for a round by the Reprise promo writer)—these things are more than enough to give an old folkie like me a working-over. I'll even cool it with the harmonica when this is playing. P.R.

RECORDING OF SPECIAL MERIT

B.B. KING: *Back in the Alley*. B.B. King (vocals and guitar); various orchestras. *Sweet Little Angel*; *Sweet Sixteen*; *Lucille*; *Watch Yourself*; and five others. BLUESWAY BLS 6050 \$4.98, © M 8051 6050 \$6.98.

Performance: **Brut**
Recording: **Variable**

Listening to B.B. King is like being able to order the choicest of champagnes from the wine list. Although his subject matter is generally back-alley muscatel, his performances transform everything into rare vintage. This collection is chosen from several of his previous albums, and there isn't a track here that doesn't move, exhilarate, and purge the listener in the way all good art does. Perhaps the best bands are *Please Love Me* and *Sweet Little Angel*, both from his classic "Live at the Regal" album. King doesn't settle for mere communication with an audience, he grabs it by the short hairs and transfixes it.

"Back in the Alley" should be compulsory listening—especially for those middle-class white kids who feel they've got-a-right-to-sing-the-blues and who have been boring the hell out of all of us for the last few years. P.R.

RECORDING OF SPECIAL MERIT

JERRY LEE LEWIS: *The Session*. Jerry Lee Lewis (vocals and piano); instrumental accompaniment. *Drinking Wine Spo-Dee-O-Dee*; *Music to the Man*; *Baby What You Want Me To Do*; *Bad Moon Rising*; *Sea Cruise*; *No Headstone on My Grave*; *Big Boss Man*; *Memphis*; *Trouble in Mind*; *Early Morning Rain*; *Sixty Minute Man*; and eight others. MERCURY SRM 2803 two discs \$9.96. © MCT 8 2803 \$9.98, © MCT 4 2803 \$9.98.

Performance: **Good ole boy!**
Recording: **Excellent**

The story goes that Jerry Lee, long a country music power and respected by later generations of rockers for his part in the First Golden Age during the Fifties, got a little testy when he saw his contemporaries—Chuck Berry, Howlin' Wolf, Muddy Waters, and nearly everybody else—going to London for all-star recording sessions with British guest artists acting as backup men. J.L. allowed as how he would do the same thing, and "The Killer," as he describes himself, flew forth with to old Angle-land.

And what did he do there? Why, record one of the most thumpingly swiny albums of all time. Nobody makes any serious mistakes, even though the band can't seem to end a tune together: it is just a wonderful, sloppy jam session with everyone having a marvelous time. All the rococo excesses of the sort of rock that most of the sidemen play on their own are stripped here: the music is the sweet fat just by the bone. I am particularly zapped by Albert Lee's guitar; the syncopated dexterity in his solos is a joy to hear. Lewis' whorehouse piano, always great fun, here reaches the apex of that crude style; some of the passages he plays are simply astonishing. He takes boogie piano about as far as it can go.

Lewis obviously had a marvelous time. He roars, whines, yodels, keens, snickers, burps, and guffaws his way through the session, throwing out spoken asides like "Think about it!," which is equal to W.C. Fields' "I hate youuuuu. . . ." His selection of material, composed mostly of blues, jumps, and leering



JERRY LEE LEWIS

"The Killer" rollicks and roars once more

ditties, is perfect for this jam. His version of *Pledging My Love* is superior to the original (heresy!) by Johnny Ace, and he does some fine new material—the rollicking *Jukebox and Music to the Man*.

I was fearful that this kind of music—white Southern hoo-raw potlikker country rock—would not get recorded again, since the later examples by Dale Hawkins and the late Gene Vincent were commercially unsuccessful and/or sweetened up from the raw original sessions. But my fears have been laid—hell, stomped—to rest by this delirious album. Pure pleasure! J.V.

LINDA LEWIS: *Lark*. Linda Lewis (vocals); orchestra. *Spring Song*; *Lark*; *It's the Frame*; *Old Smokey*; *Waterbaby*; *Been My Best*; and six others. REPRIS MS 2120 \$5.98

Performance: **Excellent**
Recording: **Keep off the tracks!**

This is a persuasive and charming debut by a London-based young West Indian girl. Linda Lewis isn't breaking any new ground, but everything that she does (which is considerable in that she wrote, produced, and performed everything on the album) has a secure,

unpretentious, musicianly quality. Her songs, particularly *Gladly Give My Hand* and *Spring Song*, have an unforced clarity and simplicity. She performs them with a communicative reality in an expert and unmannered jazz-soul style. Push comes to shove, however, and mannerisms abound in her production techniques. She seems to have only just discovered the wonders of multi-tracking, with the result that there is a plethora of Linda Lewises on almost every band. Just how irritating it all is doesn't really penetrate until the last song, *Little Indian*, which she sings straight (i.e., solo), accompanying herself on percussion and displaying a delightful pop mini-coloratura.

At twenty-two, Linda Lewis has a lot going for her in all directions, and as soon as she stops confusing herself with the Mormon Tabernacle Choir I think we can expect a good deal of first-rate entertainment from her. Certainly the basic talents are there. P.R.

THE NEW SEEKERS: *Come Softly to Me*. The New Seekers (vocals and instrumentals). *For You We Sing*; *Blowin' in the Wind*; *Come Softly to Me*; *Goin' Back*; *Morning Has Broken*; *Down by the River*; and six others. MGM/VERVE MV 5090 \$5.98.

Performance: **Young and healthy**
Recording: **Very good**

The New Seekers are a gentle, soft-singing yet spirited group of two boys and three girls who, unlike so many of their contemporaries, have the modesty and decency to sing real songs by real composers instead of their own. Here they do harmonic justice to Bob Dylan's *Blowin' in the Wind*. Stephen Schwartz's *Day by Day*, José Feliciano's *Rain*, and Cat Stevens' *Morning Has Broken*, along with lesser known but deserving songs by a number of other competent people. Only occasionally do they resort to sound effects and tricks—and then only when they can do it effectively, as when they bring in the voices of children at play in the nostalgic *Goin' Back*. The rest of the time they concentrate on the music, touching lightly on ecology in *Down by the River*, braving the "deep dark waters of life" in *Captain Stormy*, and working up a kind of Baptist beat and fervor in *Why Can't We All Get Together*, a wistfully anti-racist number. When they finally do sing one of their own songs—Peter Doyle's unaffected ballad *Unwithered Rose*—we are ready to listen. It's good to hear young singers who don't try to be too big for their jeans, and at the same time are able to fill so adequately the ones they wear. P.K.

DORY PREVIN: *Mary C. Brown and the Hollywood Sign*. Dory Previn (vocals); instrumental accompaniment. *The Holy Man on Malibu Bus Number Three*; *The Midget's Lament*; *When a Man Wants a Woman*; *Cully Surroga He's Almost Blind*; *Left Hand Lost*; and eight others. UNITED ARTISTS UAS 5657 \$5.98. © C 5657 \$7.95. © U 8471 \$6.98. © K 0471 \$6.98.

Performance: **Trenchant words, tired tunes**
Recording: **Good**

Dory Previn is a sharp-toothed satirist who comes at injustice with a sardonic snarl, sometimes sinking her fangs accurately into the jugular of her prey, at other times biting down too hard in the wrong place and probably (Continued on page 88)

We can warranty our components for five years. Because we know what's inside them.

Dependable stereo performance depends in great part on the parts that make up each component.

In order to give you the longest warranty* in the stereo industry Yamaha engineers had to feel confident in the reliability of all the various parts that go into our many audio products.

They had good reason to feel confident.

Because we make more of our own parts than other stereo companies. We mill our own trees for the cabinet-wood.

We actually make the machinery that forms our chassis and other metalwork.

We make the magnets for our speakers. We make these under stringent conditions, in our own facilities.

The result is stereo that can be warranted for five years on parts, three on labor.

And some very clear, natural sounding reproduction from our receivers, amplifiers, tuners, speakers, turntables and tape decks.

Come hear them at your nearest Yamaha stereo dealer.

YAMAHA

We know what's inside.

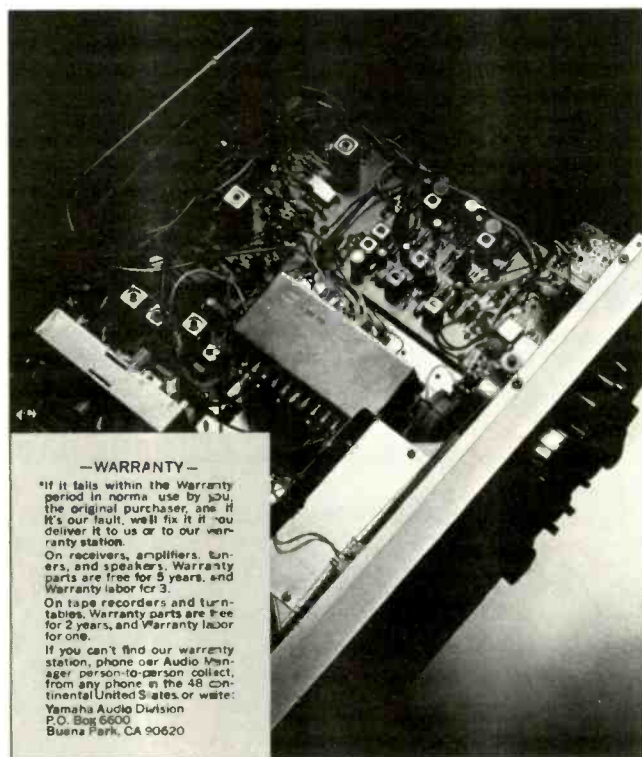



Columbia

IGGY (POP) AND THE STOOGES

The apotheosis of every parental nightmare

Reviewed by LESTER BANGS

THE biggest trend on the rock circuit this year is decadence. Go to any concert, and you'll be amazed at the sudden change in American youth, who are now as far from last year's organic coveralls and bushy hanks of hair as they are from the madras shirts and slacks of 1963; teenagers of both sexes are piling on clots of make-up and swaddling themselves in flashily indeterminate glad rags. Boys with rouge and glitter on their eyelids, girls with the stark white faces and rinsed-out blonde hair of the Marilyn Monroe look they picked up from the drag queens in Andy Warhol movies—all of them seem to be a mite confused, as if they'd just seen *Cabaret* and decided that whatever all that was, they wanted its trappings. But they're working very hard at it nonetheless, and embracing as well a whole new set of pop idols consonant with this all-out sprint toward chic degeneracy: the actually rather tame showman Alice Cooper, David Bowie, the fey mime with a brilliant publicity machine, and rafts of kohled-eyed stragglers mincing in their wake. Somehow, though, it all comes off as synthetic and as ultimately emotionless as the audience's gingerly experimentation with their own sexual identities. And every bit of it is missing that essential spark, that certain urgency that is at the root of all great rock-and-roll.

Shake hands, then, with Iggy and the Stooges, the latest and last word in shock-

rock. You may find yourself repulsed by them, you may not be able to abide a single note of their music, but they are undeniably the sound and look of the future. The Stooges surpass their competition in this murky area of pop by taking all the elements that have made the Bowies and Coopers suddenly (and transitionally?) potent—glitter, sexual confusion, subcultural shock, a sense of the garish and lurid—and adding to these a staggering dose of bone-scraping rock frenzy straight from the heart of adolescent darkness.

Another reason the Stooges loom so large among nascent glitter rockers is that, like Lou Reed (who has influenced them greatly), they were shoving this sort of thing at the world and the rock audience long before either was ready for it; they were the originators. In 1968 the Stooges were putting on shows in which lead singer Iggy Pop would fling his scabbed body to the floor of the stage in a truly convincing display of the self-destructive impulse at its purest, whereupon he would proceed to perform fellatio on the microphone while his lead guitarist jabbed him brutally from behind with the neck of his instrument. It was crude, even disgusting, but the Stooges were innovators of a sort, and both Bowie and Cooper have freely looted Iggy's stage act for gimmicks to beef up their own highly controlled but rather cold shows.

Iggy claimed that he taught everybody else in the band to play their instruments, and when their first album came out I believe they had all been playing for only about two years. It was, as was observed at the time, a *reductio ad absurdum* of rock-and-roll, but it was also music that was totally impossible to ignore and successful on its own aboriginal terms: hypnotic repetitions of a single thunderous chord at a volume that would reduce dogs to agony, over which Iggy would croon and bark and shriek improvised gut-level ditties about adolescent torments in a voice rather like some henbane mutant shade of Mick Jagger. They were songs about being lonely, shy, and awkward; they were fidgety, self-pitying rants about having *No Fun*; and, most of all, they were about sexual inadequacy and inexperience, with a strong accent on the ultimate confusion of the two. Identity-crisis music on a perhaps too-basic level, it was as extreme in its aggressive neurosis as everything else about the Stooges. If ever there was a band predicated upon extremism on all levels, this was it—they ended up wasted on drugs, dropped by their record company, their instruments repossessed.

FOR better or worse, though, time has vindicated the Stooges, and 1973 will see them making a comeback of major proportions. They are possessed of a monomaniacal fury so genuine that it makes the posturings of Bowie and the cheery, beery Alice Cooper seem like something from a Ross Hunter production. Their new album is called "Raw Power," and that's exactly what it delivers, in an unremitting torrent that may be too much for many listeners to take. The by-now banal words "heavy metal" were invented for this group, because that's all they've got, and they're brutal with it: ram-paging guitar lines hurtling out or colliding like opiated dervishes, steady, mindless, four-four android drumming, Iggy outdoing even his own previous excesses with a ragged tapestry of yowls, caws, growls, raspy rants, epithets, and imprecations. The song titles tell the story: *Search and Destroy*, *Your Pretty Face Is Going to Hell*, *Death Trip*. The ferocious assertiveness of the lyrics is at once slightly absurd and indicative of a confused, violently defensive stance that's been a rock tradition from the beginning: "I'm the runaway son of the nuclear A-Bomb/I am the world's forgotten boy. . . ."

It's the essential terror and pain of growing up, and nowhere in rock-and-roll has it been rendered more vividly—or more energetically—than by this bunch of acne-ridden social reprobates who seem to have made a career out of *not* growing out of their teenage traumas. Whether you laugh at them or accept their chaotic rumble on its own terms, they're fascinating and authentic, the apotheosis of every parental nightmare.

IGGY AND THE STOOGES: *Raw Power*. *Search and Destroy; Gimme Danger; Your Pretty Face Is Going to Hell; Penetration; Raw Power; I Need Somebody; Shake Appeal; Death Trip.* Iggy Pop (vocals); James Williamson (guitars); Ron Asheton (bass, vocals); Scott Asheton (drums). COLUMBIA KC 32111 \$5.98. Ⓢ CA 32111 \$6.98. © CT 32111 \$6.98.

Why you should buy the best turntable you can afford.

Chances are you've already put more money into your record collection than into the rest of your entire component system.

That's reason enough to make sure that nothing happens to your records when you play them.

Remember, records are made of soft vinyl, and they're played with a diamond-tipped stylus. And there's nothing harder on this earth than a diamond.

If that stylus can't respond easily and freely to all the contours of the record groove, there's trouble. Especially with the sharp and fragile curves which produce the high frequencies. Instead of going around these peaks, the stylus will simply lop them off. And with those little bits of vinyl go the high notes, your record and your investment.

There's still more to consider. The record must rotate at precisely the

right speed, or pitch will be off. The motor must be quiet and free of vibration, or rumble will be added to the music.

In short, the turntable should neither add sounds to a record, nor take any away. And that's the kind of turntable you should want. To get that kind of turntable, we suggest you ask someone you know and trust who really knows components. A friend. A record reviewer. An audio engineer, or a good audio dealer.

And if you'd like to read more about turntables, we'll send you two booklets that someone else wrote. One tells you what to look for in turntables. The other tells you what independent test labs have reported about the Duals they've evaluated.

We'll leave it to you to decide if you can afford anything less than a Dual.



United Audio Products, Inc., 120 So. Columbus Ave., Mt. Vernon, N.Y. 10553

Exclusive U.S. Distribution Agency for Dual

bly leaving a sour taste in her own mouth as well as ours. In the title song, she sings of one Mary C. Brown who jumps off that big ugly sign that glitters above Hollywood and goes to her death as the symbol of all the refugees who ever went out West pursuing unredeemable dreams ("Give me your poor, your tired, your pimps, your carhops, your midgets, your chumps . . . your whores, your harlots . . .")—didn't she sing that one on her last record?). In *The Midget's Lament* she sees the world from a dwarf's point of view; the effect is predictably grotesque. In *Starlet Starlet on the Screen* she is back berating the ugly side of show business. Later she deals with King Kong's angle on the King Kong story, protests the conformist practice of turning exceptional left-handed children into right-handed nonentities, and in *Morning Star/Evening Star* discovers the one-ness of her own personality, putting herself together at last: "and what I have joined together let no one put asunder." In her epitaphs for outcasts Miss Previn sings sense most of the time; it is only in ballads like *Cully Surroga*, *He's Almost Blind* that she crosses the line hopelessly into bathos and tasteless hideosity, telling the story of a boy blinded by the indulgence of a misinformed mother. Otherwise, Dory Previn is a master of the bitter line and the ironic delivery: the only thing her songs lack is music to match the wit of her words. Wanted: a composer to collaborate with a gifted, terrifyingly knowing woman. P. K.

RECORDING OF SPECIAL MERIT

TODD RUNDGREN: *A Wizard, a True Star*. Todd Rundgren (vocals); instrumental accompaniment. *International Feel*; *Never Never Land*; *Tic Tic Tic It Wears Off*; *You Need Your Head*; *Rock and Roll Pussy*; *Dogfight Giggle*; *You Don't Have To Camp Around*; *Flamingo*; *Zen Archer*; *Just Another Onionhead/Da-Da Dali*; and nine others. BEARVILLE BR 2133 \$4.98, Ⓟ M8 2133 \$6.98, Ⓞ M5 2133 \$6.98.

Performance: **Well done, my boy!**
Recording: **Very good**

If Paul McCartney had more of a sense of humor he would be Todd Rundgren. The first side of this album is a giddily entertaining pop concerto, some of whose lyrics might have pleased the late Sir Noël Coward. Where the honored second side of "Abbey Road" was a medley of unfinished or pasted-together tunes, Rundgren's stuff seems to be carefully put together, and the jabbing, distracting, tickling instrumentals and sound collages are a deliberate part of the texture.

The first side sounds like a movie score without a movie: listening to the songs brings up visual images of characters and situations, which may have been part of Rundgren's intent. "Sergeant Pepper," the root of all ambitious rock albums, was an attempt at phonographic theater. It acted on the same principle as old-time radio did: state a dramatic situation, give voices to the characters, and let the audience fill in the visuals. Rundgren has not done it the way the Beatles did; his way of bringing the audience in is to be more of an outright entertainer and more outlandish than the B's were on "Pepper." But it leads to the same place—which is a very interesting, witty, and generally happy place at that. Rundgren is a harlequin; he likes and wants it that way, and his world is pleasing.

You may imagine that, after all that build-

up, the second side of the album isn't as good. No, it's not, but it's not the same kind of thing either. This is mostly top-Forty material, although *Sometimes I Don't Know How To Feel* has an interesting construction and arrangement. But getting back to side one: the kid may just be a wizard, after all. J.V.

HURRICANE SMITH. Hurricane Smith (vocals); orchestra. *Who Was It?*; *Take Suki Home*; *Auntie Vi's*; *Wonderful Lily*; and six others. CAPITOL ST 11139 \$5.98, Ⓟ 8XT 11139 \$6.98, Ⓞ 4XT 11139 \$6.98.

Performance: **Hoke, hokum, hokiest**
Recording: **Fair**

I still can't quite believe this one. Said Hurricane Smith is, according to the liner notes, actually Norman Smith, an English producer-engineer. My friend Margo Lane, who is still dating that dummy, Lamont Cranston, says she knows a lot about secret identities and told me "strictly *entre nous*" (Margo uses a



BRUCE SPRINGSTEEN
An important city-minded newcomer

lot of words like that) that Hurricane-Norman is in reality Ted Weems, moved to England to prove that his Forties hit *Heartaches* wasn't just a flash in the pan.

Just might be, since the prevailing style here is rancid music hall with a boomp-de-boomp accompaniment. Hurricane has had several English chart hits, such as *Oh, Babe*, *What Would You Say?* and *Don't Let It Die*, which are included here. What that says about English pop taste at its lowest level—a level I had thought was the sole domain of the Osmond Brothers—is perhaps better left unsaid. However, one thing I'll say about Hurricane's work is that it is consistently bouncy. Even the record itself bounced as I scaled it into the wastebasket. P.R.

DUSTY SPRINGFIELD: *Cameo*. Dusty Springfield (vocals); orchestra. *Learn to Say Goodbye*; *Who Gets Your Love*; *Tupelo Honey*; *Of All the Things*; *Comin' and Goin'*; and six others. DUNHILL DSX 50128 \$5.98, Ⓟ M 85128 \$6.98, Ⓞ M 55128 \$6.98.

Performance: **Expert, hyper-emotional**
Recording: **Excellent**

Yet another hard-drivin', hard-breathin' album from Dusty Springfield, who can make

even as benign a song as *Tupelo Honey* sound as melodramatic as a motor car accident. Gutsiness is her game and a uniform grimness of approach is her tactic. When it works, as it does in *Breakin' Up a Happy Home*, she's just fine. When it doesn't, as in *The Other Side of Life*, she still gamely battles it through. Long ago Springfield accurately marked off her territory, and its inhabitants seem to get as much kick out of her travails as she does in recounting them.

Here, as always, she is provided with an excellent and very suave recorded production. In short, she is a real pro, pulling out all the emotional stops, in gilded surroundings, for a known audience. So c'mon and suffer along. P.R.

RECORDING OF SPECIAL MERIT

BRUCE SPRINGSTEEN: *Greetings from Asbury Park, N. J.* Bruce Springsteen (vocals, guitar, harmonica, conga, bass); Gary Tallant (bass); David Sancions (keyboards); other musicians. *Blinded by the Light*; *Growin' Up*; *Mary Queen of Arkansas*; *Does This Bus Stop at 82nd Street?*; *Lost in the Flood*; *The Angel*; *For You*; *Spirit in the Night*; *It's Hard To Be a Saint in the City*. COLUMBIA KC 31903 \$5.98, Ⓞ CT 31903 \$6.98.

Performance: **Dazzling**
Recording: **Very good**

The main thing about Bruce Springsteen's semispectacular debut *should* be that he is a city-minded kid—like most people in such places as Asbury Park, he is preoccupied with New York. The city's toughness, particularly, fascinates him, and its speed, chaos, spontaneity, contriving, and conniving actually do—I believe—pass through him and out into a sort of sidewalk-Baroque style of music. Unfortunately, the main thing about him may be those "Next Dylan" pronouncements already starting; computers this minute are scanning *Blinded by the Light* alongside *Like a Rolling Stone* for profundity comparison readings.

Before the data fog closes in, note Springsteen's singing style. It probably will prove distinctive enough, but not by a lot. He uses a puffy-jawed projection that's a little too campy, but he superimposes a redeeming buzz, and there's an urgency about it all that suits his subject matter and his treatment of it. Some treatment, too—so many words! So many rhymes! "Madman drummers bummers and Indians in the summer . . ." he'll say. "In the dumps with the mumps as the adolescent pumps. . ." He doesn't require much of his melodies, and they generally respond accordingly. He's a rocker, essentially, as such a downtowner would logically be. Still, it is pleasantly unsurprising to find that *Spirit in the Night* has a really haunting melody and sticks in the mind.

The arrangements are what you call unobtrusively rollicking, and Springsteen handles himself well on several instruments. The disc version, with lyrics printed on the jacket, is a better deal than the Dolbyized cassette, which sounds good but has the sequence of tunes rearranged in a dunderheaded manner and provides no lyrics.

Springsteen is an important newcomer. The language, the images, the rhythms, the fragmented impressions just keep rolling on, relentless and maybe out of control a little, like the taxicabs on Fifth Avenue. The language is so *right* sometimes it's almost spooky. But

then there are times when something that was handy and little else was grabbed for the interior rhyme scheme . . . and times when I, not being city-minded, find it—overwhelming. My God, say hicks like me, is *that* still going on? I fancy that, instead of “Don’t lose your mittens,” the Uptight Mommy must now be sending her kid out with “Don’t let the excessive stimuli freak you out.” No Next Dylan would affect me that way, not here in the laid-back Seventies. Bruce Springsteen is something else, read both ways, and seems to be already proving that street poeting still has a kick or two left in it, although—with the lure of Country Comfort being what it is now—his may be becoming a specialized line of work.

N.C.

STEALERS WHEEL. Stealers Wheel (vocals and instrumentals); various other musicians. *Late Again*; *Stuck in the Middle with You*; *Another Meaning*; *I Get By*; *Outside Looking In*; *Johnny’s Song*; *Next to Me*; and three others. A & M SP 4377 \$5.98, Ⓣ 4377 \$6.98, © 4377 \$6.98.

Performance: **Promising**
Recording: **Very good**

This is an inventive, promising rock group with a knack for finding just the instrumental wrinkle that fits in some neat, unexpected way that makes you back the needle up a few grooves. There are also problems. The vocals by Joe Egan and Gerry Rafferty (also the songwriters) are good, but, gosh, haven’t we heard this before? Egan, if I have sorted him out properly, sounds like a combination of Jesse Colin Young and Paul McCartney. The differential in song quality is a bit unnerving, too; you could get the bends going from strong, simple *Late Again* down to *You Put Something Better Inside of Me*, which is Klee-Shay City. Still, it all averages out pretty well, thanks to those open but never empty arrangements. And where did they get that name, anyway?

N.C.

TRAFFIC: *Shoot Out at the Fantasy Factory*. Traffic (vocals and instrumentals). *Shoot Out at the Fantasy Factory*; *Roll Right Stones*; *Evening Blue*; *Tragic Magic*; (*Sometimes I Feel So*) *Uninspired*. ISLAND SW 9323 \$5.98, Ⓣ 8WX 9323 \$6.98, © 4XW 9323 \$6.98.

Performance: **Arid**
Recording: **Very good**

Traffic has a great reputation, much of it deserved. But something—nay, nearly everything—is missing from this album. Though skillfully performed, the material (except the instrumental *Tragic Magic*) is a collection of meandering doom-saying ditties, the lyrics of which are filled either with vague symbols or flat-out statements of chilling banality. Stevie Winwood seems to take both life and his vocals lying down. Much as I’d like to report otherwise, the record is an unexpected and woeful dud.

J.V.

URIAH HEEP: *The Magician’s Birthday*. Uriah Heep (vocals and instrumentals). *Sunrise*; *Spider Woman*; *Blind Eye*; *Echoes in the Dark*; and four others. MERCURY SRM 1 652 \$5.98, Ⓣ MC8 1652 \$6.98, © MCR4 1652 \$6.98.

Performance: **Fraught and flat**
Recording: **Good**

Years ago they used to call Uriah Heep’s kind of music “acid-rock.” I don’t know what

JULY 1973



Minolta helps you discover the mysteries of women.

It takes a quick eye and a responsive camera to find the woman in every little girl.

You’re comfortable with a Minolta SR-T from the moment you pick it up. This is the 35mm reflex camera that lets you concentrate on your subject. The viewfinder gives you all the information needed for correct exposure and focusing. Because you never have to look away from the finder to adjust a Minolta SR-T, you’re ready to catch the one photograph that could never be taken again.

Next time you see a little girl playing a woman’s game, have a Minolta SR-T camera in hand. It will help you look into her future. For more information, see your photo dealer or write Minolta Corporation, 200 Park Ave. So., N.Y., N.Y. 10003. In Canada: Anglphoto Ltd., P.Q.

Minolta SR-T 101/Minolta SR-T 102



When identified by a factory-sealed “M” tag, Minolta 35mm reflex cameras are warranted by Minolta Corp. against defects in workmanship and materials for two years from date of purchase, excluding user-inflicted damage. The camera will be serviced at no charge provided it is returned within the warranty period, postpaid, securely packaged, including \$2.00 for mailing, handling and insurance.

RECEIVERS
TUNERS
AMPLIFIERS

TAPE
RECORDERS
DECKS

**LOW
PRICES**

ON FAMOUS BRAND
NATIONALLY ADVERTISED
**STEREO
COMPONENTS**

FAST DELIVERY
FACTORY SEALED CARTONS
WRITE TODAY FOR OUR QUOTE

**A.D.R.
AUDIO**

6200 CHILLUM PLACE N.W.
WASH., D.C. 20011
(202)
723-6060

SEND FOR
OUR FREE
CATALOG

SPEAKERS
CARTRIDGES
COMPACTS

ALL
STEREO
SYSTEMS

CIRCLE NO. 1 ON READER SERVICE CARD

the term for it is today, if there is one. but the music is no better now than it was then. Its characteristics are hammy vocals, puffy lyrics set to the barest of melodies, and a lot of dial-twisting on the guitar amplifier and the control board in the recording studio.

The title tune is the only one of the eight selections that comes close to being interesting. Unfortunately, it just comes close. The album reminds me of those amateur opera singers who rent Carnegie Recital Hall to give recitals for their tone-deaf friends and for those knowledgeable aficionados who need a good laugh. Uriah Heep, however, takes it all utterly seriously. Give these boys a Dutch rub and six months under house arrest.

J.V.

WISHBONE GOOF

Apologies to our readers (and to MCA Records) for the confusion resulting from Joel Vance's review of "Live in Memphis" by Wishbone Ash (June). It seems that this was one of those "for your eyes only" promo efforts not intended for commercial release, and that there are now more than a few Wishbone Ash fans understandably miffed at the record's unavailability. In our defense, we can only say that the packaging was more than a trifle vague. Nevertheless, we goofed, so again, our sincere apologies for the inconvenience, disappointment, rage, disgust, and discombobulation.

—S.S.

RECORDING OF SPECIAL MERIT

BILL WITHERS: *Live at Carnegie Hall*. Bill Withers (vocals and guitar); orchestra. *Use Me; For My Friend; Better Off Dead; Let Us Love*; and twelve others. Sussex SXBS 7025-2 two discs \$11.98.

Performance: **Interesting**
Recording: **Good**

Bill Withers picks up so many vibes, all good, from a live audience that he should consider making more recordings like this one. He has always been a good enough singer, and a more than good guitarist, but the lack of nuance in performance—a monotony from song to song—on his previous albums resulted in an eventual draining of any real interest.

As a songwriter, Withers has usually been good-to-very-good. All the material here is his own, with the exception of *I Can't Write Left Handed*, and even that he performs persuasively. The best track is *World Keeps Going Around*, in which he communicates so simply and so affectingly that the audience breathes along with him. His closing medley, *Harlem Cold Baloney*, is a true showpiece of talent and mass rapport.

This is Withers' most impressive album to date, for the reason that what is being given to him up front, on the other side of the footlights, jolts him into idiomatic and personally responsive performances that can't be generated in the recording studio. Encore. P.R.

COLLECTIONS

SOLID GOLD ROCK 'N' ROLL. Volume One: *Sh-Boom* (Crew Cuts); *The Stroll* (Diamonds); *Chantilly Lace* (Big Bopper); *One Summer Night* (Danleers); *My Boyfriend's Back* (Angels); *You Don't Have to Be a Baby to Cry* (Caravelles); *Running Bear* (Johnny

Preston); *I Saw Linda Yesterday* (Dickey Lee); *Little Darlin'* (Diamonds); *Crazy 'bout Ya Baby* (Crew Cuts); *Game of Love* (Wayne Fontana and the Mindbenders); *Come Along with Me* (Del-Vikings); *Walk Away Renee* (Left Banke); *Mendocino* (Sir Douglas Quintet); *Na Na Hey Hey Kiss Him Goodbye* (Steam). MERCURY SR 61371 \$4.98. Ⓜ MC8 61371 \$6.98. Ⓞ MCR4 61371 \$6.98.

SOLID GOLD ROCK 'N' ROLL. Volume Two: *Earth Angel* (Crew Cuts); *Church Bells May Ring* (Diamonds); *Apples, Peaches, Pumpkin Pie* (Jay and the Techniques); *Hey Paula* (Paul and Paula); *Ko Ko Mo* (Crew Cuts); *Sea of Love* (Phil Phillips); *Wooden Heart* (Joe Dowell); *A Groovy Kind of Love* (Mindbenders); *Great Pretender* (Platters); *Why Do Fools Fall in Love* (Diamonds); *Great Balls of Fire* (Jerry Lee Lewis); *A Sunday Kind of Love* (Del-Vikings); *Hey! Baby* (Bruce Channell); *Patches* (Dickey Lee); *It's My Party* (Leslie Gore); *Ahab, the Arab* (Ray



BILL WITHERS

Good vibes on an impressive live album

Stevens). MERCURY SR 61372 \$4.98, Ⓜ MC8 61372 \$6.98, Ⓞ MCR4 61372 \$6.98.

Performances: **Variable**
Recordings: **Variable**

Early rock depends on how you hear "at" it. If you go by pure nostalgia, then probably most of it sounds good. If you go by its ability—like any musical form's—to touch certain basic emotions, then early rock becomes a matter of personal taste. One gooey, sloppy, sentimental, hammy record can be great and another can be perfectly awful. One beaty, twang-twang rocker can still be thrilling and another can seem as ridiculous as it did when you first heard it fifteen years ago (provided you were a teenager during the 1950s; I was).

Much of early rock—the songs as well as the live and recorded performances—was melodramatic and vaudevillian. Sentiments so corny that they had been laughed off the legitimate stage at the turn of the century were still viable for Fifties rock. It was, above all, a youngster's music. It did not attempt to be cosmic or to vend eternal truths about people or the world or the country, as rock today has attempted to do. It was meant as specialized entertainment for a specialized audience.

BIG DISCOUNTS

STEREO COMPONENTS

Largest selection of top name brands... try us and see...

It's worth a call
(301) 488-9600



6330 Frankford Ave.
Baltimore, Md 21206

All mail answered within 24 hours

Phone Daily 9 AM to 9 PM
Saturday 9 AM to 4 PM
Phone (301) 488-9600

CIRCLE NO. 20 ON READER SERVICE CARD

Since rock today is juicy meat for sociologists, assistant professors at cow colleges, and elder critics who want to prove they can stay young by catering to the kids, it is often conveniently forgotten that rock was not the *only* musical form popular during the Fifties. nor was it at all times the dominant one, artistically or commercially. Such people as Tony Bennett, Andy Williams, Mantovani, and Ray Price sold as well then as they do now, and their records were often bought by the same people who bought rock records.

The "rock revival," insofar as it brings overdue recognition to truly original and talented artists like Bo Diddley, Chuck Berry, Little Richard, and others, is wonderful and healthy. But the rock revival has also spawned the Nostalgia Business, which has caused some record companies to go digging in their vaults and to reissue whatever they have there.

The problem with this is that Fifties rock was not the property of any one label, and certainly not of what are considered the major labels. They really had very little to do with rock-and-roll. They were slow to recognize it and fell into it almost by accident. Most of the great rock records of the Fifties were made for small independents; to get a true retrospective of what the music sounded like, you would have to combine the catalogs of dozens of these small labels. (Some smart merchandisers have done so, as the interminable radio and TV ads by such former luminaries as Chubby Checker—who is a hell of a performer, though by no means a major talent—and Fabian—who always said he couldn't sing and made records to prove it—keep telling us over and over.) So I get suspicious when any one record company offers the public a Complete Retrospective of what the songs of a whole era were like. If they use only their own catalog, they are inclined to pass off second-raters as the original stuff. RCA did it with their nostalgia series, and Mercury tries to do it here.

Mercury's collection of Fifties hits is spotty because they simply did not have that many of them. Here there are at least three cases of nonprosecutable fraud. Jerry Lee Lewis' recording of *Great Balls of Fire*, included on Volume One, is not the original one he made (and fans of the Fifties rock sound thrill to the *original* recordings, not remakes, even though the remakes may be by the same artist); Lewis went to Mercury *after* he made his wonderful, clumsy, original hits on the Memphis-based Sun label. The Diamonds, a standard second-string club act before their accidental success, had one real hit, *Little Darlin'*, which was made as a deliberate goof. They certainly did not have the real hit on *Why Do Fools Fall in Love*; that honor belongs to Frankie Lyman and the Teenagers. The Del-Vikings are remembered for two swell singles, *Come Go with Me* and *Whispering Bells*, both of which they recorded for another label; then they went to Mercury and soon faded, but while there they recorded something called *Come Along with Me*, an emulation of their first hit. This is included in the Mercury Volume One—and to the nostalgic buyer without a careful eye, it will appear to be the original.

Although the rest of the selections were genuine hits, these albums are by no means a really representative or satisfying collection of the Fifties sound. They are cleverly packaged, and there are some genuine antiques in there. But, finally, both volumes are, in content and intent, a little sleazy. J.V.

JULY 1973

While others struggle to meet the demands of discrete four channel sound...

AUDIO-TECHNICA introduces its 2nd generation 4-channel phono cartridges.

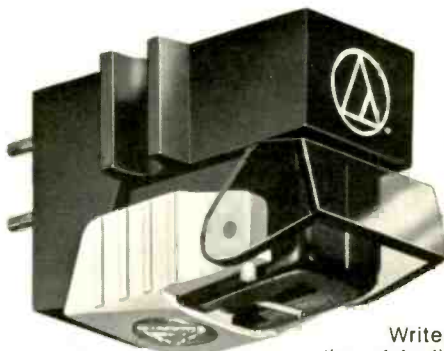

MODEL AT14S
\$75.00

Write today for technical data on the entire line of Audio-Technica Dual Magnet cartridges for every high fidelity system.

*Patents pending.

audio-technica®

AUDIO-TECHNICA U. S., INC., Dept. 73F, 1655 W. Market St., Fairlawn, Ohio 44313
CIRCLE NO. 4 ON READER SERVICE CARD

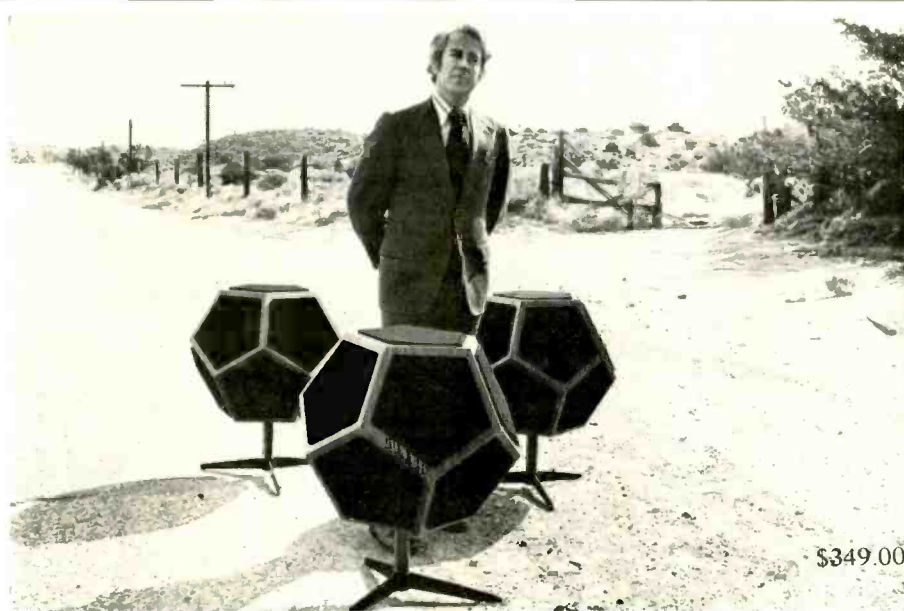

BE PATIENT, AUDIOPHILES.

Julian Hirsch has already stated "Without a doubt, the Design Acoustics D-12 is one of the finest-sounding home-speaker systems we have ever encountered."

What makes the D-12 sound so good? Well, as Mr. Hirsch said elsewhere "In our judgement, wide dispersion at all frequencies is the major factor separating an excellent speaker from a merely good one . . . unlike many other controversial (and often arcane) speaker properties . . . the unique sound can be heard by anyone, under almost any circumstance."

But unfortunately, you may not see the D-12 in most stereo shops right now. Our dealer network is growing, but you may have to look before you listen.

So, if you have problems finding us, call (213) 531-7841 collect and we will give you the name of our nearest dealer.

Most of all, be patient like we are. We know it even took time for people to believe the world is round.



P.O. Box 2722, Palos Verdes, CA. 90274

CIRCLE NO. 10 ON READER SERVICE CARD

91

JAZZ



ELLA FITZGERALD: *Ella Loves Cole*. Ella Fitzgerald (vocals); orchestra, Nelson Riddle cond. *I Get a Kick Out of You; Down in the Depths; At Long Last Love; I've Got You Under My Skin; So Near and Yet So Far; All of You; Without Love; My Heart Belongs to Daddy; Love for Sale; Just One of Those Things; I Concentrate on You; Anything Goes; C'Est Magnifique*. ATLANTIC SD 1631 \$5.98, TP 1631 \$6.98, CS 1631 \$6.98.

Performance: **As we like it**
Recording: **Splendid**

Our beloved Ella, now past the half-century mark, has done her full stint in the recording

style. After hearing both singers perhaps too many times, it may seem an academic question to most of us whether Ella or Bobby "loves" Porter's music more. But apparently Miss Fitzgerald replayed her old album and regretted having left some of her favorites out of it, so what we have here are new tapings mixed with the old in a single volume which is nothing if not pleasant to the ears, especially as Norman Granz was able to get Nelson Riddle back to his studio to play the accompaniments, as he did the first time around.

So well, indeed, has the new disc been mastered that I wasn't able to guess for sure which tunes are the new additions, but I was particularly pleased at the full-scale treatment of *Love for Sale*, the especially carefree handling of *Just One of Those Things*, and the contagion of *C'Est Magnifique*, which winds up the concert. If you like Ella Fitzgerald, "love" Cole Porter, and don't have the earlier collection already on your shelf, this new recorded edition is certainly highly recommended. P.K.

BILLIE HOLIDAY: *Strange Fruit*. Billie Holiday (vocals); various recording groups. *I'll Get By; My Old Flame; Embraceable You; I Cover the Waterfront; On the Sunny Side of the Street; I'm Yours*; and ten others. ATLAN-

forsaken robot. Billie's life so infiltrated her performances that one could read her personal joys and sorrows in her songs and delivery; like no other performer I have heard, she could express her own heartbreak in a joyful song. Phoniness was simply not in her.

The claim that these are "newly discovered and previously unreleased" recordings is not true. Most of the material has for years circulated on tape among collectors, and much of it has been available on European albums since the mid-Sixties. Not as disgraceful as ESP's release of pianist Bud Powell's last feeble attempts to capture his past brilliance, this Holiday release is nevertheless an unnecessary one, especially when one considers the wealth of excellent recordings already available.

The packaging, too, is sloppy (though we are luckily spared another set of liner notes by Maylie Dufty, whose self-serving ramblings accompanied ESP's first Billie Holiday album). For instance, *All of Me*, which is listed on both album cover and label, does not appear on the disc. What do appear are three unfortunate versions of *My Man*. A note on the album announces two more volumes to come; let us hope ESP will be discouraged from further efforts along these lines.

The Atlantic album is in another league altogether. Here, for the first time under one cover, are the sixteen titles Billie recorded for the Commodore label in 1939 and 1944. This is Lady Day at her peak, singing the famous original version of *Strange Fruit*, two of her own blues, and thirteen pop songs which she characteristically rewrote. The accompanying groups, led by trumpeter Frankie Newton and pianist Eddie Heywood, feature some of the finest black musicians of the Swing period.

The 1939 session (Billie was on loan from Columbia, which had found *Strange Fruit*'s message "too inflammatory" to record) produced four classics: *Strange Fruit*, of course, here in its definitive performance; *Yesterdays*, a poignant minor-key tune which was to become increasingly relevant to Billie, and which features a Chu Berry-ish statement by tenor saxophonist Kenneth Hollon; Billie's own *Fine and Mellow*, one of a handful of blues in her repertoire; and *I Got a Right to Sing the Blues*, featuring Tab Smith's alto sax. These alone are worth the price of the album, but the 1944 crop was also outstanding.

Three of the tunes are heard in previously unreleased takes: *Billie's Blues*, a longer version than the original; a faster version of *He's Funny That Way*; and *Lover Come Back to Me*. The latter two feature horns, which were not heard on the originally released takes, and I must confess a preference for the more familiar, trio-backed versions. Collectors will welcome these alternate takes, but, since collectors traditionally only account for a small fraction of jazz record sales, and since only *Billie's Blues* is an artistic improvement over the previously released version, I fail to understand the substitution. I would also like to have seen the recordings programmed chronologically. Those are my only real complaints, and they are minor ones. The album is superb, and I cannot recommend it strongly enough.

Overprinted, as they are, on a photograph of 52nd Street, Leonard Feather's liner notes are difficult to read, but they contribute greatly to the album's excellence. If you have not seen *Lady Sings the Blues*, and are thinking of doing so, forget it. You will learn more about Billie Holiday from two and a half minutes of the Commodore recordings here than you



HUBERT LAWS: *Poetic beauty and a touch of spice from one of the finest flute players in the nonclassical field.*

studios for the composers she "loves." I know of no other singer who might have held my attention as she did through five LPs of Gershwin songs (in the historic "Ella Fitzgerald Sings the George and Ira Gershwin Songbooks" on the Verve label). Over the years, she has done as much for the songs of Harold Arlen, Jerome Kern, Irving Berlin, and Richard Rodgers, according them two records each, also for Verve. More than fifteen years ago she also made a two-disc set for the same company in homage to Porter.

Her approach to a song is usually easy-going, dreamy, and good-humored. She will bend any tune to her own style as it suits her. Sometimes she repeats familiar mannerisms and the relaxed beat she favors to the point of monotony, yet her way with the popular classics wears well, and is especially congenial to Porter. By now we may well be numb to the tunes from *Anything Goes*, and even the image of that typical spoiled Porter heroine "down in the depths on the ninetieth floor" may fail to provoke the requisite supercilious smile, but as people like Bobby Short rummage among the non-hits in that fabulous trunk for fresh material, Porter's urbanity and hand-in-glove matching of tune to lyric and sentiment continue to afford delight, especially to those of us who grew up humming his songs. They may never go completely out of

TIC (M) SD 1614 \$5.98, TP 1614 \$6.98, CS 1614 \$6.98.

Performance: **Peak of perfection**
Recording: **Faithful mono**

BILLIE HOLIDAY: *1953-56 Radio and TV Broadcasts*. Billie Holiday (vocals); Count Basie Orchestra; other unidentified groups. *God Bless the Child; I Cover the Waterfront; Lover Come Back to Me; My Man; Billie's Blues*; and eight others. ESP-Disk' ESP 3003 \$5.98.

Performance: **Not for posterity**
Recording: **Unbalanced**

Few artists have been as widely discussed, re-evaluated, and exploited in recent months as Billie Holiday. The fact that new generations are discovering the greatness of Lady Day somewhat lessens the pain of seeing her shamefully exploited in a ridiculous screen version of her "life" as Hollywood has chosen to portray it, but it is adding insult to injury when record companies ride the crest of the wave with further exploitation. The ESP album is a sad case in point.

Capturing more pathetic moments than good ones, these recordings of broadcasts from the mid-Fifties do Billie Holiday a great disservice, but even at her worst this incredible artist makes Diana Ross sound like a soul-

could from two and a half hours of that film.
C.A.

PAUL JEFFREY: *Family* (see Best of the Month, page 77)

YUSEF LATEEF: *Hush 'n' Thunder*. Yusef Lateef (tenor saxophone, shennai, flute, pneumatic flute); Jimmy Owens (flugelhorn); Kenny Barron, Ray Bryant (piano); Kermit Moore (cello); Al White (organ); David Spinozza, Cornell Dupree, Keith Loving (guitar); Bob Cunningham, Gordine Edwards, Bill Salter (bass); Kuumba "Tootie" Heath (drums); Monroe "Bones" Constantino (vocals); the J. C. White Singers. *Come Sunday; The Hump; Opus, Parts I and II; This Old Building*; and four others. ATLANTIC SD 1635 \$5.98, TP 1635 \$6.98, CS 1635 \$6.98.

Performance: **Disappointing**
Recording: **Good**

Yusef Lateef is a man of many assets, not the least of which is his sense of humor, but unfortunately his humor seems to have gotten out of hand in this release. A strange mixture of the beautiful (*Come Sunday*) and the dreadful (*Prayer*), "Hush 'n' Thunder" is mostly the latter, wasting the talents of such remarkable musicians as Kenny Barron, Bob Cunningham, and Ray Bryant (who appears on one track, but is barely heard) and featuring a sloppy choral group (the J. C. White Singers) and the alleged "vocals" of one Monroe Constantino, who never should have stepped out of oblivion.

In my opinion, Yusef Lateef has far greater talent than this album indicates. If I seem unduly harsh, it is probably because I admire Lateef so much, and I feel he has let me down. His performance isn't really all that bad here, but if you don't have his previous albums already, pick up one of them instead of this one.
C.A.

RECORDING OF SPECIAL MERIT

HUBERT LAWS: *Morning Star*. Hubert Laws (flute, alto flute, piccolo); orchestra. Don Sebesky arr. and cond. *Where Is the Love; Amazing Grace; No More*; and three others. CTI RECORDS 6022 \$5.98, CT8 6022 \$6.98, CTC 6022 \$6.98.

Performance: **Smooth**
Recording: **Excellent**

Hubert Laws has recently emerged as one of the finest (some say *the* finest) flute players in the nonclassical field today. CTI Records has established itself as a label of consistent high quality and good taste. Not surprisingly, the combination continues to yield some exquisite harvests.

With an impressive number of backers—including his two sisters, Eloise and Debra—Hubert Laws soars effortlessly around *Morning Star*, brings out poetic beauty in his own compositions *Let Her Go* and *What Do You Think of This World Now?*, and tells those Highlanders to pack up their bagpipes with a rendition of *Amazing Grace* that truly befits the title.

Don Sebesky's imaginative arrangements give the whole affair a lushness that guarantees wide appeal, and Laws' performance (not to mention that of Ron Carter, Billy Cobham, Garnett Brown, and others) adds the spice that will attract those who might see nine violins, three cellos, and a harp as a threat to their enjoyment.
C.A.

Lowest of the LOW!

Shamelessly Low Prices . . .

As one of America's largest wholesale distributors, we're guilty of shamelessly low prices. Our buying volume has made our prices the lowest. We seriously doubt you can find one lower . . . and that we're proud of. What's more, at S.C.A. you can select from hundreds of NEW, Factory Sealed, Full Warrantee, Brand name, Hi-Fi Stereo components. If its in the Hi-Fi, Audio field . . . we have it!

Write for a lowest of the low quote . . . we're not ashamed.



STEREO CORPORATION OF AMERICA



2122 UTICA AVENUE, BROOKLYN, NEW YORK 11234 (212) 338-8555

CIRCLE NO. 49 ON READER SERVICE CARD

ABOUT YOUR SUBSCRIPTION

Your subscription to STEREO REVIEW is maintained on one of the world's most modern, efficient computer systems, and if you're like 99% of our subscribers, you'll never have any reason to complain about your subscription service.

We have found that when complaints do arise, the majority of them occur because people have written their names or addresses differently at different times. For example, if your subscription were listed under "William Jones, Cedar Lane, Middletown, Arizona," and you were to renew it as "Bill Jones, Cedar Lane, Middletown, Arizona," our computer would think that two separate subscriptions were involved, and it would

start sending you two copies of STEREO REVIEW each month. Other examples of combinations of names that would confuse the computer would include: John Henry Smith and Henry Smith; and Mrs. Joseph Jones and Mary Jones. Minor differences in addresses can also lead to difficulties. For example, to the computer, 100 Second St. is not the same as 100 2nd St.

So, please, when you write us about your subscription, be sure to enclose the mailing label from the cover of the magazine—or else copy your name and address exactly as they appear on the mailing label. This will greatly reduce any chance of error, and we will be able to service your request much more quickly.

Great Listening
Pleasure
Doesn't
Come
Cheap.
...Or Does It?

Yes, it does! We're one of the country's largest Mail Order Houses of Stereo Equipment and components. We pass our volume buying power right along to you.

BALTIMORE
Stereo Wholesalers

WRITE OR PHONE FOR QUOTATIONS
AND OUR LATEST CATALOG!
7A Aylesbury Road
Timonium, Md. 21093 • 301,252-6880

CIRCLE NO. 6 ON READER SERVICE CARD

THIS

OVER **67** YEARS
OF RELIABILITY

IS WHY STEREO & HI-FI
BUYERS CAN BE SURE OF

SAVINGS AT RABSONS

At Rabsons Competitive Prices, Reliability and Personal Service have been bywords for over 67 years.

It's so EASY and SAFE to deal with Rabsons. As close as your telephone — as near as your mailbox • Fast Air Mail Response on Quotation Requests • Franchised Distributor for Hi Fi Lines • All merchandise brand new in factory sealed cartons, shipped double-packed, fully insured promptly from our warehouse • Greater savings on complete systems • Export packing • 220 Volts, 50 Cycle merchandising a specialty • Free list of monthly specials.

BEFORE YOU BUY GET A RABSONS
QUOTE... YOU'LL BE GLAD YOU DID!

RABSONS 57 ST. INC.
119 West 57th Street, New York, N. Y. 10019
Tel. Area Code 212-338-8555

CIRCLE NO. 38 ON READER SERVICE CARD

There's hope for Broadway in A LITTLE SONDHEIM

Two reviews by REX REED



AUTHENTIC genius is never recognized until the genius is dead, so the saying goes, but Stephen Sondheim is proving it a lie. At forty-three he has composed the music and/or lyrics for only (!) eight Broadway shows and one television special, yet practically everybody who knows or cares anything about the subject regards him as already the most important force in American theater music since Cole Porter. His songs are witty, sardonic, intelligent, brilliantly structured, and, above all, courageous. If there's a tired old rule to be broken, he breaks it. If there's a bright new idea kicking around, he has it. And since the whole rollicking history of Broadway musicals is seemingly at his talented fingertips, when a new chord must be struck, he strikes it. All of which explains why the opening of a new show by Stephen Sondheim automatically becomes an Event.

The event at hand, the composer's latest contribution to the great tradition, is a dazzling tour de force called *A Little Night Music*. It is his most ambitiously conceived and richly creative work to date, and it has just been recorded to a fare-thee-well by Columbia Records. *Night Music* is based on Ingmar Bergman's famous film *Smiles of a Summer Night*. It is adult, intelligently crafted writing, and it requires an equally intelligent commitment from the listener. Columbia's original-cast album, moreover, is one of the best-recorded discs I've ever

heard in the musical-comedy genre. Nothing has been deleted or shortened for reasons of time or space, and a complete set of Sondheim's provocative lyrics is included in case you want to follow along when the listening gets tricky. I found this an enormous help, because the songs are anything but simple, many of them being written in a variety of quick-changing tempos involving what sounds like myriad voices singing different sets of lyrics at the same time. Much of the score is for me evocative of Strauss and Ravel (the setting is turn-of-century), and some of it might be said to border on contemporary opera—or is that still a dirty word? After two or three playings, however, the mysteries and the haunting dissonances resolve themselves, and you will probably then find yourself, as I did, open to the music's thrilling rhythmic pulse.

LIKE the arcane games and puzzles Sondheim reportedly collects as a hobby, his songs are not made up of mere surfaces, their inner workings as exposed as the contents of an open-faced sandwich. They are rather like fine watches, and just as functional. They often literally take the place of dramatic scenes, with the dialogue being sung instead of spoken. And, to serve the needs of drama, they need to take many forms. The score of *Night Music*, for example, contains patter songs, contrapuntal duets and trios, a quartet, and even a dra-

matic double quintet to puzzle through. All this has been gorgeously orchestrated by Jonathan Tunick; there is no rhythm section, only strings and woodwinds to carry the melodies and harmonies aloft. The total effect is consistently vocal, consistently dramatic. Even when the music is least hummable—hummability isn't everything—your attention is held, waiting to pounce on the clue that will lead you into the meaning of the next song. My own favorite is *Send In the Clowns*, a ripely over-the-hill sigh by Glynis Johns that throbs with worldly wisdom. And I have never heard a better set of lyrics than those for *Liaisons*, a lament croaked with sad regret by Hermione Gingold in the role of an old duenna who longs for the dear dead days when people had taste and style. "Where," asks Gingold ruefully, "is style? Where is skill? Where is forethought? Where's discretion of the heart, or passion in the art, where's craft?" Stephen Sondheim is of course answering all these questions before we've even had a chance to let them soak in. His is the style that is happening today in theater music: he is where the craft is. His work renews my faith that whatever temporarily ails that "fabulous invalid" called Broadway, it is not terminal, and the patient will move on not only to recovery, but to better health than ever. As a matter of fact, I feel a lot better myself. Sondheim has taken the musical and dramatic values of such great predecessors

as Arlen, Berlin, and Porter and catapulted them into the turbulent Seventies. His music has enriched my life, and it's a tonic I fully endorse for anybody who is as fed up as I am with the clutter and clatter that is passing itself off as music these days.

IT was further demonstrated, on Sunday evening, March 11, at New York's Schubert Theater, that this particular musical cause is far from lost, for on that night 1,600 celebrities, journalists, socialites, and just people with good musical taste (and a little money) gathered at a \$100-a-seat benefit (for the National Hemophilia Foundation) to honor the composer with a testimonial bouquet called "Sondheim: A Musical Tribute." The show presented more than forty Sondheim songs and lasted four hours: Warner Brothers has just issued a two-disc set of the event's highlights that might as well be labeled a collector's item right now.

At a time when cacophonous rock and anemic high camp from former eras threaten to overrun the culturally deprived wasteland of Broadway, such an evening must have seemed to many, as it did to me, a glorious oasis. One by one, the biggest talents in show music saluted Sondheim's achievement by performing to perfection his songs of complex sentiment, wry humor, and contemporary sophistication. The recorded version of the event—it is live, of course—is something less than a sonic triumph: microphones pop, the balances are occasionally uneven, stereo emphasis wanders, and separation sometimes disappears. Laryngitis and other vocal problems plagued some of the performers (this probably accounts for the absence of some expected numbers), and legal complications made it

numbers in with just enough of the ovations and cheers to give a rounded "you are there" feeling without turning it into another of those recorded applause meters so dear to the heart of Marlene Dietrich and so boring to the rest of us.

Some of the more familiar Sondheim items are included: Alice Playten, that mini-Munchkin with the steamroller voice, and Virginia Sandifur add new punch to *If Mama Was Married* from *Gypsy*; Chita Rivera and Pam Myers turn *America* into a rousing Puerto Rican street festival; and Angela Lansbury brings down the house with two selections from the popular but short-lived *Anyone Can Whistle*. The songs from *Company* included here are better recorded than they were in the original-cast album (listen carefully to the inventive musical embroidery of bride, groom, and church soloist on the tongue-twisting *Getting Married Today*; I finally realized how special this song is because I was able for the first time to hear the counter-parts clearly enunciated). Finally, simply everything from *Follies* is better recorded here than on the dismal original-cast recording for Capitol, especially the unabridged version of *I'm Still Here*, one of Sondheim's cleverest songs. Nancy Walker's reading of the full set of lyrics simply outclasses Yvonne De Carlo's.

And now, if you're ready, for the "inside" surprises. One of Sondheim's most lamentable career gambles was his collaboration, as lyricist, with Richard Rodgers on *Do I Hear a Waltz?* One song in particular, a bubbly ditty in the old Rodgers-Hart tradition called *We're Gonna Be All Right*, was considered too cynical for Rodgers' homespun taste, and the lyrics were changed.

presented some songs most of us haven't heard before, and eleven are included in the Warner Brothers album. Among them are *Silly People*, a rather Chekhovian love song for a lusty servant, beautifully performed by George Lee Andrews; *One More Kiss*, a Romberg-like waltz that didn't make it into the *Follies* album; a plaintive love duet, with Jack Cassidy and Susan Browning, called *So Many People* and written for Sondheim's first show, *Saturday Night* (never produced); and two selections from *Evening Primrose*, a TV special about department-store mannequins that come to life after closing hours (never before recorded). And finally, as a closing throat-catcher, the composer himself stepped to the stage amid shattering applause, sat down at the piano, and movingly played and sang his own favorite, the title song from *Anyone Can Whistle*. This is but a modest once-overlightly of what is contained on these four sides, and any part of it is worth the asking price for the whole.

BUT that's not quite all. Warner Brothers has spent what looks like a fortune packaging all this—amazing considering the fact that the record company is donating all royalties to the American Musical and Dramatic Academy and the National Hemophilia Foundation. (The performers donated their talents as well, of course. Don't tell me philanthropy is dead.) The package includes a six-page insert containing photographs of the stars in actual performance, notes on the previously unrecorded songs, and two pages of production stills and vital statistics of every Sondheim show. There is also a capsule account of the entire Sondheim career. All of which constitutes something of a miracle by today's recording standards. There are so many people who should be congratulated that I hardly know where to begin. So I'll just skip the formalities, and you go off and play the records. Get to know what a miracle sounds like.

Taken together, I think these two Sondheim albums are very much the cream of everything that is going on in American theater music today and are therefore the record event of the year as well. It is genius recognized, and thank goodness. If Sondheim is properly encouraged now, the rest of us can only look forward to many more years of benefit. Nothing posthumous about that.

A LITTLE NIGHT MUSIC (Stephen Sondheim). Original-cast recording. Glynis Johns, Hermione Gingold, Len Cariou, Victoria Mallory, Patricia Elliott, Mark Lambert; others. Orchestra, Harold Hastings cond., Jonathan Tunick arr. COLUMBIA KS 32265 \$6.98, SA 32265 \$6.98, ST 32265 \$6.98.

SONDHEIM: A MUSICAL TRIBUTE. Twenty-nine songs by Stephen Sondheim recorded in live concert. Larry Blyden, Len Cariou, Jack Cassidy, Dorothy Collins, Hermione Gingold, Glynis Johns, Larry Kert, Angela Lansbury, Anthony Perkins, Alice Playten, Chita Rivera, Alexis Smith, Nancy Walker; others. Orchestra, Paul Gemignani cond., Jonathan Tunick arr. WARNER BROS. 2WS 2705 two discs \$9.95.



Above, *West Side Story* collaborators Stephen Sondheim and Leonard Bernstein; facing page, Angela Lansbury sings at the benefit performance. *Night Music* set in background.

impossible to include Leonard Bernstein's moving piano recollections of *West Side Story* (Sondheim's lyrics, remember?) as well as selections by Glynis Johns and Hermione Gingold from *A Little Night Music*. But all such minor carping aside, it is an album that gives us the brightness and beauty of Broadway show music at its spit-and-polish Sunday best. Skillful editing has shaped and blended the show-stopping

Here we get the original, in its only recording, and it turns out to be a very cherishable song about some of the sour social attitudes that are poisoning contemporary marriages.

Last-minute cancellations by Ethel Merman, Phil Silvers, and Zero Mostel foreclosed the possibility of including much of the material from *Gypsy* and *A Funny Thing Happened on the Way to the Forum*, but I didn't miss them at all. Instead, the show



Say it again, Stan— We love the sound of your words!

As a matter of fact, Stanton has so many wonderful quotes on the warranty cards that purchasers send in, that we are letting them write this ad.

"The best sound I have ever heard from my sound system—fantastic!"

Jeff E. Booker, 4425 N. 150th St., Brookfield, Wis. 53005

"Very comfortable. Stylish, Excellent Sound."

Gary A. Wanlin, 3266 Cropley Ave., San Jose, Calif. 95132

"Absolutely Great—especially by comparison."

John E. Robinson, 199 Middle Rd. E. Portland, Me.

"The headphone is the best I've heard."

Eddy Schreyer, 5701 Cahill Ave., Tarzana, Calif. 91356

"Good sound, much better than other comparable brands. Excellent design."

Terry Ames, 2602 Calhoun St., Alameda, Calif.

"Excellent bass response. Comfortable headset."

Phil Lulewicz, 15335 Stetson Rd., Los Gatos, Calif. 95030

"The most amazing, most natural sound I've ever heard."

Stephen Sandoz, 6815 S.W. 12th Ave., Portland, Oregon

"Excellent. Best I've listened to."

J. L. Hubbard, 3625 Pine, Long Beach, Calif.

"The best I have ever used or heard."

Howard J. Millbank, 2260 Adair St., San Marino, Calif. 91108

"Sound quality is vibrant and separation is excellent. Prefer Stanton over [censored]"

Thomas L. Saunders, 2408 Phillips Dr., Alexandria, Va. 22306

"Excellent performance. Fantastic Power handling capability."

Todd Sadow, 20 Black Hawk Road, Scarsdale, N.Y. 10583

"The best I have ever heard."

Ronnie Lustig, 933 Percy Warner Blvd., Nashville, Tenn.

"Excellent, best I have ever heard."

Richard Sirois, 508 S. Michigan, Plymouth, Ind.

"Excellent."

Florence A. Davis, 191 Congress Ave., Providence, R.I.

"Excellent."

Steven D. Melchior, 4540 Hazeltine Ave., No. Hollywood, Calif.

"The headset is the most comfortable and best sounding I have seen."

Craig Biggs, 285 Andsbury Ave., Mt. View, Calif. 94040

"The best of 20+ headsets tested."

Michael Fink, 17162 Erwin Lane, Huntington Beach, Calif. 92647

"FANTASTIC!"

Brian D. McCarty, 364F Vinton Ave., Palms, Calif. 90034

"FANTASTIC!"

James P. Schwider, 5520 W. 190th St. 151, Torrance, Calif. 90503

And, that is only a sampling...
we have thousands more!



For complete information
write Stanton Magnetics, Inc.,
Terminal Drive, Plainview,
New York 11803.

STANTON

"Manufacturers of the World Famous Stanton Calibration and Professional Broadcast Cartridges."



CLASSICAL DISCS AND TAPES

Reviewed by DAVID HALL • BERNARD JACOBSON • GEORGE JELLINEK • IGOR KIPNIS
PAUL KRESH • ERIC SALZMAN • LESTER TRIMBLE

BACH-SILOTI: *Prelude in D Major, from Cantata No. 29; Siciliano in G Minor, from Flute Sonata in E-flat Major (BWV 1031); Organ Toccata and Fugue in D Minor (BWV 565); Little Organ Prelude in E Minor (BWV 555); Prelude in D Minor (Sinfonia, Pt. II), from Cantata No. 35; Chaconne, from Violin Partita No. 2, in D Minor (BWV 1004); Prelude in B Minor, from Clavierbüchlein für W. F. Bach (BWV 855a); Organ Prelude in G Minor (BWV 535).* Bernardo Segáll (piano). ORION ORS 73113 \$5.98.

Performance: **Distinguished**
Recording: **Good**

Alexander Siloti, who was born in Russia in 1863 and died in New York in 1945, studied with, among others, Tchaikovsky, Nicholas Rubinstein, and Liszt, and he was one of the outstanding pianists of his generation. As a teacher in this country, he was a member of the Juilliard faculty, and he edited a considerable amount of music. Of his arrangements of Bach, of which there is an excellent sampling on this new Orion disc, he is best known for the Organ Prelude in G Minor, a staple in the repertoire of many pianists (I remember working on it as a teenager myself). Generally, though, his Bach adaptations are not nearly as well known as those of other late-Romantic pianists, for example, Busoni, Liszt, Tausig, Reger, D'Albert, and the like. Siloti's are cast in the same general mode, although he sometimes refrains admirably from filling in too much. His version of the *Cha-*

conne, for example, is not quite as true to the original as the fascinating Brahms setting for left hand, but on the other hand it eschews some of the extra-Bach effects of Busoni's more celebrated transcription and, I think, is the better for it.

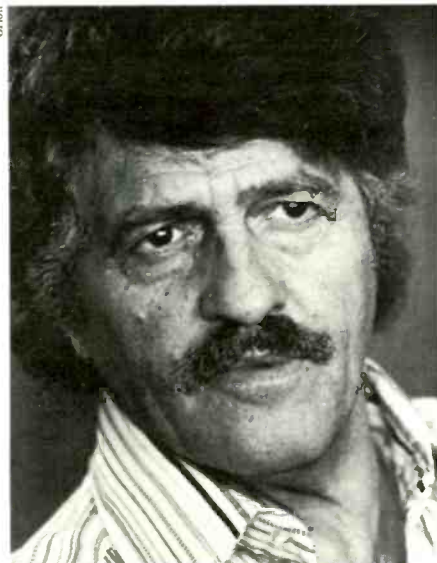

BERNARDO SEGÁLL
Ideal interpreter of Bach piano transcriptions

Judging from the samples here, Siloti's way with Bach is well worth hearing, especially as a supplement to the kind of musical excavation that has been the result of the Romantic Revival. For, make no mistake, this sort of transcribing is just as much a part of that movement as original, non-arranged instrumental pieces of the period. I don't think that one ought to listen to such transcriptions for their faithfulness to Bach or as a substitute for the original thing, but rather as an important contribution of and insight into the Romantic ethos. In this sense, listening to Siloti's Bach can be a very pleasurable experience, provided the performance adheres to the Romantic stylistic tradition and includes lots of brilliance, tonal variety, rubato, and rhetorical flamboyance.

All of these qualities may be heard to superior effect in the playing of the Brazilian-American pianist Bernardo Segáll, who studied with Siloti for ten years and who planned this recital as an homage to him. Segáll plays all of these transcriptions with such obvious sympathy and technical mastery that I am sorry he has not (to my knowledge) recorded very much recently, the last time being before 1958. He would be an ideal interpreter, say, for the Godowsky transcriptions of some of the Bach violin and cello sonatas and suites. Perhaps Orion can persuade him, and perhaps the company can also provide a slightly less close-up and less constricted (notably at the side ends) piano sound than one hears here. *I.K.*

RECORDING OF SPECIAL MERIT

BEETHOVEN: *Piano Concertos: No. 1, in C Major, Op. 15; No. 2, in B-flat Major, Op. 19; No. 3, in C Minor, Op. 37; No. 4, in G Major, Op. 58; No. 5, in E-flat Major, Op. 73 ("Emperor").* Friedrich Gulda (piano); Vienna Philharmonic Orchestra, Horst Stein cond. LONDON STS 15203-6 three discs \$8.94.

Performance: **Superb**
Recording: **Good, but . . .**

It is decidedly courageous of a pianist to record all five of the Beethoven piano concertos and allow them to be gathered together in one album. Such an album cannot fail to set forth the artist's strengths and weaknesses with an accuracy that can be cruel indeed. For these works are the very core of the piano-concerto repertoire, and to a large extent a pianist's mastery of them indicates his ability in the entire Classic and Romantic repertoire.

It is obvious in listening to these London discs that Friedrich Gulda neither flinched from the challenge nor had any reason to do so. With utter consistency, he has produced performances that intrigue the ear, the mind, and the heart, and conductor Horst Stein and the Vienna Philharmonic accompany him to perfection. Though Stein's training was not Viennese, Gulda's was, and the qualities of lyricism and textural refinement that one associates with Vienna are splendidly on display here. *(Continued overleaf)*

Explanation of symbols:

- Ⓜ = reel-to-reel stereo tape
- Ⓢ = eight-track stereo cartridge
- ⓐ = stereo cassette
- Ⓛ = quadrasonic disc
- Ⓡ = reel-to-reel quadrasonic tape
- ⓑ = eight-track quadrasonic tape
- ⓐ = quadrasonic cassette

Monophonic recordings are indicated by the symbol Ⓜ

The first listing is the one reviewed; other formats, if available, follow it.

Beethoven's youth and his slightly rebellious brand of Classicism are major ingredients of the First and Second Concertos, and Gulda brings these qualities to the fore with unflinching elegance, knitting phrases and motives together with consummate faithfulness to the ideas themselves. Slow-movement melodies sing with unbroken eloquence and perfect dynamic balances. The orchestral playing achieves exactly the same technical and musical character. Where the one leaves off and the other takes up is purely a matter of instrumental change, not of phrasal or stylistic interruption.

In the later concertos, where the weight of Beethoven's increased maturity is evident, Gulda and Stein increase the emotional richness without losing the delicate edge of lyricism and refinement that makes all this music reveal itself most fully. Gulda's slow spinning out of the touching and frightening melodies of the Fourth Concerto's slow movement is an enchantment, and the orchestra's dramatic-rhythmic collaboration borders on true wizardry.

I do have two complaints to lodge against these otherwise remarkable recordings. The first has to do with the sound itself, which is heavy in the bass and sometimes murky down there as well. On some of the discs, turning down the bass control helps. In other cases it does no good. My second complaint is that the woodwinds are a bit blowsy from time to time. The oboes, especially, are wont to inject an unpolished detail into an otherwise lovely texture. On balance, though, I do not find either of these aspects weighing very heavily. These are performances that I will be happy to keep in my library. *L.T.*

BEETHOVEN: *Piano Sonatas: No. 24, in F-sharp Major, Op. 78; No. 30, in E Major, Op. 109; No. 31, in A-flat Major, Op. 110. Six Bagatelles, Op. 126. Rondo in G Major, Op. 51, No. 2.* Jörg Demus (piano). BASF KHF 20328 two discs \$11.96.

Performance: **Unique**
Recording: **Rather over-reverberant**

How did Beethoven's piano sonatas sound to his contemporaries in Vienna? Didn't the pianos of that day, lacking the metal frames and high-tension overstringing of today's instruments, sound impossibly puny for the ideas propounded in such sonatas as the *Appassionata* and the *Hammerklavier*?

An answer of sorts is given by this two-record set, issued in the U.S. by BASF, from tapes of the European Harmonia Mundi label. The piano used here is the last one Beethoven owned—an instrument presented to him around 1825 by the Viennese maker Conrad Graf. When it was placed in the Beethovenhaus in Bonn in 1889, the piano was no longer in playable shape, but it was restored in 1964, and the present recordings were made in the Augustusburg Castle near Cologne—in 1972 if we go by the date on the record labels. I was distressed by the lack of detailed technical information in the album notes concerning the Graf piano, but from what I can see in the cover photograph, Beethoven's Graf appears to be a double-strung, six and one-half octave instrument.

I played the works recorded by Mr. Demus in chronological order, beginning with the Rondo in G Major and concluding with the Op. 126 Bagatelles. Most disconcerting on first hearing is the sharp "break" between the upper and lower registers of the Graf—almost

like that of a John Cage "prepared" piano. Running passages in the upper register were wonderfully smooth and brilliant, while solemn slow episodes in the lower register were endowed with remarkable sonority and considerable dynamic power; certainly, I did not expect as much from the *Prestissimo* of Op. 109 or the B Minor piece from the Bagatelles as emerged here. On the other hand, when the continuity of line and phrase passed between the lower and upper keyboard registers, the result, to my Steinway-Baldwin-Boesendorfer-conditioned ears, at least, can only be described as disconcerting. On the plus side, a fascinating aspect of the Graf as a conveyor of Beethoven's musical thought was the effect produced by the "soft" pedal in the ethereal *pp* slow-movement episodes of the two late sonatas: it lends a truly veiled timbre to the music, which is what Beethoven himself must have had in mind.



The Graf piano given to Beethoven around 1825, the last one acquired by the composer

In general, I found performance and piano most effective for intimate lyrical pieces and for those with swift right-hand running passages. But I do find it rather hard to accept the Graf as the vehicle for the late Beethoven sonatas, especially since the composer also had, at the time of writing these works, a more full-bodied-sounding English Broadwood piano, which he undoubtedly had in mind when he was composing the gigantic *Hammerklavier* Sonata. A comment from Beethoven's piano-virtuoso friend, Ignaz Moscheles, as quoted in Arthur Loesser's classic *Men, Women and Pianos*, is quite illuminating in this connection (Moscheles had borrowed Beethoven's Broadwood for a Vienna concert, where he played it alternately with his own Graf): "I tried in my Fantasia to show the value of the broad, full, though somewhat muffled tone of the Broadwood piano, but in vain. My Vienna public remained loyal to their countryman—the clear, ringing tones of the Graf were more pleasing to their ears."

With all due respect to Demus' knowing and sensitive performances, and despite the interest of the piano itself, I must mention yet another aspect of these discs, a factor which I feel plays both performer and piano (and Beethoven) false, and that is the excessively hard and reverberant ambience of the recording locale. In all, then, this album is a brave but not wholly successful attempt to get us closer

to the music as it was known in Beethoven's time. *D.H.*

BERLIOZ: *Reverie and Caprice* (see **GO-DARD**)

BERLIOZ: *Romeo and Juliet* (see **TCHAI-KOVSKY**)

BIZET: *Premier Nocturne; Variations Chromatiques* (see **GRIEG**)

BRAHMS: *Lieder. Wenn du nur zuweilen lächelst; Es träumte mir; Ach, wende diesen Blick; Unbewegte, laue Luft; Das Mädchen spricht; Mädchenlied; Vergebliches Ständchen; Ständchen; Am Sonntag Morgen; Während des Regens; O kühler Wald; Von ewiger Liebe; Es steht ein Lind' in jenem Tal;* and five others. Elly Ameling (soprano); Norman Shetler (piano). BASF KHB 21021 \$5.98.

Performance: **Lacks dimension**
Recording: **Good**

Together with some familiar Brahms songs, this recital also offers a few rarely heard ones, among them four songs on texts by Georg Friedrich Daumer from the Op. 57 collection of 1871. Elly Ameling is an ingratiating artist who sings with a bright tone, secure musicianship, and fine intonation, though her diction is not uniformly clear. She is most effective in the folksongs; the more passionate or more searching songs like *Es träumte mir* or *Ach, wende diesen Blick* call for more involvement, depth, and color variety. Her vocal sound, however, is consistently enjoyable, and she receives sympathetic accompaniments. Voice and piano are well balanced, but my review copy had some noisy surfaces. *G.J.*

BRAHMS: *Piano Quintet in F Minor, Op. 34.*
HAYDN: *String Quartet in D Major, Op. 64, No. 5 ("Lark").*
SCHUMANN: *Piano Quintet in E-flat Major, Op. 44.* Flonzaley Quartet; Harold Bauer (piano, in Brahms); Ossip Gabrilowitsch (piano, in Schumann). RCA VICTROLA © VCM 7103 two discs \$6.98.

Performance: **Brahms great, others good**
Recording: **Decent, historical**

BRAHMS: *Piano Quintet in F Minor, Op. 34.* André Previn (piano); Yale Quartet. ANGEL S 36928 \$5.98.

Performance: **Great**
Recording: **Superb**

A month has to be counted as exceptional if it brings not just one but two great performances of the Brahms Piano Quintet. But beware of regarding the phenomenon as indicative of a "trend" in our chamber-music life. One of the two performances under review here was recorded four years before the pianist in the other one was born.

Curiously, the differences between the way Harold Bauer and the Flonzaley Quartet played this sublime work in 1925 and the way André Previn and the Yale Quartet play it today—relatively minor differences in any case—tend in a direction quite different from what one might expect from popular conceptions of "golden-age" and "contemporary" performing styles. The older version is characterized pre-eminently by directness and unflagging drive, whereas the newer one is more concerned with subtlety, sensibility, and lingeringly affectionate phrase building.

(Continued on page 101)

The classics from KLH. Four bookshelf loudspeakers of such extraordinary quality that each has set the standard of excellence in its price range. Pictured to the far left, our popular little Thirty-Two (\$55.00†). Next, one of the best selling loudspeakers in the country, the Seventeen (\$79.95†). Up front, everybody's favorite, the Six (\$139.95†). And finally, our most spectacular bookshelf model, the Five (\$199.95†). If you really

want to know what KLH is all about, we suggest you listen to any one or all of these fine loudspeakers. And when you do, we're sure you'll agree that KLH is about the best thing to happen to bookshelves since books.

For more information, visit your KLH dealer or write to KLH Research and Development Corp., 30 Cross Street, Cambridge, Mass. 02139.

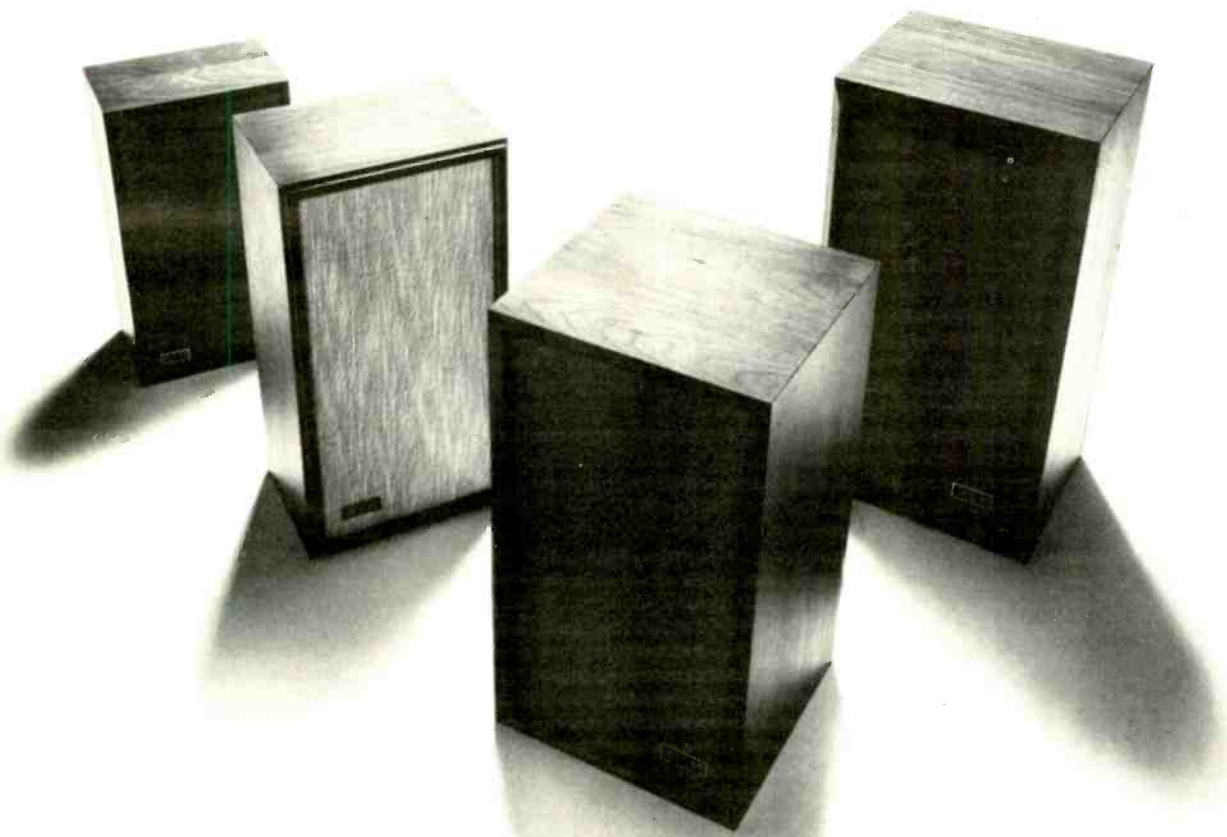

What's a bookshelf without the classics?

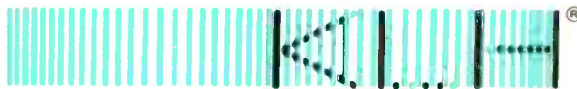

KLH RESEARCH AND DEVELOPMENT CORP.
30 Cross St., Cambridge, Mass. 02139

†Suggested retail prices—slightly higher in the South and West.

Deutsche Grammophon's new
CARMEN

"...vocally and musically
the finest Carmen I know"

Reviewed by ERIC SALZMAN



Louis Meisner/Metropolitan Opera Assn.

WELL, here it is at last: the Bernstein/Horne/Deutsche Grammophon quarter-of-a-million-dollar *Carmen*. This is not only the first big-scale American operatic production since the ill-fated Leinsdorf/Boston/RCA *Lohengrin* and the first recording by the Metropolitan Opera since the *Macbeth* of the Fifties, but the first European venture into American operatic waters and one of the most elaborate and expensive recordings ever made as well.

Was it worth it? Well, there's no purely objective way of measuring these things (one is always inclined to be subjectively dubious if not downright cynical about such super-productions). But it is an impressive recording and—now comes the heresy—much better, in my opinion, than the highly touted live production.

This *Carmen* was to have been general manager Goeran Gentele's first Met production, and he was to have directed it himself as the opening event of the 1972-1973 season. There was a great deal of talk about restoring the original version and creating a production based on dramatic and psychological values. Fate intervened in the form of an auto crash, and Gentele was gone. But under the direction of his assistant, Bodo Igesz, with an excellent cast headed by Marilyn Horne, James McCracken, and Tom Krause, and with Leonard Bernstein at the helm, the production nonetheless turned out to be virtually the musical event of the year in New York.

I went to that production with every expectation; Lennie's downbeat and the orchestral introduction fairly crackled with excitement and tension. Then the curtain went up. Josef Svoboda's sets looked curiously dingy—not at all the sort of thing one remembered from his fabulous Prague designs. When the chorus arrived at its usual comfortable half-beat behind the conductor, a wave of nostalgia swept over me. Just like the good old days! True, the version was a little different, what with spoken dialogue and all. But perhaps it might have made a nicer effect if one could only have been sure what language they were using (it did seem odd to go to all the trouble of restoring the original edition for a performance in Middle-Low-Français). And while I'm perfectly

willing to admit that Marilyn Horne and James McCracken can sing up a storm, I would not call their assignment to the roles of Carmen and Don José exactly ideal casting. Finally, whatever ideas the staging was intended to communicate, the actual results were more in the tradition of Varsity Camp than Moscow Art. Some things just never change; the "New" Met was indistinguishable from the Old.

But the recording of the new production is something else. Ironically, the dramatic values are enhanced—the recording is very well produced from this point of view, and one's own inner visualization is not spoiled by the sight of Marilyn Horne wriggling her ample hips, struggling to play the castanets, and camping it up with McCracken. And the musical values—some, such as Ms. Horne's singing, superb—are exceptionally well communicated.

Leonard Bernstein's all-too-infrequent ventures into the opera house are nearly always something special and, as might perhaps be expected, his *Carmen* is something extraordinary. He had never conducted *Carmen* before, and had expressed dissatisfaction with the usual way of doing business in this beautiful, powerful, but somewhat overdone bit of French musical cuisine. I doubt that he could have been completely happy with the Met production, but the path he chose is a valid one: he put the intensity and the drama into the *music*. Perhaps his biggest departure from routine is in the choice of slow tempos. The introduction is even a good bit slower on the recording than I remembered it from the theater, but I think this can be justified. For once, the Toreador Song is not a slow-down, but keeps exactly the same energy level as the opening. And when the opening music returns in the last act its meaning is intensified by a couple of step-ups to the more familiar up-tempo. These changes always have some inner purpose in this presentation, and they are strikingly connected with brilliant, high-energy articulation and dynamics, a superb sense of movement and phrase, and an excellent integration of voices and orchestra, all very well caught by the recording. The orchestra is never allowed to wipe out the singers, but its presence is always clearly marked.

Having put down Marilyn Horne's stage *Carmen*, let me re-emphasize the exceptional qualities of her vocal and musical realization. Ms. Horne is rare among contemporary singers in her ability to produce a rich vocal quality without recourse to a heavy, "pushy," oversupported sound—what I call corset singing. And she has extraordinary control over her instrument. The intensity and the drama are all in the singing and the music. I consider this vocally and musically the finest *Carmen* I know and an extraordinary singing achievement—as they say, alone worth the price of admission.

On the whole, the quality of the rest of the singing is good and, except for Krause's somewhat disappointing Escamillo—his singing seems effortful in this company—the curse of boomy operatics is avoided. McCracken is unfortunately not quite at his best in the Flower Song (who is?), but he is always strong and vocally effective. Adriana Maliponte's Micaëla is surprisingly effective on the recording—much more so than it was in the theater. Occasionally her voice sounds pinched in its highest parts but, by and large, she sings with a really exquisite purity, just right for Micaëla. The smaller roles are well managed, and one or two of the comprimario singers manage a far better brand of French than the principals. Indeed, the agony of the spoken French is the one major defect here, and it could not be remedied short of bringing in a whole *Comédie Française* cast to read the dialogue.

I WAS about to add a compliment to the Metropolitan Opera chorus for the musical distance they seem to have traveled since the night I was in the theater, but I discover that the choral parts are credited to something called the Manhattan Opera Chorus. The story is that there was no success in negotiating a contract with the Met chorus, so a pick-up group was hired to step in. At any rate, they come off very well.

The production is fairly elaborate, although not overbearingly so. There will be criticism of some of the effects—particularly all the ruckus that accompanies (and partially obscures) José's off-stage song in Act II. And some of the effects are unusual: the bull-ring chorus (which, in keeping with the Met production, remains "off" to the end) has been electronically processed to suggest a distant, bloodthirsty crowd. I'm generally in favor of this kind of production in recordings, and the effect here is simple, telling, and well integrated with the excellent sound. The production has all the usual trimmings—elegant booklet with libretto and articles in various languages—but the part I like best is the quiet, quality vinyl.

BIZET: *Carmen*. Marilyn Horne (mezzo-soprano), Carmen: James McCracken (tenor), Don José: Tom Krause (baritone). Escamillo: Adriana Maliponte (soprano), Micaëla: Colette Boky (soprano), Frasquita: Marcia Baldwin (soprano), Mercedes: Donald Gramm (bass). Zuziña: Russell Christopher (tenor). Dancaire, Lillas Pastia: Andrea Velis (baritone). Remendado: Raymond Gibbs (baritone), Morales. Metropolitan Opera Orchestra and Children's Chorus, Manhattan Opera Chorus, Leonard Bernstein cond. DEUTSCHE GRAMMOPHON DG 2709 043 three discs \$20.94.

A FULL 50% OFF FOR NEW SUBSCRIBERS ONLY

Stereo Review

the magazine of good music—
and the equipment it's played on—
is now yours at mere mono rates:

For only \$3.50

You'll enjoy over 1,000 critical, no-cant reviews of the latest releases on discs, tapes, cartridges and cassettes, including every musical idiom: classical; pop; folk; rock; jazz; and even the spoken word.

... incisive, informative results of lab test-reports on all the new stereo components, conducted by Hirsch-Houck Labs.

... interviews with outstanding artists and composers, as well as full-length feature articles.

... One full year is yours for half price. And you can enjoy even greater savings by choosing a two year subscription. Just check the one you want, fill in the rest of the card, and mail it off to us.

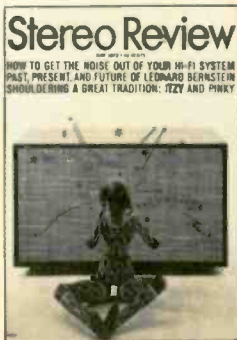

PLEASE enter my subscription to STEREO REVIEW for the length of time and the rate checked below:

2 YEARS . . . only \$7.00
(You save \$7.00 over the regular, yearly rate.*)

1 YEAR . . . only \$3.50
(You save \$3.50 over the regular, yearly rate.*)

(*Based on regular 1 year price of \$7.00)

Please add \$1.00 per year for postage outside the U.S.A., its possessions and Canada.

Payment Enclosed Bill Me Later

Name _____

Address _____

4211

City _____

State _____ Zip _____

FOR NEW SUBSCRIBERS ONLY

Stereo Subscriptions at Mono Rates.

A FULL 50% OFF FOR NEW SUBSCRIBERS ONLY

Stereo Review

the magazine of good music—
and the equipment it's played on—
is now yours at mere mono rates:

For only \$3.50

You'll enjoy over 1,000 critical, no-cant reviews of the latest releases on discs, tapes, cartridges and cassettes, including every musical idiom: classical; pop; folk; rock; jazz; and even the spoken word.

... incisive, informative results of lab test-reports on all the new stereo components, conducted by Hirsch-Houck Labs.

... interviews with outstanding artists and composers, as well as full-length feature articles.

... One full year is yours for half price. And you can enjoy even greater savings by choosing a two year subscription. Just check the one you want, fill in the rest of the card, and mail it off to us.

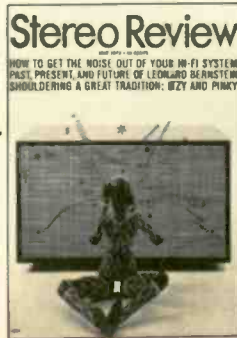

PLEASE enter my subscription to STEREO REVIEW for the length of time and the rate checked below:

2 YEARS . . . only \$7.00
(You save \$7.00 over the regular, yearly rate.*)

1 YEAR . . . only \$3.50
(You save \$3.50 over the regular, yearly rate.*)

(*Based on regular 1 year price of \$7.00)

Please add \$1.00 per year for postage outside the U.S.A., its possessions and Canada.

Payment Enclosed Bill Me Later

Name _____

Address _____

4211

City _____

State _____ Zip _____

FOR NEW SUBSCRIBERS ONLY

Business Reply Mail

First Class
Permit No. 903
Boulder,
Colorado

NO POSTAGE NECESSARY IF MAILED IN THE UNITED STATES

Postage Will Be Paid By

Stereo Review

P.O. Box 2771

Boulder, Colorado 80302

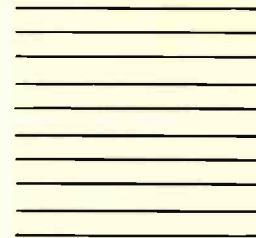

Stereo Review:
The magazine of good music...
Yours at a really good price.

Business Reply Mail

First Class
Permit No. 903
Boulder,
Colorado

NO POSTAGE NECESSARY IF MAILED IN THE UNITED STATES

Postage Will Be Paid By

Stereo Review

P.O. Box 2771

Boulder, Colorado 80302



A comparison of the two scherzos provides vivid justification for Felix Weingartner's dictum that the apparent speed of a performance is more a matter of rhythmic tautness than of mere arithmetic tempo—the Bauer/Flonzaley performance is only three seconds shorter than the Previn/Yale (seven minutes, twelve seconds as against seven minutes, fifteen seconds), but it possesses such consuming impetus that the effect is much swifter and more exciting. In the other inner movement, the *Andante, un poco adagio*, Bauer/Flonzaley again have a slight edge, for Bauer's unaffected way with the main theme clarifies the rhythmic structure of the movement better than Previn's idea of "stretching" the initial sixteenth-note in each measure, and the Flonzaley's ensemble sound has the classic combination of sweetness and solidity that even the finest modern quartets—and the Yale is certainly one of them—cannot quite emulate.

But if the second and third rounds go to the older group, in the first and fourth Previn/Yale's artful approach yields corresponding satisfactions. Their first movement, helped by the inclusion of the repeat (which Bauer/Flonzaley omit), is a realization of extraordinary strength and cohesion, intensified by the sense of brooding quietude at the start of the development section, and in the finale they accomplish Brahms' suggestion of a slightly faster tempo for the subsidiary theme with a subtlety worthy of a Furtwängler—the new pulse is quite different from the old, but the actual moment of change is imperceptible.

I have concentrated here on the differences between the two performances in order to illuminate the field of choice. But ultimately I don't think it's a matter of choice at all. One of the most rewarding aspects of these interpretations is the way they uphold, nearly half a century apart, the same enduring principles of creative music making.

Packaged with the Flonzaley version, which is adorned with a vulgar and unnecessary puff from RCA director of classical music Peter Munves, come two other Flonzaley performances: the Schumann Piano Quintet, with Ossip Gabrilowitsch, recorded in 1927, and Haydn's "Lark" Quartet, recorded in 1928 and now released for the first time. But I feel it is not unfair to regard them as a side issue. The Schumann, a picturesquely attractive piece but vastly inferior to the Brahms, receives a much more old-fashioned sort of performance, with consistently rushed tempos and moments, as in the transition to the *Agitato* section in the second movement, where the rhythm goes completely haywire. The Haydn, though played with seductive charm, is not always stylish, and is marred not only by the absence of the first-movement repeat but also by an eight-measure cut in the slow movement.

So it is the Bauer/Flonzaley performance of the Brahms that is the real point of the release. Sounding perfectly acceptable in this well-managed transfer from the original 78's, it constitutes, together with the resplendently stereophonic Previn/Yale version and the monophonic Richter/Borodin Quartet version on Bruno, a trio of great interpretations. I would not like to be without any of them. *B.J.*

BRAHMS: *The Complete String Quartets* (see Best of the Month, page 75)

CHAUSSON: *Poème* (see GODARD)

(Continued overleaf)

Maxell announces a huge improvement in cassette tape. Magnified 10,000x so you can see it.

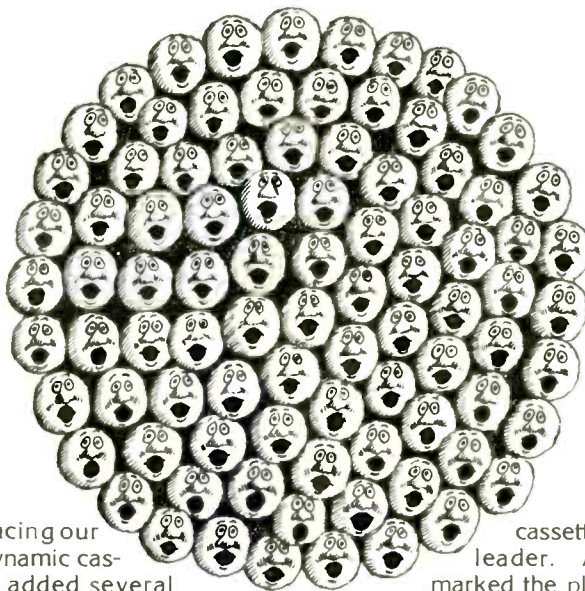

Introducing our new Ultra Dynamic cassette. We've added several new improvements to the cassette. And a little more Ultra to the Dynamic.

Our smallest improvement is our biggest improvement.

We reduced the size of the tiny PX gamma ferric oxide particles on the surface of our tape. The Hz now go up to 22,000 Hz so you get even higher highs. The signal-to-noise ratio's now 8dB more than ordinary cassettes—which means you get less noise from your cassette player and cleaner, clearer sound from your cassette. And the dynamic range is wider so you can turn the sound up loud enough to disturb the neighbors without worrying about distortion.

Little pad finally gets grip on self.

Every cassette has a little pressure pad to keep the tape pressed firmly against the tape head. Other cassettes keep their pads in place with glue—or rather don't keep their pads in place with glue. So we've designed a little metal frame that holds the pad in a grip of steel. And now the tape can't push the little pad out of place—and you don't need to worry about signal fluctuations and loss of response any more.

An improvement you can see but can't hear. The first five seconds of our new

cassette is a timing leader. And we've marked the place where it starts with three little arrows so you'll always know exactly where you are.

Amazing new miracle ingredient fights dirt fast!!!

But the leader's also a head-cleaner and what's amazing, new and miraculous about it is that it doesn't rub as it scrubs as it cleans. Because it's non-abrasive. So it keeps your tape heads clean without wearing them down.

Our new long-playing cassette is shorter.

Our new UDC-46 is twenty-three minutes per side. Which very conveniently just happens to be the approximate playing time of your average long-playing record. (Our other cassettes are 60, 90 and 120.)

And that's our new improved Ultra Dynamic cassette.

And its ultra dynamic new improvements.



maxell

The answer to all your tape needs.

Maxell Corporation of America, 130 West Commercial Avenue, Moonachie, N.J. 07074

RECORDING OF SPECIAL MERIT

CHOPIN: *Seventeen Polonaises.* Garrick Ohlsson (piano). ANGEL SB 3794 two discs \$11.96.

Performance: **First-class**
Recording: **Very good**

Chopin wrote his first Polonaise, a twenty-two-bar piece in G Minor with a sixteen-bar trio section, when he was seven. Between that time, in 1817, and the date he completed the *Polonaise Fantaisie* (1846, three years before his death), Chopin wrote a grand total of seventeen Polonaises. Of these, the first nine are not performed very often, partly because most of them are juvenilia, and most recordings start with the dramatic and virile C-sharp Minor Polonaise, Op. 26, No. 1, and proceed through the remaining pieces of Chopin's maturity. Such was the case with Antonio Barbosa's recording for Connoisseur Society, a splendid interpretation which I reviewed in June.

Now we have Garrick Ohlsson, the 1970 winner of the International Chopin Competition in Warsaw, providing the absolutely complete set, including all the earlier pieces as well as the piano solo version of the Op. 22 *Grande Polonaise*. Interestingly, he presents the Polonaises out of chronological order. His arrangement has the merit of interspersing the better-known pieces with the rarities, but it also interferes with an appreciation of Chopin's growing mastery of the form. Ohlsson, whose previous Chopin on discs (for Connoisseur Society) stemmed from the prize-winning competition performances, begins this set with a slow, deliberate, majestic "Military" Polonaise: the pianist has an excellent grasp of Chopin's style and varies his moods accordingly. I found much to admire in his real display of temperament in Op. 26, No. 2, the lovely and poetic middle section of Op. 26, No. 1, the strength and virtuosity of the familiar "Heroic" Polonaise, the unfrenetic and tempered control manifested in the *Fantaisie Polonaise*, and the sensitivity and lack of surface brilliance in the Op. 22 *Grande Polonaise*. Though another pianist might have brought more aristocratic elegance to some of the earlier pieces, such as Op. 71, No. 3, overall I have nothing but praise for Ohlsson's interpretative and technical mastery. His versions easily stand with the best available. And the sound is very satisfactory. *I.K.*

COPLAND: *Preamble for a Solemn Occasion; Symphonic Ode; Orchestral Variations.* London Symphony Orchestra, Aaron Copland cond. COLUMBIA M 31714 \$5.98.

Performance: **Composer-directed**
Recording: **Excellent**

It is always an interesting experience to hear a composer's own interpretation of his orchestral music, and the present recording with Copland leading the London Symphony Orchestra in three of his less frequently performed works is no exception. Generally speaking, it has been my impression that Copland tends to keep his music at a cooler temperature than other conductors do, allowing its craggy qualities to hold the foreground and playing its jazzy, polyrhythmic passages not only to produce excitement but to bring out their contrapuntal values as well.

In these performances he seems to be following this pattern, and all three works exhibit similar attributes of eloquence, a kind of

stately ponderousness in slow sections, and a great deal of what might be called "rational playfulness" in the fast parts. Since there is so little opportunity to hear any of these early and relatively early pieces, it is something to be thankful for that they are available. On the other hand, the London Symphony Orchestra does not do the kind of spectacular job with them I expected. Perhaps there was too little rehearsal. But I frequently had the feeling that Copland was dragging the players through the music by the tips of their noses. This is true even in slow sections where the problems could not have been technical, but rather interpretive. In fast portions, when polyrhythms get going, the players can sound pretty ragged. It's a pity. But don't let this scare you away from the record. Its virtues far outweigh its failings. *L.T.*

DONIZETTI: *Anna Bolena* (see Best of the Month, page 76)



GARRICK OHLSSON
An excellent grasp of Chopin's style

DVOŘÁK: *Psalms 149, Op. 52/79; Mass in D Major, Op. 86; Biblical Songs, Op. 99, Nos. 1-5.* Marcella Machatková (soprano); Stanislava Skatulová (alto); Oldřich Lindauer (tenor); Dalibor Jedlička (bass); Maria Helenita Olivares (soprano); Gianni Maffeo (baritone); Jindřich Jindrak (baritone); Czech Philharmonic Chorus; Prague Symphony Orchestra, Václav Smetáček cond. SUPRAPHON H 20981/2 two discs \$11.96.

Performance: **Fair to excellent**
Recording: **Generally effective**

Here is a fascinating package of off-the-beaten-track Dvořák, all of it with religious themes but extremely varied in manner and content.

The terse, powerful *Psalms 149*, with its militantly nationalist undertone, was Op. 52 in its initial male choir version of 1879 but became Op. 79 when rescored for mixed choir in 1887. The Mass in D was written on commission in 1887 for the consecration of the private chapel of a wealthy arts patron; the original organ accompaniment was later expanded for full orchestra. The spirit of the piece strikes me as being more akin to a late Haydn Mass than to anything as dramatic as the Beethoven *Missa Solemnis*. There is much skillful fugal writing, especially in the brilliant *Gloria*, and there are some lovely contemplative epi-

sodes, as in the *Benedictus*. But I find the general level of melodic inspiration somewhat less than top-drawer Dvořák. The opening of the *Credo*, for example, is of almost Anglo-Victorian banality. Yet it is transformed into a splendid peroration by the close of the highly elaborate and effectively developed movement. The soloists here are no more than adequate, and the wavy tenor is downright bad in his *Agnus Dei* solo.

The *Te Deum*, composed in 1892 for four-hundredth-anniversary Columbus celebrations in the U.S.—Dvořák was about to assume his post as director of the newly established National Conservatory in New York—is something else again, a splendidly extroverted, yet often poetic festival piece laid out along the lines of a four-movement symphony. The opening pages have a bell-like repetitive motif, almost a direct anticipation of Janáček. Absolutely inspired in its originality of musical content and exquisite scoring is the "scherzo," *Aeterna fac cum Sanctis tuis*. The soloists here, Maria Olivares and Gianni Maffeo, are both first-rate, especially Maffeo in his imposing *Tu Rex gloriae*.

Dvořák's *Ten Biblical Songs*, Op. 99, were written during his American sojourn in 1894, and all are based on Psalm texts. The first five were orchestrated by Dvořák, and as sung here seem a bit heavy-handed—though the Negro spiritual tinges in No. 2 (Psalm 99) and No. 4 (Psalm 23) are curiously touching. Baritone Jindřich Jindrak sings with appropriate fervor but with a rather heavy vibrato. If you really want to know what these songs are all about, try to get Supraphon 50898, which contains the entire set of ten in exquisitely nuanced performance, with the original piano accompaniments, by contralto Věra Soukupová. The pianist, by the way, is Ivan Moravec, whose Connoisseur Society discs have earned him some fame on this side of the Atlantic.

The singing of the Czech Philharmonic Choir is handsomely vital and full-blooded, and veteran Vaclav Smetáček maintains a good and steady hand at the conductorial helm. The sonics, in an essentially church acoustic, are generally satisfactory. *D.H.*

GODARD: *Concerto Romantique.* Aaron Rosand (violin); Orchestra of Radio Luxembourg, Louis de Froment cond. **CHAUSSON: *Poème.*** SAINT-SAËNS: *Introduction and Rondo Capriccioso.* BERLIOZ: *Reverie and Caprice.* Aaron Rosand (violin); Southwest German Radio Orchestra, Rolf Reinhardt cond. TURNABOUT TVS 34466 \$2.98.

Performance: **Excellent**
Recording: **Good**

Here's a bouquet for French Romanticists. Violinist Aaron Rosand gives four fine performances of works familiar and unfamiliar. The Chausson *Poème*, which used to be played a lot, is seldom heard these days, but it still retains the gentle attractiveness that once accounted for its popularity. So, too, the Saint-Saëns *Introduction and Rondo Capriccioso*, a standard "flashy song" piece, comes across with its old élan and elegance. Godard's *Concerto Romantique*, if it ever had a vogue, certainly did not deserve it; it is refreshing to read in the program annotations not an advertising puff for it, but an honest description of "drawing-room music for solo violin and orchestra." Rosand treats it respectfully, though, which puts a passably fair face on it. Berlioz's *Reverie and Caprice*, composed five
(Continued on page 104)

THE LAFAYETTE LR-4000



Don't just take our words for it, take someone else's...

"... Lafayette's wave-matching logic circuit . . . represents the state of the SQ art. . . ."

—*Modern Hi-Fi & Stereo Guide*, Feb. '73

"The LR-4000 epitomizes the art of matrixed 4-channel sound."

"Enough power there to give you all the decibels of hi-fi sound you could conceivably crave."

—MARTIN CLIFFORD, *FM Guide*, Nov. '72 & March '73

"... the decoding is essentially the ultimate that can be expected of a matrix system limited to a 20- to 20,000-Hz bandwidth. . . . The listening effect is almost that of discrete surround-sound."

—HERBERT FRIEDMAN, *Hi-Fi Stereo Buyers' Guide*, Spring '73

"It causes [SQ encoded] discs to sound as real four-channel should. . . . This unit, in fact, takes the SQ system as far as it can go—and proves that it is capable of good four-channel."

—*Stereo & Hi-Fi Times*, Spring '73

"Featuring all modes 4-channel operation, this receiver delivered excellent performance. Amplifier distortion is unusually low."

"FM Tuner: The sensitivity measured 1.6 μ V IHF."

—*4-CHANNEL Quadraphonic Buyers Guide 1973*

"A superb four-channel receiver. . . ."

—ROBERT ANGUS, *Modern Hi-Fi & Stereo Guide*, June '73

"... It is evident that the designers of the LR-4000 have done a remarkable job of producing the "most" SQ receiver for the money we have yet seen. . . . We were impressed also with its human-engineering aspects: the controls are laid out in a simple and functional manner, without sacrifice of flexibility. Its quadraphonic performance . . . was outstanding, as was its overall sound quality and general ease of operation. All in all, the LR-4000 is a most impressive achievement—especially so considering its price [499.95]."

—*Stereo Review*, April '73

CBS, the developer of the SQ system, uses the LR-4000 when monitoring 4-channel program material. As do thousands of people to whom sound really matters. But, listen to one for yourself. Then you won't have to take anybody's word for it!

Lafayette: If sound matters to you, listen to us.

Lafayette Radio Electronics P.O. Box 10, Dept. 11073, Syosset, N.Y. 11791



FREE
The World's Largest
Consumer Electronics Catalog
Your One Complete Buying Guide
For "Everything In Electronics"

Send my FREE LAFAYETTE 1973 Catalog to:

11073

Name _____

Address _____

City _____ State _____ Zip _____

years after *Harold in Italy*, was unfamiliar to me, and this is apparently its first LP recording. Despite my addiction to Berlioz, I can't find much of interest in this work except the historical fact that it exists.

Rosand gives first-rate performances of all four pieces. The two orchestras support him excellently, and the recorded sound is very good. L.T.

GRIEG: Piano Sonata, in E Minor, Op. 7. BIZET: Premier Nocturne; Variations Chromatiques. Glenn Gould (piano). COLUMBIA M 32040 \$5.98.

Performance: **Extraordinary**
Recording: **Very good**

Bizet? The nineteenth century gives up its secrets surprisingly slowly. French piano tradition is almost as moribund as French opera, and there is, we have been assured, nothing but salon *bonbons* between Rameau and Debussy. Wrong again. Bizet's *Variations Chromatiques* are extraordinary music. In view of the composer's reputation and the "modern" temper of this work—chromaticism from the past seems particularly affecting and profound to us, especially when handled as skillfully and imaginatively as it is here—its almost complete obscurity is hard to account for.

One can almost say the same for the only somewhat better-known Grieg sonata. How could a major work by a popular composer—and of the same period and appeal as his piano concerto—be so little known? Anyway, the Glenn Gould advocacy is a powerful one in favor of this music.

Mr. Gould, as part of his delightfully ingenious liner notes, attempts to forestall some of the obvious criticisms of his playing, of the Grieg in particular. Be forewarned, he cautions us, Grieg was a cousin of my maternal great-grandfather. "Any intemperate critical discussion of the performance at hand," he continues, "would be tantamount to a suggestion that Clara Schumann was misinformed about the inner workings of the worthy Robert's 'A minor' Concerto."

Well! Glenn Gould as the source for the authentic Nordic interpretive tradition! Who would have believed it? Why not also point out that the Canadian climate is similar to that of Norway and thus affords additional authority? Ibsenesque gloom indeed!

As it happens, I also have a maternal tradition for this piece. My mother used to play it all the time, and my first concepts of the Romantic sonata came right out of the Grieg sonata. Now, my mother is definitely not related to Grieg and does not hail from the frozen far North, but she could evoke even more gloom and self-pity from this piece than Mr. Gould and without one single claim to authenticity. However, in several respects I think she had an even more authentic tradition than this recorded performance does. She believed that something marked *fortissimo* ought to be played loudly, and that a dance measure, such as occurs from time to time in Grieg, ought to dance a bit. An *Alla menuetto ma poco più lento* that turns out to be *Alla marcia funebre ma molto più largo* doesn't make it, with or without tradition. I will admit that, in other respects, Mr. Gould is a better traditionalist than my mother; at any rate, he plays the piece at least as well.

Amusingly enough, Mr. Gould suggests that his critics consider the unfamiliarity of the Bizet as grounds for appreciating in his performance "that freshness, innocence, and

freedom from tradition that, as the late Artur Schnabel so deftly remarked, is but a 'collection of bad habits.'" On the other hand, he would like to look forward to the critical appreciation of his bold attempts to preserve the authentic Grieg tradition. Can't have it both ways.

Maybe the Grieg tradition on his maternal side is just a "collection of bad habits" (after all, his mother, unlike Clara Schumann, wasn't the composer's wife). The Grieg sonata belongs just as much to my mother or to me, and I say Mr. Gould doesn't know how to dance and the hell with it. *Alla menuetto*, anyone?

But, really, I mustn't let Glenn Gould forestall the possibility of my liking this record. Hurrah for the music! As for the performances, here's properly modified rapture.

E.S.

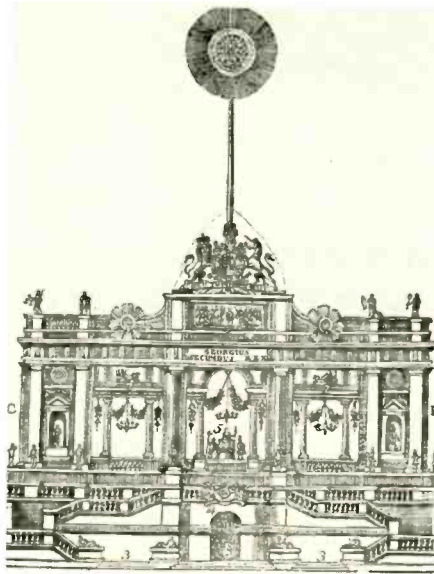

Architect's drawing of background for the 1749 public fireworks (music by Mr. Handel)

RECORDING OF SPECIAL MERIT

HANDEL: Royal Fireworks Music; Water Music. Augmented Wind Ensemble of the English Chamber Orchestra, Johannes Somary cond. VANGUARD VSD 71176 \$5.98.

Performance: **Super-spectacular**
Recording: **Likewise**

Handel's *Royal Fireworks Music* and *Water Music* are so popular with the recording companies and the people who plan radio concerts that I sometimes fear we are in danger of going up in smoke with the one or drowning in the other. Annotators never tire of telling us about that night of April 27, 1749, when traffic was tied up on London Bridge and the entire population of the city seemed to be pouring into Green Park to see the fireworks celebrating the end of the War of the Austrian Succession, and to hear Mr. Handel's music for the occasion played on one hundred wind instruments. (As a matter of fact, a little temple constructed for the celebration *did* go up in smoke that night, creating a minor panic among the celebrants.) As for the *Water Music*, there is much tiresome speculation among music historians as to whether the first suite was played on barges during a royal "water party" in 1715 or whether it all started on July 19, 1717, when the king "took water at Whitehall" with an entourage of carefully chosen

courtiers, as "fifty instruments of all sorts" accompanied the party all the way from Lambeth to Chelsea. At any rate, no two conductors since seem to have selected the same items for inclusion in any particular recorded version of the *Water Music*.

The reason Vanguard gives for issuing still another album of this music is that conductor Johannes Somary has restored Handel's "original" scoring. In the *Royal Fireworks Music*, this works stunningly—what with trumpets, horns, timpani, drums, oboes, and bassoons coming at you from all directions, providing as much pomp and circumstance as any listener possibly could bear. Mr. Handel certainly did right by the "peace of Aix-la-Chapelle" (a peace that didn't last long). The *Water Music*, scored for more conventional chamber orchestra, is not quite as hair-raising, and Mr. Somary perhaps tries to draw more drama out of the eleven selections he has chosen from the several suites than is really implicit in the score—however authentic the instrumentation. Still, it's graceful, exhilarating stuff, and the Duchess of Newcastle herself couldn't have heard it to better advantage from her barge on the Thames than the modern listener does from the grooves of this brilliant disc. P.K.

HAYDN: Piano Trios (H. XV): No. 29, in E-flat Major; No. 30, in E-flat Major; No. 31, in E-flat Minor. Beaux Arts Trio. PHILIPS 6500 400 \$6.98.

Performance: **Excellent**
Recording: **Excellent**

Probably no single eighteenth-century musical form comes as close to fulfilling the concept of *Gebrauchsmusik* as does the piano trio. It was at one point the absolute favorite of every musical amateur society, for it is light in texture and idea, relatively undemanding in performance technique, and composed for three readily available instruments. And there was a time when almost every member of the middle class in Germanic countries played either the piano or a stringed instrument, and subscribed to the notion of creating one's own home entertainment within the family circle.

These three Haydn trios are notably gentle in their sentiments, and the customary smoothness and dignity of the Beaux Arts Trio's performance style emphasizes that fact. Haydn was not seeking here to startle with the sudden, surprising modulations, progressions, or turns of phrase which he could conjure up seemingly at will. In these works, everything flows along with Sunday-afternoon sweetness, in delicate *andantes* (even one *andantino ed innocentemente*) and lilting *allegros* which are no more turbulent in spirit than the slow movements. The music is suave, polite, and comfortable. L.T.

HAYDN: String Quartet in D Major, Op. 64, No. 5 (see BRAHMS)

HOY: Piano Sonata No. 2; Eight Preludes for Piano. Bonnee Hoy (piano). ENCORE EN 1001 \$4.98 (available by mail from Encore Records, P.O. Box 11211, Philadelphia, Pa. 19117).

Performance: **Excellent**
Recording: **Excellent**

This disc presents the music and performing of a young composer who is obviously full of talent in both the creative and re-creative as-
(Continued on page 106)

With PE, West German precision begins at \$89.95.

When the new PE 3000 series was introduced last September, a new concept was introduced at the same time: A fine precision turntable for well under \$100.

Since then, thousands of price-conscious music lovers have experienced the enjoyment of playing their records on a well designed precision turntable: A turntable with the costly materials, fine engineering, and careful manufacturing you've come to expect only from the Black Forest craftsmen of West Germany.

And what's even more satisfying is the fact the PE turntables are priced at only a little more than ordinary changers, yet have quality features associated only with much higher priced turntables.

For example, the \$89.95 PE 3012 has: a variable speed control that lets you match record pitch to live instruments and compensate for off-pitch records; a cue control viscous-damped in both directions so the tonearm rises and descends with gentle smoothness; and a single-play spindle that rotates with the platter instead of sitting loosely in the shaft where it can bind and cause eccentric wear.



PE 3012. \$89.95

No other turntable at or near \$89.95 has any of these features. And no other turntable, even those priced at well over \$100, has PE's exclusive fail-safe feature which protects the stylus by preventing the tonearm from descending to the platter unless there's a record on it.

For those who want further refinements and who are prepared to spend over \$100 to get them, there are two other PE models to choose from.



PE 3015. \$129.95

The 3015 at \$129.95 which has a rack-and-pinion counterbalance, anti-skating synchronized with tracking pressure and a dynamically balanced nonferrous platter. Or the 3060 at

\$169.95, which has a gimbal-mounted tonearm, synchronous motor, two-scale anti-skating and vertical tracking angle adjustment.

Of course, we don't know if the 3012 has everything you want, or if you would prefer the additional features and refinements of the 3015 or even the 3060. To help you decide, we'll be pleased to send you our new brochure. Just circle the number at the bottom of this page.



PE 3060. \$169.95

The new PE
Precision for under \$100



Impro Industries, Inc., 120 Hartford Ave., Mount Vernon, New York 10553

CIRCLE NO. 19 ON READER SERVICE CARD

Wien" series done with small groups for Vanguard, or the New Year's Concerts series with the august Vienna Philharmonic for London. Boskovsky has been a more than worthy successor to the greats of the past, and in this latest London disc, as in its predecessors, he has done a superb job of mixing the familiar favorites with delicious new (for me) discoveries. Here the *Nordseebilder* and *Mephistos Höllenrufe* waltzes reveal a highly entertaining aspect of Johann Strauss as tone-painter, and in *Accelerationen* and *Freut' Euch des Lebens* Boskovsky pays handsome homage to the composer of the master waltz poems. The polkas, particularly *Freikugeln* with its percussion artillery and the impulsive *Sturmisch in Lieb' und Tanz*, provide delightful and frothy contrast to the waltzes. Josef Strauss, younger architect brother dragooned into composition, is represented by the lovely *Frauenherz* polka-mazurka (in many respects he seems the most innately talented of all the Strausses!).

Where Boskovsky brings a wonderful zestiness and froth to his Johann Strauss performances, Karl Böhm, an old hand in the Kleiber-Walter-Szell tradition, plays the dances like Mozart symphonies, and with delectable—to these ears—results. With all due respect to Boskovsky's performance of the liting *Annen* polka, I think Böhm gets still more meaningful nuance out of its four-minute span without ever becoming mannered. Again, the near-hackneyed *Pizzicato* polka takes on new life in Böhm's rendering, while the *Perpetuum Mobile* becomes a miniature concerto for orchestra. As for the master waltzes, *Blue Danube*, *Emperor*, and *Roses from the South*, Böhm treats them as unpretentious symphonic poems.

Both the spacious sonics of London and the more detailed pick-up of DG are ideally tailored for the character of the respective performances. Both of these discs are musts for the J. Strauss fancier.

The Ampex-processed cassette of the Boskovsky performances reverses the side order of the disc and lacks the full dynamic and frequency range of the disc original. D.H.

TCHAIKOVSKY: *1812 Overture; Romeo and Juliet, Fantasy Overture; Marche Slave*. London Symphony Orchestra, André Previn cond. ANGEL S 36890 \$5.98. 8 SX 36890 \$6.98, 4 XS 36890 \$6.98.

Performance: **Cold clangor**
Recording: **Good**

RECORDING OF SPECIAL MERIT

TCHAIKOVSKY: *Romeo and Juliet, Fantasy Overture*. **PROKOFIEV:** *Romeo and Juliet, Ballet Suites (excerpts)*. **BERLIOZ:** *Romeo and Juliet, Dramatic Symphony (second movement)*. San Francisco Symphony Orchestra, Seiji Ozawa cond. DEUTSCHE GRAMMOPHON DG 2530 308 \$6.98.

Performance: **Impassioned and eloquent**
Recording: **Superb**

Just when you are ready to swear to yourself that you never again want any part of Tchaikovsky's *Romeo and Juliet*, their hard-breathing love theme, the noisy clatter of pseudo-dramatic musical swordplay, the banal Friar Lawrence "intervention" music, the sentimental melody of mourning, or the noisy, stagey ending, along comes somebody like Seiji Ozawa and you're sucked in once again. At least I was, for Mr. Ozawa has been taking

some penetrating looks at the various musical treatments of the star-crossed lovers and comes back to the Tchaikovsky score and others with a breathtaking freshness and command. (When he was directing the Ravinia Festival early in his career he created a program called "Four Views of Romeo and Juliet": the fourth was the suite of Symphonic Dances from Bernstein's *West Side Story*, which he also recorded recently.) Ozawa's lovers are simply more beautiful, more impassioned, more musically believable than most of their recorded predecessors have been. Even Toscanini's crisp way with Tchaikovsky's music is surpassed in effectiveness by the bold, brilliant, ardent yet totally controlled approach superbly set forth here by the ever-improving San Francisco Orchestra. The excerpts from Prokofiev's ballet are, alas, only excerpts: the clash of the Montagues and



WILLI BOSKOVSKY
Strauss dances in the Viennese tradition

Capulets, a few of the more melodically scored dances, the scene at the tomb, and the death of Tybalt. But they are mounted here with uncommon clarity and grace, and the recorded sound is simply gorgeous. Even skipper is the excerpt from Berlioz's "dramatic symphony" on the subject, of which we hear only the Love Scene. It is not quite as searing nor as eloquent as in the complete recording by Colin Davis on the Philips label, but the lyricism is strikingly realized, and it rounds out a lovely exercise in Romantic programming.

After Ozawa, Previn's lovers sound reserved to the point of downright diffidence, but on his disc there is as clamorous a *Marche Slave* as you could wish, complete to the last clanking chain. And this *1812 Overture*, from opening clarinet to deafening cannons, should provide a thoroughgoing workout for anybody's audio equipment. Previn's method here is to provide the maximum in force with the minimum in emotionality, and he sacrifices something of the lyric quality of these pieces. Angel has recorded orchestras more excitingly than it did the London Symphony on this occasion. (If you must have these works in your collection, Karajan has probably wrung as much out of them as anybody ever will for Deutsche Grammophon, while maintaining a reasonable musical hold on himself and the Berlin Philharmonic.) P.K.

RECORDING OF SPECIAL MERIT

VIOTTI: *Violin Concerto No. 16, in E Minor; Violin Concerto No. 24, in B Minor*. Andreas Röhn (violin); English Chamber Orchestra. Charles Mackerras cond. DEUTSCHE GRAMMOPHON ARCHIV 2533 122 \$6.98.

Performance: **Excellent**
Recording: **Ditto**

Giovanni Battista Viotti, born in 1755 in north Italy, was the leading violinist of Europe in the Classical period and is considered the founder of "modern" violin playing. He already had a European reputation when he went to Paris in 1782 and created a sensation. After only a year and a half—he was all of twenty-eight—he retired from playing in public to devote his time to composing, conducting, teaching, and organizing musical life. He was a great favorite at court and, when the Revolution came, had to get out of the country. In 1792 he took up residence in London, where he resumed his public performances and success. But in 1798 he was, for obscure reasons, forced to leave that country, too, and became an exile in Germany. In 1801 he was allowed to come back to England, but musical life had changed and he was not able to regain his previous popularity. In 1819 he was asked back to France to take over the direction of the Paris Opéra, but his regime there was not successful and in 1823 he was back in London, where he died a year later.

In spite of the sad chronicle of the later part of his life, Viotti and his violin concertos have never been entirely forgotten. One or two of the concertos still figure in the violin student's repertoire; the A Minor, No. 22, is still occasionally performed and there are two recordings of it currently in the catalog. But, by and large, Viotti has not benefited from the revival of early music—and this in spite of the obvious shortage of good violin concertos.

Viotti's concertos are excellent examples of the high Classical style. The composer belonged to a fascinating group of Italian composers who drifted north in the late eighteenth century: Cherubini, Spontini, Clementi, and others whose music represents a last flowering of Latin Classicism in a sturdy, dramatic, almost austere form that corresponds quite closely to the neo-Classical and "Empire" trends in the other arts. This kind of art stands between the earlier, lighter style of the eighteenth century and Romanticism.

All these connections are particularly emphasized by the dramatic, *cantabile*, and minor-key character of most of Viotti's music. The E Minor Concerto, No. 16, dates from his first French period and reflects a suave integration of Italianate melodic style and fluidity, Italian-Austrian symphonic form, and French taste (Gluckian Classicism, discreet virtuosity, and a rigidly controlled sentimentality). It has several unusual features, including an intensely dramatic slow introduction that returns just before the recap, as well as a set of trumpet and drum parts added by one Wolfgang Amadeus Mozart for the Viennese premiere of the work and used in this recording.

The B Minor Concerto, No. 24, dates from London days and is, if anything, a still more expressive, sophisticated, and highly elaborate work, perhaps showing the influence of Haydn, who was making such a great success of his own in London at this time. The orchestra—particularly the winds—comes into special prominence here, perhaps in response to

the excellent quality of English wind playing. That that quality has not diminished over the years is happily revealed in this fine recording under the very excellent direction of Charles Mackerras. The violinist, Andreas Röhn, does not—presumably in keeping with the austerity and scholarly approach of Archiv recordings—receive much exterior play here, but he is nothing short of outstanding, with purity of tone, gracefulness, expressive grandeur, and virtuosic ease to recommend his interpretation of this music. Additionally, he has produced fine cadenzas that are musically and stylistically appropriate. In short, this is a very attractive recording of two really grand and beautiful works, well worth a place in your music museum without walls. *E.S.*

WEBER: *Overtures: Der Freischütz; Ruler of the Spirits; Oberon; Euryanthe; Abu Hassan; Peter Schmoll.* Berlin Philharmonic Orchestra, Herbert von Karajan cond. DEUTSCHE GRAMMOPHON DG 2530315 \$6.98.

Performance: **Echt Karajan**
Recording: **Bright and spacious**

Karajan's reading of the *Freischütz* overture is spacious and poetic in the Furtwängler tradition, with ample brilliance in the *molto vivace* sections as appropriate. The familiar *Oberon* and *Euryanthe* overtures are treated in essentially straightforward and intensely lyrical fashion. Contrast is provided with the earlier and lighter overtures, *Ruler of the Spirits*, *Abu Hassan*, and *Peter Schmoll*, all brilliantly played except for a decided overbalance of timpani in *Ruler of the Spirits*.

It was instructive to compare this disc with earlier DG Karajan recordings of orchestral textures not dissimilar to Weber's. The comparison bore out my impression of a greater mid-range pre-emphasis here than heretofore. Why not leave well enough alone? *D.H.*

COLLECTIONS

RECORDING OF SPECIAL MERIT

BALINESE GAMELAN MUSIC FROM SEBATU. *Galan Kangin; Gilak; Surja Kanta. Manuk Angutji.* Gong Kebyar Orchestra of Sebatu. DEUTSCHE GRAMMOPHON ARCHIVE 2533 130 \$6.98.

Performance: **Superb Balinese orchestra**
Recording: **Excellent on-location**

DG Archive, which has until now specialized in the documentation of early Western music, is now turning its attention to the classical musics of Asia. The *gamelan* orchestras of Java and Bali probably represent the most highly developed instrumental ensemble music outside of (and maybe including) the West. These largely percussion orchestras (they can also include flutes and occasionally other instruments) employ twenty or thirty players working together in the most intricate and interlocking ensemble patterns. Indonesian musicians can execute not only complex rhythmic counterpoint but all kinds of changes in tempo, including gradual speed-ups and slow-downs, all with perfect unanimity. The basic melodic elements are simple but endlessly embellished, and there is even a kind of strange harmonic element derived from the practice of pairing slightly out-of-tune notes. The beat-tones that result from this plus the quality of the instruments, the music, and the ensemble performance itself

ROTEL

THE ALTERNATIVE

READ THE APRIL '73 STEREO REVIEW FOR A DEFINITIVE CRITIQUE ON THE RA-1210

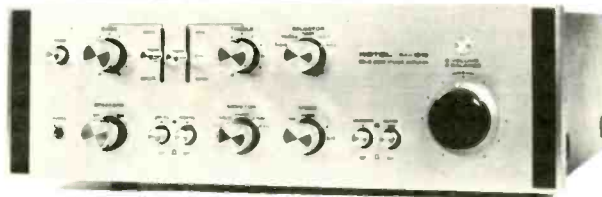

RA-1210

THE STEREO AMPLIFIER: RMS power, 60W/channel with both channels driven into an 8 ohm load. Two separate power supplies each with its own power transformer. Power Bandwidth of from 5-50KHz and a THD of below 0.3% from 20-20KHz. Add to this 2dB step controls, 3 stage differential pre-amplifier, adjustable input sensitivity/impedance on phono 2, plus tape monitoring and dubbing for two sets of tape recorders.



THE EVERYTHING LINE FROM ROTEL
ROTEL of America, Inc., 2642 Central Ave., Yonkers, N.Y. 10710

CIRCLE NO. 42 ON READER SERVICE CARD

FREE

McIntosh CATALOG and FM DIRECTORY

Get all the newest and latest information on the new McIntosh Solid State equipment in the McIntosh catalog. In addition you will receive an FM station directory that covers all of North America.



MX 113

FM/FM STEREO - AM TUNER AND PREAMPLIFIER

SEND TODAY!

McIntosh Laboratory, Inc.
East Side Station P.O. Box 96
Binghamton, N.Y. 13904
Dept. SR

NAME _____
ADDRESS _____
CITY _____ STATE _____ ZIP _____

If you are in a hurry for your catalog please send the coupon to McIntosh.
For non rush service send the *Reader Service Card* to the magazine.

CIRCLE NO. 30 ON READER SERVICE CARD

produce a music of indescribable shimmer and appeal.

Balinese music—quite distinct from the related music of Java, by the way—is a living art, and the music represented on this recording, although it has ancient roots, is in a relatively modern style. The old *gamelan gong gedé* ensembles created a repertoire of rather grand religious music for the ceremonies of the Hindu temple. The *gong kebyar* style, which appeared about fifty years ago, was a highly embellished and even syncopated version of the old religious style (as, one might say, organum was to Gregorian chant or as jazz was to the pop song). This is the Gong Kebyar Orchestra of the town of Sebatau in central Bali. The recordings were made in the open air and are excellent examples of location work. They were originally issued in a three-volume set from which the pieces on this album—complete by themselves—are drawn. This record offers an extraordinarily beautiful and satisfying experience . . . but it also whets my appetite for more.

Elsewhere I have quoted the remark of a Balinese sage who, when asked for the Balinese word for art, replied: "In Bali we have no word for art, we just do the best we can." Art is an essential part of the fabric of everyday life in that part of the world, and Balinese music, with its remarkable sense of ensemble, is the perfect expression of a very deeply rooted sense of community. As can be heard here, they do indeed do the best they can. Certainly we can listen and learn. *E.S.*

SAMUEL BARON: *Flute Plus*. Villa-Lobos: *Assobio a Jato (The Jet Whistle) for Flute and Cello*. Harold Schramm: *Song of Tayumanavar for Flute and Soprano*. Persichetti: *Serenade No. 10 for Flute and Harp*. Ginastera: *Duo for Flute and Oboe*. Bamert: *Five Aphorisms for Flute and Harp*. Peterson: *Phantasmagoria for Flute, Clarinet and Contrabass*. Samuel Baron (flute): Adele Addison (soprano); Arthur Bloom (clarinet); Alvin Brehm (contrabass); Ruth Maayani (harp); Ronald Roseman (oboe); Robert Sylvester (cello). Desto DC7 134 \$5.98.

Performance: **Excellent**
Recording: **Excellent**

This is an interesting recording on several counts. With the flute acting as *prima donna*, it brings together many different kinds of music and instrumental combinations, including voice with flute, and the roster of performers and composers is a small Who's Who of quality musicians. Baron himself, who is one of the finest flutists before the public these days, has a tone and technique matched by few, and his playing throughout this disc is exceptionally beautiful.

The late Harold Schramm's handsome *Song of Tayumanavar* is sung by Adele Addison, who gives the music an immediate and compelling performance. (As a matter of fact, all the collaborations are splendid.) Vincent Persichetti's *Serenade No. 10* for flute and harp has absolutely endearing melodic qualities, and Villa Lobos' *Assobio a Jato*, despite some of the composer's familiar lumpiness, has much appeal. The *Phantasmagoria* for Flute, Clarinet and Contrabass by Wayne Peterson, somewhat more avant-garde than the other pieces here, contains some striking instrumental writing. A tiny editorial lapse on my review copy, allowing somebody's speaking voice to be heard momentarily, is to be remedied, according to Desto, on all future

pressings. Actually, it does no harm beyond providing a split second of surprise. *L.T.*

PHILIPPE ENTREMONT: *À La Française*. Ravel: *Rigaudon; Pavane for a Dead Princess; Alborada del Gracioso*. Debussy: *Girl with the Flaxen Hair; Rêverie*. Chabrier: *Scherzo-Valse*. Satie: *Gymnopédie, Nos. 1-3*. Fauré: *Nocturne No. 6, Op. 63; Impromptu No. 3, Op. 34*. Poulenc: *Toccata*. Philippe Entremont (piano). COLUMBIA M 32070 \$5.98.

Performance: **Good**
Recording: **Good**

French piano music of the nineteenth century was, for the most part, bogged down in an almost hopeless salon mediocrity until the appearance of the composers represented here—those quirky originals Chabrier and Satie, fol-



SAMUEL BARON
Exceptionally beautiful flute playing

lowed by Ravel and Debussy, the great masters of a new style. Nevertheless, it is odd how much of their keyboard music remains in the tradition of sweet, genteel, salon-style French music. There are one or two touches of brilliance in this collection—in the Ravel *Alborada* most noticeably—but, by and large, this music is refined, intimate, quietly sentimental in a popular manner. Entremont plays it all quite simply and without affectation. Good piano sound. *E.S.*

KISSING, DRINKING, AND INSECT SONGS. Monteverdi: *Baci soavi e cari*. Schütz: *Io moro*. Josquin des Prez: *Baisemay; El Grillo*. Weckles: *Three virgin nymphs*. Anon. (17th C.): *Hodge told Sue*. Lawes: *See how in gathering of their May*. Morley: *Cruel you pull away too soon*. Farmer: *Fair Phyllis; Compare me to the child*. Ponce: *Ave color vini clari*. Lassus: *Der Wein, der schmeckt mir also wohl; La terra les eaux va beuvant*. Dowland: *It was a time; The lowest trees have tops*. Gesualdo: *Ardita zanzareta*. Sine Nomine Singers, Harry Saltzman cond. TURNABOUT TV-S 34485 \$2.98.

Performance: **Enjoyable**
Recording: **Very good**

This is an extremely pleasant collection of sixteenth- and seventeenth-century vocal pieces, mainly madrigals, each of which is concerned with (or at least makes passing reference to) kissing, drinking, or insects. Thus, for example, the opening Monteverdi madrigal begins, "Sweet and dear kisses of Cibidel-

la . . ." Juan Ponce's Latin song begins "Hail, color of clear wine," and Dowland's four-voice air starts with "It was a time when silly bees could speak." Not quite everything in the program is fatuous: the last song on the disc, for instance, is the chromatically anguished Gesualdo madrigal, "The brave fly bites the breast of my beloved who is keeping me in cruel pain." Generally, though, entertainment appears to be the album's chief aim, and there are hardly any more entertaining songs around than John Farmer's *Fair Phyllis*, the anonymous *Hodge told Sue*, and *See how in gathering their May* by William Lawes, all of which involve some very ribald material. These songs are catches, a form of round in which the end words of one line are juxtaposed with those of another line so as to have a different (frequently scurrilous) meaning. Might I suggest to Mr. Saltzman that he think about doing a whole album of catches? There hasn't been a good one since the old Experiences Anonymes collection. He and his fifteen singers have an obvious enthusiasm for all this material; and, though the group is perhaps a bit large for some of the madrigals (more rhythmic flexibility and dynamic subtlety is possible with one person per part), the diction and intonation are first-rate. My only criticism, and it is minor, concerns the pronunciation, which, together with the vocal tone, is decidedly American (it is worst in the German songs). The reproduction of the voices, barring some pre-echo, is very fine, full-bodied, and clear. Some full texts are provided, along with synopses of the rest. *I.K.*

RECORDING OF SPECIAL MERIT

LITTLE MARCHES BY GREAT MASTERS. Beethoven: *Three Marches for Military Band: No. 1, in F Major; No. 2, in F Major; March in C ("Zapfenstreich")*. C.P.E. Bach: *Two Marches, in F Major and D Major (Wq. 187, Nos. 1 and 2)*. Six Marches (Wq. 185, Nos. 1-6). Joseph Haydn: *March for the Derbyshire Cavalry Regiment, No. 2, in C Major (H. VIII No. 2); March for the Prince of Wales, in E-flat Major (H. VIII No. 3)*. Michael Haydn: *Turkish March in C Major*. Antonin Vranický: *Three Marches in the French Style*. Six Little Marches: *No. 1, in B-flat Major; No. 6, in D Minor; No. 5, in B-flat Major; No. 2, in E-flat Major*. Rosetti: *Marche (Largo) from the Partita in B-flat Major*. Netherlands Wind Ensemble, augmented with percussion. PHILIPS 6599 172 \$6.98.

Performance: **Excellent**
Recording: **Excellent**

This is a charming little excursion into march-time fun, so elegantly played by the Netherlands Wind Ensemble that even someone who hates marches could find some pleasure in it. This group of young Dutch musicians never fails to amaze me. It is truly extraordinary, and if the fact that the name Edo de Waart (who has conducted most of their recorded performances) does not appear on the disc means that they are playing here without a conductor, I'm positively agog. Their "ensemble" is as suave and impeccable as that of a virtuoso string quartet, despite the fact that they are a group several times as large.

Of the music, there's little to be said. It gives a fascinating picture of what such men as Beethoven, C.P.E. Bach, the Haydn brothers, and a few others produced in this special field of *Gebrauchsmusik*. *L.T.*

Henry Purcell's THE FAIRY QUEEN

Two new recordings
reviewed by IGOR KIPNIS

*Peter Pears: a soloist in both versions
and the deviser of one.*



Shaw Concerts, N.Y.

FOR lack of anything better to call it, Henry Purcell's *The Fairy Queen* is generally classified as a "semi-opera." The closest thing to it today might be a very long musical comedy in which half the production would be the play, the other half such musical numbers as overtures, songs, ensembles, and dances. Purcell wrote *The Fairy Queen* as an extension of a 1692 adaptation of Shakespeare's *A Midsummer Night's Dream*, the extension being a series of masques (that peculiar seventeenth-century English stage entertainment that was an amalgam of vocal and instrumental music, dancing, and spectacle). Roles other than the principal ones of Shakespeare's play were added—in fact, the original characters of the play do not participate vocally in the masques at all. A glance at some of the extra characters (Phoebus, Hymen, a nymph and a shepherd, the four seasons, Night, Mystery, Secrecy, and Sleep) reveals that the masques contain fanciful allegorical scenes. And the scenic effects, to judge from the Act IV stage directions, must have been spectacular: "The view is terminated by a walk of cypress trees which lead to a delightful bower. Before the trees stand rows of marble columns, which support many walks which rise by stairs to the top of the stage. The stairs are adorned with figures on pedestals, with balusters on each side of them. Near the top vast quantities of water break out of the hills and fall in mighty cascades to the bottom of the scene to feed the fountains which are on each side. In the middle of the stage is a very large fountain where the water rises about twelve feet."

Purcell's contribution to all this remains one of his most memorable scores, although of course there is no particular dramatic unity to it, the numbers being much closer to an immensely variegated revue than to the usual opera. Among the highlights: the scene of the Drunken Poet (pinched by the fairies for his rhymes), *Hark! th' echoing air, Turn then thine eyes, Thrice happy lovers* (an epithalamium), *If love's a sweet passion*, the echo chorus, the comic dialogue between Coridon and Mopsa, *Winter's Song*,

The Plaint ("O let me weep"), and such delightful instrumental sections as the Act IV trumpet symphony, dances for the haymakers, monkeys, fairies, and green men, and, not least, the grand chaconne at the end of Act V.

L'Oiseau-Lyre's recording of the complete Purcell score, made around 1957, has now been reissued in electronic stereo (the original was mono only), and the results are astonishingly good. There is no great feeling of spatial location of voices or instruments, but the ambiance is more spread out and the sound is very clean and unfalsified (as so often is *not* the case in fake stereo remakes). The chamber orchestra is intimate, the singers all do commendable work, the late Thurston Dart's harpsichord continuo is enchanting, and Anthony Lewis directs in a manner that speaks always of his obvious affection for the composer. A text leaflet is enclosed.

IN an effort to present the Purcell portion of *The Fairy Queen* in a more contained, less unwieldy form for the purpose of a concert production, Peter Pears (he also sang in the L'Oiseau-Lyre recording) has put the music in a different sequence, and his version is now available on a new two-disc London album (there are three records in the complete L'Oiseau-Lyre set). The whole has been reduced to four parts of between seventeen and twenty-nine minutes each: Oberon's Birthday (originally Purcell's Act IV, now the First Part); Night and Silence (mainly from Act II, with the Drunken Poet scene interpolated from Act I); The Sweet Passion (from Act III, with the Act V *The Plaint* interpolated), and Epithalamium (the wedding sequence of Act V). There is, of course, a good bit missing, such as *Thrice happy lovers*, the songs of the Chinese man and woman, *Ye gentle spirits of the air*, and some instrumental pieces, among others. A number of sections have been changed from the original sequence; for instance, the rondeau from the Second Music before Act I is used as the close to Part Three, and in a couple of pieces, notably the Coridon and

Mopsa dialogue, the voices have been transposed. The alterations, however, should not be particularly disturbing; the seventeenth and eighteenth centuries abound with even more *laissez-faire* attitudes. And, after all, what about Nahum Tate and his adaptations of Shakespeare or even the 1692 revision of *A Midsummer Night's Dream* to which Purcell contributed the music? The main criteria are whether the performance is good and whether it adheres to the proper style. This it is and certainly does, Benjamin Britten and Imogen Holst having even done some clever musical reconstruction in those places where Purcell's score was a little sketchy.

The singing is even better than on the old L'Oiseau-Lyre album (John Shirley-Quirk, for example, is better than his counterpart). The English Chamber Orchestra plays beautifully, though the sound of the orchestra is less intimate than on the older set; Philip Ledger's continuo harpsichord is splendid, and Benjamin Britten at all times reveals a profound sympathy for Purcell and the Purcell style. London's reproduction is excellent on the whole, although a few of the side endings exhibit some aural constriction.

The L'Oiseau-Lyre set is a must for the dedicated Purcell collector, but such a collector will surely want the new London concert adaptation as well (probably rueing the fact that Britten did not do the whole thing). And for the rest of us, the new London recording will undoubtedly bring much pleasure.

PURCELL: *The Fairy Queen* (Z. 629). Jennifer Vyvyan (soprano), First Fairy, Mystery, Second Woman; Elsie Morison (soprano), Second Fairy, Night, Chinese Woman, Spring, First Woman, Juno; John Whitworth (countertenor), Second Chinese Man, Secrecy, Summer; Peter Boggis (countertenor), Mopsa; Peter Pears (tenor), Phoebus, Autumn, First Chinese Man; Trevor Anthony (bass), Sleep, Winter; Thomas Hemmley (bass), Drunken Poet, Coridon, Hymen; Thurston Dart (harpsichord continuo); Granville Jones (violin obbligato); Harold Jackson (trumpet obbligato); St. Anthony Singers; Boyd Neel Orchestra, Anthony Lewis cond. L'OISEAU-LYRE OLS 121/3 three discs \$17.94.

PURCELL: *The Fairy Queen* (Z. 629). Concert performance version devised by Peter Pears and edited by Benjamin Britten and Imogen Holst. Jennifer Vyvyan (soprano), Attendant, First Fairy, Mystery, Nymph; Mary Wells (soprano), Spring, Second Fairy, Attendant; Norma Burrowes (soprano), Night; Alfreda Hodgson (mezzo-soprano), Mopsa, Attendant; James Bowman (countertenor), Attendant, Summer, Secrecy, Shepherd; Charles Brett (countertenor), Attendant, Fairy Spirit; Peter Pears (tenor), Phoebus, Shepherd, Attendant, Coridon; Ian Partridge (tenor), Autumn, Fairy Spirit; Owen Brannigan (bass), Drunken Poet, Hymen; John Shirley-Quirk (bass), Winter, Fairy Spirit, Sleep, Attendant; Philip Ledger (harpsichord continuo); Kenneth Heath (cello); Martin Gatt (bassoon); Peter Graeme (oboe obbligato); Ambrosian Opera Chorus; English Chamber Orchestra, Benjamin Britten cond. LONDON OSA 1290 two discs \$11.96.

TAPE HORIZONS

By CRAIG STARK



CASSETTES: THE NEXT STEP UP

TODAY, as open-reel tape machines get larger and run faster, incorporating such professional features as large 10 $\frac{1}{2}$ -inch reels and operation at 15 ips (inches per second), the tape-recording public continues to show a tremendous enthusiasm for cassette recorders, with their tiny "reels" and tape speed of only 1 $\frac{7}{8}$ ips—half what was once thought barely acceptable for high-fidelity recording. With Dolby (and other) noise-reduction circuits, better motors and transports, improved tape oxides, and more, no one can relegate cassettes to "for dictation only" status anymore. And although their distortion tends to run higher than that of open-reel units, their frequency response and signal-to-noise ratios (at least on the better models) are certainly "hi-fi." But they have consistently lacked one important feature: the ability to monitor off the tape.

Monitoring off the tape requires that the record and playback heads in the machine be entirely separate, so that while the recording operation is actually taking place, the independent playback facilities can let you hear the recording a moment after it goes on the tape. This way you can make a direct comparison between the source—the signal being fed to the tape—and the actual recorded result. But since the plastic shells of cassettes were originally designed to accommodate only two heads, the first of which must be used to erase any previously recorded material, cassettes have had to get along with a combination record/playback head, making simultaneous monitoring from the tape impossible. The same tape head can record *or* play back, but not, of course, at the same time.

Aside from this inconvenience, combination record/playback heads also have a technical disadvantage. A tape-head gap (the spacing between the two pole pieces) used for recording should be relatively wide to keep various distortions introduced by the recording process to a minimum. Playback heads, by contrast, should have as *narrow* a gap as possible in order to reproduce efficiently the shortest recorded wavelengths (the very high frequencies) on the tape. The slower the tape speed, the shorter the high-frequency wavelengths, and, consequently, the greater the need for an ultra-narrow playback gap. But, up to now, the conflicting requirements of a dual-function head have forced cassette-machine designers to compromise somewhat.

Recently there have been signs that the cassette's predicament has come up for some fresh scrutiny. Late last year, for example, the use of separate record and playback heads was successfully demonstrated on the new Nakamichi "professional" cassette transport, and Panasonic has had a cassette unit with a monitor head for at least as long. These technical accomplishments did not come cheaply, but the fact that they were achieved at all is a hopeful sign for the next generation of consumer cassette decks. When—and if—separate heads for cassette decks become common, they should bring with them a significant step upward in performance, and the addition of operating features that have so far been confined to reel-to-reel machines.

STEREO REVIEW JULY 1973 ADVERTISERS INDEX

READER SERVICE NO.	ADVERTISER	PAGE NUMBER
1	A.D.R. Audio	90
2	Acoustic Research	111
3	AKAI America Ltd.	109
	Audio Dynamics Corporation	32
4	Audio Technica U.S., Inc.	91
5	Audio Warehouse	110
6	Baltimore Stereo Wholesalers	93
7	Bose	11
103	British Industries-Garrard	2
	Camel Cigarettes	26
8	Capitol Records	44
9	Carston Studios	27
10	Design Acoustics	91
11	Dixie HiFi Wholesalers	27
12	Dokorder	18
13	Dual	87
14	Electrostatic Sound	28, 29
90	Empire Scientific Corporation	18
15	Epicure Products	9
	Fisher Radio Company	4, 5
16	Heath Company	19
17	Hitachi	13
18	Illinois Audio	20
19	Impro Industries, Inc.	105
20	International HiFi Distributors	90
	JVC America, Inc.	39
21	Jensen Manufacturing Company	107
22	KLH Research & Development	99
23	Kenwood Electronics	45
24	Klipsch & Associates, Inc.	43
25	Koss Electronics	4th Cover
26	Lafayette Radio Electronics	103
27	London Records	16
28	London Records	31
43	Marantz, Inc.	30
29	Maxell Corporation of America	101
30	McIntosh Laboratory, Inc.	113
51	Memorex	23
31	Midwest HiFi Wholesalers	111
32	Minolta	89
33	Onkyo	117
36	Phase Linear	7
34	Quadraflex	17
37	Rabco	106
38	Rabsons' 57th Street Inc.	93
39	Radio Shack	37
40	Revox Corporation	80
42	Rotel of America	113
44	Sansui Electronics Corp.	41
45	Sherwood Electronics	2nd Cover, 1
46	Shure Brothers, Inc.	83
47	Sony Corporation of America	15
63	Sony Superscope	120, 3rd Cover
48	Sound Reproduction	20
41	Stanton Magnetics, Inc.	96
49	Stereo Corporation of America	93
35	Technics by Panasonic	24, 25
	U.S. Pioneer	47 thru 49
13	United Audio Products, Inc.	87
50	Yamaha Audio Products	85

Printed in the U.S.A.

Onkyo designed the TX-666 to be a genuinely fine, total quality audio instrument with unmatched features. Now the verdict is in. Two highly respected evaluating experts — Hirsch-Houk Laboratories for Stereo Review (March '73) and High Fidelity (in its May '73 issue) agree that the TX-666 is a winner!

Said Hirsch-Houk: "... A first-rate tuner and powerful, low distortion amplifier — a well-designed, well-constructed receiver... (with many) often overlooked details of design and operating 'feel'. Everything works smoothly and positively... FM Interstation muting is flawless, free from noise or 'thumps'. Dial Calibration is unusually accurate... FM Frequency Response and Stereo Separation are exceptionally uniform... Alternate Channel Selectivity is excellent... (and it's) as sensitive as any on the market... Amplifier ratings are quite conservative... at any output up to the rated 53W (RMS) per channel... Phono-overload

We're Not Just Another Pretty Face. Onkyo TX-666.

capability is extraordinary... The TX-666 is an auspicious entry for Onkyo..."

High Fidelity Magazine's test experts made these comments; "The TX-666... is a solidly built, generally well-planned unit... distortion readings at frequency extremes are exceptionally good... excellent in terms of harmonic distortion... it stayed well under 0.2% (THD) to the test limit. The amplifier section proved a hard act to follow... (In FM) its thump-free behavior across the dial is an attractive plus... The TX-666 is a worthy introduction for Onkyo."

Prove it to yourself and audition this fine instrument. As for its "pretty face", you'll discover a smartly styled, walnut cabinet with a brushed black gold panel. The price for this superior receiver is only \$469.95. The TX-555 with 43W (RMS) per channel is available at a lower price.

ONKYO
Artistry in Sound

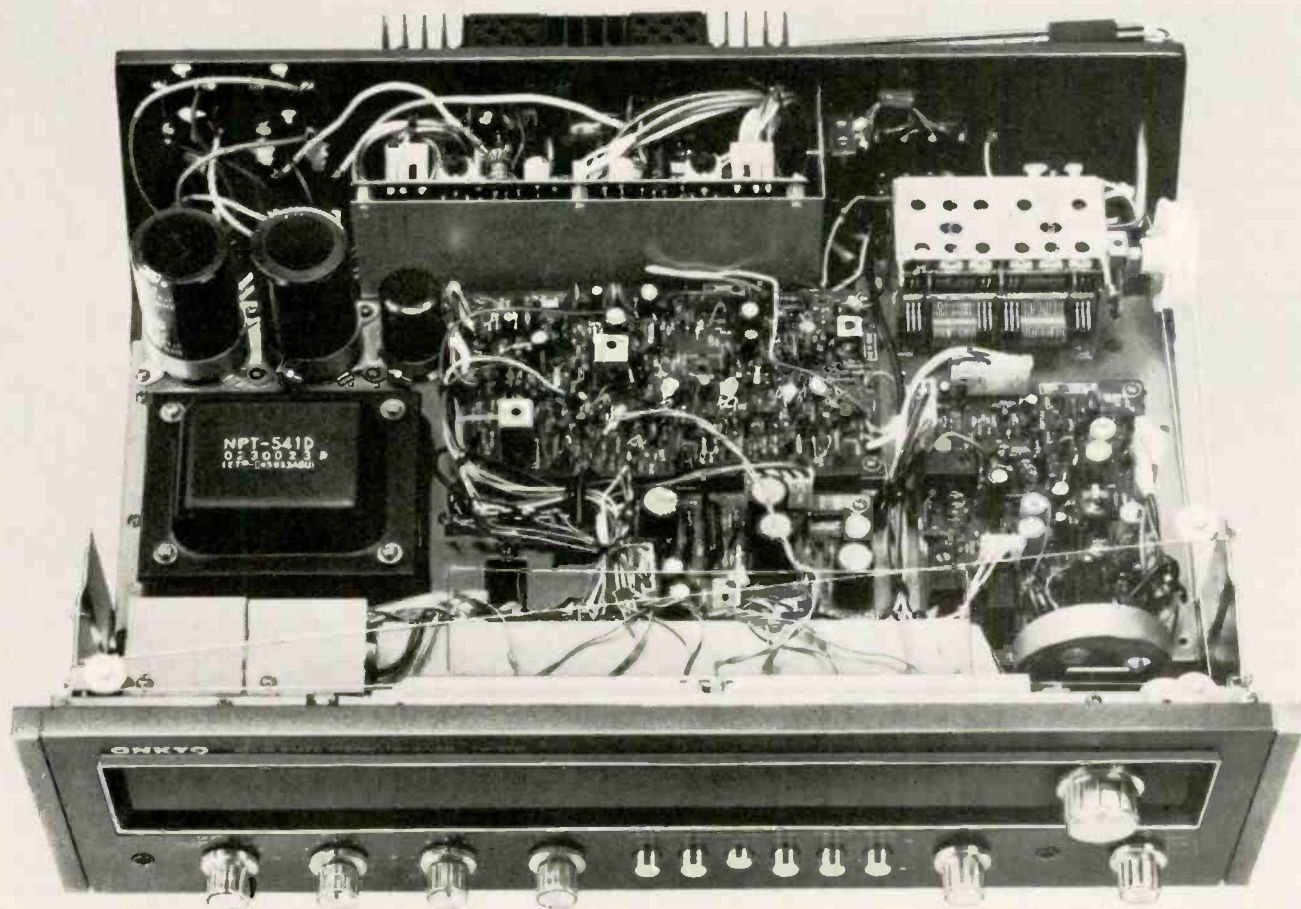

Onkyo Sales Section / Mitsubishi International Corp.
25-19 43rd Avenue, Long Island City, N.Y. 11101 / (212) 729-2323

STEREO REVIEW MARKET PLACE

NON-DISPLAY CLASSIFIED: COMMERCIAL RATES: For firms or individuals offering commercial products or services, \$1.60 per word (including name and address). Minimum order \$16.00. Payment must accompany copy except when ads are placed by accredited advertising agencies. Frequency discount: 5% for 6 months; 10% for 12 months paid in advance.

READER RATE: For individuals with a personal item to buy or sell, \$1.00 per word (including name and address). No minimum! Payment must accompany copy. **DISPLAY CLASSIFIED:** One inch by one column, \$215.00. Two inches by one column, \$430.00. Column width 2-1/4". Advertiser to supply film positives. Please write or phone for frequency rates.

GENERAL INFORMATION: First word in all ads set in bold caps at no extra charge. All copy subject to publisher's approval. All advertisers using Post Office Boxes in their addresses MUST supply publisher with permanent address and telephone number before ad can be run. Closing Date: 5th of the 2nd month preceding cover date (for example, March issue closes January 5th). Send order and remittance to: Hal Cymes, STEREO REVIEW, One Park Avenue, New York, New York 10016.

EQUIPMENT

WRITE for quotation on any Hi-Fi components: Sound Reproduction Inc., 460 Central Avenue, East Orange, N.J. 07018. 201-673-0600.

NO fair trade laws in D.C. Write for discount prices on your choice of components. District Sound, Inc., 2316 R.I. Ave., N.E., Wash., D.C. 20018. (202) 832-1900.

DIAMOND NEEDLES and Stereo Cartridges at Discount prices for Shure, Pickering, Stanton, Empire, Grado and ADC. Send for free catalog. All merchandise brand new and factory sealed. LYLE CARTRIDGES, Dept. S, Box 69, Kensington Station, Brooklyn, New York 11218.

DISCOUNT PRICES on Stereo Components and Systems. For lowest cost, fastest service, write for our quote and order form. West Coast customers: Save on shipping costs and time. Redwood Stereo Co., P.O. Box 2794, San Rafael, Calif. 94902. (415) 472-2255.

LOW, LOW prices, on audio equipment. All factory fresh, 1st quality items. Trained personnel at your disposal for audio consultation. For free catalogs or information write to: Mr. A, Dept. AMS at SMG Distributors, Inc., 46-35 54th Road, Maspeth, New York 11378.

AUDIO FURNITURE? Ask for Jerry Joseph of Toujary Designs at Hi-Fi Expo, 443 Park Avenue South, NYC 10016. Tues.-Fri. 11-5, Sat. 11-4. Full Line brochure 25 cents.

TEST FREE COMPARISONS

Comparisons by Pittsburgh's Audio experts of over 100 speakers, receivers, changers, and cartridges included in the most informative catalog of its kind. Complete with lowest wholesale prices.

Wholesale Audio Inc
3916 SAW MILL RUN BLVD., D-4
PITTS., PA. 25527 (412) 884-8797

DISCOUNTS on the undiscountable (58 major audiostereo lines). ZIPX pricing. Audiofax-DC, POB 7961, Atlanta, Ga. 30342.

A FULL OCTAVE OF NEW BASS from your AR, KLH, Advent, Dynaco, ADC, Rectilinear bookshelf speakers, using low cost electronic equalization. Three test reports, comprehensive literature, from Norman Laboratories, 520 Highland Parkway, Norman, Oklahoma 73069.

BASE 501 Loudspeakers \$187.50/pr. (25% under list) in factory sealed cartons. Send \$10/pr deposit and we will ship COD. Audio Component Warehouse, Suite 234, 310 Franklin, Boston, Mass. 02110.

AUDIO Components. Postpaid. Free Quote. AudioSales, Box 39, Bluepoint, N.Y. 11715.

SAVE your time and money. Get the lowest mail order price on stereo equipment. Free details, write GOODJOHN, P.O. Box 1018, Miami Beach, Fla. 33139.

KENWOOD, SONY, KLH, GARRARD, DYNA, ETC. Discounts to 40%. Get free price list. Nedco Distributors, 68-01 Watertown Street, Watertown, Mass. 02172.

DALQUIST PHASED ARRAY LOUDSPEAKER SYSTEM. Immediate delivery, \$350 each. This great speaker, introduced by the renowned Saul B. Marantz is the answer to the perfectionist's dream. It has the deep bass, power handling of the best dynamic speakers combined with the balance, smoothness, and transparency of the finest electrostatics. Free literature, expert advice. Opus One, 400 Smithfield, Pittsburgh, Pennsylvania 15222. (412) 281-3969.

QUAD, Radford, Bang & Olufsen audio components of superb quality for the connoisseur. Audio Imports, 5557 Versailles Dr., Indianapolis, Ind. 46227.

STEREO SPECTRUM—The money saver for mail order stereo equipment prices. Before you buy write us. Enclose \$1 for details and brochure. P.O. Box 1818, Miami Beach(br), Florida 33139.

FOR SALE

NEW Sony TC-650-4 tape deck. Plug-in two track head assembly, \$475.00. F.G. Harper, 157 Woodland, Staunton, Va. 24401.

HEATHKITS AJ-15 Tuner \$275. Caccia, 251 Ft. Washington Ave., N.Y. 10032. 927-5337.

DROWN ANNOYING NOISE! \$4.95pp (moneyback). Brochure. Mindlight, B2846R, Van Nuys, California 91404.

RECORDS

SHOW ALBUMS, Rare, Out-of-Print LP's. Large list. 16 cents. Broadway/Hollywood Recordings, Georgetown, Conn. 06829.

"HARD TO Get" records—all speeds. Record Exchange, 842 Seventh Avenue, New York, N.Y. 10019.

PROTECT your records—Poly sleeves for jackets 5 cents; Inner sleeves 5 cents; Poly lined paper sleeves 11 cents; white jackets 25 cents. Postage \$1.00. Record House, Hillburn, N.Y. 10931.

THOUSANDS of like new LP's and prerecorded tapes. Catalogue \$1.00. Records, Hillburn, New York 10931.

OPERA RECORDS. Rare live performances now available for the first time on top quality LP recordings. Ed Rosen, Box 97, Freeport, NY 11520.

FREE LP CATALOG—Deleted Soundtracks, Shows, Nostalgia. Al Roseman, P.O. Box 16083, Phila., Pa. 19114.

SOUNDTRACK Albums from films—Whalton, 2321W Hill, Redondo Beach, Calif. 90278.

FREE 200-PAGE CATALOGUE offers over 1,200 fine recordings of Renaissance, Baroque, Classical, Romantic and Modern music. All stereo recordings. Highest quality at budget label prices. Available only by mail from MUSICAL HERITAGE SOCIETY, Box 932ST, New York, N.Y. 10023.

SOUNDTRACKS—Large Free Catalog. Star-23, Rt. 2, Box 1944R, Escondido, CA. 92025.

RARE SOUNDTRACKS—SHOWS. Extraordinary list. Write to: Film Music, Box 1195, Beverly Hills, Calif. 90213.

COLLECTORS' Soundtracks. List 25 cents. Jemm's, P.O. Box No. 157, Glenview, Ill. 60025.

ANY \$5.98 album only \$3.25—send 10 cents for more information now. The Collective Ear, P.O. Box 626, Bridgeton, Mo. 63044.

MINT Old Show and Soundtracks. Free large list. Music Minstrel, P.O. Box 15271, New Orleans, LA. 70175.

JAZZ & BLUES Records & Books—at discount—Free Lists. Traditional Jazzland, Box 366-D, Dayton, OH 45401.

FILM-STAGE soundtracks. Extensive free list. Box 7342, Miami, Fla. 33155.

SHOW ALBUMS Out-of-Print. Reasonable. Hautsch, 1 S. 190 Eliot, Villa Pk., Ill. 60181.

TUBES

TV and Radio Tubes 36 cents. Free 48 page color catalog. Cornell, 4215-H University, San Diego, California 92105.

TAPE AND RECORDERS

SCOTCH RECORDING TAPE, lowest prices. TAPE CENTER, Box 4305, Washington, D.C. 20012.

OLD Time radio programs—all your old favorites. 50 cents for catalog. Robert Mussehl, R. 1, Brooklyn, Wisc. 53521.

OLD Radio Programs Catalog \$1.00 (refundable). The Radio Vault, Box 9032SR, Wyoming, Michigan 49509.

RENT stereo tapes \$1.50 week postpaid—NEW catalog 25 cents. Tape Library, Box 8126, Washington, D.C. 20024.

RENT 4-track open reel tapes—all major labels—3,000 different—free brochure. Stereo-Parti, 55 St. James Drive, Santa Rosa, California 95401.

LIVE OPERA PERFORMANCES on reel-to-reel tapes. Incredible performances dating back 40 years. From Ponselle-Callas. Catalog: Mr. Tape, Box 138, Murray Hill Station, N.Y.C. 10016.

OPERA tapes—historical performances of past 40 years. Unbelievable treasures and rarities. Free catalog. Ed Rosen, Box 97, Freeport, N.Y. 11520.

1930-1962 radio programs on tape. Huge catalog! Sample recordings! \$1.00, refundable!! AM Treasures, Box 192, Babylon, N.Y. 11702.

OLD Radio Show Monthly Special Club—TBOR, Box 1692B, F.D.R. Station, New York 10022.

OPEN REEL STEREO TAPE BUYERS!

At last! An open reel catalog, including titles, songs, etc. of 95 long play, 1 1/2-3 hour albums, by American Airlines, Continental Airlines, and Ampex 4 track stereo tapes (includes a group of "sound effects" tapes by Audio Fidelity). Send \$1.00 — and we will also mail you a 140-page Harrison stereo tape catalog — so you'll get both for \$1.00 — and this \$1.00 is refundable on your first \$10.00 purchase of open reel stereo tapes at our 30% discount.

SCOTCH MAGNETIC TAPE (USED)

#150, 1800 ft. 7 inch reel, 1 mil polyester, recorded once, bulk erased (no box), 99¢, plus 10% shipping and handling (minimum order \$10.00). Slightly used 10% inch fiberglass reels, 3/8" hole, 50¢ each, plus shipping by weight and zone. (Minimum order \$10.00).

SAXITONE TAPE SALES

1776 Columbia Road, N.W. Washington, D.C. 20009



TDK, BASF, Memorex, Scotch cassettes, reels, 8-tracks. THE LOWEST PRICES. S&S Audio, Box 523-D, Skokie, Illinois 60076.

MEMOREX & BASF audio and video recording tape. BSC, Inc., P.O. Box 1181SR, Melrose Park, Ill. 60161.

RADIO YESTERYEAR

Relive again those bygone years with recordings of actual broadcasts from the "Golden Age of Radio." Complete programs from the 1930's and 40's. THOUSANDS of different titles are available. For a FREE CATALOGUE that will bring back many memories, write to

Radio Yesteryear • Box H39
Croton-on-Hudson, New York 10520

RENT any cassette or open reel. Prerecorded Tape. All labels catalog 75 cents. Tape and Time, 1116 4th Ave. N., Sauk Rapids, Minnesota 56379.

8-TRACK blank cartridges, high quality. Send \$1.00 for 40 minute sample and prices. Tape, Box 7062, Kansas City, Missouri 64113.

OLD-TIME Radio Shows. Reels. Cassettes. Free Catalog. Garant, Box 331, Greeneville, Tennessee 37743.

MOVIE FILMS

16mm SOUND Features, Shorts, New, Used for Sale. Free Catalog. National Cinema, 333 W. 57th St., N.Y., N.Y. 10019.

PLANS AND KITS

HAN-D-MAGS, Audiophile Han-D-Kits and Magnetometers—Free Data. R. B. Annis Company, 11th and Delaware, Indianapolis, Indiana 46202.

INSTRUCTION

LEARN Electronics Organ Servicing at home. All makes, including transistors. Experimental kit—trouble-shooting. Accredited NHSC, Free Booklet, Niles Bryant School, 3631 Stockton, Dept. A, Sacramento, Calif. 95820.

ASSOCIATE DEGREE IN ELECTRONICS through correspondence instruction. G.I. Bill approved. Free catalog. Grantham, 1509 N. Western, Hollywood, Calif. 90027.

TAPE RECORDING COURSE: Taught by studio engineers. Free information. NNA, Box 721A, Rye, New York 10580.

EARN COLLEGE DEGREES at home. Many subjects. Florida State Christian University, P.O. Box 1674, Fort Lauderdale, Florida 33302.

Looking for a career in audio?

S.A.C. Society of Audio Consultants' professional hi-fi course is available to audio salesmen and audiophiles. Successful completion with one year minimum practical experience leads to certification. The SAC Certification Board comprises internationally recognized authorities whose articles appear in leading hi-fi publications.

For information, write or visit:

HI-FI EXPO

New York's free permanent hi-fi exhibit
443 Park Ave. So., N.Y.C. 10016 (at 30th St.)
Hours: Tues. thru Fri. 11-5; Sat. 11-4

MUSICAL INSTRUMENTS

30% DISCOUNT name brand musical instruments. Free catalog. Freeport Music, 455Q, Route 110, Melville, N.Y. 11746.

WANTED

QUICKSILVER. Platinum, Silver, Gold, Ores Analyzed. Free Circular. Mercury Terminal, Norwood, Mass. 02062.

HYPNOTISM

Free Hypnotism, Self-Hypnosis, Sleep Learning Catalog! Drawer H400, Ruidoso, New Mexico 88345.

SLEEP LEARNING. Hypnotic Method. 92% effective. Details free. ASR Foundation, Box 7566 EG, Fort Lauderdale, Florida 33304.

RUBBER STAMPS

RUBBER address stamps. Free catalog. 45 type styles. Jackson's, Box 443G, Franklin Park, Ill. 60131.

EDUCATIONAL OPPORTUNITIES

LEARN WHILE ASLEEP. Hypnotizel Strange catalog free. Autosuggestion, Box 24-ZD, Olympia, Washington 98501.

EMPLOYMENT INFORMATION

EXCITING Overseas Jobs. Directory \$1.00. Research Associates, Box 889-E, Belmont, California 94002.

EMPLOYMENT OPPORTUNITIES

EPICURE PRODUCTS, INC. is seeking quality applicants to meet expansion needs. Applicants must be willing to travel extensively four or five days per week; be knowledgeable of, or willing to learn, all aspects of the hi-fi industry—products, policies, and future developments. Position requires a professional approach to sales, and a person interested in rapid advancement into a growing management team. Base salary and monthly incentive. Epicure Products, Inc., Newburyport, Mass. 01950. Call: Robert Fuller, Personnel. (617) 462-8191.

BOOKS

Hi-Fi Books! "Stereo/Quad Hi-Fi Principles & Projects," \$4.95. Free Catalog. TAB BOOKS, B.R.S., Pa. 17214.

GOVERNMENT SURPLUS

JEEPS Typically From \$53.90... Trucks From \$78.40... Boats, Typewriters, Knives, Airplanes, Clothing, Multi-meters, Oscilloscopes, Transceivers, Photographic, Electronics Equipment. Wide Variety, Condition. 100,000 Bld Bargains Direct From Government Nationwide. Complete Sales Directory and Surplus Categories Catalog \$1.00 (Deductible on Orders From Separate Included Catalog). Surplus Service, Box 820-L, Holland, Michigan 49423.

BUSINESS OPPORTUNITIES

I MADE \$40,000 Year by Mailorder! Helped others Make Money! Start with \$15.00—free proof. Torrey, Box 318-N, Ypsilanti, Michigan 48197.

\$200.00 Daily In Your Mailbox! Your Opportunity To Do What Mailorder Experts Do. Free Details. Associates, Box 136-SR, Holland, Michigan 49423.

MAILORDER MILLIONAIRE helps beginners make \$500 weekly. Free report reveals secret plan! Executive (1K7), 333 North Michigan, Chicago 60601.

FREE SECRET BOOK "2042 Unique, Proven Enterprises." Beat Inflation with fabulous, successful "Little Knowns." Work home! Haylings-B11, Carlsbad, Calif. 92008.

PERSONALS

MAKE FRIENDS WORLDWIDE through International correspondence. Illustrated brochure free. Hermes, Berlin 11, Germany.

RECORDS, HI FI & ELECTRONICS

SPECIAL interest records available, produced by the editors of the world's leading special interest magazines. Send for free catalog. Record Catalog SR, Ziff-Davis Publishing Co., One Park Ave., New York, NY 10016.

MISCELLANEOUS

WINEMAKERS. Free illustrated catalog of yeasts, equipment. Semplex, Box 12276Q, Minneapolis, Minn. 55412.

OLD RADIO PROGRAMS ON CASSETTES OR REELS. Thousands of your favorites live again. Low prices, high quality. Catalog 50 cents. Remember Radio, Box 2513-I, Norman, Oklahoma 73069.

TAPE RECORDING & BUYING GUIDE 1973 Summer



With the world of tape in fast-forward, How can you keep up? Here's the magazine that unearls the facts. Compare products feature by feature, cost by cost — Reel-to-Reel • Cassette Tape • 8-Track • 4-Channel • Amplifiers • Receivers • Decoders • Headphones • Microphones • Raw Tape and more.

1973 Summer — #13

Order by number from Ziff-Davis Service Division, 595 Broadway, N. Y., N.Y. 10012. Enclose an additional 35¢ per copy for postage and handling. Outside USA all magazines are \$2.50 per copy, postpaid.

BACK ISSUES AVAILABLE:
1973 Winter—#78 1972 Spring—#51
1972 Winter—#56 1971—#19 \$1.50 each.

PAYMENT MUST BE ENCLOSED WITH ORDER

Planning to move?

Let us know 6 to 8 weeks in advance so that you won't miss a single issue of STEREO REVIEW.

Attach old label where indicated and print new address in space provided. Also include your mailing label whenever you write concerning your subscription. It helps us serve you promptly. Write to: P.O. Box 2771, Boulder, Colo. 80302, giving the following information.

Change address only.

Extend subscription. Enter new subscription.
(1) 5 years \$26 (2) 3 years \$18 (3) 1 year \$7
 Payment enclosed (1 extra issue per yr. as a BONUS) Bill me later.

AFFIX LABEL

If you have no label handy, print OLD address here.

name	address	city	state	zip-code
name	address	city	state	zip-code

0100

Add'l postage: \$1 per year outside U.S., its poss. & Can.

CLASSIFIED ADVERTISING ORDER FORM

Please refer to heading on first page of this section for complete data concerning terms, frequency discounts, closing dates, etc.

1	2	3	4	5
6	7	8	9	10
11	12	13	14	15
16	17	18	19	20
21	22	23	24	25
26	27	28	29	30
31	32	33	34	35

Words @ \$1.00 (Reader Rate) \$ _____
@ \$1.60 (Commercial Rate) \$ _____

Insert _____ time(s) Total Enclosed \$ _____

NAME _____

ADDRESS _____

CITY _____ STATE _____ ZIP _____

Signature _____

WORD COUNT: Include name and address. Name of city (Des Moines) or of state (New York) counts as one word each. Zip Code numbers not counted. (Publisher reserves right to omit Zip Code if space does not permit.) Count each abbreviation, initial, single figure or group of figures or letters as a word. Symbols such as 35mm, COD, PO, AC, etc., count as one word. Hyphenated words count as two words.

SR-773

first came the word...



And then there was music.
And then came Sony tape recorders
to capture the words and music
with perfect fidelity. Right from the
start, Sony has always been first with
the best, the newest and the broadest

selection of tape recording equip-
ment in the world. Sony tape
recorders, Sony accessories, Sony
microphones, Sony recording tape.
We could go on and on and on.
We are. **SONY.** Ask anyone.

A Product from **SUPERSCOPE.**



Flip the switch to 4-channel.

The newest thing in sound is the newest Sound of Koss. And it's right at your fingertips.

The switch is on to 4-channel. And only Koss gives you 4 ways to make it. With the big four from Koss. Four exciting Koss Quadrafones that do for 4-channel what Koss Stereophones have done for 2-channel listening.

Four separate Driver Elements.

On the left cup of each Koss Quadrafone is a 2-channel to 4-channel switch. Flip it to 4-channel and four separate Koss dynamic driver elements (two in each cup) surround you with breathtaking, full-dimensional quadraphonic sound from either your matrix or discrete system. If you thought the Sound of Koss was superb in 2-channel, wait until you hear it in 4-channel.

So you haven't made the switch.

There are two plugs on Koss Quadrafones. If you haven't made the switch to 4-channel,



nel, you only use one of them. The black one. Which you insert into your present stereophone jack on your 2-channel system. That automatically connects the two drivers in each ear cup in parallel. So what you'll have is nearly double the bass radiating area and an unbelievable increase in efficiency over the full range. Which should make the switch to Koss Quadrafones worth it even if you haven't made the switch to 4-channel.

Volume-Balance Controls.

Slip on a Koss Quadrafone and you'll slip into any seat in the concert hall. Because Koss



Quadrafones feature volume-balance controls on each ear cup. That puts any seat in the concert hall at your fingertips. From the middle of the concert hall one minute, to front row center the next. And you don't even have to leave the comfort of your own living room.



Hearing is believing.

With all that at your fingertips, it's hard to believe that you can buy Koss Quadrafones from \$39.95 to \$85. But it's true. And while you're on your way to hear them at your Hi-Fi Dealer or favorite Department Store, mail us a request for our full-color catalog, c o Virginia Lamm, Dept. SR-472. You'll find a lot more from Koss that'll switch you on.



KOSS QUADRAFONES
from the people who invented Stereophones.