

Suzanne Vega • MIDI Studios • Guitarist Tommy Tedesco

U.S. \$4.00 CANADA \$5.00 JANUARY 1988

MIX

**Computers in the Studio:
Hard Disks & Software**

**On the Road
with Pink Floyd**

THE RECORDING INDUSTRY MAGAZINE



**MICK JAGGER
ROLLS ALONE**

**Directory:
Northwest Studios**





There can be no compromise!

Tour the premier recording studios of the world — from London to New York to L.A. — and you'll find they have one thing in common: "no compromise" recorders from Studer of Switzerland.

Sure, their Studer multitrack mastering decks are a big investment, but you can make an equally sound choice for your production needs for a whole lot less. You can own a two-track production recorder with the same Studer heritage — a machine that has many of the same production features, the same uncompromising audio performance and the same level of manufacturing perfection that has made Studer Revox recorders the world standard — THE REVOX PR99 MKII is the machine!

Like its "big brothers" in the top studios, the PR99 MKII is a professional machine built for long-term perfor-

mance. From the solid diecast aluminum transport chassis and head block to the servo capstan motor and the modular electronics, everything is milled, drilled and mounted with Swiss precision. The parts fit together right — and stay there.

The PR99's professional features are perfect for efficient, accurate tape production: • Real-Time counter that reads both plus and minus hours, minutes and seconds; • True Auto Locator allows precise, automatic search-and-cue to any preselected address point; • Zero Locate to return the tape to the zero counter location — EXACTLY! • Auto Repeat to continuously replay a tape segment of any length.

Plus: • Built-in, front-panel variable speed; • Self-Sync; • Input and output mode switching; • Edit mode switch; • Tape dump; • Calibrated and Uncali-

brated "+4" balanced and floating inputs and outputs; • 10½" reel capacity.

As for sound quality, the Studer heritage again allows no compromise. We think you'll find the Revox PR99 MKII to be sonically superior to anything in its price range. Audition the Revox PR99 MKII at your Studer Revox Professional Products Dealer, or contact: Studer Revox America, Inc., 1425 Elm Hill Pike, Nashville, TN 37210; (615)254-5651.



PR99 MKII Real Time Counter and Autolocator.

STUDER REVOX

Most professional
mixing consoles perform perfectly
in the lab where they were built.
If you work in a lab, no problem.
If not, read on.

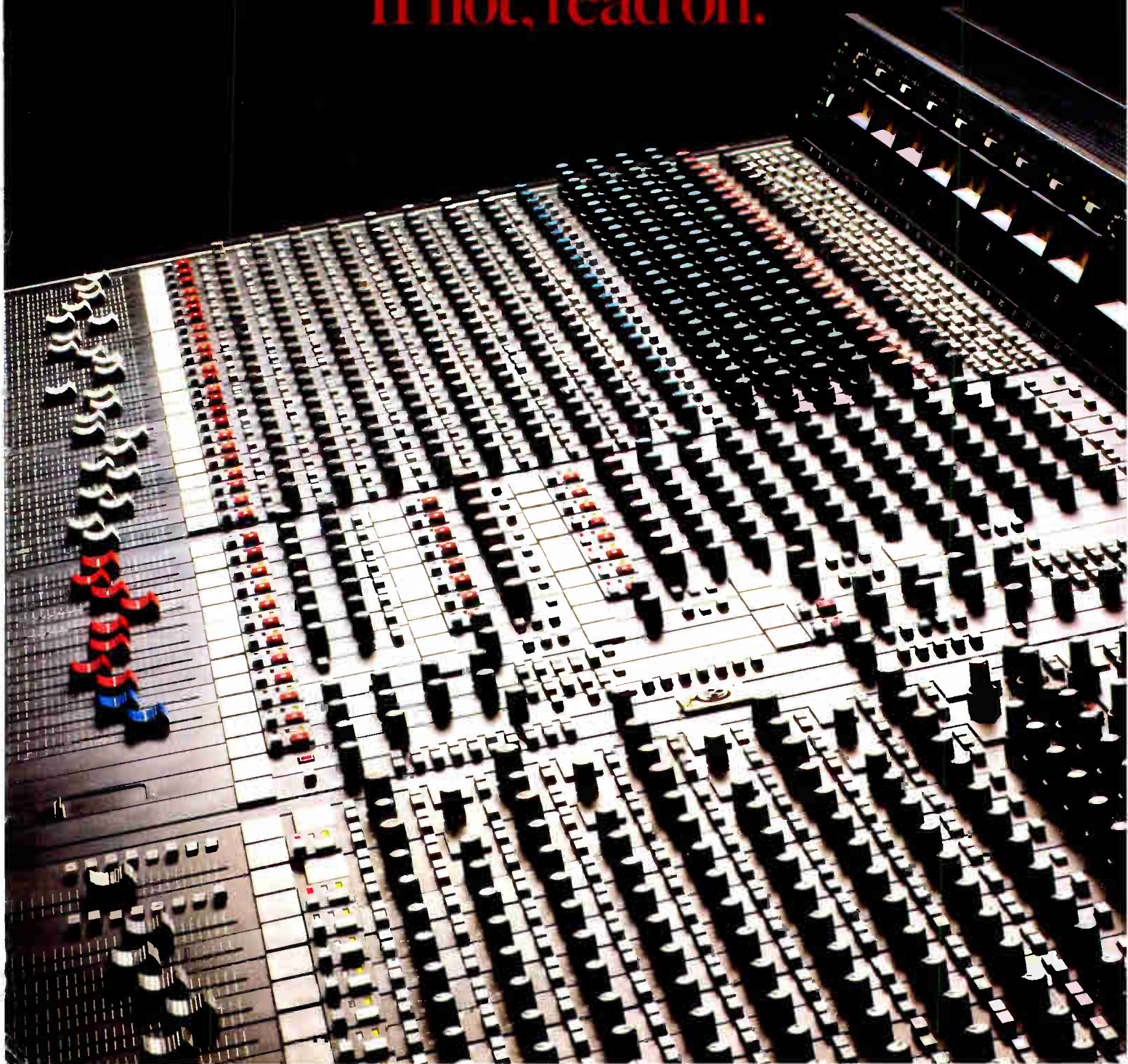

transistors and ICs are surface mounted to that substrate. The package is then potted for stability and thermal conductivity. Resistor tolerances in our



Hi-MICs can be held to within a very low 0.5%, resulting in excellent uniformity. Hi-MICs, which are essentially self-contained circuit blocks, also simplify troubleshooting.

Good, stable circuit design— It doesn't cost you any more for us to do it right!

Consider the buffer amps. Consoles invariably have many circuits to buffer one stage from the next, serving as an impedance converter without changing the gain. For example, there's always a buffer between each pan pot and its assign

simple, expedient circuit will create a peak in the response at a very high frequency, somewhere around 2 MegaHertz. The designers assume this will not cause problems because, after all, the audio range is limited to about 20 kHz, and this is 100 times higher in frequency.

At Ramsa, we know better. We realize that a 2 MHz peak is an invitation to radio frequency interference. It turns the console into a great business radio receiver so that a passing taxi cab, for example, is likely to contribute to your program. For this reason, we

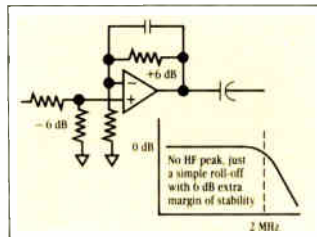

Ramsa unity gain buffer stage and its response.

designed the unity gain buffer for the WR-S840 series. It now has more parts, but the circuit is much better behaved, exhib-

any source from -60 dBu to $+4$ dBu nominal level while maintaining a full 20 dB headroom throughout this range. The circuit uses discrete transistors for low noise, and a bipolar 25 volt supply for the headroom.

Long-life MRP™ controls.

MRP (Matsushita Resistive Plastic) describes a proprietary RAMSA process for building high quality, high precision, long life controls. For example, the faders and input attenuators on the WR-S840 consoles are rated at 300,000 operational cycles. This is some 20 times the life of a typical carbon fader!

Fiberglass-Epoxy circuit boards throughout.

Fiberglass-epoxy boards may cost more, but they offer numerous advantages. They don't warp, they are much stronger than phenolic boards, they can be fabricated with

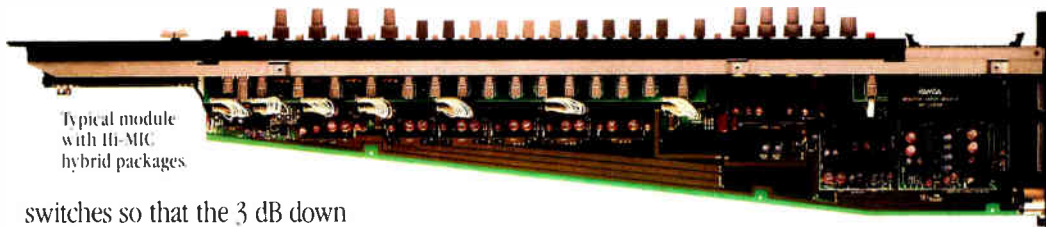

Typical module with Hi-MIC hybrid packages.

switches so that the 3 dB down point of the pan pot does not shift, no matter how many assign switches are selected. Unfortunately, the typical cir-

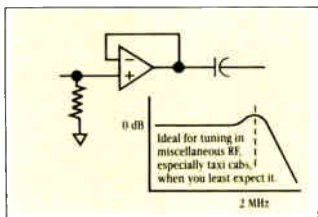

Typical single-IC, unity gain buffer stage and its response.

cuit that performs this function ends up creating problems of another sort. That's because the

iting a simple, non-peaked single-pole response and providing some 6 dB greater margin of stability than the typical designs in other consoles. What's more, all capacitors in the audio path are Elna™ "Carafine" grade low-ESR type for superior transient response.

The universal input circuit.

Our engineers developed a unique input preamp circuit. Its 41-position control can be continuously adjusted, with 15 dB detented resolution, to accept

double-sided traces and plated through holes. That's why every circuit board in the WR-S840 consoles is of this design.

Comprehensive 4-band equalization.

Each input module is equipped with a powerful 4-band, state-variable, sweep-frequency equalizer with high speed (20 volt per microsecond) bi-EET ICs. This circuit complements the engineer's acoustic and

Mono Mic/Line Input Module (W.C.-S81)

Sub Input Module (W.C.-S82)



Most professional
mixing consoles perform perfectly
in the lab where they were built.
If you work in a lab, no problem.
If not, read on.

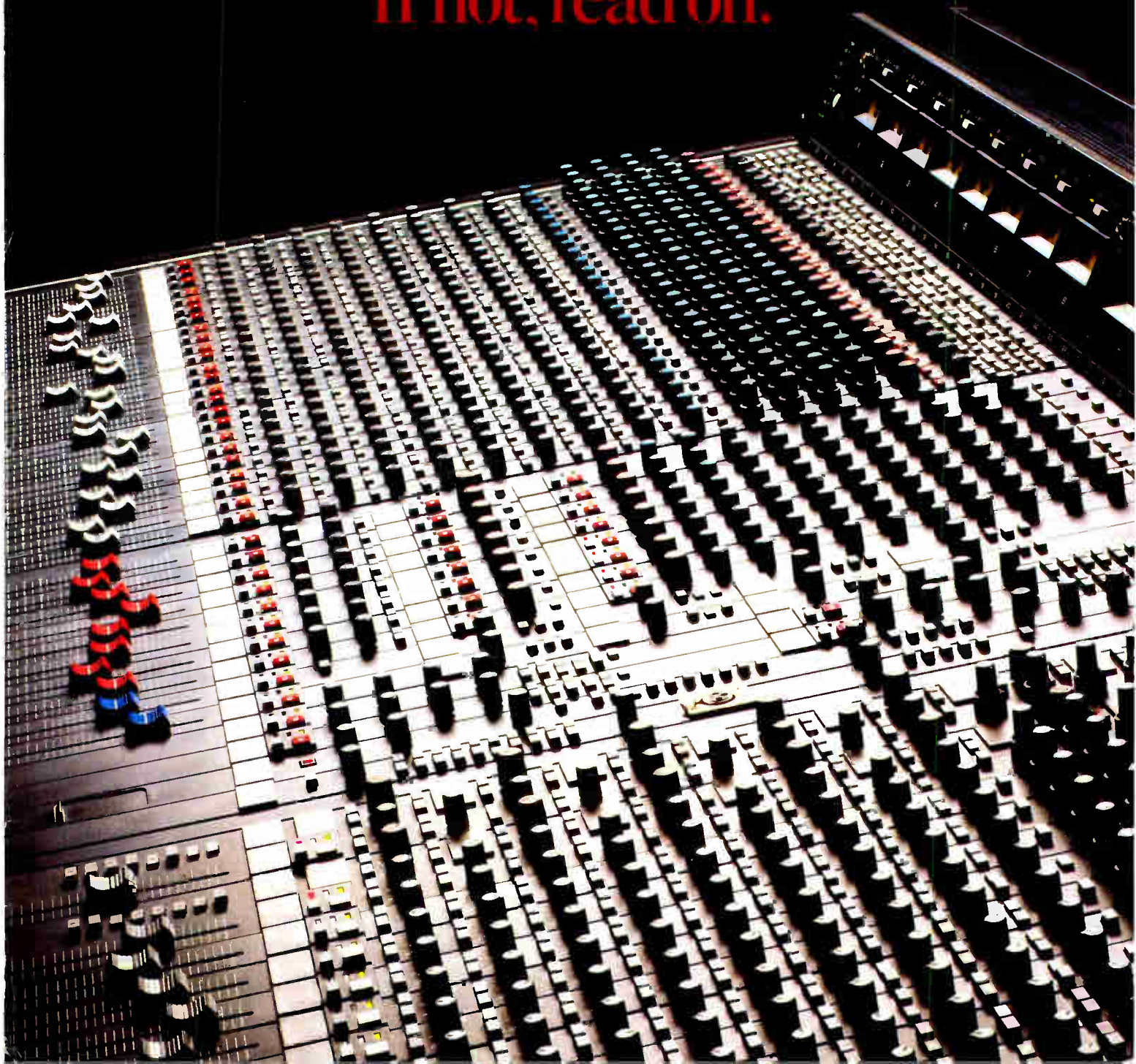

Introducing the Ramsa WR-S840 Series Professional Audio Mixing Consoles.

Why did Ramsa design this console?

How many times have you compared the specifications for two different sound mixing consoles and wondered why, though their specs were very similar, they sounded so differently? It happens all the time.

One of the primary causes for this apparent discrepancy between specs and actual performance is related to the way in which specifications are measured. Typically, a spec is measured in a laboratory, with highly controlled conditions. The console is driven from a single, well-behaved source (an oscillator or noise generator), and terminated by a resistive pad and some sort of analyzer. Under these conditions, you may see very impressive specs for noise and distortion. Yet take that same console into a studio, an arena, or a theatre and consider what happens. You'll connect dozens of inputs from a variety of locations (some carrying noise modulation from dimmers, fluorescent light ballasts, wireless mics, or the security crew's walkie-talkies). You'll hook up the outputs to loads through hundreds of feet of reactive cable. You'll patch in signal processors that may be fed from different AC systems (with hum and noise current riding on the difference

in ground potential). Suddenly, the performance is orders of magnitude less impressive.

In fact, many consoles become unusable under these conditions. This is one of the areas we sought to correct in designing the WR-S840 series.

Our market research indicated there was a genuine need for a truly professional sound mixing console without a lot of costly gimmicks. The basic function of such a console was already well-defined, yet we wanted to design a console that would become the benchmark which future consoles must emulate. One that would exhibit comparable performance and stability in the field to that exhibited in the lab. And our experience in sound reinforcement, and especially in the broadcast industry (where the demands are extraordinary), gave us the know-how to do the job. The result is the WR-S840 series of consoles.

Crosstalk: a key factor in console performance.

One of the most critical, and least understood, aspects of the performance of a console is

crosstalk, or leakage. When you put a signal into the console, and it comes out everywhere, that's crosstalk. Crosstalk is usually present even in the finest consoles. For example, the "infinity" marking on a fader really doesn't turn the signal off—it just attenuates it. Crosstalk also applies to all volume controls (aux sends, pan pots, etc.) and to switches (pre/post, assign, on/off, etc.). In other words, it affects everything in the console. The real question becomes, "how much has the crosstalk been attenuated, and what is its frequency response?"

Crosstalk is as important an attribute of a console's performance as is distortion or noise. Yet typically you will see only one crosstalk figure (adjacent inputs to adjacent outputs). No wonder you cannot determine

much about the real system performance from looking at a typical crosstalk spec!

Consider that a typical crosstalk figure of -55 dB at 1 kHz can degrade to -40 dB at 10 kHz due to the capacitive nature of high frequency crosstalk. It doesn't do much good to achieve a low distortion figure, like 0.01% (which is 80 dB below signal level), when the crosstalk is -40 dB at 10 kHz. That level of crosstalk is roughly the equivalent of 1% distortion at 10 kHz!

Ramsa uses several approaches to reducing crosstalk. In our physical bus structure, we pair a ground conductor with each signal conductor so that adjacent channels of audio are always isolated by a ground. Even with all those grounds, it would still be possible for crosstalk components to modulate the poten-

WR-S840 Configured as a
52 Input House Console.



tial on the cumulative ground bus—resulting in low frequency crosstalk, and a muddy sound. Therefore, we also run a heavy (1/8" x 3/4") chrome-plated solid copper ground bus the length of the console, to which each module's audio common is tied. You won't see evidence of this difference in the specifications, but you will sure hear the difference in the studio or in a live performance.

Another way we combat crosstalk is to back-ground all assignment switches. This means that when a bus is not assigned through a given switch, that feed to the bus is shunted to ground. This prevents the signal brought to the switch from leaking onto the bus.

In a non-back-grounded (that is, a conventionally

higher and higher as more inputs are assigned. Every time the number of inputs assigned is doubled, the white noise rises 3 dB and the hum increases 6 dB. That's why the specs can look good in the lab, and not be very impressive in the field.

You don't get something for nothing, and unfortunately, back-grounding does cause the summing amps to run at maximum noise gain. In order to keep the overall noise low in the WR-S840 series, while avoiding crosstalk by using the back-grounding scheme, we designed a discrete summing amp circuit for the console. This new amp yields an improvement of better than 12 dB in noise performance over conventional monolithic IC amps. A very pleasant side ben-

A proven method of professional console grounding.

Grounding is the most misunderstood aspect of system design. Improper console grounding can cause odd noises and unwanted sounds that are difficult or impossible to eliminate regardless of how carefully the rest of the system is assembled.

There are really just two basic types of grounding practices: single-point and distributed. Single-point grounding can work well within a small sound system. Distributed grounding lends itself to large systems, including those up to the size of your telephone company! Clearly, we selected a distributed system as being the appropriate technique for the WR-S840 series. We didn't do anything new, we just did our homework.

As far back as the 1950's, the Journal of the Society of Motion Picture and Television Engineers (SMPTE) characterized, in detail, a distributed grounding technique which they recommended for use by all equipment manufacturers. Film studios generally have

large installations—sometimes spanning many acres, with up to a dozen sound stages all fed from a central tape machine/film dubber room. Similarly, TV network facilities invariably distribute audio through multiple floors of high-rise buildings,



It's no great engineering achievement to build a console that yields good specs on the bench. But getting it to perform to those same specs under 'real-world' conditions... That's quite another matter."

**John Windt,
consulting
engineer**

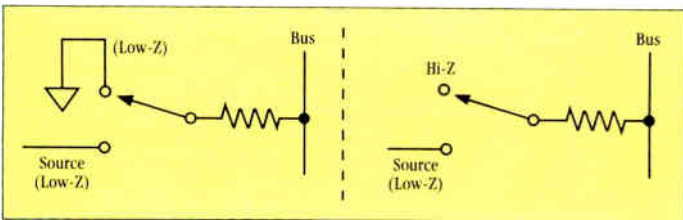

Ramsa back-grounded switch (left) versus conventional bus assign switch (right).

grounded) system, you can see very low noise figures with only one input assigned to a bus, yet the noise comes up

efit is that the system noise is not only lowered, it doesn't change as more inputs are assigned (see specs).

with a lot of RF present. Hence, the SMPTE practices have to work for the toughest of grounding situations. We followed SMPTE recommendations in the WR-S840 series because they comprise a truly professional methodology that eliminates the vast majority of hum, buzz and other ground-related problems.

NOTE: SMPTE also stated that input and output connections must be balanced, which is why all inputs and outputs on the WR-S840 series consoles are balanced. In fact, these consoles are among a very few on the market that comply with all recommended SMPTE practices for professional sound equipment.

Hi-MIC circuitry for precision and reliability.

A Hi-MIC is a cost-effective circuit package that makes use of surface-mount technology. Traces are plated on a substrate, and then all resistors, capacitors,

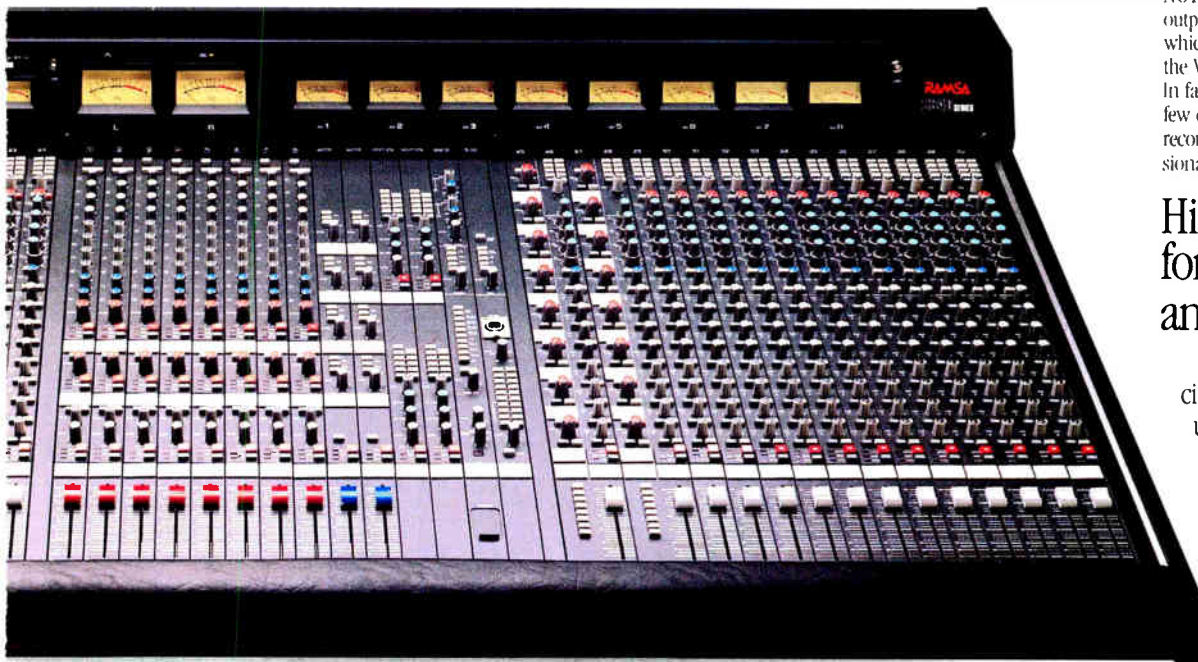

transistors and ICs are surface mounted to that substrate. The package is then potted for stability and thermal conductivity. Resistor tolerances in our



Hi-MICs can be held to within a very low 0.5%, resulting in excellent uniformity. Hi-MICs, which are essentially self-contained circuit blocks, also simplify troubleshooting.

Good, stable circuit design— It doesn't cost you any more for us to do it right!

Consider the buffer amps. Consoles invariably have many circuits to buffer one stage from the next, serving as an impedance converter without changing the gain. For example, there's always a buffer between each pan pot and its assign

simple, expedient circuit will create a peak in the response at a very high frequency, somewhere around 2 MegaHertz. The designers assume this will not cause problems because, after all, the audio range is limited to about 20 kHz, and this is 100 times higher in frequency.

At Ramsa, we know better. We realize that a 2 MHz peak is an invitation to radio frequency interference. It turns the console into a great business radio receiver so that a passing taxi cab, for example, is likely to contribute to your program. For this reason, we

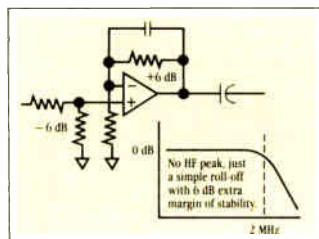

Ramsa unity gain buffer stage and its response.

designed the unity gain buffer for the WR-S840 series. It now has more parts, but the circuit is much better behaved, exhib-

any source from -60 dBu to $+4$ dBu nominal level while maintaining a full 20 dB headroom throughout this range. The circuit uses discrete transistors for low noise, and a bipolar 25 volt supply for the headroom.

Long-life MRP™ controls.

MRP (Matsushita Resistive Plastic) describes a proprietary RAMSA process for building high quality, high precision, long life controls. For example, the faders and input attenuators on the WR-S840 consoles are rated at 300,000 operational cycles. This is some 20 times the life of a typical carbon fader!

Fiberglass-Epoxy circuit boards throughout.

Fiberglass-epoxy boards may cost more, but they offer numerous advantages. They don't warp, they are much stronger than phenolic boards, they can be fabricated with

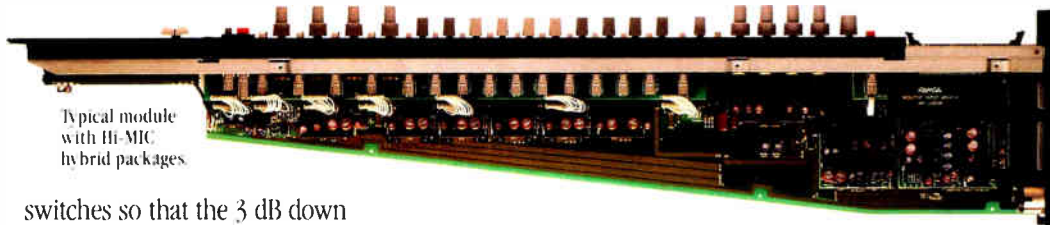

Typical module with Hi-MIC hybrid packages.

switches so that the 3 dB down point of the pan pot does not shift, no matter how many assign switches are selected. Unfortunately, the typical cir-

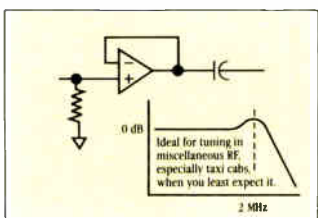

Typical single-IC, unity gain buffer stage and its response.

cuit that performs this function ends up creating problems of another sort. That's because the

iting a simple, non-peaked single-pole response and providing some 6 dB greater margin of stability than the typical designs in other consoles. What's more, all capacitors in the audio path are Elna™ "Carafine" grade low-ESR type for superior transient response.

The universal input circuit.

Our engineers developed a unique input preamp circuit. Its 41-position control can be continuously adjusted, with 15 dB detented resolution, to accept

double-sided traces and plated through holes. That's why every circuit board in the WR-S840 consoles is of this design.

Comprehensive 4-band equalization.

Each input module is equipped with a powerful 4-band, state-variable, sweep-frequency equalizer with high speed (20 volt per microsecond) bi-EET™ ICs. This circuit complements the engineer's acoustic and



Mono Mic/Line Input Module (WT-S81)

Sub Input Module (WT-S82)



Group Output Module (WU-S84)



Effect Return Module (WU-S86)



Talk Back/OSC Module (WU-S88)

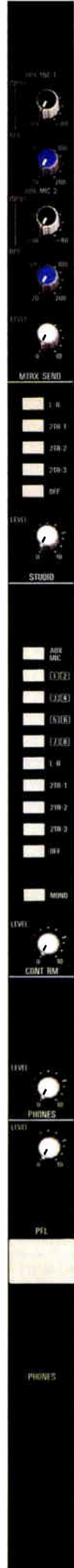

Monitor Module (WU-S87)



Master Output Module (WU-S85)

musical tastes at typical boost/cut levels where the controls are normally used for subtle shaping and enhancement. At higher levels of boost or cut, the 'Q' of the filters compounds and becomes higher, for more effective shaping of sound. Center detents on the gain controls facilitate rapid neutralization of each band.

Ribbon wire bussing and gold contacts for reliability and low noise.

All power and audio connections between modules is carried via flexible ribbon cables. These busses mate with the module PC boards through gold-plated contacts. Thus,

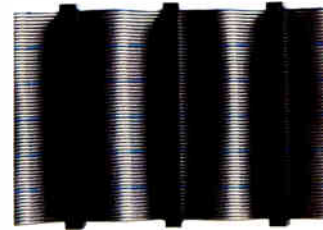

without any large motherboard, there is no strain on the connectors as the console travels and flexes, and contact resistance remains uniformly low for the entire life of the console.

Sweep-frequency high-pass filters.

Each equalizer is accompanied by a high pass filter with 12 dB/octave slope and a knee frequency sweepable from 20 Hz to 200 Hz. This affords precise control of wind noise, stage rumble, vocal plosives ("pops"), etc. without cutting desired program frequencies.

Submix modules expand your input capacity by a factor of four.

The Submix module is a double-width input module that has 8 mic/line preamp circuits, each equipped with its own phantom power, phase reverse, assign on/off, direct out and PFL switches. That's four times the input density of standard input modules. The Submix module also has the same overall 4-band state-variable EQ, variable high pass filter, PFL and channel ON switches as the standard input modules. It also has the same 18 sends, including: 8 aux bus assigns, stereo pan, and 8 primary mix busses. Just three of these function-packed modules can handle a 24 track tape mix. Stuffing a full sized mainframe with 20 modules accommodates 160 inputs, though it is unlikely you'll use such a configuration. Realistically, you may wish to fill 16 slots with 8 of these Submix modules (thus handling 64 inputs), and the remaining 24 slots with standard input modules, for a total capacity of 88 mic/line inputs.

Stage monitor modules turn the WR-S840 into a 40 x 18 stage monitor board.

By inserting Stage Monitor Input modules into the mainframe, a 40 x 18 stage monitor mixing console is created—with the features and flexibility of monitor boards costing more than twice as much. Each module includes a 100 mm fader, plus 10 mono bus level controls and 4 pair of concentric stereo bus level controls. The stereo controls are internally switchable so they can serve as 8



WR-S840 Configured as a 40 x 18 Stage Monitor Console.



independent assigns, for a total of 18 discrete mixes on each module. Each mono assign, and each pair of stereo assigns, has its own pre/post fader switch, as well as an assign on/off switch. The Monitor module also has the same 4-band state-variable EQ, variable high pass filter PFL, overall channel on, phantom power and phase reverse switching as the standard input modules. This is the perfect complement to a WR-S840 house console.

A new look and feel—a whole new console.

The WR-S840 series not only represents a major step forward in performance, it also embodies a new look and feel. Elegant, neutral styling is housed in a low-profile (12" high) package that makes it easy to peer over the meter panel. All volume controls are detented, and all knobs are subtly color coded so they don't assault the eye—yet they maintain good contrast under a variety of lighting levels and hues. The top of the meter panel is horizontal and flat, so you can stack it with small

monitors or other equipment. And it's even covered with a non-skid rubber surface to help keep these objects in place. Internally, there are many pre/post switches: the standard post fader & EQ Direct Output can be made pre-EQ to feed a house console, or pre-fader & EQ to provide a split off the mic pre without double-terminating a mic. There is a built-in dimmer circuit and 3 sockets for standard LittLites. In short, we paid attention to the little details that make your mixing pleasurable and efficient.

Uncompromising audio performance.

In keeping with the overall design integrity of this series, the mechanical and electrical performance are exemplary. High-speed 5532 opamps are used extensively. Numerous power-supply decoupling caps (7 on each input module alone) keep the supply voltage very "stiff" to avoid muddiness and interaction between circuits. The distortion is so low that at nominal operating levels it is immeasurable because it is below the noise floor (less than 0.01% THD). Even at +24 dBm output into 600 ohms, the distortion rises only to 0.05%.

The -3 dB points are 10 Hz and 140 kHz. At the same time, the console is very stable and has no tendency to oscillate even when all controls on the console are at maximum level! The overall signal-to-noise ratio (with all inputs at nominal, all channels on and assigned to a bus) is better than 80 dB. Add the 20 dB output headroom, and you've got 100 dB dynamic range in a worst-case, real-world scenario. That's quiet. In fact, the output noise approaches that of an 18 bit digital system. The common mode rejection ratio (CMRR) for the universal mic/line inputs is an impressive 75 dB at 1 kHz (65 dB broadband, 20 Hz to 20 kHz). The internal gain structure is conservative, with an extra 6 dB of headroom on the summing amps, so that as channels are added to the mix, the mixing busses do not rapidly overload and require that inputs be backed off.



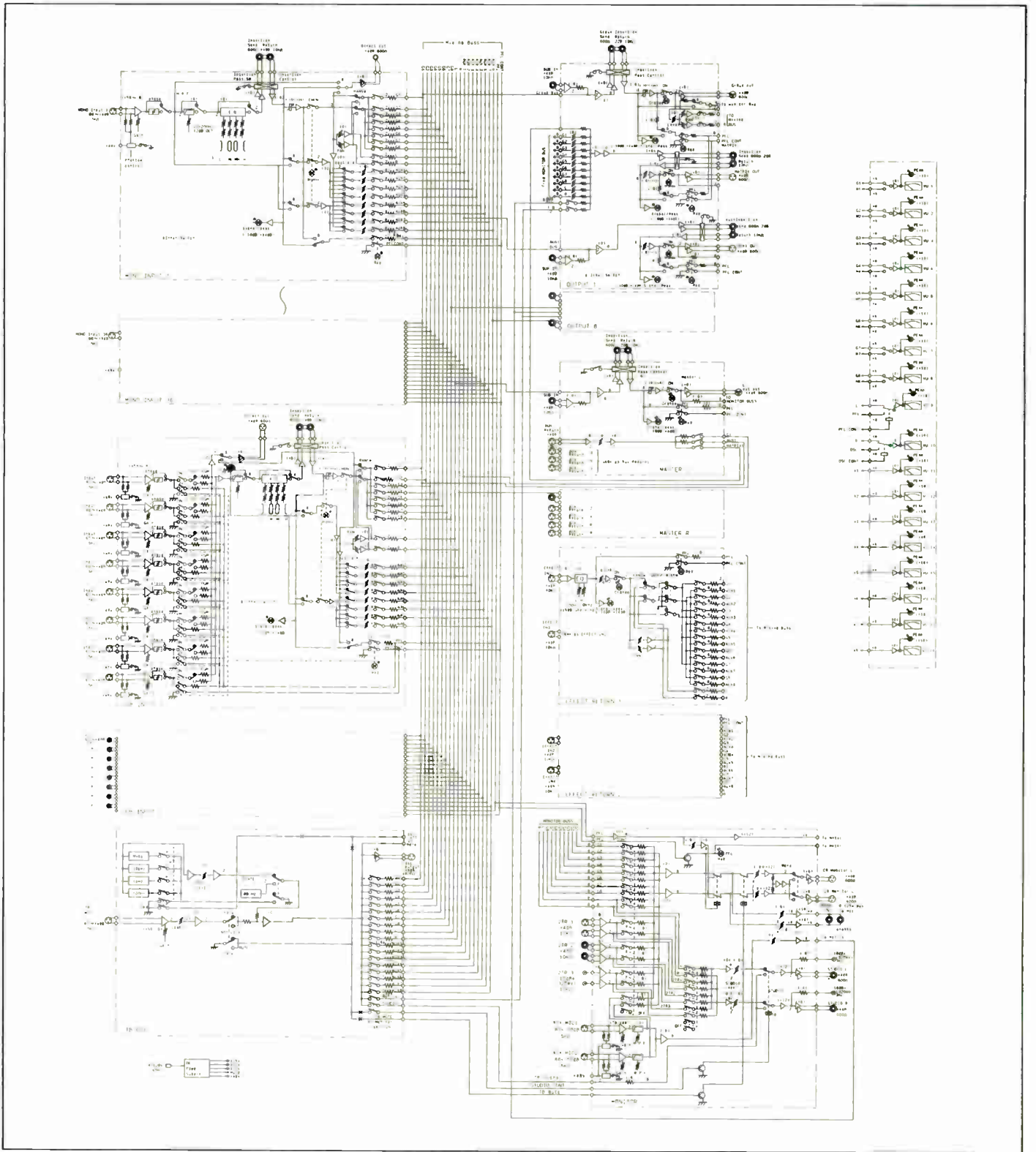

WR-S840 Test Data

Frequency Response	+0, -1 dB, 20 Hz to 20 kHz; -3 dB at 10 Hz and 140 kHz; any input to any output bus, at any level control setting	Crosstalk†	
Total Harmonic Distortion		Adjacent Input to Adjacent Output	85 dB at 1 kHz; 72 dB at 10 kHz
At Nominal Level	0.01%*(+4 dBu in & out)	Fader (Maximum Kill)	80 dB at 1 kHz; 60 dB at 10 kHz
10 dB Above Nominal	0.006%(+14 dBu in & out)	Channel On/Off Switch	95 dB at 1 kHz; 75 dB at 10 kHz
20 dB Above Nominal	0.05%(+24 dBu in & out)	Aux Send Pot	75 dB at 1 kHz; 60 dB at 10 kHz
Intermodulation Distortion		Output Module (All Combinations of Group-Aux-Matrix)	80 dB at 1 kHz; 65 dB at 10 kHz
At Nominal Level	0.01%*(+4 dBu in & out)	Common Mode Rejection Ratio	
10 dB Above Nominal	0.01%(+14 dBu in & out)	Standard Channel Input	70 dB 20 Hz to 20 kHz at any input gain control setting
20 dB Above Nominal	0.1%(+24 dBu in & out)	All Other Inputs	40 dB at 1 kHz; 35 dB at 10 kHz
Dynamic IM Distortion		Equalization	
At Nominal Level	0.01%*(+4 dBu in & out)	Low (shelving)	±15 dB, sweepable 40 Hz to 400 Hz
10 dB Above Nominal	0.005%(+14 dBu in & out)	Low-Mid (peaking)	±15 dB, sweepable 160 Hz to 1.6 kHz
20 dB Above Nominal	0.02%(+24 dBu in & out)	High-Mid (peaking)	±15 dB, sweepable 800 Hz to 8 kHz
Phase Response	+60° at 20 Hz, -20° at 20 kHz	High (shelving)	±15 dB, sweepable 1.6 kHz to 16 kHz
Noise		High Pass Filter	12 dB/octave, sweepable 20 to 200 Hz
Equivalent Input Noise	-127 dBm (150Ω source, DIN audio bandwidth 22 Hz - 22 kHz)	Mixing Bus Assigns	
Output Signal-to-Noise Ratio	86 dB (all faders off, all channel switches off, all modules assigned to the bus) 80 dB (all faders at nominal, all channels on, all modules assigned to the bus, input gain controls at +4)	Standard Input Modules	8 group, 2 stereo & 8 aux send
Maximum Voltage Gain		Monitor Module	10 mono & 4 stereo (stereo outputs are switchable to dual mono in pairs, for a total of 18 busses)
Input to Group Out	84 dB (±2 dB)	Meters	18 VU meters with LED Peak indicators; 8 switchable for Matrix or Group, 2 Stereo, 8 Aux
Input to Aux Out	86 dB (±2 dB)	Headroom	20 dB minimum throughout the entire console
Input to Matrix Out	90 dB (±2 dB)	Power Requirements	120 V AC, 60 Hz, 600 VA (Ramsa WU-PS80 Supply)
* There is no measurable distortion at nominal level; this value is actually the noise floor of the console, which is why distortion drops at 10 dB above nominal level.		Overall Dimensions (WxHxD)	72-7/8" x 12" x 39-3/8" 1851 mm x 305 mm x 999 mm
† Crosstalk values are the difference between the level fed into the driven circuit, and the level measured in the non-driven circuit.		Weight	293 pounds (133 kg) approx.

Input Characteristics	Actual Impedance	Nominal Source Impedance	Nominal Level	Max Level Before Clipping	Connector
Standard Channel Inputs	5kΩ	150Ω ~ 600Ω	-60 ~ +4 dBu	-40 ~ +24 dBu	XLR-3
Aux In, 2-Track 1 In, Efx In	10kΩ	600Ω	+4 dBu	+24 dBu	XLR-3
Input Module Insert Return, 2-Track 2 Input, Sub Input	10kΩ	600Ω	+4 dBu	+24 dBu	T/R/S Phone Jack
2-Track 3 Input	10kΩ	10kΩ	-10 dBV	+12 dBV	RCA Jack
Output Bus Insert Return	10kΩ	600Ω	-2 dBu	+24 dBu	T/R/S Phone Jack
Aux Mic Input	5kΩ	150Ω ~ 600Ω	-80 ~ -50 dBu	-60 ~ -40 dBu	XLR-5
Output Characteristics	Actual Impedance	Nominal Load Impedance	Nominal Level	Max Level Before Clipping	Connector
Group, Aux, Matrix, Stereo, Control Room & Osc. Out	75Ω	600Ω	+4 dBu	+24 dBu	XLR-3
Input Insert Send, Direct Out, Studio Out	75Ω	600Ω	+4 dBu	+24 dBu	T/R/S Phone Jack
Group, Aux, Matrix & Stereo Insert Send	75Ω	600Ω	-2 dBu	+24 dBu	T/R/S Phone Jack
Studio Out	500Ω	10kΩ	-10 dBV	+12 dBV	RCA Jack



Panasonic
Industrial Company

©1987 Panasonic Printed in U.S.A.
Data subject to change without notice or obligation.

Data measured on an Audio Precision test set is available on written request. Elma is a trademark of Elma America, Inc., Carson, CA. MRP is a trademark of Matsushita Electric Corporation of America.

NEVE



Where Creativity Meets Technology

Applied imagination. The perfect synthesis between artistry and sound technology. That's the dream that built the Neve range of consoles. From the Classic 80 Series to the V Series and Digital Studio Systems, Neve provides a full range of multitrack consoles.

The Formant Spectrum Equalizer, a technological breakthrough integral to the acclaimed sound of Neve, is now teamed up with the most comprehensive in-console dynamics units ever developed. By combining total control of limiting and compression and comprehensive noise gate with hysteresis control, processing has never been easier on the V Series and Digital Studio Systems. More than a decade ago, Neve introduced moving fader automation. Now in hundreds of installations worldwide, Necam 96 drives the finest production and post-production projects in the world's top studios.

Contact us to make Neve's sound quality, reliability, consistency of performance, speed and ease of operation your tools for translating ideas into recorded reality.



NEVE . . . PUT YOUR CREATIVITY IN FLIGHT.

 **Neve**

Rupert Neve Inc.

A Siemens Company

RUPERT NEVE INC., BERKSHIRE INDUSTRIAL PARK, BETHEL, CONNECTICUT 06801, U.S.A.
TELEPHONE: (203) 744-6230. TELEX: 96 9638. FACSIMILE: (203) 792-7863

NY: TEL: (212) 956-6464 - CA: TEL: (213) 874-8124. FACSIMILE: (213) 874-1406
TN: TEL: (615) 385-2727. FACSIMILE: (615) 297-5092.

NEVE ELECTRONICS INTERNATIONAL LIMITED, MELBOURN, ROYSTON, HERTS SG8 6AU, ENGLAND
TELEPHONE: ROYSTON (0763) 60776. TELEX: 81381. CABLES: NEVE CAMBRIDGE.
FACSIMILE: (0763) 61886

MIX

JANUARY 1988

THE RECORDING INDUSTRY MAGAZINE

VOL. 12, NO. 1



SUZANNE VEGA

P. 132



HAL BLAINE & TOMMY SANDS P. 125



PC'S IN THE STUDIO

P. 170



WENDY WALDMAN

P. 130

FEATURES

48 A SURVEY OF MUSIC SOFTWARE

by Paul Potyén

58 THE R-DAT SCARE:

Mix Readers Speak Out

66 SOFTWARE SOLUTIONS TO POST-PRODUCTION PROBLEMS

by Dale Strumpell

114 MICK JAGGER: The Stone Rolls Alone

by Iain Blair

163 GREG SHAW: Portrait of the Artist in a Computer World

by Lou CasaBianca

170 PC'S IN THE STUDIO:

How Northwest Studios Use

Computers by Linda Jacobson

COLUMNS

16 INSIDER AUDIO: CD Video

Production by Ken Pohlmann

24 JUXTAPOSITIONS:

Disk & DAT by Mel Lambert

34 PRODUCER'S DESK: Elliot

Scheiner by Larry Oppenheimer

54 STUDIO VIEW: Beyond the MIDI

Studio by Tory Thomas

80 FIELD TEST: Leonardo Librarian Software

by Jerry Ross

83 FIELD TEST: Lexicon 480L Digital

Effects Processor by Larry Oppenheimer

86 LUNCHING WITH BONZAI:

Tommy Tedesco by Mr. Bonzai

96 SOUND ON STAGE: Sound

Reinforcement News & Tour

Update by Mark Herman

100 SOUND ON STAGE: On the Road with

Pink Floyd by Elliot Luber

110 MI UPDATE: The MIDI Studio

Grows Up by Craig Anderton

125 THE HAL BLAINE STORY: Tommy

Sands by Hal Blaine with David Goggin

130 PLAYBACK: Wendy Waldman's Letters

Home by Blair Jackson

132 MUSIC NOTES: Duane Eddy, Cinema

Records, Suzanne Vega, Soundtrack

Wizard Joel Sill

146 AFTER-MIX: Formats & Futures

by Philip De Lancie

149 POST-SCRIPT: Tapeless Recording for

Television Post by Peter Wetzler

152 INTERACTIVITY: Macintosh's

HyperCard by Lou CasaBianca

FROM THE EDITOR

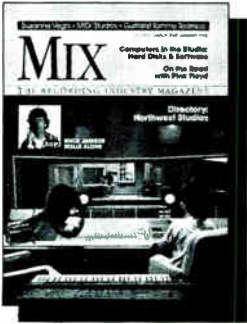

Cover: Located in Reno, Nevada, Granny's House combines the atmosphere and comfort of a Victorian home with state of the art recording facilities. The studio is equipped with an SSL 6000 fully automated console with Total Recall, Studer tape machines, UREI and Yamaha monitors driven by Crown power amps and a wide assortment of outboard gear. The studio is minutes away from the Lake Tahoe resort area. Photo by Robert Ordware, Studio One Photography.

DEPARTMENTS

6 CURRENT

8 INDUSTRY NOTES

10 SESSIONS/STUDIO NEWS

72 PREVIEW

222 CLASSIFIEDS

226 AD INDEX

DIRECTORY

184 LOCATION INDEX

186 24+ TRACK

204 12 & 16 TRACK

212 4 & 8 TRACK



Circulation independently audited and verified by Business Publications Audit of Circulation since 1986.

Mix magazine is published at 2608 Ninth St., Berkeley, CA 94710 and is ©1987 by Mix Publications, Inc. This is Volume Eleven, Number Eleven, November 1987. *Mix* (ISSN 0164-9957) is published monthly. Subscriptions are available for \$38.00 per year. Subscriptions outside U.S.A. are \$50.00 per year. Single copy price is \$4.00, back issues \$5.00. Send subscription applications, subscription inquiries and changes of address to *Mix* magazine, PO Box 3714, Escondido, CA 92025-3714 or call one of these toll free numbers: in CA, 1 (800) 255-3302; outside CA, 1 (800) 334-8152. Address all other correspondence to *Mix* magazine, 2608 Ninth St., Berkeley, CA 94710, (415) 843-7901, Fax: (415) 843-9540. Second Class postage paid at Berkeley, CA and additional mailing offices. *Mix* magazine is distributed in pro audio stores, music stores and other related businesses. If you have a recording or music-related business and would like to distribute *Mix*, please give us a call. Display advertising rates, specs and closing dates are available upon request. This publication may not be reproduced or quoted in whole or in part by mimeograph or any other printed means, without written permission of the publishers.

The big news in professional recording these days is how the computer has entered into virtually every facet of the recording process. From operating a studio business to a mixing console, from generating a score for the instrumental arrangements to creating the sounds of the orchestral palette, from building an on-line masterpiece to carving a 72-second musical tidbit into two 30s and a 60, the computer is being put to good use by the recording community.

At the fall AES Show, the barometer of pro audio's health and welfare, there were enough computer disk-based recorders and editing devices to prove that a trend has developed, and this hardware certainly received the most attention. Yet while these systems boast impressive capabilities, they go up against many time-tested procedures and require significant user learning time. Whether they'll be quickly accepted by the studios or just become the latest round of instant obsolescence remains to be seen. We plan to follow these developments over the next few months, and try to give you, in the process, a clear view of how these devices operate and their viability in the studio.

We begin our closer look at disk-based production with Mel Lambert's overview of AES and the key players in this new industry niche. This month's PostScript profiles a New York disk-based recording studio, for an applications-oriented view of the topic. Our studio operator's forum this month, hosted by Linda Jacobson, explores music hardware and software currently being used by operations in the Northwest U.S. And for the latest on music and production software, our new associate editor, Paul Potyten, has surveyed the field and reports on where the action is. Paul, a jazz musician with two engineering degrees and MIDI tendencies, replaces George Petersen, who moves over to become managing editor of *Electronic Musician*. However, George remains product editor at *Mix*.

Keep Reading,

David Schwartz
Editor/Publisher

WE'RE MOVING

As of January 20, 1987, Mix Publication's mailing address will be 6400 Hollis St., Ste. 12, Emeryville, CA 94608.

New phone: (415) 653-3307

New FAX: (415) 653-5124

CURRENT

Congress Asked to Include Music Rights in Package

Four witnesses representing the television broadcast industry told a Senate subcommittee that the cost of music copyrights in syndicated programs purchased by local TV broadcasters should be included in the purchase price of the overall program package.

Currently, broadcasters must buy expensive "blanket licenses" for the rights to millions of songs, although they may actually only need the rights to a few dozen songs contained in programs already bought.

Testifying before the Senate Subcommittee on Patents, Copyrights and Trademarks were Leslie G. Arries, Jr., chairman of the All-Industry Television Music Licensing Committee, Buffalo Broadcasting Co., Inc., Buffalo, NY; committee member C.E. Cooney, KPNX-TV, Phoenix, AZ; Philip J. Lombardo, NAB representative, Citadel Communications, New York, NY; and Dick DeAngelis, KPHO-TV, Phoenix, AZ, representing INTV.

"We are currently able to bargain directly with copyright owners for the performance copyrights to everything we air except one thing—the background and theme music which the Hollywood studios insert into the syndicated shows they sell us," says Lombardo. "All studios assign their music copyrights to one of two licensing societies, ASCAP or BMI. They in turn demand a flat payment, historically a percentage of the station's total revenues, not simply a portion of the money generated by the programs themselves."

The broadcasters have spent 13 months attempting to negotiate a fair solution with ASCAP without sat-

isfactory results. They support legislation that would eliminate "blanket licensing" and establish "source licensing"—music rights would be included with all other copyrights (script, literary or choreography) that are conveyed by the syndicator when the rights to a TV show are sold to a local station.

Video Expo Set for San Francisco

More than 8,000 prospective buyers will be combing the aisles looking for equipment at Video Expo San Francisco, February 23 to 25 at the SF Civic Center. Along with exhibits, the Expo offers an intensive seminar program, all under one roof. Booth space is now available. For more information call (800) 248-5474, or (914) 328-9157 in New York.

Disctronics Buys Two CD Plants

International compact disc manufacturer, Disctronics Ltd., has acquired LaserVideo Inc., the largest U.S.-owned CD producer, for \$55 million in cash and stocks. The LaserVideo plants in Huntsville, AL, and Anaheim, CA, combined with the Disctronics plants in Melbourne, Australia, and Southwater, England, will produce 65 million units, capturing 20% of global production, making it the third largest CD producer following Philips Dupont Optical and Sony. Disctronics has achieved this distinction less than 18 months after its original Australian plant began construction.

"As the world's major independent," says Disctronics CEO, Roger Richmond-Smith, "we can significantly enhance our commitment to client service—for majors and independents alike—in what is increas-

ingly a global market.

"We now have a balanced global capability in the compact disc and optical storage industries which will create greater effectiveness in production, supply and product development for our combined operations."

LaserVideo, formerly a wholly owned subsidiary of the Chicago technology company, Quixote Inc., adds a client base with service offices in New York and Los Angeles. LaserVideo's pioneering work in videodisc and CD-ROM mastering plus audio CD dates from 1983. It is now the second largest producer in the U.S., with the only CD plant on the West Coast. Both Disctronics and LaserVideo use a state-of-the-art Meiki injection molding technology.

Music Expo Set for Los Angeles

Music Expo '88, designed to be the world's largest showcase for music and music-related products, will be held at the Long Beach Convention Center, south of L.A., April 29 to May 1.

The three-day show will host over 200 manufacturer and vendor exhibits in a trade show format structured for consumers. Everything from drum kits and sheet music to electronic keyboards and the latest in digital technology will be on display. In addition to the exhibits, the event will include demonstrations, on-site seminars, live performances, sweepstakes and individual product promotions.

Booth space is now available. For complete information and a space reservation kit, contact Musex, Inc., 723½ North LaCienega Blvd., Los Angeles, CA 90069, (213) 659-0701.

OPPORTUNITY KNOCKS.

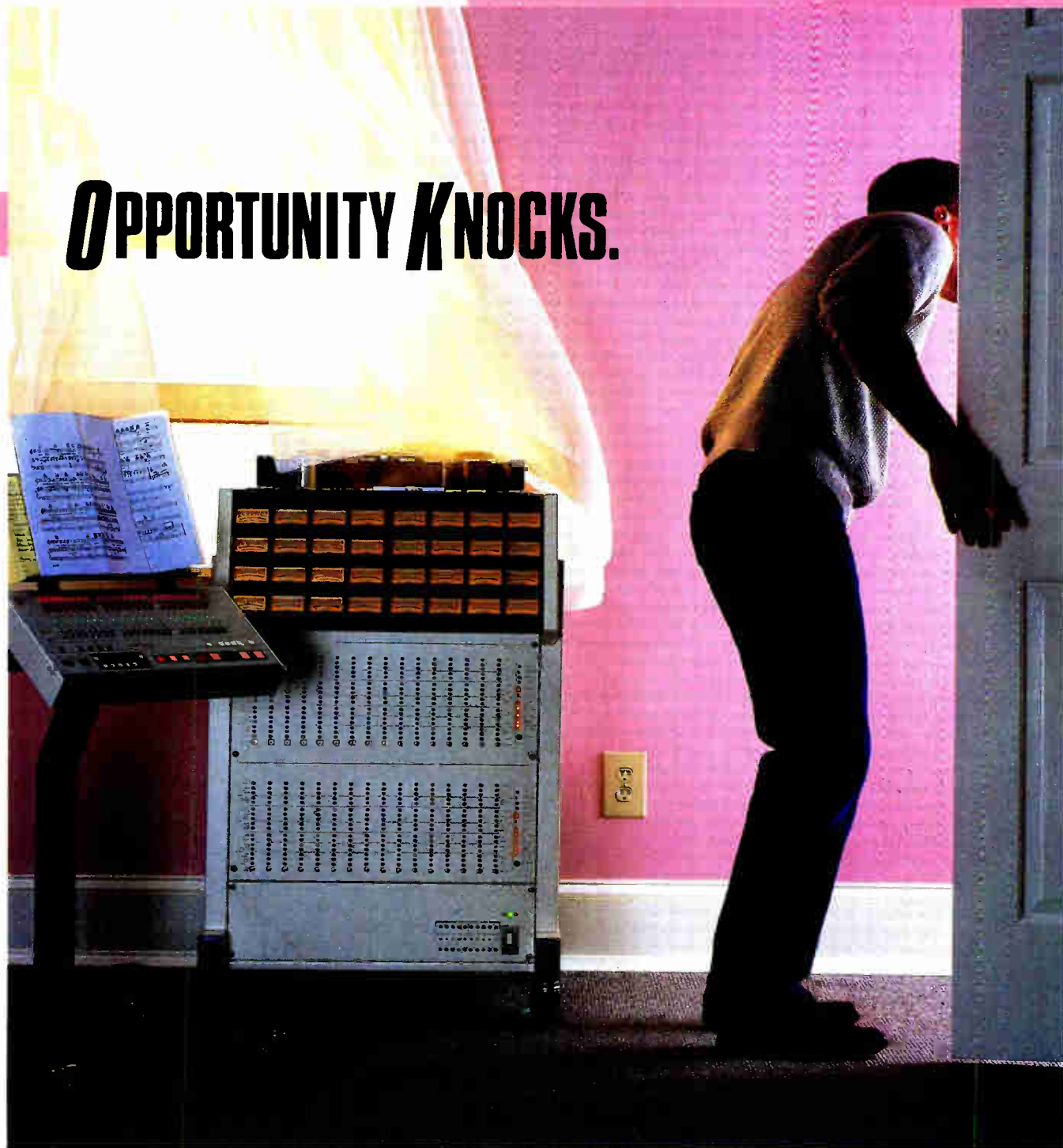

c Otari 1986

32 Tracks; constant tension tape transport; built in autolocator; noiseless and gapless punch-in/punch-out, and HX Pro—at a price you can afford. We call it “opportunity”. You’ll call it “a killer”.

We know getting started in the music business can't mean an MTR-90 in the first month, even when your talent warrants it. So we've given you the next best thing—the MX-80. Now you have room for the band, the back-ups, the strings and the horns—with some bucks left over for that new console you've been looking at. And there's a 24 channel version too! From Otari: Technology You Can Trust.

Contact your nearest Otari dealer, or call Otari (415) 592-8311.

■ Otari Corporation, 2 Davis Dr., Belmont, CA 94002

OTARI

INDUSTRY NOTES

Sound and electronics system contractors can look forward to a comprehensive seminar at the **Contractors Expo and Conference '88**, May 18 and 19 in Reno, Nevada. The seminar will include audio, video, management and computer-assisted design sessions. Nearly 300 product exhibitors are expected at the Expo. To register call the **National Sound and Communications Association (NSCA)** at (312) 593-8360 . . . The **National Computer Graphics Association (NCGA)** is holding a five-day conference March 20 to 24 in Anaheim, CA. Artificial intelligence, computer art and animation, computer-aided design and manufacturing and electronic publishing will be among the subjects of the 128 sessions conducted by over 300 speakers. For further information, contact Sharon Sutton or Bob Cramblitt at (703) 698-9600 . . . The 129th **SMPTE Technical Conference and Equipment Exhibit**, held October 31 through November 4 in Los Angeles, drew over 17,000 people, breaking attendance records for the third consecutive year. The theme of this year's conference was "Imaging and Sound—Today and Tomorrow" . . . **Nimbus Records**, a British compact disc manufacturer, announced agreement to acquire majority holdings in **Maxwell Communications Corporation** for 24 million pounds. The partnership will involve further development in the areas of electronic publishing and information technology, including CD-ROM . . . **Optical Media International**, a Los Gatos, CA company specializing in optical data storage and digital audio workstation technologies, has formed **Reflective Arts International**, a new publishing label that will be active in publishing optical discs in the CD-ROM, CD-Audio and CD-Interactive formats . . . **David Angress** joined **One Pass, Inc.** of San Francisco as vice president of sales and marketing . . . **Martin Audio Video Corp.** of NYC appointed **Michael Bogen** as vice president and **David Bellino** as sales manager . . . Japan's **Nippon Gakki Company, Ltd.**—a company perhaps unknown to most readers—decided to change its name to **Yamaha Corporation**. Nippon Gakki is the parent company of Yamaha, the giant \$2.7 billion musical instrument manufac-

urer, and will now draw upon the widespread recognition of the Yamaha name . . . **Dyan Traynor** was named director of sales and marketing at **EFX Systems** in Burbank, CA . . . **Sound Genesis Corporation** hired **Donny Johnson** as sound development team leader and has contracted with **Stephen Kay**, a NYC-based independent producer, to act as waveform and production consultant . . . **Advanced Music Systems (AMS) Industries** of England hired **Julie Wood** to work in public relations . . . **Mitchell Brill** was named **Editel/NY's** director of client services . . . **Raleigh Nelson** was named account representative for **Grace & Wild Studios** in Farmington Hills, MI . . . **David Neal** was appointed marketing manager of Great Britain's **DDA**, which also has named **Savana Communicacoes Ltd.** of Rio de Janeiro as its Brazil distributor and **Professional Equipment** of Milan and **Audio Link** of Parma as Italian distributors . . . **A/T Scharff Rentals** in NYC appointed **Scott Schachter** as video accounts manager . . . **API Audio Products, Inc.** named **Milam Audio** in Pekin, IL to represent them in the Midwest, including Nashville, and **Syco** of London as API dealer for England and most of Europe . . . **Harris Corporation** named company president **John Hartley** to the additional post of chairman of the board . . . **Victor Van Rees** has joined the staff at **Production Masters Inc.** in Pittsburgh as sales manager and **Rich Yasick** has been hired as computer graphics artist . . . **Sencore, Inc.** president **Herb Bowden** turned over his position to son **Alan Bowden** and named his son **Doug Bowden** executive vice president. The Sioux Falls, SD-based company employs over 325 people . . . **Gail Mezey Morris** was named executive vice president of San Francisco's **Snazelle Film & Tape**, a commercial production facility . . . **Steven Wenig** was appointed director, technical support at **Nakamichi Corporation** . . . **Cubicomp Corporation** has contracted with **MarTech Associates, Inc.** for help in developing its sales in the government market. MarTech is a nationwide consulting organization that specializes in assisting manufacturers sell to the government

STAFF

EDITOR/PUBLISHER David M. Schwartz	
ASSOCIATE PUBLISHER Penny Riker Jacob	
ASSOCIATE PUBLISHER/MARKETING DIRECTOR Hillel Resner	
MANAGING EDITOR Blair Jackson	ASSOCIATE EDITOR Paul Poyen
TECHNICAL EDITOR Ken Pohlmann	SENIOR EDITOR John Woram
MUSIC EDITOR David Gans	EDITOR-AT-LARGE Mr. Bonzai
PRODUCT EDITOR George Petersen	
ASSISTANT EDITORS Karen Margroff Dunn Linda Jacobson	
EDITORIAL ASSISTANT Josh Gressel	
CONTRIBUTING EDITORS Iain Blair Lou CasaBianca Dan Daley Philip Delancie Larry Oppenheimer Bruce Pilato Tony Thomas	
ART DIRECTOR Tim Gleason	
ASSISTANT ART DIRECTOR Dave Marrs	
DESIGN AND PRODUCTION Patsy Law Messerer Deborah Villa	
TYPOGRAPHY Linda Dierking Connie Wiggins Janice Leber	
PRODUCTION DIRECTOR Anne Letsch	
PRODUCTION ASSISTANT Kathy Badentscher	
ADVERTISING TRAFFIC COORDINATOR Donna Burreston	
ADVERTISING DIRECTOR Ron Taff	
ASSISTANT ADVERTISING DIRECTOR EASTERN AD MANAGER Jeffrey Turner	
NORTHWEST/NORTH CENTRAL AD MGR Horton Fimlin	
SOUTHERN CALIFORNIA/SOUTHWEST AD MGR Ken Rose	
ADVERTISING REPRESENTATIVE Dennis Gray	
SALES ASSISTANTS Randy Alberts Carol McMurray	
MARKETING ASSISTANT Jane Byer	
SALES ADMINISTRATOR Neil McKamey	
DIRECTORIES, CLASSIFIEDS MANAGER Lauri Newman	
DIRECTORIES, CLASSIFIEDS ASSISTANTS Athena Craig Jeanne Hasan Robin Boyce	
CIRCULATION MANAGER Nick Clements	
CIRCULATION ASSISTANT Cindy Lukk	
GENERAL MANAGER Mark Gunther	
CONTROLLER Craig Kennedy	
ASSISTANT CONTROLLER Linda Loooper	
ACCOUNTS PAYABLE Cathy Boyum	
ACCOUNTS RECEIVABLE Lisa Jensen	
CREDIT MANAGER Ann Cuadra	
BOOK DIVISION GENERAL MANAGER Craig Wingate	
OPERATIONS MANAGER Camille Coyne	
CUSTOMER SERVICE George Keres Brad Smith	
FULFILLMENT SERVICES Todd Souvignier	
OFFICE MANAGER Rachel McBeth	
RECEPTIONIST Lea Lewis	
MIX PUBLICATIONS INC. Chairman/CEO Rudy Hurwich President Penny Riker Jacob Executive Vice-President David M. Schwartz Vice-President, Marketing Hillel Resner Treasurer Mark Gunther	
NATIONAL EDITORIAL, ADVERTISING and BUSINESS OFFICES 2608 Ninth St., Berkeley, CA 94710 (415) 843-7901	
SOUTHERN CALIFORNIA ADVERTISING OFFICES 19725 Sherman Way, Suite 160, Canoga Park, CA 91306 (818) 709-4662	

"One layup console, cream & sugar, please."

Even in your high-speed world of ADR, Foley, and effects layup, it might seem that needs are simple.

A good cup of coffee. A comfortable chair. And a console with just a few basic features.

It's a safe bet, though, that your console can be a major headache. Noisy mic preamps, maybe. Or lame EQ that makes you reach for external. A machine interface that's a collection of add-ons and compromises.

We've designed the Essence to put an end to all that. Its a workstation for multitrack effects layup that you'll think you designed yourself.

We know that the quality of your assembly rooms sets the stage for your mix theater. So we gave the Essence the same powerful parametric equalizers and ultra quiet mic amps as our top of the line Elite.

Now you can have all the monitor inputs you want, 32 if you use a digital multitrack. Each with slide fader and SMPTE automated mutes.

Essence gives you a variety of solo functions on inputs and monitors. Even the headphone feed has its own solo system.

Our logic puts tracks into record ready from the console and you can route audio to any track you select. A sophisticated communication system knows the machines are in rewind and still lets you chat with the talent.

Best of all, we've put the Essence system, with its comprehensive master section and patch bay, into a package that fits Neotek sonic performance into your smallest assembly room. With enough desk space for your scripts and synchronizer keyboard. You can even add an Audiofile.

So sit back in your comfy chair and imagine what you could do without the compromises of a semi-pro console. Think how the quality and efficiency of your work will improve.

We can't do anything about that cup of coffee, but now at least your console won't leave a bad taste in your mouth.



NEOTEK

SESSIONS AND STUDIO NEWS

NORTHWEST

Sessions at **Starlight Sound** in Richmond, CA included a new demo by veteran rocker **Elvin Bishop**, engineered by **Josh Hecht** and produced by Hecht and Bishop; also three songs by **Al Rapone & the Country Cajuns**, produced by Rapone and **Neil J. Young** and engineered by **Bill Thompson**. . . Activity at SF's **David Litwin Productions** included music for a **Delta Dental Service** media campaign and track production for a **UC Berkeley TV** spot. . . At Sacramento's busy **Swingstreet Studios**, the production team of **Phil Silas** and **Larry Lauzon** have been working on albums with the **Heritage Singers** and **Steve Wright**. . . **Hope Sterling** has been in Vancouver's **Inside Trak Studios** completing her gospel debut album with producer **Roy Salmond** and engineers **Dave Slagter** and **Gary Tole**. . . **Satoshi Suzuki**, producer and owner of **Syncro International Studio** in San Anselmo, CA, has been working with guitarist **Bruce Bevar**, producing and writing material for an album due out on an independent label in early '88. . .

SOUTHWEST

Shallow Reign recorded and mixed new material at **Planet Dallas** with **Patrick Keel** producing; while engineer **Rick Rooney** led **The Blind** through some demo sessions. . . **Omega Audio**'s Dallas-based remote truck was on hand at Billy Bob's in Ft. Worth to record a live segment of the HBO film *Baja Oklahoma*, featuring **Willie Nelson** and **Emmylou Harris**. Engineering were **Paul Christensen**, **Philip Barret** and **Gary Bayles**. **Dick Rudolph** produced. . . Norwegian artist **Solveig Leithaug** was in at **Rivendell Recorders** in Pasadena, TX, recording her second LP for Dayspring Records. **Wayne**

Watson and **Paul Mills** produced. . . At the newly opened **Future Audio** in Dallas, **Geron Davis** was in mixing a project for **Micki Mangun**. . . The **Otis Conner Companies** in Dallas completed the recording of original music for Texas' parimutuel horse racing system. **George Weems** produced. . .

NORTH CENTRAL

Group L.A. finished its second LP, *Persistence of Vision*, at **Mus-I-Col Recording** in Columbus, OH. **Doug Edwards** engineered. Also at the studio was **Bullroper**, working with engineer Edwards. . . At **Zenith/dB Recording** in Chicago, the veteran jazz quartet **The Ken Chaney Experience** began their second LP with producers **Dave Freeman** and **Robert Hearn**, and engineer **Joe Tortorici**. . . At **Royal Recorders**, Lake Geneva, WI, Talking Head **Jerry Harrison** was in producing some tracks for Milwaukee's **John Sieger**, who's cutting his debut album for Warner Bros. Also at Royal, both **Adrian Belew** and **The Bears** (featuring Belew) have begun work on new albums. . .

SOUTHEAST

At **Ardent Recording** in Memphis, **Velvet Elvis** were in with producer **Mitch Easter** to work on their debut album for Enigma Records. **Tom Laune** assisted. Also at Ardent, ZZ Top producer **Bill Ham** remixed some early ZZ albums for CD release. **Joe Hardy** engineered. . . **Platinum Recorders** in Orlando, FL, recorded the **Cutting Crew** for a new single on Virgin Records. **Gary Platt** engineered. . . **Mr. O Audio** in Columbus, GA had producer/engineer **David Norman** in working on several projects, including a six-song demo for **The Society** and four tunes

for **A.C. Black & the Mean Katz**. . . Recent activity at **Southern Tracks** in Atlanta included completion of tracks by the group **Starbuck**, with **Bruce Blackman** and **Doug Johnson** co-producing, and Johnson engineering. . . At **Reflection Studios** in Charlotte, NC, singer **Eileen Farrell** has been recording a new album for Audiophile Records with producer **Loonis McGlohon** and engineer **Mark Williams**. . . Word recording artists **The Talleys** were in at the **Soundshop** in Nashville working on an album project with **Steve Taylor** producing. . . **Criteria** in Miami had the Epic act **Will to Power** in working on their new album. **Bob Rosenberg** produced, with **Mike Couzzi** behind the board, assisted by **Dana Horowitz**. . . At the **Bennett House** in Franklin, TN, **Amy Grant** cut tracks for her next project with producers **Brown Bannister** and Jeff Balding. . .

SOUTHERN CAL

In **Westlake's** Studio E (L.A.), former Prince bassist **Mark Brown** produced **Chico De Barge** and **Stacy Lattisaw** for Motown Records utilizing the Harrison Series Ten console. . . At **Skip Saylor Recording** in Los Angeles, the **Perri Sisters** were in with producer **Victor Flores** and engineer **Eddie Delena** overdubbing and mixing on dance tracks for MCA Records. Assisting was **Clif Jones**. . . **Sound Image** in North Hollywood had singer/songwriter **Dorie Pride** in cutting tracks for Atlantic Records with producer **Kamau Peterson** and **Conley Abrams** at the board. . . Producer **Chas Sandford** was in at **Secret Sound** in LA. mixing and overdubbing tracks for the Capitol act **House of Shock**, featuring former Go-Gos drummer Gina Schock. **Gary McGachan** and **Daren Chadwick** engineered. . . **Barry White** produced his own song, "Sho You



Our latest release

Ampex hits the top of the charts with its newest release, Ampex 467 digital mastering tape.

We not only pioneered digital audio tape, we also refined it. The result is Ampex 467, a tape that sets the highest standards for all digital audio applications. And it's available in all open reel and cassette formats, including the new 80-minute cassette length.

More top performers record their hits on Ampex tape than any other tape in the world. While opinion may vary on what it takes to make a hit, there's no argument on what it takes to master one.

AMPEX

Ampex Corporation, Magnetic Tape Division,
101 Broadway, Redwood City, CA 94063, 415/2367-2800

Circle #045 on Reader Service Card

specifications are described. For all of you trying to figure out CDV, let's take a peek over Mr. Vogelaar's shoulder for a look at some of the present and future solutions for reconciling NTSC and CD.

The digital audio portion of the CDV format utilizes the existing CD-DA format: 3/4-inch tape via Sony PCM-1630 processor. The video portion of the format sources from the one-inch C format. Clearly, the use of two different tapes is problematic, but Philips decided that combined formats such

as DASH, B and D1 are not yet in sufficiently extensive use. Their future proliferation could be used to simplify CDV mastering. Meanwhile, the use of different formats promotes the basic problem of keeping everything in sync.

The audio sampling frequency on tape and disc is 44.1 kHz; the same as CD-DA. However there is no integer relationship between 44.1 kHz and the NTSC frame rate of 29.97 Hz, which yields a video rate of 44.056 kHz. Thus the PCM processor cannot be directly locked to an NTSC sync pulse generator. As a result, any video material for digital audio must be converted from

44.056 to 44.1 kHz.

SMPTE frame modes also provide an interesting challenge for CDV. With a frame rate of 29.97 Hz, a 30 frame-per-second count yields an error of +108 frames in one hour. The SMPTE drop frame mode compensates for this by dropping the first two frame numbers at the start of each minute except for minutes 0, 10, 20, 40 and 50. SMPTE non-drop frame mode is intended for 30 frames per second field rates. However non-drop frame mode is often employed in NTSC video, particularly in music video production. Thus the correct program timing cannot be read directly from the code.

When it comes to CDV mastering, a SMPTE non-drop frame code on channel 3 of NTSC tapes is recommended. This syncs directly to the laser beam recorder's internal code generator. Because both codes are increasing monotonically, synchronization is direct.

Meanwhile, non-drop frame (30 Hz) code is recorded on audio channel 2 of the U-matic tape. The VTR retains a drop-frame (29.97 Hz) code. To resolve the conflict, the code from the U-matic is recorded to the VTR audio channel 2; the U-matic recorder is frequency-locked to the video recorder during the time code copying. Thus video, audio and two related time codes are present on one (video) tape. Why not record video time code to U-matic audio channel 1? Easy. The video is missing. Video and audio would have to be synchronized to make a work copy. In addition, audio channel 1 is reserved for CD's PQ subcode.

The frequency lock between the two machines is easier said than done. The lack of common reference between 44.056 and 44.1 kHz prevents direct locking. The solution is a PLL circuit to guarantee identical running speeds. Both proprietary and commercial sync boxes are being pressed into service. A basic hook-up is shown in **Figure 1**.

To help resolve technical difficulties in CDV production, Philips/PolyGram has identified several potential problem areas.

A major problem involves, naturally enough, sync. Most music videos are shot without lock between picture and sound. For example, the video may be shot to a pre-recorded soundtrack. The audio is typically synched to video during post-production. Ideally, the

STUDIO BASICS



FM TUBECRAFT
OFFERS ALL THE
BASIC SUPPORT
SYSTEMS NEEDED
IN HELPING YOU
OUTFIT YOUR
STUDIO.

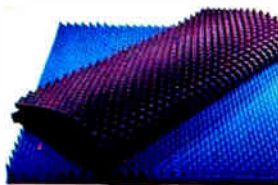
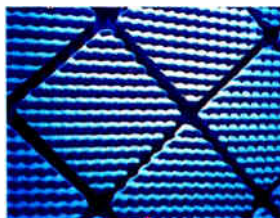

- Acoustafom
- Racking Consoles
- 19" Equipment Racks
- Keyboard Stands
- Mixing Console Stands
- Computer Tables
- Plus Much More

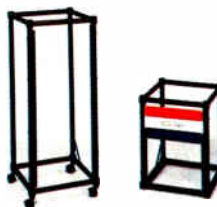

ACOUSTICAL SPECS AVAILABLE
FOR INFORMATION CALL OR WRITE:

FM TUBECRAFT SUPPORT SYSTEMS INC.

1121-26 LINCOLN AVENUE, HOLBROOK, NY 11741 • 516-567-8588



Our latest release

Ampex hits the top of the charts with its newest release, Ampex 467 digital mastering tape.

We not only pioneered digital audio tape, we also refined it. The result is Ampex 467, a tape that sets the highest standards for all digital audio applications. And it's available in all open reel and cassette formats, including the new 80-minute cassette length.

More top performers record their hits on Ampex tape than any other tape in the world. While opinion may vary on what it takes to make a hit, there's no argument on what it takes to master one.

AMPEX

Ampex Corporation, Magnetic Tape Division
401 Broadway, Redwood City, CA 94063, 415/367-3800

Circle #045 on Reader Service Card

Right," at **Larrabee Sound** in L.A. **Paul McKenna** engineered and **John Hege-**
des assisted. . . **Cherokee Recording**
 in L.A. has been busy with such artists as
Yngwie Malmsteen, working with pro-
 ducer/engineer **Jeff Glixman**, assisted by
Scott Gordon; **Vinnie Vincent**, in with
 producer **Dana Strum**, engineer **Mikey**
Davis and assistant **Jay Lean**; and singer/
 songwriter **Jack Tempchin**, cutting with
 producers **Dee & Bruce Robb**, assisted
 by **Cliff Kane**. . . At **Elumba Studios** in
 L.A., producer **Raymond Jones** was in
 working with **Pieces of a Dream** on a
 song for Spike "She's Gotta Have It" Lee's
 next movie, *School Daze*. . . Action at
The Rock House in L.A. included CBS
 recording artists **Krystol** tracking for their
 new album with **Larry Robinson** produc-
 ing and **John Van Nest** engineering. . . At
Studio Masters in L.A., the team of **L.A.**
Reid and **Babyface** have been producing
 tunes for **Karyn White**, **Paula Abdul**,
Johnny Gill and **Howard Hewitt**. **Jon**
Gass is engineering. . .

NORTHEAST

At **Dreamland Recording** in Woodstock,
 NY, **Joan Jett** was in collaborating with
 producer **Desmond Child** on two new
 songs. **Arthur Payson** engineered, with
Dave Cook assisting. . . Columbia Rec-
 ords artists **The Manhattans** were in at
I.N.S. Recording in NYC sorting and re-
 mixing tracks from two albums of oldies,
 which will be used for TV tracks. **Dan**
Sheehan was at the board. . . At **Third**
Story Recording in Philadelphia, **Jim**
Christopher and **Dan McKay** of the
 Nova Express were in to mix down their
 latest single, with Christopher producing
 and McKay at the board. . . **Quad Record-**
ing in Manhattan had **Nona Hendryx** in
 cutting "I Know What You Need." Hendryx
 co-produced with **Dan Hartman**, while
Dave Ogrin and **Henry Falco** were at
 the board. . . At **Power Play Studios** in
 Long Island City, NY, **Vince Montana** was
 in remixing old and recent tunes for a
 release on the Philly Sound Works label.
 All the tracks were engineered and re-
 mixed by **Norberto Cotto**, assisted by
Dwayne Sumal. . . At **Cove City Sound**
Studios in Glen Cove, NY, **Taylor Dayne**
 was in recording her new album for Arista
 with producer **Ric Wake**, engineer **Bob**
Cadway and assistant **Tom Yezzi**. . . The
 original, reunited **Village People** visited
Electric Lady in NYC to mix some tracks
 recorded over at Quadrasonic. Producers
Joe Maggio, **Bob Turco** and **Frosty Law-**

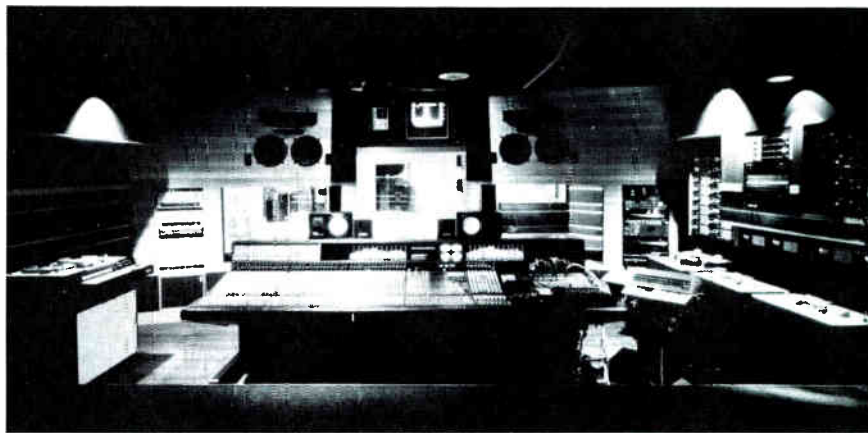

The first Amek APC 1000 console in the U.S., at Greene Street Recording in NYC.

son were behind the board. . . **Stetason-**
ic have been cutting tracks for their second
 album on Tommy Boy Records at **Calliope**
Productions in NYC. **Bob Coulter** is at
 the console. . . At **Normandy Sound** in
 Warwick, RI, **The Neighborhoods** record-
 ed and mixed their album, *Reptile Man*, for
 Roadrunner Records. The project was pro-
 duced and engineered by **Phil Greene**,
 assisted by **Ralph Petrarca**. . . **Reggie**
Lucas has been producing the **Weather**
Girls' next Columbia LP at **Quantum**
Sound in Jersey City. Engineering those
 sessions were **Doc Dougherty**, assisted
 by **Abdu Malahi**. . . **Ralph Tresvant** of
 New Edition was in at Boston's **Newbury**
Sound working on a solo album for MCA.
Paul Arnold was at the controls. . . Pro-
 ducer **Pat Moran** and artist **Danny Wilde**
 stopped in at **Barry Diament Audio** in
 NYC to master the CD of Wilde's new Gef-
 fen LP. . . Chrysalis artists **Vigil** are work-
 ing on their next album at **Sheffield Au-**
dio/Video in Phoenix, MD. Producing are
Sam Prager and **Vigil**, with **Bill Mueller**
 engineering. . . Engineer **Rob Paustian**
 was in at **Metropolis Music** in NYC to
 work on producer **Arthur Baker's** latest:
Jet Vegas. **Laura Fried** assisted. . . **Roy**
Orbison popped into **Blue Jay Record-**
ing in Carlisle, MA, to cut a new version of
 his classic "Cryin'" for the film *Hiding Out*.
 The sessions were produced by **Peter An-**
derson and engineered by **Dusty Wake-**
man. . . The "new metal" band **Deadly**
Blessing completed their album at **The**
Warehouse in Philadelphia, with **Bo**
Blaze producing and **Obie O'Brian** en-
 gineering, assisted by **Chris** and **Slave**
Brown. . .

STUDIO NEWS

The **New York Music Deli** in Manhattan
 took delivery of a Soundtracs 6800 auto-

mated board, to be the centerpiece of the
 Deli's "MIDI Kitchen". . . KRK Monitoring
 systems has signed contracts with three
 Southern California studios: **Baby-O**, **Sum-**
ma Music Group, and **Pacifique**. . .
Complete Post in Hollywood has added
 a third audio bay, built for clients requiring
 an economical bay for simple mixing and
 announce booth work for commercials,
 promos, programs, videos, etc. Audio Bay
 III is equipped with an Audiotronics con-
 sole with Cipher Softouch synchronizer,
 and much more. . . **Sound Impressions**
 in Milwaukee, OR, has added such equip-
 ment as a PCM70, UREI 813s, and a Roland
 SDE-3000 digital delay; and increased its
 engineering staff from two to four to ac-
 commodate a spate of new work. . . **Mid-**
dle Tennessee State University has
 opened a new studio featuring a control
 room designed by Bob Todrank of Valley
 Audio. It's equipped with a NEOTEK Elite
 console, a complete Roland MIDI system
 and all sorts of outboard gear. . . **Platinum**
Recorders of Orlando, FL, recently reno-
 vated its 48-track mobile facility with two
 Otari MX80 24-track recorders, Adams-
 Smith Zeta Three synchronizers, and vari-
 ous new mics and outboard devices. . .
Secret Sound in L.A. has installed an SSL
 6048 console, and an Otari MTR-90 II. . .
Sheffield Audio Video productions of
 Baltimore upgraded its audio remote track
 by installing a Neve 8068 Mk II console. . .
 The **Village Recorder** in West L.A. has
 been constructing a new studio designed
 expressly for audio sweetening and film
 and video post work. The control room
 will have a Trident T24 console and Otari
 MX-80 24-track recorder. The Fairlight CMI
 will also be available. . . **Encore Studios**
 in Los Angeles has purchased a 56-input
 Solid State Logic 6000-E console. . . **Hill-**
side Sound in Englewood, NJ has added
 Sony 3324 24-track and 3202 2-tracks to
 their studio. ■

EXPANDING THE SYSTEM

*The 480L Sampling Memory Expander. Accurate sampling in phase-locked stereo:
a Lexicon applications brief.*

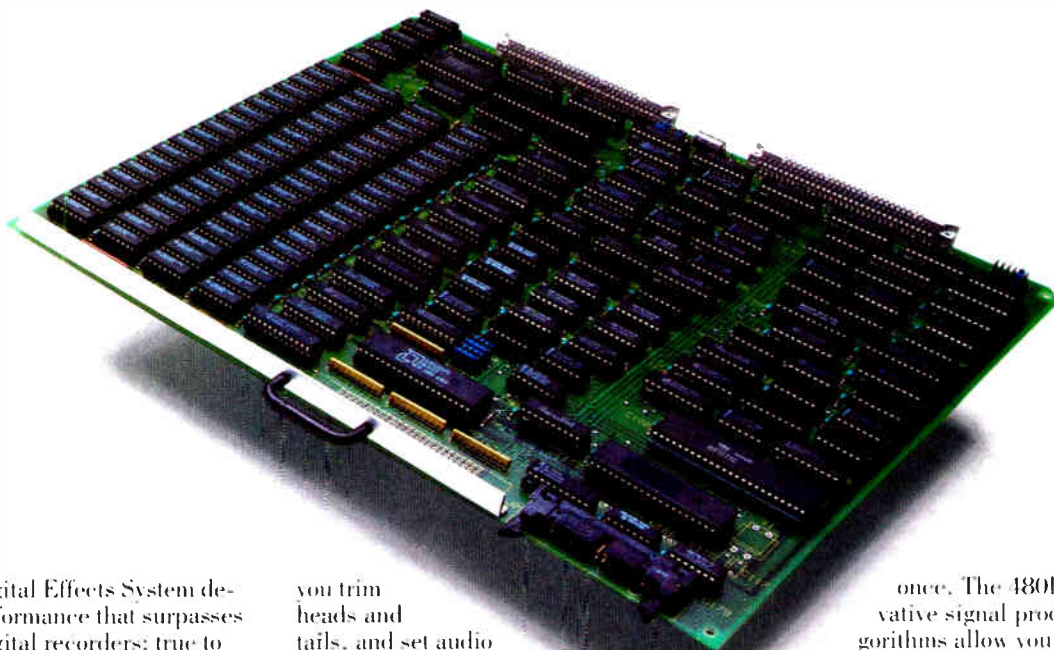

The 480L Digital Effects System delivers audio performance that surpasses conventional digital recorders: true to life sampling is a prime example of its advanced engineering. With the optional Sampling Memory Expander, the 480L becomes an astonishingly practical way to copy or move several seconds of audio from point A to points B and C.

Until now, "flying in" or "slipping" vocal and instrumental overdubs meant tradeoffs. Two-track tape is clumsy and degrades the signal; DDLs with long memories are better, but not by much. Now, with the 480L's optional Sampling Memory Expander, you can digitally record 10 seconds of true phase-locked stereo or 20 seconds of mono at a 48 kHz sampling rate. 18 bit equivalent A/D conversion produces a typical dynamic range of 98 dB, with a bandwidth of 20 – 20,000 Hz; output doesn't get any closer to input.

If you're using a digital recorder that's Sony 1610 compatible, the Sampling Memory Expander and the 480L's digital I/O interface can reproduce the original performance at any location on tape without leaving the digital domain. Slip syncing, copying and time shifting of audio segments is faster and cleaner than ever before.

You control sample recording, editing, processing and triggering from your work position using the 480L LARC. Varying up to six parameters at once,

you trim heads and tails, and set audio trigger levels. Audio trigger response time, incidentally, is under 300 microseconds – virtually instantaneous. Sampling Memory Expander enhancements include Record Trigger to trigger sampling automatically from audio input, Time Variant Record, and sound on sound digital recording in sync with the original sample. Lexicon Dynamic MIDI® lets you assign MIDI controllers to sampling parameters, for new dimensions of real-time or sequenced control.

Sometimes even the most accurate replica isn't exactly what you're looking for: if so, the 480L will take you beyond imitation into creative sampling. Play samples faster or slower (without changing the sampling rate), backwards or forwards, even both at

once. The 480L's innovative signal processing algorithms allow you to enhance sounds with advanced reverbs and effects without leaving the digital domain. Add signal processing as you sample, or process a "dry" sample on playback with digital wet-dry mixing.

The 480L digitally integrates sampling and signal processing because it's designed as a comprehensive audio production tool: a system. And sampling is only the first of many directions in which this Digital Effects System can grow. We're continually examining the possibilities, and as your needs develop we'll implement new tools to meet them. Now is the time to call your Lexicon Advanced Products dealer for a demo of the new production techniques the Sampling Memory Expander makes possible.



lexicon

Lexicon Inc., 100 Beaver Street, Waltham, MA 02154 (617) 891-6790

COMPUMIX IV

The Fourth Generation Console Automation System is here. Compumix IV advances dynamic automation technology far beyond the capabilities of other systems, to a level of sophistication and accuracy demanded by tomorrow's digital recording techniques.

The FORTH realtime software running in a 32-bit 68000 computer provides 4 simultaneous mixes on-line as well as write command recall accuracy of 1/10 frame. SMPTE time code driven, Compumix IV stores *every frame* (not only changes) making it possible to perform editing functions on-line. This requires an 80 Mbyte hard disk storage system designed for fast access in both read and write modes.

Compumix IV is designed to control up to 256 IDF fader functions in realtime through easy to operate touch-sensitive plasma control panels. An optional Graphics Display System is available.

INTELLIGENT DIGITAL FADER

The IDF is a microprocessor-based module that utilizes the most advanced technology available. The super smooth fader is a 10-bit digital encoder that supplies 0.25 dB resolution and 119 dB of dynamic range. The grouping functions are the most extensive ever supplied in a music recording console. 16 groups are assignable with 4 levels of operation: slave, group master, submaster, and grand master.

Up to 256 IDFs run independently through a revolutionary "back door control bus" without the need for external computer automation. Realtime display of dB level, groupings, status, fader position and mutes are available at all times. 9 membrane switches allow for selection of up to 160 software defined functions.

CENTRAL ASSIGNMENT

This electronic output assignment cross-point switching system assures fast and reliable connections from the console to your tape machines with full routing or mixing capability. 64 output busses are assigned from each input module by a central touch control plasma display panel controlling up to a 96 by 64 electronic switching matrix. Completely software driven, the panel allows instant selection and display of the bus assignment with 10 presets in local memory. Optional unlimited storage to disk is provided. Easy to use, the system prompts for bus assignments and provides help through informative menu displays.

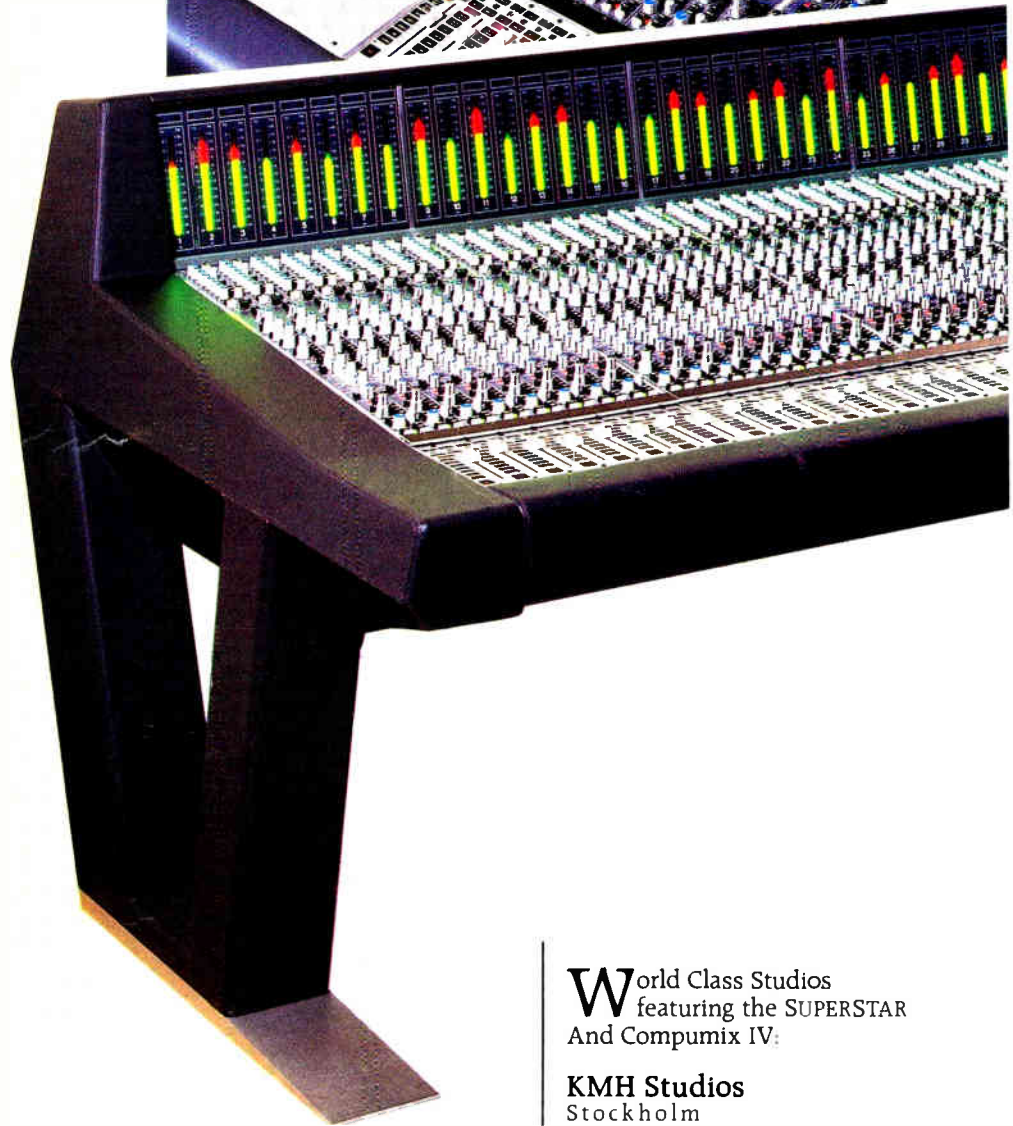
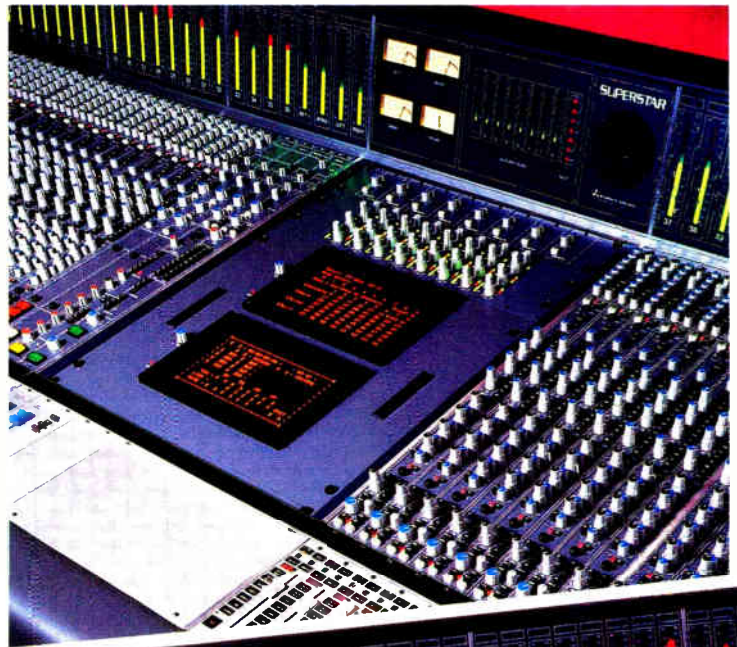

World Class Studios
featuring the SUPERSTAR
And Compumix IV:

KMH Studios
Stockholm

Salzburger Festspiele
Salzburg

Bosanova Hotel
Los Angeles

Sigma Sound Studios
Philadelphia

SUPERSTAR

Advanced technology and unparalleled flexibility come together in the SUPERSTAR music recording console. Development of this console centered around the requirement for high definition sound, improving that most important quality as necessary for digital recording.

No other single console offers the combination of desirable sound, size, and flexibility with an

affordable price. Field expandable, the SUPERSTAR provides ergonomical positioning of the console modules, allowing you to satisfy your own configuration needs. High resolution meters, central bus assignment, Intelligent Digital Faders, and the most comprehensive automation system all add up to SUPERSTAR—your next console.

*Be a Leader,
Not a Follower.*



- Superb Sound
- 36, 44, 52, 60 or 68 I/Os
- Fully Parametric 4-Band EQ
- 32 or 64 Bus Outputs
- 16 Auxiliary Sends
- Intelligent Digital Faders
- Automation Accuracy 1/3 Frame
- 4 Automated Mixes On-line

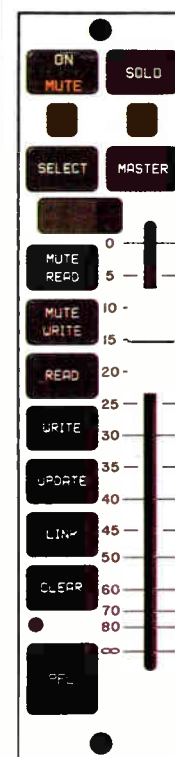

INTELLIGENT
DIGITAL
FADER



MITSUBISHI PRO AUDIO GROUP

DIGITAL ENTERTAINMENT CORPORATION

Headquarters: 225 Parkside Drive, San Fernando, CA 91340 • Phone (818) 898-2341 • FAX (818) 365-8310

New York: Suite 1321, 555 W. 57th Street, New York, N.Y. 10019 • Phone (212) 713-1600

Tennessee: 104 Eastpark Drive, Suite 306, Brentwood, TN 37027 • Phone (615) 371-6602 • FAX (615) 371-6644

Canada: 260 The Esplanade, Toronto, ONT. M5A 1J2 • Phone (416) 365-3363 • FAX (416) 365-1044

United Kingdom: Unit 13, Alban Park, Hatfield Road, St. Albans, Hertfordshire AL4 0JJ • Phone 0727-40584 • FAX 0727-67684

Circle #031 on Reader Service Card

Diamond Leasing
AVAILABLE

by Ken Pohlmann

CD-VIDEO PRODUCTION

PROBLEMS AND SOLUTIONS

The 83rd Audio Engineering Society Convention (October 16 through 19) was a forum for numerous technical papers addressing current and future advances in audio. Topics ranged from a dynamic phase meter (at last—one that really works), to digital time-coherent recording technique (at last—a console with delay nudge buttons).

But one of the most timely papers, delivered by Gert-Jan Vogelaar of Philips & Du Pont Optical Company, Baam, The Netherlands, was "CD-Video and Audio Engineering." It addressed the currently hot and problematic topic of CD-video disc production. This new format promises to merge high quality

video with digital audio, and could have significant impact on the production of both. In addition, depending on its acceptance, CDV may find itself a product niche with considerable economic clout, at once replacing the 45 rpm single, and creating a new music video format.

The problem is that the audio and video (and film) formats from which CDV is created were never intended to be synchronized, and in fact are basically incompatible. In his paper, Vogelaar describes the incompatibility, the headaches it creates, and the interfacing required for successful CDV mastering. In addition, CDV master tape

FIGURE 1
Recording of
digital audio
and video using
the PLL for
synchronization.

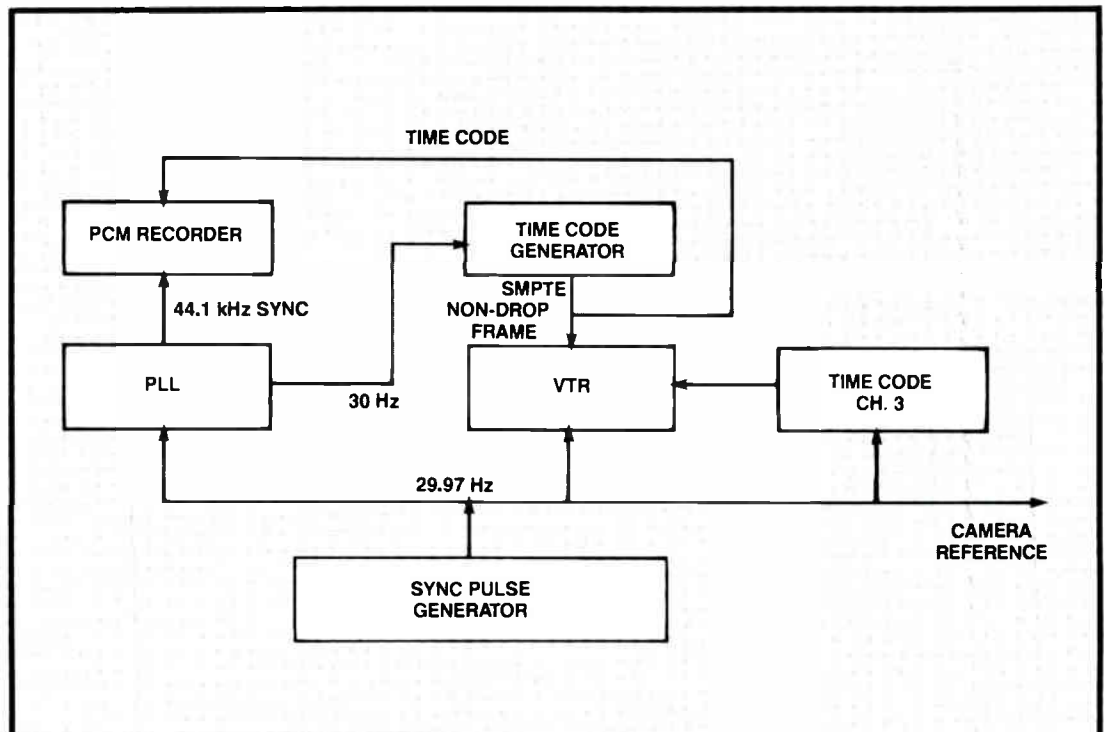

Direct-to-Disk™

DIGITAL MULTITRACK RECORDER

Already proven in leading studios throughout the world, the Direct-to-Disk Multitrack Recorder is now available in stand-alone, remote operated 4, 8, and 16-track units.

Powerful new software provides fast, flexible **automated editing** features unavailable with conventional tape-based multitracks, such as individual track offsets, auto fly-ins, and multiple loops on every track.

The terminal screen gives a complete, easy-to-read visual display of all track information.



Using a mouse you identify splice points with microsecond precision on the display, instructing the computer to digitally crossfade from section to section.

Unhappy with that edit? Splice points and crossfade times can be adjusted with **ten microsecond accuracy**. Or you can define a completely different set of edit points.

Because you never disturb your original tracks, Direct-to-Disk editing is completely **non-destructive**. You can construct dozens of different edits from the same material and A/B each one. Bounce again and again with no loss of fidelity.

Even punch-in without erasing. The computer records and logs each move, and can instantly retrieve any pass for comparison.

With Direct-to-Disk, audio information is recorded and stored on a network of reliable, high-speed winchester hard disk drives, which offer not only **superior audio fidelity** and data

integrity compared to tape, but superior performance. And because winchester disks are a **random access medium**, rewind, fast-forward, auto-locate and SMPTE lock are instantaneous.



With variable digital sampling rates of up to **100 kHz, 16-bit resolution**, 0.04% distortion and 96 dB signal-to-noise ratio, Direct-to-Disk offers by far the best fidelity of any multitrack on the market today.

The stand-alone Direct-to-Disk is based on the same hard disk storage and proprietary processing technology that has

made the Synclavier® the industry standard for reliable performance in the studio and on the road. And like the Synclavier, the Direct-to-Disk system is modular and **software updateable**.

As new features become available, you upgrade simply by loading in a floppy disk.



There is only one totally integrated disk-based digital audio recording and editing system for today's music production

and audio post-production requirements—the Direct-to-Disk Multitrack Recorder.

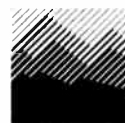
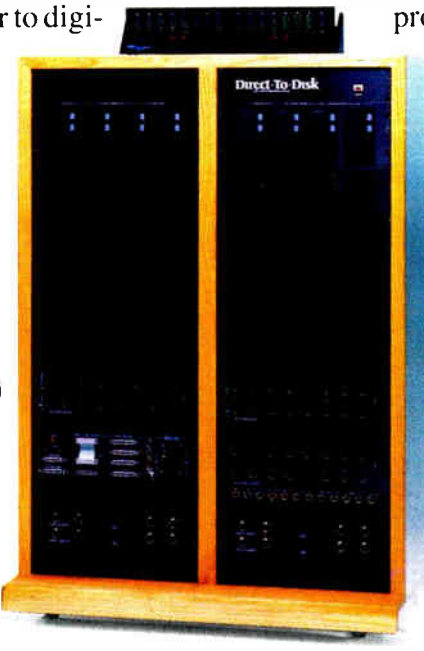
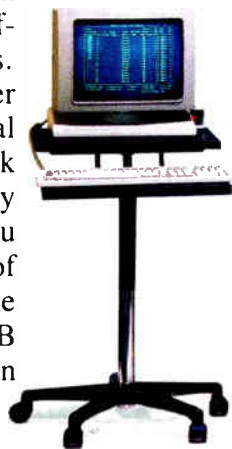

**New England
Digital™**

White River Jct., Vermont 05001
(802)295-5800

Circle #003 on Reader Service Card

NEW ENGLAND DIGITAL OFFICES New York (212) 977-4510 Los Angeles (213) 651-4016 Chicago (312) 266-0266

AUTHORIZED DISTRIBUTORS Nashville (615) 327-4343 Toronto (416) 868-0528 England 44-1-202-4366 France 33-1-48-76-1144 Japan 03-354-3317 West Germany 49-7131-4801

Synclavier, Direct-to-Disk and The Tapeless Studio are trademarks of New England Digital. Product specifications are subject to change without notice. Copyright 1987 New England Digital.

specifications are described. For all of you trying to figure out CDV, let's take a peek over Mr. Vogelaar's shoulder for a look at some of the present and future solutions for reconciling NTSC and CD.

The digital audio portion of the CDV format utilizes the existing CD-DA format: 3/4-inch tape via Sony PCM-1630 processor. The video portion of the format sources from the one-inch C format. Clearly, the use of two different tapes is problematic, but Philips decided that combined formats such

as DASH, B and D1 are not yet in sufficiently extensive use. Their future proliferation could be used to simplify CDV mastering. Meanwhile, the use of different formats promotes the basic problem of keeping everything in sync.

The audio sampling frequency on tape and disc is 44.1 kHz; the same as CD-DA. However there is no integer relationship between 44.1 kHz and the NTSC frame rate of 29.97 Hz, which yields a video rate of 44.056 kHz. Thus the PCM processor cannot be directly locked to an NTSC sync pulse generator. As a result, any video material for digital audio must be converted from

44.056 to 44.1 kHz.

SMPTE frame modes also provide an interesting challenge for CDV. With a frame rate of 29.97 Hz, a 30 frame-per-second count yields an error of +108 frames in one hour. The SMPTE drop frame mode compensates for this by dropping the first two frame numbers at the start of each minute except for minutes 0, 10, 20, 40 and 50. SMPTE non-drop frame mode is intended for 30 frames per second field rates. However non-drop frame mode is often employed in NTSC video, particularly in music video production. Thus the correct program timing cannot be read directly from the code.

When it comes to CDV mastering, a SMPTE non-drop frame code on channel 3 of NTSC tapes is recommended. This syncs directly to the laser beam recorder's internal code generator. Because both codes are increasing monotonically, synchronization is direct.

Meanwhile, non-drop frame (30 Hz) code is recorded on audio channel 2 of the U-matic tape. The VTR retains a drop-frame (29.97 Hz) code. To resolve the conflict, the code from the U-matic is recorded to the VTR audio channel 2; the U-matic recorder is frequency-locked to the video recorder during the time code copying. Thus video, audio and two related time codes are present on one (video) tape. Why not record video time code to U-matic audio channel 1? Easy. The video is missing. Video and audio would have to be synchronized to make a work copy. In addition, audio channel 1 is reserved for CD's PQ subcode.

The frequency lock between the two machines is easier said than done. The lack of common reference between 44.056 and 44.1 kHz prevents direct locking. The solution is a PLL circuit to guarantee identical running speeds. Both proprietary and commercial sync boxes are being pressed into service. A basic hook-up is shown in **Figure 1**.

To help resolve technical difficulties in CDV production, Philips/PolyGram has identified several potential problem areas.

A major problem involves, naturally enough, sync. Most music videos are shot without lock between picture and sound. For example, the video may be shot to a pre-recorded soundtrack. The audio is typically synced to video during post-production. Ideally, the

STUDIO BASICS



FM TUBECRAFT OFFERS ALL THE BASIC SUPPORT SYSTEMS NEEDED IN HELPING YOU OUTFIT YOUR STUDIO.

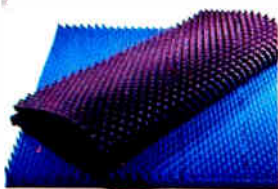
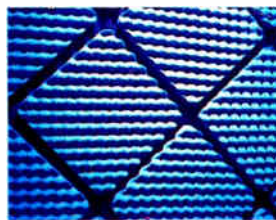

- Acoustafoam
- Racking Consoles
- 19" Equipment Racks
- Keyboard Stands
- Mixing Console Stands
- Computer Tables
- Plus Much More



ACOUSTICAL SPECS AVAILABLE FOR INFORMATION CALL OR WRITE:

FM TUBECRAFT SUPPORT SYSTEMS INC.

1121-26 LINCOLN AVENUE, HOLBROOK, NY 11741 • 516-567-8588

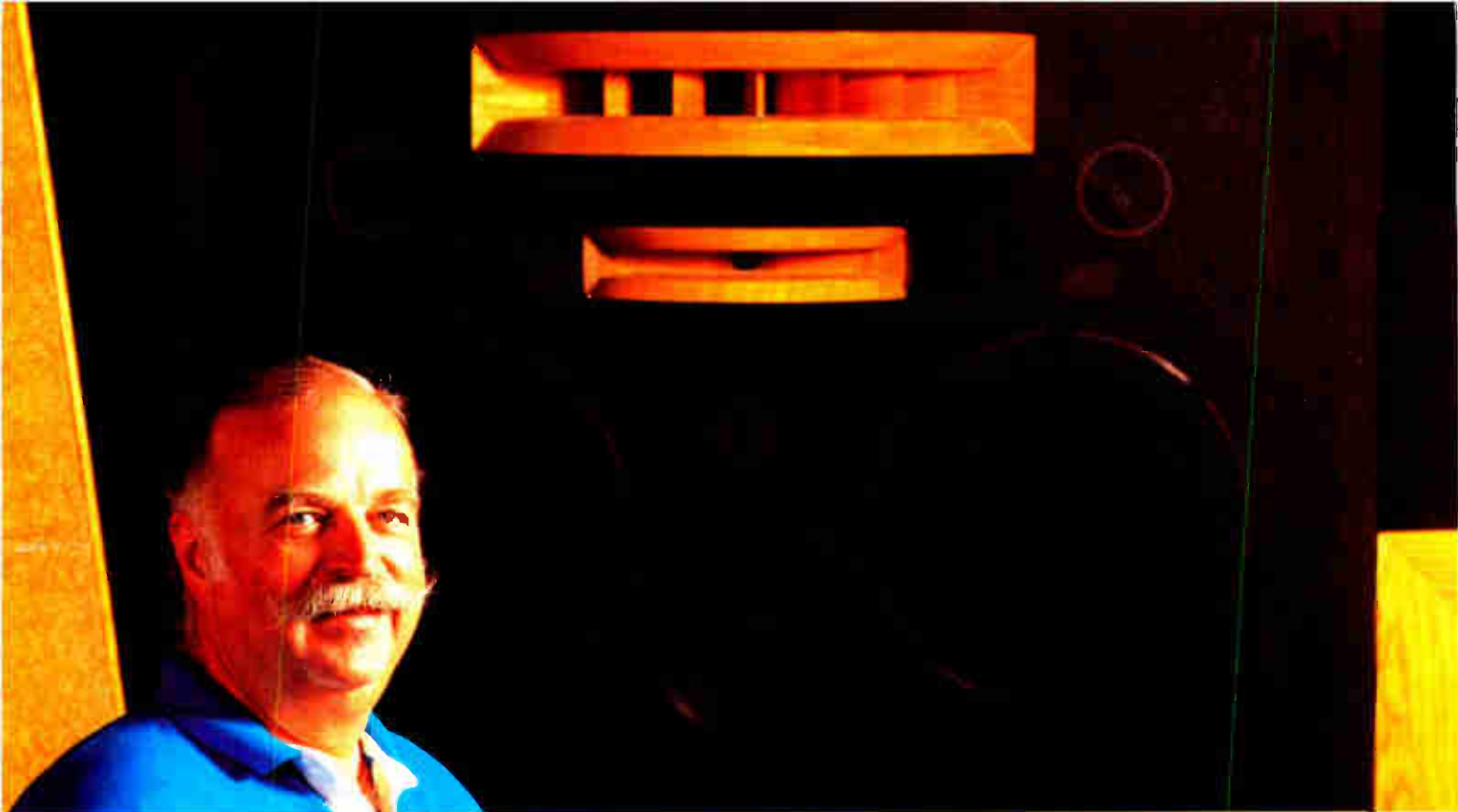

Bruce Swedien, Michael, Quincy . . . and the high-power, ultra-accurate Westlake SM-1 Studio Reference Monitors

BRUCE SWEDIEN: "We've lived with these **SM-1s** now for a pretty fair amount of time, and I can honestly say we like them better today than (we did) the day we walked in here to start Michael's project.

"I've never heard anything like the accuracy of the combination of the **SM-1s** and Studio "D". They are just like good friends, you can trust them to tell you the truth. We'll work here with the **SM-1s** on Quincy's new album as well."

Bruce Swedien's good friends, **The Westlake SM-1 monitors:** with their dual 18" active woofers, a 12" mid-bass, 2" and 1" throat compression drivers, and a 1/2" compression tweeter, the SM-1 is the world's

most powerful production reference monitor system. As a fully integrated system it yields a full 6 dB more headroom than typical 15" systems, at +/- 3dB through the full audio range of 20Hz to 20kHz in a typical control room. IM distortion is extremely low, a minimum of 6dB - often as much as 20dB compared to 2-way single amp systems.

Westlake monitor systems are the choice in more than 250 leading professional recording environments worldwide. Any substantial investment in either new room designs, or updated facilities ought to include serious consideration of the SM-1 or any of the family of Westlake reference monitors.

. . .the Westlake family of high-resolution studio monitors



SM-1



TM-3*



HR-1*



HR-7

*Available in Vertical and Horizontal Format.

from acoustic design
to down beat...

**Westlake
Audio**

Westlake Audio Manufacturing Group
2696 Lavery Court, Unit 18 Newbury Park, California 91320 • 805/499-3686
Circle #018 on Reader Service Card

How much Fairlight do you need?

If all these Fairlights look the same it's because they are.

Each one is designed and hand-built to the same exacting standards, with the same 16 bit sound quality, as our much-praised 16 voice, 14 megabyte Series III.

The difference is, now there's a Fairlight to suit your exact need and budget.

We call them e-x-p-a-n-d-a-b-l-e Fairlights.

Not a set model range. Instead a series of compatible options that allow you to choose any configuration and expand its capabilities. Right on up to an 80 voice, 140Mb RAM Series III with Gigabytes of Hard Disc and Optical WORM Disc Storage.

There are no limitations. You don't pay for features you don't need. But you do get the exact Fairlight for the job.

Just decide what you require for your composition, arrangement or production role and we'll build the Fairlight to suit.

Even our basic Fairlight is far from basic.

For \$39,950* you will start with a rack-mounted or portable Fairlight that is unchallenged by anything near its price.

16 bit Digital audio quality with oversampling capability ensures the sound that has made Fairlight the world's leading digital audio production system.

Eight voices provide the versatility required for most session work. And, if required, Fairlight's multi-port MIDI capability allows the control of up to 64 external, sampled or synthesized voices.

Advanced software.

This is sampling in its purest form from the people who invented it.

Stereo sampling, Page R and CAPS Sequencers, Waveform Editing, FFT analysis and resynthesis, and an extensive sound library are all included.

SMPTÉ chase/lock provides the ideal setting for structuring musical scores, laying-in sound effects, and synchronizing to multi-track tape and disks.

A time-code trigger/event generator also lets you program complex SMPTÉ cue lists for film and video post-production.

Real time effects allow complete control of attack, decay and vibrato for a realistic acoustic feel.

You have at your command every major section of the



orchestra, and just about any synthetic and composite sound you could ever use.

Design your own Fairlight.

For full details of the new e-x-p-a-n-d-a-b-l-e Fairlights, call your nearest Fairlight office. Los Angeles (213) 470-6280, New York (212) 219-2656, Toronto (416) 964-1885. Fairlight dealers — Chicago: Gand Music and Sound (312) 446-4263. Miami: Limelite Video (305) 593-6969. San Francisco: AIC (415) 686-6493.

fairlight

*Prices effective as at July 1, 1987 subject to change without notice. Systems above 16 voice require external rack-mount units (not shown), delivery late 1987. \$39,950 system does not include music keyboard.

video should be recorded in sync to the time code of the finished audio program, with the accuracy of lip synching dependent only on the ability of the artist.

Another problem deals with audio quality. All too often the sound finally transferred to one-inch video is of fourth or fifth analog generation quality. Only with digital audio will the problem of generation degradation be solved.

Picture quality can also present problems. The tape supplied for disc mastering is often a copy of the "gold master," which in turn is at least a fourth generation copy. To earn the "collectable" status required to achieve marketing success for CDV, both audio and video quality must be very good.

The transfer for film to video via telecine is another problem, one which is built into the production process. Telecine does not control the four-color NTSC field sequence in relation to time code. Because it starts at a random field sequence, difficulties in editing are inevitable.

Another problem stems from the fact that CDV discs (and players) must be available for both NTSC and PAL televisions. Since double post-production is cost-prohibitive, standards conversion is mandatory, resulting in visible degradation. In addition, conversion also produces a 17- to 20-millisecond delay of picture relative to sound; this can be compensated for.

A final problem is one already present, and troublesome, in CD-DA mastering. Care must be taken to achieve frame-accurate program timing of the PQ code as well as chapter codes.

The solutions to the various problems are themselves varied, depending on the equipment available, and the money (and care) budgeted for the project. Philips/PolyGram has outlined production techniques which emphasize quality, with reasonable expense.

As noted, the preparation of the audio playback tape for a video shoot is crucial. The master should be a 3/4-inch tape with digital audio (30 Hz) and both audio and video/film (29.97 Hz) time codes. This tape could be copied to a Nagra or pro-DAT recorder, along with audio and picture time codes, using an audio track as well as a time code track. The best way to lock

the tape to the cameras would be through use of camera which record time code to film. The audio recorder's picture time code could be conveyed either via VHF transmitter or cable. Once set, the camera's internal clock could be used for minimal drift, or slaving for zero error. Audio is also copied to the mag film in the case where film editing will be accomplished.

The use of time code cameras allows user bit storage of data such as production number, take number, camera

or 30 frames per second. For transfer to NTSC, 29.97 frames per second is recommended to avoid flicker. The use of 24 frames per second, for example, would necessitate a 3-2 pull-down for transfer to NTSC video. (In Europe, a speed of 25 frames per second is the best bet.) After film processing, the time code is read off onto channel 3 of the one-inch VTR during telecine. Simultaneously, a 3/4-inch copy could be made for off-line editing. In either case, the audio and video are recorded in sync on the one-inch VTR.

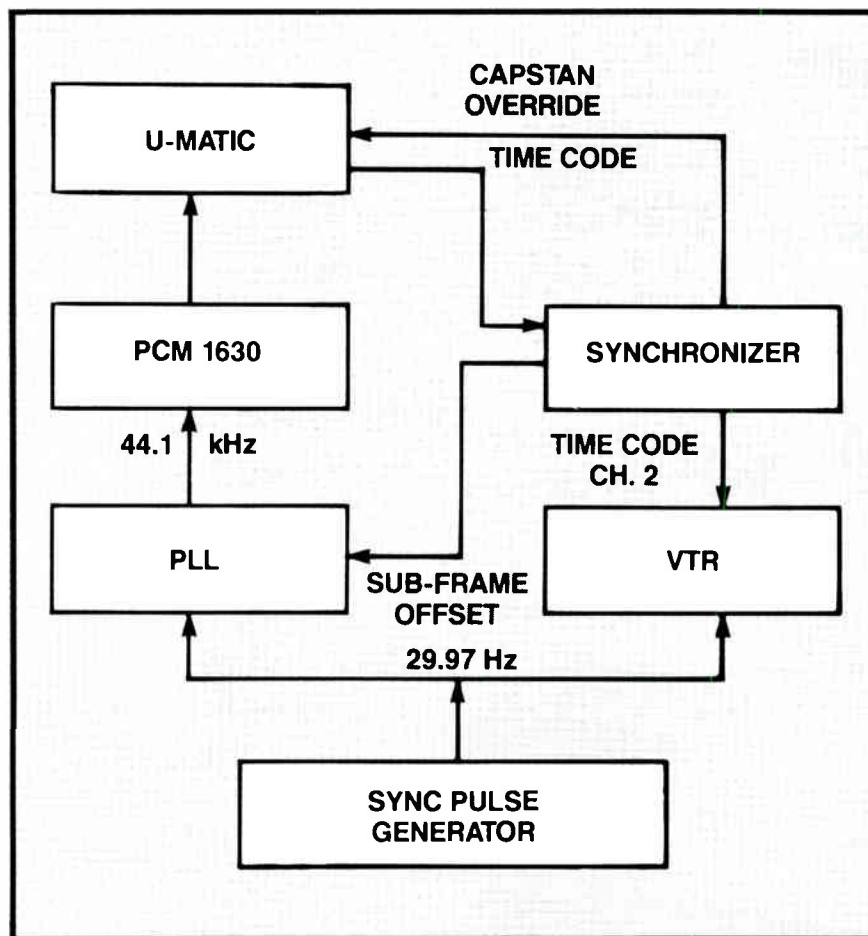

FIGURE 2: Synchronization of VTR and digital audio recorder/processor for playback with subframe offset compensation.

number, date, roll, etc. Systems manufactured by Aaton and Panavision record the duration and start of every take, and selected takes can be printed out at the end of a day, to reduce the amount of telecine work. In lieu of time code cameras, a slate could be employed—as long as there is some kind of fixed relationship between original audio master, playback tape and camera.

Either 16 or 35 millimeter film could be shot at film speeds of 24, 25, 29.97

It is during post-production that the essence of the problem of video and audio synchronization becomes apparent. Specifically, without compensation there will exist a subframe error between the VTR and U-matic recorder. The VTR will be the master, and will be locked to the sync pulse generator, with the 3/4-inch recorder slaved and frequency (not phase) locked to the same reference via a PLL and PCM processor. The synchronizer thus receives two time codes, one from the sync

pulse generator via the VTR, and one from the U-matic with drum servo locked to the PCM processor. The patch is shown in **Figure 2**.

However, there is a continuous time shift between the two references. When the VTR locks to its reference, the time shift between it and the U-matic is constant, and the synchronizer compensates for it. However when the capstan override is disabled, the U-matic's capstan servo (which controls longitudinal tape speed) locks to the drum servo so the video heads can track properly. This creates the sub-frame offset, determined by the time the VTR takes to lock. To compensate for this, an error signal from the synchronizer could be sent to the PLL at the moment the capstan override is being disabled. In this way the VTR time code can be synched to the U-matic time code by varying the word-clock until the offset is zero.

Video post-production can be done on-line by editing on one-inch VTR, then the audio tape with both time codes is synchronized to the VTR to produce a U-matic copy with video and audio time codes inserted in the picture and audio time code on channel 2. If the audio did not require additional mixing, the digital audio could be laid back on the gold master. A copy of this tape with both video and audio time code becomes the CDV master. Alternatively, U-matic video copies with sync audio and video time code in the picture could be used to create an off-line editing list.

Audio post-production can be done quite easily. The audio tape containing digital audio and both audio and video time code can be copied to a digital multi-track at 44.1 kHz, with both recorders locked. The offset between U-matic time code and multi-track time code should remain constant. Effects can be added in sync with picture and re-mixed to two tracks of the multi-track or directly to a 2-track digital recorder with the same time code, using a synchronizer for slaving.

This tape master can be edited in a digital audio editing suite. The tracks from the original audio tape are copied to a master tape in insert mode, and the multi-track mix is added using the in-point for the audio for video track, and balanced.

In the case of existing audio pro-

gram, it can be synched to picture with vari-speed after copying it to a hard disk or digital 2-track machine. In either case, a sampling frequency converter recalculates the 44.1 kHz sampling frequency, so the result can be copied correctly to the U-matic format.

Finally, audio PQ subcodes and video chapter codes must be determined. Because CDV merges two formats, to achieve backward compatibility with Laservision, both PQ and chapter codes must describe a point on the disc. Unfortunately, there are conceptual differences between the two. PQ code track numbers essentially specify the end of

**CDV may
find itself a
product
niche with
considerable
economic clout,
at once
replacing
the 45 rpm
single, and
creating a
new music
video
format.**

a pause whereas a chapter code specifies the start of a pause. In addition the Red Book specifies a two-second duration before the start of the first track. Thus at the start of that track the CDV player will find the chapter code at the start of the two second pause, but the audio start code is located at the end of the pause. In other words, the video could have started two seconds earlier. The solution is a kind of "video pause" inserted in the program, at the first track. For other tracks video code can coincide with audio code. Of course, at the end of each video chapter, the duration of the audio pause

must be added to the video program.

In practice, the determination of PQ subcode is thus slightly complex because it must also be related to video time codes. Otherwise a perfectly fine audio subcode marker would miss the video content. In general, the chapter code is located first, followed by the PQ code, taking the earliest and latest audio and video times as the start and stop times. For example, the two second pause is taken as part of the video program. As with the CD-DA format, to ensure proper player access, several frames (five or so) should be subtracted from the start time, and added to the stop time—the so-called subcode offset precaution. It should be noted that Laservision accommodates a maximum of 79 chapters, whereas CD has 99. The minimum chapter length for CDV is set at four seconds.

Fortunately, a few things about CDV are familiar to audio engineers: all digital audio tapes must be checked for error rates; depending on the QC at the facility, a high error count would necessitate remastering. Of course, as with any digital audio recording, audio levels must maintain at least 1 or 2 dB of headroom. One thing an audio-only engineer may want to consider: when a picture is added, the audio balance may be perceived differently. Ideally, a with-picture, and without-picture mix should be made, each for its appropriate format.

In summary, CDV production is certainly not easy, but as audio engineers develop production experience, and gain a greater understanding of film and video production technique, the job can only get easier. Likewise, only with greater understanding and experience will CDV production costs decrease. Of course, with the wider availability of new technology such as time code on film, and a new video standard such as D1, CDV production might become downright affordable.

Mr. Vogelaar's paper (preprint #2541) may be ordered from the Audio Engineering Society, 60 East 42nd Street, New York, NY 10165. ■

Ken Pohlmann is an associate professor of music and director of music engineering at the University of Miami in Coral Gables, FL, and vice president of U.S. Digital Disc Corporation in New York, NY. He is author of Principles of Digital Audio and The Compact Disc Handbook.

Martin Music isn't for everyone.

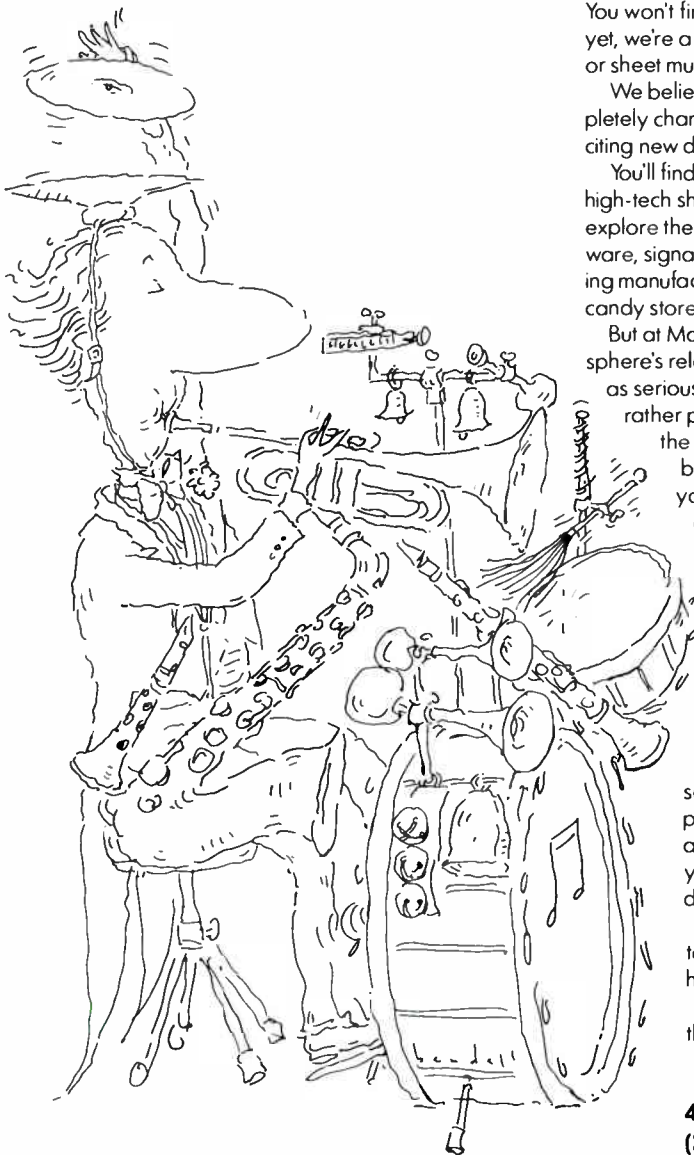

You won't find violins, saxophones or spinets at Martin. And yet, we're a music store. You won't find guitar strings, drumsticks or sheet music, either. And yet, we're a music store.

We believe the very definition of a music store has completely changed today, thanks to microchips, MIDI and the exciting new directions of electronic instruments.

You'll find that kind of excitement in our handsome new high-tech showroom and MIDI demo studio. Here, you can explore the latest synthesizers, samplers, computers, software, signal processors and recording equipment from leading manufacturers. In fact, you may feel a bit like a kid in a candy store.

But at Martin, we'll never treat you like one. The atmosphere's relaxed and professional, so we can take your music as seriously as you do. You'll be guided by a small and rather personable group of experts who'll offer you all the attention you'll need. And when you're ready to be encouraged towards a purchase, they'll quote you prices that are also encouraging. Very encouraging.

Our service doesn't stop with the sale, either. Martin's Product Specialists are always available to tell you how to get the most out of your equipment. And should the equipment itself ever appear at fault, the expert technicians in our in-store Service Department will help set things right.

Martin even sponsors a continuing series of in-house seminars in Synthesis, Sampling, Signal Processing and Recording to help you keep up with the latest developments.

If all this sounds too good to be true, it's only because you haven't been here yet.

So come and see the music store that's not for everyone.

It's for you.



423 WEST 55-STREET NEW YORK, N.Y. 10019-4490
(212) 541-5900 / TLX971846

by Mel Lambert

DISK & DAT A REPORT FROM AES

The Audio Engineering Society truly is a unique organization. Not only does the AES represent the academic and professional interests of a wide variety of audio types, each year the society also organizes a series of extremely interesting and handy conventions.

It cannot have escaped the attention of regular *Mix* readers that the AES holds an annual gathering each fall on alternating coasts, in addition to a European convention every spring and specialized seminars throughout the year. At the society's annual U.S. conventions, the accompanying exhibition of recording and production equipment is without parallel anywhere in the world; miss it at your peril!

It is obvious to many of us who have been making a regular sojourn to AES conventions and exhibitions for the past decade or so that it is increasingly difficult to keep up with the rapid technological developments which are now permeating the pro audio industry. After all there are "spe-

cies" of audio interests—ranging from transducer technologies to CD mastering hardware.

From my own lofty vantage point as marketing consultant and industry guru, I decided almost half a decade ago that I needed a barometer by which to gauge significant developments within the manufacturing base, and a respectable indicator of changing orientation within recording and production facilities. The technology, of course, was digital; my attention ever since has been focused on the fortunes of companies both supplying and using digital-based recording and editing systems.

At the recent AES Convention held

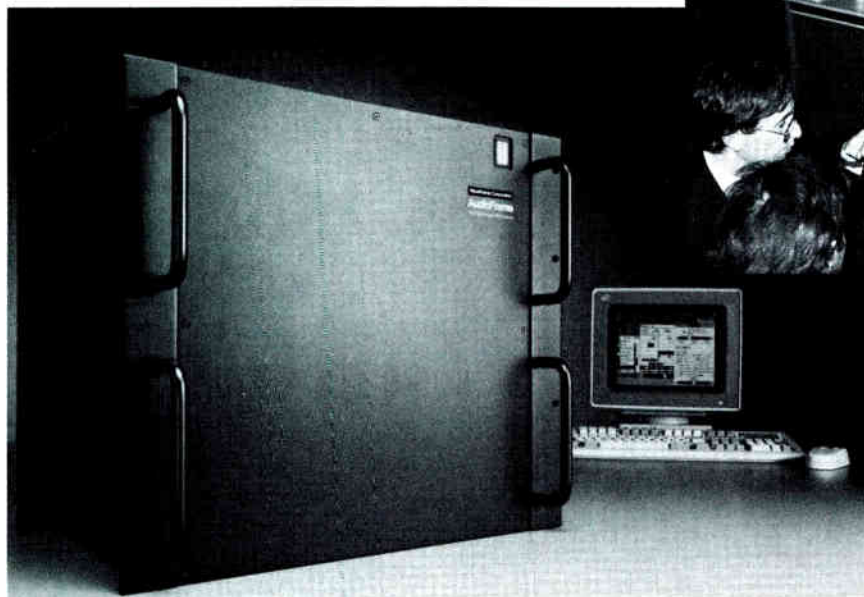

Above: DAR technical director Guy McNally demonstrates the Soundstation II. Shown left is Waveframe's AudioFrame workstation.

RELIABILITY

*because you
depend on it...*



The essence of a Professional is finesse under difficult conditions. Reliable performance day after day, night after night. At QSC, we believe that you shouldn't have to worry about your amplifiers. They should sound great and operate flawlessly. Always. Because we are committed to building the best Professional high performance amplifiers, we make reliability the number one criteria for our products, our service, and our company. We know that the reliability of your performance depends on the reliability of *our* performance.

QSC
Quality
Service

Circle #036 on Reader Service Card

QSC Audio Products, Inc., 1926 Placentia Avenue, Costa Mesa, CA 92627/714-645-2540



**BECAUSE
MASTERING CD'S
MEANS A LOT
MORE THAN JUST
PRESSING
THEM:**

MASTERED
BY NIMBUS



At Nimbus we've done more than anybody to master CD manufacturing, simply because we want our own recordings to sound as good as they sound when we make them.

We've fine-tuned and improved every step of the CD replication process and backed that up with absolute 100% quality control — so we can guarantee 100% satisfaction. And now, with our new plant in Virginia, we can offer you this same extraordinary service for all kinds of CD's, from the basic disc to a complete printed package, for any quantity. What's more, we meet our deadlines.

Mastered by Nimbus. When that appears on your CD's, it says you're as particular about who manufactures them as you are about what goes on them.

FULL-SERVICE CUSTOM PRESSING:

Mass CD replication — CD-Audio (includes CD Singles), CD-ROM, CD-V, CD-I.

Flawless digital and analog mastering.

Fast turn around — on-time delivery.

Full range printing and packaging services available, plus drop shipping and warehousing.

Now — your graphic design laser-mastered on CD singles. Only from Nimbus.



New York Sales Office:

200 West 57th Street New York, NY 10019 Telephone (212) 262-5400 Telex 239406 NMBS UR Telefax (212) 262-5409

Charlottesville Manufacturing Facility:

P.O. Box 7305 Charlottesville, VA 22906 Telephone (804) 985-1100 Telex 9102408303 Telefax (804) 985-4692

WONDER *Stevie*



 Meyer
Sound

“If Music is the Sound,
make Meyer the Source.”

Stevie Wonder mixes
exclusively with the
Meyer Sound 833 Studio
Reference Monitor.

Circle #037 on Reader Service Card

JUXTAPOSITIONS

in New York in early October, talk on the exhibition floor was of little else. Which manufacturer had the most viable configuration? Was that system/format/implementation cost-effective now, or two/three/four/five years down the line? The few years remaining in the '80s look like they will be a tantalizing time.

Of the new systems unveiled during the AES exhibition several are likely to turn the audio production industry on its ear. In this month's column I'd like to identify some of the main players in the digital recording and editing marketplace; and next month I'll follow it up with some thoughts on why, because of shifting market forces, some of these firms and their products probably won't be around by the time we gather for next year's AES Convention.

At least a half-dozen firms appear to be squaring off for a position in the initial rounds of the "Battle of Disk-Based Recording and Editing." Advanced Music Systems (AMS) drew good traffic to routine demonstrations of its AudioFile system, of which 100 units are currently said to be in regular use around the world. I also understand that the score for the forthcoming film *Freeway Maniac* was digitally edited on an AudioFile at the LA.-based facility HTC Post. The latest software/hardware enhancements being talked about in New York included cut-and-splice software, internal digital mixing plus level control, storage expansion to beyond eight hours of 16-bit/44.1kHz sampling time, and "rock-and-roll" editing.

The British firm of Digital Audio Research (DAR), formed three years ago by Jeffrey Bloom and Nicholas Rose to develop digital audio software and hardware products, unveiled what will surely attract a great deal of attention as one of the most visually interesting digital audio workstations: Soundstation II. Described as a second-generation recorder and production center, Soundstation II features up to eight channels of analog and digital inputs and outputs (the latter comprising AES/EBU format at 32, 44.1 or 48kHz sampling frequencies, or PCM-1610/30 format); a total recording capacity on the basic system of around 60 track minutes of 16-bit audio at a sampling frequency of 44.1kHz (18-bit/48kHz combinations also can be accommo-



Soundcraft's Digitor editing workstation.

dated); and a touch-sensitive, electro-luminescent screen display.

Still passing through the final stages of beta site evaluations, first shipments of the Soundstation II system are scheduled to begin by early spring. Expected cost for a base system is in the region of \$80,000.

Behind the scenes, Lexicon is obviously continuing its refinement of the Opus digital editing, recording and mixing system. The Opus now offers an improved editing capability and windowing displays (up to ten versions of an edit can be retained for comparison purposes); copy functions and time alignments of individual track elements; and the ability to bounce up to 12 tracks into a stereo composite. Record time has also been increased to a total of 480 track minutes at a sampling frequency of 44.1kHz. I understand that the first two production systems are scheduled for shipment this month.

In addition to Digital Audio Research, another company unveiled a totally new digital audio workstation at the New York show. Co-founded by Glenn Edens and John Melanson, Wave-Frame Corporation is reported to have shipped seven of its newly developed AudioFrame systems to beta test sites last June, and used the AES Convention to publicly launch its new music performance and digital editing system.

AudioFrame production workstations will be comprised of an IBM PS-2 Model 60 computer that handles system control plus graphic display in a Microsoft Windows environment, and a separate processing rack running proprietary high-speed digital algorithms in a 24-bit architecture.

Why work anywhere else?

Satisfied customers talk about Live Oak Studios.



**Eric Muhler
Composer/Producer**

“Live Oak’s combination of state-of-the-art audio/video production equipment, a supportive business atmosphere and an excellent engineering staff has made it unnecessary for me and my customers to work anywhere else. We are very proud of the numerous successful projects we have created at Live Oak Studios.”

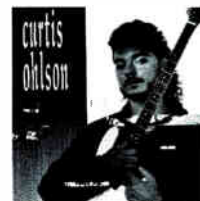

**Curtis Ohlson
Recording Artist**

“I want to express my sincere gratitude for Live Oak Studio’s instrumental involvement in my debut album, *So Fast...* Thanks to Jim and Priscilla’s help, I got the deal and was able to finish the album. They are both not only professional, but are two of my dearest friends. I’m looking forward to completing many more projects at Live Oak.”

Live Oak Studios specializes in not only recording projects, but also film and video. We offer a complete multi-track studio with a video interlock and projection system as well as a separate MIDI Keyboard Suite with 24 track recording capabilities.

For more information on one of the Bay Area’s foremost studios, call Jim and Priscilla Gardiner at (415) 540-0177.





Lexicon president Ron Noonan announces the initial production and delivery dates for their Opus system.

Recording and production facilities have the option of utilizing AudioFrame as a stand-alone, MIDI- and time code-based digital sampling and re-synthesis synthesizer and sequencer, and/or as a music/effects recorder, editor and signal processor. I understand that digital equalization and dynamics control are planned as immediate enhancements for the system.

Pro audio prices for AudioFrame, which the company says is available for immediate shipping, range from just under \$46,000 for a basic 16-voice

system with 180 seconds of sample time, a 2-channel A-to-D module, an 8-channel D-to-A module, and full Real-Time Control, VoiceEdit, Event Processor and Edit Decision List software; to just over \$86,000 for a 48-voice system with nine minutes of sample time and an additional eight channels of D-to-A capability.

In many ways, WaveFrame's AudioFrame is more akin to the New England Digital Synclavier and Fairlight Instruments' Series III than to the AMS AudioFile, DAR Soundstation II or Lex-

icon Opus, in that the former two units can be considered sophisticated musical keyboard instruments, in addition to their current applications in recording, sound editing and audio-for-video post-production.

At the AES Convention, New England Digital unveiled a stand-alone Direct-to-Disk system capable of holding 75 minutes of 100kHz, 16-bit audio on up to 16 "tracks" of hard-disk storage, each track of which can be slipped or offset against one other. Also being demonstrated was the new Audio Event Editor software that provides edit-point location to within a digital sample (a quoted 10 microsecond accuracy), and a special time code-based ADP and voice-over mode that is said to allow virtually limitless takes during a dialog replacement or commercials session.

Fairlight Instruments also appears to be taking the audio-for-video and -film post market seriously these days, and has developed a custom control panel and software for the Series III. The new MFX (Music & Effects) hardware/software package provides a control surface with dedicated transport controls, a "rock-and-roll" editing wheel and programmable softkeys for routine functions, along with Cue List time code-based sequencer and controlling software capable of initiating any Series III function at a specified time. Up to 30 events can take place simultaneously in a Cue List sequence.

Both Fairlight and New England Digital saw very healthy traffic in their respective demonstration areas, as prospective users caught up with the different systems' operational features and production capabilities for musical performance, digital sampling and replay to time code tracks, plus waveform editing.

Two companies were also showing smaller-scale digital recording and editing systems. Integrated Media Systems (IMS) demonstrated its Dyaxis Digital Audio System, which comprises a D-to-A/A-to-D rack unit and controller software for the Apple Macintosh. In its basic format, Dyaxis is capable of storing up to seven minutes of stereo, 16-bit/48kHz audio on hard disk with full waveform editing plus MIDI- and time code-based triggering of stored samples. Prices range from \$6,500 for the basic Dyaxis system (excluding the Mac Plus, Mac SE or Mac II controlling PC), to \$12,500 for 30 minutes of

EXTRAORDINARY AUDIO

Studio Consultants specializes in a select group of exceptionally fine professional audio products, including:

- **AMS AudioFile**—hard disk-based digital recording and editing system
- **API**—all-discrete equalizers and microphone preamplifiers, distribution amps, and other audio modules
- **Bryston**—professional power amplifiers, preamplifiers, and crossovers
- **T.C. Electronic**—digital delay/sampler, automated equalizers, and effects
- **Westlake**—monitor speakers

Also: **Aphex, Audio Digital, Audio Kinetics, Fostex Professional, Rane, Valley International, White Instruments**

Spec sheets, prices, and in-studio demos are available on request. And for short-term needs, **Studio Consultants** rents **API** and **Bryston**.

studio consultants, inc.

321 West 44th Street New York, NY 10036 (212) 586-7376

Equipment, support, and design services for professional audio facilities and broadcasters.

Circle #073 on Reader Service Card

BRYSTON



BRYSTON POWER AMPLIFIERS CONTINUE TO DEFINE THE STATE-OF-THE-ART IN MUSICAL ACCURACY, LONG TERM RELIABILITY AND PRODUCT INTEGRITY.

Bryston design philosophy incorporates three general concepts.

1. Musical accuracy
2. Long term reliability
3. Product integrity

MUSICAL ACCURACY

Musical accuracy is reflected throughout all Bryston power amplifiers and includes the necessity for wide-band transient accuracy, open loop linearity ahead of closed loop specifications, and power supply design as an integral part of the overall sonic and electrical performance of a power amplifier.

We have found that a simple carbonyl film resistor can contribute more static distortion to a signal than the entire remainder of the amplifiers circuitry combined.

We discovered that some parameters of transistors must be controlled as much as 1000 times more closely before their contribution to audible distortion is rendered negligible.

We discovered that under certain actual conditions of speaker loading amplifiers were incapable of yielding high-power transients without distortion.

Each of the various steps or stages in every Bryston amplifier, from

the input section to the output section, without exception, are designed to optimize the musical experience.

STANDARDS OF RELIABILITY

We consider this criterion to be exceedingly important. We have applied techniques and materials in our everyday construction of electronic equipment more typically utilized in the military and aerospace industries.

All components used in Bryston power amplifiers are specified for continuous duty at maximum power, with typical safety margins of 250%.

The power transistors used in all Bryston amplifiers are 100% tested for safe operating area, both before and after installation in the circuit. They are then taken to a "burn-in" table when they are given a capacitor load, a square-wave input signal, and set at slightly under clipping for a period of 100 hours. During this time, the input signal is cycled three hours on to one hour off, to exert additional thermal stress.

Following the burn-in period, the amplifiers are monitored for DC bias stability for approximately

another full day. At this point, they are returned to the test bench for another complete checkout of all operating parameters and functions, at which time a test sheet is made, and included in the packing with the unit.

As may be seen, Bryston takes very seriously the correct functioning and long term reliability of its products.

INTEGRITY

Bryston contends that the term 'best' should apply to the honesty, pride and courage with which we conduct our business, as well as to the performance of our products.

For this reason, you will not find Bryston's products being cosmetically "updated" on a regular basis merely in order to keep the customer's interest, in something 'new'. If we make a change in the circuitry, it will be because, and only because, it yields a worthwhile performance or reliability improvement.

We feel that regular sweeping revisions to basic circuit design (accompanied by revised jargon) to be cynical marketing on the part of the manufacturer and insulting to the discerning customer.

In the United States:

BRISTON VERMONT

RFD #4, Berlin, Montpelier, Vermont 05602
(802) 223-6159

Circle #038 on Reader Service Card

In Canada:

BRISTON VERMONT MARKETING LTD.

57 Westmore Dr., Rexdale, Ontario, Canada M9V 3Y6
(416) 746-0300

JUXTAPOSITIONS

stereo; additional storage capacity is available via extra 380-Mbyte SCSI hard disks.

Soundcraft Electronics also unveiled the Digitor system, which comprises a self-contained RAM-based recorder and editor. The unit provides up to six minutes of stereo recording into RAM from analog inputs; AES/EBU digital and PCM-1610/30-type inputs will be made available at a later date, the company says. Sampling frequency can be set to either 44.1 or 48kHz. The system can be triggered from an external DC

or audio signal, or a time code track via its proprietary sync-to-tape code. Shipment of Digitor, whose price will range from \$16,000 for a base unit to \$33,000 for a fully configured system, will begin this month.

Although developments look relatively quiet on the DASH- and PD-format reel-to-reel digital tape machine front, it would appear that the R-DAT market is warming up. Both Fostex and Tascam joined Sony in unveiling R-DAT transports for the professional audio industry. Despite the fact that I am still not fully convinced that R-DAT represents the all-encom-

passing recording format as it is touted by several manufacturers and facility owners, it does offer a potential cost saving and space advantage over conventional stationary head and video-based transports.

The battery-powered Sony PCM-2000 portable R-DAT recorder, which features mic/line analog and AES/EBU digital inputs, begins shipping in March 1988, and has a pro audio price of \$7,000. Its sister transport, the rack-mountable PCM-2500, offers line-level analog, AES/EBU digital and PCM-1610/30 ins and outs, plus switch selectable sampling frequencies of 32, 44.1 and 48kHz. Shipping is available now, Sony says, at a price of \$5,000.

Fostex was showing a pre-production prototype of a rack mount R-DAT transport equipped with variable sampling frequency, analog and PCM-1610/30 digital ins/outs which, the company says, will cost \$4,000 and will start shipping next May. Of all the R-DAT transports currently being marketed, the Fostex deck is the only one I currently know of that will chase and synchronize to external time code, and which will enable in-machine editing.

The Tascam Model R-1 rack-mountable R-DAT offers few features beyond those available from current consumer-style decks, including a record sampling frequency of 48kHz, 32kHz digital inputs and 44.1kHz replay-only; shipment is scheduled to begin in January at a price of just under \$4,000.

All in all, I would predict that the next six months will prove to be a particularly interesting settling time for the pro audio industry, as prospective users come to grips with the features and capabilities being offered by these existing and emergent companies. I'll be back next month with some thoughts of my own regarding system configurations, input/output compatibility, operational features for the recording and audio production industries, as well as possibly blind alleys being pursued by some of the leading contenders. See you then. ■

Mel Lambert has been intimately involved in the pro audio industry—on both sides of the Atlantic—for the past decade. Formerly editor of Recording Engineer/Producer magazine, he currently is a partner in the Marcus Lambert PR firm, and the president of Media & Marketing, a consultancy service for the pro audio industry.

JACK NOISE. You don't need it. — We don't make it!

No one needs jack noise, and when you specify Mosses & Mitchell jack sockets and jackfields you won't get it. What you will get is immediate noise free operation every time, plus secure plug retention and long term reliability. Talk to Penny & Giles about the world's most advanced jack sockets and jackfields. If you value performance don't settle for anything less.

- noise free operation every time
- secure plug retention
- self cleaning action
- palladium contacts
- audio and video jackfields
- audio jack sockets

Penny+Giles

Penny & Giles Inc
2716 Ocean Park Boulevard #1005
Santa Monica California 90405
Tel: (213) 393 0014 Telex: 858866 Fax: (213) 450 9860

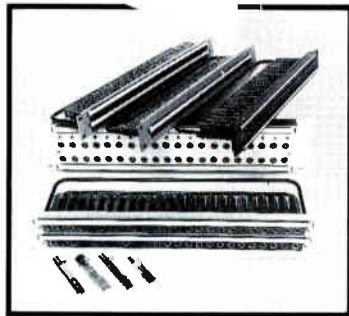
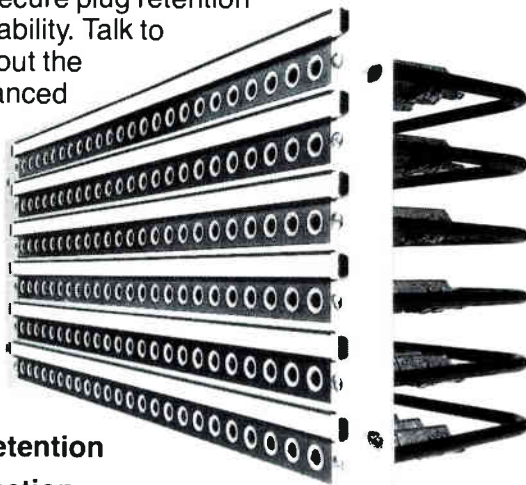



TAKE CONTROL OF A MAJOR RECORDING STUDIO

It's time to seize power.

Tascam's Studio 8 puts all the power of a professional recording facility into an 8-track production system that's as easy to handle as your own instrument.

Forget bewildering patch bay jungles. The fully assignable 8 buss mixer sends your signals anywhere you want them with the flick of a switch.

Forget open reel headaches. The unique Load feature loads the tape, senses the end automatically and never lets it run off the reel. And because Studio 8 uses 1/4" tape, you'll never be stuck trying to find someone's rare proprietary tape format.

Forget video hassles. The "One Plug" SMPTE/EBU interface gives you easy synchronizer or editor connections.

But there's something more. Something that's greater than the sum of the features. Startling sound. No other system has Tascam heads. Which means that no other system has the impact and clarity that come from Tascam's thirty years of recording experience.

Quality production is what you do. Do it with a major recording studio. Take control of a Tascam Studio 8.



TASCAM

© 1987 TEAC Corporation of America, 7733 Telegraph Road, Montebello, CA 90640. 213/726-0303.

Circle #039 on Reader Service Card

by Larry Oppenheimer

ELLIOT SCHEINER

FROM VAN TO THE DAN, AND BEYOND

In the audio world, engineer/producer Elliot Scheiner could lay claim to the sobriquet of "Mr. Clean" if he wanted and no one would argue. Today he even looks the part: cool, fresh and relaxed in a crisp white shirt, beige pants and new white Reeboks. Perhaps best known for his crystal-perfect work with Steely Dan, which brought him two Grammy awards for Best Engineered Recording (for *Aja* and *Gaucho*), Scheiner's career has included engineering and/or production work with many other musicians of equal note: George Benson, Rickie Lee Jones, Van Morrison, Billy Joel, Jimmy Buffett, Diana Ross, Manhattan Transfer, Ashford & Simpson, and on and on. As if this were not enough for

one resume, he also co-produced the smash 1986 debut album of Bruce Hornsby & the Range.

For the last two years or so, Scheiner has been working with Glenn Frey on his third solo album. The project has wended its way through a number of studios in different locales, including here at the Sandbox in Fairfield County, Connecticut, only a few miles from Scheiner's home. Interviews with Scheiner are virtually non-existent. Not that he is reclusive or inarticulate. "I've pretty much shied away from interviews," he explains warily, "because I've seen so many interviews with other guys where things get taken out of context and somehow you end up making enemies." Although he professes



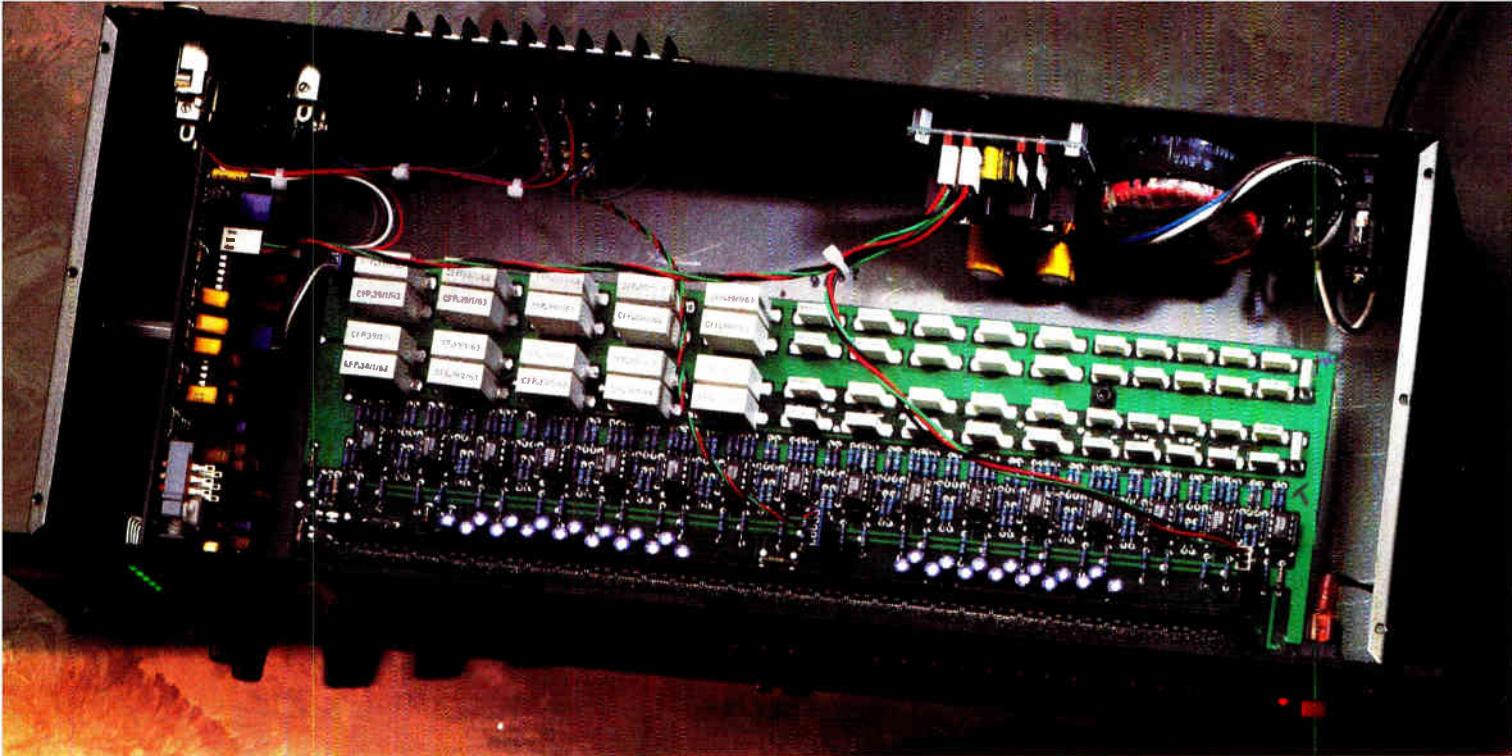

THE COMPETITION HATES OUR GUTS.

It takes a lot of guts to compare yourself to some of the biggest names in professional audio.

Of course, when you offer the quality and features found inside the Audio Logic SC31 Graphic Equalizer, it's easy to display more than a little extra intestinal fortitude.

The SC31 is a powerful signal processing tool designed for professional use. It features 31- $\frac{1}{3}$ octave centered bands of equalization with selectable 6 dB or 12 dB of boost and cut. But that's just for starters.

Take a look at the chart. It shows how the SC31 stacks up against the competition in the specs most important to audio engineers and sound contractors.

Maximum output. Dynamic Range.



	Audio Logic SC 31	RANE GE 30	JBL/Urei 5547A	Klark-Teknik DN 300
Noise	Less than -90 dBm	Less than -90 dBm	Less than -90 dBm	Less than -90 dBm
Maximum Output	+27 dBm	+24 dBm	+22 dBm	+22 dBm
Dynamic Range	+117 dBm	+114 dBm	+112 dBm	+112 dBm
Frequency Response	18 Hz to 30 kHz +/-0.5 dB	10 Hz to 40 kHz +0/-3 dB	20 Hz to 20 kHz +1/-2 dB	20 Hz to 20 kHz +/-0.5 dB
Number of Bands	31	30	30	30
THD plus noise	Less than .005% @ +22 dBm @ 1 kHz	Less than .01% @ +4 dBm	Less than .5% @ +22 dBm	Less than .01% @ +4 @ 1 kHz
Suggested Retail Price	\$550.00	\$699.00	\$849.00	\$995.00

Frequency response. Number of bands. Total Harmonic Distortion plus noise. In every category, the SC31 comes out even or on top.

In every category, that is, except price. Because the SC31 gives you all that capability, plus

incomparable sound quality, for considerably less than any other professional graphic equalizer. And that's what galls the competition most of all.

For a hands-on demonstration of the SC31, visit your professional audio dealer or sound contractor. Or write for additional information:

Audio Logic, 5639 So. Riley Lane, Salt Lake City, Utah 84107.
Or call (801) 268-8400.

AL
AUDIO LOGIC

© 1987 DOD Electronics Corporation

*All specifications taken from manufacturer's published literature.

THE IEQ WITH Smartcurve™

Not Just Another Programmable Equalizer With MIDI™

The IEQ with Smartcurve™ is a programmable, high performance graphic equalizer that includes a video output. For those who wish to enjoy the video output of the IEQ, ART makes the IEQ Video Monitor.* Smartcurve™, proprietary software developed by ART gives you instant actual frequency response as easy as the push of a button.

The IEQ Family consists of both the 2/3 octave and the 1/3 octave graphic equalizers. Both types come in two varieties, Controllers and Satellites. A Controller is a self-contained programmable intelligent graphic equalizer capable of controlling 15 satellites at once. IEQ Satellites are exactly the same unit except the front panel controls are eliminated.

IEQ Model Specifications:

Controller & Satellite

- 128 battery backed presets
- MIDI
- Frequency Response 20Hz-20kHz \pm 0.5dB
- THD \leq .009% @ 1kHz, 0dBm typical
- Dynamic Range \geq 100dB typical
- Balanced inputs and outputs

*IEQ Video Monitor Features

- 19" rack mountable
- NTSC compatible monochrome monitor
- 4 Selectable inputs
- Standard RCA jacks for easy connections

It Has To Be A Work Of . . .

ART

Applied Research & Technology

215 Tremont Street
Rochester, NY 14608
(716) 436-2720
TELEX: 4949793 ARTROC
FAX: (716) 436-3942

For more information see your local dealer.

Circle #028 on Reader Service Card

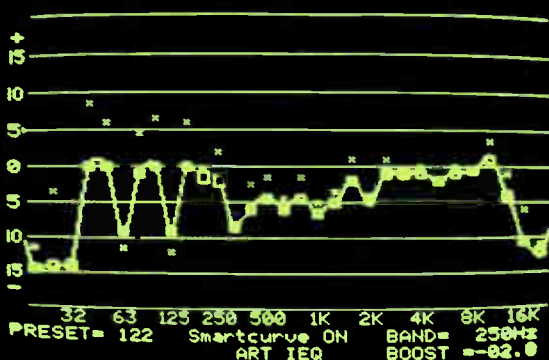
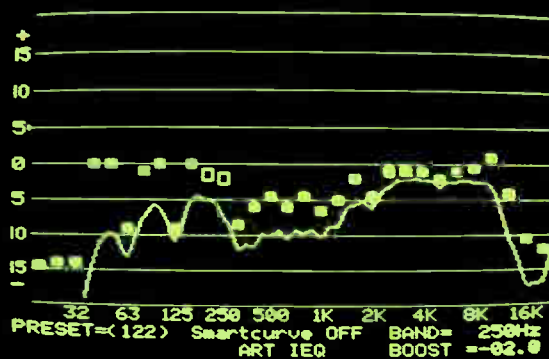
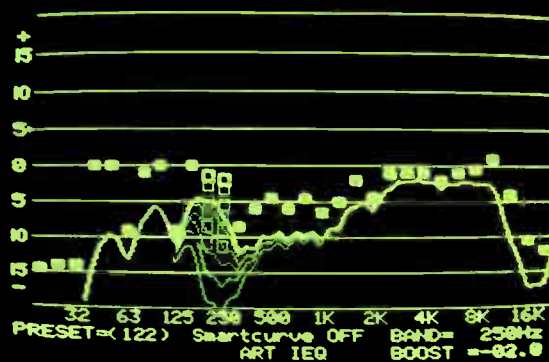

1 See the Sound

This is a video output of the IEQ as the unit is being adjusted. The sliders can be moved \pm 15dB in 1/2dB steps to get the exact response you need. With the simple push of a button, complex equalization can be done in seconds with incredible accuracy.

2 Hear the Sound

The power of the IEQ readily becomes apparent as the video display plots the frequency response due to the slider settings. The IEQ offers high quality constant "Q" equalization. The video graphic display shows the correlation between the sliders and the frequency response.

3 Perfect Sound

Turn Smartcurve™ on and perfect equalization is at your fingertips. Note the difference between the second frame, (Smartcurve™ OFF) and this frame. The position of the sliders represent the actual frequency response of the EQ. Interaction between bands is virtually eliminated. Incredible! Just think, now when you adjust the EQ you get exactly what you need. The "perfect" EQ? Let your eyes and ears decide.

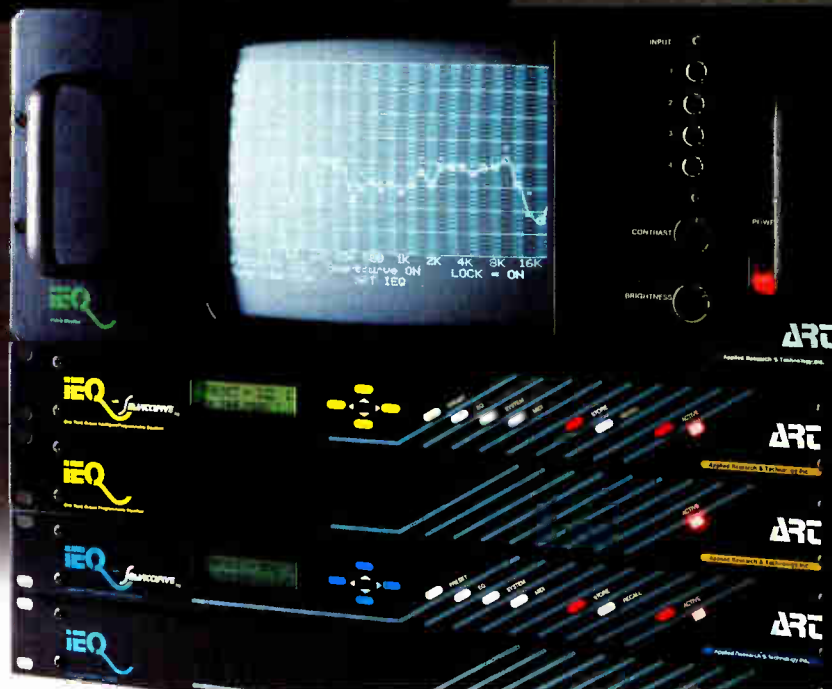

PRODUCERS · DESK

to be a poor interview subject, Scheiner proved to actually be softspoken yet not shy, opinionated but not outspoken. Unafraid to reveal his techniques, he seems confident that it is not what he does but *how* he does things that gets his sound and the clients that come calling for it. Scheiner makes a mockery of Leo Durocher: he is the nice guy finishing first.

Mix: How did you get started in the audio business?

“All the modern records have a lot of effects, but I tend not to use as much as anybody else because they’re just not as important as other things.”

Scheiner: I started in 1967. I worked for Phil Ramone over at A&R Studios. That’s how I got my engineering chops. I didn’t leave A&R for a long time; I didn’t go freelance until 1973. So it was a learning process from ’67 to ’73. It was a real transition to go from a staff engineer to freelance. Nobody was doing that; there were still a lot of staff guys. I was taking a chance going freelance, but it worked out well because I had a lot of clients.

Mix: How did that compare to branching from engineering into production?

Scheiner: The transition from engi-

neer to producer was so lengthy. I started getting involved in production about 1970 doing a few local people. I did some work for Van Morrison and sort of helped on the production of *Moondance*, but I didn’t really get involved until the end. Morrison had worked at a bunch of other studios on other tracks and then he ended up at A&R. I was the final engineer on the project and I’d done a bunch of tracks with him and finished the overdubs. It came to mixing and it had to be done before the end of the year. It was Christmas week and he was living in Woodstock and didn’t want to come in to New York. So he said, “You do the mixes and just send me copies,” and that’s how it happened. In theory I was producing and mixing, but I never said that. He stayed up in Woodstock and approved everything.

So from there, I thought, “Well, gee, I just mixed this album and produced the mixes, so I must be qualified to be a producer.” I didn’t know, geez. I made a lot of mistakes. I didn’t really have any serious success as a producer until this past year. Hornsby’s album was the first top five album I’ve had.

Mix: It’s difficult to get a picture of a producer without talking to the artist, because a producer is not an island; it’s the producer and the artist that make the energy.

Scheiner: More the artist I think.

Mix: Often it seems to be the interaction.

Scheiner: Yeah, it’s true. It’s tension and interaction that creates the album, but my outlook is that it’s still the artist’s name on the album, not mine. He’s got to pay the consequences if it’s a lousy album. They’re not really going to blame me.

Mix: The sound I hear on your work is very clear and crystalline.

Scheiner: That’s something I’ve developed over the years. Every time I work with a new artist, they can’t believe that they can hear everything. It’s a new trip for them. Like Glenn said, “It’s the first time I can hear every instrument clearly.” I’ve strived over my career to make that part of my sound; most of my records are pretty clean sounding.

Mix: Is that mostly a matter of balances or EQ or the initial sounds that you

The art of shaping sound.

SONEX is a high-performance acoustical foam that upgrades your studio inexpensively. Ideal for a temporary isolation booth, it can also eliminate slap echo and harsh resonances in the main room or silence noisy tape equipment in the control booth.

Write for our color brochure today.



Alpha Audio®

2049 West Broad St.
Richmond, VA 23220 (804) 358-3852

Circle #075 on Reader Service Card

B Burlington
Audio/Video Tapes Inc.
106 Mott St. Oceanside, N.Y. 11572

Toll Free 1-800-331-3191
In N.Y. (516) 678-4414

3M

Scotch® Audio/
Video Tape



Call for Free Catalog

In Stock and Priced Right.
Reels, Boxes, Custom Cassettes,
Leaders and Splicing Tapes.

**HARD TO GET ACCESSORY
ITEMS**

106 Mott Street, Oceanside, New York 11572

Circle #076 on Reader Service Card

get or a combination of everything?

Scheiner: It's definitely not initial sounds. I think that it's more mixing. I've mixed other people's work and I'll still come up with approximately the same thing. It's a combination of balancing and EQ.

When I grew up in this industry, there was no EQ; it was all mic technique. That's the way I learned from Phil [Ramone]: you place the mic in the right spot, you get the right sound. The old broadcast consoles that we had didn't have EQ in them. Most of

the rooms had a few Pultecs, and you used them on vocals because there was not too much mic technique on vocals—that depended on how the singer worked the mic. Back when I was learning, everybody had these old tube mics. Most of the places that I've worked in the last 15 years don't have those great old tube mics, so you end up using a lot of new mics that don't sound nearly as good. There are a few studios out in L.A. that have an unbelievable mic selection, and it's nice to get into it for a second—"Well, gee, I'm going to try to not use any EQ on the drums today. I'm going to try to

mic them so that I don't have to touch any EQ." And sometimes it will work out great. But usually it's a combination of EQ and level. That's what I've been using.

Mix: It seems like you're not afraid to use drastic EQ if that's what you need to get what you want.

Scheiner: No, I'll over-EQ until I get it to the point where I like it. I feel like if I'm having to drastically EQ something it's OK, it just wasn't right on tape and I'm compensating for it. I don't feel bad that I have to over-EQ something; it's not going to change the overall picture that much.

Mix: Can you describe the sound that you're usually looking for?

Scheiner: I like a lot of transparency. I like hearing a lot of low bottom, a lot of tap. I tend to shy away from the middle and boost the top end more than anything.

Mix: Sort of like that British sound.

Scheiner: Yeah, that's what first made me take notice of that kind of stuff. Like the old Elton John records. The first time I heard his first American record, you could hear the cellos, you could hear the basses, and it was really crystal clear. You heard every octave really distinctly: all the top end stuff, the range of the piano. So that was my goal: to get records to sound as clear as that.

Mix: We've talked a bit about EQ and balance issues. How do you get the sense of space and placement that you like?

Scheiner: I try and get the space with panning, echo. I tend to delay the inputs to the chambers with a fair amount of delay so that it creates a little bit more space on the instrument in the echo. I still use a lot of old EMT tube chambers. I'm using more and more digital stuff with it, but I always make a point of having two or three old, old mono chamber EMTs, like 140s. I'll use a mono chamber on the left and one on the right and one down the center. If I have a guitar on the right, I may want its echo returning on the left. With most of the digital chambers now, it's stereo in, stereo out, you can't send to just one side and get just one side out; you get echo down the middle in most cases. So I like to have that discretion with echo chambers.

A SENSATIONAL RECIPE



- (1) Take one professional recording engineer.
- (2) Add top quality digital recording equipment and facilities.
- (3) Season with the expertise of 20 concert artists.
- (4) Record **EVERY** note in the range of almost every instrument.
- (5) Use only the finest instruments available anywhere.
- (6) Add spices: muted strings and brass, pizzicato, natural and artificial harmonics, martelé string attacks, flutter-tongued flutes, plucked piano, bowed vibes, etc.
- (7) Record in stereo, and edit and master digitally.
- (8) For good measure, add a manual with instructions and a directory for easy access.

What do you get?

THE MCGILL UNIVERSITY MASTER SAMPLES LIBRARY ON THREE COMPACT DISCS

If you are looking for the ultimate in clean, beautiful, luscious sounds, look no more. We've got 2,267 of them. All you need is a CD player and any sampler.

Volume 1: Solo strings and ensemble violin (violin, viola, cello, bass)

Volume 2: Woodwinds and brass (piccolo, flute, alto flute, bass flute; b flat, e flat, bass, contrabass clarinets; oboe and English horn; bassoon and contrabassoon; trumpet and Bach trumpet; French horn; tenor, alto, bass trombones; tuba)

Volume 3: Pianos, percussion, and saxophones (9' Steinway: soft, loud, plucked strings; marimba, xylophone, vibraphone, glockenspiel, crotales, tubular bells, plus 102 metal, wood, and skin percussion sounds on 65 different instruments; soprano, alto, tenor, baritone, and bass saxophones)

Send \$69 (U.S.) per C.D. or \$199 (U.S.) for all three volumes, plus \$4 for shipping and handling. Quebec residents add 9% sales tax, outside North America add \$4 (Allow 4-6 weeks for delivery).

Send check or money order to:

MCGILL UNIVERSITY MASTER SAMPLES
555 Sherbrooke Street West, Montreal, Quebec.
Canada H3A 1E3 (514) 398-4548

Q-Sheet. MIDI Automation. Now.

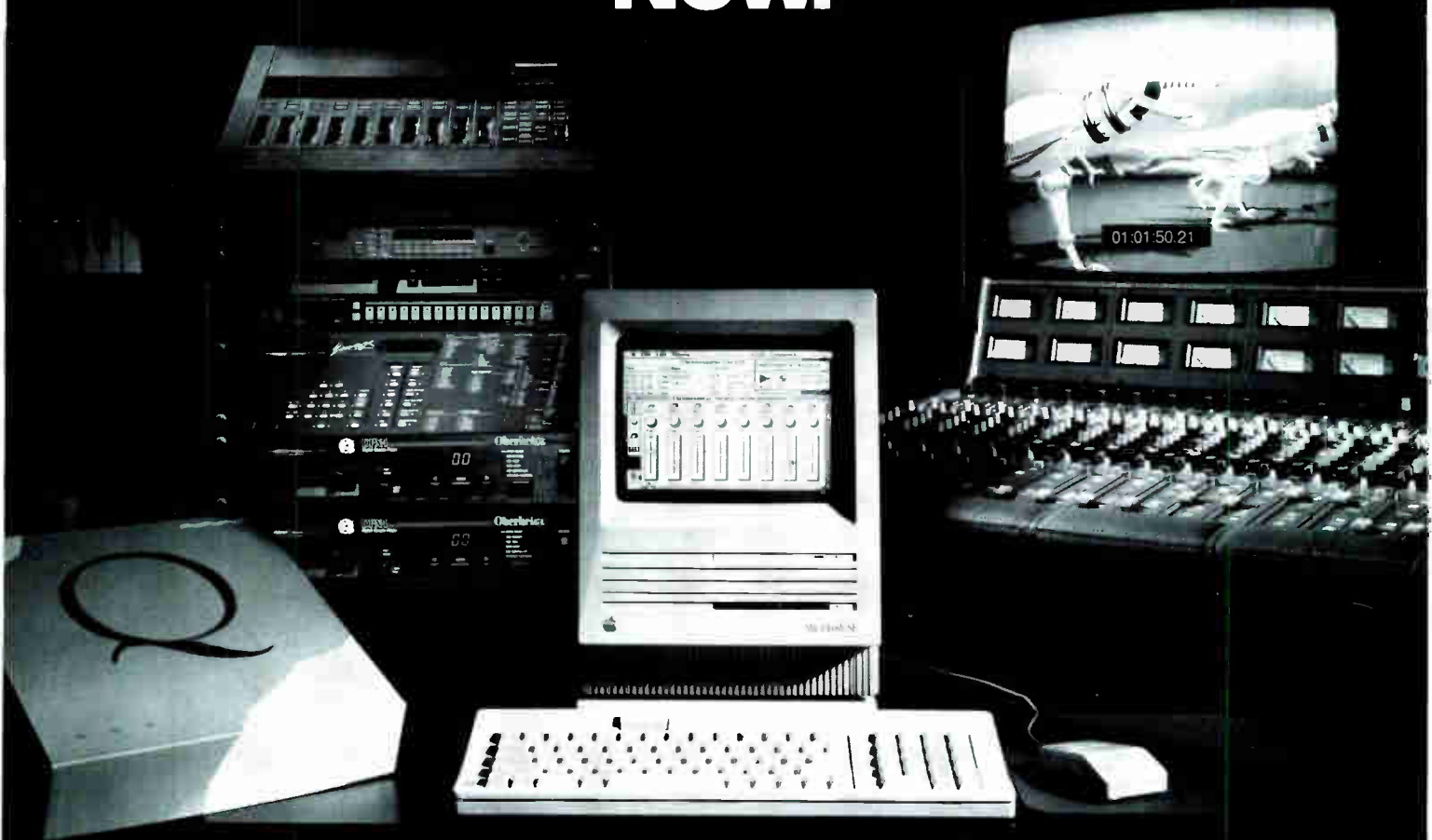

MIDI brought a new dimension to making music. Now Q-Sheet™ brings a new dimension to MIDI: Creative, SMPTE-locked automation of any MIDI device.

What does this mean to you? The power to build elaborate, automated mixes of your music using MIDI mixers, equalizers and effects processors. The ability to use samplers and synthesizers to produce video soundtracks. The creative freedom to do things you never could before.

Use Q-Sheet with the new generation of MIDI-controlled recording gear for creative control over the entire mixing process. Q-Sheet can play back a sequence created by any MIDI sequencer while dynamically automating your mixing console and effects. Powerful automation features like subgrouping and mix updating qualify Q-Sheet as a top-notch automation controller.

If you'd like to add sound effects to video, Q-Sheet can trigger effects from samplers with quarter-frame accuracy. A myriad of special editing features make soundtrack production fast and easy. You can even add music to your video using Q-Sheet's sequence playback capabilities.

Q-Sheet's ease of use is perhaps its best feature. Graphic faders, knobs, and buttons can be drawn on the screen in any size and configuration, then assigned to control any MIDI device, present or future. Innovative "pop-up" menus allow most edits to be completed with a single mouse click, so you'll work fast.

So follow your creative instincts—visit your local Digidesign dealer for a demonstration. Or send us just \$15, and we'll send you a demonstration video introducing you to Q-Sheet and the power of MIDI automation (specify Beta or VHS).

It will open your eyes to the full creative potential of MIDI.

digidesign

1360 Willow Road, Suite 101
Menlo Park, CA 94025
(415) 327-8811

Requires Macintosh with minimum 512K with 800K disk storage, and MIDI interface.
Q-Sheet is a trademark of Digidesign Inc., Macintosh is a trademark of Apple Computer Inc.

Circle #007 on Reader Service Card

PRODUCERS · DESK

Mix: I noticed on some of the Steely Dan stuff, particularly the *Aja* and *Gaucho* albums, that it has a real intimate sound. It doesn't sound dead, but it does sound like they're there in a room with you as opposed to some huge space like a lot of the records.

Scheiner: It's funny—we used big rooms, especially on *Gaucho* and *Aja*, where we used a really large room at A&R for most of the stuff. In those days, we wanted separation; we really didn't want that room sound. We used the room more so that the guys could be in the same room, play as a band, and have enough separation that if we had to replace parts we wouldn't have any guitar leakage on the drums. Everything was pretty tight miked. I hung

room mics but never used them. We created whatever room stuff we wanted with the chamber. That was a long time ago, too.

Mix: How do you feel about all the effects devices available? Do you use them much?

Scheiner: You have to use a certain amount to be competitive now. All the modern records have a lot of effects, but I tend not to use as much as anybody else. I don't use them to the max because they're just not as important as other things.

A lot of the time on recent records, you can't tell if it's a machine or a real guy, and I think it's still important to be able to make that differentiation—that there might be a real guy playing. On this project I did with [Steely Dan

producer] Gary Katz, it was a real drummer playing and he wanted to make sure that everybody knew clearly that this was a drummer. So we didn't use many effects, but there are some. I do use a lot of signal processing, but it's very, very subtle. I don't like to crowd everything in there.

Mix: Do you have preferences in speakers? Any thoughts about using small speakers as opposed to large speakers?

Scheiner: I've been using solely Visoniks now for ten or 11 years: I track on them, I mix on them, I do all my overdubs on them. I'm never without them; wherever I go they go with me. I have them in my house. I'd be totally lost without those monitors.

I don't like to listen very loud, I like

Complete control over
your MIDI system

Steinberg JONES

You know what you want out of your MIDI equipment. But more often than not you find yourself sacrificing your creativity to the technological anarchy of your tools. Up until now, you've had to choose from equipment that may satisfy one or two needs, and have ended up investing too much time just to get them to talk to each other. Steinberg offers a professional MIDI system that caters to the creative individual, bringing all the MIDI power under your control. Steinberg is here.

For more information on the Steinberg professional MIDI system, see your local dealer or write us.

17700
Raymer Street
Suite 1001
Northridge
California
91325
818-993-4091
FAX:
818-701-7452
Telex:
5106017237

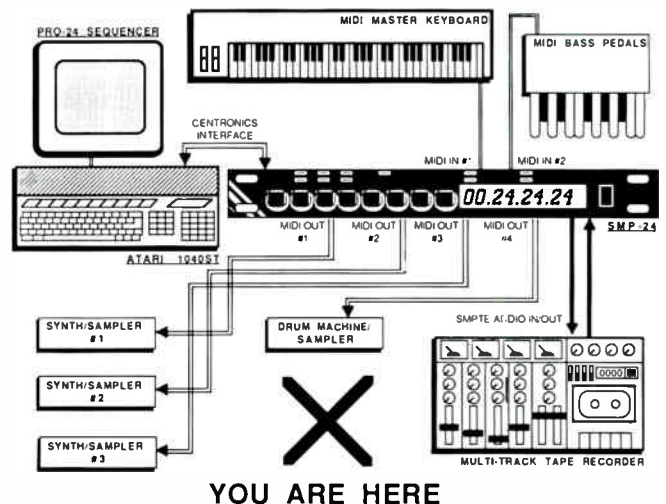

The System

The Computer:

Atari 1040ST

The Sequencer:

Pro-24 ver 2.1

The Time-Box:

SMP-24 SMPTE-MIDI-Processor or
Time-Lock SMPTE interface

The Synth Editors:

SynthWorks for the DX-7II/TX802, ESQ-1, FB-01,
TX-81Z, D-50 and more

The Sampler Editors:

SoundWorks for the Akai S900, Prophet 2000, Mirage

The Score:

MasterScore music notation printing software

FB-01, TX-81Z, and DX-7II, TX-802 are trademarks of YAMAHA CORP. INT'L. Prophet 2000 is a trademark of SCL. ST is a trademark of ATARI CORP. S900 is a trademark of AKAI CORP. MIRAGE and ESQ-1 are trademarks of ENSONIQ CORP. D-50 is a trademark of ROLAND CORP.

to monitor kind of softly. Glenn monitors incredibly softly. He feels he can hear everything a lot better if we monitor very softly, especially pitch. We cut vocals very, very softly, no echo, nothing to alter the voice.

Mix: How did you come to work with Steely Dan? I thought Roger Nichols did their engineering.

Scheiner: Prior to *Royal Scam* he was doing everything. I knew these guys from way back because I used to work with Jay & the Americans and Gary [Katz], Walter [Becker] and Donald [Fagen] used to be involved with them. When I went freelance, it was right around the time of *Royal Scam*, and about that time they felt some kind of change was necessary. They'd heard a Felix Cavaliere album called *Destiny* that I'd recorded and were really impressed with the way that album sounded, so they called me and I became involved.

What would usually work out [after *Royal Scam*] was that I would record the tracks and then not see those guys again until mixing time. All the overdubs in between were what Roger did. I didn't have the patience required to do what they wanted to do with overdubs because they were really meticulous. They could spend 20 hours doing one four-bar guitar part.

Mix: Weren't they pretty fussy about the tracks too?

Scheiner: Well, the tracks were tedious. For *Gaucho* we spent—it had to be six months—doing tracks, but it wasn't everyday. Each song must have been recorded three, four, five times with different bands. They just wanted to get the best possible track. I'd never seen recording in such a microscopic way before. It was a big learning experience for me and I was a changed guy after that.

Mix: How does the influence from that period show up in your current work?

Scheiner: That's the beginning of my cleanliness era, of putting things in perspective. The first thing I'd mixed for them was *Aja*, and that was a big challenge for me because everything was on one 24-track and three or four things were on each track. There was percussion on the same track as guitars and background vocals. So you'd only get eight or 16 bars into the song

before you'd have to stop and change EQs and everything. You really never heard the song in its entirety until you were done. You just did eight- or 16-bar segments and cut it together.

Mix: So you didn't just split everything into separate console inputs and set each one differently?

Scheiner: No, we didn't have the facility for that. The console we mixed on only had 34 or 36 inputs, and there had to be the equivalent of 40 tracks of information, so we actually had to

change over. It wasn't like, "Well, we're doing a verse section now, so since we're set up for the verse let's go to the other verses." They didn't want to do that. We would do a verse, and then break down for the chorus. I would reset the EQ, echo, panning and everything else that they wanted to do and then cut the section in, listen to the verse and the chorus and hear how it worked. Then they had in their heads what was going to happen afterwards. I certainly had no clue as to what was

—CONTINUED ON PAGE 45

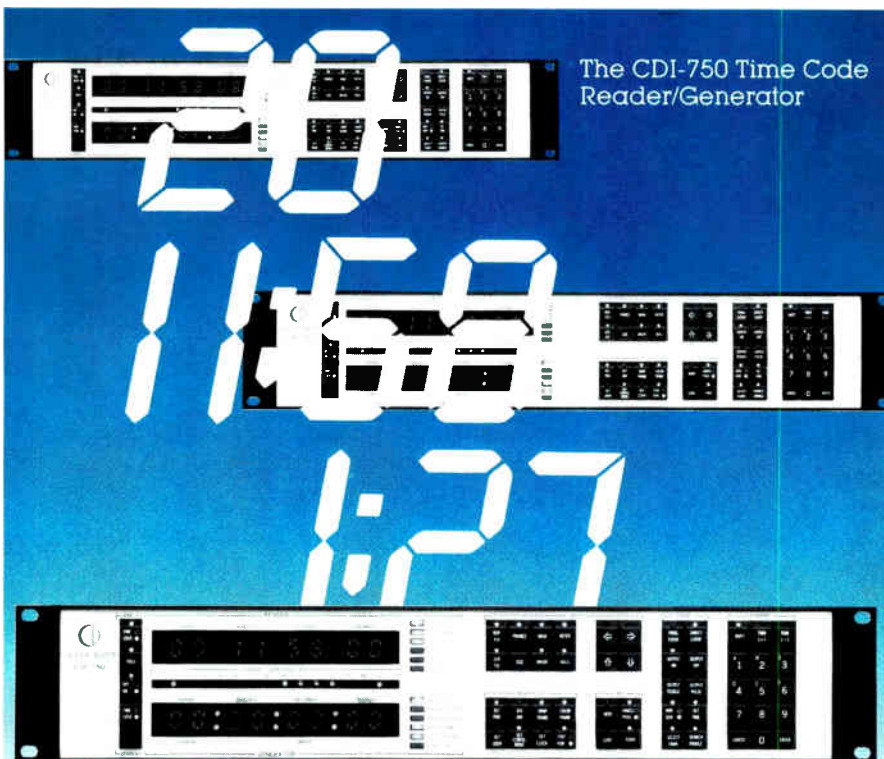

More
than just
a matter
of time

The CDI-750 is a full function reader, generator, character inserter and programmable 16-event controller all rolled into one. In addition to simultaneously generating and reading time code, this intelligent microprocessor-based instrument offers a programmable jam sync mode, built-in time of day clock, and an RS-232/422 computer interface. And with front panel controls, the CDI-750 is an easy unit to operate, affording the user greater flexibility.

Fully compatible with the Shadow II™ and Softouch™, this system's state-of-the-art software controls make it readily adaptable to future needs.

Each unit carries a 3 year warranty.

For more details contact Cipher Digital today. Call (800) 331-9066.

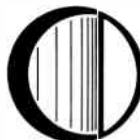

cipher digital, inc.

P.O. BOX 170 FREDERICK, MD 21701
(301) 695-0200 TELEX 272065

Timely today, consistent with tomorrow.

Circle #079 on Reader Service Card



SL 4000 G Series Master Studio System



•
G SERIES AUDIO SYSTEMS—
UNPARALLELED SONIC PERFORMANCE

•
G SERIES STUDIO COMPUTER—
A NEW GENERATION

•
THE WORLD'S ONLY TOTALLY
INTEGRATED MASTER STUDIO SYSTEM

G Series Audio systems are the result of a complete reappraisal of each and every stage between the microphone and the recorder. Together with the recently

launched Studio Computer, the G Series Master Studio System is the only totally integrated audio system in the world for both tracking and mixing.

Now, and for many years to come, the G Series Master Studio System will have no equal.



Solid State Logic

Oxford · Paris · Milan · New York · Los Angeles

Begbroke, Oxford, England OX5 1RU · (08675) 4353
1 rue Michael Faraday, 78180 Montigny le Bretonneux, France · (1) 34 60 46 66
Via Cesare Cantu' 1, 20092 Cinisello Balsamo, Milan · (2) 612 62 81
320 West 46th Street, New York, NY10036 · (212) 315-1111
6255 Sunset Boulevard, Los Angeles, California 90028 · (213) 463-4444

INTRODUCING

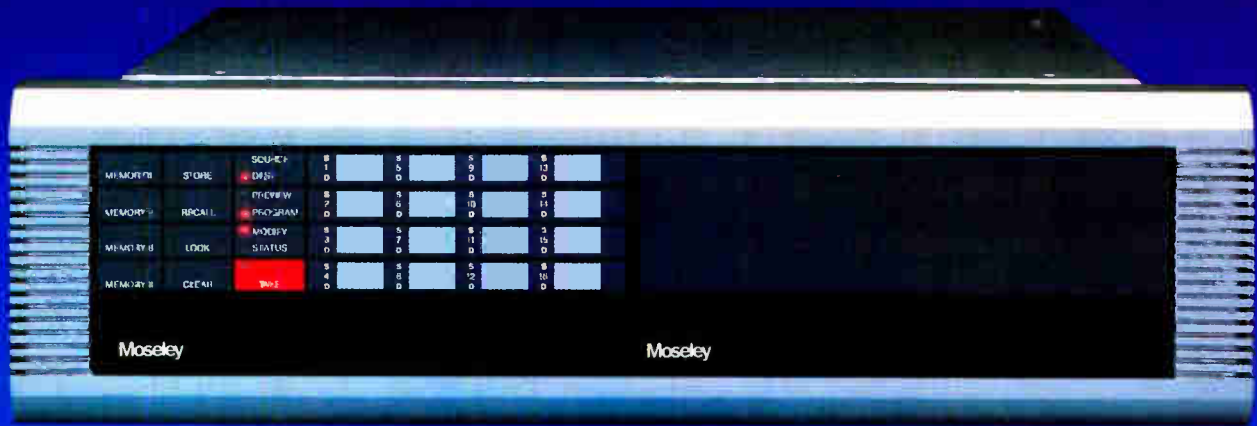

The Smart Switcher

Meet our electronically-programmable, digital-audio quality routing switcher that can handle mixing and eliminate time-consuming patchbay set-up – all at a price more affordable than you'd expect.

Control

Had enough with time-consuming patchbay set-up? Tired of reconfiguring each time? With the touch of a button, you can route/mix through local, single or multi-level remote control panels. Store commonly used routing/mixing configurations in standard, non-volatile matrices. Use the RS-232/C port for Terminal/PC control interface. Non-volatile pre-set matrices are standard.

Digital Audio Quality

The Smart Switcher routes your signal with 100 dB SNR, .004% THD, and a 0.1 dB frequency response for transparent, high quality sound.

Expansion

The Smart Switcher can be configured in multi-levels such as stereo, SAP, time codes, etc. Start with an 8 x 8 matrix and expand to 128 inputs or outputs. The units are easily stacked with no limit to expansion.

The Smart Switcher – a smart buy.

Dealer inquiries welcome.

Moseley

The trusted name in communications.

111 Castilian Drive
Santa Barbara, CA
93117-3093

a
Flow General
Company

Phone 805 968 9621
Telex 658448
FAX: 805 685 9638

—FROM PAGE 41

going to happen. They had lived with it for so long and this was really my first week on the project listening to everything.

Mix: How did you retain consistency between verses if you did a verse and then broke down?

Scheiner: Well, I'd make basic marks. There were no computers in those days. I'd write panning, echo and fader level and that would get me close enough. I'd pretty much remember EQ.

Mix: Let's talk about what you're doing here at the Sandbox. Did Glenn call you up to do the project?

Scheiner: Glenn called me just two years ago this month. He'd done a cut for the *Miami Vice* soundtrack album and asked me to mix it. I did and it was, like, a number two record for him. That was the beginning of our relationship, and he thought we should work together on something great. So we've been working for the last year and a half on this album. He has been spending a lot of time on it, taking his time writing the material; he feels it's a very important album for him. He's gone back to '60s roots—there's a lot of Memphis R&B/Motown kind of stuff on this album. That's what he feels most comfortable with. We're trying to make it modern, but we still want to keep some of that '60s flavor. It's a pretty simple album sonically. There are strings and horns on it, and we're using real strings. Most people shy away from strings and are using synthesizers; Glenn wound up using a 30-piece orchestra.

"I think that music should be capable of speaking for itself in most cases. I don't think I've had to go to any great lengths to try and make something more than it is."

Mix: What's your interaction with him like? Does he always know pretty much exactly what he wants?

Scheiner: Yeah, he's always got it in his head. He sometimes doesn't tell you right away what he's doing—you know, he's got it and he's keeping it a secret—but he always knows. It's like he's got this master plan in his head, and I always trust him. He says, "Let's do this," and although I might not agree with it right away, we go through it, because chances are that he's going to be right. I think the guy's a genius. We've been great buddies on this project; it's been a really wonderful experience for me because he's such a nice guy.

Mix: So then a lot of your role is to make his ideas a reality?

Scheiner: Yeah, a lot of that, especially technically. I think this is the first time he's used more than one tape machine on an album; he's only used one 24-track before. This album's giving him the capability to do a lot of other things: have a bunch of vocal

tracks. He's had a lot of freedom, not having to worry about space on tape. So I've brought those kinds of ideas to reality for him. And I think sonically he wanted an album that would be competitive with everything else on the market. He didn't want to have to worry that he was going to have a mediocre-sounding record. And I think we've accomplished that. You get close to it and it's hard to tell, but I'm really pleased with the album and I know he is. The material's great. Glenn is a great singer, and he does his background vocals so quickly and easily, and they're so great sounding. He just goes in and does them by himself. He'll usually end up adding other people and I haven't quite understood why he always wants other people on there singing with him when his tracks sound so great. I realize it's for different textures and stuff, but his backgrounds are unbelievable.

Mix: Well, this is interesting because you're saying that he wants it to sound modern but he wants to maintain a lot of the '60s R&B feel, and he's doing a lot of things like using real strings instead of synth stuff, but here you are at the Sandbox. [The Sandbox is overwhelmingly oriented towards MIDI instruments. See *Mix*, October '87.]

Scheiner: The Sandbox is great, especially for me because I live only five minutes from here. We spent a year out in L.A. and it was nice to come home for a while. Glenn came with me and checked out the studio: all the keyboard options, the drum machines. We already had seven or eight things which we did in various places totally done when we came here. We decided to mix what we had because they were all done and while we were doing that

"It's tension and interaction that creates the album, but my outlook is that it's still the artist's name on the album, not mine. He's got to pay the consequences if it's a lousy album."

NOTEWORTHY PROGRAMS

A Music Software Survey

by Paul Potyen

The acceptance of the MIDI standard by the music and recording community in the last three years has radically changed the way music is being made, and judging from some of the new music hardware and software, we've seen only the tip of the iceberg.

Introduced in early 1983, the first version of the MIDI specification was the result of the combined efforts of several American and Japanese equipment manufacturers. Their common goal was to create a standard interface which allowed musicians to transmit musical information between different brands of synthesizers and drum machines. In its most elementary application, MIDI enabled one or more synthesizers to be controlled remotely from a master key-

board. This was accomplished through the use of five-pin "DIN" connectors for MIDI in, MIDI out, and MIDI thru information. Some of the first MIDI-equipped products to hit the marketplace that year were the JX-3P and the JP-6 by Roland, the Prophet 5 and T8 by Sequential Circuits, and the now legendary Yamaha DX7.

It didn't take long for all of the major instrument manufacturers to be convinced that MIDI was a feature that professional musicians wanted. Likewise, computer software developers realized the potential that MIDI held for them, and they responded with a variety of software applications and MIDI adapters for the Commodore, the Apple II, the IBM PC compatibles, and what for now seems to be the industry standard, the Macintosh. And in the last year the

industry has seen the appearance of a family of excellent, high-quality, MIDI-controllable digital reverb units, mixers, and other outboard equipment. What follows is a general survey of some of the software available to support this new equipment.

Most music software can be put into one of the following broad categories: sequencers, music scoring and printing programs, editors and librarians, and miscellaneous applications. The distinction among these categories sometimes gets a little fuzzy, but it's important to clarify them before we dive into specific programs. Sequencers allow the computer to behave somewhat like a multi-track tape recorder. The MIDI spec calls for 16 MIDI channels, which can be thought of as 16 independent tracks, although that's really an oversimplification. Generally, the user can play a part on a MIDI keyboard either in real time or step time. In each case the musical information is recorded by the computer. This information can then be edited and played back, allowing the user to easily change tempo, key, note values, durations, dynamics or any other of a multitude of musical parameters. The complexity of a piece of music is limited only by the number and kind of MIDI instruments being controlled (and of course, by the imagination of the composer).

The second category, music printing, is somewhat more straightforward. Put simply, music scoring and printing programs are to composers what word processing programs are to writers. Some companies bundle music scoring programs with sequencer programs, while others allow you to import a sequencer file from a companion program. Still others provide you the option of exporting a score into a sequencer program and playing it. Finally, there are programs which simply allow you to create a finished score for printing purposes only.

MACINTOSH MUSIC SOFTWARE

program	description	company	price	phone #
Performer 2.2	sequencer	Mark Of The Unicorn	\$395	(617) 576-2760
Sequencer 2.6	sequencer	Opcodes Systems	\$250	(415) 321-8977
Mastertracks Pro	sequencer	Passport Designs	\$349.95	(415) 726-0280
MidiPaint	sequencer	Southworth Music	\$150	(617) 772-9471
KCS v1.5	sequencer	Dr. T's Music Software	*	(617) 244-6954
Professional Composer	scoring	Mark Of The Unicorn	\$495	(617) 576-2760
HB Music Engraver	scoring	HB Imaging	\$395	(801) 225-7222
Deluxe Music Const. Set	scoring	Electronic Arts	\$99	(415) 571-7171
Yamaha DX/TX	editor/librarian	Opcodes Systems	\$250	(415) 321-8977
Yamaha FB-01	editor/librarian	Opcodes Systems	\$150	-
Casio CZ	editor/librarian	Opcodes Systems	\$150	-
Oberheim Matrix 6	editor/librarian	Opcodes Systems	\$200	-
Akai MPX820 mixer	editor/librarian	Opcodes Systems	\$200	-
Kawai K-3	editor/librarian	Opcodes Systems	\$150	-
DX Ed. 1.1	editor/librarian	Altech Systems	\$49.95	(318) 226-1702
CZ Ed. 1.2	editor/librarian	Altech Systems	\$49.95	-
ESQ lib 1.0	editor/librarian	Altech Systems	\$49.95	-
Caged Artist Roland D50	editor/librarian	Dr. T's Music Software	*	(617) 244-6954
FX Designer	Lexicon PCM 70 ed.	Digidesign	\$195	(415) 327-8811
Softsynth	additive & FM synth.	Digidesign	\$295	-
Unversal Sound Designer	waveform editing	Digidesign	\$395	-
Q Sheet	automated MIDI cont.	Digidesign	\$495	-
Sound Lab 1.2 (Mirage)	waveform editor	Blank Software	\$299.95	(415) 863-9224
Drum File	SP-12 librarian	Blank Software	\$295	-
CUE	film music system	Opcodes Systems	\$499	(415) 321-8977
MIDIBASIC 3.0	MIDI programming	Altech Systems	\$99.95	(318) 226-1702
M	algorithmic composer	Intelligent Music	\$150	(518) 434-4110
Jam Factory	-	Intelligent Music	\$150	-
Upbeat	rhythm programmer	Intelligent Music	\$150	-
Sonata fonts	Postscript music font	Adobe Systems	\$95	(415) 852-0271

* shipping 1/88

DECA™ SERIES



The Award-Winning Digital MOSFET Amplifiers by Peavey

For two consecutive years, Peavey DECA™ Series power amplifiers have won *Music & Sound Output* and *Music & Sound Retailer* magazines' award for "Most Innovative Product" in the Sound Reinforcement category.

Peavey's digital energy conversion, MOSFET design has made the DECA 724 and DECA 1200 the most popular new amps among sound professionals for 1986 and 1987.

Now, Peavey continues this award-winning series with the DECA 424.

Better than 90% efficient!

Peavey engineers have combined the latest MOSFET designs along with high speed digital computer electronics and electromagnetic energy conversion technology to create an amplifier with efficiency performance

heretofore unmatched in any commercially available units!

These amps also feature a digital version of Peavey's patented DDT™ compression circuit which virtually eliminates the possibility of driving the amplifier into distortion.

No measurable TIM or slew rate induced distortion!

The unique nature of DECA circuitry produces no measurable transient intermodulation or slew rate induced distortion even with complex signals at high concert sound levels.

The DECA Series is another step in Peavey's commitment to produce the most competitive, professional power amplifiers available on a true performance basis.

See your authorized Peavey Dealer for all the details on these award-winning amplifiers. Discover how DECA power amplifiers have redefined power!



PEAVEY ELECTRONICS CORPORATION
711 A Street
Meridian, MS 39301
Telephone: (601) 483-5365/Telex: 504115
Fax: 484-4278

Circle #054 on Reader Service Card

PEAVEY DIGITAL ENERGY CONVERSION AMPLIFIERS

Simple Intelligence



Let's assume that results are what's important, not which tools you use.

Audio production is at least as much art as science; there will always be those who ascribe a magical aura to certain pieces of equipment. But if your client list is built on quality and consistency rather than techno-vooodoo, the DCM 232 in-line console with CAT automation can give you more of both.

You need more console, not more headaches.

You're working for more demanding clients, on bigger projects, with tighter deadlines. You need greater flexibility, expanded features, enhanced performance. What you don't need is a "mega-star" console—or the jumbo mortgage that goes along with it.

DDA's AMR 24 has already set new standards of audio performance and versatility in the "classic" split configuration. Now the in-line DCM 232 combines the accuracy of digital-quality audio, the flexibility of digital control and the capacity to handle a pair of synchronized digital 32 tracks.

CAT Central Automation Terminal: engineered to speed your work flow.

The DCM 232's Central Automation Terminal controls one of the most ingenious automation systems ever to shorten a mixing session. Along with the precise fader and mating control you'd expect, the CAT system includes advanced functions like *Channel Copy* that lets you duplicate a channel's signal flow as many times as you need to. The computer will recall a "snapshot" of most console switch settings manually or via SMPTE code.



With all of its convenience functions, this CAT won't leave footprints all over your tracks. The DCM 232 maintains an overall dynamic range of 100 dB with at least 22 dB headroom at each stage, thanks to exacting calculation of every circuit component.

A console investment that instantly doubles your returns.

Each of the DCM 232's channels, including the four band EQ section, can be split during mix-down. So a 56 channel frame can handle as many as 112 inputs from samplers, synths and digital storage media. You'll probably run out of control room space before the DCM 232 runs out of inputs.

The advantages of the DCM 232 in-line console with CAT automation are explained more fully in our brochure. To get a copy, write on your letterhead to the appropriate address below.

Circle #051 on Reader Service Card



Klark-Teknik Electronics Inc., 308 Banfi Plaza North
Farmingdale, NY 11735 (516) 249-3660

Unit #1, Inwood Business Pk., Whitton Rd.
Hounslow, Middlesex, UK TW3 2EB
01 570 7161

The introduction of the Yamaha DX7 synthesizer and its progeny created a demand for patch editors and librarians. These instruments were capable of producing a wide variety of complex sounds, but the process of programming these instruments without the aid of a computer was a slow and painstaking one. In addition, digital sampling devices have become a valuable tool in music production. Software programs have been very helpful in managing the many problems inherent in high-quality sound sampling, as well.

MACINTOSH SYSTEMS

Music producers and composers who previously had no experience with or access to a computer seem to have flocked to the Macintosh en masse within the last two years. Its power, ease of use, portability, price, and the availability of outstanding software have made it a very popular choice among professionals.

Performer 2.2

One of the pioneers in music software for the Mac is Mark Of The Unicorn. Their Performer 2.2 is a significant update of their popular Performer 1.22, which provided more than 200 tracks, 50,000-note capacity, 480 parts per quarter note beat resolution, and many other attractive features, including easy, single event editing. The Mac screen is set up to look like a tape deck with rewind, stop, play, pause, fast forward, and record buttons. This new version of Performer includes SMPTE frame display and editing, plus a cue sheet for film and video production. Extra features have been added to its already powerful editing options. Files can be exported to Mark Of The Unicorn's companion program, Professional Composer, for music transcription.

Sequencer 2.6

Opcode's sequencer program is the cornerstone of an extensive line of music software and hardware for the Macintosh. This latest update includes independent track looping, song pointer synchronization with SMPTE/MIDI interfaces, recordable tempo changes and many other powerful features. Version 2.6 is Multifinder-compatible and Mac II-compatible. Files can be saved in the new MIDI file format and

IBM PC MUSIC SOFTWARE				
program	description	company	price	phone #
Mastertracks PC	sequencer	Passport Designs	\$395	(415) 726-0280
Personal Composer	seq. & notation/print.	Jim Miller	\$495	(808) 328-9518
Texture 2.5	sequencer	Dr. T's Music Software	\$299	(617) 244-6954
Sequencer Plus Mk III	sequencer	Voyetra	\$495	(914) 698-3377
The Copyist	notation/printing	Dr. T's Music Software	\$225	(617) 244-6954
Cakewalk	sequencer	12 Tone Systems	\$150	(714) 594-5051
M.E.S.A.	seq. & notation/print.	Roland	\$495	(213) 685-5141
SCORE	notation/printing	Passport Designs	\$795	(415) 726-0280
FB Master (FB-01)	editor/librarian	Dr. T's Music Software	\$99	(617) 244-6954
TZ Master (TX-81Z)	editor/librarian	Dr. T's Music Software	\$99	(617) 244-6954
FB-01 Editor	editor/librarian	Passport Designs	\$125	(415) 726-0280
JX-8P Editor	editor/librarian	Passport Designs	\$125	(415) 726-0280
TX-81Z Graphic Ed. Sys.	editor/librarian	Bacchus Software	\$199.95	(213) 820-9145
TX-802 Graphic Ed. Sys.	editor/librarian	Bacchus Software	\$249.95	(213) 820-9145
DX/TX Voice Manager	editor/librarian	Bacchus Software	\$169.95	(213) 820-9145
Vision II (Mirage)	waveform editor	Turtle Beach Softworks	\$349.95	(717) 741-4972
Vision II (Akai S900)	waveform editor	Turtle Beach Softworks	\$349.95	(717) 741-4972

can be exported for transcription to either Professional Composer by Mark Of The Unicorn or Deluxe Music Construction Set by Electronic Arts.

Mastertracks Pro

Passport Designs has been in the music software business since 1980, originally marketing their sequencer for the Commodore 64 and the Apple II. Mastertracks Pro, the company's sequencer package for the Macintosh, was released some time after its competitors, but it is as sophisticated as any program currently available. It provides 64 tracks of real-time and step-time input, graphical song editing, graphical step-editing, a system-exclusive librarian and keyboard control mapper. This last feature allows you to control the sequencer from your MIDI keyboard. The program reads and generates MIDI clocks and MIDI song position pointers. To get it to operate with SMPTE codes, however, you need a sync converter.

MidiPaint

MidiPaint, Southworth Music's latest entry in the Macintosh sequencer wars, is a complete re-design of their Total Music package, which was one of the first for the Mac. It includes all of the major features of the other programs mentioned here, including MIDI file compatibility, and it's worth noting that its \$150 price tag is considerably lower than the others. If you want to sync to SMPTE, your best bet is to use Southworth's own Jambox converter. The other brands will not work without a MIDI merging device. Also, it's Multifinder-compatible and Mac II-compatible, and it's not copy-protected.

Professional Composer

Mark Of The Unicorn has recently updated its music printing program, long regarded as the standard for the Mac. Up to 40 staves of music can be entered from the Macintosh keyboard or from files imported from its companion program, Performer. Professional Composer has powerful editing features, including single event to large section cutting, copying, and pasting, as well as normal and enharmonic transposition. The system provides for odd time signatures, dynamics, lyrics and much more. A playback feature allows you to hear your score via the Mac speaker system. Version 2.1 supports Adobe Systems Sonata Fonts, which allows high-quality laser printing of music notation.

Deluxe Music Construction Set

DMCS from Electronic Arts is actually much more than a music notation program. As in Professional Composer, you can enter information from the Mac keyboard, but you can also play it in (and hear it back) via a MIDI keyboard. So essentially, DMCS is a basic, no-frills sequencer. It also includes a library of editable sounds which can be used to play your score over the Macintosh speaker, although its use in the professional market is limited. But if you own Opcode's Sequencer 2.6, you will be interested to know that files created on that program can be read by DMCS. The \$99 price tag is worth mentioning, too.

HB Music Engraver

This newest entry into music scoring by HB Imaging is described as a computer-aided engraving tool. The goal

ATARI ST MUSIC SOFTWARE

program	description	company	price	phone #
Mastertracks Pro	sequencer	Passport Designs	\$349.95	(415) 726-0280
Pro 24 2.1	sequencer	Steinberg Software	\$349	(818) 993-4091
Master Piece	sequencer	Sonus Corporation	\$375	(818) 702-0992
SMPTE Track	sequencer	Hybrid Arts	\$575.95	(213) 826-3777
KCS 1.5	sequencer	Dr. T's Music Software	\$225	(617) 244-6954
The Copyist 1.4	notation/printing	Dr. T's Music Software	\$225	(617) 244-6954
Superscore	notation/printing	Sonus Corporation	-	(818) 702-0992
EZ Score Plus	notation/printing	Hybrid Arts	\$99	(213) 826-3777
Soundfiler ST	sampling editor	Drumware	\$299	(213) 478-3956
Oasis ST Mirage	sampling editor	Hybrid Arts	\$249	(213) 826-3777
ADAP Soundrack	additive/FM synthesis	Hybrid Arts	\$1995	(213) 826-3777
Softsynth	additive/FM synthesis	Digidesign	\$295	(415) 327-8811

* shipping 1/88

is publication-quality music printing, and it stores and reads the new MIDI file format used by Opcode and Passport. It also allows you to import lyrics from word processing files. This program was expected to be shipping by mid-December.

Editor/Librarians by Opcode

There are several software companies that have taken advantage of the fact that computers can help in the job of programming synthesizers and keeping track of patches. Opcode Systems has one of the most complete lines of patch editor/librarians. They are reliable, easy to use and most of them include "Patch Factory," a random patch generator. "Patch Factory" allows you to constrain its "randomness" in a variety of ways to create and store new sounds for your synths. Also worth mentioning is Opcode's editor/librarian for the new Akai MPX820 programmable mixer.

Sound Designer

Digidesign has done for sampling units what Opcode has done for synthesizers. Anyone who has tried creating original samples without the help of a computer knows that it's a big pain. Sound Designer allows you to literally see what you're doing when you try to edit a sampled sound. You can hear the results of your edits, and when you're finished you can store the sound on floppy disks in Sound Designer's 16-bit linear format. The beauty of this format is that you can call up a sound you created on an Akai S900, for example, and then transfer it into a Roland S10. Other companies, like Blank Software, are now using this same format with their

products. Digidesign makes Sound Designer for practically all the common sampling units on the market.

Softsynth

And if you liked Sound Designer, you'll love Softsynth. It allows you to perform additive synthesis using a Macintosh. The resulting sound files can be loaded into the sampling unit of your choice. It features 40-segment amplitude envelopes, 15-segment frequency envelopes, individual control over up to 32 harmonics and five wave-shapes. It's easy to understand, simple to use and capable of producing some complex and interesting sounds.

Q-Sheet

This third program by Digidesign is their newest, described by the company as both an automating device for MIDI controllers and a method to provide MIDI-controlled sound effects editing for video and film. Q-Sheet has its own internal SMPTE clock, eliminating the need for a converter. Sequences can be created (or loaded from MIDI files created from Opcode, Passport or Southworth sequencers) to control program change information (e.g. the original Yamaha SPX 90) to full dynamic MIDI (e.g. the Lexicon PCM70). Other possibilities for Q-Sheet are complete control of a mix-down on a MIDI mixing console, such as the Yamaha DMP7, or automation of MIDI lighting controllers.

CUE, The Film Music System 2.0

This software product for the Mac is produced by Opcode Systems, and is not to be confused with Digidesign's Q-Sheet. Cue is a comprehensive support system for film music composers

and editors. It automates every paperwork task and calculation procedure that occurs in the process of creating music that synchronizes to picture. Some of its many features include the ability to enter timing points (in feet and frames, SMPTE, minutes and seconds, or measures and beats) directly from video tape with a single keystroke; display of both absolute and relative time at once; and the ability to enter up to 24 lines of description per cue point with text editing capabilities. It has a sophisticated tempo search section, allowing you to determine which cue points are hit by a given tempo. It also creates custom score paper with click and bar numbers, as well as abbreviated cue point descriptions. A master cue list and performing rights list are automatically compiled.

Intelligent Music Programs

Intelligent Music is a company on the forefront of a new kind of computer-aided algorithmic composing technology. Their catalog currently contains three different programs (M, Jam Factory and UpBeat) which allow you to use your Mac as a compositional tool.

IBM SYSTEMS

For those of you who already own and use an IBM-compatible system, the entry into music software may be more practical with your existing system. A significant number of companies support the IBM with music software, including Roland, Passport and Dr. T's Music Software.

Mastertracks PC

Passport Designs' Mastertracks program for the PC is a phrase-oriented multi-track sequencer and step editor with 64 patterns for each of its 16 tracks. Information can be entered in real time or step mode and then error corrected, merged, deleted, transposed, repeated or copied. Other features include programmable Punch In and Out, extensive single event and track editing, and MIDI song pointer for SMPTE sync. Memory is up to 40,000 MIDI events.

Personal Composer

Jim Miller's version of music software for the PC is more than a sequencer. While you can enter text from the IBM keyboard, a mouse or a MIDI key-

—CONTINUED ON PAGE 220

JOIN THE WINNING TEAM!

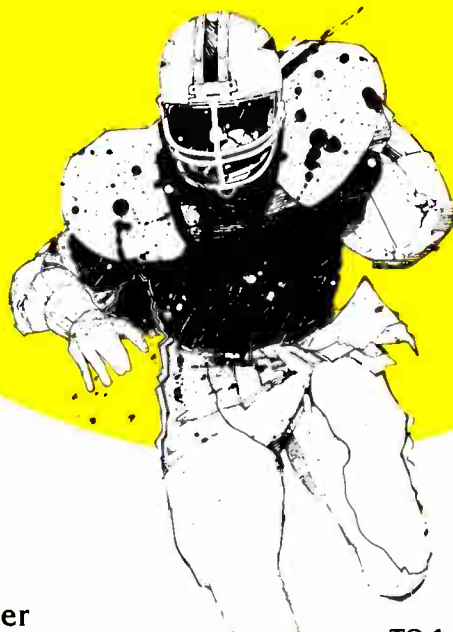

1/3 Octave Hand Held Real Time Audio Analyzer

The model 30B is a professional 1/3 octave real time audio spectrum analyzer at an affordable price and the ideal machine for:

- THE STUDIO; to check room response and monitor the mix.
- LIVE SOUND; to eliminate feedback and easily set room EQ.
- SOUND CONTRACTING; to analyze rooms, set EQ and SPL levels, eliminate feedback, verify system performance.
- BROADCAST; to adjust cart machines and check line quality.

AVAILABLE ACCESSORIES: Carry case & remote instrument microphone with phantom power source.

FEATURES INCLUDE: built-in rechargeable batteries; built-in microphone, aux line input, SPL in A or C weight, Decay settings. FILTERS: 30 bands on ISO centers to ANSI Class II double tuned specifications.

SUGGESTED RETAIL \$599.95



TS-1

Oscillator • Frequency Counter • dB Meter

Three audio test instruments combined in one unit. Features include:

- Low distortion audio oscillator with frequency range 10Hz to 30KHz.
- Frequency counter with response of 1Hz to 99.99 KHz.
- DB meter with range of -50 to 24dB from 20Hz to 20KHz.

MODELS: TS-1	- Balanced in	\$299.95
TS-1RM	- Rack Mount Balanced In	\$359.95
TS-1RMX	- Rack Mount Balanced In and Out with XLR Connectors	\$399.95



Loft Model 400B Quad Gate Plus Limiters

4 gates plus 4 limiters complete with 4 key inputs make the 400B the ideal machine for RECORDING, BROADCAST, or SOUND REINFORCEMENT application.

- You can GATE without LIMITING, or LIMIT without GATING. You can GATE and LIMIT at the same time to achieve a wide variety of special effects.
- The four Key Inputs allow you to use the limiters to suppress a sound with a separate sound source (Ducking). You can address the gates with a Key Input to emphasize a signal, open a gate for a sustained signal, or key ambient microphones.

MODEL 400A — Gates only at \$419.95
MODEL 400B — Gates with Limiters at \$599.95



1/3 Octave Spectrum Analyzer (A Growing System)

- Full 30 Bands
- Printer Option with 30 Memories via Parallel Centronics Interface
- Weighted Curves

The Model 30 features 6 memories, line level and microphone inputs, a pink noise generator, summing and averaging ability plus many other features.

Every Model 30 is supplied with 4 expansion ports to allow for growth. Now available for expansion:

- A card to provide 30 non-volatile memories plus printouts on low cost parallel interface printers.
- | | | |
|----------------|-------|-----------|
| BASIC MODEL 30 | | \$2150.00 |
| WITH INTERFACE | | \$2650.00 |

CONTRACTOR PRICES



Enclose \$2.00 for postage and handling for full literature line.

P.O. Box 115, West Redding, CT 06896, (203) 938-2588

Circle #052 on Reader Service Card

by Tony Thomas

BEYOND THE MIDI STUDIO

AN INTERVIEW WITH SHELLY PALMER CREATIVE AUDIO RECORDING SERVICES

The battle is on. Svelte and sophisticated home "MIDI Ships" (home MIDI studios) are poised in a valiant attempt to put the big, powerful "Mother Ships" (professional recording studios) out of commission, forever. This pseudo sci-fi (or is it hi-fi?) scenario is becoming more and more of a reality due to the rapid proliferation of MIDI-based musical instruments, recording gear and signal-processing equipment. Who will save the recording universe? Enter the "Death Stars."

The "Death Stars" are rooms such

as Creative Audio Recording Services' (CARS) two new tapeless recording studios—studios designed to blow the average home MIDI studio to bits. Designed around New England Digital's 200-track Synclavier Enhanced Digital Music System and 16-track Direct-to-Disk Recording System, CARS' new studios have all the firepower and horsepower needed to do it.

Shelly Palmer, CARS president (who also heads Shelton Leigh Palmer & Co., one of New York's largest and best-known music production companies),



Photo right:
SLP&CO REPS
Andree Kamin-
ski (left) and
Lisa Tesoro (cen-
ter) pose with
commercial
music com-
poser/producer
Shelton Leigh
Palmer.

USA TODAY



We love baseball, apple pie, our mom, and coming up with innovative, mind-boggling all-American technology. Take the AC 22 and AC 23, for example. They're loaded with so much exclusive American Rane technology, the blueprints will probably wind up at KGB headquarters.

Rather than improving on existing crossover technology, Rane decided to reinvent it. The result means features like 24dB/octave slopes, the distinct performance advantages of Linkwitz-Riley crossover design. State-variable filters, coupled with the precision 41-detent continuous frequency selectors,

offer unequalled accuracy, consistency and flexibility.

They're packed to the metal with so many capabilities, you could write a book on them. Which we did. And it's included with every unit. As you discover the capabilities of the AC 22 at the suggested list price of \$389, and AC 23 at \$499, your system will improve with cleaner, tighter sound. And more of your audience will hear the best sound your system can deliver. Maybe even all the way to Siberia.

Rane Corporation, 6510 216th Southwest,
Mountlake Terrace, WA 98043. 206/774-7309.



Circle #010 on Reader Service Card

Circle #082 on Reader Service Card

THE GREAT R-DAT SCARE

To Copycode Or Not To Copycode ... There Are Many Questions

by Richard Elen

Editor's note: A couple of months ago we asked for your comments and suggestions for the DAT/copycode controversy. Of the many wonderful suggestions that came in, we felt the following reflected the most imaginative and refreshing view. We feel it is a plan well worth considering.

For several years, the record business has been concerned—some would say overconcerned—about the alleged evils of illicit copying of records. Industry bodies on both sides of the Atlantic have claimed, with varying amounts of evidence, that millions of dollars are being lost every year as a result of home taping and counterfeiting. And having been a skeptic initially, I have been convinced that there is sufficient evidence to indicate that the industry is indeed selling fewer records and pre-recorded tapes because some people are copying tracks they do not own—from the radio or from other people's copies. I am, however, still of the opinion that many people simply copy their own albums onto a medium that they can listen to, for example, in the car or on a Walkman.

The record industry has proposed a number of answers to the problem, most of which are being worked on simultaneously. We have all heard of the idea of a levy on blank tape. A levy on recording hardware. Spoiler signals on pre-recorded material to prevent it from being copied. All these so-called solutions are in one way or another iniquitous. Levies on blank tapes and tape machines hit everyone, including people who do not indulge in copyright theft (which is what illicit

taping actually is—although I would not put people who tape their own material in this category). Thus, they are unfair.

Spoilers have traditionally never worked, or have been capable of circumvention: as a member of any intelligence service will tell you, to any electronic measure there is an electronic countermeasure. Now we have a spoiler which probably *would* carry out its required function: the CBS Copycode system. But like other products of CBS labs—SQ and CX to name but two—it has some fatal flaws. Demonstrations of the system have met with a mixed response: in

places where a prepared demo has been all that has been experienced, many people appear not to have heard the notch that Copycode imposes on pre-recorded material. Where there has been more flexibility in the presentation, it appears to have been more noticeable. In England, for example, it has been suggested that by the end of the demonstration it was being admitted that "Copycode changes the sound, but it's worth it."

Copycode can be circumvented, in any case, by the use of the new generation of digital audio processing consumer products—like the Yamaha DSP-1, which costs only a few hun-

Quincy Takes a Stand

I'm concerned about the impact that home taping with DAT will have on our artistic community. Home taping hurts the entire music community. It drains away the revenues needed to experiment with new music, new artists and new songwriters. I want tomorrow's creators to have the opportunity to make a career in music, as I have had the good fortune to do.

That is why I support legislation that assures creators the ability to protect their music with a new technology called the copy-code system. I've listened to it, people I trust have listened to it—producers, engineers, mastering engineers and A&R professionals. We're confident that this system would allow protection without compromising any of my music's sound quality.

Quincy Jones
Courtesy RIAA

USA TODAY



We love baseball, apple pie, our mom, and coming up with innovative, mind-boggling all-American technology. Take the AC 22 and AC 23, for example. They're loaded with so much exclusive American Rane technology, the blueprints will probably wind up at KGB headquarters.

Rather than improving on existing crossover technology, Rane decided to reinvent it. The result means features like 24dB/octave slopes, the distinct performance advantages of Linkwitz-Riley crossover design. State-variable filters, coupled with the precision 41-detent continuous frequency selectors,

offer unequalled accuracy, consistency and flexibility.

They're packed to the metal with so many capabilities, you could write a book on them. Which we did. And it's included with every unit. As you discover the capabilities of the AC 22 at the suggested list price of \$389, and AC 23 at \$499, your system will improve with cleaner, tighter sound. And more of your audience will hear the best sound your system can deliver. Maybe even all the way to Siberia.

Rane Corporation, 6510 216th Southwest,
Mountlake Terrace, WA 98043. 206/774-7309.



reportedly sunk millions of dollars into his studios, facilities that breathe new life into the word "competitive." Palmer, who has operated his own recording studio in Manhattan since 1982 to facilitate his music production work, feels that the future of recording is tapeless technology. "CARS was formed," says Palmer, "for the sole purpose of providing the highest quality, state-of-the-art, tapeless, digital audio post-production facilities to advertising agencies and directors and

producers of motion pictures."

Is there life after MIDI? We spoke to Palmer at his New York studio to find out.

Mix: What made you decide to get involved in MIDI in the first place?

Palmer: Well, I'm an old control voltage person, so CVs and gates were more fun to me than MIDI. For a long time, MIDI was a horrendous inconvenience, and only in the last year or so has it become something you need to have and something that solves more problems than it creates.

Mix: How did you justify purchasing all the gear you have from a business standpoint?

Palmer: From a business standpoint, it is more important than ever to use good management principles in evaluating equipment purchases. It didn't used to be that way because, for many years and in some people's minds today, an SSL and Studer room was a license to print money. That may have been true in 1984 through '86, but that is over now. It's sort of like what happened with synthesizers. When I was one of the four people in New York who had synthesizers, I was in extraordinarily high demand, not so much for my musicianship or my creativity, but for my equipment.

Now, anybody with \$15,000 in their pocket can own a recording studio, if he or she desires—can do real close to broadcast-quality advertising and real good motion picture soundtracks [for that kind of money]. In fact, you can do almost anything but digital record production. When the R-DAT machines become commonly available, even that is going to change.

But the fact is, you can own a Stradivarius, but that won't make any music by itself. Machines don't make music; people do. And that is where the change is going to be. Studio owners who are so used to having studios where clients bring their own engineer and who charge whatever they possibly can to make their monthly lease payments are in for a surprise. In reality, many have been nothing more than landlords. It's gone from the days when Les Paul was working in the studio with his multi-track producing all those wonderful tape tricks and trying to get the best sound he could out of a room, to what we have today, with people coming in with their own engineer and they just use the room and leave. But now, we are beginning to come back full circle and see situations where the creative engineers *are* the draw and the equipment is pretty much inconsequential. And that will happen eventually with MIDI.

Mix: What are your basic feelings about MIDI?

Palmer: Well, MIDI has forced manufacturers to do things that are basically unbusinesslike. Since it has become a standard, it's like Ford saying to GM: "I'm designing a car with a more efficient carburetor and I'd like you to

HIGH SPEED PURSUIT & AUDITION

of Sound Effects and Music Libraries
Results in Customer Satisfaction

PROFESSIONAL LIBRARIAN
software for
IBM compatible PCs

- Search & catalog any music or effects library
- Control the Sony CDK-006 CD player
- External trigger control of CD selections
- Track library usage for royalty/client billing

LEONARDO SOFTWARE

693 Washington St. • Venice, CA 90292 • (213) 305 - 1521

IBM is a trademark of International Business Machines Corporation. Sony is a trademark of Sony Corporation of America.

Circle #081 on Reader Service Card

THE GREAT R-DAT SCORE

To Copycode Or Not To Copycode ... There Are Many Questions

by Richard Elen

Editor's note: A couple of months ago we asked for your comments and suggestions for the DAT/copycode controversy. Of the many wonderful suggestions that came in, we felt the following reflected the most imaginative and refreshing view. We feel it is a plan well worth considering.

For several years, the record business has been concerned—some would say overconcerned—about the alleged evils of illicit copying of records. Industry bodies on both sides of the Atlantic have claimed, with varying amounts of evidence, that millions of dollars are being lost every year as a result of home taping and counterfeiting. And having been a skeptic initially, I have been convinced that there is sufficient evidence to indicate that the industry is indeed selling fewer records and pre-recorded tapes because some people are copying tracks they do not own—from the radio or from other people's copies. I am, however, still of the opinion that many people simply copy their own albums onto a medium that they can listen to, for example, in the car or on a Walkman.

The record industry has proposed a number of answers to the problem, most of which are being worked on simultaneously. We have all heard of the idea of a levy on blank tape. A levy on recording hardware. Spoiler signals on pre-recorded material to prevent it from being copied. All these so-called solutions are in one way or another iniquitous. Levies on blank tapes and tape machines hit everyone, including people who do not indulge in copyright theft (which is what illicit

taping actually is—although I would not put people who tape their own material in this category). Thus, they are unfair.

Spoilers have traditionally never worked, or have been capable of circumvention: as a member of any intelligence service will tell you, to any electronic measure there is an electronic countermeasure. Now we have a spoiler which probably *would* carry out its required function: the CBS Copycode system. But like other products of CBS labs—SQ and CX to name but two—it has some fatal flaws. Demonstrations of the system have met with a mixed response: in

places where a prepared demo has been all that has been experienced, many people appear not to have heard the notch that Copycode imposes on pre-recorded material. Where there has been more flexibility in the presentation, it appears to have been more noticeable. In England, for example, it has been suggested that by the end of the demonstration it was being admitted that "Copycode changes the sound, but it's worth it."

Copycode can be circumvented, in any case, by the use of the new generation of digital audio processing consumer products—like the Yamaha DSP-1, which costs only a few hun-

Quincy Takes a Stand

I'm concerned about the impact that home taping with DAT will have on our artistic community. Home taping hurts the entire music community. It drains away the revenues needed to experiment with new music, new artists and new songwriters. I want tomorrow's creators to have the opportunity to make a career in music, as I have had the good fortune to do.

That is why I support legislation that assures creators the ability to protect their music with a new technology called the copy-code system. I've listened to it, people I trust have listened to it—producers, engineers, mastering engineers and A&R professionals. We're confident that this system would allow protection without compromising any of my music's sound quality.

Quincy Jones
Courtesy RIAA

**Most mikes
make you
sound like
everybody
else.**

**You deserve
something
a little
better.**

This little mike gives your talent a big hand. Because it insures that your vocal sound comes through intact. The carefully-tailored response curve anticipates typical sound systems and hall acoustics. With an ATM5R the audience hears more YOU and less microphone.

With its advanced cardioid construction, the ATM5R gives your sound mixer more freedom to raise your vocal level to whatever loudness the music demands. Regardless of nearby monitor or side speakers. And without having to resort to drastic EQ "tricks" that distort your tone. Or the need to "force" your voice, just to be heard.

The ATM5R easily handles your dynamic range. And it doesn't change your vocal sound when you stray a little off mike. Yet it firmly rejects sound coming from the back. The ATM5R concentrates on you, so that you can concentrate on your performance.

Handling and cable noise are also better controlled than with most microphones. And the small size of the ATM5R means less bulk between you and the audience.

You know how great you sound in the studio. Now you can put that same sound on the road. Test sing the ATM5R at your Audio-Technica sound specialist today.

Actual
size

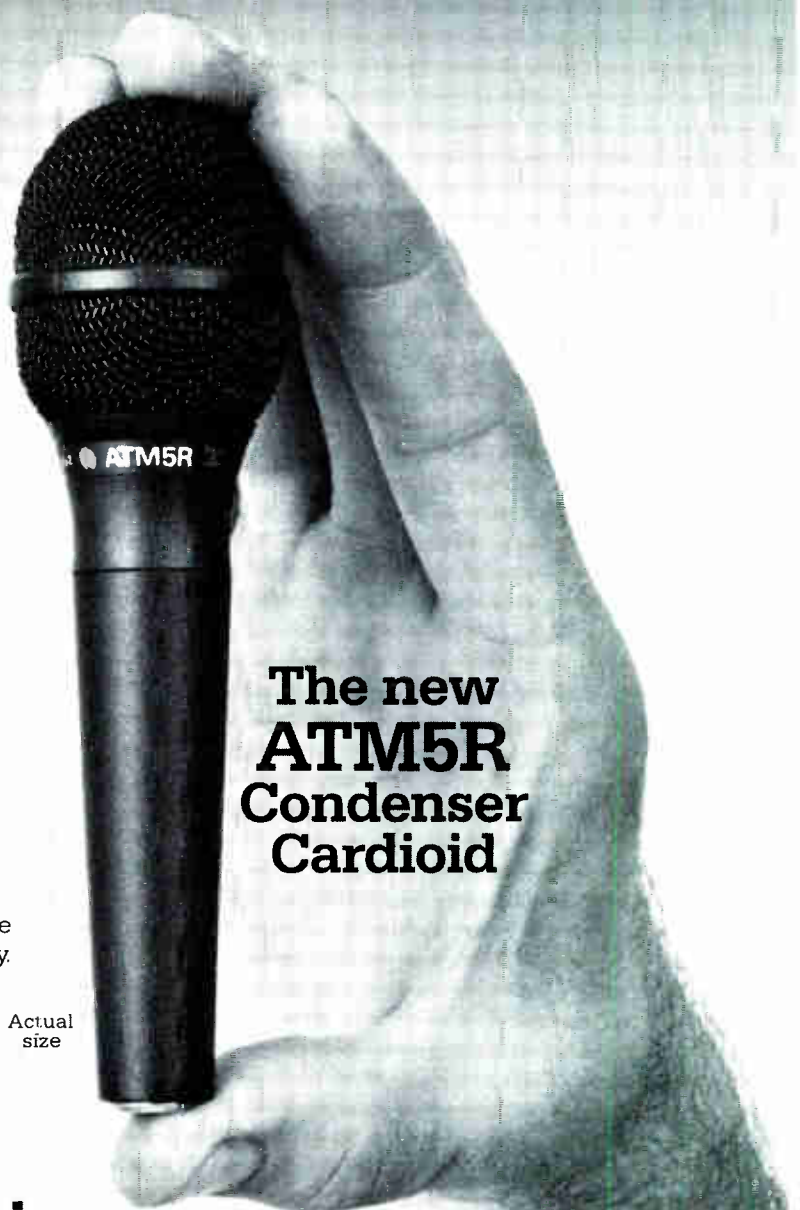

**The new
ATM5R
Condenser
Cardioid**

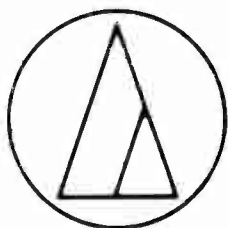

audio-technica

1221 Commerce Drive, Stow, Ohio 44224
(216) 686-2600

Circle #025 on Reader Service Card

dred dollars and allows stereo pitch-shifting sufficient to move the Copycode notch out of the way of detection chips in a DAT recorder. And there's another problem: there would have to be international legislation to ensure that the chips are indeed fitted. By the time that exists, it may already be too late.

In Britain—and probably the Euro-

pean Economic Community as a whole—we may be in danger of having the worst of all possible worlds. We may have a levy on blank tape, and thus no need for Copycode chips in our DAT recorders. But we will also have the same CDs as everyone else, which may have the notch imposed upon them if CBS has its way (and if CBS isn't bought by Sony, which

would prove very interesting).

At the moment, however, there is every sign that DAT as a system is not enjoying the sales in Japan that its proponents would like. Just like the F1 format, DAT was hailed as a god-send to the professional recording industry, but has been met with consumer disinterest. If consumers really wanted high-quality digital audio at home they would have bought EIAJ processors and hooked them up to their videos. They didn't: so why will they buy DAT machines—essentially an F1 and a video recorder squashed into a little box; no new technology there—at five times the price?

I suggest that there is another solution to the home taping "problem" which nobody, to my knowledge, has proposed, and is fairer than all the above. In the case of DAT the potential counterfeiting problem could be taken care of simply by the record companies agreeing not to release product in that format (and thereby also saving mastering facilities and record companies alike all the costs of another subcoding computer, yet another master preparation process and so on). Any "pre-recorded" DAT tape would thus be a counterfeit one, and easy to spot. CD is a more advanced technology anyway; tape will soon be a thing of the past. Why waste company money on DAT duplication facilities you really don't need?

On the home front, the solution is to charge the consumer a license fee on purchase of pre-recorded material, at the point of sale. The license has a simple function: it confers on the purchaser the right to do whatever he or she likes (within reason) with the material purchased. Tape it for yourself, tape it for your friends, whatever. Virtually anything you like as long as you don't charge money for it. It's that simple: why has nobody thought of it?

Of course, the license would probably increase the retail price of pre-recorded material (and there would be arrangements to collect the fee from broadcasters and other commercial users who expose copyright material to the possibility of home taping), but this would not necessarily affect sales. The increase of value added tax in Britain from 5% to 15% a few years ago didn't appear to have any tangible impact on sales, for example.

The license fee would be easy to

—CONTINUED ON PAGE 161

A Call for "Verifiable Packaging"

The record companies want the public to pay for something they should have invested in long ago—namely protecting their recorded material from bootleggers. Why couldn't the record companies spend *their* money protecting *their* product? Look at the credit card companies, which print into their cards a 3D logo which is hard to copy. Why can't such a logo be printed on album covers? Or maybe a code in 3D on the packaging could be printed so that stores could verify the products are not bootlegged. And what about the *distributors*? They should be held more accountable for they are the first line of defense against bootlegged material making it to market. Hey—wake up!

There are plenty of analog methods of copying music which bootleggers have used for years with great success. And what about all those foreign DAT recorders which would have no copyguard? Aren't most bootleg albums copied and manufactured outside the USA? Wake up! The record companies have complained for years, but what have they done? Nothing!

My feeling is that a lot can be done to protect musical material in the packaging, so don't start messing with the recording itself! The quality of pressed records and mass produced cassettes has steadily gone downhill, but the complaining about bootlegging has gone up. Are the record companies afraid the bootlegger armed with DAT will produce a better quality product?

Well, they better start investing in "verifiable" packaging and working very closely with distributors to stop the problem. Don't ruin DAT because of the record companies' failure to manage the manufacture, distribution and sale of their own product.

George Radovcich
San Pedro, CA

**What
Makes Sony
The Leader In
Digital Audio?**

Our trac

Before you leap into digital recording, look and listen first. You'll find that only Sony can take you every step of the way.

It all begins with the PCM-3324 digital multi-track recorder. Over 370 are already in use and that number keeps growing. Here's why: The PCM-3324 is more than a proven sonic performer, it's the heart of an unparalleled creative recording system. With the RM-3310 remote unit it offers auto-locate of 100 cue points. Automatic punch in/punch out timing precise enough for spot erasure. And the gateway to a perfect marriage with a second PCM-3324.

With two machines you get 48 perfectly synchronized channels plus added flexibility. Such as the ability to make pure digital-to-digital safeties, the freedom to do digital fly-ins, and full electronic editing capabilities.

And if you want to go beyond music recording to video or film post-production, the PCM-3324 system can go with you. Because Sony offers all the peripherals you need to make the right connections.

For mixdown, the perfect companion for the PCM-3324 is the PCM-3402



k record.

2-speed electronic editing recorder: the new generation of Sony DASH 2-channel digital machines.

Advanced digital technology and thoughtful input from Sony customers were combined to create the PCM-3402. You can hear and feel the difference. Oversampling of the playback circuitry allows super-smooth audio phase response. And new balance and level controls operate completely in the digital domain.

But what really sets the PCM-3402 apart is the incredible control it offers for virtually any recording situation. It features 12 seconds of 16-bit stereo RAM-based memory for electronic editing, insert recording on any track, PCM-1630 style metering, and selectable 48kHz/44.056kHz/44.1kHz sampling frequencies.

And if you need to merge digital audio with video, the PCM-3402 makes it easy. It gen-locks, chase-locks, performs time code based auto-cuing and auto-time fit, and time code triggered audio sampling.

Best of all the PCM-3402 and the PCM-3324 are digital links to an even bigger system. For that story, advance to the next page.

SONY

Professional Audio



How we've

Walk into practically any compact disc mastering studio and you'll hear the same song: Sony, Sony, and more Sony. The explanation is simple: Our mastering system is the standard for recording studios and CD manufacturers throughout the world. In fact, virtually all of the compact discs ever made have been mastered with Sony digital equipment.

We stay the leader in mastering systems because we constantly refine and expand them for even higher performance and ease of use. You can hear and see our commitment at the heart of the system: the PCM-1630 digital audio processor.

New analog filtering and digital oversampling contribute to dramatically improved tonal quality. It has adjustable digital peak meters with AUTO or HOLD modes and OVER indicator. And with an optional circuit card, the PCM-1630 is capable of both RAR (Read After Read) and RAW (Read After Write) functions. The DMR-4000 master recorder also features RAR and RAW.

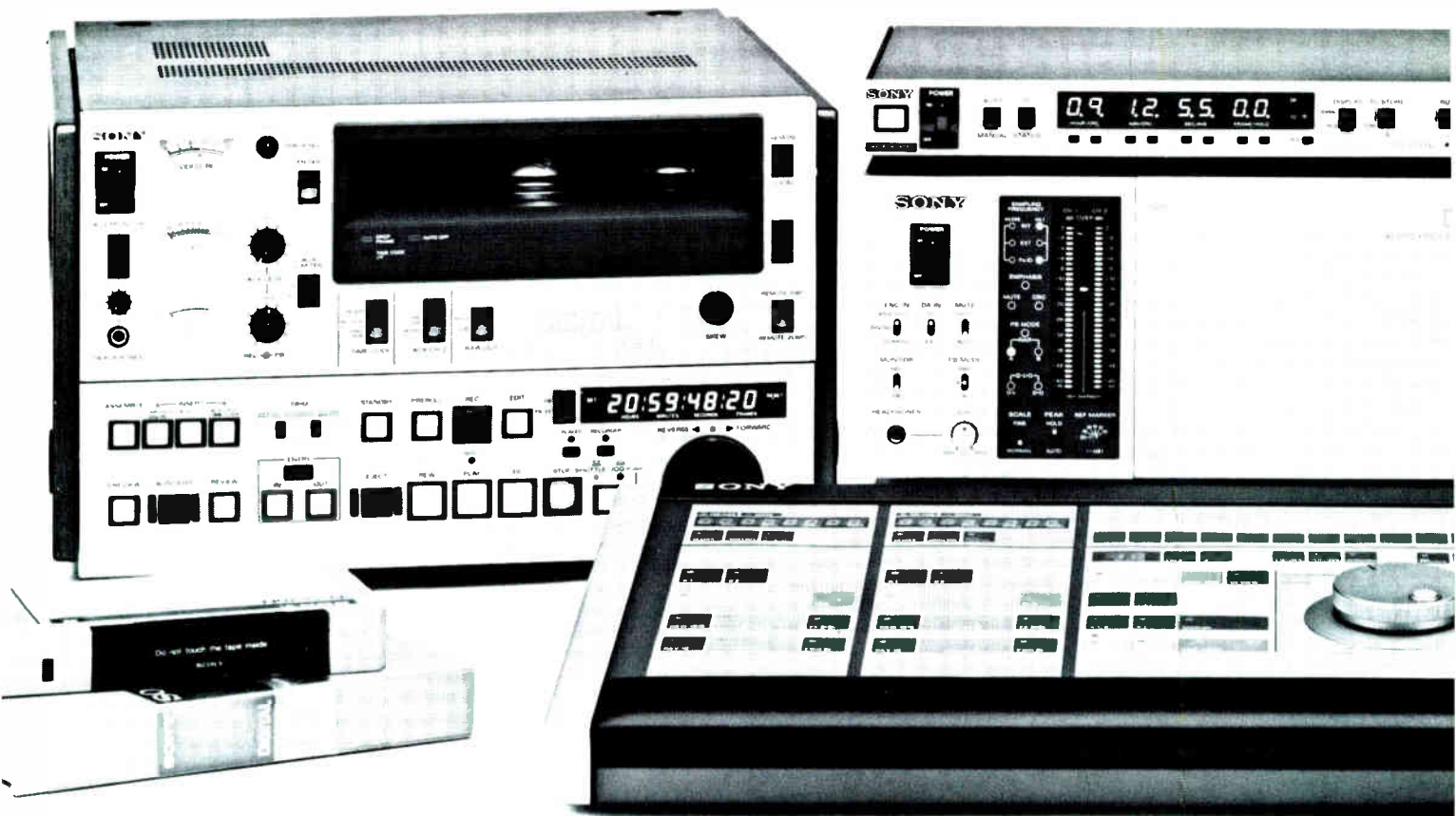

mastered it.

Of course, no mastering system is complete without insurance. You get it with the DTA-2000 digital tape analyzer. When attached to the PCM-1630 and an optional printer, it measures and prints out any code errors in the master tape.

For editing, there's the DAE-1100A digital audio editor and the DAQ-1000 cue editor, the most advanced digital audio tools of their kind. The DAE-1100A delivers seamless electronic crossfades and RAM-based cueing for the most precise electronic editing. The DAQ-1000 gives you the utmost flexibility for generating, recording and checking music track and index numbers as well as the necessary P Q subcodes for CD disc cutting.

Sony also makes digital recording tape, remote metering systems, and a full line of accessories. So if you're about to go digital, or want to get further into it, talk to the company that goes the whole route. Call The Leader In Digital Audio™ at 800-635-SONY.

SONY®

Professional Audio



SOFTWARE SOLUTIONS TO POST-PRODUCTION PROBLEMS

by Dale Strumpell

Little by little, the tasks involved in sound post-production have become more complex; together with reduced budgets and shorter schedules, the necessity for saving time and money has never been more acute. For the last several years, microcomputers have been appearing in studios and editing rooms, running modified spreadsheets, off-the-shelf filing databases and user-developed programs. Particularly in the world of video production—where technology changes more rapidly than in the film domain—people have been turning to computers to help solve and manage organizational and creative problems.

This article comprises a survey of the kinds of software solutions available commercially to the sound post-production industry. We will not be concerned with the more well-known types of programs adapted from the music industry—including programs such as sequencers, synth programming aids and patch librarians—which do indeed have their uses in sound post-production but which nev-

ertheless represent ground already well covered in other articles in this and other trade journals.

The software we will examine in this article is used by editors, mixers, assistants, recordists, apprentices, secretaries and typists: virtually anyone in sound post-production. Editors and mixers use such software to locate and compare creative choices, such as material in a sound or music library; to view the task at hand in an organized way, to automate repetitive operations and to communicate effectively. Assistants, apprentices, typists and secretaries use it to sort, display, remember, update and print the many bookkeeping and cataloging tasks essential to post-production.

What Tasks Can Be Computerized?

The following summary of post-production tasks indicates several potential processes in need of silicon assistance.

Film-Style Sound Editing

1. The sound editor receives the film or tape and begins to look for

objects, events and environments in the film that need additional sound effects. This task is often known as spotting. Reviewing a two-hour film and identifying everything to be “covered” by sound effects means creating a lot of lists: one for each sound or each scene.

2. The next step is to choose the sound effects, a task that always involves looking up the effect descriptions in a catalog of the sound effects library. The art of describing sound is an imperfect one and the editor inevitably must audition the material before deciding which effect to use. Having found the appropriate sound effects, the editor then puts their names or ID codes on the lists created during the spotting stage.

3. Inevitably, some of the required effects do not exist in the library. Various lists must be made for keeping track of the necessary effects. Such lists correspond to the means of acquiring the effects: Foley, field recording, searching through another library and creation in the studio (via synths, samplers, processing, etc.). Other effects may already exist in the production recordings, but might be contained on other takes; somebody will need to search through these tapes.

4. Transferring the effects is the next step, a process of copying sound from one medium to another. The preferred storage medium for sound effects, ¼-inch tape, is almost never used for film editing. For one reason, editors never work with master recordings; equally important is the ease of synchronizing sprocketed film. However, in preparation for the transfer process, the editor must assemble a list of the selected sound effects, sorting them by source reel. The sound effects transferred from tape to mag film comes off the film recorder in groups, usually ten-minute rolls which, due to the needs of the transfer task, are not grouped in any logical order.

5. Each sound transfer must be separated, identified and labeled. If the film or tape is a lengthy and complex one, several days have passed since the initial viewing.

6. Editing, in film terms, means viewing the picture, and selecting the effects and their synchronization with the film. If the editor has previously chosen sounds and picked effects, a list describing these decisions, as well as any additional notes, is used as a reference by the sound editing crew.

NOW
AVAILABLE!
SINGLE-ENDED
NOISE REDUCTION
The 929 Module

dbx

The future is modular...



902 de-esser with auto threshold sensing
903 OverEasy® compressor/limiter, stereo strappable
904 Fully adjustable noise gate expander
905 Precision parametric EQ with "infinite notch" mode
933 1-3/3-1 distribution amp/mixer

911 Type I noise reduction, 1-channel encode/decode
941A Type II noise reduction, 2-channel encoder
942A Type II noise reduction, 2-channel decoder
F900A 9-slot mainframe, modular power supply
FS900 Two-bay powered mini mainframe

What next—the 9 ___?! The future IS modular!

dbx PO Box 100C, 71 Chapel St., Newton, Mass. 02195 USA



A division of
BSR North America Ltd

WHAT TO LOOK FOR WHEN YOU LISTEN TO A POWER AMPLIFIER.

When it comes to evaluating amplified sound, seeing is believing.

In fact, when engineers judge the sound quality of an amplifier, they often rely on *two* precision instruments: the human ear, and the industry-standard Transient Intermodulation Distortion Test, because when measuring sound with T.I.M. what you see is what you get.

And what you see can be eye-opening. Amplifiers that seem to square off evenly spec. for spec., often perform very differently under the scrutiny of T.I.M. Pushed to their limits, many produce brittle, edgy or distorted sound especially during high frequency passages and sharp transients.

Many manufacturers deal with distortion by using massive amounts of feedback through a single overall feedback loop, placing greater demands on the amplifier and producing an inferior sound.

When we built our new JBL/UREI Amplifiers, we committed ourselves to designing the industry's purest-

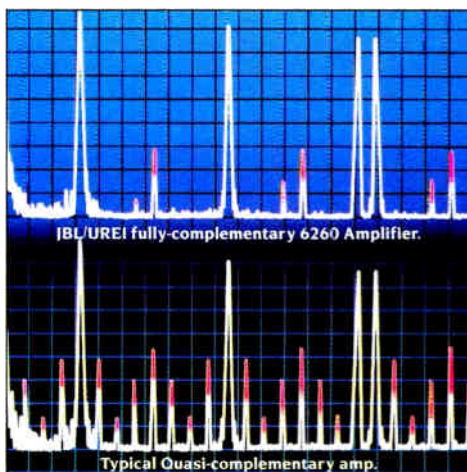

Red spikes in the TIM Spectrum reveal the dramatic differences in distortion output.

sounding amps that would not only score highest marks on the T.I.M. Test, but deliver the truest amplified sound ever heard.

Instead of sloppily force-feeding massive amounts of

output signal back into input stages, and congesting it all into one circuit loop, we've established operating points at *each* gain stage. This allows signal purity to be maintained along the entire circuit. And permits optimized use of the type and amount of feedback for each individual gain stage.

In a simple analogy, the new JBL/UREI Amplifiers do each signal track right the first time, so that you don't have to fix it in the mix. The result is sound far cleaner than typical quasi-complementary and fully-complementary output stages only. And far more pleasing to the ear.

Put JBL/UREI's remarkable new Amplifiers to the test at your local JBL/UREI dealer today. We're confident you'll think it's the finest amplified sound you've ever heard. Or seen.

For an informative Technical Paper on the unique design philosophy behind the new JBL/UREI Amplifiers, please write to:

JBL Professional
8500 Balboa Boulevard
Northridge, CA 91329



Available in Canada through Goud Marketing

Circle #047 on Reader Service Card

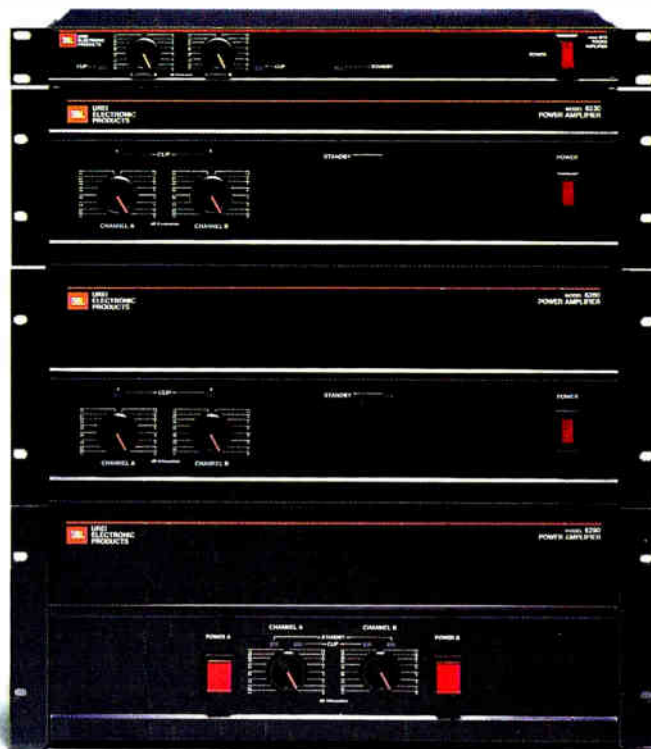

The effects often require trimming and internal deletions to make them fit exactly to picture. Juxtapositions can be checked at slow speeds to fine-tune synchronization.

7. The completed effects and dialog tracks, after being assembled with spacing leader, are ready for the mixing stage. However, somebody must now draw up the mix cue sheets, which are the standard form of representing how the sound and dialog have been prepared. Unlike a linear list of sounds and footages, cue sheet descriptions are spaced throughout many sheets of paper, similar to an orchestral score, to be read at the mixing console. Picture changes always affect the footages listed on these sheets, requiring much last-minute recalculation and rewriting.

Multi-Track Sound Editing

Multi-track sound editing, unlike film-style editing, is often a matter of playing the master recording (or a copy) directly from a tape machine and copying it to a multi-track playing in sync with the picture. Editing then becomes a matter of synchronizing the two tape machines with appropriate offsets. The editor must spot and choose the effects as in film-style editing, and cue sheets still need to be prepared for the final mix.

Sampling Keyboard or Hard-Disk Sound Editing

In this technique, the effects are sampled into memory, edited and played from a time code-based sequencing or event-listing program using a keyboard or hard disk-based sound editing system. This can be the fastest method of building up sound effects tracks. After a period of time, a large sample library will have accumulated; libraries containing over 1,000 floppy disks are not unusual.

What do you now accomplish by hand that a computer could do better?

Effects library cataloging requires the editor to carefully describe, categorize and cross-reference each effect in the library, a task which involves a great deal of typing and sorting. New effects added to the library must be appended to each relevant category and cross-reference list, an exceptionally tedious process. Over time, the organizational scheme used in the library should be reviewed to account for the

new entries, a process that involves retyping redivided categories, perhaps the worst part of the job. Fortunately, excellent programs designed to handle exactly these tasks are available.

Music library cataloging, like sound effects cataloging, is a tedious record-keeping process that computers assist enormously. Many studios use production music libraries, often searching through several library catalogs to find music for their clients. Keeping all the library catalogs in a computer provides fast centralized searching.

Sample library cataloging is a problem owners of sampling keyboards have after creating hundreds of samples spread over hard disks, tape backups and floppy disks. Strangely, the instruments themselves provide no central cataloging facility, creating a need that third-party products currently fill.

Sound effects spotting, the process of reviewing a film or tape, choosing effects to be used, recording new effects and so forth, is a prime candidate for computerization. A good supervisor maintains lists for every spot, scene and reel in the film. Sounds not in the library have to be listed for later recording or synthesizing.

Creating transfer orders, the result of searching a sound or music library, involves keeping a list of effects, sorting the list by source reel and writing labels for each sound.

Creating off-line edit decision lists for transfer into an on-line audio synchronizer is the audio counterpart of a common editing process. The idea here is to capture time code values from a videotape, choose effects and source reels, and upload this information to the synchronizer, thus saving time when working with the expensive synchronization and recording equipment.

Preparing ADR paperwork on a big film involves an incredible amount of typing, as the many dialog lines, with their appropriate footages and character names, must be listed in several different forms. Then, when footages change because of picture re-editing, many of the forms have to be typed again.

Writing mix cue sheets is a tedious task, usually performed at the last minute before the mix. Picture changes always affect the footages listed on these sheets, requiring a great deal of last-minute recalculation and rewriting.

Specific Features Needed for Each Task

At this point we will discuss exactly what the software should do: what benefits it provides, what functions it performs and what features it contains.

Effects Library Cataloging

Searching: A library program should let us add as many effects as we want, using any description we want, using as many words as we want. We should be able to find effects using the same words we use to describe a sound, whether a short general description, such as "birds," or a specific request, like "Welsh Forest Birds In the Morning." We should be able to limit a search to effects in a particular medium, including compact disc or floppy disks.

We should not have to be too literal in specifying a sound; the computer should know that a "background" is often the same as an "ambience" or an "atmosphere." We don't want to miss a good effect just because it was described with a different vocabulary.

If we use a compact disc jukebox to store and play our CD effects library, we should be able to control the player from the software program, linking the searching and auditioning process with just a few keystrokes. We should even be able to trigger playback of the CD selections from an external source, such as an event controller or a MIDI note-on command. If we are using a multi-machine synchronizer, the program should transfer a list of the reels and cue points to allow the synchronizer to cue up the effects after we have put the reels on the tape machines.

As we use the library, we need to easily change or add the description of an effect. Often when using a sound we think of additional ways to describe the sound in more detail; the program should let us quickly and easily make changes without breaking the flow of our sound editing.

As we perform searches through the library, we should be able to print a list of the effects found. We should be able to set up holding files to add to as we search, for later printing or review.

Adding New Effects: As we add new effects, the program should help us eliminate redundant typing, with user-definable defaults and reference lists to choose from. The software should carefully check the entry of

technical information; it should prevent people from misspelling and, to create consistency, replace undesirable words and abbreviations with other words of our choice. We should also be able to retroactively affect global changes in word usage, with search and replace functions similar to good word processors. We will need a print-out of the contents of each roll, tape, disk and cart. Labels for floppy disks would be convenient.

Organizing: We should be able to easily reorganize the library and the category system. Adding new effects often means we want to sub-divide an existing category that has grown too large. We should be able to do this without retyping or changing any existing descriptions. We should be able to see a print-out of the entire dictionary/category system we have created.

Printing a Catalog: It is often more useful, not to mention more convenient, to provide the sound editing staff with printed catalogs, rather than shared access to a single computer. Changes in the library, by changing categories or by adding effects, should be printed almost automatically. Categories in particular should be automatically updated. The software should be smart enough to create a table of contents and an index of our organizational scheme.

CD Effects Libraries: While using commercially available sound effects libraries we should be able to secure copies of their catalogs on floppy disks, so we don't have to type them into the computer.

Music Library Cataloging

Searching: Searching through a music library is a different process from searching an effects library; at times, the selection process is extremely specific, a circumstance that requires the software to search for titles, composers, moods, keys, tempos, categories, instrumentations, lengths, libraries or formats. Searching through a music library is almost always defined by multiple words; therefore, the program should memorize every search we request and "learn" how we use the library to perform faster searching with continued use.

While using production music libraries, we depend on the catalogs and descriptions provided by the library to identify the music; for this reason, we need to be able to personalize the descriptions of the music, to append the

pre-existing descriptions with comments of our own without breaking the flow of using the library.

Adding New Music: We should be able to easily add new material to the database, and create whatever category system we like. The computer's categorizing ability is important because each library has a different category system; the computer's ability to organize all libraries by the same criteria provides an important level of consistency.

CD Music Libraries: If we use commercially available music libraries, we should be able to obtain their catalogs on floppy disks from the librarian software publishers, ready for uploading into the librarian programs. If we use a compact disc jukebox to store and play the CDs, the librarian program should play the CD selections directly from the searching function, so that we can use the programs to audition the CD library. Some means of triggering the CD playback should allow us to play the selection on command.

Client Billing: We need the software to keep track of each client who uses the production music libraries. The software should be able to track the client's past usage of the libraries, to indicate what selections were purchased in previous sessions and what products the music was used for. At the end of each session, we want a billing report to use for accounting, detailing what royalties are due.

Sample Library Cataloging

File Names & Descriptions: The sound effects librarian software should be able to catalog each sample made on a sampling keyboard or hard-disk system as a discrete effect in the library. Because the file names that sampling instruments allow are only eight to 16 characters in length, an inadequate amount to describe a sound effect in detail, the software should let us create much longer descriptions we can use to later identify the sample.

Search Listings: Any search listing of the library should indicate if the effect is a master recording or a sample made from an existing master recording and vice versa. We need to be able to see a list of any samples made from every effect. The software should create labels for each floppy disk, and a cross-referenced catalog of only sampled effects.

Sound Effects Spotting

Centralized Lists: One of the inevitable headaches of being responsible for the sound editing of a film or video is the necessity to identify each event, object and phenomenon needing a sound effect, choosing the right sound effects for each event and, if the project is a large one, communicating these decisions to the sound editors. The benefit of using a computer to assist in this process is the convenience of using a list-keeping program rather than many paper lists and catalogs. The program should maintain a list of the type of material we normally record as we acquire sounds for a film or tape.

Automatic Searching: Additionally, to speed up the process of choosing sound effects, the database in the librarian program should be available from the spotting program. The whole process should be linked to create a list for each scene, search for the appropriate sound effects and then copy the chosen effects, pasting them into the scene list without retyping any descriptions.

Working Without Footages: We need the ability to describe the scenes without knowing the footages or the final order, in order to begin spotting before the picture editing has been completed. We should be able to move the order of the scenes around as the picture changes, with the order of the spots and effects moving automatically with the scenes.

Printing Cue Sheets: To save retyping the effect information when creating the cue sheets, we should be able to transfer the spotting information to a cue-sheet printing program. The spotting information should also be printed by reel or by scene, to indicate our editing instructions to the sound editing crew. The same editing instructions should also be capable of being sent to a time code-based multi-machine synchronizer system as an event list file.

Creating Source Reels: If the effects needed to be transferred to tape striped with time code for use by the synchronizer system, the software should help us speed up this process. If the effects to be used are stored in the CD jukebox, the software should cue them up and coordinate playback, with the recorder creating the source reel.

Creating Transfer Orders: It is important that the software provide printed orders and labels for the ef-

fects chosen during the spotting program. To prevent redundant reloading of the tape machine, such transfer orders must first sort the effects by source reels. The labels should indicate the reel, scene and spots the effect is intended for, as well as the effect description.

Preparing ADR Paperwork

Spotting & Programming Without Footages: A computer program that helps us eliminate redundant typing of those tiresome ADR forms should let us enter the lines, characters and scene numbers before we know the footages or even loop numbers; in this way we could get a jump on the programming task. The lines should be linked to the scene, letting us reorder the film as necessary, moving scenes around, from reel to reel, splitting apart and even omitting if necessary. The software should understand either footages or time code, converting between them if necessary. Any offsets necessary for the ADR recorder should be computed by the software so we need only think about the real footages.

Printing Forms: The software should be able to print a wide variety of ADR forms, listing lines by reel, scene or character, maybe even listing only a particular character's lines per scene or reel. Large, expanded-type printouts would be useful for an actor on the lectern. A print-out of the number of lines per reel per character would be valuable for estimating stage time needed.

Post-Session Changes: After the recording session, the program should let us join together lines as we may have combined at the session, and should also accept new lines created on the spot. We should be able to indicate slates and take numbers, for use on print-outs and cue sheets. Any picture changes that occur after we have entered footages should be managed by software: we should only have to enter the changes per reel and have the software ripple the changes through the appropriate footages.

All of this information should be able to transfer into a cue-sheet printing program.

Writing Mix Cue Sheets

Preparing cue sheets involves spacing the data in accordance with the footages or time code of the picture. A software program that accomplishes

this task should require us only to enter the description, footages and track numbers; the spacing and printing calculations should be accomplished automatically by the computer.

One of the problems that the computer should eliminate is the task of changing the cue sheet footages if the picture changes occur *after* the sheets have been written. We should just enter the change information and how the affected cues were conformed; the software should reprint the sheets with correctly recomputed footages.

Although the labor of entering the

post-production data into the computer is tedious, enough advantages exist to make the effort more than worthwhile. Probably most of us should start by computerizing a single function, such as the sound effects library or the ADR print-outs; then, add the functions that take advantage of the existing data, such as sound effects spotting or cue sheet print-outs. ■

Dale Strumpell is with Leonardo Software, a Venice, California-based developer of software for the audio recording and production industries.

WE GET AROUND

From a television documentary in the arctic circle to film-scoring in Hungary, from multi-track recording in Brazil to digital sampling in Australia, from outdoor football broadcasts in the United States to chamber music recording in Germany, the breadth of application of the series 4000 professional microphone range continues to expand. Isn't it time that you tried Brüel & Kjær Series 4000 microphones?

Brüel & Kjær

World Headquarters: DK-2850 Nærum · Denmark
Telephone: +45 280 0500 · Telex: 37316 brukda dk
USA (617) 481-7000 · Local representatives and service organisations world-wide

87-383

Circle #083 on Reader Service Card

NEW PRODUCTS

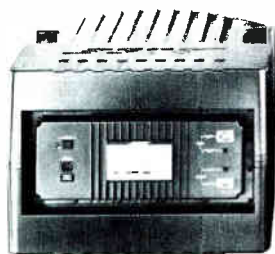

Bose Acoustimass™ Pro Speakers

With the upcoming debut of the Acoustimass Powered Speaker System, the Bose Corporation (Framingham, MA) addresses the entire pro music and sound industry. This two-way system boasts internal amplification and equalization—no external power amp or EQ connections are required. Its 12-inch woofer has an “electromagnetic braking system” combining very high power output and clarity, and its six 4½-inch drivers are arranged in an articulated array (2 x 3) for full-range optimum dispersion. The Acoustimass achieves 122 dB SPL/1 meter with 55 to 18k Hz bandwidth, and incorporates such patented Bose technologies as: a bass reproduction sys-



tem which launches sound via two air masses instead of a vibrating surface; a two-state modulation switching amp mounted on a single card, weighing 9.2 pounds and providing 400 watts continuous power (650W peak); and a reaction-injection molded enclosure of “clamshell” type, two-part construction so it’s rugged, compact, easy to move (weighing only 70 pounds) and easy to mount or install. Molded into the enclosure are handles and hang points. XLR connectors and ¼-inch jacks allow amplification of any line-level source signal. Bose will release the Acoustimass in March at a suggested unit price of \$2,500.

Circle #152 on Reader Service Card

Studer A820 8-Track

Introduced at the last AES Convention was Studer’s A820-8 one-inch 8-track recorder. The intermediate format machine, designed for audio production and video post work, is optimized for extreme speed and control flexibility. Reels up to 14 inches can be accommodated without compromising speed or control. Reel inertia-sensing enables top per-

formance with mixed size reels, and the capstan has its own processor to insure matching reel speed in slew rate and lock performance. The transport, audio performance and programmability equal those on the 24-track model. A basic A820-8 costs \$28,250, and optional plug-in NR cards are available.

Circle #153 on Reader Service Card

DAR Soundstation II

A touch-screen display, instant-access audio editing, and digital multi-track recording and signal processing are some distinguishing features of Soundstation II from Digital Audio Research (based in England). Soundstation II is designed for audio, video and film sound pro-



Yamaha Digital EQ

The dual-channel DEQ7 digital equalizer/filter from Yamaha features 44.1kHz sampling and 16-bit conversion with 32-bit internal processing. Full graphic and parametric EQ configurations and shelving, notch, and dynamic/sweep filters are among the device’s 30 factory programs. Also included are 60 user-programmable, on-board memory presets. Program location and bulk dump capability are accessible through MIDI. When used in conjunction with various Yamaha digital audio systems, the DEQ7’s digital I/Os allow “converterless” operation. Retail price is \$1,295.

Circle #154 on Reader Service Card

duction environments. Programs recorded within its 20-bit digital audio structure have their original sound quality preserved through conversion, storage and signal processing. Complicated audio edit tasks can be performed with no sound degradation. The system comprises a Control Console—with controls similar to conventional audio tape recorders—and a Processor/Storage Unit containing software and disk drives. The Control Console achieves matching gain across an edit, with digital gain control and variable cross-fade adjustment. Variable-speed playback is possible up to twice normal speed. Sound-



“It’s like
a dream
machine.”

PETER CHAIKIN,
ENGINEER/PRODUCER

Producers and engineers are calling it a dream machine.

We call it the DMP7 Digital Mixing Processor. It's a new kind of creative tool and there's never been anything like it.

For the first time, you can command true digital mixing and dramatic digital effects. And have them programmed into memory for instant, flawless recall.

All from one incredible, affordable, simple-to-use 8x2 console.

All MIDI-controllable. Remote-controllable.

And syncable via MIDI to SMPTE.

It makes unforgettable music.

The DMP7 takes a "snapshot" of all of your settings. Instead of developing writer's cramp after each session, you can digitally store your production notes into memory. Up to 97 snapshots (with RAM4 cartridge), each consisting of more than 200 parameters, from fader positions to effect settings to 3-band parametric EQ settings.

Then recall them instantly at the touch of a key, or with an external MIDI controller or sequencer.

Yamaha introduces its event programmer, a All at



All the colors are built in.

The DMP7 has three on-board digital signal processors that deliver spectacular effects like stereo chorus and echo. Panning. Four kinds of reverb, and reverb plus gate. And up to three effects can be mixed simultaneously.

There are 18 different effect types in all, with up to nine parameters for each. So you can create precisely the sounds you want, while



saying goodbye to outboard gear and their multiple data conversions. The DMP7's mixer has eight input channels, and its digital cascading feature lets you connect additional DMP7s to add more inputs (up to 32), as you require.

And build yourself the ultimate digital console.

There's a lot more you should know about the DMP7, and your Yamaha Professional Audio dealer can tell you the whole story. See him this week.

And believe in dreams.

s newest digital mixer, nd digital processor. once.



Here's the setup.

The simplicity of the diagram below belies the many capabilities of the DMP7 at work in an automated multi-track mixdown/processing system.

Dry tracks from the multi-track recorder are fed into the DMP7. A SMPTE track is fed into the SMPTE/MIDI converter. The MIDI timing track controls the MIDI sequencer/recorder.

The MIDI control information for the DMP7 can now be recorded in sync with the music. The DMP7 then automatically mixes everything down into a two-track master or



demo. Until now, this level of mixed automation was only possible with more expensive consoles.

The DMP7 doesn't just do the final mixing, but the final processing as well, to each individual track. With reverbs, flanging, delay, and stereo panning. Or whatever sweetening you

need. And again, in sync with the music.

What's more, if you have more than eight tracks, you can cascade in the digital domain to another DMP7 for 16 tracks. Or another for 24. And yet another for 32 tracks.

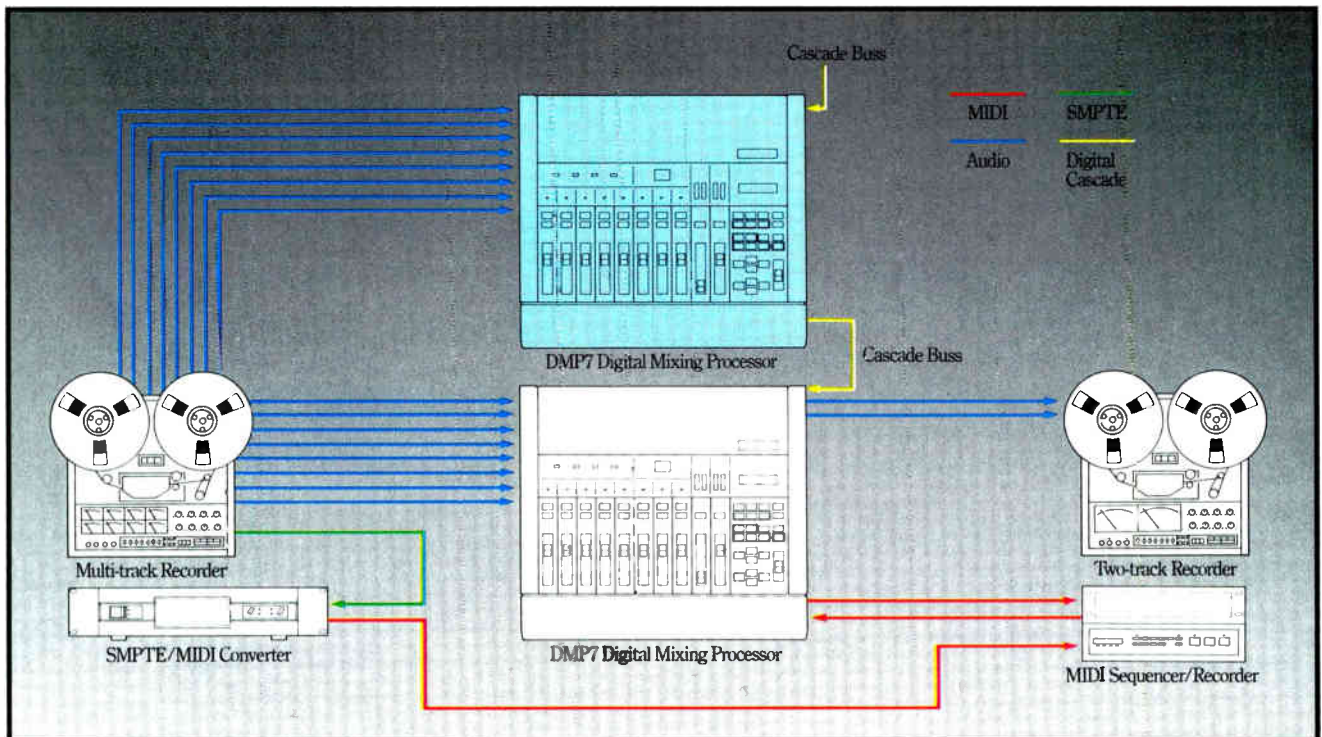

Yamaha Music Corporation, Professional Audio Division, P.O. Box 6600, Buena Park, CA 90622.
In Canada, Yamaha Canada Music Ltd., 135 Milner Avenue, Scarborough, Ontario M1S 3R1.



station II can insert or delete sound segments in program sequence, and automatically provides continuity between adjacent segments. The basic system provides four-channel recording/editing, expandable to eight channels. Both analog and digital inputs and outputs are provided for each channel, conforming to the AES/EBU digital interface. The Soundstation also interfaces with Winchester or WORM disks.

Circle #155 on Reader Service Card

Eventide Ultra-Harmonizer

Eventide (Little Ferry, NJ) has developed the H3000 Ultra-Harmonizer pitch change and effects processor. It's MIDI-programmable and includes 50 factory programs, plus on-board memory storage of user pre-sets. The H3000 incor-

porates two independent, fully de-glitched pitch change channels. Pitch change functions include "layered shift" (two different pitch shifts on one input), "stereo shift" (stereo pitch change with two-channel de-glitch to preserve stereo imaging and phase-accurate mono compatibility) and "diatonic pitch shift" (one input harmonically pitch-shifted to two separate musical intervals; the two outputs combined with the input yield a triad chord). Effects programs include

multiple reverb sounds and "Death Flange" (reverb meets flanger). An LCD display shows all parameters and allows dynamic labelling for four soft-key buttons.

Circle #157 on Reader Service Card

Alesis Digital Drum Machine

Alesis (North Hollywood, CA) announces their new HR-16 high sample rate digital drum machine featuring 16-bit drum samples and 18-bit processing system. The 48 drum and percussion samples, says Alesis, range from pure acoustic tonalities to aggressive power drums and electronic drums. Features include 16 channels, 47kHz sample rate, 20kHz bandwidth, 100 patterns, 100 songs, full MIDI implementation, song position pointer, velocity-sensitive pads, tape sync, real time record and single step editing. One can assign any sound to any MIDI note or any drum pad. Volume, pan and pitch are programmable; the outputs (two stereo pairs) are assignable. It also provides a start/stop foot-pedal jack, and all for \$499.

Circle #158 on Reader Service Card

Four Designs Son of FX

Four Designs Company (Canoga Park, CA) proudly announce the birth of Son of FX. The new arrival is intended to organize recording, computer, and rack mount equipment in a work station on wheels. Son of FX provides two adjustable shelves for multi-tracks, drum machines, mixers, sequencers, computer monitors, disk drives, etc. Ten rack space units are also provided. The all-wood design eliminates ground loop problems encountered in metal racks. Son of FX takes up just two square feet of space, is shipped flat, and



assembles easily with only a screwdriver. You can get Son of FX with mounting hardware and one-year warranty for \$139.95. The Rackdrawer (shown in photo), an option at \$39.95, is a two-space rack mount drawer for storing widgets and gadgets.

Circle #159 on Reader Service Card

Beyer ENG/EFP Mic

The new M58 omnidirectional dynamic mic is Beyer Dynamic's first product designed for electronic news gathering and electronic field production applications. It incorporates an internal shock-mount system to diminish handling noise, and its extended response rises subtly in the high end to enhance vocal clarity, even off-axis. The ergonomic design and light weight allow for minimum fatigue during long interviews, and its ruggedness withstands the harshest EFP operations. The mic is slim and finished in matte black for a low-profile TV appearance.

Circle #156 on Reader Service Card

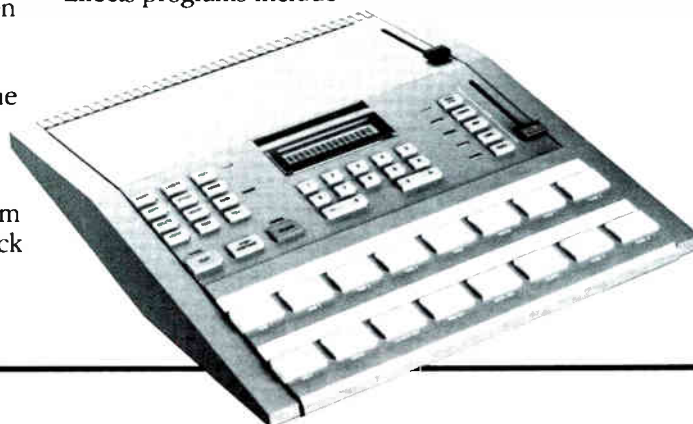



SSL-4000 G Series

Solid State Logic recently launched its 4000G Series of studio consoles. Once again integrating a digital control system with advanced analog processing power, SSL has added on-board memory for faster system operation, and a 20 Megabyte, removable data cartridge that holds as much data as 80 floppy disks. Floppies produced on 4000E Series consoles are fully compatible with the 4000G; all G systems also include a pair of floppy disk drives. A new full-size QWERTY keyboard provides a numeric keypad and special function keys; any one of the latter can be programmed to perform a complete string of commands. Enhanced software handles large, complex mixes on- and off-line, taking full advantage of the G computer's increased speed and expanded on-board memory. The G Series integrates fully with other SSL technology such as Total Recall, the SSL Synchronizer, Master Transport Selector and Events Controller, and any 4000E console can

be upgraded to a 4000G. The G Series keyboard is available as a stand-alone unit that works with upgraded E models.

WaveFrame Digital Audio Workstation

The AudioFrame from WaveFrame (Boulder, CO) is a total sound production environment in one unit that lets music, sound effects and dialog work occur entirely in the digital domain—handling synthesis, storage and editing, signal processing, mixing and mastering. The 64-channel digital audio bus and switching matrix provides the basis of an all-digital studio. Its open architecture incorporates multiple industry standards (SMPTE, MIDI, AES/EBU, MS-DOS, Microsoft Windows, IBM Token Ring network). Its fixed sample rate architecture and processing lead to pure, premium sound and eliminate aliasing and digital noise problems inherent in variable rate architecture. WaveFrame offers complete support and installa-

tion. System prices range from \$45,590 to \$86,290 and all include IBM PS/2 computer, 70 Megabyte hard disk, 60 MB tape back-up, monochrome monitor, keyboard, mouse and software.

Circle #161 on Reader Service Card

Sony Digital Audio Limiter

Sony expands its digital audio product line with the DAL-1000, a rack mount device for digital signal compressing and limiting during the CD mastering stage. Previously handled by analog circuitry which introduced degradation, the compressing/limiting can be accomplished via the DAL-1000 and its full 16-bit linear quantization. The DAL-1000 achieves "0 word" attack time and provides six programmable presets for parameter setup. It operates at three sampling frequencies (44.056, 44.1 and 48 kHz) and works in conjunction with a remote control keypad. The 19-inch, 1U rack package interfaces with Sony digital and AES/EBU formats. It's available now at \$3,200.

Circle #162 on Reader Service Card

Apogee PCM-F1/501/601/701 Electronics Upgrade

Apogee Electronics, of Santa Monica, CA, is now finalizing the design on an integrated EIAJ c format (Sony PCM-F1 family) sonic upgrade in modular form. The module will

mount into the battery compartment of PCM-F1 and Nakamichi DMP-100 processors (mounting internally in the 501/601/701s) and will be optimized for pro and semi-pro input/output levels, bypassing most of the standard analog input and output circuitry. The module utilizes Apogee anti-aliasing filters, highly evolved oversampling D/A converter technology, and improved analog output. According to Apogee, the modification kit (target priced at under \$400) also eliminates the time offset errors common to many other systems.

Circle #163 on Reader Service Card

API Mic Pre-Amps

API Audio Products (Springfield, VA) presents the rack mount 3124 and 3124M microphone pre-amp/mixer modules, available in 2- or 4-channel versions. The 3124 provides switchable 150/600-ohm XLR inputs and a front-panel, mic-level ¼-inch input, compatible with guitar, bass or keyboard direct box-type inputs. Also included is a 20dB pad for the mic input, mic/line switch, LED bar graph display (-12, -6, 0, +8, +16) and gain control. The "M" version adds stereo and aux busses, mix level control, panning, aux send, optional insert point for each channel, plus left and right master controls and master aux send with stereo return.

Circle #164 on Reader Service Card



As You Might Expect, No \$700 Amplifier Has Ever Equalled The Performance, Quality And Reliability Of The \$1000 BGW 7500...



Until Now!

Introducing The BGW 7500T. \$1000 Performance At A \$699 Price.

There are thousands of BGW 7500 amplifiers in the field today. In every case, our \$1000 model 7500 was chosen over a number of lower priced alternatives, for its superior quality, durability and sonic performance.

But BGW knows that you don't always have the luxury of choosing the higher quality, higher priced amplifier. Until now, the price-sensitive buyer has had no choice but to settle for a less expensive, lesser performing unit.

Not anymore. Because BGW's new 7500T amplifier delivers exactly the same performance as our legendary model 7500, at a price that goes head-to-head with any U.S. or foreign competitor—just \$699 professional list.

The model 7500T is a price/performance breakthrough. You get the same conservatively-rated 200/250 Watt-per-channel power (w/ 8/4 ohms), the same performance specs—in fact the exact same amplifier design, circuitry and components as our no-compromise model 7500 — at a \$300 savings.

How did we do it? We selectively trimmed a few of the model 7500's nice but non-essential frills. The 7500T has a steel front panel instead of a fancy aluminum one, and uses cost-effective barrier strip terminations. The 7500's LED indicators are omitted on the 7500T. The lower-priced model accommodates one optional BGW internal crossover card for biamp applications, while the 7500 can take two cards. These differences aside, our new economy model is a BGW model 7500 through-and-through.

The 7500 and 7500T are the most rugged and reliable amplifiers you can buy. Inside, you'll find no trouble-prone relays and no sound-degrading IC's.

And here's an important difference between the 7500/7500T and other competitive units: Many use inexpensive MOSFET designs which require high bias, and consequently run very hot. Other brands use inadequate heat sinking. These competitive amplifiers can't live without forced air cooling.

BGW's exclusive copper header output devices don't require bias at all. We mount them directly on highly efficient heat sinks. As a result, the 7500 and 7500T run cool and efficient—so they don't require forced air cooling. And that means you can forget about replacing burned-out fans every few years.

BGW's 7500 has always been the ultimate choice for quality and dependability. Now that our 7500T gives you the same unmatched performance at just \$699, there's really no reason to settle for anything less than BGW. Call us toll-free at 1-800-252-4800 (In CA, 213-973-8090) to arrange for a demo trial.



BGW SYSTEMS INC.
13130 SOUTH YUKON AVE.
HAWTHORNE, CA 90250

ENGINEERED TO BE THE BEST

by Jerry Ross

LEONARDO SOFTWARE PROFESSIONAL LIBRARIAN

Using a computer to keep track of a sound effects library is probably a new concept to many production engineers, so some orientation is in order. A useful and commonly encountered personal computer like the IBM-PC can hold the entire catalog of the largest library in its memory (on a hard disk, actually) and find effects for you faster than you can look them up in printed catalogs. The computer can only perform this function if it is running a program designed to keep track of quantities of information; such programs are known as database management software, the data being the information about the library.

Another advantage of using the computer is communicating with produc-

tion equipment; for example, after the software searches through your library and finds the sound effects descriptions, by pressing a few more keys on the computer you can tell the program to load a compact disc of the effects and play the selected effects, thus automating the entire search and audition process (assuming the effects are on compact disc and the discs are in a computer-controlled CD jukebox).

Professional Librarian is a software program for IBM-PC ATs and compatibles, requiring 512K RAM and a hard disk. Leonardo Software is a small company started by audio professionals who have a great deal of sound effects experience. They have been very responsive to suggestions, cooperative with telephone support and seem to constantly upgrade the program, adding new features several times a year. (Updates cost a nominal \$15.) Also available from Leonardo is Music Librarian, which serves the same function for music libraries.

I began using sound effects database software because, like anyone working in audio production, I have a limited time to achieve results and I like to eliminate unnecessary busywork. Until I began using Professional Librarian, I hated to look for sound effects, particularly when a client was present. Now it is a pleasure: I can complete ten searches in the time I used to take to thumb through catalogs for one.

System Setup

PL begins with an installation program that more or less automates the setup

—CONTINUED ON PAGE 140



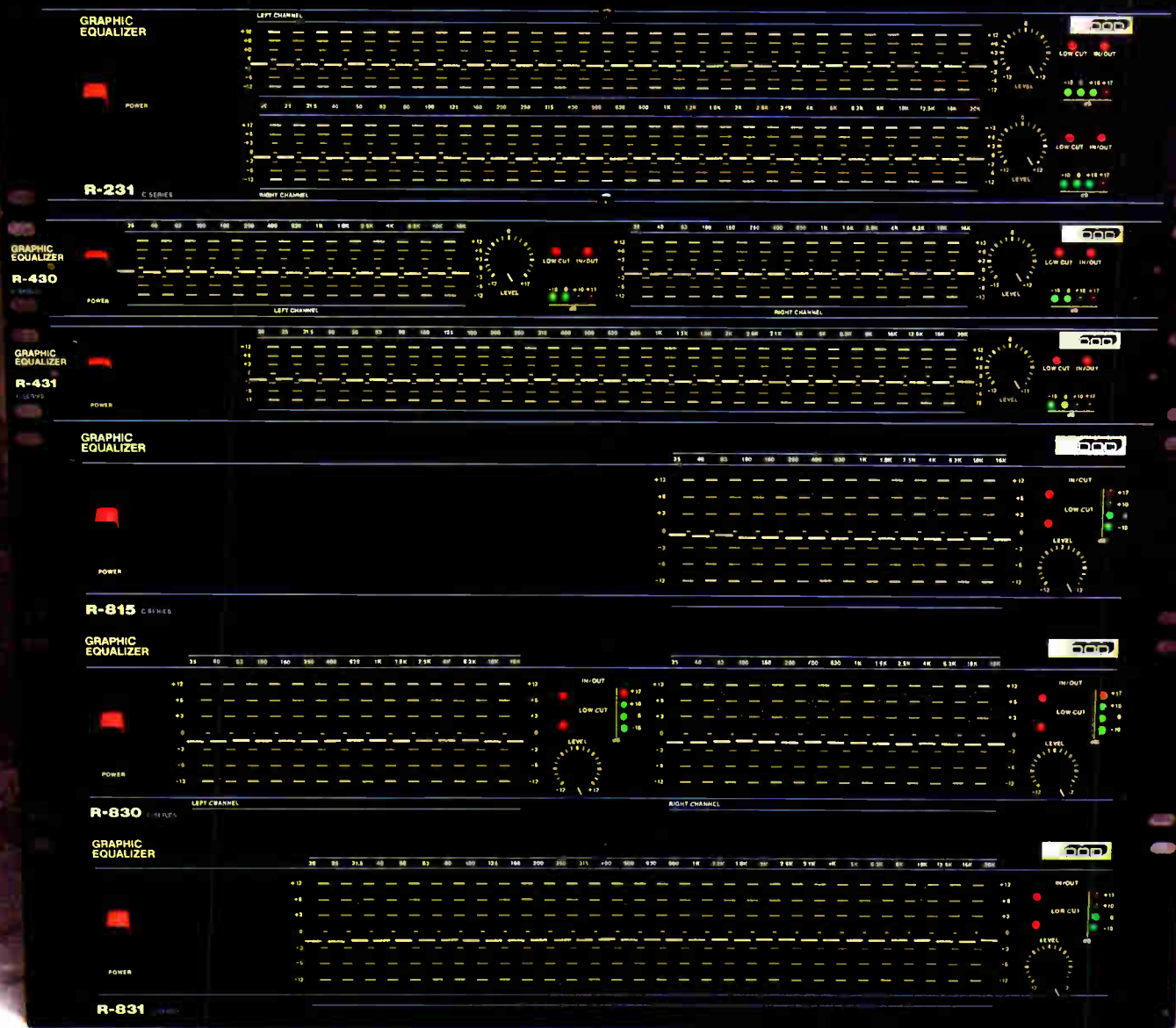

HERTZ SO GOOD.

A DOD equalizer is not only great audio gear, it's one of the world's best audio bargains.

For over a dozen years, we've reconfigured, refined, updated and enhanced our entire line of equalizers to where they are now: the world's best-selling EQs at any price. And we've worked hard to make that price a very reasonable one.

DOD manufactures more configurations of graphic equalizers than any other company, ranging from a single channel, 15-2/3rds octave band unit, to a two-channel, 31-1/3rd octave band brute that squeezes into a two-rack unit space. Each offers a dynamic range greater than

95 dB, .006% total harmonic distortion @ 1KHz, 0.01% intermodulation distortion and a control range of ± 12 dB.

Virtually anything you can do to enhance a sound—cut, boost, shape, brighten, thicken or mellow—you can do with a DOD graphic equalizer for a lot less than you'd expect.

Want to know more? Write DOD Electronics, 5639 South Riley Lane, Salt Lake City, Utah 84107 for a full-color catalog. Or call (801) 268-8400.

Manufactured in the U.S.A. with a one-year warranty.



© 1987 DOD Electronics Corporation

Circle #048 on Reader Service Card



The price you have to pay to be free.

As a musician, you know you've got to be free. Free to express the music that's inside you. But, sadly, buying an "affordable" keyboard or sound module often means compromising your expressive freedom by accepting second-rate sounds and limited capabilities.

At Kurzweil, we don't think the instrument you play should build fences around your imagination. So we developed our revolutionary 1000 Series to help turn it loose. The 1000 Series delivers authentic Kurzweil sounds with more voices, more programming power, more creative freedom than you ever thought possible at prices you never thought possible.

Freedom from Financial Oppression.

Thanks to our new VLSI microchip, Kurzweil 1000 Series modules start at just under \$2000. VLSI has enabled us to pack each Series 1000 instrument with up to 120 of the same impeccable, 16-bit floating point, digitally-sampled sounds found on the legendary Kurzweil 250.[®] Choose from the 1000 SX String Expander Module, 1000 HX Horn Expander, 1000 GX Guitar Expander, 1000 PX Professional Expander (which provides a varied collection of our most famous samples) or the K1000 (the keyboard version of the 1000 PX).

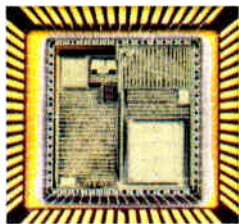

Freedom of Expression.

The 1000 Series' generous polyphonic capabilities free you from the expressive limita-

tions of 12-voice or 16-voice systems. The 1000 PX and K1000 offer the power of 24 voices while the 1000 SX, 1000 GX and 1000 HX each have 20 voices. And, if you need more voices, you can combine all four 1000 Series modules to create an 84 voice, 8-output super-system. So go ahead. Stack voices to your heart's content. Build complex, multi-voiced sequences. Go for those big, two-fisted chord shapes. The 1000 Series modules give you miles of sonic territory to roam at will.

Freedom of Choice.

The 1000 Series is truly democratic too. Three different operating modes let everyone—from novices to advanced programmers—benefit from the 1000 Series' bountiful capabilities. In Play Mode, you can use those great Kurzweil sound programs just as they are. Simply select a program and play. The Compiled Effects mode lets you apply a variety of popular effects to any of the preset sound programs. And the Modular Editing mode takes you deep inside the 1000 Series' voice architecture.

So stand up for your rights. You owe it to yourself to check out the 1000 Series. For more information, visit your nearby Kurzweil dealer. Or write to us at Kurzweil Music Systems, Inc., 411 Waverley Oaks Road, Waltham, MA 02154, (617) 893-5900. In Canada, write to Heint Electronics Inc., 16 Mary Street, Aurora, Ontario L4G 3W8, (416) 727-1951.

KURZWEIL™
Music Systems

* \$1995 suggested retail price for 1000 SX and 1000 PX. \$2,395 suggested retail price for 1000 GX and 1000 PX. \$2,595 suggested retail price for K1000. All specifications and prices subject to change without notice.

by Larry Oppenheimer

LEXICON 480L

DIGITAL EFFECTS PROCESSOR

The 480L Digital Effects Processor is Lexicon's latest generation signal processor, taking the directions set by their 224XL and PCM70 processors another step. It is capable of an exceptionally wide variety of signal processing tasks, which I have divided into four classes: reverberation, effects, sampling and utility (further elaboration on these areas follows below), and, additionally, can perform any two of these simultaneously. The 480L is controlled by the same LARC remote head that is used for the 224XL and, in fact, a 224XL and a 480L can both be controlled from a single LARC. The LARC's Machine button switches control between the two "Machines" in the 480L and a 224XL, if one is connected. The device also offers excellent interfacing capabilities, sporting MIDI control and digital input/output (in addition, of course, to standard analog I/O).

There are nine banks of programs

and a total of 60 factory presets. Fifty onboard memories can store user presets, and a RAM cartridge which plugs into the front of the chassis allows 50 presets to be loaded or dumped.

Physically, the 480L consists of a 3U rack mount chassis which contains all of the circuitry and the LARC head. The two are connected with a flexible 50-foot cable, although it is possible to connect two cables for a 100-foot run, and even longer runs can be done if the LARC is powered by a separate, local supply. The front panel of the chassis is hinged and opens simply by pulling on its handle (no screws to undo!) to reveal the card cage inside. This, along with the modular construction, makes for extraordinarily easy service access and updating. Inside is a host processor card, two identical high-speed processor (HSP) cards, a shielded module containing the analog electronics (including the "18-bit equivalent" A/D

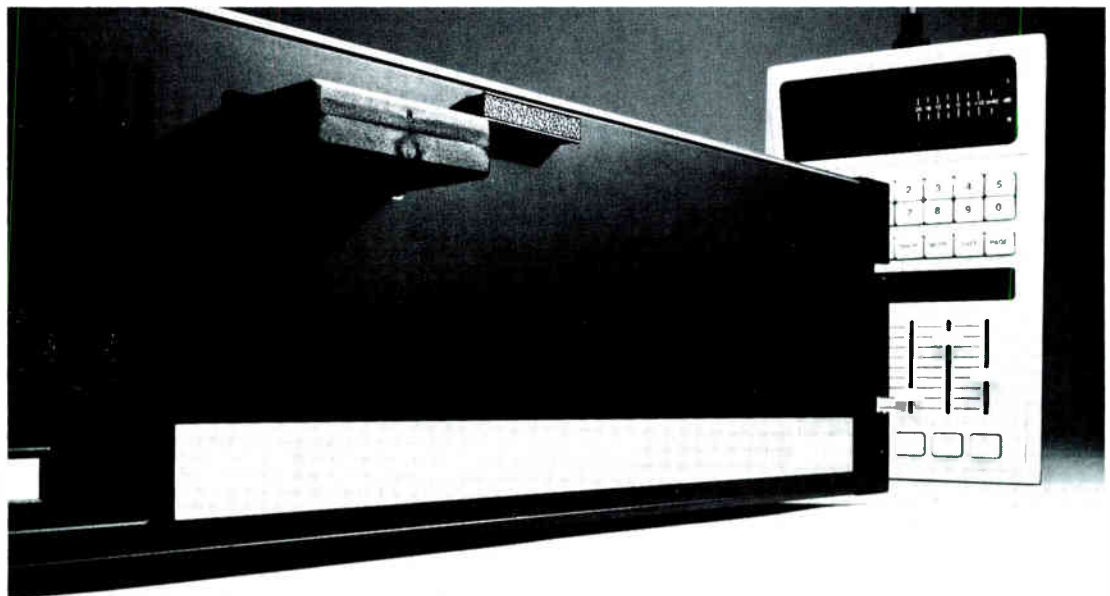

FIELD · TEST

and D/A converters as well as input and output level controls on the front), a slot for an expansion card, and the cooling fan. The front panel also contains a slot for RAM cartridges and the power switch (some manufacturers actually put the power switch on the rear panel).

The rear panel contains XLR type connectors for the two inputs and four outputs, MIDI In, Out and Thru jacks, and DE-9 connectors for LARC 1, LARC2, digital I/O, and "Automation," and the AC connector and fuse

plate. The Automation jack currently has no function outside of Lexicon, where it is used for development. The mainframe weighs in at 24 pounds, which is not bad considering what's inside.

Reviewer's Preface

By and large, the advances of technology have been a blessing to the art and science of music making and recording. Not only is it possible to easily accomplish things which were laborious or downright impossible only a few short years ago, but the cost of the equipment to do it seems

to drop on a regular schedule. The Lexicon 480L Digital Effects System is most certainly a case in point, offering signal processing functions in copious quantities at a price which, although still considered somewhat upscale, is half that of the first digital reverberator to appear on the scene a scant 11 years ago.

Even with this gracious bounty to behold, unimaginable when the first 8-track tape recorder hit the streets, some things remain the same. There is always a trade off between making full use of a complex, sophisticated and powerful device, and making quick and simple use of a device. The 480L also epitomizes this well-proven truth. "Ah!" you cry, "you are telling me that the 480L is hard to use. Strike one!" Well, no, that's not what I'm saying. It would be more accurate to say it is... deep.

Why, pray tell, is the reader troubled with such philosophical distinctions before even a word of evaluation has been rendered? Because sheer quantity of features is a primary characteristic of the 480L, and this led to two problems in reviewing it: first, finding the time and applications to evaluate it fairly and completely (even with the extra long consignment period to which Lexicon graciously agreed), and, second, fitting such a piece into the very limited space allowed by short sighted editors who believe that readers are not interested in mentally herniating themselves with 35-page reviews.

So it is hereby acknowledged from the outset that it just was not possible to try *everything* on the 480L or to describe it all here. But I sure as hell tried my best.

Configuring the 480L

There are a number of different setup parameters available in the 480L. The most basic is configuring the two HSP cards. These operate totally independently, meaning that the 480L does not do concurrent processing achieved by time-sharing the processor like the 22+XL Split programs, but true parallel processing. There are four different ways these two cards (termed "Machines" by Lexicon to emphasize their independence) can be set up: Single, in which only one Machine is used; Stereo Split, in which the Machines each receive both of the inputs; Mono Split, in which each Ma-

ADAMS-SMITH ZETA-THREE

MTC 10 29 58 23

10 HRS 29 MIN 58 SEC 23 FRAMES

We bent more than a few rules putting this much synchronizer in a single product!

MIDI SYNCHRONIZER
MIDI-to-SMPTE synchronization with MIDI sync and song pointer, tempo map storage, fractional tempos, transport control from MIDI, bar and beat display, and more!

TAPE SYNCHRONIZER
two-transport chase synchronizer, full master/slave control, sub-frame accurate rehearse/record, SMPTE/EBU time code generator, serial I/O ports, full featured ZETA-REMOTE, and more!

ZETA-THREE
by
ADAMS-SMITH

34 Tower St. Hudson, MA 01749 USA Telephone: 617-562-3801

Call or write for the name of your nearest ZETA-THREE dealer.

Circle #085 on Reader Service Card

chine receives only one of the inputs (the 480L as two mono in, stereo-out processors); and Cascade, in which Machine A is fed by the inputs and Machine B is fed by the outputs of Machine A, still in the digital domain. In all configurations except Single, the machines' outputs are available separately.

The sampling rate of the 480L can be switched between 48 and 44.1 kHz. As mentioned above, digital I/O is also available. This takes the form of SDIF (Sony 1610/1630 format) which is selected (as are the configuration and sampling rate) in the 480L's Control mode. When using the digital inputs, the 480L can be (and in most cases, would be) clocked by an external source (the digital mixer, tape deck, or workstation), in which case it can be clocked at 48, 44.1, or 44.056 kHz. An external adapter box (which is available from Lexicon) is needed to directly hook the 480L to a 1610, 1630, or many other digital devices. The digital I/O, the Cascade configuration, and wet/dry mix parameters found in several of the programs mean that a digital master could be level-adjusted, equalized (using the Stereo Adjust program) and reverberated with the desired mix, then fed to a CD mastering device or other digital destination, without ever having left the digital domain.

Program Descriptions

Reverb: Lexicon was a pioneer in the area of digital reverberation, largely due to the efforts of software engineer David Griesinger, a classical recording engineer who created a digital reverberator to satisfy his own professional needs. Griesinger's orientation in reverb is towards authentic emulation of the behavior of acoustic spaces, and this, to my ear, has always been apparent in the sound of Lexicon reverbs. It appears to be this frame of reference that has led Lexicon to introduce several new concepts in the 480L's reverb programs. The simplest of these is in the area of pre-echoes. In the past, digital reverbs have used a handful of programmable discrete echoes to simulate primary reflections from the stage, side walls, etc. This was not an accurate simulation of initial reflections in a space, which would never be discrete, and their use often resulted in comb filtering effects. The 480L uses dif-

fused groups of pre-echoes to mimic these reflections. (In many applications, such as classical music recordings of the type that Griesinger does, these reflections are wholly undesirable and, in fact, are avoided.)

Griesinger's and Lexicon's experience and research also showed that many reverberant spaces appeared to the ear to have much longer reverb decays than their measured RT60s. This indicated to him that the method of portraying space by using a pre-delay before the onset of reverb was fallacious, and that the perception of reverb decay was affected more by the quality of the initial sound build-up. Although the Diffusion parameter present on Lexicon (and many other) reverbs since early on gave one handle on this behavior, it seemed insufficient. The 480L introduces two new parameters, Shape and Spread, which sculpt the amplitude envelope of the early sound. Shape controls the contour of this early sound; as its value is increased, the initial attack becomes longer and secondary reflection areas appear (manifested as a slight sustain), until a point is passed where the contour is no longer realistic and begins to approach an "inverse" type of envelope. Spread determines the length of time that this whole operation takes. These two parameters interact strongly with each other, and the Size and Decay Optimization parameters. All of this sound takes place before the reverb decay parameters have any effect, i.e. the "early sound" precedes the reverberator. It would be difficult to overstate the importance of these parameters in the 480L's reverb programs. Many uses of the 480L's reverb require very low reverb decay settings (less than 1.2 seconds or so); the body of the work being performed in the early sound.

The remaining parameters in the reverb programs are familiar to Lexicon users: mid-frequency decay time, bass decay time multiplier, crossover size, high frequency cut (bandwidth), high frequency reverb rolloff frequency, diffusion, pre-echo levels and delays, and so forth.

The 480L offers banks of hall, room and plate reverb sounds, plus a bank called Wild Spaces that I classify as an effect. Between the first three banks there are 25 factory presets ranging from a very small room to a large

— CONTINUED ON PAGE 141

AKAI
ALLEN & HEATH
BIAMP
RAMSA
SHURE
SONY
SOUNDCRAFT
SOUNDTRACS
STUDIOMASTER
TASCAM
TOA



Soundcraft

Don't be 'MIXED UP'!

Full Compass Systems has several mixers and recorders to choose from:

170 PRODUCT LINES FOR THE PROFESSIONAL
Amplifiers • Cassettes • Headphones • Intercoms • Lighting • Mics • Mixers • Parts • Signal Processing • Speakers • Tape • Recorders • Test Equip. • Turntables • Video

TOLL FREE in 50 States
1-800-356-5844
In Wisconsin 1-800-362-5445
Consultation: 608-271-1100



6729 Seybold Rd. • Madison WI 53719-1393

by Mr. Bonzai

TOMMY TEDESCO

THE MAN WITH THE GOLDEN GUITAR

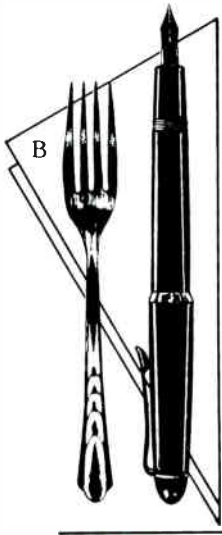

Tommy Tedesco is a hit man—the hired gun chosen by the aristocracy of recording. He is the Michaelangelo commissioned by popes and kings to decorate their musical castles. He's an old bebopper who can make a banjo sound like a shamisen.

He says he's been likened to an Italian dockworker and his speech has a streetwise offhandedness. But Tommy's articulation is in his music—he can speak almost any language: jazz, Italian, blues, Greek, rock, Congolese or classical.

Records: he's been the guitar for Elvis, Sinatra, Streisand, Ronstadt, the Beach Boys, Ray Charles, Nelson Riddle and Frank Zappa. Television: *M.A.S.H.*, *Happy Days*, *The Mickey Mouse Club*, *Ozzie & Harriet*, *Gilligan's Island*, *My Three Sons*, *The Munsters*, *The Gong Show* and *Charlie's Angels*. Movies: *Bonnie & Clyde*, *E.T.*, *Jaws*, *The Exorcist*, *King Kong*, *Mary Poppins*, *Butch Cassidy & The Sundance Kid*, *The Godfather*, *The French Connection* and *Magnum Force*.

The list of hit records, TV shows and films he's played on reads like the work of 12 men. We've all been immersed in this one man's music since the mid-'50s—and there's no sign of his letting up. He's the heavy-weight champ of guitar.

When I asked Toto's Steve Lukather why Tommy has done so well, he replied, "Because he can fit into any situation—even an intense reading session—and he can come up with great parts. He's also an unbelievable guy to hang out with—he's very funny. People like him. He's the grandfather of all studio players. He's helped out

just about everybody who ever did anything. I have the utmost admiration and respect for him as a musician."

I caught up with Tommy Tedesco just before he was about to leave for an evening at the Guitar Institute of Technology, where he is a tenured professor of music—in the real world.



Bonzai: You're about to head out to the Guitar Institute tonight?

Tedesco: Yes, I do a clinic once a month there. I'm the director of their studio guitar program.

Bonzai: What do you do with the Institute?

Tedesco: Well, I recreate session dates. Tonight I've invited a fellow musician, John Belzekian, who plays the oud. He's one of the masters in the country. And I have the cartage company bring along my instruments—about 50—so they can see what I go to work with. Too many people have a phony impression—they think it's one guitar. Tonight, the students will see my guitars, amplifiers, mandolins, banjos, bazoukis, balalaikas.

Bonzai: Is that a typical collection for a session date?

Tedesco: Every time I go to work I bring it all, unless it's absolutely specific, like "we need some solo work on a nylon string guitar" or "it's all mandolin." Ninety-nine percent of the time, everything goes, because you never know what will be called for.

Bonzai: Do you get paid more for playing different instruments?

Tedesco: I'm at the point in my career where it doesn't make much difference—I charge double scale anyway for pictures and record dates.

Bonzai: What was your last film date?

Tedesco: I was working on the Charlie Parker movie with Clint Eastwood the other day.

Bonzai: Was Clint there?

Tedesco: Yes, he's there for most of the dates. Here was a case where they were using a lot of old instruments, so I went to the trunk and got my 1947 electric Gibson. With all the instruments on hand, I have my choice and try to find the right sound.

Bonzai: Do the producers and directors and composers tell you exactly what they want, or do they expect you to come up with ideas?

Tedesco: Usually, if they choose me it is because they feel I am the right player for the session, and then it's my job to come with the right touch and the right ideas.

Bonzai: You play so many stringed

**"I didn't even
realize all the hits I
made. My work
stopped when I left
the studio. Now
I'm curious."**

instruments—how did you learn how to play them all?

Tedesco: I do it very Hollywood style. I tune 'em all like a guitar. If they want a truly authentic player, they'll hire that person. But generally, they run into problems, because they may not read, or aren't familiar with studio playing. They may be great players and sound tremendous at the Greek Theatre, but they may not be as adaptable as is needed. You've got to be able to do exactly what is called for.

Bonzai: You've even done Japanese scores.

Tedesco: I use a banjo and try to make it sound exactly like a shamisen. I've done many Japanese pictures with Japanese players. I accompany the koto with my banjo. I have a technique of playing with certain picks and I get the high sound that is needed.

I was working recently for Jerry Goldsmith and worked with a Japanese lady to get just the right sound. She plays the koto and is an expert in Japanese music. When I was done recording, she picked the track and said it sounded exactly like the shamisen. As soon as she said that, my job was done. If it was good enough for her, it was good enough for me. I believe that most people listen with their eyes and not their ears.

Bonzai: What about picking—what's your method?

Tedesco: I do what I call "economy picking," and wrote about it in my book, *For Guitar Players Only*. When you enter from one string to the next string, you always enter on a down stroke. It's worked for me. There's a

lot of guys who pick this way. I can also do alternative picking, but this way I can play runs twice as fast—I just use this method for runs. I use the style that fits the situation.

I've had people in front of me who study classical guitar and they play with their fingers and some can sound awful. I ask them why they don't use a pick and they say you're not supposed to. Why sound terrible?—get a pick. I make all my own rules—it doesn't mean a thing to me.

Bonzai: What are your favorite guitars?

Tedesco: In the studios I usually use a nylon string classical guitar, because I'm pinpointed that way. A local guy, Greg Brandt, made the one I use the most. I also have a Ramirez, and many other great guitars, but I prefer his. It was made for me, and it gets a bigger sound. It might not be as good on stage, but for recording—it has an even sound, and every time I've used it with the top engineers, they have loved to record it. It must be good enough.

Bonzai: You also have your strings designed for you?

Tedesco: I went out and tried a lot of strings from different manufacturers. There are a lot of good strings out there, but I was very happy with the strings made by GHS. I had them design a bunch of strings in my gauges, for different styles I play, like jazz and rock. You can walk into a guitar store and find a range of strings that work for you. If you like 'em, come back.

Bonzai: You've worked for so many of the great producers, going way back to people like Phil Spector. What makes a great producer—what personality, what input, what creativity?

Tedesco: Well, you see, I've always come from left field. I've never paid attention to producers. I've come from a weird background—Hal Blaine and I were so different when we were recording. We'd be on 3,000 dates together and I didn't know any of the people. I didn't know 'em before and I didn't know them during.

My whole thing was at the date. They'd call me as a guitar player and I would look at the booth and it was completely blank to me. The singers would be a blank. I would look at the music and do what I had to do.

It's kind of funny—now I look back

LUNCHING · WITH · BONZAI

tions. Doing my classes at the Guitar Institute has changed my life. I couldn't believe it when everyone knew who I was.

Bonzai: Can you recall any ridiculous sessions in your career?

Tedesco: I can remember some Phil Spector dates where Leon Russell would stand on the piano and start preaching.

Bonzai: Let's talk about Phil. What was special about those sessions?

Tedesco: Well, I went in there with the same attitude as I have now. I didn't know anything about him. I was just a guitar player. I remember the first date—after about an hour and a half we still hadn't taken a break. I finally said, "Hey, Phil, what's going on here. Don't you take breaks?" I was coming from a legitimate studio angle and he said, "In New York, Kenny Burrell never asks for breaks." I told him he was name droppin' the jazz guys. We had a big gag going. Later on that night, Phil and I went out for coffee and discussed what had gone on

during the session. We'd send gag telegrams to each other. We had a great rapport.

Bonzai: How does TV work differ from a film date?

Tedesco: A movie is the biggest. They aren't afraid to spend millions to get the music right, with a Mancini, or a Lalo Shifrin, or Johnny Williams. There are no budget problems. When you do TV, it's in and out. If there are mistakes on the music, they usually let it pass. The music is usually trite.

Bonzai: You go way back to the days of *Ozzie & Harriet*.

Tedesco: Yeah, Bob Bain, who's the guitar player for *The Tonight Show*; was doing *Ozzie & Harriet* and I started subbing for him back in '56, when Ricky was just a kid. And then later on, I ended up doing some work with him for his records. I did a lot of work in television, things like the theme for *M.A.S.H.*, *The Odd Couple*, *Green Acres*.

Bonzai: How about live TV?

Tedesco: I did a lot of it, but I never really liked it. It didn't pay well. Record dates and movie calls were what I

liked.

Bonzai: What about your role in *Fernwood Tonight*?

Tedesco: That was the exception to all the rules. That was the greatest show for me. I loved it. We got to play, Martin Mull is a gas, the people were great. It was a put-on of everyone you've known—people who were serious and talked that way, and actually acted that way.

Bonzai: Let's get some quick impressions of the people you've worked with. Elvis?

Tedesco: At the time, he was just Elvis Presley, the star. I wish I was the person I am now, because I was only concerned with my work. I did some pretty things that he loved. I think he was intimidated by me as a guitar player. A few times I was staring at him while he was recording and the next thing I knew, his people put up a blocker so we couldn't see him. When he was with his guys, he was always joking. But in the studio, he was very shy.

Bonzai: Frank Sinatra?

Tedesco: I worked on many of his

HOT TRACKS FROM ACES

SECA

24x32 inline
-40 mainframe
8 auxiliary
busses, 4 band
semi-parametric eq.,
built in 27
band spectrum
analyser, built
in 160 point
patchbay logic
switched routing
system,
P.&G. faders,
\$21,500.00
also available in
a 60 mainframe

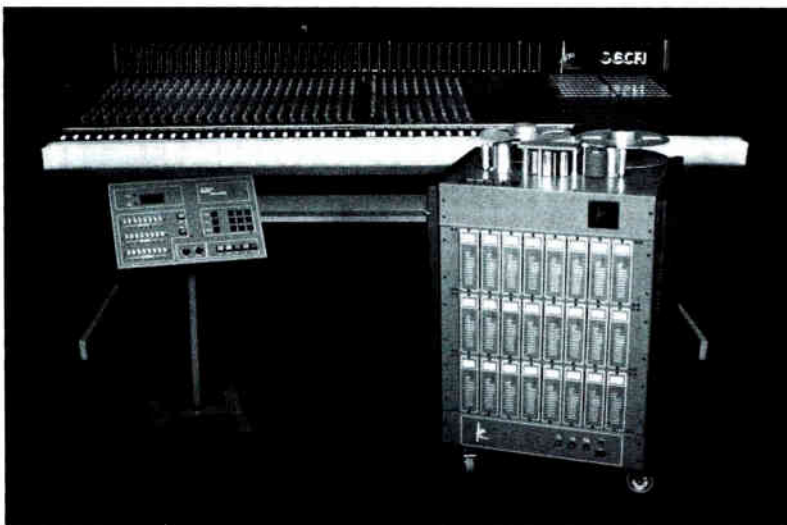

MT-24

24 Track -2"
recorder with
full function,
9 memory
autolocator
30 & 15 i.p.s.,
50% variable -
\$19,800

ACES equipment
available - 32 Track
recorders to 1/2 - 16
Track recorders. The
SECA series to the B
18 1/16 studio console, a
full line of power
amps, E.Q.'s, & P.A.
consoles.

All ACES professional equipment is covered by a 2yr. warranty.....Leasing available.

For more information on ACES complete line of professional recording equipment, contact the dealer nearest you:

aces
Sound
Professionals
MADE BY
ACES
OF ENGLAND

Power Studio Supply & Dist.
13453 Hollo Oval
Cleveland, Ohio 44136
216-238-9426

Rock Studio Supply
P.O. Box 5997
Norman, Okla. 73070
405-329-8431

Professional Audio & Video Systems
106 Ontario St.
Toronto, Ontario, Canada M5A-2V4
416-364-4848

Circle #087 on Reader Service Card

albums, and even got credit on a few. He was great to work for, because you were just in and out. You never made money with Sinatra though, because they could care less. If you asked for more money, you were usually refused. It was considered a privilege to work for Frank, and being an Italian kid from back East, I agreed with them.

Bonzai: Did you ever just hang out with Frank Sinatra?

Tedesco: None of us musicians hung out with Frank Sinatra.

Bonzai: Michael Jackson?

Tedesco: Same thing when I worked with him. Nothing. All this is because of me. I have lots of opportunities to chat, but I've never done it. People like Jan & Dean or the Beach Boys would come up to me during the sessions and I didn't really know who they were. Later on, I started coming out of my shell and realized there was a world out there beyond my guitar work.

Bonzai: Why did you stay so isolated?

Tedesco: I just grew up as a guitar player, not messing with anybody, not thinking of them or even that they knew I existed. It was just the music. The craziness that came later made up for the serious side of me in the early days.

Bonzai: Stevie Wonder?

Tedesco: Just worked for him.

Bonzai: Ray Charles?

Tedesco: Ray is tough to work for, but it's worth it. It was funny—the other day I was watching *The Cosby Show* and heard a tune that Ray made many years ago, "Green, Green," a Sesame Street number—had a lot of my guitar solos. All these years, I didn't realize what I had done. He called me recently and we did some things together, just the two of us. The reason he called was because of the work I did many years ago on "Green, Green." I heard the tune on *The Cosby Show* and it sounded pretty good. And I don't even have the record in my collection. I never bought a record for 20 years—now I'm trying to catch up.

Bonzai: Can you imagine playing music in another time?

Tedesco: Well, I'm a frustrated bebopper. I'm still a bebopper.

Bonzai: In olden times?

Tedesco: Well, I'm considered a warm and sensitive player—if they had it then, I would be playing it. I'm sure I would have made my living as a musician.

Bonzai: Is there some sort of master plan for your life?

Tedesco: I think so, but I wasn't aware of it. Everything has been by accident. I got started in this business because I went to a dance and met Ralph Marteri's band in 1953. I had stopped playing, but they auditioned me on the spot and suddenly I found myself on the road.

Bonzai: Any advice for young musicians interested in studio playing?

Tedesco: They have to be here, or someplace where there are sessions—like L.A., New York, Nashville. It's hard, because the odds are a million to one against you, but that didn't stop me. You have to be where the business is. Next step, people have to know you—you have to get out and play, and get a rep [reputation]. And never give up—as soon as you put the instrument in the corner, it's all over. I was ready to give up many times, and I didn't get started at a young age. Go to your own limit, and maybe something will happen. I'm almost 60 and I'm still playing and having a ball with the young, up-and-coming guys. If I'm still pluggin' away at this age, what's to stop you if you're 17?

Bonzai: You could put your feet up and take it easy now—why is it you're trying to develop a performance career?

Tedesco: Because I never did it before. And now I'm enjoying it.

Bonzai: You have a few albums out of your own—what's different on your work?

Tedesco: When I'm in charge, I do exactly what I want to do and choose exactly the material I like. If it fails, it's my fault. When I go to work for someone else, I'm liable to be asked to do anything—whatever they ask for, they get it if I have it in my bag of tricks. I have been making a good living, and I love playing guitar.

I recently started working every Wednesday night at The Blue Note Cafe, a jazz club, for \$40 a night. This

Attention Sony MXP-3000 Console Owners

Plug-in the
MPC-3000 Mic Preamp
and you'll notice
the superior
quality of sound.

- 990 discrete op-amp
- Jensen JE-16-B mic input transformer
- DC Servo Circuitry

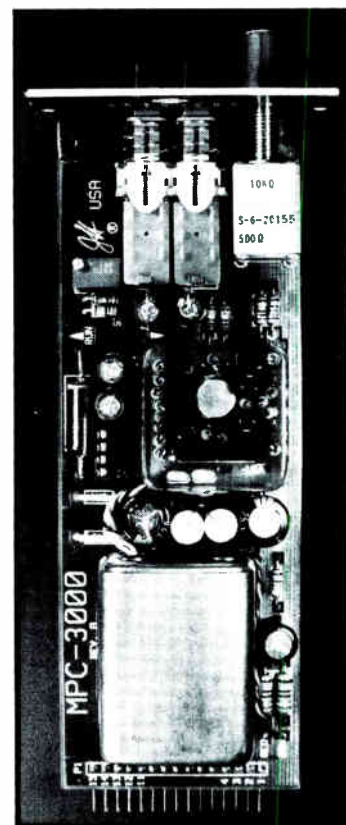

THE JOHN HARDY COMPANY

*The Manufacturers of
High-Quality Audio Equipment*

P.O. Box AA631
Evanston, IL 60204
(312) 864-8060

TELEX: 910-380-4670
(JOHN HARDY CO)

Circle #088 on Reader Service Card

ONE FOR ALL,

PERFORMING

"When I started my first band, more years ago than I care to remember – Crown was then, as it is now, definitely the amp to have. But at that time I felt beginning with Crown power was a little like taking Driver's Ed. in a Ferrari.

"As things started picking-up, we found ourselves loading in and out of a different club every weekend. It was becoming clear our equipment wasn't quite as ambitious and durable as we were. We learned quite an expensive lesson by not having Crown from the beginning."

With the advent of the **Power-Base™ Series**, today even the entry level musician can afford to have the legendary performance and reliability of the Crown product.

Al Evarts,
The Duke Tomatoe Band
Indianapolis, Indiana

Crown's ability to provide light weight power and dependability at a price that is both surprising and affordable is the essence of the **Power-Base Series**.

"The Power-Base Series starts at \$769.00 – I paid more for my first Crown amp in 1969 and it was used.

"Seems like Crown is out to make payin' your dues alot easier."



TOURING

"An amplifier must display two virtues for any given tour – it must have excellent sonic quality and it must be indestructible.

"For all of our tours we choose Crown."

The introduction of the **Macro Tech™ Series** brings a new dimension of Crown engineering to the tour – the natural progression of advancing technologies has brought about a new series of astounding amplifiers. Expanding on the incredible success of **Micro Tech®**, Crown now brings you **Macro Tech**, a series built on the premise that to succeed in any business one must never rest on one's laurels.

Developed in the usual way, by testing thoroughly before it is ever brought to the market, the new **Macro Tech** is every bit – Crown.

"Showco has depended on Crown for years – a company you stake your reputation on must be a company you can rely on. In short – if the amp doesn't work neither do we.

"Test out a new **Macro Tech** – it's a tremendous performance."



Craig Schertz,
Showco
Dallas, Texas



CROWN® INTERNATIONAL, INC.

ALL FOR ONE.

RECORDING

"It's a very simple matter really — I have never used another product I like better when it comes to powering a studio. True reproduction is the main intent here at Westlake. Though we have tried other products we have always returned to Crown and the PSA-2."

The Crown **PSA-2** has been an industry standard since its introduction. Professionals like Joe Gorfinkle rely on Crown to produce the results they expect, no compromise — no short-cuts.

Years of continuing research and development means Crown is always one step ahead of the competition. It's the reason someone of Joe's caliber chooses Crown, and will always choose Crown.

"Beyond the sonic quality is Crown dependability, they just never need attention. I'm not only very comfortable in using the Crown product, but also in recommending it."



Joe Gorfinkle,
Westlake Audio
Los Angeles, California

CONTRACTING

"We have enjoyed an extremely good relationship with the people of Crown for many years. We especially value Crown's desire to work with us in developing specific products for specific needs."

Per Haugen has been a leader in the sound contracting business for over 30 years. Heading a company that has installed literally thousands of church and other sound systems Per knows the importance of having quality products such as the **PS-200/400** Amplifiers.

"Crown's traditional qualities of performance and reliability are very well suited for my business.

"The PS Series Amplifier provides quality sound for years and years and requires very little maintenance, that translates directly to the sound contractor being able to provide more service for the dollar."

At Crown the feeling is, personal contact guarantees the success of the product line. Untold hours are spent consulting professionals like Per to insure each product satisfies the exacting requirements of those who utilize them. Crown will always value open communications with pros in the field and will always be committed in bringing products to the market that make sense.



Per Haugen,
General
Communications
Salt Lake City,
Utah

1718 W. MISHAWAKA ROAD, ELKHART, INDIANA 46517

Circle #109 on Reader Service Card

by Mark Herman

SOUND REINFORCEMENT NEWS



A Meyer sound system blasts SF during U2's free concert there. Below: lead singer Bono at the show.

This year probably won't see any radical changes in the sound reinforcement industry. Still, certain trends do seem to be appearing in my crystal ball. My three predictions for 1988 are: (1) A general trend for more tours seems to be in order. The '60s rock music fans who made this sound business possible years ago have now entered the economic mainstream and represent a good chunk of potential money (read profit) that should attract promoters and agents. But remember, this business seems to run in two year cycles and we have just had two good years; (2) Continued growth of speaker and amplifier sales due to a general trend towards upgrading and doubling of speaker systems; and (3) A healthy upsurge of interest in house and monitor consoles; upgrades would seem to be the next logical step after speaker and amplifier improvements in the developing trend for high quality professional PA systems. Now, on to the news . . .

Things seem to be on an even keel at **Showco** this new year. Their three Prism

systems have been out with **Aerosmith**, **James Taylor** and **Eric Clapton**. Additional accounts **REM**, **Willie Nelson** and

Kiss continue to keep Showco's other touring rigs active . . . When I asked **Wil Sharpe** if any of his tours posed any special problems he replied, "An interesting one is the **Barbara Mandrell** tour, which one day plays in an arena, and the next day plays a corporate program in a ballroom. With everything changing, our crew has to be ultraflexible. Also, we are general contracting everything for the entire tour—sound, lights, staging, trucking, busing, the backline crew, etc." Showco's latest act is the Australian band **Pseudo Echo**. "They have a five week tour with us that started in mid November," Sharpe said. "I think people will like them."

That leading edge sound company, **Ultra Sound** just announced that they have pur



PHOTOS: RON DELANEY

chased a new Gamble Series EX 56 channel house mixing system from Jim Gamble Associates. The new top line 56x16x2x1 + 16x16 matrix house console will be used extensively on upcoming **Grateful Dead** tours. . . . Downtown San Francisco was host

to an impromptu concert by **U2** on November 11th. Twenty thousand people packed SF's financial district after local radio stations announced U2's appearance just two hours before the surprise noontime event. Ultra Sound barely had 48 hours' notice to

assemble their Meyer Gamble Crest PA, transport it and stage the event.

Movie star and singer **Pia Zadora** took out the new **A-1 Audio** PA system for a six week tour across America (see "On The Road"). The system was comprised of Meyer

ON THE ROAD

SOUND COMPANIES, EQUIPMENT, ARTISTS & PERSONNEL ON TOUR

Artist Sound Company Tour Dates & Region	House Console #1 House Console #2 Monitor Console #1 Monitor Console #2 Crossovers	Main Speakers Other Speakers Subwoofers Monitor Speakers	Main Amplifiers Other Amplifiers Sub Amplifiers Monitor Amplifiers	Engineers: (B) band (H) house (M) monitor
Elvis Costello & the Confederates Audio Support Nov-USA	TAC Scorpion 32x8x2 ---- TAC Scorpion 40x12 ---- Meyer	16 Meyer MSL3 ---- 8 Meyer 650R2 Audio Support 2x12	Crest 4000 ---- Crest 4000 Crest 3000	Chris Beale (H) S. Flewin (M) John Doerschuk Henry Cohen
Michael Jackson Clair Brothers Sept-Dec Japan & Australia	Clair Custom 32x12x2 Clair Custom 32x12x2 Harrison SM-5 32x16 ---- Clair Custom	100 Clair S-4 ---- ---- Clair Custom	Carver 2.0 ---- ---- SAE 2600	Kevin Elson (B, H) Rick Coberly (M) Gene Clair, Tam Ford Forrest Green, Nyle Wood, Walf Mensching
Little Steven & the Disciples of Soul Andrews Audio Tours Nov-Dec Europe	Yamaha PM3000 40x8x2 ---- Wheatstone M16 40x16 ---- Meyer	16 Meyer MSL3 ---- 8 Meyer 650R2 Meyer UMI, UPA USW, MSL3	Crown MA1200 ---- Crown MA1200 Crown MA1200, MT1200	Mike Sinclair (H) N/A (M) Tommy Varaday
REM Showco Sept-Nov N. America	Soundcraft Series 4 40x16x2 ---- Harrison SM-5 32x16 ---- Showco	32 AX 8 SS front fill 4 AX Sub Showco 100, 200 300, 400	Crown PSA2, MT1200 Crown Crown Crown MT1200	Bruce Jones (B, H) Chris Lantz (M) Chris Iacuone Phil Christensen
Rush Audio Analysts Oct. 25-Jun '88 N. America	Gamble HC 40x16x2 Yamaha PM3000 40x8x2 Gamble SC 32x16 ---- JBL 5234	18 AA Arena 24 AA S3 (Quad) 8 AA SW AA 2x15, AA SF	PhaseLinear 700 QSC 3800 QSC 3800 QSC 3800	Jon Ericson (H) Steve Byron (M) Dan Shrelver Michael Caron Paul Parker
Suzanne Vega Sun Sound Audio June-Aug, Oct N. America	Yamaha PM3000 40x8x2 ---- TAC Scorpion 40x12 ---- Brooke-Siren 360	16 EAW KF850 ---- 8 EAW SBKF850 Sun Sound 2115	Crest 8001 ---- Crest 8001 Carver 1.5	Robin Danar (B, H) John Gallagher (M) Fred Mueller Mark Frink
Whitesnake Tasco Nov-Dec USA Dec-Jan Europe	Midas Pro5 40x8x2 Split Midas Pro5 32x8x2 Midas Pro5 30x10 ---- SG Engineering	26 stacks (78) Harwell ---- ---- Tasco Wedges 2x12, 2x15	BGW, Crown ---- ---- Crown MT1200	Jim Rivers (H) Ken Parkin (M) Mike Sprague Steve Brooks
Pia Zadora A-1 Audio Nov-Dec USA	Yamaha PM3000 40x8x2 Yamaha 2404 24 ch. Soundcraft 800 C 40x12 ---- Meyer	24 Meyer MSL3 ---- 6 Meyer 650R2, 6 USW Meyer UM1, UPA	Crest 4000, 4001 ---- Crest 4000, 4001 Crest 4000, 4001	Peter Savel (H) Lee Rickmers (M) Jim Stark

SOUND · ON · STAGE

cabinets, Yamaha and Soundcraft consoles and Crest amplifiers. According to the crew, this is a first-rate act with Pia flying in her jet, and the band and crew in a decked-out 727 . . . **Andy Williams** was also out for a brief holiday season tour and appeared back-to-back with Pia on some shows . . . A-1 Audio also reports they have been doing a good business selling Yamaha's PM3000 console, with hotels the main customers.

Crossroads Audio of Dallas has been around the live audio scene since 1972, primarily doing touring rock acts in the early years. Now they concentrate their expertise on commercial and industrial accounts. According to **Doug Hall**, "We mostly do one-

offs [national one-nighters] and lots of convention trade show industrial theater. For instance we have done the National Association of Broadcasters Convention, Frito-Lay, the National Association of Home Builders, Dr. Pepper and a lot of others. Generally the one-nighters are part of some convention." Some of the company's recent national one-nighters were **Run-DMC** at Fort Bliss in El Paso, **Hiroshima** at the Arcadia Theater in Dallas, **Paul Williams** at the Marriott Hotel, and the **Four Tops** at the Fairmont Hotel. . . . Crossroads also provided sound for a fundraiser for presidential hopeful **George Bush** at a private club in Dallas. . . . Asked about Crossroad's PA Doug Hall explained, "Basically we have one system that varies in size. It can be broken down into two separ-

ate systems if needed. It is a proprietary 3-way flying one-box system with additional subwoofers. There are 48 main cabinets and 12 subwoofers powered by QSC MX 1500s. The monitor console is a Midas Pro4 24x8 and the house a 40-channel Yamaha PM3000. We also have a set of 32-channel Soundtrac consoles."

Motley Crue is back out on tour with **Tasco** again after a brief break. They are carrying 36 stacks of horn-loaded Harwell cabinets. A short November leg in the U.S. preceded the European leg with **Tasco UK** supplying sound reinforcement there . . . **Whitesnake** is on a world tour (see "On The Road") using 26 stacks of Harwell PA and two Midas Pro5 house consoles totaling 72 input channels. One house console is a custom split 40-channel Midas with the left section containing masters and 15 channels, and the right section 25 channels. The other is a standard 32-input board. A 30x10 Midas console is used for monitors. Whitesnake is performing in Europe in January before coming back to America.

A new sound company, **Tennessee Concert Sound**, a division of Music Business Inc. of Brownsville, Tennessee, purchased a sound system from Nashville-based **A Little More Sound**. Designed to provide audio for crowds of up to 8,000, the main system is composed of 16 3-way Bill Little-designed custom cabinets. Monitors are EAW FM155 wedges augmented with custom sidefills. Power is provided by Crest 3501 and 2500, QSC 1400 and 1700, and Carver 1.5 amplifiers. The house console is a 40-channel Yamaha PM3000 and the monitor console a Soundcraft 32 x 10 400B. Also utilized are Brooke-Siren 340 crossovers, Klark Teknik equalizers, and a varied assortment of effects. . . . Engineering for Tennessee Concert Sound is **Bernie Bernil**, who recently worked on the Genesis tour, owner **Stewart Tritt** and PA manager **Dave White-lock**.

Matrix Sound of Daly City, CA, is another sound company that has shifted its emphasis from rock acts to industrial and commercial accounts. Owner **Joe Bajza** states, "We do a lot of local corporate shows which involve anything from vocal reinforcement for meetings to nationally known acts that perform at conventions. We also handle lighting and full production. Our inventory includes 50 Harbinger enclosures, and 50 flyable cabinets of our own design which are basically 3- and 4-way JBL component systems. Our proprietary cabinets are used exclusively for commercial accounts in hotels and convention centers." The monitor system is composed of Har-

—CONTINUED ON PAGE 160

McCAULEY

. . . Pure Performance



The quality of McCauley loudspeaker systems goes far beyond cabinetry and exterior decor. Inside every McCauley system is what our company is all about, the driving force behind every system—its components. Not just a collection of pieces and parts that you find in so many other companies' boxes, but a precisely matched set of transducers that have been designed, engineered, and manufactured at McCauley and by



McCauley to deliver a signature of pure professional performance to the term "State of the Art."

To experience the sheer power of a McCauley speaker system is reward enough for some; but to lay your claim puts you in a world of "Pure Performance." Tame the Series 800 system at an authorized McCauley dealer. Call or write the factory for detailed product specifications.



McCauley Sound, Inc.

13608 94th Ave. E., Puyallup, Washington, USA 98373 (206) 848-0363

Circle #138 on Reader Service Card

PAUL YOUNG DOESN'T ENDORSE BEYER MICS.



Paul Young shown using the Beyer MCE 81 Tourgroup Series mic.

HE USES THEM.

Paul Young's singing achieves a rare blend of classic soulfulness and modern energy. Matched to an explosive and unusually mobile stage presence, this exciting combination has won the hearts of fans and critics all over the world.

Young's passion for excellence on stage places unusual demands on his microphone. That's why he depends on Beyer Tourgroup Series mics. Their unmatched accuracy and transparent natural sound bring out the subtle nuances that form the distinctive character of his sound like no other mics could. And their solid, road-proof construction withstands any kind of punishment.

If performance means more to you than "endorsements," as it does to Paul, choose Beyer.

beyerdynamic U.S., 5-05 Burns Avenue, Hicksville, New York 11801 Tel: (516) 935-8000

TourGroup

beyerdynamic 

*Canada: ELNOVA Ltd. 4190 Rue Sere, St. Laurent, Quebec H4T 1A6
Tel. (514) 3 41 69 33 Telex 5824086*

*Great Britain: beyerdynamic, Ltd., Unit 14, Cliffe Industrial Estate
Leaves, Sussex BN86JL Tel. 273 479 411*

*Australia: Hi-Phon Distributors Pty, Ltd. 356 A-358 Eastern Valley Way
Chatswood N.S.W. 2067 Tel. (02) 417 7088*

*Germany: Eugen Beyer Elektrotechnische Fabrik GmbH & Co., Theresienstrasse 8,
Postfach 13 20, D-7100 Heilbronn Tel: (07131) 617-0 Telex: 728771*

WE DON'T HAVE TO PRAISE THE D-50

“ **Dan Goldstein**, International Associate Editor, *Music Technology*: The D-50 was the single most exciting instrument at the 1987 Winter NAMM show. It's something that's genuinely new and that's why it will have an impact. For players on stage, it has more power sonically than any comparable digital synthesizer. The sound has got the sort of punch that will take it through a mix in a way that's not possible with most digital synths. Studio players will like the D-50 for its versatility. And I think hard-core synthesizer programmers will be attracted by the breadth of its sound structure.

Dominic Milano, Editor, *Keyboard*: The D-50 has a wonderful sound. At its price point, it should appeal to just about everybody. The D-50's approach to synthesis—which lets you take PCM samples and combine them with digitally synthesized portions—makes more sense than just about anything I've seen

in the last couple of years. It takes the best aspects of what MIDI allows you to do with layering sounds from different instruments and puts it all together in one machine. It's intelligent and very powerful, and I think it will have a musical impact that will show up in what people hear on record.

David Pratt, Associate Editor, *Upbeat*: I think the D-50 sounds very good. It's very user friendly—it's not intimidating. Musicians are always looking for new sounds, they're always searching for something different—sounds they haven't heard before. I think they'll definitely be looking at the D-50.

Bob O'Donnell, Associate Editor, *Music Technology*: I think the D-50 is an incredible value for the price—you've got real high quality sound and all the signal processing built in. I think the fact that digital signal processing is incorporated into it is going to be the start of a very interesting trend in which all the elements for creating a complete sound will be contained in a single instrument.



PAUL YOUNG DOESN'T ENDORSE BEYER MICS.



Paul Young shown using the Beyer MCE 81 Tourgroup Series mic.

HE USES THEM.

Paul Young's singing achieves a rare blend of classic soulfulness and modern energy. Matched to an explosive and unusually mobile stage presence, this exciting combination has won the hearts of fans and critics all over the world.

Young's passion for excellence on stage places unusual demands on his microphone. That's why he depends on Beyer Tourgroup Series mics. Their unmatched accuracy and transparent natural sound bring out the subtle nuances that form the distinctive character of his sound like no other mics could. And their solid, road-proof construction withstands any kind of punishment.

If performance means more to you than "endorsements," as it does to Paul, choose Beyer.

beyerdynamic U.S., 5-05 Burns Avenue, Hicksville, New York 11801 Tel: (516) 935-8000

TourGroup

beyerdynamic))))

*Canada: ELNOVA Ltd. 4190 Rue Sere, St. Laurent, Quebec H4T 1A6
Tel. (514) 3 41 69 33 Telex 5824086*

*Great Britain: beyerdynamic, Ltd., Unit 14, Cliffe Industrial Estate
Lewes, Sussex BN86JL Tel. 273 479 411*

*Australia: Hi-Phon Distributors Pty, Ltd. 356 A-358 Eastern Valley Way
Chatswood N.S.W. 2067 Tel. (02) 417 7088*

*Germany: Eugen Beyer Elektrotechnische Fabrik GmbH & Co., Theresienstrasse 8,
Postfach 13 20, D-7100 Heilbronn Tel: (07131) 617-0 Telex: 728771*

by Elliot Luber

ON TOUR WITH PINK FLOYD

The current Pink Floyd tour may very well live up to its name: "A Momentary Lapse Of Reason." For only a madman, or perhaps P.T. Barnum, would have the guts to take this complex a multimedia production around the world in a fleet of semis.

A century after Barnum's Greatest Show On Earth first hit the road, Pink Floyd concerts seem hauntingly familiar in organization and scope, if not content. The elephants are hardly replaced by a giant blow-up pig (which really blows up at outdoor shows), but

Maryland Sound Industry's quadraphonic production of the band has got the old calliope beat.

Some critics have apparently missed the boat. Wrote one New York reviewer, "Pink Floyd is best listened to through headphones in a darkened room." Reviewing the Montreal Show, *Rolling Stone* called the production "the obligatory Pink Floyd Sensaround." But if audiences pay more to see spectacle, as Barnum long espoused, the tour provides enough fog for London, enough candle power to





Listen to it ...not to us!

Really, there's nothing we can say about our JF-500 that will induce you to buy it except this: try it. Because the evidence provided by your own two ears will be, as it should be, far more convincing than anything you'll read here.

True, we invented the horn-loaded single-box reinforcement system over a decade ago. True,

we continually refined it to stay well ahead of our imitators. And, true, our single-box system is still the qualitative standard of the industry.

But, enough words. You can buy anybody's single-box reinforcement system you choose. We're utterly confident you'll choose the one that sounds best to you. Our JF-500.



Eastern Acoustic Works, Inc., 59 Fountain Street, Framingham, MA 01701 • (617) 620-1478

Circle #014 on Reader Service Card

practically melt the stage, more lasers than the strategic defense initiative, a movie, a flying hospital bed that crashes in a ball of flame—you can literally feel the heat on your face—spacecraft-like light droids, Telescan pods hovering about the stage, and a giant disco ball that opens like a flower to reveal dazzling strobes.

To come together in a production these effects require sophisticated technologies and synchronization techniques more akin to Hollywood than the road. Production director Bobby Williams of Britannia Row Productions can tell you: it's an exhaustive exercise in logistics, engineering and intestinal fortitude. But he won't, of course. He'll just say: "It's a bit of fun."

Above all, the tour remains true to Floyd's *Dark Side Of The Moon* concept, whereby the whole is larger than the sum of its individual songs. Floyd has always strived to be larger than its individual members—its concerts larger than a musical performance. When the group came out with *The Wall* album, it was forced to make a film in order to successfully bring its full presentation to the masses. There were only two live show dates in the United States—at which a brick wall was actually constructed and, later in the evening, demolished.

In 1987, the group realized it had to go one better, or admit to the charges it was past its prime, that departed leader Roger Waters had taken its creative spark with him. And so, the stage was set, as it were, for the current one-year, approximately 150-show, three-continent tour.

"When you're working with Pink Floyd, the whole idea is that you don't necessarily focus on the individual band members," Williams says, "so you really have to create something that seems to take over the whole arena or stadium. And we use the quad sound system to do that, and then we go on to create the largest thing at the far end of the stadium for people to look at."

Design work began in March with set designer Paul Staples and Hollywood lighting designer Mark Brickman. "We spent a lot of time in both London and Los Angeles," says Williams. "We realized that we wanted to get away from the normal look of a show, which is basically to have 10



DYNAMIC RANGE of products – huge in-store inventory
SWEET savings with consistently low prices
WARM, knowledgeable sales people
RESPONSIVE 24-hour delivery available
AWARD-WINNING service center
SENSITIVE to your needs: mail order layaways available

SOUND GOOD TO YOU?

THOROUGHBRED MUSIC

2204 E. Hillsborough Avenue, Tampa, Florida 33610 (813) 237-5597

FREE U.P.S. DELIVERY IN THE CONTINENTAL U.S.!



Circle #089 on Reader Service Card

Noise Gates Should be Seen & Not Heard

With its unique application of optical switches (rather than the noisier VCA's used conventionally) the Omni Craft offers **very low noise & high performance** – at an affordable price.

Just \$395.00 buys you four noise gates in an AC powered/rack-mounting package, with facilities to "key" the gates from external triggers as well as adjustable Range, Threshold and Release Time.

Also available are plug-ins for most popular rack systems. Studio performance for the budget-conscious! Call us for literature & information.

Omni Craft - - - the quiet one!

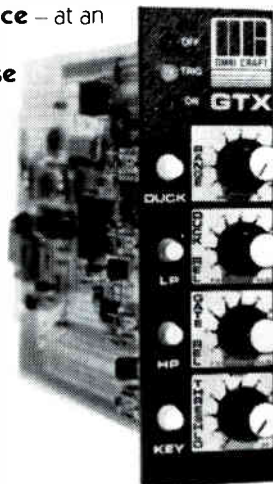

CALL 1-800 CT AUDIO

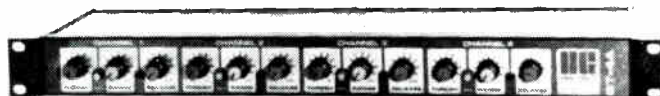

SEE US AT NAMM BOOTH #1007

In Florida Call (305) 738-0622
CT Audio Marketing Inc., 3050 S.W. 14 Place, #3
Boynton Beach, FL 33426

Circle #090 on Reader Service Card

million par cans hanging 30 feet above the stage.

"The idea of the pods [like many of the tour's concepts and even elements] came up out of the system we used to use in previous tours. We used to have two large cherry picker trucks behind the stage, enabling us to move around the stage and go to a very high trim height. We've achieved that in about every hall we've worked so far."

Lighting

The next step in the design phase was to bring in a lighting company to see what Brickman had to work with. Williams called in four.

"We went to Samuelson's for the basic grids and a few bits of base lighting, Varilite of Dallas for the Varilites, Cameleon of Paris for the Telescans and Laser Media for the lasers. For film projection, we went to Long Island's Associates & Farren," he says. For explosives, another traditional Floyd element, they went to LunaTech.

"On August 1st we took over a hangar in Toronto for six weeks and started assembling the various components. The actual stage, for example, was built

by FM Productions in San Francisco. The lighting pod mechanisms and all of the mechanics that go with it were built in England by Kempt Engineering—it's an endless list. Basically, we spent six weeks honing the thing, changing aspects, giving Mark Brickman a chance to see exactly what components we had there to work with, and developing the look you saw tonight."

Adds Brickman: "We basically put together a system to enhance the music's attitudes and one which is in keeping with the Pink Floyd concept, which is a totally audio/visual presentation, where the band is but one element of that show. Everything complements the other elements; there is a mixture, you don't just see one personality."

"It took a few incarnations first, of course," Williams notes. "It all comes together finally and you have a great show worked out, and then you look at it again and realize 'My God! We've got to tour with all this!' And you proceed to tear parts of it down and rebuild the entire set so that it is to some extent of the imagination transporta-

ble. It takes hours and lots of thought."

Brickman continues, "We ended up with four Droids [light robots that come up from under the stage on risers] from Color Ray technology with some help from Laser Media Technology. I came up with the idea of life-like light figures with the Color Rays in them, and they customized the software for us. We also have two tracking-pods [Varilite clusters that raise and lower on winches and travel around the stage from a suspended track]. In all we have 85 Varilites, 24 Telescans, and two full-power, full-color lasers, which really means four lasers, which all must be water-cooled. The foot of the stage has 280 PAR-46 periaxialoids in panels that spin around with three faces. One face is mirrored, one is black and one has the lights."

He says the Varilites surround the circular movie screen above center stage, and others are on the tracking pods which at one point in the show come down to either side of guitarist David Gilmour during his "Comfortably Numb" guitar solo.

Besides Brickman, the lighting crew includes Christof Ducret from Camel-

HEARD ANY GOOD ONES LATELY ?

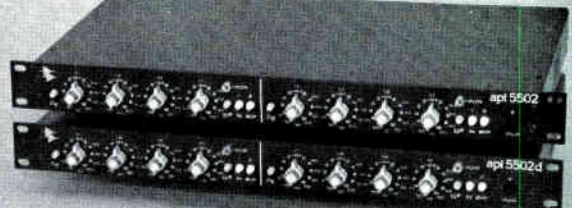

NEW PRODUCTS:

- 3124 Mic pre/direct box
- 3124m Mic pre/direct box/mixer
- 5502 Dual equalizer
- 5502d Disc & CD mastering eq

(all discrete OP-AMPS)

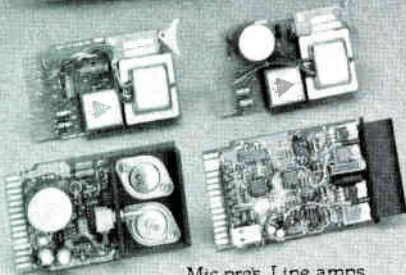

Mic pres. Line amps.
Power amps & Distribution amps



The famous 550a
(all discrete)

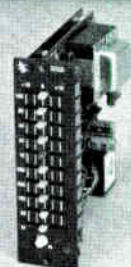

560b 10 band eq
(with 2520)

api audio products, inc.

7951 Twist Lane, Springfield, VA 22153
(703) 455-8188 tlx: 510-600-1898

ea Everything Audio
2721 U. Burbank Blvd., Burbank, CA 91505 818-862-4175

studio consultants, inc.
321 West 44th Street, New York, NY 10036 (212) 586-7376



L to R: Nick Mason, David Gilmour and Rick Wright.

eon to operate the Telescans, Joe Polansky of Varilite to operate the Varilites, Mark Grega to operate the droids, Adain Bradley to control the pods, laser operator Scott Cunningham and "Hammer," from the U.S. firm LunaTech, to handle the pyrotechnics.

Film

According to Williams, much of the film used on the tour was originally shot and used for previous tours. "Everything in the first half (of the three-hour concert) is new production because the music is new. Film stuff is always the last minute it seems. I think we got the final set of prints about a week ago [three weeks into the tour]. We had re-edits, and new bits were coming in almost right up to the show tonight," he adds, laughing.

MSI film projectionist Steve "Ziggy" Bartlett, a veteran audio engineer, formerly with Tasco, explains the synchronization: "This particular system is pretty much state-of-the-art. The projector is a 35mm with a 7,500 watt lamphead built by Associates & Farren.

The device is controlled by an IBM PC computer using Associates & Farren's proprietary control software. The PC receives SMPTE time code from the Otari 8-track recorder by the audio console. On the 8-track there are four audio tracks [effects only, all music is provided live by Pink Floyd] and four control tracks."

Sync

Assistant house engineer Jim Geddes says the tour originally used an Audio Kinetics Pacer synchronizer in the equipment racks, but that the tricky nature of sprocketed film sync caused some frame lags. "We got the PC and it all seems to be working much better now," he says.

One control track feeds SMPTE time code directly to the computer, which knows what frame it's at and what frame it's supposed to be at. The lock is accurate to half a frame at 24 frames per second, or accurate to about 1/50 of a second.

"The beauty of the system," projectionist Bartlett says, "is that you can

program in a start cue for the motor, program in the shutter opening, and an open pass, close pass, stop, park, search for the next frame, wait for the next instruction. I can change all of the cues to make it do whatever I want."

The remaining tracks, he explains, contain the audio effects with audible instructions and countoffs recorded by Gilmour. For example, Gilmour's stage mix includes a countdown for the guitar part to enter in sync with the rest of the production. Similar audio counts feed the lighting director and special effects technicians: "Release the pig: four, three, two, one. . . ."

"It all fits together," says Bartlett. "For example, in the beginning of 'Welcome To The Machine,' the creature crawls up on the film from the background, and just as David Gilmour begins his guitar part there is a flash of light across the screen. It comes across as a natural coincidence to the audience. It's not, believe me."

Audio

Steve Guest, the Maryland Sound In-

Today's tougher audio requirements demand a new choice

Telex *Pro Series* 6120 —XLP

A new duplicator with 8X speed and tougher specs.

Improved frequency response plus less distortion and crosstalk are just a few of the technical gains achieved in the new Telex Pro Series duplicator. This means that you'll make duplicates that are **truer to the master** than with any comparable tape duplicator on the market today.

Yes, here's a system with all the advantages of the famous 6120 high speed duplicator plus enhanced specifications. Features that made the 6120 popular such as compact size, unlimited expandability, track select, audio

level monitors and easy one-button operation remain distinct Telex advantages. But, by developing the 6120XLP with 8X speed, Telex gives you the advantage of improvements in many **important professional specifications** such as distortion, frequency response, speed accuracy and crosstalk. And, the new cassette transport speed allows you to duplicate directly from 15 ips open reel masters for the ultimate in quality and convenience.

The Pro Series 6120 uses a newly developed, highly effi-

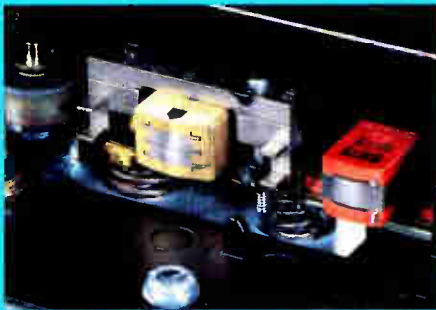

New XL LIFE cassette head.

cient **XL LIFE™** cassette head featuring ultra-hard physical characteristics for **extra long life (10X normal)** plus a satin smooth surface that resists excessive oxide build-up preventing the need for frequent maintenance. Its advanced engineering, precision design and painstaking manufacturing techniques contribute immensely to the Pro Series improved specs including an **unmatched frequency range** of 50 to 13KHz. For further technical details and the name of your nearest 6120 dealer, call or write Telex Commu-

nica-tions, Inc., 9600 Aldrich Ave. So., Minneapolis, MN 55420.

Up to 12 months to pay with no interest!

The entire Telex 6120 duplicator series is available with special **NO INTEREST** financing through participating Telex dealers. Yes, with only 10% down and up to 12 months to pay, you could be eligible for special **NO INTEREST** financing. Think of it! You could pay for your 6120 out of the savings or income generated.



TELEX®

Call Toll Free in U.S. 800-828-6107 • In Minnesota Call (612) 887-5531

Circle #015 on Reader Service Card

WE DON'T HAVE TO PRAISE THE D-50

“**Dan Goldstein**, International Associate Editor, *Music Technology*: The D-50 was the single most exciting instrument at the 1987 Winter NAMM show. It's something that's genuinely new and that's why it will have an impact. For players on stage, it has more power sonically than any comparable digital synthesizer. The sound has got the sort of punch that will take it through a mix in a way that's not possible with most digital synths. Studio players will like the D-50 for its versatility. And I think hard-core synthesizer programmers will be attracted by the breadth of its sound structure.

Dominic Milano, Editor, *Keyboard*: The D-50 has a wonderful sound. At its price point, it should appeal to just about everybody. The D-50's approach to synthesis—which lets you take PCM samples and combine them with digitally synthesized portions—makes more sense than just about anything I've seen

in the last couple of years. It takes the best aspects of what MIDI allows you to do with layering sounds from different instruments and puts it all together in one machine. It's intelligent and very powerful, and I think it will have a musical impact that will show up in what people hear on record.

David Pratt, Associate Editor, *Upbeat*: I think the D-50 sounds very good. It's very user friendly—it's not intimidating. Musicians are always looking for new sounds, they're always searching for something different—sounds they haven't heard before. I think they'll definitely be looking at the D-50.

Bob O'Donnell, Associate Editor, *Music Technology*: I think the D-50 is an incredible value for the price—you've got real high quality sound and all the signal processing built in. I think the fact that digital signal processing is incorporated into it is going to be the start of a very interesting trend in which all the elements for creating a complete sound will be contained in a single instrument.



THE EXPERTS ARE DOING IT FOR US.

Ted Greenwald, Assistant Editor, *Keyboard* (NAMM Winter Market Wrap-Up): The Indefatigable Roland led the way with the D-50 Digital Synthesizer, the obvious highlight of their prolific new offerings and possibly of the entire show.

Bill Lewis, Senior Editor, *Music, Computers & Software*: Roland has managed to meld the complexities of computer controlled synthesis with an ease of programming. This, along with the combination of sampled with synthesized waveforms points the way to the future of sound creation.

Jock Baird, Editor, *Musician*: Five months after its Anaheim introduction, the D-50 has no challengers as 'Best New Synth of the Year.' What's also interesting is that with programs like its Developer's Workshop, Roland is trying to jump-start the same support web of sound and computer-editor programmers that took a couple of years to grow up around other synthesizers.

Craig Anderton, Editor, *Electronic Musician*: As Editor of *Electronic Musician* magazine it's easy to gauge a product's impact by the degree of reader interest. Based on what I've been hearing, Roland has a real hit on their hands with the D-50.

Simon Trask, *Music Technology*: Whichever way you look at it, the D-50 is one hell of a good instrument and one that has already booked itself a place in the synthesizer's hall of fame.



WE COULDN'T HAVE SAID IT BETTER IF WE'D SAID IT OURSELVES

Circle #016 on Reader Service Card

Roland
WE DESIGN THE FUTURE

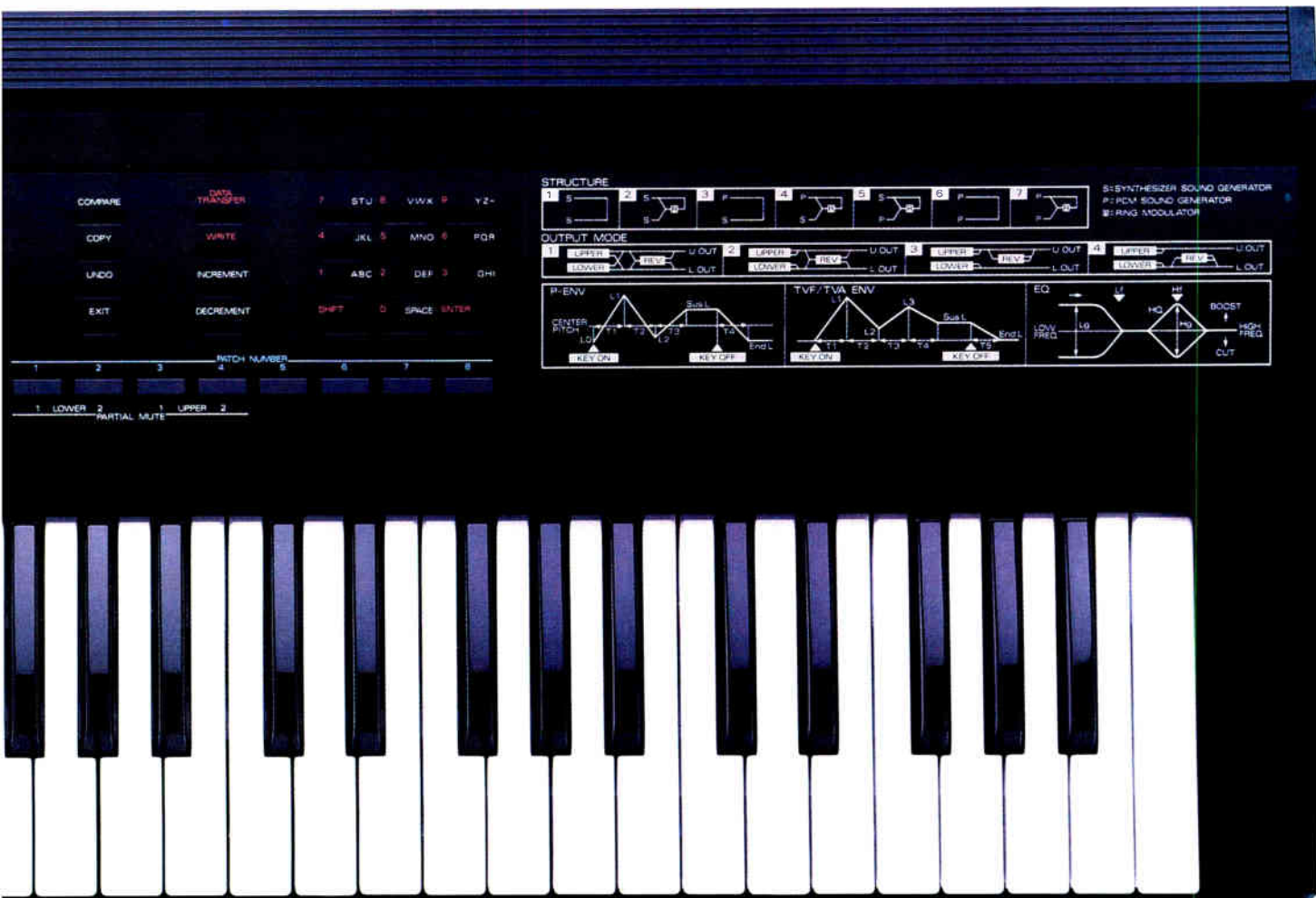

by Craig Anderton

BRAVE NEW PRODUCTION

THE MIDI STUDIO GROWS UP

Ever since Les Paul invented multi-track recording, musicians have used this technique to translate creative impulses into audio reality. A by-product of multi-tracking is that it gives composers a chance to construct entire compositions in their own studios and at their own pace, so they can hear a rough sketch of work before hiring musicians to play the "real" version. In fact, thanks to advances in synthesizers and samplers, in some cases the composer can see a work through from the first creative flash to the final mixed-down stereo master without ever having to leave the multi-track environment.

Despite the huge contribution that multi-track recording has made to the world of music, progress never stops and many musicians seek more than what tape has to offer. Specifically, tape is difficult to edit on a microscopic, note-by-note basis; and mechanically speaking, the time it takes to constantly rewind and fast forward adds up to a lot of wasted hours. Another problem is the relative permanence of parts recorded on tape. If you want to change a violin track to a cello track, for example, you'll have to re-record an entirely new part. Even fairly simple tricks, like shifting an individual track up or down an octave, is difficult—if not impossible—in a tape-based studio.

Enter the MIDI studio. The definition of a MIDI studio has yet to be etched in stone, but try this one on for size: a studio where more recording is done via tapeless means (typically, a computer running MIDI sequencing software) than via tape, and where direct injection recording takes prece-

dence over recording with mics. Some MIDI studios are *all* MIDI—pre-production is done entirely on a computer sequencer, and for the final recording, the sequencer drives MIDI instruments in real time. These outputs then mix directly into a 2-track mastering deck (often a PCM-F1, or analog 2-track with Dolby SR). Other studios combine MIDI with tape; the tape is synchronized to the sequencer, so the

A MIDI room at Unique Recording in New York City.



sequencer plays the electronic instruments and the tape stores the acoustic parts (guitar, vocals, percussion, etc.). Tape can also store bunches of effects and other unusual sound sources that would be difficult to do in real time in an all-MIDI setup. Still other studios are set up primarily as tape studios, but to keep current, are willing and able to accommodate MIDI projects.

House of Music, in New Jersey, is an example of one such studio. Larry Fast, known for his work with Peter Gabriel, Hall & Oates, Bonnie Tyler, Jim Steinman, and as a solo artist in his own right under the Synergy name, uses House of Music for a lot of his projects and also has a financial interest in the studio. He says, "House of Music is more of a traditional studio, partly because of our location. Being on the fringe of the New York metropolitan area, space is not at quite so much of a premium, and many of our clients—like Kool & the Gang—have extensive MIDI setups in their homes. In New York, cartage, parking, using elevators, and so on is such a nightmare that the idea of being able to walk into someplace like Unique Recording with a couple of diskettes and some RAM cartridges, and simply plug those into an existing array of MIDI gear, is very attractive. Here, there's no real pressure to use a studio like House of Music for pre-production; we concentrate on the finished product."

At House of Music, groups will generally bring their own MIDI gear and set up a personalized MIDI studio within the context of the existing studio. This approach still requires some special treatment, though; as Fast says, "When we rebuilt Studio A in 1984, we went for a much larger control room space to accommodate the heavily electronic sessions that were then becoming commonplace. We also did things like scatter patch points around the control room. For the people who want to do MIDI sessions, the enlarged control room is very helpful; we also have the world's largest supply [laughs] of MIDI and power cables, plenty of console inputs, and several keyboard stands."

Still, the idea of a separate MIDI room is under serious consideration. "We have the space available. We're looking at putting in a rack of 'generic' synths; we already have a Macintosh running Master Tracks Pro, some DX7s, and so on. If there's a big demand to

do MIDI pre-production, we'll put in suitable facilities." Fast, by the way, practices what he preaches. On his latest release for Audio, *Metropolitan Suite*, he did months of pre-production at home in his own MIDI studio, then carted the equipment off to the House of Music, ran his MIDI sequences under SMPTE control, and fed the outputs direct into a Sony digital multi-track. The proof of how well this approach works is particularly apparent in the CD version of *Metropolitan Suite*.

In New York, Bobby Nathan, co-owner and president of Unique Recording and MIDI City, confirmed Fast's statements about logistic and real estate problems. When asked why he started MIDI City back in the spring of '85, Nathan's answer was simple enough: "We needed a bigger room. Setups were getting so involved—this was before rack mounts were popular—that standard control rooms couldn't handle a couple dozen full-size keyboards. Also, Simmons drums were a factor since players wanted to drive Fairlights, DX7s, and so on with the Simmons. We couldn't really set all this up in the studio, because you al-

ways had to re-patch something, or change some settings, whatever." Unlike some MIDI studios that are intended mostly for pre-production chores, MIDI City is a full-blown studio with 24-track tape facilities (48-track is also available). Their artist roster includes Stewart Copeland, Dan Hartman, Chaka Khan, Billy Idol, Bob James and many others—proof that the MIDI studio serves a real need among professionals. There's also a separate "programming room" as part of MIDI City. Here, artists can go through sound libraries to pick the sounds most suited to their work, tweak presets, or even do some sampling if needed.

Economics of the MIDI studio seem to benefit both owner and client. For the owner, as Nathan says, "it costs less to build a MIDI room. You still have to float it, but the isolation problem isn't as extreme. And many clients see the MIDI room as a way to keep on budget. A lot of work can be done on a tune without using the main room." I asked if most people bring in their own gear, or whether, as Fast suggested, they just bring in their disks and RAM cartridges.



INTRODUCTORY OFFER on SONY PCM-2500 R-DAT

NOW YOU CAN AFFORD DIGITAL

No matter what size your studio, digital makes you more competitive. Better sound. Better client appeal. CSE works with studios of all sizes, from Kodak to the basement 4 track! We've got Sony R-DAT machines in stock now!

CSE

CSE Audio
1200 Scottsville Road
Rochester, NY 14624
716 • 436-9830

Call for our Line Card and Sales Brochure • Lease/Purchase programs available

Circle #091 on Reader Service Card

"If an artist has gear set up at home, it should stay at home," Nathan responded. "Bob James would work here using our equipment, but he had his studio set up at home and if he wanted to make some changes at home, he could do that, too. So yes, he basically transported just data back and forth. But people had already gotten used to that approach with us anyway. We've always had lots of instruments around, since this helps us avoid cartage problems, renting instruments that aren't properly maintained, and such. Actually, this has traditionally been the kind of place where you can bring in a sequencer disk and plug into different instruments."

Looking towards the future, Nathan has some interesting comments. "People think that because we started MIDI City, we think this is the wave of the future or that it's going to take over or something. Not so. It's just another way of doing things. I wouldn't advise a heavy metal band to do their whole project in a MIDI room, but for a lot of types of music this kind of studio is best-suited to what needs to be done."

Another studio owner who is happiest blending MIDI with other elements is David Vartanian of DV Productions. Located in Milwaukee, DV does much of the work for new age label Narada Records; but the Violent Femmes, Jerry Harrison and others have also worked there. While designed to accommodate acoustic recording, the control room is often used as a MIDI room. The computer of choice is a Macintosh running Performer; instruments include an Emulator II ("I'm anxiously waiting for the E-III," says Vartanian), D-50, TX rack, DX7, and SP12. He also uses the JamBox extensively—"I love it"—and makes automation a creative part of the whole effort as well.

I first met Vartanian while assisting with mixdown and doing technical consultation for David Arkenstone's Narada release *Valley in the Clouds*. This album was a classic case of effective use of a MIDI studio. The parts had been worked out by Arkenstone at home on a Commodore SX-64 driving a bunch of lower-cost instruments, and with a demo made in this fashion, he landed a record contract. He then took the SX-64 to DV, sequenced the available upscale instruments (and brought

a few of his own), recorded them on tape, and went straight to mixdown. Although the synths did not go live to tape, Vartanian says that on his latest project (with artist Bruce Mitchell), he's "sending a lot of synths live into the 2-track along with the multi-track. You can open up more tracks, and of course there's no tape hiss. It's just like having another multi-track. What we really need for the future is better communications between machines." (The latter sentiment was also echoed by Nathan, who is looking forward to the day when sequencers, drum machines, and so on read SMPTE directly and painlessly.)

The Mitchell project itself started off in an unusual manner. Vartanian and producer Eric Lindert basically got two

There's no doubt that the MIDI studio has earned its legitimate place in the grand scheme of recording. Anything that makes life easier for studio owners and artists, and saves them both money, can't miss.

Performer disks and an outline of what sounds would be appropriate, but had complete leeway in substituting voices from the array of available soundmakers. This suggests to me that perhaps the producer of the future will be someone who is extremely adept at picking the right musical voice for the parts written by the composer.

DV also has a separate pre-production space where artists can check patches, edit sequences, and the like. This comes in particularly handy when a project runs over time and/or budget, and an artist wants to continue working on a project even if the main room is being booked by someone else.

Private studios are also embracing the MIDI studio concept. Best known for his sound effects work (*Tron*, *The*

Day After), Frank Serafine's studio is essentially just one big control room, linked together by SMPTE and, thanks to the JamBox, via MIDI-to-SMPTE. The biggest advantage, according to Serafine, is "you can always make changes and get back to where you were before. When someone tells you 12 seconds was cut from a scene, it's vital to be able to make changes rapidly. You just don't have the same kind of freedom with tape." He doesn't use his 16-track recorder very much; most of the music goes direct to PCM-F1 with no intervening tape stages. The studio houses four computers: Mac Plus, Mac SE, Mac II, and Amiga. His main programs are MIDIPaint (Southworth), Sound Designer (Digidesign), and CUE (Opcode); the Amiga he uses "mostly to run Laurie Spiegel's 'Music Mouse.'" These days, a studio really does need to have more than one computer."

As Frank points out, though, the MIDI studio brings a new set of limitations. "It's time-consuming to map out all the different data to the different synths, and make sure you keep your program changes and such in order. You also need auxiliary gear, like the Axxess Mapper or a Cooper switchbox, and they have to be programmed too."

Right now, Frank is scoring an Isaac Asimov film, called *Nightfall*, entirely in his MIDI studio. He's looking towards going to 32-track, mostly so he doesn't have to set up his whole MIDI system every time he wants to make an adjustment or two in an older piece of music.

It's fitting that everyone we talked to feels tape is still very much a part of the MIDI studio, and likely to stay that way for at least a while. After all, there's only so much that can be done in real time using the MIDI protocol—and tape can take up that slack like no other medium. But there's no doubt that the MIDI studio has earned its legitimate place in the grand scheme of recording. Anything that makes life easier for studio owners and artists, and saves both of them money, can't miss. It will be most interesting to see what happens with the next generation of this new type of studio. ■

Craig Anderton is the editor of our sister publication Electronic Musician, and is guitarist/keyboardist for the synth band Transmitter, as well as author of numerous books and articles for MIDI users.

Sampler: Up to 26 seconds sample time at 18 kHz bandwidth (40 kHz sampling rate) • Special enhanced 12 bit format for very low noise • 16 simultaneous voices • 32 drums • Dynamic sensitive drum pads • Stereo mixer and echo send mixer • Sample editing.

Sequencer: 60,000 notes • 99 sequences • 99 tracks • Tape recorder-style operation • 2 record modes—record or overdub • Looping in record • Instant-playback timing correction • Shuffle • Full-screen step edit • Insert/delete bars • Copy/merge tracks • Edit loop • Timing shift • Song mode • Tempo changes • Meter changes • Pressure-sensitive note repeat • 4 independent Midi outputs.

Sync interface: SMPTE • Midi Time Code • Song Position Pointer • Sync to ¼ notes • SMPTE chase.

Features:

320 character LCD with graphics • 3½" disk • Built-in electronic reference manual in HELP key • Very fast to learn and use • And much, much more

The MPC60 is a complete midi production studio—just add synths.

A MIDI PRODUCTION STUDIO IN A BOX

The MPC60
Integrated Sampling Drum Machine,
Sequencer, and SMPTE Interface

New from Roger Linn and **AKAI**
professional
Creative at Heart



Also available without drums as the ASQ10 sequencer.

For complete details
contact your local
Akai Dealer, or write:

AKAI
professional
P.O. Box 2344
Fort Worth, Tx. 76113
(817) 336-5114

It's mid-afternoon in the sleepy, nondescript San Fernando Valley suburb of Reseda, and the only sign that something unusual is going on is the row of film trucks parked outside The Country Club, and the muffled roar of a rock band revving up for action inside.

And what a band. Fretboard pyrotechnics courtesy of guitar hero Jeff Beck. Solid backing from a powerhouse rhythm section that includes Terry Bozzio on drums. Harmonies and seductive choreography by three curvacious singers. And tough, kick-you-in-the-teeth lead vocals from Mick Jagger.

Rock's perennial bad boy and sometime singer for the Rolling Stones is hard at work shooting a video for "Throwaway," the catchy second single from his second solo album, *Primitive Cool*.

Perhaps the rest of the Stones can't get it together to get back on stage again for a while, but it's obvious that Jagger loves his work. After a quarter of a century of rock and roll, the face that launched a thousand leers may be weathered and lined now, but Jumping Jack Flash can still wiggle his hips and shimmy across the stage with the best of them. And he sounds better than ever.

In between video takes and an impromptu show that included killer versions of "Little Red Rooster" and Jimi Hendrix's "Foxy Lady," Ol' Rubber Lips took some time out to answer the questions on everyone else's lips. Will he tour as a solo artist? Does this mean the end of the Rolling Stones? How's Charlie Watts' gardening coming along?

Mix: Let's start with the question everyone wants to know the answer to. Does this second solo album spell the end for the Rolling Stones?

Jagger: I really don't know. The Stones are a bit of a hassle really, and it just all got so problematical. The major difficulty with a band that's been together that long is that *everyone's* a star in his own right. And you have to plug into it, when everyone's happening, when everyone's in *exactly* the right mood to go on the road, or go into the studio. And if you're

MICK JAGGER

THE STONE ROLLS ALONE

by Iain Blair



not, and some people are having problems, and some people aren't getting along, it's just not going to work.

Mix: There were all these stories about you and Keith not talking to each other.

Jagger: Yeah, well, it was a bit of a problem.

Mix: Are you talking now?

Jagger: Yeah, sort of. Hopefully we're going to get on a bit better. But it's not just Keith and myself. There were a lot of other problems which I don't particularly want to get into. I mean, there are the other guys in the Stones—Charlie, Bill and Ronnie, and it wasn't happening. I think it's a big problem just to say, "O.K. Now we're gonna tour," when things aren't right, 'cause when you drag everyone on the road, you *have* to be in tiptop shape and condition, mentally and physically, and the vibe has to be right. It *has* to be great. You can't go on the road saying, "We oughta" when you're kicking and screaming. I think it's a shame to do that, so I just had to say to Keith that I didn't think it was the right time.

Hopefully the right time will come.

Mix: You assembled a pretty hot band for your second solo album *Primitive Cool*, including Jeff Beck on guitar, Simon Phillips on drums and Doug Wimbash on bass, plus helping hands from Dave Stewart, Omar Hakim, David Sanborn, etc. Are you going to tour as a solo artist?

Jagger: Well, I'm just starting to play again. We had a bit of a hiatus in rehearsing when Jeff kind of disappeared for a while, but he seems to be back on track now. There are obviously other players around, but I like playing with him. We've done two albums together now, and I think we work well together, both in the studio and on stage. It's a good feeling. But we have to start it off really small. I don't think you just go out and bang off in huge stadiums. You have to warm up to it gradually, so I'm just going to see what happens over the next few months or so. We're starting with this video shoot and warm-up gig, and we'll just go on from here.

**"ASTOUNDING PERFORMANCE
AT AN ASTONISHING PRICE!"**

micro

FROM VALLEY INTERNATIONAL.

FX

NOISE GATE



To eliminate unwanted noise in musical program, instrument amplifier hum and buzz.

COMPRESSOR



To afford complete control of dynamic range, with an automatic downward expander to remove undesirable noise level recovery.

DE-ESSER



To remove excessive "ess" sounds commonly called sibilance.

NOISE REDUCTION



One-way noise reduction unit to eliminate unwanted noise from audio signals, while improving signal-to-noise ratios.

ATTENUATOR



Reduces +4 professional standard operating level signals to -20 musical instrument/amplifier levels or -10 operating levels, while properly matching all impedances.

BOOSTER



Amplifies and impedance-matches musical instrument/amplifier levels and -10 operating levels to +4 professional standard operating levels to ensure proper interface and low noise, low distortion performance.



*** SUGGESTED RETAIL LIST PRICE:
\$149.00 EACH.**

**BEFORE YOU PAY
THE SAME PRICE FOR A PRODUCT
THAT OFFERS LESS, TRY MICRO FX.**



Inexpensive signal processors are not new. But, inexpensive processors capable of delivering truly professional sound quality were practically nonexistent prior to the introduction of Micro FX. Each Micro FX product is designed and manufactured to the same exacting standards which have made Valley International an industry leader in the field of analog signal processing. The time-proven proprietary processing circuitry found in our more expensive processing products is also designed into every Micro FX unit. You will find the same high quality components in each Micro FX unit that you find in the rest of the Valley line, so you can be assured of years of trouble-free operation. And, all of the Micro FX products are made in the U.S.A.

P.O. Box 40306 • 2817 Erica Place
Nashville, TN 37204 • (615) 383-4737

Circle #042 on Reader Service Card

Finally: an HF driver that doesn't turn cymbals into trash can lids

It's easy to assume that the best-selling HF driver is also the best-sounding. And it's easy to conclude that the performance of the leader represents the highest achievable standards. Easy, yes. And wrong.

Because now there's something better: the Electro-Voice DH1A—a driver that **demand**s comparison with any other HF transducer you have ever heard or used.

Spend a few minutes in comparative listening and prepare to revise your idea of what constitutes "reality" in the world of sound above 10 kHz. Hear, for the first time, accurate reproduction with all the presence and vibrancy of a fine home audio system. Experience clean, distortion-free sound without



"ringing," the result of the diaphragm's inability to control inertia—to stop its own mass when required by fast transients.

To create the DH1A, EV engineers chose a magnet with extremely high flux density, plus an optimized, balanced magnetic circuit to ensure more exact correspondence between the input signal and diaphragm movement, further improving transient response.

The 10 kHz breakup you've heard as a "sound-smearing" effect in "their" driver is avoided in the DH1A by using a 3-inch, rather than a 4-inch, diaphragm. This moves the

first mode intermodulation distortion all the way out to 15 kHz, providing piston-like diaphragm motion to a point well beyond audibility.*

A field-replaceable diaphragm makes the DH1A still more useful. We also added the option of 8- and 16-ohm impedance match. And our EV-exclusive PROTEF™ feature that guards against voice coil damage.

We don't ask you to accept all this without proof. Make us prove our claims. Audition a DH1A today. Hear for yourself how easily you can prevent cymbals from sounding like trash can lids.

For more information, write Electro-Voice, Inc., 600 Cecil Street, Buchanan, MI 49107.

EV Electro-Voice®
SOUND IN ACTION™

Circle #021 on Reader Service Card

*For convincing proof of the performance difference between the DH1A and the industry's leader, see the actual TEF "waterfall" curves, plus additional product information. Write to Electro-Voice, Inc., 600 Cecil Street, Buchanan, MI 49107.

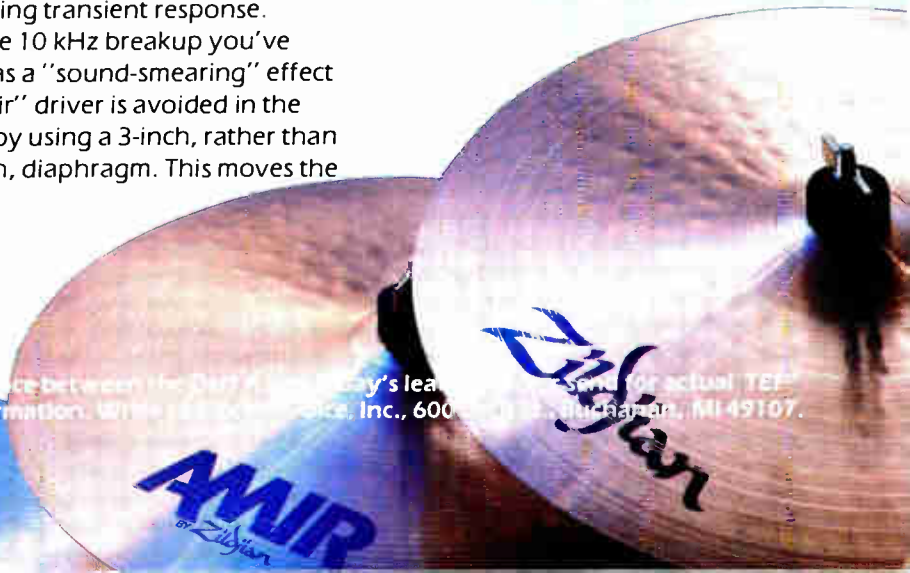
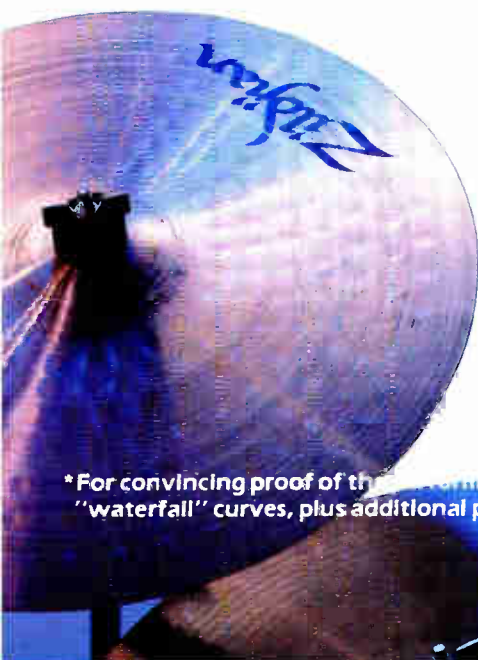



The Stones on the set for the video of "Start Me Up," 1981.

Mix: Will you take the same players on the road?

Jagger: Some of them would be the same, yeah. It depends on everyone's schedules. For instance, right now, Simon Phillips is off working with Pete Townshend, so Terry Bozzio is standing in. I'm very happy with the band as it is, but we probably need to add some more players gradually. It's great to start off small and then add, 'cause I like to cover a lot of different kinds of music eventually. I'll start off very rock and roll, and then get into a bit more funk and country and so on. I'm not talking about a hundred pieces; just adding as necessary.

Mix: Do you pay much attention to the current music scene?

Jagger: I guess so. It's hard to avoid it, really. You hear music everywhere you go, don't you? And as far as the overall scene goes, I don't know if in reality there's a huge difference between the scene today and the one ten years ago, or when the Stones first started, in terms of all the trends. It

also depends a lot on where you are. If you move around a lot like I do, you get a very different perspective on what's going on, both in production and studios and the *sound* of records, than if you just live in one town, even a record town like Los Angeles or New York. It's funny, 'cause when you travel, you hear and see the similarities in music, but you also see the differences, and what makes some countries go apeshit for a *sound* and what makes others reject it.

Mix: Do you check out a lot of new acts?

Jagger: I don't do it that much. I'm not really in the A&R business [laughs]. I go and see shows if I like the act, and in New York I go to CBGB's and all that. I went to see that act I'd produced two sides on, Vernon Reid and Living Color. They're a New York band that was playing CBGB's and I really liked them, but they couldn't get a record deal. So I went in the studios with them and produced two tracks, and then they got

picked up by Epic, which was cool. It's great when you can help an act like that.

Mix: Do you use your power much in terms of producing unknown acts like Living Color?

Jagger: Not often enough, unfortunately. When I produced them, I was on such a hectic schedule, but I just wanted to do it, so we rushed in the studio. But I like doing that, and I'm pleased with the results.

Mix: In terms of wearing your producer's hat, do you listen to a lot of radio?

Jagger: Yeah, I like to keep up on the latest sounds. I just think it's very compartmentalized in the U.S. And it's very odd and peculiar in England. I rather like radio stations in Paris, which tend to play highly eclectic mixtures. That's very refreshing after the highly programmed, formatted stations in America. I personally don't like formatted music, and never have. I like to play all different kinds, and

CALL FOR OUR NEW
CASSETTE CATALOG

THE OPUS

AUDIO, VIDEO, COMPUTER
& CASSETTE TAPE

LOW PRICE, ONE STOP
CATALOG!



RECORDING & EQUIPMENT CO. 4825 Grand Avenue Gurnee, IL 60031
312-336-(OPUS)-6787

OPUS RECORDING
&
EQUIPMENT

Gurnee, IL

312-336-6787

Circle #092 on Reader Service Card

RECORD PRESSING • TAPE DUPLICATION

TOLL FREE
NUMBER

1-800-
527-
3472

MAJOR IN-HOUSE
U.S. RECORD
PRESSING FACILITY

- Custom Albums
- 45 RPM Singles
- Mastering with Neumann VMS70 Lathe & SX74 Cutter
- Digital Mastering Available

TAPE DUPLICATION
• Custom Packaging

SPECIAL!!

1000 7" 45 RPM Record Package \$469
1000 1 Color 12" Album Package \$1372



A & R RECORD &
TAPE MFG CO.
902 North Industrial Blvd.
Dallas, Texas 75207
214-741-2027

Circle #093 on Reader Service Card

what I like doesn't always fit in with people's ideas of what I should like. Basically I hate *formula* music—it's commercial, it's just for money. It's just sad that except for college radio, no one else seems to be able to do anything else.

Mix: You co-produced four tracks on your album with Dave Stewart. How did you hook up?

Jagger: I met him at a gig, a couple of years ago, and we just started talking. It turned out we have quite a lot in common, 'cause we both like to throw a lot of ideas around and experiment with unusual sounds rather than just stick to what might be considered straight ahead rock and roll. So I like working with Dave 'cause he pulls in these ideas from completely different places, and he's very creative in the studio.

Mix: How do you go about organizing material for recording?

Jagger: I write a lot of songs, in different batches. I'll write perhaps a group of songs, and then go off in another direction and write some more, and gradually build up my ideas. So for *Primitive Cool*, I wrote the songs in three batches. Basically I like to keep writing all the time, because if you start from scratch, it's really hard. The other way, you know you've got one or two numbers to build up from.

Mix: Is writing a laborious process for you?

Jagger: I don't like to labor over songs too much. I mean obviously sometimes there's parts that you work over and craft, but I like to work relatively fast and capture the energy of that initial inspiration. I also like to write the lyrics quickly for the same reason. If it takes you months and months to write a lyric, it kind of loses it for me.

Mix: When inspiration hits, do you immediately get it down on tape?

Jagger: Yeah, I make a quick demo at home, either on 4-track or 8-track, or even on a small portable Sony recorder—anything that's handy.

Mix: Do you have a home studio?

Jagger: Not really. I just use a regular 4-track Tascam machine with various bits and pieces. I hook it up to a drum machine, and then play rhythm guitar or play some keyboards, and then put down a rough vocal track to get the

idea down. Unfortunately, even when I use the 4-track I have to have a roadie around to help, which is a drag, 'cause sometimes you just want to be completely on your own. But even with a 4-track you need an engineer—you *have* to, to get a decent track—and I find that really boring.

Mix: When you go into the studio, do you go in with relatively finished ideas, or do you start building up from a groove and a rough lyric?

Jagger: Generally I prefer to go in with a very clear idea of what I want to record, so I also like to rehearse a song idea first. But that's for my solo albums. It's very different from working in the studios with the Stones, where a lot of the time it's very loose. Sometimes there's a finished idea, but more often there's a groove, or a riff, and an idea for a chorus, and it gradually comes together. Of course the Stones spend a lot of time rehearsing material *in* the studio, which can get pretty expensive.

Mix: When you went in to record *Primitive Cool*, were you feeling your way in terms of an overall direction, or was it fairly clear to you?

Jagger: It was pretty clear, and I also knew the kind of *sound* I wanted on the album. There are quite a few people playing on it, but they're basically peripheral to the core band, so the *sound* and feel is fairly unified from track to track, I think.

Mix: Are you a tech-head?

Jagger: Well, not totally. I'm pretty involved in keyboards and sampling and all the usual things musicians and producers get into. I *use* all that equipment all the time, but I wouldn't claim to be on the cutting edge of technology, no. I'm just naturally curious and interested in the latest equipment. I mean, I was using computerized mixing boards on the *Some Girls* album way back in 1978, which was long before most producers got into it.

Mix: Since the early '60s when the Stones first recorded an album on a 4-track machine, the state of the art in recording has changed out of all recognition, largely thanks to computers and hi-tech equipment. What do you see as the drawbacks, if any?

Jagger: Well, I like using machines and hi-tech equipment, but I still prefer the sound of *live* drums on a rec-



"In-line System"

- 30 mm Module Width Yields Unparalleled Compactness**
Up to 56 Modules in less than 5½ feet
Up to 112 "Mix" inputs in less than 5½ feet
- Unique "Floating Subgroup System"**
Any input can be subgroup
Each input module has a "Summed" output
- In-line "Tape Monitor" section**
Monitor patch point, aux sends, and equalizer
Monitor solo, mute, and fader reverse
- Four Band Equalizer**
High and Low shelving with two sweepable mids
EQ split (EQ on channel and monitor)
- 8 Effects send busses per module**
- Stereo "In-place" solo and PFL (pre-fade listen)**
- Hand-crafted cabinetry with pedestal base**
- Digital quality specifications**



Crafted By:

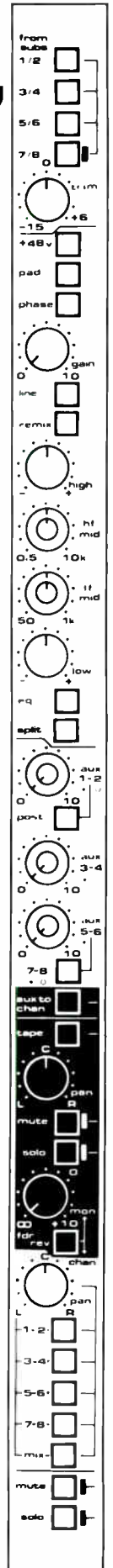

D&R USA
1720 Chip N Dale Drive
Arlington, TX 76012
Ph. (817) 548-1677
FAX 817-277-6066

D&R Electronica b.v.
Rijnkade 15B
1382 GS Weesp, Holland
Ph. 02940-18014
FAX 2940-16987

Circle #094 on Reader Service Card

See us at Booth #1009 NAMM, Anaheim

Beyond Comparison

ly, this really felt like success. When our first payday rolled around, we all huddled in the small office of the paymaster, ready for the big bucks. Crying and bellowing, however, our leader informed us that he had gambled the entire payroll away at the tables! Shock, disbelief, horror and then murder entered all of our minds simultaneously.

But sometimes a bad experience can lead to a good one. The owners let us all draw cash in advance, we finished our few weeks there and were booked next at Harvey's Wagon Wheel in Lake Tahoe, Nevada. This was another great lounge for showcasing funny hat bands and these jobs usually led to bigger and better things. Again, we opened to a great crowd and did a rousing first set. We were back on Cloud Nine.

When I had visited my brother at Lake Tahoe a few years earlier, I became friendly with other dealers, pit bosses, security men and the like who worked at the hotels and casinos at the lake. One boss was Felix.

As we came off stage after our opening show at Harvey's Wagon Wheel, a

hand grabbed me and whirled me around. It was Felix and he was obviously happy to see me. I had at times hung around the Wagon Wheel Lounge while working at Sahati's and often sat in with Ian Bernard and his group. Ian, a great pianist and composer, was making a big name for himself in television and movies.

Felix said, "Well kid, you're making the big bucks. I'm proud of ya."

"Well," I said, "three hundred and fifty bucks a week is better than a poke in the eye with a stick, but I wouldn't exactly call it the big bucks." Boy, was I wrong. Felix took me up to the office and showed me a contract that said we were making \$7,000 a week! Now, we were a co-op band, a corporation band making equal money. What a laugh! I was supposed to be making around a thousand a week and our bum band-leader was obviously taking all the money. That's all I had to see.

In seconds I was on the bandstand packing my drums. On my way out a young Latin-looking guy said, "Hey, what are ya doin'?"

"I'm splitting man," I said. "I've been had and now I've had it up to here!"

"How about joining my group next door at Harrah's Lounge?" he said. "It's just a small casino but we're going to open in Hollywood in a couple of weeks. My drummer got sick and we could really use you."

It was an opportunity I couldn't pass up. "Grab a case," I shouted, "and let's go!"

My drums were set up in nothing flat and that was the start of my tenure with the Carol Simpson Quartet. Now I was playing out-and-out jazz, my love of the day. Our first stop was the Garden of Allah in Hollywood, the jazz lounge famous for drawing a crowd of movie stars and producers. I knew this could be the stepping stone to a studio career.

I was on top of the world, working every night at the Garden playing for the Hollywood crowd. It was the kind of job I had dreamed of getting. One night, just about closing time, a man walked up to me and said, "I like the way you play, kid. I got a hot job for you." It turned out that he was the manager of a country group called The Raiders and they were working at a little dump out in Bell, south of L.A. These kids were neighbors of Tommy Sands.

Tommy was on his way to becoming America's latest teenage idol. Elvis was still tops, of course, but was in the service at the time. Elvis' infamous manager, Colonel Tom Parker, knew Tommy and Tommy's mother, Grace, from their Houston days. When the Kraft Theater made a special called *The Singing Idol*, Elvis was all set to do it but his military stint made his participation impossible, so the Colonel called Tommy to do it. Tommy was a DJ in Houston at the time, and he jumped at the chance. Even without Elvis, the show was a smash and Tommy was an overnight star. Thousands of letters poured into NBC and all of a sudden every record company in town was after Tommy. He eventually signed with Capitol and recorded "Teenage Crush," which made it to #2 on the charts in early 1957. Now Tommy needed a band.

Tommy had heard The Raiders practicing noisily in a room at a hotel across the street from his house and he liked what he heard. He told them that he was looking for a back-up band, but they would have to find a drummer. So their manager told me that I could make some really big money—Sands was hot and the group was booked all

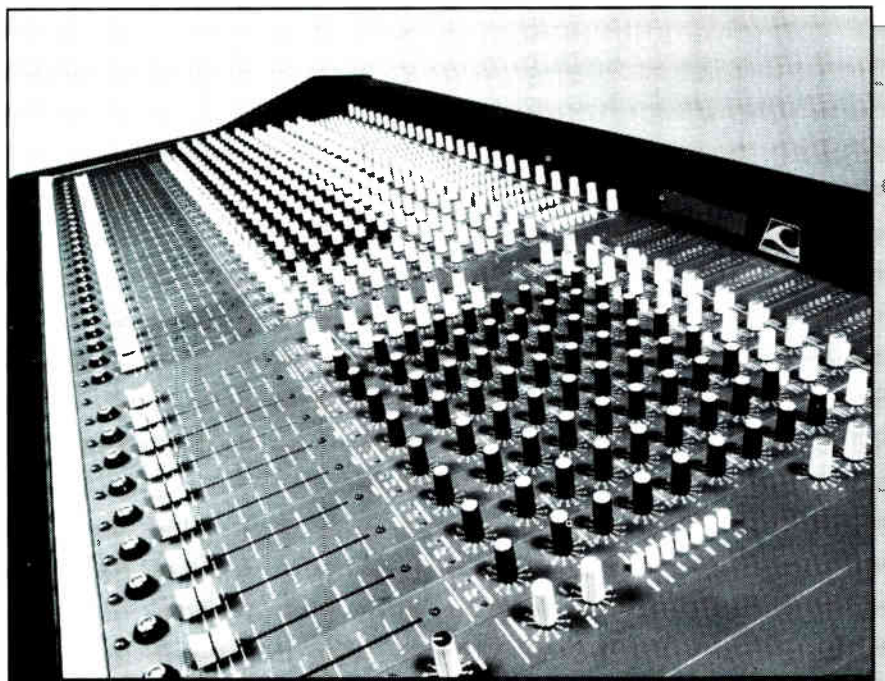

WALKER DDS

Series 80 Mixing Consoles

6850 35th NE
Seattle WA 98115
(206)-527-4371

Circle #097 on Reader Service Card

DAYNER[®]

“In-line System”

- 30 mm Module Width Yields Unparalleled Compactness**
Up to 56 Modules in less than 5½ feet
Up to 112 “Mix” inputs in less than 5½ feet
- Unique “Floating Subgroup System”**
Any input can be subgroup
Each input module has a “Summed” output
- In-line “Tape Monitor” section**
Monitor patch point, aux sends, and equalizer
Monitor solo, mute, and fader reverse
- Four Band Equalizer**
High and Low shelving with two sweepable mids
EQ split (EQ on channel and monitor)
- 8 Effects send busses per module**
- Stereo “In-place” solo and PFL (pre-fade listen)**
- Hand-crafted cabinetry with pedestal base**
- Digital quality specifications**



Crafted By:

D&R

D&R USA
1720 Chip N Dale Drive
Arlington, TX 76012
Ph. (817) 548-1677
FAX 817-277-6066

D&R Electronica b.v.
Rijnkade 15B
1382 GS Weesp, Holland
Ph. 02940-18014
FAX 2940-16987

Circle #094 on Reader Service Card

Beyond Comparison

See us at Booth #1009 NAMM, Anaheim

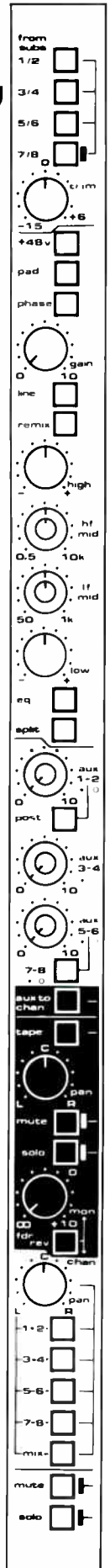



Custom pressing, tape duplication
and packaging.

1,000

7"-45^s

including mastering,
metal parts and
processing,
white sleeves,
labels, pressing.

\$439.00

**12" Albums
with jackets**

including mastering,
metal parts and
processing, poly dust
sleeves, labels, pressing
and printing of full
colour ultra high gloss
board jackets from
customer supplied
process film.

\$1,390.00

(F.O.B. DETROIT)

- 2 - 3 WEEK SERVICE
- VIRGIN VINYL
- HIGH GLOSS BOARD JACKETS
- CrO₂ CASSETTES
- CUSTOM 7" SLEEVES
- INHOUSE ART & TYPESETTING

Call Toll Free Continental U.S.A.

1-800-263-7798

Canada's Largest Custom Producers



**WORLD
RECORDS**

BASELINE ROAD WEST, BOWMANVILLE, ONTARIO L1C 3Z3

Circle #095 on Reader Service Card

NAGRA UPDATE!

Scotch 208 tape replaced by
new Scotch 3M 808 tape . . .



Alan Gordon Enterprises offers re-bias servicing of your Nagra IV series recorders to accommodate the new tape. The update is low-cost, fully guaranteed and our expert technicians will have your Nagra back in action in just two working days! For more details, contact our service department today.

ALAN GORDON ENTERPRISES, INC.

1430 Cahuenga Blvd., Hollywood, CA 90078
Telephone (213) 466-3561 • (818) 985-5500
TWX: 910-321-4526 • Cable: GORDENT

Circle #096 on Reader Service Card

ord. I use a drum machine at home for demos, but in the studio I like to work with *people*. The thrill for me of making a great record is working with other musicians and capturing their best, most energized performances.

Mix: You recorded *Primitive Cool* at Wisseloord Studios in Holland and Blue Wave Studios in Barbados. Why those two places?

Jagger: Well, I think they're both pretty good studios. In fact, I didn't mean to spend so much time in Barbados, but Jerry [Hall, his girlfriend] got busted there, so I was stuck there! [laughs] So I just carried on, working and recording. Then I did all the mix-downs at Right Track Studios in New York, and it was mastered at Sterling Sound, also in New York.

Mix: Which tracks did you record where?

Jagger: I think we did "Throwaway," "Let's Work," "Kow Tow" and the title track in Holland. [He pauses and laughs.] You know, I can't remember for sure. I produced one track, "Party Doll," on my own, and the rest were co-produced, either with Dave Stewart, or with Keith Diamond.

Mix: Who engineered?

Jagger: Ed Stasium, who also mixed all the tracks except for "Let's Work," which was done by Steve Thompson and Michael Barbiero. Ed was assisted by Bob Rosa, Manu Guiot and John Bavin, and they all did a great job.

Mix: As one half of "The Glimmer Twins" [Mick and Keith] you've produced most of the Stones' records. How actively involved are you in terms of engineering the sessions?

Jagger: I'm fairly active, I'd say. I'm there in the studio nearly all the time and you always have to oversee that end of it. I mean, I'm not always leaning over the shoulder of the engineer and fiddling with the EQ or reverb, but you always have to be there, especially at the beginning, to get drum sounds and guitar sounds. Of course you get to a certain point where people can do quite a lot without you, but unfortunately I've never met anyone where you can just play out in the studio and say "record it." It just never works like that. You have to be there.

Mix: How have recording methods

changed since you first went in the studios in the '60s?

Jagger: Well apart from all the obvious things like the equipment, and the advent of multi-track and digital and all the effects that are now available, I think people are generally a lot more knowledgeable about recording. I remember back in the middle '60s no one could get a decent drum sound that quickly—it took *forever!* Engineers would run around stuffing blankets in the bass drum and experimenting with different mics to see what sounded best. Today, you can pretty much go into any studio anywhere and get a fairly decent drum sound quite quickly. It's all experience.

Mix: Do you still have favorite studios you like to record in? For instance, I was thinking of Olympic Studios in London where you did a lot of the early Stones albums and where Led Zeppelin liked to record.

Jagger: You know, I haven't been back there in years. The thing is you get rooms that suddenly become fashionable, and I can remember that it's always been like that. At one time Sunset Sound in L.A. was real fashionable—everyone wanted to work there. And then there was RCA in L.A., where we recorded "Satisfaction." That was a big room, and that's one thing I like—*big* rooms with a big, *live* sound. They also afford you some sort of privacy. Small rooms just drive me crazy. I hate those low ceilings and the acoustics. I don't think they're very conducive to working.

Mix: Who do you rate as producers?

Jagger: I think producers are a bit like rooms in that they also suddenly become fashionable. You know, one year it's Nile Rodgers, the next it's Jimmy Jam and Terry Lewis, and *everyone* wants them to do their album. I like working with different producers, and I don't have any one guy I think is the ultimate. It all depends on what material you're recording and the kind of sound you're after. Obviously producers can be terrifically helpful in the studio, but you've got to know what you're doing. And I do. ■

"Count" Iain Blair, British writer, musician and author, was an original cast member of the Rocky Horror Show and the film version for 20th Century Fox. He's currently writing screenplays in Los Angeles.

The scope and challenges of today's music keep expanding daily. Basic musical craft remains the indispensable foundation for success. But there is also a whole new dimension of music technology. It is an inseparable part of our musical present and future.

For the emerging musician, Berklee has a comprehensive selection of course offerings, professional faculty, and technical facilities including:

A Music Synthesis Complex equipped with nearly 100 of today's latest instruments, such as the Kurzweil

Midiboard and 250 Expander; Oberheim OB8 and Xpander; Yamaha DX, RX, TX and QX series; Emulator II; Roland Juno 106, MSQ 700, and Jupiter 6; Rhodes Chroma; the Notebender Keyboard; and Apple II, Macintosh, and Commodore computers.

Six professional recording studios featuring three 24-track Studer/Otari facilities with automation and digital capability.

Two Movieola film studios and BTX Softouch System for film and video scoring and editing.

Berklee will make you more of a musician by teaching you more than music.



Berklee

COLLEGE OF MUSIC

Where careers in music begin.

For a current catalog, contact the Berklee Admissions Office. Call toll-free: 1-800-421-0084 (9 a.m. to 5 p.m. EST). In Massachusetts call: 617-266-1400. Or write: BERKLEE, Admissions Office, Dept. MX12, 1140 Boylston Street, Boston, MA 02215.

Circle #022 on Reader Service Card

*In search of total
creative freedom*

FAIRFIELD COUNTY SAND-BOX

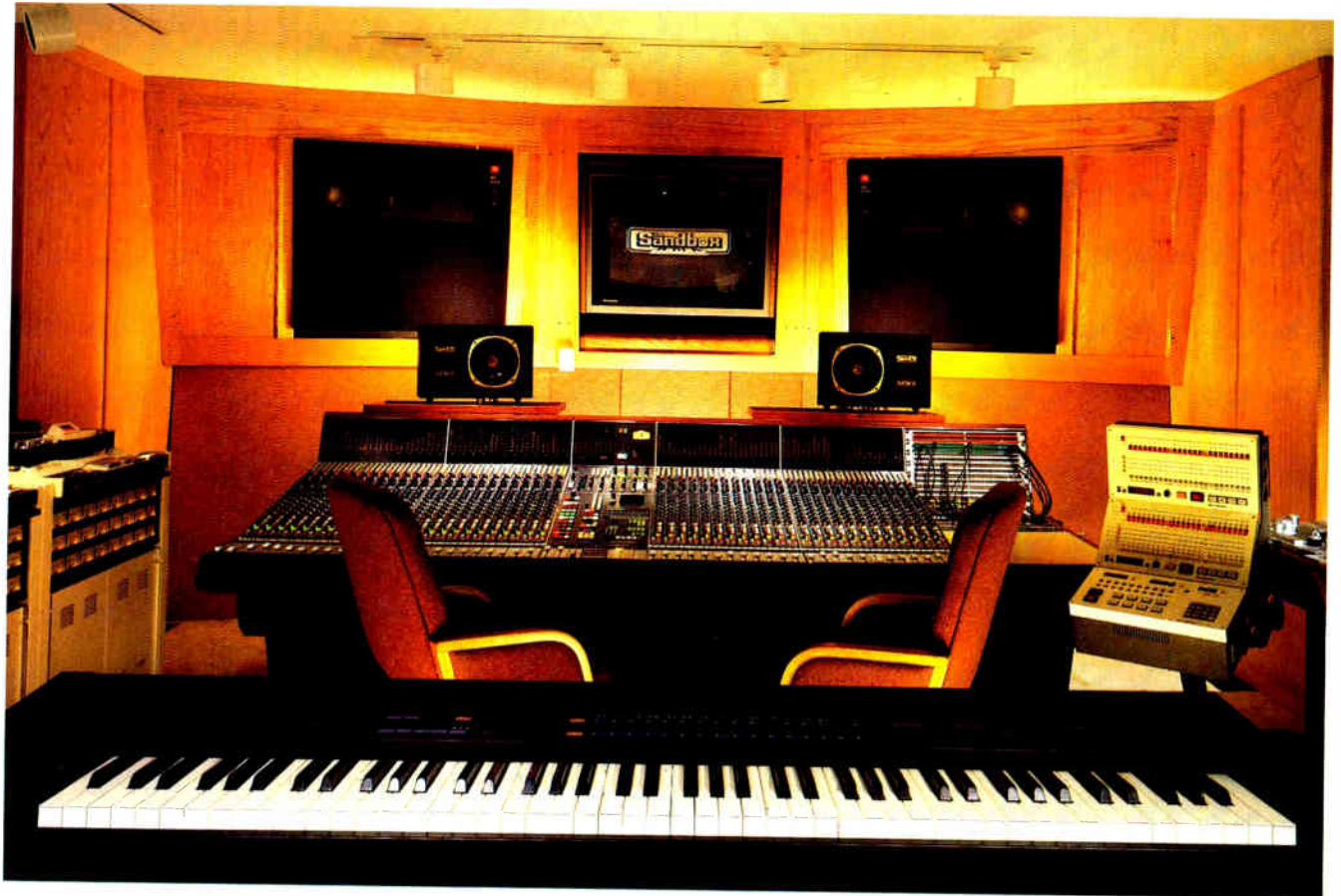

sand-box \ˈsɑn(d)-bɑks\ n:

a box containing loose sand for children to play in, promoting imagination, spontaneity, and creativity. b: an automated 48 track recording studio in Fairfield County, Connecticut.



Spectral Music Corporation of New York City has opened its fully integrated MIDI studio in Fairfield County, Connecticut. The basic premise in the design of the studio was to create a 48 track facility in which

no compromise was allowed in integrating the systems. At THE SANDBOX all synthesizers, sequencers, drum machines, computers, samplers, tape machines, and the NEVE "V" SERIES console are interfaced at all times.

This allows for any complex, computer controlled MIDI configurations to be applied easily for an immediate response. Great care was taken to ensure that traditional recording techniques were addressed equally.

As the name indicates, the result is a beautiful work-ing environment where spontaneity and creative freedom come together, the technical side of which is transparent to the client.

Although THE SANDBOX has been open for only six months, it's no surprise that "word-of-mouth" has already brought us such industry greats as Russ Titelman, Daryl Hall and John Oates, Gary Katz, Elliot Scheiner, Glenn Frey, Average White Band, Felix Cavaliere, Chris Jasper, and many more. Never has a new studio seen more acclaim or such extraordinary clientele so quickly.

THE SANDBOX surpasses all competition in nearby New York and delivers at a fraction of the cost. There are none of the distractions and hassles of the city to interfere with the progress of your project. Whether it is the privacy of the luxurious retreat, the beauty of the accommodations, or the unsurpassed technology, we promise you the most fulfilling recording experience anywhere.

If you are interested in our rates or would like to see the facility, phone Spectral Music in New York City at (212) 757-0110.

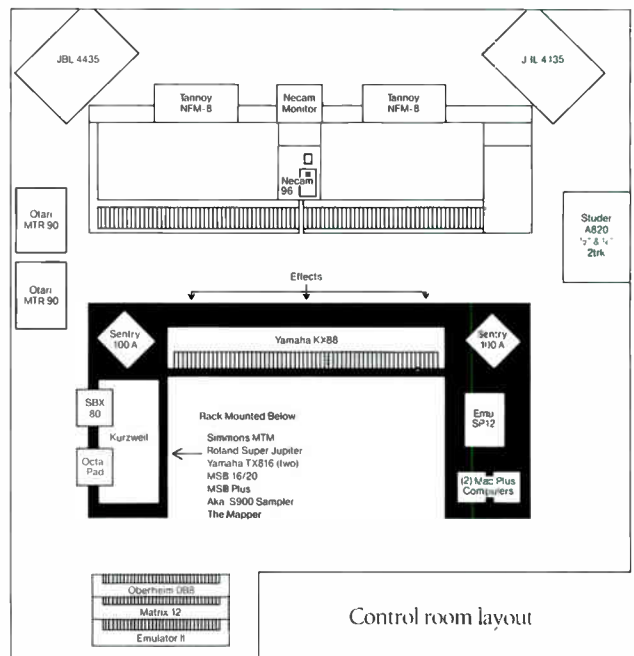



SOUNDS INCREDIBLE!

THE WORLD'S BIGGEST SELLING LIBRARY IS NOW THE WORLD'S BIGGEST LIBRARY!

The Sound Ideas' Series 1000 sound effects library is a premier collection of over 3,000 stereo effects on 28 compact discs. It's also today's biggest selling library.

Now, with the introduction of the Series 2000, an additional collection of over 2,000 all-new digitally recorded stereo sound effects on 22 compact discs, the Sound Ideas library gives you more selection than any other library. Each sound effect can

be found instantly, because the new full-size Sound Ideas catalogue provides both a fully cross-referenced alphabetical listing and a CD track and index listing. Own for the incredible sounds...

Buy for the incredible value!

Call a Sound Ideas Account Executive today!

In Canada - (416) 977-0512.

In U.S. - 1-(800) 387-3030.

86 McGill Street, Toronto,
Ontario, Canada, M5B 1H2.

***THE WORLD'S MOST
INCREDIBLE SOUND
EFFECTS LIBRARY.***



TOMMY SANDS

Here I was, the drummer in a name group. This would be an opportunity for my folks to finally see me perform and maybe understand there might be a future for me in this crazy business."



by Hal Blaine & David Goggin

This month we go back a few more years in Hal's career to one of his first big "breaks," playing drums for the teen idol, Tommy Sands.

The endless touring continued, and in 1957 I was working with a nondescript comedy band traveling all over the United States. I was doing jokes, MC'ing and playing my drums. We worked Duluth, Minnesota, in February and Tucson, Arizona, in August. We'd travel from one end of the U.S. to the other to work for five days, only to find out that we had to go back again. Another 3,000-mile drive. These days were among the lowest for me. But then, almost magically, the leader informed our seven-piece group that we were finally going to Las Vegas—that magic town—where working in a lounge meant a shot at the big time. After months of being financed by our singer, Shirley Claire, and barely eking out a living, this was like a dream come true.

We opened at the Golden Nugget in downtown Vegas. The crowds liked our music and we felt pretty good about the group. We each earned around \$250 a week. After the scant money we had been making previous-

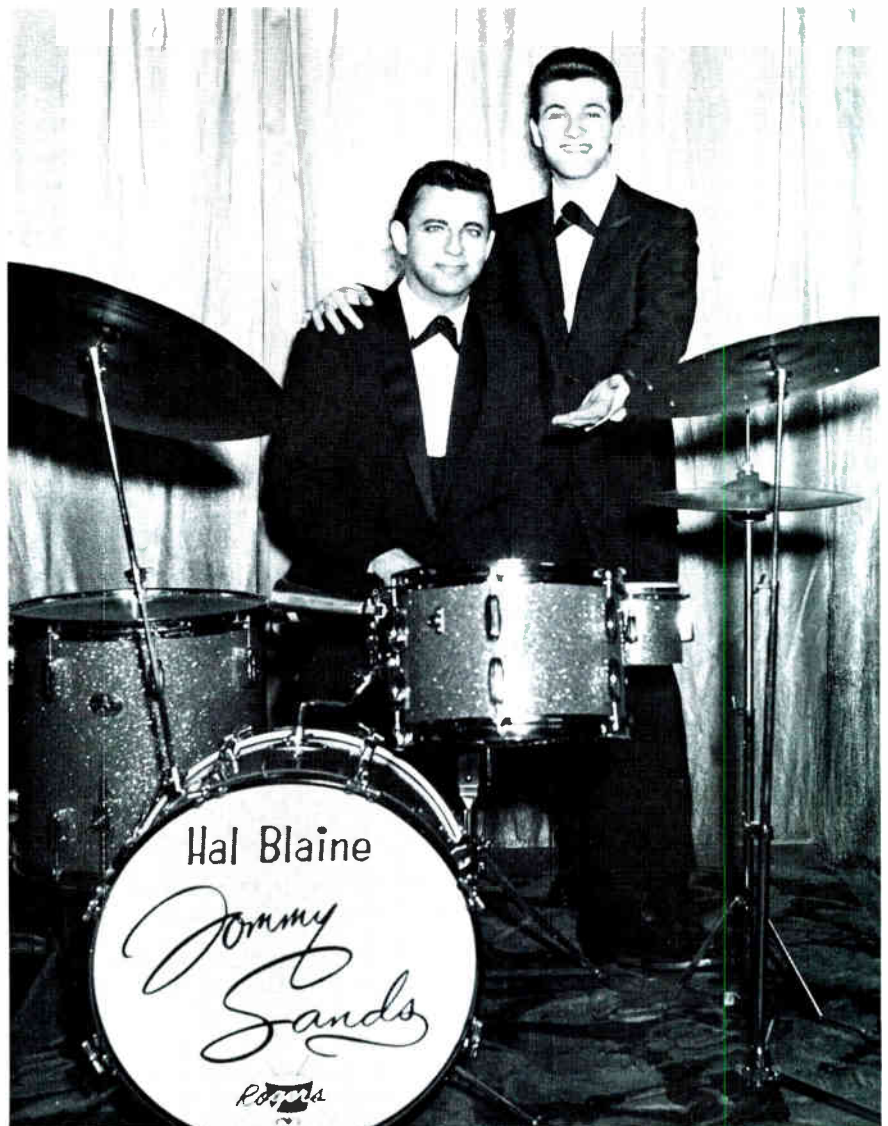

Hal with Tommy Sands

ly, this really felt like success. When our first payday rolled around, we all huddled in the small office of the paymaster, ready for the big bucks. Crying and bellowing, however, our leader informed us that he had gambled the entire payroll away at the tables! Shock, disbelief, horror and then murder entered all of our minds simultaneously.

But sometimes a bad experience can lead to a good one. The owners let us all draw cash in advance, we finished our few weeks there and were booked next at Harvey's Wagon Wheel in Lake Tahoe, Nevada. This was another great lounge for showcasing funny hat bands and these jobs usually led to bigger and better things. Again, we opened to a great crowd and did a rousing first set. We were back on Cloud Nine.

When I had visited my brother at Lake Tahoe a few years earlier, I became friendly with other dealers, pit bosses, security men and the like who worked at the hotels and casinos at the lake. One boss was Felix.

As we came off stage after our opening show at Harvey's Wagon Wheel, a

hand grabbed me and whirled me around. It was Felix and he was obviously happy to see me. I had at times hung around the Wagon Wheel Lounge while working at Sahati's and often sat in with Ian Bernard and his group. Ian, a great pianist and composer, was making a big name for himself in television and movies.

Felix said, "Well kid, you're making the big bucks. I'm proud of ya."

"Well," I said, "three hundred and fifty bucks a week is better than a poke in the eye with a stick, but I wouldn't exactly call it the big bucks." Boy, was I wrong. Felix took me up to the office and showed me a contract that said we were making \$7,000 a week! Now, we were a co-op band, a corporation band making equal money. What a laugh! I was supposed to be making around a thousand a week and our bum band-leader was obviously taking all the money. That's all I had to see.

In seconds I was on the bandstand packing my drums. On my way out a young Latin-looking guy said, "Hey, what are ya doin'?"

"I'm splitting man," I said. "I've been had and now I've had it up to here!"

"How about joining my group next door at Harrah's Lounge?" he said. "It's just a small casino but we're going to open in Hollywood in a couple of weeks. My drummer got sick and we could really use you."

It was an opportunity I couldn't pass up. "Grab a case," I shouted, "and let's go!"

My drums were set up in nothing flat and that was the start of my tenure with the Carol Simpson Quartet. Now I was playing out-and-out jazz, my love of the day. Our first stop was the Garden of Allah in Hollywood, the jazz lounge famous for drawing a crowd of movie stars and producers. I knew this could be the stepping stone to a studio career.

I was on top of the world, working every night at the Garden playing for the Hollywood crowd. It was the kind of job I had dreamed of getting. One night, just about closing time, a man walked up to me and said, "I like the way you play, kid. I got a hot job for you." It turned out that he was the manager of a country group called The Raiders and they were working at a little dump out in Bell, south of L.A. These kids were neighbors of Tommy Sands.

Tommy was on his way to becoming America's latest teenage idol. Elvis was still tops, of course, but was in the service at the time. Elvis' infamous manager, Colonel Tom Parker, knew Tommy and Tommy's mother, Grace, from their Houston days. When the Kraft Theater made a special called *The Singing Idol*, Elvis was all set to do it but his military stint made his participation impossible, so the Colonel called Tommy to do it. Tommy was a DJ in Houston at the time, and he jumped at the chance. Even without Elvis, the show was a smash and Tommy was an overnight star. Thousands of letters poured into NBC and all of a sudden every record company in town was after Tommy. He eventually signed with Capitol and recorded "Teenage Crush," which made it to #2 on the charts in early 1957. Now Tommy needed a band.

Tommy had heard The Raiders practicing noisily in a room at a hotel across the street from his house and he liked what he heard. He told them that he was looking for a back-up band, but they would have to find a drummer. So their manager told me that I could make some really big money—Sands was hot and the group was booked all

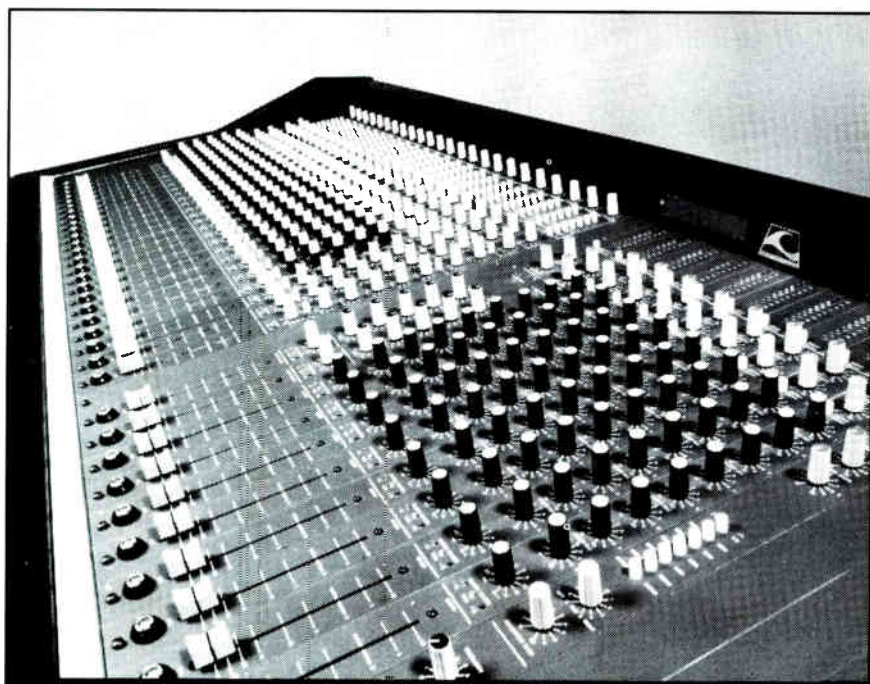

WALKER DDS

Series 80 Mixing Consoles

6850 35th NE
Seattle WA 98115
(206)-527-4371

Circle #097 on Reader Service Card

THE SOUND DECISION

Sound Image presents Phase-Loc: the ultimate sound reinforcement system.

Phase-Loc is an engineering breakthrough in quality acoustics and electronics. Full audio spectrum coverage over a wider area, flexible enough for any application, rugged yet compact.

Phase-Loc is the result of 15 years of professional touring sound experience, plus extensive research and development.

It's the sound choice for quality, and the sound choice for the touring professional.

Here's why.

A unique enclosure design allows cabinets to be splayed — for better area coverage

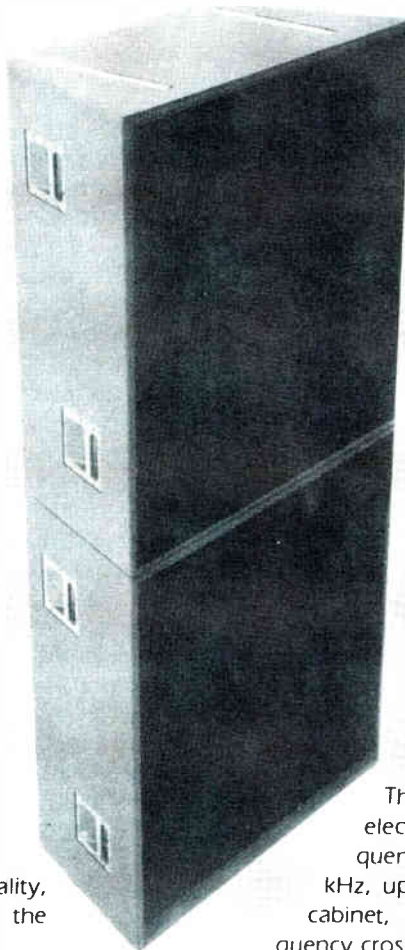

without sacrificing acoustic coupling. Trapezoidal design also minimizes lobing and phase cancellation at higher frequencies. Modular construction gives Phase-Loc the flexibility for top performance anywhere, any time. And its interlocking cabinets can fly four high, eliminating barriers between performers and audience, and making more seats available.

The system's state-of-the-art electronics delivers full frequency coverage, 40 Hz to 20 kHz, up to 1750 watts audio per cabinet, and zero-phase-shift frequency crossover.

Last, but not least, Phase-Loc's rugged, tour-proof construction and compact packaging conserve valuable truck space and shorten setup and strike time.

Phase-LOC[®]
SOUND IMAGE

The Sound Decision

388 ENTERPRISE, SAN MARCOS, CA 92069 – 619 744-8460

"The next weeks were my initiation in the really big time: screaming fans, signing autographs, people ripping at our clothing, leaping into limos. Amazingly, though, Tommy seemed unaffected by his celebrity."

over the world. But I wasn't interested. I didn't know the first thing about rock and roll or country, and rockabilly seemed to be their thing. The manager came back the next night and offered me a lot of money just to audition with the group so that he could get the trio signed. At the last minute they could replace me, he said, but this would insure his trio getting signed with Tommy for the tour. So I agreed, knowing that I would pull out.

The next afternoon I went to the Algiers hotel where I met the three guys. I found them to be really good, honest, hard-working musicians—Leon Bagwell, bass; Eddie Edwards, rhythm guitar; and Scotty Turnbull on electric guitar. I had no idea that these three hillbillies would change the course of my career and my life.

Leon Bagwell was a slap bass player. A good-looking Texan, he spoke with the most countrified drawl I had ever heard. Hailing from Loop, Texas, where he had been a dirt farmer for all of his 19 or 20 years, Leon was green to the business. He was the tall silent type, but boy could he slap that old upright bass!

Eddie Edwards was from San Saba, Texas, famous for its paper shell pecans. Eddie was the comedian of the group. He was also a great rhythm guitar player, but it took me the longest time to get used to his tobacco spitting. Audiences loved him.

Scotty Turnbull, from Lachine, Quebec, was a mixture of country and rock and roll. He was also one hell of a picker and also songwriter—Tommy recorded a bunch of his songs. The trio had met at Texas Tech and formed their group there. (That's where their name, the Texas Raiders, came from.)

We all sat down to our instruments and one of the guys called out "My

Bucket's Got A Hole In It." They started pickin' and grinnin' and I fell in playing with them. I didn't know this tune from Adam, so I just *played*. They did a standard ending and that was that. Unknown to us, Tommy and his manager, Ted Wick, were standing in the hallway and listening just outside the open door. When we finished the song Tommy and Ted walked in and greeted us with, "Well you found the right drummer. Let's go on the road!"

Wick was a lovable, pudgy, round-faced man with a broad smile, obviously wise to the world. I was about 27 at the time and Ted took me aside and said, "I can see that you really know what you're doing and I need an experienced man as road manager for this crew. How about drumming and being the road manager and I'll start you out at three hundred a week?" I said, "Let me think about it." "Don't think too long," he quipped, "you're leaving next week!" We spent the rest of the afternoon running over tunes and it seemed like I did everything right. Tommy was impressed, the kids were impressed and in no time we had a mutual admiration society going.

I spent the next few days with Tommy and the group and really fell in love with everything they were doing. I knew that going to New York and doing *The Gary Moore Show* and *The Perry Como Show* wasn't the worst thing that could happen. Here I was, the drummer in a name group—the chance of a lifetime for a showoff like me. This would also be an opportunity for my folks to finally see me perform and maybe understand that there might be a future for me in this crazy business.

The next weeks were my initiation into the *really* big time: screaming fans, signing autographs, people rip-

ping at our clothing, leaping into limos. We worked state fairs with people like Gabby Hayes, Johnny Cash, and Sky King & Penny. I walked the midways filling up on sweet corn on the cob. It was heaven. And I was treated with more respect than I had ever known.

Amazingly, Tommy seemed unaffected by his celebrity—except when we were about to board an airplane. Then he would suddenly disappear. Time after time the airlines held up the plane while I went searching for Tommy. And I'd always find him at the magazine stand reading movie magazines. He was in every one of them. I even started seeing my puss in one now and then.

The guys in the band were wonderful. They taught me more about the true "feel" of country music than I could have ever learned in a school. I was tuned in to every hit of the day and we were even doing a lot of them on stage. Whenever possible we visited Leon's and Eddie's home towns and the red carpet would always be rolled out for these local kids who made it big. We were quite the celebrities in Texas and Canada, and the parents of these kids treated me like a son. More than that, we all became like brothers, which posed some challenges along the way.

I'll never forget when we worked the Starlite Room of the Waldorf Hotel in New York City with the Count Basie Band. It was an incredible experience for me. Count's drummer, Sonny Payne, got sick so I got to play the gig—a real drummer's dream come true. I knew most of the charts already and now there I was, kicking my favorite big band!

Count Basie, the gentleman of the keyboard, even offered me the job of a lifetime: "I'll make you the most famous white drummer in the world!" I was flabbergasted. What an opportunity! But I explained that being in Tommy's band was my job and I couldn't think of leaving the group. We had worked so hard and the guys in the group were brothers to me. Count even offered me the job as road manager along with the drum chair if I'd change my mind, but there was no reconsidering.

Many years later I was walking through the hallway of United Studios in Hollywood and heard that unmistakable sound from Studio A. I popped

—CONTINUED ON PAGE 162

EXPERIENCE M.E.S.A.: THE POWER OF INTEGRATED MUSIC SOFTWARE



Finally, one single program gives musicians the power to control every aspect of their MIDI environment to create, arrange and produce masterful music compositions. That program is M.E.S.A. (Music Editor Scorer Arranger) from Roland. Integration is the key to M.E.S.A.'s strength as it allows you to move swiftly between its three operating modes (Song, Score and Print) to record, edit and print professional music scores without ever having to change disks or re-boot new modules — operations that could slow down your creativity. By any standards, M.E.S.A. is a breakthrough, for not only does it provide unparalleled power, its mouse-based point-and-click user interface assures that its sophisticated operation isn't complicated. Music can be entered via a MIDI keyboard, the mouse or the PC keyboard to allow even non-keyboard players to express themselves beautifully. M.E.S.A.'s Song Mode contains advanced sequencing functions to record and play back MIDI performances including: 50,000 note capacity, eight tracks, programmable tempo changes, timing offsets, looping function, text function and editing (Delete/Add/Merge/Move) of notes, beats, bars, phrases, or tracks. The Song Mode screen graphically displays the structure of a composition allowing easy cut-and-paste editing and arranging. The Score Mode transfers and displays the recorded MIDI performances in standard musical notation on the screen, automatically placing notes, rests and beams. In Score Mode,



complete compositions can be created and individual notes and MIDI events can be inserted, deleted and modified. Text, phrase marks, triplet brackets, clefs and other musical symbols can be inserted into the score.

The Print Mode screen uses high-resolution graphics to display a page of up to eight staves of music exactly as it will appear when printed. Score layout is user-definable and can consist of up to 16 staves per page. Individual measures can be cut-and-pasted into any order and printed on an IBM compatible dot matrix printer or Laser printer. Spectacular, engraved-quality manuscripts can be created by using a compatible plotter such as Roland's DXY-880, DXY-990 or DPX-2000.

Hardware requirements: IBM PC, XT, AT or full compatible with two floppy disk drives or hard disk (recommended), 512K min. RAM (640K recommended), IBM or compatible EGA, CGA, or Hercules monochrome display system, parallel printer port (25 pin D-connector), Microsoft or Mouse Systems Mouse (optional), Roland MPU-401 MIDI Processing Unit, Roland MIF-IPC Interface Card, any MIDI Instruments.

If you're ready to experience the ultimate in control, you're ready to experience M.E.S.A. For the name of a M.E.S.A. dealer near you, contact *Roland Corp US* 7200 Dominion Circle, Los Angeles, CA 90040 (213) 685-5141.

by Blair Jackson

“LETTERS HOME”

WENDY WALDMAN DOES IT HER WAY

It's always nice to see an overlooked artist get a fresh career boost. Wendy Waldman has made a number of excellent records through the years—albums that showed her to be both an emotive singer and a highly sophisticated songwriter—yet for whatever reasons she's never quite found her audience. Until now, that is. Signing a

year ago with the self-proclaimed “yuppie” record label Cypress Records, Waldman is currently enjoying the strongest sales of her career with *Letters Home*, and is also thriving on every other front: personal, songwriting and producing. For the Los Angeles-born and bred Waldman, the turning point came when she left L.A. and moved to Nashville a few years ago.

“I pulled out and went to Nashville to try to get a fresh start,” Waldman says. “I did a lot of songwriting, a lot of back-up work and a lot of recovering from my last adventures in the record business in California. If you're not a trend-oriented artist and you want to survive, you've got to be prepared to take your lumps and you also have to figure out creative ways to stay in the game. Nashville was so open and there was a lot of work for me and, as importantly, a lot of appreciation for the whole body of my work. I had gone through a really horrible bout with Epic Records and I needed to find a place that was more supportive than L.A. For a while, I commuted back and forth between Los Angeles and Nashville, but then I finally moved. And almost immediately it really did change things for the better.”

To say the least, this was a big move for Waldman. Rightly or not, she had long been considered a member of the “L.A. mafia,” that amorphous group of singer/songwriters who dominated the music scene in Southern California for most of the '70s, including Jackson Browne, J.D. Souther, The Eagles, Andrew Gold, Karla Bonoff and Warren Zevon. “I think Warner Bros. sort of

—CONTINUED ON PAGE 144



PHOTO: KAREN MILLER



Point Source Monitors for Point Blank Truth.



FOSTEX RP TECHNOLOGY

When it comes to sound, some people get a little funny about the point blank truth, in that they don't want to hear it.

They've come to expect that low end bump around 200 Hz because it makes the kick drum punchier, or they like the phase irregularities of the typical tweeter because the highs are all tst-tst.

At Fostex, we believe that truth is stronger than fiction. That's why we made the RM-Series. Point Source. Phase Coherent. Near Field.

They are reference monitors. They tell you exactly what you have and let you hear precisely what you're doing. Period. With neither apologies nor pamperings. Just the point blank truth.

What's more, when you mix with RM-765s or 780s, tape playback remains relatively the same from studio mains, to home stereo to car.

How many times have you heard just the right sound on a mix, only to find a completely different sound when you hear the tape on other monitors?

When you work with sound, you need a truthful reference. One that lets you hear the misses as well as the hits.

We encourage you to audition these Fostex reference monitors with a known source. Because we're confident that you'll know the truth when you hear it.

Point Blank.



RM-765/780

Fostex

Pro Sound Division
15431 Blackburn Ave.
Norwalk, CA 90650
(213) 921-1112

Circle #017 on Reader Service Card

songwriters of the era too.

across the globe.

Real Time...

Real time means real *quality*. ESP provides real time tape duplication (for the highest quality), professional service, a quick turn-a-round, complete packaging services, and low prices.

ESP customizes each order to your needs. All cassettes are custom loaded onto Shape Mark 10 shells.

- Real Time Audio Cassette Duplication
- Full Printing and Packaging
- Custom Loaded Blank Cassettes
- Hi-Fi Video Duplication



CALL TOLL FREE **1-800-527-9225**
Or in NY call collect **716-876-1454**

ESP EASTERN STANDARD PRODUCTIONS, INC.
26 BAXTER STREET, BUFFALO, NEW YORK 14207 / (716) 876-1454

Circle #140 on Reader Service Card

ers," Abrams notes. "You ask some of them their favorite record and they name one that came out when they were one year old. And a substantial number of late college age people looking for something more adventurous."

Abrams feels that upper-aged buyers are "disenfranchised," and he attributes the "classic rock" revival to that. "The 25- to 40-year-olds are still very musically active," he points out and says his research proved that they want an evolution in progressive rock.

Somach admits that Cinema is following a demographic bulge of baby boomers: "The average record buyer isn't 20 years old anymore. The average buyer of Springsteen is 29.5 years old. Most kids buy Cinderella and Megadeth. Cinema's not really for them. Another thing that proves it is the death of the single—nobody's buying them."

Both Abrams and Somach contend that Cinema isn't a bloodless child of market research, but a labor of love whose *raison d'être* was simply buttressed by research. "These days everything's so research-oriented," says Somach. "It's OK to have a little bit of research, but it should really be used to confirm what your gut feelings are, and too many people have lost sight of that."

Cinema's recording budgets, which max out at \$25,000, could be considered low in the rock industry. Somach agrees, "But just because someone spent a million dollars on a record, so what? Where did it go? It didn't go into the record. The first Police record was made for \$18,000. Most of our artists are self-contained and some have their own studios. So why would it cost more to make a record?" Budgetary considerations are part of the Cinema signing criteria. "But that's not to say that if someone wanted to try something and needed additional funds that we wouldn't consider it," says Somach.

Cinema aims to market itself through traditional venues like record stores, though Somach says they're trying to stay out of the new age sections and are shooting instead for the rock bins. Other methods include cross-promotion by including promo on other label artists in each record, an approach that harkens back to the

Power Stroke

PRODUCTIONS

24 Track Studio

24 HOUR RECORDING
DISCOUNT BLOCK RATES
"MIDNIGHT SPECIAL'S"
EQUIPMENT RENTAL

Kurzweil 250
Trident Console • Studer 24 track
Studer 820 2 track • Lexicon 480L
AKG ADR • Publison Infernal Machine
68K digital reverb • PCM 70 • 2-PCM 42
Yamaha Rev 7 • 4 Drawmer gates • EMAX
T.C. 2290 sampler delay • Sontec & White EQ
Yamaha Grand Piano • Meyers Monitor System

For more information and bookings call:

673-1829

245 Hyde • SF • Studio A

Circle #100 on Reader Service Card





Point Source Monitors for Point Blank Truth.



FOSTEX RP TECHNOLOGY

When it comes to sound, some people get a little funny about the point blank truth, in that they don't want to hear it.

They've come to expect that low end bump around 200 Hz because it makes the kick drum punchier, or they like the phase irregularities of the typical tweeter because the highs are all tst-tst.

At Fostex, we believe that truth is stronger than fiction. That's why we made the RM-Series. Point Source. Phase Coherent. Near Field.

They are reference monitors. They tell you exactly what you have and let you hear precisely what you're doing. Period. With neither apologies nor pamperings. Just the point blank truth.

What's more, when you mix with RM-765s or 780s, tape playback remains relatively the same from studio mains, to home stereo to car.

How many times have you heard just the right sound on a mix, only to find a completely different sound when you hear the tape on other monitors?

When you work with sound, you need a truthful reference. One that lets you hear the misses as well as the hits.

We encourage you to audition these Fostex reference monitors with a known source. Because we're confident that you'll know the truth when you hear it.

Point Blank.



RM-765/780

Fostex®

Pro Sound Division
15431 Blackburn Ave.
Norwalk, CA 90650
(213) 921-1112



SUZANNE VEGA COMES TO GRIPS WITH SUCCESS

by Derk Richardson

With only two albums to her credit, Suzanne Vega, the frail-looking waif of the folk music revival, is already playing catch-up with her young career. The success of the single "Luka" (from her LP *Solitude Standing*) and the resurgence of interest in poetic singer-songwriters have Vega out of the bohemian folk clubs and into major city concert halls. The leap has inspired subtle shifts in her songcraft and given her cause to weigh her lifelong outsider stance against the responsibilities of moderate stardom.

"I think my public and private personas are not very separated," Vega explains. "Sometimes I

wish I could separate them a little bit more and put on a public face, but I don't. There are times when I wish I could take a weekend off." Her growing popularity has forced Vega into the limelight offstage as well as on, and she is learning to adapt to the expectations engendered by her visibility. Since the release of *Solitude Standing* and the beginning of her tour, she says, many mailbags of letters have amassed at the record company. "One widower wrote me a letter," she says. "He had four children, and he said I should come have dinner with him."

Vega spent much of her early life on the margins of social life, with words and music providing the main links to the world beyond her private domain. "I think I always did feel somewhat apart as a child," she allows, "partly because I did read at a really early age, and some of it was being a fairly

obvious white girl in a mostly black and Hispanic neighborhood. I also think that if you have any sort of artistic sensibility in America you feel on the outside, because people don't see it in the same light as they do in other countries. Everyone thinks of it as a phase you're going through. 'Oh, you're kind of artsy, maybe you'll grow out of it and do something useful.' I can remember being in the second grade and deciding I wanted to be a dancer, and a whole bunch of girls in my class deciding that wasn't any good, that it was better to be a nurse because nurses help people but dancers didn't help anything. I remember not seeing it in quite that light and not knowing how to say that I thought being a dancer was better for me."

Vega was born in Southern California, but lived there only two years before her family moved to New York. In her own idiosyncratic way, she feels most at home in "almost any big city." "I like that feeling of being together with a lot of people but not necessarily *with* them," she says. "It's the feeling of being in a diner and eating by yourself when it's full of people; no one's asking you questions or talking to you but you're kind of with them anyway." Vega grew up in a household without TV, at least until all four children got chicken pox at the same time and forced the issue. Her parents encouraged the kids to read, think and talk, things which pre-occupy Vega to this day.

She started writing songs

—CONTINUED ON PAGE 134

BACK TO THE FUTURE CINEMA RECORDS TAKES NEW AGE A STEP FURTHER BY GOING A STEP BACKWARD

by Dan Daley

Some old music refuses to die. But where many record companies and radio programmers attribute this longevity to nostalgia, Cinema Records, a year-old venture based in Philadelphia, has a different view. They feel that there is a solid market of adults who still like the music of the '60s and '70s and are willing to pay to hear it in an evolved '80s form.

Where major labels are sporadically making room on rosters for former heavyweights hoping for one more shot at stardom, Cinema has virtually dedicated itself to this proposition. Cinema president Denny Somach and his partners, radio programmer/marketing whiz Lee Abrams and former Steve Morse manager Larry Mazer, call their roster "new progressive." They hope "to fill the void left by Genesis, Yes and Pink Floyd," Somach says. "We wanted to capitalize on the next level. You'll notice that Genesis and Gabriel are both bigger than ever, Pink Floyd is back, Yes had their biggest album of all time a couple of years ago.

"No one is serving the type of people who grew up on that music and who now find new age music to be too many waterfalls and sunsets. By interviewing people who had bought

progressive rock through the early '70s, Lee Abrams found that they were looking for the next level of new age and though they thought new age was fine, it really wasn't serving their needs. So the idea for a label like Cinema came about." Or, as Abrams puts it: "Our goal is to create the music that has the adventurous spirit of the early '70s with today's technology and tomorrow's vision."

Somach began his career as a DJ and a music director in Philadelphia. In 1979 he started his own production company—Denny Somach Productions—which originated syndicated radio and television programs, including *Legends of Rock*, *Scott Muni's Ticket to Ride*,

(WNEW-FM DJ Muni's Beatles paen), and the *Psychedelic Snack*. The titles of the shows reveal less a pattern of nostalgia than an astute realization that 20-year-old music again is selling big, a trend which has exploded of late with the Beatles' "Revolution" being used to sell running shoes, and so on.

So it would seem that Somach was a perfect match for Abrams, whom he met in 1975 when the latter was consulting at WYSK in Philadelphia, his first gig as a consultant in a career that has seen him become the most well-known and respected radio fixer in the biz. Abrams pioneered market research techniques that turned a confused industry

—CONTINUED ON PAGE 136



PHOTO: T. J. HERRIN

DUANE EDDY: IT DON'T MEAN A THANG IF IT AIN'T GOT THAT TWANG

by Bill Milkowski

Guitarist Duane Eddy is living proof that what goes around comes around. It's been nearly 20 years since his last American release, *The Biggest Twang Of Them All* on Reprise, and now he's back in the saddle again with his debut on Capitol, *Duane Eddy*.

Has the twangy formula changed over the years?

"Not at all," says the bearded six-stringer from his home in Phoenix, Arizona. "I like to do what I do. I don't know how you would describe it. I just like the sound that I get and I like making records with it."

Eddy's signature sound is a warm, gutsy, resonant voice, enhanced by echo and judicious use of the tremolo bar. He plays

mostly on the low E, A and D strings, picking economically instead of racing up the neck with flurries of 16th and 32nd notes, as is the fashion of many guitarists today. It's the approach he took on his 1958 hit, "Rebel Rouser" (which has racked up sales of 3 million to date) and it's the same minimalist approach he takes on the new Capitol album. In fact, it's the very same guitar.

"Yep, the old Gretsch," he chuckles. "Same one I had all the early hits on back in the late '50s. It's a custom-made red Chet Atkins model 6120 Gretsch that I bought in 1956 brand new, and I've had it ever since. I've used others through the years. I've got a Guild DE 500 Duane Eddy model that I use for concerts and I can get pretty much the same sound on it. And I've also got a green Country Club model 6120 Gretsch, which

—CONTINUED ON PAGE 139

THE FAR SIDE

By GARY LARSON



Songwriters of the Old West

MUSIC · NOTES

—FROM PAGE 132, SUZANNE VEGA

when she was 14. "It was something I was always interested in," she remembers, "and the whole idea of a singer-songwriting fascinated me as far back as I can remember. I remember thinking that singer-songwriters seemed special because they were able to project their personality in such a way that people listened. To me, a singer-songwriter had all the freedom in the world to say what he or she wanted to and to create their own character. I remember being 12 years old and thinking, 'God,

that's the best. I wish I could write lyrics, it would be so wonderful if I could write lyrics,' and then two years later I started to write. And when I was 16 I decided, Well, I have these songs—I guess I should go out and perform them."

Shy and deathly nervous, Vega inaugurated her performing career in a small coffeehouse in a church basement, the kind of proper 1970s bohemian spot with candles on the table, serving brownies and apple juice. She was 20 when she first went down to Greenwich Village, "to see what this folk revival was all about." Vega was

one of the youngest in a crop of singer-songwriters that included Steve Forbert, Willie Nile, Carlyne Mas and The Roches. "It was really exciting," she recalls. "There was a feeling of hope and a feeling that things might actually get a little easier for people who were doing that kind of music." But already, she says, "the scene has lost some of its focus," and, besides, she's not around enough any more to be a part of it the way she was.

In folk music Vega found fewer of the obstacles that greet most women performers in pop, but she was and is aware of the gender issue. "I think it's hard for any woman coming up," she says, "especially in a field that has so many men in it. But I think if someone sticks to their own unique way of performing, they'll make it through. If you develop your unique characteristics, you'll be respected for them whether you're a woman or not. I never wanted to get attention because I was a woman. I never wanted to be deliberately sexy. It meant a lot to be respected for my songs and for being intelligent.

"Lately," she continues, "people have more role models to look up to. You can play it any way you want, from Laurie Anderson, who is completely androgynous, to Madonna, who is certainly not androgynous by any stretch of the imagination. There is a whole range of people you can at least look at and think about. If I would want to be like anyone it would probably be Chrissie Hynde or Rickie Lee Jones: they have a certain toughness about them that I admire."

But however much she rocks out or toughens up, Vega's appeal will always be based on her detailed attention to words. Her audience, she surmises, is interested in the kind of "poetic songwriting" that was popular 15 years ago. But more than a throwback, the cool, measured and often soothing sound of her music is not far removed from the placid instrumental new age music that is in vogue today. Vega sees her songs as filling a need that she felt when she was growing up, and that she believes is felt by a significant audience of all ages. "I feel that my music does have a service," she explains. "I'll never forget what it was like to be a fan, to be working as a receptionist and music was my inspiration. It meant so much to me to be able to go home and listen to Leonard Cohen or Paul Simon. It was one of the reasons for

PROSONUS®



Better Than Live

The softness of a sax. The smoke of an electric guitar, the dancing rhythms of a xylophone.

When you're sampling sounds, nothing's as good as live. And nothing's as much trouble.

The new Prosonus Sound Library puts you in control. We offer an on-going series of direct-to-disc recordings on CD that give you the live sounds you need — without the hassles.

Just connect any CD player to any sampler. You get complete and easy access to hundreds of live error-free sounds — each one recorded or designed by professional musicians and engineers.

So sample Prosonus. The professional's sound library.

Because better sounds make better music.

For more information, visit your favorite music store or call Prosonus at 213 463-6191.

S O U N D L I B R A R Y

(formerly known as CSI)

Circle #098 on Reader Service Card

getting up in the morning, so you could go to the record store. And I'll never forget that view of the world. Now I feel like I speak things for people who can't speak them for themselves."

"Luka," the successful single from *Solitude Standing* is the best example of Vega speaking up for the relatively inarticulate. Not only does the song contain her most overt social commentary, illuminating the fear and silence around the issue of child abuse, it is arguably her best song to date because of its straightforward, unadorned lyrics. "I was trying to capture the point of view of the person who is being victimized," Vega explains. "I tried to put it in the language of a 9-year-old boy. I tried to write it as simply as I could." In so doing, she created far more powerful images in "Luka" than the often overwrought word tapestries of some of her other songs. But "Luka" has also placed new burdens on the songwriter. "Two years ago when I was on tour," she explains, "the words I heard most linked to my name were 'folk music.' Now it's 'child abuse.' At some point I'd like to work through that so people can see I've written other songs, about other things also."

Vega also does not want to generate expectations of explicit political commentary in every song. "I feel that the small situations I write about," she says, "if you take them and put them in different circumstances, they become big issues. I think about those issues a lot. I just have not yet found the way to put them into writing in any way that I feel is meaningful. I'm not just going to sit down and write a political song because people think I should be the new Bob Dylan. That did happen for a while where I'd get, 'You're supposed to be a folk singer, where are your political songs?' I don't subscribe to that."

These days, Vega is concentrating on her new creative relationship with a working band—bassist Michael Visceglia, synthesist Anton Sanko, guitarist Marc Shulman, and drummer Stephen Ferrara. On *Solitude Standing* all the musicians contributed to the music writing, and it was the first time Vega had collaborated on her songs. "At first it made me very nervous," she admits, "but I found after a while that it was a very natural way to work, and in some ways it is more natural to work with the band that you're going to be recording with and touring with

rather than doing everything myself. Suddenly it left me free to do things I knew I was good at and then I could parcel out the work to everyone else. I'd say, 'I need a bridge, could you write me something like that?' I wanted to learn more about writing. I think a lot about the lyrics. I didn't always know how to think about the music. In some ways, the way I was thinking about music was somewhat primitive compared to the way I think about lyrics. I found when I was working with the band I could expand a lot more and work from their perspective."

The band has also given Vega, a consummate loner, a new sense of

home. "I like sitting on the bus with the band," she says, "and traveling with them. In some ways it reminds me of the one time when I did fit in: when I came down to the Village in 1980 and I found a whole group of people who were doing what I was doing. I found a certain comfort in that, and now that I'm away from that scene a lot, I find I go to the band for that sense of support."

Last year, Vega missed the ten-year reunion of her graduating class at New York's High School of Performing Arts. She confesses curiosity about who made it and who didn't. "In that high school," she says, "that's kind of what



Move your Fairlight™ CMI up to first chair with The Master Sampler Collection™ of fully-engineered virtual instruments for professional sound producers. Unlike a "sound library" of raw notes that you must sample, trim, loop, filter, transpose, ... every virtual instrument in The Master Sampler Collection is ready to load and perform.

The Master Sampler Collection provides producers with the highest fidelity and sonic realism that digital sampling computers can produce.

Along with the collection, you receive ScoreKeeper™ which organizes the entire collection of virtual instruments. ScoreKeeper allows you to listen to each waveform on an Apple Macintosh™. After you have selected virtual instruments and prepared a score, ScoreKeeper takes your decisions to the Fairlight and minimizes wait time by handling all the loads from disk to RAM.

Don't play second fiddle! The Master Sampler Collection moves you up to concertmaster.



SOUND GENESIS

Sound Genesis Corporation
7808 CreekrIDGE Center • Minneapolis, MN 55435
(612) 944-8528

Fairlight is a trademark of Fairlight Instruments, Pty. Ltd. Macintosh is a trademark licensed to Apple Computer Inc.. Master Sampler Collection and ScoreKeeper are trademarks of Sound Genesis Corp.

Circle #099 on Reader Service Card

DON'T MISS YOUR DIRECTORY

**NORTHEAST STUDIOS
MAY 1988
Questionnaire Deadline:
February 3, 1988**

**REMOTE RECORDING
& SOUND REINFORCEMENT
FACILITIES
JUNE 1988
Questionnaire Deadline:
March 3**

85% of *Mix* subscribers read *Mix Directories* for information on Recording and Production Services.* Don't miss this opportunity to get the valuable exposure you're looking for!

To be listed in *Mix Directories* or for more information, please call or write:

**Mix Directories Dept.
2608 Ninth Street
Berkeley, CA 94710
(415) 843-7901**

*1987 *Mix* Readers Survey.

MUSIC · NOTES

everyone was aiming for. I'm amazed that so many people who I thought would make it never did. I'm certain that a lot of people are astonished that I made it, because I was very quiet, introspective and moody. I don't think I was someone you would have picked out as most likely to succeed." If her success has come fairly quickly and unexpectedly, Vega wears it well. Her test will be to decide what to do with it, and discover how to keep her creativity apace. ■

—FROM PAGE 133, CINEMA RECORDS

around. As he was programming Somach's playlists, Somach saw that their personal tastes were similar and ran to The Nice and King Crimson. "Lee's one of the biggest Yes fans in the world," he says, "and I shared that with him."

Two years ago the pair began looking for ways to take advantage of the burgeoning new age audience and the technology that was paralleling it, but employing the "progressive" music that was born of art school dropouts in London 20 years ago rather than the wind chimes and mantras of the West Coast. "We were looking for *Dark Side of the Moon 1987*, and it just wasn't happening," he says. But he was convinced that it was out there:

"This is basically an English type of music. But 18-year-olds over there who would make this kind of music look around and realize they're not going to get signed [to labels] doing it. As a result there really aren't a lot of new artists doing this kind of music. But we found that there are a lot of veterans of it who haven't been out there for a while—people like Tony Kaye of Yes [whose *Cinema* record is pending release], Pete Bardens from Camel and Patrick Moraz of Yes and the Moody Blues."

Thus was born the *Cinema* roster. Along with Michael Hoenig, who toured briefly with Tangerine Dream (a band that Somach and Abrams consider seminal) and Amin Bhatia, the only "new" artist they've signed, they pulled together a collection of older recording artists making new music. The company's first release was on June 4, 1987, distributed by Capitol Records.

A roster based on retreads? You put the question that way and then duck. But Somach has a sense of humor: "We like to call them dinosaurs," he laughs. "But remember, the Moody Blues are bigger than ever; they just had their biggest album in five years and did a major tour. Yes is going to have a bigger album than the last. We look at our roster as established, veteran, pro-type guys. Individually they may not have the marquee value of the group they were in. But generally what happens with a guy like Patrick Moraz or Keith Emerson, who we also spoke to, is these guys spend a year doing their album with their group, then they spend a year on the road, then the record company, as a favor, gives them a solo deal and that's why they never put out great solo records. Part of our criteria is that this can't be like a hobby, like it's been in the past. If you want to make a solo record for *Cinema* it has to be better than that.

"And every one of our artists is a real artist in the sense that they all tour—not like Windham Hill where three or four of the artists tour and the rest just make records. Pete Bardens will most likely be doing a tour, Patrick Moraz will do a tour." Somach assures that *Cinema* will support these tours.

He then takes the rationale a step further by adding, "Nowadays, people would rather get a record from a real pro veteran like Keith Emerson or Patrick Moraz than take a chance on a new artist. People have less money to fool with. Years ago you could get a record for three or four dollars. Now, with higher prices and CDs, you're taking more of a risk on a purchase. And there's more new media competing for your money."

But will this close off slots to yet more new artists, something that Classic Rock formats have been accused of doing by clogging the airwaves with records made nearly two decades ago? "No, not at all," Somach responds. "If we had more new artists who made this kind of music, we'd sign them, but they just don't exist. And that's mainly because those who would—before we came along—felt that they wouldn't get signed, so why should they make that music? Ours is a long-term plan, but people need to be educated to it. As soon as we educate the public to what we're doing, this thing will really just explode."

Somach is careful in signing new artists. "We talk to a lot of people and what we look for is those who have the 'it' factor," he says enigmatically. "Of every 20 we talked to, 19 didn't have that. Only one really understood what we were doing. They [people with 'it'] know how to use the technology of the '80s and they have a vision of the '90s and they are able to produce this kind of music. Basically, we're looking for artists who have kept up with technology."

While he says he'll listen to other types of music, he makes it clear that he's looking for artists who came out of the art rock movement and that what defines the Cinema sound is, in a word, *technology*: Or more precisely, its artistic applications.

Pete Bardens had a video track from his LP, *Seen On Earth*, in heavy rotation on MTV a year ago, and Somach contends that MTV made a statement about the music's viability by running the instrumental cut. He admits there was some resistance initially: "Everyone said, 'You're crazy.' But this is like the progressive rock movement of the late '60s where you had groups like the Grateful Dead and the Jefferson Airplane drawing people to concerts and everyone wondering what's going on. Then it started to creep onto the radio and then it exploded. The same thing's going on now. Six years ago, Windham Hill started and now you have George Winston and Will Ackerman selling millions of records without any airplay. As soon as it starts to get airplay with the advent of all these so-called new age stations, it'll get bigger." Just as the advent of cassettes and component stereo aided progressive rock years ago, Somach draws an analogy to CD's explosion now, and the new type of music it might usher in.

Of course, it doesn't hurt to have as your partner the biggest *wunderkind* radio has seen since Marconi blew his first tube. When Abrams talks, E.F. Hutton listens; trade and business publications from *Advertising Age* to *The Wall Street Journal* have acknowledged his primacy in the radio programming field. And as much as Somach professes to truly love the stuff, market research played an important part in the formation of Cinema, if only, as Somach states, "To make sure we weren't fooling ourselves."

Abrams developed a system of "call-

back cards" in 1972 in which record buyers fill out cards as they make a purchase and are then called afterwards and quizzed about the purchase and other preferences. Over the last 15 years, the files have become massive. "He tracked down some guy who bought Genesis at 19," says Somach. "He's now much older and works for a brokerage house. When Lee got to those people he checked what they were into now and found out that his instincts were correct. They still want what they listened to back then."

The response was catalytic if not cataclysmic, according to Abrams,

speaking from his home in Atlanta, GA. "Not everybody loved it, but there was a definite segment that's really into it," he says. "Certainly enough to create a renaissance for a lot of these artists and unquestionably enough to constitute a client base for a new record company."

Abrams says his research outfit, Burkhart/Abrams/Douglas/Elliott, had about a 20% success rate in finding the people from call-back files after 12 years, about 1,200 people out of 5,000 calls. The numbers broke down to a 60% male group, 25 to 40 year old. "And surprisingly a lot of teenag-

TRIDENT



THE PRODUCERS' CHOICE

Take One Recording Studios
Burbank, CA (818) 841-8697

**PROFESSIONAL
AUDIO SERVICES
AND
SUPPLY CO.**

619 South Glenwood Place
Burbank, CA 91506 • (818) 843-6320

Real Time...

Real time means real *quality*. ESP provides real time tape duplication (for the highest quality), professional service, a quick turn-a-round, complete packaging services, and low prices.

ESP customizes each order to your needs. All cassettes are custom loaded onto Shape Mark 10 shells.

- Real Time Audio Cassette Duplication
- Full Printing and Packaging
- Custom Loaded Blank Cassettes
- Hi-Fi Video Duplication



CALL TOLL FREE **1-800-527-9225**
Or in NY call collect **716-876-1454**

ESP EASTERN STANDARD PRODUCTIONS, INC.
26 BAXTER STREET, BUFFALO, NEW YORK 14207 / (716) 876-1454

Circle #140 on Reader Service Card

ers," Abrams notes. "You ask some of them their favorite record and they name one that came out when they were one year old. And a substantial number of late college age people looking for something more adventurous."

Abrams feels that upper-aged buyers are "disenfranchised," and he attributes the "classic rock" revival to that. "The 25- to 40-year-olds are still very musically active," he points out and says his research proved that they want an evolution in progressive rock.

Somach admits that Cinema is following a demographic bulge of baby boomers: "The average record buyer isn't 20 years old anymore. The average buyer of Springsteen is 29.5 years old. Most kids buy Cinderella and Megadeth. Cinema's not really for them. Another thing that proves it is the death of the single—nobody's buying them."

Both Abrams and Somach contend that Cinema isn't a bloodless child of market research, but a labor of love whose *raison d'être* was simply buttressed by research. "These days everything's so research-oriented," says Somach. "It's OK to have a little bit of research, but it should really be used to confirm what your gut feelings are, and too many people have lost sight of that."

Cinema's recording budgets, which max out at \$25,000, could be considered low in the rock industry. Somach agrees, "But just because someone spent a million dollars on a record, so what? Where did it go? It didn't go into the record. The first Police record was made for \$18,000. Most of our artists are self-contained and some have their own studios. So why would it cost more to make a record?" Budgetary considerations are part of the Cinema signing criteria "But that's not to say that if someone wanted to try something and needed additional funds that we wouldn't consider it," says Somach.

Cinema aims to market itself through traditional venues like record stores, though Somach says they're trying to stay out of the new age sections and are shooting instead for the rock bins. Other methods include cross-promotion by including promo on other label artists in each record, an approach that harkens back to the



Power Stroke

PRODUCTIONS

24 Track Studio

24 HOUR RECORDING
DISCOUNT BLOCK RATES
"MIDNIGHT SPECIAL'S"
EQUIPMENT RENTAL

Kurzweil 250
Trident Console • Studer 24 track
Studer 820 2 track • Lexicon 480L
AKG ADR • Publison Infernal Machine
68K digital reverb • PCM 70 • 2-PCM 42
Yamaha Rev 7 • 4 Drawmer gates • EMAX
T.C. 2290 sampler delay • Sontec & White EQ
Yamaha Grand Piano • Meyers Monitor System

For more information and bookings call:

673-1829

245 Hyde • SF • Studio A

Circle #100 on Reader Service Card

early '70s (remember Warner's sampler series?). Marketing plans also call for ads in publications like *Playboy* and *Esquire* as well as music-oriented magazines.

Somach says that they didn't really factor radio into their marketing plans, and that they lucked out with the acceptance of Pete Bardens. Otherwise, they're concentrating on specialty niches, like headphone oriented shows. Somach points out that Cinema's were the first simultaneous vinyl, cassette and CD release in Capitol's history, and that their approach is similar to Capitol's progressive Harvest label in the early '70s, whose roster included Pink Floyd, Babe Ruth and Quatermass.

Radio does figure in Cinema's future, however: "As soon as more [alternative] radio stations go on line and a general awareness of this type of music gets through, I think the whole thing's going to explode," remarks Somach. "Every record company has a new age division. And we feel like our type of stuff is going to be even bigger in Europe and Japan than new age." ■

—FROM PAGE 133, DUANE EDDY

I used last year on 'Peter Gunn' with The Art Of Noise. I get pretty much the same sound on all my guitars. It's my sound and I wouldn't change it for anything."

That 1986 session with The Art Of Noise is partially responsible for bringing Duane Eddy back into the lime-light after all these years. Between July 1958 and February 1963, Eddy and his twangy guitar scored an incredible 15 Top 40 singles. But with the emergence of The Beatles and other British Invasion bands of the mid-'60s, Eddy's strictly instrumental approach suddenly fell out of vogue.

During the late '60s and throughout the '70s he surfaced only occasionally—in England, ironically, where there was still a sizeable market for instrumental music. In 1975, his single "Play Me Like You Play Your Guitar" reached #9 on the British charts, but he was still ignored in the States.

Then The Art Of Noise called. The British techno band brought Eddy over to England to work on a remake of his 1960 best-seller, "Peter Gunn." The song became an instant hit, reaching the Top 10 around the world, and

ranked #1 in the summer of 1986 on *Rolling Stone's* dance track chart. The twang was back.

"The record came out and did well and I ended up doing a little tour with them last summer," Eddy recalls. "And during that tour, Huey Lewis' manager, Bob Brown, called up and asked me if I'd like to go out on a tour, opening up for Huey Lewis & The News. Naturally, I accepted."

Suddenly, interest from record companies surged. "Up until that point," he adds, "record companies weren't all that interested in me. They thought the 'Peter Gunn' record was sort of a fluke—a novelty and all that sort of thing. But when I went out with Huey, that got their attention. Huey let it be known that he really liked what I did and that he was gonna take me out again come spring, so they figured they'd better come up with some product."

Capitol signed him and released *Duane Eddy* the following summer. The album was something of a globe-trotting project for Mr. Twang, involving sessions in Nashville, Los Angeles and London. And for this comeback album, Eddy ended up getting a little

help from his friends.

"I had this idea that if I had different producers working on the album it wouldn't take so much time out of their lives, and also I'd get the best of their singles-thinking, so to speak.

"The first people I called were the folks from The Art Of Noise. They happened to be in L.A., so they flew down to Nashville and we did two tracks, 'Spies' and 'Lost Innocence,' live at Treasure Island studio. Then they took the tapes with them back to London and finished overdubbing some of their effects and things over there.

"Next, I went out to the Capitol studios in Los Angeles to work with Ry Cooder, who's been a friend of mine for several years. He had written a couple of songs with me in mind, 'Blue City' and 'Los Companeros.' So we did them live and he overdubbed some strings there and finally mixed it at Ocean Way studio, which is the old United studio. Lee Herschberg did the engineering on that. He's been around a long time—probably as long as I have.

"Then I went to London to work with Jeff Lynne, who I had met in Mon-

—CONTINUED ON PAGE 220

JBL
ALESIS
Roland
YAMAHA
FOSTEX
TRIDENT
SONY
TASCAM
OTARI
AMPEX
Soundcraft
dbx

10 years of satisfied customers nationwide...
a reputation built on superior service and
competitive pricing.



PROFESSIONAL AUDIO-VIDEO
2641 E. McDowell • Phoenix, AZ 85008
602-267-0600

Circle #101 on Reader Service Card

—FROM PAGE 80

procedure of loading the program onto the hard disk. You simply feed the disks in as it asks for them. Once you've started adding your own data, you employ the backup/restore technique to move the library from one computer to another. PL gives you direct access to the DOS backup and restore programs, which facilitate making backups of the data, stored in separate sub-directories from the program. Another feature I like is the auto-save function: PL waits for you to stop typing and after 20 seconds writes the latest changes to the hard disk.

Leonardo has adopted the Lotus 1-2-3 style of horizontal menus, which most people seem to catch on to pretty quickly, and has added a title bar for each menu as well. PL is a menu-based program: telling it to do something always involves choosing an option from a menu. First-letter selection of the menus is possible, just like Lotus, and context-sensitive help is just a key-stroke away. PL supports color with extensive user-definable choices. Most of the time when entering something at a prompt, PL can display a pop-up window to give you a list to choose from.

When PL lists effects on screen you can switch between one line per effect or as many lines per effect as necessary to see all of the information about that effect. The effects are displayed clearly, in a manner that corresponds to the printed version in the catalog or roll listing.

Adding Your Own Data

To enter information about sound effects into PL, you fill out a screen resembling a blank form for each effect in the library. Each line you type on is called a field, a computer term that indicates a piece of information. The different types of information (length, format, effect number, description, etc.) are each entered on a different line: after typing one, you press Enter and the cursor jumps down to the next prompt.

Context-sensitive help is available at all prompts, by pressing the F1 key, to explain what each prompt is for. Even better are the pop-up reference lists available at most prompts, to remind you of potential choices.

Typing the effect descriptions into

the computer was a big job for our library, which numbers about 10,000 effects; we were typing for months. That is the downside of the computerized catalog. At least for the commercial libraries we didn't need to enter anything because Leonardo provided us with the information already typed in the computer. As more libraries are released on CD, Leonardo plans to keep providing the new descriptions in the catalog and providing their customers with floppy disks containing the data. We've already received some for the BBC, Elektra, Valentino, Sound Ideas and Digiflex libraries.

Searching the Effects Library

One of PL's strongest features is its ability to create equivalents. Equivalents are words that describe the same sound, like "CARS" and "AUTOMOBILES." It is a simple matter to tell PL to link those two words; from then on, any time you ask for "CARS," PL will automatically also search for "AUTOMOBILES" and vice versa. You can link as many words as you want; you can remove the link words at any time later on. However, "CARS" is a very general word, probably used in many effects; a search for "CARS" would turn up a huge list. Fortunately, PL also lets you be as specific as you want: you could just as easily ask for "1957 CHEVY BEL-AIR PASS-BY AT 30 MPH ON A DIRT ROAD."

The great advantage is being able to look for any word in any description. For example, say I had a traffic background described as "NYC TRAFFIC—TIMES SQUARE AT NIGHT—RECORDED FROM WINDOW—DISTANT CITY PRESENCE—HORNS & TIRE SQUEALS"; I might usually use that as a traffic effect. But let's say that one day I need distant car horns. Since this description contains the words "Distant" "Car" and "Horns" I would find it in a search based on "Distant Car Horns," although when I put the effect in the library, I felt it was basically a traffic effect. As long as the words are in the description you can find the effect.

PL also provides a clipboard list that you can add effects to as you search, so you can selectively build up a list over a period of time. That listing can be viewed on screen or printed. You can even give it a unique title when it prints. For example, if you were looking for sounds for something in par-

ticular, like a specific scene in a film, you could search and select and search some more until you found all the effects you needed. Then print the select list with the title of the scene. A very useful function.

Floppy Disk Libraries

We use the E-mu Systems Emulator to create sounds, which means we have effects samples stored on floppy disk. PL handles samples very intelligently: each sample is a unique effect in the library, even if it is a copy of another effect; however, PL can "link" the sampled copy and the original. So if you search for effects you can see if the effect displayed is an original or a copy, if any copies have been made, and what the copies are. PL also prints nice labels for the floppies and uses the paper sleeves to hold labels that show the descriptions of the effects sampled.

Problems

As much as I like PL, I do have a few gripes about some features I hope they'll fix in the next software update. The effect descriptions are always converted to upper-case letters. The program won't run on a computer without a hard disk (they probably can't do anything about that). The program doesn't use a mouse or pull-down menus like the Macintosh. Once you know your way around the menus, being able to mouse-click on a command line would be a faster way to get from point to point.

Newer, better and cleaner sound effects are always being recorded, leading inevitably to larger libraries. Unfortunately, the bigger the library, the more difficult it becomes to use, unless you put in the effort to keep it organized. PL does a superb job of helping you keep on top of an effects library. It is rich with features that anticipate the most complex problems, it provides extremely fast and flexible access and it is clear and straightforward to use.

Once you've tried the convenience of Professional Librarian, you won't ever want to use paperwork again.

To find out more about the availability of Professional Librarian software, contact Leonardo Software, 693 Washington Street, Venice, CA 90292-5418; (213) 305-1521.

The PL software package for IBM-PC ATs and compatibles costs \$750. A remote control unit for the Sony CDK-006 multiple compact disc player costs \$250. ■

Jerry Ross is a supervising sound editor working in the Los Angeles feature film industry. His credits include D.O.A., Raw Deal, Delta Force, Bedroom Window and Times Square.

FIELD TEST

—FROM PAGE 85

church, and including such interesting simulations as wood rooms of several sizes and halls with and without stage reflections.

Effects: In this category I have lumped two banks: Wild Spaces and Effects. With only a few exceptions, these programs do not provide any realistic sounds. Wild Spaces appears to be a reverb algorithm gone crazy, while Effects is a high-powered multi-tape delay algorithm with an emphasis on random modulation of the delay times (as in the 224 and 224XL Chorus programs). Wild Spaces shares the parameters of the reverb programs and includes in its complement of factory presets sounds that are reminiscent of the inside of an oil drum, or a number of silica beads bouncing around a surface. Obviously, it is difficult to describe such sounds other than to say that they will make purists cringe and pop producers smile.

The Effects program introduces yet more new parameters. The algorithm provides for up to 40 randomly time-varying voices; the Number, Length, Spin and Wander parameters control the quantity, delay time, rate of delay time modulation, and depth of modulation, respectively. Slope controls the delays' amplitude characteristics, which range from a linear decay, through flat (equal amplitude for all delays), to a linear increase. Number and Length interact: the greater the number, the smaller the available length. If 40 voices do not sound thick enough, the voices can be divided into clusters, and a single tap is available for feedback. There are a few other notable aspects of this program. One is the ability to delay the original, dry signal so that the effect can precede it (all reverb and effects programs have a wet/dry mix param-

ter). Used on backbeat snare, for example, the delays can be heard before the snare itself. Easier than turning the tape over, if slightly more limited. Another parameter allows the two inputs to be continuously varied from normal stereo through mono to reverse stereo.

But the unique aspect of this program is that any pitch shifting that would ordinarily result from varying the delay times is suppressed. This means that a piano or guitar can be chorused without any pitch wobble.

Sampling: With a 48 kHz sampling rate and 18-bit A/D conversion, the 480L offers extremely high fidelity, making it excellent for sampling. There are two banks for sampling, the difference between them being that the Sampler program uses a 5-milli-

second fadeup on playback, whereas the Drum Sampler is instantaneous.

The Sampler program allows a sample to be played forwards, backwards, or both, with a programmable overlap. The Rate Changer provides pitch shifting of the sample, and the Dual Sampler does Forward/Reverse and Rate Changing. Sampling length for the Forward/Reverse and Rate Changer are 1.5 seconds; other factory presets allow three seconds of mono, three seconds of stereo, or six seconds of mono, but all three of these require all of the 480L's memory, mandating the use of the Single configuration. Samples can be triggered manually, by an audio trigger (with an adjustable threshold), or by a MIDI note event.

The first card for the 480L's expan-

480L Software/Hardware Update

As this review was going to press, *Mix* received word from Lexicon of both hardware and software updates for the 480L. *Mix* was unable to evaluate these updates, so the information presented here comes from Lexicon. The hardware update is in the form of the Sample Memory Expansion (SME) board (which plugs into the extra slot on the 480L chassis) that expands available sample time to more than ten seconds of stereo or 20 seconds of mono at a 48 kHz sample rate. The SME also adds to the current sampling programs all enhancements included in the software update described below, as well as stereo rate changing and stereo forward/reverse sample playback.

On the software side, Version 2.0 software has been released. Version 2.0 contains a simple two-channel pitch shift program which will work on stereo or dual mono material. Pitch shifts up to a major 7th above and an octave below original pitch can be performed, with programmable pre-delay and feedback for each channel and adjustable splice time. Several enhancements to the 480L's sampling programs are also included: the ability for sampling to be triggered from an audio source, synchronized sound-on-sound recording, and "Time Variant Recording." This last is a feature that creates a sort of sampling "pre-roll" time. After choosing a time value for this parameter, the 480L begins continu-

ously sampling. When recording is actually triggered, the programmed amount of time before the record trigger is saved, along with the sample after the trigger. This avoids losing important attack transients due to the user's reaction time when triggering. Of course, this "pre-roll" is subtracted from the total sample time available.

The Stereo Adjust program has been restructured and enhanced. Instead of individual level controls for each channel there are coarse and fine level controls and a balance control. Stereo image can be altered with a Rotation control, which operates similarly to changing balances in an M-S recording. EQ features include ganged stereo treble and bass shelving EQ with programmable rolloff frequencies, separate treble shelving controls for each channel (in addition to the ganged stereo EQ), and the Spatial EQ. Other processing features are on/off toggles for: 11.5 microsec delay (used with Sony PCM-F1 recordings to compensate for delays resulting from the multiplexed A/D), de-emphasis (used for recordings made with Sony PCM series processors that have the pre-emphasis feature), and phase inversion for one channel.

The SME is priced at \$2,000 (which includes the board and support software), and the Version 2.0 upgrade is \$99.

—by Larry Oppenheimer

sion slot will be a memory expansion which will allow around 30 seconds of mono sampling. This should be available by the time you read this.

Utility: The Doppler and So What Else? banks provide several useful utility programs. As one might imagine, Doppler is a program, designed for film and video work, that simulates a "fly by" such as one experiences when a train or car drives past. The program uses pitch and amplitude cues and provides extensive controls, such as apparent speed, approach (and recede) time, apparent distance from the listener as it passes by, normal or parabolic (zoom) path of travel, and a "fudge factor" which alters the pitch shift/amplitude shift ratio. The effect is triggerable manually or from audio.

The Stereo Adjust program, intended primarily for CD mastering applications, allows ¼ dB resolution control over level of each channel, ½ dB resolution control over two bands of EQ on each channel, plus a parameter called Spatial EQ. Griesinger's research has led him to believe that, contrary to popular notion, directionality of low frequencies is not only perceptible, but vital to the perceived "spaciousness" or stereo width of an image. Thus, Spatial EQ deals with the stereophony of low-frequency material, yielding influence over perceived stereo width. It is my understanding that the second version of the 480L's software, which will probably be available when you read this, will feature some revision of this program. A Twin Delay program with cross-feedback as well as same channel feedback is also included.

MIDI: The 480L incorporates the same Dynamic MIDI (a Lexicon copyright) concept as the very successful PCM70. MIDI events can be mapped to up to ten parameters at a time and can then vary those parameters continuously. As I have written before, some parameters lend themselves to this control better than others. As of this writing, the 480L is not capable of dumping/loading via System Exclusive messages, but this will reportedly also be in the Version 2 software release.

Subjective Evaluation

So what did I think of this thing? Good grief, there's a lot to look at in

the monster! That was not simply my thought on reviewing it, but on using it. For some, the sound and versatility of the unit alone will justify its cost, even though they will never go much beyond calling factory presets. If that is your bent, I can assure you that the unit sounds excellent and offers some fine factory presets, especially in the reverb programs. The 480L is far and away the quietest digital signal processor I have ever used, and the audio quality is beautiful, probably due to the high sampling rate and A/D/A resolution. The Plate program was compared to an excellent EMT plate and, while it did not actually sound as good as the EMT, it sounded closer than any digital reverb that I or any of the other engineers at Russian Hill Recording who helped me evaluate the unit had heard. Certainly, it sounds like Lexicon's best effort in this area.

The "+Stage" presets of the Hall program were useful not just for music, but for dialog on a film project, and the Wood Room presets of the Room program proved to be quite sweet sounding on guitars. The Metallica preset was recommended for crunch guitar, and it worked great on that. Silica Beads sounded like its name, and it was fun, too. Obviously, I can't go through every program and name what I liked, but I did find a solid number of useful presets.

The question is: what if you want to go beyond the presets? This is a very sophisticated unit which is imposing in sheer quantity of features and parameters, and it became clear to me that it was "power users" who would get the greatest benefit out of it. However, it was equally clear that to learn to really use this tool required a number of hours dedicated solely to learning the 480L. This is not a good device to try to learn on the fly. Even some of the basic setup parameters require knowledge that is not intuitively evident. More to the point, some of the new concepts, particularly Shape and Spread, are not easy to grasp and get in the ear. In other words, if you want to learn the 480L, you *must* read the manual closely and you *must* set aside time to play with it. Fortunately, the manual is very well written and put together.

I did find that there were a few "meat and potatoes" types of things which were surprisingly difficult to do on the 480L. Inverse and gated

reverb could be simulated, but not done as well as even the PCM70. These two areas, though, have never been Lexicon's strong point. Although I liked the no-pitch-shift chorusing for some applications, I missed the pitch wobble on things like synthesizers. I tend to use pitch wobble not only for chorusing, but in reverb also. This is one place where I am not always concerned with authenticity. The 480L is also not capable of the types of discrete delay effects that the PCM70 excels at. Again, some variations on these ideas can be achieved, but not easily and not as well. I found that only MIDI note events could be used to trigger samples, which left out switches, such as footswitches or buttons on a MIDI controller.

Units like the 480L also present a challenge to users and marketing personnel alike when it comes to naming presets. How does one name a bizarre effect so that it is easy to get some idea what it is? "Silica Beads" does well on this score, but what does "Surfin'" tell me? Although this seems trivial, it turned out that when the 480L was being used in session, several of the engineers flipped through the presets in frustration and eventually turned instead to another unit, such as the PCM70 (Version 2 software—they have the same problem with the preset names in the Version 3 software).

In sum, I think the 480L is tremendous: it sounds superb, offers a lot of useful functions, presents a good value for the money (the mainframe is \$8,200; the LARC controller is \$1,500), performs well, and delivers on the promises of which the march of technology has spoken. It is not all things to all people, though. This is reasonable, but you must decide before you spend the money whether its limitations are ones you can live with. If you can only afford to choose one signal processor, this might be a problem, but with the availability of inexpensive processors whose limitations might lie elsewhere, it should not be. ■

Prolific writer Larry O is a musician, sound engineer and electronics technician. His SF-based company, Toys in the Attic, offers consulting services in the fields of MIDI, product documentation and signal processing, and is affiliated with Russian Hill Recording.

**AUDIO PROFESSIONALS!
YOU CAN'T AFFORD TO MISS**

**VIDEO
EXPO**
San Francisco

**February 22 - 26, 1988
(Exhibit Hall Open February 23,24,25)
Civic Auditorium
San Francisco, CA**

**Attending will be the wisest
business decision
you make all year!**

**SPECIAL NEW FEATURE
New Power House Seminars
Includes admission into the
exciting exhibit hall**

To make the most of your valuable time, plan to:

Attend one or all of your choice of 6 one-hour "powerhouse" sessions—held each day from 10:00am to 11:00am. These sessions, a new feature this year, will zero in on the most vital issues of concern to video professionals. Topics to be addressed include: "Low Cost Pizzazz," "Video Publishing Update," "New Production Technologies," "Shooting in San Francisco," "Video Management: Issues and Challenges," and "Video Job Clinic."

Then visit the more than 170 companies represented on the exhibit floor to see the latest in products and services, featuring:

Audio for Video	Interactive Systems	Receivers	Video Accessories
Cameras	Lighting Equipment	Rentals	Videodisc Players
Cases	Monitors	Switchers	Video Projectors
Character Generators	Music Libraries	Tapes and Cassettes	VTRs
Duplicators	Production Companies	Time Base Correctors	...and dozens more
Editing Systems	Publications		

**Exhibit Hall Open 11:00am - 5:30pm on February 23 and 24, and
11:00am - 4:00pm on February 25**

PLUS: A complete seminar program

Register for the in-depth seminar program, half-day sessions scheduled each afternoon 3:00pm - 6:00pm. Full day seminars, two-day expanded sessions and a five day basic hands-on production workshop (with one afternoon free to visit the exhibit hall) have been planned to help you make the most of your **VIDEO EXPO SAN FRANCISCO** experience. Seminars will focus on a Basic Track covering, The Script, Audio: The Basics, Editing, Producing Programs, Shooting....a Production Track featuring, Print to Screen, Writing for Video, Corporate Video Applications, Seven Steps to Better Video Graphics, Getting A Grip on Light, How to Operate and Adjust Video Test Equipment, Managing the Video Project...and a Masters Series centering on Mastering Special Effects, Advanced Camera Techniques, Audio Post Production, Advanced Budgeting for Film and Video.

If you are involved in—or about to become involved in—professional non-broadcast television, send for your free Advanced Planning Guide to **VIDEO EXPO SAN FRANCISCO**, or call **(800) 248-KIPI (in NY call (914) 328-9157)**.

Mail to:

Video Expo San Francisco Planning Guide
Knowledge Industry Publications, Inc.
701 Westchester Avenue, White Plains, NY 10604

Co-sponsored by

MIX
THE INTERNATIONAL VIDEO EXPO

MIX-VESF' 88

Please send me a free copy of VIDEO EXPO SAN FRANCISCO's Advance Planning Guide with information about events, seminars, exhibitors and registration.

I may be interested in taking exhibit space, please send me your exhibitor kit with price information.

Name _____
Title _____
Organization _____
Business Address _____
City _____ State _____ Zip _____
Telephone _____

—FROM PAGE 130

saw me as their girl Randy Newman," Waldman says of her label in the mid-'70s. "But I never felt I was part of any Hollywood mafia, and I don't think most of those musicians did. I've always been different and I think that's one reason record companies have had a hard time figuring me out."

Her last experience with a major record company, Epic Records, left her shattered and disillusioned: "I thought the record I made for them, *Which Way to Main Street* [1982] was the greatest achievement of my career. I put everything I had into it and I thought it came out great, but I couldn't get to first base with it. After a few weeks it just completely disappeared; you couldn't find it anywhere. There's something wrong with that system—you work so hard and then this thing that's so important to you is allowed to vanish almost immediately."

When Waldman moved to Nashville in 1983, she more or less acknowledged that her recording career was at least temporarily on hold, and decided

to concentrate on her songwriting and back-up work. She made good contacts quickly and seemed to fit in easily with the changing Nashville scene. "When I got there," she says, "it was the tail end of the 'old Nashville,' but I could tell that things were opening up. Ten years ago I don't think I would have been accepted the way I have been. But the people have been great."

It was Mike Robertson, owner of 1030 Studio in Nashville (and now her manager), who convinced Waldman in early '85 that she should try to make another record. "At first I said no," she remembers. "Let's keep working with other people. But I looked at the songs I was writing and I felt good about them and about working with Mike, so I finally said, 'OK, it's been 15 years in the record business working with others; it's time to make my own records, my own way. I'd love it if [producer] Jimmy Iovine would jump in and help, but that's not gonna happen.'"

After some initial work co-producing tracks with Harry Stinson (who joined Steve Earle's band) she decided she would produce herself. "I was al-

ways interested in what went on in the studio when I made records," she says, "and I got to work with some good producers, like Chuck Plotkin and Mike Flicker. I talked to Lenny [Waronker, producer at Warners] for years about producing but I never got to first base. On this album I finally became a producer, and as a result I've also been producing other acts."

Letters Home was recorded over a two-year period at Robertson's studio; she'd worked on it for a year before she even signed with a label, paying the musicians herself from songwriting royalties. As a partner in the album, Robertson absorbed the studio time. Unlike some artists, who feel that spending a lot of time on a project can make things seem unfocused, Waldman thinks that she gained valuable perspective on her work.

"One advantage to stretching a project over a long period of time is it allows you to look at the work and update it; whereas when you do it in six weeks, you don't get that chance to catch your breath and re-evaluate," she notes. "The song 'Easy Way Out' started out with no synths and it had different lead and background vocals. About four months went by after the sessions and I just couldn't relax about that song. So I went in and cut a new vocal and it completely brought the song to life. Then I talked to Mac McAnally and changed the background vocal so we both sang it. That was six months after the original. Then earlier this year, we transferred it to 32-track digital, which opened up some new tracks, so we put synthesizer on it. I think all of those things were improvements and came about because I was able to live with the song for a while.

"I'm very zen about the studio," she continues. "I know you can't force things. If you're going to produce, you have to accept your role and accept the fact that you've taken responsibility. I sing a vocal; I'm not allowed to throw a hysterical fit—I sound so terrible!"—because there's no one to pick me up but me. So I have to realize, 'Well, that's as good as we're going to get today, so maybe we should work on something else.'"

Waldman says her greatest joy in working in the studio comes from the interaction with the players, and feeling like part of a team. "I'm extremely involved in the instrumental performances," she says. "I've been very fortu-

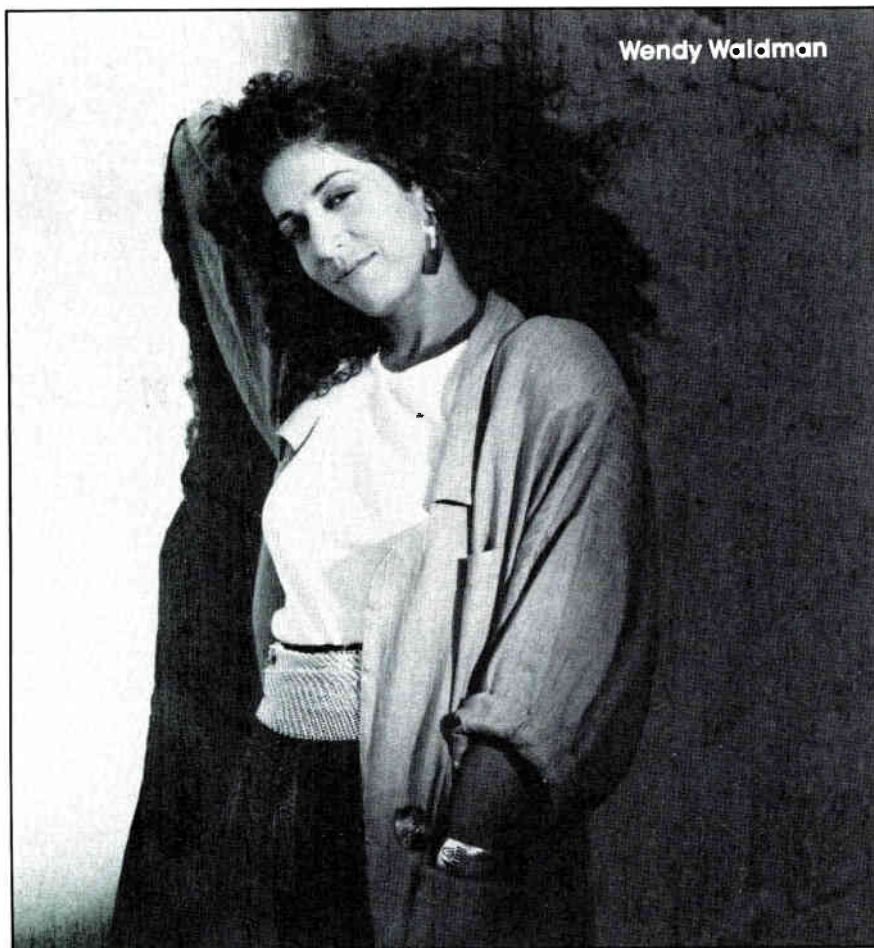

nate: I'm a musician myself and when I put out a call for musicians, they usually come eagerly because they know they're going to get a challenge. I have high standards. Because I grew up in L.A. in a classical music family, I'm not afraid of creative chord changes or odd time signatures. Musicians enjoy that. I try to build a situation in the studio and in my live band where you can create a framework and certain guidelines, but then you turn them loose. You make your music a chance for them to express their musicianship, which is very different from most Nashville producers and a lot of pop producers. I'll give them boundaries and a context, but enough rope that musicians really feel like they're contributing—because they are."

From working on her own album and producing others, Waldman has developed a close relationship with her engineer, John Wiles, and makes it a point to work with him whenever she can. "We've grown together as a team," she comments. "I think he's brilliant. He's a serious techno-head. We'll have long discussions like, 'How did Pete Townshend get that sound on "Face to Face?"' I want this sound on the snare on "Easy Way Out.'" And he'll work on it and come up with something, or tell me it's not happening. Jim and I did the final mix of the album together. I'm a hands-on mixer because I feel that as producer/arranger, I know when I want to pull a lead guitar line back a little or when we need to make the double of the lead vocal shadow it, instead of be right up there. John might work more with the rhythm section.

"On the whole, I'm really, really happy with how this record sounds," she continues, "and on our next project we'll do even better." And how about digital, which has swept Nashville during the last few years? "We don't need to cut my albums digitally, except it would be nice to have more tracks. We hadn't worked in such an automated context before this record. We had a Neve console with NECAM—not an SSL—and it was fine. We stumbled through the darkness a few times, but in the end we took something that had been recorded in a number of different settings over a long period and made it sound consistent."

According to Waldman, when she played early mixes of her work-in-progress to people at Cypress Records,

the label "flipped" and immediately signed her to what she admits was "a low money deal." Buoyed by Cypress' enthusiasm and support, she went back into the studio, cut some new tracks and, over the course of the next year, finished the record.

"The irony of this situation," Waldman notes, "is that when I signed with Cypress, my career was in the best shape it had been in 15 years. I had learned to stand in the music business without being a recording artist. I was collaborating successfully as a writer, producing other people and not being crushed that I wasn't a platinum recording artist. But I also came to terms with the fact that I needed to make albums whether they were successful or not, because Wendy Waldman albums are like novels or paintings to me—they're my literature. I might never have the success singing my own songs that others might, but that doesn't matter. I'm the happiest I've ever been."

She's also the busiest she's ever been. Aside from making the album and touring all summer and fall opening for Dan Fogelberg (Waldman's band includes her guitarist/husband, Brad Parker), she continues to write constantly and she's become an active producer as well—recent projects included a contemporary Christian artist named Pam Hall; her longtime friend Jonathan Edwards; the Ozark Mountain Daredevils; and country singer Suzy Boggus, whose Waldman-produced record was a big seller for Capitol. "The word has gotten out that I'm producing and doing pretty good work," she says. "So now I'm digging in and seeing what else comes my way."

Another Cypress album is likely, and this time it won't be five years between records. "The L.A. mentality is if you're not on a major label, you don't have a career," the ever-defiant singer says. "But there are a lot of people out there proving that's not true. Look at John Prine—he's got his label and is selling more than ever. Small companies are more flexible than the majors and more willing to take chances on an artist. That suits me fine, because I'm always going to take chances with my music." ■

Blair Jackson is managing editor of Mix magazine.

THE RECORDING ACADEMY®*

NEEDS YOU!

If you have been involved in the creation of six recorded and commercially released selections as:

- Vocalist, Singer, Narrator
- Leader, Conductor
- Composer, Songwriter
- Engineer (mixer, master cutter)
- Instrumentalist, Musician
- Arranger
- Art Director, Photographer, Artist or Album Designer
- Producer
- Video: starring Vocalist, Conductor Musician, Director or Line Producer

You could be an active (voting) member who makes the Grammy® Nominations and votes for the Ultimate Winners. Even if you don't have these minimum qualifications you can become an associate member. Just fill out the coupon below and mail to SFNARAS, 1124 Rivera, SF 94116, to receive the necessary information.

BENEFITS DISCOUNTS

5% on tape and accessories at Leo's Audio

10% on tape at Different Fur
10% on all accessories at Sherman Clay

25% on California Talent Guide (\$30 each instead of \$40)

25% on Music Industry Reference Guides:

California Music Directory, Music Business Directory, Music Radio Directory (\$25 each instead of \$33.45, all 3 for \$60, a savings of \$40)

HEALTH INSURANCE

NARAS® membership in Media Alliance allows NARAS members Group Health Insurance rates through a variety of policies

LEGAL ADVICE

½-hour free consultation, next 2 hours at \$75/hour, all additional time at \$100/hour from Attorney Marc Greenberg.

CREDIT UNION

in which a \$25 share deposit plus a \$1 membership fee into the Franklin Media Credit Union entitles you to reduced rates on loans, checking and savings accounts, plus low a.p.r. Visa accounts

San Francisco N.A.R.A.S.® Membership Invitation The Grammy® People

Yes! I am active in the music industry and want to become a member of the San Francisco Chapter of the National Academy of Recording Arts and Sciences.®

Name _____

Address _____

City _____

State _____

Zip _____

Day Phone _____

Evening Phone _____

PLEASE SEND ME AN APPLICATION

*The National Academy of Recording Arts and Sciences® The Grammy® People

Circle #132 on Reader Service Card

by Philip De Lancie

FORMATS & FORTUNES

Final Recording Industry Association of America (RIAA) figures on net shipments of pre-recorded products for the first six months of 1987 provide relatively good news for just about every sector of the industry. While units shipped in 1986, exclusive of returns, had fallen 5% relative to 1985, the first half of 1987 brought a healthy 18%

the impending introduction of DAT, combined with a probable continued reduction in CD pricing, makes any long-term prediction tricky at best. At any rate, the new figures show a slowing of momentum, at least temporarily, in some of the trends that have been in evidence since 1984.

After years of impressive growth,

CD revenues continue to move up;
the vinyl LP is heading down.
Cassettes are still going strong, but
the 8-track is finished. But the big
question is: will DAT make a dent?

increase over the same period one year earlier. In dollar value terms, calculated at manufacturer's suggested list price, the increase was greater than 28%, reflecting the ever increasing market share held by the highest priced configuration: CDs. But the upswing is especially welcome because it clearly goes beyond just those consumers who own CD players to a general trend of more people buying more music.

A look at the recent comparative performance of the various configurations suggests the possibility that dramatic shifts in format popularity may be moderating, with several formats perhaps eventually coexisting at relatively stable market shares. But

unit shipments of pre-recorded cassettes advanced only incrementally in 1985 and '86, seeming to portend the onset of a decline for the nation's most popular music program carrier. Sales of duping equipment were reportedly stagnating, and many duplicators began to sense that the future of their industry lay more in spoken word than music cassettes. But for the first part of 1987, net shipments of pre-recorded music cassettes were up 22% in units and 23% in value. The format's reported share of the total market, at 57%, was slightly higher than ever before. And, looking just at those formats whose shipments showed gains, the cassette increase represented more than 57% of all the

increases. This means not only that the cassette is holding its own, but that for the first time since 1984 the growth in the cassette market has exceeded, in numbers of units shipped, the growth of CDs.

To record company accountants, of course, the units-shipped figures are less important than those concerning dollar value. With average suggested list price in the recent report at almost \$16 (down from over \$17 in 1986), CDs certainly deliver the record companies more buck for the bang. Cassette prices, by way of comparison, average out at just over \$7 per unit. That explains why CDs accounted for 27% of the total market value with only 13% of the units. Similarly, CDs contributed nearly 60% of the value jump in the up-moving formats with only 40% of the increased shipments. Compared to the first half of 1986, CD value and units were up 113% and 131% respectively. These gains come as little surprise, and may even seem disappointing compared to the growth rates of two or three years ago. But in sheer numbers of units, the January through June figures for 1987 were close to double those for all of 1985.

Even for fans of the black vinyl formats, the RIAA report is mildly encouraging. LP/EP shipments continued to fall, clipping by 5%. The drop in value, at 10%, was somewhat steeper, reflecting in part a 40-cent decrease in average list to \$7.05. But compared to the unit shipment slides of 17% and 25% respectively in 1985 and '86, these setbacks seem relatively mild. The same may be said with respect to shipments of vinyl singles, which fell 10%, instead of 22% as in 1986. It might be that the vinyl formats, particularly LPs, are reaching a plateau in their decline that can be sustained for a time by a core of consumers disinclined to take the CD plunge. If the trend holds, the LP's market share, near 17% of units in the RIAA report, could linger above 10% for close to a decade.

For the 8-track cartridge, on the other hand, the lingering days are over. After years on the sidelines of the race for format pre-eminence, the 8-track has finally bottomed out. In this latest RIAA report, perhaps the configuration's last, 8-track figures were apparently too low to actually

list. In place of numbers were dashes like those used in charts on cereal boxes to denote the absence of a particular vital nutrient. Perhaps in affirmation of the cycle of life, however, a new category appeared just as the 8-track expired. Cassette singles made their debut in trace quantities of 842,000, or 0.26% of units shipped. Rumor has it that this new configuration, introduced experimentally early in 1987, picked up steam in the latter half of the year, providing one more good reason to eagerly await the next RIAA report.

September 1986's "After-Mix" covered Sony's then relatively new Sprinter system for high-speed video duplication, and speculated on the applicability of the magnetic contact printing technique to duplication for R-DAT. At the time, Sony representatives were cautious about the future of DAT, and especially reticent concerning DAT duping. The company acknowledged its concern about the impact of DAT on the ascendance of the precocious yet still vulnerable compact disc. The technology for DAT duping was certainly within Sony's reach, but the introduction of actual hardware would depend on both the health of the CD and the development of a market for the new format.

In the intervening time, DAT has been thrust to the front lines of the record industry's war against sales displacement from home taping. Lobbyists on both sides of the "home taping rights" issue have had their say before Congressional hearings in Washington, and the controversy has even been reported in the regular news sections of daily papers. Proposed inhibitions on the ability of DAT machines to copy from pre-recorded music sources would likely strike a fatal blow to the format. As of this writing, however, action on bills to require inclusion of the CBS "copy code scanner" chip in all U.S. DAT machines is stalled, pending an evaluation by the National Bureau of Standards of the copy code's effect on encoded music. So DAT hardware manufacturers have a strong incentive to bring product to market now, be-

MIDI and the Modern Guitarist

Phi Tech, manufacturer of the Photon MIDI Converter, has produced a 16-page guide to help guitarists better understand the benefits of MIDI. Explore sections on enhancing the guitar, effects control, tricks with MIDI and more.

Discover how the pros are using MIDI, with comments from:

John Abercrombie, Carlos Alomar, Steve Bargonetti, Brian Bromberg, Bunny Brunel, Larry Coryell, Mikail Graham, Nick Moroch, Chris Stein & Al Weissman.

For Your
FREE
Copy
Contact:

Phi Tech
4605 N. Stiles, Dept. MX1
Oklahoma City, OK 73105
(405) 521-9000



Circle #102 on Reader Service Card

RCA Test Tapes

A Sound Measure

- Cassettes
- Open Reel up to 1"
- Custom Formats

For a catalogue of standard test tapes or further information contact:

RCA TEST TAPES
DEPT M
108 Monticello Road
Weaverville, NC 28787
(704) 658-2067

Circle #103 on Reader Service Card

fore Congress makes any moves. And Sony, dropping its hesitant pose of mid-1986, has made it clear with a recent set of product introductions that it intends to reassert its leadership role in the propagation of DAT technology.

Heading up Sony's DAT lineup are two professional recorders shown at the recent New York AES. The PCM-2000 is a portable machine for "outdoor recording and field sound acquisition" applications, priced in the \$7,000 range. For non-remote applications, Sony offers the PCM-2500 at roughly \$5,000. This unit features 4x oversampling digital filters in the D/A section, double-encoded Reed-Solomon code for error detection, and independent conversion/processing of each channel. Three sampling rates may be selected, as well as three types of digital interfacing: S/P DIF (RCA connectors), AES/EBU (XLR) and SDIF-2 (BNC). Analog ins and outs are +4 balanced transformerless XLRs. A variety of cue/search capabilities are in-

cluded utilizing helical scan subcode data tracks. Longitudinal auxiliary tracks at each edge of the tape may be used for time code.

If enough studios choose DAT as a cost-effective way to mix to digital, the PCM-2500 or similar units promised soon from TEAC, Fostex, Nakamichi and others may well become standard equipment in mastering and production facilities. But the new machine shares an important drawback with its forebears in the F1 family: it does not provide the user with editing capability. Since F1s have gained a fair measure of acceptance for certain professional applications, there may be little incentive to switch over to the pro-DAT equipment if it doesn't offer the added advantage of editing.

In the area of DAT duplication, Sony has, as mentioned in the July 1987 column, been working on the development of both high-speed and real-time systems. Specifics on the configuration and operation of these products have now become available. The \$600,000 high-speed system is, as an-

anticipated, based on the Sprinter video duplicating process mentioned above. (Readers are referred once again to the September 1986 "After-Mix" for a full explanation of Sprinter and the bias magnetic field contact printing process.) The configuration used for high-speed DAT is designed to integrate with existing Sony equipment used in compact disc production. The process begins with playback of a PCM-1630 format production master on a DMR-4000 video deck (see Fig. 1a). The digital output of the 1630 processor is fed, along with signals from Sony's DAQ-1000 PQ generator, into the AS1-100 signal converter, one of three "key components" newly developed for DAT duplication. The AS1-100 translates the PCM signal of the source into DAT PCM, inserts DAT subcode into the PCM signal, adds error correction signals, and generates the ATF (Automatic Track Finding) signal which will allow playback machines to differentiate between "normal" (real-time recorded) and "wide" (high-speed recorded) track pitch modes. The combined signals are then RF modulated and outputted to one or more AM1-12 Mirror Mother recorders, which record DAT signals in a mirror-image track pattern on a modified high-coercivity metal mother tape.

The third new component in the chain is the AP1-12 high-speed printer. The AP1-12 is loaded (see Fig. 1b) with the mirror mother and a blank copy tape which utilizes a barium ferrite oxide formulation developed by Sony for this application. The tapes are run together around the "transfer drum" through a "bias magnetic field" emitted by the "transfer head." Field strength and orientation are such that the barium ferrite copy tape is biased, while the higher coercivity metal tape of the mirror mother emerges unscathed. As the two tapes, held oxide-to-oxide by pressurized air, exit the bias field, the oxide particles of the copy tape are oriented by the field of the metal mother oxide against which they are pressed. A mirror image of the mirror mother is created, resulting in a properly oriented DAT format copy tape. Sony advertises a print speed of 327 times faster than real time, allowing an 80-minute program (the maximum time for DAT in the wide mode) to be reproduced in a mere 15 seconds.

—CONTINUED ON PAGE 221



sun valley audio

THE SOURCE
IN THE ROCKIES
FOR PRO
AUDIO AND
RECORDING
EQUIPMENT

NEW PRODUCTS.

OTARI • JBL • AKG
KURZWEIL • LEXICON
3M TAPE • YAMAHA
SHURE • RAMSA
VALLEY INTERNATIONAL



ADAMS-SMITH
"ZETA-THREE" SYNCHRONIZER

OTARI MX55
¼ SEMPTE CENTER-TRACK

BOX 285, SUN VALLEY, IDAHO 83353 208-726-3476

Circle #104 on Reader Service Card

by Peter Wetzler

TAPELESS RECORDING

A COMPONENT HARD DISK- MIDI SCORING SYSTEM

MIDI technology and hard disk audio recorders make an effective combination for working in the field of music composition/post-production. The advantage of scoring to picture with an interactive hard disk and MIDI controlled electronic synthesizers is apparent to anyone who has spent his career synching sound to picture and creating musical designs. Digital audio quality is only part of the benefit—a major advantage is increased speed.

The CompuSonics DSP 2002 system combined with a wide selection of keyboards, sampling devices, computer and signal processors serves my needs and performs all necessary post-production and music design requirements with the requisite speed and increased creative flexibility.

Almost everything you can do with reel-to-reel tape you can do on hard disk—and faster. For example, synching can be done with one keystroke; all I have to do is engage a videocassette with time code in “play,” set up my synthesizers to a particular sound color, put the CompuSonics in “record” mode and let it follow the time code. Working this way, I can often score things in one pass. There is no fast forward and rewinding involved. If I scored a five-minute section and needed to locate a transition at the four-minute mark, I would enter four minutes and have it play right from there. Synching that transition to video is simply a matter of entering the correct time code number. The computer does all the number crunching and I never have to rock and roll any tape reels.

The CompuSonics lets you make critical time code adjustments as fast as your fingers can fly. For instance, when I score live to picture, I find that my keyboard response time is often three to five frames late. I can slide the cue with one keystroke. This feature is very important to composers like me who like to work in a spontaneous manner—scoring on the fly.

*Digital audio is only
part of the benefit
of using a system
like this—a major
advantage is
increased speed.*

Synthesizer technology is changing rapidly and as the keyboard and alternate controllers evolve, we can advance with them. In the process we simply keep our hard disk separate from this development; it can be expanded as the storage need arises. At this point it already has all the flexibility and storage capacity we need since the system we've assembled at Transcom Digital offers ten hours of stereo

EXCELLENCE is the result of uncompromising dedication to quality and service.

JRF is proud of its reputation as a leader in the field of magnetic heads. Our technical and engineering staff is committed to providing the finest products and services:

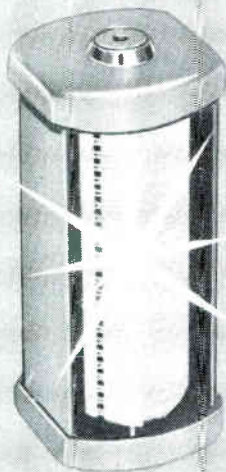

- Magnetic Head Refurbishing
- Optical/Digital Assembly Alignment
- Full line of replacement heads **IN STOCK**
- MCI/Sony parts dealer
- 3M parts dealer
- Technical Assistance
- Fast, reliable service that's unmatched for quality



Responsive to the needs of the recording industry, we at JRF feel there can be no substitute for **EXCELLENCE**.

Kennedy Road • P.O. Box 121 • Greendell, NJ 07839
Tel: (201) 579-5773 • Fax (201) 579-6021 • Telex 325-449



Circle #105 on Reader Service Card

Professionals demand the best tools available.

Manny's supplies the best support systems necessary to help achieve excellence—professional tools to assist in creating that excellence.

Manny's—the professional's choice.

MANNY'S MUSIC
156 W. 48th Street
NYC, NY 10036
(212) 819-0576
Mon.-Sat. 9:00-6:00

Circle #106 on Reader Service Card

POST · SCRIPT

sound storage on 14 hard disks. For my purpose, I have allocated 2.5 hours of sound space (at 50 kHz) with a digital streamer "Megatape" for back-up.

A Sample Component System Design

The music design studio we've assembled is built around three samplers: the Emulator II, Kurzweil 250 and Akai S900; the Yamaha DX7, Casio CZ and an analog synthesizer, the Rhodes Chroma Polaris. An array of outboard effects that have become increasingly important for coloring the sound includes the Lexicon 224, the Eventide SB1026, Yamaha SPX90, Yamaha REV7 and Lexicon PCM60. MIDI software is run on both Macintosh and Amiga personal computers. Since the Amiga is a multi-tasking machine, we've placed the CompuSonics screen on a memory resident window that we pull up as an overlay at any time. This consolidation has reduced the number of terminals cluttering up the work-space.

I have access to massive sound effects libraries on the CompuSonics. Edit lists constructed in the dialog suite and in the off-line sound effects studio are available to me in an instant. I also have direct access to all the outboard equipment (i.e., harmonizers, compressors, digital delays, etc.) stored in the main recording studio featuring a 36-input SSL 6000E mixing console and Sony 3324 multi-track digital recorder. There are 24 tielines linking my studio to this mixing suite, so I can either send instruments direct to the digital multi-track or pull effects from the racks into my machines at any time. The studio has devised a unique D-to-D interface between the CompuSonics and the Sony 3324 based on the 1630 protocol so that my music never leaves the digital domain.

Working with the CompuSonics

Working with the hard disk falls into three basic categories: recording, sampling and networking. Despite its many applications, the CompuSonics serves primarily as a recording device. A MIDI sequencer cannot actually store sound data. Once you have done all your MIDI multi-tracking you have to record it somewhere. With the hard disk tied to my studio, I have access to a considerable memory bank's worth of

stereo storage space. This affords me the luxury, for example, to record to picture on the CompuSonics and the MIDI sequencer concurrently. If I like the take, it is stored in the CompuSonics and I'm ready to move on to the next cue. If the mix or tempo was wrong, I simply make adjustments on the MIDI sequencer and fire it back into the CompuSonics.

Storage is only part of the picture, since the editing capabilities are considerable as well. Takes can be dissected and pieced together in much the same way as a writer works with his word processor. Samples can be auditioned and synched to picture for quick review and comparison. Sound effects can be pulled from archive with instant access and then be sampled or processed with a range of digital devices. As already mentioned, time code slips and slides are simple numeric keystrokes away.

I have other recording options from which to choose. The Sony F1 works nicely as an auxiliary multi-tracking device. I can create an original bed with a synthesizer, record that to F1, bring it back through my mixer, track another layer of sound to the F1 and then add the combination to the CompuSonics. It's a fast and easy way of digitally multi-tracking off-line without leaving the room.

In addition, I have the option of going direct to the SSL and the Sony 332+ if time and budget permits. In post-production we sometimes have to do an entire television episode in one day. Someone is in one room compiling the effects track while I'm in another room creating three or four separate stereo music tracks. All of this sound data is assembled to the 24-track recorder, perfectly synched to SMPTE time code and ready to mix.

Working with MIDI

The Macintosh and Amiga personal computers are essential elements in an overall digital audio post-production picture. The Amiga's own stereo sound is plugged into the patchbay and occasionally the samples are even good enough to record. There are a lot of sequencing and librarian programs available for the Mac while there is a growing range of algorithmic programs for the Amiga (i.e., Henry Lowengard's Lyre, Laurie Spiegel's Music Mouse, and the forthcoming M from Intelligent Music) that actually work

as interesting compositional tools. I have been sequencing with Mark of the Unicorn's Performer 2.1 and will probably switch to Opcode's sequencer for compatibility with Intelligent Music's M, Jam Factory and the new drum programmer, Upbeat.

The standard MIDI/SMPTE interface, meanwhile, is handled by the Roland SBX-80. If I want the sequencer to fire a keyboard at a particular time code number, this box makes all the impulse connections.

The combination of tools become an artist's varied palette. The hard disk serves as my storage bin while the

CompuSonics software is a tremendous editing tool. Overall, it is the kind of setup that allows for tremendous creative flexibility and still lets the musician/composer play a pivotal position on the audio/video post-production team. ■

Peter Wetzler is staff music designer at Transcom Digital, a New York-based television production and post-production studio. A classically trained pianist and experimental music composer, he has written and performed soundtracks for a range of feature films and TV shows.

Now! A Single Channel BBE with Mic Level, Line Level and Phantom Power!



The clarity, definition, presence, texture and voice intelligibility for which BBE has become world renowned is now in a single channel format. For *all* microphone uses—from vocalists to instrumental soloists and lecturers to distributed sound systems, the BBE 401 will become indispensable.

High or low impedance mics and musical instruments can plug directly into the front or rear panel jacks. The BBE 401 has its own preamp with gain controls, can be used as a direct box and will accept -10dBu line levels. 24 volts of phantom power are available from the low impedance mic output.

The BBE processors achieve time alignment of harmonic and fundamental frequencies that were present in the live performance but became reshuffled in the often convoluted paths of recording, playback and broadcast of audio.

The BBE 802

For use in broadcast, recording and large concert systems and industrial audio. Balanced and unbalanced lines +24 dBu headroom, hard wire bypass. The ultimate BBE for professional use.



The BBE 402

For use in home recording, clubs, discos, and systems using unbalanced lines.

+14 dBu headroom -10 dBu levels. Home audio and cassette copies are greatly improved.

BBE

5500 Bolsa Ave., Suite 245, Huntington Beach, California 92649

714-897-6766 • 800-233-8346 (USA) • 800-558-3963 (CA)

(In Canada contact Daymen Audio, 3241 Kennedy Rd. #22 Scarborough, Ontario M1V2J9 or call

+16-298-9644

Circle #107 on Reader Service Card

by Lou CasaBianca

HYPERCARD

A NEW KEY TO INTERACTIVITY

For years, the demystification of technology and its integration with the arts has been my ongoing personal avocation. As an 18-year-old songwriter/producer, I was committed to the concept that the left brain and the right brain could and should co-exist peacefully. After a brief honeymoon in the studio, writing, singing and learning about the recording process, I came to the conclusion that making music and its technical production were organically and creatively compatible.

In the mid-'70s that commitment was put to the test in my first encounters with a Buchla computer music system, mainframe computer-generated graphics and their attendant programmers. Like high priests guarding the oracle, the programmers seemed to have a vested interest in placing barriers and computer jargon between users and their objectives. Years later, I found myself in front of seminar and workshop audiences, explaining and sometimes defending the creative freedom to be gained from synthesizers and computers in music and animation. Things have come full circle. Desktop publishing, PC-based graphics and MIDI music workstations are now familiar and integral parts of the "new media" landscape. As one of *Mix's* resident Macintosh advocates, I have been pleased to see the Mac technology achieve its place in the sun—in graphics and in the studio.

In essence the message has been the same: computers are not just tools or robots—they can be powerful, friendly extensions of our own creative consciousness. Elegantly designed software can allow an expert's knowledge to become a "personal guide" in converting data into knowledge. In the 1960s, programming pioneers Ted Nelson and Doug Englebart created the concept of "Hypertext" to design

the linked or connected text possibilities that allow a reader to pursue references behind words and concepts. Initially, their work was relegated to theoretical problem-solving software and expert systems. As microprocessors and chip design have increased speed and storage capability, the convergence of audio, music, film, video

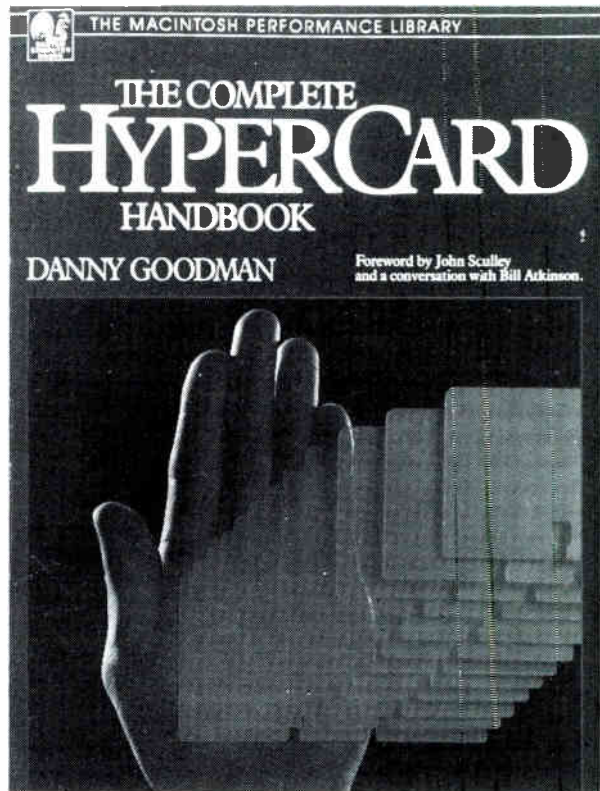

and interactive programming has brought about the existence of what they called "hypermedia." Nelson's ideas are detailed in an updated edition of *Computer Lib/Dream Machines*, published by Microsoft Press. There are now more than 20 software incarnations of his hypertext vision, a futuristic computer-based method for rethinking the way we read, write and communicate.

Affordable Management Software for the Studio Executive

Keeping it under control can make or break you. Now Pristine Systems Inc. presents a fully supported, integrated modular business system designed to increase your chances for lifetime success. Everything your studio needs for planning and organization, accountability and professional credibility!

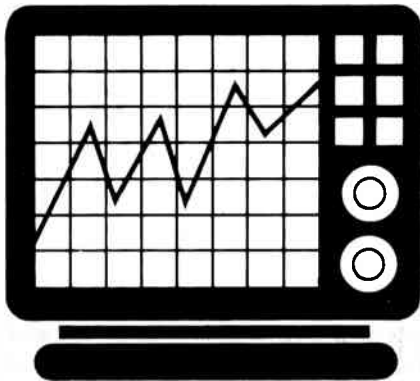

- ▶ Bookings and Work Orders
- ▶ Billing and Accounts Receivable
- ▶ Tape Library Management
- ▶ Inventory and Equipment Control
- ▶ General Ledger and Financial Reporting
- ▶ Accounts Payable and Check Writing

All the above software modules may be purchased individually or as a package for single-user or network systems. In addition, Pristine Systems, Inc. can provide a "fixed price bid" for performing any custom modifications to the system that you may require.

From the initial bookings, through billing, all the way to financial statements, this system will save you endless hours of labor each month.

Nominated for a 1987 TEC Award (Technical Excellence and Creativity) in the category of Outstanding Technical Achievement in Computer Hardware/Software.

"The instant accessibility to financial information is extraordinary. It used to take days to compile information of this detail and clarity. I don't know how we managed all these years without it. This is definitely the way to go. I would recommend it to anyone without reservation!"
—Paul Camarata, President, Sunset Sound

"As a studio owner, I find this is the only system that addresses our particular industry and helps keep you on top of it. . . An essential tool for today's studio businessman."
—Angel Balestier, Owner, Group IV Recording

For more information, call or write Mix Bookshelf, 2608 Ninth Street, Berkeley, CA 94710, (415) 843-7901. Call TOLL FREE (800) 233-9604, in California (800) 641-3349.

RECORDING EQUIPMENT

—All Major Brands—

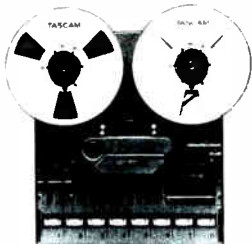

FOR STUDIOS/HOMES CHURCHES/CLUBS

- Reel to Reel Decks (2-4-8-16 Track)
- Cassette Decks • Mixing Boards
- Mikes • Studio Monitor Speakers
- Special Effects Units Accessories

TASCAM
Hi-Fi Production Products



- VOLUME DEALER
- NEW & USED
- E-Z TERMS
- ALL MAJOR CREDIT CARDS
- PROFESSIONAL ADVICE

Call for a catalog and pricing information.

RHYTHM CITY

287 East Paces Ferry Road N.E.
Atlanta, Georgia 30305

1-404-237-9552 • 1-404-237-8526

CALL TOLL-FREE IN GA 1-800-282-7995

Circle #108 on Reader Service Card

INTERACTIVITY

Hypermedia

One of the most important new developments in bringing hypermedia to the general business and creative community is Apple's release of HyperCard for the Macintosh computer. Its inventor calls it an "interactive erector set." It can be used to organize your desktop, create a personal management system or to realize your own vision of interactivity. Contrary to the implications of its name, HyperCard is not hardware or an add-on board. It is a creative software database environment which allows the user to generate and link interactive custom programs. The HyperCard will do for interactive video what the laser printer and page layout software have done for desktop publishing. The program is being given away with the purchase of every new Macintosh.

HyperCard uses the metaphor of stacks of cards, where each card is the equivalent of a database record containing up to 32K of information. Stacks of cards are created and linked to accomplish the desired programming effect. The user can determine how the cards are linked to each other, and a powerful scripting language lets the user customize the application. Users can also access cards residing on another Macintosh running on the same network.

HyperCard provides the development tools for writing applications previously too complicated for non-programmers. For media and interactive producers, Apple has prepared driver "stackware" which allows HyperCard commands to control videodisc machines. Apple describes HyperCard as "a personal toolkit that gives users the power to use, customize and create new information using multiple information types such as text, graphics, video, music, voice and animation." It could also be described as a high-level programming language (similar to Pilot or Logo) which provides an authoring environment for people who would not consider themselves computer programmers. It enables users to create and customize their own applications, organizing information by context rather than hierarchy. HyperCard uses icons, fields and buttons which can be configured by function as a database manager, word processor, spreadsheet application, communications terminal pro-



LEARN THE ART OF RECORDING

LEARN CREATIVE RECORDING SKILLS ON THE LATEST EQUIPMENT AT THE LEADING SCHOOL FOR SOUND ENGINEERS, PRODUCERS AND STUDIO MUSICIANS. WITH OR WITHOUT PREVIOUS EXPERIENCE, IF YOU'RE SERIOUS ABOUT A CAREER IN RECORDING, OUR 'HANDS-ON' TRAINING PROGRAMS CAN GET YOU STARTED AND PUT YOU AHEAD. FOR FREE BROCHURE, PLEASE CALL OR WRITE TODAY.

**THE
RECORDING
WORKSHOP**

THE RECORDING WORKSHOP

455-X MASSIEVILLE ROAD, CHILLICOTHE, OHIO 45601

(800) 848-9900 (614) 663-2544

OHIO STATE BOARD OF SCHOOL AND COLLEGE REGISTRATION #80-07-0696T

gram, and interactive video authoring system. In fact, there are few computer applications for which HyperCard *cannot* be used.

HyperCard required over three years of research and development. The development team was led by Bill Atkinson, an Apple Fellow and the developer of QuickDraw and MacPaint software, two fundamental building blocks of Macintosh technology. The program is based on the concept that "cards," the basic units of information, may be organized into "stacks." Users can work with existing ones or create a variety of cards and stacks, and can purchase third party stacks developed for special purposes. While the original release of the program contains sample stackware, Apple expects most stackware applications to be written by third party developers and users. In fact, I predict that well-designed stackware will become a minor industry satisfying needs in wide range of vertical applications.

Why HyperCard?

According to Atkinson, "the promise of modifying and controlling your own environment is a promise that has not been fulfilled. HyperCard is a personal tool kit for putting together an information environment that works the way you do." Coping with the revolution in information has become a full-time job for media production professionals and members of the general business community. Anyone who has to keep records and make decisions based on referring back to those records is a candidate for HyperCard. When we look at the functional use of information we find that the process of decision making is based on linking bits of data into chains of information. The traditional database is built around an arbitrary architecture, with limited ability to customize the model. Beyond the database applications, HyperCard is an invaluable tool in the organization of the day-to-day activities of managing a project, a business or a career.

Practical Applications

As a Mac user I was able to easily transfer my computerized Rolodex, appointment calendar, job lists, and budget templates into the HyperCard environment. Subsequently, I linked these stacks to current projects, scripts and articles in development. Today, HyperCard is the center of my Macintosh

world. The programming involved in linking these applications was a challenge, and the satisfaction of having a program concept up and running in a matter of minutes or hours, not days or weeks, was exhilarating. I approached HyperCard, as I do with any new Macintosh software, without consulting the documentation, and found it an amazingly intuitive program.

HyperCard organizes data by meaning and context, allowing users to browse or search through large bodies of information quickly, making it an ideal access medium for CD-ROM and videodisc technology. Apple is currently working on CD-ROM drivers for the

program. HyperCard creates a new platform for developers which will result in stackware programs using the HyperCard metaphor of card stacks. The program will be distributed on disk at first, but will eventually be put in the system's ROM, according to Apple's higher education marketing manager, Bud Colligan.

Browsing through HyperCard is a very natural process. The off-the-shelf package comes with a number of stacks, including clip art, stack ideas, Rolodex card layouts, calendars, tape box labels, and more. The user level can be set at browsing, typing, painting, authoring or scripting. The basic erec-

WE CAN TRANSFORM YOUR PROJECT FROM THIS



...ndr...

NORTHEASTERN DIGITAL RECORDING, INC.

- **Services:** Transfers from 1/4" and 1/2" analog to Sony PCM-1610/30 for archiving and LP or CD mastering.
Digital transfers to PCM-1610/30 from other digital formats: PCM-F1, 701, or 501, DASH 1/4" (Sony PCM-3202), others.
Digital Editing and Compact Disc tape mastering with the Sony DAE-1100 Digital Editor.
Complete Compact Disc Services.
Rentals.
- **Credits:** Frank Zappa, Arlo Guthrie, Rubber Rodeo, Ritchie Havens, Swimming Pool Q's, Matt Glaser, Lucio Dalla Soundtrack to Diva, A & M, Polygram, Rounder, Rykodisc, Musical Heritage Society, Centaur, Second Hearing, Titanic, Bose, CompuSonics, Polaroid, Wang
All editing performed by Dr. Toby Mountain, PhD. Music.

Call: 617-753-1192

for information, prices and our PR package.

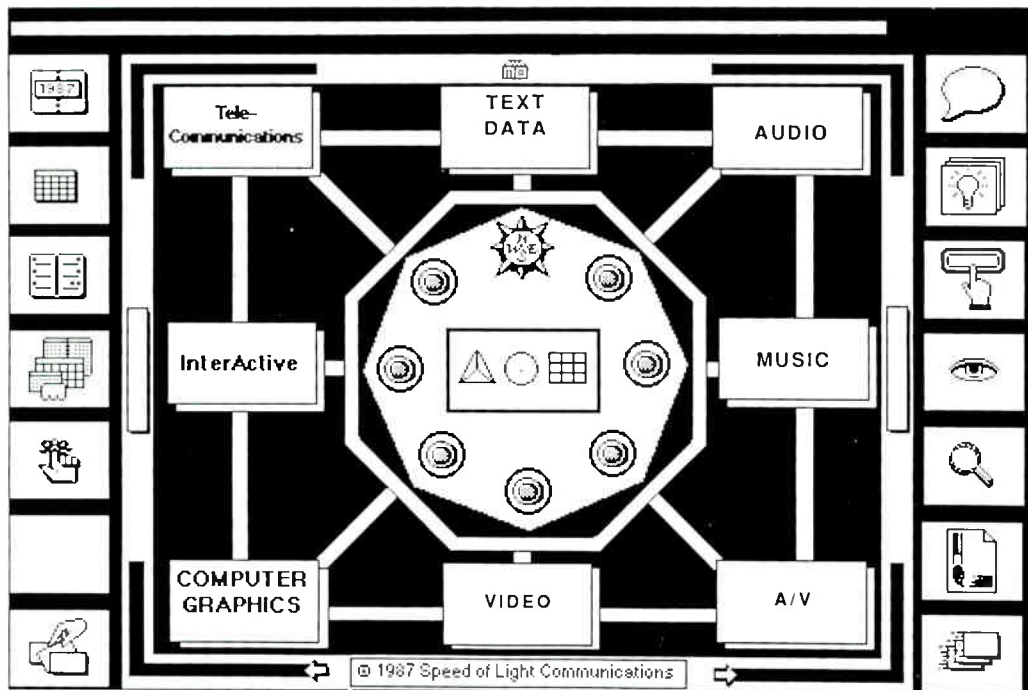

HyperVision Control Panel

HyperVision, an integrated audio-video production software package, is an example of the kind of HyperCard-based "stackware" products that are starting to come on to the market. HyperVision provides templates, buttons and fields programmed to permit the linking of scripts, budgets and schedules with the storyboard, image and sound libraries, and the edit decision list.

tor set piece is the card. Cards have definable backgrounds, buttons and fields. A group of cards is a stack. All activity starts at the "Home Stack." The home stack card is a series of icon buttons and fields which can be selected and arranged to the user's specifications. At any given point you can ask to review the cards you have browsed through by clicking on "Recent," a feature which is also invaluable in the design and linking of stacks. The "message box" allows you to navigate through or locate a given card, graphic or entry. The search through the HyperCard file is extremely fast and is a key aspect of the programming breakthrough designed into the package by the developers. Finding and entering information, the retrieval environments and the browse tool are unique aspects of the program.

Cross-referencing information, for example linking a sound file with the sheet music, or script with budget information, is the kind of application that illustrates the power this program delivers. HyperCard's ability to print out data as text, graphics or reports is another important function. You can customize these reports to reflect the particular way in which you want to see the text or graphics in a given stack, within the window restrictions built into the program.

HyperCard Authoring

HyperCard's "authoring" component allows you to create stacks that communicate ideas or present scenarios that you may want to share with your clients, co-workers or family. Authoring means that you can harness the power of HyperCard to create your own Macintosh world view. The HyperCard screen can be expanded beyond the 9-inch diagonal 512 by 342 pixel display area. The 12-inch Macintosh II screen can handle 640 by 480 pixels, with larger screens going up to 1,000 pixels in each dimension.

Stacks and Layers

Stacks can be homogeneous, all the same kind of cards, or they can be heterogeneous, with a variety of different kinds of cards. The HyperCard author can decide on the levels of access and security applicable to a given stack, or through the use of a password, protect the stack from being accidentally changed or deleted. Multiple picture, field and button layers are another innovative aspect of the program's design capabilities. A wide variety of blank backgrounds are provided with the program. These backgrounds can then be customized with fields, buttons and graphics. Card and background interaction come into play in the design process. Essentially, the

ability to separate the background from the card is reused. Cards can have specific ID numbers or specific names that allow them to be accessed unerringly. A card maintains its card ID as long as it exists. In mixed card stacks discrete names may prove to be more practical.

Fields and Buttons

The "Field and Button Tools" are located on the "Tool Menu." Fields are fill-in-the-blank programmable text areas. Each field has an optional visual layer and font properties. The HyperTalk programming language can be directed to access and respond to data entered into the field. HyperCard permits the cloning, copying and pasting of fields between stacks.

Buttons perform actions. HyperCard "buttons" may be created and used any place on a card or stack. They can be used to link the functions of the cards and stacks so that highly specialized functions may be called up for any application. Using buttons to link one card to another requires absolutely no knowledge of how HyperTalk works. Buttons have selectable and customizable visual properties. Over two dozen buttons are included in the package. Buttons can also be cloned, copied and pasted between stacks. This is a real timesaver, eliminating

the need to re-invent the wheel each time you want to re-use a given field or button.

Linkage is the very essence of a HyperCard. Card fields, buttons and scripts can be linked to create the particular functionality you are shooting for in your program design. The elegant simplicity of this aspect of HyperCard is where the Mac's friendly interface, and the art and science of the program come together.

Hyperpaint

HyperCard includes a new and improved version of MacPaint. The "Painting Tools Menu" has been expanded to include some extremely functional new additions. The Painting Palettes include the Selection Tool, the Lasso (for moving images), the Pencil, the Paintbrush, the Eraser, the Straight Line Tool, the Rectangle Tool, the Rounded Rectangle Tool, the Paint Bucket Tool (for filling in patterns), the Oval Tool, the Curve Tool, the Patterns Palette and the Text Tool.

The Paint Menu includes all of the MacPaint functions and several new additions. The Regular and Irregular Polygon Tool and the Spraypaint Tool are new additions to the MacPaint tool kit. The paint program is the onboard graphics generator. Images can be created and stored for use later. Existing images can be digitized and scanned into the program for storyboards, etc. Virtually any graphic image can be rendered through the use of the paint capabilities.

HyperTalk

HyperTalk is HyperCard's programming environment, a powerful authoring tool for nontechnical users. It is a language which allows the owner to "roll your own" software. Despite the complexity of programming for the Macintosh with programs like Basic, HyperTalk is consistently easier to use than other customizing environments. Author Danny Goodman calls HyperTalk the deluxe Swiss Army knife of programming. You can program in plain English. "Go to the next card," "zoom in," "dissolve" are a few examples of the commands that can be used to obtain the desired result.

Programming commands are written in scripts. Scripts can retrieve data from other cards and perform calculations combining retrieved and current card information. The two major limi-

tations in HyperCard are the size of the active window, which is limited to screen size, and the fact that you can only see one card at a time. While frustrating for power users, considering what the program delivers, these limitations are endurable. The modularity of the Script Editor structure allows you to re-use pieces from existing programs. This would be the equivalent of cutting and pasting "code," something not as easily executed in traditional programming languages. The structure of the HyperTalk script is based on a short series of instructions that are to be carried out as a

result of some kind of action. The Script Editor's automatic formatting ability insures that plain English commands are written properly.

HyperCard Hierarchy & Commands

HyperCard operates within a very specific hierarchical structure. The program itself is at the top of the object hierarchy. The "Home Stack" is the platform from which all functions may be launched. "Stacks" are the next basic element. The cards in a given stack share a common "Background." Each "Card" contains text, numbers and/or

TANNOY®



FSM-U
(retrofit)

FSM

Imitation is the sincerest flattery.

The main competitor of our new FSM studio monitor is surely the most popular large monitor in use in the U.S. today. It is, in fact, a standard. And perhaps for good reason too. Originally conceived as a high SPL pop monitor, it took advantage of the dual-concentric principle of speaker design pioneered by Tannoy over forty years ago.

Now there's a new alternative destined to become the **next** standard. And although it may be the obvious advantages that establish Tannoy's FSM as the new industry standard, it's really the subtle differences that we're most proud of.

ON THE OBVIOUS SIDE:

- **Far greater** power handling ability
- **Greater full bandwidth** sensitivity
- **More extended** low frequency response
- The lowest stated phase shift of **any** large studio monitor
- **Separate** sub-enclosure for bass driver

- **Sync-source** time compensated, **biamplable** passive crossover with gold buss bar contacts.
- **User defined** low frequency window allowing 4 or 8 ohm operation

ON THE SUBTLE SIDE:

It is the artful blending together of these obvious advantages that yield a more musical, accurate, powerful, non-fatiguing presentation of sound. This allows the engineer and producer to mold the finer details of a mix in a more precise way than ever before.

At any sound pressure level . . . even at very low listening levels . . . certainly at high ones. Can you say the same about the current standard?

TANNOY®
Professional Products

Tannoy North America, Inc.
300 Gage Ave., Unit 1
Kitchener, Ont.,
Canada, N2M 2C8
(519) 745-1158 Telex 069-55328

Circle #111 on Reader Service Card

graphics. Commands or instructions to create reports or perform specific actions are accomplished through the use of "Buttons" and "Fields." Within a stack and in the generation of a new stack based on an existing one, HyperTalk's object-oriented language permits users to leverage its "Inheritance" abilities.

HyperTalk commands are the most complex element of the program. They require knowledge and application of "Notation Conventions," "Navigation Commands" and "Action Commands." The commands permit a complete range of "Arithmetic Commands." The screen, menus, window, buttons and fields can be accessed through "Screen and Object Manipulation Commands." HyperTalk is capable of producing the "beep" sound, the standard Mac reaction to unacceptable requests. It can also be used to play back electronically recorded sounds through the computer's speaker or audio port. HyperCard has a fairly extensive single-voice music generator controlled by the "play" command. It can extract the waveform from a prerecorded sound and allow you to play it back at any tempo or note pitch.

The fundamental value of the sound management aspects of HyperCard is the ability to program sounds with interactive programs, ideal for stand-alone programs or interactive video simulations. There is also a series of "File Manipulation Commands" and "HyperCard Properties" dealing with text, fonts, margins and other related aspects. Programmable HyperTalk functions include "Time and Date," and "Math Functions," such as sine, cosine and tangent. As you can see HyperCard offers an endless array of opportunities for individual development of custom applications.

Multifinder

The HyperCard's capabilities will become even more extensive with the introduction of Multifinder, Apple's new multi-tasking operating system. A multi-tasking operating system executes several instructions and applications concurrently. During concurrent execution, each program informs the operating system of its actions and resource needs by a technique known as interprocess communication (IPC). This function allows concurrent appli-

cations to talk to each other. Multifinder supports fast switching between applications and interprocess communications on the Mac II, SE and Plus. Multifinder was developed at Apple by Erich Ringwald and Phil Goldman. The program enables users to open as many as 30 applications at once, and supports background laser printing. With slight modification to the pro-

gram, it can support other applications, such as electronic mail and terminal emulation.

When used with AST Research's DOS Card it will allow Mac IIs to run DOS software. This will eliminate the barrier in information sharing between operating systems. Apple president John Sculley has described the arrival of multi-tasking and other technolo-

Hypermedia: A View From the Top

John Sculley, chairman and CEO of Apple Computer, Inc. was the corporate advocate behind the development of HyperCard. The following comments are excerpts from his foreword to Danny Goodman's book The Complete HyperCard Handbook:

Hypermedia. It's a new word for most of us. Yet this term and its definition will become increasingly important the more we rely on personal computers to store, manage, and retrieve information.

In broad terms, hypermedia is the delivery of information in forms that go beyond traditional list and database report methods. More specifically, it means that you don't have to follow a predetermined organization scheme when searching for information. Instead, you branch instantly to related facts. The information is eternally cross-referenced, with fact linked to fact, linked to fact.

Hypermedia is particularly true to its name when it links facts across conventional subject boundaries. For example, when studying chemistry, you may wish to study the life of a chemical compound's creator. One hypermedia link would connect that compound to the chemist's biographical information located in an entirely different reference work. Another link might connect the chemical compound to a listing of grocery store products that incorporate the compound, or to long-term health studies on the compound. We can focus more on content, while ignoring the organization.

Until recently, there has been little need to address hypermedia on personal computers, largely because

of the limited amount of information most computers could manage "on line" at any one time. But as high capacity magnetic hard disks become nearly standard equipment on computers like the Macintosh, established methods of finding related pieces of information become cumbersome. At the same time, we've scarcely begun to take advantage of new magnetic and optical mass storage technologies that place on our desktops more information than the largest mainframe computers managed ten years ago.

The hardware that holds the information is only one side of the hypermedia equation. The balancing side—and unquestionably the most difficult part—is the software that lets us function in a hypermedia environment. By "function," I mean working with linked information in an intuitive and interactive way. And not putting information delivery just into the hands of computer professionals, but giving everyone sufficient power to bring information to life. Bill Atkinson's HyperCard puts hypermedia into the hands of nearly every Macintosh owner.

I should stress that HyperCard is not an application, like a word processing, spreadsheet or database program. It is, rather, a software engine—a hypermedia tool kit, if you will. With HyperCard, virtually anyone can become a software author, producing an information-based application that looks like a professionally designed Macintosh application. HyperCard shatters the barrier between a person's information handling dream and its realization. The expertise embodied in HyperCard applications will be the expertise of business people, professional people and educators—in short, the people who work with information daily. ■

gies as bringing Apple a step closer to "interpersonal computing." It's important to note that Apple's Multifinder (unlike the promised IBM OS/2) is not at present a true multi-tasking system. It does not do foreground-concurrent processing. Limitations of the 68000 CPU and of current Mac applications prevent Apple from producing a true multi-tasking system this time out. What the Multifinder does is some very facile and fast context switching (like Switcher, only better integrated with the Finder and other Mac applications), while allowing some background-concurrent processing to occur. The background processing, mostly communications and print spooling, uses a programming construct called "wait-next-event" to handle the processor interrupts.

Multifinder is Apple's first step in the direction of multi-tasking and all the benefits it offers. True multi-tasking will require a break in upward compatibility with current limited Mac applications. At some point expect to see Apple make the jump to true multi-tasking with an operating system that may run only on the Mac II (and subsequent Mac incarnations). That operating system will use the memory address space, its Nubus slots and its hardware support for virtual memory. So, true multi-tasking may not be available on the Mac Plus and Mac SE.

HyperCard

Mike Leibhold of Apple's Optical Media Systems Development Advanced Technology Group told me that the driver software for virtually every videodisc player capable of Level Three control has been placed on separate cards. Users can instantly integrate a videodisc player into a HyperCard application. Drivers for audio tape recorders and CD-ROM units are under development. Videodisc driver cards will be distributed at a nominal fee through the Apple Programmer Developers Association (APDA, 290 SW 43rd Street, Renton, WA 98055, 206-251-9798).

Apple is so positive about HyperCard's value in microcomputer applications that they include the package as a "no-charge" application provided with every new Macintosh computer. The program and 220-page user manual is now available to previous Macintosh owners through Apple's dealer network for nominal charge of \$49. A number of companies have created

Billboard's #1 Album
"Dirty Dancing"

MASTER A FULLERSOUND

Complete Mastering Services for:

- Compact Disc
- Records
- Cassette

Billboard's #1 Single
"I've Had" "The Time of My Life"

Sony PCM 1630/DMR-4000

Sony PCM 3202, Sony PCM 601

Mitsubishi X-80



ENG: Michael Fuller

FULLERSOUND, INC.

1755 N.E. 149 STREET / MIAMI, FLORIDA 33181 / (305) 945-6697

Eric Clapton
Rod Stewart
Kenny Rogers
Judas Priest
The Romantics
Company B
Barry Manilow
Expose
Julio Iglesias
Eddie Money
Dionne Warwick
Brullio
Bee Gees
Bellamy Brothers
Kenny Loggins
George Clinton

Circle #112 on Reader Service Card





FUTURE DISC
SYSTEMS

COMPLETE ANALOGUE & DIGITAL MASTERING SERVICES

FOR COMPACT DISC, RECORD & CASSETTE MANUFACTURING

3475 CAHUENGA BLVD. WEST, HOLLYWOOD, CALIFORNIA 90068
(213) 876-8733

Circle #137 on Reader Service Card

INTERACTIVITY

software and videodisc products for the HyperCard environment. The Voyager Company has developed HyperCard stackware that controls a videodisc containing the complete works of The National Gallery of Art. OWL International president, Alan Boyd, has announced OWL's intention to move its own excellent hypertext program, *Guide*, with added HyperCard features, to the IBM PC environment. Macomind's Video Works II has built-in HyperCard "hooks" to allow the two programs to operate as one from the user's point of view. Video Works also has been upgraded for the Mac II color capabilities and with HyperCard delivers one of the most evolved interactive programming and simulation packages available.

The Complete HyperCard Handbook

The Complete HyperCard Handbook, written by Danny Goodman and published by Bantam Computer Books, is the definitive resource for those who are interested in HyperCard. The author had the unique opportunity to be on the inside and literally participate in the development of HyperCard while he was writing the handbook. His affection for the Macintosh, respect for the accomplishments of the HyperCard team and incisive approach to explaining and organizing a gargantuan amount of information (720 pages), combine to make his book the "bible" for HyperCard users. He has also developed a HyperCard stackware product called "Focal Point," which is an integrated time management, scheduling and personal management package. HyperCard is a major step forward in bringing interactivity and interactive video to the general user. ■

SOUND · ON · STAGE

—FROM PAGE 98, REINFORCEMENT NEWS
binger 524s, Matrix's custom 3-way JBL-loaded double 15s for the occasional rock bands encountered, and Yamaha 2408 consoles. Crest 4001s power the entire sound system and house consoles are Midas, Hill, and Yamaha PM2000.

New York's **Audio Support** was busy with three different tours right before the holidays—**Elvis Costello & the Confederates** with **Nick Lowe** opening carried Meyer main PA and TAC Scorpion house and stage consoles for a brief junket in

November (see "On The Road"); in conjunction with England's **Audio Lease**, they provided equipment for **Depeche Mode's** U.S. tour. Their Meyer main PA consisted of 36 MSL3s and 18 650R2 subs powered with Crest amplifiers . . . And **Joe Cocker's** tour in November-December was handled jointly with Audio Support covering the Eastern and **Ultra Sound** the Western duties.

Located in Northampton, Massachusetts, 100 miles west of Boston, **Sun Sound Audio Inc.** has been in business for eight years and traditionally has provided sound reinforcement for colleges in the New England area. But they have also been involved with several national and regional tours over the last few years, and just finished the North American leg of **Suzanne Vega's** world tour (see "On The Road"). She used Sun Sound's new PA system that consists of Eastern Acoustic Works' new flyable KF 850 cabinets, Crest's new 8001 amplifiers and a new 40-channel Yamaha PM3000. Asked about the EAW cabinets, **Herb Mayer** responded, "We have been working with EAW for the past six or seven years. Since they are right here in Massachusetts, we have had a close relationship with them and have been involved in this KF 850 project for the last two years. We give EAW user feedback such as how it sounds, rolls, sets up, packs in the truck, etc. They have been very receptive to having that input so it has been a good relationship for us. This new cabinet is tremendous and we've had nothing but good reports." Sun Sound has been working with **Southside Johnny** for the past three years . . . Last spring they did a national tour with **Arlo Guthrie** . . . They also work with **Great Adventure** (one of Six Flags' amusement parks) in New Jersey, which has an outdoor arena where they have shows every week throughout the summer . . . In the spring, Sun Sound keeps busy around New England's colleges with a novel idea called **The Great College Drive-In** where a portable drive-in screen is erected and audio played through speaker cabinets and/or transmitted on AM for car radios.

The heavyweight championship boxing match between **Mike Tyson** and **Tyrone Biggs** at the Atlantic City Convention Center utilized a Meyer PA provided by **Andrews Audio Tours**. Twenty MSL3s and ten UPAs arranged in a center cluster over the ring gave knockout coverage for the 20,000 people in attendance . . . A complete Meyer house and monitor system was shipped across the Atlantic for **Little Steven & the Disciples of Soul's** November and December European tour (see "On The Road") . . . Other shows keeping Andrews busy were the **Grammy Lifetime Achievement Awards** at the Mark Hellinger Theater

in NYC taped November 5; **Gladys Knight & the Pips** at the New York Hilton; and **David Bromberg** and **Jorma Kaukonen** at the Beacon Theater in Manhattan . . . The **Pat Metheny Group**, **Lisa Lisa** and **Engelbert Humperdinck** were some of the national acts that Andrews Audio provided equipment for at Radio City Music Hall in New York City. . . . New purchases include a Yamaha PM3000 40-channel house console.

This month's **EQUIPMENT SPOTLIGHT** is on Panasonic's new **RAMSA WR-S840 Series** sound reinforcement console. RAMSA has unveiled a new house and monitor console that looks like it could take a good sized bite out of the mid-priced professional mixing console market. I got a chance to see the WR-S840 at the New York AES convention and came away quite impressed at the quality and price (approx. \$27,000 retail, fully loaded). House model configuration is 40x8x2 with an 11x8 matrix capability. The state board has 40 inputs, 18 outputs and utilizes the same frame as the house console. Some things that impressed me about the 840 console were the resistive plastic faders designed to last 20 times the life of a typical carbon fader; flexible ribbon cables that mate with the modular PC boards through gold-plated contacts; the elimination of fragile motherboards; fiberglass-epoxy circuit boards with double-sided traces and plated holes; a distributed grounding system with a solid copper bar running the length of the frame; and the input-saving submix module that is a double wide input with eight mic/line preamp circuits and the same 4-band state-variable sweep-frequency EQ, high pass filter, PFL, and channel "on" switches as the standard input modules. Designed to increase the input potential, it is ideal for keyboards, effects, strings, and other groupings that can be submixed.

To be honest, I would like to have seen eight stereo (or 16 mono) submasters instead of the eight mono, and I prefer full LED metering. Still, the 18 meters provided should be adequate for most applications. And if the noise specs given by the manufacturer are met in subsequent field testing, and the rumors I hear of good audio quality are verified by more veteran engineers, one would have to think RAMSA has a winner on its hands.

Got any news? Call (415) 726-2428 or E Mail Herman-US IMC 2560 or send press releases, photos, etc. to: Sound Reinforcement News, *Mix* magazine, 2608 Ninth Street, Berkeley, CA 94710. ■

Mark Herman owns Hi-Tech Audio, a sound reinforcement company specializing in console rentals.

—FROM PAGE 60, R DAT

collect: there are already the mechanisms in place to collect royalties from retail sales, radio stations and the rest. And those procedures are specifically designed to route the correct percentages of these royalties to the appropriate recipients. Incorporating a license fee clause into an artist's contract would be easy to do, also.

There are no complex exemption requirements as would be needed for a tape levy to enable the blind, journalists, nature recordists, home musicians and others to get their tapes levy-free; a recording royalty is much more straightforward than that. No vast expenditure on spoilers like Copycode that affect the sound. No need for equipment modification or international legislation (the license can be enacted on a country-by-country basis with no trouble). In fact there would probably be no need for legislation at all. It's simply an agreement between the record company and the consumer which could be printed on the inner sleeve of an album, in the booklet of a CD, on the inlay card of a cassette: "In breaking the shrink-wrap on this package, you hereby agree to the following license conditions. . . ." A good deal of computer software includes a licensing agreement: why not an album?

At a stroke, a recording royalty charged to the purchaser or commercial user would solve many of the problems which plague—or are said to plague—the record business today, with no unpleasant bending. It's simply a matter of incorporating an additional royalty (not unlike the "blanket license" issued to broadcast users of production music in the United States today) into the existing structure.

Why the idea hasn't been raised before I'm not sure. And I'd like to hear some reasons as to why it shouldn't be proposed now. It could be a good deal easier and fairer than present schemes—and cheaper, too, for all concerned. The principle is simple: instead of trying to stop people from doing something they want to do, charge them for the privilege. Home taping? Legalize it! ■

Richard Elen, formerly editor of Studio Sound magazine, is a recording engineer, producer and computer music and communications specialist based in England's West Country. He is an occasional contributor to Mix.

Direct from Digital?

No problem!

Experience *Ultimate Fidelity*
on the world's largest
 Nakamichi real time
cassette duplication system.

Call toll free (800) 323-AAPX
In northern California, call
(800) 327-AAPX or (707) 585-1132

AAPEX™
WE UNDERSTAND SOUND

*"Our Success
is the result of
people caring
about Quality"®*

Circle #113 on Reader Service Card

Nobody gives you more sound for less than Sam Ash.

You'll find everything you need to make music at Sam Ash at consistently low prices. It's a fact that Sam Ash has been filling America's playing and recording needs for more than 60 years. So whatever your needs may be, you'll find that the helpful and expert people at Sam Ash will bring music to your ears.

YOUR SOURCE FOR MUSIC AND SOUND

Call Toll Free: 1-800-4-SAM-ASH
OR 1-718-347-7757

 **Sam Ash**®

124 FULTON AVENUE HEMPSTEAD, N.Y. 11550 **MUSIC STORES**

Circle #114 on Reader Service Card

“After the applause died down, we were back in the dressing room welcoming a continuous stream of Hollywood well-wishers, acquaintances and friends. And then came the big one for all of us—Nancy Sinatra.”

—FROM PAGE 128, TOMMY SANDS

my head into the booth and Count was at the console listening to a playback. After the tape stopped and everyone agreed that that was the take, I quietly walked up to him and reintroduced myself as cool as I could be. I said, “Count, I don’t know if you remember me or not but . . .” He interrupted me, “Hal Blaine, as much drums as you play, you think I’m gonna forget you?”

Everything was going wonderfully with the Tommy Sands show. I was getting great studio experience with Tommy doing his records. I met all the top producers at Capitol Records, and I even worked in Tommy’s films doing bit parts, standing in for Tommy and later working with many notables. We were working at the Sands Hotel where we recorded *Sands at the Sands*, my first big band show album. Unfortunately, it was also the start of the finish for our group, The Raiders, now called The Sharks, a name we adopted after playing Hawaii a number of times. The Sharks were coming to a close because Tommy was starting to play only big rooms, and large orchestras couldn’t really use country pickers.

But one of our biggest gigs was still to come: the Coconut Grove. We had been building to this event for three years and the stakes were high. After all, L.A. was the toughest town for any entertainer.

The houselights dimmed. Jeff Lewis threw the tympanist his cue to start the thunderous roll. The curtain came up and the goosebumps started, reminding me again of my childhood sitting front row center back in the State Theater in Hartford.

It was such an emotional experience. This was *it* as far as I was concerned. If I never did another thing in the business, I knew I had made it.

The Tommy Sands fans were there along with Tommy’s friends, most of whom were celebrities themselves. This was Hollywood’s new generation, and Tommy Sands was a top draw.

Well, the show was a knockout. After the applause died down we were back in the dressing room welcoming a continuous stream of Hollywood well-wishers, acquaintances and friends. Each time the door opened and the maitre d’ announced another name we looked at each other in shock and excitement. And then came the big one for all of us—Nancy Sinatra. She’d been sitting near the stage during the show, laughing and having a ball as she watched Tommy move through his paces, so handsome in his tuxedo. They hit it off immediately.

Tommy was about 19 then and Nancy was 17. After their first meeting they were constantly together. Nancy insisted on being on the road with us and we all fell in love with her, too. She was everybody’s friend, kid sister and mentor. She had kind words for everyone and wasn’t at all the spoiled Hollywood brat some had feared. Nancy had gone to public schools and was surprisingly normal.

Nancy’s mother (also named Nancy) turned out to be the exact same way. She was the Italian counterpart of a Jewish mother—there was always food on the table and I was constantly amazed to find her making drapes for the living room or sewing somebody’s torn clothing. Her opening line was always something like, “C’mon. You must be hungry”—just like my mom.

Tommy’s mother Grace and “Big Nancy” (as we affectionately called her) consented to Nancy coming out on the road with us on one condition: either or both of them would come along and chaperone the lovebirds. I

remember a wonderful trip to Vancouver, British Columbia, when we all drove together and Tommy and Nancy were just inseparable. Grace would say, “Now look you kids, no hanky panky!” and we would laugh for hours. But there was no hanky panky. We all had separate rooms and I know how tough it was for them. Watching these kids was a show in itself, especially when they were saying goodnight and fighting to keep their hands off of each other.

Tommy and Nancy’s engagement party was a blow-out affair. Every star I had ever heard of was there. There was even a special heart-shaped cake for the celebration. They were married not too long after that and for a while seemed like the happiest couple around. They lived in a gorgeous white apartment that Auntie Tina decorated. Frank often called the kids when we were performing, and he always said, “Blainey, pick up the check and sign my name!” The kids lived a fairy tale life, often going to Dad’s house in Palm Springs, and on special occasions I was lucky enough to be invited along.

The marriage didn’t last too long, though. In a short time it seemed like the perfect marriage wasn’t that perfect after all. Maybe Tommy and Nancy were just too young. No one knows the reason for sure, but they did eventually break up and Tommy more or less quit the business. Rumors had it that Frank Sinatra put out the word that Sands was not to work anywhere, but insiders knew that was total hogwash. Tommy called me just prior to his move to Hawaii and told me he didn’t really want to work anymore. He wanted to find himself and get back on the right track. He just had to get away, and what better place than Hawaii? My feeling was that this teenager had gotten too much too soon and just couldn’t handle it.

Tommy had been retired for some time and was attending college when promoter Tom Moffatt talked him into putting together an act for the Outrigger Hotel in Honolulu. Tommy did really well there. One year when I came over I decided to surprise him. While he was doing his act I snuck backstage and got on the drums. Tommy finished his speech to the audience and away we went doing the Hawaiian favorite “Ain’t No Bit Ting.” In a matter of seconds Tommy turned and somehow just knew it was me. It was a wonderful reunion. ■



GREG SHAW

For years I've noticed that a strikingly large number of musicians are involved with computers. At the same time, a seemingly large group of computer programmers are musicians, or involved with computers in music. I am sure this is one of the reasons computers have been so successfully put to use in the generation and recording of music. San Francisco-based composer-musician Greg Shaw is an excellent example of the hybrid artist-scientist involved with shaping the leading edges of both worlds. He is a gentle, humorous man with an irrepressibly exuberant outlook on life. Recently we met at Gentle Synergy, his Synclavier-based studio. What follows is a revealing portrait of one of the most interesting and creative minds actively involved in bridging the gap between today's technology and the vision of tomorrow's new media.

Mix: Why do you think so many musicians and computer programmers

Portrait of an Artist in a Computer World

by Lou CasaBianca

cross over into each others' fields so easily?

Shaw: Both music composition and computer programming involve putting together a small number of elements (notes, bits) into patterns (phrases, instructions) that when assembled together into complete works (songs, programs) have an aesthetically pleasing effect on the consumer (listener, user).

Mix: Tell us about your computer and computer music roots.

Shaw: When I first became involved with computers in 1970, text was put into a computer using punched cards and JCL. By 1972, I was using a line editor and batch processors like RUN-OFF on a Texas Instruments hard-copy ASCII terminal. By 1975 I was using a character editor, TECO, on an ASCII CRT terminal. By 1977 I was using a scroll mode WYSIWYG [What You See Is What You Get] editor, Bravo, on the Xerox Alto bit-map CRT. Only recently, in 1986, I started using a page mode

1988 MIX ANNUAL DIRECTORY

OF RECORDING INDUSTRY
FACILITIES & SERVICES

ONLY \$25.00!
NEW & ENLARGED!
MORE THAN 7,000
UPDATED LISTINGS!



The Recording Industry's most comprehensive Sourcebook.

Audio/Video Professionals everywhere rely on the regularly updated, monthly MIX Magazine directories for accurate, thorough and *fresh* information about their business. The new **1988 MIX ANNUAL DIRECTORY** is an exhaustive, "nuts 'n' bolts," single-source reference compiled from these detailed directories and expanded with other indispensable industry data.

When you want information fast, the **1988 MIX ANNUAL DIRECTORY** has everything you need right at your fingertips—in one, easy-to-use, definitive reference source. Because the new 1988 edition contains more than *400 pages of new information*, we've added new, heavy-duty, *tabbed Index Pages* which makes sourcing fast and easy.

The totally revised **1988 ANNUAL DIRECTORY** contains more than **7,000** up-to-date listings, arranged by geographic region, in more than a dozen different categories, including:

- Recording Studios of the U.S. & Canada.
- Video Production & Post-production Facilities.
- Facility Designers and Audio/Video Equipment Suppliers.
- Mastering, Pressing and Tape Duplication Facilities.
- "A to Z" listing of Audio, Video and Musical Equipment Manufacturers.
- Enlarged Market Data & Industry Statistics section.

NEW LISTINGS FOR 1988!

Sound Reinforcement companies including lighting, staging and audio/video equipment rentals. Remote Recording Services. Recording Schools, Programs and Seminars. Other essential industry services.

Don't pass-up this opportunity to get your hands on the recording industry's most comprehensive Sourcebook. The price is just \$25.00 each. Use the convenient order form or place your order TOLL-FREE at: (800) 233-9604. In California: (800) 641-3349.

© 1987, MIX Publications, Inc.

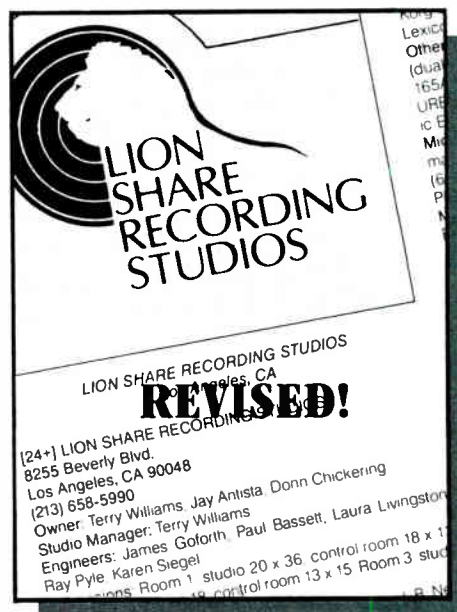

1988 MIX ANNUAL DIRECTORY listings have the detailed and important info industry professionals need to make decisions.

✂

• • • • •

Please send me _____ copies of the New & Revised 1988 Mix Annual Directory of Recording Industry Facilities & Services as soon as it's off the press. I've also enclosed \$2.00 per copy for postage and handling. If I'm a California resident, I've enclosed 6% for the Duke (sales tax).

Enclosed is _____ Check Money Order

Charge to my credit card
 Visa Mastercard American Express M188

Card # _____ Exp. Date _____

Signature _____

Name/Title _____

Company _____

Address _____

City, State & Zip _____

Mail this Order Coupon directly to: **ANNUAL DIRECTORY c/o MIX Bookshelf**, 2608 Ninth, Street, Berkeley, California 94710. You may also place your order TOLL-FREE at: (800) 233-9604 (In California: 800 641-3349).

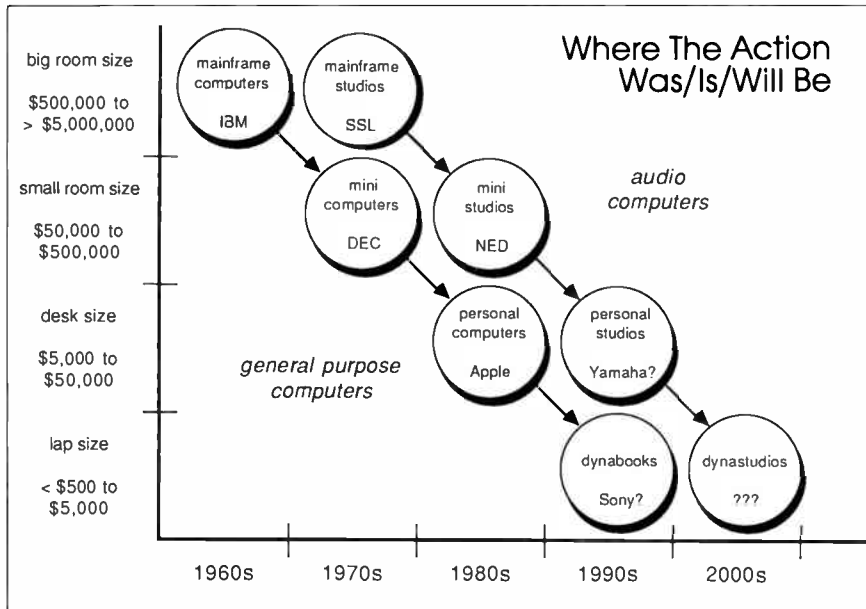

The manufacturers indicated are used by way of example of the types and approximate costs of the various technologies involved.

WYSIWYG editor, ReadySetGo, on the Apple Macintosh. Music processors have followed a similar evolutionary path in my experience. Luckily, I missed the punch-card music editor phase, although I suspect many Music V users did not. The first computer-based music editor I used was a line editor, Music Box LOGO, at the MIT Artificial Intelligence Laboratory in 1972. The PDP-11 I used in 1973 in Barry Vercoe's laboratory sported ASCII CRT terminals. My first use of scroll mode WYSIWYG music editors was Jim Miller's Personal Composer on the IBM PC in 1985, later superseded by Mark of the Unicorn's Professional Composer/Performer on the Macintosh. Page mode WYSIWYG music editors are doubtless soon to follow. Music processors are following in the footsteps of word processors.

Mix: When did you first conceive the "dynastudio" concept?

Shaw: In 1978, while I was working as a computer programmer at Xerox Corporation in Palo Alto, the dynastudio only existed in my imagination. A dynastudio is the musical analog of Alan Kay's dynabook. By the turn of the century I figured that a lap-size box, \$300 at retail, could be mass-marketed internationally. It would contain the equivalent of an entire audio recording studio, capable of enabling a single person to create complete musical works of the finest professional quality. It would allow you to go from initial concept to final

mastering; yet it would be so easy to use that a 2-year-old child could create hit records with one. One of the first steps I took was to organize and implement a 22-year plan which included raising some seed capital. In 1979, I co-founded a computer company, 3Com Corporation, with Bob Metcalfe, inventor of the Ethernet local area network. I left 3Com in 1985, after the company reached over \$50 million in sales and was named the 22nd fastest growing company in the U.S. by *Inc.* magazine.

Mix: This is when you were able to concentrate on composing and the dynastudio?

Shaw: Right. In 1986 I spent a year consulting with New England Digital, since they had built the closest thing to a dynastudio yet available. At this point I've assembled a prototype dynastudio from professional audio equipment as applicable technologies have become available. For example, I've made daily use of the Apple Macintosh since June 1985, Synclavier since June 1986, Direct-to-Disk since November 1986, and the Synclavier Optical WORM disk since October 1987. I'm using this prototype dynastudio to compose and produce music and sound effects for a variety of professional applications.

Mix: What are some of the musical projects you've worked on?

Shaw: I've composed and produced music for such commercial clients as

Canterbury of New Zealand (TV and radio spots), the California Strawberry Advisory Board (radio spots), and the 1987 Mill Valley Film Festival (TV spot and film trailer) with Saatchi & Saatchi, BBDO and other agencies. I've produced music for home video such as *Cooking With Country Stars* from IVE/MVS, the Winter Olympic Games from ABC Sports/Mindscape/3 Star, for interactive home video, and computer-based audio such as music for the Macintosh II dealer demo for Apple. I've done sound effects for *Dear America*, a feature film for HBO/Courtie. Half of the projects I do by myself, and half in collaboration with others.

Mix: In your opinion, when will the dynastudio become a reality?

Shaw: Two more generations of increased ease of use will be required before the real dynastudio I envisioned in 1978 arrives as a global commodity. The current generation of Synclavier-type ministudios requiring substantial power, air conditioning and computer expertise will evolve over the coming decade into a generation of personal studios that can fit on a single desk top. They won't require any more power, air conditioning or expertise than a typical office machine. The following decade will see the emergence of dynastudios small and easy enough for a child to carry around and use. This trend in audio studio computers roughly duplicates the evolution of the general-purpose computer, delayed by ten years.

Mix: What was your motivation or inspiration to make dynastudios?

Shaw: Because of my personal experience when I was 2 years old. When I was 2, I remember having a tremendous passion for music. I wanted to play the trumpet, but I had to wait until I was 8 years old before I was strong enough to hold one. Life is short, and I wish there had been an instrument I could have played when I was 2. Building dynastudios will give future 2-year-olds that instrument I never had.

Mix: Do you think 2-year-olds are developed enough to create music?

Shaw: Studies have shown that the period from 1½ to 3 years old is the time when the neurons in the brain are most sensitive to forming path-

ways that determine a person's ability to think creatively. People exposed to a creative environment at this age are more likely to exhibit creativity throughout their lives. Being able to think creatively has given me a lot of options in life that may not have been available to me if I had not been raised in a creative environment. Building dynastudios for 2-year-olds will make a creative environment available to more people in the world, and consequently provide greater lifetime options for the next generation of people on earth.

I tell people dynastudios will be easy enough for a 2-year-old child to make a hit record. Perhaps even younger. Recently, while I was working on the sound effects for the HBO documentary *Dear America: Letters Home From Vietnam* with Doug Murray, Doug brought his 6-month-old son, Alex, into the Gentle Synergy studio to try out the interim dynastudio. Within seconds Alex started playing on the Synclavier keyboard, instantly and gleefully noticing that his banging produced music. While not the most mature composition I've ever heard, it was clearly the artwork of a mind, at six months old, already capable of agile aural awareness and expression.

Mix: Fortunately educational technology is advancing on the same curve.

Shaw: I recently had the pleasure of hearing Alan Kay give a talk in which he screened a videotape of Harry Reasoner challenging Tim Gallwey, author of the book *The Inner Game Of Tennis*, to prove Tim's claim that he could teach anyone to play tennis in 20 minutes live on national TV. Amazingly, the video shows Tim doing so with ease. He explains that this is possible because everyone has long ago developed muscle coordination, and it is just a matter of getting the mind out of the way so the body can do what it already knows how to do. Alan pointed out that the same is true of music. We all have long ago developed the aural coordination to create music and it is just a matter of getting our mind out of the way so the body can do what it already knows how to do. This immediately made sense to me: explaining music can actually interfere with expressing music. That's what enables some people to write songs even though they can't read music or explain how they do it. And that's how

2-year-olds will be able to compose music with a dynastudio, because they won't have to understand how to compose music. They'll just do it.

Mix: How would you describe the market for the dynastudio?

Shaw: I want a dynastudio, and almost everybody I describe the dynastudio to wants one too. A recent random survey conducted in the U.S. by Casio discovered that the majority of people surveyed wish they could play a musical instrument, and yet only a small fraction of them do. More people would if the difficulty and cost were not so great. Dynastudios will greatly lower the difficulty and cost of creative musical expression, allowing more people to turn their wish into reality.

Mix: This will be an extension of the success of other personal expression markets.

Shaw: Major industries thrive on satisfying every person's quest for personal identity as expressed through each of the senses. The quest for a personal visual identity is addressed by the fashion and cosmetics industries. The quest for a personal olfactory identity

is addressed by the perfume industry. The quest for a personal tactile identity is expressed by playing sports and going out dancing. The quest for a personal expression of taste is addressed by home cooking. The majority of people I know have a clear personal identity in terms of each of these senses, and yet few people I know have a personal aural identity. Dynastudios will make it possible for anyone to create a much richer personal musical identity than ever before with very little effort and cost.

Mix: Let's talk about upcoming dynastudio/music technology breakthroughs.

Shaw: The first thing is turn-key simplicity. A dynastudio must be so easy to use that anyone can take one home, turn it on, and be composing music within ten minutes without ever reading a manual. Since most people today think harder means better, achieving this is more of a shift in design attitude than technology.

Mix: What about size?

Shaw: A dynastudio must be easily portable by everyone. Within the coming decade, erasable optical technol-

DEVONSHIRE AUDIO/VIDEO POST-PRODUCTION STUDIOS

- Sony and RCA 1" Type C Video with TBC
- Four Studios with Sony BVU-800 and Adams-Smith 2600
 - VITC capability in all rooms
 - Neve 8128 Necam 96 with 56 inputs
- Separate Video Transfer room for laydown/layback & copying
 - Otari and MCI 24-Tracks with Dolby
 - Digital Effects Libraries
 - Digital sampling and synthesis
- Digidesign Q-Sheet™ & Sound Designer™ for MIDI-Based Sound Effects Editing & Placement

10729 Magnolia Blvd. • North Hollywood
Bookings and Information — (818) 985-1945

ogies will make gigabytes of storage available in a pocket size area at a mass-market consumer price-point. This will permit lifetime access archiving. Music created on a dynastudio must be archived in a way that it can be accessed for a lifetime or more. This is as much a design attitude as a technology. Innova Digital Archive, in Boulder, Colorado, is the first record company I am aware of to adopt this attitude. Digital cloning is making such an attitude possible, and within a decade it will be the norm.

Mix: How do you see the human interface evolving beyond the mouse, touch screens, light pens, etc.?

Shaw: Vocal input is the key. A dynastudio must be able to easily take input from a composer who sings, hums, whistles or grunts a musical motif. Improvements in signal processing technology are needed before audio input can be transformed and manipulated as easily as keyboard input. Composers must be able to dance, wave their hands in the air, draw or tap out a melody, rhythm, harmony or timbre into a dynastudio. There's also tactile input. Much of this technology is currently available, and will be steadily refined.

When I was growing up, my family would occasionally invite the entire neighborhood over for a jam session. Everyone would be given a musical instrument to play—grandmothers, little babies, everyone. Later on, the music teachers I studied under attempted to teach me by example that anything less than technical perfection should be scorned and ridiculed. I still have some tape recordings I made of those early jam sessions; each time I listen to them I'm reminded of the enthusiasm and satisfaction everyone felt in the *absence* of ridicule.

Mix: How much do you think a dynastudio will cost?

Shaw: Mass-marketed consumer products like the dynastudio must be low cost—in today's dollars, \$300 or less. For equivalent functionality, computer technology decreases in price roughly a factor of two every year. As a result, the prototype dynastudio's current cost on the order of \$300,000 will decrease to the \$300 price-point in roughly ten years, around 1997, allowing mass-marketing of the dynastudio to begin. A dynastudio must work properly for as long as consumers expect,

typically several years or more. Current computer music technology is nowhere near this level, and care will be required to catch up to the level of reliability consumers have become accustomed to expect.

Mix: What was your first experience with intelligent instruments?

Shaw: An intelligent musical instrument is one whose output depends on continuing user input and is constrained to always sound good. My first experience with such a beast was in 1972 during my freshman year at MIT. Ed Fredkin, my favorite professor, had an instrument in his office called a MUSE, which was little more than a panel of knobs and faders controlling a collection of flip-flops attached to a speaker, set up so that no matter how you twiddled the knobs, it would always produce an interesting melody. I thought to myself, "Anybody could have fun with one of these things." Looking back, this MUSE was one of the seeds planted in my mind that later grew into the dynastudio concept.

Mix: How do Ted Nelson's hypertext and hypermedia concepts fit in?

Shaw: Ever since I ran across Ted Nelson's book *Computer Lib/Dream Machines* in 1974, it has been my most referenced and revered source of vision into what is possible for computers to be: pleasure tools expanding what our minds can visualize, create and produce. I am still amazed each time I browse through the book at how many of the visions Ted described have come about, and how many are yet to come. For example, the essence of the Apple Macintosh and its major applications are foreshadowed in great detail. This book was my first introduction to hypertext, and is still the most compelling source of insight into the subject I've ever seen. Anyone who designs or uses music, graphics or word processors should devour this book. It's quite tasty.

Mix: In mixing, we use words like "color" and "image" when referring to aspects of sound. Do you see visual analogies being used in music composition technology?

Shaw: Many of the notions used in the Macintosh painting and drawing programs can be directly applied to music composition. For example, a visual pattern could represent a re-

peating musical motif. A section of music could be filled in using the paint bucket, or random subsets of a pattern could be sprinkled around using the spray can. A snap-to grid could be used to constrain placement of notes and motifs to measure, phrase and section boundaries. Grabbing a handle on a rectangle filled with a pattern and stretching it out could be one way of increasing the length of a section of music. Intuitive visual analogs such as these will become increasingly popular in music software.

Mix: Do you see new technologies and standards like MIDI coming together to create the dynastudio?

Shaw: More multi-vendor cooperation is needed. MIDI is an outstanding cooperative effort that should be wholeheartedly supported by the entire consumer and professional audio industry because it dramatically leverages the value of all equipment that is MIDI-capable. However, MIDI has limitations. It should be a bi-directional link with CRC handshaking for reliability and configuration. It should be faster—fast enough to support all of the devices that want to use it, like pianos and automated consoles. Higher level protocols above MIDI should be defined in layers that correspond to the International Standards Organization Open Systems Interconnection Reference Model, such as presentation layer protocols that enable the transfer of samples and sequences between dissimilar machines, and peer-to-peer control protocols so that any machine can control any other. As such things are standardized, care must be taken to provide backward compatibility for existing MIDI equipment.

Media standards for archive and transfer media are essential to the growth of the audio industry. As new technologies appear, designers must take great care to cooperate with one another to agree on compatible formats long before any products are developed. Such cooperation in the case of the audio compact disc resulted in the CD becoming the most successful consumer electronics product in history. Musicians, engineers, manufacturers and developers should all strive to continue such cooperation as new technologies appear on the market, such as optical WORM and erasable optical discs, so that they, too, can be as valuable and successful as the CD has been. ■

CARVIN's MX2488 for \$4395!

THE AMERICAN-MADE MIXER THAT LEADS IN VALUE!

MX2488 RECORDING FEATURES

- Eight Track Studio Control Center
- Quick Tape Playback and Rough Mix Capability
- Three Band Parametric EQ with Defeat
- Complete Cue Mixing Facilities
- Four Auxiliary Busses with Pre-Post Switching
- Two Effects Returns with Panning and Soloing
- Patch Jacks and Direct Outputs On Each Channel
- Solo and Mute On All Input and Output Channels
- Built-In Talkback System and Monitor Dimming

If you want a transparent sound that fits into today's "digital" recording world, then the MX2488 is worth considering. The CARVIN MX2488 console offers the features and performances you expect from a professional recording console—at a price that's unmatched! CARVIN sells DIRECT, saving you about half the retail price with no commissioned salesmen or store overhead to pay.

The MX2488 is versatile. It handles every recording requirement with ease, from basic tracks to overdubs and mixdowns. The MX2488 is professional—right down to its modular design and outboard rack power supply. A recent MX1688 test review quoted: "Total harmonic distortion at mid freq. measured only .025% while line inputs measured only 0.01%—very low for a console of this type."

Write for literature and a recent test review, or send \$15 for the complete manual (100 pages) including schematics and circuit layouts.

"Having lived with the Carvin MX1688 for a couple of weeks before reluctantly sending it back to the manufacturer, I can attest to the fact that it is truly targeted at the professional recording engineer or sound reinforcement engineer. It is obvious that the people who designed this unit spent a lot of time in both recording studios and at concerts where sound reinforcement is both critical and complex."
 Len Feldman—db magazine
 September/October—1986



FACTORY PRICES:

	LIST	DIRECT
MX2488 24x8x2.....	\$8995	\$4395
MX1688 16x8x2.....	\$6950	\$3395
MX1644 16x4x2.....	\$4595	\$1895
AN-16 16ch Anvil Case	\$ 395	\$ 269
AN-24 24ch Anvil Case	\$ 469	\$ 299

CARVIN

FACTORY MAIL ORDER:

Dept. MX77, 1155 Industrial Ave.
 Escondido, CA 92025
 TOLL FREE: 800-854-2235

HOLLYWOOD STORE:

7414 Sunset Blvd.
 Hollywood, CA
 (213) 851-4200
 STORE HOURS: 10 a.m. - 8 p.m. M-F
 10 a.m. - 6 p.m. Sat.

CARVIN 1155 Industrial Ave. Escondido, CA 92025

Free Catalog \$15 Enclosed for MX88 Manual

NAME _____
 STREET _____
 CITY _____ STATE _____ ZIP _____

PC'S IN THE STUDIO

How Northwest Facilities Use Computers



Dr. Richie Moore at Gate Five Studios

by Linda Jacobson

Lots of studios use personal computers in the office to lighten the load of bookkeeping and inventory chores. But it's still not a garden-variety item in the control rooms of the great American Northwest—even though this is the home of Silicon Valley and growing high-tech communities in Seattle and Portland. It looks like a couple more years will pass before there's a computer in every studio.

It *will* happen because even today there exists software for music printing, recording and production tasks to be handled by any breed of PC. All the late models of Apple Macintosh, IBM PC and clones, Atari ST and Commodore Amiga can work as cost-effective, hard-to-beat SMPTE/MIDI tools. One can run programs for digital signal processing, EQ, sample editing, and sound merging, storage and mixing. Specialized PC packages can control Sony's 60-CD "jukebox" or edit Lexicon PCM70 sound effects. And PC systems can provide the foundation

of fantastic audio/visual workstations with full synchronization, programmable audio mixing, direct-to-disk recording, and programmable audio and video patchbays.

Today, however, while it seems nearly every recording facility in the Northwest uses a personal computer to help manage business operations, a far smaller group has actually gone PC in the control room or studio. In fact, some of the area's best-known

establishments have opted for the computer-built-into-the-world-class-console approach. San Francisco's Different Fur, for instance, has a fully automated Solid State Logic console, and The Plant in Sausalito has Melquist automation for its Trident console.

We contacted several studios that work with personal computers and we learned that their PCs usually interface MIDI instruments, handle sound storage duties and provide se-

A DIFFERENT EMPHASIS

by Josh Gressel

Regular readers of *Mix* might get the impression that to be a top studio means to have the latest mixing board, or, as the accompanying article emphasizes, to be involved in computer-assisted music. But who says the "art" in "state-of-the-art" has to refer to technology? Following a hunch that some engi-

neers might translate the word "art" differently in their studio and their work, we checked with a few places that have chosen *not* to emphasize computers and asked them why.

The following three studios are alike in that each feels itself capable of handling high-tech projects, and each engineer emphasizes his openness to any musician who wants to record. But beyond this, each feels

A new approach to sound...



Granny's House is the best of both worlds. Old fashioned charm plus the latest in recording technology make for an incredibly unique creative experience.

We start with superior technical capabilities... an SSL 6000 fully automated console, Studer mastering machines, plenty of synthesizers, Midi samplers and a large selection of outboard gear, all of which is surrounded by a Chips Davis designed control room.

Warm hospitality from our professional staff, quiet Victorian bedrooms and an incredible cook will make your session at Granny's House a delightfully productive experience.



and that's why *RENO ROCKS...* at Granny's House



Call us at (702) 786-2622
for a complete brochure.

quencing functions in pre-production and recording. Around these parts, Macintosh leads the pack, followed by IBM PC and IBM clones (some places use both Mac and IBM). The Atari 1040ST is next most popular.

In discussing software and computer-to-MIDI interfaces, studio managers most often mentioned Opcode. That fits in nicely with our geocentric theme—Opcode Systems is headquartered in Silicon Valley's Menlo Park (hometown of the Music Annex production complex). Opcode's Mac-based sequencing, patch editors and librarian programs are closely followed in number by the preeminent Performer, a sequencer/editor program by Mark of the Unicorn (chosen by *Mix* readers as the winner of a 1987 TEC Award in the Computer Hardware/Software category).

Atari in the Studio

Jah Works Recording Studio (O'Brien, Oregon, ten minutes north of the California border on Redwood Highway) is "an alternative energy-based, Rasta owned-and-operated, multi-track studio in the heart of the woods that



a certain indifference to technology as an art form in and of itself. Listen to them explain why.

Oliver DiCicco, chief engineer, Mobius Music Recording, San Francisco:

"For all the modern technology that's happening, look at pieces of gear that are prized," says DiCicco. "They're 20-year-old tube microphones, tube limiters and equalizers. These things are popular not because of their technology but because of the way they sound."

Mobius Music's Yamaha grand piano sits in the main studio overlooking the isolation booths.

"It doesn't seem that there are as many good songs being written now," he continues. "If you listen to Motown or that genre of music of The Beatles, basically there's not a whole lot of technology involved in that music-making process. It's pretty straightforward. But the music, the arrangements, and the songs were really strong. Nowadays, you hear a lot more production. You hear a lot more of the equipment that's making the music. Whatever piece of gear is hot at the current time is the sound you hear."

DiCicco feels that many are turning back to the "human" touch: "There's some degree of a backlash to drum machines. People are getting tired of the sounds and are looking to get real drum sounds. Instead of using a complete drum machine setup, they'll maybe use a kick and a snare from the drum machine and then add live toms

YOUR ASSISTANT OPERATOR.

Orban's new model 464A Co-Operator™ is a four stage, easy-to-use Gated Stereo Leveler/Compressor/HF Limiter/Peak Clipper in a powerful and economical dual-channel package. Front-panel pushbuttons let you configure the unit as a subtle, automatic gain-rider, as a transparent safety limiter, or both. Use it to assist you in recording and transferring audio and video tape, mastering cassettes, CD's, and digital tape, or protecting high performance sound systems. It features:



- Ultra-smooth leveler for transparent gain riding—without long-term, distortion-producing overshoots
- Fast compressor with peak clipper for protection against short-term transients
- "Silence Gate" to prevent pumping and breathing during pauses
- HF Limiter with six switchable pre-emphasis curves to de-ess and protect pre-emphasized media from overload

Ask your Dealer about Orban's popular Co-Operator—your polished, assistant operator.

Orban Associates Inc. 645 Bryant St. San Francisco, CA 94107 USA
(415) 957-1067 Telex: 17-1480 FAX: (415) 957-1070
Circle #116 on Reader Service Card

and live cymbals. Anybody can plug a synthesizer into a mixing console. There's no art to that."

DiCicco hastens to add that synthesizers also make viable music: "The art is to get the synthesizer to sound a lot better than it really does and to create that aural image, that sense of space. I try to work with a whole palette of sounds. I don't really care what the source of the sound is—whether it's a synthesizer, or a violin, or someone squeezing a cat—as long as we can get something out of that.

"All music is an emotional thing. I want to be able to capture that. I like the human element. I like the tension that gets set up when you're listening to someone and you ask 'Are they going to make this note? Are they going to get through this passage?' There's a breathing. The music has a dynamic to it that doesn't necessarily exist with a computer-generated program where the notes all have equal value. People spend a lot of their time programming those human elements into their music. They'll say: 'Yeah, I programmed the drum machine so it almost sounds like a real guy. I programmed in a couple of mistakes and stuff.' It almost seems to me: 'Well, why bother? Why don't you just play it?'"

**Warren Dennis, owner,
Banquet Sound Studios,
Santa Rosa, CA:**

"I think computers make it possible to make mediocre music sound great," says Dennis. "I think it's one of the dangers of the technology—it's being utilized a lot by people who are fascinated by the sounds.

"I like to use the computer to serve the music, not to make the music from that. Computers are wonderful in terms of flexibility of sound texturing. And there are certain advantages to them in commercial work. But when I listen to the radio I'm tired of music that sounds computerized. I'm tired of hearing everybody having the same snare drum. And I think it's a pretty universal feeling in terms of the artists out there."

Dennis' attitude is reflected in his studio business philosophy as



**Warren Dennis of The Banquet
Sound Studios.**

well: "The studio is selling not so much the studio and the time as much as the creativity of the people who work here," he explains. "We are less and less infatuated with time and material—having to stay up at night to buy the next piece of gear and then having the guy go down the street because he can save \$5 an hour. I'm not really interested in that kind of studio atmosphere any longer. Most of the projects have some relationship with us beyond the studio, either on a producer's level, or co-producer's level, where we have a little bit more at stake than a studio being hired by the hour.

"Our equipment is very, very high quality [they have a \$30,000 Yamaha 9-foot concert grand piano Dennis says no computer has been able to imitate] and if we don't have a piece of equipment we can rent it or hire a musician who has it. But I think our clientele [who range from heavy metal to Christian choirs] are people who want not just somebody who plugs the stuff in and who gets things on tape without distorting. They want people working on their production who can add that fourth dimension."

**Dave Wellhausen, owner,
Dave Wellhausen Studios,
San Francisco:**

"The people who are doing music that doesn't come off a SMPTE track need a place to come to, too," says Wellhausen. "The main reason I haven't got a computer is that it hasn't seemed to have paid. I stay booked two months in advance. The regular analog musician scene

is very, very healthy.

"Any pro 24-track studio like ours must be well-versed in doing the synthesized music," Wellhausen emphasizes. "But the acoustic music and the in-between music is alive and well and there are plenty of activities where people don't run a sync track before they do their songs, and the whole computer revolution has had little to no impact on countless people."

Does Wellhausen feel there's a technological discrimination, creating a pressure on studios and artists to invest in computers?

"People for whom technology doesn't have anything to do with their music will make little bows in its direction," Wellhausen admits. "I might do these folksy kind of bands and we'll put this inconsequential synthesizer in a couple of songs just to go 'Yeah, we've got this in here.' It is kind of weird when you see that there's this kind of pressure, even for those people.

"It doesn't look good when you think about the people who I work with who are really great musicians. They started playing when they were kids, practiced every day for hours and hours on how to get a good tone on the violin or play the guitar chord cleanly. You have to face facts that if kids are going to be interested in music, a great deal of them are going to spend their talents in learning how to program synthesizers and drum machines instead of learning how to play acoustic instruments."

Does Wellhausen feel there is any intrinsic difference between acoustic and synthesized sounds?

"Yes, I do," Wellhausen responds. "Acoustic instruments make air move. Synthesizers and drum machines only make a speaker move, which makes the air move. I notice that when you're doing a synthesizer overdub in the control room, the only sound that the instrument makes is voltage. That's kind of weird when you think about it. In all the acoustic instruments, the person moves the air directly. If you're playing a wind instrument it's the air out of their body into a tube. It's got to have a different impact spiritually. Anyone can see those differences clearly." ■

specializes in reggae and world beat music," according to studio owner Jah Levi. A producer, engineer and multi-instrumentalist, he spent his Philadelphia boyhood immersed in learning electronics and playing music, and hung out in recording studios, where his father Kenneth Goldstein produced and engineered records by blues artists. Levi moved out West and toured with the Oregon-based reggae band Strictly Roots, then left to assemble a studio and establish his two labels, Tree of Life Records and Theocratic Records. Levi's own original reggae cassette recordings, which he produced and engineered, have sold well

enough for him to build a full-service 24-track facility which opened for business early this year.

Levi himself designed, constructed, and wired the two-story, 33-foot by 12-foot building. He lives on the second floor; on the first he installed Jah Works, two floating control room/studios. Jah Works' 8-track room is a MIDI-controlled, automated studio with a Fostex 80 and 4050 auto-locator, and various MIDI controllers. The 24-track room holds a Sony/MCI JH-24 tape machine and a MIDI-muteable Studiomaster Series II console. Mix-down is to 2-track digital, on the Nakamichi DMP-100. The overall stu-

dio focus is on blending electronic music and sounds with acoustic music, particularly ancient instruments made available to clients, including the niyabinghi drum, sitar, Chinese singing bowls and Tibetan bells.

Levi's computer system of choice was the Atari 1040ST and Steinberg Pro 24 software, used to control his Korg DSS-1 sampler, Casio CZ-5000, Fairlight Voicetracker, four Yamaha FB01s, Photon MIDI guitar controller, and assorted Roland, Korg, Linn and JL Cooper gear. "When I put the studio together, I had money only for the basics. So I picked the Steinberg for sequencing and for its note editing grid, rather than go with a librarian or patch editor. I do quite a bit with sequencers, often using eight or nine at once—sometimes with the ST as a slave sequencer because the other sequencers have better resolution for synching to tape—either the Sequential Circuits Studio 440 or Yamaha QX1, which I run off of SMPTE." Before he purchases any editors or librarians, Levi hopes to acquire visual editing and MIDI data analysis software, perhaps Steinberg's editing program for the DSS-1 and the Studio 440.

Jah Works may be the only studio in the country whose electronics, light and heating systems run on solar power generators, power bank and sine wave inverters ("the general setup for alternative energy"), all enclosed in a small building adjacent to the main structure. "If it's wintertime and there's not much sun," notes Levi, "I have to run the generator every so often. If I'm running the generator and it runs out of gas, then I lose whatever data I'm working on. But it doesn't mess up the machines." So he must often and regularly back-up data from the computer's internal storage to floppy disk, or—as Levi does frequently—"sequence things and immediately mix them onto digital 2-track; I don't waste any time. As a result, things come together very quickly."

Levi's reasons for choosing Atari? "I spent a lot of time researching. I liked the built-in MIDI ports, the price, the amount of memory and how much it can be upgraded to, and the fact that it can work with the [Hybrid Arts] ADAP Soundrack—I like the idea of having digital editing set up in the computer."

In Richmond, California, Starlight Sound is an automated 24-track/digital mixdown facility with a full MIDI

MOTORISED FADERS — THE WAY AHEAD

Penny & Giles motorised faders
— the way ahead for the new
generation of manual and
automated mixing consoles.
Just part of
Penny & Giles'
comprehensive
range of audio and
video controllers.

- rapid response to commands
- sensitive manual control
- digital, VCA or analogue compatible
- update signalling incorporated
- positioning repeatability 0.5mm

For further information and technical data contact us on (213) 393 0014

Penny + Giles

Penny & Giles Inc
2716 Ocean Park Boulevard #1005
Santa Monica California 90405 USA
Tel: (213) 393 0014 Telex: 858866 Fax: (213) 450 9860



Penny & Giles audio and video controllers are renowned for high quality and reliability. Join the world's leading broadcasting and recording organisations — don't settle for anything less.

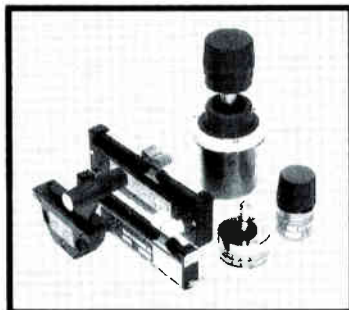

patchbay to interface with their myriad samplers and synthesizers. They do a lot of commercial rock, jazz and R&B projects here, and this year claimed platinum and gold records for the work they did with client Club Nouveau.

Studio owner Bill Thompson went for an Atari 1040ST; he chose a monochrome monitor for its high resolution, necessary because there's so much happening on screen when he runs Steinberg's Pro 24 sequencing program. Thompson points out that in this application, the color display is distracting, and its low resolution "looks a bit squashed." But a color monitor purchase is planned so that games can be played and computer art created—one important function of the Atari is to entertain band members in the lounge while they wait for each other to track vocals or overdub. Starlight also uses Atari's Word Writer software and a Panasonic dot matrix printer to write and print out lead sheets. Patch editing and library tasks are handled by Dr. T's (DX100, DX7) and Digidesign software (Prophet 200, Akai S612).

When Thompson went to Leo's Audio in Oakland to select a computer for Starlight, he "worked for eight hours, a Macintosh at my right and an Atari at my left. There was no question which made more sense, for music. Particularly for the ability to use the Steinberg software, which is much more visually oriented than the software I used on the Macintosh. Instead of data appearing as a list of numbers, the musical score with the notes on the staff appears on screen, and you have full editing by actually seeing your music on 'paper' as well as hearing it. It's designed like a 24-track digital tape machine and it's really fast. And it's more fun and efficient for the musician."

The Mac Pack

Overlooking San Francisco Bay from scenic Sausalito is Gate Five Studios (featured on this issue's directory cover). The studio is album-oriented, but offers powerful MIDI/SMPTE interface capability and earlier this year hosted Corey Lerios as he created and recorded his synth-laden soundtrack for ABC-TV's *Max Headroom*. Dr. Richie Moore designed the facility, and works there as engineer. Gate Five has two Macintosh Plus systems: one in the control room, and one that travels

DAVID BYRNE • TRUE STORIES • LUIS VALDEZ • CORRIDOS •
 ALEX COX • WALKER • BEACH BOYS • CARROLL BALLARD
 • NEVER CRY WOLF • JOE STRUMMER • DAVE BRUBECK
 QUARTET • NORMAN MAILER • TOUGH GUYS DON'T DANCE
 • WAYNE WANG • TROUBLE IN MIND •
 JOHN LEE HOOKER • NEVER CRY WOLF
 • DAVID BYRNE • CORRIDOS
 • KRONOS STRING QUARTET • PAUL
 SHRADER • TROUBLE IN MIND •
 NORMAN MAILER • WAYNE WANG
 • DIM SUM • DAVID
 BYRNE • ALEX
 COX • WALKER • NORMAN
 MAILER • TOUGH GUYS DON'T DANCE • DIM
 SUM • ALAN RUDOLPH • TROUBLE IN MIND • JOHN LEE
 HOOKER • DAVID BYRNE • TRUE STORIES • LUIS VALDEZ •
 CORRIDOS • KRONOS STRING QUARTET • PAUL SHRADER
 • MISHIMA • JOE STRUMMER • DAVE BRUBECK QUARTET •
 THE BEACH BOYS • ALEX COX • WAYNE WANG • DIM SUM



Russian Hill Recording

A recording and mixing facility dedicated
to the music and film communities

•

1520 Pacific Ave., San Francisco, CA 94109
Call Gail Nord: (415) 474-4520

Circle #118 on Reader Service Card

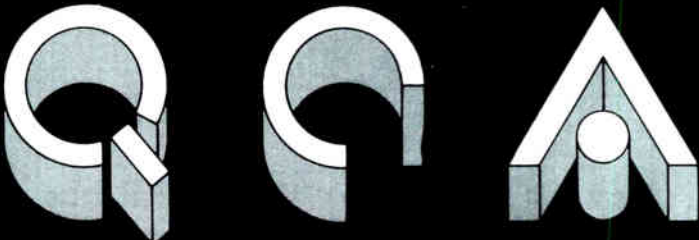

**The Masters
of Sound
Sculpture**

When it comes to quality
record manufacturing and
cassette duplication, QCA
has no equal.

2832 Spring Grove Ave.,
Cincinnati, Ohio 45225
513/681-8400



Circle #119 on Reader Service Card

from office to studio. The latter is often powered up to run MacDraft, Microsoft Word and Acousticalc—the last, an electrical and acoustical layout/design package written by programmer Annie Moore (Richie's wife) to run under Excel, the Mac spreadsheet/utility program.

When brought into the studio, this Mac uses the latest version of Performer to run all the MIDI keyboards, which also interface with the studio's new Roland S50 sampling synth. Gate Five's favored patch librarians are Opcode's programs for storing and loading TX/DX sounds.

The control room Mac also runs Performer, interfaced (via the Opcode Studio Plus thru-box) with a Soundtracs MIDI PC board. On mixdown the console takes 48 inputs, so guitars, vocals and FX record to the 16-track, synchronized with live MIDI stuff going direct into the console. And the Mac can store console mutes for the mix and change MIDI programs in the SPX90 and other outboard gear.

Gate Five is young enough (just over a year old) to have had its choice of studio-savvy computer systems when first installing equipment. So



Bob Ross, manager of the keyboard room at Fantasy Studios in Berkeley. The Macintosh (left) loads and stores sounds for the Kurzweil 250 (bottom right).

why did Moore go Mac? "It's user-friendly. Just for that. If you can point, you can use it. And you can teach it to people fairly quickly, and that's the important thing—other people can learn to use it really fast. So everybody can share in the process [of pre-production and recording]. If you go for an IBM, you have to go for its operating system. The Macintosh has its own built-in operating system, and that makes life easier."

Another new Bay Area business is Midnight Records, an independent label formed last January by some of the San Francisco Bay Area's record industry "heavies." Engineers/producers Jeffrey Norman (John Fogerty, Huey Lewis & the News, Bruce Hornsby) and Ann Fry (Van Morrison, Rick James) joined forces a few years ago in a production company to do demos and soundtracks. They worked regularly at The Plant, at that time managed by their friend Claire Pister. When The Plant closed (it has since been re-opened and updated by Bob Skye), Jeff Norman says, "as independents, we thought it was a good time to start a record company. People were interesting in financially backing us, and there was a lot of interest from the recording community. Our compatriots include producer/engineer Jim Gaines [profiled in July '87 *Mix*] and Bonnie Simmons, a radio DJ and former promo director of Warner Bros." The three set up shop in the Albany (East Bay) offices/studio owned by John Fogerty who gave them a good lease-to-buy option.

"Right now the studio is a 'musician's studio'—all the equipment is in the room you play in," Norman says. "John could play and just reach over and punch 'record.' We're going to expand to a 24-track control room, with a Studer machine and Trident board. We're looking at it as being a real clean, state-of-the-art overdub room, ready for us to use in April or May." So far Midnight has signed Heist, a melodic heavy metal band that just cut tracks in Studio D in Sausalito.

Midnight is about to purchase a Macintosh Plus to handle keyboard and sound storage duties, and to interface and sequence instruments. Until the Midnight Studio is ready, Ann Fry's Macintosh travels to other facilities. They use Performer for sequencing, and Opcode editor/librarian programs for their DX7 and Super Jupiter. Fry also uses the Mac's older sibling, the Apple IIe, to run Passport's MIDI/8 sequencing program.

Fry says she chose the Macintosh for studio work because the computer "has much more music software available than any other system, and also it's very portable. It was ideal for us as a production company, for publishing demos and to sequence drum machines."

In the venerable Fantasy Studios' (Berkeley) 24-track keyboard/MIDI

Thunder... from downunder!



2 models: 900w and 1600w
Built **TOUGH**—custom alloy chassis

- Whisper cooling
- Superior Specifications
- Full protection features
- Classic sound
- 2 ohm capability

Grafton Sound

(213) 306-0759

DEALERS REQUIRED!

VISIT US AT NAMM: BOOTH #159

Circle #141 on Reader Service Card

SPECIFICATIONS

TAPE FORMAT

- 1/2 inch AKAI original cassette tape (MK20)

HEAD CONFIGURATION

- Super GX recording/playback head

WDW AND FLUTTER

- 19 cm/s: 0.03% (W-RMS) \pm 0.05% Peak (DIN/IEC Weighted)
- 9.5 cm/s: 0.04% (W-RMS) \pm 0.06% Peak (DIN/IEC Weighted)

DISTORTION

- 19 cm/s: 0.5% OdB (315Hz third harmonic distortion)
- 9.5 cm/s: 0.8% OdB (315 Hz third harmonic distortion)

DYNAMIC RANGE

- 115dB, 1kHz (19cm/s, 9.5 cm/s)

FREQUENCY CHARACTERISTICS

- 19 cm/s: 50Hz - 20kHz, 9.5 cm/s: 50 Hz - 16kHz

SN RATIO

- 94 dB (NAB A - WTD, 315 Hz, 3% third harmonic distortion)

CROSS TALK

- (Between neighboring channels) 55 dB, 1 kHz (19 cm/s, 9.5 cm/s)

EQUIVALENT INPUT NOISE

- MIC: -126 dB

PARAMETRIC EQUALIZER

- HIGH: 1.5kHz - 15kHz \pm 15dB
- MID: 350 Hz - 5kHz \pm 15dB
- LOW: 40Hz - 800Hz \pm 15dB

A COMPLETE RECORDING STUDIO ... IN ONE UNIT.

The revolutionary AKAI MG1214 incorporates a 12 channel mixer, a 14 track recorder, an auto locator, and a digitally switched bussing system in one single unit. This makes the MG1214 invaluable as a production tool. A must have item for your audio arsenal.

AKAI
professional
Creative at Heart

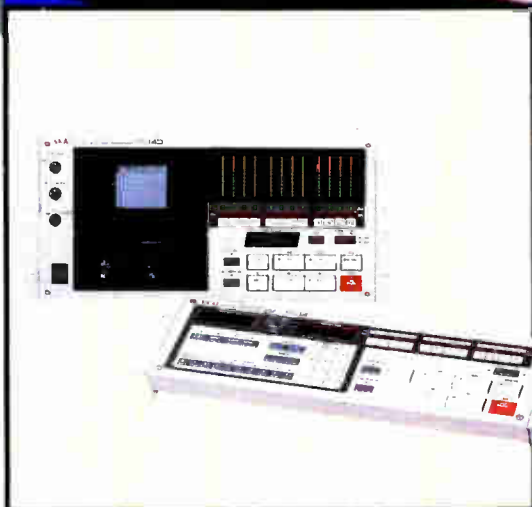

Circle #029 on Reader Service Card

For more information contact your dealer or write to:

AKAI
professional

P.O. Box 2344 • Ft. Worth, TX 76113
Phone: 817-336-5114
FAX 817-870-1271
Telex 163203 IMCTX UT

Also available MG14D/ML14
Recorder/Autolocator
Rackmountable MTR

Send me a data sheet on the MG1214 and the MG14D/ML14.

Name _____
Address _____
City _____ State _____ Zip _____
Tel. (____) _____

SESSION MIX

Two versatile, compact mixing consoles from Studiomaster available as 8-2 or 16-2

Applications:

Front-of-House P.A. Club Installations Keyboard Mixing Theatre

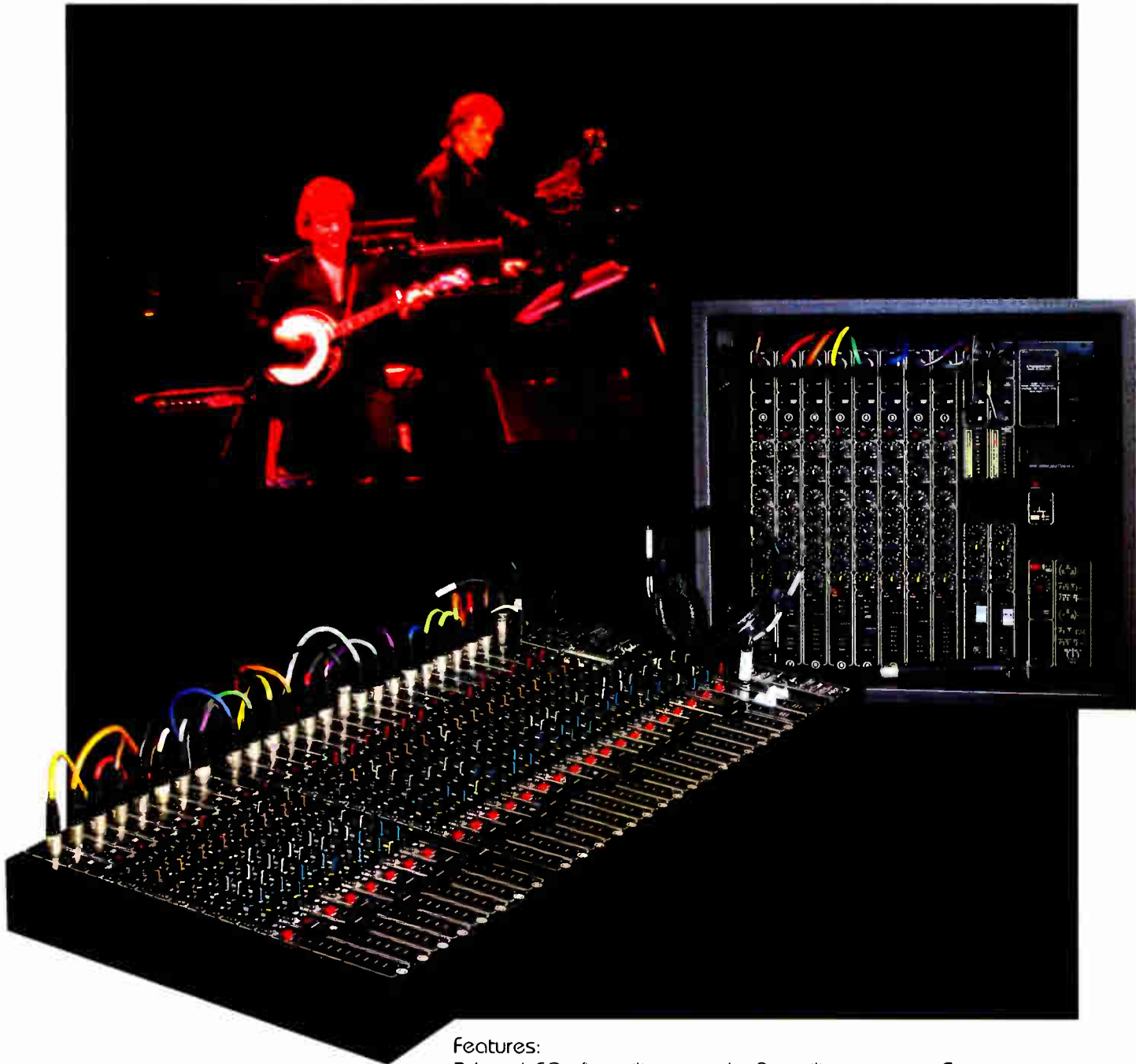

Features:

3-band EQ, 4 auxiliary sends, 2 auxiliary returns, Stereo returns (16-2), Output EQ (16-2), LED output meters, Insert points, Post-fade Direct Outs (16-2), 5-pin DIN Record/Replay Socket, Expandable inputs, 8-2 can be rack-mounted, wall-mounted or stood free with unique endcheek design.

For further details, contact *Paul Reeve* or *Tony Allen* at STUDIOMASTER INC., 1340-G Dynamics Street, Anaheim, CA 92806. Tel: (714) 524 2227 Fax: (714) 524 5096

STUDIOMASTER
The sound experience

Circle #030 on Reader Service Card

room, the main sampling tool is the Kurzweil 250. And as engineer Bob Ross says, "If you get a Kurzweil, you've got to get a Mac to store sounds and load samples." However, he adds, 95% of his computer-using clients happen to work on the Macintosh, so that's the system (512K) that makes life easier in the Fantasy keyboard room.

Ross explains that he often starts a song on the Linn 9000 drum computer/sequencer "because it's so fast," then transfers the data to the Mac for detailed editing and sequencing with Performer. Synths here include four DX7s (modified to store extra banks of patches, so the in-house Opcode librarian is often idle), Oberheim Xpander (with Opcode librarian) and Roland D50. Clients have a choice: they can program everything to be played later in the studio, then bring the computer or synth system into the studio for recording; or they can record MIDI keyboard, bass and drum arrangements onto 24-track (using Austin Development's MIDIface II interface, JL Cooper MIDI switchers, and the Roland SBX-80 SMPTE/MIDI device to coordinate it all), then take the tape into one of Fantasy's four studios to tape vocals and acoustic instruments, or to mix down. Ross works as programmer and engineer, but also as keyboardist and co-producer. His Fantasy clients range from major TV/radio commercial and video producers to rock and jazz artists including Jeffrey Osborne, Eddie Money, and Richie Cole—working with Ross or in a "self-service" capacity.

2 PCs: Better than 1?

Live Oak Studios in Berkeley primarily handles album, demo and EP projects (most recently, a Curtis Ohlson LP for Enigma Records). Ten months ago they officially opened The Attic, a computer-based, 24-track pre-production and recording studio. It's on the building's top floor, complete with cathedral ceiling and panoramic Bay view. The Attic served as a beta test site for Digital Creations' (IBM PC-based) Diskmix II console automation software, so naturally Live Oak has an IBM system to enjoy it. Here one can also find Macintosh Plus computers which use Performer to sequence Kurzweil, Yamaha, Oberheim, and Emu instruments, Opcode patch editors for Casio and Yamaha synths, and Opcode librarians for all their keyboards. The setup is enhanced by the

SHOW US A BETTER CASSETTE...

AND WE'LL EAT IT!

We're so confident here at MUSIC ANNEX DUPLICATION, that if you'll bring us a sample duplicated cassette that's better than our own high speed OTARI/DOLBY HX PRO™ product, we'll eat it.

Better, by the way, means better sounding, a better price than you're now paying, and better because we can get the run done faster.

Much faster.

If you think we're ready to eat these words too, pick up the phone and give us a shot.

With the money we'll save you on a better, more consistent product, who knows - you might even want to buy us lunch.



Music Annex Duplication

970 O'BRIEN DRIVE • MENLO PARK, CA 94025 (415) 328-8338

Circle #121 on Reader Service Card

TASCAM • FOSTEX • JL COOPER • SOUNDCRAFT • JBL

TAKING MULTITRACK BY STORM- LIGHTNING MUSIC & SOUND!



TELEPHONE-MAIL ORDERS
SHIPPED ANYWHERE

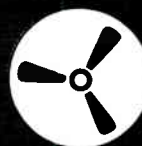

Huge Selection of Recording Gear & Effects
MIDI/SMPTE Specialists

The Southwest's only Authorized
TASCAM ATR 80 24 Track Dealer



4801 Spring Valley #103 A • Dallas, Texas 75244

(214) 387-1198

• TOA • SHURE • BEYER • MEYER • LEXICON • ALESIS

• RAMSA • AKG • SENNHEISER • CROWN • EAW • UREI

Circle #122 on Reader Service Card



Jim Gardiner in his Attic at Live Oak Studios in Berkeley.

ability to print out musical scores. The Attic Mac also triggers outboard effects while tape's rolling, and controls the parameters of their new Yamaha 8 by 2 mixing console, the MIDI- and remote-controllable DMP7 digital mixing processor. Opcode's Studio Plus links the systems. And a Garfield Master Beat encourages dialog between MIDI, SMPTE and other clock formats.

Live Oak's 20-Meg IBM PC/XT with color monitor runs the Diskmix software for the Attic's new Sound Workshop Series 34 console. Owner Jim Gardiner employs the IBM for mixing, and prefers the Mac for working with music because "it's easier. We used to use a 32-track sequencer on the IBM which is why we got the computer in the first place, before the Mac came out. I wasn't a computer nut; we just got the system for convenience. With

IBM you go through a lot more stuff to do the same thing as the Mac. Just to copy a disk, you have to go through all the DOS [operating system] command stuff. So we started to use the IBM for mixing. Then we got the Mac, which has Performer, a beautiful sequencing program that never crashes."

Across the Bay, Russian Hill Recording hosts a growing number of feature film clients, and devotes its Studio C, an off-line MIDI/keyboard room, primarily to editing sound effects and dialog to picture. Macintoshes have been active here since their introduction in '84. Bob Shotland tells us they use Digidesign's Sound Designer package to edit and reshape Emulator patches, sound samples and effects (the system that enhanced the soundtrack of *Tough Guys Don't Dance*), and they use Mark of the

Unicorn's Composer and Performer programs for MIDI composition, notation, control and sequencing. They also employ a database management program in which they've entered catalog info on their huge Emulator SFX disk library.

Because of the existence of a single, powerful program, Russian Hill purchased an IBM PC five months ago. This SMPTE-based Kelly Quan Research synchronization and editing system (consisting of PC circuit board and software; see *Mix*, April '87) provides high power for editing dialog, sound effects and music to picture. Says Shotland, "It auto-assembles an entire show from the source onto the master reel, and it also does all the clerical work, giving a printout of the edit list with time code numbers. It will replace a lot of what the Mac does for us now, in terms of assembling and editing sound effects."

Up north in Seattle, the busy Steve Lawson Productions comprises three studios and accompanying control rooms tielined to a MIDI room, and does everything from jingles and demos to finished scoring of video projects. The MIDI room houses a Fat Mac (512K), used mostly to store Kurzweil sounds and to run Opcode librarians for their Yamaha synth modules and Juno 108. The Mac handles sequencing, too, with Opcode's Sequencer 2.5. When the MIDI room is empty, the Mac is used "the old-fashioned way—for word processing," says Steve Lawson. "We write and produce our newsletter on it, and take the disk out for laser printing."

The facility recently purchased two hard disk-based Whole Earth PCs (IBM XT clones) for the two control rooms. These systems will be dedicated to Diskmix automation software for their MCI-automated Sony 636 console, and later used for managing CD-based sound effects.



Midnight Records' staff. From left: Ann Fry, vice president of marketing and promotion; Mick Higgins, chief of maintenance; Patty Watson, marketing director; Claire Pister, president and CEO; Anita Pister, sister; Jeffrey Norman, vice president of A&R. (Missing from photo: Jim Gaines, director of A&R; Bonnie Simmons, promo director; Maureen Dronney, A&R coordinator.)

Singing the Big Blues

"I never expected myself to be computer-oriented," says musician/engineer Peter Buffett of San Francisco's Independent Sound, which he co-owns with vocalist/producer Mary Buffett. Yet computer-oriented they are, even though the Buffetts are looking for a buyer for their studio Macintosh. Since a Synclavier purchase last year has them figuring to sell their Kurzweil 250 and Linn 9000, "the Macintosh is going to go, too," says Buffett. "It was a sad waste of computer power just using it to store Kurzweil sounds, and now I can store *everything* on the optical disk."

As Independent Sound "keeps trying to keep up with the world and technology, we keep buying stuff and moving forward. The latest, neatest thing is the optical disk for our Synclavier," says Buffett. The new OSI CD-ROM system stores a massive amount (2 gigabytes) of data on-line, and was developed for New England Digital by Philips and Control Data. Independent Sound already had dozens of floppies holding Synclavier sounds, as well as an 80-Meg hard disk that Buffett filled to the limit. "So I transferred all my stuff from floppies and the hard disk to the CD-ROM, so I have all the sounds right there, on-line, when I need to access them." With the optical disk storing sounds and patches, Buffett can use the 80-Meg disk as a giant sketch pad and

workspace to compose and arrange a commercial score or video soundtrack.

"My whole quest in purchasing the Synclavier is the versatility and time-saving. We can do entire commercials—music, effects, voiceover—in the Synclavier, entirely in the digital domain, synched to the 3/4-inch video deck, and we can do six needle-drop spots in one day." Sometimes the benefits are more than efficiency and flexibility—it was one of Buffett's original Synclavier jingles written for U.S. Sprint that caused his record company, Narada/MCA, to request a similar composition to lead off his new album, *The Waiting*.

The computer the Buffetts want to hold onto is their hard disk-based IBM clone. This is dedicated to running the studio's Diskmix program for their Sound Workshop board, which lets Independent Sound merge and splice mixes, store fader positions, and enter info about the mix, including notes on the client ("all the house-keeping stuff that you often forget to do"). And it runs off SMPTE time code, which is great for a company that creates and produces scores of major TV commercials (U.S. Sprint, Emporium-Capwell department stores, Lincoln Mercury). "So from one track on the 24-track," Buffett enthuses, "I can run the Synclavier, the video stuff, and the mix. The IBM software lets it all be tied together."

—CONTINUED ON PAGE 221

Russian Hill Recording's Studio C, an electronic production facility integrating a Macintosh-based MIDI network and an IBM PC-based automated editing system to perform audio post-production tasks such as sound effects and dialog editing.



RECORD JACKETS & LABELS • 7" SLEEVES • CASSETTE INSERTS & LABELS • CD PACKAGING
PRESSURE SENSITIVE PRODUCTS • IN-HOUSE COLOR SEPARATION • DESIGN • ART • TYPESETTING

MANHATTAN

SEPPING THE RECORDING INDUSTRY SINCE 1911

Printed Specialties Co., Inc.

KEYSTONE

1 KEYSTONE PLACE • JESSUP, PA 18434
PH: 717-383-3280 • FAX: 717-383-2320

U.S.A.

Circle #139 on Reader Service Card



We can't drop Names, but...

some of the most innovative and respected Film and Television composers have been producing soundtracks for some of the hottest feature films and network TV. Shows in home studios designed and executed by **AEA's MidiWorks**.

What are they doing that you're not? Gaining a cost advantage with a properly designed system that's ready when they are, day or night, no bookings required.

Which is why, when I asked if I could mention their names in this ad, most of them didn't think it was a good idea, just in case everyone finds out how easy and cost effective it can be to put in your own home facility.

But you can find out what a properly put together SMPTE/Midi based production system can do for you. Just call me, Karl Wirz, and I'll spill the beans.

AEA's MidiWorks. Multitrack Audio, Synchronizers, Midi Computer Systems, for the professional composer.

Featuring **Fostex, Tascam, Sony/MCI, Trident, Soundcraft, Akai, Sequential, Digidesign, Opcode, JL Cooper, 360 Systems.**
Complete Patchbay, wiring and Installation Service.

AUDIO ENGINEERING ASSOCIATES'

MIDIWORKS

1029 N. Allen Ave., Pasadena, CA 91104
Call 818-798-9127 or 213-684-4461
Please ask for Karl Wirz, our demo rooms are by appointment for your convenience



Production: **Zarkov Unchained** Cue: 21
Begins **1:07.33** From Start of Reel 2

TIME: 0.00 ✓ CUT CU of Zarkov, his face sits deep in thought

8.63 CUT Medium CU of Morg gazing in awe at Zar

METER: 4
Start of Cue. CU of a

METER CHANGE:

Ad Jingle #3

2 BARS

PLAY PAUSE RECORD

Playing: Seq-1

Counter 11131345
1:5 1.27
1:30:2 1:08

Memory 141K free

Metronome

120

120.5 bpm

Man. Auto.



1988 MIX DIRECTORY

NORTHWEST STUDIOS

Information in the following directory section is based on questionnaires mailed earlier this year and was supplied by those facilities listed. *Mix* claims no responsibility for the accuracy of this information. Personnel, equipment, locations and rates may change, so please verify critical information with the companies directly.



At left is the MIDI/SMPTE room at Gate Five Studios in Sausalito, California. Designed by Richie Moore and owner Chris Hubbard, this facility opened in January '86. It is equipped with a Yamaha acoustic grand piano, a Kurzweil MIDIboard, a Yamaha DX7 and several other synthesizers, samplers and drum machines. A Mac Plus with Performer software is set up to control the MIDI equipment. An Otari MX70 and a Soundtracs MIDI PC series mixing console are located in the adjacent control room. Photo: Barry Shapiro

CONTENTS

116	LOCATION INDEX
118	24+ TRACK STUDIOS
136	12 & 16 TRACK STUDIOS
145	8, 4 & 2 TRACK STUDIOS

Mix listings procedure: Every month, *Mix* mails questionnaires to recording studios and/or other vital facilities and services for the recording, sound and video production industries. Basic listings (name, address, contact) are provided free of charge. Extended listings (equipment, credits, specialization), and photographs or company logos may be included at a nominal charge. If you would like to be listed in a *Mix* Directory, write or call the *Mix* Directories Department, 2608 Ninth Street, Berkeley, CA 94710, (415) 843-7901.

Upcoming Directory Deadlines:

Video Production/Post-Production: **January 13, 1988**

Northeast Recording Studios: **February 3, 1988**

Remote Recording/Sound Reinforcement: **March 3, 1988**

N O R T H W E S T

LOCATION INDEX

STUDIOS

All studio information listed has been supplied to *Mix* by studios responding to questionnaires mailed in August 1987. People, equipment and locations change, so please verify critical information with the studios directly. *Mix* does not take responsibility for the accuracy of the information supplied to us by the studios.

ALASKA	Denair	Nevada City	Recording
Anchorage	16 Musical Image Productions 208	4 Crystal Clarity 213	Sunnyvale
8 Christian Artist Studio Productions or "Christian Studios" 212	Dutch Flat	Newark	24 Arriviste 186
8 Real Time Recording 216	8 Jude Productions 215	24 Montage Recording Studios 195	4 DMK Sound Design/Frogs Productions 213
8 Sound Innovations 218	Emeryville	Novato	16 The Recording Studio, Inc. 209
8 South Central Sound 218	16 Dancing Dog 205	24 Color Zone Productions Inc. 188	24 Bruce Tambling Sound 202
24 Surreal Studios 202	8 Emeryville Recording Co 206	Oakland	Tahoma
Fairbanks	8 Sound Sule 218	8 Antomar Studio 212	8 Rubber Park Productions 217
16 Dome Studios 205	Eureka	8 Artichoke Productions 212	Trinidad
24 True North Recording 203	2 Allerc+ Video 212	16 Bunyup Bakeries 205	8 Humboldt Records 214
Sitka	Felton	16 Deva Records 205	Ukiah
4 Raven Radio Foundation 216	8 Fox Recording 213	16 Freeway Recording, Inc. 206	2 North Woods 216
Soldotna	Foster City	24 Denny Jaeger Creative Services, Inc. 192	Vallejo
8 Foundaton Studios 213	8 Linear Productions 215	24 Peakdesign 198	8 Pseudo Studio 216
CALIFORNIA	Garberville	24 The Source Studio 200	Visalia
Alameda	8 Step One Studios 218	2 Svxrx Recordings 218	8 Absolutely Gripping Creative Sound Production 212
24 Infinite Studios 192	Garden Valley	Occidental	Weatland
Aptos	8 Timeless Productions 218	24 Joe Hoffmann Studios 191	8 Studio Sea 218
8 Aptos Audio-Pineforest Studio 212	Greenville	4 Miss W+b, Abroad 216	COLORADO
24 Music Art Recording Studio 196	Guerneville	8 Onion Audio 216	Aurora
Atwater	4 In Without Knocking 214	Hayward	8 Xanadu Studios 219
16 Anwater Recording 204	24 Phil Edwards Recording 190	Healdsburg	Boulder
Auburn	24 Master Track Productions 194	8 Schechter Studios 217	24 Aron Audio 189
8 Blue Crystal Studio 212	Hemlock	8 Wild West Graphics & Communications 219	8 Claws On Productions 212
Belmont	8 Little People Studio 215	Livermore	16 Coupe Studios 205
24 OTR Studios 197	Lodi	8 Little People Studio 215	8 Fergus Sound Enterprises 213
Ben Lomond	16 Nacnud Sound 208	Los Gatos	24 Slow Boat Studios 200
8 Phantasma Sound 216	Los Gatos	16 Bear Creek Recording Studio 204	Colorado Springs
Berkeley	8 Highland Studio 214	16 Jopheir 12 206	8 Homely Productions 214
16 Bay Records 204	Madera	Merced	2 Midnight Blue Productions 216
16 Bob Kat Studio 205	24 Ken Carlton Recording 187	8 Rat-Recording 216	24 Pan Studios 197
4 Control I 212	Menlo Park	Mill Valley	8 Play It Again, Sam 216
24 Fantasy Studios 190	24 Music Annex, Inc. 196	8 Globe Studios 214	24 Professional Sound & Recording, Inc. 198
24 Live Oak Productions 194	Merced	8 Sensation+ Sounds 217	16 Startsong 210
4 Open Door Productions 216	8 Mililbrae	Millbrae	16 White Dove Recording Studio 211
2 Robert Shumaker Recording Services 217	8 Chinese Outreach of San Francisco 212	Modesto	Denver
4 Stax Sound ET Vision 218	24 The Music Complex 196	8 Jade Productions 214	16 Fred Arthur Productions, Ltd. 204
8 Syntonos Recording 216	Modesto	4 Uphill Productions 219	16 Beyond Sound 205
4 Vinyl Touch Productions 219	Monte Sereno	Mountain View	16 Christian Recording Studios 205
Big Bend	24 Vista Sound Recording 203	8 Full Spectrum Productions, Inc. 214	24 CPS Productions Co (Christian Production Services) 205
8 Transient Sounds Recording 219	Monterey	8 Bob Wilson Recording Services 219	8 Daystar Recording Studios 213
Blue Lake	8 The Soundsmith 218	Napa	2 Emerson Film and Video Sound 213
16 Redwood Creek Recording 209	8 Slotz's Sound 218	16 Staffordshire Productions 210	16 Fasttrack Recording Studio 206
Boulder Creek	8 Sunset Recording 218	Napa Valley	8 Free Reelin' Sound 213
8 Mt. Studio 216	Mountain View	8 Fred Fox Music Co 213	24 FTM Studios 191
Campbell	8 Full Spectrum Productions, Inc. 214	8 Pmg-Pong Productions 216	8 Full Circle Studio/Full Circle Productions 213
4 Reel Time Reproductions 216	Napa	San Anselmo	4 Hank's Basement Audio 214
Carmichael (Sacramento)	8 Jade Productions 214	16 Napa Valley Recording 208	2 Marilyn Hickey Ministries 214
24 Pacific Mobile Recorders 197	4 Uphill Productions 219	San Anselmo	16 Infall Records, Co 206
Chico	24 Vista Sound Recording 203	16 Syncro International Studio 210	8 Mammoth Recording Studios 215
16 Starshine Audio Enterprises 210	Monterey	San Carlos	16 Multivision Of Denver 208
Concord	8 The Soundsmith 218	24 Positive Audio 198	3 Reel Art/Reunion Productions 216
24 R.O. Studios 199	8 Slotz's Sound 218	San Francisco	16 Clay Ryan Productions 209
Cotati	8 Sunset Recording 218	24 Spectrum Inc. 200	24 Studio Soren 201
24 Prairie Sun Recording 198	Mountain View	San Francisco	8 Time Capsule Recording 218
Cupertino	8 Full Spectrum Productions, Inc. 214	8 Antomax Recording 204	8 Valentine Productions 219
24 Autoloff Recording Studio 186	8 Bob Wilson Recording Services 219	8 Astral Sounds Recording 204	4 Western Cine Film and Video 219
Danville	16 Staffordshire Productions 210	8 Bent Nail Studios 212	Englewood
24 Akashic Records Group/Rheem Theatre 186	Napa	8 Champaign Sound 212	16 Brown Bag Productions 205
Davis	16 Staffordshire Productions 210	24 Chrome Dreams Prod 188	8 Heartbreak Hotel Studio 214
16 Davis Sound Studio 205	Napa	16 Creative Sound Studio 205	Estes Park
		16 E.J. Sound 206	16 Zepplin Ltd 211
		12 Incognito Remote Recorders 206	Evergreen
		4 PFS Recording 216	16 Rocky Mountain Artists 209
		8 Platinum Sounds Recording Studio 216	Frisco
		24 Tiki Recording Studios 202	4 Event Audio Productions 213
		San Lorenzo	Grand Junction
		8 J&R Audio Labs 214	4 Gary R. Smith Productions 217
		16 Avid Productions 204	Lafayette
		12 B Street Music & Recording 204	8 Reels on Wheels 217
		San Rafael	LaPorte
		16 Atmosphere 204	16 Eye In The Sky Sound 206
		8 Hun Sound Inc 214	Littleton
		8 Lion Tracks Studio-Creative Enterprises 215	24 Audioworks Recording Studios 186
		16 Rolls Recording 209	8 Sow's Ear Sound 218
		8 Shyne Sound 217	Louisville
		16 Synchronicity 210	4 Caledonia Street Sound 212
		16 Syntasy 211	Loveland
		24 Tarpan Studios 202	8 Melodic Services Productions 216
		24 Wizards & Cecil B 203	Northglenn
		Santa Clara	24 Avalanche Recording Studios, Inc. 186
		16 Audio Visions 204	12 Downhome Demo's 205
		8 Egomaniac Studio 213	Thornton
		8 Thomas Recordings 218	8 Underground Sound 219
		Santa Cruz	Westminster
		16 Magic Sound 207	24 Colorado Sound Recording 188
		4 Sounds Natural Audio Services 218	IDAHO
		4 Square One 218	Boise
		Santa Rosa	4 Snake River Sound 217
		24 The Banquet Sound Studios 187	Idaho Falls
		8 Page Studios 216	
		16 The Sound Source 210	
		Saratoga	
		24 Archive Audio 186	
		Sausalito	
		16 Gate Five Studios 206	
		24 The Plant Recording Studios 198	
		24 Studio D Recording Inc 201	
		Scotts Valley	
		24 Point Blank Recording 198	
		Sonoma	
		12 Sonoma Sound 210	
		South Lake Tahoe	
		4 Studio in the Back 218	
		South San Francisco	
		8 Fred Fox Music Co 213	
		8 Pmg-Pong Productions 216	
		Stinson Beach	
		24 Ocean Studio 196	
		Stockton	
		24 Atlanta Productions 186	
		24 Studio C/Custom 186	

8 Mike's Music	216	16 Gung-Ho Studio	206	UTAH		Gig Harbor		Production	209
4 Snake River Studios	217	8 D. Ross Productions	217	Castle Dale		4 CW Recording	213	8 Reciprocal Recording	216
Ketchum		24 Trad Recording Studios	202	4 Eagle Nest Recording and Sound Reinforcement	213	Index		16 The Right Track Studios	209
24 Sun Valley Audio	201	Gleneden Beach		4 Marcan Studio	215	24 Paradise Sound Recording Inc.	197	8 Roxound Studios	217
Lucile		4 Pine Apple Studios	216	Kanab		Kirkland		8 Salmon Bay Productions	217
16 Shewbrend Music Co	209	Grants Pass		4 Rocky Mtn. Productions	209	8 John Wesley Production	219	8 Sound Productions	218
Meridian		8 Little Oak Sound and Video	215	Mapleton		Marysville		24 Star Trak Recording Inc.	200
16 Horizon Audio Recording	206	Hood River		2 Aesthetic Productions	212	8 August Productions	212	8 TDS Productions	218
Pocatello		2 Keyboard Resources	215	North Ogden		Mill Creek		24 Telemation Productions	202
8 Clockworks	212	Lake Oswego		8 Alberta Recording Studios	213	16 The Power Base	208	8 Tinderbox Studios	219
MONTANA		4 Ground Zero Sound	214	Provo		Orca		16 Trax Recording	211
Billings		8 Leon-Forrrest Productions	215	4 Fine Arts Recording Studio	190	4 Flamingo Ranch Productions	213	8 Vineyard Studios	219
16 Jester Sound and Video	206	Medford		24 Rosewood Rec. Co.	199	Redmond		24 Woodmont Beach Studios	203
Bozeman		16 Sirius Productions	209	8 Covariant Recordings Inc.	212	16 Full Scale Productions, Inc.	206	Selah	
8 Peak Recording & Sound	216	24 Staunton Studios Inc	201	16 Forest Productions	206	24 Triad Studios	203	16 Creative Commercial Concepts	205
Helena		Milwaukie		16 KSL Recording	207	Renton		Spokane	
8 Vallron Recording	219	24 Sound Impressions	200	24 L.A. East	194	16 The Recording Chamber Inc.	209	12 Doctor Black Studio	205
Kalispell		O'Brien		2 Norman Ross Productions	217	4 Rosedale (Gig Harbor) Productions	217	8 Inland Audio Visual Company	214
8 Kalago Productions Inc	215	24 JAH Works Studios	192	8 Telescene, Inc	211	Rosedale (Gig Harbor)		4 Reel Creations	216
Red Lodge		16 Artist Sound	204	16 WT Studios	211	Seattle		8 Romance Recording Studios	217
4 Aerial Audio	212	8 Bible Temple Recording	212	WASHINGTON		4 American Tape Duplicating	212	16 Sound Recording Company	210
NEVADA		4 Nathan Bryden Music Company	212	Arlington		8 Applewood Recording Studio	212	Tacoma	
Incline Village		24 Desitrek Studios	188	24 Sage Recording	199	24 Audio Design Group	186	16 PLU Audio (Pacific Lutheran University)	208
4 Lane Cameron Studios	212	4 Foot O' Mah Bed Recording	213	Bellevue		8 Audio Recording Inc.	212	16 Sound West Recording	210
Reno		8 Gary Gadwood Custom Recording	214	24 Extra Sensory Productions	190	8 Bade Art & Music	212	24 T.J. Recording Studio, Inc.	202
24 Granny's House Recording Studios	191	8 Little Pond Productions	215	24 Miramar Recording Studios	194	8 Camera One	212	Vancouver	
24 Starsound Audio, Inc.	200	2 David Mathew Recording Services	215	8 Sound Design	217	24 Crow Recording Studio	188	8 Cozy Dog Recording	213
8 Toe Jams Recording	219	16 Moonbaby Music, Inc.	107	Bellingham		8 Current Rutledge Lab	213	8 Ruther Remote Recording	217
Sparks		16 Jon Newton Music	208	16 Lay-A-Track Recording	207	8 Hummingbird Sound	214	Wenatchee	
24 Axe-Trax Recording Studio	187	16 Northwestern Inc	208	24 Diamond Star Recording	188	8 Kenny Husted Productions	214	16 Apple City Music	204
OREGON		24 Pace Video Center	197	4 Polytones	216	24 Ironwood Studio	192	Woodinville	
16 Trioga Recording Studio	211	16 Rainbow Recording	209	Buckley		8 JB Recordings	214	24 Bear Creek Studio & Music Production	187
Beaverton		24 Recording Associates	199	16 C-M-I	205	24 Steve Lawson Productions	194	WYOMING	
4 Radioactive Records	216	24 Rex Recording Co.	199	Centralla		8 Lew's Recording Place	215	Cheyenne	
Central Pt.		24 Spectrum Sound Studios	200	8 Jake Barner Studios	212	4 Location Recording	215	24 Rough Cut Recording	199
4 Crystal Clear Recording	213	8 Teknifilm/Tecknifilm Video	218	Everett		24 London Bridge Studios Inc.	194	Jackson	
Cottage Grove		8 Wayne Mark Studio	219	8 Metrix Recording & Production Studio	216	16 Michael Lord Productions	207	16 Media Works	207
24 Data Tracks Recording	188	Salem		4 Federal Way		4 Microfl Systems	216	8 Saddle Butte Music	217
Eugene		8 Western Oregon Sound and Recording	219	24 Horizon Recording Studio	192	24 Milltree Productions	194	Thermopolis	
24 Color Blind Music	188	Tigard		Willams		24 The Music Source	196	16 Mountainwood West	208
8 Deroy Productions	213	4 Forte	213	8 Beautiful Heart	212	16 Rainwood Studio &		8 Zion's Sounds	219
8 Em-An-Ee Sound Studio	213	Willams							
8 Full Moon Recording Company	213								
8 Generation Organization	214								

COMING IN APRIL... A MIX SPECIAL SUPPLEMENT

HYPERMEDIA

P · R · O · D · U · C · T · I · O · N

HyperMedia: the production and delivery of information and entertainment by methods that go beyond the traditional.

Breakthrough technologies are rapidly changing the way music and other forms of entertainment are produced and delivered to the end user. We've barely digested the impact of digital audio on our industry—yet a host of new systems and methods are following in its wake.

Learn about the technology of HyperMedia, and

how it will affect your job as a production professional in the 1990s:

- CD-ROM
- Computer Graphics
- Digital Video
- CD-V
- Interactive Video
- Fiber Optics
- CD-I
- Telecommunications
- Optical Media
- DAT
- Digital Workstations
- HyperCard
- HDTV
- On-Line Databases
- Digital Effects

For information on advertising in the HyperMedia Supplement, call (415) 843-7901.

AD CLOSING: FEBRUARY 7

MATERIALS DUE: FEBRUARY 15

MICMIX XL-305, MXR flanger/doubler.
 Other Outboard Equipment: Symetrix 522 (5 function stereo), Symetrix SG200 stereo gate, (2) Symetrix 501 comp/limiter, (2) UREI LA-4 comp/limiter, (2) Phase Linear ES1 parametrics, (10) dbx 150, (4) Dolby C, Technics SL-1200 MkII, Shure V15 Type 5 cartridge, Barcus-Bery Electronics processor, Dolby A 24 channels, Dolby SR mastering, CD player.
 Microphones: AKG, Audio-Technica, B&K, Beyer, Countryman, E-V, Sennheiser, Shure, Sony, Tascam, Neumann M249 tube.
 Monitor Amplifiers: Peavey DECA 700, Carver 1200, JBL 660, Rane HC-6 (cue)
 Monitor Speakers: KEF Model 105/2, KEF 104/2, Yamaha NS-10, Toa 312-ME, Auratones.
 Musical Instruments: Steinway 9' concert grand
 Video Equipment: Live session shoots arranged with a local production company in 1/2" or 3/4" video format.
 Rates: \$35-\$50/hr. Please call for rate card and literature
 Extras & Direction: The owner designed and built the studio from the ground up, using state-of-the-art concepts. It's located in a gorgeous rural setting near the Russian River resort area. Skylights and a large picture window provide plenty of natural light. The studio, including lounge, is climate controlled and wheelchair accessible. Certified massage and hypnosis are available for performance preparation. Complete production capabilities: albums, demos, cassettes, video soundtracks, radio drama, musicals... The acoustic design of the studio offers remarkably warm and rich sound for acoustic instruments. Recent credits: 1986 Windham Hill albums. We offer sensitive professional engineering in a good feeling environment.

[24+] HORIZON RECORDING STUDIO
 also REMOTE RECORDING
 1317 S. 295th Pl.
 Federal Way, WA 98003
 (206) 941-2018
 Owner: Roger A. Wood
 Studio Manager: Bill Gibson

[24+] HYDE STREET STUDIOS
 245 Hyde St.
 San Francisco, CA 94102
 (415) 441-8934
 Owner: Michael Ward
 Studio Manager: Ricky Lee Lynd
 Engineers: Garry Creiman, John Cuniberti, Ricky Lee Lynd, Brian Risner, E. J. Emmons, Wendy Bardsley, Andrew Murdock.
 Dimensions: Studio 31 x 20, control room 20 x 18.
 Mixing Consoles: Amek 2500 48 x 24 x 48 automated/Master-Mix disc-based.
 Audio Recorders: Otari MTR-90 II 16-/24-track w/autolocator, 3M M-79 16-track (w/autolocate), Otari MTR-10 2-track 1/4", Otari MTR-12 2-track 1/2", (2) Otari MX-5050B 4-track, Scully 280 1/2".
 Echo, Reverb, & Delay Systems: Acoustic chamber, Yamaha REV7 (digital reverb w/MIDI), Lexicon PCM60, Lexicon PCM41, Lexicon PCM42, Eventide 949 Harmonizer, DeltaLab DL-2, Lexicon PCM70, stereo EMT plate, Lexicon 480L w/LARC.
 Other Outboard Equipment: (6) Drawmer noise gates, (5) Dyna-Mite, Teletronix LA-2A, (4) ADR F760 compressors, (2) UREI 1176LN, ADR Vocal Stresser, (2) UREI 546 stereo parametric EQ, (2) Furman parametric, (2) White 10-band EQ, Klark-Teknik 1/3-octave room EQ, (2) dbx 165A, UREI 565 Little Dipper.
 Microphones: Neumann M49, Neumann U47 (tube w/omni capsule), Neumann U67, Neumann U87, Neumann KM54, AKG C12 (tube), (4) AKG C12A (tube), (2) AKG 414EB, Sennheiser, Beyer, Shure, Crown P2M etc, Countryman direct boxes.
 Monitor Amplifiers: Haller, Soundcraftsmen, Crown.
 Monitor Speakers: Meyer, Yamaha NS-10M.
 Musical Instruments: Steinway 9' grand piano, Emulator II, Hammond B-3 organ w/Leslie, Music Man amp, Rogers drum kit and percussion.
 Video Equipment: Adams-Smith 2600 synchronizer system, Sony VO-5800 3/4" video deck w/address track modification.
 Rates: Please call for rates.
 Extras & Direction: Dual multi-track lock-up in-house production of musical scores for film and video, real time duplication, cassette, 1/2-track, 1/2" 1/2-track and 2" safety masters, call screening, game and lounge room, free Peet's coffee. Now providing quality audio for film, video, radio, theater as well as traditional musical recordings for disc and demos.

[24+] INDEPENDENT SOUND
 San Francisco, CA
 (415) 929-8085
 Owner: Peter Buffett, Mary Buffett
 Studio Manager: Yvonne Graves
 Engineers: Peter Buffett
 Dimensions: Studio 13 x 12, control room 17 x 10
 Mixing Consoles: Sound Workshop Series 34C automated 32 x 24
 Audio Recorders: Otari MTR-90II 24-track, Otari MTR-12 2-track, Otari 5050B 2-track
 Cassette Recorders/Duplicators: TEAC 122B, Sony TCD5M.
 Synchronization Systems: Otari CB121
 Echo, Reverb, & Delay Systems: Lexicon 224 XL, Lexicon PCM70, Roland DEP-5, Eventide 949 Harmonizer, Bel stereo

NORTHWEST

24+ TRACK

STUDIOS

flanger
 Other Outboard Equipment: (2) Drawmer gates, (2) Drawmer compressors
 Microphones: AKG 414, Neumann U87.
 Monitor Amplifiers: BGW 750, AB Systems 205
 Monitor Speakers: JBL 4411, MDM 4, Yamaha NS-10, Auratones
 Musical Instruments: Synclavier digital audio system, Kurzweil 250, Linn 9000, Roland D-50, Yamaha TX7, Roland MKS-80, Roland MKS-20
 Video Equipment: JVC 3/4" video deck, Sony PVM-1910 monitor
 Rates: Call for rates

[24+] INFINITE STUDIOS
 PO Box 1709
 Alameda, CA 94501
 (415) 521-0321
 Owner: Michael Denten
 Studio Manager: Michael Denten



IRONWOOD STUDIO
 Seattle, WA

[24+] IRONWOOD STUDIO
 601 NW 80th St.
 Seattle, WA 98117
 (206) 789-7569
 Owner: Paul Scoles
 Studio Manager: Myron Partman
 Engineers: Jay Follette, Paul Scoles, Ron Phillips
 Dimensions: Studio 34 x 28, control room 16 x 14.
 Mixing Consoles: Harrison Raven automated 32 x 24
 Audio Recorders: Sony JH-24 24-track, Sony JH-110C 2-track 1/2" and 1/4", Tascam ATR-60 2-track 1/4" w/center time code
 Cassette Recorders/Duplicators: (2) Sanyo, Technics
 Synchronization Systems: Audio Kinetics Q Lock 4 10 synchronizer
 Echo, Reverb, & Delay Systems: Lexicon 480L w/LARC, Lexicon 200, Lexicon PCM70, Lexicon Super Prime Time delay, Yamaha SPX90, DeltaLab DL-2 delay, Roland SRE-555 tape echo.
 Other Outboard Equipment: dbx 900 rack w/(4) gates, (3) compressors, de-esser, Teletronix LA-2A tube limiter, (2) UREI 1176 compressors, Aphex Type C Exciter, (2) Symetrix parametrics, (2) Symetrix compressors, (2) Symetrix gates, MXR pitch transposer, Roland Dimension D, Roland flanger
 Microphones: Telefunken U-47 (tube), Neumann U67 (tube), (2) Neumann U87, Neumann U47, (2) Neumann KM56 (tube), (2) Neumann KM84, AKG Tube, (2) AKG 451, AKG D-12E, (2) Sennheiser 441, (2) E-V RE20, (2) Sony C-37A, Sony C-500
 Monitor Amplifiers: Haller P-500, (2) Yamaha P2050, Crown D-60
 Monitor Speakers: JBL 4430, JBL 4311, Yamaha NS-10, Auratones
 Musical Instruments: Yamaha 7'4" grand w/Forte MIDI, Korg DSS-1 digital sampling synthesizer, Roland JX-10 synthesizer, LinnDrum, Hammond M-3 w/Leslie, Micromoog, Hohner clavinet, Pearl drums.
 Other MIDI Equipment: Yamaha QX-5 sequencer
 Video Equipment: Sony JH-110C 1" layback recorder, Sony VO-5600 3/4" VTR, (2) NEC color monitors
 Other: Diskmix console automation system
 Rates: Please call for rates.

[24+] DENNY JAEGER CREATIVE SERVICES, INC.
 Oakland, CA
 (415) 339-2111
 Owner: Denny Jaeger
 Studio Manager: Denny Jaeger
 Dimensions: Studio 14.5 x 24, control room 14.5 x 22 w/adjoining equipment room 10 x 18.5.
 Mixing Consoles: Harrison Series X virtual console 112 inputs x 48 bus
 Audio Recorders: (2) Sony 3324 24-track digital, Ampex ATR-124 24-track, Ampex ATR-104 2-/4-track 1/2", Sony PCM-F1 2-track digital, Otari MTR-20 4-track w/1/2" heads, Otari MTR-20 2-track w/1/2" heads
 Echo, Reverb, & Delay Systems: (4) Quantec room simulators, Lexicon 224XL, (2) Lexicon PCM70, (2) Lexicon PCM42, Lexicon 200, Eventide SP2016
 Other Outboard Equipment: (4) Drawmer stereo gates, Aphex Dominator, (2) Aphex compellers, (2) dbx 160X limiter/compressors, (2) LA-4, (2) UREI Universal filter sets, E-mu voltage controlled low pass filter, E-mu voltage controlled high pass filter, Aphex Aural Exciter II, Dolby SR 24 channels, Dolby 361A, (5) Lynx modules
 Microphones: Schoeps, B&K, Neumann U87, Sony (many varieties), E-V RE20, Shure SM56, Shure SM57
 Monitor Amplifiers: Meyer MS1000 amp, Crest 4000, BGW 250, Briston
 Monitor Speakers: Meyer 833 w/processor and Complementary Phase EQ
 Musical Instruments: Yamaha grand piano, Synclavier digital system w/32 megabytes of RAM, 64 voices, (2) 140 megabyte Winchester, velocity keyboard, guitar controller, SMPTE, MIDI, Kennedy cartridge device, music printing, Yamaha DX7, Ensoniq ESQ-1, Oberheim Matrix-6
 Video Equipment: JVC 6650U 3/4" recorder, JVC 8250 3/4" recorder, Sony KV-25XBR monitor, Q Lock 4 10 synchronizer
 Rates: Upon request

[24+] JAH WORKS STUDIOS
 PO Box 15
 O'Brien, OR 97534
 (503) 596-2180
 Owner: Jah Levi
 Studio Manager: Luna Dove
 Engineers: Jah Levi
 Dimensions: Room 1, studio 10 x 12, control room 12 x 12
 Room 2 studio 12 x 12, control room 10 x 12
 Drum booth 9 x 9
 Mixing Consoles: Studiomastr Series II 24 x 16, Yamaha RM1608 16 x 16, Sound Workshop Logex II 12 x 8, TEAC 2A 6 x 4, Gemini 8 x 4 disco mixer
 Audio Recorders: Sony/MCI JH-24 24-track w/ALII, Fostex Model 80 8-track, Nakamichi DMR-100 2-track digital PCM, Tascam ATR-60 2-track 1/2"
 Cassette Recorders/Duplicators: Eumig FL-1000, Technics RSB-100, TEAC W-880RX dubbing deck, Nakamichi 600
 Noise Reduction Equipment: dbx 224 Type II 2-track
 Synchronization Systems: Fostex 4050 auto/locator, Korg KMS-30 MIDI-FSK sync
 Echo, Reverb, & Delay Systems: TC Electronic 2290, Yamaha REV7, Yamaha SPX90, Roland DEP-5, Roland SRV-2000, Roland SDE-2000, Alesis MIDverb, Korg SDD-3300, Rockman rock modules, DOD Electronics 2-sec sampling delay and TC Electronics flanger
 Other Outboard Equipment: Aphex Type C Aural Exciter, TC Electronic 2240 para EQ, Orban parametric EQ, dbx 166 comp/limiter, Demiter tube bass preamp, Roland 2020 EQ, dbx 48X expander, dbx 120X subharmonic synth, Kyocera DA-810 CD player, Akai CD player
 Microphones: Beyer MC-740, (2) Beyer M-88, Beyer M-69, Beyer M-160, AKG 414, (2) AKG D-310, AKG DT-330, (3) E-V PL10, E-V PL20, Audio-Technica ATM-2"
 Monitor Amplifiers: (2) Sumo "The Nine" Class A, Yamaha AVC-50
 Monitor Speakers: JBL 4430, JBL Control 1, JBL 4612B, Klipchorn La Scala, Roland SRS-80
 Musical Instruments: Korg DSS-1, Casio CZ-5000, (4) Yamaha FB-01, Photon MIDI guitar converter, JL Cooper MSB 16/20, Korg DVP-1, Linn 9000, Sequential Circuits Studio 440, (2) MPC percussion computer, set of North drums, Yamaha RX11, (2) Ken Smith bass, many guitars, basses, amps, percussion, sitar and ethnic instruments, Trace-Elliott, Fender and Roland Jazz Chorus—120 amps
 Other MIDI Equipment: Roland Octapad, Atari 1040ST w/Steinberg Pro-24, Fairlight Voice-tracker, Yamaha QX-1
 Video Equipment: Samsung VHS VCR
 Other: Biotech Bionaire 2001, industrial air filter and negative ion generator, Honda EX5500 generator, (2) heart interface sine-wave inverter and chloride battery pack, (20) Arco photovoltaic panels
 Rates: 8-track \$25/hr., 24-track \$45/hr., also open to bartering.

[24+] JENSEN SOUND
 San Francisco, CA 94115
 (415) 469-0192
 Owner: Eric and Suzanne Jensen
 Studio Manager: Suzanne Jensen

8 Mike's Music	216	16 Gung-Ho Studio	206	UTAH		Gig Harbor		Production	209
4 Snake River Studios	217	8 D. Ross Productions	217	Castle Dale		4 CW Recording	213	8 Reciprocal Recording	216
Ketchum		24 Triad Recording Studios	202	4 Eagle Nest Recording and		Index		16 The Right Track Studios	209
24 Sun Valley Audio	201	Glendale Beach		4 Sound Reinforcement	213	24 Paradise Sound Recording		8 Roxound Studios	217
Lucile		4 Pine Apple Studios	216	Kanab		Inc.	197	8 Salmon Bay Productions	217
16 Shewbrend Music Co.	209	Grants Pass		4 Marcan Studio	215	Kirkland		8 Sound Productions	218
Meridian		8 Little Oak Sound		2 and Video	215	2 John Wesley Production	219	24 Star Trak Recording Inc.	200
16 Horizon Audio		Hood River		Mapleton		Marysville		8 TDS Productions	218
Recording	206	2 Keyboard Resources	215	16 Rocky Mtn. Productions	209	8 August Productions	212	24 Teleration Productions	202
Pocatello		Lake Oswego		2 Aesthetic Productions	212	Mill Creek		8 Tinderbox Studios	219
8 Clockworks	212	4 Ground Zero Sound	214	North Ogden		16 The Power Base	208	16 Trax Recording	211
MONTANA		Lincoln City		8 Elberta Recording		Orcas		8 Vineyard Studios	219
Billings		8 Leon-Forrest		Studios	213	24 Flamingo Ranch		24 Woodmont Beach	
16 Jester Sound and Video	206	Productions	215	Provo		Productions	213	Studios	203
Bozeman		Medford		24 Fine Arts Recording		Redmond		16 Creative Commercial	
8 Peak Recording &		16 Sirius Productions	209	Studio	190	Full Scale Productions,		Concepts	205
Sound	216	24 Staunton Studios Inc.	201	24 Rosewood Rec. Co.	199	Inc.	206	Spokane	
Helena		Milwaukie		24 Salt Lake City		24 Triad Studios	203	12 Doctor Black Studio	205
8 Valtron Recording	219	24 Sound Impressions	200	8 Covenant Recordings		Renton		8 Inland Audio Visual	
Kalispell		O'Brien		Inc.	212	Inc.	209	Company	214
8 Kalago Productions Inc.	215	24 JAH Works Studios	192	16 Forest Productions	206	Rosedale (Gig Harbor)		4 Reef Creations	216
Red Lodge		24 Portland		16 KSL Recording	207	4 Rosedale Audio		8 Romance Recording	
4 Aerial Audio	212	Portland		24 L.A. East	194	Productions	217	Studios	217
NEVADA		16 Artist Sound	204	2 Norman Ross		Seattle		16 Sound Recording	
Incline Village		8 Bible Temple Recording	212	Productions	217	4 American Tape		Company	210
4 Lane Cameron Studios	212	8 Nathan Bryden Music		8 Tapestry Productions	218	Duplicating	212	Tacoma	
Reno		Company	212	16 Telescene, Inc.	211	8 Applewood Recording		16 PLU Audio (Pacific	
24 Granny's House Recording		24 Destrek Studios	188	16 WT Studios	211	Studio	212	Lutheran University)	208
Studios	191	4 Foot O' Mah Bed		WASHINGTON		24 Audio Design Group	186	16 Sound West Recording	210
24 Starsound Audio, Inc.	200	Recording	213	Arlington		8 Audio Recording Inc.	212	24 T.J. Recording Studio,	
8 Toe Jams Recording	219	8 Gary Gadwood Custom		24 Sage Recording	199	8 Bade Art & Music	212	Inc.	202
Sparks		8 Little Pond Productions	215	Bellevue		8 Camera One	212	Vancouver	
24 Axe-Trax Recording		2 David Mathew Recording		24 Extra Sensory		8 Crow Recording Studio	188	8 Cozy Dog Recording	213
Studio	187	Services	215	Productions	190	8 Current Rutledge	213	Walla Walla	
OREGON		16 Moonbaby Music, Inc.	107	24 Miramar Recording		8 Hummingbird Sound		8 Ruther Remote	
Allegany		16 Jon Newton Music	208	Studio	194	Lab	214	Recording	217
16 Tioga Recording Studio	211	16 Northwestern Inc.	208	8 Sound Design	217	8 Kenny Husted		Wenatchee	
Beaverton		24 Pace Video Center	197	Bellingham		Productions	214	16 Apple City Music	204
4 Radioactive Records	216	16 Rainbow Recording	209	16 Lay-A-Track Recording	207	24 Ironwood Studio	192	Woodinville	
Central Pt.		24 Recording Associates	199	8 Bothell		8 JB Recordings	214	24 Bear Creek Studio & Music	
4 Crystal Clear Recording	213	24 Rex Recording Co.	199	24 Diamond Star Recording	188	24 Steve Lawson		Production	187
Cottage Grove		8 Spectrum Sound Studios	200	4 Polytones	216	Productions	194	WYOMING	
24 Data Tracks Recording	188	8 Teknifilm/Tecknifilm		Buckley		8 Lew's Recording Place	215	Cheyenne	
Eugene		Video	218	16 C-M-I	205	4 Location Recording	215	24 Rough Cut Recording	199
24 Color Blind Music	188	8 Wayne Mark Studio	219	Centralia		24 London Bridge Studios		Inc.	194
8 Deroy Productions	213	Salem		8 Jake Barner Studios	212	16 Michael Lord		Jackson	
8 Em-An-Ee Sound Studio	213	8 Western Oregon Sound		Everett		Productions	207	16 Media Works	207
8 Full Moon Recording		and Recording	219	8 Matrix Recording &		4 Microft Systems	216	8 Saddle Butte Music	217
Company	213	Tigard		Production Studio	216	24 Milltree Productions	194	Thermopola	
8 Generation Organization	214	4 Forte	213	Federal Way		24 The Music Source	196	16 Mountainwood West	208
		Williams		24 Horizon Recording		16 Rainwood Studio &		8 Zronic Sounds	219
		8 Beautiful Heart	212	Studio	192				

COMING IN APRIL... A MIX SPECIAL SUPPLEMENT

HYPERMEDIA

P · R · O · D · U · C · T · I · O · N

HyperMedia: the production and delivery of information and entertainment by methods that go beyond the traditional.

Breakthrough technologies are rapidly changing the way music and other forms of entertainment are produced and delivered to the end user. We've barely digested the impact of digital audio on our industry—yet a host of new systems and methods are following in its wake.

Learn about the technology of HyperMedia, and

how it will affect your job as a production professional in the 1990s:

- CD-ROM
- Computer Graphics
- Digital Video
- CD-V
- Interactive Video
- Fiber Optics
- CD-I
- Telecommunications
- Optical Media
- DAT
- Digital Workstations
- HyperCard
- HDTV
- On-Line Databases
- Digital Effects

For information on advertising in the HyperMedia Supplement, call (415) 843-7901.

AD CLOSING: FEBRUARY 7

MATERIALS DUE: FEBRUARY 15

N O R T H W E S T

24+ TRACK

STUDIOS

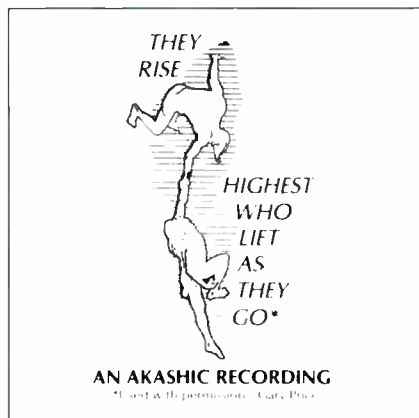

AKASHIC RECORDS GROUP/RHEEM THEATRE
Danville, CA

[24+] AKASHIC RECORDS GROUP/RHEEM THEATRE
also **REMOTE RECORDING**

PO Box 395
Danville, CA 94526
(415) 837-7959
Owner: Stephen Jarvis
Dimensions: Studio 250L x 100W x 50H, control room 15 x 21.
Mixing Consoles: MCI JH-800 12 x 12 x 4, (8) Massenburg 8 x 8 microphone preamps, (4) Drawmer 4 x 4 preamps, Ampex MX10 4 x 2.

Audio Recorders: 3M M79 24-track transformerless, Otari 5050B 2-track, Sony PCM F-1 2-track digital processor w/Meyer correction filter, Nakamichi DMP-100 2-track digital processor

Cassette Recorders/Duplicators: Nakamichi 550
Noise Reduction Equipment: Dolby XP-24 SR 24-track w/auto switching for Otari, Studer, MCI, 3M, Dolby SR 361 stereo pair
Echo, Reverb, & Delay Systems: AMS RMX16, Lexicon PCM70
Other Outboard Equipment: (3) Drawmer noise gates, (8) Aphex EQF2 parametric equalizers

Microphones: (2) AKG C-12, (2) Neumann M49, Telefunken ELAM 251, Neumann SM69 stereo, Neumann J87, (2) Neumann TLM170 transformerless, (3) AKG 460, (5) Sennheiser 421, Sennheiser 441, (3) Shure SM56, Shure 546, (3) Synchron S-10, (2) Beyer M160, E-V RE20, Shure SM7, AKG D112, Shure "Silver Bullet."

Monitor Amplifiers: McIntosh 2100, Yamaha 2050.

Monitor Speakers: Yamaha NS-10, UREI 809.

Musical Instruments: E-mu SP-12 turbo.

Rates: Please call.

Extras & Direction: This equipment is located in the 1,000-seat Rheem Performing Arts Theater, Moraga, California. We specialize in "live feel" studio production and recording of live performances in 24-track SR Dolby. The large sound stage is also used for pre-production and recording prior to studio recording at other Bay Area facilities. Individual equipment rental and remote recording is available.

[24+] ALPHA & OMEGA RECORDING

245 Hyde St.
San Francisco, CA 94102
(415) 885-4999

Owner: Sandy Pearlman Inc
Studio Manager: Nancy Evans
Engineers: Paul Mandl, Mark Senasac, Ken Kessie, Mary Ann Zahorsky, Ann Maria Scott, Doug Gaines.
Dimensions: Studio 20 x 35, isolation room 130 sq.ft., control room 18 x 22.

Mixing Consoles: API 44-input w/36 monitors w/automation, ARMS moving fader, 80 inputs for mixing
Audio Recorders: Otari MTR-90, Ampex 124 24-track, Ampex 124 16-track, Ampex ATR-102 2-track 1/2" and 1"
Echo, Reverb, & Delay Systems: Lexicon 480L, AMS 15-80S,

AMS RMX-16, Eventide SP-2016, Quantec stereo room simulator, Lexicon Prime Time II, Lexicon PCM42, Loft Delay, live large echo chamber, Eventide 949.

Other Outboard Equipment: Fairchild limiters, (4) dbx 160, Drawmer tube stereo compressor, NTP limiter, Trident stereo limiter, UREI LA-4, UREI 1176, Compex limiter, Aphex compellor, Massenburg stereo limiter, (2) CBS audimax tube limiters, (2) API 525, (2) Pultec EQP-1A, (2) Pultec MEQ, Pultec HLF filter, (2) Massenburg EQs, (4) API 560, (2) Massenburg microphone preamps, Aphex Aural Exciter II, EXR Exciter, Barcus-Berry Electronics exciter, (3) Drawmer DS-201 gates, Q.Lock synchronizer, Lynx Time synchronizer.

Microphones: Sanken CU-41, TLM-170, U89, U47 FET, AKG C414, Sennheiser 421, Shure SM57, AKG 460, Countryman DIs, Simon DIs.

Monitor Speakers: Custom system (call for details), Yamaha NS-10M, ROR

Musical Instruments: E-mu SP-1202, (6) Marshall
Video Equipment: Sweetening w/Sony BVH-3100, Sony BVW-75SP Betacam, Sony BVW-40 Betacam, Sony BVU-800DB.
Rates: Please call for rates.

[24+] ARCHIVE AUDIO

PO Box 3800
Saratoga, CA 95070
(408) 241-6406
Owner: Bruce Gast

[24+] ARRIVISTE

also **REMOTE RECORDING**
Sunnyvale, CA
(408) 745-1571
Owner: Axis Recording and Creative Services
Studio Manager: Pat Doran



ATLANTA PRODUCTIONS
Stockton, CA

[24+] ATLANTA PRODUCTIONS

6884 Atlanta Cir.
Stockton, CA 95209
(209) 473-2345

Owner: Ralph & Diane Stover
Studio Manager: Diane Stover
Engineers: Ralph Stover, independents.
Mixing Consoles: Neotec Elite 32 x 24 w/MIDimute automation.
Audio Recorders: Studer A80 MKIV 24-track, Studer A812 2-track.
Cassette Recorders/Duplicators: Nakamichi
Noise Reduction Equipment: (2) Dolby SR
Synchronization Systems: (3) Lynx time code modules, Jambox 4+
Echo, Reverb, & Delay Systems: Lexicon 480L, Lexicon PCM-

70, TC Electronic delay and effects, Yamaha REV7, Yamaha SPX90, Alesis MIDiverb II, Alesis Microverb, Yamaha R1000

Other Outboard Equipment: (4) dbx 903 compressor, (4) dbx 904 Kepex, dbx 902 de-esser, Eventide Harmonizer
Microphones: AKG tube, Neumann U87, Neumann U89, (2) Neumann KM84, AKG C414, Beyer M380, Shure, AKG Dynamics.

Monitor Amplifiers: QSC, Perreaux, (2) Rane headphone amps.
Monitor Speakers: (2) Westlake BBSM-8, (2) Yamaha NS-10M
Musical Instruments: Emulator II w/CD-ROM, E-mu SP-1200, E-mu SP-12, Roland MKS-80 Super Jupiter, Roland MKS-20 digital piano, Roland D-50, Oberheim DPX-1, Yamaha TX802, Yamaha TX816 rack w/8 modules, Prophet 2000, Ensoniq ESQ-1, Steinberger w/Roland synth electronics, Steinway grand piano, Yamaha KX88

Other MIDI Equipment: Sycologic 16 x 32 MIDI switcher, Macintosh SE, Mega mix automation system, Performer 2.0, Digidesign sampling and O-sheet

Video Equipment: JVC CR-850 3/4" video deck w/remote, Sigma Electronic color sync generator, JVC digital VHS, (2) Sony color monitors

Other: Macintosh 512K, Fender, Ibanez, Yamaha bass guitars, Yamaha MJC8, Yamaha QX1 sequencer, etc
Rates: Please call.

Extras & Direction: Atlanta Productions is a full-service commercial production facility specializing in audio post-production and music scoring. We cater specifically to the independent producers who wish to complete their project on time and within budget. We also have an extensive library of music, sounds and sound effects to choose from. Our experienced staff of programmers, engineers, composers, arrangers and musicians can help your project look and sound its best. Work can be performed in a relaxed, friendly and professional atmosphere complete with swimming pool and spa. Local transportation and lodging can also be provided. For any questions regarding our services please call Diane.

[24+] AUDIO DESIGN GROUP

1921 Minor
Seattle, WA 98101
(206) 623-1418
Owner: Audio Design Group Inc
Studio Manager: Craig Ormond

[24+] AUDIOWORKS RECORDING STUDIOS

also **REMOTE RECORDING**
7479 S. Teller St.
Littleton, CO 80123
(303) 972-4255
Owner: Bill Prentice
Studio Manager: Bill Prentice

[24+] AUTOLOFT RECORDING STUDIO

21103 Patriot Way
Cupertino, CA
(408) 257-8178
Owner: Galane Productions
Studio Manager: Michael Galane



AVALANCHE RECORDING STUDIOS, INC.
Northglenn, CO

[24+] AVALANCHE RECORDING STUDIOS, INC.

10650 Irma Dr., #27
Northglenn, CO 80233
(303) 452-0498
Owner: Avalanche Recording Studios, Inc.
Studio Manager: Linda Warman
Engineers: George Counnas, Harry Warman, Steve Forgy, Michael Pfeifer
Dimensions: Studio 44 x 30, control room 20 x 30
Mixing Consoles: Soundcraft 2400 52 x 24 modified, automated

Audio Recorders: Sony/MCI JH-24 24-track, MCI JH-16 16-track, Sony digital 2-1/4-track, Studer Revox PR99 2-track 1/4", Studer Revox A77 2-track 1/4".
 Cassette Recorders/Duplicators: Technics RSB100.
 Noise Reduction Equipment: Upon request.
 Synchronization Systems: (3) Lynx TimeLines.
 Echo, Reverb, & Delay Systems: Lexicon 224XL, Lexicon 200, Lexicon PCM70, Lexicon 95, Audi-ence RFS-2 plate reverb, Lexicon 41, TC Electronic 2290 (11-sec.), Eventide H949 Harmonizer, MXR flanger/doubler.
 Other Outboard Equipment: (2) Aphex CX1 comp/exp., (2) B&B F-2 EQ, (2) dbx 160, UREI 1176LN, (2) Symetrix 522, dbx 263X, dbx 166, (2) Stratagate, UREI 546 parametric EQ, Aphex Type B Aural Exciter.
 Microphones: (4) Neumann U87, Neumann U47, (2) Neumann U48 (tube), Neumann U67 (tube), AKG C414, AKG C451, AKG D112, (2) Telefunken ELA-M251 (tube), (3) Sony C-37A (tube), Sony C-37R, (7) Sennheiser 421, Sennheiser 441, (2) RCA 77, RCA 44, (2) E-V RE20, (2) Crown PZM-30 GPB, (2) Beyerdynamic M260, (5) Shure SM57.
 Monitor Amplifiers: UREI 6500, Hafler 200, Phase Linear 400, Technics SE-9060.
 Monitor Speakers: (2) JBL 4430, (2) Yamaha NS-10, (2) Tannoy SRM-12, (2) Auratone cubes.
 Musical Instruments: Yamaha C7, Hammond B3 w/Leslie 147, Korg DSS1, Yamaha RX11, Fender 1965 P Bass, Fender 1954 Telecaster, Seymour Duncan 100-watt convertible (all modules), Fender Bassman 10, miscellaneous percussion.
 Other MIDI Equipment: Programmers available with various equipment.
 Video Equipment: JVC CR6650U 3/4" video recorder, Panasonic CT 1930 19" color monitor, (3) Transport TimeLine synchronizer.
 Rates: Upon request. Rate card and color brochure available.
 Extras & Direction: Up to 40-track capability with automated mixes also available. Accommodation service for mountain retreats or Denver's best hotels w/transportation arrangements available. Less than an hour drive to Rocky Mountain serenity. Top studio musicians, producers, arrangers and composers. Digital 2-track mastering and synchronizer lockup with any additional equipment available upon request. Credits: The Pretenders, The Wynans, Michael McDonald, The 4 Tops, Leon Russell, Jock Bartley (Firefall) Highway 101, Flash Cadillac Producers: Paul Worley, Bill Porter, Geoff Workman, Warner Brothers, Geffen Records, Island Records. We continue to offer our clients the best in state-of-the-art equipment, engineers and personal service. Avalanche has a highly creative and comfortable atmosphere and total privacy.

[24+] AXE-TRAX RECORDING STUDIO
 1558 Linda Way
 Sparks, NV 89431
 (702) 358-7484
 Owner: Dr. Lawrence R. Davis
 Studio Manager: Ron Starcevic

[24+] AXON AUDIO
 Sunshine Star Route
 Boulder, CO 80302
 (303) 440-0277
 Owner: John Hobbs, Sherry Livingston
 Studio Manager: John Hobbs

[24+] THE BANQUET SOUND STUDIOS
 540 E. Todd Rd., Ste. B
 Santa Rosa, CA 95407
 (707) 585-1325
 Owner: Warren Dennis
 Studio Manager: Janet Stark Krick



BAYVIEW STUDIO
 Richmond, CA

[24+] BAYVIEW STUDIO
 1368 S. 49th St.
 Richmond, CA 94804
 (415) 237-4066
 Owner: Stephen Suda, Robert Hall
 Engineers: Tom Anderson, Jack Crymes
 Dimensions: Studio A 45 x 20 x 17, studio B 19 x 16 x 17, control room 14 x 18 x 8
 Mixing Consoles: Soundcraft TS-24 40 x 24.
 Audio Recorders: Studer A800 24-track, Ampex ATR-102 2-track, Studer A80 MkII RC 2-track 1/2".
 Echo, Reverb, & Delay Systems: (2) EMT 140 stereo plates, Yamaha REV7, Roland SRV-2000.
 Other Outboard Equipment: Eventide 949 Harmonizer, Lexicon Prime Time II, (4) UREI 1176, (2) UREI LA-4A, Teletronix LA-2A, dbx 161, (2) Valley People Dyna-Mite, (2) Pultec MEQ-5, (8) Dolby 361.
 Microphones: AKG 414EB, AKG 414EB-P48, AKG 451, AKG C-422 stereo, Neumann U87, Neumann KM84, Neumann U47 FET, Neumann M49B, Crown PZM, E-V RE20, Shure SM57, Shure SM7, Sennheiser 421, Sennheiser PMLDC-73, Countryman Iso-max, direct boxes, Sony ECM-50.
 Monitor Amplifiers: Hafler
 Monitor Speakers: Meyer 833, Yamaha NS-10, JBL 4311, Auratone 5C, MDM-4
 Musical Instruments: Gretsch, Yamaha "R" Series, Simmons drums available by arrangement, vintage Fender basses and guitars, Martin guitars, Gretsch guitars, old Fender amps, Ampex B-15 bass amps, Steinway B piano also available by arrangement.
 Rates: Please call for rates



BEAR CREEK STUDIO & MUSIC PRODUCTION
 Woodinville, WA

[24+] BEAR CREEK STUDIO & MUSIC PRODUCTION
 6313 Maltby Rd.
 Woodinville, WA 98072
 (206) 481-4100
 Owner: Joe & Manny Hadlock
 Studio Manager: Victoria Wirth
 Engineers: Joe Hadlock, Steve Henke
 Dimensions: Studio 25 x 38, control room 19 x 17
 Mixing Consoles: Trident TSM 32 x 24
 Audio Recorders: MCI JH-114 24-track (modified), (2) Ampex ATR-102 2-track (1/4" and 1/2"), (2) Revox A-77 2-track
 Cassette Recorders/Duplicators: (2) Revox B710.
 Noise Reduction Equipment: Dolby A 26 channels.
 Synchronization Systems: Lynx TimeLine
 Echo, Reverb, & Delay Systems: Lexicon 224, Ecoplate II, Yamaha SPX90, AMS 15-80 w/chorus interface, Lexicon Prime Time, MXR DDL, Master-Room MR-2
 Other Outboard Equipment: Teletronix LA-2, (2) UREI 1176, UREI LA-3A, Trident stereo limiter, ADR Scamp rack w/noise gates, de-esser/auto-pan/auto-flange, UREI and Orban parametric EQ, (2) Allison Kepex, (2) Allison Gain Brain, MXR auto-flanger
 Microphones: (2) Telefunken U-47 (tube), AKG C-24 stereo (tube), (2) AKG 414, (2) AKG 452, (2) Neumann U87, (2) Neumann KM84, (2) Sennheiser MD-421, Sennheiser MD-441, E-V RE20, (4) Shure SM57, Milab DC96B, (2) Crown PZM, (2) Sony ECM-22, RCA 77-DX
 Monitor Amplifiers: Custom Eico stereo tube, McIntosh MC2300, McIntosh MC240, Crown PSA-2, BGW 250B, Phase Linear 400, Spectra Sonics, Tapco.
 Monitor Speakers: Altec custom, Yamaha NS-10M, Auratone 5C, JBL 4333, JBL 4311
 Musical Instruments: 1919 Steinway B 7' grand, E-mu Emulator II sampler w/disc library, Yamaha DX7, Alpha Synlauri digital, Prophet 5 w/MIDI and sequencer, Apple Mac w/Southworth, Oberheim DMX w/MIDI, Music Man 212, Camco drums.
 Video Equipment: JVC 6650V 3/4" VCR, Proton 600M monitor, (3) Lynx TimeLine synchronizers, Ampex ATR-102 w/CTTC.
 Rates: \$125/hr., \$175/hr video interlock, block and evening rates available.

[24+] KEN CARLTON RECORDING
 (FORMERLY SOUND TECHNIQUE REC. STUDIO)
 11240 Hwy. 41
 Madera, CA 93638
 (209) 431-5275
 Owner: Ken & Marilyn Carlton
 Studio Manager: Ken Carlton
 Engineers: Ken Carlton
 Dimensions: Studio 20 x 22, control room 14 x 17, w/8 x 8 piano alcove, iso room 9 x 10, vocal booth 5 x 10
 Mixing Consoles: Sound Workshop Series 34 32 x 24 w/Disk-mix II
 Audio Recorders: Otari MTR-90 16-/24-track, Otari MTR-10 2-track, Otari MTR-12c 2-track, Otari 5050B 2-track, Pioneer RT707 1/4-track
 Cassette Recorders/Duplicators: (2) Akai GX-912, (13) Hitachi DE-7
 Noise Reduction Equipment: Dynalex (2 channels)
 Echo, Reverb, & Delay Systems: Lexicon 224XL, Lexicon PCM70 V.3, Ecoplate II, DeltaLab DL-3, Eventide 949 Harmonizer, Marshall 5402 Time Modulator, tape delay
 Other Outboard Equipment: ADR Vocal Stresser, Stereo Express com/lim/exp., (2) UREI LA-4, (2) UREI 1176LN, (4) Allison Gain Brain and Kepex, (2) dbx 165, Orban 622B parametric EQ, Aphex Aural Exciter, total Power One protection on all AC
 Microphones: Neumann U87, Neumann U89, Neumann KM86, (2) AKG 414EB, (7) AKG 451EB, (2) Sennheiser 441, (9) Sennheiser 421, (2) E-V RE-20, E-V RE-16, (2) Crown PZM, Shure 56, (8) Countryman FET 85 DIs and more
 Monitor Amplifiers: Bryston 4B, Hafler
 Monitor Speakers: JBL 4430 BiRadials, Bryston biamped, Yamaha NS-1000 in studio, Yamaha NS-10, Auratones
 Musical Instruments: Kurzweil 250 w/all updates, fully loaded, Linn 9000 w/sampling, Yamaha DX7 w/EI, Yamaha C7 grand piano, Moog, others, Peterson Strobe Tuner, many guitars and amps, Rockman Rock Module, various effects pedals and black boxes
 Other MIDI Equipment: Macintosh Plus w/MIDIport and Jam Box 4
 Rates: \$35/hr 2-track; \$55/hr 24-track Engineer and all equipment and instruments included

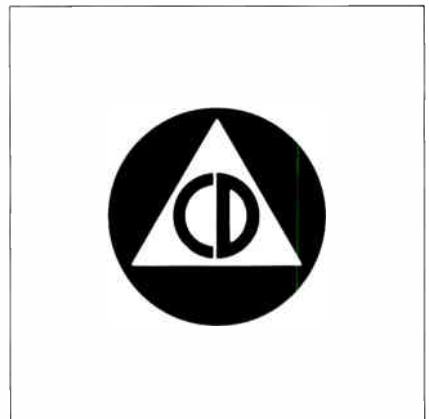

CD STUDIOS
 San Francisco, CA

[24+] CD STUDIOS
 1230 Grant Ave., Ste. 531
 San Francisco, CA 94133
 (415) 285-3348
 Owner: David Ferguson
 Studio Manager: Gary Hobish
 Engineers: Gary Hobish, Gary Mankin, Amy Atchison, Robert Geller, independents welcome
 Dimensions: Studio 30 x 40, control room 200 sq.ft
 Mixing Consoles: MCI JH-636 30 x 24 automated transformerless w/parametric EQ
 Audio Recorders: Studer A80 MkIV 24-track transformerless w/autolocator, MCI JH-110B 2-track transformerless, Sony PCM-F1 2-track digital w/Propack transformerless interface, Otari 5050B MkII 2-track
 Cassette Recorders/Duplicators: Awa M700B, Technics M280
 Synchronization Systems: SMPLE system SMPTE synchronizer
 Echo, Reverb, & Delay Systems: Lexicon 480L digital reverb and processor, AMS RMX-16 digital reverb, Lexicon 200 digital reverb, Yamaha REV7 digital reverb, AKG BX-10 spring reverb, Lexicon PCM42 digital delay line, Lexicon Super Prime Time digital delay, DeltaLab DL-4 digital delay, ADA STD-1 stereo tapped delay
 Other Outboard Equipment: Drawmer noise gates, Dyna-Mite noise gates, UREI LA-4 compressor/limiters, Symetrix 501 compressor/limiter, Scamp rack w/compressor/gate/dynamic filter/EQ, DeltaLab DL-5 HarmoniComputer, API 554 EQ
 Microphones: Neumann U64 tube, Neumann U67 tube, Neumann U87, Neumann KM54, AKG C24 stereo tube, AKG

—CONTINUED ON NEXT PAGE

C414EB, AKG C12A, AKG C460B, AKG C451, Sony C-48, Sony ECM-22P, Sennheiser MD-421U, Sennheiser MD-441, Shure SM57, Shure SM58, Shure SM81, Shure SM85, E-V RE20, E-V RE16, E-V DS35, Crown P2M, Beyer M-88, Countryman direct boxes

Monitor Amplifiers: Halfer P-225, Crown DC-300A, Crown D-60, Phase Linear D-60, Klark-Teknik DN-27A 1/3-octave EQ, Monitor Speakers: UREI 811A time aligned, Yamaha NS-10M, MDM-4, JBL 4301, JBL 4313, Realistic Minimus-7, Auratone 5C

Musical Instruments: 1929 Baldwin 7' grand piano, Emulator II sampling keyboard, Yamaha DX7, Oberheim OB-8 w/MIDI, LinnDrum LM-2, Rickenbacker bass, various guitars and amps, Hammond M3 w/Leslie cabinet
Other MIDI Equipment: Roland MSQ-700 sequencer, Garfield Mini-Doc Clock divider

Extras & Direction: Fresh ground coffee, large client lounge with refrigerator and microwave, sleeping facility, shower; one block from Willie McCovey batting range. CD Studios is an extraordinary facility at exceptionally reasonable rates. Our huge, live recording space is suitable to a multitude of tracking situations from heavy metal to orchestral recording; it is made even more versatile by our two isolation booths. We offer a wide variety of keyboards (including the Emulator II, Baldwin grand piano and Hammond M-3 w/Leslie), four digital reverbs (including the new Lexicon 480L), new and vintage tube microphones, digital and automated mixdown and much more. In addition, our parent company, CD Presents, can help the independent record maker with manufacturing and distribution. Recent clients include Tramaine Hawkins (A&M Records), Game Theory (produced by Mitch Easter for Enigma Records), Seahags (produced by Kirk Hammett), True West, Twisted Roots, Rat Music Volume III (CD Presents Records). Check us out for your next project!

[24+] CHROME DREAMS PROD.
5852 Sentinel St.
San Jose, CA
(408) 268-6066
Owner: Leonard Giacinto
Studio Manager: Monette Paparrotti

[24+] COAST RECORDERS
1340 Mission St.
San Francisco, CA 94103
(415) 864-5200
Owner: D&M Enterprises
Studio Manager: Steve Atkin
Engineers: Steve Atkin, Bob Lundner, Jim Hilson
Dimensions: Room 1: studio 25 x 40, control room 18 x 20. Room 2: studio 12 x 18, control room 16 x 18. Room 3: studio 6 x 12, control room 10 x 12. Room 4: control room 14 x 14
Mixing Consoles: MCI JH-428B 28 x 24 automated, Harrison 3624 36 x 24 automated, API 1604 16 x 4, NEOTEK 20 x 4
Audio Recorders: MCI 24-track, MCI 16-track, MCI 8-track, MCI 4-track, MCI 2-track, Ampex 8-track, Ampex 4-track, Ampex 2-track, Ampex mono, 3M 16-track.
Cassette Recorders/Duplicators: Sony, TEAC, Nakamichi
Noise Reduction Equipment: Dolby 30 channels
Synchronization Systems: BTX 4600, BTX 4500 synchronization systems.
Echo, Reverb, & Delay Systems: EMT 140 stereo plates, Yamaha REV7, Yamaha SPX90.
Other Outboard Equipment: Lexicon Super Prime Time II, Lexicon 1200 time compressor, UREI 1178, UREI 1176, UREI 537, UREI 535, Orban de-essers, Drawmer noise gates, Eventide 949 Harmonizers, UREI digital metronomes, Korg digital delay Microphones: Neumann U87, Neumann KM84, AKG 414, AKG 451, Sennheiser 421, Sennheiser 441, E-V RE20, Beyer 160, Shure SM56, RCA 77DX.
Monitor Amplifiers: UREI 6500, UREI 6250, UREI 6260, UREI 6150
Monitor Speakers: UREI 813, UREI 811, UREI 809, Auratone 5C.
Musical Instruments: Steinway grand piano, Celeste.
Video Equipment: JVC 8500-U VCR, JVC 850 VCR, BTX 4450, Jam-sync general 3-way machine lock.
Rates: Audio \$75 to \$100, w/video \$105 to \$165
Extras & Direction: Hi-speed open-reel and in-cassette duplicating, total mailing/trafficking service. Phone patches in all studios. For over 25 years the leader in audio services for the advertising industry. Total service except film and location.

[24+] COLOR BLIND MUSIC
also REMOTE RECORDING
1128 Alder, Ste. C
Eugene, OR 97403
Owner: Glove Productions
Studio Manager: Michael K. Pfohl

NORTHWEST

24+ TRACK

STUDIOS

[24+] COLOR ZONE PRODUCTIONS INC.
PO Box 1911
Novato, CA 94947
(415) 892-8027
Owner: Color Zone Productions
Studio Manager: Elissa Alford, Peter Gilford



COLORADO SOUND RECORDING
Westminster, CO

[24+] COLORADO SOUND RECORDING
also REMOTE RECORDING
3100 W. 71st Ave.
Westminster, CO 80030
(303) 430-8811
Owner: Kevin Clock
Engineers: Kevin Clock, Tom Capek
Dimensions: 650 sq ft., 550 sq ft., control room 450 sq ft., control room 10 x 13.
Mixing Consoles: Trident TSM 24 x 24 x 2
Audio Recorders: Otari MTR-90 24-track and 16-track, Ampex ATR-104 2-1/4-track 1/4" and 1/2", Studer A80 2-track 1/4" and 1/2", Revox PR99 2-track, Technics 1500 2-track
Cassette Recorders/Duplicators: Technics RSB100, Yamaha K2000
Echo, Reverb, & Delay Systems: AMS RMX-16, Lexicon PCM-70, (2) Yamaha SPX90 II, Ecoplate, Lexicon Prime Time, (2) DeltaLab 1024, Ursa Space Station, MXR digital delay, Lexicon 92
Other Outboard Equipment: (2) API 550 EQ, (2) API 525D compressor/limiters, Audioarts 4200B Parametric, Teletronix LA-2, (2) UREI LA-3A, (2) UREI 1176, (2) UREI LA-4, (4) Valley People Dyna-Mites, (2) dbx 902 de-essers, Barcus-Berry Electronics 802
Microphones: Neumann U47 tube, (2) Neumann U87, (2) Neumann U47, Neumann KM84, Neumann KM86, AKG C24 stereo tube, (4) AKG 414, (2) AKG 451, AKG C33, (2) Sennheiser 441, (2) Sennheiser 421
Monitor Amplifiers: UREI 6300, Yamaha, Crown
Monitor Speakers: UREI 813, UREI 809, Yamaha NS-10, Auratone
Musical Instruments: Yamaha C7 grand piano, Emulator II, (2) Yamaha DX7, Emulator SP12 drum machine, Hammond C3 w/Leslie, Oberheim Matrix 6, Oberheim Matrix 6R, Roland MKS-20 digital piano, Yamaha KX88, Yamaha TX802, Mesa/Boogie guitar amp, Rockman Type BII
Other MIDI Equipment: Macintosh sequencer/editor program.
Rates: \$600/day, \$60/hr.

[24+] CROW RECORDING STUDIO
also REMOTE RECORDING
4000 Wallingford N.
Seattle, WA 98103
(206) 634-3088
Owner: John Nelson
Studio Manager: John Nelson

[24+] JAMES DANIELS PRODUCTIONS
PO Box 618
Palo Alto, CA 94301
(415) 325-8574
Owner: James Daniels
Studio Manager: Bruce Kaplan

[24+] DATA TRACKS RECORDING
also REMOTE RECORDING
2155 Bennett Creek Rd.
Cottage Grove, OR 97424
(503) 942-5877
Owner: James Roger Nelson
Studio Manager: Jimmy Blue

[24+] DESITREK STUDIOS
3415 SE Hawthorne Blvd.
Portland, OR 97214
(503) 232-8606
Owner: Michael Demmers, Douglas Durbow
Studio Manager: Michael Demmers

[24+] DIAMOND STAR RECORDING
Bothell, WA
(206) 481-9439
Owner: Grant Gittins
Studio Manager: Grant Gittins



DIFFERENT FUR, LTD.
San Francisco, CA

[24+] DIFFERENT FUR, LTD.
3470 19th St.
San Francisco, CA 94110
(415) 864-1967
Owner: Susan Skaggs, Howard Johnston
Studio Manager: Susan Skaggs
Engineers: Howard Johnston, Mack Clark, Marc Senasac, Mark Stagle, David Plank, Devon Bernardino
Dimensions: Studio 25 x 35 x 12, control room 17 x 21 x 12 plus isolation
Mixing Consoles: SSL 4056 48 x 48 w/Total Recall
Audio Recorders: Studer A80 VU MkIII 24-track, Sony 3324-PCM 24-track, Studer A80 VU MkIII 2-track 1/2" and 1/4", MCI JH-110A 2-track and/or 4-track, Sony PCM-F1 2-track digital
Cassette Recorders/Duplicators: Sony R-DAT, (5) Technics Noise Reduction Equipment: (2) Dolby A
Synchronization Systems: (3) Lynx
Echo, Reverb, & Delay Systems: Lexicon 224XL, Lexicon 224 digital reverbs, Yamaha SPX90, Yamaha REV7, EMT 240 Gold Foil, Eventide digital delay, (2) Lexicon Prime Time, live echo chamber, Lexicon 480L
Other Outboard Equipment: Dolby A 2 channels, Kepex IIs, Gain Brain IIs, 1176s, LA-4As, Eventide Harmonizer, White 1/6-octave digital spectrum analyzer, MXR flanger.
Microphones: Neumann SM69 stereo tube, Neumann 269, Neumann 254 (pair), Neumann U87, Neumann U47, Neumann KM84, AKG 414, AKG 452, Beyer, Sennheiser, Sony, E-V, Shure, many rare tube mics available.
Monitor Amplifiers: Crown, BGW, Spectra Sonics, Phase Linear, Yamaha
Monitor Speakers: Westlake TM-1s, 604Es, JBL 4310s, JBL 4311s, Yamaha NS-10s, Auratone
Musical Instruments: Yamaha C-7B grand piano also available at specially arranged rates, 32-voice Synclavier, T-8, Yamaha DX7
Video Equipment: Sony 25" monitor, JVC U-matic 1/4".
Rates: \$125/hr., \$1,500/12-hour lockout, rates subject to change. Telephone for rate card.
Extras & Direction: Sauna/shower, lounge w/kitchen, color TV. Custom services in a state-of-the-art studio designed by John Storyk, with acoustical consulting in 1987 by Russell Berger of the Joiner-Rose Group, offering both digital and analog expertise. Complete seclusion in a very private atmosphere. Media and jingle recording. Recent clients include Windham Hill Records, Virgin Records, Warners, RCA, Solar, Manhattan, CBS, DEG, Word and Ralph Records.

BREATH-TAKING AUDIO

recreates what was on your final mix down
the way you want it heard
every time your client's cassette is replayed.

LISTEN TO AN EXAMPLE

Send for this free demo tape

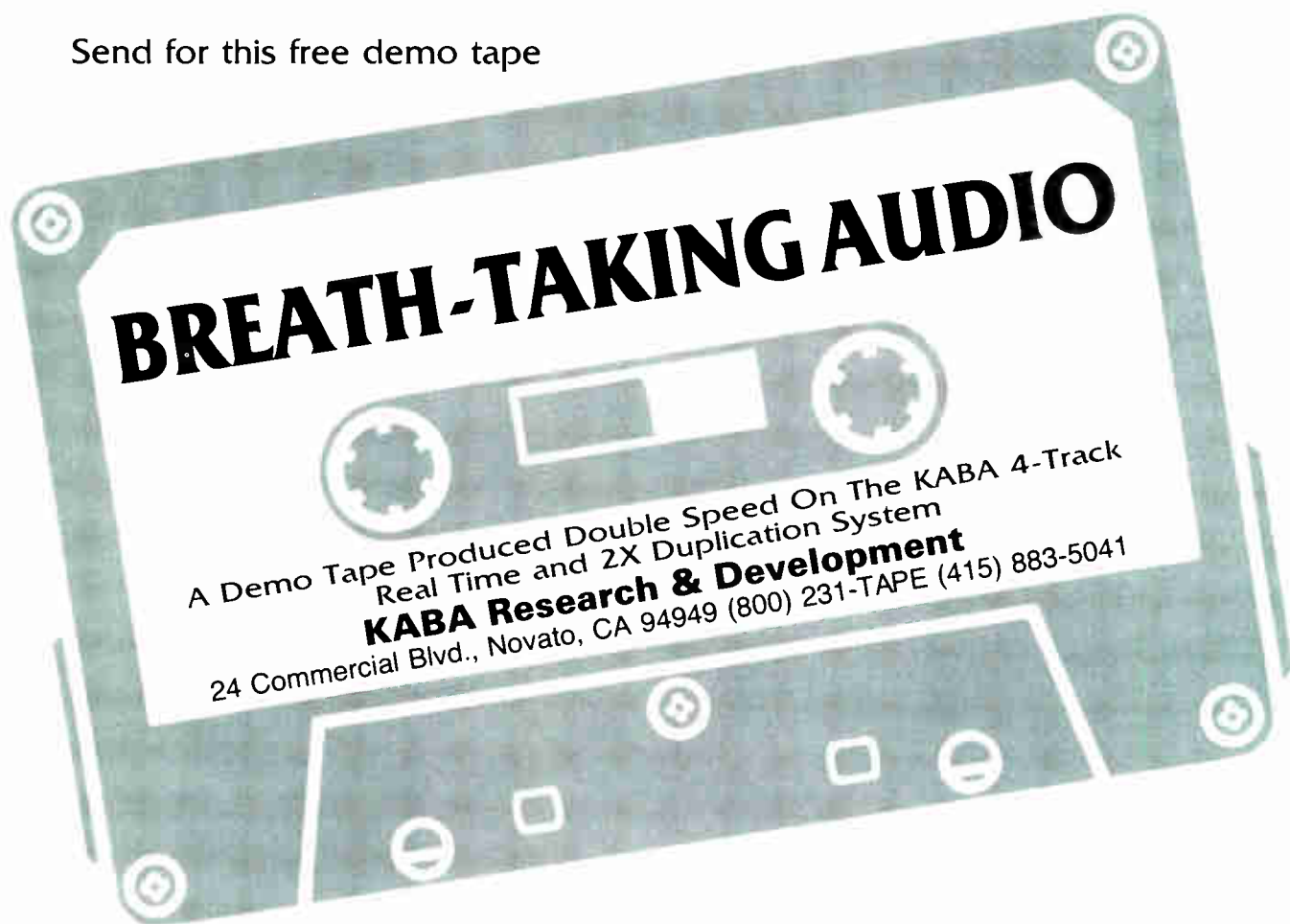

Find out how easy and economical it is
to produce cassette copies you'll be
proud to have carry your name.



KABA Research & Development

Toll-Free
800-231-TAPE

From California
(415) 883-5041

24 Commercial Blvd., Suite E, Novato, CA 94949



DRAGON STUDIOS
2" 16-Track Recording
 (415) 325-5575

DRAGON STUDIOS
 Redwood City, CA

[24+] DRAGON STUDIOS
 also REMOTE RECORDING
 100 Fifth Ave.
 Redwood City, CA 94063
 (415) 366-5575
 Owner: Charles and Sally Albert
 Studio Manager: Cathy Furness
 Engineers: Charles Albert, Bruce Kaphan, Laetitia Sonami, Tom Carr
 Dimensions: Room 1 studio 24 x 22, control room 22 x 23
 Room 2 studio 9 x 8, control room 13 x 7
 Mixing Consoles: MCI JH-636 32 x 24 w/JH-50 automation, Ramsa WR-8816 16 x 8
 Audio Recorders: MCI JH-16/24 16-/24-track autolocate II VSO, Otari MX-5050 MkIII 8-track VSO counter, MCI JH-110B 2-track locate, remote, VSO, counter, Ampex 440C 2-track servo, VSO/display, Otari MX-5050B 2-track VSO, Sony PCM-501ES 2(4)-track digital
 Cassette Recorders/Duplicators: (10) Nakamichi BX-100, (3) Technics M205
 Noise Reduction Equipment: (4) dbx 155 Type II, (2) Dolby A, Dolby SR
 Synchronization Systems: BTX 2 3-machine sync to video or audio-audio.
 Echo, Reverb, & Delay Systems: Lexicon 224 digital reverb, Lexicon PCM70 digital reverb/effects, Yamaha REV7 digital reverb/effects, (2) Yamaha SPX90 digital reverb/effects, ART 01A digital reverb, Master-Room XL-305, Master-Room XL-121, Lexicon PCM41 DDL, DeltaLab DL-4 DDL, (2) ADM 256 Effectron, (2) ADM 1024 DDL, ADA STD-1 stereo tapped delay, Sequential Circuits Pro-FX DDL, phaser/flanger.
 Other Outboard Equipment: (3) UREI 1176LN limiter, (2) Valley People Dyna-Mite Dynamics processor, (2) Valley People Kepex gate/expander, Symetrix CL-100 compressor/limiter/de-esser, (2) Symetrix SG-200 signal gate, Roland Vocoder, (2) White 4001 1/3-octave EQ, (4) PE-40 Parametric EQ 4-band, Aphex Aural Exciter, Technics SL-1200 MkII turntable.
 Microphones: (2) Neumann U87, Neumann U89, (3) Neumann KM84, (2) AKG 414, AKG D190E, (3) Sony C-37A (tube), Sony C-33F, (6) Sennheiser 441, Sennheiser 421, Crown PZM-6LP, (2) Countryman EM-202PPM, isomax IIC, E-V RE20, (7) Shure SM57, Shure SM58, (4) Beyers M-500, Beyers Soundster, (4) Countryman DI, Conquest DI.
 Monitor Amplifiers: Hafler P500, (2) BGW 100, BGW 150, (3) Crown, Symetrix, Sweet C
 Monitor Speakers: (2) UREI 813, (4) Yamaha NS-10, (2) JBL 4311, (2) Auratone, Klipsch, (6) Realistic Minimus 7, (12) AKG, Fostex, Sennheiser headphones.
 Musical Instruments: Baldwin grand piano, Gretsch 5-piece drum set, Ludwig "Black Beauty" snare, (2) Yamaha DX7, Yamaha TX, E-mu E-max, Ensoniq Mirage, Ensoniq ESQ-1, Sequential Circuits Prophet 10, Roland JX-3P, Korg DDD digital drums, LinnDrum w/JL Cooper MIDI, Gibson Les Paul 1960 custom, custom strat w/Floyd Rose, Ibanez artist, Santa Cruz D-46C acoustic, Fender bass, deluxe amp (Amp Lab modified)
 Other MIDI Equipment: Macintosh Plus computer and drive, Opcode Studio plus two interface, Mark of the Unicorn Performer 2.0, 1.22, Composer, Opcode patch editor/librarians, sequencer
 Video Equipment: JVC high band 1/2", Sony BVU 3/4" A/B roll editing system, Grass Valley GVG-100 switcher, JVC CCD 700 line res, Ikegami, Sony cameras, Mindset character generator, Lowell light kits
 Other: Sound effects library (digital), in-house original music library
 Extras & Direction: Air conditioned, lounge, kitchenette, parking, walk to restaurants and stores (24 hr). Fully equipped MIDI/keyboard/8-track room at special rates. Nakamichi chrome cassette dupes. Production, arrangement, full staff of session musicians, vocalists, programmers, etc. Founded, owned and run by professional musician/engineers with years of experience on both sides of the glass. Staff engineers specialize in production and arrangement and understand music. We'll even play a part for you at no extra charge. Beginner or veteran—we've been there, and will work with you. We care about every single project

N O R T H W E S T
24+ TRACK
STUDIOS

and respect your budget like our own. For better product, without compromises, for less money—call us. At Dragon Studios, the bottom line is music. Catero/Fantasy, Mayfield Records; Windham Hill, CBS; Pacific International; Random House; MR Records; First Strike. John Lee Hooker; Buddy Miles; Tuck & Patti; Wire Train; Strange Toys; Daddy in his Deep Sleep; Baxter Robertson (148)



PHIL EDWARDS RECORDING
 1534 WEST WINTON AVENUE • HAYWARD, CA 94545 1311

PHIL EDWARDS RECORDING
 Hayward, CA

[24+] PHIL EDWARDS RECORDING
 also REMOTE RECORDING
 1534 W. Winton Ave.
 Hayward, CA 94545
 (415) 784-1971
 Owner: Phil Edwards
 Studio Manager: Brian Hague
 Extras & Direction: Specializing in remote recording, broadcast spot production and album post-production. Call for rates and brochure

[24+] EXIT RECORDS STUDIO
 9844 Business Park Dr.
 Sacramento, CA 95827
 Owner: Exit Records Inc.

[24+] EXTRA SENSORY PRODUCTIONS
 1028 Bellevue Way SE
 Bellevue, WA 98004
 (206) 451-2652
 Owner: Charles Meserole
 Studio Manager: Charles Meserole

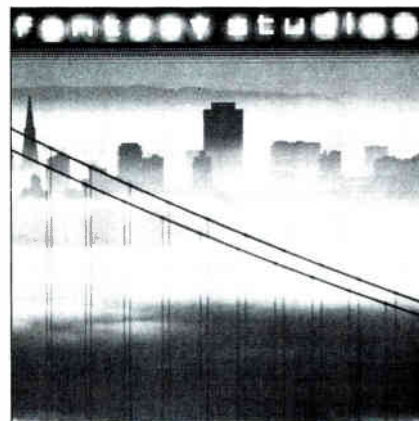

FANTASY STUDIOS
 Berkeley, CA

[24+] FANTASY STUDIOS
 10th & Parker Sts.

Berkeley, CA 94710
 (415) 549-2500
 Owner: Fantasy Records
 Studio Manager: Nina Bombardier
 Engineers: Danny Kopelson, Dave Luke, Michael Rosen, Tom Size
 Dimensions: Studios: (A) 30 x 50, (B) 21 x 26, (C) 24 x 37, (D) 30 x 50 w/18 x 30 string room. Other rooms: CD and d.s.c. mastering room, keyboard room w/Kurzweil 250 and tape copy room.
 Mixing Consoles: SSL 4056E 56 x 32 Total Recall and automation, Neve 8108 40 x 32, Neve 8108 32 x 24, Trident Series 80 32 x 24 x 32
 Audio Recorders: Mitsubishi X-850 32-track digital, Mitsubishi X-80 2-track digital, Sony PCM-1630 2-track digital w/D4000, Sony PCM-F1 2-track digital, Studer A800 24-track, Studer A80 2-track 1/2" and 1/4", Studer A80 4-track 1/2", MCI 110C 4-track and 8-track
 Echo, Reverb, & Delay Systems: Live chambers, EMT 140, Eclipate, AMS, EMT 250, Lexicon 224XL, Lexicon 200, PCM60
 Other Outboard Equipment: Bel DDL, Eventide DDL, Eventide 910 Harmonizer, Eventide 949 Harmonizer, Lexicon Prime Time, Dyna-Mite gates, Drawmer gates, Lexicon PCM42 DDL, Space Station, ADR Compex limiter, ADR Vocal Stresser, dbx 160 limiters, Orban de-esser, Scamp rack, MXR phaser and much more
 Microphones: (174) microphones—ribbon dynamic, condenser and PZM
 Monitor Amplifiers: Crown, McIntosh
 Monitor Speakers: Sierra-Hidley, UREI Time Aligned, Yamaha NS-10s, Auratones, Visoniks, MDMs, JBL 4311
 Video Equipment: Video sweetening, video transfers, 3/4" to VHS or Beta 1/2", SMPTE code, window dubs, etc.
 Rates: Call for rates, Nina, Andrea or Roy.

[24+] FINE ARTS RECORDING STUDIO
 also REMOTE RECORDING
 C-550 HFAC
 Provo, UT 84602
 (801) 378-2854
 Owner: Brigham Young University
 Studio Manager: Jon Holloman

[24+] FOCUSED AUDIO
 30 Berry St.
 San Francisco, CA 94107
 (415) 777-3108
 Owner: Jeff Roth
 Studio Manager: Jeff Roth
 Engineers: Jeff Roth, Jaime Kibben, James Allen
 Dimensions: Room 1 studio 12 x 14, control room 20 x 40, Room 2 studio 12 x 14, control room 12 x 14
 Mixing Consoles: Studio B. Allen & Heath 16 x 16, upgrading Studio A's 32 x 24 console.
 Audio Recorders: Otari MX-80 24-track, Fostex B-16 16-track, Otari MTR-10 2-track center track SMPTE, Technics RS-1500 2-track
 Cassette Recorders/Duplicators: Sony Hitachi, Akai
 Noise Reduction Equipment: (3) dbx 155 (4 channels each).
 Synchronization Systems: IBM clone w/Kelly Quan Audio Editing System, (3) Cypher Digital Shadow, Shadowpad
 Echo, Reverb, & Delay Systems: (2) Yamaha SPX90, ADM 1024 Effectron DDL, MIDiverb, Master-Room reverb, Roland SDE-1000 DDL
 Other Outboard Equipment: (2) Kepex noise gates, (2) Gain Brain compressor/limiters, UREI 1176 stereo peak limiter, Aphex Aural Exciter, (2) Orban paragrahic equalizers, White passive equalizer, Roland 15-track CompuEditor SMPTE automation, (3) Orban de-esser.
 Microphones: RCA DX77 ribbon, RCA BK5A ribbon, Schoeps, Sennheiser 421, Sennheiser 441, Sennheiser condensers, (3) E-V R15, Neumann available.
 Monitor Amplifiers: NAD, Crown.

Monitor Speakers: JBL bi-rials, Yamaha NS-10M
 Musical Instruments: Roland S-50 digital sampler, Ensoniq Mirage digital multi-sampler, (2) Oberheim OB-8 polyphonic 8-voice synth, Roland D-50 Linear 16-voice synth, Roland Juno 60 programmable 6-voice synth, Roland MD-8 MIDI/DCB interface, Yamaha TX7 6-voice digital FM synth, Oberheim digital drum machine, E-mu Drumulator, Roland G-303 guitar, Roland GR-300 synth, Fender Telecaster, (2) Music Man amplifiers.
 Other MIDI Equipment: Opcode Studio Plus 2 interface, Farralon computing Phone net interface, Korg MIDI synchronizer.
 Video Equipment: JVC 8250 3/4" w/address track time code, JVC BR8600 VHS editor, JVC VHS Hi-I recorder, BTX synchronous time code generator, BTX regenerator.
 Other: (2) Apple Macintosh Plus w/hard disks, Apple Macintosh SE, (19) software programs for sequencing, sampling and editing digital audio.
 Rates: Studio A: audio only \$60/hr., audio-for-video \$125/hr.; Studio B: audio only \$50/hr., audio-for-video \$85/hr. Consultation, complete soundtrack design and booked rates on a per project basis.
 Extras & Direction: Focused Audio specializes in post-production sound for theatrical, broadcast and corporate film and video. Working with SMPTE synchronization since 1983, Focused has been an innovator in the development and application of software for audio post-production (see *Mix* article April 1987 "Focused Audio Meets Kelly Quan Research"). With audio engineers experienced in film, video and music/MIDI produc-

tion. Focused has pioneered the development of new techniques which bring together the best qualities of these previously distinct audio disciplines. Speed, flexibility and creativity in soundtrack design and production are the result of our hardware, software and talent mix. From feature films to documentaries, Universal Studios to "Gumby", HBO to MTV, Focused Audio is committed to client satisfaction. In two SMPTE studios, Focused offers total audio post-production services, including original music and sound FX creation (as well as vast CD libraries); ADR; Foley; narration recording; digital sampling and editing; MIDI sequencing; SMPTE-based automated mix



FTM STUDIOS
Denver, CO

[24+] FTM STUDIOS
also REMOTE RECORDING

1111 S. Pierce St.
Denver, CO 80226
(303) 922-3330

Owner: John & Diane Sundberg
Studio Manager: John F. Sundberg

Engineers: John Sundberg, Dave Lumaye, approved independents: Jeff Shuey, Steve Avedis, Michael Pfeifer, Dan Diamond
Dimensions: Room 1 studio 2,200 sq ft w/5 isos, control room 550 sq ft Room 2 studio 1,500 sq ft w/4 isos, control room 450 sq ft Room 3 550 sq ft w/1 iso, control room 350 sq ft
Mixing Consoles: Soundcraft 2400 24 x 24 x 24 customized and modified, Soundcraft 2400 24 x 24 x 24 customized and modified, Tascam 15 24 x 16 x 8.

Audio Recorders: Otari MTR-90 24-track w/autolocator, (2) Soundcraft 760 24-track w/autolocator, Otari MTR-10 2-track 1/2" and 1/4" w/center track SMPTE, (3) Otari MkIII 2-track 1/4", Otari MkIII 4-track 1/2", (2) Ampex ATR-700 2-track 1/4", Tascam Series 70 4-track 1/2", Tascam 80-8 8-track 1/2", Otari 5050B 8-track 1/2"

Echo, Reverb, & Delay Systems: EMT 140 plate, Audi-ence plate, Quantec QRS, (2) Lexicon 200 w/6 programs, Roland SRV-2000, AKG BX-10, (2) Scamp stereo, (2) Lexicon Prime Time II, Lexicon Prime Time, (3) DeltaLab, Eventide 949 Harmonizer, Eventide 910 Harmonizer, (2) 1024 Effectron II, MXR pitch transposer, DL-5 pitch transposer, Ursa Major Space Station, Lexicon PCM70, (4) Yamaha SPX90.

Other Outboard Equipment: Galax, Scamp: (4) limiter/compressors, (4) expander gates, (4) noise gates, automatic panner, (2) parametric EQs, (4) Symetrix 501 limiters, (2) Symetrix 522 limiter/exp, (8) Biamp limiters, (3) dbx 161, (4) dbx 160X, (2) dbx 162, (3) Aphex, (2) Sontec, (2) Audioarts 4200B parametric EQs, (2) dbx 905 parametric EQs, (2) Orban stereo parametric EQ, (2) dbx 902 de-essers, (2) Orban 536A de-essers, (3) Orban 516EC de-essers, UREI LE5, 1176, Valley People Dyna-Mite gates, (2) MXR 1/3-octave EQs.

Microphones: AKG C-24, AKG 442, AKG 414, AKG D112, Neumann U87, Neumann KM86, Neumann KM84, Neumann U47, Shure SM81, Shure SM85, Shure SM57, E-V RE20, E-V RE15, E-V RE10, E-V RE16, E-V RE11, Sennheiser 421, Sennheiser 431, Crown PZM, Countryman Pressure Zone Monitor Amplifiers: Crown Delta Omega, (8) Haller 500, Crown 300D, Crown 150D, Crest 3501.

Monitor Speakers: UREI B13B, E-V 500, Yamaha SP10, Auratone, Tannoy 12B, Tannoy 10B, E-V 100

Musical Instruments: Kawai 7' grand piano, Kawai US50, Kurzweil 250 w/all blocks and sampling, Oberheim OB-Xa, Oberheim DMX, Oberheim DSX, Rhodes, Korg C-30 organ, ARP Odyssey, Korg DW8000, Yamaha TX7

Video Equipment: Adams-Smith 2600 SMPTE-EBU, JVC CR-850U 3/4" video stereo recorder, Otari 1/4" w/center track SMPTE, NEC 25" high resolution monitor

Rates: (1) \$65 w/eng., (2) \$40 w/eng., (3) \$15 w/eng

Extras & Direction: Large lounge w/big screen TV, kitchen and meal table. Conference room with high ceilings for practice and relaxing. All rooms acoustically designed. Constructed from the ground up. Studios 1 & 2 with RPG diffusers on rear walls. Real time cassette duplication. CD Sound effect and music libraries. 48 tracks available, commercials, jingles, audio sweetening, film scoring. Arrangers and producers are available. One of the

nation's finest studios. Located on the west side of Denver. Near summer mountain activities and winter skiing

[24+] PHILIP ROSCOE GALLO PRODUCTIONS
3112 Laguna
San Francisco, CA 94123
(415) 563-8223
Owner: Roscoe Gallo
Studio Manager: Roscoe Gallo



GRANNY'S HOUSE RECORDING STUDIOS
Reno, NV

[24+] GRANNY'S HOUSE RECORDING STUDIOS
1515 Plumas St.

Reno, NV 89509
(702) 786-2622

Owner: Robert Forman
Studio Manager: Robert Forman



JOE HOFFMANN STUDIOS
Occidental, CA

[24+] JOE HOFFMANN STUDIOS
also REMOTE RECORDING
PO Box 840

Occidental, CA 95465
(707) 874-2278

Owner: Joe Hoffmann
Studio Manager: Tina Dungan

Engineers: Joe Hoffmann, Randy Quan, Stephen Hart

Dimensions: Studio 23 x 26 skewed, drum/iso booth 10 x 14 skewed, control room 16 x 21 skewed

Mixing Consoles: NEOTEK Series II 28 x 24, Ramsa 8210A 10 x 4

Audio Recorders: Otari MTR-90 16-/24-track, Otari MX-5050 MkIII 8-track, TEAC 3340S 4-track, Otari MX-5050B 2-track, Otari MTR-12 2-track (30 ips)

Cassette Recorders/Duplicators: Akai GX-F71, (5) TEAC for real time dupes

Echo, Reverb, & Delay Systems: Klark-Teknik DN-780, Lexicon 60, Lexicon 70, Lexicon 200, Roland DEP-5, Roland SRV-2000,

—CONTINUED ON NEXT PAGE

AUTOMATION... NATURALLY

Adding automation to a mixing console has never been easier.
Using automation has never been more natural.

Simply patch proMIX in series with the audio path of your existing console and connect it to your MIDI sequencer. No computer is needed.

proMIX

editing can be done on any or all channels simultaneously.

proMIX is a modular system that can grow with you. The basic system can be expanded up to 64 channels in any multiple of 8. Prices start under \$2000.

Now do your mixdown using the proMIX panel in MANUAL mode — just as you would use your existing board. Because proMIX is recording every subtle movement of faders and mutes, you are hearing your mix just as it will sound when you play it back in the AUTO mode. With proMIX, what you hear is what you get.

There is much more to the proMIX story. Call or write today for more information on the most comprehensive, easiest to use automation system you can add to your mixer.

If changes are needed, the EDIT mode allows you to either modify or replace fader moves using the unique proMIX Auto Splice system. And with a fader dedicated to each channel,

Microsystems, Inc.
2500 E. Foothill Blvd., Suite 102
Pasadena, CA 91107 • (818) 577-1471

Circle #123 on Reader Service Card

MICMIX XL-305, MXR flanger/doubler
 Other Outboard Equipment: Symetrix 522 [5 function stereo], Symetrix SG200 stereo gate, (2) Symetrix 501 comp/limiter, (2) UREI LA-4 comp/limiter, (2) Phase Linear E51 parametrics, (10) dbx 150, (4) Dolby C, Technics SL-1200 MkII, Shure V15 Type 5 cartridge, Barcus-Berry Electronics processor, Dolby A 24 channels, Dolby SR mastering, CD player.
 Microphones: AKG, Audio-Technica, B&K, Beyer, Countryman, E-V, Sennheiser, Shure, Sony, Tascam, Neumann M249 tube Monitor Amplifiers: Peavey DECA 700, Carver t200, JBL 660, Rane HC-6 [cue]
 Monitor Speakers: KEF Model 105/2, KEF 104/2, Yamaha NS-10, Toa 312-ME, Auratones
 Musical Instruments: Steinway 9' concert grand
 Video Equipment: Live session shoots arranged with a local production company in 1/2" or 3/4" video format
 Rates: \$35-\$50/hr Please call for rate card and literature
 Extras & Direction: The owner designed and built the studio from the ground up, using state-of-the-art concepts. It's located in a gorgeous rural setting near the Russian River resort area. Skylights and a large picture window provide plenty of natural light. The studio, including lounge is climate controlled and wheelchair accessible. Certified massage and hypnosis are available for performance preparation. Complete production capabilities: albums, demos, cassettes, video soundtracks, radio drama, musicals... The acoustic design of the studio offers remarkably warm and rich sound for acoustic instruments. Recent credits: 1986 Windham Hill albums. We offer sensitive professional engineering in a good feeling environment

[24+] HORIZON RECORDING STUDIO
 also REMOTE RECORDING
 1317 S. 295th Pl.
 Federal Way, WA 98003
 (206) 941-2018
 Owner: Roger A Wood
 Studio Manager: Bill Gibson

[24+] HYDE STREET STUDIOS
 245 Hyde St
 San Francisco, CA 94102
 (415) 441-8934
 Owner: Michael Ward
 Studio Manager: Ricky Lee Lynd
 Engineers: Garry Creiman, John Cunibert, Ricky Lee Lynd, Brian Risner, E.J. Ermons, Wendy Bardsley, Andrew Murdock
 Dimensions: Studio 31 x 20, control room 20 x 18
 Mixing Consoles: Amek 2500 48 x 24 x 48 automated/Master-Mix disc-based
 Audio Recorders: Otari MTR-90 II 16-/24-track w/autolocator, 3M M-79 16-track (w/autolocate), Otari MTR-10 2-track 1/4", Otari MTR-12 2-track 1/2", (2) Otari MX-5050B 4-track, Scully 280 1/2"
 Echo, Reverb, & Delay Systems: Acoustic chamber, Yamaha REV7 (digital reverb w/MIDI), Lexicon PCM60, Lexicon PCM41, Lexicon PCM42, Eventide 949 Harmonizer, DeltaLab DL-2, Lexicon PCM70, stereo EMT plate, Lexicon 480L w/LARC
 Other Outboard Equipment: (6) Drawmer noise gates, (5) Dyna-Mite, Teletronix LA-2A, (4) AD R F760 compressors, (2) UREI 1176LN, ADR Vocal Stresser, (2) UREI 546 stereo parametric EQ, (2) Furman parametric, (2) White 10-band EQ, Klark-Teknik 1/3-octave room EQ, (2) dbx 165A, UREI 565 Little Dipper
 Microphones: Neumann M49, Neumann U47 (tube w/omni capsule), Neumann U67, Neumann U87, Neumann KM54, AKG C12 (tube), (4) AKG C12A (tube), (2) AKG 414EB, Sennheiser, Beyer, Shure, Crown PZM etc, Countryman direct boxes.
 Monitor Amplifiers: Haller, Soundcraftsmen, Crown
 Monitor Speakers: Meyer, Yamaha NS-10M
 Musical Instruments: Steinway 9' grand piano, Emulator II, Hammond B-3 organ w/Leslie, Music Man amp, Rogers drum kit and percussion
 Video Equipment: Adams-Smith 2600 synchronizer system, Sony VO-5800 3/4" video deck w/address track modification.
 Rates: Please call for rates
 Extras & Direction: Dual multi-track lock-up in-house production of musical scores for film and video, real time duplication; cassette, 1/2-track, 1/2" 1/2-track and 2" safety masters, call screening, game and lounge room, free Peel's coffee. Now providing quality audio for film, video, radio, theater as well as traditional musical recordings for disc and demos.

[24+] INDEPENDENT SOUND
 San Francisco, CA
 (415) 929-8085
 Owner: Peter Buffett, Mary Buffett
 Studio Manager: Yvonne Graves
 Engineers: Peter Buffett
 Dimensions: Studio 13 x 12, control room 17 x 10
 Mixing Consoles: Sound Workshop Series 34 Automated 32 x 24
 Audio Recorders: Otari MTR-90II 24-track, Otari MTR-12 2-track, Otari 5050B 2-track
 Cassette Recorders/Duplicators: TEAC 122B, Sony TCD5M
 Synchronization Systems: Otari CB121
 Echo, Reverb, & Delay Systems: Lexicon 224 XL, Lexicon PCM70, Roland DEP-5, Eventide 949 Harmonizer, Bel stereo

N O R T H W E S T

24+ TRACK

STUDIOS

flanger.
 Other Outboard Equipment: (2) Drawmer gates, (2) Drawmer compressors
 Microphones: AKG 414, Neumann U87
 Monitor Amplifiers: BGW 750, AB Systems 205
 Monitor Speakers: JBL 4411, MDM 4, Yamaha NS-10, Auratones
 Musical Instruments: Synclavier digital audio system, Kurzweil 250, Linn 9000, Roland D-50, Yamaha TX7, Roland MKS-80, Roland MKS-20
 Video Equipment: JVC 3/4" video deck, Sony PVM-1910 monitor
 Rates: Call for rates

[24+] INFINITE STUDIOS
 PO Box 1709
 Alameda, CA 94501
 (415) 521-0321
 Owner: Michael Denten
 Studio Manager: Michael Denten



IRONWOOD STUDIO
 Seattle, WA

[24+] IRONWOOD STUDIO
 601 NW 80th St
 Seattle, WA 98117
 (206) 789-7569
 Owner: Paul Scoles
 Studio Manager: Myron Partman
 Engineers: Jay Follette, Paul Scoles, Ron Phillips
 Dimensions: Studio 34 x 28, control room 16 x 14
 Mixing Consoles: Harrison Raven automated 32 x 24
 Audio Recorders: Sony JH-24 24-track, Sony JH-110C 2-track 1/2" and 1/4", Tascam ATR-60 2-track 1/4" w/center time code
 Cassette Recorders/Duplicators: (2) Sanyo Technics
 Synchronization Systems: Audio Kinetics Q.Lock 4 10 synchronizer.
 Echo, Reverb, & Delay Systems: Lexicon 480L w/LARC, Lexicon 200, Lexicon PCM70, Lexicon Super Prime Time delay, Yamaha SPX90, DeltaLab DL-2 delay, Roland SRE-555 tape echo.
 Other Outboard Equipment: dbx 900 rack w/(4) gates, (3) compressors, de-esser, Teletronix LA-2A tube limiter, (2) UREI 1176 compressors, Aphex Type C Exciter, (2) Symetrix parametrics, (2) Symetrix compressors, (2) Symetrix gates, MXR pitch transposer, Roland Dimension D, Roland flanger
 Microphones: Telefunken U-47 (tube), Neumann U67 (tube), (2) Neumann U87, Neumann U47, (2) Neumann KM56 (tube), (2) Neumann KM84, AKG The Tube, (2) AKG 451, AKG D-12E, (2) Sennheiser 441, (2) E-V RE20, (2) Sony C-37A, Sony C-500
 Monitor Amplifiers: Haller P-500, (2) Yamaha P2050, Crown D-60
 Monitor Speakers: JBL 4430, JBL 4311, Yamaha NS-10, Auratones.
 Musical Instruments: Yamaha 7'4" grand w/Forte MIDI, Korg DSS-1 digital sampling synthesizer, Roland JX-10 synthesizer, LinnDrum, Hammond M-3 w/Leslie, Micromooq, Hohner clavinet, Pearl drums
 Other MIDI Equipment: Yamaha QX-5 sequencer
 Video Equipment: Sony JH-110C 1" layback recorder, Sony VO-5600 3/4" VTR, (2) NEC color monitors
 Other: Diskmix console automation system
 Rates: Please call for rates.

[24+] DENNY JAEGER CREATIVE SERVICES, INC.
 Oakland, CA
 (415) 339-2111
 Owner: Denny Jaeger
 Studio Manager: Denny Jaeger
 Dimensions: Studio 14.5 x 24, control room 14.5 x 22 w/adjoining equipment room 10 x 18.5
 Mixing Consoles: Harrison Series X virtual console 112 inputs x 48 bus
 Audio Recorders: (2) Sony 3324 24-track digital, Ampex ATR-124 24-track, Ampex ATR-104 2-/4-track 1/2", Sony PCM-F1 2-track digital, Otari MTR-20 4-track w/1/2" heads, Otari MTR-20 2-track w/1/2" heads
 Echo, Reverb, & Delay Systems: (4) Quantec room simulators, Lexicon 224XL, (2) Lexicon PCM70, (2) Lexicon PCM42, Lexicon 200, Eventide SP2016
 Other Outboard Equipment: (4) Drawmer stereo gates, Aphex Dominator, (2) Aphex compellers, (2) dbx 160X limiter/compressors, (2) LA-4, (2) UREI Universal filter sets, E-mu voltage controlled low pass filter, E-mu voltage controlled high pass filter, Aphex Aural Exciter II, Otari SR 24 channels, Dolby 361A, (5) Lynx modules
 Microphones: Schoeps, B&K, Neumann U87, Sony (many varieties), E-V RE20, Shure SM56, Shure SM57
 Monitor Amplifiers: Meyer MS1000 amp, Crest 4000, BGW 250, Bryston
 Monitor Speakers: Meyer 833 w/processor and Complementary Phase EQ
 Musical Instruments: Yamaha grand piano, Synclavier digital system w/32 megabytes of RAM, 64 voices, (2) 140 megabyte Winchester, velocity keyboard, guitar controller, SMPTE, MIDI, Kennedy cartridge device, music printing, "amaha DX7, Ensoniq ESQ-1, Oberheim Matrix-6
 Video Equipment: JVC 6650U 3/4" recorder, JVC 8250 3/4" recorder, Sony KV-25XBR monitor, Q Lock 4 10 synchronizer.
 Rates: Upon request

[24+] JAH WORKS STUDIOS
 PO Box 15
 O'Brien, OR 97534
 (503) 596-2180
 Owner: Jah Levi
 Studio Manager: Luna Dove
 Engineers: Jah Levi
 Dimensions: Room 1: studio 10 x 12, control room 12 x 12, Room 2: studio 12 x 12, control room 10 x 12, Drum booth 9 x 9
 Mixing Consoles: Studiomaster Series II 24 x 16, Yamaha RM1608 16 x 16, Sound Workshop Logex 8 12 x 8, TEAC 2A 6 x 4, Gemini 8 x 4 disco mixer
 Audio Recorders: Sony/MCI JH-24 24-track w/Alli, Postex Model 80 8-track, Nakamichi DMP-100 2-track digital PCM, Tascam ATR-60 2-track 1/2"
 Cassette Recorders/Duplicators: Eumig FL-1000, Technics RSB-100, TEAC W-880R dubbing deck, Nakamichi 600
 Noise Reduction Equipment: dbx 224 Type II 2-track
 Synchronization Systems: Postex 4050 autolocator, Korg KMS-300 MIDI-FSK sync
 Echo, Reverb, & Delay Systems: TC Electronic 2290, Yamaha REV7, Yamaha SPX90, Roland DEP-5, Roland SRV-2000, Roland SDE-2000, Alesis MIDiverb, Korg SDD-3300, Rockman rock modules, TOD Electronics 2-sec. sampling delay, TOD Electronics flanger
 Other Outboard Equipment: Aphex Type C Aural Exciter, TC Electronic 2240 para EQ, Orban parametric EQ, dbx 166 comp/limiter, Demiter tube bass preamp, dbx 2020 EQ, dbx 48X expander, dbx 120X subharmonic synth, Kyoocera DA-810 CD player, Akai CD player
 Microphones: Beyer MC-740, (2) Beyer M-88, Beyer M-69, Beyer M-160, AKG 414, (2) AKG D-310, AKG DT-330, (3) E-V PL10, E-V PL20, Audio-Technica ATM-21
 Monitor Amplifiers: (2) Sumo "The Nine" Class A, Yamaha AVC-50
 Monitor Speakers: JBL 4430, JBL Control 1, JBL 4612B, Klipphorn La Scala, Roland SRS-80
 Musical Instruments: Korg DSS-1, Casio CZ-5000, (4) Yamaha FB-01, Photon MIDI guitar converter, JL Cooper MSB 16/20, Korg DVP-1, Linn 9000, Sequential Circuits Studio 440, (2) MPC percussion computer, set of North drums, Yamaha FX11, (2) Ken Smith bass, many guitars, basses, amps, percussion, sitar and ethnic instruments, Trace-Elliott, Fender and Roland Jazz Chorus—120 amps
 Other MIDI Equipment: Roland Octapad, Atari 1040ST w/Steinberg Pro-24, Fairlight Voice-tracker, Yamaha QX-1
 Video Equipment: Samsung VHS VCR
 Other: Biotech Bionaire 2001, industrial air filter and negative ion generator, Honda EX5500 generator, (2) Heart interface sine-wave inverter and chloride battery pack, (20) Arco photo-voltaic panels
 Rates: 8-track \$25/hr., 24-track \$45/hr. also open to bartending

[24+] JENSEN SOUND
 San Francisco, CA 94115
 (415) 469-0192
 Owner: Eric and Suzanne Jensen
 Studio Manager: Suzanne Jensen

BACK ISSUES

- 1985 January, Northwest Studios.** Superbowl Sound. Springsteen on Stage. Ray Parker Jr. Leon Russell.
- 1985 February, Independent Engineers & Producers.** Brian Eno. The Art of Touring. Roger Powell on MIDI. Les Paul.
- 1985 March, Southeast Studios.** Loudspeaker Technology. Martin Rushent. Cotton Club Sound. John Fogerty.
- 1985 April, Video Production Supplement with Facilities Listings.** Compact Power Amps. Radio Recorders' Harry Bryant. Eurythmics.
- 1985 May, Northeast Studios.** Digital Reverb. Flo & Eddie. Holophonics. Emmylou Harris. Humberto Gatica.
- 1985 June, Sound Reinforcement & Remote Recording Listings.** Location Recording Tutorial. Grateful Dead Sound. Weird Al Yankovic. Synthesizer Oriented Studios. David Sanborn.
- 1985 July, Recording School Listings and Southwest Studios.** Mixing Consoles. Dr. Demento. Kashif's Studio. Roger Nichols and John Denver.
- 1985 August, Studio Design Issue: Listings of Designers & Suppliers.** Control Room Acoustics. Thomas Dolby. Orchestral Recording. On the Road with Prince. Neil Young.
- 1985 September, Southern California Studios.** Film & TV Sound. Frank Zappa. Digital '86 Supplement. *Mishima* Sound. David Foster.
- 1985 October, New Products for AES.** Maintenance & Testing. Abbey Road Studios. Ambisonics. Ben Burt on Imax. Nile Rogers.
- 1985 November, North Central & Canadian Studios.** George Massenburg.

Video Supplement. Alligator Records. Women in Media Production.

- 1985 December, Tape-to-Disc Listings.** Mastering, Pressing & Duplication. TEC Award Winners. Sound for the *Twilight Zone*. Tom Waits.
- 1986 January, Northwest Studios.** Equipping Home Studios. Paul Winter. SMPTE/MIDI Connection. Yoko Ono.
- 1986 February, Independent Engineers & Producers.** Microphone Special Report. Laurie Spiegel. Budgeting for Sessions. Joni Mitchell.
- 1986 March — SOLD OUT**
- 1986 April, Video Production & Post Production Facilities.** Video Supplement. Al Kooper. Wireless Mics. Alan Parsons.
- 1986 May, Northeast Studios.** Digital Supplement. Sampling Primer. CD Facilities. Future of Console Design. Steve Lillywhite.
- 1986 June, Remote Recording & Sound Reinforcement Listings.** Roadability. Russ Titelman. CD ROM & CD I. Ry Cooder.
- 1986 July — SOLD OUT**
- 1986 August — SOLD OUT**
- 1986 September, Southern California Studios.** Film Sound. Telecommunications. Production Music Libraries. David Byrne's *True Stories*.
- 1986 October — SOLD OUT**
- 1986 November, New Products Directory.** CD I Supplement. Kenny Loggins' Tour Sound. Daryl Hall. Grounding Printer. Rupert Neve.
- 1986 December, Tape-to-Disc Issue: Mastering, Pressing & Duplication Facilities.** CD Manufacturing. Mastering Engineers' Forum. Lee Ritenour's Studio. Casey Kasem.

1987 January — SOLD OUT

- 1987 February, Independent Engineers & Producers.** International Recording Supplement. APRS Studio Directory. Bruce Lundvall. DMM for CD. Kitaro.
- 1987 March, Southeast Studios.** Digital Recording Supplement. Tom Jung. CD Mastering Forum. Richard Thompson.
- 1987 April, Video Production & Post-Production Facilities.** Location Mic Techniques. Adrian Belew. Synchronizer Survey. Pee wee's Playhouse.
- 1987 May, Northeast Studios.** Stevie Wonder & Nile Rodgers Record by Satellite. Programmable Signal Processors. GRP Records. Digital Video Interactive. George Martin.
- 1987 June, Remote Recording & Sound Reinforcement Listings.** Touring Con

soles. Video's Stephen Johnson. Women in Sound Reinforcement. Paul Simon Live in Zimbabwe.

- 1987 July — SOLD OUT**
- 1987 August SOLD OUT**
- 1987 September, Southern California Studios.** Recording in Hawaii. The Doors. Analog 2 tracks. Phil Spector.
- 1987 October, New Products Directory.** Producers' Forum. John Hiatt. Tape Recorder Maintenance. Laurie Anderson.
- 1987 November, North Central and Canadian Studios.** George Harrison. Pioneers and Trends in Film Sound. Localization. Maurice Jarre.
- 1987 December, Mastering, Pressing, Tape Duplication and CD Facilities.** Chet Atkins. Alf Clausen's Scoring for TV. Steve Lukather.

CHECK THE ISSUES YOU'RE INTERESTED IN.

of BACK ISSUES CHECKED ABOVE at \$5.00 each (\$6.00 outside U.S.) _____

CHECK ENCLOSED FOR TOTAL (U.S. Funds) Payment must accompany order. \$ _____

NAME _____
ADDRESS _____
CITY _____ STATE _____ ZIP _____

MAIL TO: Mix Back Issues, 6400 Hollis Street, Suite 12, Emeryville, CA 94608
Make checks payable to Mix Publications; allow four weeks for delivery within U.S.

BINDERS

MIX MAGAZINE is a year-round reference tool. Keep your issues protected, ordered, and easily accessible in our handcrafted magazine cases and binders.

Both styles hold a year's worth of *Mix*, and are bound in crimson leatherette with the *Mix* logo embossed in gold.

MAGAZINE CASES: \$7.95 each, 3 for \$21.95, 6 for \$39.95

BINDERS: \$9.95 each, 3 for \$27.95, 6 for \$52.95

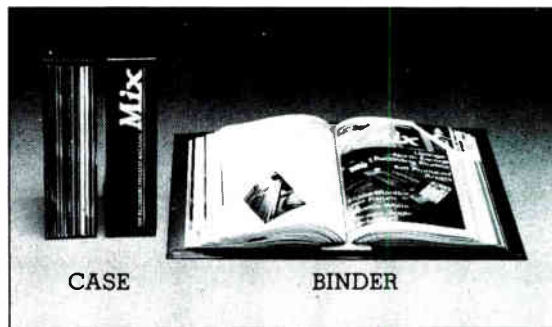

CASE

BINDER

MAIL TO: Jesse Jones Industries
Dept. MIX
499 East Erie Avenue
Philadelphia, PA 19134

TOLL FREE PHONE (Charge Orders ONLY):

1-800-972-5858

Print Name _____

Address _____

No PO Boxes Please

City _____ State _____ Zip _____

Satisfaction Guaranteed by Jesse Jones Incl.

Please send me _____ CASES and/or _____ BINDERS.
Add \$1 per unit for Postage & Handling, (\$2.50 outside U.S.)
PA residents add 6% tax.

CHECK ENCLOSED FOR _____
(U.S. funds only; payable to Jesse Jones Industries)

OR CHARGE MY: (minimum \$15)

_____ American Express _____ Visa _____ MasterCard _____ Diners Club

Card # _____ Exp. Date _____

Signature _____

[24+] L.A. EAST
915 W. 100 South
Salt Lake City, UT
(801) 532-3278
Owner: Randall Thornton, Brian Holheins, Gary Jackson
Studio Manager: Jeff Carter



STEVE LAWSON PRODUCTIONS
Seattle, WA

[24+] STEVE LAWSON PRODUCTIONS
2322 6th Ave.
Seattle, WA 98121
(206) 625-9153

Owner: Steven Lawson Productions, Inc
Studio Manager: Steve Lawson
Engineers: Bob Israel, Steve Lawson, Jim Wilson, Terry Date, Vince Werner, Bruce Calder, Carol Howell, Randy Yount
Dimensions: Room 1, studio 27 x 16.5, control room 17 x 13, Room 2, studio 13 x 14, control room 12 x 13, Room 3, studio 50 x 14, control room 16 x 11
Mixing Consoles: (2) MCI 636 automated 28 x 24, Tangent 3216
Audio Recorders: (2) MCI JH-24 24-track, MCI JH-110C 8-track, (3) MCI JH-110C 2-1/4-track, (3) Otari 5050 2-track, Sony ATR-5003 2-track center track time code
Echo, Reverb, & Delay Systems: Eventide 949 Harmonizer, Lexicon 224X w/LARC, AMS reverb, Lexicon Prime Time, Lexicon Prime Time II, (3) PCM-42, Klark-Teknik DN-780, AMS RMX-16, Yamaha REV7
Other Outboard Equipment: (2) UREI 1176, UREI 1178, Symetrix 501, Gain Brains, Kepex, Scamp rack w/assorted modules, Symetrix Hybrid telephone interface, Orban de-esser, Symetrix 522, (2) Teletronix LA-2 tube limiter, CD players, satellite downlink to studios around the country
Microphones: AKG, Shure, Neumann, Sennheiser and others
Monitor Amplifiers: UREI, BGW, Crown, Hafler
Monitor Speakers: JBL 4430, JBL 4311, UREI Time Aligns, MDM 4, Auratone, Yamaha NS-10
Musical Instruments: (2) Yamaha 7'4" grand pianos, Tama SuperStar drum kit w/power-toms, LinnDrum, DMX, Oberheim drum machines, Music/MIDI suite, Kurzweil 250 advanced, Yamaha TX rack w/4 modules, Juno 106 synthesizer keyboard, Macintosh computer, Opcode MIDImac 2.5 sequencer, and assorted edited programs, books w/operator tie lines to all studios

Video Equipment: Audio Kinetics QLock synchronizer, Sony BVU-800, MCI 1" layback machine for laying audio directly to 1" videotape.
Rates: Call for information.

Extras & Direction: Our equipment and rooms are state-of-the-art, but it is our people that make us shine. We work on many different types of projects from heavy metal to light banter, LP project and audio sweetening soundtracks, radio and TV commercials and audio sweetening of video projects. We also offer high quality high-speed reel to reel and cassette dubs in mono and stereo. Call for rates. Our great rooms and comfortable atmosphere attract superb engineers. Our commercial work has been recognized by the world's largest awards including: Clio, IBA, Andy's, One Reel Show and Best in the West. Our music production includes major label releases with top producers. And best of all, our clients from around the country come back. Again and again. Give us a call. We'd love to give you a tour.

[24+] LIVE OAK STUDIO
also REMOTE RECORDING
1300 Arch St.
Berkeley, CA 94708
(415) 540-0177

Owner: Jim & Priscilla Gardiner
Studio Manager: Priscilla Gardiner
Engineers: Daie Everingham, Arne Frager, Jim Gardiner
Dimensions: Studio 350 sq.ft., attic 800 sq.ft., control room 275 sq.ft.

N O R T H W E S T

24+ TRACK

STUDIOS



LIVE OAK PRODUCTIONS
Berkeley, CA

Mixing Consoles: MCI JH-636 console w/ARMS III/Diskmix automation, Sound Workshop Series 34C 32 x 28 x 24 automated, Yamaha DMP7 8 x 2 digital record console
Audio Recorders: MCI JH-24 16-1/4-track w/autolocator III, Otari MTR-10 2-track 1/2" and 1/4", Sony PCM-F1 2-track digital, MCI JH-24/16
Echo, Reverb, & Delay Systems: Lexicon 224XL, Lexicon Prime Time II, Lexicon PCM42, Lexicon SDE-3000, Publison America Internal Machine 90 stereo audio computer w/controller, Yamaha REV7, (2) MIDVerb II
Other Outboard Equipment: Full Scamp rack, Vocal Stresser, Drawer gates, UREI LA-2, UREI LA-3A, UREI 1176, Spectra Sonics 610, Publison America fullmost vocal exciter, Publison CL20C, Drawmer DS-201, Symetrix 544, dbx compressor/limiter
Monitor Amplifiers: Bryston 3B, Bryston 4B, Yamaha, Crown, Crest, (2) UREI 809
Monitor Speakers: JBL 4430 Bi-Rad at JBL 4401, Yamaha NS-10, Toa 265 ME, Auratone
Musical Instruments: Kurzweil 250 w/50kHz sampling option, (thousands of voices available), E-mu SP-12 sampling drum machine, Yamaha TX816 rack system w/8 DX7 modules, Opcode Voice Editor and Librarian software (5,000 patches), Oberheim Matrix 12 synthesizer, Casio CZ-101 synthesizer, Garfield Master Beat, Emulator II, IBM PC, Apple Macintosh system w/Mark of the Unicorn Performer software for up to 250 tracks of MIDI control/recording, sequencing and music notation
Video Equipment: Audio Kinetics QLock 4 10-E synthesizer w/Eclipse editor, JVC 8250 3/4" U-VCR, Sony VTH-1020 Q-I high resolution color projection system w/100" screen, Sony KV-1311CR 13" color monitor
Rates: Upon request

Extras & Direction: Artists lounge with spectacular views of the Bay, Private garden with redwood decks and brick patios. Complete pre-product on services available using top of the line synthesizers and computer programs. Live Oak Studio is designed for the artist/composer or producer who wishes the highest quality recording tracks for his or her project. We are equipped to produce albums or to record tracks for movie scores or video work. We have the very latest synchronization gear, a computer-automated mixing console and an outstanding collection of outboard gear including the Publison Internal Machine 90. We have a long list of satisfied clients who enjoy the beautiful and peaceful private atmosphere. If you need a producer for your project, Jim Gardiner is available to help you get the best product.

[24+] LONDON BRIDGE STUDIOS INC
20021 Ballinger Way NE, #A
Seattle, WA 98155
(206) 364-1525

Owner: London Bridge Inc
Studio Manager: Rajan Parashar
Engineers: Rakesh Parashar, Peter Barnes, Kurt Bujack, Scott Shangle
Dimensions: Studio 27 x 46, control room 20 x 21
Mixing Consoles: Neve 8048 30 x 16 x 24 w/1081 EQs
Audio Recorders: Studer A800 MkIII 24-track, Sony APR-5002 2-track
Echo, Reverb, & Delay Systems: Lexicon 224XL, Yamaha SPX90, Yamaha SRV-200, Yamaha REV7, (2) CompuElectronics, (3) Roland SDE-3000, (2) Roland SDE-2500, Lexicon Prime Time
Other Outboard Equipment: (4) Neve compressor/limiters, (2)

Neve noise gates, ADR Vocal Stresser, (6) Scamp gates, (4) Scamp compressors, ADR de-esser, UA-176 tube compressor, ADR Panscan, Aphex Aural Exciter
Microphones: (2) Sheffield Lab custom tube mics, (2) Neumann U47, (2) Neumann U87, AKG 414, AKG D-12, AKG 460, Sennheiser 421, E-V RE20, Shure SM57, Shure SM58
Monitor Amplifiers: Crown, Hafler
Monitor Speakers: JBL 4435, Yamaha NS-10, Auratone
Musical Instruments: Yamaha C7E grand piano, SP-2 Emulator, (2) Yamaha DX7, (2) Mirage sampler, Casio CZ-1, Roland JX8P, Korg DW-8000, Roland Super JX, Roland TR-707
Other MIDI Equipment: Macintosh computer, Mark of the Unicorn, DRT, Opcode, Commodore 64 computer
Rates: Upon request

[24+] MASTER TRACK PRODUCTIONS
1524 W. Winton Ave.
Hayward, CA 94545

(415) 782-0877
Owner: Don Enns
Studio Manager: Linda Rebeck
Extras & Direction: For over 15 years we've been producing albums in the fields of contemporary and traditional gospel, jazz, rock and other styles with an emphasis on gospel music. Our facility is a completely professional, fully equipped 24-track studio with spacious rooms and high ceilings, plus a wide assortment of microphones and signal processing gear. We deliver quiet and sonically superior recordings with our transformerless 32 x 24 NEOTEK Series IIC console and Stephens Electronics multi-track recorder. We also include 30 ips Studer A80 2-track recorders and Dolby A noise reduction systems. Our engineering staff is experienced, knowledgeable and helpful with a long list of album and radio credits. Their combined expertise in the fields of musical performance and technical production assures a high level of excellence and understanding of each client's needs. MTP is also a complete, high-volume cassette duplication and packaging plant. Please call for additional information.

[24+] MILLTREE PRODUCTIONS
also REMOTE RECORDING
PO Box 70322
Seattle, WA 98107
(206) 782-3115

Owner: Milltree Productions, Inc
Studio Manager: Claude Autry
Extras & Direction: With an emphasis on innovation and quality, Milltree makes Music Magic™. Our full service audio post-production studio is designed for flexibility with audio, video, MIDI and computer tie-ins to all rooms. Analog and digital recording including Sony/MCI 1/4" broadcast and 1/2" stereo VHS/Beta video. Complete synchronization. Extensive MIDI systems, outboard equipment, computer systems, CD and software instrument/FX libraries. Digital recording/editing/sound design workstation. Pre-production & post-production Foley, ADR, voicing. Comfortable, great sounding, working environments. With 20 years of musical experience, composer, producer, Claude Autry's accomplishments include complete soundtrack scores, scoring to picture, sound design and in-house production. We proudly serve the video, film, multi-image, theater, broadcast communities in the Northwest and across the U.S. We also give special attention to the individual artist. Our clientele includes award winning corporate, commercial, feature presentations. Call or write for more information.

[24+] MIRAMAR RECORDING STUDIOS
(FORMERLY NOVA RECORDING SERVICES)
14715 SE 37th St.
Bellevue, WA 98006
(206) 747-5233

Owner: Miramar Images, Inc
Studio Manager: Paul Speer
Engineers: Paul Speer, David Lanz, James Reynolds
Dimensions: Studio 15 x 25, control room 12 x 15
Mixing Consoles: Biamp Birmix 24 x 16
Audio Recorders: Sony/MCI JH-24 24-track, Otari 5050 2-track, Sony F1 2-track
Cassette Recorders/Duplicators: Awa, Technics
Noise Reduction Equipment: Symetrix 511
Synchronization Systems: BTX Shadow
Echo, Reverb, & Delay Systems: Lexicon PCM70, ART 01A, Yamaha SPX90, Roland SDE-1000
Other Outboard Equipment: dbx 900 rack w/comp/gate/EQ/de-esser, dbx 166 stereo comp/gate, Symetrix 522 comp/gate
Microphones: E-V RE20, (2) Sennheiser 421, (2) AKG 414, Neumann U87
Monitor Amplifiers: Crown D-150A, Symetrix headphone amp
Monitor Speakers: (2) JBL 4425, (2) Yamaha NS-10, (2) Auratone 5C
Musical Instruments: Prophet VS, Yamaha DX7, Yamaha TX7, Roland MKS-20 piano, Yamaha KX88 MIDI board, Korg EX-8000, E-mu Emax, LinnDrum, Simmons drum kit
Other MIDI Equipment: Yamaha QX5 sequencer
Video Equipment: Sony 19" monitor, Sony 12" monitor, Sony 3/4" VCR and Beta Hi-Fi VCR, Magnavox VHS VCR
Other: Krups espresso machine
Rates: Vary. Private facility/invitation only



MOBIUS MUSIC RECORDING
San Francisco, CA

[24+] **MOBIUS MUSIC RECORDING**
also **REMOTE RECORDING**
1583 Sanchez St.
San Francisco, CA 94131
(415) 285-7888
Owner: Oliver DiCicco
Studio Manager: Oliver DiCicco
Engineers: Oliver DiCicco, Ken Kessie, Maureen Dronoy
Dimensions: Studio 38 x 16, control room 18 x 16, plus two iso booths
Mixing Consoles: Audiotronics 30 x 20
Audio Recorders: MCI JH-114 16-/24-track, Studer A820 2-track, MCI JH-110 2-track
Cassette Recorders/Duplicators: (2) Sony FX-44 Nakamichi 600
Echo, Reverb, & Delay Systems: Lexicon 224 reverb, Master-Room MR-3 reverb, Yamaha REV7, Yamaha SPX90, DeltaLab DL4, Lexicon 92
Other Outboard Equipment: (2) dbx 160 limiters, (2) UREI LA-4 limiters, (2) Dyna-Mite processors, (2) Kepex gates, Lang program equalizer UREI 530 graphic EQ, Orban 622 parametric EQ
Microphones: Neumann U47 tube, (2) Neumann KM54 tube, (2) Neumann U87, (2) Neumann KM84, (2) Neumann KM85, (6) Sennheiser 421, Sennheiser 402, Beyer M500 ribbon, (2) Shure SM57 E-V RE15 E-V RE11
Monitor Amplifiers: Hafler 500, Crown D150, Crown D60
Monitor Speakers: (2) UREI 811 (2) Altec 604 w/Mastering Lab crossovers, (2) Auratone
Musical Instruments: Yamaha C3 6' grand piano, Fender Telecaster (w EMG pickups), Yamaha RX15, Slingerland "Radio King" drums, Fender Vibrolux amp, Fender Bandmaster amp
Other MIDI Equipment: Available as rentals
Video Equipment: Available as rentals
Rates: Available on request Block rates and lock out rates available

[24+] **MONTAGE RECORDING STUDIOS**
37532 Sycamore St.
Newark, CA 94560
(415) 794-2992
Owner: Will Mullins, Bill Walsh
Studio Manager: Will Mullins
Engineers: Will Mullins, Jerry Merrill, David Hartzheim, Rob Beaton
Dimensions: Studio 25 x 35, control room 14 x 16
Mixing Consoles: MCI 528 28 x 52 w/JH-50 automation, 8 returns/6 sends
Audio Recorders: MCI JH-114 16-/24-track w/autolocator II, Ampex ATR-102 2-track, Pioneer 2+2 2-track master recorder
Cassette Recorders/Duplicators: Nakamichi MR-1B
Noise Reduction Equipment: (2) Dolby SR
Echo, Reverb, & Delay Systems: Lexicon 224 digital reverb, (2) Yamaha SPX90 digital reverb (MIDI), Lexicon Prime Time stereo delay, Effectron II delay
Other Outboard Equipment: Audioarts stereo parametric equalizer (2) UREI LA-4 compressor/limiter, UREI 1178 stereo compressor/limiter, (6) Scamp rack style noise gates, (4) Scamp F-300 expanders, Scamp auto panner, (2) Scamp so1 stereo compressors, Scamp sweep EQ, Scamp parametric EQ, Aphex Type B Aural Exciter
Microphones: (4) AKG 414, (4) Sennheiser 421, (2) E-V RE20, AKG tube, Neumann U87, (6) Shure SM57, KM84, AKG 451, (2) Shure SM58, (3) Shure SM56
Monitor Amplifiers: Bryston (1,200-watt) mains, Yamaha (600-watt) studio monitors, Crown (150-watt) near fields
Monitor Speakers: UREI mains, MDM-4 alternate, Toa studio
Musical Instruments: Simmons SDS-1000, Roland RD-1000, Roland JX-10 Sequential Circuits Prophet 10, Sequential Circuits Prophet 2000, Helpinstill electro-acoustic grand, Hammond C-3 w/Leslie, Nippon acoustic guitar, Gibson 335, Fender Strat, Takamine 12-string, Mesa/Boogie amplifier, Roland jazz chorus, E-mu Drumulator, Oberheim DMX drum computer,

Roland Octapad, Roland digital sequencer, Moog Taurus pedals, Akai S-900 rack mounted sampler, Mellotron, Chamberlain, Moog Prodigy
Other MIDI Equipment: Roland sequencer, self-designed MIDI patching system w/Fiber Optic data transmission, in-house designed software for IBM PC implementation, as well as Macintosh
Other: Extensive and rapidly growing library of sounds and other software for Akai S-900 and Prophet 2000 samplers
Sample library composed around audio post-production needs
Rates: Call for quotes Block/lockout available

[24+] **MOON RECORDING**
156 Otto Cir.
Sacramento, CA 95822
(916) 392-5640
Owner: George Whyler
Studio Manager: George Whyler
Engineers: David Houston, Gary Woltman
Dimensions: Studio 22 x 34, control room 17 x 18
Mixing Consoles: MCI JH-636 28 x 24 fully automated
Audio Recorders: MCI JH-24 24-track, Otari MkIII-8 8-track Otari MTR-10 2-track 1/4"
Cassette Recorders/Duplicators: (2) Tascam 122B
Echo, Reverb, & Delay Systems: Lexicon Prime Time II, Delta-



MOON RECORDING
Sacramento, CA
—CONTINUED ON NEXT PAGE

NOISE REDUCTION FOR UNDER \$10.

MIXING CONSOLES
SWITCHES
MICROPHONE CONNECTORS
SNAKE CABLES
BATTERY CONTACTS



ALL PLUGS & JACKS
(XLR, PHONE, PHONO, DIN, MIDI, ETC.)
PATCHBAYS
FADERS, POTS
TERMINAL STRIPS
SPEAKER TERMINALS

CRAMOLIN®

Even the finest equipment in the world can't guarantee a noise-free recording. One "dirty" connection anywhere in the electrical path can cause unwanted noise or signal loss.

"MORE THAN A CONTACT CLEANER"

CRAMOLIN® is a fast-acting, anti-oxidizing lubricant that cleans and preserves all metal surfaces, including gold.

When applied to metal contacts and connectors, **CRAMOLIN®** removes resistive oxides as it forms a protective molecular layer that adheres to the metal surfaces and maintains maximum electrical conductivity.

CRAMOLIN® - USED BY THOSE WHO DEMAND THE BEST:

Bell & Howell	Hewlett Packard	MCI(Sony)	Nakamichi
Boeing	John Fluke Mfg.	Motorola	RCA
Capitol Records	McIntosh Labs	NASA	Switchcraft

SINCE 1956

CAIG LABORATORIES INC.

1175-O Industrial Ave., (P.O. Box J) - Escondido, CA 92025-0051 U.S.A. • (619) 743-7143

Circle #124 on Reader Service Card

Lab CompuEffectron, Eventide Harmonizer, Lexicon PCM70, Lexicon PCM60, Lexicon PCM42, Yamaha REV7, Ecoplate II. Other Outboard Equipment: (2) UREI LA-3A limiters, UREI 1178 comp/limiter, Orban 424A comp/limiter, (2) dbx 160 comp/limiter, Aphex studio Dominator, Aphex B Aural Exciter, Valley People 415 Sibilance processor, (2) Valley People Maxi-Q, (6) Valley People Kepex 810, (2) Valley People Gain Brain II. Microphones: (2) Neumann U87, (2) Neumann U67, (4) E-V PL20, (5) E-V RE15, (2) Sennheiser 441, (3) Sennheiser 421, (2) AKG 451, AKG 414, (2) Crown PZM-3-S, Sony ECM-56F, (3) Shure SM53. Monitor Amplifiers: UREI 6300, JBL/UREI 6290, Crown 1200. Monitor Speakers: (2) UREI 8"3B, (2) JBL 4, (2) E-V Sentry 100A, (15) AKG 240 headphones. Musical Instruments: Yamaha 7" grand piano, Emulator II, SP-12 drum machine, Yamaha DX7, (8) Yamaha 816, Yamaha RX11 drum machine, Roland Octapad, Minimoog, Macintosh 512 w/CD sound library. Other: Sony PCM-701 digital processor, Sony 2710 Beta VCR, Sony 520-ES CD player, Sound Ideas sound effects library. Rates: Please call. Block rates available.



M.S. STUDIO
San Francisco, CA

[24+] M.S. STUDIO
PO Box 24182, 5191 3rd St., Ste. 7
San Francisco, CA 94124
(415) 282-4806
Owner: Melvin Seals
Studio Manager: Melvin Seals
Engineers: Melvin Seals
Mixing Consoles: Sound Workshop Series 34
Audio Recorders: Otari MTR-90II 24/24 24-track Otari MTR-10 2-track.
Cassette Recorders/Duplicators: Sony, Technics
Echo, Reverb, & Delay Systems: Lexicon 224XL, Eventide Harmonizer, Marshall Time Modulator, MICMIX, Lexicon 95 w/memo update, Lexicon PCM70, Lexicon Prime Time II, (2) Yamaha REV7
Other Outboard Equipment: (4) UREI 1176, (2) UREI 530, ADR Scamp rack, (2) S01, (2) S04, (2) F300, S100 dual gate, Orban 622B, UREI 537, F760X-RS Compex Limiter, (2) Orban deessers, (4) LA-4 comp/limiters, (2) Aphex Aural Exciters, much more available
Microphones: E-V, Countryman, SGP, Sennheiser, AKG, Shure, Neumann, Neumann mic cables
Monitor Amplifiers: Crown PS-200, (2) BGW 750
Monitor Speakers: JBL 4312, JBL 4411, MDM TA3, Yamaha NS-10, Auratone
Musical Instruments: Emulator II, grand piano, ARP string ensemble, (2) Hammond B3 w/4 Leslies, Wuritzer electric piano, Minimoog, Fender Rhodes, DX5 synth, LinnDrum, sight tuner, much more available
Rates: \$50/hr

[24+] MUSIC ANNEX, INC.
also REMOTE RECORDING
970 O'Brien Dr.
Menlo Park, CA 94025
(415) 328-8338
Owner: Music Annex, Inc.
Studio Manager: Michelle Le Comte
Engineers: Russell Bond, David Joslyn, Jim Dean, Rainer Gembalczyk
Dimensions: Room 1: studio 28 x 25, control room 22 x 25. Room 2: studio 16 x 13, control room 21 x 18. Room 3: studio 30 x 20, control room 26 x 22. Room 4: studio 42 x 36, control room 10 x 16
Mixing Consoles: Neve 8036 24 x 8, Soundcraft 3-B 32 x 24, (2) Amek TAC 16 x 8.
Audio Recorders: Studer A80 16-/24-track, MCI JH-114 8-/16-/24-track, (4) MCI JH-110B 2-track, (6) Ampex 440B 2-track, (2) Otari 5050B 2-track, Otari 2-track.
Cassette Recorders/Duplicators: (8) Tascam 122, (2) Naka-

NORTHWEST 24+ TRACK STUDIOS



MUSIC ANNEX, INC.
Menlo Park, CA

michi MR-2
Noise Reduction Equipment: dbx 157 8-channel, Dolby 361 Type A 4-channel, Dolby 361 Type SR 2-channel
Synchronization Systems: SF facility only
Echo, Reverb, & Delay Systems: Lexicon 224, Quantec QRS room simulator, (4) Yamaha SPX90, Lexicon Prime Time, Lexicon Super Prime Time, Klark-Teknik DN34 analog processor, EMT 240 gold foil plate, EMT 140 plate, Roland 2000 DDL, Marshall Time Modulator
Other Outboard Equipment: (4) UREI 1176LN limiters, (2) UREI 1178 stereo limiters, ADR Vocal Stressor, ADR stereo EQ, UREI Little Dipper filter set, (3) Scamp racks 30 modules, (2) Drawmer noise gates, Aphex stereo compeller, (2) Valley People Gain Brain, (2) Valley People Dyna-Mite gates
Microphones: (120) AKG, Neumann, E-V, Sony, Shure, Sennheiser, Mesa/Boogie and Calrec, (12) Countryman FET direct, (3) Crown PZM-30 GP, (3) Tram levelers
Monitor Amplifiers: BGW, Crown, Yamaha, AB Systems, Haller
Monitor Speakers: UREI Time Align primary, various auxiliary monitors including Yamaha NS-10, Klavitter 702, MDM-4, Auratones, Augspurgers, JBL 4333, JBL 4310, JBL 4301
Musical Instruments: Yamaha C7, Fender Rhodes, Yamaha DX7, E-mu Drumulator
Video Equipment: (2) Sony 2860 3/4", (2) Sony color monitors, soundstage with Moie Richardson lights and 600-amp grid.
Other: Sony 701-PCM, Sony 2860 3/4" U-matic, (2) SMPTE-based automation systems
Rates: \$30-125/hr

[24+] MUSIC ANNEX, INC.
also REMOTE RECORDING
69 Green St., 2nd Floor
San Francisco, CA 94111
(415) 421-6622
Owner: Music Annex, Inc.
Studio Manager: Angela Goodison
Engineers: Randy Bobo, Roger Wiersma, Robert Bradford, Patrick Fitzgerald
Dimensions: Room 1: studio 12 x 16, control room 23 x 28. Room 2: studio 13 x 11, control room 17 x 14
Mixing Consoles: Amek 2500 28 x 24, Amek TAC 16 x 8
Audio Recorders: MCI JH-114 24-track, Otari 5050 MKII 8-track, Ampex 440-B 4-track, (2) Otari MTR-12 2-track CTC, (2) MCI JH-110B 2-track, (2) Otari 5050 2-track
Cassette Recorders/Duplicators: (3) Tascam 122, Otari C-2 master w/2 slaves
Noise Reduction Equipment: Dolby M-24, (3) Dolby CAT-43/361 A, (2) Dolby SR 361
Synchronization Systems: (2) Q Lock 3- or 4-machine lockup
Echo, Reverb, & Delay Systems: Lexicon 480 LARC, Lexicon 224, (2) Yamaha SPX90, 949 Harmonizer
Other Outboard Equipment: (2) Symetrix phone patch, (4) UREI 1176 limiters
Microphones: (2) Neumann U87, (4) AKG 414EB, (2) Sennheiser 421, (2) AKG 452
Monitor Amplifiers: Yamaha 2200, BGW 750, (4) BGW 100
Monitor Speakers: JBL 4430, JBL 4425, MDM-4, (4) Auratone, Klavitter 702
Musical Instruments: Emulator III, Mac II, Yamaha DX7
Video Equipment: JVC 850 3/4", JVC 8250 3/4" U-matic, Sony BVH-1100 1" C-format, JVC 5760 1/2" VHS Hi-fi.
Other: Datametrics time code generator, Sigma black generator.
Rates: \$75-\$175/hr

[24+] MUSIC ART RECORDING STUDIO M.A.R.S.
PO Box 1838
Aptos, CA 95001
(408) 688-8435
Owner: Ken Capitanich
Studio Manager: Ken Capitanich
Engineers: Ken Capitanich, Ken Kraft, David Gibson, Eric Bates.
Dimensions: Studio 16 x 18, control room 14 x 15.
Mixing Consoles: NEOTEK Series II 24 x 24
Audio Recorders: Ampex MM-1100 24-track, Tascam 80-8 8-track w/dbx, Ampex 440-C 2-track, Otari MX-5050 2-track, Pioneer 2-track.
Cassette Recorders/Duplicators: (3) Sony TC-K81
Noise Reduction Equipment: (8) dbx.
Echo, Reverb, & Delay Systems: Lexicon 200, Ecoplate II, Lexicon Prime Time, Eventide Harmonizer, MICMIX XL-305, S-24 time shape module, Yamaha SPX90.
Other Outboard Equipment: (3) ADR expander/gates, (5) ADR comp/limiter, (2) ADR parametric EQ, Aphex Exciter, (2) Summit Audio tube limiters, Pultec tube EQ, Aphex Aural Exciter
Microphones: Neumann, AKG, Sennheiser, Sony, Shure, E-V, Beyer, Neumann U67 tubes
Monitor Amplifiers: Crown DC-300A, Crown D150A, (2) Crown DC75, Crown DS400
Monitor Speakers: UREI 811, MDM-4, JBL 4313B, Auratone
Musical Instruments: Chickering 6'6" grand piano, Hammond B-3, DX7II FD
Rates: Available upon request

[24+] THE MUSIC COMPLEX
also REMOTE RECORDING
348 Broadway Ave., Ste. 4
Millbrae, CA 94030
(415) 697-4488
Owner: Cliff Spencer, John Maciejewski, Pat Maciejewski

[24+] THE MUSIC SOURCE
615 E. Pike
Seattle, WA 98122
(206) 323-6847
Owner: Jim Wolfe
Studio Manager: Peter Barnes
Engineers: Jim Wolfe, Peter Barnes, Glenn Lorbeck, Ron Gagnes, David Raynor, Ron Simmons
Dimensions: Room 1: studio 27 x 24, control room 27 x 18. Room 2: studio 15 x 13, control room 15 x 21. Room 3: studio 11 x 12, control room 11 x 12
Mixing Consoles: MCI 636 automated 36 x 44, MCI 636 28 x 28, Yamaha 24 x 24
Audio Recorders: (2) MCI JH-24 48-track in room A, (2) MCI JH-114 24-track in B & C, (2) Sony/MCI JH-110 2- and 4-track, Tascam ATR62 2-track center channel time code, Sony layback 1" video, Magna-Tech 16/33mm recorder/reproducer, Sony PCM-F1 digital
Cassette Recorders/Duplicators: (10) cassette real time duplicators, Nakamichi, (8) Tascam 22-2 and Revox A77 dubbing decks
Noise Reduction Equipment: dbx 8 channels, other formats available
Synchronization Systems: Adams-Smith 2600 for 5 slaves including compact controller.
Echo, Reverb, & Delay Systems: Lexicon 224X w/LARC, Lexicon Prime Time, Lexicon Super Prime Time, (2) Yamaha SPX90, Yamaha REV7, Eventide Harmonizer, Alesis digital reverb, AKG BX10, DOD Electronics digital delay.
Other Outboard Equipment: Scamp rack, UREI, Symetrix, dbx, Spectra Sonics limiters, graphic and parametric EQ, Aphex and EXR exciters, Garfield Master Beat and Drum Doctor, Roland vocoder, UREI 1/3-octave equalizers, Bercus-Berry BBE802.
Microphones: Neumann U87, Neumann U67 (tube), AKG 414, AKG 451, AKG D-12E, AKG "The Tube", E-V RE20, Shure SM57, Sennheiser MD421, Beyer ribbons, RCA 77dx, Altec M-20 condensers (tube), Sony tube condenser
Monitor Amplifiers: UREI 6500, Crown, BGW, Phase Linear, Symetrix
Monitor Speakers: JBL 4430s, JBL L-100s, Yamaha NS-10, Auratones, UREI time aligns
Musical Instruments: Kurzweil K-250, Yamaha DX7, Oberheim OB-Xa, Minimoog, (2) Emax, Yamaha FB-01, Yamaha TX81Z, Yamaha RX5 drum machine, LinnDrum (w/MIDI), Oberheim dmx (w/MIDI), Kawai '9' concert grand, Simmons electronic drums, Yamaha acoustic drum kit
Other MIDI Equipment: Garfield Master Beat and Drum Doctor, Macintosh Macplus w/hyperdrive running Opcode software.
Video Equipment: Sony layback (1"), Sony 5850 3/4" w/address track, Magna-Tech film dubber (16/35mm)
Rates: Available upon request

[24+] OCEAN STUDIO
Box 747
Stinson Beach, CA 94970
(415) 868-0763
Owner: Tim Tomke
Studio Manager: B.J. Meines

[24+] ONE PASS
One China Basin Bldg.
San Francisco, CA 94107
(415) 777-5777
Owner: Scott Ross
Studio Manager: Ruth Scovill

[24+] QTR STUDIOS
also REMOTE RECORDING
PO Box 874
Belmont, CA 94002
(415) 391-9861
Owner: Cookie Marengo
Studio Manager: Cookie Marengo
Engineers: Randy Sellgren, Cookie Marengo, Mike Cutter, Victor Bellorno
Mixing Consoles: Sound Workshop Series 30, Soundcraft 600
Audio Recorders: Otari MTR-90 Series II 24-track, Otari 5050 8-track, Otari MTR-10 2-track 1/2" 1/4" and center track time code heads, Otari 5050B 4-track, Otari 5050 2-track, (2) Sony PCM 2-track digital encoder/decoder
Cassette Recorders/Duplicators: Yamaha C200, Tascam 122, Nakamichi
Noise Reduction Equipment: dbx, Dolby A, Dolby SR available upon request
Synchronization Systems: Audio Kinetics Eclipse Q Lock 4 10 Echo, Reverb, & Delay Systems: Lexicon 224XL reverb, AMS RMS-16 reverb, Lexicon Super Prime Time delay, Lexicon PCM42, Lexicon PCM60, Yamaha SPX90, DeltaLab 1024
Other Outboard Equipment: Eventide 949 Harmonizer, Aphex Compellor, Drawmer noise gates, Valley People Dyna-Mite gates
Microphones: AKG 414, AKG 451, Neumann U87, Neumann U67, E-V RE20, Crown PZMs, Shure SM56, Shure SM57, Nakamichi C-100, Sennheiser 421, Sennheiser ME80, Sennheiser ME88, Beyers
Monitor Amplifiers: Crown
Monitor Speakers: Tannoy, Yamaha NS-10M, Auratones, Meyer 833
Musical Instruments: Steinway 7" piano (1885) Yamaha DX7, Yamaha TX7, Prophet 2002 samplers, Prophet VS synthesizer, Prophet 5 w/MIDI, Minimoog, LinnDrums, Casio CZ-101 Roland 505 drums, Roland MSQ-700 sequencer, Roland MC-500 sequencer, Hammond B-3 organ
Other MIDI Equipment: Macintosh Plus computer MIDI system, Mark of the Unicorn 2.2 Performer/Composer software, Op-code patch librarian, Digidesign Sound Designer software
Video Equipment: (3) recorders, (2) monitors
Other: Roland SBX-80 sync box, Garfield, Nanodoc

[24+] PACE VIDEO CENTER
2020 SW 4th Ave.
Portland, OR 97201
(503) 226-7223
Owner: Ed Cornelius
Studio Manager: Greg Smith

[24+] PACIFIC MOBILE RECORDERS
only REMOTE RECORDING
2616 Garfield Ave.
Carmichael (Sacramento), CA 95608
(916) 483-2340
Studio Manager: Kat Coffey Hibbard

[24+] PAN STUDIOS
1767 S. 8th St, M-6
Colorado Springs, CO 80906
(303) 633-6764
Owner: Dale Nixon
Studio Manager: John Standish

[24+] PARADISE SOUND RECORDING INC.
also REMOTE RECORDING
PO Box 63
Index, WA 98256
(206) 793-2614
Owner: Patrick Sample
Studio Manager: Karen Sample
Dimensions: Piano room 15 x 20 x 8, drum room 20 x 20 x 8, iso booth 12 x 5 x 8, control room 20 x 9 x 8
Mixing Consoles: Harrison MR4 32 x 24
Audio Recorders: Otari MTR-90 24-track, Otari MTR-12 2-track, Otari 5050 2-track, Revox B77 2-track, Sony 2-track digital mastering, dbx 2-track digital mastering
Cassette Recorders/Duplicators: Nakamichi, Yamaha Echo, Reverb, & Delay Systems: Lexicon 200, Lexicon PCM60 reverb, Lexicon PCM41
Other Outboard Equipment: Aphex Compellor, dbx 163X comp/limiter, dbx 463X noise gates, Symetrix 511 noise reduction, Yamaha SPX90II
Microphones: Neumann U89, Beyer M88, AKG 414, Sennheiser 441, (4) Sennheiser 421, (2) E-V PL20, (3) E-V PL76, Shure SM81, (2) Shure SM57, (2) Fender P-2
Monitor Amplifiers: Haller P5050, Yamaha M80
Monitor Speakers: JBL 4411, E-V Century 100
Musical Instruments: Hammond B-3 organ w/Leslie, Yamaha



PARADISE SOUND RECORDING INC.
Index, WA

DX7, Yamaha RX11 drum machine, Yamaha QX7 sequencer, Pearl drum set w/Zildjian cymbals, Mesa/Boogie amp, Marshall amp, Emulator II w/outstanding library, Roland S-50 sampler
Other MIDI Equipment: Roland MPU-401 MIDI processor controlled by IBM compatible w/Personal Composer software
Video Equipment: Lynx synchronizer
Rates: \$45/hr (package rates available)
Extras & Direction: We specialize in 24-track albums, demos and remixing and we also offer real time and high-speed cassette duplication. Quality and pride keep us both satisfied. Lodging for those of you who need a few days to "track your dreams," we provide a package session that includes lodging in a cabin right next to the studio. It features its own kitchen and a spectacular view to inspire your creativity. There is also dining available nearby. Lounging and food available. Please call. Equipment, expertise and inspiration in a breathtaking setting. Quality and pride keep us both satisfied. We put the extra time and care into our recording that it takes to create a professional and creative product.



PARADISE STUDIOS
Sacramento, CA

[24+] PARADISE STUDIOS
1020 35th Ave.
Sacramento, CA 95822
(916) 424-8772
Owner: Arne Peterson
Studio Manager: Kirt Shearer, Craig Long
Engineers: Kirt Shearer, Craig Long
Dimensions: Room 1 studio 22 x 30, control room 22 x 16, Room 2 studio 14 x 10 (booth)
Mixing Consoles: Amek TAC 32 x 8, Hill 16 x 4 multmix
Audio Recorders: (2) Fostex B-16 16-track (sync'd for 32), Fostex E-2 2-track (30 ips) w/center SMPTE stripe, Otari 5050B II 2-track, TEAC 3440 4-track w/dbx noise reduction
Cassette Recorders/Duplicators: (2) JVC TD-V66 w/Dolby B/C, Synchronization Systems: Fostex 4030 synchronizer w/4050 autolocator
Echo, Reverb, & Delay Systems: Lexicon PCM70 effects processor with 1 2 and 3 0 software, (2) Yamaha SPX90 effects processor, Yamaha REV7, Alesis XT C digital reverb, Roland SDE-3000 digital delay, ART 01A digital reverb w/updates
Other Outboard Equipment: Aphex studio dominator stereo peak limiter, (2) Drawmer DS-201 dual channel noise gates, (3) Symetrix 522 dual channel compressor/limiter/expander, Tascam PE-40 4-channel 4-band parametric EQ, Barcus-Berry BBE-202R phase compensator

—CONTINUED ON NEXT PAGE

CLEAN PATCH BAYS NO DOWN TIME



VERTIGO BURNISHERS AND INJECTORS RESTORE ORIGINAL PERFORMANCE TO YOUR PATCH BAYS

VERTIGO 1/4" TRS AND TT BURNISHERS:

Each used to eliminate noise caused by contamination of main contacts in normal patching situations

VERTIGO 1/4" TRS AND TT INJECTORS:

Each allows injection of cleaning solvent in breaking contacts (normals), to eliminate intermittency that occurs when patch cord has been removed

STILL ONLY \$29.95 Ea. (Cont. USA)

Please write for additional information and order form
Used by Professionals Worldwide Patent Pending

VERTIGO RECORDING SERVICES

12115 Magnolia Blvd #116
North Hollywood, CA 91607
Telephone: 818.769-5232
Telex: 5106006748 VERTIGO RECRD

Circle #125 on Reader Service Card

Masters of Duplication.

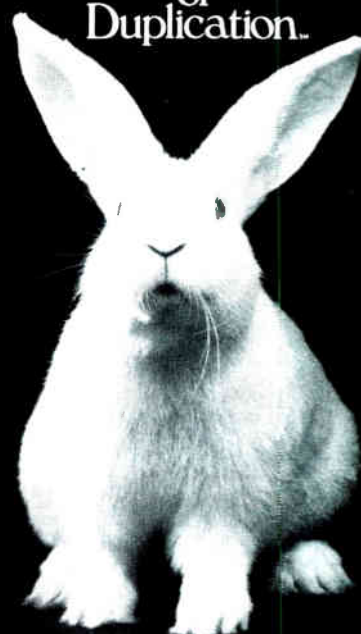

CASSETTE WORKS
Audio & Video Duplication

Call or Write for Free Services Kit
P.O. Box 158 Pasadena, CA 91102
1-800-423-TAPE & 1-800-972-TAPE &

Circle #126 on Reader Service Card

Microphones: Telefunken Elam 251 tube mic, Neumann U87, (4) AKG 414 (EB and ULS series), (2) AKG 451, (2) Shure SM81 condensers, (3) E-VRE20, (3) Sennheiser 421, (5) Shure SM57, (2) Shure SM58, (4) Countryman direct boxes, (2) Boss DI-1 active direct boxes

Monitor Amplifiers: (2) Haller P-225, (2) McIntosh "60s" tube amps, Carver M-400 cube amp

Monitor Speakers: UREI 813A, Yamaha NS-10M "studio" version nearfields, Auralone 5-C cubes

Musical Instruments: 1947 Baldwin 6.3" grand piano, 1967 Hammond B-3 organ w/Leslie model 122, Rogers 6-piece drum set w/Zildjian cymbals, Yamaha DX7 synth, Yamaha TX7 synth, E-mu SP-12 turbo sampling drum machine, Fender Rhodes 73-key, Mesa/Boogie 100-watt guitar amp w/5-band EQ, Mesa/Boogie 4 x 12 cabinet w/EV drivers, Mesa/Boogie bass cabinet w/15" EV driver, AMP 4100-watt bass amp w/6-band semi-parametric EQ

Other MIDI Equipment: Macintosh computer w/Performer and Composer software, 6,000 sounds for DX, TX stored on Opcode librarian/editor software, sample library and segment storage for SP-12 on Drumfile software, Fostex 4050 allows SMPTE/MIDI sync to tape for all MIDI equipment

Video Equipment: Audio-to-video SMPTE interlock, (for both 16- or 2-track)

Rates: \$35/hr for 16-track, \$45/hr 32-track, block rates available

[24+] PARVIN'S STUDIO
also REMOTE RECORDING
PO Box 16191
San Francisco, CA 94116
(415) 559-1853
Owner: Lee Parvin
Studio Manager: Lee Parvin

[24+] PEAKDESIGN
6114 La Salle Ave., Ste. 314
Oakland, CA 94611
(415) 531-5331
Owner: Tony Milosz
Studio Manager: Joanna Rayska
Engineers: Tony Milosz, Stanislaw Krupowicz and freelance engineers
Dimensions: Integrated control room studio 18 x 40
Mixing Consoles: Dynamix D3000 32 x 8 x 16 (hot-rodded) w/automation, 500-point patchbay, miscellaneous submixers
Audio Recorders: Sony/MCI JH-24 24-track transformerless w/Autolocate III, Otari MX-5050 8-track 1/2" (hot-rodded), Sony PCM-501ES 2-track digital, Otari MX-5050 2-track 1/4"
Cassette Recorders/Duplicators: Sony 650 2-track 1/4"
Echo, Reverb, & Delay Systems: (2) Roland SRV-2000, Yamaha SPX90, (2) Yamaha R1000 (for gating), (3) DeltaLab Effectron 1024, Korg SDD-1000 (modified), (2) custom springs, ADA flanger, Wavemaker phaser, Ibanez analog delay, misc effects and any other processing equipment available on request
Other Outboard Equipment: Cyclosync FS1 2-channel, 3-dimensional panner w/sync, Orban, Tascam, Advent, DOD equalizers, Aphex Exciter, Dynalex noise reduction, Orban, dbx compressors, GateX 4-channel noise gate (modified), Peakdesign custom MIDI/SMPTE control computer, Yamaha CX5F system, Roland SBX-80 SMPTE sync, Roland and Yamaha sequencers, Sony 520-ES CD player, Sony turntable w/Monster Alpha II MC cartridge, (4) IBM PC/XT and PC/AT computers w/all major software for sequencing, editing, notation printout and librarians (over 8,000 DX voices) We design custom gear/software as needed Spectrum analyzers, scopes and misc equipment.
Any other processing equipment available on request
Microphones: Beyers MC-740 (N/C), PZM, Sennheiser, Sony and other misc.
Monitor Amplifiers: Yamaha
Monitor Speakers: Calibration standard instruments, MDM-TA2 Time Aligned, JBL, Altec Lansing
Musical Instruments: Yamaha TX816, (2) Yamaha DX7, Akai sampler, (2) E-mu Drumulators w/custom chips and MIDI, Roland, Oberheim, Sequential Circuits (VS), Moog synths, Fender tube twin reverb amp, grand piano, Fender P-bass, Gibson ES-335 Many other instruments available on request
Video Equipment: 1/2" Beta and VHS w/SMPTE sync, PCM/Beta Hi-Fi dubbing and transfers, 1/4" equipment available on request
Soundtrack composition and production to existing or planned video/film pieces. Overloaded? We handle partial subcontract work
Rates: Competitive rates include all gear and knowledgeable engineers Call for details
Extras & Direction: Compact disc pre-production CD production subcontracted in Japan. We are a complete electronic music facility. Our solid technical expertise in software and hardware combines with music production skills to create a state-of-the-art, yet practical working environment. MIDI mastering, new music, MIDI-to-stereo master via 8-track, 24-track or direct-to-2-track digital, with or without acoustic overdubs, such as vocals, piano etc. 8- to 24-track transfers, mixes, digital remixes. With music prepared on sequencers, truly professional mixdown becomes affordable. Our resources and expertise make the difference between a "demo" and a finished product. We also offer production/composition work, from discreet subcontracting and helpful suggestions to complete projects.

N O R T H W E S T

24+ TRACK

STUDIOS



THE
Plant
RECORDING STUDIOS

THE PLANT RECORDING STUDIOS
Sausalito, CA

[24+] THE PLANT RECORDING STUDIOS
also REMOTE RECORDING
2200 Bridgeway
Sausalito, CA 94965
(415) 332-6100
(415) 332-5738 (FAX)
Owner: Bob Siye
Studio Manager: Alice Young
Extras & Direction: Three solid studios and our mobile are available for your music, audio for video and film, and location recording. Studio A is equipped with a Trident TSM board and Studer A80 and will soon be rebuilt to accommodate a 750-sq ft control room for additional keyboard and production space as well as complete video sweetening facilities. Studio B also features a Trident TSM and Studer. Studio C is equipped with a Trident 80B and Studer equipment. All studios and mobile are equipped for quick setup of video sweetening and sync lock-up equipment. Digital multi-track and 2-track mastering are available. Rover, the mobile recording unit, now a member of The Plant family, delivers and records consistent, translatable audio in a comfortable, functional atmosphere. We are minutes from San Francisco on the Bay in Sausalito, yet out of the hustle and pressure of the city. The Plant maintains the finest in recording artistry and technology. And, as always, it's all offered in a setting that rivals the comforts of home.

[24+] POINT BLANK RECORDING
19 Locke Way
Scotts Valley, CA 95066
(408) 438-2331
Owner: Rick Chaisse, Robert Crow
Studio Manager: Rick Chaisse

[24+] POSITIVE AUDIO
1250 San Carlos Ave.
San Carlos, CA 94070
(415) 595-4041
Owner: The Andre Perry Groupe, Inc
Studio Manager: Michael David

[24+] POWER STROKE PRODUCTIONS
245 Hyde St., Studio A
San Francisco, CA 94102
(415) 673-1829
Owner: Sally Procter
Studio Manager: Bill Jackson
Engineers: Mark Needham, Maric Senasac, Steve Fontana
Dimensions: Studio 35 x 25, control room 15 x 18
Mixing Consoles: Trident Series 80B 32 x 24
Audio Recorders: Studer 880 24-track, Studer 820 2-track
Cassette Recorders/Duplicators: (2) Nakamichi MR-2
Noise Reduction Equipment: (2) Drawmer gates
Synchronization Systems: Studer remote, Adams-Smith Zeta 3
Echo, Reverb, & Delay Systems: Yamaha REV7, Lexicon 480L, AKG ADR 68K, Lexicon PCM70, (2) Lexicon PCM42, TC Electronic 2290 sampler/delay, Publison America Internal Machine 90
Other Outboard Equipment: (2) Sontec EQ, (2) Tube-Tech program EQ, (2) UREI limiters, Adams-Smith Zeta-3, Valley People Dyna-Mite 430 compressor/limiter, (2) White EQ
Microphones: (8) Sennheiser 421, (2) Neumann U87, Neumann

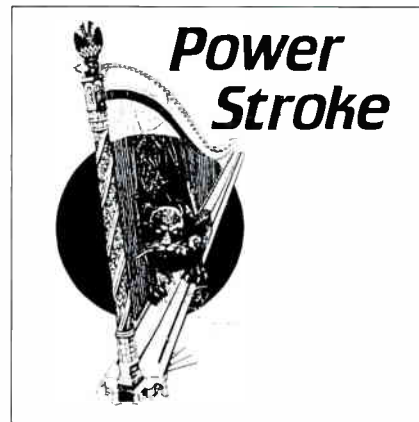

POWER STROKE PRODUCTIONS
San Francisco, CA

U47 FET, (2) AKG 414, (4) SM57, (2) AKG 441, (2) AKG 460B, misc. studio mics
Monitor Amplifiers: Meyer MS1000, Meyer 833 preamp, (2) Haller 500-watt power amp
Monitor Speakers: (2) Meyer 833, (2) Meyer 834, (2) Yamaha NS-10M
Musical Instruments: Kurzweil 250 w/A3C Sound blocks and complete Mac Plus system, Yamaha baby grand piano
Other MIDI Equipment: Most all outboard gear MIDI compatible
Video Equipment: Sony BVU-800 1" sync
Other: Full PA rental available
Rates: Available upon request

[24+] PRAIRIE SUN RECORDING
also REMOTE RECORDING
Box 7084
Cotati, CA 94928
(707) 795-7011
(707) 795-8184
Owner: Mark "Mooka" Rennick
Studio Manager: Mark "Mooka" Rennick
Dimensions: Room 1, studio 25 x 30, control room 10 x 15
Room 2, studio 8 x 10, control room 22 x 23
Mixing Consoles: Trident TSM 48 x 32 x 80 automated, Trident Series 80 32 x 24 x 56, Biamp 16 x 2
Audio Recorders: (2) Studer A80 VU 24-track, (2) Ampex ATR-102 2-track, Otari 5050 2-track
Cassette Recorders/Duplicators: (2) Technics RSB, (2) Nakamichi
Synchronization Systems: QLock synchronizer
Echo, Reverb, & Delay Systems: AMS RMX-16, AMS DMX-15, Publison America Internal Machine 21-sec stereo, (4) Yamaha SPX90, Yamaha REV7, 1,000-sq-ft. live chamber, (2) EMT stereo, Lexicon 92, Lexicon PCM41, (2) DeltaLab 1024
Other Outboard Equipment: (4) 1176 limiter compressor, (4) dbx 160X, dbx 165, Neve stereo comp/limiter, Publison America stereo tube comp/limiter, (3) Drawmer noise gates, (2) Valley People Dyna-Mites, (2) Kepex, Eventide 949, Sontec stereo parametric, Orban stereo parametric, (2) Rane SP parametrics, dbx de-essers, Publison America "Fu-Imost" exciter, Aphex Type C, EXR Exciter, Pultec EQ, Lang EQs, etc
Microphones: Neumann, AKG, Sony, Sennheiser, Shure, E-V All tubes are regularly maintained by the famous "Klaus Heyne" microphone technician.
Monitor Amplifiers: Crown, Haller, Audio Research, UREI, Fostex, McIntosh
Monitor Speakers: UREI 811, UREI 813, Yamaha NS-10, Wharfedales, MDM-4, Big Reds, JBL 4311, B&W
Musical Instruments: E-mu II, Kimball 5'7" grand, Macintosh w/all music software, MSB MIDI patcher, Prophet 10, Yamaha DX7, Casio CZ-101, Drumulator. Please call about these because we are updating all the time
Video Equipment: QLock sync in-house
Rates: Lock-outs between \$600 and \$1,000/day, depending on studio choice. Please call
Extras & Direction: Located 50 minutes north of SF. We have two 24-track studios including our new 48-track automated mixing room. We have excellent maintenance, video lock-up and on-site economical lodging. We pride ourselves on making your budget work from rehearsal to tracking, to mixing to duplication. Many talented musicians and producers are available if you so need. If you have any questions, please ask for "Mooka" and I will be happy to assist you.

[24+] PROFESSIONAL SOUND & RECORDING, INC.
only REMOTE RECORDING
3320 Chelton Loop S.
Colorado Springs, CO 80909
(303) 597-8125
(303) 578-0682
Owner: Chris Mickle
Studio Manager: Chris Mickle
Engineers: Chris Mickle, Mickey Houlihan, Mike Chilcote, Kevin

Clock, Ron Wesley
 Dimensions: Studio 12 x 7.5 1984 Winnebago Centauri van
 Mixing Consoles: Soundcraft 1624 24 x 24, Rowland Research
 8 x 2 audiophile, additional consoles available in most configurations as needed.
 Audio Recorders: (2) Stephens 821B 16-/24-track, (2) Nakamichi DMP-100 PCM 2-track digital, Revox PR-99 2-track
 Cassette Recorders/Duplicators: (1) TEAC V-2RX real time, Pentagon C-4322 high-speed
 Echo, Reverb, & Delay Systems: Lexicon PCM60, DeltaLab ADM-1024, Yamaha REV7, Yamaha SPX90
 Other Outboard Equipment: Barcus-Berry Electronics 202R, Dorrrough meters, full line of Symetrix compressors/limiters/gates, dbx 166, any piece of outboard equipment available upon request, full dbx 900 rack
 Microphones: Schoeps, AKG, E-V, Neumann, PZM, Sennheiser, Shure (all internal audio wiring is Mogami Neglex).
 Monitor Amplifiers: Intersound SP-300, Hafler DH-200, Rowland Research Model 5
 Monitor Speakers: B&W DM100, Spica TC-50, Yamaha NS-10, JBL Control 1
 Video Equipment: 58 input x 14 isolated output access bay Full audio for video services. Clear-Corn system, stage cameras and video monitors. Completely self-contained production unit
 Audio AC circuit is transformer isolated and maximum draw of all AC circuits is 15 amps or less. Extensive transformer/splitter system
 Rates: Available upon request.

[24+] KELLY QUAN RECORDING
 also REMOTE RECORDING
 1249 1/2 Green St.
 San Francisco, CA
 (415) 771-6716
 Owner: Kelly Quan
 Studio Manager: Marie Davalos

[24+] RECORDING ASSOCIATES
 also REMOTE RECORDING
 5821 SE Powell Blvd.
 Portland, OR 97206
 (503) 777-4621
 Owner: Jay Webster, Bob Stoutenburg
 Studio Manager: Jay Webster, Bob Stoutenburg

[24+] REX RECORDING CO.
 also REMOTE RECORDING
 1931 SE Morrison
 Portland, OR 97214
 (503) 238-4525
 Owner: Sunny Day Productions
 Studio Manager: Rhner P. Johnson



R.O. STUDIOS
 Concord, CA

[24+] R.O. STUDIOS
 3359 Walnut Ave.
 Concord, CA 94519
 (415) 676-7237
 Owner: The Henry Bros.
 Studio Manager: Ralph F. Henry Jr.
 Engineers: Rick Henry, Chris Boggs, independents welcome
 Dimensions: Room 1 studio 25 x 15, control room 16 x 15
 Room 2 studio 20 x 15
 Mixing Consoles: Sound Workshop Series 40 28 x 24 w/VCA's, 24-channel high resolution metering.
 Audio Recorders: Otari MTR-90II 24-track, Otari MTR-10 2-track, Technics SV-110 digital audio processor
 Cassette Recorders/Duplicators: Denon DR-M44
 Echo, Reverb, & Delay Systems: Lexicon 224XL digital reverb, (2) Lexicon PCM70 digital reverbs, Eventide H969 Harmonizer, Lexicon digital delay, TC Electronic TC-2290 Dynamics effects

control processor, TC-1210 Spatial Expander and stereo chorus flanger, Alesis MIDVerb II 16-bit digital effects processor, (3) Alesis Microverbs
 Other Outboard Equipment: (2) UREI 1176LN peak limiters, (2) Valley People Dyna-Mite 430, UREI LA-4 limiter, 1178 limiters, MX-MIDI device, MX1 + triggering device, Garfield Master Beat SMPTE device, Studio Tech mic pre-amp, any outboard equipment available upon request
 Microphones: Neumann, AKG, Sony, Sennheiser, Shure, E-V, any mic available upon request
 Monitor Amplifiers: Hafler DH-500, BGW 750B, McIntosh 2105
 Monitor Speakers: UREI 811, Yamaha NS-10, Auratone, KEF listening speakers, PAS studio monitors I
 Musical Instruments: Yamaha grand piano, (2) Prophet 2002, (4) TX modules, Macintosh computers w/3,000 DX7 sounds, Sound Designer and Performer software, Linn 9000 fully loaded w/SMPTE, Marshall amps, Steinberger XL-2 bass, Sequential Circuits 440 drum machine and sequencer, rock boxes, Lee Jackson guitar pre-amp, Sequential VS, Prophet 3000 16-bit stereo samplers, Roland GM-70 guitar MIDI converter, any instruments available upon request
 Rates: Call for rates. Block rates available
 Extras & Direction: Swimming pool, shower and kitchen facilities, listening room, special thanks to our clients of 1987 Eddie Money, for the *Can't Hold Back* album, Jimmy Lyons *Johnny Gunn*, Jack Gerow, Jon Gibson, Z Boy, CBS Records, Motown Records, Capitol Records and especially producers Ritchie Zito, David Kershenbaum and Tom Dowd. Here at R.O. we have the most modern state-of-the-art equipment available along with a very relaxed atmosphere. Come work with the best for less!

[24+] ROSEWOOD REC. COMPANY
 2288 W. 300 North
 Provo, UT 84601
 (801) 375-5764
 Owner: Rosewood Rec. Inc.
 Studio Manager: Kristen Randle

[24+] ROUGH CUT RECORDING
 also REMOTE RECORDING
 2525 E. 12th St.
 Cheyenne, WY 82001
 (307) 638-9894
 Owner: Richard P. Creswell
 Studio Manager: Richard P. Creswell

[24+] RUSSIAN HILL RECORDING
 also REMOTE RECORDING
 1520 Pacific Ave.
 San Francisco, CA 94109
 (415) 474-4520
 Owner: Jack Leahy, Bob Shotland
 Studio Manager: Gail Nord
 Engineers: Jack Leahy, Sam Lehmer, Jeff Kliment, Gary Clayton
 Dimensions: Room 1 studio 20 x 30, control room 15 x 24
 Room 2 studio 18 x 28, control room 13 x 22
 Room 3 studio 12 x 14, Room 4 studio 12 x 14
 Mixing Consoles: SSL 4040E 32 x 32, NEOTEK Series III 28 x 24, Soundcraft 600 24 x 16, Sony FT 8 x 2
 Audio Recorders: (3) MCI JH-24 24-track (4) MCI JH-110 2-/4-track, (2) Technics 1506 2-track, (2) Fostex E-16 16-track, Fostex E-22 3-track
 Cassette Recorders/Duplicators: (2) Awa, Tascam
 Noise Reduction Equipment: Dolby A 24-track, Dolby 360 6-track
 Synchronization Systems: (2) Q.Lock 3 10 (3 machine), Kelly Quan 610 (4 machine), Fostex 4035
 Echo, Reverb, & Delay Systems: EMT plate, (2) Lexicon 224, (4) Lexicon PCM70, (2) Lexicon PCM60, (2) Lexicon Prime Time, other various delays and reverbs available
 Other Outboard Equipment: Anything currently available, if not in house, we'll rent it!
 Microphones: Full complement, Neumann, AKG, RCA, E-V, Sony, Sennheiser, Crown, Shure, Countryman, etc
 Monitor Amplifiers: Hafler, McIntosh, QSI
 Monitor Speakers: UREI 813 TA, JBL 4311, Yamaha NS-10, Auratone
 Musical Instruments: Steinway grand, Yamaha grand, E-2, DX7, various synths
 Other MIDI Equipment: Macintosh driven systems, various MIDI interfaces
 Video Equipment: All studios equipped for sync A/V work
 Film-to-tape transfer suite, all formats big screen projection studios, A and B
 Other: KEM K-800 six plate and full bench, mixing to all film release formats, mono to 6-track on custom SSL in studio A.
 Rates: Brochure on request

[24+] SAGE RECORDING
 also REMOTE RECORDING
 14311 Stehr Rd.
 Arlington, WA 98223
 (206) 691-5203
 Owner: E.W. Littlefield, Jr.
 Studio Manager: Caroline Littlefield

HAVE THE PACKAGING BLUES GOT YOU DOWN?



Don't know where to turn for superior quality products at competitive prices? Then come to the source, Stoughton Printing Co. We have been supplying top quality products for the recording industry since 1965. Direct board record jackets, 7 and 12 inch sleeves, labels, CD booklets and inlay cards. We even offer special "custom-look" generic CD long boxes with windows, ready for immediate shipping.

Record or CD packaging - whatever your needs, if it's worth doing, it's worth doing right. Come to the source . . .

stoughton printing co.

130 N. Sunset Avenue, City of Industry, CA 91744
 From Los Angeles: (213) 686-2753
 (818) 961-3678

Quality Printing For The Record Industry Since 1965

© 1988 Stoughton Printing Co.

Circle #133 on Reader Service Card

San Francisco Conservatory of Music

SAN FRANCISCO CONSERVATORY OF MUSIC San Francisco, CA

[24+] SAN FRANCISCO CONSERVATORY OF MUSIC also REMOTE RECORDING

Transparent Recordings
1201 Ortega St.
San Francisco, CA 94122
(415) 564-8086
Studio Manager: Lolly Lewis
Extras & Direction: The San Francisco Conservatory of Music's Hellman Hall is a 330-seat performance hall with an adjoining recording facility. Capable of 2- and 4-track recording, Hellman Hall is ideal for live solo or ensemble recording. Our engineers are experienced in high-detail tape editing. Center stripe SMPTE and digital recording are also available. Transparent Recordings, affiliated with the Conservatory, can bring high-quality 2-channel recording to your location. Call for details.

[24+] SLOW BOAT STUDIOS only REMOTE RECORDING

1135 Pearl St., Ste. 7
Boulder, CO 80302
(303) 443-9822
Owner: Wind Over the Earth Inc.
Studio Manager: Mickey Houlihan

[24+] SOUND IMPRESSIONS

4704 SE View Acres
Milwaukie, OR 97267
(503) 659-5953
Owner: Dan Decker
Studio Manager: Bob Stark
Engineers: Bob Stark, Brian Willis, Dan Decker
Dimensions: Room 1: studio 24 x 22, control room 20 x 18
Room 2: studio 10 x 14 (MIDI room)
Mixing Consoles: Amek Matchless 26 x 24 x 8 x 2 (modified for 62 returns), Biamp 1642 16 x 4 x 2, Biamp 602 6 x 4 (head-phone mixer)
Audio Recorders: 3M 79 Series 24-track, Tascam 52 2-track.
Cassette Recorders/Duplicators: Nakamichi MR-1, Sanyo dubbing deck
Echo, Reverb, & Delay Systems: Lexicon PCM70 effects processor, (2) Yamaha REV7 digital reverbs, Ibanez SDR-1000 digital reverb, Roland SDE-3000 programmable delay, Lexicon PCM41 digital delay, Effectron 1064 digital delay, Effectron 64 digital delay, ADA 1000 digital delay.
Other Outboard Equipment: Aphex Type B Aural Exciter, Aphex stereo Compeller, Symetrix CL-150 compressor, (2) Symetrix CL-100 compressors, (2) Symetrix 544 Quad noise gates, Audio Logic Quad noise gates, Roland CompuEditor (automation unit).
Microphones: AKG "The Tube," (2) E-V RE20, AKG D12, (7) Shure SM57, (7) Audio-Technica ATM-63, (2) Tascam PE-250, (2) AKG 330, (2) AKG 320, (2) E-V PL-76, (2) AKG 451, (2) Sony condensers, American ribbon.
Monitor Amplifiers: (2) Crown D-75, Symetrix headphone amp, (2) Biamp TC-120
Monitor Speakers: UREI 813, Yamaha NS-10M, Auratones
Musical Instruments: Yamaha C3 6' grand piano, Yamaha DX7, Korg DW-8000, Oberheim Matrix 6, Sequential Circuits Prophet 5, Sequential Circuits Drumtrax and chip library, 1962 Fender Telecaster, 1968 Telecaster, 1960 Fender J-bass, 1964 Fender P-bass, Kramer DMZ-5000 fretless bass, 1968 Rickenbacker 4001 bass, Gibson J-40 acoustic guitar
Other MIDI Equipment: Multiteck 1100 AT (IBM compatible) w/42 meg drive, Voyetra 4001 MIDI interface, 48-track PC II sequencing software
Other: AKG B-15 bass amp, Roland Cube amp, Fender Sidekick amp.
Rates: \$35 regular, \$25 block, \$250 lockout per day

[24+] SOUND RECORDING ORGANIZATION S-R-O also REMOTE RECORDING

1338 Mission St.
San Francisco, CA 94103

NORTHWEST 24+ TRACK STUDIOS

(415) 863-0400
Owner: S-R-O Inc.
Studio Manager: D. Dobkin

[24+] THE SOURCE STUDIO
2423 Magnolia St.
Oakland, CA 94607
(415) 421-6262
Owner: Smokey Towers
Studio Manager: Rich Pena

[24+] SPECTRUM INC.
also REMOTE RECORDING
PO Box 757
San Carlos, CA 94070
(415) 593-9554
Owner: Paul L. Weaver
Studio Manager: Wes Weaver



SPECTRUM SOUND STUDIOS
Portland, OR

[24+] SPECTRUM SOUND STUDIOS

1634 SW Alder St.
Portland, OR 97205
(503) 248-0248
Owner: Michael Carter, Lindsey McGill
Studio Manager: M. Carter
Engineers: M. Carter, Chris Douthitt, Jim Baer, Rob Perkins, Mike Moore, Jeff Dennerline, Jim Rogers.
Dimensions: Room 1: studio 38 x 30, control room 25 x 23
Room 2: studio 27 x 19, control room 21 x 22, Room 3: 17 x 16, control room 20.5 x 22, Room 4: studio 11.5 x 17, control room 20.5 x 22, Scoring suite 20.5 x 22
Mixing Consoles: SSL 6056E 56 x 32, MCI JH-536 36 x 32 automated, (3) Spectrum Studios 16 x 8.
Audio Recorders: (2) Otari MTR-90 MkII 24-track, Otari MTR-12 2-track, Mitsubishi X86a 2-track, (2) Ampex ATR-104/2 2-/4-track, (18) Scully 280B 4-/2-track and monos.
Cassette Recorders/Duplicators: (14) Tascam 124AV, (2) Nakamichi LX-5, (2) Tascam 133AV.
Noise Reduction Equipment: (2) Dolby M24h, (4) Dolby 361 w/Dolby A, (2) Dolby SR, (3) dbx 187, (7) dbx 180.
Synchronization Systems: Audio Kinetics Q.Lock 3.10.
Echo, Reverb, & Delay Systems: Lexicon 224XL, (2) Lexicon PCM70, Lexicon Prime Time II, Eventide H910, Eventide H949, Eventide flanger, (4) Yamaha REV7, (2) Yamaha SPX90, Ursa Major Space Station, EMT 240TS plate, AKG BX-20.
Other Outboard Equipment: (3) ADR Vocal Stressers, (2) Barcus-Berry Electronics 802 exciters, (4) dbx 160, dbx 162, (4) Roger Mayer noise gates, Orban 622B, Orban de-esser, (5) UREI LA-3A comp/limiter, (2) UREI 1176 comp/limiter, UREI Little Dipper, (3) Valley People Gain Brains.
Microphones: Neumann TLM170, Neumann U47FET, Neumann U87, Neumann KM84, Neumann KMR81, AKG C414, AKG C451, Shure SM57, Shure SM54, Sennheiser MD-421, Sennheiser 815L, RCA 77DX, trams.
Monitor Amplifiers: (2) UREI 6500A, (6) Yamaha PC2002, (4) Yamaha PC1002, (4) Yamaha PC2075.
Monitor Speakers: (4) UREI 813C, (4) UREI 811C, Auratone, Yamaha NS-10, Yamaha NS-20.
Musical Instruments: Yamaha C3 grand piano.
Other MIDI Equipment: Anything on request
Video Equipment: Sony BVH-1100a 1" Type C VTR w/Dolby

NR, (2) Sony KV-25XBR monitors 3/4" and 1/2" machines, complete DA system, monitoring and patching
Other: Nagra IV STC, Nagra 4 2L, complete location recording kit including Sennheiser, Neumann, Cetelec Vega wireless mics, 16mm reproducers/dubbers.
Rates: Weekly lock-out and block time available. Prices on request

Extras & Direction: New facility Russ Berger, Joiner-Rose Group designed rooms. Five room recording complex. Measured noise floor NC-8. One of the quietest studios in the world. 18' ceilings create an ambience that must be experienced. Large control room offers extremely accurate imaging. Central tech room handles all power, grounding, amplification, video, audio and MIDI between studios.

[24+] STAR TRAK RECORDING INC.

19351 23rd NW
Seattle, WA 98177
(206) 542-1041
(206) 745-1427
Owner: Bob Long, Richard Eaks
Studio Manager: Richard Eaks

[24+] STARLIGHT SOUND also REMOTE RECORDING

617 S. 13th St.
Richmond, CA 94804
(415) 233-7140
Owner: Bill Thompson, Neil Young
Studio Manager: Jon Long
Engineers: Bill Thompson, Steve Counter, Jamie Bridges, Kay Arbutckle
Dimensions: Studio 54 x 28, control room 38 x 28, iso/piano booth 18 x 28
Mixing Consoles: Harrison 40/32 40 x 32 w/Allison 65k automation
Audio Recorders: MCI JX-24 24-track, Ampex ATR 102 2-track w/1/2" and 1/4" headstacs, Otari 5050B 2-track, Sony F1 2-track digital
Cassette Recorders/Duplicators: Nakamichi MR-I, Nakamichi MR-II.
Synchronization Systems: Yamaha FSK sync-MIDI, Roland SDX-80 SMPTE-MIDI
Echo, Reverb, & Delay Systems: Lexicon 224X digital reverb, Lexicon PCM70 digital reverb, Lexicon PCM60 digital reverb, Yamaha SPX90 digital reverb, Roland CEP-5 digital reverb, Alesis MIDiverb, MIDI FX, (2) Effectron DDLs, Lexicon PCM42 DDL, Roland SDE-1000 DDL, MXR flanger/DDL, 910 Harmonizer.
Other Outboard Equipment: (2) Dyna-Mite noise gates, (2) Drawmer noise gates, (3) Symetrix noise gates, (2) Audioarts parametric equalizers, (2) Biamp graphic EQ, (2) EXR Exciters, (3) UREI 1176 comp/limiter, LA-3 limiters, Rocktron power play GTR FX
Microphones: (2) Neumann KM250 tube, Neumann KM69 stereo tube, Neumann U87, Neumann U47 tube, Neumann U47 FET, (2) AKG 414, (4) Sennheiser 421, E-V RE20, RCA 77 ribbon, (4) Beyer M160 ribbon, (4) Shure SM57
Monitor Amplifiers: Bryston, Haller, Crown, Yamaha
Monitor Speakers: UREI 813 time aligned w/custom subwoofer (non-EQed), Yamaha NS-10s, Auratones
Musical Instruments: Yamaha DX7, Yamaha DX100, Prophet 2000 sampling keyboard, Oberheim Matrix 6, LinnDrum, Yamaha RX-11 drum machine, Roland TR-505 drum machine, Akai 612 sampler, Rogers drum kit, (2) Roland Pad-8 Octapads, MSQ 700 sequencer, Simmons sampler and EPROM blower, Columbia congas, Yamaha C-7 concert grand piano, various guitar amps, Marshall, Boogie, Vox, Fender.
Other MIDI Equipment: Atari 1040 ST computer w/Steinberg sequencing software and visual patch editors for the DX7, DX-100, Oberheim M-6 and Prophet 2000.
Rates: Call for rates and studio tour.

[24+] STARSOUND AUDIO, INC.

2679 Oddie Blvd
Reno, NV 89512
(800) 354-7252
Owner: Scott Bergstrom
Studio Manager: Mark Ishikawa
Engineers: Mark Ishikawa, Scott Bergstrom, Dave Jensen, Lee Taggart
Dimensions: Studio 35 x 30, (3) iso rooms 8 x 14, 7 x 10, 8 x 16; control room 15 x 25
Mixing Consoles: Amek Angela 28 x 24, CPE-800 RSS mix-down computer.
Audio Recorders: Studer A80 24-track, Otari MkIII-2 2-track, Tascam 52 2-track
Cassette Recorders/Duplicators: Yamaha C200
Echo, Reverb, & Delay Systems: Lexicon PCM70, Lexicon PCM60, Yamaha REV7, Yamaha REV5, (2) Yamaha SPX90, Roland SRV-2000, Roland SDE-3000, (2) DEP-5 Brick Audio 3300 plate, DeltaLab CPE-1700
Other Outboard Equipment: Aphex II broadcast, Aphex C (mod), UREI LA-4, dbx 166, Valley People Dyna-Mite, Symetrix 522, Orban 674A parametric, Roland Vocoder Dimension D, dbx 503.
Microphones: AKG 414EB, AKG 460, AKG 451, AKG 330, Sennheiser 441, Sennheiser 421, Sennheiser 431, Sennheiser

409, Sennheiser 211, E-V PL20, E-V RE20, E-V RE15, E-V RE18, Shure SM56, Shure SM57, Shure SM81, Shure SM85, Sony C-37, PZM, Countryman 101
 Monitor Amplifiers: Crown PSA-2, Crown DC-300, Yamaha PC2002, Crown PS-400
 Monitor Speakers: JBL 4333, JBL 4435, JBL 4425, JBL 4411, Auratone T6, Auratone 5C, Yamaha NS-10.
 Musical Instruments: Large set Fibes drums, Simmons, Kawai 7'4" grand, Prophet 2000, Prophet VS, E-mu SP12, Yamaha DX7, Yamaha DX21, Akai S900, Ensoniq Mirage, Roland JX-10.
 Video Equipment: (2) JVC 8250 3/4" recorder, (2) JVC 5550 3/4" players, JVC 86-U editor, Sony SEG-2000 6-camera switcher/special effects generator, Sony DCX-M-3A camera, Sony CCD-3000 chip camera
 Rates: \$45-\$65/hr depending on project
 Extras & Direction: Over 2,000 instruments available in Star-sound Audio/Bizarre guitar complex TEF analysis available to clients. Studio in Reno, 45 minutes from Lake Tahoe, endless recreation potential. Also provide concert sound, lighting and staging for any Reno/Tahoe venues. State-of-the-art production facility with a high-tech, low key staff. Complete album projects, tracking only, demos; the key is the quality of service for the small cost

[24+] STAUNTON STUDIOS INC.
 FORMERLY MOUNTAIN MOBILE RECORDING
 also REMOTE RECORDING
 5450 Coleman Creek Rd.
 Medford, OR 97501
 (503) 535-3972
 Owner: Web & Karen Staunton
 Studio Manager: Web Staunton
 Engineers: Web Staunton, Chris Wood, Jeff Bates, all independents welcome
 Dimensions: Room 1 studio 26 x 20, control room 14 x 20
 Room 2 studio 8 x 8 Room 3 studio 11 x 12
 Mixing Consoles: NEOTEK Series II 28 x 28
 Audio Recorders: Otari MTR-90 24-track, 3M 79 2-track, additional recorders (digital and analog) are available upon request
 Cassette Recorders/Duplicators: Yamaha K960/Dolby-dbx, (11) Technics M-205/M-224 real time duplicators
 Noise Reduction Equipment: (2) dbx 150, Dolby SR available upon request
 Echo, Reverb, & Delay Systems: (2) Alesis XT, Lexicon Prime Time, Yamaha SPX90
 Other Outboard Equipment: (6) Valley People Gain Brain II comp/gates, Teletronix LA-2A, (4) dbx 160X comps
 Microphones: Neumann U87, Neumann KM84, Sennheiser 421, E-V RE20, Countryman Dis and mics, Shure SM81, Shure SM58, Shure SM57, etc
 Monitor Amplifiers: Haller 500, Crown DC-300A, Unisync 50.
 Monitor Speakers: UREI 811 time align, E-V Century 3, Auratone 5C
 Musical Instruments: Yamaha C7 grand piano, keyboards and drum machines are available upon request
 Rates: Call for rates and info
 Extras & Direction: Situated on eight tree-covered acres, Staunton Studios provides the Northwest with one of the finest combinations of environments and facilities for the recording artist and producer. Our studio is situated on a private hill that overlooks the beautiful Rogue Valley of Southern Oregon. Our wraparound deck and hiking trails allow our clients to relax when not in session. The studio's full security system gives the client the peace of mind without interruptions. Located only 15 minutes from the Jackson County Airport, which is served by United, PSA, Continental and Horizon Airlines, you will have the conveniences of the city with the atmosphere of the country. We also provide free transportation from your motel-hotel and from the airport. Our list of major artist and corporate clients is quite extensive and include a Grammy nomination and numerous advertising awards. Come see us in Oregon! and enjoy your recording experience

[24+] STUDIO C. CUSTOM RECORDING
 2220 Broadridge Way
 Stockton, CA 95209
 (209) 477-5130
 Owner: Dr. Thomas T. Chen, MD
 Studio Manager: Bryan Caldwell
 Engineers: John Edman, Dr. Thomas Chen, Bryan Caldwell
 Dimensions: Studio 32 x 30, control room 12 x 8
 Mixing Consoles: Sound Workshop Series 30 28 x 24 w/ARMS automation, Interface Electronics 8 x 4
 Audio Recorders: Otari MTR-90 24-track, 3M 8-track 1", Otari MTR-10 2-track
 Cassette Recorders/Duplicators: Nakamichi MR-1, Denon DR-M12HX, Otari high speed duplicator
 Noise Reduction Equipment: Dolby SR, Hush IIC
 Synchronization Systems: (2) Lynx time code modules
 Echo, Reverb, & Delay Systems: Quantec QRS room simulator, Lexicon 224, Yamaha REV7, (2) Yamaha SPX90
 Other Outboard Equipment: Aphex Compeller, UREI 1178 limiter, Eventide Harmonizer, Valley People Kepex II, Valley People Gain Brain II, Valley People Maxi Q
 Microphones: AKG, Neumann, Shure, E-V, Sennheiser, Crown PZM, etc
 Monitor Amplifiers: Spectra Sonics 701, Crown D-60
 Monitor Speakers: Yamaha NS-10, Rogers LS3/5A, MDM-4, ADS L-2000.

Musical Instruments: New England Digital digital Synclavier II music system including polyphonic sampling, music printing, SMPTE, MIDI, IBM interface, 200-track digital recorder, video sync, etc, Steinway 6'8" grand piano, Hammond B-3 organ, Alembic bass w/graphite neck, Oberheim DMX drum machine, assorted guitar and bass amps, Roland MKS-20 digital piano
 Other MIDI Equipment: Complete Synclavier II system.
 Video Equipment: JVC 8250 3/4" VTR.
 Rates: Rates available upon request.

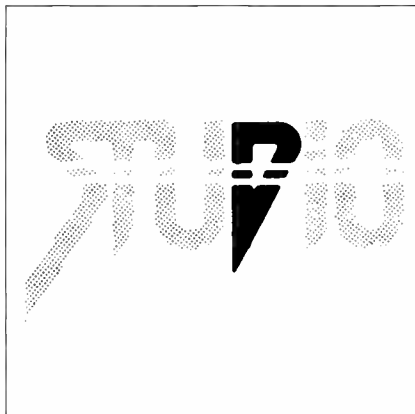

STUDIO D RECORDING INC.
 Sausalito, CA

[24+] STUDIO D RECORDING INC.
 425 Coloma St.
 Sausalito, CA 94965
 (415) 332-6289
 Owner: Dan Godfrey, Joel Jaffe
 Studio Manager: Joel Jaffe
 Engineers: Ricky Sanchez, Bob Hodas, Karl Derfler, Dr. Richie Moore, Lenette Viegas, James "Watts" Vereecke, Robert Missbach, Jim Gaines, Jim Stern.
 Dimensions: Studio 29 x 36 x 20, iso booth 7 x 14 x 16, control room 20 x 20 w/compression ceiling
 Mixing Consoles: Trident TSM 40 x 32 x 32
 Audio Recorders: Studer A800 MkII 24-track, Ampex ATR-102 2-track, Studer/Revox B77 2-track.
 Cassette Recorders/Duplicators: Awa 770, Awa 660
 Echo, Reverb, & Delay Systems: EMT 140 plate (tube), AMS RMX-16 reverb, Roland SRV-2000 reverb, Roland SDE-3000 delay, Bel BD-80 delay/sampler, Yamaha SPX90 optional, Yamaha SPX90II
 Other Outboard Equipment: (2) Pultec EOP-1, (2) Pultec EOP-1A, (2) Lang PEO-2, Pultec MEO-5, (2) UREI Model 545 parametric EQ, (2) Drawmer DS-201 dual gates, (4) Kepex II, dbx 165 compressor, (2) Teletronix LA-2A, (2) UREI 1176LN, (2) UREI LA-4, Eventide H910 Harmonizer, MEQ 15.
 Microphones: (2) Neumann U87, Neumann M49b, Neumann U67, Neumann U47 tube, AKG C-24 stereo tube, AKG C414EB, AKG C451EB, (2) AKG D-200E, AKG D-12, Sennheiser MD-421, Sennheiser MD-441, Beyler 201, E-V RE20, (2) PZMs, (2) 47 FET, Sony ECM-50, E-V 666, KM84, (6) Countryman direct boxes, (4) AKG C28, (6) Sennheiser, (6) SM57
 Monitor Amplifiers: Haller 500, (5) Haller 220 custom modified 2-line, (4) 2-link modified.
 Monitor Speakers: Hidley custom, Yamaha NS-10M, Auratones.
 Musical Instruments: Lindrum, Yamaha DX7, Hammond B-3 organ, Korg Polysix, Jazz Chorus amp, Marshall JCM 800, Gallien-Krueger studio amp, Roland Super Jupiter w/remoteprogrammer optional, MKS 20 and MKS 80 extra rental
 Video Equipment: Studio is located next to major soundstage. Video tie-in to control room. Q Lock and all VTR formats available upon application
 Rates: Please call for rates.

[24+] STUDIO SOREN
 7450 E. Jewell, Ste. F
 Denver, CO 80234
 (303) 755-4802
 Owner: Soren Bredsdorff
 Studio Manager: Soren Bredsdorff

[24+] SUN VALLEY AUDIO
 808 Warm Springs Rd.
 Ketchum, ID 83340
 (208) 726-3476
 Owner: Amos Galpin
 Studio Manager: Amos Galpin
 Engineers: Lance Parker, Randy Young
 Dimensions: Studio 32 x 23 x 16, piano room 9 x 15, control room 15 x 25 w/"The Wedge" patented control room.
 Mixing Consoles: ICC 9000 noise gates and limiters and auto-

—CONTINUED ON NEXT PAGE

RECORD PRESSING • TAPE DUPLICATION

TOLL FREE
 NUMBER
1-800-527-3472

MAJOR IN-HOUSE
 U.S. RECORD
 PRESSING FACILITY

- Custom Albums
- 45 RPM Singles
- Mastering with Neumann VMS70 Lathe & SX74 Cutter
- Digital Mastering Available

TAPE DUPLICATION
 • Custom Packaging

SPECIAL!

1000 7" 45 RPM
 Record Package **\$469**
 1000 1" Color 12"
 Album Package **\$1372**



A & R RECORD &
 TAPE MFG CO.
 902 North Industrial Blvd.
 Dallas, Texas 75207
 214-741-2027

Circle #142 on Reader Service Card

Want More Information?

The advertisers in *Mix* are happy to supply readers with additional information about the products and services advertised in this issue.

To receive more information, just circle the appropriate numbers on the Reader Service card on page 194.

MIX
 THE
 RECORDING
 INDUSTRY
 MAGAZINE

mation in each channel. 24 x 24.
 Audio Recorders: Sony DAT-1000ES, Stevens 24-track w/BTX, Ampex ATR-104 2-track 1/4", Ampex ATR-102 2-track 1/2".
 Cassette Recorders/Duplicators: Nakamichi, (10) Akai Synchronization Systems: Adams-Smith Zeta 3
 Echo, Reverb, & Delay Systems: (3) Lexicon PCM60, (4) ICC plate reverb system, live echo chamber 30 x 20 x 16, Lexicon 93, Echotron, Foxtex DDLs.
 Other Outboard Equipment: Eventide 949, Eventide flanger/ phaser, Kurzweil AS 250, LinnDrum, Simmons head, (10) Akai cassette recorders for real time duplication, unreal in-house technician.
 Microphones: AKG Tube, AKG 414, AKG 460B, Neumann U87, Sennheiser 421, Shure.
 Monitor Amplifiers: Hafler, PS Audio.
 Monitor Speakers: JBL, TAD custom monitors, JBL 4430, MDM TA-2, Auratones.
 Musical Instruments: Kurzweil AS 250, Yamaha 9' grand piano, Prophet 5, studio drum sets.
 Rates: \$70/hr, block rates available.
 Extras & Direction: To fill out a full service profile, Sun Valley Audio has developed a pro audio and recording equipment division to provide equipment and tech. support to the growing numbers of 4- and 8-track studio in the state. Direct-to-DAT recording Dealerships include JBL, Otari, 3M/Scotch audio tape, Lexicon, Eventide, Hafler, QSC and Kurzweil

[24+] SURREAL STUDIOS
 355 W. Potter Dr.
 Anchorage, AK 99518
 (907) 562-3754
 Owner: Kurt Riemann
 Studio Manager: Sarah Middleton

[24+] SWINGSTREET STUDIOS
 620 Bercut Dr.
 Sacramento, CA 95814
 (916) 446-3088
 Owner: Ashley, Lauzon, Silas
 Studio Manager: Larry Lauzon
 Engineers: Martin Ashley, John Bacciga'uppi, Larry Lauzon, Craig Lvaich, Phil Silas.
 Dimensions: Studio 34 x 37, control room 21 x 24
 Mixing Consoles: Quad/Eight Pacifica 28 x 24.
 Audio Recorders: MCI JH-16 8-/16-/24-track, (2) MCI JH-110B 2-track
 Cassette Recorders/Duplicators: (2) Technics M-85.
 Noise Reduction Equipment: dbx 28 channels.
 Echo, Reverb, & Delay Systems: Lexicon 224 digital reverb 4, AKG BX-20E reverb, Yamaha SPX90 digital effects, Lexicon 97 Super Prime Time, Eventide H910 Harmonizer, (2) Marshall Time Modulator, Yamaha D1500 delay.
 Other Outboard Equipment: (2) UREI 1176LN limiters, (2) Teletronix LA-2A limiters, (2) Allison Gain Brain, (2) Quad/Eight CL-22 companders, (3) ADR/Scamp expander/gates, ADR/Scamp autopan, Gregg Labs 2530 3-band compressor, Aphex Aural Exciter, (2) Pultec PEO-1S equalizers, Pultec HLF-3C filter.
 Microphones: Neumann U47FET, Neumann U67, Neumann U87, Neumann KM84, AKG C414EB, AKG C451, AKG C34, Countryman EM-101, Crown PZM30, Crown PZM31, E-V RE20, E-V 654A, E-V 666, E-V 667A, Sennheiser 409, Sennheiser MD-421, Shure SM7, Shure SM53, Shure SM57, Shure SM58, Shure SM81, Shure 545, Shure 300, Sony ECM-22, Sony ECM-280, RCA 77DX, Altec M-30
 Monitor Amplifiers: UREI 6500, Yamaha P2150, (2) McIntosh 2100
 Monitor Speakers: UREI 813A Time Aligns, JBL 4333, JBL 4313, JBL 4311, Auratone 5C.
 Musical Instruments: Yamaha DX7 digital synthesizer, Emulator Emax sampling keyboard, Yamaha C3 grand piano, various percussion, total instrument rental available.
 Rates: Available upon request.

[24+] BRUCE TAMBLING SOUND
 1151 W. Iowa Ave.
 Sunnyvale, CA 94086
 (408) 733-4240
 Owner: Bruce Tambling
 Studio Manager: Bruce Tambling

[24+] TARPAN STUDIOS
 1925-G Francisco Blvd. E.
 San Rafael, CA 94901
 (415) 485-1999
 Owner: Narada M. Walden
 Studio Manager: Janice Lee
 Engineers: David Frazer, Dana Chappelle, Matt Rohr, Gordon Lyon, Doc Shaffer
 Dimensions: Studio 25 x 35 irregular (including isos) ceiling 12 x 14, drum booth 9 x 8 x 12, control room 19 x 18 w/ceiling from 12 to 9 to 10.
 Mixing Consoles: Trident TSM 40 x 32 w/Allison automation
 Audio Recorders: Studer A80 VU MkIV 24-track, MCI JH-24 16-/24-track, (2) Ampex ATR-102 2-track (1/2" and 1/4"), Otari MX-5050 8-track (1/2"), Otari MX-5050B 2-track (1/4").
 Cassette Recorders/Duplicators: (2) Technics RS-B100, (2) Technics RS-B50, Aiwa ADWX909.

N O R T H W E S T
24+ TRACK
 STUDIOS



TARPAN STUDIOS
 San Rafael, CA

Synchronization Systems: Audio Kinetics Q Lock 3 10 synchronizer, Roland SBX-80 sync box
 Echo, Reverb, & Delay Systems: (2) AMS RMX-16 reverb, AMS 15-80S digital delay, (2) Yamaha SPX90, Lexicon Prime Time, Eventide 949 Harmonizer, Ecoplate 1, DeltaLab DL-4 w/memory module, Marshall Time Modulator, ADA SD-1, anything available upon request
 Other Outboard Equipment: (2) Focusrite 110 modules, NTP compressor, Aphex Compeller, anything available upon request, Drawmer gates, Valley People Dyna-gates, Orban deesser, (4) Teletronix LA-2A, (4) UREI LA-4 compressor/limiter, Symetrix gates, (4) Allison Kepex and Gain Brains
 Microphones: Neumann, AKG, Sennheiser, Beyer, Shure, PZM
 Monitor Amplifiers: Crown DO-2000 w/Delta Omega modules, BGW 750, (2) Crown D-150 Series II, Crown PS-400, (2) Crown Micro-Tech 1000 amps
 Monitor Speakers: UREI 813B, (2) Yamaha NS-10M, Auratones, UREI 811
 Musical Instruments: Fairlight CMI Series III w/custom sound library, Baldwin 9' grand piano
 Other MIDI Equipment: Kahler Human Clock
 Video Equipment: Mitsubishi 35" color monitor w/RGB, NEC DX-2000U VHS videocassette player.
 Other: Sony CDP-310 CD player, Denon DP-30L II turntable w/Shure V15 V cartridge.
 Rates: Please call for rates

AWARD WINNING SOUND

Where ideas come to life.

206-623-5934
 1200 Stewart Street
 Seattle, WA 98101

SEATTLE CHICAGO DENVER PHOENIX

TELEIMATION PRODUCTIONS
 Seattle, WA

[24+] TELEIMATION PRODUCTIONS
 also REMOTE RECORDING
 1200 Stewart St.
 Seattle, WA
 (206) 623-5934
 Owner: Teleimation Productions
 Studio Manager: Michael C. Olds
 Engineers: Peter B. Lewis, Gordon R. Glascock, Kathie Hopkins, Brian Joseph, qualified freelancers welcome
 Dimensions: Room 1: studio 28 x 38, control room 18 x 16.

Room 2: studio 9 x 13, control room 15 x 13
 Mixing Consoles: Neve 5116 24 x 24 x 4, Neve 5432 8 x 2.
 Audio Recorders: Studer A800 MkII 16-/24-track, MCI JH-110B 2-/4-track, Nagra T 2-track center track TC, Sony 5003 2-track center track TC, (2) Ampex ATR-800 2-/4-track, (3) Ampex 350 2-track w/Inovonics Electronics.
 Cassette Recorders/Duplicators: (2) Nakamichi MR-1, (5) Ampex high speed 1/4" dubbers, (9) 3M high speed cassette dubbers.
 Synchronization Systems: Audio Kinetics 3 10 w/ADR, JVC CR-8200U 3/4"
 Echo, Reverb, & Delay Systems: EMT 190 plate reverb, Yamaha SPX90, Eventide H949 Harmonizer, Urso Major Space Station, Clover 500, additional equipment available
 Other Outboard Equipment: (3) TC Electronic generators and regenerators, (4) Neve compressor/limiters, Audio & Design Vocal Stresser, (3) Orban 622B parametric EQ, (3) UREI graphic EQ, (6) UREI LA-4A, (2) Technics turntable, Denon GDC-1500, (2) Ashly SC-50 limiter/compressor
 Microphones: (2) Neumann U87, (2) Neumann KM84, (2) AKG 414-EB, (2) RCA 77D (reconditioned), Crown PZM, E-V RE20, Sennheiser 816, Sennheiser 416, additional mics available including Calrec Soundfield.
 Monitor Amplifiers: BGW
 Monitor Speakers: (6) Altec 604E, (4) Yamaha NS-10M, (4) Auratone cubes
 Musical Instruments: Yamaha C7 grand piano, assorted percussion, all standard instruments, synthesizers, sequencers and samplers available.
 Other MIDI Equipment: Available on request
 Video Equipment: (2) CMX 3400 edit bays 1" and 3/4", BetaCam or M-format w/ADO, Bosch FDL60B, DiVinci color corrector, Nagra T 38 x 60 x 16 stage, light rates available.
 Extras & Direction: Telemation Productions offers complete production services from concept to distribution, all under one roof. We have the most extensive collection of music libraries in the Pacific Northwest and our sound effects library includes the latest CD libraries as well as many field recordings we have collected over the past 20 years. We can also provide composers, arrangers and musicians for original score to picture. The Telemation Studios are designed for music scoring, Foley, voice and ADR recording. We specialize in synchronous transfers and can solve virtually any audio sync problem. Our Nagra T allows us to resolve neo-pilot, FM-pilot or center-track time code to 16-, 24- multi-track, 1", 3/4", BetaCam and M-format video; as well as 16 or 35 mm mag stock. Telemations experienced staff will provide you with the best product within your production budget! Try our award winning sound on your next audio sweetening project

[24+] TIKI RECORDING STUDIOS
 195 S. 26th St.
 San Jose, CA 95116
 (408) 286-9840
 Owner: Gracie & Jeannine O'Neal
 Studio Manager: Gracie O'Neal
 Extras & Direction: Specializing in country, gospel, rock, all styles of Mexican, Portuguese, Vietnamese and international music. Chart proven producers, arrangers and musicians available. Three active publishing companies, one active record company. In-house cassette duplication for short or long run cassettes. Record and CD manufacturing available.

[24+] T.J. RECORDING STUDIO, INC.
 also REMOTE RECORDING
 2718 E. 96th
 Tacoma, WA 98445
 (206) 537-0123
 Owner: Thomas J. Landon
 Studio Manager: Thomas J. Landon

[24+] TRIAD RECORDING STUDIOS
 352 W. 12th Ave.
 Eugene, OR 97401
 (503) 687-9032
 Owner: Allan Weyl
 Studio Manager: Allan Weyl, Alexis Maddock
 Engineers: Peter Lornez
 Dimensions: Studio 30 x 40, control room 20 x 30
 Mixing Consoles: Triad 26 x 16 x 24 x 8 automated.
 Audio Recorders: Ampex 1200 24-track 20-point/search-to-cue/remote/VSO, Studer B67 2-track, Otari 5050 2-track, Revox A70 2-track.
 Cassette Recorders/Duplicators: Nakamichi 582, Nakamichi DP 40-50 duplicator.
 Echo, Reverb, & Delay Systems: EMT plate stereo tube reverb, Klark-Teknik DN-780 digital reverb, Klark-Teknik DN-36 delay, Lexicon Prime Time delay, DeltaLab Acousticcomputer, MICMIX Super C Master-Room reverb.
 Other Outboard Equipment: Scamp rack w/(4) limiter/compressor, (8) noise gates, (4) parametric EQ/delay/autopan, (2) dbx 160 compressor, (2) Roger Mayer noise gate, EXR Exciter, (2) White 27-band EQ.
 Microphones: (2) Neumann U87, (2) Neumann U47, (2) Neumann KM8U, (2) AKG 414, (2) RCA 77DX, (2) Sennheiser 421, AKG D-112, (2) Shure 57, (4) AKG 251, PZM
 Monitor Amplifiers: Phase Linear 700B, McIntosh 7270, McIntosh 2105.

Monitor Speakers: Custom tri-amplified system, Tannoy Gold Line, UREI 809.
Musical Instruments: Steinway B vintage concert grand, Kurzweil 250.
Rates: \$50/hr. includes engineer.

[24+] TRIAD STUDIOS

4572 150th Ave. NE
Redmond, WA 98052
(206) 881-9322
Owner: Emerald Studios, Inc.
Studio Manager: Jim Loomis
Engineers: Lary Neizger, Tom Hall, Mike Tortorello
Dimensions: Studio 40 x 24, control room 19 x 24.
Mixing Consoles: NEOTEK IIC 36 x 24.
Audio Recorders: MCI JH-24 24- and 16-track, MCI JH-110B 2-track 1/2", Otari MTR-12-2 2-track center band, Pioneer PT701.
Cassette Recorders/Duplicators: Technics RSM85, (2) Aiwa F660, (22) Ken A. Bacon Associates real time duplicators.
Synchronization Systems: Lynx time code, Synhance MTS.
Echo, Reverb, & Delay Systems: Lexicon 224XL, Lexicon PCM-70, (2) Lexicon PCM41, Lexicon Super Prime Time, (2) Eventide H910, Klark-Teknik DN780, (3) Alesis Microverb.
Other Outboard Equipment: Klark-Teknik DN60 real time, ADR panscan, ADR F760X complex-limiter, (2) dbx RM160, Aphex 602B, Kepex II, UREI 1176, (2) Teletronics LA-2A, (2) API 550A, (2) Barcus-Berry Electronics EQF-2, Orban 536A de-esser, Pulteq EGH-2, Akai M30P, Macintosh Plus.
Microphones: AKG 414-EB, AKG 451-EB, AKG C-60, AKG D-12E, Neumann U47, Neumann U87, Neumann KM84, Neumann KM88, Sony C-37A, Sennheiser 421, Sennheiser 441, Shure SM53, Shure SM56, Shure SM57, Shure SM58, E-V RE20, Beyer M-500, Countryman E101, Countryman M85, Fostex M77.
Monitor Amplifiers: Hafler DH500, Hafler DH220, Hafler DH200.
Monitor Speakers: (2) JBL 4435, (2) JBL 4311, (2) Yamaha NS-10M, (2) Auratone 5C.
Musical Instruments: Yamaha C7D grand piano, Emulator II, Yamaha DX7, Prophet 5, LinnDrum, Gretsch drum kit.

[24+] VISTA SOUND RECORDING
17760 Vista Ave.
Monte Sereno, CA 95030
(408) 395-5945
Owner: Dan Wyman
Studio Manager: Timm Burleigh



DAVE WELHAUSEN STUDIOS
San Francisco, CA

[24+] DAVE WELHAUSEN STUDIOS
1310 20th Ave.
San Francisco, CA 94122
(415) 564-4910
Owner: Dave Wellhausen
Studio Manager: Janet Wellhausen
Engineers: Dave Wellhausen, John Altmann, Marc Senasac, Gary Mankin, Mikey Razor, Steve O'Hara and independents.
Dimensions: Studio 25 x 15 x 12 w/vocal and drum booth, control room 15 x 15 x 12.
Mixing Consoles: Sound Workshop 34C 32 x 24 x 6 w/ARMS II automation 52 inputs in mxdown.
Audio Recorders: MCI JH-24 16-/24-track transformerless, MCI JH-110 2-track, (2) Otari MX-5050 MKII, Pioneer RT-707

1/4-track.
Cassette Recorders/Duplicators: (2) Nakamichi MR-1, (2) Aiwa 6900.
Noise Reduction Equipment: Dolby 361 on 2-track machine.
Echo, Reverb, & Delay Systems: Lexicon 224XL digital reverb w/LARC and all updates, Roland SRV-2000, Roland DEP-5, Alesis Microverb, Yamaha D1500, Yamaha SPX90, Lexicon Prime Time digital delay, DeltaLab ADM-1024, DeltaLab ADM-64.
Other Outboard Equipment: Eventide Harmonizer, Marshall Time Modulator analog delay, Valley People Dyna-Mite, SAE graphic equalizer, SAE parametric equalizer, (2) Drawmer gates, ADR Vocal Stresser, Symetrix noise gates, (2) UREI 1176 limiters, (2) UREI LA-4, Aphex Aural Exciter, Aphex Compellor, Microphones: (2) Neumann U87, Neumann KM84, (2) AKG 414EB, (2) AKG 451, (2) AKG 460B, AKG D12E, (3) E-V RE20, (2) E-V RE15, (6) Sennheiser 421, Sennheiser 441, (5) Shure SM57, Shure SM58, (2) Countryman direct boxes, Countryman EM101, Beyer M101, Beyer M201, Beyer M300, Sony C36P, Sony ECM-33, (4) Crown PZM.
Monitor Amplifiers: AB Systems 600 precedent, BGW 250, Symetrix A220.
Monitor Speakers: (4) Ed Long MDM-4, (2) Yamaha NS-10M, (2) Auratone, (12) AKG 240 headphones.
Musical Instruments: Yamaha C3 6' conservatory grand piano, Yamaha DX7, Roland MKS-30, Roland TR-707 drum machine, Roland MSQ-700 sequencer, drumulator, Les Paul, Roland Octapad, Fender Precision Bass, Casio CZ-101, MIDIBass and anything else available upon request.
Rates: You'll find our rates to be the best value for pro recording in the Bay Area. Please call for rates.

[24+] WIZARDS & CECIL B.
also **REMOTE RECORDING**
1111 Second Ave.
San Rafael, CA
(415) 453-0335
Owner: Pete Slauson
Studio Manager: Mike Brannon

[24+] WOODMONT BEACH STUDIOS
PO Box 98553
Seattle, WA 98198
(206) 941-2430
Owner: Richard & Jillene Rogers
Studio Manager: Rich Rogers

ADVERTISEMENT

"Elvis spoke to me from the grave and told me to go to LD Systems. He's my idol."

As a special tribute to The King, I am re-recording the complete Elvis catalog. Needless to say, I wanted the best recording equipment; the latest in MIDI technology. I didn't know where to turn. And then one night, Elvis appeared to me in a dream and sent me to LD Systems. What did I find there? Over 160 of the finest pro-audio lines available and on display in the most beautiful showroom I ever saw this side of Graceland. The salespeople really knew their stuff and helped me demo all the gear I was interested in. Naturally I got everything I needed there.

Thanks Elvis! When I take my show on the road, I'm going back to LD for my sound reinforcement equipment too.



LD SYSTEMS, INC.

467 W. 38TH, HOUSTON, TEXAS 77018
(713) 695-9400



"LD can be contacted electronically on ESI Street."

- | | |
|----------------|--------------|
| Adams-Smith | Klark-Teknik |
| Agfa | Lexicon |
| AKG | Littlite |
| Amek | Loft |
| Ampex | Maxell |
| Anchor | Mogami |
| Annis | MRL |
| Anvil | Nady |
| Aphex | Nakamichi |
| ART | Neumann |
| Ashly | Neutrik |
| Audio-Technica | Nortronics |
| Auratone | Numark |
| AXE | Omnicroft |
| BBE | Omnimount |
| Beyer | Orban |
| Biamp | Otari |
| Brooke | Proco |
| B&K | QSC |
| Carver | Ramsa |
| Cetec-Vega | Renkus-Heinz |
| Clearcom | RTS Systems |
| Community | Ruslang |
| Countryman | Scotch/3M |
| Crest | Sennheiser |
| Crown | Sescom |
| C Tape | Shure |
| dbx | Simon |
| dbx digital | Soundcraft |
| DeltaLab | Star Case |
| EAW | Switchcraft |
| Electrovoice | TAC |
| Eventide | Tascam |
| Fostex | TOA |
| Gauss | Turbosound |
| GLI | Urei |
| Goldline | Ursa |
| HME | White |
| Interface | Whirlwind |
| Ivrie | Williams |
| JBL | Wireworks |

N O R T H W E S T

12&16 TRACK

STUDIOS

[16] APPLE CITY MUSIC
PO Box 2192
Wenatchee, WA 98801
(509) 663-8739
Owner: Robin Goodrich

[16] THE ART OF EARS
1217 A Fell St.
San Francisco, CA 94114
(415) 864-4641
Owner: Andre Ernst
Studio Manager: Nance Urquidez

[16] FRED ARTHUR PRODUCTIONS, LTD.
1218 E. 18th Ave.
Denver, CO 80218
(303) 832-2664
Owner: Fred Arthur
Studio Manager: Susan Weber

[16] ARTIST SOUND
only REMOTE RECORDING
12311 NE Glisan, #254
Portland, OR 97216
(503) 254-9742
Owner: Richard Paige
Studio Manager: Richard Paige

[16] ASTRAL SOUNDS RECORDING
482 Reynolds Circle
San Jose, CA 95112
(408) 436-1153
Owner: Joan Hare, Bill Hare, Randy Musumeci
Studio Manager: Bill Hare

modified
Synchronization Systems: SMPL system w/MIDI interface.
Echo, Reverb, & Delay Systems: Lexicon 224XL, EMT 240, Ursa Major SST-282, Marshall time modulator, Lexicon Delta-T, TC-2290 (11-second), (2) SPX90, (3) Effectron II, Microverb, Roland DEP-5
Other Outboard Equipment: (2) 1176LN, (2) LA-3A, stereo complex, Eventide Omniphosor, Aphex Studio II, Moog Poly Phaser, (2) Pultec MEQ-5, Lang PEQ-2, (2) ITI EQs, Ashly SC66 stereo parametric
Microphones: Telefunken, Neumann, AKG, Sennheiser, Sony, Crown, E-V, RCA, Beyer, Countryman, Altec (tube)
Monitor Amplifiers: Meyer ACD, Eagle-7 (Electron-Kinetics), McIntosh
Monitor Speakers: Meyer ACD, JBL 4230, JBL 4315, Yamaha NS-10
Musical Instruments: Fender Lap Steel, Baldwin/Howard baby grand, tympani, vibraphone, mellotron, Oberheim DX.
Other MIDI Equipment: Apple II Plus w/Synth software, SMPL MIDI interface w/measure pointer
Video Equipment: JVC 19" monitor, Ardek 15" monitor, JVC 3/4" VCR, VHS and Beta
Other: 1/3-octave RTA and X-Y scope on-line.
Rates: Call for rates

[16] ATWATER RECORDING
also REMOTE RECORDING
1468 Broadway
Atwater, CA 95301
(209) 358-7431
Owner: Jim Schniber
Studio Manager: Hugh Self

[16] AUDIO VISIONS
313 Brokaw Rd.
Santa Clara, CA 95050
(408) 988-2048
Owner: Lee Graziani
Studio Manager: Dave Portera

automated, Audio-Technica AT-IRM64 6 x 4 w/onboard 4-track cassette, (2) Yamaha MM10 4 x 2 AC/DC portable mixers.
Audio Recorders: Otari MTR-9011 16-track, (2) Otari MX-5050BII 2-track
Cassette Recorders/Duplicators: (10) Sony TC-FX320 real time cassette, (2) JVC DD-7 3-head cassette, (2) Technics M-205.
Synchronization Systems: BTX Shadowpad synchronizer.
Echo, Reverb, & Delay Systems: Lexicon 224 digital reverb, Lexicon PCM70 digital effects processor, DeltaLab DL-4 digital delay.
Other Outboard Equipment: dbx 900 rack w/noise gates/de-essers/limiters, Eventide H949 Harmonizer, Orban Parasound 674A parametric EQ.
Microphones: Neumann U67 tube-type, Neumann U47, Sennheiser 421, Sony ECM-30 Lavalier, Audio-Technica AT-803a Lavalier, (4) Shure SM58, (2) Shure SM57, (2) Beyer M69, (2) E-V RE20.
Monitor Amplifiers: (2) AB Systems.
Monitor Speakers: (2) JBL 4430, (2) Ed Long MDM-4, (2) Infinity, (2) Yamaha S2115H stage, (2) E-V S15-3.
Musical Instruments: Yamaha DX7, Ensoniq Mirage sampling keyboard, Casio CZ-1000, Yamaha RX11 drum machine, Linn-Drum, Simmons SDS-7, Roland TR-808, (6) guitars and basses, (4) amplifiers.
Other MIDI Equipment: Macintosh Opcode MIDI sequencing system, Yamaha QX1 sequencer.
Video Equipment: 3/4" and VHS A/B roll edit system, Chyron VP-2 broadcast character generator, (2) Ikegami ITC-730A broadcast video cameras, 3/4" portable production package w/lights
Rates: Please call Peter for rates/demos/tours
Extras & Direction: Avid Productions is a fully integrated audio and video production complex offering complete production and post-production services. Creative innovation has kept Avid growing steadily in the areas of industrial, commercial and corporate audio and video communications. Nestled in downtown San Mateo, Avid clients enjoy the newly renovated, tree-lined streets and the abundance of good restaurants, shops and convenient parking the area offers. Broadcast video production, audio for video, scoring to picture, radio and television programs, music videos, albums, demos and duplication for clients ranging from Star Search hopefuls and independent producers to major corporations such as Fortune Systems, Apple Computer, Nikon, US Sprint and Safeway

[12] B STREET MUSIC & RECORDING
also REMOTE RECORDING
47 N. B St.
San Mateo, CA 94401
(415) 342-2208
Owner: Gary Zimmerman
Studio Manager: Tim Azzaria

[16] BAY RECORDS
1741 Alcatraz
Berkeley, CA 94703
(415) 428-2002
Owner: Michael Cogan
Studio Manager: Michael Cogan
Engineers: Robert Shumaker, Michael Cogan
Dimensions: Studio 30 x 34, control room 15 x 20
Mixing Consoles: Biamp Bimix 20 x 16
Audio Recorders: M79 16-track, M79 8-track, Ampex ATR-800 2-track, Sony PCM-F1 2-track, Ampex AG-350 2-track.
Cassette Recorders/Duplicators: (2) Sony
Noise Reduction Equipment: dbx 4 channels outboard.
Echo, Reverb, & Delay Systems: Yamaha SPX90, MICMIX Super C, Effectron.
Other Outboard Equipment: dbx 160 limiter, SAE 2700 equalizer.
Microphones: (2) Neumann U87, Neumann SM69, (3) Neumann KM84, Neumann KM83, (2) AKG C452, (2) AKG D224, more
Monitor Amplifiers: (2) Hafler
Monitor Speakers: (2) JBL 4311
Musical Instruments: Kawai 6'9" grand, misc percussion.
Rates: \$45/hr first ten hours, then \$40/hr.
Extras & Direction: We are pleased to announce the addition of Robert Shumaker—former manager of 1750 Arch Studios—to our staff along with our move to larger quarters in Berkeley which include a 1,000 sq. ft. studio designed by Randy Sparks. We still offer our record pressing package and now also do cassettes and compact discs. 1,000 LPs from your tape and artwork cost \$3,400 complete including color covers, everything.

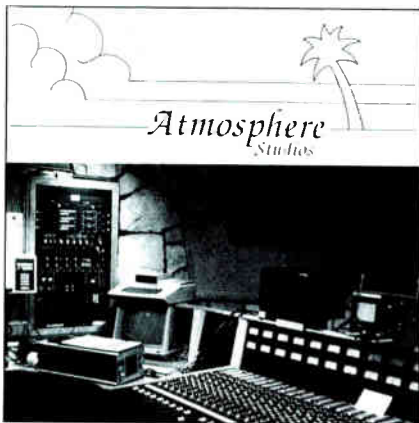

ATMOSPHERE
San Rafael, CA



AVID PRODUCTIONS
San Mateo, CA

[16] ATMOSPHERE
23 Joseph Ct.
San Rafael, CA 94903
(415) 479-2125
Owner: Robert Brown
Studio Manager: Gregg Schnitzer
Engineers: Gregg Schnitzer, Ray Bobo.
Dimensions: Studio 15 x 25, control room 12 x 14, with separate drum booth.
Mixing Consoles: Tangent 3216 custom 28 x 24.
Audio Recorders: Stephens 16-track 2" 30 ips, 3M 64 2-track 1/2" 30 ips, Technics 2-track digital.
Cassette Recorders/Duplicators: (2) Sony 777, (4) Onkyo 2048

[16] AVID PRODUCTIONS
235 E. Third Ave., Ste. 215
San Mateo, CA 94401
(415) 347-3417
Owner: Henry Bilbao
Studio Manager: Peter Nixon
Engineers: Chris Craig, Peter Nixon.
Dimensions: Room 1: studio 18 x 20, control room 12 x 10.
Room 2: studio 18 x 23, control room 12 x 10.
Mixing Consoles: Sound Workshop Series 34B 24 x 24 fully

[16] BEAR CREEK RECORDING STUDIO
20711 Bear Creek Rd.
Los Gatos, CA 95030
(408) 354-2351
Owner: Justin Mayer
Studio Manager: Justin Mayer

[16] ROBERT BERKE SOUND
50 Mendell St. #11
San Francisco, CA 94126
(415) 285-8800

Owner: Robert Berke
 Studio Manager: Mark Escott
 Engineers: Steve Brawn, Mark Escott, Chris Miloslavich
 Dimensions: Room 1 studio 15 x 18, control room 14 x 19
 Room 2 studio 7 x 12, control room 15 x 21. Room 3: control room 11 x 13. Room 4: control room 10 x 13
 Mixing Consoles: Audiotronics 700 16 x 16, Sound Workshop 34C 16 x 16 w/DiskMix, Soundcraft 600 12 x 16, Soundcraft 200B 8 x 4
 Audio Recorders: (2) Otari MTR-90II 16-track, Otari MTR-10 4-track, (7) Otari MTR-10 2-track, (3) Otari MX-5050B 4-track, Otari MX-70 8-track
 Cassette Recorders/Duplicators: (3) Technics, (4) Akai
 Noise Reduction Equipment: dbx 32-channel noise reduction system
 Synchronization Systems: (2) Kelly Quan computer systems
 Echo, Reverb, & Delay Systems: (2) Yamaha SPX90 reverb systems, Yamaha REV7 reverb systems, Lexicon 200B, Eventide H949 Harmonizer
 Other Outboard Equipment: (3) Dynalex noise reduction systems, (4) Orban 424 limiter/compressors, Orban 464 limiter/compressors, (3) Orban 622B parametric EQ, (4) Orban de-essers, Valley People Gain Brain, (2) Symetrix telephone interface systems, (4) Yamaha/Technics CD players, (4) Technics turntables
 Microphones: Neumann, Shure, E-V
 Monitor Amplifiers: (3) Bryston YB, (8) BGW
 Monitor Speakers: JBL 4430, JBL 4430, JBL 4425
 Video Equipment: Sony BVH-1100 1" VTR w/TBC and Dolby audio, (2) Sony BVU-800 3/4" VTRs, JVC 850 3/4" VTR, Panasonic 1/2" VCR, Sony/Panasonic color monitors, (4) Cipher Digital time code generator/readers, EC 101 synchronizer, (4) Cipher Digital Shadow synchronizers
 Rates: Please call for rates
 Extras & Direction: Thousands of music and sound effects cues from the leading production libraries, client lounge, conference room and kitchen. Robert Berke Sound is an audio production facility specializing in audio for video, commercial and A/V sound production. The complex now features full 1" VTR transfer and layback capability, three acoustically identical control rooms and studios designed by Pandy Sparks of RLS Acoustics, and the most up-to-date music and sound effects library available. The studio has completed post-production sound for hundreds of network, local and commercial video programs during the previous year.

[16] BEYOND SOUND
 6300 Federal Blvd.
 Denver, CO
 (303) 427-6789
 Owner: Paul Stenwig

[16] BOB KAT STUDIO
 PO Box 5503
 Berkeley, CA 94705
 (415) 548-9766
 Owner: Kat Epple, Bob Stohl
 Studio Manager: Bob Stohl

[16] BROWN BAG PRODUCTIONS
 4134 S. Eudora St.
 Englewood, CO 80110
 (303) 756-9949
 Owner: Dr. Michael Lee, Robert Lee
 Studio Manager: Robert Lee

[16] BUNYUP BAKERIES
 PO Box 10562
 Oakland, CA 94610
 (415) 534-4641
 Owner: Bill Carrico, Maureen Coyle
 Studio Manager: Bill Carrico

[16] CHRISTIAN RECORDING STUDIOS
 6300 Federal Blvd.
 Denver, CO 80221
 (303) 427-2075
 Owner: Dean R. Carroll, Larry P. Stasny

[16] C-M-I
 10125 227th Ave. Ct. E.
 Buckley, WA 98321
 (206) 862-1877
 Owner: Tom Thrasher
 Studio Manager: Tom Thrasher

[16] COUPE STUDIOS
 also REMOTE RECORDING
 2539 Pearl St.
 Boulder, CO 80302
 (303) 447-0551
 Owner: Scott Roche, Patrick Cullie
 Studio Manager: Scott Roche, Patrick Cullie

[16] CPS PRODUCTIONS CO. (CHRISTIAN PRODUCTION SERVICES)
 only REMOTE RECORDING
 10225 E. Girard Ave.
 Denver, CO 80231
 (303) 695-4558
 Owner: Stuart V. Simon
 Studio Manager: Mike Nelson

[16] CREATIVE COMMERCIAL CONCEPTS
 9790 N. Wenas Rd.
 Selah, WA 98942
 (509) 575-6685
 Owner: Mark Farmer
 Studio Manager: Mark Farmer

[16] CREATIVE SOUND STUDIO
 602 Cree Dr.
 San Jose, CA 95123
 (408) 224-1777
 Owner: Richard Dias
 Studio Manager: Ramah Dias

[16] DANCING DOG
 1500 Park St., B210
 Emeryville, CA 94608
 (415) 655-6760
 Owner: David Bryson
 Studio Manager: David Bryson



DAVIS SOUND STUDIO
 Davis, CA

[16] DAVIS SOUND STUDIO
 1205 Oak Ave.
 Davis, CA 95616
 (916) 758-6661
 Owner: Andy Lang
 Studio Manager: Andy Lang
 Engineers: Andy Lang, Christine Webster
 Dimensions: Studio 13 x 12, control room 18 x 10. Iso room 1 7 x 6, iso room 2 5 x 4
 Mixing Consoles: Amek/TAC Scorpion 16 x 8
 Audio Recorders: Otari MX-70 16-track, Otari MX-5050B II 2-track, TEAC X-3 MkII 2-track
 Cassette Recorders/Duplicators: Bang and Olufsen Beocord 9000, Nakamichi BX-300, Denon DR-M4
 Noise Reduction Equipment: (2) dbx 224X
 Echo, Reverb, & Delay Systems: (2) Lexicon PCM70 digital effects processor, Lexicon PCM60 digital reverb, DeltaLab ADM-1024 Effectron II digital delay, Ibanez DM-1000 digital delay
 Other Outboard Equipment: (4) Valley People Kepex II noise gates, (2) Valley People Gain Brain II compressor/limiter/ducker, (3) Valley People Maxi-Q 3-band parametric EQ, (2) Rane DE-15 5-band parametric EQ, Orban 674A 8-band, 2-channel parametric EQ, Orban 424A 2-channel compressor/limiter/de-esser, dbx 166 2-channel compressor/limiter/gate, Aphex Type B 2-channel Aural Exciter, Burwen TNE7000 2-channel transient noise eliminator
 Microphones: Neumann U89i, (3) Neumann KM84i, AKG C414, (2) Sennheiser MD-421, (2) Audio-Technica AT813R, Audio-Technica ATM-63, Beyer M-500, Beyer M-201, Shure SM57, (2) Crown PZM-30 GPB
 Monitor Amplifiers: Tandberg TIA-3012, Hitachi HA-610 (headphone), Rane HC-6 (headphone)
 Monitor Speakers: Spica TC-50 w/2 Spica servo subwoofers (main), ADS L-400 (console), Canton GL-300F (studio), ADS L-400 (console), ADS 300i (car type), JBL 4627 (bass cabinet), Musical Instruments: Sequential Circuits Model 400 drum machine, Memorymoog plus analog synthesizer, Ibanez Roadstar II electric guitar, Yamaha G240 acoustic guitar, Marshall Lead 12 guitar amplifier/cabinet, Wing and Son concert grand up-

right piano
 Other MIDI Equipment: Roland Octapad Pad-8
 Other: (6) Phi Tech acoustic drum triggers, (2) Axe kLuk-Trac, NAD 5255 compact disc player, Bang and Olufsen TX turntable w/B&O MMC 2 cartridge
 Rates: 1-10 hrs: \$30/hr, 11-50 hrs: \$25/hr, 50+ hrs: \$20/hr
 All prices include engineer and any studio instruments the client desires to use
 Extras & Direction: Davis Sound Studio strives not only to make the best possible recordings technically, but also to provide a very friendly, comfortable, relaxed and creative atmosphere for our clients. We treat every project with care and concern for what our clients want, and turn their desires into a professional quality finished product. We handle all types of projects including narration, voice-over, commercial and jingle production, (we have the entire Sound Ideas 1,000 Series sound effects library on 28 compact discs), demo tapes and albums. We also offer real time tape duplication. In addition, production services and session musicians are available upon request. Our lounge area includes TV, video games and refrigerator (always stocked with water, soft drinks, coffee and tea). Access to Davis Sound Studio is easy via nearby freeways and airports. As you can see, we are more than just competitive! Please give us a call or just stop by.

[16] DEVA RECORDS
 3525 Calafia Ave.
 Oakland, CA 94605
 (415) 638-3341
 Owner: Bruce Mishkit
 Studio Manager: Bruce Mishkit

[12] DOCTOR BLACK STUDIO
 W1627 10th Ave.
 Spokane, WA 99204
 (509) 456-0622
 Owner: Robert Schwartz
 Studio Manager: Mark Bews, Jamie Melville

[16] DOME STUDIOS
 1912 Gilmore Trail
 Fairbanks, AK 99712
 (907) 457-1993
 (907) 456-2604
 Owner: Gerald Ralson
 Studio Manager: Ron "Rif" Ralson
 Engineers: Rif Ralson, Jerry Ralson
 Dimensions: Studio 460 sq ft (irregular polygon), control room 150 sq ft
 Mixing Consoles: Hill B-3 24 x 8 x 2, Tascam Model 3 8 x 4 x 2, (2) Shure 4 x 1 sub-mixers
 Audio Recorders: Tascam MS-16 16-track, Tascam 80-8 8-track, TEAC 334DS 4-track, Technics RS1500US 2-track, Pioneer RT 1050 2-track
 Cassette Recorders/Duplicators: Tascam 122B, Technics
 Noise Reduction Equipment: dbx 8 channels, Symetrix 511
 Echo, Reverb, & Delay Systems: ART ProVerb, DL-2 Acoustic-computer, AKG BX-5 reverb
 Other Outboard Equipment: Orban 622B parametric equalizer, Rane GE-27 graphic equalizer, Rane RE-27 real time equalizer, (2) Furman LC-2 comp/limiters
 Microphones: Neumann U47 tube, Beyer, Shure, AKG, Crown PZM, Audio-Technica, Toa, Calrec, Peavey, Countryman direct boxes
 Monitor Amplifiers: Haller, Crown, Rane HC-6 headphone amp
 Monitor Speakers: Klipsch Cornwalls, JBL 4313, Auratone
 Musical Instruments: Yamaha DX7, Yamaha QX7, E-mu drumulator, E-drums, electric and acoustic bass, guitars, upright grand piano
 Other: Macintosh SE
 Rates: Upon request.

[12] DOWNHOME DEMO'S
 Northglenn, CO
 (303) 457-1740
 Owner: Steve McGowan
 Studio Manager: Steve McGowan

[16] DRONE STUDIOS
 2516 El Camino Real
 Redwood City, CA 94061
 (415) 366-4212
 Owner: Brett Brown
 Studio Manager: Brett Brown

[16] DUNCAN STREET STUDIO
 240 Duncan St.
 San Francisco, CA 94131
 (415) 285-9093
 Owner: John Blakeley
 Studio Manager: John Blakeley

Son of FX

ORGANIZE YOUR RECORDING, COMPUTER AND RACK MOUNTABLE EQUIPMENT IN AN ATTRACTIVE, MOBILE WORK STATION

SON OF FX FEATURES:

- Two adjustable shelves for multi-tracks, drum machines, computers and more!
- Holds up to 10 rack "spaces" of equipment.
- Shown with optional "Rack Drawer"

ASK YOUR DEALER FOR A DEMONSTRATION
CALL OR WRITE FOR FREE BROCHURE

FOUR DESIGNS COMPANY 6531 GROVE AVENUE • CA10GA PARK, CA 94307
(818) 716-8540



FOR ADDITIONAL FOUR DESIGNS
PRODUCT INFORMATION, CALL:
1-800-544-3746
SAY YOU SAW IT IN MIX!

RACK

ECONOMICAL 19" RACK MOUNT "FURNITURE" FOR THE PROFESSIONAL OR HOME STUDIO

FX RACK FEATURES:

- Holds up to 18 "spaces" of equipment.
- Attractive black textured vinyl laminate
- Shown with optional wheels

ASK YOUR DEALER FOR A DEMONSTRATION
CALL OR WRITE FOR FREE BROCHURE

FOUR DESIGNS COMPANY 6531 GROVE AVENUE • CA10GA PARK, CA 94307
(818) 716-8540



Circle #131 on Reader Service Card

MOVING?

FOR UNINTERRUPTED SERVICE
MAIL TO:
**MIX PUBLICATIONS
2608 NINTH STREET
BERKELEY, CA 94710**

(PLEASE ATTACH OLD ADDRESS LABEL HERE)

(PLEASE PRINT NEW ADDRESS BELOW)

NAME _____

COMPANY _____

ADDRESS _____

CITY _____ STATE _____ ZIP _____

N O R T H W E S T

12&16 TRACK

STUDIOS

[12] SONOMA SOUND
also **REMOTE RECORDING**
PO Box 1623
Sonoma, CA 95476
(707) 996-4363
Owner: Arron Johnson
Studio Manager: Arron Johnson

[16] SOUND RECORDING COMPANY
also **REMOTE RECORDING**
West 503 Indiana Ave.
Spokane, WA 99205
(509) 326-0222
Owner: Paul W. Carter
Studio Manager: Irene Carter

[16] THE SOUND SOURCE
741 4th St., 2nd Floor
Santa Rosa, CA 95402
(707) 528-1530
Owner: Randy Teaford, Dave Armijo
Studio Manager: Claire Teaford, Marilyn Armijo
Extras & Direction: The Sound Source is a unique new 16-track audio/digital production facility located above one of Northern California's largest music stores, Stanroy Music Center. Our primary function is to offer all musicians, producers and film makers, integrated computer sequencing via Macintosh Plus/Apple II computers with the very latest keyboards, synthesizers and digital samplers available as cost-effective techniques for production. An expanding library of software and samples featuring Performer/Composer, Opcode, Digidesign, Passport, Blank, Intelligent Music and many others offers the client the option to do their own pre-production if desired and then download their data here for final engineering. Currently The Sound Source is hosting the musical scoring and engineering for the next Charles Shulz film for TV "The Girl in the Red Truck," a TV musical production for "Satin Steel" and various commercial broadcast projects. Rates and equipment list upon request.

[16] SOUND WEST RECORDING
2321 Tacoma Ave.
Tacoma, WA 98402
(206) 272-4251
Owner: Steve Paulik, Carl Schneider
Studio Manager: Steve Paulik
Engineers: Steve Paulik, Carl Schneider
Dimensions: Studio 19 x 25, control room 19 x 14
Mixing Consoles: Soundcraft TS-12 24 x 12 x 24
Audio Recorders: Tascam MS-16 16-track w/dbx, Technics 1500 1/2-track w/dbx, Akai GX-635D 1/4-track, TEAC X10R 1/4-track
Cassette Recorders/Duplicators: TEAC C1, Akai GXC-709D, Pioneer CT-F900
Noise Reduction Equipment: dbx 16-channel, dbx 150 2-channel
Synchronization Systems: E-mu SP-12 SMPTE lock and MIDI interface
Echo, Reverb, & Delay Systems: Lexicon PCM70, Lexicon PCM60, Lexicon PCM42, Roland SRV-2000, Roland SDE-1000, Ibanez SDR-1000
Other Outboard Equipment: Aphex Type C Exciter, Symetrix 544 gates, (2) UREI LA-4, Yamaha Q1027 EQ
Microphones: AKG, Sennheiser, E-V, Sony, Beyer, Beyer PZM, Shure, Audio-Technica
Monitor Amplifiers: Carver, Crown, Yamaha, Harman Kardon
Monitor Speakers: UREI 809, Yamaha NS-10M, Auralone 5C, AKG 240M (phones)
Musical Instruments: Ensoniq Mirage sampling keyboard w/extensive library, Yamaha TX81Z, Akai AX73, E-mu SP-12 sampling drum computer w/extensive library, Roland Octapad, guitars: Les Paul, SG, Ibanez, Ovation, Strat, amps: Gallien-Krueger, Rockman, Yamaha, Lab Series, Fender Twin, Ampeg, keyboards: (available w/advanced booking), Yamaha DX7, Roland JX-8P, Roland Juno-2, Roland Jupiter 6, Korg DW-8000, Korg DW-6000, Korg Poly 800, E-mu Emax
Other MIDI Equipment: Mark of the Unicorn Performer software (version 2.1), Macintosh 512K, Yamaha MJCB (MIDI switcher)
Video Equipment: 1/2" VHS Hi-Fi and Beta Hi-Fi, JVC GX-NSU camera, Panasonic PK-956 camera.
Rates: Please call for rates

[16] STAFFORDSHIRE PRODUCTIONS
PO Box 4364
Napa, CA 94558
(707) 226-8273
Owner: Kent Monson
Studio Manager: Kent Monson

[16] STARSHINE AUDIO ENTERPRISES
PO Box 3305
Chico, CA 95927
(916) 345-3027
Owner: Hugh E. Santos
Studio Manager: Hugh E. Santos

[16] STARTSONG
3218 E. LaSalle
Colorado Springs, CO 80909
(303) 634-2045
Owner: Tom Gregor

[16] STRATEGIC AIR COMMAND RECORDS
440 Pepper Ave.
Palo Alto, CA
(415) 325-0542
Owner: Dan Arlie
Studio Manager: Eric Dodd

[16] SYNCHRONICITY
Box 596
San Rafael, CA 94915
(415) 472-2523
Owner: Windsor Riley
Studio Manager: Windsor Riley
Engineers: Tom Rollison, Windsor Riley
Dimensions: Studio 18 x 11, live space 6 x 4
Mixing Consoles: Ramsa WR-T820 20 x 8 x 2, Kawai MX-8R x 2
Audio Recorders: Fostex B16 16-track, Sony PCM-501ES 2-track w/Super Betamax, Betamax.
Cassette Recorders/Duplicators: Technics M-235X
Noise Reduction Equipment: Dolby C (on B16)
Synchronization Systems: Fostex 4050 MIDI/SMPTE/autolocator
Echo, Reverb, & Delay Systems: Roland SDE-2500, Roland SRV-2000, Yamaha SPX90, Lexicon PCM60
Other Outboard Equipment: Symetrix 525 compressor/limiter/gate
Microphones: AKG, Fostex, Sony
Monitor Amplifiers: Haller 500, Harman Kardon
Monitor Speakers: Celestion SL65, Toa 230ME
Musical Instruments: Yamaha KX88 keyboard controller, Yamaha DX7II, Roland D-50, Roland JX-8P, Roland MKS-20 digital piano module, Kawai K3M, Akai S612, Akai S900, Korg DSS-1
Other MIDI Equipment: Macintosh Plus w/20 Megabyte hard disk and Performer software for Mac (sequencing), Atari 1040-ST w/Steinberg Pro 24 sequencing, D-5C editor/librarian, Hybrid Arts DX android editor/librarian, Digital Music Corp MX-8 MIDI patchbay, 360 Systems MIDI patchbay
Rates: Negotiable

SYNPRO

INTERNATIONAL

STUDIO

SYNPRO INTERNATIONAL STUDIO
San Anselmo, CA

[16] SYNPRO INTERNATIONAL STUDIO
2 Allmand Ln.
San Anselmo, CA 94960
(415) 457-4852
Owner: Satoshi Suzuki
Studio Manager: Dr. Space
Engineers: Daniel Ryman (credits for Color Purple w/Quincy Jones), Derek Stowe
Dimensions: Booth 8 x 8, room 20 x 20, reverb room 17 x 6, control room 12 x 20
Mixing Consoles: TAC Scorpion 32 x 16 x 8
Audio Recorders: Tascam MS-16 16-track, Sony PCM-601ES 2-track digital, (2) Fostex E-16 30-track w/synpro, Fostex E-22
Cassette Recorders/Duplicators: Nakamichi MR-1, Aiwa WX-220
Noise Reduction Equipment: (2) Dolby SR

Owner: Robert Berke
 Studio Manager: Mark Escott
 Engineers: Steve Brawn, Mark Escott, Chris Miloslavich
 Dimensions: Room 1: studio 15 x 18, control room 14 x 19
 Room 2: studio 7 x 12, control room 15 x 21. Room 3: control room 11 x 13. Room 4: control room 10 x 13
 Mixing Consoles: Audiotronics 700 16 x 16, Sound Workshop 34C 16 x 16 w/DiskMix, Soundcraft 600 12 x 16, Soundcraft 200B 8 x 4
 Audio Recorders: (2) Otari MTR-90II 16-track, Otari MTR-10 4-track, (7) Otari MTR-10 2-track, (3) Otari MX-5050B 4-track, Otari MX-70 8-track
 Cassette Recorders/Duplicators: (3) Technics, (4) Akai
 Noise Reduction Equipment: dbx 32-channel noise reduction system
 Synchronization Systems: (2) Kelly Quan computer systems
 Echo, Reverb, & Delay Systems: (2) Yamaha SPX90 reverb systems, Yamaha REV7 reverb systems, Lexicon 200B, Eventide H949 Harmonizer
 Other Outboard Equipment: (3) Dynaflex noise reduction systems, (4) Orban 424 limiter/compressors, Orban 464 limiter/compressors, (3) Orban 622B parametric EQ, (4) Orban de-essers, Valley People Gain Brain, (2) Symetrix telephone interface systems, (4) Yamaha/Technics CD players, (4) Technics turntables
 Microphones: Neumann, Shure, E-V
 Monitor Amplifiers: (3) Bryston YB, (8) BGW
 Monitor Speakers: JBL 4430, JBL 4430, JBL 4425
 Video Equipment: Sony BVH-1100 1" VTR w/TBC and Dolby audio, (2) Sony BVU-800 3/4" VTRs, JVC 850 3/4" VTR, Panasonic 1/2" VCR, Sony/Panasonic color monitors, (4) Cipher Digital time code generator/readers, EC 101 synchronizer, (4) Cipher Digital Shadow synchronizers
 Rates: Please call for rates
 Extras & Direction: Thousands of music and sound effects cues from the leading production libraries, client lounge, conference room and kitchen. Robert Berke Sound is an audio production facility specializing in audio for video, commercial and A/V sound production. The complex now features full 1" VTR transfer and layback capability, three acoustically identical control rooms and studios designed by Randy Sparks of RLS Acoustics, and the most up-to-date music and sound effects library available. The studio has completed post-production sound for hundreds of network, local and commercial video programs during the previous year.

[16] BEYOND SOUND
 6300 Federal Blvd.
 Denver, CO
 (303) 427-6789
 Owner: Paul Stenwig

[16] BOB KAT STUDIO
 PO Box 5503
 Berkeley, CA 94705
 (415) 548-9766
 Owner: Kat Epple, Bob Stohl
 Studio Manager: Bob Stohl

[16] BROWN BAG PRODUCTIONS
 4134 S. Eudora St.
 Englewood, CO 80110
 (303) 756-9949
 Owner: Dr. Michael Lee, Robert Lee
 Studio Manager: Robert Lee

[16] BUNYUP BAKERIES
 PO Box 10562
 Oakland, CA 94610
 (415) 534-4641
 Owner: Bill Carrico, Maureen Coyle
 Studio Manager: Bill Carrico

[16] CHRISTIAN RECORDING STUDIOS
 6300 Federal Blvd.
 Denver, CO 80221
 (303) 427-2075
 Owner: Dean R. Carroll, Larry P. Stasny

[16] C-M-I
 10125 227th Ave. Ct. E.
 Buckley, WA 98321
 (206) 862-1877
 Owner: Tom Thrasher
 Studio Manager: Tom Thrasher

[16] COUPE STUDIOS
 also REMOTE RECORDING
 2539 Pearl St.
 Boulder, CO 80302
 (303) 447-0551
 Owner: Scott Roche, Patrick Cullie
 Studio Manager: Scott Roche, Patrick Cullie

[16] CPS PRODUCTIONS CO. (CHRISTIAN PRODUCTION SERVICES)
 only REMOTE RECORDING
 10225 E. Girard Ave.
 Denver, CO 80231
 (303) 695-4558
 Owner: Stuart V. Simon
 Studio Manager: Mike Nelson

[16] CREATIVE COMMERCIAL CONCEPTS
 9790 N. Wenas Rd.
 Selah, WA 98942
 (509) 575-6685
 Owner: Mark Farmer
 Studio Manager: Mark Farmer

[16] CREATIVE SOUND STUDIO
 602 Cree Dr.
 San Jose, CA 95123
 (408) 224-7777
 Owner: Richard Dias
 Studio Manager: Ramah Dias

[16] DANCING DOG
 1500 Park St., B210
 Emeryville, CA 94608
 (415) 655-6760
 Owner: David Bryson
 Studio Manager: David Bryson



DAVIS SOUND STUDIO
 Davis, CA

[16] DAVIS SOUND STUDIO
 1205 Oak Ave.
 Davis, CA 95616
 (916) 758-6661
 Owner: Andy Lang
 Studio Manager: Andy Lang
 Engineers: Andy Lang, Christine Webster
 Dimensions: Studio 13 x 12, control room 18 x 10. Iso room 17 x 6, iso room 2 5 x 4
 Mixing Consoles: Amek/TAC Scorpion 16 x 8
 Audio Recorders: Otari MX-70 16-track, Otari MX-5050B II 2-track, TEAC x-3 MkII 2-track
 Cassette Recorders/Duplicators: Bang and Olufsen Beocord 9000, Nakamichi BX-300, Denon DR-M4
 Noise Reduction Equipment: (2) dbx 224X
 Echo, Reverb, & Delay Systems: (2) Lexicon PCM70 digital effects processor, Lexicon PCM60 digital reverb, DeltaLab ADM-1024 Effectron II digital delay, Ibanez DM-1000 digital delay
 Other Outboard Equipment: (4) Valley People Kepex II noise gates, (2) Valley People Gain Brain II compressor/limiter/ducker, (3) Valley People Maxi-Q 3-band parametric EQ, (2) Rane DE-15 5-band parametric EQ, Orban 674A 8-band, 2-channel parametric EQ, Orban 424A 2-channel compressor/limiter/de-esser, dbx 166 2-channel compressor/limiter/gate, Aphex Type B 2-channel Aural Exciter, Burwen TNE7000 2-channel transient noise eliminator
 Microphones: Neumann U89i, (3) Neumann KM84i, AKG C414, (2) Sennheiser MD-421, (2) Audio-Technica AT813R, Audio-Technica ATM-63, Beyer M-500, Beyer M-201, Shure SM57, (2) Crown PZM-30 GPB
 Monitor Amplifiers: Tandberg TIA-3012, Hitachi HA-610 (headphone), Rane HC-6 (headphone)
 Monitor Speakers: Spica TC-50 w/2 Spica servo subwoofers (main), ADS L-400 (console), Canton GL-300F (studio), ADS L-400 (console), ADS 300i (car type), JBL 4627 (bass cabinet).
 Musical Instruments: Sequential Circuits Model 400 drum machine, Memorymoog plus analog synthesizer, Ibanez Roadstar II electric guitar, Yamaha G240 acoustic guitar, Marshall Lead 12 guitar amplifier/cabinet, Wing and Son concert grand up-

right piano
 Other MIDI Equipment: Roland Octapad Pad-8
 Other: (6) Phi Tech acoustic drum triggers, (2) Axe kLIX-trac, NAD 5255 compact disc player, Bang and Olufsen TX turntable w/B&O MMC 2 cartridge
 Rates: 1-10 hrs: \$30/hr, 11-50 hrs: \$25/hr, 50+ hrs: \$20/hr. All prices include engineer and any studio instruments the client desires to use.

Extras & Direction: Davis Sound Studio strives not only to make the best possible recordings technically, but also to provide a very friendly, comfortable, relaxed and creative atmosphere for our clients. We treat every project with care and concern for what our clients want, and turn their desires into a professional quality finished product. We handle all types of projects including narration, voice-over, commercial and jingle production, (we have the entire Sound Ideas 1,000 Series sound effects library on 28 compact discs), demo tapes and albums. We also offer real time tape duplication. In addition, production services and session musicians are available upon request. Our lounge area includes TV, video games and refrigerator (always stocked with water, soft drinks, coffee and tea). Access to Davis Sound Studio is easy via nearby freeways and airports. As you can see, we are more than just competitive! Please give us a call or just stop by.

[16] DEVA RECORDS
 3525 Calafia Ave.
 Oakland, CA 94605
 (415) 638-3341
 Owner: Bruce Mishkit
 Studio Manager: Bruce Mishkit

[12] DOCTOR BLACK STUDIO
 W1627 10th Ave.
 Spokane, WA 99204
 (509) 456-0622
 Owner: Robert Schwartz
 Studio Manager: Mark Bews, Jamie Melville

[16] DOME STUDIOS
 1912 Gilmore Trail
 Fairbanks, AK 99712
 (907) 457-1993
 (907) 456-2604
 Owner: Gerald Rafson
 Studio Manager: Ron "Rif" Rafson
 Engineers: Rif Rafson, Jerry Rafson
 Dimensions: Studio 460 sq.ft (irregular polygon), control room 150 sq ft
 Mixing Consoles: Hill B-324 x 8 x 2, Tascam Model 3 8 x 4 x 2, (2) Shure 4 x 1 sub-mixers
 Audio Recorders: Tascam MS-16 16-track, Tascam 80-8 8-track, TEAC 334DS 4-track, Technics RS1500US 2-track, Pioneer RT 1050 2-track
 Cassette Recorders/Duplicators: Tascam 122B, Technics
 Noise Reduction Equipment: dbx 8 channels, Symetrix 511, Echo, Reverb, & Delay Systems: ART ProVerb, DL-2 Acoustic-computer, AKG BX-5 reverb
 Other Outboard Equipment: Orban 622B parametric equalizer, Rane GE-27 graphic equalizer, Rane RE-27 real time equalizer, (2) Furman LC-2 comp/limiters
 Microphones: Neumann U47 tube, Beyer, Shure, AKG, Crown PZM, Audio-Technica, Toa, Calrec, Peavey, Countryman direct boxes
 Monitor Amplifiers: Hafler, Crown, Rane HC-6 headphone amp
 Monitor Speakers: Klipsch Cornwalls, JBL 4313, Auratone
 Musical Instruments: Yamaha DX27, Yamaha QX7, E-mu drumulator, E-drums, electric and acoustic bass, guitars, upright grand piano
 Other: Macintosh SE
 Rates: Upon request.

[12] DOWNHOME DEMO'S
 Northglenn, CO
 (303) 457-1740
 Owner: Steve McGowan
 Studio Manager: Steve McGowan

[16] DRONE STUDIOS
 2516 El Camino Real
 Redwood City, CA 94061
 (415) 366-4212
 Owner: Brett Brown
 Studio Manager: Brett Brown

[16] DUNCAN STREET STUDIO
 240 Duncan St.
 San Francisco, CA 94131
 (415) 285-9093
 Owner: John Blakeley
 Studio Manager: John Blakeley

[16] E.J. SOUND
7096 Coronado Dr.
San Jose, CA 95129
(408) 446-2473
Owner: Eric Harding
Studio Manager: Eric Harding

[16] EMERALD CITY PRODUCTIONS
512 Lisbon St.
San Francisco, CA 94112
(415) 585-6219
Owner: Christopher Grinstead, Veronica Labeau
Studio Manager: Christopher Grinstead, Veronica Lab

[16] EMERYVILLE RECORDING CO.
1331 61st St., Unit C
Emeryville, CA 94608
(415) 655-9490
Owner: Randy Rood
Studio Manager: Randy Rood

[16] EYE IN THE SKY SOUND
4315 N. Hwy 287
LaPorte, CO 80535
(303) 482-3947
Owner: Randy Motke
Studio Manager: Randy Motke

[16] FASTTRACK RECORDING STUDIO
also REMOTE RECORDING
4220 Broadway
Denver, CO 80216
(303) 292-2115
Owner: Terry McMurtry
Studio Manager: Wayne K. Gerbrant

[16] FOREST PRODUCTIONS
also REMOTE RECORDING
PO Box 9201
Salt Lake City, UT 84109
(801) 466-7330
Owner: A Forest Production Company
Studio Manager: Leigh Nichols

[16] FREEWAY RECORDING, INC.
2248 E. 14th St.
Oakland, CA 94606
(415) 532-3700
Owner: Bernie, Billy, Peggy Rivera
Studio Manager: Ronnie T. Thomas

[16] FULL SCALE PRODUCTIONS, INC.
also REMOTE RECORDING
16241 Cleveland St., Ste. B
Redmond, WA 98052
(206) 883-4037
Owner: Full Scale Productions, Inc.
Studio Manager: David M. Kryger



GATE FIVE STUDIOS
Sausalito, CA

[16] GATE FIVE STUDIOS
also REMOTE RECORDING
2 Gate Five Rd.
Sausalito, CA 94965
(415) 332-2866
Owner: Christopher G. Hubbard
Studio Manager: Kathie Plaskiewicz

N O R T H W E S T

12&16 TRACK

STUDIOS

Engineers: Dr. Richie Moore, PhD, Terry Chambers, Lenette Viegas
Dimensions: Studio 20 x 20, control room 12 x 12
Mixing Consoles: Soundtracs MIDI PC audio console, Ramsa WR1820

Audio Recorders: Otari MX-70 16-track, Otari MX-5050 2-track mastering deck, Sony DTC-1000ES R-DAT, Tascam ATR-60 4-track

Cassette Recorders/Duplicators: Akai professional studio deck, Onkyo TA-2047 stereo
Synchronization Systems: Lynx TimeLine SMPTE modules, Roland SBX-80

Echo, Reverb, & Delay Systems: (2) Yamaha SPX90 digital processors, (2) Roland DEP-5 digital effect processors, Roland SRV-2000 digital reverb, Roland SRV-3000 digital delay

Other Outboard Equipment: Aphex Compellor, Aphex studio Dominator, (2) Furman signal processors, (2) Rane ME-30 1/3-octave graphic equalizer, Rane 1/2-octave graphic equalizer, (2) Furman LCX expander/compressor/limiter, Brooke-Siren DPR-402 compressor peak limiter, (2) Furman power conditioning modules w/lights, Symetrix 544 quad expander
Microphones: AKG "The Tube," Neumann U87 AZ, (4) AKG ULS-460, (2) Sennheiser MD-421, (2) Shure SM81 LC, (5) Shure SM57 LC, (2) Sennheiser 409 U3, Sennheiser MD-409, Crown PZM and power supply, Toa K4, (2) AKG C-414 EB, AKG P48

Monitor Amplifiers: (2) Z-Link 450W stereo audio amplifiers, Yamaha 2200 power amp, Peavey CS-1200 power amp
Monitor Speakers: (2) Tannoy SRM-12B studio monitor, (2) Yamaha NS-10M, (2) Toa 380SE loudspeakers, (2) Toa 312-ME reference monitors, (2) Toa 280-ME reference monitors
Musical Instruments: Roland S-50 digital sampling synthesizer, Yamaha DX7, Yamaha TX7, Kurzweil MIDIboard controller, Yamaha 7" baby grand piano (MIDI controlled)

Other MIDI Equipment: Roland MKS-20 digital piano module, Roland MKS-70 Super JX synthesizer module, (2) Apple Macintosh Plus computers, Mark of the Unicorn "Performer" sequencer software, Opcode Studio Plus MIDI interface for Macs, Toa D4 electronic music mixer, Toa D4-E electronic music mixer
Video Equipment: Sony VO-5600 3/4" video cassette deck, (2) Sony KV-1311CR RGB video monitors, Sony KV-M270 25" video monitor, Mitsubishi HS-402UR Hi-fi stereo/V-scan/digital auto tracking video cassette recorder.

Other: Technics SL-1200 MkII turntable, Technics SL-P500 compact disc player, ADC 288 point patchbay, (2) Furman PB40 patchbays, Rane HC6 headphone amp.
Rates: Call for rates.

Extras & Direction: Central location in beautiful Sausalito 15 minutes from San Francisco. Lounge with full kitchen and showering facility. Professional staff of full time engineers and full time technical support. Gate Five Studios in the past two years has grown to be a full service audio and audio-for-video production studio. We have become one of the most fully equipped 16-track recording facilities in the Bay Area. Major accomplishments have included the musical soundtrack for ABC's television series *Max Headroom*. Audio commercials for Levi's and Cal-Train, as well as numerous albums for local artists. Besides being so diverse technically, Gate Five offers the ultimate in acoustics, aesthetics, privacy and most importantly, an environment totally conducive to creativity.

[16] GUNG-HO STUDIO
86821 McMorott Ln.
Eugene, OR 97402
(503) 484-9352
Owner: Bill & Julienne Barnett
Studio Manager: Bill Barnett
Engineers: Bill Barnett, independents
Dimensions: Studio 24 x 20 plus 2 iso booths, control room 17 x 12
Mixing Consoles: Trident Series 65 24 x 16 x 2
Audio Recorders: Tascam MS-16 16-track, Otari 5050B-II 2-track, Revox A-77 2-track
Cassette Recorders/Duplicators: (8) Nakamichi MR-2-B, Awa 770, Akai GX-9, Sony Pro Walkman
Noise Reduction Equipment: dbx on all channels 16-track selective, dbx 180, dbx 150.
Echo, Reverb, & Delay Systems: Lexicon PCM70, Yamaha SPX90, ART DR-1, Lexicon PCM41, DeltaLab CE-1700, DeltaLab AM-1024.

Other Outboard Equipment: Valley Autogate (2 channels), Valley 4-channel GateX, Orban 536A de-esser, (2) dbx 160X compressor/limiters, dbx 166 stereo gate/comp/limiter, Symetrix 525 gate/comp/limiter (2-channel), Aphex Type C Aural Exciter (stereo).
Microphones: (2) Neumann U87, Neumann KM84, (2) AKG C-414EB, (2) AKG C-451E, AKG D-112, (2) AKG D-224E, Sennheiser 441, (4) Sennheiser 421, (4) Shure SM56, Shure SM57, (2) Shure SM58, Beyer M-422

Monitor Amplifiers: Hafler 220, McIntosh, Rane HC-6 head-

phone
Monitor Speakers: Yamaha NS-10M, JBL 4411, Auratone 5C, Eclipse, AKG 240 headphones.
Musical Instruments: 1959 Fender P-Bass, 1967 Fender Telly w/Bigsby, Yamaha C-3 6' grand piano, 1947 Martin 0018, assorted Zildjian cymbals, synth and drum machine rentals available on request
Rates: \$25/hr.

[16] HORIZON AUDIO RECORDING
4115 E. McMillan
Meridian, ID 83642
(208) 939-6197
Owner: Rob & Kim Matson
Studio Manager: Rob Matson

[16] HORODKO SOUNDTRAX/T.L.A.
also REMOTE RECORDING
111 Valjejo St.
San Francisco, CA 94111
(415) 956-8729
Owner: Edward Horodko
Studio Manager: Georgia Anderson

[12] INCOGNITO REMOTE RECORDERS
only REMOTE RECORDING
97 Boston Ave.
San Jose, CA 95128
(408) 294-8754
Owner: Clay Reid
Studio Manager: Norman Berwick

[16] INFAL RECORDS, CO.
also REMOTE RECORDING
2217 Champa St.
Denver, CO
(303) 295-1500
Owner: Victor M. Hernandez
Studio Manager: V.M. Hernandez

[16] JESTER SOUND AND VIDEO
also REMOTE RECORDING
423 Kuhlman Dr.
Billings, MT 59105
(406) 248-5896
Owner: Bob Hale
Studio Manager: Grace Fillmore

[16] JOPHEIR 12
PO Box 2207
Los Gatos, CA 95031
(408) 266-1779
Owner: Joe Rizza, Opher Segev
Studio Manager: Opher Segev

[16] KEYBOARD STUDIO PRODUCTIONS
also REMOTE RECORDING
Pacifica, CA
(415) 355-6617
Owner: Grant Ewald
Studio Manager: Grant Ewald
Engineers: Grant Ewald
Dimensions: Studio 15 x 35, control room 10 x 12.
Mixing Consoles: Fostex 440 16 x 4, Kawai 8 x 2 keyboard mixer.
Audio Recorders: Fostex E16 16-track w/built in Dolby, Fostex #20 2-track w/cue strip
Cassette Recorders/Duplicators: Nakamichi MR-1, Sony MR-6, JVC DD5
Noise Reduction Equipment: Fostex 3070 comp/limit
Synchronization Systems: Fostex 4050 autolocator
Echo, Reverb, & Delay Systems: Alesis Microverb, Alesis MIDI-verb II, Orban spring, Fender reverb Yamaha E1010 delay, etc.
Microphones: Sennheiser 421, Shure SM5, (2) Shure SM58, Shure SM57, Beyer MKII, AKG 221, AKG Tube, (2) PZMs, various others.
Monitor Amplifiers: (2) Crown DC 300, McIntosh 225 Mac M1010 pre amp.
Monitor Speakers: (2) Yamaha NS-1J, E-V SH15-2, (2) Voice of Theatre, many others
Musical Instruments: (2) Yamaha DX7II, Yamaha TX7, Yamaha FB01, (2) JL Cooper Minimoogs MIDI interface, Chroma w/MIDI, ARP string, Korg CX-3 organ thru real Leslie, Yamaha RX15 drum machine, Alesis drum machine sampler, ESQ1, MU Logix Slave 32, Akai 5612 sampler, Roland 550 sampler, Hammond C3, Fender Rhodes Silver Top, Wuritzer 140B elec., Yamaha C3 studio grand (upright).
Other MIDI Equipment: Roland MPU-104 input, Roland MPU-105 output, Roland MPU-101 MIDI/CV interface, Yamaha YMC10 MIDI converter.
Video Equipment: Sony Camcorder and Sanyo Beta Hi-fi 7300, Sony color camera
Other: Macintosh ext. drive printer, Mark of the Unicorn 2.1 Performer/Composer, patch librarian for DX7.

Rates: \$25/hr (Discount for original song projects includes keyboard player and computer programming.)

[16] KSL RECORDING
also REMOTE RECORDING
Broadcast House, 5 Triad Center
Salt Lake City, UT 84180
(801) 575-7600
Owner: Bonneville International Corp.
Studio Manager: Suzi Loritz

[16] LAY-A-TRACK RECORDING
also REMOTE RECORDING
1805 Academy Rd.
Bellingham, WA 98226
(206) 733-8824
Owner: Jim & Mary Ann Zender
Studio Manager: Jim Zender

[16] MICHAEL LORD PRODUCTIONS
9508 17th Ave. NE
Seattle, WA 98115
(206) 527-9002
Owner: Michael Lord
Studio Manager: Jeanne Castle
Engineers: Michael Lord
Dimensions: Studio 24 x 13, control room 12 x 13
Mixing Consoles: Soundtracs CM4400 32 x 12 x 24.
Audio Recorders: MCI JH-16 16-track, Sony APR-5002 2-track,
Otari MX-5050B 2-track
Cassette Recorders/Duplicators: Nakamichi BX-100
Echo, Reverb, & Delay Systems: Yamaha REV7, Ibanez SDR-1000+, Lexicon PCM40, DeltaLab DL4, Advance Audio Designs DL-250, MXR System II (3.8 sec)
Other Outboard Equipment: Orban 424A stereo C/L, (4) Symetrix CL-100 C/L, Orban 622B parametric EQ, Ibanez GE-1502 15-band stereo graphic, Rocktron Hush IIC noise reduction, Rocktron RX2H exciter/imager, (4) Furman QN-4 noise gates, Rockman rack mounted preamp.
Microphones: Neumann U47, (2) AKG 451, AKG D-12, (2) Sennheiser 421, (7) Audio-Technica AT63, (2) Audio-Technica AT813R, Audio-Technica ATM-21, (2) E-V PL77, Beyer X1N Soundstar, Beyer M500N, Beyer M220
Monitor Amplifiers: UREI 6250, Dynaco, Symetrix HA-10B
Monitor Speakers: JBL 4311, Auratone C5, Yamaha NS-10.

Realistic Minimus 7.
Musical Instruments: Yamaha 6' C-3 grand, Roland MKB-1000 MIDI controller, Roland MKS-80 sound module, Oberheim Matrix 6R, Yamaha RX5, Oberheim DX w/Stretch, Roland Octapad
Other MIDI Equipment: Apple Macintosh Mac+. Southworth Jam Box 4
Rates: On request

[16] LUNA PRODUCTIONS
909 Sonoma Ave.
Petaluma, CA 94952
(707) 778-1039
Owner: Jim Stern
Studio Manager: Rhonda Block

[16] MAGIC SOUND
also REMOTE RECORDING
1780 Chanticleer Ave.
Santa Cruz, CA 95062
(408) 475-7505
Owner: Alan Goldwater
Studio Manager: Alan Goldwater, Merle Sparks
Engineers: Alan Goldwater, Merle Sparks
Dimensions: Studio 16 x 20 x 12 (asymmetrical wedge ceiling), isolated drum room 12 x 14, booth 5 x 6 x 7, control room 12 x 14 x 16.
Mixing Consoles: Custom 36 x 8 separate 16-track fully equalized monitor, section, full patchbay, API 550 mixboard EQ.
Audio Recorders: MCI/Inovonics JH10 16-track 15/30 ips, Rockwell computer autolocator, Ampex AG 440 2-track 15/30 ips, Otari MX-5050 2-track, Sony PCM-701 2-track digital Cassette Recorders/Duplicators: (2) Kenwood KX 1060
Echo, Reverb, & Delay Systems: Ecoplate II multi-track reverb, Marshall Time Modulator, Roland Space Echo, Lexicon Prime Time II
Other Outboard Equipment: (2) MXR flanger, (2) MXR 2/3-octave graphic EQ, UREI LA-4 limiter, (2) Universal Audio 175B tube limiters, Allison Gain Brain, Roger Mayer noise gates, (8) API 550A EQs, (2) UREI LA-4 limiter, Thorens/Rabco disc player.
Microphones: Neumann KM54a, Neumann U67, (2) AKG 414-EB, AKG C-451, AKG D-190, AKG D-160, AKG D-12, AKG C28-A (tube), Beyer M-260, (2) Beyer X1N, (2) Sennheiser MD-421, Shure SM57, Shure SM58, Shure SM81 (several each), Sony C-377, Sony C-22, Sony C-37A (tube), Altec M30s (tube), RCA BK5 (ribbon), (2) AKG C-61a tube, AKG C-12 (tube), Shure SM7

Monitor Amplifiers: Hafler 250.
Monitor Speakers: Altec/UREI 811, White 4100 EQ, Sennheiser and AKG headphones.
Musical Instruments: Cable upright piano, Apple computer 16-voice synthesizer system, Guild F30, Danelectro and Rick-enbacker 12-string guitars, Fender Princeton and Deluxe amps, Polytone amps, CB drums w/Zildjian cymbals, E-mu Drumulator w/computer sequencer
Video Equipment: Panasonic NV8200 w/computer search, Panasonic 8500 VHS editing system.
Rates: \$40/hr 16-track; \$35/hr block (10 hrs or more); \$30/hr 8-track; \$30 block; \$30/hr 2-track and editing, 1-hour free setup. Above rates include engineer and instruments.

[16] MEDIA WORKS
also REMOTE RECORDING
1250 Huff Ln.
Jackson, WY 83001
(307) 733-1300
Owner: Jeff McDonald
Studio Manager: Jeff McDonald

[16] PETER MILLER RECORDING
only REMOTE RECORDING
PO Box 11013
San Francisco, CA
(415) 567-7040
Owner: Peter Miller
Studio Manager: Peter Miller

[16] MOONBABY MUSIC, INC.
231 SE 88th Ave.
Portland, OR 97216
(503) 257-3280
Owner: Doug Rowell
Studio Manager: Doug Rowell
Engineers: Doug Rowell, Dave Miles
Dimensions: Control room 15 x 23
Mixing Consoles: Biamp 3228 32 x 8 x 2 (64-input mix-down)
Audio Recorders: Fostex B-16 16-track, Sony PCM-501ES 2-track digital Beta and VHS.
Cassette Recorders/Duplicators: Nakamichi MR-1, Technics M255X

—CONTINUED ON NEXT PAGE

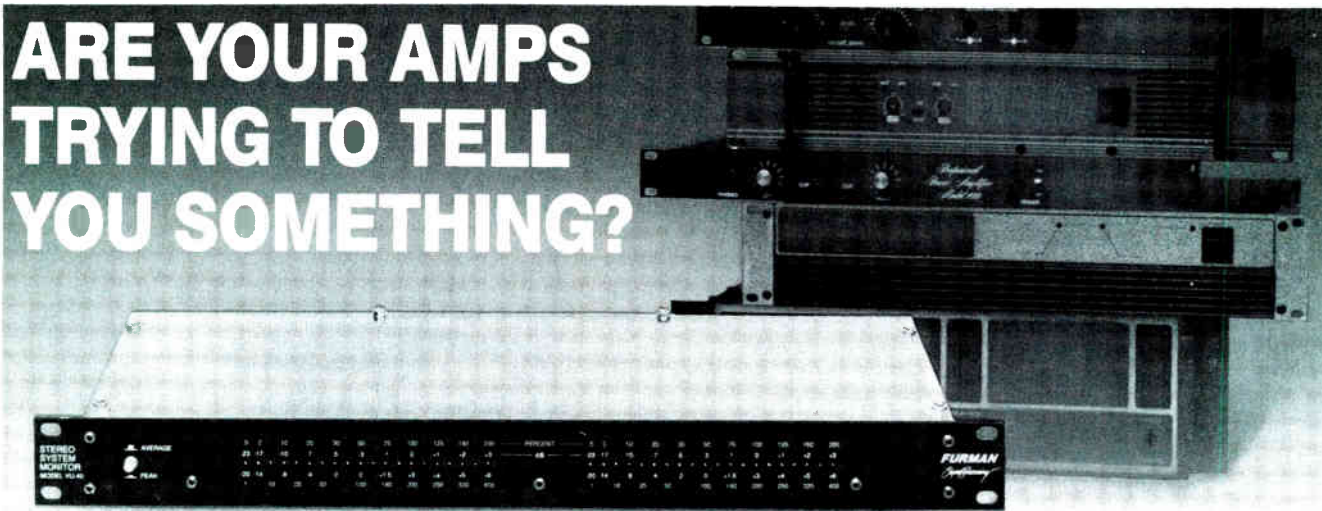

Many power amps have a hard time communicating—because they lack meters. Meters that show the presence or absence of signal or the headroom available. Meters that can reveal ultrasonic oscillations or other system problems.

The Furman VU-40 Stereo System Monitor is the inexpensive solution. Comprised of two 20-LED color-coded bar graph meters, it gives you an instant visual check of amp function—even from across a dark stage. The meters may be set with a front panel switch to read either Peak or Average response. There are sixteen Power Output range choices, from 20 to 1250 watts, selectable on the rear panel. If you're not using power amps, or prefer to read line levels, the VU-40 can accommodate you, too. It has two line level settings with the VU "zero" at your choice of -10 or 0 dBV.

And that's not all. The VU-40 has a bonus feature: turn-on/turn-off transient muting. To use it, line level feeds to the power amp are routed first to the VU-40, then back out to the amp. When AC power is applied or removed, the feed will be muted for one second, eliminating loud thumps with their potential for speaker damage.

The VU-40. Another Problem Solver from Furman. Call or write for more information.

Furman Sound, Inc.
30 Rich Street
Greenbrae, California 94904
Phone: (415) 927-1225
Telex: 425900

FURMAN
Signal Processing

Circle #128 on Reader Service Card

Otari's compact EC-201 SMPTE/EBU time-code reader is a natural for field or studio operation, and it costs only \$495. It offers 1/20 to 60X playspeed reading, 40 hour continuous use on battery power, and re-shaping circuitry on the loop output.

This advanced reader features a full hexadecimal user bits display (with a hold-button for edit logging), a -10 to +10 dBV input range, balanced XLR inputs/outputs, and includes an AC adapter, belt clip and batteries. It measures 1.5" x 4.2" x 5" and weighs 18 oz.

Contact Otari at (415) 592-8311 for your nearest dealer. From Otari: Technology You Can Trust. Otari Corporation, 2 Davis Drive, Belmont, CA 94002.

OTARI

TIME OUT!



© Otari 1986

Circle #130 on Reader Service Card

N O R T H W E S T

12&16 TRACK

STUDIOS

—LISTING CONTINUED FROM PAGE 207

Synchronization Systems: Fostex 4050 autolocator w/SMPTE/MIDI converter, Fostex 4030 synchronizer

Echo, Reverb, & Delay Systems: Yamaha REV7 digital reverb, Ibanez SDR-1000 digital reverb, Yamaha SPX90 digital effects processor, Roland SDE-3000 DDL, DOD RDS-1900 DDL
Other Outboard Equipment: Symetrix 501 comp/limiter, Barcus-Berry Electronics 402 exciter

Microphones: AKG Sennheiser, Shure, Sony
Monitor Amplifiers: (2) Crown DC-300A, (2) Crown D-60
Monitor Speakers: UREI 809 Time Aligned

Musical Instruments: Ensoniq Mirage, (2) Yamaha TX812, Prophet 600 SC1, Roland GR-700 guitar synth (w/TTL mod and MIDI in), E-mu SP-12 turbo, Minimoog, (2) hand-built Boogie Bodies "strats," Roland G-707 guitar synth controller, Hagstrom "Swede," G&L L-1000 bass guitar, Scholz sustainer chorus/echo, Rockman X-100, Marshall 50-watt amp w/assorted speakers and cabinets, Ampex V-4 amp and more
Other MIDI Equipment: (2) Macintosh Plus computers w/2.5 meg RAM and 40 meg hard disk, JL Cooper automation, Synch MIDI switch box, Beaverton digital system MIDIface II interface

Video Equipment: Sony SL-HF400 Super Beta Hi-fi, Magnefax VHS VTR

Other: Mark of the Unicorn Performer (ver 1.22 and 2.2)/Composer, Soundlab and Sound Designer visual waveform editors, drum file, Beaverton Digital Systems editor/librarians on-line BBS, large sample and patch libraries

Rates: Vary, depending on service

Extras & Direction: Moonbaby Music, Inc., established in 1986 as a private studio, is a full production MIDI recording facility. We have written and recorded jingles, records, television and film scores. In 1987 we opened our doors to producers and artists in need of cost-effective pre-production. Real time recording on the Macintosh allows intricate and precise editing of all MIDI information. The Mac also gives us the ability to quickly load samples and patches for auditioning. Since the Macs and SP-12 are locked to tape via SMPTE they usually go directly to 2-track, leaving tape tracks open for vocals and acoustic instruments. Drum patterns, track editing and sounds can be modified even during mix-down. Being composers and performers ourselves has given us knowledge in the use of technology for practical applications. We enjoy a one to one relationship with our clients and offer assistance in all stages of production.

[16] MOUNTAINWOOD WEST
PO Box 1232
Thermopolis, WY 82443
(307) 864-2245
Owner: Don Jackson
Studio Manager: Don Jackson

[16] MULTIVISION OF DENVER
also REMOTE RECORDING
720 S. Colorado Blvd., Ste. One
Denver, CO 80222
(303) 691-2700
Owner: Corporation
Studio Manager: Dirk Phannensteil

[16] MUSICAL IMAGE PRODUCTIONS
3013 E. Monte Vista
Denair, CA 95316
(209) 632-8415
Owner: Gary Shriver
Studio Manager: Eric Cripe

[16] NACNUD SOUND
6748 Hogan Ln.
Lodi, CA 95240
(209) 334-2845
Owner: Rick Duncan
Studio Manager: Cecil Ramirez
Engineers: Rick Duncan, Fred Eichel, Mark Zarek, Chris Watson
Dimensions: Studio 22 x 40, control room 22 x 12
Mixing Consoles: Soundtracs 32 x 16
Audio Recorders: Tascam MS-16 16-track w/autolocator, Otari MX-5050 1/2-track master w/remote, Pioneer RT-707 2-track Cassette Recorders/Duplicators: Nakamichi MR-2
Noise Reduction Equipment: dbx 16 tracks
Echo, Reverb, & Delay Systems: Lexicon Prime Time II DDL, Lexicon PCM70, Yamaha REV7, (2) Yamaha SPX90 II, Yamaha REV5, AKG BX-20
Other Outboard Equipment: dbx 160X comp/limiter, Valley People gate/limiter/EQ/multi-rack, Aphex Aural Exciter



NACNUD SOUND
Lodi, CA

Microphones: Neumann U87, AKG 414, AKG 441, AKG 442, Sennheiser 421, E-V RE20, Shure SM81, Shure SM56, Shure SM57, Sony ECM-23F
Monitor Amplifiers: Halfer D-500, Yamaha P2200, Accorn GFA-1

Monitor Speakers: (2) Westlake BB-SM10, (2) Yamaha NS-10M studio (2) Auratones

Musical Instruments: Yamaha KX88, Yamaha DX7IID, Roland MKS-20 MIDI digital piano, Oberheim Xpander, Matrix 6R, Roland Jupiter 6, JX8P, Prophet 5, Oberheim DPX-1 sample playback of Mirage Prophet 2000, E-2, Minimoog w/MIDI, Fender Rhodes, Menorymoog, Pearl 7-piece maple set w/Zildjian cymbals, custom basses, Ibanez guitar, Emulator SP-12, hi-watt guitar amp, Yamaha bass rack, JBL cabinets

Other MIDI Equipment: Yamaha QX1, Macintosh Plus, Southworth MIDI interface, Opcode storage libraries, Performer sequencer, computer modem, Yamaha MuC8 Matrix switcher
Other: Rane headphone monitors, Crown paragratic EQ
Rates: Available upon request

[16] RAY NAKAMOTO PRODUCTIONS
3054 Gold Canal Dr., Ste. D
Rancho Cordova, CA 95670
(916) 638-7770
Owner: Ray Nakamoto
Studio Manager: David Whitaker

[16] NAPA VALLEY RECORDING
1815 Spring Min. Rd.
St. Helena, CA 94574
(707) 963-9528
Owner: Bob Foley
Studio Manager: Bob Foley

[16] JON NEWTON MUSIC
Box 42526
Portland, OR 97242
(503) 233-9421
Owner: Jon Newton
Studio Manager: Michael Bard

[16] NORTHWESTERN INC.
1224 SW Broadway
Portland, OR 97205
(503) 226-0170
(800) 547-2252
Owner: Bob Lindahl
Studio Manager: Michael Lee Hellums

[16] PLU AUDIO (PACIFIC LUTHERAN UNIVERSITY)
also REMOTE RECORDING
121st & Park Ave.
Tacoma, WA 98447
(206) 535-7268
Owner: Pacific Lutheran University
Studio Manager: Bob Holden

[16] THE POWER BASE
16212 Bothell-Everett Hwy.
Mill Creek, WA 98012
(206) 337-4285
Owner: Kevin Bielaga
Studio Manager: Kevin Bielaga

[16] RAINBOW RECORDING
also REMOTE RECORDING
6614 SW Garden Hm. Rd.
Portland, OR 97223
(503) 246-5576
Owner: Gailen L. Hegna
Studio Manager: Gailen L. Hegna

[16] RAINWOOD STUDIO & PRODUCTION
also REMOTE RECORDING
7930 Rainier Ave. S.
Seattle, WA 98118
(206) 722-4144
Owner: Greg & Roger Wood
Studio Manager: Greg Wood

[16] BILL RASE PRODUCTIONS, INC.
also REMOTE RECORDING
955 Venture Ct.
Sacramento, CA 95825
(916) 929-9181
Owner: Bill Rase
Studio Manager: Wayne Johnson

[16] THE RECORDING CHAMBER INC.
18912 SE 133rd Pl.
Renton, WA 98056
(206) 235-TAPE
Owner: Dennis Palmer

[16] THE RECORDING STUDIO, INC.
1016 Morse Ave., #17
Sunnyvale, CA 94089
(408) 734-2438
Owner: The Recording Studio, Inc.
Studio Manager: Scott Smith, Doug Hopping
Engineers: Scott Smith, Kai Gilbert, Doug Hopping, Lare Garcia, Kevin Casey
Dimensions: Room 1 studio 15 x 18 x 12, control room 21 x 14 5 x 12 Room 2 studio 8 x 10 x 12 Room 3 studio 12 x 15 x 8
Mixing Consoles: TAC/Amek Matchless 20 x 24 x 8 x 2. Roland CPE-800 compu-editor (16-track digital automation)
Audio Recorders: Ampex MM-1000 16-track w/autolocator, Otari 5050B 2-track, TEAC A-3340S 4-track.
Cassette Recorders/Duplicators: (2) Sony TCK-444 ES2, JVC KD-D4
Echo, Reverb, & Delay Systems: Lexicon 200 digital reverb, Roland SRV-2000 digital reverb, Ecoplate III plate reverb, Lexicon Prime Time DDL, Lexicon PCM41 DDL, Yamaha SPX90 multi-effects processor, Eventide 910 Harmonizer, MXR flanger/doubler
Other Outboard Equipment: UREI LA-4 compressor, dbx 160X compressor dbx 161 compressor, Symetrix 522 noise gates, Symetrix SG-200 noise gates, Barcus-Berry Electronics exciter, EXR Exciter
Microphones: AKG, E-V, Neumann, RCA, Sennheiser, Shure, Sony
Monitor Amplifiers: Haller, BGW
Monitor Speakers: JBL 4430 Bi-Radials, Yamaha NS-10, Auratones
Musical Instruments: Kawai 6'1" grand piano, Emulator II HD, Yamaha DX7, E-mu SP-12 drum machine, LinnDrum drum machine w/extensive chip library, Roland D-50, Roland Octapad
Other MIDI Equipment: Akai 600 sampler w/extensive sample library
Rates: Please phone for rates. Weekend specials available

[16] REDWOOD CREEK RECORDING
also REMOTE RECORDING
5865 Stover Rd.
Blue Lake, CA 95525
(707) 668-4244
Owner: Bert Pectol
Studio Manager: Ann Pectol

[16] THE RIGHT TRACK STUDIOS
218 SW 153rd
Seattle, WA 98166
(206) 241-4850
Owner: CKO Enterprises
Studio Manager: Ron Combs, Ed Kron

[16] ROCKY MOUNTAIN ARTISTS
also REMOTE RECORDING
6851 Highway 73
Evergreen, CO 80439
(303) 674-2379
Owner: John Newkirk
Studio Manager: Ric Lawrence

[16] ROCKY MTN. PRODUCTIONS
also REMOTE RECORDING
1050 E. 1600 N.
Mapleton, UT 84663
(801) 489-7850
Owner: Walt C Jones
Studio Manager: Carl Fritch

[16] ROLLS RECORDING
767 Lincoln Ave., #14
San Rafael, CA
(415) 258-0535
Owner: Mark Baker
Studio Manager: John Lawrence
Engineers: Kirk Schreier, Elfrim Delunff, independents welcome
Dimensions: Room 1 studio 20 x 30, control room 12 x 16 Room 2 studio 18 x 22
Mixing Consoles: Trident Series 65 24 x 16 w/300 point TT patchbay, 40 inputs on mix
Audio Recorders: Otari MX-70 16-track, Otari 5050B-MKIII 2-track
Cassette Recorders/Duplicators: Technics MR222
Synchronization Systems: SMPTE
Echo, Reverb, & Delay Systems: (2) Yamaha SPX90, (2) Roland 3000, Roland 1000, custom 2 sec. Effectron, Ibanez SDR-1000+, DR11 digital reverb, Fostex 3080 reverb
Other Outboard Equipment: Teletronix LA-2, Dyna-Mite gates, Fostex 3020 comp/limiter, MXR pitch transposer
Microphones: AKG 414EB, Sennheiser 421, (6) Shure SM98, (4) Shure SM57, Beyer Dynamic, (2) PZMs, (2) RE15
Monitor Amplifiers: Crown DC-300, (2) AB Systems 300
Monitor Speakers: Yamaha NS-10, Auratone
Musical Instruments: E-mu Emulator II v. 3.0 w/huge custom library, E-mu SP12 v 2.6 w/Commodore 1541 disc drive, Korg Poly 61
Other MIDI Equipment: Amiga 2000 PC w/Soundscape sequencer, Casio MIDI splitter boxes
Video Equipment: Minolta VHSVCR and color monitor, genlock available
Rates: Call for rates, block time discounts

[16] CLAY RYAN PRODUCTIONS
901 Sherman, #1017
Denver, CO 80203

(303) 861-9451
Owner: Clay Ryan
Studio Manager: Clay Ryan

[16] SAVAGE STUDIOS
372 Brannan St.
San Francisco, CA 94107
(415) 546-1374
Owner: Fun Productions, Inc.
Studio Manager: Steve Savage
Extras & Direction: Savage Studios is a newly constructed facility with a very large control room, live studio room, and comfortable lounge in the thriving South of Market district of San Francisco. Construction features the finest in modern studio design concepts, with easy street-level access. Operated by producer/engineer Steve Savage, the studio offers complete audio and creative services for albums, band demos, song demos, radio ads, etc. Video facilities are planned for the near future. Independent producers and engineers are welcome. The 1" 16-track facility includes a new Soundcraft mixer with 36 channels available at mix-down, a wide variety of high-quality signal processors and microphones, Otari MTR-10 2-track recorder as well as computer sequencing. Call us for information and/or assistance in planning your next project.

[16] SHEWBREND MUSIC CO.
Hwy. 95
Lucile, ID 83542
(208) 628-3944
Owner: Phil Moulton
Studio Manager: Phil Moulton

[16] SIRIUS PRODUCTIONS
also REMOTE RECORDING
2125 Knowles Rd.
Medford, OR 97501
(503) 772-6031
Owner: Waldo Thompson
Studio Manager: Waldo Thompson

flexibility!



Little®
Gooseneck Lamps & Accessories

mixing consoles, amps,
turntables, effects racks,
multi-tracks, synthesizers,
music stands, drum machines,
keyboards, orchestras,
d.j. consoles

Little/CAE, Inc.
P.O. Box 430
Hamburg, MI 48139
313/231-9373

Circle #134 on Reader Service Card

Son of FX



ORGANIZE YOUR RECORDING, COMPUTER AND RACK-MOUNTABLE EQUIPMENT IN AN ATTRACTIVE, MOBILE WORK STATION.

SON OF FX FEATURES:

- Two adjustable shelves for multi-tracks, drum machines, computers and more!
- Holds up to 10 rack "spaces" of equipment.
- Shown with optional "Rack Drawer"

ASK YOUR DEALER FOR A DEMONSTRATION
CALL OR WRITE FOR FREE BROCHURE

FOUR DESIGNS COMPANY
1531 GROSS AVENUE • CAROLINA PARK, CA 91307
(818) 716-8540

FOR ADDITIONAL FOUR DESIGNS PRODUCT INFORMATION, CALL: 1-800-544-3746
SAY YOU SAW IT IN MIX!

FX RACK



ECONOMICAL 19" RACK MOUNT "FURNITURE" FOR THE PROFESSIONAL OR HOME STUDIO

FX RACK FEATURES:

- Holds up to 18 "spaces" of equipment.
- Attractive black textured vinyl laminate.
- Shown with optional wheels.

ASK YOUR DEALER FOR A DEMONSTRATION
CALL OR WRITE FOR FREE BROCHURE

FOUR DESIGNS COMPANY
1531 GROSS AVENUE • CAROLINA PARK, CA 91307
(818) 716-8540

Circle #131 on Reader Service Card

MOVING?

FOR UNINTERRUPTED SERVICE
MAIL TO:
**MIX PUBLICATIONS
2608 NINTH STREET
BERKELEY, CA 94710**

(PLEASE ATTACH OLD ADDRESS LABEL HERE)

(PLEASE PRINT NEW ADDRESS BELOW)

NAME _____

COMPANY _____

ADDRESS _____

CITY _____ STATE _____ ZIP _____

N O R T H W E S T

12&16 TRACK

STUDIOS

[12] SONOMA SOUND
also REMOTE RECORDING
PO Box 1623
Sonoma, CA 95476
(707) 996-4363
Owner: Arron Johnson
Studio Manager: Arron Johnson

[16] SOUND RECORDING COMPANY
also REMOTE RECORDING
West 503 Indiana Ave.
Spokane, WA 99205
(509) 326-0222
Owner: Paul W. Carter
Studio Manager: Irene Carter

[16] THE SOUND SOURCE
741 4th St., 2nd Floor
Santa Rosa, CA 95402
(707) 528-1530
Owner: Randy Teaford, Dave Armijo
Studio Manager: Claire Teaford, Marilyn Armijo
Extras & Direction: The Sound Source is a unique new 16-track audio/digital production facility located above one of Northern California's largest music stores, Stanroy Music Center. Our primary function is to offer all musicians, producers and film makers, integrated computer sequencing via Macintosh Plus/Apple II computers with the very latest keyboards, synthesizers and digital samplers available as cost-effective techniques for production. An expanding library of software and samples featuring Performer/Composer, Opcode, Digidesign, Passport, Blank, Intelligent Music and many others offers the client the option to do their own pre-production if desired and then download their data here for final engineering. Currently The Sound Source is hosting the musical scoring and engineering for the next Charles Schulz film for TV "The Girl in the Red Truck," a TV musical production for "Satin Steel" and various commercial broadcast projects. Rates and equipment list upon request.

[16] SOUND WEST RECORDING
2321 Tacoma Ave.
Tacoma, WA 98402
(206) 272-4251
Owner: Steve Paulik, Carl Schneider
Studio Manager: Steve Paulik
Engineers: Steve Paulik, Carl Schneider
Dimensions: Studio 19 x 25, control room 19 x 14
Mixing Consoles: Soundcraft TS-12 24 x 12 x 24
Audio Recorders: Tascam MS-16 16-track w/dbx, Technics 1500 1/2-track w/dbx, Akai GX-635D 1/4-track, TEAC X10R 1/4-track
Cassette Recorders/Duplicators: TEAC C1, Akai GXC-709D, Pioneer CT-F900
Noise Reduction Equipment: dbx 16-channel, dbx 150 2-channel
Synchronization Systems: E-mu SP-12 SMPTE lock and MIDI interface
Echo, Reverb, & Delay Systems: Lexicon PCM70, Lexicon PCM60, Lexicon PCM42, Roland SRV-2000, Roland SDE-1000, Ibanez SDR-1000.
Other Outboard Equipment: Aphex Type C Exciter, Symetrix 544 gates, (2) UREI LA-4, Yamaha Q1027 EQ.
Microphones: AKG, Sennheiser, E-V, Sony, Beyer, Beyer PZM, Shure, Audio-Technica.
Monitor Amplifiers: Carver, Crown, Yamaha, Harman Kardon.
Monitor Speakers: UREI 809, Yamaha NS-10M, Auratone 5C, AKG 240M (phones).
Musical Instruments: Ensoniq Mirage sampling keyboard w/extensive library, Yamaha TX81Z, Akai AX73, E-mu SP-12 sampling drum computer w/extensive library, Roland Octapad, guitars: Les Paul, SG, Ibanez, Ovalion, Strat. amps: Gallien-Krueger, Rockman, Yamaha, Lab Series, Fender Twin, Ampeg, keyboards: (available w/advanced booking), Yamaha DX7, Roland JX-8P, Roland Juno-2, Roland Jupiter 6, Korg DW-8000, Korg DW-6000, Korg Poly 800, E-mu Emax
Other MIDI Equipment: Mark of the Unicorn Performer software (version 2.1), Macintosh 512K, Yamaha MJC8 (MIDI switcher).
Video Equipment: 1/2" VHS Hi-fi and Beta Hi-fi, JVC GX-NSU camera, Panasonic PK-956 camera.
Rates: Please call for rates.

[16] STAFFORDSHIRE PRODUCTIONS
PO Box 4364
Napa, CA 94558
(707) 226-8273
Owner: Kent Monson
Studio Manager: Kent Monson

[16] STARSHINE AUDIO ENTERPRISES
PO Box 3305
Chico, CA 95927
(916) 345-3027
Owner: Hugh E. Santos
Studio Manager: Hugh E. Santos

[16] STARTSOUND
3218 E. LaSalle
Colorado Springs, CO 80909
(303) 634-2045
Owner: Tom Gregor

[16] STRATEGIC AIR COMMAND RECORDS
440 Pepper Ave.
Palo Alto, CA
(415) 325-0542
Owner: Dan Arlie
Studio Manager: Eric Dodd

[16] SYNCHRONICITY
Box 596
San Rafael, CA 94915
(415) 472-2523
Owner: Windsor Riley
Studio Manager: Windsor Riley
Engineers: Tom Rollison, Windsor Riley
Dimensions: Studio 18 x 11, live space 6 x 4
Mixing Consoles: Ramsa WR-T820 20 x 8 x 2, Kawai MX-8R x 2
Audio Recorders: Fostex B16 16-track, Sony PCM-501ES 2-track w/Super Betamax, Betamax.
Cassette Recorders/Duplicators: Technics M-235X
Noise Reduction Equipment: Dolby C (on B16).
Synchronization Systems: Fostex 4050 MIDI/SMPTE/autolocator.
Echo, Reverb, & Delay Systems: Roland SDE-2500, Roland SRV-2000, Yamaha SPX90, Lexicon PCM60
Other Outboard Equipment: Symetrix 525 compressor/limiter/gate
Microphones: AKG, Fostex, Sony
Monitor Amplifiers: Haller 500, Harman Kardon.
Monitor Speakers: Celestion SL65, Toa 280ME
Musical Instruments: Yamaha KX88 keyboard controller, Yamaha DX7II, Roland D-50, Roland JX-8P, Roland MKS-20 digital piano module, Kawai K3M, Akai S612, Akai S900, Korg DSS-1.
Other MIDI Equipment: Macintosh Plus w/20 Megabyte hard disk and Performer software for Mac (sequencing), Atari 1040-ST w/Steinberg Pro 24 sequencing, D-50 editor/librarian, Hybrid Arts DX android editor/librarian, Digital Music Corp MX-8 MIDI patchbay, 360 Systems MIDI patchbay
Rates: Negotiable

**SYNCR0
INTERNATIONAL
STUDIO**

SYNCR0 INTERNATIONAL STUDIO
San Anselmo, CA

[16] SYNCR0 INTERNATIONAL STUDIO
2 Allemand Ln.
San Anselmo, CA 94960
(415) 457-4852
Owner: Satoshi Suzuki
Studio Manager: Dr. Space
Engineers: Daniel Ryman (credits for Color Purple w/Quincy Jones), Derek Stowe.
Dimensions: Booth 8 x 8, room 20 x 20, reverb room 17 x 6, control room 12 x 20.
Mixing Consoles: TAC Scorpion 32 x 16 x 3
Audio Recorders: Tascam MS-16 16-track Sony PCM-601ES 2-track digital, (2) Fostex E-16 30-track w/syncho, Fostex E-22.
Cassette Recorders/Duplicators: Nakamichi MR-1, Awa WX-220
Noise Reduction Equipment: (2) Dolby SR.

Echo, Reverb, & Delay Systems: Natural room reverb, AMS, Yamaha REV7, (4) Yamaha SPX90, Lexicon PCM70, TC Electric 2290, Roland DEP-5

Other Outboard Equipment: dbx 900 rack w/compressors/EQs/limiter, 1960 Drawmer vacuum tube compressor, Yamaha DMP7, DDD 944

Microphones: Neumann U87, AKG 414, BNK 4007

Monitor Amplifiers: Bryston 4B, Eagle II modified Jan C Iverson Monitor Speakers: JBL 4430 Bi-Radial, Tannoy SRN-10B, Celestion SL6S, Auratones

Musical Instruments: Emulator II+ w/hard disk, Oberheim OB-Xa synth, DSX sequencer and DMS drum machine, Korg polyphonic synth, Yamaha DX7, Fender Rhodes, Roland B-50, Casio CZ-3000, Casio CZ-101, Casio CZ-230, Yamaha TX7 rack, Roland GR-700, Roland G-707, fully upgraded

Other MIDI Equipment: Macintosh 2+ Julian Strapmick 20 megabyte hard disk, Korg KMT-60, Mark of the Unicorn Performer expansion, Opcode DX librarian and Digidesign Opcode PCM digital design FX designer.

Video Equipment: Video post-production equipment is available

Extras & Direction: We proudly feature a "state-of-the-art" MIDI system. The final mix is mastered digitally, providing maximum assurance of exceptional excellence in sound quality. We specialize in hi-quality/low budget master and/or demo work as well as scoring for soundtracks/industrial and new age/synthesizer music. Recent projects: Satoshi Suzuki & Marty Balin/Spirit of America—Satoshi and Dr. Space Band/MTV score with Debra Winger and Kevin Tigh/director Karl Krogstad, written by Tom Robbins. Satoshi Suzuki & Bruce Beckver "Everywhere Magic" (Windham Hill artist). Also providing a production service, we will pleasantly surprise you with our ability to make the most of your production dollar. This service, based upon experienced and advanced technology, is highly versatile in many musical areas from pop to new age. We tailor productions (budget and product) to your artistic personality. After "your sound" is found, post-production direction will provide support for exposure in the current atmosphere of music production.

[16] SYNTASY
PO Box 6283
San Rafael, CA 94903
(415) 499-8747

Owner: Bernard Xolotl
Studio Manager: Bernard Xolotl

[16] TELESCENE, INC.
2185 South 3600 West
Salt Lake City, UT 84119
(801) 973-3140
Studio Manager: Jeff Hall

[16] TIOGA RECORDING STUDIO
also REMOTE RECORDING
PO Box 205
Allegany, OR 97407
(503) 267-2330
Owner: Jim Flanagan
Studio Manager: Jim Flanagan

[16] TRAX RECORDING
3008 NE 110th
Seattle, WA
(206) 361-8622
Owner: Jeff Gossard
Studio Manager: Jeff Gossard
Engineers: Jeff Gossard, Marty Frazu.
Dimensions: Studio 18 x 12, control room 12 x 12
Mixing Consoles: Audtronic 501 24 x 26
Audio Recorders: Tascam MS16 16-track 1", Otari 5050 1/4" master
Cassette Recorders/Duplicators: Nakamichi MR-2
Echo, Reverb, & Delay Systems: Yamaha SPX90, Lexicon PCM60, Yamaha RD1000, Roland R-1000, MIDiverb
Other Outboard Equipment: (2) Fairchild Instruments 670, (2) LA-4s, (2) dbx 160s, (4) Symetrix 544 noise gates.
Microphones: Neumann U47 tube, E-V PL20, (2) Sennheiser 421, AKG D-12E, (2) AKG 451 condensers, (2) AKG 535 condensers, Beyer 201, (2) Shure SM57, Shure SM58, Audio-Technica
Monitor Amplifiers: Yamaha 2250
Monitor Speakers: (2) JBL 4412, (2) Yamaha NS-10, (2) Auratone
Musical Instruments: Yamaha RX5 drums, Ludwig live drums, Yamaha DX7, Roland JC 120 amp, Seymour Duncan Convertible amp, Les Paul 1976 standard, Fender 1971 Precision Bass, 1960 strat, Casio FZ1 16-bit sampler, Roland FX8P, Yamaha FB01, Casio CZ-101, Roland TR707, Suzuki XGIM MIDI guitar
Other MIDI Equipment: Atari 1040ST Dr T program, sound libraries for all synths.
Rates: \$25/hr or block time at \$20/hr.

[16] WHITE DOVE RECORDING STUDIO
also REMOTE RECORDING
4680 Edison Ave., Ste. C
Colorado Springs, CO 80915
(303) 597-8709
Owner: Anthony B. Walkins
Studio Manager: Wes Cavalier

[16] WT STUDIOS
2025 S. 900 E.
Salt Lake City, UT 84105
(801) 486-4977
Owner: Brent Marshall
Studio Manager: Brent Marshall

[16] ZEPPELIN LTD.
also REMOTE RECORDING
Box 1321
Estes Park, CO 80517
(303) 586-8265
Owner: Glenn L. Harrington
Studio Manager: Glenn Harrington

The extensively updated and enlarged FALL/WINTER MIX BOOKSHELF CATALOG contains over 600 items: the most comprehensive selection of books, audio and video tape courses, music software, sound effects libraries and databases available anywhere for the audio, video and music production professional. See page 153 for your FREE copy!

The affordable solution to AUTOMATION.

Finally there is an inexpensive, simple-to-operate, modular, full featured Automation System to retrofit any console at any budget. MidiMation, from JLC Cooper, gives your console all the power and all the features previously only available as built-in features on a few megabuck consoles. MAGI (Mixer Automation Gain Interface), MAGI VCA (dbx® VCAs), SAM (SMPTE AUTOMATION MANAGER), SAMDisk 3.5" floppy sub-system, and MIDI MUTE truly constitute a breakthrough in console automation.

Now, you can automate your studio starting for as little as \$549. And, like all JLC Cooper products, these grow with you — up to 56 channels! Buy only the features you need, as you need them, and add to your MidiMation system as your needs change. Best of all, MAGI, MAGI VCA, SAM, SAMDisk, and MIDI MUTE require no modification of your console.

* dbx is a registered trademark of the dbx Corp

MidiMation, affordable state-of-the-art automation.

JL COOPER ELECTRONICS

1931 Pontius Avenue • West Los Angeles, CA 90025 • (213) 473-8771 • TLX: 5100110679 JL COOPER

N O R T H W E S T

4 & 8 TRACK

STUDIOS

[8] ABSOLUTELY GRIPPING CREATIVE
SOUND PRODUCTION
also *REMOTE RECORDING*
PO Box 1779
Visalia, CA 93279
(209) 732-5767
Owner: Ken Emmer, Jean Inman
Studio Manager: Ken Emmer, Jean Inman

[4] AERIAL AUDIO
also *REMOTE RECORDING*
PO Box 908
Red Lodge, MT 59068
(406) 446-2710
Owner: Grant West
Studio Manager: Grant West

[2] AESTHETIC PRODUCTIONS
5894 Sierra Ave.
Morgan, UT 84050
(801) 876-3391
Owner: James A. Banas
Studio Manager: James A. Banas

[2] ALLERICE VIDEO
also *REMOTE RECORDING*
350 E St., Ste. 309
Eureka, CA 95501
(707) 445-3922
Owner: Darrell Shull
Studio Manager: Esmee Martin-Shull

[4] AMERICAN TAPE DUPLICATING
7023 15th NW
Seattle, WA 98117
(206) 789-1011
Owner: Conrad Denke
Studio Manager: Ella Bachmann

[8] AN TOMAR STUDIO
also *REMOTE RECORDING*
Oakland, CA
(415) 482-0839
Owner: Anthony Pascinco
Studio Manager: Tony Pashuco

[8] APPLEWOOD RECORDING STUDIO
4542 49th SW
Seattle, WA 98116
(206) 932-6348
Owner: Harlan Michael Weniger
Studio Manager: Harlan Michael Weniger

[8] APTOS AUDIO - PINEFOREST STUDIO
also *REMOTE RECORDING*
PO Box 1445
Aptos, CA
(408) 684-1555
Owner: Kenneth Mabie
Studio Manager: Kenneth Mabie

[8] ARCAL PRODUCTIONS
2732 Bay Rd.
Redwood City, CA 94063
(415) 369-7348
Owner: Arcal Inc
Studio Manager: Steve Viola

[8] ARTICHOKE PRODUCTIONS
also *REMOTE RECORDING*
4114 Linden St.

Oakland, CA 94608
(415) 655-1283
Owner: Paul Kalbach
Studio Manager: Paul Kalbach

[8] AUDIO RECORDING INC.
also *REMOTE RECORDING*
4718 38th Ave. NE
Seattle, WA 98105
(206) 525-7372
(206) 623-2030
Owner: Kearney W. Barton
Studio Manager: Kearney W. Barton

[8] AUGUST PRODUCTIONS
6822 21 Dr. NE
Marysville, WA 98270
(206) 653-6117
Owner: Gregory G. Landon
Studio Manager: Gregory G. Landon

[8] BADE ART & MUSIC
also *REMOTE RECORDING*
8017 Stroud N.
Seattle, WA 98103
(206) 522-8274
Owner: Michael Bade
Studio Manager: Michael & Lisa Bade

[8] JAKE BARNER STUDIOS
also *REMOTE RECORDING*
120 S. Barner
Centralia, WA 98531
(206) 736-9476 (national office)
(206) 736-1764 (Studio A)
Owner: Barner Communications
Studio Manager: Allen Fadness

[8] BEAUTIFUL HEART
also *REMOTE RECORDING*
PO Box 345
Williams, OR 97544
Owner: John Borland
Studio Manager: John Borland

[8] BENT NAIL STUDIOS
2375 Cory Ave.
San Jose, CA 95128
(408) 244-0766
Owner: Dave Morris
Studio Manager: Dave Morris

[8] BIBLE TEMPLE RECORDING
7600 NE Giisan
Portland, OR
(503) 252-3852
Owner: Bible Temple Inc
Studio Manager: Steve Trujillo

[8] BLUE CRYSTAL STUDIO
also *REMOTE RECORDING*
11520 Edgewood Rd.
Auburn, CA 95603
(916) 888-7478
Owner: Jeff L. Bond
Studio Manager: Jeff L. Bond

[8] BRALOVE PRODUCTIONS
621 Lawton St.
San Francisco, CA 94122
(415) 566-9811
Owner: Bob Bralove

[4] NATHAN BRYDEN MUSIC COMPANY
also *REMOTE RECORDING*
526 NW 24th
Hoyt Professional Center
Portland, OR 97210
(503) 243-2634
Owner: Bryden Music Company
Studio Manager: Charles Bryden

[4] CALEDONIA STREET SOUND
250 Caledonia St.
Louisville, CO 80027
(303) 666-9678
Owner: George T. Ward
Studio Manager: George T. Ward

[8] CAMERA ONE
also *REMOTE RECORDING*
431-A N. 34th St.
Seattle, WA 98109
(206) 547-5131
Owner: Gray Warriner
Studio Manager: Orlando Duenas

[4] LANE CAMERON STUDIOS
PO Box 5267
Incline Village, NV 89450
(702) 831-6516
Owner: Lane Cameron
Studio Manager: Lane Cameron

[8] CHAMPAIGN SOUND
PO Box 7003
San Jose, CA 95150
(408) 252-4536
Owner: Ted Champaign
Studio Manager: Ted Champaign

[8] CHINESE OUTREACH OF SAN FRANCISCO
also *REMOTE RECORDING*
1 Spruce St.
Millbrae, CA 94030
(415) 872-1277
Owner: Chinese Outreach
Studio Manager: Mattson Chau

[8] CHRISTIAN ARTIST STUDIO PRODUCTIONS
OR "CHRISTIAN STUDIOS"
3420 E. 64th
Anchorage, AK 99507
(907) 349-5239
(907) 349-5502
Owner: Meri Shandley, Laura Hall
Studio Manager: Dan Nelson

[8] CLAWS ON PRODUCTIONS
1355 C Bear Mtn. Dr.
Boulder, CO 80303
(303) 499-1144
Owner: Lisa & Dan Clawson
Studio Manager: Dan Clawson

[8] CLOCKWORKS
also *REMOTE RECORDING*
240 W. Center
Pocatello, ID 83204
(208) 232-1829
Owner: Michael Worona
Studio Manager: Dave Baumert

[4] COMMAND PRODUCTIONS
also *REMOTE RECORDING*
Custom House POB 2223
San Francisco, CA 94126
(415) 332-3161
Owner: Warren Weagant
Studio Manager: Michael Dupen

[4] CONTROL I
also *REMOTE RECORDING*
2207 Shattuck Ave.
Berkeley, CA 94704
(415) 848-4395
Owner: KPFA
Studio Manager: Jim Bennett

[8] COVENANT RECORDINGS INC.
also *REMOTE RECORDING*
1345 S. Major St.
Salt Lake City, UT 84115

(801) 487-1096
Owner: Lew Kofford
Studio Manager: Chris Jensen

[8] COZY DOG RECORDING
603 SE Morrison Rd.
Vancouver, WA 98664
(206) 694-1845
Owner: Tad Suckling
Studio Manager: Cozy Dog

[4] CRYSTAL CLARITY
14618 Tyler Foote Rd.
Nevada City, CA 95959
(916) 292-3111
Owner: J. Donald Walters

[4] CRYSTAL CLEAR RECORDING
PO Box 5067
Central Pt., OR 97502
(503) 776-2423
Owner: Roger Green
Studio Manager: Roger Green

[8] CURRENT RUTLEDGE
only REMOTE RECORDING
614 12th Ave. E.
Seattle, WA 98102
(206) 324-7530
Owner: David Current
Studio Manager: Carol Holland, William Borden

[4] CW RECORDING
also REMOTE RECORDING
4014 155th St. NW
Gig Harbor, WA 98335
(206) 857-7588
Owner: Charles Wright
Studio Manager: Charles Wright

[8] DAYSTAR RECORDING STUDIOS
also REMOTE RECORDING
1105 Leyden St.
Denver, CO 80220
(303) 394-4637
Owner: Kirk Hutchinson
Studio Manager: Kirk Hutchinson

[8] DEROY PRODUCTIONS
1210 Washington
Eugene, OR 97401
(503) 683-6866
Owner: Ron Royer, D. Roberts
Studio Manager: Ron Royer

[4] DMK SOUND DESIGN/FROGS PRODUCTIONS
also REMOTE RECORDING
PO Box 2218
Sunnyvale, CA 94087
(408) 739-2222
Owner: Dennis M. Kambury
Studio Manager: Frogs
Extras & Direction: DMK Sound Design was built to provide producers, arrangers and composers with a flexible, cost-effective pre-production MIDI facility that is upwardly compatible with full service 24+ track recording studios. Sampling, FM, harmonic and subtractive synthesis formats are all supported and coordinated by the Mac Plus, as well as software by Digidesign, Opcode, Passport and more. Planned enhancements for 1988 include video production capabilities and 2-track digital recording. Please call or write for current cost schedule and available services.

[4] EAGLE NEST RECORDING
AND SOUND REINFORCEMENT
PO Box 1184
Castle Dale, UT 84513
(801) 381-2120
Owner: Craig C. Garrett
Studio Manager: Craig C. Garrett

[8] EGOMANIAC STUDIO
90 Woodhams Rd.
Santa Clara, CA 95051
(408) 243-7431
Owner: Sani Sasmita
Studio Manager: Myron Dove

[8] ELBERTA RECORDING STUDIOS
also REMOTE RECORDING
343 E. Elberta Dr.
North Ogden, UT 84404
(801) 782-4666
Owner: David T. Brimhall
Studio Manager: Richard L. Myrup

[8] EM-AN-EE SOUND STUDIO
66 Club Rd., Ste. 250
Eugene, OR 97401
(503) 342-4039
Owner: Gary M. Kaplan
Studio Manager: Andrew Widders-Ellis

[2] EMERSON FILM AND VIDEO SOUND
only REMOTE RECORDING
1490 S. St. Paul St.
Denver, CO 80210
(303) 744-3001
Owner: James Emerson
Studio Manager: James Emerson

[8] ENHARMONIK STUDIOS
also REMOTE RECORDING
PO Box 22243
Sacramento, CA 95822
(916) 443-0373
Owner: Mad Rover Records
Studio Manager: John Baccigaluppi
Extras & Direction: Enharmnik Studios is the in-house studio for Mad Rover records. Indie bands and labels are our specialty. Complete recording and production services available. Record, CD and cassette manufacturing services are available. Digital mixing is also available on request. We have excellent relations with two 24-track studios and can take your demo or record project all the way from pre-production to 24-track if your project needs it. Tons of processing, MIDI and SMPTE stuff. Way cool engineers and producers. Coffee's free, meals and accommodations are available too. Previous clients have included 7 Seconds, Richard McGrath and Gavin Blair (True West), Richard T. Hardesty, Headface, The Borman Six, Scott Moon (Bourgeois-Tagg), Twice Shy, Tommy Tutone, John McCrea, Vicious Gel, Robert Kuhlmann, Donny Woodruff (La Rue-Jay King Productions), The Fringe, Rhythm School, Neo Geo, I Love Ethyl, Captain Carrot, The Beer Dawgs, Ryo Antony and The Cactus Liquors

[4] EVENT AUDIO PRODUCTIONS
only REMOTE RECORDING
PO Box 1292
Frisco, CO 80443
(303) 668-0153
Owner: Scott Ikier
Studio Manager: Mark Westby

[8] FERGUS SOUND ENTERPRISES
also REMOTE RECORDING
1925 Orchard Ave.
Boulder, CO 80302
(303) 442-3939
Owner: Fergus
Studio Manager: Fergus

[4] FLAMINGO RANCH PRODUCTIONS
also REMOTE RECORDING
PO Box 56
Orcas, WA 98280
(206) 376-5176
Owner: James Barkshire
Studio Manager: Andre Frye

[4] FOOT O' MAH BED RECORDING
11 SW Curry, #7
Portland, OR 97201
(503) 223-2327
Owner: Robert Vandiver
Studio Manager: Millie Watt

[4] FORTE
also REMOTE RECORDING
12495 SW Summercrest Dr.
Tigard, OR
(503) 620-7849
Owner: Walter Bruhn
Studio Manager: Walter Bruhn

[8] FOUNDATION STUDIOS
also REMOTE RECORDING
PO Box 2192
Soldotna, AK 99669
(907) 262-9847
Owner: Mark Gaede
Studio Manager: Mark Gaede
Engineers: Mark Gaede
Dimensions: Studio 19 x 19, control room 10 x 8
Mixing Consoles: Tascam M-35 + 35EX 16 x 4
Audio Recorders: Tascam 38 8-track, Tascam 32 2-track 1/2", TEAC X-1000R 4-track 1/4"
Cassette Recorders/Duplicators: TEAC C-3RX
Noise Reduction Equipment: (2) Tascam DX-4D dbx NR, Tascam DX-2D NR
Echo, Reverb, & Delay Systems: Yamaha REV7, DeltaLab ADM-1024
Other Outboard Equipment: Yamaha Q2031, ADC SS315, dbx 160X, (2) TEAC Model 1
Microphones: (2) Shure SM81, Shure SM7, (4) Shure SM58
Monitor Amplifiers: Hafler 500, Hafler 220
Monitor Speakers: JBL 4401, Speaker Lab S-7
Musical Instruments: Yamaha DX7, Yamaha RX11, Korg Poly-6, Yamaha TX81Z, Kawai KG-6C 7'4" grand piano
Other MIDI Equipment: 360 Systems MIDI patcher, Atari 1040ST w/Dr. T. KCS and Copyist

[8] FOX RECORDING
also REMOTE RECORDING
PO Box 120
Felton, CA 95018
(408) 335-5562
Owner: Tom Fox
Studio Manager: Tom Fox

[8] FRED FOXX MUSIC CO.
also REMOTE RECORDING
5 Elkwood Dr.
South San Francisco, CA 94080
(415) 994-5908
Owner: F.H. Nesbitt Jr.
Studio Manager: V.A. Nesbitt

[8] FREE REELIN' SOUND
also REMOTE RECORDING
1175 S. Lincoln St.
Denver, CO 80210
(303) 744-9751
Owner: Shirley Kenneally
Studio Manager: Mark Derryberry

[8] FULL CIRCLE STUDIO/FULL CIRCLE PRODUCTIONS
7441 Granada Rd., PO Box 21591
Denver, CO 80221
(303) 426-0901
Owner: Craig Cutcliff
Studio Manager: Paul Bernadou

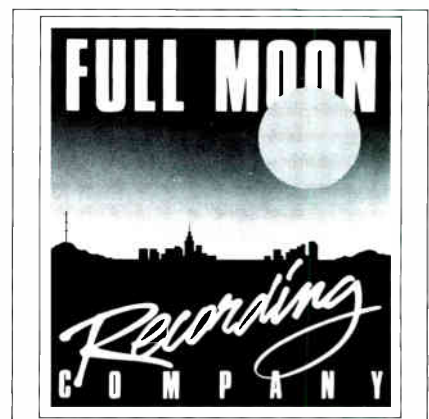

FULL MOON RECORDING COMPANY
Eugene, OR

[8] FULL MOON RECORDING COMPANY
also REMOTE RECORDING
197 W. 12th Ave.
Eugene, OR 97401
(503) 343-1294
Owner: PRN, Inc.
Studio Manager: Steve Diamond
Engineers: Steve Diamond, Jon Davie
Dimensions: Room 1: studio 24 x 15 plus 2 isolation booths,

—CONTINUED ON NEXT PAGE

control room 15 x 12. Room 2: control room 15 x 12.
 Mixing Consoles: TAC Scorpion 16 x 8, Ramsa 12 x 4.
 Audio Recorders: Otari MX-70 8-track, (2) Otari MTR-10 2-track, Otari MX-5050 2-track, Ampex 350 1-track, Ampex 700 2-track.

Cassette Recorders/Duplicators: Otari DP-4050C2 stereo hi-speed w/5 slaves, Nakamichi MR-1, Nakamichi MR-2 and others.

Echo, Reverb, & Delay Systems: Lexicon PCM70, (2) Yamaha SPX90.

Other Outboard Equipment: dbx 166 dual channel compressor/gate, Aphex compellor dual channel, Valley People Dyna-Mite 2 channels, Valley People Gatex 4 channels, UREI 533 EQ. Microphones: (2) Neumann U87, (2) Neumann TLM-170, (4) Neumann KM84, (2) AKG 460, (2) AKG C414EB, Beyer 500, (2) Sennheiser MD-421, others.

Monitor Amplifiers: Haller DH-220, Yamaha, Rane HC-6, (2) McIntosh C-60 tube.

Monitor Speakers: Tannoy Little Red w/sync source, JBL 4315, JBL 4311, Auratone 5C.

Musical Instruments: Many synths available.

Video Equipment: Coming soon!

Other: Technics SL1200 MkII turntable, (4) Harris cart machine, (2) custom phone patch couplers.

[8] FULL SPECTRUM PRODUCTIONS, INC.

150 E. Dana St.
 Mountain View, CA 94041
 (415) 967-1883
 Owner: John A. McCauley
 Studio Manager: Terry Collins

[8] GARY GADWOOD CUSTOM RECORDING

also *REMOTE RECORDING*
 11995 NW Keamey
 Portland, OR 97229
 (503) 644-0683
 Owner: Gary Gadwood
 Studio Manager: Gary Gadwood

[8] GENERATION ORGANIZATION

4840 Brookwood St.
 Eugene, OR 97405
 (503) 484-9087
 Owner: Lew Thorne
 Studio Manager: Lew Thorne

[8] GLOBE STUDIOS

also *REMOTE RECORDING*
 16 Locust Ave.
 Mill Valley, CA 94941
 (415) 381-1702
 Owner: Tim Eschliman
 Studio Manager: Tim Eschliman

[4] GROUND ZERO SOUND

also *REMOTE RECORDING*
 5665 SW Bonita Rd.
 Lake Oswego, OR 97035
 (503) 639-3694
 Owner: Mark Gensman
 Studio Manager: Mark Gensman

[2] HALF INCH VIDEO

185 Beroy St., Ste. 467
 San Francisco, CA 94107
 (415) 495-3477
 Owner: Mark Lamper

[4] HANK'S BASEMENT AUDIO

also *REMOTE RECORDING*
 5665 E. Colorado Ave.
 Denver, CO 80224
 (303) 756-8777
 Owner: HBA Enterprises Inc.
 Studio Manager: Hank Anderson

[8] HEARTBREAK HOTEL STUDIO

also *REMOTE RECORDING*
 3885 S. Logan St.
 Englewood, CO 80110
 (303) 761-8060
 Owner: Cary Steinberg
 Studio Manager: Cary Steinberg

[2] MARILYN HICKEY MINISTRIES

also *REMOTE RECORDING*
 405 S. Platte River Dr.
 Denver, CO 80223
 (303) 698-1155

N O R T H W E S T

4 & 8 TRACK

STUDIOS

Owner: Marilyn Hickey Ministries
 Studio Manager: Haran M. Hunter

[8] HIGHLAND STUDIO

PO Box 554
 Los Gatos, CA 95031
 (408) 353-3952
 Owner: Joe Weed
 Studio Manager: Joe Weed

[4] HOLLCRAFT RECORDING

also *REMOTE RECORDING*
 1961 Rose Ln.
 Pleasant Hill, CA 94523
 (415) 689-3444
 Owner: E.J. Hollcraft
 Studio Manager: E.J. Hollcraft

[8] HOMELY PRODUCTIONS

8264 Timothy Ct.
 Colorado Springs, CO 80920
 (303) 598-5857
 Owner: Jay Jernigan
 Studio Manager: Jay Jernigan
 Engineers: Jay Jernigan
 Dimensions: Studio 10 x 16, control room 8 x 10.
 Mixing Consoles: Biamp 1221 modified 12 x 2, Toa RX-208 8 x 2.

Audio Recorders: Fostex 80 8-track, Pioneer RT 707 2-track.
 Cassette Recorders/Duplicators: GXAX deck.
 Noise Reduction Equipment: dbx Type II, Dolby B, Dolby C.
 Synchronization Systems: Yamaha YMC-10 FSK to MIDI.
 Echo, Reverb, & Delay Systems: Yamaha SPX90 signal processor, Roland SDE-1000 digital delay, Alesis MIDVerb II, Alesis Microverb.

Other Outboard Equipment: Symetrics 528 preamp de-esser compressor parametric EQ, Yamaha GC2020 stereo compressor/limiter/gate, Valley People Gatex 4-channel noise gate, Rocktron RX2H Exciter imager Hush II, ADC 10-band stereo EQ (house), (4) Realistic 1-octave graphic EQ.

Microphones: Shure, Audix.
 Monitor Amplifiers: Technics
 Monitor Speakers: Yamaha NS-500M, Auratone 5-C cubes.
 Musical Instruments: Roland Alpha Juno-1 synth, Yamaha RX-5 drum machine, Yamaha SG-1500 guitar, ESP strat, Fender jazz bass, (3) Yamaha G-100 Mark II amps, full complement of Boss pedals.

Other MIDI Equipment: Alesis MMT-8 8-track digital sequencer.
 Other: (4) AKG 240 DF and Fostex T-20 headsets, Audio Source RTA 1 spectrum analyzer, ADC patchbays, Connectronics cables throughout.
 Rates: Available on request.

[8] HOUSE OF FAITH

also *REMOTE RECORDING*
 119 Lowell Ave.
 Palo Alto, CA 94301
 (415) 324-9483
 (415) 322-5152
 Owner: Bart Thurber
 Studio Manager: Bart Thurber

[8] HUMBOLDT RECORDS

also *REMOTE RECORDING*
 PO Box 713
 Trinidad, CA 95570
 (707) 677-3305
 Owner: Robby Jarvis
 Studio Manager: Robby Jarvis

[8] HUMMINGBIRD SOUND LAB

10201 Belgrove Ct. NW
 Seattle, WA 98177
 (206) 782-1512
 Owner: Robert Casper, Donnee Casper
 Studio Manager: David Casper
 Engineers: David Casper.
 Dimensions: Studio 16 x 15, control room 16 x 8.
 Mixing Consoles: Sound Workshop 1280B 12 x 8 Super EQ.
 Audio Recorders: Otari MX-5050B 8-track, Otari MX-5050B 2-track.
 Cassette Recorders/Duplicators: (6) Nakamichi BX-100, Nakamichi BX-125.
 Noise Reduction Equipment: dbx 155.
 Echo, Reverb, & Delay Systems: Lexicon PCM60, Lexicon

PCM42, Master-Room XL-305, DOD Electronics RDS-900.
 Other Outboard Equipment: Orban 424A gated compressor/limiter/de-esser, UREI 1176LN peak limiter, dbx 164 compressor/limiter, Symetrix SE-400 stereo parametric equalizer, Aphex Type C Aural Exciter.
 Microphones: (2) Neumann KM84, Sennheiser MD-441, Sennheiser MD-421, Countryman, Beyer, E-V.
 Monitor Amplifiers: McIntosh 1900.
 Monitor Speakers: (2) JBL L100.
 Musical Instruments: Steinway B 7' grand piano, Prophet 2000 sampling keyboard w/expanded memory, Casio CZ-101, 3-octave chromatic marimba, silar, (3) Chinese chengs (harp-like zithers), butterfly harp, (4) thumb pianos, (7) ocarinas, large quantity of world percussion and unusual instruments, including new inventions.
 Other MIDI Equipment: Yamaha QX21 sequencer, Yamaha YMC MIDI converter.
 Rates: \$24/hr general, \$20/hr for solo composers.

[8] HUN SOUND INC.

also *REMOTE RECORDING*
 647 Irwin St.
 San Rafael, CA
 (415) 454-2911
 Owner: Don Podesto
 Studio Manager: Marianne Rhea Podesto

[8] KENNY HUSTED PRODUCTIONS

7026 30th NE
 Seattle, WA 98115
 (206) 524-6996
 Owner: Kenneth J. Husted
 Studio Manager: Kenny Husted

[8] HYBRID MUSIC

2777 Devonshire Ave.
 Redwood City, CA 94061
 (415) 364-0354
 Owner: Ron Torbensen
 Studio Manager: Ron Torbensen

[4] IN WITHOUT KNOCKING

also *REMOTE RECORDING*
 14536 Eastern Ave.
 Guerneville, CA
 (707) 869-9350
 Owner: Jack Ellis
 Studio Manager: Jack Dupp

[8] INLAND AUDIO VISUAL COMPANY

also *REMOTE RECORDING*
 2325 N. Monroe
 Spokane, WA 99203
 (509) 328-0706
 Owner: Larry Ellingson
 Studio Manager: Bruce Hemingway

[8] J&R AUDIO LABS

also *REMOTE RECORDING*
 16028 Via Segundo
 San Lorenzo, CA 94580
 (415) 278-9870
 Owner: Randy Heise, Joan Miller
 Studio Manager: Randy Heise

[8] JADE PRODUCTIONS

also *REMOTE RECORDING*
 PO Box 4803
 Modesto, CA 95352
 (209) 578-3770
 Owner: Gina Rose
 Studio Manager: Alvin Rose

[8] JB RECORDINGS

6532 5th Ave. NW
 Seattle, WA 98117
 (206) 783-6579
 Owner: JB
 Studio Manager: Mr. James Bachman
 Engineers: Jim Bachman.

Dimensions: Room 1: studio 11 x 18 x 8. Room 2: studio 14 x 15 x 8, vocal booth 11 x 6 x 7, control room 11 x 8 x 7.
 Mixing Consoles: Studio Master patchbay 24 x 8.
 Audio Recorders: Otari MX-5050 MkII 8-track, Tascam 32 2-track.

Cassette Recorders/Duplicators: Nakamichi BX-2.
 Echo, Reverb, & Delay Systems: Lexicon Model 200 reverb, Lexicon PCM42 delay w/ext. memory, Fostex 3050 delay.
 Other Outboard Equipment: Dyna-Mite 430J, Symetrix SE-400 parametric EQ, MXR dual limiter, Phase Linear 1300 Series 2 noise reduction, Symetrix HA-10B headphone amp, Rane SM26 splitter/mixer, Otari CB-116 autolocator, Aphex Type C, Axiom Ten Stereo Imager.

Microphones: (2) Neumann U89, (2) Beyer M69, AKG 330 BT, Shure SM57
Monitor Amplifiers: Pioneer Spec 4.
Monitor Speakers: E-V Sentry 100A
Musical Instruments: Assorted things with strings
Rates: \$15/hr.

[8] JUDE PRODUCTIONS
PO Box 90
Dutch Flat, CA 95714
(916) 389-2326
Owner: Russell Brian Brooker
Studio Manager: Victoria Brooker

[8] KALAGO PRODUCTIONS INC.
also REMOTE RECORDING
559 Maple Rd.
KalisPELL, MT 59901
(406) 752-0155
Owner: Todd Stillwell

[8] KALEIDOSOUND
185 Berry St., Ste. 2805
San Francisco, CA 94107
(415) 543-0531
Owner: Forrest G. Patten
Studio Manager: Dina Kaler

[2] KEYBOARD RESOURCES
also REMOTE RECORDING
PO Box 700
Hood River, OR 97031
(503) 352-MIDI
Owner: Debbie Skinner
Studio Manager: Debbie Skinner

[8] LEON-FORREST PRODUCTIONS
(FORMERLY HARBINGER PROD.)
4416 SE Hwy. 101
Lincoln City, OR 97367
(503) 996-2575
Owner: L. F. Caulkins
Studio Manager: L. F. Caulkins

[8] LEW'S RECORDING PLACE
also REMOTE RECORDING
1219 Westlake Ave. N., #115
Seattle, WA 98109
(206) 285-7550
Owner: Lew Lathrop
Studio Manager: Lew Lathrop

[8] LINEAR PRODUCTIONS
1131 Compass Ln.
Foster City, CA 94404
(415) 349-8780
Owner: Tony T
Studio Manager: Gene O.

[8] LION TRACKS STUDIO-CREATIVE ENTERPRISES
also REMOTE RECORDING
647 Irwin St.
San Rafael, CA 94901
(415) 454-2911
Owner: Mario Lewin
Studio Manager: Mario Lewin

[8] LITTLE OAK SOUND AND VIDEO
2028 SW "G" St.
Grants Pass, OR 97526
(503) 479-3205
Owner: Rosie Moore
Studio Manager: Roy Duckworth

[8] LITTLE PEOPLE STUDIO
also REMOTE RECORDING
2111 Research Dr., #2
Livermore, CA 94550
(415) 449-9820
Owner: Michael Ferrucci, Doug Mann
Studio Manager: Michael, Doug

[8] LITTLE POND PRODUCTIONS
PO Box 20594
Portland, OR 97220
(503) 254-5776
Owner: David B. Miller
Studio Manager: Jo Anna Burns-Miller

[4] LOCATION RECORDING
only REMOTE RECORDING
4202 NE 105th St.
Seattle, WA 98125
(206) 527-0318
Owner: Al Swanson

[8] MAMMOTH RECORDING STUDIOS
8580 Essex Dr.
Denver, CO 80229
(303) 287-2382
Owner: Kenneth Hendricks
Studio Manager: Kenneth Hendricks

[4] MARCAN STUDIO
also REMOTE RECORDING
360 E. 200 South, #71
Kanab, UT 84741
(801) 644-2442
Owner: Adrian & Marcia Hymen
Studio Manager: Marcia Hymen

[2] DAVID MATHIEW RECORDING SERVICES
only REMOTE RECORDING
2815 NE 35th Ave.
Portland, OR 97212
(503) 287-1420
Owner: David Mathiew
Studio Manager: David Mathiew

[8] MCCUNE STUDIOS
also REMOTE RECORDING
951 Howard St.
San Francisco, CA 94103
(415) 777-2700
Owner: McCune Audio Visual Video
Studio Manager: Jim Draper
Engineers: Dave Duca, Jeff O'Sammon, Jim Draper, Don Geis
Dimensions: Studio 16 x 26, control room 15 x 19.
Mixing Consoles: Amek TAC 1682 16 x 8 x 2
Audio Recorders: Otari MX-5050-8 8-track, (2) MCI JH-110 2-track, Otari MX-5050 BQII 4-track, Ampex 440 2-track, Ampex/Inovonics 350 2-track, Ampex 350/351 mono, 16-track (1" / 2" on request).
Echo, Reverb, & Delay Systems: AKG BX-20, Scamp S-24 Time Shape module, AMS reverb and delay on request
Other Outboard Equipment: Scamp rack including compres-



MCCUNE STUDIOS
San Francisco, CA

sor/limiter, parametric EQ dynamic noise filters and Time Shape module, UREI 1176LN compressor/limiter, Orban de-esser, Technics SL-1200 MkII turntables w/Burwen TNE7000A transient noise eliminator and other devices from McCune rental stock.

Microphones: Neumann U87, Neumann KM84, AKG 414, AKG 451, AKG 202, Sony C-37, RCA 77, Shure SM56, Shure SM57, Shure SM58 and many others from McCune rental stock
Monitor Amplifiers: Hafler DH200 (biamped)
Monitor Speakers: McCune SM-4B Alt'ec 604 w/active X-over, including time-correction and EQ circuitry, Auratones
Musical Instruments: On request.

Video Equipment: Full production services: 3/4" and 1" studio/location recording, 3/4" editing, full duplication services, (1", 3/4", VHS, Beta), 16mm and slide-to-video transfers; SMPTE coding; audio control room equipped w/video playback/recorder and monitor

Rates: Audio \$50/hr All equipment in stock no extra charge. Video on request. Call for rate card

Extras & Direction: McCune Studios are fully equipped to serve the needs of our media clients, from television and radio spots, to multi-image presentations, to films and videos. Free parking and coffee.

If You Supply A Product or Service...

MIX CLASSIFIEDS

are the best way to reach thousands of professionals in the audio-video industry! Find out why Mix Classifieds are the most cost-effective way to advertise—see the Classified section in the back of this issue for categories and complete details.

**FOR MORE INFORMATION,
OR TO PLACE A MIX CLASSIFIED AD,
CALL (415) 843-7901. DEADLINE: 15TH OF MONTH,
6 WEEKS PRIOR TO PUBLICATION.**

[8] MELODIC SERVICES PRODUCTIONS
PO Box 393
Loveland, CO 80539
(303) 669-1525
Owner: Brian W. Salyards
Studio Manager: Brian W. Salyards

[8] METRIX RECORDING & PRODUCTION STUDIO
also *REMOTE RECORDING*
10830 1st Dr. SE
Everett, WA 98208
(206) 347-3824
Owner: Doug & Debbie Williams
Studio Manager: Doug Williams

[4] MICROFT SYSTEMS
1314 NE 43rd St.
Seattle, WA 98105
(206) 547-2440
Owner: Dave Halliday

[2] MIDNIGHT BLUE PRODUCTIONS
also *REMOTE RECORDING*
PO Box 77013
Colorado Springs, CO 80970
(303) 520-9079
Owner: Ken Toal
Studio Manager: K. Toal

[8] MIKE'S MUSIC
2455 N. Yellowstone
Idaho Falls, ID 83401
(208) 524-4441
Owner: Mike Doggett
Studio Manager: Don Christensen

[4] MISS WHIB, ABROAD
only *REMOTE RECORDING*
PO Box 185
Greenville, CA 95947
(916) 284-7258
Owner: Jean A. Souders
Studio Manager: J.A. Souders

[8] MT. STUDIO
17835 Hwy. 9
Boulder Creek, CA
(408) 338-9555
Studio Manager: Steve Kritzer

[4] NEW LIFE BROADCASTING
also *REMOTE RECORDING*
PO Box 117, 440 Lawrence St.
Quincy, CA 95971
(916) 283-4144
Owner: Ron Trumbo
Studio Manager: Ron Trumbo

[2] NORTH WOODS
also *REMOTE RECORDING*
3905 N. State St.
Ukiah, CA 95482
(707) 485-0253
Owner: John Denninger
Studio Manager: J.D. Fletcher

[8] ONION AUDIO
also *REMOTE RECORDING*
PO Box 869
Greenville, CA 95947
(916) 284-6929
Owner: Hank Alinch
Studio Manager: Lanis Le Baron

[4] OPEN DOOR PRODUCTIONS
PO Box 8556
Berkeley, CA 94707
(415) 527-9311
Owner: Burke Trieschmann
Studio Manager: Burke Trieschmann

[8] PAGE STUDIOS
also *REMOTE RECORDING*
1220 Bertha Ln.
Santa Rosa, CA 95405
(707) 579-5335
Owner: Steve Ruiz
Studio Manager: Dan Chappell

N O R T H W E S T

4 & 8 TRACK

STUDIOS

[8] PEAK RECORDING & SOUND
also *REMOTE RECORDING*
PO Box 1404
Bozeman, MT 59715
(406) 586-1650
Owner: Peak Recording & Sound, Inc.
Studio Manager: Gil Stober

[4] PFS RECORDING
also *REMOTE RECORDING*
Box 6840
San Jose, CA 95150
(408) 275-6322
Owner: Mike Halloran
Studio Manager: Mike Halloran

[8] PHANTASMA SOUND
also *REMOTE RECORDING*
7909 Fremont Ave.
Ben Lomond, CA 95005
(408) 336-2494
Owner: Errol G. Specter
Studio Manager: Errol G. Specter

[4] PINE APPLE STUDIOS
also *REMOTE RECORDING*
PO Box 427
Gleneden Beach, OR 97388
(503) 764-2617
(503) 757-8702
Owner: Clay Ashley
Studio Manager: Henry Zellers

[8] PING-PONG PRODUCTIONS
also *REMOTE RECORDING*
PO Box 708
South San Francisco, CA 94083
(415) 968-1257
Owner: R. Duane Hoopes
Studio Manager: John Cigiutti

[8] PLATINUM SOUNDS RECORDING STUDIO
516 Martha St.
San Jose, CA 95112
(408) 629-4729
Owner: Cornell Watson, N.D. Johnson
Studio Manager: Elsa Hendrex

[8] PLAY IT AGAIN, SAM
2001 W. Colorado Ave.
Colorado Springs, CO 80904
(303) 578-9738
Owner: Samuel Hall
Studio Manager: Samuel Hall

[4] POLYTUNES
also *REMOTE RECORDING*
3211 Silver Crest Dr.
Bothell, WA 98012
(206) 337-4322
Owner: Paul Havrilak
Studio Manager: Paul Havrilak

[8] PREGNANT BADGER STUDIOS
10010 Biscanewoods Way
Sacramento, CA 95827
(916) 363-8361
Owner: Decision Systems Design
Studio Manager: Colin Aiken
Engineers: Colin Aiken, Bill Barton.
Dimensions: Studio 13 x 21, control room 6 x 16.
Mixing Consoles: Tascam Model 308 8 x 4, Biamp 12/83 12 x 2.
Audio Recorders: Tascam Model 38 8-track, Tascam Model 22-2 2-track.
Cassette Recorders/Duplicators: Tascam 225, Yamaha 520, Yamaha MT44 4-track.
Noise Reduction Equipment: dbx 166 comp/limiter, dbx 160 comp/limiter.
Echo, Reverb, & Delay Systems: Yamaha SPX90, Alesis XTC digital reverb, ADM 1024 Electron, Orban reverb.
Other Outboard Equipment: Rane HC-6 headphone amp.
Microphones: (2) Shure SM58, (3) Audio-Technica Pro 5, (3)

AKG 707E, (3) Shure SM10 headset
Monitor Amplifiers: (2) NAD 3130
Monitor Speakers: Auraltones, Toa 265-ME, ESS HD series.
Musical Instruments: Yamaha RX11, Yamaha RX21L, Yamaha DX9, (2) Yamaha DX7, Kawai K3, Roland Juno 106, Minimoog, Sequential Circuits Prophet 5, Yamaha TX81Z

[8] PSEUDO STUDIO
125 Tennessee St.
Vallejo, CA 94590
(707) 552-7370
Owner: Robert L. Detweiler
Studio Manager: Eddie Carpenter, John Westbury

[8] PUDDINGSTONE PRODUCTIONS
4804-58th St.
Sacramento, CA 95820
(916) 452-2956
Owner: Bruce Bolin
Studio Manager: Bruce Bolin

[4] RADIOACTIVE RECORDS
170 SW 139th
Beaverton, OR 97006
(503) 626-2331
Owner: Mark Hannah
Studio Manager: Mark Hannah

[8] RAL-RECORDING
6 Southfork
Merced, CA 95340
(209) 722-3220
Owner: Robert Laughton
Studio Manager: Robert Laughton

[4] RAVEN RADIO FOUNDATION
102 B Lincoln St.
Sitka, AK 99835
(907) 747-5877
Owner: Raven Radio Foundation
Studio Manager: Mary Baker, Rich McClear

[8] REAL TIME RECORDING
also *REMOTE RECORDING*
8101 Peck Ave., #34E
Anchorage, AK 99504
(907) 333-1189
Owner: Patric D'Eimon
Studio Manager: Patric D'Eimon

[8] RECIPROCAL RECORDING
4230 Leary Way NW
Seattle, WA 98107
(206) 782-6411
Owner: Chris Hanzsek
Studio Manager: Chris Hanzsek

[8] RECORDING ETC.
also *REMOTE RECORDING*
633 Cowper
Palo Alto, CA 94301
(415) 327-9344
Owner: Dennis Reed
Studio Manager: Ted Brooks

[8] REEL ART/REUNION PRODUCTIONS
534 Acoma St.
Denver, CO
(303) 534-7775
Owner: David E. Rice
Studio Manager: Michel Crowley

[4] REEL CREATIONS
also *REMOTE RECORDING*
E. 11321 37th
Spokane, WA 99206
(509) 928-2460
Owner: Alan J. Perry

[4] REEL TIME REPRODUCTIONS
only *REMOTE RECORDING*
190 Marianna Way
Campbell, CA 95008
(916) 487-5364
Owner: Timothy Whyte
Studio Manager: Timothy Whyte

[8] REELS ON WHEELS
also REMOTE RECORDING
959 Vetch Cir.
Lafayette, CO
(303) 666-9593
Owner: John B Arnold
Studio Manager: John B Arnold

[8] ROMANCE RECORDING STUDIOS
4215 E. 30th Ave.
Spokane, WA 99223
(509) 534-5933
Owner: Richard Vallance
Studio Manager: Richard Vallance

[4] ROSEDALE AUDIO PRODUCTIONS
also REMOTE RECORDING
8602 86th Ave. NW
Rosedale (Gig Harbor), WA 98335
(206) 851-2838
Owner: David Breneman
Studio Manager: David Breneman

[8] D. ROSS PRODUCTIONS
3097 Floral Hill Dr.
Eugene, OR 97403
(503) 343-2692
Owner: Don Ross

[2] NORMAN ROSS PRODUCTIONS
also REMOTE RECORDING
2810 E. Evergreen Ave.
Salt Lake City, UT 84109
(801) 484-0401
Owner: Norman B Ross
Studio Manager: Alice L. Ross

[8] ROXOUND STUDIOS
2833 NE 115th
Seattle, WA 98125
(206) 365-7949
Owner: Mark Angelesdes
Studio Manager: Tony Elzmar

[8] RUBBER PARK PRODUCTIONS
also REMOTE RECORDING
PO Box 120
Tahoma, CA 95733
(916) 525-6554
Owner: David F Chance
Studio Manager: Steve Teshara

[8] RUTHER REMOTE RECORDING
also REMOTE RECORDING
108 N. Roosevelt
Walla Walla, WA 99362
(509) 522-0438
Owner: Bud Ruther
Studio Manager: Bud Ruther

[8] SADDLE BUTTE MUSIC
also REMOTE RECORDING
PO Box 2232
Jackson, WY 83001
(307) 733-9008
Owner: Barbara Moore
Studio Manager: Roger Lavake

[8] SALMON BAY PRODUCTIONS
Seattle, WA
(206) 782-9182
Owner: Glen Travis
Studio Manager: Diane Travis

[8] SAN FRANCISCO PRODUCTION GROUP
550 Bryant St.
San Francisco, CA 94107
(415) 495-5595
Owner: Jeff Cretcher, Joel Skidmore

[8] SCHECHTER STUDIOS
PO Box 1153
Healdsburg, CA
(707) 433-1720
Owner: Randy Schechter
Studio Manager: Randy Schechter

[8] RANDALL SCHILLER PRODUCTIONS
also REMOTE RECORDING
1207 Fifth Ave.
San Francisco, CA 94122
(415) 661-7553
Owner: Randall Schiller
Studio Manager: Randall Schiller
Engineers: Randall Schiller, Cathy Cohn.
Dimensions: Studio 12.5 x 15, drum room 9 x 9, control room 12.5 x 15
Mixing Consoles: TEAC/Tascam 5B 8 x 4, TEAC/Tascam M-35EX 12 x 4
Audio Recorders: TEAC/Tascam 80-8 8-track, Otari 5050B 2-track, Sony TC-8544S 4-track, Sony TC-850 2-track
Cassette Recorders/Duplicators: Awa AD-F990
Echo, Reverb, & Delay Systems: DeltaLab 2048 digital delay, DeltaLab DL-2 Acousticcomputer stereo digital delay, Eventide H910 Harmonizer, Yamaha REV7 digital reverb, Yamaha SPX90 digital reverb, Sound Workshop 242 stereo reverb.
Other Outboard Equipment: Yamaha Q2031 31-band stereo graphic equalizer, MXR dual 15-band stereo equalizers, Orban 622 parametric equalizer, dbx 161 compressor/limiter, dbx 163 compressor/limiter, UREI 1178 stereo compressor/limiter, dbx 154 Declinear noise reduction, Crown VFX-2A stereo electronic crossover/filter, SAE 5000 impulse noise reduction, dbx 503, dynamic range expander, Technics SL-1200 MkII turntable, assorted patchbays and necessary support equipment
Microphones: Neumann U87, AKG C-414s, E-V RE15, E-V RE20, E-V 635A, Shure SM81, Shure SM58, Shure SM57, Shure SM78, Shure 55SH, Shure SM91, Shure "Green Bullet," Sony ECM-33P, Sony ECM-33F, Sony ECM-16, Sennheiser MD-421, Sennheiser MD-431, AKG D12, Crown PZMs
Monitor Amplifiers: SAE A-201, SAE A-501, Crown Microtech 1200LX, BGW Model 100-01
Monitor Speakers: JBL 4411, Auratone 5C, Altec A7-500 (modified and biamped), Pioneer CS-88
Musical Instruments: Story & Clark console piano
Video Equipment: Sony SL-2700 stereo Hi-Fi video cassette recorder
Rates: 8-track, \$25/hr., 4-track, \$20/hr., 2-track \$20/hr Location recording available upon request

[8] SENSATIONAL SOUNDS
PO Box 2069
Mill Valley, CA 94942
(415) 381-4224
Owner: Michael Angelo
Studio Manager: Michael Angelo

[2] ROBERT SHUMAKER RECORDING SERVICES
also REMOTE RECORDING
2321 Russell St., Ste. 1E
Berkeley, CA 94705
(415) 548-9986
Owner: R S
Studio Manager: R S

[8] SHYNE SOUND
also REMOTE RECORDING
Box 9906
San Rafael, CA 94912
(415) 459-2833
Owner: Leroy Shyne
Studio Manager: Leroy Shyne

[4] GARY R. SMITH PRODUCTIONS
also REMOTE RECORDING
2154 McKinley Ct.
Grand Junction, CO
(303) 243-7551
Owner: Gary R Smith

[4] SNAKE RIVER SOUND
also REMOTE RECORDING
1008 N. 6th St.
Boise, ID 83702
(208) 386-9276
Owner: David Smyth

[4] SNAKE RIVER STUDIOS
also REMOTE RECORDING
Rt. 6, Box 46
Idaho Falls, ID
(208) 529-3786
Owner: Max E. Harrison
Studio Manager: Max E. Harrison

[8] SOUND DESIGN
201 165th Ave. NE
Bellevue, WA 98008
(206) 747-1815
Owner: Ed Masters

Moonvalley Audiophile Quality
Cassette
Manufacturing
cassette

Hi-output/low-noise BASF-LHD
Tape in 5-screw Premium
Cassettes duplicated with
OTARI 16:1 bin loop equipment.

• Audio Cassette Mastering
• Stereo Duplication
• Printing/Package Design

Moonvalley Cassettes 10802 N. 23rd Avenue Phoenix, Arizona 85029
(602) 870-3987
A division of Wintersun, Inc.

Circle #136 on Reader Service Card

Electronic
MUSICIAN

...the first magazine
devoted exclusively to
the new technology
that's revolutionizing
the industry, covering
MIDI, computer music
applications, SMPTE/
synchronization, video,
music sampling/
synthesis, and much
more! See page 146 for
complete information.

A Mix Publication

[8] SOUND INNOVATIONS
(FORMERLY AUDIO PRODUCTION STUDIO/
RAINBOW RECORDING)
5520 Lake Otis Pkwy, Ste. 104
Anchorage, AK 99507
(907) 563-8273
Owner: Creative Productions, Inc.
Studio Manager: Bruce Graham

[8] SOUND PRODUCTIONS
also REMOTE RECORDING
402 NE 72nd
Seattle, WA 98103
(206) 525-9999
Owner: Sound Productions Incorporated
Studio Manager: Brian Bouchard

[8] SOUND SUITE
6400 Hollis
Emeryville, CA 94608
(707) 463-0930
Owner: Tim Tully
Engineers: Tim Tully
Dimensions: Studio 15 x 15.
Mixing Consoles: Hill 32 x 16 x 2.
Audio Recorders: Fostex 8-track, Revox B77 2-track (1/2"), Hitachi DMP-100 2-track A/D PCM
Cassette Recorders/Duplicators: Hitachi 99-DE.
Noise Reduction Equipment: Dolby C.
Synchronization Systems: Master Tracks Pro to 8-track.
Echo, Reverb, & Delay Systems: Yamaha SPX90, Effectron II, NEC 351 5-band reverb, Yamaha REV5.
Other Outboard Equipment: Rane parametric EQ, Dyna-Mite comp/limiter, Symetrix 528, Aphex Type C stereo.
Monitor Speakers: Visonik Davids
Musical Instruments: Korg DSS-1, Casio CZ-101, Prophet 600, Yamaha TX81Z, TR707.
Other MIDI Equipment: Macintosh sequencers, Sound Designer, various librarians, Apple 2E
Rates: Ad Hoc

[4] SOUNDS NATURAL AUDIO SERVICES
also REMOTE RECORDING
214 Keystone Ave.
Santa Cruz, CA 95062
(408) 425-8015
Owner: Bill Burnside, Ken Botelho, Bill Van Bloom
Studio Manager: Bill Burnside

[8] THE SOUNDSMITH
PO Box 1567
Monterey, CA 93942
(408) 394-6940
Owner: David Kempton
Studio Manager: Jeremy Hertzberg

[8] SOUTH CENTRAL SOUND
also REMOTE RECORDING
2019 Sunrise Dr.
Anchorage, AK 99508
(907) 277-0538
Owner: Rick Gay
Studio Manager: Rick Gay

[8] SOW'S EAR SOUND
7057 S. Kline St.
Littleton, CO 80127
(303) 973-2672
Owner: Eddie D. Eads
Studio Manager: Eddie D. Eads

[4] SQUARE ONE
also REMOTE RECORDING
104 Yosemite Ave.
Santa Cruz, CA 95060
(408) 429-6929
Owner: John V. Reynolds
Studio Manager: John V. Reynolds

[4] STAX SOUND ET VISION
also REMOTE RECORDING
Berkeley, CA
(415) 528-1144
Owner: Marshall Stax
Studio Manager: Marshall Stax

[8] STEP ONE STUDIOS
432 Church St.
Garberville, CA 95440
(707) 923-3388
Owner: Jimmy Dangler
Studio Manager: Jimmy Dangler

NORTHWEST 4&8 TRACK STUDIOS

[8] STOTZ'S SOUND
also REMOTE RECORDING
576 Cypress St.
Monterey, CA 93940
(408) 375-9718
Owner: Gary M. Stotz
Studio Manager: Gary M. Stotz

[4] STUDIO IN THE BACK
also REMOTE RECORDING
PO Box 7838
South Lake Tahoe, CA 95731
(916) 542-1121
Owner: Frank Chiaverini
Studio Manager: Frank Chiaverini

[8] STUDIO P
1831 Lake St.
San Francisco, CA 94702
(415) 221-4VOX
Owner: Joe Paulino
Studio Manager: Bob Ducatt

[8] STUDIO SEA
418 Front St., Box 1078
Weatland, CA 95962
(916) 633-4277
Owner: Curt & Lee Burrows
Studio Manager: Skip

[8] STUDIO Z RECORDING, INC.
also REMOTE RECORDING
1030 48th St.
Sacramento, CA 95819
(916) 456-2737
Owner: Zack Boles
Studio Manager: Mary Golden
Engineers: Zack Boles, Jay Lemmons
Dimensions: Room 1: studio 16 x 20, control room 22 x 24.
Room 2: studio 10 x 8, control room 12 x 14.
Mixing Consoles: Sound Workshop Series 30 18 x 8.
Audio Recorders: MCI 110C 8-track, MCI 110C 2-track, (2) Otari 5050 2-track, Ampex 440 2-track
Cassette Recorders/Duplicators: TEAC 122
Noise Reduction Equipment: Dynaflex DFX-2
Synchronization Systems: (2) Adams-Smith Zeta 3.
Echo, Reverb, & Delay Systems: Yamaha REV7, Yamaha SPX-90, Deltalab Super TimeLine, Master-Room B (MICMIX)
Other Outboard Equipment: (4) Valley People Dyna-Mite, (2) Aphex compeller, Aphex Aural Exciter, MXR graphic EQ, Symetrix phone patch, Technics SPL-1200 CD.
Microphones: Neumann U87, AKG 414, RCA 77, RCA 44, Crown PZM, Shure SMSB.
Monitor Amplifiers: Crown D75, Yamaha.
Monitor Speakers: Tannoy Gold, JBL 4311, Yamaha NS-10, Auralone 5C, E-V 100A
Musical Instruments: Yamaha DX7
Video Equipment: Sony XBR-36 monitor, Sony 3/4" U-matic, Sony Beta, Technics VHS
Other: (5) music libraries, (6) sound effects libraries.
Extras & Direction: With totally new facilities, Studio Z Recording is now Sacramento's most elaborate audio post-production studio. We are dedicated to superior commercial production. We have upgraded our equipment to include video synchronization and also offer one of the largest music and sound effects library collections available. We are also available for music demo's and special audio production projects. Studio Z Recording is a winner of numerous Clio's, IBA's Telly's and other national awards. Our work is our best advertising.

[8] SUNSET RECORDING
also REMOTE RECORDING
856 Airport Rd.
Monterey, CA 93940
(408) 375-2861
Owner: Sal Marullo
Studio Manager: Sal Marullo

[8] SYNTONOS RECORDING
also REMOTE RECORDING
1571 San Lorenzo Ave.
Berkeley, CA 94707
(415) 527-5367
Owner: J. Gordon Finder
Engineers: J.G. Finder

Dimensions: Control room 14 x 12.
Mixing Consoles: Dynamix D-3000 24 x 8 x 2.
Audio Recorders: Otari 5050 MKIII 8-track 1/2", Technics SV-100 PCM 2-track, Technics RS10A02 2-track
Cassette Recorders/Duplicators: JVC KDD-99, Aiwa WX220 dub.
Noise Reduction Equipment: GateX noise gate/expander, Orban 424A compressor/de-esser, dtx 161 compressor
Synchronization Systems: SMPL sy:tem w/SMPL lock, SMPTE to MIDI converter
Echo, Reverb, & Delay Systems: Lexicon 224, Lexicon Prime Time DDL, Yamaha SPX90, ART 01A, Orban 111B dual reverb.
Other Outboard Equipment: Eventide H910 Harmonizer, Lang PEQ-2 parametric EQ, (2) Yamaha GQ1031 1/3-octave EQs, (3) MSC-1 semi-parametric EQs, Roland SVC-350 vocoder.
Microphones: Neumann U47, Neumann KM85, AKG 451, (2) AKG C-61, (2) AKG D-24, AKG D-13, AKG D-15, Sennheiser 413, Shure SM76, Shure Unisphere B.
Monitor Amplifiers: McIntosh 2105
Monitor Speakers: (2) JBL 4312, (2) Yamaha NS-10M, (2) Auralone 5C.
Musical Instruments: Yamaha TX81Z, Yamaha TX7, Ensoniq Mirage DSK, Prophet 10 w/MIDI, Pro-1 w/MIDI, E-mu drumulator w/MIDI, Yamaha CX5-F, Roland GR700 guitar synth, (2) Stratocaster guitars, (2) Precision basses (1 fretless), Martin D12-35, Martin 0-18, alto sax, trumpet.
Other MIDI Equipment: IBM XT clone w/MPU 401, sequencer plus MKII, 64-track sequencer w/song pointer, Bacchus voice manager for TX7, Vision sampler editor for Mirage.
Video Equipment: JVC BT-6400U Pro VHS recorder, Panasonic portable VHS, Mitsubishi portable VHS.
Other: JL Cooper 8 x 10 MIDI switchbay, Yamaha YMN-2 MIDI merge, LAB L-5 guitar amp, Fender Pro reverb guitar amp, Gallien-Krueger guitar amp
Rates: \$20/hr.
Extras & Direction: Syntonos specializes in sound design for theater and video. Several projects have won awards, including the 1981 Bay Area Theater Critics' Circle Award for best live theater soundtrack. Our work has appeared in half a dozen Bay Area theaters as well as on cable TV. We welcome sound designers, MIDI composers and independent engineers who need 8-track mix facilities.

[2] SYRINX RECORDINGS
only REMOTE RECORDING
182 Caldecott Ln., #314
Oakland, CA 94618
(415) 548-3996
Owner: Robert L. Miller

[8] TAPESTRY PRODUCTIONS
also REMOTE RECORDING
4077 S. Cowan Way
Salt Lake City, UT 84120
(801) 969-TUNE
Owner: Steve Aubery
Studio Manager: Steve Aubery

[8] TDS PRODUCTIONS
PO Box 31983
Seattle, WA
(206) 284-2399
Owner: Tom Dyer
Studio Manager: Tom Dyer

[8] TEKNIFILM/TEKNIFILM VIDEO
also REMOTE RECORDING
909 NW 19th Ave.
Portland, OR 97209
(503) 224-3835
Owner: Frank Hood, Arian Evensen
Studio Manager: Wayne Woods

[8] THOMAS RECORDINGS
Santa Clara, CA
(408) 985-6967
Owner: L. Thomas
Studio Manager: L. Thomas

[8] TIME CAPSULE RECORDING
1042 Perry St.
Denver, CO 80204
(303) 534-6977
Owner: James Jackson, T.J. Jackson
Studio Manager: J. Jackson

[8] TIMELESS PRODUCTIONS
5050 Traverse Creek Rd.
Garden Valley, CA 95633
(916) 333-1335
Owner: David A. Blonski
Studio Manager: David A. Blonski

[8] TINDERBOX STUDIOS
also REMOTE RECORDING
505 14th Ave. E., Ste. 106
Seattle, WA 98112
(206) 323-5066
(206) 283-3662
Owner: Music Etc., Jamie Jones
Studio Manager: Len Wallick

[8] TOE JAMS RECORDING
895 Vassar
Reno, NV 89502
(702) 323-2471
Owner: Keith Irwin
Studio Manager: Keith Irwin

[8] TRANSIENT SOUNDS RECORDING
only REMOTE RECORDING
PO Box 93
Big Bend, CA 96011
(916) 244-4462
(916) 337-6798
Owner: David B. Green

[8] TRANSMEDIA, INC.
also REMOTE RECORDING
350 Pacific Ave.
San Francisco, CA 94111
(415) 956-3118
Owner: David B. Adams
Studio Manager: Frank C. Canonica

[8] T.S.R. PRODUCTIONS
3387 Marysville Blvd.
Sacramento, CA 95838
(916) 648-9613
Owner: Tarik Roshdy
Studio Manager: Tarik Roshdy

[4] ULTIMA MOBILE RECORDING
only REMOTE RECORDING
PO Box 20604
Sacramento, CA 95820
(916) 395-4733
Owner: Almeritt I. Covington
Studio Manager: Almeritt I. Covington

[8] UNDERGROUND SOUND
also REMOTE RECORDING
4577 E. 129th Ave.
Thornton, CO 80216
(303) 450-0168
Owner: Scott Flores
Studio Manager: Scott Flores

[4] UPHILL PRODUCTIONS
also REMOTE RECORDING
PO Box 1158 (609 Palm)
Modesto, CA
(209) 526-3457
Owner: James M. Lopez
Studio Manager: James M. Lopez

[8] VALENTINE PRODUCTIONS
910 16th St., Ste. 900
Denver, CO 80202
(303) 893-0912
Owner: Laurie Gordon, Sam Bearman
Studio Manager: Jim Passarelli

[8] VALTRON RECORDING
also REMOTE RECORDING
1002 E. Broadway
Helena, MT 59601
(406) 442-0734
Owner: Sandra Liedle
Studio Manager: Mike Liedle

[4] AL VEDRO ASSOCIATES, INC.
also REMOTE RECORDING
725 Second St.
San Francisco, CA 94107
(415) 957-1131
Owner: Al Vedro
Studio Manager: Al Vedro

[8] VINEYARD STUDIOS
PO Box 69522
Seattle, WA 98188
(206) 630-3466

Owner: Roger B. Cox
Studio Manager: Dale Stetson

[4] VINYL TOUCH PRODUCTIONS
also REMOTE RECORDING
Berkeley, CA
(415) 841-0605
Owner: Frank Estrada
Studio Manager: Linda Cowles

[4] VIOLET RACE STUDIO
also REMOTE RECORDING
350 Arballo Dr., #5D
San Francisco, CA 94132
(415) 334-5716
Owner: Sven Jorgensen
Studio Manager: Richard Serna

[8] WAYNE MARK STUDIO
8622 SE 11th Ave.
Portland, OR 97202
Owner: Michiel Harth, Gary Miles
Studio Manager: Gary Miles

[2] JOHN WESLEY PRODUCTION
441 1/2 11th Ave. W.
Kirkland, WA
(206) 827-7299
Owner: John Wesley
Studio Manager: John Wesley

[4] WESTERN CINE FILM AND VIDEO
312 S. Pearl St.
Denver, CO 80209
(303) 744-1017
Owner: John Newell
Studio Manager: Paul Emrlich

[8] WESTERN OREGON SOUND AND RECORDING
also REMOTE RECORDING
3430 48th NE
Salem, OR 97305
(503) 370-7906
Owner: Duane Sheets
Studio Manager: Gary Brown

[8] WILD WEST GRAPHICS & COMMUNICATIONS
also REMOTE RECORDING
PO Box 346, Lake Tahoe
Homewood, CA 95718
(916) 525-5201
Owner: Edward Miller
Studio Manager: Edward Miller

[8] BOB WILSON RECORDING SERVICES
also REMOTE RECORDING
83 Devonshire, #2
Mountain View, CA 94043
(415) 967-4921
Owner: Bob Wilson
Studio Manager: Bob Wilson

[8] XANADU STUDIOS
also REMOTE RECORDING
1163 Lewiston St.
Aurora, CO 80011
(303) 366-6815
Owner: Richard Abitbol
Studio Manager: Richard Abitbol

[8] XANDOR RECORDING STUDIOS
also REMOTE RECORDING
407 Camino Sobrante
Orinda, CA 94563
(415) 254-9077
Owner: Jim Weyeneth
Studio Manager: Jim Weyeneth

[8] ZIONIC SOUNDS
also REMOTE RECORDING
Box 562, 1117 Division St.
Upton, WY 82730
(307) 468-2742
Owner: Randy Crain
Studio Manager: Randy Crain

served Huey Lewis & the News, Van Morrison, Kantner/Balin/Casady Band, Aretha Franklin, and Bruce Hornsby) decided not to buy a PC, but to invest in a dedicated musical computer. They just installed the Yamaha C7E, a 7-foot grand piano with internal computer that stores 164 MIDI-controllable presets and provides four MIDI outs, two processors, and can control 16 keyboards at once. The piano player can pre-program arrangements and change settings while playing, thus controlling a complete orchestration situation while tickling real ivories. A far cry

know how to use the computers, how to use sequencers, how to merge keyboards. People do their pre-production at home with their own computers, then they bring in their setup and we have the ability to handle their setup. That seems to work best for us." ■

Linda Jacobson, Mix assistant editor, does all her writing on an antiquated Eagle PC2—a 5-year-old IBM clone that has never crashed. Nevertheless, she rents a Macintosh to desktop-publish newsletters.

NEXT IN MIX

FEBRUARY

- International Recording
- Directory: Independent Engineers and Producers
- Automation and Control Systems
- European AES Issue

MARCH

- Southeast Studios Directory
- Nashville Recording Supplement
- Studio Monitors

AD CLOSING:

JANUARY 7

MATERIALS DUE:

JANUARY 15

APRIL

- Video Production/NAB Issue
- HyperMedia Supplement
- Directory: Video Production and Post-Production Facilities

AD CLOSING:

FEBRUARY 7

MATERIALS DUE:

FEBRUARY 15

Only Mix has a BPA-audited circulation of over 44,000 copies each month!*

Call (415) 843-7901 for space reservations and complete advertising information.

*Source: Publishers' BPA statement of circulation for six months ending June, 1987 (average of qualified and non-qualified circulation).

JANUARY 1988, MIX 219

especially at today's unfavorable exchange rates. For further information, JPI may be reached at Akasaka Residential Hotel #801, 9-1-7 Akasaka Minato-Ku, Tokyo 107, Japan. ■

Phil De Lancie is one of our resident voices on topics relating to record mastering and manufacturing, tape duplication, CD replication, storage and formats. He's also a mastering engineer at Fantasy Recording Studios in Berkeley, right across the street from the Mix offices.

—FROM PAGE 52, NOTEWORTHY PROGRAMS

board, and perform a wide variety of editing functions, this program also lets you convert your files into music notation for print-out. Each of the 32 tracks is assignable to one of 16 MIDI channels which can be looped, bounced and otherwise edited. A voice librarian for the Yamaha DX/TX series is also included on the disk.

The Copyist

This scoring program from Dr. T's Mu-

software program like Hybrid Arts' ADAP Soundrack, to become a full-fledged 16-bit sampling device.

Mastertracks Pro

The Atari version of Passport's sequencer is basically the same as its Macintosh version. However, as noted above, there is no need to purchase a MIDI interface with this version.

Pro-24 2.1

Steinberg Research offers a sequencer

will read and write files from its companion sequencer program, KCS 1.5.

Others

Dr. T's carries a full complement of quality editor librarians (including a program for the PCM70) for the ST. Hybrid Arts also supports the ST with its ADAP Soundrack (mentioned above), as well as sequencer, notation and patch editing software, including one for the Ensoniq Mirage sampler.

CLASSIFIEDS

Business Opportunities

Owner of established (1978) New York City recording studio looking to expand. Seeks working partner with capital. Industry experience a must. Serious inquiries only. Call Joel: (212) 362-7840.

Employment Offered

Midwest-based National Radio Production facility needs PROD. ENGINEER w/management skills. Must have 5 years experience incl. documentaries and radio commercials. Send tape, resume, salary history and references to Classifieds, PO Box 2526, Berkeley, CA 94702.

PRODUCT ENGINEER MONSTER CABLE

Monster Cable is looking for engineering talent in the areas of prod., product development and mechanical design. Experience in computers and pro-sound equip. pref. Build a future in a young, friendly, high energy, fast-growing co. Send resume to: MONSTER CABLE, 101 Townsend, SF, CA 94107. Attn: Personnel.

Recording studio manager/engineer. Excellent opportunity no security. 16-trk recording studio located 90 miles south of Memphis, Tennessee. Great facilities and equipment. Knowledge in audio maintenance preferred. If you love a challenge send a resume to: Domino Recording Inc., PO Box 816, Grenada, MS 38901.

ADVERTISING ENGINEER

Major NYC studio, catering to ad agency clients, wants to make you and your clients happy. Call Bob or Sandy (212) 840-1350.

A Major Audio Mixing/Post-Production facility in Toronto, Canada has an opening for a skilled Sound Mixer experienced in Television Commercials. The successful applicant will have a good track record, excellent customer relations skills, and be a team player. This is a terrific opportunity for a creative, energetic person. Send a resume and salary expectations to: General Manager, Mastertrack Ltd., 35A Hazelton Avenue, Toronto, Ontario, Canada M5R 2E3.

MANAGEMENT MBA MONSTER CABLE

We are a small fast-growing audio manufacturer who needs a manage-

ment hand with our monstrous growth. If you are an MBA with a successful track record w/growing companies w/knowledge of audio, please call: Personnel, 2-4 p.m. (415) 777-1355, San Francisco, CA.

INSTRUCTOR to teach audio production beginning Fall, 1988. Courses include multi-track recording in our newly remodeled studio and field audio production. Master's degree and experience required. Salary \$20,000-\$22,000. Search closes January 15, 1988. Contact: Mike Mirarchi, School of Telecommunications, OHIO UNIVERSITY, Athens, OH 45701. An affirmative action/equal opportunity employer. Women and minority candidates are encouraged to apply.

FAIRLIGHT SALES OPPORTUNITY

The ideal candidate has team leadership qualities, is self motivated and has experience in audio production as well as sales.

This is an outstanding opportunity with unlimited growth potential selling the world's most respected digital audio workstation.

Send resume to
Frank Daller
Fairlight Instruments, Inc.
110 Greene St.
New York, NY 10012

No Phone Calls Please!

TECHNICIAN WANTED

Fairlight Instruments requires a technician to work on digital audio and digital video workstations. Training on systems given. Must be able to travel. Call West or East Coast offices of Fairlight Instruments. LA: (213) 470-6280, NY: (212) 219-2656.

Employment Wanted

English audio technician, 30s, Swiss resident, seeks professional experience in U.S. (pref. CA) 1-2 yrs. Broad-based background in film and video production/post-production, system engineering, maintenance. Full cv on request. Jim Brogdale, CH-6516, Gerra Piano, Switz.

Equipment For Sale

Reliable Music
Serving the Southeast for 25 years, offering an excellent selection of musical instruments, pro sound and recording equipment in a hands on environment. We have a progressive, experienced sales staff, factory trained technicians and our price are competitive.



704/375-8662

1101 N. ...
C.N.B. ...

NEW, USED, DEMO SALE RECORDERS, CONSOLES, OUTBOARD EQUIPMENT
Otari MTR-90 24-trk, Tascam MS-16, Ramsa T-820 20x16 mixer, Aries 24x8x16 mixer, Scamp Rack, Cypher Shadow Synchronizer w/Remote, Yamaha DMP-7, Yamaha REV5, UREI 813C monitors, Tannoy PBM 6.5 monitors, Yamaha NS-10M, Roland S-550, D-550, MT-32, Southworth Jambox 4+, Performer & Composer software...
E.A.R. PROFESSIONAL AUDIO (602) 267-0600

IF YOU'RE NOT USING IT —SELL IT!
Your national clearinghouse for used audio and video! Call for free copy of our latest listings, or to list your used gear free. The Bertech Organization Call toll free: (800) 992-2272 In Calif. call: (818) 909-0262 **THINK BERTECH FIRST!**

LEASE/BUY/SELL
Great prices and great service on over 200 lines including Otari, Harrison, Soundcraft, Tascam, JBL, Lexicon, AMS, Akai, Trident, KT, dbx and all the rest for the best in new or used. **AVC SYSTEMS (800) 323-0281**, in MN call (612) 729-8305.

USED EQUIPMENT Bought & Sold



Summit Audio Inc.
P.O. Box 1678
Los Galos
CA 95031
408-395-2448

4-trk, 8-trk and MIDI studio gear. Best prices—courteous, knowledgeable staff. Most major lines of pro audio

keyboard and studio equipment. Call our toll free wats line 1-800-354-7252 when you're ready. Mike, Bill, Terry or Marty.

New Used & Demo Soundcraft Neotek, Otari, Akai, Klark-Teknik, dbx, E-V, **LEXICON. USED NEO-TEK CONSOLES**, microphone sale, over 200 mics in stock. E-V, AKG, Beyer, Sennheiser, etc. New E-V N-DYM mics in stock. Call **Pyramid Audio Inc (312) 339-8014. Call Us Last!**

SIDEREALKAP. The SiderealKap was designed from its inception to be the finest sounding capacitor available for audio today. Find out what the music lover's capacitor doesn't sound like. Free literature and price information upon request. Dealer inquiries invited. **SIDEREAL AKUSTIC**, 1969 Outrigger Way, Oceanside, CA 92054, (619) 722-7707.

MCI/SONY PRODUCTS
JH-24 recorder, MXP-3000 mixing console, ARR 5003 center track recorder, Sony PCM-3324 digital. Cash, lease or finance—Quick service call Dick McCalley (612) 929-4000.

Westlake studio monitors, MegaMix console automation, Yamaha NS-10M reference monitors, Yamaha SPX90 effects processor, call Dick McCalley at (612) 929-4000.

STUDIO FINANCING and leasing plans for qualified buyers. Quick service, 36-60 month terms. \$5K to \$200K—for information call Dick McCalley at (612) 929-4000.

DO YOURSELF A FAVOR
If you're ready to buy any type of recording gear or musical instrument, do yourself a favor and call us before you buy. We have most name brands at some of the lowest prices you'll find anywhere. Call us before you buy, you won't regret it. (318) 234-5021.

3M M-79 TAPE HEADS
IN STOCK 16- & 24-TRACK 2" We stock tape heads 1/4" thru 2" & spare parts for most recorders (800) 553-8712 or (800) 325-4243 CA, (818) 994-6602, Telex: 754239, Sprague Magnetics, Van Nuys, CA

D&R MIXING CONSOLE!! SERIES 8000 MOD II, DEMO EX. 8 MONTHS OLD. IN-LINE 32/24 IN OUTPUT CHANNELS, PENNY & GILES FADERS, T&T PATCHBAY, 8 AUX + 32 EFFECT RETURNS. MINT! RETAIL \$57,850 —ONLY \$39,500—(612) 866-2999.

[8] TINDERBOX STUDIOS
also *REMOTE RECORDING*
505 14th Ave. E., Ste. 106
Seattle, WA 98112
(206) 323-5066
(206) 283-3662
Owner: Music Etc., Jamie Jones
Studio Manager: Len Wallick

[8] TOE JAMS RECORDING
895 Vassar
Reno, NV 89502
(702) 323-2471
Owner: Keith Irwin
Studio Manager: Keith Irwin

[8] TRANSIENT SOUNDS RECORDING
only *REMOTE RECORDING*
PO Box 93
Big Bend, CA 96011
(916) 244-4462
(916) 337-6798
Owner: David B. Green

[8] TRANSMEDIA, INC.
also *REMOTE RECORDING*
350 Pacific Ave.
San Francisco, CA 94111
(415) 956-3118
Owner: David B. Adams
Studio Manager: Frank C. Canonica

[8] T.S.R. PRODUCTIONS
3387 Marysville Blvd.
Sacramento, CA 95838
(916) 648-9613
Owner: Tarik Roshdy
Studio Manager: Tarik Roshky

[4] ULTIMA MOBILE RECORDING
only *REMOTE RECORDING*
PO Box 20604
Sacramento, CA 95820
(916) 395-4733
Owner: Almeritt I. Covington
Studio Manager: Almeritt I. Covington

[8] UNDERGROUND SOUND
also *REMOTE RECORDING*
4577 E. 129th Ave.
Thornton, CO 80216
(303) 450-0168
Owner: Scott Flores
Studio Manager: Scott Flores

[4] UPHILL PRODUCTIONS
also *REMOTE RECORDING*
PO Box 1158 (609 Palm)
Modesto, CA
(209) 526-3457
Owner: James M. Lopez
Studio Manager: James M. Lopez

[8] VALENTINE PRODUCTIONS
910 16th St., Ste. 900
Denver, CO 80202
(303) 893-0912
Owner: Laurie Gordon, Sam Beaman
Studio Manager: Jim Passarelli

[8] VALTRON RECORDING
also *REMOTE RECORDING*
1002 E. Broadway
Helena, MT 59601
(406) 442-0734
Owner: Sandra Liedle
Studio Manager: Mike Liedle

[4] AL VEDRO ASSOCIATES, INC.
also *REMOTE RECORDING*
725 Second St.
San Francisco, CA 94107
(415) 957-1131
Owner: Al Vedro
Studio Manager: Al Vedro

[8] VINEYARD STUDIOS
PO Box 69522
Seattle, WA 98188
(206) 630-3466

Owner: Roger B. Cox
Studio Manager: Dale Stetson

[4] VINYL TOUCH PRODUCTIONS
also *REMOTE RECORDING*
Berkeley, CA
(415) 841-0605
Owner: Frank Estrada
Studio Manager: Linda Cowles

[4] VIOLET RACE STUDIO
also *REMOTE RECORDING*
350 Arballo Dr., #5D
San Francisco, CA 94132
(415) 334-5716
Owner: Sven Jorgensen
Studio Manager: Richard Serna

[8] WAYNE MARK STUDIO
8622 SE 11th Ave.
Portland, OR 97202
Owner: Michiel Harth, Gary Miles
Studio Manager: Gary Miles

[2] JOHN WESLEY PRODUCTION
441 1/2 11th Ave. W.
Kirkland, WA
(206) 827-7299
Owner: John Wesley
Studio Manager: John Wesley

[4] WESTERN CINE FILM AND VIDEO
312 S. Pearl St.
Denver, CO 80209
(303) 744-1017
Owner: John Newell
Studio Manager: Paul Emrnch

[8] WESTERN OREGON SOUND AND RECORDING
also *REMOTE RECORDING*
3430 48th NE
Salem, OR 97305
(503) 370-7906
Owner: Duane Sheets
Studio Manager: Gary Brown

[8] WILD WEST GRAPHICS & COMMUNICATIONS
also *REMOTE RECORDING*
PO Box 346, Lake Tahoe
Homewood, CA 95718
(916) 525-5201
Owner: Edward Miller
Studio Manager: Edward Miller

[8] BOB WILSON RECORDING SERVICES
also *REMOTE RECORDING*
83 Devonshire, #2
Mountain View, CA 94043
(415) 967-4921
Owner: Bob Wilson
Studio Manager: Bob Wilson

[8] XANADU STUDIOS
also *REMOTE RECORDING*
1163 Lewiston St.
Aurora, CO 80011
(303) 366-6815
Owner: Richard Abitbol
Studio Manager: Richard Abitbol

[8] XANDOR RECORDING STUDIOS
also *REMOTE RECORDING*
407 Camino Sobrante
Orinda, CA 94563
(415) 254-9077
Owner: Jim Weyeneth
Studio Manager: Jim Weyeneth

[8] ZIONIC SOUNDS
also *REMOTE RECORDING*
Box 562, 1117 Division St.
Upton, WY 82730
(307) 468-2742
Owner: Randy Crain
Studio Manager: Randy Crain

NEXT IN MIX

FEBRUARY

- International Recording
- Directory: Independent Engineers and Producers
- Automation and Control Systems
- European AES Issue

MARCH

- Southeast Studios Directory
- Nashville Recording Supplement
- Studio Monitors

AD CLOSING:
JANUARY 7
MATERIALS DUE:
JANUARY 15

APRIL

- Video Production/NAB Issue
- HyperMedia Supplement
- Directory: Video Production and Post-Production Facilities

AD CLOSING:
FEBRUARY 7
MATERIALS DUE:
FEBRUARY 15

Only *Mix* has a BPA-audited circulation of over 44,000 copies each month!*
Call (415) 843-7901 for space reservations and complete advertising information.

*Source: Publishers' BPA statement of circulation for six months ending June, 1987 (average of qualified and non-qualified circulation).

—FROM PAGE 52, NOTEWORTHY PROGRAMS

board, and perform a wide variety of editing functions, this program also lets you convert your files into music notation for print-out. Each of the 32 tracks is assignable to one of 16 MIDI channels which can be looped, bounced and otherwise edited. A voice librarian for the Yamaha DX/TX series is also included on the disk.

The Copyist

This scoring program from Dr. T's Music Software contains the full selection of music symbols necessary for professional use. Notes are entered directly from the PC keyboard, and can be edited singly or in groups. Copyist supports most of the standard printers, including Laserjet for publishing-quality output.

Others

Bacchus Software, Dr. T's Music Software, and Passport Designs all carry a wide range of editor/librarians for Yamaha, Roland, Casio and other synth manufacturers. In addition, Turtle Beach Software sells a wave editor for both the Mirage and Akai S900 samplers.

ATARI ST

For those interested in starting from scratch, the Atari 520ST and 1040ST computers offer an attractive alternative to a Macintosh-based system. This is an inexpensive but powerful computer which seems to have been made with the musician in mind. It provides direct MIDI access and it has the ability, when used in connection with a

software program like Hybrid Arts' ADAP Soundtrack, to become a full-fledged 16-bit sampling device.

Mastertracks Pro

The Atari version of Passport's sequencer is basically the same as its Macintosh version. However, as noted above, there is no need to purchase a MIDI interface with this version.

Pro-24 2.1

Steinberg Research offers a sequencer program that can handle as many as 5,000 patterns and 200,000 MIDI events with edit features as powerful as any available for the ST. In addition, the screen is set up to resemble a multi-track tape recorder with "buttons" for record, play, rewind, etc. This updated version of Pro-24 requires at least 1 Meg of RAM, and includes new features such as "logical edit," "score edit," loop recording, and aural feedback of event edits.

Master Piece 1.64A

This two-disk sequencer package from Sonus Corporation features real-time and step-time input, search and delete, and filter editing. A separate program, called Microevent Editor, is included on the disk, and is used to edit single events in a file created by Master Piece. Files can be exported to Sonus' Super-score for printing.

The Copyist 1.4

Dr. T's Music Software has developed the Atari version of its music scoring program with fundamentally the same features as The Copyist for the PC. It

will read and write files from its companion sequencer program, KCS 1.5.

Others

Dr. T's carries a full complement of quality editor librarians (including a program for the PCM70) for the ST. Hybrid Arts also supports the ST with its ADAP Soundtrack (mentioned above), as well as sequencer, notation and patch editing software, including one for the Ensoniq Mirage sampler.

This survey only scratches the surface of what's currently available in music software. If you're thinking about jumping in the pool, you would be well advised to do some comparison shopping. Each program has its strong and weak points, and the best way to know what you like is by playing with the ones you think are right for your needs. In general, the companies listed here have been in existence for a while (by software company standards) and their products are reliable. You will want to buy from a company that is willing to provide you with technical support and software update information six months from now. In fact, six months from now you'll probably be looking at a whole new world of software choices. ■

Paul Potyén is associate editor of Mix, and co-leads the progressive Latin band, Canoneo, which is currently working on their third album. He also composes, arranges and produces music for commercial and industrial applications in his spare time, if any. He is not related to Paul Shaffer.

MUSIC · NOTES

—FROM PAGE 139, DUANE EDDY

treux, Switzerland, when I was working with The Art Of Noise. At that time, Jeff seemed to think I was going to get a deal from some record company on the strength of that 'Peter Gunn' thing, so he said, 'Well, when you get your deal, let me know and I'll be glad to help in any way I can—write, produce, play, anything you want.'

"So when the Capitol deal came down, I called Jeff. He was very busy at the time working on George Harrison's new album, but he called back a day later and said, 'I spoke to George about it and he wants to put his album on hold for a couple of weeks while we

get yours done.' He knew I was on a deadline with this project. It's like, wait 20 years for a deal and then you get one and they tell you, 'We want it yesterday.'

"So I flew to London, hooked up with Jeff and we did three songs there—"The Trembler" and "Theme For Something Really Important," both of which George plays slide guitar on, and 'Rockabilly Holiday,' which Jeff plays bass, drums, rhythm guitar and synths on. We did those three tracks at George's Friar Park Studio, which is his fabulous home facility. I had a fantastic time with those guys.

"And while I was there in London I thought, 'The way things are going, why not give Paul McCartney a call and

ask if he'd produce a piece for me?' I had his 'Rockestra Theme' in mind, which was a tune he had written several years ago [for the *Back To The Egg* album] and I had always liked that melody. So I got in touch with Paul's office, set up a meeting with him and he was all for it. And he not only ended up producing the track but he played bass on it as well. We did that session at his studio, The Mill.

"Then I came back to California to do the last few sides myself. I wanted to get together with some of my old friends—guys I used to work with back in the old days with The Rebels, like Larry Knechtel and Jim Horn. And I wanted to hook up with James Burton, who's another old friend. So we began

cutting at the Lighthouse, and John Fogerty came by. Then Stever Cropper showed up and we put him to work too. And it turned out to be a great, fun jam—guitar players' heaven, for me. I mean, Burton, Fogerty and Cropper on the same cut ['Kickin' Asphalt']!

"And then the second day we did 'Last Look Back,' which sort of summed

make it perfect, so they can get it where you don't lose the feeling. I think digital works great for new age music, classical music, jazz, things like that. But for rock and roll and country, it's still missing a little feeling. Digital cleans it up a little too much. You need a little grit in there when you're doing rock and roll or country.

"I think people are hungry for this kind of basic, gritty rock and roll now. It seems there's a natural swing back to live musicians and the original rock and roll feel."

up how I felt about the whole project. I knew it was going to be the last song of the project and I got kind of emotional about that. It was just so great to be working with those guys again; back in the studio with some of the original Rebels. And we had a great time, just playing live in the studio. John Guess, the engineer, said that was the first live session he had done in over a year and a half.

"We did everything in analog. I happen to like that because I think they need to do one more thing to digital to

"A lot of my support comes from England," he says, "but it's also sweeping here. I think people are hungry for this kind of basic, gritty rock and roll now. I like all the new MIDI stuff but I think, like everything, you tend to overdo it. Some people have gone to extremes with all that technology, but it'll settle back down. It seems that now there's a natural swing back to live musicians and the original rock and roll feel. After all those synths and MIDI and stuff, my simple, twangy guitar is starting to sound fresh again." ■

—FROM PAGE 181, *PCS IN THE STUDIO*

Have Computer, Will Travel

Yes, many facilities incorporate personal computers, but throughout the Northwest, many prefer their functions to be B.Y.O.P.C.—clients bring their own system of choice. For instance, the aforementioned Studio D (a relatively new tracking facility which has served Huey Lewis & the News, Van Morrison, Kantner/Balin/Casady Band, Aretha Franklin, and Bruce Hornsby) decided not to buy a PC, but to invest in a dedicated musical computer. They just installed the Yamaha C7E, a 7-foot grand piano with internal computer that stores 164 MIDI-controllable presets and provides four MIDI outs, two processors, and can control 16 keyboards at once. The piano player can pre-program arrangements and change settings while playing, thus controlling a complete orchestration situation while tickling real ivories. A far cry

from a plastic QWERTY keyboard, and miles from a mouse.

Studio D's Joel Jaffe says they haven't installed a PC in the studio "because much of the time, computers are used in pre-production. People don't come into the studio for that; it just isn't economically sane. Both Richie [Moore, Studio D's technical director in addition to his Gate Five gig] and I know how to use the computers, how to use sequencers, how to merge keyboards. People do their pre-production at home with their own computers, then they bring in their setup and we have the ability to handle their setup. That seems to work best for us." ■

Linda Jacobson, Mix assistant editor, does all her writing on an antiquated Eagle PC2—a 5-year-old IBM clone that has never crashed. Nevertheless, she rents a Macintosh to desktop-publish newsletters.

—FROM PAGE 148

For those who can afford to duplicate at a more leisurely pace, Sony also has the "Real Time DAT Software Production System." As with high-speed duping, the production chain begins with a 1630 format master played through the 1630 and DAQ-1000 PQ generator into an AS1-100 signal converter. The output of the AS1-100 is fed to one or more DRD-100 real-time duplicators, used in the "master recorder" mode. Once master recording is complete, a DRD-100 may be switched to "master reproducer" function, with its digital output fed to a daisy chain of up to 50 additional DRD-100s in "slave recorder" mode for duplication. The multi-function capability of the DRD-100 allows flexible allocation of machines depending on the requirements of the job or jobs at hand.

Naturally, there may be many who are reluctant to rush right out and buy DAT duplication gear until some kind of reasonable market develops for the format. These folks might be pleased to know that DAT duplication is already available to them should the need arise during the early stages of DAT's introduction here. Japan Program International (JPI) is offering its services to the U.S. market, billing itself as "the only company in the world providing mass duplication of DAT today." Prices for their product are denominated in yen and vary depending on the program length and the type of master provided by the client. Unless the master tape is already DAT, a master is made from CD "because of the subcode requirement." If no CDs of the program are available, JPI will make some from the client's master. As one might imagine, this process starts to get a little pricey, especially at today's unfavorable exchange rates. For further information, JPI may be reached at Akasaka Residential Hotel #801, 9-1-7 Akasaka Minato-Ku, Tokyo 107, Japan. ■

Phil De Lancie is one of our resident voices on topics relating to record mastering and manufacturing, tape duplication, CD replication, storage and formats. He's also a mastering engineer at Fantasy Recording Studios in Berkeley, right across the street from the Mix offices.

CLASSIFIEDS

Business Opportunities

Owner of established (1978) New York City recording studio looking to expand. Seeks working partner with capital. Industry experience a must. Serious inquiries only. Call Joel: (212) 362-7840.

Employment Offered

Midwest-based National Radio Production facility needs PROD. ENGINEER w/management skills. Must have 5 years experience incl. documentaries and radio commercials. Send tape, resume, salary history and references to Classifieds, PO Box 2526, Berkeley, CA 94702.

PRODUCT ENGINEER MONSTER CABLE

Monster Cable is looking for engineering talent in the areas of prod., product development and mechanical design. Experience in computers and pro-sound equip. pref. Build a future in a young, friendly, high energy, fast-growing co. Send resume to: MONSTER CABLE, 101 Townsend, SF, CA 94107. Attn: Personnel.

Recording studio manager/engineer. Excellent opportunity no security. 16-trk recording studio located 90 miles south of Memphis, Tennessee. Great facilities and equipment. Knowledge in audio maintenance preferred. If you love a challenge send a resume to: Domino Recording Inc., PO Box 816, Grenada, MS 38901.

ADVERTISING ENGINEER

Major NYC studio, catering to ad agency clients, wants to make you and your clients happy. Call Bob or Sandy (212) 840-1350.

A Major Audio Mixing/Post-Production facility in Toronto, Canada has an opening for a skilled Sound Mixer experienced in Television Commercials. The successful applicant will have a good track record, excellent customer relations skills, and be a team player. This is a terrific opportunity for a creative, energetic person. Send a resume and salary expectations to: General Manager, Mastertrack Ltd., 35A Hazelton Avenue, Toronto, Ontario, Canada M5R 2E3.

MANAGEMENT MBA MONSTER CABLE

We are a small fast-growing audio manufacturer who needs a manage-

ment hand with our monstrous growth. If you are an MBA with a successful track record w/growing companies w/knowledge of audio, please call: Personnel, 2-4 p.m. (415) 777-1355, San Francisco, CA.

INSTRUCTOR to teach audio production beginning Fall, 1988. Courses include multi-track recording in our newly remodeled studio and field audio production. Master's degree and experience required. Salary \$20,000-\$22,000. Search closes January 15, 1988. Contact: Mike Mirarchi, School of Telecommunications, OHIO UNIVERSITY, Athens, OH 45701. An affirmative action/equal opportunity employer. Women and minority candidates are encouraged to apply.

FAIRLIGHT SALES OPPORTUNITY

The ideal candidate has team leadership qualities, is self motivated and has experience in audio production as well as sales.

This is an outstanding opportunity with unlimited growth potential selling the world's most respected digital audio workstation.

Send resume to
Frank Daller
Fairlight Instruments, Inc.
110 Greene St.
New York, NY 10012

No Phone Calls Please!

TECHNICIAN WANTED

Fairlight Instruments requires a technician to work on digital audio and digital video workstations. Training on systems given. Must be able to travel. Call West or East Coast offices of Fairlight Instruments. LA: (213) 470-6280, NY: (212) 219-2656.

Employment Wanted

English audio technician, 30s, Swiss resident, seeks professional experience in U.S. (pref. CA) 1-2 yrs. Broad-based background in film and video production/post-production, system engineering, maintenance. Full cv on request. Jim Brogdale, CH-6516, Gerra Piano, Switz.

Equipment For Sale

Reliable Music

Serving the Southeast for 25 years, offering an excellent selection of musical instruments, pro sound and recording equipment in a hands on environment. We have a progressive, experienced sales staff, factory trained technicians and our prices are competitive.



704/375-8662

1605 W. Main St. • 160 • 3rd Fl. •
650 E. Stanwell Street • Charlotte, NC 28202

**NEW, USED, DEMO SALE
RECORDERS, CONSOLES,
OUTBOARD EQUIPMENT**
Otari MTR-90 24-trk, Tascam MS-16, Ramsa T-820 20x16 mixer, Aries 24x8x16 mixer, Scamp Rack, Cypher Shadow Synchronizer w/Remote, Yamaha DMP-7, Yamaha REV5, UREI 813C monitors, Tannoy PBM 6.5 monitors, Yamaha NS-10M, Roland S-550, D-550, MT-32, Southworth Jambox 4+, Performer & Composer software...
**E.A.R. PROFESSIONAL AUDIO
(602) 267-0600**

IF YOU'RE NOT USING IT —SELL IT!

Your national clearinghouse for used audio and video! Call for free copy of our latest listings, or to list your used gear free. The Bertech Organization Call toll free: (800) 992-2272 In Calif. call: (818) 909-0262 **THINK BERTECH FIRST!**

LEASE/BUY/SELL

Great prices and great service on over 200 lines including Otari, Harrison, Soundcraft, Tascam, JBL, Lexicon, AMS, Akai, Trident, KT, dbx and all the rest for the best in new or used. **AVC SYSTEMS (800) 323-0281**, in MN call (612) 729-8305.

USED EQUIPMENT Bought & Sold



Summit
Audio
Inc.
P.O. Box 1678
Los Gatos
CA 95031
408-395-2448

4-trk, 8-trk and MIDI studio gear. Best prices—courteous, knowledgeable staff. Most major lines of pro audio

keyboard and studio equipment. Call our toll free watts line 1-800-354-7252 when you're ready. Mike, Bill, Terry or Marty.

New Used & Demo Soundcraft
Neotek, Otari, Akai, Klark-Teknik, dbx, E-V, LEXICON. **USED NEO-TEK CONSOLES**, microphone sale, over 200 mics in stock. E-V, AKG, Beyer, Sennheiser, etc. New E-V N-DYM mics in stock. Call **Pyramid Audio Inc (312) 339-8014.**

Call Us Last!

SIDEREAL KAP. The SiderealKap was designed from its inception to be the finest sounding capacitor available for audio today. Find out what the music lover's capacitor doesn't sound like. Free literature and price information upon request. Dealer inquiries invited. **SIDEREAL AKUSTIC**, 1969 Outrigger Way, Oceanside, CA 92054, (619) 722-7707.

MCI/SONY PRODUCTS

JH-24 recorder, MXP-3000 mixing console, ARR 5003 center track recorder, Sony PCM-3324 digital. Cash, lease or finance—Quick service call Dick McCalley (612) 929-4000.

Westlake studio monitors, MegaMix console automation, Yamaha NS-10M reference monitors, Yamaha SPX90 effects processor, call Dick McCalley at (612) 929-4000.

STUDIO FINANCING and leasing plans for qualified buyers. Quick service, 36-60 month terms. \$5K to \$200K—for information call Dick McCalley at (612) 929-4000.

DO YOURSELF A FAVOR

If you're ready to buy any type of recording gear or musical instrument, do yourself a favor and call us before you buy. We have most name brands at some of the lowest prices you'll find anywhere. Call us before you buy, you won't regret it. (318) 234-5021.

3M M-79 TAPE HEADS

IN STOCK 16- & 24-TRACK 2" We stock tape heads 1/4" thru 2" & spare parts for most recorders (800) 553-8712 or (800) 325-4243 CA, (818) 994-6602, Telex: 754239, Sprague Magnetics, Van Nuys, CA

D&R MIXING CONSOLE!! SERIES 8000 MOD II, DEMO EX. 8 MONTHS OLD. IN-LINE 32/24 IN OUTPUT CHANNELS, PENNY & GILES FADERS, T&T PATCHBAY, 8 AUX + 32 EFFECT RETURNS. MINT! RETAIL \$57,850 —ONLY \$39,500—(612) 866-2999.

LEASING

Specialists in
Audio Equipment

Rent or
Lease All
Brands

WE TAKE
TRADE-INS!

PMI, Inc.
567 N. Market St.
Wooster, OH 44691
(216) 262-1518

TRIDENT TSM

40x32 mainframe console in exc. condition. (612) 872-0646—Steve (612) 824-8921.

Southeast's largest broker has available quality, used recording equip. for sale—MCI & Harrison consoles, MCI & STUDER machines, QUANTEC QRS—steal at \$7K; LEXICON 224's—mics—all types of outboard equip. Lots & lots of MCI parts avail. Call for new list. Special: Dolby M-24H—\$8,000; EMT 251 w/250 prog.—Inquire. Randy, Bobby or Tim (615) 361-8429 or 361-6768. We are always looking for good used audio & video equip.

MCI JH-416 console 24x24. Now in use at a home studio. Well-maintained, spare parts. Will accept ANY reasonable offer. Call Joe (301) 761-6159.

3M-79 24-TRK RECORDER W/SELECTAKE; AUDITRONICS 501 CONSOLE 18x16; (2) UREI 529 1/3 OCTAVE EQ-CUT ONLY. CALL LEE (415) 359-153C.

Ampex MM1200 24-trk tape recorder with remote and 20 point memory \$25,000 Canadian. Ampex ATR-102 tape recorder with autolocator \$5,500 Canadian. Ampex VS-10 vari-speed \$500 Canadian. For more information call George (416) 622-4568.

DAT

We have Digital Audio Tape decks and tape ready for delivery!!

PCM

We buy and sell all Sony PCM products. Call for info!!

Micro Seiki Turntables
SAEC Toucarms—Cartridges
LC-OFC wire—the best!!
Portable DATs available.

Audio Gallery (213) 829-3429
2718 Wilshire Bl., Santa Monica, CA 90403

VINTAGE TUBE MIKES

Call Bill Bradley
(312) 751-1216

(3) Studer A800 MKIII 24-trk. 1 year old machines w/autoloc stand. \$50,000. Call Bobby (212) 921-1711.

OTARI MX-80 24-TRK. 3 MO. OLD \$23,950; NEUMANN "TUBE" U67 \$1,200; NEUMANN NEW KM-84 \$359 EA; RAMSA WRS-820 20 X 8/METER BRIDGE \$4,800; FOSTEX E-16 NEW \$5,400; OTARI MTR-12 6 MO. OLD \$6,950; TASCAM MS-16 W/LOCATOR, STAND, BRIDGE \$7,500; NEUMANN TLM 170 "NEW" \$1,250. CALL OPUS FOR ALL YOUR EQUIP. QUOTES 312/336-OPUS (6787).

BUILDING AN AUDIO SUITE? NEED PA EQUIP?

DON'T BUY A THING... UNTIL YOU'VE HEARD MY PRICES on the brand you're looking for! Call David Wynn—American Audio Systems (612) 929-4000. Prices too low to afford an 800 number. Financing and/or leasing avail.

Used Trident 80B 30/24/24—\$30,000 w/MasterMix automation add \$11,000. Used Soundcraft 2400 Series 28/24/24 console, home studio use only—\$24,950; (813) 960-5100.

Trident Series 75 console 28x24, 8 sends, 4-band EQ, EQ on monitors, 1½-yrs-old, exc. cond. \$17,500. Call (201) 653-6389 or 653-6729.

AMPEX MM1200 16-trk exc. condition, priced for quick sale—\$8,000 firm. PROPHET 2000—\$975, AKG C12A—\$695, SONY C37FET—\$150, (2) SPECTRASONICS 610 limiters—\$100 each. (805) 466-1833.

"AMAZING"

LOW, LOW PRICES
INVENTORY REDUCTION SALE

- ✓ Quality Recording & Midi Gear
- ✓ Digital Reverb & PCM Processors
- ✓ P.A. Systems & Power Amplifiers
- ✓ Multitrack Recorders & Consoles
- ✓ All Equipment New & Warranted
- ✓ Major East Coast Audio Supplier
- ✓ Great Buys on Rare Equipment



TekCom
CORPORATION

Mastercard & Visa are Welcome

CALL 215-426-6700

MIDAS CONSOLES

(1) Custom 38x8x4 Pro 5 House; (1) LS4 32x8x2 Pro 5 House; (1) Custom 16x8x4 Pro 5 Studio; (1) 30x10 6 blank Pro 4 monitor; EXCELLENT CONDITION. (705) 674-1450.

CONSOLE FOR SALE

TASCAM—Model M-16 24x8, 4-band semi-parametric EQ. 16-trk mixdown, patch for 24. NEW CONDITION, w/power supply \$7,500 OBO. CALL —ANDREW (916) 877-4703.

MCI 24-TRK—2-TRK HEADS IN STOCK

We stock tape heads ¼" thru 2" & spare parts for most recorders (800) 553-8712 or (800) 325-4243 CA, (818) 994-6602, Telex: 754239, Sprague Magnetics, Van Nuys, CA.

24 channel Dolby rack fitted with 361 cards. Excellent condition—\$10,000. E-mu Emulator II w/3.0 software—\$4,500. Call E.A.R.S. (201) 673-5680.

—Emulator II+— Large library and flight case. \$4,200 or b/o.

—Soundtracs MR24 Console— Like new—\$7,500. Call Eric Jensen (415) 469-0192

FOR SALE BY AUCTION. RARE ROCK 'N ROLL COLLECTORS ITEMS. Two Tannoy Red Speakers in Lockwood Cabs. One Rickenbacker 4001 Bass. Blue. Speakers used by Pete Townshend to record "My Generation" and "Pinball Wizard." These items have been donated by Pete Townshend to the Merseyside Unemployed Resource Centre in Liverpool, England to help raise funds for their Recording Studio. The studio is used for recording demos and records by unemployed bands in Liverpool, and as an Educational Facility. The Centre is an important facility helping to stimulate the creative use of leisure time amongst kids in an area where unemployment, crime and misuse of drugs are endemic. The sale of these items could help find the new Beatles?? Reply to: Mix Classifieds, PO Box 2526, #1, Berkeley, CA 94702.

db ENGINEERING

(formerly NE Equip. Exchange)
The only Broker w/OTARI & TASCAM service. Used Otari MX5050B—\$1,200, EVRE20—\$275, Orban de-esser—\$350, Sony VP-5000 U-matic—\$1K, Lexicon PCM60—\$650, Roland 16-ch. Compu-Editor, SMPTE auto.—\$2K, Ramsa T820, 20x8 mixer mint w/mtr bridge—\$3,500, Neumann U47 tube—\$1,500, MCI JH-428—\$9,000, JH-24—\$13,500, Neve 8048 3-band—\$60K, Soundcraft 800, 18x8x16 w/300 bay—\$8K. List with us for FREE! Specials on new gear. AKG 414-UJS—\$650, Beyer M69—\$150. Call for prices on Aphex, Klark-Teknik, Orban, Gauss, Aries & Trident. We design & build studios, custom PB & more. (617) 262-0311.

AKAI MG1214 12 TRK REC., 7 MO. OLD, MINT COND., \$5,800 OR B/O. (312) 677-3550.

AUDIOCRAFT 32x16 recording console \$7,500, TEAC 90-16 track recorder w/dbx \$7,500, (212) 581-2305, FILMUS Recording, Ben or Peter.

NEOTEK Series III 28x24 Recording Console, Logic control, Full patch-bay w/cables, producers desk, rosewood cabinetry, 4-band EQ. Exc. condition, 20K, (312) 429-2760.

AVR GROUP

The widest selection of used gear. Otari MX5050B—\$1,200; Neumann U87 \$850; Otari Mark III-8—\$3,300; Neve 36x24 \$55K; Wheatstone 24x8—\$6K, Pultec MEQ—\$650; Tascam 48—\$3,000. All used equip. warranted and calibrated to factory specs or your \$ back. (617) 332-1441. Call for prices on new equip.

NOW—A solid oak, 16-space rack with ½" steel rails, sturdy metal casters for portability and a fully adjustable tilt for easy access. Also avail. 8-space desk top & 20-space floor racks. For more info. contact STUDIO WOODS INC., 20437 W. Outerdrive, Dearborn, MI 48124, (313) 563-8588.

Highest Performance Audio Transformers!

- Wide bandwidth • Low hysteresis distortion
 - Flat group delay • No overshoot or ringing
- Call for free applications assistance
(Mon-Thurs. 9am-5pm Pacific time)

jensen transformers INCORPORATED

10735 Burbank Blvd. • North Hollywood, CA 91601
FAX (818) 763-4574 Phone (213) 876-0059
TELEX 6502919207 MCI UW

STUDIOMIXER II REC. CONSOLE 24x8x2 3-band EQ & 6 sends, never used \$3,900. Scully 284-8 1" 8-trk, late model w/silent punch in & motion sensing. Used only in home studio. Will include 4 spare record/repro modules. Exc. condition—\$2,000. (914) 356-6553.

SUNSET SOUND CUSTOM CONSOLE

Star-studded studio 2 console, selectively seeks new home. Available early 1988. Serious inquiries only. (213) 469-1186.

Equipment Rental

Design Tr Audio

DIGITAL AUDIO RENTALS

Specializing in digital tape machines, reverbs and effects processors. Technical consultation included.

(213) 838-6555
Outside CA (800) 441-4415
P.O. Box 491087
Los Angeles, CA 90049

MIX
CLASSIFIEDS
WORK!

On-Call

24 Hours



1619 Broadway, N.Y., N.Y. 10019
(212) 582-7360

The Best That Money Can Rent

- Digital Multitrack
- Outboard Equip
- Time Code Equip
- Mixing Consoles
- PA Equip
- Walkie Talkies
- Wireless Mikes
- Video Playback

DIGITAL DOMAIN

Sony 3324—\$750 per day, Focusrite EQ (6)—\$200 per day, Sony 3202—\$225 per day, Free cartage within 25 mi. of NYC (914) 639-1091.

AUDIO AFFECTS

STUDIO EQUIP. FOR HIRE
Technician on staff 7am-1am
Open 7 days a week
Digital Tape Machines,
Synclavier Systems,
Effects Processors, Reverbs

(213) 871-1104 (818) 980-4006

Equipment Wanted

PULTECS, FAIRCHILDS, API 560s,
TUBE MICS, ANYTHING NEVE,
ANYTHING EXOTIC!
(213) 45-SOUND

Instruction

INSTITUTE OF COMMUNICATION ARTS. Commercial Music Performance, Audio Engineering/Prod., Video Prod./Sound Reinforcement, Music & Entertainment Bus., Communications, Electronic Music, Music Theory & Arrang. 2 Yr. Prog./P.T. Studies. 12-12840 Bathgate Way, Richmond, B.C. Canada (604) 278-0232.

14511 Oelano
Los Angeles, CA 91411



818 994-9976

Recording INSTITUTE

EDUCATIONAL VIDEOS

2/6/12 hour sound mixing/recording courses: \$39, \$119, \$239; 2 hour MIDI course \$39; Add \$5 shipping/handling for each course. Visa/MC/check. For brochure: RECORDING ASSOCIATION, 5821 SE POWELL, PORTLAND, OR 97206, (503) 777-4621.

The new fall 1987 *Mix* Bookshelf Catalog is now available! Write or call now for your free copy of the most comprehensive selection of books, tape courses, music software, SFX libraries, databases and more.

MIX BOOKSHELF

2608 Ninth Street
Berkeley, CA 94710

CALL TOLL FREE: (800) 233-9604
In California: (800) 641-3349

Maintenance Services & Repair

TLM ELECTRONICS INC

343 MANVILLE RD
PLEASANTVILLE, NY 10570

Pro Audio Service

- Consoles • Multi-Trax
- Amplifiers • FX equip

- Repairs
 - Modifications
 - Performance Testing
- (914) 769-6423

RCA MICROPHONES — Repair service on all models. Complete sound and cosmetic restoration. 35 yrs. experience with company. ENAK Microphone Repair, 420 Carew Avenue, Pitman, NJ 08071. (609) 589-6186.

NY TECHNICAL SUPPORT, LTD.

Factory Trained & Equipped
Ampex/API/MCI/Neve/Otari
Scully/SSL/Studer/3M/Trident
CALL GREG HANKS
Service/Design/Consults/Installs
35 Hardscrabble Hill
Chappaqua, NY 10514
(914) 238-4171

Music Products/Software

DISKS?
Exclusive library of over
400 disks: Emulator II, EMax,
Oberhelm DPX-1, Mirage, S-50

\$20⁰⁰ per disk
Call or write for Specials:
Northstar Productions
13718 S.E. Bancroft, Portland, OR 97236
(503) 760-7777

Recording Services

EVEN IF YOU DIDN'T RECORD AT REFLECTION, ALL IS NOT LOST—YOU CAN STILL MIX AT REFLECTION. We handle remix work from studios all over the country (and a few in Europe). You have heard our work on REM, Don Dixon, Marti Jones, Marshall Crenshaw, Let's Active,

Tammy Faye Baker, and many others. 24-, 16- or 8-trk mix through Hard Disc Automated Sony 3000 board going to PCM-3202 Digital or APR-5000 1/2" Analog. IT'S NOT TOO LATE! Call us for rates and scheduling, (704) 377-4596 (Charlotte, NC).

CD MASTERING & DIGITAL TRANSFERS

DIGITAL SERVICES

P.O. BOX 694
LYNBROOK, N.Y.
11563
(516) 872-2325

Records, Tapes & CD Services and Supplies

Disc Mastering and Record Production LPs, EPs, 45s—Plating, Labels, Pressing, Jackets.

DIGITAL NOW AVAILABLE! THE CUTTING EDGE

Box 217M
Ferndale, NY 12734
(914) 292-5965

REAL TIME

Best Quality Cassettes using Nakamichi decks only. Custom loaded Agfa or BASF Chrome. Label and insert printing, shrinkwrap, blank tapes.

SUPERB QUALITY AT LOW PRICES

Uni-Sette, Inc. 1854 Fulton Ave., Sacramento, CA 95825. (916) 485-9534.

FACTORY DIRECT PRICES ON 3M TAPE & AMPEX TAPE

Discounts available.

We can & have saved you money! Call us—you'll like us. We're in the business, just like you. **STUDIOWORKS** is also a supplier of pro recording equipment. (800) 438-5921 & (704) 375-1053.

Super Low Prices on Agfa, BASF, Ampex and Mag Media, Bulk Cassettes and Accessories. Real-time and High Speed Duplication. Call or write for prices and brochure. **TRAXX RECORDING PRODUCTS**, 24 Crest Way KC, New Fairfield, CT 06812, (203) 746-3561.

ULTIMATE FIDELITY

The World's largest Nakamichi real time cassette duplication system. Full service packaging. 50 to 50,000 qty. Call toll free—in NO. CAL., (800) 327-AAPX outside CAL., (800) 323-AAPX or (707) 585-1132 —Call AAPEX today!

CRYSTAL INC.
DUPLICATED CASSETTES
AS LOW AS 43¢ PLUS SET UP

FULL COLOR CASSETTE INSERTS
AS LOW AS \$53.00 PER 1000
ORDER OF TEN

FULL COLOR GLOSSY PRINTS
Suitable For Framing 23¢ EACH
LOTS OF 1000

HIGH ENERGY CASSETTES
AS LOW AS
C-62: 28¢ and C-92: 34¢

FULL COLOR POSTERS OR BROCHURES
AS LOW AS \$195.00 PER 1000

FULL COLOR ALBUMS
58¢ EACH PLUS SET UP
PER QUANTITY

PHONE TOLL FREE:
1-800-826-6540
TN: 615-843-0717
8002 Middle Valley Road, Hixson, TN 37343

PROFESSIONAL RECORDING SUPPLIES

We are a major wholesale Distributor of Ampex, Agfa & 3M reel to reel mastering tape (1/4" to 2"). We also stock broadcast video tape, assorted reels and boxes, splicing/leader tape, and pre-packaged cassettes. We load bulk cassettes in custom lengths using a variety of tape brands. Please call or write for our FREE catalog.

Advance Recording Products

7190 Clairemont Mesa Blvd.,
San Diego, CA 92111
(619) 277-2540
Inside CA: (800) 858-1061
Outside CA: (800) 854-1061
Visa/MC Accepted

ESP EASTERN STANDARD PRODUCTIONS

26 BAXTER ST., BUFFALO, N.Y. 14207

- AUDIO CASSETTE DUPLICATION
High Quality Real Time
- VIDEO CASSETTE DUPLICATION
All Formats
- CUSTOM PRINTING & PACKAGING
Labels - Inserts - Shrink Wrap

CALL COLLECT
For Free Brochure
(716) 876-1454

Best AGFA Prices!

2" Reel = \$105.
1/4" Bulk = \$9.50
WORLD CLASS TAPES
(313) 662-0669

Diskmakers

RECORD PRESSING CASSETTE DUPLICATION
SEND FOR OUR PRICE LIST
CALL TOLL FREE
1-800-468-9353
925 N. 3rd St., Phila., PA 19123

Neumann to Eventide, AKG to dbx. All in stock, ready to ship. UAR Pro Systems. 8535 Fairhaven, San Antonio, TX 78229. (512) 690-8888.

3M SCOTCH AUDIO TAPES
 Prompt Service—Low Prices
 1/4" pancakes, 1/4"-2" reels, accessories, Scotchcarts & cassettes.
 Call or Write for Price List
R & M PRO AUDIO
 1080 Pacheco, S.F., CA 94116
 (415) 665-8480

DISTRIBUTORS WANTED

Major manufacturer of bulk-loaded cassette blanks looking for distributors outside California. Standard and custom lengths. Send for confidential price list and samples on your letterhead. Phylco Audio, 4697 Brooks St., Montclair, CA 91763.

Technetronics Technetronics Technetronics
Technetronics COMPACT DISC Technetronics
Technetronics MANUFACTURING Technetronics
Technetronics FULL SERVICE Technetronics
Technetronics FASTEST TURNAROUND Technetronics
Technetronics ANY SIZE ORDER Technetronics
Technetronics Technetronics Technetronics
Technetronics AUDIO CD/CDV/CD-ROM Technetronics
Technetronics Technetronics Technetronics
 CALL FOR RATES AND INFORMATION:
 215 430-6800
 PO BOX 496, 201 CARTER DRIVE
 WEST CHESTER, PA 19381

OUR 10TH ANNIVERSARY



IF YOU ARE LOOKING FOR A RELIABLE ENDLESS CASSETTE. YOU'VE FOUND IT YOUR ENDLESS SEARCH IS OVER

UP TO 120,000 • PASSES. HEAVY DUTY SELF CLEANING TAPE SOUNDS BETTER LONGER

PLAYS VERTICALLY OR HORIZONTALLY IDEAL FOR ON HOLD TELEPHONE MUSIC TALKING HOUSE RADIO TRANSMITTERS, POINT OF PURCHASE DISPLAYS, ETC

ALSO SPECIAL ENDLESS TAPE PLAYER AVAILABLE CALL OR WRITE FOR PRICING INFORMATION

MANN ENDLESS CASSETTE INDUSTRIES
 P.O. Box 1347 San Francisco, CA 94101
 (415) 221-2000 EXT 9

Studios For Sale

24-TRK STUDIO EQUIPMENT
 Complete Package Includes: Harrison Console, Studer 24-trk, AMS, Eventide, Lexicon, UREI. Call Jim at (513) 681-8715.

48 TRK WORLD CLASS STUDIO
 EXCEPTIONALLY BEAUTIFUL LOADED LARGE AND PRIVATE, W/house in residential, exclusive Alpine, NJ, nine minutes from NYC. \$1,950,000. BROKERS or AGENTS WELCOME. LANDCASTLE. (201) 767-8453.

FANTASTIC RECORDING STUDIO
 MCI 16/24 trk, 8 trk. Additional equip. incl. Located in Midwest area. Studio designed and equip. 1st class. Realty and as package. Lease to own. (812) 446-0003. Write—1 1/2 W. National Ave, Brazil, IN 47834. Attn: Warren Grey.

PUT THE MUSIC INDUSTRY AT YOUR FINGERTIPS!

- THE 1987/88 CALIFORNIA MUSIC DIRECTORY—\$33.45.
- THE 1987/88 MUSIC BUSINESS DIRECTORY—\$33.45.
- THE 1987/88 MUSIC RADIO DIRECTORY—\$33.45.

32 trks made to order. Custom PB. & panels. Will install as desired & quality control guaranteed. (805) 251-6547. Call for estimates. Dolby racks, outboard racks, PC board work, all done to your specs.

Miscellaneous

TRACK SHEETS BOX & REEL LABELS

- Cassette Labels & Inserts
- Drum Machine Sheets
- Alignment Plaques
- Plus many other items

PRINTED WITH Your Studio Name Address & Phone

FREE CATALOG of specialized forms for the recording & music industries

STUDIOFORMS Co

186 Glen Cove Avenue, Suite 201/M-28
 Glen Cove, NY 11542-3505
 (516) 671-1047

Special discount—All 3 for \$80. Checks/M.O./VISA/MC to:
MUSIC INDUSTRY RESOURCES
 Box 190, Dept. MIX
 San Anselmo, CA 94960
 (415) 457-0215—ORDER TODAY

SYNCLAVIER COPYIST Synclavier Music Engraving

Lead sheets to complete orchestra scores. Full editing including corrections and transpositions. Write: Studio C, 2220 Broadridge Way, Stockton, CA 95209 (209) 477-5130.

STAR'S CUSTOM CABLES

Audio & Video snakes, 16, 24 and

—SOUND EFFECTS—
180 SOUNDS YOU REALLY NEED
 5 STEREO LPs GROUPED BY CATEGORY: \$89.95. POSTPAID.
 EFX 2325 GIRARD S.
 MINNEAPOLIS, MN 55405

Rare & Hard-to-Find
 Professional video supplies & accessories for recording, production & broadcasting at the best prices in America — the industry's most unique catalog!
 Call or write now for your free copy:
Marker™
 Technologies of America
 145 Ulster Ave - Saugerties, NY (USA) 12477
 800-522-2025 · in NY 914-246-3036

How to Place a Mix Classified

Please print or type in CAPITAL LETTERS and lower case. There are 8 lines to the inch and approximately 24 CAPITAL letters per line or 32 lower case letters. \$80 per inch — 1" minimum. Additional lines \$10 per line. BOLD TYPE or Black Border \$10 per line. Gray screen \$15 extra. Logos or display advertising up to 4" will be charged at \$100/inch. Frequency discount rates available. Call for information. Payment by check, money order or charge must accompany ad. DEADLINE is the 15th of the month, 6 weeks prior to publication.

Categories Available (Check one.)

- | | | |
|---|--|--|
| <input type="checkbox"/> Acoustic Consulting | <input type="checkbox"/> Equipment Rentals | <input type="checkbox"/> Records, Tapes & CD |
| <input type="checkbox"/> Business Opportunities | <input type="checkbox"/> Equipment Wanted | Services and Supplies |
| <input type="checkbox"/> Employment Offered | <input type="checkbox"/> Instruction | <input type="checkbox"/> Recording Services |
| <input type="checkbox"/> Employment Wanted | <input type="checkbox"/> Maintenance Services | <input type="checkbox"/> Studios for Sale |
| <input type="checkbox"/> Equipment for Sale | <input type="checkbox"/> Music Products/Software | <input type="checkbox"/> Miscellaneous |

Name _____

Address _____

Phone _____

I am paying by (Check one.): VISA MASTERCARD AMERICAN EXPRESS

Card #: _____ Expiration Date _____

Signature: _____

Check or Money Order #: _____ Amount Enclosed: \$ _____

Mail to:
 Mix Classified, 2608 Ninth Street, Berkeley, CA 94710
 (415) 843-7901

Ad Copy: _____

Please attach your classified ad copy on a separate sheet, typed double-spaced or printed out clearly.

ADVERTISERS INDEX

PAGE	ADVERTISER	PAGE	ADVERTISER	PAGE	ADVERTISER
118, 201	A & R Record & Tape Manufacturing	116	Electro-Voice, Inc.	118	Opus Recording and Equipment
161	Aapex	20	Fairlight Instruments	172	Orban Associates, Inc.
84	Adams-Smith	18	FM Tubecraft	7, 208	Otari Corporation
113, 177	Akai/IMC	131	Fostex Corporation	49	Peavey Electronics Corporation
89	AKG Acoustics	210	Four Designs Company	108	Penn Fabrication
227	Allen & Heath Brenell	85	Full Compass Systems	32, 174	Penny & Giles
37	Alpha Audio	159	Fullersound	147	Phi Tech
11	Ampex Corporation	207	Furman Sound	138	Power Stroke Productions
103	API Audio Products, Inc.	159	Future Disc Systems	90	Power Studio Supply
36	Applied Research and Technology (ART)	53	GoldLine/Loft	137	Professional Audio Services & Supply
47	APRS	120	Alan Gordon Enterprises, Inc.	134	Prosonus
161	Sam Ash Music	176	Grafton Sound	175	QCA Record Pressing
182	Audio Engineering Associates (AEA)	171	Granny's House	25	QSC Audio Products, Inc.
35	Audio Logic	91	Hardy Company	55	Rane Corporation
59	Audio-Technica	46	Institute of Audio Research	147	RCA Test Tapes
151	Barcus Berry Electronics (BBE)	68	JBL Professional	154	The Recording Workshop
121	Berklee College of Music	40	Russ Jones Marketing Group	154	Rhythm City Music
99	Beyer Dynamic	150	JRF Magnetic Sciences	93	Rocktron Corporation
79	BGW Systems, Inc.	189	KABA Research and Development	106, 107 & 129	RolandCorp US
71	Bruel & Kjaer	181	Keystone Printed Specialties Co., Inc.	175	Russian Hill Recording
31	Bryston	82	Kurzweil Music Systems	122-123	The Sandbox/Spectral Music
37	Burlington Audio/Video Tapes, Inc.	203	LD Systems, Inc.	92	Simon Systems
102	C-T Audio Marketing, Inc.	56	Leonardo Software	42-43	Solid State Logic (SSL)
209	CAE/Littlite	13	Lexicon, Inc.	61-65	Sony Professional Audio
195	Caig Laboratories	179	Lightning Music and Sound	135	Sound Genesis Corporation
169	Carvin Corporation	29	Live Oak Studios	124	Sound Ideas
197	Cassette Works	150	Manny's Music	127	Sound Image
41	Cipher Digital, Inc.	23	Martin Music Technologies	228	Soundcraft
211	J.L. Cooper Electronics	38	McGill Master Sample	199	Stoughton Printing Co.
94-95	Crown International, Inc.	98	McCauley Sound, Inc.	2	Studer Revox
111	CSE Audio	28	Meyer Sound	30	Studio Consultants, Inc.
119	D & R USA	191	Microsystems, Inc.	178	Studiomaster
67	dbx, Inc.	14-15	Mitsubishi Pro Audio Group	148	Sun Valley Audio
50	DDA, Inc.	164-165	1988 Mix Annual Directory	57	Symetrix
126	Design Direct Sound (DDS)/Walker	153	Mix Bookshelf	157	Tannoy Professional Products
167	Devonshire Audio/Video	217	Moonvalley Cassettes	33	TASCAM
39	Digidesign	44	Moseley	105	Telex
81	DOD Electronics	179	Music Annex Duplication	102	Thoroughbred Music
139	EAR Professional Audio-Video	145	National Academy of Recording Arts and Sciences	115	Valley International, Inc.
101	Eastern Acoustic Works, Inc. (EAW)	9	NEOTEK Corporation	197	Vertigo Recording Services
138	Eastern Standard Productions, Inc. (ESP)	3	Rupert Neve, Inc.	143	Video Expo
		17	New England Digital (NED)	19	Westlake Audio
		26-27	Nimbus Records	120	World Records
		155	Northeastern Digital Recording, Inc.	73-76	Yamaha Music Corporation, Professional Audio Division

FLEXIBILITY

Designed for the Working Professional!
The Sigma Series offers you the Maximum Flexibility, in layout and design features that reflect the evolution of Sigma Engineering.

Built to the Highest Standards, to which AHB has established its reputation on... for over 14 years.

Performance

Sigma will satisfy your Current and Future needs in 16, 24 and 32 track recording as well as MIDI First Generation Recording and Sound Reinforcement Applications.

For more detailed information on the New AHB Sigma Console, Contact your Authorized AHB Dealer Today.

ALLEN & HEATH BRENNELL

U.S.A.

Allen & Heath Brenell (USA) Ltd.

Five Connair Road

Orange, CT 06477 / (203) 795-3594

U.K.

Allen & Heath Brenell Ltd.

69 Ship St. Brighton, BN1 1AE England

Tel. (0273) 24928 / Telex 878235

CANADA:

GerrAudio/Toronto

(416) 361-1667



AHB SIGMA SERIES

This is the mixing console that will cause a revolution in 24 track studios.

The world's first Dual Mode mixing console.

With the advanced features and performance of a desk you'd expect to cost a great deal more than it actually does, it's a remarkable achievement. Take Dual Mode.

When you record with the TS12, its in-line monitoring means you create a control room mix on the main faders.

In mixdown this becomes the basis for your master mix. Saving time and helping you keep a train of thought as to how the final mix will sound.

Unlike other in-line desks, though, the TS12 also allows true stereo subgrouping on long-throw group faders.

In this mode the routing matrix offers either six stereo groups or four extra auxiliary sends – totalling ten sends – plus four stereo groups.

No other console in the world provides such versatility.

The TS12 is an open-ended investment, with optional disc-based SMPTE automation for faders, mutes, EQ in/out and auxiliary on/off. Again, at the price it's unique.

And fittingly, audio performance is superb.

Recent Soundcraft advances in summing amp technology, and in grounding and decoupling systems, make the TS12 one of the cleanest and quietest consoles ever.

The mic amplifiers, a critical factor in console quality, create less than 0.01% distortion at 10kHz at 70dB of gain. (Easily exceeding 16-bit digital specifications.)

Standard features are impressive, to say the least. Six auxilliary sends, seven stereo line inputs or effects returns, a 'musician friendly' headphone mix, an extensive 19" metal frame patchbay – and the option to create a massive total of 102 inputs.

Quite a line-up.

Attention to detail is equally stringent with modular PCBs, no dual concentrics and a clear, logical layout that belies the sophistication inside.

But the most remarkable feature of the new TS12 is without doubt the price.

We suggest you call us today to find out just how remarkable.

ALL THE FEATURES YOU'D EXPECT
IN A \$50,000 CONSOLE, EXCEPT ONE.
THE PRICE.

