

Radio o™

THE RADIO TECHNOLOGY LEADER

NAB Radio preview What to see as radio returns to the East Coast

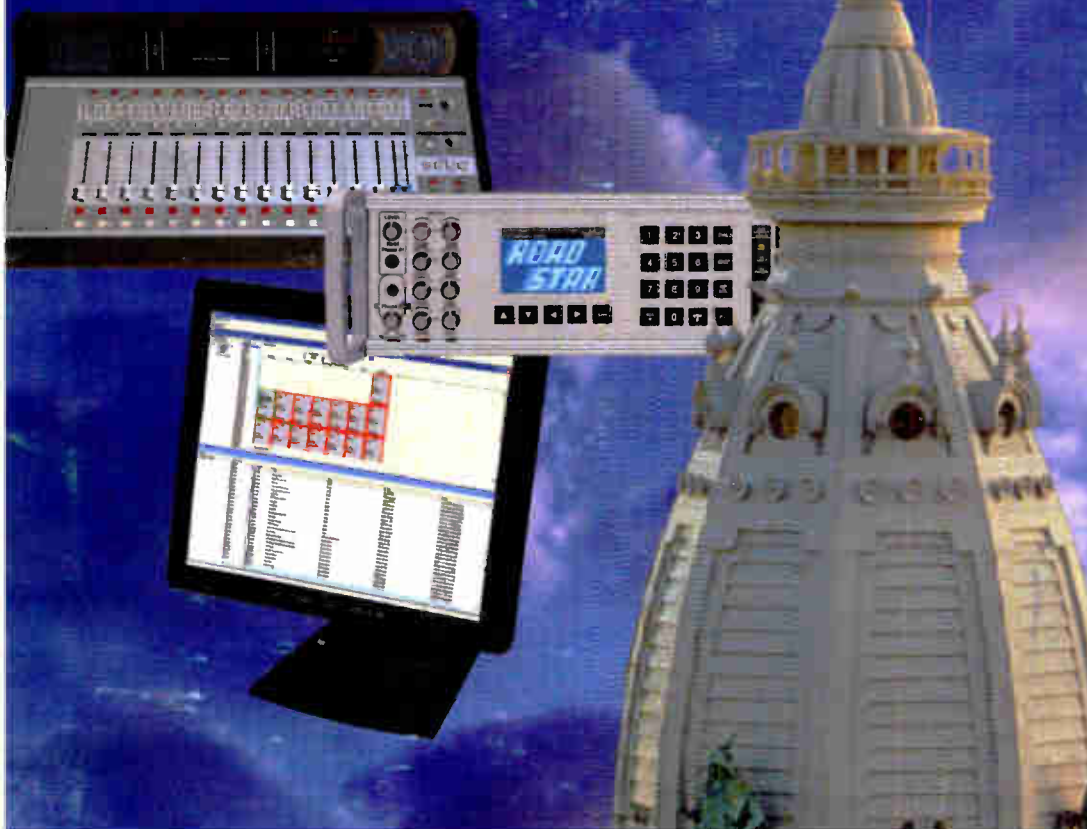

The Philadelphia Story



Radio has a strong history in the city of brotherly love
page 60

Trends in Technology

The ins and outs of automation
page 70

A Famous Sound



Inside the facilities of Bill Young Productions
page 76

New Products



Plus a peek at what to see at AES
page 86

RF Engineering

Staying neutral is good
page 10

FCC Update

Defining a market
page 14

Field Report

Sounding good at WGUC
page 84

extreme digital...
from HARRIS

Unleash The Power Of Extreme Digital Excitement.

Take your station to the digital edge of excitement with the full spectrum of Harris DAB solutions. Just contact us at www.broadcast.harris.com to learn how Harris can go to extremes for your business.

www.broadcast.harris.com • 1.800.622.0012



A PRIMEDIA Publication



GENERATION 9 DIGITAL CONTROL SURFACE

Designed to integrate flawlessly with the Wheatstone BRIDGE digital audio network router, the Generation 9 control surface allows you to easily create large or small platform-based systems that are exceptionally user-friendly and flexible. Wheatstone BRIDGE network cages house all I/O ports and engine cards, and may be wired in tandems within a single equipment room or interconnected to separate remote locations by means of fiberoptic or CAT-5 cables to provide single wire studio integration schemes.

Once configured, the system operates entirely independently of external computers. Configuration itself is intuitive and carried out onsite by means of user-friendly graphic interfaces provided by Wheatstone desktop software. We have gone to great lengths to make these setups easy for your field engineers, allowing expansions and changes to be achieved painlessly. Naturally, the Generation 9 system also takes full advantage of Wheatstone's exclusive VDIP® configuration

software as well, so that studio functions (like mutes, fader and timer starts, tallies, etc.) are easily accomplished right at your desktop. Once set-up is completed the desktop is disconnected; all settings are retained in nonvolatile storage and the entire system runs standalone. Ethernet protocol is built in, providing interface with automation, scheduling, and hardware controllers as you require.

Whether you're planning a small, centrally located studio network or a large, multiple format build-out, the Generation 9 Digital Control Surface can form the basis for a fully integrated, reliable and user-friendly broadcast system that will handle your most demanding requirements *and* be able to change with your varying needs as they arise.

At Wheatstone we have more combined digital design expertise than anyone. **Benefit from our hard work!** Choose **WHEATSTONE—the Digital Audio Leader.**

 *Wheatstone Corporation*

600 Industrial Drive, New Bern, North Carolina, USA 28562
www.wheatstone.com / sales@wheatstone.com

copyright © 2003 by Wheatstone Corporation
tel 252-638-7000 / fax 252-635-4857

Networked Audio from Harris? You Betcha!



Want to maximize your facility and studio capacity? Leverage your existing equipment to do more for your talent, station — and bottom line? You can with the power of VistaMax™ from Harris.

VistaMax is a digital audio management system that lets you network your audio studios together. With universal access to all of your resources simultaneously you increase productivity and quality while decreasing maintenance. You can smoothly migrate from a dedicated analog studio to a digital networked infrastructure with this distributed approach — on your timeframe. Benefits include:

- Autonomous console operation, when needed
- Easily share resources to gain economies of scale
- Quickly reconfigure your facility when program or format changes occur
- Reduce installation time and cost for any reconfiguration

As a natural extension of our BMXdigital™ expertise, VistaMax is built on field-proven technologies such as familiar user interfaces without the complexity of a PC.

Empower your audio management with VistaMax.

Contact Harris today.



Features

16 NAB Radio Preview

by Chriss Scherer

Find out what's going on in Philadelphia

60 Philadelphia Radio Roots

by Chriss Scherer

Strong ties between radio and Philly

68 Passing Time in Philadelphia

by Kari Taylor

What to do after the convention

70 Trends in Technology: Automation

by Chriss Scherer

More than just storage and playback

76 Facility Showcase: Bill Young Productions

by Gary Eskow

Tour this prolific production facility



Departments

Online 06

at www.beradio.com

Field Report: Behringer Ultramatch SRC 2000 82

by John Landry

Field Report: Audio Technica 3060 84

by Don Danko

AES & New Products 86

by Kari Taylor

Classifieds 102

Contributor Pro-File 103

Meet John Landry

Sign Off 104

by Heidi Hueseman

Nights when the lights went out

Columns

Viewpoint 08

by Chriss Scherer

A man of action

RF Engineering 10

by John Battison

Staying neutral

FCC Update 14

by Harry C. Martin

Learn about the new duopoly rules

10 Years of Radio 79

A review of 1998 and 1999

ON THE COVER:

The historic city of Philadelphia hosts this year's NAB Radio Show. Grab a cheesesteak, view some public art and take in the sights at the convention. Philadelphia City Hall photo by Comcast-Spectacor; copyright Philadelphia Convention and Visitors Bureau
Cover design by Michael J. Krust.

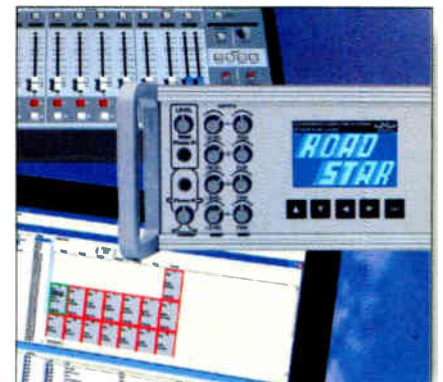



LIVE FROM LONDON

IMAGES FROM ISLAMABAD

REPORT FROM RUSSIA

CORRESPOND FROM CAMBODIA

TRACKING DOWN THE STORY MIGHT BE HARD. SENDING IT WON'T.

Unfortunately, the places in the world that make news don't always build the best local communications networks. Which can be a bit of a problem for reporters and broadcasters, especially when live transmissions or urgent news updates are demanded. But, fortunately, Inmarsat has the answer. Or rather, a range of them. Our unique network covers almost the entire globe, with an unrivalled record for reliability. And offers a full suite of Inmarsat Global Area Network solutions, including high-speed voice, data and video transmission; web access; e-mail and fax. To find out how we can help make sure your stories get across, just visit our website at www.inmarsat.com/media

an inmarsat ventures company

©2003 Inmarsat Ltd. All rights reserved.

inmarsat
Total Communications Network™

Wherever. Whenever.

Monitoring World Radio History Tracking

+

Voice

+

Data

Portable Mast Serves Multiple Vehicles!

Complete line
of mast and
pan-and-tilts,
all applications



Allen Osborne Assoc., Inc. Rapid Deployment Unit

- Extends up to 40 feet
- Easily clamps to the vehicle's gutter or to a vehicle roof rack.
- Vehicle weight holds the foot of the mast in place.

Enjoy the benefits of a telescoping pneumatic mast without making it a permanent feature. Carry the mast on the roof. Quickly erect upon reaching desired location.

Contact Jim Osborne for competitive pricing.
email: j_osborne@aoa-gps.com

ALLEN OSBORNE ASSOC., INC.

Tel: (805) 495-8420
www.aoa-gps.com/hilomast.htm



www.beradio.com

Contents Online

www.beradio.com

Currents Online

Highlights of news items from the past month

Ibiquity Adopts new Audio Coder for IBOC

The new codec, called HDC, was developed jointly with strategic partner Coding Technologies.

FCC Announces Settlement Period Pending LPFM Apps

The FCC's Media Bureau has announced a settlement period for the mutually exclusive Low Power FM (LPFM) new station applicants named in a six-page list.

Patent Awarded for Internet Radio Ad Insertion

David Minter and Albert Baldocchi have been awarded US patent 6,577,716 covering insertion of advertising and other content into radio broadcasts streamed over the Internet.

FCC to Study Effect of Towers to Migratory Bird Paths

This Notice of Inquiry is part of the Commission's environmental and historic preservation action plan announced by Chairman Powell in May 2003.

Powell Announces Plans to Enhance Localism

A Localism Task Force will gather information on broadcast localism and advise the Commission on concrete steps that can be taken to promote localism.

FCC Filing Freeze Ends, New Forms Made Available

The FCC has revised and approved forms 301, 314 and 315.

Site Features

10 Years of Radio Cover Gallery

Take a look back at the past covers of *Radio* magazine.

Applications and Solutions

The *Radio* magazine website includes links to articles on related topics, such as automation systems and processing.



Tieline is the "Clear" choice for POTS, ISDN and Wireless Codecs



**Clark Dixon, Chief Engineer
Clear Channel Tulsa.**

"We do numerous remotes and have had great success using Tieline codecs. Tielines codecs give us a lot of control we previously didn't have. They are versatile and they perform very well".

The Essential Codec Checklist

- ☑ Compatible with other 15kHz POTS codecs
- ☑ Unrivalled link stability over POTS (Used for STL's)
- ☑ Connects to other ISDN codecs via G.722 (ISDN option)
- ☑ 15kHz audio bi-directional over POTS
- ☑ 15kHz audio bi-directional over ISDN (optional)
- ☑ GSM Wireless Connectivity for mobile phones
- ☑ Automatic Intelligent Gain Control
- ☑ Low 100ms POTS latency
- ☑ Music/Voice + up to 9600bps data simultaneously
- ☑ Remote relay, RS232 control and remote audio level control
- ☑ Auto Reconnection on power or line loss
- ☑ Upgrade over the Internet
- ☑ Rugged Metal Construction

A small selection of network users

- | | | |
|------------------------------|--------------------------------|---|
| ■ Clear Channel | ■ Jefferson-Pilot Broadcasting | ■ University of N. Alabama Sports Network |
| ■ Entercom | ■ Tribune Broadcasting | ■ Tennessee Titans Radio Network |
| ■ Talk America Radio Network | ■ Simmons Media | |
| ■ Sandusky | | |



**Sold and serviced locally
2 year warranty**

**Ask your favorite dealer
for a FREE demo today!**

Tieline 
TECHNOLOGY

www.tieline.com

Tieline Technology - 7202 East 87th Street, Suite 116, Indianapolis, IN 46256. Toll Free (888) 211-6989
email: sales@tieline.com

A busy month

Every month when I sit down to write this column, I review the events of the past few weeks to decide on a topic. This month brought a new challenge, in that there are so many things happening it was hard to decide which one warranted the most attention.

Coding for IBOC

The pursuit of a terrestrial digital transmission system is rolling forward with renewed vigor. After stalling mid-flight with a substandard encoding scheme, Ibiqity has partnered with Coding Technologies to introduce HDC, a new perceptual audio encoder designed for the low bit-rates of IBOC.

After the NRSC nixed the PAC algorithm from its consideration, Ibiqity had to move fast to before all momentum was lost. While Ibiqity is fairly mum about the inner workings of the new encoder, the use of Spectral Band Replication, Coding Technologies' secret weapon to enhancing perceptual audio encoders, has already shown promise when it was applied to MP3pro and AACplus.

Meanwhile at Ibiqity, some heavy staff cuts have also been made. The company maintains that the "staff departures" were not made for budgetary reasons and says little more, but it makes one wonder if the encoder change and the staff cuts are related.

Ownership blues

While much of the heavy debate has ebbed on the new ownership rules, they are far from final. For radio, the market definition issue is causing problems. While the final outcome is still uncertain, I must praise FCC Chairman Powell for standing up to Congress. When the legislators said the new rules are no good and must be changed, Powell said fine—tell me how you want them to read. I guess there were some lessons learned while trying to write the

equal employment rules.

Powell's new pet project is an increase in localism. Unfortunately, this appears to be a way to push LPFM and not reduce ownership limits.

Meanwhile, the FCC has also taken on a new project to study the effects of communication towers on migratory birds. Here we go again. I've heard the stories of entire flocks colliding to their deaths with tall towers, but I have never seen a flock of birds fly single file.

Don't get me wrong, I'm all for protecting other species. With our ability to change the environment comes the responsibility of watching out for the animals we affect. I expect that the results of the study will show that just as many birds have trouble navigating natural barriers—such as trees—as they do tall towers.

Net disconnect

At the end of August came a persistent worm that sent unwanted e-mail messages everywhere. A writer in the *San Francisco Chronicle* summarized the best defense to virus/worm infection: Just disconnect everything from the Internet. She went on to write that the excitement of the Internet peaked in 1995; eight years later we are left with a form of communications that is so overloaded with spam messages and odd returned messages that we never sent.

Besides, one of the natural functions of the Internet—file sharing—has become a criminal act thanks to the free music downloaders.

Maybe the RIAA can insist that all music file sharing must use the PAC algorithm. Then the quality will be so bad that no one will want to listen anyway.



Chris Scherer, editor
cscherer@primediabusiness.com

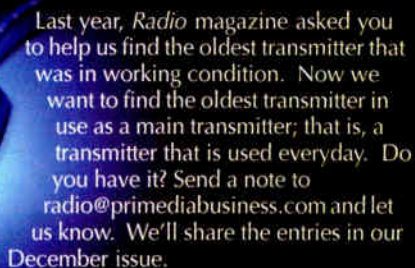

Last year, *Radio* magazine asked you to help us find the oldest transmitter that was in working condition. Now we want to find the oldest transmitter in use as a main transmitter; that is, a transmitter that is used everyday. Do you have it? Send a note to radio@primediabusiness.com and let us know. We'll share the entries in our December issue.

Send comments to: E-mail: beradio@primediabusiness.com
Fax: 913-967-1905

The Best Just Got Better!

With new rock solid, fully digital modem technology, the Matrix is the most reliable, best sounding codec available. And now the Matrix offers another tool for your remote kit:

The GSM Wireless Module.

- New** Built-in GSM Phone.
- New** Aggressive Algorithm delivers 7 kHz on GSM.
- New** Error Handling Technique.
- New** External Antenna.
- New** Increased Power for More Reliable Connections.
- New** Remarkably Stable Modem Technology.

All this adds up to better stability, improved audio, and greater flexibility. Already own a Matrix? **Call us and we'll upgrade you to the newest modem technology for FREE!** Plus we'll be happy to set up a demo of the new GSM module.



Here is what some of our numerous Beta Testers had to say:

Clear Channel Director of Engineering for St. Louis Daryl McQuinn said: **"Sounds much better than a bad [RPU], almost as good as a good [RPU], and way better than you should ever expect from a cell phone remote!"** but all KLOU's Program Director Al Brock could say was, **"Wow!"**

Shaun Kassity from Salem Communications' 104.7 The Fish in Atlanta: **"Thanks to Matrix GSM we had the best sounding remotes ever on our station!"**

Steve Kirsch of Silver Lake Audio: **"The feed was rock solid. I'm very impressed—it sounds much better than I thought it would."**

Collin Mutambo, Radio Simba, Kampala, Uganda: **"We are indeed quite impressed."**

But our personal favorite, from Jerry Dowd of Jefferson Pilot's WBT in Charlotte, NC: **"We hope to keep the betas until you get nasty with threatening letters."** Thanks Jerry. We'll take that as a compliment!

Testing has been successful in 25 US states and on 6 continents with more results coming in every day. The Matrix with the optional GSM Module delivers 7 kHz on GSM wireless. Now accepting orders.

Call us today at 800-237-1776 to learn more about the Matrix!

COMREX

19 Pine Road, Devens, MA 01432 USA

Tel: 978-784-1776 • Fax: 978-784-1717 • Email: info@comrex.com • www.comrex.com

World Radio History



Staying neutral

By John Battison, P.E., technical editor, RF

At the heart of radio transmission is the oscillator. Without an oscillator to generate a basic RF signal, which can be multiplied as many times as required to reach the desired operating frequency, transmitters would make good boat anchors. The use of controlled oscillation in an electrical environment makes the system function. Unfortunately, because the average tube or transistor stage has so many random potential inductive (L) and capacitive (C) circuits associated with it, it is often easy for undesired and usually unwanted oscillations to be generated in an amplifier stage.

Sometimes these random LC circuits will resonate and develop unwanted RF voltages. Depending on the physical char-

acteristics of the tube, RF can be developed between various tube elements, often depending on the relative voltages on these elements. An often unanticipated problem can be caused by coupling between the plate and grid elements.

acteristics of the tube, RF can be developed between various tube elements, often depending on the relative voltages on these elements. An often unanticipated problem can be caused by coupling between the plate and grid elements.

In the early days of radio when triode tubes were the mainstay of radio receivers, the simplest and most popular type of receiver was the regenerative. It used

an early version of feedback that controlled external coupling between the plate and grid circuits. By adjusting the amount of feedback—positive in this case—the sensitivity and gain of the stage could be controlled. It was controlled until the positive feedback became so high that the stage broke into oscillation. Many years ago, it was common to hear whistles and squeals on a station because another ham-fisted listener turned his regeneration controls up too far and into oscillation. In the 1920s, receiver feedback control was usually accomplished by varying the coupling by means of a knob that physically changed the spacing between the grid and plate coils.

Although it seems reasonable to assume that all tubes of a given type will have the same internal inter-electrode capacities, this is not necessarily so. New models and different manufacturers usually show some differences. Many chief engineers have simply pulled out the bad tube and popped in a new one without checking that the stage is still properly neutralized. I have seen transmitters in which tube types have been changed (with similar base connections) without checking neutralization. Then they wonder why the signal doesn't sound quite right.

Tubes lend themselves more easily to the demonstration and discussion of power-stage neutralization. Despite increasing use of solid-state devices in transmitters, there are still many transmitters using power tubes in their final amplifiers. Some transmitter handbooks contain information on neutralizing power stages in transmitters. Simply replacing a failed final tube with a new tube may not return a transmitter to full normal operation, and it is essential to check neutralization when replacing a PA tube.

The fact that a stage may not be neutralized, is unstable and is generating a spurious frequency may not be noticed by a careless operator. This oscillation does not usually occur at the station's licensed frequency (the tuned frequency of the output circuit), but at a slightly lower frequency. This may or may not be passed by the antenna system.

The power tube is a high-impedance input device, while the transistor has a low input impedance and generally is less susceptible to spurious signal generation. Undesired feedback in a stage is usually due to the presence of unintended magnetic coupling, produced by poor equipment design, or feedback/coupling between the plate and the grid in the final amplifier. The former effect can be corrected by careful stage redesign. Oscillation because of a tube's internal capacitance coupling requires external inductive or capacitive neutralization.

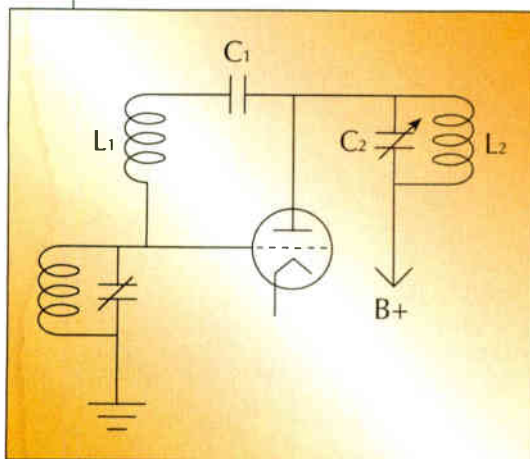

Figure 1. For inductive neutralization, coil L_1 provides a path to the grid. Capacitor C_1 blocks the high voltage. The inductive reactance of L_2 is adjusted to cancel the capacitive reactance of the grid and plate elements.

Neutralization requires the introduction of an out-of-phase voltage of equal amplitude to the grid of the tube. Figure 1 shows a method of inductive neutralization. There is no control of feedback voltage; it's basically the circuit

simplydifferent.



AT3060
phantom-powered tube microphone

thenewtube



30 | *series*

Never satisfied to rest on their laurels, our engineers were inspired to improve upon the technical excellence and coveted sound of valve design. How? By making it simpler.

The new **AT3060** tube microphone offers the convenience and easy setup of a standard studio condenser by operating exclusively on 48V phantom power – so there's no dedicated power supply requiring you to reconfigure your boom arm with special cables. An all-new large-diaphragm cardioid capsule, with the warm sound of a vintage tube mic, has been specially tailored to keep proximity effect and P-pop under control. Meticulously crafted in a rugged, compact housing, the **AT3060** is set in a low-profile shock mount for easy copy reading.

Top it all off with the exceptional quality and consistency you count on from Audio-Technica, and the result is, quite simply, something special, for a lot less than you'd expect.

 **audio-technica.**

used in the old regenerative receivers. It is more difficult to vary the feedback voltage in this system of neutralizing. For this reason this method is not often used.

Capacitive neutralization is shown in Figure 2. Capacitor C_2 controls the feedback from the plate to the grid circuit. This circuit is generally easier to adjust than inductive neutralization and is convenient to use if a

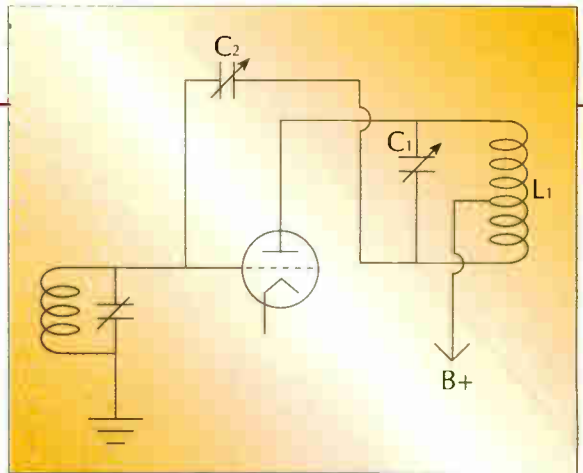

Figure 2. With capacitive neutralization, the tank coil L_1 is center-tapped and one end provides a 180° voltage differential. Capacitor C_2 not only blocks the high voltage, but it provides a broad range of adjustment to cancel any internal tube coupling.

tube type is changed. Basically, a center-tapped PA tank coil is used with B+ being fed to the center tap, with one end to the tube plate and the other through the neutralizing capacitor to the grid.

There are several different methods of obtaining the necessary out-of-phase signal.

Screen grid tubes

As tube and stage amplification figures increased, the screen grid tube was developed in an effort to avoid the need for neutralizing circuits. An additional grid with a positive voltage lower than that of the plate is interposed between the control grid and the plate. This is known as the screen grid. This is connected to ground directly or through a large capacitor. This low-reactance grid effectively shields the control grid from the plate and reduces the capacity between these two elements. This system operates efficiently in lower gain stages, but when stage gain is increased, it is necessary to add a neutralizing circuit.

The high-efficiency of a high-gain screen grid stage requires that no RF coupling occurs between the plate and the control grid. The circuit is similar to that used for a triode and varies depending on the level of feedback required.

In solid-state amplifiers, a low-frequency parasite occasionally occurs. This sometimes appears as noise adjacent to the operating frequency. This is not as common these days, however it is good to know about it in case some unusual phenomena should appear in your signal.

E-mail Battison at batcom@bright.net.

V3 | MORE MUSIC

SUPPORTS 2ND OUTPUT FOR HD RADIO OR NETCASTING

SUBTERRANEAN BASS SLAM WITH NEW GREGG PRESETS



WEST COAST
Doug Tharp
Voice 866.673.9267
Cell 818.398.7314
Email dtharp@san.rr.com

CENTRAL
Bernie O'Brien
Cell 731.695.1714
Email bernieob@earthlink.net

MID-SOUTH
Bob Mayben
Voice 877.391.2650
Fax 256.543.0595
Email bobmayben@usa.net

SOUTH-WEST
Tyler Callis
Cell 817.312.6338
Email tylercallis@integrity.com

MID-WEST
Mary Schnelle
Voice 1.800.245.4307
Fax 513.583.1343
Email mschnelle@maryschnelle.com

NORTH-EAST
Dan Lohse
Voice 908.722.6015
Fax 908.722.4359
Pager 877.792.8024
Email scmsnorth@aol.com

OPTIMOD-FM 8400 v3

MUSICAL CONSISTENCY THAT BRANDS YOUR SOUND.

SCMS, INC.
YOU-KNOW-WE-KNOW-RADIO!

Trade-ins welcome

CORPORATE SALES OFFICE - PINEVILLE, N.C.

Toll FREE 800.438.6040 Fax 704.889.4540

www.scmsinc.com

"If you can think it, Logitek can do it."



WKDF / WGFX Studio Console Configurations

Two Logitek Audio Engines, with a total of eight IO24A cards (up to 96 analog inputs and 96 analog outputs), five IO8D cards (up to 40 stereo digital inputs and 40 stereo digital outputs), and network cards providing fibre optic connections between Engines

- 24 mix-minus buses available per studio
- Supervisor software for complete control of fader assignments/router functions
- Custom scripting provided by Logitek to pass audio and control from the Numix to other studios in the facility that have old analog boards
- vRoute "virtual" router controllers

WKDF: 1 Numix-12 Console w/12 fully assignable faders, access to 8 stereo buses

WGFX: 1 ROC-5 Console, 1 ROC-10 Console, 1 RTE-3 Router Controller

"The limitations of average consoles and routers just don't apply."

—Cameron Adkins, Citadel Broadcasting, Nashville, Tennessee

Take what you know about the average audio router and console and throw out the normal limitations. The Logitek Audio Engine not only can accommodate any input or output standard, analog or digital, but automatically handles all remote machine control functions within the engine and routes those functions to whatever room or control surface at the same time. *This is not your father's router!*

With Logitek at the heart of this facility, I am most proud of what it has allowed me to accomplish here. The Logitek system has taken away the boundaries of the traditional project and allowed me to be a better engineer.

Logitek Electronic Systems, Inc.

5622 Edgemoor

Houston, TX 77081 USA

713.664.4470

1.800.231.5870

www.logitekaudio.com

Logitek

© 2003 Logitek Electronic Systems, Inc.



The ins and outs of the new duopoly rules

By Harry Martin

www.beradio.com

The new multiple ownership rules for radio contain some important regulatory changes that go beyond the Commission's decision to use Arbitron methodology to define radio markets. Here are some examples:

• *JSA Attribution.* The FCC has determined that it will now, for the first time, count a brokered station toward the brokering licensee's permissible ownership totals under the revised local ownership rules. Thus, where a broadcaster owns or has an attributable interest in one or more stations in a local radio market, and has a JSA with another station in the market under which the broadcaster controls more than 15 percent of the brokered station's advertising time per week, the JSA station will be counted toward the brokering station's ownership caps. Licensees with in-market JSAs entered into prior to the adoption of the new rules that now exceed ownership limits have two years from the effective date of the rules to terminate the agreements or otherwise come into compliance.

• *Deadlines.* Some new reporting deadlines apply to JSAs. (1) Parties with existing, attributable JSAs in Arbitron metros under the new rules are required to file a copy of the JSA with the FCC within 60 days of the effective date of the rules. (2) JSAs involving stations located outside of Arbitron metros must be filed within 60 days of the effective date of the decision in the pending rulemaking dealing with market definition in non-rated markets, *i.e.*, late 2004 at the earliest.

• *New Forms.* FCC forms are being modified to require applicants to file attributable JSAs at the time an application is filed, regardless of whether the markets implicated by the application are located in Arbitron metros.

• *Noncommercial Stations.* Another important change is that the Commission will, for market-size purposes, now count commercial and noncommercial stations in the market. Previously, the Commission ignored noncommercial stations.

Localism promoted

FCC Chairman Michael Powell, at least partly in response to criticism of the new broadcast multiple ownership rules, announced in August that the Commission will pursue the following initiatives to promote localism:

• *Speeding the activation of low power FM stations.* The Chairman stated the FCC would shortly open a settlement window for low power FM applications, during which exclusive applicants could amend to use all available frequencies to resolve conflicts and gain new station licenses. This settlement opportunity could rapidly push the total number of outstanding LPFM authorizations to over one thousand by year end.

• *A Localism Task Force.* This task force will:

1. Conduct studies to rigorously measure localism and how it may be affected by existing FCC rules.
2. Organize a series of public hearings on localism around the country.
3. Advise the Commission on recommendations to Congress relating to the licensing of thousands of additional low power FM radio stations.
4. Make recommendations to the Commission within 12 months on how the Commission can promote localism in television and radio.
5. Advise the Commission on legislative recommendations to Congress that would strengthen localism.

• *Notice of Inquiry.* In September, the staff was to deliver to the Commissioners a proposed Notice of Inquiry (NOI) on localism. The NOI will seek comment on a wide range of FCC rules and procedures aimed at promoting localism.

FCC may relax LPFM third-adjacent protections

An FCC-commissioned study has recommended, based on technical measurements and analyses, that existing third-adjacent channel distance restrictions be waived to allow LPFM stations to operate at locations that meet all other FM requirements. This is good news for LPFM applicants, who are likely to find more nooks and

Dateline:

Renewal applications are due Oct. 1 for radio stations in Florida, Puerto Rico and the Virgin Islands. Stations in the following locations must file their biennial ownership reports with the FCC, and place their annual EEO reports in their public files and on their websites, by Oct. 1: Florida, Puerto Rico, Virgin Islands, Iowa, Missouri, Alaska, Hawaii, Oregon, Washington, American Samoa, Guam and the Mariana Islands.

crannies in the spectrum where they can squeeze themselves. It is bad news for full-service stations concerned about the potential impact of third-adjacent interference (although the report's conclusions may allay those concerns).

In December 2000, the Congress required that the FCC prescribe third-adjacent channel spacing requirements for LPFM stations. As a result, many then-pending LPFM applications were dismissed because they could not satisfy third-adjacent channel interference protection requirements.

At the same time, Congress instructed the Commission to conduct an experimental program to test whether LPFM stations would interfere with existing FM stations if LPFM stations were not subject to third-adjacent channel spacing requirements. The Commission retained the MITRE Corporation to compile and analyze relevant data. The report by MITRE has now been completed and can

FCC ECFS search page
http://gulfoss2.fcc.gov/prod/ecfs/comsrch_v2.cgi

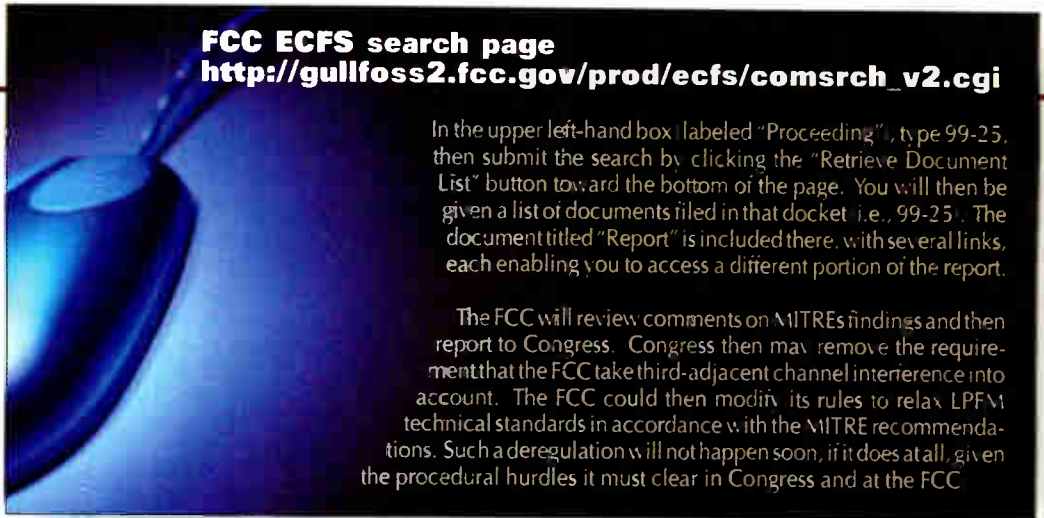

In the upper left-hand box labeled "Proceeding", type 99-25, then submit the search by clicking the "Retrieve Document List" button toward the bottom of the page. You will then be given a list of documents filed in that docket (i.e., 99-25). The document titled "Report" is included there, with several links, each enabling you to access a different portion of the report.

The FCC will review comments on MITRE's findings and then report to Congress. Congress then may remove the requirement that the FCC take third-adjacent channel interference into account. The FCC could then modify its rules to relax LPFM technical standards in accordance with the MITRE recommendations. Such a deregulation will not happen soon, if it does at all, given the procedural hurdles it must clear in Congress and at the FCC.

be accessed on the FCC's website through the ECFS search page.

Martin is an attorney with Fletcher, Heald & Hildreth, PLC, Arlington, VA. E-mail martin@fhhlaw.com.



Swing

Portable ISDN Audio Codec:

- Compact, light weight and easy to operate with a worldwide ready ISDN connection.
- Works anywhere and is compatible with all codecs on the market.
- It has a built-in digital phone hybrid for POTS connection and it works simultaneously with the ISDN connection.



Now with MP3 !!!

Eagle

ISDN Audio Codec

- Stereo and Mono.
- Digital and Analog I/O.
- Capable of establishing an On Air conversation with two callers.

TH-02 Ex
Digital Telephone Hybrid

- Known worldwide for its high performance



AEQ: Phone: 954 - 581 7999 Fax.: 954 - 581 7733 sales@aeqbroadcast.com www.aeqbroadcast.com

Radio takes CENTER STAGE

The fall convention returns to the East Coast after a long absence.

The NAB Radio Show is radio's big chance to stand on its own without being overshadowed by other media segments. This convention focuses on delivering audio entertainment to a mass audience. The event goes beyond the borders of traditional radio by integrating information about non-traditional radio topics, such as streaming and a station's online presence.

Philadelphia hosts the convention this year, a city that has not seen the Radio Show in a long time. Speculation as to the convention's success varies in opinion, but the new location offers easy access for the eastern seaboard and parts of the Midwest.

The sessions and show floor offer something for almost everyone at the station. *Radio* magazine's NAB Radio Show preview provides plenty of useful information to help you get the most from the convention.

By the way, the show floor has been given a new name this year. It is called the Radio Exchange by the NAB. Keep this in mind when using the NAB materials to plan your time at the convention.

Index

Session spotlight	page 18
New products from the floor	page 29
NAB Radio Exhibitors	page 57
NAB Radio Exhibits Map	page 59

Stuck With A Sound You Can't Get Rid Of?

YOU NEED THE NEW APHEX 2020MKIII AUDIO PROCESSOR



Settling for flabby, undefined bass? Buried, clouded, mids? Shrill, annoying high end that you just can't tune out of your current processor? Is your only comfort that some of your neighbors on the dial sound as bad or worse than you do? Then it's time to step up to the new Apex 2020MKIII.

Radically new processing algorithms and circuitry bring even greater loudness while maintaining clarity and musicality. The bass is tight, deep and resonant, the mids are detailed and forward, and the highs are open and natural. The 2020MKIII is so powerful, yet so clean, it is the only "broadcast" processor used in world class post production and mastering facilities.

With an extensive range of useful controls you can readily achieve your own unique sonic signaturea sound that you'll never want to get rid of.

Call us today to audition the new 2020MKIII at your station.

APHEX
SYSTEMS

*Improving the way the world sounds*SM

11068 Randall Street, Sun Valley, CA 91352 U.S.A.
818-767-2929 Fax: 818-767-2641 www.aphex.com

ApheX is a registered trademark of Apex Systems

World Radio History

Session SPOTLIGHT

The NAB Radio Show has a strong programming and management feel, but there are also three full days of technical sessions, which feature knowledgeable presenters and topics relevant to the current state of radio. In addition to the technical program, there are sessions in the management track that cover radio technology and topics of interest to technology managers. Between the exhibit floor and the sessions, attendees will have plenty to do to keep busy for three days.

The Technical Workshops concentrate on radio transmission for analog and IBOC digital systems. Each full-day workshop features speakers who are recognized in their field. The sessions provide practical and theoretical information that should help attendees improve their stations today and prepare for the changes tomorrow. Workshop attendees also receive a certificate signifying their attendance. Attendance may also be used to earn SBE recertification points.

Technical Workshops

Whether your interest is in the latest digital technologies, such as DAB and networked facilities operations, to the optimization of an RF facility, the technical workshops provide practical information to operate the station today and plan for its operation tomorrow.

AM/FM Antenna Certification Workshop

October 1, room 201B

The antenna system is the final link between a station and the listener's receiver, and proper maintenance of this system is important to a station's success. This workshop will provide engineers with helpful tips on maintaining antenna systems and troubleshooting RF problems related to the antenna, transmission line, coupling and monitoring systems. In addition, the presenters will also provide suggestions on dealing with the FCC when a transmission system problem is encountered or changes in the RF system are required.

The presenters for this day-long session are Charles A. Cooper, engineer, du Treil, Lundin and Rackley; Benjamin Dawson, president, Hatfield and Dawson; Ronald Rackley, partner, du Treil, Lundin and Rackley; Thomas Silliman, president, Electronics Research; and Bob Surette, manager RF engineering, Shively Labs.

12,000 -XP ONE OF THE MOST POPULAR
CONSOLES EVER!!!



For more detailed information visit us at: www.arrakls-systems.com or call: (970) 461-0730



Broadcast Multiple Channels of Live Audio over any LAN or WAN Network

... ANY COMPUTER ON
THE NETWORK CAN TUNE IN

AudioTX

MULTIPLEX

- Superior replacement for Audio Ringmain or Monitor Select systems for office/station listening.
- Greater capacity and better flexibility than RF modulated coax or multi-pair wired systems.
- Requires no additional cabling - uses your existing computer network.
- Easily and instantly add extra listening points or new channels.
- Broadcast quality, low delay audio - can be transmitted as MP2, MP3 or uncompressed.



1

The AudioTX Multiplex Server runs on one or more PCs and Broadcasts multiple channels of live audio.

Each PC can broadcast up to 30 channels.

2



Install the AudioTX Multiplex Receiver on all of your office, newsroom and even studio PCs.

And they can tune into any channel quickly and simply.

www.audiotxmultiplex.com

(FREE TRIAL VERSION AVAILABLE FOR DOWNLOAD)

Telephone: +44 (0)121 256 0200 email: sales@audiotxmultiplex.com

World Radio History

The new range from AudioTX

ISDN, IP & POTS Codec software for Windows PCs and Laptops

Audio TX POTS

ISDN quality over an ordinary telephone line

AudioTX POTS™ gives you broadcast-quality speech over a standard analogue telephone line - ideal for reporting and outside broadcasts from the field.

- ▶ 7.5kHz live, bi-directional, low delay audio from anywhere there's a phone line
- ▶ Ideal for news-gathering and sports reporting
- ▶ Low-cost, portable software solution - requires just a standard sound card and modem in your PC or Laptop
- ▶ Also works with high-speed GSM/data facilities on mobile phones

£500 · \$725 · €799

Audio TX Capture

The Answering-Machine for ISDN codecs

AudioTX Capture™ takes incoming calls from ISDN codecs and records the incoming audio direct to disk - like an answering machine for ISDN codecs.

You can set up Capture so that the received audio is kept in an inbox, copied to any location on your network or even emailed to the correct person - using internal or external email servers.

- ▶ Compatible with almost all manufacturers' ISDN Codecs
- ▶ The simplest way for reporters and correspondents to file their audio
- ▶ Take commercials or pre-produced audio without having to wait in the studio
- ▶ Audio can be played back using the Capture software or using Media Player or imported into most audio-editing/playout software
- ▶ Can email the audio to the right person or copy it to anywhere on your network
- ▶ Get the audio to the right person fast - set up email or network location by MSN number

£1290 · \$1850 · €1,999

Audio TX Communicator ISDN and IP Codec

AudioTX Communicator™ is an ISDN Codec in your PC! It's compatible with virtually all other ISDN Codecs AND allows you to connect live across IP networks and the Internet.

- ▶ Compatible with CDQ Prima, Telos Zephyr and almost all other ISDN codecs
- ▶ Live, bi-directional, low delay audio connections for outside broadcasts, studio links, voice-over work, reporting and news-gathering
- ▶ File playback during live connections - allows you to playback pre-recorded WAV files during a live connection
- ▶ Low-cost, portable software solution - requires just a standard sound card and compatible ISDN card in your existing PC or Laptop
- ▶ The cheapest ISDN codec available today - and the high quality you'd expect from AudioTX
- ▶ Also works over any IP-based network for studio-quality audio connections and even STLs - from Ethernet to ATM, leased lines, satellite or wireless links and even over the Internet using any high-speed connection

£500 · \$725 · €799

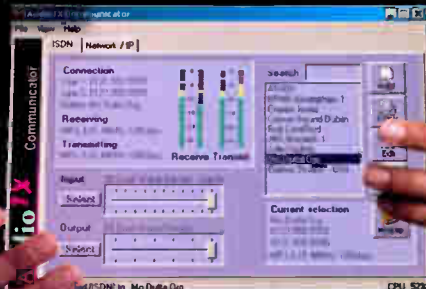
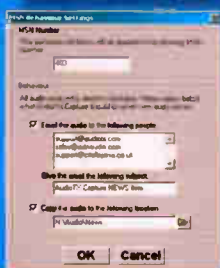
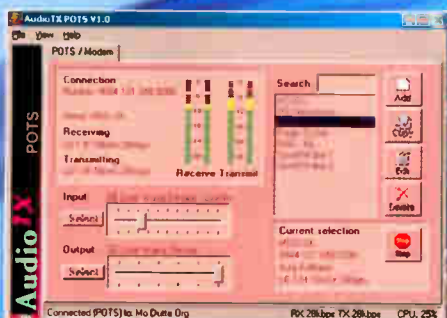

Audio TX

Communicator
POTS
Capture

Download a FREE, fully working trial version today.

www.audioTX.com

Tel: +44 121 256 0200 (GMT)

Email: sales@audioTX.com

Session schedule

8 a.m. to 9 a.m.

FM Antenna Systems Overview

9 a.m. to 10 a.m.

FM Antenna System Maintenance

10 a.m. to 11 a.m.

Break

11 a.m. to 11:30 a.m.

Working with the FCC

11:30 a.m. to 12 noon

Questions & Answers

1 p.m. to 1:45 p.m.

The RF Components of an AM System

1:45 p.m. to 2:20 p.m.

AM Directional Antenna Troubleshooting

2:20 p.m. to 2:50 p.m.

AM Directional Antenna Repair

2:50 p.m. to 3 p.m.

Break

3 p.m. to 3:25 p.m.

*Bandwidth Concepts for
AM Antenna Systems*

3:25 p.m. to 3:50 p.m.

Dealing with the FCC

3:50 p.m. to 4 p.m.

Questions & Answers

RADIO

2004 BUYERS GUIDE

Announcing the 2nd Annual **Radio Magazine Buyers Guide:**

The Radio Industry Sourcebook of Equipment, Services & Technology



After the successful launch of the 2003 Buyers Guide, *Radio* magazine is assembling the latest products and services in its 2004 Buyers Guide. This reference edition includes:

- Company contact information
- Featured suppliers
- Product listings
- Company listings
- Company Profiles/Field Reports
- And more

Don't miss out on this special issue. To subscribe to *Radio* magazine, visit www.beradio.com and click on the link under *Subscriptions*.

Session SPOTLIGHT

Digital Radio Certification Workshop

October 2, room 201B

Everything is turning to digital and radio is no exception. While the final details on digital transmission are still in the works, converting a station's studio facilities to digital today is realistic and practical.



Session Schedule

9 a.m. to 12 noon

Ethernet for Studio Audio Systems

Presenter:

Steve Church, CEO, Telos Systems

1 p.m. to 4:30 p.m.

HD Radio Conversion 101

Presenters:

Jeff Detweiler, broadcast technology manager, Ibiquity Digital; Scott Stull, director of broadcast business development, Ibiquity Digital

4:30 p.m. to 5 p.m.

New Methodology for Presenting AM Coverage and Interference Data

Presenter:

E. Glynn Walden, consultant

BROADCAST TOOLS® *new*

"Rack-Ables"

The upgraded SS 2.1/TERM III & BNC III switcher/routers are improved with new front panel switches. They may be used as a desktop device, and are equipped with mounting holes for wall mount installation or may be installed on the new RA-1 "Rack-Able" 1RU mounting shelf.

The new "Rack-Able" SS 4.1 III switcher replaces the popular SS 3.1 while adding a fourth stereo input channel and front panel control. We've kept the best of the SS 3.1 features and added a few more.

The new Silence Monitor III improves on the features of the original SSM, with front-panel control, removable screw terminals, "Plug & Play" installation, built-in program switcher, restore timing delay, aural alarm and relays for most remote functions. Now rackable!

The new SS 8.1 II switcher replaces the popular 6x1 with the addition of two more stereo input channels and GPI, while keeping the price the same! The SS 8.1 II may be desktop, wall mounted or installed on the new "Rack-Able" mounting shelf.

The new RA-1 (1-RU rack shelf) provides mounting for three tri-rack or two half-rack "Rack-Able" configured products. The RA-1 is pre-drilled for flush and recessed product mounting. The RA-1 is furnished with filler panels and mounting hardware.

Look for additional
"Rack-Able" products soon.



www.broadcasttools.com

**BROADCAST
tools**

639 Sunset Park Drive • Suite 101
Sedro-Woolley, WA 98284 USA
(360) 854-9559 • FAX: (360) 854-9479

LEDtronics LEDs Put the Status in Status Indicators.

LEDs and LED Lamps for All Your Control Panels.

Every Size. Every Shape. Discrete LEDs

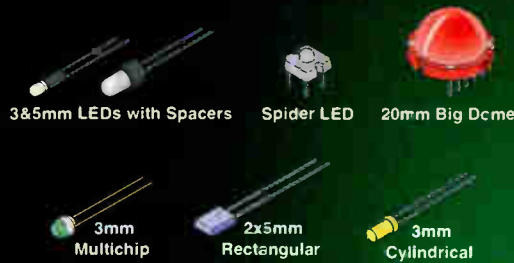

Low-Cost. Snap-In. Relampable. Panel Mount LEDs



Direct Incandescent Replacement. Based LED Lamps



Made to Meet Your Application. Custom LED Products

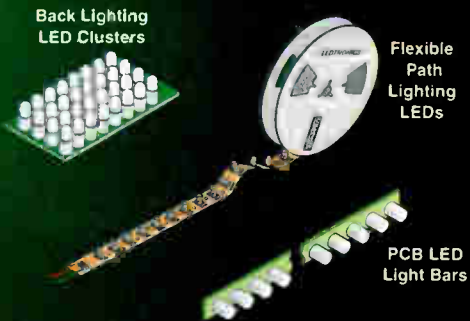

Today's Precision Technology. SMT LEDs



Low-Current. PCB Indicators



LED
LEDTRONICS, INC.
THE FUTURE OF LIGHT
An ISO-9001 Registered Company

100,000 Hour LED Life • High Shock and Vibration Resistant • 80 - 90% More Energy-Efficient Than Incandescent Lamps • Solid-State Construction • Colorfast • Fast Response Time

23105 Kashiwa Court, Torrance, CA 90505
Phone: (800) 579-4875 or (310) 534-1505
Fax: (310) 534-1424
E-mail: webmaster@ledtronics.com
Website: <http://www.ledtronics.com>

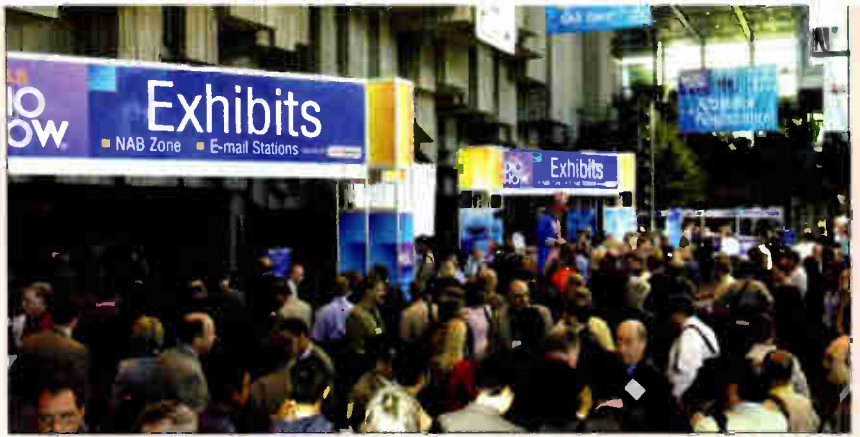

TURNING GREAT IDEAS INTO EXCEPTIONAL INNOVATIONS

Continental is Investing
in
Future Broadcast



We are inviting you to design your next transmitter. Continental is currently investing time, people, and funds to make it happen. We are committed to broadcast and proving it!



800.733.5011

www.contelec.com

AM/FM Transmitter Certification Workshop

October 3, room 201B

This session complements the Broadcast Antenna Workshop and presents a thorough discussion of transmitter troubleshooting. The 8th annual transmitter workshop will provide insight to new RF technicians and a refresher to seasoned engineers. It will cover the basic building blocks of transmitters and investigate a variety of real-world transmitter failures. A panel of representatives from the major transmitter manufacturers will be on hand to discuss maintenance tips for their products. Practical disaster examples will be discussed, as well as the solution for recovery. In the Chief Engineer's Lessons Learned panel discussion, attendees will review a checklist of transmitter site maintenance duties, which is useful for helping station management understand the depth of an engineer's responsibilities. A workbook will be provided to each attendee.

Presenter:

John Bisset, RF district sales manager, Harris

9 a.m. to 10:30 a.m.

Principles of Transmitters

10:30 a.m. to 10:45 a.m.

Break

10:45 a.m. to 12:00 noon

Basic Troubleshooting

1:45 p.m. to 3 p.m.

*A Discussion with the
Transmitter Manufacturers*

3 p.m. to 4 p.m.

*Living through the Nightmare
- You're Off the Air*

www.beradio.com

INTRODUCING NETSTAR™

Now shipping with
advanced features



A new codec with Advanced Audio Coding for use over the Internet, ISDN or DSL

The newest codec from CCS/
MUSICAM USA does it all! While
maintaining compatibility with
existing codecs, NetStar opens a
new realm of connection capabili-
ties. NetStar can send and receive
full fidelity, real-time stereo audio
not only via ISDN and dedicated
data lines, but also via IP.

NetStar contains not only standard
coding algorithms like G.711, G.722,
MPEG 1 & 2 Layer 2 and MPEG 1 & 2
Layer 3, but also the latest MPEG 2
Advanced Audio Coding (AAC) and
MPEG 4 AAC-Low Delay.

NetStar can even connect bi-
directionally via IP *with*
uncompressed linear audio and
near-zero delay!

NetStar automatically recognizes the
calling codec, and even comes with
its own built-in web server for easy
remote control from any web
browser. And, because living within
your budget is essential, NetStar is
not only our most capable codec
ever, it's also our most affordable.

Contact us, or your authorized CCS/
MUSICAM USA dealer for details



MUSICAM USA
670 North Beers Street, Bldg #4
Holmdel, NJ 07733 USA
732-739-5600
732-739-1818 fax
sales@musicamusa.com
www.musicamusa.com

MUSICAM USA is the d/b/a of Corporate Computer Systems, Inc

the NEXT generation for DLII, DLIII, and DL-IV systems...

Upgrade to Digilink-Xtreme



- ... Newest Generation of the #1 Satellite Automation system
- ... New Digilink hardware converts a standard PC into a powerful Automation system
- ... Compatible with DLII, DLIII, and DL-IV traffic schedules for ease of upgrading
- ... Supports audio files produced by Cool-Edit and other 3rd party editors
- ... Supports PC networks... network multiple Digilink-X systems for AM, FM, and more
- ... Multi-format agile... .WAV, MP2, and MP3... mono and stereo... any sample rate
- ... Supports two sound cards for On Air and Cue play outputs
- ... NO expensive sound cards required

Our new Arrakis DIGILINK-XTREME Windows software combines with our new Arrakis BROADCAST AUDIO DOCKING STATION hardware to create the most powerful PC based radio workstation ever. All that you do is add an ordinary Windows PC with basic sound and you are ready to go. No special order, expensive audio sound card is required.

The Docking Station has all of the switcher and logic hardware required for full satellite automation. The system therefore supports Live On Air operation, Live assist, Hard disk based automation, Satellite automation, or any combination of the above. Digilink-Xtreme is a complete On air system in a single package.

Your radio audio library of songs, spots, beds, jingles, etc are stored on your PC hard drive and then played back through the docking station. Because the audio is stored on the PC, you can use a PC network to move audio, schedules, and text around your station. Digilink-Xtreme combines the best of the PC computer and the best of broadcast hardware to create a professional solution for On Air automation systems.

For audio production, the built in PC recorder, 8 input record input switcher, and timed record features make the system ideal for a News room or Production room. The Docking station is great for use with third party software such as Cool-Edit. The 8 input record station can select your record input and the balanced IO turns your PC into a professional audio recorder.

Digilink-Xtreme has a full featured one week schedule system that can create schedules manually or import schedules from 3rd party music and traffic systems. Because Digilink-Xtreme uses the industry standard Digilink scheduling format, you can easily upgrade from a DL2 or DL3 workstation without changing scheduling software. Digilink-Xtreme literally does it all in a single package. Network multiple workstations to create an entire multi-studio radio station.

arrakis systems inc. www.arrakis-systems.com (970) 461-0730

INTRODUCING NETSTAR™

Now shipping with
advanced features



A new codec with Advanced Audio Coding for use over the Internet, ISDN or DSL

The newest codec from CCS/MUSICAM USA does it all! While maintaining compatibility with existing codecs, NetStar opens a new realm of connection capabilities. NetStar can send and receive full fidelity, real-time stereo audio not only via ISDN and dedicated data lines, but also via IP.

NetStar contains not only standard coding algorithms like G.711, G.722, MPEG 1 & 2 Layer 2 and MPEG 1 & 2 Layer 3, but also the latest MPEG 2 Advanced Audio Coding (AAC) and MPEG 4 AAC-Low Delay.

NetStar can even connect bi-directionally via IP *with uncompressed linear audio and near-zero delay!*

NetStar automatically recognizes the calling codec, and even comes with its own built-in web server for easy remote control from any web browser. And, because living within your budget is essential, NetStar is not only our most capable codec ever, it's also our most affordable.

Contact us, or your authorized CCS/MUSICAM USA dealer for details



MUSICAM USA
670 North Beers Street, Bldg #4
Holmdel, NJ 07733 USA
732-739-5600
732-739-1818 fax
sales@musicamusa.com
www.musicamusa.com

MUSICAM USA is the d/b/a of Corporate Computer Systems, Inc

World Radio History

Session SPOTLIGHT

More Sessions of Note

Here are some sessions that cover technical and legal issues that may be of particular interest to *Radio* magazine readers.

October 1

Grappling with New Ownership Rules

8:30 a.m. to 11:30 a.m., room 201C

This session will look at the new ownership rules and the new definition for radio markets in particular.

October 2

FCC Breakfast

7:30 a.m. to 8:45 a.m.,
Philadelphia Marriott Salon E
Bruce Reese, president and
CEO of Bonneville International,
will moderate this session
with FCC Commissioner Kathleen
Abernathy.

Keynote Address

9 a.m. to 10:15 a.m.,
Pennsylvania Convention
Center Ballroom
A member of the NAB Broadcast
Hall of Fame and Marconi Radio
Award winner, Rush Limbaugh
will deliver this year's keynote
address.

Ownership Etc.:

The Changing FCC Regulatory Environment

10:30 a.m. to 11:45 a.m.
Session moderator Jack
Goodman, senior VP/ and general
counsel of the NAB, will host
panelists Ken Ferree of the
FCC, John Fiorini of Wiley Rein
and Fielding, attorney Brian
Madden of Leventhal Senter
and Lerman, and Melodie
Virtue of Garvey Schubert and
Barer as they discuss the new
ownership rules, spectrum use,
IBOC and more.

What You Always Wanted to Know About IBOC but Were Afraid to Ask

10:30 a.m. to 11:45 a.m.
This session for managers will
discuss the various aspects of
IBOC from finance to formats.
Planned panelists include
manufacturers, digital experts
and industry leaders.

"Still The BEST..."



STLs/RPU

Digital, Analog,
Composite, Mono,
Reciters

Monitors TV FM AM



EAS

Encoder/Decoders
Decoders Only
Accessories

NEW

Digital
Insertion Unit



...Still Around"

TFT INC

408-943-9323

www.tftinc.com e-mail: info@tftinc.com
2243 Ringwood Ave. San Jose, CA 95131 fax: (408) 432-9218



"A beginner to the industry, I found NexGen easy to learn. The flexibility really makes the system work for you."

Amy Flaherty

KNOM volunteer Amy Flaherty joined the station in June 2002. She deejays the morning show and produces feature interview programs.

Congratulations to KNOM, a 2003 Crystal Award recipient.

NexGen 2 Studio Suite, the revolutionary "all in one" radio system designed with you in mind.

Prophet Systems has integrated all our software packages into one ultra powerful software suite, NexGen 2 Studio Suite. NexGen 2 is the product of our many years of experience, and our well deserved reputation for thinking outside of the box. NexGen 2 utilizes the same classic Prophet feature-rich software, but it's packaged into hardware that maximizes your investment of money and time like never before!



"In today's economy, we all have to stretch our dollars and our time. Large, complex solutions are too costly and too time consuming for the realities of modern radio. But everyone still needs all the features and redundancy possible, because off-air is simply not an option. NexGen 2 Studio Suite is all about convenience, and getting the most for your money."

Kevin Lockhart

President of Prophet Systems

Choose from four affordable Studio solutions, each designed to handle your specific needs.

Studio 11 ~ \$4,500

Cost-effective solutions for the standalone AM, FM or LPFM. Ideal for remote or home-based voice tracking and music scheduling.

Studio 22 ~ \$7,000

Designed for mostly automated, satellite or voice tracked stations.

Studio 41 ~ \$7,500

Perfect for active control rooms and production studios.

Studio 44 ~ \$9,700

The best of both worlds! This powerful workstation can handle live or automated operations.

With any Studio solution, we include all the software you need to run your station.

NexGen Digital™

WANcasting™

VoiceTRAC™

MusicGen

CDX/AFC

Digital Reel-to-Reel

PhoneTRAC



1-877-774-1010

www.prophetsys.com

sales@prophetsys.com

Research and order directly
from our website.
www.prophetsys.com/Studio1.asp

See us at NAB Radio, Booth#439

Session SPOTLIGHT

How Can Arbitron's Portable People Meter Help You?

4 p.m. to 5 p.m., room 204C

Representatives from Arbitron will discuss the methods behind the system that has been undergoing tests in Philadelphia.

More IBOC outside the convention

Broadcast Electronics will host an IBOC seminar on October 1 at the Downtown Courtyard by Marriott hotel from 1:30 p.m. to 3:30 p.m. The company has conducted similar sessions around the country over the past two years.

The session will be conducted by Broadcast Electronics' engineering and marketing departments. There is no charge to attend, but reservations are required. To register, e-mail HDR@bdcast.com.

October 3

Congressional Breakfast

7:30 a.m. to 8:45 a.m., Philadelphia Marriott Salon E. Congress has focused on issues delving into issues of broadcast ownership, Internet streaming and copyright, advertising regulation and political ad costs. Members of Congress will be on hand to discuss these topics and more.

New Technology: Gadget, Godsend or Gotcha?

9 a.m. to 10 a.m.

New technology offers new opportunities, but it also offers new distractions. This session will discuss how to best use breakthrough technology to be more efficient and effective.

The People Meter: Does It Measure Up?

1:45 p.m. to 3 p.m., room 204C

This candid discussion of the Arbitron Personal People Meter will cover the system's potential effects on management and ad rates and also discuss how it works.

MAGER SYSTEMS, INC.
The Best in Sound Furniture

Custom Studio Furniture

TEL: 623-780-0045
FAX: 623-780-9860
mager@magersystems.com
www.magersystems.com
Visit our website for more information

Since 1979 Mager Systems, Inc. has been custom designing and fabricating **award winning** furniture for the broadcast industry nationwide. We are still the innovators and leaders in **solid surface tops** and applications which comes with a **10-year warranty**. Our complete **one-stop-shop** includes installation, **turnkey prewiring**, switches and components, conference rooms, reception desks, and office furniture. Our blending of art form with cutting edge techniques, and a clear understanding of each client's application allows us to produce your **showplace** tailored to your budget.

COOL STUFF AWARD 2002
radio world

WBAA
Purdue University

MSI introduces our new award winning "Sound Choice" furniture. Our modular in stock furniture boasts unsurpassed quality for the economical budget with a 10-year limited warranty. See details on our website.

Touch Sensitive Switches & Keyboards

12,000-xp

one of the most **POPULAR** consoles ever...

- ... modular 18 channel mainframe
- ... 2 mic and 10 line input modules
- ... powerful telephone interface
- ... many options available

35% off Sale

MODULAR MAINFRAME

18 input position model shown. Available in 8, 18, & 28 module sizes. Universal design allows any module in any position. Fully shielded with metal side panels. All electronics is on modules for ease of repair. I/O connectors are under VU meter panel for ease of access while in use (no connectors under modules).

COLORS & DESIGNS

The console is available in standard Arrakis beige or in Arrakis platinum, as well as in the standard tabletop configuration or low profile through-table option.

MONITOR SYSTEM

powerful and yet easy to use monitoring for the Control room AND two studios

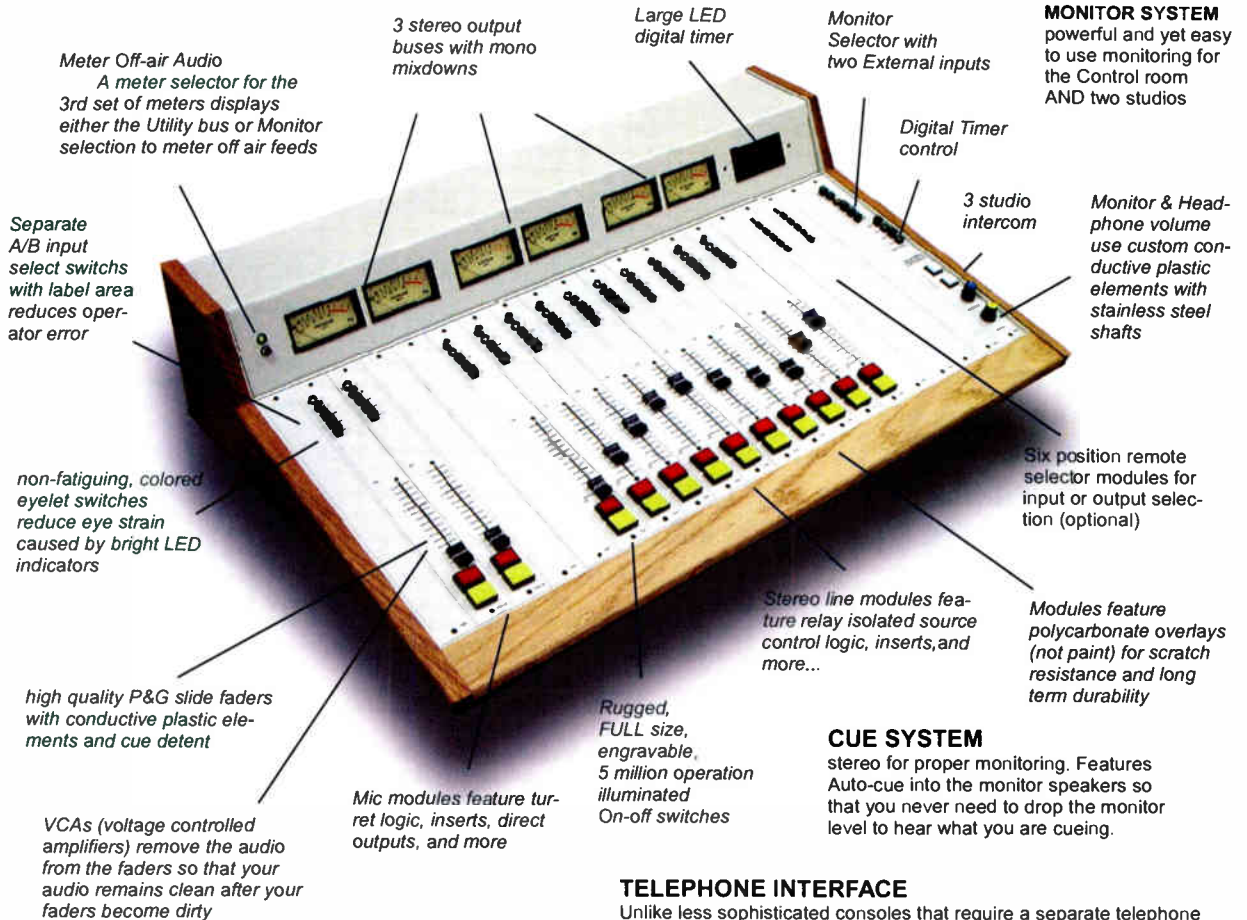

MODULES

A wide variety of modules are available for this mainframe. A six input remote selector module, distribution amplifier module, machine control module, mic input modules, stereo line input modules, advanced input modules with panning and mode select.

12K18-12 normally \$7,075

\$4,695

arrakis systems inc. www.arrakis-systems.com [970] 461-0730



the NEXT generation for DLII, DLIII, and DL-IV systems...

upgrade to Digilink-Xtreme



- ... **Newest Generation of the #1 Satellite Automation system**
- ... **New Digilink hardware converts a standard PC into a powerful Automation system**
- ... **Compatible with DLII, DLIII, and DL-IV traffic schedules for ease of upgrading**
- ... **Supports audio files produced by Cool-Edit and other 3rd party editors**
- ... **Supports PC networks... network multiple Digilink-X systems for AM, FM, and more**
- ... **Multi-format agile... .WAV, MP2, and MP3... mono and stereo... any sample rate**
- ... **Supports two sound cards for On Air and Cue play outputs**
- ... **NO expensive sound cards required**

Our new Arrakis DIGILINK-XTREME Windows software combines with our new Arrakis BROADCAST AUDIO DOCKING STATION hardware to create the most powerful PC based radio workstation ever. All that you do is add an ordinary Windows PC with basic sound and you are ready to go. No special order, expensive audio sound card is required.

The Docking Station has all of the switcher and logic hardware required for full satellite automation. The system therefore supports Live On Air operation, Live assist, Hard disk based automation, Satellite automation, or any combination of the above. Digilink-Xtreme is a complete On air system in a single package.

Your radio audio library of songs, spots, beds, jingles, etc are stored on your PC hard drive and then played back through the docking station. Because the audio is stored on the PC, you can use a PC network to move audio, schedules, and text around your station. Digilink-Xtreme combines the best of the PC computer and the best of broadcast hardware to create a professional solution for On Air automation systems.

For audio production, the built in PC recorder, 8 input record input switcher. and timed record features make the system ideal for a News room or Production room. The Docking station is great for use with third party software such as Cool-Edit. The 8 input record switcher can select your record input and the balanced IO turns your PC into a professional audio recorder.

Digilink-Xtreme has a full featured one week schedule system that can create schedules manually or import schedules from 3rd party music and traffic systems. Because Digilink-Xtreme uses the industry standard Digilink scheduling format, you can easily upgrade from a DL2 or DL3 workstation without changing scheduling software. Digilink-Xtreme literally does it all in a single package. Network multiple workstations to create an entire multi-studio radio station.

arrakis systems inc. www.arrakis-systems.com (970) 461-0730

many new features

- ... hundreds of Jingles at your touch
- ... search by Cart #, Title, Text, & Runtime
- ... time adjust changes length of files
- ... one week Air & Record schedule
- ... easy to use Touch screen or Mouse
- ... play 3 files to Air simultaneously while cueing and recording
- ... many other features

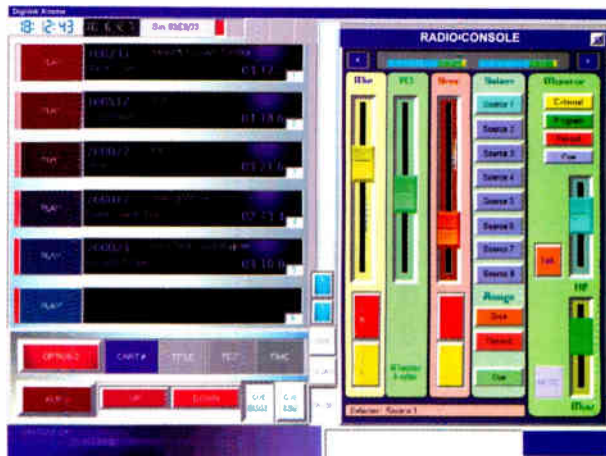
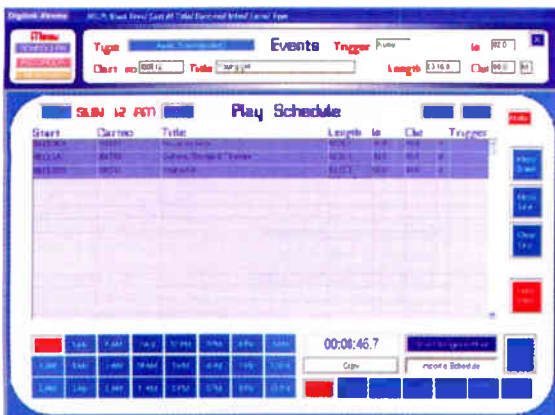

built in Mixing console

In many live on air or automation situations, it is important to be able to preview (cue) an audio file while something else is playing on air. Digilink-Xtreme supports a 2nd sound card for your PC so that you can cue an audio file while playing on air at the same time. The power to support a second play also allows on air automation while scheduling at the same time from a single PC.

Advanced Scheduling system

To make scheduling and recording easier, Digilink-Xtreme has full screen displays of the scheduling and recording features of the system.

The Scheduling screen features easy navigation between hours and days. It has an advanced "Events" manager at the top of the screen to quickly search for the right song, bed, effect, jingle or other sound bit.

The advanced Recorder screen displays the Manual recorder, Tagged text manager, and Timed Recorder for efficient management of your production recording schedule.

Manual, Timed Recording & Text

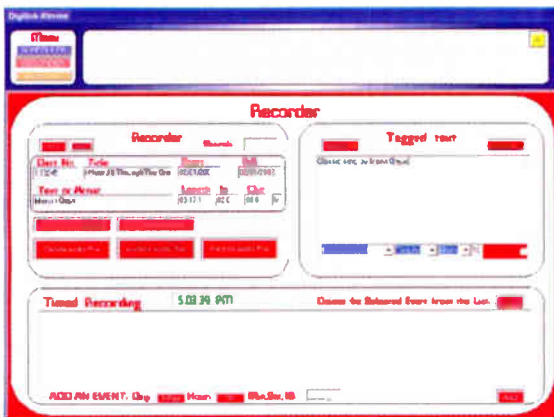

Broadcast Quality Hardware

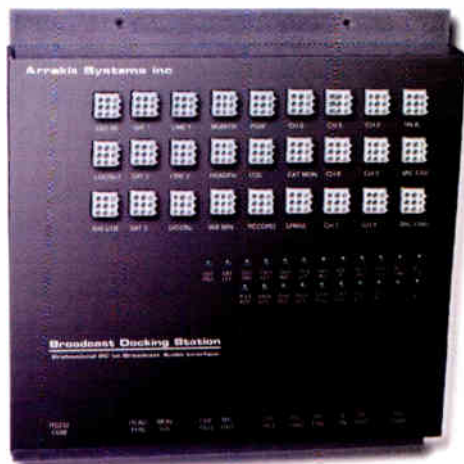

The new Arrakis broadcast docking station interfaces a standard off the shelf PC with consumer type audio to the professional Radio world of balanced, high level audio. An 8 input by 3 output switcher, professional quality mic preamp, analog & SP/DIF digital audio inputs and outputs, and full console logic turns an ordinary PC into a professional audio product.

only... **\$2,495** per studio
just add PC



Radius-Xp

... studio furniture

the most POPULAR furniture lines ever...

New

new for 2003

- ... all plastic surface & trim design
- ... modular for flexibility
- ... highest quality materials
- ... precision crafted
- ... professional features
- ... many options available



This new studio furniture line is engineered for studio decors where non-wood trims are a design goal. Available in a wide variety of colors, this furniture will complement any size market application. The modular design enables the furniture to be ordered in almost any configuration that can be imagined.

... call Arrakis today and choose from among our several models of studio furniture

as config. **\$2,995**

sit down version

arrakis systems inc. www.arrakis-systems.com [970] 461-0730



Products FROM THE FLOOR

RBDS encoders

Audemat-Aztec (booth 6)

FMB80 and FMB10: A dynamic RBDS generator with embedded Web server, this encoder communicates with



automation software through its serial or Ethernet/TCP/IP ports to send song titles, artist information or advertising messages for immediate display on listener's radios. The unit can mix as many as 10 radio text messages, so that the user can show dynamic (coming from the automation software) and static (station's call letters, slogan, station's format) information. The encoder also features the TA flag that can override other listening choices, even tapes and CDs, when the station broadcasts an important traffic alert. The FMB10 includes the same RBDS generator as the FMB80, but with a more limited message set and simple control from a single terminal.

305-692-7555; fax 305-682-2233

www.audemat-aztec.com

contact@audemat-aztec.com

Web-based service

Enco Systems (booth 401)



Interactive: This Web-based service allows broadcasters to enhance their listeners online experience and retain them longer, by using interactive tools. It also allows broadcasters to derive revenue from the listener base and NTR revenue from clients through Short Message Service texting on mobile phones. By implementing a range of services from requests to dedications to contests, listeners can interact with the station to the level desired by the station from perceived control of music played, to actual control of music played. Mine demographic information from listeners and put the gathered information to work generating revenue and obtaining data from the most active listeners. This service works with analog radio and HD Radio.

800-362-6797; fax 248-827-4441

www.enco.com; support@enco.com

www.beradio.com

**your voice is your life.
spend it wisely.**

www.neumannusa.com/103

Neumann USA *the TLM 103*
Telephone: 860.434.5220 • FAX: 860.434.3148

“This is not your ordinary, average microphone.”

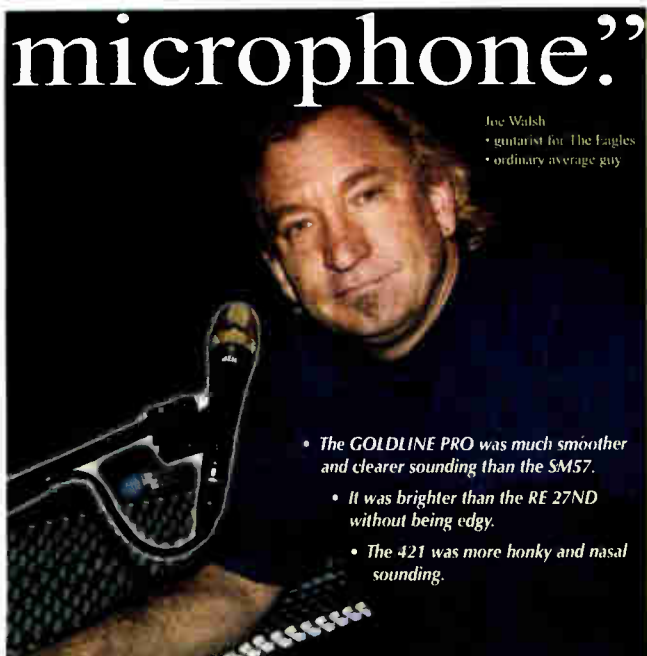

Joe Walsh
• guitarist for The Eagles
• ordinary average guy

- The GOLDLINE PRO was much smoother and clearer sounding than the SM57.
- It was brighter than the RE 27ND without being edgy.
- The 421 was more honky and nasal sounding.



Bob Heil, pioneer innovator of live sound reinforcement systems for such greats as the “Who”, the Grateful Dead, Joe Walsh, Peter Frampton, and countless others have been carefully listening to broadcast engineers, industry professionals and talented performers for many years. Bob has now allied his vast knowledge and 37 years of experience into his new line of high quality microphones and audio hardware.

The introduction of this great new product line marks the birth of the new “PROLINE” division at Heil Sound, Ltd. It is truly documented in recent product reviews that the new Heil dynamic microphone element has raised the bar for dynamic microphone technology.

This latest Heil technology captures every note and feeling with brilliant, natural articulation. Clean, clear condenser-like sound producing an exceptional rich, warm sound – the way you want it ...

The new Heil GOLDLINE PRO.



AVAILABLE AT BROADCASTERS GENERAL STORE

(352)622-7700

www.broadcasterdealer.com

www.heilsound.com

Products

FROM THE FLOOR

Audio codec/mixer

Musicam USA (booth 530)

Roadstar: Audio professionals now have a new method when sending and receiving real-time audio, ancillary data and contact closures from remote locations by this portable stereo digital audio codec. The product is based on the Netstar IP and ISDN digital audio codec. It is housed in a compact, portable enclosure with



protective elements for controls, cables and connectors. Four Neutrik XLR inputs feed labeled individual level and pan controls. Each input can be switched for mic, line or unbalanced operation. All inputs are equipped with switchable phantom power. A separate AES/EBU input can be enabled to bypass the mixer section. Analog and AES/EBU outputs for return audio are standard. The codec can send and simultaneously receive bidirectional audio via IP through its Ethernet port, and can connect to ISDN codecs through its ISDN terminal adapter. Both U and S/T ISDN interfaces are supported. Simultaneous operation on both IP and ISDN is possible. The unit communicates via G.711, G.722, MPEG 1 and 2 Layer II and MPEG 1 and 2 Layer III to ensure compatibility with older CCS and other codecs. In addition, the product includes MPEG 2 AAC, and MPEG 4 AAC Low Delay, for improved audio performance at lower bit rates. The device also supports bidirectional, uncompressed, linear audio over IP, for use over networks of sufficient bandwidth.

732-739-5600; fax 732-739-1818

www.musicamusa.com; sales@musicamusa.com

Tower construction and consulting

ERI-Electronics Research (booth 333)

Tower services: ERI's full line of single and multi-station FM antennas, self-supporting, guyed towers, combiner and filtering systems, structural engineering services, tower reinforcement products, lightning protection and enhanced grounding systems and FM IBOC implementation solutions make the company a complete one source supplier for all broadcast antenna, tower, transmission line and RF system requirements.

812-925-6000; fax 812-925-4030

www.ERInc.com; dcombs@ERInc.com

FROM THE FLOOR



RBDS encoders

Audemat-Aztec (booth 6)

FMB80 and FMB10: A dynamic RBDS generator with embedded Web server, this encoder communicates with automation software through its serial or Ethernet/TCP/IP ports to send song titles, artist information or advertising messages for immediate display on listener's radios. The unit can mix as many as 10 radio text messages, so that the user

can show dynamic (coming from the automation software) and static (station's call letters, slogan, station's format) information. The encoder also features the TA flag that can override other listening choices, even tapes and CDs, when the station broadcasts an important traffic alert. The FMB10 includes the same RBDS generator as the FMB80, but with a more limited message set and simple control from a single terminal.

305-692-7555; fax 305-682-2233

www.audemat-aztec.com

contact@audemat-aztec.com

Web-based service

Enco Systems (booth 401)



Interactive: This Web-based service allows broadcasters to enhance their listeners online experience and retain them longer, by using interactive tools. It also allows broadcasters to derive revenue from the listener base and NTR revenue from clients through Short Message Service texting on mobile phones. By implementing a range of services from requests to dedications to contests, listeners can interact with the station to the level desired by the station from perceived control of music played, to actual control of music played. Mine demographic information from listeners and put the gathered information to work generating revenue and obtaining data from the most active listeners. This service works with analog radio and HD Radio.

800-362-6797; fax 248-827-4441

www.enco.com; support@enco.com

www.beradio.com

**your voice is your life.
spend it wisely.**

www.neumannusa.com/103

Neumann USA *The TLM 103*
Telephone: 860.434.5220 • FAX: 860.434.3148

“This is not your ordinary, average

microphone.”

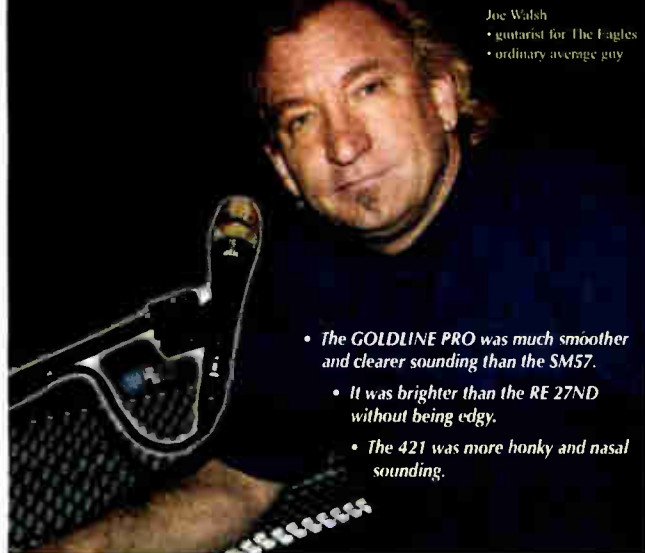

Joe Walsh
• guitarist for The Eagles
• ordinary average guy

- The GOLDLINE PRO was much smoother and clearer sounding than the SMS7.
- It was brighter than the RE 27ND without being edgy.
- The 421 was more honky and nasal sounding.



- Internal pop filter
- Wide bandwidth 40 Hz.-18 kHz.
- Low IMD
- Balanced 600 ohm Output
- 3 pin XL

Bob Heil, pioneer innovator of live sound reinforcement systems for such greats as the “Who”, the Grateful Dead, Joe Walsh, Peter Frampton, and countless others have been carefully listening to broadcast engineers, industry professionals and talented performers for many years. Bob has now allied his vast knowledge and 37 years of experience into his new line of high quality microphones and audio hardware.

The introduction of this great new product line marks the birth of the new “PROLINE” division at Heil Sound, Ltd. It is truly documented in recent product review’s that the new Heil dynamic microphone element has raised the bar for dynamic microphone technology.

This latest Heil technology captures every note and feeling with brilliant, natural articulation. Clean, clear condenser-like sound producing an exceptional rich, warm sound – the way you want it ...

The new Heil GOLDLINE PRO.



AVAILABLE AT BROADCASTERS GENERAL STORE

(352)622-7700

www.broadcasterdealer.com

www.heilsound.com

Products

FROM THE FLOOR

Audio codec/mixer

Musicam USA (booth 530)

Roadstar: Audio professionals now have a new method when sending and receiving real-time audio, ancillary data and contact closures from remote locations by this portable stereo digital audio codec. The product is based on the Netstar IP and ISDN digital audio codec. It is housed in a compact, portable enclosure with



protective elements for controls, cables and connectors. Four Neutrik XLR inputs feed labeled individual level and pan controls. Each input can be switched for mic, line or unbalanced operation. All inputs are equipped with switchable phantom power. A separate AES/EBU input can be enabled to bypass the mixer section. Analog and AES/EBU outputs for return audio are standard. The codec can send and simultaneously receive bidirectional audio via IP through its Ethernet port, and can connect to ISDN codecs through its ISDN terminal adapter. Both U and S/T ISDN interfaces are supported. Simultaneous operation on both IP and ISDN is possible. The unit communicates via G.711, G.722, MPEG 1 and 2 Layer II and MPEG 1 and 2 Layer III to ensure compatibility with older CCS and other codecs. In addition, the product includes MPEG 2 AAC, and MPEG 4 AAC Low Delay, for improved audio performance at lower bit rates. The device also supports bidirectional, uncompressed, linear audio over IP, for use over networks of sufficient bandwidth.

732-739-5600; fax 732-739-1818

www.musicamusa.com; sales@musicamusa.com

Tower construction and consulting

ERI-Electronics Research (booth 333)

Tower services: ERI's full line of single and multi-station FM antennas, self-supporting, guyed towers, combiner and filtering systems, structural engineering services, tower reinforcement products, lightning protection and enhanced grounding systems and FM IBOC implementation solutions make the company a complete one source supplier for all broadcast antenna, tower, transmission line and RF system requirements.

812-925-6000; fax 812-925-4030

www.ERInc.com; dcombs@ERInc.com

FROM THE FLOOR



ISDN codec

AEQ (booth 535)

Eagle: This 1RU, dual-channel ISDN codec can connect to U.S. and Euro ISDN networks. Connectivity is available via G.711, G.722 and MPEG Layer II algorithms to offer as much as 12kHz audio bandwidth using one ISDN B channel and up to 15kHz joint stereo or 20kHz mono, using two ISDN B Channels. The codec also features the company's LD algorithm, providing 15kHz joint stereo with low delay, using two ISDN B channels.

It also has the capacity to multiplex channels one and two. Full input and output monitoring is available via LED bargraph meters on the front panel, along with a mic and headset and an external phone connector.

954-581-7999; fax 954-581-7733

www.aeqbroadcast.com; sales@aeqbroadcast.com

LAN/WAN

Add-on module

Mediatouch (booth 423)

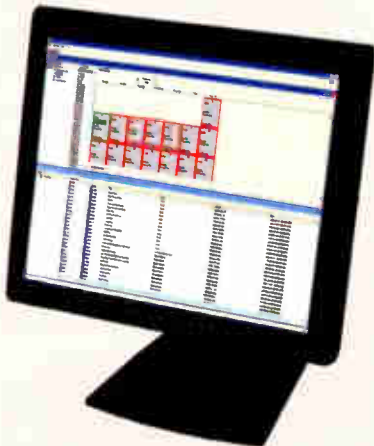

Imedia Access Server: This server, a LAN/WAN add-on module for Imediatouch, allows control of audio assets across all stations. Using a drag-and-drop interface, operators can copy audio (voice tracks, songs, commercials, IDs) to and from on-air or production studio locations. The operator can create and view on-air schedules, monitor the on-air status of a remote location and view TTA information via HTML. The module provides a wide area connectivity strategy for radio groups. It features content, scheduling and operational management functions. The system can be designed and configured for various connectivity needs. It also features remote production capabilities, audio transfer verification, schedule transfer confirmation and user security.

888-665-0501; fax 204-783-5805

www.mediatouch.net; omt@omt.net

www.beradio.com

Looking for some
free time?



You need
iMediaTouch.



Frustrated with your current digital audio delivery system?

Since 1984, over 500 radio stations around the world have trusted iMediaTouch broadcast automation software. With a host of award winning features designed to save both time and resources without breaking the bank, the iMediaTouch digital audio delivery system is easy to use and dependable time after time.

iMediaTouch broadcast automation software.
Big market dependability. Small market affordability.



To find out more call us Toll Free 888 665 0501 or download a FREE trial version at www.omt.net



THE NAB RADIO SHOW See us at the NAB Radio Show 2003 - Philadelphia, PA - Booth #423



FROM THE FLOOR

Control surface for Audio Engine Logitek (booth 527)

Remora Digital Console: The Remora is a small, modular control surface for the company's Audio Engine and can incorporate one or more pieces. The main control module incorporates fader input selection, monitor and headphone controls, and stereo VU meters along with four faders. Fader modules, containing six



faders each, can be linked to the control module as desired. Because it is simply a control surface, the faders do not have to be dedicated to specific inputs; users can set up fader assignments to accommodate individual needs and tastes. Applications for this product include news workstations, small edit suites, production rooms and on-air studios where space is at a premium. Because the unit is designed to sit on a desktop, it can be used in locations where traditional consoles are not a practical choice.

877-231-5870; fax 713-664-4479

www.logitekaudio.com

info@logitekaudio.com

Asset management Dalet Digital Media (booth 534)

DaletPlus Media Library: The library is a cost-effective turnkey solution for any organization that needs to manage and archive mass amounts of media assets. From the desktop, over a standard network, users can easily enter, catalog and archive media. Users can quickly locate and retrieve important media files or exchange their creative work among team members. Valuable media assets can be repurposed without loss of quality. The library also comes with easy-to-use editing tools for storyboarding and packaging media. The library provides an administration module for configuring workflows and privileges. From defining authorized users to automating ingest and archive procedures, administrators have maximum control. The open architecture enables users to integrate this media library with their existing infrastructure.

212-825-3322; fax 212-825-0182

www.dalet.com; sales@us.dalet.com

Stepping Up To...

Many have realized the benefits of going HD Radio with BE, as orders for new equipment and system designs have poured in since last year. Entercom, Clear Channel, Greater Media, Crawford Broadcasting, Beasley Broadcast Group, WJLD-AM (first non-experimental AM station to broadcast HD Radio), and many more have chosen BE to help them prepare for the future—the HD Radio future.

"We're excited about the impact of HD on the future of Radio. BE's solutions have the flexibility to make our implementations easy and cost-effective."

— Bob Demuth, Vice President and Chief Technology Officer
Beasley Broadcast Group, Inc.

Take your first step towards tomorrow's new radio format by calling BE at **888-232-3268** or visit us on line at www.bdcast.com.



888-232-3268

www.bdcast.com

HD Radio is the Format of the Future.

And the Future has Arrived.

©2003. HD Radio is a trademark of iBiquity. The BE emblem is a registered trademark of Broadcast Electronics, Inc.

FROM THE FLOOR

Composite STL transmitter

Marti Electronics (booth 317)

STL-20C: This is the company's latest STL transmitter, replacing the STL-15C for the 950MHz band. Several changes were made to make this a price-value leader in composite STL products. The transmitter features a new synthesizer and a new RF amplifier as well as a cooling fan. It offers more power, reliability, it runs cooler and is easier to tune.

817-735-8134; fax 817-735-9340

www.martielelectronics.com; sales@martielelectronics.com

Suppressor

LEA International

(booth 541)



DS2S: Featuring the patented Wagon Wheel design, the suppressor combines MOV and silicon technologies for suppression across all modes and features replaceable modules. The unit is UL and CSA listed and carries a standard five year unlimited warranty.

800-881-8506; fax 208-762-6099

www.leaintd.com
crassier@leaintd.com

Wireless data link

Moseley Associates

(booth 12)

Max-Link: This wireless data link consists of the Max-Link IDU and the AB-Access wireless data radio. The IDU is a full duplex packetizer for up to eight E1/T1 highways that can operate in E1 or T1 mode, and whose individual 64kb/s channels can be ATM cell networked to a composite ATM 25 port. The Max-Link IDU connects to the all-outdoor AB-Access radio by a regular CAT5 cable. The two units can be as much as 150' apart. Features of this product include a license exempt wireless link, rapid ROI, split IDU/ODU architecture, switchable ATM or IP interfaces and it is fast and easy to deploy.

805-968-9621; fax 805-685-9638

www.moseleysb.com
info@moseleysb.com

www.beradio.com



Buy one of our
DA's, Phone Hybrids or Silence Sensors
any time this year
and get a
CT-2002 Clock - up/down Timer FREE!
(a \$135.00 value)

radio SYSTEMS • 601 Heron Drive, Logan Township, NJ 08085
(856) 467-8000 • (856) 467-3044 FAX
www.radiosystems.com

CALL ONE OF THESE PARTICIPATING DEALERS



(352) 622-7700



(800) 426-8434



(800) 433-2105



(800) 438-6040

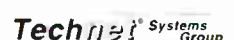

(888) 832-4638

Products

FROM THE FLOOR

Music scheduler

Prophet Systems (booth 439)

Musicgen: Prophet's music scheduler works with most digital automation systems. The scheduler is easy to use, yet allows the user to create the most complex music rotations. Now this software can be downloaded from the company's website. Features of this music scheduler include configurable output files that can be imported to most digital automation systems; easily import and export the current song library; create custom coding and base new rules on this new coding; and categorize songs and build clocks with drag and drop features.

800-658-4403; fax 308-284-4181

www.prophetsys.com; sales@prophetsys.com

Tower monitoring

Towerswitch (booth 428)

NB-5: Designed for multiple station broadcast towers, the NB-5 provides important safety and contact information in plain speech to those requiring tower access. It's an easy way to ensure compliance with FCC-mandated radiation exposure guidelines in a multi-transmitter environment. Messages may be highly customized to each tower location and are recorded on inexpensive camera-style memory cards.

561-482-7334; www.towerswitch.com; sales@towerswitch.com

Transmitter Broadcast Electronics (booth 317)

FMI-703: The FMI-703 transmitter for FM analog and HD Radio offers the flexibility to convert FM stations to HD Radio now, or function as the main transmitter for the existing FM analog service until the time comes to add HD Radio. The transmitter, available from 17W digital-only to 28,000W of combined digital and analog power, is based on the company's C-series solid state FM transmitters and S-series models, but use linearization techniques to ensure maximum efficiency and peak digital performance.

217-224-9600; fax 217-224-9607; www.bdcast.com; bdcast@bdcast.com



CUSTOM CABINETRY & PREWIRED SYSTEMS

BUILDING STUDIOS FOR OVER 34 YEARS

DESIGN



INSTALLATION



FABRICATION



SATISFACTION

RAM BROADCAST SYSTEMS, INC.

USA: 800-779-7575 • www.ramsyscom.com • CANADA: 705-487-5111

FROM THE FLOOR

Wireless transmission Comrex (booth 123)

Matrix GSM module: With the GSM Module, broadcasters can transmit high-quality remote audio over a wireless network without a telephone line or a separate wireless phone. The module incorporates a GSM wireless phone and firmware into a compact housing, compatible with all portable Matrix units. The system adds an external antenna and increased power over standard hand-held phones, resulting in improved reliability and stability. Installation takes seconds, and with the optional battery kit, the unit can broadcast in the field for as long as four hours. The updated firmware provides as much as 7kHz frequency response. The module enables broadcasters to deliver broadcast-quality audio live from sports events, press conferences, parking lots or nearly anywhere, without the hassle of installing a phone line.



800-237-1776; fax 978-784-1717; www.comrex.com; info@comrex.com

Digital on-air radio board Audioarts Engineering (booth 14)

DX-16: This console features a compact footprint and a built-in router that assigns any source to any input or monitor. The unit controls

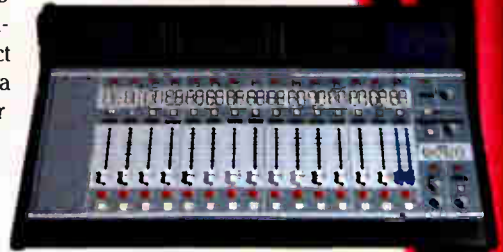

16 input channels and two caller phone channels. It is equipped with digital bargraph metering and alpha source displays. This product provides analog and digital stereo PGM and AUD, mono I and 2 output buses, in addition to four mix-minus outputs. Assignable machine control ports are opto-isolated. Direct access to rear DB-25 I/O connectors facilitate easy countertop installation.

252-538-7080; fax 252-637-1285
www.wheatstone.com; sales@wheatstone.com

Microphone preamplifier ATI (booth 536)



as well as LED readouts of signal presence and signal clipping, switchable output level meter. Other features include internal switches for input summing into multiple outputs, and active balance or transformer balanced outputs.

215-443-0330; fax 215-443-0394; www.atiguys.com; sales@atiguys.com

MMA800-XLR: The MMA800-XLR features eight mic preamplifiers in a rugged single rack space enclosure with XLR connectors in and out. Each low noise preamplifier includes a front panel selection of level, high or low gain, phase reverse and low cut filter as

RDS FM Datacasting

Use your FM RDS sub carrier to boost your audience and distinguish yourself from your competition. Display your station's call letters or slogan, song titles, artist names, and many other services...



Prices start
at \$1,350



Affordable static RDS generator **FMB10** ●
Dynamic RDS generator with embedded web server **FMB80** ●
Digital stereo generator, RDS and DARC generator, sound processor and composite clipper. **FMX410/FMX480** ●

www.audemat-aztec.com - Aventura, FL USA: tel: +1 (305) 692 7555 Fax: +1 (305) 682 2233 - ussales@audemat-aztec.com

Products

FROM THE FLOOR

Audio control surface Sierra Automated Systems (booth 435)



Rubicon: A stand-alone control surface, the Rubicon integrates seamlessly into the SAS 32KD Digital Audio Network for its mixing, switching, level control and effects. Completely modular, extensively customizable and fully programmable, this control surface is useful for a medium- or large-market facility.

818-840-6749; fax 818-840-6751
www.sasaudio.com; sales@sasaudio.com

Digital carrier power meters Coaxial Dynamics (booth 508)

Digital Watchman: The Coaxial Dynamics Digital Watchman rack-mounted station monitor/alarm is similar in function and appearance to the company's 81090 series, except that it is designed for the accurate measurement of complex RF waveforms such as CDMA (Code Division Multiple Access) and DAB signals. It will also function well with AM and FM signals. A digital station monitor/alarm system installation consists of a Digital Watchman, a dual socket line section and two digital broadcast plug-in elements for monitoring forward and reflected power. The Digital Watchman is supplied with four 25' cable assemblies for connection to the line section and elements, and a six' ac power cord. Installation requires inserting the line section and elements into the transmission line, connecting the terminals of the transmitter interlock systems to the proper terminals on the Digital Watchman and providing ac power.

800-COAXIAL; fax 216-267-3142; www.coaxial.com; sales@coaxial.com

Control and sensing system

LakeSoft (booth 433)

Airemote: This multitask control and sensing system features various input and output options that can be customized. Any combination of input and output cards can be installed in the 12 modular slots of the main chassis. As many as 64 chassis can be linked together to create a maximum capacity of 768 cards. Connections are made to each card via standard connectors. Most cards use Amphenol connectors to allow for ease of installation directly to punch blocks. The Airemote supports the English, Spanish, French, Chinese, Hungarian, Dutch and Croatian languages. It is compatible with most existing remote controls and integrates easily, allowing for expansion. In addition, RBDS encoders, automation systems, IBOC transmitters, backup playback units, audio processors and more can be interfaced via serial or TCP/IP to the unit.



866-599-5253; fax 541-967-8721; www.lakesoft.com; info@lakesoft.com

ALTRONIC
RESEARCH INC.

Complete line of RF coaxial dummy loads from 1kW to 1500 kW available in water cooled, air cooled, and self contained heat exchangers.

partnerships through performance

Altronic Research Inc.
P.O. Box 249
Yellville, Arkansas 72687
1.800.482.5623 in U.S.
870.449.4093
www.altronic.com
altronic@mtnhome.com

PETALIZED
DESIGN

C / KU DIGITAL

2° CERTIFIED

125 MPH
SURVIVAL



VARIETY OF
MOUNTING OPTIONS

MULTIBEAM FEEDS

TURNKEY SYSTEMS

LOW COST
TRANSPORTATION

CATV / BROADCAST



WWW.SEPATRIOT.COM



From the President

Dear Chief Engineer / Technician:

Thank you for expressing interest in the family of products from Patriot Antenna Systems. We are constantly looking to improve and expand our product line, while offering you superior customer service. Our goal is to provide a "One-Stop" shop, where the customer can place an entire order with one simple phone call, and receive the very best prices possible.

To accomplish our goal, we have made many changes and additions to our Patriot family of products. We recently acquired ADL Antenna Feeds and Eagle Communications. Customers who have purchased these products in the past, may now purchase them directly from Patriot, as part of a complete system.

By focusing on the future, Patriot has expanded our product line to offer transmit / receive antenna systems as well as our receive-only products. We currently hold various Type-Approvals from Intelsat, Eutelsat, and Asiasat, and each antenna conforms to the FCC 29-25 Log Theta sidelobe envelope. In addition to these Type-Approvals, Patriot manufactures the only Ka/Ka transmit/receive antenna system that has been Type-Approved by Eutelsat at Ka-Band.

To sum it up, Patriot has been very busy! Our recent acquisitions are part of a larger plan to improve and expand our product offerings. Whether you need an LNB, receiver, transceiver, fiber optic link or a complete transmit/receive system. Patriot Antenna Systems wants to be YOUR one-stop source!

Thank you for choosing Patriot,



Jeff Mathie
President

Patriot Antenna Systems



Contents



Antenna Systems

Our Complete Line of Prime Focus and Offset Antennas and Mounting Options

3



Feeds

Feedhorns Designed for Both Prime Focus and Offset Systems

5



LNBS

Quality LNBS by California Amplifier, Norsat, Patriot, and More

7

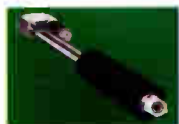

Accessories

Additional Components Make Patriot Your One-Stop Shop!

9

***Special "pullout" satellite arc chart inside!*

Terms & Conditions

Prepayment by check or wire transfer. We accept Visa, Discover, MasterCard, and American Express. Net terms are available with credit approval. Call our office to request a credit application. Pricing, availability, and product specifications are subject to change without notice. Please verify pricing and availability at time of order.

Return Policy

All claims for shortages, defects, and nonconforming goods must be made within five days of receipt of merchandise. All returns for repair must show a return authorization number. Any merchandise without an authorization number will be refused. Customers will be responsible for freight charges. Any equipment returned to stock must be returned in original packing and in new condition within thirty days. The customer is responsible for a 25% restocking charge. All credits are merchandise credits.



Prime Focus Antenna Systems

Antenna Size	C-Band Gain	Ku-Band Gain	F/D Ratio	Mount Type	Shipping Weight	Price
1.8 m	35.7 dBi	45.6 dBi	0.45	Az-El/Polar	223 lbs	\$450.00
2.0 m	36.9 dBi	46.5 dBi	0.3	Az-El/Polar	260 lbs	\$520.00
2.4 m	38.5 dBi	48.1 dBi	0.34	Az-El/Polar	310 lbs	\$585.00
2.8 m	39.8 dBi	49.4 dBi	0.3	Az-El/Polar	405 lbs	\$745.00
3.1 m	40.7 dBi	50.3 dBi	0.336	Fixed Az-El	385 lbs	\$915.00
				Polar	385 lbs	\$930.00
				Navigator	590 lbs	\$2,835.00
3.8 m	42.4 dBi	52.1 dBi	0.413	Fixed Az-El	705 lbs	\$2,170.00
				Fixed K.P.	1,335 lbs	\$4,050.00
				Navigator	820 lbs	\$4,500.00
				Motorized DAKP	1407 lbs	\$4,680.00
4.5 m	43.1 dBi	53.1 dBi	0.35	Fixed Az-El	964 lbs	\$6,640.00
				Fixed K.P.	1,600 lbs	\$7,400.00
				Motorized DAKP	1,670 lbs	\$7,985.00
5.0 m	44.95 dBi	53.4 dBi	0.488	Fixed K.P.	1,510 lbs	\$10,850.00
				Motorized DAKP	1,960 lbs	\$14,875.00
6.1 m	46.24 dBi	55.2 dBi	0.4	Fixed K.P.	2,900 lbs	\$21,875.00
				Motorized DAKP	3,420 lbs	\$29,800.00

K.P. = King Post Mount, **DAKP** = Dual Axis King Post Mount

800.470.3510 • www.sepatriot.com • 517.629.5990

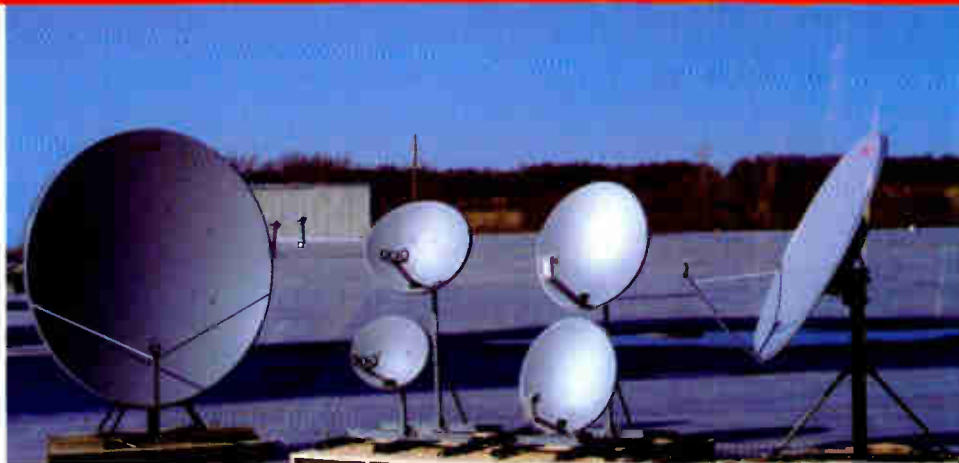

Offset Antenna Systems

Antenna Size	Ku-Band Gain	Beamwidth	Shipping Weight	Price
Commercial				
1.0 m	40.7 dBi	1.7°	96 lbs	\$115.00
1.2 m	42.1 dBi	1.4°	127 lbs	\$145.00
1.8 m	45.6 dBi	.9°	329 lbs	\$365.00
2.4 m	48.0 dBi	.7°	550 lbs	\$1,080.00
Cost Effective				
.60 m	35.8 dBi	3.1°	12 lbs	\$32.00
.76 m	37.1 dBi	2.6°	16 lbs	\$38.00
.90 m	38.8 dBi	2.0°	25 lbs	\$49.00
1.1 m	40.2 dBi	1.8°	69 lbs	\$89.00
1.2 m	42.2 dBi	1.4°	108 lbs	\$120.00
1.5 m	44.0 dBi	1.1°	150 lbs	\$210.00
1.8 m	45.5 dBi	.9°	245 lbs	\$265.00
Elliptical				
.76 m	37.1 dBi	2.4°	22 lbs	\$42.00
.84 m	38.8 dBi	2.3°	24 lbs	\$43.00

Patriot Antenna Systems



**Professional
C & Ku Feeds**

ANTENNA FEEDS

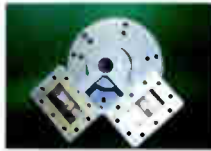

ADL Antenna Feeds

ADL-KU-801 US Ku-Single 11.7-12.5 GHz Linear w/Servo	\$55.00	ADL-KU-901 US Ku-Dual 11.7-12.5 GHz Linear, Manual	\$50.00
ADL-KU-805 Euro Ku-Single 10.95-11.7 GHz Linear w/Servo	\$55.00	ADL-KU-905 Euro Ku-Dual 10.95-11.7 GHz Linear, Manual	\$50.00
ADL-RP1-C 3.7-4.2 GHz / TI Single Polarity C-Band (Linear) with Servo	\$65.00	ADL-RP1-CP-300 3.7-4.2 GHz / TI Single Polarity C-Band (Circular) Manual	\$195.00
ADL-RP1-CKU 3.7-4.2 GHz / 10.95-11.7 OR 11.7-12.5 GHz TI Single C-Band & Single Ku Feed (Linear) with Servo	\$115.00	ADL-RP1-CP-400CKU 3.7-4.2 GHz / 10.95-11.7 OR 11.7-12.5 GHz Single C-Band (Circular) & Single Ku Feed (Linear) with Servo	\$410.00
ADL-RP1-CP-400 3.7-4.2 GHz / TI Single Polarity C-Band (Circular) with Servo	\$295.00	ADL-RP1-OR-100 3.7-4.2 GHz / TI Dual Polarity C-Band (Linear) Manual	\$150.00
ADL-RP1-CPOR-100 3.7-4.2 GHz / TI Dual Polarity C-Band (Circular) Manual	\$360.00	ADL-MOTKUDL 11.7 - 12.5 GHz Ku-Band Dual Polarity Motorized Feed with Pot. (Linear)	\$825.00
ADL-RP3-C 3.7-4.2 GHz / Adjustable C-Band (Linear) with Servo	\$65.00	ADL-RP3-OR-100 3.4-4.2 GHz / Dual Polarity Extended C-Band (Linear)	\$85.00
ADL-RP3-AZOP-122 3.7-4.2 GHz / 11.7-12.5 GHz Dual C & Dual Ku Skewable Ortho-Mode Feedhorn with Gears and Pot.	\$1,375.00	ADL-RP3-CKU 3.7-4.2 GHz / 10.95-11.7 OR 11.7-12.5 GHz Adjustable C/Ku Feed (Linear) with Servo Motor	\$115.00

More Quality Feedhorns

Feedhorns

Patriot Tx/Rx Transmit Ku-Band Feed/OMT/Filter	TX-FDKULOMT	\$65.00
Patriot Tx/Rx Transmit Ka-Band Feed/OMT/Filter	TX-FDKALOMT	\$68.00
Patriot Single Polarity Ka-Band Feed	PRT-KA100	\$42.00
Patriot Single Pol Ku-Band rx prt-feed Linear	PRT-OF100	\$17.00
Patriot Single Pol Ku-Band rx ptx-feed Circular	PTX-OF150	\$15.00
Patriot Dual Polarity Ku-Band OMT (requires feed)	PRT-OF200	\$20.00
Patriot Dual pol DBS LNBF Prime Focus	PRT-PFLNBF	\$89.00
Seavey Single Pol Linear Ku-Band Feed	SVY-ESA120	\$175.00
Seavey Single Pol Circular Ku-Band Feed	SVY-ESA120C	\$220.00
Seavey Dual Pol Linear Ku-Band Feed	SVY-ESA1212	\$180.00
Seavey Dual Pol Linear Ku-Band Motorized w/Pot	SVY-ESR1212-2	\$1,025.00
Seavey Single C-Band Linear Feed	SVY-ESA40-2	\$97.00
Seavey Dual C-Band Linear Feed	SVY-ESA44-2	\$285.00
Seavey Dual C-Band Linear Motorized w/Pot	SVY-ESR44-2	\$1,100.00
Seavey Single Pol Circular C-Band Feed	SVY-ESA40C-2	\$370.00
Seavey Dual Pol Circular C-Band Feed	SVY-ESA44C-2	\$560.00
Seavey C/Ku-Band 4-Port Feed (fixed)	SVY-ESA124D	\$700.00
Seavey C/Ku-Band 4-Port Motorized w/Pot	SVY-ESR124D	\$1,950.00
Chaparral Dual C-Band 1329 Feedhorn	CHAP-1329	\$85.00
Chaparral Single C-Band Superfeed	CHAP-SUPER	\$30.00
Channel Master Ku Single Pol Feedhorn	CHA-FCKU	\$18.00
Offset Feed Cover for PRT Antennas	COVR-OF	\$15.00
Standard Feed Cover - 2 pc. W/ Locking Ring	COVR-STD	\$30.00
Feed Cover for Seavey Feed Systems	COVR-SVY	\$115.00



Patriot and Norsat LNBs

>> Norsat and Patriot made by the same manufacturer.



New



Patriot LNBs - C-Band DRO 3.4 - 4.2 GHz

C-Band LNB +/- 500 KHz, 20 K	PAT-8520	\$90.00
C-Band LNB +/- 500 KHz, 15 K	PAT-8515	\$99.00
C-Band LNB +/- 150 KHz, 15 K	PAT-8115	\$110.00
C-Band LNB +/- 1 MHz, Minimag, 15 K	PAT-BC4036	\$35.00

Patriot PLLs - C-Band 3.4 - 4.2 GHz

C-Band PLL +/- 25 KHz, 20 K	PAT-3520	\$218.00
C-Band PLL +/- 10 KHz, 20 K	PAT-3220	\$225.00
C-Band PLL +/- 5 KHz, 20 K	PAT-3120	\$385.00
C-Band PLL +/- 5 KHz, 25 K	PAT-3125	\$360.00

Patriot LNBs - Ku-Band DRO 11.7 - 12.2 GHz

Ku-Band +/- 500 KHz, .6 dB	PAT-4506	\$90.00
Ku-Band +/- 250 KHz, .6 dB	PAT-4206	\$118.00
Ku-Band +/- 150 KHz, .6 dB	PAT-4106	\$165.00

Patriot PLLs - Ku-Band 11.7 - 12.2 GHz

Ku-Band +/- 25 KHz, .8 dB	PAT-1208	\$230.00
Ku-Band +/- 10 KHz, .7 dB	PAT-1107	\$295.00
Ku-Band +/- 5 KHz, .7 dB	PAT-1507	\$337.00

Norsat LNBs - C-Band DRO 3.4 - 4.2 GHz

C-Band LNB +/- 500 KHz, 20 K	NOR-8520	\$109.00
C-Band LNB +/- 250 KHz, 15 K	NOR-8215	\$145.00
C-Band LNB +/- 150 KHz, 15 K	NOR-8120	\$155.00

Norsat PLLs - C-Band 3.4 - 4.2 GHz

C-Band PLL +/- 25 KHz, 20 K	NOR-3520	\$269.00
C-Band PLL +/- 10 KHz, 20 K	NOR-3220	\$275.00

Norsat LNBs - Ku-Band DRO 11.7 - 12.2 GHz

Ku-Band +/- 500 KHz, .6 dB	NOR-4506A	\$115.00
Ku-Band +/- 150 KHz, .6 dB	NOR-4106A	\$195.00

Norsat PLLs - Ku-Band 11.7 - 12.2 GHz

Ku-Band +/- 100 KHz, .8 dB	NOR-11008LA	\$237.00
Ku-Band +/- 25 KHz, .7 dB	NOR-1208HA	\$275.00
Ku-Band +/- 10 KHz, .7 dB	NOR-1107HA	\$365.00

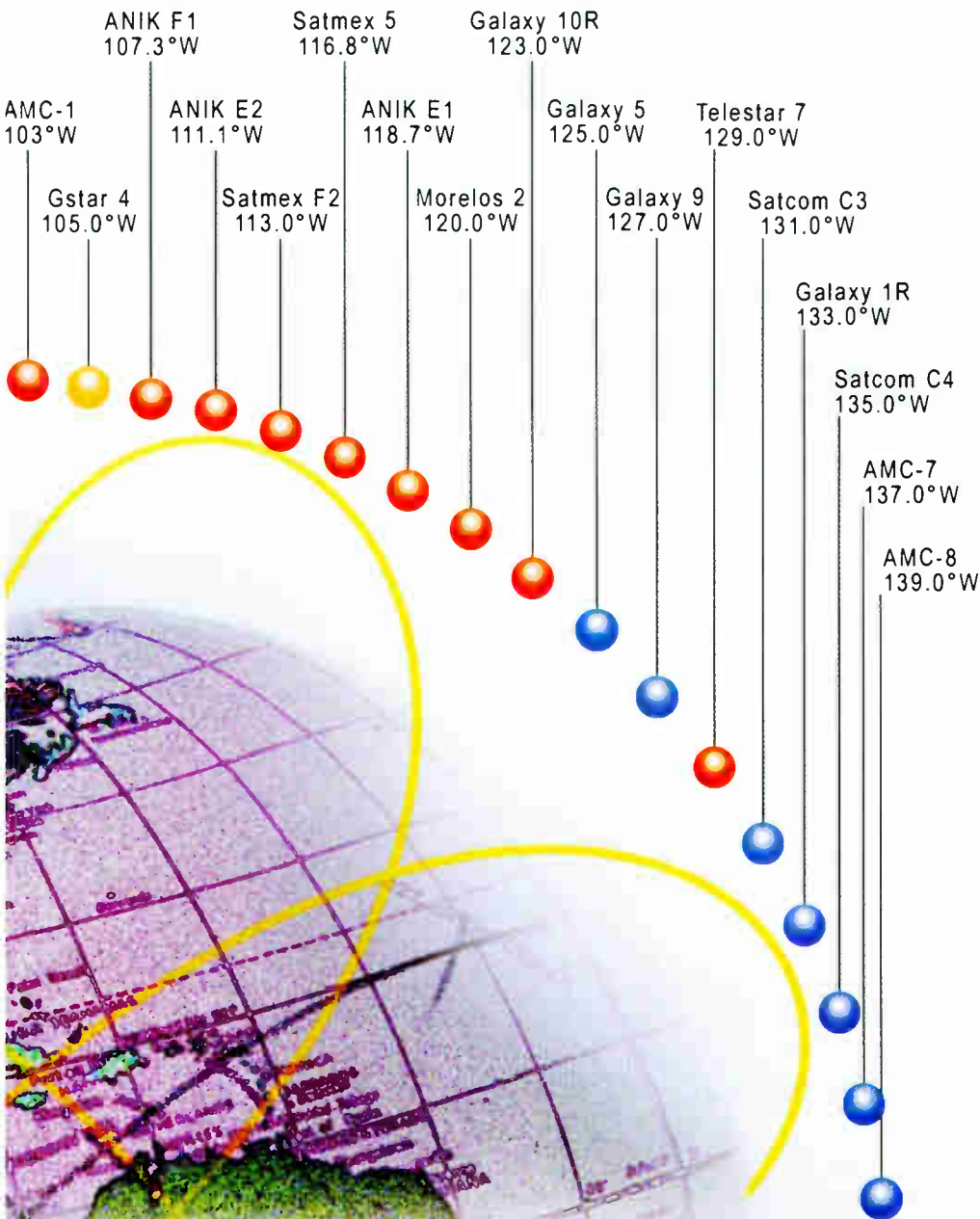

atriot.com

510 Toll Free or +1.517.629.5990



Featured Patriot Packages

Broadcast (Motorized)

4.5m Motorized Dual Axis Kingpost Antenna **\$ 9,350**

Galvanized King Post Mount, Actuators, Dual Axis Controller, 2-port C/Ku Feedhorn, and Digital Ready LNBS.

(3.8m Dual Axis King Post Package @ \$ 6,150.00)

3.8m Motorized Navigator Dual Axis Antenna **\$ 5,999**

Actuators, Dual Axis Controller, 2-port C/Ku Feedhorn, and Digital Ready LNBS.

(Optional 4-port Motorized Feedhorn @ \$ 1,375.00)

Cable (Fixed)

3.8m Single Satellite Receive Package **\$ 2,150.00**

3.8 meter Fixed Az/EI Antenna, Dual C-Band Feedhorn, Digital Ready LNBS.

3.8m Multiple Satellite Receive Package **\$ 3,000.00**

3.8 meter Fixed Az/EI Antenna, Dual Multifeed, Digital Ready LNBS.

(Optional Three Feed System additional \$400.00)

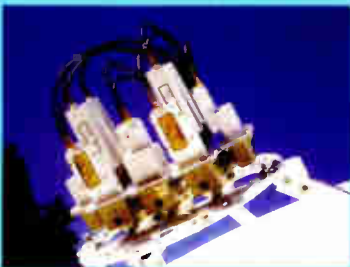

NEW! Motorized Tx/Rx Remote Systems



- Base Footprint of 50x80x23 inches
- Auto Locate and Smart Jog Controller options
- Flex waveguide kits for interface with any RF transmitter
- Includes cabling and wiring harness
- 180 Lbs
- 360° Travel



VSAT SNG Packages

1.2m SNG Mount with Ku Feed \$ 8,970.00

Reflector mounted on base. Ku-Band motorized feedhorn, Cros-Pol Filter/OMT.

Ku-Band Freq. 10.75-12.75 Rx, 13.75-14.5 Tx

1.8m SNG Mount with Ku Feed \$ 19,400.00

Reflector mounted on base. Ku-Band motorized feedhorn, Cros-Pol Filter/OMT.

Ku-Band Freq. 10.75-12.75 Rx, 13.75-14.5 Tx

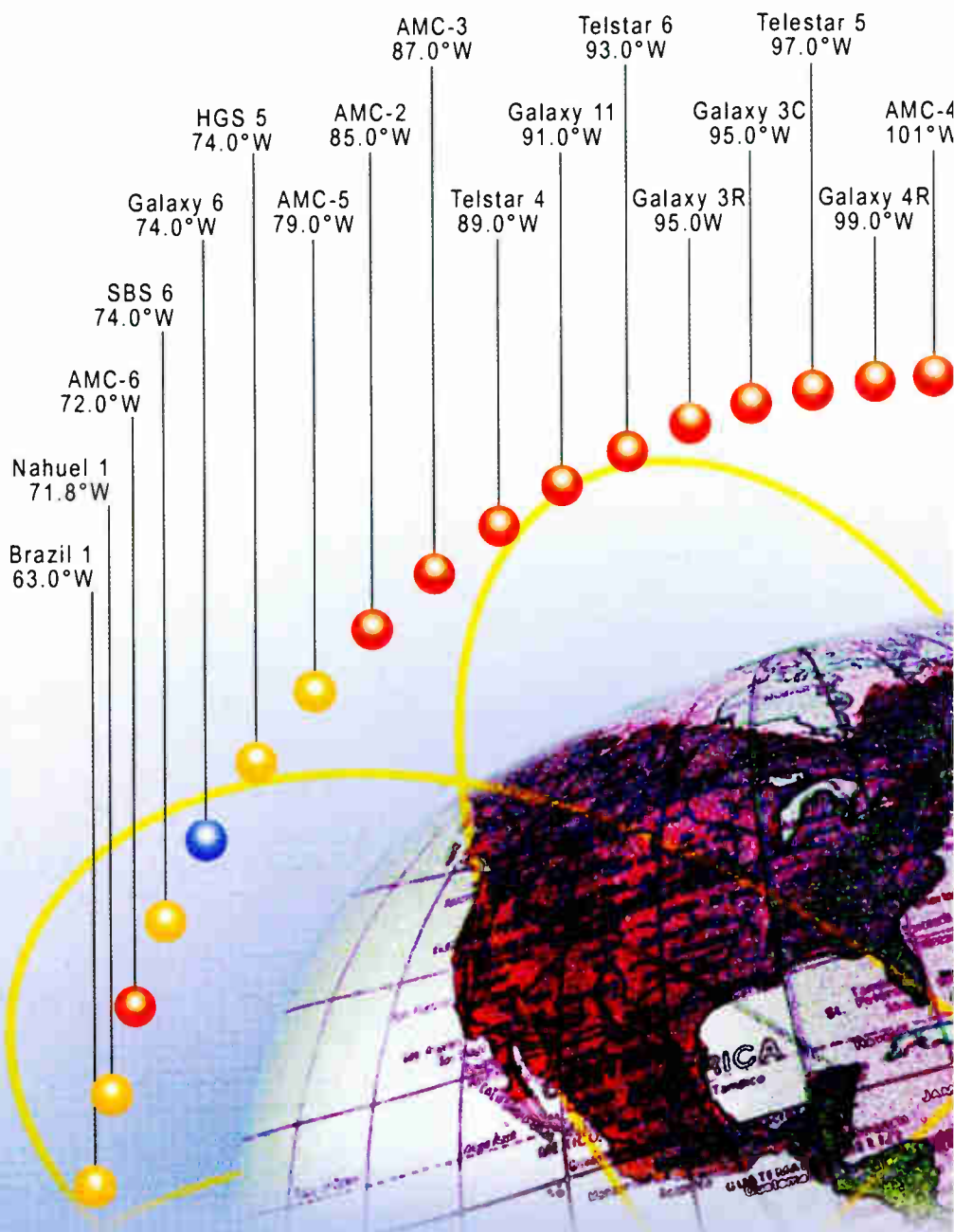

- C-Band
- Ku-Band
- C/Ku Hybrid

www.sepa.com

Albion, MI 49224 USA • 800.470.4700

California Amplifier LNBs

Cal - Amp LNBs

DBS Dual LNB (DirecTV or Dish)	CA-150517	\$23.00
C-Band Digital Pro II 17K +/- 500KHz	CA-140105-17	\$120.00
C-Band PLL LNB 20K +/- 12KHz	CA-140194-20	\$290.00
C-Band PLL LNB 25K +/- 125KHz (3.7-4.2 GHz)	CA-140230	\$195.00
C-Band PLL LNB 20K +/- 125KHz	CA-140194-1	\$200.00
<hr/>		
Ku-Band PLL LNB +/- 25KHz 11.7-12.2GHz	CA-150338	\$325.00
Ku-Band PLL LNB +/- 210KHz 11.7-12.2GHz	CA-150338-1	\$225.00
Ku-Band DBS LNB w/Tx reject filter +/- 1.5 MHz	CA-150743	\$98.00
US High Stability Ku-Band .7dB (11.7-12.2 GHz)	CA-150279	\$105.00
US Ku-Band LNB .7dB	CA-150262-6	\$70.00
US Ku Wideband LNB	CA-150223	\$119.00

Miscellaneous LNBs

Patriot Ku-Band Digital LNB +/- 500KHz .6 dB	PRT-AK21LCW	\$99.00
Patriot Ka-Band LNB +/- 1MHz	PRT-KA210	\$185.00
Patriot Ku-Band LNB Linear 11.7-12.2 GHz, 10.75 LO	PRT-AP8/8D	\$18.00
Patriot Ku-Band DBS LNB-dish/Directv 12.25-12.75	PRT-HGLNBFD	\$22.00
Patriot C-Band Mini-Mag LNB 15K +/- 1MHz	PRT-BC4036	\$35.00
<hr/>		
Pro-Brand Ku-Band US LNB for WSNET	PB-STK57OF	\$75.00
Pro-Brand Single pol Ku-Band Lnb 1 output (11.7-12.2)	PB-170SKU	\$45.00
Pro-Brand Dual pol Ku-Band LNB 2 output (11.7-12.21)	PB-270DKU	\$52.00
Pro-Brand DBS 12.25-12.75 GHz LNB (DTVdual)	PB-LNBF-D	\$23.00

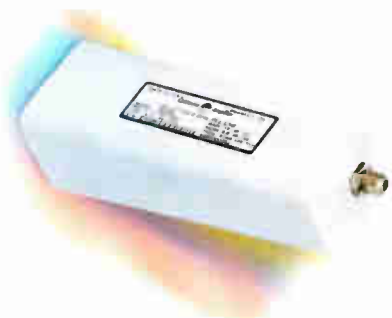

>> **Patriot is the only master distributor of the California Amplifier product line.**

Receivers & Controllers



Receivers

Motorola 4DTV	MOT-4DTV	\$799.00
Chaparral Free-to-air Digital Receiver	CHAP-DSR100	\$375.00
General Instruments DSR 4500	GI-DSR4500X	\$2,550.00
General Instruments DSR 406V	GI-DSR406	\$650.00
Digital Digi II SDR7100	STD-SDR7100	\$1,600.00
Digital Digi II DSR4001	STD-DSR4001	\$1,600.00
Standard Agile Omni Global Broadcast Receiver	STD-MT930BR	\$2,900.00
Standard MT900C Broadcast Receiver	STD-MT900C	\$1,900.00
Standard Agile IRDSC	STD-IRDSC	\$1,050.00
Standard MT630	STD-MT630	\$440.00
Standard MT650	STD-MT650	\$775.00
Standard Digital Receiver 422CI	STD-422CI	\$3,100.00

Controllers & Software

RCI 1000A Single Axis Controller	RCI-1000A	\$740.00
RCI 1500A Single Axis with Feed	RCI-1500A	\$1,250.00
RCI 2000A Dual Axis Controller	RCI-2000A	\$1,600.00
RCI 2000C Dual Axis Controller	RCI-2000C	\$2,025.00
RCI 2KPOL Option Feed Drive	RCI-2KPOL	\$325.00
RCI Smart Booster	RCI-SMART	\$400.00
Pulse Generator for Polorotor Feeds	AST-P6762	\$135.00
Auto-Pilot 2 x 16 Automated Software	RCI-APDLM2/16	\$1,635.00
Auto-Pilot 4 x 16 Automated Software	RCI-APDLM4/16	\$2,585.00



800.470.3510 • www.sepatriot.com • 517.629.5990

De-Icing Systems - Prime Focus

1.2 Meter w/Back Cover - 100% with feed de-ice	ETI-120-100	\$865.00
1.8 Meter w/Back Cover - 50% with feed de-ice	ETI-180-50	\$1,200.00
3.1 Meter w/Back Cover - 50% with feed de-ice	ETI-310-50	\$2,685.00
3.8 Meter w/Back Cover - 50% with feed de-ice	ETI-380-50	\$3,170.00
3.8 Meter w/Back Cover - 100% with feed de-ice	ETI-380-100	\$3,900.00
4.5 Meter w/Back Cover - 50% with feed de-ice	ETI-450-50	\$3,600.00

>> Inquire about additional sizes

Snow Covers

1.8 Meter Prime Focus Snow Cover	CS-180-PF	\$180.00
2.0 Meter Prime Focus Snow Cover	CS-200-PF	\$180.00
2.4 Meter Prime Focus Snow Cover	CS-240-PF	\$230.00
2.8 Meter Prime Focus Snow Cover	CS-280-PF	\$250.00
3.1 Meter Prime Focus Snow Cover	CS-310-PF	\$280.00
3.8 Meter Prime Focus Snow Cover	CS-380-PF	\$365.00
4.5 Meter Prime Focus Snow Cover	CS-450-PF	\$600.00

>> Inquire about additional sizes

Multi-Beam Feed Systems

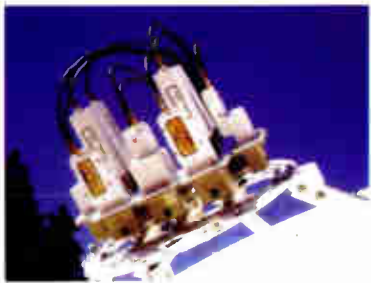

Multi-Beam Feed Systems

Dual Beam Feed for 3.1 (Specify Antenna & Sats)	SUP-310-2	\$710.00
Dual Beam Feed for 3.8 (Specify Antenna & Sats)	SUP-380-2	\$865.00
Triple Beam Feed for 3.8 (Specify Antenna & Sats)	SUP-380-3	\$1,085.00
Quad Beam Feed for 3.8 (Specify Antenna & Sats)	SUP-380-4	\$1,300.00
Dual Beam Feed for 4.5 (Specify Antenna & Sats)	SUP-450-2	\$1,100.00
Triple Beam Feed for 4.5 (Specify Antenna & Sats)	SUP-450-3	\$1,300.00
Quad Beam Feed for 4.5 (Specify Antenna & Sats)	SUP-450-4	\$1,500.00
Five Beam Feed for 4.5 (Specify Antenna & Sats)	SUP-450-5	\$1,750.00
Dual Beam (2) Ku-Band LNBF for Offset Antennas	PRT-MBLNBF	\$89.00

Actuators



Patriot 24" Ball Screw Heavy Duty	PRT-ACT24	\$165.00
Patriot 36" Ball Screw Heavy Duty	PRT-ACT36	\$285.00
Thomson-Saginaw 24" Ball Screw	TS-24BRL	\$260.00
Thomson-Saginaw 36" Ball Screw	TS-36BRC	\$395.00
Thomson-Saginaw 36" Ball Screw	TS-36BHC	\$415.00
Actuator Clamp Kit	TS-CLMP	\$35.00

TI Filters

Terrestrial Interference Bandpass Filter (copper)	FLT-MFC-7892	\$449.00
Terrestrial Ku-Band Bandpass Filter	FLT-MFC-9349	\$399.00
Multi-Beam TI Filter (thinner aluminum unit)	FLT-MFC-13961	\$380.00
Terrestrial Interference Filter (light weight unit)	FLT-CEC-458TI	\$350.00

Test Equip. & Headend Accessories

Satellite Signal Finder	PM-2050	\$89.00
Compass & Inclinator	SUN-CLCOMP	\$225.00
Spectrum Analyzer (Avcom)	PSA-37D	\$2,950.00

Cable & Accessories (Priced per Foot)



Co-Axial RG-6 Cable (400 ft. spools only)	CAB-RG-06	\$0.09
Co-Axial RG-11 Cable	CAB-RG-11	\$0.28
15 Lead Control Cable (250, 500, 1000 ft.)	CAB-CC-15L	\$1.95
Ribbon Cable - All-in-One	CAB-RG-01	\$0.50
Jumper 100ft RG-6 with F-connector	CAB-RG6-1002	\$11.75

Splitters / Power Dividers

2-Way L-Band Splitter	MCR-102	\$11.00
4-Way L-Band Splitter	MCR-104	\$19.00
8-Way L-Band Splitter	MCR-108	\$29.00
Rack Unit, 4 sets of 1x4 split w/ zero loss, LNB Powering	LS2150A/4	\$575.00
Rack Unit, 1x12 split with zero loss, LNB Powering	LS1200A-112	\$270.00
8x1 L-Band Rotary Switch	ORS1000	\$885.00
16x16 L-Band Switch	SRM2150-1616	\$14,200.00
Panamax Surge Suppression	PRT-PANAMAX	\$199.00
Lightning Surge Suppressor (in line)	DTK-VSPA	\$79.00
Lightning Surge Suppressor (8 outlet AC/2 F-conn Coax)	DTK-DSS	\$99.00

Web Accessories

B2C2 PCI Card with CD Driver for ISPs	B2C2-PCI	\$99.00
B2C2 USB Modem Box with CD Driver for ISPs	B2C2-USBMOD	\$149.00

Cal - Amp Wireless Products

Planar Array, 31 Channel	CA-2240/200 /100	\$90.00
Dipole, 31 CH High Gain (IF 222-408 MHz)	CA-2040-020A	\$77.00
LNBY, 31CH (IF 222-408 MHz)	CA-131534	\$65.00
Integrated Downconverter, 31 Ch, IMMDC, RDR, 22 dB	CA-2040/220A	\$90.00
Power Supply, 110V	CA-71109	\$14.00
Feed Assembly 21 dBi	CA-130120	\$27.00
21 dBi Reflector	CA-130093	\$27.00
Feed Assembly 24 dBi	CA-130135	\$32.00
24 dBi Reflector	CA-130094	\$32.00
Extender Tube Kit for 24 dBi Reflector	CA-90017	\$6.50
Antenna Assembly-Super Grill 24 dBi Reflector	CA-131555	\$48.00

Fiber Optic Products

Foxcom L-Band Transmitter High Power	FOX-7000T	\$2,459.00
Foxcom L-Band Receiver	FOX-7000R	\$1,959.00
Foxcom Rack Chassis & Power Supply	FOX-7000M	\$989.00
Foxcom Redundant Power Supply	FOX-7000S	\$775.00
Foxcom L-Band Trans Card (Short Distance)	FOX-7320T	\$1,425.00
Foxcom L-Band Rec Card (Short Distance)	FOX-7320R	\$1,125.00
Foxcom Outdoor Enclosure Unit w/Power Supply	FOX-4000	Call for Price



Mounting Options

Patriot Single-Tray Non-Pen 1.8-2.4 Plr, 1.8 Tx 4" OD	PTX-NP400S	\$420.00
Patriot Dual-Tray Non-Pen 2.4-2.8 Plr, 1.8 Tx 4" OD	PTX-NP400D	\$590.00
Patriot Single-Tray Non-Pen 1.8-2.4 Az-El 5½" OD	PTX-NP550S	\$480.00
Patriot Dual-Tray Non-Pen 2.4-2.8 Az-El 5½" OD	PTX-NP550D	\$650.00
Patriot Triple-Tray Non-Pen 2.8-3.1 Az-El 5½" OD	PTX-NP550T	\$695.00
NPR for PTX 60 - 1.2 and PRT 1.0/1.2 low wind	PTX-NP238S	\$35.00
NPR for PTX 1.1 & 1.2 and PRT 1.0 & 1.2 high wind	PTX-NP238D	\$58.00
NPR for .90 - 1.2 tx/rx Commercial Version low wind	PTX-NP300S	\$38.00
NPR for 1.2 tx/rx Commercial & 1.5 PTX high wind	PTX-NP300D	\$62.00
Baird PL-2 Non-Penetrating Mount	BRD-PL2	\$925.00
Baird PXL-2 Non-Penetrating Mount	BRD-PXL2	\$1,375.00
Baird PXL-2 Non-Pen - Heavy Duty	BRD-PXL2HD	\$2,885.00
Baird AFC Non-Pen - Heavy Duty 16 x 16	BRD-AFCHD	\$5,585.00
NPRM Padding (width:4ft) price per foot	PTX-NPRPAD	\$6.00
5ft. Pipe Stand with 5 1/2" OD w/ Bolt & Temp Kit	PRT-PST550	\$300.00
5ft. Pipe Stand with 6 5/8" OD w/ Bolt & Temp Kit	PRT-PST658	\$315.00
10ft. Pipe with 5 1/2" OD w/ Rebar	PRT-P550-10	\$315.00
10ft. Pipe with 6 5/8" OD w/ Rebar	PRT-P658-10	\$325.00
Bolt & Template Kit for 3.8/4.5/5.0 Meter King Post	PRT-BTK-38455	\$250.00
Bolt & Template Kit for 6.1 Meter King Post	PRT-BTK-610	\$475.00

Patriot Antenna Systems

Inquire About Patriot's Other Publications:

VARIETY OF
MOUNTING OPTIONS

LNBS
FEEDHORNS

C-BAND
KA-BAND
KU-BAND



BETTER SURFACE
ACCURACY

EASY
INSTALLATION

LINEAR
CIRCULAR
UNIVERSIAL

DBS/DTH



WWW.SEPATRIOT.COM

DBS / DTH Antennas

60 cm Offset Antenna with Universal Mount	PTX-060UNV	\$32.00
76 cm Offset Antenna with Universal Mount	PTX-076UNV	\$38.00
90 cm Offset Antenna with Universal Mount	PTX-090UNV	\$49.00
1.1 Meter Offset Antenna w/ Az-El Pole Mount	PTX-110AZ	\$89.00
1.2 Meter Offset Antenna w/ Az-El Pole Mount	PTX-120AZJ	\$120.00
1.5 Meter Offset Antenna w/ Az-El Pole Mount	PTX-150AZJ	\$210.00
1.8 Meter Offset Antenna (3½" O.D. Pipe Req.)	PTX-180AZJ	\$265.00

Caribbean Antenna Packages

1.2 m with Tilt-Mount and Multiple Satellite Feed System (110° / 119°)	PTX-120AZ-CAR	\$188.00
---	---------------	----------

DBS Accessories

12.25-12.75 Circular Ku LNBF Dual-Polarity for Prime Focus Dishes (DirecTV & Dishnet)	PRT-PFLNBF	\$89.00
3.7-4.2 GHz / 11.7-12.5 GHz Adj Dual C & Dual Ku LNBF	ADL-RP3+DBS	\$187.00
DBS Dual LNBF (DirecTV or Dish)	CA-150517	\$23.00

800.470.3510 • www.sepatriot.com • 517.629.5990

TX/RX
EQUIPMENT

RADIOS

LNBS

C-BAND
KA-BAND
KU-BAND



BETTER SURFACE
ACCURACY

EASY
INSTALLATION

LOW PRICE

LARGE
PRODUCT LINE

VSAT



WWW.SEPATRIOT.COM

VSAT Antenna Packages

.90 m Antenna with Az/EI Mount, Feed/OMT/Reject Filter 1.5-Watt Ku BUC, LNB ±500 KHz	\$535.00
1.0 m Antenna with Az/EI Mount, Feed/OMT/Reject Filter 1.5-Watt Ku BUC, LNB ±500 KHz	\$550.00
1.2 m Antenna with Az/EI Mount, Feed/OMT/Reject Filter 1.5-Watt Ku BUC, LNB ±500 KHz	\$585.00
1.8 m Antenna with Az/EI Mount, Feed/OMT/Reject Filter 1.5-Watt Ku BUC, LNB ±500 KHz	\$840.00

Additional VSAT Antennas and Components

1.2 m SNG Mount with Skewable Ku-Band Feed, Reflector mounted on base, Ku-Band feedhorn, Cros-Pol Filter/OMT (Ku-Band Frequency Range 10.75-12.75 Rx, 13.75-14.5 Tx)	TXSNG-120KU	\$8,970.00
1.2 m Ku-Band Tx/Rx Antenna (Intelsat) Reflector, Az/EI Head (2-7/8 - 3" OD), Ku-band feedhorn, Cros-Pol Filter/OMT (Ku-Band Frequency Range 10.7-12.75 Rx, 13.75-14.5 Tx)	TXINT-120KU	\$180.00
2.4 m Single Optics C-Band Linear (FCC) Reflector, Az/EI Head (6 5/8 in OD), C-band feed horn, Cros-Pol Filter/OMT (C-Band Frequency Range 3.625-4.2 Rx, 5.85-6.425 Tx)	TXFCC-240CSL	\$1,885.00
Smart Jog Controller	RCI-3050A	\$3,150.00
Auto Locate Controller	RCI-3000A	\$5,485.00

Ask about our NEW 3.0 and 3.8 meter offset antennas

Patriot Antenna Systems



704 N. Clark St. • Albion, MI 49224 USA
800.470.3510 • 517.629.5990 • 517.629.6690 fax

www.sepatriot.com

NAB Radio EXHIBITORS

452 Chelmsford Entertainment	11
615 Music Library	615
AEQ	535
American Blues Network	2
Arbitron	113
Armstrong Transmitter	18
Army National Guard	409
ATA Audio	16
ATI - Audio Technologies Inc.	536
Audemat-Aztec	6
Audioarts	14
Auditronics	14
BIA Financial Network	426
BMI	8
Broadcast Electronics	317
Broadcasters General Store	509
Business TalkRadio	4

CMBE	17
Coaxial Dynamics	508
Communication Graphics	514
Comrex	123
Connecticut Schools of Broadcasting	513
Dalet Digital Media Systems	534
Date Nation	101
Dick Robinson's American Standards	513
Dielectric Communications	223
dMarc Networks	339
Emkay Designs	529
Enco Systems	401
Energy-Onix	329
ERI-Electronics Research	333
FamilyNet	10

Show floor hours

Wednesday, October 1 - 5 p.m. to 8 p.m.
 Thursday, October 2 - 8 a.m. to 4 p.m.
 Friday, October 3 - 8 a.m. to 2 p.m.

issue advertisers shown in red

Info current as of Aug 26, 2003

Digilink-Xtreme

the NEXT generation for DLII, DLIII, and DL-IV systems...

... The #1 manufacturer of satellite automation systems for Radio introduces

Digilink-Xtreme, the most important advance in Radio automation in more than a decade.

Combining the best of PC computers and the best of professional Broadcast audio hardware,

Arrakis re-invents Satellite automation, ... again !



only **\$2,495** plus PC

call 970-461-0730 ext 329



arrakis systems inc. www.arrakis-systems.com (970) 461-0730

NAB Radio EXHIBITORS

Federal Communications Commission	631
FirstCom Music	310
Gepco International	415
Ibiquity Digital	336
InterTech Media	311

IVP New Media	15
LakeSoft	433
Larcant	533
LEA International	541
Logitek Electronic Systems	527
LPB Communications	313
Mackay Communications	510
Marketron	417

Marti	317
Media Professional	
Insurance	430
Mediaguide	323
Mediatouch	423
Megatrax	613
Miller, Kaplan, Arase	327
Moseley Associates	12
Musicam	530
National Weather Service .	107
Nautel	429
NPR Satellite Services	307
Preston-Patterson	301
Prophet Systems	
Innovations.....	439
Radian Communications	
Services	434
Radio Advertising Bureau...	634
Radio magazine	7
Radio Music License	
Committee	636
Radio Systems	408
Radiotechniques	614
RCS	539
RedLine Press.....	5
Register Data Systems.....	414
Roll a Sign	308
Rules Service Company	512
S.W.R.	331
SCA Promotions	13
Scott Studios	9
Shively Labs	424
Sierra Automated Systems .	435
SmartRadio	201
Staco Energy Products	411
StratosAudio.....	143
Superior Electric	432
The Earadio	543
The Media Audit	129
Towerswitch	428
Valcom	407
V-Soft Communications	436
Wheatstone	14

New Simian 1.5

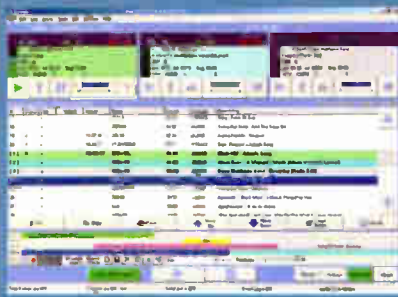

Simian
digital automation
Just \$1499

Simian 1.5 makes your life easier. Its Windows-based design is easy to use, and it keeps things running smoothly.

The new Simian includes additional production mode capability, the ability to save different sessions of Simian and launch them from different desktop icons, and more.

Simian is still the most feature-complete automation in the industry and provides powerful, reliable automation for stations in the US and around the world.

Thousands of users have discovered how easy and versatile BSI Simian really is.

Test and try before you buy.

Broadcast Software International
1925 Bailey Hill Road, Suite A
Eugene, OR 97405
www.bsiusa.com
888-BSI-USA1 (888-274-8721)
info@bsiusa.com

Para el español, llámadla Felipe Chavez,
Distribuidor de los E.E.U.U.
(916) 368-6332
fchavez@ommedianet.com



issue advertisers shown in red

Info current as of Aug 26, 2003

Exhibit HALL

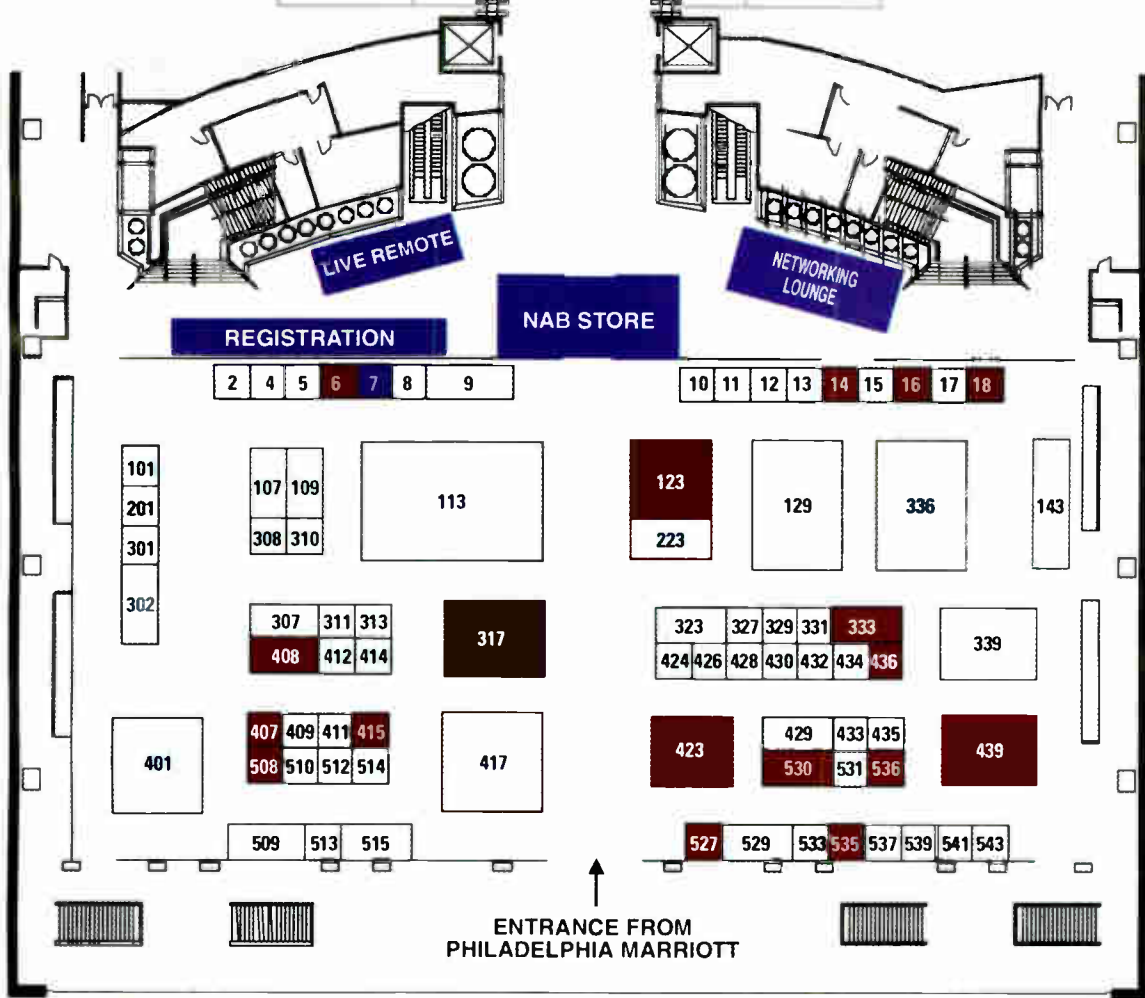
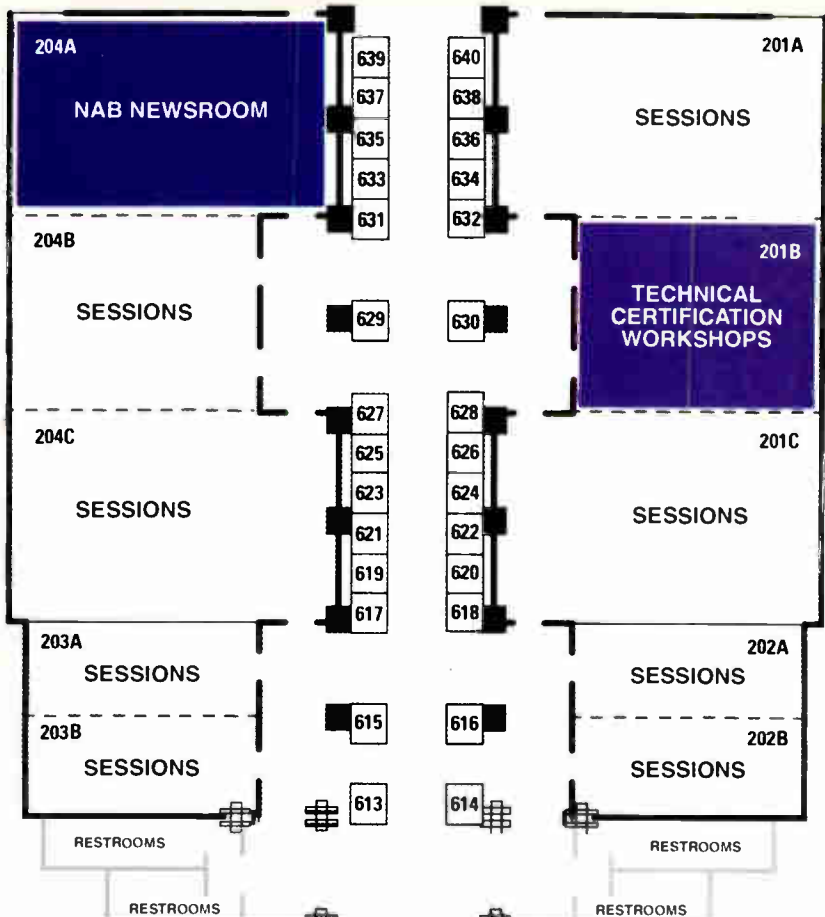

An aerial night photograph of Philadelphia, Pennsylvania. The skyline is illuminated with various colors, including blues, yellows, and reds. In the foreground, a multi-lane highway with light trails from traffic runs diagonally across the frame. A large, multi-story brick apartment building is prominent in the middle ground. The overall scene is a vibrant cityscape at dusk or night.

The Roots of Radio run deep in Philadelphia.

By Chriss Scherer, editor

Philadelphia today is known for many things, ranging from outdoor public art to cheese steak sandwiches. But Philadelphia has a long history with radio as well. At one time, our nation's former capitol was the seat of the dominant radio broadcast manufacturing company RCA. During our preparation for the NAB Radio Show in Philadelphia, we were reminded of the role that this city has played in radio's development. Many manufacturers have roots in or near Philadelphia. Other companies, while located elsewhere, can claim ties to Philadelphia and RCA

as well. As radio continues to look forward to its future, this gives us good reason to look back at our past to see how so many companies are able to trace links back to the city of brotherly love.

For many years, RCA called the Philadelphia area home with its manufacturing facility in Camden, NJ. In time, other radio broadcast manufacturers took roots in Philadelphia, many of which were started by former RCA employees. This long and sometimes complex history has many interesting twists that now stretch beyond the Philadelphia area.



The Roots of Radio

Four into one

When the United States entered World War I, the transatlantic radiotelegraph station at New Brunswick, NJ, was taken over by the U.S. Navy. The radiotelegraph station was owned by the Marconi Wireless Telegraph Company of America, which was a division of the British Marconi Company. General Electric, at the Navy's request, upgraded the 50kW Alexanderson alternator with a 200kW unit. The Marconi company did not want to finance the upgrade, so GE paid for the installation, which provided the Navy with reliable transoceanic communication. On March 1, 1920, the radiotelegraph station was returned to Marconi.

British Marconi, knowing that the station would return to its possession one day, began negotiations with GE to purchase additional Alexanderson alternators for its American and British divisions. When the Navy learned of this potential transaction, it intervened, knowing that the sale would result in foreign interests having a monopoly on global communications.

Navy Rear Admiral W.H.G. Bullard, director of communications of the Navy, proposed that GE

organize an American radio-operating company—controlled wholly by American interests—to keep U.S. interests in worldwide communications.

GE ceased negotiations with British Marconi and focused on creating the proposed corporation. The plan was to purchase American Marconi and obtain the rights to use various radio circuits that were owned by other companies. Tentative agreements were made, each being contingent on the confirmation of the complete package.

On Oct. 17, 1919, the Radio Corporation of America (RCA) was established. On Nov. 20, 1919, the American Marconi Company was officially merged with the Radio Corporation of America. On this same date, a cross-licensing agreement was initiated between RCA and GE. On July 1, 1920, a cross-licensing agreement was concluded with GE and AT&T. By another agreement on the same date, these rights were extended to RCA and the Western Electric Company. A similar cross-licensing agreement between RCA and the Westinghouse Electric and Manufacturing Company was signed June 30, 1921.

Originally, RCA was formed as an operating company for the purpose of providing ship-to-shore communication. In 1929, the three partners consolidated their research and development, manufacturing and marketing. It had no manufacturing facilities until RCA acquired the Victor Company in 1929 for \$154 million and later established RCA Radiotron in 1930.

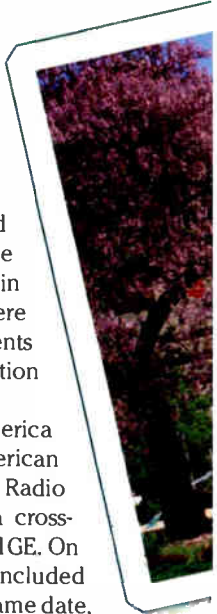

CONDON
BROADCAST ENGINEERING

The Call Screener for Windows®

Discover what it can do
for your talk shows!

- Control your studio Telos® or Gentner® phone system from anywhere in the world!*
- Receive screening/phone status from anywhere in the world!*
- Clear, easy to read screens
- Reliable & easy to use!
- Talk Show Host friendly!



* With a TCP/IP connection

One-time charge...no yearly fees!
Site licenses available.
Group & Network pricing! Affordable!

The Call Screener for Windows®
For more info, pricing and a free demo,
log on to www.cbsoftware.cc



NAGRA

ARES-P-II . . . LINEAR & FAT 16 format

- New DSP and Audio PCBs
- Linear recording possible
- All files standard Broadcast Wave format
- Flashcard formatted FAT16
- Flashcard recognized by PC or MAC
- Markers can be inserted during record and playback
- Compressed recording up to 384kb/s (Stereo)
- New 'Vortex' filter reduces wind noise
- Phantom power available
- Separate line output connection

*Existing ARES-P / RCX220 can be upgraded with new DSP board to add many of the above features.

Nagra USA, Inc.

800 813-1663

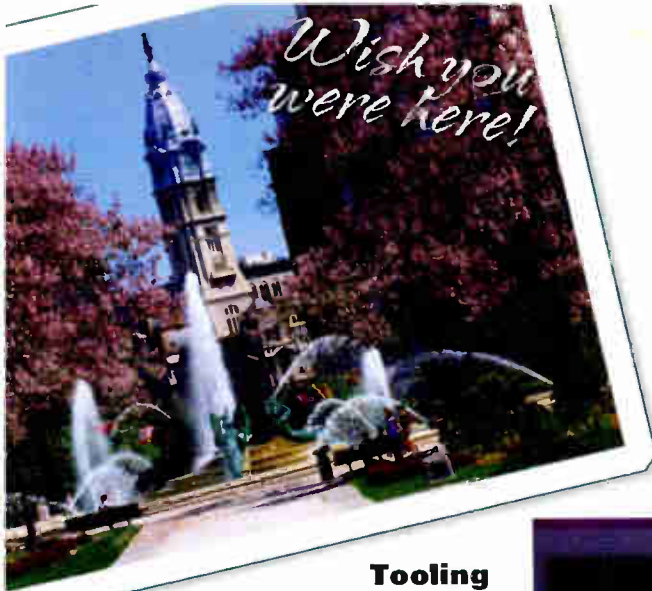

Tooling for an empire

On purchasing the Victor Company, RCA was able to establish a manufacturing presence. RCA had interests that spanned all elements of broadcasting, from origination at the studio and network to the final receiver. It was the broadcast manufacturing in Camden that became the powerhouse until 1986. The Camden facility also housed the communications and government equipment manufacturing operations.

Growth and expansion is a natural course for any company or individual. As RCA continued to thrive, talented individuals would also seek their own growth potential and move to begin their own companies. It was through these changes that many radio manufacturers have their roots in Philadelphia.

One of the better-known results is CCA, but it was preceded by another company called ITA. Bernie Wise left RCA in 1957 and formed ITA, which he operated until 1962 when he sold it to Triangle Publications. ITA manufactured transmitters. When ITA was sold, Wise founded CCA, which he operated until 1974. While with CCA, Wise purchased a division of Ampex that later became Comark. Since then, CCA has been through several owners.

CCA and ITA later spawned new companies as employees would leave to pursue their own careers and goals.

For example, Belar was founded around 1975 when Arno Meyer left ITA where he was a transmitter engineer. At the time FM stereo was making its inroads and Meyer had the idea to develop a stereo modulation monitor. ITA wasn't interested in the idea so Meyer left and started his own company.

When ITA was sold, some of the employees went to CCA and others went to AEL. AEL, based in Lansdale, PA, was founded in 1951 and began working on contract projects for the University of Pennsylvania, the Navy and Philco. In 1952, AEL became a supplier of UHF TV antennas for RCA. AEL

manufactured FM radio transmitters starting about 1962, and AEL manufactured broadcast transmitters well into the 70s, but eventually left broadcast and continued with government contracts.

QEI was founded in 1971 by broadcast professionals who had previously worked for Belar and AEL. As CCA was making its mark, the company was interested in manufacturing its own modulation monitors and frequency analyzers. QEI was formed to manufacture monitors that would be branded for CCA. QEI also manufactured a synthesized

Bridging the gap between
radio and the Internet.

WARP
radio

www.warpradio.com

Distance and Time Mean Nothing

303.799.9118

sales@warpradio.com

Coaxial Dynamics'

Line of Liquid/Air Terminations are quickly becoming the industry standard for testing, adjusting and alignment of R.F. Transmitters.

Liquid/Air Cooled Loads are available to handle requirements from 600W to 12.5kW.



COAXIAL DYNAMICS

SPECIALISTS IN RF TEST EQUIPMENT & COMPONENTS

15210 Industrial Parkway, Cleveland, OH 44135
 216-267-2233 800-COAXIAL FAX: 216-267-3142
 E-Mail: coaxial@apk.net
 Web Site: <http://www.coaxial.com>



your
 signal
 picture
 sound
 message
 vision
 reputation
 is only as good
 as your
cable



CABLE, CONNECTORS,
 ASSEMBLIES, PATCHBAYS,
 PANELS & ACCESSORIES



1-800-966-0069 www.gepco.com email: gepco@gepco.com

The Roots of Radio

phase-locked loop oscillator module for CCA.

In a similar way, CSI was formed by former CCA employees Bernie Gelman and Joe Ponist. CSI was founded around 1973 and ceased manufacturing in the early 80s. CSI manufactured transmitters and used QEI exciters that were branded with the CSI name.

LPB was founded by Dick Crompton in 1960 to manufacture a 5W, carrier-current AM transmitter for low-power and college stations. While the company does not claim an origin to RCA,

LPB became involved with RCA in 1979 when it was contracted to manufacture a series six-, eight- and 10-

channel stereo audio consoles for RCA.

Guffy Wilkinson founded Wilkinson Electronics in the 60s after he left ITA.

Wilkinson Electronics was sold to TTC in 1990, which was then sold to Larcan in 1993.

Another former ITA employee is ATI founder Ed Mullin.

Ed Shively worked at RCA and then went on to ITA to make antennas. He later started his own company, which he moved to Maine. Phelps

Dodge also started working with FM antennas through ITA.

Dr. Charles Brown, who designed antennas for RCA and tested them at the antenna test range in Gibbsboro, NJ, formed Dielectric in 1942. Dielectric moved to Raymond, ME, in 1954. Dielectric bought the TV and FM antenna division of RCA in 1986, closing the Gibbsboro range and moved the test facility to Maine.

Ampro was founded by Alex Meyer about 1970. His preceding company manufactured audio consoles and cart machines for RCA. Ampro was started so that the company's equipment could be sold through other channels.

There are undoubtedly more manufacturers that could be added to this list. In some cases, no formal history exists. In other cases, exploring the ties would be a long and tedious process. If you have some history that you would like to share, let the *Radio* magazine staff know. While RCA is no longer manufacturing broadcast equipment today, the legacy of the company's roots in Philadelphia survive through other companies still in business today.

References for early RCA history:

Saga of the Vacuum Tube, by Gerald Tyne, which originally appeared as a series of articles in Radio News from 1943 to 1946

Personal interview with Dr. Robert Lane, president emeritus, Midland Antique Radio Collectors Club, Kansas City, MO.

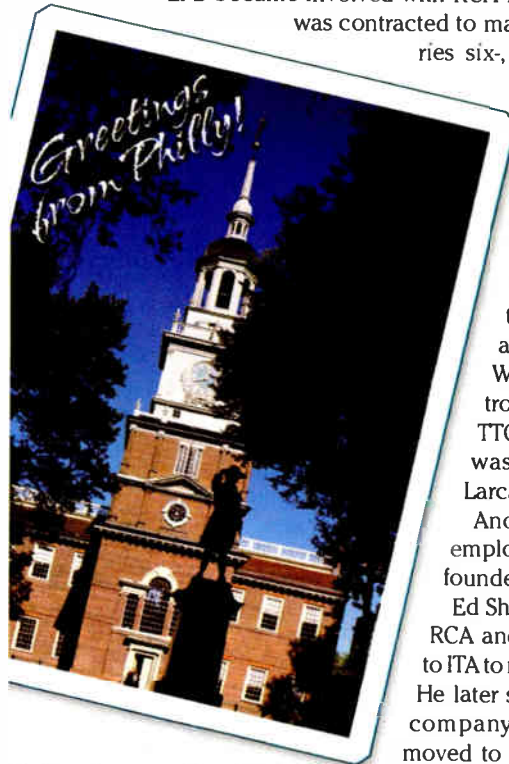

Radio history in Philadelphia — the receiver side

The radio connection to Philadelphia also touches the receiver side. RCA is still a popular brand name in consumer electronics, and its history goes back to Philadelphia as well.

But RCA isn't the only receiver manufacturer that called this area home. There are two other names that are well known and several more that tried their hand at radio receiver manufacturing.

RCA

RCA was the exclusive radio sales agent for the four largest electrical manufacturing companies: General Electric (which had bought American Marconi), AT&T, Wireless Specialty Apparatus and Westinghouse. These four companies owned nearly every practical patent for radio, made most of the commercial equipment, manufactured vacuum tubes and had strong ties to international companies. Through the 1920s, RCA did not actually manufacture anything itself, but rather had its name on products made by the four partner companies.

In 1929, it was decided that the conglomeration of these companies was a monopoly, and they were forced to disband. About that time, RCA bought the Victor Company, a manufacturer of phonograph players, so that RCA would be able to continue as a manufacturer. (Victor manufactured

a few radios in 1928 that did not sell well.)

The first radio receivers to carry the RCA brand name were the Radiola models. The Radiola 1, a

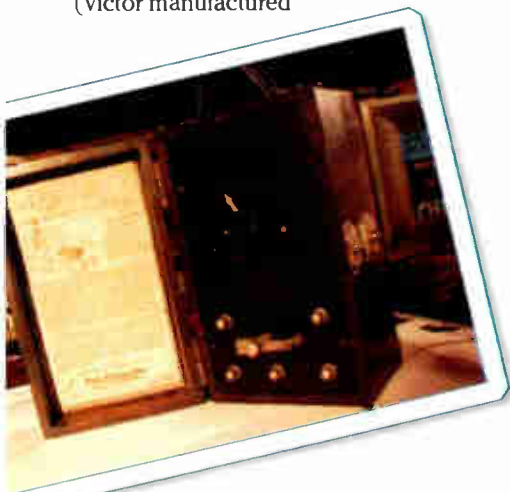

The Radiola 1 was RCA's first mass-produced crystal radio set. This unit was manufactured in August 1922 by General Electric.

SCMS, INC.

YOU-KNOW-WE-KNOW-RADIO!

SPREAD TOO THIN AND FEELING DRAINED?

- ▶ Experienced Staff
- ▶ 26 Years of Personal Service
- ▶ Competitive Prices for over 600 Quality Manufacturers of New Equipment
- ▶ Huge Stock of Rebuilt RF and Audio Gear
- ▶ Extensive Rental Fleet (Audio, RF, Codecs, Test Equipment, and more!)
- ▶ Trade-Ins Welcomed

TRY SCMS ON FOR SIZE - WE CAN FILL YOUR NEEDS

WEST COAST

Doug Tharp
Voice 866.673.9267
Cell 818.398.7314
Email dtharp@san.rr.com

CENTRAL

Bernie O'Brien
Cell 731.695.1714
Email bernieob@earthlink.net

MID-SOUTH

Bob Mayben
Voice 877.391.2650
Fax 256.543.0595
Email bobmayben@usa.net

SOUTH-WEST

Tyler Callis
Cell 817.312.6338
Email tylercallis@integrity.com

MID-WEST

Mary Schnelle
Voice 1.800.245.4307
Fax 513.583.1343
Email mschnelle@maryschnelle.com

NORTH-EAST

Dan Lohse
Voice 908.722.6015
Fax 908.722.4359
Pager 877.792.8024
Email scmsnorth@aol.com

CORPORATE SALES OFFICE - PINEVILLE, N.C.

Toll FREE 800.438.6040 Fax 704.889.4540

Email sales@scmsinc.com

www.scmsinc.com

The Roots of Radio

crystal set, was manufactured in 1923. The wooden case opened on two sides. The front lid exposed the tuning control and connec-



The Radiola Special (1923) was designed for portable and outdoor use and was housed in a metal case. This radio used a Radiotron UB199 tube. This unit was manufactured by the Wireless Specialty Apparatus Corporation.



This Radiola RS (1923) had a square wooden case and used two tubes. This model was manufactured by Westinghouse.

tions for the antenna and headphones. The rear compartment provided a space to store the owner's headphones. The Radiola II was a similar unit, but used two tubes in the tuning section.

Atwater Kent

Founded in 1902 and originally created to build small electrical items and automobile parts, the Atwater Kent Manufacturing Company began manufacturing radio components in 1922. The first

Modular Sound Isolation Studios



For the best performance, choose a modular enclosure from Acoustic Systems for your new studio's sound foundation.

ACOUSTIC SYSTEMS
The science of silence

800/749-1460
FAX: 512/444-2282
www.acousticsystems.com
e-mail: info@acousticsystems.com

It's New!



FlipJack FJ-500
3 channel cell phone interface

- Two headphone jacks
- Two Mic inputs & Line Input
- Connection To A Standard Telephone Line.
- Operates on "AA" batteries or external power
- Balanced Line Level Output
- Small Size: 1.5"H x 4.8"W x 4.5"D
- Tuner input for off-air monitoring
- LED level indicator

www.conex-electro.com

GONEX ELECTRO SYSTEMS

1602 Carolina St. P.O. Box 67 Bellingham, WA 98227
360-734-4323 FAX 360-676-4822
EMAIL: conex@conex-electro.com

800-645-1061

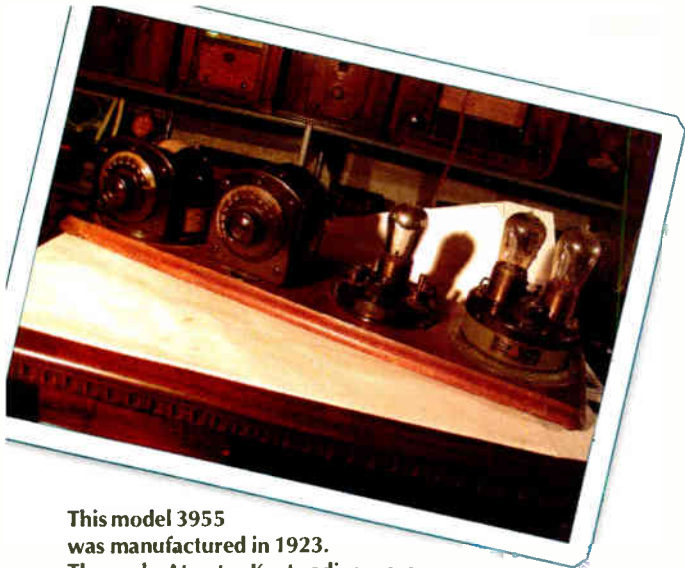

This model 3955 was manufactured in 1923. The early Atwater Kent radios were based on this open breadboard design.

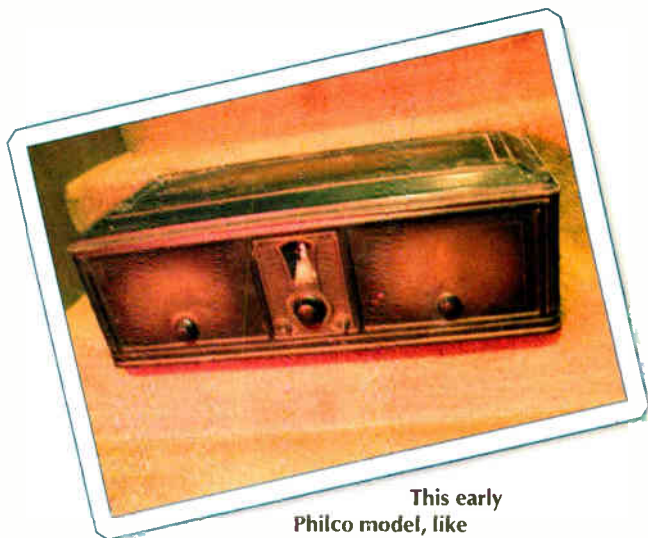

This early Philco model, like other early models, was housed in a metal case. The metal cases were soon replaced by wooden cases, mainly for aesthetic reasons.

models were breadboard styles, built on wooden planks. By 1924, the company began selling radios in wooden cabinets. From 1925 to 1927, the company sponsored the Atwater Kent Radio Hour. As was the case with many companies, Atwater Kent was unable to survive during the depression and closed in 1936.

Philco

In 1906 the Philadelphia Storage Battery Company was founded to build batteries and powersupplies. In the early 1920s battery sales began to decline until a new market appeared: radio receivers. In 1927, the company began manufacturing radio receivers. In 1930 Philco led the industry in radio receiver sales and remained one of the top radio sellers through the 1950s. In 1960, the company's profits were suffering and the company was sold to Ford.

Other manufacturers

Appleby had a short run at manufacturing. The company's model 60 was a table-top unit with a wooden, low, rectangular case. The front panel was made of metal and two dials and a meter on it. The top lifted for internal access.

Heteroplex manufactured the Deluxe model in 1925. This table-top radio operated on batteries, had three tubes, a two-dial front panel, a top door and was housed in a low, wooden, rectangular case.

Music Master traces its roots to 1908 when Sheip and Vandegrift began manufacturing wooden horns for phonographs under the trademark of Music Master. In the company changed its name to Music Master. It began manufacturing radios by 1925, but was out of business by 1926 because of financial difficulties and mismanagement. Several different models were produced with designs using five, six or seven tubes. Most of the models were table radios, but a few console-style units were also made.

Norden-Hauck was in business in 1926 and made a 10-tube table radio that measured 36" long. This unit was called the

Super-10 Admiralty. The company also manufactured a model called the Universal.

Viz, a division of the Molded Insulation Company, manufactured the RS-1 in 1947. This table radio featured a plastic case and round front dial. It operated on batteries or ac power.

The photos are of units in the collection of Dr. Robert Lane, Leawood, KS.

Simple • Effective • Reliable



Con/Air Switcher

eliminates delay from headphone monitor
monitor audio can be individually tailored
immediate warning on air signal failure
air signal is not altered in any way
optional rack mount panel available

model cas-1



Telephone Announcement System

digital message storage - no moving parts
variable outgoing message format
inactive or defective line indicator
resettable incoming call counter
temperature in Fahrenheit or Celcius
battery backed AC synchronized clock
low cost system - no leased equipment

model tas-1



Message Board Controller

converts status inputs to LED display data
15 prioritized logic-level signaling inputs
momentary or maintained signal inputs
fully programmable display with graphics
pre-programmed "starter" messages
multiple displays from one controller
(display device shown not included)

model mbc-1

innovative solutions

nashville, tennessee • 615.228.3500 voice • 615.227.2393 fax-on-demand • www.sinesystems.com



Passing time in Philly

By Kari Taylor

Once the NAB Radio show floor is closed for the day, what are attendees supposed to do to pass the time? To avoid sitting in a hotel room watching television, try one of these suggestions:

- **The Battleship New Jersey Memorial and Museum** is home to the Battleship USS New Jersey, which is the most decorated warship. The battleship is 11 stories high and nearly three football fields long. Visitors can take guided tours through simulated operations areas spanning five deck levels. It is open daily from 9 a.m. to 5 p.m. See www.battleshipnewjersey.org for more details.

- **Independence National Historical Park** is definitely a place to visit for attendees interested in history. From the Liberty Bell to Independence Hall, visitors will gain first-hand knowledge about the United States' history. But if you want to see the historic buildings on Independence Square, get tickets ahead of time because free timed tickets are required for the tours.

- Also in the historical park is **Carpenter's Hall**. The hall was built in 1774 and just weeks after its completion, the hall hosted meetings of the First Continental Congress. Carpenter's Hall offers exhibits and presentations from 10 a.m. to 4 p.m. Tuesday through Sunday with free admission.

- For anyone who enjoys Italian cuisine, the **Italian Market** in south Philadelphia is worth exploring. The market is the oldest and largest working outdoor market in the United States. For more information visit www.phillyitalianmarket.com.

- Halloween is only a month away, and for people who want to celebrate early, a ghost tour through the streets of Philadelphia is a perfect way to commemorate the holiday. At www.ghosttour.com, guests will find several tours to choose from, including walking tours and trips through haunted houses.

- For visitors who would like to stay indoors, the **Franklin Institute Science Museum** offers sightseers more than a dozen interactive learning environments, including **Fels Planetarium** and an **IMAX Theater**. The museum is open 9:30 a.m. to 5 p.m. and admission costs \$12.75. See www.fi.edu for more details. ■



Photo by Comcast-Spectacor; Copyright Philadelphia Convention & Visitors Bureau

Philadelphia Focus

The technology leaders in the Delaware Valley

QEI Corporation Williamstown, NJ

Founded in 1971 in Philadelphia, QEI has been a leader in the design and manufacture of broadcast monitoring and transmitting equipment for more than 30 years.

Through the years QEI has developed innovative and reliable products for broadcast. QEI engineers developed the first commercial syn-

thesized phase-lock loop exciter (Type 675), the famous 691

FM modulation monitor, and the first commercial high-power solid-state FM transmitter (model 695T1KW). QEI continues to manufacture a full line of FM broadcast transmitters (20 watts to 30kW), FM exciters, 691 modulation monitor and the CAT-LINK STL/TSL for broadcasters throughout the world.



www.qei-broadcast.com
800-334-9154

AudioScience New Castle, DE

AudioScience Sound Cards: Built For Broadcast. These sound cards are designed for today's fast-paced digital broadcasting world, with innovative features such as TSX Time Scaling, which can expand or compress audio by up to 20 percent while preserving pitch and clarity, MRX Multi-Rate Mixing, which allows users to record, mix and playback multiple streams simultaneously with differing sample rates, and MP3 compression that uses onboard DSP to allow

recording and playback of MPEG-1 Layer II and MP3 formats. If you're serious about audio, go with the brand that's Built for Broadcast: AudioScience.



www.audioscience.com
302-324-5333

Studio Technology Malvern, PA



Studio Technology designs, constructs, delivers and installs studio furniture to the broadcast industry nationwide. Broad-based design and construction expertise

enables the company to provide a range of custom furniture to its clients. Studio Technology can provide a simple custom configuration that is competitive with modular furniture pricing, as well as higher-end furniture using solid surface or other alternative materials. Studio Technology now owns and maintains production facilities on both sides of the country. This enables us to increase our production capability while reducing shipping costs. Studio Technology has participated in major consolidation projects on both coasts and in Hawaii. The company will work with any systems integrator or your local staff and provides complete delivery and installation of the furniture it manufactures.

www.studiototechnology.com
610-640-1229

Radio Systems Bridgeport, NJ



Radio Systems specializes in quality audio equipment and studio accessories

for broadcasters. Our products include:

- Millennium Mixing Consoles are available in 6, 12, 18 and 24 channel models. No other consoles provide the level of quality and features at such an affordable price.
- The CT-2002 Clock and Timing Systems, an inexpensive multi-display analog or digital system for multiple studios.
- Radio Systems Studio Products, including the DA-8, DA-16, DA 2x4a and DA 4x4a Distribution Amplifiers, and the DI-2000 and TI-101 Telephone Hybrids.
- Our newest product, StudioHub+, is a wiring system made up of pre-made patch cables, RJ-45 connectors, special connecting blocks and companion amplifiers that are all designed to plug together easily and work together in any studio. Because StudioHub+ uses CAT-5 data cable, it works equally well for analog and digital studio wiring.

www.radiosystems.com
856-467-8000

Inside Automation

By Chris Scherer,
editor

These computer-based systems have evolved beyond simple audio storage and playback tasks.

Consolidation and technological advances have made radio automation affordable and necessary for modern broadcast facilities. In response to the industry, automation systems are becoming better described as digital-asset management systems. Simple cart replacement isn't the goal anymore. Stations expect digital playback systems to help manage media inventories, automatically record and insert live feeds and voice tracks, work seamlessly with satellite formats and operate as a live assistant for shows. The need for interaction, control and insertion from a distance has become extremely important, as have WAN-based media sharing and the ability to manage multiple stations from a central site.

Most manufacturers have addressed these needs, and now these systems offer much more than basic radio automation.

Many systems take advantage of interaction with rich media associated with radio and audio content. This capability has direct applications as stations exploit their Internet presence. Automation systems can send "now playing" data to Web pages, and some companies offer solutions that allow listeners to hear radio on specially designed audio players with a station logo and sponsor ad space, as well as methods for Internet listeners to click and find out more about the music or spot being played or even begin a purchase process. This type of interactivity is being refined, but expect this information and extra features to be a part of future digital radio iterations.

Use this information as a beginning, following up the research by contacting the manufacturer or the broadcast equipment dealer for more information.

Resource Guide

A sample of available radio automation systems and some complimentary applications.

II Software



Jockey Pro runs on Windows 98 SE, 2000 or XP and uses standard Windows sound cards. The system includes Internet Time Sync and the Auto Go To Feature, which automatically jumps the loaded playlist to the current time position

when the log is started. It features triple on-screen carts, multiple programmable recorders when full-duplex cards are used, WAV and MP3 playback, editing and voice tracking capability while the system is on the air, audio overlap and segue and variable audio marker in and out times. The system can also automatically generate Web content for streaming media applications.

Also from II Software:

Jockey Pro LT · *V-Tracker LT*

Spotman Suite - Remote file upload and reporting system.

Audio Rack - A cart wall player that can access as many as 64 audio files at once.

www.jockeypro.com

Broadcast Technical Services Group



Generation IV provides music on hard drive, satellite, live-assist and voice tracking automation in one package. Voice tracking is handled by the DJ Tracker module, which is included in the package. The software requires a 1GHz or faster Pentium IV and Windows 2000

Professional or XP Professional. The system supports a nearly limitless number of Quik Button sets that can be triggered by the keyboard function keys or the mouse. Users can set a timed event to automatically load sets of Quik Buttons. Audio files can include additional information such as title, artist, outcue, length, sample rate, mode, start point and end point.

Also from BTSG:

Miniplayer Automation · *Proradio III Digital*

Automax 2000 · *Broadcast Event Scheduler*

Spotmax - On-screen cart decks · *Clipmax* - Cartwall playback

www.btsg.com

Broadcast Electronics

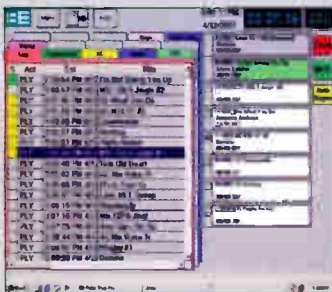

Audio Vault 2 uses an open system architecture and off-the-shelf hardware. The software runs on Windows and is cross-compatible with the company's other digital audio systems. It allows for LAN or WAN program generation, centralized or decentralized audio storage, a touch-screen interface, local or remote playlist

administration, an on-screen voice track editor, drag-and-drop program log building and editing and the capability to edit a log while it is on the air. On-site and off-site training is available. The system can also communicate with other systems via MIDI.

Also from Broadcast Electronics:

Vault Express • *Web Vault*

www.audiovault.com

Mediatouch Systems



Mediatouch version 2 was released at NAB2003. It features an improved graphic interface, search engine capability and editing functions for production, voice tracking from the studio or production studio, an on-screen phone recorder, hot key fade out and repeat modes, and the ability to playback programs while they are being recorded. The voice tracking features allow up to six hot start elements to be included in the voice track, level control for fades and beds and quick access to auto post, ducking and other quick record controls. A new playback feature allows users to test an entire log before it airs.

Also from Mediatouch:

Imediaaccess - Provides WAN access for Imediatouch systems.

www.omt.net

Broadcast Software International



Simian's interface combines two digital recorders with a voice tracker and Instant Response hot-keys for on-air automation. Simplicity of use is one of its main features, minimizing the need for extra training on multiple pieces of equipment. BSI's Smart Carts ensure that a valid, billable spot

plays for each client scheduled. In addition, Dynamic Time Compression allows users to squeeze or stretch content to maximize potential revenue in the available time. Simian allows clustered stations to consolidate spots and music on a single server.

Also from BSI:

WaveCart 3.1 - On-screen cart machine

Stinger 2.0 - Instant audio player cartwall

www.bsiusa.com

Computer Concepts



Maestro includes external start, stop and pause connections to trigger audio events from a console. Users can search for songs by title, artist, category or length, and can also configure the screens to suit individual preferences that display automatically during that shift. Each user has 20

instant-play cuts and junctions with 20 color-coded buttons on a page, each playing through a separate console channel. These can also be set as global Cart Express pages that all announcers can access. On-screen copy can be entered from news, copy or programming computers, as well as from news wires.

Also from Computer Concepts:

Protege

www.ccc-dcs.com

Raduga/Spry Group

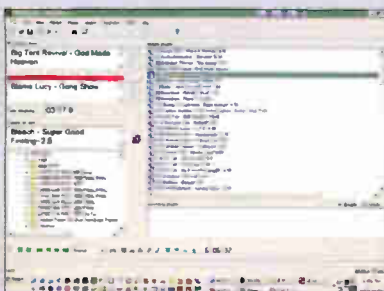

Raduga 3.6 runs on Windows 98, ME, NT, 2000 or XP and supports MP2, MP3, WAV and WMA files. It can operate in full automation or live assist modes. There are nine instant-fire hot keys for cart emulation. The included event scheduler can build

event logs and playlists. Six play modes are available: normal, manual, repeat, random, shuffle and intro scan. A built-in silence sensor can minimize on-air failures. The system chooses random tracks from a given directory, build play lists using rotations, schedule jingles and work with a joystick for playback control. The system can interface with Live365 for Internet webcasts.

www.raduga.net

Arrakis Systems

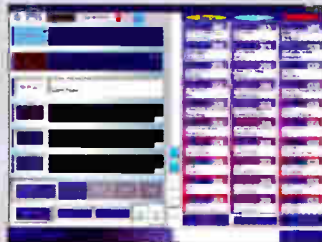

The Digilink family of products is available in three configurations. Each configuration adds additional capabilities and features. Digilink Free is a free software package for full automation and live assist applications. It plays WAV, MP2 and MP3 formats and can mix three

audio files to air at the same time for a music segue with voice over. It can also automatically adjust the length of an audio file to fit a specific window. Digilink Xtra adds support for a second sound card to allow audio previews and the ability to program event schedules. Digilink Xtreme adds more features, such as support for satellite automation, an eight-input source switcher, timed recording, console interface logic, an on-screen mixer and audio monitoring capabilities.

www.arrakis-systems.com

Inside Automation

Dalet Digital Media Systems

Dalet Plus Radio Suite is a media management system that incorporates production tools and a workflow management module that facilitates each step of the process: audio and wires acquisition, search and retrieval, production, script editing with embedded audio, planning, scheduling, broadcast and archiving. The on-air module user interface and layout can be configured to the needs of an individual broadcast studio or studio operator. After a recording has started, it can be played on the air or edited even while still recording.



www.dalet.com

Jutel

Radioman R5 improves on previous versions and adds additional features. The system supports files for music, audio segments, complete programs, scripts and combined cross-media. It also simultaneously supports multiple media formats for a single item. The extended Media Publisher supports parallel Web, DAB and mobile phone media interfaces that are synchronized to the main program flow. Standard features such as voice tracking are included.

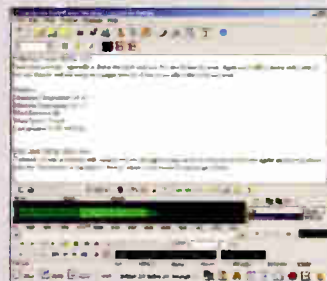

Also from Jutel:
Radioman v4

www.radioman.fi

Scott Studios

SS32 operates on Windows 2000, NT, Novell or Linux. Systems are provided on non-proprietary computers and non-proprietary sound cards. The system uses an exclusive belt-and-suspenders approach with redundant audio drives so that every recording is kept up-to-date locally and on a server or networked production studio. For file playback, the systems use pull networking. A token is sent to the air studio where the software looks at the current log, Instant Play keys and Cart Walls to see if the new cut is a priority.



www.scottstudios.com

D.A.V.I.D.

The Digasystem concept began more than 10 years ago to provide instant access to digital audio files over a standard network. The software runs on standard PC hardware running Novell, Windows or Unix servers and Windows 95, 98, 2000, NT or XP workstations. Audio files can be stored in MP2 or WAV format. The database is organized through the Database Manager. A built-in audio editor is included. A hardware interface, called the Digi-studio, provides machine-like controls and faders for the system.

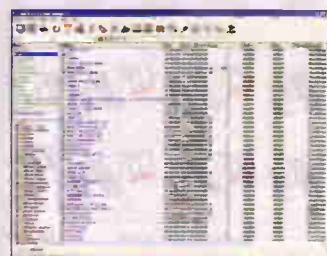

Distributed by Harris

www.david-gmbh.de

Shouldn't your transmitter remote control be

Good As New?

BURK TECHNOLOGY



At Burk Technology, **your future needs are just as important as today's**. That's why our products feature the most robust designs for years of continued use. And that's why it's time your current product is **GOOD AS NEW**.

Take advantage of our **GOOD AS NEW** offer and get:

- All the latest hardware and firmware changes
- New Lynx 4 software for GSC3000 and VRC2500 users
- Front panel enhancements for ARC-16 systems
- New two-year factory warranty
- Same-day service

We'll bring any GSC3000, VRC2500 or ARC-16 up to date – **no matter when you bought it or who sold it to you.**

Call today to find out how you can benefit from Good As New.

800-255-8090 (MAIN OFFICE) | 800-736-9165 (KANSAS CITY) | WWW.BURK.COM

Enco Systems

DAD Pro 32 offers a set of features for storing and reproducing digital audio on demand in a robust 32-bit environment, running on Windows NT or 2000. Included in the DAD Pro 32 feature set is inherent networking that offers connectivity throughout the same building or from across the world. The system can be configured to provide voice tracking, cart emulation, feed recording, waveform editing, a master log for live-assist operation and a general purpose interface.



Also from Enco Systems:

Interactive Radio - Online content creator, interactive online listener interface

www.enco.com

Prophet Systems

Nexgen Digital version 3 contains several customer-driven enhancements for audio storage and playback. Delivering files via WANcasting is made easier with bulk file feeds and off-peak time delivery. Increased tracking capabilities in the WANcasting module allow the user to distinguish data recordings. The Digital Reel To Reel element now includes features to help control outside hardware, as well as options for recurring recordings.

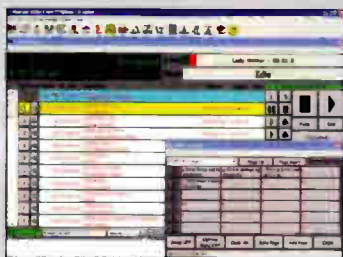

Also from Prophet Systems:

Musicgen - Music scheduling software

www.prophetsys.com

Wireready

Wireready32 can be used in live-assist, satellite and music on hard drive installations. Any workstation can run live-assist and automation at the same time. With multiple PCI-based sound cards or a sound card with multiple inputs and outputs, a single machine can capture programs while playing on the air. As many as eight independent automation schedules can be run at one time. The system runs on all Windows platforms, but NT or 2000 are recommended.

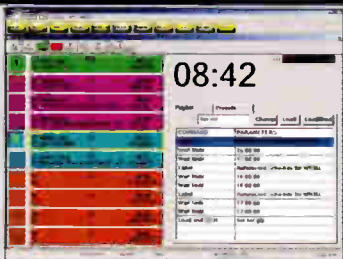

Also from Wireready:

News Ready - On-screen wire service management

Web Ready - Web delivery and ad insertion system

www.wireready.com

Register Data Systems

The Phantom provides all the tools required to manage, integrate and air local and satellite delivered programming in a seamless and live-sounding manner. Files are recorded by selecting the Record Audio command and then selecting the desired input. The system can start recording manually or start on audio sense. Features include automated time announcements, free-form cart rotations, archive maintenance, command carts (to schedule events through contact triggers) and LAN remote control to control multiple systems from a remote location.



Also from RDS:

The Replicator - Time-shift audio storage and playback

www.registerdata.com

ANALOG CLOCKS

"5100" Series



16"

LX-5116



12"

LX-5112



5"

LX-5105

The LX-"5100" Series can read Time Code (ESE, SMPTE/EBU & ASCII), as well as operate as Stand-Alone or Impulse Clocks. These clocks are loaded with many features, here's just a few...

FEATURES:

- Self-setting time code readers
- 5", 12" & 16" models
- Sweep & Step second hand modes
- Lighted Dial and Rack Mount options
- Time Zone Offset
- 3 Year Warranty

ESE

www.ese-web.com

310-322-2136 • FAX 310-322-8127
142 SIERRA ST., EL SEGUNDO, CA 90245 USA

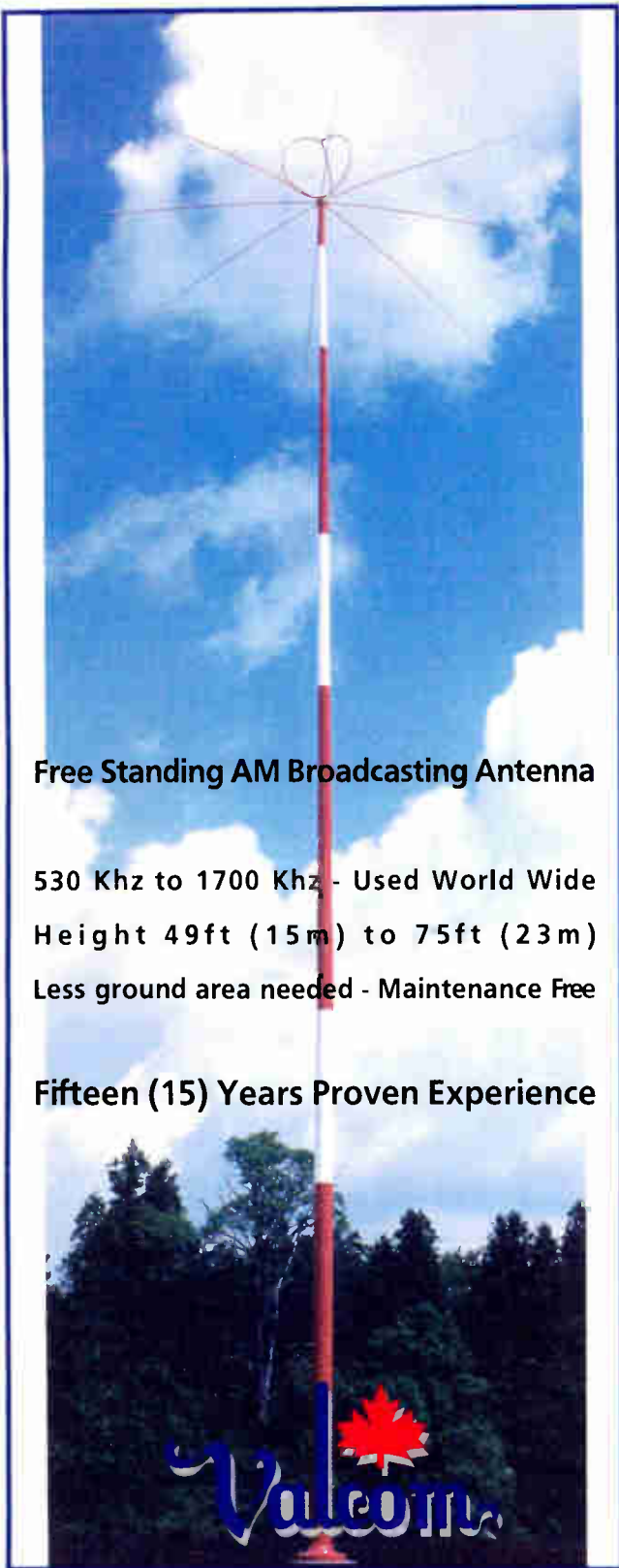

Free Standing AM Broadcasting Antenna

530 Khz to 1700 Khz - Used World Wide

Height 49ft (15m) to 75ft (23m)

Less ground area needed - Maintenance Free

Fifteen (15) Years Proven Experience



175 Southgate Drive,
Guelph, Ontario, Canada N1G 3M5
P.O. Box 603,
Guelph, Ontario, Canada N1H 6L3
Tel: (519) 824-3220 Fax: (519) 824-3411
Email: enquiries@valcom-guelph.com
Internet: www.valcom-guelph.com

On Air Digital

The Radio Suite HD uses Linux for mission-critical elements and Windows workstations in less critical applications. Systems are inherently networkable through Linux. The efficiency of Linux allows the system to play four simultaneous sound files and use the same CPU resources as a PC running just the Windows operating system. Audio data encoding/decoding is done through software and allows the system to work with nearly any audio file format including WAV, MP2, MP3, ADPCM and now Apt-x. UDS II is the control system, which currently runs on Windows but is being updated for Linux.

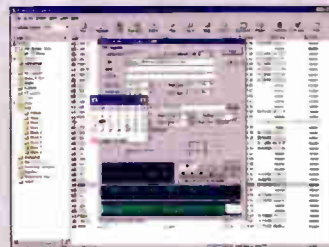

www.onairusa.com

Netia

Radio Assist 7 is a modular set of programs that allows the user to choose modules as needed



and configure them to individual needs. User categories, file types and other parameters can be set as desired. The software runs on Windows NT 4.0 and higher and uses a Microsoft SQL 7 database engine. Audio file sampling rates are adjustable from 32kHz to 48kHz. Files can be recorded in Layer II or linear WAV formats. The system can provide audio and data for on-air, online and DAB applications, as well as audio-on-demand functions.

www.netia.net

Smarts Broadcast Systems



Smartcaster is designed for satellite and music on hard drive automation. In the last year, Smartcaster Digital Audio completely redesigned its system to operate on Linux, which provides a solid operating system that provides a high level of reliability and high-resolution graphic screens.

It is capable of storing large amounts of data. The Linux Smartcasters can now play virtually any audio file including MP2, MP3, WAV, ADPCM and optionally Apt-X. Systems use non-proprietary, off-the-shelf hardware.

www.smartsbroadcast.com

A preview of
what's to come in
**TRENDS IN
TECHNOLOGY**

**October
DAWs**

**November
Speakers**

**December
Racks & Furniture**

www.beradio.com

Inside Automation

Pristine Systems/Cartworks

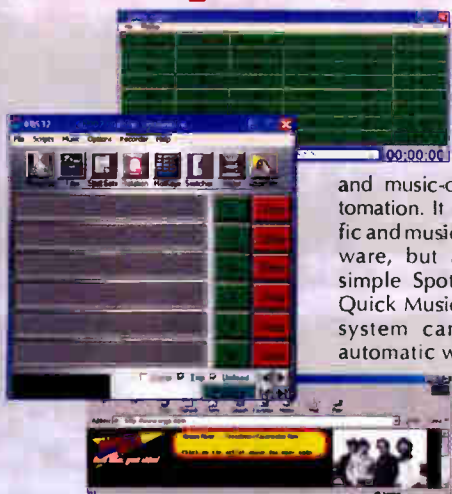

CDS32 Pro runs on Windows 2000 or XP. It offers live-assist, full automation, satellite and music-on-hard-drive automation. It supports all traffic and music scheduling software, but also includes a simple Spot Set Editor and Quick Music Scheduler. The system can also provide automatic website content.

Other features include automatic spot set fill, complete remote control, support of

multiple networks, extended instant play features, multiple-cut spot rotation, multi-station file access, an audit log function for affidavits, in-context voice tracking and support of all traffic software formats.

www.pristinesys.com

Radio Computing Services (RCS)

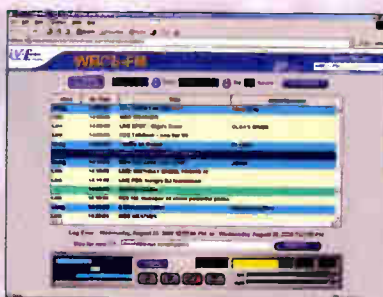

Master Control XV features a Living Log, Internet Voice Tracking and audio storage management tools. The Living Log integrates with other event scheduling systems. All changes made to the schedule can be seen instantly by

any workstation on the network. Real-Feel Voice Tracking and Internet Voice Tracking allows talent to perform locally on a network of stations from anywhere. The Audio Storage Manager manages data at a central production facility, enabling a group of stations to share audio in the same building or anywhere in the world. The system uses non-proprietary, off-the-shelf computers, networking and backup products. Audio can be played from any combination of formats including WAV, MP2, BWF and Cart Chunk.

Also from RCS:

Iselector - Customized audio player
Selector - Music scheduling software

www.rcsworks.com

Mediatron

Air Control NT 2000 Professional runs on Windows NT or 2000 and provides a 32-bit system. It was designed as an open system for future developments with Mediatron's plug-in approach. Through this method, features are added to the base program as they needed. The software runs on standard, off-the-shelf PCs and network hardware. Available plug-ins provide a hotkey interface, enhanced cueing functions, cross-fade mixing, voice tracking, a database search engine, a CD-ROM jukebox controller, a production tool for making hooks, an Internet/intranet Web display interface, an RBDS data module, program-associated data output and remote interface for I/O control.

Also from Mediatron:

Media Station - Automation for small to medium markets

www.mediatron.com

Find more information in the *Radio* magazine Online Buyers Guide

www.beradio.com

Truthful

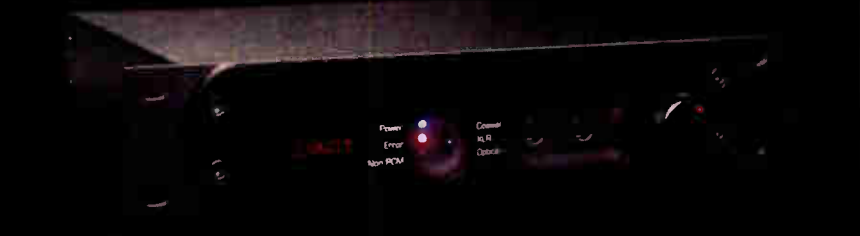

DAC1

"The Benchmark is a killer! I've only had it plugged in for a few hours, and gain-matched to the Weiss and my TC and the Benchmark sounds: (1) spacious (excellent width and depth) (2) clean (3) robust (4) solid (5) pure"
Bob Katz - Mastering Engineer - Digital Domain, Orlando, FL

The two-channel DAC1 is perhaps one of the more significant recent advances in digital-audio conversion technology.

It provides some of the finest digital-to-analog conversion through 96-kHz, and will play back 192-kHz with a 48-kHz analog bandwidth. The performance of the DAC1 is unrivaled. THD+N is an astonishing -108 dB measured at -3 dBFS, at any playback frequency, at any sample rate, with any degree of input jitter. You can now hear detail that was previously masked by jitter induced artifacts. If the recording was exceptional, you'll hear it; if it wasn't, you'll hear that as well. The secret? *UltraLock™* technology.

The DAC1 is essential equipment for any location that requires uncolored monitoring. Locations such as mastering and recording studios, broadcast facilities and even high-end home audio environments. The price? An unbelievably low \$795. Call today and experience what is certainly one of the finest DACs in the world.

Benchmark
...the measure of excellence!™

BENCHMARK MEDIA SYSTEMS, INC.
800-262-4675
www.BenchmarkMedia.com

A view of a room

By Gary Eskow

Bill Young Productions, a more than 20-year-old facility located in Sugar Land, TX, has a balanced workflow that includes radio and television commercial production, film trailers, print and a growing new media wing that specializes in Web design. The president of BYP, Steve Kelly, has a long history in radio that dates back to his work as a disk jockey in the 1960s.

While radio is the facility's main format, a tremendous amount of TV production is also handled here, particularly in the concert area. For example, the studio will take existing footage of Fleetwood Mac and build a 30-second commercial for a theatrical release. The facility has also done some Broadway work, using 35mm film to produce a spot, but radio still accounts for about 60 percent of the company's business.

Six of the facility's eight recording suites, which were designed by Russ Berger in 1990, have recently been revamped. Protools digital audio workstations and Yamaha DM2000 digital production consoles have been installed in each room.

"The move towards an all digital pathway is irreversible, for radio as well as television and video," said Kelly. A long time digital recording and editing proponent, Kelly recommended that the company purchase an AMS Audiofile DAW in the late 1980s. At that time, the \$100,000 AMS system was the real workhorse. When BYP moved to its current location in 1990, Kelly realized that the firm had to look at other digital editing systems, and investigated everything that was on the market. Protools, even in its early stages, impressed them from the start, and the studio has continued to upgrade its systems. There are plans to purchase some Protools HD systems soon.

While Digidesign, the manufacturer of Protools, has converted many large-format operators to its streamlined mixing surface, BYP chose to use a traditional-style console in the control rooms. The

A look into the other side of radio production

Yamaha DM2000 was the choice.

The Yamaha DM2000 is a fully digital console with 96 input channels. It is fully compatible with the surround sound work that is not necessary for the radio work BYP handles on a daily basis, but surround sound is critical to its television and theatrical productions. The console's tight integration with Protools was a major factor that led Kelly to purchase multiple DM2000s.

The console features a built-in interface that interfaces with Protools via MIDI. One side of the DM2000 is dedicated to Protools. Track punch-ins, scrubbing and all of the other common Protools editing functions are laid out clearly on the console. The combination of the console—even though it is a full-format production board—has a much smaller footprint than the analog consoles the facility had been using. After extensive research into all the available console choices, the decision was made.

Digital's delay

Like many others, Steve Kelly is surprised and frustrated at the slow pace of digital technology in the radio broadcast area. He expected that digital transmission would grow more quickly than it has. He expected that a system would have been approved by the FCC by the end of the 1990s. Consumers are taking notice of the improvement provided by digital TV, Kelly anticipates that the same improvement will be made to radio when the system's details are established.

BYP distributes more than half of its radio content via the Internet using Fast Channel. Productions are encoded in MPEG2 and sent to Fast Channel, along with tracking paperwork that includes the name of the spot, its length and who needs to receive it. Fast Channel takes it from there distributing the spot to every station to which it is assigned. Everything is done online, including the

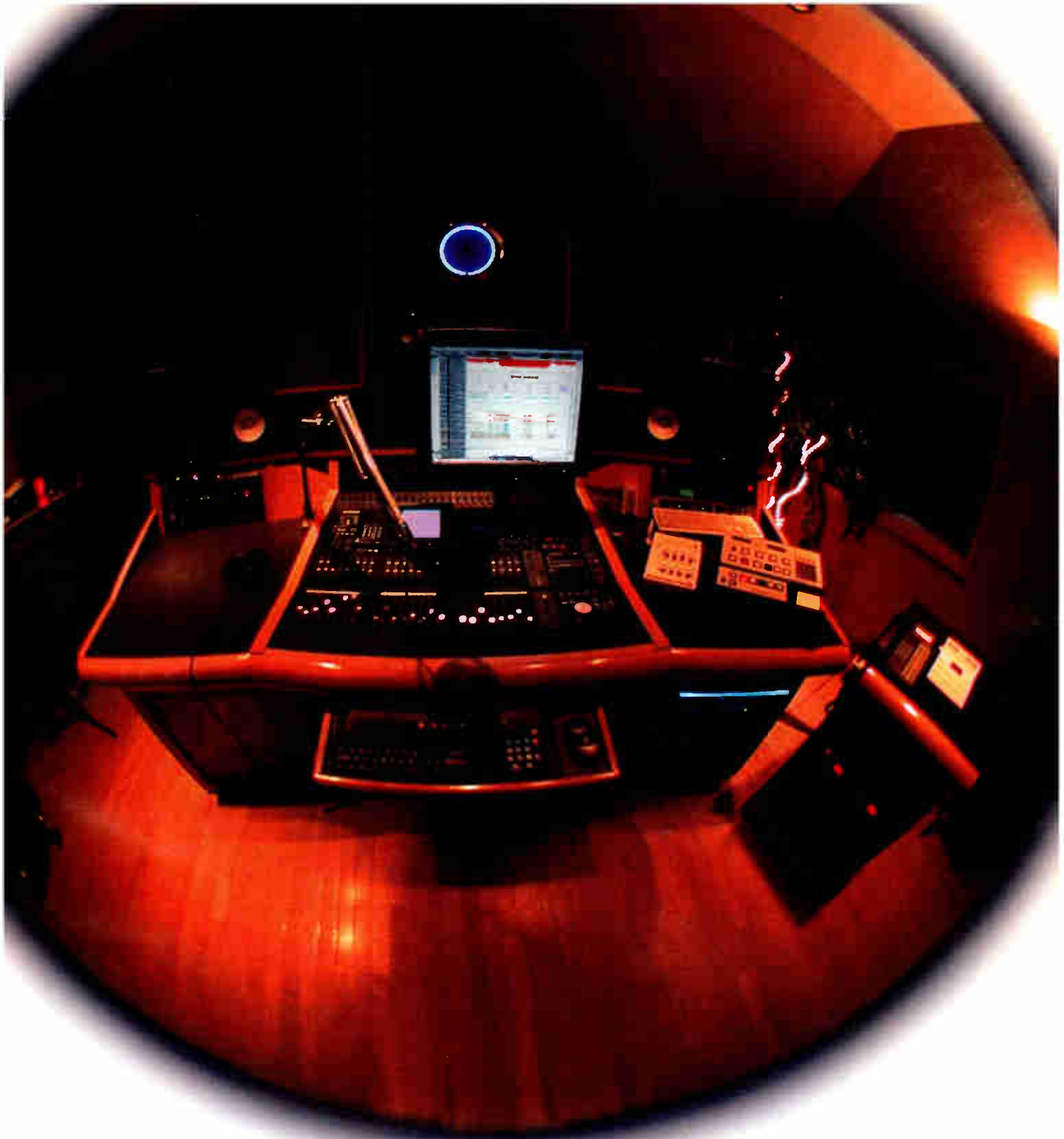

transmission of a thumbnail version in MP3 if a client needs to hear the spot in advance.

The facility maintains some legacy equipment as well. Some clients still want reel-to-reel tapes. DAT tapes are rarely used, but the facility might get one or two requests a year for them. Kelly said that distribution via Fast Channel is gaining in popularity among his radio clients.

"MP2 is the audio quality you get on a DVD. A lot of our clients request MP3 at 192kb/s, and that sounds very good. It's not audiophile quality, but it is perfectly satisfactory for commercials. I

also do a lot of freelance production work for car dealerships, and I send them all MP3s without any problem," said Kelly.

Tim Triche, a systems engineer at Bill Young Productions, says that the company is in the process of developing its own delivery system. Triche hopes to have it up and running in a few months.

The facility's own delivery system will use a commercial MP3 encoder that has been customized for their needs. A final production is mastered as a

A view of a room

24-bit, two-channel Protools file, which is fed into a server. The server then automatically processes the spot into a 16-bit stereo .WAV file. Another program then converts it into MP3 format.

Although BYP's recent upgrades did not include retrofitting an existing room to accommodate surround mixes, this will happen in the near future. The DVD projects handled by the facility include the audio and video post work, but the Protools tracks are sent to a 5.1 facility in Nashville or Los Angeles for completion. BYP would like to keep the entire project in house.

Still, in this world of digital technology, there is a place for the tried and true, according to Steve Kelly. BYP still uses its trusty Otari MTR12 four-track tape machines on a daily basis. The machines were purchased in 1985. Except for routine maintenance, they have proven to be indestructible. Kelly feels that they're so much better than any digital recorder for voice-over work, producing a fatter, warmer and punchier sound. The final mix is dubbed in into Protools.



Inside the control room of the studio.

Eskow is a composer and journalist who lives in central New Jersey. He is a contributing editor for Radio magazine's sister publication Mix magazine.

Experience Exceptional Quality, Reliability and Service! Experience Armstrong Transmitter!



FM 30000 TX

Our single tube high power FM transmitters offer you exceptional quality and affordable prices.

Built for the "real world" environment, these RF workhorses offer long term reliability and features not found in any other single tube transmitter available.

Features include:

- 1/4 Wave Grounded Grid PA.
- Fiber Optic PA Arc Detection.
- PA Temperature Protection.
- Advanced Control System with remote computer interface and auto log.
- More internal status sensors than any other transmitter.
- CD Quality Audio. (AES/EBU optional)
- Available from 15KW to 35KW. Combined systems to 60KW.

Armstrong Transmitter ... the best RF products, the best around-the-clock support, and the best prices ... because you deserve nothing less!



4830 North Street, Marcellus, NY 13108
Phone: 315-673-1269 Fax: 315-673-9972

Web Site: armstrongtx.com
email: sales@armstrongtx.com

Recent projects

The work of Bill Young Productions can be heard on several recent radio spots including concert productions for the Eagles, Fleetwood Mac, the Dixie Chicks, Tim McGraw and Brooks and Dunn, as well as the recent ad campaign for Pony shoes.

Equipment List

Yamaha NSM-10
Yamaha DM 2000 digital console
TC Electronics Finalizer
Symetrix 528 mic processor
Rosendahl Nanosyncs
Pro Tools Mix 24 system
Otari MTR 12-4 track
Otari MTR 12-2 track
Otari DTR-7 DAT recorders
Neumann TLM103 mic
Meyer Sound HD-1 monitors
Manley Vox Box mic processor
Lexicon MPX 1 reverb
Eventide H3500 Harmonizer
Demon DNC-680 CD player
DBX 166 compressor/limiter
Avalon VT-737SP mic processor
Aphex Dominator
AKG 414 BTL II mic

The Best 10 Years of *Radio* magazine



1998 & 1999

Time Line

1998

- *Radio* magazine is the first publication to launch a radio-industry website.
- High-speed data connectivity, such as DSL, sees early acceptance.
- Popularity of POTS codecs booms.
- Low Earth-orbit satellite usage threatens RPU usage in the 455MHz band.
- Flat-screen computer monitors reduce space needs in control rooms.
- DRM forms in China.
- IP Multicast continues efforts to become preferred format for Internet broadcasts.
- Radio station webcasting starts to be considered a practical effort; Internet audio processors introduced.
- The Consumer Electronics Manufacturers Association releases a report on digital radio that endorses Eureka 147 and condones IBOC and IBAC systems.
- Digital Radio Express publicly announces its plans to develop an IBOC standard. Lucent Digital Radio is also formed when Lucent's partnership with USADR ends.
- FCC takes first steps at creating LPFM.
- *Radio* magazine technical editor John Battison receives NAB's Radio Engineering Achievement award.
- USB and Fire Wire standards are introduced.
- Tower registration rules take full effect.
- The American Radio Manufacturers Association (ARMA) forms and holds its first convention.
- CD Radio (now Sirius) begins deploying its terrestrial repeater network.

1999

- The FCC makes construction permits valid for three-year periods.
- LPFM service is proposed.
- DVD-A (audio) standard is introduced.
- Quad Dimensions files claims for patent infringement from EAS.
- The Cart Chunk standard is proposed.
- SBE and NFL begin Game-day Coordinator program.
- CEMA proposes Mobile Multimedia Broadcast Service as DAB alternative.
- *Radio* magazine begins daily online news updates and weekly e-mail newsletters.
- FCC issues NPRM on IBOC standards-setting.
- Final preparations are made for Y2K readiness.
- Digital Radio Express and USA Digital Radio combine efforts on an IBOC system.

More online

See the Pick Hits from 1998 and 1999 and a gallery of past covers. Click on the 10 Year logo at www.beradio.com.

Continuing our retrospective of the past 10 years of *Radio* magazine, we look at the years 1998 and 1999. Since our first issue in January 1994, the radio industry has changed in many ways. Through these installments we will recall the changes in technology, FCC rules and our industry in general. These changes have made radio what it is today, and *Radio* magazine has been there all along—and we will continue to be there.

You read it in *Radio* magazine



By 1998, the Internet had shown its value as an important part of a radio station's operation. Today, it is inconceivable to operate a business without some kind of online presence. In 1998, stations were just getting comfortable with their efforts. In the February 1998 issue, our cover story looked at the various ways an Internet

presence could be used to a station's best advantage.

"There also may be significant business value in creating separate online audio content. Although it may take a bit more work than simply repeating the air signal, a number of such alternate opportunities for online audio can leverage and repurpose the existing assets of a radio broadcaster."



While the Internet was growing in popularity and function, *Radio* magazine had already recognized the potential of the new medium. Our website, beradio.com, was launched in March 1998, making it the first radio industry publication website. From the beginning we have posted the entire contents of each issue of *Radio* magazine, but we also have developed unique content that is only available online.

Since the initial launch, the site has been revised to provide better organization and enhanced features. Shown here are screen captures from the site as it appeared when it first launched and today.



When 1999 began, consolidation of ownership was in full swing, but consolidation of facilities was just getting underway. With the ink dry on station transfers and the business details clarified, many stand-alone stations found themselves facing a studio move to become part of a multistation facility

operation. Our January 1999 cover story investigated the process of consolidating facilities, and more importantly, how to integrate a technical staff to install and maintain the new headquarters.

"If you have not already done so, take time to examine the quality of your work and the state of your facility. You will soon be working with others in your chosen field on a day-to-day basis. This means you will be dealing with more than one individual working on the same project or task."

Installation Profile



Master Control



Left: KEZW on-air studio
Below: Production 2



CSS Installs New Entercom Denver Facility

Entercom Communications needed to consolidate its entire Denver broadcasting operation from multiple locations to one facility in the Denver Technology Center. Four on-air studios (KALC, KQMT, KOSI and KEZW), three news studios, four production studios and a live session studio had to be operational by mid-July. CSS worked in close consultation with Entercom Denver Chief Engineer, John Burrell. Together, they crafted an engineer-

ing and installation plan that would accomplish Entercom's studio and timeline requirements.

This was not a "cookie-cutter" job. Each of the on-air studios had different requirements. Though many of the components would be similar, the operation of those components had to be engineered and installed to meet the individual needs of the studios.

Entercom called on Creative Studio Solutions, Inc. to do the job.

Since its inception three years ago, CSS has built a national reputation for high-quality studio engineering, integration and installation services. Founded by Andrew Rosenberg, CEO and Chief Engineer, CSS approaches each project as a unique opportunity. CSS creates studio environments that meet the technical requirements of the broadcast organization, accomplishes the task within budgetary parameters and pays close attention to, not just the technical, but the aesthetic aspects of the project as well.

While Entercom's new space in the Denver Technology Center was being gutted and remodeled, CSS's core engineering unit was preparing for the in-

stallation. Entercom's transition from multiple broadcast locations to one facility had to happen in a relatively short time frame. Because of this, CSS mapped out each new studio's unique configuration at its own facility, essentially recreating all 12 studios before the new space was ready.

CSS engineers and installers stay with a project from concept to completion. The staff knew the Entercom project. CSS pre-built many of the studio components at its facility. Pre-wiring the consoles and racks, studio furniture assembly, customizing the AC power infrastructure and primary documentation was completed before moving on-site for final installation. In addition, the pre-wiring for Entercom's Master Control racks had to be completed in advance, without the benefit of having MAC equipment as it was still being utilized at other locations. Because of the CSS "concept to completion" staffing, there is no on-site learning curve. The staff was aware of the challenges and nuances of this project.

One of the challenges CSS and Entercom were faced with was the

CSS

Where Art and Engineering
Come Together

Creative Studio Solutions, Inc.

10600 West 50th Ave., Suite #5

Wheat Ridge, CO 80033

P: (303) 425-5004

F: (303) 425-5005

E: info@CreativeStudioSolutions.com

W: CreativeStudioSolutions.com

Client Q&A

Marty Hadfield, Vice President of Engineering, Entercom Communications

Left:
KOSI on-air studio

Below:
KQMT on-air studio



The custom-fabricated speaker mount allows an attractive and secure method to mount speakers in studios with a drop ceiling.



mounting and positioning of the On-Air and Production Studio speakers. Because of the architecture of the studio spaces, traditional speaker mounts could not be used. Entercom needed a solution and CSS created one. CSS designed and custom fabricated a functional and aesthetically appealing speaker mount system that met the clients' needs. (See Client Q & A for more.)

After careful consideration and consultation, Entercom decided on the Wheatstone D-8000 as its console for each of its four on-air studios. Each console was pre-wired and tested at CSS prior to installation.

One of the reasons Entercom chose CSS for its project was CSS's use of Stardraw Radio documentation software. CSS helped develop the software for use in the broadcast engi-

neering industry. This software gives the Entercom engineering staff a visual representation of the rack and wiring layouts. Entercom needed readily accessible information and a concise representation of the entire wiring infrastructure throughout the installation process and after the project was completed. Star Draw Radio Documentation provides it.

During the course of the project, CSS was able to provide updates of the progress being made on studio construction and preparation using CSS's Online Project Updates. This online service, unique to the broadcast engineering industry, allows a client to access a password coded page on CSS's website to view photographs and text updates as their project proceeds. CSS is well aware that engineers and broadcast management want to know the status of their projects and this service was developed to give them access to the information they require. Instead of having to take travel time and/or rely on a phone conversation, Entercom's project status was only a click away.

When the Entercom space was ready for the move, so was CSS. Because of the preparation, documentation and CSS's knowledge of the task at hand, CSS was able to seamlessly install the 12 studios at the new location. The actual installation of the studios and

Q: What's your assessment of the Entercom-Denver installation?

Marty: I am really pleased with how well this project went. We were consolidating four on-air studios, three newsrooms and four production studios into one new location in Denver. This was a real challenge for us and for CSS. CSS performed their duties exceptionally well.

Q: When you talk about "challenges", give us an example.

Marty: Everyone in broadcasting knows that when you have this many studios, formats and personnel, you can't "cookie cutter" your plans. Each studio has different requirements. When we asked for innovation... when we asked for something new... the staff at CSS rose to the occasion and delivered what we needed.

Q: Such as?

Marty: A good example is the speaker mounts. We needed our speakers to be in specific places in the studios and we wanted them to look good! Andrew and his team designed and manufactured, from scratch, these amazing speaker mounts that are not only functional but also look great. I think this is a product people are going to be seeing a lot more of.

Q: How has the staff reacted to the new studios?

Marty: I've talked with a number of on-air, production, management and, of course, engineering personnel here at Entercom Denver. The reaction to the final product has been nothing but positive. This is a really good team at CSS and they got the job done right. And not only that, they were good people to work with... and in this business that says a lot. ■

their components was still a significant job, but because of CSS's method of doing business, the installation was easier on Entercom Denver's on-air, production, management and engineering staff.

CSS doesn't just build and run. Entercom now has CSS's 24/7 Customer Support Hotline. If, at any time, Entercom has a question about a piece of equipment, wants to modify a studio configuration or simply needs more information about their studios' capabilities, they can call CSS 24 hours a day, seven days a week. CSS wants its clients to know that they are committed to the project before, during and after the installation.

Entercom made the right call. ■



Behringer Ultramatch SRC2000

By John S. Landry, CSRE

The Behringer Ultramatch SRC2000 is a digital processor, format converter, signal corrector and a digital distribution panel. It can accept digital signals encoded in any of three formats: AES/EBU, S/PDIF and TOSLINK. It can also accept those signals at any digital sampling rate from 25kHz to 60kHz, and it can accommodate changing copy and emphasis coding bits, remove jitter and change the corrected and cleaned up signal to one of two standardized bit rates while simultaneously feeding that signal to three separate and isolated outputs in AES/EBU, S/PDIF and TOSLINK

transfer to be made between the two devices, costing time and sometimes adding artifacts to the audio later on in the session. One afternoon after I had carefully explained a digital incompatibility like this to a producer, she walked away muttering that digital was supposed to make things easier. In one unusual case, I knew of a facility that did the digital/analog/back-to-digital transfers using a cassette deck. There are better ways.

Practical function

I had a situation where an incoming feed from an ISDN codec was being used in a voice-over session. The engineer wanted to make a safety on a DAT as well as record right into the hard disk system. Because the AES/EBU and

S/PDIF formats do not allow for bridging like an analog audio signal, this was not possible. Complicating things further was the sampling rate—the sender refused to use any other sampling rate than 32kHz (claiming that it sounds the best that way) and the hard disk system wanted 44.1kHz. The Ultramatch has

three outputs, it can function as a distribution amplifier, providing something for the DAT and the hard disk while also converting the codec audio to 44.1kHz.

The Ultramatch is a surprisingly simple box with just eight small buttons and a neatly organized panel of LEDs. But don't let the simplicity fool you. The Ultramatch accepts the digital audio and converts it up to a high oversampling rate (about 65,000 times or 3.2768GHz). In this mode the digital picture is now made up of several million samples, so the potential resolution is much better. An interpolation algorithm is used to fill in the digital waveform, all the while checking for errors and fixing them. When the signal is done, it converts everything back down to 32kHz or 44.1kHz and it is put out in all three formats to feed your devices. All inputs and outputs, except the optical TOSLINK, are transformer balanced. The manual claims "THD under 0.001 percent [with] noise below -95dBfs." Though it doesn't specify further, the presumption is that this is the maximum amount of noise and THD the Ultramatch adds on top of whatever noise is inherent in the originating A-D converter and the receiving D-A converter.

In my experience, I have yet to experience any ill effects from this processor. The Ultramatch has an anti-aliasing filter that is self-configuring. It also will allow copyright-protected material to be copied, although the manual cautions you that it was not intended to be used solely to make illegal copies of copyrighted work. The emphasis bits, which the S/PDIF format handles differently from

Performance at a glance

- AES/EBU, S/PDIF and TOSLINK inputs
- Self-configuring anti-aliasing filter
- Input sample rates from 25kHz to 60kHz
- Output sample rates of 32kHz or 44.1kHz
- Transformer-isolated I/O
- Selectable emphasis and copy-protect bits
- Multiple outputs
- External sync input

formats. It occupies 1RU, has a sleek, all-black front panel and uses a standard IEC power cord.

It is not uncommon to have audio from different sources with incompatible formats, for example an ISDN codec and a digital hard disk editor. Many times the incompatibility would be an issue of connectors, such as an AES/EBU output from the codec on an XLR and a S/PDIF input to the hard disk editor. Other times the sampling rate of the codec would not be supported by the digital recorder being used. This simple task would require an analog



AES/EBU, can be eliminated and corrected, which greatly improves the sound. Despite all of this it will not, however, correct certain problems (specifically, it can't undo distortion in a recording due to 0dBfs excesses). Thus an amateur recording will still sound amateur when you are done.

The manual for the Ultramatch could use some improvement. Many phrases are literal translations from German, and it took some time and thought to fully understand them. It would have been nice if the option of 48kHz output had been provided. The manual also indicates that the Ultramatch will not convert, and nor does it pass-through, the Alesis ADAT signal. There is an external timing input on the back of the unit and while the manual explains the concept of its use, it doesn't really specify what format this timing signal (wordclock) should be.

Landry is an engineering technician at CBS Radio/Westwood One, New York City.

Behringer

P	877-672-0816
F	425-673-7647
W	www.behringer.com
E	support@behringer.de

Editor's note: Field Reports are an exclusive Radio magazine feature for radio broadcasters. Each report is prepared by well-qualified staff at a radio station, production facility or consulting company.

These reports are performed by the industry, for the industry. Manufacturer support is limited to providing loan equipment and to aiding the author if requested.

It is the responsibility of Radio magazine to publish the results of any device tested, positive or negative. No report should be considered an endorsement or disapproval by Radio magazine.

Radius-Xp ... studio furniture

the most **POPULAR** furniture lines ever...

new for 2003

- ... all plastic surface & trim design
- ... modular for flexibility
- ... highest quality materials
- ... precision crafted
- ... professional features
- ... many options available

This new studio furniture line is engineered for studio decors where non-wood trims are a design goal. Available in a wide variety of colors, this furniture will complement any size market application. The modular design enables the furniture to be ordered in almost any configuration that can be imagined.



only **\$2,995**

call 970-461-0730 ext 329

arrakis systems inc. www.arrakis-systems.com [970] 461-0730



Audio-Technica AT3060

By Don Danko, CBRE CBNT

Over the years I have come to enjoy and respect the high quality of Audio-Technica microphones. For this reason I was excited to receive a pair of the company's latest tube microphone, the AT3060, for a demo. My professional experience is firmly placed in classical music broadcasting; because of this, I am always looking for a more natural-sounding microphone. The challenge is finding a microphone that has a full, unprocessed sound. Such a microphone will capture the true sound

of each on-air personality, from the loudest, deepest-voiced announcer to the softer, higher-vocal announcer. I have found that, generally speaking, large diaphragm microphones accomplish this better than almost any other microphone.

The AT3060 is a large-diaphragm (over an inch) tube microphone that requires a 48Vdc phantom power supply. It's

tubes in the AT3060 are shock-mounted, hand selected, tested and aged to ensure peak performance.

The mic exhibits good sensitivity with low noise and features a fixed cardioid polar pattern. The shock mount offers fantastic isolation and is no doubt based on other A-T large-diaphragm shock mounts. The output of this microphone is on a XLR male connector with the industry standard pin out. The manufacturer warns (for those who forget) that this is a tube microphone and therefore requires a warm-up time of about 10 minutes for the electronics to stabilize. The microphone comes standard with the shock mount, a protective pouch and a limited one-year warranty.

Testing

The characteristic that stood out the most on this microphone was a bump in frequency response, which is from 2kHz to 7kHz with a +4dB peak at 5.5kHz. Figure 1 shows the frequency response. It was this bump that caused the most concern during testing. The bump adversely affected the vocal audio characteristics and produced a sound that was a little harsh—with less presence—than I anticipated from a large-diaphragm tube microphone. The findings were confirmed by multiple staff members with no influence as to what kind of microphone they were testing or what others thought about it.

The AT3060's true destiny might be in a performance-based recording environment. My employer, WGUC, is a classical radio station that also operates a professional multi-track recording studio. We proceeded to put the microphone through a few different studio-recording sessions that included instruments and vocalists. We didn't cover all possible scenarios for this microphone, but enough that we are satisfied with our conclusions pertaining to the best uses for it.

Best use

Using a pair of the AT3060s in an X-Y configuration we conducted a variety of evaluations. As expected, the microphones had a high signal-to-noise ratio and good sensitivity. In a recording studio environment it was possible and desirable to minimize or eliminate the 2kHz to 7kHz frequency bump with onboard console equalization. This resulted in a much better sound that ultimately reflected the source material well. However, most broadcast consoles are not equipped with an onboard individual channel equalizer, which is the primary reason this microphone's best use may be in a professional recording studio. Adding attenuation to equalize a frequency bump out is usually more desirable and produces a much better sonic representation than adding gain to equalize a frequency dip out. Further evaluations showed the

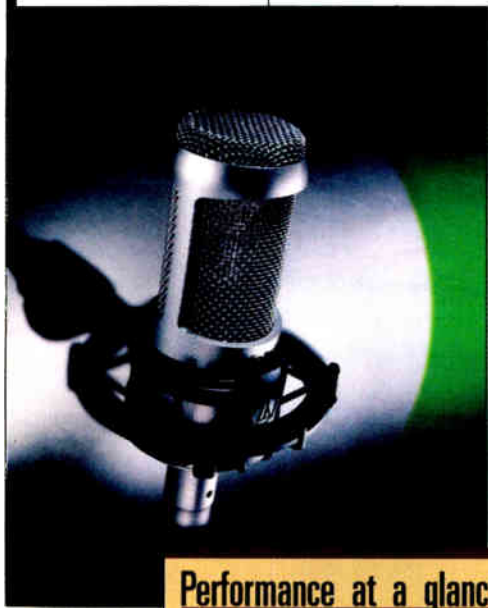

Performance at a glance

- Operates on 48Vdc phantom power
- Superior shock mount and case design
- Stands out in recording studio using X-Y stereo configuration
- Low cost includes case and shock mount
- Useful for instrument recording

interesting to note that the microphone's typical current draw is only 3mA at 48Vdc. A big plus is that no special power supply or cable is needed, which is especially advantageous if the microphone will be used for remote recording sessions. This not only saves money, but also eliminates one more potential point of failure. The

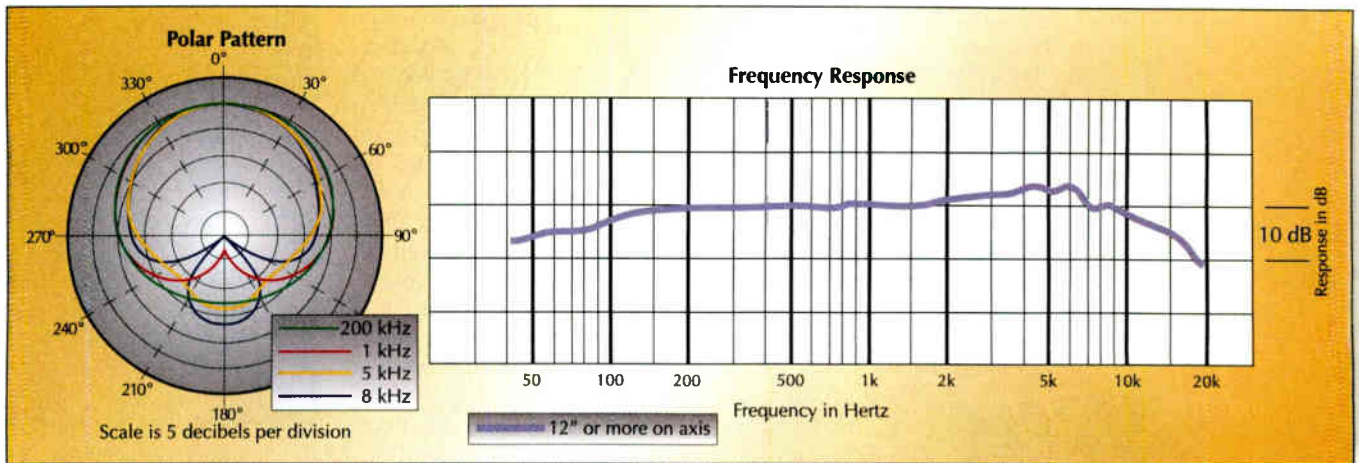

Figure 1. The polar pattern and frequency response of the microphone.

AT3060 microphone's best use more specifically may lie with recording string instruments.

Overall the microphone was good sonically, and in the proper environment and application, the results would be outstanding. Those applications are in a performance studio and not a broadcast studio. The relative low cost and phantom power operation are positives that are not generally found in the tube microphone market. The manufacturer indicated that the microphone really "stood out" when used in a two-microphone X-Y stereo configuration. Indeed, we found this to be an ideal setup for the microphone. Its superior overall appearance and rugged design makes it great to work with. With a single pick-up pattern it is not as versatile as mics with switchable patterns, but it is a solid performer nonetheless. The AT3060 is a good microphone to add to a collection and would certainly provide a quality tool for any recording studio.

Don Danko is VP of engineering for WGUC, Cincinnati.

Audio-Technica

P 330-686-2600
F 330-686-0719
W www.audio-technica.com
E pro@atus.com

Editor's note: Field Reports are an exclusive Radio magazine feature for radio broadcasters. Each report is prepared by well-qualified staff at a radio station, production facility or consulting company.

These reports are performed by the industry, for the industry. Manufacturer support is limited to providing loan equipment and to aiding the author if requested.

It is the responsibility of Radio magazine to publish the results of any device tested, positive or negative. No report should be considered an endorsement or disapproval by Radio magazine.

Operate any 3-phase broadcast transmitter from a 1-phase utility supply with the Phasemaster® Rotary Phase Converter

The most reliable alternative to utility 3-phase...
AND the least expensive!



- High efficiency output
- Maintenance free operation
- True 3-phase, NOT open-delta
- Approved by all utilities
- Over 1000 TV and radio stations rely on Phasemaster®

Turn any location into a 3-phase site within hours!
 Save thousands of dollars on utility line extensions
 Recommended by leading transmitter manufacturers

General Offices
 604 N. Hill St.
 South Bend, IN 46617
 800-348-5257
 574-289-5932 (fax)



Western Region
 4127 Bay St. #6
 Fremont, CA 94539
 510-656-8766
 510-657-7283 (fax)

The World Leaders in Single to Three-Phase Power Conversion

www.kayind.com

info@kayind.com

New Products @AES

By Kari Taylor, associate editor

www.beradio.com

Desktop space solution Presonus Audio Electronics

Maxrack, HP4: A desktop space solution, this unit houses as many as six 1/3-rack Personal Recording Series units. The new rack can store units such as the Tube PRE, EQ3B, COMP16 and HP4. The unit sits on the desktop next to the user's computer monitor. The heavy-duty rack not only houses six units, but also ships with a six-input powerstrip that accommodates all six individual power supplies and powers



all of them from one single ac plug (available in 110V U.S. and 220V European only). The device answers the project studio owner's needs for headphone distribution with professional specifications. The unit comes in a 1/3-rack space chassis, similar to the Tube PRE, and fits snugly into the Maxrack. The system accepts balanced and unbalanced inputs (stereo or mono) and outputs (1/4" TRS), with the mono selector button on the front channel

simply copying both inputs to both sides. The unit features four discrete headphone outputs, each with its own volume potentiometer and 250mW of amplification per channel on the front panel. This product has a -98dB noise floor and wide frequency response. Also, the unit allows control over control room monitors with a separate volume potentiometer that can be muted using the monitor mute button, and is powered by an external wall-mounted power supply.

800-750-0323; fax 225-926-8347

www.presonus.com; presonus@presonus.com

Signal router/monitor Furman Sound



system simplifies mixdown and dubbing between different media types without tying up additional console channels. Multiple copies can all be made simultaneously through use of the unit's Source Select switches. A/B/C listening comparisons can be made between three different speaker types, and all gains are front-panel adjustable for equal loudness when switching between speaker pairs. The unit accommodates one amplifier driving two unpowered speaker pairs, and a line level signal driving one self-powered pair. This product provides an internal, high-power headphone amp.

707-763-1010; fax 707-763-1310

www.furmansound.com; info@furmansound.com

Headphones Audio- Technica

ATH-M20: The new ATH-M20 headphones use a closed-back design and feature a rich bass response with an extended high end. Employing the company's latest transducer technology, the stereo headphones offer a high level of sonic accuracy in a design engineered to provide comfort for hours of listening. The headphones feature 40mm drivers, each with a neodymium magnet structure, and have a frequency response of 30Hz to 20,000Hz. The headphone also offers a lightweight, adjustable cushioned headband to provide maximum listening comfort. In addition, they feature a gold-plated stereo 1/8" connector with strain relief and snap-on 1/4" adapter, as well as a sturdy, ultra-flexible 10' coiled cable with single-side exit on the left side.



330-686-2600; fax 330-686-0719

www.audio-technica.com; pro@atus.com

Condenser mic Marshall Electronics

600 FET: The MXL 600 FET condenser microphone has a 20mm, three micron gold diaphragm housed in a 22mm x 130mm slim-line enclosure. The mic has the sonic characteristics to expose the soul of musical instruments. Its exceptional transparency captures the air of stringed instruments, pianos, drums and cymbals. It is useful when used in stereo pairs for recording entire rooms or for overhead miking of drum kits. The mic's harmonic accuracy will enhance any performance or recording. The mic comes complete with mic stand clip and carrying pouch.

800-800-6608; fax 310-333-0688

www.mxdmics.com; sales@mxdmics.com

SRM-80A: Providing a way to manage mixdown and dubbing in a single product, this monitor offers signal routing and monitoring for four stereo devices, plus the main console output. The

The Best Selection TV & Radio antenna systems

FM Educational Circular Polarization Antennas

Model	No. Bays	Max. Input Power	Price
MP-1	1	500 W	\$250
MP-2	2	800 W	\$650
MP-3	3	800 W	\$950
MP-4	4	800 W	\$1,250
MP2-4	4	2,000 W	\$1,750
MP3-5	5	3,000 W	\$2,250
MP3-6	6	3,000 W	\$2,700

FM Low Power Circular Polarization Antennas

Model	No. Bays	Max. Input Power	Price
GP-1	1	1,500 W	\$350
GP-2	2	3,000 W	\$1,350
GP-3	3	4,500 W	\$1,800
GP-4	4	6,000 W	\$2,500
GP-5	5	6,000 W	\$2,900
GP-6	6	8,000 W	\$3,500

FM Medium Power Circular Polarization Antennas

Model	No. Bays	Max. Input Power	Price
SGP-1	1	3,000 W	\$650
SGP-2	2	6,000 W	\$2,450
SGP-3	3	8,000 W	\$3,500
SGP-4	4	8,000 W	\$4,300
SGP-5	5	8,000 W	\$5,100
SGP-6	6	8,000 W	\$5,900
SGP-6R	6	15,000 W	\$6,500

Please Contact the OMB America
Sales Department for other
antenna systems configurations



AMERICA
2100 NW 72nd Ave. Doral FL 33122
MIAMI Florida 33122
Ph: 305 477-0472 - 305 477-0424 (6 Lines)
Fax: 305 477-9611
Internet: <http://www.omb.com>
www.omb.com

Digital audio recorder Nagra

Nagra-V: Developed to replace its analog reel-to-reel recorders, the recorder incorporates Castlewood's ORB 2.2GB ultra high-speed removable cartridge drive for a faster, easier, lower-cost recorder that helps achieve



industry-wide compatibility. The unit records just once to the Castlewood ORB drive, at a transfer speed that is four times faster than DVD. Production sound recordists can record more than two hours of

24-bit digital audio recorded at 48kHz sampling frequency. The recorder drive provides the highest storage capacity at the lowest cost per megabyte. The device offers one-step recording, 10 times faster recording than optical and 2.2GB capacity. The recorder was developed specifically for MAC and PC products.

615-726-5191; fax 615-726-5189
www.nagra.com; contact@nagra.com

Mic cable Wireworks

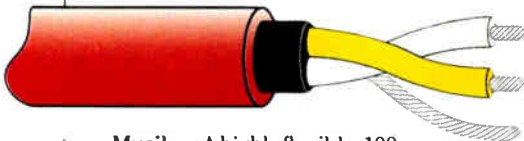

Miclux: A highly flexible, 100 percent thermoplastic-shielded cable, this cable is durable and tangle resistant. The cable comes in 10 jacket colors and strips in 1 second. The ideal installation cable is small, easy to strip and designed for fixed installations.

800-642-9473; fax 908-686-0483
www.wireworks.com; info@wireworks.com

Telephone hybrid Sonifex



and remote line hold switching, integrated auto-answer after a predetermined number of rings, a balanced mic/line input, low impedance balanced output with output gain adjustment, line limiter, bandpass filter and output noise gate with preset threshold providing low distortion and clear audio. It also can provide an output mix of the caller and the mic/line input signals for situations where both sides of the conversation need to be recorded.

207-773-2424; fax 207-773-2422
www.independentaudio.com; info@independentaudio.com

Graphic equalizer Rane



DEQ60: This stereo 1/3-octave digital graphic equalizer is part of the company's new analog-controlled digital series. The digital signal path uses advanced DSP algorithms so the output magnitude response corresponds to the front panel settings. One advantage of the Perfect-Q design is the subtle refinements of frequency response, allowing for ease of operation and clarity of sound reproduction. Changing a 1/3-octave setting changes only that setting. The equalizer features a 30-band EQ with slider controls and soft-touch knobs. Each channel includes full-cut accelerated slope three-band tone controls, separate sweepable low-cut and high-cut filters, individual input and output level controls with LED meters for each, range switches and bypass switches (fail-safe relay). It is able to slave one channel to the other, or use as an A-curve/B-curve comparison, or as two analog memories. The rear panel offers a choice of analog balanced inputs and outputs using XLR, 1/4" TRS or Euro style three-pin connectors. The power supply is internal and universal with a standard IEC line cord connector.

425-355-6000; fax 425-347-7757; www.rane.com; info@rane.com

Analog audio cables Gepco International

X-Band: This analog audio cable is available in single- and multi-pair versions. The cable is flexible and sonically transparent. It offers low noise



and is a durable, balanced cable useful in studios or live-sound venues. This cable will not retain kinks and bends when flexed. Notable features include reduced high-frequency absorption and a foam dielectric that allows for easy cutting and stripping with minimal wickback when soldering. Its shield will not open through repeated flexing and is easy to trim. Ground termination is simplified with the drain wire and the cables offer RF and EMI rejection. Pairs on multi-pair colors are color-stripped and printed for easy identification that is visible after installation.

800-966-0069; fax 847-795-8770; www.gepco.com; gepco@gepco.com

HY03: Replacing the Sonifex HY02, the HY03 is an analog telephone hybrid that features fully automatic operation, adapting to varying line conditions with automatic signal limiting, local

Compact production mixer Sound Devices

302: Developed specifically for field production audio applications, this mixer is useful for production companies wanting to take control of their audio. A compact and cost-effective battery-powered professional audio mixer, the key features include: large, 40-segment sunlight-view-



able output level meters; channel-selectable microphone powering (48V/12V phantom and T-power); three microphone inputs with Lundahl input transformers; input limiters and software-selectable output limiters and headphone monitoring, including PFLs and MS stereo matrix.

608-524-0625; fax 608-524-0655

www.sounddevices.com; info@sounddevices.com

Bundle for TDM Eventide

Clockworks Legacy: Eventide announces five new plug-ins, together in one bundle: the Clockworks Legacy for Digidesign Protools TDM. The Omnipressor is a compressor with an attitude. The Instant Phaser is a plug-in based on the first phaser, a single function analog processor featuring a sweeping filter bank. The H910 is the plug-in recreation of the first Harmonizer effects processor. The Instant Flanger is the plug-in recreation of one of the first hardware products to recreate flanging. The plug-in provides the ability to choose or combine modulation sources together, including the LFO, or input signal (envelope follower), or manual sweep, which can be controlled by MIDI. The H949 took pitch changing even further. The plug-in recreates the unique random feature, which creates slight variations in delay resulting in a less mechanical sound. Full automation and MIDI control, and control surface support have been added to take full advantage of the power and flexibility of Protools.

201-641-1200; fax 201-641-1640

www.eventide.com; postmaster@eventide.com

Large ribbon microphone Audio Engineering Associates

R84: The R84 uses the same ribbon pickup element as the company's R44. It includes an integral cushion mount/stand adapter, an attached three-meter star-quad mic cable and a custom soft case. It features a figure-eight pickup pattern that becomes tighter at higher frequencies. Frequency response is 20Hz to 20kHz (+/-6dB).

626-798-9128; fax 626-798-2378

www.wesdooley.com; stereoms@aol.com



Professional headphones Ultrasone

HFI-650: These studio headphones suppress external noise thanks to their closed construction. The headphones also provide a broad, detached three-dimensional hearing sensation. Due to customer enquiries, the company implemented an additional function that enables the user to fold back the individual earpiece without removing the headphone from his head, to be connected immediately with the outside world again. Because of this folding mechanism, the headphone can be compactly stored and easily transported. Features of the headphones include: S-Logic Natural Surround Sound System, reduced magnetic field emissions, safe hearing protection, closed-cup design, a frequency range of 15Hz to 25kHz, impedance of 75Ω and sound pressure level 94dB.

+49 8856 - 93 66-0; fax +49 8856 - 93 66-99

www.ultrasone.com



www.beradio.com

The Power of Two Companies: Pristine Systems & CartWorks



- Automatic live website content
- Live-assist, satellite or full automation
- Complete remote control
- In-context voice tracks
- Supports all traffic & music software
- 24/7 product support
- Digital automation since 1988

Call for Details

refer to BE033



Pristine Systems

www.pristinesys.com 800-795-RADIO

New Products

www.beradio.com

Power conditioner MGE UPS Systems

Topaz 800: The conditioner removes damaging electrical noise and solves quality problems that wreak havoc with sensitive equipment. The unit removes electrical noise and protects against sags, surges and brownouts, ensuring clean conditioned power for the most sensitive and demanding of applications. The units are available in sizes from small office models to floor or wall/panel mounted industrial units ranging in power ratings from 140VA to 25kVA. They provide high quality power with inherent surge and lightning protection.

800-523-0142
fax 714-557-9788
www.mgeups.com
info@mgeups.com



Active CD turntable Denon Electronics

DNS5000: A tabletop single-disc CD player, this product features an active analog turntable platter with real-time user interaction.



The live motor-driven active platter, which is 7" across, can be used to scratch, backspin, brake, search and otherwise manipulate as if the compact disc is a vinyl turntable. The turntable includes the newly developed Alpha Track capability, enabling independent playback of two tracks from the same disc at the same time, with the ability to manually mix with a single drive, just as you would with two discs. Additionally, with the Mirror Mix function, the user can also select the same track in main and Alpha and play the Alpha track after a specified time delay at 1/8, 1/4, 1/2, 1/1 or 2/1. The effect is as if the user had two copies of the same record. The Hot Disc 35-second memory feature allows you to eject the disc during playback and have play continue for as long as 35 seconds. The three-way scratching capability provides for scratch effects to be applied to the main, Alpha

or sampler track. There are also four seamless loops, plus the revolutionary A-B splice function for seamless removal of unwanted track sections. A and B points for this, plus seamless loop and sampler loop, can easily be adjusted in real time using the Scratch Disc. There are two samplers offering 15 seconds at CD quality.

973-396-0810; fax 973-396-7459; www.denon.com

Acoustics First® Materials To Control Sound And Eliminate Noise



The 1014 AcoustiKit™

The 1014 AcoustiKit is the small control room package with real studio Art Diffusers®.

Acoustics First combines these in one box with Cutting Wedge® foam, Bermuda Triangle Traps™ and specific instructions for installation.

The 1014 AcoustiKit is everything you need for a 10' X 14' control room, without buying more than you need.

Toll Free **1-888-765-2900**

Web: <http://www.acousticsfirst.com>

Multichannel sound card Audioscience

ASI6118: This sound card is aimed at high performance entertainment applications requiring multiple streams of MP3 and MPEG Layer 2 play with analog and AES/EBU digital interfaces. The card uses a 150MHz Texas Instruments TMS320C6711 DSP and provides eight stereo outputs, one stereo input, one record streams, eight stereo/16 mono play streams and a powerful multi-rate digital mixer. Audio format choices include MP3, MPEG Layer 2 and linear PCM. MRX technology supports digital mixing of multiple stream formats and sample rates. This product offers 24-bit AD/DA converters, 100dB SNR and 0.002 percent THD+N, as well as AES/EBU and S/PDIF digital audio input and output (software selectable) with sample rate converters on all inputs.

302-324-5333; fax 302-738-9434

www.audioscience.com; sales@audioscience.com

Medium-power UPS

Active Power

CleanSource UPS: In this mid-range line of uninterruptible power supply systems, there are four models in power ratings from 65kVA to 130kVA. Using the company's flywheel technology, the models store kinetic energy in a constantly spinning, quiet, low-friction, solid-steel disc. Stored energy from the flywheel is instantly converted to electricity that powers critical loads during utility disturbances or until a standby generator takes over. The units can be configured through software to integrate with generators. Standard features include internal static bypass, serial communications, LCD monitoring and control panel, programmable I/O contacts and programmable auto restart. Available options include remote notification and monitoring, CS View real-time monitoring software, remote emergency power off, MODBUS and SNMP interfaces, internal maintenance bypass and seismic Zone-4 anchoring capability.

512-744-9461; fax 512-836-4511

www.activepower.com; jlazier@activepower.com



Digital FM exciter Aquila Broadcasting Sets

D.FE.: The fully digital FM exciter combines the DSP technology for modulating signal processing and DDS for generating the FM modulated signal. The final frequency in the range 87.5MHz to 108MHz is achieved with one up-conversion. The numerous inputs accept all possible modulating signals, i.e. mono, separate L and R, AES/EBU digital stream and RDS/SCA subsidiary transmission. A micro-controller continuously monitors the operating status of the exciter including the RF power output amplifier. The user interface comprises an easy-to-use menu on LCD, RS232 port and a PS2-PC keyboard connector for external control of the operating status. The same keyboard interface can be used for the internal RDS encoder programming. The exciter is provided with adequate hardware and optional firmware, enabling it to be used as a reserved exciter for N+1 system with up to six programmable frequencies and output levels.

39 0863 995150; fax 39 0863 995215

www.asb-spa.com; support@asb-spa.com

www.beradio.com

The only industry publication that's written
by radio professionals – for radio professionals.

Radfo
THE RADIO TECHNOLOGY LEADER

The ASBPE award-winning editorial staff*, led by Chriss Scherer and featuring Harry Martin, John Battison and Kevin McNamara, reports monthly on critical updates that keep you current in an ever-evolving industry.

If you miss an issue of *Radio* magazine, you'll pass up valuable peer-to-peer advice regarding:

- New product previews;
- User reports;
- Facility showcases;
- Installation projects;
- FCC updates, and
- Application examples, so you get the most from industry tools.

Don't miss out! Subscribe to *Radio* magazine today.

To start your FREE subscription with the radio industry's community resource for radio technology, go to www.beradio.com and click on "Subscriptions."

Radio magazine – The Radio Technology Leader

*Radio magazine has received four ASBPE awards for outstanding editorial content from 1999-2001.



Rack-mount mixer Crest Audio

XRM: This compact and versatile rack-mount monitor mixer provides desktop quality mixing performance in control applications and fixed installation systems. Housed in a 10 rack-space package, the mixer can provide as many as 12 independent mono mixes, or as many as six stereo mixes for stereo in-ear monitoring systems. The mixer takes up minimal space in a sound control booth, and is small enough to travel as carry-on luggage with musicians who take their own self contained in-ear system with them on the road. Highly versatile, it can be used as a mono/stereo matrix mixer with 12 mono and four stereo mic/line input channels, all with mic preamps and individual 48V phantom power switches. The unit includes a 20 input microphone splitter system with ground-lift switches on each input channel. In addition to 12 mix bus outputs with high pass filters, insert system and balanced XLR outputs, this product features four band equalization with high-mid and low-mid sweep EQ along with -18dB per octave high-pass filters on all input channels.



201-909-8700; fax 201-909-8744; www.crestaudio.com

A/D-D/A converter AEQ

Caddy: The new AD/DA converter works in tandem with the Impact Digital Audio Matrix and also works as a stand-alone converter. One rack unit can convert 12 analog inputs to 12 digital outputs simultaneously. It can be used as an auxiliary unit with Impact to allow the connection of analog and digital circuits in current equipment at radio and sound recording studios and central control rooms.

954-581-7999; fax 954-581-7733; www.aeqbroadcast.com; sales@aeqbroadcast.com

Software application Studio Network Solutions

SANmp: This multi-platform software allows workstations with different operating systems to concurrently access information from a Storage Area Network. With this software, users now can upgrade to the latest OS or add Windows workstations to their Mac environment. In addition, this product is easy to implement and maintain because it does not require a server or Ethernet connection.

The Mac and Windows versions of this software share a common user interface, so it is simple to use on either platform. Some features found in this product are the ability to easily configure and manage the storage network, set

access privileges at the user level, and share and access audio and graphics files from a centralized storage location. Another benefit is the ability to integrate Mac OS and Windows workstations, regardless of whether the systems are running Nuendo, Sonic HD, Final Cut Pro, Pyramix, Avid or Protools.

877 537 2094; fax 314 423 4867

www.studionetworksolutions.com

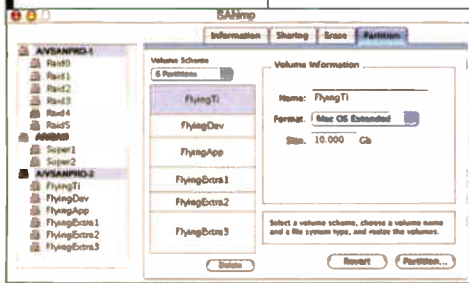

Upgrades and Updates

Harris Ships DAX 5/6

The DAX transmitters are lower-power transmitters that have been designed specifically for digital transmission, but are also suited for analog use. The DAX AM uses a new modulation technique called Digital Adaptive Modulation, which can reduce antenna load-induced distortion, resulting in a cleaner analog signal and extended coverage in digital modes, such as IBOC and DRM.

Digigram Adds Codec Upgrade

An optional MP3 codec is available for the company's PCX and LCM card range. PC Codec MP3 improves the performance of MP3 playback using Digigram PCX/LCM cards by adding the ability to directly record in the MP3 format and increase the number of MP3 files played simultaneously.

Telos Releases Profiler Version 2.0

Version 2.0 of the company's logging software features multiple simultaneous program streams support, the ability to record simultaneous mono streams using a single stereo audio card, multiple simultaneous bit-rate recordings for short- and long-term storage, an integrated logging scheduler, expanded GPIO support, and an integrated recorder and server application.

Audioscience Adds MP3 Low Sample Rate Support

Audioscience has added low sample-rate format (LSF) MP3 support to its range of ASI6000 audio adapters. The LSF formats support MP3 encoding and decoding at sample rates of 8, 11.025, 12, 16, 22.050 and 24kHz and bit rates of 8k/s to 160k/s. All signal processing is done on the adapter's DSP, reducing dependence on the host PC processor. ■

Audio replay system AMEK Systems & Controls

Trigger: Trigger is a flexible and powerful system for radio, live theatre, corporate events, theme parks and visitor attractions. The system provides easy-to-use instant play facilities, allowing sound effects, music segments and voiceovers to be simply and effectively managed from a single system. This device offers the convenience of being able to record, edit, assign and replay audio segments from within a single-screen display. Mono and stereo audio segments can be assigned across as many as four stereo outputs, with segments sequenced as four playlists, or triggered individually by the 32 instant-play Trigger keys. Specific segments can be programmed for triggering by external switching including contestants' and presenters' buttons, and console fader-starts with Trigger also able to generate or respond to MIDI commands and LTC information for synchronizing audio play-outs to other events and equipment, such as studio lighting. The disk-based system is supplied with an internal hard drive capable of storing 58 track/hours of audio, plus a choice of removable-media drives including DVD-RAM, MO and Zip.

+44 1618 346747; fax +44(0)1618 340593
www.amek.com; amek@amek.com

DAW controller Mackie Designs



Control Universal: This control surface combines the functionality and compatibility of Mackie Control Emagic Logic Control and Mackie's HUI protocol into one universal controller. The controller features full implementation for Emagic's Logic Audio as well as the entire family of DAW software currently supporting the Mackie Control including: Digidesign Pro Tools, Cakewalk Sonar, Magix Samplitude and Sequoia, MOTU Digital Performer, RML Labs Saw Studio, Steinberg Cubase SX/SL and Nuendo, Syntrium Cool Edit Pro and APB Tools TH-S software. The design features eight channel strips each with 100mm Penny+Giles optical touch fader and V-Pot for fast tweaking of effects and plug-ins. Also included is a full-sized backlit LCD, and shortcut navigation and editing for all major software functions. The stock silk screen will now correspond to Logic Audio functions, while software-specific master section overlays will continue to be available to customize the unit to other supporting DAWs.

800-898-3211; fax 425-487-4337
www.mackie.com; productinfo@mackie.com

www.beradio.com

Power distribution unit Pulizzi Engineering

T982 series: This multiple configuration power distribution unit with current monitoring allows for maximum flexibility in its configuration options. The model has six easy-to-configure options, not including the mounting options. This allows the user to customize the design to meet their needs. The PDU is 1U high, 7" deep and is 19" rack mount. The rugged construction is all steel with a black finish. The unit features detachable mounting brackets that allow for front flush, recessed, center mount or rear mount. The brackets can also be replaced with vertical mounting brackets or an optional cable restraint/management system. The unit has circuit breaker protection and surge suppression included as standard. There are a total of 12 NEMA style receptacles on the unit to distribute power to many devices.

800-870-2248
fax 714-641-9062
www.pulizzi.com
sales@pulizzi.com



www.beradio.com

Rectifier Problems?

We're problem solvers & we have a prompt, cost-effective solution.

www.rectifiers.com
800-649-6370

• 360 Systems • AKG Acoustics • Audioarts • Behringer • Belar •

• Mackie • Mediatouch • Omnia • Radio Design Labs • Shure • Symatrix • Tascam • Telex • Telos •



Transmitter Lines*:

Continental
Nautel
Armstrong

Broadcast equipment at exceptional prices.
Customized automation systems.
Complete systems integration.
Quality pre-owned equipment.
Pre-wiring packages.
Broadcast equipment repair.
Complete engineering services.
Transmitter, tower, and antenna packages.

For service after the sale, choose

Lightner Electronics

Your Ultimate Solution.

Toll Free: 866-239-3888
Fax: 814-239-8402
www.LightnerElectronics.com



*Regional only, call for details

• Middle Atlantic • LPB • JK Audio • JBL • Inovonics • Gepco •

Burk • Beyer Dynamic • Burk • Coastal Dynamics • Crown • Denon • Electro-Voice • ETA •

CircuitWerkes Telephone Solutions



AC-12 Telephone Autocoupler Bay

The AC-12 rack-mounted coupler bay is the best way to eliminate a wall or cabinet full of yesterday's couplers. Our unique dual audio busses eliminate the tedious and messy wiring associated with mass feeds. Each card can also individually either send or receive telco audio, making it perfect for IFBs, etc. Best of all, a loaded AC-12 lists for under \$175 per coupler.

HC-3 Advanced Telephone Autocoupler

The HC-3 is ideal for a variety of tasks like listen lines, concert lines & remote broadcasting. The HC-3 automatically answers on a user set ring number and disconnects at the end of the call. Its dry relay contacts can interface to remote recorders, tally lights, etc. Remote connections include: aux. relay closure, pickup-enable, remote pickup trigger, call end sink, & Ring / Online sink. Optional ComboLok provides password security.

TELCO-6 Ringer Relay

Calls come in, you get relay outputs. It's that simple. Accepts up to six independent telephone lines. Each incoming ring closes the associated relay. Each relay has two sets of form "c" contacts. Relays stay steady on during rings. All interface connections on screw terminals.

For complete information about all of our products, including downloadable tech manuals, brochures and pricing for all of our products, visit our website at www.circuitwerkes.com.

CircuitWerkes, Inc. - 2805 NW 6th Street, Gainesville, Florida 32609 USA 352-335-655E

rfSoftware, Inc.

The deadline for translator applications is fast approaching.

See how we can help!

www.rfsoftware.com

352-336-7223

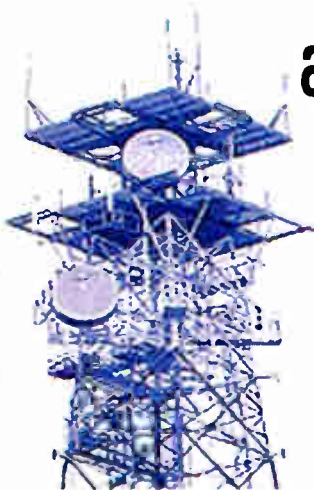

AES/EBU DIGITAL AUDIO DISTRIBUTION AMPLIFIERS

DDA106-XLR (1X6) • DDA112-BNC (1X12)
 DDA112-XLR (1X12) • DDA124-BNC (1X24)
 DDA206-XLR (Dual 1X6) • DDA212-BNC (Dual 1X12)
 DXA112-XLR (1x12) • DXA124-BNC (1x24)



- Accepts sample rates from 27 to 96kHz
- Transformer balanced inputs
- Data reclocking and regeneration
- Adjustable input cable equalization
- Loop-thru inputs w/switchable terminations
- Sample rate, Status and Error indicators
- Up to 12 XLR or 24 BNC outputs

ATI AUDIO TECHNOLOGIES INCORPORATED

Dedicated to sound engineering
 ATI • 328 W. Maple Avenue • Horsham, PA 19044
 800-959-0307 • 215-443-0330
 Fax: 215-443-0394
<http://www.atiguys.com>
 Free Brochure Available Upon Request

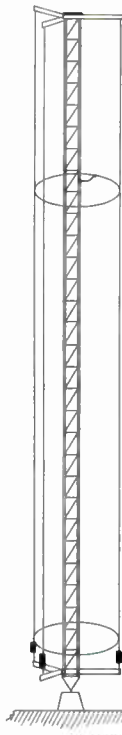

REMEMBER THE CORTANA FOLDED UNIPOLE ANTENNA? WE STILL MAKE IT WITH THE SAME HIGH QUALITY MATERIALS AND WORKMANSHIP. IT FEATURES...

- **BROAD BANDWIDTH** for better sound,
- **GROUND ANTENNA** for lightning & static electricity,
- **ELIMINATES ISOCOUPERS** in VHF & UHF antenna lines,
- **BEST ANTENNA FOR DIRECTIONAL ARRAYS.**

ALSO

DETUNING SYSTEMS FOR ANYTHING THAT DISTORTS YOUR AM COVERAGE PATTERN: TOWERS, POWER LINES, TANKS OR ANY METAL STRUCTURE.

FOR INFORMATION CALL, FAX OR WRITE:

nott ltd.

4001 La Plata Hwy
 Farmington, NM 87401



phone 505-327-5646 fax 505-325-1142



RF PARTS™
 COMPANY

- ✓ Audio
- ✓ Broadcast
- ✓ Industrial
- ✓ Communications

Audio Tubes • Transistors
 Modules • Gasfets • Coax
 Capacitors • Rectifiers



Svetlana • Taylor • RFP • Eimac
 Amperex • MA/Com • Motorola
 Toshiba • Thompson • Mitsubishi

- Se Habla Español
- We Export



760-744-0700 • 800-737-2787

Fax: 760-744-1943

E-mail: rpf@rfparts.com

www.rfparts.com

Gallery Radio

www.beradio.com

Buy simplicity,
 reliability and service.

EAS
 Price \$1750.00

Equipment in-stock
 for immediate delivery.

Phone 740-593-3150

GORMAN-REDLICH MFG. CO.
 257 W. Union St. Athens, Ohio 45701

FAX 740-592-3898

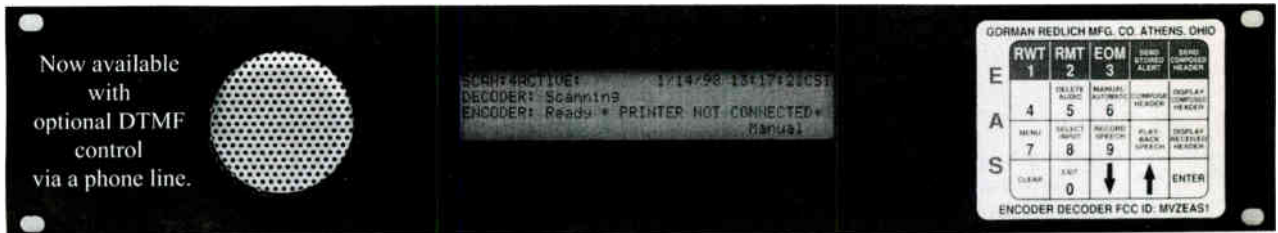

Now available
 with
 optional DTMF
 control
 via a phone line.

SEARCHING: 1714:58 13172051
 DECODER: Scanning
 ENCODER: Ready • PRINTER NOT CONNECTED
 Manual

GORMAN REDLICH MFG. CO. ATHENS, OHIO					
	RWT	RMT	EOM	SEND STORED ALERT	SEND COMPOSED HEADERS
E	1	2	3		
	QUALITY AUDIO	MANUAL AUTOMATIC	COMMERCIAL HEADERS		DISPLAY COMPOSED HEADERS
A	4	5	6		
	MANUAL SELECT INPUT	RECEIVED SPEECH	FLIP BACK SPEECH		DISPLAY RECEIVED HEADERS
S	7	8	9		
	CLEAR	EXIT	ENTER		
		0	↓	↑	
ENCODER DECODER FCC ID: MVZEAS1					

- 5 two-way RS inputs/outputs for computer, remote signboard & character generator
- 6 audio inputs on standard models. All audio inputs & outputs are transformer isolated from encoder-decoder board
- Automatic interruption of program audio for unattended operation
- 4 line 40 character LCD display with LED backlighting
- 20 key keypad to program unit, set modulation level, set input levels
- Now available with optional built in character generator which can crawl alert messages and station ID on the hour
- Will handshake with automation equipment
- 2 year warranty
- 2 minutes of digital audio storage
- 25 pin parallel printer port for external printer
- 52 terminals on the rear to interface with other equipment by removable plugs
- BNC fitting with 600 OHM balanced audio cut for second transmitter

Web Site: www.gorman-redlich.com • E-mail: jimg@gorman-redlich.com

• Also available: weather radios, antennas for weather radios, crystal controlled synthesized FM digitally tuned radios, remote signboards, cables for interconnection, Character generators.

LBA Technology, Inc. is your proven supplier of innovative, digital-ready AM antenna systems. Our products include tuning units, phasing systems, multiplexers, AM/wireless isolation systems and components for every power level. We help hundreds of broadcasters in the USA and worldwide to --

**Reach further –
sound better!**

LBA Technology, Inc.

Broadcast and Telecommunications Antenna Products



LBA Tunipole™
Folded Unipole Systems



Diplexer, Triplexer and
Phasor Systems



Antenna Tuning Units



LBA

3400 Tupper Drive, Greenville, NC 27834

800-522-4464 / 252-757-0279 / Fax 252-752-9155

Email Lbotech@Lbagroup.com / www.Lbagroup.com



**Your #1 Source
For Quality
Used Radio
Broadcast
Equipment.**

View our latest list of equipment on-line at:

<http://www.baycountry.com>

or call and we will fax it to you.

All equipment sold with a 15 day return guarantee.

7117 Olivia Rd. • Baltimore, MD 21220 • Ph: 877-722-1031 • Fax: 786-513-0812

<http://www.baycountry.com> • e-mail info@baycountry.com

**Unlock the secret to
successful advertising
continuity is the key. Inquire
today about frequency
discounts.**

**Operate any 3-phase TV transmitter
from a 1-phase supply with the
Phasemaster Rotary Phase Converter**

The most reliable alternative to utility 3-phase
AND the least expensive!



- True 3-phase output
- High Efficiency
- Maintenance free
- More stable than open-delta
- 1000+ TV and Radio Stations rely on Phasemaster*

*Turn any location into a 3-phase site within hours!
Eliminate utility line extension and demand charges
Recommended by leading transmitter manufacturers*

**The World Leaders in Single to
Three-Phase Power Conversion**



Kay Industries
PHASEMASTER®
Rotary Phase Converters

General Offices
604 N. Hill St.
South Bend, IN 46617
800-348-5257
574-289-5932 (fax)

Visit us at
NAB 2003
Booth N2801

Western Region
4127 Bay St. #6
Fremont, CA 94539
510-656-8766
510-657-7283 (fax)

www.kayind.com

info@kayind.com

TOWER

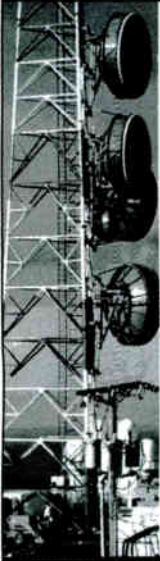

- **Fabrication**
- **Design**
- **Engineering**
- **Installation**
- **Service**
- **Maintenance**

Swager is your worldwide turnkey tower company.

Phone
1-800-968-5601
or Fax
1-800-882-3414



SWAGER
Communications, Inc.

P.O. Box 656
501 East Swager Drive
Fremont, IN 46737 USA
Phone 1-800-968-5601 • 260-495-2515
Fax 1-800-882-3414 • 260-495-4205
E-mail: sales@swager.com
Internet: www.swager.com

Superior Broadcast Products

Solid State FM Transmitters

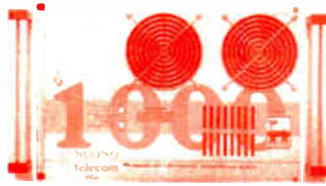

8,000 watt	44,990.00
4,000 watts	24,990.00
2,000 watt	12,990.00
1,000 watt	7,000.00
500 watt	4,000.00
250 watt	2,500.00
100 watt	1,900.00

Solid State FM Amplifiers

2,000 watt	12,000.00
1,000 watt	6,000.00
500 watt	3,000.00
250 watt	1,750.00
100 watt	1,250.00

FM STL Transmitter and Receiver

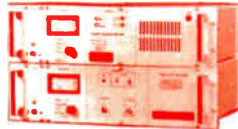

Both Transmitter and Receiver
\$3,500.00

High Performance FM Transmitters



Grounded Grid Models Feature

- Solid State High Performance Exciter
- Solid State Driver
- Ease of Installation
- Fast Delivery
- Motor Driven Tuning
- Complete Front Panel Metering
- Low Pass Filter
- Soft Start Up
- Cost Effective Pricing
- Financing Available
- LED Read out on front panel shows operating parameters

Fall Special Limited time offer
10,000 watt Transmitter **\$18,990.00**

Broadband FM Antennas

Ideal for Digital or multi station operation

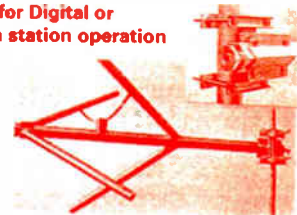

Circular polarization - DC ground for lightning protection - mounts directly to tower leg - Power input 4,000 watts per bay
Priced as low as 795.00 for a single bay
Multi bay operation up to eight bays

17194 Preston Rd. Suite 123-297 Dallas, TX 75248 Ph 972/473-2577 800/279-3326
Fax 972/473-2578 800/644-5958 e-mail jjoynt@superiorbroadcast.com website superiorbroadcast.com

Radio™

THE RADIO TECHNOLOGY LEADER

The latest radio technology headlines delivered to you via e-mail every week.

- ▶ This Week in History
- ▶ Information from the *Radio* calendar
- ▶ Conference and convention schedules

The *Radio* e-mail newsletter offers an easy-to-read format that links to the complete stories.

Subscribe to the e-mail newsletter online at www.beradio.com.

Transcom Corporation AM & FM Transmitters

Visit our new internet site at www.fmamtv.com
Send your email request to: transcom@fmamtv.com

Fine Used AM & FM Transmitters. Authorized Representatives for all major equipment manufacturers. Let us send you a customized quote!

USED FM TRANSMITTERS

2.5kW 1978 Collins 831D2
3kW 1996 QEI Quantum
3.5kW 1985 BE FM 3.5A
10kW 1980 Harris FM 10K
10kW 1991 QEI FMQ 10,000B
20kW 1976 Collins 831 G2
20kW 1982 Harris FM20K
20kW 1989 QEI FMQ20,000B
25kW 1980 CSI T-25-FA
Amplifier Only
30kW 1984 BE FM30
35kW 1989 Harris HT35
40kW 1978 2-RCA BTF 20E1
(combined)
50kW 1982 Harris Combiner w/
auto Exciter-transmitter switcher

USED AM TRANSMITTERS

1kW 1996 Nautel ND1
1kW 1980 Harris MW1A
1kW 1988 Harris SX1A
5kW 1984 Harris MW5A
5/10kW 1982 Continental 316F
50kW 1982 Continental 317C2
*50kW 1986 Nautel AMPFET 50

NEW TV - VHF

10 watt 500 watt
100 watt 1,000 watt
250 watt

NEW TV - UHF

10 watt 500 watt
100 watt 1,000 watt
250 watt

USED MISC. EQUIPMENT

Belar AMM3 Mod. Monitor
Continental 802B Exciter
Denon 720R Cassette Recorder
Harris AMS-G1 AM Stereo
Inovonics AM Stereo Processor,
Model 250-01
Kintronics 50kw AM RF Switch,
Model RFC8-1
Optimod 8100A (cards 3 - 5 only)
Potomac Phase Monitor AM1901, Digital,
2 Tower
Potomac Phase Moitor AM19, 2 Tower
Potomac TU-16 Remote Control

P.O. Box 26744, Elkins Park, PA 19027

800-441-8454 (215-938-7304) Fax 215-938-7361

ELECTRONIC COMPONENTS

Catalog #614

May 2003 - July 2003



SEMICONDUCTORS

PASSIVES

INTERCONNECTS

POWER

ELECTROMECHANICAL

TEST, TOOLS & SUPPLIES

MOUSER 
ELECTRONICS

www.mouser.com (800) 346-6873

Mini Mix 8A

Proven...Affordable...

Reliable.

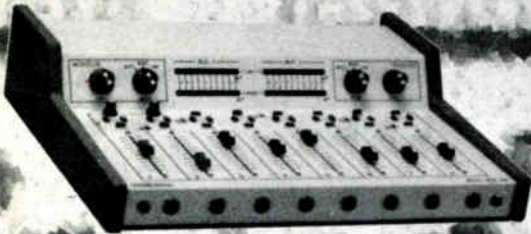

AUTOGRAM

800.327.6901

www.autogramcorp.com



If lightning strikes on your tower are causing equipment damage and lost air time - the cost of a Stati-Cat system may be recovered during your first lightning season.

www.cortanacorporation.com

**AFFORDABLE - RUGGED
LIGHTNING PROTECTION**

*The Stati-Cat
Lightning Prevention System*

provides a continuous, low-resistance discharge path for the static electric charge on tall structures. DISSIPATION POINTS ARE 1/8" STAINLESS STEEL RODS (not wires) ground to needle sharpness.

Cortana
Corporation, Inc.

Write or call toll-free for a free brochure!
P.O. Box 2548, Farmington, N.M. 87499-2548
Call 888-325-5336 FAX (505) 326-2337



Our client list continues to grow.
We would like to Thank-You
for your confidence and your
purchases.

We now have in stock, SHURE, SM-5B, wind screens. These are from the OEM vendor and are priced at \$60.00 per set. Make the best voice over microphone, new again!

We recondition Pacific Recorders BMX I-II-III, AMX, ABX and RMX mixing consoles. Let us re-work your console's modules. Obtain that added value from a proven winner. Quality built products last and last and last!

Check our WEB site for great buys on pre-owned broadcast gear. All equipment is repaired, tested and shipped with the manual.

Stretch your broadcast \$\$\$ on quality, pre-owned equipment...sold with a warranty.

TEL 800-300-0733 • FAX 231-924-7812
WWW.MOORETRONIX.COM

So...what's your "Plan B" ?

Plan B and the new Plan B Plus
keep things on the level whenever
Murphy delivers a new twist.

- digital silence sensor / passive audio switcher
- continuous, high-quality backup audio
- voice remote control, listen-line and more
- ready-to-install / 5-year warranty

NEW! Plan B Plus adds an extra level of protection:

- automatically switches to a secondary live feed
- Extra features for dialing ISDN codecs, etc.

Call your dealer or visit
www.danagger.com



Danagger Audio Works 1 888.89.AUDIO

Gallery Radio
www.beradio.com

Take the headache out
of planning your
advertising
budget



Call to find out
how advertising
in Radio can work
for you!

Steven Bell
sbell@primediabusiness.com

BROADCAST ENGINEERING
CONSULTING SOFTWARE

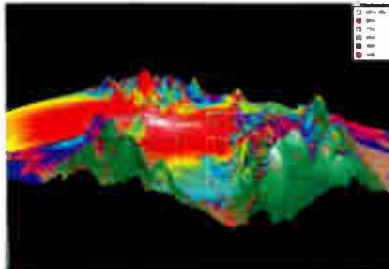

Longley-Rice over 3-D Terrain

Professional software packages for
preparing FCC applications & plotting
coverage. For Windows & NT.

- Create "real-world" coverage maps & interference studies with Longley-Rice, PTP, FCC, Okumura & other models using polygon map features.
- Search for AM, FM, TV, DTV, & LPTV channels with graphics oriented programs and FCC databases.
- Plot STL paths in 3-D using 3-Arc second terrain databases...and more!



800-743-3684 • www.v-soft.com



26,000 songs in 16 bit, 44.1
stereo .WAV files with all the
song data embedded.

11 basic libraries available
with same day shipping.

Also available in GoldDrive
MPEG Layer 2, Mode 2

And with the purchase of any
GoldWAV or GoldDrive library
you can acquire a matching,
back-up, GoldDisc library
for half price.



GoldDisc - GoldDrive - GoldWAV
The World Plays Our Music!

www.TMCentury.com
972.406.6800 • TMCI@TMCentury.com



Towers Above the Rest

- Monopoles
- Guyed Towers
- Self-Supporting Towers
- Structural Analysis
- Tower Reinforcing

Since 1943, ERI has provided excellence in engineering, reliability in service, and years of manufacturing integrity.

Our past experience is your future guarantee.

Electronics Research, Inc.
7777 Gardner Road
Chandler, IN 47610
812-925-6000 www.ERInc.com

Marketplace

Nexus Broadcast

Quality Equipment, Low Price

Frequency Agile - Digitally Synthesized
Temperature & VSWR Protected
120 - 220 volts - Front Panel Controls
Stereo Generator/Processor (Optional)
One Year Parts & Labor Warranty

20 W Exciter	\$850	100 W Exciter	\$1795
250 W Exciter	\$2995	100 W Amp.	\$ 995
250 W Amp.	\$1795	500 W Amp.	\$3955
1KW Transmitter	\$5995	1KW Amp.	\$5495

Order Toll Free 800-219-7461

www.nexusbroadcast.com

P.O. Box 433 - Mt. Vernon, TX 75457

EAS MONITORING

YAGI ANTENNAS

WEATHER CHANNEL

FREQUENCIES 162.0? MHZ

FM FREQUENCIES

88 TO 108 MHZ

ALL FREQUENCIES FROM 88
TO 1000 MHZ AVAILABLE

SAMCO ANTENNAS, INC.

(817)-336-4351

www.samcoantennas.com

email:samyagi@flash.net

Marketplace Section

for ad rates

Call Jennifer Shafer

800.896.9939

email: jshafer@primedia

AM Ground Systems

**Reliable, On-Time Installation
Quality Workmanship
Ground System Construction,
Evaluation & Repair**

www.amgroundsystems.com

1-877-766-2999

AUDIOARTS

Broadcast Equipment
Customized Automation Systems
Complete Systems Integration
Quality Pre-Owned Equipment
Pre-Wiring Packages
Complete Engineering Services

Your Ultimate Solution.

Lightner Electronics
(814) 239-8323
Toll Free: 866-239-3888
www.LightnerElectronics.com



Professional Services

**4006
BELT LINE
SITE 160
ADDISON
TEXAS
75001
972/661-5222
www.rbdg.com**

- RECORDING AND BROADCAST FACILITY DESIGN
- ARCHITECTURE/INTERIORS FOR ACOUSTICAL SPACES
- ROOM ACOUSTICS AND SOUND ISOLATION
- NOISE AND VIBRATION CONTROL

RUSS BERGER DESIGN GROUP

**JOHN H. BATTISON P.E.
CONSULTING BROADCAST ENGINEER,
FCC APPLICATIONS AM, FM, TV, LPTV
Antenna Design, Proofs, Fieldwork
2684 State Route 60 RD #1
Loudonville, OH 44842
419-994-3849 FAX 419-994-5419**

Publications

WWW.RADIOSHOPPER.COM

**New & Used Equipment
Engineering & Web Links
Publications & Catalogs
Parts & Services**

Structural Analysis

ERI
Electronics Research, Inc.
7777 Gardner Road
Chandler, IN 47610
(812) 925-6000
www.ERInc.com



AW
Applied Wireless, Inc.
... providing options.
PO Box 926
New Market, MD 21774
tel.: 301.865.1011
fax.: 301.865.4422
email: kavinnmc@appliedwirelessinc.com
www.appliedwirelessinc.com
**Kevin McNamara
President & CEO**

For Sale

AcousticsFirst™
Toll-Free Number: **888-765-2900**
Full product line for sound control and noise elimination.
Web: <http://www.acousticsfirst.com>

Classified Section

For ad rates

**Call Jennifer Shafer at 800-896-9939
email: jshafer@primediabusiness.com**

SPACEWISE®
"The Price and Quality leader...
In Broadcast Studio Furniture!"

Affordably customized systems in several price ranges. Professional Quality furniture shop construction, components, real woods, and premium laminates. Built to order and easy to assemble. Economically and safely delivered crated to you! **WHY PAY MORE ELSEWHERE?**
25+ YEARS OF RADIO BROADCAST EXPERIENCE GOES INTO THE DESIGN OF OUR PRODUCTS!
CALL US - 800-775-3660
SEE US - WWW.SPACWISE.COM

**Visit us at
www.beradio.com**

Radio Classified

www.beradio.com

Help Wanted

WDAY-AM 970, FARGO, NORTH DAKOTA IS IN SEARCH OF A TOP-NOTCH NEWS/TALK MORNING SHOW TALENT

The legendary, heritage AM News/Talk station with 80 years of service to the Upper-Midwest, WDAY AM 970 has a great opportunity for a morning show co-host. This person must have a sense of humor and ability to interact and "play along" with both morning show partner (Kim Douglas) and WDAY listeners. A strong work ethic, an ability to shine delivering information to our target and a "can-do" attitude are all a must.

If you believe in strong show prep and know how to have fun on the radio, please submit your materials for this immediate opening. Strong candidates will understand the special nuances of News/Talk radio and the hot buttons of today's adult listener, who seeks news, sports, weather and information, mixed with fun and entertainment.

Please send aircheck (scoped & unscoped) and resume. WDAY is a locally owned radio station, that is part of the Forum Communications family of newspapers and television stations. Great benefits including 401k, Profit Share, Group Health, etc.

All correspondence will be held in strict confidence.

TAPES AND RESUMES ASAP TO:
Scott Hennen / WDAY / Box 2466 / Fargo, N.D. 58103
mp3 files 4mgs or less to: scott@wday.com
EOE

AUDIO SALES

Wheatstone Corporation, a leader in the audio broadcast industry, is seeking an audio sales professional, with a proven sales record, to join our sales force. In addition to having a successful background in audio sales, candidate will have working knowledge of analog and digital audio, as well as computer experience with Microsoft Office. Salary commensurate with experience and performance. Please contact Yvette Sullivan, Wheatstone Corporation, 600 Industrial Drive, New Bern, NC 28562, ysullivan@wheatstone.com. EOE. No phone calls, please.

CHIEF ENGINEER

We are a radio company in southern Indiana who is looking for a bright, shining Chief Engineer. Can you establish the procedures for operation & maintenance of our transmitter equipment? Are you a pro at transmitter tuning & obtaining optimum operational performance of transmitting equipment? Send resume to bwarecruiting@hotmail.com or fax 317-844-6267.



A PRIMEDIA Publication

THE RADIO TECHNOLOGY LEADER

www.beradio.com
radio@primediabusiness.com

Editor - Chris Scherer, CSRE CBNT, cscherer@primediabusiness.com
Technical Editor, RF - John Battison, P.E., batcom@bright.net
Associate Editor - Kari Taylor, ktaylor@primediabusiness.com
Editorial Intern - Heidi Hueseman, hueseman@primediabusiness.com
Sr. Art Director - Michael J. Knust, mknust@primediabusiness.com
Assoc. Art Director - Robin Morsbach, morsbach@primediabusiness.com

Technical Consultants - Harry C. Martin, *Legal*
Kevin McNamara, *CNE, Computers and Networks*
Mark Krieger, *CBT, Contract Engineering*
Russ Berger, *Broadcast Acoustics*

Senior Vice President - Peter L. May, pmay@primediabusiness.com
Publisher - Dennis Triola, dtriola@primediabusiness.com
Marketing Director - Christina Heil, cheil@primediabusiness.com
Vice President, Production - Thomas Fogarty, tfogarty@primediabusiness.com
Sr. Director of Production - Curt Pordes, cpordes@primediabusiness.com
Group Production Mgr. - Charlie Rosenthal, rosenthal@primediabusiness.com
Sr. Production Coordinator - Sonja Shaffer, sshaffer@primediabusiness.com
Classified Ad Coordinator - Michelle Hooper, mhooper@primediabusiness.com
Audience Marketing Dir. - Leann Sandilar, lsandilar@primediabusiness.com
Audience Marketing Mgr. - Sonja Rader, srader@primediabusiness.com

MEMBER ORGANIZATIONS

Sustaining Member, Acoustical Society of America, • Audio Engineering Society, Society of Broadcast Engineers
Member, American Business Media

PRIMEDIA

Business Magazines & Media
COO - Jack Condon, jcondon@primediabusiness.com
Sr. VP, Business Development - Eric Jacobson, ejacobson@primediabusiness.com
Sr. VP, Sales Operations - John French, jfrench@primediabusiness.com
VP, Content Licensing & Development - Andrew Elston, aelston@primediabusiness.com



PRIMEDIA Business-to-Business Group - 745 Fifth Ave., NY, NY 10151

CEO - Martin E. Maleska, mmaleska@primedia.com
Design Director - Alan Alpanian, aalpanian@primediabusiness.com

PRIMEDIA Inc.

CEO (Interim) - Charles McCurdy, cmccurdy@primedia.com
Vice Chairman & General Counsel - Beverly Chell, bchell@primedia.com

SUBSCRIPTIONS: Free and controlled circulation to qualified subscribers. Non-qualified persons may subscribe at the following rates: USA and Canada, 1 year, \$50.00, 2 years, \$95.00, 3 year, \$140.00. Outside the USA and Canada, 1 year, \$65.00, 2 years, \$125.00, 3 years, \$185.00 surface mail (1 year, \$105.00, 2 years, \$205.00, 3 years, \$305.00 airmail delivery). For subscriber services or to order single copies, write to *Radio*, 2104 Harvell Circle, Bellevue, NE 68005 USA; call 866-505-7173 or 402-505-7173; or visit beradio.com.

ARCHIVES & MICROFORM: This magazine is available for research and retrieval of selected archived articles from leading electronic databases and online search services, including Factiva, LexisNexis, and Proquest. For microform availability, contact ProQuest at 800-521-0600 or 734-761-4700, or search the Serials in Microform listings at proquest.com.

REPRINTS: Contact Erlene Ramsey at Wright's Reprints to purchase quality custom reprints or e-reprints of articles appearing in this publication at 877-652-5295 or 218-419-5725. Instant reprints and permissions may be purchased directly from our website; look for the iCopyright tag appended to end of each article.

PHOTOCOPIES: Authorization to photocopy articles for internal corporate, personal, or instructional use may be obtained from the Copyright Clearance Center (CCC) at 978-750-8400. Obtain further information at copyright.com.

PRIVACY POLICY: Your privacy is a priority to us. For a detailed policy statement about privacy and information dissemination practices related to Primedia Business magazines and Media products, please visit our website at primediabusiness.com.

CORPORATE OFFICE: Primedia Business Magazines & Media, 9800 Metcalf, Overland Park, Kansas 66212; 913-341-1300; primediabusiness.com.

EDITORIAL, BUSINESS and CORPORATE OFFICE: 9800 Metcalf, Overland Park, KS, 66212; 913-341-1300; beradio.com, primediabusiness.com.

Copyright 2003, PRIMEDIA Business Magazines & Media Inc. All Rights Reserved.

LIST RENTAL SERVICES

Marie Briganti, Statistics

Phone: (203) 778-8700 x146

Fax: (203) 778-4839

primedia@statistics.com

EDITORIAL REPRINTS

Wright's Reprints

Phone: (877) 652-5295, ext. 106

eramsey@wrightsreprints.com

Sales Offices

NATIONAL SALES DIRECTOR

Steven Bell

9800 Metcalf Avenue
Overland Park, KS 66212-2215
Telephone: (913) 967-1848
Fax: (913) 967-7249
E-mail: sbell@primediabusiness.com

EUROPE/UK

Richard Woolley

P.O. Box 250
Banbury, Oxon OX16 5YJ
Telephone: +44 1295 278 407
Fax: +44 1295 278 408
E-mail: richardwoolley@compuserve.com

CLASSIFIED ADVERTISING

Jennifer Shafer

Telephone: (800) 896-9939
(913) 967-1732
Fax: (913) 967-1735
E-mail: jshafer@primediabusiness.com

Contributor Pro-file

Meet the professionals who write for *Radio*.
This month: Field Report, page 82.



John Landry
Engineering
Technician
CBS Radio/
Westwood One
New York City

Landry's interest in radio began at an early age when he first noticed the tower lights of WENE-AM (1340) outside his bedroom window. His entry in broadcasting was at WMCG-TV in Binghamton, NY, where Charlie Hallinan introduced him to the SBE. His career later took him to New Hampshire and then to Boston stations WBZ and WHDH.

From there it was onto Cleveland, as chief engineer of sports powerhouse WKNR-AM 1220. Many remotes and a World Series later it was back east to WALK FM on Long Island, and then to the Networks in New York City; first at ABC and now at CBS.



Written by radio professionals
Written for radio professionals

Radio, Volume 9, Number 9, ISSN 1542-0620 is published monthly and mailed free to qualified recipients by PRIMEDIA Business Magazines & Media Inc, 9800 Metcalf, Overland Park, KS 66212-2216 (primediabusiness.com). Periodicals postage paid at Shawnee Mission, KS, and additional mailing offices. Canadian Post Publications Mail Agreement No. 40597023. Additional resources, including subscription request forms and an editorial calendar are available online at beradio.com. To order single copies call 866-505-7173 or 402-505-7173.

POSTMASTER: Send address changes to *Radio*, P.O. Box 2100, Skokie, IL 60076-7800 USA.

Advertiser Index

Advertiser	Page Number	Advertiser Hotline	Advertiser Website
Acoustic Systems	66	800-749-1460	www.acousticsystems.com
Acoustics First	90	888-765-2900	www.acousticsfirst.com
AEO	15	954-581-7999	www.aeqbroadcast.com
Allen Osborne Associates	6	805-495-8420	www.aoa-gps.com/hilomast.htm
Altronic Research	36	800-482-5823	www.altronic.com
Aphex Systems	17	818-767-2929	www.aphex.com
Armstrong Transmitters	78	315-673-1269	www.armstrongtx.com
Arrakis Systems	18, 28a-28d, 57, 83	970-224-2248	www.arrakis-systems.com
ATI Audio Technologies	95	800-959-0307	www.atiguys.com
Audemat-Aztec	35	305-692-7555	www.audemat-aztec.com
AudioScience	69	302-324-5333	www.audioscience.com
Audio-Technica U.S.	11	330-686-2600	www.audio-technica.com
Autogram	98	800-327-6901	www.autogramcorp.com
Bay Country	96	877-722-1031	www.baycountry.com
Benchmark Media Systems	75	800-262-4675	www.benchmarkmedia.com
Broadcast Electronics	32	817-735-8134	www.bdcast.com
Broadcast Software International	58	888-BSIUSA1	www.bsiusa.com
Broadcast Tools	22	360-854-9559	www.broadcasttools.com
Burk Technology	72	800-255-8090	www.burk.com
Circuitwerkes	94	352-335-6555	www.circuitwerkes.com
Coaxial Dynamics	64	116-267-2233	www.coaxial.com
Comrex	9	978-784-1717	www.comrex.com
Condron Broadcast Engineering	62	801-908-1471	www.cbsoftware.cc
Conex Electro-Systems	66	800-645-1061	www.conex-electro.com
Continental Electronics	24	800-733-5011	www.contelec.com
Cortana	98	888-325-5336	www.cortanacorporation.com
Creative Studio Solutions	80-81	303-426-5004	www.creativestudiosolutions.com
Danagger Audio Works	99	888-892-8346	www.danagger.com
Electronics Manufacturing	93	800-649-6370	www.rectifiers.com
ERI-Electronics Research	100	812-925-6000	www.ERInc.com
ESE	73	310-322-2136	www.es-web.com
Gepco	64	800-966-0069	www.gepco.com
Gorman-Redlich Mfg. Co.	95	740-593-3150	www.gorman-redlich.com
Harris Corp. Broadcast Div.	FC, 3	800-622-0022	www.broadcast.harris.com
Heil Sound	30	618-257-3000	www.heilsound.com
Inmarsat	5	+44-20-7728-1000	www.inmarsat.org
Kay Industries	85, 96	800-348-5257	www.kayind.com
LBA Technology	96	800-522-4464	www.Lbagroup.com
Ledtronics	23	310-534-1505	www.ledtronics.com
Lightner Electronics	93	866-239-3888	www.LightnerElectronics.com
Logitek	13	800-231-5870	www.logitekaudio.com
Mager Systems	28	623-780-0045	www.magersystems.com
MDOUK	19-20	121-248-0200	www.audiobx.com
Mediatouch	31	888-665-0501	www.omt.net
Mooretronix	99	800-300-0733	www.mooretronix.com
Mouser Electronics	98	800-346-6873	www.mouser.com
MusicaM USA	25	732-739-5600	www.musicamusa.com
NagraUSA	62	615-726-5191	www.nagrausa.com
Neumann Microphones	29	860-434-5220	www.neumannusa.com/103BER
Nott Ltd.	95	505-327-5646	www.nottltd.com
OMB America	87	305-477-0973	www.omb.com
Patriot Antenna Systems	37-56	800-470-3510	www.sepatriot.com
Primedia Business New Media	19	212-204-2622	www.primediabusiness.com
Pristine Systems	89	800-795-7234	www.pristinesys.com
Prophet Systems	27	877-774-1010	www.prophetsys.com
QEI Corporation	69	800-334-9154	www.qei-broadcast.com
Radio Systems	33, 69	856-467-8000	www.radiosystems.com
RAM Broadcast Systems	34	847-487-7575	www.ramsys.com
RF Parts	95	800-737-2787	www.rfparts.com
rf Software	94	352-336-7223	www.rfsoftware.com
SCMS	12, 65	800-438-6040	www.scmsinc.com
Sine Systems	67	615-228-3500	www.sinesystems.com
Studio Technology	69	610-640-1229	www.studiotechology.com
Superior Broadcast Products	97	800-279-3326	www.superiorbroadcast.com
Swager Communications	97	800-968-5601	www.swager.com
TFT	26	408-943-9323	www.tftinc.com
TieLine Technology	7	888-211-6989	www.tieline.com
TM Century	99	972-406-6800	www.TMCentury.com
Transcom Corp.	98	800-441-8454	www.fmamtv.com
Valcom	74	519-824-3220	www.valcom-guelph.com
V-Soft Communications	99	800-743-3684	www.v-soft.com
WARP Radio	63	303-799-9118	www.warpro.com
Wheatstone	2, 105, 106	252-638-7000	www.wheatstone.com

www.beradio.com



Shaping radio today and tomorrow

By Heidi Hueseman

Do you remember?

On Thursday, Aug. 14, 2003, many cities on the east coast and in the Midwest lost power due to a severe blackout. Although this was not the first time a blackout ever occurred, it was monumental in that so many cities were affected. For more than



WCBS newsmen report on the 1965 blackout as the staff looks on.

two business days, many companies could not function and people were stuck without air conditioning or electricity in the stifling heat. While the cause of this blackout is still being investigated, we can learn from past blackouts what to watch out for and take caution against.

In Nov. 9, 1965, a blackout affected the city of Ontario, Canada. It took six days for Federal Power Commission investigators to locate the cause. They found a single faulty relay at the Sir Adam Beck

Station no. 2, which caused a key transmission line to disconnect (open). This small failure triggered a sequence of escalating line overloads that quickly raced down the main trunk lines of the grid, separating major generation sources from load centers and weakening the entire system with each subsequent separation. As town after town went dark throughout the northeast, power plants in the New York City area automatically shut themselves off to prevent the surging grid from overloading their turbines. Within a quarter of an hour the entire CANUSE area was down. Investigators referred to the 1965 blackout as a cascade effect—much like a row of dominoes falling one after another.

Twelve years later, another blackout took place in New York City on a hot and muggy night. Fortunately, this blackout did not have as severe an effect on radio stations and broadcasters.

That was then

In 1941, RCA designed the 76-B2 to provide "a flexible speech input system for maximum economy." It provided all the amplifying and control equipment required to successfully handle two studios, an announce booth microphone, a control-room announce microphone, two transcription turntables and six remote lines. Full facilities were provided for simultaneously auditioning and broadcasting from any combination of the studios, turntables or remote lines.



Photo by Scott Horner, Salem Communications, national project manager.

The amplifying and control equipment was mounted in a single metal console and the power supplies were located in a metal box designed for wall mounting. An override-record switch was provided, which permitted the remote operator to call in on any of the six remote lines and override the program on the control room speaker. Key switches are interlocked to disconnect the studio loudspeakers and operate "On Air" light relays. A three-position key switch in the input of the fourth preamplifier permits it to operate from a microphone in the studio, announce booth or local control room. Additional push-key sets provide circuits for feeding cue to remote lines and for bringing in monitoring circuits such as transmitter or master control outputs. The console was constructed of metal with wooden style plates on each end.

Sample and Hold

The trends affecting radio

Time Spent with Various Media among Teenagers and Young Adults in the US



Time in hours. Source: Bizreport.com, July 2003

WHEATSTONE D-4000

DIGITAL AUDIO CONSOLE



Based on the technical architecture of our popular D-5000, this new D-Series console is totally modular, offering features to satisfy the most demanding engineers—but at a lower price point than its predecessors.

- Hot-swap design
- Four stereo mix buses
- Six pointer-style true VU meters
- Any mix of digital and analog inputs
- AES and balanced analog outputs
- Choice of master clock rates
- Up to 4 mix-minus outputs using SPD-4000 phone remote modules
- 24 bit A-to-D conversion on analog inputs
- A/B source switching with fully independent logic and machine control
- Mode selection on stereo inputs
- Low profile drop-through counter design
- Multiple studio outputs with talkback interrupt

*Wheatstone has more digital audio experience than most of our competition combined. The D-4000 is a truly high performance, reliable console that will make your transition to digital a pleasure. Benefit from our expertise—**CHOOSE WHEATSTONE**—the Digital Audio Leaders!*

 *Wheatstone*

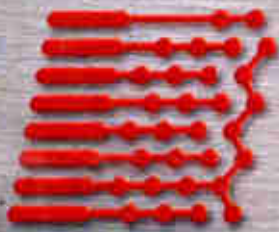

AUDIOARTS



SOURCE

Marti 2



SOURCE

ADR-32 DIGITAL AUDIO ROUTER

GET BIG ROUTER FEATURES ON A SMALL ROUTER BUDGET!

Based on **WHEATSTONE's** highly acclaimed **BRIDGE TECHNOLOGY**, the new **AUDIOARTS ENGINEERING ADR-32** brings your studio trouble free mixed signal switching. You can choose from a combination of AES digital (with 24-bit SRCs) or 24-bit A-to-D input cards as well as a combination of analog and digital output cards to help keep this system future-proof. Since all signals are routed entirely in the digital domain, crosstalk is eliminated. The ADR has a built-in monitor speaker (w/level control and external output) and supports both 485 and Ethernet hardware controllers. It comes with **WHEATSTONE's** highly acclaimed X-Point software that lets you configure, protect and integrate the system with our own consoles and third party automation systems.

BENEFIT from our extensive technology base; choose the Audioarts ADR-32 from Wheatstone—the digital audio leaders!



AUDIOARTS® ENGINEERING

tel 252-638-7000 / fax 252-635-4857 sales@wheatstone.com

www.audioarts.net

copyright © 2003 by Wheatstone Corporation