

BroadcastEngineering®

THE JOURNAL OF DIGITAL TELEVISION

NAB2005

It's a jungle out there



Las Vegas
CONVENTION CENTER

NAB preview

- 2004 Excellence awards
- Exhibitors map
- DTV marketplace
- FASTtrack



THIS IS NOT AN AUDIO CONSOLE

D-9

Audio Control



IT'S A DIGITAL CONTROL SURFACE

Production



OTHER SURFACES can share common audio resources

Studio 2



I/O CONNECTIONS can be at point-of-use and accessed by any control surface

DEDICATED DSPs and controls, redundant automatic failover CPUs, mix engines and power supplies are all integral to the system. Components interconnect via CAT5 or fiberoptic cables for single-wire system integration.

A traditional intuitive surface layout gets your operators up and running FAST—even in full 5.1 surround mode.

TRUE RELIABLE mixing power; ease and clarity of operation—take ADVANTAGE of the WHEATSTONE BRIDGE Network System!

CENTRAL FRAME can control a 1024 x 1024 mixing based router



Engineering

Engineering



Talk to your **STATION ROUTER** bi-directionally for smooth integration

 **Wheatstone**

sales@wheatstone.com / tel 252-638-7000 / www.wheatstone.com

Copyright © 2005 by Wheatstone Corporation

If Only Managing Digital Assets Were This Simple.



Make quick work of managing your station's media assets. Harris Media Asset Management solutions allow you to transform analog and digital media into an integrated digital library that offers fast search-and-retrieve access to exactly what you want, when you want it. It's a scalable and modular solution that grows with you, allowing you to add features and functionality as required. So you can ingest, index, find and retrieve with the click of a mouse. It's a proven system Harris has developed through our decade-long experience in maximizing media assets around the globe. And that can have a simply amazing effect on speed and efficiency throughout your operation.

For more information about the simple-yet-powerful range of Media Asset Management solutions, call **1-408-990-8200**, or visit us on-line at www.broadcast.harris.com/automation.

Visit us at NAB Booth # SU10048 (South Hall).

www.broadcast.harris.com

HARRIS



Becau

This is technology you can touch. AirSpeed™, a revolutionary new breed of broadcast video server, accelerates your I/O by providing immediate access to incoming feeds. Affordable, reliable AirSpeed systems scale easily and play to air within moments of editing the story – with an interface you already know how to use. Call your Avid broadcast sales manager today or visit www.avid.com/airspeed.

Photo: Sogecable Javier Serrano. ©2004 Avid Technology, Inc. All rights reserved. Product features, specifications, system requirements, and availability are subject to change without notice. AirSpeed is a registered trademark of Avid Technology, Inc. All other trademarks are the property of their respective owners.



Avid Broadcast Solutions

Be first. Because it's only news once.

From ingest to playout, nothing stands in the way of a great story.



To be a leader, you have to stay on top of the news, the competition, and the latest technology. That's why Avid has become a leading choice of news organizations around the world for innovative editing, media asset management, networking, storage, and newsroom systems. Integrated, all-digital, end-to-end broadcast solutions from Avid continue to set the pace in versatility, reliability, and price/performance, so broadcasters can focus on today's news – and not worry about tomorrow's technology.

www.avid.com/broadcast



make manage move | media™ **Avid.**

Broadcast Engineering

THE JOURNAL OF DIGITAL TELEVISION

CONTENTS

FEATURES

73 HDTV lens design: Management of MTF

By Larry Thorpe and Gordon Tubbs

The technological challenges entailed in achieving the requisite MTF characteristic required by an HDTV lens.

80 IT network equipment

By Brad Dick

Learning the basics about IT technology can help determine what IT network equipment is best suited and available for your facility.

86 NAB Preview

88 Engineering Excellence Awards

By BE staff

A showcase of this year's winning facilities.

105 Exhibit Hall Map

By BE staff

Let our extensive map guide you through the show.

129 FASTtrack

By BE staff

Navigation made easy by geographical listings of exhibitors.

146 DTV Marketplace

By BE staff

Browse our comprehensive product listing.



ON THE COVER:

"It's a jungle out there!" cover and theme by Robin Morsbach, Art Director.



BEYOND THE HEADLINES

Download

14 Won't get fooled again?

FCC Update

20 FCC planning early DTS rollout

DIGITAL HANDBOOK

Transition to Digital

22 Digital video noise

Computers and Networks

30 Professional video and film file formats

Production Clips

34 Surviving the 2GHz transition

(Continued on page 8)

HD simplified

defining ideas @ NAB 2005: making the HD transition easier



See your HD migration defined in 3D at booth #C3617. Receive the VIP treatment when you pre-register for our 3D presentation @ www.panasonic.com/NAB

Panasonic
ideas for life

Broadcast Engineering

THE JOURNAL OF DIGITAL TELEVISION

CONTENTS

SYSTEMS DESIGN & INTEGRATION

Systems Design Showcase

- 38 NYC broadcasters find redundancy at Four Times Square
- 48 San Jose's NBC11 and Telemundo 48 go all-digital
- 56 WIBC's transition to digital

Transmission & Distribution

- 64 Keeping it running — and holding down costs

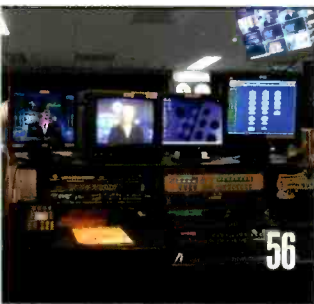

NEW PRODUCTS & REVIEWS

Applied Technology

- 250 Streamlining format conversion

Field Report

- 257 CBC/Radio-Canada selects Insciber's Inca AutoCG
- 260 NY1 News goes tapeless with Panasonic's P2 recording system

Technology in Transition

- 262 Format conversion

DEPARTMENTS

- 10 Editorial
- 12 Reader Feedback
- 264 Classifieds
- 270 Advertisers Index
- 272 EOM

FreezeFrame



Name this product. Hint: The product's original name was spelled slightly differently from today. Correct spelling of the product's original name gets the winner TWO T-shirts! Readers submitting winning entries will be entered into a drawing for *Broadcast Engineering* T-shirts. Enter by e-mail. Title your entry "FreezeFrame-March" in the subject field, and send it to: editor@primediabusiness.com. Correct answers received by May 1, 2005, are eligible to win.



▶ To The Power of Maxell Tim McGuire



A champion of the arts, guardian of the creative spirit and head of three creative service companies, Tim McGuire is blown away by the power and performance of Maxell Professional Media. "Our clients demand the best and that is what Maxell delivers from product quality to customer service." That's why Tim's editorial boutique, Cutters, uses Maxell Digital Betacam for mastering, archiving and duplication. The Maxell line of Professional Media also includes HDCAM, DVCPROHD, D-5, MPEG-IMX, DVCPRO, Betacam SP, Betacam SX and DVD-R Plus Series. You can email Tim at tim@cutters.com. To learn more about Maxell Professional Media, call 1.800.533.2836 or visit maxell.com.



© 2004 Maxell Corporation of America.



maxell

Expanding Memory & Mobility ▶

Recordable Media Data Storage Portable Energy Technological Partnerships



I won't if you don't

Today's broadcasters compete fiercely with each other at the local level. Stations wrestle and scrap for every eyeball and advertising dollar. Yet, many of these same stations will hold back implementing new technology, hoping the other guy won't upstage them with something new, which they'll then have to match. We have equilibrium.

How many of you engineering executives can recall the times your requests for a new on-air graphics system or ENG truck were rejected — until a competitor

develop billions in dollars of content every year, and what do we get for it from the cable industry? Zero.

Recently, there have been efforts to get broadcasters to cooperate in delivering content to viewers in new ways, ones that would let them participate in the revenue. Such technology would allow broadcasters to get paid for both their content and bandwidth. Two proposals, one on the air, have been voiced.

The first company with an on-air system is Salt Lake City-based U.S. Digital Television (USDTV). You can see the company at Booth N101 at the NAB convention. USDTV now provides a digital service in Salt Lake City; Albuquerque, NM; and Las Vegas. For \$19.95/month, a viewer gets multiple channels of digital quality signals, including 11 cable network channels, HD, the local broadcast channels and even Internet.

A plan proposed by Emmis Broadcasting has been endorsed by 11 broadcasters. Like the USDTV model, stations combine their excess bandwidth to provide at least 30 channels of digital content. Subscribers could buy their receivers at local stores for \$100 and would pay about \$25/month.

Both approaches require local stations within a market to cooperate by leasing their spectrum to external content packaging firms. These firms then combine the programs, develop the multiplex, route it back to the stations for broadcast, and handle all the overhead, billing and support.

What do stations get out of these deals? Money. Stations are paid a monthly fee based on factors such as coverage and bandwidth provided.

The key to both proposals is that broadcasters have to cooperate — not compete at the bandwidth level. The benefits are obvious: a new competitor to cable; a low-cost, multichannel service for the market; and broadcasters can sell any bandwidth they don't want for their own products. And they get a new revenue stream. So, what's not to like about this?

It upsets the equilibrium. We're still stuck in the "I won't if you don't" mentality.

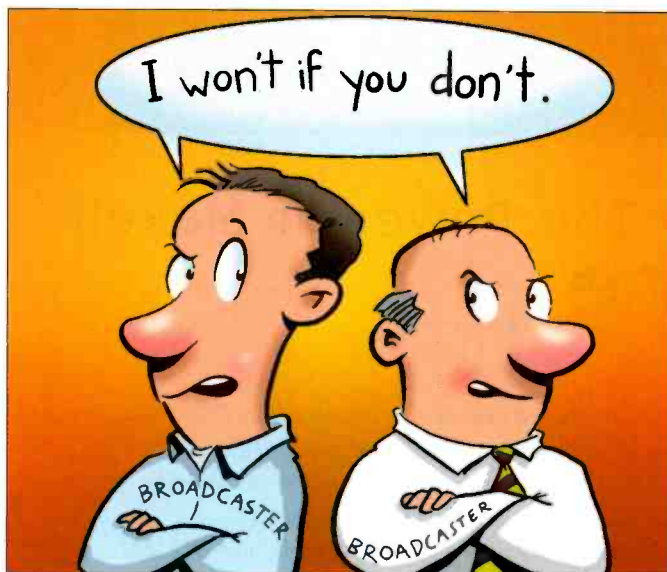

got one? Same thing with weather radar or satellite trucks. As long as the technology playing field was relatively level, no one moved. But, once another station buys a new weather radar or satellite truck, wham, everyone is suddenly competing to buy similar technology. Back to equilibrium.

At a recent DTV conference, I was moderating a panel where the topic was the schedule for implementing local HD broadcasts. A participant asked the panel when stations should begin broadcasting local HD. After a pregnant pause, one GM looked at the others and said, "I won't if you don't." Equilibrium again.

The problem is that while we've been equal, the competition has surged ahead. Cable now is the direct connection with more than 70 percent of our viewers. We

Brook Dreib
editorial director

Send comments to: • editor@primediabusiness.com • www.broadcastengineering.com

IMAGING XVP-801i

UNIVERSAL PROCESSOR UP/DOWN/CROSS CONVERTER

Miranda

HD 1080i

HD 720p

SD

XVP

HDTV

SD

Any format in. Your formats out.

If you need to work with multiple HD formats and SD, then you'll really like our new XVP-801i processor card.

This single, affordable module offers high quality up, down, aspect ratio, and HD cross conversion, as well as HD/SD signal processing, frame synchronization, and 16-channel audio processing.

It instantly detects the input video format, and effortlessly performs all the up/down conversion and processing necessary to maintain two simultaneous outputs, one HD and the other SD, in your station formats.

And if you receive material in 1080i when you're working in 720p, the XVP will automatically take care of the HD cross conversion for you.

So if you're looking for more intelligent interfacing solutions, call Miranda.

Miranda Technologies

Tel.: 514.333.1772 - ussales@miranda.com

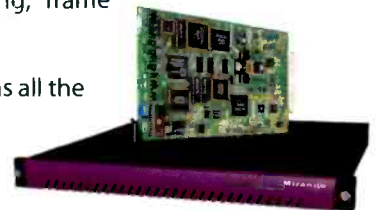

The red phenomenon

Hi Michael:

I am looking for information with regards to the phenomenon of red tearing/blooming on DTV receivers.

Certain channels/transponders appear to exhibit the problem more than others. What is the cause of this? I know red is one of the more difficult colors to truly represent in the NTSC domain due to bandwidth limitations within the NTSC domain.

Now, with digital video at 4:2:2, for example, there is more chroma sampling/bandwidth available than ever before. Is it a codec issue within DTV systems or the FTA RXs? Or have some DTV broadcasters exceeded the NTSC color gamut, which then has overtaken the encoder/decoders?

Looking forward to hearing from you. Cheers,

JERRY RADFORD
APTIN BROADCAST SERVICES
WINNEPEG, CANADA

Michael Robin responds:

Jerry:

Your problem seems to be related to a distribution system, which has some incompatible elements. Solving single-pass analog system problems is relatively simple because of the known (supposedly) types of video distortions, which create well understood (in most cases) picture impairments. Solving problems affecting a complex system, comprising several different analog and digital technologies, as, apparently, the case you are referring to, requires a clear understanding of the signal path, from signal source (i.e. camera) to the receiver. The approach would be the following:

- 1) Draw a block-diagram showing all the system path elements.
- 2) Ensure that the elements are compatible. If this is not the case, redesign the system. Compatibility failure may result in signals being "illegal" when



transformed into another format.

3) For every system element, list the performance indicative parameters and their numerical values as per the manufacturer's specifications. Verify that each component meets these specifications. Failure to meet them may result in the signals being "illegal." Bear in mind that different technologies (i.e. analog composite, analog component, digital video and compressed video) are tested with different types of signals, methods and test equipment.

4) Eventually, all elements are compatible, meet the manufacturer's specifications and are assembled into a working system.

If you are lucky, the system works, or seems to work. Some people might stop here and go home, but they would have missed an important point: To ensure that the system works well under all predictable conditions, an end-to-end system acceptance test using stressing signals has to be carried out. If everything doesn't work out, the system has to be redesigned to meet the expected performance and then checked again.

If you are not carrying out acceptance tests, then you are taking a

chance. The system's performance may be inadequate under some conditions, which you have omitted to generate or simulate, and you will get a call-back.

As to the problem that you are concerned with, be advised that red is no more difficult to encode in NTSC than any other color in the spectrum. I have encountered saturated red conditions when a SONY BETACAM field recording from a war-torn area of the world is brought to a European Production Center to feed an MPEG encoder. Now, if the local MPEG encoder has analog component inputs, they are normalized to the EBU N10 format i.e., the B-Y and R-Y components have a value of 700 mV p-p for a 100-percent saturated color bar signal.

The SONY BETACAM recorder B-Y and R-Y outputs would in all likelihood be normalized to the SONY North American level of 920 mV p-p for a 100-percent saturated color bars signal. The visible result would be oversaturated (purple) faces instead of pink faces. This should never occur in a normally operating Teleproduction Center, especially if it is well designed, maintained and operated.

I hope I have answered some of your questions.

BE

December FreezeFrame:

In December, we asked readers to name the winners of the 2003 Broadcast Engineering Excellence Awards.

Winners:

Rich Brockman
Rich Lohmueller

Test your knowledge!

See the FreezeFrame question of the month on page 8 and enter to win a Broadcast Engineering T-shirt.

Send answers to bdick@primediabusiness.com

AFFORDABILITY THROUGH INNOVATION
Sophisticated Switching
in an Affordable 1 M/E System

See us at NAB 2005
Booth # SU-7823

Performance you can afford.

KayakDD™ Digital Production Switcher

With handling you'll love and a price you can afford, the Grass Valley™ KayakDD digital production switcher offers superior image quality in a compact system with more power than any other 1 M/E switcher.

Leveraging many of the features found in our Kalypso™, Zodiac™ and XtenDD™ switchers, the KayakDD can handle everything from live studio and mobile productions to small corporate studios and editing applications.

With four keyers, two backgrounds, a utility bus, and up to four chroma keyers, the KayakDD switcher gives you more power in one M/E than any other switcher in its class. To create even higher levels of production value, the KayakDD switcher supports up to four transform engines for sophisticated digital video effects. Other options include a 4x4 second



RAMRecorder™ for internal clip and still storage and RGB color correction—all packed into a compact 2RU frame. The intuitive 19" control panel, combined with our MaKe Macro™ editor, makes it easy to create complex sequences and trigger them with the push of a button.

Give it a run.

To learn more about the KayakDD digital switcher and what it can do, contact your local distributor or visit:
www.thomsongrassvalley.com/kayak

Won't get fooled again?

BY CRAIG BIRKMAIER

The year was 1971. The world was awakening to a new era in the evolution of the broadcast media. Revolution was in the streets and in newsrooms, where a war and a president were about to be toppled by an overt effort to influence "public opinion."

Pete Townshend writes about a revolution in the Who classic, "Won't Get Fooled Again." In the first verse of the song, there is an uprising. In the middle, those in power are overthrown. In the end, the new regime becomes just like the old one: "Meet the new boss, same as the old boss." Townshend felt revolution was pointless because whoever takes over is destined to become corrupt.

The year was 1996. After years of debate about the impact that "being digital" would have on telecommunications, Congress finished up the most

extensive rewrite of U.S. telecommunications law since the original Telecommunications Act of 1934. The 1934 Act put politicians and regulators into the business of micro-managing a handful of powerful monopolies and oligopolies. The 1996 rewrite was finished just in time to help pay for that year's presidential and congressional elections.

Nearly a decade later, the digital revolution has stalled. Is it a victim of the "irrational exuberance" of the 1990s, the tech meltdown of 2000 and/or the terrorist attack of 9/11? Or was this the predictable outcome to be expected when powerful industries rely upon regulation to impede competition and technical evolution?

Meet the new boss

Based on the analysis in the January 2005 Download column, "The sense

of Congress" (see Web links), this outcome was entirely predictable. The industries that helped to write the 1996 Act and pay for the 1996 elections have effectively blocked or delayed the Act's most important provisions. The FCC has gone out of its way — some say beyond its authority — to move things along. And the Federal Appeals Courts have predictably blocked a wide range of FCC decisions, citing the lack of legislative authorization for the commission's actions.

In other words, the predictable outcome has been achieved — gridlock. The ball is now back in Congress, where new bosses have taken control of key congressional committees.

Last year, Rep. Billy Tauzin, who headed up the Committee on Energy and Commerce, announced he was leaving Congress for the "private sector." Tauzin had been rumored to be next in line to head up the Motion Picture Association of America, to replace an aging Jack Valenti. But Tauzin surprised the pundits, taking the position of president and CEO of the Pharmaceutical Research and Manufacturers of America. During his 15 years in Congress, Tauzin raised more than \$218,000 in campaign funds from pharmaceutical manufacturers. This year, he will make more than that as their chief lobbyist.

Tauzin has been replaced by Joe Barton of Texas. Meanwhile, over in the Senate, self-imposed committee chairmanship term limits resulted in Alaska Sen. Ted Stevens taking over from Arizona's John McCain. But the retirement of ranking Democrat Fritz Hollings of South Carolina has been viewed as having greater significance. Hollings, who served as co-chairman with McCain due to the 50/50 split after the 2002 election, consistently

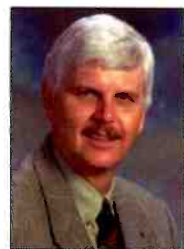

FRAME GRAB A look at the issues driving today's technology

DTV products are on the rise

Flat panel displays accounted for 38 percent of sales in 2004

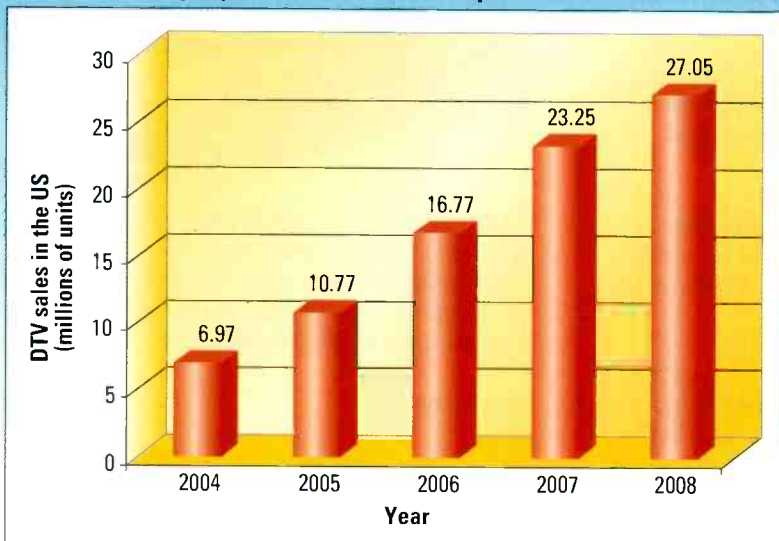

Source: The Center for Media Research

www.centerformediaresearch.com

Surround completes the HDTV experience.



Come see why Dolby® Digital 5.1 is the multichannel surround sound format for HDTV. From postproduction to set-top box, Dolby Digital technology delivers exceptional surround sound. Committed to ensuring the highest quality sound arrives in your customer's living room, Dolby offers commissioning services for postproduction and broadcast facilities. Visit us at NAB for a full demonstration on how to surround your audience in the best possible HDTV experience.

**NAB 2005, April 18–21, Las Vegas Convention Center.
Booth SU7870**

www.dolby.com/events/nab

Dolby and the double-D symbol are registered trademarks of Dolby Laboratories.
©2005 Dolby Laboratories, Inc. All rights reserved. 505/16005



opposed telecommunications industry deregulation.

The new chairmen and their ranking Democrat counterparts have already announced intentions to revisit the 1996 Telecommunications Act, as we predicted in January. By the time The Telecommunications Act of 2006 is finalized — just in time to pay for the 2006 elections — you will need a scorecard to identify the key players.

Last year, Robert Sachs, president and CEO of the National Cable & Telecommunications Association (NCTA), announced he would retire effective Feb. 28, 2005. Sachs left on a winning note, having prevailed over the NAB

2005, denies the NAB request that cable systems be required to carry the full 6MHz from each broadcaster, including all multicast content. (See Web links.)

On Feb. 16, NAB president and CEO Eddie Fritts announced his intention to leave that post when his current contract runs out in April of 2006. The press release announcing the beginning of a search for his replacement enumerates a long list of notable accomplishments under Fritts' leadership:

- Passage of the 1992 Cable Act, in which broadcasters successfully won must-carry/retransmission consent

granted greater stability to broadcasters by lengthening license renewal terms from three to eight years.

- Passage of legislation that rolled back an FCC low-power FM initiative that would have eliminated rules protecting radio listeners against additional interference.

- Elimination of the misnamed "Fairness Doctrine," which required broadcasters to air both sides of a controversial issue.

- Passage of "local-to-local" legislation as part of the Satellite Home Viewer Improvement Act, which allowed local TV stations to be "spot-beamed" back to a local market.

- Blocking government-mandated free airtime for politicians and the so-called "Torricelli Amendment" requiring TV stations to provide deeply discounted airtime above the 30 percent discounts already afforded politicians under the "lowest unit rate."

Not mentioned was the amendment to the Balanced Budget Act of 1997, which imposed the 85 percent rule that rendered the FCC timetable for the DTV transition meaningless.

Fritts is not the only boss leaving with claims to a long list of accomplishments. On Jan. 21, Michael

By the time The Telecommunications Act of 2006 is finalized ... you will need a scorecard to identify key players.

in the recent FCC decision regarding cable carriage of digital broadcasts. The NAB had asked for reconsideration of a 2001 decision on cable carriage that requires only the carriage of a station's primary program channel. The decision announced on Feb. 10,

rights and overrode the only veto by President Bush.

- The 1996 Telecommunications Act, which resulted in a loan of additional spectrum to television broadcasters to facilitate the transition to digital, deregulated radio ownership and

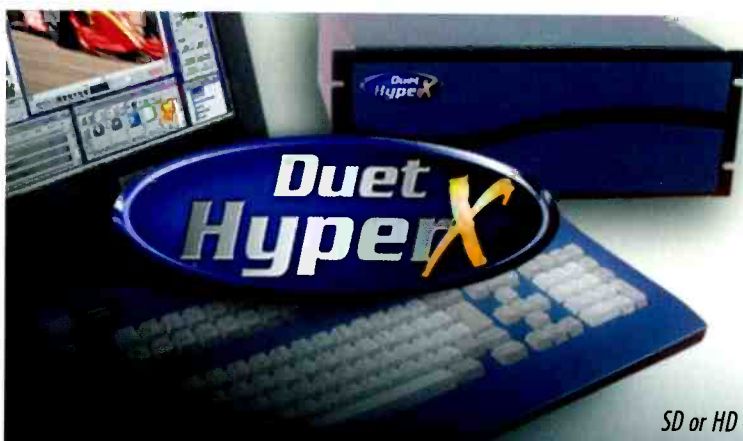

It's Not Like Any Other CG!

- Powerful multi-channel SD or HD.
- Blazing speed for real-time animations and 3D like you've never seen before.
- Fully integrated clipstore with video and key.

SD or HD -- don't compromise! It's the Duet HyperX and it's available now.

Xtraordinary Graphics



www.chyron.com

Now with
8-Channels

This game is too big for an internal DVE.

Dveous/MX



The big games demand Dveous/MX. This new machine is a higher definition of the industry-standard. More power. More functionality.

More ways to deliver superior picture quality for news, sports, specials, concerts and more.

Best of all, you get SD and HD in one box. With the same intuitive user interface. So when you're ready to work in high definition, there's no learning curve. Your Dveous/MX is totally future-proof.

Thinking about an internal DVE? Then go to www.accom.com for a free copy of DVE Smackdown — a powerful report comparing Dveous/MX to internal DVEs. You'll see why Dveous/MX is in a league of its own.

Accom®

Powell, chairman of the FCC, announced he will step down this month. The announcement contained a four-page list of accomplishments. (See Web links.) Regarding the DTV transition, the chairman claims:

with digital TV content. It issued Plug and Play rules to simplify issues for consumers, the broadcast flag and a DTV tuner mandate to ensure consumers can receive a digital signal.

- That the commission reached out to

ness of," Edwards said, siding with critics who charge the rule dictates how computers and other devices should work.

One must question the level of accomplishment when a government regulatory agency is trying to educate consumers about the DTV transition, while the broadcasters offering the services are making little effort to promote them.

There are clear signs that consumers are beginning to question the cozy relationships between the regulators and the regulated.

- That the Powell Plan dramatically accelerated DTV. It created the DTV Task Force, which called on broadcasters to build out DTV facilities (now 1445 DTV broadcast stations on air — up from 75 in 2001), cable operators to carry and provide HD and digital programming (now offer HD in 177 of 210 DMAs), and content providers in the TV industry to encourage new HD content. (Today, almost all of prime-time and major sporting events are in HD, and 18 cable channels are dedicated to HD programming.)
- That the commission made sure consumer electronics could work easily

help consumers understand the DTV transition. It created the www.dtv.gov Web site and consumer tip sheets.

Despite all of these accomplishments, the number of ATSC receivers being sold is barely measurable. While it is true that there are more than 1400 stations on the air, this was a requirement under the FCC timetable established in 1997. Unfortunately, many of these stations are still operating at low power levels. Cable and DBS are driving the real DTV transition — something that was also entirely predictable.

The DTV tuner mandates have not been effective to date. The cable plug and play agreement is starting to gain some traction; however, the FCC has been unable to create real competition in the cable set-top box market, despite legislative mandates that date back to the early 1990s. And, the broadcast flag order is being appealed.

During a Feb. 22 hearing, Judge Harry Edwards told regulators they had overstepped their authority by imposing a rule designed to limit the copying of digital television programs. "You crossed the line," Edwards told a lawyer for the FCC during arguments before a three-judge panel of the U.S. Court of Appeals for the D.C. Circuit.

"Selling televisions is not what the FCC is in the busi-

Same as the old boss?

All of this raises an important question: With so many of the "inside the beltway" bosses (who have effectively managed to thwart the digital revolution for another decade) leaving their powerful posts, will anything change?

There are clear signs that consumers are beginning to question the cozy relationships between the regulators and the regulated. To question the willingness of our elected officials and regulators to give even more power to a handful of media conglomerates.

History suggests that efforts to block and delay revolutionary changes ultimately fail; pressure builds up behind the dam until it can no longer be restrained. At best, the inevitable can be delayed as the forces of change build momentum.

Are the old bosses leaving to avoid being the first casualties when the dam bursts? Can the new bosses get out of the way and let the marketplace drive the revolution? Or will the new boss be the same as the old boss?

Let's get down on our knees and pray we don't get fooled again. **BE**

Craig Birkmaier is a technology consultant at Pcube labs, and he hosts and moderates the OpenDTV Forum.



Send questions and comments to:
cbirkmaier@primediabusiness.com

Web Links

The sense of Congress: http://broadcastengineering.com/mag/broadcasting_sense_congress/

FCC Report and Order on cable carriage: http://hraunfoss.fcc.gov/edocs_public/attachmatch/FCC-05-27A1.pdf

FCC Chairman Michael Powell accomplishments: http://hraunfoss.fcc.gov/edocs_public/attachmatch/DOC-256206A2.pdf

NAB's Fritts launches succession process: <http://www.nab.org/Newsroom/PressRel/Releases/021605Fritts.htm>

Kyle McSlarrow to serve as next president and CEO of NCTA: <http://www.ncta.com/press/press.cfm?PRid=571&showArticles=ok>





DIGISUPER 25XS PREMIUM



DIGISUPER 23XS STANDARD



DIGISUPER 22XS COMPACT

Canon's HD Compact Studio Lens. High Quality. Light Weight. Lighter Price.



HD_{XS}

About $\frac{1}{3}$ the weight of standard studio lenses.

Portable HD cameras used in studio, now have a lens they can call their own, Canon's DIGI SUPER 22xs. At about $\frac{1}{3}$ the weight (13.4 lbs.) of the big lenses, with studio performance features that surpass ENG, this compact, economical HDxs lens (XJ22x7.3 BIE-D) is a full featured studio lens that provides outstanding quality in HD and SD applications. The 22xs lens incorporates Canon's Power Optical System to achieve

the highest possible specifications. This unique lens, which features a focal length of 7.3 – 161mm (14.6 – 322mm with 2X Extender) and is equipped with Canon's new rotary encoder servo system, comes complete with a Compact Supporter plus your choice of three levels of Digital Controls. The 22xs is part of the full line of HD Studio lenses which includes the DIGISUPER 25xs and new DIGISUPER 23xs.

See US At NAB Booth #SU 7814.

Find out more at canonbroadcast.com

1-800-321-HDTV (Canada: 905-795-2012)

Maximize Your Camera's Performance.

Canon KNOW HOW[®]

©2005 Canon U.S.A., Inc. Canon and Canon Know How are registered trademarks of Canon Inc. in the United States and may also be registered trademarks or trademarks in other countries.

FCC planning early DTS roll-out

BY HARRY C. MARTIN



The FCC is reportedly preparing to begin a fast-track proceeding on Distributed Transmission Systems (DTS), technology that broadcasters and regulators hope will enable DTV stations to provide more complete, spectrum-efficient coverage to their markets.

The heralded DTS technology operates much like a cellular telephone network; the service area is divided into a number of different cells, each with its own transmitter. However, unlike cellular phone systems, where spectrum is split into channel groups and no adjacent cells share the same channel, each DTS cell transmits on the same frequency. Like a system of on-channel repeaters, DTS uses multiple transmitters on a single frequency to deliver a single signal throughout a service area.

Proponents of DTS claim that broadcasters can use it to overcome DTV

signal delivery problems. For example, DTS can be used in service areas with hilly or mountainous terrain to reach populations that would otherwise be blocked from reception by the topography. In urban areas, DTS can be used to overcome urban canyons and enable set-top reception by delivering signals from multiple directions and allowing higher signal levels.

Because DTS makes use of shorter

operations may be precluded on channels with neighboring analog stations on adjacent channels, or within four channels above or below. DTS operations may be precluded on channels with neighboring digital stations on first adjacent channels.

Further, the FCC has previously indicated concerns about DTS' service status (i.e., primary or secondary) and the impact it will have on existing and

Proponents of DTS claim that broadcasters can use it to overcome DTV signal delivery problems.

towers and lower power transmitters, it can often achieve these benefits while avoiding zoning problems or serious interference concerns. Stations using multiple transmitters can provide higher signal levels throughout their service areas without causing as much interference to their neighbors as would the use of a single main transmitter. The virtues here are obvious: more uniform signal levels over wider service areas, while causing less interference.

DTS does have some limitations. First, interference will arise among the signals from different transmitters in the same network. Adaptive equalizers in DTV receivers can manage some of this interference; indeed, it is this feature of DTV receivers that makes DTS possible. But interference beyond the capacities of most adaptive equalizers will have to be addressed through other means, such as outdoor directional antennas. Also, DTS will not work in certain adjacent and near-adjacent channel situations. Under current interference requirements, DTS

future LPTV and translator stations. The FCC still faces the task of hammering out DTS rules covering location and service area, power, antenna height, emission mask, interference protection and technical standards. These issues will presumably be the focus of any fast-track proceeding the FCC institutes.

While the commission has declined to give any indication of when it might formally initiate a rule-making proceeding, which could result in detailed regulations governing DTS operation, the smart money appears to believe that it will be sooner rather than later. However, precisely how the commission may start that process — i.e., by Notice of Inquiry or Notice of Proposed Rule Making — is not clear. **BE**

Harry C. Martin is president of the Federal Communications Bar Association and a member of Fletcher, Heald & Hildreth PLC, Arlington, VA.

Dateline

April 1 is the deadline for television, LPTV and TV translator stations in Indiana, Kentucky and Tennessee to file their renewal applications, biennial ownership reports and EEO Program Reports. Also, on April 1 stations in Michigan and Ohio must begin their pre-filing renewal announcements in anticipation of renewal filings on June 1.

July 1 is the deadline for TV stations in the top-100 markets to implement their full DTV facilities or face the loss of interference protection beyond their then-current DTV facilities. The build-out deadline for all other DTV stations is July 1, 2006.



Send questions and comments to:
harry_martin@primediabusiness.com

evolve.

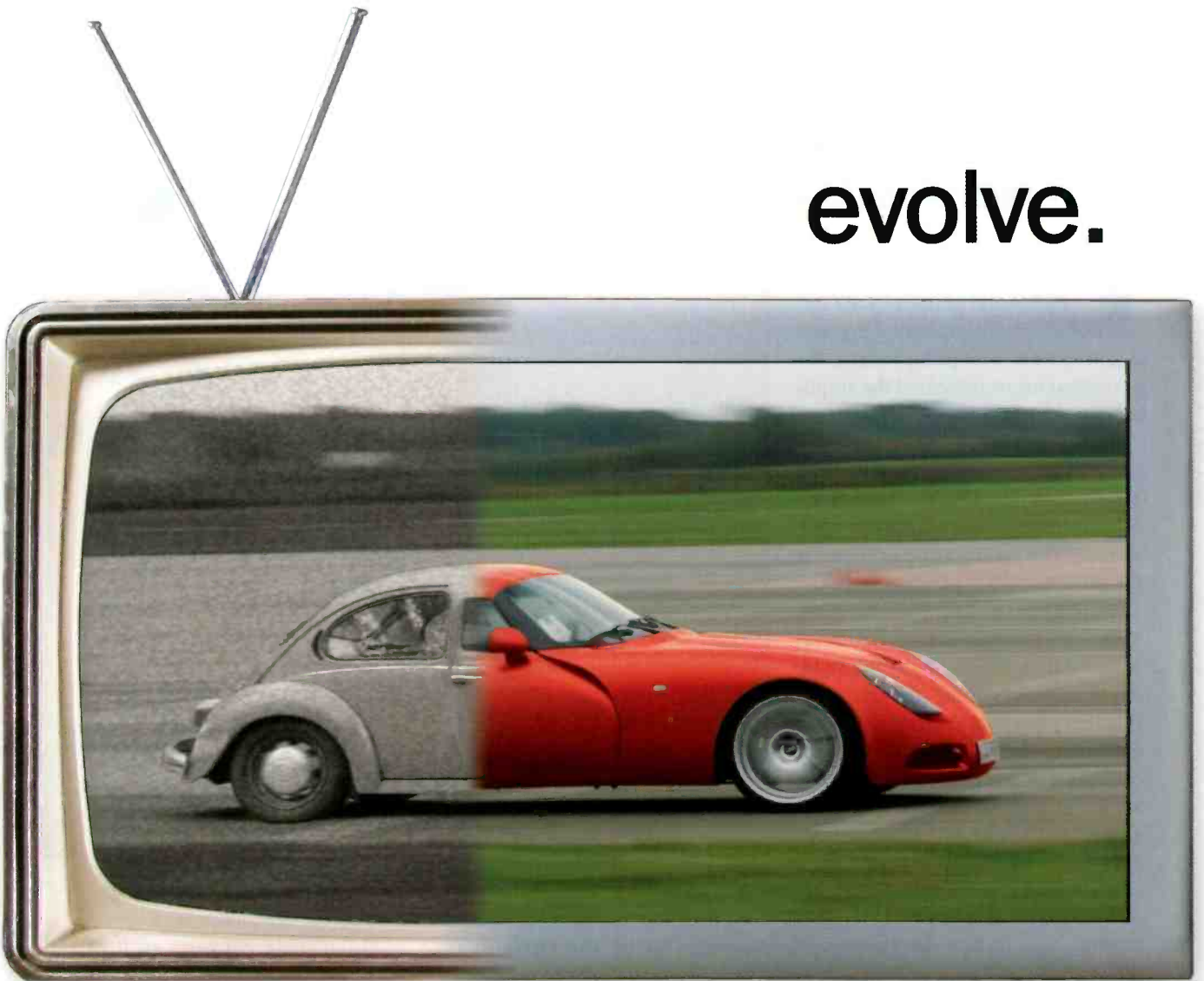

think video. think Terayon.

Digital video changes everything - how we brand, communicate, entertain and inform. Terayon accelerates your ability to evolve and capitalize on new business opportunities brought on by this digital revolution. Terayon enables you to deliver picture perfect results where it matters most - on the screen and on your bottom line.

TERAYON

www.terayon.com • info@terayon.com

evolve faster.

See Terayon at NAB 2005, South Hall #11316



Digital video noise

BY MICHAEL ROBIN

Digitizing an analog video signal involves two operations: sampling and quantization. Sampling means the periodical measurement of the amplitude of the video signal.

The significant parameter is the sampling frequency (f_s). Quantizing means assigning a binary value to the measured amplitude at each sampling instant. The significant parameter is the number of bits per sample (n).

Sampling at constant time intervals, $T=1/f_s$, results in an amplitude modulation of the sampling pulses or PAM. According to Nyquist, the sampling frequency has to be equal to or higher than twice the maximum frequency of interest to avoid aliasing. It also has to be high enough to allow for the design of realizable anti-aliasing low-pass filters with minimum ripple and group delay. Another video sampling requirement is for f_s to be a multiple of a basic video frequency,

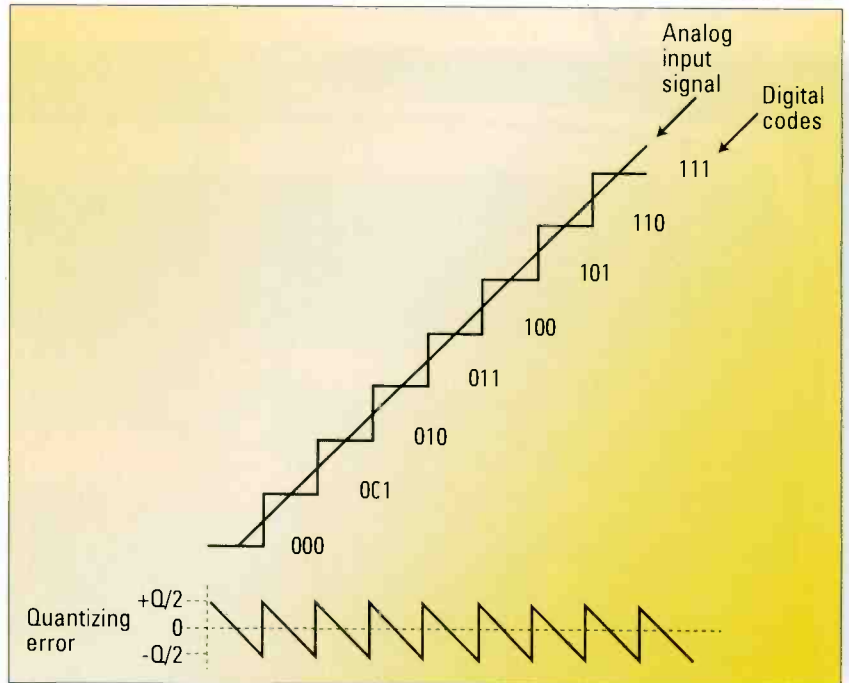

Figure 1. Quantizing errors introduced by a 3-bit codec

such as the horizontal scanning frequency (f_H) or the chrominance

subcarrier frequency (f_{sc}).

Quantizing converts each of the amplitude levels of a continuously varying analog video signal to one of a finite number of discrete levels, 2^n , where "n" is the number of bits per sample.

FRAME GRAB

A look at tomorrow's technology

Technology affects future of the cable industry

On Demand, DVRs, and VoIP to have greatest impact in 2005

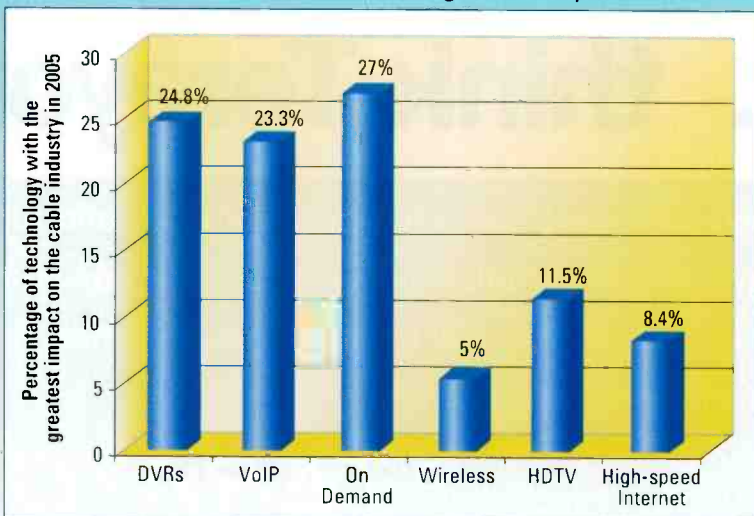

Source: CTAM SmartBrief

www.ctam.com

The quantizing error

Video signal amplitudes vary in time and can assume an infinite number of levels ranging from 0V (black) to 0.7V (white). Because the digital signal can assume only a limited number of discrete levels, it is an approximation of the original analog signal. The quantized values may be in error by as much as $\pm 1/2Q$, where Q is the amplitude of the quantizing step. This process generates a unique impairment in digital systems: the quantizing error.

In studio-type digital video equipment, all quantizing steps are of equal

Endorsed by the Leading Broadcast Stations and Post Production Houses

Learn from the experts.



The Time Tailor™ sets the new editing standards in the post production industry.

The Time Tailor™

The editing experts use the Time Tailor™ to capture additional advertising time during live feeds, pre-recorded programming and premium sold out show times.

The Time Tailor™ uses newly developed software to offer an integrated system designed and engineered to work with all equipment in a standard edit suite.

Prime Image has more than 20 years of leading the industry with high performance broadcast and production solutions.

Benefits:

- * Reduces content up to 8% with no loss of program integrity
- * No detectable change in audio and video quality
- * Operates in real time cutting work time by 70%
- * Proven technology



Standard Features:

- * Insert, delete, move black slugs all in one pass with frame accuracy
- * Micro editing technology
- * Maintains closed captioning
- * Windows based interface

NAB2005
THE WORLD'S LARGEST ELECTRONIC MEDIA SHOW

Next Show Event: Visit us at NAB 2005
Booth C5614 April 18-21

Prime Image

Performance by definition.

Tel (408) 867-6519
Fax (408) 926-7294

www.primeimageinc.com

"We had an aggressive strategy to create a tapeless, high-bandwidth, mission critical environment that also needed to support multiple file formats and be user friendly. We chose Omneon."

Alan Popkin

Director, TV Engineering & Technical Operations
KLCS-TV/DT, Los Angeles

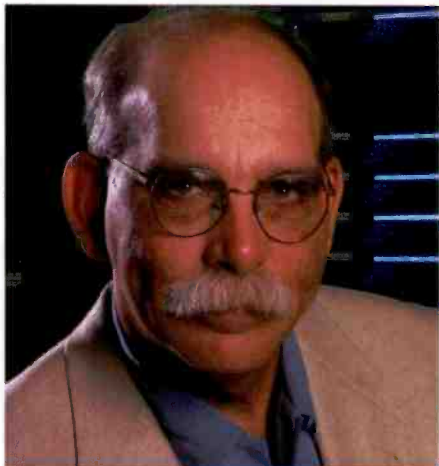

When KLCS embarked on an ambitious program to upgrade to DTV, they saw an opportunity to go far beyond just television and is now providing a host of new programming options to almost a million students and teachers.

With Omneon Spectrum™ media servers, KLCS has been able to implement an efficient model for delivering new services. Incorporating Smart Scalability™, Omneon Spectrum systems meet precise format, channel count, bandwidth and storage specifications. What's more, an Omneon Spectrum can be expanded in smart, manageable increments—without replacing the original system and in many cases, without taking the system offline.

To learn more about the unique advantages of an Omneon Spectrum media server system visit www.omneon.com.

It's not just what you serve.

It's who.



Visit us at NAB Booth #SU10724

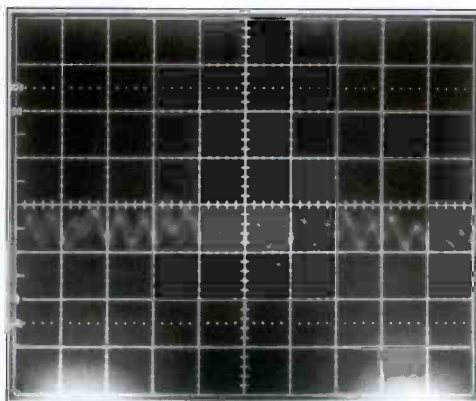

Figure 2. Oscilloscope display of 8-bit quantizing error

Horizontal display: 0.5 microsecond/cm
Vertical display: 5 millivolt/cm
S/Q_{RMS}: 58.3dB theoretical
S/Q_{RMS}: 57.9dB measured

amplitude, and the process is called uniform quantization. The number of quantizing steps and, consequently, the magnitude of the quantizing error, depends on the number of bits per sample.

Figure 1 on page 22 shows the quantizing errors introduced by a 3-bit codec. In this idealized case, all the steps have a constant width and a con-

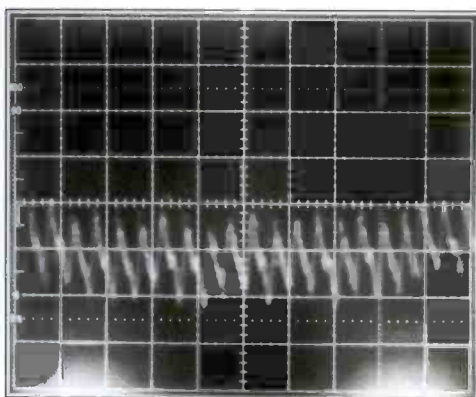

Figure 3. Oscilloscope display of 7-bit quantizing error

Horizontal display: 1 microsecond/cm
Vertical display: 5 millivolts/cm
S/Q_{RMS}: 52.2dB theoretical
S/Q_{RMS}: 51.9dB measured

stant height (Q). Early technology used seven or eight bits per sample, depending on the class of equipment. This resulted in 128 or 256 quantizing steps, respectively. With few exceptions, contemporary studio-type

equipment uses 10 bits per sample, resulting in 1024 quantizing steps.

With eight bits or more per sample, the quantizing error is perceived by the human visual system as random noise. Figure 2 shows the oscilloscope display of quantizing errors generated by an 8-bit system. Below eight bits per sample, the quantizing error results in a severe distortion of the waveform and gives rise to contouring effects. Figure 3 shows the oscilloscope display of quantizing errors generated by a 7-bit system.

Video signal to random noise specifications are usually expressed as p-p signal to RMS noise ratio. The p-p video signal value at the output of the D/A is $(2^n - 1) \times Q$ simplified to $2^n \times Q$. An ideal A/D transfer process as shown in Figure 1 results in peak values of $\pm Q/2$. The RMS value of this type of signal is equal to $Q/12$. Therefore, the peak-to-peak signal to RMS quantizing noise is:

$$\begin{aligned} S_{p-p}/Q_{RMS} \text{ (dB)} &= 20 \log_{10} [p-p \text{ Video}/\text{RMS noise}] \\ &= 20 \log_{10} [2^n Q / (Q/\sqrt{12})] \\ &= 6.02n + 10.8 \end{aligned}$$

It is evident that the higher the value of n, the better the signal-to-noise ratio. This simplified formula does not take into consideration the bandwidth of the quantizing noise nor the fact that the video signal does not occupy the whole quantizing range. In all standards, the maximum analog video frequency is lower than half of the sampling frequency, and analog video signals have a well-defined peak-to-peak amplitude.

The amplitude reference is the component analog 100-percent color bars signal, which assumes a peak-to-peak luminance value of 0.7V. It is important that these signals be handled by

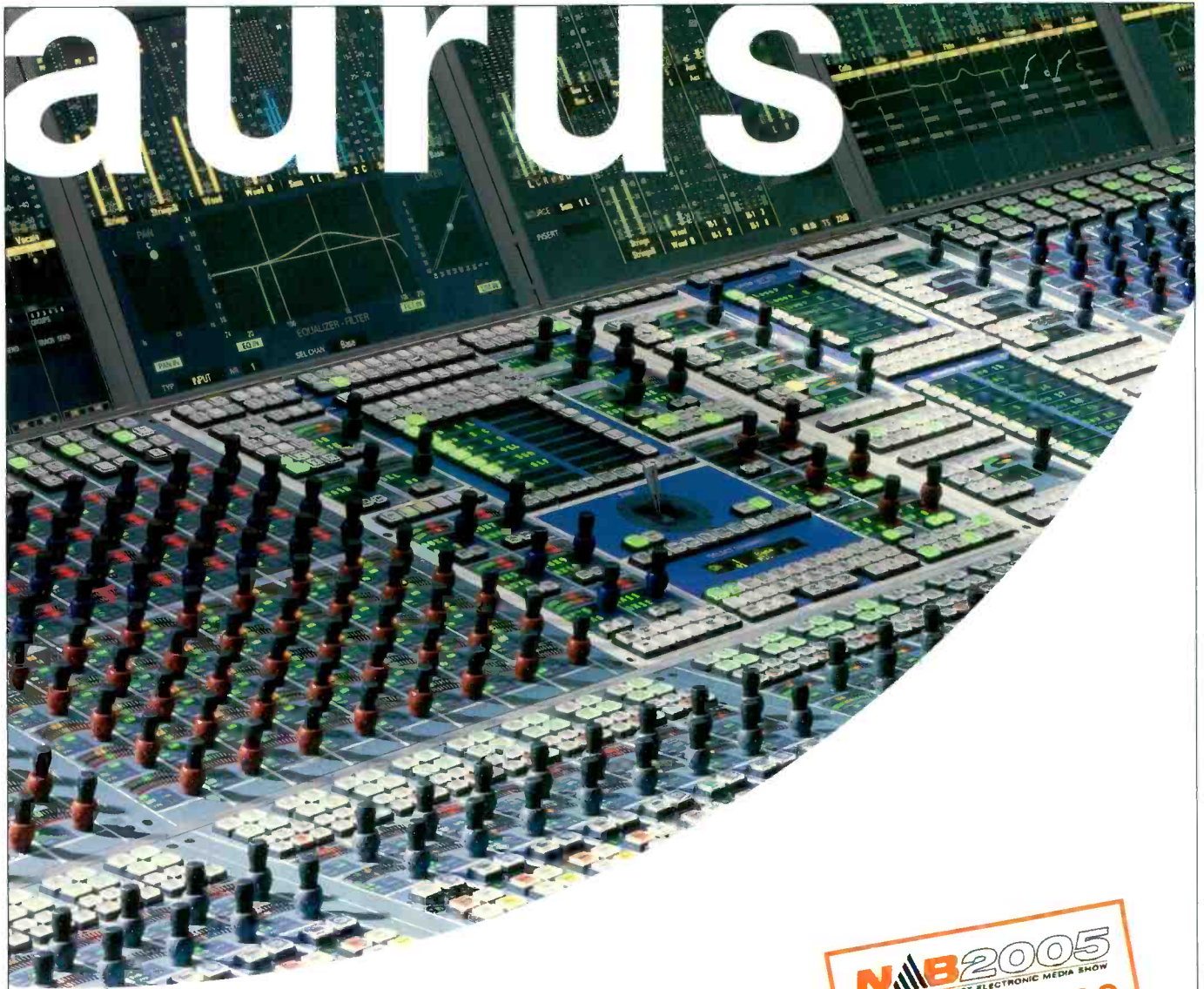

We made it a masterpiece You made it a unique success

Thanks to all our clients, who made AURUS one of the most successful digital high-end consoles in just one year:

BELGIUM VRT Flemish TV, Brussels (OB Vans K2, K3) **GERMANY** Anhaltinisches Theater, Dessau · Deutsche Welle TV, Berlin · E.T.A. Hoffmann-Theater, Bamberg · Friedrichstadtpalast, Berlin · TV Home Shopping Europe AG, München · HR Hessischer Rundfunk, Frankfurt (OB Van FÜ 1) · Informations- und Medienzentrale der Bundeswehr, St. Augustin · MDR Mitteldeutscher Rundfunk, Leipzig · NDR Norddeutscher Rundfunk, Hannover · Schaubühne, Berlin · WDR Westdeutscher Rundfunk, Düsseldorf (OB Van FÜ-Sat, Synchronstudios 1/2) · WDR Westdeutscher Rundfunk, Köln (Studio B1/2, Studio at the Philharmonie) **ITALY** RAI Italian Broadcast Service, Rome (Saxa Rubra TV 1) · ETABETA Outside Broadcaster, Rome **JAPAN** New National Theatre, Tokyo · iMedio Post Pro Studio, Osaka **LUXEMBOURG** Grand Theatre de la Ville **POLAND** TVP Telewizja Polska, Warsaw (OB Van, TV-Studio) **RUSSIA** Kremlin Palace, Moscow **SLOVAKIA** National Theatre, Bratislava **SWEDEN** SR Sveriges Radio, Stockholm (OB Van) **SWITZERLAND** Schauspielhaus, Zurich **UNITED STATES** The Guthrie Theaters, Minnesota



www.stagetec.com sales@stagetec.com

the A/D converter without clipping. Consequently, a certain amount of headroom is provided to avoid A/D converter overloading and is specified in current digital television standards. Taking these facts into consideration, the p-p video to RMS quantizing noise ratio becomes:

$$S_{p-p}/Q_{RMS} \text{ (dB)} = 6.02 n + 10.8 + 10 \log_{10} (f_s/2f_{max}) - 20 \log_{10} [V_q/V_{p-p}]$$

where

- n: The number of bits per sample
- f_s : The sampling frequency (e.g. 13.5MHz for Rec. 601 luminance)
- f_{max} : The maximum video frequency (e.g. 5.75MHz for Rec. 601 luminance)
- V_q : Signal voltage that occupies the whole quantizing range ($0.8174 V_{p-p}$)

V_{p-p} : Active video signal ($0.7 V_{p-p}$)

This formula takes into account the headroom, which is the difference between the whole quantizing range (V_q) and the p-p active video signal (V_{p-p}).

which activates all quantizing levels. The input is subtracted from the output of the codec, leaving only the quantizing errors, which are fed to a high-gain wideband oscilloscope. The p-p amplitude of quantizing error is

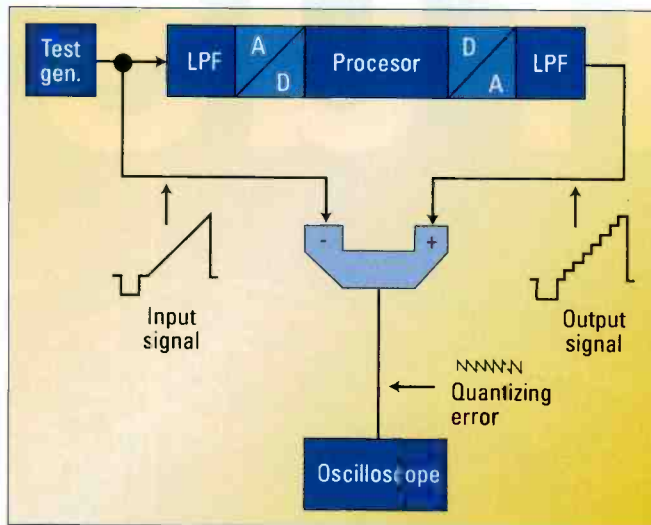

Figure 4. Conceptual block diagram of measurement of signal-to-quantizing noise ratio

The calculated theoretical value of S_{p-p}/Q_{RMS} for a 10-bit codec is ≈ 70.35 dB. The calculated theoretical value of S_{p-p}/Q_{RMS} for an 8-bit codec is ≈ 58.3 dB.

The measurement of S_{p-p}/Q_{RMS}

Figure 4 shows a conceptual block diagram of a test setup. The codec consists of an input (anti-aliasing) LPF, an A/D converter, a processor, a D/A converter and an output (reconstruction) LPF. The codec is fed a ramp signal,

sQ a revolution in technology a revolution in news

Quantel sQ is the market-leading news system – worldwide



A Quantel sQ news system is as big or as small as you need. Journalists and editors love it. News directors value the freedom it brings. It gets late-breaking stories to air in record time. And best of all, it makes compelling financial sense. The Quantel sQ revolution is coming to a station near you. Get the latest news at www.quantel.com.

sQ is news™



[King of Processors]



X75™ HD

Up/Down/Cross Converter,
Synchronizer...and More

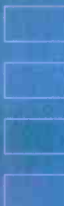

Standard Definition

Embedded Audio

Fiber Interface

Analog

Web Server

NTSC/PAL-M/PAL/SECAM

Dolby®E/AC-3 de-compression

Synchronization

Processing Amplifiers

Up/Down/Cross Conversion

Aspect Ratio Conversion

Metadata Transparency

Noise Reduction

Logos

High Definition

Multi-Channel Audio

AES/EBU

Digital

DVI-D and DV

Streaming

1080i/720p

Production/Editing

News

Broadcast

Mobile

Satellite

X75 HD



King of Processors

SHIPPING NOW!

Up/Down/Cross Conversion with Synchronization Starts With eXtra Processing Power

The X75 HD expands video processing to include "anything in" to "everything out" and simultaneous up and down conversions. Aspect ratio conversion, 3D adaptive decoding, TBC, SD/HD logos and noise reduction are all part of the vast array of X75 video capabilities.

For surround sound applications, 16 channels of audio processing with embedded SD/HD, analog and digital interfaces are provided. Integrated Dolby® decompression and voice-over brings even more functionality.

- Less equipment required for your SDTV and HDTV video processing applications
- Multiple paths of processing for video and audio
- IP-enabled for control, monitoring and streaming including SNMP

Master Your Move to HD with the X75 HD

www.leitch.com/X75

Canada +1 (800) 387 0233
 USA +1 (800) 231 9673
 Europe +44 (0) 1344 446000
 France +33 (0) 1 42 87 09 09
 Italy +39 02 3655 3450
 Hong Kong +852 2776 0628
 China +86 10 6808 6301
 Japan +81 (3) 5423 3632



www.leitch.com

carefully measured, and the S_{p-p}/Q_{RMS} is calculated using the formula:

$$S_{p-p}/Q_{RMS} \text{ (dB)} = 20 \log_{10}[\text{p-p video/RMS quantizing noise}] = 20 \log_{10}[\text{p-p video/p-p quantizing noise}] + 15$$

n	Theoretical	Measured
8	58.31dB	57.9dB
7	52.29dB	51.9dB
6	46.27dB	45.88dB
5	40.25dB	39.86dB

Table 1. Theoretical and measured Rec. 601 4:2:2 luminance S_{p-p}/Q_{RMS}

The S_{p-p}/Q_{RMS} ratio is obtained by adding a constant (15). This is a correction factor that takes into account the fact that the oscilloscope displays p-p quantizing noise instead of RMS quantizing noise. This measurement,

when carefully carried-out, gives results correlated with the calculated value within 2dB.

The disadvantage of this simple method lies essentially in the difficulty in measuring the quasi p-p amplitude in a consistent and reliable manner, since the judgment of the observer and many other factors, such as the chosen value of the correction factor, affect the accuracy of the measurement. Table 1 lists theoretical and measured Rec 601 4:2:2 luminance S_{p-p}/Q_{RMS} values for several values of n, all other parameters being kept constant.

Specialized automatic video testing equipment, such as the Tektronix VM700, has the capability of normalizing the luminance ramp test signal to a horizontal line and give direct readings of S_{p-p}/Q_{RMS} at the output of the digital black box.

A comparison of theoretical and

measured S_{p-p}/Q_{RMS} provides a useful guide in the performance of video A/D and D/A converters. **BE**

Michael Robin, a fellow of the SMPTE and former engineer with the Canadian Broadcasting Corp.'s engineering headquarters, is an independent broadcast consultant located in Montreal, Canada. He is co-author of "Digital Television Fundamentals," published by McGraw-Hill and translated into Chinese and Japanese.



Send questions and comments to: michael_robin@primediabusiness.com

Digital Television Fundamentals
DESIGN AND INSTALLATION OF VIDEO AND AUDIO SYSTEMS
SECOND EDITION
100% of original depth and including new chapters: Security, DVB and SDTV, Compression, and more...
MICHAEL ROBIN and MICHEL ZLOTNIK

The Second Edition of Michael Robin's book may be ordered directly from the publisher by calling 800-262-4729. The book is available from several booksellers.

Pomona ELECTRONICS

Built to take the stress.

Our rugged XLR connectors withstand twice the stress than the ones you're using now:

- 100 pounds of pull
- 50,000 bends under stress
- Best in industry signal clarity
- Dependable connections

Put Pomona connectors to the test. To request a **FREE SAMPLE** connector, go to www.pomonaelectronics.com/sample or call 1-800-490-2361.

When everything is riding on your connections, choose Pomona.

Copyright ©2004 Pomona Electronics. Ad No. 01834

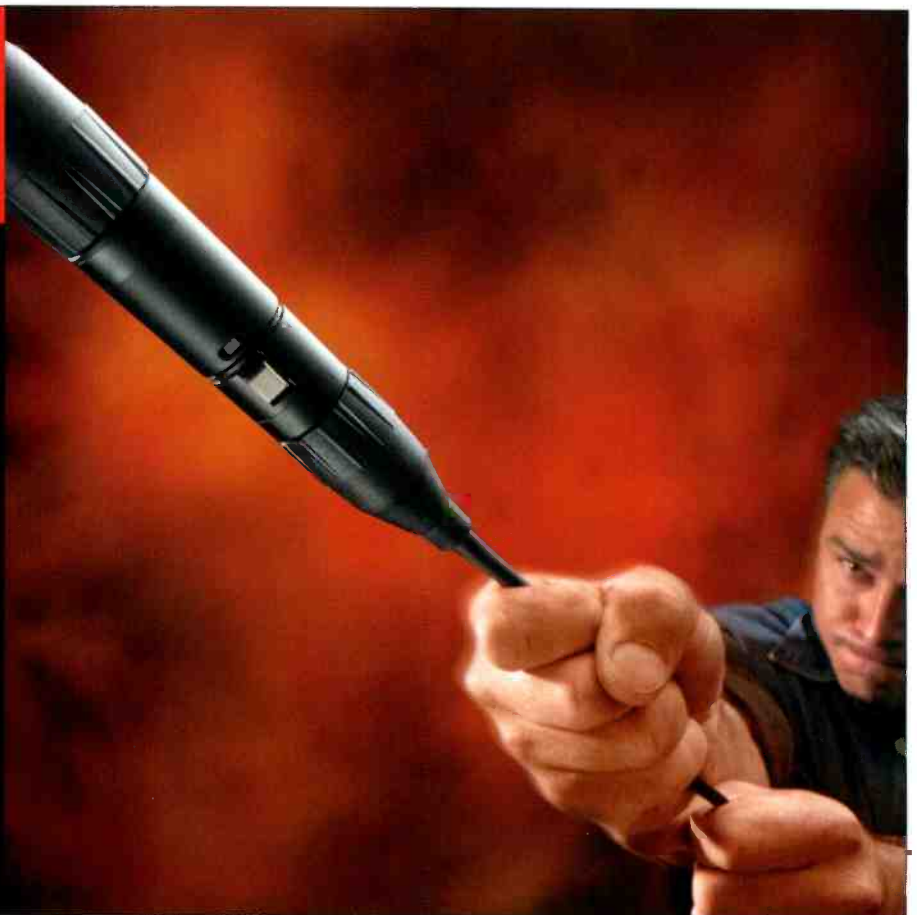

The Fastest Alternative in the World!

NEW EDITION



The new DV 15 Fluid Head is the perfect combination with any digital ENG camcorder. It is yet another example of Sachtler's proven quality being used to support the new generation of cameras. And with its central locking for immediate leg release, the new Hot Pod CF is the fastest tripod in the world. Its maintenance-free pneumatic gas spring effortlessly lifts the camera over six feet high. So why wait? Optimize your equipment now. With Sachtler!

Visit us at NAB Booth # C7319B
www.sachtler.com

sachtler
corporation of america

709 Executive Blvd.
Valley Cottage, NY 10989
Phone: (516) 867 4900
Fax: (516) 623 6844
email sachtlerUS@aol.com

3316, West Victory Blvd., Burbank, CA. 91505
Phone: (818) 845-4446



set your ideas in motion!

Sennar / Grambs, HH



Professional video and film file formats



BY BRAD GILMER

It is clear to many people in the industry that file transfer will be the dominant technology used to move video and audio between systems in the future. Already, completed programs and compositions are being moved around facilities as files. It is important for us to start thinking about file-based workflow and to anticipate how file-based production will change the facilities we build.

As Figure 1 shows, a typical file contains essence (the things you see and hear on the air) contained in a wrapper (a file format). One of the first file formats to see regular use was Digital Picture Exchange (DPX). Although it has been in the field for some time, DPX is still commonly used for film transfers. Film goes into a scanner, the scanner digitizes each frame of the film, and DPX files come out. A DPX file typically contains one film still-frame. As you can imagine, DPX file collections can become rather large.

This may seem like an unusual way to construct a file format, but it really makes sense in this application. Film work is frequently done on a frame basis; color correction, scratch removal and many other operations are all frame-based (or scene-based) functions.

Also, given past limitations on storage and memory, it made a lot of sense to load in a sequence of files representing the area of interest in a project without having to load the entire project. DPX allows you to do this by only loading the files of interest.

The first file format commonly used

for the exchange of content between servers in the broadcast environment was the General Exchange Format (GXF). GXF is still in wide use in the industry and is supported by a several manufacturers. The designers of GXF recognized early on that it was extremely important to move metadata in addition to video and audio when doing a transfer. They also placed video and audio on a timeline, and they interleaved video and audio content so that the material could be played out continuously as soon as reception of the file had begun.

While GXF is still in use, it now appears that the dominant, standards-based file format in the broadcast

so that the receiving piece of equipment can determine at the outset if it can playback the video or audio contained in the file. This information may also be useful later during post-production, where acquisition settings such as frame rate, overcrank, etc., are important. DMS-1 provides basic descriptive metadata. You can think of this as information that used to be contained on the tape label and on the cue sheet inside the cassette case.

MXF comes in two types — Operational Pattern (OP) Atom and OP-1A. The difference between the two is subtle but important. (See Figure 2 on page 32.) Applications that create OP-Atom files create a separate file for each “track” — for example, one video file, one audio file (or more), one data essence file and so on. Each file contains only one essence type. OP-1A files contain video, audio and data essence all in one file. The essence types are interleaved so that they can be played out in a streaming fashion like conventional videotape.

When it comes to post-production, the Advanced Authoring Format (AAF) dominates in the editing, compositing and

archiving environment. AAF is quite similar to MXF. AAF and MXF share the same object model; in simple terms, AAF and MXF applications use the same names for things. AAF and MXF applications also put things in the same place within the object model. As you can imagine, this is extremely handy when it comes to transferring content between broadcast and post. Where AAF and MXF differ is

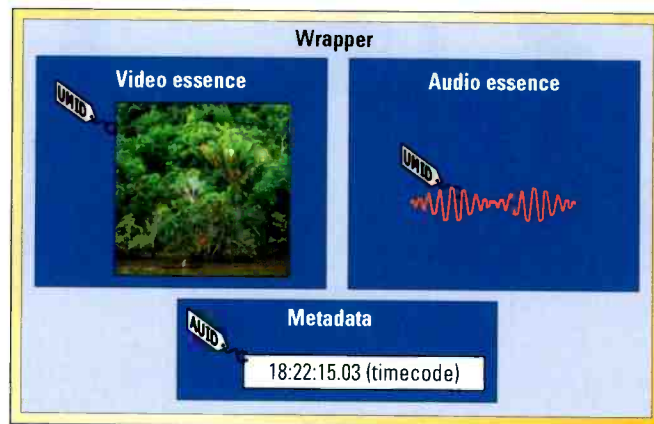

Figure 1. Essence and metadata are contained in a wrapper. The things you see and hear, along with information about those things, are contained in a file.

space will be the Material eXchange Format (MXF). MXF is a powerful enabling technology. It allows manufacturers to transfer video and audio (essence), along with information about the video and audio (metadata). MXF has a particularly well-defined set of essence descriptors. Essence descriptors describe the technical aspects of the video or audio in extreme detail. This high level of detail is required

Who are you?

TELL US & WIN

GO TO THE WEBLINK BELOW and TELL US ABOUT YOU AND YOUR STUDIO FACILITY.

STUDIO PRIZE PACKAGE valued over

\$40,000

Echolab Nova Identity⁴

HITACHI Z2500ST

Professional video switcher & camera bundle!



Andy Tkacs

Weekdays: Production Manager

Weekends: Harley Rider

It's about Personality, Creativity, Individuality.

Novaidentity⁴

A switcher as unique as you

- 1ME SDI Production Switcher
 - 16 In / 16 Out SDI : Full Conversion Options!
 - 10-bit 4:2:2 (NTSC / PAL)
 - 6 Keyers
 - 4 Chromakeyers
 - 5 Pattern Generators
 - 2 x 2DVE's with Rotation
 - 12 TIMED AUX / PRG, PRV & Clean Feed
 - 2 Matte Generators
 - 2 DVE Border Generators
 - Frame Buffer (with Alpha Channel Support)
 - Graphics Conversion / Photoshop Import
 - Ethernet Connectivity
 - Full Tally & GPIO
 - Easy to use 'Look Ahead Preview' Panel
 - Fits in a Standard Rack
- And that's just some of the standard features ...

★ Also new!

Echolab Converters



Echolab.com / identity4

Enter online now. Contest to be drawn at Booth #C4915 NAB 2005
Contest includes Bonus iPod Prizes & FREE T-shirt Giveaway

that AAF has a rich language that allows applications to describe, in detail, how a composition is built — how various video and audio clips, layers of graphics and so on were put together to yield the finished piece. One important distinction between AAF and MXF is that MXF supports streaming while AAF does not.

When thinking about file formats and workflow, it may help to look at a couple of use cases. A camera operator out in the field uses an MXF camera to capture a number of shots, which are to be edited into a news story. When the camera operator returns from the field, he plugs his camera into a network and downloads the files off the camera onto a central server. Once the content is on the server, the editor opens the files and begins to edit. After the story is edited and approved, it is transferred to a playback server so that it can be included in the evening newscast. Finally, the MXF file is ingested into an archive.

In another use case, MXF cameras are used to acquire content for a television show. When shooting is over, the content is downloaded to a server.

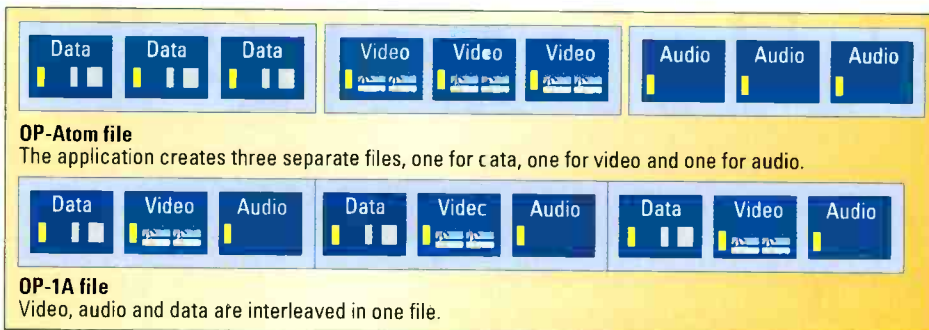

Figure 2. There are subtle differences between MXF OP-1A files and OP-Atom files. OP-1A files are interleaved and contain multiple essence types. OP-Atom files contain only one essence type.

Editors now access the content on the server and begin working on the show. Their AAF-enabled equipment reads in MXF files, and a project is begun. The project is stored in AAF files, which contain all of the information about the compositions created from the MXF files. The AAF files contain all of this metadata, but they contain none of the actual images or audio. The source video and audio is stored in MXF files, but they are referenced (pointed to) by the AAF files. Thus, the AAF files contain complex editing information, but the MXF files still remain relatively simple essence containers. When the editing session is finished, the final composition is rendered to an MXF file for transmission. The AAF file and associated MXF files are archived, preserving both the essence and composition information.

Building file-based facilities opens up exciting new opportunities for improvements in workflow. People can access the same content simultaneously. Management tools can be designed that will notify users when a particular production process is completed. Archive tools that automatically parse incoming AAF and MXF files can be created, aiding in later retrieval of this content. Expect exciting new developments as manufacturers and users begin to take full advantage of networked infrastructures. **BE**

Brad Gilmer is executive director of the AAF Association, executive director of the Video Services forum, and president of Gilmer & Associates, a consulting firm.



Send questions and comments to:
brad_gilmer@primediabusiness.com

network
the innovator

VIKINX
Flashlink
conquer

Contact Network Electronics
Phone: 800 420-5909
E-mail: ussales@network-electronics.com
11075 South Slate Street, Suite 27
Salt Lake City, Utah 84070

LATEST TECHNOLOGY

It's a competitive world. You need the latest and the best technology to stay at the top of your game. Our MTBF numbers are industry leading and will give you peace of mind.

QUICKEST DELIVERY

No more waiting! Our huge inventory guarantees speedy deliveries. 50-100 small routers usually ship in 5 working days; 10 routers or less can ship the same day.

FASTEST SERVICE

Through our Advanced Replacement Policy you will receive a new unit BEFORE you send the old one back — no questions asked!

HIGHEST INNOVATION

Need space? Need flexibility? Need expandability? Our compact routers, signal processing products and optical modules address every format in the most configurations available today.

3 YEAR WARRANTY

Worry free! Stress free! Our extensive warranty gives you peace of mind for 3 years. And if you want even more ask about our NET-CARE system that extends your coverage to 5 years or longer.

TOTAL PICTURE

A full range of products to accommodate every need, every format, every budget. Our TSS (Technical System Sales) Group is ready to design your system to suit your requirements at prices you can afford.

ROUTERS • FIBER OPTIC TRANSPORT • SIGNAL PROCESSING

www.network-electronics.com

visit us at NAB
18th - 25th April
C7319A



Revolutionary Wireless

CellCom digital wireless intercom. Truly new, truly revolutionary. The first stand-alone wireless to offer small group and person-to-person conversations among beltpacks.

- Complete programmability with up to six communications routes per beltpack
- The ability to remote and customize coverage areas, and connect with two wired party-line and four digital matrix channels
- Ten beltpacks per base - all license-free, above the UHF television bands and with no need for frequency coordination.

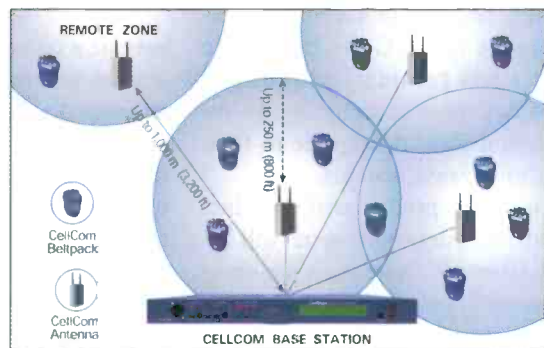

Cell Com. Join the revolution.



Surviving the 2GHz transition

BY GEORGE MAIER

Nextel moved ahead with the 2GHz BAS relocation plan beginning on February 7. According to the Report and Order, negotiations with Nextel's stage one markets must be completed by May 31. Because of time-line changes made by the FCC, the stage one deadline was moved to July 15, with projects expected to be under way by mid-year. The stage two mandatory negotiation deadline is now May 15, 2006.

Most broadcasters are acquainted with the new rules as stated in FCC document 04-168, requiring 2GHz BAS operations be moved to 12MHz channels in the new 2025-2110MHz band. (See Figure 1.) Questions remain, however, about the tactical issues of making the biggest and most complete frequency and band change in history, and completing it in a 30-month time frame.

Arguably, the biggest impact of the relocation will be on ENG equipment and operations. However, fixed links also must be moved in a seamless manner. The key to a wholesale replacement of ENG facilities is in broadcasters continuing to provide day-to-day news coverage, while undergoing a forklift upgrade to their 2GHz microwave systems.

No one can predict with absolute certainty where trouble spots will develop. However, there are a few common areas to be aware of.

Review and inventory your system — again!

This refers to Nextel's obligation to provide "comparable" facilities. New ENG central receivers and portable transmitters are obvious targets for replacement, but related hardware and subsystems should be completely re-

viewed with regard to their impact on maintaining ENG station operations.

The question of dual mode versus an all-digital system is another area that deserves examination. While an all-digital system may seem less complicated, it may not be comparable to what you now have in several ways.

One possible problem in a digital world is that all radios may not be compatible in digital mode, while analog FM is universal. When traveling outside of your normal area, analog

is efficient in many cases, but that's only half the story. Having the added discrimination of RHCP, LHCP, and horizontal and vertical linear polarization could mean the difference between getting the story and not getting it. If you have a linear antenna system, a quad polarized system may be the answer to comparable facilities in a post relocation environment.

Another potential problem area is the LNA. Most LNAs now in service cannot handle strong digital signals

Current plan	Channel edges	Channel center	New plan	Channel edges	Channel center
A1	1990-2008	1999.0	A1r	2025.5-2037.5	2031.5
A2	2008-2025	2016.5	A2r	2037.5-2049.5	2043.5
A3	2025-2042	2033.5	A3r	2049.5-2061.5	2055.5
A4	2042-2059	2050.5	A4r	2061.5-2073.5	2067.5
A5	2059-2076	2067.5	A5r	2073.5-2085.5	2079.5
A6	2076-2093	2087.5	A6r	2085.5-2097.5	2091.5
A7	2093-2110	2101.5	A7r	2097.5-2109.5	2103.5

Figure 1. Existing and new 2GHz BAS channel plans

may be a common thread. Also, analog can be used as a backup mode if an issue develops in the ENG digital decoder. Finally, 2.5GHz is not under the relocation order and can still be used as full bandwidth 17MHz analog channels in areas where interference is not an issue.

The comparable facility requirement applies equally to antenna systems as well. In a world with digital and analog systems operating side by side, the potential for adjacent channel interference will be difficult to predict as it will be random in nature. It is generally understood that COFDM signals work well in a multipath environment and that linear polarization is suffi-

cient in many cases, but that's only half the story. Having the added discrimination of RHCP, LHCP, and horizontal and vertical linear polarization could mean the difference between getting the story and not getting it. If you have a linear antenna system, a quad polarized system may be the answer to comparable facilities in a post relocation environment.

Another potential problem area is the LNA. Most LNAs now in service cannot handle strong digital signals

without going into compression. With analog transmission, the effect of overload can be quickly recognized by streaking in the video; in digital, the monitor just goes black, which can easily fool an operator into thinking the signal has been lost, when in reality, it's too strong. It's hard to imagine that reducing the RF level will bring the video back, but that's what is needed in a case like this. The cure is a replacement LNA with AGC. Existing RF channel filters will be on the replacement list as well.

Editcam

More Reasons Than Ever To Choose Ikegami's Tapeless Solution.

Acquisition

- Non-linear recording with exceptional recording times, up to 6 hours at 25Mbs or 3 hours at 50Mbs.
- Proven technology with hundreds in service, and more than 5 years field experience.
- Future proof media with planned transition from HDD to solid-state memory.
- Exciting Retroloop feature - never miss a shot.

Edit

- Removable media connects as an external drive to notebook and desk top editing systems.
- Future proof media with demonstrated HDTV compatibility at data rate up to 230Mbs.
- High speed workflow with no digitizing, direct from acquisition to edit to On Air.
- Developed in partnership with Avid Technology, instant editing on all Avid NLEs.



Flexibility For The Future



See Us At NAB Booth #C5426

Ikegami Electronics (USA), Inc. 37 Brook Avenue, Maywood, NJ 07607
East Coast: (201) 368-9171 West Coast: (310) 297-1900 Southeast: (954) 735-2203
Southwest: (972) 869-2363 Midwest: (630) 834-9774

Ikegami
www.ikegami.com

electronics. Take a second look at your requirements.

Train your operators well in advance

Operating a digital ENG link is not at all similar to operating an analog link. The encoder/decoder delay can easily trip you up when panning the antennas for best signal. You may find it easier to set up on analog and then switch to digital.

Many news directors are understandably apprehensive about the digital cliff effect and the difficulty in predicting when it will render a shot useless. Although digital quality monitors are now becoming available, until they are mainstream, there are alternatives. Low-cost, remotely accessible spectrum analyzers can provide a real-time view of the COFDM pedestal at the central receive site via a LAN or Web base interface. With a bit of experi-

ence, watching the analyzer display on a PC gives an operator the ability to see trends as they happen and to develop a feel for where the infamous cliff might be hiding.

Get involved in the process

The actual procedures that will be used during equipment replacements are still being discussed by Nextel, manufacturers and industry groups. The most likely scenario will be to replace the central receivers first, followed by the mobile gear. Initially, as the gear is replaced, everyone in a target DMA will continue to operate on the old channel centers until all of the equipment replacements in the DMA are completed, tested and ready. At a mutually agreeable time, everyone will switch to the new plan.

Some of the installation issues that are still being debated include how and when to change existing antenna

components such as LNAs and channel filters. If your system requires one or more filters in the antenna housing, multiple filter sets that can be switched between the old and new channels may be required on a temporary basis. Be sure to check your control cable to see if it has enough extra conductors to support filter switching and AGC. You may need to replace it.

Your best defense in this relocation period is good offense. Develop a transition plan that works for your operation, and talk to your Nextel coordinator about it. If you need an independent opinion, the Society of Broadcast Engineers (SBE) has a full-time coordinator working with Nextel on behalf of the broadcast community. Information is available on the SBE Web site at www.sbe.org. **BE**

George Maier is the founder of Orion Broadcast Solutions.

TELEVISIA CHOOSES FISSION SOFTWARE

To renew its most important local and repeating stations

The objective was to provide a solution on a great scale that allowed the sharing of resources and the free flow of information between the different operating areas of each television station. In addition to its own systems for automating master control, Fission Software also installed solutions for integrated non-linear editing, character generators, video sequencers, audio editing and production systems, 3D animation and compositing systems. These installations have local storage and/or centralized storage based on fiber channel (2Gb storage area network SAN) and on copper (1 Gb-based network attached storage - NAS).

"The modular design of the application for master control allows us to create systems that are tailored to the specific requirements of each station; to digitally integrate the environment and to unify operating areas" comments Arturo Mignón González, Technical Director of Telesistema Mexicano.

"The fact that these applications operate on standard hardware in an open architecture, made it possible for us to avoid the high cost that the acquisition of equipment from proprietary brands represents. This advantage, in addition to the savings in the maintenance budget for the videotape machines and tape consumption, makes Fission Software's digital platform a highly recoverable investment with the operating capacity and corresponding functionality compared to any other solution" concludes Mignón.

NAB2005
THE WORLD'S LARGEST ELECTRONIC MEDIA SHOW

Visit us at
Booth # C 9807



Fission Software, Inc.
Tel: (203) 730 2944
1(888) 644 8766
Fax: (203) 791 3844
info@fission-sw.com

Fission Software de México, S.A. de C.V.
A wholly owned subsidiary of Fission Software, Inc.
Latin America / Caribbean Sales Office
Tel: +52(55) 5559 4096
Sales: Ext. 112 and 115 Fax: Ext. 102
Email: salesla@fission-sw.com

www.fission-sw.com

FISSION SOFTWARE, INC.
BROADCAST AUTOMATION SYSTEMS

Fission Sponsor



Fission is a trademark of Fission Software, Inc. Fission Software, Inc. with the "X" design and the Fission logo are trademarks of Fission Software, Inc. © 2005 Fission Software, Inc., all rights reserved.

VIDEOTEK RAISES THE BAR FOR HD TEST AND MEASUREMENT

- High-Resolution Integrated LCD Display
- Dual Link
- Four Simultaneous Inputs
- HD/SD Eye Pattern
- Dolby® Decode, Display & Alarms
- User-Configurable Displays
- Video Metadata Display
- Alarms with Peak Level Reporting
- Closed Caption: Decode, Display & Alarms
- Format Upgradeable
- Standard Half-Rack, 3RU Configuration
- Pixel Data Analyzer/Camera Maintenance

See us at NAB in the Leitch Booth SU7805

INTRODUCING the TVM-950HD



HD/SD/Composite

Reaching New Heights in High-Definition Quality Assurance

In keeping with a tradition of technical innovation, Videotek's precision TVM-950HD offers intelligent architecture that provides unparalleled performance and flexibility and sets a new benchmark for High-Definition video and audio signal analysis. The feature rich "950" provides waveform, vector, audio and picture all in one convenient display. With back-lit controls and a compact half-rack configuration, the TVM-950HD is a perfect fit in any environment.

Once again, Videotek sets the standard.

For more information see us at NAB or contact your Regional Sales Manager.

Videotek Toll Free USA (800) 800 5719
Videotek USA (610) 327 2292
Videotek Europe +49 8093 90 4082
Videotek Asia +65 6356 5830
www.videotek.com



www.leitch.com

VIDEOTEK[®]
A ZERO DEFECTS COMPANY

Dolby® is a registered trademark of Dolby Laboratories
US Patents 6,069,607, 6,532,024, and 6,828,981

www.videotek.com

UK Patent 2,330,475 Other US and International Patents Pending



Myat UHF and VHF combiners receive signals from Harris transmitters below and selectively allow channels to pass through without causing interference to each other.

NYC broadcasters

find redundancy at Four Times Square

By John Lyons

Redundancy is integral to any modern broadcast facility. And for good reason, considering the growing importance of disaster recovery in broadcasting today. If the main site goes down, having a backup transmission facility at a different site is the best

game plan. Broadcasting from a backup site provides a reliable means of reaching at least a large portion, if not all, of the station's coverage area.

Nowhere is the importance of staying on-the-air more apparent than in New York City, where local broadcasters serve millions of viewers. Manhat-

tan remains the best position for broadcasters to reach their viewers over-the-air. However, site choices are limited, especially for rooftop towers.

Recent terrorism events and electricity breakdowns are just two factors that have forced area broadcasters to rethink their backup strategies. Some local stations keep backup transmitters at their main transmission sites. Others have secured separate backup transmission sites to ensure they remain on-the-air in a disaster. Two local broadcasters, WABC-TV and Univision, chose the latter option and secured space at Four Times Square.

The Manhattan skyscraper is owned by The Durst Organization, a real-estate company that develops, owns and manages properties in the NYC area. The company built and opened the building in 1999. The original design featured space for radio transmission

and other communications facilities, with an eye toward DTV. The initial design phase included potential for a 200ft rooftop broadcast tower. A 132ft Hemphill tower with a Shively model 6016 master FM antenna provided backup transmission facilities for five local radio stations. An 80ft tower sur-

face area to accommodate microwave communications, two-way radio systems, RPU antennas and STLs.

Television moves in

After Sept. 11 underscored the importance of backup TV transmission facilities, The Durst Organization

the city. Univision was the first TV broadcaster to lease space, establishing backup facilities for New York area analog stations WXTV-TV and WFUT-TV. Univision also decided on Four Times Square as the primary location for WFUT's digital channel.

The digital channel went on-air at low power May 1, 2003, and switched to full power on July 13, 2004. The analog channel was ready for air in mid-March 2004. Univision had its first test during the August 2003 citywide blackout. WFUT-DT's temporary low-power DTV transmitter stayed on the air using power generators, showing the importance of back-up plans.

ABC affiliate WABC leased space at

Having a backup transmission facility at a different site is the best game plan for any broadcaster.

rounds the broadcast tower for outer ancillary facilities. It features four levels with more than 11,000sq ft of sur-

replaced Four Times Square's existing tower with one that would accommodate all FM radio and TV stations in

Harris analog and digital transmitters are used at the Four Times Square retransmission facility, as seen here in the WABC-TV transmitter room. WABC uses a 50kW Platinum series transmitter for its analog channel and a 27.5kW Diamond CD transmitter for its digital station.



SYSTEMS
DESIGN
SHOWCASE

Four Times Square in the summer of 2003 to include backup transmission facilities for its analog channel 7 and digital channel 45. The latter was launched at half-power on Oct. 30, 2003. Full-power operation began in late August 2004. The backup facili-



The Myat combiner system for UHF channels 40 to 60 sends signals to a Dielectric TUA-C8/64-U-2-B-R upper UHF antenna after ensuring that potentially interference-causing signals from other channels have been filtered out during the combining process.

ties for channel 7 protect the primary site on the Empire State Building.

Signal transmission

Both broadcasters use Harris transmitters for signal transmission. WXTV uses a 50kW Sigma UHF transmitter, and WFUT employs a 100kW Sigma model. A 10.5kW (average power) Diamond CD UHF transmitter is used for WFUT's digital channel. WABC selected a 50kW Platinum Series VHF transmitter for its analog channel and a 27.5kW (average power) Diamond CD transmitter for its digital station.

Multiple-cabinet designs allow different on-air configurations. For instance, WABC's 50kW transmitter features five identical PA cabinets. These provide a high level of redundancy and allow for continuous operation in the event a module, or even an entire

cabinet, fails for any reason.

WABC's digital transmitter includes Harris Apex exciters to drive the amplifiers. The exciters convert the SMPTE 310 signal to 8-VSB, while maintaining compliant FCC mask performance and using adaptive correction to improve signal-to-noise ratio (SNR). Self-contained routines perform correction automatically, reducing the need for periodic maintenance adjustments on the exciter level. The exciters can easily be connected to a precise reference to protect against interference between adjacent channels, such as with WFUT-DT.

The two facilities are housed in separate areas on the upper mezzanine, located just below the 50th floor. Signals originating from each broadcaster's studio reach the transmission facilities over microwave and fiber. Because the stations' signal paths are similar, this article will use WABC as a model. A Microwave Radio Code-Runner two-way microwave link combines the station's analog and digital microwave signals during transmission. Verizon provides the fiber links: The analog channel is transmitted over a 270Mb/s fiber link, and the digital channel uses a SMPTE 310 19.3Mb/s link. Digital signals from the studio reach a terminal gear rack upon entering the facility. Each exciter is connected to an Evertz switcher that selects the signal that feeds it.

The analog side is slightly more complicated. WABC transmits 601 digital video with embedded audio from the studio. That signal is immediately converted to analog using Fortel conversion gear, which also disembeds the audio. Thomson Grass Valley distribution equip-

ment and processing amplifiers connect to Leitch switchers, which feed analog video and audio sources to the Platinum's dual exciters. The station created room for a "steerable" ENG antenna to establish an emergency link into the transmitter, and to support its news operations.

Fully redundant analog and digital signal paths ensure that no single component failure will take the station off the air. Dual Modulation Sciences STV-784 stereo generators provide audio processing on the NTSC-compliant audio signals.

There is a lag time of six to eight seconds when the load is transferred from the main electrical system to a generator. Both the WABC and Univision racks include UPS equipment to keep the control and processing equipment online while the generator gets up to speed. Four-foot aisles provide fire safety and a comfortable, serviceable environment, with rear access to equipment racks.

Equipment list

Harris:

HD3050P1 Sigma and HD3100P2 Sigma transmitters

DHD45P2 Diamond CD, HT50HSP Platinum Series and DHD120P4 Diamond CD transmitters

Apex exciters

ReCon control and monitoring
Microwave Radio CodeRunner

Dielectric:

TUA-C8/64U-2-B-R upper UHF antenna
TUA-C8/64U-2-B-R lower UHF antenna
THA-04-6H/24U-1-R high VHF antenna

Andrew Trasar antenna

Myat UHF/VHF combiner modules

Modulation Sciences STV-784 stereo generators

Fortel NTSC conversion gear

Evertz SMPTE 310 switchers

Leitch transmitter switching gear

Thomson Grass Valley distribution gear and processing amps

Hemphill towers

You are Invited to the Premiere Showing of 360 Systems' New Video Servers



Image Server™ 7000

Two Inputs, Six Outputs, Up to 400 hours of RAID-5 Storage, Gig-E Networking, MPEG-2, DV, TARGA Graphics, Advanced Playlisting, Redundant Power, Hot-Swap Drives.

Breakthrough Pricing on a Large Server; from \$25,000.



Self-Mirroring Servers

360 Systems' new self-mirroring servers provide full redundancy for stored content. Two Image Servers do it all, with no need for extra software or serial ports on your automation system.

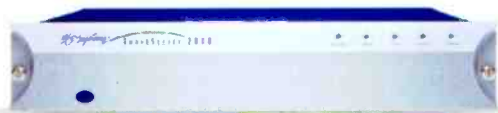

Network Time Delay

Frame-accurate time-zone delay of up to six hours. SDI & Composite video; +4 analog, AES/EBU and embedded audio, RAID-protected storage, Remote GUI, unattended startup. Also available in redundant pairs. \$12,000

NEW Image Server Features

- Advanced Playlisting Tools
- Embedded Aucio
- Fast Ethernet Import of Video and Graphics from Workstations
- Ganged Key & Fill Playout
- Video & Graphics Clip Server
- 170-hour Storage on Image Server 2000
- Remote Graphics User Interface

2005 NAB Convention - Las Vegas - April 18-21

See us at our new NAB booth location: SU-11011, South Hall.

360 Systems
BROADCAST

For more information on new products, call (818) 991-0360. www.360Systems.com.

5321 Sterling Center Drive, Westlake Village, CA 91361
E-mail: Servers@360Systems.com Fax: (818) 991-1360

© 360Systems. 360Systems and Image Server are trademarks or registered trademarks of 360Systems in the United States and/or other countries. Prices shown are for direct U.S. sale only. Specifications subject to change.



Visualize your Surround Sound

- Intuitive surround sound visualization by Jelly-Fish™
- Supports: stereo / 4.0 / 5.1 / 6.1 / 7.1
- Complete level & phase information
- Simultaneous check of Lt/Rt downmix
- Industry standard for surround sound productions
- Jelly-Fish™ red lines indicate phase errors

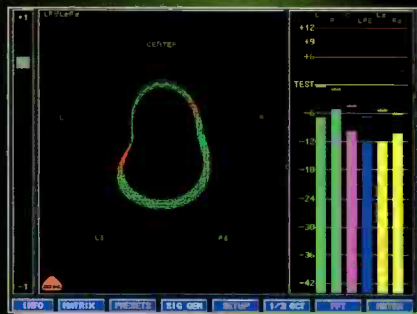

5.1 Jelly-Fish™ display

"solutions in Audio & Video"

NYC broadcasters find redundancy at Four Times Square

Having the same transmitters allows Univision and WABC's transmitters to stock fewer parts by borrowing interchangeable modules from each other, reducing costs while retaining redundancy.

The transmitters route the signals to Myat UHF and VHF combiner modules in the TV combiner room on the 52nd floor through 4-1/16in (analog channels) and 6-1/8in (digital channels) transmission line. The combiners selectively allow channels to pass into and through the system. As the signals are combined, the modules prevent signals from coming back down the transmission line and into a different transmitter's output.

The four separate combiner systems are designated by frequencies so channel signals are sent to specific antennas before going out to air. At the very top is an Andrew Trasar antenna provided by Univision for channel 68. Two Dielectric UHF antennas are featured directly below: The upper antenna is designated for channels 40 to 60, and the lower for channels 24 to 45. Overlap is provided for the middle frequencies so either antenna could handle them.

Underneath is the Dielectric high-band VHF antenna for channels 7 to 13, with the Shively analog/digital FM master antenna just below. Space is provided further down for a combined channel 4 to 5 antenna and a separate channel 2 antenna.

Additional facilities

Three additional floors complete the transmission facilities. The lower mezzanine is available and reserved for additional TV transmitter rooms. Just below the mezzanine levels, the 49th floor houses the building's three emergency generators. Two are reserved for TV and FM tenants (the other is primarily used for building fire and safety purposes). The broadcast-oriented generators provide a redundant power supply for the broadcast tenants. The

"They understand the needs of a mid-size market."

Randy Odil, General Manager | KCEN-TV, WACO, TX



For systems integration, equipment upgrades, technology expertise, installation and ongoing support, call Professional Communications Systems.

solutions visualized.™

800.447.4714

www.pcomsys.com



A MEDIA GENERAL COMPANY

Design team

John Lyons, The Durst Organization/Four Times Square, master antenna system coordination

Bill Beam, WABC-TV

Karl Lahm, Univision

James Lee, ABC/Disney Real Estate and Construction Services

Christiaan Janecka, HLW, Architects

Michael Migliaccio, AMA, electrical/mechanical engineering

Pat Hauserman, Tishman Interiors, GC

Michael Panico, The Systems Group, A/V system integration

Pat Reagan, Harris Broadcast, transmitter system design

Hatzel & Beuhler, specialized RF installation and electrical work

2GHz RELOCATION. SMOOTH MOVE AHEAD.

ATTENTION NAB 2005 ATTENDEES

2GHz Relocation is on track and in your future. Nextel is making the transition as smooth as possible. You should expect no less from a company that's all about getting things done.

VISIT NEXTEL @ NAB 2005 TO LEARN MORE.

- **Nextel Central @ LVCC Monorail Station**
Sunday, April 17th to Wednesday, April 20th
8:00am to 7:00pm
 - > Come to the Nextel lounge to recharge, view online tools and check email
- **Microwave Equipment Vendor Booths @ LVCC**
Monday, April 18th to Wednesday, April 20th
9:00am to 6:00pm
 - > Visit Nextel at the microwave equipment vendor booths
- **Refreshment Break @ RTNDA in the Hilton**
Monday, April 18th
2:15pm to 3:15pm
 - > Visit Nextel in the exhibit hall at the Hilton for refreshments
- **Broadcast Engineering Conference @ LVCC**
Tuesday, April 19th
3:30pm to 4:00pm in Room N-110
 - > With a full-conference exhibit pass, hear the presentation by Nextel leadership

SYSTEMS
DESIGN
SHOWCASE

three units together generate 5.5MW of power.

The chiller plant provides air conditioning to all TV transmitter rooms to keep the equipment functioning at a high level. Univision receives 60 tons of air, and 60 tons of chilled water for the analog transmitters' IOT heat exchangers. WABC gets 50 tons of air. Each licensee was responsible for extending the ductwork from its outlet to provide airflow throughout its space. Maintenance building engineers change filters, monitor the units and provide general HVAC service.

A Harris ReCon control and monitoring system helps keep an eye on the facility's health. It was chosen because both Univision and WABC have ReCon systems.

The system allows one person to monitor the entire facility, either remotely or on-site, through an Internet

connection. Once he or she pinpoints a signal problem, an administrator can find the source and fix the problem over the PC. Fault notification can be customized to include e-mails and alarms. All tenants have access to the system, with nine security levels in place to control exactly what each broadcaster can view over the system.

The facility uses the system to monitor everything from terminal gear to antennas. Incidental and reflected power is monitored at the combiner inputs and outputs. Temperature sensors are connected to modules in the TV and FM combiner rooms. Tower beacons and RF monitors on the roof are also connected to the system. Warning lights at all roof access points change green, amber and red depending on RF levels. Additional lights were added to the cooling towers near the FM backup antenna for worker safety.

All of the transmitters feature a con-

trol panel. A screen in a remote location provides meters in a different format from the main ReCon terminal. The nitrogen pressurization system for the transmission lines is also connected to the monitoring system. Humidity, pressure and excessive run time are other parameters that are monitored and automatically alarm if outside normal limits. The system creates log notations as the transmitters switch on and off or operate above or below normal (-10 percent to +5 percent) licensed values.

The facility is unique in that the tower design was included from the beginning. With its Manhattan location, plug-and-play design, and room for expansion, Four Times Square is well-positioned to serve NYC broadcasters far into the future.

BE

John Lyons is manager of communications and broadcast operations for Four Times Square/The Durst Organization.



Discover The Synapse Advantage

Engineered in collaboration with Axon Digital Design, the Synapse Modular Media System provides an unprecedented level of multi function signal processing in a flexible, modular, remotely controllable platform.

To integrate legacy analog equipment into a digital facility, look no further—

- > SAM-10 Digital to Analog A/V Bridge
- > ASM-10 Analog to Digital A/V Bridge

These Synapse modules handle conversion, audio embedding/disembedding, and timing. They provide the same functionality as six or more modules in comparable systems.

The SAM-10 and ASM-10 are just two of the more than 100 modules in the Synapse family.



Visit us at our new web address www.nvision.tv

Synapse the ultimate modular broadcast system

A.F. Associates



A.F. Associates (AFA) is the global leader in design and integration of turnkey systems and technology solutions for broadcast, cable, satellite, and telecom clients. Full service operations on both U.S. coasts and a new project support office in London provide comprehensive services on an international basis – from consultation to implementation and beyond.

Backed by over 35 years in the industry and our resource-rich parent company Ascent Media, AFA provides the best mix of experience, strength, and flexibility to support the long term success and growth of your business.

To learn more:

Web: www.ascentmedia.com/systems

Phone: 201.767.1200

E-mail: systemsales@ascentmedia.com

Please visit us at NAB booth #C5434

AFA

An Ascent Media Company

Engineering the Future of Television™

San Jose, CA

Northvale, NJ

Palm Bay, FL

London, UK

The XDCAM System



the
simplelife:
INTERNS

THE 5TH
DRAGON

the
mansions

Extreme
MAKEOVER
HOME EDITION



WEXLER

Watch Extreme Makeover: Home Edition Sundays 8/7c on ABC

VER
Video Equipment Rentals

bexel

KINGWORLD

As the industry leaders migrate to tapeless, they're utilizing Sony's XDCAM™ Professional Disc™ system. After all, Professional Disc media is the only nonlinear media you can afford to use in acquisition, postproduction, program exchange and archiving. The XDCAM system also has proven interoperability with all the popular NLEs and servers.

And now Sony offers the new 24PsF progressive scan option card, plus the PDW-D1 XDCAM drive, which plugs directly into your compatible PC via the i.LINK® interface.

So make the move to the XDCAM Professional Disc system.

And find yourself in very good company.



XDCAM
Professional Disc System

Get your FREE DVD on the XDCAM system at www.sony.com/XDCAM

© 2005 Sony Electronics Inc. All rights reserved. Features and specifications are subject to change without notice. Reproduction in whole or in part without written permission is prohibited. Sony, i.LINK, Like No Other, Professional Disc, and XDCAM are trademarks of Sony. i.LINK is a trademark of Sony used only to designate that a product contains an IEEE 1394 connector. All products with an i.LINK connector may not communicate with each other. Please confirm interoperability with third party manufacturers. For more information, contact Sony at 1-800-686-7669.



like.no.other™

SONY

in Very Good Company



TELEMADRID

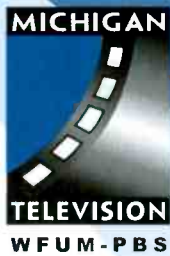

The fastest growing tapeless acquisition system in the world.
Over 6,000 units delivered worldwide.

**SYSTEMS
DESIGN
SHOWCASE**



San Jose's NBC11 and Telemundo 48 go all-digital

By Richard Swank

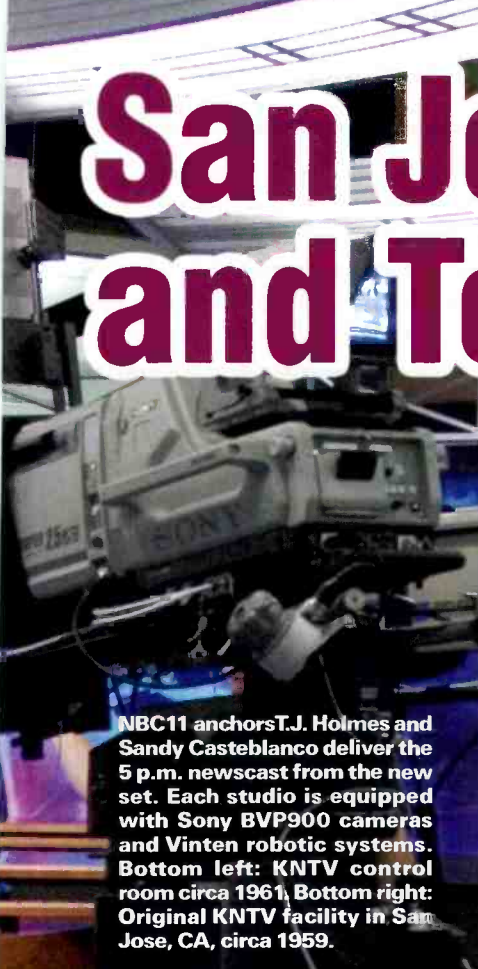

NBC11 anchors J. Holmes and Sandy Casteblanco deliver the 5 p.m. newscast from the new set. Each studio is equipped with Sony BVP900 cameras and Vinten robotic systems. Bottom left: KNTV control room circa 1961. Bottom right: Original KNTV facility in San Jose, CA, circa 1959.

With the flip of a switch on Jan. 1, 2002, San Jose-based KNTV went from a small independent station serving the Salinas-Monterey market to NBC11, the NBC network affiliate in the San Francisco Bay Area.

The station's facility, built in 1955 by the Sun-Lite Bakery, was far too small to handle the demands of a large-market television station. The building could not accommodate the larger

staff, and the technical infrastructure was strained by the production of five hours of news each week-day. KNTV required a more capable control room, studio facilities to support robotic cameras and a technical plant that would perform to today's digital standards. The

station needed the ability to handle the large number of live microwave, satellite and helicopter feeds that an area as large and geographically diverse as the Bay Area required. Because NBC owns both KNTV and Telemundo sister station KSTS (T48), the new broadcast center needed to accommodate the operations of both stations while providing employees with an enjoyable, efficient and secure work environment.

Digital from lens to living room

The stations' new broadcast center totals 81,000sq ft, about twice as large as the stations' previous spaces combined. Through the new equipment that was installed, the new facility preserves the pure digital quality of the studio and field images.

From the moment an image enters the camera lens, the picture is in a digital environment. The facility has



SYSTEMS DESIGN SHOWCASE

San Jose's NBC11 and Telemundo 48 go all-digital

three studios — a news studio for KSTS, a news studio for KNTV and a production studio for commercial production and local programming. Each studio is equipped with Sony BVP900 cameras and Vinten robotic systems.

In the field, news crews shoot on Sony Betacam SX. Local production and promotion uses Sony Digital Betacam field production. Live trucks are equipped with Beta SX field editing. The 13 ENG and two SNG trucks are in the process of being equipped with COFDM transmitters.

The new nearly tapeless facility uses a Thomson routing switcher with an

Encore control system (digital routing), media file server systems, and nonlinear video editing systems to produce news and local programs in a digital environment, resulting in the highest video and sound quality.



In the KNTV control room, the stations' iNews newsroom computer system drives a Deko MOS interface so CG and graphic insertion can be controlled straight from the desktop.

The stations use Thomson's Grass Valley News Edit systems for news editing. For promotion, commercial and local program production, the stations use Avid Symphonys, Adrenalines and ProTools, which are tied to



The new media server and patch panel provide the facility with 300 hours of news video with redundant backup.



Intelligent Master Control

World leader in scalable multi-channel playout



QMC scales from a single channel to over 60, with the flexibility to meet your needs using a unique selection of HD and SD channels, control panels and upstream routers

NEW QMC-2

- HD or SD operation from a common hardware platform
- Handles dual stream Dolby E for 16 channel audio
- Dual logo stores and up to three external keyers

See it at NAB 2005 Booth SU9652

Toll Free: 888 638 8745

sales@quartzus.com

www.quartzus.com



Distributing Satellite Content is Meant to be Easy



IVN™ YOUR WAY TO
VIDEO NETWORKING

And that's exactly how we make it. Scopus IVN™ (Intelligent Video Networking) solutions center on Scopus' best-selling, reliable, widely deployed IRDs.

Win with Scopus Satellite Solutions:

- Teleport operators and service providers reduce their bandwidth use by up to 30%
- Satellite carriers enjoy turnkey, end-to-end video delivery solutions
- Cable networks and broadcasters benefit from the most comprehensive distribution systems available
- Business TV operators enjoy flexible video and data solutions
- System integrators have one-stop source



Americas: www.scopusamericas.com • E-mail: info@scopusamericas.com
Worldwide: www.scopus.net • E-mail: info@scopus.net



CODICO® IRD-2900

- Up to 4 QPSK L-Band inputs
- ASI Transport Stream input and output, supporting up to 150 Mbps
- Over-the-air control
- Over-The-Air Software download
- IP data streaming
- MPEG-2 4:2:2 / 4:2:0 SD decoding
- Close Caption, AMOL and VBI processing
- SDI, AES/EBU and analog outputs
- Up to four pairs of audio outputs and digital AES/EBU supporting Musicam & Dolby Digital®
- DVB Common Interface (2 Slots)

See us at
NAB 2005
April 18-21, Booth#SU8470

See us at
Satellite 2005
March 22-25, Booth#464

an Avid Unity server. All Avid and Pro Tools systems are based on Windows NT or XP operating systems. Telestream's Flip Factory performs file conversions between the GV news servers and Unity server. When the production and promotion team finally archives to tape, they use Sony IMX decks.

In the control room, the stations' iNews newsroom computer system drives a Deko MOS interface so character generation and graphic insertion can be controlled straight from the desktop. Graphics are created on Pinnacle Deko-FX systems. Audio is mixed using Calrec Sigma consoles, and Sony 8000 switchers tie everything together.

Communications throughout the plant are handled by

a Telex Adam Intercom IFB system supplemented by HME wireless microphones, PL and IFB.

Virtual newsroom

Because the San Francisco Bay Area is so spread out, both stations have a news bureau and sales office in San Francisco and another news bureau in

Oakland. Fiber-optic networks connect NBC11 and T48's San Francisco news bureau with their San Jose newsroom. This, combined with the Avid iNews system and GVG NewsEdit media file server integration, allows reporters and editors separated by more than 50mi to work with video and audio as though side by side.

NBC11 and T48 are also employing VoIP systems between San Francisco, the new building in San Jose and NBC headquarters in New York. Even building management is high-tech, with systems controlling all lighting, heating, cooling and security systems.

NBC11's new tower

Because KNTV was built to serve the Monterrey/Salinas market to the south of San Jose, the station's transmitter



The facility has three studios, each of which is equipped with Sony BVP900 cameras and Vinten robotic systems.

MegaPixel Resolution



\$3995.00

1.2 TFT-MegaPixel™

Our new triple rackmount V-R653P-HDSDI has 1.2 TFT-Megapixel High Definition displays. Representing the leading edge of imaging technology, each screen will accept ALL Digital HD or SD formats, including 1080-24P, 1080-50/60i and 720-50/60P



MCS

MULTI-CHANNEL SERVER

VIDEO SERVER



HD & SD

Automated Playback
Broadcast Time Delay
VTR Replacement
Sports Slow-Mo

Doremi Labs' MCS Video Server provides up to four independent record and play video channels in a compact 3RU chassis. A second MCS Server can be added to create a six channel system with shared RAID5 storage.

System Compatibility

- HD-SDI, SDI, YUV/RGB, SVideo, Comp. in-out
- P2, VDCP, Odetics and GPI control
- Compatible with leading automation systems
- Automated playback via our ListMaker GUI

Reliable and Upgradeable Design

- One to Six video channel configurations
- Dedicated video hardware platform
- External RAID5 or internal storage
- Redundant power supply



High Definition Video Server

MCS-HD Multi-channel record & playback server

Multi-Channel Server systems start at \$10,000

Video Servers - HD MPEG2 Encoders, Decoders & Players - HDSDI to DVI Converters - Test Generator

Doremi Labs, Inc. | tel. 818 562-1101 | info@doremilabs.com | www.doremilabs.com



SYSTEMS
DESIGN
SHOWCASE

is located on a mountaintop at the extreme southern end of the San Jose area. Though most Bay Area viewers watch the station over cable or satellite (more than 90 percent of the market's homes subscribe to one service or the other), there are several thousand viewers in the northern and eastern portions of

the market who cannot receive KNTV's over-the-air signal. This problem will be remedied later in 2005, when NBC11 relocates its analog and digital transmitter to San Bruno Mountain, located just south of the San Francisco city limits. The San Bruno location will allow a dramatically better signal to reach about 400,000 additional viewers throughout the Bay Area while still delivering a strong signal to San Jose.

The location will house two Thales solid-state transmitters to deliver NBC11's digital and analog transmission signals. The analog transmitter/

antenna combination will operate at an estimated 316kW, while the digital transmitter, broadcasting on digital 12, will deliver 101.3kW. Microwave Radio Digital STLs will tie the new studio to the San Bruno site, further preserving the digital quality of the stations' signal paths.

KSTS will maintain its transmitter location on Mt. Allison in the hills to the east of the San Francisco Bay.

KNTV began as a small television station serving the largely rural communities of Monterrey, Salinas and San Jose, and it has grown to provide news to one of the country's biggest television markets.

BE

Richard Swank is the vice president of engineering for NBC11/KNTV.

Equipment List:

Avid:

- Unity shared-media environment
- iNews newsroom computer system
- Symphony finishing system
- Adrenaline editing system
- Pro Tools post-production system

Calrec Sigma audio consoles

Pinnacle Deko-FX systems

Sony:

- BVP900 cameras

- 8000 production switchers

Telex Adam Intercom IFB system

Thomson Grass Valley:

- MAN news system

- News Browse

- Profile playback

- NewsEdit editing

- Routing switcher with Encore control system

Vinten robotic system

Design Team:

NBC11/KNTV:

- Linda Sullivan, president and general mgr., KNTV

- Eddie Dominguez, vp and general mgr., KSTS

- Buddy Young, sr. project mgr., NBC Universal

- Paul Russell, dir. of tech., NBC Television Stations Division

Architects/general contractor:

- Gensler, architect/design firm

- Turner Construction, general contractor

System integrator:

- AF Associates

World's First!



Flexiscope...

See us at
NAB 2005
Booth
C7031

HD/SDI
SD/SDI

Patent:
GB 2329294
US 6,493,024B1

HD and SD waveform, vector and audio, measurement and monitoring using Patented all digital processing - ALL in the PALM of your hand!

IT'S ALL YOU EVER WANTED!

Covers ALL HD, SD, SDI standards, plus CAV, Composite, YC and DV with plug in options.

You can Exceed your Expectations

TEL: (949) 916-1070 TOLLFREE: 866-4-HAMLET E-Mail: sales@hamlet.us.com
Web site: www.hamlet.us.com

UK Tel: +44 (0) 1494 729 728 Freephone (UK): 0500 625 525 E-Mail: sales@hamlet.co.uk
Web site: www.hamlet.co.uk

HAMLET
EXCELLENCE IN VISION



total commitment



to broadcast

Different applications require different solutions. Most manufacturers' limited awareness of this fact just creates problems.

Calrec solves them.

Whatever your requirements, Calrec have a solution available right now.

Specialists in broadcast console design for over 30 years, Calrec provide all the broadcast features your programme needs, now and in the future.

Calrec's unique family of digital production consoles all share the same high levels of resilience, all have hot-swappable cards and panels and all operate independently of the on-board PC.

In short, all Calrec consoles share the same comprehensive broadcast specifications essential for live to air production. It's no wonder they have the finest reputation for quality and reliability.

Calrec, Total commitment, total solution.

Calrec Digital Broadcast Console Users:

- Clear Channel
- CNBC
- KJRH Ch 2 Tulsa
- KNSD-TV Ch 39 San Diego
- KXAS-TV Ch 41 Dallas
- KXTX-TV Ch 39 Dallas
- Maryland Public Television
- NBC Olympics
- NBC Television Network
- NEP Supershooters, Inc.
- Trio Video
- Univision Network
- WTVJ Ch 6 Florida
- WVTM-TV Ch.13 Birmingham
- WXYZ Ch. 7 Detroit

- Powerful, flexible feature set to meet all programme needs
- Embedded control system allowing for power-up and operation without the PC

- Automatic redundant DSP, control processor and PSU systems
- High input headroom, excellent audio performance

- Hot-swap cards and modules throughout - ALL cards and panels are removable and insertable under power
- Full system reboot in less than 20 seconds

CALREC AUDIO LTD, NUTCLOUGH MILL, HEBDEN BRIDGE, WEST YORKSHIRE, HX7 8EZ, UK TEL: 01144 1422 842159 EMAIL: enquiries@calrec.com WEB: www.calrec.com

South and Mid West States - TEL: (615) 871 0094 EMAIL: ericj@redwoodweb.com

North East States and Canada - TEL: (212) 586 7376 EMAIL: dsimon@studioconsultants.com

Western States - TEL: (818) 841 3000 EMAIL: jschaller@audiospec.com

SYSTEMS
DESIGN
SHOWCASE

WIBC'S





transition to digital

By Ian MacSpadden

Despite the busy news year in 2004, Reuter's technical team in Washington, DC, was able to squeeze in a facility upgrade that entailed completely transforming the facility and newsroom to a digital system.

The Reuters Television bureau in Washington, DC, is the coverage hub for all video news acquisition from the Americas. As part of the world's international multimedia news agency with 197 bureaus in 130 countries, coverage of both North and South American news requires tremendous resource coordination and management. The stories created by the Americas staff are broadcast to clients worldwide via the World News Service and World News Express satellite delivery systems.

In the summer of 2003, as part of the facility's global technology upgrade, the bureau was asked to create a technical and logistical plan to migrate the existing analog facility to a new server-based digital newsgathering operation. The existing facility that had been built in 1993 consisted of a 24/7 MCR supporting a 10-dish/30+ fiber teleport, a 16-machine tape intake room and 11 edit bays. Feeds were brought in from locations ranging from Los Angeles to Argentina via satellite and fiber, recorded to tape, and produced and edited in cuts or Avid edit bays before being injected into the WNS regional and global feeds. The system had worked well for years, but it was labor-intensive and costly to manage.

The goal was to create a more streamlined and efficient facility that would take advantage of new digital technologies. As part of a global plan,

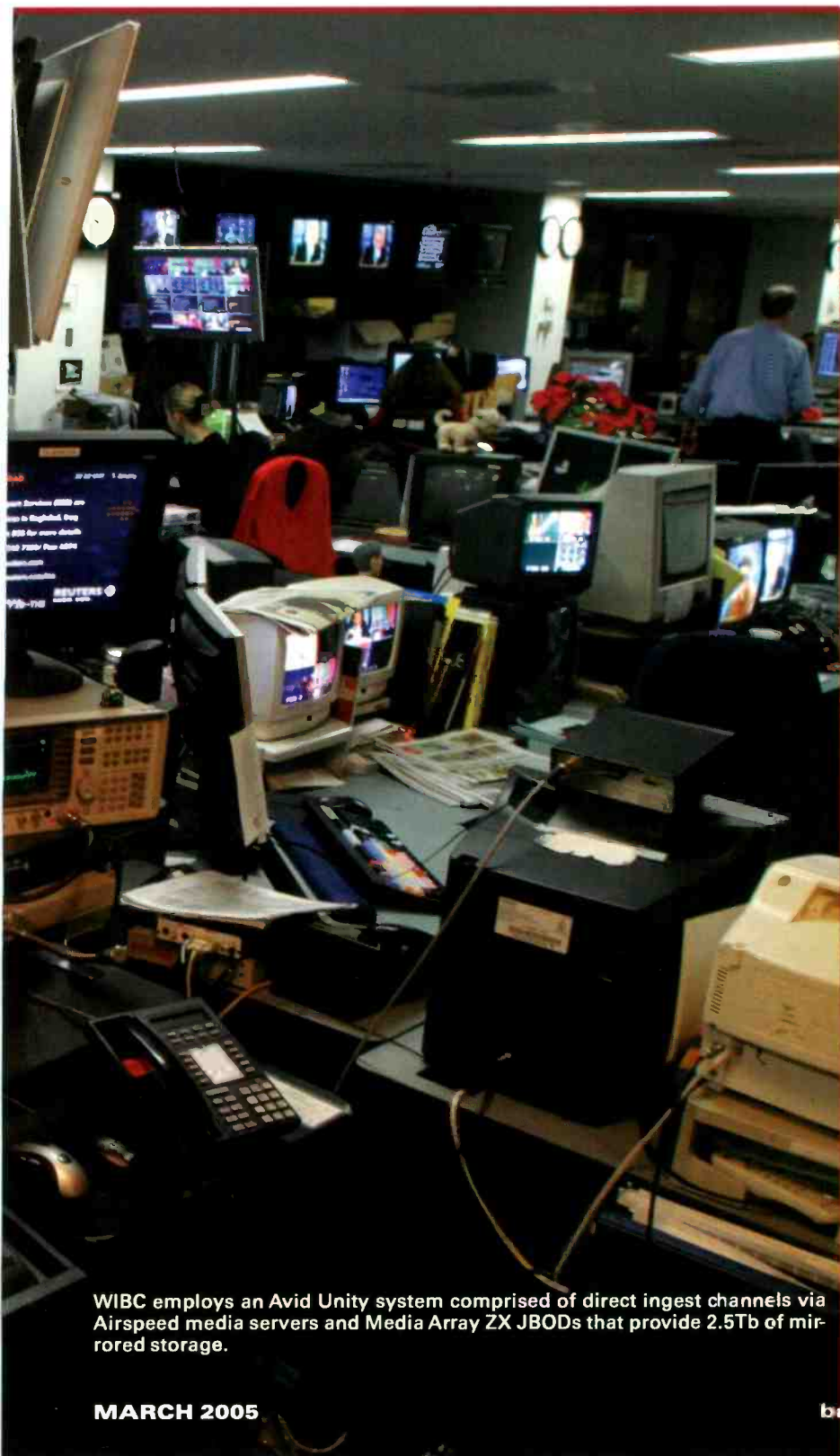

WIBC employs an Avid Unity system comprised of direct ingest channels via Airtspeed media servers and Media Array ZX JBODs that provide 2.5Tb of mirrored storage.

SYSTEMS DESIGN SHOWCASE

WIBC's transition to digital

the facility also was going to take its streaming media product creation in-house and begin to deliver its product via an IP-based system. The Washington technical team was tasked with finding the right products, figuring out how to integrate them into a 24/7 facility and provide a transition plan in just four months.

A wide array of products had to be considered for the project, most importantly the desktop editing and asset management system. Because of the size of the operation and the desire for scalability, the facility began looking at vendors who supplied integrated



Video levels are checked via a Videotek VTM-150 on multiple LCD monitors. Audio monitoring is provided by Wohler AMP2-AM/AMP2A-4S audio meters and a PTV PT0600C-11 stereo correlation meter.

were tailored to the bureau's unique needs as an "agency" news organization. Much of what Reuters supplies news clients with is video from many

past, the tape intake room required 16 beta machines to cross roll on daily incoming feeds. The eight shared-storage system ingest channels provide more people access to more material. The tape-based method frequently required multiple rolls on the same footage for different departments within the newsroom. Often, a single feed might have elements that were simultaneously needed. The new system allows anyone at one of the NewsCutter workstations to pull down video

just seconds after the feed begins and create his or her own edits.

Because the system allows new functionalities, such as direct control of scheduling what sources are recorded via control of the BTS router, the decision was made to move the MCR staff into the newsroom to better facilitate coordination. In years past, the news desk called the MCR on the house RTS system to give satellite coordinates and ask for a router source. Then it called the tape intake room via the RTS to begin rolling. Now with the MCR operations desk beside the news desk, the editors simply

Anyone at one of the NewsCutter workstations can pull down video just seconds after the feed begins and create his or her own edits.

ask on what source their feed would appear. Through the Avid Capture Manager interface, they create their own capture with any metadata that needs to be associated with it. The great benefit to having the MCR in the newsroom is that throughout the feed, the news desk and MCR operator can keep each other informed about any issues that arise.

Moving technical control of the MCR into the newsroom took a lot of thought and planning. Many of the manual functions that the MCR operators were used to performing had to be remoted. Great attention was paid to providing the operators with

countries, for many countries. Stories are not generally voiced, and edits are long to provide the end client with usable footage for integration into its



The bureau uses an Avid Adrenaline for finishing work, Mojo DNA systems for desktop tape ingest and NewsCutter workstations.

newscasts. Because of this, much of the acquisition footage is sent in from contributing bureaus, edited down for content and sent on to clients. In the

editors simply ask on what source their feed would appear. Through the Avid Capture Manager interface, they create their own capture with any metadata that needs to be associated with it. The great benefit to having the MCR in the newsroom is that throughout the feed, the news desk and MCR operator can keep each other informed about any issues that arise.

Moving technical control of the MCR into the newsroom took a lot of thought and planning. Many of the manual functions that the MCR operators were used to performing had to be remoted. Great attention was paid to providing the operators with

(Continued on page 62)

EXTREME Definition

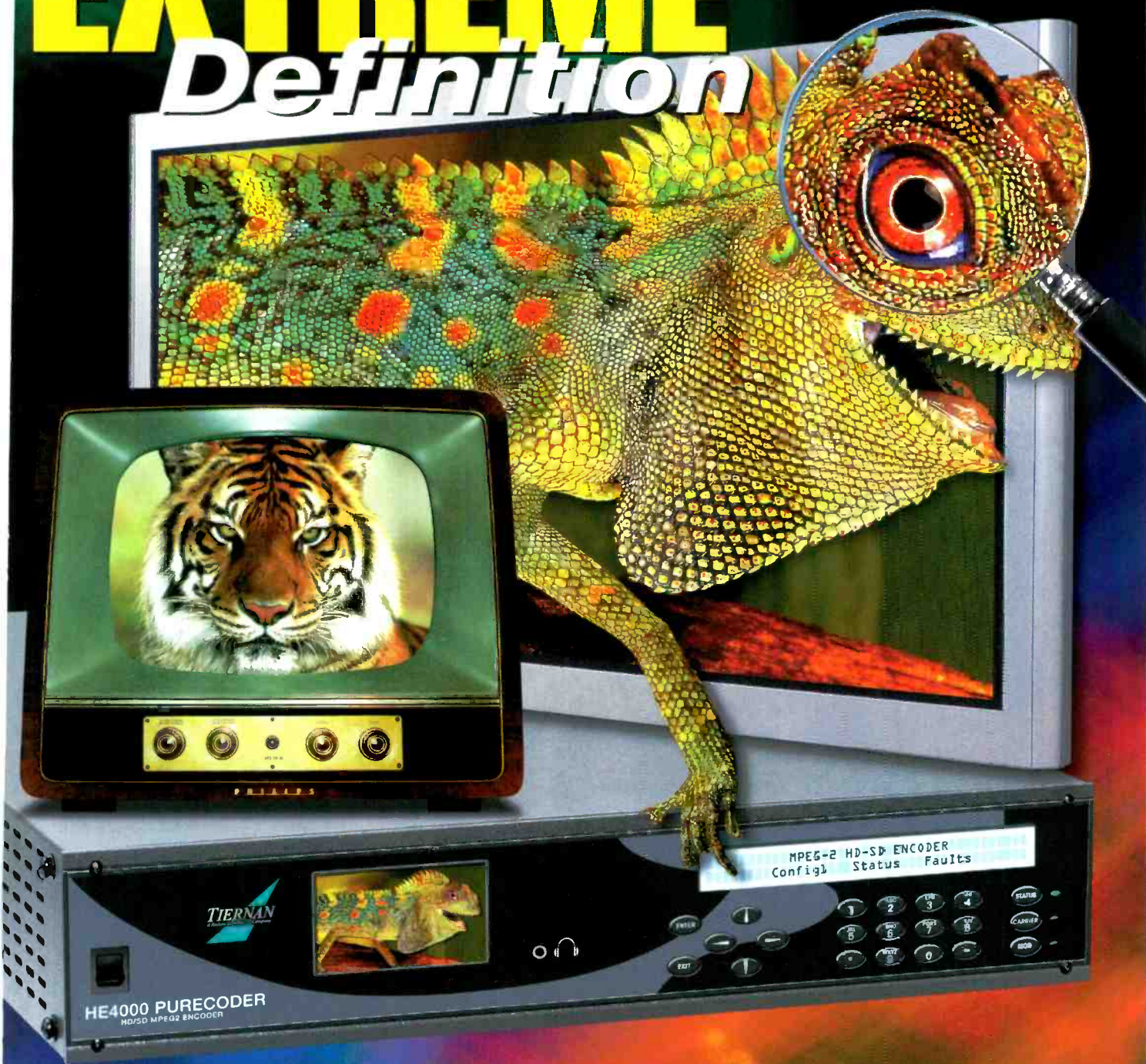

HE4000: HD AND SD Encoder

- HD and SD Encoding Simultaneously
- Front Panel Monitor
- Advanced "PUREPEG" Technology
 - Enhanced Low Bit Rate Performance
 - Absolute Finest Picture Quality
- Satellite and Terrestrial Interfaces
- 1 MB/s to 160 MB/s

TIERNAN
A Radnyc ComStream Company

Phoen x: 602-437-9620
San Diego: 858-458-1800
UK: 44-1420-542333
America: 858-458-1800
Singapore: 65-6225-4016
Beijing: 86-10-65831975
www.radn.com
www.tiernan.com



XL2



Whether you're a videographer, documentarian, or filmmaker, you'll find the XL2 possesses all the range required to help you realize your creative vision. Its all-star cast of features gives you complete image control and lets you put to

©2005 Canon U.S.A., Inc. Canon and Canon Know How are registered trademarks and "digital revolutionized video, we revolutionized digital" is a trademark of Canon Inc. and may also be registered trademarks in other countries. Mac and the Mac

The Cast (In Order of Appearance)

Aspect Ratios: Native 16:9 and 4:3	As Itself
Frame Rates: 60i, 30p, and 24p	As Itself
3 Progressive Scan CCDs	As Itself
Customizable Cine Settings	As Itself
Canon Interchangeable Lens System	As Itself
20x Professional Fluorite Lens	As Itself
Optical Image Stabilizer	As Itself
SMPTE Time Code	As Itself
Built-In XLR Audio Inputs	As Itself
Four Channel Independent Audio Control	As Itself
SMPTE Color Bars With Tone	As Itself
Program Auto Exposure Modes	As Itself
Zebra Pattern	As Itself
Skin Detail Adjustment	As Itself
3 Custom Presets	As Itself
Multifunction Color LCD Viewfinder	As Itself
BNC Video Terminal	As Itself
Rugged Magnesium Alloy Frame	As Itself

screen exactly what you see in your mind's eye. In fact, with so much creative power in your hands, you'll find the XL2 allows you to be the visionary you always thought you could be. To find out more, please log onto www.canondv.com. **digital REVOLUTIONIZED video ■ we REVOLUTIONIZED digital™**

logo are trademarks of Apple Computer, Inc., registered in the U.S. and other countries. Microsoft, Windows, and the Windows logo are trademarks or registered trademarks of Microsoft Corporation in the U.S. and/or other countries. The Designed for Windows XP logo refers to the digital camcorder and its driver only.

Canon
KNOW HOW®

(Continued
from page 58)

the ability to thoroughly monitor, adjust and route all the signals that went through the facility. A new IP-based Crystal Control system was installed to replace the original serial control of all the satellite dishes, receivers and support equipment. Additional flexibility needed to be added in RF routing, so a Quintech SRM2150 series 32x16 L-band router was added to provide flexible routing of downlinks to multiple receivers. In the past, receivers were hardwired or patched to an incoming signal. In order to maintain quality control of the incoming ingest signals, DPS575-AV units were installed in line before the Xdecks to provide audio and video adjustments through both remote panel and Web Interface. A Marshal V-R25P LCD monitor bank was installed post-DPS to monitor outputs. Because 24 computers now comprised the shared-storage system and other contribution systems, a BlackBox cat5 based ServSwitch Summit KVM system was installed, giving four terminals access to all 24 devices.

With limited space for video monitoring, Zenith LCD plasma displays were mounted throughout the newsroom, fed by a 16 port Leitch SuiteView system, which also provides source labeling and audio level monitoring on the screen. Video levels are checked via a Videotek VTM-150 on multiple LCD monitors. Audio monitoring is provided by Wohler AMP2-AM/AMP2A-4S audio meters and a PTV PT0600C-11 stereo correlation meter.

One of the most difficult logistics of the project was migration and installation of equipment without interrupting workflow. The new equipment and systems needed to be in-



The MCR operators were moved into the newsroom, providing better communication between the news desk and the MCR operator.

stalled in spaces currently being used without interrupting existing capacity or functionality.

The first task was to come up with a design that would allow for a seamless integration. The final plan was to locate the new MCR operations station just outside of the videotape intake room and next to the assignment desk. This would give the proximity to news and the equipment that was needed for the workflow goal. The video intake room, which housed 16 VTRs in eight racks, was chosen as the site for the Avid Unity system. The plan was to reuse the room's router destinations and sources for the Unity system, eventually replacing the decks with shared-storage system ingest channels tied to tape backup machines. The remaining router destina-

into just four racks and a side table, leaving four racks in which to begin the build-out. Team Video, a local systems integrator, was hired to help with the rewiring and build-out. This allowed Reuter's engineering staff to participate but still have time to fully support the bureau's news operation.

Eventually the new system was set up, tested and running side-by-side with the old one. Training was provided to the newsroom staff prior to the switchover on a fully operational Unity system. A training room was set up with NewsCutters for the journalists and photographers to learn non-linear editing, and the MCR staff was trained on the fully active newsroom operations center.

During this period, the old desktop workstations were replaced by the new Avid-approved NewsCutter workstations (HP 4100/HP 8000). On the day of the transition from tape to digital, a crew from Avid provided support to the newsroom as the video intake room's router destinations were switched from tape machines to the shared-storage system. From that moment forward, all material was brought directly into the shared-storage system and played out via the Airspace. As a testament to a smooth transition and proper training, the news department decided by the third day that the tape

WIBC's transition to digital

Design Team:

Avid:

Adrian Davies, project mgr
Ed Weingartner, dir. manufacturing operations
Charlie Raynsford, customer account mgr

Crystal Computer:

Roger Franklin, R&D mgr
Tim Johnson, project technician

Reuters Engineering:

Ian MacSpadden, mgr, TV news infrastructure
Roger Shull, chief eng.
Keith Allen, maintenance eng.

Team (broadcast integrator):

Larry Tyler, vp eng.

0101
010100001010011

backup of all incoming Unity feeds was no longer required. The decks are still there as a backup if Unity fails, but have only been needed during outages required to accommodate new equipment upgrades (software and the Airspeed replacement of the high maintenance Xdecks).

Since the system was commissioned, Reuters has attached an Anystream Agility system, which creates a streaming version of Reuters' products in Real and Windows media that are delivered to clients by FTP. A global Telestream network has been interfaced that now provides cost-effective feeds via the Internet from Latin America, the USA and Asia.

Reuters' own LNG digital news gathering kits throughout North and South America now contribute daily to an integrated LiveWire MediaLink FTP contribution system. With the increase and cost-effective nature of digital contribution from the field, having a solid digital core system has allowed Reuters to take advantage of new systems with minimal costs and effort. And, as the features and options continue to increase on these systems, even more opportunities for complete digital integration will be available.

BE

Ian MacSpadden manages television news operations for Reuters television in the Americas.

Equipment List:

Avid:

- Unity shared-storage system
- Router server
- Countdown server
- Port servers
- Airspeed and Airspace media servers
- Adrenaline NLE system
- Mojo DNA systems
- Newscutter XP workstations
- Blackbox Servswitch Summit KVM system
- Chromatech, Videotek, and HP audio, video and frequency quality control monitoring devices
- Crystal Computer Crystalvision monitor and control system

Leitch:

- DPS 575-av
- CCS DPS 575 Gateway
- DPS RC 575
- Suiteview monitoring system
- Pilot software
- Digibus Digital Glue
- Panasonic DVC PRO machines
- Quintech SRM 2150 32 by 16 RF routing matrix with two remote panels
- Ross Terminal gear DAS
- Zenith and Marshal LCD video monitors

12x5.3 Wide Super Zoom



True Life Cinema
Soho, New York City

“As an independent production company, you need equipment that delivers maximum

flexibility both during shoots and in post. I knew that Thales Angenieux made great film lenses, but was not aware of the

video lens line. Once I saw the images produced by the Thales Angenieux lenses, I knew I had to have them.”

said Ron Buffone, President and Principal Owner of True Life Cinema.



12 x 5.3AIF,HR Wide Super Zoom
10 x 5.3AIF,HD Wide Super Zoom

“I tried lenses from other lens manufacturers with focal ranges comparable to Thales Angenieux's 12 x 5.3 Wide Super Zoom lens, but nothing came close.”

said Mr. Buffone.

angenieux THALES

Keeping it running — and holding down costs

BY DON MARKLEY

Any long-time reader of this column will remember the author's continuous rants regarding maintenance. The argument has been made repeatedly that the least expensive action to increase both equipment life and performance is to perform regular and careful preventative maintenance. It doesn't take long, if done regularly, and the results are beyond argument.

The pity is that many of the large decisions at broadcast stations aren't being made by broadcasters anymore. Instead, some idiot with a fresh MBA looks at the books with the idea of improving the bottom line. Not understanding squat about the technical side of the business, the decision is made to get rid of those expensive technicians. The thinking is that mod-

ern equipment doesn't take all that work to keep it running — after all, his PDA doesn't require maintenance. That is the kind of thinking that leaves far too much work for the reduced technical workforce for them to be able to really care for their equipment.

The continued erosion of the technical workforce is also coupled with the really stupid idea of simply leaving everything alone until it breaks and then fixing it by doing the minimum necessary to get back on the air. That kind of thinking is similar to those who test for 240 v.a.c. by touching the wire.

On the positive side, there is some merit to the argument that modern equipment is highly reliable — not necessarily a lot more than well-maintained older systems, but somewhat

better. The biggest difference is in the exotic control systems now built into new transmitters. That refers to those systems that sample the output of the transmitter and use measurements to adjust the precorrection circuitry. That action corrects for a family of ills and can keep the on-air signal looking beautiful in the presence of otherwise severe problems. Still, there are some things that the station staff can do to help the situation and improve the useful life of the equipment.

Keep it clean

First, and simplest, keep the equipment clean. That exotic solid-state transmitter is loaded with expensive devices that are not in love with heat. Allowing a heavy dust build-up reduces the ability of the cooling system to carry away the heat normally generated inside the equipment. Therefore, everything runs hotter than the design value, reducing the MTBF, increasing the down-time for the equipment, adversely affecting the overall performance and generally causing the management to get upset.

It is a simple thing to periodically, at least once a month, shut the transmitter down for a couple of hours. Clean and/or replace the air filters, vacuum and/or wash the equipment (don't blow it out; that only moves the dirt around), and do a simple visual check for any problems.

Check the voltages

Next, go through all the power supplies and check that the voltages are correct. Most of these can be checked from front-panel metering, but there may be some low-voltage sources that



FRAME GRAB A look at the consumer side of DTV

More males will buy a DVR in the next year

Females are five percent less likely to buy a DVR

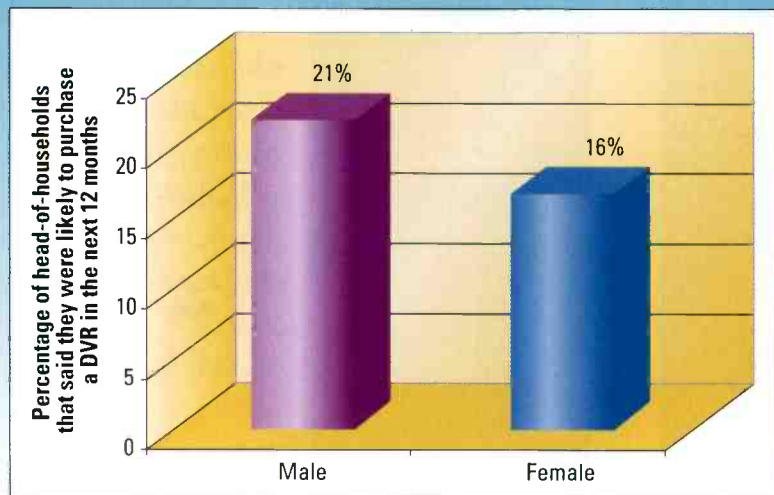

SOURCE: Parks Associates

www.parksassociates.com

our team +
worldwide experience =

PROVENTECHNOLOGY

DIGITAL TX UP TO 10kW DTV

Suitable for analog transmission (20 kW p.s.)

Configurable for Dual Cast transmission
(digital or analog by automatic switch)

LDMOS Technology

Broadband standardized design

Fully redundant, hot swappable PAs
(fault proof operation)

Remotely controllable



DMT USA

1224 Forest Parkway Unit 140,
West Deptford, NJ 08066
856.423.0010 tel - 856.423.7002 fax
sales@dmtonline.us - www.dmtonline.us

NAB2005
THE WORLD'S LARGEST ELECTRONIC MEDIA SHOW
BOOTH #C3016

require metering. Remember that the first criteria of system design is to determine the power supply voltages to be used. All the circuit design work follows from that point. If the power supply voltages vary significantly, the whole system performance will suffer.

Examine the precorrection circuitry

Remember that all the precorrection circuitry is intended to predistort the signal to compensate for the errors inherent in a properly functioning system — that is, not a system that has major problems in its own right. As an example, an improperly tuned amplifier may stretch the ability of the



When WTTA-TV in Tampa, FL, installed an Ai two-tube ESCIOT depressed collector analog/digital transmitter last June, it saved \$13,000 per month in operating costs.

correction circuits beyond their ability to adequately clean up the signal.

Turn off the corrections, and look at the system in its raw state. While the performance will certainly not be as sharp as would be desired, it should be reasonable. If not, look into where the big errors are being introduced. It may be possible to make some minor tuning adjustments to bring the system closer to proper performance. Doing so will allow the precorrection circuitry to perform as designed without having to cover up other improper operation.

Remember the transmission line system

Any discussion of maintenance at the

transmitter would be incomplete without remembering the transmission line system. Two items should be checked. The first is the VSWR indication on the transmitter or transmission line monitor. In a correctly operating system, absent icing, the VSWR meter should be so stable that it looks like the needle is painted on. If it changes, a problem is either developing or has developed. There is only one way to respond to a VSWR change. That is to get someone in who can properly sweep the antenna system. If you're lucky, it will be possible to identify the cause of the problem and get it fixed before you end up sitting quietly looking at a cold transmitter and holding some burnt pieces that fell off the tower.

The other item worth checking is the pressure on the line, whether it is waveguide or coaxial cable. Yes, you must keep it pressurized; it does not matter how tight you think the line may be. Water will get into a transmission line unless there is a pressure difference between the inside and the atmosphere. If a dehumidifier is being used, check the desiccant, if used, to confirm that the

air being placed into the line is actually dry. In the alternative, check that nitrogen still is available from the bottle in the system. Occasionally, actually check at the line to ensure that there is pressure in the transmission line as opposed to just in the little plastic tubes.

Save money

Now, for the cost part. A couple of years ago, EEV, now e2v, announced a new type of klystron. The company attached a water-cooled MSDC collector to its conventional plug-in klystron. The result was a device it called the ESCIOT, which demonstrated greatly improved efficiency.

The data shows that the efficiency

for a 30kw device is improved from 40 percent for a conventional klystron to 59 percent for the five-stage ESCIOT. No significant change is anticipated in expected device life, and the cost is not a major factor. The ESCIOT is available in either a three-stage or five-stage version. The three-stage version, which doesn't have as big an efficiency improvement at the five-stage, can be retrofitted into many existing transmitters.

Then, along comes Nat Ostroff, who has already proved his outstanding ability to take a fringe company and develop it into a real competitor. He is now president and chairman of the board of Ai, previously Acrodyne. He led that company through the development of a transmitter to use the ESCIOT that has been both popular and successful.

Ai recently issued a pair of press releases showing the costs involved in operating an ESCIOT-equipped transmitter in analog or digital service. Once you strip away the advertising hype, the fact is clear that operating costs are greatly reduced over conventional klystrons. One system is at WTTA-TV in Tampa, FL. The old system used a three-tube pulsed klystron transmitter. The new ESCIOT system uses two tubes for the same power output. The difference in the power bill is \$13,000 per month.

The second transmitter was at WNUV-TV in Baltimore. The ESCIOT system replaced a 240kw pulsed five-klystron transmitter. For a period of one year, the cost of operation was reduced by more than \$28,000 per month. Now that isn't peanuts, nor does it necessarily tell the total story. For example, the question would obviously be how much the efficiency is improved over other MSDC klystron systems. For more information, visit www.e2vtechnologies.com. **BE**

Don Markley is president of D.L. Markley and Associates, Peoria, IL.



Send questions and comments to:
don_markley@primediabusiness.com

KAHUNA - THE PRODUCTION SWITCHER THAT DEFIES DEFINITION



Standard definition? High definition? With Kahuna you don't have to worry. It can handle either of them - separately or at the same time. It can even incorporate SD sources into HD productions without upconversion.

Kahuna is the most versatile switcher on the market. And the most economical. Kahuna lets you take control of your transition to HD without having to re-equip with all-HD sources - and without having to put an upconverter on every SD input.

Even if you have no plans to go HD just yet, you can install Kahuna in SD only. Then when you are good and ready, upgrade to full multi-format SD/HD operation, with no operational disruption.



KAHUNA™





KAHUNA - DESIGNED JUST THE WAY YOU WANT IT

4 M/E Control Panel

Each of the four comprehensive M/E banks has:

- Four keyers able to perform luma, linear, and chroma keying
- Five transition wipe generators
- Still store and clipstore
- RGB color correction
- Four utility buses
- Timeline, DMEM and Macro capability

Each keyer in the system is equipped with:

- Its own FormatFusion engine to integrate SD and HD sources
- DVE send-and-return architecture that enable images to be manipulated



Every source has its own user-configurable mnemonic identification

SNELL & WILCOX
www.snellwilcox.com

Worldwide
Sales & Service
Locations

SNELL & WILCOX™
Engineering with Vision

AT LAST. COMPLETE FORMAT FREEDOM



Kahuna is the first production switcher system in the world to offer simultaneous standard definition and high definition operation in the same mainframe with the same control panel.

Even more remarkably, thanks to a new technology called FormatFusion, it enables you to integrate any SD material, such as camera feeds, graphics or archives into live HD productions, seamlessly, without the need for upconversion.

Kahuna is a truly multi-format system that puts you in control of your transition to HD. It gives you the flexibility to use existing SD equipment, without the cost of completely re-equipping with HD.

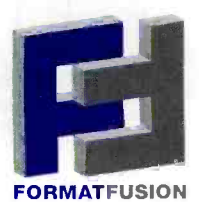

KAHUNA - THE WORLD'S FIRST TRUE MULTI-FORMAT SD/HD PRODUCTION SWITCHER

Example of HD Output from a Single M/E Using Mixed SD/HD Inputs

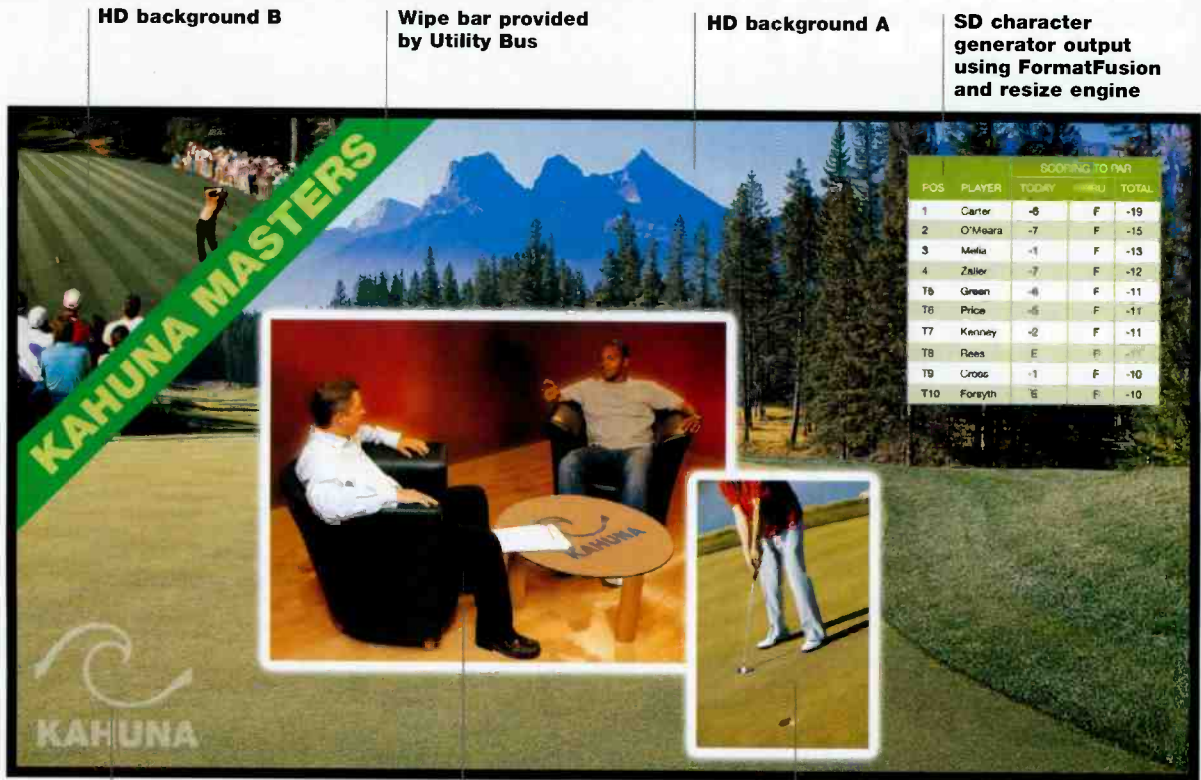

HD background B

Wipe bar provided
by Utility Bus

HD background A

SD character
generator output
using FormatFusion
and resize engine

Animation via one of
the internal clip stores

HD camera studio shot
'squeezed back' using
picture resize engine

SD hand held camera
shot using FormatFusion
and resize engine

Benefits

- Legacy-compatible and future-proof
- Feature set and formats field-upgradable through software
- Puts you in control of your transition to HD
- Competitively priced throughout the range
- Integrates SD sources into HD productions
- No need to replace all SD equipment
- No need for expensive upconversion
- Can cut SD and HD simultaneously
- Resource-sharing maximizes M/E use
- Familiar, intuitive control panels
- Robust system design ensures reliability
- Compact size, less weight, lower power consumption

Features

- 1, 2, 3 and 4 M/E versions
- All functions, options and PSUs contained in a compact 11 RU chassis

- Accepts all SD and HD standards
- Up to 80 field-upgradeable inputs
- Up to 40 assignable outputs
- 4 keyers per M/E with flexible layering
- Each keyer able to perform luma and linear keying
- Each keyer with high quality chroma keying
- Each M/E with 4 FormatFusion and resize engines
- Independent keyer transition engine
- Every M/E has 4 stores for stills and clips
- Clipstores with 12 seconds of uncompressed HD
- Five transition wipe generators per M/E
- Input and color effects RGB color correction
- 4 utility buses per M/E for video in border and multi-program outputs
- DMEM and GMEM snapshot save and recall memories

- RGB & YUV color correction for all SD & HD outputs with full broadcast specification legalizers on each output (including auxiliary)
- Programmable clean feeds per M/E
- Integration with external equipment such as VTRs, DDRs, audio desks, external routers and edit controllers
- Powerful machine control
- Full source name displays
- Highly intuitive color touch-screen GUI
- Very powerful macro facility
- DMEM and GMEM snapshot save and recall memories
- Off-line PC applications supporting still/clip transfer to switcher system
- Multi-panel and multi-frame capability

Options

- Four twin channels / 8 channels of 3D DVE effects with warps, lighting and trail store



www.snellwilcox.com



HDTV lens design: Management of MTF

By Larry Thorpe and Gordon Tubbs

In the previous paper, "HDTV Lenses, MTF and Picture Sharpness," *Broadcast Engineering*, January 2005, we related traditional discussions of lens/camera resolution to the more pertinent issue of the picture sharpness perceived when viewing a display from some distance (as is typical in both television and cinema viewing). We briefly reviewed the all-important concept of Modulation Transfer Function (MTF), its influences on picture sharpness and the optical design challenge of obtaining as even a distribution of MTF as possible across an image plane. As a reminder, MTF is a curve that describes the behavior of the contrast of increasing spatial frequencies across the total frequency band of the HDTV system.

The intent of this month's paper is twofold:

- To discuss the technological challenges entailed in achieving the requisite MTF characteristic required by an HDTV lens in comparison with its SDTV counterpart.

The digital HDTV video signal has the potential to sustain up to six times more spatial detail than the best 4:2:2 digital 4:3 SDTV video signal.

- To emphasize that lens design strategies can be quite different among manufacturers and that careful evaluation of lens-resolution characteristics

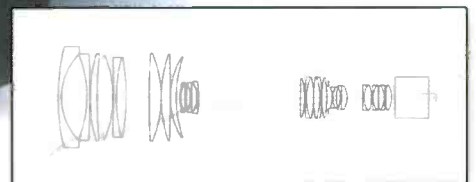

may be far more important than evaluating camera resolution.

The HDTV challenge to lens/camera design

There are four significant challenges in extending lens-resolution performance from SDTV to HDTV:

- 1) Elevating the in-band MTF and then extending this to the higher spatial frequencies required for HDTV.
- 2) Maintaining that high MTF over the focal range of the HDTV lens.
- 3) Controlling the MTF as the object distance from the lens is changed.

- 4) Managing the lens MTF as the aperture is altered for different scene lighting levels.

The digital HDTV video signal has

Pairing an HDTV lens to an SDTV camera will enhance the performance of that imaging system.

the potential to sustain up to six times more spatial detail than the best 4:2:2 digital 4:3 SDTV video signal (as defined within contemporary HDTV production standards). To fully exploit that tremendous increase in picture information, the lens must be capable of imaging and delivering sufficient spatial detail to the HDTV camera in order to satisfy its formidable digital information capacity.

In the SDTV domain, if a lens/camera system combines a lens having the ability to resolve 30 line-pairs per millimeter (LP/mm) and the 480-line camera (having a 4:3 aspect ratio and operating at 30 interlaced frames/sec) has a bandwidth of 5.0MHz, then that imaging system can resolve a maximum of 400 television lines per picture height (TVL/ph). A modern

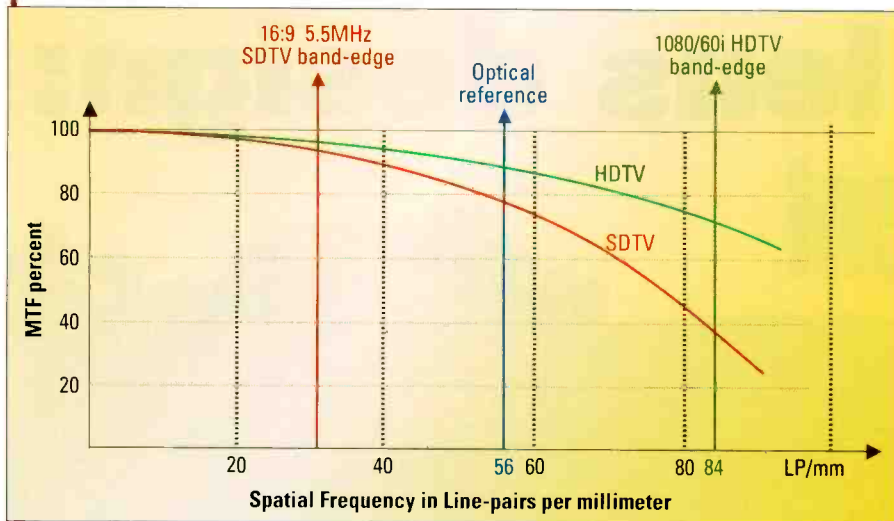

Figure 1. MTF curves for contemporary HDTV and SDTV studio lenses. This diagram highlights the challenge to lens designers to significantly raise the MTF of HDTV lenses.

high-end SDTV studio lens would be expected to exhibit a 90 percent MTF at 30LP/mm. This would typically fall to about 70 percent at 56TVL/ph (the higher HDTV optical reference frequency) and continue to fall off more quickly at higher spatial frequencies.

tem that devours bandwidth. If such a lens/camera system has a lens that can resolve 84LP/mm and the HD camera has a bandwidth of 30MHz, then the maximum horizontal resolving power of that imaging system is 875TVL/ph.

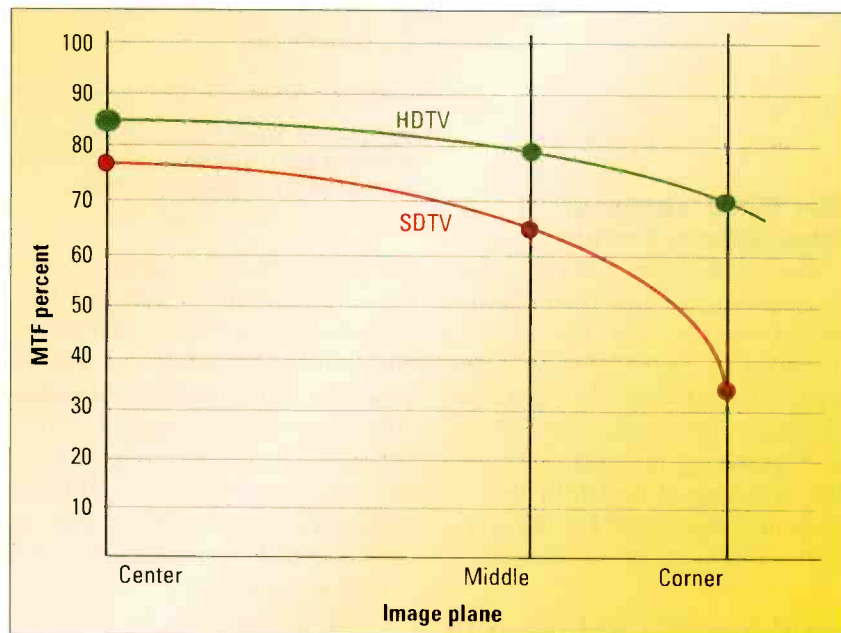

Figure 2. Comparative MTF behavior of an HDTV and SDTV lens across the image plane

In the HDTV domain, the 1080-line HDTV system is far more demanding. It is sampling 1080 lines at 30 frames/sec and has 1920 horizontal samples per television line, and is — as a consequence — a far faster sampling sys-

In the following examination, we will compare the MTF behavior of a typical SDTV studio lens in the higher HDTV spatial frequencies with that of a contemporary HDTV studio lens. It is recognized that the former was not

designed to meet the aspirations of HDTV imaging, but this comparison does serve to effectively dramatize the challenge to the optical designers aspiring to reach the best in HDTV lens performance.

The first comparison is of a typical high-end HDTV studio lens MTF with that of a current high-end SDTV studio lens. (See Figure 1).

Managing MTF across the image plane

As discussed in the previous paper, maintaining a high MTF from picture center to the image plane extremities is one of the primary challenges in HDTV lens design. New optical materials, new element design techniques, and strategic element groupings all have combined to facilitate significant lens MTF improvements.

Figure 2 shows the relative performance of a high-performance SDTV studio lens and a typical HDTV studio lens (measured at the HDTV optical reference spatial frequency of 56LP/mm, which is about 580TVL/ph for the 1080/60i system). Note: The picture center, middle and corner dimensional positions are referenced in Figure 5 in our previous paper.

The dynamic behavior of HDTV lens MTF

Lens resolution is always changing in response to any and all optical controls that are exercised in the course of a normal production. Lens MTF will alter when:

- 1) The lens focal length is changed (when exercising the zoom control).
- 2) The distance of an object from the lens is varied (and the lens is re-focused on that object) for a specific angle of view (fixed setting of the zoom control).
- 3) The lens aperture is altered (when exercising the lens iris control to restore video level with scene lighting changes or to alter depth of field in a given scene).

Each of these will be briefly examined in turn.

NEXIO™ Servers, More HD Dimensions



HD SERVER

MTS SERVER

MPEG BRANDING



Winning Strategies
Master Your Move to HD with
Integrated Multi-dimensional
HD Servers and Shared Storage

High-Definition NEXIO™ Server Systems

Make the move onto integrated high-performance platforms running our flexible software architectures.

HD NEXIO™ — server integrates the first software-based agile codec for high-definition video, allowing baseband high-definition record and playback, while supporting up and down conversion of content for simulcast applications from the same shared storage file system.

Digital Turnaround Processor™ (DTP) — uses patented software for real-time compressed video processing, enabling broadcasters to overlay motion graphics and logos on pre-compressed high-definition and standard-definition streams.

MPEG-2 Transport Stream (MTS) — server provides ASI input/output interfaces with the ability to de-multiplex a multi-program transport stream (MPTS). Stores individual programs and re-multiplexes any new MPTS created by seamlessly splicing individual HD and SD clips, thereby bridging the gap in workflow between SD and HD broadcasting.

Master Your Move to HD with NEXIO Server Systems

Canada +1 (800) 387 0233
USA East +1 (800) 231 9673
USA West +1 (888) 843 7004
Latin America +1 (305) 512 0045



www.leitch.com

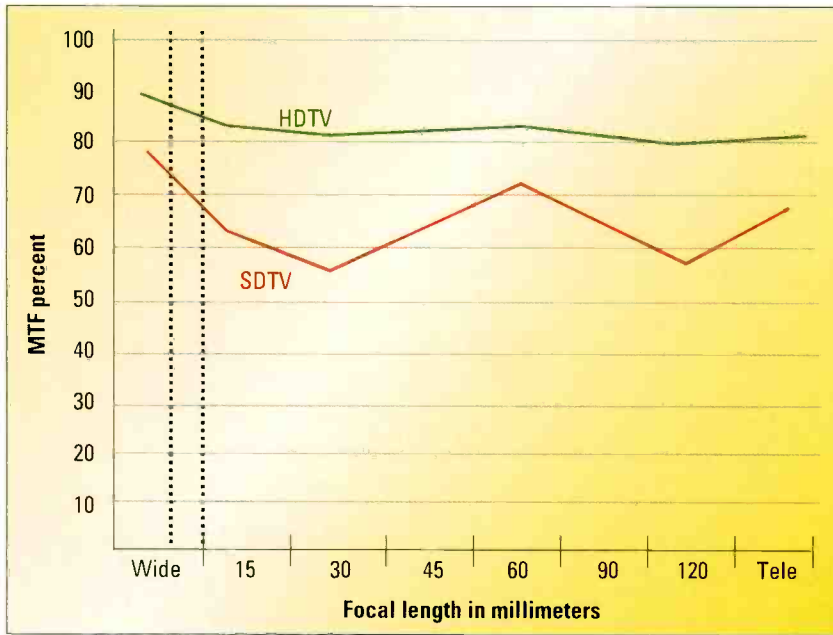

Figure 3: MTF variations over focal length range of SDTV and HDTV studio lenses

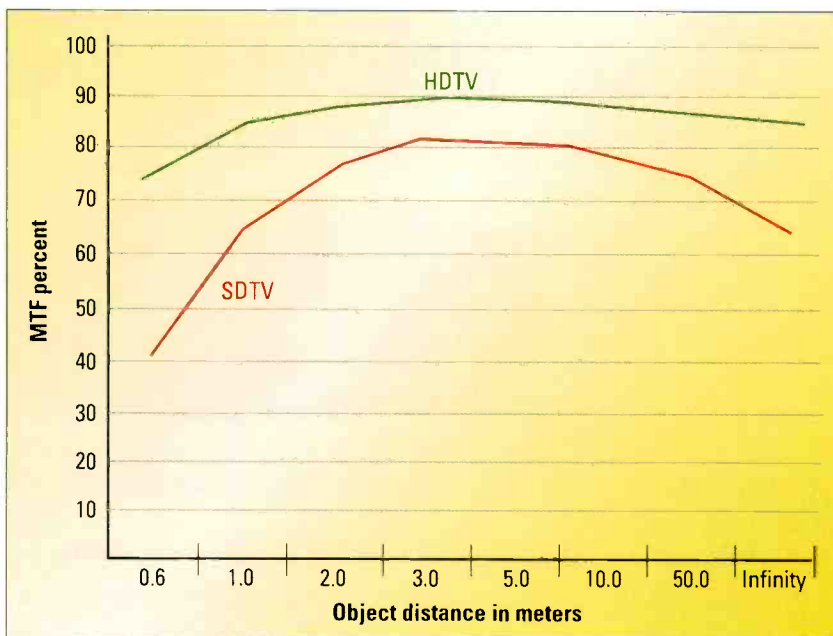

Figure 4. This illustrates the significant improvement that had to be made to the behavior of the HDTV MTF when refocusing as a subject moves from one position to another.

Maintaining high MTF over the focal range

Exercising the zoom control in a broadcast lens involves precise relative movement of two groups of lens elements. This has an inevitable impact on a variety of lens imaging characteristics — and on lens aberrations. One impact is on the lens MTF. Because of the far greater clarity of the

HDTV picture, it is necessary to institute a much tighter control over this variation. Figure 3 outlines the relative MTF variation of a typical SDTV and HDTV studio lens — measured at a reasonably high spatial frequency of 56LP/mm (a popular optical reference frequency) — being approximately 600TVL/ph for the 1080/60i

system and roughly 500TVL/ph for the 720/60P HDTV system.

Maintaining MTF with changes in object distance

Studio production regularly entails specific choices in framing for each shot (requiring appropriate adjustment of the zoom control to achieve a specific angle of view) and subsequent talent activity within that framing. For example, a principal actor may be 6ft from the lens (and sharply focused) — but then may move away to 25ft from the lens (and is refocused — with no alteration of zoom or iris). Or, the camera operator might “rack focus” between two actors separated by such a distance or greater. Lenses will change their MTF between those two focus settings — again, a consequence of lens elements physically moving during a focusing action.

Figure 4 illustrates, by way of a reference, the behavior of a high-performance SDTV studio lens at the higher spatial frequencies (where SDTV/NTSC design really does not need to concern itself). But, because of the high sharpness expectations of HDTV, the HDTV lens does need to pay close attention to MTF behavior in this critical spatial frequency region of 56LP/mm (or roughly 600TVL/ph for the 1080-line HDTV system).

The effect of aperture settings on lens MTF

Optical science is confronted by some fundamental physics, and part of that is diffraction. Diffraction is a consequence of the wave nature of light and has the effect of modifying an infinitely small point source of light by “spreading” it as it passes through an optical element.

In a perfect lens, which would be diffraction-limited, MTF would be at a maximum when wide open. This would progressively lower as the lens aperture is stopped down. In the real world, however, lens designers use a variety of optical techniques to manage the linkage between MTF and aperture setting. Depending on the

Single-Fiber Extension Systems

DVI / VGA / SDI / HD-SDI

w/Stereo Audio, Data, Keyboard & Mouse

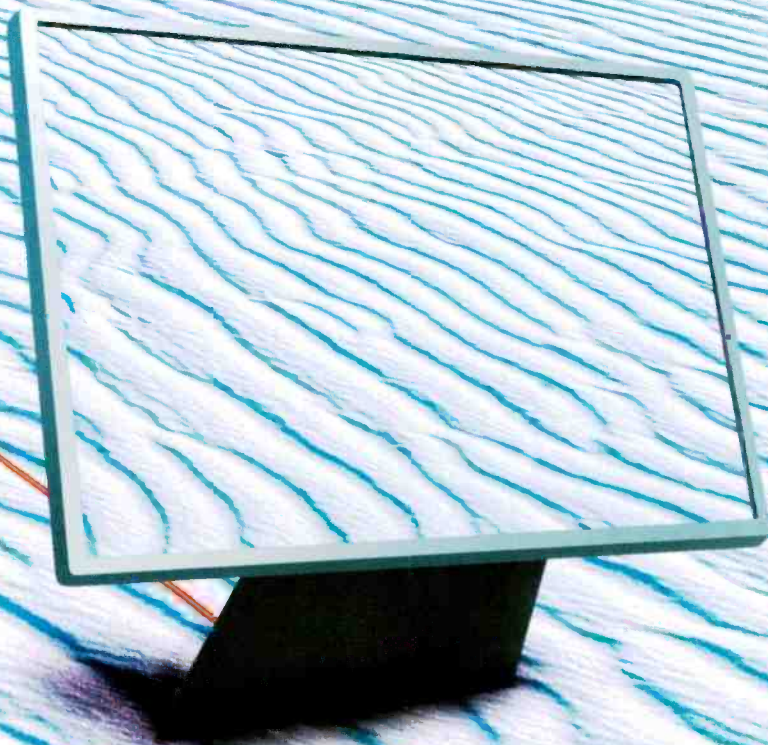

Your media is valuable.

At Opticomm, we understand this. Our single-fiber transmission systems provide the optimal solution for the remote digital display of your media, at crystal clear quality.

 **opticomm**
travel by light™

Video, Audio & Data Fiber Optic Transmission Systems

www.opticomm.com | info@opticomm.com
1.800.8.OPTICOMM (1.800.867.8426)

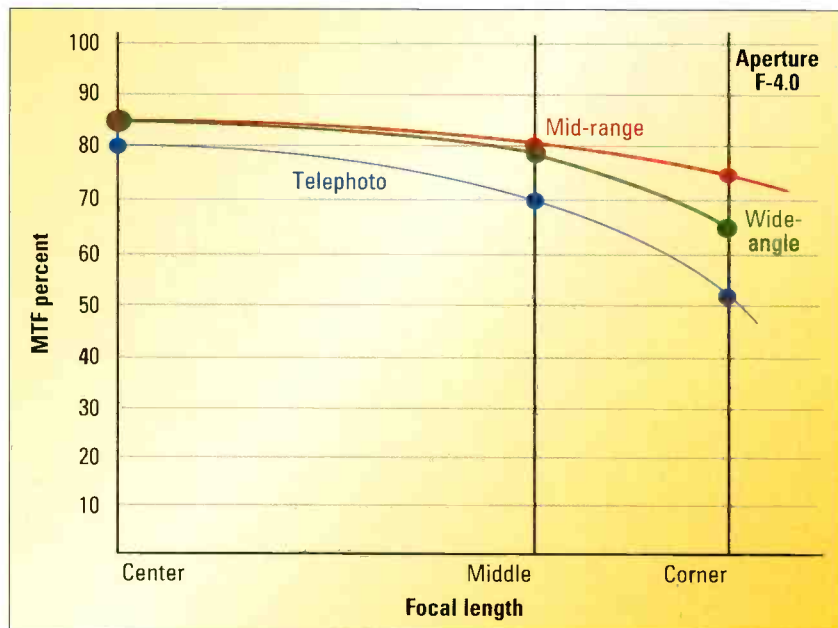

Figure 5. The variation in MTF across the image plane at a singular setting of the iris (for different focal lengths) — shown here at the aperture of f4.0 common to broadcast television studio operation

application of the lens (such as studio, field, ENG or cine) designers will optimize its overall MTF profiles

(while also paying close attention to MTF changes with focal length) to be at their very best at the anticipated lens

aperture settings for those applications. Broadcast studio lenses, for example, are generally operated in the vicinity of f-4.0, and consequently the design may optimize MTF at that aperture and at the medium focal length that is more common — allowing it to lower (to a modest degree) when the lens aperture is wide open. Long telephoto field lenses will have different optimization criteria. Cine lenses will have yet different criteria.

Figures 5 and 6 show a typical HDTV studio lens and how its MTF profiles vary between two aperture settings. The MTF is measured at 56LP/mm (again in the vicinity of 600TVL/ph for the 1080-line system), and its variations across the image plane at three different focal lengths are shown. Figure 5 shows the characteristics when the aperture is modestly stopped down to f-4.0. Figure 6 shows the alterations to those same profiles when

Introducing the **Truck-Coder II™** COFDM Transmitter from BMS.

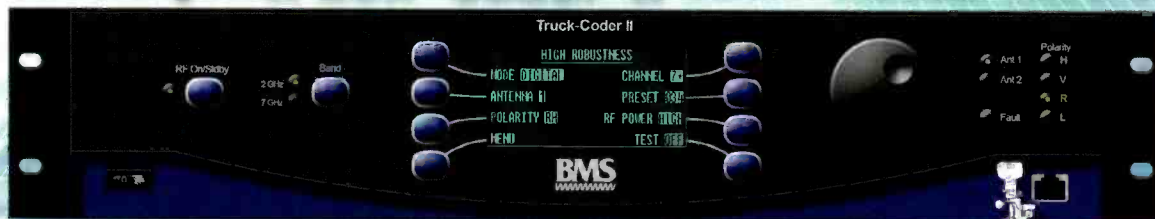

DIGITAL AND/OR ANALOG TRANSMISSION

6 MHz OCCUPIED BANDWIDTH FEATURE

SIMPLER, EASY-TO-USE OPERATOR INTERFACE

UNLIMITED PRESETS

ETHERNET PORT FOR UPGRADES & FOR PRESET DOWNLOADS

FIELD-PROVEN DESIGN

70 MHz INTERFACE BETWEEN CONTROL UNIT & RF HEAD

OPTIONAL DUAL BAND CAPABILITY

The Truck-Coder II™ transmitter blends our field-proven technology with the simplicity of operation and rich feature set you told us you need as you implement the new Frequency Relocation Plan for your ENG/OB operations.

Truck-Coder II features the Bright Selector™ panel, our intelligent user interface that makes set-up and operation a breeze; and, a front panel Ethernet port for field upgrades and unlimited preset downloads.

The Truck-Coder II transmitter operates in digital or analog mode. The two unit system includes a rack-mounted controller and mast-mounted RF head, each designed to handle your news van's tough environmental conditions.

Truck-Coder II—the latest addition to the BMS Coder II™ family of COFDM transmitters and receivers.



BROADCAST MICROWAVE SERVICES, INC.

12367 Crosthwaite Circle
Poway, CA 92064 U.S.A.

www.bms-inc.com
E-mail: dept100@bms-inc.com

Tel: +1-858-391-3050
Toll Free (U.S.): 800-669-9667
Fax: +1-858-391-3049

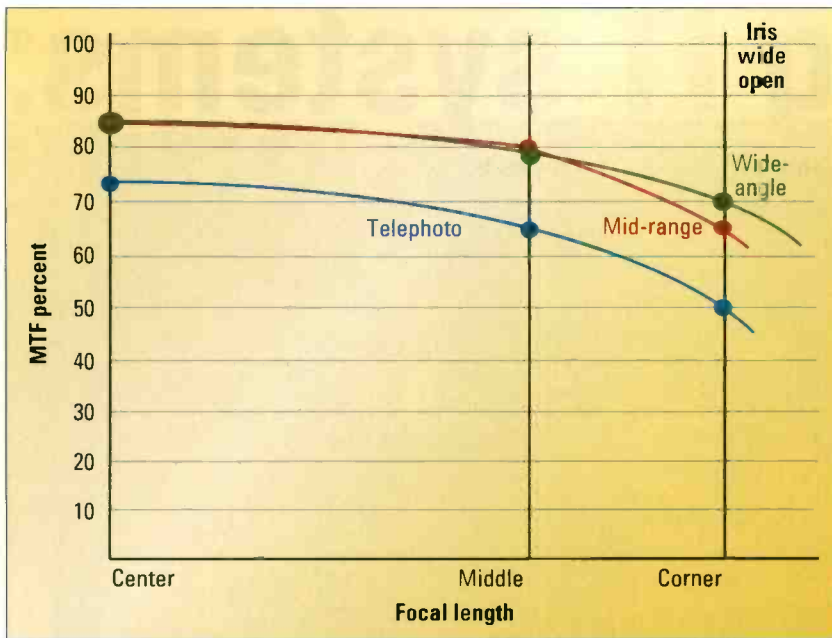

Figure 6. The variation in MTF across the image plane as the lens aperture is fully opened

is a Herculean technical task. Yet, marvelous technical progress has taken place over the past decade. The HDTV lens today exhibits extraordinarily high quality despite the multifaceted optical challenges within this enormously complex system.

It should also be clear from the imaging characteristics shown in Figures 1 through 4 that coupling an HDTV lens to an SDTV camera will significantly enhance the performance of that imaging system. Overall, SDTV picture sharpness will be visibly enhanced. This means that an investment in HDTV lenses today is worthwhile — even if you don't plan to transition to an HDTV camera for some years to come.

BE

the lens iris is opened wide. Note the favoring of the wider angle at this setting (because this is where the scene

detail is at its highest).

It should be apparent that management of MTF in an HDTV zoom lens

Larry Thorpe is the national marketing executive and Gordon Tubbs is the assistant director of the Canon Broadcast & Communications Division.



It doesn't show but reveals.

See what's been hidden with ERG's new ultra-high resolution 6" diagonal HDM-EV30D HD monitor. To further improve your view, it offers enhanced color and gamma adjustment functions, adjustable framing markers, and a convenient memory preset function. In addition, its rugged, compact design and low power consumption make it ideal for location shooting. All of which can help you look more closely. Find the new HDM-EV30D at NAB 2004, Booth #SU10134.

www.erg-ventures.com, contact@erg-ventures.com, US: 1-949-263-1630, Japan: 81-3-3760-8161



ERG HD Monitors

Building IT systems:

PART 2



KENS-TV, Belo's news and information station in San Antonio, has integrated its IT functions into the television engineering department in order to ensure that every technician is capable of installing and troubleshooting computer- and network-related issues. Image courtesy of Sundance Digital.

IT network equipment

By Brad Dick

Today's digital broadcast systems are increasingly dependent on IT technology. Indeed, the broadcast industry has embraced and used computer systems in a rapid pace over the past eight to 10 years. However, determining what IT network equipment may be best suited and available to improve the workflow at your facility can be difficult. Typically, you will need to rely on

vendors for that information. But the more you know about IT technology,

information to help you in this journey. There are several resources avail-

Determining what IT network equipment may be best suited and available to improve the workflow at your facility can be difficult.

the better consumer you'll be. This article will present some basic infor-

able to help broadcast engineers better understand IT technology. The

*Ikegami's HDK-75EX gets the award,
but our customers are the real winners.*



HDK-75EX

Star quality. Ikegami's HDK-79EX has it and we're proud that a leading industry publication agrees by choosing the camera as a Superior Technology Award Recipient (STAR) award winner. This cost-effective, fully digital HD camera uses newly developed digital process ICs, precision designed at 0.18 micro-meter rule to achieve unmatched, consistent picture quality.

The camera features a compact and lightweight camera body including integrated fiber adapter (4.5kgs), low power consumption (28W), and excellent sensitivity (f10/2000lx) and S/N ratio (56dB). Ikegami's HDK-79EX received the STAR award, but our customers are the real winners.

Another winning Ikegami customer



weather.com

"We chose Ikegami HDK-75EX HD cameras because we felt strongly that Ikegami produced superior imagery, as well as the ease of installation and complete functionality we were looking for."

Mike Smereski, Chief Engineer,
The Weather Channel

See Us At NAB Booth #C5426

Ikegami

Ikegami Electronics (U.S.A.), Inc. 37 Brook Avenue, Maywood, NJ 07607 East Coast: (201) 368-9171
West Coast: (310) 370-2400 Southeast: (954) 735-2203 Southwest: (972) 869-2363 Midwest: (630) 834-9774

Website @ <http://www.ikegami.com>

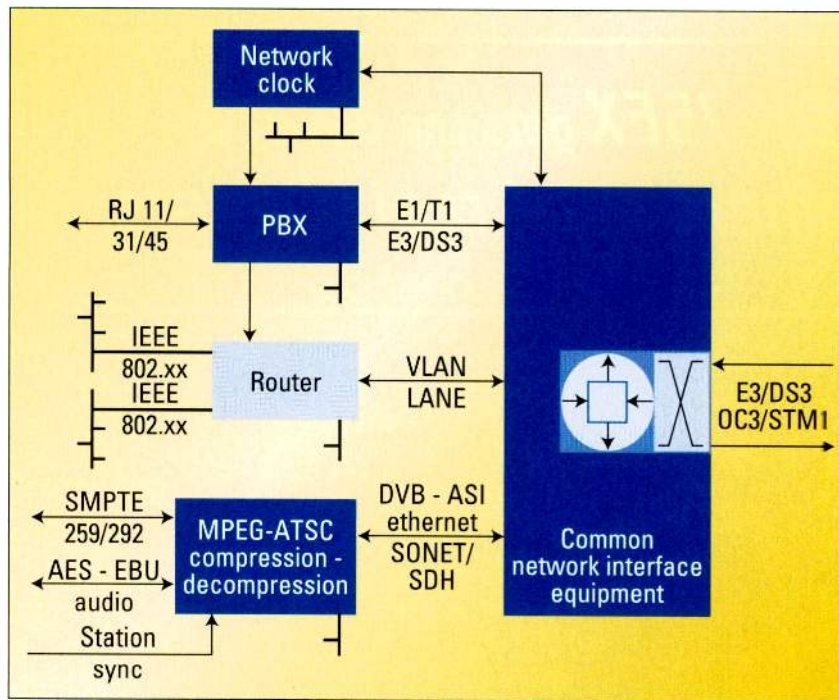

Figure 1. Typical IT interfaces and devices in a broadcast plant

EBU/SMPTE Task Force results were published in 1998 and are a good place to start. However, they are more focused on traditional broadcast technology, rather than IT and future technology. Let's get some basic terms de-

Today, the typical goal of using a network is to support the safe and secure transport of content between devices, studios, within facilities or even between continents

finied. Refer to Figure 1 as the starting point for a typical, generic broadcast plant.

IT networks and equipment

The term *network* can define a wide variety of technologies. The term *LAN* or *local area network* was originally conceived as a way to share printers among microcomputers. Today, LANs have evolved to where the "local" can

be within a studio, an entire broadcast facility or even between facilities.

Today, the typical goal of using a network is to support the safe and secure transport of content between devices, studios, within facilities or even between continents. The network may provide voice communications, control transmitters, the transfer of data between servers and an editing suite. A network can also be simply for monitoring. The successful operation of a network is based on extensive use of standard interfaces and protocols.

Standard interfaces and protocols

There are many standards and protocols used in today's broadcast and production systems. These standards are typically developed by various industry committees. Some key standards-setting bodies to be aware of

include the Audio Engineering Society (AES), Advanced Television Systems Committee (ATSC), International Telecommunications Union (ITU), Internet Engineering Task Force (IETF) and the Society of Motion Picture and Television Engineers (SMPTE).

As an engineer, you don't have to wade through long dissertations of standards-setting bodies to understand how they work and where they need to be applied. However, you do need to know how these standards should be applied in building your facility. Fortunately, today's vendors are highly reliable in properly applying the appropriate standards. You may just need to be sure that the various vendors all agree to speak the same standards when it comes to connecting all your devices together. You do not want to find yourself in the position of having to connect divergent equipment together. That is way beyond what most broadcasters have the skills to do.



Figure 2. Shown here is the front door. This bi-directional port may handle either comm traffic only, or comm plus content traffic.

Connectivity
The backbone of any facility is the network. That network needs to communicate with the devices in a reliable way and at increasingly high speeds. Today, that often means a 100Base-T or higher Ethernet connection. One free piece of advice: Build for higher speeds now, even if you don't need it. While your proxy browser news system may operate fine with a 10Base-T infrastructure, you'll soon find the need to connect devices that require 100Base-T or higher speeds. This means you should build for Gig-E speeds now. Wire is cheap; installation isn't. One good resource on the proper selection

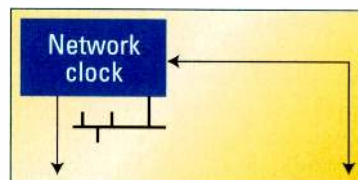

Figure 3. Digital systems need a reference clock. Use one linked to GPS for maximum stability.

An International Broadcast Standard

See us at

NAB 2005
THE WORLD'S LARGEST ELECTRONIC MEDIA SHOW

Stand Number N3211



DR



Radio France



**food
NETWORK**



C100

- HD sports at Comcast
- Regional production at Danish Broadcasting
- Lifestyle broadcasting at the Food Network
- Audiophile radio at Radio France

The SSL C100 Digital Audio Broadcast Console comfortably meets the needs of surround production and interactive programming. Security and performance are built-in, with a host of redundancy and failsafe features such as Self-Healing DSP. And the C100 can be scaled according to application and budget, while a freelance-friendly control surface further ensures efficiency.

Solid State Logic

BROADCAST AUDIO TECHNOLOGY

Beghroke, Oxford OX5 1RU, England. Tel: +44 (0)1865 842300 Fax: +44 (0)1865 842118 Email: sales@solid-state-logic.com Web: www.ssl-broadcast.com

NEW YORK
Tel: +1 (1)212 315 1111

LOS ANGELES
Tel: +1 (1)323 549 9090

TOKYO
Tel: +81 (0)3 5474 1144

PARIS
Tel: +33 (0)1 48 67 84 85

MILAN
Tel: +39 039 2328 094

and use of network cabling is available at www.belden.com/college/college.htm.

Cat 5 cabling used to be considered standard and sufficient for broadcast interfaces. A Cat 5 cable is rated for

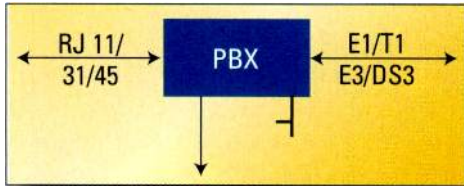

Figure 4. This interface may not exist for some stations. It represents the Plain Old Telephone System (POTS).

100MHz or 155Mbps, perhaps up to 1000Mbps if the lengths are short. That's not high enough today. If you're going to go to the trouble of wiring a facility, consider using Cat 6 wire. It will support 2.4Gbs. Now, let's look at the basic building blocks.

Figure 2 on page 82 shows what is known as the *front door*. It is telephone lingo for the identifiable access port to a facility. It could be identified

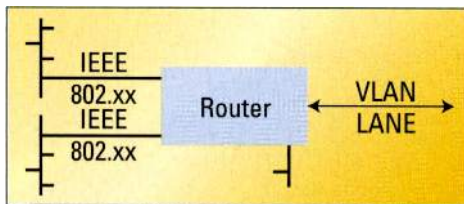

Figure 5. The data and Internet router may connect 802.xx inputs to the station VLAN.

as simply as the facility's phone number. The dual arrows indicate a passive connection (perhaps two copper coax or fiber cables) to the outside world. This is the connection between the facility and the service provider. This is also where the Customer

References

SMPTE Journal Volume 107, Number 9, September 1998 <http://www.smpte.org>
"File Interchange Handbook", Gilmer, Brad, et.al., Focal Press, Burlington, MA, 2003

Premise Equipment (CPE) equipment comes in.

Examples of this kind of terminal equipment include Cisco 12000 series and Juniper E-or T-series routers. The network side Layer 1 and 2 interface is likely to be E3 (34Mbps), DS3 (45Mbps) or OC3/STM1 (155Mbps). If your facility is involved in transmitting HD source content, you may need a higher speed interface like OC3/STM4 (622Mbps) or OC12/STM16 (2.4Gb/s).

Figure 3 on page 82 shows the network clock component in this conceptual facility. The clock serves to keep all the network elements in time with each other. Never let anyone try to convince you to try to get along without it. Every site in your network needs one. The clock is crucial in not only keeping signals in time, but also to re-sync devices should an error or disturbance in transmission occur. In addition, it's a good idea to lock the clocks to a uniform standard like GPS.

Figure 4 is probably the simplest device in our facility. It represents the standard telephone connection — plain old telephone service, or POTS for short. If you have a newer IP-based phones, you won't have this element in your system.

Now it's time to use the word *router*. In Figure 5, you will see the router connected to two IEEE interfaces and a virtual local area network (VLAN). This is not the typical cross-point router that broadcasters use to move audio and video between studios and devices, but an IP router. IP routers direct signals based on information contained in the headers of Internet packets using a routing protocol. Consider that an IP router and the typical broadcast router have little in common although they share the same name.

Configuration tasks

All network equipment has to be *configured*. This can be simple or difficult, depending on the device, the network and the complexity of the task it performs. The configuration of a mid-size router can be complex. To get an idea of the steps that might be involved, go to <http://www.ifb.com.pl/~mateo/bgp/ip/2917A-1.html>. If you are doing a system-wide install, this can be handled by the system integrator or router installer. However, you

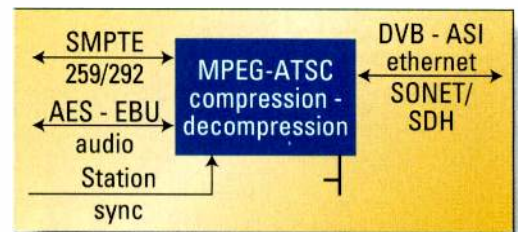

Figure 6. The compression/decompression modules perform that last-piece interface with both storage and transmission systems.

will need to identify someone on your staff to be the system administrator to make future changes.

Content transport

Now we come to the essence of broadcasting, generating the ATSC or MPEG signals for transmission. Today's digital TV plants have multiple SD and HD encoders and decoders. See Figure 6. These devices may have SMPTE 259/292 inputs, and the outputs might be DVB/ASI or Ethernet connections. It's likely they will be linked to an ASI or SMPTE 310 interface to a satellite or terrestrial network facility. The ASI signal may be further formatted to match a standard TDM or Layer 1 baseband transmission facility. It could also be mapped to ATM cells, or IP Packets at Layer 2 or 3. At this stage, it's simply another signal

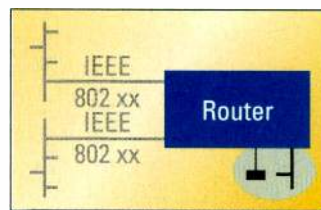

Figure 7. Managing an IT-based broadcast or production system begins by configuring the ports.

that may need to be routed again before it gets to its final destination.

Managing IP systems

With this introduction behind us, how does one manage IT systems? Very carefully could be the first response. However, the process is not dissimilar to aligning an analog system. Begin at a central point, set key parameters and continue that process throughout the system.

Setting up an IP system starts by port configuration. So what's a port? There are two kinds of ports, physical and virtual. Physical ports are always on equipment. One common physical port is the RS-232 control port. Others include the common IEEE 802.xx or 10/100/1000Base-T ports. Figure 7 is a slightly modified version of the LAN segment diagram, showing one RS-232 port and two IEEE 802.xx ports.

Configuring a port can be done either via a software routine contained

When considering the benefits of an IT-based broadcast system, it's difficult to argue against the technology.

in an application, or via a manual configuration from a keyboard. You may have already performed a minor configuration task when, acting as an administrator of a new computer, you changed the system's password. The same concept can be extended to the network level, where inputs and outputs are assigned values, one device at a time.

New territory

When considering the benefits of an IT-based broadcast system, it's difficult to argue against the technology. Even so, the changes for broadcast engineers can be difficult and challeng-

ing, if not merely because of the new language.

However, the more you know about IT technology, the better qualified you will be to understand what vendors say — and what they claim — not that any vendor would oversell their capabilities. In the end, it's you and your staff that have to use and maintain these

new systems, so knowledge is both power and protection.

BE



The Unique Azden 1000 Integrated UHF Receiver



Whether you use the Anton-Bauer® Gold Mount® or a V-Mount battery, there's an Azden 1000 that's been designed to snap right onto your battery, and to give you maximum performance with no additional batteries needed in the receiver. Using the latest production techniques and the highest quality components, we've made a bullet-proof receiver which is ideal for broadcast cameras.

- 121 UHF channels (723-735MHz) user-selectable, with LCD readout
- True diversity system with 2 complete front-ends and high-gain antennas
- Proprietary DLC (Diversity Logic Control) circuitry for reduced dropouts
- State-of-the-art dielectric filters throughout, for improved image rejection and superior diversity isolation
- High 5th order filters for improved S/N ratio
- Multi-function LCD shows channel number and frequency, battery info, AF level, and diversity operation
- Ultra small, lightweight, switchable, Earphone-out w/level control

Note: Order cables specifically for your camera and battery configuration.



Bodypack transmitter (1000BT) with reduced current-drain for improved battery life, is available with Azden EX-503H, Sony ECM-44H.

Plug-in XLR transmitter (1000XT) works with dynamic mics.



P.O. Box 10, Franklin Square, NY 11010 • (516) 328-7500 • FAX: (516) 328-7506
E-Mail: azdenus@azdencorp.com Web site: www.azdencorp.com

NAB. preview

Are you hunting for the
newest in technology?

We'll help you search
the jungle of NAB!





The NAB show has and always will provide a place for broadcasters from around the world to gather and learn more about their industry. Not only does it provide the opportunity to see new technology firsthand, but also it offers attendees the chance to get together and have questions answered on technology and policy.

Every year, the *Broadcast Engineering* staff provides a guide full of comprehensive coverage to help our readers make the most of this chaotic event. This manual is meant to serve as your ultimate resource for searching the jungle of NAB2005! First, we announce the winners of our fourth annual Excellence Awards competition. These facilities will be recognized at NAB for their achievement as a network facility, automation facility, new facility, audio facility, RF facility or new studio.

Next, our Exhibit Hall Map will help you find your way through the hundreds of booths and new products. Vendors from around the world will be displaying new solutions and updated favorites, giving broadcasters the chance to shop for a wide range of new technologies. You'll save time and not get lost if you use our map to find your way through the jungle of booths.

Our FASTtrack section will save you time and make navigating NAB easier than swinging through vines. This listing in the magazine is organized to help attendees find their way right to the vendors they are interested in — whether they are looking for transmitters or routers. Vendors are divided into categories and then listed geographically for easy reference.

Finally, our DTV Marketplace showcases this year's greatest listing of products ever! Browse more than 65 pages of product descriptions and photos to build your ultimate shopping list. Whatever you're looking for at this year's NAB, our staff wishes you the best of luck finding it! **BE**

Table of Contents

Excellence Awards	88-102
Exhibit Hall Map	105-128
FASTtrack	129-144
DTV Marketplace	146-249

The fourth annual
BroadcastEngineering

EXCELLENCE AWARDS

Entries for the 2005 *Broadcast Engineering* Excellence Awards were announced in the December 2004 *Digital Reference Guide*. That issue contained 32 entries, a 25 percent increase from last year. Each entry described the technology innovation and construction that went into each facility.

This year's winners were selected based on voting by readers who visited the *Broadcast Engineering* Web site at www.broadcastengineering.com. Award plaques will be presented at this year's NAB convention to the companies that officially entered the facility into the contest.

Be sure to look for the *Broadcast Engineering* Excellence Award in your favorite vendor or system integrator's booth. The award recognizes leading-edge design and system integration.

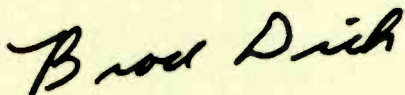

Brad Dick
 Editorial Director



This year's winners are:

- New studio technology for:**
- HD** 90
 Winner: Turner Studios
 By AZCAR
 Runners-up: TNT
 By AZCAR
 HD production trucks
 By Diversified Systems
- Network** 92
 Winner: Discovery Communications
 By CEI
 Runners-up: CNBC
 By The Systems Group
 CBC
 By Miranda Technologies
- Non-broadcast** 94
 Winner: KLCS
 By Omneon
 Runner-up: Elon University
 By Jova/Daniels/Busby
- Station** 96
 Winner: KIRO
 By Sundance Digital
 Runner-up: KCEN
 By Prof.Communication Systems
- Network newsroom technology:** 98
 Winner: Sahara TV
 By Leitch
 Runner-up: CNN NY
 By Turner
- For RF systems:** 100
 Winners: KVIE
 By Thales
 Mt. Wilson
 By Axcera
 Runner-up: WABC
 By The Systems Group
- For station automation:** 102
 Winners: KTVK
 By Sundance Digital
 Media General
 By Microfirst Engineering
 Runner-up: Media General
 By Florical



Belden Delivers Flexibility To Your Audio and Video Digital Conversion.

Analog, Digital or Data —
More Broadcast Engineers
Choose Belden Than Any Other
Brand of Cabling Products.

Why? Because broadcast engineers know that Belden has an extensive line-up of digital cabling products — including data cables — and the quality to match.

Whether you're installing cable in a television or radio studio, a video post-production facility, an indoor or outdoor sports arena, a film production studio, a church, a government chamber, or an entertainment venue — any area where a high quality signal is important — Belden has the digital cable to meet your needs.

To make your selection process easier, we're offering a 3rd Edition of our "Digital Studio Cable Guide." This Guide will help your understanding of digital cables, SDI and AES/EBU specifications, HD Radio concerns, key electrical/distance parameters, and why Installable Performance™ is important to cable performance.

Look to the leader. Call 1-800-BELDEN-4 and get a *free copy* of the definitive "Digital Studio Cable Guide." Or download a copy from Belden's Web site at: www.belden.com/tb65.pdf.





BRILLIANCE®

Belden

Performance Delivers The Future™

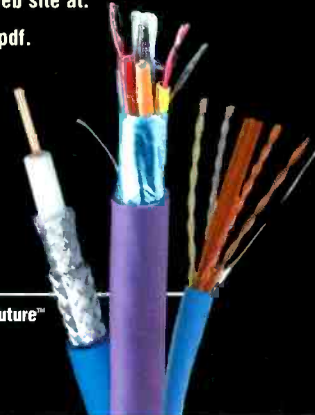
©2003, Belden Inc.



NEW STUDIO TECHNOLOGY

HD

Winner: Turner Studios

by AZCAR

Turner Studios decided to upgrade its facility in order to improve their ability to produce in HD. In addition to editorial, mixing and graphics services, it added HDTV commercial integration for live programming and converted one studio control room to full HD capability.

AZCAR designed and integrated the new control rooms. The work included increasing the size of the routing systems, considerably, as well as upgrading a significant amount of infrastructure from SD-only to SD and HD capability. The routing switchers presented a challenge because the operation is virtually 24/7. To accomplish the transition, it used the DAs and splitters to feed both the old and new routers simultaneously, and then migrated outputs one-at-a-time when they were not in use.

The control system is one of the largest in existence, with 52,000 lines of custom programming and 52 levels. The new integration control room was first used for the NBA Western Conference Finals in May. The studio control room first went online in October with NBA broadcasts.

Key technology: Thomson Grass Valley Trinx multiformat HD/SD with Apex audio routing, Kalypso HD production switchers, Dolby E encoders and decoders, Evertz modular equipment and MVP series monitor processor, 40in NEC LCD displays, Sony HD cameras. ●



Runner-up: TNT

by AZCAR

Key technology: Thomson Grass Valley Trinx and Apex routing switchers, Pinnacle Systems HD servers, Sony Flexicarts, Pro-Bel automation, Dolby E encoders and decoders, Sony SRW series VTRs, Quartz QMC HD MC switchers with 5.1 surround support, Snell & Wilcox modular equipment and MPEG encoders, Roll Call control and monitoring system, Chyron HD clip servers, Barco Hydra projection displays, Evertz provides QC ingested feeds. ●



Runner-up: HD production trucks

by Diversified Systems

Key technology: Evertz crossconverters and frame syncs, PESA 128x128 HD routers and 256x256 SD composite routers, NVISION 144x144 AES audio routers, Thomson Grass Valley Kalypso 4M/E HD switchers, Calrec Alpha 100 audio consoles, Sony HDCAMs, Canon lenses, Utah Scientific 128x128 HD routers, 256x384 SD composite routers, 208x176 AES audio routers, 256x256 analog audio routers, Yamaha PM1D audio consoles, Ikegami HD cameras. ●



DRIVING THE FUTURE OF **MOBILE BROADCAST**



ADDED mobility with the new **cheetah**

PESA understands mobile video production. This is proven by our commitment to offer one of the most flexible routing switchers in the world. The Cheetah SD/HD multi-rate digital routing switcher is the perfect solution for mobile truck applications. When size matters, the Cheetah is your answer. When flexibility is a concern, the Cheetah flexes. Features include an optional 10-bit D to A output card capable of supporting legacy analog equipment and our new HD to SDI output conversion card providing the greatest cost and space-saving solution ever. When the road to success depends on the right equipment, Cheetah is your next right turn.

Visit us at NAB2005 Booth # SU7852.



35 Pinelawn Road • Suite 99E • Melville, NY 11747 USA • Tel: +1 (631) 845-5020 • (800) 328-1008 • Fax: +1 (631) 845-5023

For More Information On These and Other Products Visit WWW.PESA.COM

- ANALOG AND SD/HD DIGITAL VIDEO
- SIZES FROM 64x64 UP TO 512x512
- NEW ADVANCED 3500PRO CONTROL
- OPTIONAL 10-BIT D TO A OUTPUT CARD
- OPTIONAL HD TO SDI CONVERSION OUTPUT CARD



PESA
Switching
Systems

NEW STUDIO TECHNOLOGY network

Winner: Discovery Communications

by CEI

Discovery Communications chose Communications Engineering (CEI) to complete turnkey project services for the design and construction of its new Discovery Creative & Technology Center.

The project consisted of relocating the 24-hour production operation to a 54,000sq ft renovated office space. A key design directive was to configure the nonlinear suites for greater creative and scheduling flexibility. The main concerns were providing a large amount of heat generation and dissipation and maintaining the support equipment for individual suites in close proximity to the suites. The solution involved creating two medium-size equipment cores as the heart of the structure.

Key technology: Acoustic Systems custom booths, ADC jackfields, Belden cable, Dolby E decoders and interfaces, Evertz VistaLINK HD-SDI DAS, Gefen fiber-optic cables, ISIS ARS-204 switchers, Leitch AES/EBU router and master clock, Sony BVM20GIU, BVM "D", and PlasmaPro flat-panel monitors, Sony HDCAM, Sony downconverters, Studio Technologies Studio Comm Surround monitors and mic panels, Tektronix multiformat generators and Waveform monitors, Thomson Grass Valley Trinix and Concerto routers, NVISION data router, Yamaha digital mixing consoles. ●

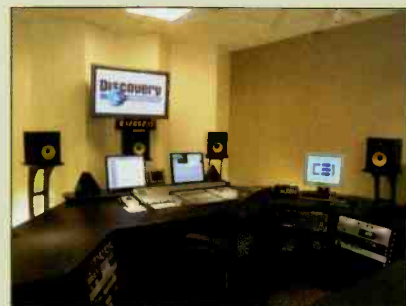

Runner-up: CNBC

by The Systems Group

Key technology: Miranda Kaleido K2 multi-imagers, Avid iNEWS Newsroom system, Leitch NEO frame synchronizer, Thomson Grass Valley Profile servers, Contentshare, NewsBrowse, NewsQPro, NewsEdit workstations, Trinix router, Sony MVS-8000 production switchers, BVP-950 studio cameras, DVE systems and CRT monitors, Calrec Sigma 100 digital audio consoles, Hydra networking system, Clarity digital projectors, Pinnacle Systems FXDeko, Systems Wireless 48-channel mics, Enco central file server with DADPro32 workstations. ●



Runner-up: CBC

by Miranda Technologies

Key technology: Miranda Imagestore automation, Densite converters and Das, iControl control and monitoring, Kaleido-K2 display processors, Barco rear-projection cubes, Omneon Spectrum media servers, VertigoXmedia graphics automation, Vertigo CG, Thomson Grass Valley Trinix 256x256 router, Encore control system, Encoda automation, TANDBERG TV satellite equipment. ●



20 GHz BAS Relocation

We're ready when you are ...

For years, MRC has been providing digital and "digital ready" radios to meet present and future bandwidth requirements for broadcasters.

We continue to lead in engineering and design innovation with our CodeRunner, STRATA, and REPORTER systems – now ready for the BAS relocation.

MRC's service and design experts are poised to help you make the digital transition with minimum interruption, while offering the most competitive product portfolio. Shouldn't you make the move to MRC?



Microwave Radio Communications
101 Billerica Ave. Bldg 6
North Billerica, MA USA 01862-1256
+1-978-671-5700

www.mrcbroadcast.com

NAB2005
THE WORLD'S LARGEST ELECTRONIC MEDIA SHOW

April 18-21

Las Vegas Convention Center — Booth # C3007

MICROWAVE RADIO
COMMUNICATIONS

NEW STUDIO TECHNOLOGY

non-broadcast

Winner: KLCS

by Omneon

Last January, KLCS completed the installation of a digital content distribution model able to reconfigure bandwidth and satisfy both over-the-air and classroom audiences. The project enables the station to provide educational content directly to the desktops of more than one million students and teachers in Los Angeles County School District. KLCS chose systems integrator TV Magic to guide the project.

KLCS required a more reliable and flexible combination of equipment that would allow large volumes of material in various file formats to flow seamlessly between various stages.

The upgrade included integration of a 28-channel media server system controlled by automation software. The server allows engineers to separate studio and edit content, play-to-air material, streaming channels, and other assets into different volumes on the same server so that the facility's automation system sees only the material relevant to it.

Teachers now can browse or search entire contents of the KLCS media library, which include not only video and audio, but also PowerPoint presentations, lesson plans and other resources.

Key technology: Omneon Spectrum media server, Sundance Digital automation, Intelli-Sat, Triveni Digital Skyscraper, Avalon IDM, XDMS archive manager, GVS Metropolis SAN/NAS, Leitch NEO SuiteView, Integrator GOLD SDI, Opus MC switcher, DPS-575AV synchronizer, 6800+ video/audio conversion, 880 Series stereo audio Das, CCS Pilot, navigator, Pinnacle Liquid Edition and blue, Dielectri 888 antenna, TANDBERG encoders and IRDs, MRC DAR Plus microwave, FOR-A Hanabi switcher, Evertz 9625 LGA, Ikegami HL-DV7AW cameras, nNovia QuickCapture drives, Sony DMX-R100 console, Digital Rapids StreamZ 2500 Web encoders, K-Tech DM-100 DTV monitoring, Rohde & Schwarz T&M. ●



Runner-up: Elon University

by Jova/Daniels/Busby

Key technology: Sony DXCD50SL studio cameras, MVS-8000 digital switcher, DRS-25 DVCAM decks, Listec T2012P LCD 15in prompter, 360 Systems Image Server 2000, Chyron Duet LE CG, Adobe After Effects, Motion, Apple Final Cut Pro 4.5, Avid Newscutter NLEs, GenArts plug-in packages. ●



When the broadcast industry needs rack systems... we deliver.

We understand the unique challenges faced by broadcast engineers and integrators, and offer engineered equipment mounting solutions to satisfy those requirements. For the past 25 years, when rack systems were needed in broadcast facilities, Middle Atlantic Products has been there with the most comprehensive line of racks and accessories available.

54 spaces for
maximum
equipment density

VMRK Series

optimized for
effective
cable management

MRK Series

VRK Series

The Middle Atlantic Products difference:

Custom configurations...
the way you want it.

On time shipping...
there when you need it.

Specify with confidence...
UL Listed, Seismic Certified standard.



Learn how we solved the racking needs of CNN, the Home Shopping Network, the Discovery Channel and more at middleatlantic.com/broadcast1.htm



INTEGRATED



architectural



thermal



cable



power

SOLUTIONS

Engineered Mounting Solutions Since 1979

800-266-7225 | middleatlantic.com

NEW STUDIO TECHNOLOGY station

Winner: KIRO by Sundance Digital

KIRO made a commitment to bring full digital automation to its newsroom. The station chose a solution based around its existing Avid iNEWS newsroom computer. From there, it replaced its tape editors and server/airplay system and brought in Sundance Digital's automation to tie them all together, handle playout and assure a growth pathway.

Efficiency was an important requirement. Previously, as many as five devices operated before an assigned story was ready for air. Now the edit moves from each stage while remaining in the same system.

During the news program itself, adding and dropping stories required many steps to remove old video and insert new video. Now, the producer simply revises the rundown, NewsLink immediately re-stacks clips for the AirSPACE, and the right video is always cued and ready.

With so much riding on the success of its news, KIRO insisted on physical redundancy for its playout. NewsLink assisted by automatically cuing the same ID in both primary and backup AirSPACE channels, and then by gangrolling them in locked sync.

A key part of KIRO's look evolved from using taped bumps to break. After the installation was under way, the station realized that the fourth AirSPACE channel it was dedicating for bumps and teases must always appear at the same switcher channel rather than automatically checkerboarding across channels after a rundown change. It was discovered that this capability was already available by using a NewsLink control initially designed for managing moving backgrounds. KIRO noticed the benefits of its new system during the November 2003 sweeps, when there was a new-found quiet in the control room. Instead of the traditional chaos associated with the urgency to align production devices and cue stories, the producer and technical director are able to discuss quality, content and effects issues.

Key technology: Sundance Digital NewsLink news automation, Avid iNEWS NRCS, AirSPACE and Unity servers, NewsCutter NL. ●



Runner-up: KCEN by Professional Communication Systems

Key technology: Panasonic DVCPRO50 ENG, Sundance automation, Chyron Digibox graphics, Duet CG, Aprisa still store, Wheatstone TV-80 audio console, Axcera transmitter, NVISION 128x128 MC switcher routing and distribution, Thomson Grass Valley 3M/E, Zodiac, HDTV pass-through systems. ●



Videotek's New Look and Feel That's Impossible to Resist!



US Patents 6,069,607, 6,532,024, and 6,828,981
UK Patent 2,330,475 Other US and International Patents Pending

VTM-450E HD/SD

Coming Soon...

**The New High Definition and
Standard Definition TVM Series**



**See us at NAB in the Leitch Booth,
#SU 7805.**

**The New VTM-300 and VTM-400 Series of
High Definition and Standard Definition Test
Instruments — Ergonomically Enriched and
Environmentally Friendly**

Now Featuring:

- Illuminated Labels and User Controls with Precision, Positive Tactile Feel
- State-of-the-Art "Whisper Quiet" Cooling System
- The Most Comprehensive and Advanced Feature Set for Audio and Video Measurement

**Contact Videotek today to learn more about
our advanced, precision instruments!**

VIDEOTEK[®]
A ZERO DEFECTS COMPANY

www.videotek.com

Videotek Toll Free USA (800) 800 5719
Videotek USA (610) 327 2292
Videotek Europe +49 8093 90 4082
Videotek Asia +65 6356 5830
www.videotek.com

LEITCH.

www.leitch.com

Network

NEWSROOM TECHNOLOGY

Winner: Sahara TV by Leitch

Sahara TV wanted to improve its competitiveness of its Hindi entertainment channel, located near New Delhi. The plan entailed launching seven 24-hour news channels, with the majority of their content resources shared from one facility, while concurrently migrating to digital. Goals included improving journalists' control over the production technology and ultimately building a completely integrated system that would operate under the control of a powerful, easy-to-use automation system.

Sahara chose Leitch's newsroom system to help it meet the requirements of scalability and highly efficient content sharing. Using the non-linear editors, journalists now have access to clips in shared storage the moment ingest begins. The facility now houses three fully mirrored domains with total storage capability of more than 3500 hours to support its current and future news channels. A mirror server provides data mirroring in each domain and keeps the content in main and backup systems synchronized.

The system links the facility's ENPS newsroom computer system with automation tools for sequencing broadcast news stories. Automation ensures all systems are integrated and MOS-compliant. The automation, coupled with distribution and routing systems, handles ingest simply and efficiently despite the size of the system. Thousands of feeds are recorded on a daily basis and given a specific name or ID through automation, making them easy to locate and accessible by editors.

Key technology: Leitch NEXIO NewsNet newsroom, NEXIO NX4000TXS servers, NEXIO NewsFlash FX NLEs, NEXIO Pilot, NEXIO Playlist event sequencer, InstantOnline EDL conformance engines, Integrator Gold wideband digital multi-rate router, Panacea Clean Switch, DPS-575 digital processing synchronizer, SuiteView multi-source display processor, NEO Simplicity processing modules, LogoMotion II logo inserter, CCS Navigator control and monitoring software, Telescript teleprompters, Pinnacle DekoCast graphics, Vizrt graphics, ENPS news production system, Omnibus systems automation. ●



Runner-up: CNN NY by Turner

Key technology: Thomson Grass Valley 512x512 Trinx router, RTS/Telex intercom, Sony MVS-8000 production switcher, Pinnacle Systems production server, encoders and decoders, Liquid Blue edit systems, Vortex Desk Edit, Vortex Browse, Ardendo DART, Aardcap. ●



DUAL MODE

not only analogue
not only digital



Screen Service
ITALIA

SCREEN SERVICE ITALIA Srl
Via G. Di Vittorio, 17 - 25125 Brescia - Italy
Tel. +39 030 3582225 Fax +39 030 3582226
www.screen.it e-mail: info@screen.it

digital & analogue

A single equipment allows transmitting digital (DVB-T or ATSC) or analogue signals digitally generated and of extreme high quality. The commutation between analogue and digital mode can be local or by any remote control system or by a command inserted into the Transport Stream.



DBT 100U (DVB-T)
DTT 100U (ATSC)



- Dual ASI input with statistical analysis and automatic switching
- PCR re-stamping
- Control of the crest factor
- Integrated SFN adaptor
- Management of the "null packets"
- Integrated test modes
- Integrated offset at steps of 1 Hz

RF systems

Winner: KVIE

by Thales

KVIE's chief goal was to install a digital system in its existing building, using equipment that could help the station move to its final digital channel. It also wanted a system that made full use of IP technology.

The first step was to fit the new DTV system in an existing analog transmitter building housing dual 30kW Ch6 transmitters. There was no easily accessible excess space available. However, the team created the needed space by reducing the size of several storage rooms and office areas.

The station chose Thales' MSDC transmitter. To meet its goal of equipment that would work for all UHF channels, the station used 5in heliax for the transmission line. This proved to be quicker and more efficient; installation of the 2000ft tower only took a week.

Key technology: Thales Paragon transmitter, View control software, Jampro Antennas JSM-32/53 antenna, Andrew HJ9-50 heliax transmission line. ●



Winner: Mt. Wilson

by Axcera

Four stations in the Los Angeles area joined together to form The Mt. Wilson Group. They hoped to benefit by achieving the goal of combining the analog and digital facilities of all four stations into a single facility on Mt. Wilson. Axcera was selected to help with this project.

To accommodate the transmission equipment, a three-story satellite transmitter building was constructed, along with a master combining room and 400ft tower. To minimize tower space, the stations share two broadband panel antennas.

Today, seven of the eight transmitters are on the air and provide reliable service, with plans to relocate the final analog transmitter.

Key technology: Axcera Visionary, DT HP50DDW, Visionary HP100DAW, RFS combiners, broadband panel antennas, MYAT digital mask filters. ●



Runner-up: WABC

by The Systems Group

Key technology: Fortel FS-411A frame synchronization, Thomson Grass Valley 8900 series video distribution, Benchmark MF-302WEC/DA-102DM audio distribution, Leitch FR-X routing, Evertz X-0401 ATSC routing, Harris Recon transmitter controls. ●



[Make the Shift to HD Graphics]



master control graphics ■ live production graphics ■ programmable graphics platform ■ networked graphics ■ information channels

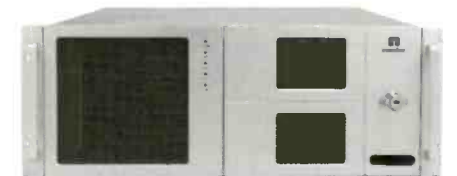

Making the shift to HD has never been easier. Inscriber's broadcast graphics tools power you through the drive to HD graphics with seamless integration into your current broadcasting environment. In addition to Standard Definition and High Definition products, Inscriber offers:

- **HD Upgradeable Graphics Products** - SD products which can be easily upgraded to HD with minimal in-the-field modifications
- **HD/SD Simulcast** - A workflow innovation where independent SD and HD graphics can be controlled from a single source to provide properly formatted and templated SD and HD graphics simultaneously
- **HD/SD Selectable Graphics Products** - Graphics products which can provide either SD or HD graphics - you select

Make the Shift to HD with Inscriber - www.inscriber.com

NAB2005
THE WORLD'S LARGEST ELECTRONIC MEDIA SHOW

Visit Inscriber at Booth #SU8100/SU7805

inscriber

North & South American Sales: +1.519.570.9111 European Sales: +31.297.380930 Asia-Pacific Sales: +81.3.5288.5237
©Inscriber is a registered trademark of Inscriber Technology Corporation. Other product names mentioned may be registered trademarks or trademarks of their respective companies. Specifications subject to change without notice.

 **LEITCH.**

www.leitch.com

Station AUTOMATION

Winner: KTVK by Sundance Digital

Belo media company embarked on a plan to centralize the master control operations of its four Arizona stations and their DTV counterparts from KTVK-TV's remodeled facility.

Because the plant's aging cart machine was close to retirement, KTVK chose to start centralcasting and installed an automation and video server large enough to run all four stations. The station chose Sundance Digital to provide them with the necessary system. The organization now produces twice as much with a smaller team.

Key technology: Sundance Digital Titan automation, Thomson Grass Valley 3500 XP Profile, Redundant Profile Open SAN system, M2100 MC switchers, Ciprico RAID chassis, San Valley 2000 Gateways, Cisco 4000 series switch and 7800 series router, TANDBERG E5710 encoders, TT6129/TT1260 decoders. ●



Winner: Media General (automation) by Microfirst Engineering

Media General Broadcast Group began centralizing master control operations for 12 of its 26 TV stations.

The company created a plan that would build on the previously created centralized traffic operations concept that was placed in service in 2001. The goals included substantial improvements in operational efficiency, high reliability, minimal capital outlay and low interconnection costs. Microfirst Engineering was called in to assist in supplying controllers. The controllers have been a key component in minimizing interconnection costs while maintaining a high degree of product quality.

Key technology: MicroFirst MPC-1600 Digital Earth station controller, GI 4800 satellite receiver. ●



Runner-up: Media General (master control) by Florical

Key technology: Florical AirBoss automation, AirBoss Editor, MediaFiler asset ingest, MediaTimer segmenting, MediaMaster AMS, ShowTimer satellite record scheduler, Satelink satellite dish and receiver control, Thomson Grass Valley iDVR video servers, Saturn MC switchers, M2100 MC switchers, SeaChange MediaClusters, Utah MC-500 MC switchers, Leitch Logomotion I and II logo inserters, Panacea, Quintech RF router, Agile-Omni 830 and 930 satellite receivers, TANDBERG Altaeia satellite receivers, Scientific-Atlanta DSR 4810 satellite receivers, Patriot RCI-2000 and RCI-1000 antenna controllers, Microfirst 1610 microcontroller. ●



Managed monitoring for broadcast and distribution

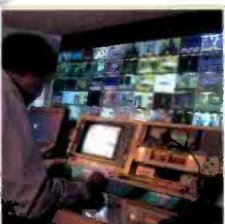

- Efficient solution to display analog, digital & High Definition video, audio, alarms, network load and computer generated data.
- Autonomous or multi-screen display to monitor up to 60 windows simultaneously.
- Perfect control room design offering the best possible combination of display technology, hardware and software for 24/7 operation.

Barco Control Rooms
Noordlaan 5, B8520 Kuurne - Belgium
Phone: +32 56 36 82 11 • Fax: +32 56 36 82 48
email: sales.bcd@barco.com

Barco Projection Systems
3240 Town Point Drive, Kennesaw, Georgia 30144 - United States
Phone: +1 770 2183200 • Fax: +1 770 2183250
email: bpsmarketing@barco.com

BARCO

Visibly yours

YOUR FUTURE STARTS HERE

The future of electronic media takes shape at the NAB show. Join thousands of future-focused professionals from more than 130 countries around the world as they gather to discover cutting-edge tools, discuss new ideas, and sharpen their competitive edge. NAB2005 will showcase the latest innovations from every facet of television, radio, film, video, audio and multimedia technology in an event unlike any other. If you work in the world of electronic media — Your future starts here.

All Industry Opening Ceremony — Distinguished Service Award Recipient



April 18, 2005

Lowry Mays
Chairman of the Board
Clear Channel Communications

Sponsored by: **accenture**
High performance. Delivered.

MultiMedia World Keynote Speaker



April 18, 2005

Hector Ruiz
Chief Operating Officer
Advanced Micro Devices (AMD)

RTNDA Paul White Award Recipient



April 18, 2005

Charles Osgood
CBS

Radio Luncheon

Keynote Speaker



April 19, 2005

John Gage
Co-Founder and
Chief Researcher
Sun Microsystems

Hall of Fame Inductee



Jack Buck
KMOX/ St. Louis

Luncheon sponsored by: **ASCAP**

Super Sessions

Convergence and Content on the Move: Riding the Digital, Mobile, Virtual and Personal Wave



April 18, 2005

Shane Robison
Chief Technology Officer/
Chief Strategy Officer
Hewlett Packard (HP)

Sponsored by:



Look Before You Leap — The Dollars and Sense of Transitioning to HD



April 19, 2005

David Krall
President/CEO
AVID

Taking It to the Streets — Mobile Devices Add Drama to Sports & Reality Programming



April 20, 2005

Mark Cuban
President
HDNet, LLC

Video — The Next Wave in Publishing



April 19, 2005

Steve Saylor
Vice President of Digital
Video and Audio
Adobe Systems Incorporated

IPTV — The Technology and Market Outlook



April 19, 2005

Jonathan Klein
President
CNN/US

New Technology for Digital Media



April 20, 2005

Kenneth Williams
Chief Executive Officer
Ascent Media

NAB2005

THE WORLD'S LARGEST ELECTRONIC MEDIA SHOW

Conferences: April 16-21 • Exhibits: April 18-21
Las Vegas Convention Center • Las Vegas, Nevada USA

www.nabshow.com

The 2005 NAB Exhibit Hall Map

Brought to you by
BroadcastEngineering®



HARRIS

Win Me!

Visit all three Harris exhibits for a chance to win a digital camera!

Surrounding broadcasters with total content delivery solutions.

- South Hall, SU10048
Traffic, Scheduling, Playout
Automation, Digital Asset
Management
- Central Hall, C1907
TV, Radio and
Networking Systems
- Central Hall, C3607A
5.1 Surround Sound
exhibit, located in the
5.1 Pro Audio Pavilion

■ See Harris at Booths C1907 and C3612a, page 6



April 18-21, 2005

■ See PAG at Booth C9719, page 7



One Battery, All Systems

The PAG L95 Time Battery, V-Mount, Snap-on or PAGlok, is the industry's most advanced Li-Ion battery



PAG ™

#C9719

We know a lot about fluorescent studio lighting.

After all, we invented it.



Our founder invented the first fluorescent lighting for television studios, more than 23 years ago. And we've been helping stars to shine ever since. With a whole range of innovative products including

the only fluorescent fixture in the industry with an adjustable beam, we pride ourselves on being a tough act to follow. In fact, we continue to set the standard in efficient design, flexibility and performance.

NAB Booth # C10519

Videssence™

10768 Lower Azusa Road
El Monte, CA 91731

626.579.0943

www.videssence.tv

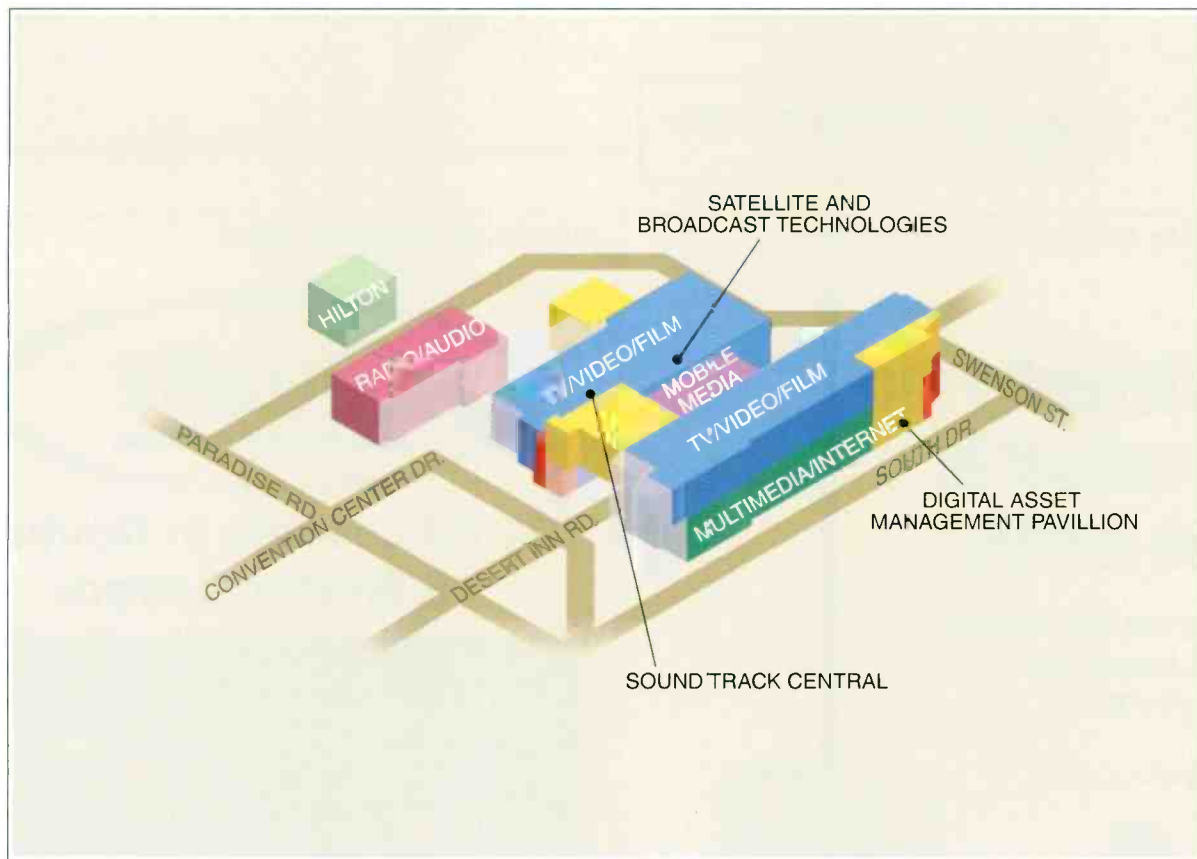

Map information matches hall colors. Colored booths highlight issue advertisers. Yellow colored booths highlight Broadcast Engineering map advertisers.

NAB2005 Exhibit Hours	
LAS VEGAS CONVENTION CENTER	
Mon. (April 18)	9:00 a.m. - 6:00 p.m.
Tues. (April 19)	9:00 a.m. - 6:00 p.m.
Wed. (April 20)	9:00 a.m. - 6:00 p.m.
Thurs. (April 21)	9:00 a.m. - 4:00 p.m.
LAS VEGAS HILTON	
Mon. (April 18)	10:00 a.m. - 5:00 p.m.
Tues. (April 19)	10:00 a.m. - 4:30 p.m.
Wed. (April 20)	10:00 a.m. - 3:45 p.m.

Table of contents (colors coincide with halls)	
 North Hall	4-5
 Central Hall	6-7
 South Hall, upper level (A and B)	8-9
 South Hall, upper level (C); lower level (A)	10-11
 South Hall, lower level (B and C)	12-13
 Mobile Media Exhibits (Outside display)	14
 Meeting rooms	15
Exhibitor index	16-22

Left: See Videssence at Booth C10519, page 7

Information current as of February 14, 2005

■ Advertisers ■ Points of Convenience ■ Map Advertisers



■ See Lectrosonics at Booth N3611, page 5

■ See Quartz at Booth SU9652, page 10

Is it really the **smallest** in the world?

See the SM wireless mic transmitter for yourself...

...and **believe.**



LECTROSONICS[®]
Booth N3611 in the LVCC North Hall



World Leaders in Routing & Master Control

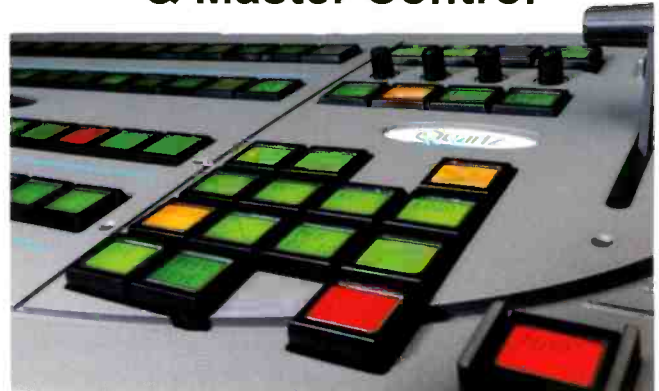

New QMC-2 Master Control
See it at NAB - Booth SU9652

www.quartzus.com

■ See Utah Scientific at Booth C5610, page 6

Why Pay Extra for Service and Support?

- ◆ **Ten-Year Warranty**
- ◆ **24 Hour Service / Support Line**
- ◆ **Full Support of All Legacy Products**

Utah Scientific gives you all three at no charge.

Central Hall

NAB Exhibit Hours, April 18-21, 2005
 Mon. - Wed. 9 a.m. - 6 p.m.
 Thurs. 9 a.m. - 4 p.m.

■ Advertisers ■ Points of Convenience ■ Map Advertisers



↑ TO MAIN ENTRANCE ↑

ENTRANCE

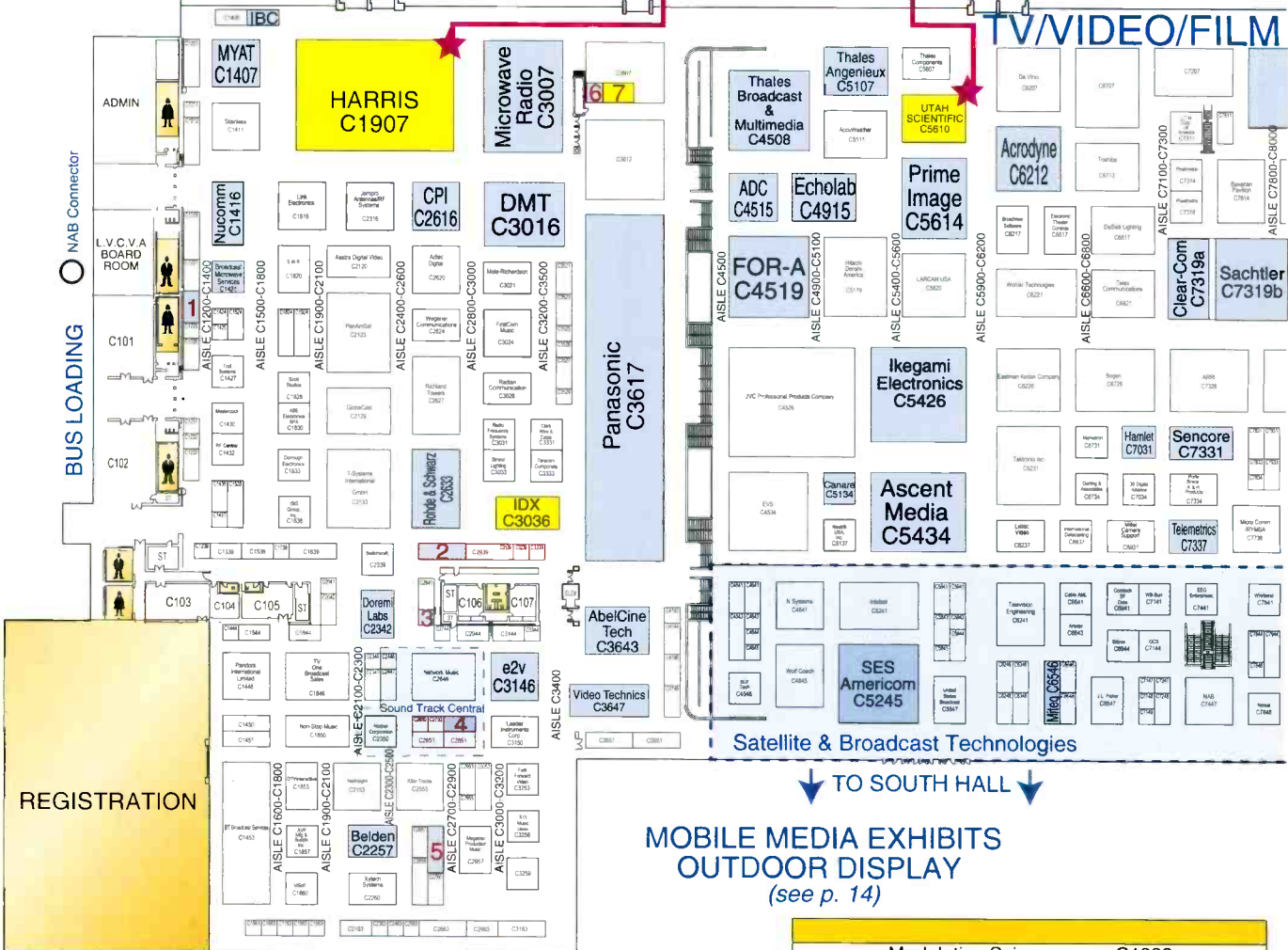

Modulation Sciences	C1223
ESE	C2639
Eartec	C2643
Multidyne	C2850

■ See Anton/Bauer at Booth C7319c, page 7

CANADA • CFCF • MONTREAL • CTV • TORONTO • CRVU • VANCOUVER • CFCN • ALBERTA • VICTORIA •
 THE WEATHER NETWORK • LYCA PRODUCTIONS • MONTREAL • CINEQUIP-WHITE • SHORE • GLOBAL TELEVISION
 • THE SPORTS NETWORK • UNITED STATES • ABC NETWORK AND OWNED & OPERATED STATIONS • NBC NETWORK AND
 OWNED & OPERATED STATIONS • CBS NETWORK AND OWNED & OPERATED STATIONS • CNN NEWS NETWORK • FOX
 NETWORK AND OWNED & OPERATED STATIONS • ESPN SPORTS NETWORK • MONDO NETWORK AND OWNED &
 OPERATED STATIONS • UNIVISION NETWORK AND OWNED & OPERATED STATIONS • SINCLAIR BROADCASTING GROUP •
 LINCOLN • BENTON & BOWLES • W. P. REYNOLDS • W. P. REYNOLDS • W. P. REYNOLDS • W. P. REYNOLDS • W. P. REYNOLDS •
 CORPORATE & RETAIL FACILITIES INCLUDING: TIME WARNER COMMUNICATIONS, NFL FILMS & TELEVISION, AMERICAN
 AIRLINES, NIKE, NCR, BEVEL, COCA-COLA, MICROSOFT, BOEING, HEWLETT-PACKARD, MCDONNELL-DUGLASS, BOEING, HEWLETT-PACKARD, MCDONNELL-DUGLASS,
 FORCE, MCDONNELL-DUGLASS, BOEING, HEWLETT-PACKARD, MCDONNELL-DUGLASS, BOEING, HEWLETT-PACKARD, MCDONNELL-DUGLASS,
 GOLF CHANNEL, NATIONAL POLICE TELEVISION, AND WALT DISNEY CORPORATION, WALT DISNEY CORPORATION, WALT DISNEY CORPORATION,
 - LONDON • BBC • CHARTER BROADCAST • CBS NEWS - LONDON • IBH • ELECTRA • TELEVISION - TX • NH •
 VIDEO EUROPE • RTE IRISH STATE BROADCASTING • PROCAM • NBC • GEARHOUSE • VMI • PANAVISION • PRESS
 ASSOCIATION • M.O.D. • SPAIN • TELEVISION • TELEVISION DE GALICIA • EUSKAL TELEBISIÓ • TELEVISION DE GALICIA •
 • CANAL SUR TV • TELEVISIÓ ESPANOLA • POPULAR TV • EUROPA PRESS • CITY • TELEVISION DE GALICIA •
 FERNSEHEN (ZDF) • RTL • B-TV • CANALC • APN • LUDWIG • VOLKER RODDE • SWF • SCHITTE • FRANCE • TFI
 • M6 • SFP • SOFT • IEC • PERFECT • BOGARD • POTUGAL • TVI • ITALY • VIDEO EUROPE • CANALE 5 •

THERE SHOULD ALWAYS BE CHOICES.

IT MAKES IT EASIER TO FIND THE Best.

BOOTH #C7319C



DK Audio	C2757, C3607c
Harris	C3607a
Fluke (Pomona booth)	C11814

Right: See Anton/Bauer at Booth C7319c, page 7

 See Anton/Bauer at Booth C7319c, page 7

THE POWER BEHIND THE BEST CAMERAS

ANTON/BAUER

CAPTURING THE *Best* IMAGES IN THE WORLDSM

MARCH 2005

antonbauer

The worldwide standard[®]

South Hall, upper level (A)

NAB Exhibit Hours, April 18-21, 2005
 Mon. - Wed. 9 a.m. - 6 p.m.
 Thurs. 9 a.m. - 4 p.m.

Advertisers
 Points of Convenience
 Map Advertisers

Map#	Company	Booth
1	TBC Consoles	SU6831
2	Forecast Consoles	SU7131
3	AJA Video	SU8948

BRIDGE MEETING ROOMS AND CENTRAL HALL

ENTRANCE

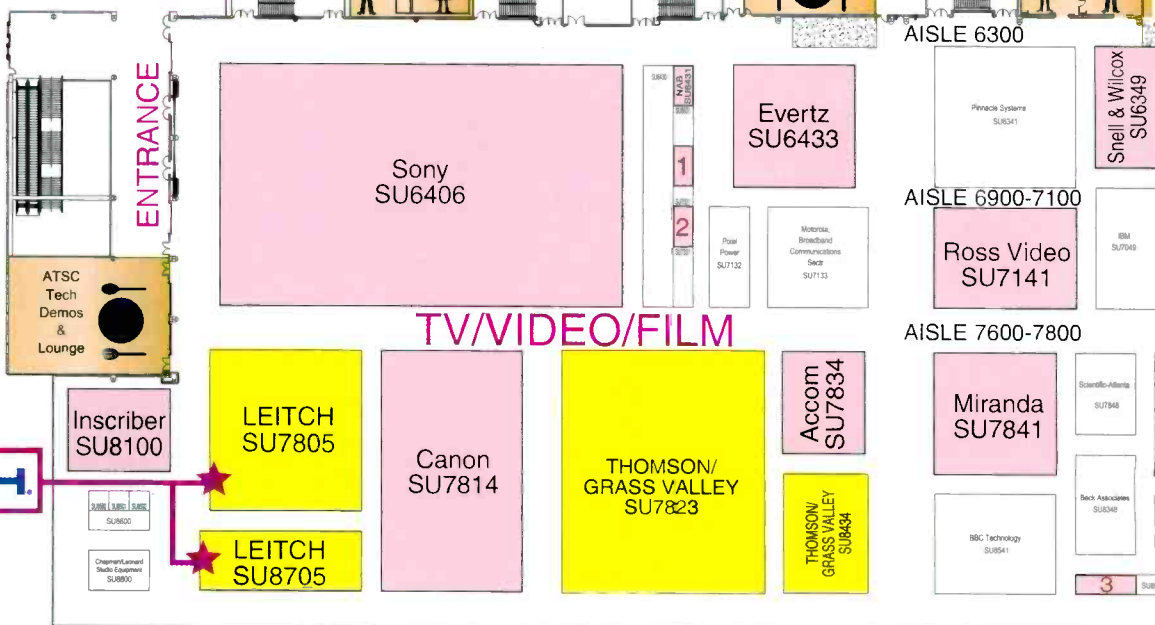

See Leitch at Booth SU7805 and SU8705, page 8

[MASTER YOUR MOVE TO HD WITH LEITCH]

EDITING

[VelocityHD™]
HD Non-Linear Editing

[NewsFlash®]
News Editing with EXIO

[TitleMotion®]
Titling and Animation Effects for NLEs

SMALL AND LARGE ROUTING

[Panacea™]
Small Routing

[Integrator® Gold]
Wideband Digital Multi-Rate Routing

SIGNAL PROCESSING
(interface and conversion)

[NEO™]
Advanced Processing

[6800+]
Modular Digital Processing

[X75™]
Up/Down Cross-Converter
Frame Sync

[Digital Legalizers]
Test and Measurement

MASTER CONTROL

[Opus™-HD]
HD Master Control

[DTP]
Digital Turnaround Processor

[Inca Station™/Inca Auto CG]
Master Control Branding and Networked Graphics

BRANDING

[Inca Station™/Inca CG]
Master Control Branding and Character Generation

[DTP]
Digital Turnaround Processor

[LogoMotion II]
Logo Generation and Control

[6800+]
Modular Digital Processing

STORAGE AND TRANSMISSION

[NEXIO™]
Scalable, Interoperable Server Foundation

[DTP]
Digital Turnaround Processor

[Digital Demodulator]

SIGNAL MANAGEMENT

[VTM]
Video Testing and Monitoring

[TVM]
Waveform Monitors and Vectorscopes

[SuiteView™]
Multi-Source Display Processor

DIGITAL SIGNAGE

[InfoCaster™]
Digital Signage and Cable Broadcasting Solution

www.leitch.com

See us at NAB
Booth# SU7805 & SU8100



VIDEOTEK®
A ZERO DEFECTS COMPANY



South Hall, upper level (B)

Map#	Company	Booth
4	Fischer Connectors	SU11812
5	ERG Ventures	SU10134

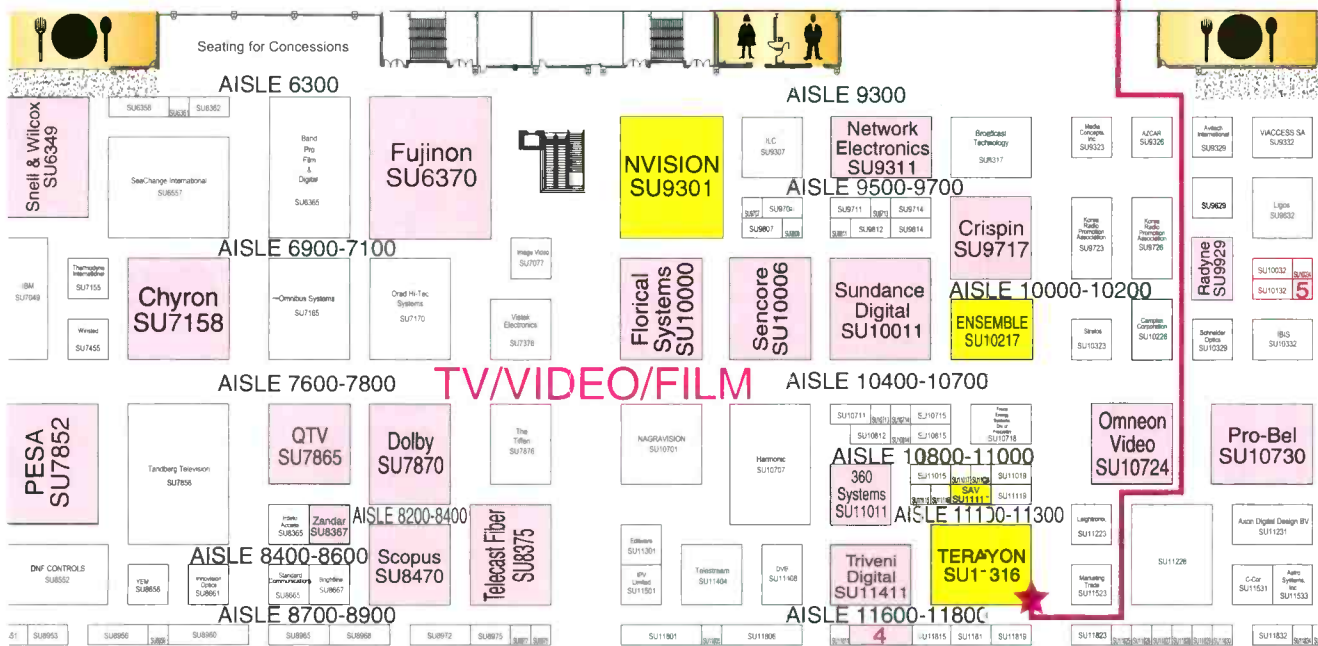

SOUTH HALL UPPER LEVEL
CONTINUES ON PAGE 10

See Fortel at Booth SU10463, page 10

MAKE YOUR HD LOOK BETTER. CHOOSE FORTEL DTV.

See us at NAB —
Booth# SU10463

**CALL NOW
TO SET UP
A DEMO.**



RCP-503 EXPRESS REMOTE CONTROL PANEL

- SUPERIOR A TO D CONVERTORS & SYNCHRONIZERS
- PERFECT PALLET LEGALIZERS
- ANALOG & DIGITAL COLOR CORRECTORS
- HIGH SNR MULTI FUNCTION AUDIO, A/D, D/A, EMBEDDERS, DE-EMBEDDERS, & SYNCHRONIZERS
- FAST, USER FRIENDLY CONTROL PANELS

www.fortelDTV.com

Phone: 770-806-0234

Toll Free: 800-530-5542



PERFECT SIGNAL. IDEAL CONTROL. CLEAR VALUE.

South Hall, upper level (C)

NAB Exhibit Hours, April 18-21, 2005
 Mon. - Wed. 9 a.m. - 6 p.m.
 Thurs. 9 a.m. - 4 p.m.

Advertisers
 Points of Convenience
 Map Advertisers

SOUTH HALL UPPER LEVEL CONTINUES ON PAGE 9

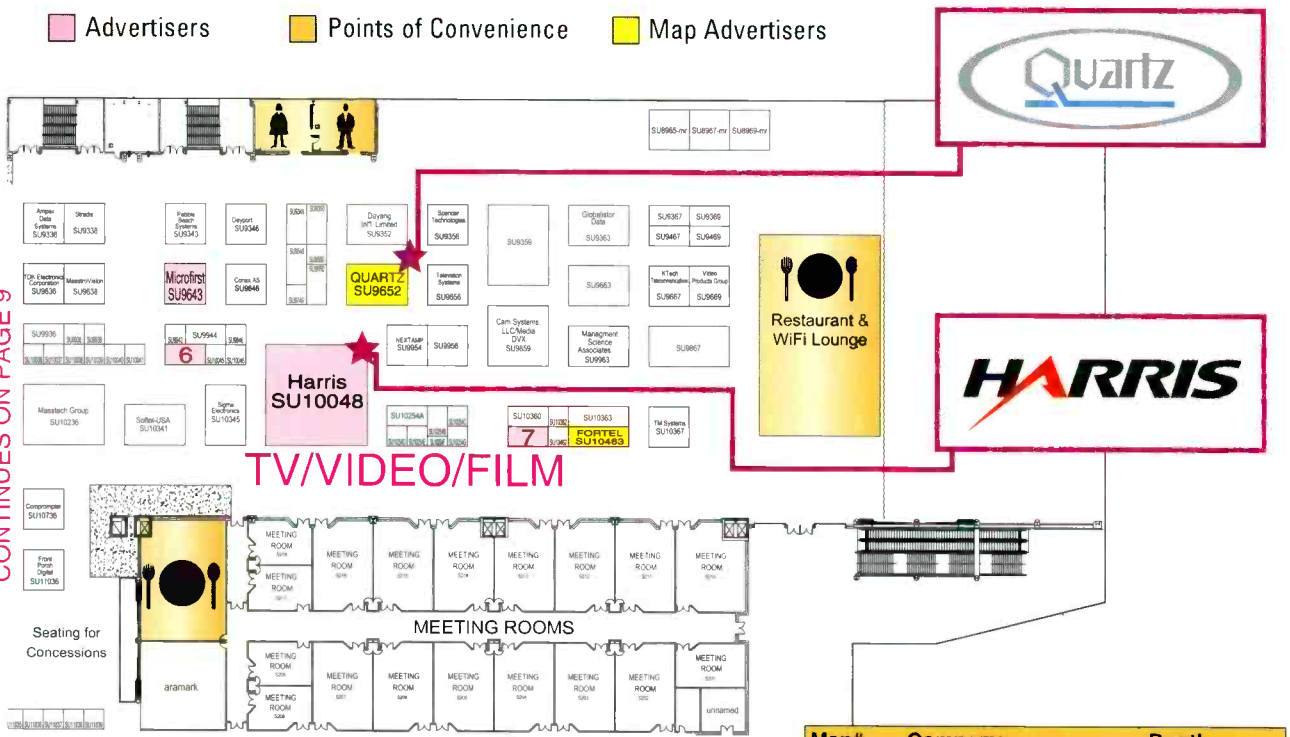

Map#	Company	Booth
6	Acterna	SU10043
7	Opticomm	SU10460

See Thomson/Grass Valley at Booth SU7823 and SU8434, page 8

See us at Booth # SU-7823

It's all about Workflows



So are we.

Whether it's repurposing content, launching new distribution channels or transmission topologies, or creating entirely new kinds of content, at Thomson we're focused on helping you maximize the return on your digital content investments.

We can make your workflows work better.

No company touches more points of today's digital media workflows—or has more experience integrating them—than Thomson. That's why we can make yours as efficient as possible.

Best of all, this approach lets you accommodate new Grass Valley devices—or those from third parties—and integrate off-the-shelf hardware and software to drive down your costs while supporting your high-quality and critical-uptime requirements.

To learn more, please visit www.thomsongrassvalley.com. Or contact your local Grass Valley sales representative.

A THOMSON BRAND

grass valley

South Hall, lower level (A)

■ Advertisers ■ Points of Convenience

Map#	Company	Booth
1	NAB	SL1011
2	Anystream	SL1210(o)



SOUTH HALL LOWER LEVEL
CONTINUES ON PAGE 12

■ See Nvision at Booth SU11226, page 9



NVISION®

Get Connected with NVISION

Stop by our booth at NAB and check out our complete range of routers, master control switchers, and terminal equipment.

New products for 2005 include:

- **NEW -- Synapse Modular Media System**
More than 100 modules provide an unprecedented level of multi-function signal processing.
- **NEW -- NV7512 Expandable Digital Audio Router**
512x512 in only 14RU, linearly expandable to 2048x2048. Handles AES, MADI, and analog I/O.
- **NEW -- NV5256 Machine Control Router**
256 bi-directional ports in only 8RU, expandable to 512 ports in only 16RU
- **NEW -- NV5128-MC Master Control Switcher Enhancements**
SD/HD capable processor with enhanced squeezeback effects, and more..



Visit our new web address: www.nvision.tv

Masters in Digital Audio, Pioneers in HDTV

BOOTH # SU9301
South Hall -- Upper Level

Advertisers
 Points of Convenience
 Map Advertisers

BroadcastEngineering

↑ TO NORTH HALL ↑

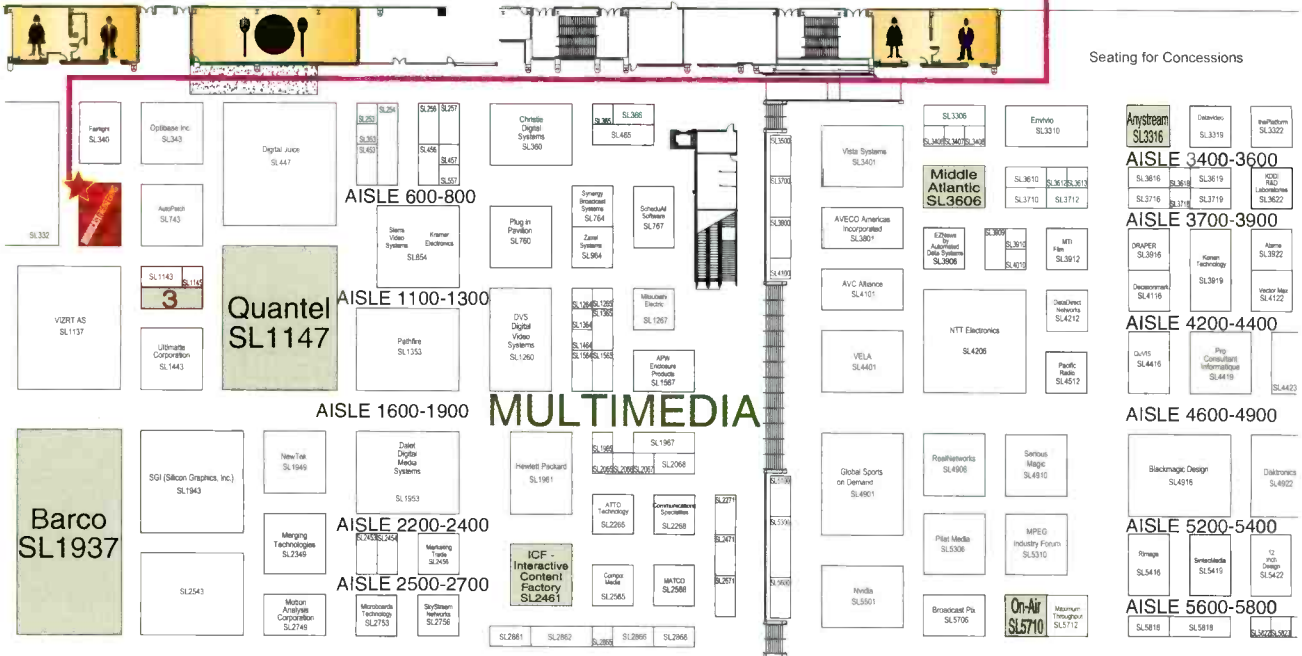

See Ensemble at Booth SU10217, page 9

Are you looking for the fastest road to HD?



Where do you want to go?
 Avenue will take you from
SD to HD.
Analog to Digital.
AES to Embedded.
 And more...



South Hall, lower level (C)

Map#.	Company	Booth
3	Laird	SL1243
4	Vqual	SL4535
5	Ai-Pixel	SL4453

↑ TO NORTH HALL ↑



■ See Ensemble at Booth SU10217, page 9

Avenue modules include video and audio converters, frame syncs and SPG's.



AVENUE™
Signal
Integration
System

Oh, and the control system rocks.

ENSEMBLE
DESIGNS

Tel +1 530.478.1830 ▲ Fax +1 530.478.1832
www.ensembledesigns.com ▲ info@endes.com
PO Box 993 Grass Valley CA 95945 USA

Outside display

NAB Exhibit Hours, April 18-21, 2005
 Mon. - Wed. 9 a.m. - 6 p.m.
 Thurs. 9 a.m. - 4 p.m.

Advertisers
 Points of Convenience
 Map Advertisers

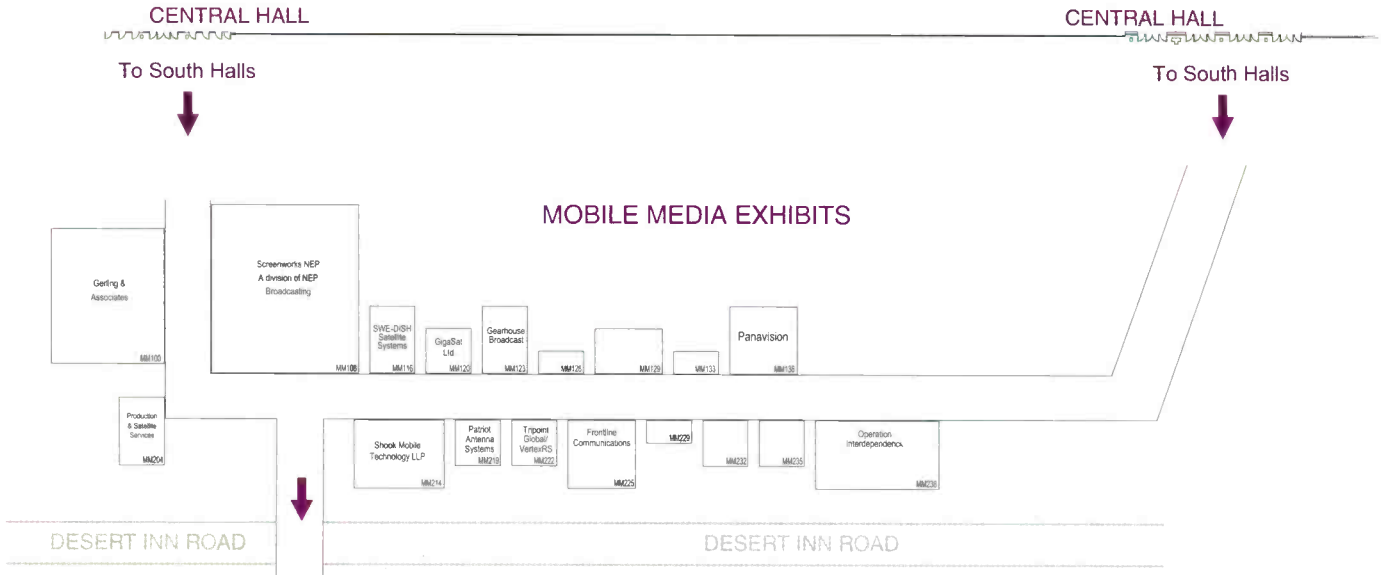

■ See *Broadcast Engineering* at Booth SL740, page 12

Don't miss the 2005 Pick Hits.

See the June issue of
BroadcastEngineering®

See the top 40
 new products
 from this year's
 NAB convention.

*Selected by
 readers like you!*



Meeting rooms

■ Points of Convenience

↑ TO NORTH HALL AND HILTON ↑

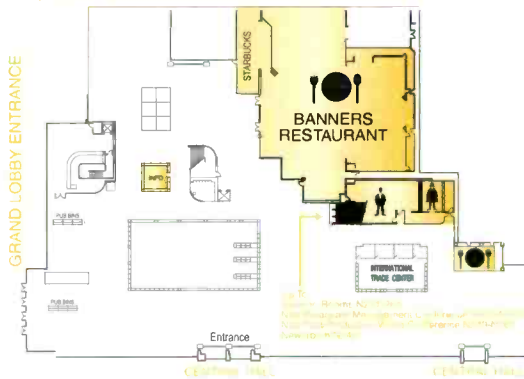

GROUND LEVEL
(between north and central halls)

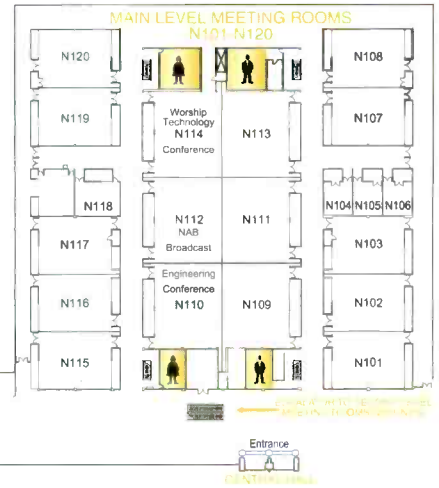

↑ TO CENTRAL HALL

BRIDGE MEETING ROOMS
(between central and south halls)

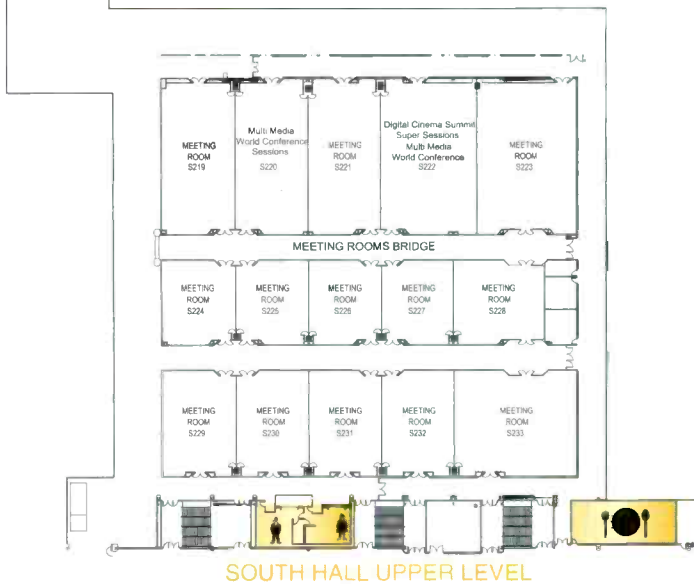

■ See Broadcast Engineering at Booth SL740, page 12

BroadcastEngineering NAB UPDATE

Get the latest news from NAB

Sign up today for your free weekly convention update from *Broadcast Engineering* at www.broadcastengineering.com

Are you involved in audio for broadcast, post, remote or studio recording?

Then sign up for the

BroadcastEngineering

Audio Technology Update newsletter.

Receive the latest news and products from manufacturers, standards committees and audio experts.
Don't miss a single issue!

Go to www.broadcastengineering.com and click on subscribe to newsletters.

Come join us
at NAB

Visit Booth SL740
located in the
South Hall lower level

BroadcastEngineering
US/Canada edition

&

BroadcastEngineering
World edition

Map index

Color indicates advertiser.

[E3]	C7614g	6
1 Beyond	SL3967	13
12 h Design	SL5422	12
16x9	SU6365	9
21st Century 3D	SU9969	10
2s2	SU9970	10
35Digital Alliance	C7034	6
360 Systems	SU11011	9
3D4Medical.com	SL4352	13
5.1 Pavilion	C36007	6

A

A.N.T. Antenna Nord Tel.	N4027	5
Aastra Digital Video	C2120	6
AATON	C2939	6
Abakus Scientific	SU10254C	10
ABE Electronica S.p.A.	C1830	6
AbelCine Tech	C3643	6
ACARD Technology	SL2866	12
Accom	SU7834	8
Accordent Technologies	SL4936	13
AccuDev Solutions	SL3662	12
AccuWeather	C5111	6
Ace Forum	C2955	6
Acoustic Systems	N4311	5
Acoustical Solutions	SU10714	9
Acrodyne Industries	C6212	6
Acterna	SU10043	10
Active Power	C2659	6
AD Telecom	C11712	7
ADC	C4515	6
ADIC	SL3710	12
Adobe Systems	SL313	11
Adrienne Electronics	SL1965	12
ADS Technologies	SL3925	13
Adtec Digital	C2620	6
ADTX	SL4555D	13
Advanced Broadcast Sys.	C11104	7
Advanced Designs	C8534	7
Advanced Industrial Comp. ..	SL5816	12
Advanced Microwave	C11142	7
Advanced Switch Tech	C9449	7
Advantech	C9644	7
Advertising Edge	C2446	6
AEQ	N1418	5
AEV	N4514	5
AFC Industries	SL3700	12
Agiosat Global Comm	C11048	7
AheadTek	SU 6362	9
Ai-Pixel BV	SL4453	13
AJA Video	SL2514	11
AJA Video	SU8948	8
Albiral-Avialec, S.L.	SL1364	12
Alcorn McBride	SL366	12
Algoith	SL3658	13
Allen Avionics,	SU10715	9
Allen Osborne Assoc.	C5845	6
Allied Tower	N615	5
Alpermann+ Velte E.E.	SU11801	9
Altera Corporation	C11212	7
Altronic Research	N3908	5
AMD- Advanced Micro Dev ..	SL2543	12
American Grip	C 7933	6
American Tower	N2837	5
AMETEK Hunter Spring	C4644	6
Amita Technologies	C7833	6
Ampex Data Systems	SU 9336	10
Amphenol RF	C11448	7
AnaCom	C7844	6
Analog Way	S1365	12
Anixter	C6643	6
Anthro	SL3631	13
Anton/Bauer	C7319C	7

Anystream	SL12100	11
Anystream	SL3316	12
Anystream	SL3372-MR	13
Apace Systems	SL4037	13
Aphex Systems	N1815	5
Apogee Electronics	SL504	11
Apple	SL1902, SL1914	11
APT- Audio Processing Tech ...	N811	5
APW Enclosure Products ...	SL1567	12
Archion	SL402	11
Arrakis Systems	N1122	5
ARRI	C7326	6
Artel	SU11828	9
Artesia Technologies	SL4259D	13
Asaca/ShibaSoku of Amer. ..	SL1426	12
Ascent Media Group	C5434	6
Ascent Media Group	C5434A	6
ASPA Vimensa Int	N4031	5
Aspera Software	SL3900	12
Association for Int. Broad. ...	C11041	7
Astro Systems	C9334	7
AT&T	SL826	11
ATA Audio	N4524	5
ATCi/Antenna Technology	C9941	7
Ateme	SL3922	12
Atha	SL2065	12
ATI- Audio Technologies	N2523	5
ATS Communications	C10041	7
ATTO Tech.	SL1210R, SL2265	11
AUDEMAT-AZTEC	N2235	5
Audio Accessories	C3651	6
Audio Precision	N1913	5
Audio Video Design	C1226	6
Audio/MacArthur Group	N4026	5
AudioScience	N503	5
Audio-Technica U.S.	N3322	5
Autocue/QTV	SU7865	9
Automatic Duck	SL760B	12
AutoPatch	SL743	12
Autoscript	C8926	7
AVC Alliance	SL4101	12
AVECO Americas	SL3801	12
Avid Technology	SL600	11
Avitech International	SU9329	9
AVL Technologies	C8146	7
Avlex	N3438	5
Avocent	SL4565	13
AVP Mfg & Supply	C1857	6
AVT Audio Video Tech.	N606	5
Axcera	C8014	7
Axel Technology	N3138	5
Axia	N3616	5
Axiom Tech.	SL3909	12
Axis Graphics -Fast Maps ..	SL1021	11
Axon Digital Design BV	SU9301	9
AZCAR	SU9326	9
Azden	N4222	5

B

B&H Photo	SU6430	8
Backbone Networks	SL920	11
Baird Satellite Sys.	C5943	6
Balcar	C9526	7
Band Pro Film & Digital	SU6365	9
Barbizon Lighting Company ..	C12016	7
Barco	SL1937	12
Baron Services	C8907	7
Bavarian Pavilion	C7614	6
BayStor/Karden Group	SL4552	13
BBC Technology	SU8541	8
BBN	SU10037	10
BDL-Autoscript	C8926	7
Beck Associates	SU8348	8

Beijing Phyllon Battery	C8232	7
Belden CDT Electronics	C2257	6
Bell Helicopter	C7926	7
Bella	SL2865	12
Bexel's Broadcast Video	C7319E	7
Beyerdynamic	C10421	7
BIAS	SL3345	13
Billboard Video	SL4070	13
Bird Electronic	N1116	5
BitCentral	SL1967	12
BITMICRO Networks	SL3660	12
Bittree	C6944	6
Blackmagic Design	SL4916	12
Blue Order	SL4255B	13
Blue Pony Digital,	SL3450	13
Bluetop Technology	C12425	7
Boeckeler Instruments	SL4631	13
Bogen	C6726	6
Boland Communications	C10435	7
Bomar Interconnect	SL3406	12
Boris FX	SL1210A, SL4045	11
BOXX Technologies	SL4427	13
Brainstorm Multimedia	C9332	7
Brick House Video	SU 9807	9
Brightline	SU 8667	9
Broadata Communications ...	C4148	6
Broadcast Asia	SL2066	12
Broadcast Engineering	SL740	12
Broadcast Engineering World ..	SL740	12
Broadcast International	SL3928	13
Broadcast Logic	SU11825	9
Broadcast Microwave Serv.	C1421	6
Broadcast Pix	SL5706	12
Broadcast Software	N2114	5
Broadcast Store	SU 6358	9
Broadcast Technology	SU 9317	9
Broadcast Tools	N1400	5
Broadcast Warehouse	N322	5
Broadcasters General Store ..	N3304	5
Broadview Software	C6217	6
Bron Kobold USA	C9641	7
Brother International	SU11819	9
BT Broadcast Services	C1453	6
BTX	C2657	6
Buena Software	SL760H	12
BUF Technology	C4546	6
Building4Media	SU8968	9
Burk Technology	N3602	5
BURLE INDUSTRIES	C3521	6
Burli Software	N2433	5
Burst Electronics	C8915	7

C

Cable AML	C6641	6
Cablecam International	C8944	7
Cabletime	SL3670	13
Calibre UK	SL3613	12
Calrad Electronics	C11442	7
Calrec Audio	N802	5
Calutech Mobile Solutions ..	MM129	14
Cam Systems	SU 9859	10
Cammate Systems	C10219	7
Camplex	SU10226	9
CamTram Systems	C12312	7
CANARE	C5134	6
Canon USA	SU7814	8
Canopus	SL325	11
Capital Networks	SL4125	13
Caption Colorado	SU10812	9
CaptionMax	SU8978	9
Carl Zeiss	SU6365	9
Carlton USA	C9719	7
Case Supplier	C1863	6

Cavena Image Products	SU9809	9	Daktronics	SL4922	12	EditShare	SL3445	13
Cavision Enterprises	SU8975	9	Dalet Digital Media	SL1953	12	Editware	SU11301	9
C-COR	SU11531	9	Da-Lite Screen Company	SL465	12	EEG Enterprises	C 7441	6
CDR Software	C11507	7	Dan Dugan Sound Design	N2532	5	Egatel	C12327	7
Celco	C1450	6	Darim Vision	SL5425	13	Equipnet U.S.A	C9216	7
Centurfax	C9332A	7	DASTO	N1526	5	ELBER	C1212	6
Century Optics	SU10329	9	Data Check	SL1264	12	Electronic Exporters Group	C11436	7
Chapman/Leonard Studio	DataDirect Networks	SL4212	12	Electronic Script Prompting	C10533	7
Equipment	SU 8800	8	DataPath	MM130	14	Electrosys	C11432	7
Chief Manufacturing	SL3625	13	Datavideo	SL3319	12	Electro-Voice	C6821	6
Chimera	C7611	6	Dataworld	N2422	5	Elenos	N2131	5
Christie Digital Systems	SL 360	12	DAVICOM/Comlab	N1100	5	Eltronika	N4218	5
Chyron	SU7158	9	DAWNco	C8141	7	ELTI	N3731	5
Ci Design	SL4649	13	Dax Solutions	SL4259A	13	EMC	SL3955	13
Cine Power International	C11646	7	Dayang International	SU9352	10	E-Mediavision.com	SL4531	13
CineBags	C11037	7	Dayport	SU9346	10	Empire State Filter Co.	C7308	6
Cineflex HiDef	C11421	7	DB Elettronica	N2138	5	EMR	N1000	5
Cinegy	SL4362	13	Decisionmark	SL4116	12	ENCO Systems	C3607B, N2826	6
Cinemills	C7931	6	Dedotec USA	C10721	7	Energy-Onix	N2527	5
Cinevation	C7034	6	Delta Digital Video	SL4253	13	E-N-G Mobile Systems	C8548	7
Cintel	C9226	7	DELTA MECCANICA	N3233	5	Enhance Technology	SL4010	12
Ciprico	SL3628	13	DELTACAST	SL5824	13	Ensemble Designs	SU10217	9
CIS Technology	SU9723G	9	Denon & Marantz Prof.	N313	5	Enterprise Electronics	C10044	7
Clarity Visual Systems	SL3328	13	DeSisti Lighting	C6817	6	EnviroCycle	SL5823	12
Clark Wire & Cable	C3331	6	DFH Global Solutions	SL2349	12	Envivio	SL3310	12
Clear Channel Satellite	C10049	7	DG Systems	C12441	7	Eonstreams	SL4450	13
Clear-Com	C7319A	6	DH Antennas	C12329	7	Equator Technologies	SL3062-MR	13
ClearStory Systems	SL4259C	13	Dialight	N3928	5	ERG Ventures	SU10134	9
Clockaudio	SU10254A	10	Dielectric Comm.	C 807	7	ERI-Electronics Research	N1306	5
Cmotion	C7614J	6	DiGico	N306	5	ESE	C2639	6
Coast to Coast Tower	C1211	6	DigiEffects	SL760J	12	ESSER TEST CHARTS	C7614a	6
Coast to Coast Tower	C11914	7	Digigram	N2428	5	ETL Systems	C11446	7
Coastal Satellite	C4643	6	Digital Anarchy	SL760A, SL1020	12	ETRI	SU9723B	9
Coaxial Dynamics	N2526	5	Digital Asset Mgmt	SL3955	13	Euphonia	N3606	5
Cobalt Digital	SU 8965	9	Digital Broadcast	C11709	7	Eutelsat	C7247	7
CodecSys	SL3928	13	Digital ERA	SL3652	13	EV Microphones	N3834	5
Coffey Sound	N4517	5	Digital Juice	SL447	12	Eventide	N502	5
Colem Communications	C10348	7	Digital Rapids	SL5331	13	Evertz	SU6433	8
Comet North America	N607	5	Digital Transaction Group	SU11231	9	EVS	C4534	6
Communications	Digital Vision	SL3649	13	Exanet	SL3957	13
Specialties	SL2268	12	Digital Voodoo	SL3357	13	Exavio	SL4634	13
Compix Media	SL2565	12	Disc Makers	SL3616	12	eyeheight	SU8501	8
Comprehensive Video	SL919	11	Discreet	SL1920	11	Eyeon Software	SL1126	11
Comprompter	SU10736	10	Display Devices	SL3667	12	EZ FX Jibs	C4144	6
Computer Prompt/Caption	C10233	7	DK Audio America	C2757	6	EZNews	SL3906	12
Comrex	N2118	5	DK Audio America	C3607C	6				
Comsearch	C4645	6	dMarc Broadcasting	N4005	5				
Comtech EF Data	C6941	6	DMT USA	C3016	6				
COM-TECH Srl RF Filters	N1834	5	DNF CONTROLS	SU8552	9				
Conax	SU 9646	10	Dolby Laboratories	SU7870	9				
Conoa	SL7601	12	Doremi Labs	C2342	6				
Control Concepts/Liebert	C1524	6	Dorough Electronics	C1833	6				
CONTROLWARE	SU 9944	10	DPA Microphones	N506	5				
Convergent Design	SL4032	13	DRAPER	SL3916	12				
Coptervision	C9729	7	DS Technologies	SU9938	10				
Countryman Associates	N1118	5	DSC Laboratories	C10119	7				
CPI	C2616	6	DSI RF Systems	C12022	7				
Crawford Communications	MM133	14	DTVinteractive	C1853	6				
Creative Network Design	SL1210E	11	DVB	SU11408	9				
Crispin	SU9717	9	DVC Digital Video Comp.	C7034	6				
Crown Broadcast	N722	5	DVEO/				
CRT, Custom Products	SL4653	13	Computer Modules	SU11119	9				
Cryptography Research	SL5822	12	DVS Digital Video Systems	SL1260	12				
Crystal Vision	SU6361	9	DynaScan Technology	SL3448	13				
CTE International SRL	N2834	5								
Cummins Power	C11343	7								
Curious Software	C9407	7								

D

D&C Electronics	N2424	5
D2 Software	SL1210J	11
D2net	SU9723D	9
Da Vi	C6207	6

E

e2v technologies	C3146	6
Eartec	C2643	6
Eastman Kodak Company	C6226	6
EBS	N500	5
Echolab	C4915	6
Econco	N1811	5
Edirol	SL4926	13

F

Facilis Technology	SL4446	13
Fairlight	SL340	12
Fast Forward Video	C3253	6
FastChannel Network	C12014	7
FCC	N3226	5
Fiber Systems International	C11035	7
FilmLight	SL2625	11
Final Draft	SL3663	12
Fischer Connectors	SU11812	9
Fission Software	C9807	7
Flir Systems	SU9469	10
Floral Systems	SU10000	9
Flow-Line
Communications	SU10254B	10
Fluke	C11814	7
Focus	SL 505	11
Focus	SL4255E	13
Focus Optics	SU8977	9
FOR-A	C4519	6
Forecast Consoles	SU7131	8
Fortel DTV	SU10463	10
FOXCOM	C6648	6
Fresh Interactive Tec's	SU 8974	9
Frezza Energy Systems	SU10718	9
Front Porch Digital	SU11036	10
Frontline Communications	C8835	7

Map index

Color indicates advertiser.

Fu Hou / FH Video	SU9707	9
Fuji Photo Film U.S.A.	SU6370A	9
Fuji Television Network	C10207	7
Fujinon	SU6370	9

G

Gamma & Density	SL760D	12
GCS	C7144	6
GDC Technology	SL5600	12
Gecko-Cam	C7614F	6
Gee Broadcast	SU10254G	10
Gefen	SL501	11
GenArts	SL760C, SL1210P	12
Gencom Technology	SU11801	9
Genelec	N1726, SL1143	5
General Dynamics	MM222	14
Geneva Aviation	C11421	7
Gennum	C8514	7
Gepco	C9341	7
Gerling & Assoc.	C6734, MM100	6
GigaSat	MM120	14
Glidecam Industries	C8929	7
Global Communications	C6346	6
Global Media Resource	C2750	6
Global Microwave Systems ..	C1221	6
Global Security Systems	N427	5
Global Society	SL4555F	13
Globalstor Data	SU9363	10
GlobalStreams	SU10360	10
GlobeCast	C2129	6
Globecomm Systems	C9048	7
Globix	SL4259J	13
GLOBO Electronic	C 7614d	6
GlowPoint	C 8143	7
GMPCS Personal Comm.	C 2944	6
G-Technology	SL4060	13

H

Hamilton Metalcraft	C1739	6
Hamlet	C7031	6
Hannay Reels	C11714	7
Hardigg Cases	SL 357	12
Harmonic	SU10707	9
Harris	C1907	6
Harris	C3607A	6
Harris	SU10048	10
Harrison By GLW	N2418	5
Hash	C12317	7

Hauppauge Computer	C5847	6
Helissio Technologies	SL3937	13
Heliuss	SL4570	13
Henry Engineering	N1300	5
Herman Electronics	SU9814	9
Hewlett Packard	SL1961	12
HHB Communications	N2822A	5
Hi Tech Systems	SU9711	9
Hibino	SL4441	13
High Tech Industries	SU6631	8
Hilomast USA	C9944	7
Hitachi Denshi America	C5119	6
Hi-Tech Enterprises	SU8600	8
HLW Architects/Engr.	SU11015	9
Honeywell Obstruction		
Lighting	N3318	5
Hoodman	C2650	6
HORITA	C10120	7
Hosa Technology	SL256	12
Hotronic	C9015	7
Huge Systems	SL3628	13
Hybrid	SL5818	12

I

IABM	C1405	6
iBASE-Technoland	N428	5
IBC	C1605	6
IBIS	SU10332	9
IBM	SU7049	8
ICF- Interactive Content ...	SL2461	12
Iconix	C7314	6
iDirect	C6348	6
IDV Global Media	SL4901	12
IDX System Technology	C3036	6
IGP	MM235	14
Ikegami Electronics	C5426	6
ILC	SU9307	9
Illbruck/SONEX	N1600	5
ILY Enterprise	SL3408	12
Image Video	SU7077	9
Imagica of America	SL4234	13
Imagineer Systems	SL 253	12
IMP Electronics	C10349	7
Impact Cases	C11143, C12330	7
IMT RF Products	N429	5
Independent Audio	N4522	5
Industrial Acoustics	N2524	5
Industry Advanced Tech	C1939	6
Ineoquest Technologies	SL4270	13
Inlet Technologies	SL5829	13

Innovision Optics	SU8661	9
Inovonics	N1818	5
Inscriber	SU8100	8
Integrity Data Systems	SL3936	13
Intel	SL1210M	11
Intellect	SU10254D	10
Intelsat	C5241	6
International Datacasting	C6637	6
Invidex	C3259	6
IPV	SU11501	9
iQstor Networks	SL3961	13
Irdeto Access	SU8365	9
Isilon Systems	SL4063	13
ISIS Group	C1836	6
I-STAR USA	SL3762	13
Iwedia Technologies	SU10362	10

J

J A Taylor & Associates	MM232	14
J.L. Fisher	C6847	6
Jadoo Power Systems	C10135	7
Jampro Antennas/RF Sys	C2316	6
Jennings Technology	N400	5
JK Audio	N3926	5
J-LAB Co. (THE)	C4641	6
JLCooper Electronics	SU11526	9
Joseph Electronics	C6248	6
Junger Audio Studiotechnik ..	N919	5
Juniper Networks	SL4550	13
Jupiter Systems	SL4568	13
Just Edit	SL3341	13
JVC Professional Products ...	C4526	6

K

K2E	SU11815	9
K5600	C10241	7
KAE	C10719	7
Kathrein, Scala Division	C8538	7
Kathrein-Werke	C8538a	7
Kay Industries	N1700	5
KD Kanopy	N2426	5
KDDI R&D Laboratories	SL3622	12
KenCast	C8545	7
Kenwood Communications ..	C12141	7
Keyhole	SL3348	13
Keywest Technology	C9337	7
Kings Electronics	C8131	7
Kino Flo	C10437	7

See **IDX** at Booth C3036, page 6

I·D·

The next generation
ENDURA System is here.



Unmatched Power

Longest Run Times

Unparalleled Technology

Endura
SYSTEM

See the most advanced power
solution at booth# C3036



www.idx.tv

Kinoton	C7034	6
Kintronics Labs	N1707	5
Klotz Digital Audio Systems ..	N2807	5
KLZ Innovations	N317	5
Knox Video	SL923	11
Ko Yong Photo	C3144	6
Konan Digital	SL3919	12
Kramer Electronics	SL856	12
KROMA TELECOM	C3239	6
KTech	SU9667	10
Kupo Company	C11349	7
KW/2 Lighting Products	C10819	7
K-WILL	C8941	7

L

L.T.M. of America	C7311	6
L-3 Electron Devices	C8507	7
LaCie	SL4452	13
Laird	SL1243	12
Lamar Systems	SL4100	12
Lamont, Hanley & Assoc.	C1232	6
LARCAN USA	C5620	6
Lasergraphics	C11449	7
Lawo	N816	5
LEA International	C1563	6
Leader Instruments	C3150	6
Lectrosonics	N3611	5
Lee Filters	C12314	7
Leightronix	SU11223	9
Leitch	SU7805	8
Leitch	SU8705	8
Lemo USA	C7831	6
LG Electronics	SU9723H	9
LIBEC USA	C11346	7
Liberty Wire & Cable	SL3362	13
Lightning Eliminators	C7834	6
LightTech Group	SU9943	10
Lightworks	SU10254H	10
Ligos	SU9632	10
LINEAR	N302	5
Linear Acoustic	C3607F	6
Linear Equipamentos	C11216	7
Link Electronics	C1816	6
Link Research	C11837	7
Listec Video	C6237	6
Litepanels	C12237	7
LNS Captioning	SU11628	9
Location Sound	N3917	5
Logic Innovations	C9947	7
Logic Keyboard/BSP	SL2471	12

Logitek Electronic Systems ..	N2022	5
Logus Microwave	C7846	6
Loral Skynet	C10644	7
Lowel-Light Mfg.	C8526	7
LSI Logic	SU10036	10
Lynda.com	SL4637	13
Lynx Technik	SU8972	9

M

M&I Network	SU10363	10
Mackay Communications	C7148	6
Mackie	SL254	12
Macromedia	SL4048	13
MaestroVision	SU9638	10
Mager Systems	N1231	5
Magma	SL3612	12
Magni Systems	SU9349	10
Magnum Towers	N1911	5
Manzanita Systems	C10222	7
Maoncept	SL3065-MR	13
Maoncept	SL4536	13
Marketron International	C6731	6
Marshall Electronics	SL 913	11
Martin & Ziegler	SL2671	12
Masstech Group	SU10236	10
Masterclock	C1430	6
MATCO	SL2568	12
Matrox Electronic Systems ..	SL1131	11
Mathews Studio Equip.	C10735	7
Maxell Corporation	C8530	7
Maximum Throughput	SL5712	12
Medea	SL3360	13
Media 3	C7149	6
Media Concepts	SU9323	9
Media Excel	SL5826	13
Medialinks Systems	C11424	7
Medialocate USA	C11136	7
Mediaplex Systems	SL4263	13
Mediaproxy	SU11801	9
Medical Coaches	MM229	14
Melenium Crane Systems ..	C10448	7
Memory Link	SU10038	10
Merging Technologies	N4225	5
Metaglue	SL12101	11
MGE UPS Systems	C10521	7
Micro Comm. (MCI)	C7736	6
Microboards Technology	SL2753	12
Microdolly Hollywood	C10833	7
MicroFirst	SU9643	10
Microsearch	SL3772	13
Microsoft Digital Theater	SL332	11

Microspace Comm.	C12046	7
Microwave & RF Resources ..	C1239	6
Micro-wave Radio Comm. ...	C3007	6
Microwave Service	C1539	6
Middle Atlantic Products ..	SL3606	12
Middle East Broadcasters ..	C12322	7
Mikrom	C7614e	6
Milestek	SL4647	13
Miller Camera Support	C6937	6
Mindspeed Technologies	C10714	7
Miranda Technologies	SU7841	8
Mirror Image Teleprompters ..	C2347	6
Miteq/MCL	C6546	6
Mitsubishi Electric	SL1267	12
Mitsutec	C12416	7
Mobile Desktop Solutions ...	SL4353	13
Mobile Power	MM126	14
Modular Components	N2533	5
Modulation Sciences	C1223	6
Modulus Video	C11416	7
MOG Solutions	SU11627	9
Mohawk	SU11629	9
Mole-Richardson	C3021	6
Monitors and More	SU7331	8
Morrow Technologies	C11649	7
Moseley Associates	N2306	5
Motion Analysis	SL2749	12
Motorola	SU7133	8
MOTU	SL5328	13
Movie Engineering	SU8661	9
Movie Tech AG	C7614i	6
MPEG Industry Forum	SL5310	12
MSoft	C1860	6
MTI Film	SL3912	12
Multidyne Video & F.O. Sys. ..	C2850	6
Myat	C1407	6
MyWeather	C10214A	7

N

N Systems	C4841	6
NAB	SL1011	11
NAB	SU6431	8
Nada-Chair	C8914	7
NAGRA	N515	5
NAGRAVISION -		
Kudelski Group	SU10701	9
Nalpak	C9437	7
Narda Satellite Networks	C5941	6
NATEXPO	C11214	7
National Captioning Inst. ...	SU10045	10

See **IDX** at Booth C3036, page 6



Light
Efficient
Durable

I·D·
The new
X3-Lite

See the revolutionary On-board
LED Camera light at booth# C3036

Another **BRIGHT** idea from **IDX!**

www.idx.tv

Map index

Color indicates advertiser.

National		
Semiconductor	C12704-MR	7
National Weather Service	N311	5
Nautel	N2811	5
ND Satcom	C11046	7
Nebtek	C1444	6
Nelson Case	SL3965	13
Nemal Electronics	C1844	6
NEP	MM108	14
Nero	SL2068	12
NES Communication Serv.	C1424	6
Net Insight	C2153	6
NETIA	N3622	5
Network Electronics	SU9311	9
Neutrik	C5137	6
New Wave Technologies	SL3960	13
Newpoint Technologies	C9447	7
Newsroom Solutions	C12019	7
Newtec America	C9344	7
NewTek	SL1949	12
Nexsan Technologies	SL3672	13
Nexstar	C12112	7
Nexstar	SL3935	13
NEXTAMP	SU9954	10
Nicom	N425	5
NIXUS	SL1216	11
NKK Switches	SL2454	12
NL Technology	SL1210F	11
nNovia	SL3759	13
Noren Products	SL3618	12
Norpak	C2350	6
Norsat	C7848	6

North Plain Systems	SL4555E	13
Novella SatComs	C10248	7
NPR Satellite Services	C5944	6
NTT	SL4206	12
NTT Electronics	SL4206	12
Nucoda (Digital Vision)	SL3649	13
Nucomm	C1416	6
NVerzion	C8541	7
Nvidia	SL5501	12
NVISION	SU 9301	9

O

Ocean Systems	SL1210G	11
OMB Sistemas Electronicos	N3433	5
Omneon Video Networks	SU10724	9
Omnia	N2816A	5
OmniBus Systems	SU 7165	9
Omnirax	N1800	5
Omnitek	SU9714	9
ON-AIR Systems	SL5710	12
One Domain	C3612A	6
ONTIMETEK	SU9723C	9
Optec Displays	SL3352	13
Optex	SU10254E	10
Optibase	SL343	12
Opticomm	SU10460	10
Optimal Solutions	C10707	7
Opvision Technology	SU11017	9
Orad Hi-Tec Systems	SU7170	9
ORBAN/CRL	N813	5
Orbital Data	SL1210T	11

Otari	N4511	5
Overly Door Company	N4507	5

P

P+S TECHNIK	C7034	6
P+S Technik	C7614h	6
PACSAT	C10042	7
PAG USA	C9719	7
Paladin Tools	SU11826	9
PanAmSat	C2123	6
PanAmSat	MM136	14
Panasonic Broadcast	C3617	6
Pandora	C1446	6
Paradise Datacom	C11444	7
Patchamp	C4146	6
Path 1 Network Tech.	C11419	7
Pathfire	SL1353	12
Patriot Antenna Sys.	C5843, MM219	6
Pebble Beach Systems	SU9343	10
Pelican Products	SL3970	13
Penny & Giles Controls	SL365	12
Personal Telecom	SU9723E	9
PESA Switching Sys.	SU7852	9
Peter Storer & Associates	C6312	6
Petrol	SU6365	9
Pharos Communications	SU11835	10
Phasetek	N602	5
Photoflex	C12429	7
Photron USA	SL1145	12
Pictron	SL1210C	11

See SAV at Booth SU11117, page 9

Master Control Tools SWITCHING & BRANDING

Audio
Video
Switcher



- > 8 SDI inputs expandable to 16
- > 8x2 AES/EBU inputs expandable
- > Embedders & de-embedders
- > Logo, text & clock insertion
- > 2 to 4 DSKs
- > Voices-over
- > DVE



Logo
Text
Clock

NAB 2005 - Booth # SU11117

www.sav.tv



Pilat Media	SL5306	12
PilotWare Systems	SL3760	13
Pineapple Technology	N315	5
PIN-MIC	N4313	5
Pinnacle Systems	SU6341	8
Pioneer Electronics	C8136	7
Pixel Instruments	SU8953	9
Pixel Power	SU7132	8
Pixelmetrix	C7316	6
PixelTools	SL2453	12
PLAYBOX Digital	SL4255D	13
Pleora Technologies	SL3350	13
Plug In Pavilion	SL1019	11
Pomona Electronics	C11814	7
Porta Brace	C7334	6
Porta-Jib/Hollywood	C12319	7
Post Holes	SL400	11
Precision Communications ...	C7507	6
Premier Mounts	SL4231	13
Preton Case West	SL1464	12
Prime Image	C5614	6
Primedia Business	SL740	12
PrimeLED	N604	5
Primeria	SL4267	13
Prism Media Prod.	N1813, N2412	5
Pristine Systems	N1111	5
Pro Consultant Infor.	SL4419	12
Pro8mm	C12417	7
Pro-Bel	SU10730	9
ProMax Systems	SL405	11
Prompter People	C9716	7
Propagation Systems	C9229	7
ProPrompter	SU8502	8
Prowave Technology	SL4449	13
Proximity	SL4562	13
PSNI	Mtng Rm S225	15
PSSI Global Services	MM204	14

Q

QEI	N2831	5
Qlogic	SL3634	13
QTV	SU7865A	9
Qualstar	SL3355	13
Quantel	SL1147	12
Quartz Electronics	SU9652	10
Quest Research & Dev.	C11414	7
Quickset International	C3529	6
Quintech Electronics	C9348	7
QuVIS	SL4416	12
QVS	SL3500	13

R

Radian Communication Serv.	C3028	6
Radiant Communications ...	SL3719	12
Radio Frequency Systems ...	C3031	6
Radyne	SU9929	9
RAIDON Technology	SL4033	13
Rapidtext	C3344	6
RCS	N1411	5
Real Image Media Tech.	SU9968	10
RealVision	SL4265	13
Realviz	SL4065	13
Red Giant Software	SL760F	12
Renegade Labs	SU11817	9
Rentex	SL3931	13
RES Media Group	SL3932	13
Research Concepts	C9347	7
RF Central	C1432	6
RF Parts	N619	5
RF Technologies	C3523	6
RGB Spectrum	SL1565	12

Rhozet	SL2067	12
Richardson Electronics	C1824	6
Richard Towers	C2627	6
Riedel Communications ..	C11107	7
Rimage	SL5416	12
RIZ - Transmitters	N304	5
Rohde & Schwarz	C2633	6
Rohn Products	C3028	6
Rololight	C7307	6
Ross Video	SU7141	8
R-Quest Technologies	SL4035	13
RSG Media Systems	SL4255A	13
RTI-Research Tech. Int.	C3951	6
RTS	C6821	6
RUSHWORKS	SU9549	10
Russ Bassett	SU9708	9
RVR Elettronica	N1102	5
Rycote Mic. Windshields	N3232	5
RYMSA	C7736A	6

S

S.two	SL3325	13
S.W.R.	C1820	6
Sabre Towers	N308	5
Sachtler	C7319B	6
Saft America	C11509	7
Sam Woo Electronics	N4516	5
Samsung Electronics	SU9723F	9
Samtel Electron Devices	C11412	7
Samy's Camera	C7207	6
Sanken Microphones/plus24 ..	N617	5
Sanyo Fisher Company	SL1931	11
Sarnoff	SL3056-MR	13
Satellite & Business Tech.	C7447	6
Satellite Engineering Group ..	C7248	6
Satvision Technology Int'l	C1231	6
SAV Systemes	SU11117	9
SBS Technologies	SU8959	9
Scatter TV	C12324	7
ScheduAll Software	SL767	12
Schill	C1233	6
Schneider Optics	SU10329	9
Schoeps Microphones	N3231	5
Scientific-Atlanta	SU7848	8
Scopus Network Tech.	SU8470	9
ScoreBox	SU11115	9
Screen Service Broad.	N3922	5
Screen Subtitling Systems	SU8956	9
SeaChange International	SU6557	9
Secuencia Pixels	SU8951	9
Sencore	C7331	6
Sencore	SU10006	9
Sennheiser Electronic	N2822	5
Seratel Technology	N1831	5
Serious Magic	SL4910	12
Server Technology	SL1010	11
SES Americom	C5245	6
SGI (Silicon Graphics)	SL1943	12
SGT	SL3367-MR	13
Shaxon Industries	C11044	7
Shining Technology	SU10040	10
Shively Labs	N2007	5
Shook Mobile Technology ...	MM214	14
Shotoku Broadcast Systems	C10641	7
Shure	N3206	5
Siemens	SU8541	8
Sierra Automated Systems & Eng.	N806	5
Sierra Video Systems	SL854	12
Sigma Electronics	SU10345	10
SIGNUM Bildtechnik	C7614C	6
Silhouette FX	SL1024	11

Silicon Color	SL3665	12
SintecMedia	SL5419	12
SIRA	C8538b	7
SKB/Cases by Source	SL2868	12
Sky Micro	SL3761	13
Skyline Communications/ Tek-Pacific	SU7031	8
SkyLite Communications	C10047	7
SkyStream Networks	SL2756	12
SLIK BROADCAST	C10648	7
SLS Loudspeakers	N4002	5
Smart AV	N3135	5
SMART Technologies	SL4423	13
SmartDisk	SL5828	13
Smartsound Software	C2961	6
Smartsound Software	SL710	11
Snell & Wilcox	SU6349	8
Softel-USA	SU10341	10
Softier	SL4068	13
SoftNI	SL1210B	11
SoftNI	SU8960	9
Solid State Logic	N3211	5
Sonic Solutions	SL 308	11
Sonifex	C3526	6
Sony Australia	Mtng Rm S205	10
Sony Brazil	Mtng Rm S217	10
Sony Electronics	SU6406	8
Sony Hong Kong	Mtng Rm S227	15
Sophia Wireless	C3525	6
Sorenson Media	SL1210H	11
SOS Global Express	C11441	7
Sound Devices	N4212	5
Soundminer	SL3347	13
SpectSoft	SL3661	12
Speedsix Software	SL1564	12
Spencer Technologies	SU9356	10
SPG Media	C11038	7
Spider Support Systems	C8911	7
Spinner	C7614b	6
Spirent Communications ...	SL4646	13
SRS Labs	N2026	5
Staco Energy Products Company	C1207	6
STAGETEC (Salzbrenner Stagetec Mediagroup)	N4208	5
Stainless	C1411	6
Standard Comm.	SU8665	9
Statmon Technologies	C11404	7
STE-MAN	C9719	7
StorageTek	SL4632	13
Stradis	SU9338	10
Strand Lighting	C3033	6
Stratos	C11809	7
Stratos International	SU10323	9
Streambox	SL3655	13
Streamer Networks	MM139	14
Streamtel	SU11226	9
Studer Soundcraft	N3626	5
Studio Network Solutions ...	SL3331	13
Sun Microsystems	SL5234	13
Sundance Digital	SU10011	9
Sunray Manufacturing	C11407	7
SuperCircuits	C12136	7
Superior Broadcast	C1218	6
Superior Electric	N608	5
Sure Shot Transmissions	C5841	6
Surface Heating Systems ...	C10249	7
SWE-DISH Satellite Syst. ...	MM116	14
SWIT Electronics	C1339	6
Switchcraft	C2339	6
Switronix	C11401	7
Symetrix	N4006	5
Synergy Broadcast Syst.	SL764	12

Right: See Terayon at Booth SU11316, page 9 | Back cover: See Thomson/GrassValley at Booths SU7823 and SU8434, page 8

SyntheSys Research SU10132 9
 Synthetic Aperture SL760D 12
Systems Wireless C7319D 7
 Systor Systems SL711 11

T

TAMUZ - LCD Video SU11801 9
 Tandberg Television SU7858 9
 TASCAM SL1516 12
TBC Consoles SU6831 8
 TC Electronics C3607G 6
 TDK Electronics SU9636 9
 Tec Nec Distributors C2042 6
 Tech Imaging Services SU11818 9
 Tech-ex Dot Com SU10032 9
 Techflex C2041 6
 Technical Innovation C3647A 6
 Techni-Tool C9530 7
 Techno System N4227 5
 Technocrane C8510 7
 Technology Exchange SU10032 9
 Technosteria C12316 7
 Tecnovision SL3716 12
 TEDIAL SL1210N 11
 Tekstil Industries C8916 7
 Tektronix C6231 6
Telecast Fiber Systems SU8375 9
 Teledyne MEC C1437 6
 Telefunken N434 5
Telemetry C7337 6
 Telesat C9647 7
 Telescript C8932 7
 Teletream SU11404 9
 Teletest C11042 7
 Televue SU11823 9
 Television Engineering Corp. C6241 6
 Telex Communications C6821 6
 Telos Systems C3607D 6
 Telos Systems N2816 5
 Tentel C4143 6
 Teracom Components C3333 6
 Teranex C12024 7
Terayon SU11316 9
 Texas Instruments SL3058-MR 13
 Texas Instruments SL3060-MR 13
 Texas Instruments SL3845 13
Thales-Angenieux C5107 6
Thales Broadcast C4508 6
 Thales Components C5607 6
 The Eizo Shimbun C11137 7
 The Electronic Farm SL4447 13
 The Tiffen Company SU7876 9
 Thermo Bond Buildings N2136 5
 Thermodyne International .. SU7155 9
Thomson Grass Valley SU7823 8
Thomson Grass Valley SU8434 8
 Tieline Technology N517 5
 Tiernan SU9929 9
 TM Systems SU10367 10
 Tokina Company C10733 7
 Toner Cable Equipment C7944 6
 Tools for Stagecraft C1425 6
 Torpey Time SU9811 9
 Toshiba C6713 6
 Tote Vision C11341 7
 Tower Engineering N3436 5
 Towerline Software N516 5
 Trans Media SL4906 12
 Transmedia Dynamics SU10254I 10
 TRANSMEDIA C10821 7
 Trapcode SL760G 12
 Triangle Software C1225 6

Trilogy Broadcast C11722 7
Triveni Digital SU11411 9
 Troll Systems C1427 6
 Trompeter Electronics SU10323 9
 TRON-Tek C1544 6
 TSL (Television Systems) .. SU9656 10
 T-Systems International C2133 6
 Tut Systems SU9956 10
 TV Logic SU9723A 9
 TV One Broadcast Sales C1846 6
 TWR Lighting N2431 5

U

U.S. Helicopters SU10067 10
 UAL - Moore Wallace C2744 6
 Ultimatte SL1443 12
 UNIMAR N2512 5
 UNI-SET C3339 6
 United States Broadcast MM209 14
 United States Broadcast MM210 14
 Unitek Pasadena SL3910 12
 US Concepts C10710 7
Utah Scientific C 610 6
 Utility Tower Company N2522 5

V

Vaddio SU11829 9
 Vantage Point SL4128 13
 Varizoom Lens Control C4543 6
 VBrick Systems SL3070-MR 13
 VBrick Systems SL4931 13
 VCI (Video Communications) C6312 6
 VCom SU11834 9
 VDOsys SU11116 9
 VDS SL5300 12
 VectorMAX SL4122 12
 Veetronix SU10713 9
 VELA SL4401 12
 Venaca SL3636 13
 Venue Services Group C9634 7
 Verizon Wireless SU11830 9
VertigoXmedia SL2620 11
 VFGadgets.com C2163 6
 ViACCESS SA SU9332 9
 VidCAD Documentation Programs C9826 7
 Video Accessory Corporation SL500 11
 Video Products Group SU9669 10
Video Technics C3647 6
 VideoBank SL3335 13
 VideoCodes C2363 6
 Videoframe SU11806 9
 VideoHelper C2851 6
 VideoHelper SL557 12
 Videokey SL4041 13
 Videomagnetics SU10711 9
 Videoquip Research C1535 6
Videssence C10519 7
 Viewcast SL4572 13
 Vin Power SL3619 12
 Vinten C7319F 7
 Virage SL4934 13
 Virtual Katy SL1210D 11
 Vision Effects SL760E 12
 Visionary Solutions SL4533 13
 Vislink Communications C3007A 6
 Vista Systems SL3401 12
 Vistek Electronics SU7376 9
 Visual Data Media Services SU9550 10

VitalStream SL1023 11
 Vitec Multimedia SL3306 12
 VIZRT SL1137 12
 Vmatte SL3407 12
 Vocas C10137 7
 Vodium SL3758 13
 Voice Factor SL4650 13
 Volicon C11707 7
Vqual SL4535 13
 V-SOFT Communications N508 5
 Vyvx C11719 7

W

W&W Communications SU10039 10
 Wacom Technology SL3610 12
 Wagner Media SL5100 12
 Walters-Storyk Design SL456 12
 WAMNET SL4259I 13
 Ward-Beck Systems C1924 6
 Wavestream C10048 7
 WC Interactive C10214 7
 Weather Central C10214 7
 Weather Metrics C10419 7
 WeatherData C11409 7
 Wegener Communications ... C2624 6
 Westcott (F.J. Westcott Co.) SU11019 9
Wheatstone N2802 5
 Whirlwind C7841 6
 WhisperRoom SL3712 12
 White Sands Engr. N3536 5
 Will-Burt C7141 6
 Winsted SU7455 9
 Wire-Cable C1839 6
 WireCAD C8231 7
 Wireready N700 5
 Wireworks C4541 6
 Wohler Technologies C6221 6
 Wolf Coach C4845 6
 wondertouch SL453 12
 World Video Group C12138 7
 WSI C9211 7
 WYNIT SL4236 13
 Wysong Enterprises C1663 6

X

XenData SL4259F 13
 Xicom Technology C8148 7
 Xilinx Mtng Rm S201 10
 Xtore SL911 11
 Xytech Systems C2260 6

Y

Yamaha N2531 5
 Yang Ming International SL4370 13
 YEM SU8658 9
 Yingda Electronics C11510 7
 Y-Vamp SU11811 9

Z

Z Technology C3139 6
Zandar Technologies SU8367 9
 Zaxcom N4215 5
 Zaxel Systems SL964 11
 Zaxwerks SL811 11
 Zero Manufacturing C2663 6
 ZGC C7034 6
 Zinwell Digitalmedia SL4252 13

Color indicates advertiser.

evolve.



think video. think Terayon.

Digital video changes everything - how we brand, communicate, entertain and inform. Terayon accelerates your ability to evolve and capitalize on new business opportunities brought on by this digital revolution. Terayon enables you to deliver picture perfect results where it matters most - on the screen and on your bottom line.

TERAYON

www.terayon.com • info@terayon.com

evolve faster.

See Terayon at NAB 2005, South Hall #11316

It's all about **Workflows**



AFFORDABILITY THROUGH INNOVATION

So are we.

Whether it's repurposing content, launching new distribution channels or transmission topologies, or creating entirely new kinds of content, at Thomson we're focused on helping you maximize the return on your digital content investments.

We can make your workflows work better.

No company touches more points of today's digital media workflows—or has more experience integrating them—than Thomson. That's why we can make yours as efficient as possible.

Best of all, this approach lets you accommodate new Grass Valley devices—or those from third parties—and integrate off-the-shelf hardware and software to drive down your costs while supporting your high-quality and critical-uptime requirements.

To learn more, please visit www.thomsongrassvalley.com. Or contact your local Grass Valley sales representative.

FASTtrack

The quickest way through the jungle of NAB!



With more than 1400 exhibitors to see in just four days, how about a little help finding the shortest route between two points?

Once again, *Broadcast Engineering* is offering two tracking options that will ensure you see what you want to see, as well as save your feet. The first is our exhibitor map, which includes a floor plan of the main meeting rooms and the mobile media exhibits between the Central and South Halls. All advertisers are highlighted in the map index, and map advertisers have the added advantage of being highlighted on the map to help attendees locate their booths.

The second tracking option is our FASTtrack section. Simply find what you're looking for in our category list below. Then go to the indicated page, where you'll find a listing of the companies showing that product. For your

added convenience, the exhibitors' booth numbers are listed in geographic order. Therefore, scouring the show floor for a particular piece of equipment will be as efficient as possible. Issue advertisers are highlighted in orange in the FASTtrack section. Listings are based on information provided to *Broadcast Engineering* by manufacturers. Booth numbers are provided by NAB and are current as of our press deadline.

For additional copies of our NAB map, please visit the *Broadcast Engineering* booth in the South Hall, lower level, SL74D. Happy hunting, and we'll see you at the show! **BE**

C = Central Hall; N = North Hall; MM = Mobile Media; SL = South Hall, Lower Level; SU = South Hall, Upper Level

Table of Contents

Audio accessories	130	Microwave, fiber optic, telco equipment	138
Audio mixers, on-air, portable, studio, playback	130	New media, streaming products, multimedia/Internet	138
Audio recording, storage, playback	130	Power products, batteries, generators	138
Audio routing, distribution	132	Production switchers, video effects, keyers	139
Automation, including news and master control	132	Recording media	139
Cable TV equipment	134	Satellite equipment, services	140
Camera support, robotics, virtual sets	134	Studio, facility support products	140
Cameras, lenses, accessories	134	TBCs, frame syncs, conversion equipment	140
CGs, prompters, captioning	135	Test and measurement equipment	142
Consulting services, technical engineering	135	TV transmitters, feedline, antennas, towers, services	142
Film equipment, duplication, distribution equipment	136	Video editing systems	143
Graphics, animation products	136	Video routing	143
Intercom, IFB products	136	Video storage	144
Lighting equipment	136	Weather/data services	144
Microphones, accessories	136	Wire, cable, connectors	144

AUDIO ACCESSORIES

ISIS Group.....	C1836
MSoft.....	C1860
Ward-Beck Systems.....	C1924
Doremi Labs	C2342
ESE	C2639
Sonifex	C3526
ENCO Systems	C3607B, N2826
DK-Technologies	C3607C,C2757
Linear Acoustic	C3607F
Audio Accessories	C3651
Wireworks	C4541
Allen Osborne Assoc.....	C5845
Wohler Technologies	C6221
Anixter	C6643
Hamlet.....	C7031
Systems Wireless	C7319D
Bexel's Broadcast Video Gear (BVG)	C7319E
Whirlwind	C7841
HORITA	C10120
Riedel Communications	C11107
Hannay Reels	C11714
Wheatstone.....	N2802
Acoustic Systems	N4311
DPA Microphones	N506
Lawo.....	N816
Mager Systems.....	N1231
Henry Engineering	N1300
RCS	N1411
Genelec	N1726, SL1143
Logitek Electronic Systems	N2022
Sennheiser Electronic	N2822
Audio-Technica U.S.	N3322
Lectrosonics	N3611
Location Sound.....	N3917
JK Audio	N3926
Symetrix	N4006
Sound Devices	N4212
Zaxcom	N4215
Independent Audio	N4522
Gefen	SL501
Kramer Electronics	SL856
Comprehensive Video Group	SL919
TASCAM	SL1516
Adrienne Electronics.....	SL1965
WhisperRoom.....	SL3712
Exanet	SL3957
Band Pro Film & Digital	SU6365
Thermodyne International	SU7155
Leitch	SU7805, SU8705
Dolby Laboratories	SU7870
Zandar Technologies	SU8367
Herman Electronics	SU9814
Sigma Electronics	SU10345
Acoustical Solutions.....	SU10714

Allen Avionics	SU10715
Chief Manufacturing	SL3625

AUDIO MIXERS, ON-AIR, PORTABLE, STUDIO, PLAYBACK

ISIS Group.....	C1836
Ward-Beck Systems.....	C1924
Doremi Labs	C2342
Telos Systems.....	C3607D, N2816
Burst Electronics	C8915
Wheatstone	N2802
Calrec Audio	N802
Aphex Systems.....	N1815
Prism Media Products	N2412, N1813
Harrison By GLW	N2418
Klotz Digital Audio Systems	N2807
Euphonix	N3606
Studer Soundcraft	N3626
STAGETEC (Salzbrenner Stagetec Mediagroup) ...	N4208
Azden	N4222
Mackie	SL 254
TASCAM	SL1516
Sony Electronics	SU6406
Dolby Laboratories	SU7870
Pixel Instruments	SU8953
Sonifex	C3526
Whirlwind	C7841
Logitek Electronic Systems	N2022
Sennheiser Electronic	N2822
Location Sound.....	N3917
Sound Devices	N4212
Independent Audio	N4522
Herman Electronics	SU9814

AUDIO RECORDING, STORAGE, PLAYBACK

Doremi Labs	C2342
ENCO Systems	C3607B, N2826
Audio-Technica U.S.	N3322
Zaxcom.....	N4215
Alcorn McBride	SL366
TASCAM	SL1516
Digital Vision	SL3649
Exanet.....	SL3957
Sony Electronics	SU6406
Dolby Laboratories	SU7870
DNF CONTROLS	SU8552
NAGRAVISION - Kudelski Group	SU10701
Omneon Video Networks	SU10724
Pharos Communications.	SU11835
MSoft	C1860
Sonifex	C3526



Highlight indicates advertiser

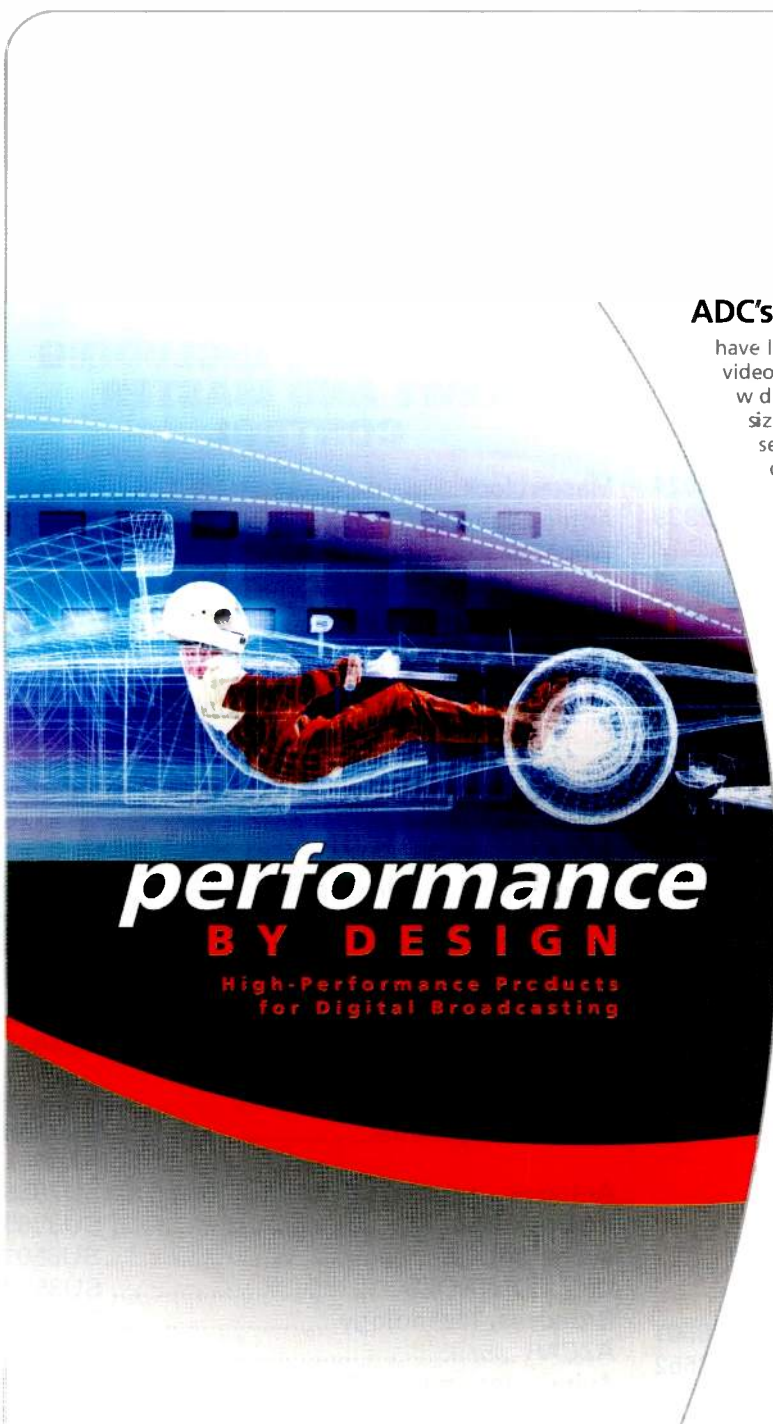

performance BY DESIGN

High-Performance Products
for Digital Broadcasting

ADC's Pro Patch™ video panels

have long been recognized as the leader in video patching. Panels are available in a wide variety of configurations for rack sizes, jack types, and color options. The PPI series panels are the ideal choice for demanding professional environments:

- Durable welded-steel frames prevent bent, cracked and broken ears
- Widest variety of jack types available including standard, midsize, and MUSA standard
- Exclusive snap-over designations keep cards and windows in place and make changes easier
- Durable molded ABS inserts prevent stripped screws and cracked inserts

Whether it's copper or fiber, ADC's audio, video and data products are built to provide unmatched performance and reliability, and all ADC products are backed by outstanding pre/post-sale engineering support as well as the industry's best warranty.

Contact us today and find out why ADC means "performance by design."



2x32 Midsize PPI Series Super Video Jack Panel

Call today for fast delivery!

For a free copy of ADC's 13th edition broadcast product catalog, call 1.800.366.3891 ext. 20000. Or visit adc.com/broadcast.

Learn more at NAB booth #C4515





Henry Engineering	N1300
RCS	N1411
Aphex Systems	N1815
Euphonix	N3606
Location Sound	N3917
Independent Audi	N4522
Mackie	SL254
Gefen	SL501
Pixel Instruments	SU8953

AUDIO ROUTING, DISTRIBUTION

ISIS Group	C1836
Ward-Beck Systems	C1924
Switchcraft	C2339
Doremi Labs	C2342
Wegener Communications	C2624
Multidyne Video & Fiber Optic Systems ..	C2850
DK- Technologies	C3607C, C2757
Linear Acoustic	C3607F
Patchamp	C4146
Utah Scientific	C5610
Anixter	C6643
Keywest Technology	C9337
Riedel Communications	C11107
Wheatstone	N2802
Sierra Automated Systems & Eng.	N806
Sierra Video Systems	SL854
Kramer Electronics	SL856
TASCAM	SL1516
Communications Specialties	SL2268
Crystal Vision	SU6361
Evertz	SU6433
Image Video	SU7077
Ross Video	SU7141
Leitch	SU7805, SU8705
Thomson Broadcast and Media Solutions	SU7823, SU7823A
Miranda Technologies	SU7841
Dolby Laboratories	SU7870
Telecast Fiber Systems	SU8375
eyeheight	SU8501
DNF CONTROLS	SU8552
Axon Digital Design BV	SU9301
NVISION	SU9301
Network Electronics	SU9311
Broadcast Technology	SU9317
Quartz Electronics	SU9652
Ensemble Designs	SU10217
Sigma Electronics	SU10345
Pharos Communications	SU11835
MSoft	C1860
ESE	C2639
Sonifex	C3526
Audio Accessories	C3651
Wohler Technologies	C6221

Whirlwind	C7841
Burst Electronics	C8915
Aphex Systems	N1815
Logitek Electronic Systems	N2022
Klotz Digital Audio Systems	N2807
STAGETEC (Salzbrenner Stagetec Mediagroup	N4208
Gefen	SL501
Comprehensive Video Group	SL919

AUTOMATION, INCLUDING NEWS AND MASTER CONTROL

Masterclock	C1430
Adtec Digital	C2620
Wegener Communications	C2624
Video Technics	C3647
EVS	C4534
BUF Technology	C4546
Fission Software	C9807
Broadcast Software International	N2114
Avid Technology	SL600
Quantel	SL1147
Pathfire	SL1353
Ultimatte	SL1443
Barco	SL1937
Dalet Digital Media Systems USA	SL1953
MATCO	SL2568
VertigoXmedia	SL2620
Just Edit	SL3341
Blue Order	SL4255B
Proximity	SL4562
ON-AIR Systems	SL5710
Fujinon	SU6370
OmniBus Systems	SU7165
Miranda Technologies	SU7841
Autocue	SU7865
Irdeto Access	SU8365
eyeheight	SU8501
DNF CONTROLS	SU8552
Broadcast Technology	SU9317
AZCAR	SU9326
Avitech International	SU9329
Spencer Technologies	SU9356
MicroFirst	SU9643
Quartz Electronics	SU9652
Hi Tech Systems	SU9711
Crispin	SU9717
Floral Systems	SU10000
Sundance Digital	SU10011
Masstech Group	SU10236
Gee Broadcast	SU10254G
Lightworks	SU10254H
Pro-Bel	SU10730
Leightronix	SU11223

Highlight indicates advertiser

Radio and TV broadcast systems made simple.

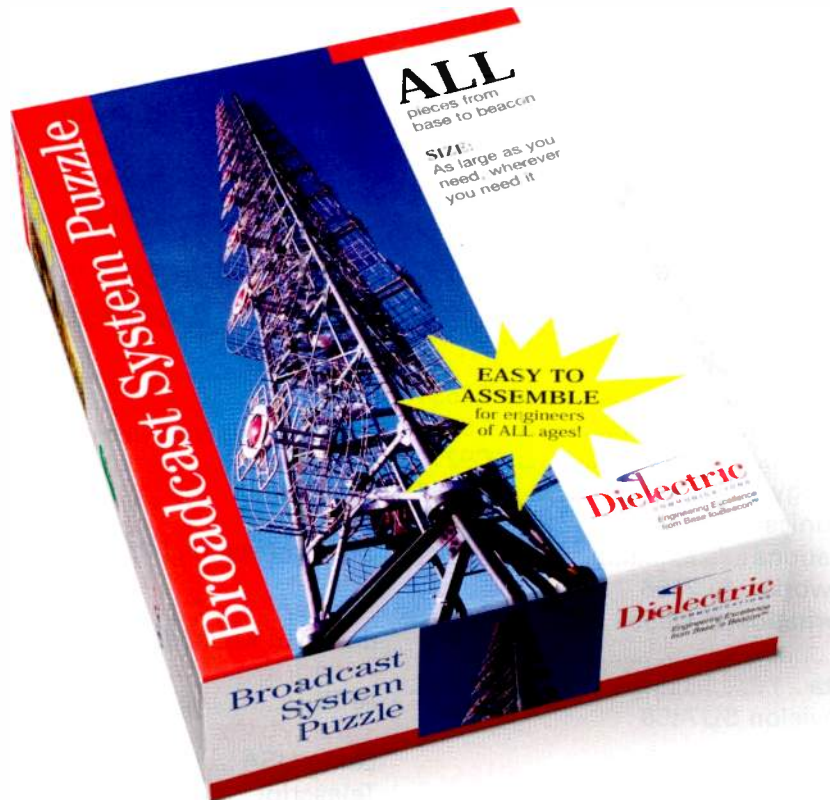

Dielectric has all the essential pieces to make your TV or radio project anything but puzzling. From design and site surveying, to excavation and construction, rigging and maintenance — we'll connect you with everything you need from the transmitter output, including:

Towers • Rigid or flexible transmission lines • Lighting • Antennas • Combiners • RF Systems

The warranty you want. The capability you need. The experience you demand.

Put Dielectric to work on your next project and watch everything seamlessly come together in picture perfect fashion.

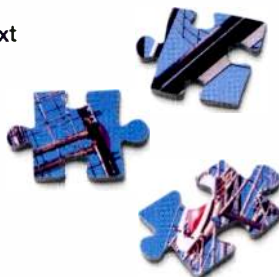

Dielectric
COMMUNICATIONS
*Engineering Excellence
from Base to Beacon™*

Digital Transaction Group	SU11231
Teletream	SU11404
Triveni Digital	SU11411
Videoframe	SU11806
Pharos Communications	SU11835
Sierra Automated Systems & Eng.	N806
RCS	N1411
Klotz Digital Audio Systems	N2807
Chief Manufacturing	SL3625
Ross Video	SU7141

CABLE TV

Wegener Communications	C2624
Multidyne Video & Fiber Optic Systems ..	C2850
Broadata Communications/ Physical Optics	C4148
Thales Broadcast & Multimedia	C4508
EVS	C4534
Comtech EF Data	C6941
Egripment U.S.A.....	C9216
Keywest Technology	C9337
Quintech Electronics and Communications	C9348
SkyStream Networks .	SL2756
SeaChange International	SU6557
Motorola.....	SU7133
Scientific-Atlanta	SU7848
TANDBERG Television	SU7858
Scopus Network Technologies	SU8470
Broadcast Technology	SU9317
ViACCESS.....	SU9332
Opticomm	SU10460
Harmonic.....	SU10707
Terayon	SU11316
DVB	SU11408
Triveni Digital	SU11411
Allen Osborne Assoc.....	C5848
HORITA	C10120
Patriot Antenna Systems	C5843, MM219
Irreto Access	SU8365
Zandar Technologies	SU8367
Network Electronics	SU9311
Avitech International	SU9329
Herman Electronics	SU9814
NAGRAVISION - Kudelski Group	SU10701

CAMERA SUPPORT, ROBOTICS, VIRTUAL SETS

AbelCine Tech	C3643
FOR-A	C4519
Bogen	C6726
Miller Camera Support	C6937
Sachtler	C7319B

Vinten	C7319F
Telemetrics	C7337
Spider Support Systems	C8911
Glidecam Industries	C8929
Shotoku Broadcast Systems	C10641
VIZRT	SL1137
Band Pro Film & Digital	SU6365
Orad Hi-Tec Systems	SU7170
Innovision Optics	SU8661
Chapman/Leonard Studio Equipment ...	SU8800
Complex	SU10226
Frezzi Energy Systems	SU10718
Allen Osborne Assoc.....	C5848

CAMERAS, LENSES, ACCESSORIES

RF Central.....	C1432
TRON-Tek	C1544
GMPCS Personal Communications	C2944
IDX System Technology	C3036
Panasonic Broadcast	C3617
AbelCine Tech	C3643
JVC Professional Products Company	C4526
Thales- Angenieux	C5107
Ikegami Electronics	C5426
Eastman Kodak Company.....	C6226
Anton/Bauer	C7319C
ARRI	C7326
Telemetrics	C7337
Lemo USA	C7831
Telescript	C8932
PAG USA (A Div. of Ste-Man)	C9719
CineBags	C11037
Link Research	C11837
Teranex	C12024
Da-Lite Screen Company	SL465
16x9.....	SU6365
Band Pro Film & Digital.....	SU6365
Carl Zeiss	SU6365
Petrol	SU6365



Evertz	SU6433
Canon USA	SU7814
Miranda Technologies	SU7841
Century Optics	SU10329
Frezzi Energy Systems	SU10718
Fischer Connectors.....	SU11812
Bogen	C6726
Bexel's Broadcast Video Gear (BVG)	C7319E
Fujinon	SU6370
Innovision Optics	SU8661
AZCAR	SU9326
Complex	SU10226

Highlight indicates advertiser

CGS, PROMPTERS, CAPTIONING

Mirror Image Teleprompters	C2347
Wegener Communications	C2624
ENCO Systems	C3607B, N2826
FOR-A	C4519
Listec Video	C6237
EEG Enterprises	C7441
BDL-Autoscript	C8926
Telescript	C8932
Astro Systems	C9334
Keywest Technology	C9337
Computer Prompting & Captioning	C10233
VIZRT	SL1137
SoftNI	SL1210B, SU8960
Compix Media	SL2565
VertigoXmedia	SL2620
Pinnacle Systems	SU6341
Evertz	SU6433
Pixel Power	SU7132
Leitch	SU7805, SU8705
Miranda Technologies	SU7841
QTV	SU7865A
Inscriber	SU8100
eyeheight	SU8501

Cavena Image Products	SU9809
Adtec Digital	C2620
Burst Electronics	C8915
HORITA	C10120
Broadcast Software International	N2114
Spencer Technologies	SU9356

CONSULTING SERVICES, TECHNICAL ENGINEERING

ND Satcom	C11046
SGI (Silicon Graphics)	SL1943
Digital Voodoo	SL3357
BBC Technology (see Siemens)	SU8541
Siemens	SU8541
Crispin	SU9717
Masstech Group	SU10236
Frezzi Energy Systems	SU10718
Triveni Digital	SU11411
Patchamp	C4146
Mager Systems	N1231
Pixel Instruments	SU8953
AZCAR	SU9326
Harmonic	SU10707
DVB	SU11408

Master Control Tools SWITCHING & BRANDING

Audio
Video
Switcher



- > 8 SDI inputs expandable to 16
- > 8x2 AES/EBU inputs expandable
- > Embedders & de-embedders
- > Logo, text & clock insertion
- > 2 to 4 DSKs
- > Voices-over
- > DVE



Logo
Text
Clock

www.sav.tv

NAB 2005 - Booth # SU11117



broadcastengineering.com **135**

MARCH 2005

FILM EQUIPMENT, DUPLICATION, DISTRIBUTION EQUIPMENT

AbelCine Tech	C3643
EVS	C4534
da Vinci	C6207
Video Accessory	SL500
Evertz	SU6433
ESE	C2639
Quantel	SL1147
Digital Vision	SL3649
Thomson Broadcast and Media Solutions	SU7823, SU7823A
Scientific-Atlanta	SU7848
Network Electronics	SU9311

GRAPHICS, ANIMATION



AccuWeather	C5111
Baron Services	C8907
Keywest Technology	C9337
Weather Central	C10214
Avid Technology	SL600
Digital Anarchy	SL760A, SL1020
VIZRT	SL1137
GenArts	SL1210P, SL760C
Discreet	SL1920
VertigoXmedia	SL2620
Realviz	SL4065
BOXX Technologies	SL4427
Pinnacle Systems	SU6341
Chyron	SU7158
Leitch	SU7805, SU8705
Accom	SU7834
Inscriber	SU8100
eyeheight	SU8501
DNF CONTROLS	SU8552
AJA Video	SU8948, SL2514
SAV Systems	
Audiofrequency Videonique	SU11117
Panasonic Broadcast	C3617
da Vinci	C6207
Burst Electronics	C8915
Broadcast Software International	N2114
Quantel	SL1147
Ultimatte	SL1443
SGI (Silicon Graphics)	SL1943
Digital Voodoo	SL3357
Proximity	SL4562
Orad Hi-Tec Systems	SU7170
Spencer Technologies	SU9356

INTERCOM, IFB

Modulation Sciences	C1223
Eartec	C2643

Multidyne Video & Fiber	
Optic Systems	C2850
Television Engineering	C6241
Telex Communications	C6821
Clear-Com Communication Systems	C7319A
Riedel Communications	C11107
Comrex	N2118
Evertz	SU6433
Opticomm	SU10460
Broadata Communications/	
Physical Optics	C4148
Systems Wireless	C7319D
Sierra Automated Systems & Eng.	N806
Klotz Digital Audio Systems	N2807
Location Sound	N3917
JK Audio	N3926
Herman Electronics	SU9814

LIGHTING

AbelCine Tech	C3643
Anton/Bauer	C7319C
ARRI	C7326
K5600	C10241
Kino Flo	C10437
Videssence	C10519
Dedotec USA	C10721
Sabre Towers	N308
Dialight	N3928
16x9	SU6365
Band Pro Film & Digital	SU6365
LightTech Group	SU9943
Frezzi Energy Systems	SU10718
Westcott (F.J. Westcott Co.)	SU11019
Allen Osborne Assoc.	C5848
Bogen	C6726
Alcorn McBride	SL366
Innovision Optics	SU8661

MICROPHONES, ACCESSORIES

Beyerdynamic	C10421
Riedel Communications	C11107
DPA Microphones	N506
Audio-Technica U.S.	N3322
Band Pro Film & Digital	SU6365
Broadata Communications/	
Physical Optics	C4148
Wireworks	C4541
Allen Osborne Assoc.	C5848
Bogen	C6726
Systems Wireless	C7319D
Lemo USA	C7831
Whirlwind	C7841
Sennheiser Electronic ..	N2822

Highlight indicates advertiser

UHF broadcasting doesn't get any better than this

THALES



DCX Paragon MSDC-IOT
Thales' DCX Paragon is designed to provide broadcasters with the most cost-effective and efficient transmitter ever created. DCX Paragon utilizes Soft Arc Technology™ (SAT), which eliminates the need for a crowbar, dramatically increasing the transmitters' overall reliability. Designed with cost of ownership in mind, DCX Paragon has a beam efficiency of up to 60%. Available in oil-cooled and liquid-cooled versions, UHF broadcasting doesn't get any better than this.



www.thales-bm.com

Visit us at NAB 2005 Booth # C4508.

Location Sound..... N3917
Azden **N4222**
 Independent Audio N4522
 Herman Electronics SU9814

MICROWAVE, FIBER OPTIC, TELCO

Harris **C1907, SU10048**
Nucomm **C1416**
Broadcast Microwave Services **C1421**
 Multidyne Video &
 Fiber Optic Systems C2850
Microwave Radio Communications **C3007**
 ADC C4515
 N Systems C4841
Ikegami Electronics **C5426**
Miteq/MCL **C6546**
 L-3 Electron Devices C8507
 Quintech Electronics
 and Communications C9348
Riedel Communications **C11107**
 Rycote Microphone Windshields N3232
Screen Service
Broadcasting Technologies **N3922**
 ATTO Technology SL1210R, SL2265
 Crystal Vision SU6361
Evertz **SU6433**
Canon USA **SU7814**
Miranda Technologies **SU7841**
 TANDBERG Television SU7858
Telecast Fiber Systems **SU8375**
ERG Ventures **SU10134**
Opticomm **SU10460**
Fischer Connectors **SU11812**
 TRON-Tek C1544
 Audio Accessories C3651
 Communications Specialties SL2268
Thomson Broadcast
and Media Solutions **SU7823, SU7823A**
Network Electronics **SU9311**
 Camplex SU10226
 Harmonic SU10707
 Allen Avionics SU10715

NEW MEDIA, STREAMING PRODUCTS, MULTIMEDIA/ INTERNET

Harris **C1907, SU10048**
 Celco C1450
 BT Broadcast Services C1453
 Wegener Communications C2624
Rohde & Schwarz **C2633**
 AccuWeather C5111
 Keywest Technology C9337
 Logic Innovations C9947

Optibase SL343
Avid Technology **SL600**
Anystream **SL12100, SL3372-MR, SL3316**
 Pathfire SL1353
 VBrick Systems SL3070-MR, SL4931
Canopus **SL325**
 Envivio SL3310
 VELA SL4401
 Viewcast SL4572
Sony Electronics **SU6406**
Miranda Technologies **SU7841**
Crispin **SU9717**
Floral Systems **SU10000**
 Gee Broadcast SU10254G
 Lightworks SU10254H
 Sigma Electronics ... SU10345
 Telestream SU11404
 Triveni Digital SU11411
 IPV SU11501
 MSoft C1860
 Adtec Digital C2620
 Sonifex C3526
Thales Broadcast & Multimedia **C4508**
 JVC Professional Products Company C4526
 Alcorn McBride SL366
 SkyStream Networks SL2756
 Digital Voodoo SL3357
 Digital Vision SL3649
Thomson Broadcast
and Media Solutions **SU7823, SU7823A**
 Irdeto Access SU8365
 Zandar Technologies SU8367
Network Electronics **SU9311**
 AZCAR SU9326
 Harmonic SU10707
 DVB SU11408



POWER PRODUCTS, BATTERIES, GENERATORS

Staco Energy Products Company C1207
 Superior Broadcast Products C1218
 Control Concepts/Liebert C1524
 Active Power C2659
AbelCine Tech **C3643**
Anton/Bauer **C7319C**
 Pioneer Electronics C8136
 Kay Industries N1700
 Band Pro Film & Digital SU6365
 Brick House Video SU9807
 Frezzi Energy Systems SU10718
 Audio Accessories C3651
 Location Sound N3917
 Herman Electronics SU9814

Highlight indicates advertiser

PRODUCTION SWITCHERS, VIDEO EFFECTS, KEYERS

ISIS Group	C1836
FOR-A	C4519
Echolab	C4915
Ikegami Electronics	C5426
Utah Scientific	C5610
Keywest Technology	C9337
Laird	SL1243
RGB Spectrum	SL1565
Broadcast Pix	SL5706
Snell & Wilcox	SU6349
Crystal Vision	SU6361
Evertz	SU6433
Leitch	SU7805, SU8705
Miranda Technologies	SU7841
eyeheight	SU8501
NVISION	SU9301
Quartz Electronics	SU9652
Sigma Electronics	SU10345
SAV Systems	
Audiofrequency Videonique	SU11117
Bogen	C6726
Bexel's Broadcast Video Gear (BVG)	C7319E

Astro Systems	C9334
Logic Innovations	C9947
Comprehensive Video Group	SL919
Ross Video	SU7141
Thomson Broadcast and Media Solutions	SU7823, SU7823A
Accom	SU7834
AZCAR	SU9326
Spencer Technologies	SU9356
Brick House Video	SU9807
Pro-Bel	SU10730

RECORDING MEDIA

ISIS Group	C1836
Global Media Resource	C2750
Fast Forward Video	C3253
Ikegami Electronics	C5426
DVC Digital Video Computing	C7034
Maxell Corporation of America	C8530
VELA	SL4401
Autocue	SU7865
Crispin	SU9717
Videomagnetics	SU10711

Cerify

AUTOMATED VIDEO CONTENT VERIFICATION

Know your content is correct before you transmit it



Check:

- ◆ Content correctness
- ◆ Video standard
- ◆ Video formats
- ◆ Resolution
- ◆ Audio
- ◆ and more...



MPEG-2 • MPEG-4 • AVC • VC-1 • NTSC • PAL • SD • HD • 24fps

www.vqual.com tel: +44 (0)117 3101 244
see us at NAB 2005, Las Vegas, 18-21 April, booth SL 4535

Vqual



MSoft	C1860
Bexel's Broadcast Video Gear	C7319E
Pioneer Electronics	C8136
MATCO	SL2568
Spencer Technologies	SU9356

SATELLITE EQUIPMENT, SERVICES

Harris	C1907, SU10048
BT Broadcast Services	C1453
Wegener Communications	C2624
Intelsat	C5241
SES Americom	C5245
Miteq/MCL	C6546
L-3 Electron Devices	C8507
Frontline Communications	C8835, MM225
Quintech Electronics and Communications	C9348
ND Satcom	C11046
ScheduAll Software	SL767
TANDBERG Television	SU7858
Scopus Network Technologies	SU8470
Crispin	SU9717
Microwave Radio Communications	C3007
Thales Broadcast & Multimedia	C4508
Patriot Antenna Systems	C5843, MM219
Logic Innovations	C9947
SkyStream Networks	SL2756
Motorola	SU7133
Scientific-Atlanta	SU7848
Irreto Access	SU8365
AZCAR	SU9326
Avitech International	SU9329
ViACCESS	SU9332
Harmonic	SU10707
Terayon	SU11316

STUDIO, FACILITY SUPPORT

Harris	C1907, SU10048
Leader Instruments	C3150
RTI-Research Technology International	C3951
FOR-A	C4519
Ascent Media Group	C5434, C5434A
Boland Communications	C10435
Shotoku Broadcast Systems	C10641
Statmon Technologies Corporation	C11404
Christie Digital Systems	SL360
Kramer Electronics	SL856
Marshall Electronics	SL913
Laird	SL1243
Pathfire	SL1353
Middle Atlantic Products	SL3606
Chief Manufacturing	SL3625
B&H	
Photo-Video-Pro Audio	SU6430

TBC Consoles	SU6831
Image Video	SU7077
Forecast Consoles	SU7131
Winsted	SU7455
TANDBERG Television	SU7858
eyeheight	SU8501
Siemens	SU8541
NVISION	SU9301
Broadcast Technology	SU9317
Crispin	SU9717
NEXTAMP	SU9954
Triveni Digital	SU11411
Fischer Connectors	SU11812
Pharos Communications	SU11835
Masterclock	C1430
ESE	C2639
Wohler Technologies	C6221
Bogen	C6726
Hamlet	C7031
Lemo USA	C7831
HORITA	C10120
Mager Systems	N1231
Sennheiser Electronic	N2822
Da-Lite Screen Company	SL465
Gefen	SL501
ScheduAll Software	SL767
RGB Spectrum	SL1565
SGL (Silicon Graphics)	SL1943
Digital Vision	SL3649
Zandar Technologies	SU8367
Chapman/Leonard Studio Equipment ...	SU8800
AJA Video	SU8948, SL2514
AZCAR	SU9326
Avitech International	SU9329
ERG Ventures	SU10134
Allen Avionics	SU10715
Videoframe	SU11806

TBCS, FRAME SYNCs, CONVERSION EQUIPMENT

Ward-Beck Systems	C1924
ADC	C4515
FOR-A	C4519
Prime Image	C5614
Hotronic	C9015
Keywest Technology	C9337
Trilogy Broadcast	C11722
Kramer Electronics	SL856
Laird	SL1243
Data Check	SL1264
Snell & Wilcox	SU6349
Crystal Vision	SU6361
Band Pro Film & Digital	SU6365
Evertz	SU6433
Leitch	SU7805, SU8705

Highlight indicates advertiser

Define the Future

HD/SD Switchable Product Lineup

Guarantees a reliable future with HD/SD Switchable Products. Join us at NAB2005 to see and experience why so many broadcasters are choosing FOR-A.

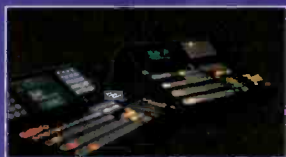

Video Switchers

Introducing the next generation of our popular HD/SD switchable HANABI series. Now, our 3D DVE and color correction functions are available for the 1 M/E HANABI. FOR-A, providing the ultimate switcher for your versatile production requirements.



Broadcast Graphics

Debating our technically advanced and cost-effective VFP-70HS chroma keyer. We're also exhibiting the newest version of digiStorm, a virtual studio solution born out of our technical collaborations with Brainstorm Multimedia. Don't miss a hands-on demo of VertigoXmedia's Xpresenter.



Frame Synchronizers

We'll be showing UFH-70FS with color correction, the newest addition to our industry proven frame synchronizer product lineup and FA-128, the world's first FS with a 14-bit internal processor. Come and see the difference.



Modular Products

Several HD/SD switchable products have been added to the UFH Series lineup, including frame synchronizers, still stores, title generators, distribution amplifiers, upconverters, downconverters, MUXs, DeMUXs, and more...

Visit FOR-A @ NAB #C4519

www.for-a.com

Miranda Technologies	SU7841
eyeheight	SU8501
YEM	SU8658
Cobalt Digital	SU8965
Axon Digital Design BV	SU9301
Broadcast Technology	SU9317
Magni Systems	SU9349
Ligos	SU9632

Ensemble Designs	SU10217
Fortel DTV	SU10463

Sonifex	C3526
Wohler Technologies	C6221
Bexel's Broadcast Video Gear (BVG)	C7319E
RGB Spectrum	SL1565
Digital Vision	SL3649

Ross Video	SU7141
Thomson Broadcast	

and Media Solutions	SU7823, SU7823A
AJA Video	SU8948, SL2514

Pixel Instruments	SU8953
-------------------------	--------

Network Electronics	SU9311
----------------------------------	---------------

Brick House Video	SU9807
-------------------------	--------

Videoframe	SU11806
------------------	---------

TEST & MEASUREMENT

Harris	C1907, SU10048
---------------------	-----------------------

Modulation Sciences	C1223
----------------------------------	--------------

ISIS Group	C1836
------------------	-------

Ward-Beck Systems	C1924
-------------------------	-------

Rohde & Schwarz	C2633
----------------------------------	--------------

Multidyne Video & Fiber Optic Systems ...	C2850
---	-------

Z Technology	C3139
--------------------	-------

DK- Technologies	C3607C, C2757
-------------------------------	----------------------

Tektronix	C6231
-----------------	-------

Pixelmetrix	C7316
-------------------	-------

Sencore	C7331, SU10006
---------------	----------------

K-WILL	C8941
---------------------	--------------

DSC Laboratories	C10119
------------------------	--------

Kramer Electronics	SL856
--------------------------	-------

Vqual	SL4535
--------------------	---------------

Band Pro Film & Digital	SU6365
--	---------------

Evertz	SU6433
---------------------	---------------

Image Video	SU7077
--------------------------	---------------

Leitch	SU7805, SU8705
---------------------	-----------------------

Miranda Technologies	SU7841
-----------------------------------	---------------

TANDBERG Television	SU7858
---------------------------	--------

eyeheight	SU8501
-----------------	--------

DNF CONTROLS	SU8552
--------------------	--------

Broadcast Technology	SU9317
----------------------------	--------

KTech Telecommunications	SU9667
--------------------------------	--------

Acterna	SU10043
---------------	---------

SyntheSys Research	SU10132
--------------------------	---------

Triveni Digital	SU11411
-----------------------	---------

ESE	C2639
-----------	-------

Leader Instruments	C3150
--------------------------	-------

Audio Accessories	C3651
-------------------------	-------

Wohler Technologies	C6221
---------------------------	-------

Hamlet	C7031
--------------	-------

Bexel's Broadcast Video Gear (BVG)	C7319E
--	--------

Whirlwind	C7841
-----------------	-------

Burst Electronics	C8915
-------------------------	-------

Hotronc	C9015
---------------	-------

Astro Systems	C9334
---------------------	-------

HORITA	C10120
--------------	--------

Prism Media Products	N2412, N1813
----------------------------	--------------

Sound Devices	N4212
---------------------	-------

Data Check	SL1264
------------------	--------

Magni Systems	SU9349
---------------------	--------

DVB	SU11408
-----------	---------

Videoframe	SU11806
------------------	---------

TV TRANSMITTERS, FEEDLINE, ANTENNAS, TOWERS,

Harris	C1907, SU10048
---------------------	-----------------------

Myat	C1407
-------------------	--------------

Broadcast Microwave Services	C1421
---	--------------

BT Broadcast Services	C1453
-----------------------------	-------

Jampro Antennas/RF Systems	C2316
----------------------------------	-------

CPI	C2616
------------------	--------------

Richland Towers	C2627
-----------------------	-------

Rohde & Schwarz	C2633
----------------------------------	--------------

DMT USA	C3016
----------------------	--------------

Radian Communication Services	C3028
-------------------------------------	-------

Radio Frequency Systems	C3031
-------------------------------	-------

e2v technologies	C3146
-------------------------------	--------------

Teracom Components	C3333
--------------------------	-------

ADC	C4515
-----------	-------

Thales Components	C5607
-------------------------	-------

LARCAN USA	C5620
------------------	-------

Acrodyne Industries	C6212
---------------------------	-------

Micro Communications (MCI)	C7736
----------------------------------	-------

Dielectric Communications	C7807
---------------------------------	-------

Axcera	C8014
--------------	-------

L-3 Electron Devices	C8507
----------------------------	-------

Advanced Designs	C8534
------------------------	-------

Kathrein, Scala Division	C8538
--------------------------------	-------

ND Satcom	C11046
-----------------	--------

RF Parts	N619
----------------	------

ERI-Electronics Research	N1306
--------------------------------	-------

Magnum Towers	N1911
---------------------	-------

Shively Labs	N2007
--------------------	-------

UNIMAR	N2512
--------------	-------

Utility Tower Company	N2522
-----------------------------	-------

Screen Service	
-----------------------	--

Broadcasting Technologies	N3922
--	--------------

Canon USA	SU7814
------------------------	---------------

Radyne	SU9929
---------------------	---------------

Opticomm	SU10460
-----------------------	----------------

TRON-Tek	C1544
----------------	-------



Microwave Radio Communications C3007
Thales Broadcast & Multimedia C4508
 Comtech EF Data C6941
 Sabre Towers N308
 KTech Telecomm. SU9667
 DVB SU11408

Utah Scientific C5610
 Keywest Technology C9337
 Sierra Video Systems SL854
 Kramer Electronics SL856
 VELA SL4401
Snell & Wilcox SU6349
 Crystal Vision SU6361
Evertz SU6433
 Image Video SU7077

VIDEO EDITING

Fast Forward Video C3253
 Video Technics C3647
 EVS C4534
 Ikegami Electronics C5426
 Prime Image C5614
 Optibase SL343
 Avid Technology SL600
 Matrox Electronic
 Systems SL1131
 Adobe Systems SL313
 SL3370-MR
 Viewcast SL4572
 Pinnacle Systems SU6341
Leitch SU7805, SU8705
 DNF CONTROLS SU8552
 Masstech Group SU10236
 Sigma Electronics SU10345
 Editware SU11301
ESE C2639
Panasonic Broadcast .C3617
 JVC Professional
 Products Company C4526
 Astro System C9334
 Discreet SL1920
 SGI (Silicon Graphics) SL1943
Canopus SL325
 BOXX Technologies SL4427
 Pixel Power SU7132
**Thomson Broadcast
 and Media
 Solutions** SU7823,
 SU7823A
Accom SU7834
AJA Video . SU8948, SL2514
 Brick House Video SU9807
 IPV SU11501

VIDEO ROUTING

Harris C1907, SU10048
 BT Broadcast Services . C1453
 ISIS Group C1836
 Wegener
 Communications C2624
 Multidyne Video &
 Fiber Optic Systems C2850
FOR-A C4519

Over 1,000,000,000 seconds of precision timing



WHEN you require the best, most accurate in precision timing look only to ESE. Designed for "Precision Timing", ESE Master Clocks & Accessories have been the industry standard for over three decades.

Whether using GPS, WWV, Modem, Crystal or line frequency accuracy – all ESE Master Clocks can drive digital or analog slave clocks, as well as interface with video and/or computer based systems. Call or visit our web site for more details.

• 3-Year Warranty •



142 Sierra Street • El Segundo, CA 90245 USA
 Phone: (310) 322-2136 • Fax: 310.322.8127

www.e-se-web.com

Visit us at NAB Booth #C2639

Leitch	SU7805, SU8705
Miranda Technologies	SU7841
PESA Switching Systems	SU7852
eyeheight	SU8501
DNF CONTROLS	SU8552
NVISION	SU9301
Broadcast Technology	SU9317
Quartz Electronics	SU9652
Sigma Electronics	SU10345
SAV Systemes Audiofrequence Videonique	SU11117
Pharos Communications	SU11835
Patchamp	C4146
Burst Electronics	C8915
Hotronic	C9015
Logic Innovations	C9947
HORITA	C10120
Video Accessory	SL500
Gefen	SL501
Comprehensive Video Group ..	SL919
Communications Specialties	SL2268
SkyStream Networks	SL2756
Ross Video	SU7141
Thomson Broadcast and Media Solutions	SU7823, SU7823A
Scientific-Atlanta	SU7848
Zandar Technologies	SU8367
BBC Technology	SU8541
Network Electronics	SU9311
AZCAR	SU9326
Allen Avionics	SU10715
Pro-Bel	SU10730
Leightronix	SU11223

VIDEO STORAGE

BT Broadcast Services	C1453
ISIS Group	C1836
Wegener Communications	C2624
Fast Forward Video	C3253
Video Technics	C3647
Ikegami Electronics	C5426
Solid State Logic	N3211
Avid Technology	SL600
Studio Network Solutions	SL3331
Medea	SL3360
Ciprico	SL3628
Konan Digital	SL3919
DataDirect Networks	SL4212
VELA	SL4401
Ai-Pixel	SL4453
BayStor/Karden Group	SL4552
StorageTek	SL4632
Pinnacle Systems	SU6341
Leitch	SU7805, SU8705
Siemens	SU8541
DNF CONTROLS	SU8552

Crispin	SU9717
Masstech Group	SU10236
Gee Broadcast	SU10254G
Lightworks	SU10254H
Omneon Video Networks	SU10724
360 Systems	SU11011
Front Porch Digital	SU11036
Pharos Communications	SU11835
Panasonic Broadcast	C3617
RTI-Research Technology International	C3951
JVC Professional Products Company	C4526
Maxell Corporation of America	C8530
Quantel	SL1147
SGL (Silicon Graphics)	SL1943
Thomson Broadcast and Media Solutions	SU782, SU7823A
BBC Technology (see Siemens)	SU8541

WEATHER/DATA SERVICES

Baron Services	C8907
AccuWeather	C5111
Keywest Technology	C9337
VIZRT	SL1137
Triveni Digital	SU11411
Allen Osborne Assoc.	C5848
Advanced Designs	C8534
Weather Central	C10214
Pixel Power	SU7132
Irreto Access	SU8365

WIRE, CABLE, CONNECTORS

Belden CDT Electronics Division	C2257
Switchcraft	C2339
ADC	C4515
CANARE	C5134
Neutrik	C5137
Dielectric Communications	C7807
Kings Electronics	C8131
Gepco	C9341
Kramer Electronics	SL856
Telecast Fiber Systems	SU8375
Trompeter Electronics	SU10323
Fischer Connectors	SU11812
Audio Accessories	C3651
Patchamp	C4146
Wireworks	C4541
Lemo USA	C7831
Whirlwind	C7841
Fluke	C11814
Patriot Antenna Systems	C5843, MM219
Sabre Towers	N308
Klotz Digital Audio Systems	N2807
Marshall Electronics	SL913
Communications Specialties	SL2268
Terayon	SU11316

Highlight indicates advertiser

The Ai-Pixel VRX-8100 Video Network Server:

The best kept secret in broadcast solutions!

The Ai-Pixel Video Server is my Digital Octopus!

The system records up to 4 channels simultaneously, has up to 2 Terabyte internal storage and many other features for Broadcast & Commercial Logging, Playout Server and Video over-IP solutions.

We chose the Ai-Pixel system for its excellent performance, efficiency improvements and great value for money. But above all, for its reliability.

*Jules Hartogs, manager Audio Visual Services,
IP (RTL Netherlands' broadcast advertising sales company)*

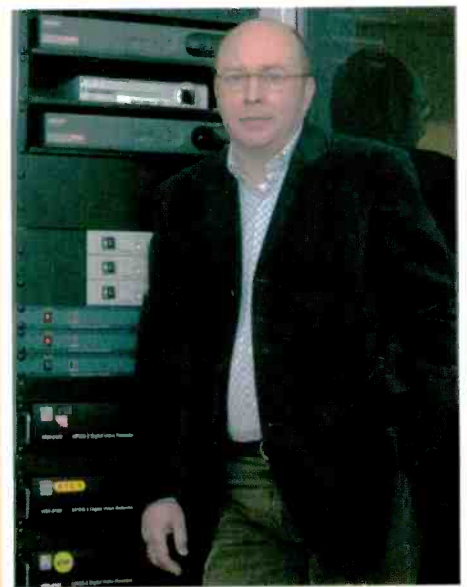

Be sure you discover it @ NAB 2005,
Hall South 2, Ai-Pixel booth SL4453



Industrial Digital Video Solutions

Ai-Pixel BV

Antareslaan 26, 2132 JE Hoofddorp, The Netherlands

tel: +31 (0)23 554-3564

e-mail: info@ai-pixel.com

www.ai-pixel.com/NAB2005



D'TV marketplace

Let us guide you through the
jungle of products and new
technologies at NAB this year.





As always, Broadcast Engineering is here to guide you through the jungle of products and new technologies that will be displayed at NAB this year.

The products are divided into categories for easy reference, and our unique table of contents lists page numbers so that you can turn directly to the product category of your choice. The listings include contact information and booth numbers to make finding vendors easy -- before, during and after the show. (Issue advertisers are highlighted.)

With more than 60 pages of new products, this year's show coverage is larger than ever. So, read on and hunt for the latest and most up-to-date technology you can get at NAB2005! **BE**

Table of Contents

Audio accessories	148
Automation	158
Cameras	171
CGs, prompters, captioning	180
Editing systems	184
Encoders/decoders, streaming & demods	186
Graphics systems	190
Intercoms	196
Lighting	198
Microwave, fiber optic, telco	200
Production switchers, video effects, keys	205
RF systems	210
Satellite equipment/cable/encoding/trucks	216
Storage	218
Studio & facility support technology	230
TBCs, frame syncs, conversion equipment	238
Test & measurement	241
Video routing	245
Wire, cable, connectors	247

AUDIO ACCESSORIES



Studio monitors ▲

TASCAM VL-X5

Powered speakers feature 5 1/4in woofers, silk-dome tweeters and a 60+30-watt bi-amplified active power amp; the monitors feature low- and high-frequency controls and an Acoustic Space Control to optimize their performance for room placement or listener preference; the monitors are shielded to prevent magnetic damage to CRTs; the deep cabinet and ported design produce a large amount of bass for the size of the monitors.

323-726-0303; www.tascam.com

Booth: SL310



Digital cinema solution ▲

Dolby Digital Cinema

A digital cinema solution, designed and built specifically for today's cinemas; incorporates the open standards being established by Digital Cinema Initiatives (DCI) and is easy to integrate with existing cinema automation and sound systems; at its core are Dolby Show Store and Dolby Show Player units.

415-645-5293; www.dolby.com

Booth: SU7870



Microphone ◀

Beyerdynamic M58

Designed for electronic news gathering (ENG) as well as electronic field production (EFP) in both indoor and outdoor situations; has a frequency response of 40Hz to 20,000Hz and has a non-reflective Nextel finish, which results in a low profile on camera.

631-293-3200; www.beyerdynamic-usa.com

Booth: C10421

Monitor system ▶

SLS Loudspeakers PS8R

Offers studios S8R ribbon equipped reference monitor as a standalone, bi-amplified nearfield critical listening monitor system; Evenstar Sigma-Delta digital amplifier in the unit is customized and matched to power the S8R drivers with exceptional head-room, damping and uniform response; unique amplifier topology lowers distortion, increases bandwidth and improves noise performance over traditional amplifier technologies.

417-883-4549; www.slsloudspeakers.com

Booth: N4002

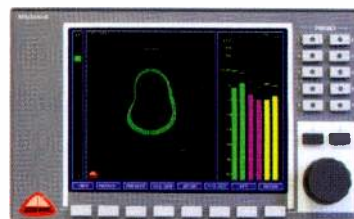

Multichannel/multiformat audio monitor ▲

DK-Technologies MSD660R

Incorporates a base unit and a remote panel with VGA display and control buttons; features point-to-point connection via Ethernet Cat. 5 cable/connectors, logging software for overs and mutes, and surround sound compatibility at 4.0, 5.1, 6.1 and 7.1 to monitor up to 32 channels of audio.

+44 44 85 02 55; www.dk-technologies.com

Booth: C2757



Receiver system ▶

Systems Wireless Venue

A modular UHF design that operates with Digital Hybrid Wireless transmitters, and a variety of analog transmitters; the receiver uses a host assembly that includes an antenna multi-coupler, computer communications interface and mechanical rack mounting for up to six receiver modules; design combines 24-bit digital audio with an analog FM radio link; provides outstanding audio quality with the extended operating range of the best analog wireless systems.

703-397-9249; www.swl.com

Booth: C7319D



Shotgun microphone ▲

Beyerdynamic MCE 86 II

An extremely light and rugged microphone; easy to mount onto cameras or camcorders; the electrostatic transducer element and the hypercardioid/lobe polar pattern result in a directional polar pattern with high sensitivity to the intended sound source; two different elastic suspensions are available, both suppress footfall sound and vibrations from zoom motors; the frequency response is 50Hz to 1800Hz; can handle a sound pressure of 128dB.

631-293-3200; www.beyerdynamic-usa.com

Booth: C10421

Encoder

Dolby DP563

Encodes discrete four- or five-channel surround mixes into Left total/Right total (Lt/Rt) stereo for delivery via two-channel television and radio broadcasts, PC and console games, CDs, and VHS tapes; provides two surround encoding algorithms.

415-645-5293; www.dolby.com

Booth: SU7870



Surround sound analyzer
Modulation Sciences
SpiderVision

A complete audio analysis solution; features a built-in, full color display; in a half-rack wide case it has the same form factor as a standard waveform monitor for easy mounting; features a simple push-button or remote screen selector; a true plug and Play instrument; important user selectable features include operating level adjustment, vu, peak or ppm metering standards and SpiderVision or standard XY display modes.

732-302-3090; www.modsci.com

Booth: C1223



Digital console ▲

TASCAM DM-3200

Features 48-channel mixing, DSP and integration with DAW recording systems; based on the DM-24; adds more busses, more effects, more auxes, and USB connectivity; its user interface includes 16 rotary encoders with LED indicators to display mixer settings; up to 6.1 surround panning is available, and the optional IF-SM/DM surround monitoring interface card adds multi-channel monitor and downmix capabilities.

323-726-0303; www.tascam.com

Booth: SL310



Microphone ◀

DPA Microphones
WINDPAC

An ultra-lightweight weather-proof solution for location recording; fully wind and water resistant; weighs 9oz; comprised of a shock mount and a collapsible windshield; adjustable elastic straps with different settings to accommodate microphones of any brand; elastic straps can be adjusted according to the weight of the microphone being used; fabric blocks wind noise in gusts of up to 70mph while allowing accurate sound reproduction and audio transparency.

+45 4814 2828; www.dpamicrophones.com

Booth: N506



Headworn Microphone ▲

Audio-Technica AT892

Uses a condenser capsule with a diameter of 2.5mm; offers ergonomic, flexible, ultra-lightweight, under-ear design; available in non-reflective black or theater-beige finish; provides maximum intelligibility and clean, accurate reproduction for broadcasters.

330-686-2600; www.audio-technica.com

Booth: N3322

Digital console

Calrec Audio ZETA 100

Combines simplistic operation and instant access with bullet-proof engineering features such as hot-swappable cards and panels and intelligent redundancy on all system-critical elements; provides broadcast-specific solutions for all types of production environments; three frame sizes — 24, 32 and 48 faders.

+44 1422 842159; www.calrec.com

Booth: N802

Display

DK-Technologies PT0660M

19in half-rack size modular multi-channel and surround sound analyzer with extended CPU speed and memory; up to 32 channels; similar functionality as the PTO600M, but with the additional front panel preset selections and volume control; extended matrix application software for audio monitoring applications.

+45 4485 025 5; www.dk-technologies.com

Booth: C3607C, C2757

Why Pay Extra for Service and Support?

- ◆ Ten-Year Warranty
- ◆ 24 Hour Service / Support Line
- ◆ Full Support of All Legacy Products

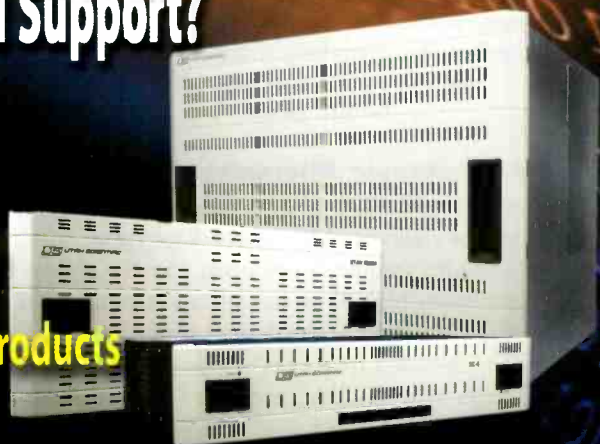

Utah Scientific gives you all three at no charge.

When you are choosing a routing or master control system, remember to consider the cost of support.

Only Utah offers these first-class support services to all customers at no additional charge.

US UTAH SCIENTIFIC

New Directions in Digital Switching

www.utahscientific.com

Display

DK-Technologies MSD200C

Non-modular stereo analog and one AES-3 digital input MSD with built-in full color VGA-display, stereo analogue and AES-3 digital output and external VGA monitor output; shares the standard application software platform; offers the same functionality as the modular 600MM series; standard speed CPU and memory.

+45 4485 025 5; www.dk-technologies.com

Booth: C3607C, C2757



Digital console ▲

Calrec Audio Sigma 100

Up to 64 faders, with A & B layers of control, plus 2 main output faders with 2 sub-main outputs available; 120 equivalent channels: up to 48 stereo plus 24 mono channels or 60 stereo channels; comprehensive surround panning and monitoring with optional motorised joystick; optional I/O expansion via a wide area interface such as MADI or Hydra, Calrec's audio networking system.

+44 1422 842159; www.calrec.com

Booth: N802

Cardioid Condenser Microphone

Audio-Technica AT2020

Features custom-engineered low-mass diaphragm, providing extended frequency response, plus the ability to handle extremely high SPLs; has a fixed cardioid polar pattern to allow isolation of the desired sound source; features a flat, extended frequency response (20Hz to 20,000Hz), high SPL handling capability (144dB), and a wide dynamic range (124dB).

330-686-2600; www.audio-technica.com

Booth: N3322

24-channel stereo loudness meter

Ward-Beck Systems RLM24

Offers high-density LED metering; 24 stereo LED bar graph meters are provided in two racks of space; available with analog or AES digital inputs; silence sensor with audible alarm and GPI output provided for each stereo input pair; powered by two supplies in dual-redundant configuration.

800-771-2556; www.ward-beck.com

Booth: C1924

Wireless microphone system

Lectrosonics Digital Hybrid Wireless 400 Series Wideband UHF

Uses new design (patent pending) that combines digital audio with an analog FM radio link; offers users the best of both worlds — the high quality of digital audio and the extended range of analog wireless systems.

800-821-1121; www.lectrosonics.com

Booth: N3611

Wireless microphone system

Lectrosonics 200 Series Synthesized Wideband UHF

Includes a rack mount diversity receiver, two compact receivers and two belt pack transmitters; a handheld wireless mic is also available in Europe in limited quantities; an excellent choice where RF interference is a problem, such as more urbanized areas; the group's receivers are small enough to mount on DV Camcorders, yet offer powerful features such as a dual-band compandor for improved audio, and tracking front ends with advanced diversity reception to minimize RF interference and maximize range.

800-821-1121; www.lectrosonics.com

Booth: N3611

Audio codec

Dolby Digital Plus

An audio codec designed specifically to adapt to future audio, video delivery, and audio storage systems while simultaneously retaining backward-compatibility with the vast installed base of existing Dolby Digital 5.1 channel home theater systems; accepted by ATSC as a proposed standard for adoption in the future robust channel specifications within the ATSC standard.

415-645-5293; www.dolby.com

Booth: SU7870

Speakers

Genelec Large theater sound systems

Control room main monitor systems; very powerful studio monitor loudspeakers; consists of two large speaker enclosures and one or two equipment racks containing active crossovers, power amplifiers and driver protection; are designed for flush mounting in the control room wall, although they may be used free standing.

508-652-0900; www.genelecusa.com

Booth: N1726, SL1143

Are you looking for the fastest road to HD?



Where do you want to go?
Avenue will take you from
SD to HD.
Analog to Digital.
AES to Embedded.
And more...



Avenue modules include
video and audio converters,
frame syncs and SPG's.



NAB
SU 10217



Oh, and the control system rocks.

AVENUE™
Signal
Integration
System

ENSEMBLE
DESIGNS

Tel +1 530.478.1830 ▲ Fax +1 530.478.1832
www.ensambledesigns.com ▲ info@endes.com
PO Box 993 Grass Valley CA 95945 USA

Professional digital audio editing software Sony Sound Forge 8

Features application scripting, batch converter functionality, automated file format encoding and customizable keyboard mapping; saves paths in rendered media; offers updated regions list and playlist windows; includes CD Architect 5.2 software with CD text support; direct file export to CD Architect software; provides 24-bit, 32-bit/64-bit float/192KHz support; VU meters for RMS playback and record monitoring; CD extraction and track-at-once CD burning.

800-686-SONY; www.sony.com/professional
Booth: SU6406



Multichannel audio monitors ▲

Ward-Beck Systems AMS28-1 and AMS8-2
Two new audio monitors; AMS8-1 (one-rack unit) and AMS8-2 (two-rack unit) monitors integrated speaker systems and LED bar graph meters; feature four selectable digital inputs (75 or 110 ohms), which may be PCM, Dolby E or Dolby AC-3.

800-771-2556; www.ward-beck.com
Booth: C1924

Digital mixing console

Studer OnAir 500 Modulo

Consists of one or two fader modules, one master module, the meter bridge and a 19in electronics rack, resulting in a six-fader or 12-fader mixing desk; is based on the same platform as the OnAir 500 in its fixed frame version but also offers the freedom to place the individual modules wherever it is most convenient for the users.

+41 1 870 75 11; www.studer.ch
Booth: N3626



Channel audio logger ▲

Sonifex Net-Log 4

Fitted with a 200GB hard drive as a minimum spec; enhanced with the option to record using G.729 as the recording algorithm; for spoken language recordings, the amount of data required using G.729 can be reduced by a factor of between three and six.

+44 1933 650700; www.sonifex.co.uk
Booth: C3526

Digital console Lawo MC²

Is based around an IBM-ATM data switch; its basic design is fixed, but it has an open architecture allowing for free placement of the center section modules, user definition of soft key cassettes for functions such as machine control, communications and monitor selection, and for the integration of third-party hardware; all DSP functions are individually and independently available on each channel strip for multi-operator control.

+49 7222 1002 0; www.lawo.de
Booth: N816

Digital audio edit suite mixer

The ISIS Group (Graham-Patten Systems) D/ESAM 8000

Employs the Klotz VADIS mixing engine and routing system; features include send outputs, monitor sub-mixer, fader range, user configuration registers and D/MEM write protection.

888-622-4747; www.isis-group.com
Booth: C1836

Digital audio playback system

ENCO Systems DADtv

New features include uncompressed 5.1/7.1 surround capabilities for high-quality multichannel audio delivery, PBUS-II support and CD ripping functionality; features four stereo digital and analog inputs and outputs, each capable of handling up to three stereo streams at once, along with several user interface options.

248-827-4440; www.enco.com
Booth: N2826



High-definition eight-channel embedder ▲

The ISIS Group (Graham-Patten Systems) SoundPals HDDM-8

Provides eight channels of analog audio output; can be rack-mounted in the studio or operated on batteries in the field.

888-622-4747; www.isis-group.com
Booth: C1836

Audio synchronizer

Crystal Vision SYNAD-E

Allows a mixture of Dolby E and AES in the same audio group; either stereo pair within an audio group can be defined as Dolby E; onboard tracking audio delay avoids resampling and corrupting the Dolby E; instead data is separated and processed by a different path before being combined back with the AES into the synchronized SDI video.

954-788-3334; www.crystalvision.tv

Booth: SU6361

Audio mixing systems

Euphonix System 5-B and Max Air

Showing both digital audio mixing systems for on-air broadcast applications.

818-766-1666; www.euphonix.com

Booth: N3616

Software for audio meter

DK-Technologies Graphical Leq Software

Software for company's flagship audio meter, the MSD600M++; allows users to mix to the highest score on the Leq loudness standard; SMPTE timedcode input brings automated start/stop points and gives direct readout of where the sound material can be optimized for louder trailers/commercials.

+44 44 85 02 55; www.dk-technologies.com

Booth: C2757



Multichannel audio distribution system

Linear Acoustic StreamStacker Provides multichannel audio distribution for broadcasters, program providers, cable head-end or satellite organization facilities; combining up to four multichannel AC-3 programs into a single AES pair, unit offers enhanced channel density – more than 20 channels fit in the same space required for eight channels in Dolby E-encoded audio data.

717-735-3611; www.linearacoustic.com

Booth: Surround Pavilion/
C3612; C6221

Console

Euphonix 5-MC

Designed for audio post applications; interfaces directly to Digital Audio Workstations, such as Steinberg's Nuendo and Merging Pyramix using the EuCon high-speed control protocol.

818-766-1666; www.euphonix.com

Booth: N3616



Our approach to station automation:

get just the stuff you like.

(Don't worry, you can always go back for more.)

With Crispin's completely modular and cost-effective automation solutions, we can help you put together exactly what your facility needs – a system that's easy to add to when you feel like more. And whatever you order, it'll come with the kind of service only found at the finest establishments.

Automation just got easier.



www.crispincorp.com sales@crispincorp.com 919-845-7744

Come visit us at NAB, Booth SU9717 South Hall.



Console system

Harrison by GLW Trion 2005

Traditional surface architecture eliminates need for a central, shared-knobs control panel; controls and assignments for each channel are fully accessible as traditional vertically arranged strips or in an enhanced version expanded across eight channels for an intuitive know-per-function control; shares and supports remote control panels in applications where distributed control is desired.

615-641-7200; www.glw.com

Booth: N2418



Automatic dialog normalization system ▲

Linear Acoustic LA-5124

New version of the LA-5124 StreamStacker De-Multiplexer/AC-3 Splicer; long-term dialog loudness is measured in an ATSC standard manner, appropriate dialog level value is inserted into one of more precompressed Dolby Digital (AC-3) streams by the LA-5124; system is then able to provide automatic control of the long-term loudness of programming without need for decoding and re-encoding or for manually setting audio metadata parameters.

717-735-3611; www.linearacoustic.com

Booth: Surround Pavilion/C3612; C6221

D/A converter board

SALZBRENNER STAGETEC MEDIAGROUP XDA+

Dynamic range enhanced from 126dB(a) to 132dB(a) while latency has been lowered from 0.6 to less than 0.2 milliseconds; maximum output level of 24dBu exceeds the current studio standard of 22 dBu supported by previous XDA version; power dissipation loss is just 5W for eight channels instead of 4W for four channels as with the previous XDA board.

818-701-6201; www.stagetec.com

Booth: N4208



Smart audio consoles ▲

Smart AV Elite Series

Provides new standard of ergonomic efficiency for mixing and editing large numbers of channels with this new line of consoles; available in 48-, 72-, and 96-channel variants that can accommodate most professional sound applications; design features a physical arc that spans the console within reach of the operator; fitted with touch sensors, unit allows easy access to any channel.

+61 2 9648 6744; www.smartav.net

Booth: N3135

Router integration

Euphonix

Integration of consoles with facility routers enabling audio and panel-controlled router operators to have independent control of every source on the system.

818-766-1666; www.euphonix.com

Booth: N3616



Digital consoles ▲

Logitek Electronic Systems Mosaic

Multiple frame sizes allow configuration consoles to range from four to 24 faders; multiple full-color LCD screens; ability to change the color on some console buttons' backlighting; 16-character source names provide more information on sources at faders and meters; additional GPI/GPO control for external equipment.

713-664-4470; www.logitekaudio.com

Booth: N2022

Wireless microphone transceiver

Zaxcom TRX900

Features built-in IFB receiver, an RF remote control and 1.5 hour internal recorder with time code.

973-835-5000; www.zaxcom.com

Booth: N4215

18XX

Everyone's waiting to see it.

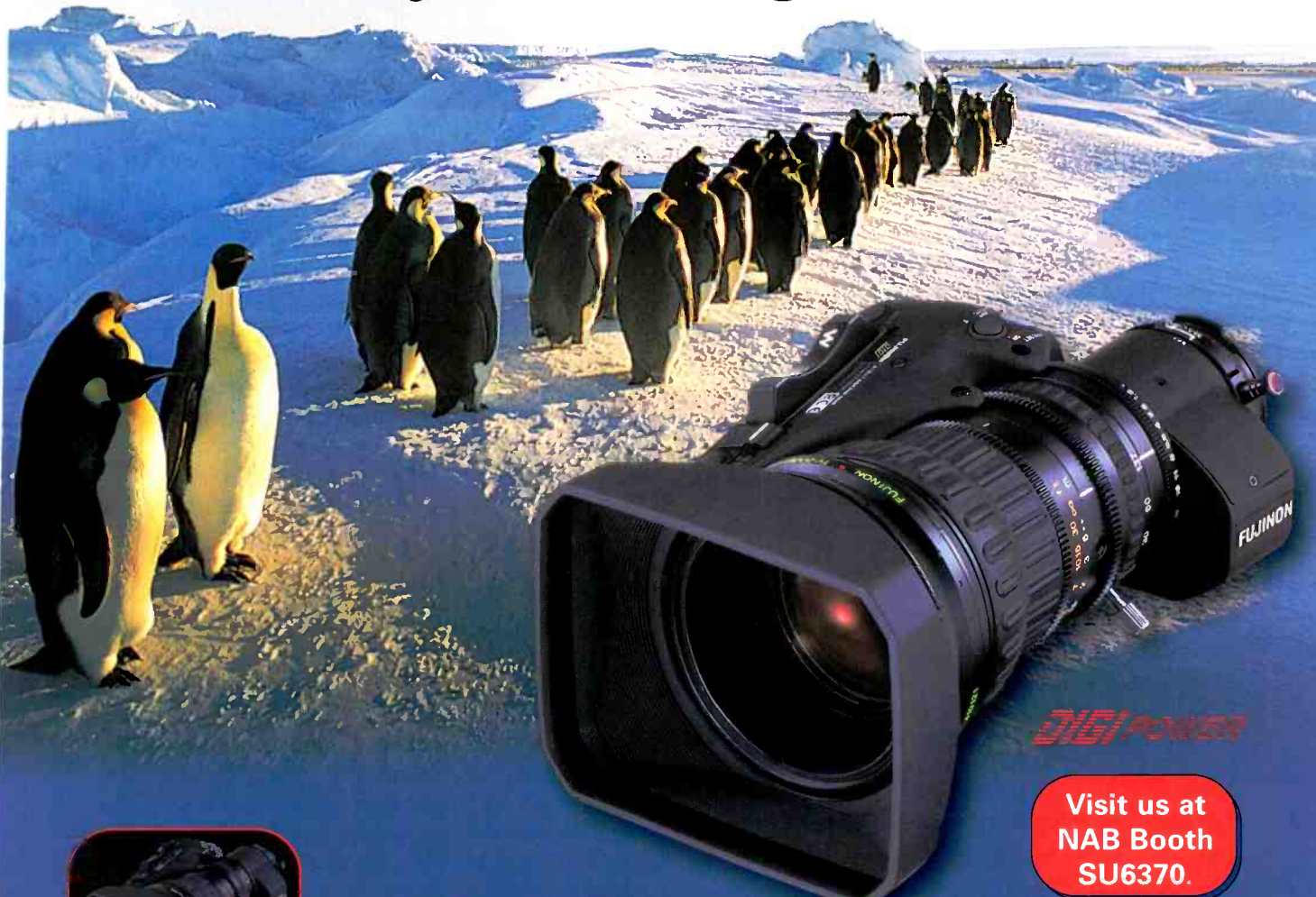

DIGIPOWER

Visit us at
NAB Booth
SU6370.



HA18x7.6ERM/ERD
High Definition



A18x7.6ERM/ERD
Standard Definition



HA18x7.6BMD
Motor Drive

Features vary with model.

ONLY FROM FUJINON!

- 18X Standard Zoom Range
- Longest and Widest Standard Lens
- DigiPower Servo
- User-Programmable Functions
- Remote Control

FUJINON

Broadcast and Communications Products Division

FUJINON INC. 10 High Point Dr., Wayne, NJ 07470-7434 Phone: (973) 633-5600, FAX: (973) 633-5216

FUJINON CORPORATION 1-324 Uetake, Kita-Ku, Saitama City, Saitama 331-9624 Japan Phone: 81-48-668-2152

www.fujinon.com



Audio console ▲
Wheatstone Gen 6 Console

Incorporates features from the series' larger surfaces into a studio-friendly footprint; integrates with the Bridge Digital Audio Router and allows system-wide access to a station's on-air and off-air audio resources via interlinked Cat. 5 or fiber-optic cable; features include Ethernet protocol, VDIP configuration, X-Y controllers, eight-character controller displays, AUX sends and increased PRESET options to boost save-recall capability.

252-638-7000; www.wheatstone.com
 Booth: N2802

SDI embedder/de-embedder board
SALZBRENNER STAGETEC
MEDIAGROUP
XSDI and XSDI 02

Designed for the digital audio router NEXUS; XSDI allows for asynchronous treatment of signals with different clock sources; on XSDI 02 the SDI signal does not need to be in synch with the NEXUS because unit implements sample rate converters on the XSDI board, creating a clock boundary between the asynchronous SDI signal and the NEXUS system.

818-701-6201; www.stagete.com
 Booth: N4208



Audio processor ▲
Wheatstone Audio Processor

Two channel/stereo audio processor features single-rack design; provides an array of analog/digital inputs and outputs, four-band parametric EQ, three band compressor and tunable filters along with overall AGC, limiting and expansion; all settings can be stored and replayed as password-protected presets.

252-638-7000; www.wheatstone.com
 Booth: N2802



Digital broadcast console ▲
Solid State Logic C100

New feature, TouchPan, provides full 5.1 panning access from the central touchscreen, with color coded displays and comprehensive control of all surround parameters, allows simple setup and control for sophisticated 5.1 productions; comes with new channel TFT Graphics, which enhance the operator's overview through per-channel display of processing, panning and source allocations; supports new I/O expansion for the Centuri core.

+44 1865 842300; www.solid-state-logic.com
 Booth: N3211

AUTOMATION TECHNOLOGY

Content management control system
WEGENER MediaPlan

Allows operators digital asset management in an end-to-end environment, supporting ingest of analog and digital assets, management of archived digital assets, remote tracking, updating or deleting of individual assets on the company's iPump media servers, targeting the company's receiver groups, regions or individual sites.

770-814-4000; www.wegener.com
 Booth: C2624

Media asset management system
Nesbit Systems (NSi) Media Library System 2006 (MLS-2006)

Multi-user, client/server SQL application allows enterprise-wide access for data distribution; optional WebMLS-2006 Module enables password-protected, 24/7 global access to archived media assets; offers multiple search options as well as criteria searches and a text retrieval engine.

609-799-5071; www.nesbit.com
 Booth: TBA

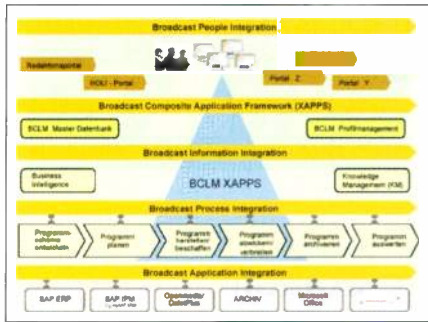

Systems integrator ▲

Siemens Content Lifecycle Management
For the integration and control of organizational, technical, commercial and administrative business processes in broadcasting companies; defines the best possible integrative control, administration and reuse of content across all business processes, makes the key processes within broadcasting corporations transparent for employees, partners and customers.

+49 (211)-474-31 89; www.siemens.co.uk
Booth: SU8541

Ingest system

ON-AIR Systems Kapture

Integrates the ingest of tape-based content and satellite and line feeds into a single application; enables monitoring of tasks across multiple channels, providing reduced running costs in a traditionally labor-intensive process.

800-379-0809; www.on-air-systems.com
Booth: SL5710

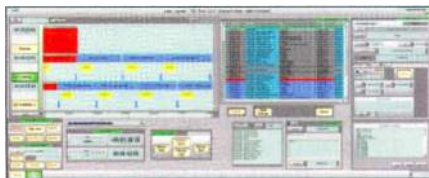

Automation system ▲

Omnibus Systems Colossus V3
New automation system for the transmission arena; combines the automation architecture of the delivery system with the modular flexibility of G³ technology; is able to control large numbers of channels, items, or devices all through customizable desktop-based user interfaces; features an intuitive user interface with a timeline-based display; allows a single operator to monitor the status of all channels and to focus in on any single stream, confirm its data, and drive it in the traditional manner should the schedule require it.

704-319-2231; www.omnibus.tv
Booth: SU7165

Open-standards ingest system

Snell & Wilcox Comet

Powered by company's MediaX real-time MPEG-2 PCI encoder; enables broadcasters to create multi-vendor systems with complete interoperability and begin to move away from proprietary server storage and asset management systems.

+44 20 8917 4300; www.snellwilcox.com
Booth: SU6349

Automation software

Sundance Digital Fastbreak Automation V4.0

Fourth-generation reliable workhorse solution for broadcast automation shares some elements of the company's advanced Titan system architecture as well as an updated graphical user interface (GUI).

972-444-8442; www.SundanceDigital.com
Booth: SU10011



Camera Track Systems

- Smooth, quiet direct drive motorized trolley with variable speed operation and preset positioning.
- Eliminates the cost of multiple cameras and pan/tilt heads.
- Lightweight aluminum track with in-line cable trolleys or companion cable track
- Ceiling, wall or floor mounting
- Straight or curved configurations

Telemetrics Inc.
CAMERA CONTROL SYSTEMS
www.telemetricsinc.com



Broadcast control ▲

Pharos Communications Pilot Ria
Eliminates the clutter and expense of hard-wired panels and resource-hungry desktop applications; provides full reactive control of broadcast routing equipment from any Web browser via local or secure-coupled intranet; can be deployed quickly and easily throughout a single-site or multi-site facility; when necessary, allows engineering staff to reconfigure a system from home or while traveling.

+44 1189 502 323; www.pharos-comms.com

Booth: SU 11835

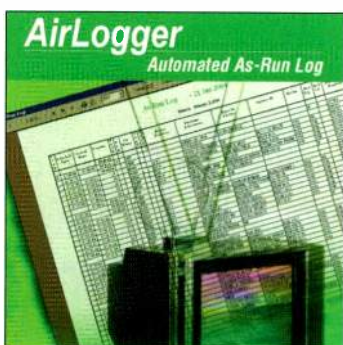

Automation ▲

Florical Systems AirLogger

Off-air recording of 100 percent of transmitted video and audio in S-VHS resolution in AVC or MPEG-4 format can now be stored permanently on inexpensive DVDs.

352-372-8326; www.florical.com

Booth: SU10000

Automation system

IBIS PAC

Allows broadcasters to implement a range of process, control and automation systems; adds to and integrates with the company's existing range of systems, including station automation, news/sports automation and channel/asset management.

877-541-IBIS, www.ibis.tv

Booth: SU10332



Encoder ▲

Doremi Labs ORCA Capture Station

A HDMPEG2 record and playback solution capable of compression rates up to 160Mb/s; consists of Doremi's ORCA Encoder and a DVB/ASI stream recorder housed in a Linux based 4RU chassis with 500GB of storage; combines all the tools for real-time HD MPEG2 processing in one package; encodes SDI or HD-SDI to the system's hard drive; the encoding process can be previewed live or played back at a later time via composite, DVI, SDI or HD-SDI video outputs.

818-562-1101; www.doremilabs.com

Booth: C2342

Content management system

Strategy & Technology and SysMedia iTV system
End-to-end solution for production and distribution of OCAP/ACAP/MHP-compliant iTV programming; uses SysMedia's Plasma Magenta content and production management technology and S&T's TSBroadcaster DSMCC Object Carousel.

S&T. +44 20 7336 7878; www.s-and-t.com

SysMedia: +44 1293 814 200; www.sysmedia.com

Booth: SU11408

Digital delivery management system

Sundance Digital DDMS

Works in conjunction with various digital content delivery providers, such as Pathfire; minimizes labor-intensive tasks involved with bringing program-length and commercial content into the broadcast facility.

972-444-8442; www.SundanceDigital.com

Booth: SU10011



in the news

CNN Takes it to the Max with Nine Consoles

New York—Washington D.C.—Atlanta

After an extensive evaluation process, Cable News Network (CNN) has selected Euphonix as the vendor of choice for their digital audio mixing consoles. A total of nine Max Air consoles have been employed, including four at the new CNN facility at Columbus Circle in New York City, two at CNN Washington D.C. and three at CNN Center in Atlanta, Georgia—the company's headquarters.

The Euphonix Max Air consoles, located in New York, handle all of CNN Domestic programming.

The day begins at 5am with *Day Break* and closes at 10pm with Aaron Brown's *Newsnight*. Throughout the day, the consoles broadcast a wide range of other shows including *Lou Dobbs Tonight*, *Anderson Cooper 360*, *Paula Zahn Live* and *Larry King Live* (when he is in town).

Two Euphonix Max Air audio consoles will be installed and on-air by the end of March in CNN's Control Room A and B in Washington D.C. CNN's Director of Operations, Robert Jackson commented, "I've always had my eye on Euphonix consoles and always loved what their products are capable of. We like the ease of use. The mix minus is very easy to figure out and we can access it on the fly. In addition, the routing is very intuitive."

First Max Air for South African Broadcast Corp.

South African Broadcast Corporation—SABC, the national public service broadcaster for South Africa, has installed a Euphonix Max Air digital audio console in their new Studio 12 control room in Johannesburg. The console is being used to broadcast news and current affairs.

"We decided to go with the Max Air due to cost-effectiveness and design. Max Air is priced such that it was actually more affordable, based on features, for us to go digital rather than analogue," commented Carl Naude, SABC Technology Manager, TV News Facilities.

"Max Air is extremely competitively priced for its rich digital feature set and advanced technology, which makes it easier to handle large numbers of inputs from a compact control surface and to recall settings at the push of a button."

"I've always had my eye on Euphonix consoles and loved what their products are capable of."

— Robert Jackson,
CNN Director of Operations



inside this edition

in the news

- >> CNN Takes it to the Max with Nine Consoles
- >> First Max Air Console for South African Broadcast Corp.

sound advice

- >> Going Digital? What to Keep in Mind
- >> Mobile Advice Column—KCET

production

- >> 'The Tonight Show' Makes Major Upgrades
- >> Canal+ Sports Three Euphonix Consoles
- >> Euphonix Broadcast—New Full Router Integration

mobile

- >> Gearhouse Upgrades to Max Air
- >> MTG Saves Money, Time and Weight with Euphonix
- >> CBC Goes Mobile with Third Euphonix Console

demo

- >> Test Drive Max Air

He continued, "When going from analog to digital you also want to make sure the audio console manufacturer you choose is on solid ground, which Euphonix is. The company has a good reputation and its customer service is great."

The consoles in Washington D.C. will be used for *CNN Headline News*, *CNN International*, *CNN Español*, all of the Wolf Blitzer shows, *On the Air*, *Late Edition*, *Capital Gain*, *Inside Politics*, and *On the Story*.

Two more Max Air consoles will also be used for CNN Interactive in Atlanta and at the CNN Center.

"Max Air was able to put our minds at ease."

— Carl Naude
SABC Technology Manager

He continued, "Besides being well priced, we found Max Air to be exceptionally well designed and unproblematic. The console layout is very intuitive with the majority of the channel controls above the faders. We liked the idea of not having to assign everything to a central channel when making adjustments such as routing and EQ. In a news environment fast operation is essential. Max Air was able to put our minds at ease."

<< continued on next page >>

Gearhouse Broadcast Upgrades to Max Air

"After an extremely successful deployment of two Max Air digital consoles at the 2003 Australian Tennis Open, we were keen to integrate Max Air in our OB fleet," commented George Hennessey, Audio Supervisor, Seven Network Melbourne. "We found the desks easy to use, and solidly reliable. It was only natural that when Gearhouse was contracted to provide our OB facilities we requested these consoles."

In November 2004, Gearhouse Broadcast secured an open ended contract with Seven Network, commencing with the Centenary Australian Open Golf Tournament. Gearhouse Broadcast has gone on to provide equipment and personnel for the majority of Seven Network's OB events including the Australian PGA, the Australian Masters, the Sydney Carols

and Seven's Summer of Tennis

To accommodate this comprehensive schedule, Gearhouse Broadcast acquired one of Seven Network's Melbourne OB trucks and thoroughly refitted it. One of the major upgrades was the installation of a 96 channel Euphonix Max Air audio console with 16 aux, 24 group busses and 24 mix busses.

"We're delighted with the choice of Euphonix," commented Dennis Doval, Operations Manager, Gearhouse Broadcast. "For us it's essentially a good business decision. Seven Network is comfortable and confident with Max Air. The product has a clear and proven development path—our bases are covered."



"For us it's essentially a good business decision."

— Dennis Doval, Operations Manager
Gearhouse Broadcast, Australia

demo

Max Air Broadcast Tour Let us Come to You ...



"The Euphonix Max Air Broadcast Tour helped simplify our decision making process. I was able to evaluate the board in an installed environment, operated by a very knowledgeable sales person—this made all the difference." —Ed Williams, Director of Engineering, KPTV

Make sure you don't miss your chance to 'Take it to the Max' with the latest Euphonix digital audio console—Max Air. Euphonix's Max Air Broadcast Tour truck is outfitted with a 96 channel Max Air mixing system and is set-up to simulate a local TV station digital audio control room with playback of 48 channels of digital audio and 8 video streams, which includes program, preview and 6 camera/OB sources. Engineers can get hands-on experience with the console and discuss requirements and applications with our expert staff. For our latest tour schedule go to: euphonix.com/tour/index.htm

Euphonix
digital emotion

euphonix.com

©2005 Euphonix, Inc. All rights reserved. Max Air, System 5, System 5-B, and System 5-BP are trademarks of Euphonix Inc.

Gordon Bell —
Director of Engineering,
KCET, Los Angeles

Q. What's important to you in choosing a digital audio mixer?
A. Flexibility—and ease of operation.

Q. What made you go with Euphonix?
A. Euphonix has a tremendous record for support, service and training. It has proved invaluable

Q. What upcoming events will you be using the console inside the OB Truck for?
A. We have used our Euphonix audio console for PBS's interview/music show *Tavis Smiley*, ESPN's *Jim Rome is Burning* and *The Big Spin* — a California Lottery Corporation show airing on KCAL.



KCET OB Truck

About Euphonix:

Euphonix is a world leader in manufacturing digital audio equipment. Celebrating its 17th year, Euphonix supplies products to premier broadcast and post production facilities around the globe. All of the company's products are designed and manufactured in Palo Alto, California—the heart of Silicon Valley.

Nearly 200 facilities worldwide have selected Euphonix products for on-air news, OB/Mobile units and production audio mixing applications. The Euphonix product line includes the System 5-B and Max Air. All systems feature robust and reliable construction, a full line of integrated audio converters and routing products engineered to suit your needs.





Broadcast software ▲

ICF – Interactive Content Factor

Product line designed for the ingest, management, production and delivery of digital content; HSM is an add-on module to ICF enabling near line archiving in partnership with ADIC; ICF inabox is a complete ICF in a mobile flight case; NetEdit SDK is a suite of components that enables broadcasters and integrators to build proxy video editing applications using the Windows Media 9 Series platform.

617-783-9032; www.twii.net

Booth: SL2461

Station management system

Omnibus Systems G³ Control for automation
An advanced station management system; offers flexibility in providing device access, operation and management over distributed networks for efficient, integrated broadcast operations; encompasses solutions for router control, machine control and integration with signal processing equipment, all from a customizable user interface with access available to multiple local and remote users.

704-319-2231; www.omnibus.tv

Booth: SU7165

Media interface adapters

Omneon Multiport 4100 series

Line of media interface adapters available for Omneon Spectrum media server systems; can support simultaneous playback of both SD and HD MPEG2 material; features integrated capability for the simultaneous playback of HD and SD content on either the same channel or independent channels; in addition to outputs for SDI video, HD-SDI video, audio, timecode, and control, it also includes connectors to allow for the use of external up- and downconversion equipment.

408-585-5000; www.omneon.com

Booth: SU10724



Automation ▲

Pharos Communications Playtime iA

Designed to meet growing demand for interactive programming; enables broadcasters to deliver dynamic presentation such as viewer-controlled games and vote-enabled content; elaborate interactive audience-participation effects can be achieved reliably and efficiently under automated control; next event to air can be based on aggregated audience feedback or other data; ideal for managing audience reactions and playout from live studios.

+44 1189 502 323; www.pharos-comms.com

Booth: SU 11835

Automation system

Sundance Digital Titan

Remote control functionality; capable of controlling hundreds of play-out channels within a single facility or play lists at multiple remote locations.

972-444-8442; www.SundanceDigital.com

Booth: SU10011

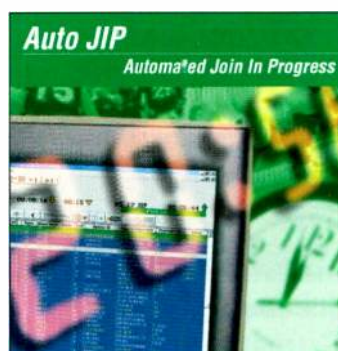

Automation ▲

Floral Systems Automated Join in Progress (JIP)

Featured in the AirBoss presentation controller; is fully automated to provide potentially unattended join in progress of local recorded programs based on a remote signal from the network.

352-372-8326; www.floral.com

Booth: SU10000

Transfer tool

DNF Controls Playlist Transfer Tool

Designed to work hand-in-hand with the company's 3040P Playlist Playout System; allows operators to create playlists offline on about any Windows -based text editor and transfer them easily into the 3040P prior to show time; reads and reformats the playlist into the 3040P's native file format, then transfers the list over a serial connection; users can save the transferred playlist into List 1, List 2, List 3, List 4, or List 5 locations in the 3040P.

818-898-3380; www.dnfcontrols.com

Booth: SU8552



Automation

Florical Systems Breaking News

Use of pre-programmed sequences makes it possible for a single operator to perform a complex production of insertion of local or network breaking news with a variety of effects that would normally require a production crew.

352-372-8326; www.florical.com

Booth: SU10000



Editing application

Crispin Supervisory View

Recently added to RapidPlayX; enables operators to see, from a single screen, multiple play-to-air channel status complete with visual notification of messages, warnings and operator intervention requests; notifies operators of an impending event through a set of color-specific flashing indicator boxes; operators can also see a scrolling index of cued and on-air events per channel; allows operators to configure multiple workstations on the network to monitor multiple channels.

919-845-7744; www.crispincorp.com

Booth: SU9717

Production control system

Ross Video OverDrive

V 3.0 of the OverDrive Production Control System includes applications for news, sports, faith-based and live event productions; increases the power and flexibility of OverDrive by adding control for Chyron CGs, text feedback from newsroom systems and safety crossover switch for redundant server applications; enhanced audio and video server control added to the DirectControl display.

613-652-4886; www.rossvideo.com

Booth: SU7141



Editing application

Crispin RapidPlayX

On-air playback application; provides playlist monitoring and control, allowing facilities to create and load playlists, edit events, issue playlist commands and monitor event status; automatically loads daily program and record schedules for 7/24 operations and instantly updates events when new material is available on the video server or is updated in AssetBase, Crispin's Web-enabled database.

919-845-7744; www.crispincorp.com

Booth: SU9717

Video air check system

Axon Digital Design BV TRACS (Transmission Recording And Compliance System)

Offers a highly reliable platform that fully automates the process of audio and video recordings for 30 or 90 consecutive days; consists of a range of networked digital video recorders connected to a request server that also acts as a web server and monitoring unit; records and plays out full Vertical Blanking Interval (VBI) content; the recorders, which use the MPEG-2 or MPEG-4 compression format with variable bit rate, are accessed through the request server by means of web pages.

+31 13 511 6666; www.axon.tv

Booth: SU9301

8vsb RECEIVER/ANALYZER

The **msi-4400** 8vsb ANALYZER—a cost-effective tool for receiving and evaluating 8vsb signals without breaking your budget.

Hardware

A single rack unit controller, the **msi-4400** Analyzer receives and processes the 8vsb signal using a Windows-based PC. Front panel indicators show the status of alarms, and confirm RF level and signal strength. External connections for alarms, and transport stream in LVDS, SMPTE 310M and DVB-ASI formats are all accessible from the rear panel.

Software

The **msi-4400** Analyzer's software runs on a Windows-based computer. The software provides a complete display that shows the critical 8vsb parameters in a clear, easy-to-understand format:

- ◆ Eye Pattern Diagram
- ◆ Constellation Display
- ◆ Signal Strength Metering
- ◆ Signal to Noise/MER/EVM Readout and Strip Chart
- ◆ Tap Weight Equalizer Graphs
- ◆ Data Logging
- ◆ Bit Error Rates
- ◆ User-configurable alarms with E-mail notification

You can configure the tap weight scale display, data logging, SNR/MER/EVM strip charting and full remote control to meet your specific requirements.

All reports and controls are available locally on a rack-mount PC or a laptop computer, or from a remote location through the Internet.

The **msi-4400** Analyzer is covered by MSI's three-year warranty.

Introductory price: \$9860

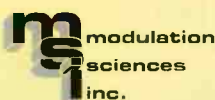

12A World's Fair Dr. Somerset, NJ 08873
(800) 826-2603 Toll Free · (732) 302-3090
E-mail: sales@modsci.com · Web: www.modsci.com

Specifications subject to change without notice.

Visit Us at NAB2005 Booth # C1223.

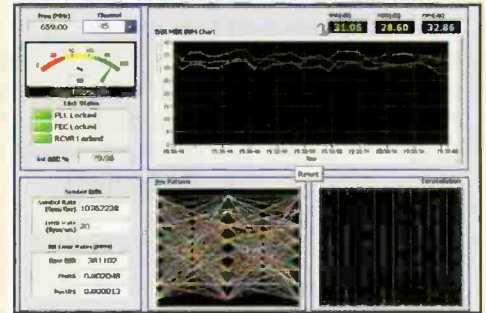

✓ **Accurate**

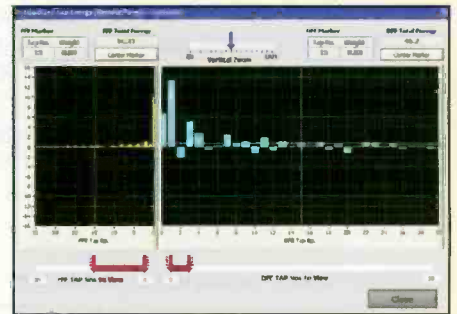

✓ **Affordable**



✓ **Comprehensive**



Digital delivery management system

Sundance Digital DDMS

Works in conjunction with various digital content delivery providers, such as Pathfire; minimizes labor-intensive tasks involved with bringing program-length and commercial content into the broadcast facility.

972-444-8442; www.SundanceDigital.com
Booth: SU10011

Transfer tool

DNF Controls Cue List Transfer Tool

Enhances the power of DNF Controls' 4040CL and 2044CL clip controllers; allows easy access and retrieval of cue lists from a PC; the list of cue points learned into the 4040CL or 2044CL may be uploaded to the PC and stored there as a file; if the cue points need to be changed for a different show or show segment, or are inadvertently deleted, users can restore them quickly and easily by downloading them from the PC back into the DNF controller.

818-898-3380; www.dnfcontrols.com
Booth: SU8552

Newsroom computer system

OCTOPUS Newsroom Trading OCTOPUS5

Offers integration of assignments, newsgathering, scheduling and transmission; features include wires browsing, SMS alerts, personal notifications, shared user folders, stories planning, script history tracking, multiformat low-res video browsing and MOS 2.8 support.

+420 221 181 511; www.octopus-news.com
Booth: C8233

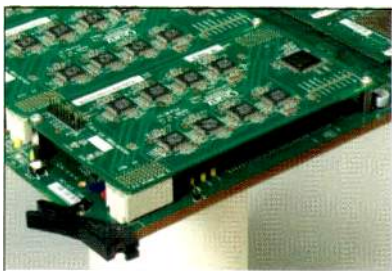

Master control product ▲

Quartz Electronics QMC-2

Can switch between multiple HD and SD signals and formats and provides enhanced features, including 16 channels of audio with internal Dolby E decoding, two layers of internal logo storage/keying with animation capabilities, and three external key layers.

530-265-2815; www.quartzus.com
Booth: SU9652

Automation

Vqual Cerify

An automated system for verifying/checking content prior to transmission or use; all aspects are checked, including compliance/correctness to video and audio standards, video formats, resolutions, bit-rates and video quality.

+44 117 3101 244; www.vqual.com
Booth: SL4535



Television automation software ▲

Digital Transaction Group Eclipse

Eclipses traditional automation with a new technology framework and architecture; employs standard IT networking, non-proprietary hardware and high-performance SQL database.

800-243-2001; www.dgtv.com
Booth: SU11533

Asset management

ON-AIR Systems Kore

Application for scheduling, media asset management and database workflow automation; part of the ingest-payout workflow, providing a powerful set of tools for automating the traditionally labor and data intensive tasks for program scheduling, media management and report generation.

800-379-0809; www.on-air-systems.com
Booth: SL5710

Newsroom automation

Pathfire News Connect

Integrates Digital Media Gateway (DMG) functionality into AP ENPS and Avid iNEWS newsroom computer systems (NCS); content is added automatically to the NCS as soon as it arrives on DMG server; users work within a single interface and area able to browse, view low-resolution clips and drag-and-drop script information into news scripts from within their NCS.

770-619-0801; www.pathfire.com
Booth: SL1353

WIRELESS INTERCOM



DX 200

Spread Spectrum, Frequency Hopping, 2.4Ghz Digital Wireless Intercom

THE BEST OF BOTH WORLDS!



PRO 850

Dual Channel, Frequency Agile system with PC monitoring Software

AVAILABLE RIGHT NOW!

Systems Wireless and Audio Specialties Group

Demo both at

NAB 2005

THE WORLD'S LARGEST ELECTRONIC MEDIA SHOW

Booth C7319D

FULL SERVICE • COMPETITIVE PRICING • TECH SUPPORT

Intercom Specialties
888.810.1001

HME
www.hmepro850.com

Systems Wireless
800.542.3332

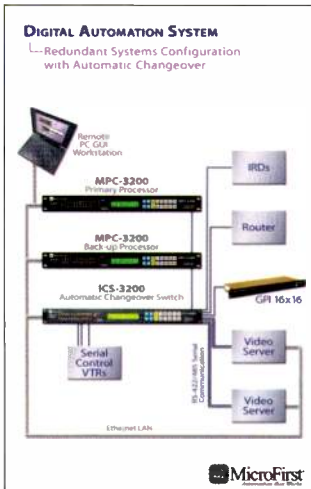

Digital automation system ◀

MicroFirst Engineering D.A.S.

Provides meta data management and device control through real-time automation and management system; offers sophisticated logging functionality, dynamic near real time integration, full-functioned graphical device control, distributed

or centralized IP control, monitoring and maintenance of WAN television system as well as interfaces to near line storage and archive management systems.

201-651-9300; www.MicroFirst.com

Booth: SU9643

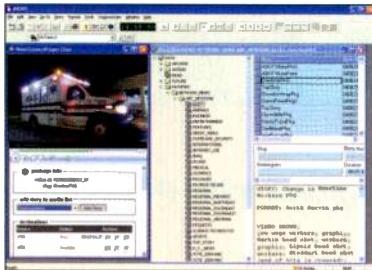

Automation platform ▲

Pathfire Automation Connect

Automation system has direct access to metadata and control of content movement; eliminates need for manual processes; all content timing, air date and rating information is transferred electronically, providing accurate automated metadata and content management.

770-619-0801; www.pathfire.com

Booth: SL1353

Traffic and programming system

BroadView Software Traffic & Programming module

Updates to the system include advanced secondary event management, detailed library management, robust avails analysis functions and a sales data warehouse; the integrated modular system is designed for any size broadcast or cable operation, from single-channel to large multichannel operations.

416-778-0623; www.BroadViewSoftware.com

Booth: C6217

Broadcast automation

Fission Software software

Integrated extensible software has the ability to digitally capture, insert, and manage and control the blocking of commercial spots and programming in all types of broadcasting facilities, including network local television stations, satellite ground stations, and remote repeater stations; created to replace tape playback systems and modernize station workflow.

203-791-3866; www.fission-sw.com

Booth: C9807

Digital news production

Just Edit vsnnews

A powerful, entirely integrated news system that allows text/video editing in the same application; it covers all issues in a uniform environment, including rundown planning and creation, resource management, word processing, video feed recordings, and archive storage, organization, and cataloguing; is completely integrated with vsnarchive system, the real-time titling system, the teleprompter, and the automated web publishing of news; also included in the seamless integration is the shared video and audio editing, with voice over from journalists computers.

+34 937349970; www.vsn-tv.com; www.justedit.es

Booth: SL3341

Newsroom automation software

Dalet Digital Media Systems

DaletPlus News Suite

Source material, work in progress and finished packages are shared and instantly available on the desktop or remotely through secure web access; Metadata is captured automatically, and repetitive tasks can be automated; integrated asset management and archive capabilities provide access to tape and DVD libraries.

212-825-3322; www.dalet.com

Booth: SL1953

Digital signage/broadcast system

ON-AIR Systems infoKast

Delivers graphic information and live video from a single workstation; enables users to integrate up-to-the-minute news, weather, sports results and stock market information into live and pre-recorded video in a fully customizable screen layout; designed for a range of applications, including television broadcasting and point of sale, information points in airport terminals, underground stations and shopping malls.

800-379-0809; www.on-air-systems.com

Booth: SL5710

Video network server

Ai-Pixel VRX-8300

Provides cost-effective MPEG-2 industrial digital video solutions; 4-channel; allows for simultaneous recording, playback, streaming and export on all channels and has an exceptional internal storage capacity of up to 2Tb or four months of video content; features full SDI I/O, balanced audio (XLR) I/O, closed captioning/V-chip support, and Enhanced Broadcast Graphical User Interface.

+31 6 21 884 675; www.ai-pixel.com

Booth: SL4353

Video server

Ai-Pixel Playout Server

Designed for small to medium sized TV Station Operations; offers compliance with all standards (SDI, PAL, NTSC, analog, digital), compliance with automation servers (VDCP), easy operation, easy import/export, easy to use, high functionality Playlist, allowing the user to make "on the fly" changes in the Playlist without interrupting any simultaneous operations, guaranteed high quality and reliability.

+31 6 21 884 675; www.ai-pixel.com

Booth: SL4353

CAMERAS/ LENSES AND ACCESSORIES

Camera battery

IDX System Technology Endura

Next-generation Lithium Ion technology; new ENDURA components provide the highest power to weight ratio in the industry, more power, longer run times, and longer life; new chargers provide faster charging, less weight, and incorporate unique advanced power technology; fully compatible with all existing ENDURA components and continue to meet all worldwide safety and air transportation regulations.

310-891-2800; www.idx.tv

Booth: C3036

Storage/archive system

Software Generation Ltd (SGL)

SGL will demonstrate its leading digital video storage/archive management software at the following Booths: ASACA (Booth SL1426), Avid (Booth SL600), IBIS (Booth SU10332), Sundance Digital (Booth SU10011).

+44 23 8023 3322; www.sgluk.com

Booth: see above



Look Smart.

Choosing Sundance Digital to be your automation provider isn't only good for operations. After all, making the smart decision always makes you look good. Not to mention that the smart call helps you avoid the other call — the one that gets you out of bed in the middle of the night.

Point being, the people at Sundance understand what you expect from an automation company, and they deliver on all counts. Reliability, professionalism, customer service, technical support, flexibility, integrity and rock-solid software. All these advantages make Sundance Digital the world's best automation value — and choosing that value makes you look smart.

Not to mention better rested.

www.sundancedigital.com 972.444.8442

SUNDANCE
DIGITAL

BROADCAST AUTOMATION SOLUTIONS

Visit us at NAB Booth #SU10011



**Televator II Elevating Pedestal
Telemetrics EP-PT-S3**

A two-stage version of the Televator series; provides greater range and speed; operation can be further enhanced with the addition of a new Flex Trak Interface that enables the product to be used in conjunction with Telemetrics' CTS Floor Track for motorized pedestal applications.

201-848-9818; www.telemetricsinc.com
Booth: C7337



Camera bag ▲

Cinebags The Cinematographer
Designed with numerous padded compartments; ensures that meters, digital cameras, and laptop are all in the same bag and well protected; all compartments feature heavy padding and a label holder that provides easy navigation through the bag to find the needed tool quickly; other features include heavy duty buckles, large padded shoulder strap, six padded meter compartments for tools such as lightmeter, sportmeter, digital camera, palm pilot, viewfinder, spare Laptop battery or charger, and similar sized tools and a large padded compartment for Laptop, script, or grayscale.

818-662-0605; www.cinebags.com
Booth: C11037



Pan and tilt system ▲

Frezzi Energy Systems Total Control
Can support 30lb and 15lb camera loads; Pilot Controller is ergonomically designed, is simple to use and can control all functions of the camera and lens; each CPU is capable of controlling up to 18 cameras, 3 pilots, and 100 plus other devices including a 17in Touch Panel Display with Shot Recall.

800-345-1030; www.frezzi.com
Booth: SU10718

Battery charger

Frezzi Energy Systems Dual channel quick charger FQC-2

Provides simultaneous two channel charging of NiCd and NiMH Brick style batteries ranging from 12 to 14.4 volts of any manufacturer; weighs 2lb; measures 3.75in by 3.75in by 4.75in; with Auto-Select 90-240VAC operates world-wide trouble free.

800-345-1030; www.frezzi.com
Booth: SU10718

HD camera

Panasonic AK-HC900

Weighs 3.9lb; provides astounding color reproduction accuracy and its compact size opens new avenues for high-definition sports coverage, television program production, business communications, and government and scientific imaging; offers a 720-line high definition output at 60 progressive frames per second; employs three 2/3in 1 million-pixel (1280 x 720) IT CCDs with dramatically improved dark and highlight image quality.

201-392-4127; www.panasonic.com/broadcast
Booth: C3617

Hybrid/Fiber/Triax Adapters

Telemetrics HFT-BS and HFT-CA

Can reduce the costs associated with running bulky and expensive SMPTE 311M hybrid cable between a HDTV camera and its CCU with power provided through existing triax or locally with batteries.

201-848-9818; www.telemetricsinc.com
Booth: C7337



CALL ANY TIME.

We want to be your first call. That's why SES AMERICOM is building what we think you'll agree is the best 24x7 occasional broadcast service with our OCCASIONAL ALWAYS ON service.

With the acquisition of Verestar teleports, we're now providing you with expanded and improved occasional broadcast solutions. You get access to more satellites and ground facilities, improved online booking, dedicated account representatives, and great customer service.



Our experienced staff will work with you 24x7 to solve your occasional needs for special events, breaking news, entertainment, sports and teleconferences. Our tradition of excellence, based on 30 years of industry leading service, assures we'll be here when you call. OCCASIONAL ALWAYS ON delivers an expanded domestic and global network of distribution services – full-time and ready to serve. We offer 120+ fixed and agile antennas spread among five major earth stations (two on

the West Coast, two on the East Coast, and one in Europe). We also have multiple access and connectivity to the AVOC in Washington, 60 Hudson in NYC, and BT Tower in London. SES AMERICOM is North America's leading trusted and reliable source for your satellite-delivered distribution needs.

Call any time for OCCASIONAL ALWAYS ON's complete teleport and satellite services: 800-732-3273 or +1-609-987-4144. For more information visit us at NAB 2005, Booth C5245, or online at: www.ses-amicom.com

SES AMERICOM
An SES GLOBAL Company



Time battery ◀ **PAG L95 V-Mount**

A digital Li-Ion battery offered in three formats: V-Mount, Snap-on (Anton-Bauer), and PAGlok; combines power, accuracy and reliability; the 14.8V 6.5Ah pack has a capacity of

95 watt-hours and weighs 745g; increased run-time for both a camcorder and a camera light up to 35W; two L95s provide enough power for a days shooting with most camera and lighting set-ups.

818-760-8285; www.pagusa.com

Booth: C9719

Camera support system **Anton Bauer STASSIS**

A lightweight shoulder mount; redirects the geometry of a mini-DV camera to make use of the body as a stable support platform; the body support system improves both the ergonomics and performance of a professional min-DV handheld; its adjustable front plate comfortably takes weight off the operator's hand; and the rear battery mount counters the forward weight of the camera; using any professional Gold Mount battery delivers extended runtimes up to 10 hours.

800-422-3473; www.antonbauer.com

Booth: C7319C



2/3in camcorders ▲ **Sony DSR-400 and DSR-450WS**

Feature a rugged design for use in electronic news gathering; engineered around three 2/3-inch PowerHAD EX CCD imaging sensors; the DSR-450WS is a widescreen model that can capture images in 60i at 24PsF, 25PsF (PAL mode only) and 30PsF; the DSR-400 features a 4:3 version of the Power HAD EX CDD; feature a -65dB signal-to-noise ratio with a -140dB of vertical smear.

800-686-SONY; www.sony.com/professional

Booth: SU6406

Camera lens

Canon IFpro lenses

Internal Focus enhances optical performance and provides user benefits, including improved chromatic aberrations, increasing resolution; no sensitivity to changes in object distances; a decrease in flare by use of a square hood; a higher level of creative filter work; no affect on the focusing operation when heavy optical accessories are attached at the front of the lens.

516-328-5000; www.canonbroadcast.com

Booth: SU7814

Camera battery

IDX System Technology NP-L50/NP-L50

Lithium Ion battery; weighs less than a pound; lasts nearly twice as long per use as typical NiCd batteries and never need a discharge.

310-891-2800; www.idx.tv

Booth: C3036

Fluid head

Sachtler DV II

For use with MiniDV camcorders; easy to operate, lightweight, and automatically create clean pictures; weighs 4.7lb; payload is 0.8kg to 3.6 kg /1.8lb to 7.9lb.

516-867-4900; www.sachtler.com

Booth: C7319B



Camera Control System ▲ **Telemetrics CPS-ROP-S**

Provides flexible architecture for control of up to 50 cameras or devices; employs a GUI for ROP controls and hardware interface; features joystick trim control of pan, tilt, zoom, focus, iris and master pedestal to emulate manufacturers' remote operating panels; provides full camera controls and presets for various Hitachi, Sony and Panasonic cameras.

201-848-9818; www.telemetricinc.com

Booth: C7337

Blue highlight indicates advertiser

PANTHER

INTRODUCING THE NEW LINE OF BROADCAST PRODUCTS

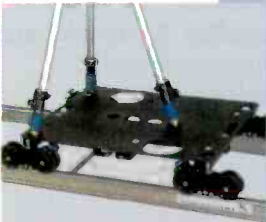

ROLLER PLATE



HUSKY DOLLY

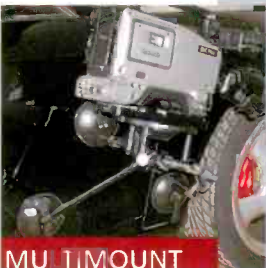

MU TIMOUNT



PIXY AS JIB

THE PASSION OF MOVEMENT

Abel Cine Tech and Panther GmbH have joined forces in the US for the launch of the Panther Broadcast line of high quality products.

After 20 years in the motion picture industry as a leading manufacturer of dollies, jibs and cranes, Panther has taken their expertise to a wider arena to bring new production tools to the professional HD and broadcast industry.

At NAB this year, come and see the impressive range of Panther broadcast gear, including Romy on-board lights, Pixy modular crane / jib system, Roller Plate doorway dolly, Husky fold-up dolly, and the new line of Panther tripods and fluid heads, highlighted by the US debut of the Panther X15 continuous drag / continuous counterbalance fluid head for cameras up to 15kg / 33 lbs.



X15 FLUID HEAD

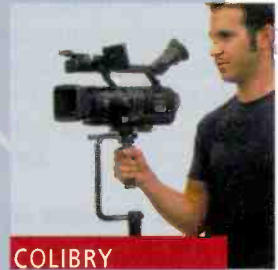

COLIBRY

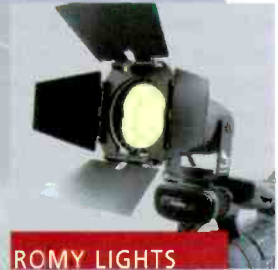

ROMY LIGHTS



AbelCineTech

NY 888.223.1599 LA 888.700.4416 www.abelcine.com www.panther.tv

NAB BOOTH C3643

DV tape

Panasonic Advanced Master Quality (AMQ)

Includes a new surface treatment process that improves the thickness, quality, reliability and durability of the tape's diamond-like coating and improves interaction with its dry lubricant; the new Mini-DV and standard DV tapes offer better still photo performance and improvements against head clogging; provide an easy-to-write-on cassette label where the label is already affixed to the tape, and a two-way open soft case.

201-392-4127; www.panasonic.com/broadcast

Booth: C3617

Wireless camera system

RF Central RFX Clip-On

No cable needed from truck to camera; no direct line-of-sight needed between camera and truck; package includes transmitter in housing (2 audio sub-carriers); Omni Tx antenna or directional antenna with cable and tripod; receiver rack-RFXtreme ENG in portable case with removable rack ears; Rx antenna with cable set and tripod; camera mounts for Anton Bauer Gold or V Type; assorted power, RF, audio and interconnecting cables; Pelican 1550 transport case; external down converter.

717-249-4900; www.rfcentral.com

Booth: C1432

Wireless microphone

Azden 100LT

Offers 63 user-selectable channels in the 794MHz to 806MHz band; includes the 100UPR receiver and 10BT body-pack transmitter, both of which are housed in small, 3 7/8in by 2 3/8in by 13/16in cases, ideal for smaller digital cameras.

516-328-7500; www.azden.com

Booth: N4222



Camera Light ◀ IDX System Technology X-3-Lite

ENG/EFP On-board camera light; uses LEDs to provide high-intensity,

low-power illumination in ENG/EFP video production situations; provides cool long-lasting illumination for roughly 10,000 hours before replacement; LEDs produce 35W output of daylight color temperature lighting requiring only 11W of power.

310-891-2800; www.idx.tv

Booth: C3036

Camera lens

Canon HDTV and SDTV Remote Control Lenses

Based optically on the Canon HD ENG/EFP lenses of the same specifications, with the advanced capabilities of the HDxs system and the Power Optical System with the X-Element; the SD line includes the J22ex7.6B ITS, J17ex7.7B ITS, and wide angle J11ex4.5B ITS; all six lenses come with a manually controlled 2X extender, and can be paired with an optional motorized version.

516-328-5000; www.canonbroadcast.com

Booth: SU7814



Multipurpose HD camera ▲

Sony HDC-X310

Includes an optical fiber interface; allows cable runs to be increased to a maximum of 3300ft; optional interface cards allow for inexpensive XGA monitoring, SD signal output to integrate with an existing SD system; and i.LINK IEEE-1394 (HDV) digital interface connection for HD recording on Sony's professional HDV system; scanning modes include 59.94i, 50i, 29.97psf, 25psf and 23.976psf, with 2:3 pulldown.

800-686-SONY; www.sony.com/professional

Booth: SU6406

Wireless camera system

Link Research LinkXP

Lightweight; low power consumption; signal delay allows live interviews with no visual/sound delays when used with wireless microphones; can be mixed with wired cameras with no signal delay problems; its live feeds can be edited with pictures from ordinary cameras.

+44 1923 200900; www.linkres.co.uk

Booth: C11837

Camera lens

Canon DIGI SUPER 100xs

A triple digit zoom lens; incorporates Canon's Image Stabilizer technology; features a focal length of 9.3mm to 930mm (18.6mm to 1860mm using the 2X extender), a speed of F/1.7, and a weight of 23.5kg (50.18lbs); provides viewers with shake free images that offer incredible detail; the M.O.D. from lens front is 3.0m.

516-328-5000; www.canonbroadcast.com

Booth: SU7814

Camera products

AbelCine Tech Sales and rental equipment

Sales and rental equipment suppliers offering comprehensive film, HD and digital camera solutions; specializing in Panasonic DVCPROHD and SDX-900 camera systems, Aaton 16mm and 35mm, Aaton Cantar-X field recorders, Heden motors, Benz wireless control systems, Canon, Fujinon, Losmandy, Chrosziel; technical and post consultation.

888-223-1599; www.abelcine.com

Booth: C3643

Convertible camera

Panasonic AW-E860

A native 16:9 2/3in 3-CCD convertible camera, and complementary accessories to bolster its line-up of remotely-controllable, multi-purpose cameras; new accessories include the AW-PH400 high-speed pan-tilt head, AW-PH360 pan-tilt head, the AW-RP400 pan-tilt controller, AW-RL400 rolling unit, AW-CB400 camera control unit and AW-RC400 cable compensation unit.

201-392-4127; www.panasonic.com/broadcast

Booth: C3617



Zoom control for LANC cameras ▲

16x9 Zoe-DVL

Designed for use with the Sony HDR-FX1 and HVR-Z1U, Canon XL2 and other LANC cameras; provides variable stepless zoom speed control with preadjusted maximum speed, focus, record start/stop and camera on/off.

818-972-2839; www.16x9inc.com

Booth: SU6365

HD camcorder

Ikegami Editcam

Uses the Avid DNxHD high-quality mastering codec to deliver HD resolution, full-raster images that can be edited on laptop and desktop systems in real time; employs a data rate of 140Mb/s to provide 1080/60i, 1080/24p and 720/60p recording and playback using FieldPak2 recording media.

201-368-9171; www.ikegami.com

Booth: C5426

just add water...

Visit us
at NAB 2005
on booth C3146

e2v ESCIOT®s

Already delivering substantial cost savings to US broadcasters.

Energy saving collector IOTs (ESCIOT®s)

Proven water cooled designs

Increased efficiency up to 60%

30kW average digital power

60kW analog power

Plug-in style for ease of maintenance

e2v technologies inc.

Tel: +1-914-592-6050

Toll Free: +1-800-342-5338

Email: enquiries@e2v.com

<http://comms.e2v.com>



e2v

e2v technologies

Tripod system

Sachtler ENG 75/2D

Tripod systems for DV cameras; compact dimensions — weight is 2.3kg / 5.1lb, payload is 20kg / 44.1lb, height minimum and maximum are 33.5cm to 146.5 cm and 13.2cm to 57.6cm; transport length is 65cm/25.6; the Touch & Go system enables fast changeover, so camera operators can go from using the tripod to shooting from the shoulder within a matter of seconds; in combination with fluid heads DV 4 II and DV 2 II, it is ideal for MiniDV camcorders starting from around 1kg / 2.2lb.

516-867-4900; www.sachtler.com

Booth: C7319B



Prime lens ▲

Band Pro Film & Digital Carl Zeiss DigiWide 3.9mm T1.9

Designed for HD cinematography; engineered to eliminate geometric distortion; in 4:3 format, the lens' angle of view is 98.2 degrees horizontal, 81 degrees vertical and 111.8 degrees diagonal; in 16:9 format, the angle of view is 103.6 degrees horizontal, 70 degrees vertical and 111.8 degrees diagonal; color fringing is minimized; ideal for maintaining natural-looking perspectives when working with miniatures.

818-841-9655; www.bandpro.com

Booth: SU6365

Camera lens

Canon HD Electronic Cinematography Lenses

Utilizes the Power Optical System featuring the X-Element, Hi-UD (High Index, Ultra Low Dispersion) glass and Flourite, which contribute to the lens' overall optical performance; the HJ21 has up to three times less focus breathing than any other comparable lens and with a maximum relative aperture (T Stop) of 2.1 .

516-328-5000; www.canonbroadcast.com

Booth: SU7814

HD wireless camera link

Link Research LinkHD, LinkXP, LinkXPRV

Range of wireless camera systems and accessories, including Link HD, LinkZP, and LinkXPRV.

+44 (0) 1923 2000900; www.linkres.co.uk

Booth: C11837

Format converter/interface

Miranda Technologies DV-Bridge Cam

Lightweight and high quality DV-to-SDI converter for low-cost news gathering DV cameras; mounts securely under a handheld DV camera or between tripod and camera. Converts DV output to SDI-compatible signal with embedded audio and time code.

561-477-6124; www.miranda.com

Booth: SU7841



Wide angle converter ▲

Schneider Optics Century Division Century .7X Wide Angle Converter

Designed to complement the Sony HDV camcorder's higher resolution, wider angle lens system; attaches to the front of the 12X lens to offer 30 percent more coverage at any setting from wide angle to telephoto; fully compatible with most professional matte boxes.

818-766-3715; www.centuryoptics.com

Booth: SU10329

HD ENG-style lens

Fujinon HA25X11.5BERD

Ideally suited for gyro stabilized platforms in aircraft, wildlife photography in remote areas and HD surveillance applications, where light weight and unobtrusive appearance are critical; weighs 6.2lb; has a maximum focal length of 576mm (2x), reduced focus breathing, an F-stop range of 2.0 to 2.8 and DigiPower servo system for fast and accurate zooming.

847-945-8923; www.fujinon.com

Booth: SU6370

HD and DV camera interfaces

Miranda Technologies DVC-802/822

HD downconverter and DV encoder for Sony and Panasonic HD cameras as new, as well as the MDC-902-922 HD downconverters; all feature 24p to 50i support; DV-Bridge-CAM interface for DV cameras provides high-quality DV-to-SDI conversion.

561-477-6124; www.miranda.com

Booth: SU7841

NEW!
Sound Forge



What more do you need?

Sound Forge® software, the leading digital audio editing application for over ten years, has been relied on by professionals for editing, recording, mastering, effects processing, and streaming media creation. How did it get to be number one? By doing what it does better than any other program: providing a comprehensive, powerful set of tools designed to make you more productive.

Now in version 8, Sound Forge adds new features like scripting functionality, batch processing, VST effects and ASIO driver support. It's even more of a good thing; but we didn't stop there.

CD Architect™ 5.2 software is now included with Sound Forge 8, making it a comprehensive CD mastering solution for Red Book audio CD creation. With this much production firepower, really...what more do you need?



LIKE NO OTHER™

© 2005, Sony Music Digital Inc. All rights reserved. Sound Forge and CD Architect are trademarks of Sony Music Digital Inc. CD Architect is a registered trademark of Sony Music Digital Inc.

Pneumatic pedestal

Shotoku Broadcast Systems TP-80

Operates half the air pressure of existing pneumatic pedestals, minimizing effects caused by temperature change; features a newly designed built-in cable guard height adjustment mechanism.

949-754-9005; www.shotoku.tv

Booth: C10641

HD lenses

Thales Angenieux 70X HD OB/Sports Lens

Designed for studio and sports applications; features unique advanced display system; new 26X HD Telephoto Zoom Lens also displayed, which provides extended focal range.

+33 0 477 90 78 00; www.angenieux.com

Booth: C5107

Tripods and fluid heads

AbelCine

Complete line of AbleCine and Panther products; T4 and T6 designed for compact DV cameras; T10 for general ENG camcorders; T45 for 16/35mm systems; L-shaped, modular L40 fluid head; X15 fluid head for HD and broadcast cameras up to 15kg/33 lbs.

888-223-1599; www.abelcine.com

Booth: C3643

Focus assist for lenses

Fujinon Precision Focus Assist system

A built-in feature that addresses precise focus issues in HDTV production stemming from the format's shallow depth of focus and the lack of size and resolution in camera viewfinders; will be available on the company's XA101x8.9BESM HD zoom, HA22X7.3BRD HD EFP lens and the HA13x4.5BRD-S28K HD wide-angle lens.

847-945-8923; www.fujinon.com

Booth: SU6370

CGS, PROMPTERS, CAPTIONING

Character generator

Pixel Power Clarity300

Is a single-channel expandable CG; features a compact 3RU frame that is only 21in deep; features uncompressed clip playback, two channels of 2-D DVE and SDI prev view, and program outputs; can be operated as a dual channel clip/still store.

954-943-2026; www.pixelpower.com

Booth: SU7132

Closed captioning software

Baystor Teletext Search Software

Allows user to locate assets on a network; users can type in a keyword or phrase and instantly see the timecode In & Out locations and keyframe of the clip containing that phrase; will search assets that reside anywhere on the network of BK-2500's and within the BK-1500 player; once the original clip is located, it can be played back, copied to a DVD, scheduled for playback or transferred directly into an editing system, all without generation loss.

813-645-6666; www.baystor.com

Booth: SL4552

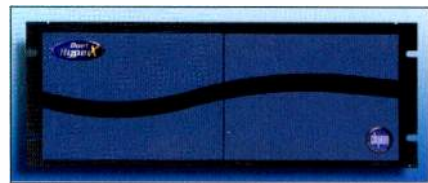

Character generator ▲

Chyron Duet

New additions have been made to the line; used for HD, 3D, and ease-of-use, systems in every price range; each product includes Lyric content creation and playout software; enables 3D graphics, stunning real-time animations, and fast creation of advanced messages.

631-845-2000; www.chyron.com

Booth: SU7158

Recorder

Autocue Qlog+

A more sophisticated version of QLog, a low-resolution disk-based MPEG output recorder; includes capture of closed caption information, audio indexing and searching, the ability to 'print to tape', and, to use SDI inputs instead of analogue; can use the more efficient Windows Media 9 compression format.

+44 (0)208 870 0104; www.autocue.co.uk

Booth: SU7865

Prompter

Listec Video Z-Prompter Series

Mounts the prompter with camera over the pan head's balance point; eliminates need for a large balance plate and counterbalance weight, provides a range of adjustment; easy to transport; eliminates stress on tripod systems; can be supplied with either a Studio or Fold-down Hood; available with flat-panel displays through 15in; can be configured as a Presto system.

561-683-3002; www.listec.com

Booth: C6237



Teleprompter ▲

Telescript Fold and Go
Enhancements to company's line of Fold and Go teleprompters; available in 8in, 13in and 15in value and 12in and 15in broadcast/studio quality configurations and are built to move from the studio to the field; feature precision cut aluminum parts, solid construction, glass beam splitters, high-quality LCD displays and the ability to mount to any ENG or DV camera.

888-767-6713; www.telescript.com

Booth: C8932

Character generator

Pixel Power Clarity5000
Offers HD functionality equivalent to the Clarity500 range of character generators, including real-time 3-D animation, video/audio clip player and 2-D DVE squeezeback capability.

954-943-2026; www.pixelpower.com

Booth: SU7132



Character generator ▲

FOR-A VertigoXmedia's X-Presenter

Allows users to integrate broadcast-quality graphics and video into Microsoft PowerPoint presentations without using a scan converter; allows operators to use familiar tools to produce CG graphics and animations; users can import images in any format and link slide elements to real-time data and add live video inputs, a real-time crawling ticker, and multiple animated logos and clocks to their presentation.

212-861-2758; www.for-a.com

Booth: C4519

Broadcasters Trust Telecast Fiber for ALL their Fiber Optic Needs.



ADDER and ADDER II

Whether you need analog audio, AEC, intercom or ever A-D and D-A signal conversion, there is an Adder system ready to handle any audio challenge. Up to 256 channels per fiber, at 24-bit resolution, with optical redundancy for quiet, reliable sound.

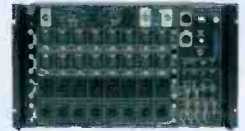

SHED/HDX and COBRA

For Triax and hybrid cabled cameras, we have solutions to liberate you from your heavy copper. SHEDs eliminate your costly hybrid cables on HD cameras, while Cobras replace triax on HD or SD camera systems...with ten times the distance.



VIPER I / SIDEWINDER

For 14 years the Viper and Sidewinder have supported ENG/SNG applications around the globe. The reel-mounted Sidewinder and Viper Mussel Shell are immediately familiar as the workhorse systems that have proven themselves in the most extreme conditions...day in and day out.

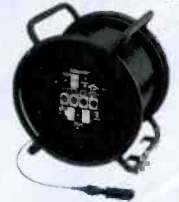

VIPER II

With small "throw down" modules that can be converted to rack mount, the Viper I is an expandable system that grows with your facility. Modules range from video/audio to Ethernet to robotic HD/POV, for incredible flexibility using simple building blocks.



COPPERHEAD HD/SDI

Our camera-mounted CopperHead makes light work of a wide range of applications, from news coverage to digital cinematography. Turn your ENG camera into a remote production camera, and avoid the cumbersome expensive triax backs and base stations.



DIAMONDBACK II

Picking up where its predecessor left off, the DBII now offers 8 channels of broadcast-quality NTSC/PAL video on each wavelength. With optional audio and CWDM technology a huge backbone can be implemented on a single optical core.



Save time on your event production schedule. On a single lightweight cable we support all your broadcast signals from the field and the booth to the truck. From Telecast, the leader in fiber for television broadcast production.



Telecast
Fiber Systems, Inc.

(508) 754-4858

All products mentioned herein are trademarks of Telecast Fiber Systems

www.telecast-fiber.com

Visit us at NAB, Booth #SU8375

broadcastengineering.com 18

Logo generator SAV LG50C

Digital clock generator; can be fitted in an extensive range of frames (RK6, RK6-D, RK6-3, RK14L); are 100 percent compatible with the MX-AIR, allowing users to have logo, animation, clock and text generation into the MX-AIR.

+33 1 53 38 22 00; www.sav.tv
Booth: SU11117

Digital signage player

Keywest Technology MediaXtreme MX3
Delivers IP addressable control over playback of video and graphics displayed on a single PDP or LCD panel or hundreds in digital signal network; features a new graphical user interface with four timelines adding drag-and-drop simplicity to building playout events, advanced playback scheduling software and character generator functionality with Tru Type support.

913-492-4666; www.keywesttechnology.com
Booth: C9337

Subtitle software

TM SYSTEMS QC Station and RenderStation
QC Station, an independent quality control module for individual desktop use, is a quality control software application that alters the traditional workflow of a dubbing and/or subtitling project; RenderStation, a bitmap generation module that takes subtitling scripts in the form of Word documents created by the company's TranStation.

818-508-3400; www.tm-systems.com
Booth: SU10367

LCD prompter QTV FDP-7

Is designed to be used with all portable or lightweight cameras; assembles in seconds; its compact TFT screen provides clear, bright and readable text, even in conditions of high ambient light; is powered by 12V DC.

203-406-1400; www.qtv.com
Booth: SU7865A

Logo generator SAV LG50TL

Logo (still or animated) and text generator; can be fitted in an extensive range of frames (RK6, RK6-D, RK6-3, RK14L); are 100 percent compatible with the MX-AIR, allowing users to have logo, animation, clock and text generation into the MX-AIR.

+33 1 53 38 22 00; www.sav.tv
Booth: SU11117



Multi-layer graphics ▲ Inscriber Inca Studio HD

For real-time, multi-layer graphics for broadcast and post-production; provides real-time clip-to-clip transitions, real-time organic dissolves and multichannel effects on a single channel.

519-570-9111; www.inscriber.com
Booth: SU8100

Digital signage system

Keywest Technology MX5 PLUS HD
Offers multimedia messaging control functionality, character generator and seven independent element layers of the original MX5 with the addition of new capabilities; allows users to input NTSC source video and, with a built-in video scaler, up-res the video to the native resolution of the digital signage display; supports 4:3, 16:9 and 9:16 aspect ratio display with a high-resolution RGB progressive scan and DVI output.

913-492-4666; www.keywesttechnology.com
Booth: C9337



Digital signage creation and display ▲ Inscriber InfoCaster

Designed to quickly create attractive multi-zone layouts for immediate digital display; users can integrate crawls, rolls, animations, clocks, video and audio clips.

519-570-9111; www.inscriber.com
Booth: SU8100



Perfect Connection

Easy to clean. Innovative. Reliable. Canare's Hybrid Fiber-Optic Camera Connectors feature a high-quality new fiber design that ensures optimal performance.



Tech Notes

Outer diameter of the clad is 0.125mm with a core of 0.010mm. Although the cables have superb transmission quality, even a minuscule speck on the core can have a disabling effect and cause a signal to be lost. Canare recommends proper maintenance and verifying the connector before use. Simply detach the alignment sleeve along with the insulator part for easy cleaning.



before cleaning



after cleaning

California

531 5th St., Unit A San Fernando, CA 91340
Tel: 818 365 2446 Fax: 816 365 0479

New York

60E, 42nd St., Suite 2306 NY, NY 10165
Tel: 212 682 9661 Fax: 212 682 9480

FC Series

SMPTE 304M and ARIB Compliant

Stainless Steel Body Shell

AdPC Polish

Insertion loss $\leq 0.5\text{dB}$; $\text{RL} \geq 45\text{dB}$

Visit us at NAB 2005 Booth # C5134

"Affordable, compact, simple and smart solutions"

Discover our all new Optic Products and more!

- Hybrid Fiber Optic camera connectors
- Palm size camera cable checker
- Converters and CWDM
- New Mid size video jacks

Teleprompting products

Autoscript

Company will show ActiveX controller, which enables a prompter to be managed and scrolled from any newsroom client; updates to +WinPlus+ Prompting Software, which operates as a standalone system or can be networked to any major automated newsroom system; TFT flat panel on-camera prompters will be shown in eight sizes ranging from 6in to 20in, including a new 17in version.

203-338-8356; www.autoscript.tv

Booth: C8926

EDITING SYSTEMS



Editing system ▲

Avid Technology Media Composer Adrenaline HD

HD, SD and DV editing and finishing; features include 10-bit video capture and playback, real-time HD and SD multicamera editing and support for the most popular HD frame rates.

978-640-3594; www.avid.com

Booth: SL600

Editing system

Canopus Workflow

Combines the EDIUS realtime HD/HDV/DV editing solutions and ProCoder transcoding expertise with the MediaEdge enterprise video distribution solution; allows users to create, purpose and deliver video at a highest quality for broadcast, DVD, streaming and video-on-demand.

408-954-4500; www.canopus.com

SL325

News production

Quantel Newsbox

Is "news to go" – a complete newsroom in a box; package includes everything from ingest and playout automation to journalist and craft editing, all based on Quantel's sQ server technology.

203-972-3199; www.quantel.com

Booth: SL1147



SD and HD editing system ▲

Optibase Media 100 HD

Mixes SD and HD media, 4:3 and 16:9 aspect-ratio media, uncompressed and compressed media, M-JPEG, DV, animation, analog and digital video, and other QuickTime codecs in the same timeline — in real time without lengthy importing or rendering; views SD and HD output simultaneously regardless of source material.

800-451-5101; www.optibase.com

Booth: SL343

DVCPRO/DV VTR

Panasonic AJ-SD255

A versatile, half-rack size VTR tailor-made for nonlinear editing applications, as well as a variety of production tasks; compact and easy to carry; can undertake assignments ranging from viewing and dubbing to feeding an NLE system; performs DVCPRO and DV recording and playback with both standard and mini-DV cassettes for cost-effective, extended-time applications.

201-392-4127; www.panasonic.com/broadcast

Booth: C3617



Multi-format post-production system ▲

Dayang D3-Edit

Offers editing, effects, compositing, titling, transcoding, DVD authoring and Web creation in a single system; designed for standalone operation or to integrate into a server-based network; employs network-aware file management, allowing easy interfacing to third-party software and hardware.

+852 2730 2117; www.dayang.com

Booth: SU9352

Turnkey system

Pinnacle Systems ChromeHD

Hardware/software package that offers all of the broadcast quality SD and HD I/O options, including HD-SDI I/O to complement the native FireWire support; enables users to connect to a variety of professional breakout boxes as well as output SD and HD to tape simultaneously.

650-526-1600; www.pinnaclesys.com

Booth: SU6341

Nonlinear editing laptop

1 Beyond 3817 HD

Designed for editing and graphics applications, including HD; optimized for HD editing and delivering (including 720p and 1080i); features 3.8GHz Pentium processor with Hyperthreading technology for dual processor optimized software, up to 4GB memory and 200GB of internal storage, eight channels of high-definition audio and support for new high-speed PCI express video bus.

617-591-2200; www.1Beyond.com

Booth: SL3967

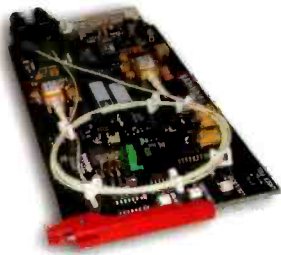

Dual Optical Converters ▲ Network Electronics SDI-EO-2/OE-2 and HD-EO-2/OE-2

Furnish increased density and improved cost efficiency in a compact 2 RU package offering enhanced functionality and flexibility; provide a wide set of features, including high sensitivity receiver / high performance laser for the long haul, full DVB-ASI compatibility, built-in crossover allowing wavelength swap and emergency switching, and re-clocker bypass for non-video formats.

800-420-5909; www.network-electronics.com

Booth: SU9311

Digital intercom system

Trilogy Broadcast Mercury

Offers G722, 7kHz quality voice communications over an IP network; matrix-free system without the requirement for central TDM switching; multiple independent voice channels from each station; intelligent integration with existing digital matrixes giving all Trilogy intercoms an upgrade path to communicate over IP networks.

+44 1264 384000; www.trilogy-broadcast.co.uk

Booth: C11722

Scalable performance.



The portable DVM 400

High performance and flexibility for MPEG2 transport stream analysis.

The new DVM family of MPEG 2 instruments lets you know exactly what's going on, with powerful analysis capabilities. It gives you:

- Real-time monitoring
- In-depth analysis
- Networkability (SNMP)
- Scalability up to 20 signals

It's also a very flexible family that lets you get the configuration you need, and then add to it as your needs grow. We even offer a portable version.

So don't spend time puzzling over your MPEG2 transport streams. Ask us about the DVM family – with the performance you need, and the scalability you've been looking for.

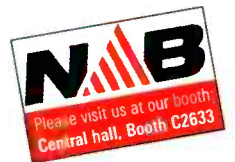

The DVM 100/120 monitoring system



The single/dual-stream DVM 50



ROHDE & SCHWARZ

Rohde & Schwarz, Inc. • Columbia, MD • 1-888-837-8772
www.rohde-schwarz.com/USA

Editing system

Lightworks Touch

The console is an ergonomically designed playing and splicing tool, which connects the editor directly to the material; gives fast, responsive control over pictures and sound, whether playing forwards, backwards, shuttling or jogging; also contains graphical user interface; comes with a number of real-time effects, including chroma and luminance keying, color correction and 2D DVE.

+44 1256 810123; www.lwks.com

Booth: SU10254

Network platform

Exavio ExaMax 9000

Designed for HD post-production, digital film intermediate and broadcast applications; is scalable from 128GB up to 2TB; mitigates disk contention and fragmentation issues; features a 5GB/s bandwidth for fast non-blocking switch fabric; can expand to 36 2GB Fibre Channel ports in one chassis to support various post-production environments, including HD, and 2K and 4K digital film resolutions.

408-213-5500; www.exavio.com

Booth: SL4634

Post-production software

Leitch Technology Technology VelocityHD

Format-flexible HD/SD nonlinear editing system; features full-quality HD playback of two video streams (compressed or uncompressed), two dynamic graphics streams, true real-time HD transitions and effects, optional 3D effects and SD performance.

859-371-5533; www.leitch.com

Booth: SU7805, SU8199



ENCODERS/DECODERS, STREAMING & DEMODS



Broadcast-quality decoder ▲

Crystal Vision EMDEC-200

Product can be used in two ways: as a decoder or as a decoder with embedder; converts PAL/NTSC or Y/C composite video to SDI using 12-bit decoder; data is sampled at 54Mb/s; can be upgraded to embed AES or analog audio by adding an audio piggyback.

954-788-3334; www.crystalvision.tv

Booth: SU6361



Broadcast platform ▲ Terayon BP 5100

Features enhancements to the system's digital graphic insertion capabilities; graphics can be inserted within the compressed MPEG video domain eliminating the need to decode and re-encode digital programming; can localize branding at distribution points closest to viewers.

408-235-5500; www.terayon.com

SU11316

Encoders

TANDBERG Television E5780 and E5782

High definition MPEG-2 encoders; for professional ATSC and DVB broadcasters capable of operating in standard definition; E5782 is capable of encoding in the HD 4:2:2 profile and is ideally suited for HD contribution and HD cinema applications; both support multi-pass encoding technology to all greater efficiency in multiplexed systems using the REFLEX system.

+44 23 8048 4000; www.tandbergtv.com

Booth: SU7858



www.abc.org

the world of content

creation • management • delivery...



is evolving fast

**make sure you adapt and develop
by visiting IBC2005**

- See state-of-the-art technology from 1,000 exhibitors.
- Network with more than 40,000 key players from Europe and 120 countries.
- Take part in the world's best opinion forming conference.
- Take advantage of IBC's free visitor attractions including the Training, Displays and Content for Mobiles Zones.
- Be guided to hot topics and products by experts in our free 'what caught my eye' sessions.

Exhibition 9 - 13 September
Conference 8 - 12 September
RAI Amsterdam





Integrated high-speed networking platform ▲ Harris NetVX

A key enhancement is a new MPEG-2 HD encoder that supports multiple HD video formats, including 1080i/29.97, 720p/59.94 and 1080i/25, as well as both standard 4:2:0 and 4:2:2 professional profiles; other upgrades include statistical multiplexing to enhance bandwidth efficiencies and support for constant bit rate to variable bit rate conversions of MPEG transport streams.

800-442-7747; www.broadcast.harris.com

Booth: C1907; SU10048

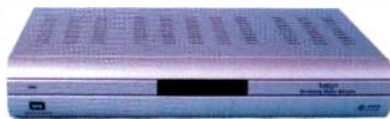

Streaming media decoder ▲ WEGENER SMD 515

Advanced technology delivers widescreen, theater-quality movies with as little as 5Mbps of data; digital and analog A/V outputs make unit compatible with virtually all subscriber entertainment systems.

770-814-4000; www.wegener.com

Booth: C2624

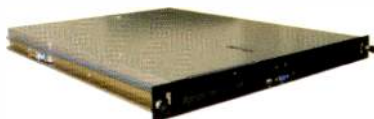

Encoding system ▲

Ligos MediaRig Encoder SD

A complete standard definition MPEG-2 encoding system for ATSC, DVB and broadband encoding applications; a compact 1RU encoder capable of dual-channel processing, with options for either analog or digital input of NTSC/PAL formats, and SCPC/SPTS and MCPC/MPTS output to DVB-ASI, IP (UDP) or file; supports Dolby Digital (AC-3) 2-channel audio, PSI and PSI/SI control tables, closed captioning, bug insertion, and remote control and management of multiple encoders through its user interface.

415-249-0100; www.ligos.com

Booth: SU9632



Multistandard off-air receiver/demodulator ▲

Broadcast Technology Showman 1000

Can be used with PAL, SECAM and NTSC television standards around world; is designed for transmitter feeds and monitoring, OB reception and service acquisition; high-specification units are available incorporating IF inputs and outputs, alarms and logging.

+44 0 1264 332 633; www.btl.uk.com

Booth: SU 9317



DTV data broadcasting system ▲

Triveni Digital SkyScraper

Allows broadcasters to offer new services by delivering various types of digitized content through their DTV signals; supports streaming media, Web pages, interactive TV, and any other type of digitized data; features receiver targeting, encryption, and support for multi-station networks; can schedule content for distribution simultaneously through many DTV broadcast streams in a multi-station network.

714-378-5841; www.trivenidigital.com

Booth: SU11411

Conditional access system

TANDBERG Television DirectorV5

The latest version of the Director CA platform; new version includes an embedded Simulcrypt scrambling system for flexible and secure Conditional Access and receiver control on a single PC platform; modular system allows users to mix and match functionality.

+44 23 8048 4000; www.tandbergtv.com

Booth: SU7858

HD video encoder

Modulus Video ME6000

Real-time full-resolution AVC video encoder with support for encoding digital video at Main Profile at Level 4; uses a slice partition methodology and includes advanced features such as CABAC entropy coding, macro block adaptive field frame coding and multi-frame references.

408-245-2150; www.modulusvideo.com

Booth: C11416

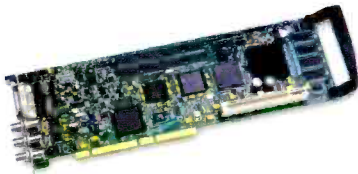

HD decoder ▲

Vela Cineview

Users can simulcast SD and HD format video via SDI; users can also up-convert standard-definition materials to high-definition format; existing high-definition content can be down-converted to the standard definition format; has capability to frame-accurately combine SD and HD file output by simply switching the asset format through an A/B switch at any time.

727-507-5352; www.vela.com

Booth: SL4401



Automated transcoding ▲

Telestream FlipFactory New features to company's FlipFactory transcoding automation and delivery solutions; offers automated SD to HD conversion and expanded MXF format support; SD to HD conversion capability provides broadcasters with an automated, scalable software for migrating content to the new HD standard.

877-257-6245; www.telestream.net

Booth: SU11404

Digital media software

Anystream Agility 5.0

Broadcast transcoding solution for digital media production workflows; options for scaling Agility software to accommodate any of the four package applications; options add multi-system command, control, and failover management layers; includes workflow enhancements such as HD support to closed captioning.

703-450-7030; www.anystream.com

Booth: SL3316

WE CAN TAKE YOU TO THE FUTURE - TODAY

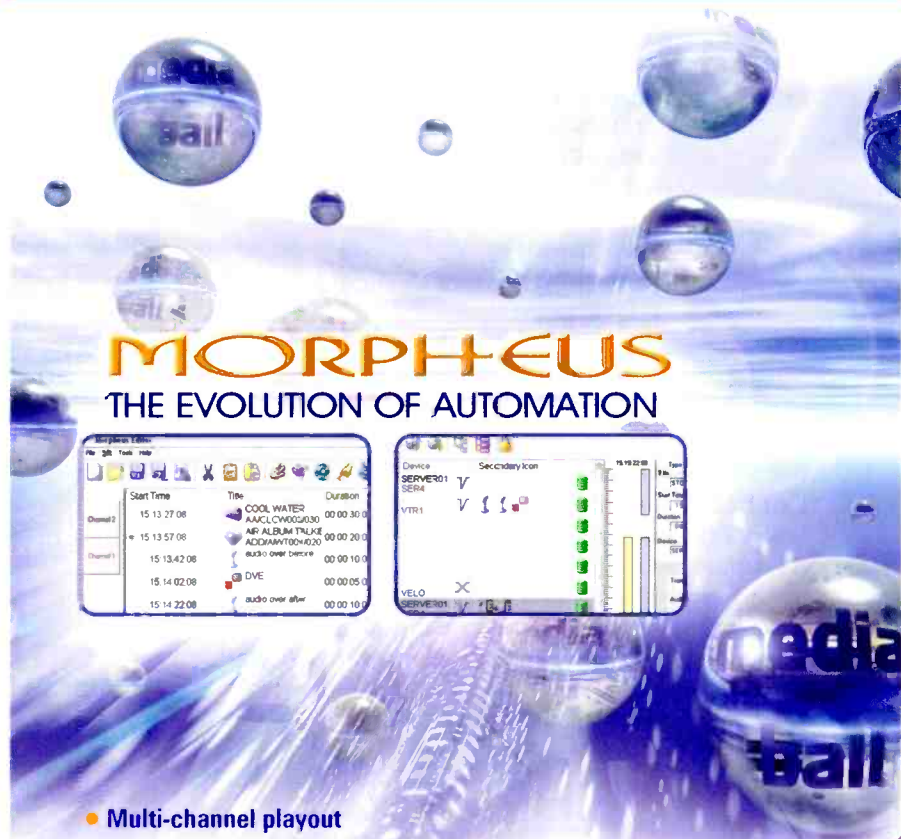

- Multi-channel layout
- Scalable and flexible architecture
- Real-time, frame precise control
- Complex event support with MediaBall™ technology
- MXF compliant



www.pro-bel.com



UK +44 (0) 1189 866 123 USA +1 631 549 5158 France +33 (0) 1 45 18 39 80 Asia +852 2850 8383



Digital content distribution ▲

Pathfire Direct

Enables networks, broadcasters with remote bureaus or station groups to monitor, gather, and disseminate breaking news stories from remote locations; content can be moved over any IP network connection; production staff can preview, track and acquire content and get breaking live video feeds to air within seconds.

770-619-0801; www.pathfire.com

Booth: SL1353



MPEG-2 encoding platform ▲

Optibase MPEG MovieMaker 200S (Mac)
Offers a full range of video and audio interfaces, video resolutions, audio encoding formats and MPEG multiplexing capabilities; unit is fully integrated with the company's developer tools and video streaming and networking platforms; bundled with the MPEG Composer 200 encoding management application.

800-451-5101; www.optibase.com

Booth: SL343



Video capture cards ▲

ViewCast Osprey-440

Supports four channels of inputs that can handle up to 16 cameras or other video sources; includes additional features for video surveillance and monitoring applications, such as four standard alarm inputs and four alarm

outputs supported within the Osprey AVStream driver.

972-488-7200; www.viewcast.com

Booth: LS4936

Conditional access system

Conax AS CAS7

Standalone CA solution with strong anti-piracy record; allows broadcaster or content providers to start with basic system supporting pay-TV and then add additional components to support more complex operations and business models, such as a mobile ordering and payment server, virtual video on demand, voucher server, and CAStream IP encryptor.

+44 22 405 2 00; www.conax.com

Booth: SU9694

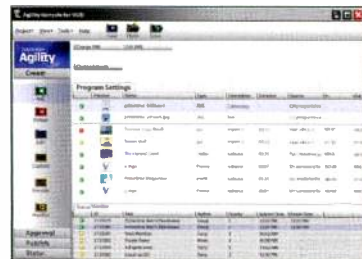

Video-on-demand production software ▲

Anystream Agility VOD

Enterprise-level product; allows content producers to serve VOD outlets; designed in response to demand from broadcast customers for a way to create and deliver content to burgeoning video-on-demand outlets affordably as opposed to outsourcing.

703-450-7030; www.anystream.com

Booth: SL3316

GRAPHICS SYSTEMS

Broadcast mapping software

Curious Software Map Presenter

Interactive playback system directly links to Traffic Producer; rundown of graphics or live video can be played directly to air with drag and drop ordering, automatic or presenter-cued playback and live or recorded telestration.

505-988-7243; www.curious-software.com

Booth: C9407

Graphics automation system

VertigoXmedia Product X

A powerful and extremely easy-to-use, PC-based graphics automation system; enables even non-programmers to build professional-quality graphics quickly, link on-air elements to live data sources, and create fully customized operator control screens all in one step.

514-397-0955; www.vertigoxmedia.com

Booth: SL2620



Who Would You Trust to Protect Your Broadcast Signal?



When the ultimate service that you require is coming from another continent, minutes can quickly turn into days. That's too long when it comes to your analog or DTV transmitter.

Axcera's products are designed, manufactured and supported right here in the USA by our dedicated staff of RF experts who are serious about keeping you on the air - 24 hours a day, 7 days a week, 365 days a year.

Axcera's serious commitment to customer service starts even prior to your transmitter purchase with our knowledgeable sales and application engineers, and it lasts for the life of your transmitter. At Axcera, we have never discontinued support for any of our products, and we never will.

The most complete line of UHF and VHF transmitters available today and superior lifetime customer service... only from Axcera, the RF experts.



t: 724.873.8100 f: 724.873.8105 www.axcera.com info@axcera.com

the **rf** experts

Come Visit Us At

NAB 2005

BOOTH #

C8014



Data service ▲

AccuWeather StormTeam Live

Allows local stations to complement their broadcast with live segments from the same severe weather experts seen nationally on *FOX NEWS*, *CNN*, *CNBC*, *MSNBC*, *PBS* and *ESPN*.

814-235-8636; www.accuweather.com

Booth: C5111

Graphics system

VertigoXmedia Vertigo XG

A full-featured SD/HD graphics system optimized for use with the Producer Xmedia Suite; provides single- or dual-channel graphics and video playout capabilities for a wide range of advanced real-time broadcast applications; combines broadcast video hardware with a real-time software rendering system, flexible on-air control interface, and the Product X authoring tool; users can link on-air graphics elements to live data feeds through simple drag-and-drop operations, and control them from user-definable "soft" control panels.

514-397-0955; www.vertigoxmedia.com

Booth: SL2620

Crawl solution

Chyron DynaCrawl

A 2RU system featuring a simple-to-use GUI that enables quick creation of eye-catching tickers and crawls plus time and temperature display, complete with dynamic data fields and 3D object animations; allows user to insert up to four news elements fast.

631-845-2000; www.chyron.com

Booth: SU7158

Graphics platform

e-medivision.com Point HD

HD broadcast graphics presentation system; designed for sports, news, and weather program applications; works in HD and SD as well as allows simultaneous dual-format programming graphics in 2D and 3D; allows presenters to annotate over live video using a touch screen.

310-545-9731; www.e-medivision.com

Booth: SL4531

Automation

VertigoXmedia Producer Xmedia Suite Version 3.5

Users can browse a library of templates stored in a central Xmedia Server, select a template style, and automatically insert finished graphics and animations directly into the video timeline; templates can include links to live data sources as well as pre-programmed production logic that automatically updates elements based on user selections; Graphics Work Order Management feature enables users to generate work orders for new graphic elements electronically; acts as a centralized asset management system, storing and managing all digital assets as well as real-time data feeds from virtually any source.

514-397-0955; www.vertigoxmedia.com

Booth: SL2620

Video display system

Chyron ChyTV

A low-cost informational display video system; users can display messages anywhere there's a television without disrupting the video source; displays a variety of graphic and text information overlaid or surrounding a live video region; the video region can be resized and repositioned from page to page with smooth, dynamic transitions.

631-845-2000; www.chyron.com

Booth: SU7158



Graphics ▲

AccuWeather Local AccuWeather Channel

An automated around-the-clock loop of customized local weather and news information designed by our team of weather and graphics experts with opportunities to include your local live content; available in SD or native HD; allows advertisers and sponsors to package their message with the information you are delivering.

814-235-8636; www.accuweather.com

Booth: C5111



3-D on-air graphics ▲

FOR-A Corporation of America

Centered on Brainstorm Multimedia's eStudio virtual studio software program; features include VS Virtual Studio, used to construct simplified virtual studios, VS/RCG Virtual Studio for construction of both a simplified virtual studio and real-time computer graphics, Maya 3ds XSI, which enables 3D files and data to be imported

714-894-3311; www.for-a.com

Booth: C4519

Graphics platform

Quantel Paintbox

Features one-touch ergonomics, in which all the tools are just where the designer needs them – not hidden behind multiple layers of pull-down menus; a pen tablet and hand unit interface further speeds the design process with two-handed operation.

203-972-3199; www.quantel.com

Booth: SL1147

Broadcast mapping software

Curious Software Traffic Producer

Creates broadcast-quality maps for illustrating traffic reports; uses pre-defined design templates to generate rundown of still or automatically-animated maps showing traffic flow and planned or unplanned incidents.

505-988-7243; www.curious-software.com

Booth: C9407

Visualization system

Silicon Graphics (SGI) Silicon Graphics Prism Handles the 4K requirements of digital cinema mastering and digital intermediates.

650-960-1980; www.sgi.com

Booth: SL1943

TBC Consoles' definitive technical furniture system sets new video production standards for modularity, user friendly adjustability and high end aesthetics. Laterally sliding and infinitely positionable rack turrets are easily upgraded or relocated as equipment and operational requirements change.

True ergonomics are delivered through continuous front and rear device tracks which allow unlimited lateral positioning of critical equipment. A full range of articulating arms for distance, height and tilt control may be utilized for mounting flat panel monitors, speakers, phones, and task lighting.



NAB 2005
Booth #SU6831

absolute modularity

intelliTrac



www.tbconsoles.com

Plug-in filters for effects

Boris FX Volume II of Boris Continuum Complete for Discreet Sparks

Extend the capabilities of Discreet Inferno, Flame, Flint, Fire and Smoke systems; the IRIX-based addition to the Continuum product line is based on Discreet's Sparks architecture, an advanced API for developing custom plug-ins.

617-451-9900; www.borissfx.com

Booth: SL4045

Graphic software

Digital Anarchy Data Animator 1.0

Set of seven plug-ins allow After Effects users to generate animated charts and graphs; EasyChart provides a graphical user interface and chart presets for animating the data; other plug-ins offer unique visualization options for animating chart data from pie and bar to 3D effects.

415-586-8434; www.digitalanarchy.com

Booth: SL1019

Real-time HD/SD graphics

Pinnacle Systems Deko 1000HD

Delivers industry standard Deko power, 2D motion and effects, clip playback with matter and unique SuperChannels; upgradeable to Deko 3000HD effects; offers a switchable HD/SD version.

650-526-1600; www.pinnaclesys.com

Booth: SU6341

Telestration tool

Chyron CodiStrator

An easy-to-use digital telestration tool; features unmatched presentation capabilities for highlighting over live video of sports, weather, news and security.

631-845-2000; www.chyron.com

Booth: SU7158



Graphics platform ▲

FOR-A Corporation of America X-Presenter

For-A Corporation will be showcasing VertigoXmedia's X-Presenter PowerPoint CG solution; X-Presenter allows users to integrate broadcast-quality graphics and video into Microsoft PowerPoint presentations without using a scan converter; perfect for digital signage.

714-894-3311; www.for-a.com

Booth: C4519

Graphics system

Pinnacle Systems Deko 3000HD

Comes standard with internal clip record and playback functionality; switchable between native SD output and native HD output modes; provides functionality to use 4:3 SD graphics in the 16:9 HD format.

650-526-1600; www.pinnaclesys.com

Booth: SU6341



Real-time weather software ▲

Vizrt Viz/Weather 3D

Version 1.6 meets fast-paced demands of local weather events; powered by company's Viz/Engine, product provides the ability to control, switch and manipulate weather data and graphics in seconds; data includes temperature, wind speeds and direction; weather symbols, 3D maps, radar maps and weather alerts can be displayed automatically with corresponding graphic elements in real-time using pre-made templates.

323-908-7004; www.vizrt.com

Booth: SL1137



K2 IOT and K3 MSDC IOT's from

Eimac

EASE OF USE

No IOT amplifier is easier to tune and maintain than the Eimac K2 and K3 MSDC systems.

K2 tube replacement and maintenance can be handled by one person without removing the cavity assembly from the cabinet.

RELIABILITY

Oil-cooled K3 MSDC IOT

- no electrolysis with oil.
- minimal maintenance.
- low pressure, low flow rate operation.

K3 three stage MSDC design simplifies power supply requirements.

- simplicity = reliability

Eimac IOT's have documented lifetimes of up to 70,000 hours or more.

EFFICIENCY

Eimac's Klystroce IOT pioneered high efficiency UHF-TV power amplifiers.

The K2 continued this leadership with enhanced ease-of-use.

The K3 three stage MSDC IOT demonstrates efficiency of up to 58%.

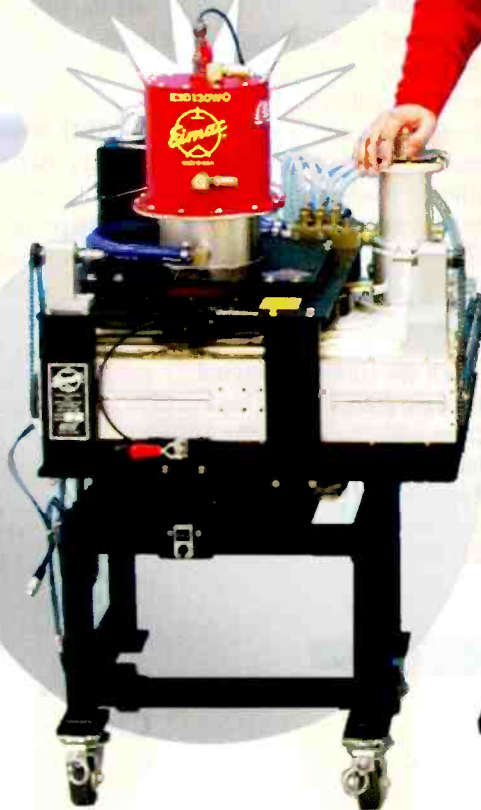

Eimac Division

301 Industrial Road
San Carlos, CA 94070

tel 650.592.1221

fax 650.592.9988

email.iot@cpil.com

www.eimac.com

ISO 9001:2000 Certified Made in USA



Communications & Power Industries

Visit us at booth C2616 - NAB 2005

Deko software upgrade

Pinnacle Systems Deko version 4
Offers user-definable motion behaviors, dual HD/SD
compose, smart textures, usability improvements,
QuickTime export, and extended clip format support.

650-526-1600; www.pinnaclesys.com
Booth: SU6341

INTERCOMS



Beltpacks ▲

Clear-Com RS-600 series

Features latch disable/enable, listen-only, call button
bright/dim/flash/steady, built-in limiters, noise gates,
electret or dynamic microphone compatibility, and
supervisor lockout; contains four programming modes,
an optional software programming interface, and RTS-
compatibility; available five different models.

510-496-6666; www.clearcom.com
Booth: C7319A

Digital belt-pack/headset intercom station Riedel Communications C3

Fully digital two-channel belt-pack for combined digital
matrix and party-line style intercom; platform can be
used standalone or in conjunction with matrix systems;
comprised of the C3 Digital Belt-Pack, the C44 System
Interface Box and the C31 1x3 splitter.

818-563-4100; www.riedel.net
Booth: C11107



Digital Matrix System ▲

Clear-Com Eclipse 32

A digital matrix intercom frame in a 1-RU chassis; offers
32 full-duplex communication ports, plus four extra 4-
wire ports; builds on the capabilities of Matrix Plus 3;
supports the same Clear-Com i-stations and ICS digital
matrix panels and interfaces as the larger Eclipse 208
frame, and is programmed and controlled with the same
ECS-WIN software suite.

510-496-6666; www.clearcom.com
Booth: C7319A

Trunking software

Riedel Communications Trunking Software

Developed for Artist intercom systems placed in diverse
locations; provides networking of individual Artist Fiber
Network installations; each system connects to a central
trunk master via a WAN connection that allocates the audio
trunks between the systems; audio trunks between the
systems can be analog or digital (AES3) and routed through
ATM, ISDN, VoIP, digital leased lines or analog land lines.

818-563-4100; www.riedel.net
Booth: C11107

Beltpack software

Clear-Com V-Pack software

Software for RS-600 series beltpacks; comes with
software, a manual, and a special programming cable to
be connected from the beltpack to the serial port of your
PC; users may program the beltpack using an array of
options and save it to one of the four possible program-
ming modes on the beltpack, which can be recalled at
any time from the beltpack; Beltpack Cloning enables
writing to a succession of beltpacks in quick order.

510-496-6666; www.clearcom.com
Booth: C7319A

Digital intercom system

Trilogy Broadcast Commander

Suitable for complex broadcast television studio, OBs,
multi-networked conference and business applications;
modular design from 6x6 up to 576x576 expandable in
the field; options for analog telephone and ISDN
interfacing; multi-system networking and control with
other Trilogy or third-party intercom systems; intuitive
PC software control package offers easy access to system.

+44 1264 384000; www.trilogy-broadcast.co.uk
Booth: C11722



Digital wireless intercom ▲

Clear-Com CellCom

Combines digital transmission with an intelligent base
station that interconnects with wired communications,
such as party-line and digital matrix systems; operates
above the UHF television bands; is license-free in over
100 countries; allows users to go beyond the typical
party-line or even two-channel capability of conven-
tional wireless; enables one-to-one and small-group
conversations initiated from the beltpack.

510-496-6666; www.clearcom.com
Booth: C7319A



Wireless intercom system ▲
Eartec TD 900

Available as a stand alone system and can interface with wired intercoms such as ComR, RTSR, and TelexR; a simple interface allows wireless remotes to communicate as though plugged in with a cable; operates without base station repeaters, is powered by rechargeable ni-cad batteries, and has a 1/4mi range.

800-399-5994; www.eartec.com
 Booth: C2643

Digital telephone hybrid interface
Riedel Communications DHY-101

Designed to be compatible with the company's Artist Series of intercom systems as a plug-in card for the 19in 1RU DHY-401 mainframe; provides bidirectional communication between the intercom matrix and a standard DTMF-capable analog telephone line; both transformer balanced analog and AES3 audio I/Os are provided on individual RJ-45s to connect to analog or digital matrix ports; can be fitted with the VoIP option to provide interfacing to H.323 VoIP telephone systems.

818-563-4100; www.riedel.net
 Booth: C11107



AES interface board ▲
DELEC AES interface for ORATIS

New interface board for company's ORATIS intercom system; allows for forwarding intercom signals over AES; with add-on board installed, ORATIS can use virtually any conventional audio router for signal distribution; unit is plugged into the ORATIS mainframe and connected to the AES ports of the audio network.

+49 9545 440 0; www.delec.de
 Booth: N4208

INERTIA™

Ultimate Interface Tool.

World's Most Advanced Media Transcoder.



Convert Anything to Anything Including DV & SDI.

Blows the doors off all other media converters & transcoders. Converts any format to any format including SDI & DVI. ALL outputs active all the time! Dual analog outputs. 2RU.

MSRP \$2,995.00



Come See Us
 At Booth # SL1243

LAIRD®
 TELEMEDIA
www.lairdtelemedia.com
 Life is Good.

Shared storage system

Studio Network Solutions globalSAN

A multi-user shared storage iSCSI SAN available for both Mac and PC; is offered in turnkey configurations of eight, 16 and 24 SATA drive arrays; enables iSCSI bridging to external Fibre Channel and SCSI storage devices.

877-537-2094; www.studionetworksolutions.com

Booth: SL3331

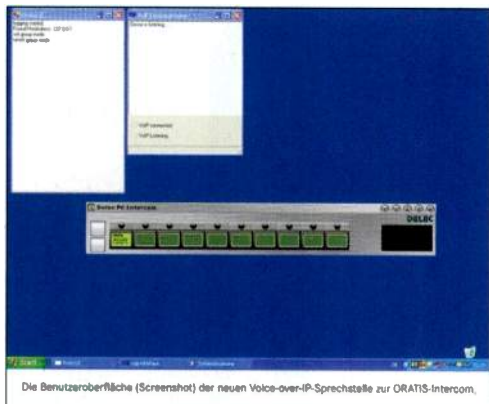

Voice-over-IP subscriber unit ▲ DELEC VoIP for ORATIS

Connects to the ORATIS system via computer network; addressing within this network achieved using IP; subscriber units over the Internet as the Internet also based on IP addressing; operates on the basis of the G.722 standard; uses data reduction and a data rate of 64Kbps to transfer audio signals as well as control and signaling data over the same network line.

+49 9545 440 0; www.delec.de

Booth: N4208

LIGHTING

Light

Kino Flo ParaBeam Zip 400 and 200

Optics compress the focal range of the light wave to produce a broad soft source along the horizontal axis and a narrow beam on the vertical axis; measures 24in by 24in; can light a four-person news desk from approximately 15ft away; sweeps back the darkness in the foreground without washing out the foreground on the set; can focus on just one of the four subjects when it is rotated.

818-767-6528; www.kinoflo.com

Booth: C10437

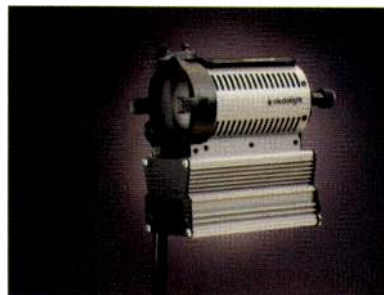

Lighting ▲

Dedolight DLH200D

Focusing light fixture; soft-light head works within its own collapsible large surface soft box; features two Aspherical lenses and a zoom focus mechanism; provides smooth and even light distribution; has wide focusing range between 46 degrees and 4 degrees; dims to half power without disturbing change in color.

973-857-8118; www.dedolight.com

Booth: C10721



Lighting fixture ▲

ARRI ARRI X Ceramic 250

Employs new Ceramic ST 250 HR discharge lamp from Philips; provides almost the same light output as a 1K halogen lamp yet consumes a quarter of its power (250W); based on the design of the ARRI X Series but includes a built-in ballast and igniter and can be plugged directly into the power.

845-353-1400; www.arri.com

Booth: C7326

Light

Kino Flo Kamio 6E

Ring-shaped light; weighs less than 1lb; for speed and performance when shooting digital video production or electronic news gathering (ENG) assignments.

818-767-6528; www.kinoflo.com

Booth: C10437

We proudly present the new member of the mc² family: the mc²66. It has been developed with over 30 years of experience and is equipped with the finest technology you can purchase today.

Fitted with 48 + 8 faders, the mc²66's lightweight construction is ideally suited for OB vans as well as studios. The core with 3072/8192 mono channels offers 192 fully equipped DSP channels at 96 kHz. The central control section and the flexibly assignable channel strips allow intuitive operation.

Further features of the mc²66 are the straightforward matrix and console configuration, advanced audio-follows-video as well as parallel clean-effects summing.

All these new features, together with the proven architecture of the mc² series, come at a surprisingly modest price, making the mc²66 the ideal choice for all future requirements.

BROADCAST

PRODUCTION

RADIO

ROUTING

OB VAN

SERVICE

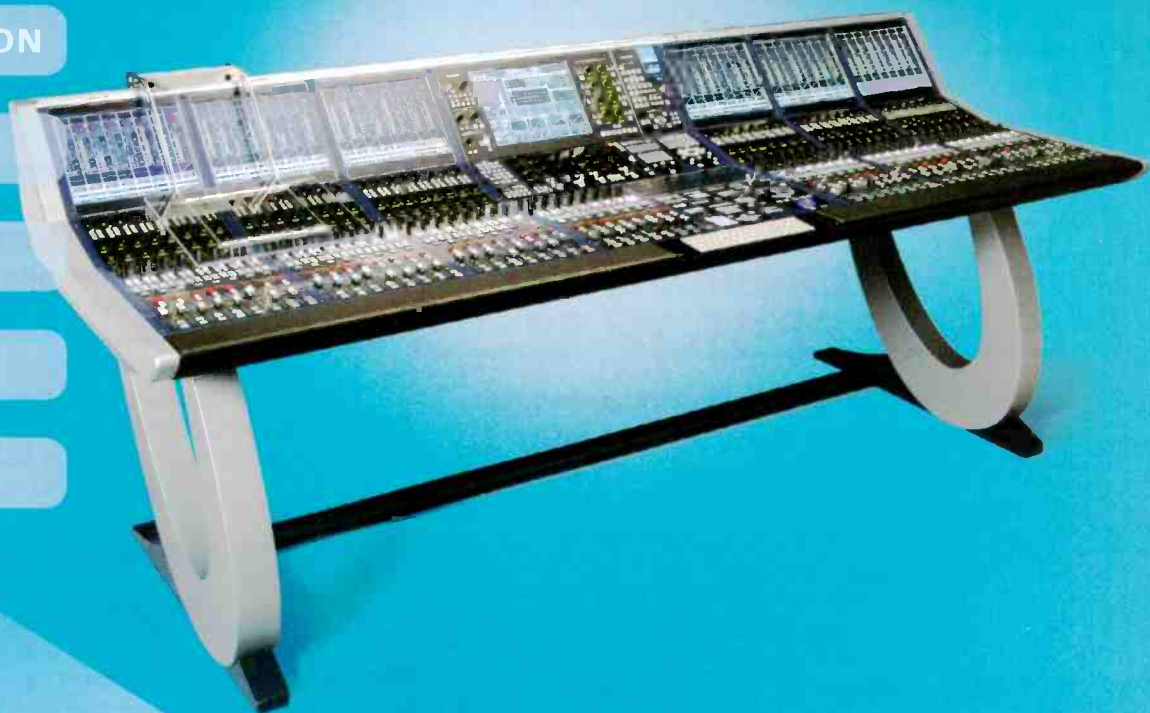

mc² 66



NETWORKING
AUDIO
SYSTEMS



Las Vegas, April 16–21 2005, Booth No N816

Headquarters: Lawo AG · Rastatt/Germany · +49 7222 1002-0 · www.lawo.de
Lawo North America Corp. · Canada · +1 416 292-0078 · www.lawo.ca



Studio lighting ▲ Videssence Shooter

New addition to the line provides 57W intense light output from a lightweight compact housing; 10in length by 6in width by 6.5in height; permanent intensifier/barn doors can focus or shield the light intensity; adjustable mounting yoke allows rotation for ease of focus and may be locked into place.

626-579-0943; www.videssence.com

Booth: C10519

MICROWAVE, FIBER OPTIC, TELCO

Audio, intercom and data multiplexer line Telecast Fiber Systems Adder II

Equipped with the new Matrix high-speed digital bus; units can be cascaded in complex add-and-drop configurations with hundreds of analog and/or digital AES audio channels on a single fiber.

508-754-4858; www.telecast-fiber.com

Booth: SU8375

Wireless camera Microwave Radio Communications REPORTER

For news or sports, handheld portable use and wireless studio applications; designed to broadcast live video to a central receiver site over distances not exceeding 1000m; features integrated MPEG-2 encoding with COFDM modulation.

978-671-5700; www.mrcbroadcast.com

Booth: C3007

Optical infrastructure Telecast Fiber Systems Mamba ISS Series

Fully integrated optical infrastructure approach to HD/SDI and audio distribution; enables facilities to use fiber for all their video, audio, data and communications distribution.

508-754-4858; www.telecast-fiber.com

Booth: SU8375



Rack-mounted control unit and mast-mounted transmitter ▲ Broadcast Microwave Services Truck-Coder II (TCII)

Two unit systems features a Bright Selector panel display; front panel Ethernet port supports downloadable field upgrades and preset configurations; RF unit is configured to operate in the 2GHz frequency band; second optional RF unit can be added to allow selectable operation at either 2GHz or 7GHz.

800-669-9667; www.bms-inc.com

Booth: C1421

Wireless camera transmitter Microwave Radio Communications Reporter

Broadcast live video to a central receiver site up to 1093yd away; features integrated MPEG-2 encoding (4:2:2/4:2:0) with COFDM modulation; accepts NTSC/PAL composite, component or SDI video inputs and offers selectable audio inputs for standard analog (two channels), AES/EBU digital bit stream or de-embedded SDI; operates on stand-alone DC power or other common "brick-type" battery packs.

978-671-5700; www.mrcbroadcast.com

Booth: C3007



Digital/analog transmitter ▲ Nucomm Newscaster VT2

Includes a rack-mounting control unit and mast-mounting RF unit on this digital/analog ENG/OB van transmitter; available in single and dual band; features include an internal 4:2:2 MPEG-2 encoder, COFDM modulator, ASI, SDI and composite inputs; optional 10W digital PA is available.

908-852-3700; www.nucomm.com

Booth: C1416

Portable digital receiver Microwave Radio Communications QuikVue

Ideal for electronic news gathering; features COFDM demodulation and MPEG decoding; supports low delay mode; offers a 6.4in LCD color video screen for active monitoring from a portable transmitter; can interface with standard digital or analog monitors and recorders.

978-671-5700; www.mrcbroadcast.com

Booth: C3007

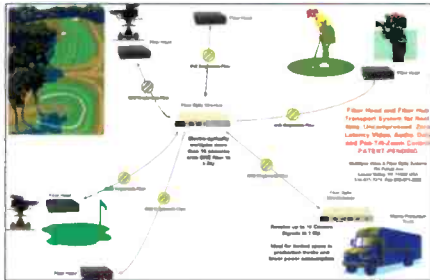

Fiber optic transport technology ▲

Multidyne fiber optic platform simplifies the architecture of a fiber optic network, reduces equipment costs, simplifies design and maintains uncompressed, digital, broadcast quality video from end to end; reduces the equipment required at the central node from 8 to 10; the Fiber Hub unit has one high speed fiber optic output for the main fiber trunkline; the equipment complexity and size is also reduced at the destination point from 3 to 4 down to 1 to 2 rack-units.

516-671-7278; www.multidyne.com

Booth: C3151

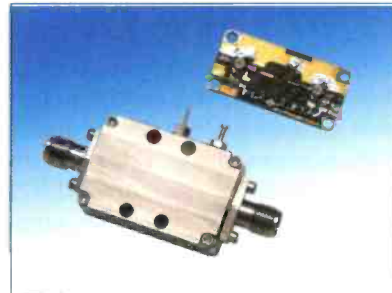

Multipliers ▲

MITEQ SYS2XA4509H and SYS3XA1957H

Available in either carrier form or standard SMA housing form; model SYS2XA4509H is a doubler with 10 dBm output from 6GHz to 12GHz, for a +5 dBm input; model SYS3XA1957H is a tripler with 12 dBm output from 4.2GHz to 7GHz, for a +4 dBm input; both units operate on +5 volts and have typical input harmonic suppression of 15 dBc; both measure .920in by .444in by .125in in carrier form.

630-759-9500; www.miteq.com

Booth: C6546

Fair and Balanced Color



It's true. Kino Flo's telegenic ParaBeam 400 studio fixture delivers 3,000 Watts worth of tungsten soft light on 2 Amps—without the heat and without compromising your picture's color quality! The ParaBeam's cool brilliance owes to

a special parabolic reflector that practically turns light waves into projectiles.

As for image quality, the fixture uses Kino Flo designed True Match® lamps that display professional tungsten and daylight balanced illumination (CRI 95). A center mount lets you rotate between a horizontal and vertical beam. Slide in your choice of focusing louvers to spot the beam down to a 90°, 60° or 45° pool of light. DMX, analog and manual controls can dim the light to black. Like all Kino Flos, the ParaBeam is flicker free and dead quiet.

If you think the ParaBeam looks good on paper, wait 'til you see how it looks on video.

ParaBeam

2840 North Hollywood Way Burbank CA 91505 818 767 6528 voice 818 767 7517 fax



www.kinoflo.com

Transmitters/receivers

Evertz 7707 ADVT; 7707ADVR

Single card modules, which transport Analog or SDI video and 4 channels of Analog or AES audio over fiber optics; features auto-sensing (analog or digital) video and audio inputs; accepts digital video with analog audio (or vice versa) combinations; supports NTSC and PAL analog or 4:2:2 component digital video; supports 32, 44.1, 48KHz AES audio; features broadcast quality 12 bit analog video and 24 bit analog audio processing; Dolby E compatible; supports single-mode and multi-mode fiber; comprehensive local and remote status monitoring via VistaLINKTM.

905-335-3700; www.evertz.com
Booth: SU6433



MPEG-2 encoder ▲

Nucomm Newscoder TX3

Unit is standalone 4:2:2/4:2:0 MPEG-2 encoder; features up to three software-based modulation formats, integrated SDI to composite video converter, and integrated dynamic color bars with ID.

908-852-3700; www.nucomm.com
Booth: C1416

Transmitter

Broadcast Microwave Carry-Coder II

A portable module for video cameras; performs wireless digital transmission of video, audio, and user defined private data; can be used in a backpack configuration or plugged directly to the back of most professional video cameras; mechanical adapters are available on request for most professional video camera models; capable of driving a power amplifier in vehicle or helicopter applications; performs MPEG2 encoding, COFDM digital modulation and RF amplification in a very compact package.

800-669-9667; www.bms-inc.com
Booth: C1421

Single fiber extension

Opticomm DVI Series

For digital media transport; the DVI-1000 system extends to 1000m (3280ft) the distance permitted for the placement of a digital monitor or projector up away from the controlling computer without loss of resolution; traditional copper cables are limited to 3m (9.84ft); each system consists of a transmitter and a receiver connected by a single multi-mode fiber.

800-867-8426; www.opticomm.com
Booth: SU10460

Optic transport system

Multidyne RGB-5000

Features improved resolution; provides a long haul, transport solution for high-quality, up to 1600 by 1200, high-resolution, RGB or VGA video sources via one fiber; provides a total analog bandwidth of up to 600MHz; has a data throughput of 3.125GB/s with no compression or very low color space compression; automatically detects the Horizontal and Vertical Sync configuration with support for sync on green, CS sync and separate HS and VS sync inputs; systems are available to transport RGB video as well as audio, keyboard and mouse control.

516-671-7278; www.multidyne.com
Booth: C3151



Aerodynamic SNG antenna ▲

ND SatCom AG SkyRAY Compact

Combines need for a powerful uplink with roof top box fixed on standard mounts; compact Jet Box-like casing houses a high-performance SNG antenna; accommodates company's 400W TWT amplifier or redundant SSPA configuration; system can be moved to another vehicle quickly and easily.

214-231-3400; www.ndsatcom.com
Booth: C11046



Portable transmitter/receiver ▲

Nucomm ChannelMaster

Lightweight unit is suitable for portable, van, or airborne applications; available in single- and dual-band; features internal MPEG-2 and COFDM, FM modulator and an integrated SDI-to-composite converter.

908-852-3700; www.nucomm.com
Booth: C1416

Create with EDIUS



Edit HD, SD, HDV, and DV

EDIUS includes hundreds of features offering powerful, streamlined, mixed format editing, a flexible user interface, and full 1080i realtime output to a monitor or deck:

EDIUS	NX	SP	HD	HD
DV	✓	✓	✓	✓
HDV	✓	✓	✓	✓
SD (uncompressed)			✓	✓
HD				✓
IEEE 1394 (FireWire) w/deck control	✓	✓	✓	✓
Composite Video Output	✓	✓	✓	✓
Composite Video Input	✓	✓	✓	✓
Component Video Output	✓	✓	✓	✓
Component Video Input		✓	✓	✓
RS-422 Deck Control		✓	✓	✓
AES / EBU Audio			✓	✓
SD SDI			✓	✓
HD SDI				✓



www.canopus.com
or call 1-888-899-EDIT

canopus[®]

Create. Purpose. Deliver

ESOE All trademarks or registered trademarks are properties of their respective holders. VA080205-D

Fiber optic transmitters/receivers

Evertz 7707RGBT; 7707RGBR DVI/RGBHV

For DVI and RGBHV video signals; includes DVI/RGBHV versions, DVI/RGBHV with two channels of analog audio and DVI/RGBHV versions with analog audio, keyboard and mouse signals for KVM applications; features DVI or RGBHV over a single fiber; supports up to 1920 by 1200 WUXGA resolution; both DVI and RGBHV outputs available simultaneously on receiver; superior digital data transmission; comprehensive local and remote (via SNMP) signal and card status monitoring; supports both single-mode and multi-mode fiber; optional 2 channel stereo analog audio; optional keyboard and mouse.

905-335-3700; www.evertz.com

Booth: SU6433

2.5G Multirate Optical Converter and Transponder

Network Electronics MR-TR-2.5G

A multirate optical O/E – E/O converter and O/O transponder in one unit capable of data rates up to 2.5Gb/s; supports a wide-range of signal formats, including SDI, HD-SDI, SMPTE 310 MPEG, DVB-ASI, SDH/SONET up to STM-16/OC-48, Gigabit Ethernet, and Fiberchannel enabling flashlink networks to be built in combination with STM-16 and OC-48; features enhanced functionality with 3R regeneration for optical signal formats and is available with 1310nm, 1550nm, CWDM and DWDM laser.

800-420-5909; www.network-electronics.com

Booth: SU9311



Fiber-optic transmitters

Crystal Vision FTX202 and FRX204

Conform to SMPTE 297M; work with multi-mode and single-mode fiber; both units are dual-channel products; fit in the latest versions of the company's standard 4U and 2U frames; FTX202 has one coaxial input and one optical output per channel; FRX204 has one optical input and two coaxial outputs per channel.

954-788-3334; www.crystalvision.tv

Booth: SU6361

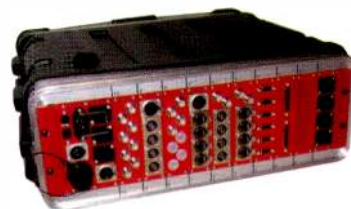

Mobile Transport Enclosure

Network Electronics MOT-BOX

A compact 3RU, lightweight mobile transport enclosure; available to the flashlink's housing options; houses all flashlink optical transport, signal processing and distribution cards including WDM/CWDM; its rugged design and connector panel, including an expanded beam hermaphroditic fiber connector, make it the ideal choice for all mobile and outside broadcast applications; options include a fiber reel with MIL specified tactile fiber, AC and DC power supplies, and a monitoring/ alarming function via Network's GYDA controller.

800-420-5909; www.network-electronics.com

Booth: SU9311



CWDM system

Network Electronics 16-Channel CWDM system

Offers 16 independent SDI or HD-SDI channels multiplexed onto a single fiber strand; based on the company's new dual optical converters and widely deployed ultra-compact 8-Channel CWDM filter, the low power design consumes only 30W and operates without fans; features dual redundant AC/AC, AC/DC, or DC/DC power supplies with dual mains and front-loaded, hot-swappable optical transmitter and receiver cards.

800-420-5909; www.network-electronics.com

Booth: SU9311

Fiber optic transmission

Opticomm DVX-5000 Series

1-8 channels of uncompressed SDI (up to 64 channels may be transported over one single-mode fiber using MDM-7000 CWDM Multiplexer); provide for the digital transport of Uncompressed SDI with embedded audio or data per SMPTE 259M; accept SDI, ASI, DTV, and DVB up to 540Mb/s per channel; transmission is extended up to 40Km over 1 singlemode fiber with a 20dB budget loss.

800-867-8426; www.opticomm.com

Booth: SU10460

Digital/analog receiver ▶
Nucomm CR6D



Device comes with internal MPEG-2 decoder and COFDM demodulator; compatible with most remote controls; capable of multi-band operation when used with block down converters.

908-852-3700; www.nucomm.com
 Booth: C1416

PRODUCTION SWITCHERS, VIDEO EFFECTS, KEYERS

Scratch and film dirt concealment system

Digital Vision ASC3 ME

Supports real-time removal and concealment of film dirt and random scratches; incorporates Digital Vision's PHAME motion estimation algorithms; can process 4:2:2 SDTV, 4:2:2 HDTV and 4:4:4 RGB/YUV images.

+46 8 546 182 00; www.digitalvision.se
 Booth: C9732



Production switcher ▲

Eyeheight irisHDi

Switcher with eight HSDI inputs, program and preset control and two auxiliary bus outputs; features video mix, wipe, cut as well as U and V fades/transitions under manual or automatic control; is structured as an 8x4 HSDI crosspoint router with referenced dual-input HSDI vision switcher; self-contained and field upgradable; based on Eyeheight's new geNETics Evolution hardware platform.

+44 1923 256 000; www.eyeheight.com
 Booth: SU 8501



INNOVATION IN TELEPROMPTING STARTS WITH QTV



For confidence, QTV is your only choice.

With over 50 years broadcast experience, QTV has led the way in teleprompting technology, producing the most reliable and cutting-edge equipment in the world today. For ease-of-use, durability and performance nothing compares to QTV prompters—that's why every major network in the country uses them.

Whatever your prompting needs, QTV has it. Contact us for information or a product catalog.



203 Harbor Drive, Stamford, CT 06902
 Tel: (203) 406-1400 • Fax: (203) 323-3394
www.qtv.com

Endorsed the world over

Visit us at NAB, Booth #SU7865



Multi Channel Master Control System ▲ NVISION NV5128-MC

New master control processor with enhanced squeezeback effects is field-upgradeable from SD to HD; and new single module SD master control processor with A/B mixer, 3 external keyers, built-in logo store, providing up to 8 channels of master control in a single 8RU frame.

530-265-3055; www.nvision.tv

Booth: SU9301



HD chroma keyer ▲

Crystal Vision Safire HD

Works with all common HD formats; features additive and multiplicative keying; can be used with transparent and reflective objects; offers numerous fine adjustments for edge optimization and sophisticated shadow processing as well as key shrink; Force Foreground, Force FB and Luma Keying features are ideal for inserting graphics onto sporting surfaces during live events.

954-788-3334; www.crystalvision.tv

Booth: SU6361

Video I/O card

Blackmagic Design DeckLink for Macintosh v4.8

New features include HD downconversion on capture for DeckLink HD models, Photoshop plug-in that directly integrate 8-bit or 16-bit video frame capture and output via DeckLink cards in the graphics application; other features include single-field pause, 12-channel HD-SDI audio support on DeckLink HD models and improvements in compatibility with the voice-over tool in Final Cut Pro HD.

+61 3 9682 4770; www.blackmagic-design.com

Booth: SL4916



3D animation system ▲

Discreet 3ds max 7

3D modeling, animation, and rendering solution; defines art in 3D animation for game development, design visualization, feature film and television effects, and education; includes Cloth Extension, the sophisticated cloth simulation system that gives artists the creative tools to build realistic, film-quality clothing for 3D characters in Film, Television, Advertising and Games projects; artists can turn modeled geometry into cloth, or design/import clothing patterns for the design of full garments for their characters.

514-393-1616; www.discreet.com

Booth: SL1920



Effects platform ▲

Discreet Inferno 6

Offers users a spline-based warping and morphing tool that gives users control using animated splines with support for tracking data, 3D look-up-table (LUT) capabilities for accurate colour display, an improved automated 3D Tracker that analyses a clip, the ability to select the tracking points and process the results in the background, clip history that allows artists to see how clips have been constructed and to quickly modify previous settings, and Collaborative workflow enhancements like open file access, the ability to add schematic notes, and support for the Adobe PSD layered file format.

514-393-1616; www.discreet.com

Booth: SL1920

Ross lets you Focus on the Big Picture

More people are looking to Ross products to handle their production needs

... so they can stay focused on their production rather than their equipment.



KJLA
Los Angeles, California
Ross Synergy 3,
RossGear Terminal Equipment

SD or HD, Ross products are known for robust feature sets, user friendly installation and operations, extensive warranties and years of trouble-free use... making them the choice of many broadcasters, sports stadiums, educational institutes, corporate and government agencies, as well as religious institutes.



Cool Practical Technology™

(613) 652-4886
solutions@rossvideo.com

www.rossvideo.com



Synergy SD
Production Switchers
Synergy MD
SD / HD Production Switchers



OverDrive
Production Control System



Talia
Routing Systems



RossGear
Terminal Equipment
RossGear MD
SD / HD Terminal Equipment



GearLite
Compact Terminal Equipment
GearLite MD
SD / HD Compact Terminal Equipment

New Products at Ross NAB '05 Booth # SU7141

Synergy SD

- More Squeeze & Tease Warp Effects
- New machine control capabilities
- More powerful control panel CPU
- Keyboard support
- USB removable storage

Synergy MD

- Now shipping!
- SmartConversion cross converter tie line management for simultaneous SD and HD production

OverDrive

- v3.0 software
- Chyron CG integration
- NCS text feedback
- Enhanced audio and video server control
- RapidSwitch™ for quick redundant changeover

Talia

- 16x4 NK compact router
- MD (multi-def), NK 16x16 and 32x32 systems
- 64x64 systems
- Enhanced NK Control System
- NK virtual mapping

RossGear

- Introducing RossGear MD, SD and HD Terminal Equipment
- New SD & HD distribution, monitoring and conversion gear

GearLite

- Rack mounted redundant power supply
- New conversion and distribution modules in SD and HD



Combustion software ▲

Discreet Combustion 4 software

Combustion software for Windows and Macintosh; features a complete set of tools for visual effects creation, including vector paint, particles, effects, animation and 3D compositing tools; provides users with Discreet's cleaner encoding software and its flint, flame, inferno, fire and smoke systems products.

514-393-1616; www.discreet.com

Booth: SL1920

Video effects system

Eyeheight SQ-2E 2D DVE

A 2D digital video effects system with integrated keying; designed for picture-in-picture and image-squeeze applications; can perform real-time horizontal and/or vertical resizing effects; each input can be positioned in any part of the picture area and keyed over or behind the other incoming channel; signals can also be cropped in width or height; preview output allows operator to check setup and transitions; up to three SQ-2E DVEs can be housed in a 1U under local, remote or automated control.

+44 1923 256 000; www.eyehight.com

Booth: SU 8501

Switcher

Echolab Nova identity4

Provides high-speed, next generation interconnectivity; have 100Mb Ethernet ports, supporting simultaneous connections to the outside world through Web, TFTP and XML-RPC servers; the Web server enables an operator to remotely access the switcher from anywhere in the world via a web page to check on status and configuration; the XML-RPC Server provides a high-bandwidth remote control protocol for operation of any switcher function over a local or remote Internet connection; the TFTP Server allows an operator to upload and download graphics to the frame buffer

978-262-0063; www.echolab.com

Booth: C4915

DVE

SAV 2D DVE

A dual channel 2D DVE; fits into the MX-AIR frame; works in several modes like Video + Video, Video + Key and Video + preview; the inputs feeding the DVE are selectable by the key bus and can be squeezed, teased, cropped, have color borders and 2D xyz moves; the effects can be controlled via the T-bar, the automation and the autotransition button; they can be recalled from a library of 40 presets or can be created via the user friendly touch screen and joystick.

+33 1 53 38 22 00; www.sav.tv

Booth: SU11117

SD & HD production switchers

Ross Video Synergy MD

New SmartConversion-Cross Converter Tie Line Management option can be added to any Synergy MD/X model; allows cross converters to be switched in and out automatically as needed during production.

613-652-4886; www.rossvideo.com

Booth: SU7141

HD/SD production switcher

Ikegami HSS-3000

Can output HD, SD or SDI signals; a total of 96 inputs and 64 outputs can be supported, with all outputs fully assignable; offers four M/Es, with either HD or SD signals assignable to each M/E; a two-channel DVE is built into each M/E for basic programmable effects; features include optional frame store, external machine control and a dual LCD touchscreen.

201-368-9171; www.ikegami.com

Booth: C5426



Switcher ▲

SAV MX-AIR

An 8 inputs SDI master control room switcher with built-in embedders and de-embedders; it can integrate extra-levels of DSKs, logos, texts, clocks generators and a digital multi-channel digital audio mixer; it can be controlled through an automation connected via serial port, Ethernet or remote key-board.

+33 1 53 38 22 00; www.sav.tv

Booth: SU11117



Live video production system ▲

Broadcast Pix PixMaster

An integrated pre-production environment designed to simplify the creation of multi-layer live video; enables a producer to click on any of the switcher's still or graphic stores to reveal its library content and then click on any element to open it in Inscrber for editing; clips and graphics can be set to automatically start as they go on-air and cue the next one as they come off-air.

781-221-2144; www.broadcastpix.com

Booth: SL5706

Digital production switchers

Ross Video Synergy SD

New, more powerful control panel CPU, keyboard support and USB removable storage; new Squeeze & Tease Warp effects include corner pinning, lens flare, obscure, and shards; automatic white flash effect added to generate this type of effect; robotic cameras, audio mixers, character generators and support for numerous additional manufacturers' products.

613-652-4886; www.rossvideo.com

Booth: SU7141

Desktop video products

AJA Video Desktop Video Product Line

Company is expanding desktop video product line; new features will increase capabilities of existing desktop video products; will also introduce several new video converters for broadcast and film/TV production industries.

530-274-2048; www.aja.com

Booth: SL2514 (desktop video products);

Booth: SU8948 (video converters)

See us at

NAB

2005

April 16-21 - Las Vegas, NV

Booth SU#10000

When it's your job on the line,

which automation system will you choose?

The Leader in TV Automation

Join the many other successful broadcasters who already rely on Florical automation.



4581 NW 6th Street, Gainesville FL 32609
Ph: 352.372.8326, Fax: 352.375.0859
sales@florical.com, www.florical.com



High-definition switcher PRO-BEL MASTERPIECE

New high-definition switcher can either be specified new or purchased as an upgrade for the TX520; can be used to upgrade existing SD video switchers and benefits from two keyers with the ability to place a DVE into the signal chain before or after either keyer.

631-549-5159; www.pro-bel.com

Booth: SU10730

SD/HD production switcher Snell & Wilcox Kahuna

Offers simultaneous HD and SD operations in the same mainframe with the same control panel; enables the seamless integration of SD sources into HD productions without outboard upconversion; users can work initially in SD-only or HD-only mode and then upgrade to multiformat SD/HD operation; allows users to mix existing SD camera feeds, graphics, handheld shots, and archive footage directly into an HD production.

212-481-2416; www.snellwilcox.com

Booth: SU6349

DV switcher Laird Telemedia DV4X1A

4x1 DV switcher with selectable external XLR audio insert onto the Firewire stream.

800-898-0759; www.lairdtelemedia.com

Booth: SL1243

RF SYSTEMS



Air-dielectric coaxial cable ▲

Radio Frequency Systems (RFS) HELIFLEX Available in sizes from 3/8in to 9in; minimizes discontinuities and achieves low return loss over the entire UHF bandwidth; in the case of dual feeder lines, the product's inevitable proximity facilitates phase matching and eliminates the need for inherent temperature compensation.

203-630-3311; www.rfsworld.com

Booth: C3031

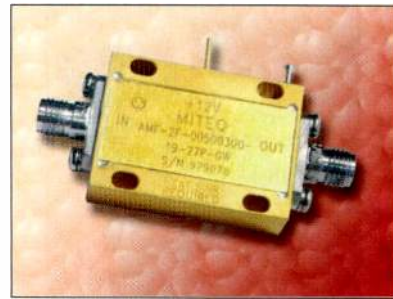

Amplifier ▲ MITEQ LNA Model AMF-2F-00500300-25-26P

A high dynamic range, low noise amplifier; operates over the 5003000MHz communications band; has +26 dBm (1 dB) output power, an IP3 of +39 dBm and a 2.5 dB NF; makes an ideal Low Noise Front end with minimum distortion; gain is 29 dB Min., +/-2.5 dB flatness and operates from +15 VDC at 650 mA; size is 1.22in by .88in by .35in.

630-759-9500; www.miteq.com

Booth: C6546

Antennas Dielectric 7C, 7P, and 7S Series antennas

A full line of antennas designed for the 700MHz spectrum; product line includes slotted coaxial antennas as well as panel antennas; all antennas in this new product line can be horizontally, vertically, or circularly polarized.

207-655-4555; www.dielectric.com

Booth: C7807

Transmitter e2v Klystron

Are used as the final amplifier stage in UHF television transmitters of 5kW peak sync output power and above; will fit most transmitter types and extends from the older unpulsed tubes to modern wideband types and the latest Energy Saving Collector klystrons.

914-592-6050; www.e2v.com

Booth: C3146

Oil-cooled CEA tube

L-3 Communications Electron Devices CEA 130 High-efficiency tube covers the UHF-TV band; combines a multistage depressed collector with inductive output amplifier; DC power is made almost proportional to RF output over a wide power range; can be used in analog transmitters to improve efficiency over standard IOTs.

570-326-3561; www.edd.l-3.com

Booth: C8507

On-Air

Automated VOD Production

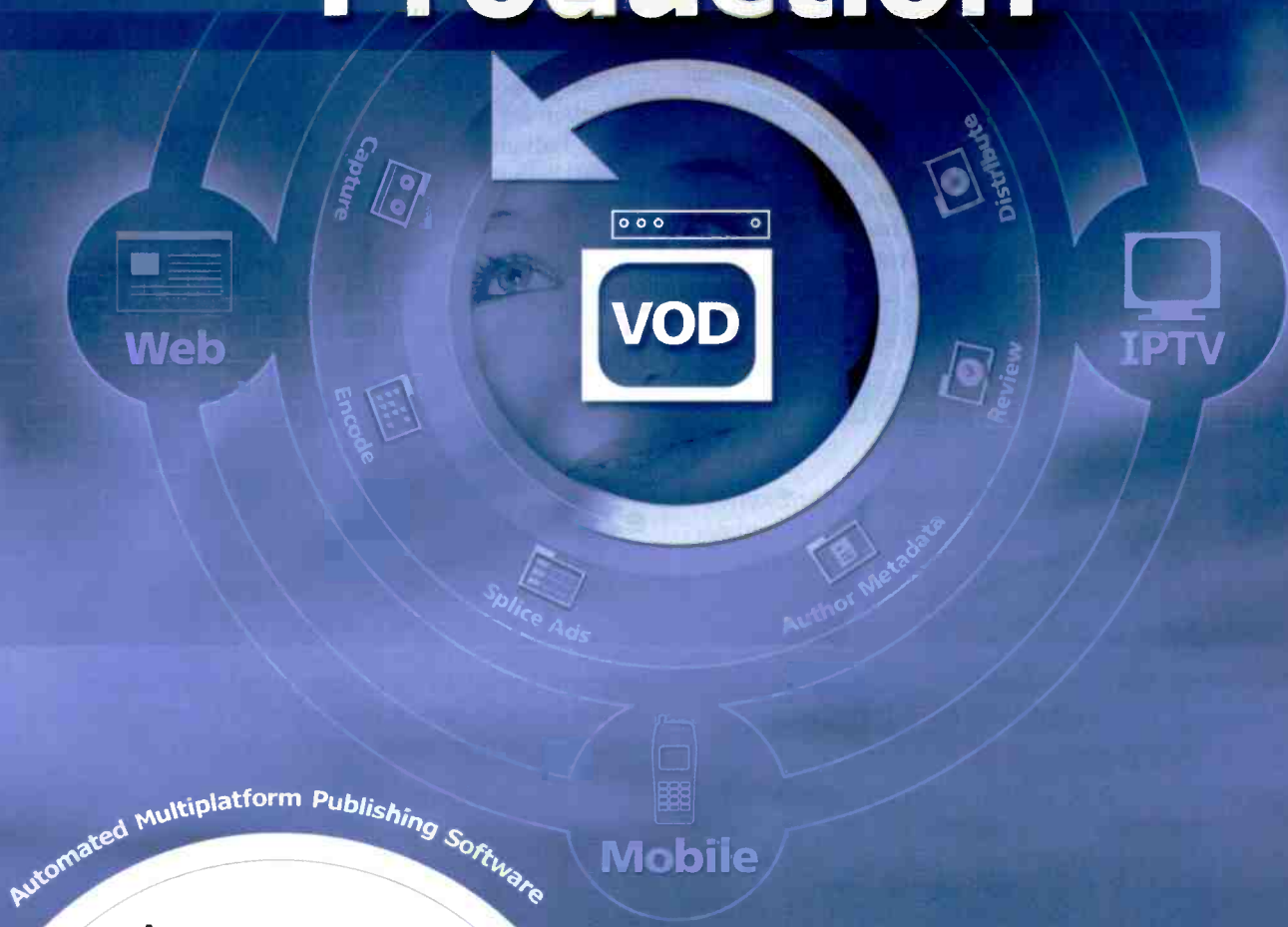

Anystream.
Agility



See VOD at NAB
 Anystream Booth SL 3316

Good news: VOD is here!

Bad news: Your content production process isn't VOD-ready...

Anystream can solve your problem. Our Agility software automates routine media conversion and publishing tasks, giving you the efficiency, scalability and flexibility you need to serve emerging outlets.

Top media companies every day rely on Anystream Agility to transcode content for network exchange among multiple manufacturers' servers - whether HD or SD - and repurpose media for the Web, mobile, VOD and more.

Let Agility automation take your content to new places!

Call us today at 888-ANystream or visit www.Anystream.com

 **anystream.**
 software transforms content.

Transmitter

Screen Service Italia MDS/MMDS Systems

Microwave Multipoint Distribution Systems; designed for the transmission of amplitude-modulated analogue television signals, with combined audio/visual amplification, in the 2.0GHz to 2.7GHz band; available both in the separate amplification version for each individual channel and in the common amplification version for combined groups of channels; the separate amplification systems consist of a transmitter and, where necessary, of an RF amplifier which directly powers a radiant antenna or a power combiner in the case of multichannel transmission.

+39 030 2582225; www.screen.it

Booth: N3922



Digital transcoder ▲

LARCAN USA 8VSB REGEN Transcoder/Exciter
Built for digital translator networks; uses 8VSB translator technology that extends digital coverage to rural areas.

303-665-8000; www.larcan.com

Booth: C5620

MSDC-IOT transmitter

Thales Broadcast & Multimedia DCX Paragon

Supports DTV, NTSC and various manufacturers' tubes in both water- and oil-cooled versions; features the patented Soft Arc Technology, which eliminates the need for a crowbar and substantially increases the transmitter's overall reliability.

413-998-1100; www.thales-bm.com

Booth: C4508

Transmitters

Thales Broadcast & Multimedia Ultimate/Optimum

Analog, digital, air-cooled and liquid-cooled versions are available; the solid-state architecture is easily upgradeable from NTSC to DTV.

413-998-1100; www.thales-bm.com

Booth: C4508

8VSB Modulator

Axcera Axciter

Second-generation fully adaptive modulator; uses Intelligent Modulation and Adaptive Digital Equalization for fast and accurate equalization; produces an extremely stable output signal with unrivalled SNR performance.

800-215-2614; www.axcera.com

Booth: C8014

Power conditioning ▶

Staco Energy Products
Firstline Conditioning
Power System (CPS)
Designed for use in broadcast transmitters to protect equipment from damage by poor power quality; can provide a high level of protection for equipment where traditional UPS cannot be used because of environmental or cost considerations; completely isolates the connected load from the primary AC supply, protecting it from voltage sags, high voltage spikes, transients, and frequency variations; delivers a true sine wave output.

937-253-1191; www.stacoenergy.com

Booth: C1207



Transmitter e2v IOTs

For high power analog and digital UHF TV transmitters; includes low power plug-in types, higher power plug-in and build-up types, and a range of high efficiency water cooled energy-saving-collector IOTs (ESCIOTs); hydrogen thyratrons make them suited as protection devices for IOTs in high power UHF TV transmitters; single IOT systems range in power from 15+1.5kW to 77+7.7kW (combined amplification).

914-592-6050; www.e2v.com

Booth: C3146



Depressed collector IOT transmitter ▲ Acrodyne (Ai) Quantum

Designed to operate efficiently in either digital or analog service; is field-convertible; uses e2v ESCIOT water-cooled tubes; engineered to provide a high level of energy efficiency.

888-881-4447; www.acrodyne.com

Booth: C6212



Antenna ◀
**Dielectric
 TFU-UT
 antenna**

Patented bow tie slot turnstile; is an economical low-power broadband (470MHz to 860MHz) UHF omni-directional antenna; features a simple feed system and durable construction; each bow tie slot represents two batwings in a turnstile configuration; design eliminates feedlines, hardware, and radiators, as

well as the need for a support mast; design allows for dual inputs designed for single-channel operation or the simultaneous broadcast of two channels without the need for a separate combiner.

207-655-4555; www.dielectric.com

Booth: C7807



Transmitter ◀
**DMT USA
 1kW DTV UHF
 Transmitter**

Air cooling; LDMOS technology; broadband standardized design; "dual-cast" option; built-in output filter.

888-912-TEAM; www.dmtonline.us

Booth: C3016

Transmitter
MYAT High power UHF load

The solution for coaxial high power system load requirements; the glycol/water coolant mixture facilitates effective heat transfer, providing consistent, low-maintenance stability; a highly efficient coolant flow-thru path minimizes the device's contribution to your station's cooling system pump capacity requirements; features high power capacity, low VSWR, efficient coolant 'flow-thru' path, cost effective system load solution, rugged construction; available with 3 1/8in, 4 1/16in and 6 1/8in inputs.

201-767-5380; www.myat.com

Booth: C1407



well with others
 simultaneously in openly
 shared environments.

easily with users
 and manage assets
 for seamless ingest,
 edit, playout and archive.

end-to-end solutions
 for the next generation
 IT-based broadcast world.



VIDEOTECHNICS INC

Go Digital. Go LIVE.

So easy, it feels like play. Video Technics offers solid IT-based and non-proprietary solutions that are designed to easily integrate and scale from small to large broadcast environments. So now, you can afford to transition from tape to digital using a seamless ingest, edit, playback and archive solution.



Call (404)327.8300 or
 visit www.videotechnics.com
 for more information.

NAB 2005 Booth #C3647

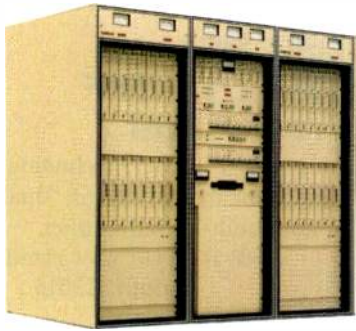

Solid-state UHF transmitters ▲

LARCAN USA Meridian Series

High-performance, cost-effective, solid-state broadcast solution; designed to meet specific needs of broadcasters; performs at 1kW to 10kW.

303-665-8000; www.larcan.com

Booth: C5620

Wireless camera transmitter ▶

Nucomm CamPac

Consists of a docking station and 10W HPA; features an internal 4:2:2/4:2:0 MPEG-2 encoder/COFDM modulator, 250mW out, and SDI and composite inputs; available in either 2GHz or 7GHz; GoPac provides a multi-role format for the transmitter, allowing it be used in an ENG van, helicopter or news car.

908-852-3700; www.nucomm.com

Booth: C1416



UHF Digital and Analog Transmitter ◀

Axcera Innovator HX

Based on the advanced design of the Innovator HX VHF transmitter; high-power solid-state UHF transmitter; features broadband amplifiers and combiners, high-gain power modules and hot swappable amplifiers; design

offers the choice of linear or switching power supplies and uses identical amplifiers for internally diplexed, externally diplexed and DTV operation.

800-215-2614; www.axcera.com

Booth: C8014



High-power UHF ATSC transmitter ▲
Harris PowerCD

Features E2V's high-efficiency ESCIOT tubes, Harris' APEX exciter with its real-time adaptive correction for linear and nonlinear distortions, and other Harris filtering and correction techniques; liquid cooling minimizes expenses by reducing a transmitter facility's heat load and related cooling costs.

800-442-7747; www.broadcast.harris.com

Booth: C1907; SU10048

Plug-in IOTs

L-3 Communications Electron Devices IOT 70

Used in new or existing transmitter installations; designed as a replacement for popular build-up style IOTs; provides convenience of a drop-in tube without expense of a new trolley; existing output cavity is ready for the L-3 plug-in; company can also supply new input-cavity assemblies that are shorter, lighter and more efficient than the older e2v units.

570-326-3561; www.edd.l-3.com

Booth: C8507

Digital Klystrode IOT
CPI/Eimac K2

For use in digital UHF television service in the output stage of DTV transmitters; suitable for use with 8VSB and COFDM modulation schemes; have a magnetically focused electron beam that is density-bunched by an RF cavity-driven grid; optimized to maintain a high gain and linearity at the average or rms signal levels as well as at the peak power levels; efficiency is optimized at the average or rms level for low operating cost.

650-594-4089; www.cpii.com

Booth: C2616

fischer connectors

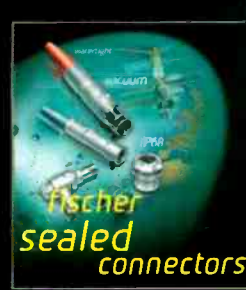

- ▶ Widest range of connectors for studio and outside broadcasting
- ▶ Sturdy watertight design with corrosion resistant finish for reliable outside broadcast application
- ▶ All approved triaxial cables accepted due to an extensive range of body styles and cables
- ▶ Intermateable with the American Standard (Series 1052)

- ▶ Mixing different purpose contacts in one connector body provides unprecedented design flexibility
- ▶ "Mix-and-Match" contact elements as needed:

- Fiber-Optic (single - or multimode)
 - Coaxial (50 or 75 Ω)
 - Fluid or Gas
 - High voltage
 - High current
- ▶ Sealing to IP68
 - ▶ Positive-locking, lightweight design
 - ▶ Fully insulated plastic body provides maximum user safety and shock-protection
 - ▶ Impervious to 1000's of sterilizations
 - ▶ Intermateable to Fischer metal connectors
 - ▶ Sealing to IP68: ideal for wet applications
 - ▶ EMI/RFI shielding available

- ▶ Hermetically sealed (10⁻⁶ mbar / \pm) and pressure tight for extreme environments and safety
- ▶ Meets and exceeds highest protection levels of IEC60529, BS5490, DIN40050
- ▶ High performance O-ring seals made of VITON as standard
- ▶ Insulator-contacts sealed by 3 component glass epoxy



Fischer Connectors, Inc.
1735 Founders Parkway Suite 100
Alpharetta, GA 30004
Tel. 800-551-0121
Fax 678-393-5401

www.fischerconnectors.com
mail@fischerconnectors.com



Subsidiaries

Asia
FISCHER CONNECTORS ASIA Ltd.
Hong Kong
Tel. +852 2268 6837
Fax +852 2268 6729
mail@fischerconnectors.com.hk
France
FISCHER CONNECTORS Sarl
Paris
Tel. +33 1 5578 2578
Fax +33 1 5578 2575
www.fischerconnectors.fr
mail@fischerconnectors.fr

Germany and Eastern Europe
FISCHER CONNECTORS GmbH
Kirchseon-Eglharting
Tel. +49 8091 5583 0
Fax +49 8091 5583 23
www.fischerconnectors.de
mail@fischerconnectors.de
Italy
FISCHER CONNECTORS Srl
Monza
Tel. +39 039 321 275
Fax +39 039 326 766
www.fischerconnectors.it
mail@fischerconnectors.it

United Kingdom, Ireland and India
FISCHER CONNECTORS Ltd.
Havant/Hampshire
Tel. +44 2392 459 600
Fax +44 2392 459 601
www.fischerconnectors.co.uk
sales@fischerconnectors.co.uk



UHF and VHF antennas ▲

Micro Communications

Offers line of broadband UHF and VHF antennas for both NTSC and DTV services; more than one channel horizontal pattern can be provided in a single antenna.

603-624-4351; www.mcibroadcast.com

Booth: C7736



PSIP generator/ Metadata management ▲

Triveni Digital GuideBuilder

Metadata management systems; allow broadcasters to comply with the ATSC PSIP standard, retain and enhance their market branding, and protect their channel identities in on-screen Electronic Program Guides (EPGs); supports the distribution of SCTE 35 digital cue tones and network program information networks and their affiliates to synchronize splicing between local and national programming while delivering up-to-date information.

714-378-5841; www.trivenidigital.com

Booth: SU11411

SATELLITE EQUIPMENT/ CABLE/ENCODING/ TRUCKS

HD and SD encoder

Radyne HE4000

In its minimal configuration, the unit can simultaneously encode one HD and one SD video stream as well as up to four stereo audio pairs; can be equipped with an advanced satellite modulator, making it ideal for both contribution and distribution; includes front-panel video and audio confidence monitors that provide verification of input sources; offers 1Mb/s to 160Mb/s encoding.

602-437-9620; www.radn.com

Booth: SU9929



Satellite equipment ▲

Quintech XRM RF Matrix

Features a complete high isolation 32 by 32 matrix, including hot-swappable cards, redundant power supplies, and system controller in a 6 RU chassis; improves space savings and operational flexibility; users can easily access PCBs for upgrades and maintenance via front panel without disconnecting cables or disrupting the signal paths of the other cards in the system; design permits a wide variety of configurations ranging from 32 by 32 up to 512 by 512 and systems can be easily expanded; offers wide array of control options for an RF Matrix.

800-839-3658; www.qecinc.com

Booth: C9348



Receivers/decoders ▲

Scopus Network Technologies IRD-2900

Solution for descrambling and retransmission; supports a wide range of front-end options, including ASI transport-stream input and output supporting rates over 155Mb/s, up to four QPSK L-Band inputs, and up to four pairs of balanced outputs; features a dual decoder that provides decoding of two programs within the same transport stream as well as built-in full transport stream descrambling capability.

609-987-8090; www.scopusamericas.com

Booth: SU8470

Field acquisition system

Telecast Fiber Systems Baker Box (BBX)

Converts stereo field microphones to AES via Cat. 5; RJ-45/Cat. 5 alternative to dry-pair and line amps; each unit amplifies and converts two microphone signals to one digital AES signal and transports it up to 500m on unshielded twisted-pair cable; up to four units can be daisy-chained together.

508-754-4858; www.telecast-fiber.com

Booth: SU8375

Will your digital video delivery be well received?

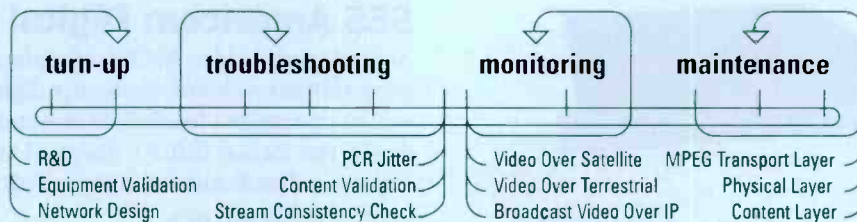

Not without Acterna's Digital Broadcast Test Platform.

For broadcasters, equipment manufacturers and operators -- terrestrial, cable, telco, or satellite -- the Acterna DTS test instruments are the only one-box solutions for MPEG-2, DVB and ATSC testing. The DTS-330 is able to support up to six different combinations of inputs and outputs while the DTS-200 provides mobility, flexibility of plug-in modules and remote troubleshooting. Both platforms have the ability to host multiple test access interfaces - such as QPSK, COFDM/8VSB, ASI, full bandwidth Gig-E, SMPTE-310, and QAM - to help analyze, segment, or isolate issues anywhere in the delivery chain.

Acterna was the first to introduce a MPEG stream analyzer and the only test & measurement solutions provider to combine lab-grade quality with user-friendly and mobile designs. And, as with all of Acterna's products, they are backed by the same market leading service, support and expertise you experienced from Wavetek. It is The Acterna Advantage. To learn more, call 1-866-ACTERNA or e-mail cable.info@acterna.com. For all the details, please visit www.acterna.com/nabdts

Visit us at the NAB show in Vegas, April 18-21, in booth SU10043 to see the latest advancements in MPEG analysis!

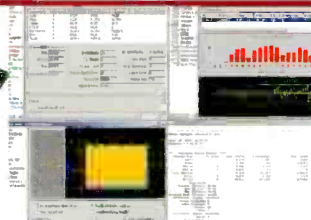
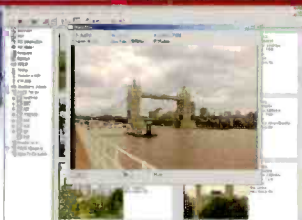



Encoder ▲
**Scopus Network Technologies
 UE-9000**

Universal MPEG Encoding Platform; now implements dual-channel MPEG-2 real-time encoding; provides broadcasters with a migration path from MPEG-2 to new compression algorithms such as the standard and high definition MPEG-4 Part 10 (H.264) and VC1 formats.

609-987-8090; www.scopusamericas.com
 Booth: SU8470

Satellite data service
SES Americom IPlex solution

Features LAN-to-LAN connectivity between a central office and numerous remote sites for e-mail transfer, database applications and more; videoconferencing between any number of designated offices, via satellite or SES AMERICOM's terrestrial backbone network; multicast delivery of customer data, files and audio/video program streams from a central office to a customer's remote sites or between remote sites.

609-987-4000; www.ses-amicom.com
 Booth: C5245



News van ▲
Wolf Coach B-3 HYBRID DSENG

A combination satellite uplink and traditional terrestrial microwave in a small and agile van-sized vehicle; equipped with an AVL 1.2m SNG antenna, single stream digital satellite encoder and also includes a COFDM modulator in the microwave system.

801-565-9533; www.wolfcoach.com
 Booth: C4845

Satellite data service
SES Americom Digital C

An end-to-end video MCPC solution that offers programmers a choice of popular digital platforms, as well as customized bandwidth in a multiple-channel-per-carrier format (MCP); designed to facilitate the economic distribution of compressed, digital cable programming services.

609-987-4000; www.ses-amicom.com
 Booth: C5245



Encoder ▲
**Scopus Network Technologies
 E-1720 DSNG Encoder,
 Modulator, and L-Band
 Upconverter**

Features modulation and upconversion in a compact 1-RU unit, ideal for the DSNG mobile news market: uplink vans, SUVs, and flyaway packages; provides broadcast quality of 70/140 IF and 950MHz to 2150MHz L-band outputs, as well as a separate L-band monitoring output; various satellite modulation schemes are supported in the form of QPSK/8PSK/16QAM; provides a high picture quality with steady low-power consumption.

609-987-8090; www.scopusamericas.com
 Booth: SU847

STORAGE

DVR
**Fast Forward Video Outrider-IDE
 Board-Level DVR**

Is equipped for use with a 2.5" hard drive; features a time/date stamp and character display, time-lapse recording, NTSC/PAL compatibility, composite and Y/C inputs and outputs, pre-event record, and loop record of PC-viewable or secure video files.

949-852-8404; www.ffv.com
 Booth: C3253

Video storage and playback
Masstech Group MassDR

Incorporates replication and transfer tools from existing infrastructure video servers and transfers files and scheduling information to remote system; full resolution MPEG-2 video and transcoded WM9 low resolution full frame size can be intermixed and delivered at the remote site.

905-886-1833; www.masstechgroup.com
 Booth: SU10236



Media server ▲
Avid Technology Airspeed

A cost-effective, intelligent replacement for VTRs or any older server technology that no longer fits your budget or your plans; has two-channel DV25, DV50, and IMX50 playout capability; compact, its modular 3RU form factor reduces space requirements and its proven IT-standard design integrates easily with your existing equipment, applications, and processes – including third-party automation systems.

978-640-3594; www.avid.com
 Booth: SL600

HD input interface
Omneon MediaPort 4010

Provides an interface for HD material by ingesting an incoming ASI-based transport stream and demuxing the content into HD MPEG essence material; can use the HD encoder of their choice to ingest HD MPEG material while using the integrated HD playback capability provided by the MultiPort 4000 series or MultiPort 4100 series for direct playback.

408-585-5000; www.omneon.com
 Booth: SU10724

Storage

Ciprico 4Gb Fibre Channel RAID solution
 Offers affordable, high performance, redundant storage for the video content creation market; demonstrates single and dual stream HD content (uncompressed 10 bit 1080i) playing live from this storage family.

800-727-4669; www.ciprico.com
 Booth: SL3628



NUCOMM'S NEWSCASTER VT₂

MULTI-MODE ENG/OB VAN TRANSMITTER

Integrated MPEG2-COFDM plus FM Analog

Optimized for
 2 GHz Relocation

- 2, 7 or 13 GHz single or 2+7 GHz dual band
- Up to three integrated modulation formats: MPEG@/COFDM, analog FM modulator, plus DVB-S, VSB or QAM
- Digital RF power to 10 watts
- Composite video, SDI, DVB-ASI and 70 MHz
- Four analog plus two AES/EBU audio inputs with SDI de-embedding
- MPEG2 4:2:2 and 4:2:0 encoding with low delay
- Seven quick-keys for commonly used functions
- Six programmable presets access modes of operation



Visit Us at NAB2005, Booth #CI416

101 Bilby Road, Hackettstown ■ New Jersey 07840 USA ■ Phone: 800.968.2666 ■ Fax: 908.813.0399 ■ www.nucomm.com

Decoder

Omneon MultiPort 4000 Series

HD MPEG decoders for integrated playback of HD material ingested into an Omneon Spectrum media server; provides one or two independent channels of HD playback; capable of supporting material in either 4:2:0 or 4:2:2 profiles; includes outputs for HD-SDI video, audio, timecode and control.

408-585-5000; www.omneon.com

Booth: SU10724

SD/HD production server

Accom MultiflexMX

Delivers a high performance feature set, Media Management software, faster than real-time network media transfers, scaleable high capacity RAID storage and 24/7 reliability; allows mix and match of SD and HD channels using new high-quality JPEG-2000 compression technology; can record or play up to eight SD streams, or up to four HD streams, or any combination of SD/HD streams in the same chassis.

650-328-3818; www.accom.com

Booth: SU 7834



Server and VTR/DDR controllers

Hi Tech Systems actiV

Range of 5-channel server and VTR controllers; comprises the base model HT445 actiV Filer, the HT445s actiV Sports; adds a T-bar for slow-motion, and the HT446 actiV Cart Box for live insert operation; includes control panels, popular control protocols, 5.5in graphic displays and single playlist capability; options include more protocols, actiV Loader for playlist translation and transfer, on-screen display, routing switch, scheduling over 10 playlists, video editing, GPIs, master-to-slave linking and scheduled recording.

+44 1256 780 880; www.diskcontrol.com/www.vtrcontrol.com

Booth: SU9711

DVCPRO P2 STORE

Panasonic AJ-PCS060

A portable hard disk unit with a P2 card slot that quickly transfers the content of P2 cards to an internal hard disk drive; the 2.5in 60GB hard disk drive can hold the contents of up to 15 4GB P2 cards, and the entire contents of a 4GB P2 card can be transferred to the internal hard disk drive in approximately four minutes; after the P2 content has been transferred, the P2 store can connect to an NLE or Server Ingest PC via a USB 2.0 interface and appears as an external disk drive.

201-392-4127; www.panasonic.com/broadcast

Booth: C3617



Automated CD/DVD burner and printer

Primera Technology BravoPro Disc Publisher

Copies and prints up to 100 discs per job hands-free with Mac and PC compatibility; available with two 52x CD-R drives or two DVD±R/CD-R combination drives; records DVDs at 16x and CDs at 32x; 4800 dpi printer prints photo-quality color images directly on the surface of the disc; no labels required.

800-797-2772; www.primera.com

Booth: SL4267

Storage

Medea VideoRaid FCR2

Fibre Channel array optimized for a variety of high bandwidth applications, including HD video editing with the FCR2X; equipped with a single channel 2Gb Fibre Channel interface; provides sustained data transfer rates of 180 MB/s; features a built-in 4-port Fibre Channel hub that allows for direct connection of up to four workstations; desktop enclosure provides up to 1.6TB of storage on five removable disk drive; compatible with Pinnacle CinèWave SD 8bit, Blackmagic Decklink SD 8bit and 10bit, AJA Kona SD 8bit and 10bit, AJA Kona 2 SD 8bit and 10bit, and AJA SD 8bit and 10bit.

949-852-8511; www.medeac.com

Booth: SL-3360



SENCORE

We've Got A Full House
Of Solutions For You!



SENCORE Provides Products You Can Rely On Day-In, Day-Out.

- *Modular Receiver Decoders - That Change With Your Needs.*
- *Content Servers - With Editing Or Program Delay Capabilities.*
- *Signal Sources - To Show Your Product, Not The Competition's.*
- *Modulators - Used To Route Signals Throughout Your Facility.*

Look to
SENCORE
for the Solution,
not just a Solution!

NEW Products are coming to NAB 2005!
See how we can turn your laptop into
a MPEG-2 Analyzer, or a Portable
RF Analyzer, including 8-VSB and QAM.

Stop By Our Booths At NAB 2005
Booths: SU100006 Or C7331

Call Us at: 1-800-SENCORE (736-2673) or Visit us at: www.sencore.com

TBC control systems

Ensemble Designs TC400D & CP10

Controls video, chroma, setup, hue and timing of digital and analog VTRs, TBCs and Frame Syncs; built-in networkability; any size system can be achieved with control of any VTR from any control panel; TC400D provides control of the proc-amp functions of four VTR Time Base Correctors; features hands-on control of levels and timing.

530-478-1830; www.ensembledesigns.com
Booth: SU 10217



Codec Media server ▲

Omneon Spectrum media server

Delivers unparalleled scalability and modularity; capable of supporting both real-time (isochronous) broadcast connectivity and non-real-time (asynchronous) network connectivity; gives broadcasters the freedom to use multiple formats and applications simultaneously, with the compatibility required to support existing systems and add new services easily.

408-585-5000; www.omneon.com
Booth: SU10724

Recorder

Autocue QLog

Based on IPV's analog package; a low-resolution, disk-based MPEG output recorder; enables fast searching of archives for spoken words or phrases without prior transcription; enables multiple users to review material as it's being recorded and record channels output; can be used to evaluate viewer complaints, for proof of advertising playout, to playback competitor's output, and archive review.

+44 (0)208 870 0104; www.autocue.co.uk
Booth: SU7865

Plug-in PC card

Panasonic DVCPRO P2

Is HD-ready with a video transfer rate fast enough for high definition recording that's compatible with existing systems; new products and enhancements include the AJ-PCS060, a ruggedized DVCPRO P2 hard disk drive, and enhancements to its AJ-SPX800 DVCPRO P2 camcorder and AJ-SPD850 P2 VTR.

201-392-4127; www.panasonic.com/broadcast
Booth: C3617



Storage ▲

Omnibus Systems OPUS Suite of Content Management Solutions

Delivers highly specialized solutions that can be adapted to the very different operational requirements of broadcasters around the world; design enables it to take a cost-effective, holistic approach by ensuring content is efficiently ingested, managed, and tracked in and around production facilities and taken to air simply and smoothly; broadcasters can integrate all of their systems under a single operational interface with content and individual operator tasks flowing seamlessly through the facility.

704-319-2231; www.omnibus.tv
Booth: SU7165

Recorder

Panasonic AJ-HD3700B

An international mastering recorder that can record, edit and playback both 625 PAL and 525 NTSC D-5 cassettes as well as D-5 tapes from all previous versions; can record, edit and play back in 720p/59.94p, 1080/23.98p and 1080/24p HD formats; its progressive image recording of 24-fps film sources without frame-rate conversion enhances artistic image expression and allows high-quality digital mastering of film content.

201-392-4127; www.panasonic.com/broadcast
Booth: C3617



Recorder/playback ▲

DVC ClipRecorderXTreme

Offers an open platform for the uncompressed recording and playback of SD, HD, 2k and film data; features the new XENA2 (former KONA2) uncompressed multistandard I/O boards; all models have dual-Link HD, HD & SD input and outputs with 8 or 10 bit, and the option to operate in 4:2:2 or 4:4:4 modes.

+49 8152 930 10; www.digitalvideo.de
Booth: C7034

Storage ▶

Exanet Exastore 2.0 NAS storage solution; applications for editing, digital archives, digital intermediates and graphics; features no single point of failure in a full high-availability failover environment; scalability allows any level of capacity and total performance desired in a system; consolidates data into a single pool that can be directly accessed by all workstation clients and workflow servers, regardless of operating system (Unix, Linux, Windows, Mac, etc.).

917-210-8290; www.exanet.com

Booth: SL3957



Videotape recorder ▲ Sony SRW-5500

Simultaneously provides HD and SD output and Digital Betacam payout; can record and playback HDCAM and HDCAM SR tapes at 24PsF, 25PsF and 30PsF, as well as at 1080/60i, 1080/50i and 720/60p; captures content to tape at 440Mb/s at 10-bit depth using the MPEG-4 Studio Profile compression scheme; records 12 channels of 24-bit uncompressed audio; features metadata handling, dynamic tracking playback, pre-read, and confidence playback and recording.

800-686-SONY; www.sony.com/professional

Booth: SU6406

The New SHAPE of UHF Television.

SPECTRAGUIDE
ELLIPTICAL WAVEGUIDE

Yesterday's challenges made do with yesterday's technology. Today's challenges and those of tomorrow require looking for a fresh, new approach... or a new angle on innovation. That's why customers continually depend on Myat.

Now, with our new **SPECTRAGUIDE** Elliptical Waveguide, you can meet your most demanding challenges in a whole new way. The patented **SPECTRAGUIDE** Elliptical Waveguide's unique shape combines the electrical stability and broad-banded response of traditional rectangular waveguides with the reduced wind load and pressure capacity of a circular waveguide... but at HALF the weight of those "sheathed" alternatives.



SPECTRAGUIDE's reduced cross section allows it to fit into already crowded tower environments while delivering a multi-channel high power UHF signal to the antenna. And it does this while providing the low loss you demand from waveguide. It's a design that's clean, simple, and efficient.

KTBU, Missouri City, Texas

When you've got challenges that demand smart solutions and focused innovation, chances are we've got a whole new angle on the situation. So, give us a call!

• Filters/Combiners • Waveguide Systems • Transmission Line and Accessories

DEPEND ON MYAT.

1-201-767-5380 • www.myat.com



Leitch Technology NEXIO HD

Software-based agile codec for high-definition video; based on true 64-bit dual processor platform, which allows the integration of baseband high-definition record and playback directly into the server system; the NX4200HDX platform provides two channels of HD output (decoding), or one channel of input (encoding) and one HD output in either 720p or 1080i format; initial decoding for outputs support MPEG-2 main-level, main-profile and main-level, and 4:2:2 profile; initial support for encoding is MPEG-2 I-frame at high level and 4:2:2 profile at 50Mb/s, with other formats such as Panasonic's DVCPRO-100 HD to follow.

800-775-3314; www.leitch.com
Booth: SU7805, SU8199



Video server ▲ 360 Systems Image Server

New features include Advanced Playlisting software, a 1.6Tb drive array with 170 hours of storage, embedded audio, remote-location of the server GUI, and built-in frame sync; new Advanced Playlisting software provides clear, on-screen presentation and an intuitive user interface that enables users to quickly build and edit commercial breaks, news rundowns and clip lists; Playlist features include drag-and-drop list building and editing, editing while running, on-the-fly use of Pause, Skip, Hold and Next functions.

818-991-0360; www.360systems.com
Booth: SU11011

Storage

Incentra Solutions DIVArchive 5.7

Enables interoperability between multiple tiers of storage devices, video servers, editing systems and digital asset workflow applications in the broadcast, media and entertainment industries; offers enhanced integration with video server, broadcast control and storage equipment, as well as expanded end-user functionality; features tape import/export, metasource support, a DIVA Storage Plan Manager (SPM), and the ability to create new object copy.

888-935-4383; www.managedstorage.com/inc_index.php
Booth: SU11036

Storage

Chyron X-Clyps

Server that allows hours of HD clips to be compressed in storage; includes Raid 5 protection, redundant power supplies, VDCP interface, and a networked control architecture.

631-845-2000; www.chyron.com
Booth: SU7158



Half-rack VTR ▲ Sony HDW-S280

Upgraded version includes the addition of 24p playback and recording capability; the upgrade is designed to create a lower cost of entry into HDCAM 24p production; is designed for ENG, OB van and field production applications; features 100/59.94i and 50i, switchable operation; offers legacy support and upconversion for Sony's Betacam, Betacam SP and Betacam SX formats.

800-686-SONY; www.sony.com/professional
Booth: SU6406



DVD archive ▲ Baystor BK-1500 Playback Only Unit

Facilitates retrieval of assets stored on DVD; uses the BK-1500 to play back assets while archiving others on the BK-2500 recorder; built-in RS-422 and frame accuracy guarantee DVDs to operate the same as tape, preserved with original timecode, CC and VBI; a built-in 40GB hard drive and programmable playback allows this unit to be used as a video server.

813-645-6666; www.baystor.com
Booth: SL4552

Finally. A transmitter company broadcasters love.

WJET Erie, PA **KDSM** Des Moines, IA **WNYS** Syracuse, NY **WSTR** Cincinnati, OH **WABM** Birmingham, AL **KWKT** Waco, TX
KSNF Joplin, MO **KDNL** St. Louis, MO **WTAT** Charleston, SC **KRRT** San Antonio, TX **WCHS** Charleston, WV **KVEO** Brownsville, TX
KSMO Kansas City, KS **WGGB** Springfield, MA **WZZZ** Jacksonville, FL **WTTA** Jacksonville, FL **WSMH** Flint, MI **KMSS** Shreveport, LA
KOVR West Sacramento, CA **WPGH** Pittsburgh, PA **WVBT** Charlottesville, VA **WJL** Richmond, VA **KTAL** Shreveport, LA **KSHV** Shreveport, LA
WXLV / WUPN Winston-Salem, NC **WB** Pittsburgh, PA **WBSC** Birmingham, AL **KGAN** Birmingham, AL **WNYO** Dayton, OH **WGMB** Baton Rouge, LA
WLFL / WRDC Raleigh, NC **WVC** Tallahassee, FL **WVBT** Birmingham, AL **WVBT** Birmingham, AL **WVBT** Dayton, OH **WVLA** Baton Rouge, LA
KASN Little Rock, AR **WEAR** Pensacola, FL **KOKH** Jacksonville, FL **WTFE** Jacksonville, FL **WDKY** Lexington, KY **WEVV** Evansville, IN
WBUW Madison, WI **WUXP** Nashville, TN **WVBT** Baltimore, MD **WVBT** Baltimore, MD **WUTV** Grand Island, NY **KDBC** El Paso, TX
KWBA Tucson, AZ **WVBT** Milwaukee, WI **WVBT** Milwaukee, WI **WVBT** Milwaukee, WI **WVBT** Milwaukee, WI **KFRE** Fresno, CA
KMWB St. Paul, MN **WVBT** Milwaukee, WI **WVBT** Milwaukee, WI **WVBT** Milwaukee, WI **WVBT** Milwaukee, WI **KPTM** Omaha, NE
WTVZ Norfolk, VA **WYST** Syracuse, NY **KV** Las Vegas, NV **WVBT** Las Vegas, NV **WVBT** Las Vegas, NV **KXVO** Omaha, NE
WRGT Dayton, OH **WVAH** Hurricane, WV **KV** Las Vegas, NV **WVBT** Las Vegas, NV **WVBT** Las Vegas, NV **WTTO** Birmingham, AL

Pappas Telecasting Companies

"High Efficiency UHF transmitters are no longer an oxymoron; Ai has helped us make that happen."

Dale Scherbring
VP/Director of Engineering

Sinclair Broadcast Group

"We've cut our utility bills in half, with a Digital ready system."

Del Parks
VP of Engineering & Operations

Clear Channel

"The reliability is fantastic. The service is world class. It's nice to sleep worry free."

Rusty Mooney
Television Transmission Systems Support Engineer

Nexstar Broadcasting Group

"My Engineering staff is very pleased with the simple elegant design, high reliability, and customer support."

Rick Stolpe
Vice President, Director of Engineering

Acme Communications

"These transmitters were designed by broadcasters. You can tell."

Brent Stephenson
VP/Operations & Engineering

CCA

"The simplicity of the design and ease of operation makes it an outstanding product from the best team in the business."

Matt Sanderford
President of Marsand Inc. for CCA

Hundreds of stations can't be wrong: find out why.

When considering the purchase of a new transmitter, consider this. Only one company — Ai — puts the broadcaster first.

Built on best of breed technology, Ai **Quantum**® transmitters help budget-conscious broadcasters keep costs low and reliability high. Brilliant engineering combined with customer-focused service makes this the one transmitter you can simply set — and forget.

What do these broadcasters know — that you don't? Call 410.568.2105, or visit acrodyne.com today.

Satisfaction. Engineered.



A publicly traded American company.

Multi-channel video server Doremi Labs MCS-HD

Features two record and two play independent high definition video channels with shared storage and selectable compression rates; features a front panel that mimics familiar VTR controls and is compatible with Odetics and VDCP automation protocols as well as Sony 9pin machine control; can record all popular High Definition and Standard Definition video formats.

818-562-1101; www.doremilabs.com

Booth: C2342

Studio videotape players/recorders Sony DSR series of DVCAM Master Series

Have been enhanced with the addition of an integrated i.LINK IEEE-1394 digital interface; the existing DSR-1600, DRS-1800 and DSR-2000 models will be upgraded with this new built-in connectivity feature and relaunched as the DSR-1600A, DSR-1800A and DSR-2000A; upgrade provides professional video producers who use the DSR series greater compatibility with DV I/O-equipped cameras, VTRs and nonlinear editing systems.

800-686-SONY; www.sony.com/professional

Booth: SU6406



Video server ▲ 360 Systems Image Server 7000

Full-featured, six-channel broadcast server; designed for satellite ingest, production and play-to-air; the 2-input, 6-output multi-format design supports MPEG-2, DV and TARGA graphics; up to 400 hours of internal RAID storage is available (accessible from the server front panel), plus redundant, hot-swappable power supplies; design supports MPEG-2 broadcast formats to 50Mb, in I-frame and long-GOP modes.

818-991-0360; www.360systems.com

Booth: SU11011

Broadcast video servers

Gee Broadcast Systems GeeVSXT

A family of flexible servers for post-production, production and transmission; all models ship with the standard Geevs Control Client; five different models available: XT50, XT100, XT250, XT500, XT100; new features include a new user interface, new file handler, and new database architecture.

+44 1256 810123; www.geevs.co.uk

Booth: SU10254



Video server ▲

Pathfire Server Connect for News

Enables newsrooms to transfer digital content from their DMG server to editing systems and play-to-air servers; streamlines content movement process; users can move content with drag-and-drop simplicity while the media remains in digital format throughout the entire delivery process, avoiding the conversion to video.

770-619-0801; www.pathfire.com

Booth: SL1353

Storage

StorageTek Flexline 600

Designed to provide the foundation for an adaptable, agile disk-based storage infrastructure; new items to the line include FLA300 access-centric disk 2Gb/s Fibre Channel-switched FlexLine array and FlexLine FLX210 storage system; new and current offerings are enabled by SANtricity™ 9.1 software suite for FlexLine 200 and 300 Series storage systems that allows customers to mix different drive types in the same system, while increasing their disaster recovery/business continuance capabilities through asynchronous, remote disk-to-disk mirroring.

303-661-5079; www.storagetek.com

Booth: SL4632

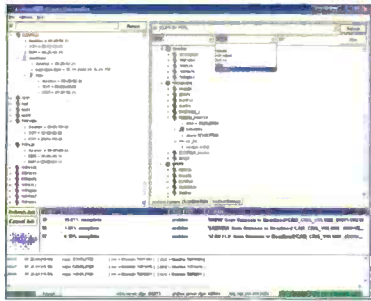

Archive management ▲

Crispin ArchiveManager

Recently added dual internal Professional Disk for Data (PDD) drives; increases overall archive storage to 23.3GB of data capacity per single-sided disc; file transfer speeds are rated at 11MB/s read and 9MB/s write for both record-once and rewritable media.

919-845-7744; www.crispincorp.com

Booth: SU9717



Client/server architecture ▲

SeaChange MediaClient

Leverages Broadcast MediaLibrary (BML), which provides fault-resilient storage, independent of the image format, compression standard and file type; BML24000e available as a high-performance CIFS server and is complemented by the new software-based MediaClient codecs, which couple real-time, broadcast-quality I/O and high-quality MPEG-2 and DV coding with CIFS storage access over Gigabit IP networks.

978-897-0100; www.schange.com

Booth: SU6557



Keepin' It Real

Our HD and SD converters consistently score a hole in one, working flawlessly 24/7 to deliver perfect signal and image quality at breakthrough prices. No worries. Now enjoy that doughnut.

HD and SD Converters

boast solid performance. Rigorously tight specs. Unsurpassed reliability. That's precisely why they're the products of choice for major professional sports events. From miniature stand-alones to rackmount interface cards and frames, we offer a full range of digital/analog models. Built by video pros for video pros, they deliver top-of-the-line quality at a can't-beat-it price.



Prepare for the ultimate reality.

Check out our product line at **NAB booth #SU8948**.

If you just can't wait, call **530.274.2048** or visit www.aja.com for details.



Storage arrays ▶

Huge Systems
MediaVault U320R
Max and U320RX Dual
Max RAID

Both arrays are now compatible with the Kona 2 dual-rate HD/SD capture card from AJA Video Systems; Kona 2 supports uncompressed 8- and 10-bit SDI, HD-SDI, and Dual-link 4:4:4 HD at 10 and 12 bits; applications include SD and HDTV, uncompressed broadcast video storage, content creation, medical imaging, and military installations.

818-991-1188; www.hugesystems.com
Booth: SL3628



High definition server EVS HD maXs

Features two I/O configurable channels and supports the most common formats: 1080i, 720p, 625i and 525i, 50Hz or 59.94Hz where applicable; all commonly used RS-422 protocols are implemented, which can thus be driven by your existing VTR/Edit controller, switcher, graphics engine or station automation.

+32-4-361 7000; www.evs.tv
Booth: C4534

Portable DVR

Fast Forward Video FieldPro DVR
Features video capture and playback at 60fps, resolution greater than 550 lines at 4:1 compression, user-selectable compression ratios ranging from 4:1 to 20:1 and recording times averaging from four to 20 minutes per gigabyte; offers scalable MJPEG compression and 720x486 pixel image resolution.

949-852-8404; www.ffv.com
Booth: C3253

HD MPEG-2 real-time record and playback system

Doremi Labs
ORCA Capture Station

HD MPEG-2 processing; encodes SDI or HD-SDI to HD MPEG-2 at up to 160Mb/s direct to the system's hard drive; encoding process can be previewed live or played back at a later time via composite, DVI, SDI or HD-SDI video outputs; unit consists of company's ORCA encoder and DVB/ASI stream recorder housed in a Linux-based 4RU chassis with 500GB of storage.

818-562 1101; www.doremilabs.com
Booth: C2342

Archive and asset management

Masstech Group MassStore

Provides from 1,000 to 100,000+ hours of nonlinear audio/video storage with full content management and tracking; new features include distributed redundant architecture, intelligent partial file extraction and restore, scalable data mover technology, integrated parallel access high-performance file system and disk storage platform, distributed multiple tape library support, support of latest LTO-3 tape drives, and smart avid interface.

905-886-1833; www.masstechgroup.com
Booth: SU10236

Video server

Leitch Technology NEXIO HD

Integrates baseband high-definition record and playback directly into NEXIO server system; provides two channels of HD output or one channel of input and one HD output in either 720p or 1080i format.

859-371-5533; www.leitch.com
Booth: SU7805, SU8199

Storage systems

Silicon Graphics (SGI) InfiniteStorage RM610
Addresses broadcasters' multiple stream and low latency, real-time requirements by delivering increased reliability and substantially increased stream playout on SGI Media Server; intended for playout, ingest, and newsroom and program editing; easily configurable as an ingest/playout server, a playout SAN or a central repository serving nonlinear editing systems.

650-960-1980; www.sgi.com
Booth: SL1943



DVD media ◀

Maxell Corp. of
America DVD-R
Plus 16X Series

Both new models feature 4.7GB capacity and support 16X write speeds for 200 percent more productivity; DVD-R Plus uses advanced proprietary organic dye recording layer; DVD-R BQ designed for post-production environment and is 40

times more scratch resistant and 20 times more dust resistant than standard discs.

800-533-2836; www.maxell.com
Booth: C8530

ANOTHER INDUSTRY FIRST...

**MCL + MITEQ =
3-Year TWTA
Warranty!**



Based upon our proven field history, and the combination of both **MCL** and **MITEQ's** *commitment to quality, reliability and service*, MCL is now proud to offer the industry's **First 3-year Warranty**, *including the traveling wave tube*, on our state-of-the-art 400 and 750 watt rack-mounted HPAs.

For additional information, please contact a MCL Sales Representative at (630) 759-9500 or visit us at mcl.com



&



Committed to providing comprehensive solutions for

GLOBAL COMMUNICATIONS

Storage systems

Silicon Graphics (SGI) InfiniteStorage RM660 Optimized for production, including high-resolution capture from scanner, digital cinema cameras and telecines, resolution-independent editing and compositing applications as well as digital film mastering applications for color grading and digital intermediate facilities; stores up to 16 feature length films in 4K format.

650-960-1980; www.sgi.com
Booth: SL1943



Dockable solid-state recorder ▲ Thomson Grass Valley Venom FlashPak

Created for the company's Grass Valley Viper FilmStream Digital Cinematography cameras; captures uncompressed output of the Viper camera in a lightweight solid-state system that is compact, dockable, and rugged.

503-526-8200; www.thomsongrassvalley.com
Booth: SU7823 and SU8434



Media server ▲ Video Technics Apella HDS

Resolution independent SD and HD server; compatible with Apella video clip server and company's NewsFlow solution; a scalable, multi-format, multi-channel and multi-resolution HD server built on flexible software codecs; four independent HD or SD SDI output ports or two HD or SD SDI output ports with corresponding key signals are available within one Apella HDS chassis for instant playout of DV or MPEG-2/4 up to 100Mb/s.

404-327-8300; www.videotechnics.com
Booth: C3647

Video server

Pathfire Digital Media Gateway server Allows programming content to be transferred digitally from the DMG server to editing systems and play-to-air servers; digital file transfer eliminates degradation associated with transporting video.

770-619-0801; www.pathfire.com
Booth: SL1353

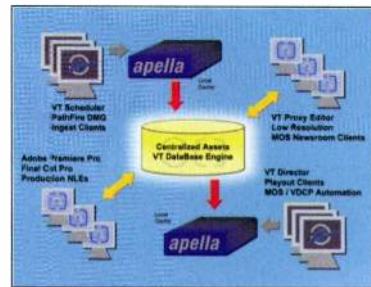

Tapeless newsroom solution ▲ Video Technics

Third generation product; new features include complete offline and nearline archiving solutions through the Apella Auto Archive and Auto Purge function for video clips and audio tracks; supports SGL and is certified with high-end nearline and offline archiving solutions.

404-327-8300; www.videotechnics.com
Booth: C3647

STUDIO & FACILITY SUPPORT TECHNOLOGY

Convention International Association of Broadcasters:

Conference focuses on the creation, management and delivery of entertainment content; attracts more than 40,000 attendees from more than 120 countries; includes more than 1000 exhibitors; IBC2005 will take place Sept. 8-12.

+44 20 7611 7500; www.ibc.org
C1605

Broadcast and audiovisual integrator and equipment supplier Professional Communications Systems (PCS)

Offers a host of services — from consulting, design and engineering to equipment procurement, documentation and training, and after sales support; specializes in design, installation, and maintaining turnkey audio and video communication systems.

813-888-5353; www.pcomsys.com
Booth: TBA



Long-distance range extender ▲

Kramer Electronics TP-300FW FireWire Used in pairs for a basic end-to-end solution; converts signal to be sent over unshielded Cat. 5 cable up to 300ft to second extender, which converts signal back to its native format; repeaters used in conjunction with the product can extend signals up to 236ft; supports plug and play standards, hot swamping and isochronous and asynchronous applications.

888-275-6311; www.kramerelectronics.com
Booth: SL854

SD/HD audio/video air delay unit Accom Aircleaner

Is housed in a 1RU chassis with a front panel LCD screen; accepts either standard definition or high definition SDI video signals and up to eight channels of AES/EBU audio with 24bit resolution at 48kHz; allows a maximum delay of up to 10 seconds in HD formats (1080:60i, 59.94i, 50i or 1080:30psf, 29.97psf, 25psf, 24psf, 23.98psf or 720:60p, 59.94p) and up to 30 seconds in SD formats (525/59.94i and 625/50i).

650-328-3818; www.accom.com
Booth: SU 7834

Master Sync/Clock Generator Evertz 5600 MSC

Has a 1 in 10- frequency reference; a free running drift of 10MHz reference will be less than 0.1Hz (amounting to less than 1 millisecond time drift per day); guarantees that any frequency drift will be within the tolerances expected from the best SPGs or mater clocks available; may be referenced to an external master oscillator; offers other devices a high stability 10MHz output reference.

905-335-3700; www.evertz.com
Booth: SU6433

Your
graphics workflow
is *different...*

VERTIGO X MEDIA
we know graphics

WE KNOW

From simple data-driven tickers to centralized broadcasting to automated newsrooms -
we know your graphics workflow better than anyone.



Graphics
Authoring

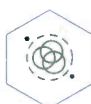

Asset
Management



Graphics
Systems

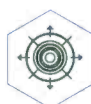

Real-Time Data
Management



Playlist/Playlist
Controllers

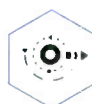

Content
Editing Tools

The Xmedia Suite, VertigoXmedia's 3rd generation graphics automation platform, is the only open system connecting your newsroom tools, station automation, asset management and news databases to your CGs, Clip Players and Still Stores. And our VertigoXG family of graphics systems combines the ultimate rendering engine with the on-air robustness you require. For your next graphics project, large or small, contact VertigoXmedia - We Know Graphics.

www.vertigoXmedia.com/know | 1-877-4-VERTIGO | info@vertigoXmedia.com

NAB 2005
THE WORLD'S LARGEST ELECTRONIC MEDIA SHOW

Visit us at NAB 2005
Booth #SL2620

Creative and technical solutions services provider

Ascent Media Group

Provides creative and technical solutions through its Creative Services, Creative Sound Services, Media Management Services and Networks Services groups for content creation, management and distribution; provides effective solutions for the creation, management and distribution of content to major motion picture studios, independent producers, broadcast networks, cable channels and advertising agencies.

310-434-7000; www.ascentmedia.com
Booth: C5434



Multi-display controller ▲

Dayang Magic Wall

A 16-channel television channel monitor; designed for use in broadcast control rooms and transmission playout centers; has a wide range of preset and user-configurable image sizes and supporting information-display modes.

+852 2730 2117; www.dayang.com
Booth: SU9352

Cable trade association

National Cable and Telecommunications Association

Represents cable operators, cable program networks and equipment suppliers; hosts the industry's annual trade show; offers traditional video services and provides broadband services such as high-speed Internet access and telecommunications services.

202-775-3550; www.ncta.com
Booth: TBA

Control solution

Barco iPresent

A complete backdrop solution that consists of specifically adapted rear-projection modules, combined with a customized controller and dedicated software; allows broadcasters to use the wall as a high-quality alternative for a traditional on-stage video wall; shows a multitude of video and graphical windows and produces smooth transitions from one display wall layout into another.

770-218-3200; www.barcocontrolrooms.com
Booth: SL1131

Racks

Sigma Electronics Saber series modular rack

A highly flexible rack system for housing a wide variety of signal processing equipment; all modules are front-loading, with a dedicated rear interface to simplify maintenance and installation; includes modules for analog and digital audio and video, all housed in the same frame; the frames can house a wide diversity of units, side-by-side in complete harmony, including distribution, generation, conversion and routing modules.

425-315-1724; www.sigmaelectronics.com
Booth: SU10345



Nonlinear editing ▲

Prime Image Time Tailor

Designed to meet requirements of post production houses and their clients; reduces content up to eight percent with no loss of program integrity; no detectable change in video and audio quality; maintains closed captioning; operates in real time, cutting work time by 70 percent; features insert, delete, move black slugs.

408-867-6519; www.primeimageinc.com
Booth: C5614

Profanity protection device

Evertz HDSD9545DLY-PRO

Enables the operator to insert the desired time delay, via a front panel control and a display panel; there are two program paths that are HD and SD compatible; the main program feed will usually be focused on the main detailed action, the secondary back-up path will generally offer a wide angle shot, or some suitable alternative picture to the main content; both channels are delayed by the same amount of time; if an unscheduled, offensive event occurs, the operator has only to hit one remote button to cause the program video and audio output to be clean switched to the alternative back-up channel; the delay can be adjusted up to a maximum of 24 seconds for HDTV or SDTV.

905-335-3700; www.evertz.com
Booth: SU6433



MPEG monitor ▲

Sencore Video Bridge

Designed to provide you with continuous monitoring of MPEG signals in any network where the data is being carried over IP frames; capable of verifying the signal integrity of multiple TV multicasts in parallel; designed in both field and rack mountable version; work anywhere in the network and in a variety of MPEG-2 video and audio Over IP applications; provides helpful troubleshooting information such as IP packet jitter and MPEG-2 Transport Stream packet drops.

800-736-2673; www.sencore.com

Booth: SU10006, C7331

Consoles

TBC Consoles intelliTrac

Laterally sliding and positionable rack turrets easily upgraded or relocated as equipment and operational requirements change; continuous front and rear device tracks allow unlimited lateral positioning of critical equipment; articulating arms for distance, height and tilt control may be utilized for mounting flat panel monitors, speakers, phones and task lighting.

631-293-4068; www.tbconsoles.com

Booth: SU6831



Power products, batteries, generators ▲

Staco Energy Products UniStar Sx

Single-phase on-line UPS product; double-conversion design isolates and conditions the power coming into the unit before it is distributed to the protected equipment; eliminates the manual resets required of digital equipment in unprotected circuits; available in sizes from 700VA to 3000VA.

937-253-1191; www.stacoenergy.com

Booth: C1207

Widescreen LCD monitor

Panasonic BT-LH1700W

A broadcast-quality 16:9 high definition/standard definition LCD monitor for studio and field applications; displays brilliant, highly color saturated images; the 17in space-saving, widescreen monitor produces exceptional color reproduction and gradation and allows the user to display widescreen high definition images in their natural resolution.

201-392-4127; www.panasonic.com/broadcast

Booth: C3617

Check it out: Booth C11107



RIEDEL

1 WORLD'S FIRST DIGITAL BELTPACK



Riedel Communications Inc. • 3605 W. Pacific Avenue • Burbank, CA 91505 • USA
Phone: +1 818 563 4100 • Fax: +1 818 563 4345 • www.riedel.net

Quad processor

Image Video VxV-4-DVI

A Quad processor; accepts SDI and Analog video inputs to a DVI output; with embedded audio metering and UMD tally capability.

416-750-8872; www.imagevideo.com

Booth: SU7077

Signal integration system

Ensemble Designs Avenue

An expandable, modular tray-based signal integration system; housed in a 1RU or 3RU frame; allows any combination of HD video, SD video, DVB-ASI and audio modules in the same frame; modules include: embedders, synchronizers, converters, routers, sync gens, protection switches, and more.

530-478-1830; www.ensembledesigns.com

Booth: SU 10217

Monitoring solution

Barco iStudio

Consists of a high-quality display with rear-screen projection, a graphic controller, and Web-based operating software; one projection module can display up to 60 video or audio windows simultaneously.

770-218-3200; www.barcocontrolrooms.com

Booth: SL1131

Desk system

Middle Atlantic Products LCD Monitoring Desk

Designed to provide more usable space in a smaller footprint; optimized for use with LCD screens; modular design allows economical additions and limitless configuration choices; 64in and 48in widths available; optional lower light bridge allows better line of sight to video monitor walls.

973-839-1011; www.middleatlantic.com

Booth: SL3606



Cat. 5 transceiver

Laird Telemedia PHATCAT

Consists of 1000ft long haul Cat. 6 transceivers for 14- and 26-pin cameras in varied configurations.

800-898-0759; www.lairdtelemedia.com

Booth: SL1243



Portable HD monitor for Sony HDV camcorders

ERG Ventures HDM-EV85

8.4in monitor is designed for the HDV camcorder, Sony HVR-Z1U and HDR-FX1; offers enhanced color, frame markers and a memory preset function; its HD analog input enables the HDV to connect to the HDM-EV85 directly; accepts most popular video image formats; with two 7.2V batteries, the monitor lasts for 2.5 to 3 hours.

949-263-1630; www.erg-ventures.com

Booth: SU10134

Multipurpose interface

TSL ESP-1

Connects with the system via an Ethernet port and provides parallel 32 in and 32 out; serial port can be used to connect to a serial tally source or programmed for a router or router control panel.

+44 1628 687 200; www.televisionssystem.com

Booth: SU9656



8.4-inch HD monitor

ERG Ventures HDM-EV80D

Offers enhanced color, gamma adjustment functions, additional framing markers and a memory preset functions; serves as a rack-mount monitor that can easily be adapted for location shoots; its HD/SD inputs can be intermingled; has four inputs; is able to flip the image right-side up.

949-263-1630; www.erg-ventures.com

Booth: SU10134

Technical furniture

Forecast Consoles MASTERail Console System

Designed to offer infinite potential layouts and design configurations; universal mounting system allows for random placement of all monitors, EIA rack boxes, speakers, script stands and special-purpose devices anywhere along the length of the console.

631-253-9000; www.forecast-consoles.com

Booth: SU6431

Monitoring and control over IP system

Miranda Technologies iControl

Adapted for key applications including incoming food management, multichannel HD/SD master control, and network operation centers for cable, satellite and IPTV operators; leverages industry standard SNMP protocols for monitoring and control of video as well as surrounding transmission, networking and building infrastructure.

561-477-6124; www.miranda.com

Booth: SU7841

Dual-screen LCD monitor Marshall Electronics V-R72P-2HDSDI

Occupies only three SRU of a standard 19in EIA equipment rack; 1.2-million pixel TFT screens have wide 130 degree viewing angles and incorporate digital signage processing; SMPTE/ITU high definition and standard definition digital (HDSDI/SDI) video standards and signal types are accepted and displayed on each screen; analog signals are digitized using an advanced 10-bit process on each signal path with 4x over sampling and adaptive five line comb filter with exacting color space conversion.

310-333-0606; www.lcdracks.com

Booth: SL913

Digital asset maximization initiative Thomson Grass Valley dMAX

Product expands company's Grass Valley C2MD program for centralized facility monitoring and management; new service level agreement gives users flexibility to implement multi-distribution workflows.

503-526-8200; www.thomsongrassvalley.com

Booth: SU7823 and SU8434

Zandar
TECHNOLOGIES

GET THE COMPLETE
PICTURE...



...WITH
ZANDAR TECHNOLOGIES

Zandar Technologies is a world leader in the provision of multi-window display solutions – with everything from simple screen splitters to advanced visual display systems. The virtual monitor wall concept is proven – don't be left with an outdated monitor stack, when you can have a display wall that is configurable, dynamic, and controllable. We have product to match your specific input sources, for display devices from CRT to rear projection, with extensive control options & interfaces. With Zandar you can be sure of excellent image quality, unsurpassed system flexibility and genuine value.

Fusion Series: Modular 3RU (25 inputs) and 1RU (8 inputs) racks; input cards for composite video/YC, SDI, HD-SDI and VGA sources; high resolution RGBHV output.

Predator Series: Fixed configuration solutions for 4, 12 or 16 video inputs; select from composite video, YC, SDI or HD-SDI inputs; RGBHV output.

DX Series: For 4, 8, 12 or 16 composite or SDI video inputs (auto-detecting); high quality composite, component, SDI and VGA outputs.

MX Series: For 4, 8, 12 or 16 NTSC or PAL inputs; composite, component or VGA outputs; preset layouts or custom layouts on request.

Think Zandar for:

- Master Control Rooms
- Command & Control
- Security & Surveillance
- Broadcast Multi-video
- Mosaic & Interactive Channels
- Audio Visual Presentations & Audio Monitoring
- Video-conferencing



FusionPro



DX



Predator

HEADQUARTERS:

Bracken Court, Bracken Road,
Sandyford, Dublin 18, Ireland.

Tel: +353 1 2938 966 Fax: +353 1 2936 955

E-mail: sales@zandar.com

US OFFICE:

1970 E. Osceola Parkway, No. 330,
Kissimmee, FL 34743, USA.

Tel: 321 9390 457 Fax: 321 9390 458

E-mail: advancedms@msn.com

WWW.ZANDAR.COM

Visit us at NAB Booth #SU8367

broadcastengineering.com

235

Tally interface

Image Video GSI-3

Tally interface c/w Tally Mapper software and interfaces to production switchers and Under Monitor Displays.

416-750-8872; www.imagevideo.com

Booth: SU7077

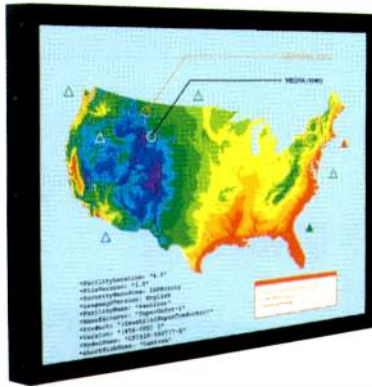

Direct-view LCD displays ▲

Clarity Visual Systems Bay Cat X and Bobcat X Two new versions feature improved panel response time, modular I/O architecture with available HD-SDI connectivity for improved video; 40-inch Bobcat X offers 1366 x 768 resolution, native 16:9 aspect ratio, increased brightness (500 nits) and contrast ratio of 800:1; 46in Bay Cat X offers 1920 x 1080 resolution, 16:9 aspect ratio, and 8ms response time.

503-570-0700; www.clarityvisual.com

Booth: SL3328

Display processors

Zandar Technologies FusionPro

A multi-window display processor designed to accurately render multiple video and computer graphics sources to high resolution displays; currently supports resolutions up to SXGA (1280x1024) with pristine image quality achieved through a combination of 10 bit RGB outputs, an advanced video processing engine and dynamic phase adjustment for accurate pixel mapping; founded on a modular architecture consisting of a range of plug in processing cards and associated i/o.

+353 1 293 8966; www.zandar.com

Booth: SU9311

Content management and production

SYSMEDIA

SysMedia and Strategy & Technology (S&T) are jointly exhibiting and will be demonstrating end-to-end solutions for the production and distribution of OCAP/ACAP/MHP-compliant interactive content.

+44 (0) 1293 814 200; www.sysmedia.com

Booth: SU11408

Video watermarking content protection system

Nextamp S.A. NexMaster

Uses invisible digital video watermark ID to discourage movie piracy; embeds in either SD or HD formats during tape duplication or file copying; comes with Sd-SDI, HD-SDI or Gig-E interfaces; offers embedding in uncompressed material as well as directly within MPEG-2 or H264 files.

+33 02 99 22 61 62; www.nextamp.com

Booth: SU 9954



Display mounts ▲

Chief Manufacturing FMA-220 and FMA-320

The FMA-220 dual horizontal array and FMA-320 triple horizontal array are used with many combinations of Chief small flat-panel mounts, including height-adjustable, pivot and swing, and pole mounts; no bolt adjustments are necessary; feature Chief's Centris technology for gravity-centered pivot adjustments allow 15 degrees of pivot/pitch positioning.

952-894-6280; www.chiefmfg.com

Booth: SL3625

System service and support

Thomson Grass Valley OnCall

Service level agreement limits broadcasters exposure to potential equipment failures and helps them manage unplanned service costs; customized to user requirements.

503-526-8200; www.thomsongrassvalley.com

Booth: SU7823 and SU8434

Flat-panel LCD display

Panasonic TH-32LHD7UY

A 1366 x 768 pixel (approx. 3.15 million pixels) WXGA-resolution LCD panel; brightness of 500 cd/m² and a high 800:1 contrast ratio; the high definition 16:9 aspect ratio panel can display 16.77 million colors and offers a 170 degree horizontal and vertical viewing angle; the 3D Color Management system is a new correction process that works in a three-dimensional color matrix (hue, saturation and brightness) rather than the conventional two-dimensional color differential plane.

201-392-4127; www.panasonic.com/broadcast

Booth: C3617

Dual HD monitor
Marshall Electronics
V-R72P-2HDA

Rack-mounted monitor features high resolution, 1.2 million pixel screens with digital signal processing; designed for analog applications; accepts DVI and HDMI computer or video signals plus high definition and standard definition analog video standards and signal types.

310-333-0606; www.lcdracks.com
 Booth: SL913

Signal monitoring system

Trilogy Broadcast Sentinel
 Includes a number of card-based modules that can be interchanged within the company's fully flexible frame system; applications include monitoring, changeover switching, signal comparison, fault reporting and logging.

+44 1264 384000; www.trilogy-broadcast.co.uk
 Booth: C11722



Monitoring and control software
Thomson Grass Valley NetCentral 4.1 and Grass Valley XMS

NetCentral 4.1 facility monitoring software enables technicians to easily evaluate system software, hardware, storage, and devices in their facilities and across their networks; XMS network management for digital content delivery systems enables users to control and monitor digital content delivery applications over satellite, terrestrial, DSL or cable.

503-526-8200; www.thomsongrassvalley.com
 Booth: SU7823 and SU8434

Product supplier

Elquip

Has nearly 25 years of experience in furnishing electrical and electronic workshops; the product offering consists of (anti-static) workbenches, cabinets, chairs, ESD protectives, measuring instruments and tools.

+040-2 645 345; www.elquip.com

TBA

 **interactive content factory**
 media software products

www.icf.tv
 NAB - SL2461

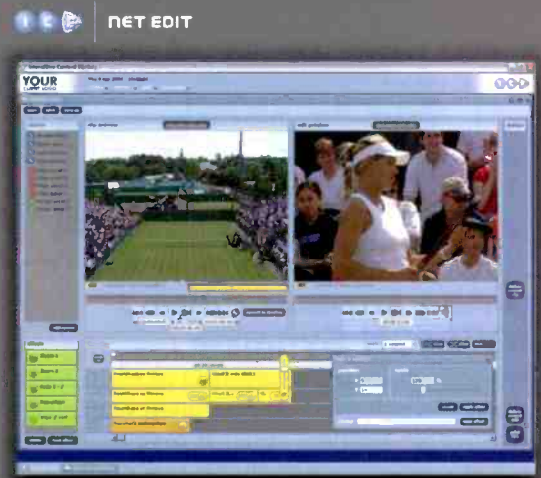

The only solution for Windows Media editing over IP

Browser-based
 Microsoft Internet Explorer is all you need. Ideal for archive browsing and proxy editing solutions.

Edit anything, anywhere
 Local or remote, all it takes is a 2mbps network or Internet connection. Edit while record capability for sport and news.

Brilliant quality
 Frame-accurate editing using standard Microsoft Windows Media 9 Series files, PAL and NTSC.



Fully-featured but easy to use
 Cuts, transitions, effects, graphics and voiceover in a simple package designed for producers and journalists.

Available as an SDK or as part of the  **MEDIA PLATFORM**

TBCS, FRAME SYNCs, CONVERSION EQUIPMENT

HD Audio/Video converter

Leitch Technology X75 HD

Combines up/down/cross conversion, HD frame sync and extensive video and audio processing capabilities; is equally suited for analog, digital, or high-definition hybrid facilities; level/color control; optional 3D adaptive color decoding with time base correction; optional noise reduction; and frame synchronization; the 16 channels of internal audio processing include timing with video for lip sync corrections; level control; analog-to-digital and digital-to-analog conversion; and embedding and de-embedding for both SDI and HD-SDI serial digital signals and integrated Dolby decompression for interfacing any audio signal in a professional environment.

800-775-3314; www.leitch.com

Booth: SU7805, SU8199



Modular Broadcast System ▲

NVISION Synapse

Provides an unprecedented level of multi-function signal processing in a flexible, modular, remotely controllable platform; family is comprised of more than 100 modules, including 20 that support HD-SDI.

530-265-3055; www.nvision.tv

Booth: SU9301

Video and audio synchronizers

Fortel DTV Integrity 500 Series

Include Quadra-Comb decoder technology, plus differentiating features; each video synchronizer has both composite analog and SDI inputs and outputs to bridge the gap from audio to digital; all models are both NTSC and PAL switchable.

770-806-0234; www.forteltdtv.com

Booth: SU10463



Serial digital to analog video converter ▲

Ensemble Designs BrightEye 15

A serial digital to analog video converter; allows user to time the analog output into a production switcher or routing switcher; offers video conversion and signal timing; useful for broadcasters that are integrating digital and analog signals into the same system; frame synchronization is accomplished by conventional drop/add of frames.

530-478-1830; www.ensembledesigns.com

Booth: SU 10217

Converters

Fortel DTV Integrity 300 Series

The bridge between analog and digital video; Composite Analog Decoders, NTSC and PAL Encoders, YUV and RGB conversion, are all included in this series.

770-806-0234; www.forteltdtv.com

Booth: SU10463

SD and HD terminal equipment

Ross Video RossGear MD

Line includes wide range of modules that handle both standard definition SDI and high-definition HD-SDI signals; features a new 2RU modular MD frame; modules designed for audio/video distribution, conversion, synchronization, multiplexing and demultiplexing also shown.

613-652-4886; www.rossvideo.com

Booth: SU7141

Video processing and distribution

Leitch Technology Technology X75HD

Combines up/down/cross conversion, HD frame sync and video and audio processing capabilities in a 1RU package; features simultaneous up conversion and down conversion with aspect ratio conversion for hybrid standard- and high-definition facilities, level/color control, optional 3D adaptive color decoding with time base correction, optional noise reduction, and frame synchronization.

859-371-5533; www.leitch.com

Booth: SU7805, SU8199

SDI-DV-SDI with embedded audio

Laird Telemedia DVBETA

Bidirectional SDI-DV-SDI with embedded audio.

800-898-0759; www.lairdtelemedia.com

Booth: SL1243



High-definition synchronizer ▲
Prime Image HD/Sync

Offers I/O flexibility, supporting standards from SD through HD in either analog or digital formats; incorporates 10-bit processing, digital FIR filtering, a 3 dimensional adaptive COMB filter, full proc amp controls, color correction, and adaptive noise reduction; other features include a test signal generator, frame store with linear keyer, dual buffer still store with dissolve/clean cut, and an animated logo inserter.

408-867-6519; www.primeimageinc.com
 Booth: C5614

Composite converter module
Marshall Electronics MC-0201-4

Provides simultaneous conversions of four separate S-Video (Y/C) channels to composite video; S-video is processed and amplified for output to another device such as a vision mixer or VCR; offers four channels of conversion compared to other products that provide only one channel.

310-333-0606; www.lcdracks.com
 Booth: SL913

Infrastructure components
Snell & Wilcox IQ Modular

Twenty-five new components consist of converters, synchronizers, distribution amplifiers, routers, and audio modules; all products are capable of operating in either SD or HD resolutions and are designed to enable broadcasters to take control of transition to digital and HDTV broadcasting.

+44 (0) 20 8917 4300; www.snellwilcox.com
 Booth: SU6349

Time code inserter interface
Laird Telemedia TC100

External SMPTE LTC time code inserter interface onto the Firewire stream.

800-898-0759; www.lairdtelemedia.com
 Booth: SL1243



Time code processor ▲

Horita TCP-50

Provides a variety of time code functions to address the requirements of dealing with multiformat longitudinal time code; translates between 23.976, 24,25,29.97 and 30 FPS time codes; users can substitute/replace input time code user bit data with manually entered user bit data on a "nibble by nibble" basis, as well as resynchronize free running time code to an input video signal.

949-489-0240; www.horita.com
 Booth: C10120

800.966.0069
 www.gepco.com email: gepco@gepco.com

The Measurable Difference
in Precision and Clarity

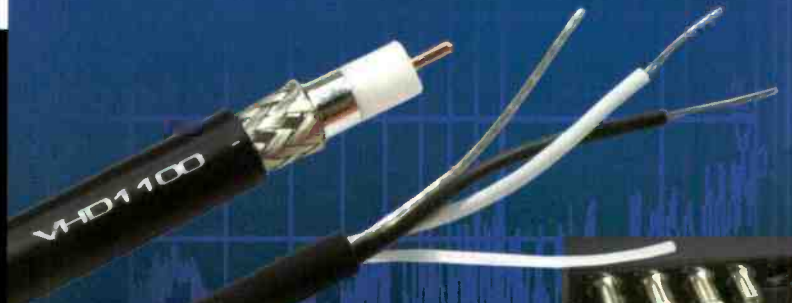

- HDTV Video Coax
- 110Ω Digital Audio Twisted Pair
- Analog Audio Cable
- Fiber and Triax Camera Cable
- Network and Automation Cable



See us at NAB, Booth #C9341



Time code interface card ▲ ESE PC-471PCI

For PC-compatible computers; receives SMPTE, EBU or ESE time code; using the supplied software, the card will automatically synchronize the PC's internal time-of-day clock; the time code is provided via a rear-mounted BNC connector.

www.esweb.com

Booth: C2639



Frame synchronizer ▲ FOR-A Corporation of America FA-128

Available as a standalone unit or as a modular card (UFM-128FS), which can be inserted into the company's UF-106 or UF-112 frames; 14-bit internal processing frame synchronizer features analog composite I/O, 4:2:2 component internal signal processing, NTSC/PAL automatic detection, digital three-line adaptive comb filter processing, full frame memory to prevent picture field inversion during processing, process control functions (video level, chroma level, setup level and chroma, H and subcarrier phase).

714-894-3311; www.for-a.com

Booth: C4519

Extended HD interfacing and signal processing range

Miranda Technologies Series XVP HD

New HD cross- and downconverter, upconverter and crossconverter, and an HD frame synchronizer and downconverter now available for Imaging Series XVP HD; interfaces feature firmware that can be upgraded to provide additional signal processing functionality.

561-477-6124; www.miranda.com

Booth: SU7841

SMPTE time code generator

ESE ES-461U

Is a microprocessor-based presettable SMPTE time code generator with Jam Sync; provides a front panel mounted thumbwheel switch that allows the presetting of hours, minutes and seconds data and six digits of user bits; additional features include a video sync input, a color frame pulse input and a clock "hold" function.

310-322-2136; www.esweb.com

Booth: C2639

Motion-compensated broadcast upconverter

Snell & Wilcox HD5300

Housed in a compact 1-RU enclosure; uses motion compensation derived from company's Alchemist Ph.C standards conversion range; allows centralized setup and monitoring through RollCall, which enables broadcasters to choose a customized financial model, such as centralcasting of multiple stations over a wide area network or use of a few modules in a single facility.

212-481-2416; www.snellwilcox.com

Booth: SU6349



Media converter ▲

Laird Telemedia LTM-7000C

Accommodates any format, including SDI and analog HD I/O.

800-898-0759; www.lairdtelemedia.com

Booth: SL1243



Encoder ▲

Eyeheight Enigma data transcoder

Enables metadata and machine-control information to be transported through an SDI channel; applications include forwarding camera pan/tilt angle and speed from the point of capture to 3D FX equipment in a post-production studio; can also be used to deliver recorded-media details such as date, time and clock number.

+44 1923 256 000; www.eyeheight.com

Booth: SU 8501

Timing, reference/test signal generators

Trilogy Broadcast Mastermind

Changeover unit complements the Mentor and Mentor Plus units; monitoring signal status and provides automatic changeover should failure be detected; actively monitors the condition of both analog and digital reference and test signals; configuration is selectable to suit specific engineering environments; standard units monitor one pair of main and reserve black burst inputs and include changeover, plus relay changeover of three other pairs of signals.

+44 1264 384000; www.trilogy-broadcast.co.uk
Booth: C11722



Storage ▲

DNF Controls Analyst RS422/RS232 Tester

Data logging option for Analyst; provides non-volatile storage of bidirectional data communication with timestamping; allows users to upload log files from The Analyst into a PC for review and analysis; allows users to isolate, identify, and resolve RS422 and RS232 interface problems quickly and easily.

818-898-3380; www.dnfcontrols.com
Booth: SU8552

TEST & MEASUREMENT

Test and measurement

Tektronix MTS 400

Compressed stream analyzer

Compressed video test system; automatically monitors, analyzes and debugs live and deferred time video transport streams; supports world transmission standards including; ATSC, DVB-T, -S, -H, -C, ISDB-S, IP and UMTS plus compressed video standards including; MPEG-2, -4, H.264, VC-1 and 3GPP; up to 400Mb/s analysis, modular design, hardware and software versions available; shipping in March.

800-833-9200; www.tektronix.com
Booth C6231

Bitstream analyzer

Dolby DM100

A portable, handheld diagnostic tool that can monitor and generate Dolby Digital, Dolby E and PCM bitstreams; has a built-in test-signal generator; accepts digital input signals via XLR, BNC, and Toslink optical connectors; a standard 1/8in stereo headphone jack can be switched to monitor any two decoded channels or a downmix of the whole program, while a small built-in speaker provides a mono output.

415-645-5293; www.dolby.com
Booth: SU7870

MicroFirst
Automation that Works

DIGITAL Automation SYSTEM

"It really works!"
- Bill Ziegler, CTO WLVT

"Far more efficient!"
- Joe Glynn, VP Eng. WVIA

"Flexible, reliable, & stable!"
- Mike McGraw, Dir. Development Clear Channel Spectacolor

"Easy to use!"
- Paul Byers, Dir. Eng. & Ops. WQED

- Modular Expandability: Schedules, Devices, Workstations
- Comprehensive Intuitive G.U.I.
- Context Sensitive On-Line Help
- Remote Control, Diagnostics, and Upgrades
- Dynamic Logging, Error Checking, and Alarming
- 24/7/365 Technical Support
- Interface to any Traffic System

NAB Booth #SU9643

www.microfirst.com

Automation that Works!



Analysis software ▲

Sencore H.264 Analysis Software

Provides in-depth analysis for Main Profiles at all levels including High and Low level; full bit stream analysis capabilities (SPS, PPSI), plus a video information overlay on top of the video frames (MB, MV, and Slice); provides picture level analysis capabilities that include current picture type, encoded picture size, and percentage of macro-block types per picture; allows you to be able to identify sub-partitions, or any quantized parameters or coded Block patterns, as well as, motion vector values.

800-736-2673; www.sencore.com

Booth: SU10006, C7331



Test Generator ▲

Doremi Labs HD-G10

Portable test generator; features a dual-link HD-SDI 2k resolution video output; provides 15 still patterns and 7 moving test patterns in SD and HD formats; outputs audio tone, time code and close caption characters; has ability to combine any still pattern with a moving pattern to create hundreds of video pattern options.

818-562-1101; www.doremilabs.com

Booth: C2342

Test and Measurement

Acterna COFDM and 8VSB Interfaces

Allows the DTS to meet the demands of digital video deployment within the terrestrial broadcast industry more precisely; product line now supports both the COFDM and 8VSB modulation called for in the European and North American standards.

240-404-1913; www.acterna.com

Booth: SU10043

Evaluation systems

K-WILL VP21S and VP21H:

Performs detailed measurements and comparisons of reference and copies videos on a real-time and fully automated basis; offers pixel-by-pixel comparison and provides more than 150,000 real-time measurements on each field of video.

650-329-9988; www.kwillcorporation.com

C8941

Transport stream monitor and analyzer

Triveni Digital StreamScope

Enhanced version of real-time DTV transport stream monitor and analyzer family; monitors, measures, and analyzes DTV streams and signals to ensure their integrity, reliability and compliance with MPEG-2, ATSC and SCTE standard; allows broadcasters and cable operators to remotely supervise multiple concurrent input sources from diverse physical locations; ideal for monitoring multichannel operations, or multiple points in the signal chain of one channel; can display HD and SD audio/video programs of all ATSC and SCTE formats.

714-378-5841; www.trivenidigital.com

Booth: SU11411

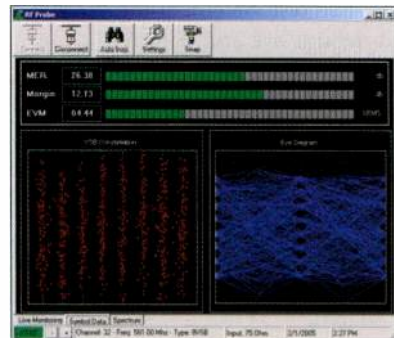

RF Probe ▲

Sencore DTU-234SX

Allows you to connect any analog, 8 VSB or QAM64/256 signal directly to your laptop computer and make both quantity and quality measurements of that signal; provides full tuning capabilities from 50MHz to 870MHz, plus allows you to measure signals from -30 dBmV up to +50 dBmV; can build up to five custom channel plans or choose from one of the standard channels plans that include FCC, IRC, HRD, or UHF/VH.

800-736-2673; www.sencore.com

Booth: SU10006, C7331

Generator

DK-Technologies PT5300 option

A new HD sync and patterns generator option; will support all TriLevelSync formats and will also be downwards compatible with SDI, 270M and Analogue options.

800-421-0888; www.dk-technologies.com

Booth: C2757; C3612

Test and analysis Vqual Approve

For analysis, test and optimisation of compressed audio, for codec engineers either developing or evaluating audio codecs; provides detailed error checking, syntax analysis, and performance reporting, with the aim of saving man weeks or months of development time.

+44 117 3101 244; www.vqual.com
Booth: SL4535

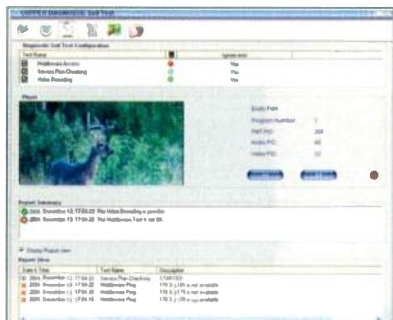

Video over IP application software ▲ Sencore VIP 1350

Designed to provide Real Time IP Analysis and the ability to extract the MPEG transport stream data and direct it to a physical transport stream output such as ASI, LVDS, 310M or DHEI; capable of recording the incoming IP stream through a Gig-E Ethernet (Copper and Optical) inputs to a hard disk for full off-line analysis or playback at a later date.

800-736-2673; www.sencore.com
Booth: SU10006, C7331

Signal analysis Videotek TVM-950HD

Offers high-definition video and audio signal analysis; provides waveform, vector, audio and picture all in one convenient display; features back-lit controls and a compact half-rack configuration.

800-800-5719; www.videotek.com
Booth: SU7805

Video tester

Tektronix K15 Version 2.1

Provides the ability to analyze H.324M video telephony quality of service by monitoring the UMTS core network IU-CS interface; displays all video calls in a live 3G network; offers the selection of H.324 video calls on the Iu-CS interface, calculation of key performance indicators (KPIs) and the extraction of the voice/video stream of each H.324M video call.

800-833-9200; www.tektronix.com
Booth: C6231

Handheld spectrum analyzers Rohde & Schwarz FSH Family

Models go up to 6GHz; provides analog and digital TV measurements; performs true power measurement with external power sensors.

888-837-8772; www.rohde-schwarz.com
Booth: C2633

Monitor Video Quality at the Pixel Level

Get reliable answers about the quality of your feed. You'll see differences in signal quality immediately – and be able to do something about it.

Eliminates concerns about human error, equipment malfunction and system failure. Our products can provide automated monitoring of video quality at the pixel level in real time.

K-WILL supplies a full line of high quality test and monitoring equipment that give broadcast engineers a forensic view of the signal they're putting out and the power to make immediate adjustments.



DigitalTV Magazine's
"EDITOR'S PICK OF SHOW" AT NAB-2004
TSI-2000 provides centralized monitoring of video networks with automated, real-time assessment of the quality of MPEG-2 video transport streams.

QuMax-2000's flexible architecture can be customized for real-time on-air quality monitoring, dubbing and inspecting video quality written to servers.



Recommended by ITU Document J.144
The VP series includes the VP21S, which performs before and after quality evaluations in real-time of SD video. An HD product is also available.



K-WILL Corporation
100 Hamilton Ave., Suite 103
Palo Alto, CA 94301
PH: (949) 553-9701
salesus@kwillcorporation.com
www.kwillcorporation.com

See us at NAB, Booth C8941



MPEG test system ▲ Acterna DTS-330

Supports MPEG-2, DVB, and ATSC testing in one box; users can troubleshoot their digital video networks via the platform's application modules, which include the analyzer for continuous, detailed, real-time analysis of all transport stream content and statistics including PIDs, PCR/PTS timing, programs/channels, conditional access, and PSI/SI/PSIP tables and descriptors; the multiplexer for continuous real-time transport stream creation; and the generator for real-time transport stream recording and playout.

240-404-1913; www.acterna.com

Booth: SU10043

Multiformat, HD SDI monitor ▲ Videotek TVM-950HD

Offers high-resolution color LCD display; provides accurate, stable display of single or multiple waveform, vector, gamut, audio, picture, timing and data analyzer functions in quadrant or full-screen views; capabilities include advanced analysis tools, an extensive alarm set with peak level reporting, metadata, EIA-608, 708 closed caption, Teletext and XDS displays.

416-445-9640; www.videotek.com

Booth: SU7805; SU8705



Transport stream generator ▲ Rohde & Schwarz DVM400

Upgrade offers transport stream generator/analyzer/recorder functionality in one box; MPEG-2 analyzer and monitor with up to four stream inputs now includes MPEG-2 generator/recorder/player and data broadcast analysis option that includes DVB-H functionality.

888-837-8772; www.rohde-schwarz.com

Booth: C2633

HD SDI, SD SDI, analog and audio signal monitor Hamlet LCD Scope 292

Uses a liquid crystal display; produced a range of unique HDSDI, SDI, NTSC and PAL composite, CAV, YC and DV capable devices, which may be used for a variety of environments; makes an ideal replacement for existing or failing CRT units; is only 160mm deep.

+44 1494 729728; www.hamlet.co.uk

Booth: C7031



DVI pattern generator ▲ Kramer Electronics 840 DVI

Comes with 32 built-in patterns; evaluates refresh rate performance, testing of overall linearity, the linearity of each pixel component and identifying missing pixel components of fixed resolution display devices, such as LCD and plasma monitors and LCD/DLP projectors; patterns designed to aid in testing DVI accessories.

888-275-6311; www.kramerelectronics.com

Booth: SL854

Waveform, vector and audio monitor Hamlet Flexiscope

Uses a built-in 3.5in diagonal high-quality TFT display to show the picture in 4:3 or 16:9 formats; also shows conventional waveform, vector and audio displays together with data analysis; easy to plug-in input option modules allow operation in all current formats and enables future standards to be accommodated

+44 1494 729728; www.hamlet.co.uk

Booth: C7031

Test and measurement software Pixelmetrix DVStation DTA

Allows users to apply DVStation MPEG analysis features offline to transport files captured in IneoQuest IQController software; runs as companion application on the same PC, DVStation DTA tests SPTS and MPTS captured using IneoQuest's Singulus G1-T; features TR 101 290, PCR measurement, bandwidth and video thumbnail capability.

866-749-3587; www.pixelmetrix.com

Booth: C7316



Broadcast test system enhancements ▲ **Rohde & Schwarz SFU**

SFU enhanced with capabilities to operate with DVB-H, DVB-T, DVB-S, DVB-S2 (broadcast services), TDS-OFDM (DMB-T), DVB-C and DirecTV Legacy (DSS) standards; options include noise, phase noise and fading generation, an MPEG-2 generator/recorder/player, arbitrary waveform generator, BER measurement and true power measurement using external power sensors.

888-837-8772; www.rohde-schwarz.com
Booth: C2633

Portable HD video test generator **Doremi Labs HDG-10**

Provides 15 still patterns and seven moving test patterns in SD and HD formats at full broadcast quality; outputs audio tone, time code and close caption characters; video outputs include SDI, HD-SDI and dual-link HD-SDI; formats include NTSC, PAL, 720p, 1080i, 1080p and 2048x1080; can be paired with HDVI converter to provide DVI output.

818-562 1101; www.doremilabs.com
Booth: C2342

Timing, reference/test signal generators

Trilogy Broadcast Mentor Series

Full SPG, multi-format with up to nine adjustable timing planes, syncs 625 or 525 line signals, provides three parallel outputs of main black burst, plus two subsidiary; combinable test signal facilities with optional hardware or software configurations.

+44 1264 384000; www.trilogy-broadcast.co.uk
Booth: C11722

VIDEO ROUTING



Router ▲

NVISION NV5256

Expandable 256 port machine control router; 8RU bi-directional port router for SMPTE 207M, RS-422 or RS-232 data, expandable to 512 ports using two frames.

530-265-3055; www.nvision.tv
Booth: SU9301

ON-AIR
SYSTEMS



The Next Generation of Broadcast Automation

ON-AIR playKast

A new master control system for TV and corporate playout, all in one easy to use integrated broadcast environment

- Automated & manual control playout
- Multi-layer graphic overlays
- On-line/off-line media management
- Scheduling & logging
- Commercial insertion
- Fully open system

Based on four generations of software development used by hundreds of single and multi-channel broadcasters worldwide, **ON-AIR playKast** is a powerful, proven and easy to use system for all playout applications.

www.on-air-systems.com - sales@on-air-systems.com

Tel: +44 20 7663 3671 / 1-800 379 0809 (US)

Visit us @ NAB 2005
Stand # SL5710

Fiber optic switcher

Multidyne FOS fiber optic switcher

Smaller matrix sizes to the FOS Series of fiber optic routing switchers; ideal for video broadcast, production, security and other video applications requiring transmission and switching of high quality optical signals; available in matrix sizes ranging from 8 by 8 to 32 by 32 bi-directional optical ports; delivers non-blocking, ultra-low loss, deterministic switched video over fiber optic connections without conversion to electrical format; based on Polatis' photonic switching technology; the FOS eliminates video signal degradation; switches any video format over distances in excess of 20km.

516-671-7278; www.multidyne.com

Booth: C3151

Routing system

Quartz Electronics Topaz-HD

Offers a full 1.5Gb/s bandwidth to handle uncompressed HD signals; dual link operation is supported using ganged pairs of inputs and outputs to carry higher bandwidth signals or data; available in 16 by 16 or 32 by 32 sizes.

530-265-2815; www.quartzus.com

Booth: SU9652

Routing switcher

Leitch Technology Panacea Clean/Quiet Switch

Clean video with embedded audio routing switcher; provides many features, functions and signal outputs; delivers master control features at a router price; provides simulcast of SD and HD, switch transitions and auxiliary outputs.

800-775-3314; www.leitch.com

Booth: SU7805, SU8199

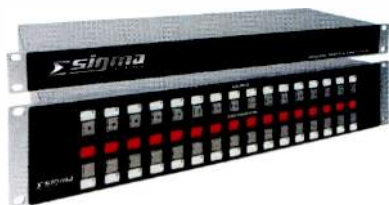

Video matrix switcher ▲

Sigma Electronics DVS-1616

Newly redesigned; now includes auto-equalization circuitry to compensate for up to 1000ft of Belden 8281 cable; optional reclocking circuitry assures data rate accuracy; 16 by 16 SDI router; available as a standalone router (DVS1616) or can be incorporated into an existing Sigma 2100 series.

425-315-1724; www.sigmaelectronics.com

Booth: SU10345

Multiformat, multi-level routing switcher

Sierra Video Systems Sierra NLE

Designed for nonlinear editing facilities; 8x8 matrix switcher in compact 3RU frame is capable of routing SDI video, composite video, composite video, s-Video (Y/C), component video (YUV) and/or RGB signals along with either balanced analog stereo audio (or two balanced analog mono audio) and /or AES/EBU digital audio; multi-format and multi-level capable.

888-886-8875; www.sierravideo.com

Booth: SL854

Control

Leitch Technology Command Control System (CCS) panel

Communicates in real time with NEO, 6800+, and X75 processing products as well as Leitch Technology routers; also communicates with Panacea and Integrator routers in real time; provides a color display, four knobs for parametric range adjustments, soft menu keys and dynamic LCD navigation buttons; users may customize the panel to display only those parameters that are relevant to their operations.

800-775-3314; www.leitch.com

Booth: SU7805, SU8199

Optical routers

Evertz X1616-OO; X3232-EO

SNMP-enabled optical routers for digital rates up to 3Gb/s; the X1616-OO has 16 optical inputs and 16 optical outputs; the X3232-EO has 16 optical plus 16 electrical inputs and 16 optical plus 16 electrical outputs; the mixed optical/electrical I/O on the X3232-EO provides built-in EO/OE conversion for signals such as HDSDI, SDI and ASI that originate/terminate on coaxial cable; the 3Gb/s rate capability allows many other signal types such as Fiber Channel, Serial HIPPI, SONET, etc, to be switched using these routers; both routers utilize an OEO architecture where optical input/output signals are converted to the electrical domain for regeneration and switching.

905-335-3700; www.evertz.com

Booth: SU6433

Router

PRO-BEL SIRIUS GOLD

Features router sizes to 512x512; ability to mix and match different signals within the same frame; incorporates built-in analog and digital signal conversion for both video and audio signals; formats available are SDI/HD/analog video and AES audio.

+44 118 986 6123; www.pro-bel.com

Booth: SU10730

Router control system

Utah Scientific SC-4

Complete line of routing switchers and control systems offered; new additions to the SC-4 control system will be unveiled at the show.

801-575-3770; www.utahscientific.com

Booth: C5910

Data router

Utah Scientific UTAH-400

New addition to the UTAH-400 line for routing RS-422 machine control data, offers 64 ports in 4ru chassis with expansion capability for adding more ports; units can be fitted with optical I/O ports for direct connection of SD and HD signals on fiber without need for external converters.

801-575-3770; www.utahscientific.com

Booth: C5910

Video processing and distribution line

Leitch Technology 6800+ Modular Platform

Line adds nine new HD configurations, including: HFS6800 video frame synchronizer/processor, HMX6800 multiplexers and HDX6800 demultiplexers, NEO SuiteView multi-viewer solutions, CCS-TRAX, NEO HUC-3902 deinterlacing upconverter module, NEO DLY-3901-4 SDI delay module, Next-Generation CCS Control panel, and SNMP Support monitoring application.

859-371-5533; www.leitch.com

Booth: SU7805, SU8199

Router

Leitch Technology Panacea Lite

Available as a dual-format (analog video and audio, SD video and AES, HD video and AES) router or in standalone formats (analog video, analog audio, SD video, HD); enables front or rear rack mounting; offers mixed format, broadcast-quality 12x1 utility routing within a 1RU frame.

859-371-5533; www.leitch.com

Booth: SU7805, SU8199

HD router

PESA Switching Systems Cheetah

Upgraded versions of Cheetah router; routers are full-featured digital routing switchers with the power to handle SDI, HDTV, and non-standard digital signals in the same frame; available in 64x64, 128x128, 256x256 and 512x512 frame sizes; can handle bit rates from 3Mb/s up to 1.5 Gb/s.

631-845-5020; www.pesa.com

Booth: SU7852

Router

Quartz Electronics Xenon

Comes in two frame sizes; active assemblies are all hot swappable from the front of the frame; power, control, cooling and reference generation are all available in dual redundant configurations; every output can be switched in the same TV frame; any number of Xenon frames may be combined to make larger multi-level routing systems; supports a number of signal formats.

530-265-2815; www.quartzus.com

Booth: SU9652

Software control platform

PRO-BEL PROCION

Contains major new features for the management of broadcast systems and media workflow; allows customers to design their own user interfaces; supports router control, modular product monitoring and control, media management, automation and master control.

+44 118 986 6123; www.pro-bel.com

Booth: SU10730

WIRE, CABLE, CONNECTORS

Fiber optic cable

Telecast Fiber Systems SHED

Expanded line now includes support for Ikegami camera systems; new SHED adapters allow production crews using SMPTE fiber-equipped broadcast cameras to replace hybrid optical fiber/copper cabling with single-mode fiber; reduces bulk and expense associated with hybrid cabling and extends distance capabilities of the camera.

508-754-4858; www.telecast-fiber.com

Booth: SU8375

SINGULARLY LUCID

REDEFINING THE INTERCOM

SCAM1? No! DELEC LCD keys speak plain English. Up to 18 freely selectable characters per key abolish acronyms, SCAM1 becomes what it always was - Studio Camera One. Different colors clarify call status and precision bargraphs show levels. Singularly lucid DELEC eloquence redefines intercom. For real one-touch communication you need look no further. **DELEC.**

NAB2005
Booth N4208



D-96155 Bittenheim
Phone: +49 9545 440-0
Fax: +49 9545 440-333
sales@delec.de
www.delec.de

DELEC distributed by
SALZBRENNER STAGETEC MEDIAGROUP



Camera Connector ▲ Canare Hybrid fiber optic camera connectors

New F.O. camera connector design; with a detachable alignment sleeve and insulator; easy maintenance; made with a stainless steel body shell; the connectors are SMPTE 304M compliant with an insertion loss =0.5dB; AdPC polish for a RL =45dB.

818-365-2446; www.canare.com

Booth: C5134



Cable connectors ▲ Pomona Electronics XLR connectors

Features a clamping mechanism that withstand 100lb of pull without disconnecting the cable; designed to deliver high-quality, low-noise audio transmission; feature gold contacts and black nickel coating to reduce reflection; are also available on 10ft to 25ft foot cable assemblies made with Belden 1172A four-conductor Star Quad, low-impedance cables.

800-490-2361; www.pomonaelectronics.com

Booth: C11814

High definition coax cable Gepco VHD1100

Features a 3GHz bandwidth (for HDTV transmission), a gas-injected foam polyethylene dielectric, lower attenuation, more RG types, excellent crush resistance, easy termination, and a flexible, riser rated jacket; conductive elements consist of a precision-drawn solid copper center conductor and a 95 percent braid with 100 percent foil shield for complete broadband shielding; available in wide range of sizes to accommodate short distance rack wiring or extended distance point to point interconnect

800-966-0069; www.gepco.com

Booth: C9341

Connectors

Switchcraft H Series

New S-Video, Firewire and USB options; allow a wide variety of connectors with in the same XLR housing and panel cutout; BNC and RCA options also available.

773-792-2700; www.switchcraft.com

Booth: C2339

Cables

Multidyne DVI fiber optic transport link and extension cables

Provides a transport solution for high resolution, 1600 by 1200, DVI digital video sources via four fibers; maximum transmission distance is 700m; system has a data throughput of 1.6GB/s with no compression; extends the distance limitations of DVI digital video signals to 100m; resolutions of up to 1600 by 1200 are support; cables are available in varying lengths from 10m to 100m; provides the capability for the separation of a video signal source and the monitor.

516-671-7278; www.multidyne.com

Booth: C3151



Cable connectors ▲ Neutrik NC**XX Series

Available in three to seven pole configurations; die cast shell has internal threads that mate with the external threads on the boot to eliminate damage sometimes found on exposed threads; incorporates chuck-type strain relief; provides stylish color-coding on the boot; features female cage type contact that will increase conductivity and reduce wear of the male contacts; features a new ground contact that will provide better integrity between the chassis and cable connectors; available in nickel housing with silver contacts, black metal housing with silver contacts and black metal housing with gold contacts

732-901-9488; www.neutrikusa.com

Booth: C5137



Fiber-optic connector for HDTV cameras ▲

Fischer Connectors 1053 Series

Co-developed with Corning; "No Epoxy – No Polish" fiber-

optic contacts enable users to field-assemble and field-repair HDTV camera connectors anywhere; eliminates polishing fiber-optic elements a well as preparing special epoxies when using the new Series 1053T connector.

800-551-0121; www.fischerconnectors.com

Booth: SU11812

Fiber optic cable ▶

Gepco HDC120P



12mm heavy-duty hybrid fiber optic cable; SMPTE 311M compliant; designed specifically for high-definition camera to CCU interconnections in studio or mobile production environments; features a 12mm puncture-resistant polyurethane jacket; aids in the reduction of cable kinking; a special nylon-based polymer and a 16-gage steel strength member is cabled at the center of each core fiber; includes a Kevlar wrap and PVC jacket for added protection; features heat-resistant insulation for operation in high-temperature environments.

800-966-0069; www.gepco.com

Booth: C9341

Patching system ▼

ADC Telecom UniPatch



Modular patching system with universal chassis; combines full Audio Engineering

Society compliance, a highly durable RS-422 patching interface, and a modular design; allows technicians to combine data, audio, and video patching modules in a single two-rack-unit (2 RU) modular panel.

800-366-3891; www.adc.com

Booth: C4515

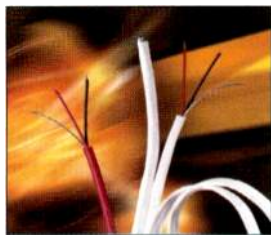

Analog audio cables ◀

Belden CDT Brilliance cable

Plenum versions of company's popular 9451 and 9451D analog audio cables; designed for line-level audio connections, audio distribution equipment, and

studio wiring with room-to-room and plenum versions; applications include sports arenas, broadcast studios, post-production facilities, corporate boardrooms and houses of worship.

800-235-3364; www.belden.com

Booth: C2257



Coax cable ◀

Gepco VDM260

An ultra-miniature high definition coax cable; low weight and small size; features a 26 gage solid conductor that provides lower attenuation and superior mechanical integrity; ideal for mobile production trucks, has a broadband foil and braid shield that offers RF/EMI protection and structural integrity; 75 Ohm precision impedance and low structural return loss up to 3GHz; meets and exceeds the bandwidth required for a 1.485 Gb/s HD video transmission; can be used with SDI Digital Video, Analog Video and Digital Audio formats.

800-966-0069; www.gepco.com

Booth: C9341



Plug connector ◀

ADC Telecom BNC-3T

A custom straight BNC 75 Ohm plug connector; offers improved performance with true 75-ohm characteristic impedance through the connector, not just the interface; the BNC

plug connector prevents damage during test or mating plug termination, has 100 percent guided mating, improved bandwidth performance to 3GHz, and sizes for multiple cable types.

800-366-3891; www.adc.com

Booth: C4515

All booth numbers were provided by NAB and were current as of press time. Every effort has been made by Broadcast Engineering to ensure the accuracy of these listings.

Wireless Headsets for your Wired Intercom

**Simultaneous Talk
Hands Free
No base station**



Wireless user communicates in full duplex with all wired stations

TDx 901 Proline . . . \$655

Includes:

- 2 TD 900 Radios
- 1 TDx INT Wired Interface
- 1 Proline Headset

Interface plugs into existing rack mounted power source or wall jack

Indicate Clear Com®, Telex® RTS®, etc.

**1-800-399-5994
www.eartec.com
free catalog!**

EARTEC®

Streamlining format conversion

BY FADY LAMAA

Broadcasters readily acknowledge the benefits of adopting digital media production and distribution workflows. Media in digital file formats can be searched, archived, managed and distributed more efficiently and cost-effectively over now widely available broadband networks. However, the union of network-based and broadcast technologies is proving to be a more complicated process than initially envisioned.

Broadcasters who have made significant investments in digital editing and production systems are finding they are still burdened with inefficient media conversion chores required to move media and metadata through content acquisition, editing, production and playout. This is caused by a wide range of incompatible file formats — such as M-JPEG, MPEG-2 long GOP or I-frame, and DV — and incompatible metadata.

Even when metadata has been standardized on MXF, essence formats remain incompatible due to proprietary implementations for each manufacturer's hardware. In order to fully realize the promise of digital media production, broadcasters still need an easy, reliable way to exchange media between incompatible digital systems.

Transcoding

Anystream's Agility automated transcoding software enables broadcasters to enjoy the efficiency and economy of network-based media production and delivery without having to acquire specialized IT skills. Its software-based design offers broadcasters the flexibil-

ity to add emerging formats, to scale as their volume grows, or to build new revenue streams by re-purposing content to new syndication, on-line and other publishing outlets.

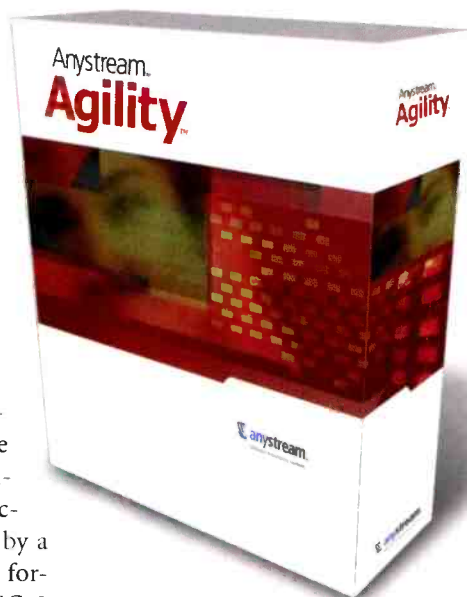

Broadcasters can use automated transcoder software systems such as Anystream's Agility to transfer media between incompatible file-based systems.

The system automates the many file format conversion steps required to transfer source media among incom-

patible editing, playout and distribution systems. The automation is done via user-defined profiles that outline the various steps in the media conversion process, such as automated ingest,

transcoding and delivery of content.

For example, when transcoding a file from an editing system to a play-to-air server, the software can automatically ingest the source media, transcode it and upload the output to the broadcast server for on-air playback. The software can even bypass transcoding by rewrapping compatible essence media, and carry through metadata between systems.

By comparison, in a tape-based process, someone has to edit programming on a nonlinear editor and then lay it back out to tape — in real time. Someone then has to add basic metadata (program name, start and stop time codes, etc.) by hand and hand carry (or courier) the tape to the intended broadcast server. Then the tape has to be digitized for ingest back into the broadcast server, with additional metadata added manually. And then, finally, the segment is ready for playout. This widely used workflow wastes valuable creative resources on mundane conversion steps and is too time-consuming and error-prone to scale or adapt for new requirements.

Streamlined workflow

Agility can deliver cost and time savings throughout many digital media production workflows, including edit/play-to-air, electronic news gathering,

Broadcasters are finding they are still burdened with inefficient media conversion chores.

content distribution, and program repurposing for the Web and other outlets:

- *Edit/play to air:* Using a software-based transcoder can bring additional

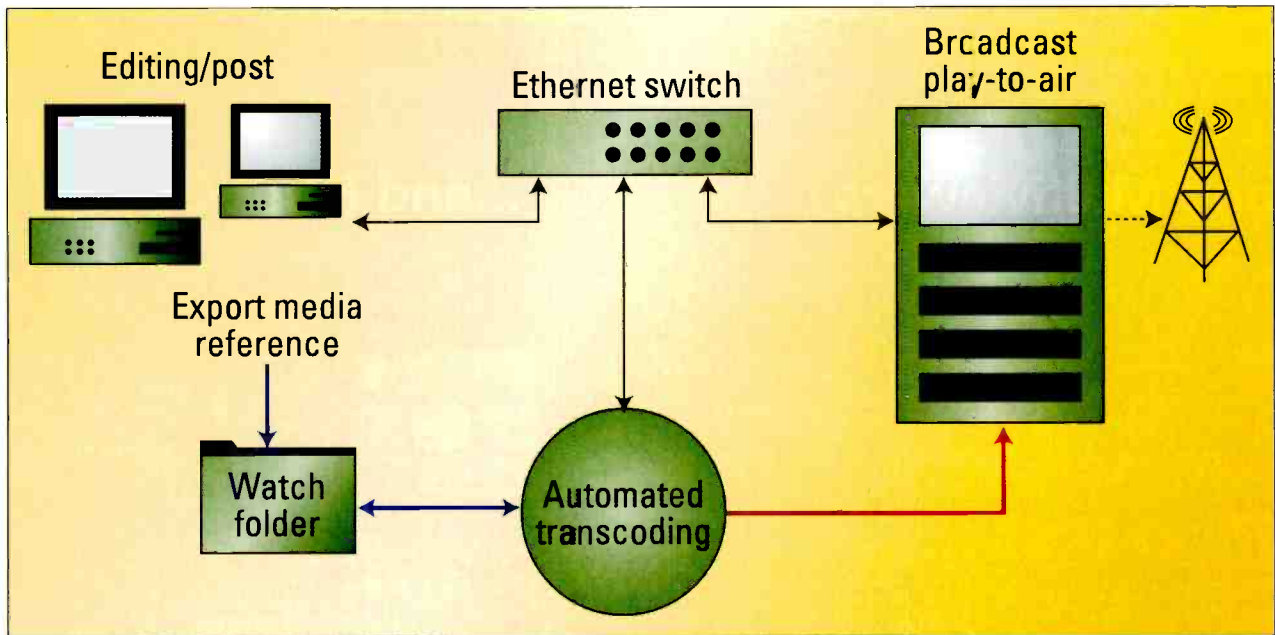

Figure 1. To send an edited news story to air, the editor exports a source media reference to the watch folder. Anystream's Agility finds the source media on the network and finishes the transcoding and file delivery process automatically.

efficiencies by allowing editors to use networked, file-based systems in the workflow described earlier. The broadcaster sets up profiles specifying the transcoding process from one format to another (for example, from Avid OMF to Thomson Grass Valley or SeaChange MPEG-2) and specifying which play-to-air server the content should be delivered to. He or she then sets up a "watch folder" on the network and assigns it a particular transcoding profile. To send an edited news story to air, all the editor has to do is export a reference to the source media to the watch folder. The transcoding software finds the source media on the network and finishes the transcoding and file delivery process automatically, greatly speeding the process and eliminating the need for tape. (See Figure 1.)

• *Electronic newsgathering:* Transcoding software also can expedite news file-based applications, including remote news submission via the Internet when satellite or microwave connections are impractical. Products like AP ENPS SNAPfeed let journalists create stories with a PC and DV camera and then transmit them over an Internet

connection as a Win9 file. News organizations can then use the transcoder to automatically ingest the streaming media files into the newsroom production system for conversion for browsing, editing or play to air.

• *Content distribution:* Broadcasters can use a software-based transcoder to streamline content exchange be-

tween networks and affiliate stations. Affiliate news stories usually come into the station in an MPEG-2 file format that is often incompatible with editing or broadcast playout systems. The transcoder automatically converts the media to the appropriate format for delivery to producers and journalists browsing content, editors preparing stories, or directly to air.

• *New consumer outlets:* Now that the viability of premium online subscription service models has been proven, broadcasters are evaluating how they can repurpose digital media assets for new consumer revenue opportunities.

The transcoding software allows broadcasters to set up encoding profiles to automatically convert high-quality media to Windows Media, Real, QuickTime or Macromedia Flash formats at different data rates to serve consumers on the Web. The transcoder will also convert media to other formats suitable for distribution to

Anystream's Agility software enables media to move seamlessly among a variety of servers.

consumers through emerging VOD and mobile outlets.

In all-digital production workflows, Anystream's Agility software enables media to move seamlessly among a variety of servers, systems and devices. It lets broadcasters streamline operational efficiency by taking full advantage of digital file-based editing, post-production and broadcast systems. This leads to better, more innovative content that reaches a wider range of audiences. **BE**

Fady Lamaa is the vice president of product marketing at Anystream.

THE LEADER IN HDTV...

...and Multiviewers

...and Fiber Optics



...and Distribution & Conversion

...Closed Captioning

...Production & Post Production

...Time Code

and Much More...

U.S. West Coast Sales
818-558-3910
LAsales@evertz.com

U.S. & International Sales
Tele: 905-335-3700
sales@evertz.com

New York Sales
newyorksales@evertz.com

Washington Sales
dcsales@evertz.com

evertz®

www.evertz.com

UK Sales
uksales@evertz.com

Beijing Sales
beijingsales@evertz.com

Visit Us at NAB 2005 - Booth #SU6433
Order your new 2005 Catalog
from your Evertz Representative

VistaLINK™ ...For All Applications

Monitoring & Control

Remote Broadcast Site

Central Monitoring Facility

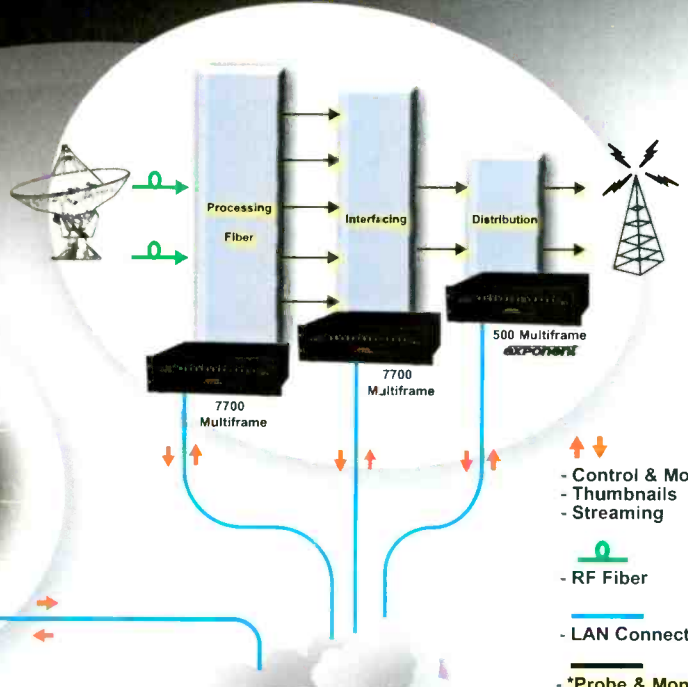
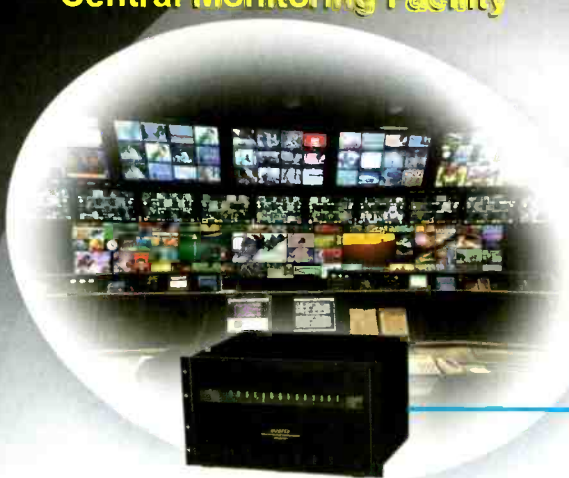

3000 MVP™ / 7700FR-C Multiframe / 500FR *exponent*

Transmission Site

• Cable • Telco • RF

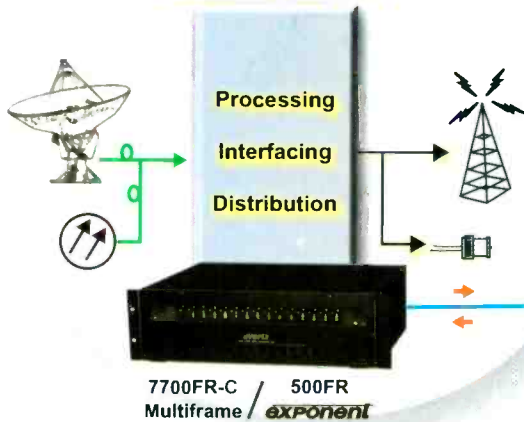

7700FR-C / 500FR Multiframe / *exponent*

Mobile Trucks Conversion and Distribution



7700FR-C / 500FR Multiframe / *exponent*

Simple, reliable, secure and efficient network monitoring and control for your facility equipment through VistaLINK™ and SNMP

*All Evertz VistaLINK™ enabled products have built-in Probing and Monitoring

See VistaLINK™ in action @ NAB 2005 Booth #SU6433



are used. There are static and animated logos that are rarely updated, and elements that change daily. These include animated tabs with messages such as 'coming up next' Last-minute items such as crawls are also handled

standby in case the first PC fails.

Both PCs double as CG workstations by using Inscrber Inca Studio offline. Any of the NCC operators can log into one of these machines via a KVM matrix to make last-minute changes,

were trained and became familiar with the new system.

Although extensive testing took place prior to installation with an offline automation, configuration adjustments had to be made to work flawlessly with the busy on-air automation. CBC Television initially installed one machine into one of the channels and resolved its issues there before proceeding with the remaining channels.

The broadcaster recently implemented two HD channels as part of the NCC network delivery. These channels went on-air in late February. Two AutoCG machines were integrated into the branding delivery system to deliver the branding elements in HD format seamlessly to those channels.

BE

Manfred Weitzmann is a senior systems designer with CBC Technology, Broadcast Engineering Toronto.

Both PCs double as CG workstations by using Inscrber Inca Studio offline.

by this system and can be delivered to air via automation or manually.

The broadcaster's workflow involves daily tabs created by a department responsible for on-air scheduling. These tabs are loaded into two server PCs in the branding delivery system via FTP. One of these PCs updates all of the branding machines with the latest changes on a continuous basis, while the second machine is continuously synchronized to the first and acts as a

create crawls or verify the material.

The broadcaster had to overcome several challenges during the installation of the system in order to integrate into the live on-air national network without interrupting normal operation. Before it could proceed with the installation, all the branding material had to be prepared and tested. Even though the system is transparent for most of the normal NCC operation, it was important that all operators

THE MOST IMPORTANT 64 HOURS IN CABLE.

Synchronize your watches. Because for 64 hours, the most important deal makers you need to meet are all going to be in one place. Elbows will rub. Socks will be knocked off. Ink will dry.

Don't miss a second.

NCTA • THE NATIONAL SHOW

APRIL 3-5, 2005

SAN FRANCISCO, CA

www.thenationalshow.com

Major projects for broadcast industry leaders like:
CNN, ESPN, NBC, FOOD, VIACOM, ABC, HGTV, CNBC, HBO,
COURT TV, ASCENT MEDIA, CISCO, CBS and many more
...all had something in common.

MASTERail™

Dynamic Technical Furniture

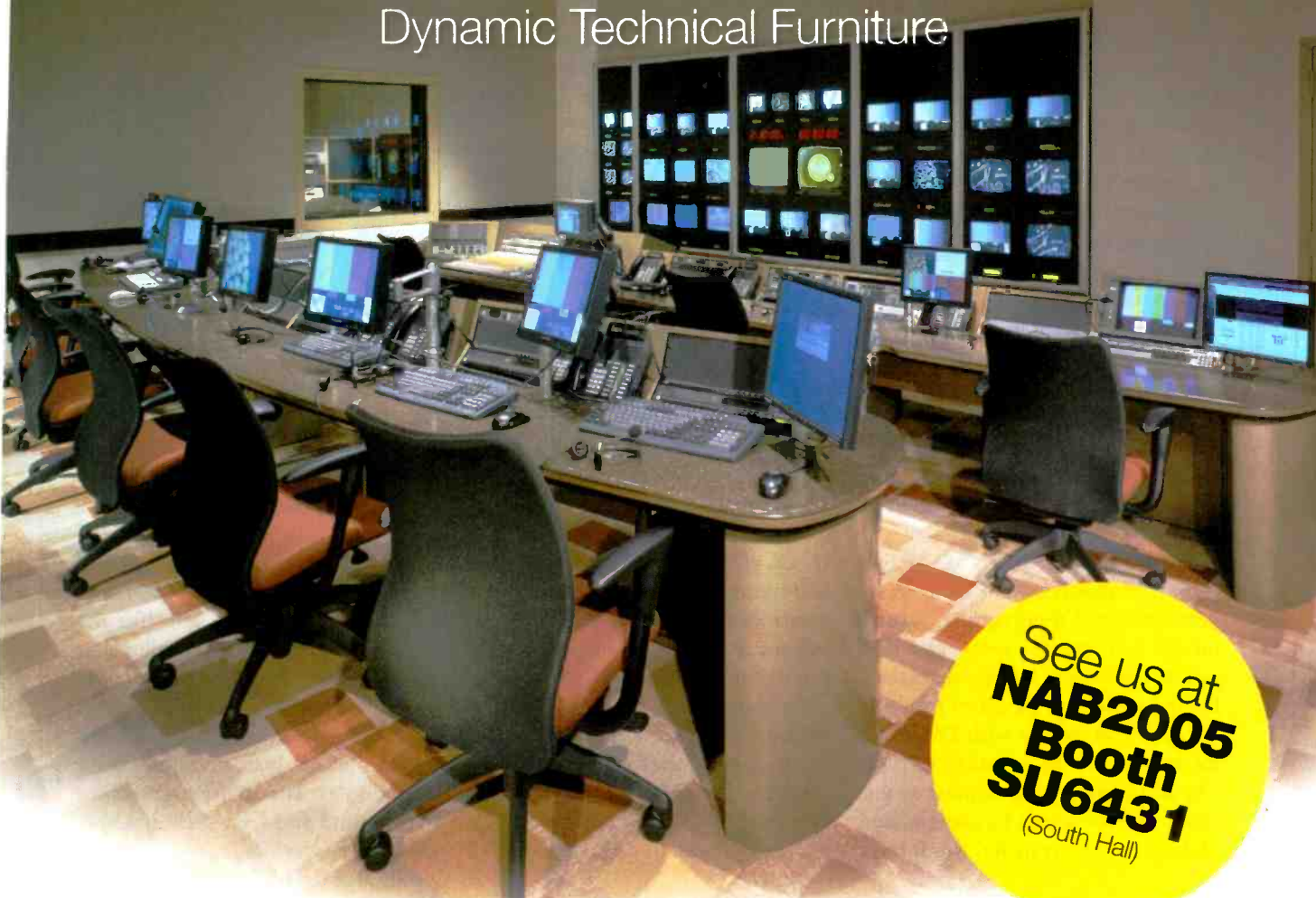

See us at
NAB2005
Booth
SU6431
(South Hall)

INNOVATION NEVER IMITATION

Elegant designs created with pre-engineered components for that custom look without the custom price.
A totally flexible system, precision-manufactured to expand, reconfigure, re-purpose and reuse.
You get the ultimate value — quality consoles for today and tomorrow

MASTERail "For all the right reasons"

FORECAST
consoles

For more information call **1-800-735-2070** or visit us on the web at
www.forecast-consoles.com

NY1 News goes tapeless with Panasonic's P2 recording system

BY JOETRUNCALÉ

Last spring, NY1 News, Time Warner's 24-hour, all-news cable station in New York City, announced a large investment in Panasonic DVCPRO P2 solid-state recording system equipment. The station's goal was to convert its news operations to tapeless acquisition in its progression to an all-tapeless, multichannel 24-hour news facility.

The purchase included 22 AJ-SPX800 camcorders, eight AJ-SPD850 studio decks, nine AJ-PCD10 drives, and several P2 cards and accessories. Based on its feature set, the station saw P2 as the critical next

step in giving it the ability to FTP files from field shoots into its main server faster than real time, getting pictures on-air with greater speed and efficiency. The format is a logical next step for the station, as P2 series products are fully compatible with DVCPRO, the station's house format since 1996.

In addition to the nonlinear acquisition, instant access to material and high-speed file transfer, the format

break down or wear out from repetitive use has the potential for significant maintenance cost-savings.

Further, the products are resistant to environmental extremes, including



At last summer's Republican National Convention, NY1 News used Panasonic's P2 recording system to move material back to the station quickly and get it on-air.

shock, vibration, cold, dust, moisture and humidity — in short, exactly the conditions the station's videojournalists encounter day in and day out on the streets of New York City.

The station took delivery of most of the equipment last summer. It chose a world stage for the format's debut, the four-day Republican National Convention (RNC) at Madison Square Garden. (The station also used the P2

adapted to the equipment quickly, citing its ease-of-use and flexibility. Its videojournalists were able to mark clips and do a rough edit as they shot, a huge benefit when dealing with the

late-breaking stories typical of such a major event as the RNC. All told, the equipment performed successfully over the course of four high-pressure days, with the constant imperative of moving material back to the station quickly and getting it on-air.

Throughout the fall, the station broadly implemented the P2 format. It has rolled out most

of the cameras, which have performed well — certainly to the satisfaction of the station's shooters, who like the cameras' functionality, versatility and such accoutrements as the color viewfinder. As one-person crews, they like being able to see their stand-ups on the built-in, high-resolution color LCD display. The ability to move the files around and feed clips in a specific order is terrific.

Although the station is not yet working at an optimal transfer rate, the workflow model it established during the convention has worked out better than it anticipated. The station can use the P2 drive to ingest material into its Pinnacle Liquid NLE system in the field. It is able to ingest MFX files at 2X real-time into the Pinnacle NLE, edit locally and feed back the stories to the station as complete packages.

The ability to prioritize all those thumbnails and ID what it wants to feed is beneficial. The station uses the

The station can use the P2 drive to ingest material into its Pinnacle Liquid NLE system in the field.

offers laptop field editing without requirement for proxy videos, compatibility with off-the-shelf data storage drives for low-cost archiving, and the elimination of traditional digitizing and ingesting operations. The system's absence of any moving parts that can

system for the convention coverage of its 24-hour Spanish news channel, NY1 Noticias.)

Throughout the convention, the station was consistently impressed with how versatile the gear was, continuing to find useful features. Its staff

AJ-SPD850 decks in the field to feed material back to the main server, or they can be used off- or on-site as viewing stations.

Before the end of the year, the station swapped out its 2GB cards for 4GB cards, giving it 80 minutes of

launched two new bureaus in Staten Island, NY, and Bergen County, NJ. It is poised to convert these new local bureaus to P2 acquisition as soon as Avid issues new releases for integration with P2.

While the station has been waiting

While NY1's transition to P2 continues, it has been impressed with the newfound speed and efficiencies of the format.

DVCPRO recording (25Mb/s) each. Presently, the station has approximately 210 4GB cards. Given the cost of the media, operations is being vigilant with the cards, making sure that the videographers go out with five cards in the camera, and come back and do a five-card swap-out.

As is almost always the case with new acquisition formats, there's some lag time before the editing systems catch up with the technology. That's been



The station replaced its 2GB cards with 4GB cards, giving it 80 minutes of DVCPRO recording (25Mb/s) each.

true in this case. The station is waiting for Pinnacle's upgrade to its Liquid system so that it can ingest FTP files versus baseband. So far, it has been ingesting material at 2X real time, but it expects much quicker transfer rates with the upgraded system. (It is already ingesting FTP files at NY1 Noticias, as its Liquid system is on a DV platform, versus M-JPEG for the English-speaking station.)

Since committing to P2, NY1 has

on very, very fast ingestion versus very fast ingestion, it has conducted many tests off-site (for example, from Time Warner facilities in Albany and Syracuse) to establish some benchmarks for the FTP to FTP transfer a day's worth of material from the field. The station is anticipating considerable cost-savings once it eliminates all the uplink and fiber chargers.

Another P2 component it is eagerly awaiting is the optional DVD-R/DVD-RAM drive for the studio recorder, which offers optical disc backup for economical video archiving and international "air courier" field-to-studio data transfer. According to Panasonic, the station will have this by April.

While NY1's transition to P2 continues, it has been impressed with the newfound speed and efficiencies of the format. The speed of getting material onto the server is already greatly accelerated, which can only support breaking stories faster. **BE**

Joe Truncale is the NY1 news director of operations and engineering.

ATTENTION READERS!
 Sign up now for
Broadcast Engineering's
News Technology Update
 e-newsletter
 at www.broadcastengineering.com

A PRIMEDIA Publication

Broadcast Engineering

www.broadcastengineering.com

Editorial Director: Brad Dick, bdick@primediabusiness.com
 Editor: World Edition: David Austerberry, dausterberry@primediabusiness.com
 Managing Editor: Susan Anderson, sanderson@primediabusiness.com
 Assoc. Editor/Webstr: Chevon Payton, cpayton@primediabusiness.com
 Asst. Editor: Angela Dauris, adauris@primediabusiness.com
 Sr. Art Director: Michael J. Knust, mknust@primediabusiness.com
 Art Director: Robin Morsbach, morsbach@primediabusiness.com
 Technical Consultants: Computers & Networking - Brad Gilmer
 Antennas/Radiation - John H. Battison
 Digital Video - Michael Robin
 Transmission Facilities - Donald L. Markley
 Legal - Harry C. Martin
 New Technology - John Luff
 Industry Watcher - Paul McGoldrick
 New Media - Craig Birkaier

Sr. VP, Peter L. May, pmay@primediabusiness.com
 Group Publisher: Dennis Triola, dtriola@primediabusiness.com
 Marketing Dir.: Kirby Asplund, kasplund@primediabusiness.com
 Online Sales & Marketing Dir.: Samantha Kahn, skahn@primediabusiness.com
 Vice President of Production: Lisa Parks, lparks@primediabusiness.com
 Sr. Ad Prod. Coord.: Kathy Daniels, kdaniels@primediabusiness.com
 Classified Ad Coord.: Mary Corcoran, mcorcoran@primediabusiness.com
 Dir., Audience Marketing: Barbara Kummer, bkummer@primediabusiness.com
 Group Show Director/LDI: Sharon Morabito, smorabito@primediabusiness.com

PRIMEDIA

Business Magazines & Media

COO: Jack Condon, jcondon@primediabusiness.com
 Executive Vice President: John French, jfrench@primediabusiness.com
 Corp. Comm/Mkg.: Karen Garrison, kgarrison@primediabusiness.com

Primedia Inc.: 745 Fifth Ave., NY, New York 10151
 Chairman: Dean Nelson, dean.nelson@primedia.com
 President and CEO: Kelly Conlin, kconlin@primedia.com
 Vice Chairman & General Counsel: Beverly Chell, beverly.chell@primedia.com

MEMBER ORGANIZATIONS

Sustaining Member of:
 • Society of Broadcast Engineers
 Member, American Business Media; Member, BPA International



BROADCAST ENGINEERING, ISSN 0007-1994, is published monthly (except semi-monthly in June and December) by PRIMEDIA Business Magazines & Media Inc., 9800 Metcalf Ave., Overland Park, KS 66212 (primediabusiness.com). Current and back issues and additional resources, including subscription request forms and an editorial calendar, are available on the World Wide Web at broadcastengineering.com.

SUBSCRIPTION RATES: Free and controlled circulation to qualified subscribers. Non-qualified persons may subscribe at the following rates (Prices subject to change): USA and Canada, 1 year, \$70.00, 2 years, \$135.00, 3 years, \$200.00, Outside USA and Canada, 1 year, \$85.00, 2 years, \$165.00, 3 years, 245.00 surface mail (1 year, 155.00, 2 years, \$295.00, 3 years, \$440.00 airmail delivery). For subscriber services or to order single copies, write to Broadcast Engineering, 2104 Harwell Circle, Bellevue, NE 68005 USA; call 866-505-7173 (USA) or 402-505-7173 (outside USA); or visit www.broadcastengineering.com.

ARCHIVES AND MICROFORM: This magazine is available for research and retrieval of selected archived articles from leading electronic databases and online search services, including Factiva, LexisNexis and Proquest. For microform availability, contact ProQuest at 800-521-0600 or 734-761-4700, or search the Serials in Microform listings at proquest.com.

REPRINTS: Contact FosteReprints to purchase quality custom reprints or e-prints of articles appearing in this publication at 866-436-8366 (219-879-8366 outside the U.S. and Canada). Instant reprints and permissions may be purchased directly from our Web site; look for the RSCopyright tag appended to the end of each article.

PHOTOCOPIES: Authorization to photocopy articles for internal corporate, personal, or instructional use may be obtained from the Copyright Clearance Center (CCC) at 978-750-8400. Obtain further information at copyright.com.

PRIVACY POLICY: Your privacy is a priority to us. For a detailed policy statement about privacy and information dissemination practices related to Primedia Business Magazines & Media products, please visit our Web site at www.primediabusiness.com.

CORPORATE OFFICE: Primedia Business Magazines & Media, 9800 Metcalf, Overland Park, Kansas 66212 • 913-341-1300 • primediabusiness.com

Copyright 2005, PRIMEDIA Business Magazines & Media Inc. All rights reserved.

Format conversion

BY JOHN LUFF

To paraphrase a popular statement, the nice thing about formats is that there are so many of them. In our industry, we have analog and digital formats with different frame rates, coding schemes, scan formats, bandwidth, aspect ratios, compression systems, bit rates, bit depths, file formats and interconnection media. Increasingly, production personnel expect that any format can be converted to any other. That may well be precisely true, but as in all things technical, it is not always practical or affordable given the economics of any particular application.

The most important example today might be conversion between the various HDTV and SDTV formats. Manufacturers of hardware select from support silicon to find high-quality and low-cost solutions, or they use considerably more hardware processing power to craft a dedicated solution at the highest quality possible, perhaps at the expense of low cost. The result is that there are an array of single-board solutions at modest prices (\$3-\$10,000), as well as a family of much more expensive products that can cost five times that much for the highest possible performance.

Inside each of these products, one

often needed, with HDTV standards using a wider gamut than older 525 and 625 scanning systems. Progressive to interlace conversion is well understood and important. Lastly, and most difficult, is frame rate conversion.

The right way to do frame rate conversion is to interpolate missing time samples to recreate smooth motion in the target format. It is cheaper to duplicate or drop frames when data underflows, or overflows, with predictably jarring results. When the frame rates are closest together, as in 60Hz to 59.94Hz conversion, the repetition rate is quite long, and the difficulty of doing a smooth temporal conversion is highest. When there is an integer relationship, as in 24 frame to 30 frame, the conversion is much more straightforward, and the number of frames needed to do a thoughtful interpolation is more restricted (actually 23.976 to 29.970 in real-world implementations, both being related to the integer rate by the vertical offset of 1/1.001).

In a production environment, it is often the case that aspect ratio is the most obvious conversion. Deciding how to handle the active picture content is not always straightforward. For instance, take the case of commercials

Increasingly, production personnel expect that any format can be converted to any other.

must do several functions, none of which is intrinsically simple. Converting picture formats, for instance 486x720 to 1920x1080, used to be the province of high-cost standards converters, especially when HDTV signals were involved. That is just the starting point. Color space conversion is

in a downconverted HDTV program. As long as the content is consistent, you could choose to either letter box or crop the sides. But if a commercial that came from a 4:3 source run in the HD program is presented in "pillar box" mode, the result of the downconversion and letter box would be a



London facility On Sight uses the Alchemist Platinum Ph.C from Snell & Wilcox for upconversion from SD to HD of general material for U.S. and UK consumption.

commercial that originally occupied 80 percent of the screen area as a pillar box, but only 45 percent when converted back to SDTV as a pillar box inside a letter box.

A second complication arises when a production is intended for "dual release," i.e. in both 16:9 and 4:3. For example, Hollywood for years has been shooting television content in 16:9 with 4:3 framing protected (technically 16:9 is "protected" when shooting 4:3). Now that a serious amount of sports content is being produced for dual release, it has become quite clear that graphics are a major challenge. When a lower third fits the 4:3 release, it often looks odd in 16:9 release. On the Super Bowl this year, FOX did an excellent job of finding acceptable compromises that left both releases of the program looking

normal, though 4:3 was obviously the target that was favored. Think about a replay transition; when the picture first hits the edge of the 16:9 frame and the audio effect is heard, it might be several frames before the 4:3 picture shows the transition, which might not be acceptable.

Cross-conversion between the two predominant HDTV formats entails several simultaneous conversions. 720p to 1080i, the most common conversion in at least some facilities, involves both progressive to interlace conversion as well as line and vertical formats, and frame rate as well. At least the color space and aspect ratios are the same! Making an interlace frame from a progressive is not hard, for the time samples exist on each line of each frame in the 60p source. Making interlace amounts to throwing away half of the lines in a simplistic view, and then rescaling the picture up to 1080 lines by 1920 samples. Going the other

way requires a de-interlacing step, which is not as friendly to the new format as information on successive fields were not sampled at the same time. The practical results achieved by modern hardware are quite acceptable going both directions.

At one time, when the P vs. I "battle" raged early in the HDTV transition, I was involved in a major effort in 720p which the producer had sold to NHK, decidedly in the 1080i opposite camp. Even then everyone was quite surprised that the end result was remarkable and quite acceptable to all. That same result is available in much cheaper hardware today.

Also remarkable is the variety of form factor that format conversion devices come in today. Some are plug-in options in videotape recorders. Others are several rack units and offer noise and grain reduction, and advanced temporal interpolation. Several manufacturers have created

single-board converters using integrated image scaling silicon, which has been on the market for several years.

Our industry has benefited from research and manufacturing done for the consumer electronics industry. Essentially, every HDTV consumer display, or at least set-top receiver, must be able to handle a variety of formats. To get the cost to acceptable levels, a great deal of research has been done, and the quality of products is remarkable. For the highest quality conversion, I am sure designers can still eek more performance out of more complex products, but as professionals we benefit from the economies of scale that consumer electronics bring to bear (again). **BE**

John Luff is senior vice president of business development at AZCAR.



Send questions and comments to:
john_luff@primediabusiness.com

TRUST



SUBSCRIBE

to the **Trusted Technology Leader**
and **Stay on Top of the Industry!**

For over 45 years, readers have learned to **TRUST**
Broadcast Engineering editors to bring them timely, reliable
and indispensable technical information.

You can **TRUST** *Broadcast Engineering* to deliver the best: It is ranked #1 most authoritative global source of technology information in the industry.*

Stay on top of the latest technology developments, new players, products & decision-makers.

SUBSCRIBE to *Broadcast Engineering*.

To start your **FREE** subscription, go to www.broadcastengineering.com
and click on **SUBSCRIBE NOW**.

*2003 Paramount Research Study



Celebrating 45 years
as the Technology Leader.

TRUSTED, Technology Industry Leader

MultiDyne makes big things happen.

MultiDyne video and fiber optic solutions have been used by the Networks to cover major events such as the National Political Conventions in 2004 to supporting our National Security with the Department of Defense.

Fiber Optics • Routing Switchers • Distribution Amplifiers • Test & ID Generators

For more information call 800-488-8378 or visit our website at www.multidyne.tv
Come see what's new at the NAB Show, C2850. Receive a FREE fiber cleaning kit.



NAB 2005 Booth C10120



BSG-50 \$289
Blackburst, Sync, & Audio Tone

★★★★★
“...Versatile and powerful performance.”

★★★★★
“...Just what you've come to expect from Horita.”

The **HORITA** BSG-50 takes center stage in the edit bay with multiple user-configurable outputs. Select from 6 blackburst, 4 sync, burst flag, and subcarrier *plus* audio tone.

Unconditionally Guaranteed!

HORITA
www.horita.com

(949)489-0240 horita@horita.com

TALLY MAPPER™

- ◆ Tally Routing & Mapping
- ◆ One Button Operation
- ◆ Store Maps Internally
- ◆ Edit From a PC/Laptop



A Compact Solution,
Ideal for Mobile Units and
Multiple Production Setups.

Videoframe™
Control System Solutions
Tel: 530-477-2000
www.videoframesystems.com

HD Encoding Workstation
Real-time, PC-based
High-resolution (1080i)



The HD Maestro

- Input HD-SDI, output DVB-ASI
- Based on the LSI Logic DoMiNo™ chipset
- Perfect for post production HD content distribution
- PC platform provides flexibility and connectivity

For more information on the HD Maestro or any DVEO products, call 858 613-1818. Or visit www.dveo.com

DVEO
Pro Broadcast Division
by **CMI**

NAB 2005 Booth SU 1119

BROADCAST VIDEO OVER IP

See us @ NAB 2005
Booth SL 3655

Streambox[®]
Power To Do More™

PROFESSIONAL QUALITY
ENCODERS FOR IP/T1/E1



ACT-L3 VIDEO TRANSPORT

Advanced Forward Error Correction
for wired/wireless/sat networks

HD Encoder
3Mbps - 9Mbps

SD Encoder
20Kbps - 7Mbps

ENG Portable Encoder
20Kbps - 7Mbps

Call or Visit Today! www.streambox.com • sales@streambox.com • 206/956-0544 x222

OTLighting
Tower Lighting Specialists
www.otlighting.com



OTL
EXTRA LONG LIFE
TOWERS LAMPS

**GUARANTEED
FOR
50,000 HOURS.**

**THE LAMPS
CAN SAVE YOU
THOUSANDS
OF DOLLARS.**

1-800-647-9110
43, Durkee Street, Office 719
Plattsburg, N.Y., 12901
Developed in conjunction with
OSRAM SYLVANIA

AP41-VP

TBC/Frame Synchronizer

The best filter is no digital comb filter
No vertical resolution loss
ideal for satellite feed

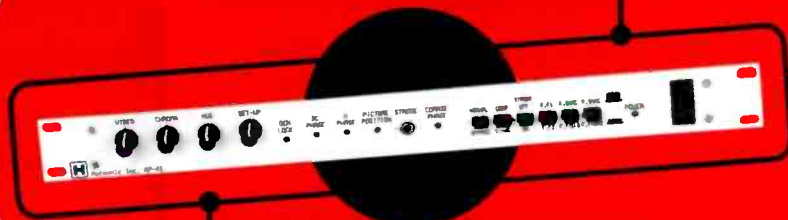

Automatically detects stable
NTSC signal or signal with
time base error

HOTRONIC, INC.

1875 S. Winchester Blvd. Campbell • California 95008 U.S.A.
Tel: 408-378-3883 • Fax: 408-378-3888
Website: www.hottronics.com • Email: sales@hottronics.com



BROADCASTENGINEERING.COM

You'll find everything you need to know about advertising in 2005!

**Don't Gamble with Your Signal
Improve Your Odds with The ERI
Advantage!**

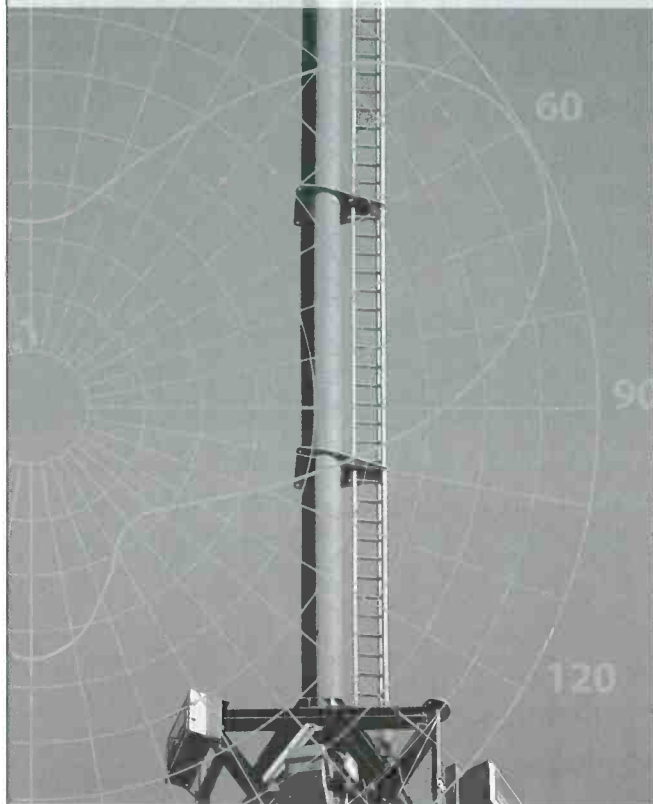

Choosing ERI with our dedication to **Quality** and **Innovation** coupled with the **Synergy** achieved through a complete ERI broadcast system gives you **The ERI Advantage**.

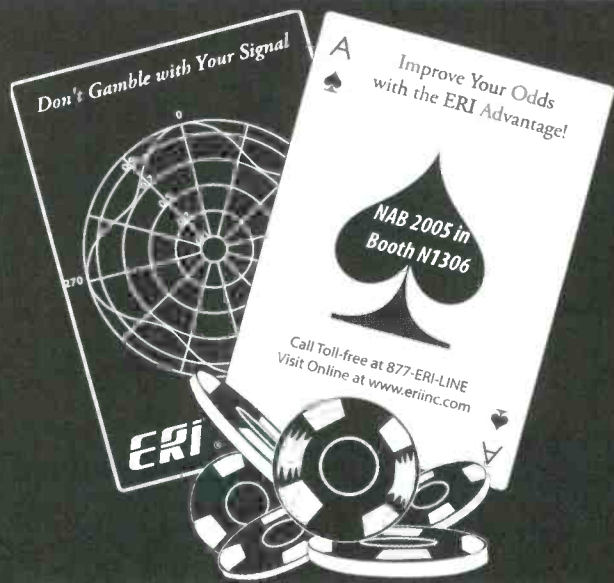

ELECTRONICS RESEARCH, INC. ERI®
Your Single Source for Broadcast Solutions™

The world's largest full-service
USED & NEW
pro video and audio
dealer on the planet!
LOGIN NOW
and start saving today!

**5% to 50%
DISCOUNTS!**

BROADCASTSTORE.COM
LA 818-551-5858 • NY 212-268-8800
See us at **NAB 2005** Booth #SU6358

Advertise in



Broadcast Engineering



...it just makes **cents!**

For more information, please contact:

Susan Schaefer

Galler / Classified Sales

p: 484.478.0154

f: 913.514.6417

sschaefer@primediabusiness.com

Tests & Measurement

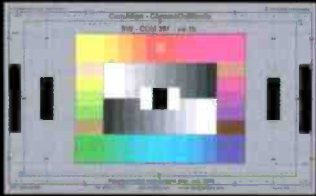

**Precision charts
the industry trusts**

From **DSC** Labs

For HD, SD and digital cinema

See tech reports, papers
and user info at:

www.dsclabs.com

'Better images through research' - since 1962

Career

Where can I find... **a new job?**
an engineer?

SBE **RESUME**Bank
JobsONLINE
www.sbc.org • (317) 846-9000

Business for Sale

Uplink Truck Operator

Must have experience in C/band and Ku/band operation, CDL class B or higher required. Operator will have access to highest pay and best equipment in the business.

Please send resumes to:

Confidential

**Classified Production Coordinator
Broadcast Engineering
Dept. 115
9800 Metcalf Avenue
Overland Park, KS 66212.2215**

Help Wanted

Maintenance Technician - Upstate New York affiliate is looking for Television Maintenance Technician to work in our recently completed digital facility. Applicant needs two years prior broadcast maintenance experience or equivalent experience in a related Industry. A background working within a strong news environment including repair of ENG equipment and computer or IT experience is a plus. Self motivated, detail oriented with good communication and people skills. Candidate needs a positive attitude and willingness to get the job done. We offer a competitive compensation and benefits package. Send resumes to: WTEN. c/o Human Resources Dept, 341 Northern Blvd, Albany NY 12204 or Skeeter.Lansing@wten.com No phone calls please. EOE.

Help Wanted



TURNER STUDIOS

TURNER STUDIOS is the full service broadcast and post production division of Turner Entertainment Group, providing turnkey services for film, video and audio production. Turner Studios provides facilities and resources for all of the Turner Entertainment Networks worldwide from our state-of-the-art television complex in Atlanta Georgia.

We are seeking motivated, experienced, client-oriented Engineering professionals to join our expanding team. If your passion is cutting edge technology in a creative, fast-moving environment, Turner Studios Engineering is looking for you!

We're currently accepting resumes for:

ENGINEERING MANAGERS

Design, budget, plan, implement, support, project and personnel management
Data Systems - Digital Media, Render, Storage, Security, Server systems.
Projects - Live, Studio and Post Production systems, SD & HD

ENGINEERS IN CHARGE

Lead engineers in fast paced event environment
Studio - Live and Taped Event Engineering
Remote - EIC / Maintenance - HD Mobile units

PRODUCTION ENGINEERS

Design, install and maintain SD/HD production and post facilities

- Studio
- Audio
- Editorial
- Effects
- IT / Network

Workstation, application, OS, server support / MSCE, Cisco, Linux, SGI

Help Wanted

Please send resumes to:

Jeff Sharpe

Director of Engineering

Fax - 404-878-4014

Email - jeff.sharpe@turner.com

For more information,
please visit:

<http://www.turnerstudios.com>

<http://www.turnerjobs.com>

ARBITRON is a leading marketing research and information services company providing solutions that will shape the future of the broadcasting industry. Our organization is constantly growing and changing to meet the needs of the media industry, and are always on the lookout for talented individuals like you to join our team. We are looking for a Senior Broadcast Engineer, to join our Encoding Operations team in Columbia, MD.

**FORTUNE®
100 BEST
COMPANIES
TO WORK FOR 2005**

The **Sr. Broadcast Engineer** will be responsible primarily for the installation and maintenance of Encoding equipment in Network Television locations, commercial production facilities, retail outlets, sporting venues, and other non-standard encoding applications. The applicant should have significant experience in a broadcast environment and will ideally have direct working knowledge of network operations facilities as well as personal contacts at the same.

Ideal candidate should have working technical knowledge of broadcast audio/video equipment, connections, and related environments, ideally at the network level. Five years technical experience in a broadcast environment. Three years experience managing projects with demonstrated ability to deliver on time.

Arbitron offers a comprehensive employment package, including competitive compensation, excellent dental, medical and vision care plans, 401(k) matching, tuition assistance, stock purchase and a series of work/family resources.

Recently named in the **FORTUNE** magazine as "100 Best Companies To WORK For in 2005"
Check us out at www.arbitron.com

Send resumes to: opsjobs@arbitron.com

OE Recruiter, Arbitron

9705 Patuxent Woods Drive

Columbia, MD 21046

Fax: 410-312-8607



BROADCAST CHIEF ENGINEER - Univision 41/San Antonio is seeking a Chief Engineer with 3-5 years exp. in Engineering field, preferably bilingual (Eng/Sp). Candidate must have a good track record as a proven project manager, staff developer & administrator, & must be computer literate. Experience in all areas of TV broadcast maintenance, including UHF transmitters, ENG systems, studio equipment, and FCC Rules & Regulations. Please reference KWEX 05-03 and submit resume to: ENG0503@univision.net

Broadcast Engineering

To advertise in the BE Classifieds contact:

SUSAN SCHAEFER

p: 484.478.0154

f: 913.514.6417

sschaefer@primediabusiness.com

Help Wanted



NEW ENGLAND CABLE NEWS

TV MAINTENANCE ENGINEER

New England Cable News (NECN) is America's largest regional news channel, serving more than 3.2 million households from its network facilities in Newton, MA. NECN seeks a full time Maintenance Engineer to join our expanded team. Qualified candidates must have 3 to 5 years electronic maintenance experience in a cable or broadcast operation and the ability to perform component-level repair on a variety of production equipment. The ideal candidate will have factory training and/or previous experience with Thomson-Grass Valley networked production technologies, Pinnacle and Chyron products, WideOrbitSundance/Seachange master control, Sony BetaSP, Blue Laser XD and Panasonic DVC Pro. SBE, technical degree or military training required. Significant installation/project and IT experience desired. Hourly, excellent benefits, shift work including evenings and weekends required. EOE

Please, no calls. Send resume w/cover letter to:

techjobs@necn.com,
or mail to:

David Beauvais
Director of Operations
NECN
160 Wells Ave.
Newton, MA 02459

Broadcast Engineers - Nationwide Opportunities

Qualifications: A minimum of 2 years of broadcast engineering experience including troubleshooting, maintenance, and repair of satellite, TV studio systems. A four year technical degree, preferably electronics (or equivalent education/experience/training). Strong computer networking skills a plus.

Duties: Perform installation, maintenance, and repair of sophisticated digital, audio, and video broadcast and television

Email: resumetocareers@etalentstaffing.com or fax to 678-476-9583.

Help Wanted

Technicolor Vancouver, a television post production facility, has an opening for a Chief Engineer. Reporting to the VP of Vancouver Operations, the Chief Engineer is responsible for the installation and maintenance of all Operation, Production and Support Equipment. The ideal candidate will have a minimum of ten years experience in the television post production industry, at least five of which are in a managerial or supervisory position. Also, extensive knowledge of Telecines and videotape equipment (all formats) as well as MPEG and New Media applications are critical. The Chief Engineer will also provide education to other Engineers in the department. To apply, please e-mail humanresources@compt.com. No phone call please.

ARE YOU THE BEST AUDIO PRODUCER YOU KNOW? Are you excellent at ProTools? Do you know the difference between good enough and GREAT! Well if so, send us an MP3 of your demo! Come join the fastest growing production studio in America. With locations in Memphis, Las Vegas, Virginia Beach/Norfolk and more opening this year...we need more great producers like you. So send us your demo, what have you got to lose besides a brilliant career in audio production? Send an MP3 of your production demo, a resume and cover letter to: WilliamPrettyman@staudiocenter.com

Help Wanted

ENGINEERING MANAGER (Washington DC) TV - WTTG/FOX5 & WDCA/UPN24 seek an experienced hands-on technical manager to assist the VP Engineering with overseeing the day-to-day technical operations of this fast-paced duopoly, news station. Requires minimum 6 years experience providing Engineering and IT support to broadcast News and Master Control / On-Air operations at a major market television station. Managerial responsibilities include employee supervision. Must be knowledgeable in complex digital video, digital audio and LAN systems, with proven ability to quickly and accurately diagnose and resolve problems. Must be knowledgeable in users' workflow requirements and provide training on new systems. Requires excellent communication skills. Must be able to effectively work with others in challenging situations. Strong background in video, audio, RF and IT components and systems. Project management experience required. Experience working with collective bargaining agreements in a union represented facility preferred.

For consideration, please forward resume and letter of interest to: Mary Talley, Regional VP/Human Resources, FOX 5/WTTG · DC/FOX Television Stations, Inc., 5151 Wisconsin Avenue, NW, Washington, D.C. 20016. Fax: 202-895-3286 email: wttg-hr@foxtv.com Web site: www.fox5dc.com EOE/M/F/D/V.

For Sale

For Sale

SKYLINE BROADCAST
QUALITY REFURBISHED BROADCAST EQUIPMENT

• BUY
• SELL
• TRADE

CALL: 866-804-1184 FAX: 866-804-1179
www.SkylineBroadcast.com

Help Wanted

WMAR-TV, Baltimore has an immediate opening for an Assistant Chief Engineer. The Assistant Chief Engineer will assist the Director of Engineer in planning and executing capital projects.

The successful candidate must have a minimum of 5 – 10 years in the broadcast field in an engineering supervisory capacity as well as:

- Strong knowledge in broadcast engineering including newer digital technologies; computer and IT skills are highly desirable.
- Strong supervisory skills and the ability to motivate and supervise the operations and maintenance staff.
- Proven ability to thrive in a fast paced broadcast news environment, demonstrating strong technical, management skills with the ability to diagnose and resolve technical problems.
- Knowledgeable of FCC rules and regulations.
- Familiarity with Sabanes-Oxley IT Compliances is a plus.
- SBE certification is desirable.

The E.W. Scripps Company, a diversified media concern with interests in newspaper publishing, broadcast television, national television networks, interactive media and television retailing, is an equal opportunity employer and a drug-free workplace. Send resumes to WMAR-TV Human Resources 6400 York Rd Baltimore Md 21212.

Broadcast/Audiovisual Systems Design Engineer: Atlanta, GA based systems integration firm is looking for an individual with 5+ years experience in systems design and engineering who possesses a mastery of teleproduction, broadcast and presentation systems principles. A background and understanding of installation/integration processes is also useful. Candidates must be able to assess system functionality goals and create solutions, system documentation and job costing. Excellent written and verbal communication skills, as well as proficiency with AutoCAD are required. Interested candidates please email resume to jobs@ctgatlanta.com. EOE.

For Sale



AcousticsFirst
Toll-Free Number: **888-765-2900**

Full product line for sound control and noise elimination.

Web: <http://www.acousticsfirst.com>

For Sale

For Sale

HI DEF @ AFFORDABLE PRICE!

Precise image acquisition
Superb detail
Comprehensive functionality



The
NEW

SONY
HVR-Z1U
1080i HDV
CAMCORDER

WEST COAST LEADER
IN BROADCAST AND INDUSTRIAL
PRODUCTION PACKAGES

Studio Exchange



Authorized
Professional
Reseller

818.840.1351
studio-exchange.com

816 N. Victory Blvd. Burbank, CA 91502

Employment

EMPLOYERS / EMPLOYEES



Click On No. 1 Staffing & Job Service:
www.KeystoneAmerica.com

TECHNICAL ENGINEERING SALES/MGMT VPGM

VIEW OR POST JOBS - FREE

BROADCASTENGINEERING.COM

The digital landscape is changing.

Stay informed.



Get the information you need to make informed decisions. Broadcast Engineering. The must-read publication of digital television. Visit our Web site today for a free subscription.

www.broadcastengineering.com

BroadcastEngineering

Ad Index

Broadcast Engineering is not responsible for errors in the Advertisers Index.

	Page #	Advertiser Hotline	Web site Address
Abel Cine Tech / Panther Broadcast	175	888-223-1599	abelcine.com
Accom Inc.	17		accom.com
Acterna	217		acterna.com/nabdts
ADC Telecommunications Inc.	131	800-366-3891	adc.com/broadcast
Ai	225	410-568-2105	acrodyne.com
Ai-Pixel B.V.	145	+31 (0) 23 554-3564	ai-pixel.com/nab2005
AJA Video	227	530-274-2048	aja.com
Anton/Bauer	149, Map 6, 7	203-929-1100	antonbauer.com
Anystream	211	888-anystream	anystream.com
Ascent Media Network Service	45	201-767-1200	ascentmedia.com/systems
Avid Technology	4-5		avid.com/broadcast
Axcera	191	724-873-8100	axcera.com
Azden	85	516-328-7500	azdencorp.com
Barco Projection Systems Inc.	103	770-218-3200	barcocontrolrooms.com
Belden	89	800-belden4	belden.com/tb65.pdf
Broadcast Microwave Services	78	800-669-9667	bms-inc.com
Calrec Audio Ltd.	55	+44 1422 842159	calrec.com
Canare Cable Inc.	183	818-365-2446	canare.com
Canon USA Inc.	60-61		canonndv.com
Canon USA Broadcast Lens	19	800-321-hdvt	canonbroadcast.com
Canopus Corporation	203	888-889-edit	canopus.com
Chyron Corporation	16		chyron.com
Clear-Com Communication Systems	33	510-496-6666	clearcom.com
CPI/Eimac Division	195	650-592-1221	eimac.com
Crispin Corporation	155	919-845-7744	crispincorp.com
DELEC Audio und Videotechnik GmbH	247	+49 9545 440-0	delec.de
Dielectric	133	866-dielectric	dielectric.com
DK Audio	42		dk-technologies.com
DMT USA	65	856-423-0010	dmtonline.usa
Dolby Laboratories Inc.	15		dolby.com/events/nab
Doremi Labs Inc.	53	818-562-1101	doremilabs.com
Eartec - Porta Phone	249	800-399-5994	
Echolab	31		echolab.com/identity4
Ensemble Designs	153, Map 12, 13	530-478-1830	ensembledesigns.com
ERG Ventures Co. Ltd.	79	949-263-1630	erg-ventures.com
ESE	143	310-322-2136	ese-web.com
Euphonix	161-164		euphonix.com
Evertz Microsystems Ltd.	252-256	905-335-3700	evertz.com
E2V Technologies	177	800-342-5338	comms.e2v.com
Fischer Connectors	215	800-551-0121	fischerconnectors.com
Fission Software Inc.	36	888-644-8766	fission-sw.com
Florical Systems Inc.	209	352-372-8326	florical.com
Fluke Corporation / Pomona Electronics	28	800-490-2361	pomonaelectronics.com/sample
For-A Corporation of America	141	+81 (0)3-3446-3936	for-a.com
Forecast Consoles Inc.	259	800-735-2070	forecast-consoles.com
Fortel DTV	Map 9	770-806-0234	forteldtv.com
Fujinon Inc.	157	973-633-5600	fujinon.com
GEPCO	239	800-966-0069	gepco.com
Hamlet Video International Ltd.	54	866-4-hamlet	hamlet.co.uk
Harris Corp./Broadcast Div.	3, Map 1	408-990-8200	broadcast.harris.com/automation
IBC	187	+44 (0)20 7611 7500	ibc.org
ICF - Interactive Content Factory	237		icf.tv
IDX Systems Technology	Map 18, 19		idx.tv
Ikegami Electronics Inc.	35, 81	201-368-9171	ikegami.com
Inscriber Technology	101	1-519-570-9111	inscriber.com
Kino Flo Inc.	201	818-767-6528	kinoflo.com
K-WILL Corporation	243	949-553-9701	kwillcorporation.com
Laird Telemedia	197		lairdtelemedia.com
LAWO AG	199	+49 7222 1002-0	lawo.de
Lectrosonics	Map 4		
Leitch	BC, 27	800-231-9673	leitch.com/x75

	Page #	Advertiser Hotline	Web site Address
Leitch	75, Map 8, 273-347	800-231-9673	leitch.com
Marshall Electronics Inc.	52	800-800-6608	lcdracks.com
Maxell Corp. of America	9	800-533-2836	maxell.com
MicroFirst Inc.	241		microfirst.com
Microwave Radio Communications	93	978-671-5700	mrcbroadcast.com
Middle Atlantic Products Inc.	95	800-266-7225	middleatlantic.com
Miranda Technologies Inc.	11	514-333-1772	miranda.com/xvp
MITEQ	229	630-759-9500	mcl.com
Modulation Sciences	167	800-826-2603	modsci.com
MYAT Inc.	223	201-767-5380	myat.com
National Association of Broadcasters	104		nabshow.com
National Cable & Telecomm. Assoc.	258		thenationalshow.com
Network Electronics	32	800-420-5909	network-electronics.com
Nextel	43		2ghzrelocation.com
Nucomm Inc.	219	800-968-2666	nucomm.com
NVision Inc.	44, Map 11		nvision.tv
Omneon Video Networks	24		omneon.com
On-Air Systems Ltd.	245	+44 20 7668 3671	on-air-systems.com
Opticomm Corporation	77	800-867-8426	opticomm.com
PAG Ltd.	Map 1		
Panasonic Broadcast	7		panasonic.com/nab
PESA Switching Systems	91	800-328-1008	pesa.com
Prime Image Inc.	23	408-867-6519	primeimageinc.com
Pro-Bel	189	631-549-5159	pro-bel.com
Professional Communications Systems	42	800-447-4714	pcomsys.com
QTV	205	203-406-1400	qtv.com
Quantel Ltd.	26		quantel.com
Quartz USA	50, Map 4	888-638-8745	quartzus.com
Radyne	59	602-437-9620	radn.com
Riedel Communications Inc.	233	818-563-4100	riedel.net
Rohde & Schwarz	185	888-837-8772	rohde-schwarz.com/usa
Ross Video Ltd.	207	613-652-4886	rossvideo.com
Sachtler Corporation of America	29	516-867-4900	sachtler.com
Salzbrenner Stagetec Media	25		stagetec.com
S.A.V.	135, Map 20		sav.tv
Scopus Network Technologies	51		scopusamericas.com
Screen Service Italia	99	+39 030 3582225	screen.it
Sencore	221	800-736-2673	sencore.com
SES Americom	173	800-732-3273	ses-americom.com
Snell & Wilcox Ltd.	67-72		snellwilcox.com
Solid State Logic Ltd.	83	+44 (0)1865 842300	ssl-broadcast.com
Sony Business Systems	46-47	800-686-7669	sony.com/xdcam
Sony Pictures Digital Media	179	800-577-6642	sony.com/mediasoftware
Sundance Digital	171	972-444-8442	sundancedigital.com
Systems Wireless	169	800-542-3332	hmeopro850.com
TBC Consoles Inc.	193		tbconsoles.com
Telecast Fiber Systems Inc.	181	508-754-4858	telecast-fiber.com
Telemetrics Inc.	159		telemetricsinc.com
Terayon Communications	21, Map 23		terayon.com
Thales	137		thales-bm.com
Thales Angenieux	63	973-812-3858	angenieux.com
Thomson/Grass Valley	13, Map 10, 24		thomsongrassvalley.com/kayak
Utah Scientific	151, Map 4, 5		utahscientific.com
VertigoXmedia	231	877-4-VERTIGO	vertigoxmedia.com
Video Technics	213	404-327-8300	videotechnics.com
Videotek Inc.	37, 97	800-800-5719	videotek.com
Videssence	Map 2	626-579-0943	videssence.tv
Vqual Ltd.	139	+44(0)117 3101 244	vqual.com
Wheatstone Corporation	IFC	252-638-7000	wheatstone.com
Zandar Technologies	235	321-939-0457	zandar.com
360 Systems	41	818-991-0360	360systems.com

US/CANADA

WEST

George Watts III
(360) 546-0379; Fax: (360) 546-0388
georgeww3@aol.com

EAST

Josh Gordon
(718) 802-0488; Fax: (718) 522-4751
jgordon5@bellatlantic.net

EAST/MIDWEST

Joanne Melton
(212) 462-3344; Fax: (913) 514-9249
jmelton@primediabusiness.com

INTERNATIONAL

EUROPE

Richard Woolley
+44-1295-278-407
Fax: +44-1295-278-408
richardwoolley@btclick.com

EUROPE

Tony Chapman
+44-1635-578-874
Fax: +44-1635-578-874
ARCintect@aol.com

ISRAEL

Asa Talbar
Talbar Media
+972-3-5629565; Fax: +972-3-5629567
talbar@inter.net.il

JAPAN

Mashy Yoshikawa
Orient Echo, Inc.
+81-3-3235-5961; Fax: +81-3-3235-5852
mashy@ta2.so-net.ne.jp

CLASSIFIED ADVERTISING

Susan Schaefer
(484) 478-0154
Fax: (913) 514-6417
sschaefer@primediabusiness.com

REPRINTS

FosteReprints
(866) 436-8366;
International inquiries, (219) 879-8366

LIST RENTAL SERVICES

Marie Briganti, Statistics
(203) 778-8700 x146
(203) 778 4839
primedia@statistics.com

Customer Service:
913-967-1707 or 800-441-0294

BROADCAST ENGINEERING & World Edition
March, 2005, Vol. 47, No 3 (ISSN 0007-1994) is published monthly and mailed free to qualified persons by Primedia Business, 9800 Metcalf Ave., Overland Park, KS 66212-2216. Periodicals postage paid at Shawnee Mission, KS, and additional mailing offices. Canadian Post Publications Mail Agreement No. 46597023. Canada return address: DHL Global Mail, 7496 Bath Road, Unit 2, Mississauga, ON L4T 1L2. POSTMASTER: Send address changes to *Broadcast Engineering*, P.O. Box 2100, Skokie, IL 60076-7800 USA. CORRESPONDENCE: Editorial and Advertising: 9800 Metcalf, Overland Park, KS 66212-2216 Phone: 913-341-1300; Edit. fax: 913-967-1905. Advert. fax: 913-967-1904. © 2005 by Primedia Business. All rights reserved.

Confusing the customer

BY PAUL MCGOLDRICK

We have been subjected to some really strange numbers when it comes to the delivery of DTV and HDTV systems. A bunch of those reporting, including research groups and analysts, cannot get it right. There seems to be a universal agreement that about 4 million DTV "units" were delivered in 2003, and an estimated 7 million in 2004, but there is a universal disagreement about what proportion of those numbers were actually HDTV deliveries. It is also exceptionally common for customers to *believe* that they have HDTV capabilities.

Are most of the problems created by retailers who do not seem to know what they are selling? Or, are the retailers deliberately manipulative in training their staff badly? It seems hard to believe, but some of the retail speak is so "cunning" (in "Much Ado About Nothing" terms) that even I don't understand it.

Take a recent ad from my state newspaper. It first advertises a "Mitsubishi 42in Tabletop Rear Projection HDTV* with AMVP Image Enhancer & Full A/V Connections." The asterisk refers to the small print at the bottom of the full-page ad, which I have difficulty reading even with my glasses. It says, "ALL HD READY TVs require external HDTV receiver/decoder to process HDTV signals."

Where does one begin to try and understand that? First of all, what the heck is an AMVP Image Enhancer? And what does "Full A/V Connections" mean? Are component video capabilities included? And, of course, the "HDTV*" isn't actually an HDTV receiver because it needs an "external receiver/decoder." Well, well, and I would have thought it might need an

HDTV tuner or STB because the picture flags an "HDTV Ready" sign.

Not to be outdone in the acronym department, the next item advertised is a "JVC 52in Microdisplay HDTV* with D-ILA & Four-Point Color Management Technology for True-to-

Life Images." "Microdisplay" obviously doesn't refer to the picture's diagonal size! "D-ILA" and "Four-Point Color Management Technology" leave me completely defocused. And, that nasty asterisk has snuck in there again.

Keeping up with its fellow Japanese products — and I cannot imagine that this stuff originates from any of the vendors themselves — last advertised is a "Sony 42in Plasma WEGA HDTV* with Built-In TV Tuner, Audio Amplifier & Stereo Speakers." Wow, that's almost understandable. Now, I know what the WEGA engine is all about; but how many consumers will have any kind of clue? And, of course, although the "receiver" has a tuner, it's not an HDTV tuner — that darned asterisk again.

The confusion created by advertising like this is just one example of what retailers are doing. The rules on having an "ATSC tuner" built-in to monitors to make them DTV receivers has only confused the situation more.

ATSC reported last year that there were 575 models of HDTV monitors available on the market and 106 with integrated HDTV capabilities. Where are they, and why do you never see them advertised?

An apparently cooperative "tip sheet"

for consumers has been produced by the FCC, the Consumer Electronics Association (CEA) and the Consumer Electronics Retailers Association (CERC) and is available at www.ce.org/shared_files/resources/DTV_Tip_Sheet.pdf. It intends to reduce the



It seems hard to believe, but some of the retail speak is so "cunning" (in "Much Ado About Nothing" terms) that even I don't understand it.

confusion out there and spells out very clearly that "a component solution includes a DTV monitor (screen) without a DTV tuner (these monitors are sometimes labeled 'HD Ready.')" Apart from arguing about the "sometimes," what makes not having a DTV tuner "HD Ready?" Similarly, we have the wonderfully helpful definition of "Integrated HDTV: An HDTV that has the digital tuner built into the set. It does not need a separate set-top box to receive over-the-air DTV signals."

So, research says there will be 47 million DTV units in use by 2007 and 37 million in service by 2008. The numbers don't seem important when you have no definition of what kind of "units" we are actually talking about. It's not just the consumers who are confused; it's me too. **BE**

Paul McGoldrick is an industry consultant based on the West Coast.



Send questions and comments to:
paul_mcgoldrick@primediabusiness.com

ATTENTION READERS!
Sign up now for
Broadcast Engineering's
e-newsletter
BEYOND
the headlines
at www.broadcastengineering.com

[King of Processors]

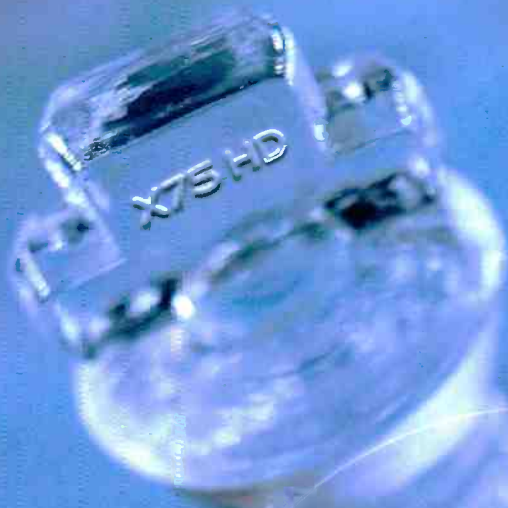

X75™ HD

Up/Down/Cross Converter,
Synchronizer...and More



Standard Definition

Embedded Audio

Fiber Interface

Analog

Web Server

NTSC/PAL-M/PAL/SECAM

Dolby®E/AC-3 de-compression

Synchronization

Processing Amplifiers

Up/Down/Cross Conversion

Aspect Ratio Conversion

Metadata Transparency

Noise Reduction

Logos

High Definition

Mult-Channel Audio

AES/EBU

Digital

DVI-D and DV

Streaming

1080i/720p

Production/Editing

News

Broadcast

Mobile

Satellite

X75 HD



King of Processors

SHIPPING NOW!

Up/Down/Cross Conversion with Synchronization Starts With extra Processing Power

The X75 HD expands video processing to include "anything in" to "everything out" and simultaneous up and down conversions. Aspect ratio conversion, 3D adaptive decoding, TBC, SD/HD logos and noise reduction are all part of the vast array of X75 HD capabilities.

For surround sound applications, 16 channels of audio processing with embedded SD/HD, analog and digital interfaces are provided. Integrated Dolby® de-compression and voice-over brings even more functionality.

- Less equipment required for your SDTV and HDTV video processing applications
- Multiple paths of processing for video and audio
- IP-enabled for control, monitoring and streaming including SNMP

Master Your Move to HD with the X75 HD

www.leitch.com/X75

Canada	+1 (800) 387 0233
USA	+1 (800) 231 9673
Europe	+44 (0) 1344 446000
France	+33 (0) 1 42 87 09 09
Italy	+39 02 3655 3450
Hong Kong	+852 2776 0628
China	+86 10 6808 6301
Japan	+81 (3) 5423 3632



www.leitch.com

We Have You Covered

Whether you are designing and implementing a complete, new master control facility or starting out with a small HDTV island within your existing SDI facility, Leitch has the products to meet your HDTV applications needs.

EDITING

[VelocityHD[™]] [NewsFlash[™]] [TitleMotion[™]]

SMALL AND LARGE ROUTING

[Panacea[™]] [Integrator[™] Gold]

SIGNAL PROCESSING (interface and conversion)

[NEO[™]] [6800+] [X75[™]] [Digital Legalizers]

MASTER CONTROL

[Opus[™] HD] [DTP] [Inca Station[™] / Inca Auto CG]

BRANDING

[Inca Station[™] / Inca CG] [DTP] [LogoMotion[™] II] [6800+]

STORAGE AND TRANSMISSION

[NEXIO[™]] [DTP] [Digital Demodulator]

SIGNAL MANAGEMENT

[VTM] [TVM] [SuiteView[™]]

DIGITAL SIGNAGE

[InfoCaster[™]]



Product	Description	Page	Product	Description	Page
HDTV Products					
HSD6800+, HSE6800+	HDTV, ASI, SDI Distribution Amplifier; HDTV, ASI, SDI Redocking Distribution Amplifier	5	MXA-3901H-B4, C4 DMX-3901H-B4, C4	HDTV 4 AES Audio Multiplexer HDTV 4 AES Audio Demultiplexer	36 36
HOS6800+ OHS6800+ HFS6800+ HUC6800+ HDC6800+ HMX6800+B2, +C2, +B4, +C4 HDX6800+B2, +C2, +B4, +C4 HSE-3901 VFS-3901H XHD-3902-U XHD-3902-D XHD-3902-C HRC-3902 HUC-3901 HDC-3901, HDC-3901-AD MXA-3901H-B4, C4 DMX-3901H-B4, C4 AS-3901-B, C, AD, DA, DA-600	HDTV to Single-mode Optical Converter Single-mode Optical to HDTV Converter HDTV Frame Synchronizer/Processor HDTV Up Converter HDTV Down Converter HDTV AES Audio Multiplexers HDTV AES Audio Demultiplexer HDTV and SDI Redocking Distribution Amplifier HDTV Video Frame Synchronizer/Processor HDTV Upconverter with Audio Processing HDTV Downconverter with Audio Processing HDTV Crossconverter with Audio Processing HDTV Aspect Ratio Converter HDTV Upconverter HDTV Downconverter, HDTV Downconverter with Demultiplexer HDTV 4 AES Audio Multiplexer HDTV 4 AES Audio Demultiplexer 2 AES Audio Synchronizer/Delay/Processor, 4-Channel Analog/ 2-Channel AES Audio Synchronizer/Delay/Processor	5 6 6 7 7 8 8 32 32 33 33 34 34 35 35 36 36 37	MXA-3901-A,B,C MXA-3901-B4,C4 MSA-3901-A,B,C, B4,C4 DMX-3901-A,B,C DMX-3901-B4,C4 DSA-3901-A	4-Channel Analog or 2 AES Digital Audio to SDI Multiplexer 4 AES Audio to SDI Multiplexer Audio Synchronizer/Delay Processor & Multiplexer SDI Demultiplexer to 4 Analog or 2 AES Audio SDI Demultiplexer to 4 AES Audio Analog Audio Synchronizer Delay Processor & Demultiplexer	52 52 53 53 54 54
Advanced Applications					
NSV-xxxx MGI-3901-H MTG-3901 ACO-3901 TSG-3901	NEC SuiteView Multi-Source Display Processor HDTV LogoMotion II Master Timing Generator Automatic Changeover Module Test Signal Generator	37 38 38 39 39	DVR-3901 MGI-3901, MGI-3901-H NSV-xxxx CSD-3902 GPS-3902 IRB-3901 GPI-3901 MTG-3901 ACO-3901 TSG-3901 ARC-3901	Digital Video Recorder SDI LogoMotion II, HDTV LogoMotion II NEC SuiteView Multi-Source Display Processor Master Clock Driver GPS Receiver and Antenna IRIG-B to/from SMPTE / EBU Timecode Converter GPI and Marker Beep Module Master Timing Generator Automatic Changeover Module Test Signal Generator Aspect Ratio Converter	40 40 37, 61, 62 41 41 42 42 38 39 39 50
Switching Products					
YSR-4041 VTS-6801 NSM-8x1SHD, NSM-7x2SHD NSM-8x1V, NSM-7x2V NSM-8x1AES-B,C, NSM-7x2AES-B,C NSM-8x1-A2	SDI 4x1 Switch Video Timer Switch HDTV and SDI Video Switches Composite Video Switches AES Audio Switches 2-Channel Analog Audio Switches	29 30 55 55 56 56			
Distribution Amplifiers					
HDC6800+ HSD6800+, HSE6800+ YSM6800+ VFM6800+ VAM6800+ VSD6800+ VSE6800+ VSI6800+ VDA6800+ VEA6800+ VRG6800+ YCA6800+ VPD-6830 VMS-6800 ARG6800+ AES6800+B, +C HDC-3901, HDC-3901-AD YSM-3901 VSE-3901 VEA-3901 ADA-3981-66, 600 AES-3981	HDTV Down Converter HDTV, ASI, SDI Distribution Amplifier; HDTV, ASI, SDI Redocking Distribution Amplifier SDI Monitoring Distribution Amplifier SDI Triple Monitoring Distribution Amplifier SDI Video & Analog Audio Monitoring Distribution Amplifier SDI Video Distribution Amplifier SDI Video Equalizing Distribution Amplifier SDI/ASI Equalizing Redocking Distribution Amplifier Composite Video Distribution Amplifier Composite Video Equalizing Distribution Amplifier Composite Video Remote Gain Distribution Amplifier Composite Video Equalizing and Clamping Distribution Amplifier Composite Video Programmable Distribution Amplifier Universal SDI Encoder/Distribution Amplifier Analog Audio Remote Gain Distribution Amplifier AES Audio Distribution Amplifier HDTV Downconverter, HDTV Downconverter with Demultiplexer SDI Monitoring Distribution Amplifier SDI and ASI Redocking Distribution Amplifier Composite Video Equalizing Distribution Amplifier Analog Audio Distribution Amplifier AES Audio Distribution Amplifier	7 5 19 20 20 21 21 22 23 23 24 24 24 24 24 24 25 25 35 57 57 58 59			
Fiber Optics					
HOS6800+ OHS6800+ SOS6800+, SOM6800+ OSS6800+, OSM6800+	HDTV to Single-Mode Optical Converter Single-mode Optical to HDTV Converter SDI to Single-Mode & SDI to Multi-Mode Optical Converters Single-Mode Optical & Multi-Mode Optical to SDI Converters	5 6 26 26			
Logo Generator, Keying, Flash Slide					
LGI-6801 DSK-6801, DSK-6803 VES-6801, VES-6801-2 MGI-3901, MGI-3901-H	SDI Logo Generator/Inserter SDI Downstream Keyers SDI Video Slide Generators SDI LogoMotion II, HDTV LogoMotion II	27 27 28 39, 40			
Reference, Test Signal Generator					
YIG-6801-1 DAR-6880 CSD-3902 GPS-3902 IRB-3901 GPI-3901 MTG-3901 ACO-3901 TSG-3901	SDI Test Signal Generator AES Audio Reference And Test Generator Master Clock Driver GPS Receiver and Antenna IRIG-B to/from SMPTE / EBU Timecode Converter GPI and Marker Beep Module Master Timing Generator Automatic Changeover Module Test Signal Generator	28 29 41 41 42 42 38 39 39			
Frames					
FR6802+ FR-6801-1 ICF6800+ FR-3923 FR-3901	6800 + 2RU frame 6800 1RU frame CCS Ethernet Communications Card 3RU NEO Frame 1RU NEO Frame	3 4 30 31 31			
Infrastructure & Transmission					
ICE Opus NEO SuiteView Distribution Amplifiers Panacea Integrator / Integrator Gold CCS CCS Navigator X75	Integrated Content Environment Master Control Multi-Source Display Processor Video, Audio D/A's Small Routers Mid-Sized Routers Command Control System Graphical User Interface System Software HDTV / SDI Frame Synchronizer	1 60 61, 62 63, 64 65 66 67 68 69, 70			
Decoder/Synchronizers and A to D converters					
DES6800+, DES6800+ ADV6800+ ADC-6801 DEC-3902 DES-3902 DES-3901-S DNS-3902 DMS-3901-S ADC-3901	Composite Video Decoder; Composite Video Decoder/Synchronizer Analog Component Video to SDI Converter Component Analog to SDI Converter Composite Video to SDI Decoder Composite Video to SDI Decoder/Synchronizer Composite Video to SDI Decoder/Synchronizer with SDI Input Composite Video to SDI Decoder/Synchronizer/Noise Reducer Composite Video to SDI Decoder/Synchronizer/ Noise Reducer with SDI Input Analog Component Video to SDI Converter	9 11 10 46 46 47 47 48 50			
Encoder/Synchronizers and D to A Converters					
ENC6800+, ENS6800+ DAC-6801 DAV6800+ ENS-3901	SDI Video Encoder; SDI Video Encoder/Synchronizer SDI to Analog Component Video Converter SDI to Analog Component Video Converter SDI to NTSC/PAL Color Encoder/Synchronizer	9 11 12 48			
Video Synchronizer — Delays					
HFS6800+ VFS6800+ VFS-3901H VFS-3901 DLY-3901-4	HDTV Frame Synchronizer/Processor SDI Frame Synchronizer/Processor HDTV Video Frame Synchronizer/Processor SDI Frame Synchronizer SDE/Video Delay	6 10 32 49 49			
Audio Conversion Products					
ADC6800+A2BC, +A4BC DAC6800+BCA2, +BCA4 ADC-3981 DAC-3981 (-600)	Audio Analog to AES Converters AES to Analog Audio Converters 4-Channel Analog to 2 AES Audio Converter 2 AES 4-Channel Analog Audio Converter	12 13 51 51			
Audio Synchronizer — delays					
ADS6800+B2, +C2 ADS6800+A2BC, +A4BC AS-3901-B, C, AD, DA, DA-600	AES Audio Delay Synchronizer Audio Delay Synchronizer with A to D Conversion 2 AES Audio Synchronizer/Delay/Processor, 4-Channel Analog/ 2-Channel AES Audio Synchronizer/Delay/Processor	17 18 37			
Multiplexers and Demultiplexers					
HMX6800+B2, +C2, +B4, +C4 HDX6800+B2, +C2, +B4, +C4 MSA6800+A2, +A4 MSA6800+A2, +A4 MSA6800+A2B2, +A2C2, +A4B2, +A4C2 MSA6800+A2B2, +A2C2, +A4B2, +A4C2 MSA6800+B2, +B4, +C2, +C4 MSA6800+B2, +B4, +C2, +C4 DMX6800+A2B, +A2C, +A4B2, A4C2 DMX6800+B2, +B4, +C2, +C4	HDTV AES Audio Multiplexers HDTV AES Audio Demultiplexer Analog Audio Multiplexers Audio Multiplexer with Synchronizer and Delay Analog / AES Audio Multiplexers Analog / AES Audio Multiplexers with Synchronizer and Delay AES Multiplexers AES Multiplexers with Synchronizer & Delay Analog/AES Audio Demultiplexers AES Audio Demultiplexers	8 8 13 14 14 15 15 16 16 17			

Specifications and designs subject to change without notice.

monitoring and video thumbnails, and one for video and audio streaming) makes PC control and monitoring over large networks entirely manageable. A built-in Web Server and optional SNMP (Simple Network Management Protocol) are industry-standard means of controlling and monitoring the X75 over Ethernet. Leitch's CCS Command and Control System Navigator software further enhances the remote control aspects of the X75 for any application.

Limitless Applications

Expanding video processing to include "anything in" to "everything out" and M-PATH Multiple Path and Simulcast conversions, Leitch's new X75 is equally suited for use in analog, digital, or high-definition hybrid facilities. The X75 provides a simple solution for even the most complex applications. For production and editing, the X75 provides conversion to and from any signal type for HDTV productions. In news environments, it can time base correct any tape format — analog, digital or HDTV. For broadcast, the X75 can perform up-conversion for HD output, down-conversion for monitoring/logging, and cross-conversion for programs that are recorded in other than the native format for the station. As a switcher, the X75 can switch between any two inputs with clean and quiet outputs with voiceover. In mobile environments, the X75's fast operator controls provide automatic input select to the proper HD output format, making the X75 an easy choice for live events.

M-PATH™ Multiple Path Processing Supports Bi-Directional Processing

The following examples include the HDTV upgrade. Leitch's exclusive M-PATH™ feature provides multiple directional connectivity between analog, digital and high-definition tape transports or routing systems. Enabling simultaneous converter and frame synchronizer operation, M-PATH mode routes HDTV optical fiber or HD-SDI and converts and synchronizes directly to the SDTV analog and SDI video outputs, which feed the inputs of analog composite and component and digital tape machines and routing systems. The analog or digital

outputs of tape machines or routing systems can be simultaneously connected to one of the synchronizer's SDTV analog or digital inputs where it can be processed and output via the HDTV optical fiber and HD-SDI port. Audio signals are handled in a similar fashion, with eight or sixteen channels of processing in each direction. Analog (two stereo pairs), AES/EBU (two or five inputs and two or five outputs) and embedded HD-SDI and SDI audio are also supported.

M-PATH — Simultaneous UP and DOWN Conversion Example

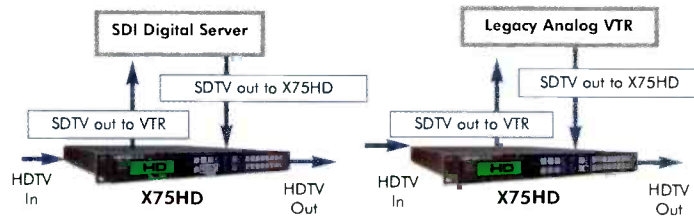

Simulcast — Switching Between SD/HD with SD and HD Output

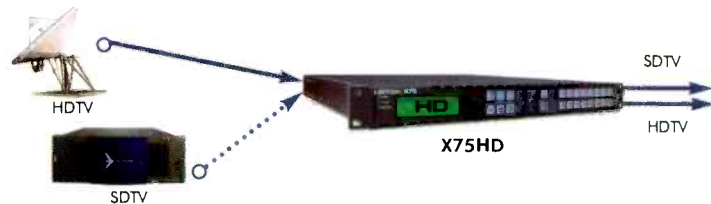

Compressed/Embedded Audio — Audio Processing for Discrete Embedded and Compressed Audio

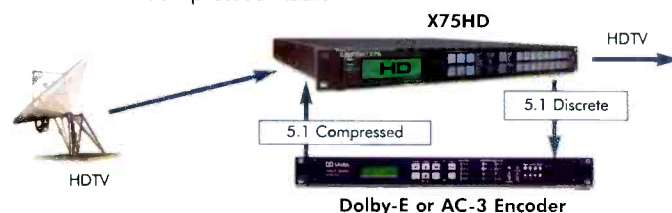

[X75HD/SD]

Multiple Path Converter, Synchronizer...and More

Combining HD and legacy standard-definition video and audio processing capabilities, all in a space-saving 1RU package, the X75 is the definitive, all-in-one solution for broadcasters who have made or are making the transition to HDTV.

More Than Just a Synchronizer

- Upgrade from SDTV to HDTV
- Audio Embedder/De-Embedder for SDI and HD-SDI
- Bi-Directional Standard/High-Definition Converter
- Video Processor with Auto-Switch Time Base Corrector
- 8 or 16 channel internal audio processing
- Integrated optional Dolby® E/AC-3 decompression
- Video and Surround Sound Audio Processing
- Metadata Processing
- Video and Audio Test Signal Generators
- Digital Noise Reducer with Digital Bandwidth Filtering Option
- Audio Limiter Option
- Auto-sensing, multi-standard device (PAL-B/PAL-M/NTSC/SECAM/NTSC) for worldwide use
- Redundant Power Supplies

More Functionality with Less Equipment

With capabilities that far exceed a synchronizer, the X75 allows broadcasters to do more with less equipment. Video processing features include level/color control; 3D adaptive color decoding; noise reduction; frame synchronization and time base correction for nonsynchronous signals; and up-, cross-, and down-conversion with aspect ratio conversion for hybrid facilities. The X75's 8 or 16 channels of internal audio processing include level control, analog/digital conversions, and embedding and de-embedding for both SDI and HD-SDI serial digital signals for interfacing any audio signal in a professional environment. Integrated

Dolby® decompression and voice-over brings even more functionality.

Infinitely Flexible I/O

The exceptionally flexible input options for the X75 with HD upgrade capability provide up-, down- and cross-conversion from up to seven input video formats — more than any similar product currently on the market — to almost any output video format. In addition, the X75 features auto-detected inputs with auto-changeover and user-selectable alarms for reduced downtime. Providing separate connections for all video input and output formats, the X75 allows for convenient front panel selection between multiple input devices — all of which may be connected simultaneously. Video input

format options for HDTV optical fiber and HD-SDI and optional analog composite/component/(Betacam®) and Y/C (S-VHS/Hi-8) inputs are possible. Dual SDI inputs are included. Ten broadcast-quality outputs of the same signals are provided, as well as optional streaming video and audio over Ethernet, RGBS, DVI-D, or auxiliary PAL-B / PAL-M / SECAM / NTSC composite video outputs.

Effortless Control

Control and monitoring of signals passing through the X75 is enabled using IP over Ethernet, and instant operator control from the local or remote control panels allows for easy manipulation of video and audio signals. Using two Ethernet ports per unit (one for control,

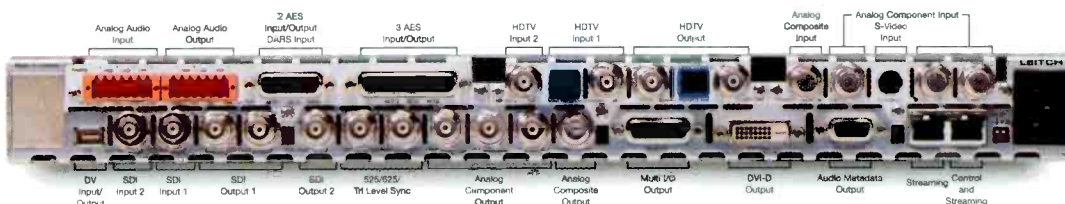

CCS Navigator is a Windows®-based software application that provides the graphical tools to create easy-to-use GUIs (Graphical User Interfaces) that visually represent operational environments. These GUIs will consolidate and ease network-wide status monitoring, leading to more efficient deployment of human resources for monitoring and troubleshooting tasks.

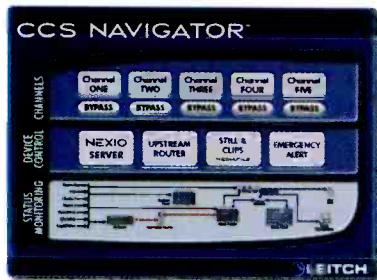

CCS Navigator offers simple wizards that allow users to quickly generate customized GUIs. Customized GUIs permit users to consolidate network-wide supervision and maintenance. They also allow complex operations to be enacted by a simple mouse click. This capability streamlines the facility operation and minimizes opportunities for mistakes.

CCS Navigator allows the user to import system-level schematic block diagrams and superimpose product

alarm notifications directly over top of product icons. User pre-determined actions occur when the product icon is clicked. In fact, corrective actions can also be automatically invoked so that when critical facility alarms are detected, corrective actions are already been invoked.

Wizards permit the user to quickly create router control panel surfaces. These software-based control panels can control simple single-bus routers or more complicated multi-bus

routers. Wizards also permit the user to quickly generate NEO and 6800+ frame views that show both the exterior of the frame and the modules that are contained within.

CCS Navigator tracks both CCS alarms and SNMP traps, providing a consolidated facility view. CCS Navigator is not limited to Leitch-only alarms but can create a powerful control and monitoring system that enables users to mastermind their operations.

Key Features

- Centralized or distributed monitoring of Leitch and third-party equipment
- Real-time local or remote control with individually configurable control parameters
- Scalable from simple control of one or two devices to the control of large distributed systems with many of devices
- Secure access to network resources by user groups and individual settings
- Creation and placement of action/status hotspots over user-supplied images
- Wizards enable quick creation of control panel surfaces to control/monitor routers
- Buttons, images, text and CCS-enabled products symbol gallery
- Browsing (backward & forward) across Navigator pages
- Single button to launch simple or multiple presets
- Single click to launch web-based applications

Leitch's Command Control System, CCS, is a powerful system of protocols, software applications, control panels and gateways that enable monitoring and control of products within a network.



Any product identified with the CCS check mark will bring you all the value of Leitch's award-winning Command Control System.

Open architecture. Scalable infrastructure. Industry-standard networking. All key components to any critical network design. CCS provides the underlying fundamentals upon which to base any broadcast network.

CCS-enabled products operate within a distributed, practical real-time TCP/IP based network. CCS-enabled software tools provide configuration, monitoring, control and secure access to Leitch products and third-party equipment within a network, whether that network is local to a single facility or extends to multiple facilities worldwide. The underlying CCS Protocol,

which enables practical real-time control of CCS-enabled products, has been designed to elegantly scale from small system designs to very large systems designs without compromising on the practical real-time performance.

CCS Protocol is a published, documented protocol. Third-party control and monitoring systems can easily integrate into the CCS network to provide network supervision alongside existing CCS software applications and or control panels. Additionally, many of the Leitch product lines support SNMP for easy integration into SNMP-enabled system monitoring tools.

CCS software tools allow the user to supervise and maintain products within the broadcast infrastructure. These software tools complement hardware control panels. They provide customized access to system-level applications in an easy to understand, straightforward user interface. They provide alarm notification and detailed alarm logs that track both CCS-enabled products and third-party SNMP-enabled products. Any ActiveX plug-in can be launched directly from within the software application, further consolidating system supervision.

Flexible, multi-format routing switchers that provide unrivaled performance and control options for all mid to large routing applications.

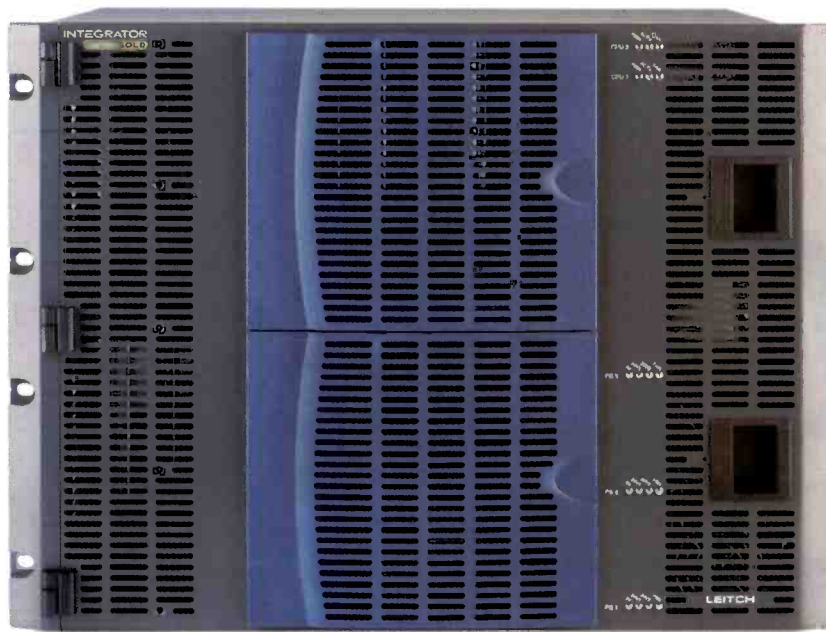

Expandable Architecture

Integrator™ is a series of economical, scalable, multi-format routers packed with advanced features and redundancy that provides unrivaled performance and control options for all mid-to-large sized routing applications. The Integrator allows you to mix different types of signals and I/O connections within the same frame by offering modular I/O back panels.

Our Integrator prepares your facility to switch today's and tomorrow's formats. The Integrator solutions include routing systems in 4, 6 and 8RU frames that provide expandability from 32x32 to 256x256, and our 8RU Integrator GOLD™ wideband digital multi-rate router will easily expand from 8x8

to 256x256. Other features include optional redundant hot-swappable logic cards and power supplies and incorporated alarms for control, fans and power supplies.

Comprehensive Control

Leitch provides a powerful and complete control system through programmable control panels and our RouterMapper, RouterWorks, CCS Pilot2™ and CCS Navigator™ control software. Our control options free you from hardware constraints with virtual crosspoint mapping and soft-matrix partitioning; crosspoint restrictions such as locks and protects; up-loadable drivers for diagnostics and control of other vendors equipment; system polling for new or added component configuration without interrupting operations; and traceable

system signal paths. Integrator is fully compatible with existing Leitch control software and hardware, allowing you to easily integrate into or upgrade existing or new router installations.

Integrator GOLD

Integrator GOLD is the standard when it comes to wideband digital multi-rate routing. With the capability of routing signals from 3 Mb/s to 1.5 Gb/s, Integrator GOLD offers a clear growth path from lower bit rate AES, SDI and ASI to high-bandwidth, high-definition format signals.

The 8RU Integrator GOLD can easily scale from 8x8 to 128x128 in multiples of 8 I/O. Features include redundant power supplies, redundant logic cards and easy-to-use, front-loading, hot-swap capability. Integrator GOLD provides complete digital format support: HD, SDI, AES, ASI and common Telco rates and an option for SDI-only.

New Integrator Gold encoder and decoder boards support analog video via high-quality 10-bit conversion.

Control Topologies

TCP/IP (Ethernet)	Standard	<input checked="" type="checkbox"/>
RS-232/422	Standard	<input checked="" type="checkbox"/>
X/Y Coaxial	Standard	<input checked="" type="checkbox"/>



Panacea is an affordable, compact router that offers on-air quality in every professional format from analog to HD.



Comprehensive Format Coverage

Panacea offers comprehensive format coverage, with HD, SD/ASI, AES, and analog video and audio available in the most complete and flexible array of matrix sizes.

Advanced Control Options

Panacea's advanced control options — including remote, local, RS232/422, X/Y and Ethernet control direct to the frame — raise the standard for small routing. Because Panacea shares a common control base with all other Leitch routers, integration into existing and new router installations is effortless.

Superior Performance

Leitch is an industry leader in incorporating the most advanced technology to meet the latest broadcast and professional media applications. With Panacea, performance was not sacrificed to provide a compact, cost-effective solution.

Excellent Value

Panacea provides the same flexibility, performance and reliability customers have come to expect from Leitch routers — all at an exceptionally cost-effective price.

Panacea is for Everyone

Television production facilities, cable operators, outside broadcast vans/trucks, DBS satellite operations, post production facilities, Webcasters, Telcos, corporate boardrooms, schools, military, government, videographers, or anyone else who wants a compact, on-air quality routing switcher with the ability to mix and match signal formats within the same frame.



Key Benefits

- Industry's most powerful SD and/or HD Clean Video with embedded audio routing switcher
- Discrete clean switching of SD and HD video, as well as quiet switching of AES signal options available
- CCS Pilot integrated control capabilities
- Control via local panel, RS232/422, X/Y, or IP/Ethernet option
- Internet access and control of Panacea routers is available without external gateways or controllers with the Panacea Web option
- Signal diagnosis capabilities (i.e., signal presence, error detection)
- Numerous local control panel options
- Frame architecture provides both front and rear rack attachment capabilities
- External (Brick) universal power supplies or built-in universal power supplies
- Redundant power supplies option

UDA-683 Utility Video Distribution Amplifier

The UDA-683 is a one in, eight out analog video utility distribution amplifier, ideal for analog composite/component, color black, subcarrier and analog HDTV video installations.

VDA-683 Video Distribution Amplifier

The VDA-683 is a one in, eight out analog video distribution amplifier with a differential input, ideal for analog composite/component, color black, subcarrier and analog HDTV video installations.

VEA-683 Video Equalizing Amplifier

The VEA-683 is a one in, eight out analog video equalization distribution amplifier with a differential input for long cable runs using analog composite/component, color black, subcarrier and analog HDTV video signals.

VEA-684 Video Equalizing Amplifier

The VEA-684 is a one in, eight out analog video equalizing and clamping distribution amplifier with a differential input and AC or DC coupling for long cable runs using analog composite/component, color black, subcarrier and analog HDTV video signals.

VPD-683 Video Programmable Amplifier

The VPD-684 is a one in, eight out analog video equalization and clamping distribution amplifier with a differential input and AC or DC coupling for long cable runs using analog composite/component, color black, subcarrier and analog HDTV video signals. Optional, removable submodule with different gain and EQ settings is available.

VEH-683 Video Wide Band Equalizing Amplifier

The VEH-683 is a wide bandwidth one input, eight output video equalizing and clamping distribution amplifier with differential input and equalization for up to 100 meters (325 ft.) of coaxial cable. Ideal for analog composite/component and computer-generated video installations.

**INT-EX1x2 and INT-EX1x6
Analog Video, Digital Video,
Digital Audio Distribution Amplifier Packages**

The INT-EX1x2 is a 1RU package containing 16 one input, two output distribution amplifiers for analog composite/component, 75 ohm AES digital audio and SDI digital video signals.

For applications where price and space are limited, the INT-EX1x6 distributes 16 signals of virtually any format without extra processing and cost, allowing distribution of wideband analog video, SDI video, and AES audio. The INT-EX1x6 offers 16 channels of 1 input, 6 output distribution and redundant power supplies with fail alarms via GPI contacts in a single 2RU frame that can be mounted in either the front or rear of your equipment rack.

[AUDIO AND VIDEO DISTRIBUTION AMPLIFIERS]

AMD-880 Mono Audio Distribution Amplifier

The AMD-880 is a one in, eight out monaural analog audio distribution amplifier for balanced 66 or 600 ohm signals.

ASD-880 Stereo Audio Distribution Amplifier

The ASD-880 is a one in, four out stereo (2 channels) analog audio distribution amplifier for balanced 66 or 600 ohm signals.

APD-880 Mono/Stereo/Summing Programmable Audio Distribution Amplifier

The APD-880 can be programmed using plug-in submodules to provide monaural, stereo or summed, or a combination of outputs.

ARG-880 Audio Remote Gain Amplifier

The ARG-880 is a one in, eight out monaural analog audio distribution amplifier for balanced 66 or 600 ohm signals with remote gain control.

AES-880 AES/EBU Digital Audio Distribution Amplifier

The AES-880 is a one in, eight out AES/EBU digital audio distribution amplifier for use in 110 ohm balanced installations.

ATG-880 Audio Tone Generator

The ATG-880 provides audio tones of 400 and 1000 Hz on four dual outputs at levels of +8, +4, 0 and -10 dBm. 440 Hz tone may be requested in place of 400 Hz.

ADC-880 Analog to Digital Audio Converter

The ADC-880 is a two-channel analog audio to 110 ohm balanced AES digital audio converter with 20-bit precision.

DAC-880 Digital to Analog Audio Converter

The DAC-880 is a 110 ohm balanced AES digital audio to two-channel analog audio converter with 20-bit precision.

INT-EX1x4A2 Analog Audio Distribution Amplifier Package

The INT-EX1x4A2 is a 2RU package containing 32 one input, four output stereo (two channels) distribution amplifiers.

Additional Distribution Amplifiers

ARG6800+	Analog Audio Remote Gain Distribution Amplifier	VSI6800+	SDI/ASI Equalizing Reclocking Distribution Amplifier
VSM6800+	SDI Monitoring Distribution Amplifier	USM-6800	SDI Component Video Monitoring Distribution Amplifier
VTM6800+	Triple Monitoring Distribution Amplifier	VAM6800+	SDI SDI Video and Analog Monitoring Distribution Amplifier
VCA6800+	Composite Video Equalizing & Clamping Distribution Amplifier	HDC6800+	HDTV Downconverter
VDA6800+	Composite Video Distribution Amplifier	HDC-3901	HDTV Downconverter and Distribution Amplifier
VEA6800+	Composite Video Equalizing Distribution Amplifier	HDC-3901-AD	HDTV Downconverter and Distribution Amplifier with audio outputs
VRG6800+	Composite Video Remote Gain Distribution Amplifier	VSM-3901	SDI Monitoring Distribution Amplifier
VPD-6830	Composite Video Programmable Distribution Amplifier	HSE-3901	HDTV / SDI Reclocking Distribution Amplifier
AES6800+	AES Audio Distribution Amplifier	VSE-3901	SDI Reclocking Distribution Amplifier
VSE6800+	SDI Video Equalizing Distribution Amplifier	AES-3981	AES Audio Distribution Amplifier
VSD6800+	SDI Video Distribution Amplifier	VEA-3901	Video Equalizing Distribution Amplifier
HSD6800+	HDTV, ASI, SDI Distribution Amplifier	ADA-3981	Analog Audio Distribution Amplifier
HSE6800+	HDTV, ASI, SDI Reclocking Distribution Amplifier		

NEO SuiteView Solo™

A compact, high-resolution multi-source display processor supporting up to 12 inputs in 1RU. NEO SuiteView Solo provides a very affordable, high-resolution monitoring solution for full-featured applications requiring fewer inputs.



- Compact and cost-effective with up to 12 inputs in 1RU
- 8-input version providing ultimate affordability
- Auto-sensing video inputs for HD-SDI, SDI, composite, component (YUV, Y/C) and streaming video
- High-resolution configurable outputs support up to UXGA (1600x1200) for use with plasma, LCD, computer monitors and projection displays
- Optional local or remote control panel available
- Easy-to-use Layout Manager provides configuration and control capabilities

Smaller High-quality Monitoring Applications

- Mobile Trucks
- QA stations, edit suites, tape rooms
- Master control and production control rooms
- Corporate board rooms, Schools
- Video conferencing
- Trade shows and kiosks



SuiteView™

A simple yet versatile multi-source display processor offering from 4 to 16 inputs in 1RU. Supporting a wide range of video outputs simultaneously, SuiteView provides an extremely cost-effective monitoring solution for use with video-based displays.



- Compact and versatile with from 4 to 16 inputs in 1RU
- Auto-sensing video inputs for SDI and composite video signals
- Multiple video outputs provided simultaneously, including SDI (x2), component and composite video
- Well-suited for use with SDI, composite or component video monitors, smaller plasma displays, or for routing across video networks
- Local control panel provided standard
- Optional user-friendly Layout Editor provides configuration and control capabilities

Simple Monitoring Applications

- Mobile trucks
- Master/production control rooms
- QA stations, edit suites, tape rooms
- Monitoring remote sites
- Cost-effective "as run" confirmation
 - Record multiple feeds simultaneously
 - Interstitial / Security / Traffic monitoring

[SUITEVIEW]

SuiteView Multi-Source Display Processors

The SuiteView processors are capable of rendering multiple video and computer graphics signals in real time to either high-resolution plasma, LCD, computer monitors and projection displays or video-based displays. *See page 37 for ordering information.*

NEO SuiteView™

An advanced, modular multi-source display processor scalable up to 44 inputs. Integrated with our award-winning CCS Navigator™ application, NEO SuiteView provides fully customizable system-wide monitoring solutions for mission-critical 24/7 operation.

- Highly scalable and modular with up to 44 inputs in 3RU (smaller configurations available in 1RU)
- Unique auto-sensing inputs support a wide range of signal formats from HD-SDI, SDI, composite, component (YUV, Y/C) and streaming video to VGA and DVI graphics inputs
- High-resolution configurable outputs support up to UXGA (1600x1200) for use with plasma, LCD, computer monitors and projection displays
- Mix-n-match other NEO processing modules within the same frame
- Drive multiple unique displays with the same frame (up to 6)
- Front-loading, hot-swappable PSU, fans and modules for mission-critical applications
- Peace of mind with optional redundant PSU and controller
- Dual outputs provided standard with approaches for redundancy/backup in event of display unit failure

Mission-critical Monitoring Applications

- Multi-channel master control rooms
- Production control rooms
- Network control centers
- Satellite transmission sites
- Traffic monitoring
- Security monitoring



Feature-rich digital master control switcher acclaimed for exceptional operational ease.

Comprehensive Value

Optimized for demanding environments, Opus performs effortlessly in live, on-air environments, managing one or more channels from a single control panel, from multiple panels, or under full automation. Opus provides eye-catching dual-channel squeeze effects, unrivaled audio processing capabilities, keys, audio overs, quick selects and much more. Most features are provided standard, yielding a cost-effective and integrated system from day one that is superior to others that must add many expensive options trying to match Opus.

Attention to Detail

Opus addresses SD and HD environments with a completeness that is refreshing and reassuring. Audio can be discrete AES and/or embedded with four AES pairs per input/output, or stereo analog audio, with total control over audio channel assignments. Multi-channel control, audio metering, machine control and upstream router panel come standard in the Opus control panel — streamlining your work surface.

Unique features include automatic key removal when switching to specified commercial sources; eliminating make-goods; and Program Special mode, which frees the panel for training or other off-line use without affecting the program stream. Smooth integration within



your facility is further enhanced with the flexibility of five auxiliary outputs, 36 each GPLs/GPOs, and more.

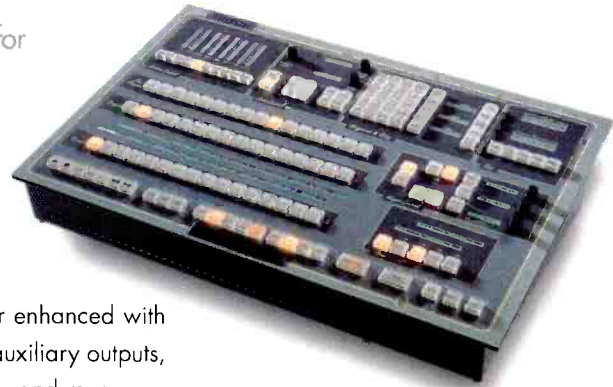

The Best Image

The 1-channel and 2-channel squeeze effects options deliver intriguing motion with multi-stage setups that alter size, position and video content — so much more than a one-step

squeeze and reveal. Combined with exceptional video/audio quality and functionality, you can count on Opus for a most impressive on-air image.

General Features

- Panels and frames assignable in "n" x "m" network configuration
- Industry-standard automation interface
- CCS Pilot option provides configurable alarm notifications on-screen, to a database, or by e-mail

Video Features

- 10-bit quality video processing throughout
- Two independent linear keyers, downstream of effects
- Sixteen primary inputs and four key (key & fill) inputs
- Five aux outputs
- Extended input range using external routers
- Full program/preset transitions
- Full monitoring output
- Clean outputs available prior to each keyer
- One line buffer on all inputs
- Program Special for off-line use
- Optional 2D squeeze effects
- Optional key border/shadow

Audio Features

- Sixteen primary and eight audio over inputs
- Four AES pairs, or two-channel analog audio, with selectable 20-bit or 24-bit resolution
- Embedded configuration supports both discrete and embedded I/O
- Complete channel control, including sum, swap, left/right to both, phase reversal, etc.
- Full control panel metering (VU & PPM ganged)
- Full audio breakaway capability
- Two separate over/under stages
- Program Special for off-line use
- Clean outputs available prior to each A/O stage

ADA-3981-66, 600 — Analog Audio Distribution Amplifier

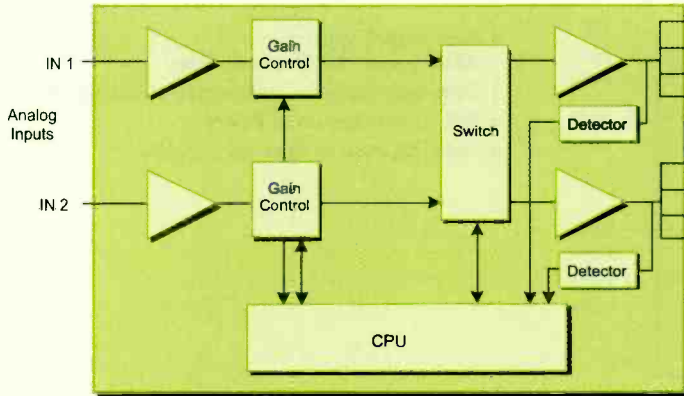

- OUT 1
 - OUT 2
 - OUT 3
 - OUT 4
 - OUT 5
 - OUT 6
 - OUT 7
 - OUT 8
- 1 in, 8 out (mono) or 2 in, 4 out (stereo)
 - 20-20kHz bandwidth
 - +30Bu (66ohm), +24dBm (600ohm) maximum input level
 - ✳ Gain range of -6 to +33dB
 - Remote gain(.5dB steps), channel swap, mute
 - Channel swap and mute
 - Left and right inputs can be summed to mono

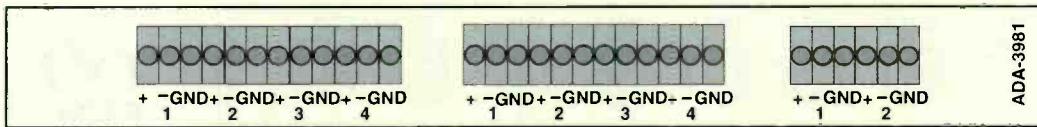

AVM-3901-C

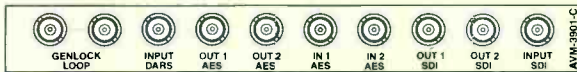

AVM-3901-B4



AVM-3901-C4



MXA-3901-C



DMX-3901-B



DMX-3901-C



AS-3901-C



AS-3981-DA



MSA-3901-C



MSA-3901-B4



MSA-3901-C4



NSM-7X2AES-C



NSM-8X1AES-C

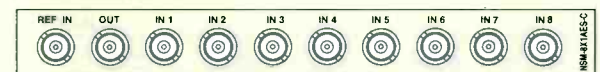

Additional back modules intended to complement product information provided on product pages.

NEO DISTRIBUTION

BACK PANELS

AES-3981 — AES Audio Distribution Amplifier

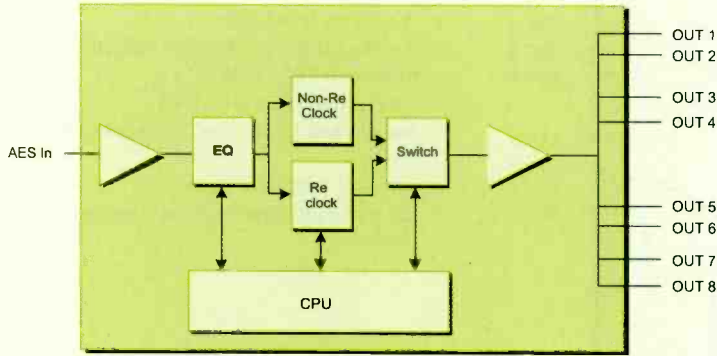

- Input signal types: AES 75 and 110 Ohm interfaces
- Data-only mode for compressed audio signals
- AES frame rates up to 96kHz
- Auto EQ, auto re-clock up to 96kHz

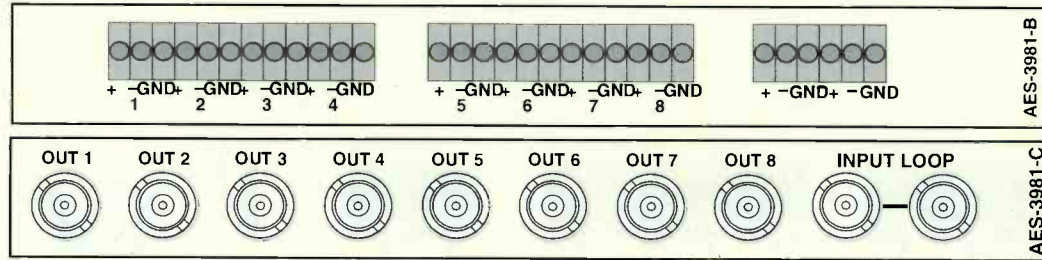

VEA-3901 — Composite Video Equalizing Distribution Amplifier

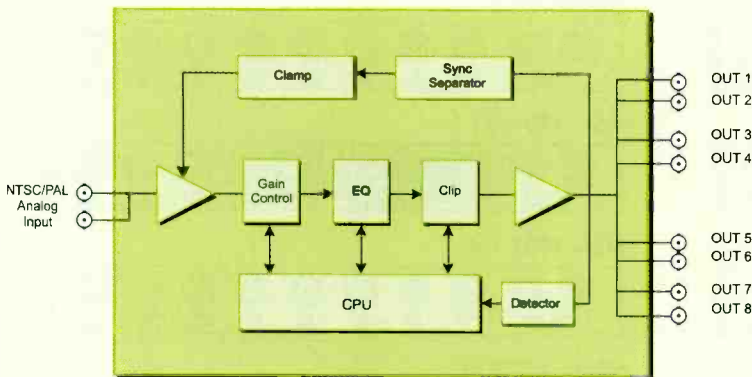

- Input signal type: passive looping 1Vp-p video
- SMPTE310M, E3 DS3 compatible
- Clamp off / soft / hard
- White clip, hard and soft
- AC/DC coupling (jumper selectable)
- Remote control of gain (-3 to + 3dB)
- Remote control of EQ (300m)

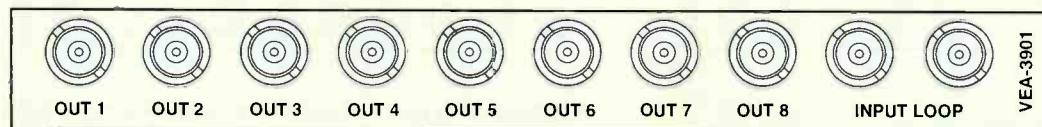

VSM-3901 — SDI Monitoring Distribution Amplifier

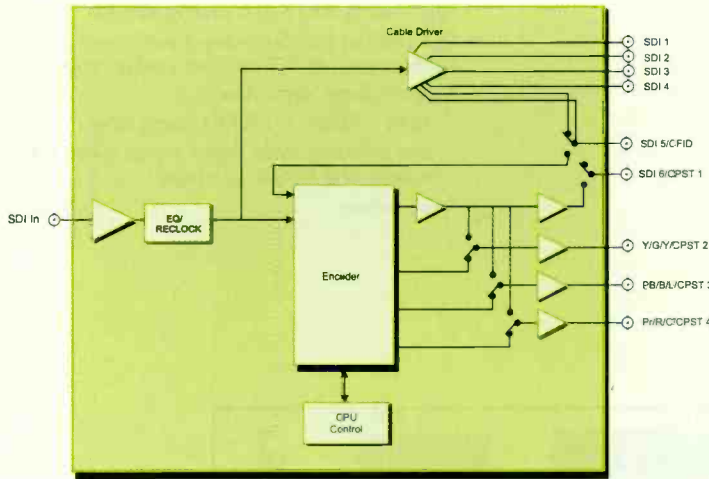

- 10-bit signal processing path
- Up to 6 reclocked, equalized 4:2:2 serial outputs
- Up to 4 NTSC/PAL-B analog composite color outputs or 1 component (GBR / Y, Pb, Pr, / YC)
- Delete, chroma on/off, setup on/off, burst on/off and chroma filter bandwidth select

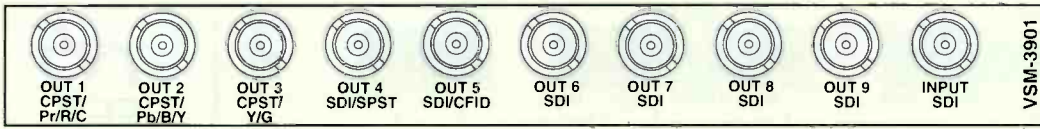

VSE-3901 — SDI and ASI Reclocking Distribution Amplifier

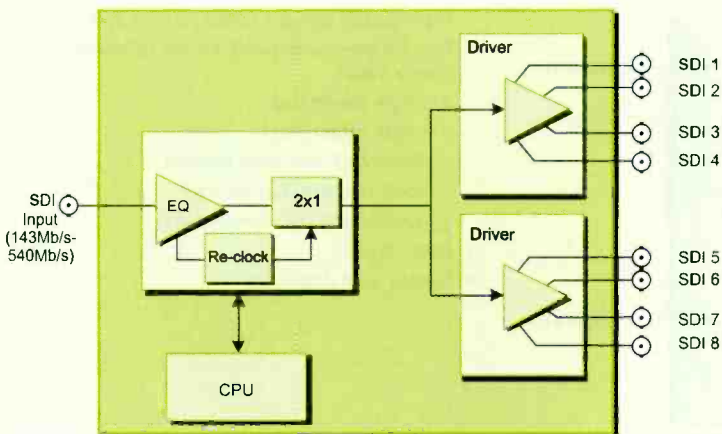

- Input signal types: SMPTE 259M, 344M, DVB-ASI
- Differential input, transformer coupled inputs and outputs
- 8 reclocked and auto-equalized outputs
- Automatic bypass if unable to lock at the above rates
- Forced bypass capability
- ASI compliant

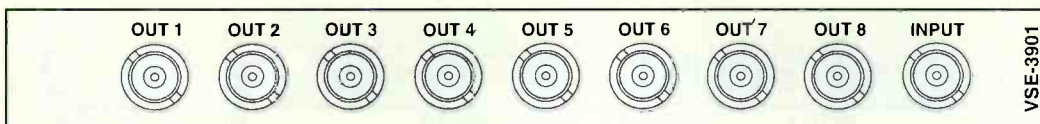

NEO DISTRIBUTION

NEO DISTRIBUTION

NSM-8X1AES-B, C, NSM-7X2AES-B, C — AES Audio Switches

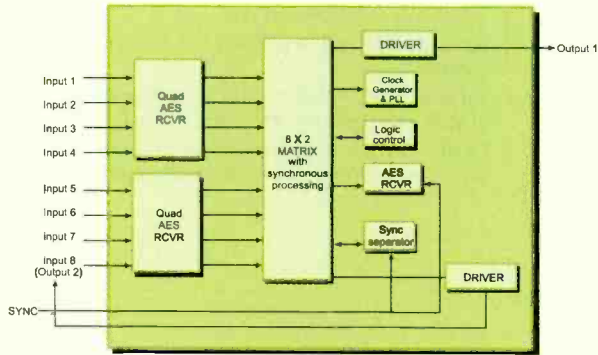

- High-quality AES audio routing switcher
- 8x1 switcher with auto-detect switchover configuration or 7x2 switcher configuration
- Supports these signal types:
 - AES3 – 30kHz – 100kHz frame rates
 - Any 50% duty cycle digital signal within the voltage and frequency range
- Relay bypass

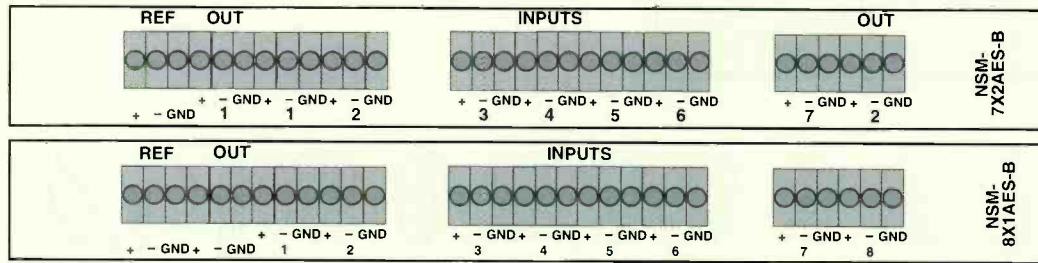

See page 59 for other back panels: NSM-7x2AES-C and NSM-8x1AES-C

NSM-8X1-A2 — Analog Audio Switches

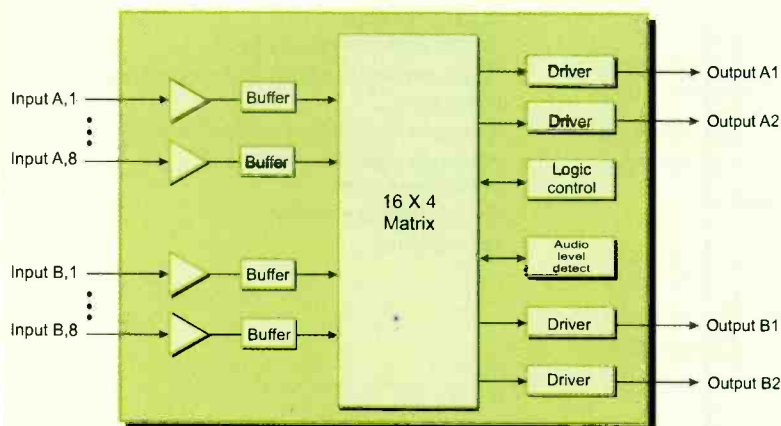

- High-quality analog audio routing switcher
- Can be user-configured for the following matrix sizes:
 - single stereo 8x2
 - single mono 16x4
 - stereo 8x1 with dual outputs
 - quad mono 4x1 (married)
 - quad mono 4x1 (breakaway)
- Relay bypass
- Swap / sum capability

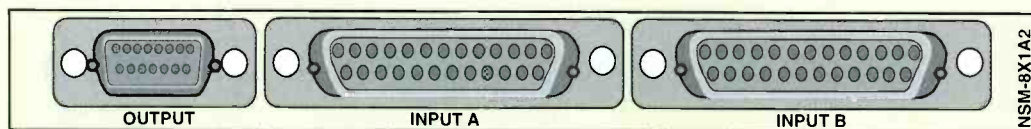

NSM-8X1SHD, NSM-7X2SHD — HDTV and SDI Video Switches

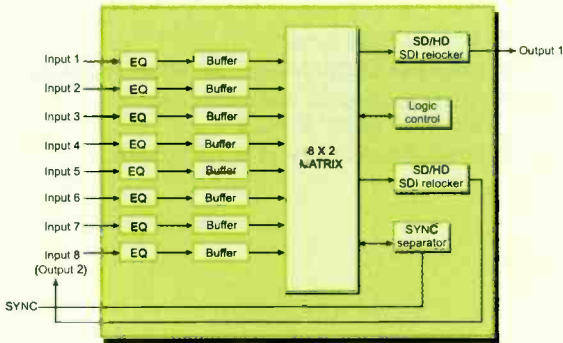

- High-quality HD/SDI wideband video routing
- 8x1 switcher with auto-detect switchover configuration or 7x2 switcher configuration
- Supported signal types (10Mb/s to 1.5 Gb/s):
 - SMPTE 259 — 143, 177, 270, 360, and 540 Mb/s
 - SMPTE 292 — 1.485 Gb/s
- Deterministic, line-accurate switching
- Relay bypass
- Reclock both SMPTE 259M and SMPTE 292M bit rates
- Bypass operation for signals at nontraditional video rates
- Auto-equalize all inputs up to 1.5 Gb/s

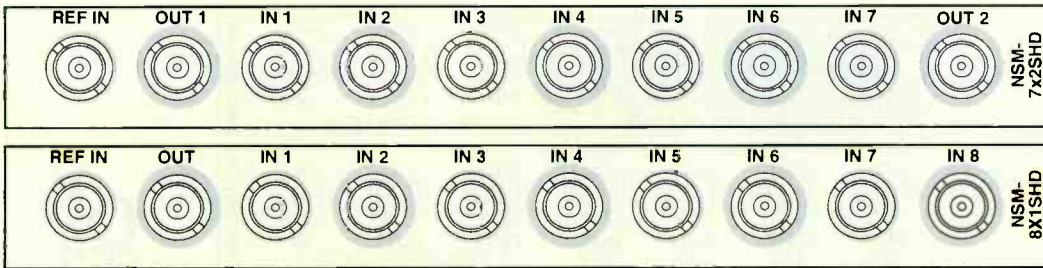

NSM-8X1V, NSM-7X2V — Composite Video Switches

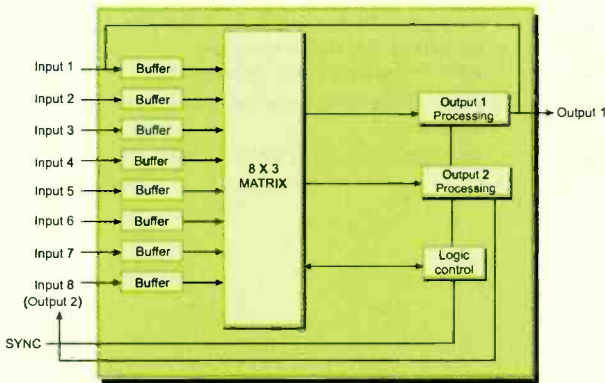

- High-quality analog video routing switcher
- 8x1 switcher with auto-detect switchover configuration or 7x2 switcher configuration
- Deterministic, line-accurate switching
- NTSC/PAL analog reference
- Relay bypass
- Bypass operation for signals at nontraditional video rates

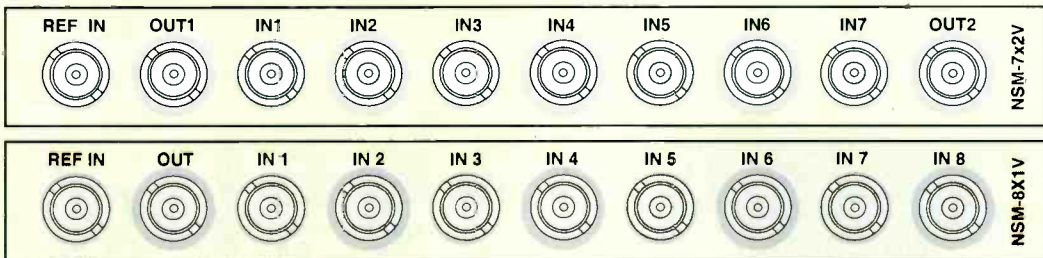

NEO SWITCHES

NEO SWITCHES

DMX-3901-B4, C4 — SDI Demultiplexer to 4 AES Audio

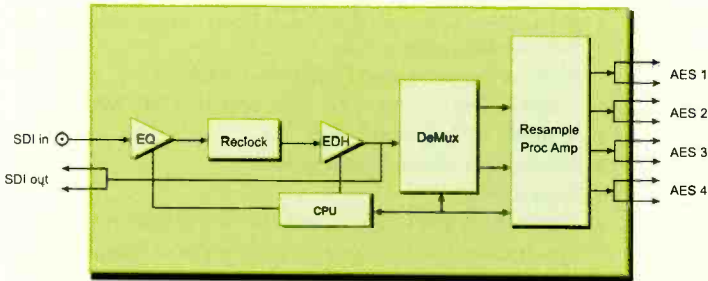

- 4-channel AES output
- Selectable 16/20/24-bit audio delay/processing
- Passes compressed audio data, i.e., Diamond, Dolby® E, AC-3™
- Variable audio delay up to 1.3 seconds

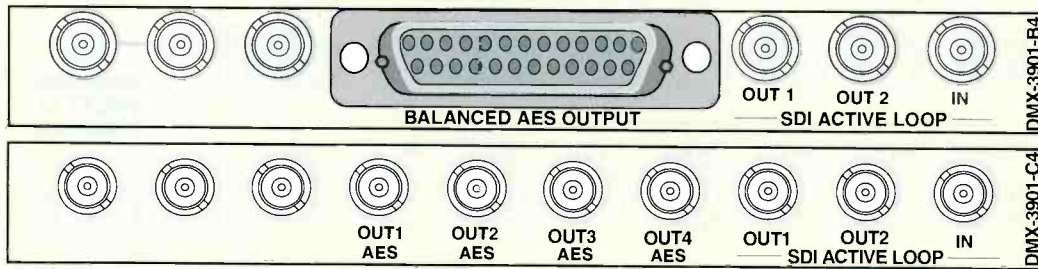

NEO AUDIO

DSA-3901-A — Analog Audio Synchronizer Delay Processor and Demultiplexer

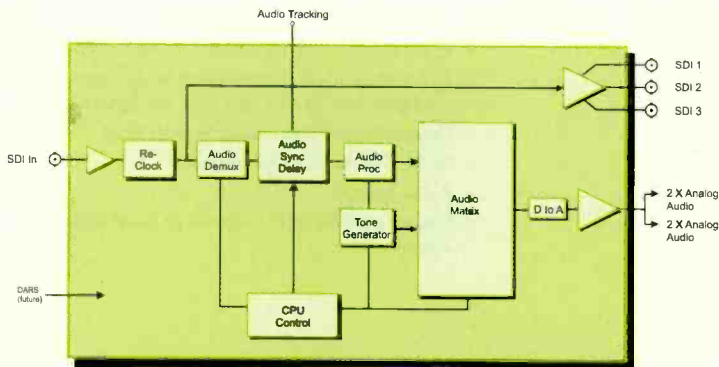

- 4-channel analog audio demultiplexer
- Selectable 16/20/24-bit audio synchronization/delay/ processing
- Audio processing amplifier: gain, swap, invert, summing
- Variable audio delay up to 1.3 seconds

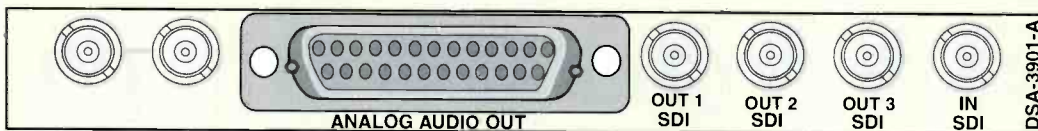

NEO AUDIO

MSA-3901-A, B, C, B4, C4 — Audio Synchronizer/Delay/Processor and Multiplexer

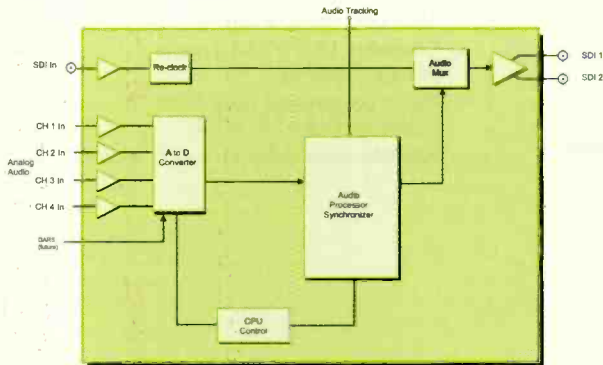

- SDI video input, 2 or 3 processed outputs
- Analog and digital audio versions
- Selectable 16/20/24-bit audio synchronization/delay/ processing
- Audio re-sampling for 32-108kHz AES inputs, with bypass for data over AES operation
- C, U & V bit transparency for AES versions
- Variable audio delay up to 1.3 seconds

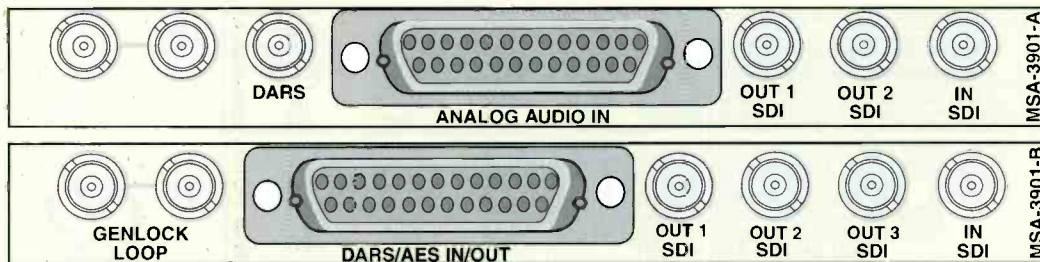

See page 59 for other back panels: MSA-3901-C, B4, C4

DMX-3901-A, B, C — SDI Demultiplexer to 4-Channel Analog or 2 AES Audio

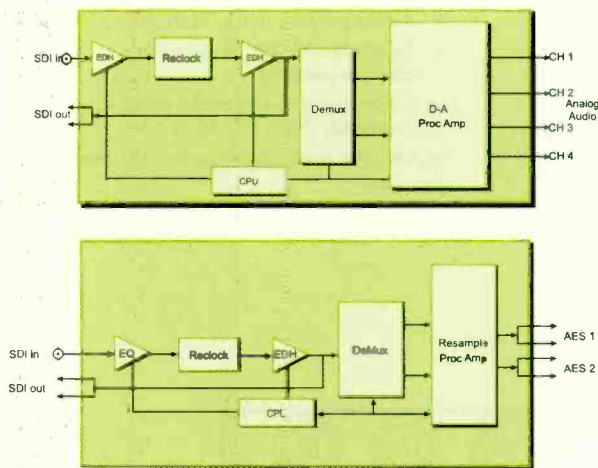

- Versions for analog or 2-channel AES audio outputs
- Selectable 16/20/24-bit audio delay/processing
- Passes compressed audio data, i.e., Diamond, Dolby® E, AC-3™
- Variable audio delay up to 1.3 seconds

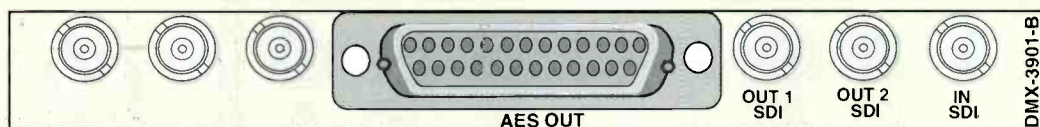

See page 59 for other back panel: DMX-3901-C

NEO AUDIO

NEO AUDIO

MXA-3901-A, B, C — 4-Channel Analog or 2 AES Audio to SDI Multiplexer

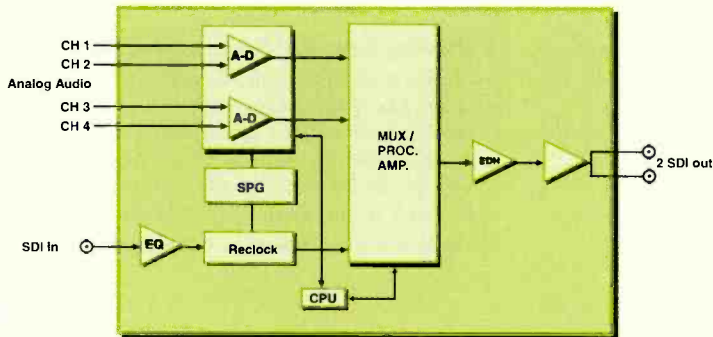

- 4-channel analog or 2-channel AES audio multiplexing into SDI
- Selectable 16/20/24-bit audio delay/processing
- Passes compressed audio data, i.e., Diamond, Dolby® E, AC-3
- Variable audio delay up to 1.3 seconds

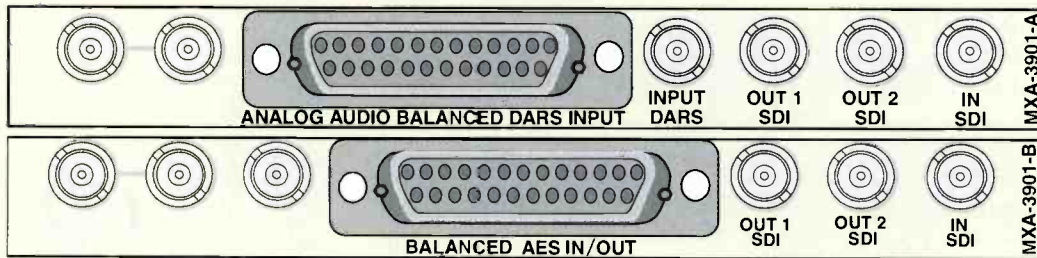

See page 59 for other back panel: MXA-3901-C

MXA-3901-B4, C4 — 4 AES Audio to SDI Multiplexer

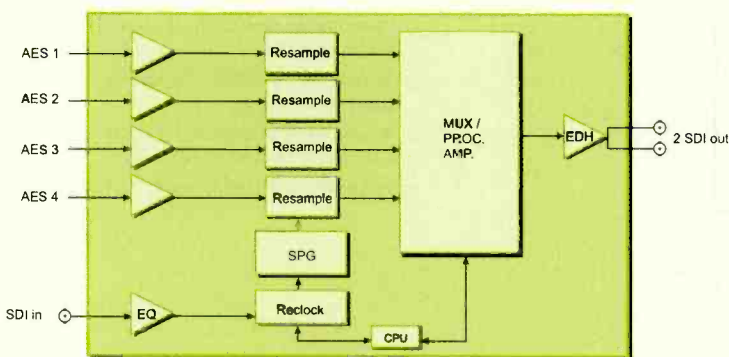

- 4-channel AES audio multiplexing into SDI
- Selectable 16/20/24-bit audio delay/processing
- Passes compressed audio data, i.e., Diamond, Dolby® E, AC-3
- Variable audio delay up to 1.3 seconds

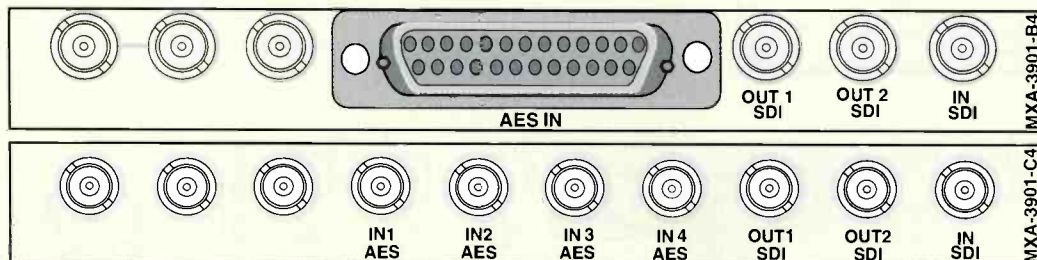

ADC-3981 — 4-Channel Analog to 2 AES Audio Converter

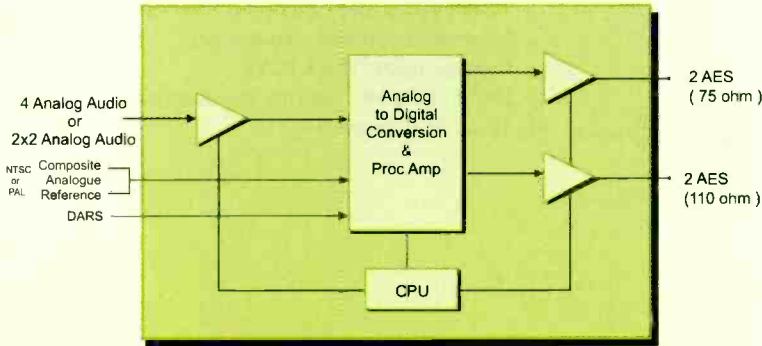

- Simultaneous balanced and unbalanced AES outputs
- 32/44.1/48/96 kHz output sampling rate
- 16/20/24-bit quantization
- Audio processing amplifier with: channel invert, channel swap, gain, delay
- Variable audio delay up to 1.3 seconds

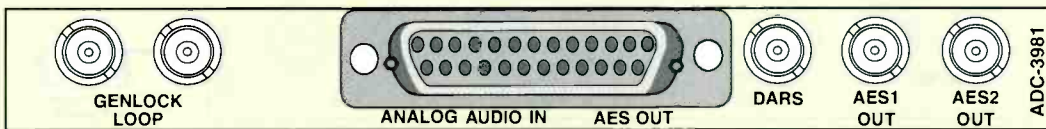

DAC-3981 (-600) — 2 AES 4-Channel Analog Audio Converter

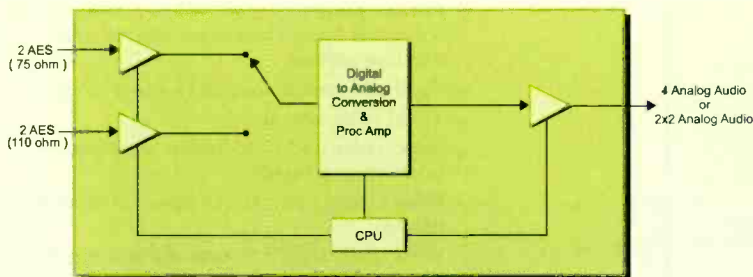

- Input signal types: 2 AES-75 or 2 AES-110 (selectable)
- 4 balanced analog audio outputs (4 channel or 2 x 2channel)
- Audio processing amplifier with: channel invert, channel swap, gain, delay
- Variable audio delay up to 1.3 seconds
- 32/44.1/48/96 kHz sampling rate support

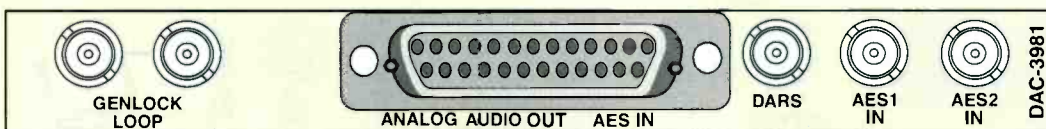

NEO AUDIO

NEO AUDIO

ADC-3901 — Analog Component Video to SDI Converter

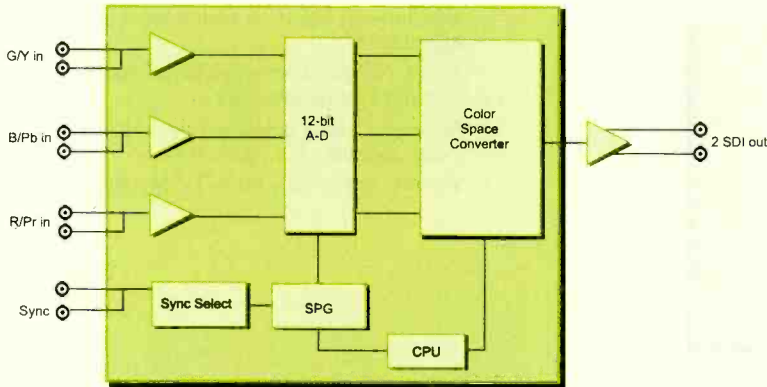

- 12-bit high-quality video conversion to SDI
- Smart clip to prevent output errors
- Looping inputs: YPbPr, RGBS
- SMPTE, EBU, MII, Betacam standard levels
- 12-bit video processing

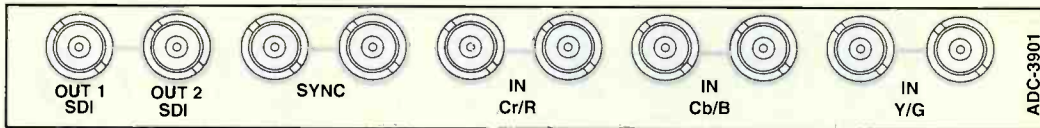

ARC-3901 — Aspect Ratio Converter

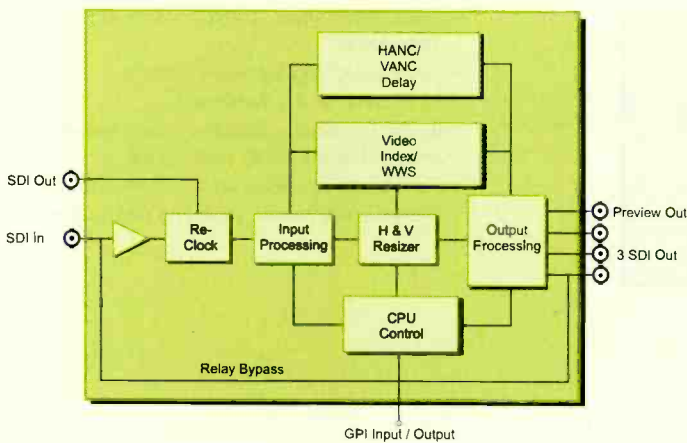

- Motion-adaptive, 4-field, 4-line conversion for enhanced vertical resolution with minimal interlace artifacts
- Fixed and variable picture re-sizing ratios
- 10-bit video processing
- Video Index and Wide Screen Signaling handling and insertion
- Relay bypass upon loss of power or module failure
- VANC and HANC are passed transparently
- Monitor BNC output with selectable "used area" overlay or key output

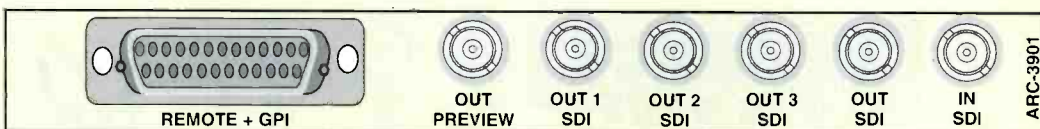

VFS-3901 — SDI Frame Synchronizer/Processor

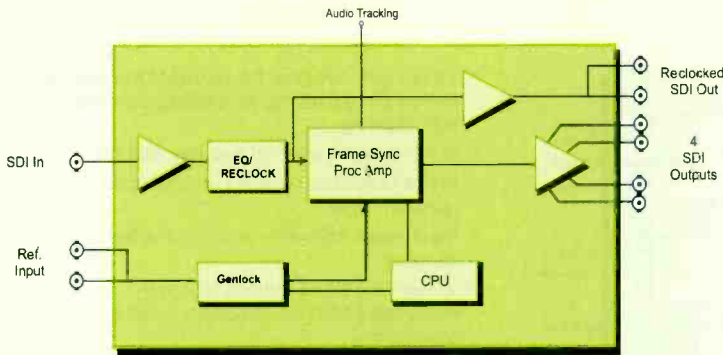

- Frame sync with infinite timing
- Video Processing Amplifier: black level, luminance level, chrominance level, black/white clip, hue (525 only)
- Video delay mode
- Provides internal audio tracking to audio synchronizers

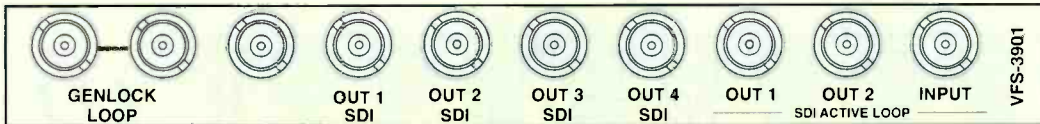

DLY-3901-4 — SDI Delay Processor

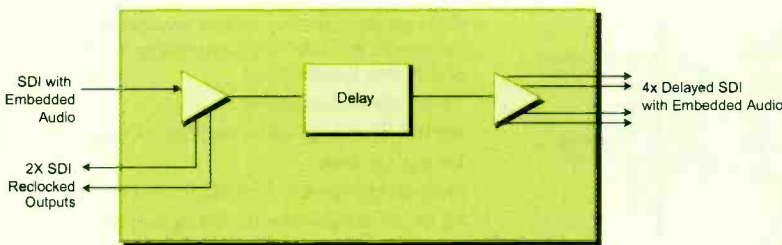

- Up to 4 seconds of video delay
- 525/625 SDI input
- 4 delayed SDI outputs
- 2 reclocked, non-delayed SDI outputs
- HANC and VANC passed transparently
- Auto-detect or user-selectable input video standard
- EDH status monitoring of SDI input (presence, error count)
- NeoScope video signal monitoring at card edge

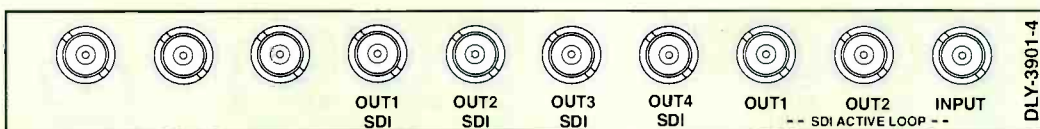

DNS-3901-S — Composite Video to SDI Decoder/Synchronizer/Noise Reducer with SDI Input

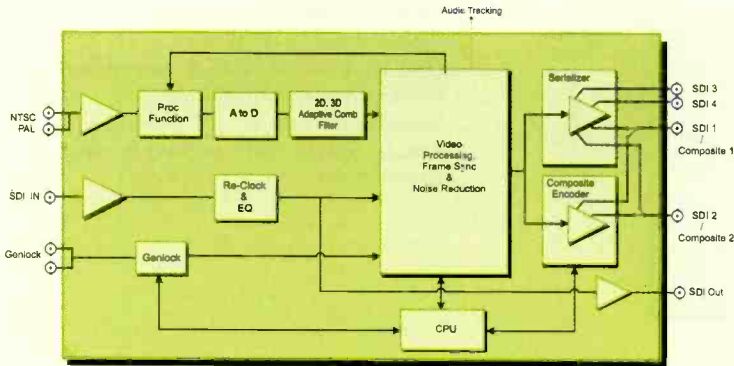

- 12-bit fully adaptive frame/field/3-line/notch composite decoding, processing amplifier with clipping
- SDI input with internal decoder bypass
- Noise reduction removes impulse and random noise
- Input noise immunity and input video soft clipping
- 2 user-selectable outputs (SDI with embedded EDH or composite analog monitoring)
- Video proc amps for digital and analog inputs
- Line-by-line VBI selection (normal, simple, bypass, delete)
- Provides internal audio tracking to audio synchronizers

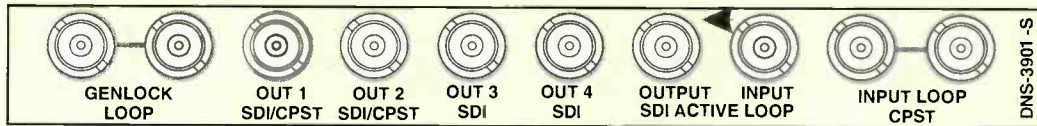

ENS-3901 — SDI to NTSC/PAL Color Encoder/Synchronizer

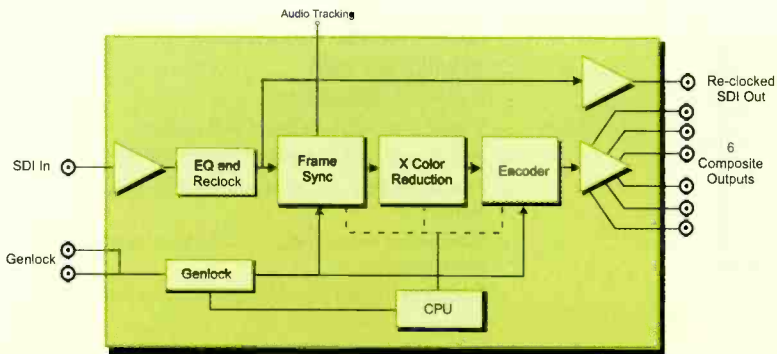

- High-quality, chroma-locked broadcast composite encoder with processing amplifier and frame synchronizer
- 12-bit signal processing
- Vertical Blanking Field/Line/Mode Control
- Timing Controls: Vertical, Horizontal, Fine SC (from Genlock)
- IQ or UV modulation for the composite output
- Cross Color Reduction (525) and Aperture control (2 dimensional)
- Frame sync or delay mode
- Provides internal audio tracking to audio synchronizers

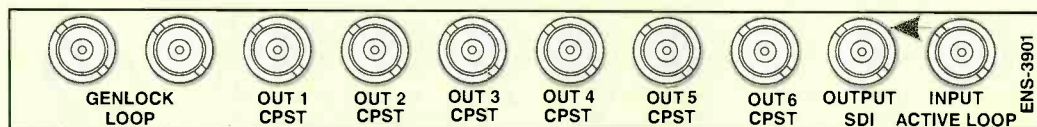

DES-3901-S — Composite Video to SDI Decoder/Synchronizer with SDI Input

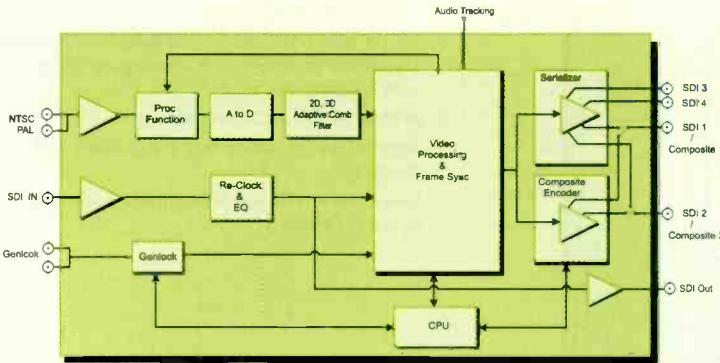

- 12-bit fully adaptive frame/field/3-line/notch composite decoding, processing amplifier with clipping
- SDI input with internal decoder bypass
- A to D 12-bit input processing
- Video proc amps for analog and digital inputs
- Input noise immunity and input video soft clipping
- 2 user-selectable outputs (SDI with embedded EDH or composite analog monitoring)
- Line-by-line VBI selection (normal, simple, bypass, delete)
- Provides internal audio tracking to audio synchronizer

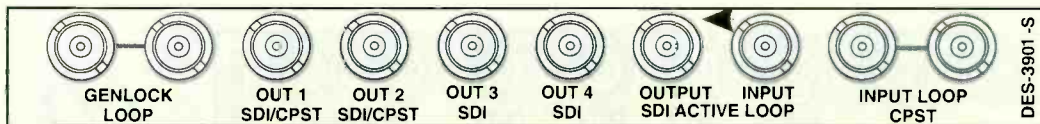

DNS-3902 — Composite Video to SDI Decoder/Synchronizer/Noise Reducer

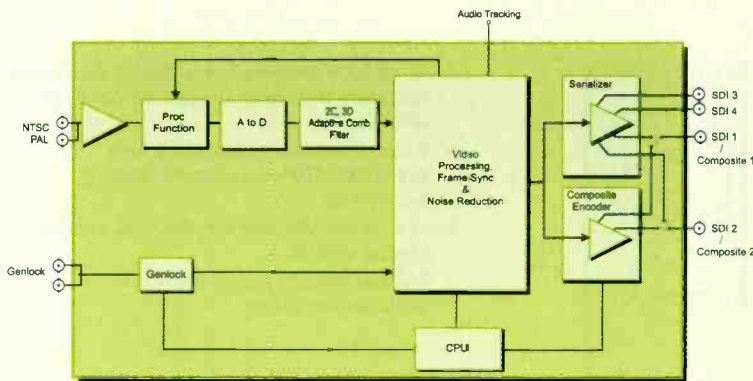

- 12-bit fully adaptive frame/field/3-line/notch composite decoding, processing amplifier with clipping
- Noise reduction removes impulse and random noise
- Input noise immunity and input video soft clipping
- 2 user-selectable outputs (SDI with embedded EDH or composite analog monitoring)
- Line-by-line VBI selection (normal, simple, bypass, delete)
- Provides internal audio tracking to audio synchronizers

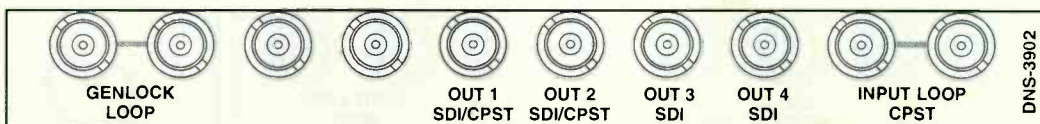

NEO VIDEO

NEO VIDEO

DEC-3902 — Composite Video to SDI Decoder

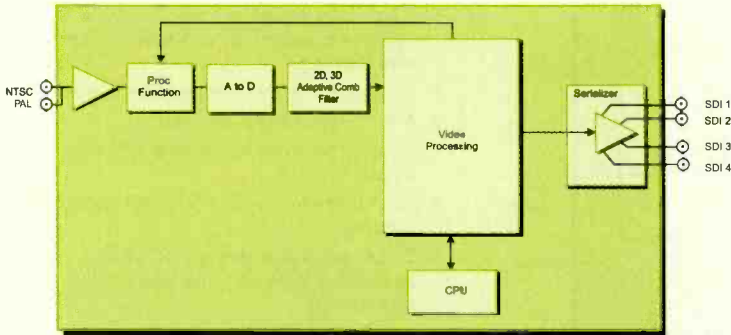

- 12-bit fully adaptive frame/field/3-line/notch composite decoding, processing amplifier with clipping
- A to D 12-bit input processing
- Input noise immunity and input video soft clipping
- Line-by-line VBI selection (normal, simple, bypass, delete)

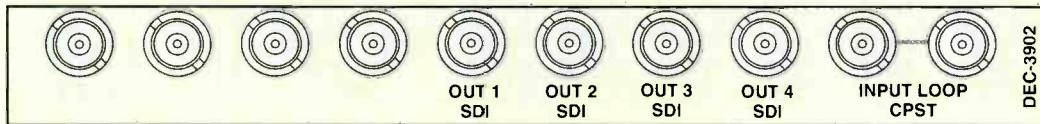

DES-3902 — Composite Video to SDI Decoder/Synchronizer

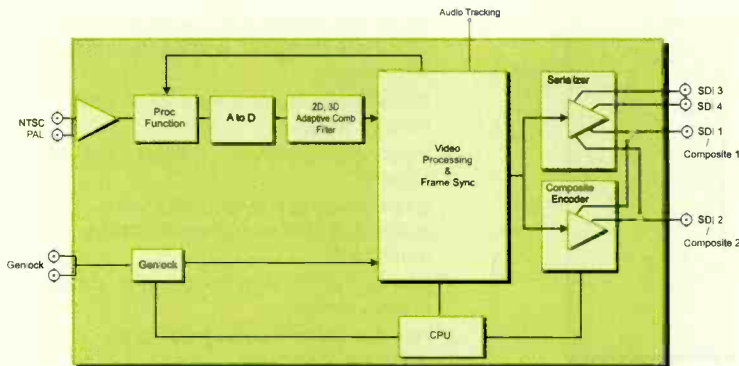

- 12-bit fully adaptive frame/field/3-line/notch composite decoding, processing amplifier with clipping
- 2 user-selectable outputs (SDI with embedded EDH or composite analog monitoring)
- Line-by-line VBI selection (normal, simple, bypass, delete)
- Provides internal audio tracking to audio synchronizers

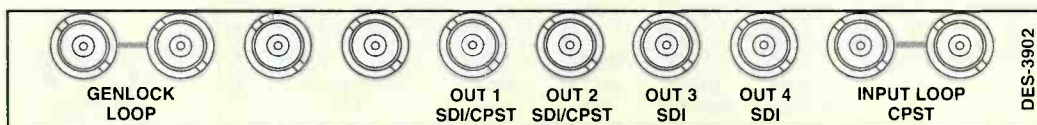

AVS-3902-B, C — SDI/AES and Embedded Audio Synchronizer/Processor

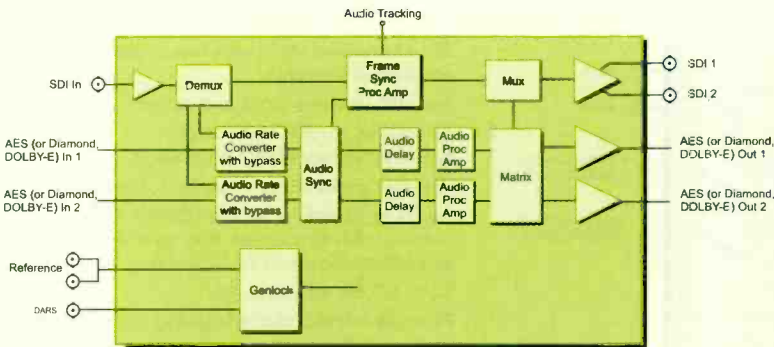

- Cleanly handles hot switch on input for video AES and embedded audio
- Embedded audio is demultiplexed and subsequently remultiplexed to avoid audio distortion during frame drop/repeat
- 3-color space video processing amplifier (YPrPb/composite/ GBR)
- 16/20/24-bit AES and embedded audio synchronization/ delay/processing
- Variable audio delay up to 1.3 seconds
- Passes compressed audio data, i.e., Diamond, Dolby® E, AC-3™
- Up to 30 frames video delay in delay mode
- Provides internal audio tracking to additional audio synchronizer

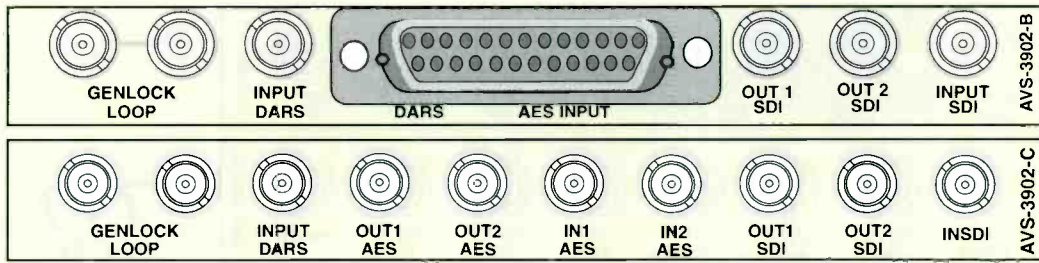

AVM-3902-B4, C4 — SDI/AES and Embedded Audio Synchronizer/Processor and Multiplexer

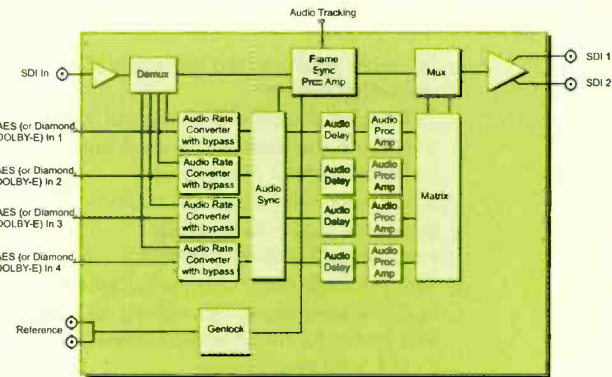

- Cleanly handles hot switch on input for video AES and embedded audio
- Embedded audio is demultiplexed and subsequently remultiplexed to avoid audio distortion during frame drop/repeat
- 3-color space video processing amplifier (YPrPb/composite/ GBR)
- 16/20/24-bit AES and embedded audio synchronization/ delay/processing
- Up to 30 frames video delay in delay mode
- Variable audio delay up to 1.3 seconds
- Provides internal audio tracking to additional audio synchronizer

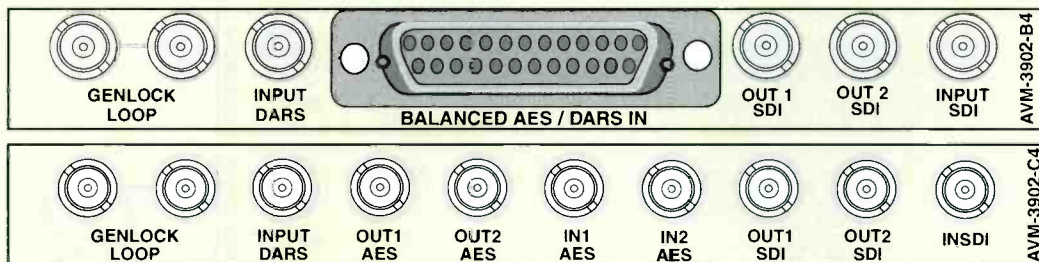

NEO SIMPLICITY

NEO SIMPLICITY

AVS-3901-B, C — SDI/AES Synchronizer/Processor

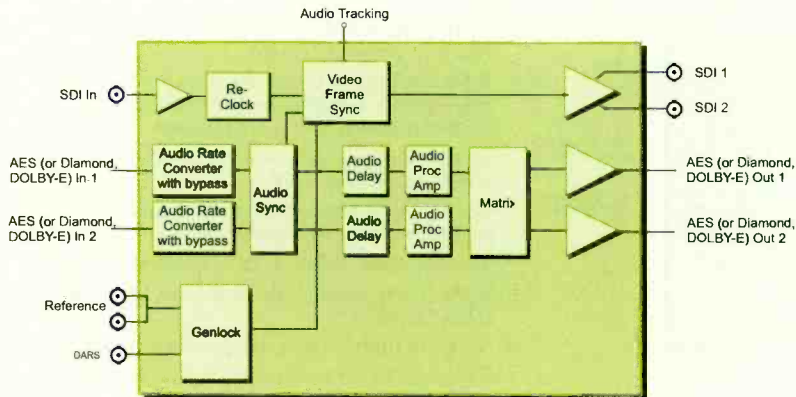

- SDI embedded input with two processed SDI embedded outputs
- Two AES streams input and output
- Selectable 16/20/24-bit audio synchronization/delay/ processing
- Variable audio delay of up to 1.3 seconds
- Audio re-sampling for 32-108kHz AES outputs, with bypass for data over AES operation, Diamond or Dolby® E
- C, U & V bit transparency
- Provides internal audio tracking to additional audio synchronizer

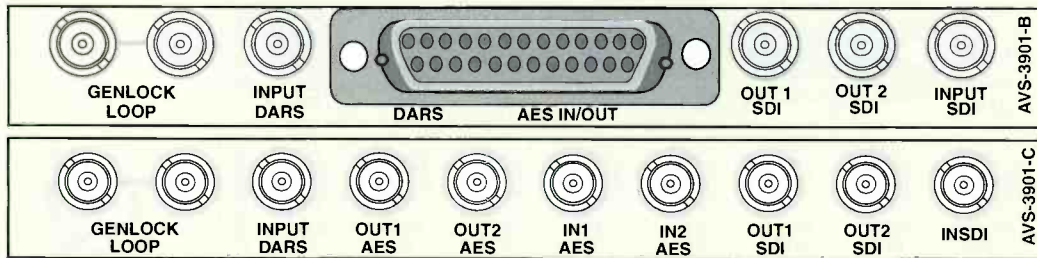

AVM-3901-A, B, C, B4, C4 — SDI/Audio Synchronizer/Processor and Multiplexer

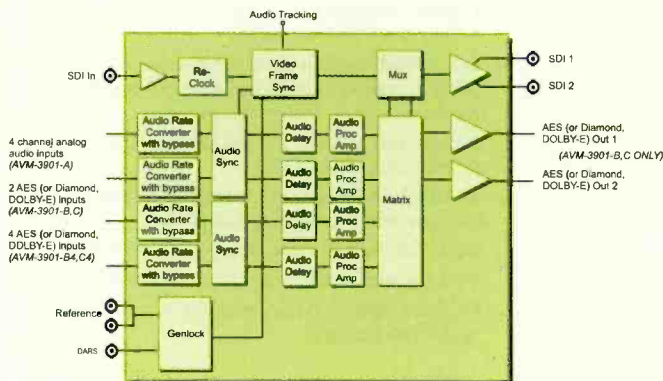

- SDI video input with two processed SDI embedded outputs
- 2 SDI video outputs with embedded audio
- 2 AES or 4 channels analog input with multiplexed and 2 AES outputs
- 4 AES input with multiplexed output
- Selectable 16/20/24-bit audio synchronization/delay/processing
- Variable audio delay of up to 1.3 seconds
- Audio re-sampling for 32-108kHz AES outputs, with bypass for data over AES operation
- C, U & V bit transparency
- Provides internal audio tracking to additional audio synchronizer

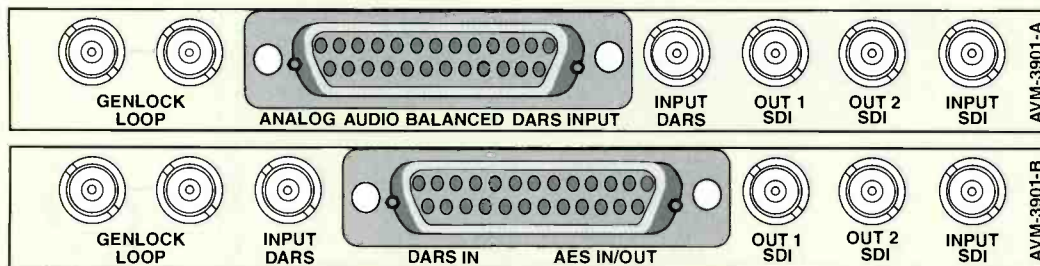

See page 59 for other back panels: AVM-3901-C, B4, C4

DAS-3901 — Composite Video/Analog Audio Synchronizer/Processor/Multiplexer

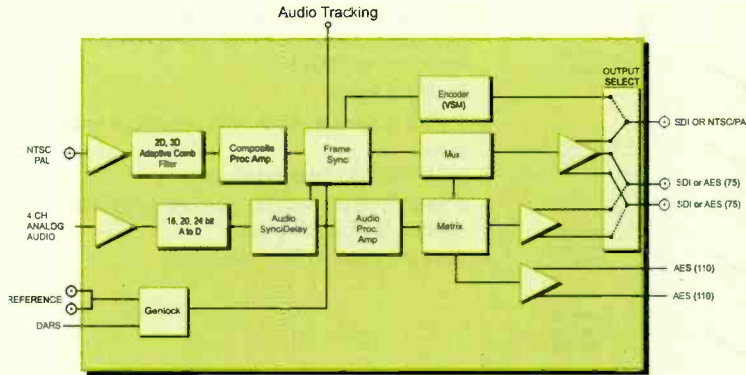

- 12-bit fully adaptive frame/field/3-line/notch composite decoding, synchronization, processing amplifier with clipping (hue, chroma, video, setup controls)
- Line-by-line VBI handling and processing
- Selectable 16/20/24-bit A to D, synchronization, delay and processing amplifier (gain, swap, delay, invert, mix) for audio input
- Variable audio delay of up to 1.3 seconds
- Audio multiplexer
- Provides internal audio tracking to additional audio synchronizer

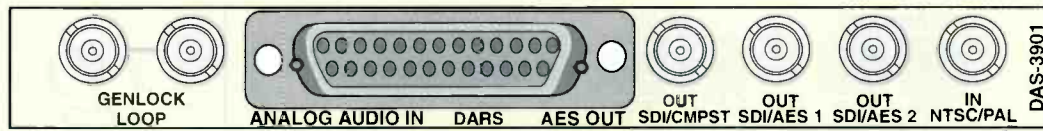

SFS-3901 — SDI and Embedded Audio Synchronizer/Processor

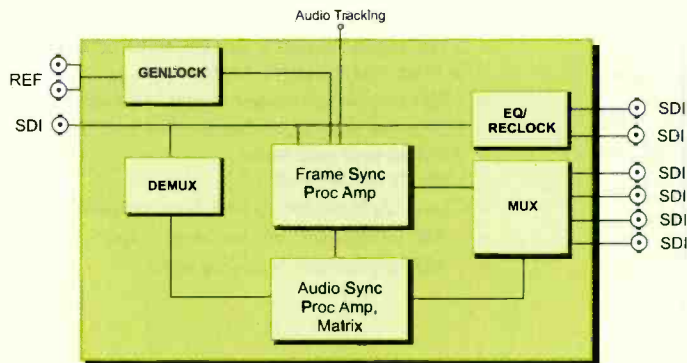

- Cleanly handles hot switch on input for video and embedded audio
- 3-color space video processing amplifier (YPrPb/ Composite / GBR)
- Up to 30 frames video delay in delay mode
- Embedded audio is demultiplexed and subsequently remultiplexed to avoid audio distortion during frame drop/repeat
- 16/20/24-bit embedded audio synchronization/delay/ processing
- Variable audio delay of up to 1.3 seconds
- Passes compressed audio data, i.e., Diamond, Dolby® E, AC-3™
- Provides internal audio tracking to additional audio synchronizer

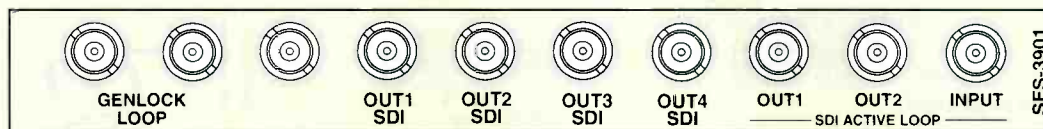

NEO SIMPLICITY

NEO SIMPLICITY

IRB-3901 — IRIG-B to/from SMPTE/EBU Timecode Converter

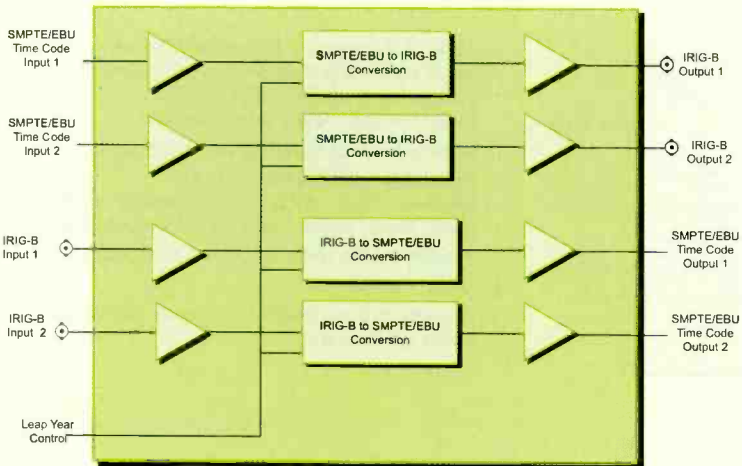

- Simultaneous conversion of IRIG-B to SMPTE/EBU timecode and SMPTE/EBU timecode to IRIG-B
- 2 IRIG-B inputs
- 2 IRIG-B outputs, each with selectable timecode inputs
- 2 SMPTE/EBU timecode inputs
- 2 SMPTE/EBU timecode outputs, each with selectable IRIG-B inputs
- Output locked to input timecode

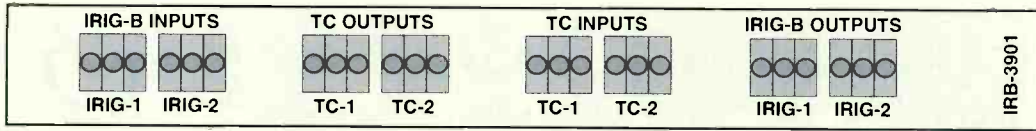

GPI-3901 — GPI and Marker Beep Module

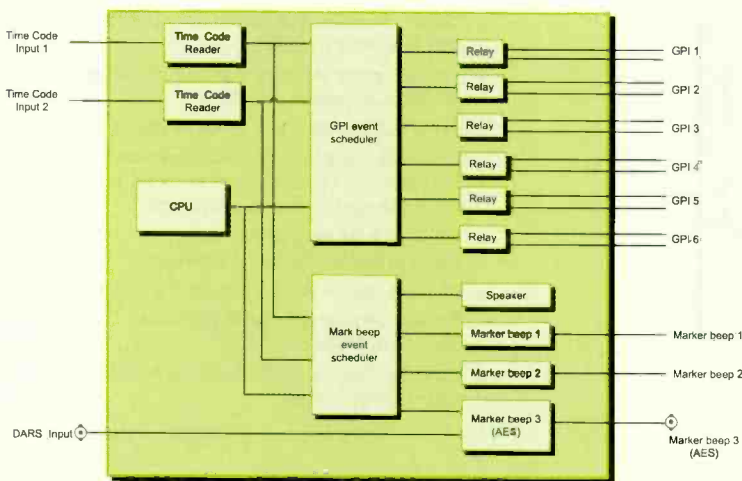

- 2 LTC inputs. Supports simultaneous operation of drop and non-drop timecode
- 6 GPI outputs with programmable events. Events are programmable for time and date, duration and recurrence. Outputs can be inverted.
- 2 user-configurable marker beep outputs
- 1 AES unbalanced marker beep output
- 1 AES unbalanced reference input

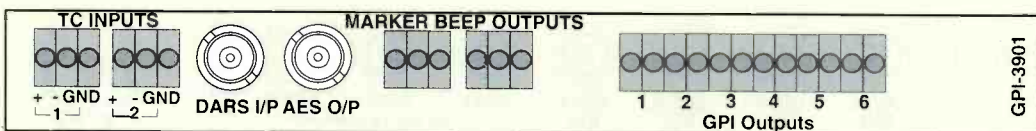

CSD-3902 — Master Clock Driver

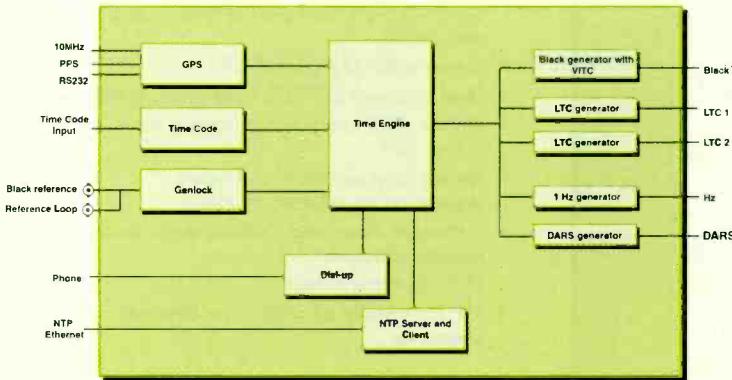

- GPS Interface for time reference (standard)
- Timecode input
- SMPTE/EBU drop-frame or non-drop timecode (Time/Date)
- Programmable DST Settings
- Built-in modem for dial in/out
- Dual timecode configurable for offsets and drop-frame and non-drop frame timecode
- Ethernet port for supplying NTP (Network Time Protocol)
- Impulse drive output (CSD-3902 only)
- Compatible with ACO-3901 automatic changeover

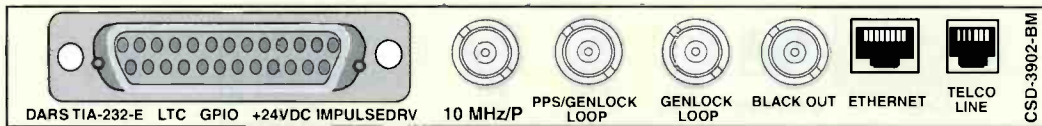

GPS-3902 — GPS Receiver and Antenna

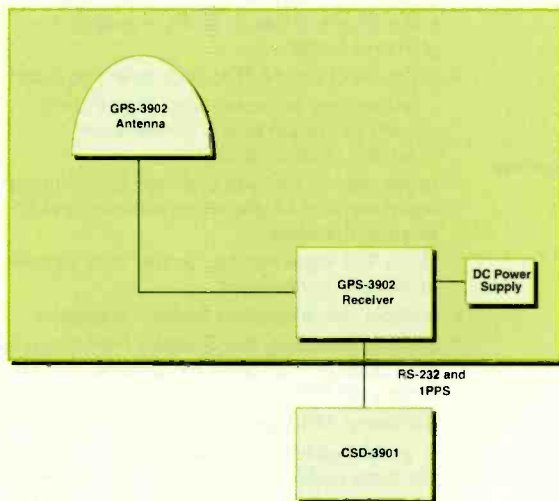

- Compatible with CSD-3902 MTG-3901 and CSD-5300
- GPS provides an accurate time reference available globally
- Separate antenna and receiver for mounting flexibility
- Accurate to 10ms

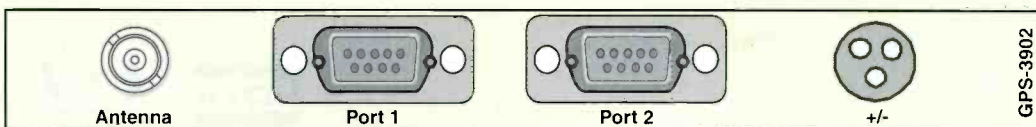

DVR-3901 — Digital Video Recorder

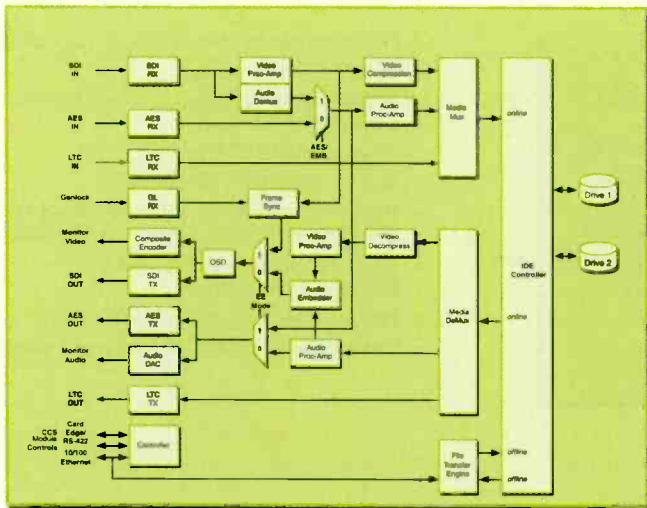

- Enhanced functionality including record and playback, variable speed playback, and jog and shuttle
- Supports RS-422 control link
- Dual onboard 2.5" IDE hard drive, 40GB each
- Motion JPEG compression ranges from 4:1 to 10:1
- Record time per drive: 2-8 hours, depending on selected bit rate
- 1 channel video and 1 stereo audio being recorded/played
- LTC input and output
- FTP file transfer of content via Ethernet connector

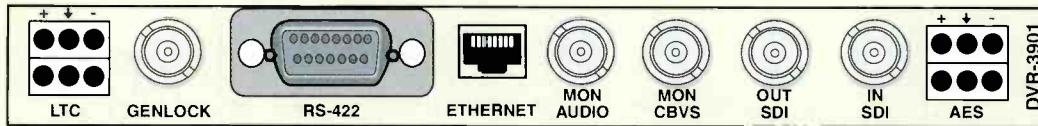

MGI-3901 — SDI LogoMotion II

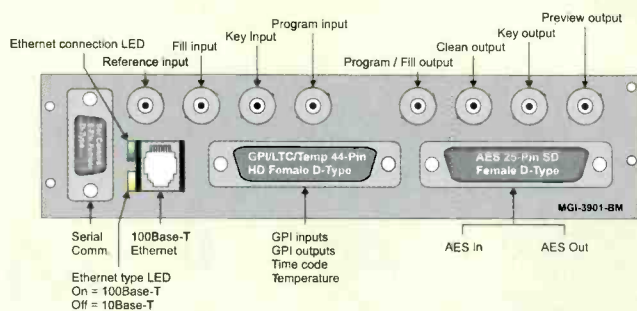
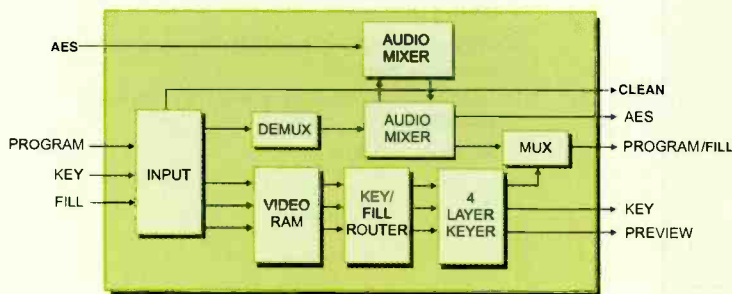

- Mix SD and HDTV modules in one NEO frame
- Bypass relay equipped as standard
- Front hot-swappable PSUs and modules
- User-configurable "apology/trouble slide" airs automatically if loss or errors in program or reference inputs
- Up to four logos in SDI; each layer (logo) can be:
 - Static logo, animated logo, digital clock (with or without time & temperature), analog clock or external key
- Logos may be any size and may be positioned anywhere with varying size transparencies and prioritized overlap, if desired
- Up to 999 logos can be "online" and instantly accessible on any layer
- Multiple native graphics formats supported
- Transfer files using the Compact Flash Card and/or over Ethernet from other file systems, machines or servers via NFS
- 4-channel AES capability (SDI)
 - 24-bit resolution, embedded and / or discrete, associate audio clips with logos or independently
- Operates in Program / Preview or Key / Fill modes



MGI-3901H — HDTV LogoMotion II

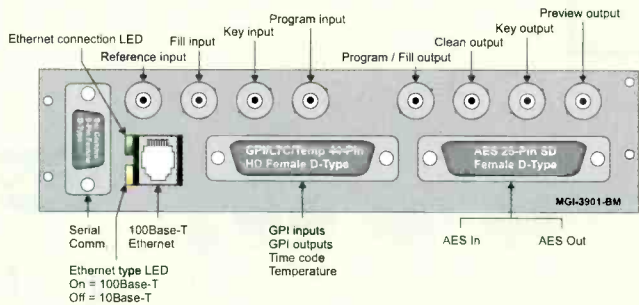
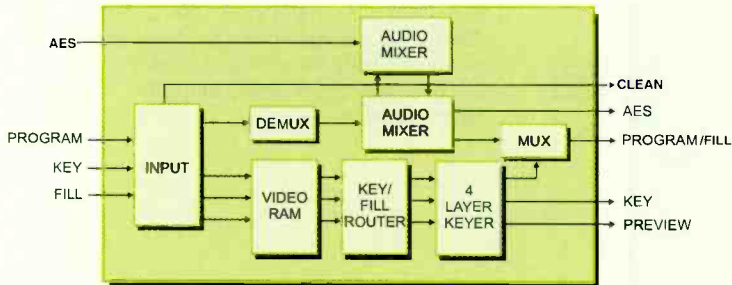

- Mix SD and HDTV modules in one NEO frame
- Bypass relay equipped as standard
- Front hot-swappable PSUs and modules
- User-configurable "apology/trouble slide" airs automatically if loss or errors in program or reference inputs
- Up to two logos in HDTV; each layer (logo) can be:
 - Static logo, animated logo, digital clock (with or without time & temperature), analog clock or external key
- Logos may be any size and may be positioned anywhere with varying transparencies and prioritized overlap, if desired
- Up to 999 logos can be "online" and instantly accessible on any layer
- Multiple native graphics formats supported
- Transfer files using the Compact Flash Card and/or over Ethernet from other file systems, machines or servers via NFS
- 4-channel AES capability (SDI)
 - 24-bit resolution, embedded and / or discrete, associate audio clips with logos or independently
- Operates in Program / Preview or Key / Fill modes



MTG-3901 — Master Timing Generator

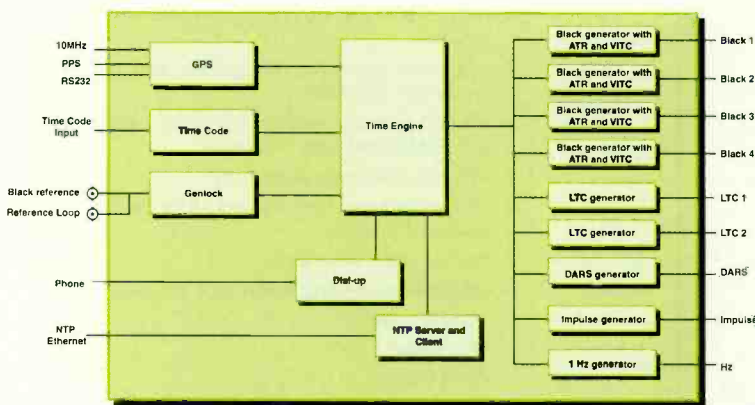

- Fully integrated reference signal generator system
- High-density modular packaging for any application
- Comprehensive array of reference signals for maximum flexibility and economy
- GPS synchronization for maximum precision (Optional)
- Integrated automatic changeover unit for enhanced reliability (Optional ACO-3901)
- Fully redundant and standalone configurations available

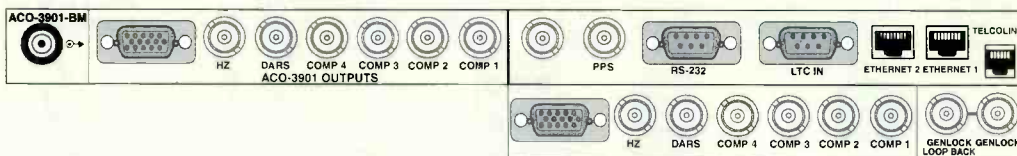

AS-3901-B, C — 2 AES Audio Synchronizer/Delay/Processor AS-3981-AD, DA, DA-600 — 4-Channel Analog/2-Channel AES Audio Synchronizer/Delay/Processor

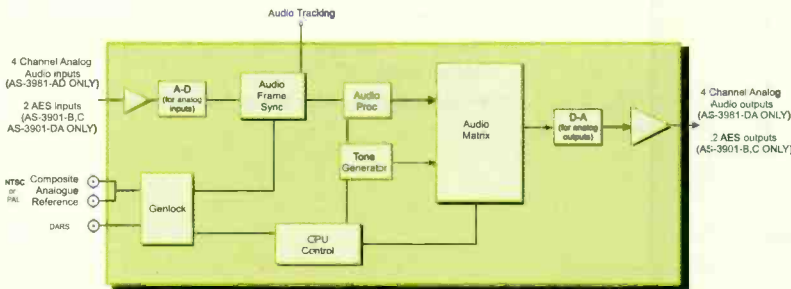

- Companion audio synchronizer to any NEO SDI/HDTV frame synchronizer
- Analog or digital audio interfaces
- Tracks to video synchronizer products
- Full audio processing (gain, channel swap, invert, delay)
- Balanced or unbalanced AES
- Variable audio delay up to 1.3 seconds

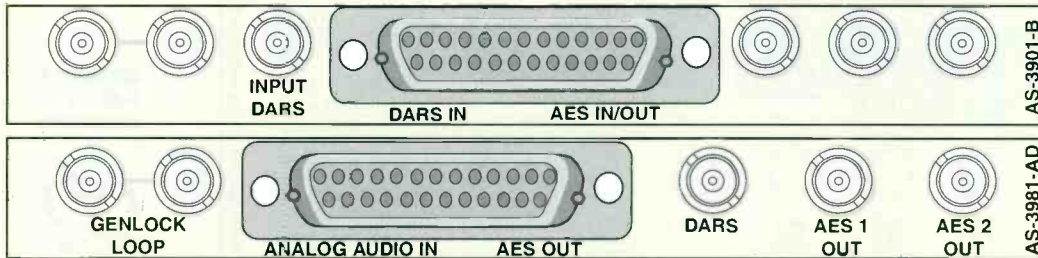

See page 59 for other back panels: AS-3901-C, AS-3981-DA

NSV-xxxx — NEO SuiteView Multi-Source Display Processors

Highly scalable, modular, multi-source display processor renders multiple video & computer graphic signals in real time to plasma, LCD, high-resolution computer monitors and projection displays.



- Up to 44 inputs in 3RU frame, up to 12 inputs in 1RU frame
- Unique auto-format detecting HD-SDI, SDI & composite inputs
- NTSC, PAL, PAL-M, VGA & DVI inputs supported
- Outputs configurable up to UXGA
- Redundant outputs standard
- Separate external graphics input
- Reliable flexibility with NEO
 - Ideal for mission-critical applications (24/7 operation)
 - Redundant PSU & controllers
 - Front-loading, hot-swappable modules and PSUs
 - Mix-n-match with other NEO modules in the same frame
- Audio metering & alarm support for embedded, analog stereo & AES/EBU audio
- Dynamic UMDs & multiple tallies
- Extensive alarming capabilities

NEO SuiteView Related Modules

- NSV-H4 Quad auto-detecting HD/SDI/composite video input module
- NSV-S4 Quad auto-detecting SDI/composite video input module
- NSV-V4 Quad analog composite video input module (also supports fewer YUV, Y/C) inputs
- NSV-G3 Triple VGA/DVI graphics input module
- NSV-OUT Output module with redundant outputs
- NSV-EAxx Embedded audio option, per video input (xx)
- NSV-AUD16 16 channel stereo analog audio input module
- NSV-AES16 16 AES channel audio input module
- NSV-AB+8 Audio module with 8 analog stereo audio + 8 AES channels



See page 61, 62 for more information.

MXA-3901H-B4, C4 — HDTV 4 AES Audio Multiplexer

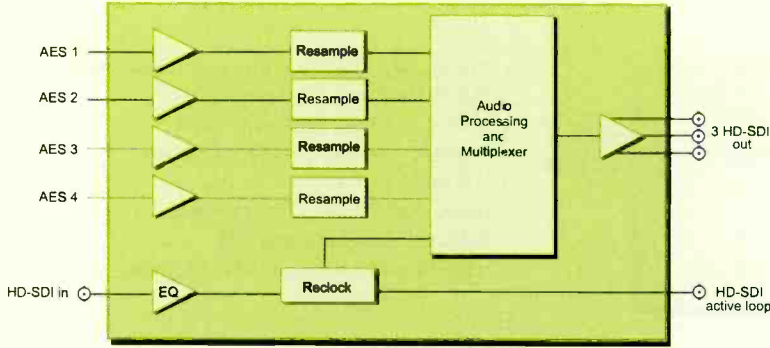

- 4 AES audio multiplexing into HDTV
- Selectable 16/20/24-bit audio delay/processing
- Passes compressed audio data, ie., Diamond, Dolby® E, AC-3™
- Variable audio delay up to 1.3 seconds

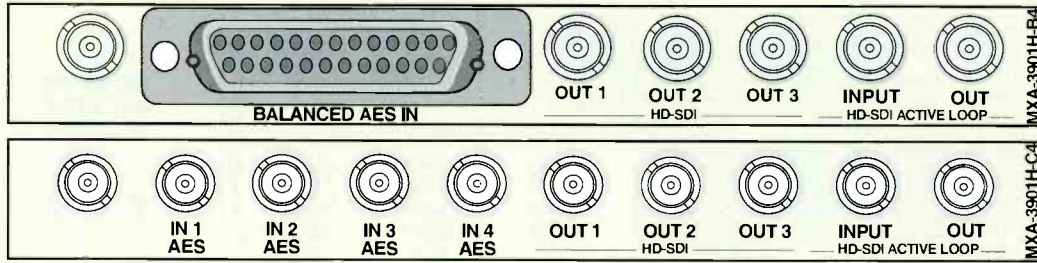

DMX-3901H-B4, C4 — HDTV 4 AES Audio Demultiplexer

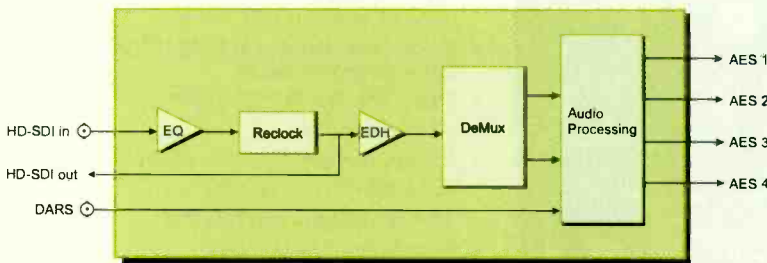

- 4 AES audio demultiplexing from HDTV
- Selectable 16/20/24-bit audio delay/processing
- Passes compressed audio data, ie., Diamond, Dolby® E, AC-3™
- Variable audio delay up to 1.3 seconds

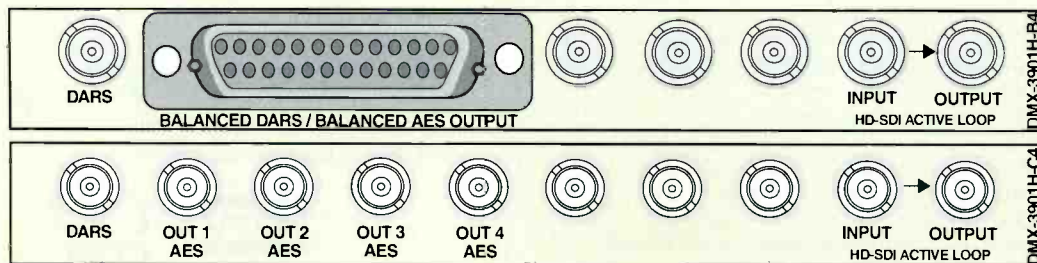

HUC-3901 — HDTV Upconverter

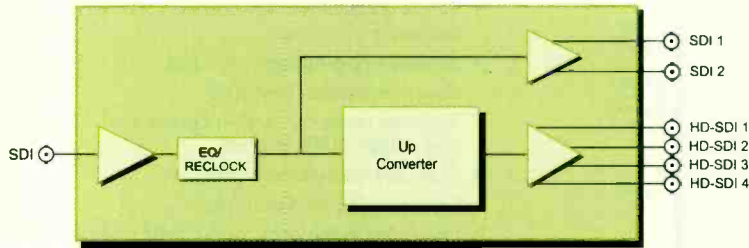

- Single-channel HDTV upconverter
- Supports 480i, 720p and 1080i formats
- Ideal for upconversion of existing SDI content

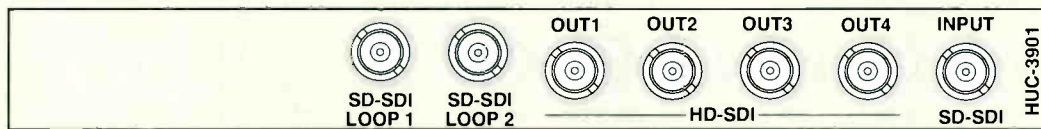

HDC-3901 — HDTV Downconverter HDC-3901-AD — HDTV Downconverter with Demultiplexer

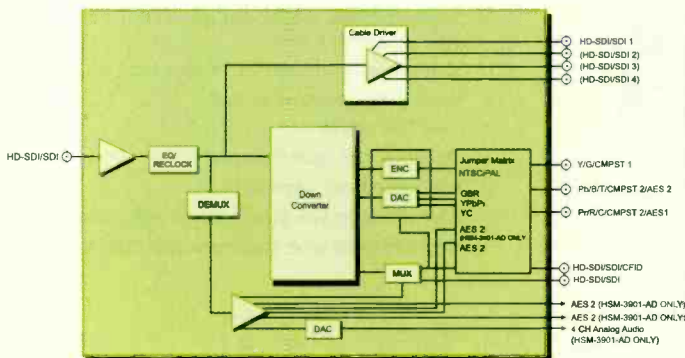

- Supports HDTV signals for 1080i/59.94, 1080i/50, 720p/59.94, 720p/50, 1080p/25 for down-conversion
- SD and HD input capability
- NTSC/PAL (3) or GBR, YPbPr (1) converted video monitoring outputs
- Supports five display types for downconverted HDTV signal:
Anamorphic, Letter Box, Crop, 14:9 and Zoom In
- Embedded audio (one group) is passed from the HD-SDI input to the SDI output
- Monitoring outputs for analog and digital audio:
2 AES audio outputs; 4-channel analog audio outputs

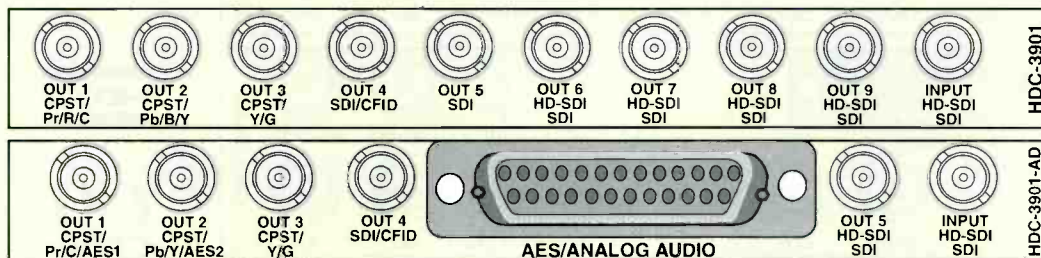

XHD-3902-C — HDTV Cross Converter

PRELIMINARY
See Page 69 for current X75HD

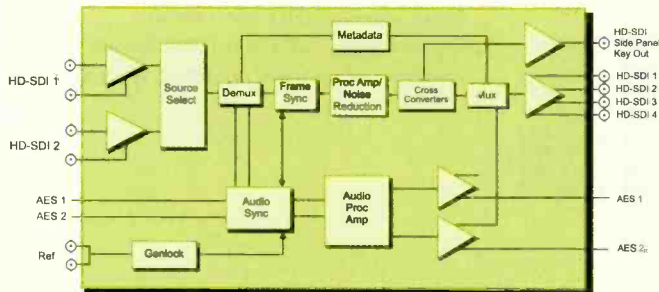

- Single-channel motion-adaptive HDTV cross converter
- Software-upgradeable up- and down-conversion (optional)
- Supports cross-conversion between all 720p and 1080i HDTV formats
- Dual SDI-embedded inputs
- Optional AES audio support
- Integrated video proc, audio proc and noise reduction
- Separate sidebar key channel output

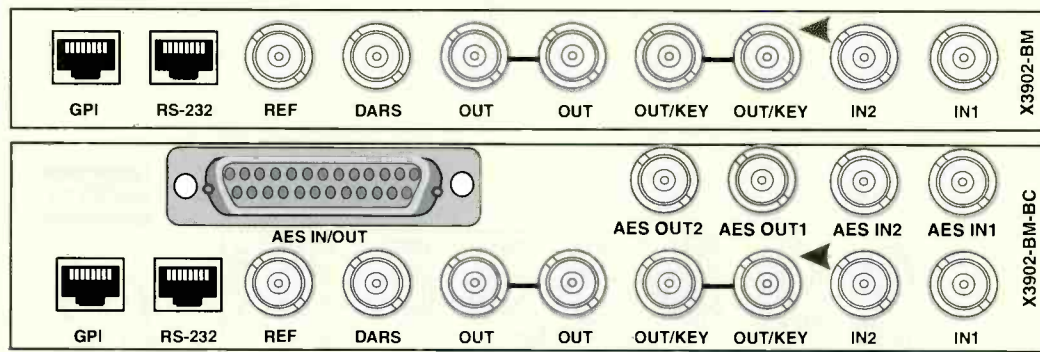

X75™HD



HRC-3901 — HDTV Aspect Ratio Converter

PRELIMINARY
See Page 69 for current X75HD

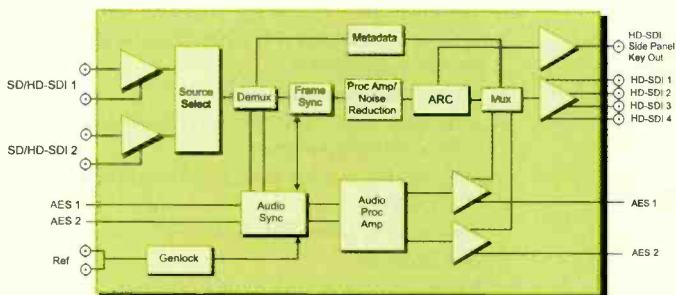

- Single-channel motion-adaptive HDTV aspect ratio converter
- Supports all common SDTV and HDTV formats
- Sidebar key channel output
- Dual SDI inputs
- Optional AES audio support
- Selectable fixed aspect ratios
- User-configurable aspect ratios with presets
- Integrated video proc, audio proc and noise reduction

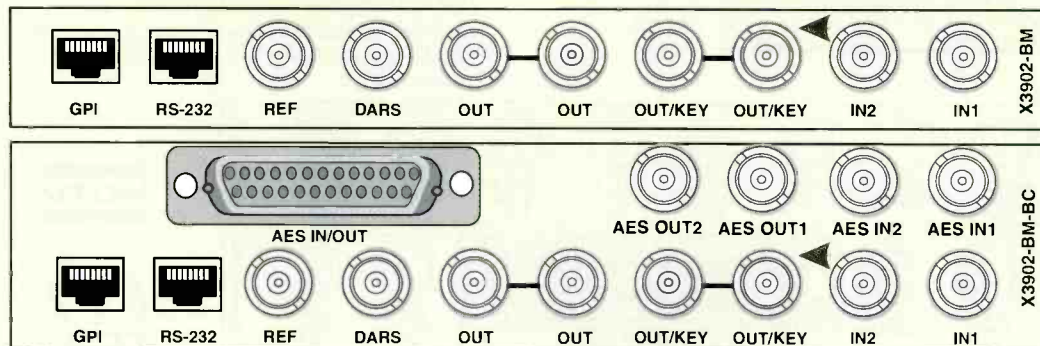

XHD-3902-U — HDTV Upconverter with Audio Processing

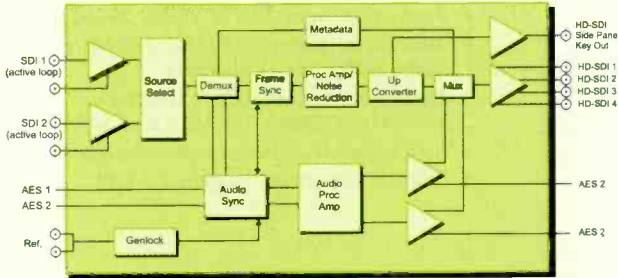

- Single-channel motion-adaptive HDTV upconverter
- Software-upgradeable down- and cross-conversion (optional)
- Supports, 720p and 1080i formats
- Dual SDI-embedded inputs
- AES audio supports (optional)
- Remapping of SDI metadata into HDTV output
- Integrated video proc, audio proc and noise reducer
- User-configurable output image ARC and picture position
- Separate sidebar key channel output

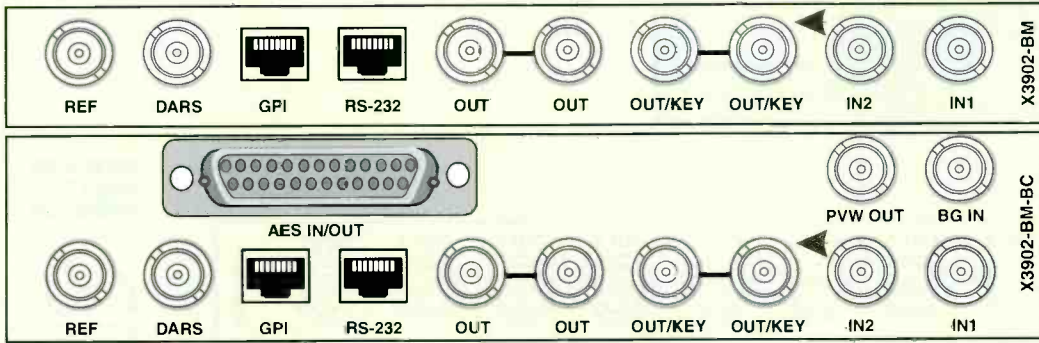

X75'HD



PRELIMINARY
See Page 69 for current X75HD

XHD-3902-D — HDTV Downconverter

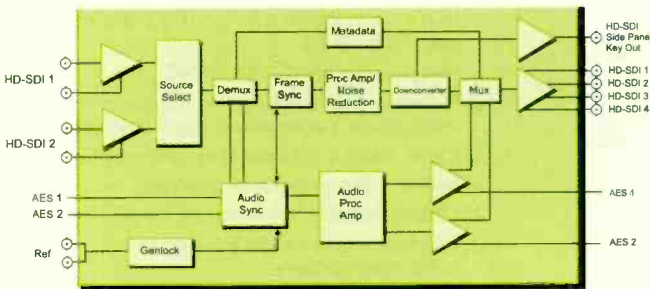

- Single-channel motion-adaptive HDTV downconverter
- Software-upgradeable up- and cross-conversion (optional)
- Supports down-conversion of 480P, 720P and 1080i formats
- Dual SDI inputs
- Optional AES audio support
- Integrated video proc, audio proc and noise reducer
- Remapping of closed captioning
- Sidebar key channel output

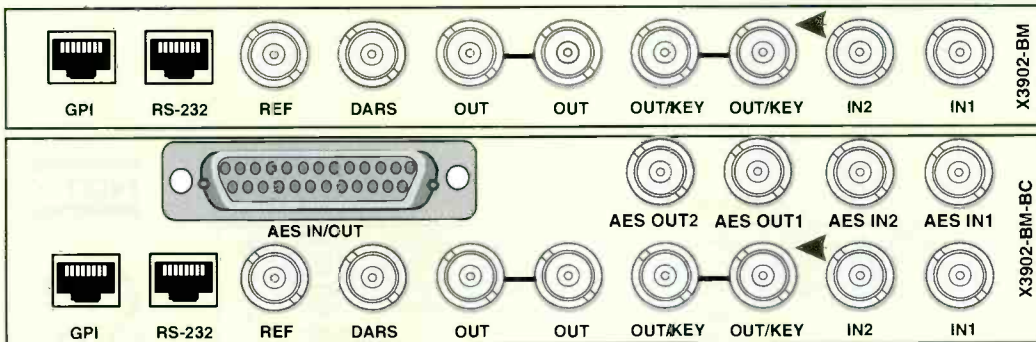

X75'HD



HSE-3901 — HDTV and SDI Reclocking Distribution Amplifier

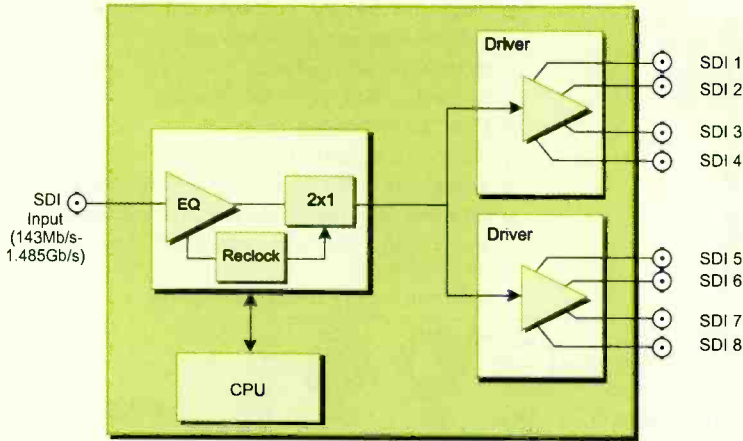

- Input signal types: SMPTE 259M, 292M, 344M
- Auto EQ for 300m (983ft.) for 270 Mb/s and 159m (483 ft.) for 1.485Gb/s
- Auto reclocking at 1.5Gb/s, 143Mb/s, 177Mb/s, 270Mb/s, 360Mb/s and 540Mb/s
- Auto bypass if unable to lock at the above rates
- DVB-ASI compatible (outputs 2,4,6,8)

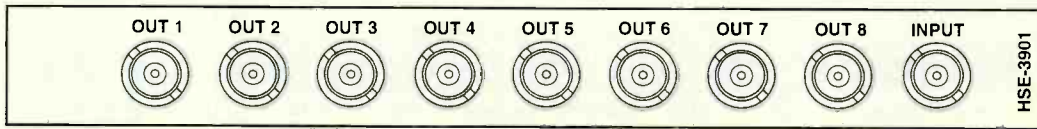

VFS-3901H-1 — HDTV Video Frame Synchronizer/Processor

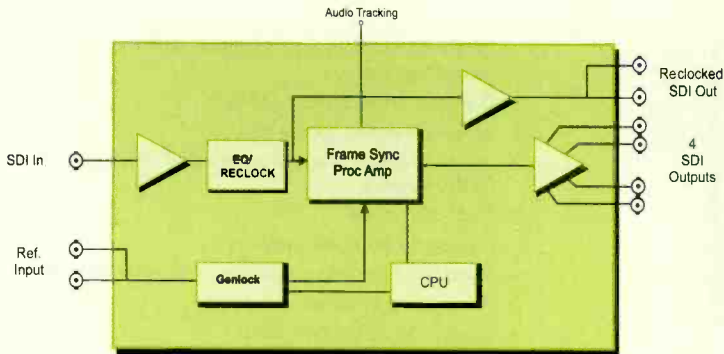

- HDTV video frame sync for 1080i-50/59.94 and 720p-59.94
- Passes entire VANC and HANC
- Provides audio tracking and hot-switching internally to a companion audio synchronizer
- Color, black or tri-level sync reference input
- Built-in video processing amplifier
- Cleanly handles hot switch on input
- Provides internal audio tracking to audio synchronizers

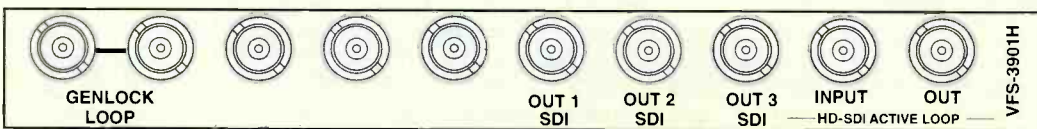

NEO: For Advanced Applications — NEO frames have been designed with the future in mind, offering flexibility for multiple applications of use and housing any combination of video/audio analog/digital conversion and distribution modules. The frames offer an easy upgrade path of video and audio from analog to SDI and HD for Broadcast, Post Production, Cable and Telco applications requiring monitoring and control capability of incoming and outgoing feeds. There are two frame sizes available for NEO products: A 1RU frame that holds four NEO products and a 3RU frame that holds twelve NEO products. Additionally, a local control panel can be provided at time of order or can be field retrofitted for the 1RU frame.

CCS-Resource Communications Module

When external communications and/or a local control panel are necessary, a resource communications module is required. External contact closures and Ethernet communications are supported. The FR-3901-E, FR-3901-E-P and FR-3923-E frames contain this module. There is room for one resource module in the 1RU frame and room for two (redundant) resource modules in the 3RU frame.

3901PS Power Supply

The 3901PS provides power to the modules inside the 1RU frame. The 1RU frame can hold a single power supply. It is hot-swappable from the front of the frame.

3923PS Power Supply

The 3923PS provides power to the modules inside the 3RU frame. The 3RU frame can hold up to two power supplies. The 3923PS is hot-swappable from the front of the frame.

Features

- Capacity of four modules in the FR-3901 and twelve modules in the FR-3923
- No power or thermal limits for any module combination within the NEO frame
- Front-loading, hot-swappable modules, fans, power supplies and resource modules
- DejaView: Intelligent, automatic parameter recovery in cases where spare modules replace failed ones

Remote Control Panel

The RCP-CCS-1U remote control panel provides simple control and monitoring of devices on a Leitch CCS network. This control panel supports all CCS-enabled products.



RCP-CCS-1U



FR-3901



FR-3923



VTS-6801 — Video Timing Switch

- Fixes SAV/AEV errors
- Fixes illegal codes in active picture
- Recalculates EDH (Error, Detection and Handling)
- 2 x 1 clean-switch router
- Used to time input signals for devices with no time buffers on inputs
- Can be used as two independent delay lines (no reference input)
- GPI control for video switching
- Horizontal phase adjustment
- **Note:** This is a 6800 series module

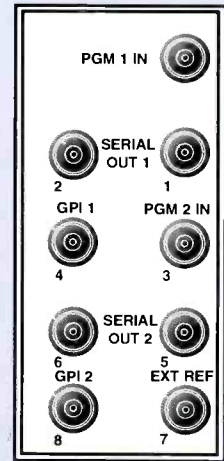
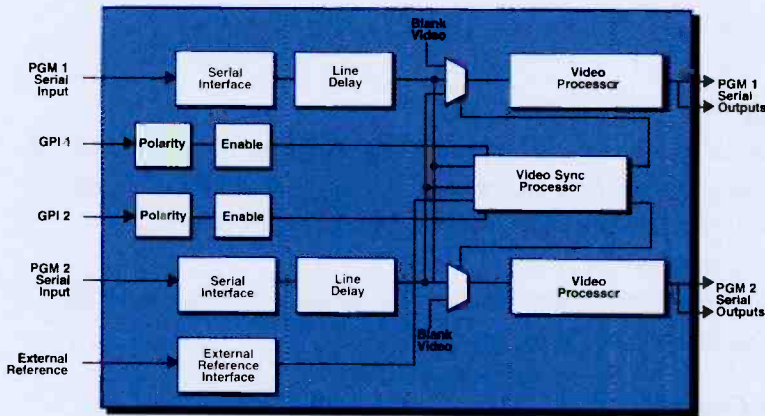

VTS-6801
Double-Slot
Back Connector

ICE6800+ — CCS Ethernet Communications Card

Each CCS Ethernet card provides connectivity of up to nine 6800+ frames to Leitch CCS Networks.

- Fits in FR6802+X and FR6802+XF frames
- Controls 8 additional frames (FR6802+DM/DMF and/or FR6802+X/XF) via simple coaxial interconnections
- Full CCS client support including Pilot, Navigator, CCS Control Panel, etc.
- Supports real-time remote control access via Ethernet to PC for get/set/adjust, automatic status monitoring and alarming
- Status and change monitoring is achieved off of the network, minimizing traffic for optimal use
- Interface option to external SNMP monitoring systems
- Supports full Leitch External Protocol (EP) with third-party automation capability

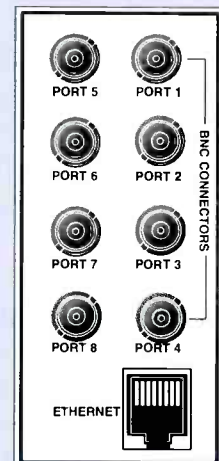
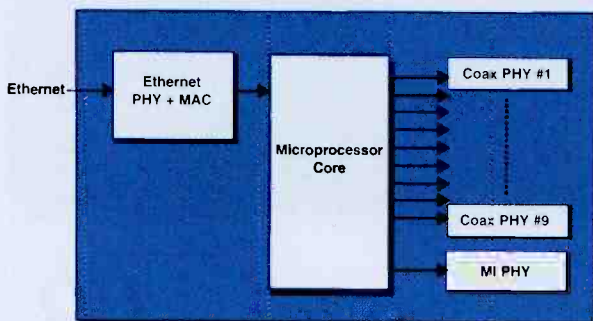

ICE6800+
Back Connector



DAR-6880 — AES Audio Reference and Test Generator

- Locks to video or AES audio
- Auto-detects PAL/NTSC
- Provides 8 Digital Audio Reference Signal (DARS) outputs:
 - 5 DARS outputs with card edge selection of tone or silence
 - 3 dedicated DARS outputs (1-tone, 1-silence, 1-word clock)
- Generates self-clocking AES grade-2 reference at loss of sync or in free-run mode
- Versatile DARS tone signal – Output level adjustable from 0 to 31 dBFS in 1dB increments
- Note:** This is a 6800 series module

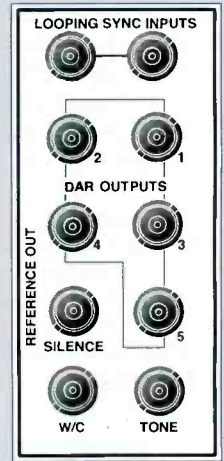

DAR-6880
Back Connector

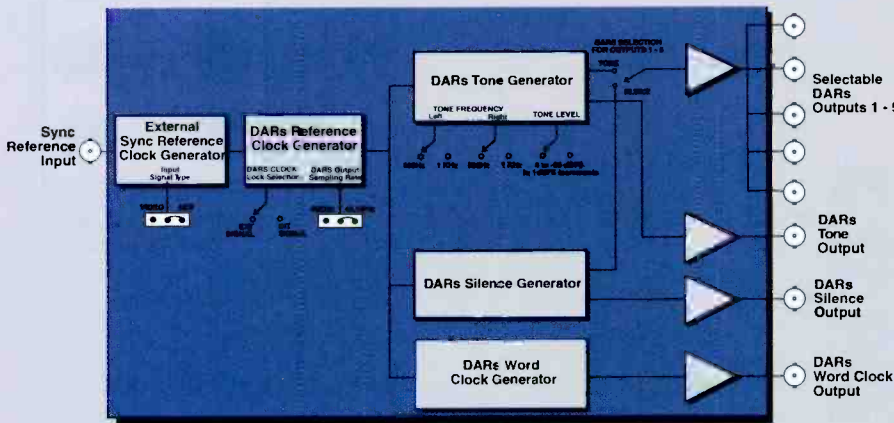

VSR-4041 — SDI 4x1 Switch

- 4x1 serial digital switcher
- Digital component or composite video
- Two serial outputs
- Local and/or remote operation
- All inputs equalized for up to 200m (675ft)
- Reclocked outputs
- Note:** This is a 6800 series module

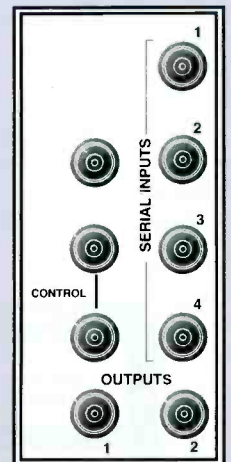

VSR-4041
Double-Slot
Back Connector

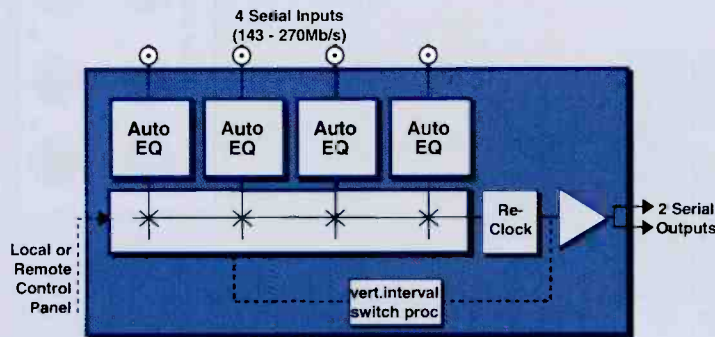

VES-6801, VES-6801-2 — SDI Video Slide Generators

- Single-channel and dual-channel models
- Storage for two 8-bit or single 10-bit images per channel
- 4 serial digital 270Mb/s outputs with embedded EDH
- Analog reference input (black or sync) provides genlock capability
- Infinite phasing relative to reference, s/w controlled V and H adjust
- Supports both 525- and 625-line standards, and can accommodate slides of both standards on a single module
- Card edge controls for timing and slide selection
- GPI input for slide selection
- Fully compatible with complete set of Logo Graphics Utilities (LogoWIN and LogoDOS)
- Front PCB-mounted DB-9 serial port for image downloading, RS232 also available on two BNCs
- **Note:** This is a 6800 series module

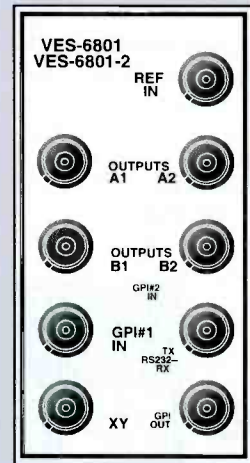
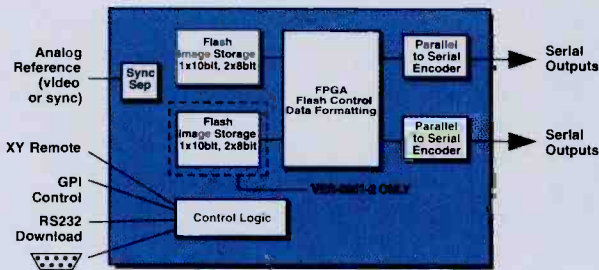

VES-6801 and VES-6801-2
Back Connector

VTG-6801-1 — SDI Test Signal Generator

- Up to 32 selectable 4:2:2 digital test signals (10-bit)
- 8 serial outputs
- Optional embedded digital audio (AES/EBU) test signals
- Optional embedded EDH check words in test signal
- 4:3, 270Mb/s interlaced
- Free run or genlock operation
- Infinite timing range
- **Note:** This is a 6800 series module

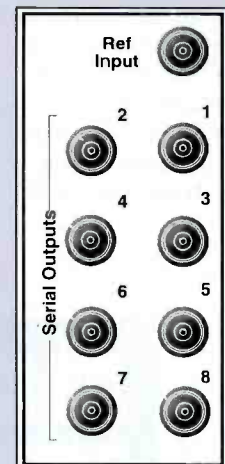
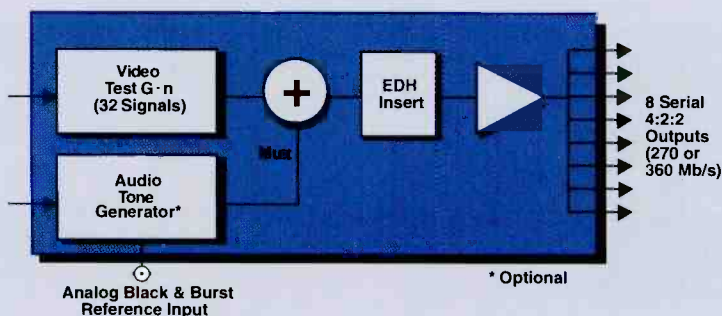

VTG-6801-1
Back Connector

LGI-6801 — SDI Logo Generator/Inserter

- 525/625 line formats supported (auto detect)
- TARGA, TIFF, JPEG, PICT file formats supported
- GPI control interface
- **Note:** These are 6800 series modules

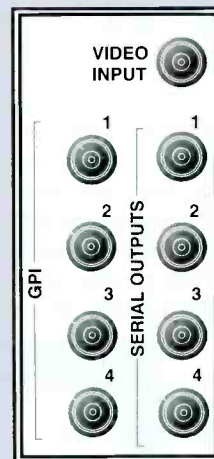

LGI-6800
Double-Slot
Back Connector

DSK-6801, DSK-6803 — SDI Downstream Keyers

Both DSKs Feature:

- Full 10-bit program path with 12-bit keyer for optimum quality
- MIX keying mode
- Control via card edge controls or GPI contact closures
- RS232/422 serial port for automation and editor control
- Luminance or linear keying
- Adjustable transparency, gain, offset, fade rates
- Fade-to-black

DSK-6803 Adds:

- Preview path
- Additive keying mode
- Simple chroma keyer
- Simple wipe transitions
- **Note:** These are 6800 series modules

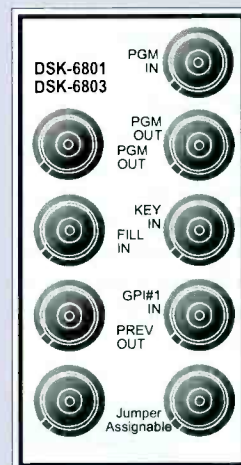
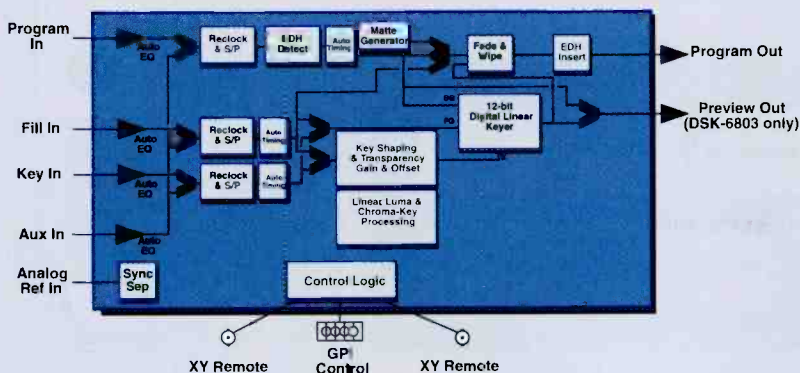

DSK-6800 and
DSK-6803
Back Connector

6800+ SPECIALITY

6800+ SPECIALITY

SOS6800+ — SDI to Single-mode Optical Transmitter SOM6800+ — SDI to Multi-mode Optical Transmitter

The SOS6800+ is suited to transmitting over longer "metropolitan" distances.
The SOM6800+ is best suited for "enterprise" distances.

- Cost-effective solution for transmitting SDI and DVB-ASI signals over fiber
- Automatic detection or fixed setup for 143, 177, 270, 360 or 540 Mb/s
- Bypass mode for non-relocked data rates
- Detection and alarming of equalization and video format
- Automatic cable EQ up to 300 meters for Belden 1694A at 270Mb/s
- 1310nm wavelength output on SC-, ST- or FC-type fiber connector
- Optical power better than -7.5dBm
- Fit up to 20 modules in FR6802+X(F) frame

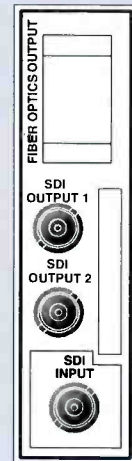
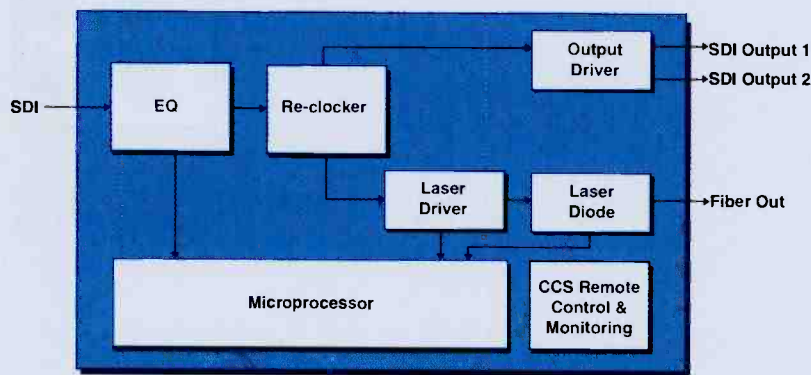

SOS6800+,
SOM6800+
Back Connector



OSS6800+ — Single-mode Optical to SDI Receiver OSM6800+ — Multi-mode Optical to SDI Receiver

The OSS6800+ module is suited to reception over longer "metropolitan" distances.
The OSM6800+ is best suited for "enterprise" distances.

- Cost-effective solution for reception of SDI and DVB-ASI signals over fiber
- 1310 to 1550nm wavelength input on SC-, ST- or FC-type fiber connector
- Minimum input power better than -29 dBm (270 Mb/s)
- Automatic optical input signal detection
- Alarming of input signal loss and non-locked data rate
- Automatic or fixed relocking of output at 143, 177, 270, 360 or 540 Mb/s
- Bypass mode for non-relocked data rates
- Fit up to 20 modules in FR6802+X(F) frame

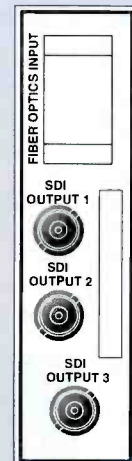
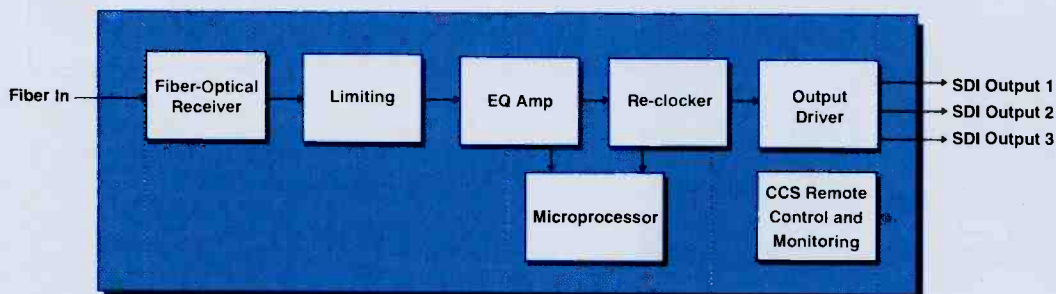

OSS6800+,
OSM6800+
Back Connector



AES6800+B, C — AES Audio Distribution Amplifier

The AES6800+ B/C is a differential input, nine outputs AES/EBU digital audio distribution amplifier for use in balanced or unbalanced installations.

- Manual or automatic equalization modes
- Bypass mode for non-AES (non bi-phase encoded) signals up to 30MHz 50% duty cycle
- Data relocking provides jitter reduction
- LED indication of input lock and other important errors

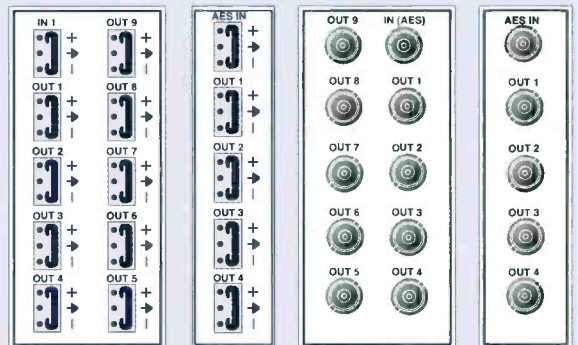

AES6800+B Double-Slot Rear Connector AES6800+B Single-Slot Rear Connector AES6800+C Double-Slot Rear Connector AES6800+C Single-Slot Rear Connector

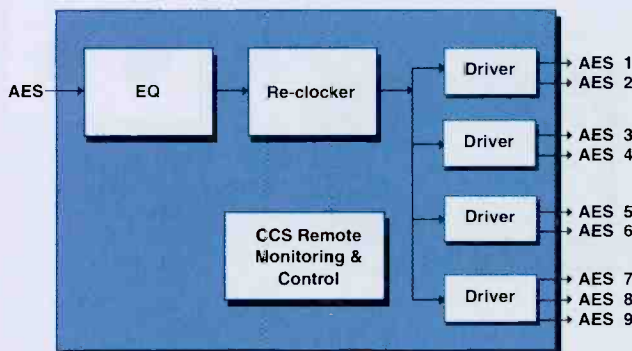

ARG6800+ — Analog Audio Remote Gain Distribution Amplifier

- Balanced inputs and outputs
- Remote control for mute settings
- Remote indication for channel state and overload
- Remote and local control for independent channel gain adjustment
- Local control for selecting output configuration
- Configurable outputs to one of the following options:
 - 8 outputs designated to 1 channel (1x8)
 - 4 outputs designated to channel A, 4 outputs designated to channel B (dual 1x4)
 - 8 outputs designated to the combined stream of both channels (2x8 sum)

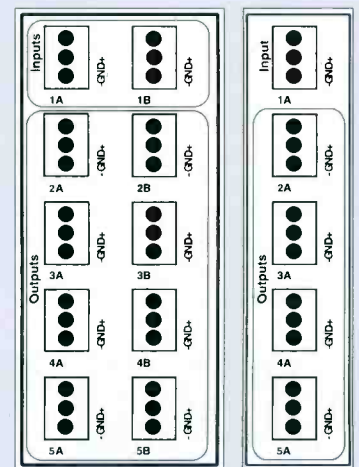

ARG6800+ Double-Slot Back Connector ARG6800+ Single-Slot Back Connector

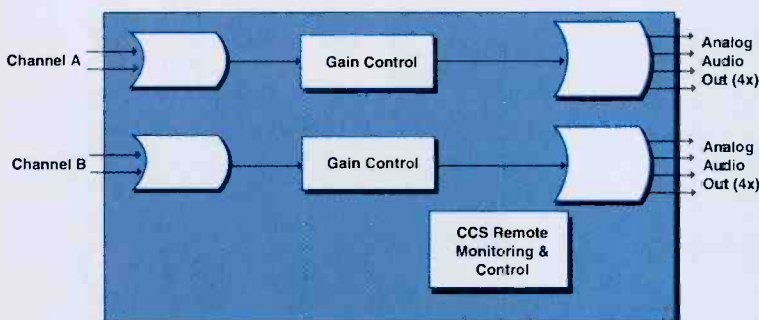

6800+ DISTRIBUTION

6800+ DISTRIBUTION

VPD-6830 — Composite Video Programmable Distribution Amplifier

- Differential input, 8 outputs
- 30 MHz bandwidth (-3dB)
- Jumper-selectable soft back porch clamp
- Jumper-selectable AC or DC coupling
- **Note:** This is a 6800 series module

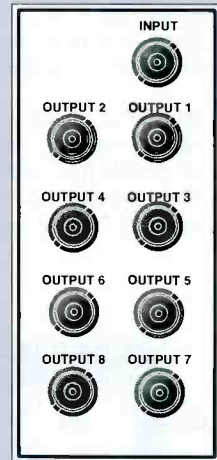

VPD-6830
Back Connector

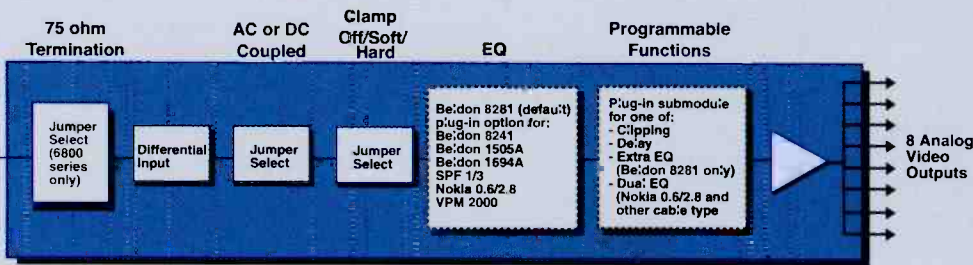

VCA6800+ — Composite Video Equalizing and Clamping Distribution Amplifier

The VCA6800+ is an analog video clamping and equalizing distribution amplifier. This distribution amplifier is capable of hard and soft clamping to the composite NTSC and PAL video signal.

- AC and DC input coupling selectable
- Looping and internal terminating selectable with double-slot back module, internal terminating with single-slot back module
- ± 3 dB gain adjustable range, >50 MHz bandwidth
- Continuous cable equalizing up to 984 ft (300 m) Belden 8281 cable, or equivalent
- Back porch clamp with selectable soft, hard and non-clamp modes
- Optional gain/EQ control

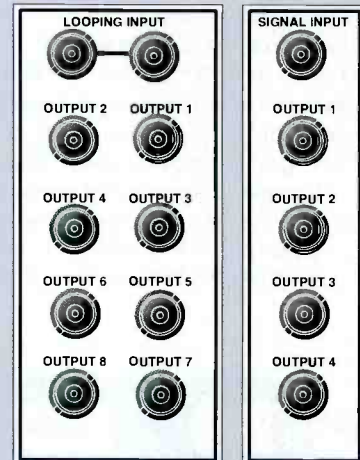

VCA6800+
Double-Slot
Back Connector

VCA6800+
Single-Slot
Back Connector

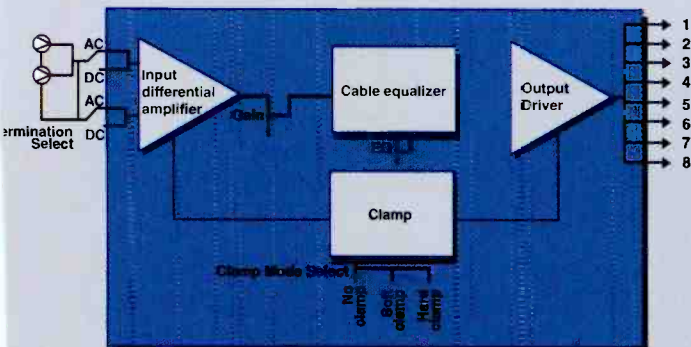

VDA6800+ — Composite Video Distribution Amplifier

VEA6800+ — Composite Video Equalizing Distribution Amplifier

The VDA6800+ is a high-performance, high-reliability, cost-efficient general purpose analog video distribution amplifier. The VEA6800+ adds input video equalization.

- DC input coupling
- Looping and internal terminating selectable with double-slot back module, internal terminating with single-slot back module
- ± 3dB gain adjustable range, > 50 MHz bandwidth

VEA6800+ Adds:

- Continuous Cable Equalizing up to 984 ft (300 m) Belden 8281 cable, or equivalent

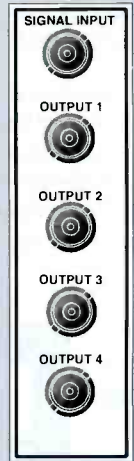
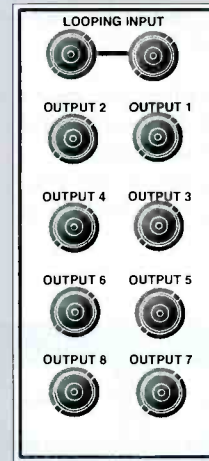
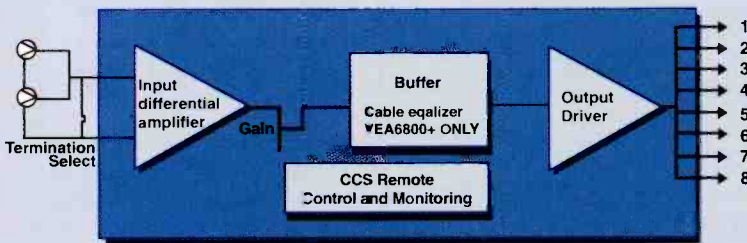

VDA6800+ and VEA6800+ Double-Slot Back Connector

VDA6800+ and VEA6800+ Single-Slot Back Connector



VRG6800+ — Composite Video Remote Gain Distribution Amplifier

The VRG6800+ is an analog video remote gain and EQ distribution amplifier.

- Remote gain, EQ and clamping timing adjustability
- Looping and internal terminating selectable with double-slot back module, internal terminating with single-slot back module
- Back porch clamp with selectable soft, hard and non-clamp modes

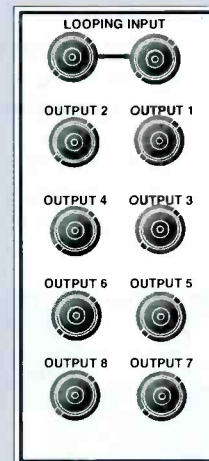
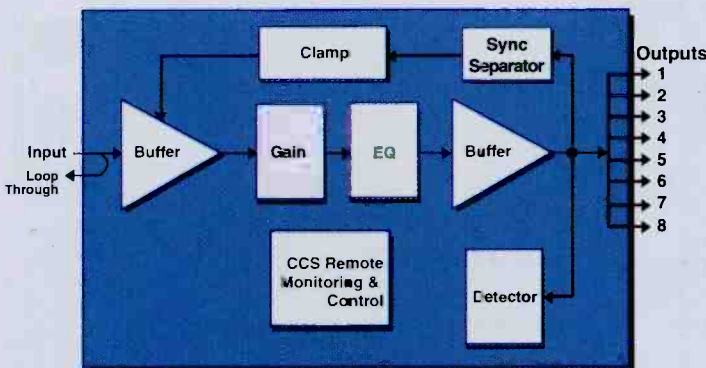

VRG6800+ Double-Slot Back Connector

VRG6800+ Single-Slot Back Connector



VSI6800+ — SDI/ASI Equalizing Reclocking Distribution Amplifier

The VSI6800+ is a serial video distribution amplifier that meets the requirements of SMPTE259ABC and DVB-ASI.

- Transformer coupling at the input and output
- Identical polarity between the input and outputs
- Automatic cable equalization
- Automatic reclocking at 143, 177, 270 (SDI and ASI), and 360 Mb/s
- Automatic bypass if the signal is not able to be reclocked
- Enforce bypass

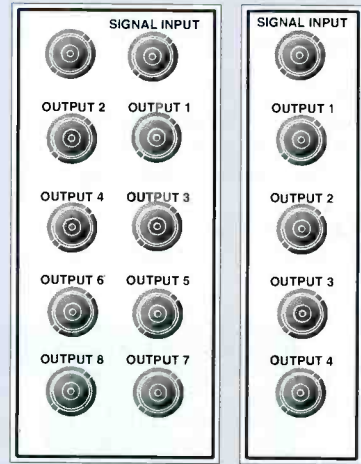
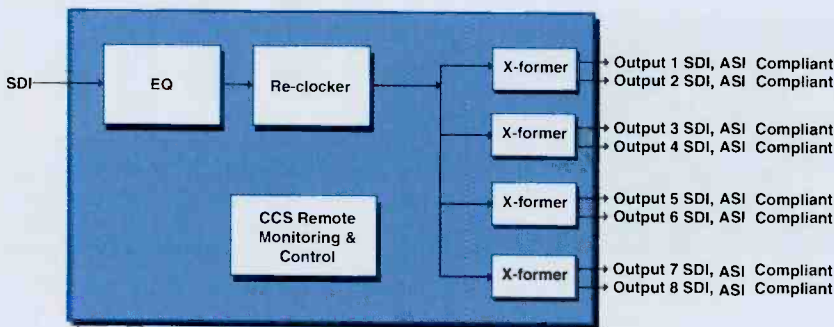

VSI6800+
Double-Slot
Back Connector

VSI6800+
Single-Slot
Back Connector



USM-6800 — Universal SDI Encoder/Distribution Amplifier

- PAL/NTSC Monitoring Encoder
- Selectable outputs, all with 4 serial outputs
 - 4 NTSC/PAL composite analog
 - 1 RGB or YUV and 1 composite analog
 - 1 YC and 2 composite analog
- Automatic data re-clocking of 143, 177, 270 & 360 Mb/s
- 525/625 line auto-switching/4 equalized, reclocked serial outputs
- **Note:** This is a 6800 series module

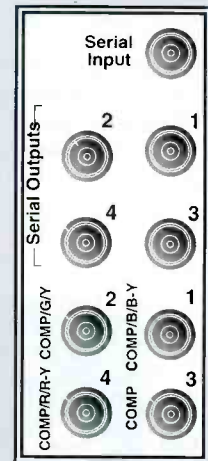
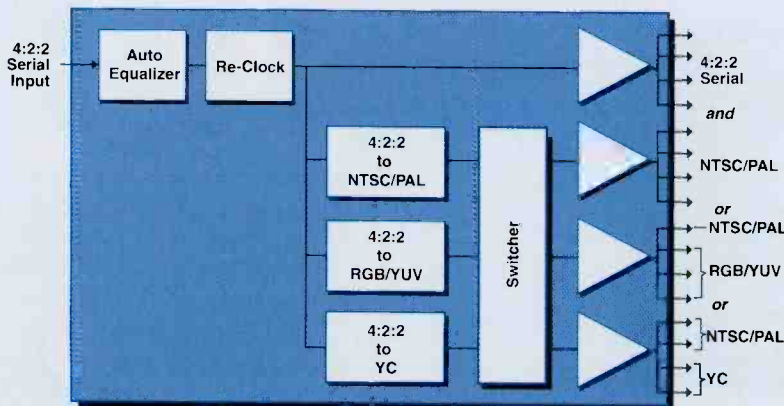

USM-6800
Double-Slot
Back Connector

VSD6800+ — SDI Video Equalizing Distribution Amplifier

The VSD6800+ is a serial digital video distribution amplifier with cable equalizing.

- High video performance and low cost
- Distributes any 10-540Mb/s data within the amplitude limitation
- Other VSD6800+ features include the following:
 - Input signal presence detect
 - Automatic cable equalization
 - Alarm output

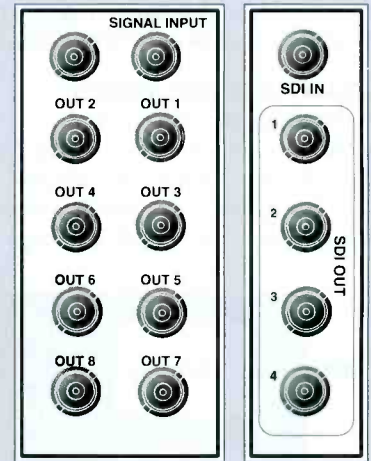
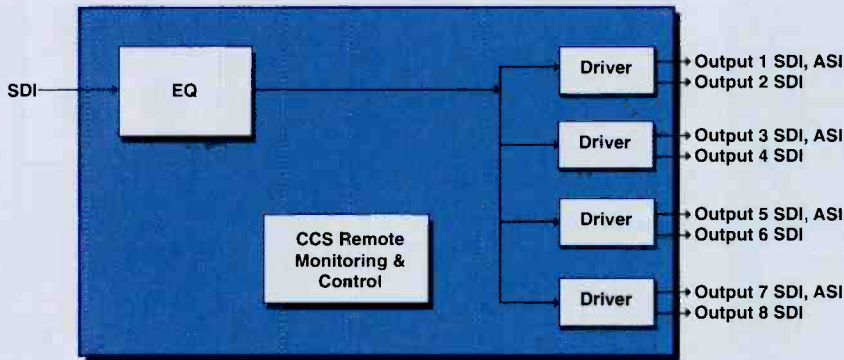

VSD6800+
Double-Slot
Back Connector

VSD6800+
Single-Slot
Back Connector



VSE6800+ — SDI Video Equalizing and Reclocking Distribution Amplifier

The VSE6800+ is a serial digital video DA with cable equalizing and reclocking.

- High video performance and low cost
- Handles 143, 177, 270, 360 and 540Mb Mb/s SDI signals; and ASI signal (4 outputs only)
- Other features include:
 - Input signal presence detect
 - Automatic cable equalization
 - Alarm output
 - Automatic/manual reclock rate select at 143/177/270/360/540 Mb/s
 - Reclocking status report
 - Automatic/manual bypass

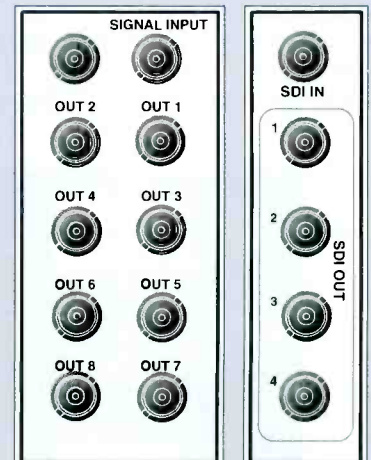
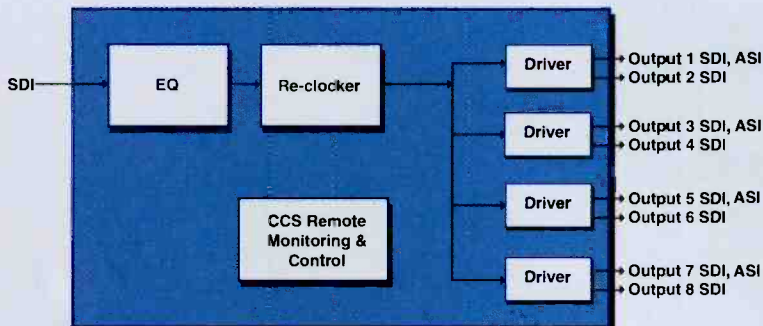

VSE6800+
Double-Slot
Back Connector

VSE6800+
Single-Slot
Back Connector



VTM6800+ — SDI Triple Monitoring Distribution Amplifier

The VTM6800+ triple serial monitoring DA combines the functions of three equalizing, re-clocking serial DAs and three composite video encoders on a single module.

- **SAVE SPACE AND MONEY!**
- Vertical blanking (pass/delete)
- Set-up on/off option (per channel) NTSC only
- Local Gain control for each channel
- Zero SCH and proper picture position
- Burst and chroma on/off (jumper per channel)

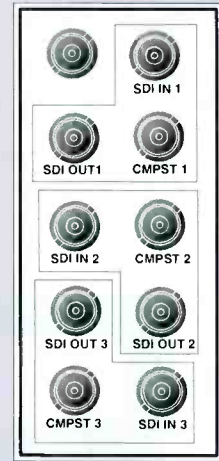
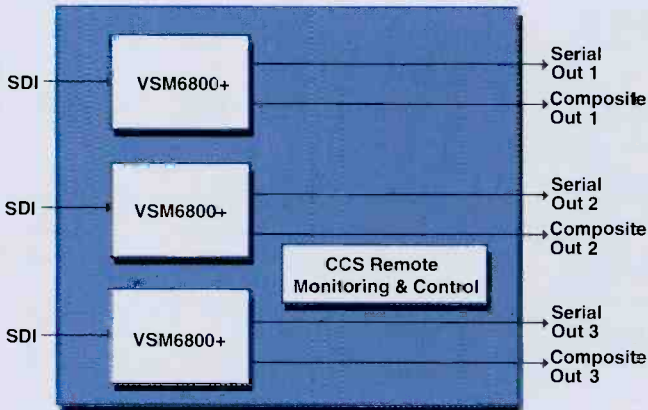

VTM6800+
Double-Slot
Back Connector



PRELIMINARY

VAM6800+ — SDI Video and Analog Audio Monitoring Distribution Amplifier

- 525/625 operation
- SDI input with serial and composite analog outputs
- Analog audio outputs
- Command Control System (CCS)-enabled

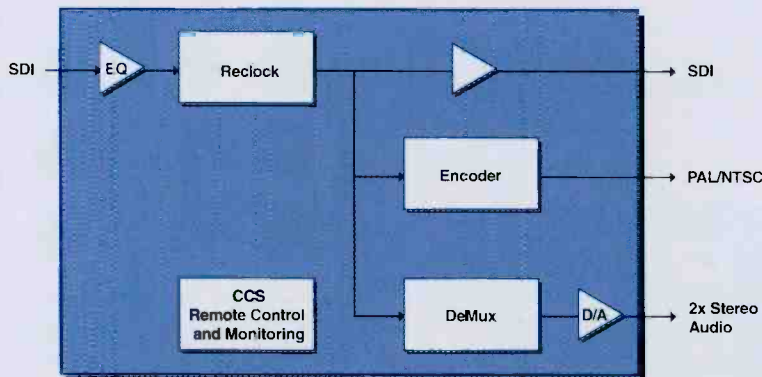

PRELIMINARY
See Page 43 for current SFS-3901

SFS6800+ — SDI and Embedded Audio Frame Synchronizer

The SFS6800+ combines embedded audio and SDI video processing functions on a single module.

- SDI frame sync with up to 30 frames incremental delay
- Variable audio delay up to 1.3 seconds
- 3-color space video proc. amp: Composite, YprPb, GBR
- Demultiplex/remultiplex up to 2 groups embedded audio
- Audio channel shuffler with mute, phase invert and summing
- Selectable 16-/20-/24-bit audio processing
- Audio re-sampling for 32-108kHz AES inputs
- Cleanly handles hot switch on input for video and embedded audio
- Data I/O signal for audio tracking with compatible 6800+ audio modules

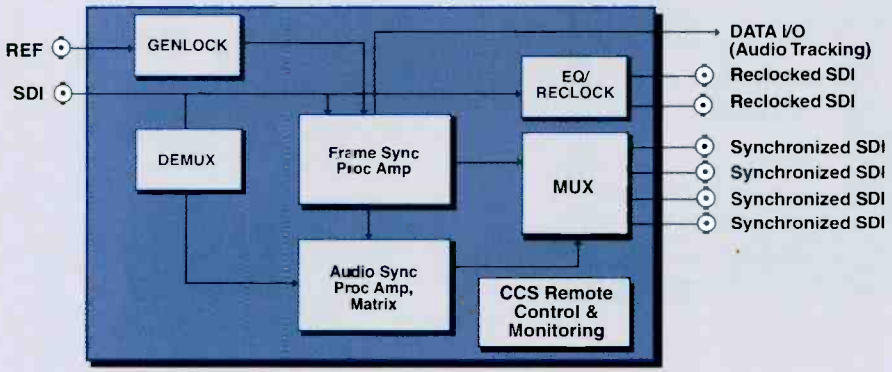

VSM6800+ — SDI Monitoring Distribution Amplifier

The VSM6800+ serial monitoring DA combines the functions of an equalizing, re-clocking serial DA and a composite video encoder on a single card.

- Vertical blanking (pass/blank) – Line 10 to 22 (NTSC); Line 10 to 23 (PAL)
- V-Blanking chroma, plus chroma on/off
- Mono burst on/off

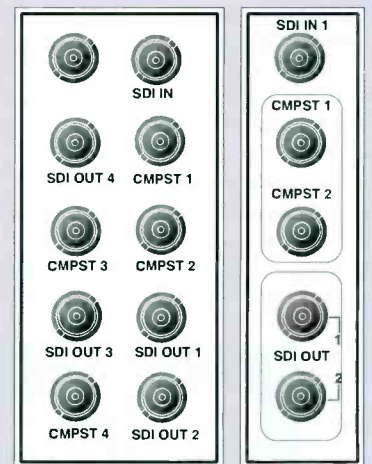
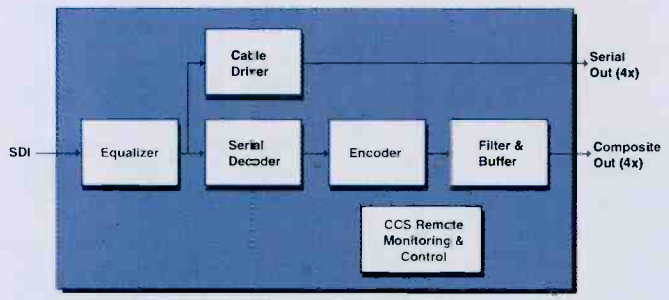

VSM6800+
Double-Slot
Back Connector

VSM6800+
Single-Slot
Back Connector



6800+ SIMPLICITY

6800+ DISTRIBUTION

ADS6800+A2BC, A4BC — Audio Delay Synchronizer with A to D Conversion

The ADS6800+ A4BC/A2BC are audio delay synchronizers with on-board analog-to-digital conversion capabilities. To be used in conjunction with the 6800+ DES, ENS and VFS modules.

- Internal audio processing amplifier
- Fixed delay of up to 1.3 seconds
- 32/48/96Khz sampling
- Selectable 16/20/24-bit analog-to-digital conversion
- Channel ID tone generators (750 Hz, 1.5 kHz, 3 kHz, and 6 kHz)
- Selectable delay adjustment for each channel

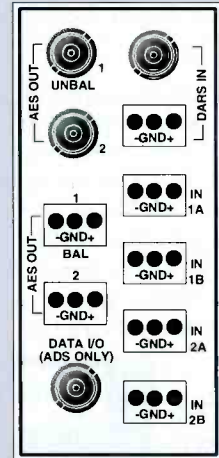
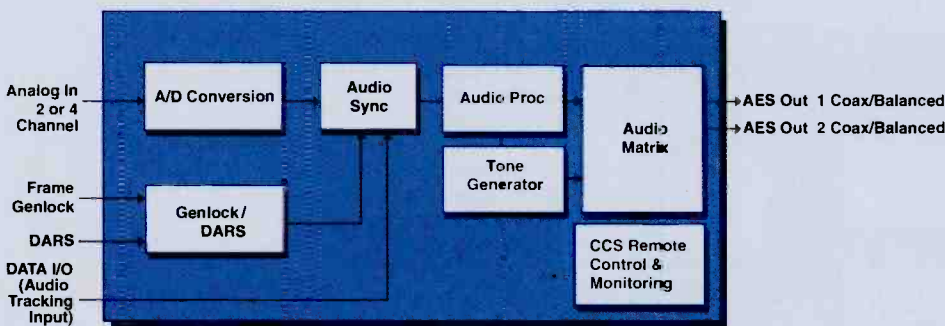

ADS6800+A2BC and A4BC Back Connector



AVS6800+B2, C2 — SDI/AES Synchronizer/Processor

The AVS6800+ B2/C2 are single modules that combine SDI frame synchronizer and an audio delay synchronizer function in a single module.

- Video Proc Amp
- Frequency jitter removal
- Delay or synchronize modes
- Audio adjustment proc amp
- Audio synchronizer tracks video frame sync
- Fixed delay of up to 1.3 seconds
- AES input and output ports provide full 24-bit capability, as well as compressed (Diamond, Dolby® E) pass-through capability

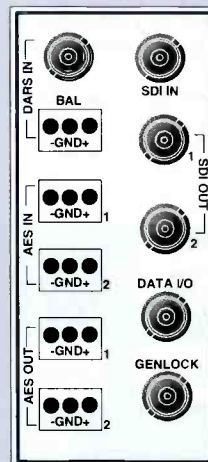
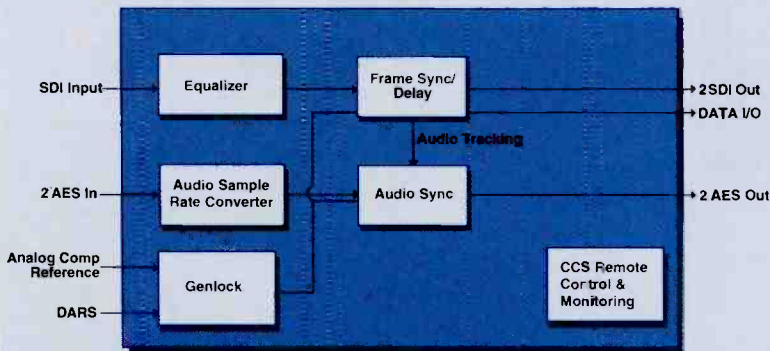

AVS6800+B2 Back Connector

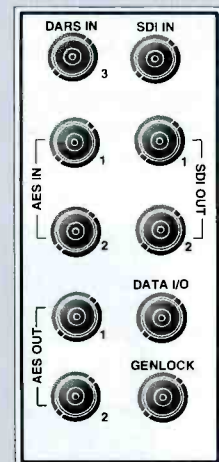

AVS6800+C2 Back Connector



DMX6800+B2, B4, C2, C4 — AES Audio Demultiplexers

The DMX6800+ B2/B4/C2/C4 AES digital audio demultiplexers support up to four balanced or unbalanced AES audio outputs.

- Internal audio processing amplifier
- 16-bit, 20-bit, or 24-bit audio processing
- C-bit, U-bit and V-bit transparency
- Adjustable audio delay of up to 1.3 seconds

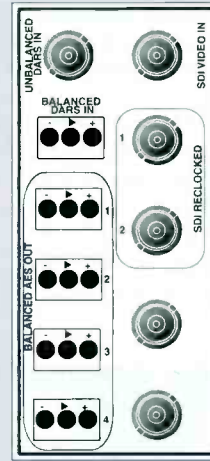
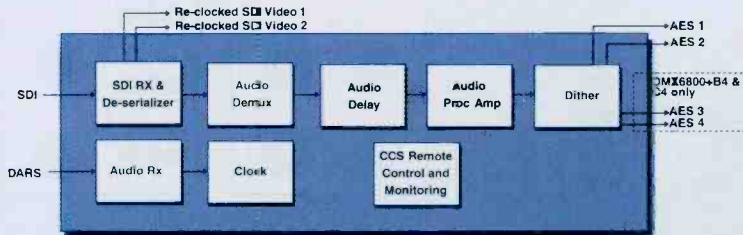

DMX6800+B2
and B4
Back Connector

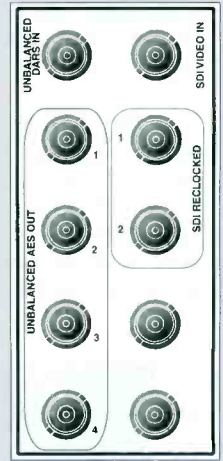

DMX6800+C2
and C4
Back Connector



ADS6800+B2, C2 — AES Audio Delay Synchronizer

The ADS6800+ B2/C2 are the audio delay synchronizers used in conjunction with the 6800+ DES, ENS and VFS modules.

- Two 24-bit digital audio inputs
- Audio adjustment proc amp for levels and mute
- Framestore tracking and system delay operation
- Fixed delay of up to 1.3 seconds

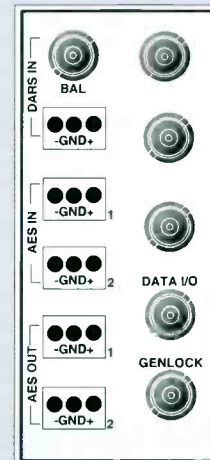
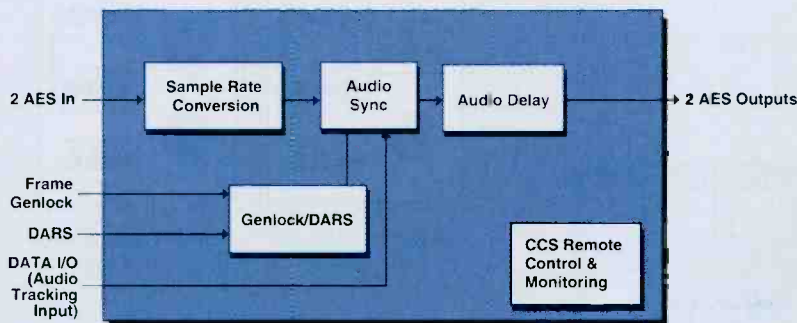

ADS6800+B2
Back Connector

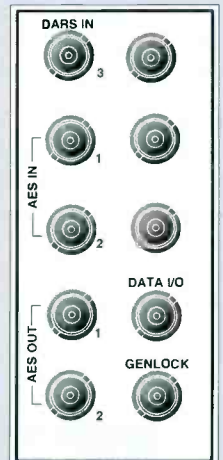

ADS6800+C2
Back Connector



MSA6800+B2, B4, C2, C4 — AES Multiplexers with Synchronizer & Delay

The MSA6800+ AES digital audio multiplexers with audio sync and delay combine the function of embedding up to two audio groups onto a serial digital video stream with video synchronization and delay capabilities, all in one module.

- Embedder input can be selected from any audio input
- Input audio sample rates from 32 kHz to 108 kHz
- 24-bit audio processing with adjustable fade rate, gain, invert and mute, independent per channel
- Adjustable audio delay up to 1.3 seconds
- Black video generator at loss of video input
- Adjustable embedding group and mode

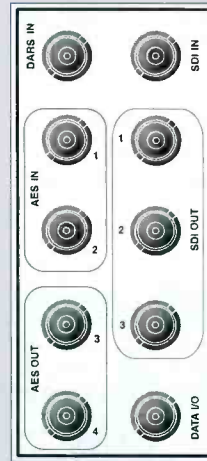

*MSA6800+C2
Back Connector.
Balanced (+B2) version
also available*

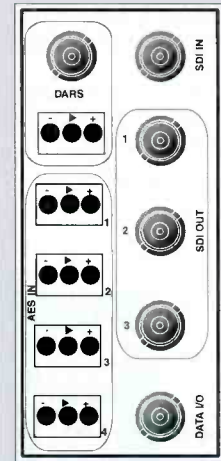

*MSA6800+B4
Back Connector.
Unbalanced (+C4)
version also available*

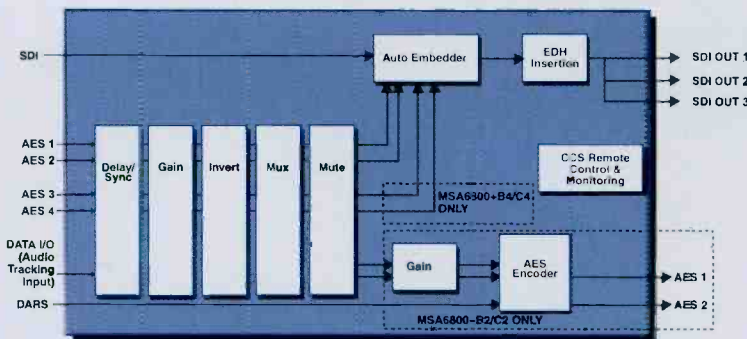

DMX6800+A2B, A2C, A4B2, A4C2 — Analog/AES Audio Demultiplexers

The DMX6800+ A2B/A2C/A4B2/A4C2 analog and AES audio demultiplexers provide audio de-embedding from an SDI input with up to two-channel AES and up to four-channel analog output.

- Selectable 16-, 20- and 24-bit resolution during audio processing
- Adjustable audio delay up to 1.3 seconds
- Selectable on/off mute function for audio errors
- Adjustable gain, invert, channel swapping
- Left/Right channel swapping
- Audio group selection
- Add "Z" at end of part number for 600ohm output impedance option

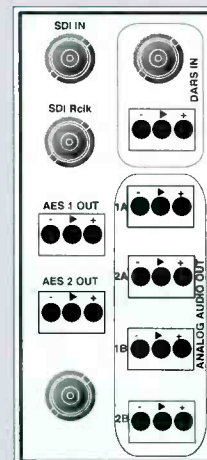

*DMX6800+A4B2, A2B
Back Connector*

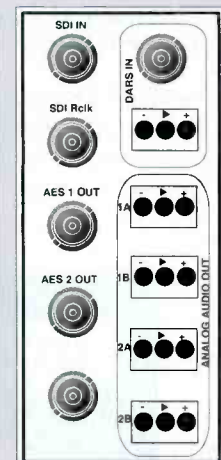

*DMX6800+A4C2, A2C
Back Connector*

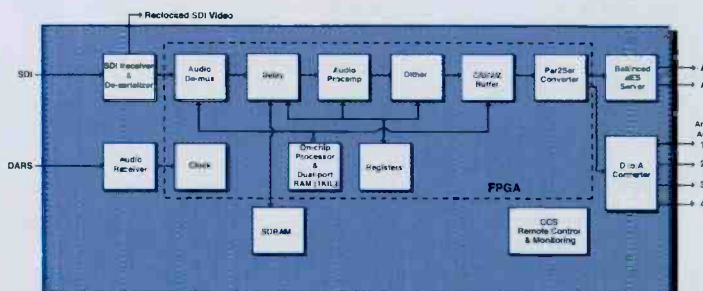

MSA6800+A2B2, A2C2, A4B2, A4C2 — Analog Audio Multiplexers with Synchronizer, Delay and AES Outputs

The MSA6800+ analog audio multiplexers with sync and delay combine the function of embedding one audio group onto a serial digital video stream with video synchronization, delay capabilities and AES outputs all in one module.

- Selectable 16-, 20- and 24-bit resolution during audio processing
- Accepts 32kHz and 48kHz audio
- Adjustable audio delay up to 1.3 seconds
- Customer-selectable on/off mute function with adjustable mute duration
- Adjustable gain, invert, channel swapping
- Audio group selection, insertion/pass-through/delete
- Audio and time code selectable delay

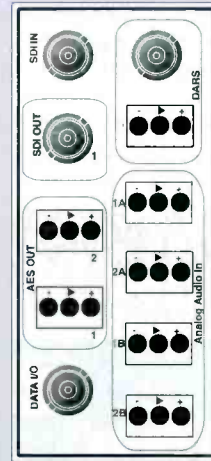
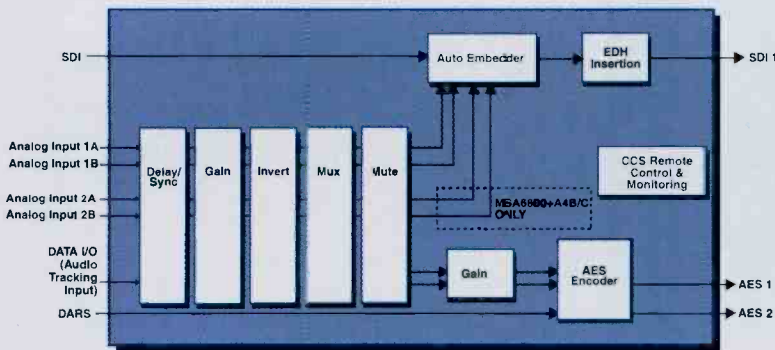

MSA6800+A2B2
and A4B2
Back Connector

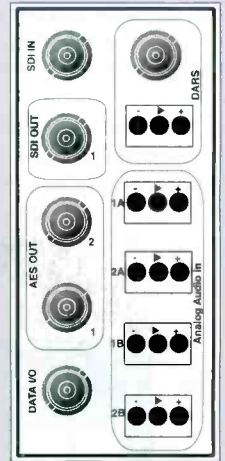

MSA6800+A2C2
and A4C2
Back Connector



MXA6800+B2, B4, C2, C4 — AES Digital Audio Multiplexers

The MXA6800+ B2/B4/C2/C4 AES audio multiplexers embed up to two audio groups onto a serial digital video stream.

- Embedder input can be selected from any audio input
- Input audio sample rates from 32 kHz to 108 kHz
- 24-bit audio processing with adjustable fade rate, gain, invert and mute, independent per channel
- Adjustable audio delay up to 1.3 seconds
- Black video generated on loss of video input
- Adjustable embedding group and mode
- Choice of unbalanced or balanced AES inputs

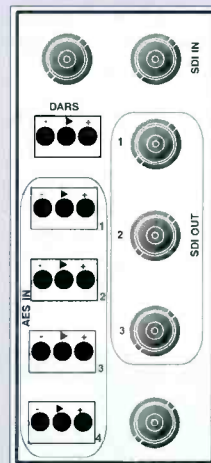
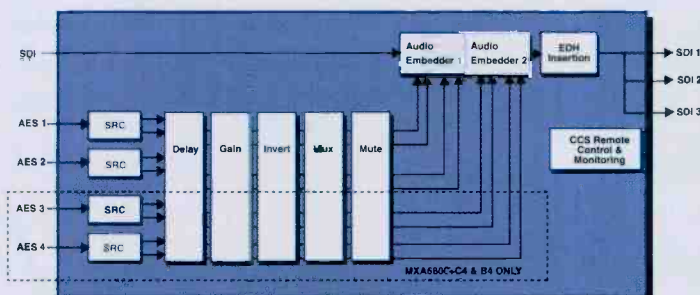

MXA6800+B2
and B4
Back Connectors



MXA6800+C2
and C4
Back Connectors



MSA6800+A2, A4 — Analog Audio Multiplexers with Synchronizer and Delay

The MSA6800+A2/A4 analog audio multiplexers with sync and delay combine the function of embedding one audio group onto a serial digital video stream with video synchronization and delay capabilities, all in one module.

- MUX-enabling embedder input can be selected from any audio input
- 24-bit audio processing with adjustable fade rate, gain, invert and mute
- Adjustable audio delay up to 1.3 seconds
- Black video generator at loss of video input
- Adjustable embedding group and mode

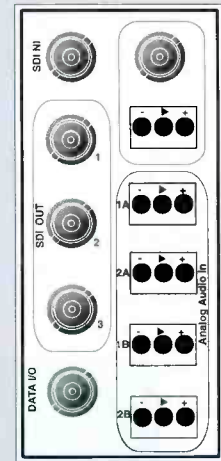
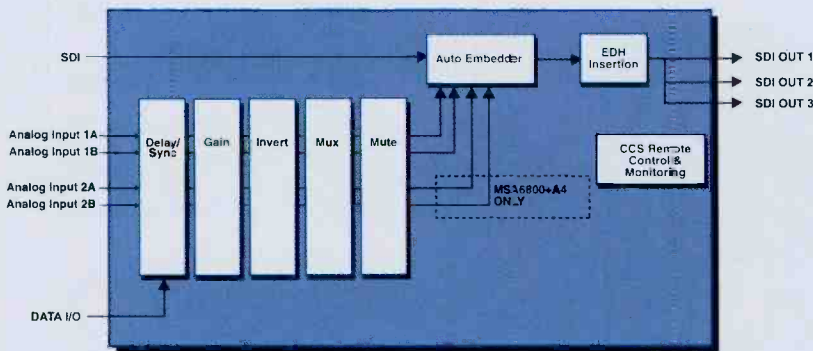

MSA6800+A2 and A4
Double-Slot
Back Connector



MXA6800+A2B2, A2C2, A4B2, A4C2 — Analog/AES Audio Multiplexers

The MXA6800+ A4B2/A2B/A4C2/A2C audio multiplexers provide audio embedding up to four-channel analog to a serial digital interface (SDI) output, and up to two-channel AES with outputs.

- Selectable 16-, 20- or 24-bit resolution audio processing
- Accepts 32kHz & 48kHz audio
- Adjustable audio delay up to 1.3 seconds
- Customer-selectable on/off mute function with adjustable mute duration
- Adjustable gain, invert, channel swapping
- Audio group selection, insertion/pass-through/delete
- Audio and time code selectable delay

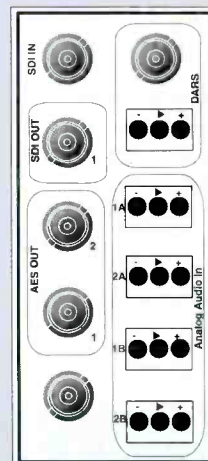
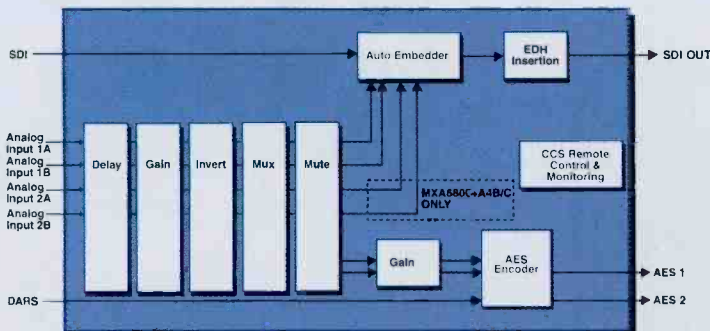

MXA6800+A4C2
and A2C
Back Connector

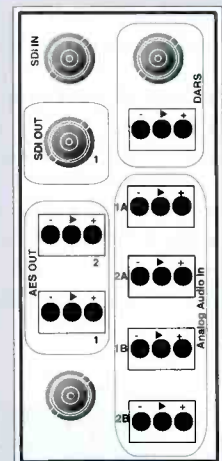

MXA6800+A4B2
and A2B
Back Connector



DAC6800+BCA2, BCA4 — AES to Analog Audio Converters

- High-quality, 24-bit D to A conversion
- 2-channel and 4-channel versions
- Provides 110 ohm balanced (AES3-1992) and 75 ohm coaxial (SMPTE-276) AES inputs
- Add "Z" to end of part number for 600ohm output impedance option

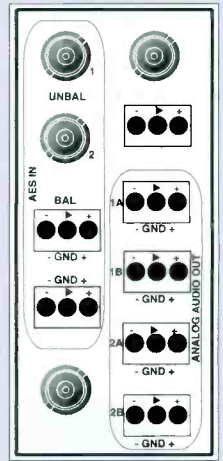
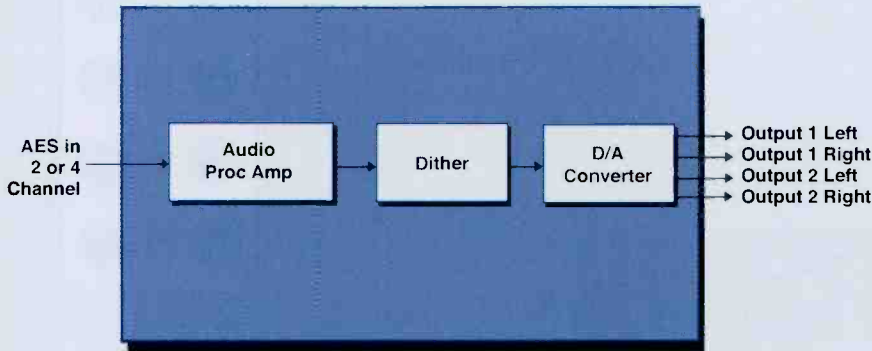

DAC6800+BCA2
and BCA4
Back Connector



MXA6800+A2, A4 — Analog Audio Multiplexers

The MXA6800+ A2/A4 analog audio multiplexers embed up to two audio groups onto a serial digital video stream.

- MUX-enabling embedder input can be selected from any audio input
- 24-bit audio processing with adjustable fade rate, gain, invert and mute
- Black video generated on loss of video input
- Adjustable audio delay up to 1.3 seconds
- Adjustable embedding group and mode

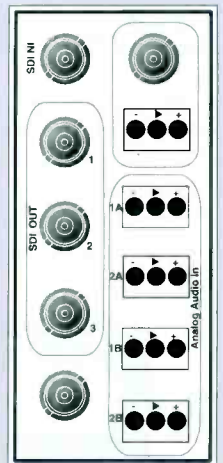
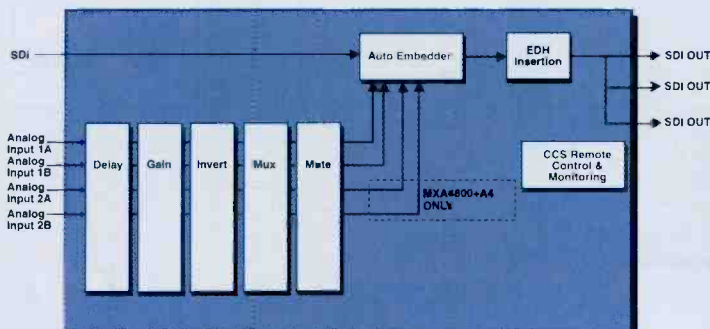

MXA6800+A2
and A4
Back Connectors



PRELIMINARY
See Page 11 for current DAC-6801

DAV6800+ — SDI to Analog Component Video Converter

The DAV6800+ is an SDI to analog component video converter.

- 4X over-sampling
- High-end 10-bit conversion and signal path
- Selective Vertical Blanking
- Built-in color bars as alignment aid
- Digital gain offset calibration



DAV6800+
Back Connector

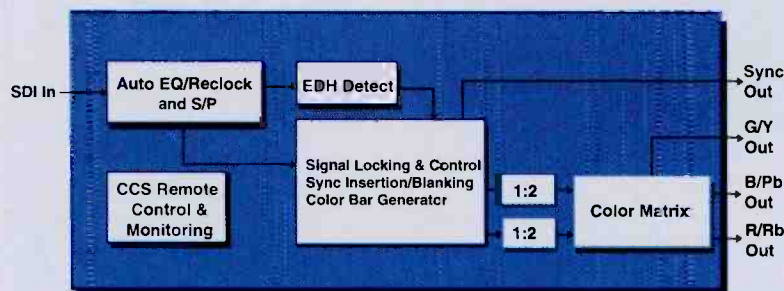

6800+ VIDEO

ADC6800+A2BC, A4BC — Audio Analog to AES Converters

The ADC6800+ A2/A4BC are two-channel or four-channel analog audio to AES audio converters with delay.

- Internal audio processing amplifier
- Fixed delay operation of up to 1.3 seconds
- 32/48/96kHz sampling
- Selectable 16/20/24-bit analog-to-digital conversion
- Channel ID tone generators (750 Hz, 1.5 kHz, 3 kHz, and 6 kHz)
- Selectable delay adjustment for each channel

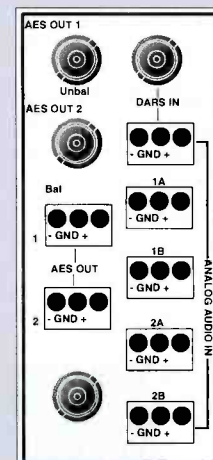

ADC6800+A2BC
and A4BC
Back Connector

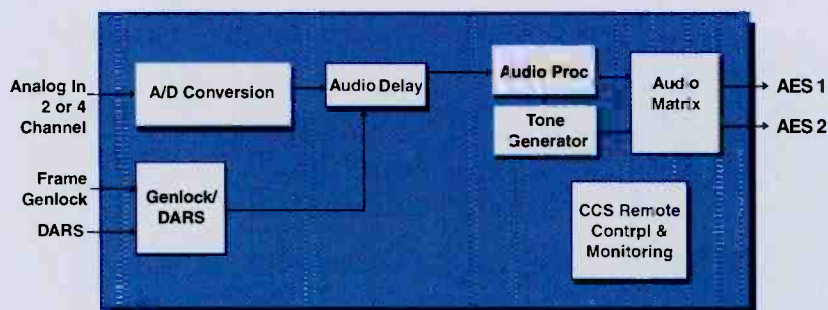

6800+ AUDIO

DAC-6801 — SDI to Analog Component Converter

- 525/625 line operation
- 4x over-sampling
- 10-bit conversion and signal path
- Auto-calibration
- Built-in color bars as alignment aid
- Automatic line-standard switching
- Sync on G/Y or external sync
- RGB, SMPTE/EBU component, Betacam and MII
- **Note:** This is a 6800 series module

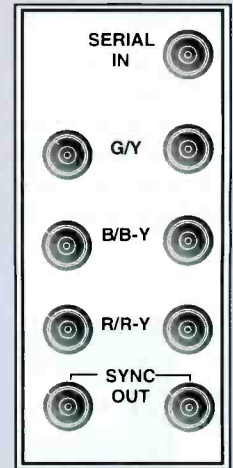
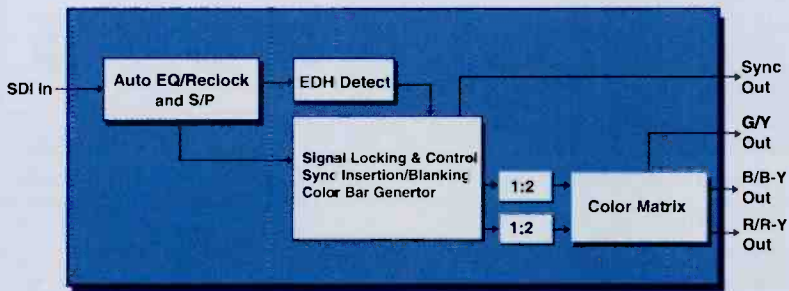

DAC-6801
Back Connector

PRELIMINARY
See Page 10 for current ADC-6801

ADV6800+ — Analog Component Video to SDI Converter

- 525/625 line operation
- 10-bit converter and 12-bit signal path
- Looping inputs supporting SMPTE/EBU component and RGB, Betacam and MII, and NTSC RGB
- SMPTE 259M outputs (2)
- Sync on G/Y or external Sync/Video (looping input)
- Built-in color bars as alignment aid
- EDH Insertion on output
- Card edge and remote communications

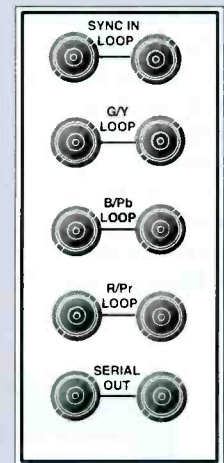
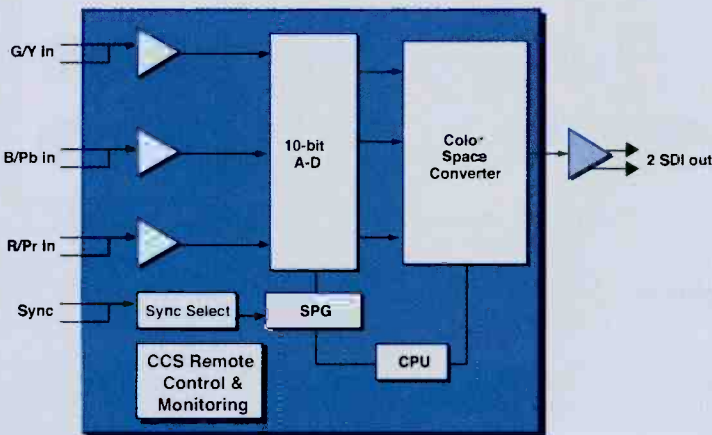

ADV6800+
Back Connector



VFS6800+ — SDI Frame Synchronizer/Processor

The VFS6800+ is a full-featured 10-bit serial 4:2:2 video frame synchronizer.

- Video Proc Amp
- Jitter removal
- Passes all ancillary data including embedded audio, VBI (HANC and VANC)
- Infinite Phasing relative to reference (both V and H)
- 1 Frame Delay buffer
- Delay or Synchronize Modes

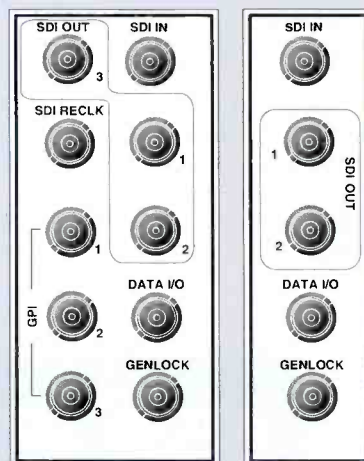
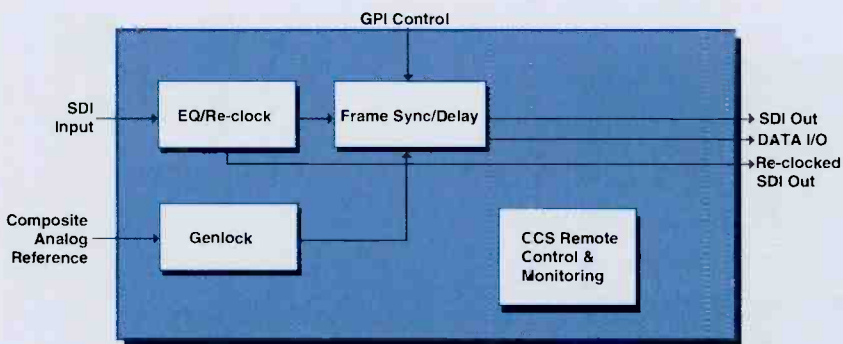

VFS6800+
Double-Slot
Back Connector

VFS6800+
Single-Slot
Back Connector



ADC-6801 — Analog Component to SDI Converter

- 525/625 line operation
- 2x over-sampling, 27MHz Y 13.5MHz Cr/Cb
- 10-bit conversion and signal path
- Auto-calibration
- Built-in color bars as alignment aid
- Automatic line-standard switching
- Sync on G/Y or external sync
- RGB, SMPTE/EBU component, Betacam and MII
- Optional 8-bit rounding
- **Note:** This is a 6800 series module

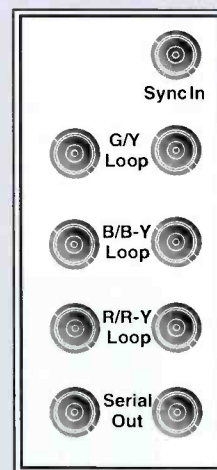
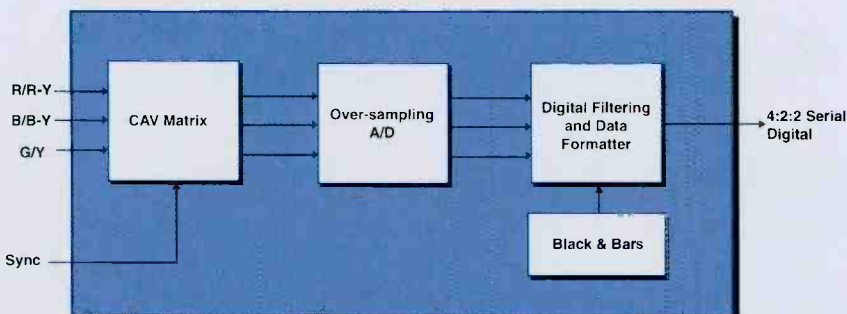

ADC-6801
Back Connector

DEC6800+ — Composite Video Decoder DES6800+ — Composite Video Decoder/Synchronizer

The DEC6800+ and DES6800+ are compact, high-precision 12-bit decoders that convert NTSC or PAL composite video signals into superior-quality component (4:2:2) digital video.

- 2-D Adaptive comb filtering using Leitch Phase Quadrature Modulation (PQM) algorithm
- Full line-by-line VBI handling and processing
- Black level adjustment
- DES6800+ additionally provides frame synchronization and TBC capabilities

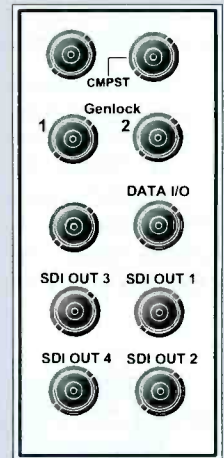
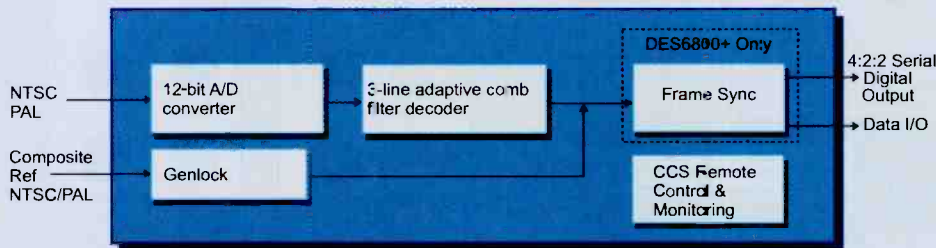

DEC6800+ and DES6800+ Back Connector



ENC6800+ — SDI Video Encoder ENS6800+ — SDI Video Encoder/Synchronizer

The ENC6800+ and ENS6800+ are high-precision 12-bit digital encoders that convert 4:2:2 digital video into NTSC or PAL composite video.

- NTSC, PAL-M/B with settings shadowed/restored
- 12-bit digital processing, output over-sampled at 54MHz
- Jitter removal; EDH detection
- VB Field/Line/Mode control
- User controls: Luma, chroma, black levels; chroma phase; SCH offset

ENS6800+ Adds:

- Frame sync or delay modes
- Bypassable cross color reduction with 1-line delay
- Fine phase adjustments
- Audio tracking for compatible module (ADS/MSA800+), uses one Reclock out
- Black, Pass or Freeze if loss of input
- Test signal generator

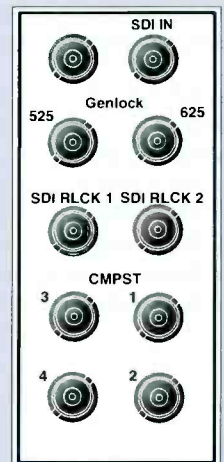
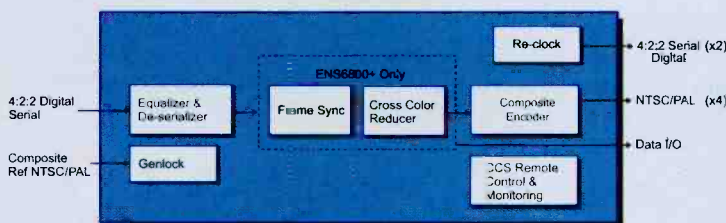

ENC6800+ and ENS6800+ Back Connector



6800+ VIDEO

6800+ VIDEO

HMx6800+B2, C2, B4, C4 — HDTV AES Audio Multiplexers

The HMx6800+ AES multiplexers embed two to four AES audio signals into a single 1.485Gb/s HD video signal.

- Automatic detection of all SMPTE 292M HD-SDI standards
- Select any mix of audio channel(s) to embed into up to 4 groups, including channel sum or audio tones
- 16-bit, 20-bit, or 24-bit audio processing
- Audio proc for delay, gain, invert, mute, channel multiplexing and dithering
- Programmable audio delay from 0 to 1320 msec
- Disable sample rate conversion to handle compressed data such as Dolby®E
- Four internal audio test tones

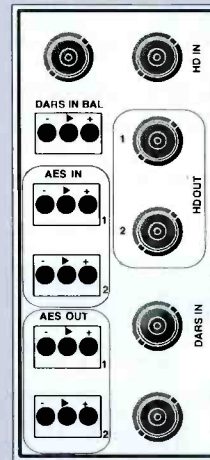
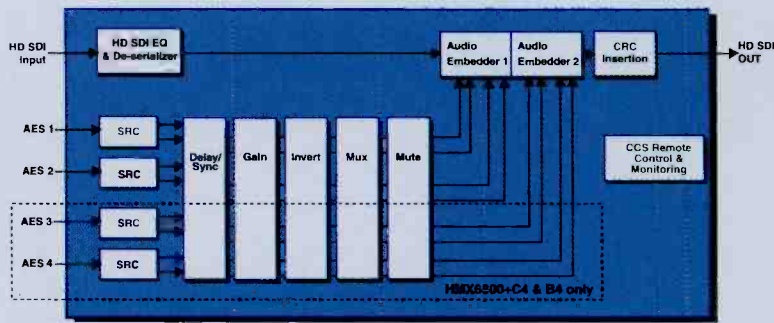

HMx6800+B2
Back Connector.
Unbalanced (+C2)
version also available

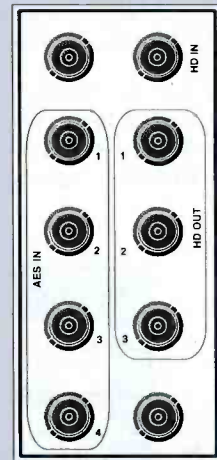

HMx6800+C4
Back Connector.
Balanced (+B2) version
also available



HDX6800+B2, C2, B4, C4 — HDTV AES Audio Demultiplexers

The HDX6800+ audio demultiplexers de-embed two to four AES audio signals from a single 1.485Gb/s HD video signal.

- Automatic detection of all SMPTE 292M HD-SDI standards
- 24-bit AES audio de-embedding
- User assignment of any audio group/channel mix for output, including tones
- Audio proc for delay, gain, invert, mute, channel multiplexing and dithering
- 16-bit, 20-bit, or 24-bit audio processing per channel pairs
- Programmable audio delay from 0 to 1320 msec
- Passes compressed audio such as Dolby® E (by channel pair)
- Four internal test tones: 750Hz, 1.5Hz, 3kHz, 6kHz (all at-20dBFS)

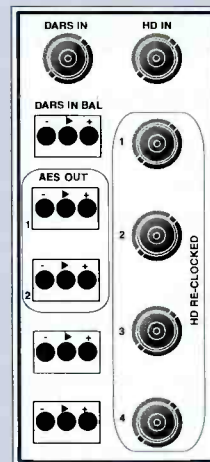
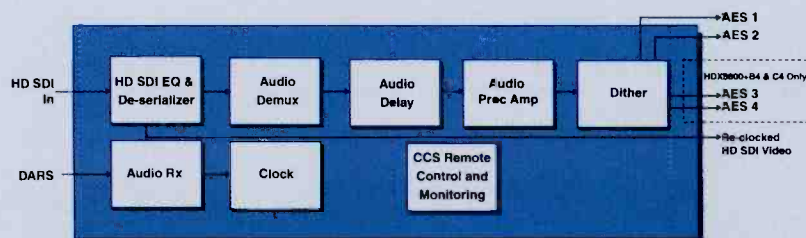

HDX6800+B2
Back Connector.
Unbalanced (+C2)
version also available

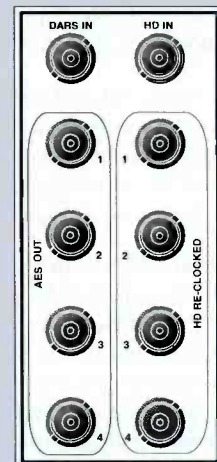

HDX6800+C4
Back Connector.
Balanced (+B4) version
also available



PRELIMINARY
See Page 35 for current HUC-3901

HUC6800+ — HDTV Upconverter

The HUC6800+ provides 10-bit digital up-conversion of SDI video for use in utility applications in HDTV environments.

- High-performance 2D scaling
- Auto-sensing or user-selectable 525/625 input
- 3 reclocked SDI outputs
- 4 up-converted HDTV outputs, 1080i, 720p, or 1080p
- Remaps four groups of embedded audio, with matching delay, into the HD outputs
- Aspect ratios: 16:9 anamorphic; 16:9 middle cut; 14:9; 4:3; Pixel True (1 to 1 mapping)
- User-variable horizontal and vertical resizing and picture position
- User-selectable color and super-black background
- HD video test generator

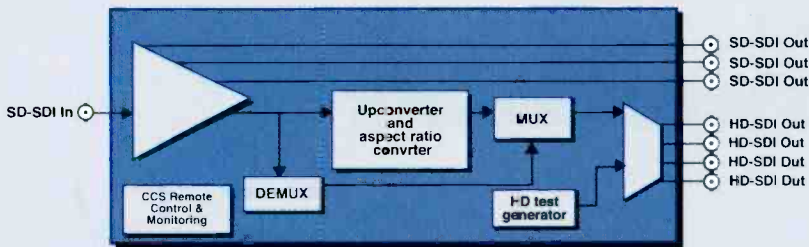

PRELIMINARY
See Page 35 for current HDC-3901

HDC6800+ — HDTV Monitoring Downconverter

The HDC6800+ provides 10-bit digital down-conversion with user-selectable choice of outputs for use in utility applications.

- Auto-sensing HD-SDI or SD-SDI input
- 1080i, 720p and 1080p HDTV input formats
- User selection of 5 converted video outputs:
 - 4 SDI and 1 NTSC/PAL
 - 3 SDI and 2 NTSC/PAL
 - 2 SDI and 3 NTSC/PAL
 - 2 SDI and 1 component (GBR or YpbPr)
- 4 reclocked outputs function as mini DA
- Passes two groups of embedded audio to the down-converted SDI outputs
- Display types: Anamorphic, Letterbox, Crop, 14:9, Zoom In
- Passes ancillary data

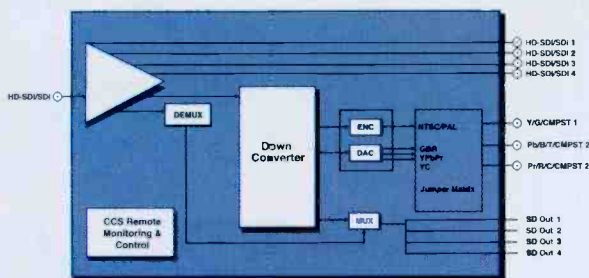

OHS6800+ — Single-mode Optical to HD-SDI Receiver

The OHS6800+ is a fiber optic to HD-SDI/SDI/DVB-ASI receiver.

- Supports single-mode operation
- 1310nm to 1550nm optical input on choice of SC-, FC- or ST-type fiber connector
- Minimum input power better than: -20 dBm for HD-SDI; -27dBm for SDI/ASI
- Auto-detect and relocking for 143, 177, 270, 360, 540Mb/s or 1.485Gb/s
- Can bypass reclocker when input signal does not lock
- Fit up to 20 modules in FR6802+X/XF frame

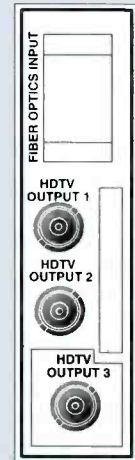
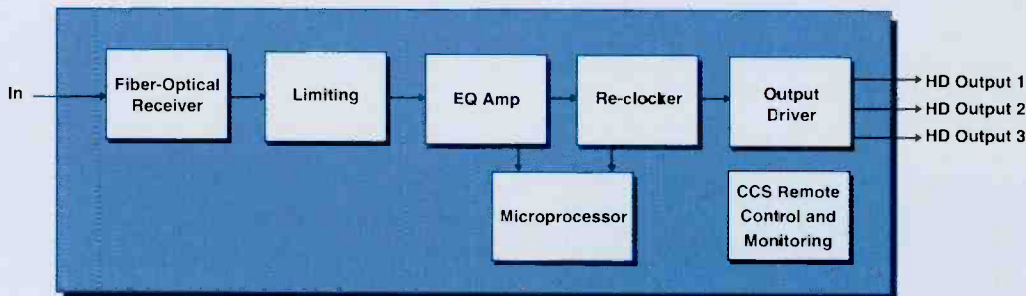

OHS6800+
Single-Slot
Back Connector



HFS6800+ — HDTV Frame Synchronizer/Processor

The HFS6800+ is an HDTV frame synchronizer.

- Automatic detection of input video standard
- Provides 4 synchronized 1080i/25, 1080i/29.97, or 720p/59.94 outputs
- Add up to 8 frames of delay for 1080i inputs, 16 frames for 720p
- Video proc amplifier for luminance offsets and chrominance gain
- Set pass, black or freeze mode when loss of input video
- In Delay mode passes VANC/HANC data, including compressed data such as Dolby®E
- Data I/O output provides hot switch and I/O delay signals for tracking audio processing
- For use in FR6802+X/XF frame

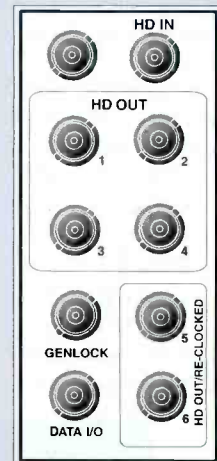
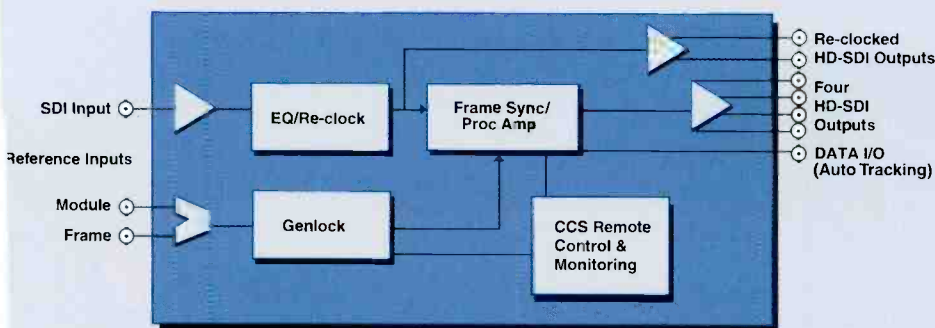

HFS6800+
Back Connector



HSD6800+ — HDTV, ASI, SDI Distribution Amplifier HSE6800+ — HDTV, ASI, SDI Reclocking Distribution Amplifier

HSD6800+ and HSE6800+ are SD/HD/ASI serial digital video distribution amplifiers with cable equalization.

- Input signal presence detection
- Automatic cable equalization
- Automatic/manual reclock rate setting at 143, 177, 270, 360 and 540 Mb/s; and 1.485 Gb/s (HSE6800+ only)
- Reclocking status report and Automatic/enforced bypass (HSE6800+ only)
- For use in FR6802+X/XF frame.

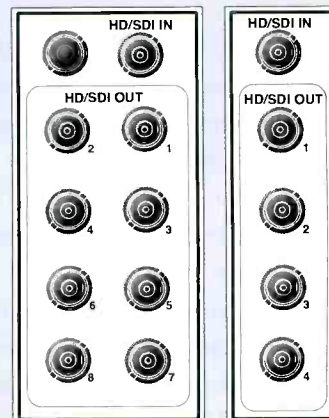

HSD6800+ and HSE6800+ Double-Slot Back Connector

HSD6800+ and HSE6800+ Single-Slot Back Connector

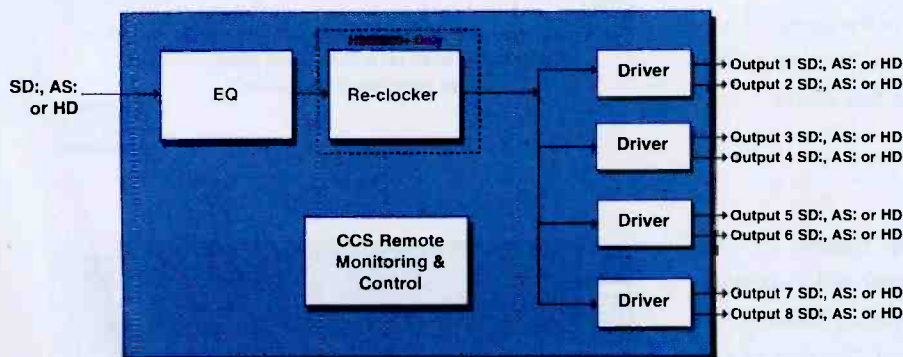

HOS6800+ — HD-SDI to Single-mode Optical Transmitter

The HOS6800+ is an HD-SDI/SDI/DVB-ASI to fiber optic single-mode transmitter.

- Supports single-mode transmission over longer "metropolitan" distances
- Auto-detect and reclocking for 143, 177, 270, 360, 540Mb/s or 1.485Gb/s
- Automatic cable EQ up to 100 meters for 1.485Gb/s, or 300 meters for 270Mb/s with Belden 1694A
- Can bypass reclocker when input signal does not lock
- 1310nm optical output on choice of SC-, FC- or ST-type fiber connector
- Optical power is better than -7.0dBm
- Fit up to 20 modules in FR6802+X/XF frame

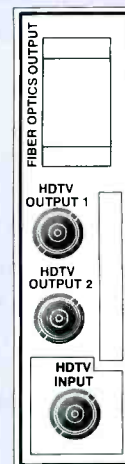

HOS6800+ Single-Slot Back Connector

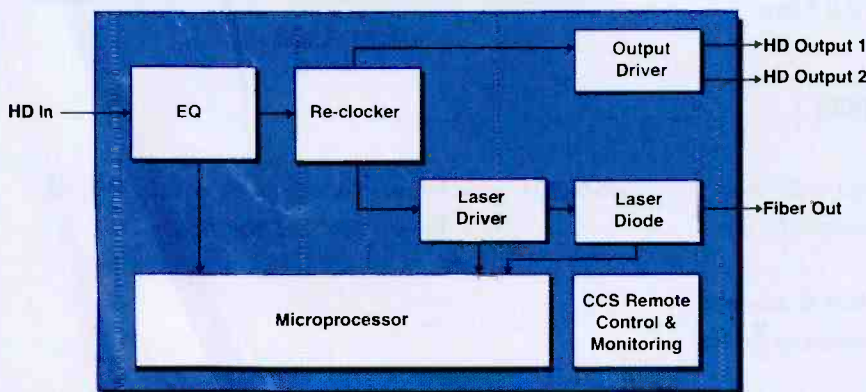

FR6802+X(F)

The FR6802+X(F) is the core 6800+ frame. Specifically designed for maximum flexibility, the back of the frame accommodates removable back-connectors that are module-function specific.

- ALL 6800+ and ALL 6800 modules can be housed in this frame
- Houses up to 20 modules, in any combination (both single- and dual-slot modules at the same time)
- Requires back-connectors to be ordered for both 6800 and 6800+ modules to be housed in this frame



FR6802+X(F) back view with blank plates



FR6802+X(F) back view with blank plates removed to insert back connectors



FR6802+DM(F)

The FR6802+DM(F) incorporates the benefits of the 6800+ platform, with further considerations for ultimate cost-effectiveness. For applications requiring housing for coaxial products only, this frame is ideal. The rear of the frame is a fixed BNC panel, eliminating the need to order separate back-connectors (as in the FR6802+X(F) frame).

- Fits coaxial (all-BNCs) 6800+ modules: SDI, composite video, and unbalanced AES
- Fits some older 6800 series coaxial modules (Contact Leitch for specifics)



FR6802+DM(F) back view

- Fits up to 10 double-slot modules
- Not suitable for HDTV and non-BNC modules (fiber optics, analog audio, balanced AES, ICE card)

FR-6801-1

- 1 rack unit frame is also available for only coaxial 6800+ modules and most 6800 modules
- No access to Leitch CCS control with this frame



FR6801-1 back view

PRODUCT NUMBER ORDERING DETAILS

xxx6800+D — D implies that the product is delivered with a "2 slot" back-connector for an FR6802+X(F) frame

xxx6800+S — S implies that the product is delivered with a "1 slot" back-connector for an FR6802+X(F) frame

xxx6800+ — Implies that only the module is delivered for an FR6802+DM(F) frame

6800+ For All Core Processing — The 6800+ frames house and power 6800 family modules and enable a new generation of 6800+ style products. These frames allow genlocking, remote control, higher product and power capacity and modular interfaces.



Main Features

General

- Capable of handling HDTV, SDI, analog and AES audio, fiber optics and other (non-BNC) interfaces (in the FR6802+X(F) frame only)
- Holds up to 20 single-slot cards (in the FR6802+X(F) frame only) or 10 double-slot cards or any combination of the two totaling 20 single slots
- Provides continuity to legacy products, housing 6800 modules
- All modules and PSUs are hot-swappable
- Frame-based looping video reference distribution across frame midplane
- Lightweight for mobile production applications
- Rear support extension rail and cable strain relief/tie-down options available

Power and Thermal Considerations

- Frame can house two (redundant) power supplies: AC, 48V DC, or one of each
- AC power cord is locked in place (no DC cord provided)
- Single power supply unit can support entire frame load
- Able to support any combination of modules in every slot of the frame
- Optional integral fan cooling; front to back primary airflow
- Frames equipped with integral fan cooling; may be rack-mounted on top of one another without restrictions
- Processing products must be housed in frames with fans

Control and Monitoring

- Frame status monitoring by means of GPI contact closure
- Every frame supports serial control and monitoring with free +Pilot Lite application
- Option to connect to Leitch CCS control through an interface card (ICE6800+)
- Each ICE6800+ module enables control and monitoring for up to 9 frames



RCP CCS-1U

Remote Control Panel

The RCP-CCS-1U remote control panel provides simple control and monitoring of devices on a Leitch CCS network. This control panel supports all modular platforms.

6800+ and NEO provide unmatched product choice for both Core Processing and Advanced Applications allowing flexible system designs that reduce both upfront capital and ongoing operational costs. Both platforms support networked integrated control and monitoring and are SNMP-friendly for easy integration within larger facility supervision infrastructures.

Competition and cost pressures drive increased productivity, posing an ongoing challenge to a facility's technical infrastructure. Advances in content compression, networking and storage technology present opportunities, but without integrated, networked platforms on which to implement those advances, these opportunities cannot be fully realized.



6800+ for all Core Processing — An exceptional value and high-quality processing platform that provides all the core processing and distribution functions in analog, SD, HD and optical. Products are designed with a “core function per module” concept that ensures straightforward system designs with lower costs and higher performance. Based on the highly successful “Digital Glue®” platform, 6800+ has been completely redesigned to offer integrated control and monitoring and is SNMP-friendly. 6800+ offers a modern, future-proofed solution for any analog/SD/HD core processing infrastructure requirements.

NEO for Advanced Applications — Unique and innovative products that are specifically targeted at advanced broadcast applications. NEO products are designed to tackle complex operations within a facility. NEO offers integrated control and monitoring and is SNMP-friendly. Beyond convention modular processing, new products like the Master Timing Generator and the future Test Signal Generator extend the use of NEO within the facility. Industry-leading products like NEO Simplicity (combined audio/video synchronizer/processors), NEO LogoMotion II, NEO SuiteView and the award-winning NEO VR digital disk recorder provide a unique and powerful application base to improve broadcast operations.

CCS Navigator — Unify facility monitoring and control under a common, networked system application. Both 6800+ and NEO products are fully CCS-compliant and can be remotely monitored and controlled by Navigator over industry-standard Ethernet networks. Navigator’s highly customizable GUIs permit users to supervise complex facility infrastructures by navigating through intuitive, linked pages. Navigator also allows users to supervise third-party SNMP-compliant products.

6800+ and NEO — Together 6800+ and NEO allow you to design and build cost-effective and integrated systems, which are greatly enhanced through CCS control and monitoring applications.

Backed by over 34 years of delivering industry-leading, high-quality infrastructure for professional video and audio facilities, Leitch is uniquely able to leverage our corporate strength, experience and scope to protect customers’ investments.

[Integrated Content Environment (ICE)]

The ultimate goal of the chief engineer or vice president of engineering at every professional television and video operation is a fully integrated environment for the streamlined production, processing, distribution and management of content, allowing audio, video and metadata to be instantly and securely accessible. When workflow is optimized — quality and productivity are improved.

Content Processing

Leitch remains the world leader in platform integration and control, offering the widest range of functions in a choice of flexible platforms — NEO and 6800+. The products offered in these platforms make processing simple and enable increased performance, productivity and control.

Content Transmission and Infrastructure

Leitch's industry-leading routing offerings allow customers to connect high-quality signals of all formats from analog to HD. Panacea provides affordable, compact routing in sizes from 12X1 to 32X32. The new wideband Integrator Gold provides scalable routing of any broadcast digital signal up to 128x128 in a single 8RU frame.

Transmission is an ideal application for integration, as all media is acquired and stored on a central storage system, which can be accessed by multiple users to supply multiple distribution channels with high-quality content and branding.

Our NEXIO transmission server, which supports multiple channels using multiple compression formats in both standard and high-definition resolution, will also support ASI interfaces and has the ability to record, process and playback MPEG transport streams.

Leitch's Opus master control switcher offers an array of effects and has the ability to control up to 16 on-air channels from a single operator control panel. Opus meets multi-channel digital integration challenges for both high-definition and standard-definition formats.

Content Management and Display

Integrated Content Environments offer the greatest opportunity for productivity and performance gains when employing content management and control applications that place content, operations and remote locations under common software controls.

A major workflow enhancement is our Ingest Control Manager, which controls up to 16 server channels with associated proc amps (X75), eight VTRs and eight separate routers from one control station.

CCS control applications, like Navigator, place content, operations or remote facilities under centralized software control and monitoring. These applications are further enhanced with the integration of a flexible, multi-source display processor, NEO SuiteView.

Leitch is the most trusted name for increasing performance and productivity through state-of-the-art solutions — scaling from a simple point product to full design and deployment of an entire operation. The Leitch product portfolio features multi-standard functionality, open interoperability, advanced software and user interfaces, and rock-solid viability for any future requirements — enabling each Leitch client's definition of an Integrated Content Environment.

Process, Edit | **Transmission**

Enabling Your Integrated Content Environment

Legend

- High Definition
- Digital
- Analog
- Fibre Channel
- Transport Streams
- TCP/IP

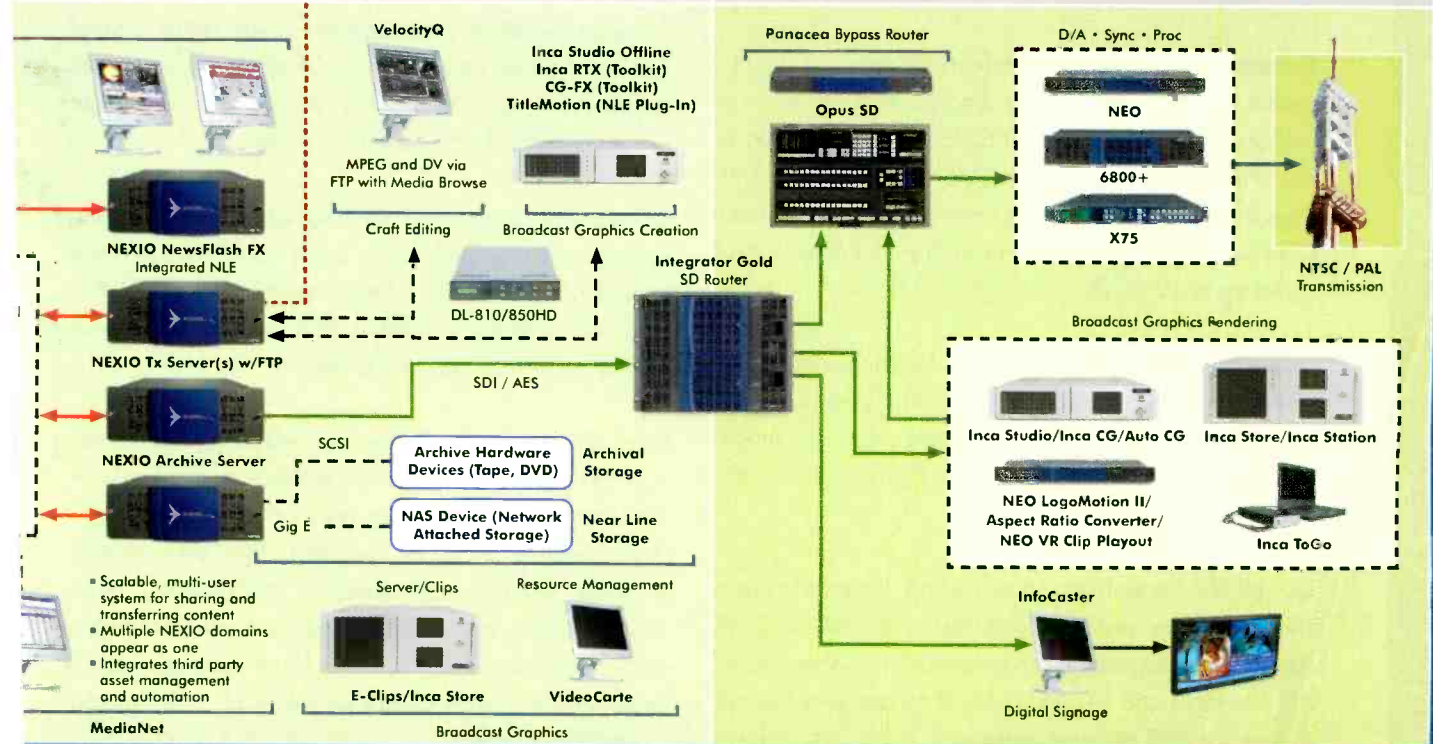
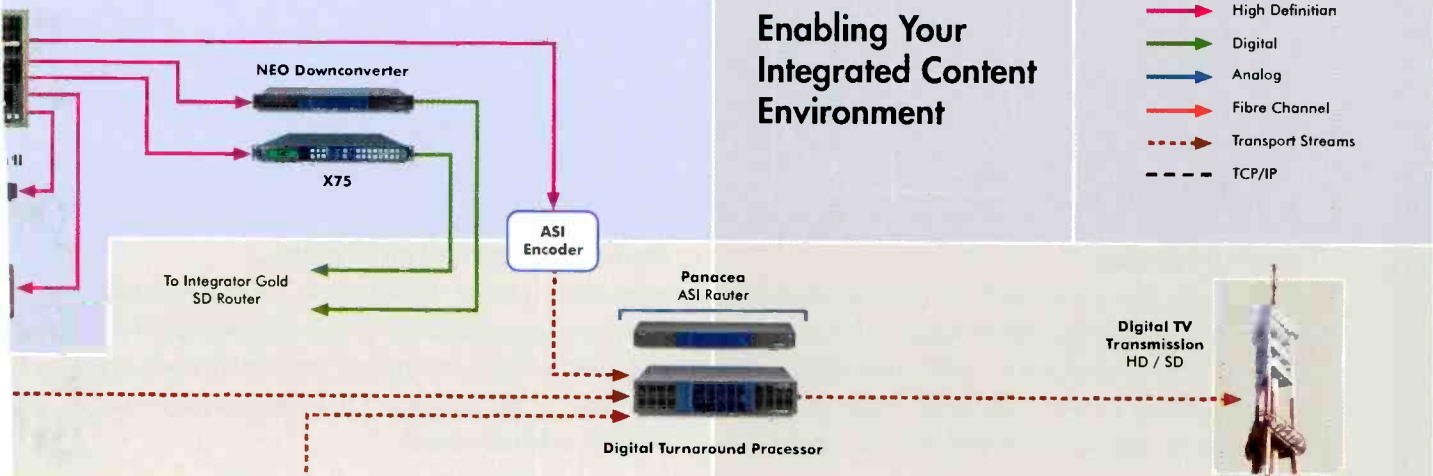

Applications

<p>Non-linear Editing</p> <ul style="list-style-type: none"> • Non-linear facts and finishing in SD (VelocityQ) or flexible HD/SD (VelocityHD) • Scalability • IMF, AAF and other change options 	<p>Command Control System (CCS)</p> <ul style="list-style-type: none"> • Unified control and monitoring solution • Control CCS and SNMP-enabled devices from anywhere in the world • Includes multiple applications, gateways and control panels • Sophisticated, customizable GUI • Distributed, real-time environment • Award-winning online documentation 	<p>CCS PILOT™</p> <p>CCS Pilot</p> <ul style="list-style-type: none"> • Configuration, control and monitoring interface for Leitch products • Local or remote control • Customizable, secure and scalable 	<p>CCS NAVIGATOR™</p> <p>CCS Navigator</p> <ul style="list-style-type: none"> • Extends capabilities of Pilot with user-configurable GUI • Symbol gallery for buttons and images • Single button can launch simple or multiple presets
--	---	--	---

Integrated Content Environment (ICE) — Overview

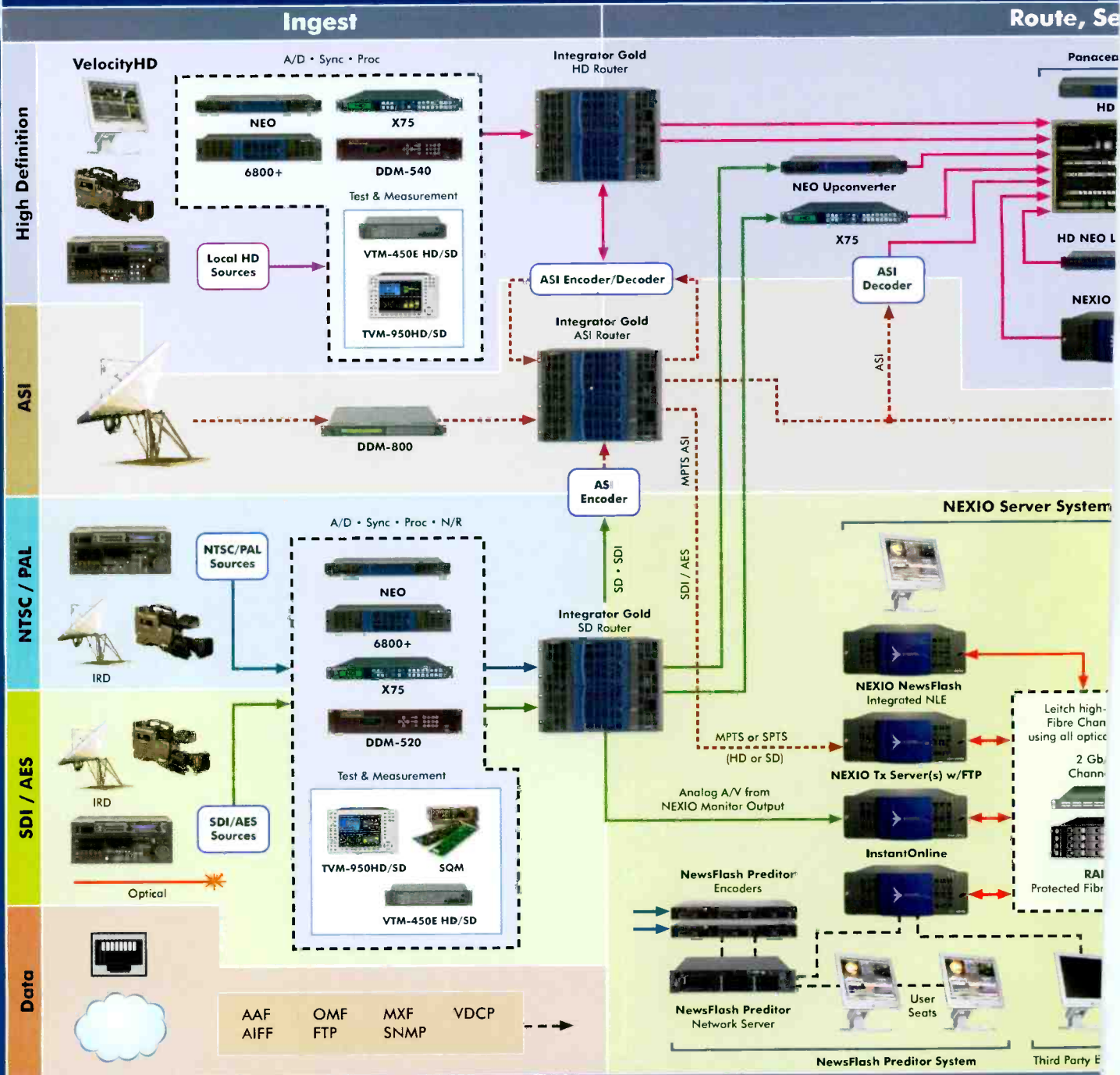

System Wide Display and Timing

SuiteView, NEO SuiteView



- Advanced, flexible, modular display processor
- High resolution for mission critical applications
- Scalable: 4 - 44 inputs



Leitch Master Clock

- Absolute Time Reference (ATR)
- Provides protocol for transmitting universal date / time reference
- Provides alignment of AV reference to data systems in sync with AV
- Defines common reference signal generation and distribution mechanisms for all TV standards

NEXIO™

- Ingest Control Manager
- NewsFlash
- NewsFlash Predictor
- NEXIO Delay
- NEXIO MediaNet
- NEXIO Pilot
- NEXIO Resource Manager
- Playlist
- MOS Rundown Manager



MEDIANET™

- Scalable, multi-user system for sharing and transferring content
- Multiple NEXIO domains appear as one
- Integrates third party asset management and automation



[6800+™]



[NEO™]



[X75™]



Master Your Move to HD
With Leitch