

# CEED

THE MAGAZINE OF BROADBAND TECHNOLOGY / NOVEMBER 1991 / \$5.00

**NCTA comments  
on tech standards**  
—page 10

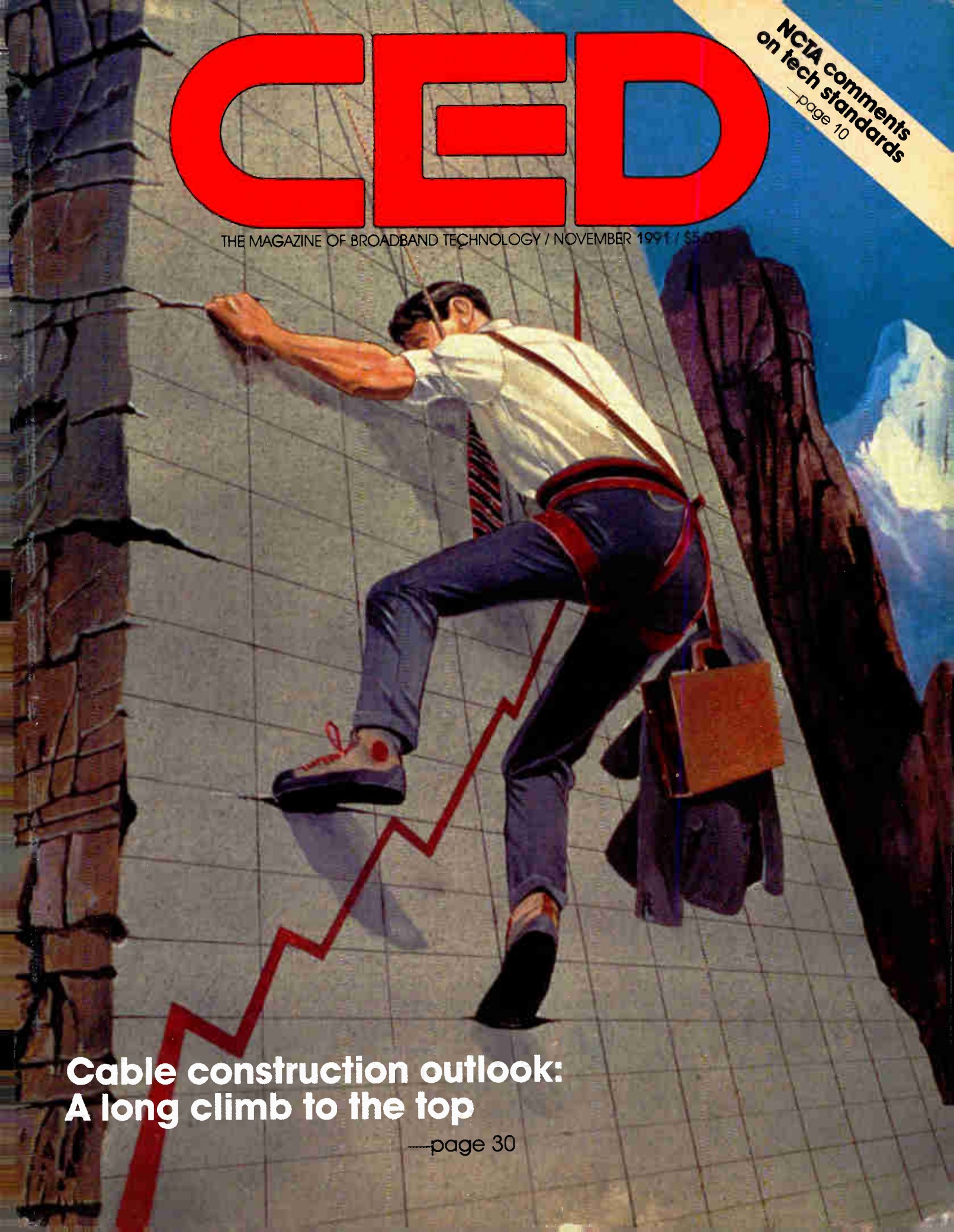

## **Cable construction outlook: A long climb to the top**

—page 30



## ***Give Your Subscribers Another Major Attraction.***

*The bigger the name, the bigger the attraction. It's what creates box office hits. Raises television ratings. Sells magazines. And makes Panasonic Cable Converters a major attraction to your subscribers.*

*Panasonic Cable Converters give you a unique selling advantage. Because Panasonic® is the most highly recognized name in the cable industry. The name customers select themselves for*

*home and business electronics.*

*And Panasonic Cable Converters are designed for convenience and ease of use. With features like volume remote control, favorite channel memory, last channel recall, parental control and sleep timers. Plus all the quality and reliability you've come to expect from Panasonic.*

*Give your subscribers another major attraction. With Cable Converters from the*

*company they're tuned into everyday. Panasonic.*

*For more information on Panasonic Cable Converters, call, NE 609-589-3063, MW 513-530-9216, SE 404-717-6845, W 415-736-4847.*

**Panasonic**  
**Video Communications**



# TRILOGY MAKES THE RIGHT MOVES

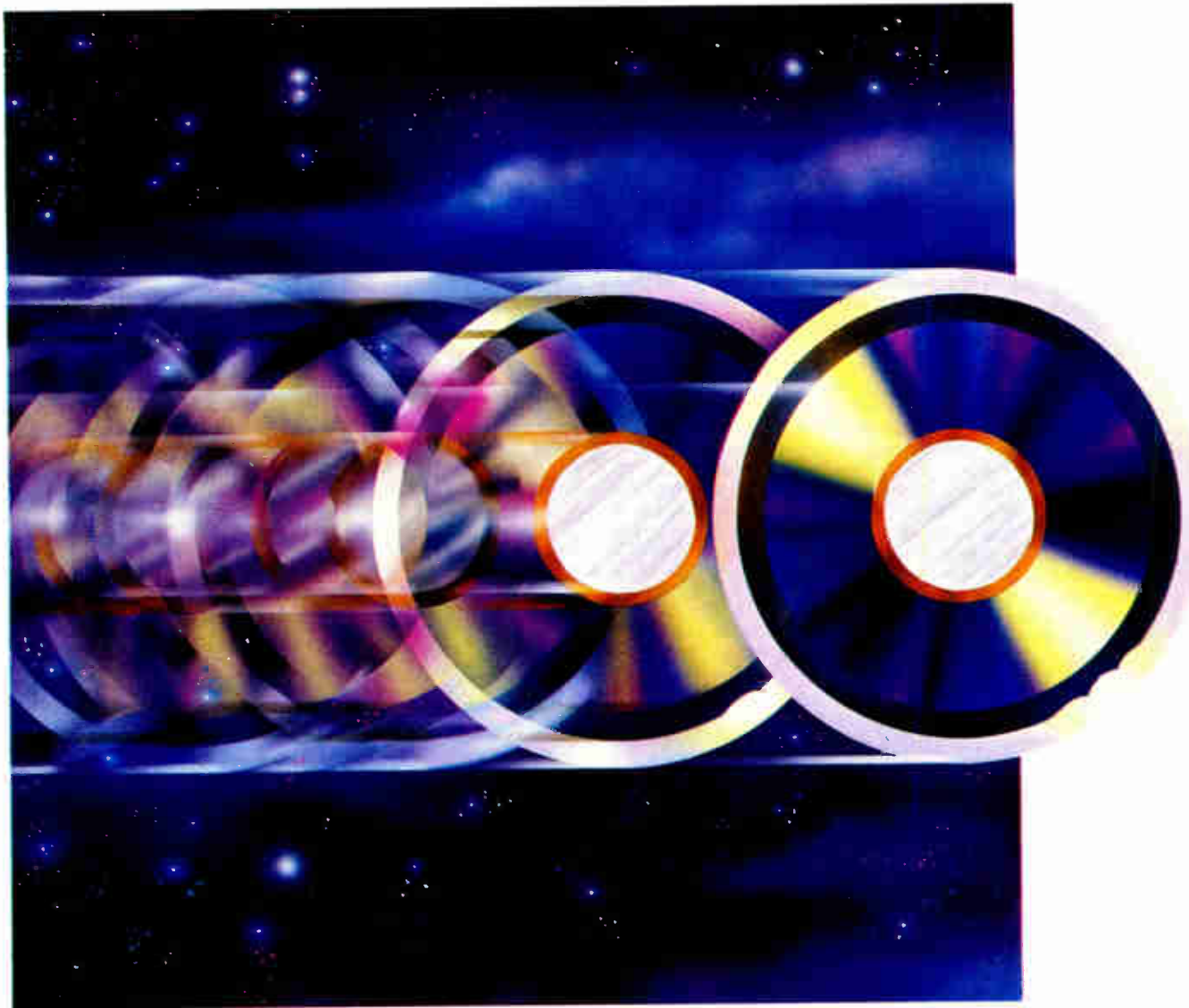

## MC<sup>2</sup> FASTER DELIVERY. FANTASTIC SERVICE.

In addition to the many product benefits you get with MC<sup>2</sup>, you also get the *plus* of faster delivery and incredible service. No costly waits. No bothersome delays. You want MC<sup>2</sup>, you got it! Quick as a wink!

And, of course, you get the special advantages of MC<sup>2</sup>. Air-the perfect dielec-

tric. MC<sup>2</sup> provides such important benefits over foam as: unequalled 93% velocity of propagation, superior attenuation, hermetically-sealed inner structure, stronger bonding, sheathed endurance, better suck-out relief, and purity of signal.

Get to know, what makes MC<sup>2</sup> go!  
**PERFECTION IS IN THE AIR!**



Circle Reader Service No. 2

**Trilogy** 

COMMUNICATIONS INC.

Call or write for your free sample and brochure: TRILOGY COMMUNICATIONS INC. 2910 Highway 80 East, Pearl, Mississippi 39208  
800-874-5649 • 601-932-4461

### The cable hardware marketplace: Clawing its way up 30

The outlook for capital expenditures and construction activity in 1992 doesn't hold any promising news. But then again, some vendors are buoyed because they don't think things can really get any worse. This article by *CED's* Leslie Ellis and Gary Kim tracks both the operators and vendors' forecasts.

### LANs, MANs and CATV 48

As cable operators seek new revenue sources, many are turning toward the business sector to garner some lucrative alternate access and data transmission contracts. This article by George Sell highlights what's happening in Portland, where three cable operators and DEC provide Ethernet over cable-TV networks.

### Is history being made in Williamsburg? 54

Interdiction made a triumphant return 18 years ago when Warner Cable chose to test Scientific-Atlanta's outdoor addressable system. What's happened since then? S-A's Angela Bauer and Warner's Ron Horchler team up to explain how the system was installed, maintained and tested.

### Understanding tape compilers 62

Cable systems that are considering or already implementing commercial insertion systems can benefit greatly from tape compiling systems, according to John Houston, a consulting engineer working with Channelmatic Inc. In this article he explains compilers, their benefits and how to choose the right component.

### Securing RF integrity in the home 78

As an increasing number of Americans comes to rely on cable service, the issue of in-home cabling will become a major headache for some operators. Bill Unsel of Square D Corp. explains a new home distribution system for video, audio and telephone that cable operators should be aware of.

### The effects of two-degree satellite spacing 82

When Galaxy I moved this past summer, cable operators apparently coped quite well. But that move was just the first in a series that will result in a new orbital arc. Is your cable system ready for the new look? Scientific-Atlanta's Steve Havey explains ways to be sure you are.

### The economics of fiber optics 94

The costs of fiber all the way to the home will come down faster than many think—but will it ever be cheaper than fiber to the bridge? That's just one question considered, and answered, by Nick Hamilton-Piercy and Robb Balsdon of Rogers Engineering in this all-inclusive economic study of fiber optic topologies.

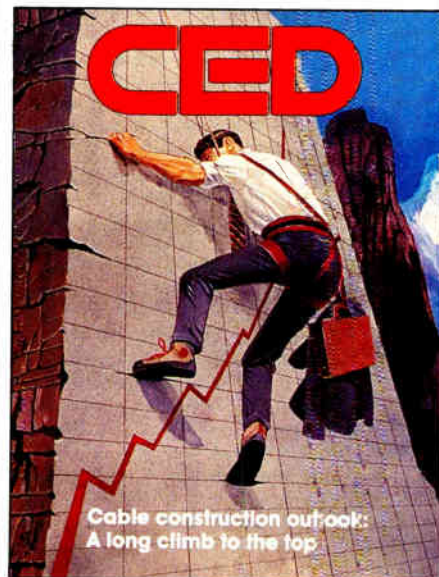

#### About the Cover:

Vendors are finding the climb out of the recession to be a tough one.  
Photo by The Image Bank.

#### DEPARTMENTS

<b>In Perspective</b> . . . . .	<b>8</b>
Forecasting the market	
<b>Color Bursts</b> . . . . .	<b>10</b>
Tech standards	
<b>Spotlight</b> . . . . .	<b>14</b>
Ted Chesley	
<b>Frontline</b> . . . . .	<b>16</b>
Standards negotiations	
<b>From the Headend</b> . . . . .	<b>20</b>
The other side of the fence	
<b>Capital Currents</b> . . . . .	<b>22</b>
Protecting frequencies	
<b>My View</b> . . . . .	<b>24</b>
Chroma delay	
<b>Fiberline</b> . . . . .	<b>26</b>
Digital transmission	
<b>Return Path</b> . . . . .	<b>28</b>
More on picture quality	
<b>What's Ahead</b> . . . . .	<b>102</b>
<b>Cable Poll</b> . . . . .	<b>106</b>
Digital compression	
<b>In the News</b> . . . . .	<b>108</b>
<b>Classifieds</b> . . . . .	<b>112</b>
<b>Ad Index</b> . . . . .	<b>117</b>
<b>Ciciora's Page</b> . . . . .	<b>118</b>
Universal remote ideas	

© 1991 by Diversified Publishing Group. All rights reserved.

*CED*. (USPS 330-510) (ISSN 1044-2871) is published monthly except twice in May by Diversified Publishing Group, a Division of Capital Cities Media, Inc., 825 7th Ave., New York, NY 10019. ©November 1991, Volume 17, Number 12. U.S. domestic subscriptions are \$48. Outside USA, subscriptions are \$69 for surface delivery or \$96 for air speed delivery, prepaid in U.S. funds drawn on a U.S. branch bank. Second-class postage paid at New York, NY 10019 and additional mailing offices. *CED* is published on behalf of the cable television and broadband communications industries. POSTMASTER: Please send address changes to *CED* Circulation, P.O. Box 3043, South Eastern PA 19398. MEMBERS OF THE BPA.



# Headend Performance to Drive AM Fiber

Nexus' Series 2000 headend is the answer to the fiber challenges of the next decade. It combines exceptional performance, flexibility and reliability with redundancy, automation and control systems all designed for the future.

The Series 2000 delivers:

- + 67 dB weighted SNR at 150 channels (1 GHz capacity)
- fully redundant powering
- computer controlled agile back-ups
- RS-485 communication systems
- full status monitoring and control

- IF and baseband switching flexibility
- guaranteed upgradable to any HDTV standard for 5 years
- covered by the famous Nexus 5 year warranty

Series 2000 is the solution to your fiber challenges. Call us today for a Series 2000 brochure or a quotation for your next system.

**NEXUS**  
**ENGINEERING CORP.**

7000 Lougheed Highway  
Burnaby, BC V5A 4K4  
Tel: (604) 420-5322  
Fax: (604) 420-5941

Bellevue, WA  
Tel: (206) 644-2371

**DEFINITELY AHEAD OF OUR TIME**



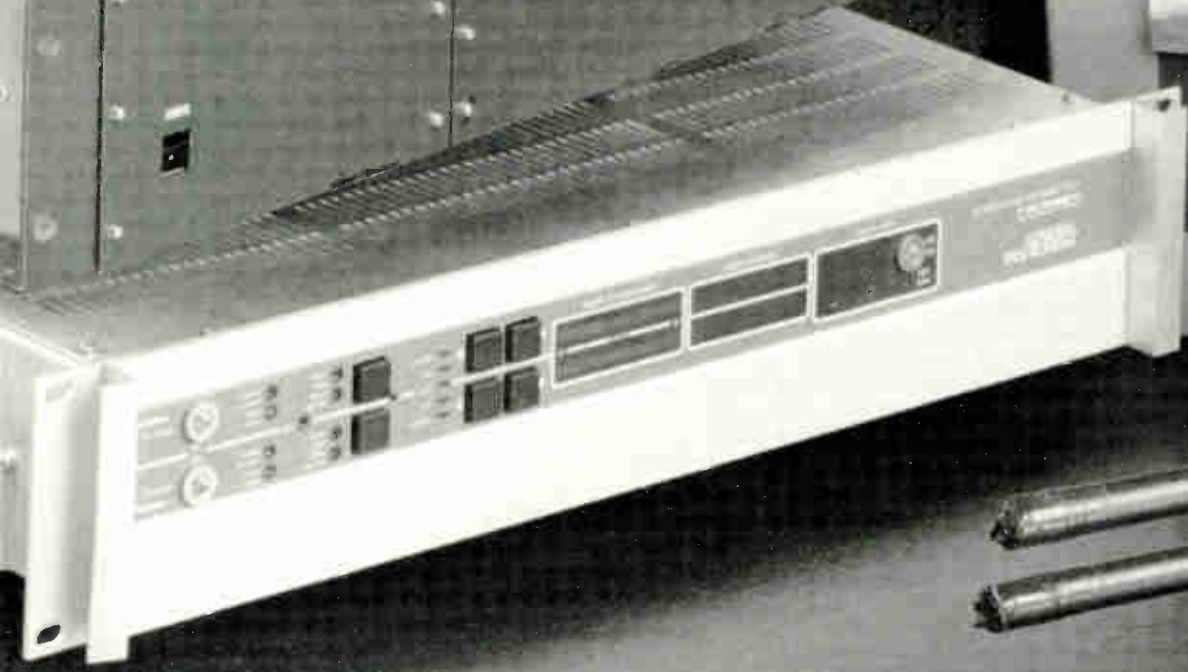
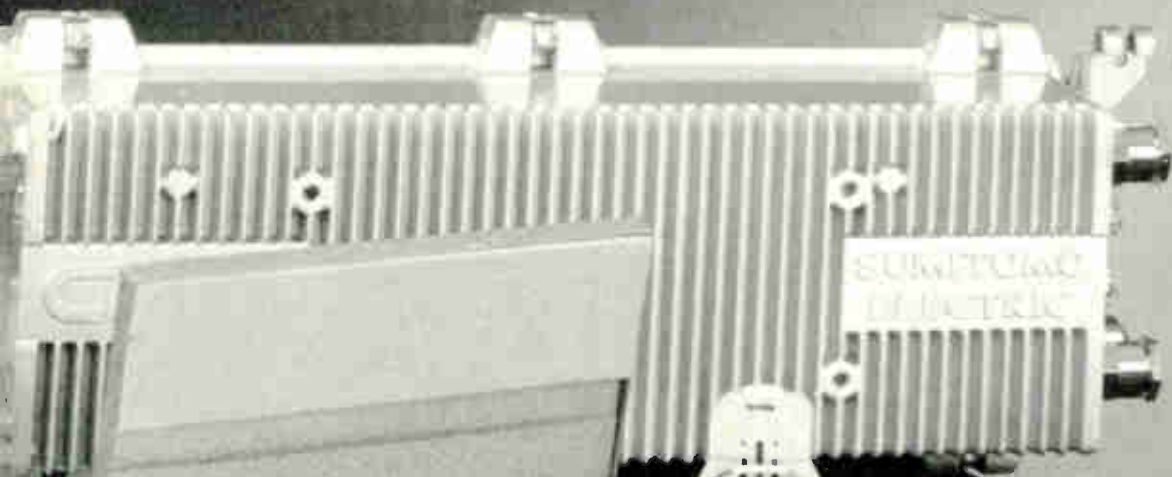



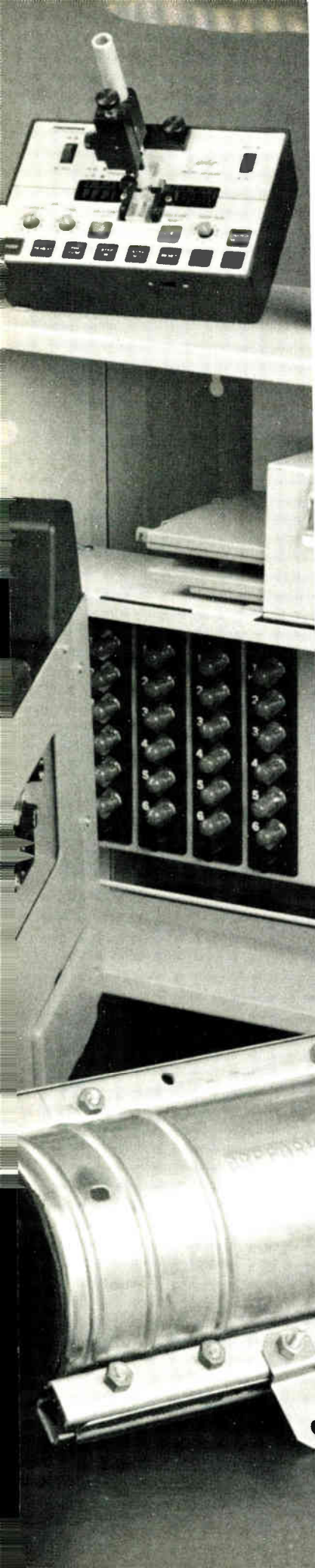

## Fiber is Good for Your System.

Any cable system committed to providing good service knows fiber optics will play an important role in delivering signal quality.

At Midwest CATV, we're equally committed to providing good service by being your full line supplier of fiber optic products. Headend equipment from Sumitomo and Jerrold. Fiber optic cable from BICC and Sumitomo. Test equipment from Noyes. And fusion splicers from Preformed.

Our full line of accessory items includes splice trays and organizing systems from AMP, BICC and Preformed. We also stock a full line of tools for stripping and cleaving from Klein and Thomas and Betts.

Our technical services group offers complete system engineering, too.

Most products are in inventory and ready for immediate shipment. So for fast response, phone 1 800 MID-CATV.

**MIDWEST**

**CATV**

a UNR Industries Company

*More than supplies. Solutions.*

**1 800 MID-CATV**

Denver, CO • Clarksburg, WV • Dallas, TX • Lafayette, IN  
Ocala, FL • Phoenix, AZ • Pottstown, PA

## The business of prognostication

It's strange how times change.

The past few construction forecasts we've researched were often an exercise of understatement. That is, vendors often underestimated the level of business they'd see for the following year, even though they privately *knew* they'd do better than their forecast indicated.

But last year that changed. The recession had already hit cable hardware suppliers and manufacturers with full force and vendors were singing the blues. But there was talk of a short, shallow recession and of how the industry would rebound by this summer.

But as we all know, that hasn't happened. The recession continues and vendors have given up hope on 1991. They're doubtful that 1992 will show any improvement except in a few product categories. Most now look forward to 1993 as the year in which franchise renewals force operators to upgrade their plants.

At the same time, this business of forecasting cable construction and spending activity has become decidedly more difficult. Cable operators are scrutinizing their budgets, looking for areas to chop millions. Consequently, every rebuild and upgrade project needs sound justification. That makes the budgeting process longer and more strenuous. This often results in projects being delayed for longer periods of time.

Consequently, vendors are losing their humor. Whereas telephone calls from trade journalists were happily accepted in the past, now no one has time (or the desire). Sales and marketing people have shorter fuses and some even criticize the press for spending too much time talking about advancing technology. If we'd stop writing about new technology, cable operators would start spending again, or so their convoluted arguments go.

Which gets to my third point. A seemingly endless stream of technological innovation and potential new revenue streams are hitting the cable industry simultaneously: Fiber optics, personal communications, alternate access, near video on demand, digital video compression, interdigitation, etc. It seemingly makes choices tougher (who wants to buy a new product and find out later that was a huge mistake?) and some argue it's a big reason why spending has slowed so much.

But is that valid? Don't forget that the vast majority of cable systems are small, suburban or rural plants that offer about 36 channels of service. Do those systems need to explore PCNs? Or alternate access? Or even NVOD? Probably not. Instead, they're pondering fiber optics and (maybe) compression. The former offers better pictures and the latter allows for more pictures. Fiber can be cost-justified and compression gives operators new ways to make more money. But on the other hand, fiber is here today and compression isn't.

I don't know what it'll take for the hardware side of the industry to rebound. Perhaps operators do indeed need time to digest what's going on. Maybe relaxation of HLT rules will spur some movement. But I don't think shooting the messenger is the answer.

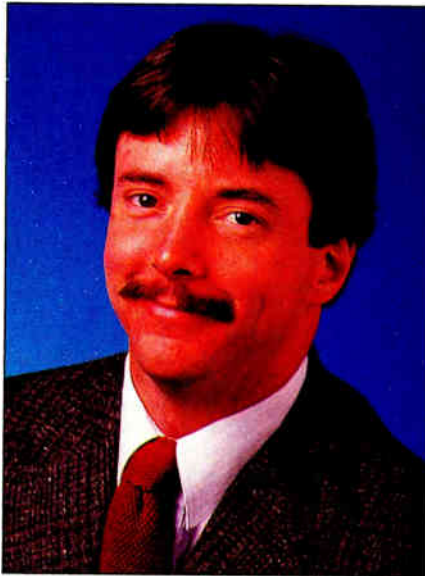

*Roger J. Brown*  
 Roger Brown  
 Editor

Publisher  
**Robert C. Stuehrk**

Editor  
**Roger Brown**

Managing Editor  
**Leslie Ellis**

Contributing Editor  
**George Sell**

**CONSULTING ENGINEERS**  
 Chairman

**Wendell H. Balley**, NCTA VP, Science and Technology

**MEMBERS**

**Jim Chiddix**, Senior VP, Engineering and Technology, ATC

**Roy Ehman**, Director of Engineering, Jones Intercable

**Tom Elliot**, VP, Engineering and Technology, Tele-Communications Inc.

**Jim Farmer**, Principal Engineer, Scientific-Atlanta

**Paul Helmbach**, VP Engineering, Viacom Networks Group

**Tom Jokerst**, Regional Engineering Director, Continental Cablevision

**Fred Kaiser**, President, Alpha Technologies

**Dave Large**, Director of Engineering, Intermedia Partners

**Robert Luff**, VP Strategic Operations, Scientific-Atlanta

**Ed Millner**, Information Systems Specialist, NCTI

**Joe Van Loan**, Senior VP Engineering, CableVision Industries

Advertising/Marketing Director  
**Cathy Wilson**

Account Executive  
**Judy Medley**

Classified Sales Manager  
**Terri Sinner**

Assistant to the Publisher  
**Michelle Pazar**

SCTE Chapter Support  
**Kendra Baldrige**

Production Manager  
**Elaine Callahan**

Art Director  
**Don Ruth**

Corporate Circulation Director  
**Renee Jordan**

Assistant Circulation Manager  
**Georgia Aristidou**

Fulfillment Manager  
**Mary Keane**

**William McGorry**, VP Group Publisher

**Mary Ellen Sack**, VP Finance

**Andrew Cunningham**, VP Operations

**CAPITAL CITIES/ABC, INC.**  
**DIVERSIFIED PUBLISHING GROUP**

Office  
 600 S. Cherry Street, Suite 400, Denver,  
 CO 80222 (303) 393-7449. Fax (303)  
 393-6654.

Subscriber Services

(215) 630-9326

Circulation Office

(212) 887-8568



# CHEAT-SEEKING DEVICE

SIGNAL PIRACY

DELINQUENT ACCOUNTS

ILLEGAL CONNECTIONS

TRUCK ROLLS

THEFT

CHURN

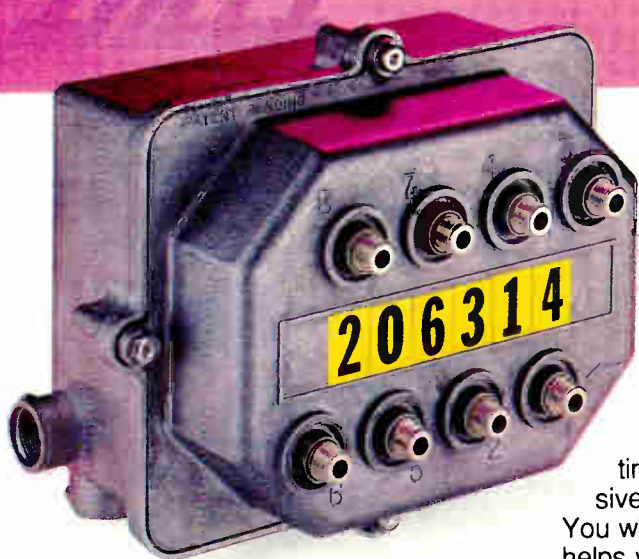

Service piracy is just one of the problems diverting revenues from your bottom line. Do delinquent receivables mean anything to you? How about the costs generated by excessive churn?

Now you can eliminate them all, simply and cost-effectively, with DROPGuard™, the new off-premises addressable tap from AM Communications that gives you control over remote service connections from your own office.

## Stop Unnecessary Truck Rolls With **DROPGuard**™

Providing instant access to individual subscriber drops, DROPGuard allows you to bring customers on and off line, immediately and for any length of time, without the need for expensive — and uncertain — truck calls. You will appreciate how DROPGuard helps you minimize churn costs and prevent illegal hook-ups while discouraging non-payment.

DROPGuard is especially well-suited for high-risk, high-churn or inaccessible areas, where truckrolls are costly and undesirable. It can replace passive taps anywhere in your system, and need not be deployed system-wide. You will find that, by increasing the efficiency of your operation and helping capture more of your profits, DROPGuard will soon pay for itself.

DROPGuard is field-proven and is supported by the Cable Data™ billing system.

For more information about DROPGuard and our other products for CATV systems, please call **1 (800) 248-9004**.



**COMMUNICATIONS**

We're Keeping Watch!

1900 AM Drive • P.O. Box 9004  
Quakertown, PA 18951-9004

Tel: (215) 536-1354 Fax: (215) 536-1475

**1 (800) 248-9004**

Circle Reader Service No. 5

# NCTA, cities ink tech standards document

11th-hour compromise calls for 43 dB C/N, +3 dBmV signal level

The long-awaited joint agreement between the cable industry and local franchise authorities on cable industry technical standards was submitted to the Federal Communications Commission late last month—and it appears that everyone comes out a winner.

Consumers will see a difference because the standards call for increased signal levels and carrier-to-noise performance, as well as regular testing to ensure those standards are being met. The franchisors gain an aspect of local control over an industry considered by many to be arrogant and monopolistic. And the cable industry establishes a politically important alliance with the cities at a time when competition promises to heat up intensely.

The eleventh-hour agreement, filed as comments to the FCC's Notice of Proposed Rulemaking on cable technical standards, was hammered out through a lengthy series of face-to-face meetings and conference telephone calls. The result of this exhausting process was perhaps the most important technical document ever written for the CATV industry, according to Wendell Bailey and Jonathan Kramer, chief negotiators for, respectively, the National Cable Television Association and the National Association of Telecommunication Officers and Advisors.

In many ways, the document mirrors the NPR written by the FCC, forcing cable operators to provide 43 dB carrier-to-noise levels in their systems and +3 dBmV signal levels at the end of a 100-foot drop. In its notice issued in June, the FCC said it preferred that the cable industry and the cities forge a joint agreement on technical standards, rather than force the Commission to create standards for and supervise cable system performance.

It was unclear as of press time how the FCC would react to the NCTA/NATOA agreement. However, Bailey said NCTA has encouraged the Commission to adopt the document in its entirety without major modification. "I firmly believe this process and product is what the Commission sought," said Bailey. Kramer agreed, saying, "This was a long process that the FCC helped stimulate to a successful conclusion." The fact remains, however, that the FCC could choose to adopt the

agreement and all its provisions, or just selected points.

In either case, it's clear that cable operators of systems with more than 1,000 subscribers will be forced to adhere to certain signal performance standards. What follows is a brief dissertation of the most important points hammered out in the compromise document:

## Signal levels

The visual signal level shall not be less than +3 dBmV as measured at the end of a 100-foot cable drop connected to a subscriber tap. Additionally, in no case shall a cable operator be allowed to provide less than 0 dBmV at any legally installed subscriber terminal.

The signal levels on each channel cannot vary more than 8 dB within any six-month period, according to the agreement. Furthermore, those signals shall be maintained within: 3 dB of visual signal level variation of any two visual carriers within 6 MHz nominal frequency separation; 10 dB of separation for non-adjacent channels in systems up to 300 MHz, with a 1 dB increase for each additional 100 MHz the system offers.

## Carrier-to-noise ratio

At the time the document is adopted by the FCC, cable operators must provide signals with at least 36 dB carrier-to-noise, measured at the subscriber terminal. Operators will have one year from the date the document is adopted to achieve no less than 40 dB C/N and an additional three years to attain no less than 43 dB C/N on all channels. (If a converter is provided by the operator, however, a 1 dB decrease in the above numbers will be allowed.)

## Other disturbances

The ratio of visual signal level to the rms amplitude of disturbances such as intermodulation products, second- and third-order distortions, etc. shall be no less than 51 dB for non-coherent channel systems and no less than 47 dB for coherent channel systems, when measured with modulated carriers and time-averaged.

Frequency modulated (FM) radio signal levels shall be maintained between 10 dB and 19 dB below the nearest visual carrier. In no case may an FM radio signal cause visual or aural disturbances to any wide channel.

The chrominance-luminance delay inequality, or chroma delay (the change in delay time of the chrominance component of the signal relative to the luminance component), shall be within 170 nanoseconds.

The differential gain for the color subcarrier of the signal (the difference in amplitude between the largest and smallest segments of the chrominance signal) shall not exceed  $\pm 20$  percent.

The differential phase for the color subcarrier (the largest phase difference in degrees between each segment of the chrominance signal and reference segment) shall not exceed  $\pm 10$  degrees.

## Proof-of-performance testing

Cable operators will be required to conduct proof-of-performance tests at least two times a year, at intervals not to exceed seven months. For systems of more than 1,000 subscribers, but less than 12,500, measurements must be taken at six widely separated points in the system. One additional test point must be added for every additional 12,500 subscribers or fraction thereof.

Additionally, at least one-third of the test points must be representative of subscriber terminals most distant, in terms of cable length, from the system's signal origination point. These tests may be made at tap monitoring points, provided the performance is related to how it would be viewed at a subscriber terminal.

The cable operator must provide the franchising authority a minimum of 30 days written notice of the start of the tests, complete with a list of channels to be tested. Signal level testing and aural rms voltage level testing must be performed on all channels; other tests must be performed on a minimum of four channels plus one additional channel for every 100 MHz of bandwidth the system offers.

The franchising authority may, within 15 days of receiving the list, provide the cable operator with a list of alternate channels it wants tested



# CALAN STAR 2010

## SETS A NEW STANDARD IN CARRIER ANALYSIS

It's a data management  
system offering:  
**DATA COMMUNICATION**  
**DATA ACQUISITION**  
**DATA ANALYSIS**



**CABLE AND LOCAL AREA NETWORKS**  
CALAN, INC.  
Dingman's Ferry, PA 18328  
1-800-544-3392 • In PA: 717-828-2356  
FAX: 717-828-2472

### CALAN's STAR 2010 SLMS (Signal Level Measurement System):

Opens a whole new era in carrier analysis  
for the cable industry.

First, it's simply the best level meter ever  
designed — covering the entire frequency  
range (5 MHz to 1 GHz) with unmatched  
speed (36 channels in less than 2 sec.),  
accuracy, stability, and simplicity of use.

It's also a data management system—  
incorporating computer interface, built-in  
comparison and analysis capability, and  
communications with PC's and printers.

STAR 2010 is field upgradeable, with  
provisions for user-installed software  
modules and plug-in option cards.

Priced right and portable. . . you  
can put STAR 2010 in the  
hands of every technician.

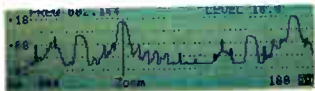

Spectrum Scan



Single Channel

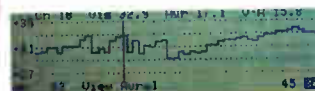

Channel Scan

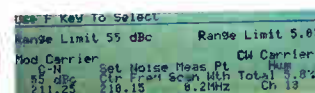

C/N and Hum  
Measurements

Circle Reader Service No. 6



Circle Reader Service No. 7

See the entire Standard line at the Western Cable Show, Nov. 20-22, booth space # 1

in lieu of the channels listed by the operator. Also, in cases where the franchising authority has received complaints regarding the signal quality of a greater number of channels than the operator is required to test, a maximum of two additional channels may be designated for testing. Finally, the franchising authority can conduct tests on additional channels.

If the franchising authority suspects the cable operator is not in compliance with the standards, it may provide a notice of noncompliance and the operator will have 30 days to demonstrate it is in compliance. If this testing demonstrates the operator does not comply, the operator must reimburse the franchising authority for its testing costs.

The cable system operator must

announcement that Comcast Corp., Motorola and General Instrument have teamed up to offer personal communications services in Trenton, N.J. early

If the test is successful, Comcast could integrate the technology into Philadelphia, where it already owns a cable system and is preparing to acquire controlling interest in Metromedia's cellular network.

### Conventional Trunk-and-Feeder

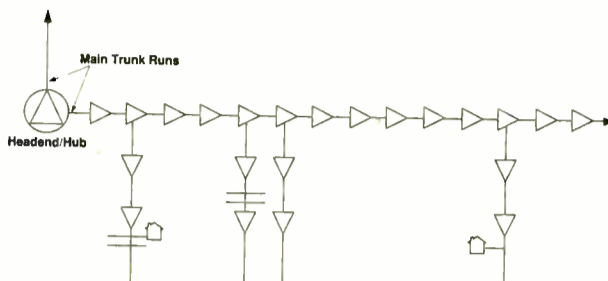

Figure 1

### S-A unveils FSA variation

Scientific-Atlanta later this month will formally unveil a

## SPOTLIGHT



Ted Chesley

### Engineering sage

In the late 1970s, Ted Chesley, director of operations for Rock Associates, stood up at a convention to make his predictions about the future of cable television. He said two things: That sooner or later, cable television would see tremendous competition from DBS-type services, and that unless operators got more involved in alternate access and I-Net type services, the industry would lose that business.

He was right. And now he's predicting again. "In five to 10 years, pay-per-view is going to dominate cable television. That will be done by digital compression," Chesley starts. Note that Chesley is speaking from experience: He was the engineer in charge of the much-publicized video compression tests undertaken with Skypix in his Coeur d'Alene, Idaho, system this year.

"Correspondingly, you'll see a downturn in the classic pay channel penetration," he continues. "Oh, there'll be a couple of survivors—maybe HBO and Showtime—but in light of PPV, a lot of traditional programmers will go away."

Pretty strong words for a guy who lives in Idaho—perhaps the epitome of the laid-back lifestyle—right? Don't be fooled. Chesley, while exuding that cheerful, relaxed, "I'm a mountain-kind-of-guy" attitude, is decidedly a mover and a shaker.

Consider this: For eight of the past 13 years, he has been elected technical VP of the Pacific Northwest Cable Communications Association. He's on CableLab's Technical Advisory

Committee. He's both the Region 3 national director and the Western technical VP for the Society of Cable Television Engineers.

Ted Chesley knows what he's talking about when it comes to cable television engineering. His cable roots go back 23 years, when he started working as a part-timer for Teleprompter while serving his stint—and picking up his engineering fundamentals—in the Air Force.

In 1968, he joined Teleprompter full time and over six years moved up the ranks to senior microwave technician. During that time, Chesley notes, he was on the team that displayed the first satellite downlink at the Western Cable Show in 1973. "That's what gave HBO its beginnings, nationwide," Chesley recalls.

After a brief time at Hughes/Theta-com, where he wrote a technical manual that is still in use today, Chesley hopped over to the operational side of the fence as a system engineer for Cox Cable.

In 1984, Chesley joined Seattle, Wash.-based Rock Associates—but opted to take up residence in Idaho. "I belong at the systems," Chesley explains, "and the Coeur d'Alene system is our largest."

For the past year, Chesley's time has been spent testing the Skypix digital compression system. "We're the only system in the country that is carrying digital video and digitally compressed signals on a day-to-day basis," Chesley unassumingly remarks. "Now, though, it's just a matter of watching it."

#### Not sold on 1-GHz

While Chesley is enthusiastic about expanded bandwidth via compression, he has some concerns about 1-GHz technology as a means to add more channels. "When you talk about these very, very high bandwidths, you're talking about larger numbers of equipment. I think that only those areas that have an extremely high customer density will be able to pay for that kind of a system," Chesley says.

"Metropolitan areas will probably fit the ticket for 1-GHz technology. But when it comes to the rural areas—and those are still the majority of the systems—you're not going to see a whole lot of people going to 1 GHz or even 750 MHz. That's because it makes no economic sense at all out here."

Indeed, Chesley spends a lot of time thinking (and speaking, at SCTE chapter meetings across the Northwest)

about emerging technologies. "We're sitting out here with more technological advancement than I've seen in this industry since the late '70s, and we can't implement it. And that's because we can't afford to."

"Right now, the name of the game is to make maximum profit and try to pay the tab," Chesley laments.

Which isn't a good situation, Chesley adds, because operators need to be directing attention and dollars toward the non-revenue producing sides of the house, like customer service. "We haven't as an industry done a good job on customer service and education as we should have," Chesley says.

"We haven't made the investment as an industry to take care of those customers in an extraordinary fashion to make them happy about paying us all this money," Chesley continues.

#### Motivators

What motivates Chesley the most is a sense of pride and accomplishment, particularly in seeing projects through to completion, handling situations fairly and being "approachable." Along those lines, Chesley says, "I don't fire very many people. But then again, I don't hire people that are liable to get fired."

Chesley believes that hiring is an art. Interestingly, his theory is that hiring processes are well-handled by engineers because "most engineers are very, very perceptive. I think they are better able to read whether someone is throwing them a line, or whether someone really has potential. I think it all boils down to the fact that engineers are relatively practical people."

Indeed, Chesley sees himself as a relatively practical person. "I see myself as an all-purpose engineer who takes a lot of pride in what I do. I can adapt easily to different situations, from microwave transmission to satellite transmission to digital compression."

Not surprisingly, the outdoors forms the basis for Chesley's spare time activities. "I live in the West. That means I like to hunt, fish, camp, ski and generally do outdoorsy-types of things with my family," consisting of wife, Janie and 16-year old Melissa, Chesley explains. Chesley's oldest daughter has already left the nest and is about to receive her degree in registered nursing.

Decidedly humble, Chesley laughs when asked to describe himself. "I don't know—I guess I'm just a nice guy." ■

—Leslie Ellis



Adding a channel? Upgrading old receivers and modulators? Maybe looking to add BTSC stereo?

Plug into Standard.

Our Agile IRD II Receiver/Descrambler and TVM450 Modulator are perfectly matched to give you outstanding performance, utilizing a unique, precalibrated RF and video/audio level adjustment system. And all you have to do is plug 'em in.

**Big performance, small package.**

The Agile IRD II is a commercial C/Ku satellite TV receiver, designed to accept a VideoCipher® descrambler module—in a package only 1.75" tall.

As you'd expect from Standard, the Agile IRD II gives you solid 100 KHz PLL tuning, dual down-conversion to 70 MHz, and superb video specs. Intelligent design features include a 70 MHz IF loop-through for inserting TI filters, and an active 950-1450 MHz RF loop-through for expansion

without signal splitters. You also get a familiar VideoCipher panel layout as well as a visual signal-strength alarm, and front-panel access to alignment controls, test points and the new VC II PLUS™ on-screen display.

**Not just another modulator.**

Need a modulator? Imagine a frequency-agile CATV modulator that rivals fixed-channel performance—and that's just for starters.

The TVM450's High Level Mixing method, among other engineering advances, all but eliminates out-of-band noise and spurious signals, so you can meet NCT-7 specs for the entire 450 MHz spectrum—without external bandpass filters. The TVM450's integrated CSG-60 BTSC generator puts stereo where it belongs—in the modulator. And whether you use stereo or mono, the TVM450's front-panel controls are factory-calibrated to radically simplify installation and set up, and so

accurate you can even use a TVM450 to calibrate your receivers.

**So advanced, they're simple.**

There's more—much more—to the IRD II and TVM450 than we have room for here. We say they're so advanced that all you have to do to add a channel is plug 'em in, set 'em—and forget 'em.

But you don't have to take our word for it. Call Standard at 800/745-2445.

And we'll prove it.

*Raise your standards.*



**SATCOM Division**

P.O. Box 92151  
Los Angeles, CA 90009-2151  
(213) 532-5300 • (800) 745-2445  
FAX: (800) 722-2329 (USA)  
FAX: (213) 532-0397 (Int'l and CA)

Represented in Canada By:  
DGH Communications Systems Ltd.  
Scarborough, Ontario • (416) 499-4746

# Plug in a new channel.



Circle Reader Service No. 7

See the entire Standard line at the Western Cable Show, Nov. 20-22, booth space # 1



Ted Chesley

## Engineering sage

In the late 1970s, Ted Chesley, director of operations for Rock Associates, stood up at a convention to make his predictions about the future of cable television. He said two things: That sooner or later, cable television would see tremendous competition from DBS-type services, and that unless operators got more involved in alternate access and I-Net type services, the industry would lose that business.

He was right. And now he's predicting again. "In five to 10 years, pay-per-view is going to dominate cable television. That will be done by digital compression," Chesley starts. Note that Chesley is speaking from experience: He was the engineer in charge of the much-publicized video compression tests undertaken with Skypix in his Coeur d'Alene, Idaho, system this year.

"Correspondingly, you'll see a downturn in the classic pay channel penetration," he continues. "Oh, there'll be a couple of survivors—maybe HBO and Showtime—but in light of PPV, a lot of traditional programmers will go away."

Pretty strong words for a guy who lives in Idaho—perhaps the epitome of the laid-back lifestyle—right? Don't be fooled. Chesley, while exuding that cheerful, relaxed, "I'm a mountain-kind-of-guy" attitude, is decidedly a mover and a shaker.

Consider this: For eight of the past 13 years, he has been elected technical VP of the Pacific Northwest Cable Communications Association. He's on CableLab's Technical Advisory

Committee. He's both the Region 3 national director *and* the Western technical VP for the Society of Cable Television Engineers.

Ted Chesley knows what he's talking about when it comes to cable television engineering. His cable roots go back 23 years, when he started working as a part-timer for Teleprompter while serving his stint—and picking up his engineering fundamentals—in the Air Force.

In 1968, he joined Teleprompter full time and over six years moved up the ranks to senior microwave technician. During that time, Chesley notes, he was on the team that displayed the first satellite downlink at the Western Cable Show in 1973. "That's what gave HBO its beginnings, nationwide," Chesley recalls.

After a brief time at Hughes/Thetacom, where he wrote a technical manual that is still in use today, Chesley hopped over to the operational side of the fence as a system engineer for Cox Cable.

In 1984, Chesley joined Seattle, Wash.-based Rock Associates—but opted to take up residence in Idaho. "I belong at the systems," Chesley explains, "and the Coeur d'Alene system is our largest."

For the past year, Chesley's time has been spent testing the Skypix digital compression system. "We're the only system in the country that is carrying digital video and digitally compressed signals on a day-to-day basis," Chesley unassumingly remarks. "Now, though, it's just a matter of watching it."

### Not sold on 1-GHz

While Chesley is enthusiastic about expanded bandwidth via compression, he has some concerns about 1-GHz technology as a means to add more channels. "When you talk about these very, very high bandwidths, you're talking about larger numbers of equipment. I think that only those areas that have an extremely high customer density will be able to pay for that kind of a system," Chesley says.

"Metropolitan areas will probably fit the ticket for 1-GHz technology. But when it comes to the rural areas—and those are still the majority of the systems—you're not going to see a whole lot of people going to 1 GHz or even 750 MHz. That's because it makes no economic sense at all out here."

Indeed, Chesley spends a lot of time thinking (and speaking, at SCTE chapter meetings across the Northwest)

about emerging technologies. "We're sitting out here with more technological advancement than I've seen in this industry since the late '70s, and we can't implement it. And that's because we can't afford to."

"Right now, the name of the game is to make maximum profit and try to pay the tab," Chesley laments.

Which isn't a good situation, Chesley adds, because operators need to be directing attention and dollars toward the non-revenue producing sides of the house, like customer service. "We haven't as an industry done a good job on customer service and education as we should have," Chesley says.

"We haven't made the investment as an industry to take care of those customers in an extraordinary fashion to make them happy about paying us all this money," Chesley continues.

### Motivators

What motivates Chesley the most is a sense of pride and accomplishment, particularly in seeing projects through to completion, handling situations fairly and being "approachable." Along those lines, Chesley says, "I don't fire very many people. But then again, I don't hire people that are liable to get fired."

Chesley believes that hiring is an art. Interestingly, his theory is that hiring processes are well-handled by engineers because "most engineers are very, very perceptive. I think they are better able to read whether someone is throwing them a line, or whether someone really has potential. I think it all boils down to the fact that engineers are relatively practical people."

Indeed, Chesley sees himself as a relatively practical person. "I see myself as an all-purpose engineer who takes a lot of pride in what I do. I can adapt easily to different situations, from microwave transmission to satellite transmission to digital compression."

Not surprisingly, the outdoors forms the basis for Chesley's spare time activities. "I live in the West. That means I like to hunt, fish, camp, ski and generally do outdoorsy-types of things with my family," consisting of wife, Janie and 16-year old Melissa, Chesley explains. Chesley's oldest daughter has already left the nest and is about to receive her degree in registered nursing.

Decidedly humble, Chesley laughs when asked to describe himself. "I don't know—I guess I'm just a nice guy." ■

—Leslie Ellis



Fiber is changing our cable environment. And Alpha Technologies again lights the way with the new powering solutions you need, assuring the most reliable signal delivery ever.

**NO POWER,**

**NO LIGHT.**

Alpha works closely with fiber equipment designers to establish powering guidelines for fiber architectures. One new direction is the FiberUPS product family. DC versions complement the new fiber technologies and yield long backup times when dedicated to fiber nodes. FiberUPS AC output versions power nodes and nearby actives.

Alpha's growing range of UPS products for headend service continue to protect vital signal processing equipment and sensitive transmitter, data-handling and telephony systems.

The XP Series, Alpha's groundbreaking "Cable UPS", provides local or wide-area powering for FTF, fiber-backbone, and other common architectures. The new APC Series of compact modular non-standby power products offers flexible, economic and reliable power for conventional distribution and feeder.

Let's face it: your fiber plans represent a major investment in reliability. Protect that investment with the most reliable power available.

Alpha Technologies. Without power, there is no light.

For more information about powering requirements when you implement fiber, call 1-800-821-0724 (extension 255) and request our free Designers Handbook: "Power and Light".

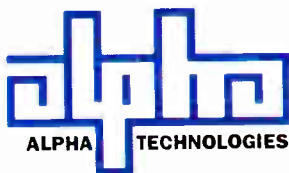

We're here to back you up.™



*Alpha's fiber optics powering family includes (clockwise from bottom left): FiberUPS; AP Series; APC Modular Non-Standby and XP Series.*



## Credit where it's due

By the time you read this article (and even as I'm writing it), the NCTA (representing cable operators) and a team of engineers representing the National Association of Telecommunications Officers and Advisors (NATOA), the U.S. Conference of Mayors (USCM), the National League of Cities (NLC) and the National Association of Counties (NACO) have concluded a series of negotiations that has been ongoing for a long time (a *very* long time).

The details of that negotiation and its result will be reported elsewhere, but I'd like to take a moment to point out the contributions and efforts of certain people. For the group representing the franchise authorities, a team of engineers headed by Jonathon L. Kramer negotiated with a team of engineers representing NCTA and CATA (the Community Antenna Television Association).

I chaired the team of cable engineers. Jonathan Kramer and I acted respectively as co-chairmen of the Joint Task Force on Technical Standards. One of the major advantages of writing a regular column is that, notwithstanding the ire of my editor, I can shamelessly praise those whom I find deserving.

Thus, I'd like to bring to your attention the extraordinary people on the cable side who made this agreement possible. The members of the cable team that did the work include: **Dan Pike**, Prime Cable; **Ted Hartson**, Post-

*By Wendell Bailey, Vice President  
Science & Technology, NCTA*

Newsweek; **Alex Best**, Cox Cable; **Mike Angi**, Colony; **Larry Lehman**, Cencom, **Tom Jokerst**, Continental/CableLabs; **Dave Willis**, TCI; **Steve Johnson**, ATC; **Nick Worth**, Telecable; **Dick Hickman**, Metrovision, **Jim Hannan**, Times-Mirror and **Frank Ragone**, Comcast.

On too many occasions, I asked these experts to come to Washington, D.C. for emergency meetings. On other occasions I've asked them to meet me in different venues, where I happened to be travelling, for the same purpose. On countless occasions I had them gather wherever they were to join in conference calls that lasted for hours.

### Displayed patience

On top of their absolute technical competence and the depth of their knowledge of the technical details of cable systems and equipment, they all displayed an amazing degree of patience with my frequent thickheadedness and lack of understanding of these very same things.

In addition to being technical experts of the very highest order, all of the above mentioned people qualify as businessmen and political thinkers second to none. Their understanding of the impact of each of these decisions on their day-to-day operations; their understanding of the political need to accomplish this task even when we had to "give" on items that we'd rather not give on made on made the process possible.

When you read the specifics of the joint agreement on technical standards and the language that has been arrived at, you'll understand the effort that went into this difficult project. Virtually every word, phrase, comma and number was negotiated and re-negotiated time and again. Merely keeping it all in my head sometimes was too difficult to do.

Even though the engineers in this group run the very systems that are most likely to already be in compliance with most of the new rules, they spent much time and energy arguing the case of systems that have less capability or fewer resources, or more difficult circumstances to contend with. They spoke and fought just as hard for those systems that were not under their direct command and did all they could to make sure other systems that might not be at these new levels yet would be able to get there with reasonable effort.

I would be remiss if I did not comment on the rather extraordinary efforts of the legal department at NCTA and one per-

son who is formerly from our legal department and now is a legislative counsel in our government relations department. In particular, Seth Davidson (now in our government relations department) has worked on this issue from the very beginning.

His understanding and knowledge of technical issues and how to deal with them is well known to many of you. In addition, Diane Burstein deserves special credit because she had just joined NCTA when the negotiations began in earnest and prior to her participation in these negotiations she had never heard many of the technical words or details that we argued about so fervently. In spite of that, she not only "hung in there" but her grasp of the nuances of the problems, as well as her insight, contributed greatly to the successful conclusion of this endeavor. NCTA's general counsel Brenda Fox was also an outstanding negotiator for our side.

There were several talented people on the other side as well. I cannot say too much about the pivotal role that Jonathan Kramer played in this process. His hard work was obvious to all, but what I saw and appreciated most was his willingness to discuss tough questions at virtually any time of the day or night. His genuine courtesy and skill at negotiation were critical ingredients to this deal.

The leadership and guidance that Susan Herman (president of NATOA and general manager of the department of telecommunications of the City of Los Angeles) gave to the members of the coalition on the franchise authority side was invaluable.

All these people were truly interested in achieving the best that was reasonable to achieve for the cable television viewing public and they worked hard to get there. The results are good for us in a business sense and good for us in terms of customer service and satisfaction.

The NCTA science and technology department will be conducting a series of seminars on these technical standards in 1992 in an effort to get the information about what these changes mean out to as many regional- and system-level people as we can.

There is a lot to do in the coming months and a lot of questions to be answered, but if the industry has the same dedication in implementing these standards as those who negotiated them, then the future relationships with our franchise authorities and our customers will be all the better for it. ■



# THE RACE IS ON

When it comes to the Olympics, Zenith has the numbers to put you a step ahead in the race to make TripleCast pay-per-view pay off.

To start, Zenith is positively the most affordable way for a system to become addressable. Per subscriber costs are as low as \$35 with the PayMaster add-on decoder, or add a full decoder with built-in bypass for only \$80.

Even our headend costs won't slow you down. Zenith's unique Event Center is a 3-channel, addressable headend with basic software package for as low as \$2,500.

And there's more. For every PayMaster you order for the Olympics, you'll automatically earn a fat 50/50\* split rate. That's \$62.50 in your pocket on the average TripleCast buy—just for choosing Zenith.

So start on the road to the gold with Zenith's winning numbers.

Call (708) 391-7702 today.



Copyright 1991, Zenith Electronics Corporation

**ZENITH** | cable  
products

\* 50/50 split rate includes bonus 2% on orders placed by December 31, 1991.

Circle Reader Service No. 9









# Our fiber lets you deliver CNN, HBO and MTV. ASAP.

When your technicians are under pressure to restore service, the one thing they don't need is a fiber that's difficult to work with.

They need a fiber that will help them get the job done as quickly and efficiently as possible. The fiber that fits that description: Corning™ fiber.

It's easy to work with and splice because of its excellent geometry, and because it's consistent—reel after reel, year after year. And it's consistent because we're very, very nit-picky. So much so that, during manufacturing for example, we measure our fiber diameter 500 times per second to within a fraction of a micron. (You don't get more nit-picky than that.)

What's more, we're constantly looking for new ways to improve our fiber. We twist, bend, snap and otherwise torture fiber, testing it in our harsh environments so it'll measure up in yours.

We'd also like to help technicians by helping them share what they've learned about handling fiber. If you or any of your people would like to let us know of an unusual or especially tough fiber-handling challenge (and its solution, if you have one), we'll spread the word.

Make your people's jobs easier by making sure they

work with Corning fiber. The fiber designed to be as hassle-free as possible—no matter how tough the job might be.

For more information (or to share your real-life fiber experiences) write to Telecommunications Products Division, Corning Incorporated, MP-RO-03, Corning, NY 14831, or call Loretta Maloney at (607) 974-7181.

Corning. Fiber you can count on.

**CORNING**

Circle Reader Service No. 10

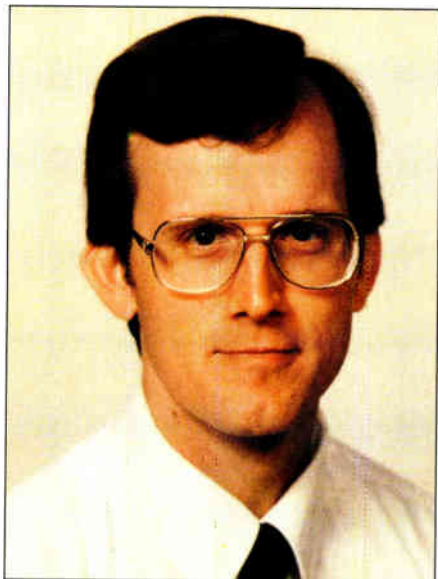

## A view from the other side

As I write this, I am beginning a new opportunity in the CATV industry on the "other side of the fence" as group vice president/technology, and chief technical officer of Jones Intercable. The opportunity is an exciting one, and an enormous responsibility, that comes at a time when technology is truly playing a key role in the design and construction of future CATV architectures.

### Development role

The future of educational networks, PCN, HDTV, video compression, twoway interactive, and business and personal data communications, etc., will all combine to shape the networks of the future. My hope is that I can play at least a minor role on the operations side of the business, in the definition and development of these new key technologies, to help determine when and where they might make good sound business sense, and to help pave the way for the deployment of these technologies into the CATV/telecommunications networks of the future.

The move to operations, and Denver, while tremendously exciting, does not come without an abundance of mixed emotions. I leave behind in

*By Chris Bowick, Group Vice President / Technology, Jones Intercable*

Atlanta quite a number of friends and coworkers with whom I've had the opportunity and privilege to work for almost 11 years. They will be deeply missed. They are true professionals, and a wonderful group of people with whom I am proud to have worked.

Yet the family is very excited about the prospect of developing new friends and relationships in our new community in Denver and with my new coworkers at Jones Intercable. While I am sincerely thankful for the opportunities that were afforded me in Atlanta as I rose through the ranks of engineering, so too am I thankful for the opportunity being given to me, and the confidence being shown in me, in my new role at Jones.

Another area of mixed emotions stems from the simple fact that I've "grown up" in the CATV industry on the manufacturer's side of the business. What this means is that, while I'm well versed on the industry from a business and technology standpoint, I still have a lot to learn about the other side of the fence—a new view of the industry from an operator's perspective.

I hope, therefore, to be both a teacher and a student in my new role. To learn as much as I can, as quickly as I can, about the operations side of the business, while also providing as much knowledge and insight on future technologies as I can muster. It will be quite a challenge, but one that I am really looking forward to.

### Future columns

So what does all of this have to do with the future of this "From the Headend" column? If *CED* will have me, my plan is to continue writing the column just as I have done for the last four-and-a-half years. The only column I missed during that time was last month, due to the extraordinary circumstances surrounding this job change (the gut-wrenching decision to leave Atlanta, the excitement of finding a new home in Denver, and the deadline for submitting the column were all happening simultaneously). But I've sincerely enjoyed writing the column, and I hope that it has been and will continue to be useful to you as a tool for better understanding the technology.

When I first conceived of the column, back in May of 1987, I envisioned it as a bridge between theory and practice, or as my introduction to

the first column (July 1987) stated:

"In the coming months, From the Headend will attempt to merge theory with practical application as they relate to headend performance. We'll be exploring the background, mystique, and theory surrounding headend performance while at the same time applying that knowledge through practical examples."

Over the years, I think the column has done a reasonably good job of fulfilling that pledge with a reasonable mix of basic topics such as: return loss, video performance (differential gain, differential phase, C/L delay), BTSC stereo, C/N vs. S/N, FM, VSB-AM, etc., with occasional forays into more advanced topics such as HDTV, digital video compression, 16-QAM, and optical vs. electrical power.

I've tried my best to stay away from detailed mathematics, unless there was no other way to explain the topic, or unless the math was being used as a "cookbook" of equations, with examples, for finding the solution to a complex problem. (Sometimes, you just have to pick up the old calculator—there's just no way around it.)

### Focus remains the same

In the future, now that I'm on the other side of that fence, From the Headend will continue to try to bridge the gap between theory and practice, to expand its topics to include PCN, fiber optics, two-way interactivity, and video compression...and their effects on system architectures, as well as their impact on the headend.

In other words, the title of the column will remain the same, and its approach and "feel" will remain the same, but its base and reach of topics will expand significantly beyond just the headend.

But I need help! If you have any ideas or suggestions of topics for exploration in this column, please jot it down on a sheet of paper and let me know. I'm always delighted to hear from those who are interested enough in the column to write.

As one of my co-workers in Atlanta quipped when he found out I was heading to Denver: "Is it true that after you move to Denver, you're still planning to continue your column in *CED*, but you'll change the title to From the Slopes?" Thanks, Gerry, but the title remains the same—even though I'll probably write a few of them...from the slopes. ■



# BREAK THROUGH TO THE 21<sup>ST</sup> CENTURY!

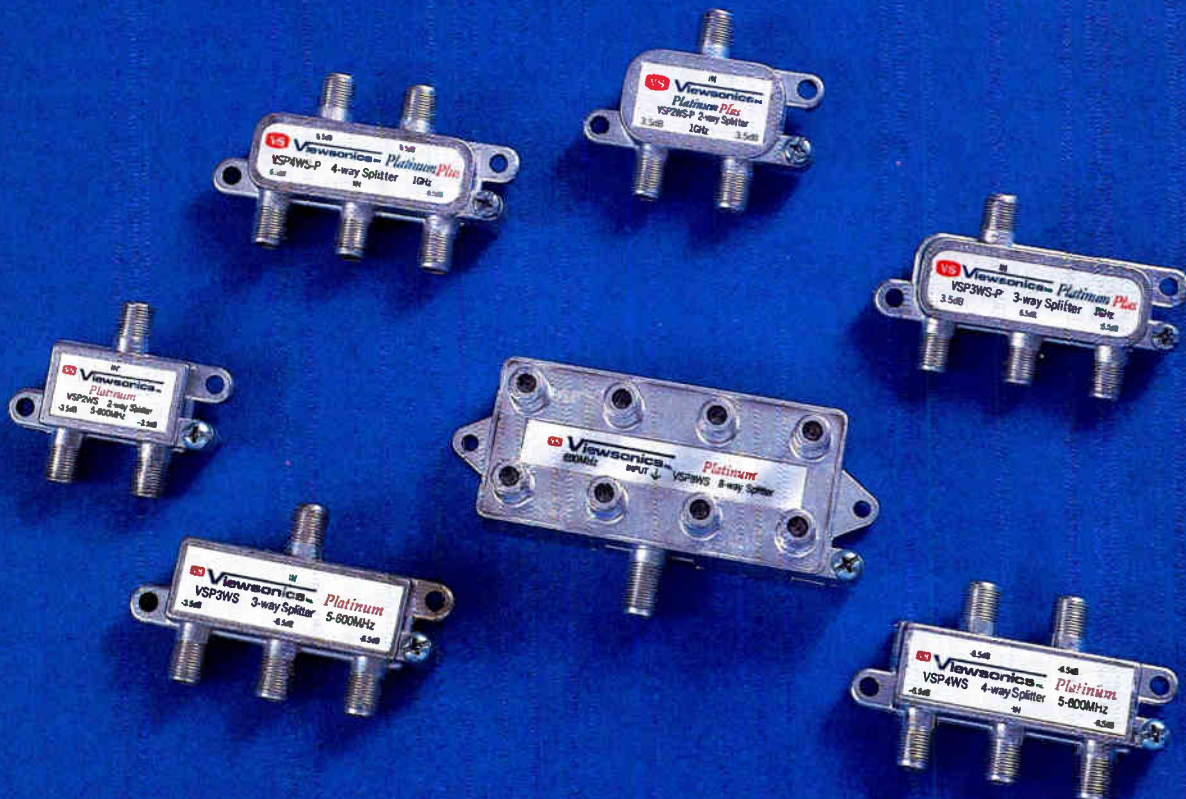

## 130dB RFI Shielding and 1GHz Bandwidth Platinum and Platinum Plus Splitters.

Viewsonics opens the door to the 21st Century with the revolutionary new Platinum and Platinum Plus Splitters, both boasting 130dB RFI Shielding. The Platinum Splitters perform from 5-600MHz and the Platinum Plus Splitters from 5MHz-1GHz.

Quality is built in. Our unique tin-plated, solder-sealed housings are the only certain method to achieve our excellent specifications and ensure a high degree of anti-corrosive protection and superior conductivity.

*Platinum and Platinum Plus Splitters - available only from Viewsonics.*  
For more information, contact Viewsonics today.

**Viewsonics** inc.

PRODUCTS ■ WITH ■ INTEGRITY

6454 E Rogers Circle, Boca Raton, FL USA 33487  
Telephone: 800 645 7600  
In Florida: 407 998 9594 • FAX: 407 998 3712

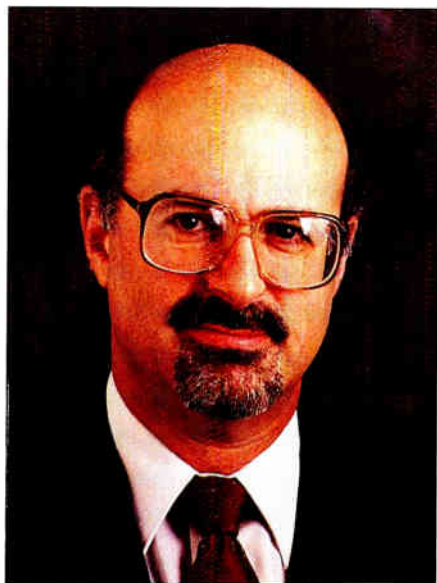

## Leakage rules: What do they protect?

I just finished reading about a cable system that was fined nearly \$40,000 by the FCC for violating the leakage rules. The FCC leakage rules protect against interference to entities that are licensed to use the radio spectrum for communications and other purposes. If the proposed FCC standards on signal level are adopted, leakage control will become more difficult. Have you ever wondered just what is being protected? Read on.

### Frequency allocations

While I won't cover every one of the bands, the following explains the most important ones:

**108 MHz to 137 MHz.** This is the band used worldwide for commercial and private aviation. It includes frequencies for air traffic control, tower communications, approach and departure control, etc. The specific frequency assignments vary from one airport to another, and pilots carry books with them to tell them what frequencies to use as they fly across the country.

From the FCC's perspective, all aeronautical frequencies are considered to be "safety of life" frequencies

*By Jeffrey Krauss, Independent Telecommunications Policy Consultant and President of Telecommunications and Technology Policy of Rockville, Md.*

because of the potential for life-threatening problems on board aircraft. One particularly critical frequency is 121.5 MHz, which is an internationally accepted emergency frequency. One reason we have the tough leakage regulations we have is that, some years ago, an FCC official who was also a private pilot observed some radio interference as he was flying and was able to trace it to cable TV leakage.

**150 MHz to 162 MHz** Parts of this band are for land mobile communications by police departments, fire departments, tow trucks, radio and TV stations, taxicabs, highway departments and cable TV companies—in short, just about any business and state or local government agency. Other parts of the band are used for ship-to-shore and ship-to-ship communications.

Some parts of the band are allocated to specific users. For example, the channels between 154.13 MHz and 154.445 MHz are for fire department use only; 154.65 MHz to 154.95 MHz is for police use only. Frequencies around 160 MHz are used by railroads and local transit agencies.

Frequencies around 156 MHz and 157 MHz are used for maritime communications. There are channels assigned for port operations, bridge-to-bridge communications, and other specific uses. The frequency 156.8 MHz (marine channel 16) is the international marine radiotelephone distress and urgency frequency, and 156.3 MHz (marine channel 6) is used for search and rescue operations.

**162 MHz to 174 MHz.** This is used by the non-military parts of the federal government for land mobile communications. There are lots of channels assigned to the FBI, the Secret Service and the Drug Enforcement Administration. There are also channels assigned to park rangers, to security officers at Federal office buildings, and postal service supervisors.

While these frequencies are used primarily for land mobile communications, there is occasional aircraft use.

**216 MHz to 220 MHz.** Part of this band is used by Waterway Communications Inc. for its ship telephone service on the Mississippi River. Another part is expected to be allocated by the FCC for a new Interactive Video and Data Service, in response to the request of TV Answer Inc.

**220 MHz to 222 MHz.** This band was recently taken away from the amateur radio community and allocat-

ed for a new narrowband land mobile service. Instead of the traditional 25 kHz channel bandwidth, these channels will have only a 5 kHz bandwidth. You can expect to see new digital voice compression techniques used here.

**225 MHz to 400 MHz.** This is a huge band, used for military aircraft communications. Just like in the 108 MHz to 137 MHz band, there are frequencies assigned for routine aeronautical operations: tower frequencies, approach control, departure control, etc. Every Air Force base and Naval Air Station has a set of frequencies for these purposes.

In addition, there are frequencies for operations of a more military nature, such as in-flight refueling operations, range operations at weapons test ranges, and tactical frequencies used by fighter squadrons in air-to-air combat.

There are command-and-control frequencies in this band. For example, 311.0 MHz is the primary command frequency for the Strategic Air Command. There are also safety and distress frequencies. The frequency 243.0 MHz is an international distress frequency. Note that this is exactly twice 121.5 MHz, which is also an aeronautical distress frequency. In addition, 282.8 MHz is assigned for search and rescue operations.

This band also contains military satellite communications from FLTSATCOM and AFSATCOM. Frequencies around 261 MHz to 264 MHz are often used for satellite communications.

**406 MHz to 420 MHz.** This band is used in the same way as 162 MHz to 174 MHz, for mobile communications by non-military Federal Government agencies. For example, the Secret Service, the White House Communications Agency and DEA all have numerous channels in this band. You can sometimes hear the White House Communications Agency on 407.850 MHz arranging phone patches for top Government officials flying on Air Force 2 or other special aircraft.

**450 MHz to 470 MHz.** This band is used for land mobile communications by private companies and state and local government agencies, in the same way as 150 MHz to 162 MHz.

**470 MHz to 512 MHz.** Although these are the frequencies for TV channels 14 through 20, some of these frequencies are also used for private and local government land mobile communications in the top 13 metropolitan areas. ■



# Introducing the first play-it-again SAM.

## Meet new LINE SAM<sup>®</sup> from Wavetek.

The first signal level meter with “learn” and “repeat” modes for fully automated testing.

On cue, LINE SAM automatically runs a programmed sequence of tests — again and again. Saving you time—and money. You can even program for unattended, time-delayed testing.

Without missing a beat, the LINE SAM stores up to 80 sets of test point data for 100 channels. And downloads to a PC or printer for spectrum or tabular printout. Comparing amplifier specifications couldn't be easier or more accurate!

LINE SAM. Easy. Accurate. Cost-efficient. For field or headend testing, we're playing your song.

Call Wavetek today at 1-800-622-5515 — in Indiana, 317-788-5965 — and ask for LINE SAM. This could be the beginning of a beautiful friendship.

©1991 Wavetek

**WAVETEK**

Circle Reader Service No. 12





## Chroma delay

In 1941, the first National Television Systems Committee (NTSC) recommended the basic 525-line, interlaced standards for television that remain essentially intact 50 years later. In December 1953, the Federal Communications Commission adopted the fully compatible color television standards recommended by the second NTSC, on which nearly half of the world's television depends.

### Pre-correction

From the beginning, engineers from RCA, GE, Hazeltine, Dumont, Philco and others recognized that phase shifts would be generated in the vestigial sideband filters and those separating sound from picture in the TV receivers. The engineers were agreed that "...even for receivers of rather different amplitude responses, the phase characteristics at the upper end of the video passband were sufficiently similar that compensation at the transmitter was practical." This assumed that the receiver circuits would be minimum phase shift networks in which phase characteristics are uniquely determined by the amplitude response.

From June 1953 to date, NTSC and FCC specifications require  $-170 \pm 50$  nanoseconds delay (negative delay is actually advance) at 3.58 MHz relative to low frequency luminance (0.1 MHz).

*By Archer S. Taylor, Senior Vice President, Engineering Malarkey-Taylor Associates, Inc.*

Unfortunately, the premises were incorrect. Measurements in 1970 on typical receivers showed delay inequality ranging from  $-120$  to  $+100$  nanoseconds. Engineers at CBS and NBC found that pictures actually looked better when the NTSC pre-correction was bypassed (illegally) at the transmitter. Obviously, receiver designers have used other criteria than minimum phase shift. The pre-correction standard is probably at least as likely to cause as to correct displaced color images. However, the FCC could not be persuaded to delete the precorrection specification.

Norman Parker, formerly chief scientist at Motorola, once suggested that most receiver engineers did not even know what "envelope delay" meant. According to him, they were apt to adjust the filters to make the pictures "look good" when tuned to their favorite TV station in Chicago.

### Envelope/group delay

In this case, the terms "envelope delay" and "group delay" are simply two names for the same thing. Ideally, the time required for the video envelope of the transmitted signal to travel through the system should be the same for all frequencies. However, because of phase shifts near the cut-off frequency of band-pass and sound notch filters, it may take a little longer for the group of frequencies representing chrominance at 3.58 MHz, than for the group representing luminance at about 100 kHz. This is known as "chrominance-luminance delay inequality" or more commonly as "chroma delay."

Chroma delay means simply that the group of frequencies carrying color information are delayed slightly relative to luminance. What you see on the TV screen is mis-registered color that appears to have slipped off (usually to the right) like a poorly printed comic book.

### Measuring chroma delay

The proposed FCC specification for cable TV is 150 nanoseconds delay inequality. Theoretically, this would show up on a 24-inch NTSC TV screen as a displacement of the color by nearly 1.5 mm (approximately 1/16 inch). For several reasons, the displacement probably appears to be somewhat less than that.

Better ways to measure the inequality objectively are readily available, using specially designed video test signals in

either full field or vertical interval format. The 12.5 T sinesquared pulse (originally 20 T) modulated with the 3.58 MHz chrominance subcarrier has been the accepted standard for many years. T is the so-called transient time constant of the TV system and is defined as  $1/2 f_u$  where  $f_u$  is the upper video frequency limit, or 4.0 MHz. 12.5 T is also the duration of the pulse at half-amplitude (HAD), or 1.5625 microseconds. The envelope of the pulse provides the reference delay at luminance frequencies, and the modulation provides a measure of the delay (or advance) at chrominance frequencies.

Inequality shows as deformation of the baseline in the test pulse waveform display, as shown in Figure 1. The mag-

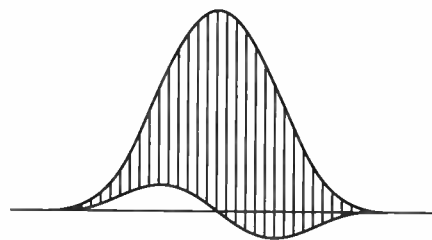

nitude of the deformation above ( $Y_1$ ) and below ( $Y_2$ ) the normal baseline are a measure of the inequality in nanoseconds, according to the formula:

$$20\sqrt{|Y_1| \times |Y_2|}$$

Another method recently introduced is based on a test signal called "bow-tie" for obvious reasons, as seen in Figure 2. A 500-kHz wave is transmitted in the luminance channel; 502 kHz in the chrominance channel. The two are exactly out of phase at the center of the display. The shift of the crossover point, as in Figure 3, is a direct measure of the chrominance delay relative to luminance.

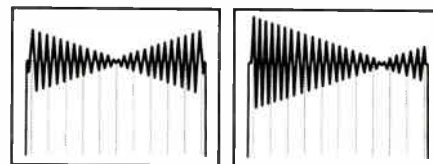

Modulators used for cable TV are generally equipped with the FCC precorrection delay filter specified by FCC for broadcast transmitters. Unless the demodulator used to extract the test signal is equipped with a proper filter to offset the -170 nanosecond precorrection, the measurement is likely to indicate excessive delay inequality. ■



# Lectro's

Newest Additions...

The 2 and 3 Battery

## UNI-MAX

Designed  
for the  
Future



### *Modularity in a Common Ferro Standby Power Unit*

**UNI-MAX**, the newest addition to the **Lectro** family, is now available in both **2 and 3 battery** versions. **UNI-MAX** is a totally new concept incorporating **high efficiency** and a unique design to save you money and reduce heat. This helps extend battery life, saving you even more. And **Lectro's** exclusive "**Cool Core**" heat sinking technique ensures the coolest running transformer available.

Like all **Lectro** standby power units, **UNI-MAX** is **modular** with totally enclosed electronics. Modules are easily removed without tools providing safe and easy servicing without losing power. A full range of **plug in options** is available.

Call **1-800-551-3790** to learn more about **UNI-MAX**. Another dependable product from **Lectro**, a leader in power supplies for the cable industry since 1972.



## Lectro

Lectro Products, Inc./420 Athena Drive  
Athens, Georgia 30601 USA  
Tel:(404)543-1904/Fax:(404)548-5493

Circle Reader Service No. 13

# 1-800-551-3790

See us at the Western Show, Booth # 553

# Digital delivery technology for CATV networks

Last month's article focused on the North American (NA) digital hierarchy—its history, digital channel banks and primary rate facilities. This month, I'd like to examine digital multiplexers and higher bit rate systems.

The task of combining multiple digital bit streams into a single higher rate line, a process referred to as time division multiplexing (TDM), is far more complex than its frequency division multiplexing (FDM) counterpart.

## Sequential Multiplexer

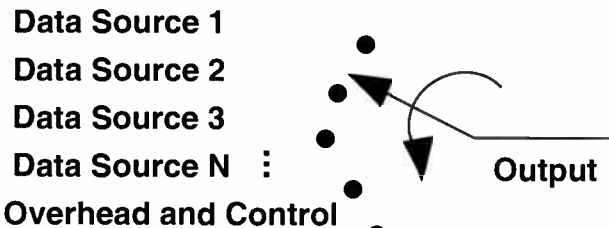

formation.

For the NA hierarchy, the technology choices permitted channel banks and other 64 kilobits per second (kb/s) channel combiners to work on a byte (8 bit) interleave basis (take eight bits at a time from each source), but limited higher rate combiners to bit level interleaving to keep the instantaneous rate on any one source link within the limited electronic capability of the time.

### Bit stuffing

A technique known as positive bit stuffing was developed to address the need for exact average bit rates from each input source. Simply put, each input was allocated an average

bit rate higher than its maximum allowable rate. If a bit is not available from the low speed source when it is needed by the high speed combiner, the combiner hardware supplies one (a dummy or redundant bit) and continues on.

Of course, the multiplex must now in-

form the far end demultiplex of its actions so that the "stuffed" bit can be removed and the original bitstream passed on. This is achieved by control bits (a communication channel) defined in the frame format.

### Positioning of multiplexers

The position of the higher rate digital multiplexers in the overall telephone network, by virtue of their very large channel capacity, places significantly higher emphasis on facility maintenance issues such as availability (up time), failure di-

agnostics and sectionalization and on dynamic performance issues such as recovery from transients and facility failures.

Virtually all multiplexers at or above the DS3 rate include automatic fault diagnosis and failed unit replacement (protection switching). In order to accommodate these needs, an enhanced end-to-end signaling/communications channel and more sophisticated framing algorithms needed to be implemented. The result, for the DS3 rate, is a rather complex "frame structure" shown in Figure 2, the M13 frame. What should be most apparent from this graphical representation of the format is that a significant portion of the channel is now being used for non-revenue generating traffic. This penalty, 2.7 percent at DS2, grows rapidly with bit rate and approaches 10 percent for gigabit level systems.

### Inefficiency minimized

From a transmission perspective, the evolution to fiber optic based transmission minimizes the impact of this inefficiency since bandwidth (bit rate) is available and "cheap." However, since the hierarchical combining scheme makes low rate or tributary rate administrative overhead difficult and costly to access, the true cost of this combining inefficiency was in the combining hardware itself, used to gain maintenance access to the overhead.

This, coupled with the continuing expansion of the nationwide switched digital network, provided the necessary impetus for the development of a solution. Thus was born ANSI T1.X1 standards activity and the Synchronous Optical Network (SONET).

Although a detailed look at SONET is beyond the scope of this piece, next month's article will take a look at the standard, focusing on the SONET foundation and transmission concepts. ■

For example, a 100 MHz wide analog channel may be populated with several analog sub-channels of arbitrary bandwidth (or partially unused spectrum) with the primary limitations being total power in the channel and spectral overlap when the various channels are combined.

On the other hand, a digital multiplex interfacing with a 100 megabit per second (Mb/s) digital facility must derive exactly 100 Mb/s of information from its input sources in order to meet the signal parameter constraints of the facility, and in general it must create this stream from a finite set of known inputs.

### Multiplexing process

A simplified view of the digital multiplexing process is shown in Figure 1. A set of N inputs (digital sources) are sampled in an orderly fashion and the results combined into a bitstream at the higher output rate. Unique to the problem is how much information to take from each input (how many bits before moving on), what to do if an inadequate number of bits are available when needed, and how to signal to the far end demultiplex (bitstream disassembler) with parsing in-

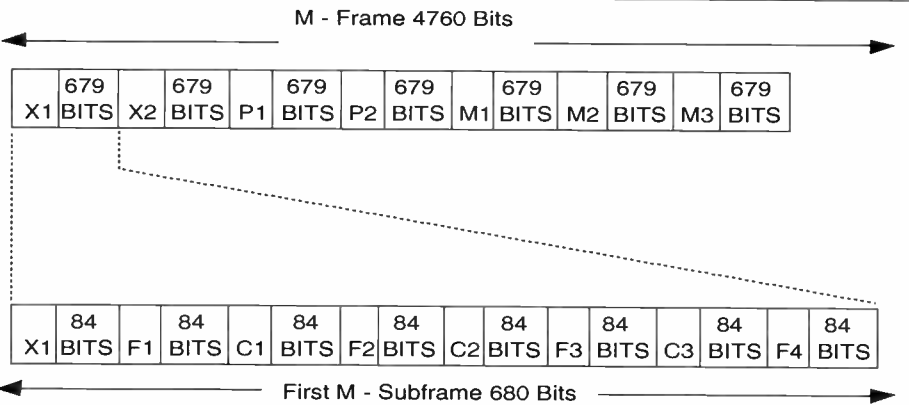

DS3 Frame Structure

Figure 2

By Carl J. McGrath, AT&T Bell Laboratories





McMACKEN

## Choose Your Weapon.

In your quest to build the ultimate cable TV system, put Siecor fiber optic cable on your side. Today's competitive environment demands nothing less than the best cable and components, and by selecting our cable and precisely the components you need, you get a system able to handle even extraordinary hazards. Plus, you have a system that delivers the exacting performance specifications you need. And you can rest assured our cable is compatible with electronics components from virtually any supplier since we have extensive experience working with them.

Our industry-leading cable also ensures excellent durability and signal quality. What's

more, with Corning's consistently proven, high-quality fiber and our leading cable design, you get performance you can count on in a rugged, craft-friendly cable. And in a variety of sheath and core designs, it can handle aerial, duct and underground applications. Of course, our cable meets or exceeds all EIA, REA and Bellcore standards. And we offer a complete line of products and service including hardware, splice equipment, test equipment, training, consultation and splicing.

So arm yourself with Siecor cable. Call 800 SIECOR 4 Ext. 5998. Or write Siecor Corporation, 439 Siecor Park, Hickory, NC 28603-0489. **SIECOR**

# RETURN PATH

## Wrong diagram used

I am writing on behalf of Square D Company, whose Elan system you featured in an article in your August publication ("Making in-home wiringwork," p. 62). We appreciate the coverage, but unfortunately you published an erroneous block diagram of our system.

In particular, the MATV antenna input is shown to be connected to a two-way splitter, which would be in violation of FCC part 76 rules for antenna termination isolation.

We are currently working closely with MSOs across the country regarding hookup to our system, and signal leakage and FCC compliance are at the forefront of our discussions with them.

As you can imagine, there is some initial reluctance by the operators to connect to an Elan system and we are sensitive to erroneous information regarding these issues.

We would like to request that you publish a corrected block diagram of our system in an upcoming issue to set the record straight regarding the interconnection scheme of our system to the outside world.

**Bob Farinelli**  
Principal Engineer  
Square D Company

**Editor's Note:** A corrected version of the block diagram is printed here. (Figure 1) We regret any misunderstanding or confusion that may have been caused by the error. For more detail on the Elan system, see the article on page 78.)

## Better perspective

Some of your readers may have been a bit dismayed by the figure in "My Turn" for October 1991 (reprinted here as figure 2). To put matters in a better perspective,

**RF Distribution System Block Diagram**

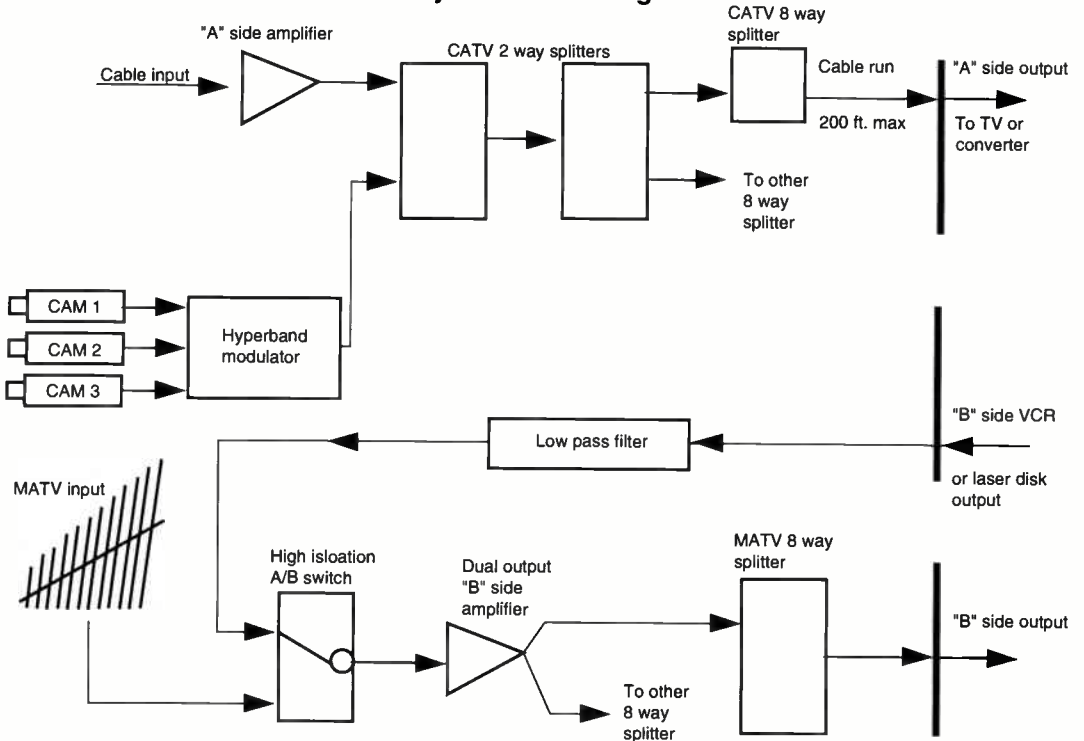

**Figure 1**

the enclosed figure shows that the average viewer rated 43 dB carrier-to-noise ratio (CNR) as only "Somewhat Annoying," although a few considered it to be just plain "Annoying." Actually, some viewers rate 43 dB CNR even more favorably, as "Perceptible But Not Annoying." There is always a spread of opinion in subjective ratings.

In school, a grade of "D" was the min-

imum passing grade. However, most of the students got As, Bs and Cs. While the FCC proposed to set minimum passing CNR at 43 dB, it is understood that most of the subscribers will have 48 dB, 46 dB or 44 dB CNR.

**Archer Taylor**  
Sr. VP Engineering  
Malarkey-Taylor Assoc.

## RANDOM NOISE

Subjective Ratings by Average Viewer at 9 feet from 24-inch screen

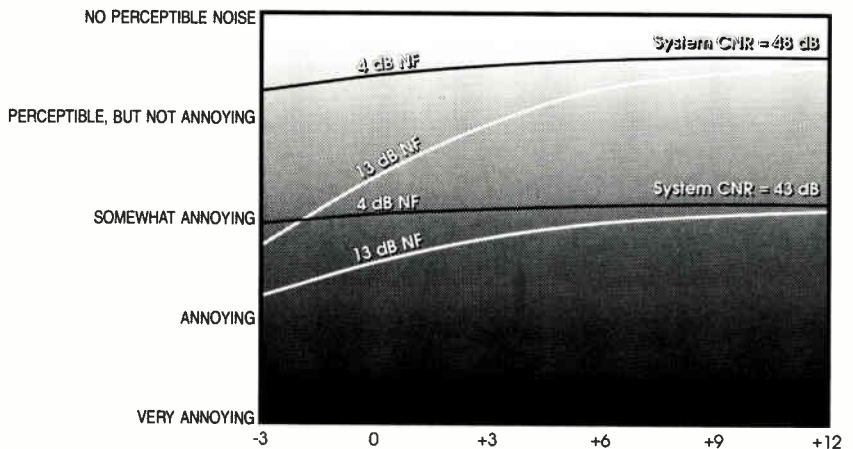
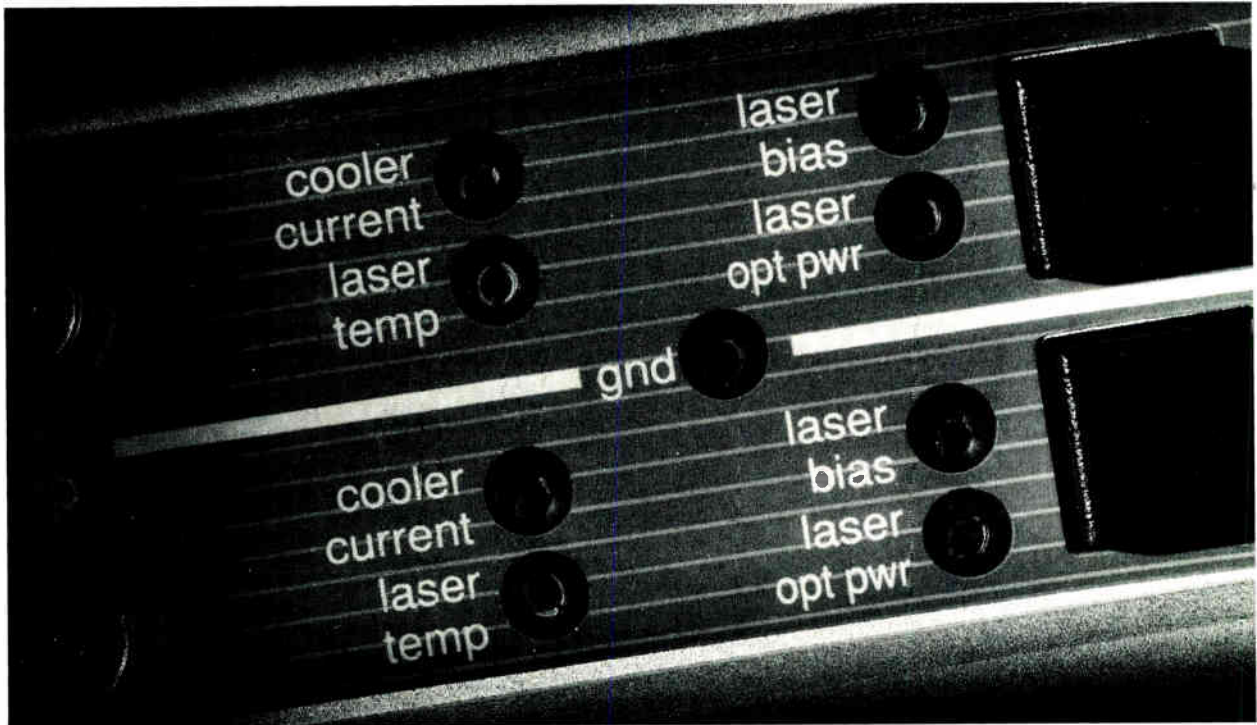

**Figure 2** Subscriber Terminal Signal Level -dBmV



**Some call it the way of the future.  
We're ready now.**

©1990 General Instrument Corporation



Fiber optics. For years it's been discussed at the trade shows and written about in the journals. But when the time for talk came to an end and the call went out for it to finally become a reality, you knew that Jerrold would respond.

Designed, tested, and perfected at our Applied Media Lab, Jerrold's breakthrough Cableoptics™ products include the STARLITE™ AM-550AT Advanced Transmitter that contains the first and only laser developed exclusively for cable TV. Complemented by our full line of STARLITE Receiver products, Cableoptics is serving fiber-to-the-feeder backbone and super truck applications.

Jerrold has met the challenge. We can do it for you, too. Our Cableoptics engineers can provide a sample design and analysis to demonstrate the efficiency of fiber optics in your systems. To arrange an appointment, call 1 800 523-6678.

*Responsive*

**JERROLD**  
COMMUNICATIONS

Circle Reader Service No. 15

# Vendors' view: Nowhere to go but up

**S**tagnant with a few pockets of fresh water. That's really the only way to describe the CATV hardware market in 1991. Undoubtedly, the past year has marked a period of belt-cinching and long faces for cable's equipment suppliers, with operators spending an estimated \$2 billion on capital expenditures. That's just about what operators spent in 1990, and looks just like what operators will spend in 1992.

As for 1992, there's good news and bad news. The bad news is, equipment suppliers will likely have to keep the belt cinched, no matter how much it already hurts. Bank loan availability, regulatory concerns and the fear of making technological decisions that may become obsolete will likely keep operator appetites light.

The good news is, underlying factors shaping the current slowdown couldn't get much worse. Banking institutions can't turn off the money spigot; they already did. The industry doesn't have to grapple with an economic recession; it already happened. Operators don't have to wonder whether telco, MMDS or DBS competition is on the horizon; they already know that it is. And, the FCC can't threaten to regulate the industry's technical standards; it already did (see Color Bursts, pg.10).

And when things can't get any worse, they usually get better, as the "nowhere to go but up" adage holds. The real question, though, is *when*.

Not surprisingly, equipment suppliers have mixed opinions on that question. "It's such a schizophrenic market," remarks ONI President Andy Paff. The general consensus, however, points to a slight amount of growth in 1992 and a more robust leap in 1993, when franchise renewal activity picks up across the nation.

Some industry people feel the spending hiatus was destined to happen. "More than 80 percent of the homes in this country are passed by cable. We've already built the major urban areas. What else is left?" asks Fred Rogers, president of Quality RF and an owner of an independent cable system in rural Virginia.

Apparently, though, there are pockets of business left, even if they are

scarce. Vendors serving the different CATV product areas including headend, distribution, drop and subscriber, cite an emergence of independent, segment-specific trends. In other words, how much operators decide to buy next year depends largely on the menu. Overall, though, the following holds true:

- Headend gear is flat or slightly down,
- Distribution gear is still down drastically,
- Drop materials are flat or up, depending on who is answering the question,
- Subscriber materials are up, largely because of TCI's purchases,

## ROGER KENNEDY

'In 20 years,  
I've never seen it this  
bad. We're down 50  
percent. We've got some  
promises for next year,  
but we'll just have to  
wait and see'.

- Optoelectronics gear, fiber optic cable and repair components are at record-high levels.

### Construction contractors

One sure gauge of construction activity comes from contracting companies. And although one major construction contractor told *CE*D that he was "not interested" in talking about 1991 or 1992 market trends, some construction companies did come to the phone—even though the story wasn't particularly happy.

Roger Kennedy, president of construction contracting company Kennedy Construction, admits being battleweary but falteringly optimistic. "In 20 years, I've never seen it this bad. We're down 50 percent," Kennedy says. The bulk of his company's work

this year included fiber optic installations and electronic upgrades. "We've gotten some promises for next year, but we'll just have to wait and see," Kennedy laments.

### Headend gear

Within the headend, both Scientific Atlanta and Standard Communications experienced flat or "slightly down" sales this year. And, both companies agree they'll experience a slow rate of growth—roughly five to 10 percent—in 1992. Growth will hinge on factors including new channel launches (including TCI's systemwide implementation of Encore), movement in the orbital arc, and multiplexing efforts.

A recent survey initiated by Standard Communications and targeted at engineers revealed that "1992 marks the start of a refranchising window for cable operators. And it's much easier for the ones that can do it to add a few more channels on their headend than to rebuild or upgrade their whole plant," relates Standard's Satcom Director Mason Truluck.

Further, Truluck says, more than 50 percent of systems in the U.S. have between 10 and 30 channels, which "makes you think you'd have some growth potential there," Truluck adds. "But we're seeing limited additions."

### Other headend equipment

Predictably, the commercial insertion market is hotter this year, too, as operators seek alternative ways of fattening their wallets. Jones Intercable is reportedly focusing heavily on commercial insertion projects next year, says director of technology Ken Wright. Also, TCI's commercial insertion expenditures increased, says John Boland, director of sales/marketing for Texscan/MSI. As a result of that and pent-up demand from slow 1990 expenditures, Texscan/MSI expects an increase "of 20 to 25 percent" this year, Boland says.

Channelmatic's VP of Sales Mike Watson also predicts "significant increases" for next year, even though 1991 was "relatively flat."



# FIBER OPTICS AND WHITE MOUNTAIN CABLE: THE CHOICE IS CLEAR.

Cable companies everywhere are switching to fiber optic cable for new and retrofit video and data communication systems.

And it's easy to see why.

Fiber optics allows a cable to carry far greater quantities of information as pulses of light than traditional copper wire — with virtually no loss of signal or electromagnetic interference.

But fiber optics is still a relatively new technology. Installing it requires special equipment, know-how and experience.

**White Mountain Cable** has all three.

As one of the few construction companies anywhere thoroughly familiar with fiber optics, White Mountain has successfully installed fiber optic communication systems in various locations across the country.

To find out how White Mountain Cable can greatly enhance *your* operation, call Dennis Nolin, David Pouliotte or Mike Fitzpatrick at 1-800-233-7350.

**WHITE MOUNTAIN**

*fiber optics* **cable**

**CONSTRUCTION CORP.**

P.O. Box 459, Epsom, NH 03234

**1-800-233-7350**

In NH (603) 736-4766

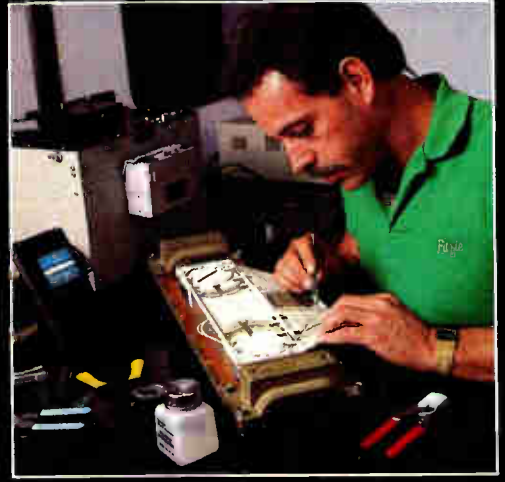

**Distribution equipment**

Probably the weakest market segment is still distribution electronics—amplifiers, bridgers, line extenders, taps and passives. "Distribution got shot in the head about a year and a half ago," laments Jerrold President Hal Krisbergh. "And I mean, business just went off a cliff. Prior to that, sales (of distribution electronics) were the most robust I'd seen for 10 years. We were up 25 to 30 percent, with an extra little zap because of CLI last spring. Then August hit, and the world died, and here we are a year later with the market showing some recovery, albeit weak."

Krisbergh compares the 1991 slowdown to maintenance in general. "You can hold off putting oil in your car—or upgrading channel capacity—for a certain amount of time, because money is tight or whatever. But sooner or later, maintenance and upgrade activities have to happen."

Along those lines, Krisbergh thinks operators are "loading the spring" for 1992 business activity. "During a good period of time, which we had up until 1989, a (cable) company builds up a good inventory to service its good

business. Then the market goes south—or just dies. I think operators decided to take a breather. Why hurry? Business had been good, so they rested for a while. They could afford to take a little time."

Krisbergh expects the spring to uncoil sometime in 1992, pending loosened credit by the nation's banking institutions. But if that doesn't happen, Krisbergh says, the loading will be that much greater in 1993.

Scientific-Atlanta's transmission president Dave Fellows also notes the drop in distribution materials purchases. "I

see it as being extremely flat with minor blips up and down. It's significantly down from two years ago," Fellows says. "As for the future, all I can see is flat. I hope it will come up again in January (1992), but I don't have any indication that it will." Fellows is confident, though, that monies not being spent are simply delayed projects, rather than eradicated projects.

"I hope we can soon predict when the market will turn, because if we don't I'll go from being desperate for sales to having huge lead times. It'll be a different kind of tearing my hair out," Fellows says.

**TOM CARBAUGH**

**'What (rebuild and upgrade) projects operators are doing, they're doing with fiber.'**

**Fiber rich**

One area that is seeing 20 to 25 percent growth across the board is fiber optic materials. "What (rebuild and upgrade) projects operators are doing, they're doing with fiber," says Tom Carbaugh, president of Jerry Conn Associates, an equipment distribution company on the East Coast.

Optical products have seemingly escaped the indecision noose as well. "We went through an initial fear of fiber. But there's no technical gridlock

**THE CHOICE IS YOURS**

We sell a product – They sell a product – You have a choice. Cable Prep can be trusted to get it done right. We are competent, well-organized and responsive to your needs.

**CHOOSE CABLE PREP®.**

The way we do business makes all the difference.



207 Middlesex Avenue, P.O. Box 373 • Chester, CT 06412  
(203) 526-4337 • FAX (203) 526-2291

**The Proof is in the PERFORMANCE. Check for Yourself:**

- Fiber Optics
- Electronic testing of cable systems and LAN's:
  - sweep
  - balance
  - proof of performance
  - cumulative leakage testing and repair
- Electronic upgrades
- Retro-fits
- Technical evaluations

We are fully equipped to perform all services for CATV and LAN operators related to electronics.

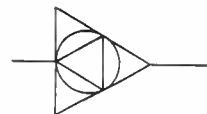

**Systems Performance Engineering Inc.**

PO Box 24927 Jacksonville, FL 32217  
**(904) 262-8269**  
**FAX (904) 260-0383**



## Projected expenditures: A flat line

Although it remains unclear just how they'll spend it, total capital budgets anticipated by nine of the top MSOs 12 suggest that sums earmarked for 1992 will match amounts budgeted in 1991. The dollar amounts total \$1.22 billion and represent about 27 million 1992 subscribers, about 49 to 50 percent of the total U.S. basic subscriber base anticipated next year. Overall capital budgets for this group of MSOs, in fact, show a remarkable consistency since 1989, when they had \$1.10 billion earmarked.

For 1991, the same nine MSOs report capital budgets totalling \$1.20 billion, up just a hair from the \$1.1 billion they earmarked in 1989.

The biggest variances in capital spending plans center—perhaps predictably—on actions to be taken by Tele-Communications Inc. Aside from its own considerable spending, it plans to digest UAE in 1992, adjusting UAE capital spending plans as a result. TCI now forecasts a hike in its own capital spending from the 1991 level of \$320 million to \$360 million, according to Dave Willis, TCI director of engineering. TCI allocated about \$338 million for capital in 1990, or about \$56 a subscriber, TCI officials said.

Last June, TCI announced a companywide PPV rollout to virtually all of its 6.4 to 6.5 million basic subs. At that time, TCI vice president J.C. Sparkman estimated that as many as 500 TCI systems could get PPV capabilities as a result.

In this case, an eight-percent buy

rate for the PPV Olympics by TCI customers could mean \$50 million in 1992 purchases of addressable terminals alone, Krisbergh said.

So it's at least conceivable that TCI's capital requirements for next year could total \$410 million, if the Olympics generates an eight-percent buy rate.

### Wild card: United Artists

The other budgetary wild card is what becomes of capital budgets for the former United Artists Entertainment subscribers, assuming the proposed incorporation of UAE into TCI proceeds as planned.

In 1990, for example, UAE budgeted \$232 million for capital and ended up spending \$307 million, in part because \$60 million was plowed into UAE's United Kingdom systems. So that left \$247 million for U.S. operations. That represented per-sub expenditure of about \$112.

Final figures for 1991 aren't available yet, but assuming there was a five-percent dip from the 1990 figures, about \$235 million would have been available. If internal sub growth was five percent for 1991, then \$101 would have been spent on a per-sub basis.

But the real issue is what happens when UAE systems are fully incorporated into TCI. Indeed, while sources indicate it may take a couple of years, UAE capital expenditures will have to be brought into general alignment with TCI practice.

The difficulty is that the UAE hold-

ings incorporate former Daniels & Associates; United Cable; and UAE systems, each with a different style of operating and varying capital requirements. United was heavily addressable and hence still requires higher expenditures per-sub generated by the need for addressable terminals.

The Daniels systems represent a technical polyglot and are hard to characterize while the UAE holdings tend to operate in a manner similar to TCI, sources indicate.

So beyond the fact that capital spending for former UAE subs will fall, it isn't precisely clear how much of the reduction will occur next year. But taking the advice of one observer, which was to "throw a dart about half way between where TCI is and UAE was," it's conceivable the former UAE subs will require something on the order of \$77 a sub, or \$188 million, a \$47 million dip from the estimated 1991 figure of \$235 million.

Four additional MSOs representing 2.2 million subs provided figures that indicate roughly the same flat level of spending, reporting \$101 million budgeted for capital in 1991 and an estimated \$98 million for 1992.

Keep in mind, too, that leading MSOs are in the very early stages of their capital budgeting processes. To this point, requests from the operating divisions have been received and initially reviewed.

But the complex matter of digesting those requests and balancing them against financial goals set at the corporate level has yet to begin in earnest. ■

—Gary Kim

Tune into the Right "Channel"...

# CHANNEL COMMUNICATIONS

Complete Coaxial & Fiber Optic Services  
Aerial & Underground Construction  
Mapping, Design, Splicing, Installation, CLI  
Sweeps, CLI Repairs

Construction: Jeff Ebersole

Engineering: David Huff

5430 Highway 42

Sheboygan, WI 53083

(414) 565-3378



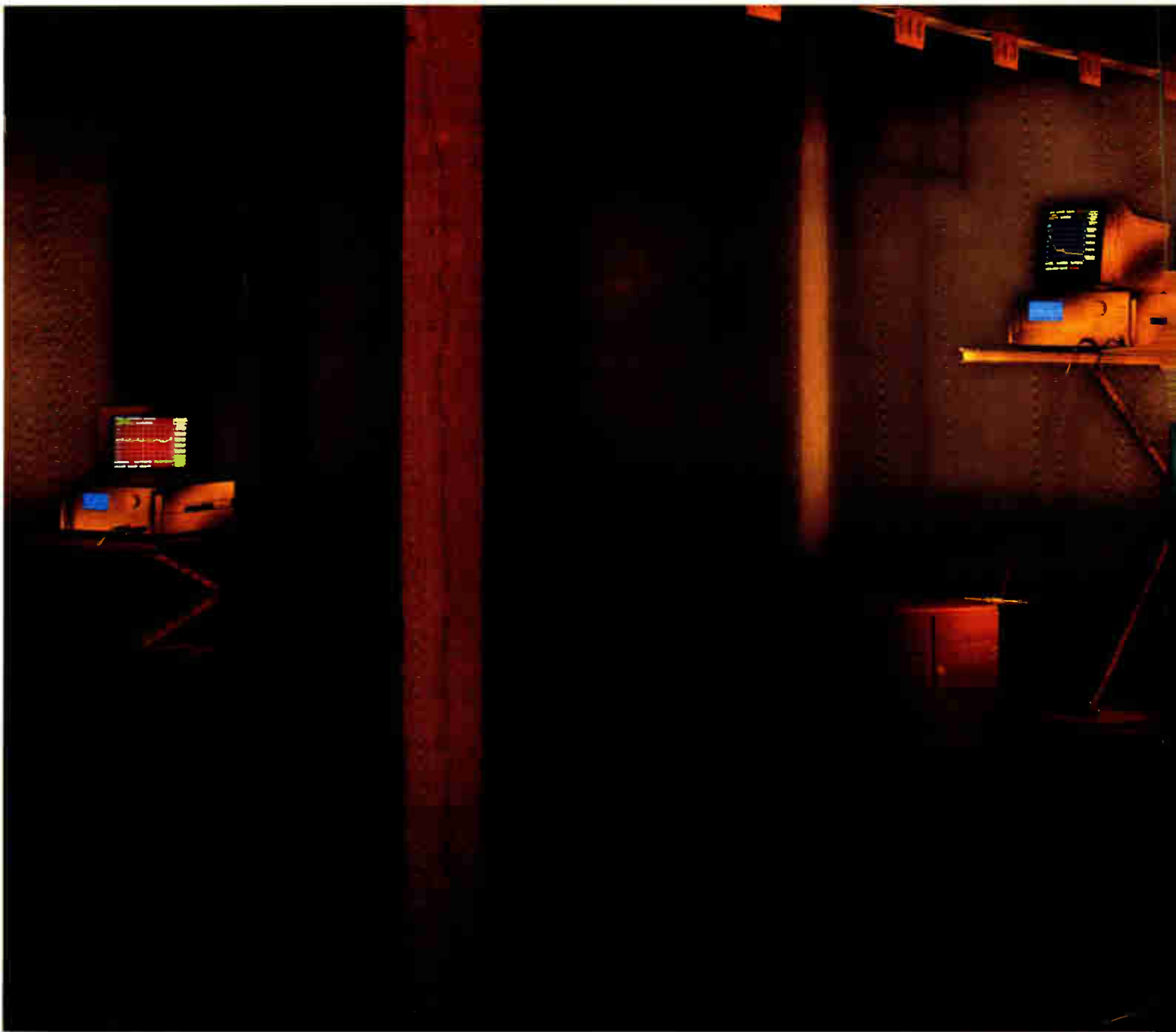

# BENCH

[ *Nothing else measures up.* ]

With the Benchmark 1175,<sup>™</sup> Wavetek has truly redefined the science of bench sweeps.

Now you can see your sweep *measurement results* instantly on a 14" super VGA monitor. No calculations. No interpretations. Just on-screen readouts of "real time" sweep measurements.

Sweep parameters are entered with simple keyboard and spin-knob control. Five markers spot user defined points on the high resolution display. Marker search functions find





# ■ M A R K

peak and valley points quickly and easily.

The no-drift synthesized signal generator and normalized path calibration provide unprecedented accuracy. Self-diagnostics eliminate setup or connection problems. Memorized settings speed up repetitive tests. Spin knob and keyboard controls make entering and manipulating information almost automatic.

The Benchmark 1175 system consists of a synthesized 2 to 1100 MHz signal generator

with 0.0005% frequency accuracy, a scalar network analyzer with 55 dB dynamic range, 14" color super VGA high resolution monitor, and a dual diode balanced sensor. At \$11,000 for the complete system, it may be the single most cost-effective testing instrument you'll ever buy.

For a demonstration, contact your local Wavetek representative, or call Wavetek direct, 1-800-622-5515.

*See us at the Western Show.*

anymore when it comes to fiber implementation, because no matter how you implement (optical products), there's no wasted product or effort," says ONI's Paff. "We crossed those bridges two years ago. Now it's more of a question of how deep to take the fiber into the system."

Overall, operators are "unquestionably" deploying fiber backbones, says Jerrold's Krisbergh, with an eye toward fiber to the feeder (FTF) designs

in the future. "There is absolutely no question that fiber will displace or replace coax in the trunk portion of cable systems."

"I predict that overall consumption and volume of optical products will increase at a 25 percent rate over the next five years," says Jon Chester, market development manager for Corning's CATV segment. "Fiber has proved in both financially and strategically for cable operators; 1991 has been a very

healthy year for us (because of that)."

Undeniably, fiber electronics and cable seem to be enjoying a growth cornerstone this year. But "don't let that fool you," says Krisbergh, "because (this area) represents such a small portion of total capital expenditures." Krisbergh estimates the total market for optoelectronics at \$15 million. Add in estimated optical cable at another \$15 million to total \$30 million—or two percent of the \$1.52 billion capital expenditure budget.

However, vendors in the fiber segment are confident that when operator purse strings loosen, the number of fiber projects will go through the roof.

### Repair parts

Another bright spot is the sale of repair components, says QRF President Rogers. "Operators are clearly fixing equipment (amplifiers) rather than

### FRED ROGERS

**'Operators are clearly fixing equipment rather than replacing it. I'm selling more repair components now than ever.'**

replacing them. I'm selling more repair components now than ever."

That doesn't mean repair component suppliers are anywhere near fat and happy, though. According to Rogers, as slow rebuild/newbuild activity forces some construction contractors out of business, an increased number of fledgling companies are glutting the repair component piece of the pie. "Sales volume is up, yes—but prices are being driven down and marketshare spread because of increased competition," Rogers says.

Converter repair is also seeing an upswing. Notably, Contec International has reported a "record month" in September with sales up 30 percent over the same month in 1990, and foresees steady growth throughout next year, says Paul Madelone, VP of sales and marketing for Contec.

In fact, one cable engineer based on the East Coast has more than doubled his converter repair budget for 1992.

\$27,995



## Shhh ...

### Don't Look At Our Price

Sure you can get a fully equipped Telsta A-28 for only \$27,995.00\* complete. But that shouldn't be your only reason for buying a Telsta.

After all, Telsta built its reputation on outstanding quality . . . that's why more Telsta's are on the road today than any other aerial lift. Quality you can see, and quality you can't see. Like sealed permanently lubricated roller bearings, baked on paint that goes on before assembly so there are no hidden spots to rust out and plating instead of painting on high wear surfaces.

It's the little quality touches that add up to lower operating cost, long-time productivity and a unit that still looks good in your fleet after years of service.

Call us and we'll show you how little it takes to move into Telsta quality.





## TELSTA®

A LIFT ABOVE THE REST



Ford F-350 utility version.

General Cable Company

P.O. Box 666, 5600 West 88th Ave.  
Westminster, Colorado 80030  
Phone: 303/427-3700

Facilities in: Westminister, CO  
Hayward, CA  
Pomono, CA  
Frederick, MD  
Lithonia, GA  
Ft. Wayne, IN

*A Unit of Penn Central Industries*

\*Prices slightly higher in California. Prices good for 1991 chassis only. All prices FOB Telsta plant excluding taxes and registration.



# SYSTEM CONSTRUCTION: ON TIME, ON BUDGET.



Whether your system measures three miles or 3,000, you can be sure of one thing: we'll construct it for you on time, on budget. That's because Cable Services has been building cable systems almost since the industry began, both aerial and underground.

Now we're ready to help you incorporate fiber optics and other advanced technologies into your operation Not ten years from now. Today.

SERVING  
THE  
CABLE  
INDUSTRY  
SINCE  
1964

THAT'S SERVICE. THAT'S  
**Cable Services Company/Inc.**



2113 MARYDALE AVENUE, WILLIAMSPORT, PA 17701-1498  
ONE NUMBER NATIONWIDE: 1-800-326-9444 □ FAX 717-322-5373

## CONSTRUCTION FORECAST

"All of my systems are addressable, and all the converters are old. However, I don't want to buy something that will be obsolete. Until I figure out what's going to happen with interdiction and video compression, I'll fix the inventory that I have," he says.

### Drop materials

Opinions about the health of the drop material market are mixed. According to Midwest CATV VP of Marketing Chuck Krone, sales of drop hardware is up considerably from 1990. "Our drop sales were up 22 percent this year, and we expect that segment to grow 30 percent in 1992," Krone predicts.

Len DeRenzo, VP of market development for Augat/LRC, echoes Midwest's predictions. "I'd say that we're not seeing a drop in the drop business," DeRenzo says. "It's maintaining fairly well right now. It'll definitely go up next year, probably by April."

Why the increase? "Operators focused on connecting subscribers this year, as a means of increasing revenues. The Persian Gulf war and CNN hookups didn't hurt, either," Krone says. "We see a big increase next year

as well, because of a number of factors—the Olympics Triplecast, even more attention to generating subscriber revenues and a need by the operators to increase penetration of homes passed."

Anixter President Marty Ingram isn't quite so enthusiastic. "Drop materials are still active, but relatively

### LEN DERENZO

'I'd say that we're not seeing a drop in the drop business. My guess is, business will pick up, probably next April.'

flat," Ingram remarks. "As for next year, I expect a minimal amount of growth. The world could change tomorrow, and my focus is to be poised for any changes. Don't get me wrong—I'm optimistic about 1992, but I'm more

concerned with being realistic."

### Subscriber equipment

Predictably, Jerrold's Krisbergh is bullish about converters, especially in light of TCI's decision to launch Jerrold's addressable converters into 500 of its systems, representing 6.4 million subscribers, next year. "What you try to do when the market is weak is increase market share. We did that," Krisbergh says. He boasts of reaching 70 percent market share for addressable converters and predicts Jerrold will hit 80 percent by the end of 1992.

"And I can easily say that after the next Tyson fight, operators will realize that without pay-per-view, they're shooting themselves in the foot. Especially with (an estimated) \$75 million total buy rate," Krisbergh says.

And because converters represent 80 percent of Jerrold's \$400 million yearly sales total, Krisbergh says Jerrold wasn't hurt quite so bad when the "bottom dropped out" of distribution electronics. "We've definitely been buoyed by market share growth in the converter area, and international sales activity in Latin America, Europe and the Far East."

MOORE, FEDERAL TELECOM, ISS, CONTROL TECHNOLOGY, INC., FITEL, GENERAL, TPC, ALPHATRIM, EEG, BUD, LABEL-LOCK, SACHS, SIGNAL VISION, STERLING, SARGENT, MULTILINK, TAP-IT, TYTON, MAID, TRILOGY, LRC, ARROW, CABLE PREP, BUD, CABLEMATIC, D'VERSIBIT, KLEIN, LEMCO, SARGENT, MULTILINK, COMTECH, ISS, APPLIED INSTRUMENTS, COMTECH, IDEA/ONICS, TPC, COMTECH, CABLE MAID, PTI/TRAYS, N, LPS, S.A.F.E., B.E.I., CONTROL TECHNOLOGY, INC., AVVOX, TYTON, ISS, MOORE, FEDERAL TELECOM, CONTROL TECHNOLOGY, INC., FITEL, GENERAL, TPC, ALPHATRIM, EEG, BUD, LABEL-LOCK, SACHS, SIGNAL VISION, COMTECH, STERLING, TAP-IT, TYTON, TRILOGY, LRC, ARROW, CABLE PREP, CABLEMATIC, D'VERSIBIT, KLEIN, LEMCO, SARGENT, MULTILINK, CHARACTER GENERATORS, COMTECH, BUD, IDEA/ONICS, ISS, TPC, EEG, METRO-TECH, PTI/TRAYS, CABLE MAID, SADELCO, CARLON, LPS,

## HAVE YOU MADE THE JCA CONNECTION?

Let us connect you to a whole line of quality products; including connectors. Our extraordinary service and follow-up is recognized throughout the CATV industry. With twenty years experience and a newly expanded distribution facility we can supply your CATV needs.

Isn't it time for us to connect.



**JERRY CONN ASSOCIATES, INC.**

P.O. Box 444, Chambersburg, PA 17201

FAX (717) 263-1547 / (800) 233-7600 (in USA) / (800) 692-7370 (in PA)



# IN AN ERA OF LIMITS BELDEN EXPANDS YOUR OPTIONS.

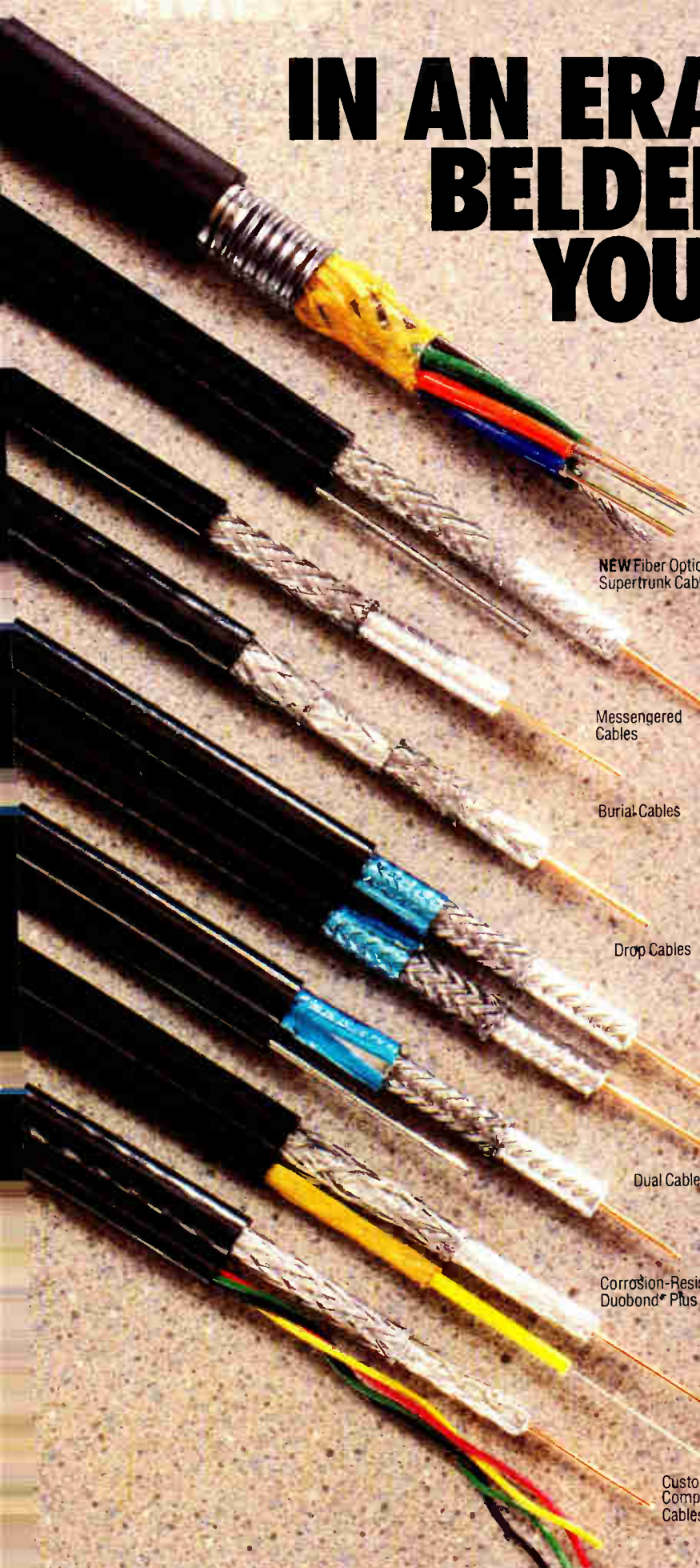

NEW Fiber Optic Supertrunk Cables

Messengered Cables

Burial Cables

Drop Cables

Dual Cables

Corrosion-Resistant Duobond® Plus Cables

Custom Composite Cables

New Belden® Fiber Optic Supertrunk presents another option in a full line of cables for CATV. Since the 70's, when Belden first integrated fiber optic technology into large-scale communications networks, Belden innovations have kept customers a step ahead of technological and product requirements. Now the proven benefits of Belden fiber optic technology expand the options available to Cable Television Systems.

Full line selection, combined with unsurpassed service and technical support, give you the *Belden Quality Advantage*. That means long-term savings for your business. Compare Belden's documented performance benefits to those of any other cable manufacturer:

- **Guaranteed structural return loss values** of 23dB minimum on RG-6, RG-11 and RG-59 cables.
- **100% sweep testing** of every reel of Belden drop cable, from 5 to 750 MHz for RG-6, 5 to 550 MHz for RG-59 and RG-11.
- **SuperDrop™ Cables** are 100% sweep tested from 5 to 1,000 MHz, with guaranteed structure return loss of 26dB minimum.
- **Complete corrosion protection** provided by unique non-drip gel barrier in Belden's new line of aerial drop cables.
- **Highest shield effectiveness in the industry** provided by Belden's DUOBOND® PLUS . . . even greater than quad shield designs!
- **Fewer call-backs** because of Belden's tight dimensional controls and easier termination. Saves you money over the long run.
- **Turnkey system design and installation capabilities** with Belden's nationwide network of Authorized Systems Integrators.



For a FREE copy of Belden's CATV Catalog, FAX your business card to 1-319-395-9719 or call toll-free:

**1-800-BELDEN-4**



**BELDEN**

Copyright © 1990, Cooper Industries, Inc.



Scientific-Atlanta hasn't had such a great year in subscriber products, says Gary Trimm, president of subscriber systems. "This past year has been a tough one," Trimm remarks. Next year looks better, Trimm adds, because of the company's new 8600 series addressable converter designed specifically to zero in on PPV ordering. "We have about 75,000 of those units in the field right now, and expect that number to increase significantly next year for two

reasons: Operators are interested in products that will increase revenue streams, and the basic fact that after a year of not buying much of anything, there will be a lot of pent-up demand for addressable converters," Trimm says.

And, Scientific-Atlanta hasn't thrown in the towel on its interdiction line of products either. "Operators are definitely showing more interest as they look for consumer-friendly, economic

ways to deliver cable signals." To date, S-A's interdiction system is serving "more than 25,000" subscribers, says Trimm.

Digital music services are also faring well. "We have (Digital Music Express) installed in about 15 sites right now, and expect that to increase to 60 or so sites by next year," Trimm projects. Also, international opportunities have bolstered S-A's revenues, specifically in Japan, where Trimm says S-A is enjoying number-two status in addressable marketshare.

## Aeroquip Utility Products...

### FoDuct® multi-cell innerduct maximizes your existing duct systems

- Install six chambers in a 4" duct
- Requires only two reels
- Fast Track Service places FoDuct innerduct on your job in days
- Full line of installation accessories

Circle Reader Service No. 24

### Underground Products Duct Spacers

Vertical-lok duct spacers stabilize duct banks, prevent distortion of bottom tiers and allow pre-assembly outside the trench.

- Easy to assemble
- Unsurpassed strength
- Rapid service

Circle Reader Service No. 62

For more information, request Free Bulletins DPG-21A (FoDuct Innerduct) and DPG-10A (Duct Spacers). Aeroquip Corporation, Utility Products, 1818 Elm Hill Pike, Nashville, TN 37210. Phone: 615-391-2100. Fax: 615-391-2101.

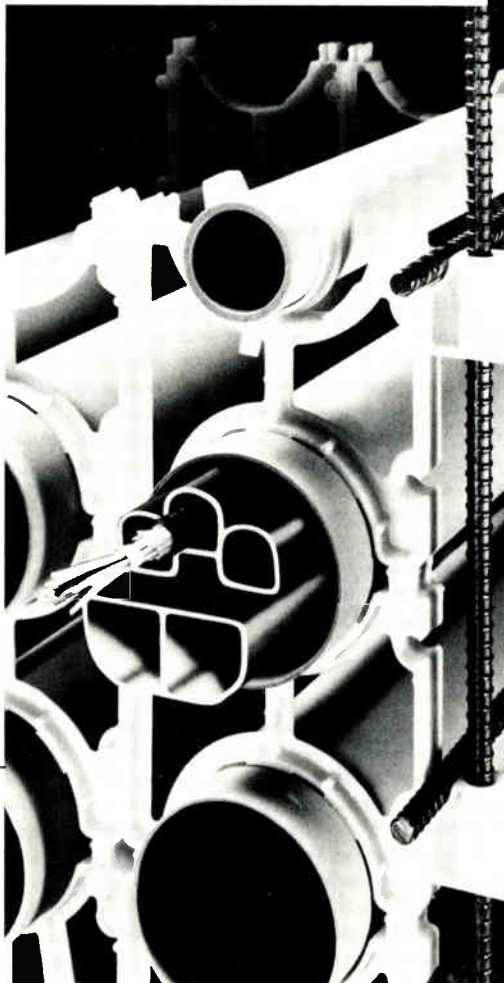

**Aeroquip**

**A TRINNOVA Company**

© 1991 Aeroquip Corporation

DE9

### Survival tactics

Indeed, the stagnant equipment market has forced some companies to get creative in order to survive. Standard Communications launched a broader base of headend products in early 1990, in order to tap into previously un-

### MARTY INGRAM

'There's only one thing to do when business goes south like this: Work harder.'

touched operator funds. "If we hadn't done that, we'd really be hurting," says Truluck.

Jerrold's approach was to chomp away at converter market share and focus on international opportunities. Still other companies focused on "cutting out the fat" in their operations by eliminating jobs and ancillary spending.

### No windfalls ahead

If supplier's forecasts hold true, one thing is clear: Next year won't be a banner year. To get business, suppliers will likely have to spend more time strategizing to get the few tidbits of food in cable's stagnating pond of business. And no matter how weary—and hungry—equipment suppliers are, "there's really only one thing to do when business goes south like this," concludes Anixter's Marty Ingram: "Work harder." ■

—Leslie Ellis



# **NaCom**

***A Full Service Communications Contractor  
Specialists in: Design/Drafting, Construction,  
Installation, LAN***

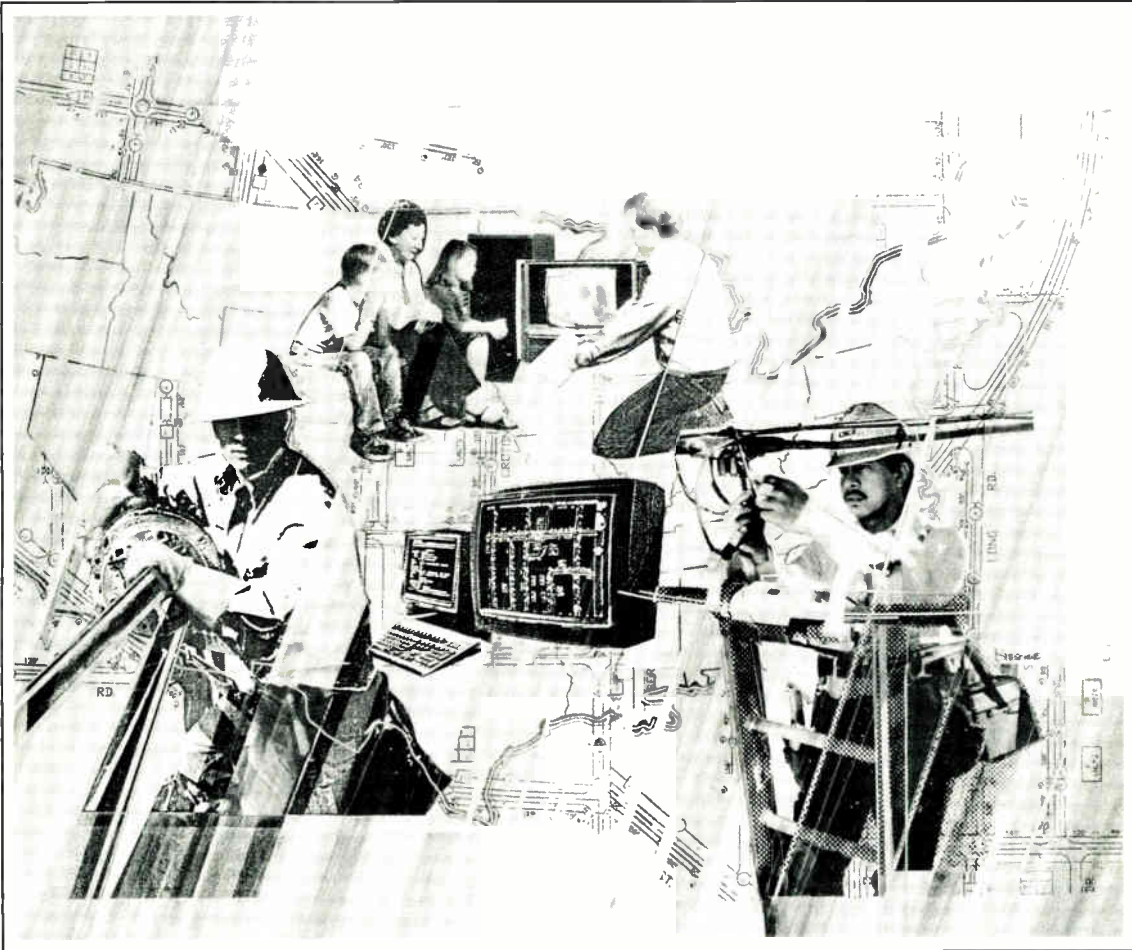

BUILDING COMMUNICATION SYSTEMS THROUGHOUT AMERICA

- Full Installation Services
- Aerial/Underground Construction (Including Fiber Optics)
- Strand Mapping (AutoCAD & LYNX)
- Field Engineering, Make-Ready, As-Builts
- RF Design (CADSUM II & LYNX)
- CLI Detection/Correction
- Converter Exchanges, Audits, Special Projects
- MDU, SMATV, LAN, Pre/Postwiring & DBS

## **NaCom**

1900 E. Dublin-Granville Rd.  
Columbus, Ohio 43229

614/895-1313 • 800/669-8765 • FAX 614/895-8942

**CONSTRUCTION CALLBOOK**

The following companies have paid a fee to have their listing appear in the Construction Callbook.

**Contractors**

**CATV  
Subscriber  
Services, Inc.**

**CATV Subscriber Services .(919) 273-5553  
FAX . . . . .(919) 274-9734**

808 Summit Ave.

Greensboro, NC 27405

PERSONNEL: Raymond L. Galtelli,

President; J. Fred Robertson, VP

DESCRIPTION: Satisfying the cable television industry contracting needs since 1971. Specializing in fiber optics and coaxial construction, new build, rebuilds, upgrades, aerial and underground, engineering, mapping, designs, signal leakage and detection; audits; installations; pre and post wire apartments; door-to-door sales.



**Cable Services Company Inc.**

**Cable Services Co. Inc. .(717) 323-8518  
FAX . . . . .(717) 322-5373**

2113 Marydale Ave.

Williamsport, PA 17701

PERSONNEL: George A. Ferguson, VP,

Sales; John M. Roskowski, VP, Construction

DESCRIPTION: Complete turnkey supply and construction including pole walking, strand mapping, design, and engineering for both coax and fiber optic builds (aerial and underground). Also, stocking distributor of all major suppliers plus on-premise repair facility.



**Cochran Communications .(619) 328-6778  
Construction**

**FAX . . . . .(619) 328-4139**

36-630 Cathedral Canyon Dr.

Cathedral City, CA 92234

PERSONNEL: Michael Cochran, Owner;

Greg Williams, Engineering Manager; Vicki

Cochran, Office Manager; Mark Estler,

Engineering Supervisor

DESCRIPTION: Cochran Communications Construction is a full service communications equipment contractor serving Southern California and Southwestern Arizona with the best in aerial and underground

construction, antenna, tower and earth station construction, CLI checks and repairs and subscriber installation and audits.



**Communications Construction Group Inc.**

**Communications . . . . .(215) 696-1800  
Construction Group Inc.**

235 E. Gay St.

PO Box 561

West Chester, PA 19380

PERSONNEL: George Tamasi, President;

Thomas Polis, Executive Vice President

DESCRIPTION: Providing high quality construction services for cable television, fiber optics, and twisted pair communications networks. Services include field strand surveys, manual and CAD based drafting, system design, field engineering and all aspects of rebuild of new build construction. Service packages include full or modified turnkeys and unique management turnkeys customized for the operators' needs.



**Kennedy Cable . . . . .(912) 557-4751  
Construction Inc.**

**WATS (National) . . . . .(800) 673-7322**

Hwy. 280 W

Reidsville, GA 30453

PERSONNEL: Roger Kennedy Jr., President;

Bob Skelton, Vice President, Operations;

Thomas Heath, Marketing Manager

REGIONAL OFFICES: Florida, (800) 344-0976

DESCRIPTION: Aerial and underground line construction of CATV, LANs, telecommunications and fiber optic systems. Strand mapping, design, splicing, upgrades, rebuild, new extensions of system, balance, sweep and proof system. 18 years of experience.

**LINE TECHS**

**CATV RE-BUILDS - NEW BUILD - SPLICING**

**Line Techs, Inc. . . . .(313) 688-3057  
FAX . . . . .(313) 688-3336**

PO Box 386

North Branch, MI 48461

PERSONNEL: J. David Giesy, President;

Ken A. Gasper, Vice President Construction

Services; Carol Davis, Vice President

DESCRIPTION: Rebuild/upgrade of aerial

and underground CATV systems, either turnkey or labor. Includes coaxial, fiber optic installation, as-built mapping. Fiber to feeder design, splicing, retrofit, engineering analysis, sweep, CLI, proof. Also auditing and installation service. Consulting on project analysis and cost management. 15 years experience in all facets of CATV.

**NaCom**

**NaCom . . . . .(614) 895-1313**

**WATS (National) . . . . .(800) 669-8765**

**WATS (California) . . . . .(800) 767-6772**

1900 East Dublin-Granville Rd. #100A

Columbus, OH 43229

PERSONNEL: Stan Johnson, VP Operations;

Joe Govern, VP; Larry Linhart, President

DESCRIPTION: Full service communication

contractor providing CAD strand mapping;

drafting & RF design; make ready

engineering; aerial & underground plant

construction; fiber optic installation &

splicing; residential installations; CLI

detection & correction; pre- and post-wire

MDUs; DBSs; traps; audits; converter

exchanges; SMATV; and LANs throughout

the continental United States.



**RTK Corporation Inc. . . . .(908) 665-0133**

**FAX . . . . .(908) 665-0990**

120 Floral Ave.

New Providence, NJ 07974

PERSONNEL: James MacGeorge, President

DESCRIPTION: Full/modified turnkey

residential and commercial installations,

audits, rebuild, converter changeouts and

upgrades, MDU pre- and post-wiring, survey

and design.



**Schenck Construction . . .(206) 867-9694**

15042 NE 95th

PO Box 3159

Redmond, WA 98073-3159

PERSONNEL: Edward A. Schenck,

President; Bud Longnecker, VP/Aerial; Imel

L. Wheat, Jr., VP/Underground

DESCRIPTION: Aerial and underground

cable TV construction; turnkey.



## CONSTRUCTION CALLBOOK



**Triax Communications, Inc.**  
**Corporate** . . . . .(612) 437-6007  
**Colorado** . . . . .(303) 841-3577  
**California** . . . . .(408) 335-9170  
 204 Sibley St., Ste. 101  
 Hastings, MN 55033  
**PERSONNEL:** Rick W. Truax, President;  
 Harold "Kwigs" Bowen, VP Construction  
**DESCRIPTION:** Aerial and underground  
 construction for CATV, LAN's and fiber  
 optic networks. Strad mapping, design,  
 splicing and activation/sweep. Fiber optic  
 and twisted pair installation and splicing.  
 Turnkey construction.

**WHITE MOUNTAIN**  
*fiber optics* **cable**  
 CONSTRUCTION CORP.

**White Mountain Cable** . . .(603) 736-4766  
**Construction Corp.**  
**WATS (National)** . . . . .(800) 233-7350  
**FAX** . . . . .(603) 736-8163  
 PO Box 459  
 Epsom, NH 03234  
**PERSONNEL:** Dennis Nolin, President;  
 David Pouliotte, Vice President  
**DESCRIPTION:** Cable TV and fiber optic  
 cable construction. Splicing, engineering,  
 strand mapping and system maintenance.

## CAD and Design



**Metronet, Inc.** . . . . .(404) 475-9956  
**FAX** . . . . .(404) 475-9944  
 1111 Alderman Dr., Ste. 210  
 Alpharetta, GA 30202  
**PERSONNEL:** James P. Worthen, President;  
 Frank Walker, Director of Sales  
**DESCRIPTION:** CAD fiber optic and coaxial  
 system design (Lode Data). On site project  
 management; turnkey services; mapping  
 services—strand and as-builts; drafting  
 services—base, strand and electronics;  
 autoCAD conversion to Lynx; auto LISP  
 programming-client specific; CAD training  
 and set up; marketing services (dark fiber).

## Proof of Performance

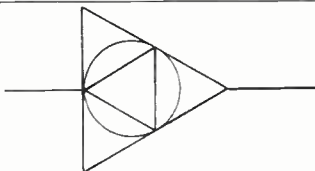

**Systems Performance** . . .(904) 262-8269  
**Engineering Inc.**  
**FAX** . . . . .(904) 260-0383  
 PO Box 24927  
 Jacksonville, FL 32241  
**PERSONNEL:** Peter J. Otten, President;  
 Sherrie Otten, Secretary/Treasurer  
**DESCRIPTION:** Electronic testing of cable  
 systems and LANs: sweep, balance, proof of  
 performance, cumulative leakage testing  
 and repair. Electronic upgrades, retro-fits,  
 technical evaluations. The company is fully  
 equipped to perform all services for CATV  
 and LAN operators related to electronics.  
 Database computerized amplifier data.

## Cable

**Comm/Scope, Inc.**  
 THE Cable in Cable TV.

**Comm/Scope Inc.** . . . . .(704) 324-2200  
**WATS (National)** . . . . .(800) 982-1708  
**FAX** . . . . .(704) 328-3400  
 PO Box 1729  
 Hickory, NC 28603  
**PERSONNEL:** Gene Swithenbank, VP/  
 Sales and Marketing; Stan Lindsay, VP/  
 Sales and Marketing; Elaine Jones, Customer  
 Service Manager  
**DESCRIPTION:** Manufacturer and supplier  
 of quality fiber optic cable and coaxial cables  
 featuring Quantum Reach, PIII, CableGuard  
 jacketed PIII, Extended Reach high  
 bandwidth coaxial cables, Optical Reach, a  
 full line of drop cables including cables that  
 meet the NEC requirements and two versions  
 of corrosion resistant drop cables.



**BELDEN**

**Cooper Industries** . . . . .(800) 235-3362  
**Belden Division**  
**FAX** . . . . .(317) 983-5503  
 PO Box 1980  
 Richmond, IN 47375  
**PERSONNEL:** Jim Hughes, National CATV  
 Sales Manager; Les Hunt, CATV and  
 Broadcast Product Manager  
**DESCRIPTION:** Full line manufacturer of  
 coaxial drop cables including RG-59, RG-6,  
 RG-7 and RG-11 constructions. Product

offering features messengered and non-messengered cables, as well as flooded burial products. Shield configurations including Duobond II (foil/braid), Duobond III (tri-shield), Duobond IV (quad) and Duobond Plus designs. Belden cables conform to NEC requirements including CATV rated cable for in-house applications.

**Trilogy**  
 COMMUNICATIONS INC.

**Trilogy Communications** . . .(601) 932-4461  
**WATS (National)** . . . . .(800) 874-5649  
**FAX** . . . . .(601) 939-6637  
 2910 Hwy. 80 E  
 Pearl, MS 39208  
**PERSONNEL:** Shinn Lee, Chairman, Board  
 of Directors; John Kaye, VP/Engineering &  
 Manufacturing; Bill Kloss, National Sales  
 Manager  
**REGIONAL OFFICES:** Mr. Gene Gough,  
 Atrium Bldg., 309 Morris Ave., Ste. B,  
 Spring Lake, NJ 07762, (201) 974-8164;  
 Kevin Duncel, 2335 W. Lakeside Dr.,  
 Aurora, IL 60504, (708) 820-0420  
**DESCRIPTION:** Full line manufacturer of  
 MC<sup>2</sup> air dielectric trunk and feeder cables;  
 foam coaxial drop in standard, tri and quad  
 shield configurations; UL approved CATVX  
 drop cables along with M-III plenum cable.

## Scrap Cable



— NATIONWIDE BUYERS —  
 CATV SCRAP CABLE AND USED LINE GEAR

**Midwest Cable** . . . . .(219) 892-5537  
**Services, Inc.**  
**FAX** . . . . .(219) 892-5624  
 PO Box 96  
 16095 Linden Rd.  
 Argos, IN 46501  
**PERSONNEL:** Ralph Howard, President  
**DESCRIPTION:** Nationwide buyers of scrap  
 CATV cable and used line gear. Dispatched  
 mobile units. On-site pick up.

## Pre-Assembled Duct

**Integral**  
**Corporation**

**Integral Corporation** . . . . .(214) 826-0590  
**WATS (National)** . . . . .(800) 527-2168  
**FAX** . . . . .(214) 823-4845  
 1424 Barry Ave.  
 PO Box 151369

## CONSTRUCTION CALLBOOK

Dallas, TX 75315

PERSONNEL: Jim Gray, President; Dean Taylor, Vice President  
 Represented exclusively by Channell Commercial Corp. (714) 694-9160, (800) 423-1863.

DESCRIPTION: Integral Corp. specializes in manufacturing continuously extruded CABLECON® Cable-in-Conduit and LUBADUK® cable pulling lubricant. Fiber-in-duct.

## Signal Level Meters



CALAN Inc . . . . . (800) 544-3392  
 (717) 828-2356  
 FAX . . . . . (717) 828-2472

1776 Independence Dr.

Dingmans Ferry, PA 18328

PERSONNEL: Ian R. Jones, President; Phyllis Thompson, Director, Major Accounts  
 DESCRIPTION: Calan manufactures the STAR 2010 SLMS signal level measurement system. The STAR 2010 is a revolutionary new signal level meter. In addition to one-step measurement of all the carriers on your system, the STAR 2010 makes data acquisition, data analysis and data communication a functional reality. The STAR 2010 will enhance your ability to perform system maintenance. Calan has done it again—bringing the same high quality you've come to expect from our sweep systems, to the signal level meter market.

## Tools



Cable Prep® . . . . . (203) 526-4337  
 Ben Hughes Communication Products Co.

FAX . . . . . (203) 526-2291  
 207 Middlesex Ave.

PO Box 373

Chester, CT 06412-0373

PERSONNEL: Deborah Morrow, President; David Morrow, Vice President; Eric Smith, Sales Manager; Patricia Anderson, Inside Sales

DESCRIPTION: Manufacturer of Cable Prep® tools. Product line includes hex crimp tools for CATV, MATV, STV and standard RF connector applications; coring and stripping/coring tools for all major cables (Cable Flex, Times Fiber, Comm/Scope PIII and Quantum Reach); the CPT-6590, a stripping tool for RG-6 and RG-59 drop wire cables; Ratchet handles for all coring and

stripping/coring tools; jacket stripper tools and other accessory tool items. Special tools made to order. Products area sold through major distributors. Call or write for information.

## Pedestals &amp; Enclosures



## Cable Security

Cable Security . . . . . (205) 742-0050  
 WATS (National) . . . . . (800) 288-1506  
 FAX . . . . . (205) 742-0058

801 Fox Trail

PO Box 2796

Opelika, AL 36801

PERSONNEL: Mike W. Springer, Vice President Sales; John S. Demos, Account Executive

DESCRIPTION: The industry's number one manufacturer of high security, low maintenance apartment boxes and custom CATV enclosures. Our Beast™ lines of self locking hinged boxes will eliminate theft of service and the additional liabilities that illegal hookups create.

CHAMPION  
PRODUCTS INC.

Champion Prods. Inc. . . . (417) 736-2135  
 Route 1, Box 422  
 Strafford, MO 65757

PERSONNEL: Rick Huggins, VP of Sales and Marketing; Carl Teidt, VP of Operations  
 DESCRIPTION: Products for OSP buried distribution and building entrance. Products include steel pedestals, apartment boxes, stakes, signs, and miscellaneous hardware. Custom design and fabrication of metal products is available to meet specific customer needs.

RELIANCE  
COMM/TEC

Reliable Electric/ . . . . . (708) 455-8010  
 Utility Products

FAX . . . . . (708) 451-5629  
 11333 Addison St.

Franklin Park, IL 60131

PERSONNEL: Mike Corkran, Director of Marketing; Tom Coyne, Product Manager, CATV Products

DESCRIPTION: Reliance Comm/Tec, a manufacturer of CATV products for three decades, offers the industry the widest range of outdoor enclosures, including amplifier housings, pedestals, and MDUs. Our new

Access 360 pedestals feature complete access to internal components, and are available in PVC and metal. All metal parts are treated with our patented 9-step process to ensure superior environmental protection.

## Bucket trucks



Time Manufacturing Co. . . (817) 776-0900  
 FAX . . . . . (817) 776-7531

PO Box 20368

Waco, TX 76702-0368

PERSONNEL: Charles Wiley, President; Jack Evans, Western Region Sales Mgr.; Lee Taylor, Central Region Sales Mgr.; Terry Harrison, Eastern Region Sales Mgr.  
 DESCRIPTION: Manufacturers of Versalift aerial lifts, telescopic and elbow types, truck or van-mounted, with working heights up to 65 feet. Sold internationally, through distributors.

## Test Equipment

## WAVETEK

Wavetek RF Products, Inc. (317) 788-5965  
 WATS (National) . . . . . (800) 622-5515  
 WATS (Cust. Svce.) . . . . (800) 851-1198  
 FAX . . . . . (317) 782-4607

5808 Churchman Bypass

Indianapolis, IN 46203-6109

PERSONNEL: Jack Webb, Product Marketing Manager; Mike Richardson, Western Regional Sales Manager; Tony Shortt, Eastern Regional Sales Manager  
 DESCRIPTION: A full line manufacturer of CATV and LAN test equipment for use on coaxial and fiber optic cable. Products include optical signal level meters, system analyzers, system sweep equipment, frequency agile leakage detection and bench sweep gear.

## Fiber Optics



Synchronous Comm., Inc. (408) 943-0222  
 FAX . . . . . (408) 943-0269

1885 Lundy Ave., Ste. 102

San Jose, CA 95131

PERSONNEL: Vincent R. Borelli, President; Herman Gysel, Vice President Engineering; John H. Kennedy, Controller  
 DESCRIPTION: Makers of FM fiber optic video links, digital fiber optic video links,



**CONSTRUCTION CALLBOOK**

and other fiber optic video products, including Synclink scrambling-transparent modulators and demodulators.

**Dist./Suppliers/Reps**

Cable Services Company Inc.

**Cable Services Co., Inc.** . . . (800) 233-8452  
**WATS (National)** . . . . . (800) 332-8545  
**FAX** . . . . . (717) 322-5373

2113 Marydale Ave.

Williamsport, PA 17701

**PERSONNEL:** Sales Department

**DESCRIPTION:** Suppliers of cable, distribution, splicing, tools and hardware for CATV coaxial and fiber optic systems.

**MIDWEST****CATV**

a UNR Industries Company

More than supplies. Solutions

**Midwest CATV** . . . . . (303) 799-4343  
**WATS** . . . . . (800) MID-CATV  
**FAX** . . . . . (303) 643-4797

Fairway II at Inverness

94 Inverness Terrace East

Suite 310

Englewood, CO 80112

**PERSONNEL:** Chris Sophinos, President; Jim McCauley, VP Sales; Chuck Krone, VP Marketing; John Johnson VP Materials; Ken Carroll, VP Finance

**DESCRIPTION:** Midwest CATV is a full line supplier of products for the CATV industry. A complete line of construction materials, including aerial hardware, underground materials, cable, connectors, pedestals, heat shrink, tools, test equipment, fiber optic cable, fusion splicers, fiber enclosures, splice trays, and other construction materials are in stock and available for immediate delivery from any of our nationwide network of warehouses.



**Power & Telephone** . . . . . (901) 324-6116  
**Supply Co. Inc.**

**WATS (National)** . . . . . (800) 238-7514

2701 Union Extended

Suite 300

Memphis, TN 38112

**PERSONNEL:** Sonny Dickinson, National Director/CATV Sales; Derwin Otwell, National Accounts Manager

**DESCRIPTION:** Full line distributor for cable, amplifiers, meters, taps, strand, hardware, drop material, headends, earth stations and all associated equipment.

VERSALIFT

# GAIN MORE SIDE REACH AND BETTER LINE ACCESS WITH THE NEW TEL-29EA



*Boom-tip-mounted bucket puts your operator two feet closer to that hard-to-reach splice.* And it provides line access from 3 sides of the bucket, eliminating expensive rotators.

Positive hydraulic bucket leveling gives a solid, stable work platform, leading to increased productivity and greater worker satisfaction.

A "cat-track" carrier system for control, air and hydraulic lines means less maintenance, more "up-time."

The VERSALIFT TEL-29EA can be mounted on any 10,500 dual rear wheel chassis with 60" C.A. and can be tailored to meet any aerial work requirement.

See your VERSALIFT Distributor for complete specifications, pricing and a demonstration!

**It's TIME to  
check out VERSALIFT!**



**TIME**  
MANUFACTURING COMPANY

P.O. Box 20368 Waco, Texas 76702-0368  
 (817) 776-0900 TELEX (910) 894-5218 FAX (817) 776-7531

TEL - 29EA

# VERSALIFT

# Cable cyberspace: Ethernet over I-nets

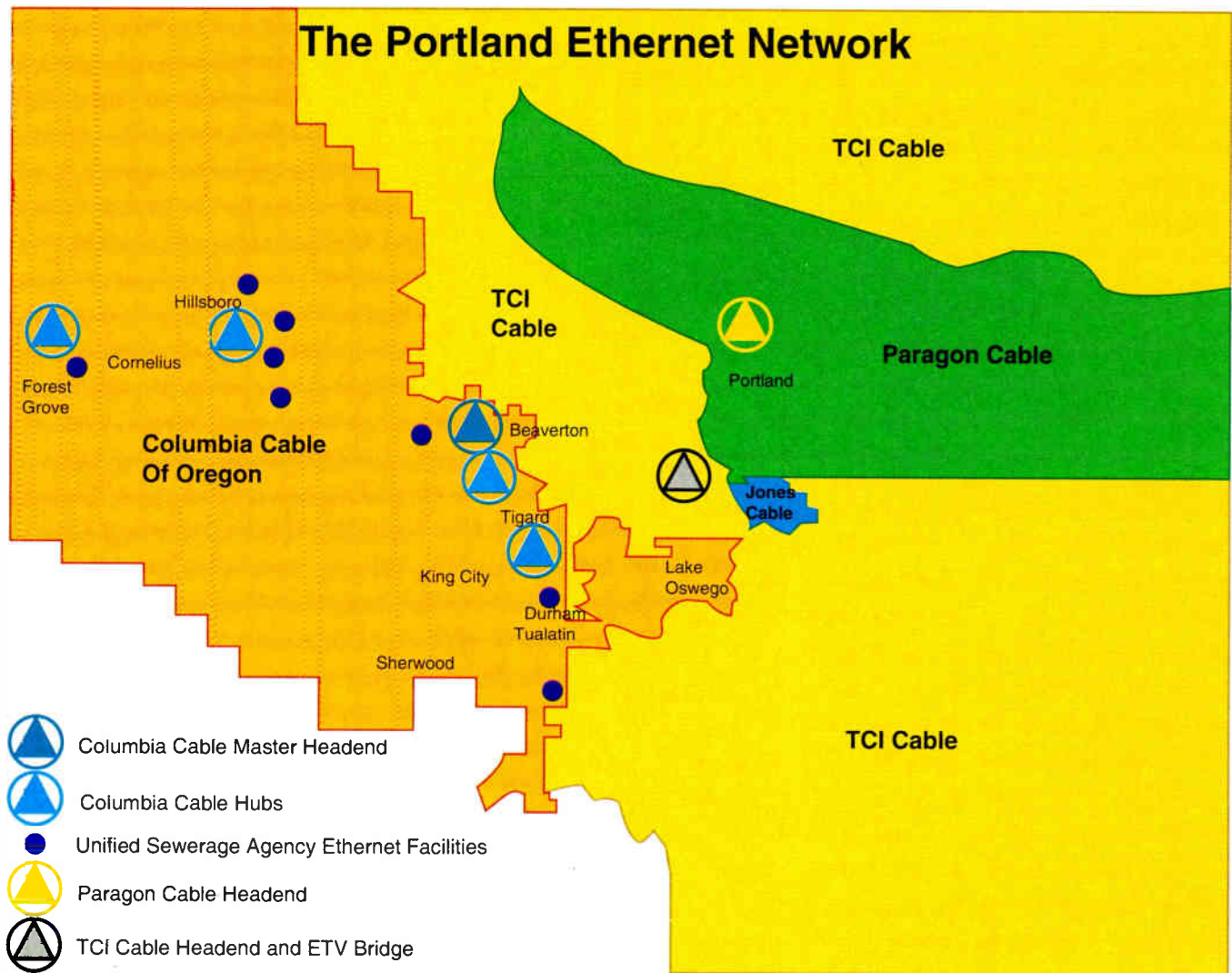

Figure 1

**A** decade ago, most cable-television franchise agreements called for some kind of institutional use of cable systems by public agencies. But until recent years, I-nets were only sparingly used for low-speed traffic and operators showed little interest because they were not profit centers.

However, that mindset is beginning to change. Today's coaxial cable systems are far more robust and have greater bandwidth than ever before. And with the deepening of fiber optics into cable systems, high-speed data

transmission as an alternative revenue source is on everyone's mind.

Indeed, cable's bandwidth attracts some like bees to honey. One vendor intent on marketing a data transmission scheme on cable is Digital Equipment Corporation (DEC). DEC, using Ethernet, a packet-switched, distributed data processing method and various hardware components, has developed a system it calls ETV for CATV applications.

### The connection

ETV provides Ethernet connectivity

over a local area network (LAN) or a metropolitan area network (MAN). It can potentially operate at speeds of 10 million bits per second, taking just 100 nanoseconds (billionths of a second) to send each bit. One bit can zip through 1.5 kilometers of a cable network in 10 microseconds.

Ethernet typically transmits signals in a broadcast mode heard by all receive sites. If another transmission is detected, a transmitter ceases and waits a random amount of time before trying again to send its message. Thus, data collisions are minimized. This sharing of a single channel is called

By George Sell, Contributing Editor



# NORTHERN CABLE SERVICES SAYS, "NOTHING WORKS LIKE QUANTUM REACH®!"

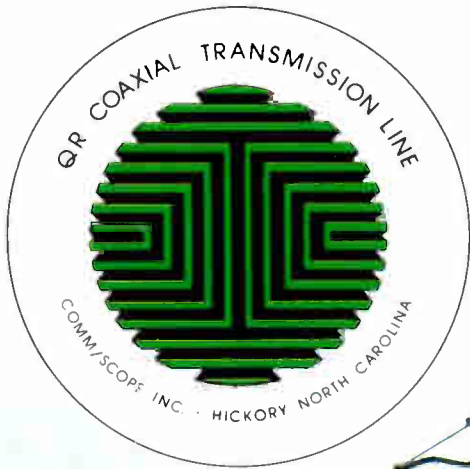

Premature coax cable failure in the Sudbury, Ontario area used to be commonplace because of the weather extremes. Abrupt 12-hour 60°F temperature swings in the Spring and Fall. Winter lows to -40°F and Summer highs in the 90's. Blizzards, freezing rain and average daily winds of 16 mph with gusts exceeding 50 mph. These severe conditions kept maintenance crews busy repairing or replacing sections of cable that may have been installed only months before.

Denis Côté, Service/Plant Maintenance Supervisor for Northern Cable Services, and lineman, Wayne Minor, knew these problems firsthand. But, since they installed their first section of Quantum Reach back in 1984, they have been smiling from ear to ear. That's because QR cured their cable failure problems. They've seen how QR's unique design makes it lightweight and easy to handle yet strong enough to outperform any other cable. "Nothing works like Quantum Reach," they say with good reason.

So, don't let people try to tell you how good their cable is without solid proof. Chances are theirs was one of the ones that didn't make it past the first blizzard in Sudbury. For a free comprehensive article detailing the Sudbury installation and more information about QR, contact your nearest Comm/Scope representative or call us at (800) 982-1708.



SUDBURY

**Comm/Scope, Inc.**  
THE Cable in Cable TV

Comm/Scope, Inc., P.O. Box 1200, Hickory, NC 28633  
Phone: (800) 982-1708

Circle 10 on Reader Service Card

carrier-sense multiple access (CSMA). While it's an efficient way to transmit data, this multi-user approach works well only over short distances.

ETV gets around the distance limitations by bridging between short runs of Ethernet. These bridges, essentially a modem-bridge-modem configuration with all data packets passed over the bridge via a single token, allow broadcast Ethernets to span large distances. According to Jim Albrycht, senior consultant for advanced development at DEC, "It looks like one contiguous Ethernet."

"The product we are currently selling, called ETV-1, is capable of operating up to 35 cable miles between modems. These are not point-to-point. These are totally distributed. We also have what we call an interchannel bridge, which is a gateway with modems on both ends. One bridge could be looking at a set of channels on one cable network and another set of channels on a different cable network.

Presently, DEC has its ETV system up and running on two adjacent cable systems serving the Portland, Ore. area. The two systems are Columbia Cable and Paragon Cable. An added twist is that the physical bridge is

located in the headend of a third cable operator, Tele-Communications Inc., that is sandwiched between Columbia to the west and Paragon to the east. "This is how we end up concatenating these two networks," Albrycht explains. The bridges have the capability to recognize 255 unique customer codes.

### Oregon MAN experiment

This intereconnected network got its start about a year and a half ago, when the Unified Sewerage Agency (USA), a Portland-area governmental body that administrates all sewer and water services for Washington County, approached Columbia Cable to inquire about transporting high-volume information over the 550-mile public communications network (I-net). "We indicated that, of course, we had the bandwidth to do it," reports Harlan Cook, operations manager for Columbia Cable.

Andy Beecher of the Metropolitan Area Communications Commission (MACC), Columbia's cable regulator, says: "There was no Ethernet or anything like that on the network. We were doing packet-switching and point-to-point services as far as data commu-

nications and the fastest we were doing anything was at the T1 rate (1.5 Mbps).

At that time, Unified Sewerage was doing telemetry and sending some data point-to-point over the network. But it wanted to start sending mapping and transferring huge file transfers that would require speeds approaching 10 Mbps. MACC allowed for a cable drop to DEC's offices be installed and an experiment was set up whereby DEC would deliver ETV over Columbia's I-net and provide high-speed data services for Unified Sewerage.

"The first product did not operate very well on the system over distance," says MACC's Beecher. "Then DEC brought in another product called Applitek and got it operating according to specs. And, low and behold, it worked between a couple of the key sites." Unified Sewerage then agreed to purchase equipment for three sites.

### A tale of two cable systems

A bridge between two cable systems allows the ETV interconnection to span an entire region or, as Mark Gershman of Paragon Cable refers to it, "a LAN to MAN type of thing." However, setting up bridges within one cable system is one thing, but the interchannel bridge between two different cable systems is quite another.

According to Gershman, "We (Paragon Cable) seem to be more in a test phase. It's point-to-point right now with the ability for the Digital people to monitor it from an additional point.

"We have one application with a particular hospital (Kaiser Permanente) that can be serviced just through our system area. We have also done some testing that required an interconnect with Columbia Cable."

Gershman's first impressions have been positive. "It was pretty amazing when we set up out here at the far boundary of our system and patched into Columbia and headed on out to Beaverton."

But Dave Griggs, network sales consultant for DEC in Oregon, paints a slightly different picture. "We are still trying to stabilize a net over Paragon. They let their I-net go to pot and so we are still finding ingress problems. We're really not stable out there yet. But it will be up and working within the month (of October)."

The interchannel bridge between Columbia and Paragon, says Griggs, "has been shaky, which makes it hard for us to manage the Paragon system. If you can't see the bridges that you

## YOUR MAP TO THE FUTURE... METRONET, INC.

- CAD Fiber Optic and Coaxial System Design (Lode Data), Audio
  - On Site Project Management
  - Turnkey Services
- Mapping Services-Strand and As-Builts
- Drafting Services-Base, Strand and Electronics, AutoCAD Conversion to Lynx
  - Auto LISP Programming - Client Specific
    - CAD Training and Set Up
  - Marketing Services (Dark Fiber)

James P. Worthen - President

Frank Walker - Director of Sales

For more information call (404) 475-9956

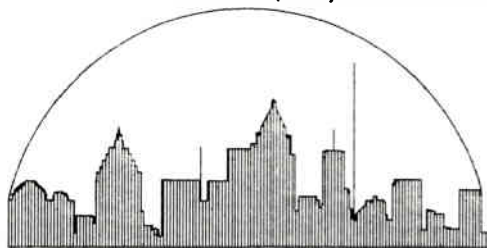

**METRONET INC.**

Building 200, Suite 210, 1111 Aldeman Drive, Alpharetta, GA 30202

(404) 475-9956 FAX (404) 475-9944



installed at Kaiser, how can you be sure that they are working properly?" Once it is stabilized and working correctly, the ETV system will total nearly 1,400 miles across the MAN.

"About six months ago, our tests had gone so well that we had written a contract with Unified Sewerage," Columbia's Cook explains. "Digital Equipment had asked us to attend a meeting with Paragon as well as our regulator and their regulator, to see if we could develop a MAN configuration using this Ethernet equipment that had proved so successful on our public communications network.

"We went to those meetings and Paragon agreed to set up a test. That test began about five months ago, in February or March. Since that time they have done a lot of work on that network—we had heard they had a few problems," Cook continues.

Says Kevin Robbins, chief engineer at Paragon, "Applitek and Digital came in and placed it on our system and we went to our far extremes and ran a test. And it ran real well. Now we are back trying to get any little bugs worked out between here and a potential client. Once we do that, then, hopefully, we should have a full-time system up and running."

Paragon acquired the Portland franchise from Rogers Cablesystems. Robbins had been the engineering manager at that time and became the chief engineer when Paragon took over. He explains that the I-net got lost during the ownership transition. "Anytime a cable system is sold, no matter where it is or who it is, capitol dollars always shrink; plant enhancements don't happen. That happened here with the I-net business; and it's very difficult to compete with the phone company.

"We've run data services before. We've had all of First Interstate Bank's locations on our cable. We don't now because they have upgraded to a higher speed and got a better deal with the phone company."

But Robbins is hopeful that he will get the support he needs to focus on I-net. "Corporate is going to look at this (system). We should have what we are going to do in the next couple of weeks and then go forward.

"I'm confident that our cable plant will be fine and it will work fine. It's just that a total commitment to it has not been 100 percent yet because we want to understand what it's going to bring to the table for us." Robbins is concerned that it may just be a small niche business and wants to take a

prudent course. "We are crawling before we walk, and walking before we run."

### A success story

However, on the other side of this tale of two systems, the Columbia technical managers are bullish. "We've got over 100 sites on our network. So, our network is well seasoned and maintained," says Cook. "After a three-

month test, we entered into a three-year contract with Unified Sewerage for providing Ethernet services to a number of sites. They are sending full CAD/CAM to these five sites back and forth to their mainframe."

Scott adds, "Very few service-oriented problems have been reported to my staff." The applications software has had some bugs, but, "the bridges are flexible as far as signal level goes. We maintain a pretty consistent signal

## Power & Telephone brings you Reliance quality!



Call any one of our regional offices for fast delivery of the unique and rugged Access 360 line of CATV pedestals from Reliance Comm/Tec. They are pre-assembled for quick installation and are available in steel or PVC models for 25 years of steady service. The lift-off cover provides a full 360 degrees of access to the enclosed equipment.

Other features include a practical rectangular design, multiple locking options for security and versatility, and flow-through louvers for improved ventilation.



**Power & Telephone  
Supply Company**

2701 Union Extended, Suite 300  
Memphis, TN 38112-4417  
901/324-6116 FAX 901/320-3082  
1-800-238-7514

Circle Reader Service No. 29



Low Voltage Wire  
and Sheathed Cable

# STAPLE GUN TACKERS

A Model to Fit Every  
Wire and Cable Fastening  
Requirement  
**TELEPHONE • ELECTRONICS  
COMMUNICATIONS • CATV  
ALARM SYSTEMS**

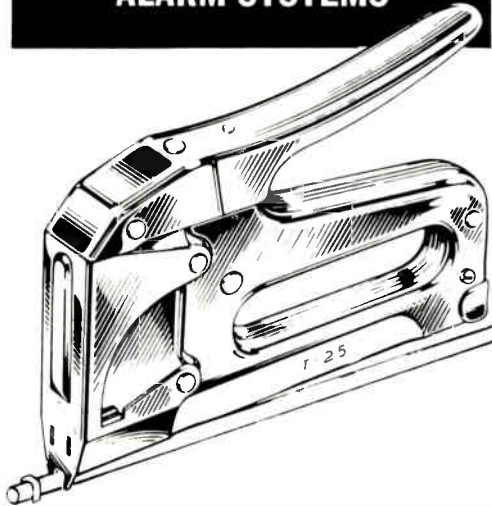

## THE RIGHT ARROW TACKER AND STAPLE SIZE TO USE FOR THE RIGHT INSTALLATION



**T-18** Low Voltage Wire Tacker  
For wires up to 3/16" dia.  
Loads staple leg lengths:  
3/8" & 7/16"



**T-25** Low Voltage Wire Tacker  
For wires up to 1/4" dia.  
Loads staple leg lengths:  
9/32", 3/8", 7/16" & 9/16"



**T-37** Low Voltage Wire Tacker  
For wires up to 5/16" dia.  
Loads staple leg lengths:  
3/8", 1/2" & 9/16"



**T-75** Sheathed Cable Tacker  
For wires up to 1/2" dia.  
Loads staple leg lengths:  
9/16", 5/8" & 7/8"



271 Mayhill Street, Saddle Brook, N.J. 07662

## ETHERNET OVER CABLE

level per our franchise agreement. We keep a pretty tight plant and haven't had any problems with service or maintenance of equipment," says Scott.

What kinds of things does a cable system need to do to be able to offer this kind of highly sophisticated data communications over its I-net? Cook offers: "There are some basics. Keep the system on and give good service. If the customer does call, answer the phone call and determine what the problem is. And if it's within the cable company's area of responsibility, get it fixed fast and get out of their hair. And, be willing to spend money to get it running. We have pumped a lot of money into this system since we purchased it in May 1988."

"Really it comes down to the issue of reliability," Scott notes. "There's a great deal more attention put on reliability, keeping power supplies on-line, keeping a good, tight plant. Off-air ingress can cause a great deal of damage to these data circuits."

"There are a whole bunch of conditions," Cook adds, "including the quality of your people, the quality of your facility and the commitment of your staff to provide that service."

"It takes a dedicated staff," echoes Robbins of Paragon. "You don't want to take an I-net and have it run by regular maintenance technicians because you are asking them to split their focus. Really you have to have a whole separate group and run it as a separate entity. It's not easy to intermix."

"We need to be a service provider 24-hours a day, seven days a week," says Cook. We have service technicians' work scheduled seven days a week at customer's houses. All of our preventive maintenance work happens between 2 a.m. and 6 a.m. because we don't want to inconvenience our customers. We make all of our new plant additions between those early morning hours."

According to DEC's Griggs, the key is cable system integrity. "If you have a good infrastructure, boy, this ETV stuff is unbelievable. It's so solid beyond what we are used to. We see that on the Columbia side and we are working out the relationship where we can call up and say, 'We're having a problem with this leg, could you have a look at it,' and they will get right on a bucket truck. They understand data. The Paragon side doesn't seem to have a clue yet. And they have, in a way, a more sophisticated network."

MACC reports that the Columbia Cable I-net's reliability rate is 99.58

percent.

### Net manager?

The question of who should be the data network manager, the cable system, the vendor, the users themselves, or even the government regulator, gets tossed around by all the players like a hot potato. Currently DEC is the net work manager on an experimental basis.

"We have granted a drop to Digital's office and they are assisting Unified Sewerage with the network management," says Beecher with MACC. "But the concern that has been voiced to us is that that network management scheme hasn't evolved to the point where the individual agency can do it on its own. There's a whole lot of interest in public agencies doing their own network management rather than having DEC do it for them."

"There are several agencies that are looking at other bridging standards and equipment configurations to run on the network. Right now there is an evaluation underway of three broadband LAN bridge products on the network, including the DEC/Aplitek configuration. We should have results on that shortly. That's very important because it's going to determine the real throughput," Beecher suggests.

What about Columbia Cable assuming the role of network manager? "They tried to twist our arm and we keep saying, 'no, we just want to be the pipeline,'" Cook responds. "Our experience lends itself better, being a cable operator, to providing a reliable pipeline and we try to stay in that mode."

"The cable companies that I've talked with who have tried to manage data are very frustrated with the whole idea," says Digital's Griggs. Consequently, most cable systems want the vendor to manage the data. That means that a company like Digital would have to get into the network management business of cable franchise networks. That turns out to be not as simple as it sounds.

"Let's say that something went wrong with somebody's connections. Maybe a hospital got deleted from its clinics. The (service) call goes into a central facility and (the computer company tries) to determine what went wrong. Meanwhile, the clock is ticking and they finally decide it must be the leg out of the headend, which is a cable company problem. You try to dispatch the cable company and they go out not knowing for sure why they were called. There are some holes that have to be filled in before you turn your cable network



over to a computer company.

**Bringing it home**

Digital Equipment Corporation has an evolutionary marketing scenario for the future of ETV. It is called Community Multimedia Networking (CMN). First comes ETV over cable's I-nets, followed by workstations at the homes of professionals employed by the institutions on the I-nets. Then as telecommuting catches on, home workstations are brought up on the residential cable system. The path to the home also involves interactive smart terminals replacing converter boxes. DEC even hints that it might get into the television set manufacturing business.

But for many in the cable industry, the potential threat of the telephone industry's much ballyhooed integrated services digital network (ISDN) looms here as well. Albrycht, DEC's senior consultant, views it differently. "ISDN is a rainbow, from my perspective. It's been chased for years.

"The difference between the telco solution and the cable solution is very obvious. The cable solution has a natural migration path based on business pull, not technology push. The telco solution requires a large central investment and a central switch, point-to-point fiber optics all the way home, and the home unit is a relatively dumb terminal. This concept of intelligence in the center and dumbness on the periphery is an AT&T/IBM hierarchical model.

Digital's model is that the person is the most intelligent aspect of the network, the next most intelligent is the PC or workstation, the next level of intelligence is on the local area network, and the least amount of intelligence is at the center of the network. As a result, all the switching, via the VCR and TV set, is purchased by the consumer and not purchased by the infrastructure. And as a result of the branching tree topology and the logical ring access, DEC has the ability to come on-line instantly.

"The next generation technology can be integrated extensively, performance can be improved extensively, and that will continue. We can drive the stuff all the way down to where it's sitting on a chip," Albrycht projects.

DEC's home-as-cyberspace scenario seems to be predicated on pay-per-view demand and revenues in the early phases. "What the cable industry is looking at and where we can help them over time is the video store market. This market is somewhere in the area of \$15 billion to \$20 billion. As I understand it, the cable industry is very interested in putting those 50,000 videos on-line.

"We think we can get pretty fast access to that through an Ethernet-type capability, with 10 Mbps. We are not necessary looking for capacity as

much as response time," Albrycht says. "What you are able to do is get the same type of user interface a person now gets with remote control. We think we can click through a number of remote all-digital databases with the same type of capability."

Albrycht sees myriad technologies converging over the next decade and believes Digital is well positioned to exploit them. And cable television is central to its scenario.

"The cable industry says that compression is its number-one technology and fiber optics is its number-two technology. What cable wants fiber optics for is not necessarily bandwidth, but for reliability and to reduce cascades of amplifiers. The telco says its number-one technology is fiber optics because it can't push the information it needs through the twisted pair," Albrycht explains.

"What's interesting about compression is that it is computer-intensive and compute power is moving up the curve very fast. Last year we looked at 25 Mbps on the desktop. We are looking at 100 Mbps on the desktop today. And in a couple of years we will be pushing 500 to 600 Mbps on the desktop. This is more compute power than most data centers have ever seen."

Albrycht disputes those who claim the home-as-cyberspace is an idea that won't come about until the next century. "The predictions are that in the '90s, things will move six times faster than they did in the '80s. So, whatever you think will be long term, I would really evaluate it. Because the computer and television industries are converging. There's some tremendous power here." ■

**'The computer and television industries are converging. There's some tremendous power here.'**

# Service Calls Got You Down?

The only good thing about a service call is completing it...quickly, efficiently, effectively and with the least inconvenience to the customer.

The key to good service calls is training. Effective training to limit the amount of time required to fix the problem and to ensure it is fixed right the first time.

NCTI's **Installer Technician course** can give you and your staff the training you need to bring out the good in service calls. Recently revised, updated, improved and expanded lessons include:

- Troubleshooting TV Problems
- Troubleshooting Drop Cable
- Troubleshooting Drop Passives
- Troubleshooting Picture Distortions
- Signal Leakage Detection

Additional lessons give you the background you need to understand the "whys" behind the troubleshooting process, and include advanced topics like MDU installation and decibels.

And that's just the beginning! Installer Technician is just one of a five-level career path progressing from Installer to Advanced Technician which can give you the professional background you need to take advantage of the industry's ever expanding need for expert technicians and engineers.



Call us or return the coupon for full information on our courses.

**Scholarships available through the Society of Cable Television Engineers!**

**Please rush me:**

- A complete Training Kit with information on all NCTI courses
- More information on Installer Technician
- Information on SCTE scholarships

Name \_\_\_\_\_

Title \_\_\_\_\_

Company \_\_\_\_\_

MSO affiliation \_\_\_\_\_

Address \_\_\_\_\_

City \_\_\_\_\_ State \_\_\_\_\_ Zip \_\_\_\_\_

Daytime phone \_\_\_\_\_

Mail this form to: **CED 11/91**

**National Cable Television Institute**  
 P.O. Box 27277, Denver, CO 80227  
 (303) 761-8554



Colonial

Williamsburg

Will  
history  
repeat  
itself?





Since January 1990, subscribers in a small area of Williamsburg, Va. have been using addressable interdiction, an off-premise addressable technology which provides cable service with no in-home equipment. Almost two years later, the results continue to demonstrate interdiction's advantages. The technology provides cable operators with flexibility to control subscriber service levels of up to 49 individual channels and connect/disconnect of the tap port. Subscribers benefit because they can use their own video equipment and no appointment is necessary to install or change cable services.

Interdiction in the Warner system is functioning as expected. Technically, the product performs and is reliable. Operationally, truck rolls have decreased and preventive maintenance on the product has been minimal. With respect to marketing interdiction, the following results are encouraging:

- Basic and pay penetrations are increasing. This growth bucks the industry trends. Even more impressive is the fact that Warner's penetration is increasing in an already heavily penetrated area.
- Contrary to industry expectations, remote rentals and additional outlets have actually grown.

More importantly, customer satisfaction and service levels have improved as a result of the interdiction technology. These are important considerations as the market becomes increasingly competitive.

In this article, the details of the installation, subscriber reaction to the technology, product changes made, operations issues and their results and the reliability of interdiction will be reviewed.

**Installation details**

**Interdiction area.** The off-premise area was chosen because it is close to the remote headend and contains both aerial and underground plant. The subscriber group is located in a typical middle to upper income neighborhood of single homes with only one small apartment complex. Key facts about the test are shown in Figure 1.

**Installation.** The interdiction-based plant upgrade was divided into two

Plant Miles	3.38
Plant Age	19 years
# of channels	35
Plant requery	Upgraded from 300 to 330 Hz
% of Underground Plant	30%
# of Interdiction Four Port Units	111
# of Subscribers/Homes Passed	211/259
Basic Penetration in Test Area (Before/After)	81.47%/89%
Pay/Basic Penetration in Test Area (Before/After)	50.24%/52.7%
Installation Date	January 29, 1990

Figure 1

phases. First, the underground area and apartment complexes were reviewed in order to upgrade any enclosures before the units were spliced into the plant. Next, the 19-year old aerial plant was redesigned for the placement of the interdiction taps. The trunk cable required no changes other than amplifier respacing.

Overall, the installation was simple, similar to a piece of line gear. However, installing interdiction is slightly different. Each interdiction unit required

**Warner believes the value of the cable service increased with interdiction.**

three separate visits by three different skill groups. The first person was a splicer who removed old taps and spliced in a fully loaded generic four-port interdiction tap, rough balanced it with a directional coupler and equalizer according to the design map and hooked the drops to the tap ports. Customers received all services at installation. Later, service levels were adjusted via CableData's billing computer. This first step took about 30 minutes (the same time to install a line extender).

Next, a second technician balanced the unit by verifying that the proper directional coupler and equalizer values were providing the performance needed. The technician also documented the values and logged the automatic gain control (AGC) voltage; then moved on to the next unit. This step took under 10 minutes to complete.

Lastly, an installer verified that the drop cable was connected to the proper port, reworked the drop connectors and recorded the port address with the tap

port number and the address of the connected home to this port. This information was later entered into the computer system for billing and authorization of proper service level. This person

also visited the home to remove converters, A/B switches and to inform subscribers about the new technology. This third step took approximately 30 minutes per home, mostly to educate customers on their in-home equipment. The last step could be done by a joint installation and sales team visiting subscribers and non-subscribers. The conversion of each home took anywhere from 20 to 30 minutes. The area of 259 homes passed was converted in five working days from 6:30 p.m. to 9:30 p.m. each evening.

**Reactions to interdiction**

Subscribers were pleased to be able to use their own TV and VCR again. Here are two representative remarks:

One couple stated, "All we have is our own equipment, a VCR, we go right through that and right into the TV. It's really neat. We had a lot of wires before and in order to show a movie you unscrewed one wire and screwed another one in and it was very, very complicated to see a movie. We didn't understand any of the uses (functions) of the VCR..."

Another woman said, "Even though we had a remote control before and our television is cable-ready, we weren't able to use our remote control because of the converter box. In order to tape off the television, we had what was called an A/B switch and it was really too complicated for us to use. So as a result, we didn't tape anything off the television."

Warner believes the value of the cable service increased with interdiction because the subscribers can use their own video equipment. However, in Williamsburg we learned that we first had to help customers use their equipment (TVs and VCRs) properly because they were accustomed to a set-top converter. TVs and VCRs were not programmed; unused remotes were stuffed away in closets. Therefore, the install team needed batteries for the TV and VCR remotes and a flashlight to see behind the TV set. Old converters seemed to migrate to the additional

*By Ron Horchler, Technical Operations Manager, Warner Cable Communications Inc., and Angela Bauer, Senior Market Specialist, Scientific-Atlanta Inc.*

outlet where older television sets were not cable-ready. In Williamsburg, approximately 40 percent of the basic converters remained after interdiction was installed.

### Marketing results

The Williamsburg area was divided into two areas: a test area for interdiction of 259 homes passed and a control

using their TV's rabbit ear antenna with an A/B switch to watch either cable or off-air television channels.

The result? After two months (June and July 1991), 20 buys via ARU were received from the six connected customers. In addition, four of the six people were converted into permanent subscribers. Note that these customers all had VCRs and are entertainment-oriented. Although the sample size of

the test site is small, we believe that incremental cash flow can be realized from all non-subscribers.

### Troubleshooting and PM

Troubleshooting and preventive maintenance are easy, similar to that of a line extender. In order to measure levels for preventive maintenance, the interdiction tap must be opened. This is because level measurement at the tap port may show the proper levels but the port level could be off because the unit has AGC. However, a new housing will provide RF test ports so levels can be tested without opening the unit.

### Instant installs

Half of all new subscriber connections were performed without truck rolls. Truck rolls to connect were caused by non cable-ready sets, which require a converter. Usually, the first TV and VCR were cable-ready and any additional outlets were not.

The National Cable Television Association's standard for installation backlog is seven working days. Warner has a corporate goal of four working days. However, in the interdiction area the install backlog is zero days. This quick response assists Warner in its customer service goals and customer satisfaction. The system also receives three or four days extra revenue (estimated at \$54,000/year) with the immediate hookup and no truck roll cost.

### Truck rolls

Traditionally, Warner-Williamsburg expects 80 percent of all service calls to be drop related. Of that 80 percent, 20 percent are converter related. With interdiction, the need for constant physical disconnects and installs are eliminated; therefore, the drops are sealed and reworked to make them a more rugged and permanent part of the plant in an effort to reduce drop-related calls.

Over the last nine months, Warner has seen service calls per subscriber in the interdiction area to be half the amount of service calls per subscriber in the control area. Truck rolls for interdiction typically fall into two categories: Customer education (on their equipment) and non cable-ready additional outlets.

### Powering

For the field test, most of the units were cable-powered except for two home-powered units. Since the interdiction units are active devices, powering requirements and costs will rise. However, most operators find other

Category	Test Area (228 subs.)	Control Area (150 subs.)
Basic Penetration	up 9%	dn 7%
Pay Penetration	up 8%	dn 7%
# of Additional Outlets	up 26%	dn 21%
# of Remote Rentals	up 9%	dn 27%

(data from Jan. 1990 to Sept. 1991)

**Figure 2**

area of approximately the same size. The results a year and a half later indicate the successes match the predictions for the technology (see Figure 2):

- Basic and pay penetration rose significantly. This fact is especially pertinent since the industry trends have seen stagnation in basic numbers and decline in pay numbers. Also, the lift in penetration is even more impressive given the fact that Williamsburg already had over 80 percent basic penetration.

- The number of additional outlets and remote rentals rose in the interdiction area. Many industry professionals presume that these numbers will go away when a clear signal is delivered. However, we saw these figure grow. Customers chose to connect more TV sets because no extra equipment was needed. This, in turn, increased remote rentals because most of these second sets were not cable-ready.

Warner also began marketing to non-subscribers in June of 1991. The "cable by the day" offering included basic/day, HBO/day and PPV events. At first, contact with non-subscribers was made via a letter with little response. However, door-to-door contact was successful.

Of the 31 non-subscriber homes in the area, 12 were actually contacted. The others did not respond, or the homes were vacant. Of the 12 people reached, six potential subscribers (50 percent take rate) agreed to allow Warner to wire their homes for cable with no obligation to buy. These "potential" subscribers received service one of two ways—either by a drop into the TV set which they connect, or by

Module	Item Changed	Reason
Seizure Board	1. Added a plastic cover	—safety, guide for dc & EQ
	2. Wire jumper added for directional coupler	—facilitates installation
	3. Moved AC fuse from power supply to seizure board	—easier access
Motherboard	4. Modified AGC test point	—more visible, easier access
	5. Re-layout out band reject filter	—improve performance
Housing Bottom	6. Added bar code label with serial numbers and digital addresses	—easier for field installation
	7. Changed thread length "D-D"	—standard length
Top	8. Changed hinge design	—fit in 8 inch pedestal
	9. Changed strand clamp material to stainless steel	—more resistant
	10. Added blind inserts	—prevent water collection
Power Supply	11. Changed tamper switch cover design	—more secure
Subscriber Module	12. Added bar code label	—easier inventory tracking

**Figure 3**



# A CLEAR ADVANTAGE

The Eagle SIS Decoding Filter descrambles high frequency channels economically with NO video loss!

Compare the new Eagle Sideboard Interdiction System (SIS)\* to competitive products. At high frequencies, Eagle SIS decoding filters reproduce an image as clear as the original while others produce washed-out pictures that lack sharpness.

The Eagle SIS system operates at 450 MHz and higher with no *jamming carriers* so there is no video deterioration. **In fact, video enhancement is possible if desired.**

For complete specifications, contact your Eagle marketing representative today.

#### Reasons to Buy Eagle SIS Decoding Filters

- Near Perfect Descrambling
- Video Enhancement Possible
- Convenient Size
- Economical Price
- High Channel Application
- Security Improved by High Channel Usage
- Extended Threaded Ends
- Available Now!



\* Patent Pending

**Headquarters:** 4562 Waterhouse Road, Clay, NY 13041 • (315) 622-3402  
• Toll Free 800-448-7474 • FAX (315) 622-3800

**Canada:** Deskin Sales: 416-475-1412 **Belgium:** Electro Service 32-15-20-95-75

**England:** ABP Ltd: 0256-881525 **Norway:** Cablecom AS: 47-34-79630

**Germany:** Stodieck: 211-41-7010 **France:** Sachs France 33-1-39-86-29-62

# "BUILT FROM EXPERIENCE" IS A KEY FEATURE PIONEER PRODUCE THE BA-6300



**John Unverzagt**  
*Director of Engineering  
Pioneer Communications of America  
Cable Systems Division*

When designing the BA-6300 addressable converter, Pioneer engineers put the same emphasis on quality and reliability as they do for all products company-wide and worldwide. The BA-6300 employs state-of-the-art converter technology, while offering dependability your subscriber can count on year after year. With the BA-6300, you can simplify system operation while maintaining security.

The BA-6300 and Pioneer offer a reliable combination which is well respected throughout the industry. Just check our references!

---

***Because your business demands performance...***

**PIONEER COMMUNICATIONS OF AMERICA, INC. CABLE SYSTEMS DIVISION**  
600 East Crescent Ave. • Upper Saddle River, NJ 07458 • (201) 327-6400 • Outside New Jersey (800) 421-6450



PRECISE, RELIABILITY  
PROVEN IN ALL  
CIRCUITS.  
PIONEER PROVES IT."

*The Pioneer BA-6300 addressable converter is especially designed for the cable operator with a desire to improve customer service, achieve the highest levels of subscriber satisfaction, increase security and simplify system operations.*

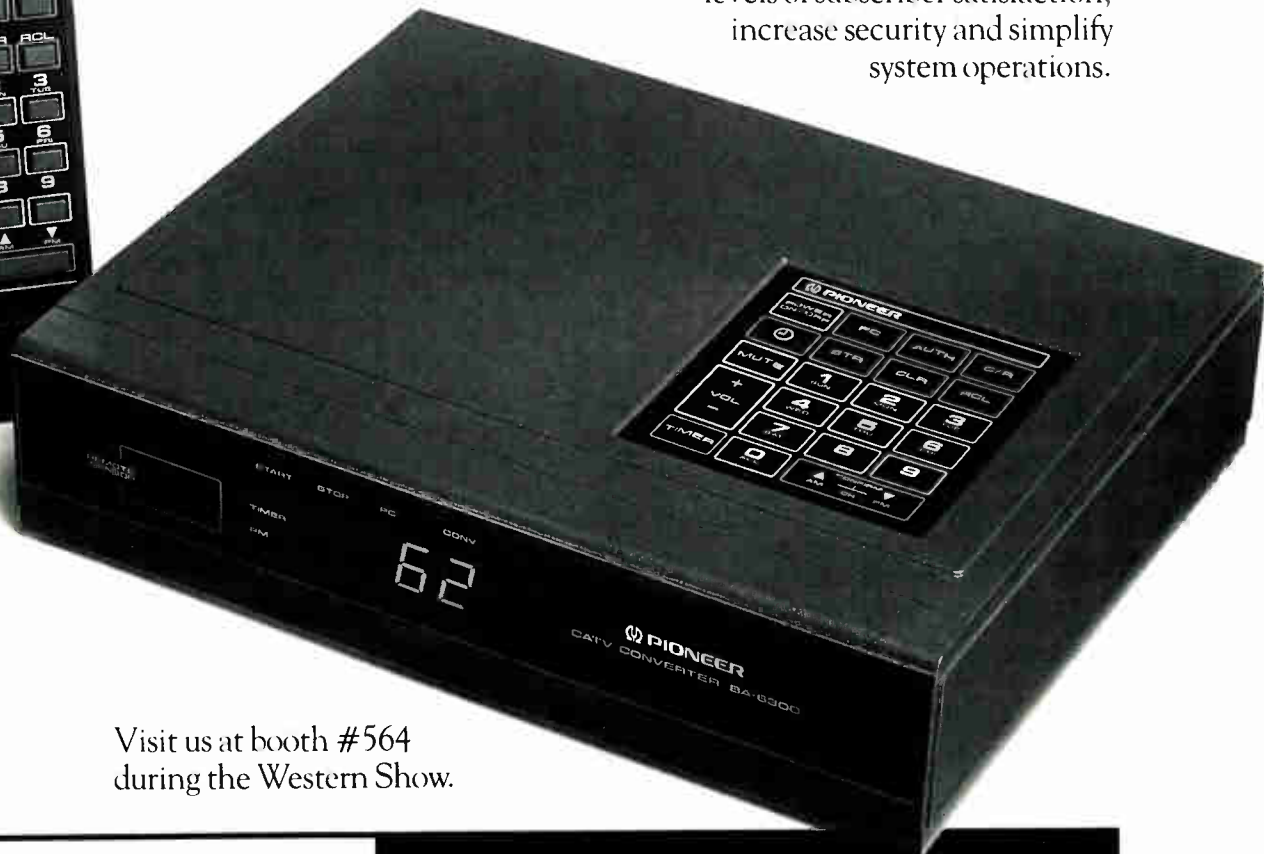

Visit us at booth #564  
during the Western Show.

 **PIONEER®**

## INTERDICTION CASE STUDY

benefits such as instant installs, fewer truck rolls and additional marketing revenue more than offset the additional powering costs.

With powering, there are two issues: Power design for maximum use and actual monthly draw. Plant design is based on the maximum usage; however, usually the actual usage will be less. The four-port unit will draw 10 watts fully loaded (four subscribers connected) or 250 milliamperes maximum. To put the number in perspective, one set-top draws 10 to 12 watts; however, since the power consumption is in the plant, additional power supplies will be needed for feeder powering.

For the test area, the installation of four power supplies was originally estimated. However, after activation of the interdiction units we realized that only two power supplies (5 amp) were required for the 3.38 miles of plant. More importantly, Warner believes it has increased the reliability of service to the customer by separating the feeder powering from the trunk powering. Since the supplies were placed in the feeder, the cable customer will not be affected by power outages, because if the cable system loses power in the feeder, then in most instances, the neighborhood (and the TVs) will not have power either. Overall, because the interdiction units are active devices, an operator needs to pay special attention to developing an intelligent system design and efficient use and placement of power supplies to minimize powering costs and increase reliability.

As part of the field test requirements, two home-powered four-port units were installed. One unit was AC powered via the drop and the other was DC powered via the drop. Within two weeks, one of the subscribers moved and took the in-home transformer with him. For this and other reasons, Warner prefers cable powering.

Home powering may not be as appealing as first thought because of such reasons. For example, Warner wants to eliminate trips to the home and provide a friendly service (with limited in-home equipment). In addition, Warner believes it would need to replace a high percentage of the existing drop cables to the home because of moisture and other damage which may make the drop unsafe and unreliable for passing power. Also, marketing to the non-subscriber would be awkward because each home would need a power pack.

### Reliability

Looking at the overall reliability of the plant with interdiction, reliability should be the same as before because there are no extra in-line active devices. The trunk design is the same. In the feeder, the interdiction tap through-path is passive, just as are other taps.

Actually, an off-premise system would have fewer total series system active devices than a converter-based system, because placing the power supplies in the feeder decreases the number of power supplies between the subscriber's home and the signal source. In addition, one interdiction unit serves four subscribers, replacing one tap and possibly four active set-tops. This means fewer overall active devices.

The added component to consider for plant reliability is the power supply. Traditionally, there may be five power supplies before a trunk which feeds an area. With interdiction, these supplies can be placed in the feeder leg of the neighborhood it feeds. This placement will decrease the trunk power supplies and increase the perceived signal reliability because if there is a power outage in the feeder leg, more than likely the homes will not have power either.

# How to build ad sales WHILE CUTTING COSTS AUTOMATICALLY

Channelmatic gives you the confidence you need to build local ad sales, knowing you have the only fully-integrated, automatic ad insertion system to back you up...a cost-effective system that'll make your insertion business much more profitable.

And what's important, all of our equipment is modular so we can custom design the system you need to optimize your investment...a system that can match your plans for long term growth. Call, FAX or write for your free copy of our AD INSERTION DESIGN GUIDE.

821 Tavern Road, Alpine, California 91901  
PHONE: (800) 766-7171 • FAX: (619) 445-3293



### AD INSERTION EQUIPMENT

From satellite-delivered interconnects to single channel ROS...the system of choice, from the unquestioned leader with more than 5000 channels on-line every day.

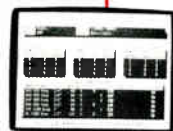

### TAPE COMPILING/EDITING

Exclusive V:base system puts control back where it belongs - with your Traffic Manager...saves time, labor and tape...eliminates the possibility of scheduling errors. Simply the best.



### PROGRAM PLAYBACK

Automatic videocassette changer randomly accesses up to fifteen 3/4" cassettes...full seven-day schedule programming of up to 100 events per day for your Access Channels and PPV...more than five years of proven performance.



### A/V SWITCHING DISTRIBUTION and CONTROL

Reliable high performance modules give you the ultimate in audio and video switching, distribution and control automation...from the leader in CATV automation systems.



**CHANNELMATIC**

Circle Reader Service No. 34



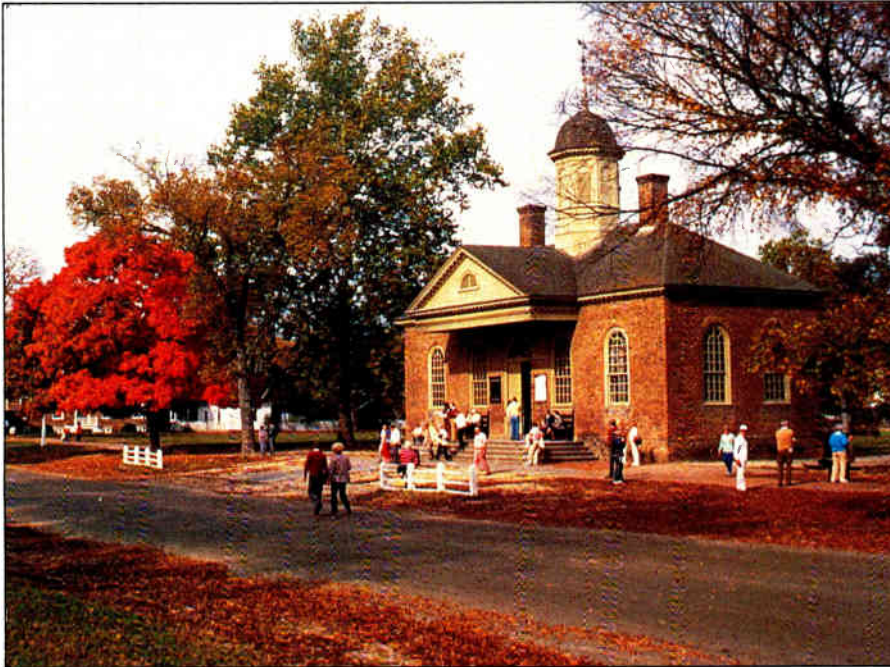

The Courthouse of 1770. Photo courtesy Colonial Williamsburg Foundation.

The test site has experienced winter cold, summer heat, lightning storms and a coastal environment. To date, eleven housings and three subscriber modules were returned for evaluation.

Two of the 111 four-port housings experienced random component failures or a 1.8 percent field failure rate. Three subscriber modules, or 1.3 percent of the 228 installed modules, failed

in the field.

These failures were attributed to workmanship problems and extra handling in producing the engineering prototypes, all of which have been corrected in subsequent production. The evaluation of the remaining units which were returned led to product changes in future production.

More than 26 product enhancements were applied to the interdiction four-port device as a result of the field test in Williamsburg. Most of the changes made the product more friendly to the operator, making it easier to install or repair the product. Other changes improved the reliability and performance of the product. A partial list of the product enhancements is highlighted in Figure 3.

As a result of the product and reliability improvements made from the field test, subscriber module failures at four other interdiction sites have been less than 0.2 percent based on a field failure rate.

The improved housing with all the product enhancements has just recently begun to be deployed. We expect the new units to yield even better results than the 1.8 percent failure rate at Williamsburg. ■

## Survival Training

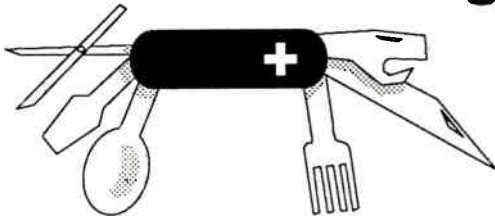

Our industry must prepare for its future by building skilled workforces. The ATC National Training Center offers training services through a variety of methods, including technical manuals, off-the-shelf and custom courses, and interactive video disc training courses.

**Trained employees are essential for your success!**

**Call Today!**  
**(303) 753-9711**



ATC National Training Center  
2180 South Hudson Street  
Denver, CO 80222

Circle Reader Service No. 35

## THE ROUGHNECKS™

Subscriber Terminal Entry Enclosures

- Reduces Field Costs
- Dress Up Your Drops
- Improve the Perceptual Value of Your Service
- Increase Customer Response Time
- Protects and Shields the Weather Away from Your Drop Passives
- Reduces 3rd Party Tampering Patent Pending

### Locking Terminator

Can be locked with any manufacturers locking terminator

For a Free Sample Kit for evaluation, prices & complete catalog, call or write our Distributor Representatives or



Engineered to Make the Difference

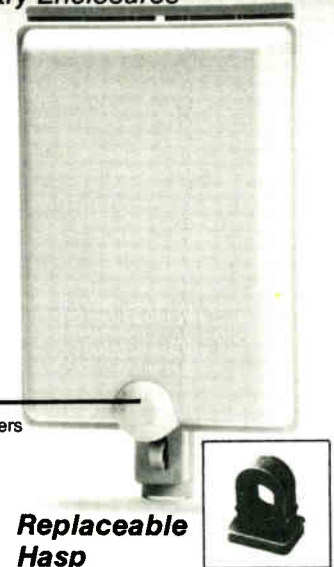

**Replaceable Hasp**

Patent Pending

196 Morgan Ave.  
P.O. Box 955, Elyria, Oh. 44035  
Phone (216) 324-4941  
FAX (216) 324-4947

Circle Reader Service No. 36

# Introduction to Tape Compilers for Commercial Insertion

**M**any cable systems are looking to commercial insertion to provide a revenue stream that complements subscriber billing. The cable systems that already have commercial insertion systems in place are interested in improving their operations. A compiler, or automatic editing system specialized to produce video tapes for commercial insertion, offers key advantages over hand-editing.

The purpose of this article is to describe how a compiler can be used to increase the productivity and quality of tape production; how the compiler can be used to handle typical tape production crises; and finally, how to choose the right compiler for your operation.

## Overview of commercial insertion

Figure 1 provides a simplified overview of the business of commercial insertion. The advertiser contacts the ad sales group of a cable system and makes a media buy with an account executive. The advertiser and the account executive create a contract which specifies when the spot should start airing, during which programs or day-parts the spot is to run on, which network or mix of networks the spot should be aired, and finally the end date for the spot.

These contract conditions are provided to the traffic group, and the production house tape containing the spot is provided to the tape production group.

The traffic group generally uses special software, called traffic and billing (T&B) software, to assign the new spot a unique identification number, called the spot ID, and to enter the spot's parameters.

The T&B software then generates a schedule, what I call a pre-log for a future date. The T&B software analyzes all the factors for each spot that needs to air, and all the network avails that are known to it, and finally produces a schedule which is designed to maximize the revenue for a given day. Pre-logs are generated for each network that is inserted upon.

There are two basic insertion strategies available to the cable systems: Sequential, where the spots are edited onto the tape in the order which they are to play on air; and random access, where a schedule that determines the order

of on-air play is downloaded from the T&B software to the commercial insertion system.

The tape production group manages the library of production house tapes, which often numbers in the hundreds. The tape production group receives the pre-logs and must edit the spots onto either a sequential tape or random-access tape depending on the insertion strategy of the cable system.

After the commercial insertion system has the on-air tapes and the schedule (if random access), the CIS is ready for insertion. When the presence of an avail is detected on a network, the CIS inserts the commercial or "pod" of commercials. Each commercial usually has its unique spot ID encoded as audio information for verification.

Next, the verification sub-system monitors the network and logs the spot IDs of all commercials that are aired. This generates the post-log. The post-log is the basis for billing the advertisers. Only spot ID entries appearing in the post-log are billed.

The pre-log (what was planned by the T&B software) should ideally match the post-log (what actually aired). And, in fact, the difference between the two can be partitioned into various factors that may indicate problems with the commercial insertion operation.

## The tape

There are two classes of CIS tapes used by commercial insertion systems: Sequential and random access. These tapes

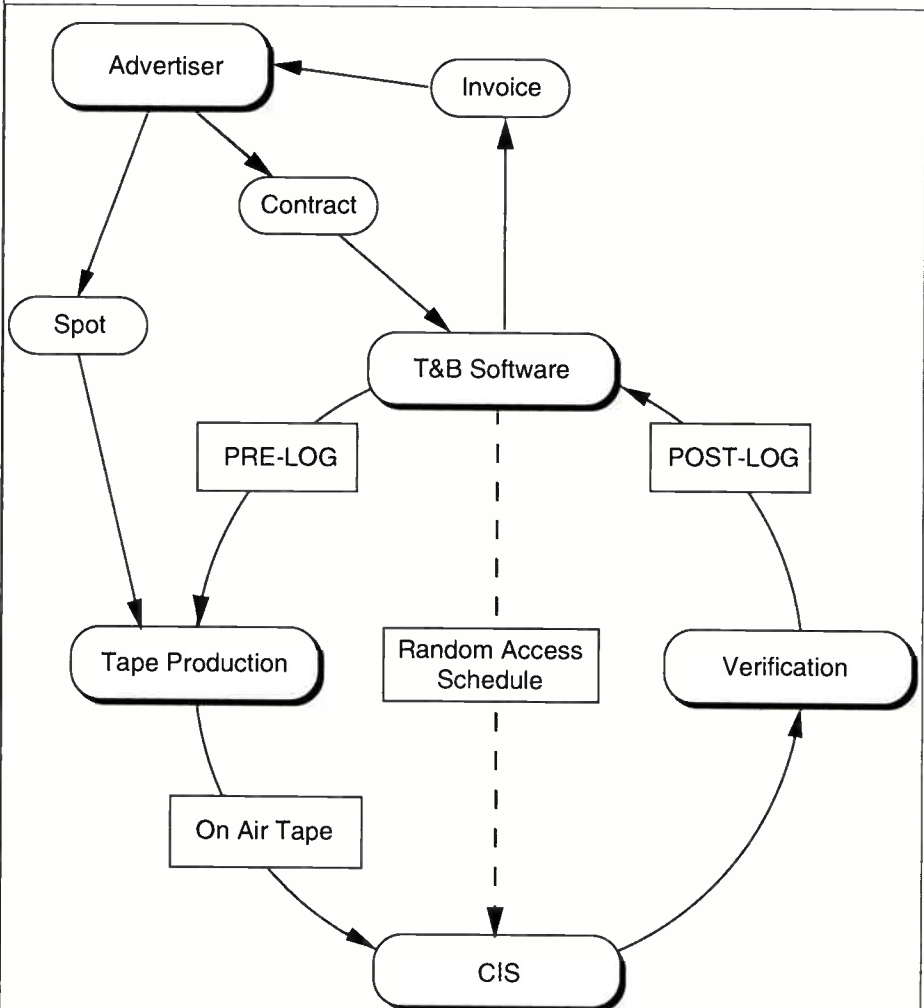

Figure 1

by John Stuart Houston, Consulting Engineer to Channelmatic Inc.



## Why Texscan's Ad Insertion Systems Build Confidence

QUALITY  
TECHNOLOGY  
EXPERIENCE  
SERVICE  
COMMITMENT

### ► Texscan Quality

When you select Texscan you're choosing the cable advertising systems leader. Leadership in the industry is a result of our total commitment to quality. We deliver a quality product mix designed to save time, minimize operator involvement and increase your advertising profits.

### ► Texscan Technology

Texscan provides a variety of system options, allowing you to select systems that fit your precise needs and budget. All our systems employ *state-of-the-art* technology.

### ► Texscan Experience

With 20 years of experience in the cable industry, Texscan has a reputation for continually exceeding the demands of the industry.

### ► Texscan Service

Texscan customers have access to a 24 hour, 7 days a week customer support hotline. Texscan also offers extensive new customer training programs.

### ► Texscan Commitment

At Texscan we're committed to the rapidly growing and changing needs of the industry—a commitment so strong it could be engraved in stone. Select Texscan with confidence.

Your source for:

- Commercial Insertion Systems
- Tape Marking & Compiling Systems
- Character Generators

*"Ask For Our Budget Planning Kit"*

**Call Us Today For More Information**  
(800) 367-6011 or (801) 359-0077

**Texscan** *MSI*

124 N. Charles Lindbergh Dr. • Salt Lake City, Utah 84116

Circle Reader Service No. 37

are also known as on-air tapes and spot reels, depending on the context. Each CIS vendor typically owns proprietary sequential and random access tape formats that differ from the other vendors' tape formats.

Spot reel formats differ in their structure and their encoding. Encoding is a method of providing cues and data about the tape's structure and content to the CIS. A few compilers can produce tapes in many formats.

Figure 2a illustrates an example sequential spot reel format. Although the spots are the most basic elements of the tape, it is important to group the spots into pods, where each pod will eventually be matched on-air to the appropriate avail. The order of the spots and their membership in pods is designed by the T&B software. The tape will generally use one of the audio tracks to encode markers to provide cues to the CIS. There is a park tone signifying the beginning of a pod, and end-of-pod (EOP) tone, and finally an end-of-tape (EOT) tone, which cues the CIS when to rewind the tape.

Additionally, each spot has its spot ID encoded within the spot for verification purposes. These cue tones are

exclusively for the CIS and are inaudible on-air.

Figure 2b illustrates an example random access spot reel format. The tape format contains a BOT (beginning of tape) marker, which is often used as a reference point for locating spots. The directory (DIR) typically provides a name for the tape, a count of the spots and a cross reference table containing the spot ID, the spot description, and the location (often in control track counts relative to the BOT marker) of every spot on the tape. Each spot is typically preceded by a park cue tone, and the tape often has an EOT (end-of-tape) cue tone.

There are additional parameters of a tape format which are set to the preferences of the tape production supervisor. These may include the number of frames of black between spots (The inter-spot interval or ISI) and the number of frames of black between pods (the inter-pod interval or IPI).

### The tape production group

Maximizing the avails and minimizing the discrepancies, while ensuring quality, are the goals of the tape produc-

tion group.

The tape production group is responsible for producing the on-air tapes and distributing them to the appropriate CIS, which may reside in multiple headends for larger cable systems or interconnects.

The tape production group manages the inventory of production house tapes, which contain the original spots provided by advertisers. Some of the larger cable systems offer commercial production services for the benefit of their advertisers.

This group produces the on-air tapes. Some groups duplicate (dub) and distribute copies of the edited spot reels to multiple headends. Therefore, the group must edit master spot reels, encode them for the CIS and make dubs. Other groups place edited tapes directly on air.

Quality control is very much a function of the tape production group. They are often the people who ensure that editing and dubbing decks are maintained and correctly adjusted and who monitor the networks during insertion to ensure the best playback for the advertiser.

Finally, this group must handle the inevitable last minute insertions and compensate for failed editing or dubbing equipment.

### Basic compiling concepts

The primary purpose of a compiler is to produce tapes to the specification of the T&B software for placement into the commercial insertion system.

Figure 3 illustrates the principal elements of a typical compiler. Of course different compilers have different implementations. My objective here is to explain the elements and data flow for one of those solutions. The underlying reason is that it will be easier for the reader to understand the nature of a compiler with a deep insight into one solution rather than a shallow overview of all.

The T&B software interface module receives the instructions for the creation of each spot reel and information about each spot.

Next, this information is imported into the central database. The central database stores information on all spots, and on all reels. There are two types of reels: Library and spot reels. The library reels are an ever-changing collection of spots which are active; that is, spots currently required to appear on the spot reels. More about library reels



- keeps you on top of program switching with simple remote control software for your Series 3000 Program.
- controls up to 30 headends with your IBM PC compatible.
- uploads and downloads program switch schedules.
- monitors status and controls outputs.
- remotely sets up system configuration.
- SYNOPSIS is the software that activates your Series 3000 Hardware.

**ME MONROE ELECTRONICS**

100 Housel Avenue, Lyndonville, NY 14098  
716-765-2254 • FAX 716-765-9330

MADE  
★ IN ★  
U S A



Panasonic® just erased the last  
advantage videotape had  
over videodiscs.

Presenting the LQ-4000,  
the first rewritable optical  
disc recorder/player.



You've never worked this  
fast. You've never worked this easy.

Because you've never had a tool with the speed and  
flexibility of Panasonic's new LQ-4000 rewritable.

It makes post-production and commercial insertion  
editing with tape seem like slo-mo.

Forget tape shuttling. Forget degraded picture  
quality. Panasonic gives you unparalleled speed and  
outstanding clarity.

You can access any frame or section of the disc in  
an average of 0.7 seconds. And play selections at up to  
10 times the normal speed (up to 300 frames/second).

You still write to or from all your familiar formats,  
like S-VHS, Analog RGB, Dubbing and Composite.  
And the LQ-4000 uses standard RS 232/422 and I/O  
Interfaces. Best of all, the picture is always near-broadcast  
quality (420 lines in Hi-Res mode), whether you're  
rewriting to disc for the first time—or the millionth.

The Panasonic® LQ-4000 Rewritable Optical  
Disc Recorder.

Tape has met its master.

For further information on the LQ-4000 or player-  
only units, call toll-free 1-800-742-8086.

*Peripherals, Computers, Printers,  
Copiers, Typewriters & Facsimiles*

**Panasonic**  
Office Automation 

# COMMERCIAL INSERTION

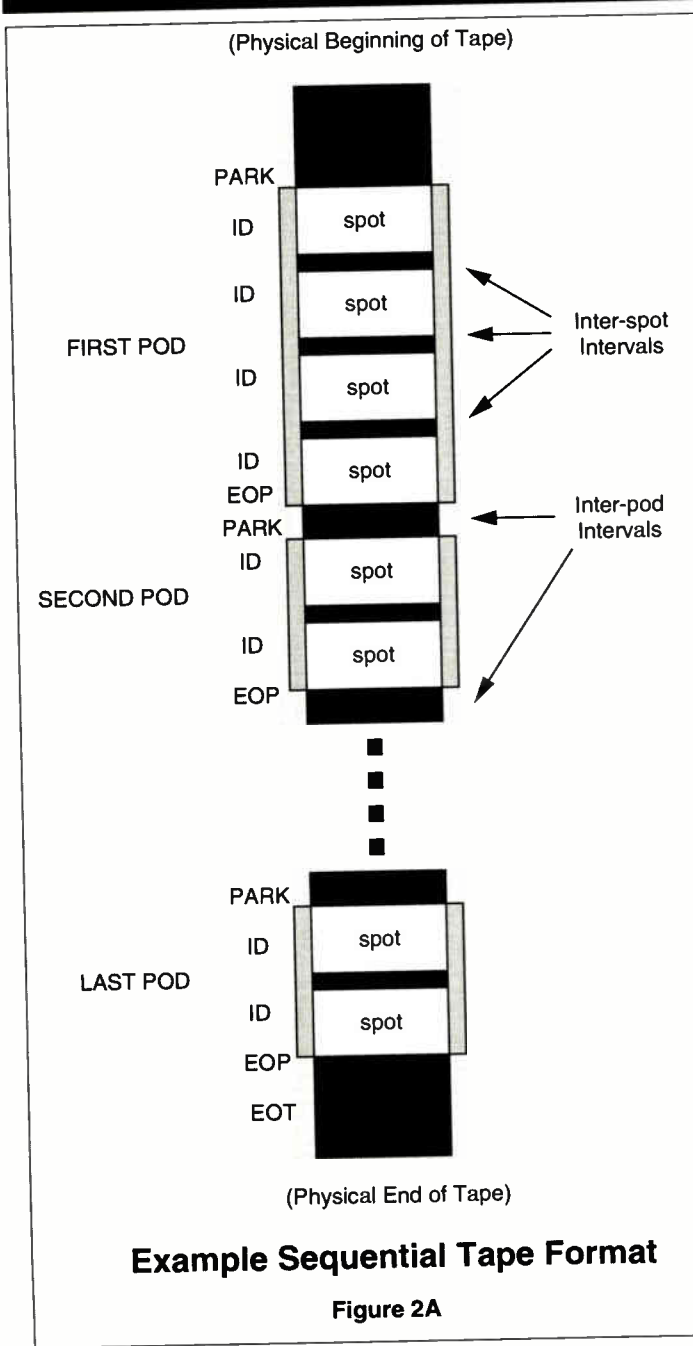

later. The spot reels are the reels which are formatted for the CIS, and will either go "on-air" or will serve as master spot reels which will be dubbed onto on-air spot reels for insertion into the CIS.

Additionally, the central database is the clearinghouse for information on the compiler resources, described below.

The central database has two "clients:" One is the T&B software, which designs the spot reels and provides the definitive descriptions of the spots; the second is the human, who has visibility into the central database to make last-minute corrections, to monitor what's going on, to manually enter information and to generally orchestrate the compilation process by selecting which reels are to be compiled.

An editor edits tapes. A reel is a physical tape that has audio video segments and data for

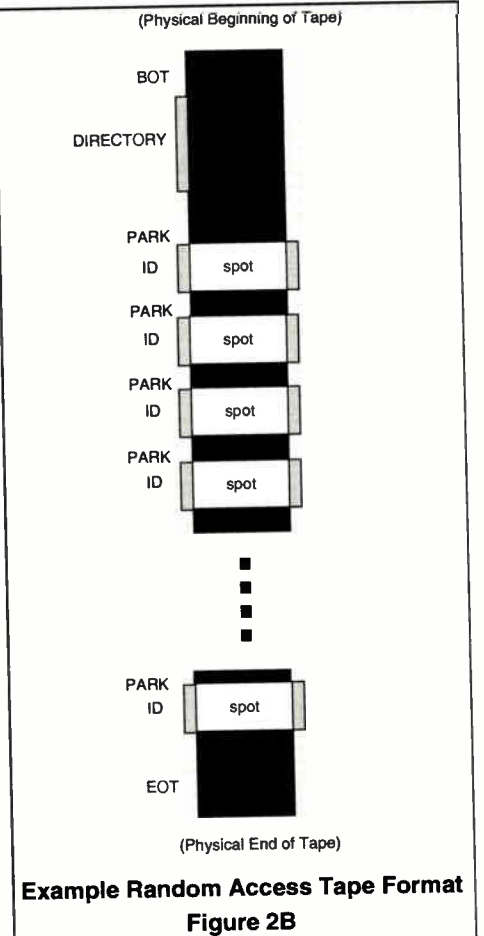

the CIS encoded onto an audio track. The editor inserts, assembles, views and changes the tape. Here's a thought: Word processing is a way to allow intuitive viewing and manipulation of a document before it is printed. Wouldn't it be great if we could have a compiler that allowed us to view and modify spot reels, to cut and paste spots, before the tape is built by the compiler?

Therefore, let us adopt the popular computer term, virtual, to describe the cen-

from  
**Refurbished Videociphers \$450**  
\* New PLUS VCII's **\$669**

- \* New Plus Board
- \* Refur Power Supply
- \* Refurbished Chassis
- \* Refurbished Buffer Board

**Most Repairs \$93**

DMK ENTERPRISES, INC.  
DBA  
**TULSAT**

1575 North 105th East Avenue  
Tulsa, Oklahoma 74116  
(800) 331-5997

**VIDEOCIPHER II REPAIRS**

**Save Money**

**2 DAY EXCHANGE \$169**

**MOST SHIPPED IN ONE WEEK!**

**VCII PLUS**

\* UPGRADES EXCHANGE

**NEW IRD + \$269.00**  
**STANDARD + \$269.00**

\* MUST BE WORKING WHITE LABEL OR IRD CARD

Circle Reader Service No. 40



THE  
OPTICAL  
ADVANTAGE  
ANYONE  
CAN  
SEE.

# DEPTH OF KNOWLEDGE

## Only Sumitomo designs, manufactures, and supports everything you need



*Sumitomo makes a full range of fiber optic cables. Choose from matched clad or depressed clad fiber in either loose tube or LitePipe™ cable construction.*

As a result, you don't get a runaround: questions get answered, problems solved, deadlines met, network goals achieved. ■ We

design, manufacture, install and support everything optical you need for video transmission. Including a full line of optical VSB-AM and digital video transmission equipment, matched clad VAD-type fiber pioneered by Sumitomo. Loose tube and economical LitePipe™ optical cables. Fully automated fusion splicers. Plus optical connectors and patch cords, all made by Sumitomo. ■ Hardware, though, is only half the story. Using



*Our compact, lightweight T-35 fusion splicer is fully automated. You get advanced features because we pioneered fusion splicing.*

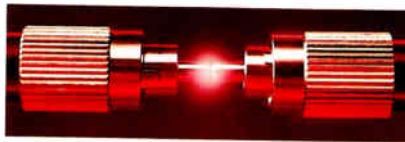

*We manufacture a full line of multi-mode and single mode cable assemblies in standard or custom lengths.*

our own in-house resources and expertise,

*Sumitomo VSB-AM video transmitters and receivers—rack, strand and pole mount—give you unmatched network design flexibility. Every unit meets uniformly high performance specs.*





# RESOURCES.

builds, installs and supports  
for video fiber optics.

we offer engineering services and turnkey construction:

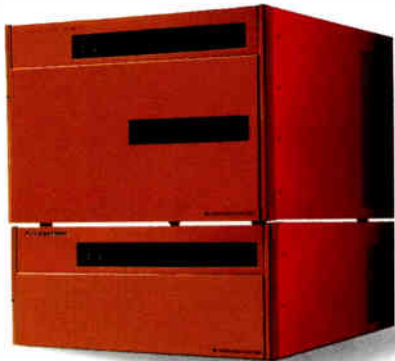

*Sumitomo digital transmission equipment is cost competitive with FM. Get up to 24 video channels on a single fiber without compression or wave-division multiplexing.*

single-source responsibility for your project, from initial design to turn-up.

■ Then there's training programs, ongoing support, maintenance/repair with loaners—whatever you need. Whatever you want, all or any part. Including peace of mind—



*We do it all, including engineering and construction—entire turnkey newbuilds and rebuilds, plus ongoing maintenance, repair and support.*

one reason we've been a leader in fiber optics and cable television for nearly 20 years. ■ Call us at (800) 358-7378. Discover the optical advantage anyone can see, but only Sumitomo can deliver.



*We think you have a big future with fiber optics, so we invested \$100 million in our North Carolina research and manufacturing headquarters facility.*

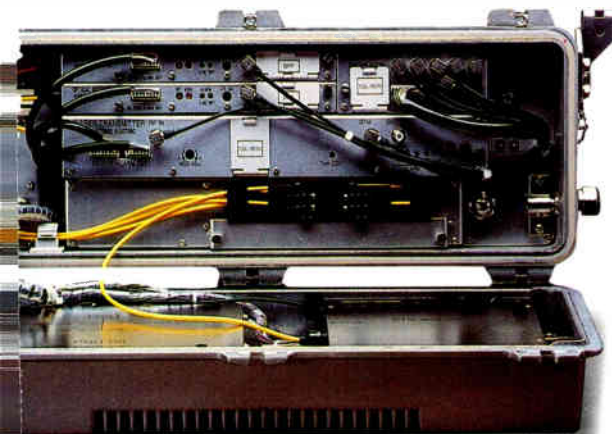

*Our new, economical VSB-AM strand mount optical receiver frees you to create fiber-to-feeder and fiber-to-line-extender architectures.*



# Sumitomo Electric, your light-support system.



## VIDEO TRANSMISSION EQUIPMENT

### ANALOG

Choose from our full line of rack, strand and pole mount equipment. Optical transmitters and repeaters are available with 4 or 6 mw lasers at 1310 nm, rack or strand mount. The rack housing accommodates up to 2 transmitter or receiver units within 2 mounting spaces. One strand-mount trunk station provides 30 dBm V output and accommodates up to 4 receivers or 2 transmitters or 2 receivers and 1 transmitter with an A/B switch plus status monitoring. Our secondary-node receiver provides 48 dBm V for fiber to the feeder architectures.

### DIGITAL

Simple to maintain, our equipment consumes far less space and power than FM — and requires fewer optical fibers. Sumitomo systems transmit, without compression, NTSC, PAL and BTSC baseband video/audio signals at 2.4 GBs, 24 channels on a single fiber; 1.2 GBs, 12 channels; or 400 Mbs, 4 channels. Up to 72 channels fit in a single 6-foot rack. Channel capacity can be doubled via Wave Division Multiplexing. Transmission distance: up to 80 km without a regenerator. Express and drop regenerators available. Systems meet RS250C medium haul specifications.



## CONNECTION SYSTEMS

### FUSION SPLICERS

Sumitomo pioneered fusion splicing, which produces economical, high-quality splices. Advanced features include high-speed imaging in two directions, self-diagnostic arc test and high-accuracy splice loss estimation, plus easy-to-use tools for fast stripping and cleaving. Sumitomo Type 35 is an industry standard, and our Type 51 splices up to 12 fibers at once. Our splice sleeves provide optimum protection.

### CONNECTORS

We make a full line of optical multimode and single mode cable assemblies with connectors such as Biconic, ST, FC, D4, mini-BNC and SC. We provide custom lengths and can make Super PC Polish connectors, even FDDI.

## DEPTH OF RESOURCES

We're part of \$6-billion Sumitomo Electric Industries, Ltd. Group. Our \$100-million, 350,000 sq. ft. manufacturing complex in Research Triangle Park, North Carolina employs more than 350 people dedicated to meeting all your optical network needs.



## OUTSIDE PLANT

### FIBER OPTICAL CABLES

We manufacture cable with your choice of matched clad or depressed clad fiber. We offer loose-tube cable in fiber counts of 4 to 216, plus our new, economical Lite-Pipe™ cable in counts of 2 to 24. Reel length: up to 12 km. Sumitomo pioneered vapor axial deposition (VAD), the matched clad fiber-making process that set the record for low loss. We offer optical cable sheath construction from all dielectric to double armoured suitable for all installations (lashed aerial, duct and direct buried) and environments.

### CONSTRUCTION & ENGINEERING

We provide any level of service including entire turnkey newbuild or rebuilds. Our in-house experts work closely with your people to evaluate design alternatives, select methods of construction, perform installation, and do turn-up, testing, fusion splicing, repair and maintenance. We offer single-source responsibility, assuring your project gets done right.

 **SUMITOMO ELECTRIC**  
Fiber Optics Corp.

YOUR LIGHT SUPPORT SYSTEM

78 Alexander Drive ■ Research Triangle Park, NC 27709 ■ (800) 358-7378 or (919) 541-8100 ■ Fax (919) 541-8265

Member of the Sumitomo Electric Industries, Ltd. Group



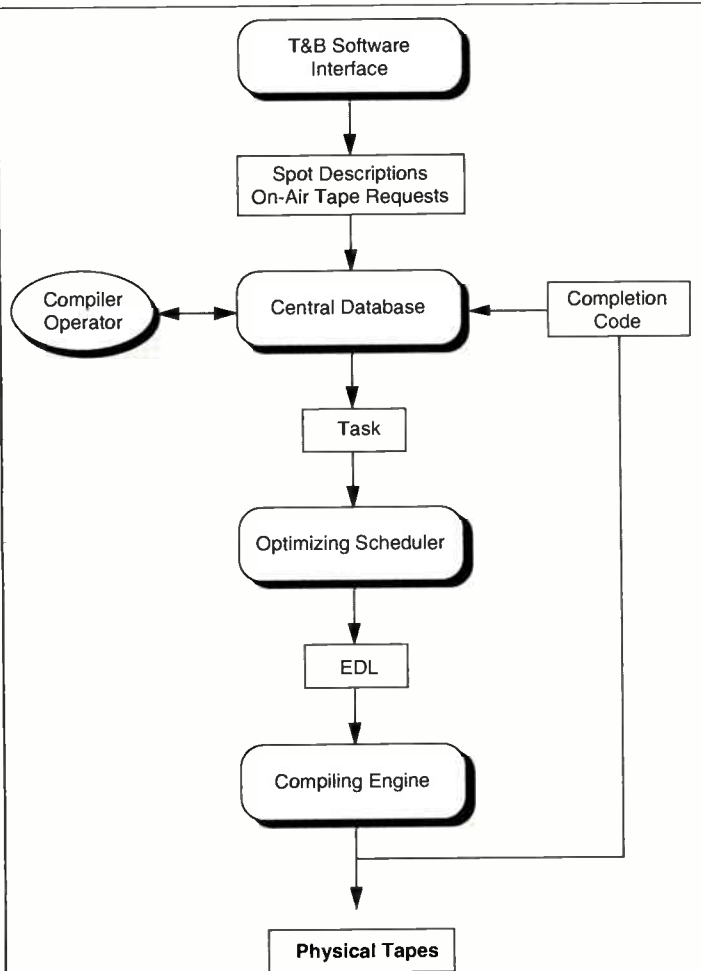

**Figure 3**

tral database representation for any spot or library reel which we can create, view, modify or print while within the database. The central database provides commands for all of these operations.

How does the compiler allow us to create the physical equivalent of the virtual reel, producing a library or CIS tape? First, the optimizing scheduler (OS) plans the extraordinary transformation of a virtual reel into a physical reel by creating two streams of instructions: First, an EDL for the compiling engine, and second, a companion sequence of prompts for the operator, often embedded within the EDL.

The OS is often the most sophisticated module in the entire compiler. The OS has to analyze the work (the task) that is chosen by the operator and generate a sequential plan to utilize the resources of the compiling engine to create the CIS tape, the ultimate product of the compiler.

The compiling engine has a variety of

resources known to the compiler for actually editing spots (both audio and video), encoding the tapes for the CIS and providing instructions to the operator via a computer monitor. These resources include at least one playback deck and one record deck, and usually a tape encoding unit (TEU) for encoding the tape for the CIS. Some compilers have multiple playback decks, multiple record decks, multiple TEU channels, a computer monitor, possibly a computer keyboard and a video switcher.

A fundamental difference between a very basic and an intermediate to high-end compiler is the ability

to insert edit. Some compiling engines provide insert editing, others provide only assembly editing. With insert editing, you can lay down the pieces of the physical tape in any order without affecting the final outcome. With assembly editing, you must start editing at the beginning of the tape and continue until the end. Insert editing provides two key advantages: A physical reel can be created in a checkerboard manner, which is a tactic used by the OS to increase throughput; often an old physical reel can be updated with a few insert edits to produce a new physical reel, which also increases throughput. The compiling engine described here has insert editing capability.

The compiling engine executes an edit decision list (EDL), which is a sequential list of instructions such as:

Prompt Operator -> "Place Library Tape One in Player Two" or  
Write BOT Marker or  
EDIT (a specific spot from a library reel in a player to a specific location on a spot

reel in a recorder making sure to encode the appropriate information for the CIS).

The standard operating procedures for a compiler operator are:

- Update library reels.
- Create new spot reels.
- Back up the central database.

The use of library reels significantly reduces the number of tapes required to be used for the compilation of the spot reels. If you have 300 spots on production house tapes, you could store that inventory on four or five 60-minute tapes. If you have four or five playback decks available, you will never have to change source tapes during a compilation.

### Updating the library reels

The central database contains representations of both library and spot reels. We can allow the operator to view and manipulate virtual library and spot reels, performing changes within the central database, then later use the OS and the compiling engine to edit the physical library and spot reels. Recall that the T&B software interface provides the central database with information about each new spot and each new spot reel.

Updating the library reels means that the operator will first delete old spots from the library reels, creating vacancies for new spots; subsequently, the operator will find a place for each new spot on one of the library reels.

Once the virtual library reels are updated, the operator must update the physical library reels. Since the compiler can remember the current composition of any physical library reel, then it will provide the following information to the OS:

- The description of the existing physical library reel;
- The description of the updated virtual library reel; and,
- The resources of the compiling engine.

Upon receiving this information, the OS first determines the edits that need to be performed on the existing physical library reel to make it identical with the updated virtual library reel. One can think of this as subtracting the old reel from the new reel, revealing the edits that, when made to the old reel, will produce the new reel.

Next, the OS considers the resources available in the compiling engine to perform the work, and then generates the EDL and operator instructions.

The operator will be prompted to load the physical library reel into a recorder, and then one-by-one to place the production house tape for a spot into a player, locate its first frame of video, and signal the compiling engine to automatically transfer the spot to the appropriate location on the destined library reel. Upon completing the library reel, the central database will be notified that the physical library tape is now updated through the receipt of a completion code.

**Creating the new spot reels**

Once the library reels are updated, then any spot that is required for the building of a spot reel is available within the library.

Recall that we have imported the specifications for all new spot reels from the T&B software into the central database. Within the central database we can view and modify, if necessary, the new virtual spot reels before we utilize the OS to create the physical spot reels. Once the operator is satisfied with the virtual spot reel, he can send it to the OS along with the description of the compiling

engine resources to allow the OS to create an EDL and operator instruction stream.

This time, the OS also looks into the central database to determine the locations of every spot required to make the physical spot reel. Additionally, if the compiling engine has the capacity to cleanly insert video and audio, then the OS can commandeer an existing but out-of-date physical spot reel to use as a basis for making the new spot reel. If the OS is requested to make a physical MTV tape for 7/4/93, for example, the OS may be able to use the physical MTV tape for 7/1/93. The OS would determine the minimum number of edits required to update the MTV tape.

Once the group of edits is determined, the OS will then analyze the available resources of the compiling engine and create an efficient EDL. Upon successful completion of the EDL for updating or creating the physical spot reel, the central database will be notified that the physical spot reel corresponds to the virtual spot reel.

You can see that in this compiler, the central database is very important

to the tape production group. The central database maintains all information of the spots, all virtual reels, all physical reels, and much more information. The loss of this information could be a major setback for a tape production group. With the inevitable lighting strikes, power surges, power fails, and general computer failure, backing up the data on a daily basis is a necessity.

**Special conditions**

Let's look at how a compiler can handle two of the common crises that the tape production group encounters.

**Losing a tape.** In the event that a physical reel is lost or irrecoverably damaged, the central database has a virtual reel that describes it. By notifying the central database that the physical reel is lost, the operator can re-create the reel via the OS and the compiling engine.

**Last-minute changes.** In the event that a physical reel has a spot that should not air, then the operator can edit the virtual reel within the central database, choosing a new spot. If the new spot is not in the library, the operator then

**ANNOUNCING..... A LITTLE AMPLIFIER THAT JUST MIGHT BE...**

**THE BIGGEST STEP FORWARD IN LINE EXTENDER DESIGN IN YEARS!**

**MINEX Series  
Line Extenders**

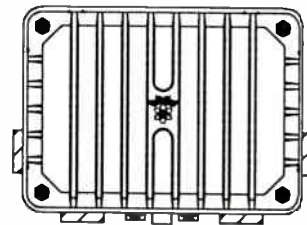

Up to now, line extenders have traditionally fallen into two categories; full function amplifiers, and "mini" amplifiers which were little more than simple line stretchers. Advances in Hybrid integrated Circuit design now allow us to offer COMPLETE, FULL PERFORMANCE LINE EXTENDER, in a LINE PASSIVE SIZED PACKAGE. The MINEX Series line extenders are designed for application as main distribution amplifiers, with the features and facilities you expect from a full sized line extender: only the size (and power consumption) are smaller. MINEX amplifiers offer all the performance and capabilities you expect, along with some features unavailable in the "traditional" (yesterday's technology) amplifier.

**SOME OF THE FEATURES AVAILABLE IN THE MINEX SERIES:**

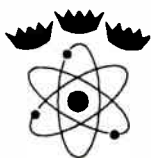

**DISCRETE, PUSH-PULL, AND POWER DOUBLED MODULES  
ALL SET-UP AND POWER DIRECTION CONTROLS BUILT IN  
BI-DIRECTIONAL OPERATION, WITH THROUGH/STOP SELECT  
CURRENT-MODE, FULL-RANGE SWITCHING POWER SUPPLY  
SELECTABLE VERTICAL or HORIZONTAL 5/8 CABLE ENTRIES  
EXTERNAL MATCHED TEST POINTS  
ALL IN A 5 1/2 x 4 1/2 INCH PACKAGE!**

**TRIPLE CROWN ELECTRONICS INC.  
4560 FIELDGATE DRIVE,  
MISSISSAUGA, ONTARIO, CANADA L4W 3W6  
Tel 416-629-1111/Fax 416-629-1115**



# WE'VE FINE-TUNED THE ART OF CONVERTER REPAIR.

Don't miss CONTEC at  
the Western Show,  
Booth 701, November 20-22.

At CONTEC, we restore converters to manufacturer's specifications—and do it with the industry's fastest turnaround.

We monitor our repair process electronically to track the quality of our workmanship every step of the way. Our factory-trained technicians service addressable and standard converters, while state-of-the-art testing ensures that every unit looks—and *performs*—like new.

The bottom line? You'll *save* money by trusting your repairs to the expert. You'll *make* money—because our

on-time delivery lets you reduce inventory, and put more converters into more subscriber homes, faster.

**Plus, consider these cost savings:** Our remote control units and remanufactured converters are available for

immediate sale and delivery. Both offer the quality and performance you can count on.

Isn't your company worth the clear advantage of CONTEC? Call our national Customer Service Hotline now at:

**1-800-382-2723.**

**CONTEC**  
INTERNATIONAL

Nationwide Service Centers: Bloomington, IN • Fenton, MI  
Longview, TX • Schenectady, NY • Seattle, WA • Tampa, FL  
Ventura, CA • West Columbia, SC.

Circle Reader Service No. 42



# COMMERCIAL INSERTION

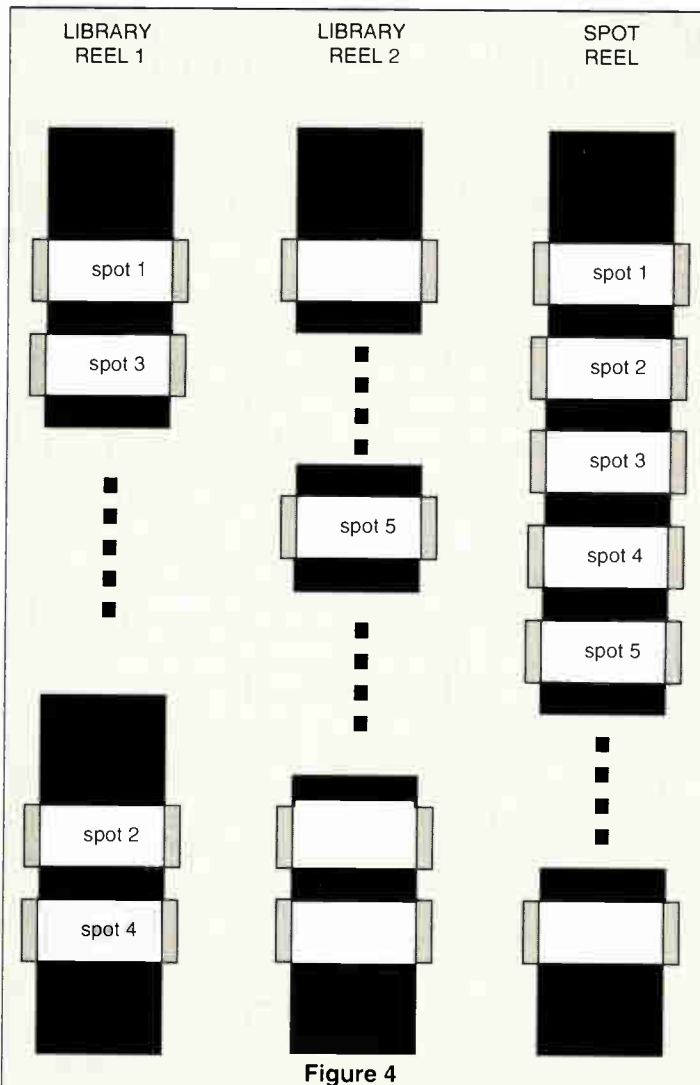

Figure 4

the OS would command library reel 1 to shuttle to spot 2. While the library reel 1 is shuttling toward its end, the OS would lay down spot 5. Finally the OS would lay down spot 2 and spot 4 (or possibly 4 and then 2).

The goal of the OS is to minimize the time required to edit the task. The OS uses two primary tactics to achieve this goal. The first is the minimization of shuttling time. Shuttling time can be minimized by having multiple playback and / or multiple record decks. The OS can strategically have multiple decks in motion, some decks participating in the edit, others shuttling to their next destinations. The OS can also strategically order the sequence of edits to increase the likelihood of this interleaving.

The second primary tactic of the OS is simultaneous editing. If the compiling engine has multiple record decks, and the OS determines that the same spot

is required on more than one spot reel currently loaded in the record decks, the OS can strategically perform a simultaneous edit, effectively killing two birds with one stone.

## Buying a compiler

The best argument for buying a compiler is that it limits the risk of something going wrong with the production of tapes for the commercial insertion systems.

The design of a good compiler recognizes that humans are very good at some tasks (such as setting up video levels or determining the first frame of video of a spot) and computers are very good at other tasks (such as managing a database or creating an EDL).

Referring back to Figure 1, I mentioned that a measure of the quality of a commercial insertion operation is how well the pre-log (that which was planned) matches the post-log (that which actually happened). Because a well-designed compiler is fully integrated into the data flow between what the T&B software requests and the creation of tapes that are suitable for the commercial insertion systems to perform their tasks, the likelihood that the pre-log and post-log match is greatly increased over manual data entry and manual editing. With the use of this specialized tool, the operator orchestrates the compile process and can successfully manage the inevitable crises that occur in tape production.

The central database maintains a tremendous amount of low-level data, thus freeing the operator to work at a higher level, and reducing the variations in spot reels that often occur with tape

production groups that employ manual editing and multiple editors.

The compiler will typically increase the productivity of the tape production group and help ensure a high quality product.

## How to choose a compiler

There is a broad selection of compilers available for the budgets of small tape production groups as well as the very large. Here are some questions that you should answer before finally selecting a compiler.

First, make sure that the compiler is capable of interfacing to your T&B software. Second, determine the power of the central database. Is the information that the central database stores sufficient for your needs and straight-forward to manipulate?

Third, what is the capability of the optimizing scheduler? How many physical reels can be built within one EDL? Can you easily reproduce a lost or damaged physical reel?

Fourth, what is the capability of the compiling engine? Does it insert edit or assembly edit? Does it support the types and numbers of playback and record decks that you wish to use?

Finally, how well does the compiler perform as a system? Does it have high throughput? Does it provide the quality of product that your tape production group requires? Does it successfully handle the types of crises that your tape production group encounters? Is the user interface of the compiler intuitive and sufficiently powerful? Last, does the compiler fit within your growth path?

## Compiler trends

Compilers are rapidly becoming strategic assets of cable systems who engage in commercial insertion. As commercial insertion systems continue to evolve, so do the compilers.

Some compilers now offer the capability to use rewritable laser discs as players and recorders. Some compilers provide advanced editing and switching features for the production of spots or tagging of spots within the tape production group.

It is well known in the cable industry that advertising sales can contribute an increasingly significant stream of revenue to a cable system. The compiler is an important asset to be considered when developing or increasing your commercial insertion capability. ■



**"There Are Two Sides To Every Powering Issue.  
We Have Both."**

Power Guard's New  
**Small Simple Standby™**  
for your Standby  
Requirements and...

**Power Cast™** for  
your Non-Standby  
Requirements



Curt Cope  
CEO, Power Guard

**Available in 3,6,9,12 or 15 amps in both standby  
and non-standby models for all of your powering  
requirements; conventional or fiber.**



506 Walker Street, P.O. Box 2796, Opelika, AL 36801  
205 742-0055 • 800 288-1507

Circle Reader Service No. 45

# Controlling RF integrity in the home

It wasn't too long ago that the NCTA Engineering Committee established an in-home wiring subcommittee to evaluate the problems caused by customers attempting to wire their own homes. Under the chairmanship of Larry Nelson of Comm/Scope, the com-

industry's commitment to solving a problem common to cable operators—poor or faulty wiring jobs done in the home by someone other than the cable operator. At a time when customer service is under such close scrutiny, service calls stemming from loose con-

solution to RF integrity through new home builders and electrical contractors. Square D's Elan Advanced Home Network improves the quality of material installed in the home through a house-wide wiring system that coordinates telephone, video, audio and elec-

## The ELAN™ Advanced Home Network

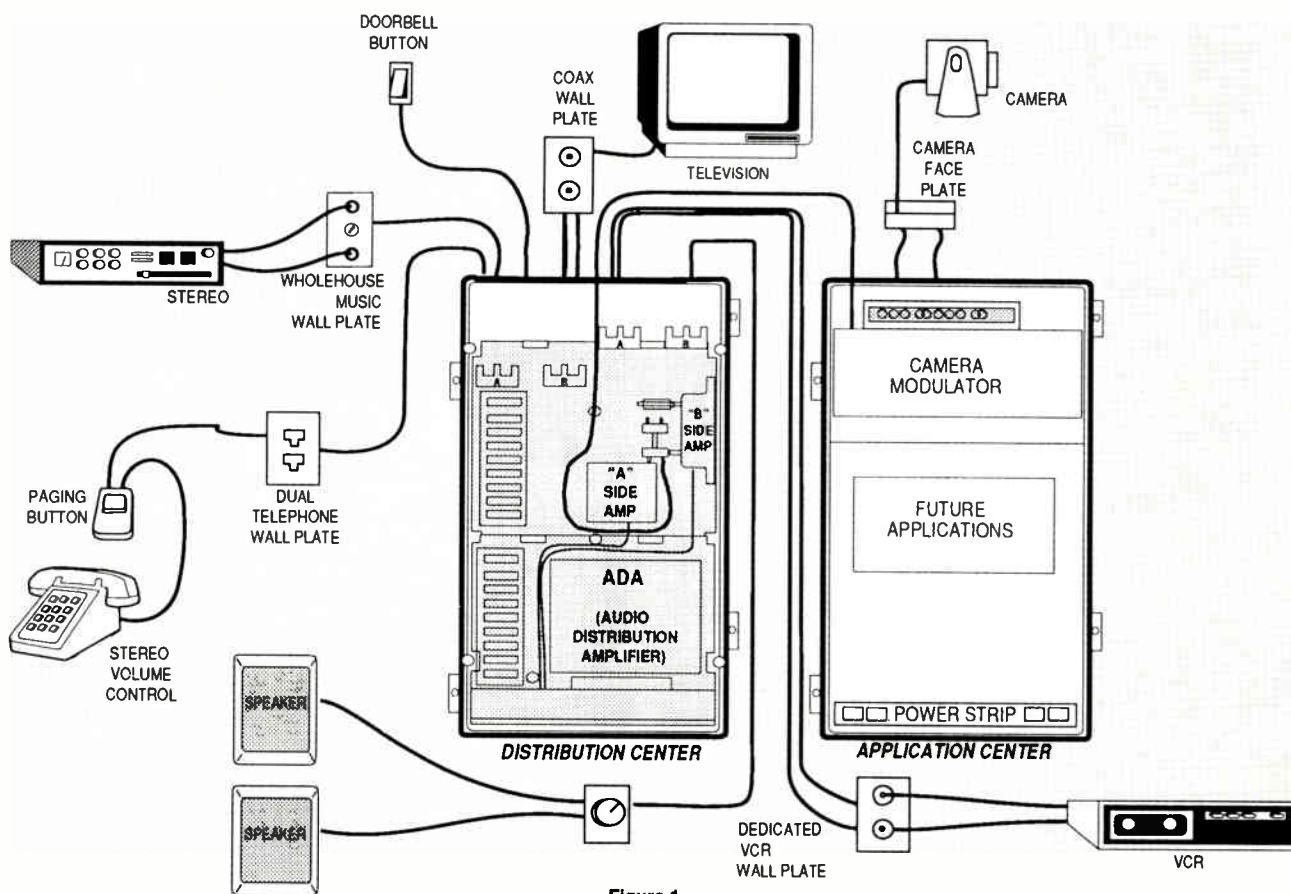

Figure 1

mittee is tasked with finding ways to improve these wiring-related problems. Nelson also heads a similar SCTE subcommittee on recommended practices which looks at requirements for making the subscriber drop better.

These committees demonstrate the

*By Bill Unseld, Manager, New Product Development Square D Company*

nectors or improperly executed hook-ups need to be eliminated.

### Authorized dealers

Although the situation is being thoroughly perused by the various subcommittees, Square D Company, an electrical equipment manufacturer based in Lexington, Ky., offers a unique

trical services in the home.

The Elan system is sold through authorized distributors to local contractors who are trained by Square D to install Elan during the new home construction phase. As a condition for authorized status, the installer must attend a rigorous training course, use only Square D approved components and contact the local cable operator. If



# Get nearly 10 times the optical output of one DFB for under \$6,000\* a node with

## The Diamond Cutter™ Externally Modulated Transmitter.

Multifaceted.  
Flawless.  
Brilliant.



No other technology can match the power of external modulation to drive fiber deeper into your system. And no one but Magnavox can offer you the Diamond Cutter's precise performance and flawless reliability at such an economically attractive price.

Driven by powerful YAG lasers, The Diamond Cutter gives you up to 40 mW of optical output so you can now cover much longer distances -- over 20 miles. And with the Diamond Cutter, you no longer have to band-split your channels over dual fibers. The low distortion, high dispersion immunity and narrow line width inherent in external modulation allows you to send up to 80 channels over a single fiber. The result is the purest optical signal transmission and brilliant picture clarity -- all for less than \$6,000. per node.

To see how the Diamond Cutter can reduce optical transmission costs in your system call your Magnavox representative today.

\* In combination with our new low cost receiver

**MAGNAVOX**  
**CATV SYSTEMS, INC.**

100 Fairgrounds Drive, Manlius, NY 13104  
Call 1-800-448-5171 (In NY State 1-800-522-7464)  
(315) 682-9105 Fax: (315) 682-9006

the local operator's material specifications are more stringent than Square D specifications, the contractor must upgrade the materials used in that cable franchise.

Once the Elan system is installed, a cable technician is able to easily connect cable television service to the Elan home through a specially designed distribution panel. The construction of the distribution panel enclosure discourages the homeowner from tampering with the wiring.

The Elan system ensures RF integrity within the home, simplifies cable hookups and reduces both time and materials expense for the cable operator. The cost of the system can be included in the purchase price of the home by the homebuilder while the electronics eliminate the need for a homeowner to become a Radio Shack patron.

### Looking at Elan

The Elan Advanced Home Network starts with a single, open-wiring format for the coordination of telephone, video, audio and electrical services. This format "reorganizes" the way a house is wired while also allowing for the addition of sophisticated telephone, video and audio systems at a later date. Furthermore, Elan gives the homeowner convenient, immediate access to these services in virtually every room.

Square D works with two companies to produce the total Elan network. International Jensen Inc. supplies the speaker systems and components while Regal Technologies Ltd. provides the video distribution products. All Elan components and product packages meet UL standards and NEC and FCC requirements.

The "hub" of the Elan system is the Elan Distribution Center and a Square D circuit breaker load center. These components consolidate all the telephone, video, audio and electrical services at one location in the home. From this hub, the necessary telephone, audio and electrical wires and coaxial cables are routed to jacks and outlets in all areas of the house (Figure 1).

The telephone wiring system consists of an eight-conductor cable that gives the home the capability of handling multiple incoming lines and assigning them to any phone in the house. In addition, the telephone wiring system offers paging capabilities, phone by phone, through the Jensen audio speakers that are part of the basic Elan package. The telephone

wiring system will also accommodate a link into data communications services such as modems, fax machines or on-line data.

The video wiring system uses dual runs of coax in order to route cable television and VCR signals to any room simultaneously. Any TV in the house can tap into either source at the viewer's discretion. The only requirement is to connect a television to the room's outlet.

The audio wiring system also provides for music and paging capabilities to any room in the home. The ceiling speakers are tapped into the homeowner's stereo system and can be installed in any room, with each room

The background speaker package comprises both the Jensen Classic ceiling speakers and individual room monaural volume controls.

The Elan basic system, containing the components and ancillary items for the network, and the Elan distribution center are the minimum product components required for the network. The basic system is available in two models. The first model provides eight coax outlets, eight telephone outlets and a maximum of eight speakers (six stereo and two monaural speakers). The second model provides for 16 outlets of each service with a maximum of 16 speakers. (Figure 2)

The Elan distribution center is re-

## CATV System Configurations

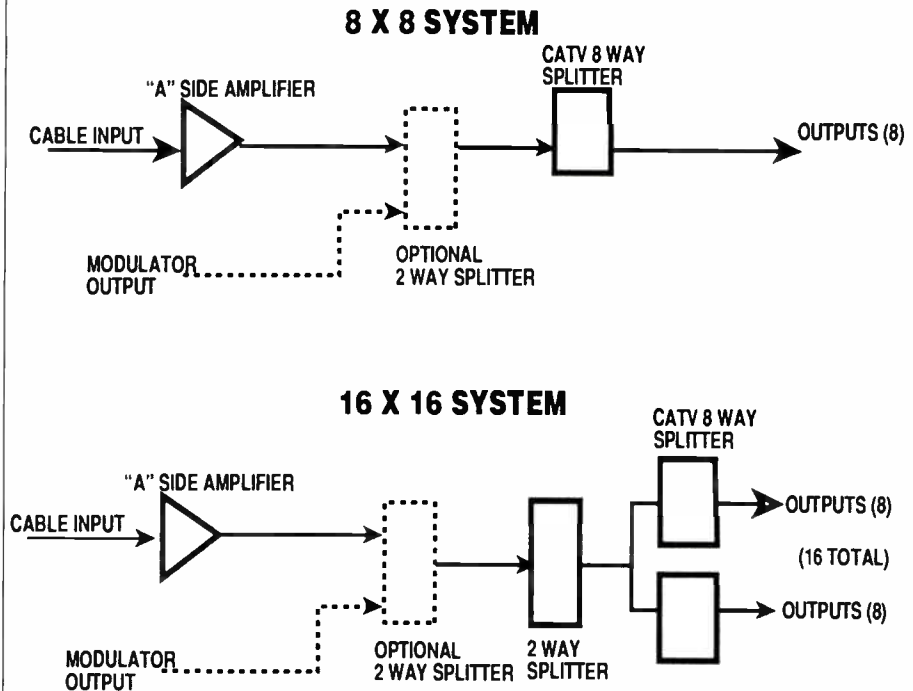

Figure 2

containing its own volume control.

The basic Elan package includes the Elan distribution center, background speaker package and phone paging controls (with paging buttons to be located with individual phones). The distribution center contains:

- Components for video distribution (for both CATV and VCR service).
- Components for telephone distribution.
- Amplifier for music and paging.
- Control for paging.
- A power supply.

quired by both basic system models and is installed at rough in. The distribution center and remaining components of the basic system are installed at trim out.

### Other options

With the basic Elan system in place, the homeowner can have a variety of optional enhanced telephone, video, and audio product packages installed. These optional packages are also purchased through, and installed by, an



authorized Elan contractor. The first of these, the Advanced Video System, allows for the addition of closed circuit television (CCTV) viewing on any television in the home.

The CCTV camera package includes two weatherproof cameras and a camera modulator. The homeowner can monitor various areas in the home by tuning the TV to a specific channel. Because the cameras include built-in microphones, the homeowner can also hear sounds in the areas monitored by the cameras.

Elan's Advanced Audio System option uses Advent audio speakers to add enhanced music distribution capabilities throughout the home. The speakers are designed for ceiling or wall mount between joints or studs after trim out. The outdoor speaker is weather-resistant to provide music to decks, patios or pool areas.

Square D also offers its Home Theater Sound Package which consists of five Advent® Illusion™ speakers that are flush-mounted into the media or family room walls and connected to the homeowner's audio and video equipment via the home theater wallplate.

### Operator input

Because of the need to establish a minimum standard for RF integrity, Square D solicited, and received, valuable input from operators concerning technical specifications for components used in the Elan system. Hence, Square D uses the highest quality products in the distribution center and subsequent distribution path. The requirement of 75 ohm termination is also a key emphasis during contractor/installer training, as is the proper handling of coax. And because the cable industry is making rapid technological strides, both a 550 MHz and 1 GHz version of the Elan system are being offered.

For those cable operators who expressed a desire to control individual television outlets in the basic system, Elan allows an installation contractor to leave the video terminations in the distribution center blank. The cable company can then install lockoffs (75 ohm lockable resistors) on each of the splitter ports except for the television sets the subscriber designates. This then gives control of television access back to the cable operator who can charge for each additional set if desired, rather than treat the Elan distribution center as the cable demarcation point.

It is important to note the distinction between the Elan network and a home

automation system. The Elan system does not work with a centralized control (you can't turn the oven on from your car phone). Rather, the Elan network is a central distribution center and wiring system that takes advantage of the consumer's phones, audio and video equipment in the house using established technology.

The Elan system actually enhances the home to accept current and future services offered by the cable operator through the installation of quality coax and components. Square D's goal is to assist the cable TV industry in improving the standards of in-home wiring by addressing the equipment and training needs of the homebuilder and electrical contractor industries.

### Meeting the goal

In order to help meet that goal, Square D recently announced an agreement with CableLabs to engage in information sharing to promote "recommended practices for in-home wiring." The relationship was established to explore ways in which the quality of the cable system network is extended into and incorporates the TV or VCR at the end of the network. It also

provides for exchange of technical information relating to interfacing intra-premise wiring into the cable television networks.

Advanced wiring systems and new products using the coax infrastructure are being installed today not only by Square D, but also by custom audio/video installers, home automation companies and others. These systems must be in tune to the needs and requirements of the operators. Without standardization, this is very difficult. By working with CableLabs, as well as the NCTA and SCTE subcommittees, overall industry awareness can be improved.

This awareness must also be pushed to the homeowner level. This can only be accomplished through close relationships between the cable, electrical and electronics industry. It is Square D's desire to remain active in subcommittees concerning in-home wiring, maintain close relationships with CableLabs, and develop further ties with cable operators. All these steps will ensure that the Elan Network is reflective of the needs of operators, while satisfying the homeowners desire for an enhanced, cost-effective, electronic environment in the home. ■

## Why do technicians prefer *RISER-BOND INSTRUMENTS* TDR'S?

The answer is **SIMPLE!**



Model 1210 \$4695



Model 2901B+ \$945

### TIME DOMAIN REFLECTOMETER Cable Fault Locator



5101 North 57th St.  
Lincoln, NE 68507  
800/ 688-8377

# Effects of two-degree satellite spacing

**O**n June 28, 1991, Hughes' Galaxy I satellite completed an eastward movement of one degree to its new location of 133 degrees west longitude in the geosynchronous satellite arc. This put it just two degrees away from General Electric's Satcom F1R satellite, at 131 degrees west longitude. With this move, two-degree satellite spacing finally became a reality for cable operators across the country.

While response from the industry indicates no major difficulties were encountered adjusting to this change, the move of Galaxy I is just the first step in a series of satellite launches and moves that will place five adjacent satellites two degrees apart from each other, as shown in Figure 1.

Scheduled for completion by September 1992, these changes will increase the potential of adjacent satellite interference problems for earth station antennas.

With two-degree spacing, more satellites are placed into the same amount of orbital arc, increasing the number of interfering signals. Also, the closer these signals are to your desired satellite, the more likely they are to interfere. This increase in adjacent satellite interference, combined with terrestrial and internal satellite interference, comprise the total interference factor for the downlink antenna.

When these unwanted signals cause excessive reduction in the ratio of

*By Steve Havey, Director of Marketing, Headend Products, Scientific-Atlanta Inc.*

## The Satellite Arc In Transition

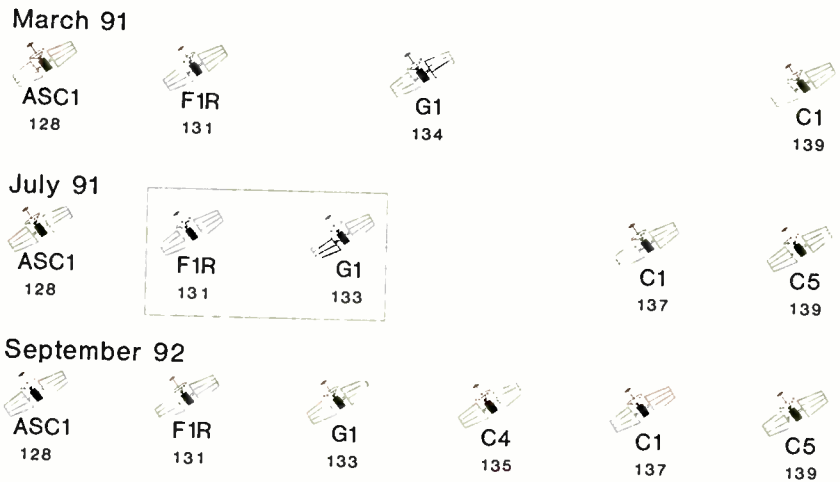

Partial arc, positions shown in degrees west long.

Figure 1

desired signal to interference, expressed as carrier-to-interference or C/I, picture quality degradation becomes noticeable. In addition to actual satellite spacing, the following factors determine how much interference you will experience from the adjacent satellites.

### Antenna discrimination

As anyone who has pointed an earth station antenna knows, they are very directional. Figure 2 shows the gain pattern of Scientific-Atlanta's Model 8345 4.5-meter antenna. This pattern shows how the gain quickly drops as

the angle increases away from true boresight. The larger the antenna, the more directional it becomes. This can be observed by comparing the 4.5-meter pattern in Figure 2 with the 3.2-meter pattern in Figure 3.

With a 2.1-degree angle from boresight, the 3.2-meter antenna signal is approximately 21 dB below the main peak, while the 4.5-meter provides 25 dB of discrimination at the same angle. The narrower beamwidth of the larger antenna provides better rejection of interfering signals from adjacent satellites. While the antenna size is the predominant factor in determining an antenna's ability to discriminate against interfering signals, other factors such as feed design and accurate feed placement are also critical.

For example, by designing a feed which over-illuminates the antenna, it may be possible to increase the gain of an antenna while increasing sidelobe levels even more. The first sidelobe on the 4.5-meter antenna occurs around two degrees off angle. Increasing this level will reduce the antenna's directivity.

In order to assure adequate antenna performance, a prospective purchaser should request a range-generated antenna pattern from the antenna manufacturer. Unlike computer-generated patterns, which only show theoretical performance, range-generated patterns reflect actual measure performance. When calculating the discrimination of the antenna, it is important to note that the angle from boresight for

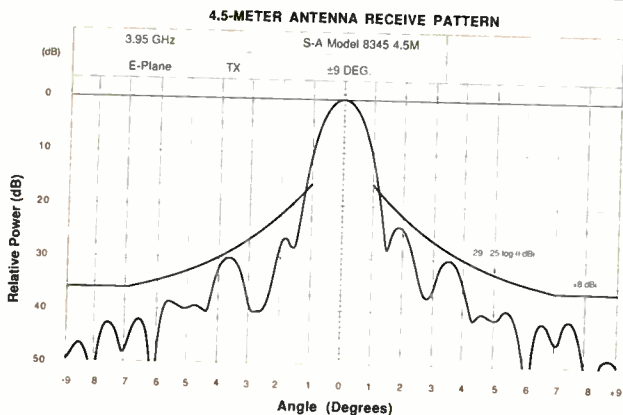



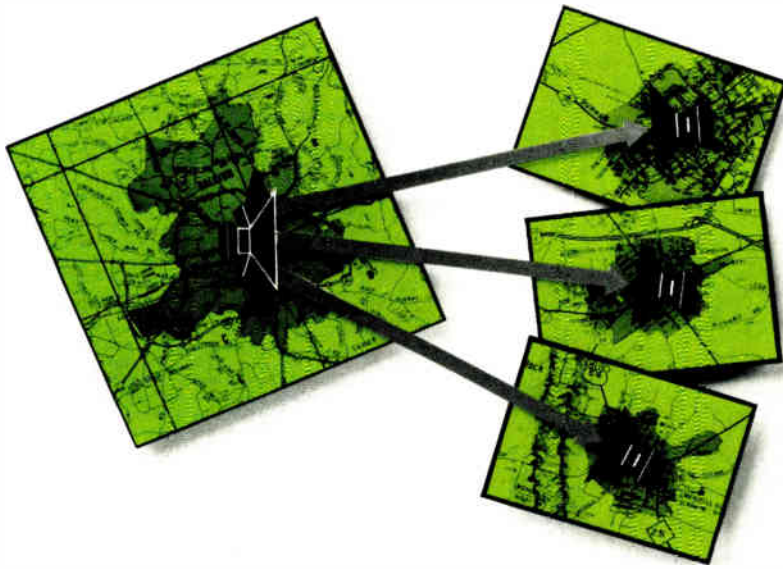

# Divide and Multiply.

Divide your headend with MICRO-BEAM<sup>®</sup> and watch your subscribers multiply.

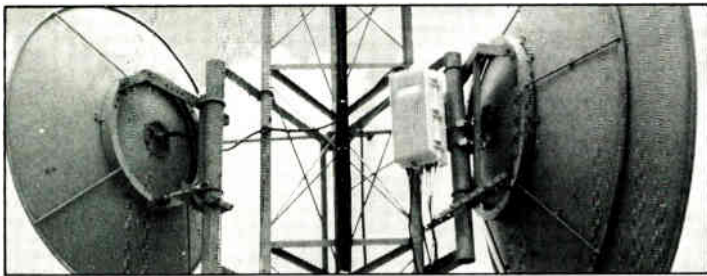

Turn those small subscriber pockets into additional revenue. Channel Master<sup>®</sup> MICRO-BEAM<sup>®</sup> transmitters can be installed anywhere in your system where there is a quality signal source—not just at the headend site. All MICRO-BEAM 1, 2, 5 & 10 watt high performance CARS-Band microwave systems can be designed in a variety of configurations delivering up to 80 channels. Whether you choose a hub, repeater, or multiplier application—MICRO-BEAM eliminates the need for additional headends or lengthy amplifier cascades and delivers maximum flexibility at a cost-effective price.

## *Total Customer Service*

- Two-Year limited warranty—Includes Parts & Labor.\*
- 24 Hour On-Site Service—7 Days a Week\*
- System Design/Path Feasibility.
- On-Site Training.
- FCC Application Assistance.
- MICRO-BEAM Equipment Installation and Path Alignment.
- Fastest Lead Time in the Industry. Equipment and spare parts are In-Stock, ready to install.

For more information about MICRO-BEAM microwave systems contact:

Randy Karr, MICRO-BEAM Sales Division

See us at the Western Show, Booth 1185.

**Channel Master** Division of Avnet, Inc.  
 Industrial Park Drive, Smithfield, NC 27577  
 Tel. (919) 934-9711 ■ Fax (919) 989-2200

\* Within the 48 Contiguous United States only. Refer to actual warranty for specifics on warranty, parts, labor or service. Two-Year Limited Warranty is available on Micro-Beam<sup>®</sup> products only and may be changed or discontinued any time without notice. Channel Master<sup>®</sup> and MICRO-BEAM<sup>®</sup> are register trademarks of Avnet, Inc. © 1991 Channel Master. All Rights Reserved.

## TWO-DEGREE SPACING

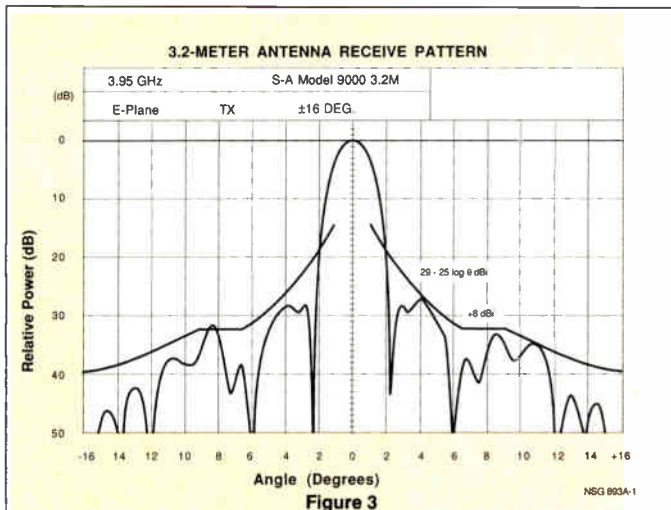

satellites spaced two degrees apart is actually greater than two degrees across the U.S. and is typically between 2.1 and 2.2 degrees.

This is because the two-degree spacing angle is calculated from the earth's axis, while the actual viewing angle is on the surface of the earth and, therefore, slightly larger. Also note that the patterns in Figures 2 and 3 show the FCC 29-25 log theta envelope. Although a good indication of an antenna's ability to operate with two-

is possible to space adjacent transponders just 20 MHz apart, even though they are 40 MHz wide. As illustrated in Figure 4, satellites spaced two degrees apart use alternate polarization schemes so that transponders of the same frequency are on opposite polarizations. This cross-polarization typically provides an additional 10 dB of discrimination between these transponders.

Placing adjacent satellite transponders of the same frequency on opposite

degree spacing, this envelope is a requirement for uplink antennas only and is used to ensure that transmit antennas do not interfere with adjacent satellites.

### Cross polarization discrimination

Cross polarization techniques are used to maximize the number the transponders available from a single satellite. With cross polarization, it

polarizations means that the upper and lower adjacent transponders are now on the same polarization, yet only spaced 20 MHz from the desired signal. This 20-MHz spacing does provide some additional discrimination which can be affected by the type of signals being carried by each transponder. For two transponders spaced 20 MHz apart and carrying full-motion video, the Federal Communications Commission considers 8 dB of isolation to be realistic.

The effective isotropic radiated power (EIRP) of the satellite is the measure of its transmit strength and is usually expressed in dBw. Newer satellites being launched have higher EIRPs than earlier-generation satellites. The resulting difference in each satellite's "footprint" for a given headend impacts the adjacent satellite interference ratio. In order to calculate the adjacent satellite interference factor for a particular location, an operator should obtain the footprints for all satellites within six degrees of either side of the desired satellite.

To properly calculate the total adjacent satellite interference ratio, it is necessary to calculate the interference from three transponders (same fre-

# WESTEC

# Microwave



## SAVE \$ ON AML SERVICE AND PRODUCTS

### SERVICES

FIELD ENGINEERING

### RECEIVERS

REPAIRS AND MODS (to 550MHz)

### TRANSMITTERS

REPAIRED, RETUNED, 141A's

### PRODUCTS

*NEW — WESTEC*

*AM & FM SYSTEMS*

KLYSTRONS SAVE \$1000

REFURBISHED HUGHES AML

TRANSMITTERS, RECEIVERS

MTX132 CHANNEL ADD-ON KITS

REPLACEMENT PARTS AND MODULES

BOOTH 154  
WESTERN  
SHOW

**USED MICROWAVE EQUIPMENT BOUGHT AND SOLD**

*IN A HURRY - KLYSTRONS OFF THE SHELF (SAVE \$1000)*

EXCHANGES, EXPEDITED SERVICE

## WESTEC COMMUNICATIONS, INC.

14405 N. Scottsdale Road, Scottsdale, Arizona 85254

(602) 948-4484 Fax: (602) 998-8701

**Microwave Service (800) 666-4441**



# NEW POWER PLAYER

BATTING 1000  
IN .250 THE SPACE

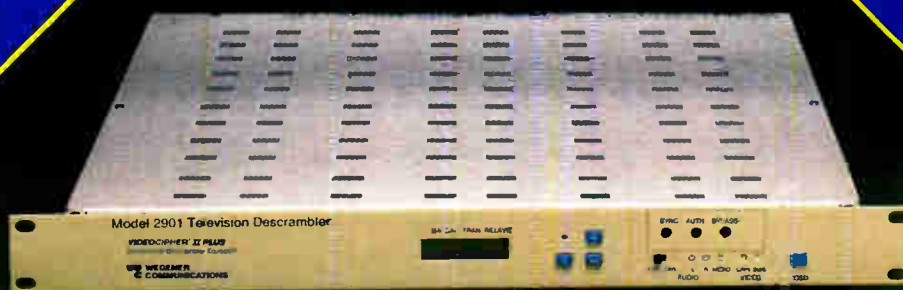

**DESCRAMBLER  
FOR ESPN AUTOMATIC  
FEED SWITCHING!**



## *Here is why Wegener's Model 2901 is a 'World Series Contender'*

- Includes VideoCipher® II Plus Commercial Descrambler
- Automatically Tunes your existing remote control receiver to the correct transponder
- Automatically selects the proper satellite feed (up to 6 inputs)
- Low Profile - only 1-3/4" rack space
- Front panel controls for easy video and audio adjustments.
- Available factory direct or through quality distributors including:
  - Anixter Cable TV
  - Mega Hertz
  - Midwest CATV

**WEGENER COMMUNICATIONS**  
TECHNOLOGY PARK JOHNS CREEK  
11350 TECHNOLOGY CIRCLE  
DULUTH, GEORGIA 30136

(404) 623-0096 TELEX 54-3634 FAX (404) 623-0698

quency, +20 MHz and -20 MHz) for all satellites six degrees to either side of the desired satellite. Theoretically, the measurement should be made for all satellites visible from your location, but satellites beyond six degrees from the primary satellite have a negligible effect on total C/I.

Figure 4 illustrates the calculation of cumulative discrimination in dB between Galaxy I and each satellite within six degrees. This calculation is

done for the satellite arc as it will exist in September 1992. Galaxy I, one of the primary satellites for cable programming, was chosen because its lower EIRP makes it the worst-case calculation for this segment of the satellite arc.

The total discrimination number is obtained by summing the antenna angle, cross polarization, frequency and EIRP discrimination factors. By performing noise summation calcula-

tions for all transponders on the five adjacent satellites, we derive an adjacent satellite C/I ratio of 21.74 dB. By noise summing this figure with approximate figures for terrestrial interference and internal satellite interference numbers, a total C/I of 19.13 is obtained. The matrix shown in Figure 5 shows the calculated total C/I for various Scientific-Atlanta antennas for today's arc and as it will exist in September 1992.

**Will existing antennas work?**

Figure 5 shows that with current satellite placement, the lowest C/I ratio for the antennas listed is 16.91 dB for a 4.5-meter antenna with a dual-beam feed, pointed at Galaxy I. Prior to the move of Galaxy I last June, 18 dB was considered the minimum desirable C/I ratio while 15 dB was generally agreed as the threshold where C/I begins to create noticeable picture impairments.

Based on actual field performance of several thousand dual-beam antennas of 4.5- to 5-meter diameter, currently receiving G1 and F1R, a C/I ratio of 16.91 dB appears acceptable. After September 1992, the C/I ratio for this antenna will drop to approximately 15.29 dB, very close to the threshold where interference is considered to be visible. Some operators may find this level acceptable while others may not. Slight variations in terrestrial interference levels, polarization adjustment and feed alignment may become critical issues at these lower C/I ratios. The following are issues to be considered with specific types of antennas:

**Antennas with a cassegrain feed.** While antennas with cassegrain feeds (feedhorn with subreflector) have slightly higher gain than a prime focus feed antenna, they also have higher sidelobes. As seen in Figure 5, this results in a lower C/I ratio for a given antenna size. Although the numbers listed in the matrix are marginal, you may find that the performance is acceptable. If interference is encountered, a retrofit kit to convert to a prime focus feed is available.

**Multiple feeds on single-feed antennas.** Several manufacturers offer multiple feeds for parabolic (single beam) antennas. Some have the capability to mount as many as five feeds on a single antenna. With parabolic antennas, offset feeds have distorted sidelobe patterns with the distortion increasing the farther the feed is offset.

With two-degree satellite spacing, a maximum of two feeds for two

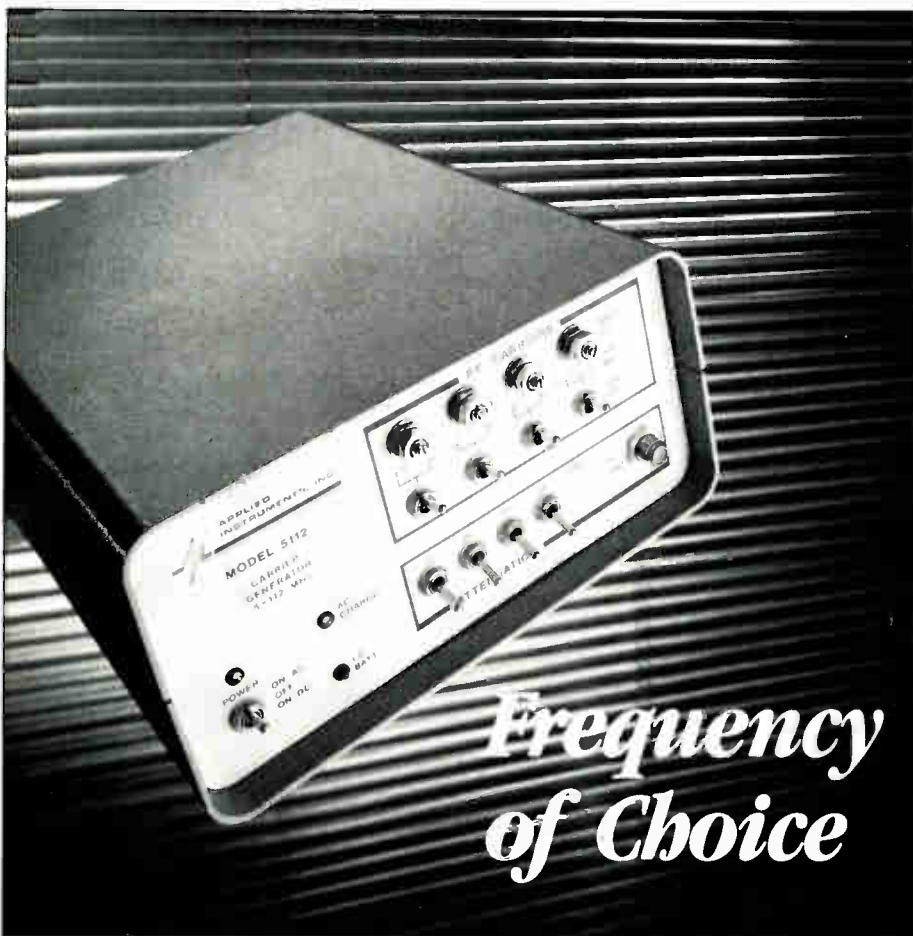

*Frequency of Choice*

Applied Instruments multi-carrier signal generators give you frequency of choice. Your choice of four individually or simultaneously activated RF carrier frequencies can be factory installed into either of two models. The rack-mountable 1645 model is designed for forward alignment of broadband local area networks. The fully portable 5112 model, designed for return alignment, features rechargeable NiCad batteries that provide up to 6 hours of continuous field use and RS 232C circuitry for remote activation. Together, they give you a complete multiple application RF test system for evaluation and maintenance of broadband local area networks. Delivery of custom built units takes as little as four weeks. Exercise your frequency of choice today. Call Doyle Haywood, President, Applied Instruments, or write for our full color brochure.

**317-782-4331**

Applied Instruments, Inc.  
5234 Elmwood Avenue  
Indianapolis, IN 46203





## TWO-DEGREE SPACING

### Scientific- Atlanta Model 8345 4.5 Meter C-Band Antenna

Satellite	ASC 1			F1R			G1			C4			C1			C5		
Position, west longitude	128			131			133			135			137			139		
EIRP (dBw)	36.8			35			34			38.5			37			35		
Polarization	H			V			H			V			H			V		

On Polariz. (V)

Cross Polariz. (H)

DISCRIMINATION FACTORS (dB)															
Angle Discrimination	39	39	39	25	25	25	25	25	25	33	33	33	42	42	42
Cross Pol. Discrimination	10		10		10			10			10			10	
Off Freq. Discrimination	8		8	8		8	8		8	8		8	8		8
EIRP Discrimination	-2.8	-2.8	-2.8	-1	-1	-1	-4.5	-4.5	-4.5	-3	-3	-3	-1	-1	-1

TOTAL DISCRIMINATION	54.2	36.2	54.2	32	34	32	28.5	30.5	28.5	48	30	48	49	51	49
----------------------	------	------	------	----	----	----	------	------	------	----	----	----	----	----	----

#### CALCULATED C/I RATIO FOR GALAXY I

Adjacent Satellite Interference	21.74
Terrestrial Interference	25
Internal Satellite Interference	26.3
<b>Total Carrier-to-Interference</b>	<b>19.13</b>

■ Indicates the desired transponder.

Figure 4

satellites two degrees apart is recommended. Even then the C/I ratio shown for a 4.5-meter antenna with a dual feed will only be 15.29 dB. As experienced during the move of Galaxy I, the feedhorns in older systems will usually need to be modified or replaced to provide enough physical clearance to place them close together.

**Multi-beam antennas.** True multi-beam antennas are designed to provide uniform performance for all feeds mounted on the antenna. This is possible because the curve of the dish is not a true parabolic along the axis aligned with the satellite orbital arc. While the feed patterns are uniform, they typically do not provide the same performance as a true parabolic single-beam antenna.

As with any antenna, an actual range-measured pattern will provide verification of the antenna performance and can be used to calculate expected C/I ratios. Older feeds on these systems may also require replacement or modification to provide the physical clearance required for two-degree spacing.

**Smaller antennas.** There are varying opinions regarding the smallest acceptable antenna diameter for use with two-degree spacing. One issue is the main beam of the antenna, which is determined by the antenna diameter. The 3.2-meter antenna pattern shown

in Figure 3 shows that the main beam extends beyond two degrees either side of boresight. Even so, the calculated C/I for this antenna after September 1992 is 17.05 dB, slightly above that for a 4.5-meter, dual-beam antenna with today's satellite spacing.

In other words, if you are experiencing satisfactory performance from a 4.5-meter with a dual-beam feed today, you should see the same performance for 3.2-meter single-beam antenna after September 1992. With smaller antennas, such as the 3.2-meter, mount stability becomes an important issue

because any movement will cause the adjacent satellite signals to "ride" up and down the main beam of the antenna, resulting in large changes in C/I performance. Again, calculated C/I ratios using a manufacturer-supplied antenna pattern offer the best assurance of adequate performance.

#### Summary

While the industry has had few problems with the move of Galaxy I, this is just the first step in a transition to full two-degree spacing. Systems

#### TOTAL CARRIER-TO-INTERFERENCE CALCULATIONS

(Db)

SATELLITE: ANTENNA SIZE/FEED TYPE	SATELLITE ARC AS PROPOSED FOR:			
	JULY 91		SEPTEMBER 92	
	F1R	G1	F1R	G1
3.2 METER, PRIME FOCUS	20.46	18.61	18.2	17.05
4.5 METER, PRIME FOCUS	21.63	21.18	21.45	19.13
4.5 METER, DUAL BEAM	18.33	16.91	16.92	15.29
4.6 METER, PRIME FOCUS	22.06	21.29	21.46	20.51
4.6 METER, CASSEGRAIN	18.71	17.42	17.43	15.07
4.6 METER, DUAL BEAM	18.33	16.91	16.92	15.29
5.0 METER, PRIME FOCUS	21.49	20.84	21.06	19.06
5.0 METER, CASSEGRAIN	19.29	18.1	18.11	15.88
5.0 METER, DUAL BEAM	18.33	16.91	16.92	15.29

(1) Calculated using 32-25 log theta pattern, actual performance should be better.  
 (2) Based on same performance as 4.5 meter measured patterns.

Figure 5

already experiencing severe terrestrial interference or low carrier-to-noise ratios may require more extensive measures—such as upgrading to a larger antenna. Cassegrain, multi-beam and parabolic antennas with a maximum of two feeds for adjacent satellites should be acceptable, with minor modifications.

Most manufacturers have upgrade kits available for existing antennas. ■

# A digital fiber backbone in Syracuse

**D**uring late 1989, the engineering staff at NewChannels gathered to discuss the deployment of fiber optics within its Syracuse system. The objective of the management team was to design a fiber network which would be cost effective while allowing NewChannels to evolve into a provider of entertainment, voice, and data services.

NewChannels is a division of Newhouse Broadcasting, and operates 293 cable systems delivering service to more than 1 million subscribers. The Syracuse system, which began operating April 1, 1974, maintains 1,600 miles of plant, passes 105,000 homes and serves 73,000 subscribers. By 1989 the two-way capable system was operating at 400 MHz, delivering 42 channels.

The Syracuse system operates one central headend facility which feeds four remote receive locations. Thompson Road is the master headend facility. Two of the receive sites, Burdick and Geddes, are fed via FM fiber optic equipment. A low-power microwave link receives input from the the FM fiber equipment located at Geddes. This microwave transmitter at Geddes services both the Marcellus and Meridian receive sites. A new franchise has been granted for the area which is served by the Meridian receive hub site.

NewChannels-Syracuse considered a long-term strategy with respect to the deployment of fiber optic equipment. The system management sought to build a "regionalized" CATV system which will ultimately include a 100-mile, fully redundant fiber optic loop. A redundant loop design provides for a primary and a redundant signal path to each receive hub site.

The MSO needed to add channel capacity to the system in such a way that equipment purchased would not be technically obsolete in several years. Furthermore, this addition of channels, both immediately and in the future, must not degrade end-of-line signal performance.

Additional customer requirements were "headend quality" specifications

at each receive site, achieved by meeting the RS 250-B Medium Haul specification.

Of secondary importance was to construct the "network" to allow for the transport of auxiliary data and voice services between the headend and remote receive locations.

Because the backbone ring was critical in NewChannels' upgrade plans, a great deal of research went into determining the appropriate technology and architecture related to this portion of the system. NewChannels narrowed its choices to five alternatives for the "backbone ring." Those options were low power microwave, high power microwave, FM fiber, RF supertrunk, and a digital transmission system.

Following is the NewChannels analysis of each of the alternatives.

## AML upgrade—low power

Existing low power AML consisted of seven bays. Adding channels would require an additional bay. This increase in equipment reduces the overall output power of the microwave equipment. Reducing output power would eliminate all link margins. Furthermore, adding microwave equipment requires exhaustive multi-path analysis which can be costly and time consuming. Another reason this technology was not considered was due to weather-related outages. In this particular application, low power microwave would not provide adequate signal performance at the remote receive sites. In addition, when channels need to be added in the future, the customer would have to re-address the upgrade issues outlined above.

## AML upgrade—high power

The size of the existing buildings would not allow for the installation of high power microwave equipment. Additionally, the cost of high power microwave equipment was determined to be much higher than alternative solutions.

## FM fiber

The distance from Thompson Road

to Meridian (66 kilometers) would require the signal to be repeated at Geddes. In many cases, FM fiber equipment provides end-of-line performance which meets RS 250-B Medium Haul specifications. However, in the application requiring the FM signal to be repeated, an end-of-line performance of RS 250-B Medium Haul specification might not be met. In addition, the performance of FM fiber systems is directly related to channel loading. The performance of a fully loaded (16 channel) FM system at a given distance is degraded relative to the performance of a lightly loaded FM system at that same distance.

FM fiber equipment did not meet the requirement for delivery of headend quality signals at each receive site. In addition, this solution would constrain the system when adding future channels because performance changes with channel loading.

## RF supertrunk

The advantage to this approach is its relatively low cost. However, the link distance in this system would require long cascades of amplifiers. These cascades would not be able to deliver the required end-of-line performance at the receive hub sites.

## Digital fiber technology

Digital technology provides many advantages over the other options considered for the Syracuse system. Digital systems can be transparently repeated many times with no degradation to the end-of-line signal. This means the performance at Geddes would be identical to the performance at the Meridian receive site as well as all other receive sites. Furthermore, digital system performance does not change with channel loading. A system that delivers 16 channels per fiber will have the same end-of-line performance as one that transmits only eight channels per fiber.

In the Syracuse system there is a need to drop signals at the Geddes site while continuing the transmission path to both the Marcellus and Meridian receive sites. This "drop and repeat"

*By David Jordan, Digital Fiber Optics Product Manager, C-CORE Electronics Inc.*



# DISTORTION MEASUREMENTS? GET EXACTLY WHAT YOU NEED IN A MULTIPLE FREQUENCY SIGNAL GENERATOR.

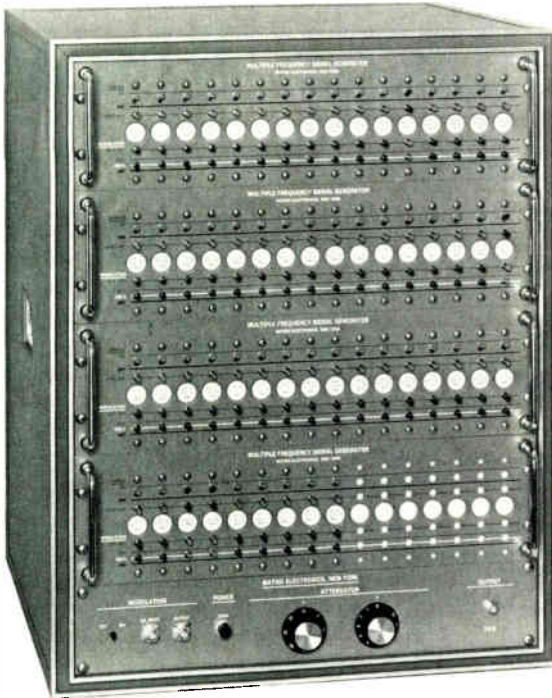

## MODEL SX-16

- Frequencies .....Any frequency from 5 MHz to 1000 MHz.  
Specials above 1000 MHz.
- Output Power .....+57 dBmV per channel with 32 channels.  
+51 dBmV per channel with 128 channels.
- Spurious ..... All harmonics and residual modulations  
better than 100 dB down.

Matrix signal generators provide pure, modulated and unmodulated, crystal controlled outputs. Versions available with from six to over one hundred fifty channels. Matrix receivers models R-12 and R-75 measure signal strength and distortion. Units available either with manual or full remote control through RS-232 or IEEE-488 interfaces.

For custom made special products and full technical support contact MATRIX.

**MATRIX**  
TEST EQUIPMENT  
INCORPORATED

200 WOOD AVE. • MIDDLESEX, NEW JERSEY 08846  
TEL. (908) 469-9510 FAX (908) 469-0418

function is transparent when digital equipment is used. Signals can be dropped off at a receive site for local distribution while simultaneously being routed to another transmission path.

Finally, the longer term strategy at the system—construction of a regionalized redundant fiber loop—eliminates any technology which could not deliver headend quality signal performance over relatively large optical loss budgets.

### The proposal

C-COR/COMLUX proposed an end-to-end digital video fiber optic solution delivering eight channels per fiber. The Syracuse system represented an ideal application for digital technology due to the long distances between sites and the requirement for high signal quality at each site. The equipment proposed for this project included 8-bit video

encoders and decoders, optical transmitters and receivers, and a digital fan out unit.

The video codecs digitize an NTSC composite video input at 8 bits of resolution. This digitizing scheme (full linear PCM) guarantees a link specification of RS 250-B Medium Haul. The optical transmitter has an output of -3 dBm. The optical receiver has a sensitivity threshold of -32 dBm. This results in an optical loss budget of 29 dB. The optical terminal sets operate at 780 Mb/s.

The digital system has a multiplexing structure which provides up to 22 Mb/s of overhead per eight video channels. This overhead can be used to provide a variety of auxiliary services by transporting them along with the video.

The equipment provides a number of open collector alarms which are available at the rear panel of each unit via a DB-37 interface. These alarms

will be used to control equipment in the system to ultimately provide a fully redundant ring network.

The cost of the digital equipment for a point-to-point applications is less than \$3,000 per channel.

Following installation, proof of performance testing was conducted by using sophisticated test equipment, such as the Tektronix 1910 Test Signal Generator, Tektronix VM 700, and a high-speed digital bit error rate tester.

### Conclusion

The Syracuse system has constructed a network which meets or exceeds all original objectives. The performance at each receive site is considered headend quality. This digital backbone allows for a simple future upgrade to a fully redundant fiber loop. The present system has the advantage of being able to transport auxiliary services while not degrading signal performance. ■

## NewChannels - Syracuse

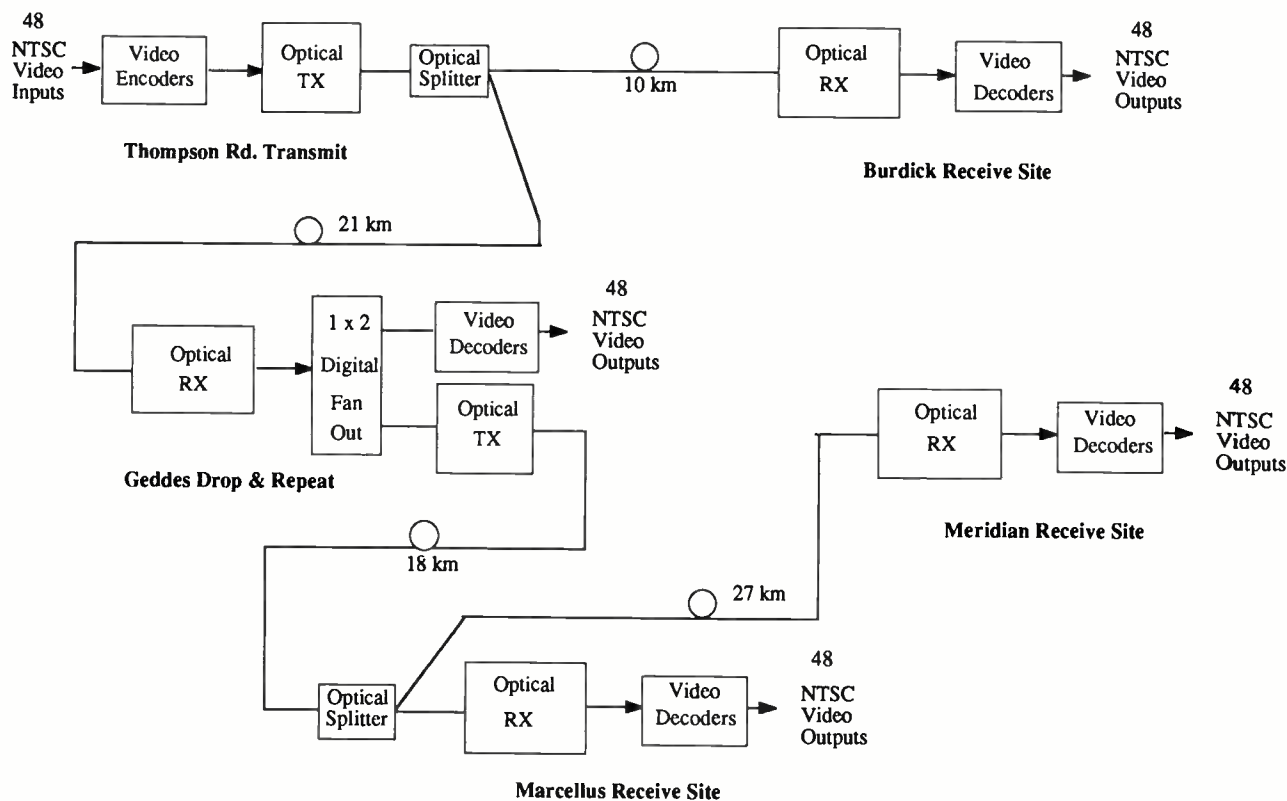

Figure 1



---

# **CALL FOR PAPERS**

**DALLAS**  
C A B L E ' 9 2 THE NATIONAL SHOW



**Send technical paper proposals to NCTA by  
December 6, 1991.**

One-page summaries of prospective papers will be selected in mid-December by an NCTA Engineering Committee subcommittee. Judges look for reference value and originality. Previously published works and product pitches will not be judged. Any topic of interest to cable TV engineering management is eligible.

Mail or FAX summaries with author(s) name and telephone number(s) to:

Katherine Rutkowski, Director, Technical Services, NCTA

1724 Massachusetts Ave., NW, Washington, DC 20036.

Facsimile # 202/775-3698.

Technical Papers proposal deadline: December 6, 1991

**Cable '92--The National Show**  
Dallas, Texas. May 3-6, 1992  
for more information call:

Exhibits: 202/775-3606

Registration: 202/775-3669

Press: 202/775-3629

Technical Program: 202/775-3637 -- Fax 202/775-3698

---

# Prospects for fiber-to-the-home

This paper considers a future package of cable television services that will require the deployment of fiber in order to meet required subscriber performance levels of 49 dB CNR and -51 dBc CTB for AM-VSB television signals.

The cable TV video program package of the future most likely will be delivered in a hybrid format consisting of standard TV channels, digitally compressed video and digital HDTV.

Although future services (such as pay-per-view, near video-on-demand, video-on-demand, compressed video and HDTV) have been identified, their number and launch time remain hazy. This stems from the overabundance of associated uncertainties including market demand, technology advancement, reduction of installed costs, signal format standards, competing delivery systems and government policy.

With the perceived demand for cable

TV bandwidth resulting from the expansion of standard TV channels and the eventual addition of NVOD, VOD, HDTV, PCS and data/telco services, it is evident that cable TV system capacities of 155 equivalent standard channels or 1 GHz of broadband spectrum are not unreasonable to expect. The objective of the cable TV system architectures presented in this paper will be to provide a 155-plus equivalent standard channel transmission platform to the home.

To determine which is currently the most cost effective deployment architecture, we analyze cost models of three architectures that deploy fiber progressively closer to the home:

- Fiber to the bridger (FTTB), which places fiber to a bridger point serving an area the size of a conventional bridger or feeder area: approximately 200 to 300 subscribers.

- Fiber to the node (FTTN), which represents a serving area approximated by a conventional line extender serving area of 25 to 35 subscribers, depending on the urban density.

- Fiber to the home (FTTH), which provides all cable TV services to the subscriber over a dedicated fiber to an optical receiver on the subscriber's premises.

As a reference point, the cost model for the deployment of these three architectures will be based on signal origination at a secondary hub with geographical coverage of approximately 10 square kilometers and 8,000 to 15,000 subscribers.

All three architec-

tures were chosen to:

- provide for expected future services cost effectively,
- maximize fiber network flexibility to allow the fiber network to evolve as fiber technology advances,
- provide low maintenance relative to an installed coaxial tree-and-branch structure, and
- result in higher reliability by reducing the number of active components a signal must pass through.

The subscriber count per region of plant or per active varies dramatically between cable systems and between different urban densities within a system.

The segmentation parameters of the model area of the cable TV system used to generate cost models of the various

Fiber to the Bridger (FTTB) From a Secondary Hub

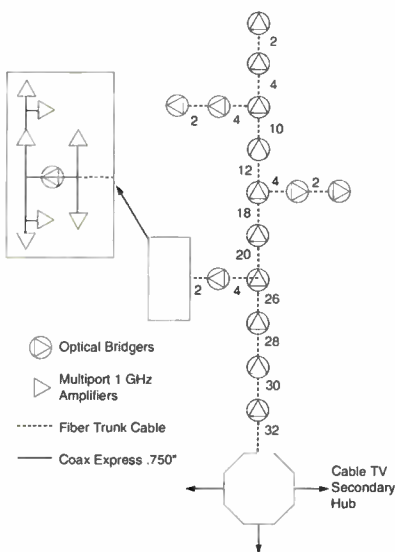

Figure 1

By Nick Hamilton-Piercy and Robb Balsdon, Rogers Engineering

Cable TV Fiber to the Bridger (FTTB) Using Superdistribution in a New Urban Area Using Buried Construction

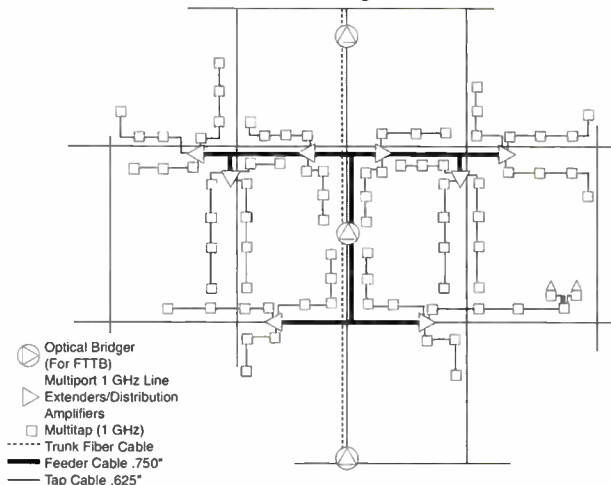
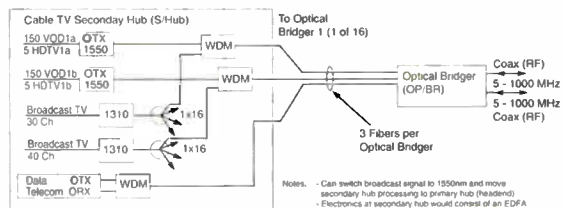

Figure 2

Fiber to the Bridger (FTTB) Architecture from Cable TV Secondary Hub



Notes: - Can switch broadcast signal to 1550nm and move secondary hub processor to primary hub (headend)  
- Electronics at secondary hub would consist of an EDFA

Wavelength	Link Loss				Total
	S+Hub Coupler	WDM	Link KM	Optical Bridger WDM	
1310nm Unit	12.6	1.0	0.4	0.05	17.6
#	1	1	5	20	
dB	12.6	1.0	2	1	
1550nm Unit		1.0	0.22	0.05	3.1
#	0	1	5	20	
dB	0	1.0	1.1	1.0	

Figure 3



## FIBER ECONOMIC STUDY

architectures is shown in Table 1 and the topology of the trunk and feeder area is illustrated in Figure 1.

### Fiber to the optical bridger

It is not necessary to install fiber all the way to the home in order to provide expected future cable TV services, PCS or even to support full duplex data transmission and multiple DSOs to the home. A portion of a secondary hub with a fiber trunk to a number of optical bridgers is illustrated in Figure 1.

In order for the cable TV plant to pass the greater 155-channel loading and to achieve required end of line performance at 1 GHz, amplifiers must be shortened to a maximum of three or four.<sup>1</sup> The use of superdistribution, where a low level, low distortion port feeds the next amplifier and two high level, higher distortion ports feed multitap cascades, allows:

- higher tap levels to overcome higher attenuation at 1 GHz,
- signals to pass through fewer multitaps and splitters on the way to the subscriber, and
- no cable TV plant power in the multitap legs.

Digitally compressed video signals can be modulated on a few carriers or modulated on a single carrier per channel (SCPC) with lower bandwidth efficiencies for transport on the cable TV system above the standard AM-VSB signals. As a result of the lower signal-to-noise requirements of the digitized signals, the carriers can be operated at lower levels on the coaxial plant, thus helping to improve distortion performance.

The cost analysis of the feeder plant is based on the design illustrated in Figure 2.

Each optical bridger has a dedicated service feed from the secondary hub employing two 1550-nm wavelengths as illustrated in Figure 3.<sup>2</sup> The fiber star configuration allows each optical

Circle Reader Service No. 54

bridger to dedicate a compressed digital video channel to each of 300 subscribers (75 x 4) for VOD.<sup>3</sup> If at the time of fiber deployment, narrowcasting to subscriber requires only NVOD, the 1550 nm optical transmitters (OTX) can be optically split and an adequate link loss can still be maintained.

Alternatively, low cost, lower performance lasers can be used to economically utilize the lower link loss at 1550 nm. The detection of the common broadcast channels, the compressed VOD channels and poten-

tially a number of HDTV signals on the 1 GHz feeder plant is illustrated in Figure 4.

PCS and data services such as multiple DSOs to each home can be supported on the third fiber in the star configuration illustrated in Figure 3. To demonstrate the compatibility of a 1 GHz coaxial system from an optical bridger with 5 MHz to 33 MHz return capability to the optical bridger with telephony type services, Figure 5 shows

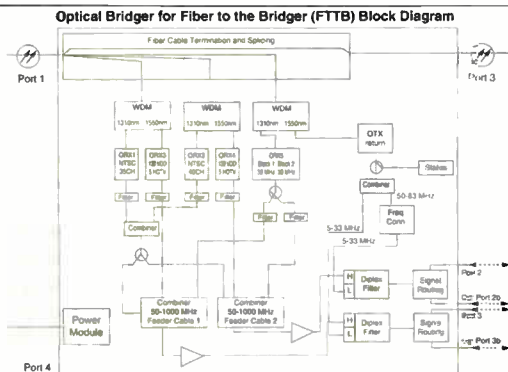

Figure 4

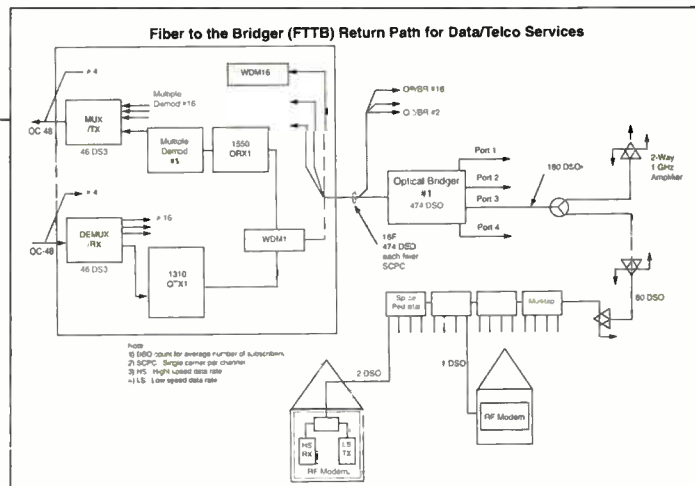
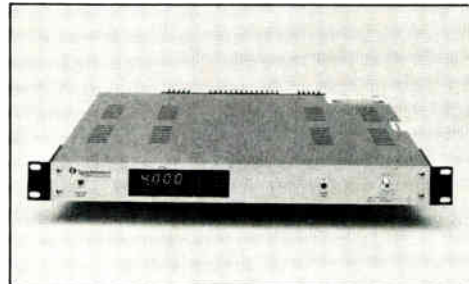

Figure 5

**It begins  
with  
innovation...  
it takes  
knowledge  
and  
perseverance  
- then you  
have the  
solution.**

Synchronous introduces the AMLT-1550 DFB Laser Transmitter, with proven technology and proven reliability.

The 2 or 4 mW Transmitter has a microprocessor controlled monitoring system and meets the industry requirements for 40 or 80 channels of AM transmission.



**Bold Innovators of  
Applied Fiber Optics**

For more information, please call 408-943-0222.

**Synchronous**  
Communications Inc. 



## FIBER ECONOMIC STUDY

a block diagram for a system that delivers two DSOs to each subscriber in an optical bridger area using time division multiplexed (TDM) signals in the downstream direction and SCPC signals with RF modems in the upstream direction.

### Fiber to the optical node

This architecture involves installing fiber to each optical node which serves approximately 25 to 35 homes and corresponds to a conventional line extender service area in a coaxial tree-and-branch network. The deployment of this architecture requires the installation of two fibers to each optical node from the optical bridger location where the common broadcast signals are optically amplified and split to service each optical node within the optical bridger area.<sup>4</sup>

The 1550 nm laser is a very narrow linewidth, potentially externally modulated laser that will launch all 70 standard AM-VSB NTSC signals onto the dispersion shifted (DS) fiber that transports the signals to the optical node. There they are detected and combined with the VOD and HDTV signals as shown in Figure 6.<sup>5,6,7,8,9</sup> The combined RF signal is then transmitted through a passive coaxial network similar in topology to Figure 3.

### Fiber to the home

In order to complete an informative cost comparison between FTTB, FTTN and FTTH, a physical configuration (shown in Figure 7) similar in topology to the FTTB architecture was used. The configuration consists of a triple star from the secondary hub to the home

with erbium doped fiber amplifiers (EDFA) at each node (see Figure 8).

The 1310 nm link is totally passive from the secondary hub to the home, resulting in a path loss of 34 dB for the compressed digital video and digital HDTV signals. This 34 dB link loss is currently achievable using commercial equipment, OTX 7 dBm output and ORX sensitivity at

-32 dBm for a BER of 10<sup>-9</sup>.

The AM-VSB signals are transported at 1550 nm because the high passive loss (caused by branching at the optical bridger and optical node) requires optical amplification that is not currently available at 1310 nm.

**Regal Technologies –  
Bringing home the best.  
1-800-36-REGAL**

Circle Reader Service No. 54

Fiber to the Optical Node (FTTN) Architecture from Cable TV Secondary Hub

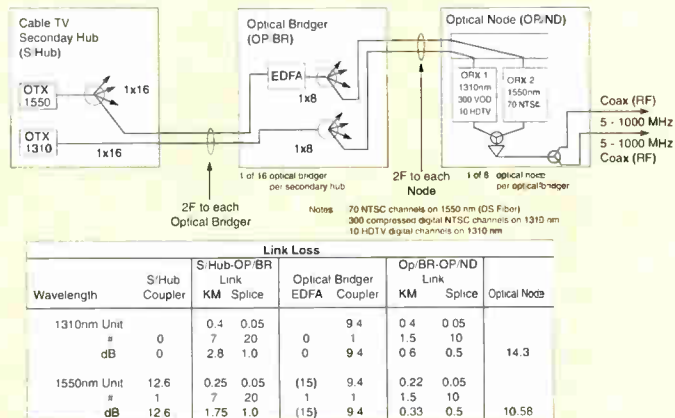

Figure 6

Cable TV Fiber to the Home (FTTH) Plant Overlay On Fiber to the Bridger (FTTB) Architecture

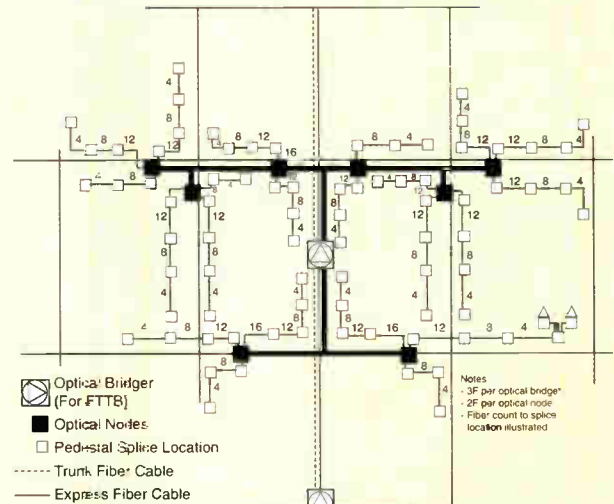

Figure 7

## 1550 nm problems

There are a number of current technical problems with the 1550 nm link. Two of the major problems are that the total link loss at 15 dB is excessive; 1550 nm lasers with sufficient output are not currently available, and lasers with adequate linearity are not available to transport 70 AM-VSB signals on one wavelength.

Dispersion shifted fiber may not be required for the 1550 nm link since electrical precompensation has been demonstrated and the net fiber cable loss of the 1550 nm link is only 2.3 dB.

Despite the current technical problems with the transport of AM-VSB signals on 1550 nm through a triple star configuration, it is informative to contrast current costs and future projected costs of this FTTH architecture with FTTB and FTTN.

Cost analysis of the fiber link from the optical node to the home demonstrated that dedicating a fiber from the optical node to the home was more cost effective than a passive bus configuration. Generally, this is because of splicing costs, passive optical component costs and the relatively low incremental cost of each fiber in a cable sheath for this architecture.

### Cost comparison

A number of basic assumptions were made to set a base for the cost model analysis:

- All costs reported are per subscriber in Canadian dollars.
- The cost analyzed for each architecture is for fiber deployment from the secondary hub to the home.
- Cost figures are for first installed costs only and do not include any life cycle cost factors.
- All per subscriber costs exclude cable placing costs including burying and trenching, because for a new or a rebuild scenario, these costs are similar for all architectures being analyzed.
- As a result of municipal pressure to bury new cable TV plant and to bury the existing plant of cable TV and other utilities, underground cable routing was used.
- Feeder plant, whether coaxial or

**Fiber to the Home (FTTH) Architecture from Cable TV Secondary Hub to the Home**

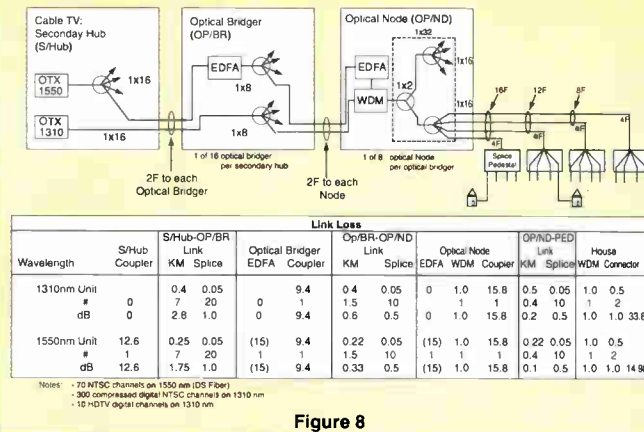

**Figure 8**

fiber, is buried on both sides of the street to minimize the number of drop street crossings.

- Deployment of fiber follows a physical star structure.
- The approximate subscriber density is 122 homes per mile (see Table 2).
- Penetration is approximately 75 percent.
- The average number of subs per optical bridger is 237.
- Plant capacity to the home is 1 GHz.
- Minimum signal performance at the home is 49 dB CNR, -51 dBc CTB for an AM-VSB NTSC television signal.

Referring to Figure 9 and Table 2, it can be seen that the first installed cost of fiber to the optical bridger (FTTB) is comparable with the cost of providing a dedicated group of 300 compressed video channels to each optical bridger using coaxial trunk and continuing from this point with coaxial feeder and drop plant.

The cost may be equivalent, but providing the future package of services to the subscriber using coaxial trunk is not technically prudent. A single trunk will be required for the 70 standard AM-VSB signals and a dedicated trunk cable or portion of RF spectrum will be required to provide VOD services to each bridger location.

This will require substantially increasing the coaxial trunk cable count and increasing the number of trunk actives tenfold, whether multiple actives are used at common locations along the coaxial trunk or split band actives are periodically placed at extremely short spacings.

By deploying fiber trunk rather than coaxial trunk, a number of benefits not reflected in the first installed costs presented can be obtained:

- lower operational costs resulting from reduced trunk maintenance,
- end-of-line performance can be improved by replacing optical transmitters with limited change required at optical receivers,

**Comparison of the per subscriber costs for each portion of cable TV plant for the three fiber architectures (FTTB, FTTN & FTTH) and the all-coaxial reference**

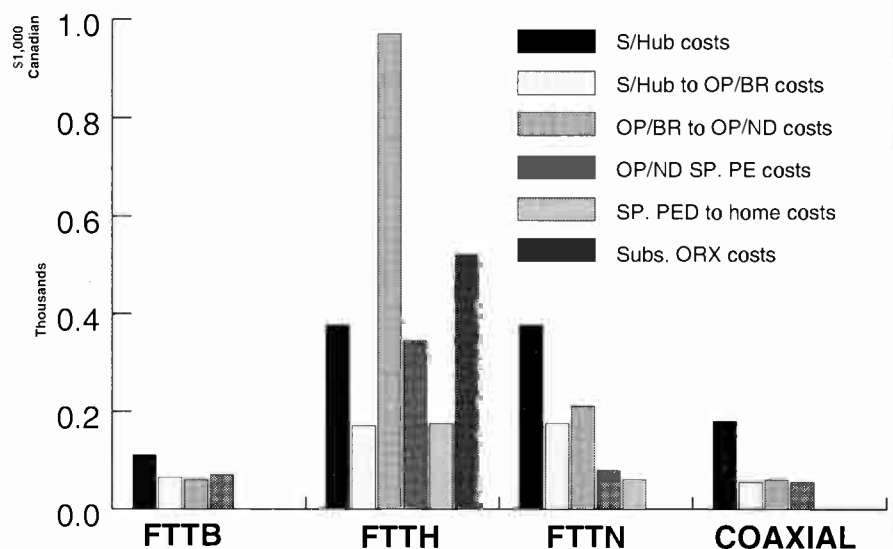

**Figure 9**



## FIBER ECONOMIC STUDY

- fiber trunk provides a platform for further segmentation of subscribers for dedicated signal feeds, and
- fiber trunk provides a platform for deploying fiber further into the cable plant.

The cost sharing attributes of the coaxial tree-and-branch architecture can still be realized from the optical bridger to the home without restricting the package of cable TV services delivered to the subscriber.

If fiber is installed to the optical node (FTTN), fiber can be deployed further into the cable plant, past the optical bridger. FTTN deployment is 34 percent of the cost of FTTH. This cost savings is attributable to three points.

First, the replacement of the EDFA in the optical node by lower cost optical receivers (ORX). Second, sharing the ORX in the optical node with more subscribers—30 vs. one. And lastly, the use of coaxial plant from the optical node to the home, where the lower component (cable and multitap) costs of the coaxial plant can be used to the best advantage.

Fiber to the home (FTTH) is seven times the cost of the fiber to the bridger (FTTB). The most expensive portions of the FTTH architecture are the optical bridger to optical node section, which comprises 38 percent of the total FTTH cost. It is 18 times the cost of the comparable coaxial alternative. The high cost of this section of FTTH is attributable to the high current costs of erbium doped fiber amplifiers (EDFA), which compose 98 percent of the cost of this section of FTTH. The EDFA located at the optical bridger location in this architecture is shared among a much larger number of subscribers and does not have as significant an impact on total FTTH installed cost as the

EDFA at the optical node.

Also contributing to the high FTTH cost is that in the FTTH scenario, an optical receiver is required in every home. The optical receiver contributes 20 percent of the total installed material cost of FTTH.

And, the cost per subscriber of the portion of fiber plant from optical node to the splicing pedestal is 13 percent of the total FTTH cost, 4.5 times higher in cost than the comparable section of coaxial plant. The optical node to splice

pedestal cost is composed primarily of splicing costs, which are 78 percent of the cost of this section of the FTTH architecture.

These splicing costs can be substantially reduced by using tapered fiber cable or cable with pre-engineered breakouts rather than complete cable splicing. Further development of fiber ribbon cable for feeder cable applications and mass splicing technology will reduce the cost of this section of FTTH plant.

### Component cost reduction

The main problems with FTTN and FTTH deployment costs are the cost of the active optical devices (EDFA, OTX and ORX) and the high labor cost associated with the many splices required to install fiber plant deeper into the cable system.

As the active components move along the "S" curve pushed by further product development, manufacturing experience and increasing production volumes, it is expected the incremental cost of FTTN and FTTH will be reduced dramatically. FTTB will fall in cost, but less dramatically because of the lower utilization of OTXs and ORXs and the inherent sharing of optical

Reductions in per subscriber deployment costs for FTTB, FTTH, FTTN and the coaxial reference as optical technologies move along the "s" curve.

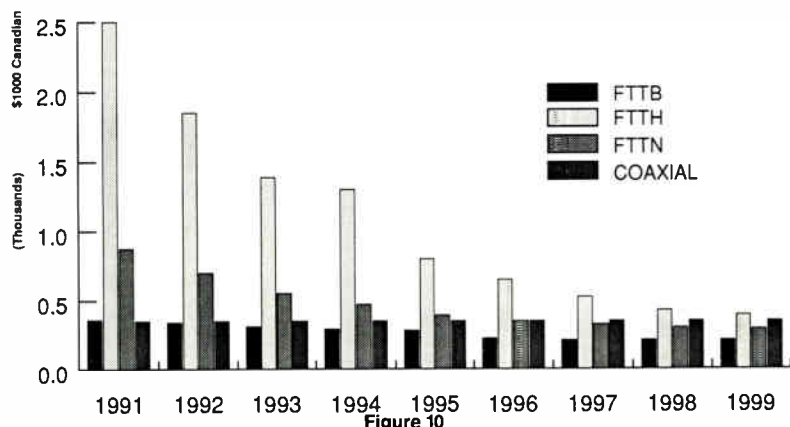

Figure 10

# Technology



Regal Technologies –  
Bringing home the best.  
1-800-36-REGAL

Circle Reader Service No. 54

## Cable TV Plant Segmentation Parameters Used For Architectural Modeling

Total Number	Relative Number	Area	Average Number of Subscribers
1	-	Secondary Hub	15,168
64	64	Optical Bridger	237
512	8	Optical Nodes or 1 GHz Amplifiers	30
5,120	10	Splice Pedestals or Multitaps	3.0

**Table 1**

device costs over more subscribers.

In order to investigate the trends associated with the cost reduction in optical components and developments in splicing technology, the three fiber architecture cost models presented were recalculated using predicted cost reductions in Table 3 and extrapolated from 1991 to 1998.<sup>10,11</sup>

It is apparent from Figure 10 and Table 2 that FTTB remains the most economical for first installed costs, but the differential costs of FTTN and FTTH will fall significantly. For example, in 1995 the cost of FTTN is 150 percent of FTTB, and FTTH will fall from seven times the cost of FTTB in 1991 to three times the cost in 1995.

### Conclusion

The size of cable television operator's systems varies significantly, but it is possible to geographically segment subscribers into hub areas of 8,000 to 10,000 subscribers depending on subscriber density. Even if this subscriber segmentation topology is not chosen, the cost comparison of the first installed costs of FTTB, FTTN and FTTH as presented in this paper still provides a relative measure of the cost effectiveness of these architectures.

For the expected package of future cable TV services including, for example, 70 channels of AM-VSB, 300 channels of video compressed VOD and 10 channels of HDTV, fiber to the bridger (FTTB) is the most cost effective platform for fiber deployment for new cable TV builds. The transmission link from the optical bridger to the home will be served by 1 GHz superdistribution feeder in the tree-and-branch configuration that will continue to provide low costs per subscriber.

FTTB is the clear winner in 1991, but as critical optical components such as erbium doped fiber amplifiers, optical receivers and higher performance, narrower linewidth lasers fall in cost

following the "S" curve, the differential cost of the architectures will decrease dramatically. It has been predicated that FTTN, which is two to three times the cost of FTTB, and FTTH, which is seven to eight times the cost of

001681, *Bellcore Fiber in the Loop (FITL) Architecture Summary Report*.

3. R.C. Loveless, *Fiber to the Serving Area: A "Star" Architecture*, 1991 SCTE Fiber Optics Conference.

4. G.Grasso, F.Fontana, M.M.Rahmar, *Application of Rare Earth Doped Fiber Amplifiers to Distribution Networks*, 1990 National Fiber Optic Engineers Conference.

5. H.Gysel, *CATV-AM Optical Transmission Links Using the 1550 nm Window*, 1991 SCTE Fiber Optics Conference.

6. R.Pidgeon and L.Thompson, *Status of 1550 nm Analog Fiber Optic Systems and Performance Advantages*, 1991 SCTE Fiber Optics Conference.

7. L.D.Williamson and D.Wolfe, *Impact of Dispersion on Analog Video Transmission*, 1991 NCTA Technical Papers.

8. Y.Trisno, M.Johnson, C.Chen, D.Huber, *The Role of a Linearized External Modulator in the Video Distribution Network*, 1991 NCTA Technical Papers.

9. J.B. Glaab, D.R. Huber, *Optical Amplifiers for Video Distribution*, 1990 NCTA Technical Papers.

10. Broadband Fiber Optic Network 1990, *Architectural Analysis: Status Report*, Electronicast Corp.

11. Broadband Fiber Optic Network 1990, *Architectural Analysis Volume 3*, Electronicast Corp.

### Summary of Per Subscriber Deployment Cost Comparison For: FTTB, FTTN, FTTH, and Coax

	1991	1992	1993	1994	1995	1996	1997	1998	1999
<b>Fiber to the Bridger:</b>									
S/Hub Hardware	\$104	\$84	\$68	\$54	\$44	\$36	\$29	\$23	\$19
S/Hub to OP/BR/Coax	\$59	\$50	\$43	\$37	\$33	\$30	\$27	\$25	\$23
OP/BR to L/E	\$54	\$54	\$54	\$54	\$54	\$54	\$54	\$54	\$54
L/E to TAP	\$72	\$72	\$72	\$72	\$72	\$72	\$72	\$72	\$72
Drop	\$56	\$56	\$56	\$56	\$56	\$56	\$56	\$56	\$56
Total	\$345	\$315	\$291	\$273	\$258	\$247	\$237	\$230	\$223
<b>Fiber to the Node:</b>									
S/Hub Hardware	\$360	\$252	\$177	\$124	\$87	\$62	\$44	\$31	\$22
S/Hub to OP/BR/Fiber	\$166	\$118	\$85	\$63	\$48	\$38	\$31	\$26	\$22
OP/BR to OP/Node	\$204	\$177	\$157	\$141	\$129	\$120	\$113	\$108	\$104
L/E to OP/TAP	\$72	\$72	\$72	\$72	\$72	\$72	\$72	\$72	\$72
Drop	\$56	\$56	\$56	\$56	\$56	\$56	\$56	\$56	\$56
Total	\$858	\$675	\$547	\$456	\$393	\$347	\$315	\$292	\$276
<b>Fiber to the Home:</b>									
S/Hub Hardware	\$360	\$252	\$177	\$124	\$87	\$62	\$44	\$31	\$22
S/Hub to OP/BR/Fiber	\$146	\$118	\$85	\$63	\$48	\$38	\$31	\$26	\$22
OP/BR to OP/LE	\$968	\$660	\$453	\$315	\$222	\$159	\$116	\$87	\$67
OP/LE to OP/TAP	\$334	\$264	\$215	\$180	\$155	\$136	\$123	\$112	\$104
Drop	\$165	\$146	\$132	\$121	\$112	\$105	\$100	\$95	\$91
Sub Term	\$500	\$395	\$301	\$231	\$178	\$139	\$109	\$87	\$70
Total	\$2513	\$1808	\$1364	\$1034	\$803	\$639	\$522	\$438	\$377
<b>Coax to the Home:</b>									
S/Hub - TK/BR OP	\$163	\$163	\$163	\$163	\$163	\$163	\$163	\$163	\$163
OP/BR to L/E	\$54	\$54	\$54	\$54	\$54	\$54	\$54	\$54	\$54
L/E to TAP	\$72	\$72	\$72	\$72	\$72	\$72	\$72	\$72	\$72
Drop	\$56	\$56	\$56	\$56	\$56	\$56	\$56	\$56	\$56
Total	\$344	\$344	\$344	\$344	\$344	\$344	\$344	\$344	\$344

**Table 2**

FTTB, will respectively fall to 1.5 times and three times the cost of FTTB.

In five to six years, FTTN will be less costly than a fully coaxial system but not less costly than a FTTB system. Fiber deployment to the node level will depend on requirements for further subscriber segmentation for new video services and geographical segmentation for new communication services (such as personal communication services) that may require higher transmission capacity. ■

### Acknowledgements

The authors wish to thank their colleagues at Rogers Engineering and Cable Television Laboratories Inc. network development subcommittee for their insights and contributions to the development of the solutions presented in this paper.

### References

1. C.J. Horton, J.C. Pavlic, *Amplifiers for Future Networks*, 1991 NCTA Technical Papers.
2. Bellcore Special Report SR-T5Y-

### "S" Curve Linear Approximation

Component	Annual % Cost Reduction
<b>Fiber Cable:</b>	
Per Fiber Strand \$/Km	5%
Fiber Cable Fixed Sheath \$/m	5%
Fiber Drop (2 fibers) \$/M	5%
<b>Passives:</b>	
Optical Splitter	11%
Optical WDM	11%
Optical Connectors	11%
<b>Installation:</b>	
Splicing \$/fiber	30%
<b>Hardware:</b>	
Splice Enclosure	5%
<b>Actives:</b>	
Optical Transmitter OTX	20%
FP OTX	20%
Optical Receiver 1310/1550	25%
EDFA	30%
Subscriber Terminal ORX	25%
<b>System Components:</b>	
Optical Bridger General	5%
Optical Node General	5%
Optical Splice Unit	5%

**Table 3**



# Regal puts all the pieces together for you



## Products, people and technology

These are the integral components in the complex picture of Regal Technologies. Products which ensure subscriber satisfaction. People who reflect our commitment to the cable TV industry. Technology that evolves from our dedication to product innovation and development.

They all fit together like pieces of a puzzle that,

when completed, provide a comprehensive system which fulfills *all* of your needs for improved quality and reliability.

From the tap to the TV, Regal is a company devoted to serving cable operators with systems and services that bring the best possible pictures into subscribers' homes.

**REGAL**   
Technologies Ltd.

*Bringing home the best.*

**1-800-36-REGAL**

CORPORATE HEADQUARTERS: 2100 NANCY HANKS DR., SUITE A, NORCROSS, GA 30071, 1-404-449-0133

Circle Reader Service No. 54

© Regal Technologies, L.d.

## WHAT'S AHEAD

# SCTE

Following is a list of SCTE technical seminars with contact name. If known, location and seminar topic are listed.

**November 6 Caribbean Area Chapter** Contact John Green, (809) 848-7746.

**November 7 Oahu Meeting Group** "Cable Basics/Sweep Systems," with Richard Covell of Texscan. To be held at the Kahikapu Building, Honolulu, Hawaii.

**November 7 Upper Valley Meeting Group** "Winter Plant Maintenance," with Rich Sutphen of Adelphia. to be held at the Holiday Inn in Whiteriver Junction, Vt. Contact Matt Alldredge, (802) 885-9317.

**November 9 Old Dominion Chapter** To be held at the Holiday Inn in Richmond, Va. Contact Joe Roney, (505) 761-6224.

**November 10-11 Desert Chapter BCT/E category I, "Signal Processing Centers."** To be held at Cocos in Palm Desert, Calif. BCT/E examinations to be administered in all categories at the technician level. Contact Chris Middleton, (619) 340-1312 ex.258.

**November 13 Appalachian Mid-Atlantic Chapter BCT/E testing** to be administered. To be held at the Holiday Inn in Chambersburg, Pa. Contact Dick Ginter at (814) 672-5393.

**November 13 Dixie Chapter** To be held in

Montgomery, Ala. Contact Richard Murphy, (205) 631-9681.

**November 13 Golden Gate Chapter** "Test Equipment." Contact Mark Harrigan, (415) 785-6077.

**November 13 Great Plains Chapter** "CLI and FCC Rules and Regulations" with Bob Huber. To be held at the Knolls, Lincoln, Neb. Contact Jennifer Hays at (402) 333-6484.

**November 13 Hudson Valley Chapter** "HBO Triplecast" with John Vartanian of HBO and "Status Monitoring" with Mike Mills of Superior Electronics Group. To be held at the Century House, Latham, N.Y. Contact Bob Price at (518) 355-3086.

**November 13 Michiana Chapter** To be held at Turners American, South Bend, Ind. Contact Russ Stickney at (219) 259-8015.

**November 13 North Country Chapter BCT/E Category II, "Video and Audio Signals and Systems."** To be held at the Sheraton Midway, St. Paul, Minn. Contact Rich Henkemeyer at (612) 522-5200 ex. 707.

**November 13-14 Big Sky Chapter** Consecutive meetings to be held November 13 in Laurel, Mont. and November 14 in Helena, Mont. BCT/E and Installer examinations to be administered. Contact Marla DeShaw at (406) 632-4300.

**November 14 Central California Chapter BCT/E**

Category V, "Data Networking and Architecture." Contact Deborah Abate, \*408) 578-1790.

**November 14 Greater Chicago Chapter** "Audio/Video." Contact Bill Whicher, (708) 438-4423.

**November 14 Wheat State Chapter** Contact Mark Wilson, (3316) 262-4270.

**November 14-15 Dakota Territory Chapter** "Preparing for the Olympics, Terminal Devices and Addressability." Consecutive meetings to be held in Pierre, S.D. (Nov. 14) and Bismark, S.D. (Nov.15). Contact Kent Binker, (605) 339-3339.

**November 16 Oklahoma Chapter BCT/E** examinations to be administered. Contact Arturo Amaton at (405) 353-2250.

**November 19 Gateway Chapter** Contact Chris Cramer at (314) 949-9223.

**November 19 New York City Chapter** "Theft of Service" with Henry Maxwell of Cablevision and "Fiber and Powering of Fiber Optics" with speakers to be announced. To be held at Time Warner's Flushing, N.Y. office. Contact Rich Fevola at (516) 678-7200.

**November 20 Bluegrass Meeting Group** "Distribution Systems." Contact Liz Robinson at (606) 299-6288.

**November 20 Great Lakes Chapter** "Subscriber relations." Contact Dennis Sartori, (800) 428-7596.

# C-COR<sup>®</sup>

ELECTRONICS INC

C-Cor Electronics has announced the dates for its three-day "Basics of Fiber Optics" course for system engineers, system managers and chief technicians. Course areas covered include:

- Broadband RF technology,
- Introduction to fiber optics/lightwave

fundamentals,

- Connectors, splices and couplers,
  - Optical transmitters and receivers,
  - Test equipment,
  - Analog fiber optic systems,
  - Digital fiber optic systems, and
  - System architectures.
- The next course will be

held **December 3-5** in Pittsburgh, Pa. The course costs \$995 per attendee, which includes course manual, catalogs, lunches, refreshments and certificate of completion. For more information or to register, contact Kelly Jo Kerstetter at (814) 231-4422.



# **SALUTING CABLE'S TECHNICAL COMMUNITY**



**THANKS FOR YOUR SUPPORT**

## WHAT'S AHEAD



AT&T Network Systems has announced a series of one- and two-day fiber optic seminars, for those who need the knowledge, technical skills and hands-on experience to specify, design, install, splice or maintain fiber optic cable television networks. AT&T's course schedule is as follows:

**November 26**  
Introduction to AT&T fiber products, Dublin, Ohio

**December 9-13** Fiber optic product applications, Lisle, Ill.

**November 14-15 and December 9-10** Fiber optic product update, Dublin, Ohio, Atlanta, Ga. or Pleasanton, Calif.

**November 18-22 and December 2-6** Fiber optic installation and splicing for the technician, Dublin, Ohio or Atlanta, Ga.

**November 11-12 or 25-**

**26 and December 9-10** Fiber optic installation and maintenance testing, Dublin, Ohio, Atlanta, Ga. or Pleasanton, Calif.

**November 14-15 and December 12-13** Assembling connectors onto optical fiber, Dublin, Ohio, Atlanta, Ga. or Pleasanton, Calif.

For more information on AT&T's courses, call 1-800-TRAINER.



**November 12-15**  
FC<sup>2</sup> has announced its schedule for a five day fiber optic workshop which includes practical aspects of splicing, terminating, and testing fiber optic communications. Additional lectures and multimedia presentations cover the history, theory and applications of fiber optic technology. The workshop is held at FC<sup>2</sup>'s training facility in Sturbridge, Mass on the following dates:

**November 18-22**  
**December 16-20**

## SIECOR

Siecor Corp. will sponsor a four-day, hands-on fiber optic training program designed for craftsmen and contractors who install, splice and test fiber optic cable in a cable television environment. Following is the date for the program "Fiber Optic Installation, Splicing, Maintenance and Restoration for Cable TV Applications." For info call (800) 634-9064.

## Trade Shows

*Western Show*  
**November 20-22** Anaheim Convention Center, Anaheim, Calif. Contact (415) 428-2225.

*Taipei Satellite and Cable TV '91 Conference*  
**December 10-12** Taipei International Convention Center, Taipei, Taiwan. Call 011-886-2-506-3335.

*Private Cable Show*  
**December 11-15** Westin Resort, Hilton Head Island, S.C. Contact (713) 342-9655.

*Cable Television Association of the Republic of China* **January** Taipei, Taiwan. Call (02) 788-5773.

*Texas Show* **February 26-28** Convention Center, San Antonio, Texas. Contact (512) 474-2082.

*Optical Fiber Communications Conference '92* **February 2-7** San Jose Convention Center, San Jose, Calif. Call (202) 416-1980 for technical information or (202) 416-1950 for exhibitor information.

*National Show* **May 3-6** Convention Center, Dallas, Texas. Contact (202) 775-3669.

*International Conference on Consumer Electronics* **June 3-5** Chicago, Ill. Call Diane Williams, (716) 392-3862.



The following training courses have been announced by the National Cable Television Institute (NCTI):

**November 12** Labor Relations for Supervisors, Washington, D.C.

**November 13-14** OSHA Compliance Seminar for CATV Operators, Washington, D.C.

**December 10** Labor

Relations for Supervisors, Detroit, Mich  
**December 11-12** OSHA Compliance Seminar for CATV Operators, Detroit, Mich.

For more information on NCTI's new training seminars, contact Michael J. Wais at (303) 761-8554, or fax inquiries to (303) 761-8556.



CED welcomes information regarding technical seminars, meetings or events.

To publish information about your next technical seminar, send all relevant information to:

**CED Magazine**  
600 S. Cherry St.  
Suite 400  
Denver, CO 80222  
Attn: Leslie Ellis





# CALL FOR PAPERS

To get a head start on the planning of next year's expo, SCTE is currently soliciting proposals for technical papers and/or workshops to be presented at Cable-Tec Expo '92 in San Antonio, Texas. Technical papers that are accepted will be presented at the Society's 16th Annual Engineering Conference on June 14, 1992.

Proposals for workshops also are being solicited. Expo workshops are "hands-on" sessions that will provide attendees with in-depth instruction on technical procedures that are used in everyday practice.

Submissions, which should include a brief abstract of the proposed paper or workshop, should be sent to Bill Riker, Expo '92 co-chairman, no later than Dec. 1. For further information, please contact SCTE national headquarters at (215) 363-6888.



*CABLE-TEC  
EXPO '91*



# The CABLE POLL

TM  
Midwest CATV • CED • CableVision

## Fiber's hot; compression's not

Fifty percent of GMs will deploy fiber in 1992; 70 percent say compression is not in their plans

With all the factors on a general manager's mind when considering the right time for a rebuild or upgrade, will the rapidly changing course of video compression technology complicate the decision-making process even further?

Probably not, according to results from the latest Cable Poll. Forty-three percent of the 405 GMs responding to the survey claim that their system will undergo an upgrade or rebuild next year. And in that 175-person subgroup, most of whom come from systems with less than 50,000 subscribers, owned by the top 100 MSOs, 70 percent say that compression will have no effect whatsoever on their construction plans.

Seven percent admit that compression developments did encourage the postponement of their rebuild/upgrade timetable from earlier dates, while eight percent note that the technology helped them start the construction process earlier than expected.

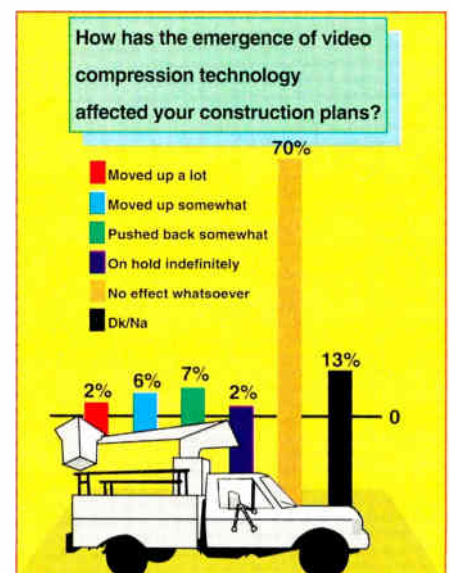
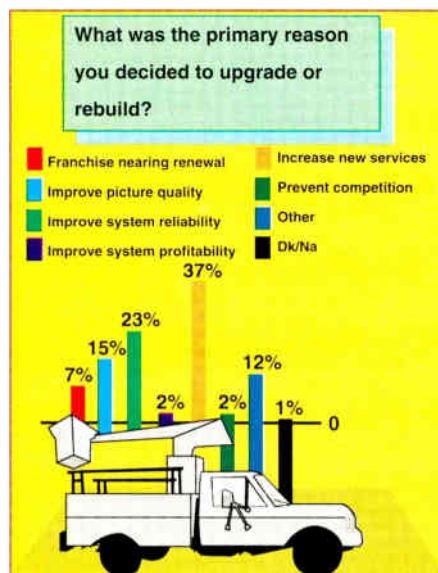
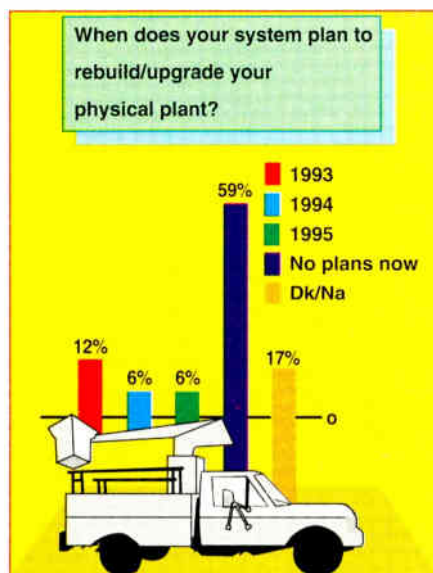
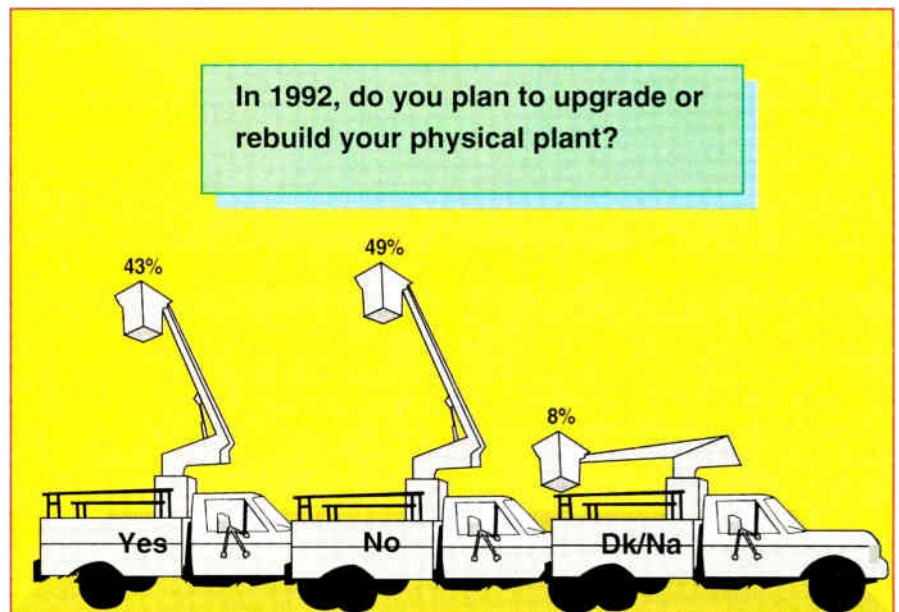



# CABLE POLL

As for the 230 GMs in the sample who will not reconstruct their systems in some way next year, 12 percent of the group will undertake that task during 1993 and another 12 percent will follow in 1994 and 1995.

## Not insistent on compression

On the other hand, operators appear to be not so insistent on the matter of figuring compression into their upgrade/rebuild plans.

Only one-quarter of the GMs looking at some type of system construction next year expect to incorporate a video compression process into their plans, regardless of when compression becomes available. Of the 43 GMs with that mindset, most come from top 100 operators and systems with less than 50,000 subscribers. Midwest operators answering Cable Poll are more likely to incorporate compression than GMs elsewhere.

## Using compression with fiber

More than 75 percent of the compression-minded managers will use the technology in conjunction with fiber optics; 14 percent plan to apply compression as a fiber alternative.

With the parameters of compression's ability changing almost monthly, and no definitive word when compatible in-home converters will be available, operators are justifiably cautious about when to implement the technology, says Society of Cable Television Engineers Executive Vice President Bill Riker.

"Our industry moves slowly on developments that carry a big up-front cost. Operators want to see a track record that showcases the benefits before making large-scale investments. Look at pay-per-view—we're still under 20 million homes with that technology," he says.

Riker believes the Poll results confirm opinions from his SCTE associates that any hopes that compression will weave into the critical mass of upgrades/rebuilds ahead are unfounded.

Just 11 percent of the systems with 1992 construction plans surveyed believe compression will be integrated among most cable systems nationwide by the end of next year. More than half the group predict that accomplishment will be reality by 1995 or later, while four percent figure that compression will never be an element of

most operators' plans.

The outlook for fiber deployment is better; more than half of the poll GMs with 1992 construction projects will utilize fiber, compared to 37 percent of respondents in that subset. Once again, managers at systems under 50,000 subs express the most interest. ■

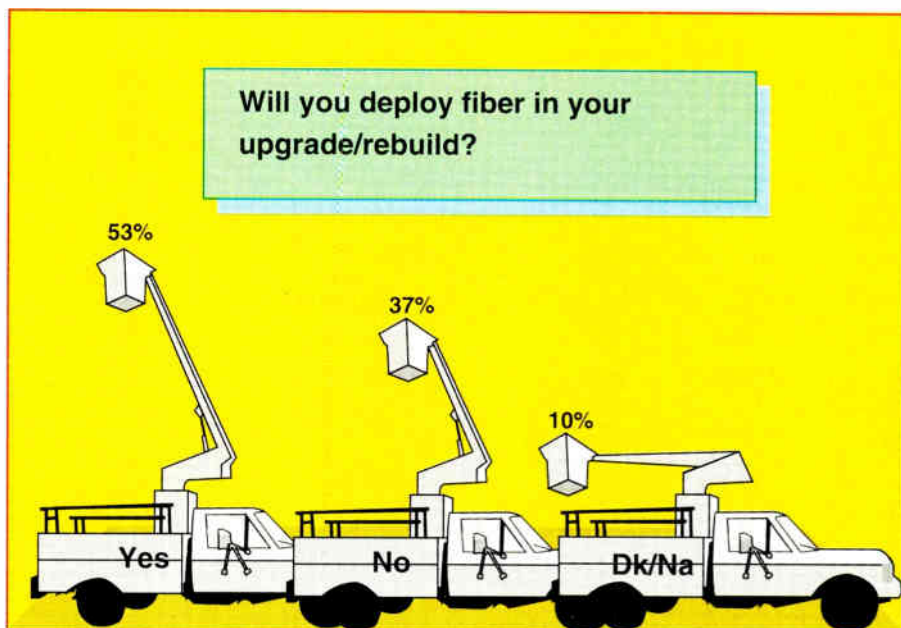
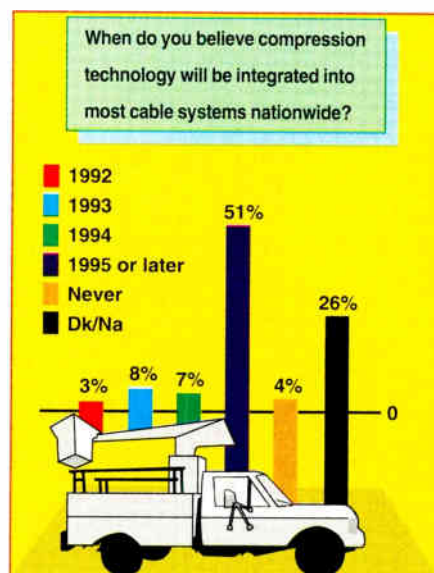
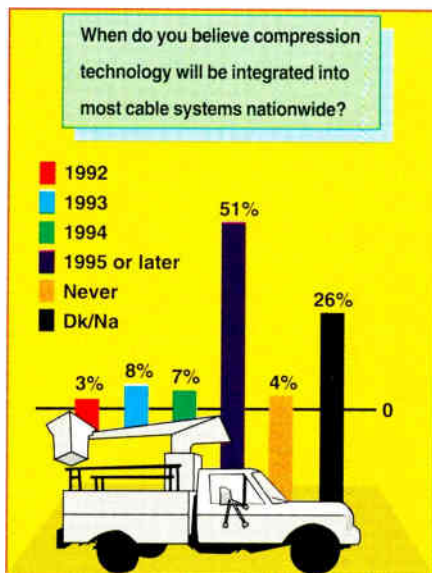
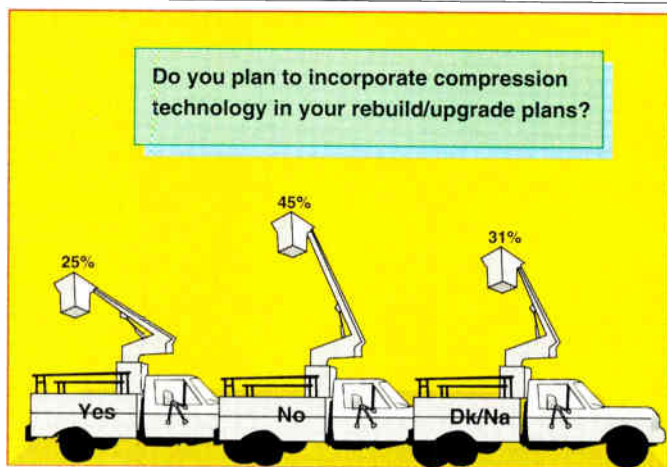

## CableLabs to participate in ghost canceling tests

Cable Television Laboratories has announced its participation with broadcasters in the Washington, D.C. area to field test multipath ghost phenomena. The end result is to determine a voluntary guideline that may be used to eliminate ghosting.

The testing was slated to begin in mid-September with the assistance of cable systems in that area and several broadcast stations, including WRC-TV, channel 4; WDCATV, channel 20; and WFTY, channel 50. These stations were chosen because their signals are located in different portions of the television spectrum—VHF, low UHF and high UHF. CableLab's portion of the tests will evaluate performance at cable headends and subscribers' homes.

"These tests allow us to test five different ghost canceling systems at a single site," comments Craig Tanner, VP of advanced television projects. The five proponent ghost canceling systems include the Broadcast Technology Association of Japan, Samsung Electronics, AT&T/Zenith, Philips Laboratories and the David Sarnoff Research Center/Thomson Electronics.

In addition to CableLabs, other test participants include the National Association of Broadcasters, the Electronic Industries Association and the Association of Maximum Service Telecasters. Results of the test will be shared with the Advanced Television Systems Committee.

CableLabs will continue its ghost canceling research in conjunction with Rogers Cablesystems in the Vancouver, British Columbia and Seattle, Wash. areas.

## Acquisitions and agreements

EDS has announced an acquisition of "some of the assets" of Creative Management Systems (CMS). CMS manufactures software that performs several CATV tasks including scheduling and dispatching, impulse PPV, credit/collection and accounting/billing.

### Fitel hooks Wendell Whitaker

Fiber optic cable manufacturer **Fitel**

General has announced the appointment of W. Whitaker and Associates as its manufacturers' representative in the states of Illinois, Indiana and Michigan (excluding the upper peninsula). Wendell Whitaker and his staff are located in Lafayette, Ind. and can be reached at (800) 433-8775.

### Siecor increases plant size

**Siecor Corp.** has announced a 40 percent size increase of its telecommunications plant, which manufactures fiber optic cable used for outdoor applications. Capacity will increase over 50 percent. Construction on the expansion is expected to be completed in April 1992. In addition to the manufacturing plant expansion, Siecor will also increase the size of its R&D laboratories and will add to its overall R&D capabilities.

## Fiber products

**Fotec** has introduced a microscope for inspecting FDDI fiber optic connectors. The V151 microscope views the optical interface of FDDI connectors to determine if connector ferrules are properly polished or if they are dirty or damaged. It sells for \$120 and is available by calling (800) 537-8254 or faxing (617) 241-8616.

### Pocket-sized test kit

Also new from **Fotec** is a pocket-sized optical test set designed for fiber to the home and fiber to the curb applications. It operates at three different wavelengths—850 nm, 1300 nm

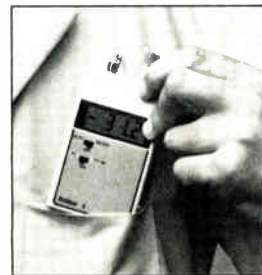

*Fotec's mini test set*

and 1550 nm. In addition, the unit includes one or two sources for testing the loss of optical fiber cables. Four versions of the test set are available. The T770 has both 850 nm and 1300 nm LED sources. The three other versions use laser sources for testing singlemode fiber cables. T780 uses a 1300 nm laser source, T790 has a 1550 nm laser source and the T795 includes both 1300 nm and 1550 nm laser sources. For more information, contact Fotec at

(800) 537-9254 or fax inquiries to (617) 241-8616.

### Heavy-duty fiber connectors

**AT&T Network Cable Systems** has introduced a new fiber optic connector assembly for CATV and broad-

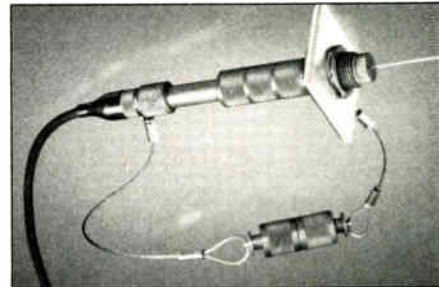

*AT&T's fiber connector*

cast applications that can accommodate cables with outside diameters from 2.5 mm to 4.0 mm. The single mode assembly with protruding fiber polish provides fiber-to-fiber physical contact, and the multi-mode assembly provides fiber-to-fiber contact through its flat polish. The connector assemblies list for \$1,600 each. For more information, call (800) 344-0223, ex.1142.

### Laser source

New from **Meson Design and Development** is the DB1300/LS laser



*Meson's laser source*

source, developed for short- and long-haul multimode and singlemode fiber runs. It can be operated at continuous wave or modulated at 20 Hz, 270 Hz or 2 kHz. It comes with rechargeable batteries and an AC adapter and battery charger. For more information, call Meson at (800) 45-MESON or fax inquiries to (607) 722-3945.

### Video production link

**Vyvx** has announced plans for the development of a project called "First Video," which will connect 50 video production facilities via the company's 8,000-mile nationwide fiber optic network (already in use by such entities as ABC, CBS, NBC and CNN).

Production facilities linked to First Video will be able to transmit real-time



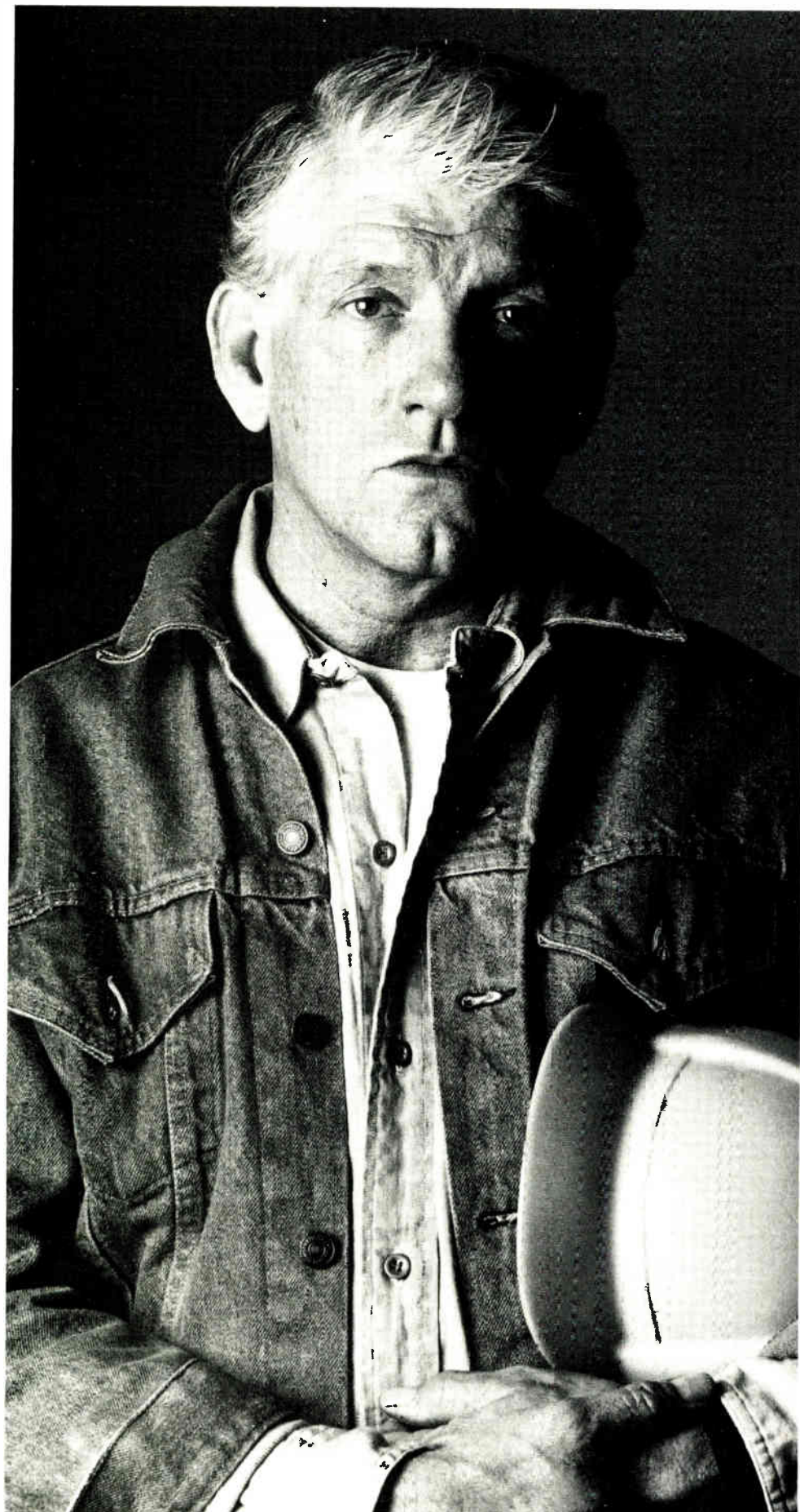

**Never forgive  
an addict.**

**That's somebody  
else's job.**

Forgiveness calls for higher powers; you're just the boss. Your job is to help. And to do it in the here and now.

And that's tough.

Because you'll have to tell a decent person to get well or get out. You'll have to deliver an ultimatum to someone who's already in trouble.

That's what it takes. No one has ever sweet-talked an addict into treatment.

Once you've done the tough part, there's help to go the next step.

1-800-843-4971 is the National Institute on Drug Abuse helpline for managers and CEOs. Call Monday to Friday, 9:00 a.m. to 8:00 p.m. Eastern Time. They'll refer you to professionals who can help your company set up drug education, employee assistance, and treatment referral programs.

That's how you can start helping—here and now.

*Partnership for a Drug-Free America*

video to other production facilities across the country. Expected uses will include transmission of commercials or news features. For example, Vyvx officials say, on-line editing with First Video will be more easily accomplished, making editing sessions with clients in distant cities more convenient and cost effective.

The most likely users, Vyvx officials predict, will be television stations, advertising agencies and local businesses, for videoconferencing. For more information on how to become a First Video affiliate, contact Vyvx at (713) 547-1000.

**High performance connector**

Augat Communications Group has announced a GB series, DIN47256-compatible fiber optic connector system, particularly useful for CATV

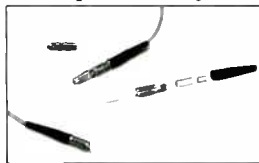

Augat's GB Series connector

systems using AM laser sources. Both single-mode and multi-mode styles are available. Preliminary tests show 0.25 dB insertion loss with -45 dB typical return loss and cable side loading of 5 Newtons (1.1 lb.) which results in less than 0.1 dB attenuation change. For more information, contact Augat at (206) 932-8428.

**Optical tester**

New from Siec Corp. is a portable, low loss test set for testing 1300



Siec's OptiTest

nm single-mode fiber. Called the Siec OptiTest, the test set performs attenuation testing of mechanical or fusion splices or passive optical components without access to fiber end-faces.

The OptiTest set uses a bi-directional transmission and receiving system to measure component loss within a fiber system. Light is launched on both sides of the splice to be measured by clipping on to the fiber. The signal crosses the splice and is detected on the other side. A receiver provides power ratio measurements on each side of the object.

Attenuation can be measured on all

passive optical components—including fibers, fusion and mechanical splices, splitters, couplers and connectors—without removing the fiber color coating. For more information, call Siec at (704) 327-5998.

**Fiber curing oven**

New from The Light Brigade is a 12-port curing oven, designed for both

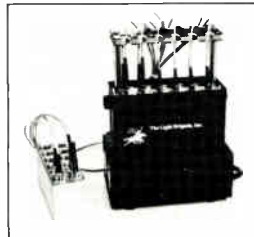

The Light Brigade's fiber curing oven

field and laboratory applications. The oven includes a variable thermostat, a timer for specific cure cycles, an adjustable strain relief system for cable assembly curing, a cooling block and curing adaptors.

For more information, call (206) 277-1240.

**Fiber optics kit**

Jensen Tools has introduced a new tool kit, the JTK-4000, which is designed to give communications technicians a universal solution to terminating fiber optic cable—regardless of connector manufacturer.



Jensen's JTK-4000

Included in the kit are most of the tools and supplies used by field service technicians. For more information and a free catalog, contact Jensen at (602) 968-6231.

**Singlemode WDMs**

Fujikora Ltd. has announced a new line of singlemode fiberoptic wavelength division multiplexors (WDMs) that are factory pre-tuned to transmit 100 percent of one wavelength and zero percent of another. Three grades are available based on excess loss characteristics—less than 0.1 dB, 0.5 dB and 1.0 dB, respectively. For more information, call Fujikora at (800) 866-3977.

**Single-mode laser transmitter**

New from BT&D Technologies is the XMT3350-PT Logic-to-Light series of laser transmitters that operate with

serial ECL signal inputs at data rates of 50 to 250 Mbit/s. The laser transmitters were designed for the local area network, Sonet/SDH, intra-office network, point-to-point and single-mode FDDI markets.

**FTTH receiver**

Also new from BT&D is a new low cost receiver designed specifically for fiber to the home (FTTH) applications. The receiver, slugged the RCV3104, is suitable for passive optical networks and local area networks operation from 1200 nm to 1600 nm.

The receiver was developed in conjunction with British Telecom Laboratories for use in customer premise equipment in TPON fiber to the subscriber systems. For more information, call BT&D at (302) 479-0300.

**Other new products**

New from Global Span Products is the Quik-Trace Touch-N-Tone Wire Identifier, designed to give bench technicians freedom of both hands while



Global Span Product's Quik-Trace Touch-N-Tone wire identifier

performing isolation tests. Applications for the device include wire tagging and identification, troubleshooting and repair for bundled wires and scanning of printed circuit board traces. The unit operates on body conductance, leaving the hands free. A removable belt clip allows for field usage. The unit sells for \$119.95. Dealer inquiries are also suggested. For more information, contact GSP officials at (408) 379-0187 or fax inquiries to (408) 379-8757.

**Large screen video projector**

General Electric Co. has announced its Imager LCD15 large screen video projector, which can display images on a screen or wall from any video source, including VCRs, laser disc players and video cameras. Images measuring from 25 inches to 300 inches diagonally can be displayed. For more information, contact any GE-authorized dealer or call (315) 456-2152. ■



## People in the news

The first Mid-America Show Cable-Tec Games recently took place, organized by **Ron Wolfe** of the ATC Training Center and **Wendell Woody** of Anixter Cable TV, who also served as Master of Ceremonies for the event.

**Al Wilke** of American Cablevision of Kansas City took home the bulk of the hardware prizes by being the first contestant ever to win medals in all four events. The complete breakdown of winners is as follows:

Signal leakage and TDRs: First place, **Joe Cvetnich**, Wheat State; Second place, **Al Wilke**, American Cablevision; Third place, **Percy Kirk**, Wheat State.

Cable splicing: First place, **Joe Cvetnich**, Wheat State; Second place, **Al Wilke**, American Cablevision; Third place, **Percy Kirk**, Wheat State.

Signal level meters: First place, **Al Wilke**, American Cablevision; Second place, **Gordon Bennett**, American Cablevision; Third place, **Percy Kirk**, Wheat State.

Fiber splicing/signal analysis: First place, **Ron Eggert**, Jones Intercable; Second place, **Joe Williams**, Wheat State; Third place, **Al Wilke**, American Cablevision.

Overall winners: First place, **Al Wilke**, American Cablevision; Second place, **Jeff Bickel**, Jones Intercable; Third place, **Tony Fox**, Jones Intercable.

**Bill Park**, VP of technical services for **Rogers Engineering**, has received the **E.R. Jarman Award for Outstanding Achievement in Engineering**. Mr. Park was chosen for his work in the development of an airborne cumulative leakage technology that

could accurately measure signal leakage from an aircraft 450 meters above the ground, record the measurements and present the data graphically. The technology has been used extensively over Canada and the U.S. since 1986, and has been licensed in the U.S. where it has been used to fly over some 10,000 strand miles of cable plant.

**Ed Milner** has joined the **National Cable Television Institute (NCTI)** as its information systems specialist. Milner has relocated to NCTI's Denver, Colo. facilities from Glen Ellyn, Ill. where he was previously VP of technology for Flight Trac Inc. In his new role, Milner will work with NCTI's client services computer system, including the development of enhancements designed to provide more information to client companies on their employees enrolled in NCTI's programs.

**Wendy Stahl** has been appointed VP of strategic planning and business development for **Landmark Communications**, parent company of **The Weather Channel**. In her new role, Stahl will seek acquisitions and develop new business opportunities for the company.



*Jeffrey Maul*

and Digital Support Systems Inc.

**Jack Bucter** has been named presi-

**Advanced Techom Inc.** has named **Jeffrey Maul** as VP of systems engineering and service. Prior to joining ATI, Maul was co-founder and VP of engineering

dent of **AT&T Network Cable Systems**. Previously, Bucter was president of AT&T's Business Communications Systems. Also, **James D. Carboy** has been named fiber optics VP for **AT&T Network Cable Systems**. Carboy has been with AT&T since 1963, most recently holding the position VP, manufacturing and sourcing.

**Telecorp Systems** has appointed **Roger Reece** to its VP of marketing slot. Reece was previously director of marketing for Melita International. In his new position, Reece will communicate the benefits of total call center solutions to cable industry officials and help define future product strategies.

**Zenith Sales Co.** has named **Stephen Sigman** VP of consumer affairs. He succeeds John Pederson, who recently retired. Previously, Sigman was director of market planning for the company. He will retain those responsibilities.

**Barry Parkin** has joined the staff of **Jerrold Communications European Operations** as director of sales. In his new position, Parkin is responsible for all Jerrold sales activity in Europe, the Middle East and Africa.

**Augat Communications and Interconnection Products Division** has promoted **William Jenson** to VP of CATV and network products and **Chris Sirianni** to VP of Telecom products. The promotions are part of a recent restructuring that combines Seattle, Wash.-based Augat Communications Group with Augat Interconnection Products out of Attleboro, Mass. **Robert McIntyre** has been appointed group VP of the combined operations.

Also, **Sally Kinsman** has joined the **Augat Communications Group** as product manager for 1 GHz-capable fiber optics distribution networks.

# WARREN, MORRIS & MADISON, LTD.

*Executive Search Est. 1983*

*Del Mar, CA  
(619) 481-3388*

*Portsmouth, NH  
(603) 431-7929*

CAREER MARKETPLACE

**Leader in the placement of Cable Television Professionals**  
**Call toll free 1-800-433-2160; In Texas call 817-599-7623. FAX 817-599-4483.**

DIR OF OPS—corporate level position for small MSO, will talk equity, \$50K base  
 DIR OF ENG—Top MSO needs administrator to oversee day to day ops of 150K sub system, \$50K  
 TECH TRAINER—Multiple opportunities, all facets of business, \$35K  
 TECH SUPER—Multiple small systems in the midwest needs leader, reports to Regional Manager, \$35K  
 TECH MGR—SE location, top MSO, \$40K  
 PLANT MGR—Top MSO, West Coast location, \$40K  
 CIRCUIT DESIGN ENG—Multiple oppt's nationwide, \$40K - \$65K  
 TECH MGR—Resort setting, East Coast location, \$45K

CHIEF TECH—Take charge of this addressable upper midwest system, \$35K  
 MAINT MGR—Attractive western location, top MSO, \$35K  
 TECH MGR—Top MSO, east coast, report to V.P. Engineering, \$35K  
 CHIEF TECH—Major MSO needs hands-on ability in SE, \$30K  
 MGR/CHIEF TECH—Multiple opportunities nationwide, \$26K - \$32K  
 CHIEF TECH—Top MSO Southern location optical technology, \$28K  
 HEADEND/MICROWAVE TECH—Multi-oppt's nationwide, top 20 MSO's top benefits, \$25K - \$40K  
 SERVICE AND LINE TECHS—Opportunities nationwide, call for geographic preference, \$9 - \$16/hr



**JIM YOUNG & ASSOCIATES**

One Young Plaza 1235 Ranger Highway Weatherford, TX 76086  
 Call for information about these and many other opportunities nationwide.

**REGIONAL SALES POSITIONS AVAILABLE**

Openings in the Cable TV marketplace for regional and area sales managers are now available.

Candidates must have both technical and computer knowledge, combined with professional sales experience.

Send resumes to:

Box 1101 - TS, C/O CED Magazine  
 600 South Cherry Street, Suite 400,  
 Denver, CO 80222

**INSTALLATION SUPERVISOR**

**Mid-Atlantic**

Large system seeks experienced Installation Supervisor with 2+ years experience. Qualifications should include a strong background in people skills and all aspects of installations. Should also have excellent customer relation skills. Organization skills a must. Salary is open + benefits. EOE. Send resume to: Box 3403-TS, C/O CED Magazine, 600 S. Cherry St. Suite 400, Denver, CO 80222.

**Baker Scott & Co.**

**THE PROFESSIONALS CABLE PLACEMENT COMPANY**

Our NATIONAL and INTERNATIONAL clients include MSO's, Networks, Regional and Independent Operators. We place ALL LEVELS OF MANAGEMENT. Call DAVID ALLEN or JUDY BOUER, PRINCIPALS. Fees paid.

1259 Rt 46, Parsippany, NJ 07054  
 201-263-3355; Fax 201-263-9255

**CHIEF TECHS**

Qualified hands-on individuals with organizational ability wanted for medium sized systems located in Upper Midwest. Strong sweep and headend experience required. Good technical planning and training. Will consider strong Asst. Chief Techs.

Send letter or resume' to:  
 Box 1763 - TS, C/O CED Magazine, 600 So. Cherry St., Suite 400 Denver, CO 80222

**We have the position for you...**

*Place help wanted ads in CED*

*"Career Marketplace" and let CED recruit for you.*

**(303) 393-7449**



BUSINESS CARD DIRECTORY

**NaCom**

BUILDING COMMUNICATION SYSTEMS THROUGHOUT AMERICA

- Full Installation Services
- Converter Exchanges, Audits, Special Projects
- MDU, SMATV, LAN, Pre/Postwiring & DAS
- Aerial/Underground Construction (Including Fiber Optics)
- Strand Mapping (AutoCAD & LYNX)
- Field Engineering, Make-Ready, As Built
- RF Design (CADSUM II, LYNX, & LODE DATA)
- CLI Detection/Correction

1900 E. Dublin-Granville Road, Suite 100A, Columbus, OH 43229  
 • (614) 895-1313 • (800) 669-8765 • FAX (614) 895-8942

*White Sands*

**Jumper Cables**

CUSTOM MADE CABLE ASSEMBLIES INCLUDING  
 F to F, N to N, BNC, RCA, F-81

Gilbert AHS	RG-56	Belden
LRC	RG-59	Times
Roychem	RG-11	Comm/Scope
Off Shore	RG-213	Intercomp
Amphenol	RG-214	

We will make any cable assembly. Quick delivery on all colors and lengths  
 Fax: (602) 582-2945 Ph: (602) 581-0331  
 335 W. Melinda Drive, Phoenix, Az. 85027

*Coastal*  
**Broadband SERVICES**

- Scheduled Maintenance Programs for Headend, TVRO and Tower Mounted Antennas.
- TVRO Installations
- Headend Pre-racking/Re-racking/Rewire
- Specializing in High Rise MDU Prewire/Postwire
- Marinas Prewire/Postwire

**(609) 848-5140**

FROM MANHATTAN TO MIAMI

ALL OF OUR TECHNICIANS ARE TECHNICAL SCHOOL GRADUATES

**JOHN JAMES CATV SERVICE**

SPECIALIZING IN

- SA EQUIPMENT
- HEADEND PROOFS
- REPAIRS
- FCC OFFSETS

26 Years HEADEND Equipment

1218 Franklin Cir. NE  
 Atlanta, GA 30324

Phone: 404-636-1031



COMMERCIAL ELECTRONICS, INC.  
 CATV ENGINEERING SERVICES

**CATV EQUIPMENT REPAIRS**

- |                          |                    |
|--------------------------|--------------------|
| Hybrid Sales             | Meter Calibrations |
| Equipment Upgrading      | Headend Alignment  |
| Performance Measurements | FCC Offsets        |
- Free Pick-up Service In Certain Geographic Areas

800-247-5883 or in Virginia 800-345-6834

209 E. Jackson St., PO Box 484, Gate City, VA 24251

**Video Page Generator & Controller \$189.95**

High Res NTSC or PAL  
 2- 240 char. crawls/ pg.

Flash, Scroll, 3 Sizes!

16 Colors, User friendly  
 Auto-sequence pages  
 Cut & Paste, WYSIWYG

12:24:30 THURSDAY 3:21:91

C64 + VIDG Displays & sequences 1000 pages, HI Res. 16 colors, scroll, flash, crawl, vary height, 24Hr. clock+ date, C64 Graphics, Color Bars, crawls! Transfer pages via modem auto-sequence at remote location. "WX1" displays temperature & humidity, "PK8" controls 8 relays. Time & date calendar: auto-loads new sequences & pages + controls relays via touchtone audio strings!

VIDG Inc. Cart, disk, manual, cable.....\$189.95  
 C64 Computer \$159.95, 1541 disk drive.....\$189.95  
 PK8 relay control & meter input.....\$189.95  
 WX1 temp. & humidity sensor (req. PK8).....\$189.95  
 C64 Hayes modem \$ 89.95, 12Volt C64 Pwr. Sup. \$129.95

ENGINEERING CONSULTING  
 583 Candlewood St. Brea, Ca. 92621  
 Tel: 714-6712009 \*\* Fax: 714-255-9984  
 Low cost remote control & video display  
 \*\* Ask for free catalog \*\*  
 Mastercard Visa Amex COD & P.O.

**PICK A CARD... 303-393-7449**  
**ANY CARD...**

**And point your business in the right direction**  
 Call Terri Sinner to reserve this space for your business card in 1992.

ENGINEERING/DESIGN/CONSTRUCTION

**FCC COMPLIANCE TESTING**



**FIBER OPTIC DESIGN & ACTIVATION**  
**HEADEND OPTIMIZATION**  
**COMPLETE SYSTEM AUDITS**

AUTOCAD CUSTOMIZED CATV MENU  
 & SYMBOLS LIBRARY  
 CAD DRAFTING & DESIGN  
 STRAND MAP & AS BUILT  
 MAP DIGITIZATION & REVISIONS

CORPORATE OFFICE (605) 665-1393  
 FAX (605) 665-1708

FIELD OFFICE (708) 541-3993



**State Wide C.A.T.V. Inc.**

466 County Road 75, Mechanicville, NY 12118  
 Telephone 518-664-5970  
 Fax 518-664-9723

*Specializing in Fiber Optics*  
*Aerial and Underground CATV Construction*

Michael Wallace, Vice President

Pres. Ron Prather Office: (404) 736-3733  
 Office: (404) 738-9797

*Prather Contracting, Inc.*

CATV Aerial and Underground Construction,  
 Service Wires and Fiber Optics

3540 Wheeler Road ♦ Suite 107 ♦ Augusta, GA 30909

**New Construction • Installs • Balancing • Splicing**

*Bigham*

**Cable Construction, Inc.**  
*Performance Built Our Company*  
**Specializing in Rebuilds & Fiber Optic Installation**

Harold Bigham P.O. Box 903  
 (904) 932-6869 Gulf Breeze, FL 32562

**MIDWEST CABLE SERVICES**



— **NATIONWIDE BUYERS** —  
**CATV SCRAP CABLE AND USED LINE GEAR**

P.O. Box 96 (219) 892-5537  
 Argos, IN. 46501 FAX(219) 892-5624

**FULL SERVICE CATV CONTRACTOR**  
 Specializing in all phases of CATV construction:

- Technical Consulting
- Aerial & Underground Construction
- Splicing & Activation
- Fiber Optic Installation

*"Service with Commitment"*



**EASTERN TECHNICAL COMMUNICATIONS, INC.**  
**CATV SERVICES**

7307-C Hull Street Road, Richmond, VA 23235 804-276-0883

**The Proof is in the PERFORMANCE**

- Fiber Optics
- Electronic testing of cable systems and LAN's
- Electronic upgrades
- Retro-fits
- Technical evaluations

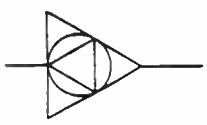

*We are fully equipped to perform all services for CATV and LAN operators related to electronics.*

**Systems Performance Engineering Inc.**  
 PO Box 24927, Jacksonville, FL 32217 • (904) 262-8269 • FAX (904) 260-0383

**GREATER VISIONS**

**"COMMUNICATION YOU CAN SEE"**

- C.A.D. Drafting Service
- Engineering
- Project Cost Analysis
- Construction

10102 Hwy. 105 W. **David Christy** 519 E. Center  
 Montgomery, TX 409-588-2099 Sikeston, MO  
 77356 83801



ENGINEERING/DESIGN/CONSTRUCTION



UNDERGROUND & AERIAL CONSTRUCTION,  
FIBER OPTICS, INSTALLATIONS, AUDITS, CLI

36-630 CATHEDRAL CANYON. DR.  
CATHEDRAL CITY, CA 92234  
LIC. #478543 (619) 328-6778



CABLE SYSTEM  
SURVEY CO.

MAPPING ■ DESIGN ■ AS-BUILTS ■ CAD &  
DRAFTING SERVICES

**Quality Construction Begins  
with Quality Maps**

126 W. Michigan Ave. • P.O. Box 824 • Marshall, MI 49068  
(616) 781-3455 • FAX (616) 781-5177

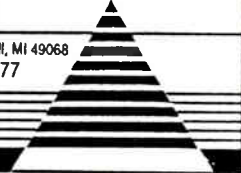

Fiber Optic Specialists

CATSKILL MOUNTAIN CONSTRUCTION CO.

Complete Construction Services  
for the Northeast

Tom Colangelo

General Manager  
518-943-6653

200 Jefferson Heights, P.O. Box 399, Catskill, New York 12414  
FAX 518-943-6603

FIRST CLASS

COMMUNICATIONS, INC.

A COMMUNICATIONS CONSTRUCTION COMPANY

Design to Installation  
Underground Construction  
MDU Installation

(714) 652-3224  
40419 ROYAL CIRCLE  
HEMET, CA 92544  
CA. LIC. # 390528

GARY CUSWORTH  
PRESIDENT  
PAGER (714) 423-3727

**RAHMER TECHNICAL SERVICES**

CAD Design & Drafting Services

**(404) 920-2074**

6280 Senior Circle, # A  
Douglasville, Georgia 30134



SPECIALIZING IN:

- Fiber Optics Construction & Splicing
- Upgrades and Rebuilds
- Aerial & Underground Construction
- Field Engineering
- Mapping & Design

*Let us help you complete your projects  
on time & under budget.*

2301 Park Avenue, Suite 401, Orange Park, FL 32073  
(904) 269-9336 • (800) 666-4SUN • FAX (904) 269-8090

WE'VE GOT

**DESIGNS**

ON YOU!

Contract this space for 1992.

**(303) 393-7449**

**EQUIPMENT FOR SALE**

**EQUIPMENT FOR SALE**

- |                        |               |              |
|------------------------|---------------|--------------|
| 1. Time Base Corrector | Portel Y688   | SN: 60115405 |
| 2. Time Base Corrector | Portel Y688   | SN: 60115406 |
| 3. Color Camera        | Hitachi FP-22 | SN: 2092382  |
| 4. Color Camera        | Hitachi FP-22 | SN: 2092405  |
| 5. Color Camera        | Hitachi FP-22 | SN: 3010178  |

Each of the three cameras above have the following accessories attached:

- |                        |  |
|------------------------|--|
| 1. 1.5" Viewfinder     | Hitachi GM-3B                                |
| 2. Tripod Adapter      | Hitachi TA-20                                |
| 3. Power Adapter       | Hitachi AP-40                                |
| 4. 4.5" Viewfinder     | Hitachi GM-5                                 |
| 5. Focus Manual Module | Fujinon FMM-6A                               |
| 6. Lens                | Fujinon RM-37<br>A14 x 10B<br>1:1.7/10-140mm |

**If more specifics are needed on the cameras, please call Robert Mellonig or Don May at 213-566-5420 or 213-566-8815**



**NATIONAL FARMERS UNION  
PROPERTY AND CASUALTY COMPANIES**

(801) 261-1353  
FAX: (801) 261-1366

Claims Office 5284 South 320 West, Suite C-144  
Murray, Utah 84107

**EQUIPMENT REPAIR**

**dB-tronics®**  
*For Your Equipment Needs*

**CALL US FIRST!**

- AFFORDABLE, QUALITY REPAIRS:**  
Converters, Line Equipment, Headend Equipment and F.S. Meters.  
(Six month warranty on ALL repairs.)
- WE BUY & SELL EQUIPMENT SPECIALS:**  
SA 8500 - 311 w/remote .... \$32.95 ea.  
New Remotes SA, Jerrold ... \$4.75 ea.  
SA 372397 FF Trunk ..... \$362.00 ea.  
SA 344030 PP Trunk ..... \$95.00 ea.  
SA 344000 PP Bridger ..... \$161.00 ea.

*Hurry, Limited Quantity Available*

FOR OTHER SPECIALS CALL:

**SALES**

Phone: 1-404-992-6730 • FAX: 1-404-992-6816

**CUSTOMER SERVICE**

Phone: 1-800-356-2730 • FAX: 1-803-439-7518

**get converted!**

**EMERGENCY  
ALERT SYSTEMS**

BY

**Idea/onics**

69 channels 14 day delivery  
compatible with all headends  
-AFFORDABLE-

(701) 786-3904

24 and 88 channel units  
also available

**Aerial Equipment Service Company**  
Cable Lashers  
Aerial Bucket Trucks

714-895-4863 • FAX 714-893-6986

*Serving the cable industry since 1981*

**COAST CATV SUPPLY**  
WANTED NEW/USED & EXCESS  
IN STOCK

SA, Jerrold, Magnavox, PathMaker  
300, 330, 400 MHz  
Call Nick Meko

714-272-2360 / FAX 714-272-3032

**Vision Electronics, Ltd.**  
Albany, NY



Quality Jerrold Addressable  
Converter Repair  
Flat Rate

(518) 462-6392

**WE NEED SURPLUS  
NEW & USED**

Connectors, Taps, Etc.  
**TM BROKERS**

Phone/FAX (208) 687-2289  
Phone/FAX (208) 687-2872

**WANTED:  
SURPLUS CABLE EQUIPMENT**

Jerrold, Oak, Hamlin & Scientific  
Atlanta equipment.  
Highest Prices Paid  
Cable Equipment Brokerage Co.

(818) 709-3724

**SPACE  
FOR  
SALE**

**303-393-7449**

Advertise

**"EQUIPMENT FOR SALE"**

or

**"EQUIPMENT REPAIR SERVICES"**

here



FLYOVER SERVICES

**FLIGHT TRAC**  
**INC**

Airborne Signal Metering

When the task is as critical as  
**Airborne CLI Testing...**  
Make Your Choice As Simple As 1,2,3...

1. Simply the most advanced technology: The "Rogers System"
2. Simply the most useful reports: 4 color on detailed franchise map.
3. Simply the most experience: over 400,000 cable miles flown in 1990/91.

And all of it with never a missed deadline or additional fee. Ever!

*That's why Flight Trac has been the choice of more MSO's year after year than all the other flyover companies combined.*

478 Pennsylvania Ave.  
Glen Ellyn, IL 60137

See us at the Western Show, Booth # 1208

Phone: (708)790-2500  
FAX (708) 790-2562

Advertiser Index

	Reader Service #	Page #		Reader Service #	Page #
AM Communications	5	9	Monroe Electronics	38	64
ATC	35	61	Multilink	36	61
Ad Systems	43	74	NBC Olympics PPV	56	103
Aeroquip Corp.	24,62	42	National Cable Television Institute	31	53
Alpha Technologies	8	15	Nacom	25	43
Anixter Cable TV	59	120	Nexus Engineering	3	5
Applied Instruments	51	86	Panasonic Video Comm.	1	2
Arrow Fastener	30	52	Panasonic Office Automation	39	65
Belden Corp.	23	41	Pioneer Communications of America	33	58-59
Cable Prep/Ben Hughes Comm.	60	32	Power Guard	45	77
Cable Services	21	39	Power & Telephone Supply	29	51
Calan, Inc.	6	11	Regal Technologies	54	95, 97, 99, 101
Channell Comm.	18	35	Riser-Bond	47	81
Channel Master	48	83	Siecor Corp.	14	27
Channematic	34	60	Standard Communications	7	13
Comm/Scope Inc.	27	49	Superior Electronics Group	58	119
Corning, Inc.	10	18-19	Sumitomo		67-70
Contec International	42	73	Synchronous	55	96
Drug Free America		109	Systems Performance	17	32
Eagle Comtronics	32	57, 33-34	Texscan MSI	37	63
Flight-Trac		33-34	Time Manufacturing	26	47
General Cable Telsta	20	38	Trilogy Communications	2	3
Jerrold Communications	15	29	Triple Crown Electronics	41	72
Jerry Conn Assoc.	22	40	Tulsat	40	66
Lectro Products	13	25	Viewsonics	11	21
Lindsay Specialty		33-34	Warren, Morris & Madison, Ltd.	61	111
Magnavox CATV	46	79	Wavetek	12, 19	23, 36-37
Matrix	52	91	Wegener	50	85
Metronet	28	50	Westec	49	84
Microwave Filter	44	75	White Mountain Cable Const.	16	31
Midwest CATV	4	6-7	Zenith	9	17



## Potentials for universal remotes

The universal remote control has a number of advanced features which should make life easier for the user. However, if they are not properly implemented, they can be a source of confusion and frustration.

One of the most advanced features currently available is the use of "macros." This is a term imported from computer usage. A macro is a single command which causes a sequence of other commands to be executed. The Zenith universal remote control has two interesting examples. When doing channel changes, the television receiver first gets a mute command, then the converter gets the channel change command, and finally, the TV set gets an un-mute command. This avoids the annoying audio "pops" that come from the TV when some RF converters change channels.

Another example is when the universal remote control's VCR "play" button is pushed. First the command is sent to the TV to tune to channel 3 (or channel 4, depending on the VCR and remote control setup), and then the play command goes to the VCR.

An example of a macro I have not seen implemented is a master "on" command. This would turn the converter on, then turn the TV on and

*By Walter Ciciora, Vice President of Technology, American Television and Communications*

tune it to the converter's output channel. It would also adjust the volume to a comfortable level and put the converter volume control at the optimum setting for stereo.

There is a hitch, of course. If the sensitivity of any device to infrared signals is poor, that device may miss its command if the subscriber doesn't aim the remote carefully or if he doesn't hold it relatively steady during the control sequence.

### Downloading

Universal remote controls come in several flavors. In one case, the code sets are in read only memory (ROM). The subscriber selects the correct code set from memory either by entering a number he gets from the written instructions or by an exercise where he attempts to get the TV set to respond to some function while stepping through the library of codes.

The second type uses the "learn" feature where the device codes are directly loaded into the universal remote control. Lastly, there is the combination device which does both. It recognizes that "learn" is often difficult for the subscriber to execute successfully. However, with both the wide variety of control codes in use and the introduction of new codes every year, a "learn" capability is necessary to be truly "universal."

There may be a much better way of teaching the remote control new codes. The receiving light-sensitive diode can be located in such a way that the remote control can be placed in a slot or depression on the converter. Then the converter can communicate with the remote control if the correct circuits are installed along with an IR emitting diode.

Using the addressability commands of the converter, the correct codes can be downloaded from the headend. These would be stored in a database in a computer. When the technician or subscriber calls in, the customer service representative enters the make and model of the subscriber's consumer electronic devices and the codes are downloaded through the converter into the remote control.

### Advanced features, dumb ideas

"One man's food is another man's poison," or so the saying goes. What one thinks is a great idea may be labeled as foolish by someone else. The correct answer comes, by definition, from the marketplace. If the sub-

scriber embraces it, it must have been a good idea. The following ideas may be brilliant approaches or just plain dumb. The only way to find out is to try them.

Most of these ideas have been tried in the remote controls which come with home satellite integrated receiver decoders (IRDs).

Many IRDs use radio frequency (RF) control links rather than infrared light. The main advantage is that the IRD can be controlled from any room in the house. If its output signal is placed on the home coaxial cable, the signal can be viewed from the upstairs bedroom or from the family room without moving the IRD around. A second advantage is that the converter can be placed just about anywhere.

On-screen displays are an important facilitator here. The LED channel read out doesn't have to be visible. There are a few disadvantages, however. The IR control is a refined, cost effective system—and RF control probably adds something like \$15 to the cost of the system.

An operational problem is frequency and code coordination. In apartment buildings, the RF remote could be controlling more than just the subscriber's converter. In the IRD example, both of these are less of an issue. The extra cost of the RF control is a smaller percentage increment. The customer buys it outright. And the large size of the satellite dish means that the IRDs are probably sufficiently far apart to not interfere.

Another disadvantage is that while this represents convenience for the customer, it provides a way of avoiding an additional outlet charge.

If the main objective is to be able to hide the converter, there is another solution: the "Killroy module." The soldiers in World War II used to draw a cartoon of a character peering over a wall with the caption "Killroy was here." The Killroy module, in this case, is an IR detector which peers over or around the TV, allowing the converter to be hidden behind. This could be an add-on or aftermarket device with an array of IR receivers aimed broadly around the room. The signal is then carried by wire to an IR emitting diode which illuminates the converter's IR window. Such a device could make up for deficiencies in the converter's IR sensitivity which normally requires careful aiming of the remote control. ■



**6 TEST POINTS** **TECHNICAL STANDARDS** **24 HOUR TEST**

Today's technical standards and requirements demand accurate documentation which is readily available. Cheetah™ the leader in **Automated Remote Testing™** has developed a system to help meet these requirements.

The Cheetah™ is programmable to perform and store measurements unattended, 24 hours a day. Compliance with 6 Remote Test Points is now easy and effective. By placing 6 **PC-4650D** (equipped with Distortion Pack) at strategic system locations, you can document every time you test. To monitor headends, utilize the **HE-4650** for levels and frequencies on HRC, IRC, Standard and Customized Frequency Assignments. All of this is controlled by **Cheetah Director Software™** which allows you to automate, test, document, and print system performance.

- **Non-Interfering Frequency Measurements in Seconds**
- **Programmable Specifications for Out-Of-Spec Reports**
- **Visual To Aural Frequency Separation 4.5 Mhz. ± 5 KHz.**
- **Trend Analysis**
- **Graphic or Columnar Printouts and Displays**

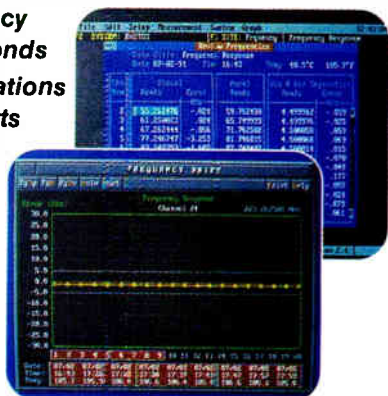

The Cheetah™ System is the only **Automated Remote Testing™** system that allows you to document and perform the majority of the required measurements!



- **Video and Aural Amplitudes**
- **Peak To Valley**
- **Adjacent Channel Level Ratios**
- **Channel Assignments Programmable to Over 44,000 Reference Points**
- **Date, Time and Temperature**

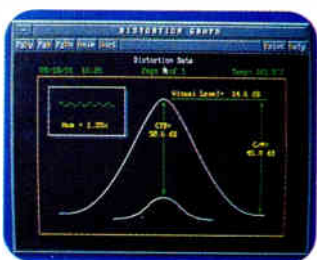

- **Composite Triple Beat**
- **Carrier To Noise**
- **Aggregate Hum**
- **Programmable for Unattended Operation**
- **Measurements Performed in Less than 60 Seconds**

**Order The Tech Standards System™ (TSS) Before 12/31/91 And Receive A Package Price Discount.\***  
**Package Consists Of: 6 PC-4650D + 1 HE-4650 + 1 Cheetah Director Software™**



\*Offer Valid In The USA Only.

**Automated Remote Testing™**



**WE MEASURE THE BEST!™**

**Cheetah™**

**SUPERIOR ELECTRONICS GROUP, INC.**  
 2237 Industrial Boulevard, Sarasota, Florida 34234  
 Telephone (813) 351-6700 • Fax (813) 351-9193

Circle Reader Service No. 58

# Are you designing optical networks or off-premise systems for the future?

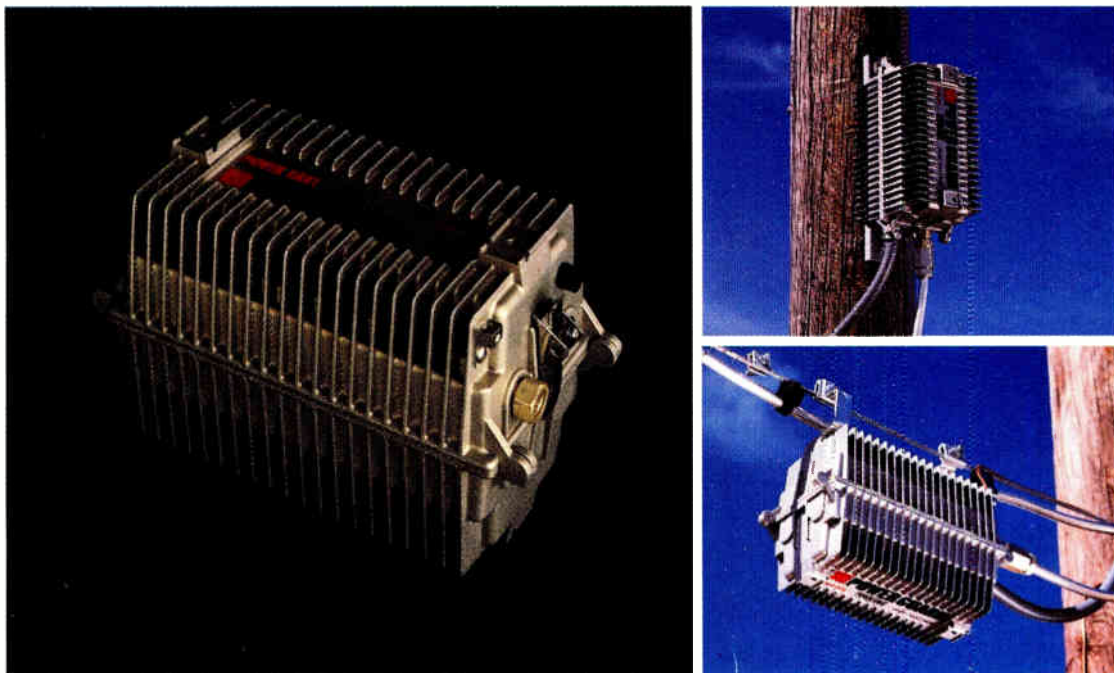

## Specify the power supply engineered for the technology demands of tomorrow.

Fiber optic systems and off-premises addressability demand a reliable, versatile power supply designed for the special applications of these systems. Power Cast is built for cool, quiet and efficient operation, with models which operate at 3, 6, 9, 12 or 15 amps.

Power Cast can be mounted virtually anywhere — on a pole, in a pedestal or on the strand. This lightweight power supply provides all the features you need along with incredible durability and performance. Backed by a five-year warranty, Power Cast is the power supply you can install today and continue using through tomorrow.



**WEST-ANAHEIM:** (714) 779-0500, (800) 854-0443; **DENVER:** (303) 740-8949, (800) 841-1531; **SEATTLE:** (206) 251-6760, (800) 426-7665; **MIDWEST-CHICAGO:** (708) 350-7788, (800) 544-5368; **CLEVELAND:** (216) 526-0919, (800) 321-8068; **DALLAS:** (214) 446-CATV, (800) 231-5006; **IRON MOUNTAIN, MI:** (906) 774-4111, (800) 624-8358; **SKOKIE, IL HDQTRS:** (708) 677-2600; **EAST-ATLANTA:** (404) 840-7901, (800) 242-1181; **NEW JERSEY:** (201) 328-0980, (800) 631-9603

In an emergency, weekends and holidays or after 5 P.M. call toll free 1 (800) 323-8166.  
CORPORATE OFFICES, ANIXTER CABLE TV, 4711 Golf Road, Skokie, IL 60076, (708) 677-2600

©1991 Anixter Cable TV