

# BROADCASTERS



# GENERAL STORE

REFERENCE



# CATALOG





# Meet the Gentners



**Otto**

One smart guy, self directed and a breeze to work with. The DH20 and DH22 digital hybrids have auto mix-minus, auto answer / disconnect, automatically adapt to changing telephone conditions and much more.

**Able**

A truly brilliant and multi-talented personality, capable of handling a surprising number of tasks. The TS612\* is able to meet the needs of a single station or a large talk network. A highly sophisticated system that requires very little training.

**Jane**

She's no "Plain Jane" and can handle almost anything you need done. The SPH10 analog hybrid is able to send or receive audio over any standard dial up telephone line. The best analog hybrid ever and very cost effective.

## Introducing the newest members of the Gentner family.

We understand the critical nature of bringing people on air, flawlessly. At Gentner Communications, quality audio is our business. We've spent the last sixteen years continuously innovating our products for you. As industry leaders in telephone interface products, we've built the name and reputation you can depend on. Gentner is now shipping our newest telephone hybrid line. The SPH10 is the simply the best analog hybrid ever. The DH20 and DH22 digital hybrids represent the latest features in telephone hybrid technology with features like built in monitor amp, auto mix-minus, selectable caller control and AGC, these products address the needs our customers have identified. When it comes to talk shows Gentner is the standard.

 **Gentner** WE PUT THE WORLD ON SPEAKING TERMS™

\*O.K., it's not new but the TS612 is still the best multi-line broadcast telephone system available.



# TABLE OF CONTENTS

## **Welcome to Broadcasters General Store**

*A special thank you to those who have been so helpful in contributing ideas, information and encouragement while we were compiling our catalog. It has been a long time in the making, now please, pull up a comfortable chair, put your feet up and browse at your leisure.*

*We are dedicated to achieving excellence in customer service through integrity and dependability and believe our growth these past 18 years is a testimonial to that effort. The General Store has become synonymous with "old fashioned" attention to customers and their requirements. We continue to offer the latest technology in a wide range of quality products backed by reputable manufacturers.*

*Thank you for allowing us to be part of your growth and prosperity!*

**Broadcasters General Store**  
2480 S.E. 52nd Street  
Ocala, FL 34480-7500

**BGS Store Hours:**  
8AM - 5:30PM EST  
Monday thru Friday

**Phone Numbers:**  
FL# 352-622-7700  
IL# 620-231-7120

Dave, Chris, Rick, Jim & Kerry, Sales  
Buck, Order Expediting  
Becky, Accounts Payable  
Debbie, Accounts Receivable  
Chad, Shipping

**Fax Numbers:**  
FL# 352-629-7000

**Phone Number:**  
GA# 770-425-0630  
Kandance, Sales  
**Fax Number:**  
GA# 770-427-0562

**BGS Email:** [bgs@mercury.net](mailto:bgs@mercury.net)  
**Web Site:** [www.bgsfl.com](http://www.bgsfl.com)

<b>Digital Audio Storage</b>	<b>1-2</b>
<b>Amplifiers</b>	<b>3-8</b>
<b>Cable &amp; Connectors</b>	<b>9-13</b>
<b>Headphone/Headsets</b>	<b>13-17</b>
<b>Intercoms</b>	<b>18-20</b>
<b>Interface/Problem Solvers</b>	<b>21-27</b>
<b>Maintenance/Cleaning</b>	<b>28-29</b>
<b>Microphones &amp; Accessories</b>	<b>30-42</b>
<b>Mixers/Consoles</b>	<b>43-60</b>
<b>Monitoring</b>	<b>61-73</b>
<b>Patchbays/Panels/Accessories</b>	<b>73-81</b>
<b>Power Conditioning</b>	<b>81-84</b>
<b>Processors</b>	<b>84-102</b>
<b>Recorders/Players</b>	<b>102-121</b>
<b>Remote Broadcast</b>	<b>122-130</b>
<b>Remote Controls</b>	<b>131-136</b>
<b>RF Related Equipment</b>	<b>137-159</b>
<b>VSWR Conversion Table</b>	<b>138</b>
<b>Fiber Optics</b>	<b>160-161</b>
<b>Router/Switchers</b>	<b>161-166</b>
<b>Satellite</b>	<b>167-169</b>
<b>Studio Furnishings</b>	<b>167-169</b>
<b>Telephone Equipment</b>	<b>182-189</b>
<b>Test Equipment</b>	<b>190-194</b>
<b>Video Equipment</b>	<b>195-200</b>
<b>ADC Normalling Q/A</b>	<b>201-203</b>
<b>SBE Book Listing</b>	<b>204</b>
<b>Ordering Information</b>	<b>205</b>
<b>Index</b>	<b>206-209</b>

*Although every effort has been made to ensure the accuracy of product specifications and price information, we all know, no one is perfect except our Moms, and our Mom is retired. Remember manufacturers' specs and prices are subject to change without notice. We appreciate your business! (Oh, and just to see if you were reading our catalog we purposely inserted a few typos.)*

**Broadcasters General Store (352) 622-7700 Fax (352) 629-7000**



# WHAT MEDIATOUCH DIGITAL INTEGRATION CAN DO FOR YOUR STATION.

Our dedication and obsession for our software,

and its ability to completely integrate a radio facility or facilities

## MULTI FADER CONTROL

separates MediaTouch from other digital audio companies.

Size is never an issue, since a network can be designed for a typical radio

## CD-JUKEBOX INTERFACES

facility of five users: Air, Production, News, Traffic and Music.

The costs of a MediaTouch system are proportionate to the amount

## MOVE FEATURE

of users and radio stations involved. In other words, the most basic

MediaTouch system is the building block of larger things to come.

Our philosophy is to complement the style of the user

## REMOTE MODEM CONTROL

rather than restrict it. Success is the direct result of individuality;

being different, cutting edge, a leader. Our software development team

## EXPANDED MANUALS

always provides the "headroom" in the software operational system to

accommodate the uncertainties of individualism.

### PROGRAMMING AND OPERATIONAL FEATURES:

- **TOUCHSCREEN**  
SINCE 1985, PATENTED TOUCHSCREEN CONVENIENCE FOR "ON AIR" USERS
- **LIVE ASSIST**  
RADIO'S "ORIGINAL" USER FRIENDLY "ON AIR" CONTROL PANEL DESIGN
- **AUTOMATION**  
WALKAWAY AUTOMATION AT THE "TOUCH" OF THE "AUTO" BUTTON
- **7 ON SCREEN EVENTS**  
7 LOG EVENTS ARE "ALWAYS" DISPLAYED WITH START / STATUS BUTTONS
- **"AUDIO CUED" STATUS**  
LOG DIGITAL AUDIO EVENTS ARE VERIFIED, AND DISPLAYED AS "CUED"
- **"CUED" CHANNEL STATUS**  
ONCE CUED, CONSOLE CHANNEL AND "POT" COLOR ARE DISPLAYED
- **BI-DIRECTIONAL START/STOP**  
CONSOLE CHANNEL BUTTON AND SCREEN EVENT BUTTON ARE INTERACTIVE
- **PLASMA DISPLAY**  
APPEARS ON SCREEN (UNDER EVENT) ONCE A LOG EVENT IS "CUED"
- **VISUAL ELAPSED TIME**  
PLASMA DISPLAY MOVES TO PLAYING TIME, SHOWS "RED" LAST 15 SECONDS
- **24 HOT KEY BUTTONS**  
24 "HOT" START BUTTONS FOR DIGITAL AUDIO OR OTHER SOURCES
- **SELECTABLE EVENT COLORS**  
MUSIC, SPOTS, LINERS, TEXT APPEAR ON SCREEN IN COLORS DESIGNATED
- **BIG! COUNTDOWN TIMER**  
TIMER COUNTS "INTRO TO POST" TIME AND SHOWS AUDIO CHANNEL COLOR



OPLOG SUPPORTS EXTERNAL ANALOG SLIDERS, DIGITAL CONTROLLED FADER BOX, OR ON SCREEN ELECTRONIC FADING OF AUDIO OR JUKE BOX

PIONEER, SONY AND NSM JUKEBOX INTERFACES ARE AVAILABLE

PICK AN EVENT, USE FUNCTION BUTTONS "UP/DOWN" TO MOVE THE EVENT IN THE LOG

TAKE YOUR STATION TO A REMOTE, FULL CONTROL WITHOUT OPERATOR AT STUDIO

NEW TECHNICAL MANUALS WITH OPERATIONS AND INSTALL DATA

LOG V8.02 Copyright (c) 1988-1996 OPT Technologies Inc.

09:54:06  
08-15-96  
AUTO OFF

03

ON AIR ZIGGY'S BEST ROCK JGL 1000 TIME 00:03

MDISK START 00:00:00 00:06

MDISK HOOTIE & BLOWFISH/HOLD MY HAND MUS 1300 CUED 02

START 00:00:05 01:17 :11/F

MDISK COLLECTIVE SOUL/THE WORLD I KNOW MUS 1400 CUED 03

START 00:00:23 01:14 :12/C

MDISK A&M AUTOLAND COM 0005 CUED 04

START 00:02:37 01:00

MDISK VALUES HARDWARE COM 0009 CUED 05

START 00:03:37 01:01

MDISK ARNOLD'S ACCENT COM 0006 CUED 06

START 00:04:38 00:59

MDISK WEATHER RED (LIVE READ) SND 2000 CUED 07

START 00:05:37 00:20

INFO TOP COPY FADE DEL

NEWS INTRO HOST MIC ABC NEWS

D'OH

CLAP WTHR BED MSTR MIC2 CBS NEWS

CHEER BEST ROCK MSTR MIC3 PROD STUD

BOO HOUR OPEN PROD MIC1 NEWS STUD

HISS COM FREE PROD MIC2 TRFC REMOTE

OHH LEGAL ID PROD MIC3 LIVE FEED

AUDIO LIB FULL LOG OPTIONS MENU

## Feel the Ultimate Control

Program manager runs your control room from scheduler while full on-line support & technical assistance is only a phone call away - 24 hours a day, toll-free!

- **LAST 60 SECONDS**  
TIMER ALWAYS COUNTS DOWN THE LAST 60 OR ANY TIME UNDER 60 SECONDS
- **7 FUNCTION KEYS**  
INFO, TOP, BOTM, UP, DOWN, FADE, DEL, FOCUS ON PICKED EVENT
- **PRE/POST LISTEN DIGITAL AUDIO**  
TOUCH THE "CUED" BUTTON TO PRE LISTEN, TOUCH AGAIN TO POST LISTEN
- **POST LISTEN WHILE PLAY**  
TOUCH "TIME" BUTTON WHILE EVENT IS PLAYING, LISTEN TO ENDING
- **ARTIST-MUSIC TRIVIA**  
PICK EVENT, TOUCH INFO BUTTON, TEXT BOX APPEARS WITH MUSIC DATA
- **ON SCREEN TEXT**  
TOUCH A COPY BUTTON, ASSOCIATED TEXT APPEARS ON SCREEN
- **"OUTCUE" TEXT**  
OO> DISPLAYS OUTCUES FOR CURRENT "ON AIR" SPOTS, PROMO'S
- **LINER NOTES**  
OO> WINDOW DISPLAYS "ON AIR" MUSIC "LINER NOTES"
- **"SHOW LOG" PRE-SETS**  
INSTANT AUDIO-HOT BUTTONS ARE USER PROGRAMMABLE AND PICKED BY "LOG NAME"



**MediaTouch**  
A DIVISION OF OAKWOOD AUDIO LABS LTD.



See page 160 & 161  
for Fiber Optic Options

# distribution ~ audio



**BGS**

# AMPLIFIERS



ATI DA208/416



AudioArts SDA-8400



ESE 246

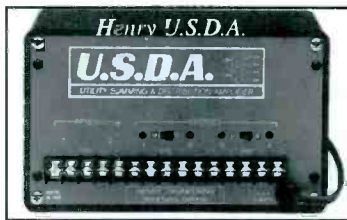

Henry U.S.D.A.



RDL RUDA-4D



Radio Systems DA-8/16



Zercom DA8S



Zercom DA8S (Back)

## Audio Distribution Amplifiers

Make/Model	Configuration	Input Conn.	Output Conn.	Meters	Level Adjust	Headphone Jack	Rack Mount	Power Supply	Price
<b>Aphex</b>									
120A	1x4	X	X	N	Y	N	O/\$29.95	120-240V	\$395.00
<b>ATI</b>									
DA 1008-2	1x8	B	B	Y	Y	Y	Y	117V	\$829.00
DA2016-2	Dual 1x8	B	B	Y	Y	Y	Y	117V	\$1,149.00
DA1000-1	1x8	B	B	N	Y	Y	O/\$25-\$28	117V	\$355.00
DA2008-1	Dual 1x4	B	B	N	Y	Y	O/\$25-\$28	117V	\$375.00
DA206	Dual 1x3	X	X	N	Y	N	Y	115V	\$479.00
DA412	Quad 1x3	X	X	N	Y	N	Y	115V	\$669.00
DA208	Dual 1x4	B	B	N	Y	N	O/\$25-\$28	115-240V	\$379.00
DA416	Quad 1x4	B	B	N	Y	N	O/\$25-\$28	115-240V	\$549.00
<b>AudioArts</b>									
SDA-8400 ST/1x8 or 2x4	M	M	N	Y	N	N	Y	120V	\$499.00
<b>ESE</b>									
ES217	1x4	B	B	N	Y	N	N	117V	\$195.00
ES217XLR	1x4	X	X	N	Y	N	N	117V	\$320.00
ES246	Quad 1x6	B	B	N	Y	N	O/NC	117V	\$395.00
ES246XLR	Quad 1x6	X	X	N	Y	N	O/NC	117V	\$695.00
<b>Henry Engineering</b>									
USDA	2x4	B	B	N	Y	N	N	115V	\$195.00
<b>Hnat Hines</b>									
DA2-12	2x12	B	B	Y	Y	N	Y	115V	\$495.00
<b>LPB</b>									
DA-1-8	1x8	B	B	N	MS	Y	Y	117-234V	\$295.00
DA-1-6	Dual 1x8	B	B	N	MS	Y	Y	117-234V	\$495.00
<b>Oxmoor</b>									
MDA16	1x6	X	X	N	Y	N	Y	110-220V	\$525.00
MDA26	2x6	X	X	N	Y	N	Y	110-220V	\$559.00
<b>Radio Design Labs</b>									
ST-DA3	1x3	TB	TB	N	Y	N	O/\$131/holds 12	O	\$126.00
STM-DA3 (mic level)	1x3	TB	TB	N	Y	N	O/\$131/holds 12	O	\$126.00
RU-BDA3	1x3	X	X	N	Y	N	O/\$29	O	\$215.00
RU-DA4D	2x4	B	B	N	Y	N	O/\$29	O	\$227.00
PS24A	Optional 24 VDC power supply								\$77.00
<b>Radio Systems</b>									
DA-8	1x8	B	B	N	Y	N	Y	115-230V	\$340.00
DA16	2x8	B	B	N	Y	N	Y	115-230V	\$425.00
<b>Rane</b>									
DA216	1x6 or 1x16	TB	TB	N	Y	N	Y	120V	\$499.00
<b>Shure</b>									
FP16A	1x6	X	X	N	Y	N	O/\$35	120V/9Vdc	\$645.00
<b>Zercom</b>									
DA8S	2x8	TB	TB	N	Y	N	Y	105-135V	\$399.00

Key: X=XLR 3-Pin Balanced TRS=1/4" Phone Balanced TS=1/4" Phone Unbal R=RCA Phono Unbal.  
B=Barrier Strip TB=Screw Terminal Block M= 3-Pin Molex MS=Master O=Optional

## ATI



The ATI DA10,000 flexible design lets you mix Basic and Metered DA's with Compressing Independent Output Modules in the same enclosure to optimize your system's performance. Ten Amplifier Modules

and two Power supplies plug into a Eurocard Spec enclosure. Typical 100dB dynamic range is ideal for distributing digital satellite feeds.

## Benchmark

### Benchmark Systems 1000

with over 14 different modules, 4 power supply options, numerous controllers and accessories provides the ability, not only to distribute audio throughout your facility, but to control it. Mounted on a distribution amplifier, System 1000 module daughter-boards place the power of remote gain or mono/stereo mode control at your fingertips.

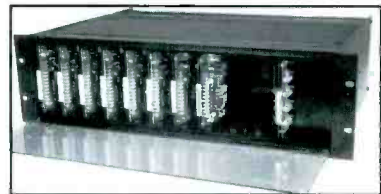

## Studio Technologies



The Studio Technologies 85 provides two AES/EBU digital audio inputs and eight AES/EBU outputs. Each of the eight outputs provides a fully isolated reproduction of either input. Source selection is provided by front-panel DIP switches. Each input provides transformer coupling and DC voltage blocking. Status indicators light whenever digital information is present on their respective input. With a nominal 60 nanosecond input to output delay, the outputs are essentially identical to the inputs. XLR type connectors. 1U

85

\$549.00

**Many Items in Stock for Immediate Delivery...Call Today!**



# distribution ~ video

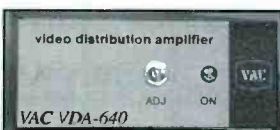
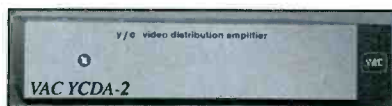
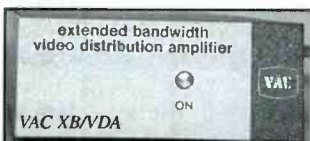

**BGS**

## Video Distribution Amplifiers

Make/Model	Configuration	Component	Composite	S/Video	I/O Conn.	Rack Mount	Power Supply	Remarks	Price
<b>ESE</b>									
ES-209	1x12	Y			BNC	Y	117VAC	2x12 Audio DA/ Master Level EQ	\$495.00
ES-207A	1x4		Y		BNC	N	117VAC	Master Level EQ	\$175.00
ES-208	1x12		Y		BNC	N	117VAC	Master Level EQ	\$300.00
ES-247A	Quad 1x6		Y		BNC	Y	117VAC	Master Level EQ	\$495.00
ES-201	1x4		Y		BNC	O	117VAC	Independent Level/EQ	\$295.00
ES-227	1x4			Y	S/VHS	N	117VAC	Y/C Level, Y EQ	\$295.00
<b>Kramer</b>									
VM-3V	1x3		Y		BNC	N	12VDC	4-5/8" Wide	\$140.00
VM-3S	1x3			Y	S/VHS	N	12VDC	4-5/8" Wide	\$140.00
BCS-1043N	1x3	Y			BNC	Y	115VAC	Can be Quad 1x3 Composite	\$800.00
BCS-1044N	1x4				BNC	Y	115VAC	Greater BW than BCS-1043	\$900.00
MS-50V	1x5		Y		BNC	O	12VDC	Has input loop thru	\$220.00
MS-50S	1x5			Y	S/VHS	O	12VDC	Has input loop thru	\$335.00
VM-6NS	1x5		Y		BNC/RCA	O	115VAC	1x5 Audio DA	\$298.00
BCS-1005	1x5		Y		BNC	Y	115VAC	Selectable clamping point	\$630.00
BCS-1010	Dual 1x6		Y		BNC	Y	115VAC	Has input loop thru	\$805.00
BCS-1020	1x20		Y		BNC	Y	115VAC	Has input loop thru	\$879.00
VM-50R	1x50		Y		BNC	Y	115VAC	Has input loop thru	\$1,200.00
<b>Shintron</b>									
336	1x6		Y		BNC	Y	115VAC	Loop thru & level adjust	\$350.00
CB100-VA	Dual 1x6		Y		BNC	N	115VAC	Has input loop thru	\$390.00
<b>VAC (Video Accessory Corp.)</b>									
VB/VDA	1x4		Y		BNC	O	12-24V	Differential Input	\$159.00
LTVB/VDA	1x4		Y		BNC	O	12-24V	Loop thru and level EQ	\$169.00
LTVB/VDA-AA	1x4		Y		BNC	O	8-36VDC	For ENG/EFP	\$209.00
CVB/VDA	1x4		Y		BNC	O	12-24V	Corrects hum & DC offset	\$209.00
YCVB/VDA	1x4			Y	S/VHS	O	12-24V	Y & C level adjust	\$209.00
VDA-640	1x6		Y		BNC	N	12-24V	Master level ctrl/loop thru	\$249.00
HN/VDA	1x6		Y		BNC	N	12-24V	Loop thru/level & null adjust	\$279.00
XB/VDA	1x8		Y		BNC	N	120VAC	Adjusts for 6 outputs	\$445.00
CVDA-3	1x6		Y		BNC	N	120VAC	Corrects hum & DC offset	\$370.00
YCDA-2	1x6			Y	S/VHS	N	12-24V	S Video, YC gain ctrl, 1 in, 6 out	\$425.00
PDA-4	1x6				BNC	N	12-24V	Pulse DA for 0 to -4V pulses	\$310.00
<b>Radio Design Labs</b>									
RU-VDA4	1x4		Y		BNC	O	O	Loop thru, 1/3 RU, level adjust	\$239.00
PS24A								Optional 24VDC power supply	\$17.00

**A  
M  
P  
L  
I  
F  
I  
E  
R  
S**

## headphone

### U.S. Audio SAT-1

Satellite Module headphone breakout box features two channels, each with two outputs, left/right volume controls and stereo/mono switches. XLR connectors for input and thru terminations allow easy daisy chaining of SAT-1's using standard mic cables.

SAT-1 **\$138.00**



### Whirlwind HBB

is a passive headphone distribution system that has a stereo in and thru jack (for daisy chaining) and six separate headphone outputs.

HBB **\$80.00**

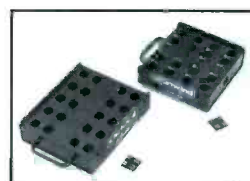

**Broadcasters General Store (352) 622-7700 Fax (352) 629-7000**





# AMPLIFIERS



Shure  
FP-22



## microphone preamp

## Headphone Amplifiers

Make/Model	Dimensions HxWxD"	Balanced Input	No. of Channels	*Power Supply	Rack Mount	Price
<b>ATI</b>						
HD100	1.5x4.15x5.5	Y	1	B	N	\$219.00
HD1000	1.75x8.5x7	Y	4	A	N	\$499.00
<b>BDI</b>						
HSA100P	N/A	Y	1	C	N	\$179.00
<b>Behringer</b>						
HA-4000	1.75x19x4	Y	4+1 aux	A	Y	\$370.00
<b>Benchmark</b>						
HPA-1	N/A	N	1	C	N	\$70.00
<b>Edcore</b>						
HA-400C	1.75x12x6.5	Y	4	A	Opt./\$23	\$256.31
HA-800C	1.75x19x8.4	Y	8	A	Y	\$320.79
<b>Fostex</b>						
PH-50	2x8.25x8	Y	5+1 aux	A	N	\$279.00
<b>OZ Audio</b>						
HM-6	2x11x12	Y	6	115VAC	N	\$299.00
<b>Radio Design Labs</b>						
ST-SH1	Stick-On	Y	1	B	Opt./\$120	\$114.00
<b>Rane</b>						
HC-6	1.75x19x8.5	Y	6	A	Y	\$479.00
<b>Rolls</b>						
RA-62HA	1.75x19x6.5	N	6	A	Y	\$228.00
<b>Samson</b>						
Q-5	1.75x8.5x6	Y	5	A	N	\$179.99
<b>Shure</b>						
FP-22	3.2x2.2x6.1	Y	1	D	N	\$425.00
<b>Stewart</b>						
HDA-4	1.6x17.1x2.8	Y	4	A	Y	\$299.00
<b>Symetrix</b>						
SX-204	1.5x8.2x6	Y	4	B	Opt./\$39	\$319.00

\* A=Built in AC pls B=Ext. wall mt. DC pls C=Ext. Bipolar supply D=Battery

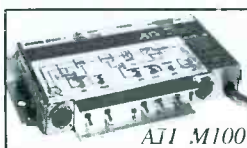

Shure  
FP-11



## Microphone Preamps

Make/Model	Frequency Response	Noise EIN	Gain	THD (distortion)	Other Features & Options	Price
<b>Aphex</b>						
107	20-20k	-128dBm	64dB	.2%	Dual ch. tube amp/phantom power	\$449.00
<b>ATI</b>						
M1000-1	50-20k	-124dBm	74dB	.2%	48V phantom pwr./RM opt.	\$429.00
M100	20-20k	-124dBm	74dB	.03%	48V phantom pwr./RM opt.	\$349.00
<b>Benchmark</b>						
MP-4	>200k	-130dB	75dB	.0009%	Circuit Card	\$190.00
MPS-400	>200k	-130dB	75dB	.0009%	RM/4-ch.	\$1,095.00
MPS-420	>200k	-130dB	75dB	.0009%	RM/4 ch./2 summed outputs	\$1,295.00
Mic-Man Jr.	160k	-130dB	76dB	.001%	Two 9V batteries/phantom pwr.	\$425.00
<b>dbx</b>						
760x	2-2000k	-128dBm	60dB	.006%	Dual ch. 1/2 RM/phantom pwr.	\$349.95
<b>Radio Design Labs</b>						
RU-MP2	25-20k	<125dB	35-65dB	<.005%	2 ch./ XLR I/O (front), Barrier Blk (rear)	\$299.00
STM-1	50-30k	<125dB	50dB fixed	.05%	Opt.-Pwr. supply	\$96.00
STM-2	50-25k	<130dB	65dB	.05%	Opt.-Pwr. supply	\$132.00
STM-2X	50-25k	<130dB	65dB	.05%	PTT switching/ Opt.-pwr. supply	\$149.00
STM-3	50-25k	<130dB	75dB	.05%	Dual/Opt.-pwr. supply	\$151.00
PS-24A	Power supply for above					\$17.00
<b>Rane</b>						
MS-1	20-20k	<131dBu	60dB	-.007%	Phantom power/TRS out	\$199.00
<b>Studio Technologies</b>						
Mic Pre-Eminence	10-90k	-129dBm	68dB	.0025%	RM/dual ch.	\$799.00
<b>Symetrix</b>						
SX202	20-20k	<129dBm	53dB	>.02%	Opt.-RM/dual ch.	\$319.00

Many Items in Stock for Immediate Delivery...Call Today!



# BGS power



Bryston  
2B-LP-Pro



Carver  
PT-2400



Carver PT 1400



Crown D-75



Crown DC-150AII



Crown DC-300AII



Crown D-45



Crown CT-200



Crown 460CSL



**BGS**

## Power Amplifiers (continued next page)

Make/	Power per Channel**	Dimensions HxWxD"	Weight pounds	Cooling	Level Control	*Input Connector	70V Direct Out	Warranty years	Price
<b>Ashley</b>									
CFT-1800	200W	3.5x19x16	42	Passive	Rear	XLR/TRS/B	N	5	\$849.99
SRA-120	120W	1.75x19x10	20	Passive	Front	TRS	N	5	\$469.99
<b>ATI</b>									
MA-1000	10W	1.75x8.5x6	5	Passive	Front	B	N	1	\$399.00
<b>BGW</b>									
200	110W	1.75x19x11.5	19	Passive	Front	XLR	N	3	\$999.00
350A	220W	5.25x19x11.8	40	Passive	Front	XLR/TRS	N	3	\$1,419.00
PS-1	110W	3.5x19x13.5	31	Fan	Front	XLR/TRS	N	3	\$849.00
PS-2	220W	3.5x19x13.5	40	Fan	Front	XLR/TRS	N	3	\$999.00
Mil 1	100W	5.25x19x13	28	Fan	Front	XLR/TRS	Y	3	\$699.00
Mil 2	200W	5.25x19x13	34	Fan	Front	XLR/TRS	Y	3	\$899.00
Mil 3	300W	5.25x19x15	40	Fan	Front	XLR/TRS	Y	3	\$1,259.00
<b>Bryston</b>									
2B-LP-PRO	60W	1.75x19x10	18	Passive	Rear	XLR/TRS	N	20	\$850.00
3B-ST-PRO	120W	5.25x19x9	22	Passive	Rear	XLR/TRS/B	N	20	\$1,565.00
4B-ST-PRO	250W	5.25x19x15.5	42	Passive	Rear	XLR/TRS/B	N	20	\$2,265.00
7B-ST-PRO	500W mono	5.25x19x15.5	42	Passive	Rear	XLR/TRS/B	N	20	\$4,795/pr.
8B-ST-PRO	120Wx4	5.25x19x15.5	44	Passive	Rear	XLR/TRS/B	N	20	\$2,995.00
<b>Carver</b>									
PM125	50W	1.75x19x13.3	17	Passive	Rear	TRS/B	O	5	\$619.00
PM420	135W	3.5x19x13.3	28	Passive	Rear	TRS/B	O	5	\$799.00
PM700	225W	3.5x19x13.3	36	Fan	Front	XLR/TRS/B	O	5	\$1,069.00
PM950	325W	3.5x19x13.3	36	Fan	Front	XLR/TRS/B	O	5	\$1,269.00
PM1400	475W	3.5x19x13.3	39	Fan	Front	XLR/TRS/B	O	5	\$1,539.00
CA400	130W	3.5x19x13.3	28	Fan	Rear	XLR/B	O	5	\$769.00
CA900	325W	3.5x19x13.3	37	Fan	Rear	XLR/B	O	5	\$1,199.00
PT1250	465W	3.5x19x10.8	11	Passive	Front	XLR/TRS	Y	5	\$1,879.00
PT1800	750W	5.25x19x12.8	42	Fan	Front	XLR/B	N	5	\$2,379.00
PT2400	750W	5.25x19x12.8	45	Fan	Front	XLR/B	N	5	\$2,799.00
<b>Crown</b>									
D-45	25W	1.75x19x8.4	12	Passive	Front	XLR/B	N	3	\$475.00
D-75A	40W	1.75x19x8.4	12	Passive	Front	XLR/B	N	3	\$625.00
D-150AII	95W	5.25x19x8.8	24	Passive	Front	TS	N	3	\$1,025.00
DC-300AII	175W	7x19x9.8	45	Passive	Front	TS	N	3	\$1,395.00
K2	475W	3.5x19x16	38	Passive	Front	XLR/TRS	N	3	\$1,795.00
MA-600	220W	3.5x19x16	39.5	Fan	Front	XLR	N	3	\$1,395.00
MA-1200	310W	3.5x19x16	44	Fan	Front	XLR	N	3	\$1,695.00
MA2400	520W	3.5x19x16	51.8	Fan	Front	XLR	N	3	\$2,195.00
MA-3600VZ	1165W	3.5x19x16	56	Fan	Front	XLR	N	3	\$2,995.00
MA-5000VZ	1300W	5.25x19x16	77.8	Fan	Front	XLR	N	3	\$3,950.00
MT-600	220W	3.5x19x16	36.25	Fan	Rear	TRS	N	3	\$1,049.00
MT-1200	320W	3.5x19x16	41	Fan	Rear	TRS	N	3	\$1,349.00
MT-2400	520W	3.5x19x16	47	Fan	Rear	TRS	N	3	\$1,749.00
CT-210	110W	3.5x19x16	29.5	Fan/O	Rear	B	Y	3	\$950.00
CT-410	230W	3.5x19x16	31.8	Fan	Rear	B	Y	3	\$1,200.00
CT-810	305W	5.25x19x16	47.3	Fan	Rear	B	Y	3	\$1,675.00
CT-1610	540W	7x19x16	58	Fan	Rear	B	Y	3	\$2,175.00

\*XLR=3 Pin Balanced//TRS=1/4" Phone Balanced//TS=1/4" Phone Unbalanced//R=RCA Phono Unbalanced//B=Barrier//TB=Screw Terminal Block  
 \*\*Stereo into 8 Ω's (unless otherwise specified)  
 O=Optional

AMPLIFIERS





**BGS**



EV 7100



Ramsa WP-14000



QSC 1400



JBL MPA-400



JBL MPA-1100



Hafler P9505



Hafler P1500



**A  
M  
P  
L  
I  
F  
I  
E  
R  
S**

**Power Amplifiers (continued next page)**

Make/	Power per Channel**	Dimensions HxWxD"	Weight pounds	Cooling	Level Control	*Input Connector	70V Direct Out	Warranty years	Price
<b>Crown (continued)</b>									
PT-1	220W	3.5x19x16	30	Fan	Front	XLR/TRS	N	3	\$1,250.00
PT-2	325W	3.5x19x16	33	Fan	Front	XLR/TRS	N	3	\$1,475.00
PT-3	540W	3.5x19x16	37	Fan	Front	XLR/TRS	N	3	\$1,725.00
460CSL	205W	3.5x19x16	30	Fan	Rear	XLR/TRS	N	3	\$975.00
800CSL	320W	3.5x19x16	32	Fan	Rear	XLR/TRS	N	3	\$1,075.00
1400CSL	500W	3.5x19x16	36	Fan	Rear	XLR/TRS	N	3	\$1,375.00
<b>Electro-Voice</b>									
7100	100W	1.75x19x12.8	18.2	Passive	Front	XLR/TRS	N	3	\$654.00
7200	140W	3.5x19x16	37	Passive	Front	XLR/TRS	N	3	\$720.00
7300A	250W	5.25x19x12.75	39	Fan	Front	XLR/TRS	N	3	\$998.00
P1200	350W	3.5x19x16.8	37.5	Fan	Front	XLR	N	3	\$1,788.00
P2000	500W	5.25x19x16.8	57.2	Fan	Front	XLR	N	3	\$2,730.00
P3000	750W	5.25x19x16.8	61.56	Fan	Front	XLR	N	3	\$3,576.00
<b>Hafler</b>									
P1000	50W	1.75x19x8.4	12	Passive	Front	XLR/TRS/R	N	5	\$499.00
P1500	75W	3.5x19x8.5	22	Passive	Front	XLR/TRS	N	5	\$549.00
P3000	150W	3.5x19x10	23	Passive	Front	XLR/TRS	N	5	\$799.00
9303	150W	3.5x19x12.5	36	Passive	None	XLR/TRS/R	N	7	\$1,300.00
9505	250W	5.25x19x12.5	50	Passive	None	XLR/TRS/R	N	7	\$2,200.00
<b>JBL</b>									
MPA275	175W	3.5x19x18	40	Fan	Front	XLR/B	N	3	\$1,219.00
MPA400	275W	3.5x19x18	42	Fan	Front	XLR/B	N	3	\$1,539.00
MPA600	400W	3.5x19x18	44	Fan	Front	XLR/B	N	3	\$1,858.00
MPA750	500W	5.25x19x18	55	Fan	Front	XLR/B	N	3	\$2,338.00
MPA1100	720W	5.25x19x18	64	Fan	Front	XLR/B	N	3	\$2,764.00
<b>Mackle</b>									
M1200	225W	1.5x19x16.7	36	Fan	Front	XLR/TRS	N	3	\$599.00
<b>Ramsa</b>									
WP1200	120W	3.5x19x15	26.5	Fan	Rear	XLR/TRS	N	5	\$680.00
WP1400	240W	5.25x19x15	38.3	Fan	Rear	XLR/TRS	N	5	\$840.00
WP9440	350W	5.25x19x19	75	Fan	Front	XLR/TRS	N	5	\$2,490.00
<b>QSC</b>									
1200	100W	5.25x19x9.5	24	Passive	Rear	XLR/TRS/B	N	2	\$726.00
1400	200W	5.25x19x9.5	34	Fan	Rear	XLR/TRS/B	N	2	\$934.00
1700	325W	7x19x10.8	57	Fan	Rear	TRS/B	N	2	\$1,464.00
MX700	170W	3.5x19x12	25	Fan	Front	TRS/B	N	3	\$650.00
MX1000a	275W	3.5x19x18	47	Fan	Front	TRS/B	N	3	\$1,095.00
MX1500a	400W	3.5x19x18	47	Fan	Front	TRS/B	N	3	\$1,165.00
MX2000a	475W	5.25x19x18	70	Fan	Front	TRS/B	N	3	\$1,555.00
MX3000a	825W	5.25x19x18	69	Fan	Front	TRS/B	N	3	\$2,285.00
EX800	175W	5.25x19x18	40	Fan	Front	XLR/B	N	3	\$1,185.00
EX1250	275W	5.25x19x18	42	Fan	Front	XLR/B	N	3	\$1,445.00
EX1600	400W	5.25x19x18	44	Fan	Front	XLR/B	N	3	\$1,765.00
EX2500	500W	5.25x19x18	55	Fan	Front	XLR/B	N	3	\$2,335.00
EX4000	800W	5.25x19x18	64	Fan	Front	XLR/B	N	3	\$2,755.00
USA400	125W	5.25x19x9.5	24	Passive	Rear	TRS/XLR	N	3	\$650.00
USA900	270W	5.25x19x9.5	34	Fan	Rear	TRS/XLR	N	3	\$785.00
USA1310	400W	7x19x10.8	54	Fan	Rear	TRS/XLR	N	3	\$1,125.00
PL1.0	210W	3.5x19x18	18	Fan	Front	XLR/TRS/B	N	3	\$1,428.00
PL1.4	325W	3.5x19x18	18	Fan	Front	XLR/TRS/B	N	3	\$1,648.00

\*XLR=3 Pin Balanced//TRS=1/4" Phone Balanced//TS=1/4" Phone Unbalanced//R=RCA Phono Unbalanced//B=Barrier//TB=Screw Terminal Blk  
 \*\*Stereo into 8 Ω's (unless otherwise specified) O=Optional

**Many Items in Stock for Immediate Delivery...Call Today!**



# BGS power

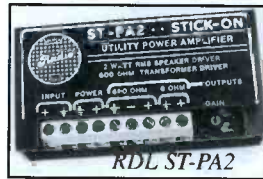

RDL ST-PA2



Symetrix 420



Stewart PA100B



Tascam PA-150



Yamaha PA100a



Yamaha P1500



BGS

## Power Amplifiers

Make/Model	Power per Channel**	Dimensions HxWxD"	Weight pounds	Cooling	Level Control	*Input Connector	70V Direct Out	Warranty years	Price
<b>QSC (continued)</b>									
PL1.9	450W	3.5x19x18	18	Fan	Front	XLR/TRS/B	N	3	\$1,978.00
PL4.0	1000W	3.5x19x18	18	Fan	Front	XLR/TRS/B	N	3	\$3,298.00
CX6	220W	5.25x19x18	44	Fan	Rear	B	N	3	\$970.00
CX6T	220W	5.25x19x18	55	Fan	Rear	B	Y	3	\$1,120.00
CX12	475W	5.25x19x18	50	Fan	Rear	B	N	3	\$1,380.00
CX12T	475W	5.25x19x18	67	Fan	Rear	B	Y	3	\$1,580.00
<b>Radio Design Labs</b>									
ST-PA2	2W mono	Stick-On		Passive	Front	TB	N	3	\$64.00
STPA6	6W mono	Stick-On		Passive	Front	TB	N	3	\$88.00
PS-24A		Power Supply for above							\$17.00
<b>Rolls</b>									
RA235	35W	1.75x19x5	5.5	Passive	None	TRS/R	N	1	\$200.00
RA280	50W	3.5x19x7.5	12	Passive	Front	TRS/R	Y	1	\$250.00
RA2105	70W	1.75x19x7.5	12	Passive	Front	TRS/R	N	1	\$368.00
RA2100B	85W	3.5x19x7.5	12	Passive	Front	TRS/R	Y	1	\$300.00
RA2110	70W	3.5x19x7.5	12	Passive	Front	TRS/R	N	1	\$338.00
RA2200A	130W	3.5x19x7.5	15	Passive	Front	TRS/R	Y	1	\$473.00
<b>Stewart</b>									
CVA7400	200W	1.75x19x8.5	10	Passive	Front	XLR/B	Y	5	\$749.00
CVA7800	400W	1.75x19x8.5	11	Passive	Front	XLR/B	Y	5	\$1,049.00
HPA1000	200	1.75x19x15	11	Passive	Fixed	XLR/R	N	5	\$1,099.00
PA50B	25W	1.75x8.2x6.2	3.5	Passive	Front	TRS/B	N	5	\$299.00
PA100	50W	1.75x8.2x10.2	5.5	Passive	Front	TRS/B	N	5	\$399.00
PR500	110W	1.75x19x8.5	10	Passive	Front	XLR/TRS	N	5	\$799.00
PR1000	200W	1.75x19x8.5	11	Passive	Front	XLR/TRS	N	5	\$1,099.00
World 250	70W	1.75x19x8.5	7	Passive	Front	TRS	N	5	\$469.00
World 600	130W	1.75x19x8.5	10	Passive	Front	XLR/TRS	N	5	\$699.00
World 1.2	225W	1.75x19x8.5	11	Passive	Front	XLR/TRS	N	5	\$999.00
World 1.6	390W	3.5x19x10	16	Fan	Front	XLR/TRS/B	N	5	\$1,199.00
World 2.1	450W	3.5x19x10	17	Fan	Front	XLR/TRS/B	N	5	\$1,399.00
<b>Symetrix</b>									
420	20W	1.75x19x7	7.6	Passive	Front	XLR/TRS	N	2	\$399.00
<b>Tascam</b>									
PA20MKII	25W	1.75x19x4	9.9	Passive	Front	XLR/R	N	1	\$250.00
PA150	115W	3.5x19x13	20.9	Fan	Front	XLR/R	N	1	\$400.00
<b>US Audio</b>									
P12	13W	1.75x19x10	10	Passive	Front	TS	N	1	\$237.00
P45a	45W	1.75x19x6	13	Passive	Front	TS	N	1	\$512.00
P45b	45W	1.75x19x6	13	Passive	Front	TRS	N	1	\$538.00
<b>Yamaha</b>									
A100a	50W	3.8x11.6x8.8	10.2	Passive	Front	XLR/TRS	N	1	\$329.00
P1500	150W	5.25x19x15.8	37.5	Fan	Front	XLR/TRS/B	N	1	\$599.00
P2500	250W	5.25x19x15.8	50.7	Fan	Front	XLR/TRS/B	N	1	\$799.00
P3500	350W	5.25x19x15.8	55.1	Fan	Front	XLR/TRS/B	N	1	\$899.00
H3000	350W	3.5x19x16	38.5	Fan	Front	XLR/TRS	N	1	\$1,139.00
H5000	550W	3.5x19x16	51.8	Fan	Front	XLR/TRS	N	1	\$1,699.00
H7000	750W	3.5x19x16	58.4	Fan	Front	XLR/TRS	N	1	\$2,249.00

\*XLR=3 Pin Balanced//TRS=1/4" Phone Balanced//R=1/4" Phone Unbalanced//R=RCA Phono Unbalanced//B=Barrier//TB=Screw Terminal Blk  
 \*\*Stereo into 8 Ω's (unless otherwise specified)  
 O=Optional

AMPLIFIERS

**Broadcasters General Store (352) 622-7700 Fax (352) 629-7000**





## Belden

The **Belden** product line includes multi-conductor, multi-paired, coaxial, flat, fiber optic, plenum, high temperature and special application cables. Listed are a few of the more common.

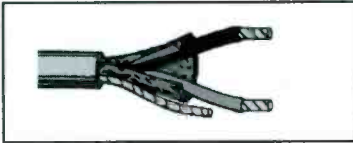

Description	No.	No. of Pr.	Nominal O.D.	Price 500'	Price 1000'
<b>Broadcast Cable, 22 Gage</b>					
Stranded Con. (7x30)	8451	1	.135"	\$57.00	\$108.00
<b>Computer Cable, 22 Gage</b>					
Stranded Con. (7x30)	8723	2	.165"	\$74.00	\$146.00
<b>Audio and Computer Cables, 22 Gage</b>					
Stranded Con. (7x30)	97681	2	.464"	\$664.00	\$1,300.00

## Canare



### Canare L4E6S Star Quad Cable

with braided shield is super flexible and designed for use with mics, but also excellent for all line-level signals. The four conductor Star Quad arrangement cancels electromagnetically induced noise and provides redundant connections. *Available in ten colors.*

conductor Star Quad arrangement cancels electromagnetically induced noise and provides redundant connections. *Available in ten colors.*

Model	Conductor	Shield	O.D.	656' Reel	\$/Foot
L-4E6S	4 = 2 x 24 Awg.	Braided	.237"	\$376.63	\$0.58



### Canare DA206

AES/EBU digital audio cable has a special PE filler rod to maintain a constant 110Ω impedance for cable runs of up to 300 meters. It's flexible twisted pair cable with a braided copper shield for use with 3 pin XLR connectors.

special PE filler rod to maintain a constant 110Ω impedance for cable runs of up to 300 meters. It's flexible twisted pair cable with a braided copper shield for use with 3 pin XLR connectors.

DA206	AES/EBU digital audio cable, Blue, 328' Wt. 19 lbs			\$301.88
-------	--	--	--	----------



**Canare Impedance Transformers** allow 75Ω coaxial transmission of all 2 channel AES/EBU Digital Audio signals. Low cost and easy to use, the I/O adapters, are designed to passively convert all standard AES/EBU digital audio signals from 110Ω/XLR3 Output (@ 4.5 Volts), to a 75Ω BNC coaxial cable and then back again to a 110Ω/XLR3 Input (200mV min). Also provides excellent rejection against hum and noise.

BCJ-XJ-TRA	XLR(F) to BNC (Converts 110Ω to 75Ω), 5 Vp-p	\$57.75
BCJ-XJ-A10TR	XLR(F) to BNC (Converts 110Ω to 75Ω) *	\$74.25
BCJXP-TRA	BNC to XLR(M) (Converts 75Ω to 110Ω) 5 Vp-p	\$52.25

\* 1 Volt peak-peak output for integrating baseband video DA's & routing switchers.

### Canare Coax Cable

**Canare Video Cable's** inner conductors are stranded for extra flexibility while a high density, basket weave braided shield blocks stray RF and electrostatic noise. Canare 75Ω video cables, matched with their 75Ω BNC connectors, offers excellent return loss characteristics and very low VSWR. Perfect for all SERIAL DIGITAL and High Definition interconnect applications.



The **Canare L-3C2VS** is a 75Ω miniature coaxial video cable that is light

weight and flexible. It is the same cable type being used inside the V-3C series RGB component cables. BNC connectors are interchangeable, .217 O.D.

L-3C2VS	(Thin Coax) 656' Wt. 20 lbs	\$252.63
---------	-----------------------------	----------

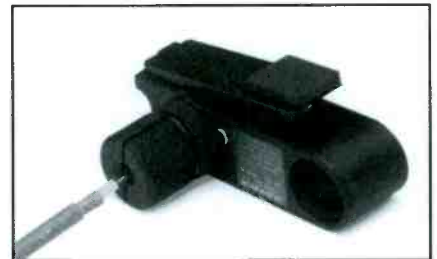

### Canare Coaxial Cable Stripper

Stripping coaxial cable is now quick and easy with the Canare stripper. You simply insert the cable, rotate and remove, completing the job in just 15 seconds. Specially designed hardened steel blades revolve around cable and offer more than 1,000 operations.

TS-3C	Cable L-3C2VS	\$73.42
TS-V3C	Cable V3-3C, V4-3C, V5-3C	\$80.04
TS-4C	Cable LV-61S, V-5C (RG59)	\$73.42
TS-5C	Cable LV-77S, L-5CFB, V-5CFB	\$73.42
TS-31C	Cable 1694A (RG6)	\$73.42

Canare makes a variety of video patchbays, coaxial cable, snake systems, cable reels and connectors. Please call us for a Canare catalog.

C  
A  
B  
L  
E



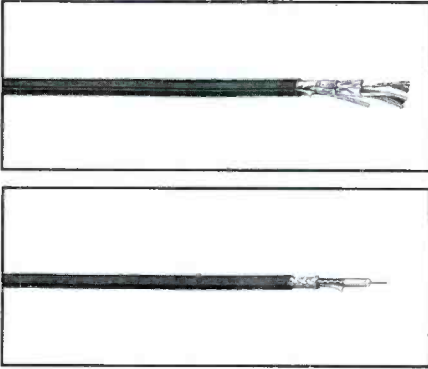

## GEPCO International, Inc.

### Audio Cable

Multipair - 42\*\* (22 gage), 44\*\* (24 gage), 46\*\* (26 gage) \*\*=Pair Count  
 Single Pair - 4201, 4201EZ, 4201D (Dual)  
 Digital Audio - 1524, 152402, 152404, 152408, 1524012, 1524SD (solid), 1526  
 Microphone - 1624, 1620, 1622, 1601, 1642  
 Speaker - GSC1020FC, 1512, 1200, 1400, 1600, 1800

### Video Cable

Coax - 7505, 2000, , 5565 (Riser Rated), 7536, 7501, 7503  
 Triax - 7826, 7827, 7820, 7820PEF, 7811, 7812  
 RGB - 753603, 753604, 763605  
 Composite Cables - VRC618, 1532, 1563, 1533, 1564, 1565  
 Digital Video - 2125B

New Part No.	Previous Pt. *	Conductor	Shield	O.D.	Price/1000 Ft.
4212	GA61812	12 Pair-22 AWG strd. TC	Indiv. w/drain & overall drain	.620 inch	\$2,627.00
4201	61801	1 pair-22 AWG strd. TC	Overall w/drain	.145 inch	\$151.00
4201EZ	61801EZ	1 pair-22 AWG strd. TC	Overall w/drain (Foil bonded to jacket)	.145 inch	\$143.00
2000	VPM2000	20 AWG BC-foam dielectric	Overall foil & braid	.242 inch	\$336.00
7505	VP6000	20 AWG BC-solid dielectric	Overall foil & braid	.304 inch	\$670.00
7811	LVT61859	20 AWG BC-foam dielectric	Inner & outer braid	.360 inch	\$979.00
7826	LVT61811	14 AWG strd. BC-foam dielectric	Inner & outer braid	.515 inch	\$1,923.00

*Gepeco is a leader in manufacturing quality audio and video cable. Above is just a sampling of what is available. Call Broadcasters General Store for a Gepeco catalog.*

## West Penn

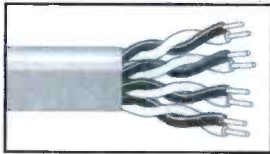

**West Penn Wire Corp.** is a complete cable supplier that manufactures everything from fiber optic cable, superflexible mic and snake cables to direct burial and plenum cable. We are showing a few of the more common cables. *Please call Broadcasters General Store for a West Penn Catalog.* Standard spools are 1000', some cables are available in a 500 foot easy box.

Model	Conductor	Shield	O.D.	500' Easy box	1000' Spool
452	1pr. x 22Awg. strd.	100% w/dr.	.135"	\$54.00	\$106.00
291	1pr. x 22Awg. strd.	100% w/dr.	.146"	\$50.00	\$99.00
510	2pr. x 22Awg. strd.	Indiv. & overall w/dr.	.190"	\$104.00	\$198.00
511	2pr. x 22Awg. strd.	Indiv. w/dr. & overall w/dr.	.205"	\$121.00	\$241.00
435	15pr. x 22 Awg. strd.	Indiv. w/dr. & overall w/dr.	.658"	N/A	\$1,505.00

## BGS cable accessories

## Canare Cable Reels



Model	Size	Wt. lbs.	Stackable	Casters	Connector Mounting Flange	Cable Cut-Out	Hanger	Price
R460S	L	22.0	NO	YES	NO	YES	YES	\$448.22
R380S	M	17.5	NO	YES	NO	YES	YES	\$426.88
R300S	S	9.5	YES	NO	NO	YES	YES	\$389.53
R300L	S	9.5	YES	NO	YES	NO	NO	\$357.51
R300CN	S	9.5	YES	NO	Parallel wired M&F XLR on Hub & Flange	NO	NO	\$440.22





**BGS**

**C  
A  
B  
L  
E**

# RIP-TIE cable accessories

## RIP-TIE



Keep mic cables, extension cords and ski ropes neat, tidy, organized and uninked. **RIP TIE** Velcro bands are sewn for flexibility and strength. One end of the wrap permanently attaches to the cable, the other end has a convenient pull tab. Company names and logos can be custom printed on the pull tabs for increased name exposure and equipment identification. Available in six sizes and ten colors.

Cat. #	Sizes	1 Pack	10 Pack	100 Pack
L6	5/8"X6"	\$2.75	\$19.95	\$175.00
H3	1"X3"	\$2.85	\$21.95	\$190.00
H6	1"X6"	\$2.95	\$23.95	\$220.00
H9	1"X9"	\$3.25	\$26.95	\$245.00
H14	1"X14"	\$3.95	\$31.95	\$285.00
H21	1"X21"	\$4.95	\$36.95	\$330.00

Colors: black, blue, red, yellow, grey, green, violet, orange, brown, white or in the 10 and 100 pack rainbow (1 or 10 of each color). 1 pack contains: 1 Rip-Tie and 2 black locking nylon ties; 10 pack: 10 Rip-Ties and 12 ties; 100 pack: 100 Rip-Ties and 110 ties.



WD - 1



WD - 2



WD - 3



WD-3S



MRLG

## Snakeskin Cable Cover

### American Recorder Technologies

**SnakeSkin** is the state of the art wire bundling and protection system. The wrap around design provides 100% coverage that holds wire snugly in place. Open weave construction will not retain moisture, and protects wires and cable from abrasion. SnakeSkin can easily be cut with scissors, or a hot knife for a neat, melted edge.



SKI-0.5/B	1/2" SnakeSkin, 1000' Black	\$200.00
SKI-1.0/B	1" SnakeSkin, 100' Black	\$250.00

## Whirlwind

Whirlwind cable reels are constructed of heavy gauge steel with welded frames for rugged durability. The premium WD Series reels feature a unique adjustable braking system that controls the speed of the spool during payout and eases turning during rewind. The economical MR Series reels offer heavy-duty cable storage in a compact design.

The **WD-1 and WD-2** are ideal for storage of microphone and small diameter multipair cable. Integral handles make them easy to carry and store.

WD-1	\$169.00
WD-2	\$227.80

The **WD-3 and WD-3S** are large capacity reels that feature removable crank handles and pillow-block bearings for smooth cranking under heavy loads. The unique split reel design offers easy access to both ends of the cable without having to unspool the entire length.

WD-3	\$403.00
WD-3S	\$403.00

The **WD-4 and WD-4D** super-large capacity reels have removable crank handles. Both feature pillow-block bearings, and the WD-4D offers split reel design. Please Call for Pricing.

The **MR reels** are lightweight and economical. The sturdy welded frame and integral fan out storage make them ideal for storing Medusa® Series snakes or microphone cables.

MRLG	\$155.95
------	----------

# BGS connectors

## Audio Adapters

SPP-XLRJ	1/4" Standard Phone Plug to 3-pin XLR jack	\$9.99
SPP-XLRP	1/4" Standard Phone Plug to 3-pin XLR Plug	\$9.99
XLRJ-BL	3-pin XLR Jack to Jack Barrel	\$10.99
XLR-FM	3-pin Plug to Jack	\$9.99
XLRJ-PJ	3-pin XLR Jack to Phono (RCA) Jack	\$9.99
XLRP-BL	3-pin XLR Plug to Plug Barrel	\$9.99





# Audio, Video & Broadcast Cables

*Cable products designed, developed, and proven for professional use.*

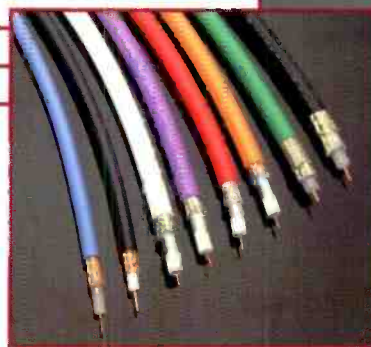
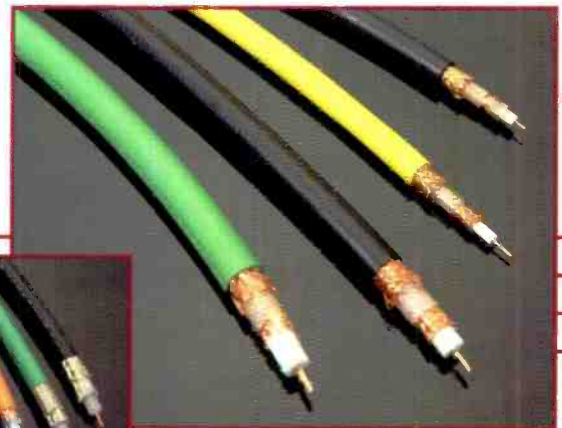
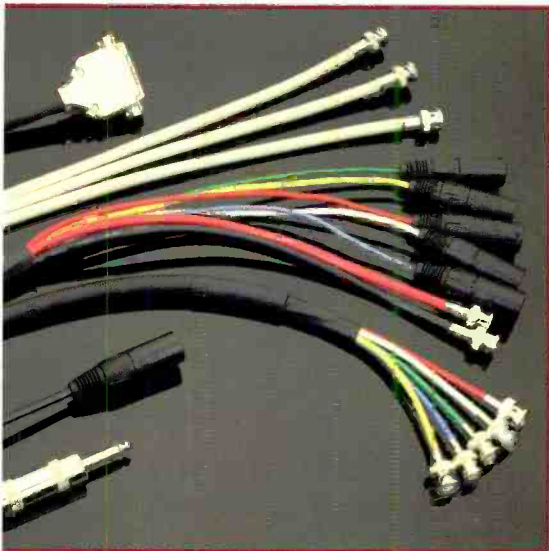
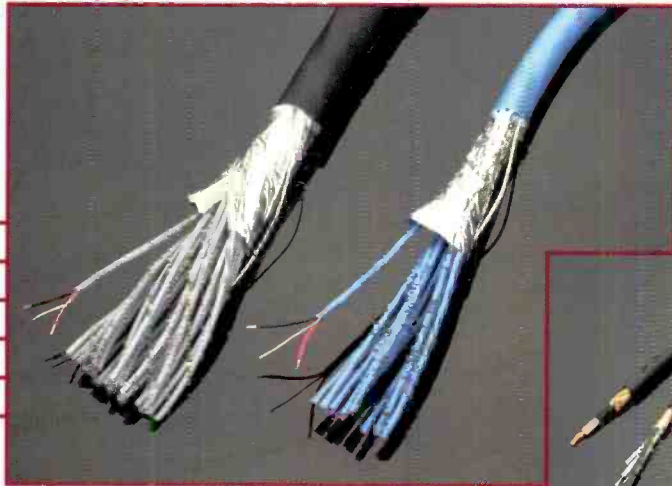

**GEPCO INTERNATIONAL**



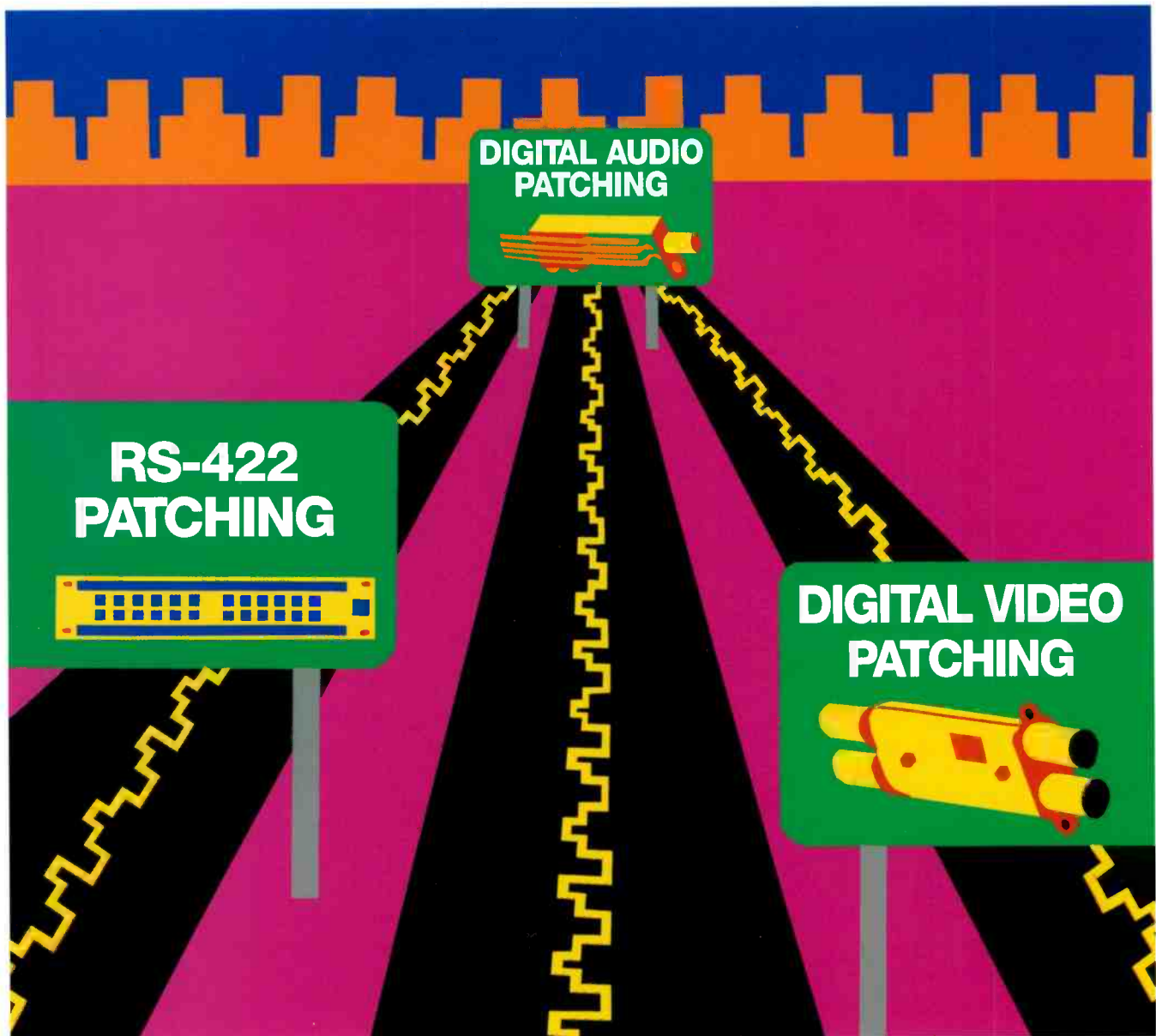

## Three-Way Access To The Digital World.

Whether it's digital audio, digital video or machine control between VTRs and edit controllers, ADC's digital patch panels provide for the access, monitor and test of digital circuits throughout your studio or station.

### *Digital Video Panels*

All ADC coax video jack panels are designed for composite analog, HDTV and serial digital video circuits, including D1, D2 and D3.

### *Digital Audio Panels*

ADC's fully-normalled digital jackfields patch AES/EBU signals up to 100 meters. High-speed, data-grade cabling assures error-free transfer of the digital signal. The patented QCP split

cylinder contact ensures gas-tight connections that can be reconfigured up to 200 times.

### *Machine Control Panels*

ADC Patch By Exception bays allow you to cost-effectively increase the number of ports available for your edit controllers and handle data applications up to 20 Mb/s, including 10 Mb/s Ethernet, T1 and ISDN.

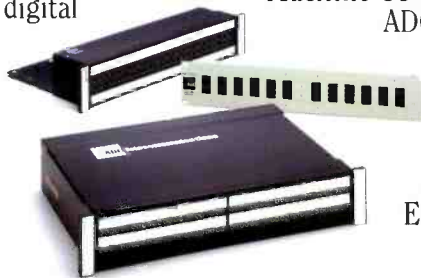

 **ADC Telecommunications**



## Neutrik Connectors

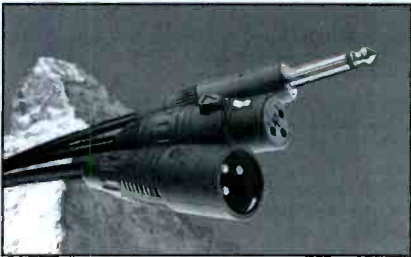

Below is a sampling of the connectors available from Neutrik. The XLR connectors are available in 3 through 7 pins, straight, right angle, and panel configuration.

*Please call for complete Neutrik information.*

Pt. No.	Description	Contact	Shell	Price
NC3MX	3-Pin Male XLR	Silver	Nickel	\$2.42
NC3MX-BAG	3-Pin Male XLR	Silver	Blk. Chrome	\$2.91
NC3MX-B	3-Pin Male XLR	Gold	Blk. Chrome	\$3.34
NC3FX	3-Pin Female XLR	Silver	Nickel	\$2.60
NC3FX-BAG	3-Pin Female XLR	Silver	Blk. Chrome	\$3.34
NC3FX-B	3-Pin Female XLR	Gold	Blk. Chrome	\$3.87
NC3MP	3-Pin Male Panel XLR	Silver	Nickel	\$2.71
NC3MP-BAG	3-Pin Male Panel XLR	Silver	Blk. Chrome	\$3.27
NC3MP-B	3-Pin Male Panel XLR	Gold	Blk. Chrome	\$3.71
NC3FP-1	3-Pin Female Panel XLR	Silver	Nickel	\$2.77
NC3FP-1-BAG	3-Pin Female Panel XLR	Silver	Blk. Chrome	\$3.28
NC3FP-1-B	3-Pin Female Panel XLR	Gold	Blk. Chrome	\$3.91
NP2C	2-Pin 1/4" Phone Plug	Nickel	Nickel	\$2.56
NP2C-BAG	2-Pin 1/4" Phone Plug	Nickel	Black	\$2.56
NP3C	3-Pin 1/4" Phone Plug	Nickel	Nickel	\$3.23
NP3C-BAG	3-Pin 1/4" Phone Plug	Nickel	Black	\$3.23

## ADC BNC Connectors

ADC has taken the traditional BNC connector and improved performance while making termination easier and more reliable. The new generation BNC features: gold plated, locking center conductors; true 75Ω impedance; .5" crimp ferrules marked with appropriate cable size; compatibility with select competitive crimp tools and die sets; tarnish resistant nickel plated body and bayonet; sizes for multiple cable types; and 12 point locking center conductor. A sampling of those available are shown below. *Please call for further information.*

Catalog #	Belden Cable type	Nominal Cable Outer Diameter	Nominal Conductor Diameter	Price
BNC8281D	8281	.305	.031	\$3.57
BNC1505D	1505A	.242	.032	\$3.57
BNC8218DB	8218	.150	.017	<b>Bulk \$357.00</b>
BNC1694D	1694A	.275	.017	\$3.57
BNC1695D	1695A	.234	.040	\$3.57

Cable Tool/Die Set		
WT-1	Conventional handle type	\$111.39
WT-2	Ergonomic handle type	\$111.39
WD-1	Die Set	\$64.61
WD-2	Die Set	\$64.61



ADC BNC Terminating Plugs are designed to eliminate any impedance mis-match in the network, greatly improving transmission in both narrowband and broadband networks. The ADC BNC-TP-1 uses a 75Ω±1.0% 1/2 watt resistor which provides greater than 26 dB return loss over the frequency spectrum of DC to 500 MHz for narrowband applications. The ADC BNC-TP-2 uses a 75Ω±0.1% 1/2 watt resistor which provides greater than 26 dB return loss from DC to 1 GHz, and better than 20dB return loss up to 2 GHz, for broadband applications. Gold plated center conductors, with tarnish resistant, nickel plated housing.

BNCTP1	75Ω±1.0%	\$6.30
BNCTP2	75Ω±0.1%	\$6.83

## Switchcraft Connectors

Switchcraft Q-G® Connector-Adapters, designed to solve common interconnection problems.

321	Phono plug to 3-pin XLR female audio-connector	\$17.10
322	Phono jack to 3-pin XLR female audio-connector	\$17.10
323	Phono plug to 3-pin XLR male audio-connector	\$15.20
324	Phono jack to 3-pin XLR male audio-connector	\$15.20
389	Adapter- XLRF to XLRF	\$18.75
390	Adapter- XLRM to XLRM	\$15.55
A3F	Satin Nickel Finish, female 3-pin XLR	\$6.70
A3M	Satin Nickel Finish, male 3-pin XLR	\$5.95

## Bodge Plugs

With a set of Bodge Plugs and a length of balanced cable, a range of 45 different adapter cables can be made quickly, saving you time and aggravation.

BOD-XLRP	XLR 3-pin Plug	\$35.00
BOD-XLRJ	XLR 3-pin Jack	\$35.00
BOD-SPPS	1/4" Standard Stereo Phone Plug	\$35.00
BOD-SPJS	1/4" Standard Stereo Phone Jack	\$35.00
BOD-SPP	1/4" Standard Mono Phono Plug	\$35.00
BOD-PP	RCA Phono Plug	\$35.00
BOD-P	RCA Phono Jack	\$35.00
BOD-BJ	BNC Jack	\$35.00
BOD-TRS	1/4" Tip Ring Sleeve Plug	\$35.00



# CABLE

# BIG mic cables



## Audio-Technica

AT8314-10	10', XLR-F-XLRM Balanced Cable	\$12.40
AT8314-20	20', XLR-F-XLRM Balanced Cable	\$15.10
AT8314-25	25', XLR-F-XLRM Balanced Cable	\$16.80
AT8314-30*	30', XLR-F-XLRM Balanced Cable	\$18.30
AT8314-50*	50', XLR-F-XLRM Balanced Cable	\$25.90
AT8314-100*	100', XLR-F-XLRM Balanced Cable	\$38.20

## PRO CO



PRO-M5FF \$22.50  
5' Mic Cable Female to Female XLR

PRO-SH5P2HXF780 \$12.00  
5' XLR-F to Mono Mini Cord

## Coiled Mic Cables

GRC1MFMS	XLR-F to XLRM Coiled, 30" to 15'	\$42.97
GRC1FSQMS	XLR-F to 1/4" TS Coiled, 30" to 15'	\$44.64
GRC1FSMQMS	XLR-F to 1/8" Mini Coiled, 30" to 15'	\$50.16

## Canare

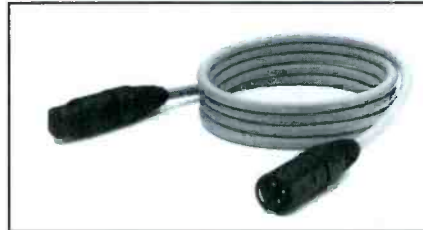

Canare StarQuad offers pre-made mic cable mated with Neutrik XLR-3 connectors with black shells and gold pins.

EC005FB	5'	\$27.65
EC015FB	15'	\$34.38
EC025FB	25'	\$41.82
EC050FB	50'	\$60.98
EC100FB	100'	\$90.53

C  
A  
B  
L  
E

# BIG headphones

## KOSS



Koss headphones have a no questions asked, *Manufacturer Lifetime warranty*. Koss headphones come with comfort, reliability and outstanding sound. Made in the U.S.A.

Pro/4AA Closed, 10-22kHz, 10' Coiled cord \$104.00

## AKG



K240M

K240M Deluxe monitor, fits around the ear, 20-20kHz, 600 Ω, 9'9" cable and std. stereo plug Wt. 8.5 oz. \$138.00



K141M

K141M Dynamic semi-closed, fits on top of the ear, high SPL, 20-20kHz, 600 Ω, 9'9" cable and a std. stereo phone plug. Wt. 8 oz. \$110.00

## Sony



These Sony headphones feature: rugged closed ear design, folding construction, gold connectors and oxygen free cord.

MDR-7502	30mm Driver Unit, 60-16kHz, (does not fold)	\$74.00
MDR-7504	30mm Driver Unit, 15-18kHz, carrying bag	\$128.00
MDR-7506	40mm Driver Unit, 10-20kHz, carrying bag	\$170.00

## Fostex



The closed Fostex T20RP, patented Regulated Phase system, ensures very low distortion, high output and long term reliability. All parts and assemblies secured by screws, assuring a long and useful life of easy maintenance. 20-30kHz, 50 Ω, 9'8" cable. Wt. 10.6 oz.

T20RP \$119.00



# BIG headphones



## Beyerdynamic

The **DT-150** is a fully enclosed studio monitoring headphone based on the DT-100 with 250Ω's, extended frequency response for critical monitoring, extended bass response, excellent isolation from ambient noise, lightweight and rugged.

DT-150 \$179.00



The **DT-770 PRO** is an enclosed, high quality monitoring headphone for professionals who require a full bass sound as clinically accurate as the high and mid-range reproduction, equalized to meet diffuse field EQ requirements. Padded headband ensures long-term comfort. Circumaural, closed, 5-35kHz, 600Ω, w/10' cable and std. plug, 9.5oz..

DT-770 PRO \$159.00



The **DT-990 PRO** high quality monitoring headphone is of a circumaural open design, is equalized to meet diffuse field EQ, has a wide frequency response, fast transient response and is durable yet lightweight for long term wear. 600Ω.

DT-990 PRO \$159.00

### PARTS

407.003	Replaceable ear pads for DT150, sold in pairs	\$24.00
407.127	Replaceable ear pads for DT770 & DT-990, sold in pairs	\$19.23
101.753	10' straight cable with 1/4" stereo plug	\$36.00
101.826	10' coiled cable with 1/4" stereo plug	\$43.00

## Sennheiser



All of the current **Sennheiser headphones** use neodymium magnets. Sennheiser headphones are fully modular allowing you to maintain perfect sound and functionality for years. All headphones above come with 10' replaceable stranded steel cable with mini plug. 1/4" stereo phone adapter included.

*Most Sennheiser headphones carry a two year parts and labor warranty.*

<b>HD25/SP</b>	Closed, supraural design, 16-22kHz(-10dB), 70Ω, 5 oz.	\$149.95
<b>HD265</b>	Closed linear, 10-30kHz, 150Ω, 7.5 oz.	\$249.95
<b>HD445</b>	Replaces the HD440II, 20-20kHz, 52Ω, 4.5oz.	\$79.95
<b>HD455</b>	Open Aire design, 18-21kHz, 52Ω, 4.2oz	\$99.95
<b>HD565</b>	Digitally Ready,"Duofol"(2-layer membrane), 16-30kHz 150Ω, 8.9 oz.	\$289.95
<b>HD580</b>	Digitally Ready, "Duofol", 12-38kHz, 300Ω, 9.2 oz.	\$349.95
<b>HZR 6</b>	Universal volume control cable, interfaces with any 1/8" stereo headphone jack. Made of kevlar-reinforced oxygen-free copper, with stereo/mono switch and independent slider-type left/right volume controls.Length 21 feet	\$31.00

# BIG headsets

## Audio-Technica



The **Audio-Technica COM Series** headsets have neodymium dynamic microphones with a flexible mic boom and cushioned ear pads. Features include: 40mm Driver • 30-20,000Hz frequency response • 90dB sensitivity • 50mW maximum input power • and -55dBv at 94dB SPL microphone sensitivity.

ATH-COM1 Mono, single muff w/4.9' cable w/2 mono mini plugs, and 2 gold-plated 1/4" mono plug adapters, 2.5 oz. \$59.95

ATH-COM2 Stereo, dual muff w/4.9' cable w/1 stereo / 1 mono mini plug, and 1 stereo / 1 mono 1/4" gold plated plug adapters, 3.5 oz. \$69.95



**H  
E  
A  
D  
S  
E  
T  
S**

## Beyerdynamic



The **Beyer DT 290** is a double-sided, reference quality, closed ear monitor with hypercardioid, electret condenser microphone complete with K 190.00 cable, lightweight, single exit, plug-in cable assembly. 8Ω

DT 290	<b>\$299.00</b>
--------	-----------------



The **Beyer DT 190** is excellent for long term wearing without fatigue. Double-sided broadcast headset. Impedance: 200/250 Ω, with a noise cancelling on-air mic, high SPL capability, studio quality monitor transducer, and is modular in design for easy servicing.

DT 190	Dual muff, dark grey	<b>\$419.00</b>
DT 180	Single muff, dark grey	<b>\$349.00</b>

The **Beyer DT 280** is a single-sided lightweight headset with dynamic microphone complete with K 190.00 cable, low profile design, reference quality, closed ear monitors, hypercardioid, single exit, and plug-in cable assembly. 8Ω

DT 280	<b>\$239.00</b>
--------	-----------------

The **Beyer DT 108** and **DT 109** dynamic headsets have a noise-cancelling mic with a frequency range of 30-20000Hz. These rugged, field-serviceable headsets have headphone transducers that feature extended frequency response for clear, audible, speech transmission. The protective earcup attenuates up to 20dB of ambient noise. Please specify headphone impedances of 50Ω (RTS), 400Ω (CC), or 600Ω, mic impedance is 200Ω, with color choice of black or grey. Comes supplied with a 5' open ended cable.

DT 108	Single-muff	<b>\$289.00</b>
DT 108.4	Same as above w/built-in pre-amp, balanced mic, for interface with carbon inputs available in 400Ω or 600Ω, grey only	<b>\$359.00</b>
DT 109	Dual-muff	<b>\$349.00</b>
DT 109.4	Same as above w/built-in pre-amp, balanced mic, available in 400Ω or 600Ω, grey only	<b>\$419.00</b>

### Beyer Headset Accessories

WS-108/109	Windscreen for DT 108/109 #280.836	<b>\$10.00</b>
K 109.00	5' Open ended cable for DT 100's #101.907	<b>\$30.00</b>
K 109.00	10' Open ended cable for DT 100's #127.949	<b>\$33.00</b>
K 190.00	5' Straight open-ended cable for DT 180/190/280/290 #431.575	<b>\$33.00</b>
WK 100.07	10' Coiled cable with 1/4" stereo jack for DT 100's #101.826	<b>\$43.00</b>
WK 109.00	10' Coiled open ended cable for DT 100's #198.900	<b>\$43.00</b>
WK 250.07	10' Coiled cable with 1/4" stereo jack for DT 200's #442.070	<b>\$36.00</b>
DT 100	Earpads sold in pairs for DT 108/109 #407.003	<b>\$24.00</b>
DT 150/190	Earpads sold in pairs for DT 150/190 #431.532	<b>\$39.00</b>
DT 200EP	Earpads (cloth covered) sold in pairs for DT 200's #442.704	<b>\$35.00</b>
DT 200EP2	Earpads (soft PVC covered) sold in pairs for DT 200's #443.549	<b>\$35.00</b>
BN 59-18/A	Headband cushion for DT 100 series #108.715	<b>\$10.00</b>
BN 59-58/A	Headband cushion for DT 150/180/190 #377.163	<b>\$14.00</b>
ClearCom Cable	5 ft. straight cable with female 4-pin XLR	<b>\$54.00</b>
RTS Cable	5 ft. straight cable with male 4-pin XLR	<b>\$54.00</b>

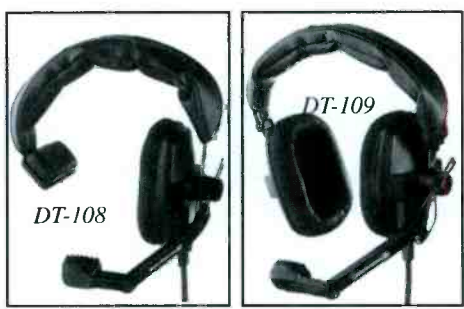

**Call us for other Beyerdynamic parts!**



## Shure

The **Shure SM-2** is a professional headset with a dynamic cardioid microphone and dual muffs. The microphone element is designed for excellent rejection of noise. The SM-2 has large, pillow-soft ear pads for external noise isolation and a double-braced, covered metal headband with a detachable cable that allows quick and easy cable changes for mono, stereo or split feed headphone functions.

SM-2	<b>\$277.50</b>
A120S Universal Cough Switch	<b>\$26.50</b>



# BIG headsets

## Sennheiser

The **Sennheiser HMD25-1** is a supraural dynamic, closed headphone with 30-16000Hz response and a super-cardioid dynamic mic with 50-12000Hz response. Sealed ear cushions and directional mic reduces surrounding noise. Microphone can be worn on either left or right side. Serviceability is assured by easy disassembly of all components. Comes supplied with a 6' stranded steel cable terminated in stripped and tinned leads. Weight 17 oz.

HMD25-1		\$525.00
HME25-1	Same as HMD but w/electret omnidirectional boom mic	\$525.00



The **Sennheiser HMD410-6** is a supraural, open-are, 600Ω headphone (20-18kHz) with a dynamic supercardioid, 200Ω boom mic (50-12kHz). Comes supplied with a 6' stranded steel cable terminated in stripped and tinned leads. Weight 18 oz.

HMD410-6		\$325.00
----------	--	----------



# H E A D S E T S

## Telex



The **Telex PH-24** has a full studio quality electret condenser microphone sound plus lightweight comfort. The PH-24 miniature noise cancelling electret microphone provides an extremely flat frequency response with significantly attenuated background noises and comes with a push to cough switch. Earphones 150Ω with a 9' cord to pigtail.

PH-24		\$250.00
-------	--	----------

The **Telex PH-25** is much like the PH-24, but it is dynamic binaural, with 250Ω omnidirectional condenser mic. Earphones 300Ω /side with a 9' cord to A3M/1/4" plug.

PH-25		\$299.00
-------	--	----------

The **Telex V-Series** professional, high fidelity headsets and headphones are modular in design. Two microphone capsules and a wide variety of five foot cord sets that plug into the headset using self-locking "Hirose" connectors are available.

V-200	Round, full cushion dual headphone (600Ω)	\$140.00
V-210	Single-sided with boom (150Ω)	\$120.00
V-220	Double-sided with boom (150Ω st. or 75Ω mono)	\$165.00
MB-11	Cardioid dynamic mic, 150Ω	\$49.00
MB-12	Cardioid electret mic, 150Ω	\$49.00
CA10	XLR-3 male/1/4" w/PS and PTC switch for electret	\$150.00
CA-11	XLR-3 male/1/4" w/PTC switch for dynamic mic	\$110.00
CA-20	XLR-4 female	\$50.00
CA-22	XLR-4 male	\$50.00
CA-30	XLR-5 female	\$65.00
CA-33	XLR-5 male	\$65.00
CA-40	Sony 1/8" mini 4-conductor	\$65.00
CA-60	Stereo 1/4" for headphones	\$50.00
CA-70	6-conductor, tinned ends	\$45.00



### Modular Microphone and Cordset Components

**Cord Assemblies**

- CA-10 (300029-007) XLR-3 Male and 1/4" phone, 5' (1.5 m) straight cord w/power supply, PTC switch for electret mic and Hirose connector
- CA-11 (300029-011) XLR-3 Male and 1/4" phone, 5' (1.5 m) straight cord w/PTC switch for dynamic mic and Hirose connector
- CA-20 (300029-001) XLR-4 Female, 5' (1.5 m) cord with Hirose connector
- CA-22 (300029-000) XLR-4 Male, 5' (1.5 m) cord with Hirose connector
- CA-30 (300029-009) XLR-5 Female, 5' (1.5 m) cord with Hirose connector
- CA-33 (300029-004) XLR-5 Male, 5' (1.5 m) cord with Hirose connector
- CA-40 (300029-006) Sony 1/8" mini 4-conductor, 5' (1.5 m) cord with Hirose connector
- CA-50 (300029-005) 1/4" mono, 5' (1.5 m) cord with Hirose connector
- CA-60 (300029-003) 1/4" stereo, 5' (1.5 m) cord with Hirose connector
- CA-70 (300029-002) pig tail, 5' (1.5 m) cord with Hirose connector
- CA-80 (300029-010) 1/8" mini stereo, 5' (1.5 m) cord with Hirose connector

**Microphone Cartridges**

- MB-11 (300029-000) Supercardioid Dynamic
- MB-12 (300029-001) Supercardioid Electret



**H  
E  
A  
D  
S  
E  
T  
S**

## Telex Announcer's Earsets

To provide optimum versatility, the **Telex Announcer's Earset** is made up of interchangeable component parts which simply snap together. Depending on the component pieces selected, users can construct a version of the Announcer's Earset that best suits their particular need.

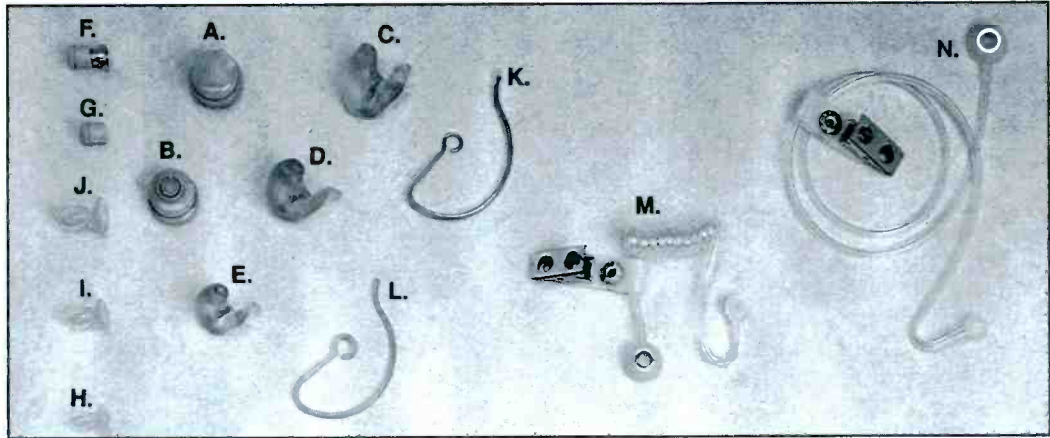

Telethin® Drivers			
A.	RTR-04	15 Ω	\$12.00
	RTV-04	125 Ω	\$12.00
	RTW-04	500 Ω	\$12.00
	RTX-04	1000 Ω	\$12.00
	RTY-04	2000 Ω	\$12.00
B.	RTW-04V*	500 Ω	\$35.00
*with volume control			
Earmolds			
C.	EML-1	Lg. R. ear	\$15.00
	EML-2	Lg. L. ear	\$15.00
D.	EMM-1	Med. R. ear	\$15.00
	EMM-2	Med. L. ear	\$15.00
E.	EMS-1	Sm. R. ear	\$15.00
	EMS-2	Sm. L. ear	\$15.00
	EM-KT	Custom kit	\$24.95

Eartips/Earcones/Earloops/Eartubes			
F.	ET-1	Eartip, Flesh tip with plug	\$4.50
G.	BT-1	Eartips for ET-1, Bag of 25	\$32.00
L.	AEF-3	Nylon earloop fits eartip & Telethin receivers	\$3.95
K.	AEF-2	Plastic covered metal earloop	\$3.95
M.	ET-2	Coiled acoustic eartube with clothing clip use w/earmold/tip	\$16.00
	ET-4	Coiled acoustic eartube with clothing clip, use w/earcones, comes w/1 ea. S, M & L earcones	\$21.95
N.	ET-3	Straight acoustic eartube with clothing clip use w/earmold/tip	\$16.00
	ET-5	Straight acoustic eartube with clothing clip, use w/earcones, comes w/1 ea. S, M & L earcones	\$21.95
H.	BT-2	S Earcones for use with ET-4 & ET-5, bag of 5	\$12.00
I.	BT-3	M Earcones for use with ET-4 & ET-5, bag of 5	\$12.00
J.	BT-4	L Earcones for use with ET-4 & ET-5, bag of 5	\$12.00

### \* Complete Earset

<b>EMV-2</b>	Includes: RTV-04, CMT-2, AEF-3, 125Ω, 5' cord w-1/4" plug	\$27.00
<b>EMY-2</b>	Includes: RTY-04, CMT-2, AEF-3, 2000Ω, 5' cord w-1/4" plug	\$27.00

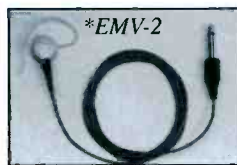

Not Shown:		
EH-S	Earphone Shell Holder for all Telethin@Drivers, Small	\$10.00
EH-L	Earphone Shell Holder for all Telethin@Drivers, Large	\$10.00
AFC-1	Under Chin Tube & Foam Cushion	\$7.95

*Cords, high-flex Telethin® cords 5 foot long, neutral gray, single tamper-proof jacket.*

O.	CMT-2	5' cord 1/4" connector	\$17.00
P.	CMT-92	5' cord w/right angle miniature connector	\$17.00
	CCX-2	5' coiled cord w/right angle miniature connector	\$18.00
Q.	CMT-98	5' cord w/straight miniature connector	\$17.00
R.	CCT-2	5' coiled cord w/1/4" connector	\$18.00
S.	CMT-95	5' cord w/sub-miniature or micro connector	\$17.00
T.	VXT-3	5' cord w/500Ω volume control & 1/4" phone plug	\$38.00
	VYT-3	5' cord w/2000 Ω volume control & 1/4" phone plug	\$38.00

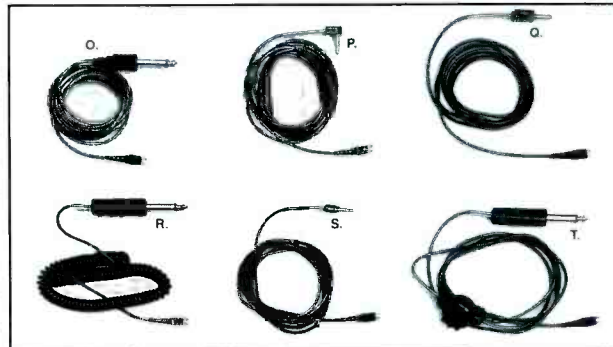



# BGS Intercoms



**BGS**

I  
N  
T  
E  
R  
C  
O  
M  
S

## Broadcast Tools



The **Broadcast Tools ICM-16** offers connectivity for up to sixteen Intercom stations. Features include single, five station work group and all-call capabilities • inexpensive 3,4,5, cabling • transformer isolated send audio • active balanced send and receive audio • receive audio mute control • and station call indication. The controller handles up to eight intercom stations and may be expanded to sixteen by adding an additional controller. The one rack unit controller supports all audio and data routing functions. All send and receive talkback audio is switched with high quality analog switch arrays. The studio intercom station consists of a 20 position keypad, approximately four inches square.

ICM-16 - 8 Station Controller	<b>\$629.00</b>
Desktop Intercom Station	<b>\$199.00</b>
Rack Mount Intercom Station	<b>\$239.00</b>

## Clear-Com

The **Clear-Com AB-100** On-Air Announcer's Console is a compact desktop unit designed specifically for sports, live event broadcasting, and voice-over work. The AB-100 integrates all of the inputs, outputs and controls necessary at the announce position, including intercom "Talkback," IFB receiver, and a silent "Mute" button that provides noise-free "Cough" and "Mic on/off" switching. It includes an adjustable mic pre-amp and high-output line amplifier for 20 to 20KHz frequency response and 0dB output with +20dB headroom. A stereo headphone amplifier guarantees talent can always hear both program audio and "cues" from the control room. It plugs into and draws power directly from most intercom and IFB systems or can be powered with the supplied AC adapter.



AB-100	Announcer's Console	<b>\$925.00</b>
AB2X	AB100 second party line channel upgrade kit	<b>\$182.00</b>

## Clear-Com

**Clear-Com Party-Line Intercom** is a full-duplex, distributed amplifier system, where all electronics are contained in each user station. This wide bandwidth system offers high level audio for your production whether it's large or small. A central power supply provides audio termination and short-circuit proof regulation for the system. The system can be designed from a host of user stations, power supplies and accessories. It can be one channel, or 12 channels and all components are compatible to allow for future system expansion.



The **MS-222** Main Station is a two channel intercom station. It has the same features and functions as the CS-222 with the addition of a built in speaker and optional plug-in gooseneck microphone.

MS-222		<b>\$870.00</b>
GM9	9" gooseneck mic	<b>\$145.00</b>
GM18	18" gooseneck mic	<b>\$155.00</b>

The **CS-222** Portable Main Station is a rugged, lightweight, two-channel intercom station. It supports up to 30 headset stations. Operator can talk or listen on either channel, combine them, or access them separately without trying both channels together.



CS-222		<b>\$780.00</b>
RK-101	Rackmount kit for CS-222, 2U	<b>\$75.00</b>

The **RS-501** beltpack is a single-channel beltpack with volume control, mic on/off switch, signal button and indicator, sidetone adjust, 4-pin headset connector, belt clip, and a 3-pin intercom and loop-through connectors. Surface-mount adapter included.



RS-501		<b>\$215.00</b>
--------	--	-----------------

The **RS-502** beltpack is a two channel, dual-listen station, with monaural output. Programmable switching lets the user listen to both channels simultaneously and select which channel to talk on. It includes individual volume control for each channel, mic on/off, call signal button and indicators, sidetone adjust, 4-pin headset connector, and a 6-pin loop-through intercom connector.

RS-502		<b>\$314.00</b>
--------	--	-----------------

The **RS-522** beltpack is a two channel unit that allows simultaneous listening and talking on two intercom channels. The headphone output operates in a "split-feed" stereo mode, feeding each channel into a separate ear of a double-muff headset. It includes individual volume control for each channel, mic on/off, call signal button and indicators, sidetone adjust, 6-pin headset and intercom connector. (To be used with CC-250/6 headset)

RS-522		<b>\$346.00</b>
--------	--	-----------------

MS-440*	4-channel headset/speaker main station w/1 amp PS, 2U	<b>\$1,299.00</b>
SB-440*	4-channel switchboard main station, 2U	<b>\$1,949.00</b>
MS-812A-12*	12-channel programmable** Master Station, 2U	<b>\$3,675.00</b>
RM-220	Remote Headset Speaker Station, two channels, 1U	<b>\$677.00</b>
RM-440	Remote Headset Speaker Station, four channels, 2U	<b>\$1,030.00</b>
KB-111A	Headset Speaker Station, two channels, wall flush mount	<b>\$312.00</b>
KB-112	Speaker/Mic Station, one channel, push-to-talk, flush wall mt.	<b>\$312.00</b>
MR-102A	Speaker Station, two channels, console or electrical box mt.	<b>\$227.00</b>
MR-104A	Speaker Station, four channels, console or electrical box mt.	<b>\$295.00</b>

\*Accepts optional plug-in gooseneck mic

\*\*Other configurations available, also needs power supply



**PL-Pro Party Line Intercom** is designed specifically for the demanding world of broadcast and video production, including multiple built-in IFBs, intuitive front panel controls with big, easy-to-use buttons and bright illuminated call signaling. All stations come standard with controllable logic that allows them to be configured with a variety of controls, and features.

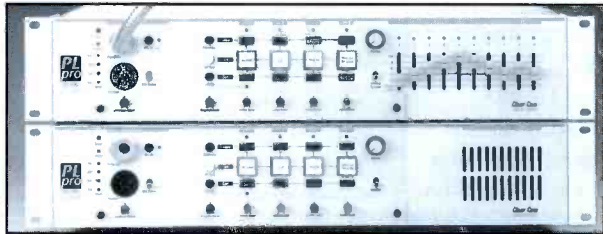

SB & MS-440

See Clearcom Headsets on following page.  
Call for Further Information and System Pricing!





INTERCOMS

## Clear-Com

### Headsets

CC-26	Single muff lightweight, 4-pin female XLR	\$142.00
CC-85	Single muff standard, 4-pin female XLR	\$175.00
CC-85-R	RTS, single muff standard, 4-pin male XLR	\$181.00
CC-250	Double muff standard, 4-pin female XLR	\$218.00
CC-250-R	RTS double muff standard, 4-pin male XLR	\$224.00
CC-250-6	Split ear double, 6-pin female XLR	\$226.00
CC-40	Single ear economy, 4-pin female XLR	\$99.00
CC-60	Double ear economy, 4-pin female XLR	\$123.00
HS-6	Telephone style handset, 4-pin female XLR	\$95.00
PT-4	Push-to-talk handheld mic, 4-pin female XLR	\$65.00
ES-1	Ear sock cover for all headsets, pair (not CC26)	\$7.00



## Intelix

### Intelix MZP Zoned Paging and Program Audio Distribution System

The MZP is a marriage of a matrix mixer, programmable remote controls and Windows based programming software. It is an integrated system for small to medium sized audio distribution and voice routing applications. Stock configurations include cross point level controlled mixer, power supply and user manual.

*Please call for custom configurations from 8 inputs/outputs to 128 inputs/outputs.*

Model	Inputs	Input type	Outputs	Output type	Control Function	Price
MZP8L8L	8	line level	8	line level	MZP software	\$3,129.00
MZP16L8L	16	line level	8	line level	MZP software	\$4,795.00
MZP24L8L	24	line level	8	line level	MZP software	\$6,099.00
MZP32L8L	32	line level	8	line level	MZP software	\$7,277.00
MZP8L16L	8	line level	16	line level	MZP software	\$4,795.00
MZP16L16L	16	line level	16	line level	MZP software	\$6,955.00

Comet Series	Remote Controls for Matrix Mixer	\$119.00
Comet PS	12VAC 200mA, will power up to 15 Comet Series Remotes	\$76.65



## Telex

The **Telex Audiocom** is a headset intercom system consisting of modular components that can be connected with conventional wiring to form a simple party line communication system or a more sophisticated network using "director controlled" multi-channel configurations. Telex also offers Radiocom wireless intercom for professionals that require the added convenience of wireless operation. Radiocom products can be used in conjunction with wired systems, or separately as a stand alone system.

*Call for further information and system pricing.*

## Motorola

**Motorola** can put the power of instant communication in the palm of your hand with **Spirit Jobsite Radios**. 1-Watt VHF models are ideal for communicating in rural areas. 2-Watt UHF models are ideal for use in urban areas, working around steel or concrete structures. They come packaged with: Radio, Antenna, Belt Clip, Rechargeable Battery, and 10-Hour Wall Charging Adapter. Spirit Radio's have a variety of charging, carrying and audio accessories. *Please fax or call Broadcasters General Store for a complete listing. (Typical useable range about 1 mile.)*

SV10	2-Way Series, 1-Watt VHF, 1-Ch., Open Squelch	\$225.00
SV11	PRO Series, 1-Watt VHF, 1-Ch., Open Squelch	\$239.00
SV11C	PRO Series, 1-Watt VHF, 1-Ch., Coded Squelch	\$289.00
SU21	PRO+ Series, 2-Watt UHF, 1-Ch., Open Squelch	\$269.00
SU21C	PRO+ Series, 2-Watt UHF, 1-Ch., Coded Squelch	\$319.00

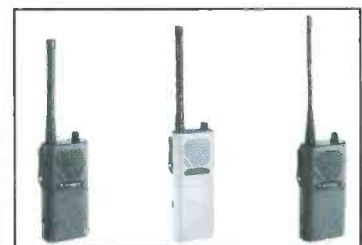

## RTS



The **RTS TW Intercom System** is a conference-line inter-communications system that features over 25 different components. This system is named TW ("Two-Wire"), because two-conductor cable is all that is needed to hook up a basic system. A unique circuit design, utilizing advanced solid state devices, enables the user to conveniently carry on two channels of communication through standard two-conductor shielded cable, telco JKT cable, or even ordinary lamp cord (single channel). It operates in a full duplex mode. A minimum of two user stations and a power supply are required for communications. up to 75 user stations can be employed.

The **RTS 803 Programmable Master Station** is a microprocessor assisted



communications control center. It utilizes a powerful microprocessor to control the selection and execution of almost all operational functions. Standard and optional features include 2-wire (full duplex) conference line intercom with separate talk/listen switching, one-way (simplex) announce/page functions, IFB, station isolate (camera/video ISO), 4-wire line connection, multisource audio assignment to mono/stereo headset/loudspeaker, and selective channel call signaling. *Please call Broadcaster General Store for system configuration.*



## SAS Sierra Automated Systems

### Matrix Intercom/IFB or Mix-Minus & IFB System

The SAS Intercom Systems are built around SAS 32000 Series Switching and Mixing System components. One 3U frame services up to 32 user stations. Software programmable features include full eight character alphanumeric subscriber designation, separate talk and listen capability, interruptible foldback (IFB) and programmable groups. Fully featured control panels include intuitive alphanumeric selection, "hot punch" programmable talk and listen push-buttons, communications mic and preamp, loudspeaker and amplifier. They are available in eight or sixteen button, rackmount and desktop configurations. Also available are single rack and console mount stations that provide control-only for locations with access to line/level mic signals and cue speakers relating to audio consoles or news desks.

Please call BGS for system configurations and pricing!



## Studio Technologies

StudioComm Series products work in conjunction with digital audio workstations to provide a full set of monitoring, dubbing, and communications functions.



**Model 50 Central Controller with Model 51 Control Console** is an advanced StudioComm system featuring seven stereo inputs, two control room outputs, studio monitoring, and three communications functions. It allows connection of up to four Model 35 or Model 38 Talent Amplifiers.

Model 50 with 51 **\$1,799.00**

**Model 40 Central Controller** is a StudioComm headphone system featuring two stereo inputs and two talent amplifier output groups. It allows connection of up to eight Model 35 or Model 38 Talent Amplifiers.

Model 40 **\$449.00**

**Model 70 Interface** creates stereo, balanced line-level signals from Model 40, 50, and 55's talent amplifier output.

Model 70 **\$172.00**



## Studio Technologies IFB Series



The **Model 2 Central Controller** contains two independent IFB channels for ENG, SNG, and

mobile production facilities. Each channel has a complete set of controls and indicators. Program source select switches allow one or more of the four program inputs, as well as incoming audio from the two telephone interfaces, to be selected as program audio. Program level controls allow adjustment of the selected program sources. Channel audio level is displayed by 5 segment LED meters. Channel interrupt activity is displayed by LED indicator lights. Other features include: internal interrupt mic • Voice operated, VOX, interrupt • and monitor amplifier. 1U

Model 2 **\$1,795.00**

### Accessories:

- M11 Panel mounted electret 12" gooseneck mic for M22 **\$155.00**
- M25 19" Rack Adapter for M22 **\$48.00**
- M28 Panel Adapter for mounting M22 & M11 in an equipment console/desk **\$48.00**
- M36 Set of two brackets used for mounting M32 & M33 underneath desk **\$27.00**
- CA9/10 10' Shielded Multi-conductor Interface cable for linking M2 & M22 **\$19.00**
- CA9/50 50' of above Interface cable **\$58.00**



**Model 55 Central Controller with Model 56 Control Console** is a reduced-feature version featuring four stereo inputs, one control room output, and two communications functions. It allows connection of up to four Model 35 or Model 38 Talent Amplifiers.

Model 55 with 56 **\$1,299.00**



**Model 35 Talent Amplifier** is a portable talent amplifier that drives up to two pairs of headphones and connects to Models 40, 50, and 55. It includes microphone stand mounting adapter.

Model 35 **\$159.00**

**Model 38 Talent Amplifier** is a portable talent amplifier with a stereo preamplifier section and allows creation of personal cue mix. It connects to Models 40, 50 and 55.

Model 38 **\$249.00**

The **Model 32 and 33 Talent Amplifiers** are self-contained "belt pack" units that drive talent ear pieces or headsets. Any combination of up to four Talent Amplifiers can be supported by the Model 2's talent amplifier output. The model 32 is intended for use by on-air personnel, and contains a source switch, along with an output level control. Either IFB channel can be sent to the talent at the desired volume. The 33 is unique in that a "mix" of IFB channels 1 and 2 can be created. Two level controls, along with a source select switch, allows camera and production personnel to hear IFB cues from either or both channels. This allows IFB signals intended for both technician and talent to be simultaneously monitored.



M32 **\$165.00**  
M33 **\$190.00**



The **Model 22 Access Station** can be used to provide additional IFB origination locations for those that

need to cue talent or related personnel. Up to four 22s can be connected to and powered by a Model 2. Normally installed with an M11 Gooseneck Mic and either M25 or M28 mounting adapter.

M22 **\$205.00**

INTERCOMS





**BGS**

**I  
N  
T  
E  
R  
F  
A  
C  
E  
S**

## Benchmark



**Benchmark AD2004 Series 20 Bit, 64 X sampling analog to digital converters** were

designed for applications that require no-compromise performance coupled with space efficiency. The chassis is 1U high, 1/3 space wide, allowing up to 12 channels in 1RU. An AES3-id reference port allows multiple converters to be phase locked to the same reference signal. Jitter reduction is outstanding and there are no measurable idle tones when either free running or phase-locked to a reference signal. This is just the first of a family of digital audio products to be offered by Benchmark.

AD2004R-44	44.1kHz -110Ω output	\$2,000.00
AD2004R-48	48kHz-110Ω output	\$2,000.00
AD2004R-DF	44.1 & 48kHz-110Ω output	\$2,200.00
AD2004B-44	44.1kHz-75Ω output	\$1,800.00
AD2004B-48	48kHz-75Ω output	\$1,800.00
AD2004B-DF	44.1 & 48kHz-75Ω output	\$2,000.00

## Troisi



**Troisi converters** offer true 20 bit performance. The modular design allows you to quickly go back to 16 bits when recording to DAT machines. The front panel connects you to AES, SPDIF and optical. Troisi con-

verters are upgradeable; you can have the latest converter technology without re-investing in a new box.

### Analog to Digital Converters

DC16ADC	16 bit A/D Converter	\$1,840.00
DC20ADC	20 bit A/D Converter	\$1,890.00
DC24ADC	24 bit A/D Converter	\$1,950.00

### A/D Plug-In Upgrade Modules

DC16ADM	16 bit A/D Converter Plug-In Module	\$360.00
DC20ADM	20 bit A/D Converter Plug-In Module	\$410.00
DC24ADM	24 bit A/D Converter Plug-In Module	\$470.00

### Digital to Analog Converters

DC20DAC	20 bit D/A Converter	\$1,650.00
DC24DAC	24 bit D/A Converter	\$1,750.00

### D/A Plug-In Upgrade Modules

DC20DAM	20 bit D/A Converter Plug-In Module	\$390.00
DC24DAM	24 bit D/A Converter Plug-In Module	\$450.00

## Z-Systems

The **z-2src** is a rack-mount sample rate converter which features AES/EBU, S/PDIF, and optical inputs and outputs, the ability to generate 32 kHz, 44.1 kHz, or 48 kHz outputs directly from precise crystal references, or generate any sample rate between 25 kHz and 55 kHz from an external reference. In addition to serving as a sample rate converter, the z-2src can also be used as a format converter and features an audio bypass switch which leaves the audio data intact, but still allows channel status bits to be manipulated. Input resolution is up to 20 bits with output resolution 24 bits.

For those needing sample rate conversion only, Z-Systems has designed the **z-link** and the **z-link+**, low-cost, compact, real-time sample rate converters. Both feature the same high quality audio path as the z-2src sample rate converter in a hand-held package. The z-link+ adds an external synchronization loop, which allows it to have its output sample rate locked to an external AES/EBU or S/PDIF digital audio signal. Both feature a professional/consumer output switch which allows the user to set the output channel status as desired. The audio specifications are identical to the z-2src. Input and output connectors are transformer isolated coaxial (RCA or BNC).

z-2src	\$1,200.00
z-link	\$430.00
z-link+	\$599.00



## Aardvark

The **Aardverter** provides A/D and D/A Delta Sigma, 64 X oversampled, 16-bit conversion in a 1RU, half rack space package. Four analog XLR connectors provide stereo I/O and 2 digital XLR connectors provide AES/EBU. I/O-S/PDIF RCA connectors are optional. A third digital XLR is provided for selectable house sync. LED bargraph monitors the digital level and both the input and output levels are adjustable.



Aardverter \$1,860.00

## Symetrix



The **Symetrix 620** excels in 20-bit A/D conversion, 16-bit A/D conversion, the addition of dither and noise shaping to 16-bit digital audio, word size conversion (20, 16 & 8-bit), and real-time sample rate conversion (44.1 to 22.04 kHz). It uses the same 20-bit delta-sigma IC found in units costing up to three times more. The Symetrix 620 delivers extremely accurate 16 or 20-bit digital audio, free of DC, at 48, 44.1, 32 or 22.05 kHz.

620 \$995.00

The **Troisi Octal A/D Converter** will give you eight channels of digital sound and interface directly to your digital multitrack. Four standard AES/EBU stereo digital outputs connect to your digital recording equipment and always stay in sync. Custom packages with SPDIF (coaxial or optical) and TDIF (DA-88) are also available. The modular design allows the user to quickly change from 16 to 20 bit recording and back again, with the future option of moving up to 24 bits. This guarantees that your investment in the Troisi stays intact for years to come.

DC8-16ADC	8-Channel, 16 bit A/D Converter (AES)	\$3,510.00
DC8-20ADC	8-Channel, 20 bit A/D Converter (AES)	\$3,710.00
DC8-24ADC	8-Channel, 24 bit A/D Converter (AES)	\$3,920.00
DC8-20DAC	8-Channel, 20 bit D/A Converter (AES)	\$3,450.00
DC8-24DAC	8-Channel, 24 bit D/A Converter (AES)	\$3,560.00





## Aphex



The **Aphex Model 124A** is a -10dBv to +4 or +8 dBm interface for linking consumer type equipment to professional equipment. The 124A fits in a half rack space.

Model 124A	\$229.00
Model 44-0085A Rack mount adapters	\$29.95



**BGS**

## ATI



**ATI Match-Maker MM100/Disc-Patcher DP100** will take the consumer levels and match them to your console or other professional equipment with the transparency and RF immunity expected from ATI.

MM100 Match-Maker	Bi-directional, stereo xfmr outputs	\$299.00
DP100 Disc-Patcher	Uni-directional, stereo xfmr outputs	\$279.00
P/N 20273-501	Rack mount for one or two units	\$28.00

The **ATI NANOAMP Series** of line level matching interface semi-pro unbalanced IHF @ -10dBv equipment into 600 Ω balanced systems @ +4dBm.

BI100	Bi-directional stereo IHF to PRO converter. Two balanced to unbalanced channels and two unbalanced to protected active balanced output channels	\$225.00
UB400	Uni-directional quad IHF to balanced converter. Converts four unbalanced IHF signals into four protected active balanced outputs.	\$230.00
BU400	Uni-directional quad balanced to IHF converter. Converts four balanced signals to four unbalanced IHF outputs.	\$210.00
Rack mounts	Specify 1 centered / 2 side by side / or 3 side by side	\$22.00 /25.00 /or 30.00



I  
N  
T  
E  
R  
F  
A  
C  
E  
S

## dbx



The **dbx 1024** brings hi-fi equipment (IHF) to professional (XLR) levels and impedance; and drives long lines without signal loss. Additional flexibility is provided by the gain/attenuation controls, allowing an even wider range of levels to be matched. Clip indicators show overload anywhere in the circuit path.

dbx 1024	\$239.95
ACC Rack mount single unit	\$20.95
<i>(Need 2 kits to mount in pairs)</i>	

## ESE

### ESE ES 244

The **ESE Audio Level interface** is a stereo, bi-directional coupling unit. It provides an easy means of connecting equipment with unbalanced inputs/outputs to equipment with balanced +4 or +8 dBm inputs/outputs.



ESE 244	XLR & RCA I/O's	\$185.00
Option P	Rack mount	\$50.00
Options P2	Rack mounts 2 units	\$50.00



**BGS**

**I  
N  
T  
E  
R  
F  
A  
C  
E  
S**

## Excalibur



The **Excalibur IA-1** is a PRO/IHF bi-directional matching interface. Pro connections are barrier strip and IHF are RCA. Input and output levels are adjustable, and a metal enclosure provides

shielding for use in high RF environments. Barrier strips I/O.

IA-A		<b>\$165.00</b>
RM-1	Holds 1 or 2 units	<b>\$21.00</b>

## Benchmark



With **Benchmark's** differential amplifiers retrofit your consumer gear to pro standards. (Requires  $\pm 15\text{VDC}$  power.)

DIA-1-6	Differential Input Amp $\pm 9$ to $\pm 22$ VDC -6 dBu	<b>\$48.00</b>
DOA-3	Differential Output Amp $\pm 9$ to $\pm 22$ VDC AC coupled	<b>\$48.00</b>
DOM-3	Differential Output Mixer $\pm 9$ to $\pm 22$ VDC	<b>\$48.00</b>

## Henry Engineering

The **Henry Matchbox II** interconnects consumer equipment with professional studio gear. It is a bi-directional unit, with four independent amplifiers providing full stereo input and output interface. All four outputs can be adjusted to accommodate a wide range of operating levels. It also features a special HI GAIN mode to match the low-level unbalanced outputs of computer sound cards. The Matchbox II is ideal for use with digital editors, DAT recorders, and other digital sources.



The **Henry Twinmatch** is a dual stereo level and impedance converter designed to interface unbalanced equipment outputs with professional studio inputs. Four channels of amplification are provided, making Twinmatch ideal for use with a pair of stereo CD players. A gain adjustment is provided for each channel. All circuitry is active and direct coupled for exceptional sonic accuracy.



Matchbox II		<b>\$195.00</b>
-------------	--	-----------------

Twinmatch		<b>\$195.00</b>
-----------	--	-----------------

## Radio Design Labs STA-1 See Page 25

## Rane



The **Rane BB44X Balance Buddy** is used to convert and provide isolation for unbalanced -10dBv consumer level RCA outputs up to balanced +4dBu professional 3-pin (XLR-type) inputs and vice-versa. Two channels each way, or a stereo pair each way. The BB44X converts one pair from -10dBv to +4dBu and another pair from +4dBu to -10dBv simultaneously. There are two female and two male XLR-type connectors, and four RCA jacks.

BB44X		<b>\$299.00</b>
-------	--	-----------------

## Russ Friend & Associates

The **Russ Friend & Associates CD100•X** was designed to interface a consumer type player to the input of any audio console. RCA inputs and barrier strip outputs with front panel recessed trim pot.



CD100•X		<b>\$99.00</b>
---------	--	----------------



# BIGS level

## SESCOM

The **Sescom** little boxes solve big audio problems. They are housed in a sturdy black anodized aluminum enclosure measuring 4.52"Wx4.5"Dx1.57"H.

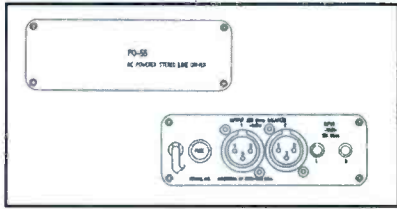

PO-55 Consumer to pro impedance/level matching interface \$200.00

## Valley Audio



The **Valley HH 2 x 2B** Level Matching Interface resolves the level and impedance matching problems associated with interfacing -10dBv equipment to the studio and broadcast equipment standards of +4dBu and +8dBu. It also ensures immunity from RF pick-up and hum, due to electronic balancing of the +4/+8 inputs and outputs.

HH 2x2B \$299.00  
HHRM Rack panel for one or two HH 2x2B \$34.99

## Tascam



The **Tascam LA-40MKII** is a four channel, bi-directional, balanced and unbalanced line converter. The rear panel has ground lift switches for each channel with an overall master switch and the front panel has a  $\pm 6$ dB trim pot for each channel. A unique feature of the LA-40 MKII is the Input Link which allows it to be used as a 1X3 distribution amp in the unbalanced mode.

LA-40MKII \$475.00

## Zercom

The **Zercom Gain Box** was designed and built as an audio boost amplifier. It has two independent channels of gain which means it can be used for stereo or as two separate monaural amplifiers. The two channels can be wired in series for up to 60dB gain.



Gain Box \$179.00

# BIGS problem solvers

## Henry Engineering



**Henry MixMinus Plus** is a differential summing amplifier designed to add a "Mix Minus" output to an audio console or teleconferencing system. This output is typically used to feed the send input of a telephone hybrid device. MixMinus Plus subtracts the hybrid receive signal from the program output, to generate a program mix - minus the receive (caller) audio. The NULL adjustment will provide 40dB caller audio rejection. It is also applicable to satellite audio systems, removing incoming audio from a return IFB or cue feed to prevent echo and feedback.

MixMinus Plus \$195.00

The **Henry Logiconverter** is an interface unit that facilitates remote control of studio equipment. It solves the incompatibility problems encountered when a broadcast console is used to provide remote start/stop control of peripheral equipment. Logiconverter converts TTL/CMOS or open-collector console outputs to relay closures for remote interface that is compatible, reliable and isolated. The unit can be user programmed via internal dip switches to generate either momentary or maintained outputs from various inputs, with 24 combinations possible.

Logiconverter \$195.00



## Whirlwind

The **Whirlwind MD-1** combines a high quality mic/line input stage with a transformer-isolated line driver and independent headphone amplifier. Ideal for boom, parabolic and interview mics, the MD-1 provides phantom power, local monitoring and a line-level balanced output for noise immunity over long cable runs. The MD-1's input stage features a level control and up to 60dB of gain, a mic/line input level switch, plus switchable 18V phantom power for condenser mics. Its output can be switch selected between the isolated gain stage and a straight loop-through. The headphone volume control provides a 60dB range of adjustment to the post-transformer input signal or to signals inserted at the headphone line in jack. The mix control allows the user to monitor a mix between the driver circuit and the direct line in. It's powered by two 9V batteries.

MD-1 \$260.00



# I N T E R F A C E S



## Radio Design Labs



**BGS**

**INTERFACES**

**Rack-Up™ Series** (All rack up & active stick-on units require an external pwr. supply.)

RU-LA2D	IHF-PRO Interface	\$266.00
RU-BLA2	Stereo line amp, XLR's ins/outs	\$234.00
RU-MP2	Stereo mic preamp, XLR ins/outs w/phtn pwr.	\$299.00
RU-MX5	5 Input mic/line mixer	\$242.00
RU-DA4D	1x4 Stereo audio DA or 1x8 mono	\$227.00
RU-BDA3	3 Output audio DA	\$215.00
RU-UDA4	2x4 Stereo unbalanced DA	\$150.00
RU-MDA3	1x3 Mic DA	\$222.00
RU-SM12	Dual channel audio meter	\$203.00
RU-SX4	Balanced audio switch	\$235.00
RU-VCA1	Digitally controlled attenuator, mono	\$246.00
RU-VCA1D	Digitally controlled attenuator, stereo	\$277.00
RU-OSC4A	Sequencing oscillator	\$255.00
RU-SC1	Serial Converter, RS-232 to RS-485 or RS485 to RS-232	\$185.00
RU-SQ6	Sequencing controller	\$208.00
RU-VDA4/*	1x4 Video DA (loop-through in, 75Ω out *Specify BNC, phono or type F, adjustable	\$239.00
RU-VA2	Video attenuator, BNC 75Ω in & out, adjustable	\$144.00

**Rack-Up Series Mounting Accessories** (Rack-ups units are 1/3 rack width)

RU-RA3	19" Rack adapter, holds up to 3RU modules	\$29.00
RC-1U	Universal rack adapter	\$127.00
JP-1	Universal jack panel	\$14.00
JP-2	XLR Jack Panel	\$15.00
STR-19B	Racking System, (19"RM for up to 10 stick-ons at an angle)	\$146.00
STR-19A	Racking System, (19"RM for up to 12 stick-ons)	\$123.00
J-RCA	Phono jack	\$1.40
J-PHN-S	1/4" Phone jack, stereo	\$2.20
J-XLR-F	XLR, female	\$7.30
J-XLR-M	XLR, male	\$7.00
J-BNC	BNC jack	\$2.00
RU-FP1	Rack filler panel/Reverse mounting kit	\$8.00
MB-1	Mounting kit, Z bracket	\$6.00
MB-2	Mounting kit, L bracket	\$6.00
RU-SHA4	Wire harness adapter kit	\$12.00
DMK	Detachable mounting pads, (Kit of 5)	\$5.00
LBL-1	Label kit	\$7.00

**Rack-Up Accessories**

RLC2	Remote level control, for RU-VCA's & ST-RG	\$120.00
RCS4	Remote channel selector, for RU-SX4	\$90.00

**Active Stick-On™ Products**

STA-1	Electronic transformer and line amp pair	\$136.00
STA-1M	Audio line amp, mono	\$100.00
STSH1	Stereo headphone amp	\$114.00
ST-IC	Intercom Amplifier, (1 mic level input; 1 @ 8Ω out)	\$120.00
ST-PA2	2 Watt power amp mono	\$64.00
STPA6	6 Watt power amp mono	\$88.00
ST-MX3	Line level mixer (3 lines in, 1 line out)	\$114.00
ST-MMX3	Mic to line mixer (3 mic lines in, 1 line out)	\$126.00
STMLX3	Mic/line to line mixer	\$120.00
ST-MXL3	Line to mic mixer	\$120.00
ST-LMX3	Line & Mic Level mixer, (2 mic-1 line bal/unbal in; 1 line bal/unbal out)	\$120.00
ST-DA3	Audio DA (1 in, 3 out line)	\$126.00

**Summary of Supply Requirements**

Product	Max Current mA	Modules per RDL supply	Product	Max Current mA	Modules per RDL supply
RU-LA2D	50	6 GF	STA-1	50	6 Floating
RU-BLA2	50	6 GF	STA-1M	50	6 Floating
RU-MP2	50	6 GF	ST-SH1	175	2 GF
RU-MX5	65	5 GF	ST-IC1	175	2 GF
RU-DA4D	120	3 GF	ST-PA2	150	2 GF
RU-BDA3	45	6 GF	ST-PA6	350	1 GF
RU-UDA4	25	6 GF	ST-MX3	55	6 Floating
RU-MDA3	35	6 GF	ST-MMX3	55	6 Floating
RU-SM12	400	1 GF	ST-MLX3	55	6 Floating
RU-2X4	75	4 GF	ST-MXL3	55	6 Floating
RU-VCA1/D	80	4 GF	ST-LMX3	55	6 Floating
RU-OSC4A	75	4 GF	ST-DA3	70	5 Floating
RU-SC1	150	2 GF	STM-DA3	30	6 GF
RU-SQ6	75*	*			
RU-VDA4	60	5			
RLC2	75	N/A			
RCS4	25	N/A			

GF = Ground Referenced  
\*RU-SQ6 uses 75mA itself, but users can connect loads to each of its 6 outputs. The total current required of the power supply will be 75mA+ the current required for the combined loads.

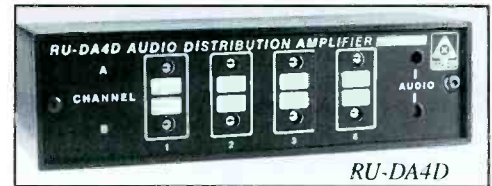

RU-DA4D



RU-MX5



RU-SM12



RU-VDA4



RU-MP2



RU-VCA1D



STA-1



ST-PA2

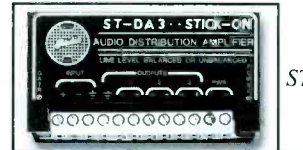

ST-DA3



# Credit Application



**Broadcasters General Store, Inc.**

2480 S.E. 52nd Street

Ocala, FL 34480-7500

Ph# 352-622-7700 Fax# 352-629-7000

Name of Firm: \_\_\_\_\_ Parent Company: \_\_\_\_\_

Ph# \_\_\_\_\_ Fax# \_\_\_\_\_ Ph# \_\_\_\_\_ Fax# \_\_\_\_\_

Contact Person: \_\_\_\_\_ Corp. Acct. Payable Person: \_\_\_\_\_

Acct. Payable Person: \_\_\_\_\_ Amt. of Credit Requesting: \_\_\_\_\_

Invoice Address: \_\_\_\_\_ Purchase order required? Yes No

\_\_\_\_\_ Circle one:

\_\_\_\_\_ Corporation Partnership Proprietorship

Shipping Address: \_\_\_\_\_ Years in business: \_\_\_\_\_ D&B Rating: \_\_\_\_\_

\_\_\_\_\_ SSN# or Resellers

\_\_\_\_\_ Fed ID#: \_\_\_\_\_ Tax#: \_\_\_\_\_

Bank References: \_\_\_\_\_ Acct.# \_\_\_\_\_

Contact: \_\_\_\_\_ Ph# \_\_\_\_\_ Fax# \_\_\_\_\_

Bank References: \_\_\_\_\_ Acct.# \_\_\_\_\_

Contact \_\_\_\_\_ Ph# \_\_\_\_\_ Fax# \_\_\_\_\_

Please list a minimum of 3 Trade References:

Company Name City/State Acct# Ph# (Important) Fax#

\_\_\_\_\_

\_\_\_\_\_

\_\_\_\_\_

\_\_\_\_\_

\_\_\_\_\_

Be advised to secure an "open account" the following conditions shall prevail: The undersigned, jointly and severally, absolutely guarantees the full and prompt payment of its invoices per the terms agreed to at the time of sale and as stated on the invoice, including all freight charges and taxes. In the event an invoice is not paid as agreed, the Buyer agrees that the Seller, Broadcasters General Store, Inc., retains title and right to possession of the goods, that the Buyer agrees to pay all costs of collections, including attorneys fees and that interest shall accrue on the full balance at the rate of 18% per annum. Any litigation concerning this agreement between the parties shall take place in Marion County, Florida. All returned checks incur a \$25 charge and all accounts over the credit terms will relinquish their privilege of open account. The manufacturers' warranties apply and commence on the invoice date. The following authorized signature constitutes your agreement to the aforesaid conditions of sale on a credit basis and is required to secure an "open account".

We authorize investigation of credit history and credit references to secure an "open account" status.

Authorized By: \_\_\_\_\_ Title: \_\_\_\_\_

Corporate Officer's Signature: \_\_\_\_\_ Title: \_\_\_\_\_

Date Requested: \_\_\_\_\_ Approval Date: \_\_\_\_\_

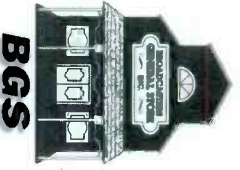

**Broadcasters General Store, Inc.**  
2480 S.E. 52nd Street  
Ocala, FL 34480-7500

# CATALOGS

Bulk Rate  
U.S. POSTAGE  
PAID  
TAMPA, FL  
Permit No. 2537

BOUND PRINTED MATTER



## Radio Design Labs

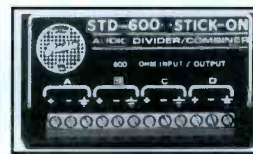

**BGS**

**Active Stick-On™ Products**

STM-DA3	Microphone DA (1 in, 3 out mic)	\$126.00
STM-1	Mic preamp, fixed gain	\$96.00
STM-2	Low noise mic preamp, variable out	\$132.00
STM-2X	Switched mic preamp, variable out	\$149.00
STM-3	High gain mic preamp, variable out	\$151.00
ST-MPA2	Mic phantom adaptor	\$83.00
ST-AMC3	Active mic combiner, 3 in - 1 out	\$114.00
ST-PH1	Stereo phono preamp	\$126.00
ST-VCA1	Voltage controlled amplifier	\$113.00
ST-RG1	Ramp generator	\$103.00
ST-VP1	Voice-over/page module	\$126.00
ST-EQ3	3 Band equalizer	\$89.00
ST-CL1	Compressor/limiter (order 2 for stereo)	\$139.00
ST-GCA1	Gain control amplifier	\$119.00
ST-GCA2	Fast gain control amplifier	\$119.00
ST-LCR1	Logic ctrl. relay-momentary	\$70.00
ST-LCR2	Logic ctrl. relay-alternate action	\$103.00
ST-ACR1	Audio ctrl. relay-release 5 to 5.0 sec., line in	\$90.00
ST-ACR1M	Audio ctrl. relay-release 5 to 5.0 sec., mic in	\$90.00
ST-ACR2	Audio ctrl. relay-release 5 to 50 sec. line in	\$90.00
ST-VOX1	Audio ctrl. VOX relay, 1 mic - 1 line unbal in	\$96.00
ST-SSR1	Solid state audio "relay", 2 line bal in & 1 mic out	\$98.00
ST-SX4	4 Input switcher, unbal line in/out	\$95.00
ST-OSC2A	Oscillator, 1K/10K, 2 line out for each freq.	\$98.00
ST-OSC2B	Oscillator, 100Hz/400Hz, 2 line out for each freq.	\$98.00
ST-NG1	White & pink noise generator	\$120.00
ST-CX1S	Subwoofer crossover, 22Hz to 80Hz	\$113.00
ST-CXW	Woofer crossover, 40Hz to 165Hz	\$113.00
ST-CX1F	Full range crossover, 100Hz to 30kHz	\$113.00
ST-HP1	300 Hz High-Pass Filter	\$113.00
ST-HP2	500 Hz High-Pass Filter	\$113.00
ST-TC1	Telephone system coupler	\$96.00
ST-PD5	Power Supply Distributor, (1 to 5 supply outputs)	\$64.00

**Passive Stick-On Products**

STD-150	Divider/combiner, 150Ω, 4 combinations	\$49.00
STD-600	Divider/combiner, 600Ω, 4 combinations	\$49.00
STD-10K	Divider/combiner, 10KΩ, 4 combinations	\$49.00
STP-1	Dual variable attenuator, 2 channel	\$55.00

**Stick-On Mounting Accessories**

STR-19	Racking kit	\$123.00
RC-36	Racking kit	\$144.00
RR-6	Racking Rail, 6 inch	\$6.00
RR-12	Racking Rail, 12 inch	\$10.00
STR-12	Rack kit snaps, 12 pack	\$34.00
MB-1	Mounting kit	\$6.00
MSR-1	Snap rail adaptor	\$12.00
SMK-12	Stick-On mounting strip	\$23.00
DTB	Detachable terminal block	\$5.40

**Stick-On Accessories**

RLC1	Remote level control, for ST-RG1	\$60.00
RLC2	Remote level control, for ST-RG1 & RU-VCA'S	\$120.00
RLC10K	Remote level control, for ST-VCA	\$56.00

**General Accessories**

ACB-1	Headphone jack box	\$23.00
ACB-2	Dual RCA jack box	\$23.00
WB-1	Sgl wall box, for mtg. 1 of the RLC1, 2, 10K & RCS4	\$5.00
WB-2	Dbl wall box, for mtg. 1 of the RLC1, 2, 10K & RCS4	\$7.00
CP-1	Single cover plate in white, for use with WB-1	\$6.00
CP-2	Double cover plate in white, for use with the WB-2	\$8.00
PS-24A	U.S. 24Vdc power supply	\$17.00
PS-24B	Continental Europe 24Vdc power supply	\$31.00

### Summary of Supply Requirements

Product	Max Current mA	Modules per RDL supply	Product	Max Current mA	Modules per RDL supply	Product	Max Current mA	Modules per RDL supply
STM-1/2/3	25	6 GF	ST-EQ3	60	4 GF	ST-OSC2A/B	80	4 Floating
STM-2X	30	6 GF	ST-CL1	60	4 Floating	ST-TC1	50	6 GF
ST-MPA2	30	6 GF	ST-GCA1/2	30	6 Floating	ST-NG1	30	6 GF
ST-AMC3	55	6 Floating	ST-LCR1/2	50*	6 GF	ST-CX1S/F/W	30	6 Floating
ST-PH1	60	5 Floating	ST-ACR1/M/2	50*	6 GF	ST-HP1/2	30	6 Floating
ST-VCA1	50	6 GF	ST-VOX1	50*	6 GF	TX-1W	150	2 GF
ST-RG1	40	6 GF	ST-SSR1	40	6 GF	GF = Ground Referenced		
ST-VP1	45	6 GF	ST-SX4	40	6 GF	*Assumes 20mA max load at (Slave) output		



### TX Series™

TX-10B	Bridging input transformer, 10KΩ in, 10KΩ out bal	\$36.00
TX-1A	Adjustable line transformer, 10KΩ/600Ω in, 10KΩ bal out	\$26.00
TX-M2	Line matching transformer, 600Ω bal in, 1 lin unbal-1 mic bal out	\$29.00
TX-70A	70v Input interface, 70V/25V speaker lin in, 1 line unbal out, adjust	\$28.00
TX1W	Music on hold amplifier, 1 unbal in, 1 bal & 1 unbal out, 1 watt	\$72.00

### EMC Products

TS-1D	Transient Suppressor, (Install up to 6 of the TS-1D w/1 GB6)	\$100.00
GB6	Ground Bar (for use with TS-1D)	\$100.00







**BGS**

**I  
N  
T  
E  
R  
F  
A  
C  
E  
S**

# problem solvers

## Whirlwind



- The **HotBox** is a totally transparent active direct box, powered by two 9V batteries or 48V phantom power. It includes a ground lift switch and an LED on indicator. **\$140.00**
- The **Director®** is a premium direct box that converts a line, instrument or speaker level signal to a low impedance mic level. **\$73.25**
- IMP Pads** are female to male XLR 3-pin inline low impedance fixed attenuation devices.
  - Input impedance: female XLR @ 1K $\Omega$ ; Output impedance: male XLR @ 150 $\Omega$
  - IMP PAD 10dB **\$22.40**
  - IMP PAD 20dB **\$22.40**
  - IMP PAD 30dB **\$22.40**
- The **IMP@2** is an economical direct box that converts a line or instrument level unbalanced signal to a low impedance balanced mic level (20k $\Omega$  input, 150k $\Omega$  output) **\$42.60**
- The **MicPower** is a portable +12 to 18Vdc phantom power supply for use with most electret condenser microphones. The unit operates on two 9V batteries, and an LED sensing circuit indicates sufficient battery power. Input impedance 1K $\Omega$ ; Output impedance 150 $\Omega$ ; Battery life 50 hours @4mA current draw. **\$65.00**
- The **Lifter** is a female to male XLR 3-pin ground lift device which disconnects pin 1 between connectors. **\$19.75**
- The **Phase Reverse** is a female to male XLR 3-pin phase reversing device which reverses the connection of pin 2 and pin 3 between connectors. **\$19.75**
- Little IMP** in-line impedance matching transformer with female XLR connector to male 1/4" connector **\$12.95**

## Shure

Problem Solvers		
A15AS	Switchable Microphone Attenuator, 15, 20, or 25dB attenuation	<b>\$43.00</b>
A15BT	Bridging Transformer	<b>\$52.75</b>
A15HP	High pass filter	<b>\$49.50</b>
A15PRS	Switchable phase reverser	<b>\$49.50</b>
A15TG	Tone generator	<b>\$86.00</b>

Impedance Transformers		
A85F	Low to High impedance matching transformer	<b>\$18.50</b>
A95UF	Low to High impedance matching transformer	<b>\$39.75</b>
A95U	Same as A95UF but w/3-pin XLR male low impedance connector	<b>\$36.25</b>
A97F	Low to medium impedance transformer w/miniplug output connector	<b>\$50.50</b>

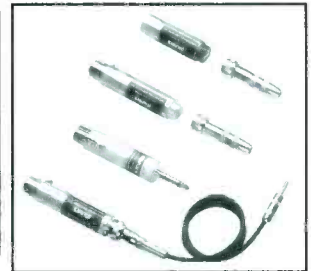

# BIGS relay

## Broadcast Tools

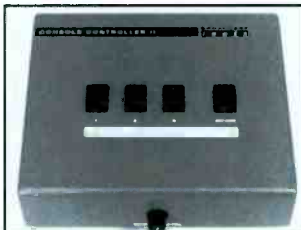

**Broadcast Tools Console Controller IIA** provides the solution for interfacing non-broadcast consoles or digital workstations to the broadcast studio. It offers three channels of insert switching to turn on or off console input channels or other source equipment. The user can program the switch indicators to either

light steady or flash when in operation, and channel three may be configured to either mute or not mute the monitors when energized. The CC-IIA offers monitor amplifier mute control, front panel monitor level control and the ability to switch between internal or external (program/off-air) monitor input sources.

CC-IIA	<b>\$299.00</b>
--------	-----------------



The **Broadcast Tools UI-4II** universal interface creates an SPDT relay and open collector output from an optically isolated 5-28 volt AC or DC input. Four channels of control are included and can operate independently, or may be combined for latched and multiple relay contact operation. Internal DIP switches allow the UI-4II to be configured in dozens of different ways. The UI-4II is supplied with a plastic bracket for easy mounting. A self contained power supply operates from 12 to 48 volts AC or DC. Optional external wall transformer is available.

UI-4II	<b>\$139.00</b>
RM1 or RM2	<b>\$49.00</b>
UI4WT	Power Supply <b>\$14.95</b>

## Henry Engineering

The **Henry Superrelay** is a quick and easy relay interface for use in any studio installation requiring multiple circuit control. Superrelay provides six double-throw relay outputs for low-voltage and audio switching. It can be controlled by any switch, momentary or maintained relay, or CMOS/TTL logic circuit. The AC output is switched with a solid-state synchronous relay for direct powering of "On Air" warning lights. Includes an internal flasher circuit and 12 VDC/250 mA utility power supply.

Superrelay	<b>\$250.00</b>
------------	-----------------





## AUDIOLAB



**AUDIOLAB TD-4A** • Erases audio, video and data tapes; U-Matic cassettes up to 750 oersteds and reels up to 16 inches in diameter and 1 inch in width. • Provides a 2550 effective Gauss Field in HI mode • Built in timer has adjustable "ON" cycle and automatic shut-off • Automatic cooling fan operation • Overheat light with automatic thermal protection prevents exceeding duty cycle on HI position • Thermal protection resets to normal operation automatically • High-Low operation with continuous duty erasing on low position for most tapes • Standard 5/16 inch center post with 3 inch NAB hub supplied. This would be the minimum required to erase DATs.

TD-4A-115-60	110-125VAC, 60Hz	\$950.00
TD-4A-115-50	110-125VAC, 50Hz	\$950.00
TD-4A-230-XX	220-250VAC. Specify 50 or 60Hz	\$1,050.00

**AUDIOLAB TD-5** • Erases audio, high coercivity video and data tapes; up to 1500 oersteds and reels up to 16 inches in diameter and 2 inches in width • Provides a 3700 effective Gauss Field in HI mode

TD-5-115-60	110-125VAC, 60Hz	\$1,695.00
TD-5-115-50	110-125VAC, 50Hz	\$1,695.00
TD-5-230-XX	220-250VAC, Specify 50 or 60Hz	\$1,795.00
2400-008	TD-5 Beta SP tape adapter	\$45.00

## Geneva



PF-211	Video/Audio 2300 gauss tape eraser	\$109.95
PF-215	Video/Audio 2800 gauss tape eraser	\$109.95

## R.B. Annis

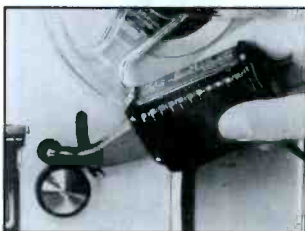

		Han-D-Mag Only	Kit K/25
Model 115-S	Short Probe (2 1/4")	\$33.00	\$96.00
Model 115-L	Long Probe (4 1/4")	\$41.00	\$104.00
Model 115TS	Thin, short probe	\$37.00	\$100.00
Model 115TL	Thin, long probe	\$45.00	\$108.00

### Options:

Model 25/5, Range 5 Gauss	\$60.00
Set of Steel Test strips	\$2.25
Clip-On Extension Probe for Magnetometer	\$4.50



### TD-1B

Erases audio, video, computer data, magnetic films, cartridges, and diskettes • for standard tapes up to 1/2 inch in width • Accommodates up to 10-1/2 inch NAB reels • Positive results every time with a simple

two pass operation • Transient protection to prevent permanent tape damage • Thermostatically protected. (Won't erase DATs.)

TD-1B	117VAC, 50-60Hz	\$145.00
TD-1BF	230VAC, 50-60Hz	\$150.00
2400-007	NAB Hub adapter	\$7.00

## Fidelipac

The **Fidelipac 395**

**BLANK-IT** is made of molded unbreakable lightweight plastic. It supplies 1550 Gauss of erasure power at 1/4 inch from its base center, and will perform at a longer duty cycle than similar units.



Model 395	Handheld, 110VAC	\$100.00
Model 395-FP	2-pack felt base pads	\$3.00



### Fidelipac's Model

**400** is a powerful bulk eraser, providing over 2000 Gauss of erasure power. Featuring a scuff resistant laminate top, die cast zinc edge guide, removable aluminum pivot pin, and non-skid rubber feet, it will efficiently erase reel sizes up to 11" in diameter.

Model 400	Table top, 110VAC	\$195.00
-----------	-------------------	----------

**Annis Hand-D-Mags** are now available in 8 different models. The "thin probe" (0.315" thick as compared to 0.415") are powerful probe type, head demagnetizers, having a husky 2000 gauss flush pole face. The Annis Pocket Magnetometer 25/5 measures residual magnetism levels in recorder heads, capstans or tape guides. It indicates when it's time to demagnetize and when it's safe to use a recorder, preventing permanent damage to recorded tapes. *Han-D-Kits include a Magnetometer, Clip-on Extension Probe plus a Set of Steel Test strips and instructions.*



**BGS**

**M A I N T E N A N C E / C L E A N I N G**





**MAINTENANCE / CLEANING**

## CAIG Laboratories, Inc.



High quality, environmentally safe cleaners to improve conductivity and maintain optimum signal quality on electrical connectors and contacts. CAIG formulations are highly concentrated - only small amounts are required (*typically one quick spray or drop per application*).

**DeoxIT** dissolves oxides and sulfides that form on metal contact surfaces. This restores the contact's integrity and leaves a thin (organic) layer that coats and protects the metal. Available with petroleum naphtha solvent (5%), or without (100%). General purpose treatment.

**PreservIT** seals, lubricates and preserves metal surfaces against oxidation and contamination. It provides long-lasting protection for newly manufactured components or those cleaned by ultrasonics, DeoxIT or other procedures.

**ProGold** is a conditioning solution that improves conductivity, lubricates and provides long-lasting protection on gold, silver, rhodium, copper, nickel and base metals. ProGold is the only product that actually penetrates plated surfaces, molecularly bonds to the base metals and seals & protects both surfaces. Available with petroleum naphtha solvent (5%), or without (100%). Maximum performance and

protection for plated connectors and contacts.

**CaiLube MCL** is a precision lubricant and enhancer for *plastic* moving contact surfaces (faders, switches, potentiometers, mouse pads and other mechanisms with sliding surfaces). Over time these components lose their original lubrication from wear and repeated cleaning. CaiLube MCL is not a deoxidizer or cleaner, use ProGold or DeoxIT for this function.



D5S-6	DeoxIT Spray, 5% Solution, 5 oz. (recommended replacement for Cramolin R5-6)	\$8.95
D5MS-15	DeoxIT Mini-Spray, 5% Solution, 15 g. (pocket sized - ideal for tool kits)	\$4.95
D100S-2	DeoxIT Spray, 100% Solution, 2 oz.	\$11.95
P5S-6	PreservIT Spray, 5% Solution, 5 oz. (recommended replacement for Cramolin B5-6)	\$9.50
G5S-6	ProGold Spray, 5% Solution, 5 oz.	\$15.95
G5MS-15	ProGold Mini-Spray, 5% Solution, 15 g (pocket sized - ideal for tool kits)	\$8.95
G100S-2	ProGold Spray, 100% Solution, 2 oz.	\$24.95
K-100A	DeoxIT and PreservIT (100%) in 7.4 ml vials with brush applicators, lint-free cloths, paper swabs, cleaning brushes	\$19.95
MCL100SL2	CaiLube MCL Spray, 100% Solution, 2 oz.	\$11.95
MCL100L25C	CaiLube MCL, needle dispenser, 100% Solution, 25 ml	\$14.95
LFC-P100	Lint-Free Cloth - Polypropylene, box of 100	\$4.95
LFC-C/100	Lint-Free Cloth - Cotton, box of 100	\$8.95

## American Recorder Technologies

**S-711** is formulated to clean tape heads, tape guides, capstans, and pinch rollers (not for use on PVC or Styrene components). It will remove tape oxides, soils, oils, waxes, greases, and other various contaminants while still maintaining the desirable properties of low toxicity and non-flammability. In addition, the evaporation rate is controlled to combine maximum cleaning power with fast drying. Due to its low surface tension and excellent wetting of surfaces, penetration of remote crevices is accomplished. S-711 is non-hydroscopic, eliminating moisture or residue which can settle on components. This will promote extended life and healthy texture to the pinch roller.

S-711B	Head Cleaner 2 oz.	\$8.00
S-711Q	Head Cleaner 1 Quart	\$22.00
S-711G	Head Cleaner 1 Gallon	\$60.00
CO-2	CO-2 Particle Duster	\$20.00
DP-3	Dispenser Pump 6 oz. Ceramic	\$20.00
VS-1B	Video Chamois Swabs, Bag of 25	\$10.00
CS-1B	Audio Cotton Swabs, Bag of 100	\$1.20
D-512	Wand Demagnetizer	\$30.00
K-161	Pro Audio Care Kit (CS-1B, S-711, D-511B, C02 Duster)	\$70.00
DAT-101D	DAT Cleaner	\$20.00
KCD-101A	CD Cleaner w/storage case	\$16.00
LL-151	Laser Lens Cleaner	\$18.00
V-311A	VHS / ADAT Recorder Cassette Cleaner	\$20.00
V-331D	8mm Cleaner Dry Type	\$20.00
LLCD	Lazer Lens/CD Cleaner Combo Kit	\$30.00

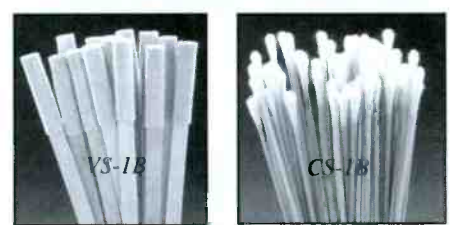

See more American Recorder maintenance products on Pages 108, 110, 112 & 114!



**Many Items in Stock for Immediate Delivery...Call Today!**



# SUPER DUOPOLY.

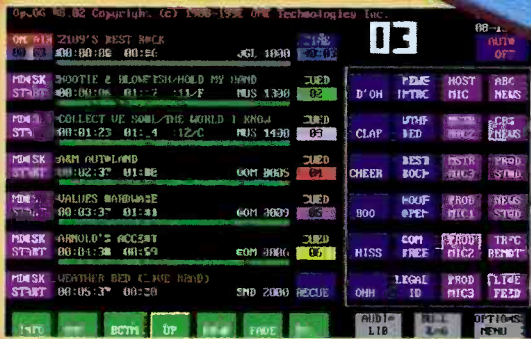

"OpLOG" Studio Control Panel

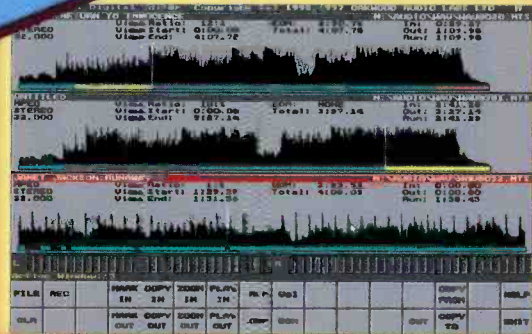

"MediaEDIT" Digital Audio Editor

## SOLUTIONS FOR MULTI-STATION INTEGRATION

We worked on our first duopoly project over 5 years ago and our experience leaves nothing to chance. No matter what configuration of stations you have, no matter what format, no matter how many studios... MEDIATOUCH can run it all through one central location, all with the ease of touch screen technology.

And MED ATOUCH works with your existing platforms. No expensive equipment to buy.

Flexible. Affordable. Easy to use. Don't roll the dice in the game of Superduopoly.

Give your stations the MEDIATOUCH advantage.



Broadcasters General Store  
2480 SE 52nd Street  
Ocala, Florida  
34480 7500  
Tel: 1-352-622-7700  
Fax: 1-352-629-7000

**CALL US TODAY FOR MORE INFORMATION**

# Slow Motion Controllers for Demanding Sports Production

## ST300 Slow Motion Controller, \$3,000

- All the features and functions you would expect to find on an \$8,000 to \$12,000 slow motion controller!
- Control up to 4 VTRs
- Simple and easy to use. Small space-saving footprint
- Quickly & Easily store and recall up to 100 Cue Points per VTR
- T-Bar or detented wheel provide fast & easy slomo control
- Can be customized for your specific application

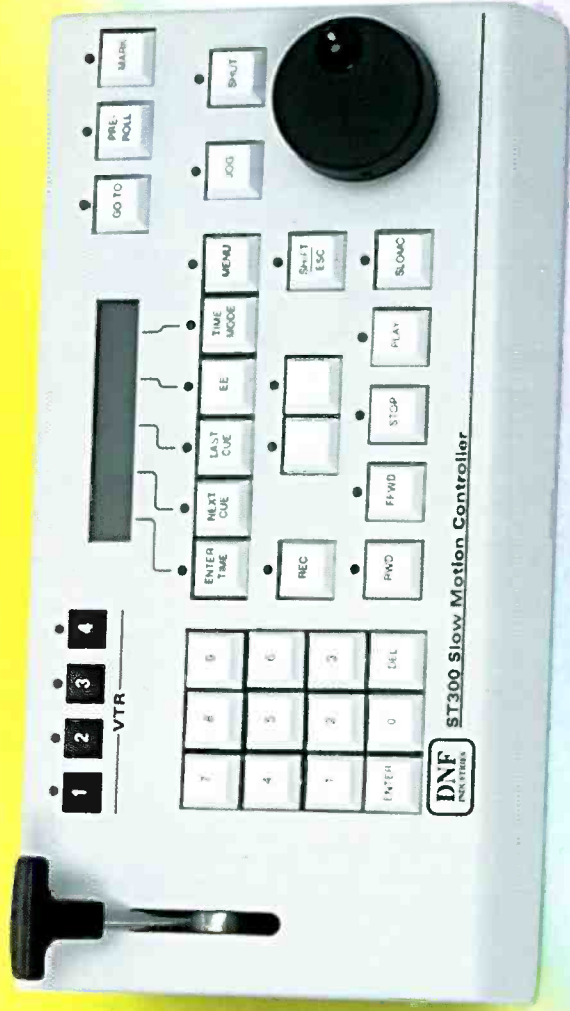

Another control solution from . . .

**DNF**  
INDUSTRIES



# BIG fishpoles



Microphone not included

## Beyerdynamic

MZA716	4 piece telescopic fiberglass boom w/swivel, extended length 10.5 ft.	\$349.00
MZA717	2 piece lightweight aluminum boom, extends from 2 ft. to 5 ft.	\$129.00
MZA718	3 piece lightweight aluminum boom, extends from 3 ft. to 10.5 ft.	\$199.00



**BGS**

## LTM

90A-613	20" to 63", 9.5 oz.	\$286.00
90A-614	31" to 9', 13.7 oz.	\$419.00
90A-615	4'1" to 13'8", 17.6 oz.	\$440.00
90A-616	5'2" to 16'7", 23 oz.	\$550.00
AA903-062	Windscreen	\$590.00
AA903-076	Windscreen Mull	\$209.00
AA-A64	Shockmount	\$84.00

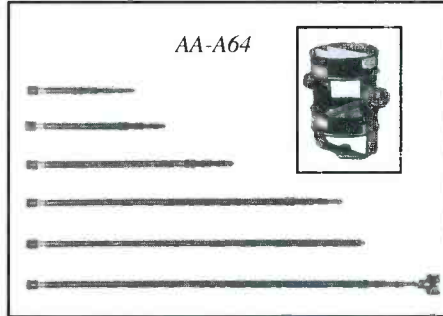

# BIG goosenecks

## Ac-cetera



R-10S	10" solid core black Rubber-neck w/std. mic threads	\$15.95
R-16S	16" solid core black Rubber-neck w/std. mic threads	\$17.95
R-20S	20" solid core black Rubber-neck w/std. mic threads	\$19.95
R-10H	10" hollow core black Rubber-neck w/std. mic threads	\$17.95
R-16H	16" hollow core black Rubber-neck w/std. mic threads	\$19.95
R-12X-1	12" wired XLR ends/male to female	\$53.95
R-12X-4	12" wired XLR ends/male to locking female	\$53.95
R-18X-1	18" wired XLR ends/male to female	\$53.95
R-18X-1	18" wired XLR ends/male to locking female	\$53.95

## AKG

LGN6	6" chrome gooseneck w/5/8" male & female threads	\$7.40
LGN6B	6" black gooseneck w/5/8" male & female threads	\$7.40
LGN13	13" chrome gooseneck w/5/8" male & female threads	\$10.40
LGN13B	13" black gooseneck w/5/8" male & female threads	\$10.40
LGN19	19" chrome gooseneck w/5/8" male & female threads	\$13.60
LGN19B	19" black gooseneck w/5/8" male & female threads	\$13.60
LMF1	5/8" male flange to surface mount the gooseneck (Note B for black)	\$5.20



## Shure

G12	12" chrome flexible gooseneck	\$14.00
G12CN	12" chrome flexible gooseneck w/3-pin F XLR connector	\$25.25
G18	18" chrome flexible gooseneck	\$15.25
G18CN	18" chrome flexible gooseneck w/3-pin F XLR connector	\$27.25
A12	Std. 5/8"-27 external thread surface mounting flange	\$6.75
A13HD	Heavy duty 5/8"-27 external thread surface mounting flange	\$9.50

**M I C A C C E S S O R I E S**

# BIG booms



**BGS**

**M  
I  
C  
A  
C  
C  
E  
S  
S  
O  
R  
I  
E  
S**

## LUXO

LM-1	41" extension for 1 oz. to 1 lbs. (external springs)	\$59.00
KM-1	41" extension for 3 to 4.5 lbs. (internal springs)	\$70.00
50001	Clamp for horizontal surface mount	\$10.50
50003	Wall or vertical surface mount	\$10.50
50005	Bench or counter-top permanent mount	\$10.50

Available in oyster/off white(OW) or black (BK)



14005



11426



11427

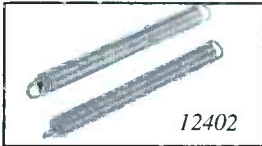

12402



14100



M2MDUR



EB-1

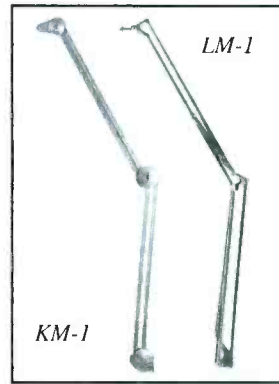

LM-1

KM-1



50003



50005



50001

## O.C. White

M2MDU	Gray heavy duty mic arm only	\$102.00
M2MDUB	Black heavy duty mic arm only	\$102.00
M2MDUR	Gray heavy duty mic arm w/riser	\$151.00
M2MDURB	Black heavy duty mic arm w/riser	\$151.00
TMA	Gray triple mic arm including riser	\$523.00
EB-1	Gray extension arm	\$58.00
EB-1B	Black extension arm	\$58.00
11426	Gray wall mount	\$23.00
11426B	Black wall mount	\$23.00
11427	Gray benchmount	\$23.00
11427B	Black benchmount	\$23.00
14005	Gray clamp mount	\$35.00
14005B	Black clamp mount	\$35.00
14100	Gray riser only	\$60.00
14100B	Black riser only	\$60.00
12402	Replacement Springs/pair	\$12.80

# BIG stands

## Desk Stands

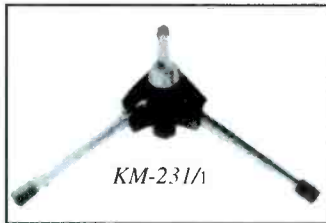

KM-231/1



ST-300



DS-2

AKG KM231/1	Collapsible tripod, chrome w/matt black fittings, 5/8"-27 thread	\$14.00
Atlas DS-2	Anti-vibration 4"x6" cast iron ebony base, 4" ht., wt. 2 lbs.	\$44.30
Atlas DS-5	5" diameter cast iron base, 4" ht., wt. 2 lbs.	\$18.03
Atlas DS-7	6" diameter cast iron ebony base, 8" to 13" ht., wt. 3 lbs.	\$28.93
Atlas DS-7E	6" diameter cast iron ebony base & tube, 8" to 13" ht., wt. 3 lb	\$28.93
Beyer ST300	Collapsible, made of plastic	\$19.00
Shure S39A	Effective vibration isolation desk stand	\$76.25

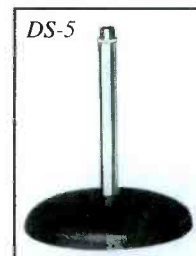

DS-5



DS-7



# BIGS stands

## Floor Stands

Atlas MS12C	Low-profile, ebony base, 41 lbs.	\$46.75
Atlas MS12CE	Low-profile, ebony base & tube, 41 lbs.	\$46.75
Beyer GST400	Adj. 35" - 65", fixed boom 33", black finish	\$79.00
Beyer GST500	Heavy duty adj. stand 35" - 65", adj. boom 18" - 30", black	\$99.00
Beyer GST590	Low profile adj. stand 18" - 49", adj. boom 18" - 30", black	\$99.00
Beyer ST400	Adj. 35" - 65", black finish	\$59.00
Ultimate MC07B	1/4 turn clutch, weighted dove tail base allows carrying 6 stands in the foot print of one, 34-3/4" - 64", wt. 9 lbs. (Come in 4-pak) each	\$37.50

## Ac-cetera

<b>Base Section lock clamp with male threaded (std) arm</b>		
M-1		\$16.95
M-3	horizontal clamp	\$16.95
<b>Microphone holders, spring style with female threaded arm. Quick release design and mic locking system.</b>		
M-4		\$16.95
M-2	horizontal clamp	\$16.95
<b>Combination Systems, base and holder clamps attached by various center sections</b>		
Flex-Eze@-3	Flexible with 3" flexible center section	\$32.95
Flex-Eze@-5	Flexible with 5" flexible center section	\$32.95
Max-Eze@	Straight with 1-3/4" center section (Clamp Swivel is adj.)	\$32.95
Min-Eze@	Short trapeze center section	\$32.95
Mic-Handler™	Unique mic holder with hand grip	\$32.95
Pig-E-Back		\$32.95

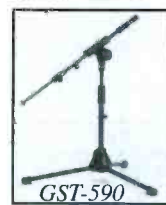

## phantom power supplies

## Audio-Technica

ATCP8506	Four channel 48V DC phantom supply (AC powered)	\$180.00
ATCP8508	Single channel 24V DC phantom supply (AC powered)	\$75.00



## Crown



The **Crown PH-1A** is a single channel battery/phantom supply unit. It operates on two 9V batteries or with the PS-24 AC to DC adapter. Use it with the Crown PCC-160, or any mic that will operate on 18 V or higher phantom.. Input-output connectors are XLR.

PH-1A	\$89.00
PS-24	\$25.00

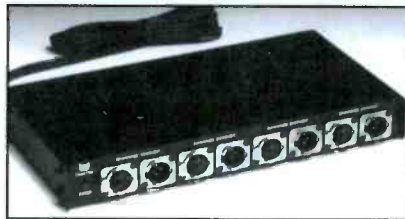

The **Crown PH-4B** is a 48V phantom supply: four in/four out. It operates on 120VAC. Connectors are female 3-pin in, and male 3-pin out.

PH-4B	\$200.00
RMPB	KIT19" Rack mounting kit \$15.00



**BGS**

**M  
I  
C  
  
A  
C  
C  
E  
S  
S  
O  
R  
I  
E  
S**

# phantom power supplies



**M  
I  
C  
A  
C  
C  
E  
S  
S  
O  
R  
I  
E  
S**

## Shure



The **Shure PS-1A** is a power supply that provides 21.5Vdc of phantom power for one or two condenser microphones. Powered by 120/240Vac.

PS-1A \$165.00

## Stewart

Stewart PM1	Single 48V Module, w/PS-1	<b>\$93.00</b>
Stewart PM2	Dual 48V Module, w/PS-1	<b>\$138.00</b>
Stewart PM4	Quad 48V Module, w/PS-1	<b>\$171.00</b>
Stewart BPS1	Single channel 48V Phantom Supply, Battery Powered	<b>\$119.00</b>



## Whirlwind



The **Whirlwind MicPower** is a portable phantom power supply for use with most electret condenser mics. It supplies +12 to 18Vdc under nominal loads at the microphone input, and the output of the unit is AC coupled. The unit operates on two 9V batteries, and an LED sensing circuit indicates sufficient battery power.

MicPower \$95.00

# mic accessories



## Porta Brace Mic Holster

Mic Holsters	Specify (MH-1) 8" or (MH-2) 10" lengths	<b>\$42.00</b>
MH-3	15" for handheld mic w/Lectrosonics H185 transmitter	<b>\$45.00</b>
VB-10	Optional Video Belt add on to mic holster	<b>\$21.00</b>

## Pop Filters



AKG TM-1, 2 & 3



ART POPKIT	Pop filter kit w/clamp & 4 or 6" gooseneck	<b>\$49.95</b>
STOP-6	6" diameter pop filter	<b>\$19.95</b>
STOP-8	8" diameter pop filter	<b>\$22.95</b>
POMT	Mic stand adapter, gooseneck, & STOP-6	<b>\$42.95</b>
SPS-K	5" Pop filter w/clamp & gooseneck, Dual	<b>\$42.00</b>

## Shock Mounts



AKG SA-26

EV 309A

AKG TM-1	Spider shock mt. for mics up to 1-3/8" dia., black finish	<b>\$22.00</b>
AKG TM-2	Spider shock mt. for mics up to 2" dia., black finish	<b>\$25.10</b>
AKG TM-3	Spider shock mt. for mics up to 2-3/4" dia., black finish	<b>\$29.40</b>
AKG SA-26	Universal clothespin-type clamp which will hold the Tensimount barrel	<b>\$12.60</b>
Electro Voice 311	3/4" dia. mic clip which will hold the Tensimount barrel	<b>\$19.50</b>
Electro Voice 309A	Shock Mount for Electro Voice RE20/RE27N/D Blk.	<b>\$122.50</b>



## WindTech Windscreens

WindTech™ manufactures the highest quality microphone windscreens available in 25 brilliant colors, and a variety of sizes and shapes to fit most popular mics. Using a proprietary non-heat manufacturing process, WindTech™ windscreens are constructed from a specially developed hypo-allergenic, open-cell foam called SonicFoam™. The use of SonicFoam™ permits the free passage of sound energy waves without affecting microphone frequency response. While remaining acoustically transparent, their windscreens are engineered to reduce wind velocity which eliminates wind noise, pop noises and breath sounds. *Nothing protects an expensive mic from dust, dampness and physical damage like an external windscreen, and they're washable too!*

Model	Description/Sampling	Inside diameter	Inside Depth	Price	3-Pack Price(-P)
900	Large Spherical/EV50/SM58	1.625"	2.125"	\$5.00	\$14.65
300	Regular Spherical/SM58/VP88	1.375"	1.750"	\$4.85	\$14.25
600	Small Spherical/EV635/SM57	1.375"	1.750"	\$4.35	\$12.80
5700	EV635/SM57/BETA57	1.000"	1.750"	\$4.35	\$12.80
1200	Large Cylindrical/SM80/SM81	0.750"	1.625"	\$4.00	
1300	Small Cylindrical/AKGD109	0.625"	1.250"	\$3.85	
500	Podium/EVCP212/SM2/10/12	0.4375"	1.250"	\$3.65	
1100	Lapel/AT803/SM98/99	0.250"	0.750"	\$3.65	
1500	Round Lavalier/ECM44/55/66	0.375"	0.750"	\$3.65	
2300	Mini Round Lavalier/ECM77	0.187"	0.350"	\$3.35	
2100	Tear-Drop/SM93/99/PH21/22	0.250"	0.750"	\$3.65	
20/421	X-Large Cylin/RE20/MD421II	1.875"	3.250"	\$39.95	
<b>Ultra-Screen Series for "hostile environments" with dual foam design.</b>					
US-1		1.00"	1.750"	\$42.95	
US-2		0.750"	1.750"	\$42.95	
US-3		0.625"	1.750"	\$42.95	
<b>Shotgun Series</b>					
SG-1		.7500"	7.250"	\$21.95	
SG-2		.7500"	11.50"	\$27.95	
SG-3		.7500"	20.00"	\$32.95	
<b>Pop Screen</b>					
SPS-1	5.0" OD 0.25" air space, 2 screens, black			\$22.00	
SPS-K	Kit has GN-19B and Mic stand clamp			\$42.00	
SG-200	Fits Sony BETACAM models BVW-200, 300, 400 & D600			\$17.95	

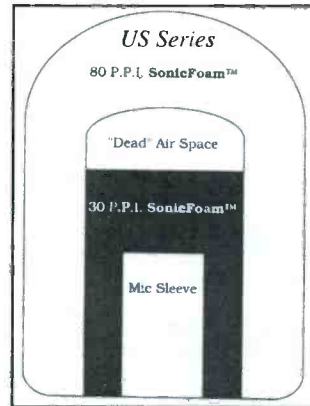
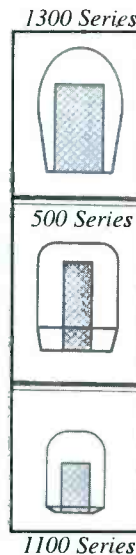
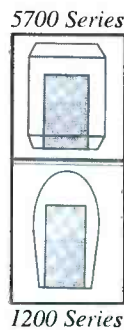
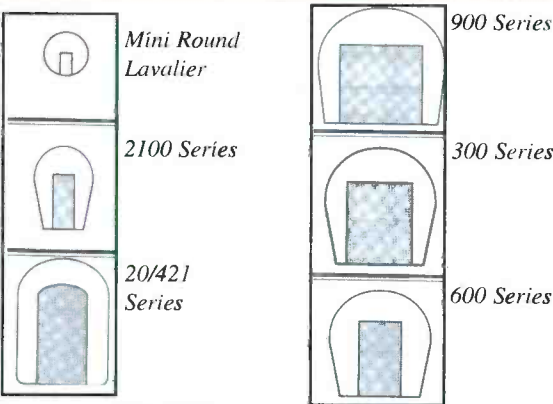
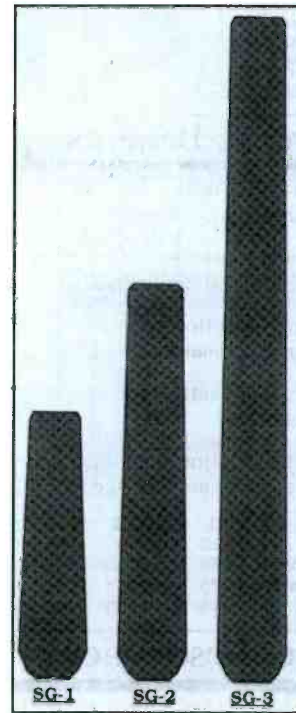

# M I C R O P H O N E S

## Alladin Mic Flags

**Custom Mic Flags** can be manufactured in any shape or size. A minimum order of 5 Mic Flags is required. Art/Logo charge (\$35.00 per color) is a one time only charge. We also can supply a typesetting service for those without logos. *Please call and we will fax you the information necessary to select the style and price out custom Mic Flags.*

ALA-4SB Blank Mic Flags are available in 2" or 2-1/2" Black or white 4 sided cube \$28.00



**BGS**

**M  
I  
C  
R  
O  
P  
H  
O  
N  
E  
S**

**microphones**



AUDIX



EV RE-20



Beyer MC-86

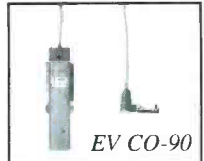

EV CO-90



EV RE-27N/D



EV 635A

Microphones												Price
Make/Model	Application	Transducer	Pattern	Z-	Freq. Range	Sensitivity	Weight or Lav length	Wind-screen	Stand Adapter	Shock Mount	Other Accessories	
<b>AKG</b>												
C391B	S	C	C	200	20-20k	10mV	9	W90*	SA40*	H38	N62E phantom supply	\$664.00
C414B	S	C	O/C/8/HC	180	20-20k	12.4mV	11	W414	SA18/30*	H15/22	N62E phantom supply	\$1,675.00
C426B	ST	C	MS	200	30-20k	11mV	16.6	W426*	*	H15/33*	H7/Pistol Grip	\$4,669.00
C460B/CK6	S	C	C	120	30-20k	8mV	10	W32*	SA40*	H38	N62E phantom supply	\$699.00
C3000	ST	C	C/HC	200	20-20k	20mV	11.3	W414	SA414*	H15/22		\$838.00
D230	E	D	O	320	40-20k	2.5mV	8	W23	SA44*	H30		\$239.00
<b>Audio-Technica</b>												
815B	SH	C	L	500	30-20k	12.5mV	7.1	AT8135	AT8405	AT8415	CP-8508, 1-Ch. Supply	\$399.00
825	ST	C	MS	200	30-20k	4.5mV	8.5	AT8120*	AT8405	AT8415		\$525.00
835B	SH	C	L	500	40-20k	12.5mV	8	AT8132	AT8405	AT8415	CP-8506, 4-Ch. Supply	\$329.00
4033/SM	S	C	C	100	30-20k	25.1mV	14.5	AT8137	AT8430	AT8441*	CP-8508 Ph. supply	\$725.00
4050/CM5	S	C	C/O/8	100	20-20k	15.8mV	19.9	AT8137	AT8430	AT8441*	CP-8508 Ph. supply	\$995.00
AT804	E	D	O	600	50-15k	3.5mV	8	AT8108*	AT8405*	AT8415		\$110.00
AT803B	L	C	O	200	40-20k	-42dB	.8"	AT8116			AT8530 pwr. module	\$190.00
MT830R	L	C	O	200	40-20k	-34dB	.62"	AT8130			AT3533 pwr. module	\$200.00
<b>AUDIX</b>												
CD-11	P	D	C	600	50-16k	-76dB	9	N/A	MC-1*	N/A		\$69.00
OM-5S	P	D	HC	200	40-20k	-68dB	10.5	N/A	MC-1*	N/A		\$329.00
OM-7	P	D	HC	150	38-21k	-78dB	10.5	N/A	MC-1*	N/A		\$359.00
<b>Beyerdynamic</b>												
M58	E	D	O	200	40-20k	1.3mV	9.1	WS58*	MKV8*			\$259.00
MC736PV	SH	C	L	150	40-20k	25mV	7	WS716	MKV11	EA736		\$1,099.00
MC737PV	SH	C	L	150	40-20k	25mV	15.5	WS717	MKV11	EA737		\$1,199.00
MC740	S	C	O/C/8	150	40-20k	10mV	14.5	WS740	MKV11	EA740	PS740 pop shld.	\$1,599.00
MC742	ST	C	MS	150	40-20k	10mV	3.2	WS740	MKV11	EA742		\$2,999.00
MC833	ST	C	MS/XY	180	30-20k	25mV	9.9	N/A	MKV11	EA833	Tie Clip MKV5/3*	\$2,599.00
MCE5.15	L	C	O	200	20-20k	14mV	1.1"	ZWS-5*			Tie Clip MKV5/1*	\$399.00
MCE10.15	L	C	HC	700	40-20k	8mV	8.26"	ZWS-10*			MHV5 supply clip*	\$499.00
MCE50.15	L	C	O	200	25-18k	12mV	1.3"	N/A			Same as MCE4.15	\$329.00
MCE86	SH	C	L	190	50-18k	4.2mV	3"	WS716	MKV11	EA19/25	MHV50 supply clip	\$399.00
<b>CAD (Equitek)</b>												
E200	S	C	O/C/8	200	10-18k	17.8mV	12	WS-1	SM-1*	ZM-1		\$749.00
E300	S	C	O/C/8	200	10-20k	17.8mV	29.8	WS-1	SM-1*	ZM-1		\$999.00
<b>Electro-Voice</b>												
635A	E	D	O	150	80-13k	-55dB	6	314E	311*	307A	635A/B Blk option	\$180.00
635L	E	D	O	150	80-13k	-55dB	6	314E	311*	307A	635L.A/B Blk option	\$198.00
635N/D	E	D	O	150	80-13k	-51dB	6	314E	311*	307A		\$204.00
649B	L	D	O	150	80-10k	-61dB	2.25"	70399			Belt clip & neck cord	\$262.00
CO2	L	C	O	100	50-20k	8.5mV	1"	N/A			3 Clips*	\$250.00
CO90	L	C	O	150	40-15k	-57dB	.85"	89631*			Dual 390 Fawn tie clip	\$310.00
CO100	L	C	O	150	30-15k	-51dB	1"	70339*			Dual 390A Blk tie clip	\$426.00
CS200	L	C	C	150	40-18k	-45dB	.85"	70339*			Dual 390A blk tie clip	\$484.00
DO56	E	D	O	150	80-18k	-61dB	5	351	312*	307A		\$272.00
RE20	S	D	C	150	45-18k	1mV	26	20/421	320*	309A		\$786.00
RE27N/D	S	D	C	150	45-20k	3.1mV	27	20/421	320*	309A		\$892.00
RE38N/D	S	D	C	150	25-20k	2.5mV	13.4	N/A	320*	319		\$698.00
RE45N/D	E	D	C	600	50-15k	-50dB	8	72434	323	307A		\$676.00
RE50	E	D	O	150	80-13k	-55dB	9.5	379	323*	N/A		\$300.00

E=ENG/EFP P=Performance SH=Shotgun ST=Stereo S=Studio C=Cardioid HC=Hypercardioid 8=Figure 8 L=Lobar MS/XY=Stereo Note: Sensitivity in dB's or mV/Pa, where 0dB=1V/microbar & 1mV/Pa=10mV/microbar

**Many Items in Stock for Immediate Delivery...Call Today!**



# BIG microphones

Sony

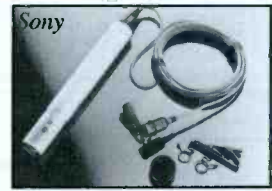
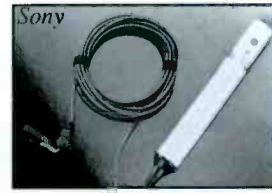

**BGS**

**M I C R O P H O N E S**



Shure VP-64



Sennheiser MKH-416



Sennheiser MKE-102



Shure VP-88



Shure



Sennheiser MD-421U



Shure SM-7



Sony C-74

## Microphones

Make/Model	Appli-cation	Trans-ducer	Pattern	Z-	Freq. Range	Sensi-tivity	Weight or Lav length	Accessories~ * Notes supplied with microphone				Price
								Wind-screen	Stand Adapter	Shock Mount	Other Accessories	
<b>Sennheiser</b>												
MD421II	S	D	C	200	30-17k	2mV	30	MZW421	MZA421*	MZS421	MZO421 quick disconnect	\$485.00
MD441U	S	D	HC	200	30-20k	1.8mV	34	MZW441	MZA441	MZS100	MZO441 quick disconnect	\$895.00
ME66	SH	C	HC/L	200	50-20k	3.5mV	3.5	MZH60-1	MZA200	MZS20-1	MSP816 pistol grip K6 Power Unit MZW60-1 blimp	\$279.00 \$375.00
ME67	SH	C	HC/L	200	50-20k	35mV	3.5	MZH70-1	MZS200	MZS20-1	MZS6	
MKE2-60	L	C	O	200	20-20k	10mV	.3"	MZW102	N/A	N/A		\$295.00
MKE40-60	L	C	C	200	40-20k	10mV	.35"	MZ26138*	N/A	N/A		\$317.00
MKE102-60	L	C	O	200	40-20k	8mV	1"	MZW-102	N/A	N/A		\$317.00
MK11416P48U3	SH	C	HC/L	400	40-20k	25mV	18	MZH60-1	MZQ100	MZS20-1	MZW60-1 blimp	\$1,350.00
MKH816TU3	SH	C	HC/L	600	40-20k	40mV	43	MZW415/H816 MZW815	MZQ100	MZS8160	MZ2816 blimp	\$1,595.00
<b>Shure</b>												
BG1.1	P	D	C	600	80-12k	5.62mV 1.41mV	11	A58WS	A25C*	A55HM		\$60.00
BG2.1	P	D	C	150	70-13k	1.58mV	11	A58WS	A25C*	A53HM		\$84.00
BG3.1	P	D	C	150	60-14k	1.78mV	11	A58WS	A25C*	A53HM		\$110.00
BG4.1	P	C	C	600	40-18k	4mV	9	A3WS	A25C	A53HM	PS1A phantom supply	\$220.00
BG5.1	P	C	C	600	70-16k	3.5mV	9	A85WS	A24C*	A53HM	PS1A phantom supply	\$220.00
Beta57A	P	D	HC	150	50-16k	-72dB	9	A57AWS	A25C*	A55HM		\$220.00
Beta58A	P	D	HC	150	50-16k	-71.5dB	9	A58WS	A25C*	A55HM		\$266.00
Beta 87	P	C	HC	150	50-16k	-74dB	6	A85WS	A25C*	A53HM	PS1A phantom supply	\$434.00
MX183	L	C	HC	150	50-17k	-48dB	1"	RK183WS			RK-183T2 tie clip	\$260.00
MX184	L	C	HC	150	50-17k	-52.5dB	1"	RK183WS*			RK-183T1 tie clip	\$290.00
SM7	S	D	C	150	40-16k	-79dB	27	RK345*	A25C*	C25B		\$566.50
SM11CN	L	D	O	200	50-54k	-85dB	1.5"	RK184WS				\$116.50
SM63LLC	E	D	O	150	50-20k	-56.5dB	4.3	RK229WS*	AS57D*	A53M	9-1/4" long	\$176.50
SM57	P	D	C	150	40-15k	-56.5dB	10	A2WS	A25C*	A55M		\$146.00
SM58	P	D	C	150	50-15k	-56dB	10.5	A58WS	A25C*	A55M		\$188.00
SM89	SH	C	C	150	60-20k	-53dB	6.9	RK257WS	A57E	A89SM		\$927.00
SM93	L	C	O	150	80-30k	-63dB	.4"	49A150*			Dual clip 90C4327	\$195.00
VP64	E	D	O	330	50-12k	-52dB	6	49C55*	A57E	A53M		\$135.00
VP88	ST	C	MS	150	40-20k	-66dB	14.7	90A4163	90B4046*	A88SM		\$995.00
<b>Sony</b>												
C48	S	C	O/C/8	250	30-16k	-41dB	20	N/A	N/A	N/A		\$1,350.00
C74	SH	C	HC	250	40-16k	-38dB	12.8	AD-74	N/A	N/A	GP5 hand grip	\$1,200.00
C76	SH	C	HC	250	40-16k	-38dB	14.4	AD-76	N/A	N/A	GP5 hand grip	\$1,325.00
ECM44B	L	C	O	250	40-15k	-53dB	.6"	AD-R44			SAD-44 single clip*	\$265.00
ECM55B	L	C	O	100	30-18k	-52dB	.8"	ADR55*			SAD-H55	\$405.00
ECM66B	L	C	C	100	70-14k	-50dB	.95"	AD-R66*				\$465.00
ECM77B	L	C	C	150	40-20k	-50dB	.5"	AD-R77*				\$465.00
ECM-MS5	ST	C	MS	150	70-20k	-40dB	7.6	AD-72	A-450818A*	N/A	AD-C77 foam WS/SAD-W77	\$1,450.00
ECM-510	E	C	O	250	40-17k	3.16mV	4.4	X254201*	A-450801*	N/A	DCM-M55 pwr. adapter	\$455.00
<b>Telex</b>												
ELM-22S	L	C	O	150	20-20k	-35dB	.75"	WS-E				\$200.00
ELM-33S	L	C	C	150	20-20k	-35dB	.7"	WS-E				\$206.00

E=ENG/EFP P=Performance SH=Shotgun ST=Stereo S=Studio C=Cardioid HC=Hypercardioid 8=Figure 8 L=Lobar MS/XY=Stereo  
 Note: Sensitivity in dB's or mV/Pa, where 0dB=1V/microbar & 1mV/Pa=10mV/microbar



# REC mic processors



**BGS**

**M  
I  
C  
R  
O  
P  
H  
O  
N  
E  
S**

## AIRcorp



500PH	Radio/Studio version*	\$799.00
500TV	Television version*	\$889.00

The **AIRcorp Pro Announcer 500** has front panel selection of input level from +4 to -50 dB, three section variable boost and cut equalization, phase rotators, compressor/expander combination, de-esser and simultaneous mic and line level outputs. A front panel headphone jack permits set up without being on the air and a dB 25 connector allows remote control of most functions including "popless" insert point for effects.

*\*They are supplied with handles (tabs) on the rack ears unless specified without handles at the time of order.*

## CRL

The **CRL IPP-100** is a programmable microphone processor for studio and broadcast. The IPP-100 combines powerful equalization and compression techniques with the ability to store 18 different user-designed processing set-ups. Special effects loop-through port and key-lock security provided.

IPP-100		\$1,895.00
IPP-100R	Digital remote control box	\$395.00
IPPCable	25 foot serial digital remote cable	\$39.00



## dbx



The **dbx 286A** is a mic processor with preamp, compressor, de-esser, enhancer and expander/gate combined in an affordable, compact unit. The preamp accepts mic or line level inputs, offers phantom power, an 80Hz, 18dB/Oct high pass filter plus an input level meter. An additional 1/4" TRS phone jack can accept balanced/unbalanced line signals and an insert jack between the 286A's mic preamp and signal processing sections can be used to "loop out" to external processors.

dbx 286A	\$349.95
----------	----------

## Orban

The **Orban 787A** programmable voice processor offers compression gating, noise gating, parametric EQ and de-essing. An effects send and effects return loop allow you to use the 787 if your console does not have an effects loop. The optional low-noise, low-distortion Jensen transformer mic preamp will convert the 787 to mic level use. With up to 99 recallable presets, nearly any voice can be processed for your radio or TV station.



RET046	Mic preamp retrofit kit for already purchased unit	\$195.00	787A	\$1,450.00	
Security Covers	1 rack unit, clear	\$55.00	787A	With MIDI or RS232	\$1,545.00
Security Covers	2, 3 or 4 rack units, clear	\$60.00	787A/UP	With microphone preamp	\$1,645.00

## Rane



VP-12	\$599.00
-------	----------

The **Rane VP 12** is a mic or line level voice processor incorporating a studio-grade microphone stage, low and hi cut filters, de-esser, gate/compressor, and two channels of parametric equalization. The microphone 3-pin XLR input features switchable 48V phantom power and an input gain control. A separate balanced line level input arrives from either screw terminals or a 1/4" TRS jack. A front panel switch selects whether the mic, line, or the sum of both inputs will be processed by the VP 12.

## Symetrix

The **Symetrix 528E** is a voice processor with an on-board preamp, compressor/limiter, downward expander, parametric EQ/notch filter, de-esser, 48V phantom power and individual by-pass switches for each section. Includes clip LED's, output level and gain reduction metering. The Symetrix 528E allows you more control over vital EQ parameters and a greater range of compression adjustments than other analog voice processors. The 528E offers 3 bands of variable frequency EQ, with variable bandwidth on each. The compressor section provides adjustable ratio control, and a downward expander that reduces studio equipment noises. The new phase rotator and selectable output level round out the features found on the 528E. There's no mystery why the Symetrix 528E is the broadcast standard for microphone processing. The **New Symetrix 628** has all the 528E features with the following additions: digital output (32KHz, 44.1KHz & 48KHz), 117 user presets and 11 factory presets, front panel lock-out and an optional remote control to access 11 presets.

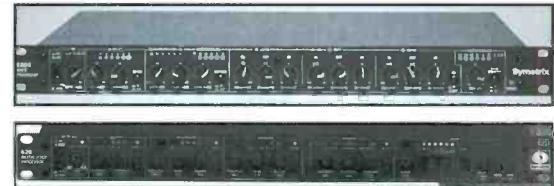

528E	\$699.00
628	\$1,195.00

## Valley Audio



401B	\$799.00
------	----------

The **Valley Model 401B** Microphone Processor was designed specifically to enhance the on-air personality's performance. The Valley 401B has a transformerless mic preamplifier, three band voice EQ, post-eq patch point, compressor with interactive expander, and de-esser with "normal" and "heavy" settings. Includes LED gain reduction meter, switch selectable input/output VU metering and an output gain control. The balanced output level is switch selectable from +4dbu to -50dbv for level matching to mic or line input circuits.



## Audio-Technica

### Audio-Technica 300 Series

An entry level wireless system with R03 receiver at 10µV sensitivity and 350mV unbalanced audio output, and T21 body pack for guitar, headworn or lavalier mics and T22 handheld for 30mW of RF power.



300 Series *Priced from \$270.00 - \$370.00*

### 500 Series

A step up in receiver (WR5) design with Tone Lock™ squelch and superior IF filtering for 3.2µV sensitivity and 800mV unbalanced audio output. The WT15 body pack and WT16 handheld produce 30mW RF power with 10dB more dynamic range.



500 Series *Priced from \$490.00 - \$620.00*

### 1000 Series

Professional level diversity receiver (R10) with rack ears and professional antenna options. Comes with balanced XLR outputs. The T31 body pack with loads of mic options, and the T32 handheld produce 30mW RF power and are totally silent when switched on/off.



1000 Series *Priced from \$690.00 - \$880.00*

### Audio-Technica 1200 Series

The R12 diversity receiver has full FM deviation, 5.6µV sensitivity in a half rack package. The T25 body pack and T36 handheld produce a full 50mW RF power. Also available is the T37C condenser mic with interchangeable elements.



1200 Series *Priced from \$750.00 - \$950.00*

### W7174

UHF diversity system featuring the R71 receiver with 16 PLL channels, Tone Lock™ squelch and 3µV sensitivity. The T74 handheld transmitter offers an N-Dym cardioid element and 10mW RF power.



W7174 *\$1,698.00*

### PRO W88

A Camcorder system which operates in 5 different VHF bands on 2 selectable frequencies. It offers omni or unidirectional lavalier mics with the body pack transmitter.



PRO W88 *\$307.00 w/mic*

## Beyerdynamic



U 700



NE700



NE600

**Beyerdynamic U 700 series** UHF range comprises of a choice of components. A modular twelve channel receiver, a two channel rack mount receiver, pocket transmitter and handheld transmitter with a range of interchangeable heads. These components can be combined to produce a system offering the highest RF integrity coupled with the best audio possible. Designed to operate in the 470 to 980MHz range, the U 700 system can accommodate up to twelve channels within an 8MHz bandwidth of one television channel.

RR7000 TG/12-2TX is a fully loaded 12 ch. 19" RM receiver, complete with monitorfield including 12 EED 700 receivers and including 12 transmitters any mix of handheld or bodypack. System comes complete with 2 antenna and cables.

RR7000TG/12-2TX *\$73,599.00*

Beyerdynamic NE 700 UHF Diversity Receiver is a two channel unit operating in the 470-980MNz range. Each channel features 10 LED indicators for monitoring incoming signal level and AF modulation, plus single LED indicators for A or B channel operation and squelch, additional LED's indicate antenna distribution and antenna power status. The ability to connect up to three receivers offers a unique maximum of six channels in a three U space.

NE700 *\$5,999.00*

The NE 600 is a frequency agile PLL synthesized receiver. 64 frequencies available in groups of 16 operable frequencies in one TV channel. Featuring MUM frequency toggling and GRIP pilot tone control.

NE600 *\$2,999.00*

S600 Handheld transmitter w/16 switchable frequencies, depending on mic *\$3,100-\$4,500.00*

TS600 Frequency agile bodypack transmitter with 16 switchable freq. + LED display *\$2,299.00*



New

S600



New

TS600

## Electro-Voice

The **Electro-Voice MS2500** wireless system is a true-diversity design, with two separate receiver front-end circuits and a diversity switch that monitors the resulting audio signals. The transmitters radiate 50mW of rf signal, the maximum level allowed by the FCC. The handheld transmitter features the N/D 757B neodymium-magnet transducer mic head. The bodypack transmitter has a TA4M 4-pin mini XLR connector. Features include: DNX™ companding • internal power supply, switchable form 115V to 235V • signal to noise ratio: 105dB, flat; 108dB. A weighted • metering for audio level, rf and diversity channel • balanced XLR output with mic/line switch; unbalanced 1/4" output • and 1U rack mount. A selection of omnidirectional and unidirectional lavalier condenser mics, as well as a headset mic and a 1/4" instrument cable are available.

MS2500 Systems *Priced from \$820.00 - \$1,100.00*



BGS

M  
I  
C  
R  
O  
P  
H  
O  
N  
E  
S





**MICROPHONES**

## NADY



The **NADY 950GS** is a 160 channel true diversity system. It includes LT-60 or the HT-60 multi-channel transmitter.

**950GS Priced from \$2,599.95**



The rack mountable **NADY RW-1** is a true diversity receiver that comes supplied with one of five factory installed frequencies. The RW-1 has balanced and unbalanced outputs with 120dB dynamic range. Packages include an HT-10 handheld or LT-20 body pack transmitter and several mic choices.

**RW-1 Priced from \$549.95-\$929.95**



The **NADY 101XL** is a compact portable non-diversity VHF receiver and the **201XL** is its True diversity counterpart. Both offer rack mount options and body pack and handheld transmitters that deliver up to 20 hours on one 9V battery.

**101XL/201X Priced from \$384.00 - \$817.00**



The **NADY 301** is a 4 channel, True diversity UHF receiver in the 920MHz band. Comes with the HT-50.

**301HT \$989.00**



The **NADY 401** has four independent true diversity receivers in one chassis. The package includes 4 HT-10 or LT-10 transmitters.

**401 Priced from \$1,539.00 - \$2,270.00**



**NADY Duet** has two independent non-diversity receivers in one chassis. The package includes 2 HT-10 or LT-10 transmitters.

**Duet Priced from \$499.95 - \$999.95**

**NADY 2000** This True diversity system is ideal for sound installations. Up to 20 units can be used at one time. You can use either the HT-40 or the LT-30 transmitters with these units.

**2000 Priced from \$1,249.00 - \$1,450.00**

## Sennheiser



The **Sennheiser BF1051** is a 2 channel true diversity VHF system offering a high performance handheld transmitter with a supercardioid element and a diversity receiver with a balanced, high level output.

**BF1051 \$795.00**



The **Sennheiser BF1053** is the same system as the BF1051, but with a road-rugged body pack with adjustable sensitivity and an MKE-2 Red Dot lavalier mic.

**BF1053 \$995.00**

## Shure



**Shure VP Series**  
The Shure VP3 compact portable receiver operates with all Shure's transmitters for up to 7 hours on one 9V battery. The antenna pivots for awkward mounting conditions.

**VP Systems Priced from \$470.00 - \$590.00**  
**VP3 ONLY \$280.00**

The **Sennheiser SK250/EM2004** is a 16 channel system with a 250mW UHF body pack. This system works from 450 - 960 MHz with a wide range of mics and adapters to select from.



**SK250/EM2004 \$6,500.00**

**Shure LX Series**  
The half rack LX4 diversity and the LX3 non diversity receivers feature an all metal chassis, single and dual rack mount kits, squelch and level controls, balanced and unbalanced mic or line level outputs. The LX1 body pack and LX2 handheld transmitters offer 50mW RF power, battery fuel gauge and the LX2 has audio level adjustments and features BETA mic elements as well.



**LX System Priced from \$666.00 - \$948.00**  
**LX Beta Priced from \$948.00 - \$1,002.00**



## Shure



**Shure Headset, Vocal, & Artist Presenter-** These 3 entry level systems feature the T4 diversity or T3 non-diversity receivers and the T1 body pack or T2 handheld transmitters. They are ideal for addressing groups where cost and portability are concerns.

*Priced from \$360.00 - \$560.00*

### Shure SC Series

The SC4, half rack diversity receiver, offers exceptional sensitivity, greater selectivity, tone key squelch and an 8-position channel select switch.

The SC1 body pack and SC2 handheld offer the 8 position channel select, battery fuel gauge, audio gain control and a wide selection of mic elements.



SC Systems *Priced from \$864.00 - \$1,140.00*  
 SC Beta Systems *Priced from \$1,164.00 - \$41,212.00*

## Sony

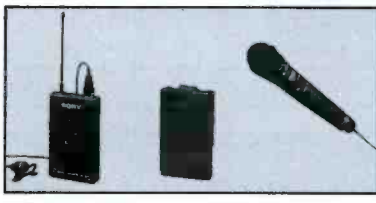

Operating around the 800Mhz band, **Sony's PLL UHF Synthesized Wireless Systems** assure interference-free operation. 94 channels are pre-programmed for

maximum efficiency in multi-system operations. System receivers include WRR-810A portable, WRR-860A68 portable diversity, WRR820A single rack mount diversity, WRR-840A dual rack mount diversity, and WRR850A dual diversity with monitoring. Transmitters include the WRT-810A handheld, WRT-830A68 handheld, WRT-867A68 handheld, WRT-820A body pack with a wide choice of mics and the WRT-860A68 miniature body pack.

*Priced from \$2,315.00 - \$7,000.00*

Package examples:

1) WRR820A	1) WRT810A	2) AN820A	\$2,806.00
1) WRR840A	1) WRT820A	2) AN820A	\$3,546.00

## Telex



The **Telex FMR 200** is the choice of professionals who

demand the best in selectivity (>75dB), sensitivity (<.4µV) and signal to noise ratio (110dB). This single channel, 1 rack unit receiver is packaged with the WT-80 metal case body pack transmitter and a choice of 4 lapel mics - or with the HT-200 handheld with your choice of 4 different mic elements.

FMR 200 *Priced from \$1,440.00 - \$1,584.00*

### Shure EC Series

High selectivity and low noise make the EC4 diversity receiver an international favorite. Balanced/unbalanced outputs as well as volume and squelch control add to its many features. The EC1 body pack offers an omni and unidirectional mic. EC2 handhelds not only look elegant, but also offer the Power Gain™ antenna, and deliver up to 10dB more ERP.



EC Systems *Priced from \$1,044.00 - \$1,182.00*  
 EC Beta System *Priced from \$1,206.00 - \$1,260.00*

### Shure's UHF System

offers features found only on higher priced systems: RF and Audio metering, LCD program display, Tone Key squelch and rugged metal housings. Standard system features include 191 selectable frequencies from 782 - 806Mhz.



MARCAD® diversity, mic or line level with XLR and 1/4" connectors and a complete line of Shure mics. System includes single or dual channel receiver, handheld (U2) or body pack (U1) transmitter.

U4S	Single ch. diversity receiver	\$1600.00
U4D	Dual ch. diversity receiver	\$2,400.00
U2	Handheld xmtr.	<i>Priced from \$790.00 - \$990.00</i>
U1	with Tiny QG connector	\$688.00

## Telex



**Telex FMR 4**  
 If you need a high quality, rackmount diversity receiver and 4 channels, look no further. Mic/line level out, audio and RF meters and headphone jack.

FMR 4 *\$2,060.00*



The **Telex ENG-1** is a camera mounted, DC-powered portable receiver housed in a molded plastic case. The **ENG-4** is the professional version with a more sophisticated front end, 4 channel selection and housed in a rugged metal case.

ENG-1	\$295.00
ENG-4	\$1,545.00



**Telex FMR 450**  
 Too congested in the VHF band? Try the 524MHz - 746MHz UHF band. Up to 50 systems can operate in the same location using the WT-450 body packs or HT-450 handheld transmitters.

FMR 450 *Priced from \$1,525.00 - \$1,863.00*



# M I C R O P H O N E S



**BGS**

**M  
I  
C  
R  
O  
P  
H  
O  
N  
E  
S**

## TOA



### TRANSMITTERS

A)	TOA WM-270 (speech quality)	<b>\$370.00</b>
B)	TOA WM-280 (vocals)	<b>\$562.00</b>
C)	TOA WM-290 (SM58 handheld)	<b>\$642.00</b>
D)	TOA WM-370 (body pack/mic)	<b>\$370.00</b>

### NON-DIVERSITY RECEIVER

A)	TOA WT-770 mainframe holds two receiver modules and includes one WP-760 tuner panel.	<b>\$442.00</b>
B)	TOA WTU-770 Non-diversity receiver module	<b>\$218.00</b>
C)	TOA WP-760 is the tuner panel, one required per receiver module.	<b>\$46.00</b>

### DIVERSITY RECEIVER

A)	TOA WT-870 mainframe holds two, single channel receiver modules and includes one WP-860 tuner panel	<b>\$560.00</b>
B)	TOA WTU-870 Diversity receiver module	<b>\$346.00</b>
C)	TOA WP-860 is the tuner panel, one required per receiver module.	<b>\$64.00</b>

## VEGA



### VEGA U2020 UHF

100 selectable channels in the 746 - 782 MHz band in a smart, ergonomic package design available with an optional rack mount. Systems include the R-2020 receiver and either the BT-2020 body pack or HT-2020

handheld with your choice of the E.V. N/D557 or the E.V. N/D757B mic elements.

U2020 UHF *Priced from \$1,200.00 - \$1,370.00*

### VEGA PRO Plus IFB

The professional IFB/talent-cueing system features the rack mount RMT-14 transmitter with up to 4 transmitter modules installed and the PL-2 miniature receiver with up to 2 frequencies.

Pro Plus IFB *Priced from \$1,844.00 - \$4,194.00*

### VEGA PRO Plus UHF

A diversity wireless system at 512 - 750MHz. Systems include R-662A receiver and your choice of T-677H or 678HS body pack or the T-682 handheld with a choice of 4 elements.

Pro Plus UHF *Priced from \$4,466.00 - \$5,046.00*

### VEGA PRO Plus Series

Carefully selected, top quality components, as well as DYNEX III processing make ProPlus Vega's top of the line VHF diversity system. Systems include: 67B/D III portable receiver or R-42A rack mountable receiver with either the 77/DIII body pack or the T82 handheld (choice of 4 elements) transmitters.

Pro Plus Series *Priced from \$2,847.00 - \$5,405.00*

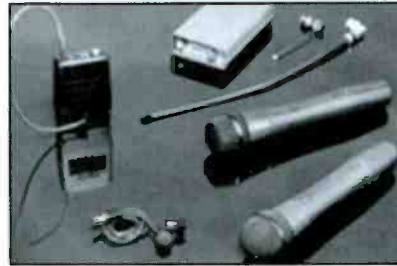

### VEGA VX-20

A portable wireless for video, ENG/EFP applications featuring the R-27 camera mount receiver that operates with the T-25 body pack, T-28 or the T-29 handheld transmitters.

VX-20 *Priced from \$1,472.00 - \$1,692.00*



### VEGA PRO 2 Series

A mid-range, professional VHF system featuring the R-32A diversity receiver with the T-37 body pack or the T-35 handheld with your choice of 4 mic elements.

Pro 2 Series *Priced from \$2,144.00 - \$2,574.00*

### VEGA AX-20 Series

For live sound, stage or conferencing, the AX-20 system is designed to provide years of dependable service under the most adverse conditions. The R-22 rack mount diversity receiver offers dual-mode squelch circuitry for use with the T-25 body pack, T-24, T-28 or the T-29 handheld transmitters.

AX-20 *Priced from \$1,422.00 - \$1,643.00*





MICROPHONES



UM190



UH190/5



UR190



M175



H187



M187



T187



CR175



CR187



M175-DC

The **Lectrosonics Digital Code System, DCS™** is a major technological advance, offering the first real solution to the most common and incurable type of interference, which is external RF signals on or close to the system operating frequency. Digital technology is combined with advanced circuit and mechanical design for an overall package clearly superior to any other!

M175DC	Belt-Pack Transmitter	\$390.00
H175DC	Plug-on Transmitter, plugs directly into any mic with an XLR connector	\$490.00
DR175	Ratio Diversity Receiver, 12VDC, rear panel BNC ant. jack & balanced XLR out	\$980.00
SR175	Basic Receiver, 12VDC, rear panel BNC ant. jack & balanced XLR out	\$580.00

<b>Systems</b>		
Basic Lavalier System	SR175 w/ant., M175DC & M119 or M140 lav. mic	\$970.00
Diversity Lavalier System	DR175 w/ant., M175DC & M119 or M140 lav. mic	\$1,370.00
Basic Plug-on System	DR175 w/ant., H175DC w/o mic	\$1,070.00
Diversity Plug-on System	DR175 w/ant., H175DC w/o mic	\$1,470.00
Optional M150	Lavalier mic upgrade when ordering system	\$50.00



DR175



R175

## Lectrosonics

### UHF Transmitters

UM190	Belt-pack with 5 pin mic/line input jack	\$850.00
UH190	"Plug-on" XLR with Lo Z input and adjustable gain	\$850.00

### UHF Receivers

UR190	Compact with audio output on rear panel XLR, adjustable from the front panel control. Optional rack mount available	\$1,450.00
-------	---	------------

### UHF Components Systems

UM190 w/UR190	\$2,300
UH190 w/UR190	\$2,300

When your field production requires compact size, durability and ultra-high quality, professionals from coast to coast turn to Lectrosonics VHF and UHF wireless systems. Attention to selectivity sets these systems apart from all others.

### VHF Transmitters & Receivers

M175	Belt-pack for use with electret	\$350.00
M175LS	Same as M175 with audio mute toggle switch	\$370.00
M187	Belt-pack with 5 pin mic/line input jack	\$570.00
H187	"Plug-on" XLR with Lo Z input. Has wide range input gain adjustment for use with high output mics	\$595.00
T-187/87	Handheld with the Shure SM-87 electret element.	\$1,295.00
CR175	AC/DC portable receiver for use on video cameras or portable PA equipment. Mic level audio output via XLR	\$770.00
CR187	Compact Receiver, mounts on camcorder, balanced XLR out	\$1,210.00

### VHF Systems

*M175 w/CR175	\$1,120
*M175LS w/CR175	\$1,140
*M187 w/CR175	\$1,340
H187 w/CR175	\$1,365
T187/87 w/CR175	\$2,065

\*Includes M119 (omni) or M140 (cardioid) mic at no charge. Add \$50.00 for the optional M150 upgrade microphone.





**BGS**

**MIXERS / CONSOLES**

## Audio-Technica

**Audio-Technica AT-MX341a** is a four-channel SmartMixer® that offers automatic input mixing with unique digital microprocessor control. Choose one channel at a time or any mix of moderator override, (a switchable manual mode overrides automatic functions). It has single threshold settings for all channels with individual gain controls for each channel. Any number of SmartMixers can be daisy-chained to control large conferences. The output and inputs are individually switchable between mic and line-level, and the last mic on stays on so that ambient sound is never muted. It comes with rack mount adapter, and two can be mounted side-by-side in a single RU with an accessory joining plate.



AT-MX341a		<b>\$799.00</b>
AT8628	Double rack mount joining plate	<b>\$24.00</b>

## Gentner



The **Gentner MPA II** is an eight channel automatic or non-automatic gated microphone mixer and 2x15 watt power amplifier. Setup is easy with six factory pre-sets and six user programmable programs that may be configured by the user with a PC connected to the unit's RS-232 port. Features include • Aux-in for audio feed (CD/tape) and aux out for recording • Locking front panel • Logic outputs for controlling cameras, etc. • Switchable microphone phantom power • and is expandable. 2U

MPA II		<b>\$2,995.00</b>
--------	--	-------------------



## Shure



The **Shure SCM 800** is an eight-channel mixer with removable header-type I/O connectors that provide fast and simple microphone connection. It includes adjustable EQ per channel, 48V phantom power selectable for each channel, superior RF resistant chassis and circuitry, LED indication and LED output meter, peak-responding output limiter with selectable thresholds and LED indicator, and linking capability for up to 32 microphones. 120/230 Vac power.

SCM800		<b>\$745.00</b>
RKC800	XLR connector kit	<b>\$225.00</b>

## Eddor



The **Eddor Q4100 & Q8100** microphone mixers have 4 or 8 balanced XLR female microphone inputs with phantom power. There are also 2 RCA auxiliary inputs with a single volume control bringing the units to 6 or 10 channel mixers. Each microphone input has individual volume control. Outputs are balanced XLR male connectors with 600Ω line level and the auxiliary level output is unbalanced RCA type connectors with maximum output of 8 VRMS into 10,000 Ω's.

Q4100		<b>\$224.07</b>
Q4000RM	Rackmount kit for Q4100	<b>\$23.25</b>
Q8100		<b>\$443.30</b>

## Intelix



All **Intelix VC Series** microphone mixers combine superior audio quality with simple DC control, computer control and on-board automation. All use VCAs to ramp the audio inputs and outputs independently. The Basic features include: Low cut input filter • Duck - manual (mute) • Remote control level & mute • and Stereo line level input (one channel). The Enhanced features include the Basic features plus: Input clip LED • Signal present input LED • Bargraph output meter • Aphex™ Aural Exciter • Limiter • Duck - Automatic (mute) • and is AMIX compatible.

4001/VC	4 input by 1 output - Basic Features	<b>\$569.00</b>
4001/VCX	4 input by 1 output - Enhanced Features	<b>\$689.00</b>
8001/VC	8 input by 1 output - Basic Features	<b>\$889.00</b>
8001/VCX	8 input by 1 output - Enhanced Features	<b>\$1,049.00</b>

*Please call for information and pricing on other connection devices.*

The **AMIX, Automatic microphone & line mixer** add-on module for the Enhanced VC Series microphone mixers. Automates and adjusts output levels according to the number of open mics on it.

AMIX		<b>\$429.00</b>
------	--	-----------------



The **Shure SCM810** is an eight-channel mixer featuring Shure's patented IntelliMix®, which activates only microphones being addressed, minimizing poor audio caused by multiple open microphones. The SCM810 features include adjustable EQ per channel, 48V phantom power, active balanced microphone or line-level inputs, line-level output, highly RF resistant chassis and circuitry, complete logic control of microphone activation, linking capacity for up to 400 microphones, with an internal power supply. 120/230 Vac power.

SCM810		<b>\$1,650.00</b>
RKC800	XLR connector kit	<b>\$225.00</b>



## Lectrosonics



### Lectrosonics LECNET™

The **Lectrosonics AM8 Automatic Mixer** is microprocessor controlled and has adaptive gain proportional algorithm that controls feedback, which improves intelligibility and reduces background noise. LecNet™ components will operate as stand-alone devices, or interconnect to provide a multitude of functions in simple to use, cost effective, rack mounted assemblies. Features include: Eight balanced inputs • Single control knob for input gain and output level • Built-in compressor/leveller with adjustable threshold • Serial port for computer interface • Remote level control • supplied with MS-DOS® software on 3.5" disc and serial patch cable for monitoring internal activity via a computer.

AM8	Basic Version	\$1,325.00
AM8-TC	W/ tone control	\$1,495.00
LNETWIN	Software, monitors and controls AM8 in Windows™, 3.5" disc	\$49.95
IC-PC	Serial interconnecting cable; DB-9 to 3.5mm stereo mini plug	\$14.50
IC-AM8	8-Pin mini-DIN 6" cable for interconnecting two AM8 mixers	\$10.00
<b>Optional Equipment</b>		
EQ1	27 Band, 1/3 octave, constant-Q, has LCD display	\$1,250.00
EQ2	As above, without display or pushbuttons, computer control only	\$1,040.00
TH2	Telephone Interface w/built in LecNet™ interface	\$1,650.00
MM8	Matrix Mixer, 12 input, 8 output w/LecNet™ interface	\$1,450.00
PA8	Multi-channel power amp for mix-minus reinforcement, 1U	\$1,250.00
TA1	Line level adapter, connects any device to the AM8 mixer	\$375.00
LI24	Logic interface, provides logic out signals from up to 3 AM8 mixers	\$375.00
NS1	Noise generator, 3kHz band-limited & wide-band pink noise	\$249.00



## Biamp



The **Biamp SCM7600** is a complete stereo control center, designed to be the heart of a high quality club sound system, with two stereo phono inputs, eight stereo line inputs, and two mono microphone inputs. It has six independent stereo outputs, plus a subwoofer/mono output and a light send output, for maximum flexibility. Biamp has a five year warranty and is made in the U.S.A. 5RU

SCM7600	\$1,537.00
---------	------------

## Denon

The **Denon SMX2000** Digi-Scratch DJ Mixer is a 3-channel mixer that includes 1 microphone, 3 stereo, and 2 phono inputs with high quality sampling sound, seamless loop, sampler and stutter. It has two master stereo and one mono output channel. Tone controllers are provided on each channel and the effects section. The monitor system provides access to CH-1, CH-2, CH-3 EFFECT and PGM. 5RU

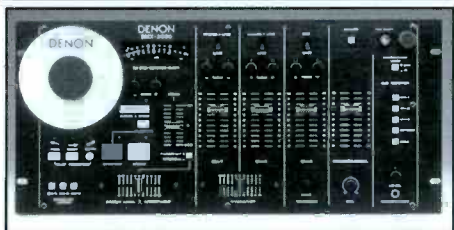

SMX2000	\$1,250.00
---------	------------



BGS

MIXERS / CONSOLES



MIXERS / CONSOLES

## Furman

The **Furman DJM-6** DJ Production Mixer with Furman's unique PUNCH™ Subharmonic Processor is designed to provide the basic features needed by today's professional Disc Jockey. It has 6 stereo inputs (2 phono and 4 line) that feed four input channels • Crossfader with assignment buttons • Mic input with volume control and on/off button; accepts either phone or XLR plug • Cue button and LED on each input fader • Headphone system w/front panel jack and control • House (master) fader • Stereo four segment level meters • Output 3-band EQ • Extra outputs for lighting system sync and mono subwoofer • illuminated on/off switch and ground lift switch.

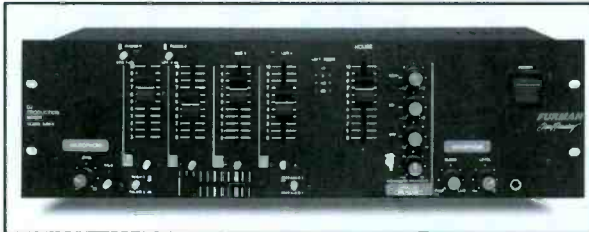

DJM6		\$499.00
DJM-6B	Balanced	\$555.00

## Technics

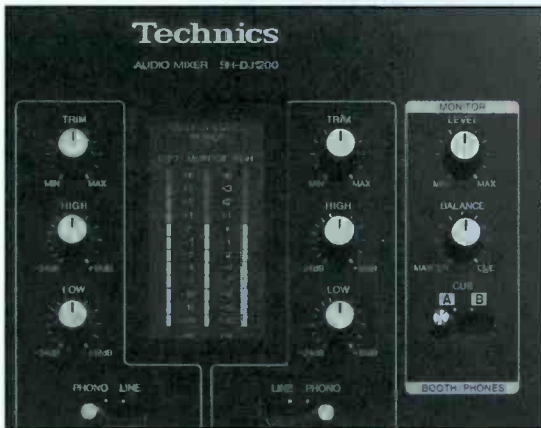

If your turntables are considered "The World Standard" by professional DJ's, they should have a "World Standard" mixer to control them. The **Technics SH-DJ1200** is a top-end Phono/Line/Mic Mixer/Crossfader with superior ergonomic design and fader construction. Each line input offers trim, HI & LO EQ shelving, and independent monitoring. Price includes a spare channel fader and crossfader inside the back panel. The faders can be replaced anywhere in order to respond to accidents that happen during performances.

SH-DJ1200		\$499.95
-----------	--	----------



## Rane



### Rane MP22/24

MP22	7 Stereo In, 2 mixing busses w/EQ, 2 Zones, 2 Mic Ins., front replaceable crossfader, 4U	\$899.00
MP24	9 Stereo In, 4 mixing busses w/EQ, zone/booth outs, 2 Mic Ins. front replaceable crossfader, 4U	\$1,299.00



## AEQ

The **AEQ BC-300** has a practical and modern design to ensure easy operation. It features: a built-in telephone hybrid • 10W/channel power amp • cue stereo monitors • talk-back mic • headphone connector • two extra input channels • and two aux outputs. The basic version (BC-306) offers 2 mic/line input channels and 4 dual stereo input channels. The deluxe version (BC-312) has 4 mic/line mono input channels and 8 dual stereo input channels.

BC-300	Prices from \$1,975.00 to \$2,795.00
--------	--------------------------------------



The **AEQ BC-500** features: six dual stereo inputs • four mono mic/line inputs • a telephone hybrid interface • studio control intercom monitor • 2 stereo and 2 mono sum outputs • power supply for on-air signaling • and four blank modules to permit expansion.

BC-500	Prices start from \$5,235.00
--------	------------------------------



## AudioArts

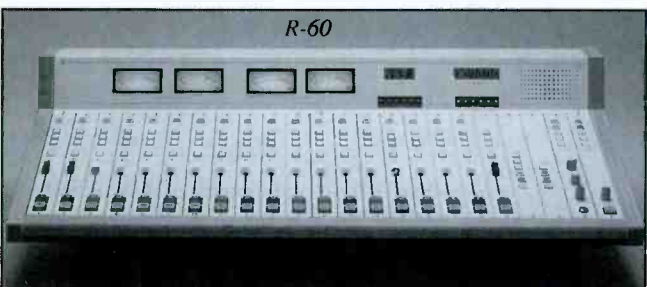

The **AudioArts R-16** is a fully modular console, with the componentry you'd expect to see in a much larger design. The console includes: two MM-10 microphone input modules • four or eight SL-10 stereo line input modules • one output master module (0-10) • one control room module • three blanks for accessories • cue speaker • power supply • white fader knobs • connector set and technical manual • and Sifam® left and right output meters. R-16 measures: 22.6"W x 6.9"H x 16.8"D.

The **AudioArts R-60** console is totally modular. All the components are located on the high tolerance modules. They can even be removed while you're on-air. Each individual module is electronically fused to isolate it from the system in event of a failure. The fuse will even automatically reset itself once the fault has been cleared. Consoles include: one LS-60 line selector • cue speaker • count-up timer • connector set and tool • technical manual • module extender • power supply • master output module • control room and studio modules • and one DMP-60 dual mic preamp card (for two mics). Note the 18 input console includes a clock and position for a second LS-60. R-60-18 measures: 7-3/16"H x 21-1/2"D x 36-3/4"W. The R-60-12 measures 27-3/4"W.

R-16	10 Inputs	\$3,895.00
R-16	6 Inputs	\$2,695.00
LS-16	Stereo Line Selector	\$275.00
FF-1	Full Function Tape Remote	\$195.00
SS-3	Start/Stop Tape Remote	\$195.00

R-60/18-18	Has 2 blanks for inputs or accessories	\$9,195.00
R-60/18-12	Has 8 blanks for inputs or accessories	\$6,795.00
R-60/12-12	Has 2 blanks for inputs or accessories	\$6,695.00
R-60/12-8	Has 6 blanks for inputs or accessories	\$4,695.00

Please call for a complete list of accessories and prices!

The **AudioArts R-5** has everything you need: two mic inputs • ten stereo line inputs • Simple Phone™ channel for easy, error-free talk segments • digital timer • onboard tape remote control • line pres-selector • a well-designed cue system and truly effective control room and studio monitor interfaces. R-5 measures 31.5"W x 7.75"H x 21.2"D.

R-5	13 Inputs	\$5,795.00
PG-5	P&G replacement faders	\$79.00
CF-5	Color Fader Knobs	\$5.95



MIXERS / CONSOLES

## Autogram

**Autogram R/TV-12** has 8 dedicated pots and the **R/TV-20** has 18 dedicated pots. These consoles have the following standard features: Penny & Giles long throw slide pots • Shadow selector switches • True API w/meters • Screw-type pluggable connectors • Optional live assist interface card & control box • Up to 8 patchable mic preamps (quad mic preamp card) • Electronic switching & VCA level control • Two mix-minus busses • All inputs have adjustable inputs • Two watt, 8Ω cue amp • Two watt, 8Ω headphone with selectable inputs. The R/TV Live Assist Package allows complete random sequencing of all console channels plus remote control.

R/TV-12	12 Pots	28 Stereo Inputs	\$11,153.00
R/TV-20	20 Pots	34 Stereo Inputs	\$13,451.00
R/TV/LAP	Live Assist Package		\$1,423.00
LAPO	Live Assist Panel Only to add another operating position		\$638.00
SPK	All spare R/TV circuit cards		\$230.00

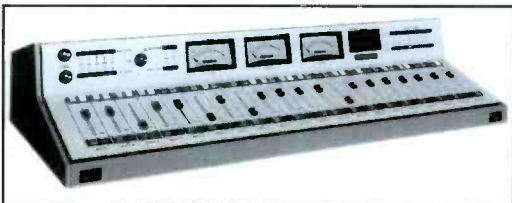

**Autogram's MiniMix 8A** professional audio console features: • Aluminum case w/oak endbells • 2 stereo output buses • mono output • 8 slide plug-in pots • 2 dedicated mic slide pots • 12 stereo inputs, 6 unbalanced stereo • 6 high level balanced pro-stereo inputs • all VCA operated • cue amplifier/speaker • Made in the USA

MiniMix 8A	Dimensions 19"x15"x5"	\$2,499.00
MiniMix 12A	Dimensions 27"x15"x5"	\$3,499.00



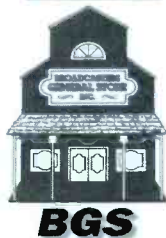

MIXERS / CONSOLES

## Auditronics



The **Auditronics 210** console is designed for On-Air broadcasting. It is available in 6, 12, 18, & 24 mainframes with multiple options. The 210 retains all features of the classic 200 console with many added updates, including an optional 3 caller telephone module.

210 Series On-Air Prices range from \$8,325.00 to \$25,000.00

The **Auditronics 2500** is the intelligent choice of audio professionals who are not willing to sacrifice quality and reliability for price. The 2500 comes in 6, 12, 18, and 24 channel modular mainframe sizes. It has solid-state switching, A/B logic control and VCA level control. Standard with the mainframe are: program, audition, 2 mono buses, 4-VU meters, line output module for busses, control room monitor module, internal power supply, digital up/down timer, extender board, headphone module, cue speaker/amp, installation kit, manual, and a 2 year warranty.

2500-6	Mainframe/with metal side panels	\$2,390.00
2500T-6	Mainframe/with table-top wood side panels	\$2,590.00
2500D-6	Mainframe/with drop-in wood side panels	\$2,565.00
(Add \$75 to \$100 for each additional 6 inputs)		
2500MI	Mono mic/line input	\$340.00
2500SI	Stereo line input	\$360.00
2500B11	11.5" Blank	\$25.00
2500BSP	Basic spares kit	\$595.00

*(Please call for complete information and pricing on other available options)*

The **Auditronics NUSTAR Series 3000** Digital Audio Console has DSP with analog and digital inputs and outputs. Sample rate conversion is standard on the digital inputs and offered as an option for the digital outputs. The NUSTAR produces 16 bit CD quality (24 bit ready), is fully modular and upgrade ready. Also available are universal "control surface" and rack mainframes.

NuStar 3000 Prices starting from \$20,000.00



2500



NuStar



The **Auditronics 801 Series Console** is available in 12, 18 and 24 mainframes. It is available with: stereo program, audition, utility and auxiliary output busses, 2 mono mix-minus output busses, L+R output summing, and 2 line telco module. This console has an extensive user-programmable logic control system. All push button controls are electronic with LED status indicators. All faders are stereo-balanced controlling VCA's.

801 Series On-Air Prices range from \$15,000.00 to \$35,000.00

## Broadcast Electronics

The **Broadcast Electronics 250 series** Broadcast Electronics consoles provide operational convenience at an economical cost. Plug in modules and modern circuit design ensure excellent audio performance. The mixer pots are sealed for long life with cue detents. In addition, one muting relay, prefader preview on all inputs, talkback capability for two studios and a headphone/monitor amp are standard. The 250A includes ladder type attenuators with a cue detent and roller cam key switches and a front panel polycarbonate overlay that makes it impossible to wear the graphics away!



8M250A	Mono-Dual Ch., 8 mixer step attenuators	\$4,650.00
8S250A	Stereo-Dual Ch., 8 mixer step attenuators	\$5,600.00
10S250A	Stereo-Dual Ch., 10 mixer step attenuators	\$7,000.00



# INTRODUCING THE AUDITRONICS 2500 SERIES THE LAST SMALL CONSOLE YOU'LL EVER HAVE TO BUY



Some people believe small means limited. At AUDITRONICS we believe small is a challenge. That's why we have again defined a new standard of excellence by combining impeccable design, precision manufacturing, and value pricing in a full featured, compact audio console. The 2500 Series is loaded with all of the "me too" features found in the competition's "wannabe world class" consoles. Plus the 2500 Series delivers much more, including:

- **SOLID STATE SWITCHING** of all signal paths
- **DC CONTROL** of all level functions
- Telephone **CONFERENCING** capability
- **20dB HEADROOM** maintained throughout
- Easily accessible wiring on **MOTHERBOARD CONNECTORS**
- **ACTIVELY BALANCED** input, patch points, and floating outputs
- Linear **CONDUCTIVE PLASTIC** 100mm faders (P & G Standard)
- Comprehensive **A/B EXTERNAL LOGIC** control
- External line selector with **CUE AND HEADPHONE ASSIGNMENT**

And remember, AUDITRONICS is the company that still supports the first console it ever sold -- over 28 years ago. So you no longer have to compromise with a "wannabe". With the 2500 Series you get the real thing!

**THE ONLY WORLD CLASS CONSOLE AVAILABLE AT "wannabe" PRICES.**

 **AUDITRONICS**

# Get Digital for the Price of Analog

## *Serial Sound* Broadcast Consoles

by **Logitek**

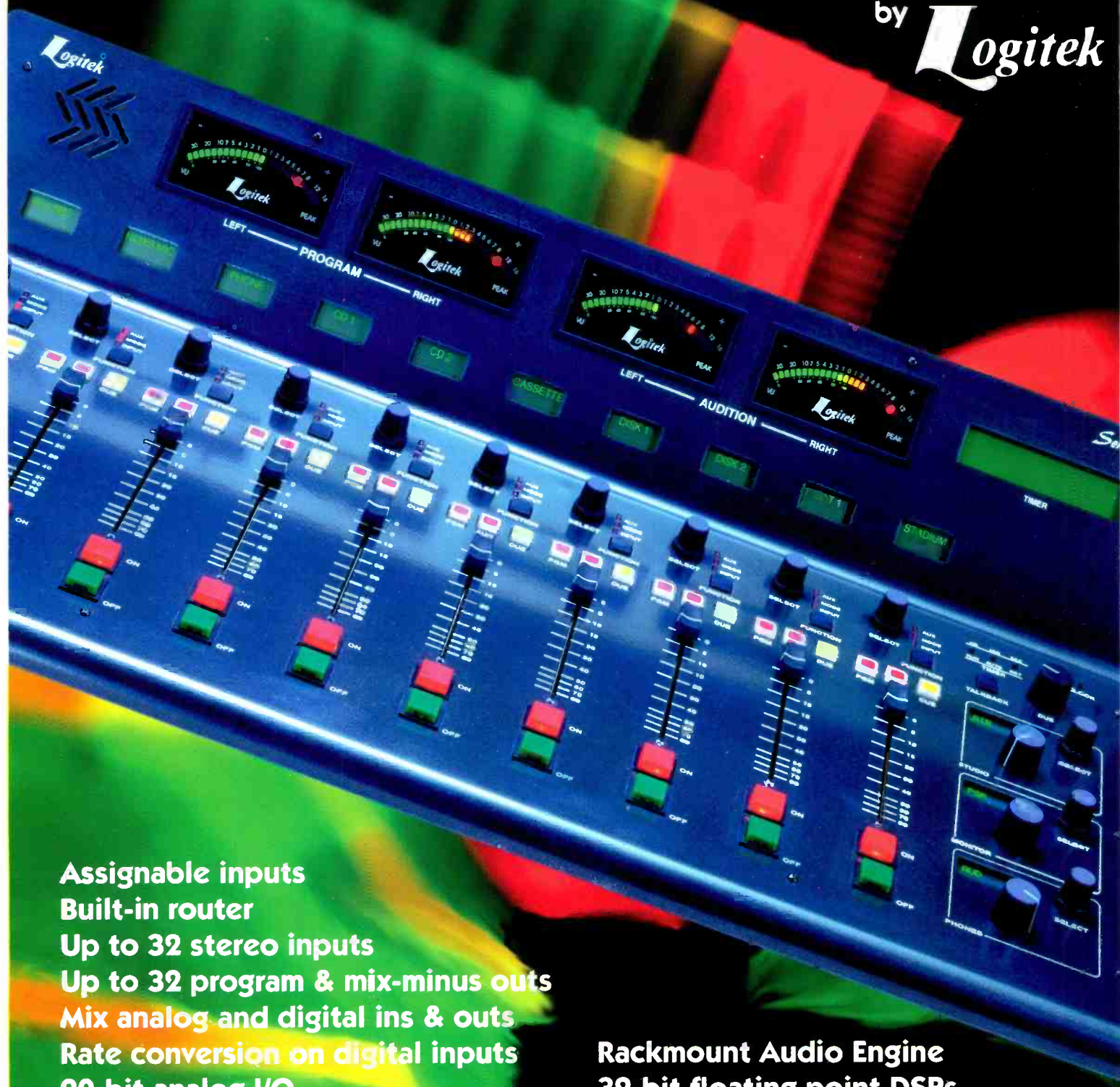

- Assignable inputs
- Built-in router
- Up to 32 stereo inputs
- Up to 32 program & mix-minus outs
- Mix analog and digital ins & outs
- Rate conversion on digital inputs
- 20-bit analog I/O
- 16 to 24 bit digital I/O
- Machine control interface
- 16 MByte delay & reverb memory

- Rackmount Audio Engine
- 32-bit floating point DSPs
- Run two consoles from one engine
- Easily connect automation systems
- Direct factory support via modem



## Fidelipac

**Fidelipac's Dynamax MX Series** is a modular console with all active circuitry on the modules, not the motherboard. Stereo program and audition outputs are assignable from the front panel and two programmable mono outputs are provided for mix-minus, cue feed, etc. Each input module features external logic switching for starting source equipment and has two inputs selectable between mono or stereo, balanced, unbalanced or mic. The Dynamax MX includes a built-in cue amplifier, speaker and simplified headphone output that can be jumpered for a variety of monitor mute/dim configurations. A single mic preamp (installed) and one technical manual are supplied with the console.



MX6R	6 Channel w/rotary faders	\$3,270.00			
MX6L	6 Channel w/linear faders	\$3,770.00			
MX8R	8 Channel w/rotary faders	\$3,710.00	MX10R*	10Ch.	\$4,400.00
MX8L	8 Channel w/linear faders	\$4,370.00	MX10L*	10 Ch.	\$5,220.00
MX8E	8 Channel w/linear faders (Narrow modules)	\$4,690.00	MX10E*	10 Ch.	\$5,350.00
MX14E	*12 Channel w/linear faders (Narrow modules)	\$6,890.00			
MX16E	*12 Channel w/linear faders (Narrow modules)	\$7,550.00			
MX18E	*12 Channel w/linear faders (Narrow modules)	\$8,210.00			

\*Indicates large mainframe console, 36" wide

MXE-BEIGE	Beige control surfaces w/oak trim for MXE consoles	N/C
MXE-EQ	5-Band mic EQ w/pan module for MXE consoles	\$225.00
MXE-TB	Studio/monitor/talkback module for MXE consoles	\$375.00
MXE-TI	Telephone interface module for MXE consoles	\$325.00
MX-RM	Spare rotary module	\$270.00
MX-LM	Spare linear module (3" wide)	\$350.00
MX-EM	Spare linear module (2" wide)	\$380.00
MPK-2	Mic preamp kit for current production console	\$50.00
TE-MX	Test Extender	\$40.00



The **Fidelipac MX/D Digital On-Air console** is equipped with up to eight interchangeable input board modules, each providing two channels with XLR inputs. Input boards are analog or digital and may be selected in any combination at the time of purchase. Analog modules digitize incoming audio and convert that signal to the MX/D mixer's internal data format. Digital modules convert all incoming digital signals to a common sampling rate and synchronize data with the internal matrix. With all signals homogenized in a common internal format, the main processor board uses the latest in DSP and microprocessor technology to perform mixing, switching and audio signal processing in a single 24 bit data stream. Three digital channels plus three analog channels are available for the MX/D consoles output. Both digital and analog outputs support program, audition and mono. Digital output is provided at a 48kHz sampling rate although, upon request, this rate can be preset at 32kHz by the factory. Future flexibility is permitted by the interchangeable design of the input modules which can be augmented or reconfigured with relative ease.

MS/D Under \$11,000

## LPB

**LPB's 7000** stereo P&G slide-fader console has modular plug-in electronics behind a fixed front panel with gold contacts throughout. It features: 2 inputs per channel; 3 stereo output buses; 3 mono outputs for mono-mixdown or mix-minus; 3 stereo tape outputs and 3 mono tape outputs. There are remote starts for all inputs with blinking ready lights and programmable muting for cue and 4 sets of monitor speakers. Channel start and stop can be controlled remotely. The timer can follow channel activation for either cumulative or event timing. Also included: headphone amplifier, cue amplifier and speaker, monitor driver, and a rack mount power supply.

7012	12 Channel Stereo	\$6,995.00
7018	18 Channel Stereo	\$9,295.00
MM-1	Mono mixdown plug-in card for single bus	\$150.00
MINUS-1	Mix-minus plug-in card for single bus	\$125.00



MIXERS / CONSOLES





**BGS**

**MIXERS / CONSOLES**

## Logitek

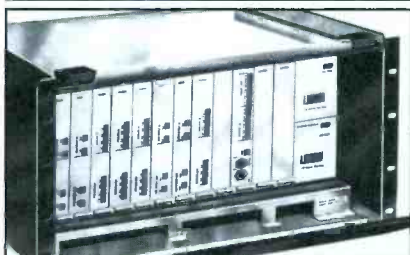

**Logitek's Serial Sound System** consists of a 12-slot mainframe which can hold up to eight, 8x8 mono/4x4 stereo analog or digital I/O cards, two DSP audio processor cards, two communications processor cards and up to two power supplies. The mic pre-amp unit is housed externally and offers four independent pre-amps with balanced I/O on XLR connectors.

The Digital I/O card accepts AES/EBU & SPDIF digital formats. The analog I/O card converts to/from the digital domain via 20-bit A/D/A. The DSP processor card comes standard with one "analog devices share" DSP, upgradable to twelve DSP's. The sample rate is selectable (32/44.1/48 KHz) and can hold up to four, 32MB DRAM chips (available at your local computer store) for up to 30 seconds of audio delay. The COMM processor has four serial ports and configurable banks of 15 relays and 15 switch inputs for machine control. It also handles all AES or wordclock synchronization. The mainframe can house up to two, 100-watt hot-swappable power supplies.

The mainframe is addressed via a modem for remote broadcasting or factory support/service; a PC/RS232 port for automation control or via 9-pin RS485 serial data from several Logitek control surfaces: the ROC-10 has ten faders & looks, feels and sounds like an air console, profanity delay control and a large writing surface.

AE32	Mainframe w/1DSP, 1 I/O card, mic pre & PS	\$3,750.00
IO20A	20-bit analog I/O card	\$750.00
IO4D	Digital I/O card	\$750.00
CSHRC	Additional DSP card w/ single DSP	\$995.00
FF-O	Extra DSP (with original order)	\$650.00
FF-U	Extra DSP (field upgrade)	\$750.00
AEC2	Redundant COMM/Control Card	\$750.00
AEP-100	Redundant Power Supply	\$399.00
MP-4	Quad Mic Pre-amp	\$525.00
ROC-10	Ten Fader Control Surface	\$3,995.00

### NUMIX

NW-FP	Fader Wedge	\$1,695.00
NW-FM	Motorized Fader Wedge	\$2,095.00
NW-M	Meter Wedge	\$1,795.00
NW-S	Selector Wedge	\$3,995.00

## Radio Systems

**Radio Systems RS Series Consoles** come with two inputs per channel that will accept from -60 to +10 levels. It has two stereo and one mono output buss, full DC control, P&G faders, full VU metering with peak LED's, and an event timer. Each module has full remote control that follows the input selection and mid-stage channel patch points. RS Series consoles come with a complete monitor section, heavy duty cue and headphone amplifiers, and an internal talkback system. All input, output and remote control wiring is via convenient removable barrier strips. These connectors simplify initial installation and provide for quick future wiring changes. RS Consoles have a two year manufacturer's warranty with next business day parts delivery.

RS-6		\$4,795.00
RS-12		\$4,995.00
RS-18	supplied with clock	\$6,995.00
RS-24	supplied with clock	\$12,995.00
6IMMB	Six input mix-minus board	\$395.00
4OMMB	Four output mix-minus board	\$495.00
DMMB	Dual mix-minus board	\$195.00
DA	DA card	\$195.00
FSE	Four source expander	\$225.00
AR	Accessory relay	\$25.00

*Options available are: Plexiglass copy stand • "Squawk-Box" • input selector switcher • remote interface modules • custom engraved switch caps • pre-made source cables & punchblock harnesses • color-coded fader knobs • spare parts kits • components • and more.*





# BGS powered



## Biamp

The **Biamp MixPak Plus 5U** powered mixer has excellent sonics, rugged construction, and professional features with a manufacturer warranty of five years. Made in the U.S.A.

MixPak 6/300	6-channel mixer w/300 watts into 4Ω mono	\$714.00
MixPak 8/300	8-channel mixer w/300 watts into 4Ω mono	\$814.00
RW-M	Rack wings	\$33.00

## Electro~Voice

**Electro-Voice powered mixers** deliver high sonic quality and versatility in a variety of sizes and configurations. These mixers can be used with the SX100 and SX200 speakers and the 100BK speaker stand to form a compact, portable sound system.

100M	8-Channel, 100/100 Watt, 8-Ω, stereo	\$2,058.00
61PMX	6-Channel, 200 Watt, 4Ω, mono w/phantom power	\$1,210.00
81PMX	8-Channel, 200 Watt, 4Ω, mono w/phantom power	\$1,428.00



## JBL

The **JBL EON Power System** consists of two bi-amped 15 inch 2-way powered speakers, an EON MusicMix® 10 channel stereo mixer with advanced performance controls, 2 ESOS dynamic microphones, and all necessary cables. With this made-to-match system, all components are built to work together. Just connect the speakers to the mixer and the mixer into the wall. It's plug and play.

EON Power System	\$2,177.00
------------------	------------

## Spirit

The **Spirit PowerStation** is a console that combines studio-quality mixing and digital effects with an audiophile power amp - everything you need between stage and speakers - in a single rugged package. A few of the main features are: 8 mono and 2 stereo input channels • 18 inputs, including tape and effects returns • UltraMic™ pre-amp • Built-in Lexicon effects processor • 3-band EQ, with swept mid frequency on mono channels • 48V phantom power • Power amp 265W per side • Dedicated record outs and tape returns • Hinged cover.

PowerStation	\$1,599.95
Rack Mount Kit	\$49.95



## TOA

**Toa MX-401** is a compact, 4-channel self-powered mixer with 150 watts into 4 ohms. Each input channel has its own level control, a two-band equalizer, pre-EQ and post-EQ sends, and balanced/unbalanced inputs. One program and one foldback output are provided. The master control section features a patchable 5-band graphic equalizer, 3-spring reverb, full patch bay with phone and tape inputs. Power amp protection circuitry and Auto compression, both include LED status indicators.

MX-401	\$756.00
--------	----------

## Yamaha



The **Yamaha EMX3500** Powered Mixer is available in 12 and 16-channel versions. Its streamlined, user-friendly design and panel controls make it easy for anyone to set up and master quickly. This full featured mixer has a wide variety of balanced inputs and outputs, 3-stage EQ with mid sweep and high pass filter, built-in digital effects processor, 9-band stereo graphic EQ, and 350W amplifier. All you need to do is connect speakers, microphones, your other sound sources and the EMX3500 will take care of the rest.

EMX350012	12 Input stereo powered mixer, 3 aux.. 350W x 2 @ 4Ω	\$1,999.00
EMX350016	16 Input stereo powered mixer, 3 aux.. 350W x 2 @ 4Ω	\$2,199.00
EMX640	6 channel powered mixer w/DSP, 200W x 2 @4	\$649.99



**BGS**

**MIXERS / CONSOLES**





**BGS**

**MIXERS / CONSOLES**

## Allen & Heath



The unique benefit of the **Allen & Heath GL2-S** is the number of stereo input channels and stereo output mixes available at any one time. From the same input sources you can control up to three independent mix outputs. One pair of outputs can be the main stereo LR output, one pair could be a special headphone mix, the other pair an independent stereo feed for recording. Other features are: 4 Band EQ with 2 mid sweeps • 6 Aux sends on individual controls • 2 Pre post switches per channel • 8 Stereo line inputs • 6 Mono balanced XLR mic/line inputs • 11RU • and more.

GL2-S		<b>\$1,595.00</b>
GL2	4 mono/ 4 stereo version of above	<b>\$1,595.00</b>
GRI	6 x 3 multiple zone mixer, 3 mono and 3 stereo inputs	<b>\$995.00</b>
GL2CMS	Console Mount Stand	<b>\$69.00</b>

## Behringer

The **Behringer Eurodesk** is very quiet, and acoustically transparent. Eurodesk sweep EQ has been specially designed to go from 50Hz to 20kHz. It gives you 60 line inputs on mixdown, and a universal expander port can link it to a second Eurodesk, or any other mixer. Many other features take the Eurodesk into new levels of performance for an 8-bus console, such as: 24 B-channel inputs, each with their own dedicated EQ, level and mute • Both solo-in-place and pre-fader listen busses • and 400W 19" RM power supply. Also available: optional 24 input meter bridge switchable between tape & channel.

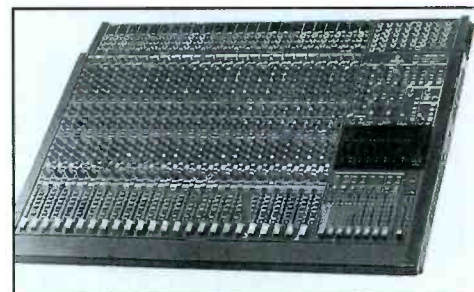

Eurodesk MX8000		<b>\$2,499.99</b>
MB8000	Meter Bridge	<b>\$349.99</b>
Cybermix CX8000	Universal 32 channel fader/mute automation system	<b>\$519.99</b>

## Logitek

The **Logitek TR2** is a compact, 12 input, modular stereo console, with up to three inputs per channel, 4 metered outputs with DAs, 2 monitor drivers plus cue, machine control and tally outputs all in a 19" rack! The TR2 mixer frame is 5U tall and the detachable meter bridge is 2U. If you need more inputs, an eight input preselector can be plugged into any unused mixer position. A 2U accessory subframe will hold 12 four band EQ modules. The meter bridge which includes the power supply and cue amp can be mounted away from the mixer, leaving room for other equipment. The Logitek TR2 console is ideal anywhere where space is at a premium but quality can not be compromised.



TR2-C8	Mainframe w/trimpot final amp, 8 TRI-3 Mixers & 4 TRI-B	<b>\$4,910.00</b>
TR2-C12	Mainframe w/trimpot final amp, 12 TRI-3 Mixers	<b>\$6,370.00</b>
TR2-FR/SL	Mainframe holds 12 input modules w/slide pot final amp	<b>\$1,990.00</b>
TR2-FR/TM	Mainframe holds 12 input modules w/trim pot final amp	<b>\$1,750.00</b>
TR2-EXP	Expansion frame holds 12 input modules w/trim pot final amp	<b>\$845.00</b>
TRI-3	Input mixer with 2 line & 1 mic level input	<b>\$385.00</b>
TRI-3L	Input mixer with 3 line level inputs	<b>\$385.00</b>
TRI-M	Input mixer with 1 mic level input & pan control	<b>\$385.00</b>
TRI-L	Input mixer with 1 line level in, mode switch & pan control	<b>\$385.00</b>
TRI-P	8 input preselector	<b>\$300.00</b>
TRI-B	Blank panels for unused input positions	<b>\$20.00</b>

## Mackie

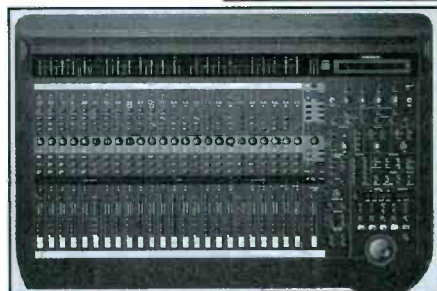

The **Mackie Digital 8 Bus** is as easy to use as an analog console so you spend more time recording and less time pushing buttons, and trying to figure out stuff from the manual. Mackie packed it with 1000 MIPS of digital processing power for simultaneous multichannel digital effects, dynamics processing and 4-band parametric EQ, plus seamlessly integrated dynamic automating of every control via Ultramix®II internal software. We would be happy to fax you a complete spec sheet.

Digital 8 • Bus	<b>\$9,995.00</b>
-----------------	-------------------





**BGS**

**MIXERS / CONSOLES**

## Auditronics 900 Series

up to 40 Input Positions in Mainframe

### TV Products from

### Auditronics

The Premier Audio Console for Television On-Air Broadcasting and Production.

**Auditronics** puts almost 30 years of experience into your hands. Your Audio and Operations will shine with it's Quality and Efficiency!

**Console Features:**

- **Pre-Select System:** Router, Computer, or Manually can handle hundreds of inputs.
- **Reliability by Design:** Top of the line components and Innovative Circuit Design.
- **Functionality in every Respect:** Each and Every Function is included to make great Television Audio Easy.

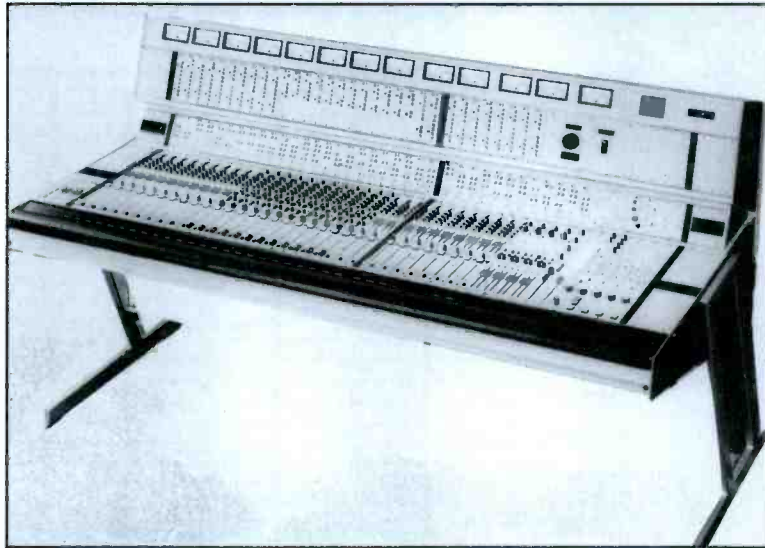

## Auditronics 851 Series

up to 30 Input Positions in Mainframe



Options available include:

- Stereo Microphone input
- 2 Channel Balance
- Mono or Stereo Equalizers
- 10 x 1 Stereo Preselector
- Multiple Dual Studio Monitor Outputs usable for IFB

The Sky is the Limit when you need the

Best Audio for your Great Video!

You want the Auditronics 851!

- Designed for Live, Interactive Television
- Four Frame sizes fit your room and budget
- Three Stereo Master Busses
- Two Mono Mix-Minus Busses
- Selectable Master Mono output
- One Auxiliary Stereo Foldback Buss and Stereo Aux Return Input
- One Multipurpose Intercom and Communication Buss
- Extensive User-Programmable Logic systems

## Auditronics 1900 Series

Infinitely Expandable Mix-Minus System with IFB

### The 1900 Mix-Minus System - "The Problem Solver"

- Unique Modular Rack-Mounted Mix-Minus/IFB Audio System
- Unlimited input, output and IFB configurations.
- Signal monitoring is provided Standard by Cue Speaker, Headphones output and VU meter.
- Producer's IFB panels, Talkback, Slate, Talkback Return and Signal Confidence (optional modules are also available).
- External to 'your' consoles which allows for Fool-Proof Setup and Operation.
- Used for Talent Foldback Mix-Minus.
- Broadcast quality electronics and specifications.
- Video Conferencing, Talk, Sports, and Interviews.

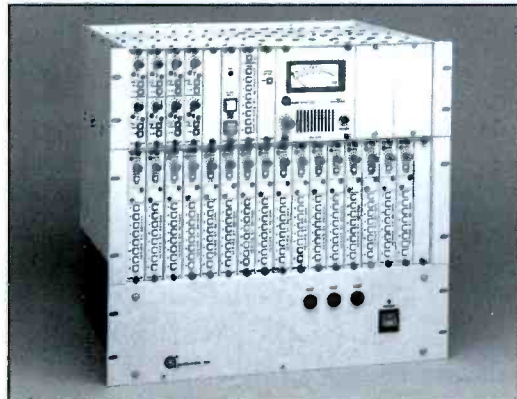



**BGS**

**MIXERS / CONSOLES**

## FEATURES & SPECIFICATIONS\*

\*Mackie reserves the right to change specifications without notice.

MODEL	CR1604-VLZ <sup>1</sup>	MS1402-VLZ <sup>2</sup>	MS1202-VLZ <sup>2</sup>	LM-3204	LM-3204E
<b>Inputs</b>	26	20	18	44	40
Mono mic/line	16	6	4	2 (mic only)	—
Stereo line	—	4	4	16	16
Tape	2 RCA	2 RCA	2 RCA	2 RCA, 2 TRS 1/4"	—
Aux returns	4 stereo	2 stereo	2 stereo	4 stereo	4 stereo
Talkback	—	—	—	—	—
<b>Outputs</b> (all 1/4" TRS are Bal./Unbal.)					
Main L/R Stereo	TRS 1/4"	TRS 1/4" and XLR	TRS 1/4" and XLR	TRS 1/4"	(—) <sup>7</sup>
Main Mono	TRS 1/4" (w/level)	—	—	—	—
Aux sends (all 1/4" TRS)	6 TRS 1/4"	2 TRS 1/4"	2 TRS 1/4"	4 TRS 1/4"	—
Tape L/R Stereo	RCA	RCA	RCA	2 RCA, 2 TRS 1/4"	—
Submaster outputs (all 1/4" TRS)	4 TRS 1/4"	2 TRS 1/4" (Alt 3-4)	2 TRS 1/4" (Alt 3-4)	2 TRS 1/4" (Alt 3-4)	—
Phones	1	1	1	1	—
Ctrl Rm L/R (all 1/4" TRS)	TRS 1/4"	TRS 1/4"	TRS 1/4"	TRS 1/4"	—
<b>Channel Strips</b>	16	10	8	16	16
Aux controls	4	2	2	2	2
Constant power pan control	YES	YES	YES	—	—
Channel mute	YES	YES + Alt 3-4	YES + Alt 3-4	YES + Alt 3-4	YES + Alt 3-4
Channel solo with metering	YES	YES	YES	YES	YES
LED indicators	-20/Solo, OL/Mute	—	—	-20, OL/Solo	-20, OL/Solo
Bus assign switches	1-2, 3-4, L-R	Mute/Alt 3-4	Mute/Alt 3-4	Mute/Alt 3-4	Mute/Alt 3-4
Volume controls	60mm faders	60mm faders	rotary	rotary	rotary
<b>Master Section</b>					
Aux send masters	2	1	1	—	—
Master aux send solo	2	1	1	—	—
Stereo aux returns	4	2	2	4	4
Global aux return solo	YES	—	—	—	—
Aux return assign to sub	1	—	—	—	—
Effects Return to Monitor	2	1	1	—	—
Global AFL/PFL solo mode	YES	YES	PFL only	—	—
Phones/Control Room level control	YES	YES	YES	YES	—
Phones/Control Room matrix	YES	YES	YES	Tape Monitor	—
Faders	4 subs, Main L/R	Main L/R, CR/Phones	L/R stereo (rotary)	Main L/R, CR/Phones	—
Built-in power supply	YES	YES	YES	YES	YES
BNC lamp socket	YES	—	—	—	—
<b>MODEL</b>	<b>CR1604-VLZ<sup>1</sup></b>	<b>MS1402-VLZ<sup>2</sup></b>	<b>MS1202-VLZ<sup>2</sup></b>	<b>LM-3204</b>	<b>LM-3204E</b>
<b>Noise<sup>1</sup></b>					
Master fader @ Unity, Ch. gains down	-86.5dBu	-89dBu	-89dBu	-86.5dBu	—
Master fader @ Unity, Ch. gains @ Unity	-84dBu	-86dBu	-86dBu	-84.0dBu	—
Signal to Noise Ratio (ref +4)	≥ 90dB	≥ 90dB	≥ 90dB	≥ 90dB	—
<b>Total Harmonic Distortion<sup>1</sup></b>	below 0.005%	below 0.005%	below 0.005%	below 0.005%	below 0.005%
<b>Crosstalk<sup>1</sup></b>					
Channel fader down, channels at Unity	-84dB	-85dB	-83dB	-73dB	-73dB
Channel muted, other channels at Unity	-84dB	-84dB	-84dB	-81dB	-81dB
<b>Frequency Response<sup>4</sup></b>					
20Hz to 60kHz	+0/-1dB	+0/-1dB	+0/-1dB	+0/-1dB	+0/-1dB
20Hz to 100kHz	+0/-3dB	+0/-3dB	+0/-3dB	+0/-3dB	+0/-3dB
<b>Maximum Levels</b>					
Mic preamp input	+14dBu	+14dBu	+14dBu	+14dBu	—
All other inputs	+22dBu	+22dBu	+22dBu	+22dBu	+22dBu
Balanced main outputs	+28dBu	+28dBu	+28dBu	+28dBu	—
All other outputs	+22dBu	+22dBu	+22dBu	+22dBu	—
<b>Impedances</b>					
Mic preamp input	1.3kΩ	1.3kΩ	1.3kΩ	1.3kΩ	—
All other inputs (except inserts)	>10kΩ	>10kΩ	>10kΩ	>10kΩ	>10kΩ
RCA tape outputs	1.1kΩ	1.1kΩ	1.1kΩ	1.1kΩ	1.1kΩ
All other outputs	120Ω	120Ω	120Ω	120Ω	120Ω
<b>Equalization</b>	3-band, swept mid	3-band	3-band	3-band	3-band
Low EQ	80Hz	80Hz	80Hz	80Hz	80Hz
Mid EQ	swept 100Hz-8kHz	2.5kHz	2.5kHz	2.5kHz	2.5kHz
Hi EQ	12kHz	12kHz	12kHz	12kHz	12kHz
Low Cut Filter	18dB/oct @ 75Hz	18dB/oct @ 75Hz	18dB/oct @ 75Hz	—	—
<b>Microphone Preamp E.I.N.<sup>5</sup></b>	-129.5 dBm	-129.5 dBm	-129.5 dBm	-129.5 dBm	—
<b>Power Requirements</b>	50 watts	25 watts	25 watts	60 watts	60 watts
<b>Weight<sup>6</sup></b>	20 lbs (9.1 kg.)	9.5 lbs (4.5 kg.)	6.5 lbs (3 kg.)	24 lbs (11 kg.)	24 lbs (11 kg.)

<sup>1</sup> 20Hz to 20kHz bandwidth, line inputs to main L/R outputs, all channels assigned, panned L/R. <sup>2</sup> Any output, 1kHz @ +14dBu, 20Hz-20kHz, channel input. <sup>3</sup> 1kHz @ 0dBu, 20Hz to 20kHz bandwidth, channel in to Main Left outputs. <sup>4</sup> Mic input to any output. <sup>5</sup> 150Ω terminated, max gain. <sup>6</sup> See following pages for dimensions. <sup>7</sup> Proprietary—connects to LM-3204.



## Mackie Consoles

Mackie consoles have sealed controls, steal chassis, built in power supply and a three year manufacturer's warranty.



**Mackie Micro Series 1202VLZ**

1202-VLZ \$429.00  
1202 7U Rack Mount \$12.00



**Mackie Micro Series 1402VLZ**

1402-VLZ \$599.00  
1402 8U Rack Mount \$12.00



**Mackie CRL1604-VLZ**

CR-1604-VLZ \$1,199.00

RP1604-VLZ Allows the CR1604-VLZ input/output pod to be used in either table-top or rack-mount positions \$25.00  
*(Classic CR-1604 Accessories still available)*

The Mackie 8-Bus Series mixing consoles are truly designed for the digital age with extended dynamic range, more headroom and reduced noise floor. Features include: In-line monitoring • Internal 116dB dynamic range • Two completely assignable headphone monitoring systems • Studio quality, discrete low noise, high headroom mic preamps on all chs. (including +48V phantom power) • EQ includes true parametric HI-MID with separate band center and "Q" controls, swept LO-MID, shelving HF and LF plus 18dB/octave Techebychev high-pass filter at 75Hz • second (MIX-B) monitor/AUX section w/pan, level and source buttons • 6 stereo, 6 assignable AUX returns • Assignable control room/studio functions • Built-in talk back system with microphone • Balanced XLR main L/R outputs for PA.



32*8	32x8x2	\$4,999.00
24*8	24x8x2	\$3,999.00
16*8	16x8x2	\$3,199.00
24*E	24-Ch. Expansion Console for 32*8 & 24*8	\$2,999.00

Mackie matching stands made of rugged steel are free standing and attach in minutes.

ST32*8	\$299.00
ST24*8	\$299.00
ST16*8&ST24*E	\$299.00

Mackie Side Car provides 11 rack spaces for patchbays, 8-bus power supplies, etc.

SC*8	\$399.00
------	----------

Please call for further information and pricing!

LM Console:		SR Series Console:	
LM-3204	\$999.00	SR32*4	\$2,299.00
LM-3204E	\$899.00	SR24*4	\$1,599.00

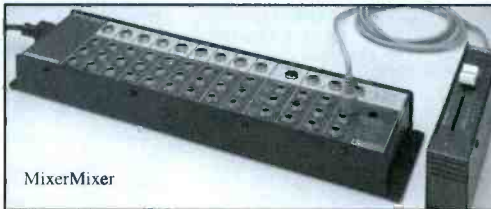

MixerMixer	Combine up to 12 outputs from any three mixers, effectively doubling or tripling your inputs without having to buy effects devices for each one	\$229.00
Remote Fader	100mm remote fader with 6' cord • allows main outputs from all mixers combined via MixerMixer to be governed by a single fader • each combined mixers main outs become sub-masters	\$75.00
CordPack	All the cables needed to connect up to three mixers with one MixerMixer. 3' cables 36 mono, 3 stereo	\$69.00

**Broadcast Tools Console ControllerIIA** provides the solution for interfacing non-broadcast consoles or digital workstations to the broadcast studio. It offers three channels of insert switching to turn on or off console input channels or other source equipment as indicated by a bright red LED on each switch. Additionally, the CCIIA offers monitor amplifier mute control, front panel monitor level control and the ability to switch between internal or external (program/off-air) monitor input sources. Audio connectors are TRS1/4" jacks, front panel switches are SPST momentary with LED, and a DB-9 male remote control. Cascade multiple CCIIA's for more than three channel inserts.

CCIIA \$299.00

## Broadcast Tools



MIXERS / CONSOLES





MIXERS / CONSOLES

## AudioArts



**AudioArts MR-40** is just right for 4-track analog and digital work stations. It can even back up your on-air console. The MR-40 has 4-track buss assign for your tape recorder, program assign so you can transfer direct to your 2-track or go right on-air. Standard features: start/stops just below the fader just like an on-air console • a 3-band EQ section • a stereo send buss that follows stereo channel balance controls • mono modules • two subgroup modules • and one each stereo output master, control room module, cue speaker, power supply, connection cable, connector kit, tools, two blank panels, and the meterbridge that includes four group meters and left and right program meter. MR-40 measures 296.9"W x 7.7"H x 22.2"D.

MR-40	4 mono mic/line modules and 8 stereo line modules	\$7,995.00
LS-40	Stereo source selector (1x5)	\$250.00
TR40FF	Tape remote, 1 set full-function	\$250.00
TR40SS	Tape remote, 3 pair start/stop	\$250.00

*Please call for other accessories and prices!*



## Auditronics

The **Auditronics 310 consoles** are designed for 4 and 8 track production. They are available in 16, 24 and 32 mainframes with multiple options. Standard features include: 4 aux send and returns, 4 or 8 output submastering, 4 group master faders, VCA fader control, cue, stereo solo, stereo monitoring, phantom mic power and a complete metering package.

310 Series Production Consoles

*Please call for pricing*

## Samson



The **Samson MPL 1502** is a 15 input stereo mixing console. It has 5 1/4" TRS stereo and 5 mono XLR mic/line inputs, 3-band EQ on each channel, 2 aux sends and returns, and a built-in head-phone amp. A

flexible metering system allows the user to monitor levels of the stereo out, phantom power and on/off status, while peak input LEDs for each channel indicate signal overload.

MPL1502	\$349.99
Rack Mount Kit	\$24.99

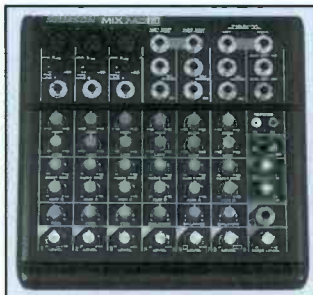

The **Samson Mixpad 9** features 3 balanced mono mic/line inputs and 3 stereo inputs (for a total of 9); 2 aux sends per channel and 2 stereo effects returns to the left and right main outputs. Independent 2-band EQ ensures precise tonal control while mic input trims let the Mixpad be used with a variety of microphones. It also features constant level pan controls on the mono channels and balance controls on

the stereo channels. Peak LEDs on the left and right main outputs and balanced stereo outs complete this versatile mixer. Only 9" x 9.6" x 2-1/2" at 3.38 lbs.

Mixpad 9	\$249.99
----------	----------



The **Samson MPL 2242** is a 22-channel, 4-buss, rack mountable mixer. It has 22 total inputs, (10 XLR balanced featuring a low-noise, padless preamp design; and 6 1/4" TRS stereo inputs). Other features include: 4-band EQ • 4 stereo aux returns • 6 aux sends, (1 pre- and 5 post-fader) • 4-bus design (using 4 dedicated group faders for submixing) with discrete group and main summing outputs • and more.

MPL2242	\$649.99
Endbell Kit	\$34.99

The **Samson PL 2404** rackmount mixer has 24 balanced line inputs (12 stereo). It features: 4-bus mixer with 56mm faders on bus outs • 3-bands of EQ, 4 auxiliary sends on each channel • 4 stereo effects returns with assign switch • pre-fader listen • and more.

PL2404	\$499.99
--------	----------



The **Samson PL 1602** rackmount mixer has 16 balanced line inputs (8 stereo). It features: 2 XLR/mic inputs (balanced) • 2-band EQ on each channel • 2 aux sends with 2 stereo effects returns • and master L/R faders for unbalanced output.

PL1602	\$279.99
--------	----------



## Spirit



The **Spirit Folio Lite** is a compact and versatile low cost mixer designed to meet the demands of a wide range of users. The main features are: a pre-fade listen solo system • High definition, ultra-low noise circuitry • Steel chassis • 12 Inputs with a maximum of 16 inputs avail-

able at mixdown • inserts available on every mono input and mix out • PFL solo on every input • 4 dedicated stereo inputs • 2 auxs with aux 1 pre/post switchable • switchable phantom powering • dedicated stereo return • dedicated tape return • 2-band EQ • and separate stereo outputs for tape, monitors and headphones. External power supply and carrying case included.

Folio Lite	\$399.95
Rack Mount Kit	\$49.95
Spare Power Supply	\$49.95

The **Spirit Folio SX** has a total of 20 inputs and 18 outputs (including auxes and direct outs) offered as standard. The mixer's twelve mono mic/line channels are all equipped with Spirit UltraMic™ preamp. In addition to mix outs, two subgroup busses allow groups of instruments to be sent either to multitrack recorders, additional speakers or be sub-grouped to mix. Four stereo inputs, eight direct outs, switchable pre/post fader, 3-band EQ with sweepable mids, high pass filters on each channel, 3 aux sends, and a separate mono output with level control and two subgroup outputs are also available. Sporting an integral carrying handle for easy portability, the chassis can optionally be rack-mounted into a 10U space.



Folio SX	\$799.95
Rack Mount Kit	\$49.95



The **Spirit Folio Notepad** achieves DAT quality audio as a result of its surface-mount design and use of components common to larger Spirit consoles. It's a versatile, portable mixer for both live and studio applications. Notepad offers the following features: 10 Inputs, (four mic/line balanced inputs, two unbalanced stereo inputs) • Mic preamps with 50dB of gain range • 2-Band EQ on every mono input • Post-fade aux send on every input • Dedicated stereo effects return • +48V Phantom power • Stereo inputs equipped with switchable RIAA preamps for turntables • 2-Track return for playback of masters • Separate mix and monitor outputs • Peak and VU metering • and headphone output .

Folio Notepad	\$279.95
---------------	----------

## The Spirit Folio Rac Pac

combines all the qualities of a studio mixer, including up to 28 inputs at mix-down, with the special requirements of live performance mixing. The connector field is located on the rear of the console, but it can be repositioned on the underside to use only 8U of rack space. Rac Pac has both an insert and a direct out on every mono channel, 10 post-fader direct outputs, a true 4 buss group section and a stereo mix output. Other features are: 3-band EQ, a high pass filter for stage rumble or mic popping, 6 aux sends, 6 stereo returns, and two stereo inputs. Rac Pac was designed from the ground up to excel in both worlds, studio and live mixing.

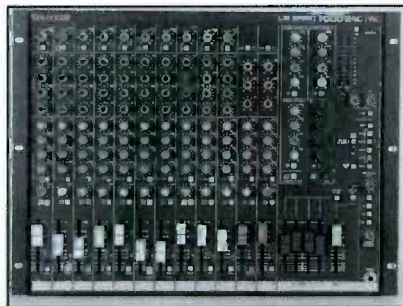

Rac Pac	\$1,199.95
Spare Power Supply	\$49.95
Power Supply Rack Kit	\$69.95

## Studio Technologies

The **Studio Technologies M750 audio mixer** was designed for use in ENG, SNG, and specialized broadcast applications. Features include 4 mic/line inputs, 2 stereo line inputs, and 2 stereo output busses. The setup section provides voice identification storage and playback, along with a precision, computer-controlled tone generator. The extensive monitor section features analog VU-type meters. The M750 has all operator controls located on the front panel. Powered by 120V, 50/60Hz, optional 220/240V. 2U

M750	\$2,495.00
------	------------

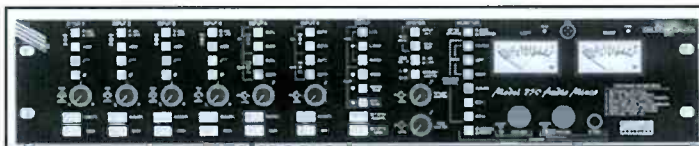

## Tascam

The **Tascam M1600**, 8-buss mixer offers many standard features not found in most consoles of its class. Advanced low-noise circuitry & high end componentry deliver natural and transparent sound with an extremely low noise floor. Eight XLR mic/line inputs plus all TRS, 1/4" inputs and outputs are also accessed through state-of-the-art D-Sub connectors. One stereo and four mono aux sends combined with 4 fully assignable stereo aux returns allow for the most flexible assignment package available. Each mic inputs offers 55db of trim plus phantom power, and all inputs offer 3-band EQ with semi-parametric sweepable mids, solo in place, mute, buss assign, pan, aux assign, aux monitor, insert, signal present/overload LED; master section offers full monitoring, buss/master control as well as buss/master metering.

M1600/16	16 Channel	\$1,699.00
MU1616	Optional meter bridge	\$500.00
MU1600/24	24 Channel	\$2,199.00
MU1624	Optional meter bridge	\$650.00
MA-8	8-Channel Expander	\$450.00



BGS

MIXERS / CONSOLES





**BGS**

**MIXERS / CONSOLES**

## Tascam

The **Tascam M2600 Series Mixers** were totally redesigned and re-engineered. They are available in 16, 24 and 32 inputs. At the push of a switch you get 64 inputs on a 32, 48 on a 24, and 32 on a 16 when mixing down. The M2600's feature: Balanced and unbalanced tape ins and outs • 48V Phantom Power • Direct group out switching and advanced signal routing means no repatching • Absolute Sound Transparency™ and a double reinforced dual-ground system • Bi-directional semi-parametric split EQ on each channel • 6 Auxes (2 stereo), available at all times • Comprehensive monitor matrix allows for 2 separate stereo mixes • In-place solo • Direct/Group switching • Talkback mic • and Optional high-intensity, multi-function meter bridge.



M2600/16MKII	16x8x2, 16 Dual Ins, 8 program outs, and 2 Master Outs	<b>\$3,199.00</b>
MU2616	Meter Bridge for M2600/16MKII	<b>\$849.00</b>
M2600/24MKII	24x8x2, 24 Dual Ins, 8 program outs, and 2 Master Outs	<b>\$3,999.00</b>
MU2624	Meter Bridge for M2600/24MKI	<b>\$999.00</b>
M2600/32MKII	32x8x2, 32 Dual Ins, 8 program outs, and 2 Master Outs	<b>\$4,999.00</b>
MU2632	Meter Bridge for M2600/32MKII	<b>\$1,199.00</b>

The **Tascam M3700 Series** was designed for multitrack recording studios. They feature: in-line monitor format with linear faders • input channels provide 6 aux sends with 4 send level controls, PFL or stereo in-place solo facilities, and mute switches for channel, monitor and aux 5 & 6 • 8 bar-graph meters with select switches for group/tape return monitoring, plus 2 VU meters on stereo returns • talkback facility • balanced XLR stereo outputs and 2TR inputs • built-in 5-frequency oscillators • PFL or stereo in-place solo • insertion point on each channel, stereo and group buss • mute switches for channel, monitor, and aux 5 & 6 • control room section provides monitor select switches, solo switch, dim switch, mono switch and level control • studio section provides control room or stereo monitor select switches, mono switch, on/off switch and independent phones and studio level controls • and the flip function swaps monitor input source with channel input source.

M3700/24	(24X8) 24 Mono In, 8 Prog. Outs, Automated	<b>\$14,999.00</b>
M3700/32	(32X8) 32 Mono In, 8 Prog. Outs, Automated	<b>\$16,999.00</b>
MU-3524	Meter expander for M3500/24 & M3700/24	<b>\$875.00</b>
MU-3532	Meter expander for M3700/32	<b>\$1,175.00</b>
LA-3500	Balancing kit for M3700	<b>\$600.00</b>
CS-3724	Stand for M3700/24	<b>\$550.00</b>
CS-3525	Top Board for M3700/24	<b>\$275.00</b>
CS-3732	Stand for M3700/32	<b>\$600.00</b>
CS-3533	Top Board for M3700/32	<b>\$275.00</b>



## Yamaha



The **Yamaha ProMix 01** with 20 BIT digital memory offers a powerful edge for studio, live sound, commercial installation applications and for use with hard disc recorders. Snapshots and moving fader automation make it ideal for complex situations where mix settings must be recalled repeatedly and precisely. The ProMix 01 is feature packed with: 16 input channels with gain trim and pad (8 balanced XLR's with 48V phantom power, 8 balanced jacks) • Stereo input channel (Unbalanced 1/4" jacks) • Outputs: Stereo out-balanced XLR (+4dB) and SPDIF digital. Record out-RCA/phono (-10dB). Monitor out-unbalanced 1/4" jack (+4dB) • Comprehensive monitor functions: stereo mix, cue, or 2-track recorder • Four fader groups, for single fader control of several faders • Pair function links adjacent input channels (EQ, fader, aux) for stereo operation • Cue function for solo of input channels and aux sends • Motorized faders • 33 Position pan control • 240 x 64 dot backlit LCD display provides metering of all channels and graphic display of mixer settings • 12-Segment stereo LED meters • Comprehensive MIDI functions • 2 internal assignable effects • and 3 compressors..

ProMix 01		<b>\$1,999.00</b>
01Stand		<b>\$299.95</b>
RK01	Rack Mount kit	<b>\$29.95</b>
W01SP	Wood side panels	<b>\$74.95</b>

**Check out IQS'S SAMM Audio MIDI Mixer Software on Page 116 !  
SAMM can control up to 16 ProMix via MIDI!**



## Yamaha

The **Yamaha 02R** has a total of 44 input channels, plus a full complement of features - all driven by RISC technology CPUs and Yamaha's latest 32-bit DSP chip. It brings powerful system control and full dynamic automation to the heart of your digital recording studio. It has 40 input channels and two full-featured stereo internal returns. There are 8 buss outputs and 8 aux sends plus 16 direct outputs. The 24 built-in analog input channels feature 20-bit linear AD/DA conversion with oversampling.

Thousands of parameters can be stored in a scene memory "snapshot" to be recalled in an instant. The 02R has a 4-band full parametric EQ and two internal effects units. EQ can be applied to each input channel and to the stereo output. The open architecture design allows you to insert up to four optional 8-track digital I/O cards (for a maximum of 32-tracks). With these cards you can select from any of the currently used formats - adad®, Tascam TDIF-1, YAMAHA, or AES/EBU.

02R	Digital 8-bus Recording Console	<b>\$8,699.00</b>
CD8AT	Interface card, adad digital format	<b>\$299.00</b>
CD8TD	Interface card, Tascam digital format	<b>\$299.00</b>
CD8AD	Interface card, AES/EBU digital format	<b>\$359.00</b>
CD8CS	Interface card kit: allows multiple 02R consoles to be cascaded for more inputs	<b>\$999.00</b>
CD8AD	Interface card kit: (2 cards & 1 cable) allows connection of 02R to Analog multitrack recorders	<b>\$799.00</b>
CD8Y	Interface card, YAMAHA digital format	<b>\$299.00</b>
MB02	Meter Bridge and connection cable	<b>\$1,299.00</b>
ME4M	Memory upgrade: 1 mbyte/ increases auto mix memory (max: 2)	<b>\$499.00</b>
W02SP	Wood side panel (attach with supplied screws)	<b>\$199.00</b>



The **Yamaha PM3500** Front of House console is available with 24, 32, 40 or 48 inputs; and PM3500 monitor console with 44 or 52 inputs. They are closely related, sharing the same body and virtually all of the same features. The only difference is their inputs. The PM3500's modules are switch assignable to the eight mix busses and the stereo buss, with eight auxiliary sends individually pre/post switchable. In addition to these modules, the console includes four separate stereo input modules that can also be used as auxiliary returns. The PM3500 has digitally controlled scene memories. The input channels, auxiliary returns and output buss ON/OFF functions are electronically controlled via a central CPU. The consoles allow up to 128 patches or "scenes" to be stored in memory and recalled via a 10-key pad on the front panel or an external MIDI device. Any of the 128 memories can be assigned to a group of eight "direct recall" switches to make them especially easy to access. External MIDI control can be used to individually turn input and output channels on or off as required.

PM3500-24	28 Ch (24 mono, 4 stereo) 8 group+st., 8 aux, 128 mute scenes, & 8 VCA groups	<b>\$36,999.00</b>
PM3500-32	36 Ch (32 mono, 4 stereo) 8 group+st., 8 aux, 128 mute scenes, & 8 VCA groups, 4 band parametric EQ, 4 stereo matrix & 4 mono matrix	<b>\$42,999.00</b>
PM3500-40	44 Ch (40 mono, 4 stereo) 8 group+st., 8 aux, 128 mute scenes, & 8 VCA groups, 4 band parametric EQ, 4 stereo matrix & 4 mono matrix	<b>\$48,999.00</b>
PM3500-48	52 Ch (48 mono, 4 stereo) 8 group+st., 8 aux, 128 mute scenes, & 8 VCA groups, 4 band parametric EQ, 4 stereo matrix & 4 mono matrix	<b>\$54,999.00</b>

Please call us for a complete list of options and pricing!



**BGS**

**MIXERS / CONSOLES**





**BGS**

**MIXERS / CONSOLES**

## ATI

The **Nanoamps** from **ATI** are compact, rugged and low cost mixers and utility amplifiers featuring XLR connectors, high performance, low noise circuitry and quiet, UL and CE approved remote power modules. Use them free standing, stack them or rack mount 1, 2, or 3 across in 1U.

MXS100	Mixer, stereo line out, 3 panned mic/line inputs	\$799.00
XPS100	Expander for the MXS100, stereo buss out, 4 panned mic inputs	\$549.00
XPS200	Expander for the MXS100, stereo buss out, 2 stereo line level inputs	\$379.00
MX100XLR	3-Ch. mic/line mixer w/LED bargraph metering w/independent level adjust & master gain control, w/selectable phantom power	\$359.00
XP100XLR	4 Input mic/line expander for the MX100XLR	\$289.00
20604-501	Center mount for single unit	\$22.00
20604-502	Side-by-side mount for two units	\$25.00
20604-503	Side-by-side mount for three units	\$30.00



## Henry Engineering



**Henry's Micromixer** will accept up to four balanced or unbalanced line-level inputs and will mix them to a stereo output. A level control for each input provides adjustment from "off" to +10db of gain. "Micro-Assign" switching permits each input to be assigned to the left, right, or both

outputs in any combination. All circuitry is active and direct coupled for exceptional sonic accuracy.

Micromixer \$195.00



The **Henry StereoMixer** is an eight input, three output stereo line mixer for line-level sources. It lets you mix four stereo or eight mono sources or a combination of both. Each bridging input will accept a balanced or unbalanced source. A level control for each input provides adjustment from OFF to

+10dB of gain. Left and Right buss inputs allow multiple StereoMixers to be linked together to expand input capacity. All connections are via barrier strip terminals.

StereoMixer \$250.00

## Broadcast Tools



The **Broadcast Tools SM-6** is a 6 input stereo mixer, equipped with 6 front panel push button type on/off switches, and stereo balanced inputs with 15 turn input trimmers and single turn output trimmers. Ample gain is provided allowing use of unbalanced consumer level devices. The SM-6 may also be configured for dual monaural output operation. Audio connections appear on the rear panel via wire captive terminals. Applications include: programmable mix minus for telephone hybrids, selectable IFB feeds and additional console input expansion.

SM-6 \$349.00

## Intelix



The **Intelix 8002 MCB** is an eight channel, dual buss microphone mixer designed for the broadcast, video field production, sound reinforcement and recording industries. It has: balanced inputs and outputs • 1U chassis • phantom power • level control • LED bargraph • limiter • front panel headphone output • dual busses • and can be AC or DC powered.

8002MCB \$599.00



## Radio Design Labs

See Other Radio Design Labs Mixers on Page 25.



The **RDL AMX-84** is both a digitally controlled audio matrix router and a low-noise audio mixer with 8 stereo inputs which can be mixed to 4 stereo outputs, in any combination. Functions are controlled by 32 data lines on an input connector. It has low noise and distortion and input gain can be trimpot adjusted for precise level matching.

AMX-84 \$1,126.00

## Rane



The **Rane MLM82** is an eight-input, two-output mic/line mixer. Inputs 1-4 are mic/line level switchable, and inputs 5-8 accommodate up to four stereo or mono line level sources. Features include: four stereo/mono balanced/unbalanced line inputs (1/4" TRS) • four mono balanced line inputs (XLR) • outputs switchable to mic or line level • phantom power switch • trimless mic stage preamps • stereo/mono switch • and bi-color signal present/overload LEDs.

MLM82 \$499.00



The **Rane SM 26B** combines 6-in/2-out line level mixer and 2-in/6-out splitter distribution amplifier in a one rack unit package. It provides Mix/Pan and level controls with 12dB gain for level matching and can be used as a line boost amp, zone level controller, or in a combination of modes at once. Inputs and outputs are balanced 1/4" TRS.

SM-26B \$429.00



The **Rane SM-82** stereo line level mixer has 8 stereo or 16 mono unbalanced 1/4" TS line inputs. Each input channel has a stereo rotary input level control, stereo aux send slider and a balance control slider. The aux return section and the output stage both include a rotary level control and a slide balance control.

SM-82 \$599.00

## Symetrix



The **Symetrix 450 Dual Zone Priority Mixer** has two mono mic/line inputs (with phantom power and low frequency filters) and four stereo line inputs. Each input may be assigned to a stereo output zone, a mono output zone or both. Its unique hierarchical Priority Override structure permits the two mic/line inputs and the first stereo line input to mute the other (lower priority) inputs assigned to the same zone. The 450's flexibility and simplicity make it the perfect choice for a wide variety of systems. By accepting audio inputs from virtually any type of audio source and selectively routing to either the mono or stereo output zone the 450 can save you time and money in the design and installation of your next project.

450 \$629.00

## Stewart

The **Stewart MM4-S** is a four-channel active stereo output mixer in a half-rack chassis.



Each of its four balanced mono inputs are individually switchable between microphone and line level, with switchable +48v phantom power. The MM4-S features an individual gain and pan control for each channel, as well as master level control, and switchable balanced output operating levels.

MM4-S	Two year warranty	\$399.00
RMK100	Single rack	\$20.00
RMK200	Dual rack	\$30.00

## Tascam



The **Tascam M08** compact mixing system features: 12-Input (4 mono, 4 stereo) • 4 XLR inputs • 2-Band EQ on all channels • 2 Dedicated AUX sends (pre and post) • 4 Mono effects returns • Mute and PFL on each input channel • Dedicated 2-track input • and 60mm Linear master fader.

M08		\$349.00
RM08	Optional rack mount kit	\$15.00



MIXERS / CONSOLES



**BGS**

**M  
O  
N  
I  
T  
O  
R  
I  
N  
G**

## ATI

**ATI Micro-Meter Studio Metering Systems** let you know at a glance where your signals are or are not. Display one, two, three or four stereo lines (eight channels) on bright, three color, sixteen segment, LED bargraphs with simultaneous VU and PPM peak display. Balanced, bridging inputs are switchable for 0VU at -10, +4 and +8dBm line levels. Wide range, backlit scale, compact 3-1/2" rack mount.

VU200	One Stereo Display	\$549.00
VU400	Two Stereo Display	\$799.00
VU600	Three Stereo Display	\$1,049.00
VU800	Four Stereo Display	\$1,299.00



**ATI Nanoamp Series Metering** has balanced bridging inputs, each drive ten segment, multi-color LED bargraph meter display. 0 dB internally selectable @ -10, +4, +8 dBu. Front panel trimmers allow for precise calibration at 0VU.



BGD200-VU	Dual bargraph meter display VU Response	\$329.00
BGD-200-VU-Ø	As above w/bi-polar LED phase indicator & headphone monitor	\$379.00
BGD200-PPM	Dual bargraph meter display PPM Response	\$329.00
BGD-200-PPM-Ø	As above w/bi-polar LED phase indicator & headphone monitor	\$379.00
BGD400-VU	Quad bargraph meter display VU Response	\$389.00
BGD400-PPM	Quad bargraph meter display PPM Response	\$389.00

## B&B Systems



**B&B AM-1B** has a quality X/Y scope with 2 VU meters and 2 peak LED's. This unit provides monitoring of stereo audio phase, program average and peak levels, plus SMPTE time code phase/genlock. It is ideal for television production and post production facilities. 3U

AM-1B	\$4,160.00
-------	------------



The **B&B AM-3B** is a real time visual and audible monitor of stereo audio. Phase, program VU levels, peak threshold, (L+R) aux., internal power amplifier and two sets of three inputs make this unit perfect for any stereo audio application. 2U

AM-3B	\$3,400.00
-------	------------

The **B&B AM-3** is a complete tool for stereo audio transmission applications. It provides monitoring of stereo audio phase, program average and peak levels, plus a third channel display selectable between left and right channel sum or SAP (second audio program). 4U

AM-3	Special order only	\$4,260.00
------	--------------------	------------



The **B&B AM-2** is similar to the AM-1B in monitoring stereo

audio phase and levels but without the features of SMPTE time code monitoring and channel selection for the CRT display. Designed for stereo radio facilities and recording studios. 3U

AM-2	\$3,560.00
------	------------

The **B&B AM-2B** is a compact version of the AM-2, with identical functions, for use in limited rack space environments. 2U

AM-2B	\$2,960.00
-------	------------



The **B&B AM-2HR** is a half-rack unit with quality full size X/Y scope, for visual "stereo" audio phase monitoring. Front panel control of line level outputs and amplified headphone/speaker outputs. Front panel selection of "stereo" or "L+R SUM" audio monitoring. 3U

AM-2HR	\$2,260.00
--------	------------

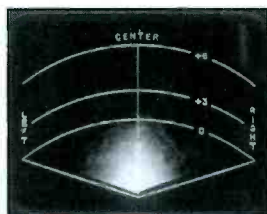

The **B&B Imagescope™** half-rack unit, is the ideal tool for any stereo audio monitoring application. It displays the complex stereo audio signal, showing the dispersion of energy as it will sound in a typical listening environment. The Imagescope™ is used to position, any track or tracks in the stereo image. At a transmission site the scope will show mono compatibility of stereo program material and allow you to observe the separation, balance and level of the stereo signal. 3U

IM-1HR	\$2,260.00
--------	------------



## B&B Systems

The **B&B MP-4 Audio Meter Panel** has four independent buffered channels. The standard unit has two rear panel female XLR inputs. The left input is internally strapped between channels one and two while the right input is internally strapped between channels three and four. The left and right inputs have one buffered VU meter and one buffered PPM meter each. The four channels allow for different calibration adjustments on each meter. 2U

MP-4 \$1,800.00

The **B&B MP-4A Audio Meter Panel** has four independent buffered channels. The standard unit has four rear panel female XLR inputs. These four correspond to individual meters with independent calibration adjustments for each meter. 2U

MP-4A	With VU Meters	\$1,800.00
MP-4A+	With Phase LED	\$2,050.00
MP-4B	With PPM Meters	\$1,800.00



The **B&B MP-2 Audio Meter Panel** has two independent VU meters resistively buffered to meet E.I.A. standards. No calibration adjustments. 2U

MP-2 \$620.00

The **B&B MP-2A Audio Meter Panel** has two buffered input channels configured as a stereo pair. The level of each channel is displayed on an independent SIFAM VU meter with calibration adjustments for each meter. 2U

MP2A	\$1,725.00
MP2A+	With phase indicating LED display <span style="float: right;">\$2,075.00</span>

## Dorrough

The **Dorrough Loudness meter** eliminates the short comings of conventional VU or PPM meters. The VU meter is too slow to respond to peak excursions, it is known as a quasi-average reading device. While the PPM meter does display and hold the peak level of waveforms, the quasi-average program level is completely ignored. The Dorrough loudness monitor solves this. It displays in an easy to read format, the actual energy content of the material, regardless of frequency, while still indicating the peak amplitude of the complex audio signal. This meter gives you more complete and more usable information than any combination of peak hold, VU and PPM indicators. All Dorrough second (2) generation meters have fully integrated peak-hold functions.

40-A2	Std loudness meter w/internal PS, 8-1/2"x2-7/8"x6-1/2"	\$475.00
40-B2	Relative loudness to peak modulation meter	\$475.00
40-C2	Scale differentiation of 40-A2 with 20dB headroom	\$475.00
20-A/B/C2	Straight line version of 40 series	\$475.00
10-A/B/C2	Panel mount 5"x2-1/2" w/external PS	\$475.00
12-A2	Dual version of the 10-A2, 8-1/2"x3"	\$950.00
40-S	Rack mount for single 40	\$45.00
40-D	Rack mount for dual 40, 19"x3.5"	\$45.00
20-S	Rack mount for single model 20	\$45.00
20-D	Dual model 20 19"x1.75"	\$45.00
10-S	Single rack	\$45.00
10-D	Dual rack	\$45.00
10-T	Triple rack allows for a center ch. sum meter when wired for both right and left channels.	\$45.00
12-S	Single rack	\$45.00
12-D	Dual rack, allows for a total of four metering ch.	\$45.00



The **Dorrough 40-P**, parity of signals, both mono and stereo, can be seen on this meter as two indications starting at center scale. A null feature is also provided.

40-P \$595.00

### Explanation of Dorrough meter suffixes

40-A2 has a scale allowing 14dB of headroom in 1 dB steps. 40-B2 is a scale differentiation of the 40-A2 and is calibrated in percent modulation, with the lower scale in dB from +3 to -36dB. 40-C2 also a scale differentiation of the 40-A2 allowing 20dB of headroom.

Please call BGS for ordering details.



# MONITORING



**BGS**

**M  
O  
N  
I  
T  
O  
R  
I  
N  
G**

## Dorrough

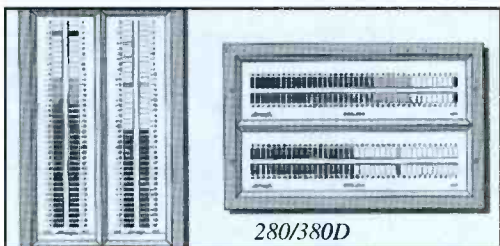

280/380D

The **Dorrough Digital-Reading Meters model 280-D and 380-D** are AES/EBU reading and feature display of both peak and average simultaneously, over indication, and selectable peak-hold. Conforms to all specifications of AES 3 1992. Console or panel mount; Euro block terminals; and uses external power (12-24 Vdc, 0.5A).

380-D	40dB, (Vertical mt.)	<b>\$850.00</b>
280-D	40dB, (Horizontal mt.)	<b>\$850.00</b>
380-E	60dB, (Vertical mt.)	<b>\$850.00</b>
280-E	60dB, (Horizontal mt.)	<b>\$850.00</b>

Products soon to be available from Dorrough: Phase Meter • Surround Sound Metering • Big LED- Large meter for stage work • Single Ch. Console Meter • In-Screen Meter • and Model 1200 Mono!

### Explanation of Dorrough meter suffixes

40-A2 has a scale allowing 14dB of headroom in 1 dB steps. 40-B2 is a scale differentiation of the 40-A2 and is calibrated in percent modulation, with the lower scale in dB from +3 to -36dB. 40-C2 also a scale differentiation of the 40-A2 allowing 20dB of headroom.

Please call BGS for ordering details.

## ESE



**ESE Digital Audio Level Meter** has been designed to simulate the action of a conventional VU Meter, yet features superior dynamic characteristics. The ES216 Audio Level Indicator displays audio levels in ten discrete steps using ten LED indicators. Levels of -20, -10, -7, -5, -3, -1, 0, +1, +2 and +3 dB are displayed. Levels below 0 dB are displayed using green LED's; 0 dB is displayed in yellow; and levels above 0 dB are displayed in red. The ES216 is available in either the peak reading mode or the VU response mode.

ES214	Digital, vertical mini-panel mount meter	<b>\$145.00</b>
ES215	Digital, horizontal mini-panel mount meter	<b>\$145.00</b>
ES215P2	Stereo or Dual Mono, 1U	<b>\$370.00</b>
ES215HP2	Side by side (horizontal) version of 215P2	<b>\$370.00</b>
ES215P3	Triple (stereo/center) audio level indicator, 1U	<b>\$540.00</b>
ES215P4	Dual Stereo, 1U	<b>\$685.00</b>
ES215P6	Triple stereo audio level indicator, 1U	<b>\$975.00</b>
ES216	Digital audio level indicator - meter	<b>\$69.00</b>
ES216P2	Stereo or Dual Mono, 1U	<b>\$190.00</b>
ES216P3	Triple (stereo/center) audio level indicator, 1U	<b>\$260.00</b>
ES216P4	Dual Stereo, 1U	<b>\$330.00</b>

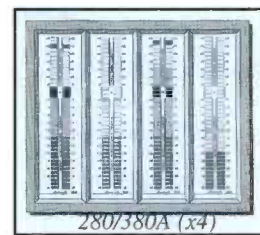

280/380A (x4)

The **Dorrough 280-A and 380-A** feature a single meter with two channels of audio. The meter measures 1-1/2"x5" and has an external power supply.

380A/B/C (V)	Analog model, vertical mount	<b>\$850.00</b>
280A/B/C (H)	Analog model, horizontal mount	<b>\$850.00</b>
280-S	Single rack	<b>\$45.00</b>
280-D	Dual rack	<b>\$45.00</b>
280-T	Triple rack	<b>\$45.00</b>

## Dorrough Video Level Meters



The **Dorrough model 1800 CATV Audio Loudness/Video Level Test Set** is designed for quick set-up of audio and video levels on multiple cable-television channels. Equal perceived loudness is adjusted with the Dorrough Loudness Meter, while accurate modulation/sync levels are set using the Video Luminance Meter. The loudness meter is the model 10-B and the video luminance meter is model 40-N(P/S) with a CATV cable converter.

1800	<b>\$1,995.00</b>
------	-------------------



The **Dorrough Video Luminance Meter Model 40-P/S** is a PAL/SECAM version scaled in volts, displays average and peak luminance, sync level, and blanking.

40-P/S	<b>\$750.00</b>
--------	-----------------



The **Dorrough Video Luminance Meter Model 40-N** is an NTSC video level meter that displays the video signals of average and peak luminance, sync level, and setup violations. Sync range -50 to -32 IRE. Meter resolution 4 IRE per LED.

40-N	<b>\$750.00</b>
------	-----------------



# metering-phase/level

## Furman

The **Furman VU-40** is a convenient rack-mount dual channel level monitor for use in any application where a quick visual check of system performance is desirable. It is comprised of two 20 LED bargraph meters, calibrated in dB like standard VU meters. You can set a front panel switch to read either peak or average response. Other features include • On/off transient muting function protects speakers • Line level/power out switch for each channel • Line level may be set to -10, 0, or +4dBu • Sixteen power out choices from 20 to 1260W, also accommodates 25 volt and 70.7 volt lines • and ground lift, on/off switches.



VU-40	Stereo System Monitor	\$249.00
VU-40B	Includes XLR balanced line level I/O on each channel	\$299.00

## Inovonics

The **Inovonics TVU** displays stereo audio level metering on the screen of a video monitor and is VU/PPM switchable. Applications include uses in television production, post-production, broadcast, cable-TV, and video duplicating facilities. 1U

TVU-00		\$620.00
TVU-20	Rack mount panel option for 1 or 2 units	\$40.00



## Logitek

### Logitek Audio Level Displays & Monitors

MON-10	10-Input selector/meter/monitor - Stereo	\$855.00
2VUB-?	2 Lighted VU meters in a 2U, w/Phase check	\$525.00
4VUB-?	4 Lighted VU meters in a 2U, w/Phase check	\$790.00

? Specify "A" for A scale (dB on top) or "B" for B scale (modulation on top)

### Bright - VU LED Bargraph Audio Level Displays:

BVM	Mono display in desktop case, requires PS	\$205.00
BVS	Stereo display in desktop case, requires PS	\$340.00
BVRM	Rack mount kit, 2U for up to 2 BVM units	\$40.00
BVRS	Rack mount kit, 2U for up to 2 BVS units	\$40.00
BVP	Power supply (runs 1 BVS or 2 BVM)	\$50.00

### Bright - VU LED Bargraph Audio Level Displays Updated Style:

BDT-*	Single stereo meter in desktop case	\$470.00
BV2-*	Single stereo meter centered in 1U enclosure	\$560.00
BV4-*	Dual stereo meters in 1U enclosure	\$795.00
BV6-*	Triple stereo meters in 1U enclosure	\$995.00
BV-UP	Upgrade to digital / Price per input	\$80.00

\*-Specify A for analog or D for digital



MON-10



4VUB

### (Logitek Continued)

#### Super - VU LED Bargraph Audio Average/Peak/Peak Hold Displays:

SDT-*	Single stereo meter in desktop case	\$725.00
SV1-*	Single stereo level display w/single image & density display, 1U	\$895.00
SV2-*	Dual stereo level display w/dual image & density display, 2U	\$1,495.00
SV3-*	Triple stereo level display w/triple image & density display, 2U	\$2,095.00
SV-UP	Upgrade to digital / Price per input (SV&SIS models)	\$195.00

#### Super - VU LED Bargraph Meter Plus Image & SUM Displays:

SIS1-*	SV1 plus Image-Sum display, 1U	\$1,095.00
SIS2-*	SV2 plus Image-Sum display, 2U	\$1,895.00

#### Ultra - VU Bargraph Meter with Image/Sum plus Zoom & Loudness Filter

UDT-*	Single stereo meter in a desktop case	\$1,080.00
UDT-B	UDT with both Digital & Analog inputs	\$1,180.00
UV1-R*	Single stereo meter in a 1U enclosure	\$1,230.00
UV1-RB	UV1-R with both Digital & Analog inputs	\$1,330.00
UV2-R*	Dual stereo meters in a 1U enclosure	\$2,100.00
UV2-RB	UV2-R with both Digital & Analog inputs	\$2,300.00

\*-Specify A for analog or D for digital

#### VU - TRAX Meter Bridge

VTX8-BA	Eight channel meter bridge with one phase display	\$995.00
VTX8-RA	Eight channel meters with one phase display in a RM	\$1,195.00
VTX8-SW	3-In preselector for VTX8-BA	\$150.00

Logitek will mix & match inputs on any of their LED meters. If you want a dual meter with one set of analog inputs and one set of digital inputs or a triple meter with two analog inputs and one digital input, let us know. We can easily arrange this for you at no extra cost.



Bright VU's



Super VU's



Ultra VU



**BGS**

**M  
O  
N  
I  
T  
O  
R  
I  
N  
G**



# metering-phase/level



## McCurdy

The **McCurdy MTR-8** LED bargraph meter has eight LED bargraph meters for four stereo or eight mono sources in one rack unit. Audio input to the unit is through rear panel mounted WECO type pluggable barrier strip connectors. The inputs are fully balanced with optional AES/EBU ins. Available for -10, 0, +4, +8 dBu, please specify level when ordering.

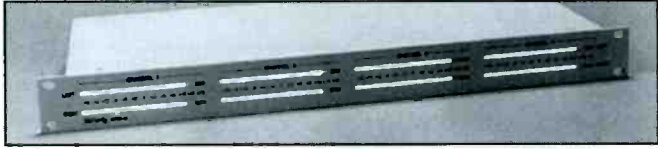

MTR-8	\$795.00
AES Option	\$TBD

The **McCurdy VUP-4 Quad VU/PPM** audio level meter features: Taut-band high quality meters • accurate readings to 0.1dB resolution • LED illumination • Balanced, bridging inputs • PPM, VU or both types • Four channel operation • Designation strip for user supplied IDs • and optional AES/EBU inputs. Available for -10, +4, +8 dBu, please specify level when ordering.

VUP-4VPVP	\$1,195.00
VUP-4XXXX*	Any configuration of 4 meters \$1,195.00
VUP-4XNNX*	Any configuration of 2 meters \$995.00



\* Specify V, P, or N for X to configure meter. V= VU, P= PPM, & N= none

## Wohler



MLH-2	2-Ch. of lg. format 24-segment, tri-color bargraph analog level meters with peak LED, 1U	\$610.00
-D	To substitute digital level meters, add to suffix	\$145.00
-P	To add Phase Indication, add to suffix	\$140.00



MLH-2AL	2-Ch. of lg. format 24-segment, tri-color bargraph analog level meters with peak LED, includes an alarm module for loss of audio and overrange. Over and under delays are independently set per pair. 1U (*D)	\$945.00
-D	To substitute digital level meters, add to suffix	\$145.00

### Standard Package Level Metering and Audio Alarm Systems

Systems shown here cover the majority of common applications, without need for user configuration and at reduced overall cost. Standard systems are priced as complete units, with chassis and power supply.



MSH-8AL	8-Ch. of compact format 25-segment, tri-color bargraph analog level meters. Includes alarm modules for loss of audio and overrange. Time delays set in pairs. 1U	\$1,300.00
-D	To substitute digital level meters, add to suffix	\$260.00
PH-2	To add Phase Indication, add to suffix	\$560.00



MSH-4AL	Same as MLH-2AL but 4 Channels, 1U	\$1,500.00
-D	To substitute digital level meters, add to suffix	\$290.00
MSH-4AL	4-Ch. of compact format 25-segment, tri-color bargraph analog level meters. Includes alarm modules for loss of audio and overrange. Time delays set in pairs. 1U	\$1,300.00
-D	To substitute digital level meters, add to suffix	\$260.00
MSH-8	8-Ch. of compact format 25-segment, tri-color bargraph analog meters. 1U	\$1,285.00
-D	To substitute digital level meters, add to suffix	\$515.00
PH-2	To add Phase Indication, add to suffix	\$560.00

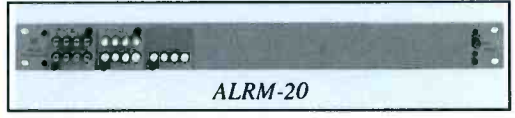

MSH-8AL	Same as MSH-4AL but 8 Channels, 1U	\$2,180.00
-D	To substitute digital level meters, add to suffix	\$515.00
MSLV-120	20-Ch. of 10-segment, tri-color bargraph analog meters, 1U	\$1,600.00
-D	To substitute digital level meters, add to suffix	\$1,100.00
MSLV-220	Same as MSLV-120 but with 25-segment, 1U	\$2,800.00
-D	To substitute digital level meters, add to suffix	\$1,260.00
ALRM-20	Alarm unit for loss of audio on 20 channels. Includes level sensing circuitry for all 20 channels	\$1,910.00
ALRM-64	Alarm unit for loss of audio on 64 channels of level meters or loss of audio and overrange on 32 channels of level meters. Used in conjunction with any Wohler level metering unit	\$3,855.00



For custom configurations and pricing, please call Broadcasters General Store.

MONITORING

**Many Items in Stock for Immediate Delivery...Call Today!**





# Wohler Technologies

Self-Powered  
Speaker Systems

Routing &  
Source Selection

Level Meters &  
Phase Indicators

Alarms for Audio Loss  
& Overrange

Innovative Audio

Monitoring Systems



## When it comes to **Audio Monitoring**, it comes from **Wohler!**

Our customers love Wohler because they provide the most comprehensive range of In-Rack audio monitoring products in the industry, providing solutions for all audio monitoring needs. They created the In-Rack revolution nearly ten years ago, and continue to offer quality products for all budgets.

Renowned for their self-powered speaker systems which have become the industry standard, Wohler also manufactures:

**Level & Phase Meters** (now including **In-Picture**); **Alarms for audio errors** and location and **Audio Routers / Source Selectors**.

Speak with us today to find out how Wohler products can help you.

- **Hundreds of models** for all applications & budgets
- **Only 1 or 2 U** high - perfect for space-critical environments
- **Magnetically shielded** - put Wohlers right next to video screens
- Accepts **multiple inputs** - analog & digital sources - **AES & SDI**
- **Plug-and-Play** - just drop in the rack - no installation hassles

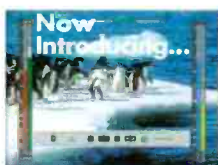

In-Picture Metering

**F**ocused Sound™ is a monitoring technique first offered by Wohler, and made possible through the use of close-range, in-rack, high fidelity drivers located right in front of the user.

Because the sound travels a much shorter distance from its source to the operator's ears, volume settings can be kept lower. The result is greater clarity, greatly reduced room noise, and much less acoustic crosstalk between adjacent bays.

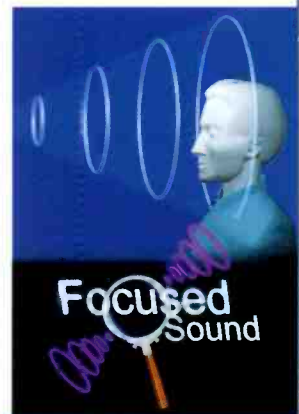



## ***MASTER CLOCKS.....***

For more than 25 Years, ESE's Master Clocks have been known for their accurate and cost effective methods of time keeping. Any of our five Master Clocks can drive up to 100 of our Digital Displays with up to 4000 feet of cable. Our Digital Displays range from .4" to 4" LED characters that are viewable from 10 to 120 feet, perfect for Broadcasting and Recording Studios. Our Master Clocks lock to GPS, WWW, Modem and Crystal.

## ***ANALOG CLOCKS.....***

Here are two types of our Analog Clocks that can be driven from any of our five Master Clocks. Our LX-5112 (12/24 Hr.) Analog Clock can self set it's hands to the correct time from three different time code inputs (SMPTE/EBU, ASCII or ESE). Alternate modes of operation allow the LX-5112 to synchronize with an alternating 12 or 24 volt impulse signal, or to act as a stand alone clock. We also carry the LX-168 "Sweep" Second Hand and the LX-162S "Stepping" Second Hand Analog Clocks, driven from Impulse Drivers.

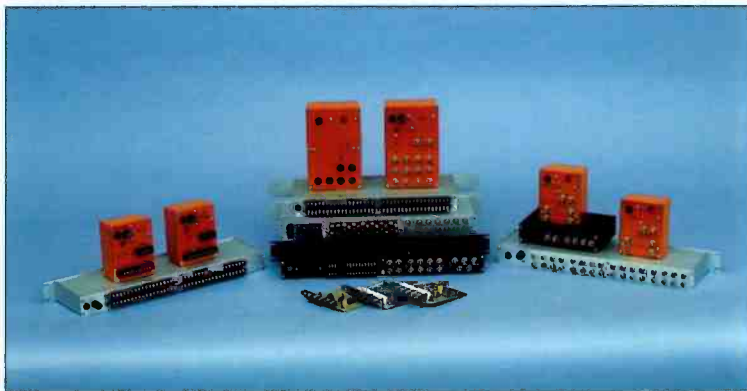
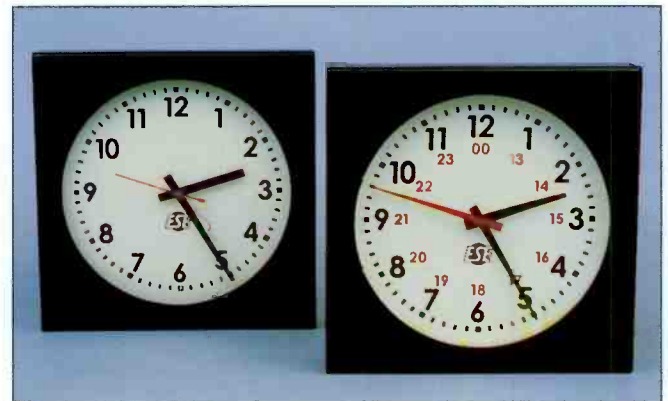

## ***DISTRIBUTION AMPLIFIERS.....***

ESE's Audio and Video Distribution Amplifiers have been designed to create exact copies of an available input signal. Whether the signal is Audio, Video, S-VHS or HDTV, these Distribution Amplifiers deliver the highest in professional broadcast audio/video quality. We supply a variety of DA's ranging from 1 x 4 to quad 1 x 6's which can be set up to have 24 outputs in a single rack. We also carry 1 x 4 video & audio PC cards for Desktop applications.

## ***AUDIO PRODUCTS.....***

These products include two different "Digital" Audio Level Indicators. Each is available in rack mount panels with as many as six mounted on a single 1 3/4" panel. Other units include the highly popular ES-244 Audio Level Impedence Interface (which allows interfacing between "pro" and consumer equipment) and the ES-212 Phone Patch (which interfaces between an audio console and the telephone).

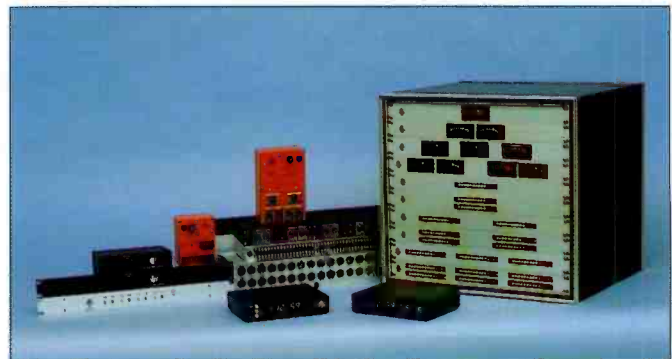

***ESE*** PRACTICAL SOLUTIONS FOR MORE THAN 25 YEARS!



# metering-phase/level

## Radio Design Labs

The **Radio Design Labs RU-SM12 Dual Audio Meter** is for anywhere you need audio level metering, digital string display indication, precise left/right meter tracking, individual channel calibration controls, selectable peak or average metering, selectable metering of peak L+R / L-R. 1/3 RU for high density rack mounting. Each channel input has a write-on label area for identification of the source or function being monitored.

RU-SM12 \$203.00



See other RDL products  
on page 25 & 26.

# speakers/monitors ~ assistive listening ~



**BGS**

## Gentner

TX-37A	Transmitter, 37 channels, with antenna (See RMK for optional rack mount)	\$599.95
PTX	Portable, 37 channels, with lavalier mic, uses 2 AA batteries	\$399.00
RX-1A	Tunable Receiver with built-in belt/pocket clip, wrist strap & single earbud	\$75.00
RX-6	6-Channel Receiver with built-in belt/pocket clip, wrist strap & single earbud	\$135.00
SRX	Tunable Speaker Receiver powered by 6 C batteries or AC power	\$199.00
MPAII	Mixer/Power Amplifier (See page 43 for full description)	\$2,995.00
BC-10	NiCad Battery Charger for up to 10 RX-6, RX-1A or portable transmitter	\$399.00
ES	Ear Speaker	\$15.00
SEB	Single Earbud	\$3.50
DEB	Dual Earbud	\$7.50
EC	Ear cushion	.16
MHP	Mono Headphone	\$12.00
RMK	Rack mount kit for TX-37A transmitter	\$45.00
PACA	Includes one TX-37A and three RX-1A's	\$824.95
PACB	Includes one TX-37A and ten RX-1A's	\$1,349.95
PACC	Includes one PTX and ten RX-1A's	\$1,149.95

Please call for further information on accessories and options not shown.



**Gentner Assistive listening systems** are designed to give the hearing impaired the highest level of hearing assistance at a competitive price. Features include: Transmitters accept virtually any input. XLR, RCA, balanced or unbalanced • Transmitters and receivers are field tunable to 37 FCC approved frequencies • Built-in multiband compressor and audio processor designed to bring the high and low sounds within a range that hearing impaired people can hear • Uses two AA size batteries for about 60 hours of life or NiCad batteries for about 30 hours • and a variety of accessories to choose from.

## Telex

**Telex SoundMate™** personal listening systems help overcome background noise and poor building acoustics that can make listening difficult for the hearing impaired listener. A Telex base station, portable belt pack transmitter, your choice of receivers, and a wide assortment of accessories allow you to meet the needs of individuals who require hearing assistance. These listening systems are even compatible with a variety of hearing instrument styles for hearing aid users.

AAT-2N	Base Station Transmitter	\$555.00
TW6	Belt Pack Transmitter	\$427.00
AAR-10N	Single Channel Receiver	\$77.00
SR-100	16-Channel Tunable Receiver	\$189.00
SM1	Includes one AAT-2N, three AAR-10N, 3 earbuds & antenna	\$803.00



## Williams Sound

With the help of a **Williams Sound Personal PA System**, hearing impaired people can enjoy a new listening experience, uninterrupted by annoying sounds. Since the message is broadcast directly from the microphone to the listener, only the sounds which are intended to be heard reach the listener's ears. The Personal PA System features an FM transmitter that connects to an existing sound system, typically using a tape output connection from the amplifier or mixer. Optional transmitters are available for facilities that do not have a sound system. The transmitter acts as a miniature radio station, broadcasting over a radius of 300 feet or more. The pocket-sized receivers operate on a single 9V battery. The receivers are designed for use with or without the user's hearing aid, through a variety of optional earphones and TeleCoil Couplers.

PPAVPE	Includes one T17 transmitter and four R7 receivers	\$895.00
PPABCSFME	Includes one T4 transmitter and three R7 receivers	\$856.00

Many other packages and options available. Please call for further information and pricing!



M  
O  
N  
I  
T  
O  
R  
I  
N  
G





**BGS**

**M  
O  
N  
I  
T  
O  
R  
I  
N  
G**

## Speaker Mounts



WA50



CA50

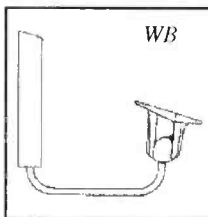

WB

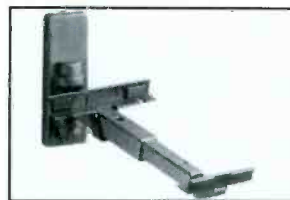
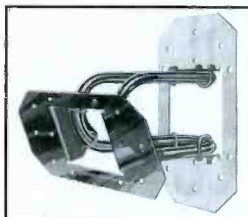

### Omnimount Speaker Mounts

Series #	Support Wt.	Price
50	6 to 20 lbs.	\$49.95
75	15 to 40 lbs.	\$74.95
100	35 to 70 lbs.	\$89.95

Other configurations and mounts for up to 225 lbs. are available.  
Please call us for Omnimount diagrams.

### Peerless Speaker

Radial Cube™ Speaker Mount, extends 9" from wall, and supports up to 75 pounds.

SPK815 \$52.00 ea.

**Pivottelli Speaker Supports** permits speakers to swing side to side and tilt up and down. Clamps speakers front to back and provides screw holes to secure bottom of bracket to speaker if desired. Sold in pairs only. Wall mount, max. wt. 44 lbs. each, Cabinet size 4" to 10" depth

SS \$99.95/pair

**NOTE;** Please be sure your speakers were designed to be "flown" and your wall or ceiling attach points are structurally adequate to support the weight of your speakers!

## Ultimate Speaker Stands

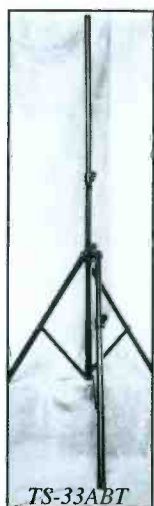

TS-33ABT

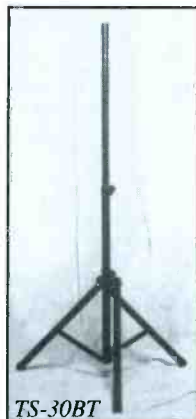

TS-30BT

### Ultimate Support Tripod Stands with bags

TS-30T	Standard tripod, silver, max. ht: 6'7", 75 lb. capacity	\$134.00
TS-30BT	Standard tripod, black, max. ht: 6'7", 75 lb. capacity	\$152.00
TS-33T	Standard tripod, silver, max. ht: 9'2", 100 lb. capacity	\$158.00
TS-33BT	Standard tripod, black, max. ht: 9'2", 100 lb. capacity	\$182.00
TS-33AT	Standard articulating leg tripod, silver, max. ht: 9'2", 100 lb. cap.	\$194.00
TS-33ABT	Standard articulating leg tripod, black, max. ht: 9'2", 100 lb. cap.	\$217.00

### Ultimate Support Utilock Tripod Stands with bags

TS-40T	Standard Utilock tripod, silver, max. ht: 6'7", 75 lb. capacity	\$158.00
TS-40BT	Standard Utilock tripod, black, max. ht: 6'7", 75 lb. capacity	\$176.00
TS-44T	Standard Utilock tripod, silver, max. ht: 9'2", 100 lb. capacity	\$182.00
TS-44BT	Standard Utilock tripod, black, max. ht: 9'2", 100 lb. capacity	\$206.00
TS-44AT	Standard Utilock articulating leg tripod, silver, max. ht: 9'2"	\$218.00
TS-44ABT	Standard Utilock articulating leg tripod, black, max. ht: 9'2"	\$241.00

### Accessories

BMB-200K	Large mounting bracket w/mounting hardware	\$28.00
TMB-400K	Two-piece slide mounting bracket w/mounting hardware	\$27.00
TSM150K	Socket mounting bracket w/mounting hardware	\$20.00
TAD-100	Adapter stud for mounting speakers with 1" diameter socket	\$14.50
TAD-138	Adapter stud for mounting speakers with 1-3/8" diameter socket	\$14.00

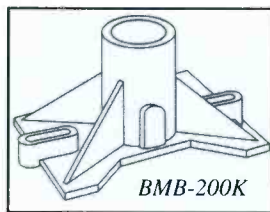

BMB-200K

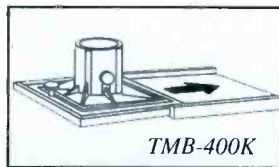

TMB-400K

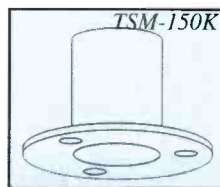

TSM-150K

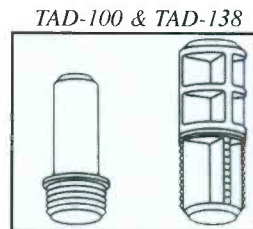

TAD-100 & TAD-138

## PRO CO

The **RMS-1** routes the outputs of a stereo amplifier to one of three pairs of speakers. The switching logic allows fast and easy "A-B" comparison between any two pairs of speakers desired. The heavy-duty toggle switches safely carry loads as high as 1800 watts. The **RMS-2** has two independent stereo sections, with the same routing capabilities as the RMS-1.



RMS-1	\$225.05
RMS-2	\$444.25





# Nearfield monitors



**BGS**

**M  
O  
N  
I  
T  
O  
R  
I  
N  
G**

## Nearfield Monitoring

Make/ Model	Frequency Response	Impedance	Power Cap.*	Approximate Dim. HxWxD"	Tweeter	Woofer	Weight Pounds	Options	Price
<b>Aconstech</b>									
8025	35-20k	8Ω	150W	10.5x17x1	26mm dome	8"	38	RM kit @ \$66	\$1,190/pr.
<b>Anchor</b>									
AN-1001X	65-20k	8Ω	100W	5.25x8.4x9	10mm dome	4.5" (shld.)	6	RM-1 @ \$55	\$125.00
AN-1001X/70V	65-20k	8Ω	30/10/5W	5.25x8.4x9	10mm dome	4.5" (shld.)	6	SB-1 @ \$50	\$145.00
<b>AUDIX</b>									
MM15	55-18k	4Ω	70W	9x6x9	1" dome	5.25"	8		\$309/pr.
MM25	55-18k	4Ω	110W	15.5x7.5x10	1" dome	2x5.25"	13		\$389/pr.
Studio1A	50-18k	8Ω	175W	13x9x10	1" cloth dome	6.5"	18	Video shield	\$599/pr.
Studio3A	47-19k	4Ω	250W	19x10x11.5	1" cloth dome	2x6.5"	29	Video Shield	\$799/pr.
NileV	40-20k	8Ω	175W	15x9.5x11	1" cloth dome	7" Kevlar	24		\$1,495/pr.
Nile X	40-20k	4Ω	250W	22.5x10x13.5	1" cloth dome	2x7" Kevlar	45		\$1,995/pr.
<b>Auratone</b>									
5PSC	100-12.5k	8Ω	35W	6.5x6.5x6	10mm dome	5" (shld.)	5		\$159/pr.
5RMC	160-12.5k	8Ω	40W	5.25x19x8.5	10mm dome	5" (shld.)	16	RM525 @ \$12	\$240.00
<b>Electro-Voice</b>									
100A	45-18k	8Ω	30W	17.25x12x11	Super dome	8"	33	SRB-7 @ \$46.50	\$459.00
S-40B	85-20k	4Ω	160W	9.8x7x6	25mm dome	5.25"	13	S40MB @ \$34.50	\$317.00
<b>JBL</b>									
4206	65-20k	8Ω	75W	15.4x9x9.5	25mm dome	6.5"	15		\$204.00
4208	60-20k	8Ω	75W	17.75x11x9	25mm dome	8"	20.5		\$268.00
4408AL,R	50-20k	8Ω	100W	17x12x11.6	25mm dome	8"	26	MR-4408 @ \$36	\$355.00
4410AL,R	45-20k	8Ω	125W	23.5x14x11	25mm dome	5" & 10"	43		\$492.00
4412AL,R	45-20k	4Ω	150W	23.5x14x11	25mm dome	5" & 12"	47		\$738.00
Control 1	70-20k	4Ω	150W	9x6x5.6	19mm dome	5.25"	4	MTC2 @ \$56	\$146.00
Control 1AW/70								Switchable Xfmr	\$236.00
Control 5	50-20k	4Ω	175W	15x10x9	25mm dome	6.5"	10	MTC-52 @ \$68	\$251.00
<b>KRK</b>									
6000	62-20k	8Ω	75W	13x9x10	1" Inv. dome	6"	18	Magnetic shld. @ \$150	\$775/pr.
M7000B	30-20k	8Ω	150W	14x11x11	1" Inv. dome	7"	25	Magnetic shld. @ \$150	\$1,175/pr.
1300B	36-20k	8Ω	200W	29x16x17	1" Inv. dome	5" & 12"	90		\$3,495/pr.
K-ROK	57-19k	8Ω	100W	14x12x9.75	1" dome	7"	18		\$495/pr.
<b>Spirit</b>									
Absolute2	45-20k	8Ω	100W	15.5x9x11.7	1" dome	6.5"	15.4		\$500/pr.
<b>Tannoy</b>									
PBM6.5II	57-20k	8Ω	100W	12.5x8.5x8.5	25mm dome	6.5"	10		\$475/pr.
PBM8II	47-20k	8Ω	125W	16x11x11	25mm dome	8"	18.5		\$795/pr.
SBM	45-20k	6Ω	70W	14x8.75x9	19mm dome	6.5"	11		\$295/pr.
<b>Yamaha</b>									
NS10MS	60-20k	8Ω	60W	8.5x15x8	1-3/8" dome	7"	14		\$239.00
S8M	50-20k	6Ω	50W	19x10.5x8.75	3"	5" & 8"	16.5		\$199/pr.

\* Power handling capacity determined with either EIA standard RS-426-A power test or IEC standard 268-5 or AES standards & denotes program power unless noted.

**Broadcasters General Store (352) 622-7700 Fax (352) 629-7000**



# powered monitors



**BGS**



Acoustech MTR-45



Anchor 1000X



EV S6120a



Fostex 6301B



Audix PH-3

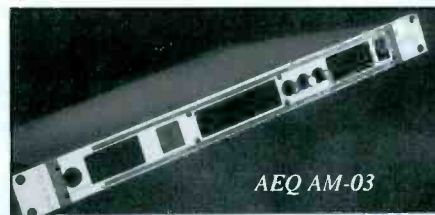

AEQ AM-03

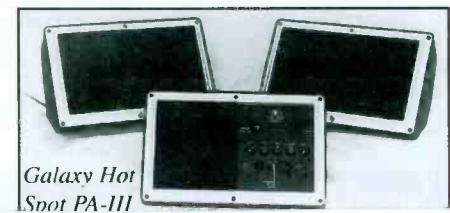

Galaxy Hot Spot PA-III

# MONITORING

## Powered Monitors

Make/Model	Frequency Response	Power	Meters	Connectors	Video Shield	Weight Pounds	Other Features	Options	Price
<b>Acoustech</b>									
MTR4.5	50-17k	55W	Y	XLR	Y	13	1/2 Rack size		\$595.00
<b>AEQ</b>									
AM-03	65-19k	10W	Y	XLR	Y	13.6	1-bass,2-mid,2-highs	3 St. inputs select	\$765.00
<b>Anchor</b>									
AN-1000X	70-14k	50W	N	RCA/TRS/XLR	Y	9.5	Bass/Treble Ctrl.	RM-1 @ \$55, RM-12 @ \$63	\$400.00
<b>AUDIX</b>									
PH-3S	100-20k	20W	N	RCA	Y	8/pr.	3.5" woofer/.75" dome tweeter		\$219/pr.
PH5-VS	75-20k	25W	N	RCA	N	11/pr.	5.25" woofer/.75" dome tweeter	Video Shld.	\$299/pr.
PH-15-VS	50-20k	45W	N	RCA	N	18/r.	5.25" woofer/.75" dome tweeter	Video Shld.	\$479/pr.
PH-25-VS	50-20k	50W	N	RCA	N	26/pr.	2x5.25" woofer/.75" dome tweeter	Video Shld.	\$649.00
<b>Clear-Com</b>									
AMS-1022	100-18k	28W	Y	XLR	Y	9	5 Speakers, JRU		\$699.00
<b>Electro-Voice</b>									
100EL	45-18k	50W	N	TRS/XLR	N	37	8" woofer/dome tweeter	SRB-7@ \$47	\$909.00
SB120a	50-25k	400W	N	TRS/XLR	N	34.4	12" woofer/bass module		\$1,134.00
SX200a	80-20k	350W	N	XLR	N	47	12" woofer/horn, 125dB SPL		\$1,298.00
<b>Fostex</b>									
6301B	80-13k	10W	N	1/4" TS	N	6	4" woofer		\$199.00
6301BEAV	80-13k	10W	N	TRS/XLR	Y	6	4" woofer, Video Shld.		\$239.00
<b>Galaxy Audio</b>									
Hot Spot PA3D	150-15k	50W	N	TRS/XLR	N	9	3-band EQ	Wall/Ceiling mt. @ \$26	\$349.00
<b>Genelec</b>									
1029A	70-18k	40Wx2	N	XLR/TRS	Y	13.2	EQ on rear/Integrated		\$535.00
1091A Sub	38-85Hz	90W	N	XLR/TRS	N	22.4	Omni-mt. & 3/8" mic stand thread		\$680.00
1092A Sub	33-80Hz	180W	N	XLR	N	66	Sgl. 8", Active Sub for 1029A		\$2,149.00
1094A Sub	29-80Hz	400W	N	XLR	N	110	Level Phase & EQ controls on rear	Video Shld.	\$3,699.00
1030A	55-18k	80/40W	N	XLR	N	15	Dual 8", L-C-R inputs for Surround		\$1,099.00
1030AM	55-18k	80/40W	N	XLR	N	15	Same as above w/sgl. 15" active subwoofer	Video Shld.	\$1,199.00
1031AP	48-22k	120Wx2	N	XLR	N	26	EQ on rear	Video Shld.	\$1,999.00
1031A	48-22k	120Wx2	N	XLR	N	26	EQ on rear/Blk "Producer" finish	Video Shld.	\$2,099.00
1032A	42-21k	180/120W	N	XLR	N	44	Blk. Birch Veneer	Video Shld.	\$2,499.00
Genelec Options: floor std., handles, grill, wall mt. & flight case									
<b>JBL</b>									
EON10P	60-16k	60W	N	XLR	N	28	10" woofer/1" horn		\$653.00
EON15P	50-20k	130W	N	XLR	N	40	15" woofer/1.75" horn		\$816.00
EONSub	40-150Hz	250W	N	XLR	N	38	15" woofer		\$980.00



# powered monitors



Genelec 1029



JBL EON

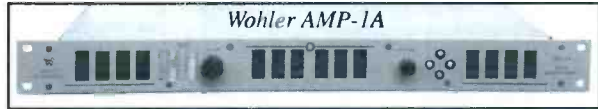

Wohler AMP-1A

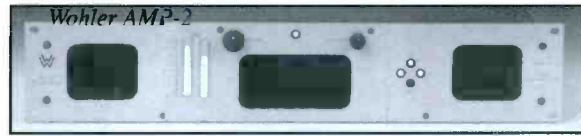

Wohler AMP-2



Genelec



McCurdy AMP100

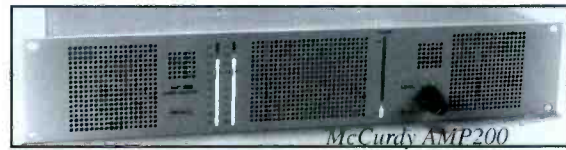

McCurdy AMP200

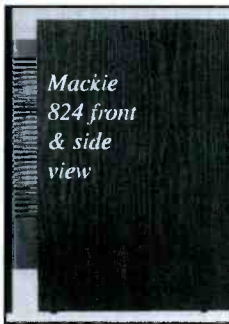

Mackie  
824 front  
& side  
view



MA-12C



Yamaha MS2020



Yamaha  
MS1011I



BGS

M  
O  
N  
I  
T  
O  
R  
I  
N  
G

## Powered Monitors

Make/Model	Frequency Response	Power	Meters	Connectors	Video Shield	Weight Pounds	Other Features	Options	Price
<b>Mackie</b>									
HR824	39-22k	150/100W	N	XLR/TRS	N	32	8.75" woofer/1" dome/Bi-amped		\$749.00
<b>McCurdy</b>									
AT2656	100-20k	3W	Y	WECO strip	Y	11	10" woofer/1" horn		\$595.00
AMP-100	100-20k	12W	N	WECO strip	N	9	IRU		\$695.00
AMP-100M	100-20k	12W	Y	WECO strip	N	9	Ø meter incld.		\$860.00
AMP-200	100-20k	12W	Y	WECO strip	N	11	Ø meter incld. 2RU		\$1,085.00
AMP-400	100-20k	10W	N	WECO strip	N	9	4 Ch. w/ Headphone Jacks		\$750.00
<b>Roland</b>									
MA12C	N/A	10W	N	TS	Y	5	Bass/Treble Control		\$145.00
<b>Wohler</b>									
AMP-1A	80-15k	10-18W	Y	RCA/XLR	Y	14	L-R & Center Speakers	*XFMR-1 @ \$50	\$710.00
AMP-1APF	80-15k	10-18W	Y	RCA/XLR	Y	14		*DC-12 @ \$145	\$975.00
AMP-1A/VTR+	80-15k	10-18W	Y	XLR	Y	15		*HPH-1 @ \$68	\$1,445.00
AMP-1/VTR+D	80-16k	10-18W	Y	XLR	Y	15		*	\$2,130.00
AMP-2	80-16k	11-20W	Y	RCA/XLR	Y	18		*SDAE-1 @ \$1,630	\$1,095.00
AMP-2/VTR+	80-16k	11-20W	Y	RCA/XLR	Y	18		*Input select options	\$1,715.00
AMP-2/VTR+D	80-16k	11-20W	Y	AES/EBU/XLR	Y	18			\$2,420.00
VM1	300-9k	10-18W	N	XLR	Y	17	Sgl. Ch/IRU		\$370.00
VM2	300-9k	10W	N	XLR/RCA	Y	12	Dual Ch/IRU		\$515.00
VM4	300-9k	10-18W	N	XLR	Y	13	Quad Ch/IRU		\$840.00
AMP-SUR	80-16k	11-20W	Y	RCA/XLR	Y	21	SurroundSound monitor		\$2,030.00
<b>Yamaha</b>									
MS-205	70-15k	20W	N	TS	N	8.8			\$249.00
MS60S	20-20k	60W	N	XL/TS	N	22			\$599.00
MS1011I	75-18k	10W	N	TS/RCA	N	4.75	1-4" woofer/EQ controls		\$159.00
MS202II	70-18k	20W	N	XL/TS	N	8.5	2-4" woofer/EQ controls		\$269.00
MS150	50-18k	150W	N	XLR/TS/RCA	N	39.6	12" woofer & horn/3 inputs		\$1,039.00

\* Fifty different options are offered for Wohler/ input switching/ metering/ etc. We would be happy to fax a complete listing!

**Broadcasters General Store (352) 622-7700 Fax (352) 629-7000**





**BGS**

**M  
O  
N  
I  
T  
O  
R  
I  
N  
G**

# sound reinforcement



EV SX-200a



EV SX-200a rear



JBL Control 12



JBL MR Series



Klipsch KP-301



Community CSX-27



Ramsa WS-A200



Tannoy System 600



Tannoy System 800



Yamaha S112III

## Sound Reinforcement

Make/Model	Frequency Response	Impedance	Power (RMS)	Sensitivity dB	Drivers	Enclosure Style	Approx. Dim. HxWxD"	Weight Pounds	Price
<b>Community</b>									
CSX25S2	70-18k	8Ω	100W	97.5	12"-W/PH horn	Blk. carpeted wood	18.25x15x13.5	38	\$418.00
CSX35S2	60-18k	8Ω	150W	99.5	15"-W/PH horn	Blk. carpeted wood	23.75x17.25x13.25	48	\$499.00
CSX52S2	40-18k	4Ω	200W	98	15"W/6.5-M/PH horn	Blk. carpeted wood	33.5x18x18	88	\$915.00
CSX57S2	40-18k	4Ω	300W	102	2x15"-W/1"-CD/PH horn	Blk. carpeted wood	33.5x26.75x8	115	\$1,049.00
<b>Electro-Voice</b>									
SX100	80-25k	8Ω	200W	99.5	12"-W/1"-CD	Molded Polymer Wedge	23x17x12.25	32	\$692.00
SX200	80-25k	8Ω	300W	101.5	12"-W/1"-CD	Molded Polymer Wedge	23x17x12.25	30	\$906.00
T22	72-20k	8Ω	300W	100	12"-W/1"CD	Blk. carpeted 7-ply fir	24.4x19x15.6	58	\$926.00
<b>Galaxy Audio</b>									
Pro 2	40-18k	8Ω	200W	96	15"-W/1.5"-T	Gray/Wht./Blk/Oak/Walnut	19x27x13.5	45	\$699.00
<b>JBL</b>									
Control 8SR	70-16k	4Ω	175W	92	8"-W/1"-CD	Molded Polymer Foam	15x10x9	12.5	\$318.00
Control 12SR	55-16k	8Ω	200W	97	12"-W/1.5"-CD	Molded Thermo Plastic	24x17x12	44	\$996.00
Control 23	85-22k	8Ω	50W	86	3.5" 90° horn	Paintable/weather resistant	7.6x5.5x4.4	4	\$98.00
Control 25	80-16k	8Ω	150W	88	5.25" 90° horn	Paintable/weather resistant	9.3x7.4x5.8	5	\$126.00
Control 28	60-16k	8Ω	175W	92	8" 90° horn	Paintable/weather resistant	15x11x8.6	12	\$221.00
EON 10	70-15k	8Ω	125W	92	10"-W/1"-CD	Molded Polymer Plastic	19.4x14x12	20	\$469.00
EON 15	60-15k	8Ω	250W	100	15"-W/1.75"-CD	Molded Polymer Plastic	27x17.5x16.6	36	\$599.00
MR918	35-4.5k	8Ω	300W	100	18"-W	Tolex covered OSB	41x28x18	92	\$769.00
MR922	60-17k	8Ω	250W	100	12"-W/2"-CD	Tolex covered OSB	23x17x11	49	\$639.00
MR925	60-17k	8Ω	250W	101	15"-W/2"-CD	Tolex covered OSB	26x19.5x14	57	\$699.00
MR926	38-17k	8Ω	250W	102	12"-W/2"-CD	Tolex covered OSB	41x28x18	110	\$839.00
MR935	38-18k	8Ω	250W	100	15"-W/8"-M/2"-CD	Tolex covered OSB	28x28x18	90	\$889.00
MR938	38-18k	8Ω	250W	100	18"-W/10"-M/2"-CD	Tolex covered OSB	32x28x18	99	\$1,035.00
<b>Klipsch</b>									
KP2011IA	50-20k	8Ω	125W	96	12"-W/2"-CD/1"-T	Painted Plywood	22x16x13	38	\$529.00
KP2501IA	65-20k	8Ω	250W	102	12"-W/2"-CD/1"-T	Painted Plywood	22x16x13	49	\$689.00
KP3011IA	45-20k	8Ω	400W	101	15"-W/2"-CD/1"-T	Painted Plywood	32.5x21x17	82	\$889.00
<b>Ramsa</b>									
WS-A80	65-18k	8Ω	80W	92	8"-W/1"-CD	Molded Resin	11x7x9.3	16.5	\$360.00
WS-A200	70-20k	8Ω	125W	98	12"-W/1"-CD	Molded Resin	15.5x22x10.75	23	\$995.00
<b>Tannoy</b>									
System 600	52-20k	8Ω	160W	90	6.5" Dual Concentric	19mm Particle Bd.	8.6x14.1x10.5	16.5	\$695/pr.
System 800	47-20k	8Ω	180W	92	8" Dual Concentric	19mm Particle Bd.	10.8x17.7x10.5	23	\$995/pr.
<b>Yamaha</b>									
S112III	60-16k	8Ω	200W	97	12"-W/2"-CD	Carpeted wood	25x15.5x12	40	\$369.00
S115III	50-16k	8Ω	200W	99	15"-W/2"-CD	Carpeted wood	28x18.5x14	52	\$429.00

W=Woofers

M=Midrange

T= Tweeter

PH=Piezo Horn

CD=Compression Driver w/horn



# special purpose speakers



## Anchor

The **Anchor Liberty 4500** from Anchor Communications, is a powerful, portable sound system which converts from efficient voice projection to a full-range, high fidelity with a simple flick of a switch. This unique product works as well indoors as outdoors, and with or without AC power.

MPA-4500	Dual Function Sound System (AC operable only)	\$1,050.00
MPB-4500	Dual Function Sound System (Battery & AC operable)	\$1,175.00
MPA-4500H	Dual Function Sound System with Heavy Duty battery installed	\$1,225.00
MP-4501	Dual Function companion (unpowered)	\$560.00

The **Anchor Mini-Vox** reaches crowds of over 200. This five-pound audio system can be hand-held or worn over the shoulder and is versatile enough to tackle a variety of situations including guiding tours, controlling crowds and organizing forces during an emergency. You need one in your newsroom!

PB-25	Handheld Portable PA system	\$270.00
PB-25SA	Same as above with Signal Alert button installed	\$295.00
PB-25WB	Wireless Mini-Vox (order mic & trans. separately)	\$400.00
WH-1000	Handheld microphone & transmitter	\$180.00
WL-1000	Body-pack transmitter only (order mic separately)	\$140.00
MIC-25	Handheld Mic with 6' coil cord and 1/4" phone plug	\$49.00
MIC-50	Handheld Mic with 10' coil cord and 1/4" phone plug	\$49.00
MIC-90P	Handheld low impedance mic w/20' cable and 1/4" phone plug	\$100.00
LM-30	Lapel mic w/3.5mm mini-plug	\$38.00
HBM-35	Economy headband type mic	\$60.00
HBM-40	Headband type mic	\$90.00
RC-25	Rechargeable Battery Kit	\$89.00
CC-25	Nylon carrying bag w/storage compartment	\$37.00



The **Anchor Porta-Vox** runs with or without AC power, weighs only 25 pounds and is powerful enough to provide crystal-clear sound to crowds up to 5,000.

PB-500	Battery operated portable P.A. System	\$975.00
PB-500W	Wireless Porta-Vox (order mic and trans. separately)	\$1,225.00
WH-58	Handheld mic/transmitter w/Shure SM-58 mic element	\$360.00
WB-II	Body-pack transmitter only	\$255.00
CM-60	CollarMic™ for use with WB-II	\$140.00
HBM-60	Headband type mic for use with WB-II	\$100.00
SP-500	Speaker pack for Porta-Vox	\$530.00
RC-16	Replacement charger / AC adapter	\$18.00

## Lectrosonics

The **Lectrosonics Long Ranger III** is the highest output portable PA system of its type. The built-in wireless microphone, rechargeable power supply, and high audio output (the amplifier produces an honest 33 Watts RMS) produce enough audio output to cover an area the size of a football field. It operates on rechargeable battery pack or external 12 Volt power.

Long Ranger III	\$1,440.00
-----------------	------------



**BGS**

**M  
O  
N  
I  
T  
O  
R  
I  
N  
G**

# special purpose speakers

## OHM/Walsh



OHM offers a complete, compact home theater system featuring 3 choices of satellite speakers and 3 choices of sub-woofers. The SAT-1 speakers are lower cost and lower power rating, making them ideal for rear channel speakers. The SAT-2's are built for perfect stereo imaging, faithful sound reproduction and 150W of power in a 7 lb., die cast metal structure you can hold in your hand. A shielded version is available for center channel audio. OHM also offers 3 subwoofers: SB-1 for music and small to medium size rooms; SB-2 for theater effects in medium to large rooms; and SB-4, the only subwoofer providing bass in all four channels.

SAT-1	\$220/pr.	SAT-2	\$430/pr.	SAT2C	\$250/ea.	SB-1	\$330.00
SB-2	\$550.00	SB-4	\$850.00	SAT-1 mounting kit \$35/pr.			

OHM has been working with the Walsh patented inverted cone driver technology for 20 years and has managed to produce the Walsh 300, which sounds virtually identical to the top of the line Walsh 5 for one half the cost. The inverted driver with its 45° crossfired super tweeter not only produces full room stereo without a center channel, but also phase-coherent, time-aligned audio that no multi-driver system could hope to accomplish. Standing about 4' tall and about 1' wide they don't just sound good, but look great too. Choose from oak, walnut or black veneer.



Walsh 100MKII	\$1,395/pr.	Walsh 200MKII	\$2,595/pr.	Walsh 300MKII	\$3,995/pr.
---------------	-------------	---------------	-------------	---------------	-------------

## NEAR Weather Proof

New England Audio Resource (NEAR) is the only speaker company in the world to design and manufacture their own all metal drivers. Metal drivers are faster than paper or polypropylene cones, they don't flex and warp (causing distortion), and they are weather-proof

			W/ Bracket
AEL1.1A	5 1/4" Metal cone, molded rust-free cabinet	\$159.00	\$175.00
AEL1.2A	Same as above but coaxial	\$179.00	\$195.00
AEL1.4A	2-Way, 5 1/4" metal cone LF, 1.1" titanium HF	\$229.00	\$249.00
AEL1.5A	2-Way, 6 1/2" metal cone LF, 1.1" titanium HF, sloped front	\$299.00	\$315.00
AEL1.6A	2-Way, 6 1/2" metal cone LF, 1.1" titanium HF Hi-density cabinet w/sealed enclosure	\$299.00	\$319.00
AEL2.0(C)	2-Way 6 1/2" metal cone LF, 1.1" titanium HF Hi-density fiberglass cabinet	\$599.00	
Optional Rack Mounts priced from \$32 to \$40 a pair.			



NEAR makes a full line of home speakers, from mini-monitors to elegant floor standing models ranging from \$399/pr. to \$7,000/pr.

## ADC Jack & Plug Cleaning

### Recommended Procedure for Cleaning ADC Audio and Video Jacks

Cleaning of ADC audio or video jacks can be accomplished ONLY by inserting and withdrawing a clean plug into the jack 5 or 6 times. This causes a mechanical wiping action which cleans both the springs that contact with the plug and the switching contacts. Burnishing tools are NOT to be used as this submits the jack springs to extreme wear and can cause intermittents. Under no circumstances should any liquids or gases be sprayed or otherwise applied into your jacks! This includes any contact cleaner, freon, compressed air, alcohol, mek or toluence. Any of these chemicals could ruin your jacks.

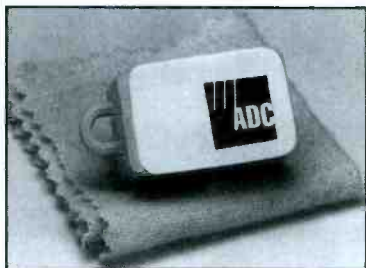

### Recommended Procedure for cleaning ADC unplated Brass Audio Plugs

- 1~ Moisten a clean cotton cloth, with clean tap water
  - 2~ Sprinkle a small amount of non-chlorine cleanser ( or a similar mild abrasive) on the moistened wipe.
  - 3~ Wrap the cloth around the brass area of the plug and rotate.
  - 4~ Rinse off the plug thoroughly in clean tap water and dry.
- Caution: DO NOT immerse the plug shell in water!





# patchbays/panels

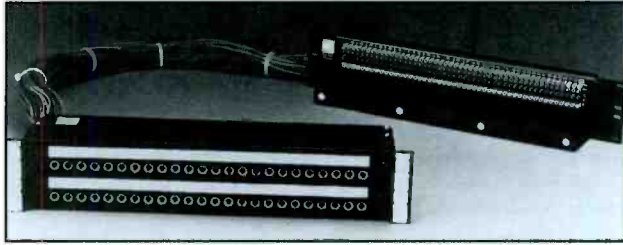

## ADC Audio Products

The ADC BKF Mark II incorporates the best features of the Pro Patch MKII into the BKF series, making the conventional patchbay quite unconventional. Your cabling and connections are secure—the unique chassis and the strain relief design see to it. Downtime is minimized because the front panel on all BKF MKIIs is removable from the front, providing easy access to the jacks.

The BKF Patchbays listed below have 4' cable harnesses. BKF Patchbays are available with 3', 4-8', 10', 12', 15', 20' and 25' harnesses. Add \$12.00/ft to your price and 3-4 weeks lead time.

### MKII BKF Patchbays, Longframe (1/4") 1.75"h, 2 x 24

BJF103-4MKII	Ultra Patch normals Brought out	\$967.00
BJF107-MKII	Ultra Patch normals Strapped	\$767.00

### MKII BKF Patchbay, Longframe (1/4") 3.5"h, 2 x 24

BJF203-4MKII	Ultra Patch normals Brought out	\$967.00
BJF207-4MKII	Ultra Patch normals Strapped	\$767.00

### MKII BKF Patchbay, Bantam 1.75"h, 2 x 48

BJF303-4MKII	Ultra Patch normals Brought out	\$1,548.00
BJF307-4MKII	Ultra Patch normals Strapped	\$1,401.00

### MKII BKF Patchbay, Bantam 3.5' h, 2 x 48

BJF403-4MKII	Ultra Patch normals Brought out	\$1,548.00
BJF407-4MKII	Ultra Patch normals Strapped	\$1,401.00

**ADC Digital Audio Jackfields** are specifically designed for patching AES/EBU digital audio signals. The fully normalised or half normalised panels are used to patch AES digital audio signals up to a total circuit length of 300 feet. As with standard ADC audio products, the patented QCP split cylinder contact is utilized for all wire terminations. This system ensures the highest quality by providing a secure, gas tight connection that can be reconfigured up to 200 times or replaced if damaged. This insulation displacement contact drastically reduces wiring time by eliminating wire stripping and soldering while providing easily identifiable circuit access.

#### Digital Pro Patch

DAL3-14MKIINS	2 x 24 rows (3.5" x 19 x 14"), longframe jacks, normals strapped	\$951.00
DAL3-14MKIIHN	2 x 24 rows (3.5" x 19 x 14"), longframe jacks, half normalised	\$951.00
DAB1-14MKIINN148	1 x 48 row (1.75" x 19 x 14"), bantam jacks, no normals	\$880.00
DAB3-14MKIIHN	2 x 48 rows (3.5" x 19 x 14"), bantam jacks, half normalised	\$1,467.00
DAB3-14MKIINN	2 x 48 rows (3.5" x 19 x 14"), bantam jacks, no normals	\$1,362.00
DAB3-14MKIINS	2 x 48 rows (3.5" x 19 x 14"), bantam jacks, normals strapped	\$1,467.00
DAL1-14MKII26ENS	2 x 26 rows (1.75" x 19 x 14") longframe jacks, normals strapped with ELCO connectors 90 Pin	\$1,040.00

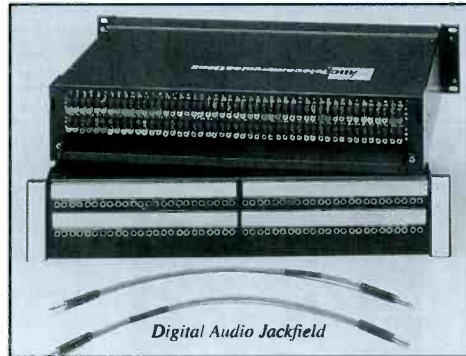

#### Digital Audio Nickel Plated Patch Cords

(Available in Black Only, Custom lengths available)

Length	Longframe	Price	Bantam	Price
1'	DA1	\$20.65	DA1B	\$14.93
2'	DA2	\$21.80	DA2B	\$16.09
3'	DA3	\$22.96	DA3B	\$17.24
4'	DA4	\$24.11	DA4B	\$18.40
5'	DA6	\$26.42	DA6B	\$20.70

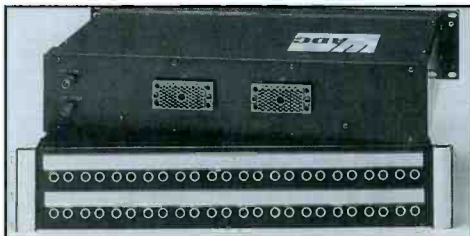

#### Digital Broadcast Jackfields (4' cable harness to QCP termination)

DAL107-4MKII	2 x 24 rows (1.75"), longframe jacks, normals strapped	\$983.00
DAL207-4MKII	2 x 24 rows (3.5"), longframe jacks, normals strapped	\$983.00
DAB307-4MKII	2 x 48 rows (1.75"), bantam jacks, normals strapped	\$1,617.00
DAB407-4MKII	2 x 48 rows (3.5"), bantam jacks, normals strapped	\$1,617.00

The ADC Connectorized Patchbays offer the maximum in installation flexibility for systems built at different locations or installations that are moved frequently. Because all the circuits are combined on multi-pin connectors, set up and tear down is fast and convenient. Cable harnesses of varying lengths can be substituted at different locations. In addition, cable harnesses can be pre-built on the bench instead of wiring in the racks, saving valuable installation time. Available in longframe or bantam versions; half or fully normalised; with 3-pin, 38-pin, 50-pin or 90-pin connectors; and I.C.O.N. breakout systems.



P  
A  
T  
C  
H  
B  
A  
Y  
S  
/  
P  
A  
N  
E  
L  
S



## ADC Audio Products

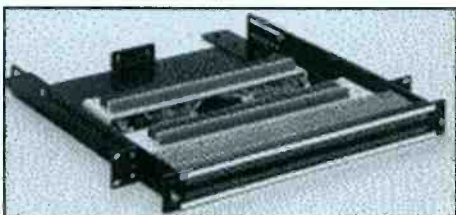

### ADC Bantam Audio Pull Out Panel (New)

ADC has developed a modified broadcast jackfield that incorporates 2 rows of 48 bantam jacks in a one rack unit panel that features a pull out drawer which houses the patented QCP punch down block for terminating audio circuits. This unit is fully normalled and was designed specifically for use in mobile trucks or where ever space is at a premium. 2RU and longframe (.25") versions are available upon request

BPOPI-NO or BPOP2-NO	<b>\$1,653.00</b>
----------------------	-------------------

The **ADC I-BJF** is a series of non-terminated patchbays designed to be terminated on I.C.O.N. wall or rack mount panels. The umbilical of the I-BJF features 24 pair cable for termination of inputs and outputs to the bay.

**Longframe**—3.5" Panel with 2 x 24 array. X Suffix denotes umbilical length in feet. Base Price shown is for 8' umbilical. Add \$ 12/ft to the suggested list price for umbilicals longer than 8'.

I-BJF-3NO-X	Normals brought out to backplane of chassis	<b>\$869.00</b>
I-BJF-3NS-X	Normals strapped at jacks	<b>\$719.00</b>
I-BJF-3HN-X	Half normalled. Top row mult, bottom row fully normalled	<b>\$719.00</b>

**Bantam**—1.75" Panel with 2 x 48 array. X Suffix denotes umbilical length in feet. Base Price shown is for 8' umbilical. Add \$ 20/ft to the suggested list price for umbilicals longer than 8'.

I-BJF-BNO-X	Normals brought out to backplane of chassis	<b>\$1,369.00</b>
I-BJF-BNS-X	Normals strapped at jacks	<b>\$1,219.00</b>
I-BJF-BHN-X	Half normalled. Top row mult, bottom row fully normalled	<b>\$1,219.00</b>



**PATCHBAYS/PANELS**

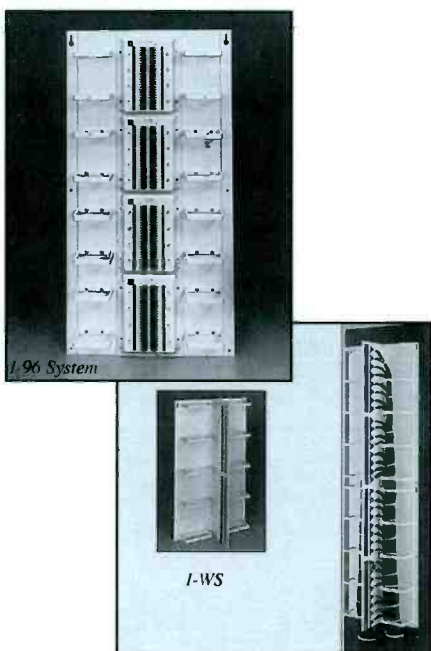

**ADC I.C.O.N. Rack Mount System** is an audio cable management system engineered for broadcast, production, recording and professional audio applications. The I.C.O.N. is used as the central termination and distribution point for the cabling in an audio system. All audio equipment cabling is terminated on the I.C.O.N. and signal routing is accomplished by cross-connecting cable terminations at this central point rather than point to point interconnections. This saves time and cable, and allows for signal path changes and equipment additions to be made quickly and easily.

### I.C.O.N. I-96 System

I-96	96 circuit termination panel	<b>\$200.00</b>
I-FPD	Fanning Panel for routing cables horizontally	<b>\$75.00</b>
I-FL	Vertical filler panel	<b>\$50.00</b>
I-FPB	Fanning Panel for routing cables horizontally and vertically	<b>\$105.00</b>
I-VR	Vertical ring bracket	<b>\$31.00</b>
I-ET3	Horizontal express trough—3.5"	<b>\$70.00</b>
I-ET5	Horizontal express trough—5.25"	<b>\$70.00</b>

### I.C.O.N. I-WS Systems

I-WS	Terminates and cross connects 192 balanced audio circuits	<b>\$599.00</b>
I-WSET	Express trough	<b>\$70.00</b>

### I.C.O.N. I-24 Systems

I-WA	Wall mount frame fitted with four I-24A blocks-Common Gnd.	<b>\$680.00</b>
I-WB	Wall mount frame fitted with four I-24B blocks	<b>\$660.00</b>
I-WFP	Wall mount fanning panel	<b>\$70.00</b>
I-24A	Terminates and cross connects 24 balanced audio circuits. Shield terminals multed. Left and right arrays multed.	<b>\$128.00</b>
I-24B	Same as I-24A but without multed shield terminals	<b>\$120.00</b>
I-24C	Same as I-24B - But unjumpered	<b>\$110.00</b>
I-24R	I-24 rack mounting rails	<b>\$24.00</b>

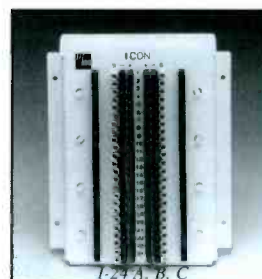



## ADC Audio Products

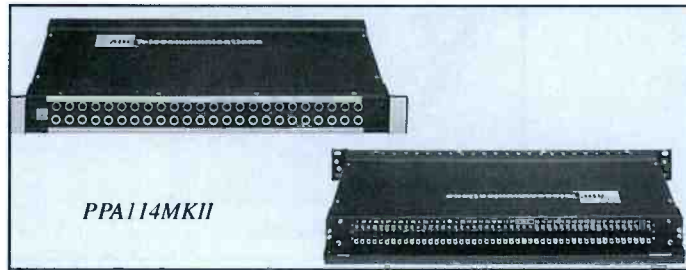
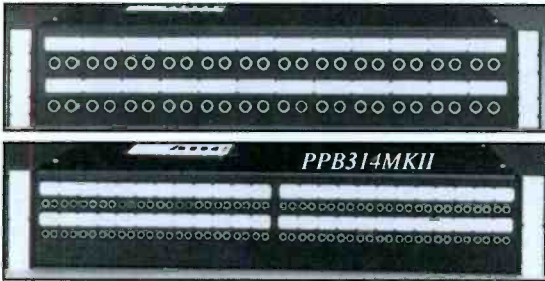

ADC has designed the **Pro Patch Mark II** panels front and back to deliver more time and work savings. In front, circuit designations are neat and convenient; and in back, the terminal layout affords faster installation and more flexibility of configuration.

### Pro Patch Stereo, Longframe (1/4"), 2 x 24

PPS3-14MKIINO	3.5" x 14", normals brought out	\$967.00
PPS3-18MKIINO	3.5" x 18", normals brought out	\$967.00
PPS3-14MKIINS	3.5" x 14", normals strapped	\$794.00
PPS3-18MKIINS	3.5" x 18", normals strapped	\$794.00

### Pro Patch Bantam

PPB1-14MKIINN	1.75" x 14", 1X48 no normals	\$1,144.00
PPB3-14MKIINS	3.5" x 14", Normals strapped, 2 x 48	\$1,250.00
PPB3-14MKIIHN	3.5" x 14", half normalled, 2 x 48	\$1,250.00

### Pro Patch Audio, Longframe (1/4"), 2 x 24

PPA1-14MKIINO	1.75" x 14", normals brought out	\$900.00
PPA3-14MKIINO	3.5" x 14", normals brought out	\$900.00
PPA3-18MKIINO	3.5" x 18", normals brought out	\$900.00
PPA1-14MKIINS	1.75" x 14", normals strapped	\$734.00
PPA3-14MKIINS	3.5" x 14", normals strapped	\$734.00
PPA3-18MKIINS	3.5" x 18", normals strapped	\$734.00
PPA3-14MKIISN	3.5" x 14", sleeve normalled	\$1,085.00



Designation Strip

### Designation Strips

SAILS-3	Labels for 3.5" Longframe Pro Patch, BJJ & PPV-24MKII	\$7.00
SAILS-S	Labels for Stereo Pro Patch	\$10.00
SAILS-1	Labels for 1.75" Longframe Pro Patch or BJJ	\$5.00
SAILS BBJF	Labels for Bantam BJJ	\$10.00
SAILS-BPP	Labels for Bantam Pro Patch	\$10.00
SAILS-V	Labels for VAMP	\$10.00
SAILS-S9	Labels for DPC chassis	\$5.00
D-3	Designation kit for 3.5" Longframe Pro Patch, BJJ, PPV-24MKII	\$15.00
D-S	Designation kit for stereo Pro Patch	\$15.00
D-1	Designation Kit for 1.75" Longframe Pro Patch, BJJ	\$15.00
D-BBJF	Designation Kit for Bantam BJJ	\$15.00
D-BPP	Designation Kit for Bantam Pro Patch	\$15.00
D-2PPI	Designation Kit for PPI2224 & 26 3.5" series	\$15.00
D-1PPI	Designation Kit for PPI1224 & 26 1.75" series	\$15.00

**Patch Kit Patchbay Panel** chassis design offers complete built-in cable support and protection for your jacks. The PJ339-L jack used in the Longframe Patch Kit features an offset ground lug for easy bussing of shield terminals.

P-KIT-1	Patch Kit, 1.75" Longframe 2 x 24	\$229.00
P-KIT-1A	Patch Kit, 1.75" Longframe 2 x 26	\$249.00
P-KIT-1S1	Patch Kit, Stereo 2 x 24	\$229.00
P-KIT-3	Patch Kit, 3.5" Longframe 2 x 24	\$229.00
P-KIT-3A	Patch Kit, 3.5" Longframe 2 x 26	\$249.00
P-KIT-3S	Patch Kit, 3.5" Stereo 2 x 24	\$229.00
P-KIT-B	Patch Kit, 1.75" Bantam 2 x 48	\$305.00
P-KIT-B1	Patch Kit, 3.5" Bantam 2 x 48	\$305.00

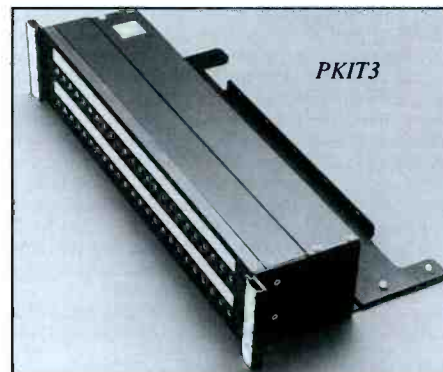

PKIT3

P A T C H B A Y S / P A N E L S



## ADC Audio Products



Pro Patch Cables

### Conventional Patch Cords - brass plugs, gray cable

Length	LF	Price Single	LF	Price Dual	Bnt	Price Single	Bnt	Price Dual
1'	PJ81	\$22.72	PJ171	\$47.63	PJ712	\$12.47	PJ762	\$19.52
2'	PJ82	\$23.79	PJ172	\$48.02	PJ714	\$13.02	PJ764	\$20.03
3'	PJ83	\$24.77	PJ173	\$48.47	PJ716	\$13.51	PJ766	\$21.17
4'	PJ84	\$25.74	PJ174	\$48.70	PJ718	\$14.02	PJ768	\$22.03
6'	PJ86	\$27.60	PJ176	\$50.59	PJ722	\$15.04	PJ772	\$23.68
Pro Patch Cord Holder			PPH	\$36.00				

New QB-2T has longer shaft with non-orienting tip for quicker, easier punch-downs!

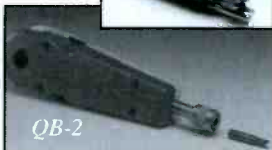

### QCP Tools

QB-2	Impact tool	\$75.00
QB-2T	Replacement tip for QB-2 & Q915	\$21.00
Q905	Replacement tip for QB-1 & Q914	\$48.30
QRK-25	QCP spare parts kit	\$30.00
Q115	Manual wire insertion tool	\$27.30
Q150	Rack mountable tool holder	\$35.70
SLVG-1	Sleeving kit, includes 100 pcs 2.5", white	\$3.00

### Pro Patch Cords - Nickel Plated

#### Long Frame Single

Length	Red	Green	Blue	Black	Price
1'	R1	G1	B1	BK1	\$21.43
2'	R2	G2	B2	BK2	\$22.23
3'	R3	G3	B3	BK3	\$23.04
4'	R4	G4	B4	BK4	\$23.84
6'	R6	G6	B6	BK6	\$25.46

#### Long Frame Dual

Length	Red	Green	Blue	Black	Price
2'	R22	G22	B22	BK22	\$46.30
3'	R32	G32	B32	BK32	\$47.11
4'	R42	G42	B42	BK42	\$47.92
6'	R62	G62	B62	BK62	\$49.53

#### Bantam Single

Length	Red	Green	Blue	Black	Price
1'	R1B	G1B	B1B	BK1B	\$16.90
2'	R2B	G2B	B2B	BK2B	\$17.71
3'	R3B	G3B	B3B	BK3B	\$18.51
4'	R4B	G4B	B4B	BK4B	\$19.32
6'	R6B	G6B	B6B	BK6B	\$20.94

#### Bantam Dual

Length	Red	Green	Blue	Black	Price
2'	R22B	G22B	B22B	BK22B	\$39.71
3'	R32B	G32B	B32B	BK32B	\$40.52
4'	R42B	G42B	B42B	BK42B	\$41.33
6'	R62B	G62B	B62B	BK62B	\$42.94

P  
A  
T  
C  
H  
B  
A  
Y  
S  
/  
P  
A  
N  
E  
L  
S

## ADC Fiber Systems

The ADC FL2000 (FL2) series of fiber optic products is designed specifically for the unique requirements of the enterprise network. Economical and flexible, the FL2 system is fully adaptable for large or small main distribution frame (MDF), intermediate distribution frame (IDF) or telephone closet (TC) applications. Flexible enough for a wide variety of customer requirements, the FL2 system provides termination, splicing and storage capabilities for in-building cables, outside plant cables and fiber optic terminal (FOT) equipment patch cords. The FL2 system's modular design provides maximum flexibility to satisfy both current needs and future growth requirements. A variety of options and accessories ensures compatibility with existing optical equipment.

### Features:

- FL2000 is a complete line of modular panels and boxes, developed for cabinet, rack and wall mounting.
- The FL2000 system accommodates the Value-Added connector modules, adding flexibility and functionality to the optical transport system. Splitters, wavelength division multiplexers (WDMs) and other optical components can be easily incorporated.
- The modular FL2 6pak plug-ins are intended for all FL2 panels and boxes and can be ordered as needed. They are available in all connector styles.
- ADC's patented removable angled retainers allow easy access for single fiber maintenance.
- ADC offers a full line of optical components to complete your installation, including optional locks.
- Superior vertical cable protection and management is provided.
- The FL2 rack mount panels are hinged on the left front side, allowing full access to the rear of the front plate and the interior of the panel.
- Rack mount panels are equipped with mounting brackets to provide 5" recess mounting. Mounting brackets are available for 1" or 2" recess for flush mounting.
- Rack mount panels are equipped with mounting brackets to provide 19" EIA rack or cabinet mounting. Optional brackets are available to accommodate 23" rack or cabinet mounting.
- Rack mount panels can also be wall mounted.
- The FL2 splice panels are available in 48 fiber and 144 fiber configurations.
- The FL2 splice deck offers a simplified and efficient means of fiber splice protection and fiber storage.

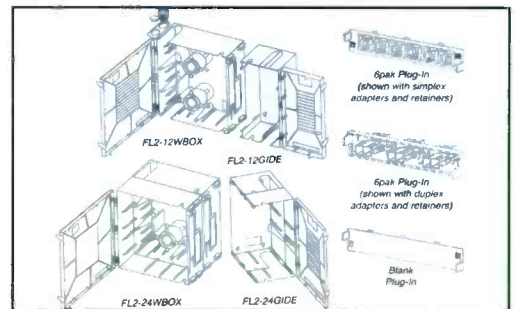

Call us for a complete ADC FL2000 Systems Catalog and pricing



## ADC Video Products



### ADC Time Delayed Patching

The length of video cable in a set of video circuits directly affects the timing of those circuits relative to each other. The difference of the length of a patch cord inserted in a video circuit can create a substantial timing error. When you use ADC's Video Pro Patch MKII panel with 3' ADC Pro Patch Video patch cords, no delay errors occur because of the delay compensation circuitry internal to each unit.

PPV-24MKII	Pro Patch Video 24 Circuits, delay compensated 31/3"H x 18"D	\$2,400.00
PPV-RPL-KIT	Circuit replacement kit (each kit replaces 1 circuit)	\$110.00

### Analog and Serial Digital Video Panels

The Professional Video (PV) panels feature a solid aluminum chassis with an insulated face plate, a top cover, side brackets, and a cable tray. The Video Patch Panel (PPI) series utilizes a standard one or two rack space insulated aluminum faceplate with an attached phenolic panel. This design has evolved into the industry standard.

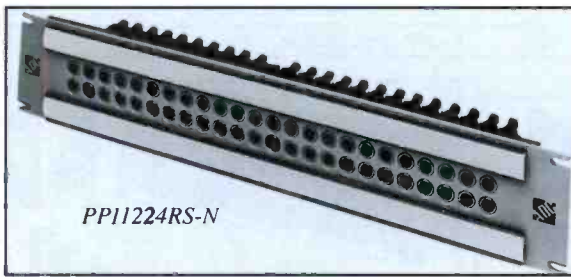

### PPI Video Blank Patch Panels

PPI1224RS	1.75" panel, 2x24 circuit	\$150.00
PPI1226RS	1.75" panel, 2x26 circuit	\$155.00
PPI2224RS	3.5" panel, 2x24 circuit	\$150.00
PPI2226RS	3.5" panel, 2x26 circuit	\$155.00

### PPV Professional Video Blank Panels

PV224B	3.5" panel, 2x24 circuit	\$125.00
PV226B	3.5" panel, 2x26 circuit	\$135.00

### PPI Video Panels with SJ2000N Jacks

PPI1224RS-N	1.75" panel, 2x24 circuit	\$1,007.00
PPI1226RS-N	1.75" panel, 2x26 circuit	\$1,080.00
PPI2224RS-N	3.5" panel, 2x24 circuit	\$1,007.00
PPI2226RS-N	3.5" panel, 2x26 circuit	\$1,038.45

### PPV Pro Video Panels with SJ2000N Jacks

PV224B-N	3.5" panel, 2x24 circuit	\$1,007.00
PV226B-N	3.5" panel, 2x26 circuit	\$1,080.00

### PPI Video Panels with SJ2000N-75 Jacks

PPI1224RS-75N	1.75" panel, 2x24 circuit	\$1,114.00
PPI1226RS-75N	1.75" panel, 2x26 circuit	\$1,209.00
PPI2224RS-75N	3.5" panel, 2x24 circuit	\$1,114.00
PPI2226RS-75N	3.5" panel, 2x26 circuit	\$1,209.00

### PPV Pro Video Panels with SJ2000N-75 Jacks

PV224B-75N	3.5" panel, 2x24 circuit	\$1,114.00
PV226B-75N	3.5" panel, 2x26 circuit	\$1,209.00

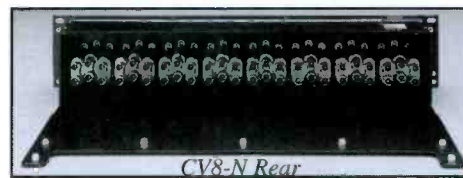

### C. A. P. S. Component Analog Patching System

#### Loaded Patchbays, (3.5"x19")

CV-8-N	8RGB Groups with SJ2000N jacks	\$1,074.00
CV-8-N75	8RGB Groups with SJ2000N-75 jacks	\$1,162.00
CV-6-NS	6RGB + Sync Groups with SJ2000N jacks	\$1,074.00
CV-6-N75S	6RGB + Sync Groups with SJ2000N-75 jacks	\$1,162.00

#### Modular Patchbays, (3.5"x19")

CV-CM	Chassis for CV-M-N and CV-M-N75 module, holds 8	\$150.00
CV-M-N	1RGB Groups with SJ2000N jacks	\$129.00
CV-M-N75	1RGB Groups with SJ2000N-75 jacks	\$141.00
CPPV-B	Blank module	\$10.00

#### Panels without Jacks, (3.5"x19")

CV-8-NJ	8RGB Groups Panel	\$390.00
CV-6-NJ	6RGB + Sync Groups Panel	\$390.00

#### RGB Patch Cords

CVPC-2	2'	\$58.00
CVPC-3	3'	\$58.00
CVPC-4	4'	\$58.00
CVPC-6	6'	\$63.00



Note: For sync patching, use an RGB patch cord and a single video patch cord. Four prong patch cords are not available.



### Component Analog Time Delayed Patchbay

CPPV-8	RGB Group delay compensated, 3.5"x19"	\$2,451.00
	(Use only with 3' patch cords)	



BGS

P  
A  
T  
C  
H  
B  
A  
Y  
S  
/  
P  
A  
N  
E  
L  
S



**PATCHBAYS/PANELS**

## ADC Video Products

### Pro Patch Video Patch Cords



	Red	Green	Blue	Black	Price
<b>Video Patch Cords</b>					
1'	R1V	G1V	B1V	BK1V	\$19.35
2'	R2V	G2V	B2V	BK2V	\$20.02
3'	R3V	G3V	B3V	BK3V	\$20.70
4'	R4V	G4V	B4V	BK4V	\$21.38
6'	R6V	G6V	B6V	BK6V	\$22.74



	Red	Green	Blue	Black	Price
<b>Video to BNC Patch Cords</b>					
2'	R2V-B	G2V-B	B2V-B	BK2V-B	\$19.18
3'	R3V-B	G3V-B	B3V-B	BK3V-B	\$19.86
4'	R4V-B	G4V-B	B4V-B	BK4V-B	\$20.54
6'	R6V-B	G6V-B	B6V-B	BK6V-B	\$21.90



	Red	Green	Blue	Black	Price
<b>BNC to BNC Patch Cords</b>					
2'	R2V-B/B	G2V-B/B	B2V-B/B	BK2V-B/B	\$19.18
3'	R3V-B/B	G3V-B/B	B3V-B/B	BK3V-B/B	\$19.86
4'	R4V-B/B	G4V-B/B	B4V-B/B	BK4V-B/B	\$20.54
6'	R6V-B/B	G6V-B/B	B6V-B/B	BK6V-B/B	\$21.90



Pro Patch Cord Holder \$36.00

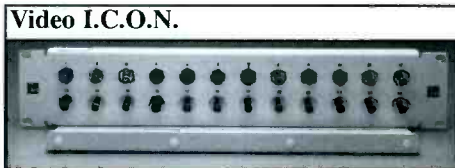

Video I.C.O.N.

VI-24	2 X 12 BNC Bulkhead Panel, 75Ω	\$281.00
VI-12	2 X 6 BNC Bulkhead Panel, 75Ω	\$187.00



Humbucking Coil \$147.00

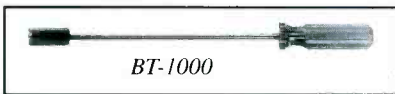

BT-1000

12" BNC Installation Tool \$40.17



CJ2011N



CJ1011

CJ1011N	Coax short body jack, BNC nickel	\$10.25
CJ2011N	Coax long body jack, BNC nickel	\$10.50



SVJ-2	\$38.00
SVJ-2-75	\$44.00

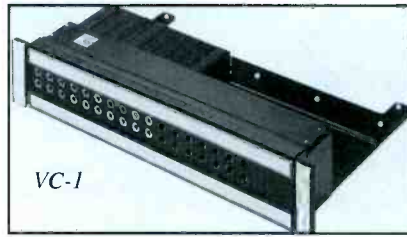

VC-1



### Video Audio Modular Patch Bay (V.A.M.P.)

VC-1	VAMP chassis, holds 20 modules	\$125.00
VA-1	VAMP audio module	\$45.00
VA-1RJ	VAMP audio Mod RJ	\$97.00
VAB-HN	VAMP audio CKT Bantam HN	\$79.00
VAB-NN	VAMP audio CKT Bantam NN	\$79.00
VAB-NS	VAMP audio CKT Bantam NS	\$79.00
VV-1	VAMP video module with SJ2000N-75 jack	\$47.00
VV-2	VAMP video module with SJ2000N jack	\$45.00
VV-3	VAMP video module with CJ2011N jacks	\$45.00
VB-1	VAMP blank module	\$2.00

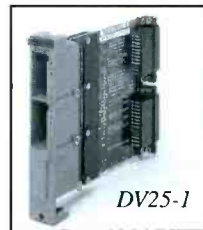

DV25-1

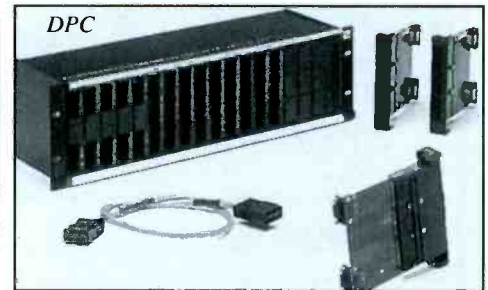

DPC

### RS -422 Machine Control Patching

S-9	Patch module, complies with RS422; ANSI/SMPTE 207M 9 Pin digital control interface standard. Two normalled ports.	\$146.00
S-9T	Same as S-9 but features two independent ports	\$143.00
DV25-1	Patch module-RS232-Digital Video 25 Pin FF	\$146.00
PMBF-1	Blank module	\$21.00
PMCG-1	Circuit guard - red	\$18.00
PMCG-2	Circuit guard - white	\$18.00
DPC	Chassis, holds 18 S-9 or RS-232 modules	\$150.00
PMP-702001	2' Balanced SMPTE patch cord	\$87.00
PMP-703001	3' Balanced SMPTE patch cord	\$87.00
PMP-704001	4' Balanced SMPTE patch cord	\$87.00
PMP-706001	6' Balanced SMPTE patch cord	\$100.00
PMCCP-M9-6	6' Conversion patch cord. PM to EIA male	\$160.00
PMCCP-M9-10	10' Conversion patch cord. PM to EIA male	\$171.00

**New from ADC (SVJ)**, a state-of-the-art, dual, self-normalling, high data rate, dust sealed super video jack. It offers >2GHz bandwidth and a true 75 Ω circuit path patched and normalled when used in concert with ADC's new CPT-75 coax plug-terminated patch cords. Designed for use in applications like: HDTV, DTV, D1 as well as analog video transmission where high bandwidth and true 75Ω integrity are paramount!



# patchbays/panels

**dbx**



The **dbx PB-48** is for the studio where there is a need to frequently change cable routing and patching. It gives you 48 TRS I/O patchpoints that are necessary when patching balanced signals or send/return signals on insert jacks. Each vertical pair of jacks is easily configurable to allow half-normalled operation. 1U

PB-48

\$179.95



**BGS**

## Gentner

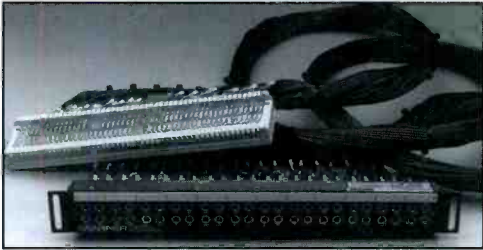

### Gentner Prewired Audio Patch Panels

All Gentner bayfronts are made of phenolic (non conductive) black thermoset material, with steel mounting brackets. Jacks are Tip-Ring-Sleeve (TRS), with normals on the Tip and Ring connections. The cable is 22 gauge, stranded, twisted pair with shield and overall shield. Standard cables are 5' in length and exit the patch panel on the left as viewed from the rear.

<b>BO-</b>	Normal brought out
<b>PU-</b>	"66" type punch block
<b>AB-</b>	Normals strapped at bay
<b>FB-</b>	Gentner Flexiblock
<b>TRB-</b>	Top row normals are bridged
<b>SP-</b>	Gentner Superpatch
<b>XT-</b>	Christmas Tree (special order)

24SR-TRS-BO-PU	\$659.00	24SR-TRS-BO-FB	\$759.95
48DR-TRS-AB-SP	\$959.00	48DR-TRS-AB-PU	\$899.00
48DR-TRS-AB-FB	\$959.00	48DR-TRS-AB-XT	\$959.00
48DR-TRS-BO-SP	\$1,299.00	48DR-TRS-BO-PU	\$1,199.00
48DR-TRS-BO-FB	\$1,299.00	48DR-TRS-BO-XT	\$1,299.00
48DR-TRS-TRB-SP	\$959.00	48DR-TRS-TRB-PU	\$899.00
48DR-TRS-TRB-FB	\$959.00	48DR-TRS-TRB-XT	\$959.00
52DR-TRS-AB-SP	\$1,199.00	52DR-TRS-AB-PU	\$1,099.00
52DR-TRS-AB-FB	\$1,199.00	52DR-TRS-AB-XT	\$1,199.00
52DR-TRS-BO-SP	\$1,399.00	52DR-TRS-BO-PU	\$1,299.00
52DR-TRS-BO-FB	\$1,399.00	52DR-TRS-BO-XT	\$1,399.00
52DR-TRS-TRB-SP	\$1,199.00	52DR-TRS-TRB-PU	\$1,099.00
52DR-TRS-TRB-FB	\$1,199.00	52DR-TRS-TRB-XT	\$1,199.00
96DR-TRS-AB-SP	\$1,799.00	96DR-TRS-AB-PU	\$1,699.00
96DR-TRS-AB-FB	\$1,799.00	96DR-TRS-AB-XT	\$1,799.00
96DR-TRS-BO-SP	\$2,599.00	96DR-TRS-BO-PU	\$2,499.00
96DR-TRS-BO-FB	\$2,599.00	96DR-TRS-BO-XT	\$2,599.00
96DR-TRS-TRB-SP	\$1,799.00	96DR-TRS-TRB-PU	\$1,699.00
96DR-TRS-TRB-FB	\$1,799.00	96DR-TRS-TRB-XT	\$1,799.00

**Gentner Versapatch II** is a 2U, chassis-enclosed stereo patch panel. It contains 48 tip-ring-sleeve jacks offset in pairs, configured in two rows.

Versapatch II/FB-BO	Normals Brought Out	\$1,349.00
Versapatch II/FB-AB	Normals Jumpered at Bay	\$899.00
Versapatch II/FB-TRB	Half Normalled	\$899.00

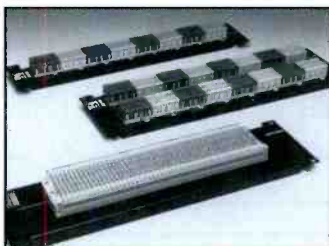
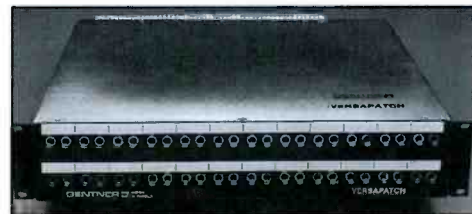

**Gentner's SuperPatch** patch panel assemblies provide you with a convenient and flexible rack mount termination for your wiring projects. SuperPatch is available with one or two rows of Flexiblocks secured to a fixed rack mounted aluminum panel to make punchdown of stranded or solid wire connections fast and easy. SuperPatch may be ordered terminated to any of Gentner's prewired patch panels at the factory.

SuperPatch/1	One row, 160 terminal w/two slots per terminal, 2 wire/slot, 2U	\$159.00
SuperPatch/2	Two row, 320 terminal w/two slots per terminal, 2 wire/slot, 3U	\$249.00

**PATCHBAYS/PANELS**



**BGS**

**P  
A  
T  
C  
H  
B  
A  
Y  
S  
/  
P  
A  
N  
E  
L  
S**

## SIEMON

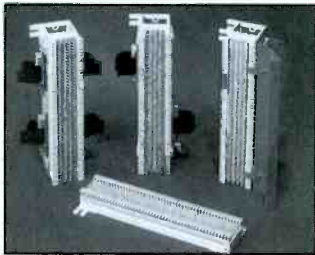

Model	Pair Capacity	Price
S66M1-25	25	\$13.45
S66M1-50	50	\$12.65
S66M1-100	100	\$28.45
S66B3-50	50	\$21.95
S66B3-75	75	\$25.75

Siemon offers over 20 different size blocks configured from 2 pair up to 250 pair per block. There are two basic series for all 66 blocks the M Series and the B Series. The M Series clips are closer together allowing for a greater packing density. The M and B series are end-stackable, but the M series stacks without losing space between blocks. All the "plug-on" adapters and accessories are designed for use with the M series

### Accessories

S20B	Cable hanger, 1-3/4" diameter top x 3" high self contained wood screw	\$1.19
S145	Single hanger with front entry, and a base. 3-1/2" base to front & 3-1/8" vertical lower hanger	\$3.25
SB6	Mounting bracket, for use with the B series blocks	\$6.95
S89D	Mounting bracket, for use with the M series blocks	\$2.09
SAI-1000	Tin-plated Copper Alloy Clips, 2-position clips, 1000 per polybag	\$29.50
SAI-100	Tin-plated Copper Alloy Clips, 2-position clips, 100 per polybag	\$3.95
S714	Automatic impact tool w/66 blade	\$79.00
S71401	Spare blade for S714 tool	\$23.75
SBT	Manual punch down tool w/66 blade	\$28.00
3M ST	Connector punch block hook-up	\$0.44

## Tascam



### Tascam Patchbays

PB-32H	32 Point Normalled and Unbalanced, Phone front to RCA rear	\$185.00
PB-32P	32 Point Normalled and Unbalanced, Phone front to phone rear	\$185.00
PB-32R	32 Point Normalled and Unbalanced, RCA front to RCA rear	\$185.00
PB-32W	32 Point Normalled and Unbalanced, Combo (20 - RCA & 12 - Phone)	\$185.00
PB-32B	32 Point Normalled and Balanced, TRS Phone front to TRS Phone rear	\$210.00

## power conditioning

### BEST

Best Power Technology, Inc. has a complete line of power back up and protection products. The Fortress® is a microprocessor-controlled, line-interactive UPS from 360VA to 3KVA. It is small and lightweight, and features a digital display with an intelligent, interactive interface. The Ferrups®, ferroresonant-based, line-interactive UPS from 700VA to 18KVA, offers Artificial Intelligence, full voltage regulation and complete galvanic isolation. The Patriot™ Standby Power Systems with enhanced power protection features; Citadel™ ferroresonant-based power conditioners from 110VA to 1.8KVA; SpikeFree™, a line of multi-stage surge suppressers; and UBS™, DC power sources that provide extended run times for 48-volt and 120-volt UPS products. This is just a small sampling of available Best power protection.

Please call Broadcasters General Store for a Best catalog.



Model	Description	VA/Watts	Runtime full/ Half Load(min.)	Volts In/Out	Price
<i>*Rack Mountable</i>					
SMT280B	Patriot® for PCs	280/175	9/27	120	\$129.00
SMT420B	Patriot® for PCs	420/260	4/12	120	\$179.00
LI1020B	Fortress® for network	1120/675	7/19	120	\$779.00
LI720BR*	Fortress® for network	720/470	5/15	120	\$699.00
LL1020BR*	Fortress® for network	1020/700	7/18	120	\$879.00
FE850VA	Ferrups® for lg. systems	850/600	11/28	120	\$1,229.00
FE1.15KVA	Ferrups® for lg. systems	1.15KVA/800	18/48	120	\$1,789.00
FE1.8KVA	Ferrups® for lg. systems	1.8KVA/1.25KW	11/30	120	\$2,649.00

## Whirlwind



Whirlwind rackable power strips have an on/off switch • a resettable circuit breaker • and 15 amp capacity.

AC6R	Six AC outlets	\$54.00
AC6RSP	AC6R with surge protection	\$79.80
AC4R2F	Four outlets on rear, two on the front	\$53.00



# power conditioning

## dbx

The **dbx Power Light** rack-mount module provides the dual convenience of an adjustable light source plus 8 separately switched, surge and spike protected AC outlets. The two retractable light tubes have their own switch and dimmer control.

dbx 115 \$159.95



**BGS**

## EDCO

The **EDCO BMC Series** is a rugged, highly reliable main or branch distribution panel surge protector. Installed in parallel, the BMC Series offers maximum protection for major facilities such as office buildings, entertainment complexes, schools, etc. In addition it is ideal for protecting computer installations and other sensitive electronic equipment. The BMC offers full redundancy which is monitored with 6 diagnostic indicator lights. 40KA to 125KA Surge Capacity • 5 year warranty • 6"Wx8"Hx4"D

Model No.	Panel Application	Electrical Service	MAX Surge	Price
BMC208Y-40R	Branch	120/208V; 3 PH-WYE; 4W + Grnd.	40,000 A/PH	\$495.50
BMC208Y-75R	Branch/Main	102/108V; 3 PH-WYE, 4W + Grnd.	75,000 A/PH	\$627.50
BMC208Y-125R	Main	102/108V; 3 PH-WYE, 4W + Grnd.	25,000 A/PH	\$811.50
BMC408Y-125R	Main	277/480V; 3 PH-WYE, 4W + Grnd.	125,000 A/PH	\$957.50



The **EDCO EMC 240B** is a rugged, highly reliable panel surge protector for 120/240V I/O applications. It features totally solid-state construction with two advanced, metal oxide varistors (MOV), each capable of 40,000 amps of surge current. After a surge, the suppressor automatically recovers and is ready for the next surge. (Hopefully)

EMC-240B \$126.00

*EDCO has a wide selection of power protection, please call to request a complete catalog.*



The **EDCO HMP Series** is a parallel suppresser, designed for use at the service entrance or branch/distribution electrical panel. It provides protection against high energy spikes and transients induced onto electrical power lines. The HMP Series features replaceable protection modules, high current fusing and per phase status indicators. 65KA Surge Rating. 8.4"Wx8.4"Hx4.0"D



The **EDCO LMC and LTL Series** surge suppressers are designed to be hardwired or cord connected, and are ideal for protecting automated equipment, computer hardware, and mainframes. Surges up to 40,000 Amps per phase.

Model No.	Electrical Service (All 3 phase)	Price
HMP208Y	120/208V; 3PH; 4-wire WYE	\$1,082.82
HMP120/240D	240V; 3PH; 4-wire DELTA	\$1,082.82
HMP240D*	240V; 3PH; 3-wire DELTA	\$1,082.82
HMP480Y	277/480V; 3PH; 4-wire WYE	\$1,082.82
HMP480D*	480V; 3PH; 3-wire DELTA	\$1,082.82

\* These special models not listed with UL

Model No.	Electrical Service	Price
LMC240A	120V/240V; 1PH; 3Wire	\$391.25
LMC208Y	120V/208V; 3PH; 4Wire	\$417.38
LTL-20	120V/240V; 1PH; 3Wire	\$438.38
LTL-30	20V/240V; 1PH; 3Wire	\$438.38

The **EDCO SRS-232** utilizing silicon avalanche clamp devices, is intended as a secondary level surge protector for IEEE Std. RS-232C peripheral devices.

SRS-232-25	Interface with 25 pin connectors, protects pins 2-8 and 20	\$69.00
SRS-232-9	Interface with 9 pin connectors, protects all pins	\$69.00



## ETA Systems



PD-9	9 Outlets, 8 lbs.	\$200.00
PD10	10 Outlets, (8 switched, 2 fixed on), 8 lbs.	\$160.00
PD10V	10 Outlets, Digital Voltage Readout, 8 lbs.	\$280.00
PD11L	11 Outlets, Hi/Low lights, 8 lbs.	\$240.00
PD11LV	11 Outlets, Hi/Low lights, Digital Voltage Readout, 8 lbs.	\$360.00
PD10VRS	10 Outlets, Digital Voltage Readout, 1.5-30 Sec. on/off Seq., 25 lbs. A.C. Line Voltage Regulator	\$990.00
PD11S	11 Outlets, 5-30 Sec. on/off Sequencing, 9 lbs.	\$380.00

### ETA conditioned power distribution

units are designed to prevent damage to sensitive equipment from sudden voltage spikes and potentially damaging power surges as well as from EMI/RFI interferences. The sequencing units are specifically designed to protect and filter any electronic equipment that requires a time delayed power up and down. 1U, 120V standard, 15 Amps per unit, with most available in 220/230/240V with IEC-320 connectors.

POWER CONDITIONING

**Broadcasters General Store (352) 622-7700 Fax (352) 629-7000**





**BGS**

**P  
O  
W  
E  
R  
  
C  
O  
N  
D  
I  
T  
I  
O  
N  
I  
N  
G**

## Furman

The **Furman PL-8** power conditioner and light module has eight switched AC outlets on the rear panel and two slide-out light fixtures with a dimmer control. The PL-8 protects your delicate electronic equipment by combining a high voltage surge and transient suppresser with an RFI/EMI interference filter. The **PL-PLUS** is an enhanced version of the PL-8. On the front panel it provides a display of AC line voltage by means of a 20 LED bargraph meter, reading from 90 to 128 volts in two volt steps. It also features a higher 15 amp rating, with a heavy-duty 10 foot power cable.



PL-8	\$159.00
PL-PLUS	\$229.00

## Juice Goose



The **Rackpower Series** are rack mounted power distribution panels with 120 volt power outputs and 15 amps of power (1800 watts) in all steel chassis with spike protection, and super discriminating EMI RFI filters.



**Juice Goose JG8.0** is a rack mount, power distribution panel with eight 120 volt power outputs. Fifteen amps of power, and angled outlets to accommodate wall warts. Includes AC line conditioning and spike protection.

Rackpower 100	Eleven outputs and a BNC connector for Litelite	\$179.00
Rackpower 200	Ten outputs with two dimmable pull out tubular lights and color-coded 20 LED input voltage meter.	\$282.00
Rackpower 320	Ten outputs, includes "star" ground, ground lift and ground fault interrupt features to safely solve ground loop problems. Automatic power drop out relay protect against damaging spikes.	\$329.00

JG8.0		\$85.00
JG8.0L	JG8.0 plus 2 dimmable, pull out tubular lights	\$120.00
JG8.0LM	JG8.0L plus a color-coded, 20 LED input voltage meter	\$189.00

## TRIPP LITE

**BC Pro UPS System** is microprocessor controlled for blackout protection and brownout switchover to battery at 101 volts • Diagnostic LEDs alert you to UPS operating conditions • Built-in self test function, surge suppression and line noise filtering • LAN UPS • \$25,000 Ultimate Lifetime Insurance on connected equipment • 2 Year Warranty.

BCPRO450	Mid-size PC or Mac, network hubs, 14" mon. protection, 450VA/325W, 4 outlets	\$199.00
BCPRO550	Large PC or Mac, routers, stand-alone PC protection, 550VA/375W, 4 outlets	\$259.00
BCPRO675	PC's, CAD station, multiple workstation protection, 675VA/425W, 4 outlets	\$299.00
BCPRO850	Heavily configured PC's, LAN fileservers protection, 800VA/570W, 4 outlets	\$399.00
BCPRO1050	Pentium network graphic workstation protection, 1050VA/735W, 6 outlets	\$449.00
BCPRO1400	Mini computer, several PC's protection, 1400VA/980W, 6 outlets	\$569.00

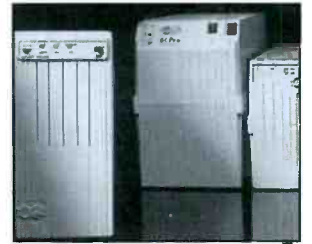

**BC Personal Battery Back-Up Systems** guard against blackouts, brownouts, surges and spikes • Compact tower style case has small footprint (9"x5"x6") • \$25,000 Ultimate Lifetime Insurance on connected equipment • 2 Year Warranty

BCPERS200	Basic PC or small Mac protection, 200VA/140W, 2 outlets	\$109.00
BCPERS280	AT, 386, or medium Mac protection, 280VA/175W, 2 outlets	\$129.00
BCPERS420	486, Windows apps, 15" color mon, large Mac protection, 420VA/295W, 4 outlets	\$175.00
BCPERS500	486, Pentium fully configured, 17" monitor protection, 500VA/350W, 4 outlets	\$229.00

All the features of the **Isobar line plus**, premium diagnostic LED indicators alert you to loss of AC power, damage to protection circuitry and improper outlet wiring. \$25,000 Ultimate Lifetime Insurance protects Isobar and connected equipment against surge damage, including lightning. Lifetime Product Warranty.

ISOBAR4Ultra	4 outlets, 6' cord, 1050 joule rating, handles spikes to 84,000 amps	\$89.95
ISOBAR6Ultra	6 outlets, 6' cord, 1200 joule rating, handles spikes to 96,000 amps	\$104.95
ISOBAR8Ultra	8 outlets, 12' cord, 1200 joule rating, handles spikes to 96,000 amps	\$116.95
ISOBAR8RM	Same as ISOBAR8Ultra but a rackmount unit	\$129.50

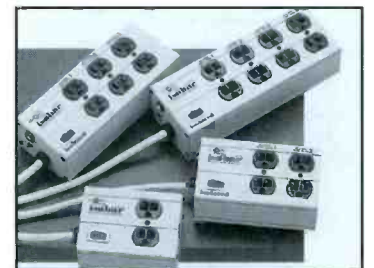

**COAX Surge Suppressors for A/V Equipment** protect your investment in big screen video, VCRs, editing and satellite equipment. "F" connectors for cable TV coax, plus six protected AC outlets. Provides: 960 joules rating and instantaneous AC surge response handling up to 36,000 amp spikes. \$25,000 Insurance coverage.

ISOBAR6COAX	\$119.95
-------------	----------

**ISOBAR Under-Monitor Surge Suppressors** plus RJ11 jacks for modem/fax protection. Lifetime Warranty.

CC16PLUS	6 outlets, handles spikes to 96,000 amps, \$10,000 Ultimate Lifetime Warranty	\$127.95
MT6PLUS	6 outlets, handles spikes to 120,000 amps, LEDs, \$25,000 Ultimate Lifetime Warranty	\$149.95



# GREAT AUDIO... FAST!

## AIRcorp model 500 TV Microphone Processor



- Eliminate flanging (hollow room) effect
- Eliminate bad room acoustics
- No talent cross talk
- Correct lapel microphone off-axis phase delay
- +4 to -50db input levels
- 48vdc phantom supply
- Three section variable phase corrector/equalizer
- Compressor/expander for maximum control
- DE-ESSER designed to protect pre-emphasis curves
- Absolute level control
- Simultaneous mic level and line level outputs

# **AIR corp**

THE ONE  
YOU'VE BEEN  
WAITING  
FOR



SHURE UHF WIRELESS

This is as good as it gets.

The new Shure UHF Wireless delivers everything you'd expect from a premium-quality UHF system — and more.

The system offers features like LCD displays on both transmitters and receivers. A generous 225 channels of frequency-agility. The flexibility to perform flawlessly in practically any application. And the built-to-last reliability you expect from Shure. All for an unbeatable price. You patiently waited for it. Now it's waiting for you.

To learn more, phone Shure Brothers Europe, 49-7131-72140.

# **SHURE**<sup>®</sup>

The Sound of Professionals...Worldwide.<sup>®</sup>

# The One-Two Punch



**The 610 Broadcast Delay makes talk radio safe and easy!**

The Symetrix 610 Stereo Broadcast Delay allows talk show hosts to "Dump" obnoxious callers and automatically build back 7.5 seconds of delay time.

Two-stage dump option allows quick turn-around of callers.

The "Cough" button mutes the program without dead air.

Easy "plug & play" installation.

A pricetag of \$2,695 US suggested retail.

# For Talk Radio.



**The 528E Voice Processor makes *any* talk show host sound good!**

Voice talent is expensive. So why not get your money's worth? The 528E is the industry standard voice processing toolbox, featuring a top quality preamp, compressor, de-esser, three bands of parametric EQ, and a downward expander plus a phase rotator all in one unit.

Three overlapping parametric equalizers.

Variable compression ratio.

3 bands of variable frequency EQ.

Switchable phase rotator.

US suggested retail price of \$699.

**Symetrix**



# power conditioning

## TRIPP LITE

**DataShield Dataline surge suppressers** are critical for the data lines connecting networked equipment. They guard against the effects of lightning, electrostatic discharge, ground surges and faulty wiring which routinely cause glitches, lock-ups and hardware damage. Installed directly at the data port, protection is now available for virtually any interface. Lifetime Product Warranty.

DHUB	RJ45, 8-port ethernet, token ring, RS422/423/485	\$279.00
D10B2	10 base 2 thin coax protector(M/F BNC jacks), for IFM 3270 & CCTV	\$33.95
D10B2T	10 base 2 thin coax protected "T" (F/M/F BNC jacks), for IBM 3270 & CCTV	\$47.95
DB9	Serial DB9 RS232 protector (pins 1-9) for any male or female 9-pin port	\$29.95
DTEL2	RJ11 two line dial-up protector, ideal for modems, faxes, answering machines, etc.	\$33.95
DCATV	Coaxial protector (M/F "F" connectors) for Cable TV applications	\$47.95



**IsoTel Surge Suppressers** gives you protection from surges, spikes and line noise from phone and data lines, as well as AC power lines. Instantaneous surge response with suppression up to 54,000 amp spikes. Ultimate Lifetime Insurance protects connected equipment for up to \$25,000 from spikes and surges, including lightning, for life.

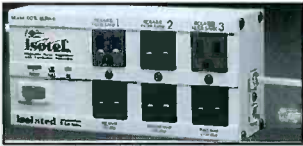

ISOTEL4Ultra	4 outlets, 6' cord, 1350 joule rating	\$109.95
ISOTEL6Ultra	6 outlets, 6' cord, 1500 joule rating	\$119.95
ISOTEL8Multimedia	8 outlet, 12' cord, 1500 joule rating, multimedia/fax/modem protection	\$134.95

**OmniPro Series Line Interactive Standby UPS Systems** are designed for poor power environments, Omnipro's UPS systems keep you working through low or high voltage conditions without using any battery power. • Multi levels of voltage correction • Recharges batteries during brownouts • up-front LED's supply information on UPS operating conditions, battery status, self-test results • \$50,000 Ultimate Lifetime Insurance protects connected equipment against surge damage, including lightning. • 2 Year Warranty.

OMNIPRO280	Hubs and routers protection, 280VA/175W, 4 outlets	\$169.00
OMNIPRO450	Heavily configured PC's protection, 450VA/280W, 4 outlets	\$274.00
OMNIPRO675	LAN file servers protection, 675VA/425W, 4 outlets	\$349.00



**SMARTPRO NET Intelligent Network UPS Systems** is a complete single carton solution to computer power problems, complete with CD-ROM Management and Shutdown Software and cabling. • Four levels of voltage correction • Front panel LED's constantly display UPS load and battery charge status • \$50,000 Ultimate Lifetime Insurance on connected equipment • 2 Year Warranty.



SMART280NET	Mid-size Mac or 14" monitor protection, 280VA/175W, 4 outlets	\$279.00
SMART450NET	Large Mac. 386 or sm color monitor protection, 450VA/280W, 4 outlets	\$369.00
SMART700NET	Heavily config. 386/486 protection, 700VA/470W, 4 outlets	\$469.00
SMART850NET	850VA/530W. 4 outlets, no software or cable	\$599.00
SMART700RM	700VA/450W, 3U, 6 outlets	\$599.00
SMART1050RM	1050VA/705W, 3U, 8 outlets, RJ11 jacks	749.00
SMART1400RM	1400VA/940W, 3U, 8 outlets, RJ11 jacks	\$949.00
SMART2200RM	2200VA/1750W, 5U, 8 outlets, RJ11 jacks	\$1,549.00

## BGS composite

### Microcon Systems



**The FM FlexiMod** composite processor will improve your sound, extend your coverage, and

keep you legal. The proprietary c-limiter module emulates the best attributes of a super-fast, very clean limiter combined with an effective, low-distortion clipper. For the first time you can be loud and punchy without being squashed and distorted. You can configure your FM FlexiMod for several different and distinct modes of operation, depending on the on-air results you desire. Features include: Distortion -cancelling circuitry • Up to 6dB of composite processing possible • Fully regulated external power supply • True 50Ω output • Full stereo separation • 4-LED activity meter • Flat or de-emphasized metering • Can be configured for regenerated pilot or can accept direct pilot from stereo generator • Knob or tweaker control • and Rack mount standard. *Please call BGS to arrange a demonstration.*

FM FlexiMod	\$1,395.00
-------------	------------

### Modulation Sciences



**Modulation Sciences' CP-803** Composite processor keeps your FM station loud, clean and legal. Use it with any combination of conventional audio processing to provide up to 6dB of additional loudness.

CP-803	Composite Processor	\$1,495.00
--------	---------------------	------------

**Broadcasters General Store (352) 622-7700 Fax (352) 629-7000**



**BGS**

**P  
O  
W  
E  
R  
  
C  
O  
N  
D  
I  
T  
I  
O  
N  
I  
N  
G**





**BGS**

**P  
R  
O  
C  
E  
S  
S  
O  
R  
S**

## CRL



The **CRL Amigo AM** is a complete, self contained processor for AM stereo or mono applications. It contains wide range multi-band AGC, exclusive matrix limiting with full mono gain support, and stereo soundfield enhancement circuitry. Easy to set up and use. 1U

Amigo AM **\$3,195.00**

The **CRL SEC-400/800** use four bands of compression and dynamic equalization to help tailor your own on-air sound. They can also be used to increase loudness and density. Selectable compress or limit operation and selectable time constants add to the flexibility of the SEC-400 and SEC-800.

SEC-400 Mono **\$1,850.00**  
SEC-800 Stereo **\$2,350.00**

The **CRL PMC-450** is a peak modulation controller that uses a combination of NRSC standard pre-emphasis, tri-band limiting, clipping and filtering to permit maximum loudness with minimum distortion. It also has a gated, wideband compressor that has 20dB of AGC range. With two separate outputs the PMC-450 can drive two transmitters.

PMC-450 Mono **\$2,150.00**

The **CRL SMP-950** is a tri-band AM Stereo matrix processor using a CRL patented combination of sum and difference limiting and adjustable single channel limiting to optimize stereo fidelity while maintaining mono compatibility. The SMP 950 also has a gated wideband compressor, integral stereo enhance and a tilt corrector for optimizing performance with older transmitters.

SMP-950 **\$2,650.00**

## Inovonics



**Inovonics 222** is an audio processor specifically intended for AM broadcasting. It incorporates an "adaptive" pre-emphasis characteristic to enhance signal intelligibility and "presence," and a sharp cut-off, low-pass function to eliminate adjacent channel interference. It also has feed-forward PWM control and a built in peak limiter.

222 **\$620.00**



The **CRL MBL-100** is a stand alone processor designed for AM news/talk and sports formats. By combining 7.5 kHz filtering with powerful multi-band limiting, very high levels of average modulation density are achieved, therefore, intelligibility of speech is improved as is signal coverage area.

MBL-100 **\$3,895.00**

MBL-100 / AGC-400 **\$5,195.00**



Shown AGC-400 SEC-400 PMC-450

The **CRL AGC-400** is a mono, gated, dual-band/wideband AGC providing up to 30dB of gain reduction range. Dynafex® noise reduction is included, as is EQ balance and selectable time constants. The AGC-400 is used before an STL or telco line to prevent overload. Stereo model is the SGC-800.

AGC-400 Mono **\$1,650.00**

SGC-800 Stereo **\$2,250.00**

**CRL AM Systems** (Most of these CRL packages offer split chassis flexibility!)

### AM Mono Systems

AM-2m AGC-400, PMC-450A **\$3,395.00**

AM-4m AGC-400, SEC-400, PMC-450 **\$4,895.00**

### AM Stereo Systems

AM Amigo Stereo processor **\$3,195.00**

AM-2s AGC-800, NRSC SMP-950 **\$4,395.00**

AM-4s AGC-800, SEC-800, SMP-950 **\$6,395.00**

## Orban

### The Optimod 9100B2

is an analog audio processing system for AM broadcast C-QUAM stereo-LW or MW. It provides you with automatic gain control to ride levels, high-frequency boost that compensates for the roll-off in receivers (giving you a brighter sound), a six-band limiter with distortion-canceling clipper for a very loud and clean sound and switchable low-pass filters (NRSC or CCIR/EBU standard). It also provides compensation for the LF tilt and HF overshoot that cause over-modulation in less-than-perfect transmitters and antennas. The result is noticeably more loudness.



9100B2/U10 Stereo **\$6,350.00**  
8200ST/U Studio chassis for 9100B **\$1,400.00**  
MRF023 AM monitor roll-off filter **\$50.00**  
RET043A Upgrades mono 9100A to stereo **\$2,000.00**  
RET043B Up-grades mono 9100B to stereo **\$1,900.00**



**Orban**

**Orban Optimod 9200** is a completely redesigned 100% digital, fully programmable processor offering conventional remote control or Windows based PC (386 4MEG RAM minimum) control. The 9200U has analog I/O's and can be upgraded to include 20 bit AES digital I/O with automatic sample rate selection for 32, 44.1 or 48kHz. The 9200 comes with eight factory presets (can't be erased) and eight user presets (stored in non-volatile memory).

9200/U	Analog in	\$3,950.00
9200/UD	Digital and analog in	\$4,550.00
9200DIO	Digital upgrade	\$650.00



**BGS**

**Aphex**

With the new **Aphex FM Pro 2020** you can literally design the sound of a radio station; to generate a highly competitive on-air sound unique and effective for your market and format. The 2020 is upgradeable and modular • has sixteen user programmable read-write presets • eight read-only presets optimized for a variety of radio program formats • an internal clock/calendar facilitates an extensive day-part automation capability • menu driven controls permit easy front panel operation while a PC computer and modem or RS232 cable can control and monitor every parameter • password security • front panel real-time indicators of all major processes • and fail-safe operation is assured by a power-off internal relay bypass and fast program recovery after shut down. All processing is accomplished in the analog domain and the basic unit has analog stereo I/O's.



2020	FM Pro Basic Unit	\$4,995.00
2020-1	AES/EBU digital I/O	\$500.00
2020-2	Pre-emphasis limiter	\$500.00
2020-3	Stereo generator & pre-emphasis limiter	\$2,000.00

**Inovonics**



The **Inovonics David-II** is a new integrated FM-Stereo processor/generator. It features digital synthesis of the composite multiplex signal for best separation and stable operation, and internal combining for SCA or RDS subcarriers. Feedforward Pulse Width Modulation (PWM) audio processing imparts loudness and fullness to the program signal with negligible artifacts and without sacrificing brilliance. A unique "bass-enhance" feature optionally suppresses sub-audible program components while augmenting legitimate "bottom-end".

716-00	David-II FM Processor/Generator w/PWM processing and adjustable composite processor	\$1,985.00
--------	---	------------

**Microcon Systems**

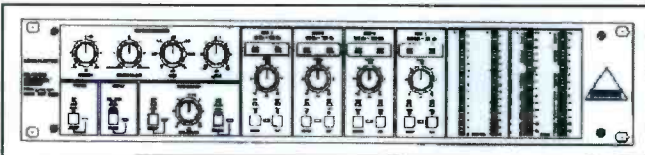

**Microcon Systems Banshee IV** is a stand-alone, 2 RU analog processor incorporating a 4-band leveler, compressor, peak limiter, intelligent peak clipper and stereo generator with an internal composite clipper working in concert to produce a loud, clean, almost tube-like processed sound. Just give us a call to arrange an evaluation!

Banshee IV	\$2,495.00
------------	------------

**Purple Processor**

The **Purple Processor™** will make your 8100, 8100A or 8100A1 spring to life like a kitten by replacing cards 3, 4, and 5. The Purple Processor™ features a feed-forward broadband AGC, four bands of compression and limiting, phase coherent crossovers, independent release gates for each band, program controlled attack/DB linear release, and low noise/low distortion VCA technology. These cards were developed by major market engineers and proven versatile, competitive, clean and loud. With the fully adjustable three card solution, you're audio will roar like a lion or purr like a cat: it's your choice with the Purple Processor™!

**Please call to arrange for a demonstration.**

Purple Processor	\$3,000.00
------------------	------------

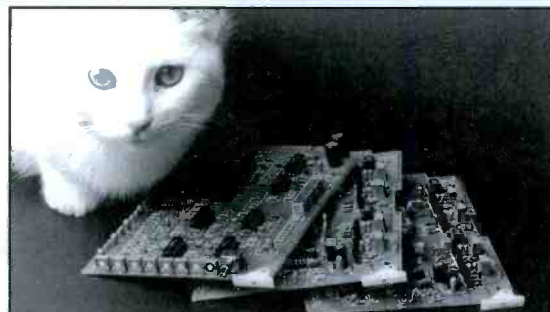

**P  
R  
O  
C  
E  
S  
S  
O  
R  
S**





**BGS**

**P  
R  
O  
C  
E  
S  
S  
O  
R  
S**

## CRL



The **CRL Amigo** is an FM stereo processing system designed for small market and educational stations. It is a stand alone system, needing no pre or post processing. The Amigo has a wide range input AGC, multi-band limiter and digitally synthesized stereo generator. User selectable options such as AGC gain reduction level, stereo sound field enhancement and limit/clip priority are included. The unit is extremely easy to set up and use.

Amigo FM **\$3,195.00**

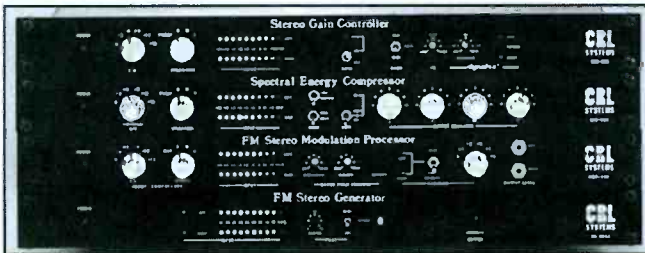

Shown    SGC-800    SEC-800    SMP850

The **CRL SGC-800** is a stereo AGC/compressor which is used before an STL or telco lines to eliminate system overloading. The AGC can be operated as "dual-band, wideband or both" and allows for up to 30 db of gain reduction. Dynafex® noise reduction is also included.

SGC-800 **\$2,250.00**



The **CRL SMP-850** consists of a dual-band AGC/compressor and advanced multi-band limiter. Precise peak modulation control is achieved using CRL's proprietary variable transfer function limiter. Also a built-in stereo sound field enhance function provides dramatic improvements in "on-air" stereo separation and loudness.

SMP-850 **\$2,750.00**

**CRL FM Systems** (Most of these CRL packages offer split chassis flexibility!)

FM-1g	SMP-850, SG-800A	<b>\$4,095.00</b>
FM-2g	SGC-800, SMP-850, SG-800A	<b>\$5,995.00</b>
FM-2g+	above plus SEC-800	<b>\$7,995.00</b>
FM-3	SGC-800, SEC-800	<b>\$4,495.00</b>

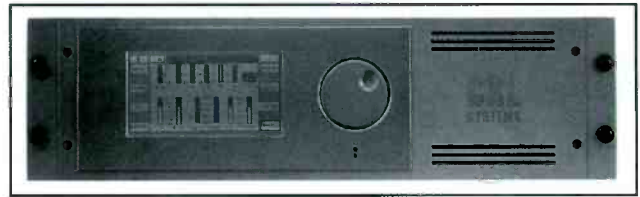

The **CRL DP-100** uses the newest technology advances and innovations developed by CRL over the last five years. These advances are used in all aspects of the processing architecture to create a whole new approach to audio processing. CRL's DP-100 gives the station a natural sound with superior loudness while maintaining outstanding quality. The DP-100 is based on a 32-bit floating point, 40 MHz DSP platform, with an internal dynamic range of greater than 770 dB. The DP-100 uses a fifth order Delta Sigma 18-Bit resolution A/D converter and eight times over sampling D/A converters, hence providing unparalleled dynamic range. The DP-100 uses a large LCD touch screen to display an exciting array of graphical menus. All normal controls can be changed with a touch of the screen and are changed in real time. You can customize your DP-100 with just a few key strokes or use one of the numerous factory presets. The 100% digital architecture of the DP-100 includes a wide-band AGC, 5 band compressor, tri-band limiting, final fast limiter, and stereo generator. Analog, AES/EBU, and Toslink fiber optic inputs are standard. Analog, AES/EBU, Toslink, and two independent composite outputs are also standard. Full remote control and easy to upgrade future software packages.

DP-100 **\$11,000.00**



The **CRL Audio Signature** is a digitally-controlled AGC/4-band compressor that is programmable, allowing a fully customized sound to be achieved. The Signature can be remote-controlled via a PC or "day-parted" using the optional CRL real-time Event sequencer. The Audio Signature works well in front of most modern stereo limiters.

Audio Signature	<b>\$4,995.00</b>
Audio Signature / Timer	<b>\$5,395.00</b>
Audio Signature / Modulation Signature	<b>\$6,995.00</b>

**We are happy to arrange  
evaluations for CRL equipment  
Give us a call!**



The **CRL BAP-2000** is a stand alone audio processor for mono FM or TV consisting of a two band AGC, limiter and built-in dynafex® noise reduction. For TV applications an Fh filter is included. Great for non-stereo TV transmitters.

BAP-2000 **\$1,950.00**



**Orban**

The **Orban 8200/U** is a true digital FM Audio Processor. The audio and all control functions are digital. It's fully digital audio processing improves the quality and clarity of the successful "Optimod Sound", while adding chargeable processing structures, programmability, expandability and PC interface capability for control from your studio, home or car. Orban's RAM-based Digital Hadamard Transform Baseband Encoder™ produces an extremely well-controlled spectrum, with indiscernibly low noise and distortion and outstanding separation.

8200/U2S	Digital Audio Processor	<b>\$7,400.00</b>
8200/U3S	As above w/multi-band processing	<b>\$10,400.00</b>
8200D/32	Digital I/O card, 32kHz	<b>\$725.00</b>
8200/SRC	Digital I/O card, w/sample rate converter	<b>\$1,550.00</b>
CIT25	Composite isolation transformer, eliminates ground loops in longer composite cable runs	<b>\$250.00</b>
8200UPG/2S/3S	Upgrade 2S to 3S	<b>\$3,350.00</b>



The **Orban 2200** has all the features of the 8100A analog Optimod FM: two-band processing, analog inputs, and stereo composite output. Other features include: AGC, Bass EQ, and HF enhancing • Protection limiter • Analog outputs • Factory presets • User programmable presets • Built-in tone and bypass • Remote switching of presets • True digital DSP processing and stereo encoding (stereo generator) • 1U • and easy to install.

2200/U	(Note: 2200 cannot be field or factory upgraded to the 2200D)	<b>\$3,850.00</b>
2200D/U	As above w/L/R digital AES/EBU digital input and output	<b>\$4,450.00</b>

The **Orban 8100A1** combines level control, peak control and stereo generation functions into an integrated audio processing system for FM broadcast. It lets you adjust your station's sound, and controls peak levels to guarantee maximum loudness without over-modulation. When desirable, Optimod-FM can be adjusted to provide automatic bass equalization. Its built-in stereo generator, pre-emphasis and filtering are handled before the peak control to prevent loss of loudness, and to eliminate modulation-robbing overshoots caused by outboard stereo generators.

8100A1/U75	Analog audio processor	<b>\$5,950.00</b>
8100A1/U75F	As above w/FM filter card installed	<b>\$6,650.00</b>
8100AXT2	Six band limiter for Optimod	<b>\$2,950.00</b>
8100AFC	FM filter card field retrofit kit	<b>\$700.00</b>
8100AST/U	Studio chassis for Optimod FM 8100A	<b>\$1,000.00</b>
CIT25	Composite isolation transformer	<b>\$250.00</b>
RET059	RDS retrofit kit	<b>\$125.00</b>
RET027	XT2 retrofit kit	<b>\$400.00</b>



**Optimod-FM 8200ST** is installed before your STL at the transmitter to protect it from peak and high frequency overload. The 8200ST also controls average levels on the link to maximize its dynamic range, translating to improved signal quality at the receiver.

8200ST/U	Studio chassis for Optimod-FM 8200	<b>\$1,400.00</b>
----------	------------------------------------	-------------------



**Modulation Sciences and Orban Stereo Enhancements**



With the **Modulation Sciences StereoMaxx** Stereo Expansion Processor in your air chain, your station will sound punchier and livelier. Stereo actually sounds wider than the speakers. Music takes on a bigger, deeper, dynamic quality that's especially apparent on car stereos, portables and walk radios. Limiters, clippers or other dynamic processors don't affect StereoMaxx adversely, because it operates in the spatial domain, not the amplitude domain.

MYB-2	<b>\$2,889.00</b>
-------	-------------------



The **Orban 275A** is designed to be placed permanently in line to automatically generate stereo from one mono channel, and allow true stereo to pass through unhindered. The 275A will noiselessly cross-fade between synthesized and true stereo material. For remote operation, the optional 275A/RC remote panel duplicates all the front panel controls.

275A	<b>\$2,400.00</b>
275A/RC	Remote panel <b>\$275.00</b>



**BGS**

**P  
R  
O  
C  
E  
S  
S  
O  
R  
S**

# on air ~FM - stereo generators -

## Aphex



The **Aphex Digicoder** FM Stereo Generator combines the functions of pre-emphasis limiting, 15kHz low pass filter and stereo encoding, plus it is RDS ready. The Aphex patented Parallel Path Digital Modulation creates a precision multiplex signal with an incredible 70+ dB of separation! It uses the highest attributes of both digital and analog signal processing to produce stability, accuracy, and sound quality. Security lock-out. 1U

Digicoder 400	PPDM FM Stereo generator	\$3,995.00
---------------	--------------------------	------------

## Inovonics

**Inovonics 708** Digital-Synthesis FM Stereo Generator includes accurate front-panel metering, adjustable pre-pilot Composite Processing, and internal combining for RDS and SCA subcarriers. New digital synthesis techniques and linear-phase filtering ensure outstanding performance, and a clean output spectrum protects low-injection digital and analog subcarriers. If your fundamental need is for a simple, yet fully-featured "basic" FM Stereo Generator, the 708 deserves your consideration. 1U



708-00		\$1,530.00
--------	--	------------

## QEI



The **QEI 772F** Stereo Generator is an economical, analog, all solid state unit. Terminals are provided to allow remote mono/stereo switching.

772F	Stereo Generator with input filters, 2U	\$1,850.00
------	---	------------

The **QEI 710A** Digital Stereo Generator is a true 24 bit numeric digital signal processing system. It is completely digital from the input oversampling finite impulse response filters to the proprietary second generation digital composite firmware and 18 bit DAC. It is designed for ease of operation with familiar control functions and remote stereo/mono mode control. Includes Q-Chain digital and analog inputs and outputs. The 710A can also be used as a digital sampling device: The digital signal can then be sent to external processing via Q-Chain and back again to the 710 for creation of the composite signal in the digital domain.



710A	Digital Stereo Generator with AES/EBU digital input, 1U	\$4,295.00
------	---	------------

# on-air ~TV

## Modulation Sciences

The **Modulation Sciences TV** encoder and baseband stereo generator provides excellent stereo separation and great performance specifications. It accepts composite video for unconditional lock to horizontal sync and complies with the BTSC standards. TSG includes operational monitoring and integral television audio processor with gating control and interleave protection circuit specifically designed for intricate multi-channel television sound requirements.

STV-784WB	TSG, Stereo TV generator w/audio processor & balanced output chips	\$13,100.00
STV-784	TSG, Stereo TV generator w/audio processor	\$13,000.00
STV-784NA	TSG, Stereo TV generator without audio processor	\$9,875.00
STV-784AO	TSG, Audio processor for STV 784 only	\$3,125.00
CLD-2503B	Balanced Composite Line Receiver for STV-784 WB (w/o balanced chips)	\$900.00

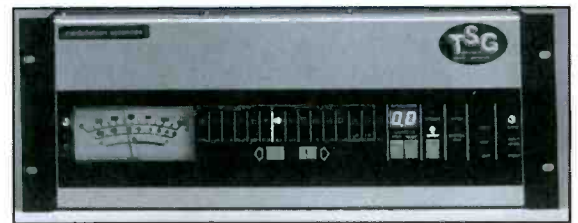

PROCESSORS



**Many Items in Stock for Immediate Delivery...Call Today!**



**CRL**

Designed for Stereo-TV, the **CRL TVS-3001** is a two-channel tri-band AGC having a capability of up to 30 dB of gain reduction. Integral Fh filters are also included as is an exclusive CRL/CBS loudness controller that "tames" loudness problems. The TVS-3001 also senses and corrects phase reversal problems on program material. The TVS-3001 is placed at the studio and prevents audio overload of the STL/telco feeds.

TVS-3001 **\$4,895.00**

The **CRL TVS-3003** is an MTS-stereo generator and audio limiter. The TVS-3003 also has a wideband AGC providing up to 20 dB of gain reduction. The stereo generator portion of the unit is digitally synthesized and therefore is drift free. Limiting is handled by a two stage "variable transfer function" limiter which smoothly handles peak transients without generating distortion products. A "stereo enhance" feature dramatically improves your viewer's received stereo effect.

TVS-3003 **\$8,795.00**

The **CRL TVS-3004** is a digitally synthesized subcarrier generator for pro channel or non-public SAP use. Features integrated audio input limiter, data and/or telemetry input ports.

TVS-3004 **\$2,150.00**

The **CRL BAP-2000** is a stand alone audio processor for mono FM or TV consisting of a two band AGC, limiter and built-in dynafex® noise reduction. For TV applications an Fh filter is included. Great for non-stereo TV transmitters.

BAP-2000 **\$1,950.00**

The **CRL TVS-3005** can be used for conventional SAP and non-public broadcast applications. It has a rock stable modulator section, auto carrier mute, full remote control capability, PRO channel input port, and low output Z-drives long cable lengths!

TVS-3005 **\$3,395.00**

TVS-3005 with BAP-2000 **\$4,995.00**



**BGS**

**P  
R  
O  
C  
E  
S  
S  
O  
R  
S**

**Orban**



222A **\$975.00**

The **Orban 222A** augments your stations spatial image to give you a more listenable sound. It expands the stereo sound stage without adding harmonic distortion or un-natural coloration.

**Studio Technologies**



The **Studio Technologies AN-2** is designed to create convincing stereo from any mono source. The Stereo Simulator creates two signals from one source; simulating a stereo perception at the ears of the listener. The Stereo Simulator is fully mono compatible.

AN-2 **\$649.00**



The **Studio Technologies Generation II** Stereo Simulator is designed expressly for on-air TV broadcasting, post production, and film applications.

Generation II **\$829.00**



**BGS**

**P  
R  
O  
C  
E  
S  
S  
O  
R  
S**



Behringer XR2000



dbx 172



Aphex 720



Symetrix 501



RDL ST-GCA2



ART MDC2001



Behringer MDX8000



Symetrix 422



Symetrix 488



Aphex 105



Behringer XR1400



DOD 844



Klark Teknik DN510



Klark Teknik DN510

# production compressor/limiter

## Expander/Gate/Ducker

Aphex 622	Dual channel w/side chain filter, 1U, XLR	\$795.00
Behringer XR2000	Dual channel, 1U, XLR	\$369.99
dbx 172	Dual channel, 1U, XLR	\$869.95

## Peak Limiter

Aphex 720	Dominator II, multi-band, stereo, 1U, XLR	\$1,350.00
Behringer MDX1800	8-channel, 1U, TRS	\$329.99
Symetrix 501	Mono Peak/RMS com/limiter, 1U, XLR	\$379.00
Symetrix 501-01	As 501 w/transformer balanced output stage	\$419.00

## Mono Compressor/Limiters

Aphex 651	Expressor, 1U, TRS & XLR. Manual operation only	\$495.00
Aphex 661	Tube Expressor, 1U, TRS, Auto or Manual	\$749.00
Aphex 323A	Compellor/Aural Exciter, multi-band, 1U, XLR Broadband	\$949.00
dbx 160A	1U, TRS & XLR	\$459.95
dbx 163A	half rack 1U, TS	\$169.95
dbx 165A	w/Peak stop, 2U, BS	\$1,499.95
Distressor EL8	Classic Knee Compressor, 1U, XLR & TRS	\$1,499.00
Furman C128	1U, TS	\$269.00
Furman C128B	1U, TS & XLR	\$303.00
RDL ST-CL1	See Page 26 Stick On, TB	\$139.00
RDL STGCA1	See Page 26. Gain control amp, Stick On, TB	\$119.00
RDL STGCA2	See Page 26, Fast Gain Control amp, Stick On, TB	\$119.00

## Multi-dynamic Processors

Aphex 106	4-channel Easyrider™ Auto compressor, 1U, TRS	\$449.00
Aphex 108	2-channel Easyrider™ Auto compressor, 1U, TRS	\$299.00
Art MDC-2001	Stereo compressor, noise gate, expander, de-esser, exciter, peak limiter, clipper, 1U, XLR	\$525.00
Art DR-X 2100 SE	1U, TS, See page 94	\$669.95
ART Pro Gate	8-channel programmable, 2U, TRS	\$1,099.00
Behringer MDX2100	New Composer, stereo compressor/limiter, peak limiter, expander gate, 1U, XLR & TRS	\$279.99
Behringer MDX4000	Stereo 2-band comp/leveler/limiter/peak limiter, 1U, XLR & TRS	\$549.99
Behringer MDX8000	Stereo 4-band comp/leveler/limiter, 1U, XLR & TRS	\$769.99
BSS DPR-404	4-channel compressor/de-esser, 1U, XLR	\$1,449.00
dbx 263A	De-esser, half/rack 1U, TS	\$169.95
Rane DC-24	w/Gate & fourth order active crossover, 1U, XLR & TRS	\$599.00
Symetrix 421M	Mono, AGC leveler, limiter, w/speech curve filters, 1U, TRS & XLR	\$569.00
Symetrix 422	Stereo, AGC leveler, 1U, XLR & TRS	\$595.00
Symetrix 488	DYNA-Squeeze™, 8-channel compressor, 1U, TRS & TS	\$579.00

## NoiseGates

Aphex 105	4-channel, Logic Assisted Gate, 1U, TRS	\$449.00
Behringer XR1400	4-channel, 1U, TRS	\$299.99
Behringer XR2400	4-channel, 1U, TRS & XLR	\$499.99
BSS DPR-504	4-channel w/parametric key filter 1U, XLR	\$1,449.00
dbx 274	4-channel, 1U, TRS	\$449.95
DOD 844	4-channel, 1U, TS	\$289.95
Furman QN44	4-channel, 1U, TS	\$429.00
Furman QN44B	4-channel, 1U, TS & XLR	\$565.00
JBL M644-BLU	4-channel, 1U, XLR	\$499.00
Klark Teknik DN510	2-channel, 1U, XLR	\$1,144.00
Klark Teknik DN514	4-channel, 1U, XLR	\$1,144.00
Valley 460 Autogate	2-channel, 1U, TRS & XLR	\$899.00



# production ~ compressor/limiter

## Dual Compressor Expander

dbx 166A	w/gate, 1U, TRS & XLR	\$329.95
dbx 266A	AutoDynamic™ attack/release, 1U, TRS	\$249.95
Behringer MDX1200	Autocom, 1U, TRS	\$189.99
Klark Teknik DN500	1U, XLR	\$1,244.00
Symetrix 425	1U, XLR & TRS	\$579.00
Valley 433	Dynamite 3, w/gate, 1U, TRS	\$799.00

## Dual Compressor/Limiter

Aphex 320A	Compellor, 1U, XLR	\$1,350.00
ART SC2	w/Gate, 1U, TRS	\$295.00
Ashly CLX-52E	w/Gate, 1U, TRS	\$499.99
BSS DPR-402	w/De-esser, 1U, XLR	\$1,449.00
dbx 168A	1U, XLR	\$999.95
dbx 1066	w/Gate & side chain insert, 1U, TRS & XLR	\$549.95
dbx 1046	4-channel compressor for use as 2 independent st. comp., 1U, XLR & TRS	\$649.95
Distressor 8LS	Classic Knee Compressor, 1U, XLR & TRS	\$2,750.00
DOD 866	w/Gate, 1U, TRS & RCA / Impedance balanced outputs	\$239.95
Furman LC6	1U, TS	\$439.00
Furman LC6B	1U, TS & XLR	\$507.00
JBL M712-BLU	w/Gate, 1U, XLR	\$499.00
Klark Teknik DN504	Quad Compressor/limiter, 1U, XLR	\$1,396.00
Yamaha GC2020BII	1U, XLR, TRS, dual-mono selectable	\$469.00

We would be happy to fax or mail complete specifications on any compressor/limiter you find of interest.

**Input/Output Connections**  
 TRS = 1/4" Tip-Ring-Sleeve  
 TS = 1/4" Tip-Sleeve  
 BS = Barrier Strip  
 XLR = 3 Pin XLR

# production ~ acoustical delay

## Biamp



The **Biamp Advantage DDL 11** digital delay line utilizes DSP technology to provide a one input/one output, single-tap delay for time alignment of remote and under-balcony speaker systems. Features: 16 bit Sigma-Delta A/D conversion • 48kHz sampling rate utilizing 64x oversampling • delay time selectable from 0 to 1.023 seconds • delay time selectable in 1 milli-second increments • short delay mode selectable for speaker driver alignment • bypass mode selectable for direct/delay comparisons • balanced I/O on barrier strip connectors • signal present and peak indicators on front panel • screwdriver adjustable input and output level controls • delay time selectable with front panel DIP switches • see-through security cover protects controls from tampering • a five year warranty.

DDL11 \$499.00

The **Symetrix 402** Dual Output Delay is a 1 input, 2 output digital audio room delay intended for acoustical alignment of distant speaker systems. The 402 allows you to delay the remote speakers to match the time it takes for the signal coming from the main speakers to reach the listener positioned near the remote speakers. Features: 19 bit A/D, 18 bit D/A's for >100dB dynamic range • Two independently adjustable outputs • Simple user interface • Delay setting stored in non-volatile memory, no battery to replace • Automatic hard wire bypass in case of power loss • Front panel lockout • Barrier terminal, XLR, and 1/4" phone connectors.

402 \$729.00

## Rane



The **Rane AD 22** Digital Audio Delay is a fully balanced, two input, two output alignment delay providing a delay range of 0.011 to 327.68 milliseconds on each output. The delay of each output is independently adjustable in 10 microsecond and 1 millisecond increments. Features: 1-Bit Dolby™ Time Link Conversion • Terminal strip inputs and outputs • Independent remote memory recall interface on rear • Two EPROM memories per channel • Sensitivity control • Signal present and clip indicators • Front panel lockout switch on rear • Delay display in mSEC, feet or meters • 5 digit LED display • Fail-safe bypass for each channel • 1U.

AD 22 \$849.00  
 AD 22B Balanced XLR in/out connectors \$849.00

## Symetrix



**BGS**

**P  
R  
O  
C  
E  
S  
S  
O  
R  
S**



# production ~ profanity delay



**BGS**

**P  
R  
O  
C  
E  
S  
S  
O  
R  
S**

## Rane

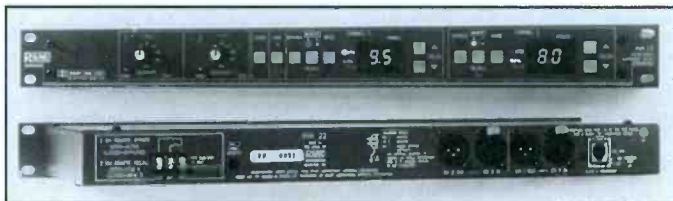

The **Rane AVA 22** Audio/Video Alignment Delay is a fully balanced two input, two output alignment delay providing a range of 0.0 to 9.5 NTSC frames (8.0 PAL/SECAM frames) on each output. The delay of each output is independently adjustable in field (half-frame) increments. Features: 1-bit Dolby™ Time Link Conversion • Front panel lockout switch on rear • Independent remote memory recall interface on rear • Active balanced 3-pin inputs & outputs • Two EPROM memories per channel, no batteries • Fail-safe bypass for each channel • 1U.

AVA 22 \$849.00

## Hotronic



The **Hotronic AL86** Solid State Frame Recorder provides the significant 6 second delay for both video and audio to instantly edit profanity during a live broadcast. In comparison, the old method needs two 2-inch or two 1-inch VTRs and a technician to operate the system. The AL86 requires no attention during operation and is more technically reliable, eliminating excess equipment, tape and storage. Features include: 20 bit audio/10 bit video resolution • selectable delay from 1 frame to 180 frames • 48 KHz audio sampling (Synchronized to video) • 14.3 MHz video sampling.

AL86 \$12,500.00

## Eventide



The **Eventide BD-500** Digital Broadcast Delay comes standard with 8.5 seconds of stereo delay, and additional delay can be added in the field. The user divides the total available delay time into not one or even two, but several discrete segments. ( the user decides how many). Each time the DUMP button is pressed, only the one segment is dumped. You still have delay protection right away. A sneeze button momentarily "edits" audio entering the delay, allowing the host to sneeze or make a comment without being heard on air, and without dead air. The unit shows an exact digital read out of delay time, and has a "quick read" bargraph which instantly confirms "you're safe" at a glance. It comes with analog XLR type I/O, or optional AES/EBU I/O. All front panel switches (except configure) can be remoted (both RS-232 and dry contacts are provided). Status indicators can be remoted as well. 1U

BD-500 \$3,395.00  
BD-500AES/EBU I/O \$4,690.00



The **Eventide BD941/BD942** delays offer cost-effective obscenity protection. Both feature a delete function, 5-20,000 Hz audio frequency, 16 bit res, and a 44.1 kHz sampling rate.

BD941-6	20kHz, Mono, 6 seconds fixed delay	<b>\$1,795.00</b>
BD941-12	20kHz, Mono, 12 seconds fixed delay	<b>\$2,195.00</b>
BD942-3	20kHz, Stereo, 3 seconds fixed delay	<b>\$1,995.00</b>
BD942-6	20kHz, Stereo, 6 seconds fixed delay	<b>\$2,395.00</b>

## Symetrix



The **Symetrix 610** Broadcast Audio Delay can unobtrusively 'stretch out' the program until 7.5 seconds of 15kHz bandwidth stereo audio is stored in memory. Once the 'DUMP profanity' button is pressed, the 610 automatically begins to stretch the program audio again until the full 7.5 second delay is attained. It can be set up so that only half of the 7.5 second memory is deleted the first time the button is pushed, thereby maintaining a 3.75 second reserve. This allows the host to bring another caller on air right away without having to wait for the memory to build up from scratch. A 'cough' button allows the host to make impromptu interruptions of the program for up to 7.5 seconds while keeping the audience unaware of the break. The 610 has remote control of all functions, active balanced XLR inputs and outputs. 1U

610 \$2,695.00



# production ~ effects processing

## ART



The **ART Multiverb Alpha SE** contains 404 of the finest and most widely used studio production and performance presets available. The Multiverb Alpha SE offers all types of delays, chorusing, flanging, phasing, pitch transposing, sampling, and stereo imaging effects. Additional features include 24 bit digital processing and full MIDI implementation and real-time control of all parameters.

Multiverb Alpha SE	#472	\$575.00
--------------------	------	----------

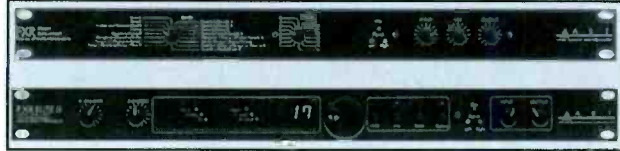

The **ART FXR and FXR Elite II** both have stereo 2 channel digital multi-effects processors that feature dual processing and ART's new ASIC audio chip. Effects include: reverb, delay, chorus, flange, and panning. The FXR is a quick set up, plug in and play processor with 255 presets. The FXR Elite II adds MIDI real time control, MIDI mapping, and the ability to edit parameters and store your changes.

FXR	#423	\$259.00
FXR Elite II	#434	\$345.00



The **ART DR-X 2100SE** will perform 10 simultaneous audio functions; features 24 bit DSP; is a full function dynamics processor with compressing, limiting, programmable EQ, noise gate and expander; studio reverberator; and multi-effector. It gives you over 2 1/2 octaves of pitch shift, 12 reverb programs, 12 reverse and gated algorithms, over 20 types of delays, stereo panning, over 400 preset, and complete MIDI interface.

DR-X 2100SE	#432 Digital Multi-Effector/Pitch Transposer/Sampler	\$669.00
-------------	--	----------

## BOSS (Roland)



The **Roland VT-1** is a unique device designed for altering and effecting the human voice or any other audio signal. It can provide everything from a slight detuning, for voice "thickening", to a full  $\pm$  octave pitch shift, enabling one person to sing a duet with themselves. Unlike tape speed adjustments or a conventional pitch shifter, the VT-1 affords separate control of pitch and format, so the users voice can be altered without the "chipmunk" effect. There is also a feature specifically designed to produce "robot-like" talking. Four preset memory locations and four user memory locations.

VT-1	(and a basic digital reverb)	\$395.00
------	------------------------------	----------

## dbx



The **dbx 290** stereo digital reverb is the perfect solution for anyone who wants professional results without the hassle of programming, while maintaining low price and high quality. With the touch of a button, choose from several different reverb types: hall, chamber, cathedral, room, plate, and gated reverb. Then select the reverb's basic size, color and decay time. While a S/N ratio of >87dB is impressive by itself, the digital noise reduction pushes the noise floor even lower when the unit is idle. It has 1/4" balanced ins and outs.

290	\$399.95
-----	----------

## Digitech



The **Digitech Studio 400** is capable of up to eight effects at one time, in any order and in an endless number of combinations. Combined with the 4 independent XLR and 1/4" balanced inputs and outputs, the Studio 400 has the needed flexibility for any professional application. The extensive list of effects includes multiple reverbs, delays, choruses, flangers, auto panner, intelligent pitch shifting, rotary speaker simulator, compressor, EQ's, detune and more. You can modify any of the 100 factory presets and save these modifications to 100 user locations. The extensive Modifier section allows total real-time control of up to eight parameters per preset, either via MIDI or with the Studio 400's unique dynamic and LFO settings. 2U

Studio 400	\$869.95
DIO Digital in/out for Studio 400 (AES/EBU, S/PDIF)	\$279.95



P  
R  
O  
C  
E  
S  
S  
O  
R  
S

# production ~ effects processing



**BGS**

**PROCESORS**

## Digitech



The **Digitech Studio Quad**, with 4 completely independent inputs and outputs, redefines multi-effects by giving you the power of two true stereo processors or 4 independent mono processors. It is driven by S-DISC® digital processor. Features: 18 Bit A/D, 20 bit D/A conversion • 46.875kHz sample rate • Multiple simultaneous effects (series or parallel) • z8 Dual mode makes it 2 processors in 1 • Parametric EQ • Accepts MIDI program changes • and 99 user programs for storing custom sounds. 1U

Studio Quad V2    1/4" unbalanced TS    **\$549.95**



The **Digitech Studio Twin** true stereo effects processor is the easy to play baby of Digitech's studio processors with all the power of an S-DISC® digital processor. Features: 18 Bit A/D, 20 bit D/A conversion • 46.875kHz sample rate • Multiple simultaneous effects (series or parallel) • z8 Dual mode makes it 2 processors in 1 • Parametric EQ • Accepts MIDI program changes • and 99 user programs for storing custom sounds. 1U

Studio Twin    1/4" balanced TRS    **\$299.95**

## DOD

The **DOD 512** is a true stereo multi effects processor that allows you to quickly get the sounds you need such as reverbs, delays, choruses, flanges, pitch shifting, phasers, tremolo, and panning. You also get series and parallel combinations of reverb or delay. Two independent sources can be plugged in and be processed through two effects separately • Two real time parameter editing controls for tweaking-in your reverb decay, delay time or modulation speed and noise reduction with adjustable threshold • 32 Effects combinations w/15 presets each - total 480 presets • and 44.1kHz sampling for full bandwidth effects.



512    **\$229.95**

## Eventide



The **Eventide H3000-B** is an entire production department in a single box! This digital audio processor offers all the effects you need, without sacrificing any quality, convenience or effectiveness. The H3000-B features 16 Algorithms, including TimeSqueeze®, Stutter and Patch Factory; 184 Factory Presets for spontaneous on-air use; and a full complement of production-oriented reverbs, delays, and digitally-generated sound effects. The Soft Keys give one-button access to key parameters making programs quick and easy to use.

H3000-B+		<b>\$2,995.00</b>
H3000-B/LT	Broadcast Lite dynamic ultra-harmonizer (w/o Time Squeeze Board)	<b>\$2,495.00</b>
HS395	95 second internal Sampler board	<b>\$995.00</b>



**Eventide's DSP4000B** Ultra-Harmonizer is based on the powerful DSP4000, but it has a unique set of software programs created especially for radio, TV and post-production by sound designer Jay Rose. The DSP4000B offers Timesqueeze® stereo time compression and expansion with higher quality than ever before. It's perfect for a fast-paced "Morning Zoo" radio show. A six line graphic LCD screen lets you choose the effect you want in seconds—They're conveniently organized into logical groupings. Every effect features a wide variety of user-adjustable parameters, and the LCD screen leads you quickly through the process, explaining how the various parameters affect the sound. In addition to saving presets you create in the DSP4000B's internal memory, you can also store them on a removable PCM-CIA memory card for convenience, added capacity and to protect your unique sounds from use by others. The DSP4000B comes standard with balanced analog inputs and outputs, with audio bandwidth extending to 22kHz. Optional is a digital I/O module that provides 24-bit AES/EBU and S/PDIF I/O.

DSP4000B		<b>\$3,995.00</b>
DSP4000	w/AES/EBU & S/PDIF I/O's	<b>\$4,995.00</b>
HS487	87 second internal sampler board	<b>\$995.00</b>
HS4174	174 second internal sampler board	<b>\$1,495.00</b>



# production ~ effects processing

## Lexicon



The **Lexicon Alex and Reflex** digital effects processor has 16 presets, 3 adjustable parameters (providing Alex with over 4,000 effects combination), plus another 16 user registers for storing your own sounds. Among the presets are various reverbs, multi-voice chorusing, flanging, straight echoes, and stereo multi-tap delays. Alex can create real stereo effects, such as panned echoes, even from a mono source. It has a 2 character LED display, and full remote control of program change and bypass via standard footswitches. Alex has stereo in and out 1/4" jacks. The Reflex goes beyond the capabilities of Alex. With new algorithms including reverb with randomizer and early reflections; tunable chromatic resonator; plate; gate; inverse; chorus; flanger; multi-tap delay; and full dynamic MIDI™ implementation, with up to four patches per effect. Reflex also has an advanced programming mode and MIDI Auto Tempo for synchronizing delays to MIDI.

Alex	\$399.00
Reflex	\$499.00



The **Lexicon PCM 80** digital effects processor with a true stereo signal path, and the ability to mix analog and digital inputs together offers an exciting range of effects possibilities. The PCM 80 also features a 24-bit digital bus and multiple DSP architecture. It includes new and old algorithms, with a host of new effects, including reverb, delays, chorusing and dynamic spatialization. Features: two DSP processors • dynamic patching • AES Digital I/O • Balanced analog XLR I/O • and unique tempo modes. The PCM80 includes SIMM slots for additional effects memory, and a PCMCIS card slot for new algorithms or memory. 1U

PCM80	\$2,795.00	
Dual FX	Dual FX card	\$249.00
Pitch FX	Pitch FX card	\$249.00
Post FX	Post FX preset card (Scott Martin Gershin)	\$199.00
Music FX	Music FX preset card (David Rosenthal)	\$199.00



The **Lexicon PCM 90** digital reverberator is the ultimate in reverberation and effects. It has a unique dual processor that allows unparalleled flexibility in reverb quality and control. Features: true stereo capability with 18 bit A/D converters • digital inputs, AES, SPDIF and balanced XLR • 24 bit internal digital bus • KeyWord search facility • 4 custom controllers • Dynamic Patching™ Matrix • Dynamic spatialization capability • 250 presets and 100 registers. 1U

PCM 90	\$2,995.00
--------	------------



The **Lexicon Multiple Processor FX technology™** stereo effects processor is a full strength reverb all the time with up to 5 effects at once. You can expect: a "goof proof" system for quickly fine-tuning any program, without having to enter an in-depth editing mode • visual feedback with on-board help guides • 56 pitch, chorus, EQ, modulation, delay and world-class reverb effects • 200 presets - with database sorting to let you find exactly what you want and more. Operating levels from -10db to +44db; analog I/O has balanced XLR and TRS 1/4" connectors, SPDIF digital I/O.

MPX-1	\$1,299.00
-------	------------

## t.c. electronic



The **t.c. electronic Finalizer** is a program compressor, master EQ, and high end A/D, at an affordable price. Strapped across the stereo output of the mixer, the Finalizer is the ultimate digital dynamics tool. It easily adds the essential boost of energy where you need it most, in the final DAT or CDR recording. It has a large LCD screen, a one-level menu system, and a unique 'Wizard' function, that identifies the best setting for any given situation. 1U

Finalizer	\$2,495.00
-----------	------------

The **t.c. electronic DBMAX™**, Digital Broadcast Maximizer is a versatile multiband dynamics processor. It includes EQ, stereo adjuster, automatic gain controller, 3-band look ahead compressor, limiter, expander, and more.....all applicable simultaneously.

DBMAX	Available August 1997	\$3,995.00
-------	-----------------------	------------



BGS

P  
R  
O  
C  
E  
S  
S  
O  
R  
S

**Broadcasters General Store (352) 622-7700 Fax (352) 629-7000**

# production ~ effects processing



**BGS**

**P  
R  
O  
C  
E  
S  
S  
O  
R  
S**

## t.c. electronic



The **t.c. electronic Wizard M2000** signal processor will enable you to create Magical Sound. Uncompromising effects processed by the TC DARC™ chip offer you a clarity, density, and feel beyond anything you have ever experienced before. The library of proprietary effects includes reverb, pitch shift,

delay, chorus, ambience, equalization, de-essing, phasing, compression, gates, expansion, limiting, and stereo enhancement. There are 250 factory presets, and another 250 of your own settings can be stored in the unit. It has digital I/O connectors, S/PDIF, AES/EBU and dithering ensures that the dynamic range in your M2000 is kept when you digitally connect it to a device with a lower bit resolution. Great care has been taken to create the ultimate user interface. With the Recall Wizard you can instantly find the preset that suits your need in any situation. The single layer interface ensures that all parameters are always only one menu level away. No more paging through endless menu levels. And much, much more.

M2000 \$1,995.00

## Yamaha

The **Yamaha SPX-1000** is a fully-equipped effects studio at your fingertips. Features: totally natural reverberation • an echo room in which you can instantly change any room dimensions • fully programmable early reflection • a full range of modulation effects • freeze programs that let you replay sound snap-shots • multi-effect programs that combine up to 5 different fully programmable effects. • pitch change, compression, expansion, distortion, rotary panning and much more! The SPX-1000 has a 44.1kHz sampling frequency, MIDI implementation, A/D-D/A are 16 bit, Yamaha format digital I/O and unbalanced 1/4" TS analog I/O connectors. 1U



SPX-1000 \$1,829.00



The **Yamaha REV 100** is basically a no-fuss signal processor — all you have to do is select one of its 99 preset effects and play. The three most critical parameters for all effect programs are adjustable via rotary panel controls — just rotate the appropriate controls until the sound is right. REV 100 effect categories include: reverb, true stereo reverb, gate reverb, delay, delay/reverb, and reverb/modulation. It has 16-bit A/D and D/A converters and a 44.1kHz sampling rate. Other important features include: advanced MIDI features • easy-to-read 2-digit LED display • and peak LEDs make it easy to set the optimum input level. 1U

REV 100 \$299.00



The **Yamaha SPX-990** has a wide selection of professional quality digital effects. It has 80 preset effects and 100 memory locations. True stereo (2-in/2-out) configuration allows stereo sources to be processed without disrupting the original stereo image. Effects include: reverb, early reflections, delay & echo, modulation, pitch change, pan, freeze, and complex effects. Inputs and outputs are analog, electronically balanced, with XLR and TRS 1/4" connectors. A/D-D/A are 20 bits. 1U

SPX-990 \$1,179.00

# production ~ enhancements

The **Aphex 104** has two processing types to enhance both ends of the spectrum. The 104 has increased presence and clarity with switch select for normal or high harmonics. Virtually noise free with the Big Bottom™ bass enhancer to increase bass sustain, density and loudness. Operates at -10dBv or +4dBu with 1/4" phone jack for I/O. 1U

## Aphex



104 \$299.00



# production enhancements

## Aphex



The **Aphex Type III** is the latest generation, fully professional Aural Exciter loaded with powerful new processing features and improved circuitry. New features: adjustable harmonics mixing • two modes of noise reduction • SPR™ Spectral Phase Refractor • servo balanced I/O on XLR type connectors • Aphex VCA 1001 • and null fill. Standard features include: operates with I/O levels from +8 to -10dBm • operates balanced or unbalanced automatically • all user settings externally accessed • RF filtered AC power input • direct relay bypass with remote control of bypass • solo function • and switches LED are indicated. Noise and distortion are virtually eliminated in the Type III circuitry, while the new special features now make enhancement possible while actually erasing noise from noisy sources.

250 \$995.00

## BBE



**BBE 462 & 862** apply different phase correction algorithms to three separate frequency bands. The variable front panel control allows the user to adjust the amount of processing desired. BBE® is used to increase the clarity and intelligibility of program material and does not add any extra noise or harmonics to the sound.

462	Dual channels & controls, 1/4" and RCA unbalanced connectors, line level operation	\$349.00
862	Dual channels & controls, 1/4" and XLR balanced connectors, +4dBu level operation	\$599.00

## SPL



The **SPL Stereo Vitalizer** takes the concept of "audio sweetening" to a new level. Designed to be compatible with the way the human ear perceives sound, the Vitalizer's network of interactive filters actually reshapes the entire audio spectrum so that listeners perceive sounds as louder, clearer and more detailed.

Vitalizer 9319	1/4" unbalanced jack version	\$599.00
Vitalizer 9320	XLR plus 1/4" jack version	\$699.00

**SPL Classic Vitalizer** has two individual channels with separate set-up controls allowing the unit to be used in full stereo mode or as 2 mono channels.

Classic V9214	1/4" unbalanced jack version	\$999.00
Classic V9215	XLR plus 1/4" jack version	\$1,099.00

The **Aphex Type III** is the latest generation, fully professional Aural Exciter loaded with powerful new processing features and improved circuitry. New features: adjustable harmonics mixing • two modes of noise reduction • SPR™ Spectral Phase Refractor • servo balanced I/O on XLR type connectors • Aphex VCA 1001

## dbx



The **dbx 296** is a dual-channel Spectral Enhancer that cleans up and details instruments, vocals and mixed program material on stage or in the studio. Independent controls for input gain, low frequency detail, high frequency detail and hiss reduction allow you to adjust the 296 for exactly the amount and type of enhancement you want. You can actually cut hiss while adding high frequency detail and add mass to the bottom end while reducing the "mud" in the mid-bass with LF detail. Other features include: LED meter to display hiss reduction filter activity • clip indicators for each channel signal clipping anywhere in the signal path • DynActive™ circuitry continually analyzes the input signal and self-adjusts to provide proper balance of high frequency detail and hiss reduction • balanced 1/4" TRS inputs and 1/4" TS outputs. 1U

296 \$349.95

## Sabine Room EQ

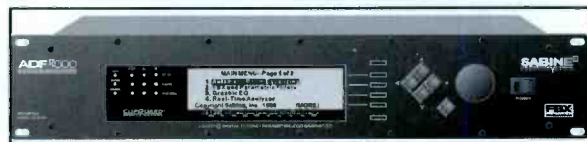

The **Sabine Real-Q** Real-Time Adaptive Equalizer, is the first adaptive DSP tool that uses artificial intelligence to automatically analyze and equalize your sound space during the program. The Real-Q only adjusts for changes in the room acoustics, not changes in the mix. If you decide to add bass to the mix, it will not compensate. However, if the audience absorbs the bass, the Real-Q automatically adds it back in. It automatically analyzes and flattens the room, or matches any curve you create, then monitors and compensates for any changes in the room. The Real-Q provides a full featured RTA and noise generator, digital graphic EQ, graphic display of the room's response curve, and storage for 100 different response curves.

REQ3101	1-Channel/zone	\$5,450.00
REQ3102	2-Channel/zone	\$6,950.00
REQ3103	3-Channel/zone	\$8,450.00



**BGS**

P  
R  
O  
C  
E  
S  
S  
O  
R  
S

# BIG production equalizers



**BGS**

**P  
R  
O  
C  
E  
S  
S  
O  
R  
S**



ART HD-15



DOD SR8300Q



Klark Teknik DN320



Klark Teknik DN332

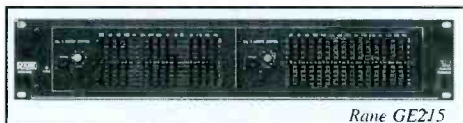

Rane GE215



Yamaha GQ2015



Behringer DSP-8000

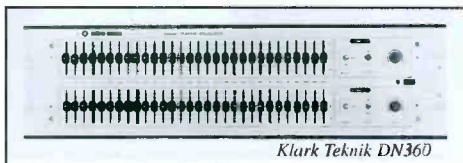

Klark Teknik DN360

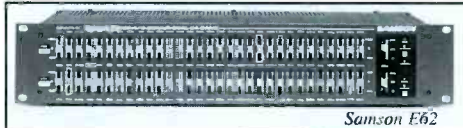

Samson E62



ART HD-31



DOD 431QX



DOD 831QX



Klark Teknik DN300

## Stereo Graphic 2/3 Octave

Art HD-15	15 Band, 2U, TRS & BS	\$459.00
Art HD-15XLR	15 Band, 2U, XLR	\$509.00
Ashly GQX-1502	15 Band, 2U, TRS, XLR & BS	\$529.99
Biamp microEQ152	15 Band, 1U, XLR	\$437.00
dbx 2215	15 Band, 3U, TRS, XLR & BX, w/limiter & type III NR	\$499.95
dbx 3215	15 Band, 2U, XLR, BS & TRS	\$749.95
DOD SR430QX	15 Band, 1U, XLR, Balanced I/O	\$244.95
DOD SR830Q	15 Band, 2U, TRS, TS & RCA	\$219.95
DOD SR830QX	15 Band, 2U, XLR, 1/4" TRS	\$239.95
DOD SR830Q	15 Band, 2U, TRS (XLR Optional)	\$214.95
Electro-Voice EQ-215	15 Band, 1U, XLR & TRS	\$548.00
Furman Q-152B	15 Band, 2U, XLR & TRS	\$557.00
Klark Teknik DN332	16 Band, 2U, XLR	\$1,204.00
Klark Teknik DN320	16 Band, 1U, XLR	\$860.00
Rane GE215	15 Band, 2U, XLR & Euroblock	\$559.00
Rane ME15B	15 Band, 1U, microGraphic, TRS & XLR	\$429.00
Rolls REQ215	15 Band, 1U, XLR, TRS & RCA	\$250.00
Samson E30	15 Band, 1U, TRS & XLR	\$239.99
White 4675	14 Band, 2U, XLR	\$866.00
Yamaha GQ2015A	15 Band, 1U, TRS & XLR	\$429.00

## Stereo Graphic 1/3 Octave

Ashly GQX-3102	31 Band, 3U, TRS, XLR & BS	\$1,059.99
Behringer DSP-8000	31 Band, 2U, XLR, TRS & 2-bit A/D & D/A converters	\$899.00
dbx 2231	31 Band, 2U, TRS, XLR & BS, w/limiter & type III NR	\$749.95
dbx 3231L	31 Band, 3U, TRS, XLR & BS	\$1,199.95
DOD SR231Q	31 Band, 2U, XLR	\$349.95
DOD SR231QX	31 Band, 2U, XLR & TRS	\$374.95
Electro-Voice EQ-231	31 Band, 2U, XLR & TRS	\$840.00
Klark Teknik DN-360	30 Band, 3U, XLR	\$1,880.00
Rane GE60	30 Band, XLR, BS & TRS	\$899.00
Rane ME60	30 Band microGraphic, 2U, XLR, TRS & RCA	\$699.00
Rolls REQ231	31 Band, 2U, XLR, TRS & RCA	\$525.00
Samson E62	31 Band, 2U, XLR & TRS	\$349.99
White 4856	31 Band, 3U, XLR & TS	\$1,550.00
Yamaha Q2031B	31 Band, 2U, XLR & TRS	\$749.00

## Mono Graphic 1/3 Octave

Art HD-31	30 Band, 2U, XLR, TRS & BS	\$459.00
Ashly GQX-3101	31 Band, 2U, TRS, XLR & BS	\$629.99
Biamp microEQ301	30 Band, 1U, XLR	\$414.00
dbx 2031	31 Band, 2U, TRS, XLR & BS, w/limiter & Type III NR	\$499.95
dbx 3031	31 Band, 2U, TRS, XLR & BS	\$749.95
dbx 3031C	31 Band cut only, 2U, XLR, TRS & BS	\$749.95
DOD 431QX	31 Band, 1U, XLR, Balanced I/O	\$249.95
DOD 831QX	31 Band, 2U, XLR, Balanced I/O	\$249.95
Electro-Voice 2710	27 Band w/pink noise gen., 2U, XLR & BS	\$1,060.00
Electro-Voice EQ-131	31 Band, 1U, XLR & TRS	\$524.00
Furman Q-302B	30 Band, 2U, XLR & TRS	\$503.00
Klark Teknik DN300	30 Band, 2U, XLR	\$1,260.00
Klark Teknik DN301	30 Band cut only, 2U, XLR	\$1,316.00
Klark Teknik DN27A	27 Band, 3U, XLR	\$1,328.00

Continued next page....



# BGS production ~ equalizers

## Mono Graphic 1/3 Octave (Continued)

Rane GE130	30 Band, 2U, XLR & Euroblock	\$529.00
Rane GE-30	30 Band, 2U, cut/boost cut, XLR & BS	\$799.00
Rane ME-30B	30 Band microGraphic, 1U, TRS & XLR	\$419.00
Symetrix 531E	31 Constant Q Bands, #U, TRS & XLR	\$579.00
White 4828	31 Band, 2U, XLR & TS	\$750.00
White 4200A	28 Band cut only, 2U, BS	\$1,125.00
White 4400	28 Band, 2U, BS	\$1,100.00
Yamaha GQ1031BII	31 Band, 1U, XLR & TRS	\$399.00

## Parametric

Aphex 109	Dual 2-band or mono 4-band, 1U, TRS, Tubessence	\$495.00
Ashly PQX-571	Mono 7 band, 1U, TRS, XLR & BS	\$399.99
Ashly PQX-572	Stereo 7 band, 2U, TRS, XLR & BS	\$699.99
Behringer PEQ305	Mono 5 band, 1U, TRS & XLR	\$329.99
BSS FCS-916	Mic/Line amplifier, 1U, XLR & TRS	\$999.00
dbx Project 1 242	Mono 5 band, 1U, TRS	\$299.95
Klark Teknik DN405	Mono 5 band, 1U, XLR	\$924.00
Klark Teknik DN410	Stereo 10 band, 2U, XLR	\$1,372.00
Rane PE-15	Mono 5 band, notch filter, 1U, XLR & TRS	\$399.00
Rane PE-17	5 band, 1U, XLR & TRS	\$549.00
Symetrix 551E	5-band, 1U, XLR & TRS	449.00

## Stereo Digital Parametric

Ross DPX Mainframe	30-Band, 1U, XLR (Options for AES/EBU)	\$995.00
Zsys. z-ql	6-Band st., 2U, AES/EBU (Time Code option \$1,000)	\$3,000.00
Zsys. z-qlm	As above w/set of display & controls for each band, 4U	\$9,900.00

## Programmable EQ

Art DR-X 2100	1U, TS	\$768.95
BSS DPR-901 II	Mono 4 band Dynamic EQ/or new split function, dual ch. 2 band, 1U, XLR	\$1,549.00
Dolby 740	Spectral Processing, 1U, XLR	\$1,760.00
Oxmoor DEQ-I	Mono 29 band, 1U, XLR	\$1,118.60
Oxmoor DEQ-II	Mono 29 band, 2U, XLR	\$1,540.00
Rane RPE 228	Stereo 28 band, Remote Programmable, 1U Euroblock I/O	\$1,249.00



Rane GE130



Yamaha GQ1031C



BSS FCS-916



Klark Teknik DN410



Symetrix 551E



ART DR-X2100



Dolby 740

### Input/Output Connections

TRS = 1/4" Tip-Ring-Sleeve

TS = 1/4" Tip-Sleeve

BS = Barrier Strip

XLR = 3 Pin XLR

We would be happy to fax or mail complete specifications on any equalizer you find of interest.

# BGS production ~ feedback eliminator

## Goldline



The new **Goldline FD-23**, used with any equalizer, is a fast and effective way to eliminate feedback. The FD-23 makes use of the same filters used in expensive 1/3 octave analyzers. You can simply and quickly ring-out any room by raising the level of the sound system until feedback occurs. The LED display of the FD-23 will indicate which frequency to cut allowing the minimum cut necessary to keep the music while eliminating the feedback. It is a rugged portable instrument with built-in microphone and is powered by AA batteries or a 12 volt DC supply. 12oz., 3-1/4"x8"x2-1/4"

FD-23	\$259.95
-------	----------

## Furman



The **Furman IP-8/IP-2 Iso-Patch** temporarily or permanently isolates line level audio signals, to break ground loops that cause buzz and hum. It features eight inputs/outputs in a standard half-normal configuration. 1U. The IP-2 is an inexpensive dual channel version of the IP-8. It features 2 Input/output channels fitted with 1/4" jacks.

IP-8	\$259.00
IP-2	\$69.00



BGS

P  
R  
O  
C  
E  
S  
S  
O  
R  
S

**Broadcasters General Store (352) 622-7700 Fax (352) 629-7000**

100



# production ~ feedback eliminator



**BGS**

## Sabine

**Sabine FBX-901 & 901/S** has automatic feedback elimination, with more gain before feedback, and no muting of sound: these are the proven benefits of Sabine's FBX Feedback Exterminators. Thousands of sound engineers and musicians are using the FBX's patented adaptive filters for fast and precise feedback control. Now Sabine brings you two new versions.



FBX-901	Single channel w/nine filters	\$649.95
FBX-901/S	As FBX-901, 1/5-octave version	\$649.95



The **Sabine FBX-SOLO**, is a miniature version of the FBX-901. One SOLO controls feedback on one input channel—you decide which feedback prone inputs get automatic feedback control and maximum gain, from one channel to all your channels. Use one FBX-SOLO per channel; up to six units per rack tray. Mix mic and line versions to match your system requirements. SOLO, DSP based automatic notch filter & feedback controller.

SL-620	Line level input version, 1/4" I/O's	\$324.95
SM-620	Microphone level input version, XLR I/O's	\$349.95
SL6Rack	Rack Tray, holds up to six SOLO's	\$44.95
SPSU-1	SOLO single unit replacement power supply	\$19.00

**PROCESSORS**

# production ~ modular

## Aphex

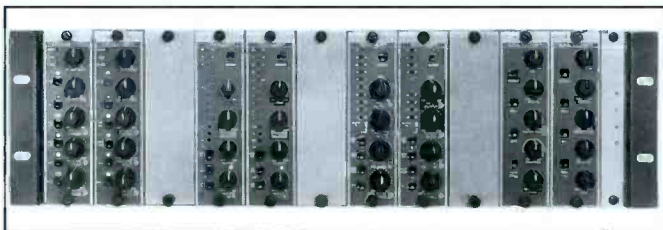

The **Aphex 9000** Modular Processing System is a space saving way to install some of the more popular Aphex products.

9000R	3U unpowered	\$379.00
9000PS	9000 series power supply, 2U Aphex modules only	\$499.00
9001PS	same as 9000PS for added DBX® compatibility	\$599.00
9005PS	3U 9000PS 5 amp power supply, Aphex only	\$699.00
9251	Aural Exciter module, single channel	\$449.00
9301A	Compeller module, single channel	\$549.00
9621	Logic assisted gate module, single channel	\$449.00
9651	Expressor module, single channel	\$449.00
9721	Dominator II, single channel	\$595.00
9901A	Parametric EQ, single channel	\$449.00
9000BP	Blank panel, single position	\$19.00

## dbx



The **dbx 900 Series** is a modular signal-processing system that eliminates redundant packaging, saves rack space and provides exceptional flexibility and serviceability.

F900A	9-Channel mainframe, 3U	\$599.95
FS900	2-Channel horizontal mini-frame, 1U	\$399.95
902	De-esser module	\$299.95
903	Over Easy Compression module	\$295.95
904	Noise Gate module	\$295.95
905	3-Band Parametric/Notch Equalizer module	\$499.95
911	Type I NR Encode/Decode module	\$239.95
929	2 Channel single ended NR module	\$399.95
941A	2 Channel Type II Encode module	\$259.95
942A	2 Channel Type II Decode module	\$269.95
BP-900A	Blank panel	\$12.95
900/EXT	Extender card	\$99.95



# GREAT MINDS DO THINK ALIKE!



## THE APHEX FM PRO

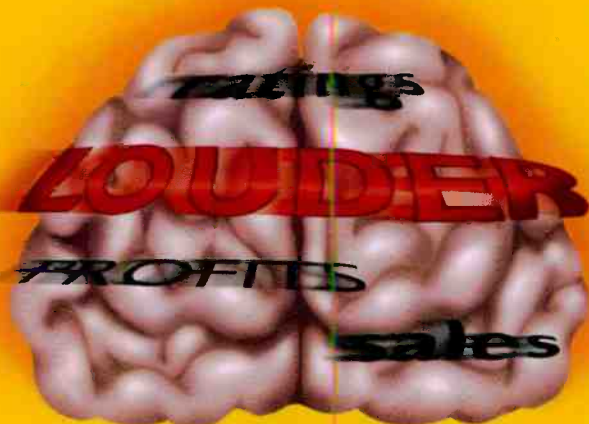

Station Manager



Engineer

**E**veryone imagines being louder than their competition without causing listener fatigue. It's no longer just a fantasy. With the new ApheX FM Pro, loudness doesn't come at the cost of mind numbing grunge and distortion any more. It took the genius of five existing patents, combined with six new inventions, to create the most powerful, greatest sounding processor ever.



Engineers will love the ease of set-up and use, plus remote control and security features to keep unwanted hands off the controls.



Program directors will love the complete flexibility to fashion truly unique processing for their particular programming and tastes.



Station managers will love the increased loudness to grab listeners and the high audio quality to keep them tuned in.

It's a no brainer - if you want loud without listener fatigue, call for a demonstration today.

**APHEX**  
SYSTEMS

*Improving the way the world sounds* <sup>SM</sup>

# Discover how good your station can sound!

## Audio Processing from CRL Systems

### DP-100 Digital Processor



The Next Generation FM digital processor with natural sound, superior loudness & outstanding audio quality.

No matter the size of your station or the size of your budget CRL has a quality system to fit your needs. Experience CRL's audio products for Radio and Television.

**Try CRL. We will help you get the most from your audio processing investment!**

#### FM Radio

- DP-100 Digital Processor
- SC-100 Digital RDS/RBDS Generator
- Amigo FM Processor
- FM-2G+ Modular System

#### AM Radio

- AM Stereo Amigo
- AM-4M Mono Modular System
- MBL-100 News/Talk/Sports

#### Television

- TVS-3003 Limiter & MTS Generator
- TVS-3001 Audio Controller
- TVS-3005 SAP Generator
- BAP-2000 Mono Processor



**Circuit Research Labs, Inc.**

*Audio processing for every market & every budget!*



# production ~ noise reduction

## Behringer



The **Behringer Denoisers** are single-ended noise reduction units with a cut-off frequency active over a range from 800 Hz to 20kHz. They greatly reduce system noise in radio and TV productions, recording studios, tape duplication facilities, cutting rooms and project suites. The active ingredients in Behringer's Denoisers reside in a side-chain, not in the way of the main signal path. This elegant 'negative feedback' design offers minimal disturbance to your valuable signal, giving you a very clean transparent audio pathway.

SNR1000	2-Channel Denoiser	\$249.99
SNR2000	2-Channel, Multi-band Denoiser	\$369.99

## Dolby



The **Dolby Model 363** provides two channels of Dolby SR and/or A-type noise reduction. Features include automatic record/play change-over, built-in Dolby noise/tone generators, auto compare test facility, and active balanced input and output circuitry.

363 SR/A	Two-channel unit with Cat. No. 300 switchable Dolby SR and A-type module	\$2,995.00
363 SR	Two-channel unit with Cat. No. 350 Dolby SR only modules	\$2,655.00

## dbx



The **dbx 140X and 150X** provide more than 40dB of extra dynamic range. The 140X is ideal for cart machines, telco lines, videotape audio tracks, STL's, etc. and the 150X for open-reel tape machines, full-bandwidth digital recorders, etc. Units are half/rack and 1U.

140X	Type II Noise Reduction, 2 Channel	\$319.95
150X	Type I Noise Reduction, 2 Channel	\$319.95

## Roland



The **Roland SN-700** is a fully digital noise elimination system that employs exclusively designed DSP circuitry to remove all types of noise without "breathing" or changing the tonality of the overall sound. This is achieved with two separate noise reduction circuits that handle noise and hum independently. The SN-700's single-ended design can perform noise cancellation in real time, making it ideal for broadcasting, sound reinforcement and other professional applications.

SN-700	Digital Noise Eliminator	\$995.00
--------	--------------------------	----------

# analog ~ cartridge machines

## Audi~cord



The **Audi-Cord DL Series** is an excellent value. The playback decks have replay lock out, audio muting (secondary tone switchable) and automatic motor turn off. The record decks have analog VU meters, automatic meter switching from record to play and an optional timer. The DL Series also has a dual transport, Record/Play available. This machine will allow you to make dubs or stereo to mono mix dubs.

DL-PM	Mono Playback	\$1,050.00
DL-PS	Stereo Playback	\$1,150.00
DL-RM	*Mono Rec/Play	\$1,550.00
DL-RS	*Stereo Rec/Play	\$1,800.00
DL-DM	*Dual Mono R/P	\$2,700.00
DL-DS	*Dual Stereo R/P	\$2,800.00
184-0009	Tertiary Tone Detector	\$40.00
185-0007	8kHz Ter Osc (Rec)	\$60.00
185-0006	Rack shelf	\$65.00
* -T	Timer option add	\$100.00

## Broadcast Electronics



The **Broadcast Electronics Dura-Trak** is built to deliver long term reliability with a

mechanical design derived from the Phase Trak 90 machine. A superior cartridge guidance system, previously played cart lockout and instrumentation quality balanced inputs and outputs are a few of the features that make the Dura Trak 90 a great cart machine value.

DT90AP	Mono Playback	\$1,650.00
DT90ARP	Mono Rec/Play	\$2,500.00
DT90APS	Stereo Playback	\$1,800.00
DT90ARPS	Stereo Rec/Play	\$2,750.00
Rack shelf	19" wide, 7" high rack shelf	\$220.00



**BGS**

P  
R  
O  
C  
E  
S  
S  
O  
R  
S

**Broadcasters General Store (352) 622-7700 Fax (352) 629-7000**



# analog ~ cartridge machines



**BGS**

**R  
E  
C  
O  
R  
D  
E  
R  
S  
/  
P  
L  
A  
Y  
E  
R  
S**

## Fidelipac

The **Fidelipac Dynamax CTR10 series** is ruggedly constructed with a precision DC capstan motor and PLL control circuitry for excellent speed stability. Inputs and outputs are via XLR's or 9 pin "D" connectors. Remote control, tallies and FSK data interfacing are accessed thru a 50 pin "D" connector.

CTR10 Series		
CTR11	Mono Reproducer	\$1,795.00
CTR12	Stereo Reproducer	\$1,935.00
CTR13	Mono Recorder/Reproducer	\$2,640.00
CTR14	Stereo Recorder/Reproducer	\$2,890.00
ESD10	Eraser/Splice Detector	\$1,390.00

CTR100 Series with CartScan and built-in Splice Detector		
CTR111	Mono Reproducer	\$2,675.00
CTR112	Stereo Reproducer	\$2,880.00
CTR123	Mono Recorder/Reproducer	\$4,475.00
CTR124	Stereo Recorder/Reproducer	\$4,830.00

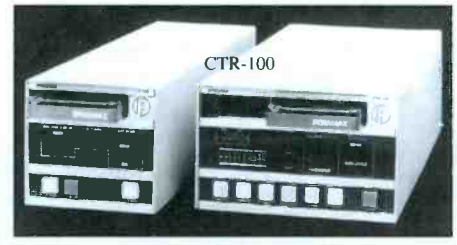

## recording media

### Audiopak~ITC~Fidelipac Carts



**Audiopak A-2's** come with a black casing and 605 ferric oxide tape for mono applications, AA-3's come with high-output, low-distortion 613 tape in the familiar dark blue "neutral-design" casing, or "digital-ready" AA-4's with 614 tape, a premium oxide formulation designed for superior high frequency

saturation headroom, in a light blue casing with the same neutral design as the AA-3. Come in 24 packs, priced each.

Broadcast Cartridges	A-2	AA-3	AA-4
Bulk Empty	3.85	5.25	N/A
Empty	4.19	N/A	N/A
10/20/35/40/50/65/70/90/100 Seconds	5.00	6.10	7.00
140Sec/2.5/3.0/3.5/4.0/4.5 Minutes	5.65	6.85	7.75
5.0/5.5/6.0/6.5/7.5/8.5/10.5 Minutes	6.35	7.90	9.00

Replacement Parts and bulk lubricated tape for all carts are available. please call for pricing.



**Audiopak IA-II** (previously ITC/Scotchcart) broadcast cartridge utilizes a passive system of internal tape guidance, which allows your cartridge machine to do a precise job. Come in 10 packs.

Cat. No.	Price each
AA-0	\$9.88
AA-10	\$10.03
AA-20	\$10.17
AA-40	\$10.32
AA-70	\$10.47
AA-100	\$10.76
AA-2.5	\$11.63
AA-3.0	\$11.92
AA-3.5	\$12.21
AA-4.0	\$12.50
A-4.5	\$12.79
AA-5.0	\$13.23
AA-5.5	\$13.52
AA-6.5	\$14.10
AA-7.5	\$14.83

**Fidelipac Dynamax®** Cobalt, Mastercart 350 & 300, Audiomax® 3000 & 4000.  
Please call Broadcasters General Store for pricing and availability!

### Mini Disc

Sony		
MDW60A	60 Minutes, box of 10	\$94.20
MDW74A	74 Minutes, box of 10	\$113.20

TDK		
MDXG60	60 Minute	\$14.17
MDXG74	74 Minute	\$17.47

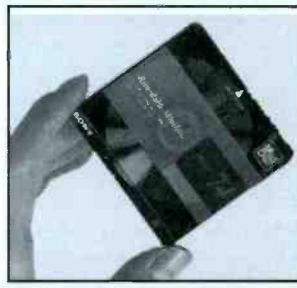

**Many Items in Stock for Immediate Delivery...Call Today!**



**Mini Disc Recorders**

Manufacturer	Analog Out	Analog In	Digital Out AES/SPDIF	Digital In AES/SPDIF	Remote Port	Price	
<b>Denon</b>							
DN-995R	X	X	X	X	P/S	\$3,800.00	
DN-990R	X	X	X	X	P/S	\$2,800.00	
DN-981F	X	N/A	X	N/A	P/S	\$2,300.00	
DNM1050R	X/R	X/R	X/R	X/R	P/S	\$1,800.00	
DN-1100R	X/R	X/R	R	R	P	\$2,600.00	
DN-80R	R	X	X	X	S	\$4,500.00	
DN-045R	Used for duplication for Serial only RS232C/RS422A					S	\$4,200.00
<b>Otari</b>							
MR-10P	X	N/A	R	N/A	P	\$2,625.00	
MR-10RP	X	X	R	R	P/S	\$3,255.00	
<b>Sony</b>							
MDS-B5	X	X	R	R	P/S	\$3,295.00	
MDS-B6P	X	X	R	R	P/S	\$2,300.00	
MDS-JE510	R	R	O	O		\$360.00	
MZ-B3	M	M		OPT	P	\$899.95	
<b>Tascam</b>							
MD-801R	X/R	X/R	X/R	X/R	P/S	\$2,499.00	
MD-801P	X/R	X/R	X/R	X/R	P/S	\$2,399.00	

Key: X = XLR R = RCA S = Serial Port P = Parallel Port O = Square Optical

MD technology was introduced in 1992 by Sony for the consumer market to compete against Phillip's DCC, eventually replacing it. Since that time many professional units have been developed based on the MD format meaning they all have similar specs and differ only in their topology, features and prices. (DCC never really got started.)

**MD Specs includes:** 2-Channel • Playback: optical laser pickups • Record: magneto optical overwriting • Compression Algorithm: ATRAC, Adaptive Transformer Acoustic Coding • Rec/Play time: 74 minutes maximum • A/D converter: 16-bit linear • Sample rate: 44.1kHz • Start time: <100ms • S/N ratio: >84dB • Frequency response: 20-20kHz • Modulation system: EFM, Eight to fourteen modulation.



**BGS**

**R  
E  
C  
O  
R  
D  
E  
R  
S  
/  
P  
L  
A  
Y  
E  
R  
S**

**Specific Model Features**

**Denon**



**DN-995R** Rec/Play • 1/3 rack by 3U • L/R level adjust I/O • External sync I/O • Serial/Parallel remote • PC control software • and rear H/P jack **\$3,800.00**

**DN-981F** Playback only version of the DN-995R without the external sync. Includes: "hot start": assign 10 tracks to be fired from PC software or parallel control. **\$2,300.00**



**DN-990R** Features similar to DN-995R like EOM, Fader Start, single track or all track play, single or all track erasure, divide/combine/move/title edit functions, but without the External sync, PC control software or RS-422A/RS-232C select functions **\$2,800.00**



**DN-M1050R** Rec/Play, 3RU, standard edit functions plus cue & A-B section editing • auto level record start • ±9.9% vari-pitch • search/scan/with jog wheel • XLR/RCA analog I/O; AES/EBU & SPDIF digital I/O • PC keyboard interface • optional ACD-25 rate converter, ACD-26 hot start kit (up to 20 tracks) and ACD-27 SMPTE TC kit **\$1,800.00**

**DN-1100R** Rec/Play with 10 "Hot Start" buttons which can be fired from parallel connector. **\$2,600.00**



**DN-80R** Housed in a rigid shock proof aluminum case, this portable MD boasts a 16MB RAM buffer (40 stereo seconds), monitor speaker mic attenuator & more. Dimensions: 8.75" x 3.3" x 10.7" Weight: 1.5 lbs. **\$4,500.00**

**Continued next page**



**BGS**

**R  
E  
C  
O  
R  
D  
E  
R  
S  
/  
P  
L  
A  
Y  
E  
R  
S**

## Denon



**DN-045R** This 3.5:1, digital-to-digital MD dubbing deck produces a defragmented copy of any highly edited, fragmented master MD. Housed in a 2U chassis the DN-045 includes: PC software for editing during dubbing via the serial port. **\$4,200.00**

## Otari

**MR-10R** Rec/Play, 1/3 rack by 3U. L/R level adjust I/O; parallel remote for CB-159 (included), EOM, repeat play, single track/program tracks play; single or all tracks erasure; divider/join/remember/title edit functions plus 32 character LCD display. Optional RS-422 serial interface card. **\$3,255.00**

**MR-10P** Playback only version of the MR-10R, includes the CB-160 remote controller. **\$2,625.00**



## Sony



**MDS-B5** Rec/Play; 1/2 rack by 3U, supplied RM-C2 remote commander; PC keyboard interface • 10-track instant start memory • high speed copy •  $\pm 12.5\%$  vari-speed • RS232C & GPI interfaces • balanced analog AES/EBU, SPDIF digital I/O **\$3,295.00**

**MDS-B6P** Including all the same features of the MDS-B5, playback-only version **\$2,300.00**



**MDS-JE510** Full size consumer MD • jog dial for track selection • text entry • unbalanced analog • optical & coaxial digital I/O • standard edit functions • remote commander supplied • no rack mount • undo editing and A-B erase make disc-based editing even easier • Time Shift Recording function actually captures music before you press the Record button **\$360.00**



**MZ-B3** MD for the boardroom! Stereo or mono (not compatible with professional units), built-in mic and speaker, auto date/time stamp function, selectable VOX operation, 3.5mm I/O and H/P jack. Uses 3-AA batteries or optional AC adapter and case. **\$900.00**

**MZ-R3** "Walkman" style MD Rec/Player with 4 MB buffer for shock resistance, LCD display, track mark/move/erase one/all tracks, edit function, internal mic/speaker, and stereo headphones with in-line remote, AC adapter, dry battery case & carrying case included. **\$550.00**



## Tascam



**MD-801R** Rec/Play, 3U, front panel input adjust, standard played it functions, SCMS ID selectable, "Jog" dial for editing to  $1/86\text{th}$  of a second, and multiple unit link functions. **\$2,499.00**

**MD-801P** Playback only version of the MD-801R **\$2,399.00**

**BU-801** RAM Buffer for MD-801 **\$249.00**



**360 Systems**



**BGS**

**R  
E  
C  
O  
R  
D  
E  
R  
S  
/  
P  
L  
A  
Y  
E  
R  
S**



The **Instant Replay** by 360 systems is a fully professional audio sampler that can store up to 1000 cuts of audio on an 8, 16 or 24 hour internal hard drive using Dolby AC-2 audio compression. 500 of these cuts can be stored in 10 banks and each bank of 50 cuts can be "Mapped" to the 50 "Hot Keys" and may be recalled by typing in the cut number, part of the cut's name or all of the cut's name. Cuts are imported via the balanced analog inputs, digital inputs or by the standard "D-NET" (8x real time) file transfer system. Each "Hot Key's" audio is loaded into a ram buffer for instant sound at the touch of the button. Cuts can be stacked, looped, paused, stopped or initiated from the beginning as fast as you can hit the button. Great for live theater, production rooms or the drive-time Jock with way too many carts loaded with sound effects, bumpers, themes, voice-overs and station ID's.



DR5508	8 Hour Instant Replay	\$2,995.00
DR55016	16 Hour Instant Replay	\$3,495.00
DR55024	24 Hour Instant Replay	\$3,795.00

**Digicart/II** is a stand alone, hard disc based digital storage device designed especially for broadcast use and is considered the most cost effective machine on the market. It becomes a direct replacement for multiple analog cart machines without the expense of routine maintenance and replacement carts. With instant access to thousands of cuts and stacks, zero shuttle time, and excellent audio quality it out performs any tape based machines. Digicart/II is configured with a standard Bernoulli drive and a choice of several large hard drives. An optional external hard drive storage system can expand the storage capacity seven fold. All three popular sample rates are supported as well as Dolby AC-2 for maximum storage capacity. Also featured are: GPI closures • BCD parallel interface • ES-bus serial interface • and non-destructive editing consisting of head/tail trims • fade in/out • and level adjust. Optional remote controls for simple labeling, "on-air" control, and production room full remote control as well as software for PC control and digital file transfer via D-Net from one machine to another. Balanced XLR I/O and AES/EBU I/O are standard.

**Digicart/II Plus** gives you the same great features of the original Digicart/II with the following added benefits: space for two internal, large capacity hard drives for up to 10 hours of 16-bit linear stereo audio or up to 49 hours with Dolby AC-2 • internal 100MB zip drive • I/O interfaces and D-Net firmware for transfer of files between existing 360 Systems equipment.

2510	Digicart/II with 1GB Hard Drive	\$4,995.00
2520	Digicart/II with 2GB Hard Drive	\$5,395.00
2530	Digicart/II with 3GB Hard Drive	\$5,695.00
2710	Digicart/II Plus with 1GB Drive (AC-2=8Hrs)	\$3,995.00
2720	Digicart/II Plus with 2GB Drive (AC-2=16Hrs)	\$4,395.00
2730	Digicart/II Plus with 3GB Drive (AC-2=24Hrs)	\$4,695.00
RC-205	Mini Keyboard Remote Control	\$130.00
RC-210	Playback Only Remote Control	\$595.00
RC-220	Full Function, 4 unit, Remote Control	\$745.00
DMF-65/10	65MB Multi-format Bernoulli Discs, 10 pcs.	\$500.00
DMF-105/10*	105MB Multi-format Bernoulli Discs, 10 pcs.	\$750.00
DMF-150/10	150MB Multi-format Bernoulli Discs, 10 pcs.	\$990.00
RS-12	Rackshelf for one or two Digicart/II or II+	\$149.00
D-NetK	Field upgrade File Transfer Firmware Kit	\$195.00
D2PlusEUPGK	Upgrade Digicart/II to Plus Series w/Ext. zip drive	\$525.00
D2Plus IUPGK	Upgrade Digicart/II to Plus Series w/Int. zip drive	\$495.00
Optional hard drives and installation kits for Digicart/II and Digicart/II Plus		
HD1GB	1GB Hard Disc and installation kit	\$495.00
HD2GB	2GB Hard Disc and installation kit	\$795.00
HD3GB	3GB Hard Disc and installation kit	\$1,095.00

Call Broadcasters General Store for upgrade kits for older Digicarts and further information!

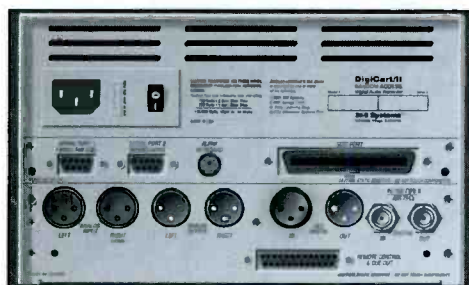
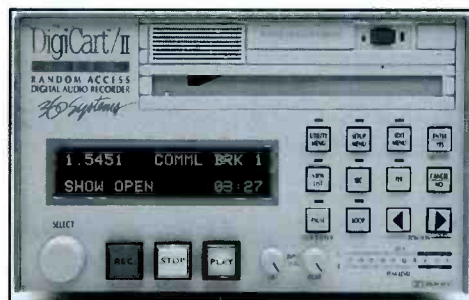

We are happy to arrange a demonstration on any 360 System equipment !



# analog cassette decks



**BGS**

**R  
E  
C  
O  
R  
D  
E  
R  
S  
/  
P  
L  
A  
Y  
E  
R  
S**



Marantz PMD-201 • PMD-221 • PMD-222 • PMD-430

## Cassette Decks

Make/Model	Frequency Response	Stereo or Mono	Heads	Capstan Motor	Reel Motor	Headphone Jack	Varispeed (+/-)	Noise Reduction #1	Dolby B/C	Auto Reverse	Music Search	Auto Locater	Dual Well #2	Mic Input #3	Line I/O #4	Meters	Frequency Response (1/2 Speed)	Mic Attenuation	Limiter	Rackmount or Portable	Wired Remote Control	Weight (lbs.)	Carry Case	AC Adapter	Price
<b>Denon</b>																									
DN-790R	15-22k	S	3	DC	DC	Y	12%	B/C/S	Y	N	Y	N	N	X/R	LED	N/A	N	N	3	N	11.2	N	N	\$1,000.00	
DN-770RM	20-20k	S	2x2	DC	DC	Y	12%	B/C	B	Y	N	C	N	R	LED	N/A	N	N	3	N	11.5	N	N	\$700.00	
DN-720R	20-20k	S	2	DC	DC	Y	12%	B/C	Y	N	N	N	N	R	LED	N/A	N	N	3	N	10.6	N	N	\$500.00	
DN-610F	20-20k	S	2	DC	*	N	12%	B	N	Y	N	N	N	R	LED	N/A	N	N	3	N	12.1	N	N	\$700.00	
<b>Marantz</b>																									
PMD-430	35-14k	S	3	DC	*	Y	6%	B/D	N	N	N	N	TRS	R	VU	N/A	Y	N	P	N	2.9	Y	Y	\$649.00	
PMD-222	40-12.5k	M	3	DC	*	Y	20%	N	N	N	N	N	X/M	R	VU	40-6.5k	Y	ALC	P	N	2.9	O	Y	\$479.00	
PMD-221	40-12k	M	3	DC	*	Y	20%	N	N	N	N	N	M	R	VU	40-6.5k	Y	ALC	P	N	2.9	O	Y	\$449.00	
PMD-201	40-12k	M	2	DC	*	Y	20%	N	N	N	N	N	M	R	VU	40-6k	Y	ALC	P	N	2.9	O	Y	\$379.00	
PMD-101	40-13.5k	M	2	DC	*	Y	20%	N	N	N	N	N	TRS	R	N	40-7k	N	ALC	P	N	2.9	Y	O	\$279.00	
PMD-500	20-16k	S	1x2	DC	DC	Y	N	B/C	Y	Y	N	B	N	R	LED	N/A	N	N	3	N	18	N	N	\$639.00	
PMD-501	20-16k	S	2	DC	DC	Y	N	B	N	Y	N	N	N	R	LED	N/A	N	N	3	N	15	N	N	\$329.00	
PMD-502	20-16k	S	2	DC	DC	Y	15%	B/C	Y	Y	N	N	TRS	X/OR	LED	N/A	N	ALC	3	N	15	N	N	\$499.00	
PMD-510	20-16k	S	2	DC	*	Y	15%	B/C	Y	Y	Y	N	C	N	X/OR	LED	N/A	N	N	3	N	19	N	N	\$829.00
<b>Sony</b>																									
TCD-5ProII	40-14k	S	2	DC	*	Y	N	B	N	N	N	N	X	R out	VU	N/A	Y	Y	P	N	3.75	Y	O	\$1,475.00	
<b>Tascam</b>																									
102MKII	25-17k	S	2	IC	IC	Y	N	B/C	Y	N	N	N	N	R	LED	N/A	N	N	3	N	8.8	N	N	\$369.00	
103	25-17k	S	2	IC	IC	Y	N	B/C	Y	N	N	N	N	R	LED	N/A	N	N	3	N	8.8	N	N	\$569.00	
202MKII	25-17k	S	2/2	DC	*	Y	N	B/C	Y	Y	Y	N	B	TRS	R	LED	N/A	N	N	3	N	10.5	N	N	\$529.00
302	25-18k	S	2/2	DC	DC	Y	10%	B/C	Y	Y	N	C	N	R	LED	N/A	N	N	3	N	16	N	N	\$629.00	
112MKII	25-16k	S	2	DC	DC	Y	12%	B/C	Y	N	N	Y	N	R/XO	VU	N/A	N	N	3	Y	18.5	N	N	\$849.00	
112RMKII	25-17k	S	2	DC	DC	Y	12%	B/C	Y	Y	N	Y	N	R/XO	VU	N/A	N	N	3	Y	19.2	N	N	\$1,149.00	
122MKIII	25-17k	S	3	DC	DC	Y	12%	B/C	Y	N	N	Y	N	X/R	VU	N/A	N	N	3	Y	18.5	N	N	\$1,349.00	

Key: #1 Dolby B, C or S/D=dbx #2 A=R/Px1 & Play only x1 B=Both R/P C=2 Independent R/P Decks

#3 X=XLR R=RCA M=3.5mm TS=1/4" Unbalanced TRS=1/4" Balanced O=Optional

Motors are DC Servo or IC Logic \*Notes: 1 motor drives reel and capstan

**Many Items in Stock for Immediate Delivery...Call Today!**



# analog ~ cassette decks



Marantz PMD-510



Marantz PMD-320

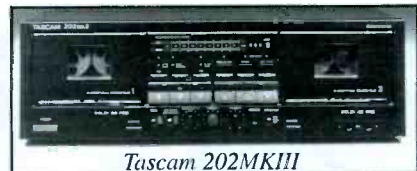

Tascam 202MKIII



Sony TCD-5 ProII



Tascam 102MKII



Tascam 302MKII



Tascam 103



Tascam 112MKII

## American Recorder Tech. Maintenance



American Recorder Technologies		
D501	Electronic cassette demagnetizer	\$20.00
C-911B	Cassette cleaner w/1/2 oz. S-711 & applicator	\$10.00
K-141	Cassette cleaner w/C-911B & case	\$16.00
K-151	Cassette cleaner K141 w/demag	\$30.00



Tascam FF2RMK1



Tascam FF2MKII

# analog ~ cassette duplicators

## Telex



The **Telex ACC Series** can make up to 27 copies of both sides of a 60 minute cassette in less than 2 minutes. The control unit allows adjustment of audio record level and provides peak reading LED meters to monitor these adjustments. A control unit copies three cassettes and expansion copy units handle four. Copy speed is 30 ips 16x with a frequency response of 50-10,000Hz.

ACC4000M	Master, 1/4 track, 4 channel	\$2,810.00
ACC4000C	Expansion Copy Unit, 1/4 track, 4 channel	\$2,810.00



The **Telex Replica™** copier is the smallest, fastest and lightest copier on the market with typical Telex simple operation and a full set of functions such as stop, rewind, copy and interrupt. It has a 16X record speed and copies both sides of a cassette at one time.

Mono Replica™	\$425.00
---------------	----------



The **Telex Copyette EH™** Series produces high quality, low cost cassettes in large quantities at nearly 16 times normal speed. This means you can reproduce both sides of a C-60 tape in less than 2 minutes. You have a choice of EH™ models that are capable of duplicating either one cassette or three at a time, in mono or stereo and features erase heads.

Copyette 121Mono	Half track, two ch., (30 ips)	\$550.00
Copyette 121Stereo	Quarter Track, four ch., (25 ips)	\$885.00
Copyette 123Mono	Half track, two ch., (30 ips)	\$1,350.00
Copyette 123Stereo	Quarter Track, four ch., (25 ips)	\$2,150.00



BGS

R  
E  
C  
O  
R  
D  
E  
R  
S  
/  
P  
L  
A  
Y  
E  
R  
S

**Broadcasters General Store (352) 622-7700 Fax (352) 629-7000**





**BGS**

**R  
E  
C  
O  
R  
D  
E  
R  
S  
/  
P  
L  
A  
Y  
E  
R  
S**

## Compact Disc Players

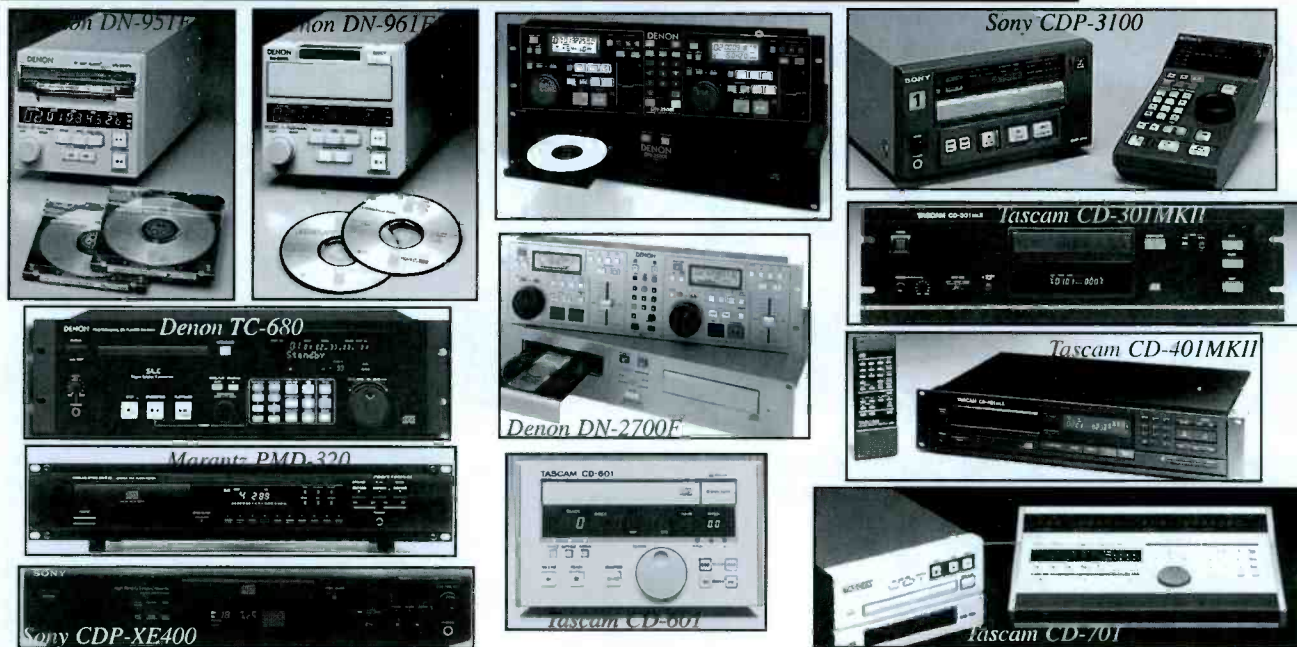

## Compact Disc Players

Make/Model	Analog Out		Digital Out		D/A Converter	Jog Shuttle Wheel	Rack Mount	Remote Control	Parallel I/F	Serial I/F	Pitch Control %	Track Select	Index Select	Cue to Music	Headphone Jack	Height in RU	Width in Inches	Depth in Inches	Weight (lbs.)	CD Capacity	Tally	Fader Start	Warranty Part/Labor (1=years) (90=days)	Price
<b>Denon</b>																								
DN-600F	R	S	18bL	N	Y	RC41	N	N	12	Y	N	N	Y	2	19	10.5	8.4	1	N	N	1/1		\$450.00	
DN-C680	R/X	S	18bL	N	Y	N	Y	N	8	Y	Y	Y	Y	3	19	10.5	10	1	Y	Y	1/1		\$900.00	
DN-951FA	X	A/S	18bL	N	O/\$127	N	Y	Y	N	Y	Y	Y	Y	4	1/3R	15.75	12	1	Y	Y	1/1		\$1,500.00	
DN-961FA	X	A/S	18bL	N	O/\$127	N	Y	Y	N	Y	Y	Y	Y	4	1/3R	15.75	12	1	Y	Y	1/1		\$1,500.00	
DN2000FMKII	R	N/A	18bL	N	Y	RC35	N	N	8	Y	N	Y	N	2/2	19	10	14	2	N	N	1/1		\$1,200.00	
DN-2500	R	N/A	18bL	Y	Y	RC44	N	N	16	Y	N	Y	N	2/2	19	10	16.5	2	N	N	1/1		\$1,800.00	
<b>Marantz</b>																								
PMD-320	R	S	1bΔΣ	N	Y	N	N	RC5	12	Y	N	N	Y	2	19	11.5	7	1	N	Y	1/90		\$429.00	
PMD-321	X	S	1bΔΣ	N	Y	N	N	RC5	12	Y	N	Y	Y	2	19	11.5	7	1	N	Y	1/90		\$529.00	
<b>Sony</b>																								
CDP-L3	X/R	S	18bL	N	Y	RMDL3	N	N	N	Y	N	Y	Y	3	19	11.5	9	1	N	N	1/90		\$600.00	
CDP-3100	X	O	18bL	N	N	CDS3100	N	Opt	12.5	Y	N	Y	Y	4	8.3	16	15	1	N	Y	1/90		\$3,650.00	
CDP-D500	X/R	A/S	18bL	Y	Y	N	Y	Y	12.5	Y	N	Y	Y	3	19	13	16	1	N	N	1/90		\$1,595.00	
CDP-XE400	R	N/A	Hybrid Pulse)	Y	N	N	N	N	N	Y	N	N	Y	3	17	15	7	1	N	N	1/90		\$195.00	
<b>Tascam</b>																								
CD-201	R	S	1bΔΣ	N	Y	RC31	N	N	N	Y	N	Y	Y	3	19	13.3	12	1	N	Y	1/90		\$529.00	
CD-301MKII	X/R	S	1bΔΣ	N	Y	RC31	N	N	N	Y	N	Y	Y	3	19	11	11	1	N	Y	1/90		\$739.00	
CD-401MKII	X/R	S	1bΔΣ	N	Y	RC401	N	N	12	Y	Y	Y	Y	2	19	11	18	1	N	Y	1/90		\$1,049.00	
CD601	X/R	O	1vΔΣ	Y	O/\$250	RC601	Y	Y	9.9	Y	Y	Y	N	3	8.7	14.2	13.3	1	Y	Y	1/90		\$1,799.00	
CD-701	X	S	1bΔΣ	N	O/\$250	RC701	Y	Y	6	Y	Y	Y	Y	3	8.7	18.4	21	1	N	Y	1/90		\$2,499.00	

Key: #1 R=RCA X=XLR #2 S=SPDIF A=AES O=Optional #3 18bL=18 bit Linear 1bΔΣ=1 bit ΔΣ Y=yes N=no O=optional



**TWECOMM**

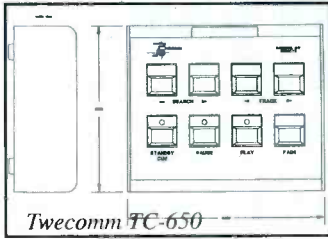

Twecomm TC-650

**Twecomm TC-650** is a remote control for the Denon DN-650F, DN-951FA, DN-961FA, DN-980F, DN-990R, and DN-995R CD players and mini disc recorder/player units. The remote has the following functions: Standby-Cue

w/LED, Pause w/LED, Play w/LED, Record w/LED, Track step up, Track step down, Search up and Search down. A 12-foot DB-25 control cable is furnished with each unit.

TC-650		<b>\$98.50</b>
TC-675	Dual adapter allows two CD or MD units to be simultaneously controlled from a single TC-650	<b>\$74.50</b>
TC-600	Hot Start for DN-981 & DN-1100R Mini Disc	<b>\$469.00</b>
TC-700	Remote for DN-720R or DN-790R	<b>\$72.50</b>
TC-770	Remote for DN-770R	<b>\$72.50</b>

**Recordable CD'S & Cleaners**



**American Recorder Technology**

KCD101A	CD Cleaning Kit	<b>\$16.00</b>
Jewel	Jewel Case (10 Pack)	<b>\$11.00</b>

**Sony**

CDQ63A	4X Drive Compatible, 63 minutes, box of 10	<b>\$139.50</b>
CDQ74A	4X Drive Compatible, 74 minutes, box of 10	<b>\$149.50</b>

**TDK**

CDR63B	Recordable CD - blank, 63 minutes	<b>\$15.95</b>
CDR74B	Recordable CD - blank, 74 minutes	<b>\$16.95</b>

**Marantz**

**Marantz CDR 620/615 Recorders**

Features	CDR620	CDR615	Remarks (pertain to CDR 620 only)
AES/EBU digital I/O	yes	no	output suitable for cascading
SPDIF digital I/O coax	yes	yes	
XLR analog I/O	yes	in	620's input sensitivity is switchable by software
Cinch Analog I/O	no	out	
Level meter accuracy	0.5dB	0.5dB	Metering according to broadcast guidelines
Sample Rate Converter	yes	yes	
Sample Rate Converter on/off	yes	option	For precise mastering of 44.1kHz source material
Auto Track Increment on level	yes	yes	
Increment level adjust	yes	yes	
Auto Track Incr. from CD	yes	yes	Frame accurate
Auto Track Incr. from DAT	yes	yes	
Auto Track Incr. from DCC	yes	yes	
Auto Track Incr from MD	yes	yes	
Index recording	yes	option	
Digital fade-in	yes	yes	
Digital fade-out	yes	yes	
Variable Audio Delay	1MB	1MB	
Variable Pause recording	yes	yes	
Emphasis on/off	yes	option	
Copy Prohibit on/off	yes	option	
ISRC code recording	yes	option	
EAN/UPC code recording	yes	option	
SCSI-II	yes	no	
Dedicated wire remote control	yes	option	
Parallel Remote I/O	yes	yes	
High Speed Copy	yes	no	



CDR-620 w/remote

CDR620	Standard with RC620 remote control	<b>\$3,600.00</b>
CDR615		<b>\$2,600.00</b>
RC620	Optional Remote Control for CDR615	<b>\$300.00</b>



**BGS**

**R  
E  
C  
O  
R  
D  
E  
R  
S  
/  
P  
L  
A  
Y  
E  
R  
S**





**BGS**

**RECORDERS / PLAYERS**

## DAT



Fostex D-5



Fostex D-10



Fostex D-25



Fostex D-30



Panasonic SV-3800



Panasonic SV-3900

## DATS

Make/Model	Sample Rate <sup>1</sup>	A/D Converter	D/A Converter <sup>2</sup>	Analog I/O <sup>3</sup>	Digital I/O <sup>4</sup>	Long Play Mode	SCMS Defeat	Rack Mount Units <sup>5</sup>	Remote Control <sup>6</sup>	SMPTC Time Code	Serial Port	Parallel Port	RAM Buffer	Number of heads	Number of motors	Varispeed	Headphone Jack	Head Hour Meter	External Sync	Weight (lbs.)	SBM*	Price	
<b>Fostex</b>																							
PD-4	B/C/D	18b $\Delta$ $\Sigma$	18b $\Delta$ $\Sigma$	X	XA	N	N	P	N	Y	N	N	N	4	3	N	Y	N	Y	7	N	\$6,995.00	
D-5	A/B/C	1b	1b	X	XS/T	Y	Y	3	N	N	N	Y	N	2	4	N	Y	N	N	15	N	\$1,495.00	
D-10	B/C	16b $\Delta$ $\Sigma$	18b $\Delta$ $\Sigma$	X/R	XA	N	Y	3	I	O	N	O	Y	Y	2	4	N	Y	N	16.5	N	\$2,895.00	
D-25	B/C	18b $\Delta$ $\Sigma$	18b $\Delta$ $\Sigma$	X	XA	N	Y	3	O	Y	N	Y	Y	Y	4	4	Y	Y	N	Y	29	N	\$7,995.00
D-30	B/C	18b $\Delta$ $\Sigma$	18b $\Delta$ $\Sigma$	X	XA	N	Y	3	O	Y	N	Y	N	4	4	N	Y	N	Y	31	N	\$10,995.00	
<b>HHB</b>																							
PDR-1000	A/B/C	1b $\Delta$ $\Sigma$	1b $\Delta$ $\Sigma$	X/R	XA/RS	N	N/A	P	N	N	Y	N	Y	N	4	4	N	Y	N	N	3.75	N	\$3,995.00
PDR100-TC	A/B/C	1b $\Delta$ $\Sigma$	1b $\Delta$ $\Sigma$	X/R	XA/RS	N	N/A	P	N	Y	Y	N	Y	N	4	4	N	Y	N	N	5.3	N	\$6,995.00
<b>Otari</b>																							
DTR90T	A/B/C/D	18b	18b	X	XA/RS	N	N/A	3	O	Y	N	Y	Y	O	4	4	Y	Y	N	N	33	N	\$10,393.00
<b>Panasonic</b>																							
SV3800	B/C	1b $\Delta$ $\Sigma$	20b	X	XA/RS	N	Y	3	N	N	N	N	Y	N	2	3	N	Y	Y	N	13	N	\$1,695.00
SV3900	A/B/C	1b $\Delta$ $\Sigma$	20b	X	XA/RS	N	Y	3	N	N	N	Y	Y	N	2	3	N	Y	N	N	14	N	\$2,895.00
SV4100	A/B/C	1b $\Delta$ $\Sigma$	20b	X	XA/RS	N	Y	3	N	N	N	N	Y	Y	2	3	N	Y	N	Y	14	N	\$2,950.00
<b>Sony</b>																							
DTCA6	A/B/C	1b $\Delta$ $\Sigma$	1bHDLC	R	RS/T	Y	N	3	I	N	Y	N	N	N	2	3	N	Y	N	N	15.5	Y	\$995.00
DTCA8	A/B/C	1b $\Delta$ $\Sigma$	1bHDLC	R	RS/T	Y	N	3	I	N	Y	N	N	N	2	4	N	Y	N	N	16	Y	\$1,475.00
PCM-R500	A/B/C	1b $\Delta$ $\Sigma$	1bHDLC	X/R	XA/RS/T	Y	Y	3	I	N	Y	N	Y	N	2	4	N	Y	Y	N	13.6	Y	\$1,875.00
PCM2800	A/B/C	1b $\Delta$ $\Sigma$	1bHDLC	X/R	XA/RS	Y	Y	3	I	N	Y	N	Y	N	4	4	N	Y	Y	N	14	Y	\$2,695.00
PCM7010F	A/B/C	18b64x	20b8X	X	XA/RS	N	N	O	O	Y	N	O	Y	Y	4	4	Y	Y	N	N	39.5	N	\$7,300.00
TCD-D8	A/B/C	N/A	1bHDLC	M	O	Y	N	P	O	N	Y	N	N	N	2	3	N	Y	N	N	2	O	\$800.00
TCD-D10ProII	A/B/C	N/A	N/A	R/X	A	N	N	P	Y	N	Y	N	N	N	2	4	N	Y	Y	N	4	N	\$4,000.00
TCD-D100	A/B/C	N/A	N/A	M	O	Y	N	P	Y	N	Y	N	N	N	2	3	N	Y	N	N	13.3	N	\$1,000.00
<b>Tascam</b>																							
DA-P1	A/B/C	1b $\Delta$ $\Sigma$	1b $\Delta$ $\Sigma$	X/R	RS	N	N	P	N	N	N	N	N	2	3	N	Y	N	N	3	N	\$1,899.00	
DA-20	A/B/C	1b $\Delta$ $\Sigma$	1b $\Delta$ $\Sigma$	R	RS	Y	N	3	I	N	N	N	N	2	3	N	Y	N	N	15	N	\$1,099.00	
DA-30MKII	A/B/C	1b $\Delta$ $\Sigma$	1b $\Delta$ $\Sigma$	XR	XA/RS	Y	Y	3	N	N	N	N	Y	N	2	4	N	Y	N	N	19	N	\$1,599.00
DA-60	B/C/D	1b $\Delta$ $\Sigma$	20b	X	XA/XS	N	Y	3	N	O	N	O	Y	Y	4	4	Y	Y	Y	Y	25	N	\$6,299.00

**Key:**

#1 A=32kHz B=44.1kHz C=48kHz D=Other  
 #2 b=Bit  
 #3&4 X=XLR R=RCA M=3.5mm  
 #4 A=AES/EBU S=S/PDIF (coaxial) T=S/PDIF (optical) Through-out O=Optional  
 #5 P=Portable  
 #6 W=Wired I=Infrared O=Optional  
 \*Super Bit Mapping produces 20-bit performance from a 16-bit format.





**BGS**

**R  
E  
C  
O  
R  
D  
E  
R  
S  
/  
P  
L  
A  
Y  
E  
R  
S**

## DAT

Panasonic SV-4100



Otari DTR8S



Sony TCD-D100



Sony PCM-2800



Tascam DA-30MKII



Sony DTC-A6



Sony PCM7010F



Sony DTC-A8



Tascam DA-60



Sony TCD-D10 Pro II



Sony TCD-D8



Tascam DA-P1



## Tascam



**DA302** 3RU, dual independent DAT recorder • high speed DAT duplicator has SPDIF I/O, AES/EBU output only digital interface and RCA analog I/O interfaces. (XLR I/O are optional) • 2x speed duplication • 1/2 speed rec/play LP mode @32KHz **\$1,999.00**

**LAD302** XLR balancing kit **\$100.00**

## DAT Tape & Cleaner

### American Recorder Technology

DAT101	Dat Cleaner (Wet)	\$32.00
DAT101D	Dat Cleaner (Dry)	\$20.00



## DAT Tape & Cleaner

To erase DAT tapes a demagnetizer with very high flux is required. See page 28.



### Ampex

467R015P	15 Minute, box of 10	\$69.30
467R030P	30 Minute, box of 10	\$84.20
467R046P	46 Minute, box of 10	\$94.60
467R060P	60 Minute, box of 10	\$107.70
467R090P	90 Minute, box of 10	\$129.40
467R120P	120 Minute, box of 10	\$152.80

### Panasonic

RTR19M	19 Minutes, box of 10	\$55.00
RT-P34M	34 Minutes, box of 10	\$63.00
RTR64M	64 Minutes, box of 10	\$75.00
RTP94M	94 Minutes, box of 10	\$88.00
RTP124M	124 Minutes, box of 10	\$99.50
RTRCLP	DAT Head Cleaning Tape	\$11.00

### Sony Professional DAT Tape

PDP34	34 Minutes, box of 10	\$120.30
PDP64	64 Minutes, box of 10	\$157.30
PDP94	94 Minutes, box of 10	\$191.30
PDP124	124 Minutes, box of 10	\$225.00





**BGS**

**R  
E  
C  
O  
R  
D  
E  
R  
S  
/  
P  
L  
A  
Y  
E  
R  
S**

## AKAI

**Akai DD1500** is a multi-track MO / hard disc recorder / editor that is easy to use by virtually anyone involved in audio editing. Being a dedicated system with no host computer required, not only is performance optimized for recording, editing and syncing audio to picture but you will find that the DD1500's performance is far more reliable than computer based systems. The DD1500 can be configured according to your needs. You may create an 8-track system using a single MO disc or, if you prefer, will be able to create a true 16-track system with a fixed hard disc. A future upgrade will also allow the DD1500M to accommodate 64MB of RAM allowing eight 'sampler tracks' thereby effectively creating 16-tracks from one MO. A custom LSI in the DD1500M offers 32 channels of audio processing which, although configured as 16-tracks, allows crossfades on butt edits to be achieved within one track and across all sixteen tracks simultaneously. All systems include the DD1500M mainframe, DD1500L controller, SMPTE/EBU time-code interface, biphasic sync, video sync, RS422 machine control and DSP.



DD1500B	Basic 16-Track System includes 4 analog and 4 digital I/Os, 16MB RAM	\$17,825.00
DD1500E	Expanded System includes 12 analog and digital inputs, 16 analog and digital outputs, 16 channels real-time digital EQ, 64MB RAM	\$26,250.00
DD1500A	Analog interface with 4 A/D and 4 D/A converters	\$1,570.00
AD4	Optional 4 A/D for DD1500	\$550.00
DA4	Optional 4 D/A for DD1500	\$390.00
DIO4	Optional 2 AES/EBU digital I/O interfaces (4 channel)	\$550.00
DD1500X	1.3GB Magneto Optical Disc Drive	\$5,475.00
SMOF52106	Second 1.3GB Magneto Optical Drive for DD1500X	\$3,250.00
EQ16	16 Channel real-time Digital EQ	\$780.00
EXM1508	8MB RAM Memory	\$615.00

**AKAI DR4's** hard disc recording medium offers 4-channel simultaneous recording and playback with a wide range of editing functions. Its simple, user-friendly operation has the feel of an analog recorder, and the large jog/shuttle wheel makes editing fast and easy. Its expansion possibilities allow you to increase the number of tracks and the recording time. The DR4 records sound data on random access hard discs so you can jump to any of the 108 assignable location points. Up to 16 tracks can be recorded or played by linking four DR4 units together and running them simultaneously. Operate the master unit, and the slave units automatically follow. Editing functions include: copy, move and insert. The DR4 contains an 18-bit, 64-times oversampling A/D converter and an advanced single-bit dual D/A converter. The DR4 has digital input and output terminals for AES/EBU Types I and II, and can backup all four channels to a DAT recorder.



DR4d	Hard disc recorder (user supplies the hard drive)	\$1,795.00
DR4d540	Hard disc recorder with 540MB hard drive	\$2,145.00
IB110D	Digital interface allows four channel playback & recording via digital I/O	\$299.00
IB111S	SCSI Interface is for backing up to an MO disc	\$199.00
IB112T	SMPTE reader/generator option, V3.0 version software	\$249.00
IB113M	MIDI Interface for MIDI sequencer synchronization, V3.0 version software	\$209.00
ALX50	Cable to connect multiple DR4d's	\$19.95

**AKAI's DR8** is a compact, rackmountable, easy to use digital recording/editing system offering 8 analog I/O's and 2 I/O channels of AES/EBU-SPDIF. Up to 7 DR8 units can be chained together for a total of 56 tracks. The edit modes include: copy, move, insert, delete, erase and slip. The onboard 16-channel mixer lets you create a stereo mix of disc tracks as well as track merging. Special features include optional internal hard drive, jog/shuttle wheel with 2 resolutions, auto/foot switch/manual punch in/out, 109 locate memories and adjustable preroll. Five expansion slots accommodate optional interfaces: SMPTE, MIDI, ADAT optical I/O, RS-422, and Bi-phase I/O for sync to film machines.



DR8	8-Track digital recorder w/16-channel mixer	\$3,495.00
DR8HD	DR8 w/ 1GB internal hard drive	\$4,295.00
DR16	16-Track digital recorder w/16-channel mixer	\$4,995.00
DR16HD	DR16 w/ 2GB internal hard drive	\$6,380.00
DL16	Remote record/edit/mix controller for DR8 & DR16	\$1,795.00
SuperView	VGA interface card for DR8 & DR16	\$699.00
IB801S	SCSI interface	\$299.00
IB802T	SMPTE interface	\$379.00
IB803M	MIDI interface	\$299.00
IB804A	ADAT interface	\$299.00
IB805R	RS-422 interface	\$299.00
IB806B	Bi-phase interface	\$299.00
EQ8	8-Channel, 3 band parametric EQ board	\$550.00
EQ16	16-Channel, 3 band parametric EQ board	\$699.00



**Panasonic**



The **Panasonic MDA-1** multi-channel digital audio tape recorder benefits from the latest developments in transport technology to incorporate an "intelligent", quick response software controlled tape transport using the ADAT S-VHS tape format. A Dynamic Braking System enables the transport to treat recording tape gently while moving quickly between locate points. It has onboard digital editing capabilities such as: Track Copy, Tape Offset and Track delay. The Track Copy creates a digital clone of a single track or a group of tracks. The Tape Offset enables shifting of time reference between multiple MDA-1's. Track Delay allows the time reference of a track to be delayed up to 170ms. Automated features include an on-board 10-point auto locate memory system, auto record, auto play, auto return and rehearse functions. An easy to read fluorescent display shows level metering with three modes of peak display while the tape counter references elapsed time in hours, minutes, seconds and hundredths of seconds. The MDA-1 offers 18 bit 128 times oversampling analog to digital converters. The digital to analog converters offer 20 bit equivalent, 8 times oversampling performance combined with a user selectable 44.1 or 48kHz sampling rate. Included are both balanced XLR and RCA inputs and outputs.

MDA-1		<b>\$3,495.00</b>
RT-DA44	44 Minute ADAT tape, box of 10	<b>\$129.50</b>

**Sony**

Employing the Hi8 video cassette tape format, the **Sony PCM-800** records and reproduces 8 channels of digital audio for 108 minutes in 16-bit linear with an NTSC standard '120' tape. It is equipped with AES/EBU digital audio I/O using D-sub 25-pin connectors and balanced XLR analog I/O for connection with professional audio equipment. The sampling frequency is selectable from 44.1kHz or 48kHz. It includes convenient noiseless auto punch in/out operation with rehearsal function, variable speed playback  $\pm 6\%$  in 0.1% steps, and two point auto locate function. Up to 16 units can be operated in perfect synchronization with the optional RCC-S1 sync cables. The PCM-800 provides SMPTE/EBU time code generation and chase synchronization with the DABK-801 sync board.



PCM-800	16-Bit 8-Channel Digital Recorder	<b>\$5,995.00</b>
RMD800	Remote control unit, controls up to six units	<b>\$1,500.00</b>
RCC-S1	Sync cable, 1m	<b>\$39.00</b>
DABK-801	Sync board	<b>\$800.00</b>

**Tascam**



Building on the success of the DA-88 the **Tascam DA98** offers exciting new features like confidence monitoring, individual track tape/source monitoring, an integrated electronic patchbay, digital track copy and switchable reference level capability. Sony P2 and MIDI synchronization are standard, it has a new LCD display and the ability to defeat it's dither function. The DA-98 utilizes the DTRS® Hi8 format to deliver up to 116 minutes of digital audio recording on 8 tracks and is compatible with all DTRS format recorders. It has a flat 20Hz to 20kHz frequency response, a dynamic range that exceeds 92dB and uses 20 bit Delta Sigma A/D converters with 64 times oversampling and 20 bit D/A converters with 8 times oversampling.

DA-98		<b>\$5,999.00</b>
RC-848	System controller, controls up to 6	<b>\$1,599.00</b>
MU-8824	24 Track remote meter	<b>\$999.00</b>
IF-88AE	AES/SPDIF interface	<b>\$1,149.00</b>
IF-88SD	SPDIF interface	<b>\$1,399.00</b>
DA-88	Digital 8 track recorder, modular	<b>\$4,799.00</b>
DA-38	Digital 8 track recorder	<b>\$3,899.00</b>

**Hi-8 Tape & Cleaner**

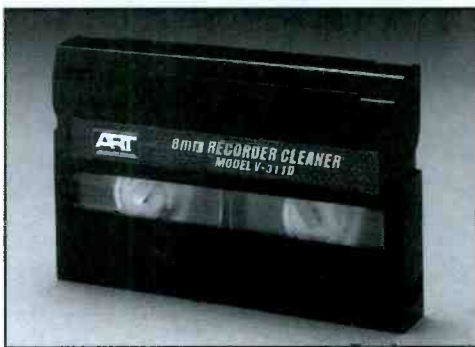

**American Recorder Technology**

V311A	VHS/ADAT Recorder Cleaner (Dry)	<b>\$20.00</b>
V311D	8mm Recorder Cleaner (Dry)	<b>\$20.00</b>
V311	8mm Recorder Cleaner (Wet)	<b>\$32.00</b>

**TDK**

P6HP Pro120	Hi8 8mm highband Video, 120 minutes	<b>\$13.45</b>
-------------	-------------------------------------	----------------

  
**BGS**  
**R E C O R D E R S / P L A Y E R S**





**BGS**

**R  
E  
C  
O  
R  
D  
E  
R  
S  
/  
P  
L  
A  
Y  
E  
R  
S**

## Roland



The **Roland PMA-5B** Personal Music Assistant is an entirely new concept in compositional and backing devices. This unique, palm-sized instrument offers unprecedented

ease of use and an impressive assortment of sequence recording and playback options. It features a high-quality GM/GS sound source, an eight-track sequencer, a powerful intelligent arranger and a whole lot more. Everything, but the volume, is accessed and controlled via the touch-panel interface or "touch-screen." Some of the main features: 306 synthesizer and instrument sounds, 16 drum sets • Roland's Intelligent Arranger with 100 Music Styles • 20 song memory, store and recall user patterns • headphone jack • battery or AC operable • Import and playback standard MIDI file (SMF) song data • ad lib function for instant "musically correct" soloing • and built-in serial computer port.

PMA-5B **\$595.00**



The **Roland DM-800** Multi Track Disc Recorder is a compact, stand alone unit - a completely dedicated digital audio workstation. It performs all digital mixing operations from audio recording editing, track

bouncing to final mixdown. It fully supports SMPTE and MIDI time codes and even features a built-in SMPTE Resolver to synchronously lock to any time code. There's very little to learn, because every function is hardware controlled and right in front of you. Since your fingers are navigating familiar territory, operations on the DM-800 are very fast. The large LCD lets you see meters, time location, waveform, edit and track information. If you need a larger display, you can connect the DM-800 to your studio's video monitor or even your home TV. Eight digital/analog outputs and six digital/analog inputs. 300 virtual tracks. Backup to audio DAT or SCSI data DAT. Time compression with multiple modes. Call Broadcasters General Store to arrange a demonstration!

DM-800	Multi Track Disc Recorder	<b>\$6,295.00</b>
DM800HD	DM-800 with 2 internal 500MB drives	<b>\$7,595.00</b>
DIF800	ADAT/DA-88/RS-422 interface, 19" Rackmount 1U	<b>\$1,095.00</b>
DM800RS	Roll Around Stand	<b>\$120.00</b>
DM800TC	Hard Travel/Shipping Case	<b>\$100.00</b>
DA400	4 Channel D/A Converter	<b>\$645.00</b>

The **Roland VS-880** provides 64 recordable tracks, a CD quality digital



recorder, a digital mixer and studio-quality multi-effects (an add-on board option) in a completely self contained unit.

Every operation is performed within the digital domain. It has 4 analog I/Os and 2 SPDIF digital I/Os. You can record 4 tracks at once with 8 layers per track making the total number of tracks per song 64.

Editing functions include: copy, move, exchange, insert, cut/erase, and time compression. The VS-880 is equipped with an internal IDE and standard external SCSI interfaces to give you extensive storage media flexibility. It comes standard with either a 540MB hard drive or an Omega Jaz Drive which uses 1GB removable cartridges. Creating backups or loading completed songs onto external storage devices is easy using the SCSI interface (daisy-chain up to seven SCSI devices). Affordable removable media devices, like the Omega Zip Drive, offer a simple way to archive massive amounts of digital data. This way you can carry or even exchange data, just as you would an ordinary cassette. You can also back up your song data to audio DAT.



VS880V2		<b>\$2,695.00</b>
VS880TC	Hard shell travel case	<b>\$150.00</b>
VS8F1	Dual St. Effect Expansion Board	<b>\$395.00</b>
Jaz™EXT1	Omega Jaz Drive, external	<b>\$499.95</b>
Jaz™1GB	1 Gigabyte Jaz Disc, each	<b>\$139.95</b>
Jaz™1GB5	1 Gigabyte Jaz Disc, 5 Pack	<b>\$549.95</b>
Zip-EXT1	Omega Zip Drive, external	<b>\$219.95</b>
Zip-100	100MB Zip Disc, each	<b>\$22.95</b>
Zip-100/5	100MB Zip Disc, 5 Pack	<b>\$164.95</b>
Zip/Zoom	SCSI Adapter for PC	<b>\$59.95</b>



## IQS~Innovative Quality Software

The **SAW**, Software Audio Workshop, software by IQS is a professional production tool that allows you to record and edit 16 bit resolution CD and DAT quality soundfiles at sampling frequencies up to 48kHz on your computer's hard drive with ease. Completely non-destructive "Region" and "Play Sequence" editing as well as "Drag and Drop" to "Multitrack" view (which has adjustable display width). Live format conversion during playback (8-bit, 16-bit, mono, stereo at any sample rate). Software emulated DSP functions provide parametric EQ, noise gate, limiter, compressor, echo effect and vari-pitch, each patchable to each track or sound card output. Other features include: realtime volume adjust, pan, mute and solo during playback • simultaneous rec/play, with professional sound card • and simultaneous playback of 4 tracks per sound card. SAW supports up to two stereo sound cards and both "WAV" and "SND" sound formats. It has 386 32 bit-register C-plus/plus assembly language, making SAW the fastest editing software available. Now with version 6.0 SAW+ architecture.

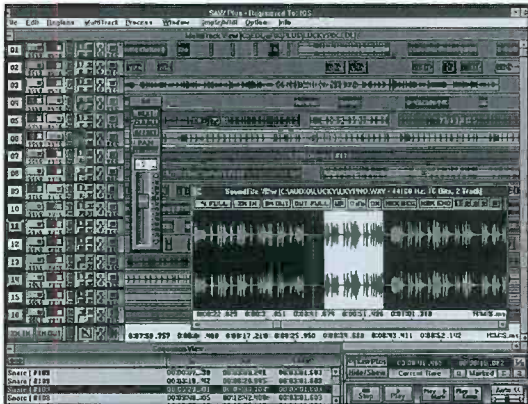

**SAW** **\$599.00**

The **SAW Plus** represents the next generation of digital hard disc editing software. They have extended the power of the SAW to a maximum of 16 mono or stereo tracks of simultaneous, live playback on any windows compatible sound card(s). Each track has controls for level, mute, solo, pan, effects patching and output assignments. Also available is a seven band parametric EQ, noise gate, compressor/limiter, peak limiter and echo effects. It supports up to four stereo sound cards and effects live format conversion. The powerful processing engine of SAW Plus performs multiple simultaneous functions, screen draws and audio processing equivalent to 64 bit resolution all without the use of DSP hardware...it's all in the software! Most of the functions of SAW are incorporated into the SAW Plus and much more. Call us for complete "turn-key" packages!

**SAW Plus** **\$999.00**

### Midiman



**Midiman** makes MIDI interfaces for PC, Macintosh, line mixers, sync boxes, time code displays, many MIDI accessories and wireless MIDI system accessories. We are highlighting two of their products. The **DMAN** is a high quality, full-duplex, PC Digital Audio Card that can record and playback stereo audio tracks simultaneously - a must for any serious digital recording system. DMAN allows you to monitor what you are recording while listening to previously recorded tracks. It also includes a high impedance microphone input and a standard wave table header for adding any wavetable daughter board. The **Syncman Pro** is a single space, rackmount unit that performs most sync functions you will ever need. All types of MIDI synchronization are supported including: SMPTE to MIDI Time Code, Direct Lock (for Performer). SMPTE to Song-Pointer, and their own new Spot-Lock Video sync. Syncman Pro also performs all SMPTE read, write, and regenerate functions and has a full .6" high SMPTE/Song-Pointer display.



**DMAN** **\$249.95**  
**Syncman Pro** **\$399.95**

### Tempo Works

**Tempo Works™** is a program which allows the user to considerably lengthen or shorten the play time of an uncompressed digital audio file without distortion or artifacts while maintaining the original pitch. The unique capability of this program allows digital audio tracks to be "companded" to exact play times thus eliminating the necessity for announcers or performers to read or play for time. Now full production attention can be given to inflection, delivery and performance. Tempo Works™ eliminates lengthy editing required to trim audio files to precise play windows by trimming of undesired deadtime at the beginning and end of tracks and companding to the nearest 1/100th of a second. Temp Works™ provides the best recording and broadcast companding available. Version 1.6 includes the modular features of pitch lowering by up to 3 musical half-steps (1.5 notes) and rate conversion from 48kHz or 44.1kHz (CD) down to 16 or 32kHz. Rate converted or pitch changed files may be companded to desired length with a separate compand program execution.

**Tempo Works™** **Call for pricing**

### tripleDAT™ by Creamware

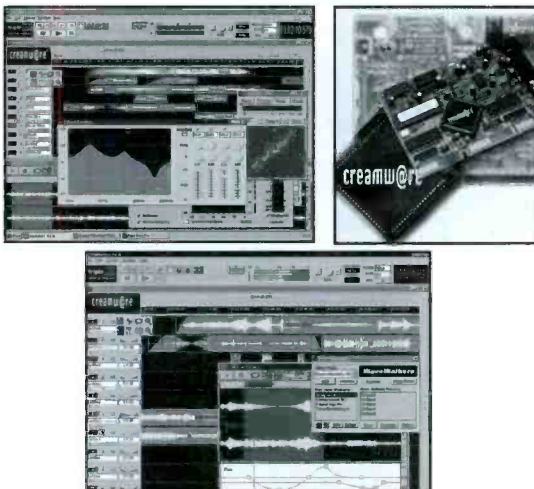

**CreamWare tripleDAT™** transforms your Windows™ PC into a high performance, multitrack digital audio recording and editing workstation with ultra fast signal processing in 32-bit code. TripleDAT™ consists of both hardware (tripleBoard 2.0) and its own versatile audio workstation software - offering a complete solution. Edit multitrack arrangements on your hard drive with tripleDAT™ from 4 to 12 stereo tracks and more, depending on the processing speed, hard drive speed and storage capabilities of your computer. You can record digital audio directly to your hard drive from any live source or pre-recorded sound source. The tripleDAT™ audio card gives you both optical and SPDIF I/Os (optional AES/EBU). Apply signal processing effects to tracks and sound samples from a sophisticated suite of DSP Pentium based filters and effects, replacing racks of gear. All signal processing operates in realtime, with no waiting for the system to calculate and apply effects such as: 4 and 8 band parametric EQ, room simulator/reverb, delay processor, dynamics processor with compressor/limiter/expander/noisegate/ and de-esser. Bonus test equipment, phase scope and 60 band RTA to trouble shoot any audio, worth the price of the system. Synchronize to internal or external MIDI Time Code or to SMPTE Time Code with an external converter box (See Midiman Syncman Pro). The tripleDAT™ System: 16-bit ISA tripleBOARD™ • optical I/O, w/cabling • SPDIF I/O, coaxial • high quality analog I/O • infrared remote, hardware and cabling for remote control of most popular DATs.

**CRE-TDAT** **\$1,798.00**  
**CRE-TDATAES** **\$1,998.00** SPDIF coax is replaced by one XLR AES/EBU I/O



RECORDERS / PLAYERS





**BGS**

**R  
E  
C  
O  
R  
D  
E  
R  
S  
/  
P  
L  
A  
Y  
E  
R  
S**

**Fostex**



The **Fostex XR-3** is the world's first easy-operation multitracker equipped with an internal microphone. The logic controlled auto bounce circuit enables anyone to perform ping-pong recording easily. Features include: 3-3/4 ips tape speed • Dolby B NR system • punch in/out function •  $\pm 10\%$  pitch control function • and one-push system record buttons.

XR-3 \$349.00



The **Fostex XR-5** is a multitracker recorder which combines a double speed 3-3/4 ips four track recorder and a four input, two mic mixer. It provides a wide range of progressive, diversified functions. Features include: input level switching for channels 1 & 2 • high/low shelving equalizers in each channel

• simultaneous 2-track recording • internal Dolby B NR •  $\pm 12\%$  pitch control, and punch in/out function.

XR-5 \$469.00

**Sony Digital Porta~Studio**



The **Sony MDM-X4** is a new Mini Disc multitracker recorder.

Features include: ATRAC technology • 4 channel recording and playback • 37 minutes per track • digital sound •

instant access • advanced editing • virtual mix • with a large display and jog/shuttle.

MDM-X4 \$1,250.00



The **Fostex XR-7** is a multitracker noted for its diversified functions. It combines: a 4-track recorder capable of simultaneous 4-track recording • a mixer with six inputs for two

mics and 4 lines • two AUX sends for each channel and an AUX return • two point shelving equalizer in channels 1-4 enhanced in channels 5-6 by a single parametric equalizer • selectable 1-7/8 ips or 3-3/4 ips • Dolby C NR • punch in/out •  $\pm 10\%$  pitch control • and a highly visible backlit LCD.

XR-7 \$579.00

**Tascam**

The **Tascam Porta 03 MKII Ministudio** is the perfect entry level audio sketchpad for aspiring songwriters, engineers and producers. This extremely economical 4-track recorder



with integrated mixer lets you overdub as well as mixdown to standard cassette. Includes: two mic/line inputs each with trim control • headphone jack • RCA out jacks • Dolby B NR • and 3-digit tape counter.

Porta03MKII \$259.00

The **Tascam 424MKII Portastudio** has superior audio quality, balanced XLR inputs, enhanced equalization and a big studio style AUX section plus tape direct outs. This 4-track recorder with 8-input mixer (4 mono and 2 stereo) has 3-band EQ with sweepable mid, 2 tape speeds, auto punch in/out, and 4-track simultaneous recording.



424MKII \$599.00



## Tascam



The **Tascam 488MKII Portastudio** gives you the functionality of a professional studio like: 8-track recorder with 8-channel, 12-input mixer • XLR inputs with 48V phantom power • 3 band EQ • auto punch in/out • 2 independent AUX sends • dbx noise reduction • and multi-function, fluorescent meter display.

488MKII **\$1,499.00**

### The Tascam 464

#### Portastudio

is a feature filled, personal studio production tool for musicians looking to get the most out of a 4-track. This

4-track recorder with 12-input mixer (8 mono, 2 stereo) has balanced XLR inputs, sync in/out for use with MIDI, auto locators, auto punch in/out and two effects sends.



464

**\$799.00**

## Yamaha



The **Yamaha MT8XII** is a high performance music production system integrating a flexible 14-channel mixer and a top quality 8-track cassette recorder in one well coordinated unit. It offers advantages that even the latest digital hard disc recording systems can't beat: more affordable • records on standard audio cassettes • 8 mono & 3 stereo channels • balanced

mic/line inputs with phantom power • 3-band EQ on all 8 mono channels • dual AUX sends • 4-group assignment • high-speed 8-track recorder • frequency response from 40Hz to beyond 15kHz • signal-to-noise ratio in excess of 80dB with internal dbx NR • logic controlled variable speed transport • punch in/out recording with auto punch I/O function • 3-point auto-locator • MIDI synchronization • and direct tape outputs. The MT8XII is the tool you need to turn your musical ideas into finished works of art.

MT8XII **\$1,199.00**

The **Yamaha MD4** is one of the first multitracker to utilize the Mini Disc format, with its superior audio quality and quick locate capabilities. The quick locate provides fast and accurate search and locate for Song Start, Song End, Last Recording In/Out point, Direct Time Locate, and eight user mark points for each song. It is a four channel analog mixer, with gain, 3-band EQ, aux send, pan, fader on input channels, MIDI sequencer sync—MTC output, auto punch in/out, bounce down to any track with simultaneous 4-track playback and multiple ping-pong with negligible signal degradation.

MD4 **\$1,199.00**



The **Yamaha MT4X** is a 4-track multitracker with flexible mixing facilities and advanced creative control. Each of the four input channels can accept mic or line level signals.

MT4X **\$599.00**



**BGS**

**R  
E  
C  
O  
R  
D  
E  
R  
S  
/  
P  
L  
A  
Y  
E  
R  
S**





**BGS**

**R  
E  
C  
O  
R  
D  
E  
R  
S  
/  
P  
L  
A  
Y  
E  
R  
S**

## Blue Group

**PhoneByte** is an AT-based premier digital phone bit recorder specifically designed for fast paced, high personality programming. Uniquely integrated into your control room operation, its features include: Extensive remote control functions, PhoneByte comes standard with 6 programmable input ports and 8 programmable relay outputs. • Integration continues with intelligent connection to your phone line selector allowing auto recording of designated lines for true one button recording. You simply answer the phone and PhoneByte records, each one with its time, date and total duration. • PhoneByte's powerful features allow fast editing, quick stacking of calls for rapid sequential playback, easy commenting and search and purge functions to manage hundreds of calls with ease. • The personal touch feature with optional 60, 176, and 300 push button panels puts hundreds of sound effects, bits and drops, specially configured for each jock, at your personalities' fingertips and big pick screens give you pages of bits on a point and play basis. Monitor sold separately.

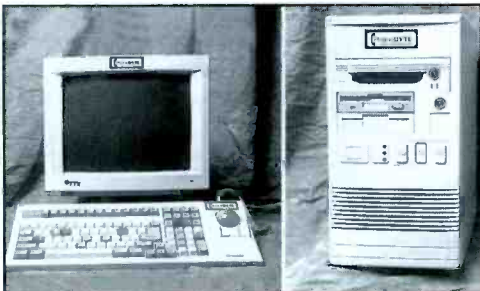

PhoneByte

Prices starting from \$4,396.80

## Eventide



VR204	Single DDS-2 DAT Drive, 60 Hr. Internal Hard Disc	\$7,495.00
VP204	4 to 24 Channel Portable Playback only DDS-2 DAT Reproducer	\$6,495.00
VP244	8 to 24 Channel Playback Only Digital DDS DAT Reproducer	\$4,995.00
SLP	Smart Label Printer with cable	\$325.00
DDS90	90 Meter DDS DAT tapes, box of 10	\$250.00
DDS120	120 Meter DDS-2 DAT tapes, box of 10	\$375.00
DDSC	DDS DAT Cleaning Tapes, box of 10	\$250.00
Labels	Additional Labels for Smart Label Printer, box of 2	\$14.00
VR240MKIIIS	Single DDS-2 DAT Drive, 60 Hr. Internal Hard Disc, 8 ch.	\$12,500.00
VR240MKIIID	Dual DDS-2 DAT Drive, 60 Hr. Internal Hard Disc, 8 ch.	\$15,390.00

### Eventide Digital Studio Logging Recorder/Player

uses digital DAT-based technology that revolutionized communications audio logging, and is now available in a compact 4-channel unit. Each data grade 120 meter DAT tape has a capacity of 500+ hours, divided among up to four channels. The VR204 recorder is also equipped with a hard disc memory module with a capacity of approximately 30 channel-hours. Tapes recorded on the 4-channel VR204 can be played back on the 24-channel VR240. The VR204 recorder/player and VP204 playback deck bring the many advantages of digital logging to new applications and an even broader group of users.

## 360 Systems



**360 Systems ShortCut**, the high speed telephone call in broadcast editor that replaces cumbersome reel recorders for: phone call ins • news actualities • promos • voice-overs • whatever comes in over the phone that you have to record quickly. It edits, too! True stereo waveform editing with dedicated edit button, shuttle wheel for "head rocking" effect, edit marker insertions on the fly, and actual "bleep" tone insertion for profanity protection. Special features include: 16 Bit linear non-compressed recording • AES digital and analog I/O's • 10 "Hot Keys" for instant access to edited cuts • password protection of individual directories • built-in mic preamp • speaker • and keyboard for titling cuts. All this in a package so small and lightweight you can carry it under your arm.

SC180-1	ShortCut with 1.5 hour internal hard drive	\$2,995.00
SC180-2	ShortCut with 160 minute internal hard drive	\$3,495.00
SC180-3	ShortCut with dual 2 hour internal hard drive	\$3,795.00
TS612 Cable	Interface cable for Gentner TS612	Call for pricing



**See Media Touch on Page 1&2 for your Automation, Live Assist, Hard Disc on-air Production and News Editing System!**



# THE ONLY TALK SHOW DELAY THAT CAN MAKE THESE STATEMENTS.

Bad words, **#@\$^&\*%!** like bad news, often come in threes. The new Eventide BD500 is the only obscenity delay in the world that can eliminate them. Now, when you hit the Dump button, you don't lose the whole delay and the obscenity **%#^!@\*\$!** protection that goes with it. You can divide the total available delay time into not one, or even two, but several discrete segments. You still have protection even after dumping two consecutive **&\*\$%#@#!** no-no's.

You also get the cleanest, quickest delay catch-up you can buy. Because there's only one way to maximize audio quality and still catch-up rapidly after a delay dump... and Eventide owns the patent. Over the years, several other brands of delay have come and gone. But the simple fact is that the catch-up methods others use must be painfully S-L-O-W to avoid serious audio problems.

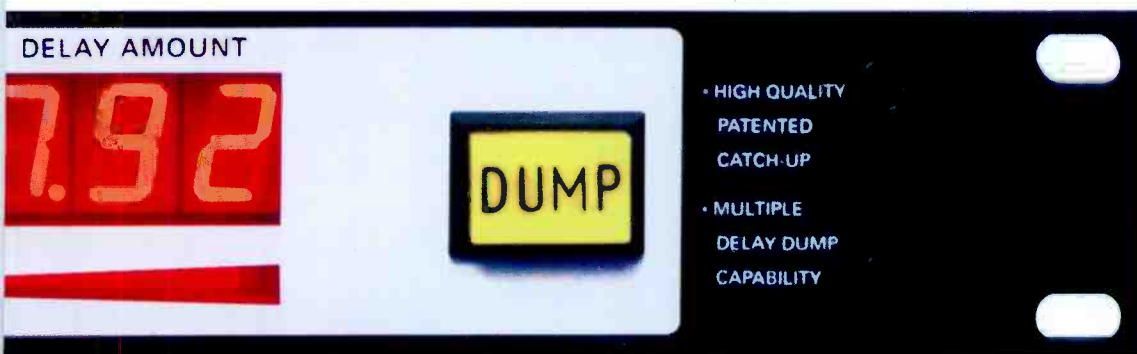

And, because you may not be using that analog console forever, the BD500 is also the only broadcast delay that's digital-

ready with optional AES/EBU digital audio inputs and outputs. It's stereo, of course. A convenient new "sneeze" button allows the talent to sneeze, cough, etc. without being heard on air, and without dead air. All front panel switches (except configure) and all status indicators can be remoted (both RS-232 and dry contacts are provided.) Plus, only the BD500 gives talent both a digital readout of delay time and a "quick read" LED bar graph that shows "you're safe" at a glance.

For all these features and quality, you'd expect top-of-the-line pricing. But surprise! The BD500 costs thousands less. It's the best value ever in a broadcast talk show delay. Exactly what you'd expect from the people who invented digital broadcast delays in the first place. Call your distributor, Eventide direct, or check it out on the Web at <http://www.eventide.com>

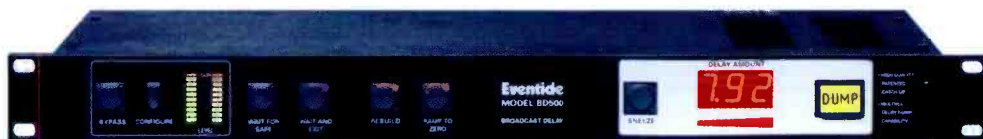

**BD500**  
**Eventide**  
the next step

It's 9:30 am. You've got to edit  
nine phone-ins, cut a dozen  
spots, record four station I.D.s  
and two promos before lunch.



Shortcut™ is 360 Systems' new editor

**SO LET US SHOW YOU A SHORTCUT**

right the first time. That's why Shortcut

for people in a hurry. It's powerful enough for production yet easy  
enough to use on-air. Shortcut delivers massive storage, scrub  
editing, a bright waveform display, and even built-in speakers.

All this in a compact self-contained package with the  
muscle to handle your toughest assignments.

We know you need to move fast, and get it

gives you real buttons for direct access to editing commands. No  
need for computers, monitors, or mice. Shortcut is complete and  
ready to go for just \$2,995. So if you have too much work and  
too little time, just take a Shortcut. Call (818) 991-0360 today.



**Shortcut**  
PERSONAL AUDIO EDITOR™

*360 Systems*  
PROFESSIONAL DIGITAL AUDIO



If you're a call-letter station, you can try DigiCart/II for 10 days with no obligation. If you decide to buy it, we'll arrange your purchase through Broadcaster's General Store. Call (352) 622-7700 or fax (352) 629-7000 today.

Broadcaster's General Store • 2480 S.E. 52nd Street • Ocala, FL 34480-7500  
(352) 622-7700 • Fax (352) 629-7000 • E-Mail: <bgs@mercury.net> • Web Site: <http://www.bgsfl.com>



## Otari



The **Otari MX5050** series feature: built in mini-autolocator with three one-touch cue point memories, search zero and repeat functions. The transports are very smooth with micro-processor controlled logic, motion sensing and dynamic braking. Standard features include a 37 pin parallel I/O,  $\pm 20\%$  speed control, transformerless active balanced inputs and out-

puts and reel size switches for both take-up and supply reels. The BQ-III now features gapless seamless punch in and punch out as well as a rehearse mode.

MX5050B-III	1/4" 2-Channel Half Track	\$4,452.00
MX5050BQ-III	1/4" 4-Channel Quarter Track	\$7,636.00
RK-2B	Rack mount kit for B-III and BQ-III	\$84.00
ZA-52L-22	Metal roll-around floor stand	\$491.00



The **Otari MX50IIN** has a built-in 5-digit tape timer display, search to cue locator with one cue point memory, zero locate,  $\pm 7\%$  vari-speed, and transformerless active balanced XLR inputs and outputs. An independent reel size selector switch allows supply and take-up reel sizes to be intermixed. The **Otari MX-55NM** is a high quality production and mastering 2 channel half track tape machine. It features: microprocessor based transport, dynamic braking,  $\pm 20\%$  speed control, 4 point auto-locator, easy access card bay, Dolby™ HX pro headroom extension, gapless seamless punch in/punch out, cue speaker, 3 frequency test oscillator and more.

MX-50IIN	1/4" 2-track, 15/7.5 IPS	\$3,233.00
MX-50IIN-L	Same as above but speed is 7.5/3.75 ips	\$3,429.00
MX-55N	1/4" 2-channel, 15/7.5 or 7.5/3.75 ips	\$5,830.00
MX-55NM	1/4" 2-channel, Console Model	\$7,791.00
MX-55TM	1/4" 2-channel w/ time code, Console Model	\$9,434.00
ZA-5EK	Rack mount kit for MX-50IIN & L	\$77.00
ZA-51A	Rack mount kit for MX-55N	\$81.00
ZB-51F	Rack mount kit for MX-55NM/TM	\$245.00
ZB-51D	Metal roll-around floor stand for MX-55N, with skirt	\$694.00
ZB-51E	Metal roll-around floor stand for MX-55NM/TM, with skirt	\$694.00

## Studer



The **Studer A807** was conceived as a multipurpose tool for recording studios and broadcasters. The A807 has a highly perfected tape transport design with advanced drive technology features: two rugged direct drive AC spooling motors, brushless DC capstan motor, comprehensive function selection and digitally controlled analog technology.

A807-2/2VU	1/4" 2-Track (3.75/7.5/15ips)	\$12,500.00
A807-2/2VU HS	1/4" 2-Track (7.5/15/30ips)	\$12,500.00
A807-2/2VUK	1/4" 2-Track w/metered overbridge and console	\$13,500.00
A807-2/2VUK HS	1/4" 2-Track w/metered overbridge and console	\$15,500.00

## Tascam



The **Tascam 30 series** features 10 1/2" reel capacity, return to zero function, pitch control, dump/edit capability, DC motors, full motion sensing with dynamic reel braking and permalloy heads. Phono ins and outs at -10dBV.

32	1/4" half track two speed (7.5/15ips)	\$2,399.00
34B	1/4" four track two speed (7.5/15ips)	\$3,049.00
RC-71F	Full function transport remote	\$135.00
RM-300	Rack mount for 32 and 34B	\$65.00
RTS-15	Deluxe roll around transport stand	\$275.00



The **Tascam BR-20** has balanced +4dBm ins and outs with all major calibration controls easily accessible through the front panel. The transport is precision servo controlled for smooth operation and accurate real time counter readings. It has a  $\pm 12\%$  pitch control, direct time locate, built in monitor speaker (optional on the BR-20T), three DC motors, a parallel remote port, three presettable locate points plus zero and built in rack mounts. The BR-20T timecode version has center channel time code, gapless punch in/out and spot erase.

BR-20	2 track reel to reel	\$3,149.00
BR-20T	2 track reel to reel w/center ch. Timecode	\$3,799.00
MA20	Mic amp kit for BR-20 & 20T	\$100.00
SP20	Internal speaker kit for the BR-20T	\$75.00
RC-402	Transport remote control	\$250.00
RTS-15	Deluxe roll around transport stand	\$275.00



**BGS**

**R E C O R D E R S / P L A Y E R S**





**BGS**

**R  
E  
C  
O  
R  
D  
E  
R  
S  
/  
P  
L  
A  
Y  
E  
R  
S**

## Technics



The **Technics SL-1200MKII** is a quartz-locked direct drive turntable that is virtually feedback-proof because of its special base design. The platter is damped on both sides to avoid ringing. Its high starting torque brings the platter to rated speed within 0.7 second. Includes base, tonearm and dust cover.

SL-1200MKII

**\$699.95**



## Cartridges

Shure	Styli Model	Tracking Force	Cartridge Price	Styli Price
SC35C	SS35C	4 to 5 grams (Spherical)	<b>\$60.00</b>	<b>\$22.00</b>
M447X	N447X	1.5 to 3 grams (Spherical)	<b>\$45.00</b>	<b>\$20.00</b>
M44GX	N44GX	.75 to 1.5 grams (Spherical)	<b>\$45.00</b>	<b>\$22.00</b>
Stanton				
681EEEMKIII	D6800EEEIII	3/4 to 1-1/2 grams	<b>\$198.00</b>	<b>\$74.00</b>
680EL*†	D6800EL	2 to 5 grams	<b>\$198.00</b>	<b>\$50.00</b>
680AL*†	D6800AL	2 to 5 grams	<b>\$168.00</b>	<b>\$43.00</b>
500AL*	D5107AL	2 to 5 grams	<b>\$91.00</b>	<b>\$34.00</b>
500AL-DP †	DP5107AL‡	2 to 5 grams	<b>\$132.00</b>	<b>\$95.00</b>
500EMKII	D50EMKII	1 to 2 grams	<b>\$80.00</b>	<b>\$28.00</b>

\* for back cueing

† extra stylus included

‡Disco Pack includes 3 styli

*We handle all Shure and Stanton cartridges and styli, please call for further information.*

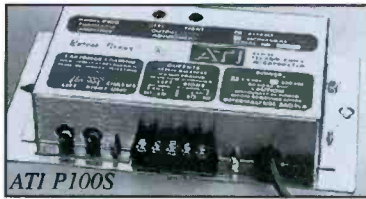

ATI P100S



Stanton 310B

## Phono Pre~amplifiers

Make/Model	Frequency Response Hz	S/N Ratio	Stereo Separation	Output Level	Features/Accessories	Price
ATI						
P100S	30-20k	80dB	<60dB	+18dBm	Selectable RIAA curve	<b>\$329.00</b>
P1000-1	30-20k	80dB	<60dB	+22dBm	Xfmr. balanced/Rack mountable	<b>\$399.00</b>
P100S	30-20k	80dB	<60dB	+24dBm	Active balanced/Rack mountable	<b>\$389.00</b>
Bryston						
BP-1	200-20k	80dB	78dB	+27dBm	Selectable low filter/Rack mountable	<b>\$750.00</b>
BP-5	200-20k	95dB	78dB	+27dBm	3 Hi level inputs/Rack mountable	<b>\$1,065.00</b>
Radio Design Labs						
	ST-PH1RIAA Curve	>70dB	>60dB	+4dBm	24VDC supply @ \$117.00	<b>\$126.00</b>
Ramko						
xLSCM2	RIAA Curve	*89dB	70dB	+24dBm	Selectable rumble filters/Rack mountable	<b>\$273.00</b>
Stanton						
310B	RIAA Curve	>70dB	>60dB	+26dBm	120 or 240VAC	<b>\$329.00</b>

\* = A-Weighted



# equip. case bags

## Clipper Products



Model #	Wt.Capacity	Cart Wt.	Price
880-2	400	19	\$169.95
770-2	400	15	\$129.95
660-2	300	13	\$109.95
440-2	150	8.5	\$79.95

## Modern Cases

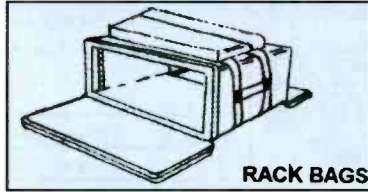

**Modern Cases Rack Bags** are a lightweight, durable protective case for your rack equipment. Made of foam covered plywood and cordura fabric, the bag simply zips open front and rear for quick access. Carrying straps are included.

Model	Depth	1U	2U	3U	4U	5U	6U
RB08	8" shell	\$51.00	\$54.00	\$57.00	\$61.00	\$69.00	\$78.00
RB10	10" shell	\$58.00	\$61.00	\$64.00	\$69.00	\$76.00	\$87.00
RB12	12" shell	\$66.00	\$69.00	\$72.00	\$76.00	\$85.00	\$94.00
RB15	15" shell	\$75.00	\$78.00	\$82.00	\$87.00	\$94.00	\$103.00
RB18	18" shell	\$87.00	\$90.00	\$93.00	\$98.00	\$106.00	\$115.00

*Modern Case also makes a variety of plywood ATA style cases. Please call for a Modern Case catalog and pricing!*

## Pelican Protector Equipment Cases

**Pelican Protector® cases** are watertight and airtight to 30 feet for the ultimate in protection. Constructed of light-weight space age structural resin with a neoprene o-ring seal and exclusive purge valve. Supplied complete with pre-scored pick n' pluck foam or padded dividers (no cutting required). Also includes locking flanges, massive multiple latches for absolute security and a comfortable molded fold down handle. Integral personalized name plates can be engraved at additional cost.

Description	Outside Dimension	Inside Dimension	Weight	Price
1200 Case™	9-1/4" x 9-3/4" x 5"	9-1/2" x 7-1/2" x 4-1/2"	3 lbs.	\$55.11
1300 Case™	10-3/4" x 9-3/4" x 7"	9-1/2" x 7-1/2" x 6-1/2"	3.5 lbs.	\$66.34
1400 Case™	13" x 12" x 6"	9-1/2" x 7-1/2" x 6-1/2"	3.5 lbs.	\$100.68
1450 Case™	16" x 13" x 7"	15" x 10-1/2" x 6"	7.5 lbs.	\$130.16
1500 Case™	18-1/2" x 15-1/4" x 6-7/8"	17" x 11-3/4" x 6"	8.5 lbs.	\$151.81
1520 Case™	19-1/4" x 15-1/2" x 7-1/2"	18" x 12-7/8" x 6-3/4"	10.5 lbs.	\$167.08
1550 Case™	20-1/2" x 16-3/4" x 8-1/2"	19" x 14" x 7-3/4"	14 lbs.	\$189.81
1600 Case™	23-1/4" x 20-3/4" x 9"	22" x 17" x 8"	17 lbs.	\$224.82
1650 Case™	31-1/2" x 21-3/4" x 11-1/2"	29" x 18" x 10-1/2"	17.5 lbs.	\$244.47

*Dimensions shown are Length x Width x Depth*



1454	1450 Case with padded dividers	\$171.99
1504	1500 Case with padded dividers	\$183.98
1524	1520 Case with padded dividers	\$213.58
1526	1520 Case w/1527 convertible travel bag	\$269.08
1527*see below	Convertible travel bag only	\$122.75
1554	1550 Case with padded dividers	\$260.15
1604	1600 Case with padded dividers	\$295.48
1654	1650 Case with padded dividers	\$314.67
1508	Photographer's Lid Organizer Holds film, filter, gadgets, notes	\$23.34
1509	Attaché Lid Organizer, fits 1500/1520 Holds paper, pens, calculator etc.	\$25.68

\*The **1527 Travel Bag** is designed to fit inside a 1520 case. Converts instantly from a hard case to soft bag, for complete hardknocks travel protection. Just pull out for short day trips etc. sling over your shoulder and go without rearranging anything. Made of heavy duty waterproof padded Ballistic Nylon with multiple front and side gadget pockets. Padded adjustable divider system protects complete outfits. Exclusive top/side access to equipment while in use with thick curved and padded shoulder strap. All nylon zippers and clips. 17 1/2" L x 12 1/2" W x 6 1/4" D in black.

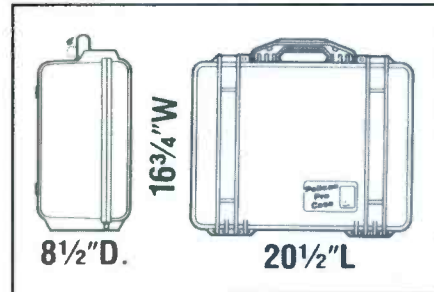

8 1/2" D.

16 3/4" W

20 1/2" L

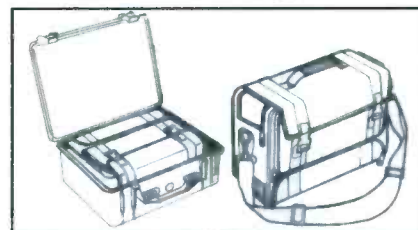

**BGS**

**R  
E  
M  
O  
T  
E  
  
B  
R  
O  
A  
D  
C  
A  
S  
T**

**Broadcasters General Store (352) 622-7700 Fax (352) 629-7000**

**122**



**BGS**

**R  
E  
M  
O  
T  
E  
  
B  
R  
O  
A  
D  
C  
A  
S  
T**

## Porta Brace



Porta-Brace has a case for any of your field production crews needs, please call Broadcasters General Store for a Porta-Brace catalog.

AO-1U	Audio Organizer, Inside measurements 6"W x 8"H x 14"L	\$255.00
RB-1	Run bag, 7"W x 9-1/2"H x 18"L	\$139.00
RB-2	Run bag, 7"W x 9-1/2"H x 21"L	\$142.00
RB-3	Run bag, 7"W x 9-1/2"H x 25"L	\$147.00
CAR-1	Cargo case, inside measurements 8"W x 10"H x 13"L	\$165.00
CAR-2	Cargo case, inside measurements 8"W x 10"H x 18"L	\$172.00
AR-***	Recorder cases for HHB, Marantz PMD's, Sony TC-D5 & Sony TCD-D10 PRO, Tascam DAP1 and more	\$172.00~\$182.00
MX-***	Mixer Cases for Shure FP-31/32/32A/33/ or 410	\$160.00

## SKB Cases

SKB cases are stackable, lightweight, and made of a strong polyethylene material. The draw tight latch covers are gasket-sealed to keep out moisture and dirt. The mounting flange is close to the edge, which makes it easy to read the dials and LCD screens on your equipment. The snap-in hardware allows for easy replacement of mounting nuts if failure should occur. Cases come with mounting hardware. Outside rack (OD) dimensions for the SKB-19 cases are 21-1/2"W x 20-1/2"D with 17" of rack-mountable depth. The SKB-9 shock cases are 36"W x 27"D with 20" of rack-mountable depth

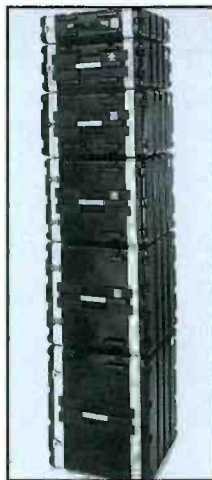

Model No/RU	Case wt./lbs.	Max. Load/lbs.	Price
SKB-19-2U	13	25	\$174.95
SKB-19-4U	15	50	\$194.95
SKB-19-6U	18	65	\$215.95
SKB-19-8U	21	75	\$285.95
SKB-19-10U	23	105	\$299.95
SKB-19-12U	26	105	\$319.95
SKB-9-08U	37	150	\$599.95
SKB-9-12U	48	150	\$659.95
SKB-9-16U	59	150	\$769.95
SKB-1904	Caster kit for SKB-19 cases, 8 lbs.		\$105.95
SKB-1916	Caster kit for SKB shock cases, 9 lbs.		\$164.95
SKB-19-AC1	Rack-mount nut and bolt kit (12 sets)		\$11.95
SKB-88	Attache case with files, 10 lbs. ID=4-1/2"Hx17"Wx12-3/4"D		\$159.95
SKB-88F	As above, with dice foam, 10 lbs.		\$159.95
SKB-600	6 hole ATA microphone case, 9 lbs. ID=10-1/2"Hx13"Wx11"D		\$149.95
SKB-1200	12 hole ATA microphone case, 13 lbs. ID=10-1/2"Hx17"Wx13"D		\$179.95
SKB-1713	ATA equipment case, 11 lbs. ID=10-1/2"Hx17"Wx13"D		\$159.95
SKB-1713F	As above, with dice foam, 11 lbs.		\$209.95
SKB-2416	ATA equipment case, 16 lbs. ID=13"Hx24"Wx16"D		\$189.95
SKB-19-P12	Pop-up Mixer Case, 26 lbs. ID=8"Hx20-5/8"Wx23-1/2"D		\$249.95

## Viking Cases

All Viking cases can be customized to fit your requirements and budget. Standard case designs available are: DJ cases, standard or shock mounted rack and double wide rack cases, pull over rack cases, and music cases. Some of the options are: rear rack rails, a variety of casters or rubber feet, locks, corner and fastener hardware, waterproofing and special foam. Normal turn around time of seven to ten working days with no additional charges for rush orders!

Call Broadcasters General Store for a Viking catalog and pricing.



## Star Case

Star Case specializes in both customized case interiors and exteriors. They work with numerous densities and grades of polyester and polyethylene foams, anti-statics, cubed foams, special cotton and synthetic material lining, hidden compartments, roll-out desk surfaces, roll-in ramps, and special partitioning devices for all types of audio, video, and computer magnetic media. Contact Broadcasters General Store for a Star Case catalog and pricing.





# BIG mixers

## AEQ



The **AEQ MP-10** portable mixer is ideal for remote transmission. It has transformer balanced selectable mic/line inputs, transformer balanced

outputs and three headphone output jacks. An internal rechargeable Nicad battery allows up to four hours of play with an automatic switch to battery if power fails. Carrying case included.

MP-10 \$1,495.00

The **AEQ PME-02** was designed to make your remote transmission problem free. It has four inputs with level controls: three mic/line selectable inputs with XLR-1/4" hybrid connector and one stereo line with mini jack connector. It has two outputs with level control and a VU meter for the main output. It can be connected to the AEQ TLE-02 telephone line extender, to send the mixed audio to the studio via telephone line or connect it to another PME-02 to enhance the number of inputs. Comes supplied with a carrying case and external power supply and works with 8 AA batteries or car cigarette lighter adapter.

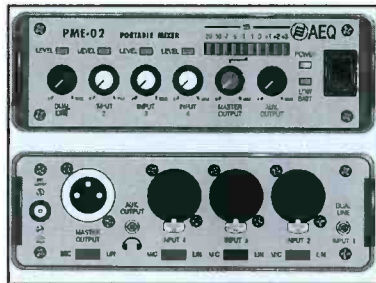

PM3-02 \$445.00  
 PME-02T With optional transformer balanced mic/line \$510.00

## Big Ears™



The **Big Ears™** is a true parabolic reflector capable of picking up sounds from well over 200 feet away. It is constructed from a patented plastic material, so that the integrity of the shape is maintained as well as the thickness, which produces sonic consistency and also visual, see-through

clarity for the operators. The Big Ears™ uses a one piece foam vinyl covered grip bar that also acts as a support bar for free-standing use. The dish is shatter and break resistant, lightweight, and can easily be mounted permanently. 25-1/2"x26-1/2"x10" overall. parabolic 23", weighs 5 lbs. Colors: Yellow, orange, blue, green, bronze & clear. All dishes are see-through.

Big Ears™	\$1,249.00
Strap complete with pads	\$30.00
'Ear Muff' Windscreen	\$99.00
Shipping Case	\$279.00
Carrying Case	\$129.00

## CircuitWerkes

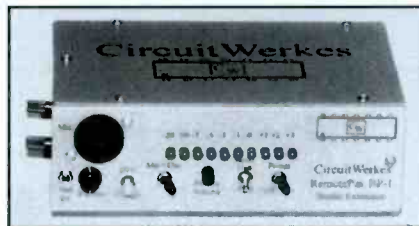

The **CircuitWerkes RP-1** combines a high quality single channel mic amp with a headphone amp in a compact package that's ideal for locker room reports and other extended remote broadcasts. The RP-1's features include: Headphone amp with variable level, balanced input and adjustable sidetone for monitoring IFB and your program audio • Active, balanced mic pre-amp and auxiliary unbalanced line inputs with separate controls • Built in 1kHz calibration oscillator • LED metering switchable to program output or cue input • Standard XLR mic and program output connector, 1/4" stereo headphone/cue jack and 3.5mm auxiliary jack • and Battery power.

RP-1 \$299.00

The **Marti Cellcast RBS-400** four channel mixer can save you time and money on your remote broadcasts. Cellcast has the flexibility to transmit via cellular or land-line so that no matter what the situation calls for you can be on the air within minutes. This unit comes in a heavy duty carrying case, complete with frequency extender encoder, antenna, 12V adapter, AC power supply, and ten nicad rechargeable batteries. Dimensions 13 5/8" x 5 1/32" x 9 3/4" Weight 15.5 lbs.

RBS-400 \$2,950.00

## Cellcast by Marti



**BGS**

R  
E  
M  
O  
T  
E  
  
B  
R  
O  
A  
D  
C  
A  
S  
T



**BGS**

**R  
E  
M  
O  
T  
E  
  
B  
R  
O  
A  
D  
C  
A  
S  
T**

## Comrex



The **Comrex "Codec Buddy"** is a multifunction remote console designed to be used with digital audio codecs. The Buddy is a complete remote studio, providing audio mixers for program feeds, communications, headphones, and public address systems. There is a versatile headphone mixer and monitor matrix allowing headphone listeners to make customized cue selections and adjust level individually. The Codec Buddy also provides a separate amplifier for feeding PA systems with local program audio or codec return audio - or an adjustable mix of the two. An analog telephone interface is built in for communications and a one-line frequency extender encoder is included as a program transmission backup.

Codec Buddy	Remote Field Mixer	<b>\$1,900.00</b>
Buddy Travel Case	Rugged Carrying Case	<b>\$175.00</b>

The **Comrex Cue System** relays both program and instructions from a transmitter (installed in a van, studio, press box, stadium, etc.) to pocket receivers. The CTA Cue Transmitter is a 1 watt rack mount transmitter that accepts two audio sources (program & cue). The cue automatically overrides the program, with program remaining audible at a lower level. The LPQRA receiver has 6kHz audio response for accurate program monitoring, ceramic filters for interference-free operation and high level output for intelligibility in noisy environments.

CTA	IFB Transmitter	<b>\$1,350.00</b>
LPQRA	IFB Receiver	<b>\$625.00</b>
LPQRA-C	2nd crystal for LPQRA	<b>\$50.00</b>



## Electro-Voice



The rackmount **Electro-Voice ELX-1R** features four balanced mic/line inputs, phantom power, switchable output limiter, low cut filters, and is powered by AC or three 9V batteries. Headphone output has a separate power amp and level control and will drive any type of headphones or small a speaker. Level setting is easy with the built-in tone oscillator.

ELX-1R	<b>\$625.00</b>
--------	-----------------

## Henry Engineering



The **Henry StereoMixer** is a 4 stereo/8 mono line mixer that is ideal as an input expander or source combiner. StereoMixer is quick and easy, has superb audio performance, lots of headroom and an internal power supply.

StereoMixer	<b>\$250.00</b>
-------------	-----------------

## JK Audio

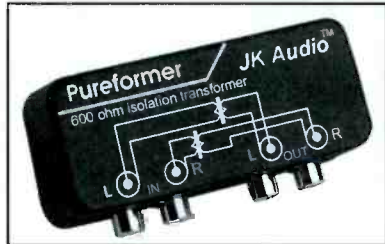

The **JK Audio Pureformer** is a hum and noise reducer for sound cards and audio equipment. It removes ground loops and DC paths that cause hum and signal break-up. Just insert it between your sound

card and your audio mixer or amplifier.

Pureformer	<b>\$59.00</b>
------------	----------------



# BGS mixers

## JK Audio



The **JK Audio RemoteMix** replaces the handset on your analog, digital, PBX, ISDN and single line telephones for professional remote broadcasts. It has balanced XLR and unbalanced RCA line I/O's, one balanced XLR mic input, and an adjustable sidetone null feature. An internal 8Ω, 1 watt/channel amplifier drives headphones or a small speaker. 9V battery or AC powered. 7"x5"x3", 2 lbs.



RemoteMix \$625.00



The **JK Audio RemoteMix C+** is a portable phone line hybrid/mixer for remote broadcast or line interviews. It works with conventional phone lines or your cellular telephone using a fax or modem adapter(available from your cellular dealer). The RemoteMix C+ has balanced XLR output and unbalanced RCA line I/O's, adjustable null feature, and two balanced XLR microphone inputs and two headphone jacks. It runs 36 hours on two 9V batteries. An AC adapter is included.



RemoteMix C+ \$595.00



The **JK Audio RemoteMix 3** is a combined phone line hybrid mixer and universal handset interface in one. It can be used on analog phone lines with the RJ-11 jack, or use it on digital PBX or multi-line phones by plugging the coily cord into the handset port. Features include: two mic inputs • tape in and out • two headphone jacks • VU meter • internal speaker and microphone for quick setup • XLR male out for IFB feed • battery and AC operation.



RemoteMix 3 \$895.00

## Ramsa

The **Ramsa WR-M10A**, multiple source mixer has four balanced XLR mic/line inputs and two stereo input channels. Each stereo channel accepts three pairs of line level signals, and one pair of RIAA-equalized phono inputs. Eight stereo and four mono sources can be connected to the WR-M10A. A built-in compressor can be switched to 'level' all mono inputs. There is priority muting for voice overs. Both stereo input faders are equipped with a microswitch for automatic 'on-cue' remote start of tape cart machines, turntables, or CD players, PFL allows you to preview stereo inputs prior to feeding the output. For convenient mounting, the connector panel can be located on the top, back or bottom of the unit.



WR-M10A \$1,050.00

## Spirit

The **Spirit ProTracker** is an 8-channel linear fader mixer in a 3 RU frame. Although at home in a small production room it is ideal as a portable remote mixer, especially when that remote involves sound reinforcement. Features include: Aux send/return for outboard EQ, effects, etc. • 60dB of mic gain • L/R Pan control • +48v phantom power • adjustable limiter • L/R Master faders • and an extensive monitor section.



ProTracker #RW5197 \$1,199.95



**BGS**

**R  
E  
M  
O  
T  
E**

**B  
R  
O  
A  
D  
C  
A  
S  
T**



**BGS**

**R  
E  
M  
O  
T  
E  
  
B  
R  
O  
A  
D  
C  
A  
S  
T**

## Shure



The **Shure FP42** has all the features and ruggedness of the M267 plus full stereo capability which makes it perfect for stereo mix-down in editing suites. All four inputs are transformer-balanced mic/line, with two stereo outputs. The FP42 has pull-pot mic cueing on all inputs for channel previewing.

FP42	<b>\$1,240.00</b>
A16R Rack Mount	<b>\$35.00</b>



**Shure's FP33** stereo mixer, will replace the highly successful FP32A. The new features include improved precision-sealed rotary potentiometers and battery switching circuit • Internal headphone level adjustments • and improved connectors.

FP 33	<b>\$1,795.00</b>
-------	-------------------



The **Shure FP410** is a portable mixer that automatically keeps unused mics turned down and will only allow one mic to be activated for each source. When someone speaks the Noise Adaptive Threshold activates within 4 milliseconds for speech, not room noise. When no one is speaking, the last mic is kept on to assure a consistent background ambience, until a new one is activated. The FP410 can control multiple wireless mics, work in the effects loop of a multi-channel console and switch to a redundant mic if the primary fails. Up to 25 FP410s can be linked for even greater versatility. The FP410 has four inputs and two outputs, all transformer balanced, mic or line switchable. Other features include: 48V phantom power, tape output jack, low cut filters, 1kHz tone oscillator, adjustable peak limiter with LED indicator, switchable peak VU meter, 1/4" and mini headphone jacks and a monitor in jack to connect an external source to the headphone amp. Powered with two 9V batteries or 120/240 Vac.

FP410, rack mount included	<b>\$1,650.00</b>
----------------------------	-------------------



**Shure's M267** features include: a switchable limiter • phantom power • LED peak indicator • headphone jack with level control • automatic muting circuit • battery check function • tone oscillator • mic/line switches on each input and output • low-cut switches on each of four transformer-balanced inputs • and is powered by three standard 9-V batteries or AC

M267	<b>\$625.00</b>
A268R Rack Mount	<b>\$35.00</b>

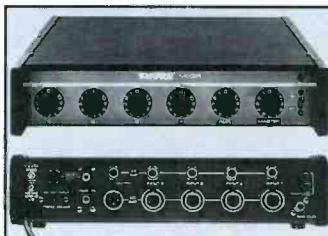

**Shure's M268** is a compact, light-weight, 5-input mixer with individual volume controls for each channel plus master volume. It includes four transformer coupled low impedance balanced microphone inputs, and four high impedance 1/4" phone jack inputs plus a high level aux input. The M268 also has switchable phantom power, mix buss, mic level transformer balanced output and aux level unbalanced output.

M268	<b>\$365.00</b>
A268R Rack Mount	<b>\$35.00</b>

## Zercom



The **Zercom MAX-Z** is a four channel mixer with both dedicated balanced and dial up phone line connections. Features include: clock, stopwatch/timer, VU meter, low battery indicator, four headphone jacks with cues fed to the left channel, wide

range audio inputs that will match mic to line levels, cue channel, phone line alarms, and tone or pulse memory dialing. Accessories supplied are carrying case, built-in rechargeable batteries and charger. Size 13"x17"x5" Weight 15 lbs.

Max-Z	<b>\$1,225.00</b>
RBP Remote Broadcast Package, Max-Z with Zercom Telephone Hybrid	<b>\$1,596.00</b>



The **Zercom MAX-Z II** is an abbreviated version of the MAX-Z. High quality audio handling is maintained in the two channels of audio input. It is AC or

DC powered with two headphone outputs, cue channel and case. Size 8"x9.5" Weight 6 lbs.

Max-Z II	<b>\$750.00</b>
----------	-----------------



## ATI



The **ATI PB2X8 Press Box** Distribution System has two balanced mic/line inputs with switched phantom power and low cut filter on mics. Both inputs have individual gain controls and are switchable together or separately into any of eight transformer balanced adjustable outputs. Calibrated test tone oscillator • Switchable LED display • Line level XLR connectors in and out • plus 1/4" and 3.5mm phone jack outputs at -10dBu.

PB2X8 \$1,399.00



The **ATI MXS100** is a portable, three channel, mic/line selectable mixer with low noise balanced mono inputs, phantom power, pan pots, switched low cut filters and a test tone

oscillator driving stereo, metered, low distortion, servo balanced line outputs with switchable peak limiting. A stereo 100mW headphone output is switchable from normal stereo program to split L+R/Q monitoring. The headphone Q feed is internally selectable from any input channel and/or an external cue input jack.

MXS100	Field or portable mixer	\$799.00
MX200	Studio mixer, stereo line out, 3 panned mic/line inputs	\$599.00
XPS100	Expander, Stereo buss out, 4 panned mic inputs	\$549.00
XPS200	Expander, Stereo buss out, 2 stereo line level inputs	\$379.00

## Whirlwind



**Whirlwind's PressPower** takes two transformer isolated XLR mic/line inputs and distributes them to sixteen transformer isolated XLR outputs (12 mic/-50dB, 2-line/0dBV, 2-line/variable). A headphone output is provided with a level control, plus, to expedite setup, a 1kHz tone is available. Powered by four 9V batteries or AC (110/230), the PressPower can be rackmounted or used with the included carrying case.

PressPower \$1,785.00



**Whirlwind's MIX-44** is a unique two rack units product that allows the creation of four discrete mixes from four separate inputs. It accepts four separate balanced line level input signals, and applies them to four separate mixer sections where they are combined through volume controls to provide four separate output mixes. Each of the four mixer sections has four input volume controls, one for each of the input signals. These signals are combined through a master volume pot and exit via balanced line level XLR's. Switches are provided to enable the MIX-44 to be used as two four by two matrices. Inputs and outputs are balanced XLR's. A meter and headphone circuit monitor the four master outputs.

MIX-44 \$1,000.00

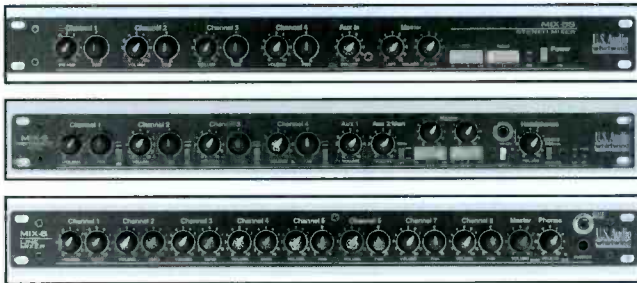

Shown from top to bottom: MIX-5S ~ MIX-6 ~ MIX-8

The **Whirlwind MIX-5S** is designed as an all-purpose mixer for sound contracting. It offers 4-input channels, each with XLR and 1/4" TRS balanced connectors, suitable for mic or line level use. An LED readout provides a visual indication of levels, and phantom power is provided for operating condenser microphones, XLR and 1/4" TRS outputs are provided, with the XLR output mic or line level switchable. The outputs have their own drive circuit for isolation. An Aux channel is provided with RCA input jacks for connecting a tuner, CD player, tape player, etc.

MIX-5S		\$370.00
MIX-5	Same as the MIX-5S, except mono	\$350.00
MIX-6	6 input stereo mixer • XLR/TRS/TR/RCA • mic/line I/O • defeatable 40db/meter	\$850.00
MIX-8	8 input stereo line level mixer with split input	\$535.00



The **Medusa Pressbox** is a rugged, passive, transformer splitting device that takes a single line level signal and provides multiple low impedance feeds.

PB06	1-in, 6-out	\$310.00
PB12	1-in, 12-out	\$581.00
PB16	1-in, 16-out	\$740.00
PB24	1-in, 24-out	\$1,075.00



BGS

REMOTE BROADCAST





## Marti

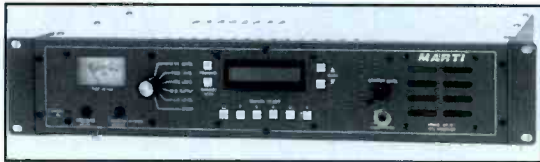

The **Marti SR-10** is a frequency agile base station receiver with superior selectivity. Features include: frequency agile over 450-455Mhz Band • Front panel selection of channels • Sub-audible tone decoder • Automatic noise reduction • Built-in monitor speaker with front panel headphone jack and level control • LCD display (backlighted) to indicate exact channel frequency • and six programmable priority channels can be scanned or selected.

SR-10	RPU rackmount Receiver	<b>\$2,500.00</b>
-------	------------------------	-------------------

### Marti RPT-30/15/2

These Marti systems enable non-technical personnel to produce professional sounding live remotes. The Marti remote transmitters are for continuous duty • have two frequency capability • sub-audible encoders, for switching repeaters • and will work on AC or DC power. The RPT-30 has four balanced mic inputs, with one switchable to a line input. The RPT 15 and RPT 2 have two audio inputs, mic and high level unbalanced. The hand held RPT-2 mic input is push to talk. The CR-10 and AR-10 receivers have dual frequency capability and sub-audible tone decoding. Marti transmitters have a one year warranty.



RPT-2	Hand held 2W xmtr w/o internal bat., 1 freq.	<b>\$1,085.00</b>
RPT-2-2	as above dual frequency	<b>\$1,115.00</b>
RPT2-B	as above w/ internal battery 1 freq.	<b>\$1,155.00</b>
RPT2-2B	as above w/internal battery dual freq.	<b>\$1,185.00</b>
RPT-15	Portable/mobile 15W transmitter 1 freq	<b>\$1,165.00</b>
RPT-15-2	as above w/dual frequency	<b>\$1,195.00</b>
RPT-30	RPU 30W transmitter, single freq.	<b>\$1,815.00</b>
RPT-30-2	as above dual frequency	<b>\$1,845.00</b>
CR-10-D	Rcvr Single frequency, w/decoder	<b>\$1,395.00</b>
CR-10D-2	as above dual frequency	<b>\$1,425.00</b>
AR-10	Mobile relay rcvr. single freq.	<b>\$1,395.00</b>
AR-10-2	as above, dual frequency	<b>\$1,425.00</b>

*Various Marti packages, accessories and antennas are available. Please call Broadcasters General Store for more information.*



The **Marti SRPT-40** and **SRPT-20** RPU transmitters have incorporated in them all the features found in the RPT-15 and RPT-30 transmitters and add the ability to change frequency by means of front panel thumbwheel switches. New switching power supplies produce 30% more power with 30% less weight and run cooler. The SRPT-40 and SRPT-20 will operate on any 50/60Hz AC voltage between 95 and 250 volts without changing jumpers or switches. They have a compressor/limiter built-in, UG-58 N female RF connector and are compatible with your existing system when not companded.

SRPT-40	40 Watt	<b>\$2,795.00</b>
SRPT-20	20 Watt	<b>\$2,500.00</b>

**REMOTE BROADCAST**



## Moseley

The **Moseley RPL 4000** Remote Programming Link is frequency agile via internal dip switches and the user programmed frequencies are selectable from a front panel switch or rear panel remote control. The system has a sub-audible encoder/decoder and a built-in 2:1 compander with provisions for user preferred external noise reduction or signal processing. The RPL 4010 portable transmitter is a 20 watt, continuous duty unit powered by 8-15Vdc. It has three balanced inputs, one switchable to a line input, a headphone monitor jack, and has comprehensive monitoring and diagnostics via a twelve position switch. The RPL 4020 receiver features a built-in loud speaker with volume control, full diagnostic metering, excellent selectivity, and adjacent channel rejection.



RPL 4010	Transmitter	\$2,950.00
RPL 4020	Receiver	\$2,950.00

## Comrex POTS CODEC



The **Comrex Hotline** has the audio clarity of a microwave link and the convenience of a simple telephone call. Just plug the Hotline into your client's phone jack, connect your mic/headphone (or the output of a wireless receiver), press the quick dial memory button for the studio (it even has last number redial memory) and you're on the air. Comrex's adaptive audio compression algorithm is designed to work with the lower speed connections associated with POTS lines. At 12kb/s (worst case) it will deliver 20Hz-4.5kHz response---better than a single line frequency extender. At 33.6kb/s (best case) it delivers 20Hz-10kHz response---microwave over the phone!!! It also offers an extra input and output for house feeds.

Hotline portable	\$2,995.00
Hotline Rackmount	\$3,195.00
Soft Carry Case	\$50.00
Small Road Case	\$175.00

## Marti POTS CODEC

**Marti SMARTI** is a telephone codec for remote broadcasting which is capable of simultaneously sending and receiving 7.5kHz audio over a single standard analog telephone line. It actually offers 3 different operating modes, one with very low delay and 7.5kHz audio • one with even less delay and only slightly lower quality performance • and the third mode is a direct analog telephone interface. Utilizing the latest MPEG compression algorithms coupled with modern DSP technology, SMARTI offers better than RPU quality with phone line convenience. Functions are push-button or menu driven from "telephone style" keypad and a 2"x16" LCD display. Ten phone numbers can be stored for easy access and calls can be initiated from the remote or studio location. It also incorporates two relay contact closure switches allowing control of equipment at the other end of the system. All controls are located on the front panel and include: compression algorithm switch • two headphone jacks with program and return mode select switches • a monitor jack with level control, return audio and line output level adjustments • four XLR audio inputs that are mic/line switchable with level controls • and a timer which allows events such as breaks to be accurately timed via the LCD display.

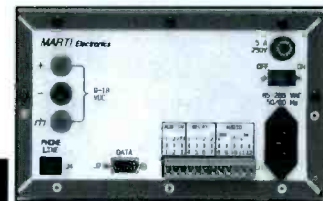

SMARTI	\$3,400.00
--------	------------

## MUSICAM USA POTS CODEC



The **Musicam USA FieldFone™** is a portable single channel, mic/line telmote codec that interfaces to a POTS line (plain telephone line) to bring you 7.5kHz of audio through the use of a high speed modem and the patented Musicam HQ™ audio compression algorithm. This full duplex unit, incorporates a telephone keypad, memory redial, balanced inputs with level controls and a local/return headphone mix. 12 lbs. The **FieldFone II** provides the following added features: 3 mic input (1 switchable for mic or line • 2 headphone monitor circuits with separate send and return level controls • balanced XLR output • unbalanced 1/4" send and receive audio outputs • 4 on-board relays for remote control of external devices • dedicated relay function keys • wider frequency response and greater dynamic range • improved internal construction • and external battery port.

FF100	\$3,350.00
C2100	6' Output Adapter Cable, 1/4" phone to XLR \$35.00
FF200	\$3,850.00

**Musicam StudioFone** is a rackmount version of the FieldFone. A few special features include: a speaker for active monitoring • four LED's for visual monitoring of activated relay closures • and a built-in talkback feature for talent IFB.

StudioFone	\$3,800.00
------------	------------



BGS

R  
E  
M  
O  
T  
E  
  
B  
R  
O  
A  
D  
C  
A  
S  
T



**BGS**

**REMOTE CONTROLS**

## Audio Fail Safe

**Consider the purchase of 2 silence sensors. Set 1 for 30 Seconds to call the studio or PD and 1 to call you after 5 minutes!**

## Belar

The **Belar AS-1 Audio Sentry** is an alarm which aurally and visually alerts station personnel of the absence of modulation or carrier. It will react immediately upon loss of carrier. In the case of loss of modulation, the Audio Sentry can be programmed to sound off anywhere between 3 and 60 seconds.

AS-1	<b>\$295.00</b>
------	-----------------

## Broadcast Tools

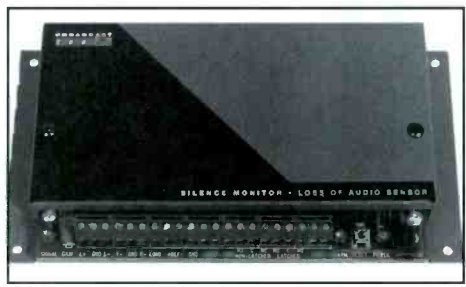

**Broadcast Tools Silence Monitor** The Silence Monitor is designed to monitor any stereo or monaural audio source for activity. The absence of audio will extinguish the "SIGNAL" LED and close a relay after a programmable time delay. The relay remains closed for the duration or the loss of audio, while a second relay is latched and may be set to flash. The precise time delay is programmed via 8 dip switches in increments of 2 seconds with a maximum time delay of 8.5 minutes. It is equipped with an on-card silence alarm reset switch, opto-isolated remote reset and defeat inputs and LEDs that display presence of audio, power and silence alarm. A new feature allows one of three ways to configure the Silence Monitor: both channels, left channel only or right channel only!

Silence Monitor	<b>\$199.00</b>
RM-2 Rackmount	<b>\$49.00</b>



The **Broadcast Tools Alert Sentry-16** provides a convenient way to monitor station alarms on Windows based PC's. The AS-16 is equipped with 16 optically isolated inputs, that may be programmed for wet or dry contacts. The AS-16 output is standard RS-232 and may be fed to the serial ports of multiple computers. It also provides two separate relay contacts. The first closes for six seconds after any high to low or low to high input on any port. The second relay contact stays closed indefinitely while any or all alarms are present. The AS-16 is provided with software that may be run under Windows and allows up to sixteen alert and sixteen non-alert, 63 character descriptions to be displayed. An alarm condition causes a high-lighted cursor to flash beside the highlighted 63 character description. Input connections are via wire captive terminals.

AS-16	<b>\$349.00</b>
RM-2 Rackmount	<b>\$49.00</b>

## Gentner

**Gentner Silence Sensor** The Silence Sensor monitors your audio source, observing both rising and falling edges of audio. In addition it observes audio on a wideband and narrowband basis, permitting the unit to ignore hum and other erroneous signals. If it notes a loss of audio an open collector output is activated and the time-out sequence begins. If audio returns before time-out, the unit reverts to a "ready" state. However, if audio does not return after a programmed delay time, a second open collector output is activated along with a relay closure to turn on lights, sound alarms or start other sources. A set of dip switches located behind a front panel insert allow you to set time-out for 1 to 165 seconds or 1 to 165 minutes.

Silence Sensor	<b>\$539.00</b>
----------------	-----------------

## Radio Design Labs

### Radio Design Labs ACR-1 & ACR-2

Radio Design Labs ST-ACR1M is designed to switch on low-level sources, such as microphones or mic-level sources. The ST-ACR2 is designed to switch on line-level sources with extended release delay. The ST-ACR2 is widely used as a Silence Sense Relay.

	Sensitivity	Release Time	
ST-ACR1	-30dBv to 0dBv	0.5 sec. to 5.0 sec.	<b>\$90.00</b>
ST-ACR1M	-60dBv to 10dBv	0.5 sec. to 5.0 sec.	<b>\$90.00</b>
ST-ACR2	-30dBv to 0dBv	5.0 sec. to 50 sec.	<b>\$90.00</b>
PS-24A	Power Supply, one will power six ACR's		<b>\$17.00</b>





## Audio Fail Safe

### Sine Systems

**Sine Systems AFS-1** The AFS-1 Audio Fail-Safe is a self-contained device that is typically used to trigger an alarm or terminate transmission if program audio fails. The AFS-1 can monitor one or two audio signals and provide a relay contact-closure for as long as either audio signal is present. When neither audio signal is present for an adjustable delay period (7 seconds to 4.5 minutes) the relay contact opens and remains open until one or both of the audio signals return. The output relay is rated (6 amperes/120 volts) to allow direct control of most equipment.

AFS-1 \$249.00

## Broadcast Tools

The **Broadcast Tools SRC-8A** adds remote relay control to your DSP-6000 (or equivalent) digital STL or ISDN remote equipment. Applications include direct relay control for your dial-up remote control, a supplement to your dedicated remote control, relay control of satellite, transponder or remote audio switching as well as machine control and talent alerting for remotes. The standard system provides one-way control. The SRC-8B is available for bi-directional control and status. All SRCs utilize a high integrity data format for maximum reliability. The SRC-8A consists of both transmit and receive units. Power adapters and serial cables are provided.

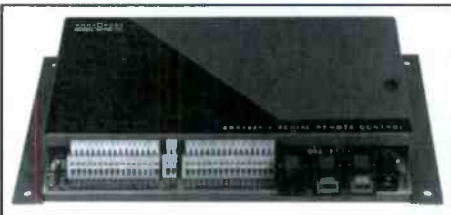

SRC-8A	\$399.00/pr
SRC-8B	\$499.00/pr
RM-2	\$49.00

The **Broadcast Tools DC-8A** is designed to connect to a standard dial-up telephone line, allowing the user to control eight SPDT relays and monitor eight digital inputs via any standard Touch-Tone® telephone. The relays may be configured for momentary, latching, interlocking or group latch/unlatch operation. The DC-8A incorporates a "Pager Alert" function, which when activated, will dial up to three digital pagers and display a programmed phone number along with the input that caused the alarm. Additional features include: programming via standard Touch-Tone® phone • up to 8 digit passwords • programmable number of rings • 1kHz tone generator • audio I/O switching to telephone line • front panel status LEDs for tone, off-hook, local control, ring and power • single high/low DTMF tones used for status of the eight relays and digital inputs. Three new features include: CPC control, allowing the automatic disconnection of the phone line when the calling party hangs up • Acknowledgment of tone defeat, disabling the feedback tones when used for on-air applications • and stand-alone DTMF Detection, enables the user to connect programming audio to the unit allowing the detection of DTMF tones one through eight. 1U



DC-8A \$399.00

### CircuitWerkes



**CircuitWerkes DR-10 Dial-Up Controller** is a microprocessor based remote control that lets you control your station's equipment from anywhere there's a phone. Auto answers on user set ring number and auto-disconnects at calls-end. Its 10 dry relays (2 are DPDT for switching balanced audio, etc.) can be programmed to decode any of the 16 DTMF tones and can be individually programmed for momentary, latching or interlocked operation. Any relay can be assigned to any tone(s). It has four logic level inputs that can cause the DR-10 to automatically activate any relay and/or call your pager. Other features include: up to 8 digit user set password prevents pirating • each relay is programmable to close at beginning or end of tone and can beep when activated (End of tone closures are after the beep!) • two-tone and detection delay modes eliminate falsing for remotes, etc. • a simple, built-in audio hybrid, with active, balanced input and outputs, lets you control your equipment while monitoring local audio sources • retains its settings and prior state after a power failure • and a silencer option removes DTMF tones from output. All outputs appear on easy to use screw terminals and programming is easily done from any DTMF telephone.

DR-10 \$449.00



The **CircuitWerkes DS-8** is a DTMF Sequence Decoder providing dry closures for eight different tone sequences. It can decode one to eight separate DTMF sequences used by networks for automating closed circuit feeds and local insertions. Each relay can be set for one to four digit code(s). Relays are easily (and independently) programmable, via DTMF phone, to operate in momentary, latching, or interlocked latching modes. Any mixture of modes and code lengths can be used and it remembers all the settings in a power failure. All connections are screw terminal. Use the DS-8 for remote audio switching, automated program recording, secured remote EAS control, you name it! Optional rack mount (pictured) is available. A two unit rack mount is also available.

DS-8 \$299.00



R  
E  
M  
O  
T  
E  
  
C  
O  
N  
T  
R  
O  
L  
S



**REMOTE CONTROLS**

## Burk

The **Burk Technology ARC-16** is a full time studio control, dial up control or both. The ARC-16 includes 16 analog metering channels, 16 status channels and 16 raise and 16 lower control outputs. The ARC-16 units have 32 character displays with labels and units you have selected for easy calibration and local operation. You decide whether to add studio control, telephone access or both. Communications between site can use dedicated lines, dial up, STL subcarriers, FM SCA or 450 MHz TRL. Subcarrier generators are built in at no extra cost. The ARC-16 system is capable of controlling two transmitter sites from one studio or one transmitter site from two studios. The telemetry links between the sites can be mixed. Full access to all sites is available at any site by pushing a button. Alarm reporting is handled immediately and is displayed at all sites no matter which site is monitored.

*Please call Broadcasters General Store for system configuration.*

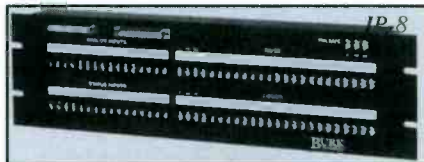

ARC-16	2 unit remote control system, one studio unit, one transmitter unit, one set of modems *	<b>\$3,895.00</b>
ARC-16S	Includes control terminal with display and modem to connect to an existing transmitter or studio unit.* May require additional modem and two port adapter, for existing unit.	<b>\$1,795.00</b>
ARC-16CI	Stand alone system w/computer interface	<b>\$2,695.00</b>
ARC-16T	Includes 16 channels of analog inputs, 16 channels of status, 32 control outputs (16 raise, 16 lower). Includes a modem to connect to an existing transmitter or studio unit.* May require additional modem and two port adapter, for existing unit.	<b>\$2,295.00</b>
ARC-16T32	Expansion unit for 32 channels, (may need 2 port adapter)	<b>\$2,195.00</b>
ARC-16SA	Transmitter unit with front panel display plus the ESI	<b>\$2,995.00</b>
AutoPilot®	Automatic transmitter control software	<b>\$595.00</b>
ESI	Enhanced Speech/Computer Interface hardware for ARC-16's	<b>\$895.00</b>
AMI-2	Antenna monitor interface up to 8 towers	<b>\$395.00</b>
CI	Computer interface hardware for the ARC-16	<b>\$195.00</b>
CDL	Control display logging software for CI or ESI	<b>\$295.00</b>
RMSx/y	Radio modem for studio unit **	<b>\$200.00</b>
RMTx/y	Radio modem for transmitter unit **	<b>\$200.00</b>
Module	Input or output module for Radio Modem	<b>\$35.00</b>
SSI	Studio Status Indicator for external user supplied indicators for first transmitter site	<b>\$250.00</b>
SIO	Studio input/output option provides 8 raise and 8 lower control outputs, 8 analog metering channels, 8 status inputs for controlling and monitoring equipment at the studio site. Two SIO's may be installed for a total of 16 Ch.	<b>\$495.00</b>
IP-8	Interface panel 8 metering inputs, 8 status inputs and 8 each raise and lower outputs, plus fail safe use at Xmtr	<b>\$495.00</b>
BTI	Indoor Sensor for BTU-4, for monitoring ambient temp. in a room	<b>\$79.00</b>
BTO	Outdoor Sensor for general purpose monitoring w/15' cable	<b>\$49.00</b>
BTS	Stack Probe for BTU-4 for temp. sensing air ducts, w/15' cable	<b>\$69.00</b>
BTU-4	Burk Temperature Unit w/1-BTO, supports 4 independent probes	<b>\$199.00</b>
TPA	Two port adapter	<b>\$100.00</b>
LVK-3	Line voltage Kit	<b>\$195.00</b>
TLM	Tower light Monitor	<b>\$109.00</b>
TE-2	Transient Eliminator	<b>\$129.00</b>
TE-RJ	Dial line Transient Eliminator	<b>\$159.00</b>
UPS 400	Backup Power Source	<b>\$297.00</b>
WMS	Wire modem for studio unit	<b>\$200.00</b>
WMT	Wire modem for transmitter unit	<b>\$200.00</b>
SCA-2	Subcarrier Receiver	<b>\$198.00</b>

\* Please specify type of modem, telco, STL, SCA, or TRL and include desired subcarrier frequencies for STL or SCA links. SCA links require SCA receiver to recover telemetry.

\*\*For Radio Modems please specify STL subcarriers, SCA and TRL links x and y are the output and input subcarrier frequencies respectively. Audio inputs or outputs are specified by substituting zero for x or y.

The **Burk BDT-115 RF Data Link** provides error-free communications between ARC-16 Remote Control units. It eliminates telco charges and SCA requirements and up to 100 units may be operated at the same site. Burk provides a range of antennas for the BDT-115, permitting line of sight operation at up to 20 miles. BDT-115 Wireless Data Transceivers use spread spectrum technology to transmit data using the unlicensed band of 902-928Mhz. For about the cost of a TRL system the Burk RF Data Link provides a bi-directional alternative.



RF Data System	2-BDT-115, 2-TPA kits, 2-BDT/BNC cable sets, ARC4.6 D firmware for BDT	<b>\$2,795.00</b>
BDT-115	Single Wireless Data Transceiver	<b>\$1,397.50</b>

*Please call Broadcasters General Store to arrange a free RF path analysis from Burk, and for cable and antenna pricing.*



# remote controls

## Conex



The **Conex DT-40** DTMF Tone Remote Control System accepts DTMF tones from an audio line, receiver, or other source. After giving your user access code, it allows remote control of sixteen SPDT relays. The relays can be momentary, latching, or interlocking. A switch settable device selection code allows up to 15 DT-40's to be individually controlled from one audio source. It has miniature screw-clamp terminal strips for easy connection.

DT-40 \$339.00

The **Conex DT-55** answers a phone line, accepts a user determined access code, then allows remote control of ten SPDT relays and the remote monitoring of ten external switch contacts or logic levels. The relays are magnetic latching. On power loss and restoration you can choose to retain their prior states or return to the de-activated state. Each relay can be set, cleared or activated momentarily, for the duration of the push-button actuation on the calling telephone. Additionally, the DT-55 can be set up to act in an interlocking mode; when a button is pressed, its associated relay is set and all other relays are cleared. Easily distinguishable tones indicate the high-low or open-closed status of the ten external inputs. Status lights indicate the ringing signal, power, DTMF tone detection, line connection and access. It uses miniature screw-clamp terminal strips for easy connection.



DT-55 \$339.00

## Gentner

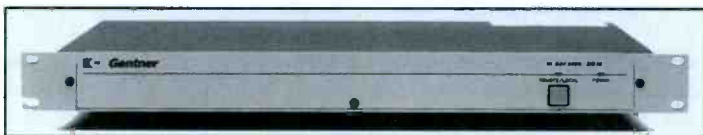

GSC I/O8	8 Channels each of metering status & command, w/System Server Software, VCR-WIN	<b>\$1,795.00</b>
GSC I/O16	16 Channels each of metering status & command, w/System Server Software, VCR-WIN	<b>\$2,795.00</b>
VS	Voice Server	<b>\$995.00</b>

*Please call for special package prices!*



VRC-2000	Includes Data interface, Set-up VCR and VCR-WIN software, and telephone line surge	<b>\$2,995.00</b>
2000Package	As above plus 1 command relay & 2 screw barrier strips	<b>\$3,499.00</b>
CRU	Command Relay unit (Phoenix type connectors)	<b>\$495.00</b>
SBS	Wiring Interface	<b>\$195.00</b>
DI	Data Interface	<b>\$549.00</b>
SS	Silence sensor	<b>\$539.00</b>
ACS	AC current sensor	<b>\$219.00</b>
TSU/F or C	Temperature Sensor Unit w/one Fahrenheit or Celsius Probe	<b>\$319.00</b>
Probe	Temperature Probe, Fahrenheit or Celsius	<b>\$99.00</b>
TSP	Telephone Surge Protector	<b>\$89.00</b>
EFI/TSP	EFI model DPI 153TLS, AC or telco line surge protection	<b>\$139.00</b>

The **Gentner GSC3000** Site Control System takes the concepts introduced by the VRC2000 Remote Control Unit to the next level. The GSC's I/O unit provides 16 analog metering inputs, 16 binary status inputs and 32 command outputs configured as 16 raise/lower command channels. Additional 'smarts', such as macro and time-based event capabilities, were added to the GSC. The GSC3000 System offers these unique features and benefits: operation of 1 to 256 sites • 8 to 256 channels of metering, status and command, per site • single or multiple PC monitoring sites • friendly Windows® and Windows95® based operation • and PC based voice/DTMF option allows control and command of multiple site locations from a single dialed number. The GSC3000 site control system is configured from: I/O Unit that performs all data collection, time and macro driven command functions • System Server Software that provides for the set up of all I/O units and allows basic operation of the complete system • Logging Management Software that amplifies the logging capability and logging post processing functions of the system • Developer's Software Package that permits the user to customize the displays and develop personalized command functions using Visual Basic • and the Voice Server.

The **Gentner VRC-2000** provides simple, effective transmitter remote control, 24 hours a day. It offers access by dial-up phone line, radio link, data link or bi-directional audio link. Its synthesized voice response provides an audio interface to the system - punch in touch tones and it talks back to you. You can get complete remote control capability with automatic time-of-day functions, and automatic alarm reporting and correction.



**BGS**

**R  
E  
M  
O  
T  
E  
  
C  
O  
N  
T  
R  
O  
L  
S**



**BGS**

**REMOTE CONTROLS**

## Monroe

**Cue Tone Receivers** manufactured by Monroe Electronics provide decoding of DTMF Cue Tone Signals transmitted over satellite transponders or telephone lines. Use of the Cue Tone Receiver permits automatic, unattended operation of channel switching functions at the headend when programming begins, ends, or changes. Models are available in wall or rackmount enclosures and may include optional features such as telephone access and audio/video switching.

Monroe **DTMF Cue Tone Encoders** are used by satellite and microwave program services to provide automated headend switching functions. These signals can be used at the headend or studio to control modulators, processors, audio/video switches, agile receivers, scramblers, video tape machines, or other unattended switchable devices. Models are available in wall or rackmount enclosures.

**Audio/Video Relay Panels** provide audio-follow-video switches that can be controlled by program timers, remote controls, or cue tone receivers. Each switch will respond to a contact closure, a transistor switch to ground, or a compatible logic level. The control inputs are buffered to eliminate high output current drive requirements of the controlling device.

The Monroe **Program Timer** is a rackmount programmable time of day and day of week switcher designed to be used alone or with Monroe Cue Tone Receivers to provide unattended time and Cue Tone switching functions. It can be used with Audio/Video Relay Panels to provide independent, time controlled audio-follow-video switches.

The **Video Recorder Control** is a rackmounted commercial insertion controller designed to provide automatic, unattended switching to local video taped commercials in response to CATV program source cues. It serves as the controller for a run-of-schedule commercial insertion system, providing the cue tone detection, VCR control and audio/video switching requirements of the system.

The **Remote Receiver Channel Selector** provides for the remote selection of satellite transponders and includes an integral FCC registered telephone line interface which allows direct connection to a standard dial-up telephone line for remote channel selection by means of DTMF commands. They also include a local audio input to provide control via a leased line, audio pair, or microwave system.

Monroe **Remote Control Systems** are available for control and monitoring over dial-up telephone, microwave, two-way radio, or other audio paths by means of DTMF commands. These systems give the calling party control of remote relays and the ability to interrogate status input points for remote control and status monitoring of unattended sites. They can also provide automatic dialing of stored phone numbers to report change of status of inputs, and can make use of an internal timer to execute control commands.

**Telephone Couplers** will answer the incoming ring signal and complete a bidirectional audio path to and from an ordinary dial-up telephone line. All Monroe Telephone Couplers are FCC registered and are available in wall or rackmount enclosures ready to connect into a standard telephone line.

The **Emergency Alert System** permits civil emergency authorities a choice of local, dial-up telephone, or dedicated telephone access to a cable/broadcast system audio channel. Use of a security access code is required when using either dial-up or dedicated telephone.

The **Remote Radio Control Units** allow a caller to monitor the traffic on a receiver, and upon depression of the Push-To-Talk switch on the handset, to key the transmitter and place the caller's voice on the air. Monroe audio frequency Push-To-Talk feature allows remote control of radio equipment where hardwire facilities are not available.



Listed below is just a sampling of what is available from Monroe. We'd be happy to supply a complete packet and pricing.

624	Video Sensor	\$295.00	935A	DTMF Sender; 2-Codes	\$825.00
625	RF Sensor	\$325.00	939A	Cue Tone Receiver w/4-digit Decoder; 90mA	\$400.00
626	Video Distribution Amp	\$195.00	948	Cue Tone Receiver w/A/V switch	\$915.00
627	Stereo A/V Switch	\$165.00	3000P-14	A/V Panel w/4 A/V switches	\$515.00
628	Encoder Sensor	\$325.00	3000R-107BD	Dual Tone Sender, 2-Codes	\$3,745.00
629	1x4 Stereo A/V amp	\$525.00	3000R-107CD	Dual Tone Sender, 3-Codes	\$4,140.00
630	4x1 RF Matrix Switch	\$425.00	3137B	Phone Answer card	\$145.00
631	Program Timer Jr	\$485.00	3171B	BCD to DTMF encoder card	\$225.00
900/22C	1 Card wall enclosure	\$65.00	3446-3	Single A/V Switch	\$105.00
900/22F	3 Card wall enclosure	\$90.00	6002-6	6 Channel Telephone Remote	\$595.00
900/22G	6 Card wall enclosure	\$145.00	CES-340J-16	DTMF 4x4 TT Pad	\$125.00



# remote controls

## Moseley

The **Moseley MRC 1620** is an intelligent integrated remote control system that has 16 raise and 16 lower command relays, 16 TTL status inputs and 16 analog metering inputs. The system will automatically log, and can be controlled and interrogated from an optional control terminal or IBM PC with Taskmaster 20 software. All status channels are simultaneously displayed on the front panel. The MRC 1620 constantly checks telemetry and status data for each channel against assigned limits and triggers audible and visual alarms for out of tolerance conditions.

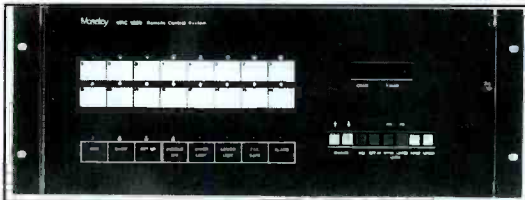

MRC 1620, Control terminal, 1 modem, 1 RS232 port	\$1,550.00
MRC 1620, Remote terminal, 1 line modem, 1 dial up modem	\$3,450.00
Taskmaster 20 software for IBM PC or compatible	\$595.00
Subcarrier Generator module (w/system N/C) Separately	\$195.00
Subcarrier demod (w/system N/C) Separately	\$195.00

The **Moseley MRC-2** will control multiple sites from multiple control points. The basic system is one Control Terminal, one stand alone Remote Terminal or one Remote Terminal with Data Acquisition/Command unit. Multiple remote terminals may be added to the system, with each remote terminal designated as a site. A stand alone remote terminals maximum configuration could be 64 command lines, 48 status channels and 48 telemetry channels. The MRC-2 can control your AM, FM or TV site individually or all three at once. Many control, data acquisition and expansion options are available. Please call Broadcasters General Store for further information.

MRC 2	Control Terminal only	\$4,980.00
MRC 2	Remote Terminal only (16 Command/16 Status/16 Analog telemetry channels)	\$7,980.00



## Phartronics

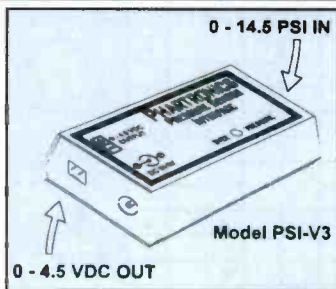

The **Phartronics Pressure Sensor Interface** provides a very precise sample voltage of 0 to 4.5VDC that varies linearly with line pressure. The DC sample is compatible with any brand of remote control. To set a Lower-Limit alarm on the pressure sample input of your remote control simply "T" into your existing pressure line to provide a line pressure sample and connect the output sample voltage to your remote control.

PSI-V3	\$225.00
--------	----------

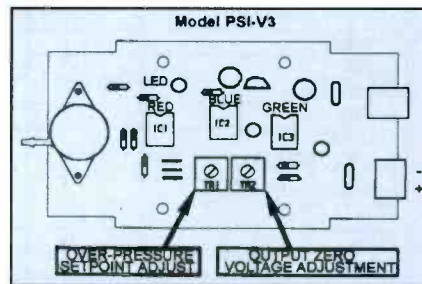

## Sine Systems

The **Sine System RFC-1** is an affordable fully-featured dial-up (from any telephone) remote control for your transmitter. It speaks to you with a natural human voice. It can also telephone you to report out-of-tolerance conditions and can automate transmitter power/pattern changes. The basic system consists of one RFC-1/B and one RP-8 eight-channel relay panel. And more RP-8s for more channels. Add the optional SP-8 heavy-duty surge protection system and Sine Systems will cover lightning damage under the one year warranty.

RFC-1/B	Remote Facilities Controller	\$1,199.00
RK-3	Rack kit for RFC	\$35.00
RP-8	8 Channel relay panel	\$399.00
RS-232	Serial communications adapter	\$249.00
SP-8	Heavy-duty surge protector	\$129.00



The **Sine System DAI-1 Dial-Up Audio Interface** provides an array of features unparalleled in the industry. It combines an autocoupler, a dial-out alarm, two AGCs, a DTMF operated equipment controller and an audio switcher into one affordably priced device. It allow "dial-up" remote broadcasts when the studios are unmanned. The DAI-RP provides a space to rack-mount the DAI-1, a power supply, a screw-terminal interface module and five general-purpose relays for equipment control and audio switching. The optional DB-1, 50 millisecond delay board prevents DTMF tones getting on the air. The optional CI-1 Composite Insertion Module is available for use when discrete audio is unavailable.

DAI-1	Dial-up audio interface	\$699.00
DAI-RP	Relay panel kit	\$229.00
CI-1	Composite interface module	\$129.00
DB-1	Delay board	\$129.00

Please call for information on other options available.

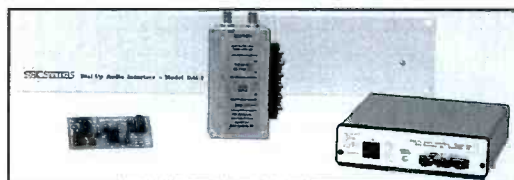

**BGS**

**REMOTE CONTROLS**

# rf related equipment



**BGS**

**R  
F  
R  
E  
L  
A  
T  
E  
D  
E  
Q  
U  
I  
P.**

	Transmitter/Exciter	Antennas	Loads	Transmission Line	Towers/Masts & Acc's	Coaxial Patch Panel/Switch	Pressurization Equip.	Watt Meters/RF Meters	De-Tuning Kits	Iso couplers	STL/TSL	RF Amps	Tubes	RF Monitors	SCA	RBDS	SAP	Pro Channel	Retransmit Rcvr/Demod	Composite DA	Satellite Downlink	Filters/Dividers/Duplexers
Aluma Tower																						
Andrew		•		•				•														
AFC		•																				
Allen Telecom		•																				
Altronic																						
Antenna Specialist		•																				
Avcom																						
Avocet																		•	•			•
Belar																						
BDI																						
Bird			•		•			•														
CRL																						
Cablewave		•		•				•														
California Amplifiers																						
Celwave		•																				
Coaxial Dynamics			•					•														
Comark		•		•				•														
Comsat/RSI(Mark Ant.)		•																				
Comtech		•																				
Cortana					•																	
Crown		•																				
Dayton Industries																						
Decibel		•																				
Delta		•						•														
Dielectric		•		•				•														
ERGO																						
EIMAC																						
Electro-Impulse			•																			
Environmental Tech.					•																	
ERI		•			•																	
EMR																						
Excalibur																						
Gabriel		•																				
Inovonics																						
Kintronic Labs				•				•		•												
LBA		•																				
M Squared		•																				
Magnum Dynalab																						
Mark Antenna		•																				
Marti		•	•		•																	
MCI				•																		
Microwave Filter Corp.																						
Modulation Sciences																						
Moseley																						
Myat				•																		
Nott Ltd.		•			•																	
Potomac																						
QEI		•																				
Rohn Towers					•																	
Scala		•		•																		
Shively		•				•																
SSAC					•																	
TIC					•																	
TFT																						
TPL																						
TTC/Larcan		•																				
Will-Burt					•																	
Zephyrus																						



# Program Conveyance

Getting your signal from Point A to Point B is not really all that difficult. Getting it there in its purest form reliably is a more difficult task. Don't leave something as important as the conveyance of your air signal to amateurs. For over 25 years, thousands of broadcasters worldwide have delivered their programming with Moseley.



## DSP 6000

The digital STL solution for the all digital airchain.



## Starlink 9003T1

An all digital, open architecture, modular system for transmitting audio and data over T1/E1 lines.



## PCL 6020/6030

Frequency-agile composite system built to perform in the harshest RF environments.



## RPL 4000

Frequency-agile UHF RPU for stations on the go who demand quality remote broadcasts.



## Starlink 900155

A 2.4 GHz Spread Spectrum link for stereo remotes up to distances of 25 miles.

# Moseley

**Legendary Quality. Uncompromised Audio. Incredible Reliability**  
**Moseley. The Trusted Name In Communications**

# Tune Your Station to Greater Flexibility and Profits.

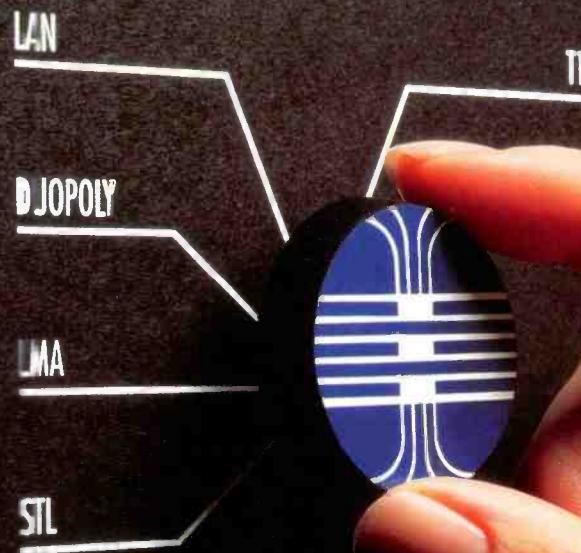

Listen to Intraplex. Improve the management and operation of multiple stations from a single facility as an LMA or duopoly. Let Intraplex channel modulate flexibility tune you in to greater profits.

Intraplex solutions provide high quality, uncompressed audio transmission over inexpensive T1 lines. You can combine data and PBX voice channels in the same circuit. And save money month after month after month. Only Intraplex provides LMA/duopoly operators the freedom to combine all your communications into a single, managed network.

Listen to Intraplex. You can call for our free booklet on radio stations that have already chosen Intraplex for a quality

transmission solution. In it, radio professionals give their own reasons for choosing Intraplex for their solution.



**Intraplex**



## VSWR Conversion Table

Our thanks to Andrew for allowing us to use this chart!

### Microwave Antenna System Slide Calculator

The Andrew "Microwave Antenna System Slide Calculator/Transmission Line Selector" is available on request. The computer includes useful scales and tables for calculating parabolic antenna characteristics, free space propagation, HELIAX cable and waveguide performance, and other antenna system calculations.

To obtain a copy, ask for Bulletin 8525 (Imperial units) or M8525 (metric units). The metric unit is available with instructions in English, Italian, German, Spanish, and French.

#### Definitions

**Return loss, RL**, is the decibel ratio of the incident voltage to the reflected voltage.

**Reflection coefficient,  $|\Gamma|$**  is the numerical ratio of the reflected voltage to the incident voltage.

**Voltage Standing Wave Ratio, VSWR**, is the numerical ratio of the maximum voltage to the minimum voltage that would exist on the uniform reference transmission line.

### Microwave Transmission Lines

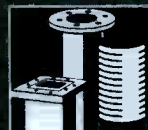

#### Conversion Formulas

The following formulas can be used for determining values not listed in the table below.

$$RL = -20 \log_{10} (|\Gamma|)$$

$$|\Gamma| = \frac{VSWR - 1}{VSWR + 1}$$

$$|\Gamma| = \text{antilog}_{10} \left( \frac{-RL}{20} \right)$$

$$VSWR = \frac{1 + |\Gamma|}{1 - |\Gamma|}$$

#### Conversion Table

Return Loss. dB	Reflection Coefficient. %	VSWR	Return Loss. dB	Reflection Coefficient. %	VSWR	Return Loss. dB	Reflection Coefficient. %	VSWR	Return Loss. dB	Reflection Coefficient. %	VSWR
14.0	19.95	1.50	22.0	7.943	1.173	30.0	3.162	1.065	38.0	1.259	1.025
14.2	19.50	1.48	22.2	7.762	1.168	30.2	3.090	1.064	38.2	1.230	1.025
14.4	19.05	1.47	22.4	7.586	1.164	30.4	3.020	1.062	38.4	1.202	1.024
14.6	18.62	1.46	22.6	7.413	1.160	30.6	2.951	1.061	38.6	1.175	1.024
14.8	18.20	1.44	22.8	7.244	1.156	30.8	2.884	1.059	38.8	1.148	1.023
15.0	17.78	1.43	23.0	7.079	1.152	31.0	2.818	1.058	39.0	1.122	1.023
15.2	17.38	1.42	23.2	6.918	1.149	31.2	2.754	1.057	39.2	1.096	1.022
15.4	16.98	1.41	23.4	6.761	1.145	31.4	2.692	1.055	39.4	1.072	1.022
15.6	16.60	1.40	23.6	6.607	1.141	31.6	2.630	1.054	39.6	1.047	1.021
15.8	16.22	1.39	23.8	6.457	1.138	31.8	2.570	1.053	39.8	1.023	1.021
16.0	15.85	1.38	24.0	6.310	1.135	32.0	2.512	1.052	40.0	1.000	1.020
16.2	15.49	1.37	24.2	6.166	1.131	32.2	2.255	1.050	40.2	0.9772	1.020
16.4	15.14	1.36	24.4	6.026	1.128	32.4	2.399	1.049	40.4	0.9550	1.019
16.6	14.79	1.35	24.6	5.888	1.125	32.6	2.344	1.048	40.6	0.9333	1.019
16.8	14.45	1.34	24.8	5.754	1.122	32.8	2.291	1.047	40.8	0.9210	1.018
17.0	14.13	1.33	25.0	5.563	1.119	33.0	2.239	1.046	41.0	0.8913	1.018
17.2	13.80	1.32	25.2	5.495	1.116	33.2	2.188	1.045	41.2	0.8710	1.018
17.4	13.49	1.31	25.4	5.370	1.114	33.4	2.138	1.044	41.4	0.8710	1.017
17.6	13.18	1.30	25.6	5.248	1.111	33.6	2.089	1.043	41.6	0.8318	1.017
17.8	12.88	1.30	25.8	5.129	1.108	33.8	2.042	1.042	41.8	0.8128	1.016
18.0	12.59	1.29	26.0	5.012	1.106	34.0	1.995	1.041	42.0	0.7943	1.016
18.2	12.30	1.28	26.2	4.898	1.103	34.2	1.950	1.040	42.2	0.7762	1.016
18.4	12.02	1.27	26.4	4.786	1.101	34.4	1.905	1.039	42.4	0.7586	1.015
18.6	11.75	1.27	26.6	4.677	1.098	34.6	1.862	1.038	42.6	0.7413	1.015
18.8	11.48	1.26	26.8	4.571	1.096	34.8	1.820	1.037	42.8	0.7244	1.015
19.0	11.22	1.25	27.0	4.467	1.094	35.0	1.778	1.036	43.0	0.7079	1.014
19.2	10.96	1.25	27.2	4.365	1.091	35.2	1.738	1.035	43.2	0.6918	1.014
19.4	10.72	1.24	27.4	4.266	1.089	35.4	1.698	1.035	43.4	0.6761	1.014
19.6	10.47	1.234	27.6	4.169	1.087	35.6	1.660	1.034	43.6	0.6607	1.013
19.8	10.23	1.228	27.8	4.074	1.085	35.8	1.622	1.033	43.8	0.6457	1.013
20.0	10.00	1.222	28.0	3.981	1.083	36.0	1.585	1.032	44.0	0.6310	1.013
20.2	9.772	1.217	28.2	3.890	1.081	36.2	1.549	1.031	44.2	0.6166	1.012
20.4	9.550	1.211	28.4	3.802	1.079	36.4	1.514	1.031	44.4	0.6026	1.012
20.6	9.333	1.206	28.6	3.715	1.077	36.6	1.479	1.030	44.6	0.5888	1.012
20.8	9.120	1.201	28.8	3.631	1.075	36.8	1.445	1.029	44.8	0.5754	1.012
21.0	8.931	1.196	29.0	3.548	1.074	37.0	1.413	1.029	45.0	0.5623	1.011
21.2	8.710	1.191	29.2	3.467	1.072	37.2	1.380	1.028	45.2	0.5495	1.011
21.4	8.511	1.186	29.4	3.388	1.070	37.4	1.349	1.027	45.4	0.5370	1.011
21.6	8.318	1.181	29.6	3.311	1.068	37.6	1.318	1.027	45.6	0.5248	1.011
21.8	8.128	1.177	29.8	3.236	1.067	37.8	1.288	1.026	45.8	0.5129	1.010



BGS

R  
F

R  
E  
L  
A  
T  
E  
D

E  
Q  
U  
I  
P.



**BGS**

**R  
F  
R  
E  
L  
A  
T  
E  
D  
E  
Q  
U  
I  
P.**

## Antenna Specialists

Base Commander, UHF Broadband Collinear Fiberglass Vertical Base Station, 7dB Gain

ASPRD700	450-460MHz	\$525.00
ASPRE700	455-465MHz	\$525.00
ASPRF700	460-470MHz	\$525.00

ASPR615	Side Tower mounting kit, mounts antenna 18" to 36" from tower	\$295.00
ASPR616	Base station tower clamp set (2 clamps per unit); galvanized	\$54.25

Whip antenna, magnet mnt., 5dB Gain

ASP-7654	445-470MHz	\$75.75
----------	------------	---------



## Cushcraft

**S  
N  
4  
5  
0  
S**

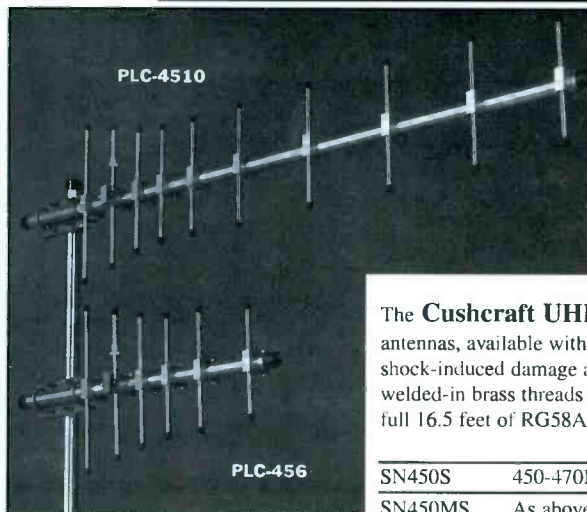

The **Cushcraft UHF Mobiles** are rugged high performance 406-512MHz stainless steel antennas, available with either PL259 or mini-UHF connector. A molded center phase prevents shock-induced damage and moisture contamination. The all-brass hardware and ultrasonically welded-in brass threads eliminate the electrolysis effect of dissimilar metals. Cushcraft includes a full 16.5 feet of RG58A/U cable with 97% braid coverage and all brass mount hardware.

SN450S	450-470MHz, 5dB, Collinear, hole mount with spring and RG-58	\$65.00
SN450MS	As above but black magnet mount	\$85.00

The heavy-duty **Cushcraft PLC Series Yagis** are factory assembled and adjusted for easy installation. They feature heavy-wall tubing elements and large rugged machined aluminum blocks for the boom-to-element junctions. Six and ten element models are available.

PLC-456N	450-470MHz, 7.5dB gain, N connector, 125 mph wind surv., 8 lbs.	\$152.00
PLC-4510N	450-470MHz, 11.5dB gain, N connector, 125 mph wind surv., 12 lbs.	\$217.00

Ruggedized mounting, all-welded joints, and complete weatherproofing are yours with Cushcraft's 900MHz Yagis. At these frequencies, antenna construction is critical. As in all **PC Yagis**, the elements are welded to the boom. The pigtail feed will withstand a 50 pound pull, and makes connector weatherproofing a snap.

PC9010N	928-960MHz, 12dB gain, 10 elements, N connector, 125 mph wind surv., 3 lbs.	\$112.00
---------	---	----------

## Decibel

Model	Pattern	Gain in dB	Frequency (MHz)	Price
DB264	Broadband Array, Omni	6.0	150-174	\$681.00
DB411B	Offset pattern antenna	9.0	450-512	\$383.00
DB420B	Broadband, Omni	9.2	450-512	\$838.00
DB432A	6 Element Yagi, economy	8.0	450-470	\$112.00
DB436C	6 Element Yagi, flex lead	10.0	406-512	\$228.00
DB438C	6 Element Yagi, boom conn.	10.0	450-470	\$275.00
DB536	Omnidirectional	6.0	406-470	\$600.00
DB538	Omnidirectional	7.5	406-490	\$786.00

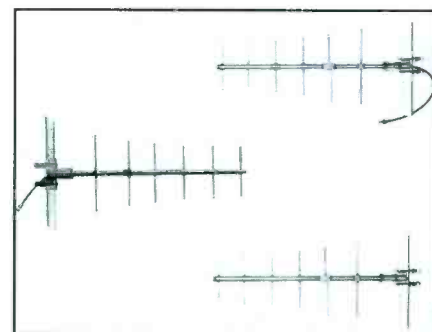

*Decibel manufactures RF amplifiers and repeaters, baseband and notch cavity filters, combiners, duplexers, ferrite isolators, monitor systems, multicouplers, and more antennas. Call Broadcasters General Store for the Decibel Products catalog*



## Mark Antennas (Comstat)

Mark Antennas meet or exceed every existing F.C.C. requirement, are lightweight, strong, heli-arc welded aluminum, multi-element parabolic grid antennas. One of the outstanding characteristics of a grid antenna is the low wind loading figures, usually 25 to 40% of solid dishes. When ordering please specify frequency.

### Mark 940-960 MHz Parabolic Grids

Diameter	~Note -1 includes mounting hardware for a 1.9"-4.5" vertical O.D. pipe			Price
	Pressurized 7/8" EIA Flange	Non-Pressurized 7/8" EIA Flange	Non-Pressurized "N" Female	
4 Ft	P-9A48G-U	P-9A48GF-U	P-9A48GN-U	\$1,110.00
6 Ft	P-9A72G-1	P-9A72GF-1	P-9A72GN-1	\$1,450.00
Diameter	~Note -2 includes mounting hardware for a 4.5" vertical O.D. pipe ONLY			Price
	Pressurized 7/8" EIA Flange	Non-Pressurized 7/8" EIA Flange	"N" Female "N" Female	
6 Ft	P-9A72G-S	P-9A72GF-S	P-9A72GN-S	\$1,570.00
8 Ft	P-9A96G-S	P-9A96GF-S	P-9A96GN-S	\$2,330.00
10 Ft	P-9A120G-S	P-9A120GF-S	P-9A120GN-S	\$2,960.00



Other diameters, frequency ranges, mounts and styles are available. Call Broadcasters General Store for a Mark catalog.

## Marti

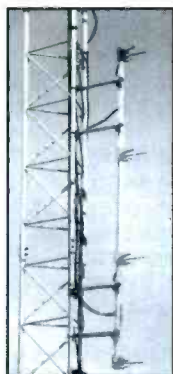

HA-450

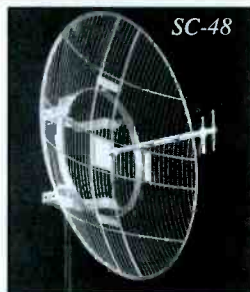

SC-48

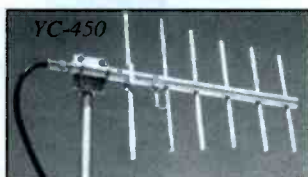

YC-450

Model	Pattern	Gain (dB)	Freq.(MHz)	Price
SC-48	4' full range parabolic	19.0	940-960	\$850.00
YC-XXX	Yagi, 5 element, specify freq.	9.0	152.08-170.45	\$200.00
YC-450	Yagi, 6 element	10.0	450.01-455.99	\$200.00

The Marti HA-450 base antennas will give you up to 30dB isolation from vertically polarized UHF transmitters. This antenna will minimize annoying interference during remote broadcasts.

Model	Gain (dB)	Mounting Length	Mounting Weight	Price
HA-450-1	Unity	12-3/4"	3 lbs.	\$138.00
HA-450-2	3.0	25-1/2"	4-1/2 lbs.	\$292.00
HA-450-3	6.0	51"	9-1/2 lbs.	\$545.00

## Scala

Scala offers a full line of antennas for VHF, UHF and telemetry systems. For twenty five years Scala antennas have delivered performance and dependability.

### Aural STL and inter-city relay systems

Model	Description	Gain (dBd)	Mhz	Mount	Connector	Price
PR-950	Paraflector®	20.0	940-960	H or V	N	\$650.00
MF-950B	Miniflector®	14.0	940-960	V only	N	\$340.00

Model	Description	Gain (dBd)	Mhz	Mount	Watts	Price
PR-460	Paraflector®	15.5	450-470	H or V	100	\$650.00
CA7-460	Seven-element Yagi	10.0	450-470	H or V	250	\$220.00

Note: No mounting hardware included with Scala Antennas. MKPX-8 is the standard mounting bracket for PARAFLECTORS at \$50.00 Must be ordered separately!

Call Broadcasters General Store for a complete Scala catalog.



PR-950



CA7-460



MF-950B



BGS

R  
F

R  
E  
L  
A  
T  
E  
D

E  
Q  
U  
I  
P.



**BGS**

**R  
F  
R  
E  
L  
A  
T  
E  
D  
E  
Q  
U  
I  
P.**

## Scala



HDCA-5

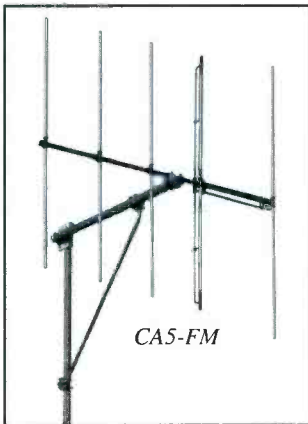

CA5-FM

### Precision Off-Air Monitoring

Model	Description	Mhz	Mount	Polarity	Ω's	Price
CL-FM/HCM	Broadband Log	88-108	C	H	50 or 75	\$550.00
CL-FM/HRM	Broadband Log	88-108	R	H	50 or 75	\$600.00
CL-FMRX/HCM	Broadband Monitoring	88-108	C	H		\$390.00
CL-FMRX/HRM	Broadband Monitoring	88-108	R	H		\$440.00
CL-FMRX/VRM	Broadband Monitoring	88-108	R	V		\$440.00

*Specify 50N, 75N or 75F*

Model	Description	Gain (dBd)	Mount	Polarity	Ω's	Price
HDCA-5/HCM	Five-element FM Yagi	7.5	C	H	75	\$330.00
HDCA-5/HRM	Five-element FM Yagi	7.5	R	H	75	\$370.00
HDCA-5/CP/RM	Five-element FM Yagi	7.5	R	C	75	75N~\$910.00 75F~\$810.00
HDCA-10/HCM	Ten-element FM Yagi	9.5	C	H	75	\$550.00
HDCA-10/HRM	Ten-element FM Yagi	9.5	R	H	75	\$570.00

*Specify 75N or 75F and frequency*

Model	Description	Mhz	Mount	Polarity	Ω's	Price
CA5-FM/HCM	Five-element FM Yagi	Specify	C	H	50(50N)	\$330.00
CA5-FM/HRM	Five-element FM Yagi	Specify	R	H	50(50N)	\$370.00
CA5-FM/CP/RM	Five-element FM Yagi	Specify	R	C	50(50N)	\$910.00

## ERI

LPX is a rugged, brass and copper, wide bandwidth antenna, with 1-5/8" tubing throughout. Rated at 9kW input for end fed models and 12kW for centered. Centered models have 3-1/8" female EIA input. End fed are 1-5/8" EIA female. Many options available.

LPX

Prices from **\$2,837.00 to 35,559.00**

### Low Power (CP-11A)

This half-wave spaced system is ideal for low power and booster sites with a maximum input of 500w to 2000w. It is available only in even numbered bays connected with non-pressurized RG-type cable. Terminated with a UHF female or 1-5/8" male EIA connector.

CP-11A

Prices from **\$1,175.00 to \$7,900.00**

### Medium Power (1105A/B)

The 1105A, 1-5/8" system offers up to 8 bays to a maximum level of 7.5kW. The 1105B, 3-1/8" system offers up to 12 bays (in pairs only) with a maximum power of 12kW. Due to their light weight, they're ideal for small structures. Many options available.

1105A/B

Prices from **\$1,727.00 to \$22,045.00**

### High Power (SHPX)

This rugged, all brass and copper, large element antenna produces a wide bandwidth and a uniform energy distribution. The "A" series, 3-1/8" inter-bay line, is rated between 32kW and 64kW. The "B" series, 4-1/8" inter-bay line, is rated at 40kW to 112kW. The "C" series, 6-1/8" inter-bay line is rated for up to 120kW! Many options available.

SHPX

Prices from **\$4,108.00 to \$96,500.00**

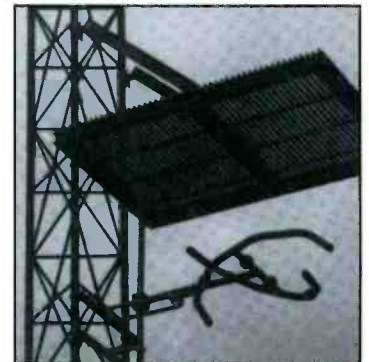



## Shively

### Low Power (6812)

Originally designed for educational broadcasting, the 6812 is perfect for budget installs, translators or standby systems. This stainless steel, non-pressurized, circularly polarized FM antenna has a maximum rating of 750w with the RG-213 inter-bay connection.

Prices starting at \$750 for a single bay

### Medium Power (6813)

Extremely low windloading and competitive pricing has made the 6813CP antenna the choice of medium power FM broadcasters. It's wide bandwidth assures excellent stereo and SCA performance. The 1-5/8" version is rated at 3kW per bay to a maximum of 12kW. The 3-1/8" version can handle up to 20kW.

Prices starting at \$4,000 (1-5/8") and \$6,100 (3-1/8")

### High Power (6810)

The choice for most Class C stations, the 6810 is rated at 10kW per bay to a maximum of 40kW. It's broad bandwidth will allow two stations separated by 2.4MHz to duplex. Standard input is 3-1/8" EIA female connector. 4-1/16" optional.

Priced ranging from \$5,000 to \$36,200 for a 12 bay (Add \$750 for each radome)

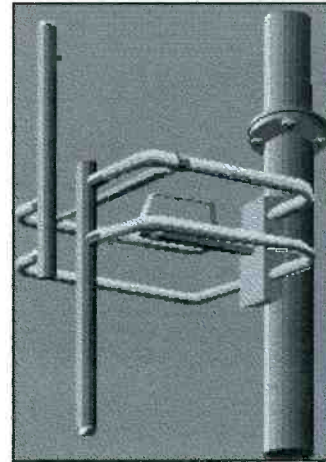

**BGS**

**R  
F**

**R  
E  
L  
A  
T  
E  
D**

**E  
Q  
U  
I  
P.**

## Will~Burt

### Standard Duty Masts

Part No.	Model No.	Conduit Length†	Price
902462	TMD-5-20-15x/16x	30'	\$3,975.00
902543	TMD-6-27-15x/16x	40'	\$4,325.00
902544	TMD-7-34-15x/16x	60'	\$4,650.00
903073	TMD-8-30-15x/16x	50'	\$3,400.00
900158	Canvas Top Cover (opt)		\$54.00

### Heavy Duty Masts

903151	TMD-6-25-35x/36x	40'	\$5,350.00
902985	TMD-6-30-35x/36x	50'	\$9,400.00
902352	TMD-7-30-35x/36x	50'	\$5,680.00
902890	TMD-7-30-45x/46x*	50'	\$9,000.00
902342	TMD-7-42-35x/36x	70'	\$9,020.00
902343	TMD-7-42-45x/46x*	70'	\$11,000.00
902604	TMD-8.5-52-35x/36x	100'	\$10,140.00
902623	TMD-8.5-52-35x/36x	100'	\$10,930.00
900210	Canvas Top Cover (opt)		\$68.00

### HURRY-UP Mast

903220	25' HURRY-UP		\$1,450.00
--------	--------------	--	------------

\*Normal delivery is 1-4 weeks; items marked \* -up to 12 weeks

†Notes NYCOIL length calculations for std non-locking collar mast model.

### Unwired NYCOIL Cable Conduit

Lgth.	1/2"IDx9"OD	3/4"IDx13"OD	1"IDx16-1/2"OD
30'	900507—\$80.00	900443—\$149.00	900444—\$258.00
40'	900507—\$94.00	900443—\$198.00	900444—\$344.00
50'	900507—\$117.00	900443—\$210.00	900444—\$420.00
60'	900507—\$146.00	900443—\$252.00	900444—\$504.00
70'		900443—\$311.00	900575—\$660.00
80'			900575—\$660.00
100'		900443—\$390.00	900444—\$775.00

### Weather-tight Strain Relief Connectors

Part No.	Description	Price
900540	90° ell for 1/2" ID NYCOIL	\$22.00
900539	90° ell for 3/4" ID NYCOIL	\$32.00
900574	90° ell for 1" ID NYCOIL	\$52.00

\*For installation of customer supplied cables in NYCOIL cable conduit contact BGS for quote.

### How to Order—TMD Model Coding TMD-X\*-XX\*-XXX\*\*

X* Notes	Nested height in feet
XX** Notes	Extended height in feet
XXX*** 1st X position Notes-	1. Std duty, non-locking 2. Std duty, locking 3. Hvy duty, non-locking 4. Hvy duty, locking
XXX*** 2nd X position Notes	5. Rotatable (Manually) 6. Non-rotatable
XXX*** 3rd X position Notes	7. Internal mt. 8. External mt. 9. Field mast

### Pneumatic Systems

Part No.	Model No.	Description	Price
902860	TMD-C-287	115 VAC, 1/6 HP	\$920.00
902861	TMD-C-288	12 VDC, 1/8 HP	\$920.00
902257	TMD-C-267	115 or 230 VAC, 1/2 HP	\$1,560.00
902297	TMD-C-271	12 VDC, 1/3 HP	\$1,720.00
902674	TMD-D-278	115 VAC & 12 VDC, 1/2 & 1/3 HP	\$2,444.00
902404	TMD-C-275	115 or 230 VAC, 3/4 HP	\$1,380.00
902675	TMD-D-284	12 VDC, 1/3 HP	\$1,560.00
902193	TMD-D-289	220V/50Hz, 1/2 HP	\$1,430.00
	TMD-C-294	220V/50Hz, w/tank, 1/2 HP	\$1,535.00
902566	TMD-C-280	Hand Pump	\$385.00
900484		Filter-Regulator-Lubricator	\$190.00
900634		Filter-Lubricator	\$125.00
900481		Swivel Air Fitting with Adapter	\$59.00

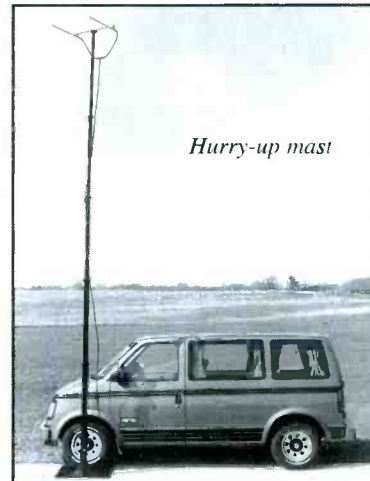

Hurry-up mast



## Andrew



Andrew Corporation provides cable, rigid transmission line, dehydrators, broadcast antennas, coaxial switches, and accessories. Phase stable, super-flexible, high temperature, low VSWR and 50 or 75 ohm are some of the types available. Please remember that some cable sizes come on a returnable reel, which requires a deposit and a return freight charge. Call Broadcasters General Store for an Andrew catalog.

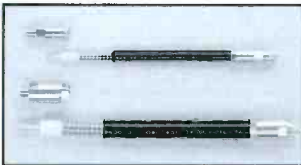

Cable size	Part Number	Attenuation dB/100ft	Connectors	Price
<b>960MHz/450MHz/100MHz</b>				
1/4" Superflex Foam	FSJ1-50A	5.87dB/3.93dB/1.81dB		\$1.66/ft
	F1PNM-H		N Male	\$14.50
	F1PNF-BH		N Female bulkhead	\$39.00
	40417		50pc. nylon tie kit	\$36.00
	223158		Grounding kit	\$22.00
3/8" Foam Dielectric	LDF2-50	3.47dB/2.3dB/1.05dB		\$1.89/ft
	L2NM		N Male	\$35.20
	L2NF		N Female	\$35.20
1/2" Foam Dielectric	LDF4-50A	2.29dB/1.51dB/.684dB		\$2.50/ft
	L4NM		N Male	\$31.70
	L4NF		N Female	\$31.70
	43211		10pc. hanger kit	\$31.00
	31670-2		2"-3" round member adapter kit	\$25.00
	204989-1		Grounding kit	\$23.00
	43094		Hoisting grip	\$29.00
7/8" Foam Dielectric	LDF5-50A	1.28dB/.834dB/.369dB		\$6.18/ft
	L5NM		N Male	\$77.00
	L5NF		N Female	\$77.00
	42396A-5		10pc. hanger kit	\$41.00
	31768A		10pc. angle adapt kit	\$67.00
	204989-2		Grounding kit	\$30.00
	19256B		Hoisting grip	\$43.50

### 108MHz/100MHz/88MHz

1-5/8" Air Dielectric	HJ7-50A	.215dB/.207dB/.194dB		\$16.22/ft
	87R		1-5/8" EIA (GP)	\$260.00
	87G		1-5/8" EIA (GB)	\$300.00
	42396A-2		10pc. hanger kit	\$41.00
	31771-4		12" thread rod (5pc)	\$80.00
	204989-4		Grounding kit	\$30.00
	24312A		Hoisting grip	\$51.00
3" Air Dielectric	HJ8-50B	.147dB/.140dB/.131dB		\$29.12/ft
	78ARM		3 1/8" EIA (GP)	\$460.00
	78AGM		3-1/8" EIA (GB)	\$485.00
	31766A-1J		10pc. hanger kit	\$65.00
	31790-1		10pc. hw. kit (1")	\$13.50
	204989-5		Grounding kit	\$32.00
	26985A		Hoisting grip	\$78.00

**Easiax kit** consists of tool, instruction sheet and 5 extra blades. Easiax makes a clean cut and decreases the risk of cutting the inner conductor.

#207866	For LDF4-50A and LDF4-75, replacement blades #209874	\$30.00
#207865	For FSJ1-50A/75 and FSJ4-50B/75A, replacement blades #209874 (Does not have jacket cutting blade)	\$30.00
#222951	For LDF5-50A, replacement blades #222954	\$45.00

## Bird

The **Bird Model 43** thru-line directional wattmeter accurately measures forward or reflected power in coaxial transmission lines under any load condition. This wattmeter consists of a line section and meter housed in an aluminum case. Quick-change-type connectors and plug-in elements are required for operation.



43	CW/Portable	\$263.00
Elements	Specify frequency and power	From \$68.00



The **Bird 3126 & 3127** protect installations from high VSWR, measuring power from

250W to 250kW at frequencies from 2-1000Mhz. Abnormal load conditions quickly cause transmitter shutdown, a buzzer alarm, and a change of illumination color of the reset button. Audible and visual alarms indicating system malfunction may be removed.

3126A	For rigid lines (15/30/60 scale meters)	\$1,024.00
3127A	For rigid lines (5/10/25 scale meters)	\$1,024.00



# cable, RF transmission

## Cablewave

Cable size	Part Number	Attenuation dB/100ft	Connectors	Price
<b>950MHz/450MHz/100MHz</b>				
1/2" Foamflex	FXA12-50J	2.9dB/1.8dB/.84dB		\$2.01/ft
	735000/735001		N Male/Female	\$31.00
	735002/735003		UHF M/F	\$31.00
	735005		HN Male	\$79.00
7/8" Foamflex	FXA78-50J	1.8dB/1.2dB/.49dB		\$5.04/ft.
	734380		7/8" EIA	\$272.00
	735100/735101		N Male/Female	\$72.50
3/8" Foam Flexwell	FLC38-50J	3.8dB/2.5dB/1.1dB		\$1.89/ft
	34761/734762		N Male/Female	\$35.20
	734773/734774		UHF M/F	\$44.00
1/2" Foam Flexwell	FLC12-50J	2.3dB/1.6dB/.69dB		\$2.50/ft
	738802/738801		N Male/Female	\$31.70
	738804/738803		UHF M/F	\$27.35
	738807		7/8" EIA	\$112.00
7/8" Foam Flexwell	FLC78-50J	1.3dB/.85dB/.37dB		\$6.18/ft.
	738841/738842		N Male/Female	\$77.00
	738843/738844		UHF M/F	\$74.00
	738845		7/8" EIA (GP)	\$116.00
<b>108MHz/100MHz/88MHz</b>				
5/8" Air Flexwell	HCC158-50J	.2dB/.195dB/.19dB		\$16.22/ft
	738303		1-5/8" EIA (GB)	\$300.00
	738314		1-5/8" EIA (GP)	\$260.00
	738300/738301		N Male/Female	\$240.00
3" Air Flexwell	HCC300-50J	.15dB/.14dB/.13dB		\$29.12/ft
	738350		3 1/8" EIA (GB)	\$465.00
	738355		3 1/8" EIA (GP)	\$440.00
3-1/2" Air Flexwell	HCC312-50J	.12dB/.11dB/.095dB		\$31.98/ft
	734578		3-1/8" EIA (GB)	\$692.00
	734579		3-1/8" EIA (GP)	\$672.00

## MYAT



### Series 301 (3-1/8" Rigid, 50Ω) Pricing

301-001	20' line assembly, flanged both ends, hdwre include., 55.2 lbs.	\$600.00
301-002	Same as above, but customer specified length, 2.6 lbs./ft + 4.5 lbs.	\$165+\$23/ft
301-004	20' line assembly, unflanged, no hdwre, 50 lbs.	\$490.00
301-006	Same as 301-001, but only one end flanged, 54 lbs.	\$550.00
301-008	Fixed flange for silver brazing	\$36.00
301-009	Swivel flange for silver brazing	\$54.00
301-013	Field flange adapter, pressurized, soft solder type	\$84.00
301-014	Flange adapter, unpressurized w/hose clamp	\$74.00
301-017	Coupling assembly w/inner connector for 2 unpressurized line assemblies	\$94.00
301-021	90 Degree Elbow, flanged w/hdwre	\$368.00
301-025	90 Degree Elbow, unflanged	\$170.00
301-050	Gas barrier with 1/8" NPT gasport	\$325.00
301-138	Manual patch panel (3, 4, 5, or 7 pole)	From \$1,400.00
301-042-1	Fixed hanger, Top of vertical run (2 min.)	\$65.00
301-042-3	Vertical spring suspension hanger	\$80.00
301-042-5	Wall anchor plate (2 per wall)	\$98.00
301-042-17	3-Point horizontal spring hanger	\$150.00

Please call for information and pricing on the Series 401(4-1/16") 50Ω, 601(6-1/8") 50Ω, 701(6-1/8") 75Ω, 801(9-3/16") 75Ω or a Myat catalog.



Cablewave is dedicated to the design and manufacture of microwave antennas, cable, waveguides and associated accessories. Other sizes, impedance's, hangers, grounding kits, dehydrators, etc. are available. Please remember that some cable sizes come on a returnable reel, which requires a deposit and a return freight charge. Phase stabilized versions of some cables are available for an additional charge.

Call Broadcasters General Store for a Cablewave catalog.

## Coaxial Dynamics

The **81000-A** Wattmeter can measure RF power in 50Ω coaxial cable and transmission lines, in the range of 0.1 to 10,000 watts full scale, and from 0.45 to 2300MHz. A rugged shock mounted meter with a mirrored-backed scale along with superior taut band technology, provides reliable and accurate readings. For added convenience, two sockets for storage of additional elements are located on the back of the unit.

81000-A	\$200.00
81001-A w/auxiliary DC input	\$273.00

### Typical Transmission Line Installation Details

**Miter Elbows (X01-021)** are used at the top of the tower to bring the vertical run close to the support structure ( a short horizontal section of line assembly may also be necessary at this point). At the bottom of the vertical run, one or two miter elbows connect the vertical and horizontal sections while allowing room for expansion and contraction

**Rigid Hangers (X01-042-1)** are used at the top of the tower to stabilize the connection between the transmission line and the antenna feed line. Normally a pair of rigid hangers spaced 10' apart is sufficient.

**20' Rigid Line Assemblies (X01-001/007)** compose the vertical and horizontal runs. Myat can also supply sections in any specified length, with or without flanged ends. Pressurized and unpressurized line sections are both readily available.

**Spring Hangers (X01-042-3)** are placed at a maximum of 10' intervals to allow the main portion of the vertical run to expand and contract with temperature changes. A Lateral Brace (X01-042-8) at the base of the tower prevents side-to-side movement of the transmission line.

**Three Point Suspension Hangers (X01-042-17)** support the horizontal run while allowing for expansion and contraction.

**Anchor Plates (X01-042-5)** are required on each side of the transmitter building's outside wall.



# R F

# R E L A T E D

# E Q U I P.



See page 160 & 161  
for Fiber Optic Options



**R  
F**

**R  
E  
L  
A  
T  
E  
D**

**E  
Q  
U  
I  
P.**

## Delta Electronics

Delta Electronics offers manually or remotely operated Coaxial Transfer Switches. They can switch pairs of transmission lines in less than two seconds. If only three of the terminals of the switches are employed, the switches can be used as SPDT types. The Models 6740B and 6742B can be pressurized up to 15 lb./sq. in. A gas barrier is built into each terminal, and an air inlet port is provided. Internal switch contacts enable remote control and status indication.

6730E	0-400Mhz, 1-5/8, 13 lbs.	\$2,775.00
6730E1	0-900Mhz, 1-5/8, 13 lbs.	\$2,900.00
6740B	0-216Mhz, 3-1/8, 65 lbs.	\$6,565.00

## MCI

MCI Coaxial Transfer Switches, as four-port transfer switches will switch two signal sources between loads. Since they can also be used as SPDT switches, complex switching matrices can be easily assembled. A unique feature of these switches is the coplanar port configuration that permits neater, more compact layouts and requires fewer elbows. Action is accomplished by a standard high torque gear motor and is bi-directional to positive stops. In the event of loss of control power, these switches can be operated manually. The switching speed of the following switchers is 2 seconds with a maximum of 3 seconds and E.I.A. male connector.

## Dielectric



Dielectric coaxial transmission line switches will accommodate single or multiple-line RF power, maintain high reliability, maximum isolation, low VSWR, and may be mounted in any position. The A50000 series are motorized blade type coaxial SPDT or 4 port transfer switches. Switch position is indicated by a mechanical pointer and through auxiliary switches. Manual operation is provided for by the included knob. The switching time of the following switches is 2 seconds, all have 4 ports, E.I.A. flange termination, and 50Ω impedance.

A50000-1XX	7/8	\$2,980.00
A50000-20X	1-5/8, 42 lbs.	\$4,990.00
A50000-30X	3-1/8, 54 lbs.	\$5,160.00
A50000-40X	4-1/16, 70 lbs.	\$6,160.00
A50000-6XX	6-1/8	\$13,800.00

*X is determined by the motor drive and control relay coil voltage & # of ports.*

### MCI Coaxial Transfer Switches

61101	7/8, 10 lbs.	\$2,450.00
61103	1-5/8, 12 lbs.	\$2,800.00
61104	3-1/8, 34 lbs.	\$3,600.00
61102	4-1/16, 46 lbs.	\$5,000.00
61105	6-1/8, 85 lbs.	\$6,200.00



## composite DA

### Broadcast Devices

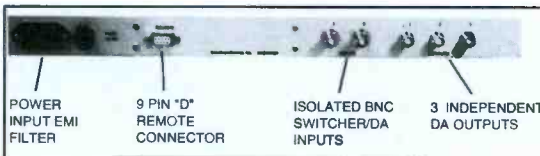
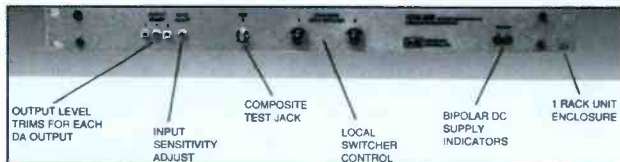

### The Broadcast Devices

**CDS-200** Composite DA/Switcher was designed to allow two switchable sources to be distributed to three location. Sources within the bandwidth of 10Hz to 100Khz such as composite audio, SCA or SAP signals can all be accommodated. Each output uses individual output amplifiers for maximum isolation. Level adjustments, switcher controls and a test jack for non-intrusive connection to a scope or spectrum analyzer are

conveniently located on the front panel. The switcher has remote control capability with status that is compatible with virtually all remote control telemetry systems in use today.

CDS-200 \$825.00

## Excalibur

The **Excalibur CDA-1** Composite Distribution Amplifier is a 1-in, 3-out distribution amplifier for stereo composite or subcarrier signals, with each output individually adjustable. For sites with ground loop problems, a ground lift switch is provided on the rear panel to separate the circuit ground from the power ground and chassis. A transient protector is part of the power supply circuitry for protection in hostile environments. 1U

CDA-1 \$420.00

## Modulation Sciences

The **Modulation Sciences CLD-2504** is an FM and TV Stereo Composite Distribution Amplifier providing four outputs. Each output is low impedance and can drive long transmission lines terminated in 50 or 75 Ωs. With more than 40dB of isolation there is no interaction among loads.



CLD-2500	Line Driver / Receiver Set	\$1,860.00
CLD-2501	Composite Line Driver (1 in/2 out)	\$975.00
CLD-2502	Composite Line Receiver (1 in/1 out)	\$925.00
CLD-2504	Composite DA (1 in/4 out)	\$950.00



# BGS dehydrators

## Environmental Technology

ADH-2COM	Rack mount-#16457	\$2,166.00
	Wall mount-#16910	\$2,279.00
	Outdoor NEMA-16911	\$3,146.00
	Outdoor unit minus Box	\$2,821.00
Opt.-1	230V	N/C
Opt.-2	SI Calibration	N/C
Opt.-3	High Pressure, 6.0 PSI	\$69.00
Opt.-4	Extended Warranty	\$207.00
Opt.-5	High Pressure, 3.0 PSI	\$69.00
Opt.-6	Master configuration on dehydrator	\$143.00

EDH™-2	Digital pressure display • High dew point alarm • low pressure alarm • and Summary alarm relay.	
	Wall Mount-#16542	\$960.00
	Outside NEMA-#17219	\$1,793.00
EDH™-3R	Manually regenerated • Microprocessor control	
	Rack mount-#16966	\$684.00
	Wall mount-#16672	\$545.00
Opt.-1	230V	\$102.00

Environmental Technology introduced the new **ADH™-3COM** computerized air dehydrator with automatic regeneration. It satisfies the need for low pressure dry air required in satellite earth stations and general purpose microwave applications. Maximum power consumption is 146W during regeneration while averaging less than 60W in typical operation. It employs: dual compressors for improved reliability and higher air flow • Low pressure and high humidity alarm relays are standard • monitoring of all parameters through its RS-485 serial communications port • and supports both the S-A and ETI proprietary protocols. To ensure safety and minimum power consumption, all internal pneumatic systems operate at the discharge pressure. 3U

ADH™-3COM	\$2,594.00
-----------	------------

The **Environmental Technology ADH-2COM** Automatic Dehydrator supplies low pressure dry air to keep waveguide and coax dry. Automatic regeneration, an alarm relay and a RS-422 communications interface make unattended operation practical. Regeneration occurs when needed rather than at fixed times and does not need a drain line. Maximum power consumption is 120W during regeneration while averaging less than 40W in typical operation. 3U



ADH-2COM

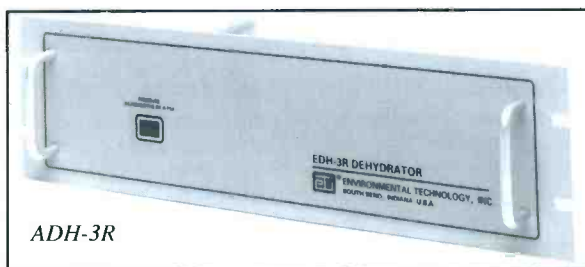

ADH-3R



BGS

R  
F

R  
E  
L  
A  
T  
E  
D

E  
Q  
U  
I  
P.

## BGS dummy loads

### Bird

Bird Electronics offers a varied selection of RF loads in their Termaline Series: dry, oil dielectric, water cooled and forced air. They range in size from 2W load to 25kW models. Accessories include replacement coolants, dollies, step up/down flange adaptors, coupling kits, thermostats and water flow switches.

### Coaxial Dynamics

Coaxial Dynamics' 4000 Series are dry, convection cooled RF loads ranging from 5W to 1kW and offer a two year warranty. The 85000 Series loads are liquid filled, convection cooled, blower assembly optional. They range in size from 600W to 10kW. Please specify connector size.

### Electro~Impulse

The **Electro~Impulse DPTC-25KFM** is an upright, dry, forced air cooled coaxial load rated at 25kW continuous from DC-110MHz with a VSWR @ 1.15 : 1. 3-1/8" EIA input is standard, 1-5/8" EIA maybe substituted.

DPTC-25KFM	\$4,150.00
------------	------------

Electro~Impulse makes several models of oil Dielectric RF loads from 500W to 5kW and dry, forced air loads from 5kW to 80kW with reflect load option (controls fan), as well as convection cooled and water cooled loads. Please specify connector size.





**BGS**

**R  
F**

**R  
E  
L  
A  
T  
E  
D**

**E  
Q  
U  
I  
P.**

## AVOCET



The **AVOCET AV-100** enables the monitoring of television station's audio as part of the FCC's requirements for the EAS program. A choice is given for feeding either SAP or Main channel audio on rear panel XLR connectors. Both signals are balanced, line level outputs. The AV-100 is frequency agile and can be easily tuned to off air channels 2 through 69. The selector is located inside the chassis to protect from accidental changes. Applications other than EAS include: recording programming off-air • recording news promos at radio stations for later rebroadcast • rebroadcasting to cable head ends • rebroadcasting to translators and network relay sites • and general studio monitoring.

AV-100 \$450.00

## HollyAnne



The **HollyAnne HU-961 EAS encoder/decoder** specifically designed to meet the new FCC EAS requirements for broadcast stations. The HU-961 was designed by the engineering organization that worked with the National Weather Service in developing the Specific Area Message Encoding (SAME) system. Using the power of a PC, (286 or better) to program the unit, the HU-961 will receive, store, and retransmit EAS messages in accordance with EAS rules and management wishes. It is capable of automatic or manual operation and may be operated with or without a PC connected. Three audio inputs and one RS-232 1200 ASCII data input are standard. The RR-962 radio receiver, (AM, FM or Weather Band) was designed to work in concert with the HU-961. The radio receivers are tunable throughout their respective frequency ranges, using a fly-wheel tuner. They feature a precise center station indicator and (defeatable) AFC as applicable.

HU-961 \$1,299.00  
RR-962 \$189.00

## SITCO Antenna

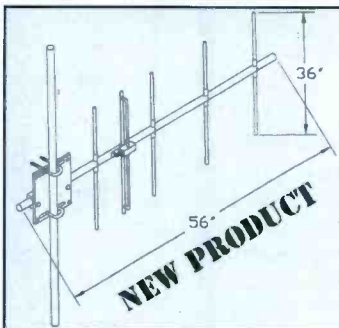

The **SITCO Antenna** will increase your EAS reception!

Frequency, 162MHz • 10dB Gain • SWR < 2:1 • Beamwidth 55 Degrees • Vertical polarization • and Female 75Ω termination.

EM5-1-EAS \$160.00

## Gorman-Redlich

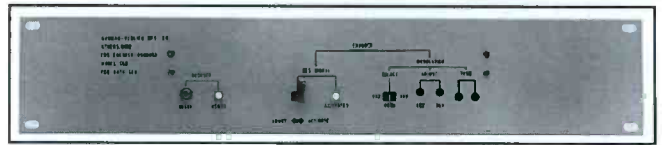

The **Gorman-Redlich EAS Encoder-Decoder** comes with 4 audio inputs, expandable to 6. It allows automatic interruption of program audio to insert EAS F.S.K. header codes, 2 tone attention signal as well as two minutes of stored digital audio and E.O.M. F.S.K. The two minutes of stored digital audio is expandable to 4.5 minutes. The stored audio will not include any 2 tone attention signal or 1050 cycle tone on the weather service transmitter. A four line, 40 character LED back-lighted LCD display is used with a 20 position keypad switch to set modulation levels on your transmitter, and set audio input levels for the broadcast stations you are monitoring. The keypad is also used to compose alert messages if your station will be originating a message. Another keypad key transfers control from automatic operation to manual operation and back to automatic. While in automatic, the encoder-decoder will completely run the emergency alert function. When an alert is received, the display will tell you the time interval of the audio portion of the message. It comes with: five, two-way RS-232 Ports (1 dedicated to a computer input) • a 25 pin printer port for an external IBM compatible printer • and 52 terminals on the rear for inter-connecting to other equipment.

EAS \$1,750.00

## TFT



The **TFT EAS911R EAS Encoder/Decoder** design is the result of extensive input from some of the industry's most respected professionals. All design features and operations including front panel push-buttons and rear panel connections were thoroughly researched. Its features include: two balanced audio inputs (expandable to 10) • two RS-232 digital ports • RS-485 port • two relay outputs • balanced audio output • digital voice recorder • help and practice key for operator training • multi-purpose LCD display • easy-to-read 24 column impact printer uses standard, off-the-shelf adding machine paper • and a rear panel connection mutes printer and speaker while air mic is keyed.

EAS911R	EAS Encoder/Decoder with two balanced audio inputs	\$2,195.00
EAS911R6	Same as 911R w/6 balanced audio inputs	\$2,395.00
Opt03	4-port COM expander for PC interface, RBDS and electronic sign driver	\$395.00
EAS930A	Multi-Module Receiver, AM, FM and 7-channel NOAA, all modules have auto-changeover and alarm	\$1,470.00
EAS940A	Transmitter/Program Interrupt Unit, four separately controllable balanced audio channels with status indicators, RM and XLR connectors	\$459.00
EAS941	RS-485 Remote Control/Status Module for EAS911 for connection to EAS911 over single, shielded twisted pair, up to 5,000 feet. Up to 16 units may be connected in parallel to provide remote operation of EAS911 from multiple studio locations.	\$495.00
EAS942	Eight channel Audio Expander (used to expand EAS911 from two to ten audio input channels), 1U with built-in power supply, channel activity monitors	\$975.00
EASAMR	AM Receiver Kit with AM loop antenna for EAS930A	\$320.00
EASFMR	FM Receiver Kit with antenna splitter for EAS930A	\$320.00
EASWRR	Weather Radio Receiver Kit with antenna splitter for EAS930A	\$360.00
EASCA	Chassis assembly and power supply kit for EAS930A	\$645.00



# generators ~ RBDS

## CRL

### The CRL SC-100 RBDS

Generator is an advanced full digital DSP design system that features the latest in RDS/RBDS transmission specifications. It supports all available RBDS groups and can be easily upgraded as new RBDS groups are defined. A built in 300 pager (group 7A) directory allows formation of small paging systems without additional paging terminals. The unit can be fully programmed from either the front panel 7 level ASCII keyboard or via full RS-232 remote control.



SC-100 \$3,395.00

## Modulation Sciences

**Modulation Sciences'** approach to RDS gives you all the functions of the U.S. RBDS standard for a fraction of the cost of dedicated hardware. MSI provides a PC board and software to turn your 286 or better PC into a full RDS Coder. Easy to understand menu guide you through RDS setup. The text and format information can be changed at anytime, either manually or by a unique format clock. Remote software is included.



RDS-1	RDS System Generator & Software	\$1,750.00
RDS-X2	RDS/RBDS Data Receiver w/Enclosure	\$895.00
PRD-3000	Precision RDS/RBDS Decoder/Monitor/Analyzer	\$2,250.00

## Belar



The **Belar RDS-1** is a fully-featured RDS/RBDS monitor and decoder. The RDS-1 is essential to monitor critical RDS parameters, such as RDS injection and the phase relationship between the RDS subcarrier and the stereo pilot. It has an RS-232 interface and a Wizard interface built-in.

RDS-1 \$2,200.00

## Inovonics



The **Inovonics 710** 'PROM'-based RBDS encoder/subcarrier generator is an easy-to-use encoder which requires no programming. As many as 15 separate "frames", or complete sets of Ids, flags and messages are held in the 710's non-volatile memory. With the touch of a button or by remote command, you select the data frame(s) to be broadcast. Later should you want to implement other options, such as paging, GPS, contests, etc., connect the 710 to any IBM-compatible PC to enter the "dynamic" mode. "Static operation remains a default should the on-line link be lost.

710 \$995.00

**Inovonics 701** RDS/RBDS is a stand-alone unit that does not require a dedicated host computer. Messages are held in non-volatile memory. It locks to 19kHz pilot from MPX sample - no special "sync" port is required. Menu driven programming software is supplied.

701 \$390.00

# generators ~ SAP

## AVOCET

The **AVOCET Pro channel** gives television broadcasters the equivalent of a one way 3kHz line, centered at 102.271kHz on the composite audio signal. Using the Pro channel for IFB eliminates the cost, interference, and legal problems associated with cellular phones. It is specifically designed for IFB applications and gives you audio quality comparable to two-way radio with built-in muting and noise filtering. The Pro-Line 102A enables you to receive data as well as voice from the Pro Channel. It's perfect for receiving scripts, messages, remote control telemetry or other information at remote sites. Front panel has headphone jack and speaker with volume control, and rear panel has balanced XLR output with level adjust plus a DB-25 connector for data.



Pro-Line 102A		\$1,495.00
Option 07	Selective cueing and Main-Mix via sub-audible tone (CTCSS) decoder	\$150.00
SCE-2	Sub-audible tone encoder	\$500.00



a versatile selection of capabilities for using your station's own audio subcarriers to cut costs and improve efficiency. The SAP channel was designed to carry a second audio channel in addition to regular program audio. SAP is a subcarrier of the audio signal centered at 78.67kHz, and has a deviation of 10kHz. The TV-2's Pro receiver is easily made part of your IFB system. The Pro channel can carry data such as scripts, messages, remote control telemetry or other information to remote sites. The Pro channel was designed to give television broadcasters the equivalent of a one way 3kHz line. The Prochannel is centered at 102.271kHz of the composite audio signal, and has a deviation of 3kHz. The receiver provides balanced XLR outputs, a front panel speaker and headphone jack for monitoring.

TV-2SAP/Pro	SAP & Pro channel receiver, includes Turbo Sound/Pro Channel	\$1,995.00
TV-2SAP	SAP channel receiver only with dbx decoding	\$1,495.00
TV-2Pro	Pro channel receiver with Turbo Sound	\$1,595.00



**BGS**

**R  
F**

**R  
E  
L  
A  
T  
E  
D**

**E  
Q  
U  
I  
P.**



**BGS**

**R  
F**

**R  
E  
L  
A  
T  
E  
D**

**E  
Q  
U  
I  
P.**

## Modulation Sciences



**Modulation Sciences PRO Sidekick™** Audio Generator produces PRO channel on your TV aural signal. A complete, self-contained PRO Channel Generator. Operates on mono or stereo TV aural transmitters. Use with PRO-I PROceiver to place your IFB or cueing signals within reach of your remote vehicles without the use of cellular phones.

PCG-II	PRO Sidekick™ Pro channel audio generator	\$3,990.00
DPRO-GEN	Data Sidekick™ 2400 bit/second transmission rate,, Crystal locked at 6.5 H (102.27kHz)	\$5,040.00



**Modulation Sciences PROceiver™ II** will greatly reduce or eliminate your dependence on cellular telephone connections for cueing and IFB information in ENG or remote activities. It contains a quartz-synthesized stand alone FM tuner which is completely independent of the visual carrier. A SAW filter protects the signal from video interference. On board noise reduction greatly enhances signal-to-noise performance. The Antenna Diversity option allows the

PROceiver to operate reliably under severe multipath conditions. The optional 12/28 VDC kit lets you use PROceiver anywhere.

PRO-II	PRO channel receiver w/Antenna diversity	\$1,895.00
PRO-II28	28 Volt PS instead of 12 Volt	\$300.00

**Modulation Sciences APRO-MOD PRO Sidekick®** Modification enables your current APRO-Generator to utilize the functions of the new PROceiverII. Factory retrofit only.

APRO-MOD		\$950.00
----------	--	----------



**Modulation Sciences TSCA-189 TV Sidekick®** SAP Generator contains audio processing and BTSC encoder. Unconditionally locked to horizontal sync via composite video. Stereo generator not required.

TSCA-189		\$5,275.00
----------	--	------------

## generators ~ SCA

### CRL

The **CRL SCA-300B** is a digitally synthesized subcarrier generator with integral two-band audio limiter. The SCA-300B subcarrier frequency is user-selectable from 40 to 110kHz. Either voice or data can be transmitted; two direct data input ports are provided. Also, the SCA-300B can be fully remote-controlled.



SCA-300B		\$2,050.00
----------	--	------------



The **CRL SG-800A** FM stereo generator is a drift-free, lab grade stereo generator due to its digitally synthesized balanced modulator design. Stereo separation exceeds 55dB. SCA inputs are provided for composite loop-through. The SG-800A's linear low-Z output drives up to 1,000 feet of RG-58 cable.

SG-800A	Digital Stereo Generator	\$2,590.00
	w/o 15 kHz low filter	\$1,800.00

### Marti

The Marti **SCG-10** subcarrier generator is designed to operate in SCA service with an FM transmitter or, with an SCD-10 subcarrier demodulator to form a subcarrier link on a microwave (STL) system. It has selectable pre and de-emphasis of 0, 75, 150 or 225 microseconds and low pass audio filters of 3, 5, or 7kHz.



SCG-10		\$798.00
SCD-10		\$798.00



# generators ~ SCA

## Modulation Sciences



**Modulation Sciences Sidekick** with audio processing especially designed for SCA, and Data Sidekick have everything you need—loop-through composite connections for easy installation, remote control provisions, crystal-locked synthesizer tuning, a super-accurate peak/hold SCA deviation meter, a noise generator and synchronous AM meter so you can tune the transmitter for minimum crosstalk. Data Sidekick's direct FM modulation technique is specifically designed for maximum reliability and throughput over the SCA subcarrier.

SCA-186	Specify frequency	\$3,835.00
DSCA-188	Data Sidekick, specify frequency	\$5,040.00

## modulation monitors

### Belar

#### FM Radio Monitor Equipment

FMM-2	FM Precision Modulation Monitor (specify frequency)	\$1,790.00
FMS-2	FM Precision Stereo Modulation Monitor	\$2,050.00
FMM-4A	FM Digital Frequency Monitor	\$1,590.00
Option 01	Eight Alarm Relay card for FMM-4A	\$250.00
SCM-2	SCA Modulation Monitor, 67kHz Std. (3 more available)	\$2,050.00
	Each additional standard SCA frequency	\$75.00
	Each additional special SCA frequency	\$100.00
RDS-1	RDS/RBDS Monitor	\$2,200.00
RFA-1A	FM RF Amplifier (specify frequency)	\$850.00
RFA-4	Frequency Agile FM RF Amplifier (10 Memory Presets)	\$1,090.00
Option 01	Module for interfacing RFA-4 with the WIZARD	\$100.00
FMMA-1	The WIZARD, Precision Digital FM Modulation Analyzer	\$3,300.00
Option 01	Precision FM demodulator with calibrator (IF Input)	\$590.00
Option 02	Down converter/sync. AM noise detector (specify frequency)	\$495.00
DC-4	Frequency Agile Down Converter for transmitter operation	\$1,500.00
FMSA-1	FM Digital Stereo Modulation Monitor and Analyzer	\$3,900.00
FMRR-4	Frequency Agile FM Rebroadcast Receiver w/calibrator & carrier fail safe	\$1,890.00
FMRR-1A	FM Rebroadcast Receiver w/ calibrator & carrier-fail safe (specify freq.)	\$1,590.00
DSD-1	Digital St. Decoder (FM Composite input, provides 48kHz AES/EBU St. output)	\$1,900.00
DSD-1A	Digital St. Decoder w/analog outputs (adds bal. analog L,R,L+R & L-R outputs)	\$2,500.00
<b>FM Accessories</b>		
MP-8	Combined remote meter panel for FMM-2 and FMS-2	\$425.00
MP-9	Remote meter panel for FMM-2	\$275.00
MP-10	Remote meter panel for SCM-2	\$275.00
MP-15	Analog remote meter panel for FMSA-1 (2 meters)	\$350.00
PWM-1	Peak weighting module (5 time constants plus FCC mode)	\$395.00

#### AM Equipment

AMM-2B	AM Modulation Monitor	\$1,590.00
AMM-3	AM Modulation Monitor (with Automatic Carrier Leveling)	\$1,790.00
AMMA-1	The WIZARD, precision digital modulation monitor/analyzer	\$3,300.00
AMM-4	AM Digital Frequency Monitor	\$1,390.00
Option 01	Three alarm relay card for AMM-4	\$250.00
RFA-2	AM RF Amplifier (specify frequency)	\$790.00

#### AM Accessories

MP-6B	Remote meter panel for AMM-2A and AMM-2B	\$350.00
MP-7	Remote meter panel for AMM-3	\$350.00
MP-14	Remote meter panel for AMMA-1	\$350.00
LP-1	Shielded loop antenna (passive)	\$295.00
LP-1A	Shielded loop antenna with preamplifier and line driver	\$375.00
Option 01	External power supply for LP-1A (not needed with RFA-2)	\$85.00



AMM-1 & RFA-4



The **Belar TVM-101** precision wide-band aural monitor is designed to measure the total modulation characteristics of mono and multi-channel television transmitters. It conforms with EIA/BTSC standards. At proof time it can be used as a low-noise, low-distortion main channel demodulator for driving audio monitor amplifiers and distortion analyzers. Wide band composite outputs are provided for Stereo, SAP, PRO and SCA monitors. The TVM-100 adds a quasi-parallel detection mode and a digital front panel voltmeter for direct reading of kHz deviation.

TVM-101	Specify channel or frequency	\$3,750.00
TVM-100	Specify channel or frequency	\$4,750.00
TVM-101E	TV Aural Mod. Mon., PAL system, specify visual/aural freq.	\$4,500.00
TVM-102	TV Aural Modulation Monitor, Dual Sound Carriers	
	Specify visual & both aural freq, will monitor 1 aural at a time	\$5,500.00
Option 01	SAP & PRO Injection board for TVM-100	\$550.00
Option 03	Peak Weighting module, 5 time constants plus FCC mode for TVM-100 & 101	\$395.00



BGS

R  
F  
  
R  
E  
L  
A  
T  
E  
D  
  
E  
Q  
U  
I  
P.



# modulation monitors



**BGS**

**R  
F  
R  
E  
L  
A  
T  
E  
D  
E  
Q  
U  
I  
P.**

## Belar



TVM-230

The **Belar TVM-230** is a DSP-based, microprocessor controlled Digital BTSC TV Stereo Monitor/Analyzer. The TVM-230 digitizes the composite baseband signal and decodes the stereo multiplex portion using digital signal processing techniques. Unlike an analog design, a DSP-based design is immune to variations due to temperature or the aging and tolerance of components. By employing linear phase FIR filters, the TVM-230 eliminates phase distortion in the recovered audio. This permits unprecedented accuracy in measuring modulation peaks on the L, R, L+R and L-R signals.

TVM-230	TV Digital St. Mod. Mon., BTSC System	\$5,850.00
TVM-250	TV SAP/PRO Monitor	\$3,900.00
TVM-2A	TV digital frequency monitor, VHF (measures aural, visual and intercarrier)	\$3,550.00
TVM-3A	TV digital frequency monitor, UHF (measures aural, visual and intercarrier)	\$4,150.00
RFA-3	TV RF amplifier, specify frequency (for use with TVM-2A & TVM-3A for off air use or to combined feed)	\$1,250.00
Option01	SAP/PRO Injection Board for TVM230	\$550.00
Option 03	PWM-1 Peak Weighting Module for TVM230/250	\$395.00
MP230	Analog Meter Panel for TVM-230	\$450.00
MP250	Analog Remote Meter Panel for TVM-250	\$400.00

## Delta



The **Delta SM-1** Splatter Monitor measures the level of splatter or any other spurious emissions which fall between 11kHz and 100kHz away from both sides of the carrier. While normally installed in an equipment rack and fed with the transmitter or common point RF sample, it also operates in the field from a twelve volt DC source fed by an optional active antenna. This portability is very useful for investigating interference complaints.

SM-1	AM Splatter monitor	\$3,995.00
AWA-1	Active Whip Antenna	\$695.00
PH-1	Peak Hold Option	\$495.00
SA-1	Spectrum Analyzer Filter	\$495.00

## Inovonics

### Inovonics' 530

combines a wide-band FM receiver with very linear demodulation and metering circuitry for precise measurement of FM broadcast carrier modulation. High-resolution displays give reliable readings of total modulation, demodulated program audio, and pilot/subcarrier injection levels. The incoming RF signal and multipath distortion components are also monitored to ensure that indicated measurements are truly valid. The 530 accepts both an antenna feed and a directly-coupled RF sample. Included are: eight station presets, balanced program audio outputs, a composite baseband I/O, and connections for remote readout of all panel displays, the peak flasher, plus dead air and carrier loss alarms and headphone jack.



530		\$2,200.00
-----	--	------------

**Inovonics' new 540** has a dual conversion design with precise, crystal-controlled digital tuning and works with any FM Mod-Monitor having a Composite (MPX) output. It measures injection level of SCA, RDS and high-speed data sub-carriers. It demodulates audio SCAs and accurately displays subcarrier deviation.

540	\$1,150.00	RDS Decode Option \$165.00
-----	------------	----------------------------

## Modulation Sciences



**Modulation Sciences' ModMinder's™** user-selectable response allows you to adjust processing for maximum legal modulation. The optional DeMod board gives you MSI's Modulation Assurance with accuracy of ±1%. ModMinder is compatible with analog remote control systems and operates by modem from any PC. The remote software package analyzes modulation to give you complete information about any FM signals density, loudness and competitive characteristics.

FMMM-1	ModMinder	\$2,395.00
FMMM-2	ModMinder with DeMod	\$3,090.00
FMMM-4	DeMod Card Upgrade	\$725.00



**TV ModMinder Modulation Status Panel**

works with any wideband precision demodulator (such as the Tektronix 1450-1). Gives continuous display of key MTS parameters - total modulation percentage with peak flasher, status and injection levels of subcarriers. Autoranging. Far more accurate and less expensive than traditional modulation monitors.

TVMM-1	TV ModMinder, Modulation status panel	\$3,295.00
--------	---------------------------------------	------------

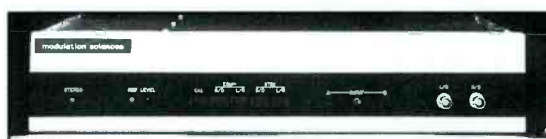

**The Stereo Reference Decoder** is the industry standard TV stereo decoder

for critical measurements. Certified compliance to BTSC standards. Compatible with all stereo generators. Operates with the Tektronix 1450-1 demodulator. Precision and balanced line outputs provided.

SRD-1	Stereo reference decoder	\$5,250.00
-------	--------------------------	------------



# modulation monitors

## QEI

The **QEI 691** is a complete proof-of-performance instrument for FM mono, stereo, and SCA measurements. It has a one year manufacturers warranty on all parts and labor.

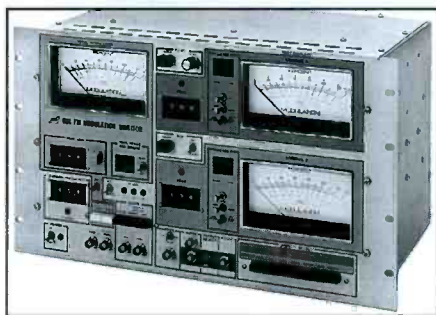

691	FM Modulation Monitor / Test Set	\$5,875.00
691/01	same as above with SCA (specify frequency)	\$6,875.00
691/02	same as above with dual SCA (specify frequency)	\$7,100.00

## Radio Design Labs



**Radio Design Labs ACM-2** is an AM noise monitor. RDL's ACM technology is the only time-proven, industry accepted method of controlling Synchronous AM Noise (the elusive varying: bandwidth-limiting gremlin that effects listeners receivers). Hundreds of top performing FM's in every major U.S. market turn to ACM technology for Maximum Bandwidth Performance! Every transmitter, new or old, can easily produce poor bandwidth, or can be made to perform as well as any signal in the market. Every FM station needs ACM technology to provide the accurate AM measurement and continuous monitoring needed for optimum transmitter tuning and performance.

ACM-2	\$834.00
-------	----------

Coaxial Dynamics #87035H X-Traxtors/RF Couplers Element 50dB for 3-1/8" line sections, 50-500MHz, 35,000W	\$133.00
---	----------

## TFT



The **TFT 844A** is an FM stereo mod monitor that has a frequency agile RF pre-selector, baseband demodulator and stereo demodulator. The 844A can be used for off-air monitoring or direct transmitter proof measurements. This monitor can be used for complete measurements of total, right and left channel modulation, channel separation, main and sub channel crosstalk. L+R, L-R, 38kHz carrier suppression and pilot injection level. All measurements can be made with front panel pushbuttons and meter, and a scope can be fed from BNC connectors. Front panel modulation calibration is possible within  $\pm 2\%$ . The preselector has two digitally tunable RF preselectors to let you switch between FM stations. The 844A has a one year manufacturers warranty.

Model 844A	FM baseband/stereo mod monitor	\$5,150.00
Option 02	Spare parts kit	\$575.00
Model 804	Remote meter and flasher	\$610.00
Option 03	57kHz RDS injection level	\$330.00



The **TFT 845** is an FM SCA monitor with up to three front panel selectable subcarrier frequencies. The 845 can be used to make SCA proof measurements and with one or two optional service channel boards it can provide uninterrupted SCA program or data output(s) separate from the monitor portion. It includes a loss of modulation alarm and a built in modulation calibrator. The 845 has a one year manufacturers warranty.

Model 845	3 Ch SCA monitor, 67kHz supplied std	\$2,735.00
Option 01	RF module preselector (specify frequency)	\$910.00
Option 02	Additional SCA freq (41kHz) components	\$145.00
Option 03	Additional SCA freq (92kHz) components	\$145.00
Option 04	Spare parts kit	\$295.00
Option 05	Service Ch module max 2 (specify frequency)	\$315.00
Model 805	Remote meter and flasher	\$610.00

## Titus

The **Titus Composite Audio Monitor** accurately meters and monitors a station's composite stereo signal. The Composite Audio Monitor has balanced bridging, floating inputs on the front and rear (the rear "loops through"). There is also a scope output on the front that provides a semi-demodulated signal as well as digitally filtered outputs for pilot and SCAs. The composite meter has a scale of 0-150% and has peak hold above 100% to measure high transients or composite clipping. There are provisions for two SCA channels.

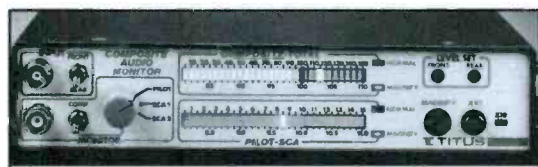

CAM	Composite Audio Monitor	\$750.00
SF	SCA Filters (specify center frequency)	\$50.00
SRM	Single Rack mount	\$25.00
DRM	Dual rack mount	\$22.00
SCC	Soft carrying case	\$25.00



BGS

R  
F

R  
E  
L  
A  
T  
E  
D

E  
Q  
U  
I  
P.

**Broadcasters General Store (352) 622-7700 Fax (352) 629-7000**

152



**BGS**

**R  
F  
  
R  
E  
L  
A  
T  
E  
D  
  
E  
Q  
U  
I  
P.**

## AVOCET

The **AVOCET SAP-16** receives SAP and Main television audio channels and is tunable to any off-air VHF or UHF station. This makes it an ideal way for listeners to pick up the SAP channel for feeding an audio distribution or P.A. system or for personal listening to SAP programming.

SAP-16 \$195.00

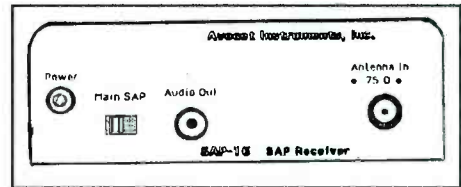

## Carver



The **Carver TX-8R** features: FM stereo/mono selector • Auto/manual scan selection • 20 Presets • Analog signal strength meter • and full function remote control. 1.7", 12 lbs.

TX-8R \$449.00

## Denon



**Denon's TU-380RD** comes with RDS, which includes program type, radio text, program service name (such as call letters or slogan), clock time and traffic program ID. It can also tune to the format of music you would like to hear. Features include: 40 station presets • RF attenuator • Character input to title your presets • Auto FM presets • low impedance output • and AM loop antenna.

TU-380RD \$325.00

## Magnum Dynalab



The **Magnum Dynalab FT-101A** offers such 'workhorse' functions as a wide band composite output for modulation peak monitoring and adjustable alarm outputs for both carrier and modulation. Also standard is separate, demodulated outputs for 67 and 92kHz SCA bands. Main channel audio output is 600Ω balanced and the SCA audio output is 600Ω unbalanced. All output levels are adjustable. The Pro 101 provides a 'benchmark' sampling of off-air signal quality. Being analog and fully tunable across the FM band, it provides infinite frequency adjustment in order to deal with adverse reception environments.

FT-101P-B19 \$1,600.00

FT-PSLU \$100.00  
Narrow band mode [Additional  
Selectivity to 30 dB (adjacent)]

The **AVOCET SAP-10** receives SAP, Main television audio channels for VHF stations and FM stations. It is a self-contained unit including antenna and power cord. Powered by batteries or AC.

SAP-10 \$149.00

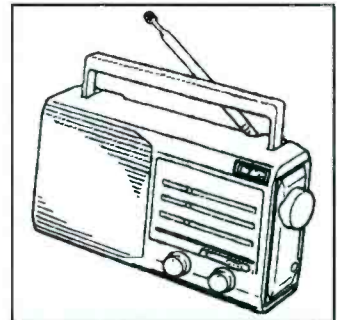

## Dayton Industrial

The **Dayton Industrial AF200 Receiver** is phase lock loop controlled (88 to 108 MHz), with a 67 or 92kHz (selectable) SCA demodulator. Power is provided by an external 115VAC to 12Vdc converter. Features include: Housed in a metal case • Frequency of operation set by switch • SCA/Main selector switch • Audio volume control • and Line out volume control.



AF200 \$199.95  
SCA Receiver, frequency agile

### Options

A	Audio-mute circuit	\$15.00
C	Composite output	\$15.00
D	Data detector circuit	\$15.00
F	Field strength output	\$25.00
S	Simultaneous SCA detector	\$50.00
T	External 67/92kHz toggle switch	\$7.50
W	Wide bandwidth	\$15.00

## Rolls



The **Rolls RS78b and RS79** are digital PLL synthesized AM/FM tuners. They have large LCD displays that can be read in daylight and show the frequency and preset. They will auto search up and down as well as store up to 16 FM and 8 AM presets and retains settings for up to 4 days with power off. The RS79 also has a signal meter, headphone out, XLR out, and remembers presets, with power off, for 3 years. 1U

RS-78b \$247.00

RS-79 \$298.00



## Scala

### Scala Triax Preamplifiers for 950 MHz Radio Links

8000/960	Low-noise preamplifier with 120VAC remote power supply, broadband 940-960 MHz, 50Ω N terminations	\$550.00
8000/960/EX	Same as above with 220VAC	\$500.00
8000/960/C	Low-noise Preamplifier less power supply, but including DC/RF diplexer for use with external regulated 24VDC supply, broadband 940-960 MHz, 50Ω N terminations	\$550.00



**BGS**

### Scala Triax Preamplifiers for 450 MHz Radio Links

8000/450	Low-noise preamplifier with 120VAC remote power supply, broadband 450-470 MHz, 50Ω N terminations	\$550.00
8000/450/EX	Same as above with 220VAC	\$500.00
8000/450/C	Low-noise preamplifier less power supply, but including DC/RF diplexer for use with external regulated 24VDC supply, broadband 450-470 MHz, 50Ω N terminations	\$550.00

## TPL

Model	Frequency (MHz)	Power In (Watts)	Nominal Power Out (Watts)	Current Drain (amps)	Price
PA6-1BE	400-512	80-20	70-100	18	\$747.00
PA6-1FE	400-512 continuous	25-40 duty w/ps	70-100	12	\$603.00
PA6-1BE-RXR	400-512	8-15	70-100		\$1,047.00
PA6-1FE-RXR	400-512	25-40	70-100		\$903.00



### Power Supplies

Model	Description	Price
PS12-2	Utility Power Supply—13.6VDC regulated, 20 amps ICS or 16 amps	\$22800
PS12-2A	Same as above except for 220VAC input	\$252.00
PS12-3	Rack Mounted Power Supply—13.6VDC regulated, 25 amps continuous duty.	\$409.00
PS12-3A	Same as above except for 220VAC input	\$434.00
PS12-4	Rack Mount—13.6VDC regulated, 37 amps continuous duty	\$458.00
PS12-4A	Same as above except for 220VAC input	\$497.00



# BIGS stl

## Intraplex

The standard equipment shelf for the Multiplexer family has a front panel that allows the door to slide up and over the top of the unit using three rack spaces. The TDM-163 T1, Terminal Multiplexer includes one CM-3A T1 module, while the TDM-165 T1, Drop and Insert Multiplexer and TDM-166 T1, Dual Terminal Multiplexer include two CM-3A T1 modules. All three include a module adapter and one power supply. A second identical supply may be installed for redundancy.

Configuration	TDM-163	TDM-165	TDM-166
Std. shelf w/115VAC, 50W Power supply	\$3,650.00	\$5,300.00	\$6,400.00
Std. shelf w/230VAC, 50W Power supply	\$3,650.00	\$5,300.00	\$6,400.00
Std. shelf w/-48VAC, 50W Power supply	\$3,650.00	\$5,300.00	\$6,400.00
Std. shelf w/-24VAC, 50W Power supply	\$3,650.00	\$5,300.00	\$6,400.00
Std. shelf w/115VAC, 100W Power supply	\$4,200.00	\$5,850.00	\$6,950.00
Std. shelf w/230VAC, 100W Power supply	\$4,200.00	\$5,850.00	\$6,950.00
Redundant, 50W AC Power supply	\$800.00		
Redundant, 100W AC Power supply	\$1,350.00		

**STL PLUS Basic Package (4200)** includes two TDM-163(115) T1 multiplexers, one uncompressed stereo audio transmitter module, and one uncompressed stereo audio receiver module, with module adapter.

**TSL Add-On Package (4101)** includes one uncompressed stereo audio transmitter module, one uncompressed stereo audio receiver module, and two 4-wire voice modules, with module adapters.

Configuration	Part No.	Part No.
Analog audio in, analog audio out	4200A-A(115)	4101A-A
Analog audio in, AES/EBU audio out	4200A-D(115)	4101A-D
AES/EBU audio in, analog audio out	4200D-A(115)	4101D-A
AES/EBU audio in, AES/EBU audio out	4200D-D(115)	4101D-D
Price for each of the above	\$8,800.00	\$2,950.00

**OPX Add-On Package** includes one two-port FXO voice module and one two-port FXS voice module, with module adapter, ring generator, and talk battery.

4102 Two off premise extension voice channels \$1,495.00

Channel Service Unit, in many cases is required for connection to a telephone company leased T1 line. One CSU should be ordered for each end of the T1 line.

CSU Channel service unit \$1,000.00

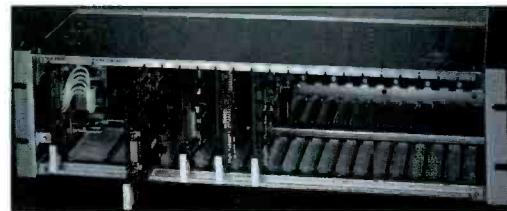

Also available from Intraplex are many specialized Interface Multiplexers such as: Linear, apt-X, MPEG audio modules in either analog or AES/EBU, Channel Modules for Multiplexer Systems, Module Adapter, Codec interfaces, Accessories and parts. Please call BGS for help in system configurations and pricing!

**R  
F**

**R  
E  
L  
A  
T  
E  
D**

**E  
Q  
U  
I  
P.**





**R  
F**

**R  
E  
L  
A  
T  
E  
D**

**E  
Q  
U  
I  
P.**

## Marti



A Marti discrete STL system will give you a noise floor near -80dB with equal stereo separation. Twelve volt battery operation is possible with the APS-28/18 power supply. Marti offers a two year limited warranty.

The Marti STL-15C transmitter and the companion R-15C receiver can be combined with the MD-2E and MD-2D to form a high quality, frequency synthesized, digital radio link. Systems are available from 140MHz to 960MHz. Depending upon the available channel bandwidth, systems can be configured for: Composite FM stereo with two subcarriers • Monophonic audio with two subcarriers • Digital stereo audio or data (requires external modems) • Multi-channel audio or data (requires external MUX) • and Digital data (requires external modems). Complex systems can be built from basic STL-15C transmitters and R-15C receivers having multiple relay (repeaters), bi-directional (full duplex), and automatic switching hot standby features. It comes with a two year limited warranty.

STL-10	Transmitter, specify frequency	<b>\$1,775.00</b>
R-10	Receiver, specify frequency	<b>\$1,775.00</b>
ARS-15A	Receiver switcher, specify frequency	<b>\$730.00</b>
ATS-15E	Transmitter switcher, specify frequency	<b>\$730.00</b>

STL-15C	Composite transmitter	<b>\$3,500.00</b>
MD-2E	2 Audio, 1 data channel encoder	<b>\$2,500.00</b>
R-15C	Composite receiver	<b>\$3,500.00</b>
MD-2D	2 Audio, 1 data channel decoder	<b>\$2,500.00</b>
Package 62CA	STL-15C and R-15C w/2 ea. Yagi Antennas, Jumper Cables & Weatherproofing Kits	<b>\$7,530.00</b>

## Moseley

The Moseley DSP 6000 Digital Transmission System can be interfaced to the PCL 6000 series and with a digital ready kit the 606 composite system. With the DSP 6000 in multiple hops, the last hop is as good as the first, full SNR is delivered down to the digital threshold. When used with the optional built-in digital stereo generator, composite stereo can be delivered directly to the FM exciter. The DSP 6000 also has a direct digital input for future digital interconnection.

DSP 6000E2	Two audio and one data channel encoder	<b>\$2,995.00</b>
DSP 6000D2	Two audio and one data channel decoder	<b>\$2,995.00</b>
DSP 6000E4	Four audio and two data channel encoder	<b>\$4,450.00</b>
DSP 6000D4	Four audio and two data channel decoder	<b>\$4,450.00</b>
DSP 6000ER	Digital repeater encoder	<b>\$2,295.00</b>
DSP 6000DR	Digital repeater decoder	<b>\$2,295.00</b>
DSP 6000/PCL 6020	System including DSP 6000E2/D2 with PCL 6010TX/6020RX	<b>\$12,000.00</b>
DSP 6000/PCL 6030	Same as above with the 6030RX	<b>\$13,000.00</b>



The Moseley PCL 6000 is a digital ready STL that can operate in either analog or digital ( by adding one of the DSP6000 pkgs), and monaural or composite modes. Both the transmitter and receivers use a synthesized reference oscillator. Two systems can be employed in a dual discrete configuration to transmit right and left stereo programs with no measurable crosstalk. The main determining factor in deciding which receiver is best suited to your application is the amount of aural STL activity in your area. Moseley provides a two year warranty.



PCL 6010	Transmitter, specify frequency	<b>\$4,000.00</b>
PCL 6020	Receiver, specify frequency	<b>\$4,250.00</b>
PCL 6030	Receiver, specify frequency	<b>\$5,250.00</b>
PCL 6060	Receiver, specify frequency	<b>\$5,950.00</b>
Extended Baseband	92kHz SCA in baseband, ordered w/receiver	<b>No charge</b>
Extended Baseband	When ordered separately	<b>Call</b>
TPT-2	Transmitter Transfer Panel	<b>\$1,350.00</b>
PD-1000	For coupling two receivers from one antenna	<b>\$350.00</b>
ICU-1D	Isocoupler 800-1000MHz	<b>\$495.00</b>



# Use the *HotLine*

...when ISDN doesn't make sense

## One-time remotes just got easier!

Sometimes it's impractical to install a special circuit like ISDN for a one-time remote. However, a plain telephone line is usually available. Wouldn't it be nice if you could have high quality two-way audio on that plain line? That's just what you get with the *HotLine*.

## Call Us for Details



### BROADCASTERS GENERAL STORE

2480 S.E. 52nd Street  
Ocala, Florida 34480-7500  
Phone 352-622-7700  
Fax 352-629-7000  
Email [bgs@mbs.net](mailto:bgs@mbs.net)

We'd be happy to send you a *HotLine* to try.

Wideband two-way audio on POTS  
(Plain Old Telephone Service)

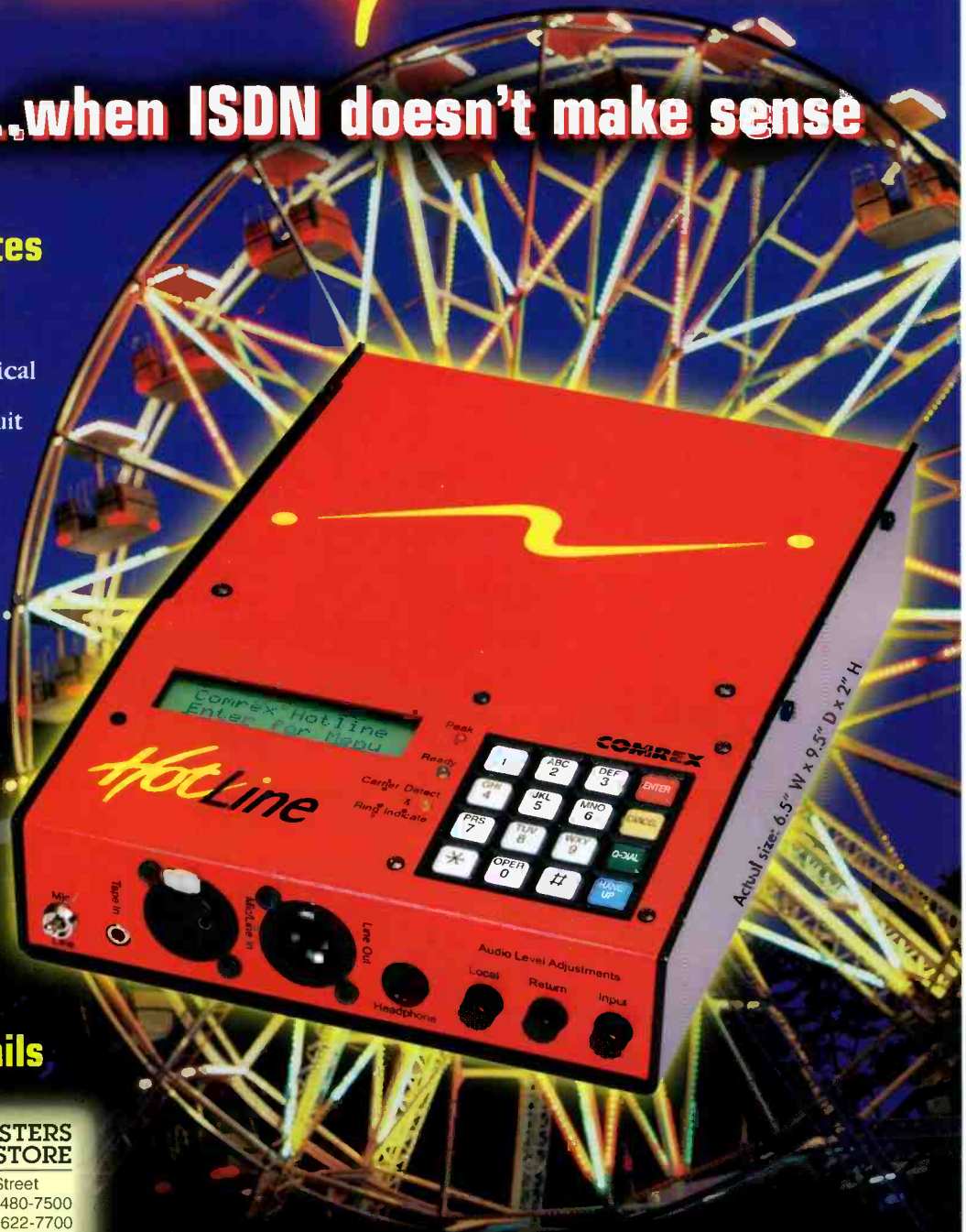

With more than 12,000 Codecs  
worldwide it's no  
**secret**...



Corporate Computer Systems  
Europe GmbH



**CDQPrima:** Intelligent codecs for remote digital audio – with the world's best sound.

- ISDN, Satellite, T1, E1 and dedicated lines
- ISO/MPEG Layer II, III, G.722, H.221, J.52 based IMUX and DAB
- Best digital audio quality for broadcast, Pro Audio, Recording and Voice-Over

**RoadRunner:** An economical, portable ISDN codec/mixer that lets you send and receive mono audio over the highest quality phone lines available.

- Built in ISDN terminal adapter with NT
- 15 kHz mono audio over a single 64 kb/s "B" channel, 20 kHz mono audio over 128 kb/s
- Optimized for ISO/MPEG Layer II & III at 56, 64, 112, and 128 kb/s and G.722

**FieldFone/StudioFone:** The first system for broadcast quality audio over a single regular phone line

- Broadcast quality – up to 8.8kHz with enhanced Layer III
- Compact and rugged, fully bi-directional, just dial and send audio
- Mic and line inputs, 2 headphone jacks plus separate return and send level controls

**WE'RE THE INDUSTRY STANDARD FOR QUALITY AUDIO TRANSMISSION**



Dealer inquiries welcome



# IS THIS YOUR RADIO STATION?

Every caller will make the connection

It's a telephone time and temperature service! Not only a great venue to promote your station, but by selling a short spot on the front end, it can generate extra advertising income as well. Tie it in with an on-the-air advertising and promotion package and the possibilities are limitless. The two-line starter package comes with everything you need to get going and it can easily be expanded as popularity grows.



## Features:

- Messages are stored in a digital "chip" recorder with no moving parts
- Internal clock is battery-backed to keep time during power failures
- Clock back-up battery is automatically recharged when power is available
- Internal calendar automatically switches to and from Daylight Savings Time (if used)
- Thermometer can report temperature in Fahrenheit or Celsius
- Counter records number of incoming calls (up to 65,535) and can be reset
- Front panel LEDs indicate lines in use, power and clock synchronization
- "Inactive Line" indicator spots defective telephone lines

IMAGE MAKING WITH OPTIMOD  
First In A Series

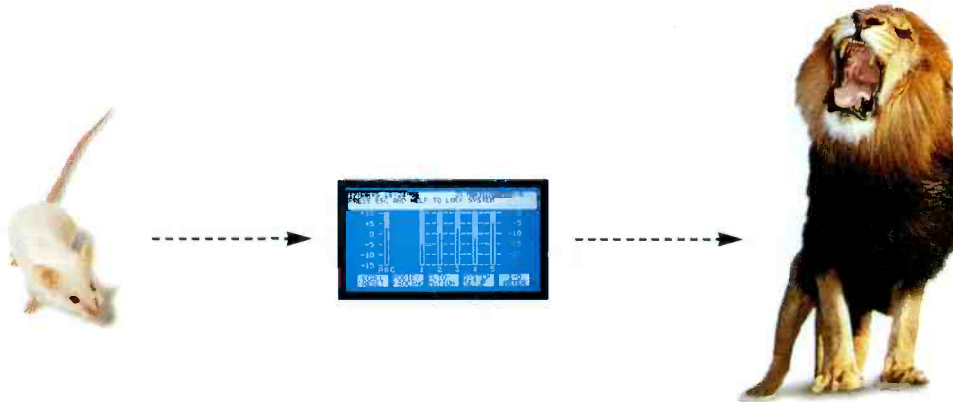

## The More Powerful Your Sound, The Stronger Your Image.

Using image to attract listeners is nothing new to radio. Just the rules have changed. Now even loyal listeners have become "dial scanners." More stations are broadcasting into every market. And, suddenly, everyone seems to be competing for the same listeners. To stand out, you need a sound that's as unique as your station's personality. And that's where the power of OPTIMOD comes in. No other FM processor lets you optimize your audio image so completely. You get loud, clear sound tuned precisely to your format, your audience, and your identity. And that's important, because: ***In Radio, Image Is Everything.***



OPTIMOD-FM 8200 Processor

**orban**<sup>®</sup>

H A Harman International Company



## Moseley



The **Moseley STARLINK 9003T1** is an all-digital, open- architecture, modular system for uncompressed digital audio conveyance over T1 or fractional T1 circuits. The STARLINK 9003T1 mainframe can house 8 application-specific personality modules which allow the user to easily configure appropriate STL/TSL systems. Other product features include: 16-bit linear audio and choice of ISO/MPEG Layer II or apt-X coding • AES/EBU and analog inputs • Built-in sample rate converter • Intelligent Mux with drop and insert; expansion slots for voice and data cards.

SL9003T1	T1 Mainframe allows up to 8 Personality Modules	\$2,000.00
SL9000SE	Source Encoder	\$1,250.00
SL9000SD	Source Decoder	\$1,250.00
SL9000DM	Digital Multiplexer	\$1,250.00
SL9000TSU	Customer Service Unit, CSU	\$1,000.00
SL9000AXC	Apt-X Encoder/Decoder	\$500.00
SL9000L2E	ISO/MPEG Layer II Encoder	\$500.00
SL9000L2D	ISO/MPEG Layer II Decoder	\$500.00
SL9000V35	V.35 Driver	\$500.00
SL9000RS4	RS-449 Driver	\$500.00
SL9000RS2	RS-232 Data Module	\$500.00
SL9000ADC	Analog to Digital Converter	\$500.00
SL9000DAC	Digital to Analog Converter	\$500.00
SL9000VTC	Voice Telephone Card	\$500.00

### Package Pricing

PAC2X0	2-Channel STL, 2 linear audio channels	\$8,250.00
PAC4X0	4-Channel STL, 2 linear, 1 data, 2 compressed audio channels	\$13,250.00
PAC2X2	2-Channel STL/TSL, 2 linear audio channels each	\$10,250.00
PAC4X2	4-Channel STL, 2 linear, 2 compressed & 1 data audio ch. & 2-Channel TSL, 2 linear audio ch.	\$15,250.00
PAC4X4	4-Channel STL, 2 linear, 2 compressed & 1 data audio ch. & 4-Channel TSL, 2 linear, 2 compressed & 1 data audio ch.	\$18,250.00

**STARLINK SL9001SS** Spread Spectrum Digital Transmission System is a digital RPL using the latest in spread spectrum RF technology and audio source coding. The STARLINK 9001SS provides CD-quality stereo remotes over distances of up to 30 miles. Untethered from telco service, point-to-point local remotes can be established quickly and efficiently. Open architecture allows a user to select plug-and-play modules for ISO/MPEG Layer II or apt-X source coding. In addition, the same open architecture allows the user to select between analog or AES/EBU input and output modes. A built-in sample rate converter keeps operation considerations to a minimum. The recently assigned 2.4Ghz band for spread spectrum requires no license. The SL9001SS package includes transmitter, receiver, source encoder, source decoder, and antennas. Source encoder and decoder available with choice of apt-X or ISO/MPEG Layer II coding (Please specify when ordering).

SL9001SSPAC	Transmitter/Receiver Package with antenna	\$8,250.00
-------------	---	------------

## QEI

The **QEI CAT-LINK** digital STL/TSL consists of studio and transmitter rack mount units, each with room for up to seven modules. Input and output modules encode or decode the composite and auxiliary channels, using linear-phase FIR filters, a 70 MIPS DSP engine with 24 bit accuracy and no audible delay.

Please call Broadcasters General Store for information and pricing.

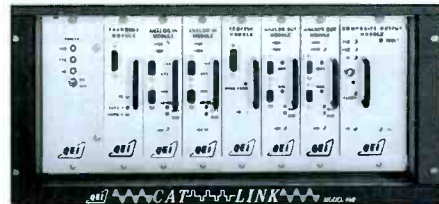

The **QEI QUICK-LINK** is a digital stereo microwave system for broadcasters to use for RPU, backup STL/TSL, or anything else requiring a high fidelity, quick and easy, digital stereo transmission, without any audio delay. It accepts stereo or monaural audio from any mixer. Features include: XLR connectors • Two LED bargraphs • Two user signals to the receiver to control or flag equipment at the studio • Ten coding channels • Powered by AC or DC • Coding channel in use and lock status indication • and can remotely select receiver's channel code.



QUICK-LINKII	Includes 2 Quick-Link terminals priced less antennas & line	\$8,495.00
QLII-R	Wireless spread spectrum repeater for Quick-Link II	\$5,495.00
QLC	Configuration software, for advanced system users	\$195.00
QLC-MA	QLC software maintenance agreement (annual renewal)	\$100.00
QL-BA	Balanced audio I/O option	\$400.00
QLM	Rack mount ears and transport handle kit	\$50.00
QL-Yagi	15dB gain Yagi with radome (N female input)	\$266.00

## TPL

### TPL Base station/Repeater amplifiers

Rated for Continuous Duty			
VHF High Band (136 to 175MHz)	Power In	Nominal Power Out	Price
PA3-1FD-RXRPS (w/power supply)	15-30W	70-90W	\$1,116.00
PA3-1FE-RXRPS (w/power supply)	15-40W	80-120W	\$1,172.00
800MHz (806 to 960MHz)			
PA8-1DD-RXRPS (w/power supply)	5-15W	70-90W	\$2,206.00
PA8-1FD-RXRPS (w/power supply)	20-40W	70-90W	\$1,961.00



**BGS**

**R  
F  
  
R  
E  
L  
A  
T  
E  
D  
  
E  
Q  
U  
I  
P.**



**BGS**

**R  
F  
R  
E  
L  
A  
T  
E  
D  
E  
Q  
U  
I  
P.**

## ERI

**ERI Towers** offer not only structural strength but also an antenna interactive design that compliments your coverage goals. Strength, durability and accountability are ERI's cornerstones. Before any support structure leaves ERI, it is first cross-referenced to the steel mill certificates. Next, it is inspected by using a non-destructive magnetic particle test, monitored by an independent certified inspection company. This procedure provides the accountability you demand and is proof solid of ERI's commitment to structural superiority. With ERI you are purchasing a complete package including antenna and structural engineering services, antenna interactive tower design, proof solid structural verification, and the best installation service.

The **SSTX Self-Supporting Tower** series is entirely constructed of solid steel members. This design eliminates any of the inherent design flaws associated with pipe legs or inner members. Another advantage of the SSTX series is the diminished requirement for redundant inner members. Decreasing the number of inner supports reduces wind load area and installation time. The net result is a very strong yet cost effective structure.

The **Bolt Together Guyed Tower** is the solution when the need arises for antenna support structures over 1200', extremely severe loading conditions, or shipping size is critical. Tower face widths range from 5' to 10' with a maximum height of 1500'.

The **GWX/GWZ Guyed Tower** series are often the most economical means of elevating an antenna system. The guys of a guyed tower have a very large base and are arranged for tension-only loading. This creates a structure using significantly less steel than a self-supporting type, thus saving on material, fabrication and installation costs. The GWZ series extends to 460' with a maximum 6-bay load, while the GWX series offers heights from 540' to 1100' with a maximum 12-bay load.

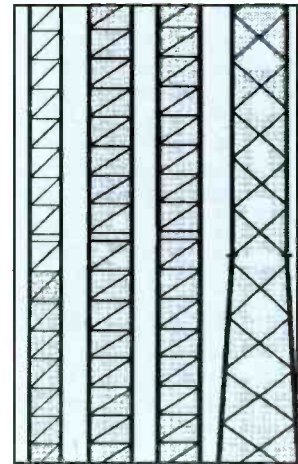

## ROHN

Since 1948 **ROHN** has been making towers for the broadcast and communications industries. Towers are available as self supporting or bracketed guyed. All towers, welds, bolt holes, etc. are "hot dip galvanized", which coats tubular steel on the inside and outside, for complete corrosion resistance. All ROHN towers are custom designed for each specific installation and can be ordered pre-painted with lighting kits and other options.

*Call Broadcasters General Store to get a quotation.*

## tower accessories

### Environmental Technologies

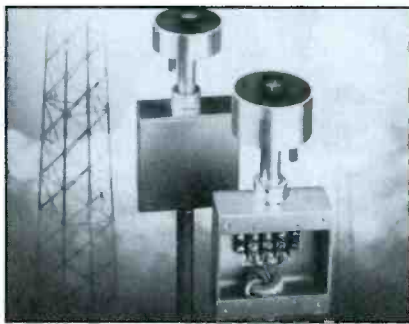

#### Environmental Technology De-icing

APS3A	Provides automatic snow melting system control	\$667.00
CIT <sup>TM</sup> -1	Sensor detects falling or blowing snow at temp below 38°F	\$320.00
LCD <sup>TM</sup> -3S	Snow Switch <sup>®</sup> . De-icing control senses both temp and precip.	Call for pricing
LCD <sup>TM</sup> -4	Automatic rain blower control	\$151.00

## SSAC

**SSAC** totally **solid-state tower flashers** have proven reliability with years of use on radio and TV towers. Flash single or multiple beacons, simultaneously, alternately or sequentially and sense lamp failure with an alarm output. SSAC gives you a modular approach to your lighting needs with efficiency and economy.

FS-155-30-T	Flasher, two beacons (120VAC)	\$89.00
FS-165-30-T	Flasher, up to four beacons (230VAC)	\$99.00

## Cortana

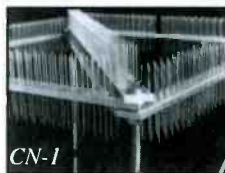

The **Stati-Cat<sup>TM</sup>** by Cortana, lightning prevention system works through the principle of charge dissipation, providing a continuous low resistance discharge path for the static electric charge found on all tall structures. Stati-Cat charge dissipaters reduce the charge above a structure, and is designed to prevent a strike. Stati-Cat will design a system for your tower at no charge. Warranty is void if their system design is not used.

*Call Broadcasters General Store to get Stati-Cat information and to make arrangements for your system design.*

SC-1	Stati-Cat <sup>TM</sup> charge dissipater	\$370.00
SC-3	Guywire and small tower dissipater	\$50.00
SC-4	Tomcat dissipater	\$420.00
CN-1	Crow's Nest dissipater	\$1,525.00
CN-1D	Diagonal Bar for Crow's Nest	\$450.00



## Crown

A Crown integrated FM transmitter system combines built-in audio processing and stereo generation in one rugged, compact unit. Each model provides excellent signal quality, ease-of-use and economical long-term reliability! The integrated FM transmitter system can be a stand-alone or stand-by transmitter, ideally suited for translator, satellator and booster operation. The integrated design makes installation quick and easy, requiring only an audio source (mono, L/R stereo or composite signal), antenna and AC or DC power. The built-in remote I/O interface supports remote control and monitoring for critical functions, and the DC power hookup can provide uninterrupted service when AC power is lost.

Exciters		Price	Transmitters		Price	Translators		Price
30 Watt	FM30E	\$3,395.00	FM30T	\$3,995.00	FM30R	\$4,290.00		
100 Watt	FM100E	\$5,195.00	FM100T	\$5,995.00	FM100R	\$6,290.00		
250 Watt	FM250E	\$6,495.00	FM250T	\$7,295.00	FM250R	\$7,590.00		
500 Watt	FM500E	\$8,695.00	FM500T	\$9,495.00	FM500R	\$9,790.00		
2000 Watt	FM2000E	\$19,995	FM200T	\$20,795.00				

FMFSK	FSK ID Module	\$295.00
FM30 Spares	FM30 Spares Kit	\$145.00
FM Spares	FM100/250/500 Spares Kit	\$365.00

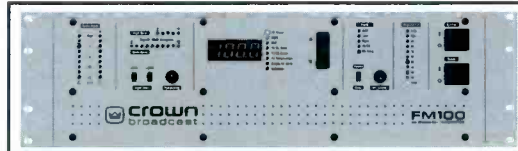

## Delta



The Delta ASE-2 is a 1U, low cost high performance AM Stereo Exciter. All controls are on the front panel. The operating frequency is crystal controlled for maximum stability and minimum phase noise.

ASE-2-1	Basic unit which includes TTL drive	\$4,095.00
ASE-2-2	Basic unit with high level output option	\$4,270.00
ASE-2-3	Basic unit with synchronous transmitter option	\$4,330.00
ASE-2-4	Basic unit with high level output option and the synchronous transmission option.	\$4,370.00

## Marti



For anyone looking for a cost effective way to demodulate a composite signal to baseband left and right audio Marti introduced the CD-15 Composite Demodulator. It enables audio monitoring at repeater sites, running a composite AM transmitter feed, or even running composite remotes (export only). All controls are front panel mounted with simultaneous left and right metering. Independent output level adjustments for each channel insure an exact match to your system.

CD-15	\$1,495.00
-------	------------



The Marti ME-40, a 40 Watt synthesized FM Broadcast Exciter/Transmitter is an excellent choice to replace your older existing exciters or for use as a standby. Features include: 40 Watt VSWR protected power output • Peak-hold baseband modulation LED display • Test multimeter with forward and reverse power range • and Full remote capability.

ME-40	\$3,995.00
-------	------------

## QEI

The QEI Quantum "E" Series is an all solid state, broadband, frequency synthesized, "on carrier" direct FM, phase locked, transmission system. It is programmed to operate on any 100kHz increment in the FM band. Direct FM "on carrier" operation ensures spurious free transmission and extremely low distortion, crosstalk and noise without stereo degradation. The Solid State FET Power Amplifier of the Quantum "E" is unconditionally stable and will withstand any magnitude or phase of VSWR indefinitely without damage by automatically reducing power. 3U

Quantum 150E	150 Watt FM Exciter/Transmitter, 115VAC	\$4,495.00
Quantum 150EA	150 Watt FM Amplifier Only, 115VAC	\$4,000.00
Quantum 300E	300 Watt FM Exciter/Transmitter, 115VAC	\$5,495.00
Quantum 300EA	300 Watt FM Amplifier Only, 115VAC	\$5,000.00
Quantum 600E	600 Watt FM Exciter/Transmitter, 115VAC	\$7,495.00
Quantum 600EA	600 Watt FM Amplifier Only, 115VAC	\$7,000.00
Quantum 230VAC	230 VAC option for E & EA	\$150.00

QEI Continued on next page.

## Sine Systems



The Sine Systems Thermal Sentry is designed to monitor the overall operating condition of a broadcast transmitter by measuring a specific thermal parameter. It provides important early-warning information about conditions that, if un-corrected, could lead to down-time and costly damage. To accomplish this, the Thermal Sentry uses two precision air-temperature sensors: one installed at the cooling-air intake and the other at the cooling-air exhaust of a transmitter. The Thermal Sentry then computes and displays the temperature difference between the two sensors. In addition, the Thermal Sentry has an alarm output that activates whenever the temperature differential exceeds a preset value.

TS	Thermal Sentry	\$299.00
----	----------------	----------



BGS

R  
F

R  
E  
L  
A  
T  
E  
D

E  
Q  
U  
I  
P.



# transmitters/exciter



**BGS**

**R  
F**

**R  
E  
L  
A  
T  
E  
D**

**E  
Q  
U  
I  
P.**

## QEI

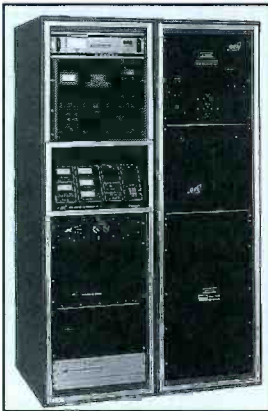

**QEI FMQ Series:** Advanced technology, reliability, and conservative design are the hallmarks of QEI transmitters. All key parameters have alarms to warn you before the critical failure point. They all utilize single EIMAC tubes in grounded grid configurations with a 15,000 hour tube warranty! The driver stages are 100% solid state and automatic power control is standard. For ease of service both the IPA and power supply modules can be removed from an on-air transmitter. All transmitters come with the 675 exciter or can be ordered with the 695 exciter which also provides automatic modulation control. Prices include a spare parts kit and a factory check out after installation. All these transmitters are available with single phase power supplies with the option of a three phase power supply.



The **QEI FM Exciters** are all solid state, on carrier direct FM, phase locked, and frequency synthesized. They are designed to meet or exceed the FCC requirements for use in the standard FM broadcast band. The Exciters may be programmed to operate on any 100 KHz increment using the same high stability 8 MHz crystal as a reference. The 695 FM Exciter's output is variable from 5 to 20 Watts with "Auto-mod" automatic modulation control, very low noise, and distortion < 0.025% independent of temperature. The 695 has bargraph modulation metering with built-in peak counter, an annunciator panel, and a spectrum display output which permits Bessel-Null calibration of modulation monitoring.

FMQ-5000	5kW FM Transmitter, single cabinet design	\$27,995.00
FMQ-10000	10kW FM Transmitter, single cabinet	\$34,995.00
FMQ20000B-3	20kW FM Transmitter, two cabinet design, three phase	\$54,000.00
FMQ20000B-1	20kW FM Transmitter, two cabinet design	\$56,795.00
FMQ30000B-3	30kW FM Transmitter, two cabinet design, three phase	\$56,500.00
FMQ30000B-1	30kW FM Transmitter, two cabinet design	\$59,295.00
Option 03	Replace 675 with 695 Exciter	\$2,650.00
Option 05	Delete 675 Exciter (Deduct)	-\$1,195.00

675B	FM Exciter, 115/230 VAC	\$2,995.00
695	FM Exciter, 115/230 VAC	\$5,450.00

## TTC/Larcan



**TTC's XLS-1000MU** solid state 1kW UHF (Ch. 14-69) TV transmitter has been refined from its cabinet to its output with the latest state of the art components for improved reliability. Its new cabinet styling has a replaceable air filter and quieter blower system. This transmitter has a newly designed XLS-5 up converter, multiple levels of redundancy, and output short circuit protection. It also has an improved AGC amp design, output metering accuracy and efficiency. The XLS-1000MU has a two year limited warranty.

XLS-1000MU Transmitter/Translator	\$45,100.00
SPK-XLS1000 Spares Kit	\$4,395.00



**TTC developed the XL-FM Translators** for customers who needed a way to fill gaps in their coverage. The XL-FM accepts a single FM channel, converts it to another FM channel, and provides for one or two outputs of 10 Watts.

XL10FM	10 Watt, Single output	\$4,095.00
XL10FM2	10 Watt, Dual output	\$4,795.00
XL100FM	100 Watt, with FMS-100 amp, less rack	\$7,070.00
XL500FM	500 Watt, with FM-500 amp, includes rack	\$9,370.00
4352-9100	Dual Output Combiner	\$500.00
1380-2002	Code Keyer with cable	\$395.00
SPK-XL10FM	XL10FM Spares Kit	\$395.00

**TTC developed the FMS Series** to keep you on the air with the cleanest signal, at maximum power, under all conditions. The advanced solid-state design eliminates tube replacements, routine tuning requirements and maximizes operating efficiency which dramatically lowers operating costs. TTC's design utilizes four 320 Watt amplifiers which generate only 250 Watts of power, paralleled to yield 1kW of output power. This significantly increases reliability and results in specifications like -60dB of synchronous AM noise, 90dB FM S/N ratio, and distortion measurements of 0.01% or less for THD, IMD and TIM. Each amplifier has its own power supply regulator to spread heat load, and the modular construction allows for maintenance while on the air. A DC short in the output harmonic filter provides excellent lightning immunity. At TTC, real life field experience guarantees your investment.

FMS-16000	4,000-16,000 Watt	Call for pricing
FMS-12000	4,000-12,000 Watt	Call for pricing
FMS-8000	4,000-8,000 Watt	\$60,800.00
FMS-4000	1,000-4,000 Watt	\$28,500.00
FMS-2000	200-2,000 Watt	\$21,200.00
FMS-1000	200-1,000 Watt	\$17,300.00
FMS-500	400-550 Watt	\$9,800.00
FMS-100	30-110 Watt	\$7,500.00



The **TTC X frequency synthesized FM Exciter** is virtually transparent with THD, IMD, and TIM < 0.01%, a dynamic range of 90dB, and flat frequency response of ±0.05dB. It is convection cooled, has five SCA inputs, and a 30 watt FET type "N" output which can drive virtually any transmitter. The Model X is designed for operation at altitudes up to 12,000 feet, and temperatures from -30 to +50 degrees Celsius and offers frequency stability of ±100Hz. It also includes a harmonic filter and a separate external rack mount power supply. TTC has a two year warranty with 24 hour parts and service.

Model X	1-30 Watt FM Exciter	\$4,525.00
---------	----------------------	------------



## Telecast

**Telecast** is a leader in mobile and fixed fiber optic video and audio communication. They manufacture a unique line of products designed for extremely high quality transmission in demanding environments. Telecast systems feature: True field portability and durability • Field or rackmount enclosures • highest quality video & audio • NTSC or PAL compatible video • Fast, easy 1-person set up • Distances up to 20 miles • Single mode or multimode fiber • Battery or AC operation • Very low power consumption • Internal NiCad UPS backup • Anton/Bauer Snap-On® option • and wide temperature range.



**BGS**



**Viper™** features: Modular "Mussel Shells" or rackmount • 4-module shell—up to 2 Video, 4 Audio + Aux • 8-module shell—up to 4 Video, 12 Audio + Aux • 2 Ch. Aux Intercom (4W, RTS or Clearcom) • 2 Ch. Aux Data (RS422 or Sony RM-X CCU) • 2 Ch. Aux Switch Closures for Tally, Call, etc. • 96dB S/N Mic/Line Audio, and 70+dB Video.

**Sidewinder™** features: Transceivers protected in rugged reel • 2 Video, 4 Audio + Optional Aux—on 1 cable • Aux Intercom—4-wire or 2-wire RTS/Clearcom • Aux Switch Closure for Tally, Call, etc. • Digital Mic/Line Audio, over 90dB S/N • SM reel 750', MD reel 1,500' XL reel 3,000' • and Durable 5mm (0.2" OD) cable, 14 lb/1,000'.



Viper™		From \$200.00 to \$2,000.00
Viper800	8 NTSC/PAL Video rack unit	\$950.00
Viper442	4 NTSC/PAL, 8 mic/line audio, 2 aux Intercom, 2 Data Video rack unit	\$1,050.00

Sidewinder™ From \$7,495.00 to \$17,345.00

**Adder™** features: Digital Multiplexing Audio Snake • 64 Audio Channels on one fiber, coax or triax • 12 lb/1,000 ft cable saves 99% weight & labor • Built-in mic pre-amps • Phantom mic power optional • 6 mile range, no repeaters or amps • Use with Viper for 8 Video + 65 Audio on 1 cable • Optional Aux Intercom & Data Channels • and optional 3-way mic splitter output.

Adder882	Audio/Data Multiplexer, 8 audio + 8 Data, both directions, rack unit	From \$3,995.00 to \$7,495.00
Adder161	Audio Mux, 16 audio channels, 2 Data, 4 Switch Closures, rack unit	From \$3,695.00 to \$6,459.00

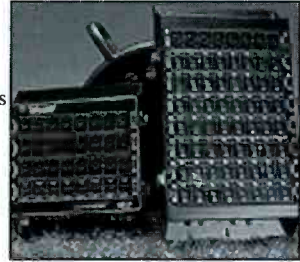

**Cobra™ 370-S** Fiber Optic Triax Interface sends all 2-way triax functions on one optical fiber for distances up to 50,000 ft. with no repeaters. It provides camera power and drives long triax runs. Switchable mic/line input and input impedance.

Narrow Band System	\$27,500.00
Broadband System	\$29,500.00
DTS System	\$30,250.00

**Military Connector** 4-pin quick release, hermaphroditic • For quick attachment to shells & vehicles • Fast cable plug-to-plug extension cables

MC From \$750.00 to \$995.00

The **New Mini-Mussel Shell** is so small and lightweight it can go anywhere. It is rugged and a compact 2.75"H x 7.0"W x 1.2"D. It fits any single Telecast module TX/RX set. It includes internal UPS battery backup. Ideal for remote spotter-cam applications!

VIMI-000	\$200.00
----------	----------

**EEL™ 12V Converter** is a 4-port AC/DC Commander featuring: Universal AC input—120/240 VAC; 47-63Hz • Fused UPS 12VDC input • 4 fused outputs—13.8VDC, 3 Amps; 4-pin XLR • Auto AC to DC input switchover protection • and optional remote control on/off. 12V

E12VC \$995.00

### Audio TX/RX Modules

TX/RX275	Basic Dual Digital Audio • Mic/Line switchable audio, 20kHz, 90dB S/N	From \$995.00 to \$2,550.00
TX/RX280	Expandable Dual Digital Audio • 2-Ch. of DC-25kHz (±0.1dB) Mic/Line Audio • 96dB unweighted S/N; 134dB Dynamic Range	From \$1,795.00 to 2,850.00
TX/RX380	Expansion Module • adds 2 Ch. of Digital Audio to TX/RS280 • up to 3 TX/RX380 sets + Intercom & Data	\$995.00

### Video TX/RX Modules

TX/RX103	Analog Video • FM-based, NTSC/PAL, 10Mhz, 70+dB S/N • Exceeds RS250-(Short Haul) • 30 kilometer Range (SM)	From \$1,375.00 to 2,850.00
TX/RX259	Serial Digital Video • Laser-based SMPTE 259M compatible; 270Mbps • No Pathological Errors (PLL & EQ) • 20 kilometer Range	From \$2,350.00 to \$3,050.00

### Options:

ADAPAC02	AC Power Adapter Indoor for Sidewinder and Viper systems	\$79.00
SHIPSWSM	Shipping & Carrying Case for SM Sidewinder & Viper Systems	\$295.00
SHIPSWMD	Shipping & Carrying Case for MD Sidewinder & Viper Systems	\$395.00
NCB	NiCad Internal Battery for Viper and Sidewinder	\$195.00
PMTRST32	Optical Power Meter, ST adapter, 3 Wavelengths, 850,1300, 1550nm	\$695.00
CONNSTQC	ST Connector installation repair kit, Quick Crimp	\$10.50

FIBER OPTICS





## BEC

**BEC Technologies Proline Series** is a modular digital audio communications system capable of transmitting up to 64 channels of full bandwidth audio. Systems may be configured as STLs, or as audio links in production studios, satellite facilities, or mobile production trucks. For shorter transmission distances (up to 750'), data may be carried on one or two twisted pair cables. On fiber optic cable, distance is extended to 2 miles, multimode with the standard LED driver, or up to 25 miles single mode with the optional laser driver. Overall system performance specifications include frequency response of 10Hz to 22.5kHz ( $\pm 3$ dB), THD+N of less than 0.01%, and dynamic range better than 92dB. Proprietary Fault Tolerant Redundant Communication (FTRC™) technology is implemented to assure fail-safe signal integrity. Modular design, with separate units for A-D conversion/data multiplexing, fiber optic transmission, and demultiplexing/D-A conversion, allows custom configuration of complex communication systems from off-the-shelf components.

AD16	Audioplex; Input A/D converter transmitter	\$3,500.00
DA16	Audioplex; Output D/A converter receiver/repeater	\$3,500.00
DPI-8	Digiplex; AES/EBU receiver/converter/transmitter	\$3,500.00
DPO-8	Digiplex; AES/EBU demultiplexer/repeater	\$3,500.00
FBII	Dataplex; Fiber Optic Transceiver module	
	(Handles up to 4 AD16s & 4 DAs for a total of 64 channels)	\$3,000.00
FBII/SM	Dataplex; Fiber Optic Transceiver module—single mode	
	(Handles up to 4 AD16s & 4 DAs for a total of 64 channels)	\$4,900.00
RPS	Redundant Power Supply module	
	(Handles up to 8 modules of any type on back up)	\$1,650.00
MP16	16-Channel Mic Preamp/Splitter	\$5,900.00
MX16	Remote Gain Controller for the MP16	\$1,200.00
AD2	Stereo analog input module	\$1,100.00
AD2/F	AD2 with fiber optic transceiver option	\$1,700.00
DA2	Stereo analog output module	\$1,100.00
DA2/F	DA2 with fiber optic transceiver option	\$1,700.00



## Lightwave Systems

The **LightWave Fibox** system is useful for permanent and temporary applications. On the transmit end, the FBAI-M module offers: two XLR mic/line inputs with high-quality mic pre-amp, gain trim, overload LED and phantom power • 20-bit delta-sigma A/D converters, 48kHz sampling and 64x oversampling • and a 1.310nm fiber-optic output driver. At the receive end, the FBAO-M module includes: a fiber-optic receiver • 20-bit co-linear D/A converters • and +4dBu balanced analog outputs on XLRs. Overall dynamic range is specified at 108dB through the system, and transmission distances of up to 4km are possible using multimode fiber. Up to five 2-channel slave modules can be added to each end and linked via multi-pair cable to the master modules, allowing a single fiber to carry up to 12 channels of 20-bit digital audio. Alternative output modules offer AES/EBU digital output (on XLR or BNC), with front-panel selectable output sampling rates of 32, 44.056, 44.1 and 48kHz, or synchronization to an external source.

FBAI-M	Master 2-channel, Analog input	\$850.00
FBAI-SL	Slave 2-channel, Analog input	\$680.00
IMS-Tx	8-Channel AES digital audio transmitter plus 1-channel SMPTE digital video transmitter	\$1,930.00
VFL300/T	Video Transmitter Module	\$797.50
FBAO	Master 2-channel, Analog output	\$895.00
FBDO-M	Master 2-channel, AES digital output	\$975.00
FBAO-SL	Slave 2-channel, Analog output	\$710.00
IMS-Rx	8-Channel AES digital audio receiver plus 1-channel SMPTE digital video receiver	\$1,650.00
VFL300/R	Video Receiver Module	\$797.50
LKI-6	Linking cable for 12 channels, input	\$125.00
LKO-6	Linking cable for 12 channels, output	\$125.00
RMK	Rackmount kit for 1, 2 or 3 units	\$65.00
ST-ST	Simplex 2 meter fiber patch cable	\$92.00
FCT-2C	Two-core tactical fiber cable, price per foot	\$1.20
TERM-ST	Terminations on cable	\$50.00
DATI-SL	RS-232/422/485/MIDI/SMPTE/Slave xmtr	\$680.00
DATO-SL	RS-232/422/485/MIDI/SMPTE/Slave revr	\$710.00
DAT-CBL	Data link cable for bi-directional transmission	\$50.00



## routers / switchers

### Zercom

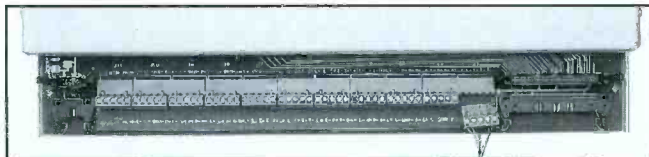

**Zercom Patch Switch PS-1** is a rack mounted, passive audio switch that's stereo 10 in and 1 out or 1 in and 10 out. This configuration allows you to reverse stereo phase and perform stereo to mono summing with the push of a button. Use the PS-1 for additional input switching to consoles, or the selection of satellite, remote or studio feeds. Buss switches together for more complex applications or add resistors to make audio pads on the inside. A zercom Gain Box can be used to increase levels as needed.

PS-1 \$379.00

FIBER OPTICS



## 360 Systems

The **360 System's AM-16/B Routing Switcher** is a compact expandable system that is field selected for either 16x16 mono or 8x8 stereo matrix. It will route any source to any or all destinations. The AM-16/E expander unit operates in parallel to provide an additional 16 mono or 8 stereo inputs and outputs. Combine one master and one slave unit for 16x16 stereo operation. Additional slaves may be used for multi-channel applications or for custom matrices. The AM-16/R remote control station will provide control of 16 inputs and outputs, stereo or mono, for up to four separate levels of audio. Multiple AM-16/R remotes may be used to control a central switching matrix from several different locations. All inputs and outputs of the AM-16B are electronically balanced, and both RS-422 and MIDI remote control facilities are provided. Front panel setups may be stored in any of 100 non-volatile memory locations, allowing recall of individual patches or complex "salvos." Memory-Protect guards against accidental erasure of programs and on power-up the last program in use is automatically selected. It has front panel patch points for two channels in and out, to serve as test points or for an emergency patch. Specifications meet today's high performance expectations.

AM-16/B	Audio Crosspoint Switcher	\$1,495.00
AM-16/B-38.4	AM-16B for operation at 38.4 KBaud when using EIA-422 serial interface (MIDI port inoperative)	\$1,495.00
AM-16/E	Audio Crosspoint Expander	\$995.00
AM-16/R	Remote Control Station, 1U, will control 1-4 AM-16/B	\$695.00
AM-16/CR	Circuit Card Remote, same as 16/R w/o chassis or buttons	\$450.00
D15M-1	Interconnect cable for 1 expander to AM-16/B	\$15.00
D15M-2	Interconnect cable for 2 expanders to AM-16/B	\$20.00
D15M-3	Interconnect cable for 3 expanders to AM-16/B	\$25.00
D15M-4	Interconnect cable for 4 expanders to AM-16/B	\$30.00



AM-16R

AM-16B



## Biamp



The **Biamp VSX41 Video Switcher** provides four video inputs and one video output, with source selection and remote control functions. Passive switching allows the VSX41 to be used as either a 4-input by 1-output switcher or as a 1-input by 4 output router, and for either video or audio signals.

Selectable back termination allows use with either video signals or line level audio signals. Dry contact relays provide complete group isolation. The VSX41 is versatile, cost-effective, easy to install, and carries a five year warranty. 1U

VSX41

\$549.00

## Broadcast Tools



The **Broadcast Tools 10X1 Stereo Audio Switcher/Router** passively switches or routes ten different stereo sources. It provides passive switching through gold contact relays and accepts levels between -20dB and +20dB. Features include: front panel switching with LED indicators • full front panel remote control and status • programmable front panel enable • audio mute control • selective channel power-up programming • and a 2400 baud serial port. Comes with wall transformer, serial cable, with audio I/O connections via wire captive terminal strip. 1U

10X1

\$529.00



The **Broadcast Tools 3X2** is a 3 input dual output stereo audio switcher. It features: 3 balanced stereo inputs, assignable to either or both stereo outputs • multi-turn input trimmers • output level adjust • front panel channel indicators • 2400 baud serial control port • two modes of parallel remote control, mode one is an on/off latching mix mode, mode two conforms to B.E. Audio Vault and Scott Studios 8255 I/O control.

3X2

\$399.00

RM-1

Rack mount

\$49.00

The **Broadcast Tools 2X1 Stereo Audio Switcher/Router** passively switches or routes two stereo inputs to one stereo output or vice versa. It features: passive switching through gold contact relays and is configured to route audio to the output in case of loss of power to the unit • I/O and control



interfacing is via wire captive terminals • it allows control with 5 volt logic levels, open collector, or switch contacts • and comes with wall transformer.

2X1

\$139.00



The **Broadcast Tools 6X1B** is a six input stereo switcher/router which can select up to six stereo balanced inputs to one stereo output. It provides passive switching through sealed gold contact relays allowing a very transparent audio path that makes it ideal for both switching and routing applications. Front panel switches with LEDs provide interlocked source selection and status. A rear panel 15 pin D connector allows for remote control and status. Remote control inputs may be momentary or maintained TTL/CMOS, open collector or contact closure and status is an open collector. It provides loss of power bypass on input one and may be programmed to power-up on any of the six inputs. Additional features include: step input for input sequencing • a mute input which mutes the stereo output when activated • programmable non-selected input termination • a second bridging output to allow monitoring of source material • and wire captive terminal strips for I/O connections.

6X1B

1/2 rack unit or desk top

\$399.00

RM-1

Rack mount

\$49.00

FP-1

1/2 rack filler panel

\$39.00



**BGS**

**R  
O  
U  
T  
E  
R  
S  
/  
S  
W  
I  
T  
C  
H  
E  
R  
S**





**BGS**

**R  
O  
U  
T  
E  
R  
S  
/  
S  
W  
I  
T  
C  
H  
E  
R  
S**

## Broadcast Tools



The **Broadcast Tools 8x2** Active Dual Stereo Audio Switcher is designed to accept 8 stereo inputs switchable to two stereo outputs via front panel switches with LED indicators. The inputs may be programmed to either overlap, mix, or interlock any source. Inputs are balanced bridging and will accept either balanced or unbalanced sources. The 8x2 can also be configured to provide adjustable dimming of up to 10dB per input. Rear panel input trimmers allow input adjustment between -10 and +8dBm. Output and dimming level adjustments are also provided. Additional features include: Eprom programming for power-up input select, mute input, front panel switch disable, monaural outputs, summing inputs & unbalanced outputs for multiple unit cascading, output selectable silence sensor. Parallel and RS-232 serial ports are also provided for remote control and status.

8X2A/ev	As above	<b>\$629.00</b>
8x2A/sv	no serial-status, latched inputs, RC status removed Tailored for B.E. Audio Vault/Scott Studios System	<b>\$629.00</b>

## Burk



The **Burk LX-1** Stereo Switcher is designed to improve your control room operation by reducing demands on your air console and eliminating the need to patch for alternate program sources. The LX-1 can connect to your remote control system for remote program switching • allows mixing of two studio sources, or lock-out of all audio sources • tally indications are provided for each source • start/stop pulses are available for each source • and it matches IHF or PRO inputs. 1U

LX-1	Six input stereo selector	<b>\$1,295.00</b>
------	---------------------------	-------------------

## Henry



The **Henry StereoSwitch** is a three-input stereo audio switcher for use as a studio switcher, line selector, or for automatic source selection under the control of a broadcast automation system. It accepts up to three stereo balanced audio sources, selecting one to be routed to the

stereo balanced output. The unit can be controlled with any momentary or maintained contact closure, open collector, TTL/CMOS logic, or DC voltage from 5-24 volts. Internal power-up programming permits the user to determine which of the three inputs is automatically selected when AC is applied. Tally outputs are provided to drive remote status indicators. Inactive sources can be automatically terminated.

StereoSwitch		<b>\$250.00</b>
--------------	--	-----------------

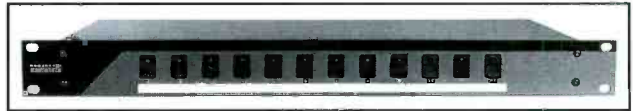

**Broadcast Tools Box-O-Switches** (previously, VersaSwitch) has two rows of six front panel switches that allow remote switching of any kind of equipment needing a normally open dry contact closure. Each of the 12 switches contains a bright red LED displaying the active status of the associated equipment connected to it. Busses include remote start and stop CD players, recorders, automation gear or any equipment. All connections are made on wire captive terminals mounted inside the unit.

Box-O-Switches		<b>\$199.00</b>
Rack-O-Switches	Same as Box-O-Switches only 1U panel mount and connection via 2 DB-25 D-Subs	<b>\$199.00</b>

## Conex



The **Conex AS-101** Audio Switcher allows any one of 10 stereo sources to be switched to the stereo output channel. Switching is accomplished by pressing one of the illuminated buttons on the front panel, or remotely, via the remote control connector on the rear panel. Several remote control devices may be connected in parallel, and all will indicate the selected channel. A compact rack-mount auxiliary unit houses a variety of optional boards including an RS232/422 interface, a relay board making possible tape deck control, and a system board allowing the AS-101 to be transformed into a simple automation system under the control of any PC. Features include connection via plug-in screw-clamp terminal blocks • Transformerless balanced inputs and outputs • and Front panel accessible input and output level controls.

AS-101	Audio Switcher	<b>\$962.12</b>
AS-401	Remote control (10 channel)	<b>\$161.25</b>
AS-501	Relay board	<b>\$317.12</b>
AS-201	RS-232 interface	<b>\$209.62</b>
AS-44	RS-232 serial interface	<b>\$119.00</b>
AS-202	RS-232 expander board	<b>\$150.00</b>
AS-95	Auxiliary chassis	<b>\$115.00</b>

## Radio Design Labs



The **RDL AMX-84** is a digitally controlled audio matrix router and a low-noise audio mixer with 8 stereo inputs which can be mixed to 4 stereo outputs, in any combination. Functions are controlled by 32 data lines on an input connector. It has low noise and distortion and input gain can be trimpot adjusted for precise level matching.

AMX-84		<b>\$1,126.00</b>
--------	--	-------------------



## Intelix

**Intelix's M series** are sophisticated matrix mixers with VCAs at every cross point. The advantage of cross point controllable mixing is the ability to independently create an appropriate mix for all outputs. It is used in room-combine, show control, zone-paging, public address, audio monitoring and a variety of other applications. Intelix Comet Series remote control modules, PC, Macintosh, as well as dedicated controllers, such as Crestron and Triad Systems, and other RS232 based devices allow the matrix to be easily supervised from remote locations. M Series mixers can be "slave" matrices when used with controllers or as stand alone mixers.



M8L8L	8 inputs, 8 outputs	\$2,499.00
M16L8L	16 inputs, 8 outputs	\$4,115.00
M24L8L	24 inputs, 8 outputs	\$5,439.00
M32L8L	32 inputs, 8 outputs	\$6,649.00
M8L16L	8 inputs, 16 outputs	\$4,115.00
M16L16L	16 inputs, 16 outputs	\$6,275.00

Stock configurations include cross point level controlled mixer, power supply and user manual. I/O are line level and control functions are externally controlled. Also available are custom configurations with any combination from 8 inputs/outputs to 128 inputs/outputs.

Please call for further information.



The **Intelix Studio Psychologist** is a remotely controlled monitor mixing system incorporating small remote controls. Eight audio channels to either four or eight monitor positions in mono or stereo and 16 audio channels to either eight (stereo) or 16 (mono) monitor positions are possible. These devices transfer control information to a matrix mixer and produce separate and preferred mixes for each musician (or monitor). This system is widely used in the recording studio, stage presentation and language lab applications. Includes chassis, power supply, CPU card and audio level control cards. Does not include remote control units or fan-in box.

P8L8L-M	Up to eight 8-channel mono remotes (8/1 Mini-Mixer)	\$2,789.00
P8L16L-M	Up to sixteen 8-channel mono remotes (8/1 Mini-Mixer)	\$3,999.00
P16L8L-M	Up to eight 16-channel mono remotes (16/1 Mini-Mixer)	\$4,065.00
P16L16L-M	Up to sixteen 16-channel mono remotes (16/1 Mini-Mixer)	\$6,069.00
P32L8L-M	Up to eight 32-channel mono remotes (32/1 Mini-Mixer)	\$6,575.00

P8L8L-S	Up to four 8-channel stereo remotes (8/2 Mini-Mixer)	\$2,399.00
P8L16L-S	Up to eight 8-channel stereo remotes (8/2 Mini-Mixer)	\$3,395.00
P16L8L-S	Up to four 16-channel stereo remotes (8/2 Mini-Mixer)	\$4,059.00
P16L16L-S	Up to eight 16-channel stereo remotes (16/2 Mini-Mixer)	\$6,225.00

### Remote Control Units, Beltpack/stand mounted adapter included

8/1 Mini-Mixer/rotary	8 channel mono w/rotary potentiometers*	\$309.00
8/1 Mini-Mixer/slider	8 channel mono w/slider potentiometers*	\$299.00
8/2 Mini-Mixer/rotary	8 channel stereo w/rotary potentiometers*	\$429.00
8/2 Mini-Mixer/slider	8 channel stereo w/slider potentiometers*	\$415.00
16/1 Mini-Mixer/rotary	8 channel mono w/rotary potentiometers*	\$429.00
16/1 Mini-Mixer/slider	8 channel mono w/slider potentiometers**	\$435.00
16/2 Mini-Mixer/rotary	8 channel stereo w/rotary potentiometers**	\$689.00
16/2 Mini-Mixer/slider	8 channel stereo w/slider potentiometers**	\$669.00
32/1 Mini-Mixer/rotary	32 channel mono w/rotary potentiometers**	\$695.00

\*7.5" wide metal chassis

\*\*13.25" wide metal chassis

### Psychologist Remote Control Units

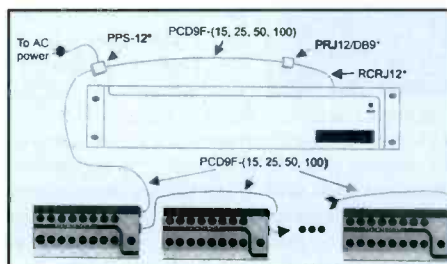

## Logitek

Top: PRE-10  
Bottom: MON-10

The **Logitek MON-10** Switcher/Meter/Monitor is great for production rooms, edit suites, remote trucks or any audio test rack. It is a one by ten stereo switcher with a full size VU meter and a 6W monitor amplifier. You can listen to right channel, left channel, L+R (mono) or L-R (out of phase check) on any of ten signal sources. The chosen signal also appears on the VU meter which has a six position meter range. The VU meter has a peak LED indicator, headphone jack as well as a front mounted monitor speaker. Logitek has a three year warranty.

MON-10	Ten input Stereo selector/meter/monitor	\$855.00
--------	---	----------

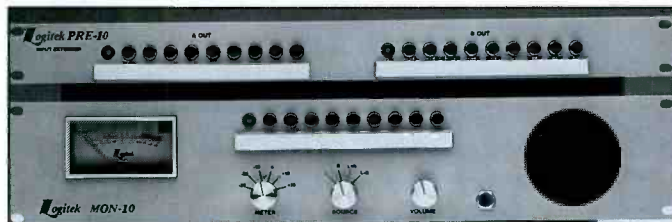

The **Logitek PRE-10** is an input expander that will mechanically switch ten inputs to either of two outputs or two inputs to 10 outputs. All inputs and outputs are XLR connectors and the unit requires no power.

PRE-10M	10 in 2 out mechanical mono switcher	\$515.00
PRE-10S	10 in 2 out mechanical stereo switcher	\$560.00



BGS

R  
O  
U  
T  
E  
R  
S  
/  
S  
W  
I  
T  
C  
H  
E  
R  
S





**BGS**

**ROUTERS / SWITCHERS**

## Radio Design Labs



The **RDL RU-SX4** can be used anywhere you need remote controlled audio switching, multiple switching control points, 4 inputs to 1 output, line-level audio switching, balanced/unbalanced I/O, and gain trim on each source. The inputs are all bridging, allowing connection from either high or low impedance sources.

RS-SX4 \$241.00

**Also See: Radio Design Labs on Pages 25 & 26.**

## Ramko

The **Ramko RS-1616** can route, amplify, distribute and mix in any combination of the full 128 input capacity to any and all outputs with no interaction. The system can be configured from as little as 8 mono/4 stereo in by 2 out. to as large as 128 mono/64 stereo in by 64 out. Up to 32 mainframes may be looped together and controlled with a single control system. It will route audio, SMPTE, DC ultrasonics, modems or any signal thru 100kHz. With the inputs strapped for DC, RS232 computer signals to 9600 baud can be routed or simultaneously distributed without loading or degrading the original signal. The RS-1616 has a three year warranty.



RS-1616LC/MF	mainframe remote serial and parallel control no front panel controls or indicators. Uses RS20C cards.	<b>\$1,119.00</b>
RS-1616MP/MF	mainframe, uses MP20C cards	<b>\$1,178.00</b>
RS20C	Two section (mono or stereo) output card, no mixing or paging.	<b>\$187.00</b>
MP20C	same as above with mixing/paging	<b>\$294.00</b>
RS81C	8 mono 4 stereo input card	<b>\$270.00</b>
RCR-2	Remote controlreceiver required for all serial remote control MSDOS usage	<b>\$556.00</b>

*Many options available, please call us for a quotation on your system.*

## SAS - Sierra Automated Systems



The **SAS 64000** Audio Routing Switcher is a high performance microprocessor controlled audio switching system designed for large-scale professional broadcast facilities. Implementation of the latest analog LSI technology has created an uncompromised level of performance and exceptionally high packaging density: 256 X 256 in one equipment frame; 256 X 256 all stereo in only two frames. It can be configured to operate as a mono, stereo or a mixed mono/stereo system. The control software allows adjacent inputs or outputs to be linked as stereo pairs and treated as one source or destination. Stereo linking provides a flexible and convenient solution for facilities which have both stereo and mono sources and destinations to manage. The central frame is 14 RU and houses all input and output modules, frame controller and plug-in power supplies. Features include: 118dB enhanced dynamic range • +28dBu Maximum input/output levels • Wide selection of control panel options • Multi-point RS-232 & RS-422 interfaces included • and Dual redundant modular power supplies.

*Please call Broadcasters General Store for systems configurations and pricing!*



**SAS GPI-1600 Salvo Sequence Generator** is a compact general purpose automation system that can be integrated with the SAS audio routing systems. It contains 16 form C relays for general purpose machine control and RS-232 serial input for station time synchronization. Event programming is menu driven via an RS-232 bus connected to a PC/terminal. The unit stores up to 1000 events and provides a seven day programming schedule. The GPI-1600 is a useful tool for capturing news feeds, reel recording machines and other time-based events.



The **SAS 32000** Stereo Automated Routing & Mixing System Series sets the standard for audio routing in professional broadcast facilities. The flexible system architecture and rugged design allow for use in a broad range of applications, even critical transmission path routing. The system is modular and easily

expanded. The heart of the SAS 32000 is a 32 stereo input/16 stereo output switching subsystem housed in three rack units. Each frame houses all input amplifiers, crosspoint cards, output amplifiers and redundant power supplies as required for a complete system. For larger systems these building blocks are simply connected together. SAS provides a comprehensive range of rack mount and vertical console mount control panels. Each system comes complete with RS-232 ports for system programming and computer control.

*We'd be happy to provide complete information!  
Complete 32 X 16 Stereo System including Central XY control and RS-232 approx. \$16,920.00*



The **SAS 16000** Audio Routing Switcher is a high performance micro-processor based

audio switching system for use in professional broadcast installations. The SAS 16000 brings SAS quality and reliability to the broadcast plant which requires 32 X 16 or 32 X 32 matrix, all at a very attractive price. The unit is housed in a two rack unit chassis, and provides alphanumeric controls on the front panel. The system comes complete with stereo partitioning PC software which allows any pair of sources and/or destinations to be programmed for stereo operation. Two units may be stacked to allow 32 X 32 stereo operation. The SAS 16000 is compatible with the complete range of SAS rack mounted and console control panels, with full alphanumeric or pushbutton capability.

*Please call Broadcasters General Store for more information and pricing.*



## VAC

You can use the **VAC Automatic Video Switch** to set up a continuous video feed to be overridden by another video source when it becomes active. If you need to switch audio along with the video, use the Stereo Balanced/ Balanced Audio Switch. You can use five 4X1 Video Switches to configure a 16X1 routing switcher. One hexadecimal switch can control all five bricks to act as a single 16X1 unit.

VB/AVS	Automatic Video Switch 2 in, 1 out • automatically switches to alternate source if main source fails • senses sync-tips at main input • can be connected to the AB/S2X1 for automatic audio-follow-video switching	\$219.00
AB/S2X1	Stereo Balanced Audio Switch 2 in, 1 out, stereo balanced audio switch	\$189.00
VB/4X1	4X1 Video Switch 4 in, 1 out • remote or local control port • can be connected to the AB/4X1 for automatic audio-follow-video switching	\$199.00
AB/4X1	Balanced Audio Switch 4 in, 1 out, balanced audio switch	\$189.00
VBRM6	Holds 5 or 6 Bricks	\$135.00

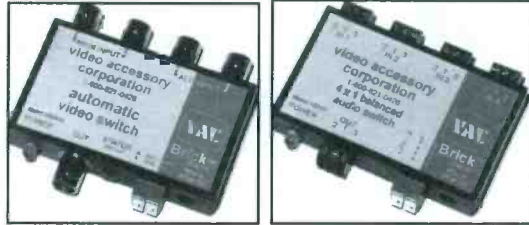

**BGS**

**R  
O  
U  
T  
E  
R  
S  
/  
S  
W  
I  
T  
C  
H  
E  
R  
S**

## Wohler

The **Wohler ARS** features a versatile, modular design that can be configured with up to twenty stereo inputs with two stereo outputs; or as a matrix switch with up to four stereo inputs and four stereo outputs. Normal output is balanced. An optional single pair of level meters or single phase/polarity indicator may be added to the Audio Routing Switcher. Rack mounted installation in a single rack space with simple rear connections by way of European style plug-in, screw-clamp terminal blocks.

### Analog Audio Routing Switchers (Source Selection)

ARS-11	5 stereo inputs to 1 stereo output	\$475.00
ARS-12	Selects one of five 4-channel groups	\$695.00
ARS-14	Selects one of five 8-channel groups.	\$785.00
ARS-21A	5 mono inputs to 2 independent outputs	\$510.00
ARS-21B	10 mono inputs to 1 stereo output	\$520.00
ARS-21C	2 independent groups of (5 mono ins to 1 mono out)	\$530.00
ARS-22A	5 stereo inputs to 2 independent stereo outputs	\$675.00
ARS-22B	10 stereo inputs to 1 stereo output	\$695.00
ARS-22C	2 independent groups of (5 stereo ins to 1 stereo out)	\$710.00
ARS-42A	5 mono inputs to 4 independent outputs	\$780.00
ARS-42B	10 mono inputs to 2 independent outputs	\$780.00
ARS-42C	2 independent groups of (5 mono ins to 2 independent outs)	\$810.00
ARS-42D	20 mono inputs to 1 output	\$810.00
ARS-44A	5 stereo inputs to 4 independent stereo outputs	\$1,015.00
ARS-44B	10 stereo inputs to 2 independent stereo outputs	\$1,060.00
ARS-44C	2 independent groups of (5 stereo ins to 2 ind. stereo outs)	\$1,015.00
ARS-44D	20 stereo inputs to 1 stereo output	\$1,135.00
<b>AES/EBU Digital Audio Routing Switchers (Source Selection)</b>		
ARS-D81	8 AES/EBU inputs to 1 AES/EBU output, BNC connectors std.	\$775.00
ARS-D82	8 AES/EBU inputs to 2 AES/EBU output, BNC connectors std.	\$975.00
ARS-D161	16 AES/EBU inputs to 1 AES/EBU output, BNC connectors std.	\$1,260.00

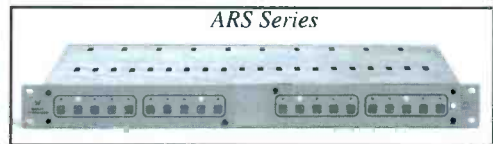

*Also Note: One PH-1 or pair of LV-1 level meters may also be installed in an ARS chassis to monitor a selected sources phase/polarity or level. Please call for prices on these modules.*

## Z-Systems

The **Z-Systems z8.8 Digital Detangler** is a digital audio patchbay, router, distribution amplifier, and format converter all in one box. Z-Systems offers an inexpensive solution to digital audio integration for those who own more than a few pieces of digital audio gear and are tired of the tangles of cables, mismatched connectors, and plugging and unplugging to reconfigure their system. The z-8.8 can connect up to 8 digital audio sources and 8 digital audio destinations reconfiguring "who speaks to whom". Once you've integrated your CD, DAT, MDM, workstations, and digital processors this way you'll wonder how you ever functioned without the Detangler. The z-8.8 comes standard with 8 AES/EBU I/O ports, but custom configurations can be built to suit your needs (totaling 8, of course).

The **Z-Systems Digital Detangler Pro Series** includes the z-8.8r, z-16.16r and z-32.32r. Each is an automated patchbay, an AES/EBU router, and a distribution amplifier all in one package. Once you hook up all of your digital audio I/O's, the connection pattern is then established by the touch of a few buttons on the z-rrc router remote control or computer control interface (Mac and Windows available).

z-8.8	Eight to eight switcher	\$980.00
z-8.8	Custom configurations	\$1,080 to \$1,325.00
z-8.8r	Pro Series, 8 stereo pairs in & out	\$1,100.00
z-16.16r	Pro Series, 16 stereo pairs in & out	\$1,600.00
z-32.32r	Pro Series, 32 stereo pairs in & out, 2U	\$5,000.00
z-rrc	Remote control for 8.8r and 16.16r	\$400.00
z-rrc/32	Remote control for 32.32r	\$730.00

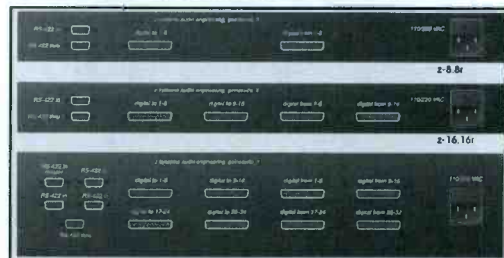





**BGS**

**SATELLITE**

## Broadcast Tools



The **Broadcast Tools USC-16** provides remote channel selection for DAT-SEDAT digital audio decoder cards installed in Scientific Atlanta DAT-32 series, Comtech/Fairchild DART-384 and Ariel Receivers, along with memory selection for the Scientific Atlanta "ENCORE"\* receiver. Four open collector outputs are provided for control of the older receivers' transponder selection via the USC-16 serial port. Using a 2400 or 9600 baud serial port (either locally or remotely via modem) the user may program using the Menu Mode to select sixteen DAT-SEDAT channels, sub-channels and 7.5/15kHz selection on each decoder card. Selection of active channels, Encore memories and latching/momentary open collector control are also provided. After these channels have been programmed and/or made active, the USC-16 may be unplugged and installed. The program information is stored in Eprom memory with a retention life of tens years. The USC-16 allows selection of the channels and memories with momentary TTL/CMOS 56 volt logic levels, open collector or dry contact closures, allowing control by a user's remote control system or switch contacts. The 2400/9600 baud serial port provides status for the two channel ports, active memory with the Encore receiver, the last momentary/latch condition of the open collector outputs and a means of performing remote last minute changes via modem or a local computer.

USC-16	\$349.00
SA-Cable For use with Scientific Atlanta DAT-32 series receivers	\$39.00

\* Note: SA "Encore" receiver software should be 4.0.1 or greater



The **Broadcast Tools Audio Fade Controller** provides a convenient means of fading stereo audio. The AFC accepts stereo balanced or unbalanced audio with levels ranging from -15dB to +10dB. The output is balanced and may be adjusted from -20dB to 10dB. The AFC is equipped with preset parallel inputs and eight node serial port.

AFC		\$199.00
RM-1	2U rack mount	\$49.00
RM-2	5U rack panel	\$49.00

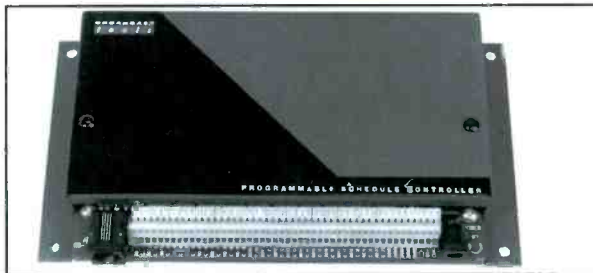

The **Broadcast Tools Programmable Schedule Controller (PSC)**, stores and controls up to 160 time and date events. The PSC is equipped with 20 spst relays, and can also send up to 12 serial custom commands. All program events are stored in non-volatile Eprom memory. To program the PSC, attach it to a non-dedicated PC running standard communications software (Bitcom, ProCom Plus, Windows Terminal, etc.). It features an AC line, 60Hz time base for precise timing. A supercap is provided to operate the clock processor when the PSC is not attached to AC. The PSC is also equipped with an optically isolated sync input allowing network time synchronization any time within the hour. Connection to the PSC is via clamp style wire captive terminals.

PSC	\$399.00
-----	----------



The **Broadcast Tools Talking Duck** identifies any audio circuit. Simply connect the wall transformer to the Talking Duck and press the record button and a 16 second identifying message may be recorded. On playback, a 4 second 1kHz tone along with the recorded message will continually run. By connecting the Talking Duck to a telco loop, the user can immediately identify a remote circuit by dialing up or selecting the circuit and listening to the message. It will continually feed the circuit until a 1/4" TRS plug is inserted into the front panel jack, at which point, the recording is disconnected and the source equipment is switched back to the circuit.

Talking Duck	\$139.00
--------------	----------

## CircuitWerkes

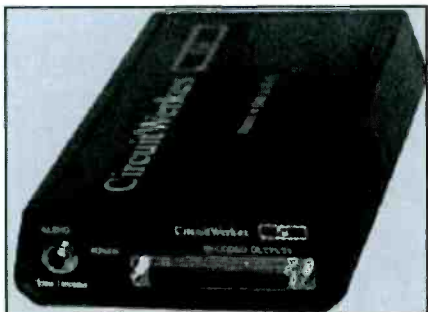

The **CircuitWerkes DTMF-16** touch-tone decoder provides up to 16 separate opto-coupled outputs using standard touch-tone signals. Jumper settable modes include: momentary, interlocked-latching, two-tone and anti-falsing. When combined with an auto-coupler it is useful for a variety of tasks such as: remote control of TV camera pan and tilt heads, emergency transmitter control, controlling remote satellite receivers, network switching equipment, repeaters or any telephone control application. An optional combination lock is available which allows for additional system security. The Silencer option board removes tones that are sent over the program channel and provides a muted, balanced audio output.

DTMF-16	Stand alone DTMF remote control	\$195.00
*-S	DTMF Silence Option - ADD	\$149.00



# automation



## CircuitWerkes

The **CircuitWerkes SUB-03a** Subaudible Tone Decoder decodes industry standard 25Hz, 35Hz and combined 25/35Hz tones and provides dry relay contacts to the user. It features audio presence and audio clipping LED indicators to help make setup a snap. Input gain adjustment and a variable, balanced output allow for level matching. Integral filtering substantially reduces the presence of subaudible tones at the SUB-03a's audio output.

SUB-03a

\$329.00

## Conex

The **Conex 25Hz tone generator** has front panel LEDs to indicate the duration of the tone and silence intervals. The CG-25A has plug-in type terminal strips with 600 Ω balanced bridging inputs and can be remotely controlled.

CG-25A	\$451.50
Special frequency requests add	\$25.00
RMK, Rack mount kit	\$27.00



The **Conex CS-25B** is a compact and modular 25 HZ tone sensor for use in broadcast automation, tape control, or remote signaling systems. The sensor detects 25 Hz sub-audible tones that typically signal the end of a program selection. The resulting relay contact closures can be used to start the next source and stop the current source. A stereo high-pass filter module is offered as an option to provide absolute protection from program tripped cues.

CS-25B-10	Dual 25Hz Sensor	\$439.64
CS-25B-11	Above with Stereo high pass filter	\$530.98
HPF-25	Stereo high pass filter board	\$91.34
CS-25B-01	Stereo high pass filter	\$319.21
CS-25B-20	Quad 25 Hz sensor	\$651.41
CS-25B-21	Quad 25 Hz sensor, w/stereo high pass filter	\$742.75
35HzOption	Change to 35Hz per module charge	\$15.00



## ESE

The **ESE 750E Series** of thumbwheel programmer/comparators is both economical and easy to use when programming 1 or 2 output events. A thumbwheel switch is set to compare the time information from an ESE clock or timer. Output occurs each time the switch setting agrees with the time display.

ES 750E	6-Digit 12 Hour Clock with One 6-Digit Comparatör	\$395.00
ES 751E	6-Digit 24 Hour Clock with One 6-Digit Comparatör	\$395.00
ES 753E	6-Digit 12 Hour Clock with Two 4-Digit (hr. & Min) Comparatör	\$475.00
ES 754E	6-Digit 24 Hour Clock with Two 4-Digit (hr. & Min) Comparatör	\$475.00
ES 760E	ES 754E with Battery/Charger and Parallel BCD Output	\$795.00



The **ESE 790** is a sophisticated 32-channel clock featuring microprocessor-based programmability. 1,000 time events can be programmed, at random rather than chronologically, to occur every minute, hour, day or week. Multiple output channels (up to 32) can be activated simultaneously or individually.

ES 790	\$2,495.00
ES 790/1 with 1 Sec/Mo Master Clock Option/ Serial Time Code Output	\$3,150.00
ES 790/3 with 3 Sec/Mo Master Clock Option/ Serial Time Code Output	\$2,985.00

# satellite

## Broadcast Tools

The **Broadcast Tools XP-3** provides remote transponder selection for Scientific Atlanta, Comtech/Fairchild and Ariel receivers. It allows selection of the three transponder channels with momentary or latched TTL/CMOS 5 volt logic levels, open collector or dry contact closures and allows control by the user's remote control systems or switch contacts. The XP-3 has three jumpers to configure which transponder is selected during power-up. It is equipped with a wire captive terminal strip providing remote control and status, along with local switches for transponder selection.

XP-3	Satellite Transponder Controller (Xtal ctrl for SA DAT-32)	\$299.00
------	--	----------

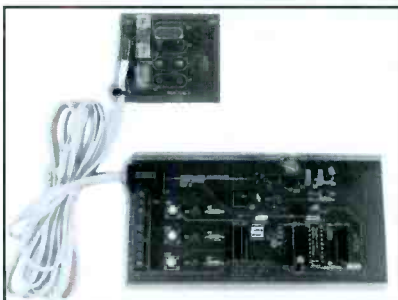

**BGS**

S  
A  
T  
E  
L  
L  
I  
T  
E



SATELLITE

## AVCOM



AVCOM's SCPC-2000E receives FM SCPC signals in the 3.7 to 4.2GHz band. It can tune up to 4 specific crystal controlled audio or data channels from a given transponder with a choice of 1:2 or 1:3 expansion and 0, 25, 50, or 75 micro-second de-emphasis. Available in either wide band or narrow band models with optional circuitry available to allow up to 8 crystals for channel selection. The SCPC-2000E may be used with the SS-1000 slave for simultaneous reception of additional channels. Other features include selectable low pass 15, 7.5, or 5KHz audio filters and an on-board output driver stage for low impedance headphones.

SCPC-2000E	High stability SCPC demodulator and downconverter	\$1,875.00
SS-1000	SCPC audio demodulator, crystal controlled	\$1,027.00
SCPC-3000E	Frequency agile synthesized demodulator w/selectable expansion de-emphasis and low pass filters	\$1,378.00

## Comtech

Comtech's 3.0 and 3.8 meter antennas keep installation costs down with a single pole mount and three-piece reflector design. The use of Comtech's unique splice-strap system yields a superior surface tolerance. The 3.8 meter has a gain of 42.9dB, ideal for SMATV, radio SCPC and Cable TV applications. The EI/Az mount permits 360° azimuth adjustment without costly foundation alignment. The elevation jack provides smooth elevation adjustment from 0 to 70°. The polar-mounted system can be selected in either manual or motorized versions. It tracks the arc with just one adjustment. The motorized version comes with its own control system. Comtech's 3.8 meter is also available in a low-profile transportable version supplied ready to roll.

		3 M	3.8 M
G2	Dual Polarization Manual Feed	\$2,785.00	\$3,195.00
G4	Dual Polarization Motorized Feed & EC1 Control	\$3,655.00	\$3,995.00



## Zephyrus

The Zephyrus Series 300. Radio Network Service, basic system consists of the 304 mainframe, a 1U platform with its own DC power supply and room for one of the two receiver cards, one of the two demod cards, and two optional control cards. The receiver cards are crystal stable but can be tuned in 1MHz steps to compensate for unstable LNB's. Demod cards offer 50-15kHz response at 0dBm nominal output.

304	Mainframe, 4 card slots	\$95.00
321	Mono "Whisper" audio demod	\$250.00
322	Stereo "Whisper" audio demod	\$325.00
327	Frequency agile "Whisper" audio demod	\$465.00
361	AFSK data demod	\$250.00
367	DFSK data demod	\$250/async & \$325/sync
381	Three-function 25/35Hz decoder, mono	\$325.00
383	6 or 15 Function 25/35Hz decoder, stereo	\$700.00
391	Satellite baseband receiver, above video	\$350.00
392	Satellite receiver (FM-FM)	\$370.00

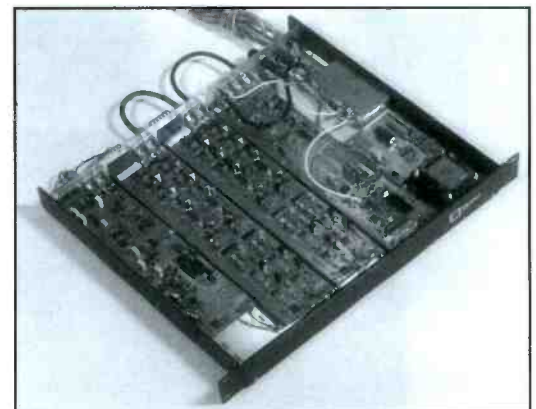



# acoustical panels

## Auralex

**Auralex's™ Studiofoam™** is wedge-cut, 60% more effective than other foams, and has a long lasting formulation that gives years of service.. It passes California firecode and is far more flame retardant than other brands. Charcoal gray is usually in stock with many other colors available. (We would be happy to send a sample) All Studiofoam panels are 2'x4' and ship in box quantities only. Auralex also makes Sonomatt™ which is a charcoal gray eggcrate panel. Sonomatt is recommended when budget is the primary concern because the panels are cut randomly, it makes the pattern hard to line up and not always square to the panel. Auralex supplies a variety of solutions for your sound control problems.

Description	Qty/Box	Coverage/sq. ft.	Price
Studiofoam 1"	20	160	\$247.80
Studiofoam 2"	12	96	\$199.08
Studiofoam 4"	6	48	\$194.94
Sonomatt 2" (2'x4')	12	96	\$173.88
Sonomatt 2" (4'x8')	2	64	\$113.38
Venus Bass Traps (2'x4')	2	16	\$230.00
LENRD Bass Traps 2' long	8	16 lin. ft.	\$166.32
Wedgies 2" (1'x1')	20	20	\$67.00
2"x2"x24" Corner-fills	36	72 lin. ft.	\$49.68
4"x4"x24" Corner-fills	9	18 lin. ft.	\$39.60
12"x12"x24" Corner-fills	1	2 lin. ft.	\$28.99
Tubetak Adhesive		Approx. 32	\$4.95
SheetBlok-10, 10'x4', tan	1	40	\$150.00
SheetBlok-30, 30'x4', tan	1	120	\$400.00
U-Boat Floaters Floor Decoupler	50	Approx. 70	\$82.50
MiniFuser, 12"x12" white paintable	12	12	\$99.00
T'Fuser, 2'x2', ceiling grid or wall	4	16	\$199.96



**BGS**

**S**  
**T**  
**U**  
**D**  
**I**  
**O**

**F**  
**U**  
**R**  
**N**  
**I**  
**S**  
**H**  
**I**  
**N**  
**G**  
**S**

## AVL



**AVL** systems designs, engineers and manufactures high performance acoustical products for any custom application; wall panels, acoustic baffles, ceiling and spec design. The wall and ceiling treatments help create an interior space that is truly an acoustically controlled environment by absorbing up to 99% of sound energy. For safety and insurance purposes, panels are rated Class A with a flame spread rating of 25 or less and a smoke developed rating of 65 or less. **Acoustical panels** in boxed sizes, available in five fabrics; Grey Mix, Crystal Blue, Wheat, Quartz, and Cherry Neutral.

Panels	Size	Total Sq. Ft.	Price
1"(4)	2' x 2'	16	\$133.00
(4)	2' x 4'	32	\$199.00
(4)	4' x 5'	80	\$390.00
(4)	4' x 10'	160	\$688.00
2"(2)	2' x 2'	8	\$83.00
(2)	2' x 4'	16	\$132.00
(2)	4' x 5'	40	\$270.00
(2)	4' x 10'	80	\$490.00

Call Broadcasters General Store for custom fabrics and panel pricing.

# clocks/timers

## Autogram



**Autogram's Autoclock** is a real time, count-up timer, that will display temperature highs and lows for the day with the time they occurred.

Autoclock Specify 100C for console mount or 100D for desk type **\$375.00**

## Calculated Industries



**Calculated Industries' Frame Master II** puts time code and film calculations in the palm of your hand. It includes true 3:2 pull-down conversions, stop-watch/timer and new sync/offset function. New user-preferences function lets you modify the calculator to your needs including: NTSC reference, frame rounding, audible buzzer (on/off), key beeps (on/off) and real-time roll-over. Calculator comes with a lithium battery and one year warranty.

Frame Master II® **\$129.95**  
Vinyl Case **\$5.00**

**Broadcasters General Store (352) 622-7700 Fax (352) 629-7000**



**BGS**

**STUDIO FURNISHINGS**

**CRL**



1/2 second contact closures. It programs down to 1 second intervals. High accuracy crystal time base and battery backup are standard.

RTES	Real-Time Event Sequencer	\$895.00
------	---------------------------	----------

The **CRL Real-Time Event Sequencer** is a time-based external controller used to activate equipment that can be controlled by contact closures. The Event sequencer stores up to 255 events occurring over a seven day clock. The unit has eight contact closures that can be programmed to latch or give 1 second or

**ESE**

The **ESE ES362A** master up/down timer is a four-digit, 100 minute timer featuring a serial time code output. It will drive as many as 100 remote serial slaves such as ES361A, ES364, ES366A, ES369A, or ES372A. Any of the ES362A's up, down, stop, reset, and preset functions can be activated from a front-mounted switch. The ES362A performs the same functions as the ES301A, with the added speed advantage of a leverwheel used for the pre-set functions.

LX362A	Master, Contemporary enclosure	\$535.00
ES362A	Master	\$435.00
ES361A	Slave 0.55" LED Display	\$210.00
ES364	Slave 4" RED LED Display, wall mount	\$650.00
ES366A	Slave 1" LED Display	\$320.00
ES369A	Slave 2.3" LED Display	\$410.00
ES372A	Slave 0.4" RED LED Display, console mount	\$192.00

The **ESE ES112E** and the **ES124E** are solid state, CMOS, six-digit clocks featuring bright orange LED displays. Three simple controls, fast or slow advance and hold, make setting to the precise second easy.

ES112E	12 hour format	\$210.00
ES124E	24 hour format	\$210.00

The **ES520** and **LX520** are four-digit, 60 minute timers which have a serial time code output capable of driving 100 slaves.

ES520	\$185.00
LX520	\$285.00

The **ES301A** is a four-digit, 100 minute up/down timer featuring six push button control switches. Minutes and seconds can be advanced simultaneously or independently to pre-set count downs.

ES301A	\$295.00
ES302A	same as above with leverwheel preset \$379.00

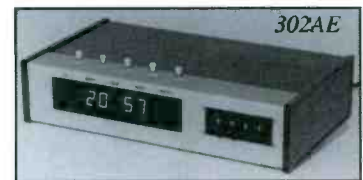

**ESE Master Clock Systems**

**ESE Masters** provide a means of keeping all time displays in the system in agreement through the use of a serial time code. Only one pair of wires is needed to distribute the time code to all remote serial input displays. An **ESE master clock system** can operate digital displays, clocks with sweep second hands, printers and also tell your computer what time it is.

*The following clocks have many options available, call Broadcasters General Store for complete literature.*

The **ESE ES180A NBS** is a 1U master clock with LED display of hours, minutes, and seconds. It receives and decodes time transmitted by the U.S. National Bureau of Standards. It provides an extremely accurate time reference, and is available with the following outputs: serial time code that drives 100 ES161A, 166A, 171A, 991A and 993A remote displays; a 1 pulse per second output; an RS-232C output at 1200 Baud, switchable to other rates; a speaker audio output; and an earphone jack.

ES180A	Specify time zone, 1U	\$2,195.00
ESAA1	Active antenna for ES 180	\$175.00

The **ESE ES185A GPS** (Global Positioning Satellite System) master clock and time code generator provides extremely accurate time and date information anywhere in the world. The unit features a 1PPS accuracy of better than 130 nS and four serial time code outputs. Time and Julian Date information are received via the internal eight channel GPS receiver and displayed on the nine .56" yellow LED's. An indoor/outdoor antenna and 4-hour battery back-up are included while several optional features are also available.

ES185A	\$2,495.00
--------	------------





## ESE Master Clock Systems~Continued

The **ESE ES160A** master clock has an internal timebase and SMPTE, ESE, ASCII and 1PPS are standard outputs. Optional are serial BCD and CMOS compatible outputs. Without buffering it can drive 100 ES161A, 166A, 171A, 991A or 993A remote displays. The ES160A displays six digits of time information on a .56" LED and comes with battery and charger. The ESE TC is both TC89 (time only) and TC90 (time & date), available on separate outputs.

ES160A	1 second per month accuracy, 1U	\$1,595.00
ES162A	Impulse Driver for LX/ES162S or existing 12/24 VDC system, 1U	\$420.00
ES162S	Impulse clock w/stepping second hand, ES162A req'd	\$130.00
LX162S	As above with "LX" enclosure	\$230.00

The **ESE ES192A** and **194A** are micro-based master clocks. They provide the output needed to drive remote serial displays such as the ES161A, 166A, 171A, 991A or 993A

ES192A	6 Digit .56" yellow LED display, 12 hour format	\$270.00
LX192A	As above with "LX" enclosure	\$370.00
ES194A	6 Digit .56" yellow LED display, 24 hour format	\$270.00
LX194A	As above with "LX" enclosure	\$370.00

The **ESE ES165** impulse clock driver is designed to provide synchronized power to ES168 impulse clocks. It can drive up to 50 impulse clocks and will keep them running during a 12-hour power failure. For optimum accuracy, the ES165 should receive either a synchronizing pulse from the 1 PPS output of a master clock or an alternating 12 or 24 volt impulse from an existing impulse clock system. When operated without this pulse accuracy will be questionable.

ES165	Impulse driver, stand alone or references master	\$345.00
ES168	Impulse clock w/sweep second hand	\$130.00
LX168	As above with "LX" enclosure	\$230.00

The **ESE ES150** is an Automatic Time Code Switchover unit. It is designed to provide a simple/automatic method for monitoring and switching between a Primary Master Clock and a Secondary Master Clock. The unit receives ESE time code from two different sources (A&B) and if a fault is detected from the Primary Clock (A), the ES150 automatically switches to the Back-up Clock (B). Once a fault is detected, the unit remains in the "B" state until manually reset. Front panel mounted LED's indicate status and a toggle switch allows manual switching between A and B. Additional "passively" switched I/O circuits include SMPTE/EBU, ASCII, 1 PPS and optionally available IRIG-B, 8 PPS, 1kHz, 10MHz and alternating 12 BDC Impulse Clock Drive.

ES150	Primary/Secondary Master Clock Switcher System	\$1,295.00
-------	--	------------

These are the basic remote displays that receive serial time code from any ESE master clock. They can be configured with numerous options to fit your application.

ES161A	Six digit .55" orange LED display, specify 12 or 24 hour format	\$210.00
LX161A	As above with "LX" enclosure	\$310.00
ES167C	Interface board translates parallel BCD into ESE serial time code	\$190.00
ES166A	Six digit .55" LED display, specify 12 or 24 hour format,	\$320.00
LX166A	As above with "LX" enclosure	\$420.00
ES171A	Six digit .4" bright red LED display, console mount	\$192.00
ES991A	Four digit 2" LED display, desk mount	\$410.00
ES993A	Six digit 2" hr. & min., 1" sec. LED display, wall mount	\$575.00
ES941	Four digit 4" hr. & min., ESE Serial Slave, wall mount	\$650.00
ES943	Six digit 4" hr., min. & sec., ESE Serial Slave, wall mount	\$795.00
ES996	Six digit 2.3" hr., min. & sec., ESE Serial Slave, 15" wall mount	\$625.00
ES126	Time & Date .55" 12 digit ESE Serial Slave, 1U	\$525.00
ES127	Time & date 1" 12 digit ESE Serial Slave, 2U	\$745.00

### Self Setting Analog Clocks

LX5105	5" Self-setting/impulse clock w ESE, SMPTE or ASCII input (sweep/step)	\$575.00
LX5112	As above but 12"	\$575.00
LX5116	As above but 16"	\$675.00

### Seth Thomas

**Seth Thomas 710 Contract 12Q** has a molded case with textured finish, plastic lens, large easy to read dial graphics, red sweep second hand, quartz movement, and operates with one AA battery. Diameter 12"; depth: 2-3/4"

710	Brown	\$34.00
712	Black	\$34.00



160/162



192AP



165



Time Code Converters

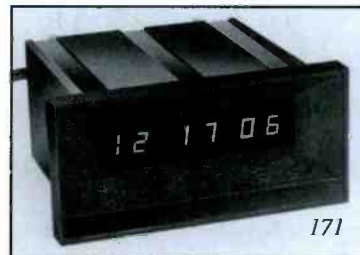

171



161A



LX5112



**BGS**

**STUDIO FURNISHINGS**





**STUDIO FURNISHINGS**

**MultiMedia**



**MultiMedia** all-indoor displays come complete with a wireless remote key-board, mounting hardware and a one year warranty. Signs can display messages in up to 20 different display modes and combinations. All units have battery backed up memory in the event that power to the sign should be interrupted for up to 30 days. Message memory is 8,000 characters or more. Enclosures are aluminum, coated black or gray with non-glare acrylic face covers. Graphics, logos and pictures are user programmable on all units. Many signs can be operated from a local computer or via phone modem (Please call for information on these options & other in & outdoor displays!).

24SC	Beta-Brite Digital Serial Clock, can be networked together for synchronized operation	\$199.00
414C*	Alpha Big Dot, 49x6x4", 1 line 4" color, 16 character	\$1,095.00
4237C*	64x8x5", 2" or 4" color text, 2"=66 & 4"=20 character	\$3,195.00
4222R*	76x8x5", 2" or 4" red text, 2"=80 & 4"=24 character	\$1,795.00

\*These models can be linked with MultiMedia news, sports & weather Broadcast Service. (U.S. Only)

**Radio Systems**



All **Radio Systems CT-6** models function as both clocks and up timers. The "mode" button selects between functions without affecting the accuracy of the timer or time-of-day.

The **CD-6 Desktop model** (RS#10846) is only 3" high and 4" deep and offers a 6-digit, 1" high display. It also houses the optional master driver board which outputs the RS-485 serial time data to synchronize any CT-6 downstream. It is accurate to within ±1.5 seconds per month and accepts top-of-hour and 1Hz sync inputs and can drive Radio Systems' AC-12 analog clocks.

The **CT-6 Thin model** (RS#10842) is only 3" high and 1" deep and can be used as a "stick-on" clock/timer. All functions are fully remotable.

The **CT-6 Large models** (RS#10844: 6-digit & RS#10869: 4-digit) offer a 2" display viewable from over 35" away. It can be slaved to the desktop model master or house the master driver board itself. Finally, the CT-6 Console model can be ordered for internal installation in Radio Systems consoles only and can be a clock/timer or a serial slave to a master clock.

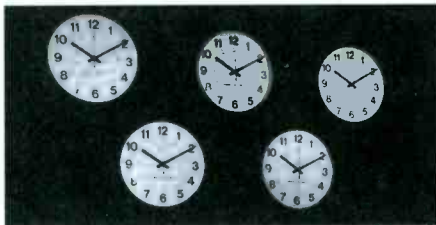

CT-6	Desktop	\$155.00
ST-6	Thin	\$155.00
CT-6L4	Large/4	\$325.00
CT-6L6	Large/6	\$375.00
CT-6C	Console	\$135.00
TCXO	Master Driver Board	\$295.00
GPS-MDB	GPS Master Driver Board	\$1,295.00
AC-12	Clock	\$65.00

**Sine Systems**

The **Sine Systems MBC-1**, combined with an electronic message board is an attractive studio display system. One MBC-1 can drive several message boards and monitors up to 15 control room devices while displaying a unique message for each one. A few message possibilities include: Fire Alarm, Transmitter Off, On Air, EAS Alert, Security Alert, Weather Bulletin, Hotline, Music Ending, and Audio Failure. An optional two channel optocoupler can provide ground isolation for two inputs. Each channel contains a coupling capacitor on the LED side which can allow direct interface to telephone lines for ring detection.

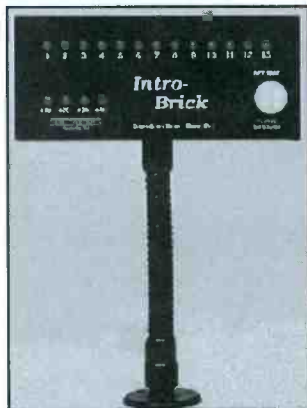

MBC-1	Message Boards Controller	\$299.00
OC-2	Two channel Optocoupler	\$19.00

**Intro-Brick** is a studio countdown timer with a bright red LED bar-graph display. It is specially designed to give air personalities a visual indication of the time remaining on an instrumental intro. This allows the air-personality to concentrate on other tasks without fear of stepping on the vocal. The Intro-Brick is easily set to the intro length with a rotary knob on the front panel. It automatically starts its countdown from up to six equipment sources.

IB-1/6	with 6" gooseneck	\$299.00
IB-1/13	with 13" gooseneck	\$299.00





# The First Name In Digital, The First Family In MiniDisc



## MD Cart Series Recorders/Players

The DN-995R/990R recorders and DN-981F player offer all the advantages of MD without the conventional tape cart problems of wow and flutter or drop-outs and tape stretching. These full-function units provide audio and computer interface as well as a multitude of options, including synchronization. Optional "Hot Start" switchbox adds instant playback of any 10 tracks (DN-981F).

The first name in digital, Denon has also become the premier manufacturer of MiniDisc products for broadcast and post production applications. Even the most demanding tasks of repetitive audio required by fixed installations are made easy and reliable with MiniDisc. Denon not only offers the most comprehensive line of MiniDisc products, they are totally committed to the further development of MD technology.

The MiniDisc format has proved to be the most convenient and reliable medium available. MD can literally be used millions of times without any signal degradation. The sonic quality is equal to Compact Disc and immensely superior to celluloid, while offering unsurpassed portability. More and more digital audio users are turning to MD for archival purposes.

From recording and replication to MD Carts and ENG MD recorders, Denon has a full family of products to integrate MD technology quickly and economically. Contact your favorite distributor and find out why Denon is the "first family in MiniDisc".



**DN-1100R MD Recorder** The DN-1100R MD recorder offers 74 minutes of stereo recording time with a 44.1 kHz sampling rate, 16-bit linear (A/D converter) quantization and ATRAC compression. The unit also features 10 independent "Hot Start" buttons to which any 10 tracks from a total of 255 can be assigned. This feature is ideal for sound effects libraries, sound bytes and announcements.

**DN-80R Portable MD Recorder** The DN-80R is the most advanced ENG recorder on the market, allowing up to 148 minutes recording time in mono and 74 minutes in stereo, per disc. The portable unit provides news gathering personnel and reporters who are on-the-move with shock-proof recording and playback capabilities from a 40 second memory buffer. Further time-saving production features include field editing on a single disc. A standard 23dx video camera battery provides maximum power for a full 148 minutes.



**DN-045R MD Replicator** The DN-045R MD replicator performs exact digital-to-digital dubs, up to 3.5 times faster than realtime without the cascade of ATRAC compression. The included Windows™ software also allows fool-proof editing during replication.

**DENON**  
The First Name In Digital Audio

Good-looking  
and loaded.  
No wonder it's  
so popular.



With its sleek front panel and top-loading shuttle, the new PCM-R500 DAT Recorder certainly catches your eye. But it's not just another pretty face.

It's packed with professional features not usually found in this price range. Like four direct-drive motors, which give you better tracking, a lower error rate, longer motor and tape life, and precision high-speed cueing and shuttling.

It has a software set-up menu for easy,

customized operation. And then there's Super Bit Mapping<sup>®</sup>, the technology that delivers superior, near 20-bit resolution sound without sacrificing compatibility with the industry standard 16-bit format.

Call 1-800-635-SONY, ext. R500 right now to learn more about the PCM-R500 DAT recorder. You'll love it because it's loaded. But hey, being good-looking never hurt.

— The PCM-R500 Professional DAT Recorder —

**SONY**

— 4 Direct-Drive Motors

— Variable Shuttle/Cueing Wheel

— AES/EBU and SPDIF Digital I/O

— New High Resolution Pulse A/D

— SBM (Super Bit Mapping) Filter in Conversion Circuitry

— A/D and D/A Monitoring Modes

— Balanced XLR Analog I/O

— User Set-up Menu



# BROADCASTERS copy holders

## Perfect Data Copy Holders

### Copy Holders

16004P	Easel Base Copyholder	\$27.50
16006P	Weighted Base Copyholder	\$42.50
16003P	Under Monitor Copyholder	\$42.50
16002P	Monitor Side Mount Copyholder	\$40.00
16007P	Flex-Arm Copyholder	\$50.00
16008P	Heavy Duty Flex-Arm Copyholder	\$57.50
<b>Accessories:</b>		
16055P	Wide Form Adapter	\$17.50
16060P	System Lamp - 110V	\$45.00
16050P	Motorized Line Guide - 110V	\$67.50
105344-1	Paper Clip w/Clock	\$7.00
105049-1	Bulb, replacement for lamp assy.	\$10.00
105512-1	Adjustable wrist rest	\$22.50

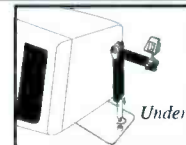
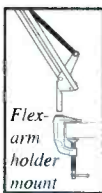

# BROADCASTERS equipment racks

## Lowell

Lowell stand alone cabinets (L60) are fabricated of MIG-welded 16 gauge CRS with 11 gauge CRS front mounting rails tapped 10-32 on universal EIA hole spacing in a textured black powder coat finish. A recessed locking rear door with concealed quick release spring loaded hinges offers versatile right or left swing. A locking plain front door, swivel casters and leg levelers are optional. Similar to the L60 cabinets are the series L65/L68 but includes locking plain front door with recessed pull handle and EIA standard mounting rails adjustable front to rear. All cabinets measure 22-1/8" wide.

Model	Vertical Panel Space	Rack Units	Height	Depth*	Ctn. Wt.	Price
L60-36	36-7/8"	21	44-11/32"	22"	98	\$531.78
L60-42	42-1/8"	24	49-19/32"	22"	106	\$554.50
L60-61	61-3/8"	35	68-27/32"	22"	142	\$634.95
L60-70	70-1/8"	40	77-19/32"	22"	158	\$707.75
L60-77	77-1/8"	44	84-19/32"	22"	169	\$741.85
L65-36	36-7/8"	21	44-11/32"	22"	102	\$815.39
L68-36	36-7/8"	21	44-11/32"	30"	108	\$989.55
L65-42	42-1/8"	24	49-19/32"	22"	110	\$883.85
L68-42	42-1/8"	24	49-19/32"	30"	116	\$1,072.63
L65-61	61-3/8"	35	68-27/32"	22"	148	\$1,025.98
L68-61	61-3/8"	35	68-27/32"	30"	156	\$1,225.25
L65-70	70-1/8"	40	77-19/32"	22"	164	\$1,094.28
L68-70	70-1/8"	40	77-19/32"	30"	172	\$1,327.98
L65-77	77-1/8"	44	84-19/32"	22"	177	\$1,143.45
L68-77	77-1/8"	44	84-19/32"	30"	188	\$1,387.68

\*Depth shown is an overall outside dimension.  
Usable inside depth is 4" less.

Lowell gangable cabinet frames afford an open-sided design for convenient wiring accessibility in single or multi-bay configurations. The frame is fabricated of MIG-welded 16 gauge CRS and has a fully recessed locking rear door and one pair of 11 gauge EIA standard tapped mounting rails adjustable front to rear with a textured black powder coat finish. Optional locking plain front door, removable louvered side panels, mounting rails, swivel casters and leg levelers.

Model	Vertical Panel Space	Rack Units	Height	Depth*	Ctn. Wt.	Price
L75-61	61-3/8"	35	68-27/32"	22"	103	\$801.48
L78-61	61-3/8"	35	68-27/32"	30"	109	\$953.98
L75-70	70-1/8"	40	77-19/32"	22"	112	\$861.88
L78-70	70-1/8"	40	77-19/32"	30"	118	\$1,018.20
L75-77	77-1/8"	44	84-19/32"	22"	117	\$892.60
L78-77	77-1/8"	44	84-19/32"	30"	127	\$1,106.18

\*Depth shown is an overall outside dimension.  
Usable inside depth is 4" less.

Please call for complete catalogs on Lowell and H.O.M.E.



## H.O.M.E.

House of Metal Enclosures, H.O.M.E. makes a comprehensive range of cabinets, enclosures, racks and consoles. Panel mounting hardware is supplied. The WRE Series is 18-1/2" deep, 22-3/8" wide and comes with fixed 11ga rack rails drilled and tapped for 10-32" screws in the standard gray hammer tone unless specified. A rear door with lock is included.

Model	Height	Rack Sp.	Price
WRE3675	41-1/8"	36-7/8"	\$553.15
WRE4200	46-3/8"	42-18"	\$576.78
WRE6125	65-5/8"	61-3/8"	\$660.43
WRE7000	74-3/8"	70-1/8"	\$736.13
WRE7700	81-3/8"	77-1/8"	\$771.55

Optional colors, solid or Plexiglas front door, cabinet shelves, locks, rack mounted shelves, rear rack rails, casters or roller truck and more.

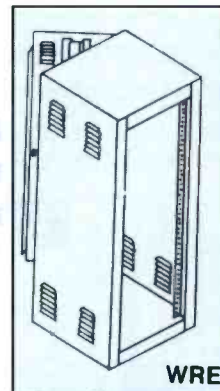

BGS

STUDIO FURNISHINGS





**BGS**

**STUDIO FURNISHINGS**

# equipment racks

## ZERO Stantron

**ZERO Stantron**  
FRK Series Knocked down and FRW Series Welded racks are 16ga w/base, top, side panels, rear door and two pairs of rack rails. The FR Series racks are Welded 14ga. with open sides, locking rear door, adjustable rails and conduit knockouts.

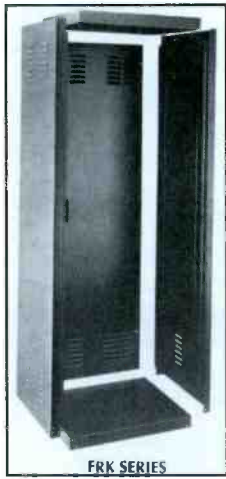

Model	Width	Height	Depth	Panel Ht.	Price	Door (-D)
FRK35-18	22-3/8"	39-1/16"	18-5/8"	35-1/16"	\$333.70	\$450.90
FRK61-18	22-3/8"	65-5/16"	18-5/8"	61-5/16"	\$425.70	\$571.00
FRK61-25	22-3/8"	65-5/16"	25-5/8"	61-5/16"	\$487.90	\$631.80
FRK70-18	22-3/8"	74-1/16"	18-5/8"	70-1/16"	\$455.30	\$611.10
FRW35-18	22-3/8"	39-1/16"	18-5/8"	35-1/16"	\$370.80	\$489.50
FRW61-18	22-3/8"	65-5/16"	18-5/8"	61-5/16"	\$479.10	\$608.10
FRW61-25	22-3/8"	65-5/16"	25-5/8"	61-5/16"	\$517.60	\$663.00
FRW70-18	22-3/8"	74-1/16"	18-5/8"	70-1/16"	\$514.70	\$671.90
FR52-18	22-5/32"	61"	18-5/8"	52-5/16"	\$603.70	
FR52-25	22-5/32"	61"	25-5/8"	52-5/16"	\$649.60	
FR70-18	22-5/32"	78-1/2"	18-5/8"	70-1/16"	\$707.50	
FR70-25	22-5/32"	78-1/2"	25-5/8"	70-1/16"	\$759.40	

Other cabinets, racks, consoles, fans (exhaust or intake) and power strips are available. Call Broadcasters General Store for ordering information.

## storage/furniture

### ABCO

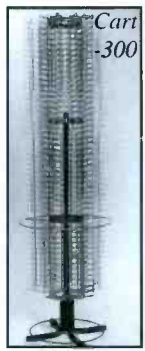

Cart Racks		
#50	Stringer holds 50 carts, 4-1/2"Wx6"Dx65"L	\$57.00
#300	Complete Lazy Susan holds 300, 6'H, 22" diameter	\$419.00
#500	Complete Lazy Susan holds 500, 6'H, 27" diameter	\$649.00
CD Racks, for standard jewel cases, (Denon cases are very snug)		
#70	Stringer holds 70 CDs, 5-1/2"Wx5-1/2"Dx69-1/2"L	\$71.00
#280	Complete Lazy Susan holds 280 CDs, 6'H, 22" diameter	\$375.00
#560	Complete Lazy Susan holds 560 CDs, 6'H, 27" diameter	\$679.00

## Alpha Storage

Alpha Black Storage Units		
CDO12	Holds 12 CD's, inter-locking and stackable	\$2.99
CDSP96	CD Spinner, holds 96	\$19.99
CDSP192	CD Spinner, holds 192	\$34.99
CDSP288	CD Spinner, holds 288	\$59.99
SSP44	CD Spinner, holds 44	\$5.99
SSP88	CD Spinner, holds 88	\$9.99
SSP132	CD Spinner, holds 132	\$13.99
SSP176	CD Spinner, holds 176	\$18.99
SSP220	CD Spinner, holds 220	\$22.99
CDMT20	Holds 20 CD's, angled design, can be wall mounted	\$4.99
CDR60	Holds 60 CD's, two rows, ideal for wall mounting	\$7.99
KDT60	CD Tower, 1 row, holds 60 CD's, angled design	\$9.99
KDT120	CD Tower, 2 rows, holds 120 CD's, angled design	\$17.99
ACR60	Holds 60 cassettes, 3 rows, ideal for wall-mounting	\$7.99

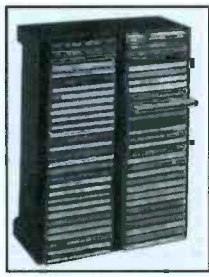
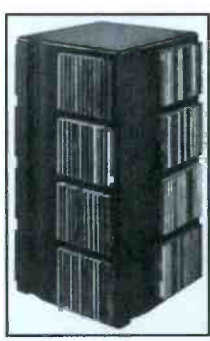

### Atlantic

Atlantic makes a wide variety of economical modular tape storage units, this is a sample.

1209	CD tower, holds 35, steel wire/mat black, 5"Wx4"Dx22"H(holds standard jewel case and Denon ACD-5B cases)	\$19.00
1229	Cassette tower, holds 25, steel wire/mat black	\$16.00
1230	VHS tower, holds 17, steel wire/mat black	\$18.00



## Masterpiece

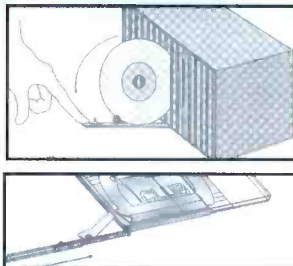

Masterpiece makes a CD case that provides easy one hand access without removing the whole jacket from the rack. You will never have to reorganize your filing system again! Made of special PP plastic, it can last much longer than regular cases. Cleaning fibers on both sides of the entrance wipe away any dust and dirt every time you access the CD. It is identical in size to the regular CD jewel case. The narrow end display material can be removed by sliding it out of the index jacket for easy index and labeling.

MPCD \$ .99

## ALPS

Alps storage for: cassettes, DATs, carts, CDs, all sizes audio reels, magnetic film, 8mm, VHS, M2, Beta, 3/4", D1, D2, and 1" reels. Alps cabinets have a reputation for craftsmanship and durability in high use situations that is second to none. If you compare cost per unit and density per square foot of floor space, you won't find a better value in media storage. All of Alps line of high density storage cabinets are 4' wide and 2' deep. Inserts come inside of every drawer and drawers can be mixed to fit your needs. The standard colors are: white, almond and gray. Other color laminates are available at an additional cost. These cabinets are shipped fully assembled by common carrier, you may want to specify inside delivery.

### ALPS CD/CD ROM Storage Cabinets:

CBA605	Five drawer base unit, holds 2120 CD's, 42"H	\$1,299.00
CBA908	Eight drawer base unit, holds 3392 CD's, 60"H	\$1,599.00
CBU466	Six drawer top unit, holds 1836 CD's, 45"H	\$1,539.00

### ALPS Audio Storage

CBA609	Nine drawer base unit, holds 2880 cassettes, 42"H	\$1,469.00
CBA913	Thirteen drawer base unit, holds 4160 cassettes, 60"H	\$1,759.00
CBU466	Six drawer top unit, holds 2016 cassettes, 45"H	\$1,539.00

### ALPS Video Cassette Storage

CBA607	Seven drawer base unit, holds 812 w/o box, 42"H	\$1,329.00
CBA910	Ten drawer base unit, holds 1160 w/o box, 60"H	\$1,579.00
CBU444	Four drawer top unit, holds 672 w/o box, 45"H	\$1,349.00
CBA606	Six drawer base unit, holds 510 w/box, 42"H	\$1,249.00
CBA909	Nine drawer base unit, holds 765 w/box, 60"H	\$1,499.00
CBU444	Four drawer top unit, holds 512 w/box, 45"H	\$1,349.00
Locks	Per cabinet charge	\$125.00



Please call for pricing on other tape storage units. This is just a sample of what's available.

## BRYCO

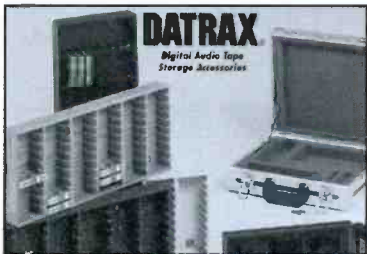

### DATRAX Wall mounts or tabletop Storage Units

DRP8	Holds 8 Dat's	\$4.99
DRP40	Holds 40 Dat's	\$21.95
CP48	Holds 48 Cassette's	\$21.95
V836	Holds 36 8mm Video	\$21.95
DR60	Holds 60 Dat's, solid oak satin finish	\$59.95
DRB60	Holds 60 Dat's, solid oak black finish	\$59.95
CD60	Holds 60 CD's	\$59.95



## Middle Atlantic

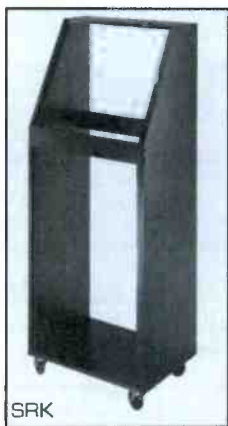

### Middle Atlantic Black Laminated Equipment Racks

They ship flat, assemble quickly and are constructed of 5/8" furniture grade MDF Board. Pre-installed rack rails are 1/8" thick black baked enamel steel, tapped for full hole spacing.

Part#	RU	Depth	Weight	Price
RK2	3U	16"	20 lbs.	\$82.50
RK4	7U	16"	23 lbs.	\$87.00
RK8	8U	14"	27 lbs.	\$120.00
RK12	12U	16"	34 lbs.	\$127.00
RK16	16U	16"	38 lbs.	\$138.00
RK20	20U	16"	44 lbs.	\$153.50
BRK8	8U	18"	31 lbs.	\$127.00
BRK12	12U	18"	36 lbs.	\$138.00
BRK16	16U	18"	41 lbs.	\$144.50
BRK20	20U	18"	46 lbs.	\$160.00
SRK	sloping rolling rack, 16U vertical by 16" deep, 12U sloped, 45 lbs.			\$273.50



BGS

STUDIO FURNISHINGS





**BGS**

**STUDIO FURNISHINGS**

## Middle Atlantic/RaXXess

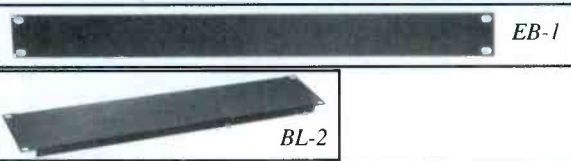

Middle Atlantic				RaXXess			
<b>Steel flat panels</b>							
1U	16ga	EB1	\$7.50	14ga	SFT1	\$6.99	
2U		EB2	\$9.50		SFT2	\$8.69	
3U		EB3	\$12.50		SFT3	\$10.59	
4U		EB4	\$15.50		SFT4	\$12.59	
5U		EB5	\$19.00				
6U		EB6	\$22.00				
<b>Steel flanged panels</b>							
1U	16ga	SB1	\$12.00	16ga	SFG1	\$11.95	
2U		SB2	\$15.50		SFG2	\$13.99	
3U		SB3	\$19.00		SFG3	\$15.99	
4U		SB4	\$20.00				
5U		SB5	\$23.00				
6U		SB6	\$26.00				
<b>Aluminum flat panels</b>							
1U	11ga	HBL1	\$17.50	1/8" Thick	AFT1	\$15.95	
2U		HBL2	\$22.00		AFT2	\$18.95	
3U		HBL3	\$31.00		AFT3	\$27.95	
4U		HBL4	\$37.00		AFT4	\$34.95	
5U		HBL5	\$39.00				
6U		HBL6	\$47.00				
<b>Aluminum flanged panels</b>							
1U	16ga	BL1	\$17.50	16ga	AFG1	\$16.95	
2U		BL2	\$21.00		AFG2	\$19.95	
3U		BL3	\$26.00		AFG3	\$24.95	
4U		BL4	\$29.00		AFG4	\$27.95	



Security Cover



Lexan Security Covers

### Security Covers

Mount easily over equipment with gasket to avoid scratching — 1" stand-off in black.

Security Covers	Middle Atlantic	RaXXess
1U big perforation	S1 \$28.00	SEC1 \$23.95
2U big perforation	S2 \$31.00	SEC2 \$23.95
3U big perforation	S3 \$34.00	SEC3 \$28.95
4U big perforation	S4 \$36.50	
1U fine perforation	SF1 \$28.00	PSC1 \$23.95
2U fine perforation	SF2 \$31.00	PSC2 \$25.95
3U fine perforation	SF3 \$34.00	PSC3 \$28.95

### Lexan Locking Security Covers

RAX/LSC-2 or 4	2U or 4U locking black enameled steel	\$44.95
RAX/LSC-2P or 4P	2U or 4U locking with lexan, see thru door panel	\$54.95
RAX/LSC-8P	8U locking with two lexan, see thru door panels	\$89.95
MAA/SECL2	2U hinged Plexi Security Cover	\$54.50
MAA/SECL4	4U hinged Plexi Security Cover	\$63.50
MAA/SECL8	8U hinged Plexi Security Cover	\$89.50

### RaXXess makes custom Rack Kits specifically designed for Technics Cassette, CD players and other consumer decks.

Assembles easily with four screws. Black, baked enamel finish on 16 gauge steel.

CDKit	2 Rack ears, 2 Filler panels, hardware	\$41.95
CSKit	2 Rack ears, 1 Filler panel, hardware	\$39.95

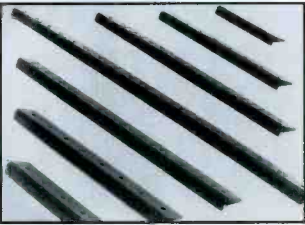

### Rack Rails

The RR and RK rack rails are 1/8" steel punched and tapped for 10-32 screws, with black enamel finish. The RRFG (.074") and GKRL (.075") are galvanized rack rails. Sold in pairs, bent for 19-1/8" wide (L to R) rough in.

### Middle Atlantic

2U	RR2	\$7.00	RRFG2	\$4.00
4U	RR4	\$11.00	RRFG4	\$7.00
6U	RR6	\$15.00	RRFG6	\$10.00
8U	RR8	\$18.00	RRFG8	\$12.00
10U	RR10	\$21.00	RRFG10	\$14.00
12U	RR12	\$25.00	RRFG12	\$16.50
14U	RR14	\$28.00	RRFG14	\$18.00
16U	RR16	\$31.00	RRFG16	\$20.00
18U	RR18	\$34.00	RRFG18	\$22.00
21U	RR21	\$38.50	RRFG21	\$25.00
27U	RR27	\$47.50	RRFG27	\$31.50
45U	RR45	\$68.00	RRFG45	\$44.50

### RaXXess

2U	RKRL2	\$5.95	GKRL2	\$3.95
4U	RKRL4	\$8.95	GKRL4	\$5.95
6U	RKRL6	\$11.95	GKRL6	\$7.95
8U	RKRL8	\$16.95	GKRL8	\$10.95
10U	RKRL10	\$19.95	GKRL10	\$12.95
14U	RKRL14	\$26.95	GKRL14	\$17.49
16U	RKRL16	\$29.95	GKRL16	\$19.49
27U	RKRL27	\$45.95	GKRL27	\$29.95
45U	RKRL45	\$64.95	GKRL45	\$41.95

CUT

Cutting charge

\$5.00

New



### Captive Washer Screws

A pre-installed nylon washer speeds installation while providing a clean, professional appearance. They are heat treated and wax-finished to resist rust. Screws are 3/4" long with 10-32 threads.



Square Bit

HW100	100 pc.	\$26.12
HW-500	500 pc. w/jar	\$100.00

### Rack Screws and Washers, Trim Strips and Shim Tabs

10-32 x 3/4" Phillips black oxide w/#10 nylon washers		
RAX/PTSW25	25 w/washers	\$5.25
RAX/PTSW50	50 w/washers	\$9.95
RAX/PTSW100	100 w/washers	\$19.95
RAX/SHWS	100—#10 nylon shoulder washers	\$7.50
RAX/SDS	100 Square Drive screws w/ washers	\$25.50
RAX/SDB	Square Drive Bit	\$2.00
MAA/HPS	25 w/washers	\$6.00
MAA/HP	100 w/washers	\$20.00
MAA/HS	100 Square Drive screws w/washers	\$25.50
MAA/SBIT	Square Drive Bit	\$3.50
MAA/HTX	50—Star Post Screws w/washers	\$15.00
MAA/TBIT	Star Post Bit	\$13.00
MAA/SW	100—Black nylon Shoulder Washers	\$8.50
MAA/TSA	Trim Strip channel that covers rack screws 77" long, black anodized	\$39.50
MAA/TSS	Trim Strip channel that covers rack screws 77" long, black powder	\$17.00
MAA/ST1MP	1-3/4" Shim Tab—.063 Thick (10 pcs. per pack)	\$44.50
MAA/ST2MP	3-1/2" Shim Tab—.063 Thick (100 pcs. per pack)	\$56.00
MAA/ST3MP	5-1/4" Shim Tab—.063 Thick (100 pcs. per pack)	\$80.00



## Middle Atlantic & RaXXess

Middle Atlantic has a custom rack shelf and bezel for almost any piece of equipment available.



Please call us for more information.

RSH4A	Black brushed aluminum custom rackshelf, 2-5 space	\$151.50
RSH4S	Black textured steel custom rackshelf, 2-5 space	\$127.00

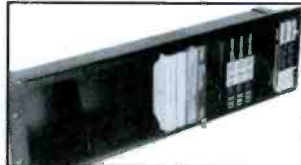

### Rackmounted Media Holders MAA RaXXess

Holds 40 CD's, 4U	CD	\$82.50	RCD	\$79.95
Holds 33 cassettes, 3U	CS	\$79.00	RCH	\$74.95
Holds 27 DATs, 3U	DAT	\$79.00	RDT	\$79.95
Holds 14 VHS tapes, 5U	VHS	\$100.00		
Holds LP/Laser disc/Binders, 8U	LP	\$193.50		
Holds 6 empty CD Jewel cases, 1U	CDI	\$42.50		



Sliding shelf  
latches in or out!

### Sliding Shelves

SS	Sliding shelf 17-1/2"W x 15-3/4"D, extends 14", up to 50 lbs. telescoping rear support fit all racks, occupies over 1U	\$131.50
SSL	Sliding shelf 17"W X 14"D, extends 11", up to 35 lbs. Universal telescoping rear support fits all racks	\$79.50

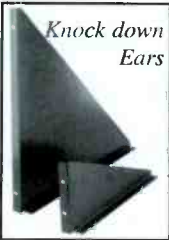

Knock down Ears



Rackmount Lockbox & Storage Drawer

### Knock down Shelves

These shelves are separate parts for putting together your own rack shelves. Flush studs are provided with the bottom for easy assembly. Fits all equipment up to 17-3/8" wide.



KDE2	2U L&R ears only, 15-1/2" deep	\$37.50
KDE2S	2U L&R short ears only, 11-1/2" deep	\$35.50
KDE3	3U L&R ears only, 15-1/2" deep	\$39.00
KDE3S	3U L&R short ears only, 11-1/2" deep	\$37.50
KDE4	4U L&R ears only, 15-1/2" deep	\$40.50
KDE4S	4U L&R short ears only, 11-1/2" deep	\$39.00
KDE5	5U L&R ears only, 15-1/2" deep	\$42.00
KDB	deep bottom 15-1/2" deep use with ears	\$21.00
KDB-20.5	20-1/2" deep bottom (for use with 15-1/2")	\$26.50
KDB-17.5	17-1/2" deep bottom (for use with 15-1/2")	\$24.00
KDSB	short bottom 11-1/2" deep use with short ears	\$20.00

These are available for up to 10 space ears at 15-1/2" deep. Approx. increase \$2/space.

### Utility Shelves

Quick and easy rackmounting for equipment not normally rack-mountable. One piece 16ga steel with a black finish.



Depth	Max. Load	Middle Atlantic	RaXXess
1U	11" 30 lbs.	U1 \$42.00	UTS1 \$41.95
2U	14-3/4" 50 lbs.	U2 \$56.00	UTS2 \$54.95
3U	14-3/5" 85 lbs.	U3 \$62.50	UTS3 \$59.59

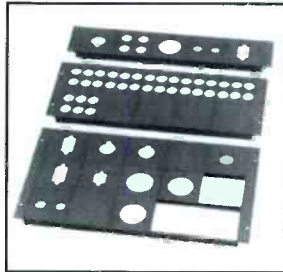

A unique system that allows you to design and put together your own custom connector panels out of stock products. UCP Panels are designed for XLR, Amp, Elco, BNC, MIDI, AC duplex, RCA, Phone, F connectors, and more. There is no panel deflection while inserting connectors and all hardware is flush making a professional custom installation.

Call us for help in configuring custom panels.

UCPS	Any punched UCP single module	\$11.00
UCPB-1	Single width blank module	\$11.00
UCPB-2	Double width blank module	\$21.00
UCPB-3	Triple width blank module	\$26.50
UCPB-4	Quad width blank module	\$30.00
FK-2	2 space UCP frame kit w/hardware	\$31.00
FK-4	4 space UCP frame kit w/hardware	\$58.50
FK-6	6 space UCP frame kit w/hardware	\$86.00
UCP-SF	Hinged FK-2 frame kit	\$38.00
UCP-CH	8" Deep UCP chassis, 2 space	\$62.50
UCP-ADP	UCP Panel 1900 box adapter	\$11.00
UCP-CT	Cable trap 5" deep, mounts to FK-2	\$27.00

### Rackmount Lockboxes and Storage Drawers

MAA-LBX3	3U by 8-1/2" deep Lockbox	\$79.50
MAA-LBX4	4U by 8-1/2" deep Lockbox	\$89.50
RAX-RKV3	3U by 9" deep Vault box	\$79.95
RAX-RKV4	4U by 9" deep Vault box	\$89.95

Economy Drawer, light duty rollers, extend to 11", 14" deep, storage height is 1/2" less rack height.

1U	N/A	RAXESD1	\$69.95
2U	MAAUD2	\$96.00	RAXESD2 \$74.95
3U	MAAUD3	\$109.00	RAXESD3 \$79.95
4U	MAAUD4	\$118.00	

Premium Drawer, ball bearing rollers, extends to 14", 14" deep, storage height is 1/2" less rack ht.

2U	MAAD2	\$144.50	RAXSDR2 \$139.95
3U	MAAD3	\$162.50	RAXSDR3 \$159.95
4U	MAAD4	\$173.50	RAXSDR4 \$179.95
5U	MAAD5	\$187.00	
8U	MAAD8	\$220.00	

### Options for Rack Drawers

MAAKYLK	User installed keylock for UD Drawers	\$18.00
MAALATCH	User installed latch, secures UD drawer closed	\$13.50
MAALK	Add this suffix to keylock any D series drawer, factory installed	\$33.50
MAADWS	Writing/work surface, fits D series drawers	\$42.50
RAXXLOCK	Optional lock for ESD & SDR	\$12.00



BGS

STUDIO FURNISHINGS





**BGS**

**STUDIO FURNISHINGS**

## Nigel B



CD  
Drawer



DAT  
Drawer



SS-18



Cassette RM



Mixer on a Stick

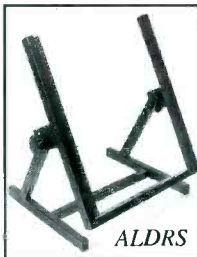

ALDRS

### Rack Mount Storage

2DATD	2U, Dat drawer, holds 92, 18"D	\$179.95
4CD	4U, CD drawer, holds 72, 18"D	\$189.95
3FDD	3U, 3-1/2" Floppy or Mini Disc drawer, holds 112, 18"D	\$179.95
AC-3D	3U, Cassette drawer, holds 60, 18"D	\$169.95
H18-3D	3U, Hi 8 drawer, holds 60, 18"D	\$169.95
VHS-3D	3U, VHS drawer, holds 30, 18"D	\$169.95
RMKS	Holds up to 15" computer/video monitor, slides out on 100 lbs rated ball bearings, faceplate 13.5"w x 11.25"h 8U	\$239.95
6FD	6U, Filing Drawer, 18"Dx10-1/2"W, 100 lbs capacity	\$199.95
SS18	1U 18" Deep Sliding Shelf	\$149.95
SS24	1U 24" Deep Sliding Shelf	\$169.95
RE-KP	Rack Mounted Adjustable Angle Shelf	\$149.95
POWS-18	Pull out 18" writing shelf, wt. capacity 100 lbs.	\$179.95
DCL	Drawer Lock Set for all Drawers	\$39.95



RS

### Equipment Stands

ALDRS	13U Desktop Rack Stand, 28lbs.	\$199.95
RS	13U Recorder Stand, additional 7U between legs, 34lbs.	\$459.95
MS	24" top adjust from flat to vertical, 7U between legs, 32lbs.	\$359.95
MP	Mobile pedestal platform, ideal for speakers or monitors	\$299.95
STU10	Audio Tallboy, 12U sloping top and 12U lower rack section	\$699.95
1202STK	Mixer on a stick for Mackie 1202, channel conceals cables	\$169.95
1015STD	Mobile Rack stand has 10U on top frame (could hold the Yamaha ProMix) and 15U below. Comes with total-lok casters	\$479.95
PROTBL	Project Table with adjustable height and angle. (fits Mackie 24/4 or Yamaha O2R) Comes with total-lok casters	\$599.95



1015STD

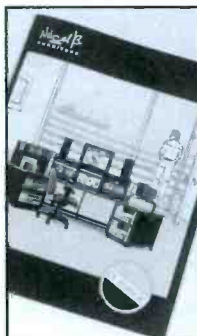

### Lighting/Power

SP8	Rack mounted 8 outlet power strip w/full surge protection receptacles allow use of wall warts to use most outlets	\$139.95
SP8-LT	Same as SP8 with switched outlet for an optional 360° Gooseneck lamp	\$169.95
12M-HI	12" Gooseneck lamp, with big shade to dissipate the heat, it will not get hot, and rotates 360° for more directional light	\$39.95
M-HI12S	12v lampset, low voltage with a Halogen lamp, built in dimmer and switch Features the larger swivel lamp shade. Comes with 117-12v transformer	\$69.95

### WorkStations

MPS	Mobile Production Station	\$1,099.95
SWS	Senior WorkStation	\$2,499.95

*We'd be happy to send you a Nigel B catalog!*



MPS

## Studio Furniture



Ruslang  
Furniture



Ruslang  
Furniture

**Murphy Studio Furniture**, located in Spring Valley, California, has a unique blend of ergonomics and aesthetics with three standard series to choose from: Classic, Premier and Elite or your own custom design.

**Nigel B Furniture**, located in Burbank, California, is a "building block" furniture system that grows with you. Its versatility allows you to make any number of changes, knowing that what you add will match your existing layout. You will find this modular concept also extends to a growing range of accessories.

**OMNIRAX Studio Furniture**, located in Sausalito, California, has a unique blend of beauty, function and solid construction.

**The Express Group**, located in San Diego, California, has a selection of six different series of furniture to choose from or will do a custom design to suit your needs. Depending on your budget and requirements you should be able to find the perfect furniture for your studio.

**Ruslang**, located in Bridgeport, Connecticut, has the standard HD and S series of furniture available or will customize to suit your need.

*Call Broadcasters General Store for complete information and pricing on any of these fine studio furnishing companies.*



# storage/furniture



## Ruslang

Ruslang CD Storage compatible with standard CD case and Denon ACD-5B cases.

CD-32	6-9/16" wide, 5-3/8" deep, 23-3/8" high	\$65.00
CD-64	12-38" wide, 5-3/8" deep, 23-3/8" high	\$89.00
CD-96	18" wide, 5-3/8" deep, 23-3/8" high	\$115.00

Ruslang Modular Record, Tape, and CD Storage systems can be mixed making many various configurations available. If you don't see what you want just ask and Ruslang will customize it for you.



**BGS**

**STUDIO FURNISHINGS**

## Littlite

"L" series sets come complete and ready for easy surface mounting. All sets are available in 6, 12, or 18 inch lengths with bulb, mounting base and fully adjustable dimmer. Each set also includes a 6 ft. cord, a two piece snap mount, screws for permanent mounting, and a wall plug-in transformer for 120 volt operation.

### Low Intensity Series

### High Intensity Series

BNC Detachable Lamp w/Base and dimmer	
L-1/6,12,18	\$57.00
L-1/6A,12A,18A	\$47.00
Attached Lamp w/Base and dimmer	
L-2/6,12,18	\$47.00
L-2/6A,12A,18A	\$37.00
Q5	5-watt tungsten-halogen replacement bulb (use w/Hi Intensity hood) \$9.00

Also available as individual BNC, 3 pin XLR, 4 pin XLR, 4 pin XLR right angle detachable lamps or as an individual permanent mount lamp.



RL-10D

The High Intensity Raktlite comes complete with a 12" flexible gooseneck, bright 5 watt halogen bulb, dimmer rheostat, 6 foot cord and transformer. The light is recessed into a sturdy black metal E.I.A 1U. It is available in single (RL-10S) or dual (RL-10D).

RL-10S	\$99.00	RL-10D	\$149.00
RL-10SA	\$89.00	RL-10DA	\$139.00

All Littlite "A" versions are available without the transformer and can be powered by any available 12 volt supply. "E" versions with Euro transformer 220V are also available.

# warning lights

## Enberg



Enberg BA-6 monitor provides your control room with a complete view of important status information at a glance. Each of the six flashing indicators are capable of 3 modes of operation: telephone latching, auto reset, and manual reset. The BA-6 also has a DC output (150ma @ channel), designed to drive the BA-6F remote monitor for duplicate displays in other studios.

BA-6	Includes 1 FN-6 and a set of labels	\$389.00
BA-6R	Remote	\$239.00
BA-6RX	Rack mount remote includes 1 FN-6	\$389.00
BA-6RXX	Rack mount remote only	\$119.00
FN-6	Phone module, detects ring on 2 separate lines	\$39.00
Labels	Standard label set (32 titles)	\$15.00
FH-6	Modification	\$20.00

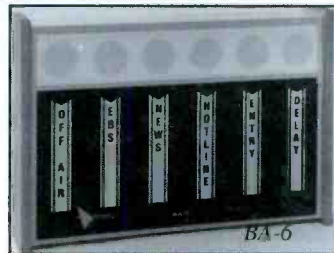

Enberg CQ-3 Cue Monitor keeps an eye on program outcues in your studios or throughout the station. A single closure will initiate a display sequence (up to 3 stages, 1-60 secs. each) that ends with the "cue" channel.

CQ-3	\$199.00
------	----------



## Wheelock

Wheelock TelStrobe® is ideal for signaling your board operator when the telephone rings. Their solid-state design utilizes a xenon flash tube for brightness, long life and low power consumption. Strobes operate directly from telephone line ring voltage and low voltage AC or DC power supplies.

PS-11A-WPW	40-130V, 16-68Hz + 115 VAC, 70KCP	\$97.30
PS-33AWPW	18-30VAC/VDC, 25KCP	\$88.59



**BGS**

**STUDIO FURNISHINGS**

**181**

# Warning lights

## On~Air Lights

Fidelipac 340	On Air (specify language w/order)	\$80.00
Fidelipac 340 REC	Record	\$80.00
Titus OAL-xyz	On Air Light Series with Oak Housings	\$125.00
Specify	x= H for Horizontal or V for Vertical y= G for Gold tone frame or S for Silver z= None for On Air or R for Recording Custom lettering, engraving and wood available.	
Pro Lights L101	Micro Series On Air Light, 24Vdc, Red or White Lens	\$32.50
Architectural Series	Flat wall mount with lens	\$149.00
Architectural Series	Ceiling or extended mount with dual lens	\$169.00
Lens	Specify Record, On Air, or Mic Picture Only	\$15.00
Lens	Blank	\$13.00
COM3636	On Air Light w/Red incandescent Bulb, 110Vdc	\$59.00
RB-1	25 Watt red replacement bulb	\$5.95
Connectronics SIS	5-1/2"x8-3/4"x7-3/4", 120V, Base & red cover	\$110.00

Specify: On Air • Recording • Mic Live • No Entry • Silence Please • Meeting in Progress • or unprinted. Other colors and legends available to order.

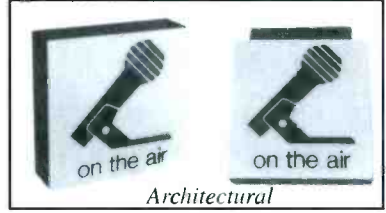

# weather instruments

## Computemp

The **Computemp 5** has continuously-alternating readouts displaying both the time of day and temperature at the two locations you are monitoring. Its unique memory function keeps track of daily temperature extremes and alerts you to critical temperature changes.

CompuTemp 5	LED display, AC powered w/9V battery back-up	\$94.95
-------------	--	---------

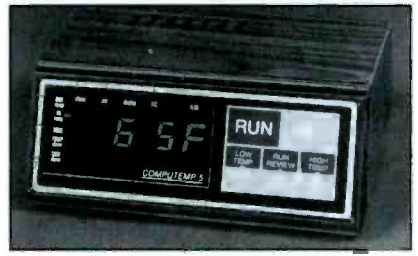

## Rainwise

The **RainWise Weather Station** provides an LED digital readout for time, indoor and outdoor temperature, barometric pressure, wind direction, wind speed, windchill, rainfall, and outdoor relative humidity. Its microprocessor computes and accumulates degree days heating and cooling throughout the year with maximums and minimums being provided for any desired period to the nearest hour, day and month.



Weather Station	\$990.00
Computer Capable Weather Station	\$1,300.00
Oracle 1	\$595.00
Oracle 2	\$559.00
Oracle 3	\$439.00
Oracle 4	\$439.00

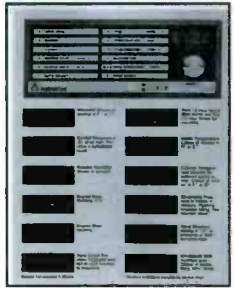

# cellular interface

## Conex



The **Conex CJ-20 CellJack** is a compact cell-phone adapter that allows easy remote broadcasts via your cellular phone. The CellJack provides a transformer isolated and balanced XLR input with switchable high/low gain for connection to either an external mixer or a standard broadcast dynamic microphone. The stereo headset jack allows monitoring of the cell-phone audio and, when an external radio is plugged into the tuner input jack, its audio is fed to one side of the headset. Includes the interconnect cable for the Motorola "bag-phone" C.

CJ-20	\$245.00
-------	----------

**Many Items in Stock for Immediate Delivery...Call Today!**



## AEQ

The new upgraded version of the **AEQ ACD-3001** makes it compatible with other audio codecs. It is a full duplex coder/decoder with an aux data channel and multiformat G.722 and ISO/MPEG II compression. It provides more than 10kHz bandwidth and uses 46, 32, 24, and 16kHz sampling rates. Suitable for switch 56 and 64, user selectable.

ACD-3001 \$2,200.00



**BGS**

## Comrex



The **Comrex DX200 Music Line** is designed to provide the lowest cost solution for high quality stereo audio on digital phone lines. The DX200 uses ISO/MPEG Layer II coding to send up to 20kHz stereo audio over digital transmission paths as low as 112kb/s. The DX200 is a "second generation" codec which implements the recent updates to the Layer II algorithm, including a choice of input sampling rates at 24, 32, and 48kHz. The DX200 encoder may be user-configured for a variety of output data rates and for stereo, joint stereo, dual mono or mono operation. It supports data transmission rates up to 384kb/s. The G.722 algorithm is also included for low delay 7.5 or 15kHz audio. Offering a wide variety of configurations, the DX200 is compatible with almost every mono or stereo codec on the market today.

DX200 \$3,000.00  
 DX200RC \$300.00



The **Comrex Nexus** has everything you need for sending great sounding audio over ISDN. Audio codec, terminal adapter and NT1 are integrated into a rugged, 3 pound, easy-to-use package. The Nexus provides low delay 15kHz bidirectional audio on 112/128kb/s circuits such as BRI ISDN. It also provides standard G.722 7.5kHz audio at transmission rates of 56/64kb/s. Audio input

is mic or line and the output is a variable mix of codec return and local program. For complete digital communications, the Nexus supports ancillary data to provide a computer link between send and receive sites.

NEXUS \$2,300.00  
 NEXUS \$2,500.00

The **Comrex DX100** is a full mono/stereo apt-X encoding/decoding system. Apt-X is considered a very stable data reduction method with high immunity to transcoding problems and very low coding delay. It is a good choice for STL or studio-to-studio applications. The DX100 is capable of bidirectional 15kHz stereo at a data rate of 256kb/s. On a single ISDN phone line, the codec can pass two-way 15kHz mono audio at 128kb/s. An Inverse Multiplexer is included which will "add together" the data rate of two independent 56 or 64kb/s data channels.

DX100 \$3,000.00

*See Adtran CSU/DSU and terminal adapters of Page 185.*



Like the Nexus, the **Comrex DXR.1** and **DXP.1** codecs provide a full 15kHz bidirectional feed on 112/128kb/s circuits and use the G.722 standard for 7.5kHz at 56/64kb/s. Since they have very little processing delay, these codecs are the best choice for live programming such as talk, news and sports, where real-time cueback is essential. The DXR.1 is a rack mount unit while the DXP.1 is compact and portable. An external DSU/CSU or terminal adapter is needed to interface these codecs to your data circuit. DB25 cable included.

DXP.1 \$1,500.00  
 DXR.1 \$1,500.00  
 V.35 Cable \$40.00

## Intraplex

The **Intraplex Model 4464** digital audio codec transceiver is designed to facilitate high-fidelity audio broadcasts over the new switched digital networks. The codec provides MPEG II audio at a nominal 15kHz or 20kHz bandwidth in both directions of an ISDN link. The Model 4464 features include: Convenient compact size, full two-way operation - encoding and decoding in the same box, built-in ISDN Terminal Adapters with S/T and U interfaces for universal network compatibility, built-in bonding - compatible inverse multiplexer for dual channel synchronization, simple user interface with "one-touch" call setup, auto-detection of the receive audio characteristics, and auxiliary data port at up to 9600 baud. The Model 4464 is the smallest, lightest, full stereo codec on the market.

4464 \$2,495.00



T  
E  
L  
E  
P  
H  
O  
N  
E  
  
E  
Q  
U  
I  
P.



## Musicam USA

**CDQPrima** codecs contain MUSICAM® enhancement to the ISO/MPEG Layer II algorithm, certified Layer II compatible by the IRT, ISO/MPEG Layer III, and G.722. All models support transmission bit rates from 24 to 384 kb/s and sampling rates from 16 to 48 kHz. AES/EBU digital I/O is optional on 110 & standard on all others. All models have 20 bit A/D converters and give you better than 92dB dynamic range and under 0.01% THD+N. All models feature Prima Logic Language for automatic functions, full remote control, multiple ancillary data streams with rates up to 38.4 kb/s, 256 speed dial addresses, multiple location TA support, split channel mode and quick configurations for simplified operation. World power supply, 90-250 VAC, 47-65Hz. Manufactured in an ISO-9000 certified facility for superior performance under harsh conditions.

*Please call for additional features, options, information and pricing.*

### Each CDQPrima codec supports MPEG-I/II/III and G.722.

110	1U, Character LCD, accepts 1 Interface Module	\$3,250.00
120	Same as the 110 plus: AES/EBU (DB9) Digital I/O, Headphone Output, Cue Keypad, Cue & Status LEDs, Front Panel RS232 Remote Control, RS485 Control Port	\$4,200.00
210	2U, Character LCD, accepts 3 Interface Modules, AES/EBU (XLR) Digital I/O, RS485 Control Port	\$3,750.00
220	Same As the 120, but 2U and accepts 3 Interface modules	\$4,700.00
230	Same as the 220 plus: Spectrum Analyzer and Phase Displays, Extended Feature Keypad with 8 Assignable "Hot" Keys	\$5,700.00
TA301	Plug-in ISDN Terminal Adapter with built-in NT-1 (for NA operation)	\$850.00
DIF102	Plug-in V.35 Digital Interface	\$100.00

### Codec Packages:

**CDQPrima—Stereo, Includes VU meters, AES/EBU I/O, headphone & front panel R/C jacks-1 interface module slot.**

#1203	120—20kHz bi-directional with ISDN terminal adapter and NT1	\$4,950.00
#1202	120—20kHz bi-directional with RS422/X.21 interface only	\$4,300.00
#1201	120—20kHz bi-directional with V.35 interface only	\$4,300.00

**CDQPrima—Economy Stereo, ideal for unattended operation, STL, Backup, Etc.-1 interface module slot.**

#1103	110—20kHz bi-directional with ISDN terminal adapter and NT1	\$4,000.00
#1102	110—20kHz bi-directional with RS422/X.21 interface only	\$3,350.00
#1101	110—20kHz bi-directional with V.35 interface only	\$3,350.00

**CDQPrima—Stereo, with VU meters, XLR AES/EBU I/O, headphone & front panel R/C jacks, RS485-3 interface module slots.**

#2203	220—20kHz bi-directional with ISDN terminal adapter and NT1	\$5,450.00
#2202	220—20kHz bi-directional with RS422/X.21 interface only	\$4,800.00
#2201	220—20kHz bi-directional with V.35 interface only	\$4,800.00

**CDQPrima—Economy Stereo, includes XLR AES/EBU & RS485-3 interface module slots.**

#2103	210—20kHz bi-directional with ISDN terminal adapter and NT1	\$4,500.00
#2102	210—20kHz bi-directional with RS422/X.21 interface only	\$3,850.00
#2101	210—20kHz bi-directional with V.35 interface only	\$3,850.00

**CDQPrima—Deluxe Stereo, includes all features above plus graphics LCD, spectrum analyzer, X-Y phase display, extended keypad with assignable hot keys and enhanced status display-3 interface slots.**

#2303	230—20kHz bi-directional with ISDN terminal adapter and NT1	\$6,450.00
#2302	230—20kHz bi-directional with RS422/X.21 interface only	\$5,800.00
#2301	230—20kHz bi-directional with V.35 interface only	\$5,800.00

**Portable Mono, Ideal for Full Bandwidth Remotes & Voice-over**

RR103	RoadRunner—20kHz bi-directional codec/mixer with built-in ISDN terminal adapter & NT-1	\$2,800.00
RR101	RoadRunner—with V.35 or X.21 interface (Please specify)	\$2,600.00

**Micro™ Series Bi-directional 7.5kHz Mono G.722 Codecs**

Micro66i	Portable, V.35 or X.21 Interface, switchable 56/64 kb/s data rate	\$1,900.00
Micro66r	As above, but with 19" Rack Mount	\$1,900.00

**CDQ1000 Bi-directional 10kHz Mono MUSICAM & G.722 Codec**

CDQ1000	19" Rack Mount, V.35 and X.21 Interfaces	\$2,995.00
---------	--	------------

**CDQ2001 Series 20kHz Stereo MUSICAM Codecs, 18 bit A/D, Remote Control, & 32/48 kHz sampling rates**

CDQ2001E	Encoder (transmit) only, 1RU, 19" rack mount	\$3,750.00
CDQ2001D	Decoder (receive) only, 1RU, 19" rack mount	\$3,250.00
CDQ2001ED	Bi-directional Encoder/Decoder, 2RU, 19" Rack mount	\$6,000.00



**RoadRunner™** is a portable, mono ISDN codec/mixer with built-in terminal adapter and NT1, and includes MUSICAM®. Layer 3. G.722 and G.711 algorithms. RoadRunner is fully bi-directional. It will deliver 15 kHz audio on a single ISDN "B" channel (using Layer 3), and 20kHz on a full ISDN BRI (112 or 128 kb/s). In addition to its RJ-45 output connector for ISDN, RoadRunner has a standard RJ-11 that can feed 3.3kHz audio into a regular phone line if ISDN is not available. It features two mic and one switchable mic/line input, two headphone monitor circuits, each with its own send & receive level controls, and four on-board dry, floating relay contacts for in-band signaling.

RR100	RoadRunner (main chassis only)	\$2,500.00
RR101	with DIF101 (X.21 or DIF102 (V.35)	\$2,600.00
RR102	with TA201 TA, for international	\$2,800.00
RR103	with TA301 TA, for North American	\$2,800.00
TC1	Travel Case for RR & accessories	\$250.00



**Olympian™** is a portable, stereo ISDN codec/mixer with memory for full duplex bi-directional operation. It contains MUSICAM®. Layer II, Layer III, G.722 & G.711 algorithms, plus hybrid interface for direct connection to an analog telephone line. Three headphone outputs, each with separate send and return level controls. 256 speed dial addresses, plus storage for multiple venue terminal adapter configurations. Olympic Memory Snap Shot—OMSS+—smart preset lets you save all parameters.

OL102	with TA201, for international	\$5,200.00
OL103	with TA301, for North American	\$5,200.00
TC2	Travel Case for Olympian	\$325.00



**BGS**

**TELEPHONE EQUIP.**

**Many Items in Stock for Immediate Delivery...Call Today!**



# BGS couplers

## CircuitWerkes

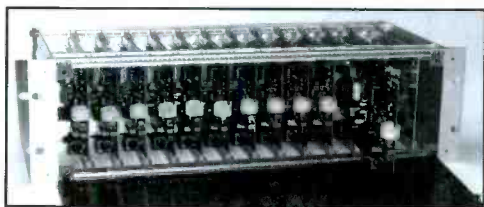

**CircuitWerkes AC-12** allows you to fit up to a dozen, full-featured telephone autoco couplers in 3U of rack space. The AC-12 has two bridging, balanced inputs and switchable, busses for audio distribution.

For network feeds you can select between two dedicated audio busses or, for special needs, each coupler card has its own individual 600Ω bi-directional audio connection. Cards can be removed or installed while powered without affecting the others. All controls and indicators are removed. Indicators include ring, on-line, audio clipping and power.

AC-12	Powered multi-bay autoco coupler chassis with 2 AC-1's	<b>\$639.00</b>
AC-1	Coupler cards for AC-12	<b>\$155.00</b>

## Excalibur

The **Excalibur HC-1** connects between the phone and handset. It will send and receive audio via 1/4" TRS jacks. There is a send level adjustment and a switch to select handset audio or external audio.



HC-1	<b>\$99.00</b>
------	----------------

## Gentner



The **Gentner Auto Coupler** can send or receive line level audio sources. It will automatically answer after one complete ring and disconnects when the caller hangs up. Use the Auto Coupler for information lines, IFB, or any use requiring automatic operation.

Auto Coupler		<b>\$329.00</b>
Auto Coupler CP	for telco lines without "loop drop" hang-up signal	<b>\$329.00</b>
Rack Mount	holds four units	<b>\$49.00</b>



**Gentner's Hybrid Coupler** connects directly to the telephone line and is used to send or receive audio or other information. Its passive design allows you to "tap" the phone line, using the telephone and coupler simultaneously, or it can seize the line. Use it for news or producer feeds, or sending a church service broadcast.

Hybrid Coupler		<b>\$189.00</b>
Rack Mount	holds four units	<b>\$49.00</b>

## Indy Audio

The **Indy Audio TC-1** is an auto-answering phone coupler. It can feed audio down the line to the caller, take audio off the line for broadcast, or can be connected to a hybrid for bi-directional communications. The TC-1 is powered by the phone line, a front panel LED indicates when the unit is in use, and a dry relay closure is provided to start a cart deck and alert the control room operator, etc. A voltage reversal or temporary open circuit is required for auto disconnect.



TC-1	<b>\$159.00</b>
------	-----------------

## The CircuitWerkes AC-3

The **CircuitWerkes AC-3** is a simple hybrid that provides a separate, unbalanced, send and receive port. Its new, on board limiting provides loudness without clipping distortion. Normally open, dry relay contacts close either momentarily or latch at the beginning of a call, and answers on a programmable number of rings. A combination lock option for a secured coupler can be easily added.



AC-3	Telephone auto coupler	<b>\$239.00</b>
C-Lock2	Combination lock	<b>\$99.00</b>

## Comrex

The **Comrex TCB-1** manual coupler provides a switched-hold connection to a telephone line so that the telephone set may be hung up during program feeds. Use with any modular phone to send or receive live or taped material. Very convenient for field use and does not require batteries or external power. The **TCB2** automatically answers a telephone line on the first ring and disconnects that line when the calling party hangs up. Ideal for unattended situations such as "listen lines", IFB feeds, dial-up networks, remote transmitter sites and satellite links. The TCB-2 requires an external AC supply.



TCB-1A	Manual Coupler	<b>\$150.00</b>
TCB-2A	Auto-Answer Coupler	<b>\$250.00</b>
Detect Board		<b>\$125.00</b>

## JK Audio



**JK Audio QuickTap** connects between your telephone and handset jack so that you can talk over your handset and record both sides of the conversation. You can also get presentation quality audio using a powered speaker or PA system. No batteries needed.

QuickTap	<b>\$59.00</b>
----------	----------------



Connect **JK Audio THAT-1** between your telephone and handset jack to record or play tapes down the telephone line. A handset/line in button enables you to either talk or play a recording down the phone line without changing

cables. It works with analog, digital, PBX, ISDN and single line telephones. You can also get presentation quality audio using a powered speaker or PA system. No batteries needed.

THAT-1		<b>\$150.00</b>
THAT-2	As above including, RCA & XLR I/O, also switches between carbon, dynamic, or electret handset types	<b>\$225.00</b>

## Sound America

These palm-sized telephone audio couplers are placed between the phone and handset and send and receive audio via a 1/8" minijack. The TAC offers a mute switch 8-32Ω input and an attenuator selector. The TAC+ has an additional 600Ω input select, more attenuation control and a cough button.

TAC	<b>\$89.50</b>	TAC+	<b>\$99.95</b>
-----	----------------	------	----------------



**BGS**

TELEPHONE EQUIP.





**BGS**

**T  
E  
L  
E  
P  
H  
O  
N  
E  
  
E  
Q  
U  
I  
P.**

## Adtran

Adtran's **ISU2X64** is a dual port version of the ISU128. The ISU2X64 can be viewed as a Dual Modem that supports two applications, simultaneously and independently, at up to 64 kbps on each DTE interface. For high speed applications over 64 kbps, a single DTE interface can achieve up to 128 kbps using the BONDING protocol.

ISU2X64 \$1,195.00

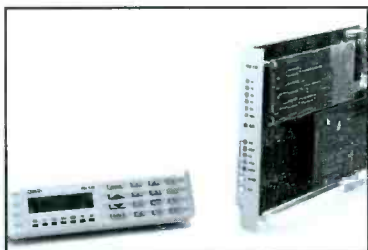
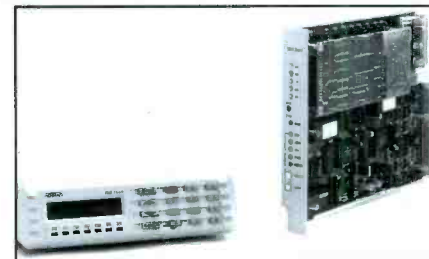

Adtran's **ISU128** is a stand-alone ISDN Service Unit that connects data terminal equipment directly to the ISDN network. The ISU128 includes NT1 network termination and terminal adapter functionality. Synchronous and asynchronous rates are supported through a V.35 or RS-530 interface. For speeds over 64 kbps, the industry standard BONDING protocol is used to aggregate the two 64 kbps "B" channels.

ISU128 \$995.00

The **Adtran DSUIIAR** is a technologically advanced, high performance data service unit (DSU/CSU). It provides an interface between Digital Data Service (DDS), Basic Data Services, 4-wire Switched 56, and the customer's data terminal (DTE). The DTE interface can be selected as either RS-232 or V.35 for all data rates.



DSUIIAR \$725.00

## frequency extension



## AEQ

The **AEQ TLE-02** is a digital phone hybrid, digital line extender and portable mixer. It has independent level control of the mic/line input, aux input and headphones. This unit is ideal for field reporters, weighing only 3.3 lbs., using 8 AA batteries or an external AC/DC adapter and supplied with a carrying bag.

TLE-02 \$1,130.00

## Comrex



The basic **Comrex LXT/R** one line frequency extender system works with a standard dial telephone line or a cellular telephone to pass 250Hz of additional low frequencies. This results in more natural sounding audio, eliminating the "tinny" telephone sound. The LXT/R combines the function of an encoder and a decoder - the choice is made by pushing a single switch. (An LXT/R is required at both the sending and receiving ends of the phone line.)

LXT/R Single Line Extender \$850.00

The **Comrex 2X** system sends 50Hz-5kHz of program audio on two ordinary dial telephone lines. Its unique noise reduction system will handle the high noise of long distance circuits for high quality program transmission. The 2XP Encoder accepts an external console input and contains abuilt-in telephone interface for two program lines, with a third for communications. The 2XR Decoder requires two Comrex TCB-1A Telephone Couplers (or equivalent) for connection to dial lines.

2XP	Two Line Encoder	\$3,500.00
2XR	Two Line Decoder	\$3,000.00
2XP	Rugged Travel Case	\$175.00

The **Comrex 3XP.1/3XR.1** Multiline Frequency Extender System allows high quality 50Hz - 8kHz audio to be sent over three standard dial telephone lines. Comrex's six-band noise reduction system assures a clean, quiet feed, even on noisy international circuits. Built-in automatic dialing and "one-button" setup makes the 3XP.1 encoder extremely easy to operate. At the receive site, the 3XR.1 automatically answers and equalizes the lines and disconnects when the remote site hangs up.

3XP.1	Multiline Encoder	\$4,500.00
3XR.1	Multiline Decoder	\$4,500.00
3XR.1	Remote Control	\$250.00
3XP.1	Rugged Travel Case	\$175.00
3XP.1	Rack Adapter	\$100.00



## AEQ



Through the use of DSP technology the AEQ TH-02EX exhibits exceptional trans-hybrid loss. By taking advantage of the built-in mix-minus buss you get 50dB null with a single caller and 45dB null with two callers. This 1U hybrid also offers transformer balanced I/O and remote connector.



**BGS**

## Gentner



The **Gentner TeleHybrid** is the only digital hybrid that can interface with the handset of your analog or digital phone. Anyone in your facility can screen calls and transfer them to the TeleHybrid, since it's connected to your phone. All the features of your phone remain active, such as speed dial, conference, transfer, etc. The TeleHybrid will automatically adjust to a variety of telephone line conditions to keep audio levels consistent. Cable to your console, cord to your phone and external power supply provided.

TH100 \$729.00

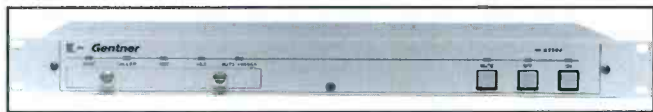

The **Gentner G2500** does not require a special mix-minus feed. Just plug it into your audio console and the G2500 creates its own mix-minus to the caller. Use it for dedicated VIP calls with your other phone equipment, conferencing through the console or for phone calls in other studios. Several units link to make a mini conference bridge. Features include: auto-answer/disconnect • auto null and auto re-null • caller mute • and up to eight units can be conferenced together.

G2500 \$1,995.00



Gentner's versatile **TC-100** telephone hybrid can be used for auto-answer information lines, on-air telephone calls, or program feeds. Simple remote control of equipment is also possible. It has a touch-tone decoder providing contact outputs when the user presses a button on the phone keypad.

TC-100RTT \$629.00



The **Gentner DH-III** uses the latest DSP technology to automatically deliver outstanding hybrid null, maximum isolation between caller and send audio, while maintaining excellent sonic quality. You can talk with callers on or off air with equal ease by using the units cue button and record those calls using the DH-III's record button. The unit will send both sides of the call to your tape machine and will start and stop the machine as well.

Digital Hybrid III \$1,895.00

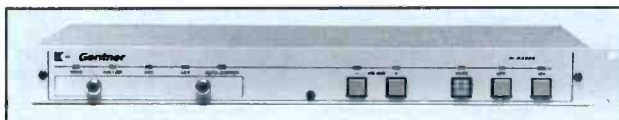

The **Gentner G3200** is designed for telephone calls with a live audience or in-studio guests. It provides both an advanced digital hybrid and an acoustic echo canceller. The G3200 keeps received audio from going back down the line to the caller, even when delayed by room size. Three mics and a speaker can be added to the G3200 for a remote talk show. It allows you to turn up the monitor's volume in the studio so the audience can hear callers. A built-in monitor amp with volume control for stage monitoring of callers and caller muting are also included.

G3200 \$2,495.00

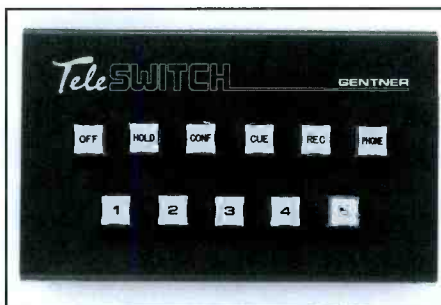

**Gentner's Teleswitch**, a simple telephone call director at an affordable price. Teleswitch is the logical solution to your basic telephone line selection needs. It is compatible with most phone systems and is simple to install.

Teleswitch \$795.00  
Interconnect cable specify hybrid \$26.20

T  
E  
L  
E  
P  
H  
O  
N  
E  
  
E  
Q  
U  
I  
P.



**BGS**

**TELEPHONE EQUIP.**

## Gentner

The **Gentner TS612** is a powerful multi-line on-air phone system with flexibility and features that meet the ever-growing demands of today's broadcast market. This expandable 6 or 12 line phone system has **two built-in digital hybrids** which allow conferencing of up to four callers on air. Features include: VIP mode • built-in caller screening • automatic recording • multi-color status lamps • and an integrated handset for simultaneous control of on-air calls and off-air screening. The TS612 Control Surface Interface looks like a simple multi line telephone but it provides capabilities that meet the most demanding customer requirements. Up to three Control Surfaces can be attached to your TS612. The TS612 Drop-In Panels are presently offered for Auditronics, PR&E, Wheatstone and BE MixTrak. The TS612 ScreenWair Call Screening Software is a DOS-based program which allows you to connect a standard PC with RS232 port directly to the TS612 mainframe. At a glance you can tell who is on air, who is next, what they want to say, how long callers have been holding, etc. Any change of status is instantly updated on the screen. The TS612 Universal Interface makes the TS612 directly compatible with your IA2 telephone system. Call lock-out protection is provided by the system to prevent the accidental pick up of an on-air line. The Universal Interface also provides the link between your PBX and the TS612 network. You can tie multiple studios together using the Network Interface. With the Network Interface a 12-line TS612 system can be expanded into 10-studios. You get a completely integrated phone solution for a fraction of the cost of a custom system.



TS612/6	Multi-line System, 6 lines	\$2,995.00
TS612/12	Multi-line System, 12 lines	\$3,990.00
ACS	Additional Control Surface	\$459.00
LEK	Line Expansion Kit, upgrades 6 line system to 12 lines	\$995.00
NI	Network Interface, 1 per mainframe (12 line system only)	\$495.00
SWS	Screen Wair call screening Software	\$595.00
DIP	Drop-In Panels, control surfaces	\$995.00
STP	SmartTalk Package, TS612/6 w/SWS	\$3,490.00
STP/12	SmartTalk Package, TS612/12 w/SWS	\$4,485.00
BOP	RJ11 Breakout Panel	\$120.00
TC	25 Pair Telco Cable, 25'	\$49.00
CSC	Control Surface Cable, 25'	\$40.00
UI	Universal Interface	\$1,295.00

The **New Gentner SPH10** is an analog telephone interface that interconnects between a standard telephone line and your audio equipment. Features include: the newest analog technology • audio filtering and equalization • balanced I/O • balanced and unbalanced mix output for recording both sides of the conversation • built-in monitor amp • automatically accepts all worldwide voltages and is worldwide compliant!

SPH10	\$499.00
-------	----------

The **New Gentner DH20 and DH-22** has their newest 16 bit DSP digital technology to deliver better and more reliable sound quality. Features include: auto mix-minus • built-in speaker amp • balanced I/O • mic or line input • selectable AGC • selectable caller ducking • selectable auto answer/auto disconnect compatible with most telephone central offices including loop current interruption and busy/reorder • remote control and status • automatically accepts all worldwide voltages and is worldwide compliant. The DH-22 is two digital hybrids in one chassis. It included all the above feature as well as selectable cross conferencing.

DH-20	\$995.00
DH-22	\$1,595.00



## Radio Systems



The **Radio Systems TI-101**, formerly Symetrix TI-101, provides easy two-way connection between your console and phone line with back panel gain switches. Its features include: equalization, send limiting, receive compression/expansion, caller mute, LED clipping indicators, conference linking, and bandpass filtering.

TI-101	\$495.00
--------	----------

## Zercom



The **Zercom Telephone Hybrid** provides full duplex audio. Zercom's Telephone Hybrid nulling circuit has two null controls and active balanced inputs and outputs with adjustable gain. The telephone line, tip, and ring connection is user selectable on the rear panel for a direct DC line hold or capacitor isolated to prevent DC flow through the hybrid's telephone line transformer.

ZHZ	\$455.00
-----	----------



# information announcers

## Bogen

The **Bogen HSR Series** employ a state-of-the-art digital design to achieve a full 64Kbps digital toll quality sampling rate for the best sounding and the most reliable on-hold message announcers available. In addition, the HSR models have a specialized audio editing circuit for seamless audio with no dead air.

HSR4	4-Minute Capacity	\$830.00
HSR6	6-Minute Capacity	\$952.00
HSR8	8-Minute Capacity	\$1,065.00
HSR12	12-Minute Capacity	\$1,187.00

## Henry Engineering



**Henry Digistor** is a digital message storage system that is ideally suited for radio and TV station information lines. The message is stored in digital memory with battery back-up. Digistor can be programmed to play the message only once, or continuously until the caller hangs up. There is no re-cue time; the caller always hears the message from the beginning.

Digistor	2:08 minutes of audio	\$395.00
Digistor XM	8:32 minutes of audio	\$595.00
Digistor HF	higher fidelity and wider bandwidth/ 1:20 minutes	\$420.00
Digistor XM-HF	include XM and HF options/ 5:25 minutes	\$620.00



**Henry Digicord** is a general purpose digital recorder that can store up to 16 different messages for random access playback in non-critical audio applications such as: network news, EAS alerts, request line calls, translator/identifier, and multi-message source in an automation system.

Digicord-5kHz	up to 5:25 minutes of audio	\$695.00
Digicord-8kHz	up to 2:40 minutes of audio	\$695.00



**Henry TeleStor** is a specialized digital audio recorder for automatically recording broadcast station "audio actualities". When called, TeleStor automatically answers the line and waits for the caller's Touch-Tone™ password. When the password is detected, TeleStor begins recording audio being fed via the phone line. Once recorded, the message is stored and is ready for instant on-the-air playback by a broadcast automation system. One message can be stored at a time. When a new message is recorded, the previous message is erased.

TeleStor STD	Recording Time 1:20 minutes, Freq. Response 2.5kHz	\$595.00
TeleStor XM	Recording Time 5:25 minutes, Freq. Response 2.5kHz	\$795.00

**Henry Audio Online** is ideal for broadcast stations, public relations firms, schools, hospitals, political offices, and other institutional users who wish to make high-quality audio presentations available via regular telephone lines. It is a caller-interactive system that allows callers to select messages from an "audio-menu". Up to 9,999 messages can be stored with excellent audio fidelity. Editing messages is quick and easy. Messages can be recorded "live" or dubbed from a prepared tape or cassette. Audio Online consists of a special 2-line telephone interface/modem card plus software that operates on a dedicated PC. An inexpensive, basic "386" DOS computer is ideal (not included). For each 20MB of hard drive space, there is about 15 minutes of recording time. The basic system answers 2 phone lines and can be expanded to handle up to 12 incoming phone lines.

Audio Online	Software and 2 line interface/modem	\$995.00
--------------	-------------------------------------	----------



## Sine Systems

The **Sine Systems Time-Temp Thing, TTT-1**, is a rackmounted device that can speak the time, the temperature, or both upon command from your automation system. It even automatically changes the way it speaks the information so it doesn't sound like a machine. Interfacing the Time-Temp Thing to most automation systems is simple. A contact-closure or open-collector output is all it needs to make it speak. When it is finished speaking it gives a momentary contact-closure back to the automation system.

TTT-1	\$599.00
-------	----------



The **Sine Systems Time-Temp Announcer, TTA-1**, is a complete, self-contained two-line time and temperature system. It does not require a computer or any other equipment to operate. In fact it comes with everything you need to set up the system and get it operating. You get the Time-Temp Announcer (that handles two lines) • a weather-proof temperature sensor with 100 feet of cable • a wall-plug power supply • a microphone to record messages • a pair of headphones to listen to the messages you record • and a comprehensive instruction book. The only optional piece of equipment you might need is a 100 foot extension cable for the temperature sensor. You can use up to 1000 feet total of extension cable and up to 10 Expansion units.

TTA-1	Time-Temp Announcer, 2 line, 1U	\$1,499.00
EC-100	Extension cable for temp sensor, 100'	\$45.00
TTA-EX1	Expansion unit, 6 lines	\$1,499.00
IC-3	Interconnect cable for up to 5 expansion units	\$20.00
IC-10	Interconnect cable for up to 10 expansion units	\$45.00

Note: The TTA-EX1 Expansion unit does not include the cable that connects it to the TTA-1. Order it separately (IC-5 or IC-10). The following example is what would be required for a 14 line system: 1-TTA-1, 2-TTA-EX1, 1-IC-5.



**BGS**

TELEPHONE EQUIP.

**Broadcasters General Store (352) 622-7700 Fax (352) 629-7000**





**BGS**

**T  
E  
L  
E  
P  
H  
O  
N  
E  
  
E  
Q  
U  
I  
P.**

## Gentner

The **Gentner ET10** is compact and portable, hooks directly into an analog or digital phone on your desk using all the features and benefits of your existing phone. Just connect the ET10 via the handset port on the base of your telephone, place the handset on the pad, and you're in conference. The ET10 incorporates full duplex sound with digital echo cancellation making your conference calls more free-flowing, interactive and natural sounding. To handle more people and larger rooms, attach an optional extension microphone. The ET100 is for larger meetings in a more permanent setting. Like the ET10 the ET100 can be used with your existing phone and has the duplex sound and digital echo cancellation technology. It has a larger speaker and three internal microphones and provides 360° sound coverage.

ET100		\$895.00
ET10		\$399.00
EM	Extension Mic with 15' cable	\$49.00
MEC	Additional 15' of Extension cable	\$14.00
DH	Dual Headset	\$129.00
CP	Companion Phone	\$49.00
CC	ET10 Carrying Case	\$39.00



# BBS telephone equip.

## CircuitWerkes



If you have **CircuitWerkes TeleRadio** at your stations, you can listen to every radio station in each of your markets in real-time. TeleRadio is a DTMF remote controlled tuner combined with a telephone coupler. When it answers, the internal radio begins playing down the phone line to you. You can control the radio by using the buttons on your phone. It features: ten random memory presets; remote controlled scanning, tuning, AM/FM band change, & memory set; FCC type approved for phone connection; automatically resets to first memory each time it answers a call; auto-answer/disconnect; and auxiliary audio input allows the coupler section to temporarily be used as an audio patch for remote talkback.

TeleRadio \$689.95

## JK Audio



The **JK Audio Tap-1**, telephone audio + power interface, separates voice into transmit and receive signals for recording or service simulation. It powers telephone with -48VDC, and provides a 2-wire to 4-wire hybrid.

Tap-1 allows clean voice recordings with a "telephone bandwidth" sound without phone line noise. Hybrid null adjustment optimizes transmit and receive separation to >50dB. Put two units back to back for TV or film studio recording.

TAP-1 \$245.00

Simply connect **JK Audio QuickTap IFB** between the handset and the base of your telephone, or replace the handset altogether. The audio from the telephone is available on a mono mini 1/8" jack with a volume control. The 1/8" jack will drive an IFB earpiece directly at nominal levels. The transformer isolated 600 Ω balanced XLR output will get the telephone signal to a distant amplifier or mixer. Features include: 1/8" mono jack with volume control • 600 Ω male XLR jack • and no batteries or AC needed.

QuickTap IFB \$125.00



## Gentner

### Gentner's Microtel

replaces the handset of the telephone, giving you hands-free phone operation and an easy way to send and receive other audio sources. Connections are provided for microphone, headset, and auxiliary inputs/outputs such as a tape machine. Ideal for news reporters, sportscasters, ENG crews, or sales people.

Microtel \$259.00



## Henry Engineering

### Henry MixMinus Plus

is a special audio device that is designed to add a "mix-minus" facility to an audio console or teleconferencing system. The unit removes the Caller audio from the Program signal. This Program-minus-Caller audio is fed back to the caller via the hybrid. Up to 40dB of caller null is typical. The MixMinus Plus needs no adjustment once installed, and will work with virtually any console and hybrid.

MixMinus Plus \$195.00







**BGS**

**T  
E  
S  
T  
E  
Q  
U  
I  
P  
M  
E  
N  
T**

## CRL

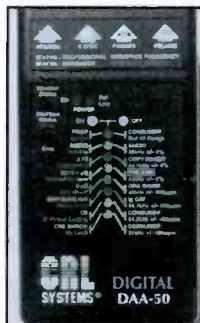

**CRL DAA-50** can receive and decode audio data according to the AES/EBU, IEC958, S/PDIF, & EIAJCP-340 interface standards. The DAA-50 checks your transmission link for an assortment of errors and reports them via defined LED status indicator lights. It contains a high quality digital to analog converter so you can monitor the decoded audio. Battery or AC powered.

DAA-50 Clip-on digital audio headphone/analyzer **\$595.00**

## Galaxy Audio



A test instrument for the audio installer or soundman which indicates absolute polarity of most audio devices or may be used as a cable tester. The send unit has balanced 1/4" and XLR jacks, an unbalanced 1/4" speaker out jack and an internal speaker. The receive unit has 1/4" and XLR jacks, a sensitivity control and an internal microphone. Both units are housed in high impact padded ABS cases and are powered by a 9 volt battery.

Cricket Polarity Test Set **\$399.00**

## EMCO



**EMCO** has a comprehensive line of test and measurement equipment including: digital & analog multimeters, oscilloscopes & probes, variable and fixed power supplies, and RF & audio signal generators. Please call *Broadcasters General Store* for an *EMCO* catalog.



BL-10K 10K  $\Omega$  Multitester w/Battery Test, (Carded) **\$22.50**

DMR-30T 1M  $\Omega$  3-1/2 Digit Multimeter w/Transistor Test, w/case **\$35.70**

DMR-35A 10M  $\Omega$  3-1/2 Digit LCD, Diode Test, w/case **\$66.00**

## Whirlwind

The **Whirlwind Qbox®** is the all-in-one audio line tester that you'll want in the toolbox every time you do field audio. In one battery powered box you have a microphone, a speaker, a test tone generator, outputs for standard headphones or a 2k $\Omega$  earpiece, and voltage presence monitoring for phantom or intercom power. You can talk into it, listen to it, watch it, and clip it on your belt or cable reel for easy access.

The Qbox is made from a rugged, lightweight industrial composite to withstand the wear and tear of fieldwork. It's powered by a single standard 9V alkaline battery that is easily replaced without tools. Plug in a dynamic mic to give it a quick test, leave the internal speaker powered as a squawk box from the console, or use the internal mic to talk back up the line. It's all easy with a Qbox! The SOURCE selector lets you send a 440Hz tone or the signal from the Qbox's built in condenser mic back to the main console at +4, -20 or -50dB levels. The SPEAKER selector lets you test dynamic mics and confirm mic or line level signals.

Qbox TBD yet approx. **\$130.00**

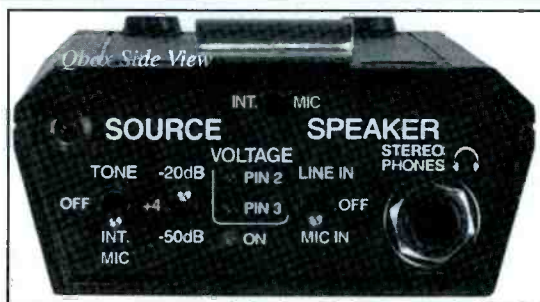

This **Whirlwind Cable Tester** can test cables with any combination of XLR, 1/4" or RCA phono plugs for shorts, opens and phase. The hands-free design allows manipulation of cable to locate intermittence. An on/off switch is provided, with LED to indicate sufficient testing power. Belt clip included.



CT Cable tester **\$60.00**





**BGS**

**T  
E  
S  
T  
E  
Q  
U  
I  
P  
M  
E  
N  
T**

## Audio Control



The **Audio Control Industrial SA-3050A** is an affordable, measurement-grade, one-third octave real-time analyzer designed for audio signal analysis. The SA-3050A offers the following features: 30 one-third octave bandwidth filters • Internal pink noise source • 9 x 30 large-format LED display with 1dB resolution • Six internal memories with battery backup • Averaging for 6 stored response curves. • Peak hold function • SPL scale with bargraph and full-screen digital readout • 92dB display range • Signal input from balanced microphone input, balanced phone jack or unbalanced BNC connector.

SA-3050A		\$995.00
SA-3050APKG	w/rechargeable internal battery & parallel printer output	\$1,300.00
AC10	A & C weighting filter	\$44.00
CP10	Customized printer format, factory install only	\$100.00
RM10	Rack mount adapter, 3U	\$55.00
SC10	Soft carrying case, for analyzer, mic and cables	\$59.00
SRD10	CD-based signal generator, CD containing numerous test signals	\$70.00

## DOD

**DOD RTA series II** Real Time Analyzer has each of the 31 bands displayed in a vertical row of 5 LED's. It is switchable between 1dB steps in a 4dB window or 3dB steps in a 12dB window, with a built in pink noise generator.

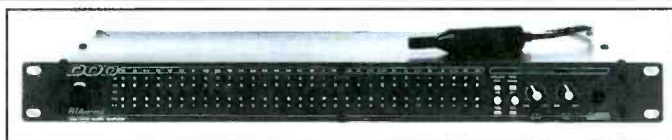

RTA	Includes mic with 30' of cable, 1U	\$399.99
-----	------------------------------------	----------

## Goldline



The **Gold Line 30M8** is a 1/3 Octave battery operated Audio Spectrum Analyzer complete with remote microphone and 8 memories which are active until the unit is turned off. It is also an accurate sound level meter and will read sound pressure levels in either A or C weighting. A calibrated instrument microphone is provided which can be attached directly to the 30M8 via the XLR mic input or it can be remoted via mic cable.



**Goldline's** hand-held 10 band Audio Spectrum Analyzers measure from 32Hz to 16kHz on ISO centers. They feature a built in microphone, fast or slow decay times, and line input.

30M8	30 band RTA with 8 memories	\$736.00
------	-----------------------------	----------

The **Goldline DSP-30** features an 85dB sound window with scroll up/down that is large enough to capture the dynamic response of a room and is capable of detailed measurements with great accuracy. The 1/4dB precision measurement range permits the engineer to utilize standard industry test tapes and view all frequencies simultaneously for faster tape head monitoring or service.

DSP-30	Digital 1/3 Octave real time spectrum analyzer	\$1,579.00
DS30RM	Rack Mount DSP-30/pink noise	\$2,300.00
<b>Options:</b>		
OPT-CVO	DOS RS232 Computer video interface	\$559.95
OPT-PCVOW	Windows Version of CVO	\$768.95
OPT-PRT	Printer Port, requires parallel Centronics Printer	\$250.00
OPT-NVM	Non volatile memory	\$125.00
OPT-RT60	RT-60 mode	\$315.00
OPT-STA	Speaker timing analysis, requires RT60 & speaker software	\$250.00
OPT-DAS	Distortion analysis	\$250.00
OPT-106	1/6th Octave, requires CVO/CVOW	\$315.00
OPT-112	1/12th Octave from 27Hz to 800Hz, requires CVO/CVOW	\$315.00
OPT-DOSE	DOSIMETER Measurements, requires CVO/CVOW	\$315.00
OPT-NC	Analyzes SPL to NC (Noise criteria standards)	\$149.95
OPT-MAC	Soft PC professional to run MAC, requires CVO	\$349.95

### Goldline Carry Cases

ASAC	For M-10, ASA-10B, SPL-120	\$19.00
CS-30M	For 30M8 (compartment for mic and pink noise)	\$41.00
DSP-M	For DSP-30 (compartment for mic and pink noise)	\$41.00

### Goldline LM27P5

The LM27P5 is a one third octave Real Time Analyzer, complete with instrument microphone and built-in pink noise generator. 1U

LM27P5		\$630.00
--------	--	----------

M-10	10 band analyzer/built-in pink noise generator (no SPL)	\$315.00
ASA 10-B	10 band analyzer with SPL(no pink noise generator)	\$374.00



The **Goldline SPL 120** is a portable instrument designed to fill the need for accurate sound pressure level measurements, all at an affordable price. It features: seven segment digital numeric display with SPL readings in dB, a built-in instrument microphone, and is battery or AC powered.

SPL120		\$259.95
--------	--	----------



# RF spectrum analyzers

Check out CREAMW@RE TripleDat Real Time analyzer for your computer!  
See page 116.



**BGS**

## AVCOM

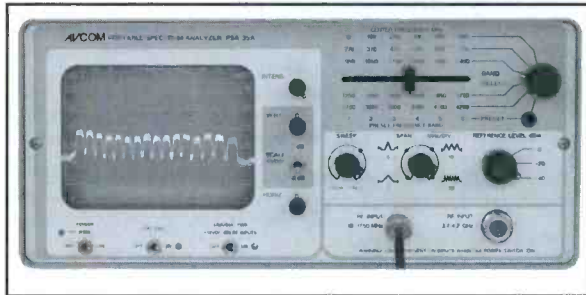

The Avcom PSA-35A is a portable spectrum analyzer with LCD frequency counter readout. It accurately measures wide band signals used in the TVRO industry. Frequency coverage from 10MHz to over 1750MHz, and from 3.7 to 4.2GHz. Please specify voltage.

PSA-35A \$1,965.00

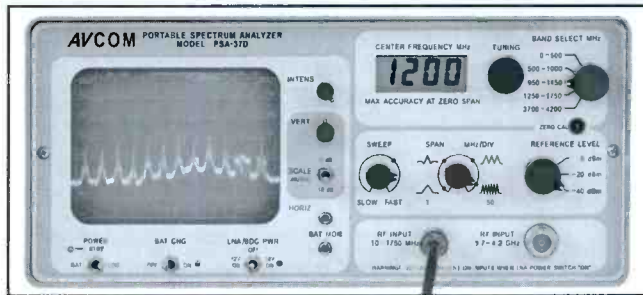

The Avcom PSA-37D portable spectrum analyzer is Avcom's answer to your downlink installation, service, and maintenance problems. Frequency coverage is from 10 to over 1750MHz and from 3.7 to 4.2GHz, in 5 bands. Frequency readout is shown in MHz on a four digit LCD front panel display. The digital readout allows you to identify and resolve terrestrial interference problems quickly and precisely by displaying the frequency of offending signals. The PSA-37D has a built-in DC block with +18VDC for powering LNA's and BDC's, accurate signal strength amplitude display and internal battery with charger. Selectable vertical sensitivity of either 2dB or 10dB/Div. is standard.

PSA-37D \$2,475.00



Avcom's PSA-65A Portable Microwave spectrum analyzer covers a frequency range from less than 2MHz to 1000MHz. This light weight, battery or line operated Spectrum Analyzer is the perfect instrument for field testing of RF systems, classroom instruction, satellite system alignment, electronic counter measures, cable TV maintenance, cellular, and production use. Options include a 10kHz resolution bandwidth filter for the 2MHz/Div. span that extends lower frequency range to approximately 200kHz, an FM demodulator for aural monitoring, and several high performance precision-machined log periodic antennas.

PSA-65A		\$2,855.00
PSA-65B	Same as 65A but freq. range 1MHz-1250MHz	\$2,930.00
10KHz	10kHz resolution bandwidth option	\$275.00
FADO	FM audio demodulator option	\$185.00
FE	Frequency extenders for 1-2, 2-3, 3.7-4.2 GHz and 950-1450 MHz (Price each)	\$565.00
ADO	AM detector option	\$119.00
OIO	Oscilloscope interface option	\$179.00

# stereo audio test set

## Dorrrough

The Dorrough 1200 is a simple and easy to operate stereo audio signal test set. It allows measurements of level, balance, crosstalk, and signal-to-noise with a dynamic range of -90 to +20dB and a measurement range of -76 to +20dB. The solution to balanced stereo lines.

1200 Stereo audio signal test set \$1,650.00



TEST EQUIPMENT

# stereo audio test set



**T  
E  
S  
T  
E  
Q  
U  
I  
P  
M  
E  
N  
T**

## Modulation Sciences

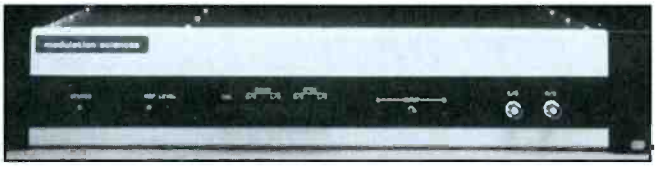

**Modulation Sciences SRD-1** Stereo reference decoder accepts wideband composite and provides left and right or sum and difference in the BTSC (companded) or equivalent mode. Transfer standard for checking the performance of any make TV stereo generator.

SRD-1	<b>\$5,250.00</b>
-------	-------------------

## McCurdy



The **McCurdy ATS-100** Stereo (or dual mono) Extended Range Audio Meter allows monitoring of audio levels over a wide range of levels and system impedance's. Features include: Taut-band high quality meters • LED illumination eliminates bulb replacement • Accurate offset adjustment in 1dB steps • 90dB range • Provides readings to 0.1dB accuracy • XLR rear connectors • An indicator is provided for accurate stereo phasing measurement • integral power supply.

ATS-100	Specify -10, +4 or +8	<b>\$1,195.00</b>
---------	-----------------------	-------------------

# tone generators

## ATI



The **ATI Audible Noise Generator NG-1** has selectable and adjustable pink or white noise, pulsed or continuous with built-in speaker and an output jack with an external amplifier and speaker. It's battery operated for portable use and includes a wall mount AC power supply for continuous operation.

NG-1	<b>\$199.00</b>
------	-----------------

## Conex

The **Conex RX-11 Tone Jack** is a compact audio frequency generator providing sine and square-wave signals

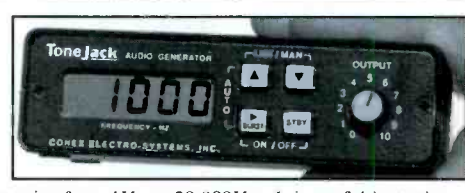

with precise frequencies from 1Hz to 29,999Hz. It is useful in testing the frequency response of systems, filters, tone sensors, etc. It is powered by a 9V battery or external power and has an RS232 interface that allows a computer or terminal to control all the normal front panel functions.

RX-11	Tone Jack Audio Generator	<b>\$229.00</b>
SC-1	RS-232 Serial Cable, RJ011 to DB-25	<b>\$15.00</b>
PS-1	Power supply	<b>\$9.95</b>
CA-1	Carrying case	<b>\$11.95</b>
OC-1	Output cable, phone jack to clips	<b>\$9.95</b>

## Delta

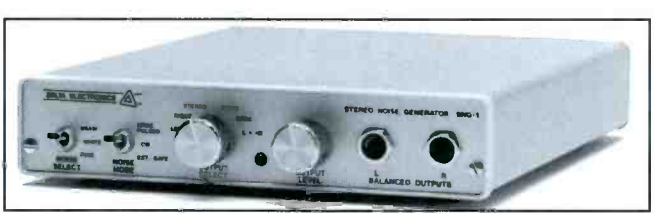

The **Delta Electronics SNG-1** stereo noise generator is designed to meet the requirements of NRSC-1 and 2 standards for testing AM stereo and mono radio transmission facilities.

SNG-1		<b>\$665.00</b>
RMK-1	Rack Mount Kit	<b>\$170.00</b>

## EMCO



**EMCO Tone Generators**

RF-1	RF Signal Generator	<b>\$240.50</b>
------	---------------------	-----------------

## Fostex



**Fostex TT-15** is a 9V battery operated, 5-frequency sine wave oscillator (40 Hz, 400 Hz, 1, 10 and 15 kHz) with 3 selectable output levels (-30, -10 and 0 dB), is useful for spot checking frequency response, calibrating mixers with tape recorders and other level matching jobs.

TT-15	<b>\$60.00</b>
-------	----------------



SS-1	Sine/Square Wave Generator	<b>\$252.95</b>
------	----------------------------	-----------------



# tone generators

## Goldline



**Goldline TS-1** is three audio test instruments in one unit. It includes: a low distortion audio oscillator with a range of 10Hz to 30kHz; a frequency counter with response of 1Hz to 99.99kHz; and a dB meter with range of -50 to 24dB from 20Hz

to 20kHz. The TS-2 is a TS-1 that will determine impedances in the audio frequency range (20Hz to 27kHz) from 1Ω to 1000Ω. Versions are available from 1Ω to 10KΩ.

TS-1	Balanced in	\$399.95
TS-1-BP	Wired for battery (battery included)	\$599.00
TS-1-RMX	Balanced in & out via XLR both front & rear w/RM	\$568.00
TS-2	TS-1 with impedance function	\$578.00
TS-2-BP	Wired for battery (battery included)	\$732.00

## Goldline's Pink Noise Generators

supply a flat noise source as a test signal for sound systems. The PN-2 is powered by a 9V battery which is turned on by the insertion of a 1/4" connector to the pink noise output and is housed in an ABS plastic case. The PN-3A is a gated pink noise source which provides continuous pink noise or bursts which are excellent for RT60 measurements plus short pulses suitable for Loudspeaker Timing Analysis. Complete with timer controls for "time on and off." Powered by a 9V battery. The output is accessed via a 1/4" unbalanced plug.



PN-2	\$95.00
PN-3A	\$147.00

## Radio Design Labs



The **RDL RU-OSC4A & B** Oscillator is for anywhere you need reference tones to verify audio system response.

Manually selectable audio tones, line level balanced/unbalanced output and gain trim for each frequency. Output connections are made on the rear panel through full-size barrier block terminals. The RU-OSC4A features 4 separate audio oscillators operating at 100Hz, 1kHz, 7.5kHz and 15kHz. These frequencies provide quick, automatic verification of audio frequency response through a piece of equipment or an entire audio chain. A 'silent' period between the 15kHz tone and the 100Hz tone provides time to verify system noise levels.

RU-OSC4A	\$255.00
RU-OSC4B	\$255.00

See Rack Up Accessories on Page 25 & 26.

## Radio Design Labs ST-OSC2A/B

is a Dual Audio Oscillator with adjustable levels anywhere you need: Precision sine-wave audio signal • Amplitude-stable oscillator • and Dual tone oscillators.



ST-OSC2A	1kHz and 10kHz	\$98.00
ST-OSC2B	100Hz and 400Hz	\$98.00
PS24A	Power Supply	\$17.00

**Radio Design Labs ST-NG1** is ideal where random white or pink, mic and/or line level noise signal is needed. It is suitable either as a reference noise source for audio measurements or as a masking noise source. It produces no repetitive frequency or amplitude pattern. PS24A (\$17) power supply optional.

ST-NG1	\$120.00
--------	----------



## Hamlet

The **Hamlet portable units** were the first rasterizing test measurement devices designed for field use. They digitally generate waveform/vector signals for display on standard field monitors, LCDs and some camera view finders. They provide a means of identifying and analyzing signal aberrations and assist in locating the equipment causing the problem. Monitoring video levels during video production can guard against a multitude of potential problems and are especially important because they confirm the quality of the video signal at the remote location, improving accuracy. The Micro Scope Series are portable units that weigh less than 2 pounds and are small enough to hold in the palm of your hand. They are powered by either rechargeable Nicad batteries or the included 12V AC adapter. Hamlet offers a complete line of portable, rack-mountable and PCB-level devices for studio, desktop video and ENG/EFP applications. All units carry a two year warranty.

302WV	Portable Composite Waveform/Vectorscope	\$1,745.00
302WVA	Portable Composite Waveform, Vector and Audio	\$1,945.00
300W	Portable Composite Waveform only	\$1,395.00
PLM-1	Portable Composite/Component Pgm. level meter	\$1,095.00

## waveform production



The **Hamlet Waveform/Vectorscopes** include the newest generation of test measurement equipment, combining both the waveform and vector functions into one compact unit. All Hamlet units digitally-generate waveform, vector and/or audio signals with their associated gratitudes for display on any standard monitor. So, you can route the signals to multiple monitors of any size or to monitors located in remote areas. You don't even need to be near the source you're measuring. Choose from a variety of models that meet all video applications and broadcast specifications. Whether you need a full-blown waveform/vector with precise measurements or simply an inexpensive way to monitor a signal, Hamlet has a waveform/vectorscope that is right for you.

301WV	Composite/Component Waveform and Vector	\$2,295.00
302WVR	1/2 Rack, Composite/Component Waveform, Vector and Audio	\$2,295.00
303WV	Composite Precision Waveform and Vector (NTSC)	\$3,495.00
301WVA	301WV w/Audio Display	\$3,435.00



**BGS**

**T  
E  
S  
T  
E  
Q  
U  
I  
P  
M  
E  
N  
T**





VIDEO EQUIPMENT

## CIPHER DIGITAL

### Cipher Digital Time Code and Machine Control Products

CDI-4815	Phantom II VTR Emulator, RS422 to parallel control	\$1,575.00
CDI-4820	RS232 to RS422 Converter for the UVW1200/1400	\$695.00
CDI-1000	LTC/VITC Reader/Translator w/CHAR Inserter	\$1,475.00
CDI-1300	LTC Reader/Generator with External Control	\$825.00
CDI-400	SMPTE/EBU Time Code Generator w/Jam Sync	\$1,375.00
CDI-750	SMPTE/EBU TC Reader/Generator w/Event Control & CHAR Inserter	\$2,595.00
CDI-825	RS422 to LTC Converter	\$350.00
TCHB-3	Time Code Handbook, Third Edition	\$22.95

Cipher Digital has a variety of cables for the VTR, VCR and Audio Transport. Prices range from \$185 to \$310. Please call BGS for further information and pricing.



## DNF Industries



Configure the **DNF ST300-S/SM Slow Motion Controller** for the way you work: Select slomo speed range • automatic Mark Cue advance • save last used slomo speed • and enable/disable Freeze at Record Out, one or two button Record. Features include: A detented Wheel ("T"-bar optional) provides a **fast and easy slow motion control**, from 0-200% or -100% to +200% of play speed, respectively. • You can quickly and easily **store and recall up to 100 cue points**. All Cue Points are retained when power is turned off. • It is fast and easy to search to a Cue Point, manually entered Timecode Number, or Record Out Point. • Manually enter/edit cue points. • Set preroll duration from 00:00:00:01 to 01:00:00:00. Freeze on last good video (Record Out Point).

ST300-S/SM	\$2,500.00
ST300-S/SM-T (with T-bar)	\$3,000.00

**Specifications for ST300:**  
 Power: 90VAC to 265VAC adapter supplied with IEC connector  
 Size: 12"L x 6"W x 1.5"H in the front slope to 3"H in the rear  
 Weight: 4 lbs.  
 Rear Panel Connectors: VTR1, VTR2, VTR3, VTR4 9 pin female "D"  
 GPI- 15 pin female "D"  
 Power- 9 pin male "D"

Easy to read 2 line, backlit LCD display  
 Jog/Shuttle Wheel with detents  
 Optional "T"-bar, slomo 0-200% of Play Speed

### Options for the ST300 VTR Controller

The **DNF SHOTLIST** and **PLAYLIST** options allow quick access to video clips stored on the Tektronix PROFILE, ASC VR, or any DDR supporting the Odetics Broadcast Protocol.

A shot list of up to 400 Clip IDs can be maintained in non-volatile memory. It allows you to view the available clips in the VDR/DDR and mark selected clips into the shotlist at single or multiple locations. Access to any location is possible by stepping through the list, one clip at a time forwards or backwards, or enter a 3 digit number for a specific location. Any clip in the shotlist can be programmed to play from beginning to end, then stop, (or loop continually until stopped).

SHOTLIST	Option to ST300	\$300.00
----------	-----------------	----------

A play list of up to 20 video clips can be quickly and easily created, for automatic payout. Each video clip in the play list can be programmed to payout in one of three modes: **Normal**- Play from beginning to end, then seamlessly play the next clip; **Loop Clip**- Play from beginning to end, then seamlessly loop back to the beginning and repeat; or **Loop List**- Play current clip from beginning to end, then seamlessly loop back to the beginning of the list, and continue playing.

PLAYLIST	Option to ST300	\$300.00
----------	-----------------	----------

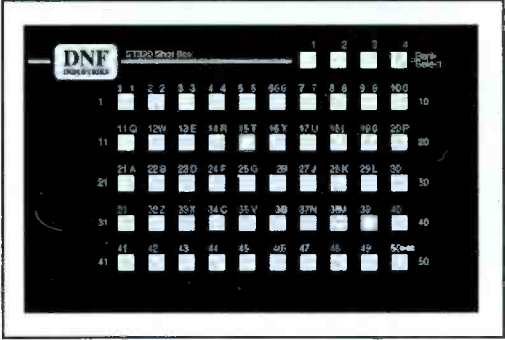

The **DNF ST320 ShotBox**, in combination with the ST300 VTR Controller and ShotList option, provides instant access to 200 video clips stored in a Tektronix PROFILE, ASC VR, or any Digital Disc Recorder that supports Odetics Broadcast Protocol. It allows you to quickly and easily assign a specific video clip to a specific button and to change assignments quickly as new clips are created. The ST320 is ideal for any fast moving production that requires instant access to pre-recorded video clips stored in a Video Server or Digital Disc Recorder. (Ideal for News, Game Shows, Award Shows, and Sports Coverage.) The ShotBox also includes a QWERTY keyboard for easy clip naming when loading clips into the Digital Disc Recorder, or Video Server.

ShotBox	(includes software for ST300)	\$1,500.00
---------	-------------------------------	------------

**DNF ST30 VTR Controller** controls serial VTRs from any simple, momentary switch, contact closure, or GPI for applications that do not require VTR status tallies. Standard functions include: Full Record, Play, Stop, Still, Rewind, Fast Forward, Preroll and Standby Off. The small 2.5" x 2.5" PCB is ready for easy mounting in your existing control panels or control equipment.

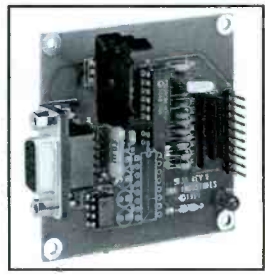

ST30	\$250.00
------	----------

- **ST30 Easy Interface**—Connect up to 8 switches & ground to the 10 pin male header input connector. Connect power to & access the RS422 or RS232 serial output at the 6 pin male header output connector.
- **Input Connector**—10 pin male header. 100 inch centers. Female header provided with unit.
- **Output Connector**—9 pin "D" connector, female.
- **Power Requirements**—12VDC, 100ma. Optional PS available
- **Power Connector**—6 pin female header, female header provided with unit.
- **Size**—The small 2.5" x 2.5" pcb is ready for easy mounting in your existing control panels or control equipment.



## DNF Industries

**DNF ST200** has an integral thirteen switch keypad, Real-time VTR Status Indicators, Timecode/CTL Tape Time Display, and Jog/Shuttle Wheel. The ST200 can be used through your facilities' existing RS422 Control router, RS422 patchbay, or 9-pin Switch Box.



### Standard functions include:

- Play, Stop, Rewind, Fast Forward, Record, Preroll, Jog, Shuttle, 2 Cue Point Memory, Search to Cue, Standby On/Off.
- A numeric keypad for entering Timecode or Tape Time "Search To" locations.
- The following record modes are available: Record Lockout, Crash (Full), Assemble, Insert-Video, Audio 1, Audio 2, Audio 3, & Audio 4. The record mode can be selected by the operator, or where required, configured by management and operator access disabled.
- Standard Real-Time Tallies: Record, Play, Stop/Still, Rewind/Reverse, Fast Forward/forward, Jog/Shuttle Mode.

ST200S	Sony VTR Controller	\$1,200.00
ST200A	Ampex VTR Controller	\$1,200.00
ST200AS	Ampex & Sony VTR Controller	\$1,350.00

**DNF ST200-S/SM Slow Motion Controller** combines all of the features of the ST200 Universal VTR Controller with Slow Motion Control and Multiple Cue Points to remotely control your slow motion capable VTR. It quickly and easily varies the play speed from +200% to -100% play speed. Standard functions include: Play, Stop, Rewind, Preroll, Record, Fast Forward, Jog, Shuttle, 100 Cue Point Memory, and Search to Cue. The ST200-S/SM can be used through your facilities' existing RS422 control router, RS422 patchbay or 9-pin switch box.

ST200-S/SM	Slow Motion Controller	\$1,700.00
------------	------------------------	------------

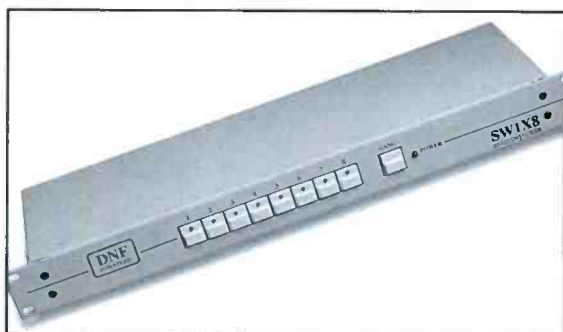

**DNF SW1X8 RS422 Switcher** allows the ST200, ST100 Universal VTR Controllers, edit controller, or any other RS422 VTR Controller, to control of up to 8 VTRs. At the press of a button, select 1 out of 8 VTRs for individual control, select a group of VTRs to control, or gang roll all 8 VTRs. Connect 2 or more SW1X8 RS422 Switchers to control more than 8 VTRs. The SW1X8 is a highly effective Routing and Distribution system. 1U

SW1X8 RS422	\$950.00
-------------	----------



**DNF SW2X1 Electronic A/B RS422 Switch** quickly and easily switch between your on-air automation system and backup control system in the event of automation failure. It has two electronically buffered inputs and one buffered output for easy interfacing. The front panel has remote A/B select and lockout for remote only operation. In the event of power failure, on board bypass relay switches "A" input to VTR output. Power supply is included with rack-mount housing.

SW2X1-4	1 Rackmount housing with four SW2X1 cards	\$1,800.00
SW2X1-3	1 Rackmount housing with three SW2X1 cards	\$1,440.00
SW2X1-2	1 Rackmount housing with two SW2X1 cards	\$1,080.00
SW2X1-1	1 Rackmount housing with one SW2X1 cards	\$720.00
SW2X1-0	1 Rackmount housing only	\$360.00
SW2X1	RS422 Electronic A/B switch card	\$360.00

DNF INDUSTRIES' VTR Control Solutions are ideal for~

- Television Stations
- Video Production
- Audio Post Production
- Corporate Video Facilities
- Cable TV
- Video Post Production
- Duplication Houses

**DNF~Your Source for High Quality, Low Cost Control Solutions!**

Control them all:

• Sony, Tektronix, Panasonic, JVC, Ampex, Pioneer, ASC VR, BTS, Sierra Design Labs, Hitachi, Mountaingate/Recognition Concepts, Rorke Data, Rapid Technology, Drastic Technologies, Doremi Labs, For-A, Pluto, MMS

D1, D2, D3, D5, DCT, Betacam, Digital Betacam, MII, 1-inch, 3/4 inch, S-VHS, HI-8, Video Laser Disc, Video Disc Recorder

• Wide range of RS422 & RS232 VTR Controllers to fit your control needs and budget

• Customize DNF's VTR Controllers for your specific application. Get the features & functions you need!



**BGS**

V  
I  
D  
E  
O  
  
E  
Q  
U  
I  
P  
M  
E  
N  
T





VIDEO EQUIPMENT

## DNF Industries

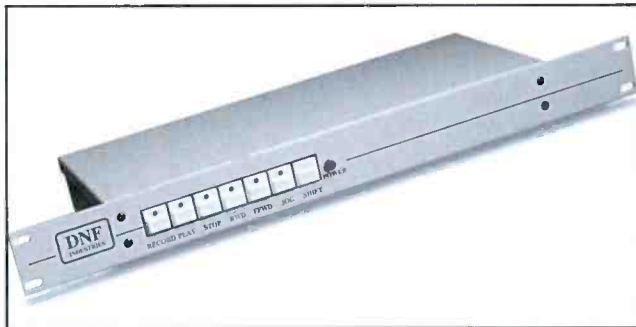

The **DNF Industries ST60 VTR Controller** is easy to install and use. Simply plug it into the VTR serial remote connector. Connect your Master Control Switcher, Parallel Machine Control system or control panel into the parallel input of the ST60. It controls Record, Play, Stop, Rewind, Fast forward, Jog & Shuttle with a simple switch or contact closure. Switch selectable Record Mode: Record Lockout, Crash, Assemble, and Insert Record. The St60 provides real-time VTR tallies: Record, Play, Stop, Rewind, Fast Forward, and Jog. Active low, Open-Collector output. It also can be easily and inexpensively customized with the functions and tallies required for your specific application.

- One ST60 controls them all: D1, D2, D3, D5, DCT, Betacam, MII, 1-Inch, 3/4 Inch, S-VHS, Hi-8.  
Sony, Ampex, Panasonic, Hitachi, Tektronix, ASC, Drastic Technologies JVC & BTS

ST60-A	Ampex VTR Controller	\$500.00
ST60-AS	Ampex & Sony VTR Controller	\$650.00
ST60-S/PS	Universal Parallel Interface	\$500.00
ST60-UVW	Sony VTRs: UVW-1200 & UVW-1400	\$500.00

All ST60 VTR Controllers do not include Keypad or Serial Cable

<b>Rackmount ST60 without Keypad</b>		
ST60-S/SRN	Single ST60-S	\$575.00
ST60-S/DRN	Dual ST60-S	\$1,000.00
ST60-AS/SRN	Single ST60-AS	\$725.00
ST60-AS/DRN	Dual ST60-AS	\$1,300.00
ST60-SPS/SRN	Single ST60-S/PS	\$575.00
ST60-SPS/DRN	Dual ST60-S/PS	\$1,000.00

<b>Rackmount ST60 with Front Panel Keypad</b>		
ST60-S/SRK	Single ST60-S	\$700.00
ST60-S/DRK	Dual ST60-S	\$1,250.00
ST60-AS/SRK	Single ST60-AS	\$850.00
ST60-AS/DRK	Dual ST60-AS	\$1,550.00
ST60-SPS/SRK	Single ST60-S/PS	\$700.00
ST60-SPS/DRK	Dual ST60-S/PS	\$1,250.00



The DNF ST100 has the features of the ST60 as well as a Timecode/tape Time Display, keypad, and a jog/shuttle wheel. It can be ordered in a rackmount or desktop version.

ST100-S	ST60-S with Keypad, Time Code Display & Jog Wheel in one unit	\$850.00
ST100-A	ST60-A with Keypad, Time Code Display & Jog Wheel in one unit	\$850.00
ST100-AS	ST60AS with Keypad, Time Code Display & Jog Wheel in one unit	\$1,000.00
ST100-UVW	ST60AS with Keypad, Time Code Display & Jog Wheel in one unit	\$850.00
ST100-S/SRK	ST60AS with Keypad, Time Code Display & Jog Wheel in rackmount unit	\$850.00

## DNF Industries options for ST60, ST100 & ST200

**DNF Smarter Switch Option** for your Universal VTR controller automatically switches control between two users controlling the same VTR. The Priority Controller (the VTR Controller with the option) automatically determines which control point gets control of the VTR using the following rules: 1. Normally, the second control point is given control of the VTR through the loop-thru connector (located on the rear of the priority controller). 2. When any function switch is pressed on the priority controller, the second control point is disabled. The priority controller takes control of the VTR. After the selected function is executed, the second control point is given control of the VTR, again. 3. While the second control point has control of the VTR, the priority control points status indicators reflect the current state of the VTR. This option must be ordered at the same time as the controller.

Smarter Switch	For use with ST60 & ST100	\$150.00
----------------	---------------------------	----------

**DNF Smart Switch Option** for your Universal VTR controller allows you to manually switch control between two users of the same RS422 VTR. Just press shift + stop to toggle the Smart Switch on and off. The Master VTR Controller with the Smart Switch Option is connected to the RS422 VTR. The second controller is connected to the Loop-Thru connector on the rear of the Master. When Smart Switch is off, the Master takes control of the VTR; when Smart Switch is on, the second controller takes control of the VTR. This option must be ordered at the same time as the controller.

Smart Switch	For use with ST60, ST100 & ST200	\$75.00
--------------	----------------------------------	---------



# video equipment

## DNF Industries

The **RS232 Computer Interface** is for controlling RS422 VTRs from your PC or Macintosh® via the ST60 VTR Controller. The ST60 handles all communication with the VTR: Formatting commands per the manufacturer's protocol, receiving and decoding VTR responses and status and providing the required baud rate and data structure interface. Most commands from your computer to the ST60 require no more than an ASCII character followed by carriage return (ASCII value 0D HEX) for execution.

ST60-CS	Sony VTR Controller Interface	\$600.00
ST60-CA	Ampex VTR Controller Interface	\$600.00
ST60-CAS	Ampex and Sony Controller Interface	\$750.00

**DNF ST60-JRX** Universal Converter converts Video Duplication System serial control, used with JVC BR-7000 and Panasonic AG-6830 type Duplication VTRs, into individual contact closures for controlling parallel VTRs, and RS422 serial control compatible with Sony or Ampex type VTRs (switch selectable). You can control any source VTR anywhere in your facility from your duplication system. Mix and match VTR formats and brands easily or upgrade to the new serially controlled VTRs without obsoleting your existing control system. The serial and parallel outputs can be looped to multiple VTRs for gang-rolling. Controls include: record, play, stop, rewind, fast forward, pause, eject and record lock-out switch to prevent your source VTR from going into record.

ST60-JRX	\$575.00
----------	----------

**DNF SR6 Serial Input/Parallel Output Converter** accepts RS422 or RS232 serial data at its input and provides six open-collector outputs. It decodes the input data to determine which output will be active (low) and which output will be inactive (high). Optional Status Input Lines allow data to be returned to the controller, describing the active/inactive state of status inputs (active line pulled to status common; inactive line internally pulled to +5VDC). Serial input data can be from several sources including the ST60, ST100, a PC compatible or Macintosh® computer or any other type of controller.

SR6	\$600.00
-----	----------

**DNF ST60-J2W** Parallel to Serial Converter converts contact closures, open-collector outputs, or switch closures, from Video Duplication Systems, Parallel Machine Control Systems, or simple Switch panels into serial data capable of controlling JVC BR-7000, AG-6830 and SVO-960 type Duplication VTRs. Controls include: record, play, stop, rewind, fast forward, pause and eject. The serial output can be looped to multiple VTRs for gang-rolling.

ST60-J2W	\$500.00
----------	----------

**Tell Them all Where to Go!**  
**With DNFs High Quality, Low Cost VTR Controllers**



**V  
I  
D  
E  
O  
  
E  
Q  
U  
I  
P  
M  
E  
N  
T**

**Broadcasters General Store (352) 622-7700 Fax (352) 629-7000**



# video equipment



**BGS**

**V  
I  
D  
E  
O  
  
E  
Q  
U  
I  
P  
M  
E  
N  
T**

## ESE



**ESE ES305 News Talent Count-down Display** is mounted to a camera so talent can see the five bright orange lights that extinguish one at a time the way a director counts down. It can display a 5 second count-down or start with 5 seconds of steady lights prior to count-down. The ES305 can be operated from 120VAC 60Hz or 400Hz, or it can run on 12VDC. It comes in a black anodized case measuring 1.6"H x 10"W x 5" D and weighs less than 2 lbs.

ESE305	News talent count down display, camera mountable	<b>\$295.00</b>
--------	--	-----------------

## Feral

### The Feral QS-400 Quad Split

is the first economical way to view and manipulate multiple images on one screen. The Quad Split combines four video inputs into one video output. Each input is independently scalable, allowing you to horizontally and vertically re-size and position each image with aspect ratio control plus, each input can be independently frozen to hold its display while moving the other inputs. The image re-sizing and transitions can be manually performed or pre-stored in memory for quick and easy recall. It has composite and Y/C inputs and outputs as well as NTSC and PAL video standards. It automatically detects and transcodes between formats. The genlock input and key output allow for easy integration with other equipment.



QS-400		<b>\$4,995.00</b>
--------	--	-------------------

## Evertz



**Evertz Microsystems Ltd.** manufactures a wide range of products including ATR and VCR transport interfaces for video edit controllers, audio/video chase synchronizers, LTC/VITC time code generators, readers, character inserters and translators, plus digital clocks, production timers and data displays.

4015	Film Footage Encoder	<b>From \$3,395.00 to \$5,495.00</b>
4025	Film Post Production System (KeyCode heads not included)	<b>\$9,495.00</b>
5150	Afterburner II LTC/VITC Reader/VCG (Reads KeyCode in user bits)	<b>\$2,595.00</b>
5500	KeyKoder Decoder with head, bracket & cables	<b>From \$5,150.00 to \$6,295.00</b>
5500A	KeyKoder/ARRI TC Decoder with head, bracket & cables	<b>\$8,900.00</b>
8025	Digital VITC Keyer	<b>From \$3,500.00 to \$4,495.00</b>
5010	LTC TC Gen/Reader/VCG or VITC TC	<b>From \$1,695.00 to \$3,650.00</b>
7100	ATR Emulator for Sony protocol editors w/interface	<b>From \$4,390.00 to \$4,790.00</b>

*EV-Bloc Series is a modular SMPTE/EBU Time Code system designed to meet a variety of needs for the Broadcast and Post Production environment. The Euro-card based design permits the addition of TC readers, generators, translators, and character generators. These modules can perform dedicated tasks or may be configured as standard or custom system applications. A single module enclosure is also available.*

Call Broadcasters General Store for system configurations and pricing!

## Hotronic

**Hotronic** was founded in California in 1982. Its main line of products was digital TBC/Frame Synchronizer systems. Since then they've added several new products for both NTSC and PAL.



AP41	TBC/Frame Synchronizer Y/C / composite I/O, full proc-amp control/Gen lock	<b>\$995.00</b>
AP41SW	AP41 plus Digital Comb Filter	<b>\$1,300.00</b>
AP41SF	AP41 plus S-VHS output, freeze frame/field, 16 speed strobe	<b>\$1,300.00</b>
DOC	Option for AP41, Digital Pixel by Pixel, drop-out compensator	<b>\$200.00</b>
AT61	10 bit Frame Synchronizer, Digital Comb Filter, Pass VIR/VIT, no quantization noise, Analog I/O	<b>\$2,400.00</b>
AT61F	AT61 plus Freeze Field or Frame	<b>\$2,600.00</b>
AT61AU	AT61 plus Analog Audio I/O	<b>\$3,400.00</b>
AT61AUD	AT61 plus Digital Audio/Video output	<b>\$3,950.00</b>
AR31	TBC/Frame Synchronizer	<b>\$580.00</b>
Remote	AR31 Remote Control Panel	<b>\$100.00</b>
AX81	8x2 Asynchronized, video router	<b>\$2,200.00</b>
Audio	AX81 Audio Follower (XLR) option	<b>\$750.00</b>
AQ21SP	Broadcast TBC Switcher, Digital effects, Scaler, Down-stream keyer, Digital Comb. Filter, 3dB noise reducer	<b>\$4,000.00</b>
8A/V	AQ21SP 8 Channel Video and 8 Channel Balanced Audio XLR inputs option	<b>\$1,400.00</b>
DOC	Digital Pixel by Pixel, Dropout compensator option for AQ21SP	<b>\$400.00</b>
Remote	AQ21SP Remote Control Panel Option	<b>\$950.00</b>
Audio	AQ21 Stereo Audio Switcher Option	<b>\$400.00</b>
AR711	Dual Channel TBC/Frame Synchronizer w/1 remote control	<b>\$1,770.00</b>
AR712	Dual Channel TBC/Frame Synchronizer w/2 remote controls	<b>\$1,870.00</b>
PCTBCY/C	PC-Based TBC/Frame Synchronizer Card Composite/Y/C I/O	<b>\$735.00</b>
Remote	PCTBCY/C Remote Control Panel Option	<b>\$100.00</b>
Chassis1	PCTBCY/C 1 Slot Option	<b>\$120.00</b>
Chassis8	PCTBCY/C 8 Slot Option	<b>\$930.00</b>
AU51	20 Bit Broadcast Audio Delay	<b>\$2,000.00</b>
SM	Service Manual for all Models	<b>\$65.00</b>



# video equipment

## Matthey



**Matthey • low pass video filters** • very sharp cut (Brickwall) filters • 601 type filters • 422 filters • slow roll off filters • HDTV high frequency, low pass filters • triple filters • S.I.L. filters • D.I.L. filters • zero loss filters • hybrid video amplifiers • noise weighting filters • group delay equalizers • differentiating pulse networks • video attenuators. For a complete Matthey catalog, please give us a call.

**Matthey Video Delay Lines** are available in metal boxes with BNC connectors. They are designed to be used either as permanent rack mounted installations, or as temporary connections in test laboratories, outside broadcast units, or when timing a new installation. The metal boxes are strong, providing good protection to the delay line; and RFI shielding. Switches are all gold plated with low noise performance.

NV180	Video delay for smaller than 180° of phase, 2ns steps and ±1ns trim	\$336.00
NV360	Video delay for up to 360° of phase, 2ns steps and ±1ns trim	\$417.00

## Modulation Sciences



**Modulation Sciences' new MSI320 Precision Television Demodulator** is a revolution in video monitoring. The new, high quality precision demodulator provides advanced, accurate measurement and

monitoring of a station's visual and aural signal at a fraction of what precision demods usually cost. The MSI320 features Modulation Sciences' own, state-of-the-art contemporary design using the most advanced components and precision technology.

MSI320	\$3,785.00
--------	------------

## PointMaker



Connected between a video source and monitor, the **Pointmaker** can be used to enhance a video presentation. Drawing and pointing is accomplished either from the back of the room with a wireless remote control, directly on the monitor with a light pen, or with a digitizing tablet. The Pointmaker may also be operated with a touch screen (call for compatibility), or a computer (via RS-232C). Compatible with monochrome EIA RS-170, composite NTSC, Y/C (S-Video), RGB, VGA (PC) and most Macintosh sources and displays. Add the letter "C" to the model number for compatibility with CCIR and PAL video instead of NTSC. The PVI-80 series models come standard with a keyboard for typing on an image.

Multiple-Sync Video Marker with digitizing tablet	PVI70D	\$1,995.00	PVI80D	\$2,695.00
Multiple-Sync Video Marker with light pen	PVI70L	\$2,095.00	PVI80L	\$2,795.00
Multiple-Sync Video Marker with wireless remote control	PVI70R	\$2,295.00	PVI80R	\$2,995.00
Videoconference Marker with digitizing tablet	PVI71D	\$2,195.00	PVI81D	\$2,895.00
Videoconference Marker with light pen	PVI71L	\$2,295.00	PVI81L	\$2,995.00
Videoconference Marker with wireless remote control	PVI71R	\$2,495.00	PVI81R	\$3,195.00
SVGA Multiple-Sync Video Marker with digitizing tablet	PVI72D	\$2,795.00	PVI82D	\$3,495.00
SVGA Multiple-Sync Video Marker with light pen	PVI72L	\$2,895.00	PVI82L	\$3,595.00
SVGA Multiple-Sync Video Marker with wireless remote	PVI72R	\$3,095.00	PVI82R	\$3,795.00
SVGA Videoconference Marker with digitizing tablet	PVI73D	\$2,995.00	PVI83D	\$3,695.00
SVGA Videoconference Marker with light pen	PVI73L	\$3,095.00	PVI83L	\$3,795.00
SVGA Videoconference Marker with wireless remote	PVI73R	\$3,295.00	PVI83R	\$3,995.00
<i>RKMT, Rack Mount Kit for PVI-70 and PVI-80 Series~~\$100.00</i>				

Please call for complete information and cable pricing.

## ~Notes~



V  
I  
D  
E  
O  
  
E  
Q  
U  
I  
P  
M  
E  
N  
T



**BGS**

## What is a half normalised jackfield? How and where is it used?

Half normalised wiring configuration: Ring of top jack to ring normal of bottom jack. Tip of top jack to tip normal of bottom jack

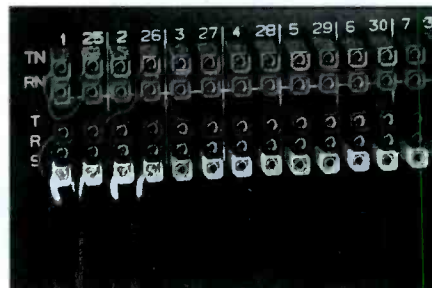

Figure 3

The term half normalised describes an audio jackfield that has vertical pairs of jacks normalised to each other. With this configuration, the switching contacts (normals) of one of the two jacks is used to break the circuit. The other jack is used as a mult to monitor (but not break) the circuit. Half of the available normals are utilized, hence the term half normalised.

With a fully normalised pair of jacks, the tip and ring normal terminals of both jacks are connected to each other. This results in both jacks providing "break access" to both the source and destination of the circuit.

The two jacks shown in Figure 1 are in a half normalised configuration. The tip and ring normal terminals of only the bottom jack are connected to the tip and ring connections of the top jack. In this configuration the bottom jack (normals connected) breaks the circuit, while the top jack (normals bypassed) monitors the circuit.

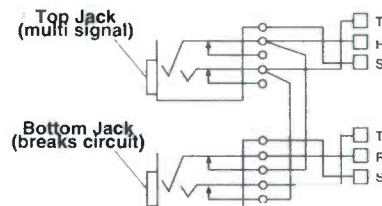

Figure 1

A typical application for a half normalised audio jackfield is illustrated in Figure 2. The source deck can be monitored by inserting a plug into the top row jack while it supplies signal to the mixer via the bottom jack. Furthermore, to send a new source to this mixer, the circuit can be broken by inserting a plug into the bottom jack.

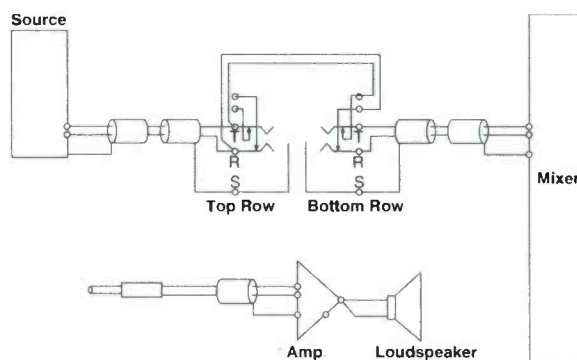

Figure 2

ADC Pro Patch and BGF series jackfields with the normals brought out can be half normalised. Figure 3 shows Jack 1 fully normalised to Jack 25. Jack 2 is wired half normalised to Jack 26.



## Audio Normaling

Audio normaling is a wiring pattern in which a circuit path is established from one piece of audio equipment to another without the use of a patch cord. This pattern is then considered to be the "normal" circuit path that is desired most of the time. If a patch cord is inserted, the normal circuit path is interrupted and rerouted to a different circuit path. Normal paths may be pre-wired at the factory or may be configured in the field by the installer. Normalled patch panels are most commonly found in vertical jack pairs: the top jack (row 1) is designated as the source and the bottom jack (row 2) is the destination.

### Normals Out

All contacts from top and bottom jacks are brought out to the rear termination panel or connectors. This option is considered to be the most flexible since each circuit can be wired independently. The installer can choose any combination of normals strapped, half normalled, or no normals at the rear of the panel.

### Normals Strapped (Fully Normalled)

The normals of the top jack are internally strapped to the normals of the corresponding bottom jack, with the tip, ring, and sleeve brought out to the rear termination. The normal circuit path of top to bottom jack can be broken by inserting a patch cord into either jack. The signal is then routed into the patch cord. The plug on the free end of the patch cord can be inserted into another jack in the patch panel, where the normal circuit path to that jack is broken and the reconfiguration is complete.

### Half Normalled

The normals of the bottom jack only are internally wired to the tip and ring connections of the top jack and the tip, ring, and sleeve of both jacks are brought out to the rear termination. In this configuration, inserting a patch cord into the bottom jack (normals connected) breaks the normal circuit path, while inserting a patch cord into the top jack (normals bypassed) monitors the circuit.

### No Normals

In this configuration no normals are present internally or on the rear termination, so there is no normal circuit path to be interrupted.

### Sleeve Normals Out

Similar to normals out, all contacts from top and bottom jacks are brought out to the rear termination, with the addition of sleeve normal contact. This allows the shield/ground connection to be brought through and switched when patched.

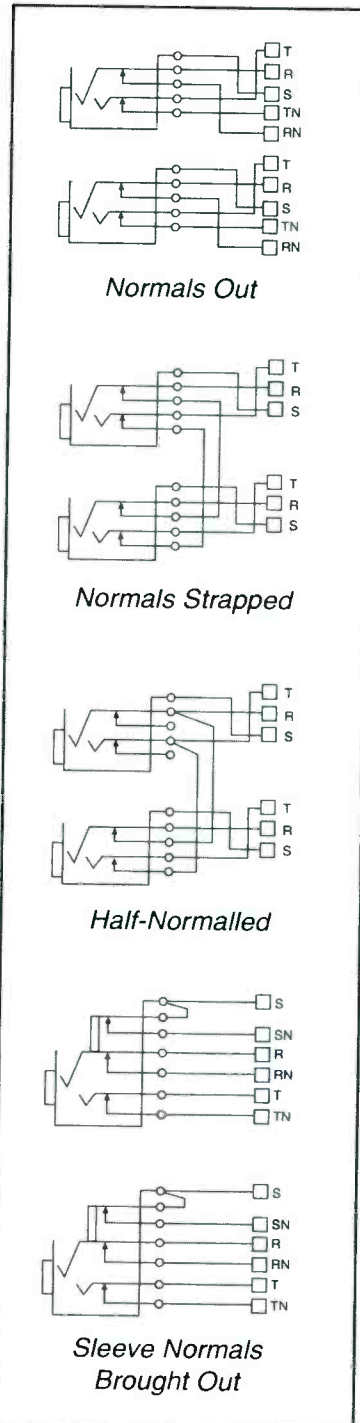



**BGS**

## Video Normalling

Video normalling typically occurs within a dual video jack. A self-normalling video jack internally routes a signal from one piece of video equipment to another, creating a "normal" circuit path. The insertion of a patch cord breaks the normal path and reroutes the signal; removal of the patch cord returns the signal to the normal path. Normalling occurs vertically in dual jacks, between the top port of the jack, designated as the source or input, and the bottom port of the jack, designated as the destination or output.

### Termination

ADC dual video jacks are available non-terminated or terminated to a 75  $\Omega$  resistor. In the terminated jacks, when patched, the unused signal is terminated to the 75  $\Omega$  resistor, as opposed to staying open in the non-terminated jacks.

Termination is important to take into account when working with high frequency signals in serial digital video applications. The primary benefit of 75  $\Omega$  termination is return loss improvement. Also, if the destination equipment is not terminated, the resistor provides a load on the line so that the cable does not become an antenna.

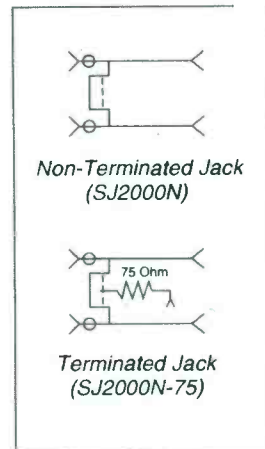

## ~Notes~







**BGS**

## ~Ordering Information~

**Customer Open Accounts:** We are pleased to ship on open account to qualified domestic businesses and educational agencies. Our credit application can be found on the cover sheet or you may request us to fax one to you. All accounts over the credit terms agreed upon will relinquish their privilege of credit terms. COD is available under certain circumstances, please call for details.

**Shipping Information:** Normally we ship via UPS. For expedited shipments, we do use UPS, Federal Express or any specific shipping company you may request. Transportation costs from the shipping point to destination will be prepaid by BGS and added to your order or billed to your account (unless quoted prepaid). Inspect all shipments immediately! If a package is damaged, please make a note of damage or any missing cartons on the receipt and have the driver sign it and give you a copy. Please call BGS if any of these problems arise. See notes below on Claims.

**Returns:** Should you need to return an item, please call for a return authorization number. We are happy to take Authorized returns which include all original packaging materials, warranty card, manuals, and accessories and are back in 14 days. Please ship it back prepaid freight and insured. Most special order items we do not stock are returned to the manufacturer and will have a manufacturer's restock of 15% to 50%. Some custom orders are not returnable. Computer software will only be accepted back if unopened and the factory seal is intact.

**Taxes:** Should Broadcasters General Store be required to collect manufacturer's drop ship sales tax, you shall reimburse Broadcasters General Store. For items that ship or bill to Florida, Georgia and Illinois we are required to collect sales tax, unless you have submitted signed documentation of your tax exemption.

**Shipment Damage Claims:** Any damaged or missing cartons should be noted on the delivery receipt by the driver, before you sign for the shipment. Please copy and fax to BGS so that we may follow up and assist you in any way we can. Save all cartons and equipment until the claim is settled. Under present ICC rules and regulations it is the responsibility of the consignee to inspect and report loss and damages promptly, within 5 working days, and in writing.

**Conditions of Sale:** Payment for the goods is as previously agreed at the time of sale and as stated on the invoice, including freight charges. In the event an invoice is not paid as agreed, the Buyer agrees that the Seller, Broadcasters General Store, Inc., retains title and right to possession of the goods, that the Buyer agrees to pay all costs of collections, including attorney's fees and that interest shall accrue on the full balance at the rate of 18% per annum. Any litigation between the parties shall take place in Marion County, Florida. All returned checks incur a \$25 charge.

**Warranties:** The manufacturers' warranties apply and commence on the invoice date. In the event of equipment failure during the warranty period, contact Broadcasters General Store promptly so that we may assist in the replacement or repair of the defective item.

**Broadcasters General Store, Inc.**

**2480 S.E. 52nd Street**

**Ocala, FL 34480**

**PH#352-622-7700 Fax# 352-629-7000**

*Specifications and prices are subject to change without notice.*





## Index

**Rack Units (13 1/4")**   **Panel Space (Inches)**

44	—	77
43	—	75 1/4
42	—	73 1/2
41	—	71 3/4
40	—	70
39	—	68 1/4
38	—	68 1/4
37	—	64 3/4
36	—	63
35	—	61 1/4
34	—	59 1/2
33	—	57 3/4
32	—	56
31	—	54 1/4
30	—	52 1/2
29	—	50 3/4
28	—	49
27	—	47 1/4
26	—	45 1/2
25	—	43 3/4
24	—	42
23	—	40 1/4
22	—	38 1/2
21	—	36 3/4
20	—	35
19	—	33 1/4
18	—	31 1/2
17	—	29 3/4
16	—	28
15	—	26 1/4
14	—	24 1/2
13	—	22 3/4
12	—	21
11	—	19 1/4
10	—	17 1/2
9	—	15 3/4
8	—	14
7	—	12 1/4
6	—	10 1/2
5	—	8 3/4
4	—	7
3	—	5 1/4
2	—	3 1/2
1	—	1 3/4

*Thank you to the following manufactures for your support! Please check out their ads on the following pages!*

<b>360 Shortcut</b>	<b>120A</b>
<b>360 DigiCart Back/Cover</b>	
<b>ADC</b>	<b>12A</b>
<b>AIRcorp</b>	<b>83B</b>
<b>Aphex</b>	<b>101B</b>
<b>Auditronics</b>	<b>47B</b>
<b>CRL</b>	<b>102A</b>
<b>Comrex</b>	<b>156A</b>
<b>Denon</b>	<b>173B</b>
<b>DNF Industries</b>	<b>30A</b>
<b>ESE</b>	<b>66A</b>
<b>Eventide</b>	<b>119B</b>
<b>Gentner</b>	<b>In front cover</b>
<b>Gepco</b>	<b>11B</b>
<b>Intraplex</b>	<b>138A</b>
<b>Logitek</b>	<b>48A</b>
<b>Marantz</b>	<b>In back cover</b>
<b>Media Touch</b>	<b>29B</b>
<b>Moseley</b>	<b>137B</b>
<b>Musicam USA</b>	<b>156B</b>
<b>Orban</b>	<b>155B</b>
<b>Shure</b>	<b>83B</b>
<b>Sine Systems</b>	<b>155A</b>
<b>Sony</b>	<b>174A</b>
<b>Symetrix</b>	<b>84A</b>
<b>Wohler</b>	<b>65B</b>

<b>360 Systems</b>	
AM-16B Router/Switcher	112
DigicartII/IIPlus	106
Instant Replay	106
ShortCut	119
~A~	
<b>Aardvark</b>	<b>21</b>
<b>ABCO</b>	<b>175</b>
<b>Ac-cetera</b>	<b>30,32</b>
<b>ACOUSTECH</b>	<b>68-69</b>
<b>Acoustic Treatment</b>	<b>170</b>
<b>Acoustical Delay</b>	<b>92</b>
<b>Acoustical Supply Int'l</b>	<b>*</b>
<b>Acoustical Solutions Inc.</b>	<b>*</b>
<b>A/D Converters</b>	<b>21,161</b>
<b>ADC</b>	<b>12,73-79</b>
<b>Adtran</b>	<b>185</b>
<b>AEQ America</b>	
Codec	182
Consoles, Mixers	45
Freq. Extension	185
Hybrid	186
Mixers	124
Monitors	69
<b>AFC</b>	<b>137</b>
<b>AIRcorp</b>	<b>37</b>
<b>AKAI</b>	<b>113</b>
<b>AKG</b>	
Headphones/Headsets	13
Microphones	35
Mic Accessories	30,31,33
<b>Aladdin</b>	<b>34</b>
<b>Alarmco</b>	<b>*</b>
<b>Alesis</b>	<b>*</b>
<b>ALC</b>	<b>*</b>
<b>Allen &amp; Heath</b>	<b>51</b>
<b>Allen Telecom Group</b>	<b>137</b>
<b>Alpha Audio</b>	<b>175</b>
<b>Alps Inc.</b>	<b>176</b>
<b>Altronic</b>	<b>137</b>
<b>Aluma Tower</b>	<b>137</b>
<b>American Recorder Tech</b>	<b>29,108,110,112,114</b>
<b>Ampex Tape</b>	<b>*</b>
<b>Amplifiers</b>	<b>3-8</b>
Audio DA	3
Composite DA	145
Headphone	4-5
Microphone Preamp	5
Phono Preamp	121
Power Amplifiers	6-8
RF Amplifiers	154
Video DA	4

<b>Analyzers</b>	<b>190-192</b>
<b>Anchor</b>	<b>68,69,72</b>
<b>Andrew</b>	<b>137,143</b>
<b>Antennas</b>	<b>139-142,147</b>
<b>Antennas for Comm.</b>	<b>*</b>
<b>Antenna Specialists</b>	<b>137,139</b>
<b>Aphex</b>	
Amplifier	3,5
Com/Limiter	91,92
Generator	89
Interface	22
Processors	86,97,98,100,101
<b>ART</b>	<b>91,92,94,99,100</b>
<b>Ashly</b>	<b>6,92,99,100</b>
<b>Astrolite/TEA</b>	<b>*</b>
<b>Astron Corp.</b>	<b>*</b>
<b>ATI</b>	
Audio Meter	61
Amplifiers	3,5,6
Interface	22
Phono Preamp	121
Mixer	59,128
Tone Generator	194
<b>Atlantic</b>	<b>175</b>
<b>Atlas/Soundolier</b>	<b>31,32</b>
<b>Audicord</b>	<b>102</b>
<b>Audio Control</b>	<b>191</b>
<b>Audio Digital</b>	<b>*</b>
<b>AudioArts</b>	
Amplifiers	3
Consoles	46,55
<b>Audiolab</b>	<b>28</b>
<b>Audiopak</b>	<b>103</b>
<b>AudioSource</b>	<b>*</b>
<b>Audio Technica</b>	
Headsets	14
Microphones	35
Mic Cable	13
Mic Mixer	43
Phantom Power Supply	32
Wireless Mics	38
<b>Audio Visual Assistance</b>	<b>*</b>
<b>Audisar</b>	<b>*</b>
<b>Auditronics</b>	
Consoles	47,52,55
Mix-Minus IFB	52
<b>AUDIX</b>	<b>35,68,69</b>
<b>Auralex</b>	<b>170</b>
<b>Auratone</b>	<b>68</b>
<b>Autogram</b>	<b>46,170</b>

~Continued~

### ~Notes~







## Index

~A~ Continued  
*Auto Couplers* .....184  
*Automation* .....1-2,167-169  
*AVCOM* .....137,169,192  
*AVL* .....170  
*AVOCET* .....137,147,148,153  
*AZDEN* .....\*
*AZONIC* .....\*

~B~  
**B&B** .....61,62  
**BBE** .....98  
**BEC Technologies** .....161  
**Behringer**5,51,91,99,100,102  
**Belar** .....137  
     Audio Fail Safe .....131  
     Modulation Monitor .....150  
     RBDS .....148  
     TV Mod. Mon. ....150-151  
**Belden** .....9  
**Benchmark** .....3,5,21,23  
**BEST Power** .....81  
**Beta Brite** .....173  
**Beyerdynamic**  
     Headphone/Headsets 14,15  
     Microphones .....35  
     Mic Accessories ..30,31,32  
     Wireless Mics .....38  
**BGW** .....6  
**Biamp** .....44,50,92,99,162  
**Big Ears** .....124  
**Bird** .....137,143,146  
**Blue Group** .....119  
**Bogen** .....188  
**BOSE** .....\*
**Brainstorm Electronics** .....\*  
**Broadcast Devices**5,137,145  
**Broadcast Electronics**47,102  
**Broadcast Tools**  
     Audio Fail Safe ...131-132  
     Automation .....167  
     Console Controller .....54  
     Intercom .....18  
     Mixer .....59  
     Relay .....27  
     Router/Switcher ...162-163  
     Satellite .....168  
**Bruel & Kjaer** .....\*
**BRYCO Storage** .....176  
**Bryston** .....6  
**BSS** .....91,92,100  
**Burk** .....133,163  
**Burst Electronics** .....\*  
**Cable**  
     Accessories .....9-11  
     Audio .....9-10  
     Coaxial .....9-10,143-144  
     Connectors .....11-12  
     Digital Analyzer .....190  
     Fiber Optic .....160-161  
     Microphone .....13  
     Testers .....190

~C~  
**Cablewave** .....137,144  
**CAD/Equitek** .....35  
**Cadence** .....\*

**Caig Labs** .....29  
**California Amplifiers** ...137  
**Calculated Industries** ...170  
**Canare** .....9,10,13  
**Cartridges** .....121  
**Carts** .....103  
**Carver** .....6,153  
*Cases/Equipment Bags* ...112-123  
**Cassette Decks** .....107-108  
**CCS** .....130,183  
**CD Players/Rec.** ....109-110  
**Celestion** .....\*
**Cellcast** .....124  
**Cellular Interface** .....181  
**Celwave** .....137  
**Chanel Plus** .....\*
**Chrontronic** .....\*
**Cipher Digital** .....195  
**Circuit Werkes**  
     Auto Couplers .....184  
     Automation .....167,168  
     DTMF .....132  
     Mixer .....124  
     Satellite Network Sequencer ..167  
     Telephone Equip. ....189  
**Clearcom** .....18,19,69  
**Clipper Products** .....122  
**Clocks/Timers** .....170-173  
**Coaxial Cable** 9-10,143-144  
**Coaxial Dynamics** .....\*
     .....137,144,146  
**Codecs** .....130,182-183  
**Comark** .....137  
**Community** .....71  
**Compact Disc** .....109-110  
**CD Storage** .....176  
**Compressor/Limiters** ..91-92  
**Computemp** .....181  
**Comrex**  
     Auto Couplers .....184  
     Freq. Extension .....185  
     Mixer .....125  
     POTs Codec .....130  
     ISDN .....182  
**Comsat/RSI** .....137,140  
**Comtech** .....137,169  
**Comtek** .....169  
**Conex**  
     Automation .....168  
     CellJack .....181  
     DTMF .....134  
     Switcher .....163  
     Tone Generator/Sensor ..168,193  
**Conneaut Audio Devices** .....\*  
**Connectronics** .....\*
**Consoles**  
     Automatic Mixer ....43-44  
     DJ .....44-45  
     On~Air .....45-49  
     Powered .....50  
     Production .....50-58  
     Remote .....59-60,124-128  
     Utility/Sub .....59-60  
**Conquest** .....\*

**Countryman Assoc. Inc.** .....\*  
**Cordlox** .....\*
**Cortana Corporation** .....137,157  
**Couplers** .....184  
**Creamware** .....116  
**CRL** .....137  
     Digital Audio Analyzer ..190  
     Mic Processor .....37  
     Processors .....85,86,90  
     RBDS .....148  
     Real Time Event Sequencer ...171  
     SCA .....149  
     Test Equip. ....190  
**Crown** .....137  
     Amplifiers .....6  
     Microphones .....\*
     Mic Accessories .....32  
     Satellite .....\*
     Transmitters .....158  
**Cushcraft Corp.** .....139  
**Crest Audio** .....\*
**CSU/DSU** .....185  
**DAT/ADAT/Hi-8/111-112,113,114**  
     ~D~  
**David Clark Co.** .....\*  
**Dayton Industries** ...137,153  
**dbx**  
     Com/Limiter .....91-92  
     Equalizers .....99-100  
     Processors ...94,98,101,102  
     Level Interface .....22  
     Mic Preamp .....5  
     Mic Processor .....37  
     Patchbay .....80  
     Power Conditioner .....81  
**Decibel Products** ...137,139  
**Dehydrators** .....146  
**De-esser** .....92  
**Delays** .....92-93  
**Delta Electronics** ...137,145,  
     151,158,193  
**Deltacomm Corp.** .....137  
**Denon**  
     Cassette Decks .....107  
     CD Players .....109  
     DJ Mixer .....44  
     Mini Disc .....104  
     Receivers .....153  
**Dielectric** .....137,145  
**DIGIMAX** .....\*  
**Digital Audio Labs** .....\*  
**Digital Audio Storage** ...1-2  
**Digitech** .....94-95  
**Digitronics** .....92  
**Distribution Amplifiers** ...3-4  
**DNF** .....195-198  
**DOD** .....91,92,95,99,100,191  
**Dolby** .....100,102  
**Dorrough** .....62,63,192  
**Drawer** .....\*  
**Dummy Loads** .....146  
     ~E~  
**EAS** .....147  
**EDCO** .....82

**EDCOR** .....5,43  
**EIMAC** .....137  
**Electro-Impulse Inc.** ...137  
**Electro-Voice**  
     Amplifiers .....7  
     Equalizers .....99  
     Mixers .....50,125  
     Microphones .....35  
     Mic Accessories .....33  
     Speakers .....68-69,71  
     Wireless Mics .....38  
**EMCO** .....190,193  
**EMR** .....137  
**E-Mu Systems, Inc.** .....\*  
**Enberg Electronics** .....180  
**Engineering Enterp.** .....\*  
**Environmental Tech.**137,146,157  
**Equalizers** .....99-100  
**Equipment Racks** ...174-176  
**ERGO Industries** .....137  
**ERI** .....137,141,157  
**ESE**  
     Amplifiers .....3-4  
     Automation .....168  
     Clocks .....171-172  
     Interface .....22  
     Metering .....63  
     Talent Count-down ....199  
**ETA** .....82  
**Eventide**  
     Effects Processors .....95  
     Logging System .....119  
     Profanity Delays .....93  
**Evertz** .....199  
**Exciters** .....158-159  
**Excalibur** 23,137,145,146,184  
**Express Group** .....179  
     ~F~  
**Feedback Eliminator**100-101  
**Fiber Optic** .....77,160-161  
**Feral** .....199  
**Fidelipac**  
     Cart Machines .....103  
     Consoles .....48  
     Eraser .....28  
     On-Air Lights .....181  
**Focusrite** .....\*  
**For.A** .....\*  
**Fostex**  
     DAT Recorder .....111  
     Digital Multitrack Recorders .....\*  
     Headphones .....5,13  
     Porta-Studios .....117  
     Speakers .....69  
     Tone Generator .....193  
**FUJI** .....\*  
**Fujinon** .....\*  
**Furman**  
     Com/Limiter .....91-92  
     DJ Mixer .....45  
     Equalizers .....99  
     Feedback Eliminator ...100  
     Metering .....64  
     Power Conditioner .....83  
     ~Continued~





**-G-**

Gabriel .....137  
 Galaxy Audio .....69,71,190  
 Garner .....\*  
 Gemini .....\*  
 Genelec .....69  
 Geneva .....28  
**Gentner**  
 Amplifier .....3  
 Auto Coupler .....184  
 Assistive Listening .....66  
 Audio Fail Safe .....131  
 Hybrids .....186-187  
 Mic Mixer .....43  
 Microtel .....189  
 Patchbays .....80  
 Remote Control .....134  
 Teleconferencing .....189  
 Telephone Equip. ....189

**GEPCO** .....10  
**Goldline** .....100,191,194  
**Gorman Redlich** .....147  
**GRADO** .....\*

**-H-**

**Hafler** .....7  
**Hamlet** .....194  
**Hannay Reels** .....\*  
**Hard-disc Recorders** .....  
 .....1,2,106,113,115  
**Har-Ken Specialties** .....\*  
**Headphones** .....13-14  
**Headphone Amplifiers** .....4-5  
**Headsets** .....14-17  
**Henry Engineering**  
 Distribution Amp .....3  
 Interfaces .....23,24,27  
 Mixer .....59,125  
 Switcher .....163  
 Telephone .....188,189

**HNB** .....111-112  
**HME** .....\*  
**Hnat Hinds** .....3  
**HollyAnne** .....147  
**H.O.M.E.** .....174  
**Hotronics** .....93,199

**-I-**

**Independent Audio** .....\*  
**Indy Audio** .....184  
**Inkel** .....\*  
 Innovative Quality Software(SAW)  
 .....116  
**Inovonics** .....137  
 Metering .....64  
 Modulation Mon. ....151  
 Processing .....85-86  
 RBDS .....148  
 Stereo Generator .....89

**Intelix** .....18,43,59,164  
**Intercom/IFB** .....18-20,52  
**Interfaces**  
 A/D/A Converters ..21,161  
 Level .....22-27  
 Problem Solvers .....24-27  
 Relay .....27

**Intraplex** .....154,182  
**ISDN** .....182-183

**-J-**

**JBL**  
 Amplifier .....7  
 Com/Limiter .....91-92  
 Mixer .....50  
 Monitors .....68,69,71

**JK Audio** ..125,126,184,189  
**JL Cooper** .....\*  
**JRF** .....\*  
**Juice Goose** .....83

**-K-**

**KACES** .....\*  
**Kay Industries** .....\*  
**Kings** .....\*  
**Kintronic Labs** .....137  
**Klark-Teknik** ..91,92,99,100  
**Klipsch** .....71  
**Knight** .....\*  
**KOSS** .....13  
**Kramer** .....4  
**KRK** .....68

**-L-**

**LBA** .....137  
**Lectrosomics** .....42,44,72  
**Lexicon** .....96  
**Lights, On Air/Record** ..180-  
 .....181  
**Lightwave Systems** .....161  
**Littlite** .....180  
**Loggers** .....119  
**Logitek**  
 Pwr. Amp .....7  
 Consoles .....49,51  
 Metering .....64  
 Router/Switcher .....164

**Lowell Manufacturing** ..174  
**LPB** .....3,48  
**LTM** .....30  
**Luxo** .....31  
**Luxor** .....\*

**-M-**

**M Squared** .....137  
**MRL** .....\*  
**Mackie**  
 Amplifiers .....7  
 Consoles .....51,53,54  
 Speakers .....70

**Magnum Dynalabs** ..137,153  
**Maintenance** .....28-29  
**Marantz**  
 Cassette Recorders 107,108  
 CD Players .....109  
 CD Recorder .....110

**Mark Antennas** .....137,140  
**Marti** .....137  
 Antenna .....140  
 RPU's .....129  
 SCA .....149  
 SMARTI .....130  
 STL/TSL .....155  
 Transmitters .....158

**Masterpiece** .....176  
**Matthey Products** .....200  
**Media storage** .....175-180  
**Meters** .....61-65  
**McCurdy** .....65,70,193  
**Micro Communications** ..137,145  
**Microphones**  
 Accessories .....30-34  
 Cable .....13  
 Mics .....35-36  
 Mixers .....43-44,59  
 Phantom Power .....32-33  
 Processors .....37  
 Wireless .....38-42

**MiniDisc** .....104-105  
**Microwave Filter Corp.** 137  
**Microcon Systems** .....84,86

**Middle Atlantic Audio** .....  
 .....33,176-178  
**Midiman** .....116  
**Mikrolab** .....\*  
**Milcom** .....\*  
**Mini Disc Rec.** .....104-105  
**Mixers** .....43-60,124-128  
**Modulation Mon.** .....150-152  
**Modern Cases** .....122  
**Modulation Sciences** .....137  
 Composite DA .....145  
 Composite Processor .....84  
 Modulation Monitor ...151  
 RBDS .....148  
 SAP .....149  
 SCA .....150  
 Stereo Enhancer .....88  
 Stereo Reference Decoder ..193  
 TV Demodulator .....200  
 TV St. Generator .....89

**Mogami** .....\*  
**Monitoring**  
 Accessories .....67  
 Assistive Listening .....66  
 Metering .....61-66  
 Nearfield .....68  
 Powered .....69-70  
 Sound Reinforcement 50,71  
 Special Purpose .....72-73

**Monroe Electronics** .....135  
**Monster Cable** .....\*  
**Moseley** .....137  
 RPU .....130  
 Remote Controls .....136  
 STL .....155-156

**Motrola** .....19  
**MTS** .....\*  
**Musicam USA** .....130,183  
**MultiMedia** .....173  
**Murphy Furniture** .....179  
**Myat** .....137,144

**-N-**

**Nady** .....39  
**Nakamichi** .....\*  
**NEAR** .....73  
**Neumann** .....\*  
**Neutrik** .....12  
**Nigel B** .....179  
**Nitty Gritty** .....\*  
**Nortronics** .....\*  
**Nott** .....137  
**Numark** .....\*

**-O-**

**O.C. White** .....31  
**OHM Acoustics** .....73  
**Omnimount** .....67  
**Omnirax** .....179  
**Orban** .....37,85,86,88,90  
**On-Air Lights** .....181  
**On-Air Processors** .....85-90

**Otari**  
 Mini Disc .....104  
 Reel to Reel .....120

**Oxmoor** .....3,100  
**OZ Audio** .....5

**-P-**

**Panasonic** .....7,111,114  
**Patchbays/panels**  
 Accessories .....73-80  
 Audio .....74-76,80  
 Video .....78-79

**Peerless** .....67  
**Pelican Cases** .....122  
**Perfect Data** .....174  
**Phartronics** .....136  
**Phonic** .....\*  
**Pioneer** .....\*  
**Pivotelli** .....67  
**Pointmaker** .....200  
**PortaBrace** .....33,123  
**Potomac** .....137  
**P.O.T.S. Codecs** .....130  
**Power Conditioning/UPS** 81-  
 .....84

**Presenta** .....\*  
**Processors**  
 Acoustical Delay .....92  
 Composite .....84  
 Compressor/Limiter 91-92  
 Effects .....94-97  
 Enhancement .....97-98  
 Equalizer .....99-100  
 Feedback Eliminator ..100-101  
 Modular .....101  
 Noise Reduction ..101-102  
 On Air-AM .....85-86  
 On Air-FM .....86-88  
 On Air-TV .....89-90  
 Profanity Delay .....93  
 Stereo Enhancement 88-90  
 Stereo Generator .....89

**PROCO** .....13,67  
**Protech** .....\*  
**Purple Processor** .....86

**-Q-**

**QEI** .....137  
 Cat/Quick Link .....156  
 Modulation Monitor ...152  
 Stereo Generator .....89  
 Trans/Exciter .....158-159

**QSC** .....7  
**Quick Lok** .....\*

**-R-**

**R.B. Annis** .....\*  
**Racks** .....174-176  
 Accessories .....177-179

**Radio Design Labs** .....  
 .....3,5,8,25,26,  
 60,66,91,121,131,  
 152,163,165,194  
**Radio Systems** 3,49,173,187  
**Rainwise** .....181  
**Ramko** .....165  
**Ramsa** .....71,126  
**Rane**  
 Audio DA .....3  
 Delays .....92-93  
 Com/Limiter .....91  
 DJ Mixer .....45  
 Equalizers .....99-100  
 Headphone amp .....5  
 Level Interface .....23  
 Mic Processor .....37  
 Mixer .....60

**Ranger** .....\*  
**Raxxess** .....33,177,178  
**RBDS Generators** .....148  
**Real Time Analyzer** .....191  
**Receivers/Tuners** .....153  
**R.B. Annis** .....28  
**Redco Audio** .....\*

**-Continued-**



## Index



**~R~ Continued**

**Recorder/Players Analog**  
 Accessories .....103,108,121  
 Cartridge .....102-103  
 Cassette .....107-108  
 Porta-Studio .....117-118  
 Reel to Reel .....120  
 Turntable .....121

**Recorder/Players Digital**  
 CD Players .....109  
 CD Recorder .....110  
 DAT/ADAT/Hi-8 .....111-112,114  
 Hard Disc 1-2,106,113,115  
 Logger .....119  
 Mini Disc .....104-105  
 Porta-Studio .....117  
 Software .....1-2,116

**Redco Audio** .....\*

**Reference Audio Design** .....\*

**Remote Broadcast**  
 Cases/Bags .....112-123  
 Mixers .....59-60,124-128  
 POTS Codec .....130  
 RPU .....129-130

**Remote Control**  
 Audio Fail Safe .....131-132  
 Dial-Up .....132-136

**Revox** .....\*

**RF Equipment**  
 Antennas 139-142,147,169  
 Coaxial Cable .....143-144  
 Coaxial Switches .....145  
 Composite DA .....145  
 Dehydrators .....146  
 Dummy Loads .....146  
 EAS .....147  
 Mast Antennas .....142  
 Modulation Monitors .....150-152  
 RBDS Generators .....148  
 Receiver/Tuners .....153  
 RF Amplifiers .....154  
 SAP Generators .....148-149  
 SCA Generators .....149-150  
 STL/TSL .....154-156,161  
 Towers .....157  
 Transmitter/Exciters .....158-159  
 TSL .....154-156,161

**RF and Relate Chart** .....137

**Richmond Sound** .....\*

**Rip-Tie** .....11

**ROH** .....\*

**Rohn** .....137,157

**Router/Switchers** .....161-166

**Roland** .....70,94,102,115

**Rolls** .....5,8,99,153

**Rorke Data** .....\*

**Ross** .....100

**RTS** .....19

**Ruslang** .....179-180

**Russ Friend & Asso.** .....23

**~S~**

**Sabine** .....98,101

**Samson** .....5,55,99

**SAP Generators** .....148-149

**Satellite**  
 Automation .....1-2,167-169  
 Demod .....169  
 Remote Channel Select 167-168

**SCA Generators** .....149-150

**Scala** .....137,140,141,154

**Sennheiser**  
 Headphones/Sets .....14-15  
 Microphones .....36  
 Wireless Mics .....39

**Sescom** .....24

**Seth Thomas** .....172

**Shintron** .....4

**Shively** .....137,142

**Shure**  
 Amplifier .....3,5  
 Cartridge .....121  
 Headset .....15  
 Interfaces .....27  
 Microphones .....36  
 Mic Mixer .....43  
 Mic Accessories .....30,31,33  
 Mixers .....127  
 Wireless Mics .....39-40

**Siemon** .....81

**Sierra Automated (SAS)** .....20,165

**Sine Systems**  
 Audio Fail Safe .....132  
 Message Bd. .....173  
 Remote Controls .....136  
 Thermal Sentry .....158  
 Time/Temp Thing .....188

**SITCO Antenna** .....147

**SKB** .....123

**Software** .....1-2,116

**Sonar Radio** .....\*

**Sony**  
 Cassette .....107-108  
 CD Player .....109  
 DAT Player .....111-112  
 Hi-8 Recorder .....114  
 Headphones .....13  
 Porta-Studios .....117  
 Microphones .....36  
 Mini Disc .....104-105  
 Wireless Mics .....40

**Sorbotech** .....\*

**Sound America** .....184

**Soundcraft** .....50,55,68,126

**Soundolier/Atlas** .....31-32

**Speakers** .....68-73

**Speaker Accessories** .....67

**SPECO** .....\*

**Spirit** .....50,55,68,126

**SPL** .....98

**SSAC** .....137,157

**Standard Tape Labs** .....\*

**Stanton** .....121

**Stantron,Zero** .....175

**StarCase** .....123

**Stewart** .....5,8,33,60

**STL/TSL's** .....154-156,161

**Studer** .....120

**Studio Furnishings**  
 Acoustic Treatment .....170  
 Clock/Timers .....170-173  
 Copy Holders .....174  
 Equipment Racks .....174-176  
 Media Storage .....175-180  
 Warning Lights .....180-181  
 Weather Instruments .....181

**Studio Technologies** .....3,5,20,56,90

**Switchcraft** .....12

**Symetrix**  
 A/D Converter .....21  
 Delays .....92-93  
 Com/Limiter .....91-92  
 Equalizer .....100  
 Mic Preamp .....5  
 Mic Processor .....37  
 Mixer .....60  
 Power Amp .....8

**~T~**

**360 Systems**  
 AM-16B Router/Switcher .....112  
 DigicartII/IIPlus .....106  
 Instant Replay .....106  
 ShortCut .....119

**Tannoy** .....68,71

**Tascam**  
 Amplifier .....8  
 Cassette .....107-108  
 CD Player .....109  
 DAT Recorder .....111-112  
 Hi-8 Recorder .....114  
 Interface .....24  
 Porta-Studios .....117-118  
 Mini Disc .....104-105  
 Mixers .....56,57,60  
 Patchbay .....81  
 Reel to Reel .....120

**T.C. Electronics** .....96-97

**TDK** .....\*

**TEA** .....\*

**Technical Projects** .....\*

**Technics** .....45,121

**Telecast Fiber Systems** .....160

**Telephone**  
 Codec/ASDN/SW56130,182183-  
 Couplers .....184  
 CSU/DSU .....185  
 Frequency Extension .....124,185  
 Hybrids .....186,187  
 Information Announcers .....188  
 Teleconferencing .....189  
 Telephone Interfaces .....189  
 Teleradio .....189

**Telewave** .....\*

**Telex**  
 Assistive Listening .....66  
 Cassette Duplicator .....108  
 Headsets .....16-17  
 Intercoms .....19  
 Microphones .....36  
 Wireless Mics .....40

**Telfax** .....\*

**Tempo Works** .....116

**Test Equipment**  
 Cable Testers .....190  
 Digital Analyzer .....190  
 Real Time Analyzer .....191  
 Spectrum Analyzer .....192  
 Stereo Audio Test Set .....192-193  
 Tone Generator .....193-194  
 Waveform/Vector .....194

**TFT** .....137,147,152

**TIC** .....137

**Tiffen** .....\*

**Titus** .....152,181

**TOA** .....41,50

**Tone Generators** .....193-194

**Towers** .....157

**TPL** .....137,154,156

**Tram** .....\*

**Transmitters** .....158-159

**Trimm** .....\*

**Tripp Lite** .....83-84

**Troisi** .....21

**TTC** .....137,159

**Turntables** .....121

**Twecomm** .....110

**~U~**

**U.S. Audio** .....8

**Ultimate Support Systems** .....32,67

**United Power** .....\*

**UPS** .....82-84

**UREI** .....\*

**~V~**

**Valley Audio** .....24,37,91,92

**Varta** .....\*

**Video Accessories Corp.** .....4,165

**VIF** .....\*

**Viking Cases** .....123

**Vega** .....41

**VSWR Conversion Table** .....138

**~W~**

**Warning Lights** .....180-181

**Weather Instruments** .....181

**Wireless Microphones** .....38-42

**West Penn Wire** .....10

**Wheelock** .....180

**Whirlwind** .....4,11,24,27,  
33,81,128,190

**White Instruments** .....99-100

**Williams Sound** .....66

**Will-Burt** .....137,142

**Windtech** .....33-34

**Winsted** .....\*

**Wohler Tech.** .....65,70,165

**~X~Y~Z~**

**Xedit** .....\*

**Yamaha**  
 Amplifier .....8  
 Com/Limiter .....92  
 Effects Processors .....97  
 Equalizers .....99-100  
 Mixer .....50,57,58  
 Monitors .....68,70,71  
 Porta-Studios .....118

**Zephyrus** .....137,169

**Zercom** .....3,24,127,162,187

**Z-Systems** .....21,99,100,165



# BEST IN CLASS

## marantz®

# CDRs



**Superscope Technologies is pleased to offer Marantz Professional Compact Disc Recorders, the most sophisticated stand-alone CD-R recorders to date, offering unmatched flexibility, functionality and value.**

### **Flexibility.**

- Stand alone operation with multiple digital and analog inputs and outputs
- SCSI-II interface allowing integration with PCs and digital audio workstations (CDR620 only)
- Full function wired remote control (optional with CDR615)
- 9-pin parallel interface for external automation
- One button record capability
- Unattended duplication

### **Functionality.**

- Built-in sample rate converter
- Auto track incrementing
- Programmable fade in and out
- CD-ROM, CD-I, CD-Photo, Video CD and CD-DA recording capability via SCSI-II interface (CDR620 only)
- Unlimited archiving (ignores SCMS)

.....and much much more!

### **Value.**

The Marantz compact disc recorders have broken new boundaries on value. It's more than you ever imagined for less. Far less. For more information call your preferred professional audio dealer.

**marantz®**

Superscope Technologies, Inc.



" MOSES PARTS THE RED SEA. TONIGHT AT 10. "

**DIGICART/II. THE VOICE OF MASTER CONTROL.** No wonder it's used by virtually every major television network in the world. Fact is, DigiCart®/II is the industry standard for playback of bumpers, voice-overs, stingers, and effects. Nothing else organizes, archives, and instantly retrieves more than 10,000 sounds with digital quality and precision. It's networkable, uses both hard disks and removable media, and supports both fully linear digital audio and Dolby® compression. With programmable playlists, full GPI, and serial control, DigiCart/II is your best insurance against dead



air, missed cues, and make-goods. So test drive a DigiCart/II in your facility at our expense. Call today and we'll send you one tomorrow.



360 Systems  
PROFESSIONAL DIGITAL AUDIO



If you're a call-letter station, you can try DigiCart/II for 10 days with no obligation. If you decide to buy it, we'll arrange your purchase through Broadcaster's General Store. Call (352) 622-7700 or fax (352) 629-7000 today.

Broadcaster's General Store • 2480 S.E. 52nd Street • Ocala, FL 34480-7500  
(352) 622-7700 • Fax (352) 629-7000 • E-Mail: <bgs@mercury.net> • Web Site: <http://www.bgsfl.com>