

CONSOLES
PHONO
TAPE
MICROPHONES

Broadcast AUDIO Equipment





About This Catalog

This is one of several catalogs published by RCA Broadcast Systems Department. It describes RCA products that serve the audio portions of the broadcast plant.

For radio broadcasting, RCA publishes a companion catalog that describes AM and FM transmitters, accessories, remote control equipment, monitors, transmission line, towers and antennas.

For TV broadcasting, companion catalogs describe camera equipment, terminal and switching gear, UHF- and VHF-TV transmitters, transmission line, towers and antennas.

These catalogs are available at RCA regional offices. Each office is staffed by a sales representative with broad experience in the broadcast business. He can help you plan your equipment facilities and supply the information you need.

Contents

Microphones

General Information	B.1001
Dynamic Microphones, BK- Series	B.1010
Microphones, SK- Series	B.1015
High Quality Ribbon Microphones	B.1020
Microphone Stands and Accessories	B.1040

Consoles

Audio Consoles, Types BC-7, -8, -17, -19, BCM-2	B.1160
Audio Consoles, Types BC-14, -15, -18	B.1170
Remote Amplifiers, Types BN-1 and BN-4	B.1180
Five-Input Mixer Preamplifier Type SN-10	B.1185
Four-Mixer Remote Console, Type PAM-1	B.1186
Remote Consoles, Type BN-7, BN-17	B.1190
Custom-Built Audio Consoles, Type BC-100	B.1210

Audio Automation

Automatic Programming	B.1250
-----------------------	--------

Intercom/Interphone Equipment

Expandable Intercom System	B.1300
Headphones and Headsets	B.1310
Interphone Equipment	B.1320

Amplifiers and Signal Processors

Modular Audio Amplifiers, Type BA-40 Series	B.1450
Console Audio Amplifiers, Type BA-70 Series	B.1460
Monitoring System, Type BA-8	B.1481

AM/FM/FM-Stereo Tuner, Type ST-6	B.1482
Public Address Amplifiers, SA- Series	B.1490
Audio Equipment Power Supplies, BX- Series	B.1495

Racks, Cabinets, Furniture, Rack Equipment

Cabinets, Racks, Panels	B.1501
Studio Furniture	B.1504
Audio Relay Switcher Module	B.1530
Audio Accessories	B.1540

Turntable Equipment

Phono Equipment	B.1600
-----------------	--------

Tape Equipment

Program Logger, Type RT-19	B.1701
Reel-to-Reel Tape Recorder, Type RT-21	B.1705
Automatic Reel-to-Reel Machine, Type RT-22	B.1707
Reel-to-Reel Tape Reproducer, Type RT-20	B.1710
Multicartridge Playback Systems, RT-16; RT-26	B.1736
Cartridge Tape Carousel, Type RT-25	B.1738
Cartridge Tape System, Type RT-27	B.1741
Tape Recorder Accessories	B.1763

Loudspeakers and Accessories

Loudspeakers and Enclosures	B.1800
Transformers, Wire and Cable	B.1860

Test Equipment

Audio Level Meter, Type BI-100	B.1900
--------------------------------	--------





Microphones, General Information

Microphones, General Information

The wide range of RCA microphones—velocity, ribbon, pressure and dynamic—offers users a choice of quality and economy; performance and price. There is considerable overlap in the applications of the various types, but each possesses certain attributes which make it particularly suited to specific applications. The chart below provides a convenient reference for selecting the RCA microphones which best match the intended usage.

Chart Showing Microphone Applications, Chief Characteristics and Recommended Mounts

Type No.	Use ³	Directional Characteristic	Effective Output Level ¹ and G_M ⁴	Output Impedance Ohms	Frequency Response Hz	Max. Hum Pick-up Level ⁵	Finish	Stand
77-DX	Program, Announce	Poly-directional	-53 dBm G_M -147 dB	30/150 250	30-20,000	-128 dBm	Satin Chrome & TV Gray	Boom, Desk, Floor
BK-1	Program, Announce	Semi- and Non-directional	-52 dBm G_M -146 dB	30/150 250	50-15,000	-102 dBm	Satin Chrome & TV Gray	Boom, Desk, Floor
BK-5	Program, Announce	Improved Cardioid	-57 dBm G_M -151 dB	30/150 250	30-20,000	-128 dBm	TV Gray	Boom, Desk, Floor
BK-6	"Off-Mike" Speech	Semi-directional	-65 dBm G_M -159 dB	30/150 250	60-15,000	-112 dBm	TV Gray	Microphone Lanyard, Clip
BK-11	Program, Announce	Bi-directional	-56 dBm G_M -150 dB	30/150 250	20-20,000	-130 dBm	Stainless Steel & TV Gray	Desk, Floor
BK-12	Program, Announce	Non-directional	-60 dBm G_M -154 dB	30/250	60-18,000	-120 dBm	Bronze epoxy & matte gold	Lanyard, Clip, Hand
BK-14	Program, Announce	Omnidirectional	-60 dBm -154 dB	30/50 150/250	20-20,000	-120 dBm	Satin Finish Nickel	Floor Hand, Desk,
BK-16	Program, Announce	Omnidirectional	-60 dBm -154 dB	30/50 150/250	20-20,000	-120 dBm	Satin Finish Nickel	Floor Hand, Desk,
SK-30	Public Address Paging	Omni-directional	-55 dBm G_M -149 dB	30/250	50-14,000	-115 dBm	Midnight Blue	Desk, Floor
SK-39	Public Address Paging	Semi-directional	-54 dBm G_M -148 dB	250	70-10,000	-105 dBm	Two-Tone Gray	Desk, Floor
SK-46	Radio & TV Announce	Bi-directional	-58 dBm G_M -150 dB	200/15,000	40-15,000	-115 dBm -98 dB below 1 volt	Satin Chrome & TV Gray	Desk, Floor

¹ Reference level 0.001 watt, sound pressure 10 dynes per square centimeter. This corresponds to a rating by the EIA system at a sound pressure level of 94 dB.

² Level referred to a hum field of 10-3 gauss.

³ For details refer to description of each particular type.

⁴ G_M = (EIA rating).

⁵ Switched low-frequency rolloff -8 and -16 dB @ 50 Hz.

High Quality Microphones

Microphones such as the Types BK-1, BK-5, BK-6, BK-11, BK-12, BK-14, BK-16 and 77DX, all have certain common performance criteria which make them especially suited. They offer smooth frequency-response characteristics, low-distortion, high output level, well-shielded output transformers (to prevent hum pick-up) and where necessary, shock mounting to reduce low-frequency "rumble."

Public Address Microphones

Public Address microphones such as the SK-30, SK-39 and SK-46 are designed as economy microphones. In general, frequency range and sensitivity are sacrificed to some extent to gain ruggedness and lower cost.

Unloaded Transformer Input

RCA Microphones work into a microphone preamplifier equipped with an unloaded input transformer. Under this condition, the voltage appearing at the input of the first amplifier stage results in a 3- to 6-dB gain in signal-to-noise ratio as compared with a matched-resistance load.

Microphone Resistance Loading

Microphones in which the moving system is highly damped, in general, have their frequency response characteristics little changed by electrical loading. The BK-1 and BK-6 are examples of this.

Microphones which show output impedance variations with respect to frequency will have their response characteristics adversely affected by resistance loading. The Type BK-5 and 77-DX (in the bi-directional and uni-directional positions) are typical examples. Resistance loading of these microphones will generally result in a reduction in low frequency response.

150 Ohms vs. 250 Ohms

When microphones connect to unloaded input transformers, impedance matching is not a consideration and the effects of connecting microphones with an output impedance of 250 ohms to a microphone amplifier designed to operate from a 150-ohm source and vice versa are usually of small consequence. The effect on the level is:

Mic. Output Impedance	Level Change dB	
	250	0
150	-2.2	0
Amp. Input Designation	250	150

In addition, there is some change in the overall response-frequency characteristic of the system below 100 Hz and above 5000 Hz, the magnitude depending on the connection and the design of both the microphone and the amplifier input transformer. Variations in response with quality microphone amplifiers, in most cases, is less than ± 1 dB.

With microphones connected to a resistance load, these changes in level result when the output is referred to a matched condition:

Mic. Output Impedance	Level Change dB	
	250	0
150	+2.0	0
Load Impedance	250	150

Microphones Shipped Less Plug

RCA microphones are supplied less the plug for connection to the wall outlet or amplifier system. This is done to allow the user to select any desired plug. As a convenience, popular types of plugs are cataloged and they may be ordered as an accessory if desired.*

Microphone Mounting

RCA has standardized on the $\frac{5}{8}$ "-27 and half-inch pipe-thread for microphone mounting. This makes it easy to add microphone stand extensions, booms, etc., made up from standard half-inch pipe and fittings. Stands listed for use with microphones having $\frac{5}{8}$ "-27 thread accommodate RCA Broadcast Microphones by the addition of an adapter. (See *Accessories, B.1040.*)

Effective Output Level

When a microphone connects to an unloaded transformer, its power output can-

* Microphones are shipped connected for 250 ohms since, in normal usage, an improved signal-to-noise ratio results when connected to a 150-ohm preamplifier input.

not be expressed in dBm because the microphone delivers no appreciable power. The logical approach is to arrive at some level figure which, when combined with the conventionally measured amplifier gain, gives the correct output level for the combination. This figure is listed in the catalog for each microphone and is called the Effective Output Level. It differs from the EIA standard rating (G_M) in the value of sound pressure and source impedance. The EIA rating computation is based on a source impedance of 150 ohms for all microphones having output impedances between 75 and 300 ohms, and on a sound pressure of 0.0002 dynes per square centimeter.

The Effective Output Level calculation is based on the nominal microphone impedance and on a sound pressure of 10 dynes/cm².

The EIA standard defines the system rating (G_M) of a microphone as the ratio in decibels relative to 0.001 watt per 0.0002 dynes per square centimeter of the maximum electric power available from the microphone to the square of the undisturbed sound field pressure in a plane progressive wave at the microphone position. Expressed mathematically:

$$G_M = (20 \log_{10} \frac{E}{P} - 10 \log_{10} R_{MR}) - 50 \text{ dB.}$$

where E = open circuit voltage (mic.)
P = the undisturbed sound field pressure

R_{MR} = mic. rated impedance
Electrical reference level = .001 watt
Sound pressure = .0002 dynes/sq. cm.

While this may look complex, the application is simple. For all practical purposes the output level of the microphone is obtained by adding to G_M , the sound pressure level relative to 0.0002 dynes per square centimeter. The sound pressure level of the program material can be measured with any of the available sound level meters.

Hum Pickup Level

An arbitrary standard, 60-Hz a-c field of 10⁹ gauss, is established as a reference. The hum level is referred to 0.001 watt and is calculated in the same fashion as the Effective Output Level, using, as the output voltage, the voltage produced by the standard field.



Dynamic Microphones, BK Series

- Smooth, wide-range frequency response for voice or music
- Semi- and omni-directional models
- Hand-held, lavalier or stand mount
- Durable design to withstand rough usage

Dynamic microphones are ideally suited for indoor, remote or outdoor TV, radio or public address applications where the mike is hand-held or worn as a lavalier. The speech balance and directional characteristics of these dynamic microphones make them especially desirable for voice pickup of interviews or performers. Omni- and semi-directional models are offered, all with smooth, wide-range frequency response.

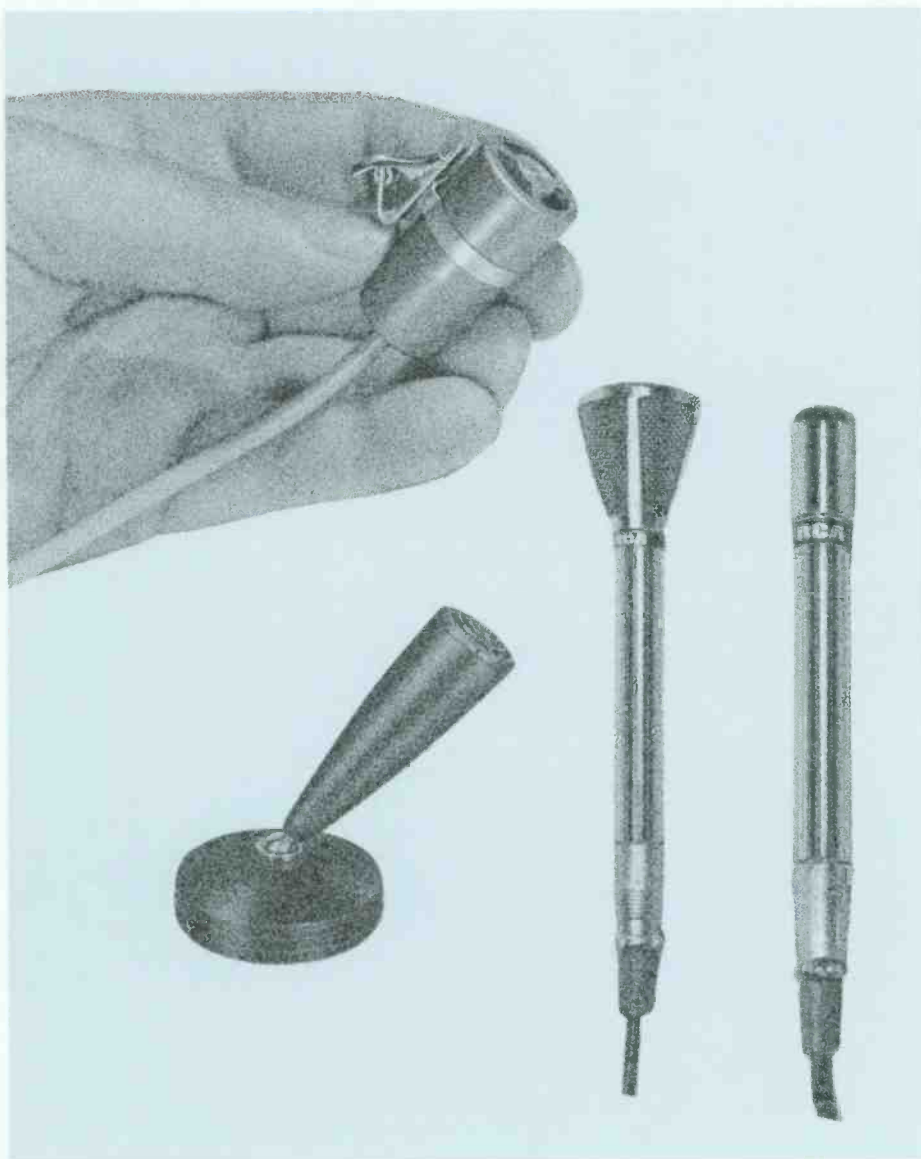

Pressure Microphone, Type BK-1



- **Wide range—50 to 15,000 Hz response**
- **Smooth response over essential range**
- **Removable from base for hand use or mounting on floor stand**
- **Ideal for remote pickups — low sensitivity to wind and mechanical vibrations**
- **Frequency characteristic independent of source distance**

The high-fidelity BK-1 Pressure Microphone is particularly well suited for remote pickups where, if used in the open air, the modern design practically eliminates the effect of air currents. It features a smooth response and frequency range of 50 to 15,000 Hz.

The BK-1 is an omni-directional microphone when mounted vertically. A semi-directional characteristic is obtained when horizontally mounted, in which case the BK-1 is essentially non-directional for frequencies below 2,000 Hz. The higher frequencies are attenuated more as the angle with the perpendicular to the diaphragm increases.

Specifications

Directional Characteristics	Semi-Directional (horizontal) Omni-Directional (vertical)
Frequency Response	50 to 15,000 Hz
Output Impedance	30/150/250 ohms (250 as shipped)
Output Level (1000 Hz):	
a. Effective (10 dynes/cm ²)	-52 dBm
b. EIA—G _m	-146 dB
Hum Pickup (.001 gauss, 60 Hz)	-102 dBm (max.)
Cable (attached)	30 ft., 3 conductor shielded, without connector
Mount	Ball and socket, 1/2" pipe thread
Dimensions	7 3/4" long, 1 7/8" dia. (200 x 48 mm)
Weight (less cable)	18 oz. (510 g)
Finish	Low luster gray and satin chrome

Ordering Information

Pressure Microphone, Type BK-1	MI-11007
Desk Stand, Type KS-11	MI-11008

Subminiature Dynamic Microphone Type BK-12



The BK-12 Subminiature Dynamic Microphone is a very small, extra lightweight mike with excellent speech balance. The BK-12's small bulk and neutral color make it inconspicuous when worn around the neck on a lanyard, clipped to the clothing, or concealed in the hand. Due to its small size, the BK-12 is essentially non-directional to 6,000 hertz, thus ordinary errors in orientation are inconsequential.

The 0.71-ounce mike has a wide range frequency response of 60 to 18,000 Hz which is compensated for proper speech balance. Other notable features include a line-impedance voice coil that permits use with 30- to 250-ohm unloaded inputs. Through elimination of the output transformer, magnetic hum sensitivity is lower than comparable microphones with line-matching transformer. The micron-mesh acoustical filter provides dirt and moisture protection. Through careful design and the availability of improved magnetic materials, an extremely high acoustical-to-electrical power efficiency is achieved in the BK-12 despite its small diaphragm area.

Due to its small size and light weight, the BK-12 is adequately supported by the tie clip holder which fastens equally well to shirt front or lapel. A lavalier holder is also supplied for suspending the microphone around the neck.

The user need never send the BK-12 back for factory repairs. A complete replacement cartridge can be installed in a few minutes. The cable is also easily replaced.

Specifications

Directional Characteristics	Non-directional
Output Impedance	Low—for use with 30- to 250-ohm unloaded inputs
Frequency Response	60 to 18,000 Hz, shaped for lavalier use
Output Level (1000 Hz):	
Effective (10 dynes/cm ²)	-60 dBm (150 ohms)
EIA—G _m	-154 dB (150 ohms)
Effective Output Level @ 1000 Hz	-60 dBm (150 ohms) (referred to a sound pressure of 10 dynes/cm ²)
EIA Sensitivity Rating	-159 dB (150 ohms)
Output Voltage (open circuit)	.75 mV/d/cm ²
Hum Pickup (0.001 gauss, 60 Hz)	-120 dBm max.
Cable (attached)	30 ft. 2-conductor shielded, highly flexible, beige PVC jacket
Mounting	Lavalier and tie clip holders supplied
Dimensions	3/4" dia. x 1 1/2" long (20 x 38 mm)
Weight (less cable)	0.71 oz. (20 g)
Finish	Bronze epoxy and matte gold

Ordering Information

Subminiature Dynamic Microphone, Type BK-12 complete with Lavalier Holder, Tie Clip Holder and Cable Clip	MI-11024
---	----------

Dynamic Microphone, Type BK-14



- Lightweight broadcast microphone
- Wind and "pop" resistant
- Internal shock resistant
- Replaceable cartridge
- Uniform frequency response—20 to 20,000 Hz

The BK-14 is a dynamic cartridge-type microphone, ideal for indoor or outdoor use where a hand held lightweight mike with good response to voice and music is required. The microphone is omnidirectional with a frequency response essentially uniform from 20 to 20,000 Hertz.

It is contained in a non-reflecting satin nickel 8-inch long case only 3/4-inch in diameter. A protective wind screen, and internal shock and isolation construction permit effective use in areas where loud "pop" noises are specified. The microphone has provisions for stand mounting. A swivel mount and a 30-foot, 2-conductor shielded cable with Cannon plug to fit the microphone base are supplied as standard equipment.

Specifications

Directional Characteristics	Omnidirectional
Frequency Response	20 to 20,000 Hz
Output Impedance	Low—for use with 30 to 250 ohm unloaded inputs
Output Level (1000 Hz):		
Effective (10 dynes/cm ²)	-60 dBm (150 ohm)
EIA-G _m	-154 dB (150 ohms)
Hum Pickup Level (.001 gauss, 60 Hz)	-120 dBm (max.)
Cable (Removable)	30 feet, 2 conductor, shielded with Cannon XLR-3-11C to fit microphone base
Mounting	Hand held or stand by means of swivel mount supplied
Finish	Non-reflecting satin nickel
Dimensions	8" long, 0.75" dia., screen dia. 2" (193, 19, 51 mm)
Weight (less cable)	4 oz. (113 g)

Ordering Information

Dynamic Microphone, Type BK-14MI-11042

Dynamic Microphone, Type BK-16



- Extremely smooth frequency response—20 to 20,000 Hz
- New slim silhouette for hand or stand use
- Replaceable cartridge
- Omnidirectional at all frequencies

The slim silhouette and light weight of the BK-16 microphone make it particularly well suited for pickups where a hand held or stand microphone is designated. It is omnidirectional, and has a smooth response over a frequency range of 20 to 20,000 Hz.

The BK-16 is encased in a non-reflecting satin nickel housing 8 inches long and 3/4-inch in diameter. It is provided with a swivel mount and a 30-foot, 2-conductor shielded cable with Cannon connector to fit at the base. Internal shock and isolation filters assure smooth speech or music pick-up.

Specifications

Directional Characteristics	Omnidirectional
Frequency Response	20-20,000 Hz
Output Impedance	Low—for use with 30 to 250 ohm unloaded inputs
Output Level (1000 Hz):		
Effective (10 dynes/cm ²)	-60 dBm (150 ohm)
EIA-G _m	-154 dB (150 ohms)
Hum Pickup Level (.001 gauss, 60 Hz)	-120 dBm (max.)
Cable (removable)	2 conductor, shielded, 30-ft. with Cannon XLR-3-11C plug to fit microphone base
Mounting	Hand held or stand by means of swivel mount supplied
Finish	Non-reflecting satin nickel
Dimensions	8" long, 0.75" dia. (193 x 19 mm)
Weight (less cable)	3 oz. (85 g)

Ordering Information

Dynamic Microphone, Type BK-16MI-11048

Miniature Dynamic Microphone, Type BK-6

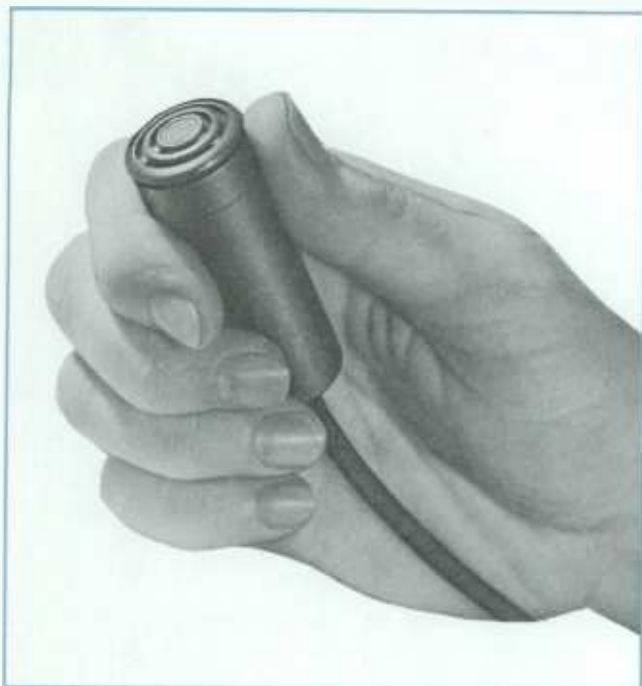

The Miniature Dynamic Microphone, Type BK-6 is specially designed for correct speech balance. Frequency response and directional characteristics are engineered to complement human speech so that the microphone has excellent balance when the performer is talking "off mike."

The BK-6 may be worn by the performer; its small bulk and neutral color make it inconspicuous. The lightweight and flexible cable permit free, unhampered movement of the performers. Suspended from the neck, resting on the chest, the BK-6 attenuates the low pitched chest sounds while at the same time it points straight up towards the lips, the position in which it is most sensitive to the high-frequency sounds that would normally be lost.

A special internal acoustic resonator is employed to support the response to lower frequencies and a damped resonator placed in front of the diaphragm reduces high frequency emphasis while extending the upper frequency limit. The result is a pleasing balance for speech when the microphone is used "off mike," or worn on the person. The special plastic diaphragm and coil assembly, output transformer and terminal board and bracket assembly are housed in a rugged and practically weather-proof case.

The cable, specially designed for the BK-6 unit, has unusual flexibility combined with long life under conditions of severe abuse. High tensile alloy conductors provide high flexibility and long life. The external jacket gives a tough, neutral color, protective covering to the cable.

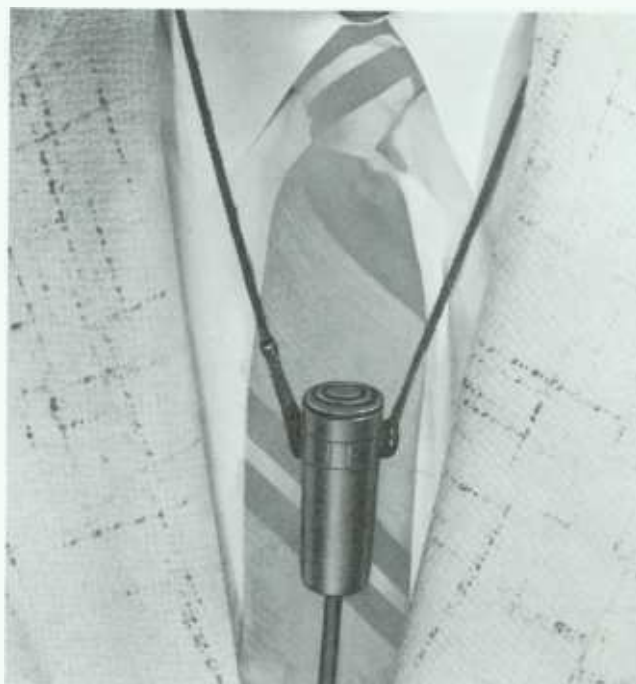

Specifications

Directional Characteristics	Semi-directional
Frequency Response	60-15,000 Hz shaped for lavalier use
Output Impedance	30/150/250 ohms (250 as shipped)
Output Level (1000 Hz):	
Effective (10 dynes/cm ²)	-65 dBm
EIA—G _m	-159 dB
Hum Sensitivity (.001 gauss, 60 Hz)	-112 dBm (max.)
Cable (Attached)	30 ft., two-conductor shielded, highly flexible, brown PVC jacket, no plug
Mounting	Removable lanyard supplied for suspending about neck
Dimensions	2 1/4" long x 15/16" diameter (65 x 24 mm)
Weight (less cable)	2.3 oz. (65 g)
Finish	Low luster gray

Accessories

Microphone Holder, Clamp Type	MI-12086
Microphone Stand Adaptor Kit (for gooseneck)	MI-11073
13" Flexible Microphone Stand	MI-11745
19" Flexible Microphone Stand	MI-11746

Ordering Information

Type BK-6 Miniature Dynamic Microphone	MI-11017
--	----------



Microphones, SK Series

- Excellent for close-talking applications
- Rugged and reliable
- Ribbon and Dynamic models
- Wide frequency range

SK Series microphones are economical and durable, designed for general purpose announce and public address functions in TV, radio and professional audio systems.

Ribbon Microphone Type SK-46

The SK-46 Ribbon Microphone puts the smooth, uncolored response of the velocity mike in a case size comparable to that of many dynamic mikes. The program quality and inconspicuous size make it preferred for professional audio systems of all types.

Unusual Low-Frequency Response

The SK-46 offers unattenuated low-frequency response all the way to 40 Hz and below. Because of this, the mike "hears" all of the mellowness required by the professional user. At the normal speaking distance of one foot (305 mm), the SK-46 is free of unnatural boominess owing to its integral acoustic damping.

Bi-Directional Pattern

The SK-46 Microphone's directivity pattern—the familiar "figure-8"—rejects sound energy incident to the sides of the mike. This characteristic is most useful where script noise or other distractions create unwanted background noise. It provides superior acoustic gain characteristics and is very effective for sound-reinforcement situations, particularly when the speakers are located directly above or to the side.

Rugged, Repairable Construction

Built to take the hard knocks of daily use with little loss in quality or looks, the SK-46 is completely unaffected by temperature, humidity or barometric pressure. Being repairable, it can always be reconditioned to perform like new.

The combination of small size and outstanding quality makes the SK-46 an excellent choice as a desk mike on TV shows.



Ribbon Microphone Type SK-46



Specifications

Directional Characteristics	Bi-directional
Frequency Range	40 to 15,000 Hz
Output Impedance	200/15,000 ohms (200 Ω as shipped)

Effective Output Level at 1000 Hz:

Low Impedance	-58 dBm, EIA G_m -150 dB
High Impedance	-60 dB below 1 volt/dyne/cm ²

Hum Pickup (.001 gauss, 60 Hz):

Low Impedance (200 ohms)	-115 dBm
High Impedance (15,000 ohms)	-98 dB below 1 volt

Cable25 feet (7.6 m), 2 conductor plus shield, no plug

MountingSwivel mount, $\frac{5}{8}$ "-27 thread

Dimensions5 $\frac{1}{8}$ " H; 1-15/16" W; 1 $\frac{3}{8}$ " D (130, 49, 35 mm)

FinishSatin chromium and low luster gray

Weight (less cable)13 ounces (369 g)

Ordering Information

Ribbon Microphone, Type SK-46MI-12046

Dynamic Microphone Type SK-30



The RCA SK-30 Dynamic Microphone is a small, light-weight unit with a broad range of applications. It is relatively insensitive to mechanical shock and wind disturbances.

Frequency response of the unit is exceptionally wide, 50 to 14,000 Hz. The microphone has an omni-directional pick-up pattern which tends to become uni-directional at high frequencies.

The SK-30 microphone may be hand held or mounted in a variety of ways. By removing the end cap, the microphone gooseneck-mounts for use on lecterns. A swivel adapter permits the microphone to mount on any standard floor or desk stand.

Specifications

Frequency Response	50 to 14,000 Hz
Output Impedance	For use with 30 to 250 ohm unloaded inputs

Output Level (1000 Hz); (150 ohm system):

Effective (10 dynes/cm ²)	-55 dBm
E.I.A.— G_m	-149 dB

Hum Sensitivity (.001 gauss, 60 Hz)

Cable (attached)2 conductor shielded cable

Dimensions1.5" diameter by 4.5" long (38 mm, 114 mm)

Weight8 ounces (140 g)

Accessories

Swivel Mounting Adapter ($\frac{5}{8}$ "-27 female thread)MI-11032

Ordering Information

Dynamic Microphone, Type SK-30:

With 20-foot (6m) of cableMI-11030-1

Less Base Cap, with 17-inch (432 mm) cableMI-11030-2

With 13" (318 mm) Gooseneck and FlangeMI-38263

Aerodynamic Microphone Type SK-39



The Type SK-39 Aerodynamic Microphone has excellent response for close talking announce purposes. Its light weight and small size make it ideal for remote pickup and mobile use. It is used for paging and announcing in areas of high noise level because its rising high frequency characteristic gives excellent intelligibility. Another application is for use by an individual soloist, where a second microphone is used to pick up the musical accompaniment.

The SK-39 is relatively insensitive to mechanical shock and wind disturbances and will withstand nominal exposure to moisture or rain because of its plastic diaphragm.

Specifications

Directional CharacteristicsSemi-Directional

Frequency Response70 to 10,000 Hz

Output Impedance250 ohms

Output Level (1000 Hz):

Effective (10 dynes/cm²)

E.I.A.— G_m

Hum Pickup (.001 gauss, 60 Hz)

Cable (attached)25 ft., 2 conductor, shielded

Dimensions2 $\frac{7}{8}$ " dia., 2 $\frac{3}{4}$ " L, 3 $\frac{1}{4}$ " H, (73, 70, 82 mm)

Weight1 lb. (.45 kg.) less cable

Ordering Information

Aerodynamic Microphone, Type SK-39MI-12039



High-Quality Ribbon Microphones

- Exceptionally smooth frequency response
- Adjustable pick-up pattern
- Best for wide-range music
- Desk, floor or boom-mount

The RCA Ribbon Microphones described here are designed for highest quality sound pickup in radio, TV or recording studio applications. Smooth response over a wide frequency range is characteristic of these fine instruments. Each is provided with a 3-position voice-music switch to permit selection of most desirable operating characteristic. These microphones are normally mounted on a desk, floor stand or mike boom.



Cardioid Ribbon Microphone, Type BK-5



A dependable, high-quality ribbon instrument with an improved cardioid directional characteristic, the RCA Type BK-5 Microphone offers essentially flat frequency response from 30 to 20,000 Hz. Its smooth response and wide frequency range make it ideal for both speech and music.

“Uniaxial” Directivity

The microphone’s maximum sensitivity lies on a single mechanical axis, (see directivity pattern). This “uni-axial” directional characteristic simplifies microphone placement.

Ribbon Element

The moving element of the Type BK-5 Microphone is a thin, corrugated, metallic ribbon clamped under tension. It vibrates in near perfect sympathy with almost any sound waves it intercepts. Placed between the pole pieces of a

magnetic circuit, one side of the ribbon is exposed to the open air while the rear side sees an acoustical labyrinth. Phase-shift openings in the labyrinth cancel essentially all of the backwave to give the instrument its cardioid characteristics.

Triple-Impedance Output

An impedance-matching transformer, housed within the microphone case, raises the extremely low impedance of the ribbon to a line impedance of 30, 150 or 250 ohms (connected for 250 ohms at the factory). Changing the connections for either 50 or 150 ohms is a simple matter done easily almost anywhere. Transformer shielding prevents hum pick-up even in moderately strong magnetic fields.

Built-In Blast Filter

So faithful is the ribbon element to the sound pressures it intercepts that a sharp, loud transient—such as a gun shot—could do it harm. However, the BK-5 mike includes a double-layer blast filter that effectively shields the ribbon from such transients without impairing its sensitivity to more pleasant sounds.

Voice-Music Switch

The essentially-flat low-frequency response of the BK-5 (see curve) makes it an outstanding choice for musical instrument pickup, even to 32-foot organ pipes, double string bass and the tympani.

A built-in, three-position switch allows modification of this low-frequency response for voice work.

Repairable Element

Unlike many microphones available in today’s marketplace, the BK-5 is built for the long haul: it is fully repairable in the event of damage and ready for recalibration at any time.

Specifications

Directional Characteristic	Improved Cardiod Pattern
Frequency Response	30-20,000 Hz (see curve)
Response Compensation	3 position, voice-music switch
Output Impedance	250 ohms, may be changed to 30 or 150 ohms
Effective Output Level at 1000 Hz	
Sound Pressure 10 dynes/cm ²	-57 dBm
EIA Rating (G _m) (150 ohm connection)	-151 dB
Hum Pickup Level (.001 gauss, 60 Hz)	-128 dBm (max.)
Cable	3-conductor, shielded, 30 feet (9 m), no plug
Dimensions (overall)	7" long, 1¾" dia. (180 x 45 mm)

Weight (less cable)	1 lb., 11 oz. (760 g)
Finish	Low luster gray enamel
Mount	Cushion-mount, ½" pipe-thread (female)

Accessories

Thread Adapter, ½-inch pipe to ⅝"-27 thread	MI-11021-4
Boom Mount	MI-11012
Wind Screen	MI-11011

Ordering Information

Cardioid Ribbon Microphone, Type BK-5	MI-11010
---	----------

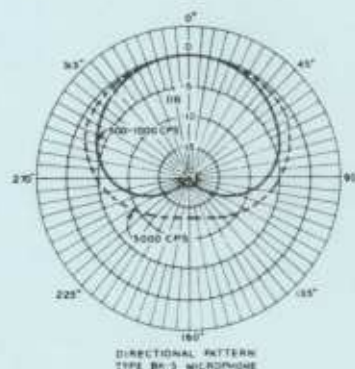
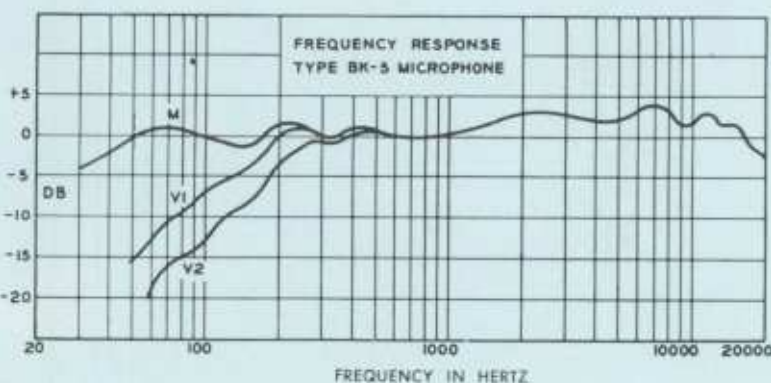

Polydirectional Ribbon Microphone, Type 77DX



Ribbon Element—Smoothest Characteristics

Ribbon mikes long ago established a reputation for response smoothness from sub-audibility to super audibility (see typical curve). The 77DX instrument has remained essentially unchanged for a decade and more because it is virtually beyond performance improvement and it continues to serve those to whom quality sound is important.

Adjustable Pickup Patterns

The 77DX includes a system that controls the mike's directivity to provide three patterns: bi-directional, omnidirectional and uni-directional cardioid. This system uses a movable shutter covering the opening of an acoustical labyrinth. The labyrinth opening is slotted directly "behind" the ribbon. When the shutter completely closes the labyrinth, the 77DX operates as a non-directional, pressure mike; with the shutter wide open, the 77DX operates as a bi-directional instrument; with the shutter partially closed, a phase-shift changes the pattern to a cardioid or uni-directional.

Best for Wide-Range Music

Unsurpassed for the pickup of string bass, tympani and other low-frequency musical instruments, a 77DX mike not only responds to these "lows" but does it with superb fidelity to the acoustical waveform. So sensitive at the low frequency end is the 77DX, a special shock mount isolates the element from ordinarily imperceptible building rumble.

Adjustable Low-End Response

For voice work, particularly in close-talk situations, the excellent low-frequency response of the 77DX captures the resonance of a trained male voice. For situations where this effect is inappropriate, a built-in, three-position switch allows adjustment of the low-frequency response (see curve).

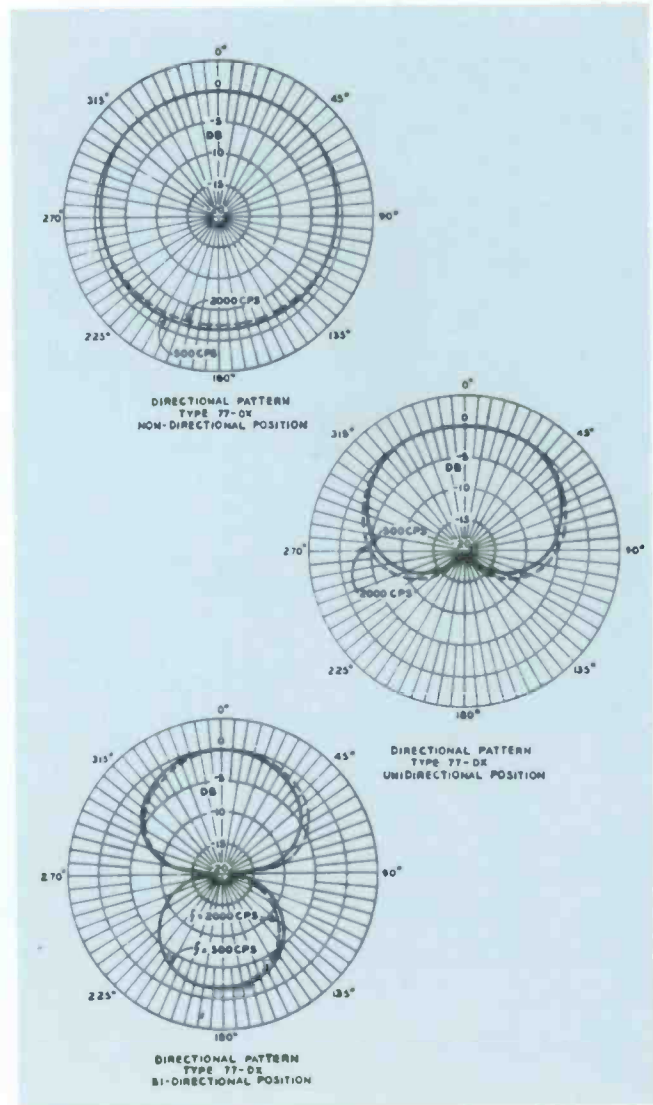
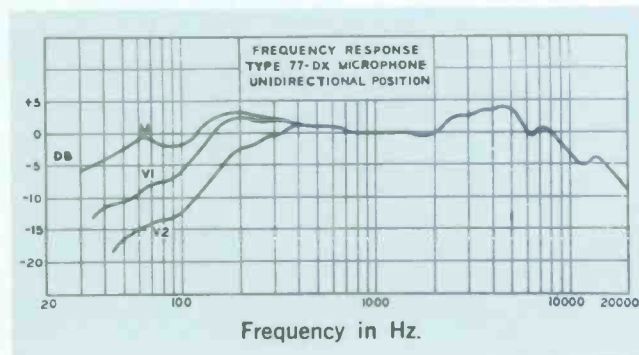

Specifications

Frequency Response Characteristic	30-20,000 Hz (see curve)		
Response Adjustment, 50 Hz	-10 dB; -15 dB		
Output Impedance	50, 150, 250 ohms		
Output Level (at 1000 Hz):			
	Bi-Dir	Uni-Dir	Non-Dir
Effective (10 dyn/cm ²) ..	-50 dBm	-53 dBm	-56 dBm
EIA-G _M	-144 dB	-147 dB	-150 dB
Hum Pickup (1mG 60 Hz field)	-128 dBm (max.)		
Physical Characteristics:			
Dimensions	11½" L; 3¾" W; 2½" D (292 x 95 x 63 mm)		
Weight (less cable)	3 lbs. (1,360 g)		
Supplied with 30-foot (9.2 m) cable (MI-43), no plug			
Mount	½" pipe or ⅝"-27 thread		

Accessories

Thread Adapter, ½-inch pipe to ⅝"-27 threadMI-11021-4

Ordering Information

Polydirectional Velocity Microphone, Type 77DX:

Satin-chrome finish	MI-4045
Low-luster enamel finish	MI-11006

Bi-directional Ribbon Microphone, Type BK-11



The BK-11 is a dependable bi-directional microphone free of the effects of cavity resonance, diaphragm resonance and pressure doubling. It is well shielded against stray magnetic fields and can perform satisfactorily in high hum fields. Acoustically designed sturdy stainless steel screens protect the microphone from mechanical injury. Internal shock and vibration isolation is provided between the case and the element. The microphone has a swivel mount which permits a 45-degree forward or backward tilt.

Specifications

Directional Characteristics	Bi-directional
Frequency Response	20 to 20,000 Hz
Response Compensation	3 position voice-music switch
Output Impedance	30/150/250 ohms (250 as shipped)
Output Level (1000 Hz):	
Effective (10 dynes/cm ²)	-56 dBm
EIA-G _m	-150 dB
Hum Pickup Level (.001 gauss, 60 Hz)	-130 dBm (max.)
Cable Attached	30 ft. 3 conductor, shielded, brown neoprene jacket
Mounting	Swivel mount 1/2" pipe thread
Dimensions (overall)8" long, 2 7/8" wide, 2 3/8" deep (200 x 73 x 60 mm)
Weight (less cable)	2 lbs. (900 g)
Finish	Low luster gray and stainless steel

Accessories

Thread Adapter, 1/2-inch pipe to 5/8"-27 threadMI-11021-4

Ordering Information

Velocity Microphone, Type BK-11 (less stand)MI-11019

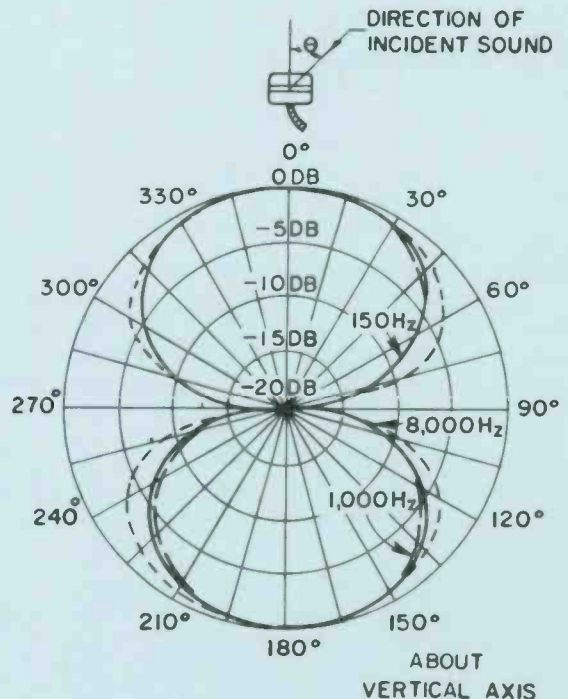
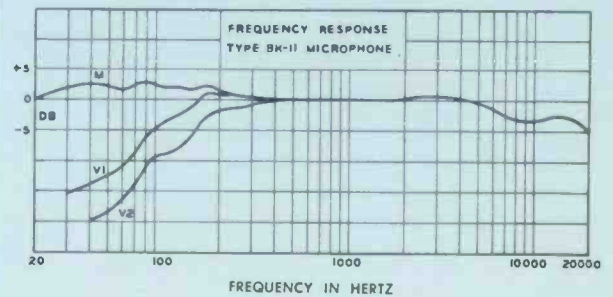



Microphone Stands and Accessories

- Rugged construction
- Attractive appearance
- Easy to assemble or take apart
- Compact and convenient for portability



MICROPHONE DESK STANDS

Type No.	Mounting	Base Dimension	Height	Weight	Finish	Ordering Information
91-D	1/2" Pipe Thread	4 1/2" by 6 5/8"	1 3/4"	4 lbs. (1.8 kg.)	Umber Gray Chrome Trim	MI-4092
KS-11A	1/2" Pipe Thread	4 3/8" diameter	—	1 1/2 lbs. (.68 kg.)	Dull Umber Gray	MI-11008
DS-10	5/8"—27 Fixture Thread	—	—	1 1/2 lbs. (.68 kg.)	Dull Gray Chrome Trim	MI-11021-3
DS-5	5/8"—27 Fixture Thread	6" diameter	4"	2 lbs. (.91 kg.)	Gun Metal Shrivel Finish	MI-11021-5
TS-6	5/8"—27 Fixture Thread	8" diameter	14 1/2" to 26"	6 lbs. (2.7 kg.)	Chrome	MI-11021-6

MICROPHONE FLOOR STANDS

Type No.	Mounting	Base Diameter	Height	Weight	Finish	Ordering Information
90-A	1/2" Pipe Thread 5/8"—27 Fixture Thread	12 1/4" diameter	44" to 74"	33 lbs. (15 kg.)	Chrome	MI-4090
CS-1	5/8"—27 Fixture Thread	Collapsible	23" to 62"	5 lbs. (2.3 kg.)	Chrome and Cadmium	MI-11021-1
MS-25	5/8"—27 Fixture Thread	17"	38" to 67"	22 lbs. (10 kg.)	Chrome and Gray	MI-11021-7
MS-20	5/8"—27 Fixture Thread	12"	37" to 66"	15 lbs. (6.8 kg.)	Chrome and Gray	MI-11021-8

BK-6 MICROPHONE HOLDER

UseTo mount BK-6 Microphone to floor or flexible stands
 Size2 5/8" long x 1 1/6" dia.
 Weight—Holder2 oz. (57 g.)

Ordering Information

BK-6 Microphone Holder, 5/8"—27 threadMI-12086

MICROPHONE STAND ADAPTOR KIT

Weight8 oz. (230 g.)

Ordering Information

BK-6 Microphone Stand Adaptor Kit (Consisting of stand adaptor flange, 3 tapping screws, microphone adaptor, 2 machine screws and rubber gasket)MI-11073

CABLE HOOK

UseFits all microphones
 Weight15 oz. (425 g.)
 FinishPolished Chrome
 Fits Stands 7/8" to 1 1/4" in diameter
 AttachmentOne screw

Ordering Information

Cable HookMI-11099

MICROPHONE ADAPTORS

Stand Thread	Microphone Thread	Ordering Information
1/2" pipe thread	5/8"—27	MI-12053
5/8"—27	1/2" pipe thread	MI-11021-4

GOOSENECK STANDS

Ordering Information

13" Flexible Stand, chrome finish,
 5/8"—27 thread, wt. 1 lb. (.45 kg.)MI-11745
 19" Flexible Stand, chrome finish,
 5/8"—27 thread, wt. 1 1/2 lbs. (.68 kg.)MI-11746
 6" Stand Bracket Clamp, 5/8"—27 threadMI-11747



MICROPHONE CABLES

RCA microphone cables are of rugged construction and are jacketed with a neoprene compound to assure long life. They are specially designed for rugged service either in studio or remote operation.

LOW IMPEDANCE CABLE, MI-43

UseLow impedance microphone circuits
 TypeThree-conductor, twisted
 ConductorsCadmium copper, stranded, equivalent to #20 AWG
 InsulationSpecial rubber compound
 Shield...Semiconducting wrapped and braided tinned copper (Complete coverage without loss in flexibility)
 Outer CoveringBrown neoprene compound
 Overall Diameter0.300

Ordering Information

Specify length in 100-foot multiplesMI-43

HEAVY DUTY CABLE, MI-13307

TypeTwo-conductor, twisted
 ConductorsStranded, equivalent to #16 AWG
 InsulationSpecial rubber compound
 ShieldTinned copper (Complete coverage without loss in flexibility)
 Outer CoveringBlack neoprene compound
 Overall Diameter0.300

Ordering Information

Specify length in 100-foot multiplesMI-13307

LIGHTWEIGHT CABLE, MI-13322

TypeTwo-conductor, twisted
 ConductorsStranded cadmium copper, equivalent to #24 AWG
 InsulationPolyethylene
 Shield...Semiconducting wrapped and braided tinned copper (Complete coverage with greater flexibility)
 Outer CoveringPYC
 Overall Diameter0.215 plastic

Ordering Information

Specify length in 100-foot multiplesMI-13322

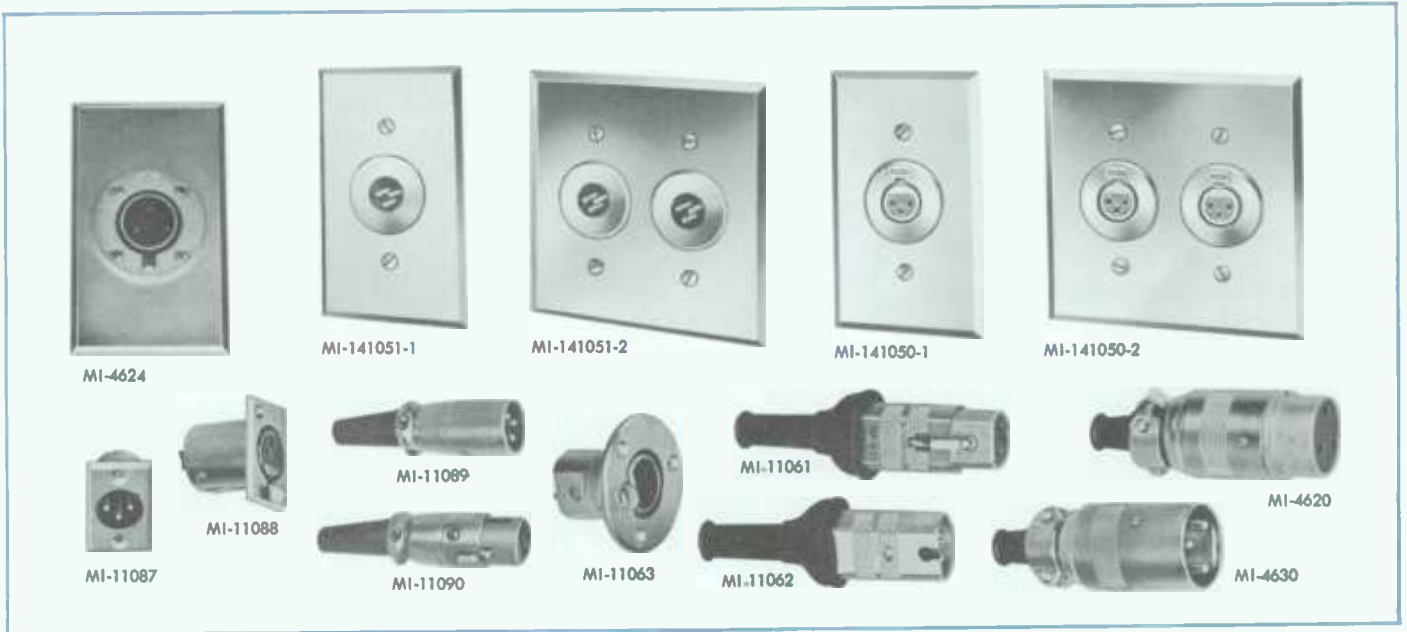

MICROPHONE PLUGS AND RECEPTACLES

RCA microphones are sold without plugs in order that the purchaser may use any type desired. Three series of Cannon plugs are stocked. These include the "UA" series of plugs which have been designed as a result of EIA recommendations, the "P" Type Connectors and the "XLR" matched family of small 3-contact connectors.

The "UA" connectors have gold-plated contacts for low-loss and noise-free operation. Flat-top construction provides positive polarization. All have thumb action latch-lock for quick insertion and firm engagement and a 1 3/4-inch rubber sleeve for cord protection.

The "P" connectors are the original connectors for audio circuits and accommodates wires up to No. 10. The "P" connectors have a 15 ampere contact capacity. The Cannon connectors "XLR" type plugs and receptacles are miniature connectors favored by many users.

ORDERING INFORMATION

Description	Cannon Stock No.	Ordering Information
Female Plug for Microphone Extension Cable (mates with MI-11062)	UA-3-11	MI-11061
Male Plug for Microphone Cable (mates with MI-11061 and MI-11063)	UA-3-12	MI-11062
Flush Mounting Receptacle (mates with MI-11062)	UA-3-13	MI-11063
Male Plug for Microphone Cords	P3-CG-12S	MI-4630
Wall Receptacle for Above Plug	P3-35	MI-4624*
Extension Cord—Female Connector..	P3-CG-11S	MI-4620
Microphone Receptacle, Female	XLR-3-31	MI-11088
Microphone Receptacle, Male	XLR-3-32	MI-11087
Microphone Plug, Female	XLR-3-11C	MI-11090
Microphone Plug, Male	XLR-3-12C	MI-11089
Wall Receptacle, Single Male	XLR-3-36	MI-141051-1
As Above but Double Male	XLR-3-36-2G	MI-141051-2
Wall Receptacle, Single Female	XLR-3-35	MI-141050-1
As Above but Double Female	XLR-3-35-2G	MI-141050-2

*Note: The MI-4624-A Receptacle will fit a standard outlet box.



ADJUSTABLE MICROPHONE SUPPORT ARMS

Type M-2-MD-U—Has 12-inch upright to raise bottom joint of arm to level of top of console. Screw attachment base for horizontal surface. Extreme extension 33 inches. Male stud 5/8"—27 thread. Shipping weight 9 lbs. (4.1 kg)

Ordering InformationMI-11020-1

Type M-2-MC Two-arm type similar to MI-11020-1 with clamp base attachment for thickness up to 2 1/2 inches. Shipping weight 7 lbs. (3.2 kg)

Ordering InformationMI-11020-2

Type M-3MW Two-arm type for wall mounting three feet above working level, male stud 5/8"—27 thread. Extreme extension 34 inches. Shipping weight 9 lbs. (4.1 kg)

Ordering InformationMI-11020-4

MICROPHONE BOOMS WITH STANDS OR PERAMBULATOR

DESCRIPTION

RCA Microphone Boom Stands and Perambulator afford proper microphone placement for programs where the best microphone position cannot be reached with conventional stands. Boom length and counter balance overhang are easily adjustable.

KS-3 MICROPHONE BOOM & STAND

Height of StandAdjustable from 5' 3" to 8' 10"
 Horizontal Arm Adjustment5' 4" to 8' 1"
 (with overhang to rear)
 Microphone MountingStandard 1/2" pipe thread
 5/8"-27 fixture thread with adaptor removed
 Weight (unpacked)67 lbs. (30.4 kg.)
 FinishSatin stainless steel and low luster gray
Ordering InformationMI-11056

BS-36 FLOATING ACTION BOOM & STAND

Height of StandAdjustable from 4' to 6'
 Boom Length62" (an additional 31" extension may
 be added if a lightweight mike is used)
 Microphone Mounting5/8"-27 Fixture Thread
 Base Diameter17"
 Weight Shipping36 lbs. (16 kg.)
 FinishChrome plated with base of polished chrome
 and gun metal
Ordering InformationMI-11021-2

MI-11070 MICROPHONE BOOM & STAND

Height of StandAdjustable from 4' to 8'
 Horizontal Arm AdjustmentTelescope 6' 10" to 18'
 Microphone MountingShockproof rubber mount
 with 1/2" pipe thread
 Microphone AdjustmentRear handwheel
 Weight (approx.)70 lbs. (32 kg.)
 FinishSatin, stainless steel and gray
Ordering InformationMI-11070

MI-26574 MICROPHONE BOOM & PERAMBULATOR

Dimensions:
 Maximum Height (with boom pedestal elevated)9' 5"
 Height (with pedestal lowered)6' 5"
 Length of Boom:
 Extended17'
 Retracted7' 4 1/2"
 Weight:
 Boom (with gunning device
 and counterweights)102 lbs. (46.5 kg.)
 Perambulator421 lbs. (190 kg.)

Accessory

Standard Clamp Type Holders
 (Mole Richardson)Type H-1 to H-7

Ordering Information

Boom and Perambulator (complete)MI-26574
 Boom OnlyMI-26574-1
 Perambulator OnlyMI-26574-2





Audio Consoles, Types BC-7, -8, -9, -17, -19; BCM-2

- All amplifiers and power supplies plug-in
- Mono, stereo, two-channel and simulcast units
- Long-life, step-type attenuators
- Noiseless, telephone-type key switches
- Expandable capabilities

RCA Audio Consoles are high-quality systems designed to stand up under day-in, day-out use and abuse. There are mono, stereo, two- and three-channel consoles plus an auxiliary console for system expansion. Modular construction permits a variety of input combinations, depending on the modules selected. For your convenience, a selection of input arrangements is included for each console.

Two-Channel Console, Type BC-7

The Type BC-7 is offered in five basic forms for dual-channel mono and stereo operation. The console provides ten input mixers.

Two-Channel Console, Type BC-8

The Type BC-8 is a dual-channel, mono console with eight input mixers. It uses plug-in modules identical to those of the BC-7 and is offered in two versions.

Mono Console, Type BC-9

Featuring four Input mixers, the Type BC-9 is a mono console ideally suited to the needs of the smaller studio or audio system. Its components are identical to those of the larger consoles described in these pages.

Simulcast Audio Console, Type BC-17

Essentially a three-channel version of the versatile Type BC-7 Console, the Type BC-17 provides mono and stereo mixing facilities together or separately without external switching or jack-field assemblies. As a result, the BC-17 can control stereo and mono program material simultaneously.

Stereo Console, Type BC-19

The Type BC-19 is a stereo or two-channel equivalent of the mono Type BC-9. Its components are interchangeable with those of the other consoles described in these pages.

Auxiliary Mixer Console, Type BCM-2

The Type BCM-2 expands the input capability of any of the foregoing consoles by five mixers. It is offered in two standard versions: one for mixer bus bridging and one for mixer input.



Two-Channel or Stereo Console, Type BC-7

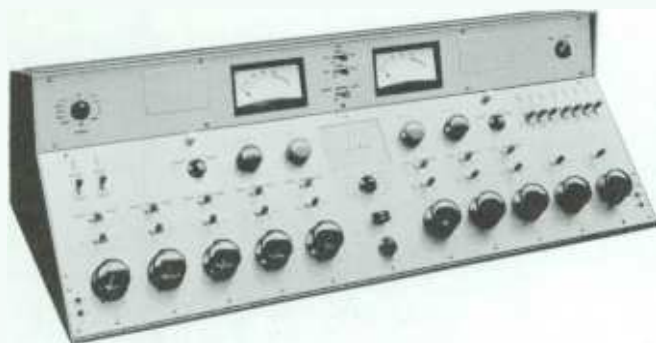

- Eight dual, two single attenuators
- Plug-in assemblies
- Easy operation
- Solid state design
- High reliability components

The BC-7 Audio Console provides stereo or mono mixing, switching, and monitoring, plus dependable plug-in amplifiers, low-impedance mixing circuits, power supply and built-in cue/intercom amplifier. Two mono and three stereo versions are available.

Ten Input Mixers

The BC-7 console contains ten mixers: five low level, three high level and two line level. All inputs and outputs are brought out to terminal connections within the console, so that wiring to jack fields is easily accomplished.

Functional Design

The BC-7 Console is designed for operating convenience with a double-sloped front panel, large illuminated VU meters and uncluttered control panel. The main control panel finish is anodized, brushed aluminum while the housing and upper panel are finished in a pleasant blue color.

Compact Control Arrangement

All switching, mixing, and operational controls are contained on the main control panel and are grouped and color coded for fast identification. Permanent panel designations are etched in black, while designations which are most subject to change, are left blank. Panel recesses, provided at these locations, accept an assortment of pressure-sensitive labels supplied with each console. Plug-in, unitized construction is the key to the flexibility of the BC-7 to meet varying studio applications. Six types of plug-in units are used in the BC-7: preamplifier, program amplifier, monitor amplifier, cue/intercom amplifier, power supply and high-level isolation unit.

All Solder Input Connectors

One feature of the design is the availability of the input and output circuits on terminals. This facilitates wiring to external sound effects equipment, compensating networks or jack panels. Another feature is the muting-relay strapping panel, conveniently located behind the main control panel at the top, center. Any of the five muting relays may be controlled by any combination of source selection lever keys associated with mixers 1 thru 8.

Self-Contained Power Supply

The power supply provides operating power for up to ten preamplifiers, two program amplifiers, five speaker muting

relays as well as reserve power for operation of five additional optional warning light relays. The 10-watt monitor amplifier and the cue/intercom amplifier include their own power supply.

Mixing Facilities

Each of the ten mixers accept one of three plug-in units: the preamplifier (for low-level sources); a high-level isolation unit (for balanced high-level sources); or a simple jumper plug (for direct, unbalanced-input). The console housing is supplied with dual attenuators in mixer positions 1 through 8.

Specifications

Mixers	10
Inputs:	
Microphones	15
Turntable, tape or film	9
Network or high-level	3
Remote lines	4
Outputs:	
Program lines	2
External monitors (one for each channel)	2
Speakers per channel (or 10 speakers, two per location for stereo using optional second monitor amplifier)	5
Source Impedance:	
Microphones	37.5/150/600 ohms
Net, Remote, Turntables, Tape, Film	600 ohms
Load Impedance:	
Line	600 ohms
Loudspeaker	16 ohms
Headphone	High Impedance
Output Level:	
Program Channels (after 6 dBm isolation pad)	+18 dBm
Monitor Amplifier (each channel at 4 ohms)	10 watts
Input Level:	
Microphone Inputs (maximum)	-22 dBm
Turntable Input (maximum)	+18 dBm
Net or Remote Line (maximum)	+18 dBm
Gain:	
Mic to Program Line	105 or 111 dB
Turntable or Remote Line to Program Line	64 dB
Frequency Response	30 to 20,000 Hz, ±0.75 dB
Distortion:	
Program Channel	50-20,000 Hz 0.5% max.
Monitor Amplifier	30-20,000 Hz 1% max.
Signal-to-Noise Ratio	
Microphone to Program Line (68 dB gain, +18 dBm output)	68 dB
Dimensions	39¼" W, 12½" H, 20" D (997, 318, 508 mm)

Accessories

Auxiliary Mixer Housing, Type BCM-2B	MI-11656
On-Air Light Relay	MI-11702
Warning Lights	MI-11706-Series
Spare Preamplifier, Type BA-72	MI-11658
Spare Program Amplifier, Type BA-73	MI-11659
Spare Monitor Amplifier, Type BA-74	MI-11661
Spare Cue/Intercom Amplifier, Type BA-78	MI-11662
Spare Power Supply, Type BX-71	MI-11663
Intercom Sub Station	MI-11452

Ordering Information

Mono, Two-Channel Consoles, Type BC-7:	
(4 BA-72 Preamps; 2 BA-73 Program Amps;	
1 BA-74 Monitor Amp; 1 BA-78 Cue/Intercom Amp;	
2 Hi-Level Iso Units; 1 BX-71 Power Supply)	ES-11176
As above, with two BA-72 Preamps	ES-11177
Stereo, Two-Channel Consoles, Type BC-7:	
(6 BA-72 Preamps; 2 BA-73 Program Amps;	
2 BA-74 Monitor Amps; 1 BA-78 Cue/Intercom Amp;	
2 Hi-Level Iso Units; 1 BX-71 Power Supply)	ES-11180
As above, with four BA-72 Preamps	ES-11179
As above, with two BA-72 Preamps	ES-11178

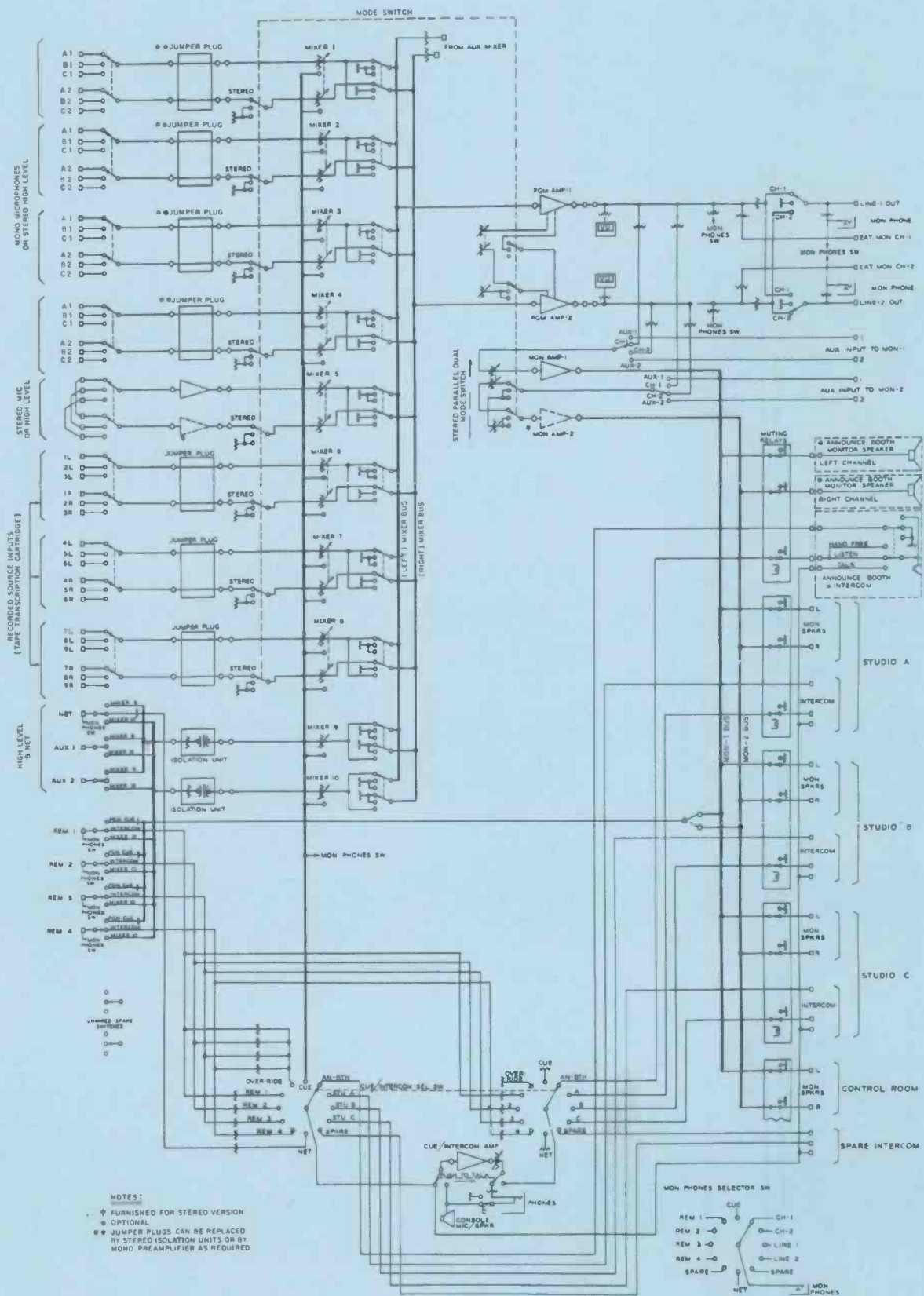

Functional Diagram, Type BC-7 Console

Two-Channel Mono Console, Type BC-8



- Complete two-channel console
- Modular electronics
- Built-in cue monitor and intercom amplifier
- Extended range performance
- Eight mixer positions

Possessing great flexibility and featuring simplified operation, the BC-8 Studio Console provides a high-fidelity audio input system for AM, FM and TV stations. Designed for operating convenience and ease of servicing, the console offers two-channel mixing and switching with monitoring facilities, plus dependable plug-in amplifiers, low-impedance mixing circuits, self-contained power supply and built-in cue/intercom amplifier. Also included are two VU meters so that simultaneous, visual monitoring of both program channels may be accomplished.

Field installation of a third program channel is possible. This is useful for pre-testing microphone circuits for quality and level before switching to program or preview channels.

Plug-In Unitized Construction

Plug-in unitized construction is the key to the flexibility of the BC-8. The basic console consists of a wired housing including all operating controls, three dust-protected speaker muting relays, two VU meters, and guide assemblies for plug-in modules. These include three preamplifiers, two program amplifiers, a cue/intercom amplifier, a monitor amplifier, a power supply, and two high-level isolation units. Plug-in units used are identical with those of the BC-7 Console and BCM-2 Auxiliary Mixer.

Eight Low-Impedance Mixers

The BC-8 Studio Console contains a total of eight mixer positions; three low-level, (each switchable to one of three inputs); three high-level, (each switchable to one of three inputs); and two line-level, (each switchable to one of three inputs). All amplifier inputs and outputs are brought out to terminal connections within the console, so that wiring to external jack fields may be easily accomplished.

Ease of Operation

All switching, mixing, and operational controls are contained on the main control panel and are grouped and color

coded for fast identification. The double-slope front panel, pleasing functional design, large illuminated VU meter and completely uncluttered control panel highlight the simplicity and beauty of the unit. The finish of the main control panel is anodized, brushed aluminum, while the housing and upper panel are finished in a harmonizing blue color. The console is intended for desk top mounting. The BCM-2 Auxiliary Mixer may be used with the BC-8 to increase the number of available mixers by five. Convenient terminals are provided in the BC-8 to extend the mixer bus to the BCM-2.

Specifications

Mixers (selectable to either program channel)	8
Inputs:	
Microphones (switchable to 3 preamplifiers)	9
Turntable, tape or film (switchable to 3 high level mixers)	9
Network or high-level (switchable to Mixer 7 or 8)	3
Remotes (switchable to Mixer 8; intercom, and cue)	3
Outputs:	
Program lines (either channel feeds either or both)	2
External monitor (one for each channel)	2
Loudspeakers	3
Source Impedance:	
Microphones	37.5/150/600 ohms
Net and Remote Lines	600 ohms balanced
Turntables, tape and film	600 ohms unbalanced
Load Impedance:	
Line	600 ohms balanced from 6 dB pad
Speaker	16 ohms
Headphone	High Impedance
Input Level:	
Microphone Inputs (maximum)	-22 dBm max.
Turntable Input (maximum)	+18 dBm max.
Net or Remote Line (maximum)	+18 dBm max.
Output Level:	
Program Line	±18 dBm
Monitor (16 ohms)	10 W.
Gain:	
Mic Input to Program Line	105 or 111 dB
Turntable or Remote Line to Program Line	64 dB
Frequency Response	30 to 20,000 Hz, ±0.75 dB
Distortion (30-20,000 Hz):	
Program Channel	0.5% max.
Monitor Amplifier	1% max.
Signal-to-Noise Ratio:	
Mic to Program Line (68 dB gain, +18 dBm output)	68 dB min.
Dimensions	34¾" W, 12½" H, 20" D (883, 318, 508 mm)
Weight (approx.)	125 lbs. (58 kg)
Finish	Blue, brushed aluminum panel, color coded controls
Power Requirements	115/230 V, 50-60 Hz, 120 W max.

Accessories

Auxiliary Mixer Housing, Type BCM-2	MI-11656
On-Air Light Relay	MI-11702
Warning Lights	MI-11706-Series
BC-8 Studio Console Housing only, less plug-in modules	MI-11667
Headphone, Double (24K ohms Impedance with plug)	MI-11750
Spare Preamplifier, Type BA-71	MI-11658-B
Spare Program Amplifier, Type BA-73	MI-11659-B
Spare Monitor Amplifier, Type BA-74	MI-11661-C
Spare Cue/Intercom Amplifier, Type BA-78	MI-11662-B
Spare Power Supply, Type BX-71	MI-11663-B

Ordering Information

Mono Two Channel Consoles, Type BA-8: (3 BA-72 Preamps; 2 BA-73 Program Amps; 1 BA-74 Monitor Amp; 2 Hi-Level Iso Units; 1 BA-78 Cue/Intercom Amp; 1 BX-71 Power Supply)	ES-11167
As above with one BA-72 Preamp	ES-11181

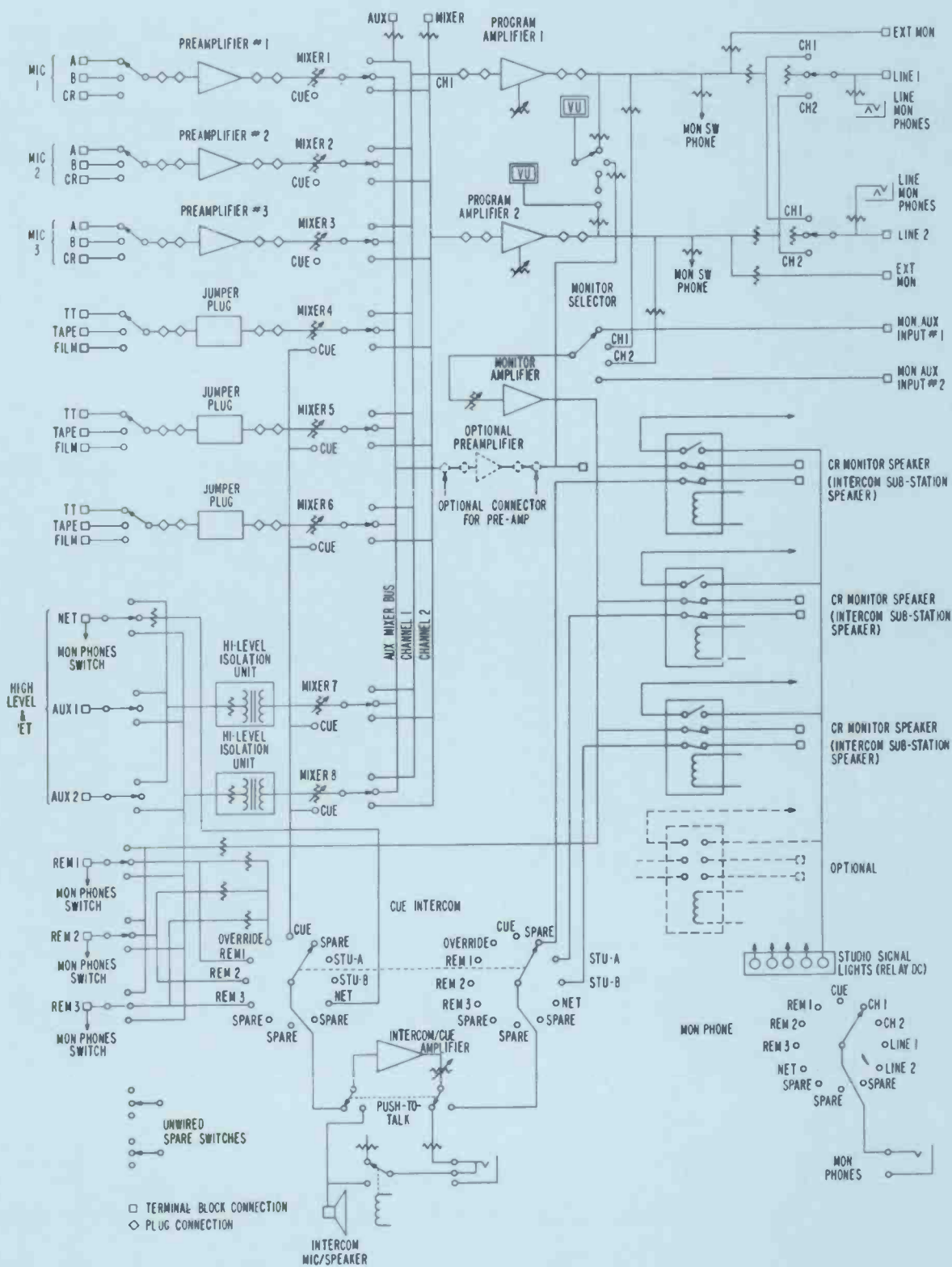

Functional Diagram, Type BC-8 Console

Simulcast Three-Channel Audio Console, Type BC-17



- Extensive FM, AM and TV facilities
- Reliable solid state design
- Easy operation
- Ten dual attenuators

The BC-17 Simulcast Three-Channel Audio Console provides modern mixing and switching facilities for the AM/FM/TV broadcaster. The console allows an operator to simultaneously delegate program material to a stereo FM transmitter and an AM transmitter.

Input Facilities

The BC-17 has provisions for 46 audio inputs; 18 mono sources, 28 stereo inputs, including two inputs for auxiliary program sources. Two extra unwired utility level keys are also provided.

Mixing is accomplished by a ten-fader low impedance mixer, using ladder attenuators. Cueing positions are provided on all attenuators.

The console has twelve single, low-level input channels allowing twelve single mono microphones to be individually switched (three per channel) into four mixing channels. Three stereo pairs of microphones may be switched separately into the first five mixing (stereo) channels.

Ten high-level stereo inputs are provided. These channels include stereo turntable, reel- and cartridge-tape and film projector sources, and one auxiliary input.

The high-level channels include one network, one auxiliary, and three remote line inputs. They are individually switched to provide maximum flexibility. These inputs are wired for one (left) channel only. However, wiring for the right channel can be added since switch facilities are available to provide stereo when desired. Two relay switching assemblies and one external auxiliary input provide fifteen stereo inputs.

Program Channels

All input sources are routed to any one of three program channels buses which, in turn, direct mono programs into a corresponding program amplifier. A stereo source is routed into the channel 1 bus and channel 2 bus, then into program

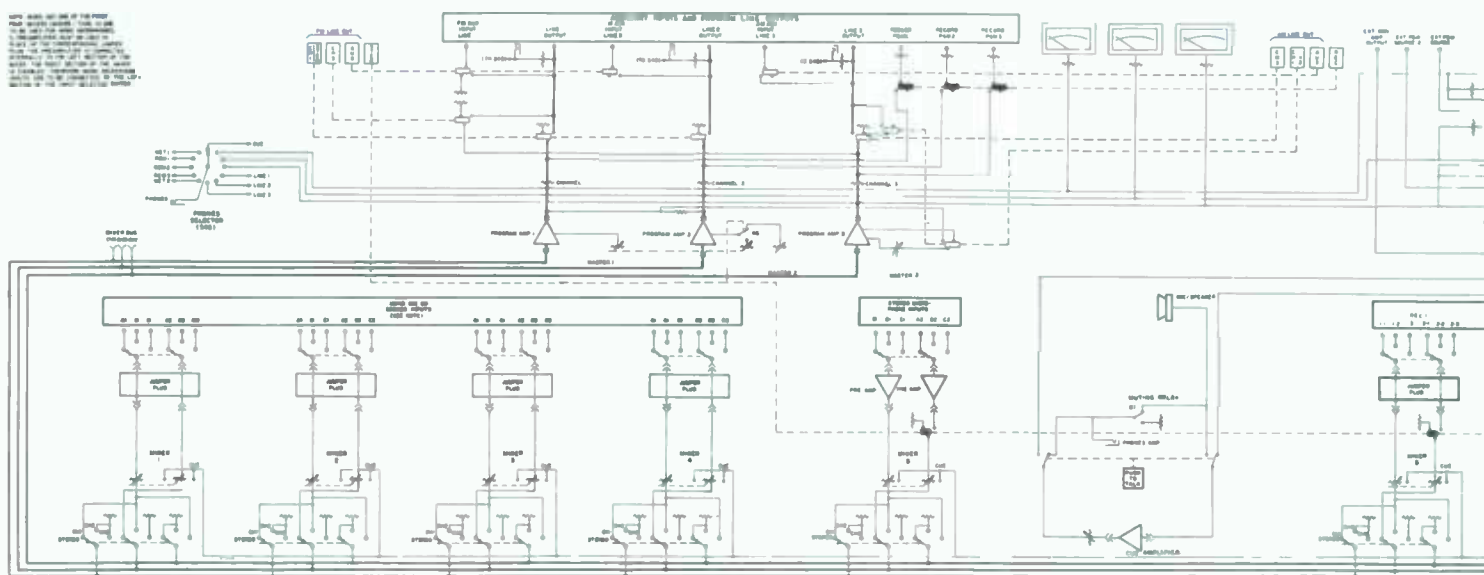

amplifiers 1 and 2 respectively. A selector switch connects the right channel of the source through the channel 2 program amplifier.

Monitoring Facilities

Monitoring facilities permit the operator to control the mode of program fed to studio speakers.

Other monitoring facilities include four phone jacks for program amplifier outputs, line outputs, cue information and network and remote line programs. Through a panel speaker, it is possible to select cue, networks, or remote line information and studio intercommunications at speaker signal level.

Specifications

Mixing Channels	10
Input Circuits	46
External High Level Sources	1 Mono; 1 Stereo
Operating Modes	Three-Channel or Stereo/Mono simultaneously
Output Levels:	
Program (Three Lines)	+8 VU; +18 dBm
Recording Outputs (Four outputs)	-10 VU; -0 dBm
Stereo Speaker Outputs (Five sets)	+30 VU; +10 W.
Auxiliary Input/Output Circuits	1 high-level auxiliary
Impedances:	
Microphone Inputs	37.5/150/600 ohms
Net, Auxiliary and Remote Lines	600/150 ohms
Turntable, Tape, Film Inputs	600 or 600/150 ohms
Output Lines	600 ohms balanced
Gain:	
Microphone to Program Line	106 or 112 dB
Recorded Inputs to Program Line	66 dB max.

Network, Auxiliary and Remote	66 dB max.
Microphone Input to Speaker Line	127 dB max.
Signal-to-Noise Ratio	68 dB min.
Frequency Response (30-20,000 Hz)	±0.5 dB
Distortion (30-20,000 Hz):	
Program Channels	0.5% max.
Monitor Amplifier	1.0% max.
Dimensions	39¼" W, 12½" H, 20" D (997, 318, 508 mm)
Weight:	
Stereo Console	180 lbs. (82 kg)
Power Requirements	115 or 230 V AC, 50-60 Hz, 130 W max.

Accessories

On-Air Light Relay	MI-11702
Warning Lights	MI-11706-Series
High Level Isolation Unit	MI-11665
Spare Preamp, Type BA-72	MI-11658
Spare Program Amplifier, Type BA-73	MI-11659
Spare Monitor Amplifier, Type BA-74	MI-11661
Spare Cue/Intercom Amplifier, Type BA-78	MI-11662
Power Supply, Type BX-71	MI-11663
Intercom Sub Station	MI-11452

Ordering Information

Three-Channel Console, Type BC-17:	
(6 BA-72 Preamps; 3 BA-74 Program Amps; 2 BA-74 Monitor Amps; 1 BA-78 Cue/Intercom Amp; 2 Stereo Hi-Level Iso Units; 1 BX-71 Power Supply)	ES-11173
As above with four preamps	ES-11174
As above with two preamps	ES-11175

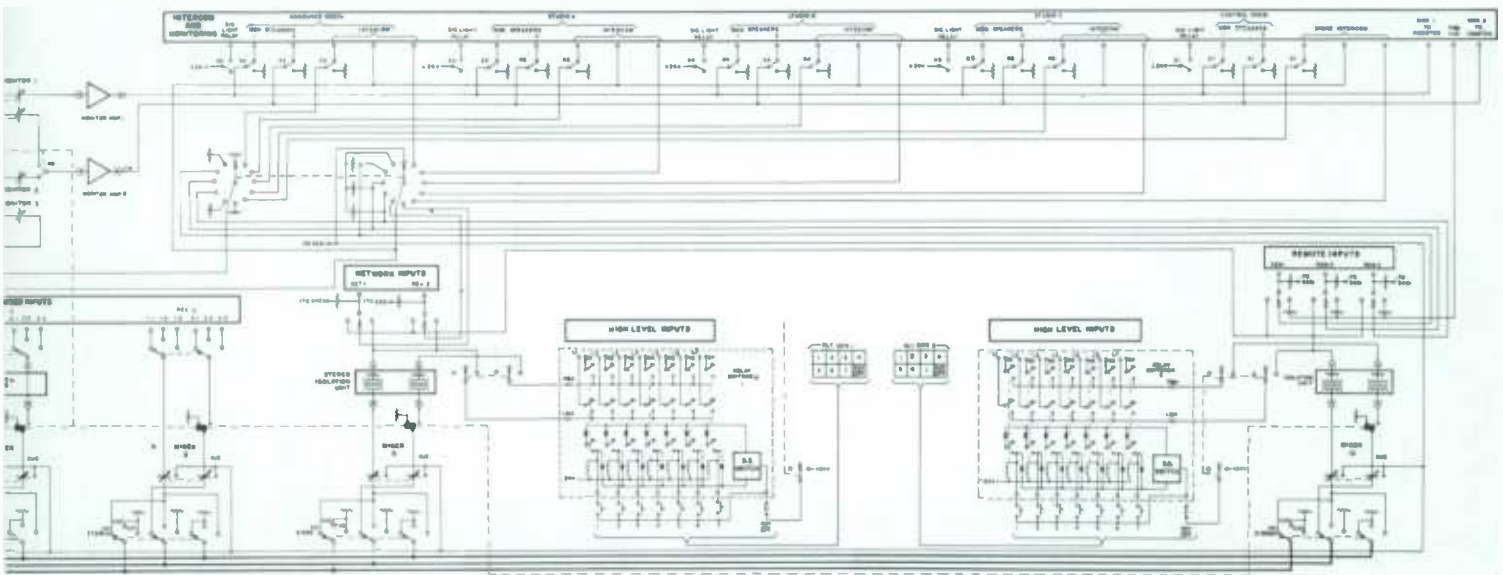

Functional Diagram, Type BC-17 Console

Mono Console, Type BC-9



- Extended frequency response
- Pushbutton source selection
- Self-contained relay switching
- Built-in intercom

The BC-9 Four-Mixer Mono Console packs a lot of versatility and convenience. Multiple pushbuttons permit easy selection of high level sources (such as tape recorders, cartridge tape, turntable, etc.) to each of two mixer controls. The BC-9 may be operated remotely, since the sources are switched by self-contained relays. Two additional mixers are provided for use with microphones.

The modular plug-in amplifiers and power supply used in the BC-9 are identical with those incorporated in several other RCA audio consoles (BC-7, BC-8, BC-17, BC-19).

Communications between control room and studio or remote locations is facilitated by the intercom facilities built into the BC-9.

Specifications

Mixers	4
Inputs	6 Low Level; 14 High Level
Outputs	1 Program; 3 Monitor Speaker
Source Impedance:	
Microphones	3.75/150/600 ohms
Turntables/Tape	600 ohms

Input Levels:	
Microphone	-22 dBm max.
Turntables/Tape/Remote	-10 dBm
Output Levels:	
Program (after 6 dB isolation pad)	+18 dBm
Monitor	10 W.
Maximum Gain	105 dB
Frequency Response	30-20,000 Hz, ± 0.75 dB
Distortion:	
Program Channel (50-20,000 Hz)	0.5% max.
Monitor Channel (30-20,000 Hz)	1% max.
Signal-to-Noise Ratio	68 dB
Dimensions	19½" W, 12½" H, 24" D (495, 318, 610 mm)

Accessories

On-Air Light Relay	MI-11702
Warning Lights	MI-11706-Series
High Level Isolation Unit	MI-11665
Spare Preamplifier, Type BA-72	MI-11658
Spare Program Amplifier, Type BA-73	MI-11659
Spare Monitor Amplifier, Type BA-74	MI-11661
Spare Cue/Intercom Amplifier, Type BA-78	MI-11662
Power Supply, Type BX-71	MI-11663
Intercom Sub Station	MI-11452

Ordering Information

Mono Console, Type BC-9: (3 BA-72 Preamps;	
1 BA-73 Program Amp; 1 BA-74 Monitor Amp;	
1 BA-78 Cue/Intercom Amp; 2 Hi-Level Iso Units;	
1 BX-71 Power Supply)	ES-11153

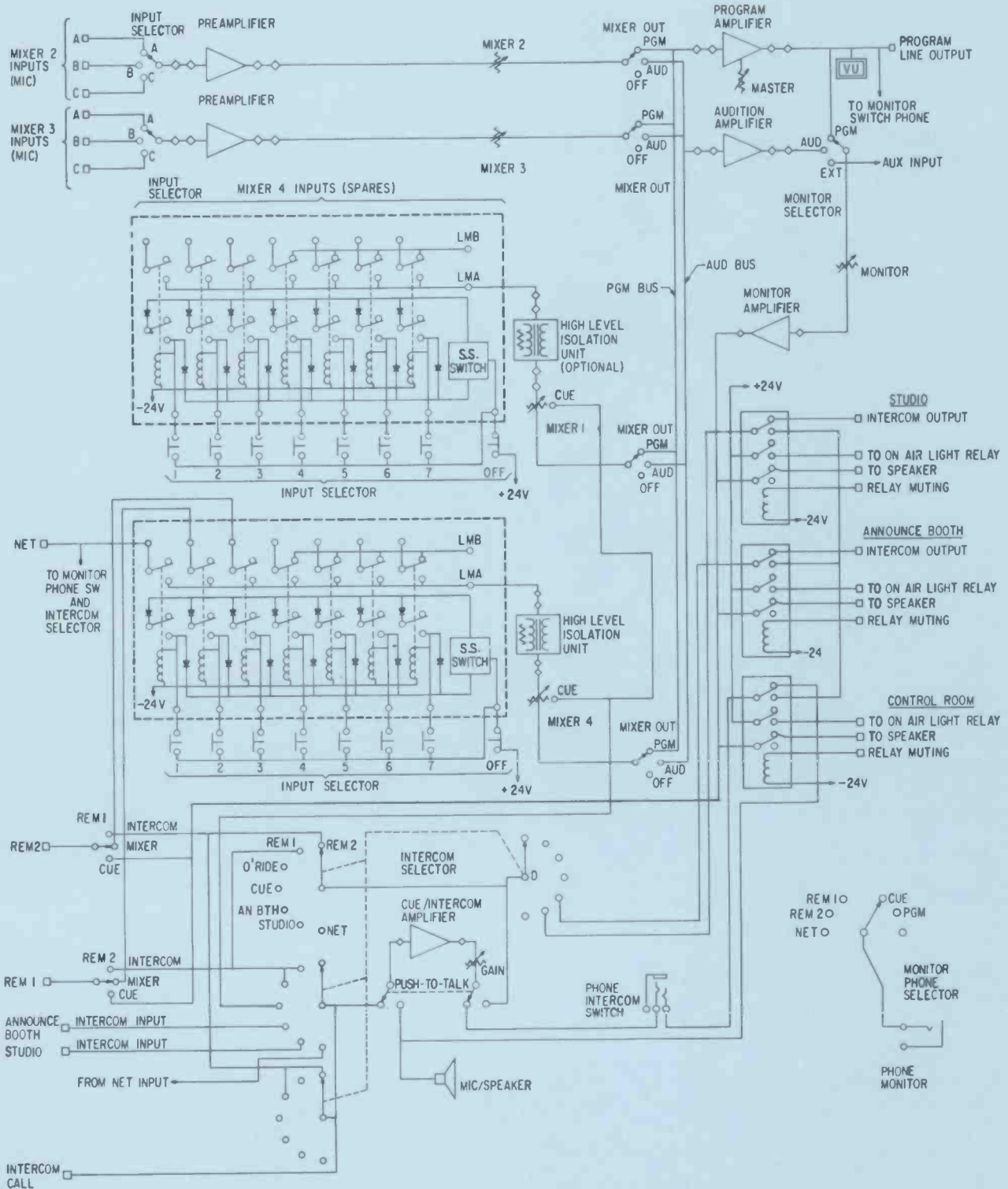

Functional Diagram, Type BC-9 Console

Two-Channel or Stereo Console, Type BC-19



- Compact and versatile
- Two-Channel or stereo operation
- Four stereo attenuators
- Fourteen high-level inputs
- Built-in intercom

The BC-19 Console which offers versatility and many performance features.

Multiple pushbuttons permit easy selection of high level sources (such as tape recorders, cartridge tape, turntable, etc.) to each of two stereo mixer attenuators. Self-contained relays switch the sources, permitting remote operation of the BC-19. Two additional stereo mixers are provided for use with microphones.

Interchangeability is another feature of the BC-19. The modular, plug-in amplifiers and power supply are identical to those used in the BC-7, BC-8, BC-9 and BC-17 consoles. Intercom facilities built into the BC-19 facilitate communications between control room and studio or remote locations.

For applications where stereo operation is not required, the console can be used to provide two program channels and a separate intercom channel. (See diagram.)

Specifications

Mixers	4 stereo
Inputs:	
Low Level (Microphone)	6 stereo (3 to each of 2 mixers)
High Level	14 stereo (7 to each of 2 mixers)
Outputs:	
Program	2 mono, 1 stereo
Monitor Speaker Relays	2
Source Impedances:	
Microphones	37.5/150/600 ohms
Turntables/Tape	600 ohms
Input Levels:	
Microphone	-22 dBm max.
Turntables/Tape/Remote	-10 dBm max.
Output Levels:	
Program (after 6 dB isolation pad)	+18 dBm
Monitor	10 W
Maximum Gain	105 dB
Frequency Response	30 to 20,000 Hz, ± 0.75 dB
Distortion (30-20,000 Hz):	
Program Channel	0.5% max.
Monitor Amplifier	1% max.
Signal-to-Noise Ratio	68 dB min.
Dimensions	19½" W, 12½" H, 24" D (495, 318, 610 mm)

Accessories

Relay Switcher Printed Circuit Board	MI-11795
High-Level Isolation Unit, Stereo	MI-11665-S
Jumper Plugs	MI-141015
Auxiliary Mixer Console	MI-11656

Ordering Information

Type BC-19 Stereo Console:	
2 BA-72 Preamplifiers; 2 BA-73 Program Amplifiers;	
2 BA-74 Monitor Amplifiers; 1 BX-71 Power Supply;	
1 BA-78 Cue Amplifier; 1 Stereo High-Level	
Iso Unit	ES-11154

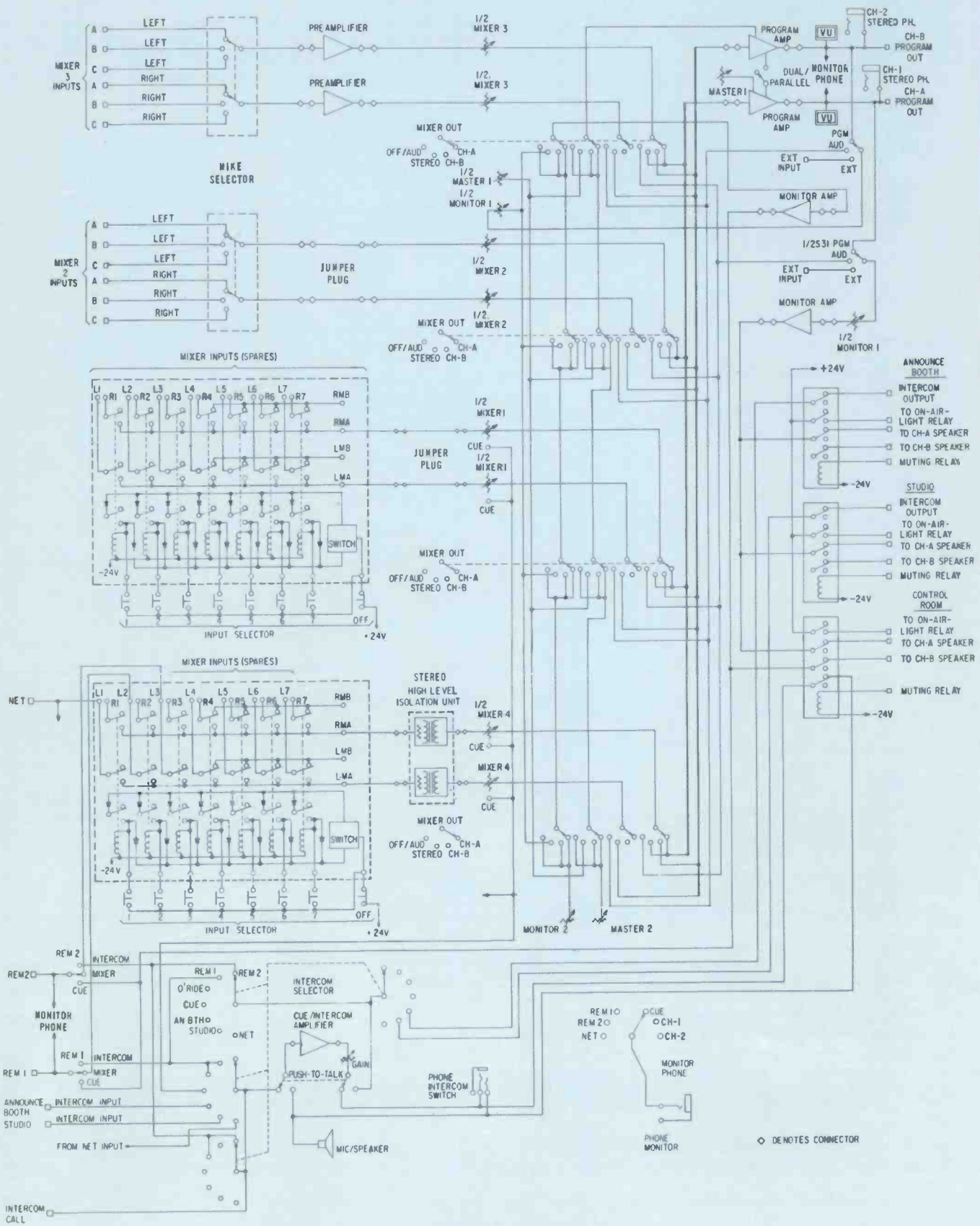

Functional Diagram, Type BC-19 Console

Auxiliary Mixer Console, Type BCM-2

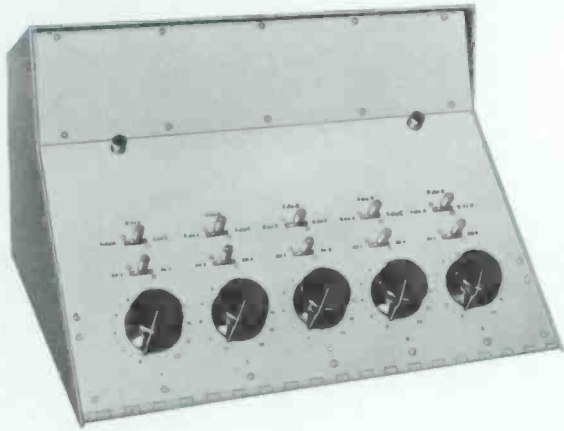

- Supplements facilities of stereo or mono consoles
- Five mixer channels with fifteen additional input sources
- Plug-in modules offer low-level or hi-level input to each mixer
- Plug-in modules interchangeable with other RCA consoles

The BCM-2 Auxiliary Console is designed to supplement RCA Mono, Dual-Channel and Stereo Consoles by providing five additional mixing channels and fifteen inputs. The console is styled to match the BC-7, BC-8, BC-9, BC-17 and BC-19 Consoles and is designed so that each mixer channel accepts a preamplifier, high-level isolation unit or straight-through jumper plug, for a wide choice of input levels.

By use of preamplifiers as booster amplifiers, the 600-ohm outputs of the console may be bridged into the console's main mixer buses; or the BCM-2 may be fed into one of the high level inputs of the main console to provide a submaster. Substitution of high level isolation units for booster amplifiers enables the auxiliary mixer outputs to be fed into the microphone inputs of the main console. The gain is such that the same mixer settings may be used on both BCM-2 and the console mixers for equivalent levels.

The console has panel space for additional equipment or controls including extra space on the main panel plus a 4½-by-19-inch panel and a spare shelf for housing additional equipment such as the BA-70 Series of plug-in amplifiers.

Five mixers and delegation switches are equally spaced across the console. Above each mixer is also a source selector switch. Throwing a fader delegation switch to the left connects it to the channel 1 mixer bus; throwing it to the right connects it to the channel 2 mixer bus; the center is an off position. Each of the five input selector keys permits selection of one of three inputs, thus the BCM-2 Auxiliary Console makes available fifteen sources.

Two Channel Facilities

Three-position fader delegation keys and two mixer buses provide facilities suitable for two-channel operation (either stereo; program-audition; or two independent channels). The mixer delegation keys are pre-wired for stereo mixers so that any mixer can be conveniently replaced by a dual (stereo) mixer available from stock. Extra contacts are provided on the input selector switches so that, if desired, it may be custom wired to simultaneously select both left and right channels of a stereo source.

Control Circuit Patch Board

A muting relay panel is located behind the main control panel. The console muting relays may be controlled by any combination of source selection lever keys.

Specifications

Mixers	5
Microphone Inputs	15-3 to each mixer
Source Impedance (Preamplifier Input)	37.5/150/600 ohms
Input Impedance (Preamplifier Input)	Unloaded input transformer
Load Impedance	150/600 ohms
Outputs (from booster or isolation units)	2-each 150/600 ohms
Gain (with controls set for max.)	77 dB max.
Maximum Output	+18 dBm
Frequency Response	±1 dB 30-20,000 Hz
Distortion	Less than 0.5%, 50-20,000 Hz
Signal-to-Noise Ratio:	
Microphone to Program Line Out (68 dB gain +18 dB output)	At least 68 dB
Dimensions Overall	19½" W x 12½" H x 20" D (495, 317, 508 mm)
Weight (approx.)	70 lbs. (32 kg)
Power Supply (approx.)	14 lbs. (6.35 kg)
Preamplifiers/Booster Amplifiers	Each approx. 2¼ lbs. (1020 g)

Accessories

Mono High-Level Isolation Unit	MI-11665
Stereo High-Level Isolation Unit	MI-11665-S
Power Supply, Type BX-71	MI-11663
Spare Preamplifier, Type BA-72	MI-11672
Jumper Plug	MI-141015

Ordering Information

BCM-2 Auxiliary Mixing Console (for Mixer Bus Bridging): (7 BA-72 Preamplifiers/Booster Amplifiers; 1 BX-71 Power Supply)	ES-11155
BCM-2 Auxiliary Mixing Console (for Mixer Input): (5 BA-72 Preamplifiers; 2 Isolation Units; 1 BX-71 Power Supply)	ES-11156

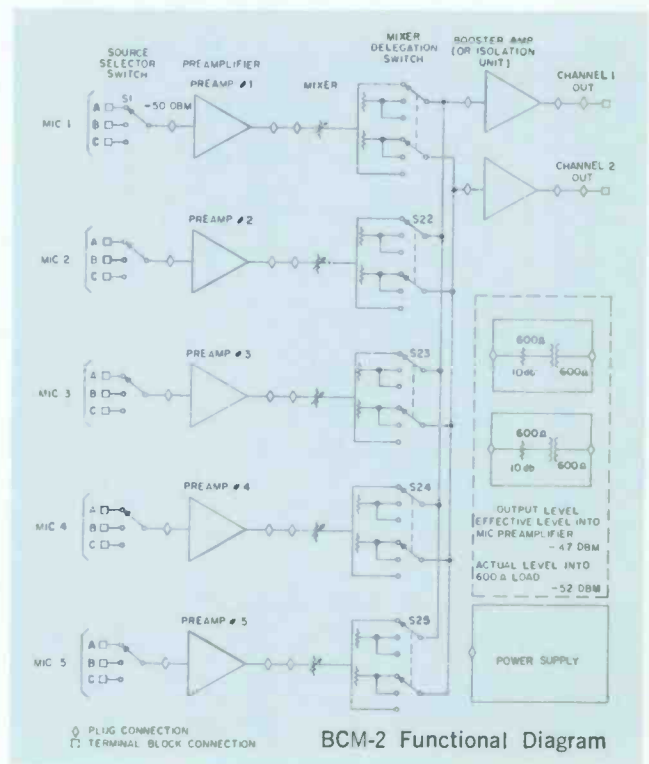



Audio Consoles, Types BC-14, -15, -18

- Competitively priced
- Mono, stereo and dual-channel
- Pushbutton input selection
- Four, five or eight input mixers
- Sixteen, twenty or thirty-two inputs

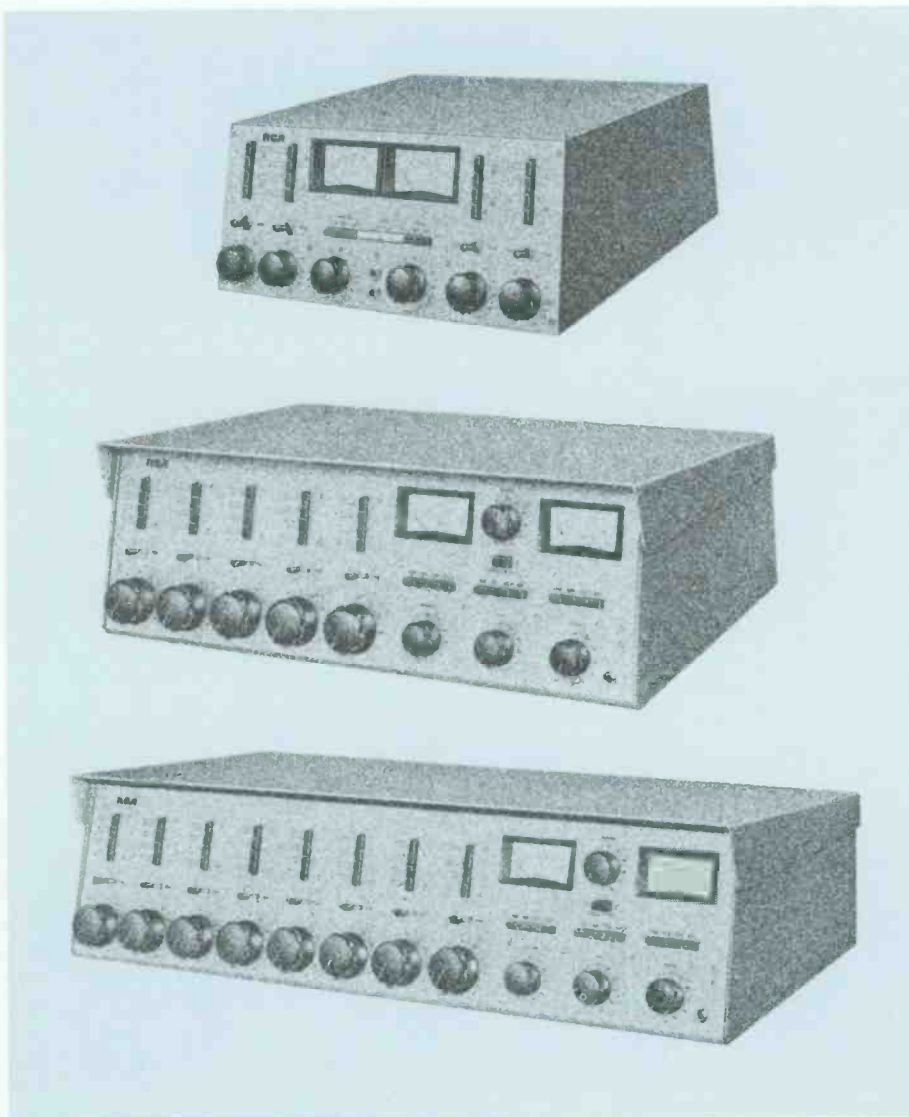

Striking an excellent compromise between capability and purchase price, the Type BC-14, -15 and -18 Consoles deliver much versatility at low cost. Each console is offered in mono, dual-channel mono and stereo configurations.

Four-Mixer Consoles, Type BC-14 Series

Available in desk-top cabinet or rack-mount versions, the Type BC-14 Console series is intended primarily for light-duty production such as in broadcasting, mobile units, sound-reinforcement systems and the like. Its low initial cost and dependable operation give it universal appeal.

Five-Mixer Consoles, Type BC-15 Series

The Type BC-15 Console series is intended for those situations where production needs are moderate and duty is severe. The BC-15 provides for twenty inputs to its five input mixers. Each mixer handles four inputs through pushbuttons.

Eight-Mixer Consoles, Type BC-18 Series

Our largest audio console, the Type BC-18 provides for 32 program inputs to its eight input mixers. Like the BC-15 consoles, the BC-18 input mixers each have four inputs, selected through pushbuttons.

Five-Mixer Consoles, Type BC-15

Eight-Mixer Consoles, Type BC-18

- Mono, stereo and dual-channel
- Built-in cue channel
- Preamp in each mixer circuit
- 10-watt monitor
- Step-attenuator mixers, with cue position

The BC-15 and BC-18 consoles are available in stereo, mono and dual-channel versions. The consoles differ only in physical size and the number of input mixers each includes. The smaller console, the BC-15, contains five input mixers; the BC-18, eight input mixers.

The consoles are ideally suited to the audio control needs of radio, TV, CCTV and recording-studio production. Too, these consoles serve in the control of sound reinforcement systems in auditoriums, amphitheaters, coliseums, stadiums and convention halls.

Each console is a self-contained audio-control center featuring pushbutton input selection, high-quality, step-type attenuators (with cue position), telephone-type lever switches, 10-watt monitor amplifiers, built-in cue amplifiers, speaker-muting re-



Five-Mixer Type BC-15 Console

lays (with space for additional relays, see *Accessories*), cue speaker and a self-contained power supply.

Preamplifier Modules

The number of preamplifiers included in each console is proportional to the number of mixers. The stereo consoles contain two preamplifiers for each input mixer; the mono and dual-channel consoles contain a single preamplifier for each input mixer.

Program Channel

A program-bus amplifier drives the Master Gain control which, in turn, drives the program amplifier and line driver amplifier. In the stereo console, the Master Gain Controls are ganged and an adjustment is provided to balance the gain of each channel individually.

The driver amplifier delivers a balanced, transformer-coupled, 18-dBm output level to the line. A balanced, bridging, zero-level recorder output is permanently connected to the program line. Program outputs are also provided to the Audition/Monitor Input Selector switch and the Program Headphone Jack.

Audition/Monitor Channel

The audition-bus boost amplifier feeds an input of the Monitor-Input Selector. Plug-in, speaker-mute relays are included: three in the BC-18 and two in the BC-15. The muting relays are energized through the mike-input selector switch.

A switchable headphone-jack output, with level control, delivers +10 dBm output.



Eight-Mixer Type BC-18 Console

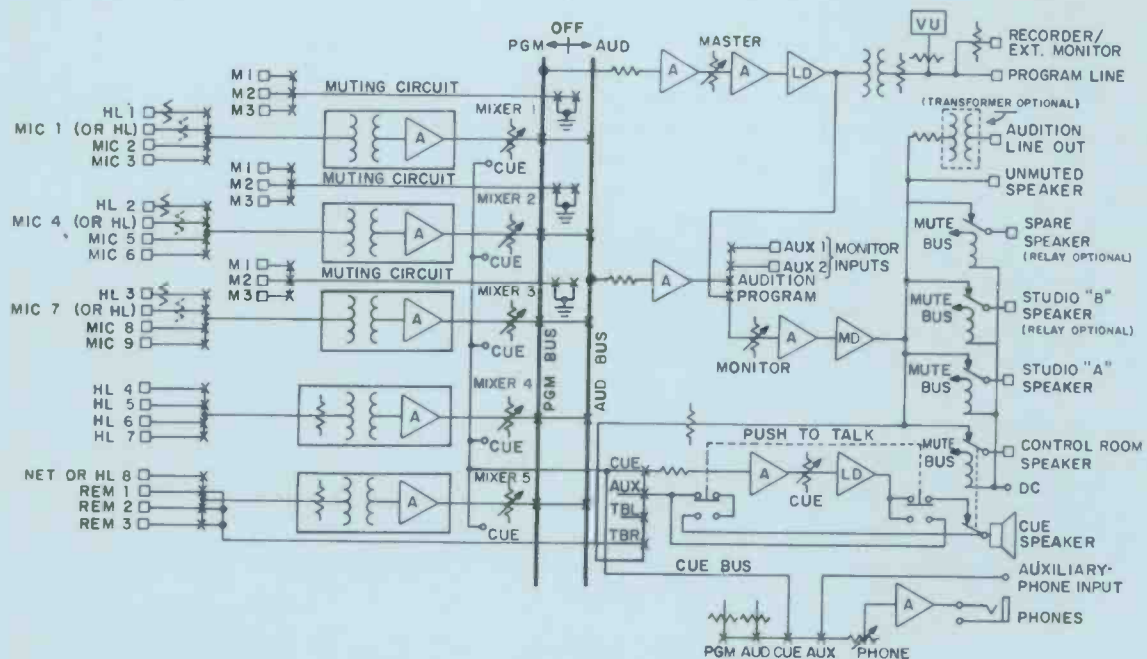

Functional Diagram, Type BC-15 Mono Console

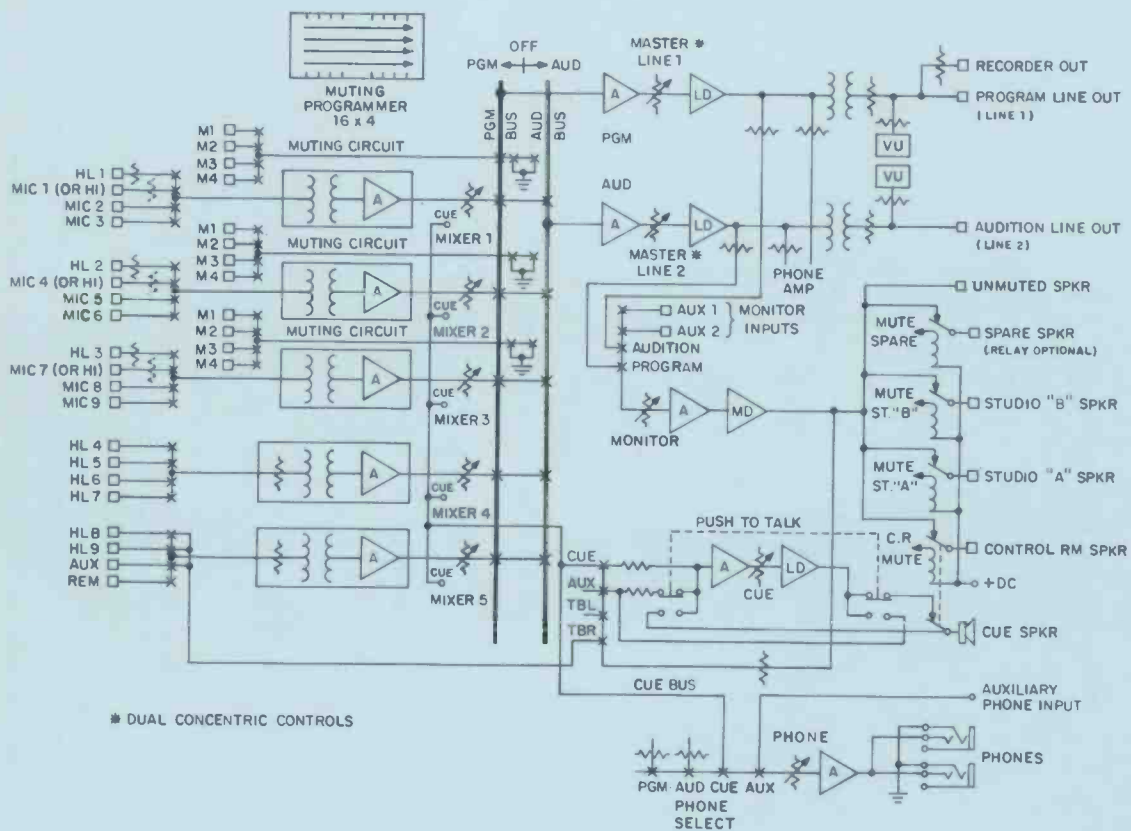

Functional Diagram, Type BC-15D Dual Channel Console

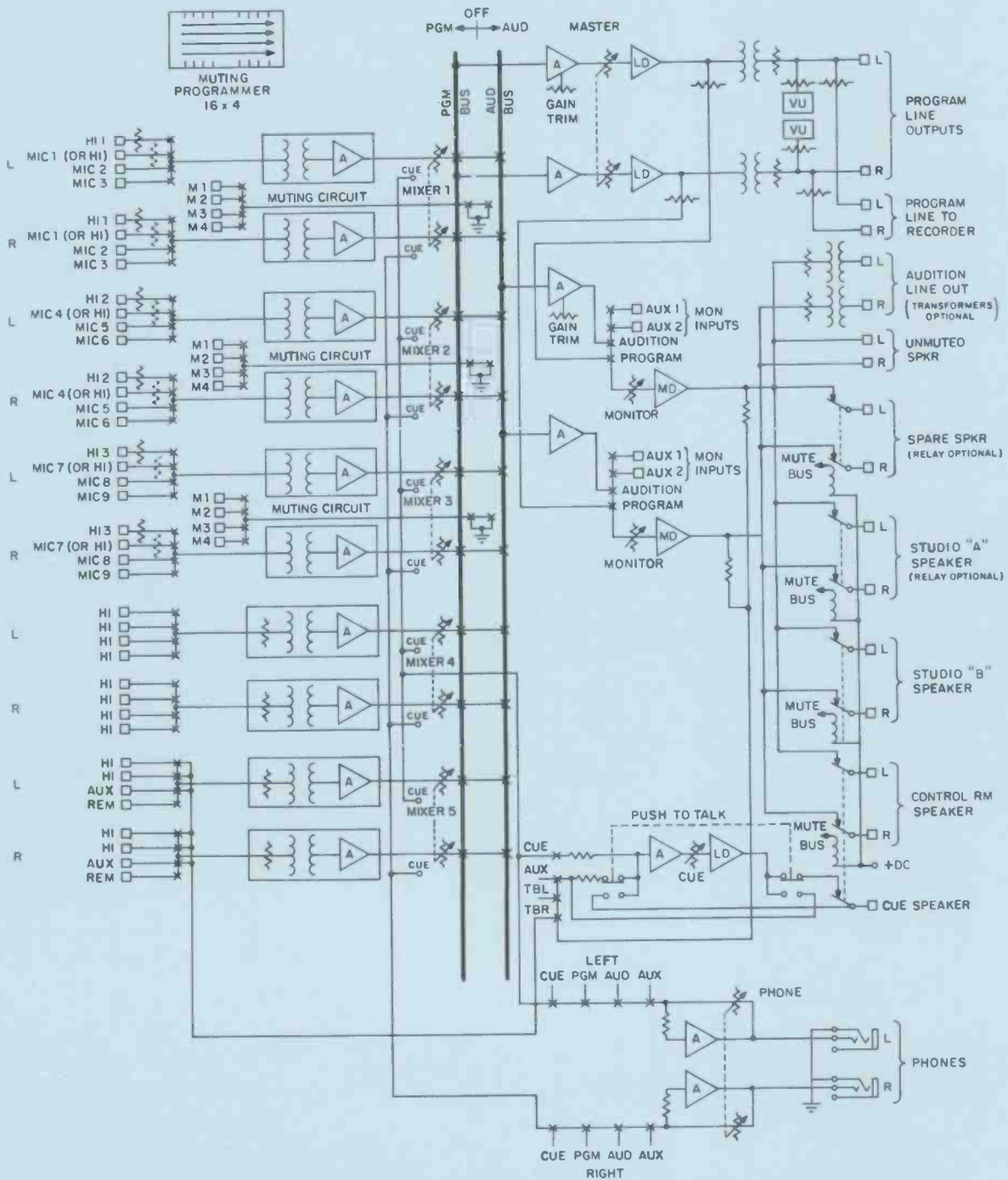

Functional Diagram, Type BC-15S Stereo Console

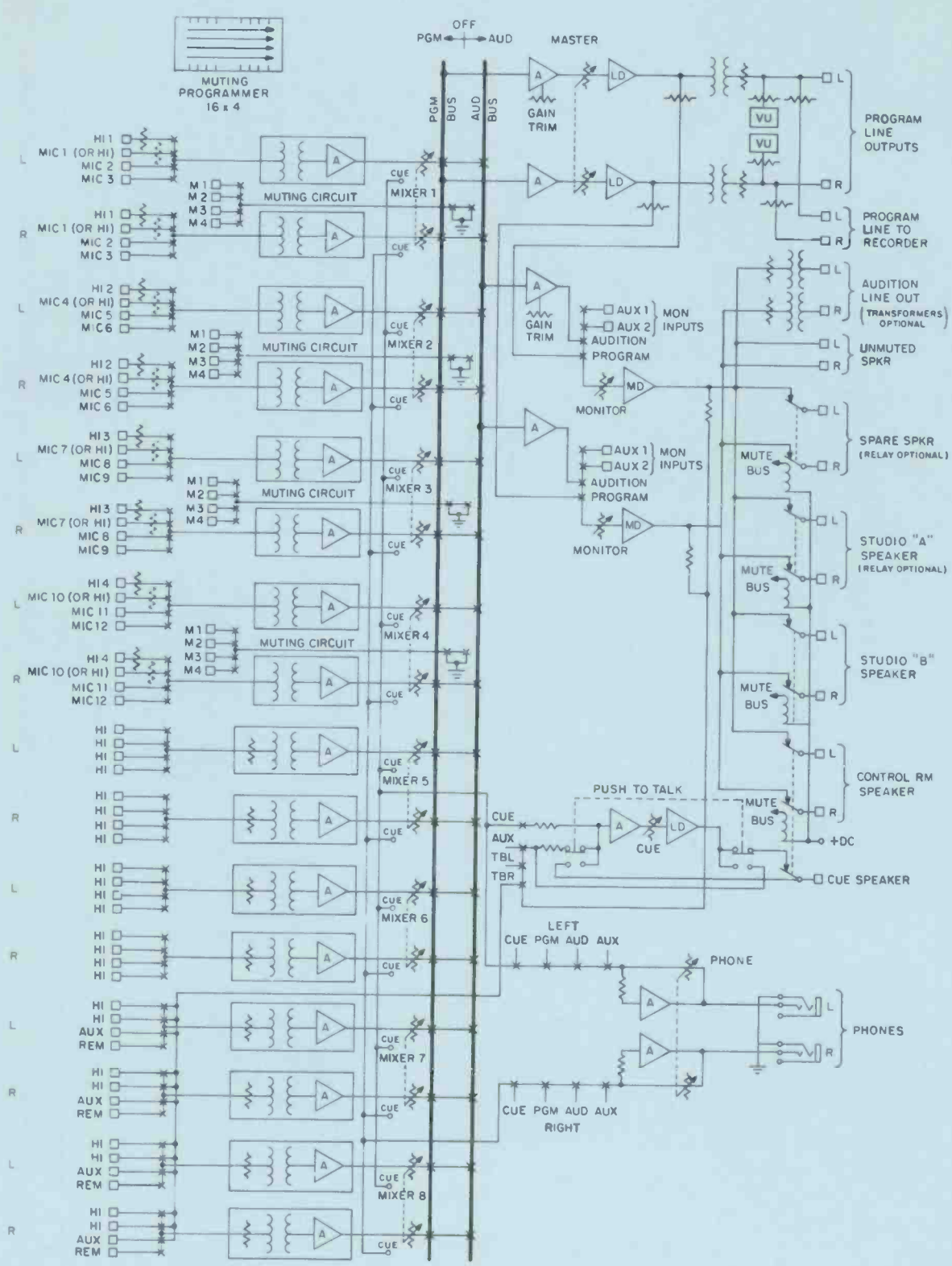

Functional Diagram, Type BC-18S Stereo Console

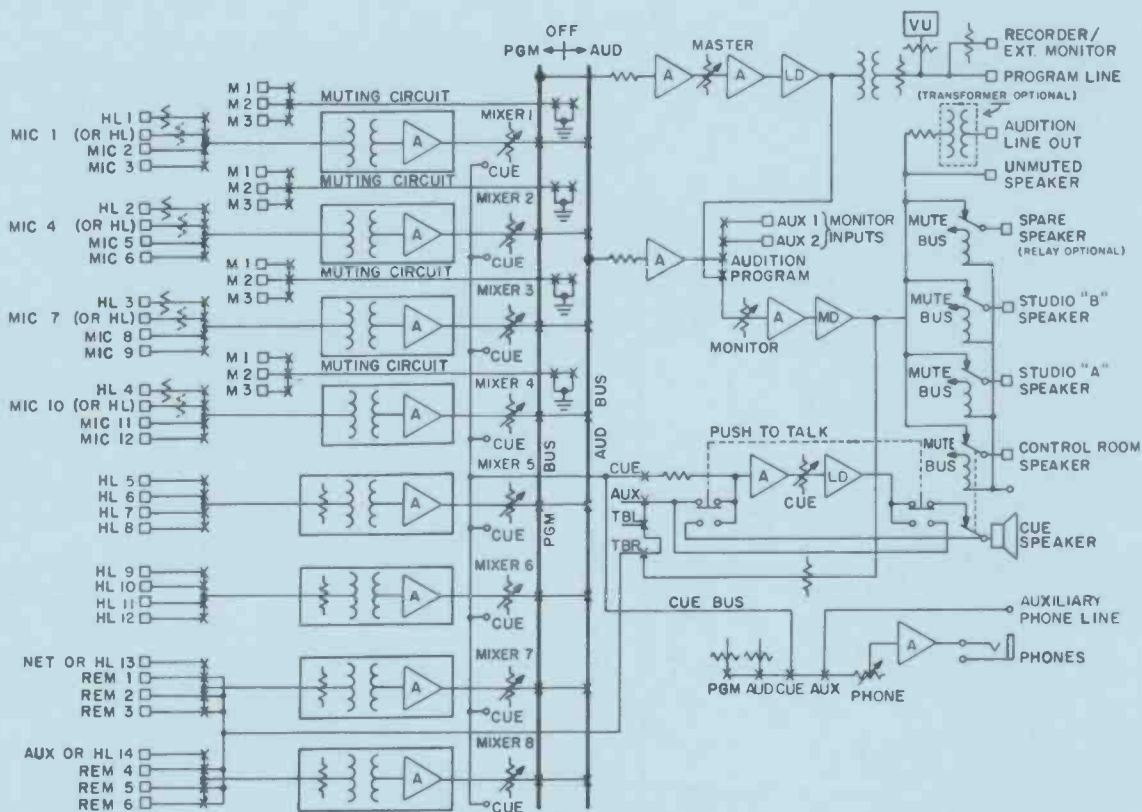

Functional Diagram, Type BC-18 Mono Console

Specifications

Inputs:

BC-15, BC-15S, BC-15D20: 9 Lo-; 11 Hi-Level*
 BC-18, BC-15S, BC-18D32: 12 Lo-; 20 Hi-Level*

Input Mixers:

BC-15, BC-15S, BC-15DFive (dual-ganged in BC-15S),
 with cue position
 BC-18, BC-18S, BC-18DEight (dual-ganged in BC-18S),
 with cue position

Input Impedances (Source):

Microphone150/600 ohms
 Hi-Level600 ohms or bridge

Input Levels (dBm):

Microphone-50 nom.; -26 max.
 Net/Remote0 nom.; +10 max.
 High Level (Bridging)-20 nom.; +5 max.

Output Levels (dBm):

Program+18 nom.; +24 max.
 Audition+10
 Monitor+40

Crosstalk67 dB down

*Factory-wired. Easily rewired in field for more high-level and fewer mike inputs.

Overall Gain104 dB max.
 Frequency Response20 to 20,000 Hz, ±1.5 dB
 Distortion (30-20,000 Hz)
 Program Channel0.75% max.
 Monitor Channel (10 W, 4/8 ohms)1% max.
 Signal/Noise Ratio (20-20,000 Hz)70 dB min.
 Power Requirements117/234 V, 50/60 Hz 110 W

Dimensions

BC-15 Series27³/₈" W; 9³/₈" H; 18³/₄" D
 (695 x 238 x 476 mm)
 BC-18 Series36³/₈" W; 9³/₈" H; 18³/₄" D
 (923 x 238 x 476 mm)

Weight:

	Mono	Stereo	Dual
BC-15	40 lbs. (18 kg)	50 lbs. (23 kg)	45 lbs. (21 kg)
BC-18	47 lbs. (22 kg)	57 lbs. (27 kg)	52 lbs. (24 kg)

Accessories

Audition Line TransformerMI-141011
 Speaker Muting RelayMI-141012
 Preamplifier Module
 (for mono or dual-channel console)MI-141013
 Hi-Level Preamp Module
 (for mono or dual channel console)MI-141014

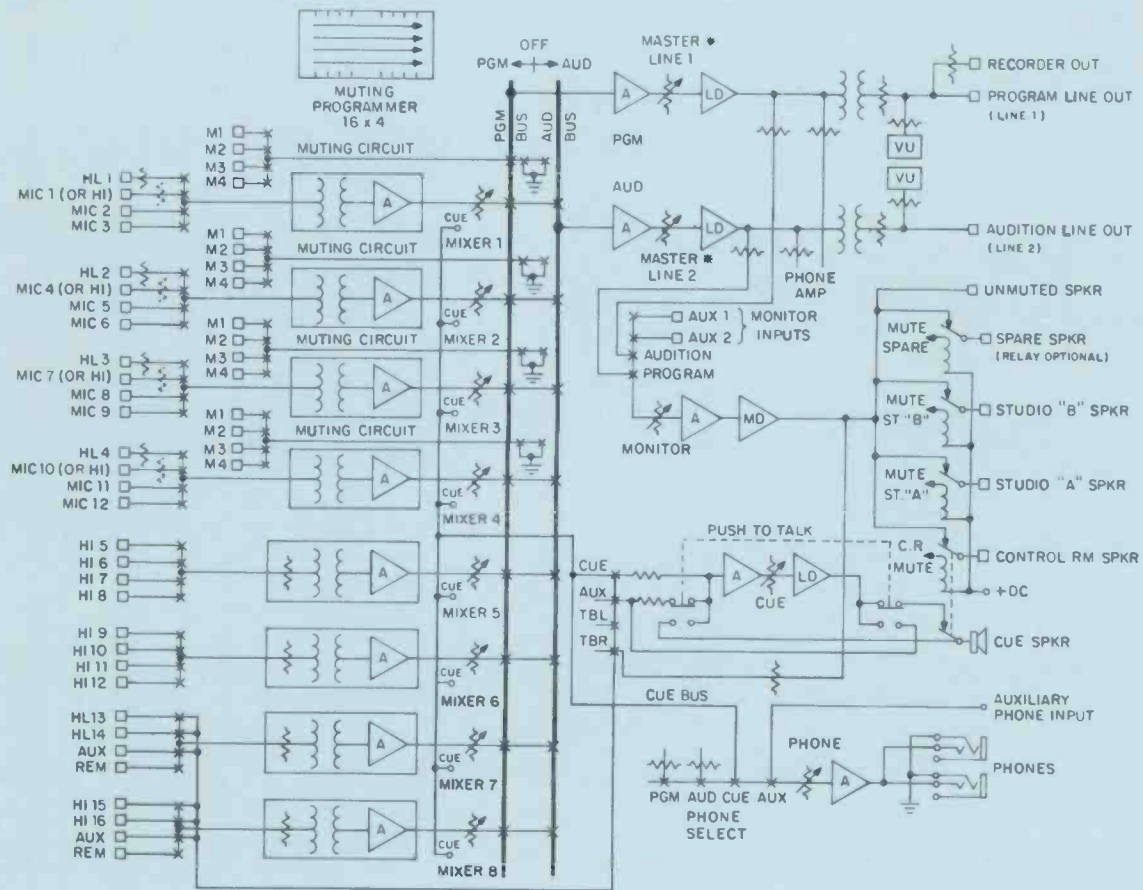

* DUAL CONCENTRIC CONTROLS

Functional Diagram, Type BC-18D Dual Channel Console

Ordering Information

Five-Mixer Consoles:

Mono, Type BC-15	MI-11676
Stereo, Type BC-15S	MI-11678
Dual-Channel, Type BC-15D	MI-11683

Eight-Mixer Consoles:

Mono, Type BC-18	MI-11677
Stereo, Type BC-18S	MI-11679
Dual-Channel, Type BC-18D	MI-11684

Shipping Data:

Packing Dimensions

BC-15	13" x 24" x 32" (330, 610, 813 mm)
BC-18	13" x 24" x 41" (330, 610, 1041 mm)

Gross Weight (approx.):

BC-15	55 lbs. (26 kg)
BC-18	70 lbs. (32 kg)

Four-Mixer Consoles, Type BC-14

- Mono, stereo and dual-channel
- Desk-top or rack-mount versions
- Pushbutton input selection
- Four Input mixers



The BC-14 consoles are provided in stereo, mono and dual-channel models, each of which is available in console and rack-mounted versions. All are identical in physical size, with the exception that the rack-mounted versions have no console cabinet housing. The consoles are ideally suited to the audio-control needs of radio, TV and CCTV program production and for the control of sound reinforcement systems in auditoriums, amphitheatres, coliseums, stadiums and convention halls. They are high-performance units designed for high-quality audio production, particularly for economical and cost-conscious applications.

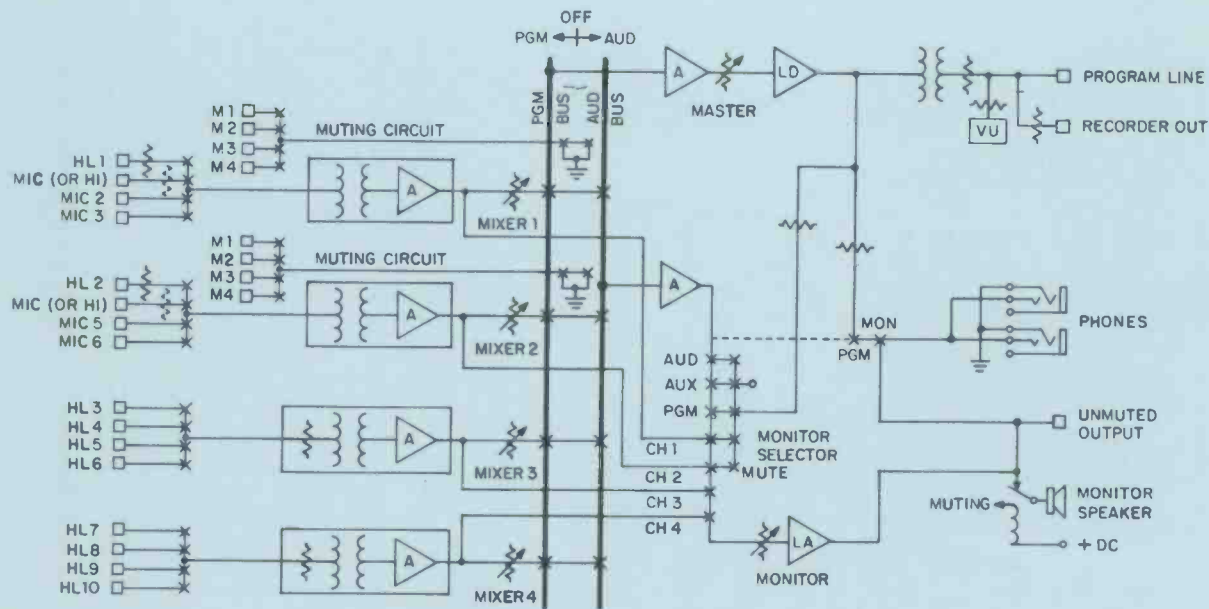

Functional Diagram, Type BC-14 Mono Console

Pushbutton Input Selection

The consoles feature pushbutton input-selection, and audition provisions on all input mixer channels. Each input mixer handles four inputs through a four-position pushbutton bank.

Low-level preamplifiers are included for input mixer channels 1 and 2. These preamplifiers (with 40 dB gain) and the program line amplifier (with 60 dB gain) provide a maximum program line gain of 100 dB. For the high-level input to these preamplifiers, a bridging pad is provided between the selector pushbutton switch and its input transformer. Thus, mixers 1 and 2 each handle three micro-

phone and one high-level inputs. With strapping, mixers 1 and 2 can handle two microphone and two high-level inputs.

Mixers 3 and 4, for high-level inputs only, include a bridging pad between the input selector pushbutton switch and the preamplifier input. Thus, input mixers 3 and 4 each handle four high-level inputs.

Separate Program Amplifier

A program-boost amplifier drives the Master Gain Controls (individual master gain controls for mono and dual-channel consoles; ganged master gain control for stereo). The program line amplifier de-

livers a balanced, transformer-coupled, +18 dBm output level, through a 6 dB pad, to the program line.

Monitor Line Output

The audition bus feeds an interlocked monitor-selector pushbutton switch which is used to select the input to the cue speaker, located in the top cover of the console housing assembly. The monitor output power is 1.5 watts into a 45-ohm load.

A single muting relay is provided. The relay is energized by operating the mike input selector switch for mixer input channels 1 and 2.

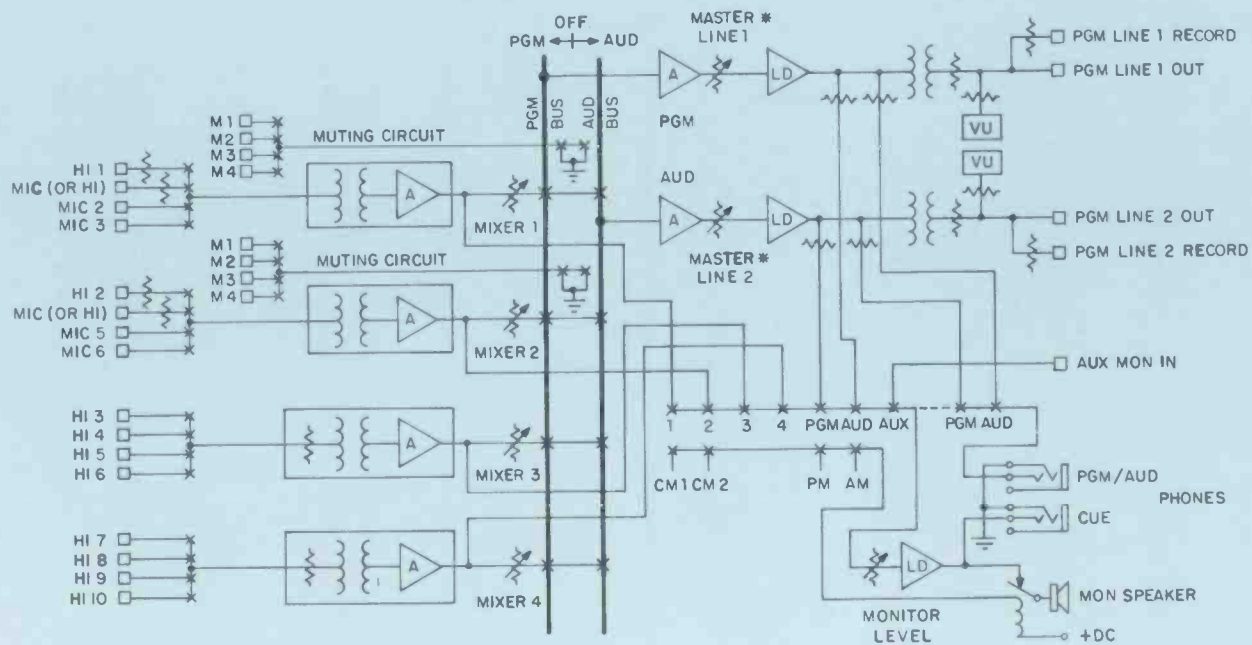

* DUAL CONCENTRIC CONTROLS

Functional Diagram, Type BC-14D Dual Console

Specifications

Program Output Level (after 6 dB pad)	+18 dBm
Monitor Output Level	+32 dBm (1.5 watts)
Frequency Response Characteristics:	
Program Channel	30 to 15,000 Hz, ± 1 dB
Monitor Channel	30 to 15,000 Hz, ± 1.5 dB
Harmonic Distortion:	
Program Line (+18 dBm output, 50 to 15,000 Hz)	1% max.
Monitor Line	1% max.
Noise Level (relative input noise in mike channels)	-120 dBm
Gain:	
Mike to Line	100 dB
High-Level to Line	55 dB
Power Requirements	117/234 V., 50/60 Hz
Microphone Inputs	Six
High-Level Inputs	Ten
Input Mixers	Four

	BC-14	BC-14D	BC-14S
Preamps	4	4	8
Program Amplifiers	1	2	2
Monitor Amplifiers	1	1	2
Physical Characteristics:			
Dimensions			
BC-14, BC-14D, BC-14S	17" W, 7½" H, 16⅞" D (432 x 178 x 411 mm)		
BC-14R, BC-14DR, BC-14SR	19" W, 7½" H, 16⅞" D (483 x 178 x 411 mm)		

Accessories

Muting Relay, Plug-in	MI-141012
Console Cabinet (converts rack-mount unit to console unit)	MI-11685
Transformer, 45-ohm to speaker, for monitor output	MI-11686

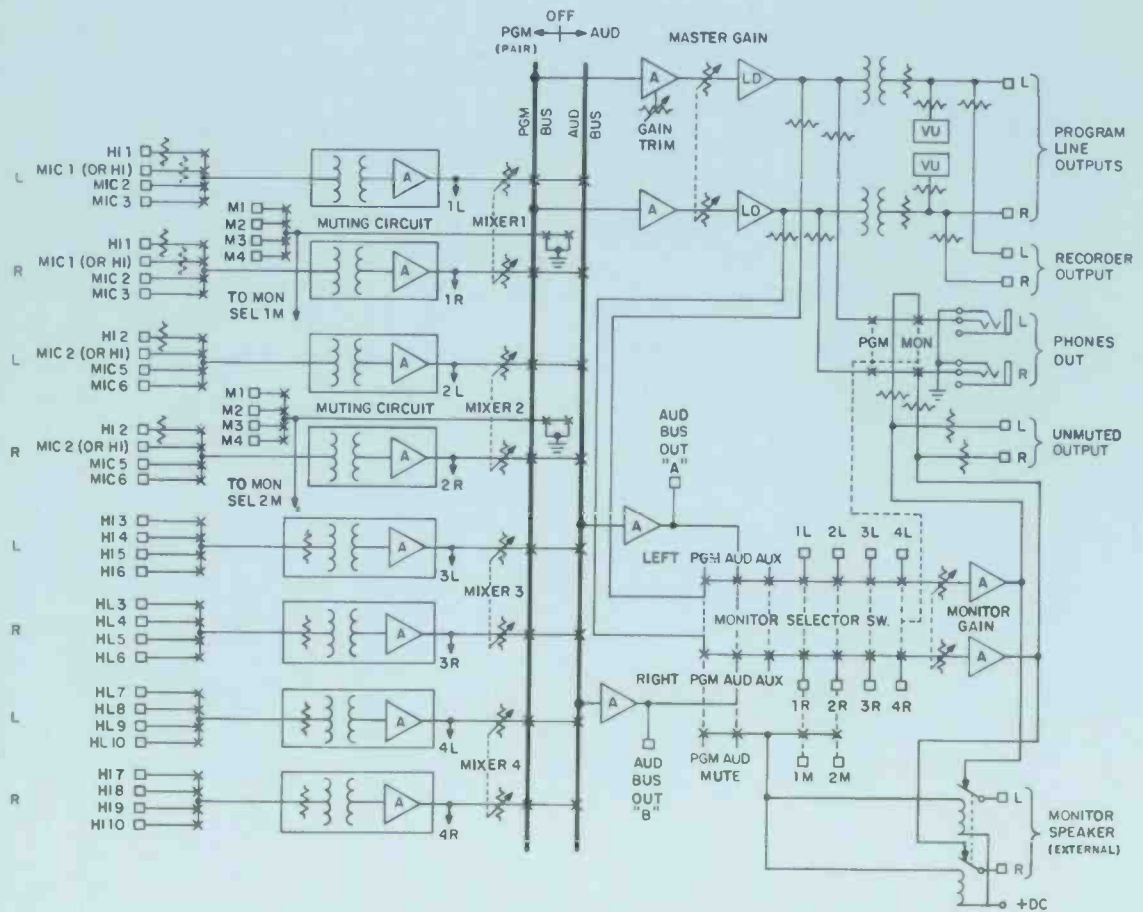

Functional Diagram, Type BC-14S Stereo Console

Ordering Information

Desk-Top Console, Four Mixer:

Mono, Type BC-14	MI-11680
Stereo, Type BC-14S	MI-11681
Dual-Channel, Type BC-14D	MI-11682

Rack-Mount Console, Four Mixer:

Mono, Type BC-14R	MI-11680R
Stereo, Type BC-14SR	MI-11681R
Dual-Channel, Type BC-14DR	MI-11682R



Remote Amplifiers, Types BN-1 and BN-4

- Broadcast quality at low cost
- Balanced-line inputs and output
- Battery or power line operation
- Two compact units: one input or four inputs
- Lighted VU Meter

Each of the amplifiers described here is a low-cost, broadcast-quality product designed and built to withstand the hard knocks of programming on location. They are fully transistorized designs with established reputations for dependability. The Type BN-1 Amplifier is a single-input device while the BN-4 handles four program sources. The Type BN-4 has usefulness in other fields beyond broadcasting. For example, it can be used as an audio mixer panel in "professional audio" situations or for sound reinforcement systems in theaters, arenas, stadiums and the like. The BN-4 serves CATV, educational sound systems (schools and colleges) and in the aural function of educational-TV systems. The BN-1 can also be used as a line amplifier by use of a bridging pad at the input. A rack-mount shelf is offered for both amplifiers (see *Accessories*) for installation of the BN-1 and BN-4 in any equipment rack or console using 19-inch (483 mm) panels.



Battery or Power Line Operation

So that they might be used anywhere, both amplifiers operate from either battery power or commercial power line. The battery pack is optional (see *Accessories*). The amplifier automatically switches over to battery power (if so equipped) when disconnected from commercial power.

Lighted VU Meter

For operation independent of ambient lighting, the BN-1 and BN-4 contain lighted VU meters. The meter lights only when the amplifier operates from a power line. If equipped with the optional battery pack, the amplifiers continue to operate from battery power but without meter lighting.

Two Compact Units

The Types BN-1 and BN-4 are the smallest ever included in the RCA product line. They are the choice where minimum size and weight are important criteria.

Specifications

Type BN-4 Remote Amplifier

Frequency Response Characteristic30-15,000 Hz, ± 2 dB
Gain (150-ohm mike; 600-ohm load)90 dB
Hum and Noise (low-Z mike; 600-ohm load)-125 dBV ¹
Distortion (at +10 dBm output)1% or less; typically 0.5%
Inputs4 low-Z mikes; 1 line (600-ohm or bridging)
Output Level+18 dBm (max.) into 600-ohm line
Power Requirements105 to 130V, 50/60 Hz
(see "Ordering Information")or 210 to 260V, 50/60 Hz
Dimensions11 $\frac{3}{8}$ " x 7 $\frac{1}{2}$ " x 2 $\frac{1}{2}$ " (289 x 190 x 64 mm)
Finish ColorShadow Blue and Silver Gray
Weight (approximate)4 lbs., 13 oz. (2 kg)
Ambient Operating Temperature0° to 135° F.
(-18° to 57°C)
Shipping Data:	
Dimensions19" x 10.5" x 5.5" (483 x 267 x 140 mm)
Cube0.6 ft. ³ (0.02 m ³)
Weight6.5 lbs. (3 kg)

Accessories

Battery Pack Power Supply (less batteries)MI-141016
Batteries for Battery PackRCA VS085 or equivalent
Portable Carrying CaseMI-141017
Amplifier Stacking KitMI-141018
Rack-Mount ShelfMI-141019
Handle/Tilt StandMI-141021

Type BN-1 Remote Amplifier

Frequency Response CharacteristicFlat +0. -2 dB,
30-15,000 Hz
Gain (150-ohm mike; 600-ohm load)94 ± 2 dB

Hum and Noise (low-Z mike; 600-ohm load)-120 dB ²
Distortion (at +10 dBm output, 15-15,000 Hz)Less than 1%
InputsOne; Low-Z mike (30-600-ohms -30 dBm max.)
Output Level+18 dBm @ 600 ohm (after 6 dB isolation)
Power Requirements105 to 130V or 210 to 260V
50/60 Hz, 5W
Dimensions7 $\frac{1}{4}$ " W; 3 $\frac{1}{2}$ " H; 8 $\frac{1}{16}$ " D (184 x 89 x 205 mm)
Finish ColorShadow Blue and Silver Gray
Weight (Approx.)5 lbs. (2.3 kg)
Ambient Operating Temperature32°F to 131°F
(0 to 50°C)

Accessories

VU Meter (for Type BN-1 only)MI-141020
Battery Pack Power SupplyMI-141016
(Batteries not included)MI-141016
BatteriesRCA VS085 or equivalent
(for battery pack, 3 required)MI-11449
Rack-Mount PanelMI-11449

1 Maximum equivalent input hum and noise, 30-15,000 Hz.
2 Referred to input, 30-15,000 Hz.

Ordering Information

Four-Input Remote Amplifier Type BN-4 for 117-volt power (less batteries and battery case)MI-141402
As above factory wired for 234-volt powerMI-141403
One-Input Remote Amplifier, Type BN-1 (less VU meter, batteries and battery case)MI-141401



Single-input, Type BN-1 Remote Amplifier (VU meter optional at extra cost).



Four-Mixer Remote Console, Type PAM1

- Internal monitor
- High/low level inputs
- Cue position all channels
- Unique mounting

The PAM-1 is a completely solid-state, eight-input audio mixer, especially for small studio, CATV and industrial use. Its small size makes it ideally suitable for either rack, wall, or standard desk top. Integrated circuits and low-noise transistors in the amplifier provide dependability and excellent performance characteristics. Eight separate input channels as well as cueing, monitoring, and switchable input selection are provided.

Operational Features

The PAM-1 is self-contained for operation on 115/230 volt, 50/60 Hz operation. Other features include four microphone input transformers, four high-level pads (one selectable per channel), headset and built-in speaker monitoring, and all line cueing facilities.

Versatile Controls

All controls are located on the front panel, including an edgewise VU meter, power switch, program/cue selection switch, four mixer controls with cue position, four mixer input selection switches including a mid-off position, and a master gain control. Also included on the front panel is a 3" speaker and cue/external phone jack.

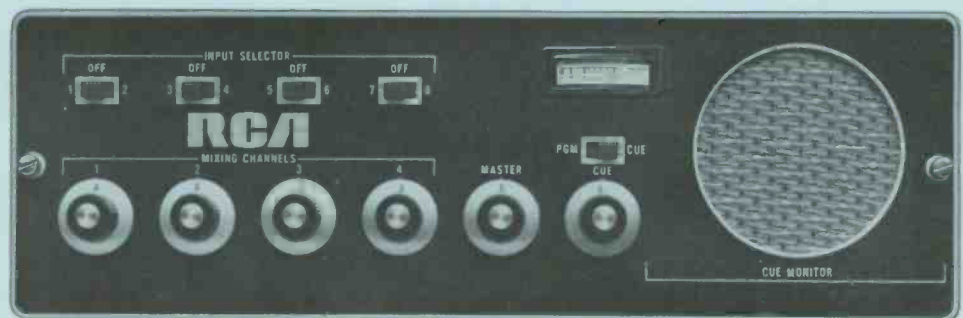

Specifications

Inputs 8 Inputs (4 Mic., 4 Line)
 Input Impedance 50 ohms to 250 ohms
 Frequency Response 20 Hz to 20 kHz, ± 2 dB
 Harmonic Distortion 0.5% max. (1 kHz, ± 10 dBm)
 into 600 ohms load on Pgm. Channel
 Gain 90 dB
 Output Level (at 600 ohms) ± 18 dBm max.
 Channel Separation (1 kHz) 55 dB
 Signal/Noise Ratio (Ref. to
 -50 dBm Input) 65 dB, 115 dBm; (Ref. to Input)

Dimensions 14" W, 4 1/4" H, 3 1/2" D (355, 107, 88 mm)
 Temperature Range 0°-55°C
 Power Input 115/230 V, 50/60 Hz or ± 12 Vdc (200 mA)

Ordering Information

Audio Mixer, Type PAM-1 (less cabinet) MI-586000
 Wall Mounting Ring MI-586001
 Rack Mount Adaptor MI-586002
 Cabinet, Desk Top MI-586003
 Connector Panel (for use with XLR Connectors) MI-586004



Two-Mixer Remote Console Type BN-7

Four-Mixer Remote Console Type BN-17

- Self-contained for a-c or battery operation
- Program and P-A outputs
- 18 dBm line output
- Lighted VU meter
- Headphone output for monitor



Type BN-7



Type BN-17

The BN-7 and BN-17 remote consoles combine high program quality with rugged portability. The major difference between the two is the number of inputs and input mixers. The larger BN-17 uses step-type attenuators and includes line-cue switch arrangement. Both are equipped with double-duty panel covers which serve as tilt-rests when the consoles are in use.

Two-Mixer Console, Type BN-7

The Type BN-7 is a fully self-contained, two-mixer console providing two unbalanced, 250-ohm inputs which convert to 37.5/150-ohm balanced inputs through the use of an optional plug-in input transformer for each input.

The BN-7 operates from commercial power or a self-contained battery pack. The batteries are contained in a special pull-out compartment to the left of the VU meter. The battery pack holds five mercury cells and one D-size flashlight cell. The latter powers the VU-meter lamp when the console operates from the battery pack.

A headphone jack, bridging the output, allows headphone monitoring. A "PA-Gain" control also bridges the output line to feed a local public-address system, when appropriate.

All connections to the console are made at the rear to appropriate connectors: Two Cannon XLR connectors for the mikes, a twist-lock connector for the 8-foot power cord and binding posts for the PA- and line-outputs. The power cord stores in cleats inside the panel cover.

Four-Mixer Remote Console, Type BN-17

The Type BN-17 Portable Remote Console is a four-channel transistor mixer amplifier designed for remote broadcasting. Its small size and low power dissipation makes it equally useful in other applications requiring additional or auxiliary mixing facilities. AC or battery operation is available at the flip of a switch. Sixteen single-type silicon transistors in the amplifier contribute to its dependability and excellent performance characteristics. Four separate, balanced-input channels and two high-level inputs are provided as well as cue, monitor, a test oscillator and a mixer facility.

AC and Battery Power Supplies

The BN-17 is completely self-contained for 115 or 230-volt, 50 or 60 Hz power or battery operation. Other features include microphone input transformers for all channels, earphone monitoring, line cueing facilities and a PA gain control.

The input facilities can be expanded by inter-connecting BN-17 Amplifiers through receptables at the rear of the unit. Bridge-in and bridge-out receptables prevent mixer-bus loading.

Simplified Controls— ±18 dBm Output to Line

All controls are located on the BN-17 front panel including an illuminated VU meter, power switch, PA gain control, cue switch, four mixers, the master control, and monitoring phone jack. The VU meter is used to monitor the output level and to test the battery voltage. Five mercury batteries may be used as a battery power supply. A separate battery provides illumination for the VU meter. The power output capability delivers ±18 dBm to the line.

Functional Styling

The BN-17 console is functionally styled with an etched wiring board including amplifier components, controls, batteries and alternate AC power supply all contained in a steel carrying case. The case, finished in midnite blue, is provided with a soft leather handle. A 6-foot power cord is located inside the carrying case. The front cover is easily removed from the hinges to serve as a tilt-rest for the console. A recess in the bottom of the case protects the AC power cord, fuse holder, high-level connectors, the test oscillator switch and the line binding posts.

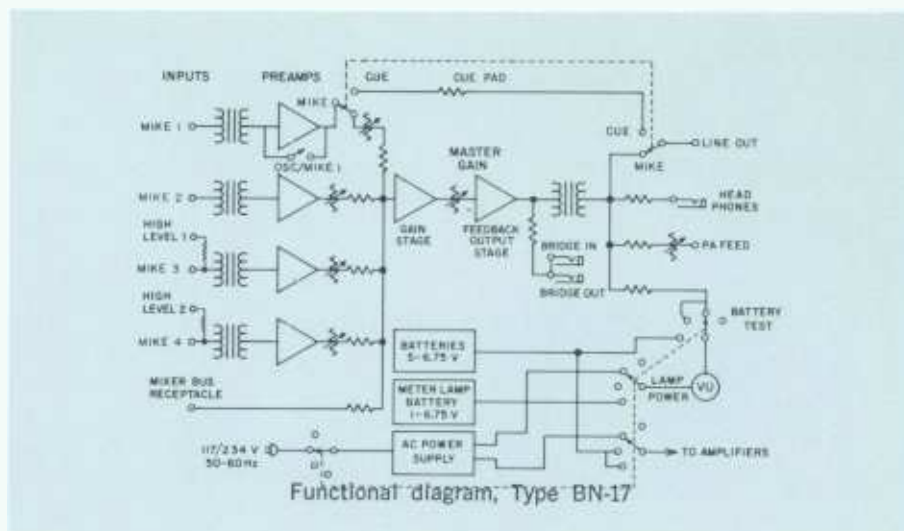

High-Level Mixing

High-level mixing on all four channels is afforded by the BN-17 console. Each channel follows a similar path through its corresponding transformer, transistor and attenuator to the gain stage. The output of Mike 1 Amplifier is fed through the cue-mic switch. When this switch is operated to the cue position, the telephone line from the output of the amplifier is connected to the Mike 1 attenuator. Cue signals from the studio are then amplified through the BN-17 to the headphones. A pad in the cue circuit reduces the signal

to proper preamplifier input level. The test oscillator uses the positive-feedback principle to make the Mike 1 Amplifier oscillate at approximately 400 Hz.

PA Gain Control

The PA gain control bridges the output of the BN-17 console and allows the operator to conveniently control the level fed to external PA equipment. Five convenient binding posts are mounted on the rear panel of the amplifier. Two are used for feeding the PA equipment, two for line output, and one for ground.

Specifications, Type BN-7

Inputs	Two
Connectors	Cannon XLR 3-12
Impedance (unbalanced)	150/250 ohms
	(37.5/150 ohms with optional plug-in transformer)
Output (balanced):	
Impedance	150/600 ohms
Level (6 dB isolation included)	+18 dBm
Gain (150 ohms in; 600 ohms out)	92.5 ± 2 dB
Frequency Response	30 - 15,000 Hz ± 2 dB
Harmonic Distortion (+18 dBm output):	
100-15,000 Hz	1.5% max
50-15,000 Hz	1.0% max
Noise Level (ref: input)	-118 dB
Power Requirements:	
Ac	117/235 V, 50/60 Hz, 5W
Dc	5 Mallory TR-135R and 1 RCA VSO 36
	(or equivalents)
Dimensions	5½"H; 14½"W; 10½"D (110, 368, 267mm)
Weight (approx.)	15 lbs (7 kg)

Specifications, Type BN-17

Inputs:	
Connectors*:	
Mike	Cannon XLR
High Level	Phone Jack
Mixer Bus	RCA Phono Jack
Impedance:	
Mike	150/250 ohms
High Level	600 ohms

Program Output:	
Impedance	150/600 ohms
Level (6 dB isolation included)	+18 dBm
PA Output:	
Impedance (balanced)	600 ohms
Level	-7 dBm
Gain	90 ± 2 dB
Frequency Response	30 to 20,000 Hz ± 0.75 dB
Harmonic Distortion (+18 dBm output)	0.75% max.
Test Oscillator Frequency (non-sinusoidal, approx.)	400 Hz
Noise Level (ref to input)	-122 dBm
(Equiv. to 72 dB s/n w/-50 in +18 dBm out, 30-20,000 Hz)	
Power Requirements:	
Ac	117/235V, 50/60 Hz, 5W
Dc	6 Mallory TR-135R Mercury Cells
Dimensions	5½"H; 18½"W; 10½"D (469, 143, 267 mm)
Weight (approx.)	18 lbs (8 kg)

*XLR connectors may be replaced with Type P or UA

Accessories

Input Connector, Cannon XLR-3-12C	MI-11089
Plug-In Transformer (for BN-7)	MI-11776
Step-Type Mixer Control (for BN-7)	MI-11751-4
Rack-Mount Panel (for one BN-17)	MI-11591-1
Rack-Mount Panel (for two BN-17)	MI-11591-2

Ordering Information

Two-Input Remote Console, Type BN-7, less batteries	MI-11451
Four-Input Remote Console, Type BN-17, less batteries	MI-14140



Custom-Built Audio Equipment Type BC-100 Series

- Built to specific requirements
- Modularized subassemblies
- Easily revised or expanded
- Increased program flexibility
- Extra operational ease

In addition to the lines of "stock" consoles, consolettes and remote amplifiers, RCA designs and fabricates audio equipment for specific needs in radio and TV-broadcast facilities audio-production organizations and sound-recording studios. Among the facilities that own and operate RCA custom-built audio consoles are: LewRon Productions and WPIX in New York, KOMO, Seattle, WSB Atlanta, JFK Center, Washington D. C. and RTV in Belgrade, Yugoslavia.

The modular idea allows assembly of systems without limitation: infinite inputs, infinite outputs, infinite switching and so on. The combination results in a superbly flexible facility capable of virtually any audio signal-handling assignment one might imagine.

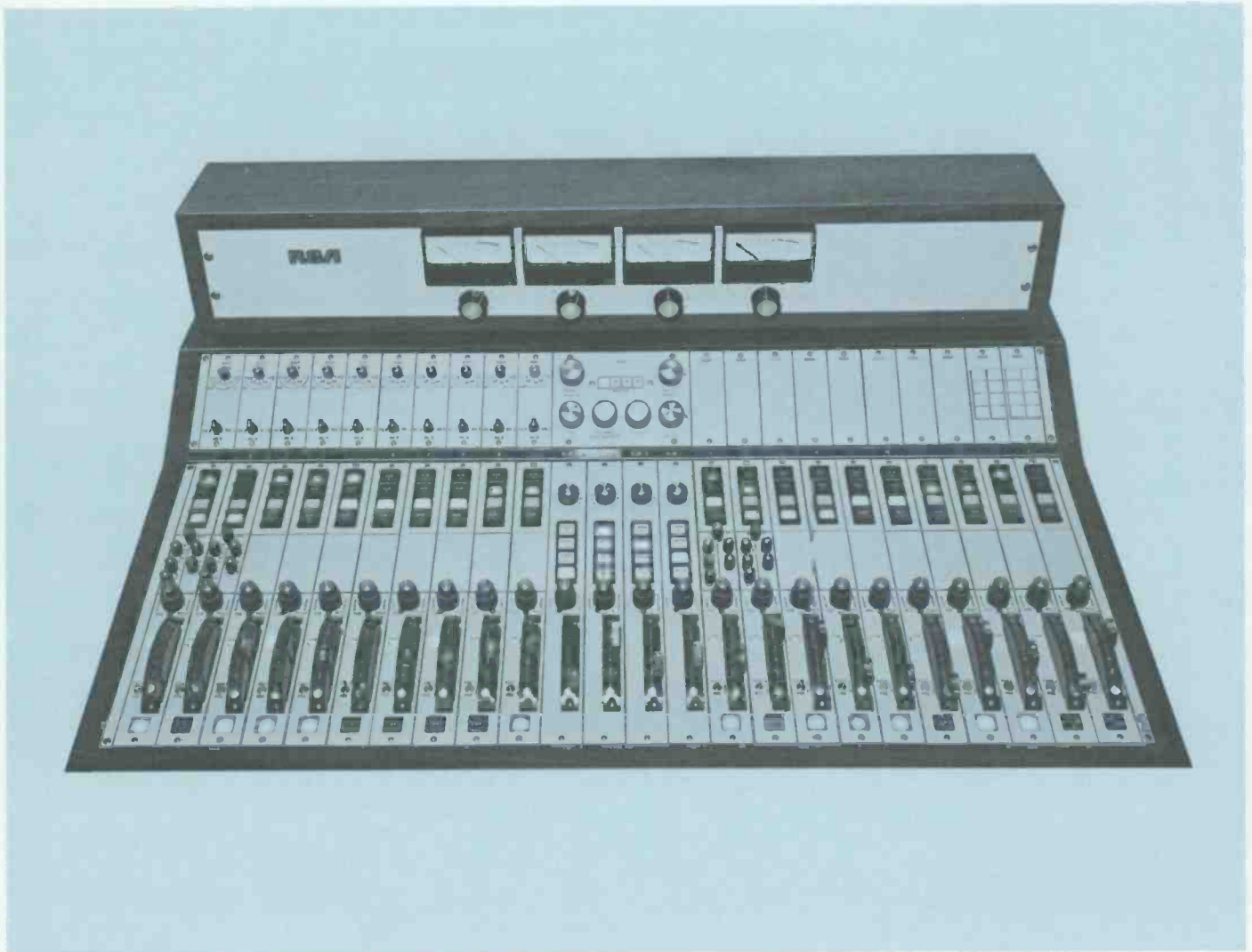

Modules for Custom-Built Audio Consoles, Type BC-100 Series

The several modules described here fit together to form custom-built audio consoles of extremely high quality, flexibility and usefulness. In all, there are five types of input modules, two mixer module types, an equalizer sub-module, an "iso-mix" submodule, suitable blank panels and a choice of console housings. Your RCA representative is ready to help specify the custom console that best fits your needs. He will help determine your audio console needs and define them in terms of console facilities.

- Choice of five input modules
- Equalization easily added anytime
- Standard 10-, 22-, 24-, 28-, 33-, or 44-mixer consoles
- Built to any customer requirement



Operational Amplifier Submodule, MI-141651

Common to every active module in the BC-100 Series, the Operational Amplifier Submodule is a device with all the characteristics useful to audio control-console applications. The "Op Amp" submodule simply plugs into a connector mounted in the module. The connections to the submodule determine the operating characteristics of the Op Amp.



Specifications

Open Loop Voltage Gain	94 dB min.
Frequency Response Characteristic:	
Small Signal Gain Bandwidth Product	40 MHz min.
Equivalent Input Noise (20-20,000 Hz)	Typically 0.7 μ V
Common Mode Input Voltage	\pm 4V max.
Differential Input Impedance	200 kohms
Output Impedance (Open Loop)	100 ohms max.
Output Voltage	\pm 10 V.
Output Current	\pm 100 mA
Output Power	20 dBm @600 ohms
Connector	Mates with ELCO No. 7024-017-163-001
Power Requirements	
(Quiescent)	-16, +16 Vdc, 12 mA (Typ.)
Dimensions	2.5" x 3.16" x 0.68" (64 x 80 17 mm)
Weight	2 oz.
Shipping Dimensions	3" x 6" x 2" (Approx.) (75 x 150 x 50 mm)
Shipping Weight	6 oz. (160 g) (Approx.)

Ordering Information

Operational Amplifier Submodule for BC-100 Series Modules	MI-141651
---	-----------

Preamplifier Modules, Types BA-101, BA-103

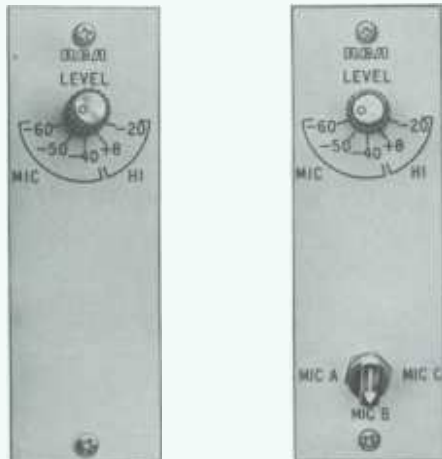

The preamplifier module comes in two forms: a single-input and a three-input unit. The modules are identical except for the three-position input-selector switch on the Type BA-103. A special feature is the five-position attenuator switch to adjust input sensitivity to the program source.

Specifications

Frequency Response Characteristics	
(1 kHz ref. 20-20,000 Hz)	+0, -0.5 dB
Distortion Characteristic (20-20,000 Hz)	0.25% max.
Noise Level (Unweighted, 20-20,000 Hz)	-126 dBm
Source Impedance	150 ohms low level; 600 ohms high level
Input Impedance	1500 ohms low level; 20,000 ohms high level
Nominal Input Level	-50, -40 or -30 dBm unterminated, low level; -10 +18 dBm terminated, high level
Output Impedance	10 ohms
Output Level (Nominal)	-10 dBm
Power Requirements	-16, +16 Vdc @ 15 mA quiescent, 30 mA peak (600 Ω load)
Dimensions	5 $\frac{1}{4}$ " H; 1 $\frac{3}{4}$ " W; 8 $\frac{1}{2}$ " D (133 x 44 x 216 mm)
Weight:	
Single-Input Module	28 oz. (794 g)
Three-Input Module	32 oz. (907 g)
Shipping Dimensions	3" x 6" x 10" Approx. (75 x 150 x 510 mm)
Shipping Weight	25 lbs. (11 kg) Approx.

Ordering Information

Single-Input Preamplifier Module, Type BA-101 (Less Op-Amp Submodule)	MI-141501
Three-Input Preamplifier Module, Type BA-103 (Less Op-Amp Submodule)	MI-141503
Operational Amplifier Submodule (one required for each of above)	MI-141651

High-Level Input Modules, Types BP-101, BP-103, BP-107



BP-103



BP-107

High-level input modules are offered in three forms: a single-input, a three-input and a seven-input. The three-input module uses a rotary switch for input selection while pushbutton switches serve in the seven-input unit. All three modules are passive, requiring no input power.

Specifications

Dimensions:

Single-Input Module1 3/4" W, x 5 1/4" H, x 1/8" D (44 x 165 x 3 mm)	3 oz. (85 g)
Three-Input Module1 3/4" W, x 5 1/4" H, x 8 1/2" D (44 x 165 x 215 mm)	22 oz. (623 g)
Seven-Input Module1 3/4" H, x 5 1/4" H, x 8" D (44 x 165 x 203 mm)	22 oz. (623 g)
Shipping Dimensions4" x 6" x 10" (100 x 150 x 250 mm)	
Shipping Weight	2 1/2 lbs. (1134 g)

Accessory

Audio Relay Switcher ModuleMI-11787
-----------------------------	---------------

Ordering Information

Single-Input High-Level Module, Type BP-101MI-141511
Three-Input High-Level Module, Type BP-103MI-141513
Seven-Input High-Level Module, Type BP-107MI-141517

Submaster Mixer Module, Type BMM-110



Includes a 30-step, tapered-to-infinity fader; an echo-mix network, an echo-return level control and selector switch, and four channel-output selector switches. The output switches are illuminated, alternate-action pushbuttons that allow simultaneous, multiple-output feeds. At the uppermost edge of the module's panel is an unwired potentiometer provided for auxiliary feed such as PA, submaster monitor, etc. (customer specified). The Submaster Mixer Module is mechanically interchangeable with the Type BMM-100 Mixer Module.

Specifications

Input Impedance600 ohms
Maximum Input Level30 dBm
Attenuator Range0 to infinity
Output Impedance600 ohms
Maximum Output Level30 dBm
Power Requirements24 Vdc @ 160 mA (lamps)
Dimensions1 3/4" x 16 1/4" x 8 1/4" (44 x 411 x 210 mm)
Weight3 lbs., 12 oz. (1620 g)
Shipping Dimensions3" x 10" x 20" Approx. (75 x 250 x 500 mm)
Shipping Weight4.5 lbs., (2040 g) Approx.

Ordering Information

Submaster Mixer Module, Type BMM-110MI-141570
--------------------------------------	----------------

Mixer Module, Type BMM-100



Includes a 30-step, tapered-to-infinity fader, provisions for a plug-in booster amplifier, an echo-select (pre- or post-) and -level control, four submaster-select pushbuttons, a cue on-off switch, channel on-off switch, and a foldback- select switch. Wired to accommodate a Type BE-100 Equalizer Module (see below). Two modules illustrated: one at left has equalizer installed; other is without equalizer.

Accessories

Op Amp SubmoduleMI-141651
Equalizer, Type BE-100MI-141560

Ordering Information

Master Mixer Module, Type BMM-100
(Less Op Amp and Equalizer) ...MI-141550

Specifications

Frequency Response (1 kHz ref., 20-20,000 Hz)+0, -0.5 dB
Distortion Characteristic (20-20,000 Hz)0.25% max.
Noise Level (Unweighted, 20-20,000 Hz)-126 dBm
Source Impedance600 ohms
Input Impedance600 ohms
Nominal Input Level-10 dBm
Maximum Input Level+15 dBm
Attenuator Range0 to infinity
Output Impedance10 ohms
Output Level+20 dBm
Power Requirements:
Lamps24 Vdc @ 200 mA
Active Circuitry-16, +16 Vdc @ 15-30 mA
Dimensions1 3/4" x 16 1/4" x 8 1/4" (44 x 411 x 210 mm)
Weight4 1/2 lbs. (2050 g)
Shipping Dimensions3" x 10" x 20" Approx.
(75 x 250 x 500 mm)
Shipping Weight5.5 lbs. (2500 g)

Equalizer Submodule, Type BE-100



Designed as a plug-in for the Type BMM-100 Master-Mixer Module, the equalizer submodule is a zero-loss device which provides separate low-, high- and peaking-frequency (presence) equalization. Maximum equalization exceeds 19 dB boost or cut at 40 Hz; 15 dB boost or cut at 10 kHz and 16 dB boost at any frequency between 800 and 10,000 Hz (see curves). Added to the mixer module at anytime.

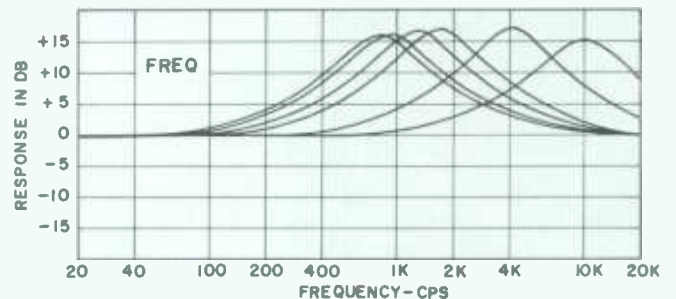
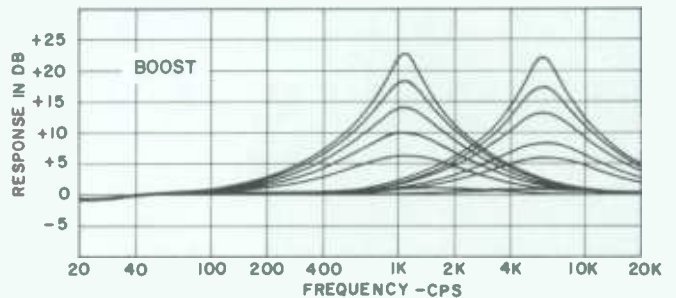
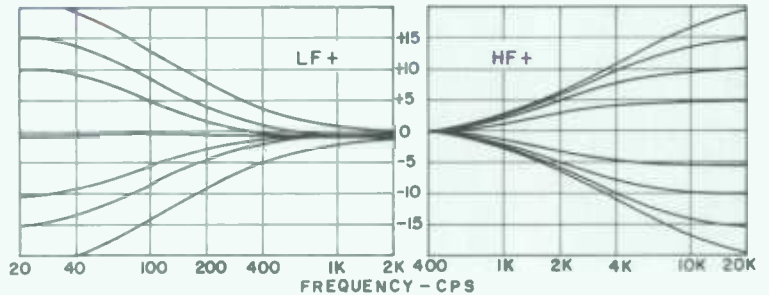

Specifications

Power Requirements-16, +16 Vdc @ 35 mA
Dimensions1 3/4" x 3 1/2" x 6 3/4"
Weight18 oz (500g)
Shipping Dimensions3" x 5" x 8" Approx.
(75 x 125 x 200 mm)
Shipping Weight32 oz (900 g) Approx.

Ordering Information

Equalizer Submodule, Type BE-100MI-141560

Iso-Mix Submodule, Type BIM-100

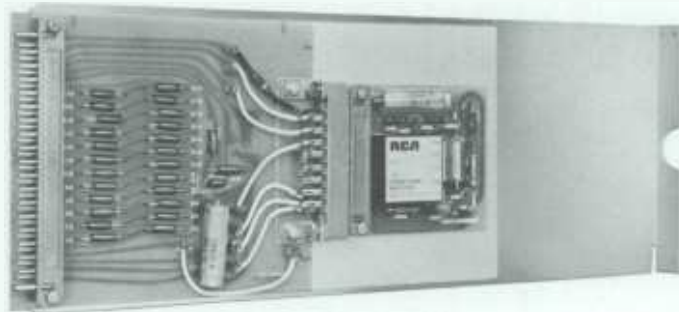

The Iso-Mix Submodule provides 90 dB isolation between inputs and imparts a voltage gain to the signals it passes. Normally this gain factor is either zero or 15 dB, pre-adjusted. However, an adjustment extends this to any value between zero and 25 dB.

The module accepts up to 24 inputs in standard form while additional inputs can be added where necessary. Two or more Iso-Mix Submodules can be cascaded to increase input capacity.

Specifications

Frequency Response Characteristic (1 kHz ref., 20-20,000 Hz)+0, -0.5 dB
Distortion Characteristic (20-20,000 Hz)0.25% max.
Noise Level (Unweighted, 20-20,000 Hz)-126 dBm
Input Channels24
Input Isolation90 dB
Input Impedance (unbalanced)12 kohms
Nominal Input Level-10 dBm
Maximum Output Level+20 dBm
Output Impedance10 ohms
Power Requirements-16, +16 Vdc @ 15-30 mA
Dimensions7/8" x 4 7/8" x 12"
Weight20 oz (560 g)
Shipping Dimensions3" x 5" x 15" Approx. (75 x 125 x 375 mm)
Shipping Weight32 oz (900 g) Approx.

Accessories

Rack-Mount Module FrameMI-557300
Operational Amplifier SubmoduleMI-141651

Ordering Information

Iso-Mix Submodule, Type BIM-100, (Less operational amplifier submodule)MI-141520
--	----------------

Blank Panels Type BP-101, BP-110

Used to fill unoccupied module spaces in control console, the Type BP-101 Blank Panel is identical to the input module panels while the Type BP-110 is identical to the mixer modules.

Specifications

Input Module Blank Panel, Type BP-101MI-141511
Mixer Module Blank Panel, Type BP-110MI-141540

Monitor Control Module, Type BMM-120

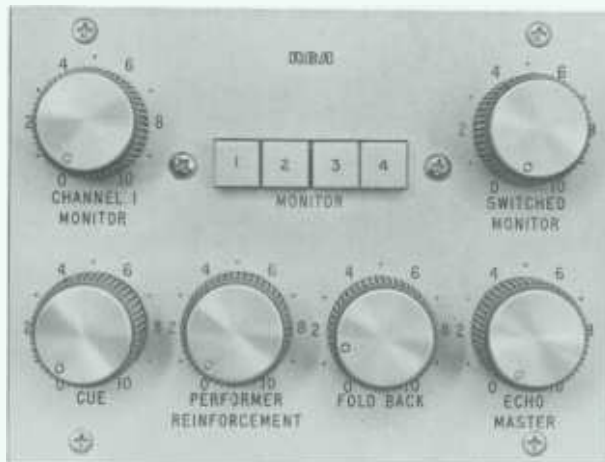

Available in any conceivable configuration to the needs of the control console, the Monitor Control Module is a built-to-order console component. The one pictured here is typical of monitor control panels and fits in the space ordinarily occupied by four input modules. Its upper controls are for control room monitors, while the lower row controls the level of cue, echo-send, foldback and/or other similar circuits.

Ordering Information

Monitor Control Module, Type BMM-120Built to requirement
---	---------------------------

Housings, Custom Audio Consoles

Three "standard" console desks are available off-the-shelf; two are ultramodern designs that accommodate 24 or 28 mixer and input modules. The third is a rack-width enclosure that accommodates as many as ten mixers and input modules. These rack-width units combine (in the factory) to make a single enclosure accommodate additional modules in multiples of eleven. The unit illustrated is a double desk which accommodates 22 module units.

Ordering Information

Console Desk for 28 Module UnitsMI-141600-1
Console Desk for 24 Module UnitsMI-141600-2
Rack-Width Desk Units for
10 Module UnitsBuilt to order





Built especially for **Lewron Television** in New York City, this is one of two custom audio consoles recently installed. The console offers 20 inputs, which accept either high- or low-level signals, fed to any or all of four output channels. A fifth output channel is equipped with built-in AGC. Each output channel feeds a one-by-two splitter. Also included is a slating switch and a built-in tone oscillator.

Designed and built to the exacting requirements of WPIX in New York City, this BC-100 audio console includes performer reinforcement (with pre- and post-fade), pre-hear and foldback facilities. Each facility is equipped with a VU meter and a level control. There are four echo-send channels with pre- and post-faders. A built-in 21 x 5 relay switcher (at the right of the meter panel) provides multiple feeds to five console inputs; digital readouts indicate the selected source on the first eight inputs in this switcher. Two of the six submasters have selectable AGC and a unique warping mixer provides for the mixing of six pre-selected inputs at various artificial levels.



Typical System Specifications

Microphone Inputs:

Source Impedance (Balanced)	150 ohms
Input Impedance	1500 ohms
Nominal Level (Unterminated, switch selectable)	-50, -40 or -30 dBm
Maximum Level	-5 dBm

Auxiliary, High-Level Inputs:

Source Impedance (Balanced)	600 ohms
Input Impedance	40 kohms
Nominal Level (Terminated, switch selectable)	-10 or +18 dBm
Maximum Level	+43 dBm

High-Level Inputs:

Source Impedance (Balanced)	600 ohms
Input Impedance	600 ohms
Nominal Level	-10 dBm
Maximum Level	+15 dBm

Program Outputs:

Load Impedance	600 ohms
Output Impedance	Less than 60 ohms
Nominal Level	+18 dBm
Maximum Level	+30 dBm

Monitor Outputs:

Load Impedance	4, 8, 16 ohms
Maximum Level	+40 dBm

Echo-Send Outputs:

Load Impedance	600 ohms
Output Impedance	Less than 60 ohms
Nominal Level	0 dBm
Maximum Level	+16 dBm

Echo-Return Inputs:

Source Impedance (Unbalanced)	600 ohms
Input Impedance	600 ohms
Nominal Level	0 dBm
Maximum Level	+13 dBm

Frequency Response

(No Equalization, 10 dB below nominal level)	
Program	+0, -1 dB, 30-15000 Hz
Monitor	+0, -2 dB, 30-15000 Hz

Harmonic Distortion

Program	Less than 0.75%, 30-15000 Hz
Monitor	Less than 1.0%, 30-15000 Hz

Signal/Noise Ratio (Bandwidth

Unweighted)	68 dB or greater, 20-20,000 Hz
-------------	--------------------------------

Crosstalk (At 1500 Hz) More than 68 dB down between any two operating channels (console input to output)

Headroom:

(At All Points in Program Circuits not with VU Meter)	
Above Test Level	+15 dB
Above Operating Level	+25 dB
Nominal Gain (Program)	+68 dB

Fader Range +14 dB to -60 dB or greater

Ambient Temperature Maximum (Operating) 90°F. (32°C.)

Equalization (Continuously variable)

Low Frequency	±18 dB @ 40 Hz
High Frequency	±15 dB @ 10 kHz
Presence Peaking	±16 dB any freq. 800-10,000 Hz



Automatic Program Systems

- Mono or Stereo
- Systems for any format
- Uses any program source
- Expandable building block design
- Free planning service—no obligation

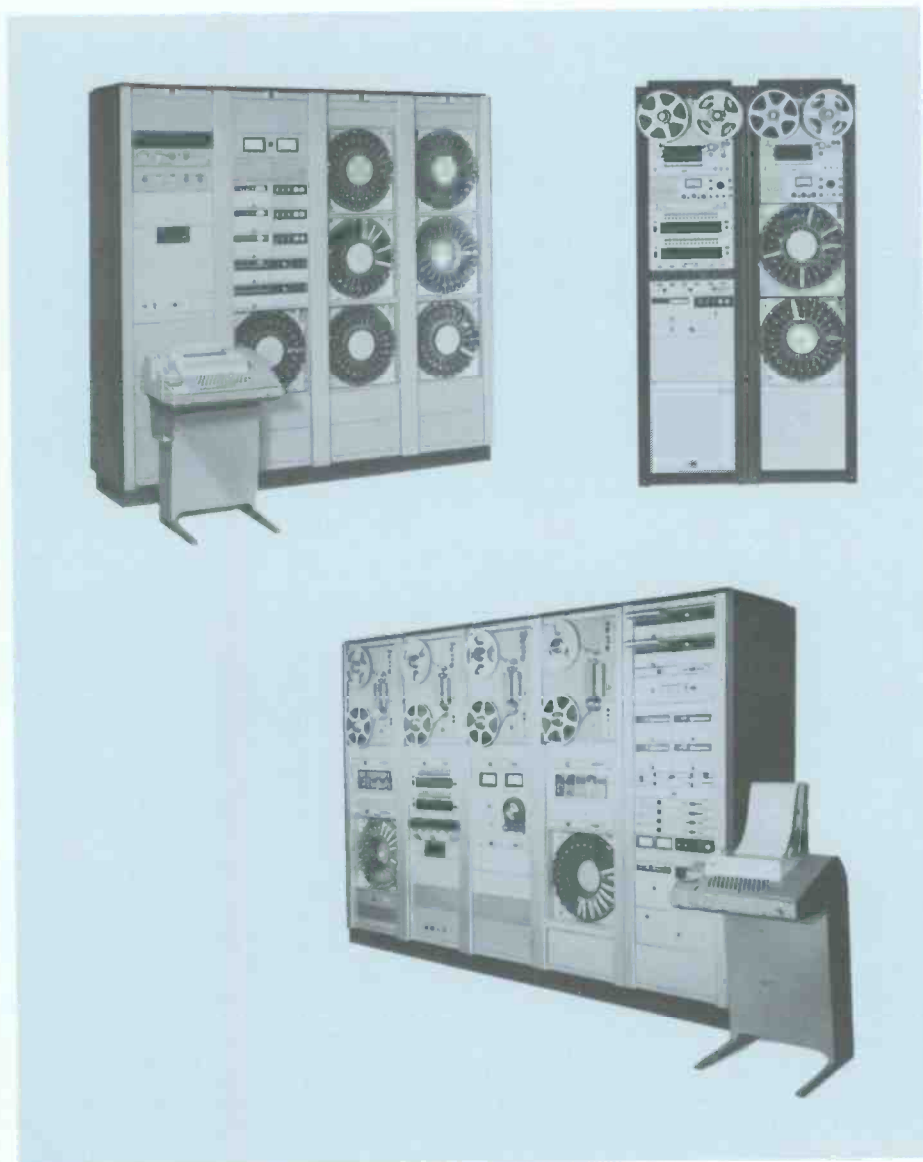

The modern station changes and grows with the needs of its audience. If the station uses an automatic program system, it must have the flexibility to accommodate format and other program changes without redesign and/or extensive modification. The RCA automatic program systems have this flexibility built-in at no extra cost. RCA customizes each system to the specific needs of the station's format and objectives. These systems utilize RCA designed-and-built, off-the-shelf, standard, subsystems including reel-to-reel tape equipment, cartridge tape equipment, consoles and so on.

In addition to these, RCA has developed a series of subsystems that complete the totally automatic program system.

This building-block design allows a station to start small (part-time programming) and expand to a larger system (fulltime) in the future with a minimum amount of effort.

The RCA automatic program systems handle all types of sources including discs, reel tape, cartridge and cassette tape or live programming.

The RCA automatic program systems can be provided utilizing any method of memory storage including punched tape, punched card, magnetic tape, sequential switching, mini-computer or any combination.

In addition to providing automatic programming, RCA systems can be customized to provide statistical information through the use of automatic program logging.

RCA Standard Subsystems

The standard subsystems used in RCA automatic program systems are well known to broadcast people. They include:

- Multi-cartridge Tape Playback System, Type RT-16/26
- Reel-to-Reel Program Logger, Type RT-19
- Reel-to-Reel Tape Reproducer, Type RT-20

- Reel-to-Reel Tape Record/Reproducer, Type RT-21
- Reel-to-Reel Tape Record/Reproducer (Automatic), Type RT-22
- Cartridge Tape Carousel Reproducer, Type RT-25
- Cartridge Tape Record/Playback Equipment, Type RT-27/BA-27
- Audio Signal Processing Equipment, Type BA-43/-45/-46/-47

- Monitoring Amplifier, Type BA-44
 - Monitoring Speaker Assemblies
 - Racks and Cabinets, Types BR-77, -84
 - Monitoring System, Type BA-8
 - Audio Consoles, Type BC- Series
- The above items are described individually on catalog pages.

RCA Specialized Subsystems for Automatic Program Systems

Random Access Carousel Programmer

The RCA random access programmer is intended to provide random selection for a Type RT-25 Cartridge-Tape Carousel.

Assignment of cartridge sequence is determined by the positions of 50 vertical slider switches on the front panel of the unit. Thus, 50 selections can be made from any of the 24 cartridges stored in the Carousel before repetition or re-programming. The 50-step sequence is repetitive in that Step 1 follows Step 50, and the sequence may be shortened to less than 50 events by setting any of the sliders to the lowest, or 25th position. This is the "S" or SKIP position. The usual procedure for setting up the programmer involves setting Slider 1 (left side) to the slot number containing the first desired tape cartridge. Each succeeding slider, in sequence, is set as required to indicate the desired sequence of the cartridges stored in the Carousel. The "Home" button is pressed once to initiate the action required to access the first selected tape cartridge.

It is possible to alter the sequence midway so that a cartridge already selected is rejected. This may be accomplished through the use of the "Advance" and "Home" buttons, even though a tape cartridge is playing at the time.

The programmer can also be used to program other cartridge-tape equipment such as the Multi-cartridge Player (RT-16 and -26).

The programmer measures 10½" H x 19" W x 10" D (317 x 483 x 254 mm), and is intended for standard rack mounting. The device is completely solid state.

Ordering Information

Random Access Carousel ProgrammerMI-141923

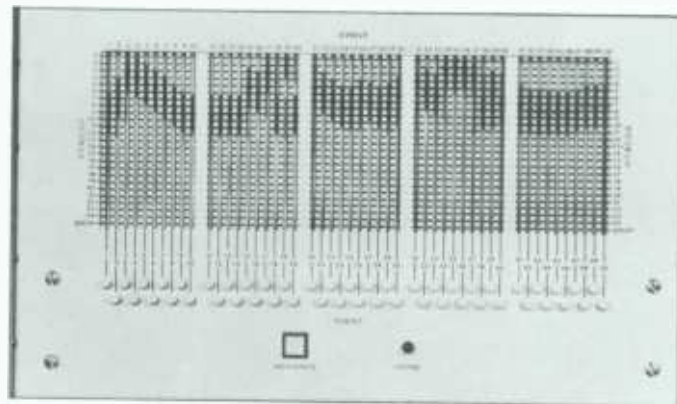

Random Access Carousel Programmer.

Programmer, Type BCA-15B

The BCA-15B Programmer selects from as many as 18 audio sources and sequences them automatically in any preset pattern as 15 consecutive program events. After being preset and started, the BCA-15B continues to program automatically up to the full set of 15 events or multiples thereof, without attention or error. If changes are necessary during programming, events can be easily substituted or skipped or the program sequence can be stopped at any time. Each of the 15 events is programmed by means of a thumb-wheel which indicates any of the 18 program sources. Control is given in sequence by circuits in the unit, the end of one

event initiating the beginning of the next.

Automatic features of the BCA-15B can always be waived and the unit used as a start panel for 18 program sources.

The basic unit can be augmented by cascading additional units to sequence or sub-sequence any number of events in groups of 15.

Dimensions—5¼" H x 19" W x 6" D (133 x 483 x 152 mm).

Accessories

BCA-15B "Advance" Circuit AssemblyMI-141917
 BCA-15B "Next" Circuit AssemblyMI-141918

Ordering Information

Programmer, Type BCA-15BMI-11365B



The Programmer sequences the program sources in the system.

Automatic Cue System

The Automatic Cue System utilizes a Type BA-8 Cue Amplifier in conjunction with an Indicator and Automatic Pass System to provide automatic monitoring of any system source started and played off line. Any source not "on air" is automatically connected to a common cue bus monitored by the cue amplifier. This arrangement allows system sources to be cued-up or played-back off-line while the

automatic program system is on air. For stereo use, a lever switch allows individual monitoring of A, A +B or B channels.

Accessories

Rack Adaptor (for BA-8)
 3½" x 19" (89 x 483 mm)MI-11449

Ordering Information

Automatic Cue System (Modified)MI-11450C

Automatic Cue System allows off-line use of program sources.



BCA-15B "Advance" Circuit Assembly

The assembly is designed for plug-in connection to a BCA-15B. The circuit provides a sequence advance function generated by sequential +24-volt pulses on a single input line. This circuit may be used in conjunction with a silence sensing device to automatically advance the BCA-15B to the next event when a source failure is detected.

The circuit consists of 15 gated-pulse storage/relay driver stages with a common monostable pulse shaper.

This option is required when a Studio Control System or an automatic advance Silence Sensor is incorporated into the automatic program system.

Ordering Information

BCA-15B "Advance" Circuit AssemblyMI-141917

BCA-15B "Next" Circuit Assembly

The "Next" Circuit addition to the BCA-15B is required when a Studio Control System or Indicator Assemblies are incorporated into the automatic program system.

This circuit scans the next programmed source, detects unavailable sources to be skipped, lights next indicators of the unavailable sources in conjunction with their Pass lights and lights only the "Next" indicator of the actual source to play next. These readouts indicate to the operator any source which is programmed next, but is unavailable or not loaded and also gives an indication of the actual source to play next after all unavailable sources are skipped.

The "Next" Assembly is a printed circuit module designed for plug-in addition to a BCA-15B Programmer.

Required Accessory

Relay Power Supply, 24 V,
 Type BX-51MI-11318C

Ordering Information

BCA-15B "Next" Circuit AssemblyMI-141918

Indicator and Automatic Pass Assembly

Each Indicator and Automatic Pass Assembly provides a status readout for its associated source as used in the automatic program system. It incorporates readouts indicating the source number which, when illuminated, shows the availability of the source to the system and that all power has been applied to the source. A "Play" readout lights when the source is playing on-line in the system.

A "Next" indicator advises that the source plays next in the program sequence.

Indicator and Automatic Pass Assembly bypasses unavailable program source automatically.

A "Pass" indicator lights whenever the source is not available to the system for any reason, including a deliberate removal of the source from the system with the "Pass" switch for service, tape rewinding, etc. A source in the "Pass" mode is automatically skipped if called for in the program sequence. The Indicator and Automatic Pass System consists of a Readout and Pass Switch Assembly which front mounts near its associated source and a control circuit assembly which mounts in the rear of the system rack.

Use of the Indicator and Automatic

Pass Assembly requires that the associated BCA-15B Programmer be equipped with the "Next" circuit option. Dimensions—1¾" H x 19" W x 4" D (44 x 483 x 101 mm).

Required Accessories

Programmer, Type BCA-15BMI-11365B
 BCA-15B "Next" Circuit AssemblyMI-141918
 Relay Power Supply, 24 V, Type BX-51MI-11318C

Ordering Information

Indicator and Automatic Pass AssemblyMI-141929



Program Timer

The program timer assembly is used to resynchronize the program on an average time basis. The timer breaks into the programmed sequence and starts a new event at a different place on the programmer. This occurs at the end of the event on the air at clock time. By programming music selections near the end of the time period, the average time clock guarantees the station ID within legal time limits.

The time source is a clock-motor-driven cam switch. The cams are adjustable and can be set for actuation at any desired time during the cycle (1 hour or 24 hours).

The timer assembly is equipped with a routing switch for each of the six cams on the clock timer. The setting of this switch determines the event to be started by the clock at the next event ending after time. One position of each of the routing switches deletes any clock control at the time set by its associated cam. The timer is equipped with indicators to show any upcoming clock operation.

The Program Timer is designed for rack mounting and dimensions are 7" H x 19" W x 10" D (17 x 483 x 254 mm).

Ordering Information

Program Timer (6 events per hour) (1 hour)MI-141919
 Program Timer (6 events per day) (24 hour)MI-141928

Program Timer and Resequencer

This unit is very similar to the 1-hour Program Timer and the 24-hour Program Timer except that two of the six clocked events are replaced by the program resequencer.

The Resequencer device increases the flexibility and programming capability of the BCA-15B Programmer by allowing a pre-programmed jump from any event to any other event in the programmer sequence. This capability permits recirculating loops to be set up on the programmers such that a series of programmed events may be repeated a number of times until interrupted by a clocked-time event.

Program Timer and Resequencer increases Programmer flexibility and capability.

In use each Resequencer circuit is assigned a source number which, when programmed on the BCA-15B Programmer, will cause the programmer to recycle to the event set up on the Resequencer routing selector switch.

Dimensions—7" H x 19" W x 10" D (178 x 483 x 254 mm).

Required Accessories

BCA-15B ProgrammerMI-11365B
 BCA-15B "Next" Circuit AssemblyMI-141918
 Relay Power Supply, 24 V, Type BX-51MI-11318C

Ordering Information

Program Timer and Resequencer AssemblyMI-141927

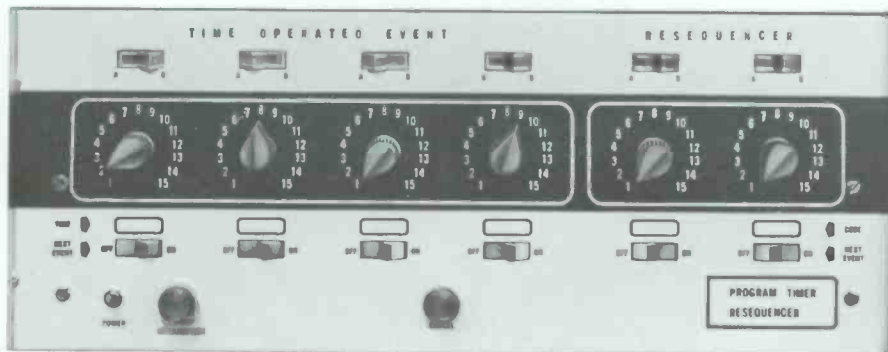

Silence Sensor Assembly

The silence sensor assembly is an adjustable time-delay switch activated by a loss of audio signal. The timing circuit is adjustable from 2 to 20 seconds before an output pulse is generated which can be used to trigger an alarm and/or advance the programmer to the next programmed event. The timing circuit is reset by audio which exceeds the adjustable threshold level. The Silence Sensor is equipped with a balanced input and a bridging/mixing network to combine stereo inputs while maintaining channel-to-channel isolation.

Silence Sensor Assembly.



The device is completely solid-state. Dimensions are 5¼" H x 19" W x 8" D (133 x 483 x 203 mm) and the unit is intended for standard rack mounting.

This unit can also be used to supply additional information to the system such as print-out of the log, transmitter off-the-air alarm, etc.

Ordering Information

Silence Sensor Assembly, single channel (mono or stereo input)MI-141932

Manual Cue and Pass Switch

The Manual Cue and Pass Assembly is a dual unit designed to allow headphone cueing of two reel-to-reel tape decks and switch-controlled removal of either deck from the automatic program system.

With the switch in the "Pass" position, the deck audio connects to the headphone jack, and the deck operates manually, independent of the automatic program system. The deck is automatically skipped if called for in the automation program while the switch is set to "Pass".

The assembly is mounted on a 1¾-inch (44 mm) rack panel. Terminal block connections to the decks are made from the rear of the panel.

Ordering Information

Manual Cue and Pass Switch (dual unit)MI-141920

25-Hz Cue-Tone Sensor Assembly

This subsystem consists of the 25-Hz Basic Sensor and Frame Assembly (MI-141930) and a Dual Switcher Module (MI-141931).

The Cue-Tone Sensor Assembly detects and interprets the 25-Hz cue tones placed on reel-to-reel source material to indicate the end of a selection or segment. The sensor monitors the output of all the tape decks which it controls and transmits an End Cue pulse to the system programmer at the beginning of the 25-Hz tone burst on the tape and sends a "Stop" command to the tape deck at the conclusion of the tone.

The unit consists of a 25-Hz sensor system with plug-in provisions for up to three separate Dual Switcher Modules. Each Dual Switcher Module controls two tape decks. With a full complement of Dual Switcher Modules, the 25-Hz Cue-Tone Sensor Assembly controls six reel-to-reel tape decks and provides all required audio switching.

The Assembly is designed for rack mounting. Dimensions are 5¼" H x 19" W x 8" D (133 x 483 x 208 mm).

Ordering Information

25-Hz Basic Sensor and Frame Assembly (provides space for up to 3 dual switcher modules)MI-141930
Dual Switcher Module for 25-Hz Sensor (will control two tape decks)MI-141931

Time Announcer

The RCA time announcer system provides pre-recorded time announcements automatically at the discretion of the operator or according to the pre-schedule of an automatic program system. Two standard Type RT-27 Cartridge Tape Playback units are used (one for odd minute announcements; one for even minute announcements). These are automatically synchronized by the time announce control

unit. The unit has a self-contained time pulse source.

Dimensions are 5¼" H x 19" W x 8" D (133 x 483 x 203 mm).

Required Accessories

Two Type RT-27 Cartridge Tape Playback Systems, Mono with end cue, trip cue and audio switching (ES-41941).

Ordering Information

Time Announce Control PanelMI-141937

Time Announcer controls recorded time announcements on cart or reel.

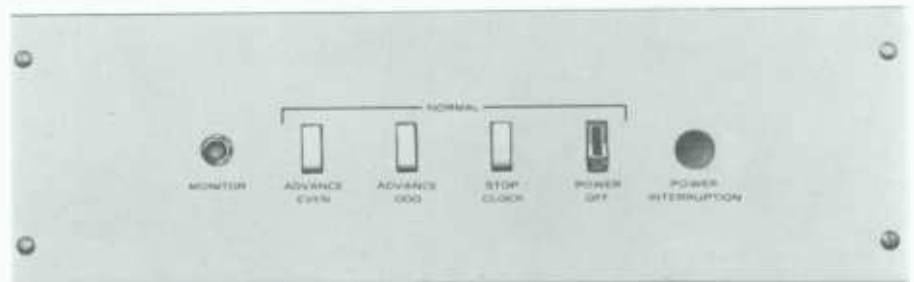

25-Hz Program Filter

This filter is placed in the left channel program output line to remove the 25-Hz tones used to cue the reel-to-reel tape equipment. This filter uses a 40-Hz cutoff and is approximately 24dB down at 25 Hz.

The unit is supplied with a mounting bracket for rear-rack mounting.

Ordering Information

25-Hz Program FilterMI-141922

Interface Assemblies

These are "black boxes" used to interface the various program sources with the automatic program system.

Ordering Information

Interface Assembly for Type RT-25MI-141924
Interface Assembly for Type RT-16/25MI-141925A
Interface Assembly for Reel-to-Reel EquipmentMI-141940

Studio Override and Manual Control System

The Studio Control System allows a live announcer or a console-controlled source to be inserted into the automation programming sequence. The Studio Control System is capable of three insertion modes for maximum flexibility of operation:

1. The live source can be pre-programmed in the normal manner by dialing the source number assigned to the live source on the BCA-15B Programmer.
2. The announcer can interrupt the automation sequence and insert live announcements at the end of the "on air" event by actuating a "Next" switch at the console or announce booth. At the conclusion of the live insertion, the pre-programmed sequence continues from the point at which it was interrupted.
3. The live source can instantaneously override the "on air" automation source and stop the programmer sequence by actuating a "Play" switch at the console or announce booth. At the end of the live insertion, the programmer continues, starting with the event following the event which was interrupted.

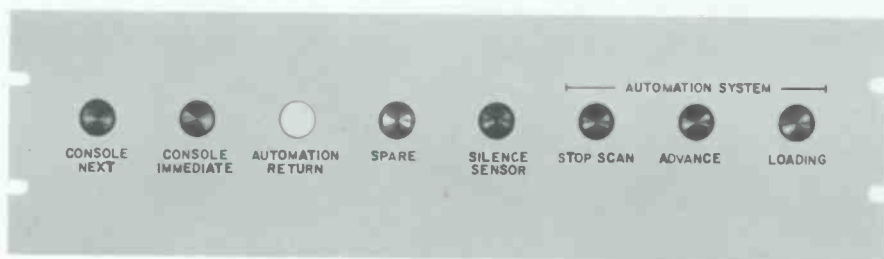

Studio Override and Manual Control System lets talent temporarily override automatic program system.

When the live insertion is pre-programmed (Mode 1), the operator receives a "Next" indication at the console or announce booth for the duration of the event preceding the live segment. The operator must reply to the "Next" light by operating a "Ready" switch to indicate his presence in the studio. If the "Ready" switch is not operated, the live segment is automatically skipped by the automatic program system.

In all operating modes, the console "on air" is indicated by illumination of the "Play" lamp and termination of the live segment is made by operator actuation of the "Pass" switch.

The Studio Control System consists of a remote readout and control panel and

a rack mounted status indicator. Use of the Studio Control System requires that the BCA-15B Programmer be equipped with both "Advance" and "Next" options.

Dimensions—5¼" H x 19" W x 6" D (133 x 483 x 152 mm).

Required Accessories

Programmer, Type BCA-15B	MI-11365B
BCA-15B "Advance" Circuit Assembly	MI-141917
BCA-15B "Next" Circuit Assembly	MI-141918
Relay Power Supply, 24 V, Type BX-51	MI-11318C

Ordering Information

Studio Override and Manual Control System	MI-141934
---	-----------

25-Hz Tone Generator and Program Input Filter

The 25-Hz Tone Generator and Program Input Filter Assembly is required to add 25-Hz cueing tones when recording reel-to-reel source material. The Program Input Filter removes all program material at 25 Hz during the recording process to prevent generation of false end-cue signals while the tape plays.

A stable, low-distortion, controlled-amplitude, 25-Hz oscillator is used to assure reliable operation during playback with minimum of harmonic generation. The pulse duration is adjustable and is immune to double- or short-pulsing.

Ordering Information

25-Hz Tone Generator and Program Input Filter	MI-141933
---	-----------

Automatic Fader Assembly

Each program source in the automatic program system requires an automatic fader assembly if a cross-fade or segue is required. The unit works either for mono or stereo. The fade time is adjustable and is activated by the end-cue tone stored on the tape. The unit can also be used to provide announce-over programming.

Ordering Information

Automatic Fader Assembly	MI-141941
--------------------------------	-----------

Network Joiner

The Network Joiner operates on real time and joins the network precisely at the correct time. The joiner takes over the operation of the automatic program system and operates the system until the network is joined. It then cuts away from the network at the precise time and starts

the automatic program system sequence again. Both electronic and mechanical systems are available.

Dimensions—10½" H x 19" W x 10" D (317 x 483 x 254 mm).

Ordering Information

Network Joiner	MI-141936
----------------------	-----------

Network Joiner Unit controls system before and after network feeds.

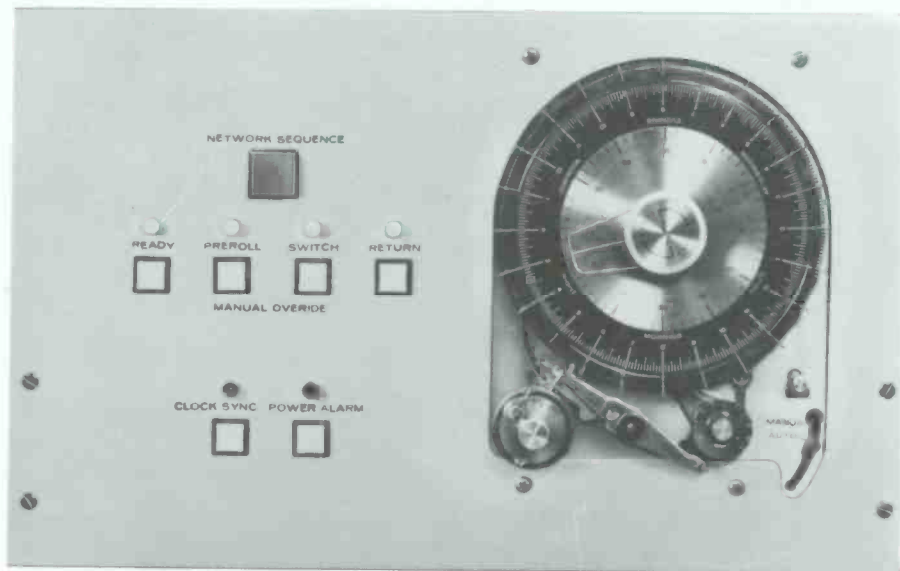

Automatic Program Logger-Printer

The automatic program logger-printer system provides a printed log of tape played, a record of other audio sources used, along with the time each source starts. The log is printed on a standard teleprinter machine, including the full title, identification numbers, and billing codes. The information printed is a reproduction of the information recorded previously on tape. In addition to an alphanumeric log, a punched paper-tape log is also produced which can be used for input to the station's billing machine.

Physical Description—The Logger-Printer System consists of a cartridge makeup station (MI-141938) and a logging station (MI-141939).

The makeup station consists of a Type RT-27A/BA-27A Cartridge Record/Playback Unit, a Teletype Model 33ASR Page Printer, and control and signal receiving electronics, and a digital time code generator.

Operation—The exact message is typed on the Makeup Station Teletype, producing a punched paper tape containing the desired message. This may be played back immediately for checkout. The pre-recorded tape cartridge, produced in the usual fashion, is placed in the Makeup Station cartridge deck. The system is placed in the data record mode and the start button depressed. The cartridge is started, and the data contained in the punched paper tape is automatically recorded. The system stops itself when the cartridge returns to its start. The cartridge may then be played back to check the data recorded by reading out on the Teletype.

When the cartridges are played in the playback system, the start impulse to each playback triggers a time readout from the digital time code generator which is printed by the Teletype. An automatic delay in the recorded message allows time for the printout. The recorded data message then prints out. At the end, the carriage returns ready for the next print-out¹.

Other Features—At each cartridge start, an external transmitter alarm line (customer supplied) is interrogated and a single character printout made which indicates transmitter "On Air Status". The character is added after the time to signify transmitter "On Air". This character is actuated by an external line grounded by the customer.

A code generator provides signals for recording a code digit to permit the identification of audio sources not containing

a data recording such as a studio, network or a music reel source. Two code generators are furnished, and are triggered by an external signal to provide a time and single digit readout. Additional code generators may be added, as required.

¹The same system can be used to generate coded information on reel-to-reel tape.

Required Accessories

Type RT-27A/BA-27A Cartridge Tape Record/Playback SystemES-41942

Ordering Information

Tape Makeup StationMI-141938
Logging StationMI-141939

This teleprinter makes hard copy of program sequence.

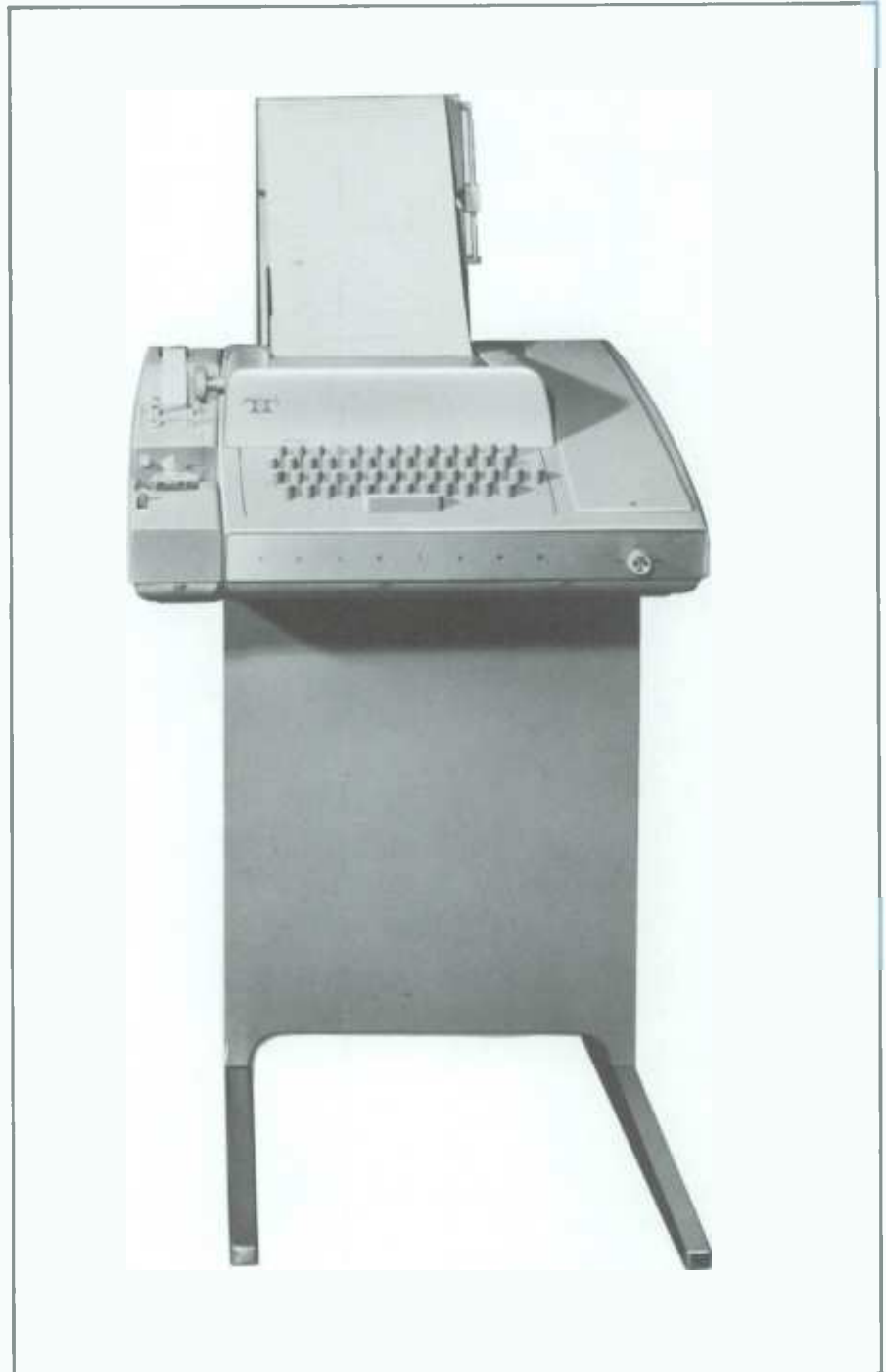



Typical medium-size automatic program system with teleprinter.

Typical full-time automatic program system complete with teleprinter.

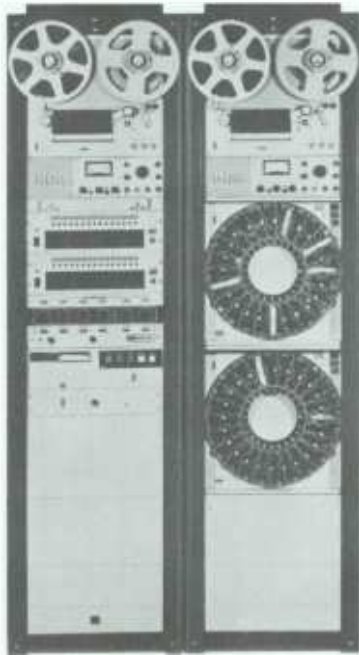
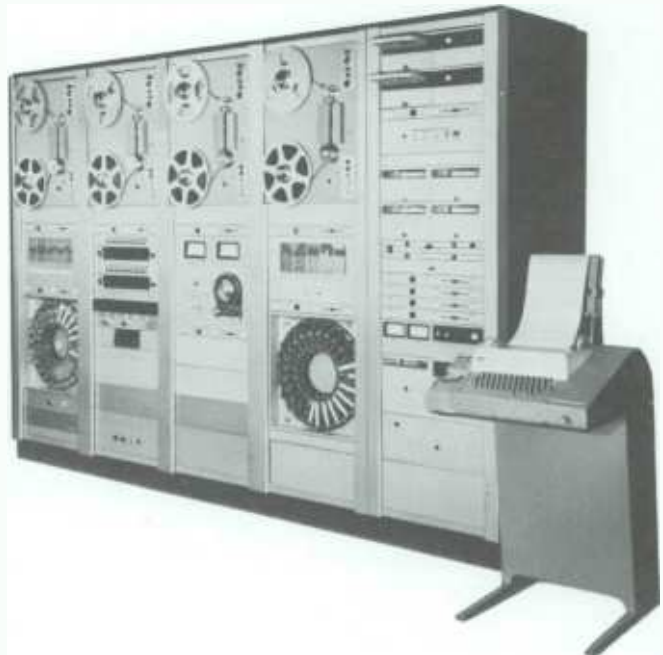

Typical part-time automatic program system.



Expandable Intercom System, Type BCS-5000

- Virtually unlimited expandability
- Custom-designed systems
- Desktop or rack-mount control stations
- Up to 5000-crosspoint capacity
- Ten basic modules



The Expandable Intercommunication System, Type BCS-5000, consists of a series of solid-state modules that may be used in various combinations to fabricate virtually any size intercom system for radio and television plant facilities.

Modular Construction

The modules include Microphone Pre-amplifiers, a solid-state Switching Matrix, Coupling Amplifiers, Monitor Amplifiers, Power Supplies and Control Panels, plus auxiliary equipment such as microphones, speakers and mounting hardware.

The "heart" of the system is a group of these modules centrally located in a standard 19-inch equipment rack plus two (or more) control panels that include microphones, speakers and/or headsets. All systems are custom designed, using the modules described here, to meet customer's individual requirements. All of the modules are constructed on printed-circuit boards which plug into pre-wired module frames. This makes it practical to expand the system at any time in the future. As a result of the electrical and mechanical design of the system, it requires considerably less rack space than comparable systems.

Monitor Amplifier

The Monitor Amplifier is the basic module of the system. In addition to its function as a 3-watt output Amplifier, it provides power and plug-in mounting for a Preamplifier or Coupling Amplifier. The Monitor Amplifier module is designed to plug into a pre-wired mounting frame, that installs in a Type BR-21 shelf. All connections are made via gold-plated contacts. Up to ten Monitor Amplifier modules mount in a single mounting frame.

An interstage gain control, to set the level for the preamplifier, is also incorporated on the Monitor Amplifier board. To adjust the preamplifier level control and the monitor amplifier level control, a screw driver access hole is located on the front panel. This allows setting of levels with the units plugged in.

Each amplifier module incorporates a transistorized voltage sub-regulator which furnishes 32(± 1) volts to the amplifier. The DC sub-regulator isolation minimizes system crosstalk through the power supply.

An important feature of the unit is the solid-state circuit which mutes the output to prevent feedback from a nearby microphone.

Carbon Microphone Preamplifier Module

This module furnishes the amplification required to feed the switching matrix from a carbon microphone. "Button" current for the microphone is supplied by the module. A unique feature is a solid-state input-switching circuit which essentially eliminates the transient generally associated with turning a carbon microphone on.

Dynamic Microphone Preamplifier Module

This module is a preamplifier which incorporates 30 dB of automatic-gain control. The AGC feature is defeated by

turning the Threshold Control fully counter-clockwise. The preamplifier increases the output voltage of a dynamic microphone to the level required to drive the Switching Matrix. The overall gain of this module without AGC is $50(\pm 2)$ dB with $47(\pm 2)$ dB of AGC.

Coupling Amplifier Module

This module provides an audio signal-interconnect with the RCA Interphone System. Mounting and connections are identical to the Carbon and Dynamic Mike Preamplifier modules.

Solid-State Switching Matrix Module

This module consists of a plug-in board

which has provisions for mounting up to 10 plug-in solid-state crosspoints for audio switching. This module is so designed that it may be used as two 5-by-1 or one 10-by-1 switcher modules. It is similar to the Monitor Amplifier modules but requires only half the mounting space, making it possible to mount up to 20 switching modules in a single frame. Using the switching module as two 5-by-1 switchers results in reduced costs and reduced space requirements. Plug-in crosspoints of this type make future expansion or modification of a system a simple matter.

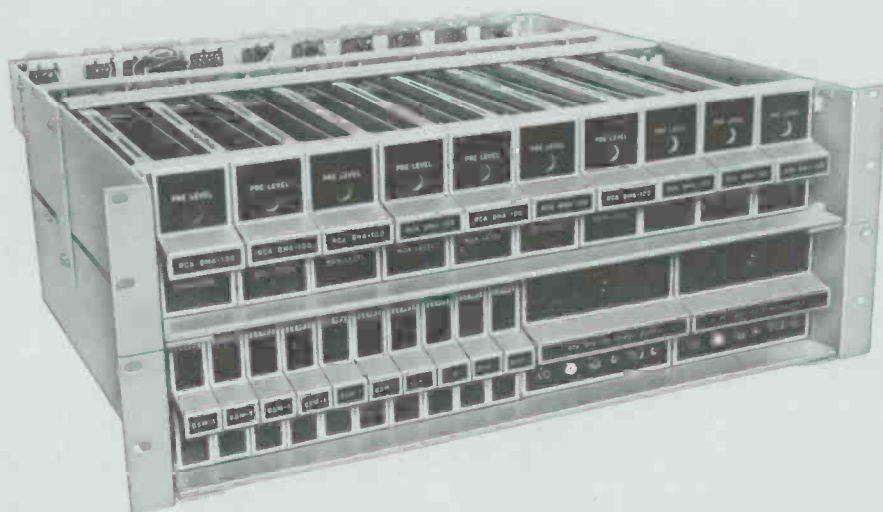

Typical module bank. All electronic functions are housed in three different modules: Preamp/Monitor Amps, Switching Matrix and Power Supply.

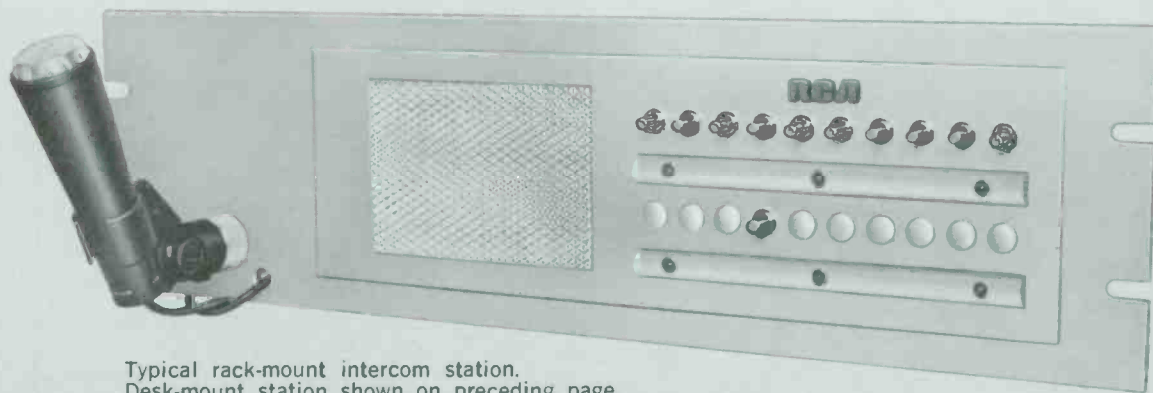

Typical rack-mount intercom station.
Desk-mount station shown on preceding page.

Solid-State Audio Crosspoints Modules

The crosspoint module is an unbalanced switching device which may be controlled remotely by means of 12-or-24-volt (DC) control energy.

The isolation between adjacent crosspoints is greater than 65 dB. The solid-state design provides a virtually transient-free switching function.

Power Supply Module

The power supply module provides regulated DC power for operation of all the modules. Two output voltages are furnished by 40 V at 800 mA (for opera-

tion of Monitor Amplifier and Preampifier modules) and 20 V at 200 mA (for operation of switching and associated crosspoints).

The power supply module plugs into the Mounting Frame and occupies 2/10 of the space.

Receptacle Board—Switching Matrix

This component provides the mating receptacles for five switching matrix modules and also provides all interconnections except for the d-c control points. These must be wired to their respective locations during installation. The board

mounts at the rear of the mounting frame perpendicular to the switching matrix boards.

Receptacle Board—Monitor Amplifier

This board provides the mating receptacle for five Monitor Amplifier modules and all the required interconnections. The board mounts at the rear of the mounting frame, perpendicular to the Monitor Amplifier modules.

Mounting Frame

The Frame attaches the various modules of the system to the Type BR-21 Mounting Shelf.

Ordering Information

Type BCS-5000 Intercom Systems are offered on a custom-built basis. RCA people design a system to your needs using the modules, accessories and equipment listed here.

Monitor Amplifier, 3-watt, Type BMA-100	MI-141080
Carbon Microphone Preampifier, Type BMA-10	MI-141060
Dynamic Microphone Preampifier with AGC, Type BMA-11	MI-141065
Coupling Amplifier (for use with RCA Interphone Equipment), Type BMA-12	MI-141063
Switching Matrix, Solid-State, Type BSM-1	MI-141075
Audio Crosspoint, solid-state (Normally open), Type BCP-1	MI-141070
Audio Crosspoint, solid-state (Normally closed), Type BCP-2	MI-141071
Power Supply, Type BPS-100	MI-141085
Receptacle Board—Switching Matrix, Type BSM-1-1	MI-141090
Receptacle Board—Monitor Amplifier, Type BMA-100-1	MI-141095
Adaptor Kit for Type BR-21 Mounting Shelf	MI-141073
Dual Preamp Mounting Module, Type BPM-1	MI-141076
Module Extender (for Type BMA-100), Type BMA-100-2	MI-141079
Mounting Shelf, Type BR-21 (3.5-inch)	MI-11567
Connector Mounting Kit	MI-141096
Connector Kit	MI-141097
Lever Switch	MI-141069
Dual Mount Control Box (requires MI-141066)	MI-141068
Rack Mounting Adaptor (requires MI-141066)	MI-141067
Front Panel Assembly	MI-141066



Power Supply Module.

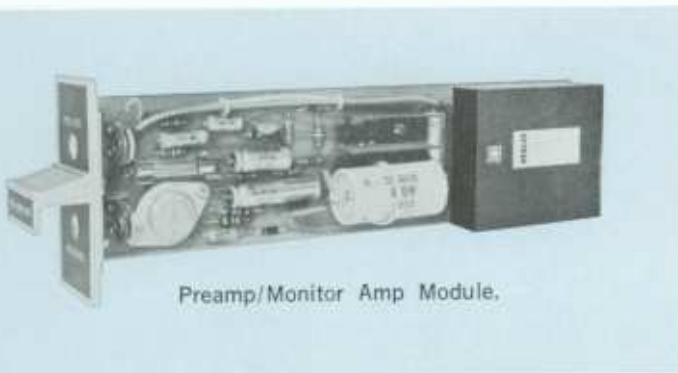

Preamp/Monitor Amp Module.

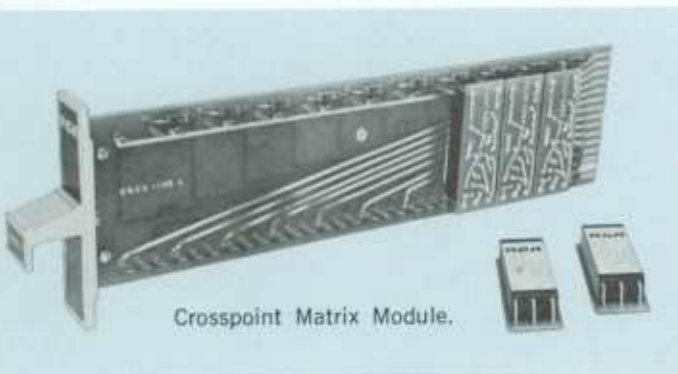

Crosspoint Matrix Module.

Accessories

Microphone, Dynamic, Type SK-30	MI-11030-1
Microphone, Dynamic, Lavalier, Type BK-6	MI-11017
Camerman Single Headset/Carbon Mic	MI-141006
Camerman Double Headset/Carbon Mic	MI-141007
Commentator's Single Headset/ Dynamic Mic	MI-141009SI

Commentator's Double Headset/ Dynamic Mic	MI-141009DI
Single Headset/Transmitter Assembly	MI-11743
Double Headset/Transmitter Assembly	MI-11744
Flexible Gooseneck Mic Extension, 13-inch (330 mm)	MI-11745
Flexible Gooseneck Mic Extension, 19-inch (483 mm)	MI-11746
Gooseneck Adaptor Kit	MI-11073

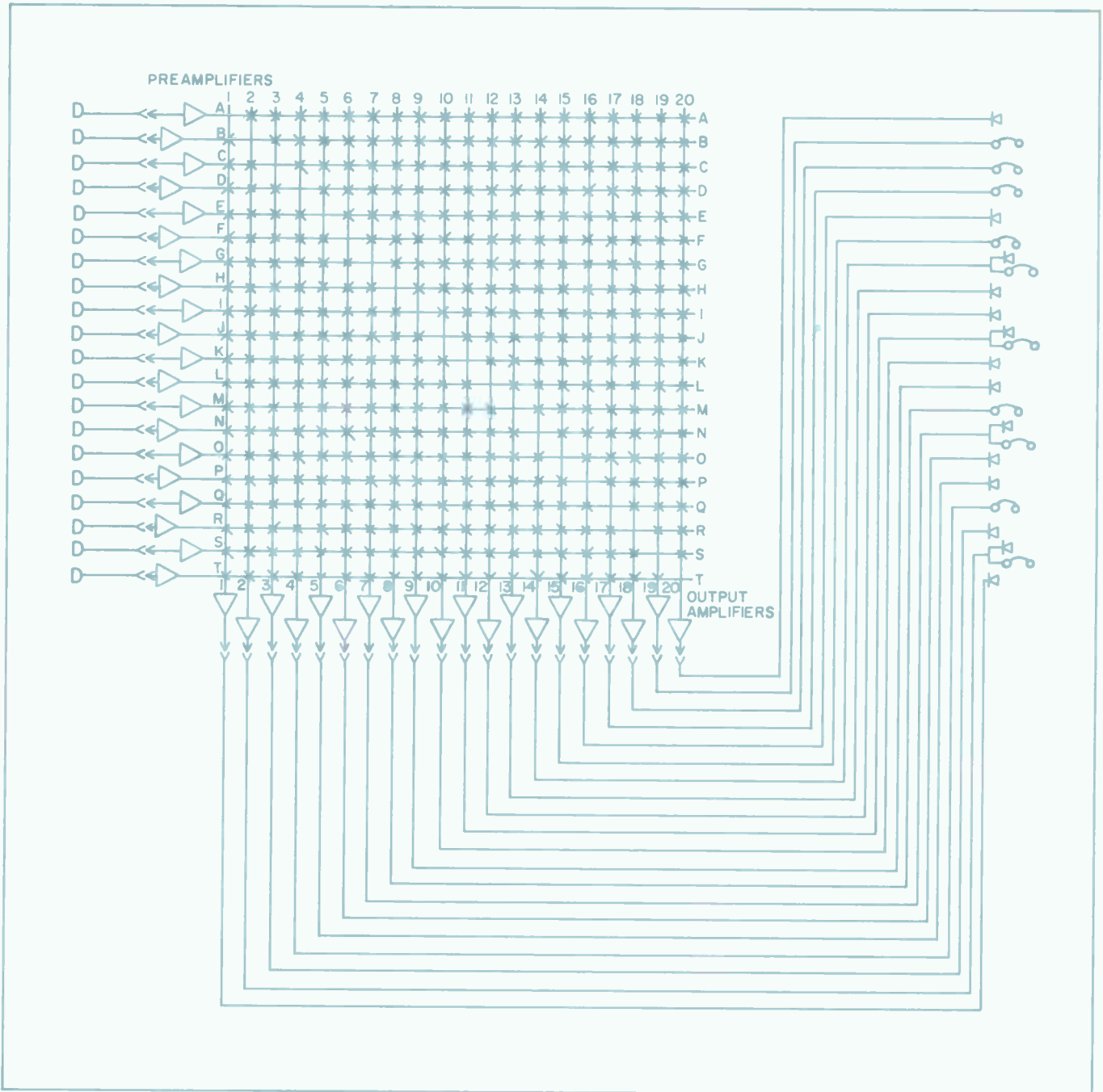

Typical 20 x 20 system diagram.



Headphones and Headsets

- Singles, doubles, with, without mike
- Noise-cancelling microphones
- Comfortable ear and headband pads
- Sliding friction headband adjustment
- Belt clip included with long cords

RCA single and double headsets are lightweight, durable assemblies for use by commentators, cameramen and other crew members. There are twelve sets in the group. The selection provides a choice between single and double earpieces, magnetic or dynamic earpiece elements, with mike or without, carbon or dynamic microphone elements, cord length, cord style and connector configuration.



Cameraman/Commentator Lightweight Headsets

Equipped with a noise-cancelling carbon or dynamic microphone. These headsets are intended for use in areas of high ambient noise. The earpieces are equipped with plastic cushions that help keep noise outside. Carbon-mike sets include a mike on/off switch that connects a dummy load resistor in the circuit while the mike is off.

Specifications

Carbon Microphone

Noise Cancellation (average)	18 dB
Sensitivity (ref: 1 mW/Nm ² , 30-ohm load)	-13 dB
Nominal Impedance	30 ohms
Frequency Range	300-4000 Hz

Dynamic Microphone

Noise Cancellation (average)	15 dB
Sensitivity (ref: 1 mW/Nm ²)	-57 dB
Nominal Impedance	150 ohms
Frequency Range	100-5000 Hz

Earphone Element

Sensitivity (in 6 cc coupler)	118 ±3 dB
Input Impedance	300 ohms
Frequency Range	100-4300 Hz
Power Handling Capability	100 mW
Harmonic Distortion	3% max.

Cord (vinyl covered) Length

MI-141006 and MI-141007 (coiled cord)	15 ft. (4.6 m)
MI-141009S and MI-141009D	62 in. (1.56 m)
MI-141009S1 and MI-141009D1 (coiled cord)	15 ft. (4.6 m)

Plugs and Connectors

MI-141006	PJ-051B
MI-141007	PJ-6
MI-141009S	PJ-051B and XLR-3-12C
MI-141009S1	Switchcraft 414

Ordering Information

Camera Headsets:

Single Earpiece with Carbon Mike	MI-141006
Double Earpiece with Carbon Mike	MI-141007

Commentator Headsets:

Single Earpiece with Dynamic Mike	MI-141009S
As above with coil cord and Switchcraft 414 plug	MI-141009S1
Double Earpiece with Dynamic Mike	MI-141009D
As above with coil cord, on/off switch and Switchcraft 414 plug	MI-141009D1

Cameraman Single and Double Headsets

These headsets are available in single and double-receiver styles. The double-earpiece set is wired to monitor both cue and program. The microphone is a noise-cancelling carbon unit on a trombone boom. Earpiece elements are dynamic. The double headset includes a mike on/off switch, a 15-foot coiled cord and a PJ-6 (WE-213) plug.

Specifications

Single-Receiver/Transmitter Headset

Receiver Impedance (at 800 Hz)	275 ohms
Microphone (noise-cancelling)	single button carbon
Cord Length (3-conductor)	5 ft. (1.5 m)

Plug	PJ-051B (WE-310)
Weight (less cord)	6½ oz. (184 g)

Double-Receiver/Transmitter Headset

Right-Side Receiver Impedance	275 ohms
Left-Side Receiver Impedance	650 ohms
Microphone (Noise-cancelling)	Single button carbon
Cord Length (In-line mike switch)	3 to 15 ft. (0.9 to 4.5 m)
Plug	PJ-6 (WE-213)
Weight (less cord)	10½ oz. (298 g)

Ordering Information

Single Headset/Transmitter Assembly	MI-11743
Double Headset/Transmitter Assembly	MI-11744



MI-141006



MI-141007



MI-141009S



MI-141009D



MI-11743



MI-11744



Interphone Equipment

- Interconnection for studio and/or remote
- Mounts to console, desk, wall, camera head
- Designed for RCA Cameras—compatible with most others
- Two types available—transistorized or induction-coil



Interphone Equipment provides convenient line-switching and headset-connection facilities for TV-camera, studio and remote communication systems.

Heart of the system is the Interphone Connection Unit. Two types of connection are available: The Transistorized Interconnection Unit (MI-11784) must be used with the RCA Type TK-44 and other late model cameras having transistorized intercommunication systems. The Intercom Interconnection Unit (MI-11734) is for use with earlier RCA studio- and field-type cameras. The two interconnection units cannot be intermixed in a system.

Interphone Connection Unit (MI-11734) for use with earlier cameras and equipment with "party-line" intercoms.



Transistorized Interphone Connection Unit (MI-11784) for use with RCA TK-44 Camera and other late-model units with transistorized intercom systems.

The MI-11784 unit includes a single stage transistorized amplifier with bridge rectifier, sidetone-compensation network and level control. Each station on the line can adjust volume to suit individual requirements. A three-way switch selects three intercom lines and separate volume controls for "phone" and "cue" adjustments are on the front panel. The box also contains two phone jacks to accommodate single or double headsets. A 9-pin and a 12-pin cable-connector plug on the rear are used for external connection.

Operating power for the MI-11784 interphone unit is derived from a common-battery circuit to which it is connected. A bridge-rectifier, in the line to the amplifier, maintains correct polarity at the amplifier regardless of line polarity. The sidetone-compensation bridge holds the sidetone level to within 2 dB of received level for any number of stations up to 32.

The Transistorized Interphone Connection Unit, MI-11784 can replace the

MI-11734 unit where it is designed to modernize the system. The unit physically replaces the MI-11734 Connection Unit and operates with virtually all commercially available TV headsets using carbon microphones. The substitution can be made only if the camera is modified by substituting an MI-11757 Transistor Amplifier for the induction coil in the interphone circuit. Other circuit changes, as outlined in the instruction book, are also required.

The Interphone Connection Unit (MI-11734), consists of a simple circuit with an anti-sidetone feature. The circuit is housed in a compact box with two phone jacks for use either with a single or double headset as required and a two-position switch for "local" circuit or "remote" line. It is designed to work in early intercom systems employing induction coils throughout.

All other components of the Interphone System are designed for operation with either Interconnection Unit.

The Retardation Coil (MI-11737), permits simultaneous use of four carbon microphones such as one interphone connection unit and three camera headsets on a common power supply. The coil permits a d-c power voltage to be imposed upon the two-wire telephone talking line. MI-11737 is an audio-frequency choke which isolates the power supply from the telephone line at voice frequencies.

The Mounting Panel (MI-11736) is recommended for mounting retardation coils. The panels have standard mounting dimensions for use in the Type BR-84 Series Racks.

The Accessory Shelf (MI-11735) is available for mounting the interphone connection units under the desktops of console housings. The plate accommodates one or two Interphone Connection Units.

Either a single or double headset can be used. One earphone unit of the double head-band assembly is used for "cue" reception. Either type can be used in the same system.

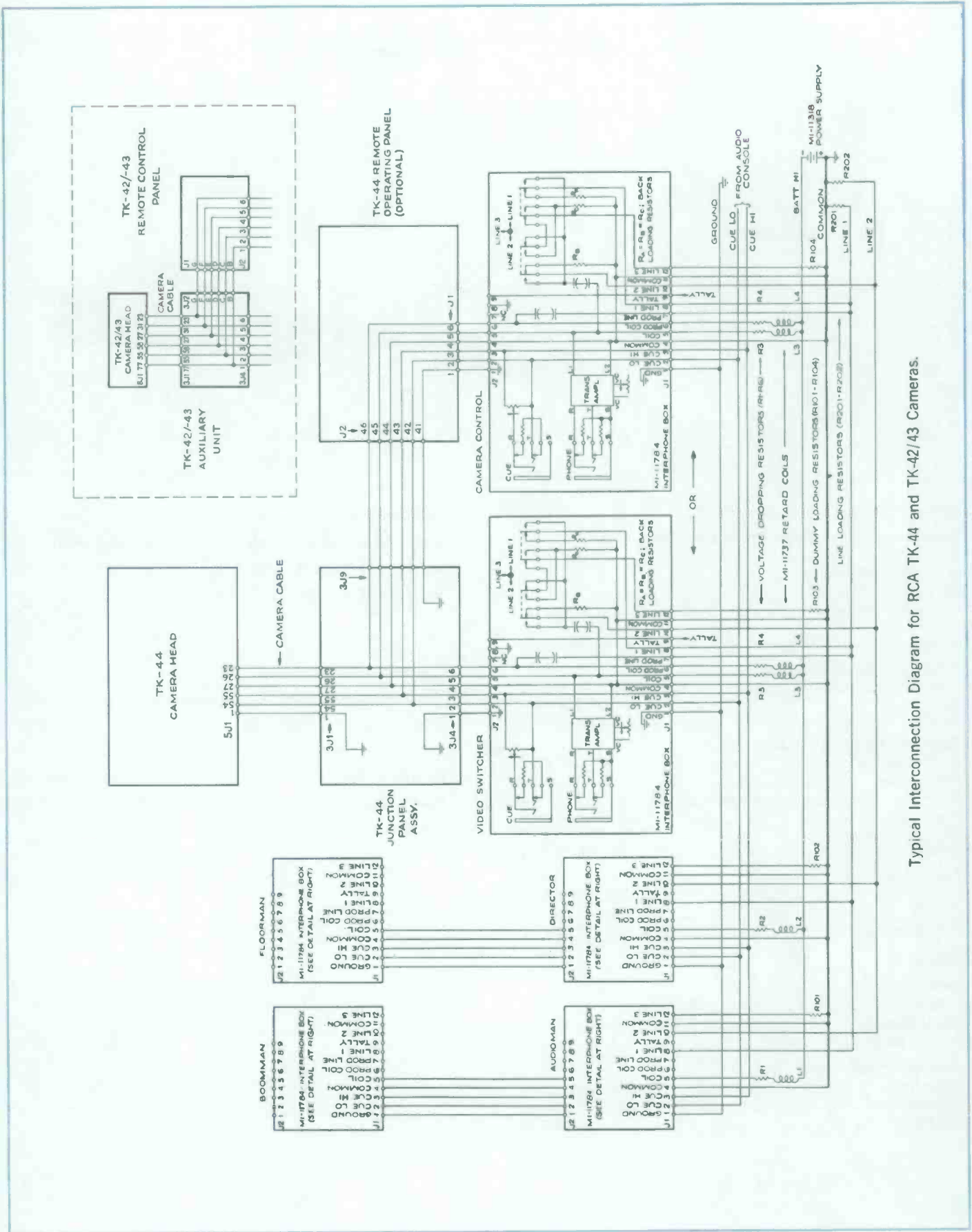

Typical Interconnection Diagram for RCA TK-44 and TK-42/43 Cameras.

Modular Audio Amplifiers, Type BA-40 Series

- Plug-in connections
- Wide frequency response—low noise
- Signal-processing systems included
- Low distortion

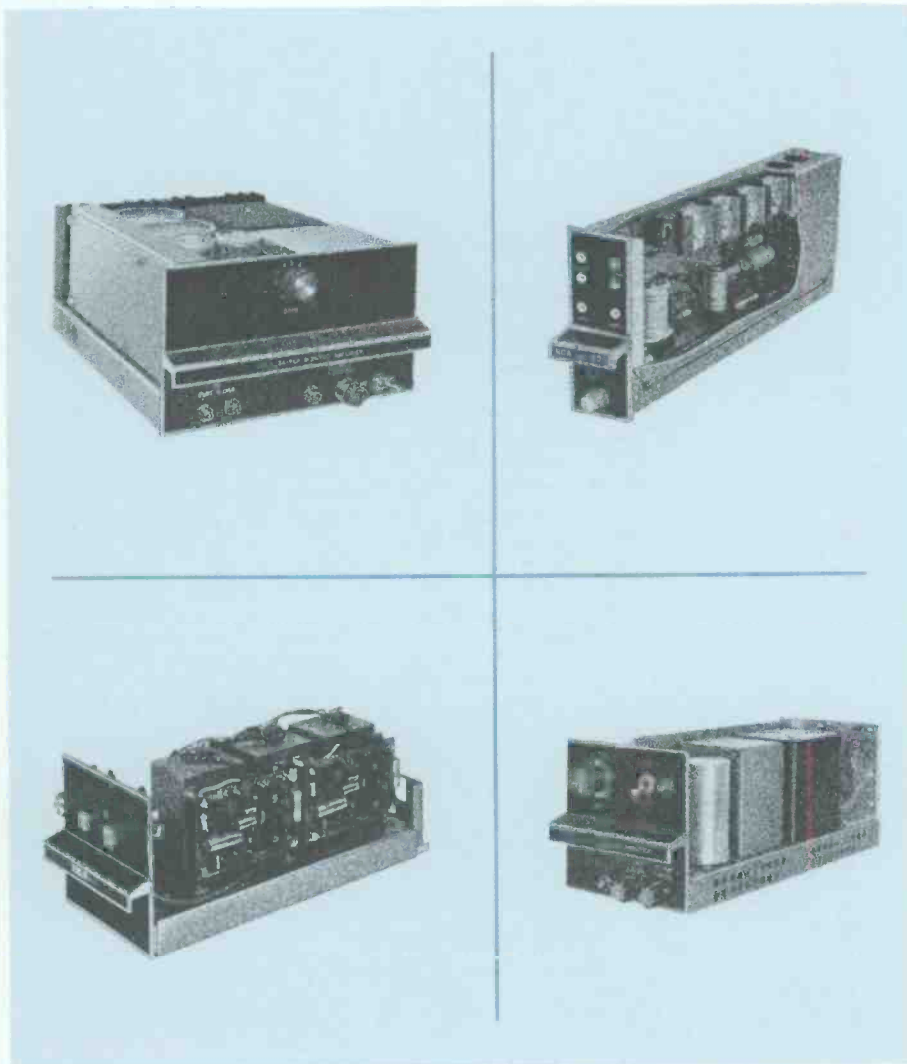

The BA-40 Series of modular amplifiers are similar to those included in RCA Consoles. They are offered separately for use wherever high-quality audio equipment is appropriate.

Distribution Amplifier, Type BA-40

The Type BA-40 converts one line into five well-isolated lines.

Preamplifier, Type BA-41

The Type BA-41 Audio Pre-amplifier is useful as a mike preamp or a line-booster amplifier.

Three-Channel Booster Amplifier, Type BA-42

The Type BA-42 is a three-channel unit designed to accept unbalanced, -20 dBm inputs and deliver balanced outputs at $+20$ dBm.

Program Amplifier, Type BA-43

The Type BA-43 Program Amplifier is a bridging as well as matching amplifier.

10-Watt Monitor Amplifier, Type BA-44

Particularly suitable for monitoring, recording and talk-back duty, the Type BA-44 provides high-quality, low-distortion operation.

50-Watt Monitor Amplifier, Type BA-48

The Type BA-48 Monitor Amplifier produces 50 watts (47 dBm) of wideband, low-distortion audio power.

AGC Program Amplifier System, Type BA-43/45

The RCA Type BA-43/45 AGC Amplifier System expands low-level program material and compresses high-level material to maintain a constant program level.

Limiter Amplifier System, Type BA-43/46

For use where extremely fast and abrupt limiting action is needed, the Type BA-43/46 Limiter Amplifier operates only on program peaks.

FM-Clipper Amplifier System, Type BA-43/47

The Type BA-43/47 Program Clipper performs two functions essential to FM broadcasting: program pre-emphasis and peak-level clipping.

Distribution Amplifier, Type BA-40



- Input for bridging or matching
- Five isolated 600-ohm outputs
- Low harmonic distortion
- Broad, flat frequency response
- Versatile input and output configurations

Designed for program-audio distribution, isolation and level recovery applications, the BA-40 Distribution Amplifier either matches or bridges a 600-ohm program line and provides five isolated 600-ohm audio output lines.

Versatile Input and Output Configuration

A high-quality transformer in the input circuit allows the amplifier to match or bridge a 600-ohm balanced transmission line. The output stages offer extremely low output impedance, and the amplifier is adaptable to a wide variety of load-impedance and power-splitting arrangements.

Built-In Voltage Regulator

The BA-40 operates from either a-c or d-c power. Operated from a-c, it needs approximately 14 watts of 50-volt power at 50 or 60 Hz. Operated from an external d-c source, the amplifier needs approximately 10 W of 60-volt negative-ground power. An optional a-c power supply (see *Accessories*) offers sufficient capability to power up to ten BA-40 Amplifiers.

Amplifiers, Interchangeable

The BA-40 packaging is such that as many as ten units fit side-by-side in only 5¼ inches of BR-22 Shelf space.

The amplifier has very little harmonic distortion even at full output. Harmonic distortion is less than 0.2% at +16 dBm output and 0.3%, or less, at maximum output, +24 dBm.

Preamplifier, Type BA-41

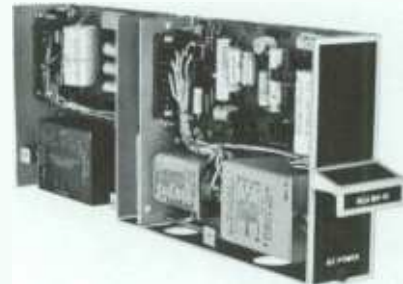

- High-gain, low-noise circuitry
- 40 or 46 dB gain
- Frequency response 20-20,000 Hz
- Excellent common-mode signal rejection

Specifications

Input:

ImpedanceMatching: 600 ohms; Bridging: 20k ohms
ModeBalanced or unbalanced
Max. Input Level-10 dBm

Outputs (five):

Impedance600 ohms, load
Maximum Level, each output+24 dBm
Matching Input Gain35 ±0.5 dB
Bridging Input GainUnity ±0.5 dB
Noise Level (20 kHz bandwidth)-70 dBm max.
Isolation between Outputs (signal)47 dB at 1 kHz

Harmonic Distortion:

At +16 dBm0.2% max.
At +24 dBm0.3% max.

Frequency Response:

30 to 15 kHz±0.5 dB
20 to 20 kHz±1.0 dB

Power Requirements:

AC40-50V, 49-62 Hz, 5-12W
DC60-70V, Neg. gnd., 4-10W

Dimensions4-21/32" H, 1½" W, 13" D (118, 42, 330 mm)
Weight3½ lbs. (1.6 kg)

Accessories

Line Transformer 150/600 ohms to 150/600 ohmsMI-11713
Rack-Mount Shelf, Type BR-22MI-11597
Spare Guide AssemblyMI-11593-7
BX-40 Power Supply (for 1 to 10 BA-40)MI-11447

Ordering Information

Distribution Amplifier, Type BA-40:

With guide assemblyES-11136
Less guide assemblyMI-11433

The Type BA-41 Preamplifier, available either with or without a guide assembly for convenient shelf mounting, is ideal as a microphone preamplifier or as a booster amplifier.

The solid-state circuit design, coupled with the flexibility of multiple-tap input and output transformers, provide low-distortion, high-gain characteristics with excellent frequency response and low noise over a wide range of input and output impedances.

Specifications

Source Impedance37.5 ohms unbal.; 150/600 ohms bal.
Input Impedance:	
MatchingUnloaded input transformer
BridgingRequires externally mounted bridging gain control (approx. 20,000 ohms)
Load Impedance150/600 ohms
Maximum Input Level:	
Matching(with 40 dB gain strapping) -22 dBm
Bridging30 dBm
Matching Gain40 or 46 ±1 dB

Frequency Response20 to 20,000 Hz ±0.75 dB
Rated Output Level and Distortion+18 dBm; 0.5%
Noise Level-81 dBm
Maximum Ambient Temperature55° C (131° F)
Power Requirements115 or 230V, 50/60 Hz
Dimensions4-21/32" H, 1 5/8" W, 13" D (118, 41, 330 mm)
Weight3 1/2 lbs. (1590 g)

Accessories

Guide Assembly for BA-41MI-11593-6
Rack-Mount Shelf, Type BR-22MI-11597
Bridging Gain Control (Panel Mount)MI-11278-E
Bridging Gain Control (Chassis Mount)MI-11278-F

Ordering Information

Preamplifier, Type BA-41:	
With guide assemblyES-11135
Less guide assemblyMI-11463

Three-Channel Booster Amplifier, Type BA-42

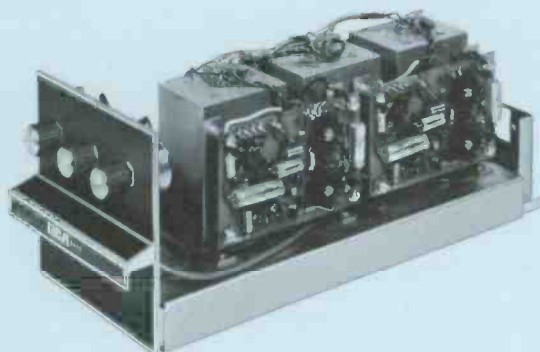

The BA-42 is a three-channel booster amplifier with unbalanced, 10 k-ohm inputs and balanced 150- or 600-ohm outputs. The three amplifiers are identical in all respects and operate from an external 24-volt power source.

The front-panel gain controls are connected as attenuators at the input to each section. As a result, the amplifiers can accept any input level between the nominal and the maximum by discrete adjustment of the gain controls.

Specifications, Type BA-42 (Each Section)

Input Impedance (unbalanced)10 kohms
Input Level-20 dBm, nom.; +20 dBm max.
Output Impedance (balanced)150 or 600 ohms
Output Level+20 dBm nom.; +24 dBm max.
Maximum Voltage Gain+40 dB
Crosstalk Between Outputs (ref: full output)-70 dB
Frequency Response20 to 20,000 Hz ±1.5 dB
Harmonic Distortion (at +20 dBm out)1% max.
Noise Level (ref: full output)-80 dB
Ambient Operating Temperature0-50° C
Power Requirements24Vdc, 100mA max.
Dimensions4-21/32" H, 5" W, 11-3/16" D (118, 127, 284 mm)

Accessories

Power Supply, Type BX-42 (24V dc, 600 mA)MI-141812
Vertical Rack-Mount ShelfMI-141813
Horizontal Rack-Mount Shelf, Type BR-22MI-11597

Ordering Information

Three-Channel Line Booster Amplifier, Type BA-42 (with guide assembly)MI-141811
--	----------------

- Three 40-dB amplifiers in one module
- Unbalanced input, balanced output
- Excellent isolation between channels
- Plug-in module construction
- Individual gain controls

Program Amplifier, Type BA-43



- Silicon transistor design and etched wiring provide uniform performance
- Extended frequency response and power bandwidth
- Self-contained, regulated power supply
- Plug-in chassis for shelf mounting

The BA-43 is a wide-band program amplifier designed for audio service by itself or in conjunction with signal processing amplifiers Type BA-45 AGC, Type BA-46 Limiter and Type BA-47 Clipper. The circuitry features silicon transistors, provides the advantages of compact design, uniform performance, reduced power consumption and long life. The high gain and low distortion of the unit make it an ideal choice for use as a program or line amplifier, bridging amplifier or as an isolation unit.

The BA-43 has excellent performance, especially in the areas of bandwidth, noise and temperature stability, due largely to the use of silicon transistors.

10-Watt Monitor Amplifier, Type BA-44



- High Gain—accepts microphone input level
- 10 watt output—very low distortion
- Plug-in chassis, shelf mounting, self powered
- For recording or broadcast monitoring

The BA-44 Monitor Amplifier is a high fidelity amplifier with 104 dB of gain and a full 10 watts of audio power output. It is particularly designed as a monitor, audition or recording amplifier. It may also be used as a program or a line amplifier. It is ideal for playback of transcriptions from the output of an equalized pickup cartridge. The BA-44 is designed for convenient plug-in installation in a mounting shelf using an optional guide assembly (see *Accessories*).

50-Watt Monitor Amplifier, Type BA-48



- Full 50-watt rms continuous power output
- Very low distortion
- Frequency response 20 Hz to 20 kHz
- Stable, solid-state design

The BA-48 50-Watt Monitor Amplifier is ideal for program-monitor facilities in professional sound studios and broadcast stations. This solid-state amplifier is capable of amplifying phono pickup, tape recorder, telephone-line sources, and the audio channels for transmitters.

The BA-48 produces 50 watts (rms) with or without an output transformer, with very low total harmonic and inter-modulation distortion. It has a broad frequency response and is temperature and frequency stabilized. Complete output short-circuit, overload, and open circuit protection is provided.

Specifications

Source Impedance	600/150 ohms, balanced
Matching Input Impedance	600/150 ohms
Bridging Input Impedance	20,000 ohms
Load Impedance	600/150 ohms
Matching Input Level	-17 dBm max.
Bridging Input Level	+13 dBm max.
Frequency Response (20-20,000 Hz)	±0.75 dB
Output Level	+30 dBm max.
Harmonic Distortion (25-20,000 Hz)	0.5% rms, max.
Matching Gain	76 ±½ dB (Loaded), 82 ±½ dB (Unloaded)
Bridging Gain	46 ±1 dB (Loaded), 52 ±1 dB (Unloaded)
Noise Level Referred to:	
Input (20-20,000 Hz)	-126 dBm
Output (20-20,000 Hz)	-44 dBm
Ambient Temperature Range	-20 to +75° C (-4 to +167° F)

Power Requirements	115/230 V, 50/60 Hz, 10 W
Dimensions	4" H, 5" W, 11¾" D (118, 127, 284 mm)
Weight	9½ lbs. (4.3 kg)

Accessories

Rack-Mount Shelf, Type BR-22	MI-11597
BA-43 Guide Assembly (with receptacles)	MI-11593-1

Ordering Information

Program Amplifier, Type BA-43:	
With guide assembly	ES-11128
Less guide assembly	MI-11454

Specifications

Source Impedance	150- or 600-ohm balanced; 37.5 ohm unbalanced (shipped connected for 150-ohm balanced)
Input Level Matching	-25 dBm max.
Input Level Bridging	+25 dBm max.
Load Impedance	4/8/16/150/600 ohms balanced and 70-volt line
Input Level Matching	-25 dBm max.
Input Level Bridging	+25 dBm max.
Average Power Output	10 watts (40 dBm) max.
Frequency Response	±0.5 dB, 30-20,000 Hz
Noise Level (20 to 20,000 Hz)	-123 dBm ref. input
Harmonic Distortion (At 10 W output)	1.0% max.

Power Requirements	115/230 V, 50/60 Hz, 35 W
Ambient Temperature	55° C max. (131° F)
Dimensions	13¾" L, 5" W, 4-31/32" H (333, 127, 120 mm)
Weight	12 lbs. (5440 g)
Mounting	Plug-in mounting on BR-22 mounting shelf

Accessories

Rack-Mount Shelf, Type BR-22	MI-11597
Bridging Volume Control (Panel Mounting)	MI-11278-E
Bridging Volume Control (Chassis Mounting)	MI-11278-F
Guide Assembly for BA-44	MI-11593-4

Ordering Information

10-Watt Monitor Amplifier, Type BA-44:	
With guide assembly	ES-11134
Less guide assembly	MI-11442

Specifications

Source Impedance (Bal. or Unbal.)	600/150 ohms
Matching Input Impedance	Unloaded input transformer
Bridging Input Impedance	20,000 ohms
Load Impedance	8 ohms
Matching Input Level	-20 dBm max.
Bridging Input Level	+22 dBm max.
Input Sensitivity (Full gain; 50 W at 1 kHz)	-35 dBm
With Remote Volume Control Kit installed	-30 dBm
Maximum Gain	82 ±1 dB
Frequency Response	20 to 20,000 Hz ±0.25 dB
Noise Level (20-20,000 Hz)	-124 dBm ref. input
Harmonic Distortion (30-20,000 Hz)	0.5% max.
Power Required	105-130/210-260 V, 50/60 Hz; 115 W
Rated Power Output	50 watts rms (+47 dBm)
Ambient Temperature	0 to 55° C max. (32 to 131° F)

Weight	26 lbs. with (12 kg); 20 lbs. less transformer (9 kg)
Dimensions	4¾" H, 8½" W, 11¾" D (143, 216, 284 mm)

Accessories

Output Transformer (4, 8, or 16 ohms)	MI-141002
Output Transformer (70-volt, 100 ohms)	MI-141003
Remote Volume Control Kit	MI-11499
Interconnection Cable (specify length)	MI-13395-1
Rack-Mount Shelf, Type BR-22	MI-11597
Guide Assembly	MI-11593-3

Ordering Information

50-Watt Monitor Amplifier, Type BA-48:	
Complete with Guide Assembly	ES-11132
Less Guide Assembly	MI-11458

AGC Program Amplifier System, Type BA-43/45



- **Wide adjustable AGC action**
- **Low distortion**
- **Input and output controls**
- **Provision for remote metering**
- **Step attenuator output**

The BA-43/45 Automatic-Gain-Control Program Amplifier System automatically controls variations in audio program level. The amplifier maintains a nearly constant average output level over wide variations in input level, since it provides compression of high-level signals and expansion of low-level signals.

The AGC Program Amplifier System consists of the BA-45 Automatic Gain Control Unit used in conjunction with an RCA Type BA-43 Program Amplifier, from which it derives power and signals. The system can be used in program or preamplifier channels. The amplifier may be used with an external bias source for remote gain-control or automatic fading, to permit unattended remote-controlled operation.

Limiter Amplifier System, Type BA-43/46



- **200 μ s limiting action**
- **Low distortion**
- **Separate input and output controls**
- **Provision for remote metering**
- **Plug-in module**

The BA-43/46 Limiter Amplifier System provides extremely fast audio limiting action for audio fed to broadcast transmitters. It automatically limits the peaks to a pre-determined level to prevent overmodulation or overload.

Using a BA-43/46 permits more effective use of transmitter power by allowing the system to operate at near maximum output. It raises the average modulation percentage several dB without increasing harmonic distortion appreciably. The limiting characteristics of the system also adapt it readily to use in recording.

FM-Clipper Amplifier System, Type BA-43/47



- **Prevents transmitter overmodulation with no audible signal degradation**
- **Built-in standard 75 μ sec pre-emphasis network**
- **Highly sensitive monitoring circuit**
- **Front panel indicator light**
- **Reliable solid-state circuitry**

The Type BA-43/47 FM-Clipper Amplifier System is a solid state unit that performs both the functions of pre-emphasis and peak clipping. When this combination is fed from a BA-43/46 Limiter Amplifier System only the signal peaks in the pre-emphasis range above 100 percent modulation are clipped. The unit provides absolute protection against overmodulation with no audible signal degradation.

Specifications

Source Impedance (balanced or unbalanced)600/150 ohms
Input Impedance6000/1500 ohms
Load Impedance600/150 ohms
Frequency Response20-20,000 Hz, +0 to -3/4 dB
Operating Levels:	Input, dBm Output, dBm
Verge of Compression-54 (adj.) +26 (adj.)
Verge of Expansion-70 (adj.) 0 (adj.)
Maximum Rated-17 +26.5
Maximum Uncontrolled-17 +32
Expansion/Compression Range+10/-20 dB
Gain, Maximum below Verge of Compression80 dB unloaded
Compression Ratio20 dB into 0.5 dB
Time Constants:	Attack Recovery
Expansion4 sec. 6 sec.
Compression15 μ s 3 sec.
Uncontrolled2 μ s 2 μ s
Harmonic Distortion (Total rms, 25 to 20,000 Hz)0.6% max.
Noise Level (20 to 20,000 Hz):	
Input-125 dBm
Output-55 dBm

Input Gain ControlContinuous
Output Gain Control (15 2-dB steps)30 dB total
Power Requirements115/230 V, 50/60 Hz, 10 watts
Ambient Temperature Range-20 to +55° C (-4 to 131° F)
Dimensions (BA-45 only)4-21/32" H, 3-5/16" W, 11-3/16" D (118, 84, 284 cm)
Weight3 3/4 lbs. (1.7 kg)

Accessories

Rack-Mount Shelf Type BR-23*MI-11564
Guide Assembly (for BA-45 only)MI-11593-2

Ordering Information

AGC Program Amplifier System, Type BA-43/45:	
MonoES-11112; Stereo.....ES-11113
AGC Program Amplifier System, Type BA-43/45 with:	
Limiter Amplifier System, Type BA-43/45:	
MonoES-11116; Stereo.....ES-11116S
AGC Module, Type BA-45:	
Less guide assemb.MI-11455; with guide.....ES-11129

*Accommodates a BA-43/45 and a BA-43/46

Specifications

Source Impedance (balanced or unbalanced)150/600 ohms
Input Impedance1500/6000 ohms
Load Impedance150/600 ohms
Frequency Response20 to 20,000 Hz, \pm 0.38 dB
Operating Levels:	Input, dBm Output, dBm
Verge of Limiting-60 (adj.) +30 (adj.)
Maximum-17 +30 (adj.)
Maximum Uncontrolled-17 +32 (adj.)
Maximum Gain Through System90 dB
Attenuators: Input; Continuous: Output; 15 2-dB steps	
Noise Level (20-20,000 Hz)-125 dBm
Harmonic Distortion (25-20,000 Hz):	
Total rms at 20 dB limiting, slow action0.75% max.
Limiting Characteristic30 dB
Compression Ratio20 to 0.5 dB
Time Constants:	Attack Recovery
Uncontrolled2 μ s 2 μ s
Fast Action Limiting200 μ s 400 ms
Slow Action Limiting200 μ s 3 s.

Power Requirements115/230 V, 50/60 Hz, 100 W
Ambient Operating Temperature-20 to 50° C (-4 to 131° F)
Dimensions4-21/32" H, 8-5/16" W, 11-3/16" D (118, 211, 284 mm)
Weight13 1/4 lbs. (6 kg); Module 3 3/4 lbs. (2 kg)

Accessories

Rack-Mount Shelf, Type BR-23MI-11564 & MI-11565
Spare guide assembly (BA-46 only)MI-11593-2

Ordering Information

Limiter Amplifier System, Type BA-43/46:	
MonoES-11114; Stereo.....ES-11115
AGC Program Amplifier and Limiter Amplifier System,	
Type BA-43/45 and BA-43/46:	
MonoES-11116; Stereo.....ES-11116S
Limiter Amplifier System and Clipper Amplifier System,	
Type BA-43/46 and BA-43/47:	
MonoES-11118, Stereo.....ES-11118S
Limiter Module Type BA-46:	
Less guide assemb.MI-11456; with guide.....ES-11130

Specifications

Source Impedance (balanced)600/150 ohms
Input Impedance(20 to 20,000 Hz) 150 kohms, min.
Load Impedance600 ohms
Frequency ResponseStandard 75 μ s pre-emphasis curve
Harmonic Distortion (below clipping)0.5% max.
Clipping Level+27 dBm \pm 0.2 dB
Maximum Output Level+27 dBm (Factory set for +10 dBm \pm 0.5 dB)
Noise Level (20 to 20,000 Hz referred to input)-127 dBm
Ambient Temperature-20° C to +75° C (-4° F to 167° F)
Clipping Indicator Sensitivity(20 to 20,000 Hz) 0.5 dB max.
Power Required115/230 V, 50/60 Hz, 10 W
Dimensions:	
BA-43/474 5/8" H, 8 5/8" W, 11 3/8" D (118, 211, 284 mm)
BA-47 Only4 5/8" H, 3 3/8" W, 11 3/8" D (118, 84, 284 mm)

Weight (approx.):	
BA-43/4712 1/2 lbs. (6 kg)
BA-47 Only3 lbs. (1.4 kg)

Accessories

Spare Guide Assembly (for BA-47A only)MI-11593-5
Rack-Mount Shelf, Type BR-23MI-11565

Ordering Information

FM-Limiter/Clipper Amplifier System,	
Type BA-43/46, 43/47:	
MonoES-11118; Stereo.....ES-11118S
FM-Clipper Module, Type BA-47:	
With guide assemblyES-11131
Less guide assemblyMI-11459



AGC Program Amplifier and Limiter Amplifier System mounted in a Type BR-22 Rack-Mount Shelf. See preceding page for description.

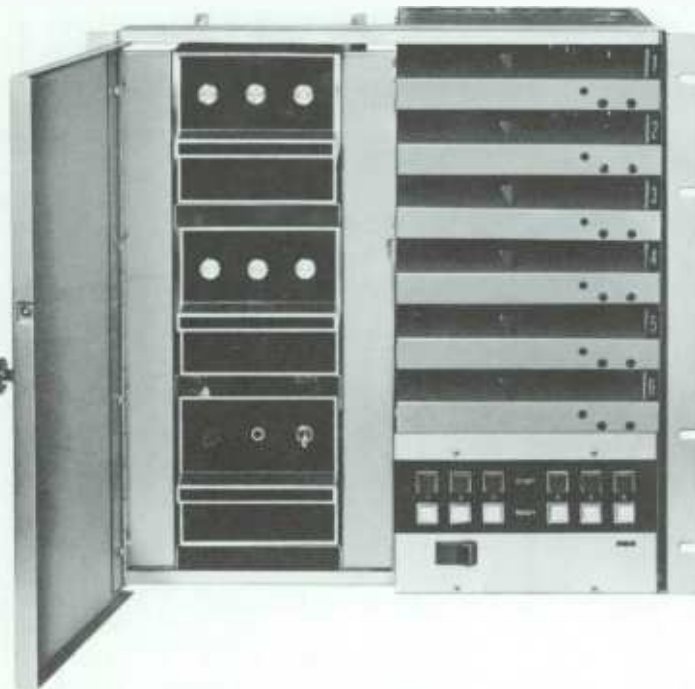

Two Type BA-42 Amplifiers and a Type BX-42 Power Supply mounted in the accessory vertical rack-mount shelf offered as an accessory. The cartridge machine is a Type RT-16 Multicartridge Playback System.



Console Audio Amplifiers, Type BA-70 Series

- Console or rack-mount capabilities
- Plug-in connections
- Wide frequency response—low noise
- Low distortion
- Extra sensitivity for versatility

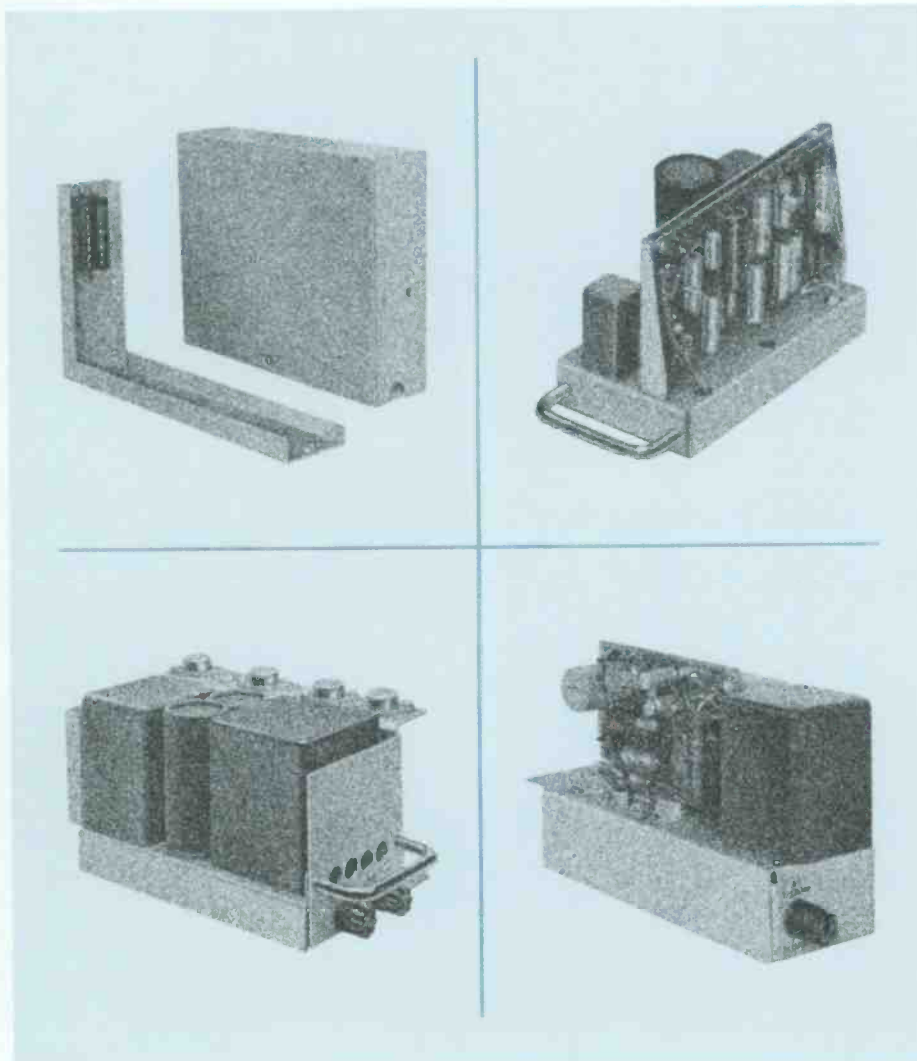

The BA-70 Series of Console Audio Amplifiers are used in the RCA deluxe line of Audio Control Consoles. The amplifiers are offered separately for use in custom-built installations.

Preamplifier, Type BA-72

A sensitive, compact unit useful as either a microphone preamp or a line-booster, the Type BA-72 is a three-stage amplifier with up to 46 dB of gain, smooth frequency response and low waveform distortion.

Program Amplifier, Type BA-73

An amplifier of enviable quality, the Type BA-73 doubles as either a program or line-booster amplifier. Its input sensitivity, smooth frequency response and low distortion characteristics give it wide application in audio installations.

10-Watt Monitor Amplifier, Type BA-74

Capable of delivering 10 watts of wideband, high-quality audio to a loudspeaker load, the Type BA-74 Monitor Amplifier features cool-running, dependable circuitry and hermetically sealed transformers.

8-Watt Cue/Intercom Amplifier, Type BA-78

An 8-watt, AGC-equipped power amplifier with up to 100 dB gain, the Type BA-78 maintains an essentially constant output level with a varying input level. A 25-dB change in input level results in an output level change of less than 1 dB.

Preamplifier Module, Type BA-72

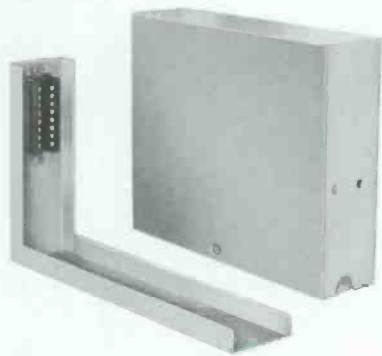

- High-gain, low-noise circuitry
- 40 or 46 dB gain
- Frequency response: 20-20,000 Hz
- Excellent common-mode signal rejection

The RCA Type BA-72 Preamplifier Module is ideal as a microphone preamplifier or as a booster amplifier.

The preamplifier's solid-state design, coupled with the flexibility of multiple-tap input and output transformers, provides low-distortion, high-gain characteristics with excellent frequency response and low noise over a wide range of input and output impedances.

Specifications

Source Impedance	150/600 ohms balanced or unbalanced; 37.5 ohms unbalanced
Input Impedance:	
Matching	Unloaded input transformer
Bridging	Externally mounted bridging gain control required (approx. 20,000 ohms)
Load impedance	150/600 ohms
Maximum Input Level:	
Matching	-22 dBm (40 dB gain)
Bridging	30 dBm
Matching Gain	40 or 46 \pm 1 dB
Frequency Response	20 to 20,000 Hz \pm 0.75 dB
Output Level	+18 dBm
Distortion (+18 dBm output, 25-20,000 Hz)	0.5% max.
Noise Level (20 kHz bandwidth)	-127 dBm referred to input; -81 dBm referred to output; 99 dB maximum s/n referred to +18 dBm
Maximum Ambient Temperature	55°C (131°F)
Power Requirements	30 Vdc, 80 mA
Overall Dimensions	4 $\frac{5}{8}$ " H, 1 $\frac{3}{8}$ " W, 7 $\frac{5}{8}$ " D (128 x 35 x 194 mm)
Weight	2 $\frac{1}{4}$ lbs. (1200 g)

Accessories

Guide Assembly for BA-72	MI-11759-1
Mounting Shelf, Type BR-22 (accommodates ten amplifiers)	MI-11597
Bridging Gain Control (Panel mounting with knob)	MI-11278-E
Bridging Gain Control (Chassis mount with screw driver type adjustment)	MI-11278-F
Power Supply Module, Type BX-72	MI-11320
Power Supply Module, Type BX-71	MI-11663

Ordering Information

Preamplifier, Type BA-72:	
With Guide Assembly	ES-11172
Less Guide Assembly	MI-11672

Program Amplifier, Type BA-73

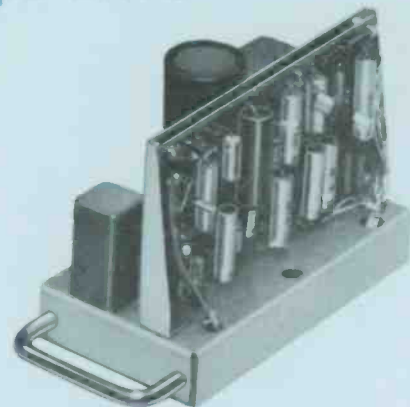

- High gain, low distortion
- Ideal for custom applications
- Very low noise level, -122 dBm
- Response, 30 to 20,000 Hz \pm 0.5 dB

10-Watt Monitor Amplifier, Type BA-74



- Very low distortion
- 64 dB gain; -50 dB noise level
- Low heat dissipation
- Self-contained power supply

8-Watt Cue/Intercom Amplifier

Type BA-78



- Automatic Gain Control
- Self-contained regulated power supply
- High gain—full output with mic level input
- One watt (+30 dBm) output with AGC
- 8-watt output without AGC

The Type BA-78 8-Watt Cue/Intercom Amplifier is a compact chassis-mounted unit featuring automatic gain control and a self-contained power supply. It is designed specifically for plug-in use with the RCA Broadcast transistor consoles, for intercom and cueing purposes. However, it may also be shelf-mounted by use of an accessory guide assembly (see *Accessories*).

The principal feature of the BA-78 is its ability to maintain essentially constant output for a wide variation of input level. Automatic gain control action is maintained over a 25-dB range. Output level changes are limited to approximately 1 dB for each 5-dB input change, over the operating range. The BA-78 amplifier is nominally a 1-watt amplifier but has an output capability of 8 watts with AGC disconnected.

The BA-78 has a self-contained power supply with taps for 117 or 234 volts 50-60 Hz operation, making it easily adaptable to general applications independent of the consoles. Its relatively high-power and high-quality output makes it useful with loudspeakers for applications where a communication or monitoring channel with AGC is specified.

Specifications

Source Impedance50-150 ohms
 Input Impedance150 ohms with center tap
 Load Impedance50 ohms floating, 8 ohms unbalanced

Effective Input Level-69 dBm for verge of AGC action
-61 dBm handled by AGC action
 Output LevelNominally set at 1 watt average
 (+30 dBm) by AGC action (8 watts max. with AGC disabled)
 AGC ActionApprox. 0.5 dB change in output level
 for each 5 dB change in input level throughout operating
 range of 25 db
 Gain100 dB (with AGC disabled)
80 dB with max. AGC
 Frequency Response30 to 20,000 Hz ± 1.25 dB
 Distortion (at 1 watt output with 10 dB
 AGC action, 35 Hz to 20 kHz)3% max.
 Noise Level
 (with no gain reduction)At least 60 db below max output
 Power Required117/234 V, 50/60 Hz, 18 W
 Dimensions Overall4 $\frac{5}{8}$ " H, 2 $\frac{7}{8}$ " W, 8 $\frac{1}{2}$ " D
 (118 x 73 x 216 mm)
 Weight5 lbs. approx. (2.2 kg.)
 Temperature Range-10 to +131°F (-23 to 55°C)

Accessories

Guide Assembly for BA-78MI-11759-5
 Mounting Shelf Type BR-22MI-11597

Ordering Information

Cue Amplifier, Type BA-78:
 With Guide AssemblyES-11162
 Less Guide AssemblyMI-11662



Monitoring System, Type BA-8

- Built-in loudspeaker
- Equalized for high intelligibility
- Optional rack-mount panel
- Ten-position input selector
- Bridging or matching inputs

The Type BA-8 Monitoring System is a compact, low-cost system designed to provide high intelligibility. It is an ideal monitor for the announce lounge, program director's office, newsroom, executive office, TV-studio prop area, etc. Muting provisions are included in the amplifier for use in the control room or any location where a microphone is also used.

It serves equally well as a quality monitor for "house" sound systems in hotels, hospitals, stores, auditoriums, stadiums and churches. The selector switch and volume control give it an extra measure of convenience.

Up to ten inputs may be selected by the input selector switch. Connections to the amplifier are made at a rear terminal board. The first input is wired for bridging a 600-ohm line, the other nine are matching inputs, but convert into bridging inputs by installation of a resistor network within the unit.



Specifications

Power Requirements117/235 volts, 50/60 Hz, 13 W
Frequency ResponseEqualized for high intelligibility
Number of Inputs9 matching, 1 bridging
Input Impedance:	
Matching600 or 150 ohms
Bridging10,000 ohms
Input Level:	
Matching (1W Output)-23 dBm \pm 2 dBm, min.
Bridging (1W Output)+8 dBm \pm 2 dBm, min.

Gain (Approx.)53 dB
Maximum Output Level+30 dBm (1 watt)
Distortion (1 W at 1 kHz)2% max.
Muting ProvisionStrapping on rear terminals
Dimensions7¼" W, 3½" H, 8¾" D (184, 89, 205 mm)
Weight6½ lbs. (3 kg)

Ordering Information

Monitoring System, Type BA-8MI-11450
Rack-Mount PanelMI-11449



AM/FM/FM-Stereo Tuner Type ST-6

- For off-air monitoring or rebroadcast
- 35 dB stereo separation
- Built-in ferrite AM antenna
- High signal-to-noise ratio
- Automatic stereo switching

The Type ST-6 AM/FM/FM-Stereo Tuner is a high-quality, fully solid-state unit ideally suited to off-air monitoring or rebroadcast. It is also most useful as a tuner for quality sound systems in hotels, hospitals, stores, auditoriums, etc.

The tuner circuitry is entirely solid state and features an RF amplifier in both the AM and FM sections. The AM section uses a built-in ferrite loop antenna (with an external antenna connection) while the FM section provides a 300-ohm input for an external antenna. The extra sensitivity in both sections assures excellent signal-to-noise ratio under most conditions.

The ST-6 Tuner includes "Interchannel Hush", a type of squelch that silences the FM tuner when no signal appears at the antenna input. A front-panel switch provides defeat of the squelch whenever appropriate.

Another feature is the Automatic Stereo/Mono Switch. This device switches the circuitry to stereo whenever it receives a stereo program. A green jewel, in the dial, lights when a stereo signal is received.

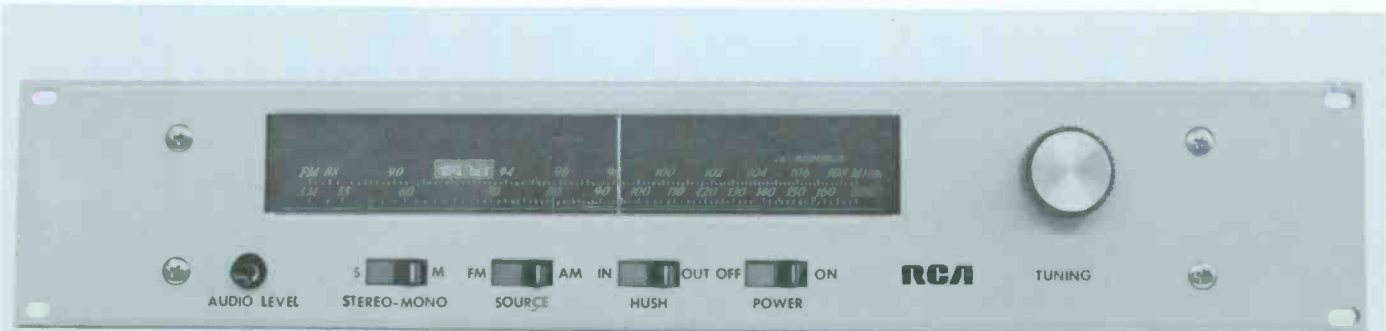

Specifications

FM Sensitivity	1.8 μ V for 30 dB quieting
Typical Quieting Sensitivity:	
FM	6.0 μ V for 50 dB
AM (60% mod.)	2.0 μ V for 6 dB
Typical Selectivity:	
FM	6 dB down at 250 kHz; 60 dB down at 820 kHz
AM	6 dB down at 7.5 kHz
FM Detector Bandwidth	800 kHz peak/peak
FM Capture Ratio	2.4 dB
Tuning Range	530 to 1650 kHz; 87.5 to 108.5 MHz
FM Distortion (Harmonic at 100% mod.)	0.15% max.
FM Cross-Modulation Rejection	95 dB
Hum and Noise Level:	
FM (Below 100% mod.)	70 dB
AM (Below 100% mod.)	56 dB
FM Oscillator Stability	\pm 10 kHz (\pm 0.01%)
FM Oscillator Radiation	3 dB below FCC Requirements

FM Output (100% Mod.)	1.0 V
Antennas:	
FM	300-ohm balanced input
AM	Directable ferrite rod with external antenna connection
Frequency Response:	
FM (Mono)	20-20,000 Hz \pm 1/2 dB
FM (Stereo)	20-15,000 Hz \pm 1/2 dB
AM	-6 dB at 4.0 kHz
Stereo Separation	35 dB
Output Impedance	600 ohms, balanced
Power	117/234 V, 50/60 Hz, 15 W
Controls	Audio Level; Automatic Stereo/Mono; FM-AM; Hush On/Off Switch; Power Switch; Tuning
Dimensions	19" W, 3 1/2" H, 10 1/2" D (483, 89, 267 mm)
Weight (Approx.)	10 1/2 lbs. (4.8 kg)

Ordering Information

AM/FM/FM-Stereo Tuner, Type ST-6	MI-12116
----------------------------------	----------



Public-Address System Power Amplifiers, Types SA-115, -1000, -1004, -2000

- For studio monitors or concert-hall auditoria
- Four in series: 10-watt to 200-watt power capability
- Rated and tested under EIA industrial standards
- Multi-impedance output circuitry
- Conservatively rated for long life
- Wideband response at low distortion



10-Watt, SA-115

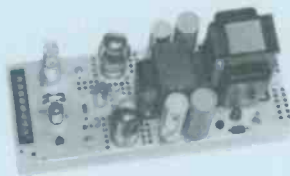

100-Watt, SA-1000



100-Watt, SA-1004



200-Watt
SA-2000

The amplifiers in the "SA-" series are high-quality units intended primarily for high-fidelity public-address applications. There are four amplifiers in the series: an all-transistor 10-watt unit, two 100-watt, tube-powered amplifiers and a 200-watt theater-type amplifier.

Three of the four are "bridging" amplifiers while the other two include preamplifier stages for the extra sensitivity microphones require. Each includes a line-bridging input as well.

10-Watt Transistorized Amplifier, Type SA-115

The smallest amplifier in the "SA-" series is the totally solid-state Type SA-115. It is both a "bridging" and preamplifier unit providing for one microphone input.

100-Watt Bridging Amplifier, Type SA-1000

Intended for operation singly or in multiples, the Type SA-1000 provides only a line-bridging input. Its tube-powered design increases expected life and operational dependability.

100-Watt, Tube-Powered Mixer- Amplifier, Type SA-1004

The choice wherever mike inputs are needed, the Type SA-1004 provides for four microphone inputs, two "phono" inputs and a bridging input. The amplifier is a well refined design with a reputation for dependability.

200-Watt Power Amplifier, Type SA-2000

The largest amplifier in the line is the Type SA-2000, a unit capable of delivering the sound requirements of the largest of indoor auditoria. For use in outdoor systems, the SA-2000 is used in multiples to obtain the extra sound power required. The amplifier rack-mounts with a tilt-down front for easy maintenance.

10-Watt Transistorized Amplifier, Type SA-115



- Built-in mike preamp
- Multi-impedance output
- Continuous tone control

The SA-115 is a compact, fully solid-state 10-watt audio amplifier for general use. It provides two inputs: one low-level for any high-impedance microphone and a high-level, high-impedance input for tuners and the like. Both inputs can be converted to low impedance (50 to 600 ohms) through use of a plug-in transformer (see *Accessories*).

The output circuit provides an 8-ohm unbalanced, and two balanced outputs: a 70.7-volt and a 25-volt for connection to a multiple-speaker sound system.

The Type SA-115 is tested and rated in accordance with EIA industrial standard SE-101A.

Specifications

Power Output8W cont. (1 kHz) 12W music; 16W peak
Frequency Response20 to 20,000 Hz ± 3 dB; 30 to 15,000 Hz ± 2 dB
Distortion (50 to 15,000 Hz at 1W; 1 kHz at 8W)1% max.
Hum and Noise (Below 8W) (Mike channel: 55 dB)70 dB
Inputs (Without Accessory Transformer):	
Program Input (Unbalanced)15 kohms
Mike Input (Unbalanced)Hi-Z
Inputs (With Accessory Transformer):	
Program Input (Balanced or Unbalanced)600/10,000 ohms
Mike Input (Balanced or Unbalanced)125/600 ohms
Outputs8 ohms unbal; 25, 70V bal
Tone Control0 to 20 dB cut at 10 kHz
Power Requirements115/230V*, 50-60 Hz, 18W
Dimensions9" W; 4½" H; 7" D (229, 114, 178 mm)
Height (Approx.)6 lbs. (2700 g)

*Factory wired for 115V; easily reconnected for 230V input.

Accessories

Plug-In TransformerMI-38482
Panel, Rack Mount (for SA-115 only)MI-38481

Ordering Information

10-Watt Transistorized Amplifier, Type SA-115MI-38480
--	---------------

100-Watt Bridging Amplifier, Type SA-1000

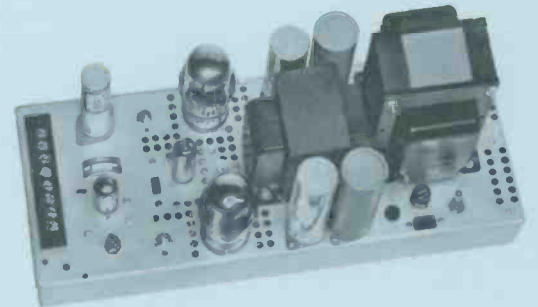

100-Watt Mixer Amplifier, Type SA-1004



- Six inputs: four mike, one bridging, two "aux"
- Built for continuous duty
- Built-in bias-balance controls

The Type SA-1004 is essentially an extension of the Type SA-1000 described above with four microphone preamps, two auxiliary inputs (for high-level phono or tuner) in addition to bridging input. Separate bass and treble tone controls are also included. The bass control cuts 20 and boosts 15 dB at 50 Hz; the treble control boosts 10 and cuts 20 dB at 20 kHz.

Each mike input is equipped with a separate level control; the two auxiliary inputs share a single level control of the "fader" type which inhibits mixing of the two auxiliary inputs. However, one aux. input or the other mixes with the mike channels and the bridging input. From the bridging input to the output connections, the SA-1004 circuit is identical to that of the SA-1000 described above.

- **Rated for continuous operation**
- **Beam-power output tubes**
- **Compact, open-chassis design**
- **Bifilar-wound output transformer**
- **Built-in bias-balance controls**

The Type SA-1000 is a compact, tube-powered 100-watt amplifier for use wherever high quality and long life are appropriate. It provides an unbalanced bridging input and a multi-impedance output. The input is convertible to balanced with an optional transformer (see *Accessories*).

The amplifier is a three-stage design using push-pull drivers and output stages. The phase inverter stage offers exceptional balance qualities that are independent of the effects of tube condition as the result of aging.

The output tubes are the efficient Type 6550 beam-power design. The output transformer uses grain-oriented, silicon-steel laminations and bifilar winding to achieve the low distortion important in high quality systems.

Specifications

Power Output	100W cont.; 175W max.; 238W peak
Frequency Response (Bridging Input)	20 to 20,000 Hz \pm 2 dB
Distortion (50-20,000 Hz, 100W)	2% max.
Output Regulation (No load to full load)	1.5 dB
Hum and Noise (Below 100W)	-93 dB
Input	
Sensitivity (For 100W Output)	0.53V rms
Impedance (Unbalanced)	10,000 ohms
Outputs	
Speaker	3.2, 8, 16 ohm
Line	12.5, 25, 35, 70V
Power Requirements	120/130V, 50-60 Hz, 90 to 228W
Dimensions	6 $\frac{3}{4}$ " H; 7" W 17" L (171, 178, 432 mm)
Weight (Approx.)	24 lbs. (11 kg)
Weight, Shipping (Approx.)	30 lbs. (14 kg)

Accessories

Shelf, Rack Mount (8 $\frac{3}{4}$ " Rack Space)	MI-38195
Panel, Blank (For above)	MI-38100-8
Trim Panel (For above)	MI-38100-9
Rack Mount (Swing-out)	MI-138196
Step Down Transformer, 220/110V, 50/60 Hz	MI-141010-250
Input Transformer (10k/100k ohms, wire-in)	MI-38703

Ordering Information

100-Watt Bridging Amplifier, Type SA-1000	MI-38194
---	----------

Normal-Special Switch

The SA-1004 includes a chassis-mounted switch for use when increased microphone sensitivity is appropriate. This switch increases preamp gain by 10 dB and increases treble response. In the "Normal" position, the switch reduces preamp gain 10 dB and introduces a roll-off characteristic which is easily offset, if desirable, with the treble tone control.

Input-Output Bridging Connection

The bridging inputs works in both directions in that it is both an input and an output. As an output, it lets the mikes and other inputs feed a second power-amplifier system, for example, an SA-1000 Amplifier; as an input, it makes the power-amplifier section of the SA-1004 available to external input systems, an audio console, for example.

Convertible to Low-Impedance Inputs

Each mike input is equipped with a socket for a plug-in transformer (see *Accessories*) to convert the high-impedance inputs for use with low-impedance mikes. Changeover is a simple matter of removing the dummy plug and replacing it with the accessory transformer.

Specifications

Power Output	100W cont.; 175W max.; 238W peak
Frequency Response (Bridging Input)	20 to 20,000 Hz \pm 2 dB
Microphone Inputs*	25 to 20,000 Hz \pm 1.5 dB
Auxiliary Inputs	25 to 20,000 Hz \pm 1 dB
Distortion:	
50 to 20,000 Hz, 100W	2% max.
Output Regulation (No load to full load)	1.5 dB
Hum and Noise (Below 100W)	
Bridging Input	-93 dB
Auxiliary Inputs	-70 dB
Microphone Inputs (-126 dBm equiv.)	-53 dB

Crosstalk Rejection (At 20,000 Hz):

Non-adjacent channels	50 dB min.
Adjacent channels	30 dB min.

Input

Sensitivity (for 100W output)	
Bridging Input	0.53V
Auxiliary Inputs	0.16V
Microphone Inputs	7.0 or 2.2 mV

Connections

Bridging	Phone Jack
Auxiliary	Phone Jack
Microphone	Switchcraft C3F

Gain

Bridging Input	58 dB
Auxiliary Inputs	88 dB
Microphone Inputs	113 or 123 dB

Outputs

Speaker	3.2-, 8-, 16-ohm
Line	12.5, 25, 35, 70V

Power Requirements 120/130V, 50-60 Hz, 110-250W

Dimensions

Chassis (no cover)	7" H; 17" W; 10 $\frac{1}{8}$ " D, (178, 432, 257 mm)
Cover Installed	7 $\frac{1}{4}$ " H; 18 $\frac{3}{8}$ " W; 10 $\frac{1}{8}$ " D, (184, 473, 257 mm)

Weight (Approx.) 30 lbs. (14 kg)

Shipping Weight (Approx.) 34 lbs. (16 kg)

*Normal-Special Switch in "Special"; tone controls centered.

Accessories

Perforated Metal Cover	MI-38174
Shelf (For equipment-rack mount)	MI-38195
Blank Panel (For above)	MI-38100-8
Trim Panel (For above shelf)	MI-38100-9
Rack Mount (Swing-out)	MI-138196
Plug-In Mike Transformer	MI-12399
Bridging Input Transformer	MI-38703
Step Down Transformer, 240/120V, 50/60 Hz	MI-141010-250
Adapter, Plug, High-Level Input	MI-38155

Ordering Information

Mixer Amplifier, Type SA-1004 (Less cover)	MI-38191
--	----------

200-Watt Power Amplifier, Type SA-2000



- Built for continuous duty
- Tilt-down chassis, easy maintenance
- Built-in bias meter
- Regulated power supply
- Sensitive: 70 mV input level

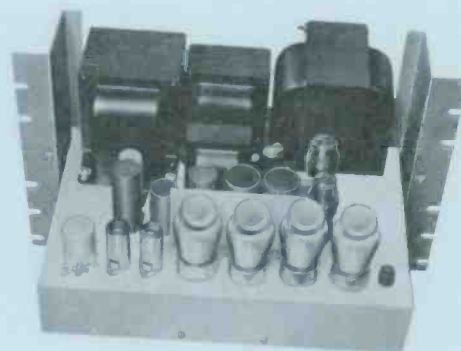

The 200-watt Power Amplifier is a bridging type amplifier using four Type 6550 beam tetrodes in a push-pull, Class AB₁, circuit. Its exceptional frequency response and low distortion make it ideal for wide-range reproduction of music. When more than one amplifier is used in a system the inputs are paralleled. With 16 decibels of inverse feedback for frequency stabilization, it produces 200 watts of clean audio power.

The self-contained a-c power supply operates from 105/115/125 volts, 60 hertz source. Power consumption of the amplifier is 168 watts idling and 440 watts at maximum signal. The amplifier is equipped with screw-type terminals.

The frequency range is essentially flat from 20 to 20,000 hertz with the high frequency end down 1.5 dB at 20,000 hertz. The amplifier uses a 470-pF capacitor in the input circuit to provide the frequency response rolloff required for larger drive-in theatre installations.

The amplifier is designed for mounting in a standard 19-inch rack or cabinet. Because of a "tip-out" feature, the amplifier is serviced from the front side.

A meter, with a selector switch, tests the balance of the power-amplifier tubes.

The meter also indicates the power output (as a VU meter). When the amplifier mounts in an open cabinet or rack, an additional front cover is available. (See *Accessories*).

Specifications

Power Output	200W cont.; 240 max.; 410W peak
Frequency Response	20 to 20,000 Hz \pm 1 dB
Distortion (40 to 10,000 Hz, 175W*)	3% max.
Output Regulation (No load to full load)	1.8 dB
Hum and Noise (Below 200W)	.95 dB
Referenced to 1 mW	-49 dBm
Input	
Sensitivity (for 200W output; 1 kHz)	.230 or 70 mV
Impedance	600 ohms
Connections	Barrier Strip Terminals
Gain (400 Hz)	.69 or 79 dB
Output	
Impedance	3.57; 7.15; 28.6; 114.3 ohms
Voltages (At 175W)	25; 35.3; 70.7; 141V
Connections	Barrier Strip Terminals
Feedback Level (At 1 kHz)	.16 dB
Power Requirements	105-125V, 50/60 Hz, 168-440W
External Power Load (Max.)	.10 mA, 250 Vdc; 0.6 A, 6.3 Vac
Duty Rating	Continuous, 24 hr/day

*600-ohm source; 114.3-ohm load on 114.3-ohm output.

Accessories

Relay, 24 Vdc Coil	MI-38154-1
Relay, 115 Vac Coil	MI-38153-1
Microphone Input Transformer	MI-38665

Ordering Information

200-Watt Power Amplifier, Type SA-2000	MI-9289
--	---------



Audio Equipment Power Supplies

Types BX-40, BX-42,
BX-51, BX-71, BX-72, BX-100

- For console modules
- For rack equipment
- For custom-built systems
- For emergency spares

Here are six of the power supplies RCA uses in its audio consoles, audio systems and other equipment. They are made available as spares for operating equipment, for use as part of equipment installations or custom-built systems.

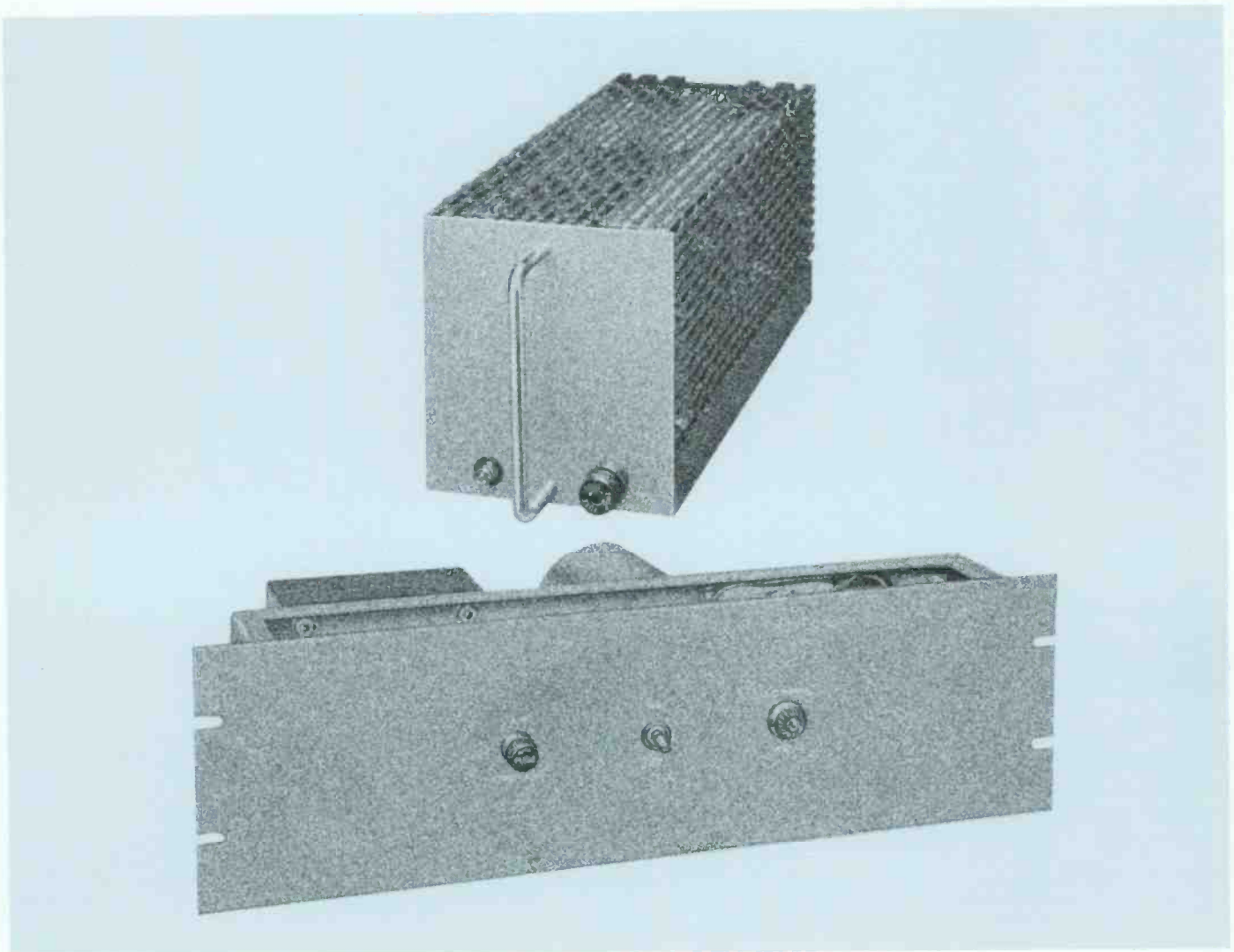

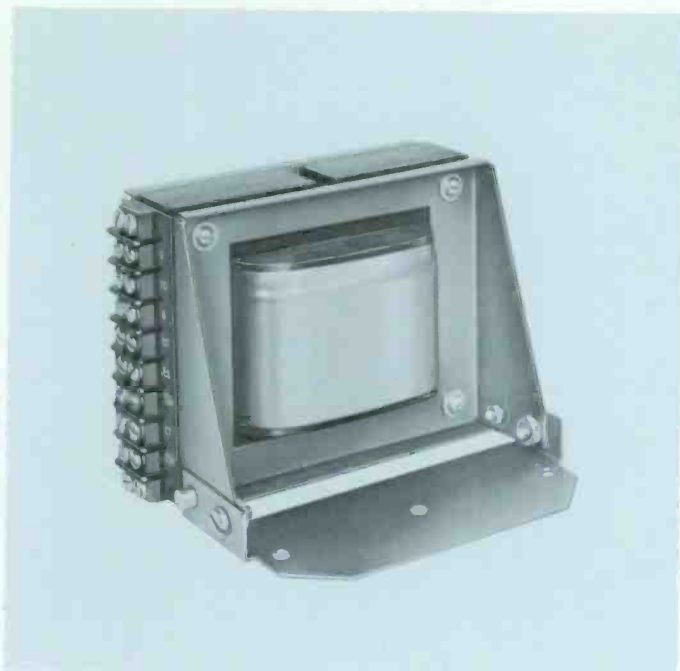

Distribution-Amplifier Power Supply, Type BX-40

The Type BX-40 is an a-c power supply built to power up to ten Type BA-40 Audio Distribution Amplifiers. It is an isolation and step-down transformer delivering 40 to 50 volts at up to 50 watts from a 117- or 234-volt power line. It usually mounts at the rear of a Type BR-22 Mounting Shelf with the hardware supplied.

Specifications

Input117/234 V, 50/60 Hz
 Output40-50 V at 50 W
 Dimensions5¼" W, 3¾" H, 4¾" D (33, 95, 120 mm)
 Weight6 lbs. (2.7 kg)

Accessories

Rack-Mount Shelf, Type BR-22MI-11597
 (Mounts ten BA-40 Amplifiers and one BX-40 Power Supply)

Ordering Information

Distribution-Amplifier Power Supply, Type BX-40.....MI-11447

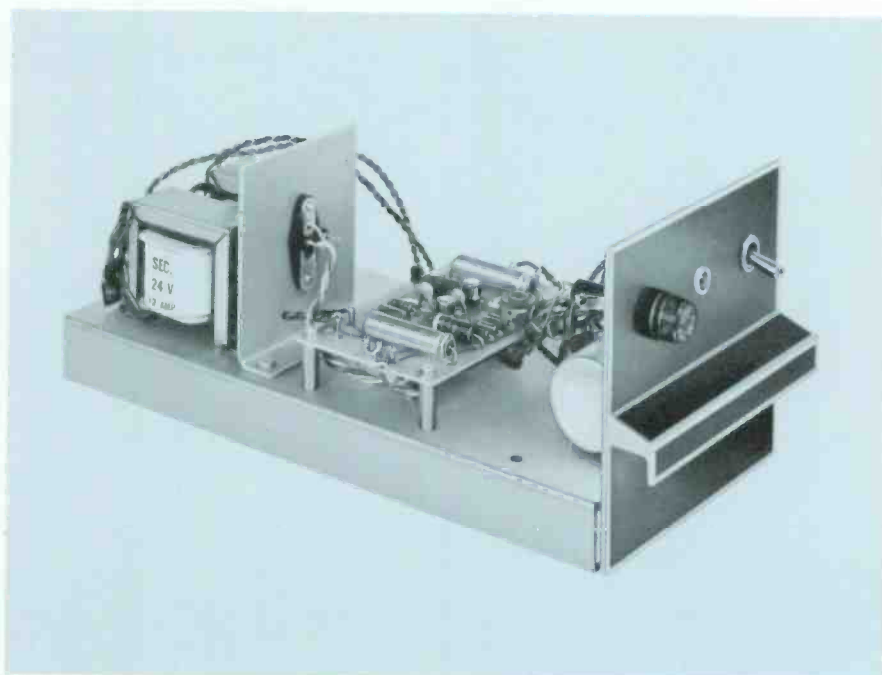

Line-Amplifier Power Supply, Type BX-42

The BX-42 provides operating power for one or two Type BA-42 Line Amplifiers. It is built on a 5-inch, plug-in module chassis for mounting in a vertical or horizontal mounting shelf (see *Accessories*). Either shelf mounts three power supplies.

Specifications

Input115/230 V, 50/60 Hz
 Output (Adjustable $\pm 10\%$)24V dc at 1.25A
 Dimensions4¾" H, 5" W, 11¾" D (118, 127 284 mm)
 Weight8 lbs. (3.6 kg)

Accessories

Vertical ShelfMI-141813
 Horizontal (Rack-Mount) Shelf, Type BR-22MI-11597

Ordering Information

Line-Amplifier Power Supply, Type BX-42
 With guide assemblyMI-141812



Regulated Power Supply, Type BX-51

The Type BX-51 Power Supply delivers up to 6 amperes at 24 volts to any suitable load, inductive, capacitive or resistive. This power supply is used widely in relay-switching systems, tally-light circuits and other loads requiring a constant-voltage, d-c source.

Specifications

Input117/230V, 50/60 Hz
 Output24V dc at 6A max.
 Regulation:
 No load to full load7.5%
 Half load to full load2.5%

Ripple Voltage0.2V max.
 Dimensions19" W, 5¼" H, 9¾" D (483, 133, 245 mm)
 Weight (approx.)25 lbs. (11 kg)

Ordering Information

Regulated Power Supply, Type BX-51MI-11318



Console Power Supply, Type BX-71

The Type BX-71 delivers a well-regulated d-c voltage for operation of the BA-70 Series preamplifiers and program amplifiers. It powers as many as 22 BA-72 Preamps or three BA-73 Program Amplifiers or any combination with total current requirements of 1000 mA or less. In addition, the BX-71 provides an unregulated d-c voltage for powering speaker-mute relays and "on-air" lights and the like. A 6-volt a-c output is included for VU-meter and other panel lamps.

Specifications

Input (Tapped primary)115/230V, 50/60 Hz
 (Taps at 105, 115, 125, 210, 230, 250 volts)
 Regulated Output30V dc 1A max.
 Unregulated Output24V dc 0.56A; 6V ac 1.5A
 Regulation (zero load to full load)0.35%
 Ripple (in 30-volt output)0.15 mV max.
 Dimensions4¾" H, 7½" W, 8¾" D (118, 191, 225 mm)
 Weight14 lbs. (6.4 kg)
 FinishCadmium plate; clear chromate dipped

Accessories

Rack-Mount Shelf
 (accommodates 2 power supplies)MI-11597
 Spare Guide AssemblyMI-11759-4

Ordering Information

Console Power Supply, Type BX-71:
 With guide assemblyES-11163
 Less guide assemblyMI-11163

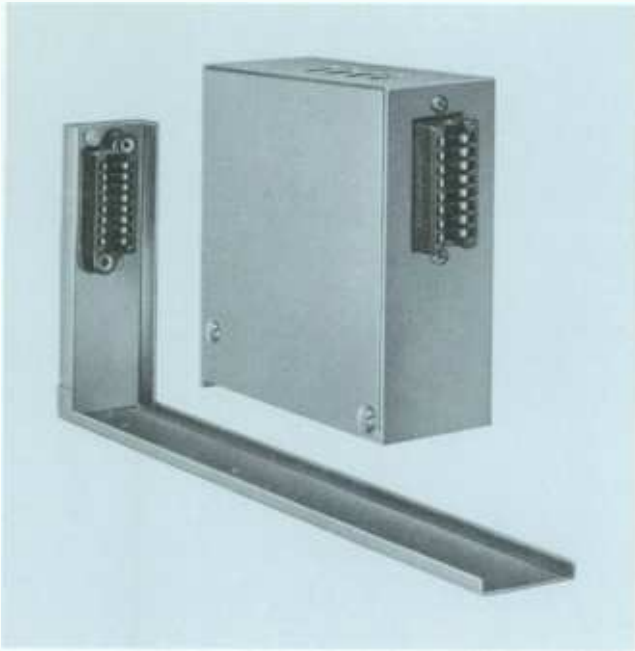

Pre-amplifier Power Supply, Type BX-72

The BX-72 provides a regulated, positive-grounded, 30-volt d-c output for operating a single type BA-72 Pre-amplifier. It is designed to fit between the amplifier module and the guide assembly connector. The BX-72 is useful wherever there is a need for a small, well-regulated, low-ripple power supply.

Specifications

Input	105-125V or 210-250V, 50/60 Hz
Output (regulated)	-30 V dc, 80 mA.
Regulation (no load to full load)	0.35%
Ripple Content	0.15 mV max.
Dimensions	4½" H, 1¾" W, 5½" D (127, 37, 140 mm)
Weight	20 oz. (567 g)

Accessories

Rack-Mount Shelf, Type BR-22	MI-11597
Spare Guide Assembly	MI-11759-1

Ordering Information

Pre-amplifier Power Supply, Type BX-72	MI-11320
--	----------

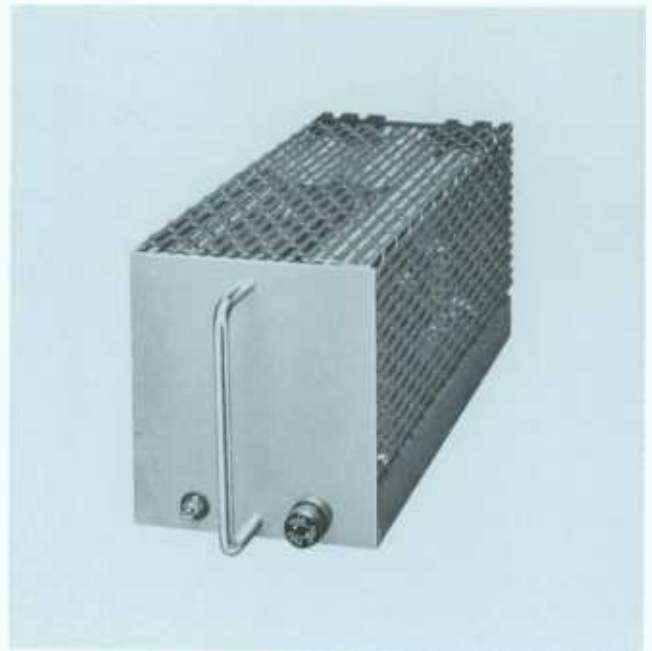

Console Power Supply, Type BX-100

The BX-100 provides operating power for modules in the BC-100 series of custom-built audio consoles. It provides two separate outputs: +16 volts and -16 volts dc from a 115-volt 50 or 60-hertz power line.

Specifications

Input Requirements	105/125V, 50/60 Hz, 75 W
Output	+16V, 0.75A; -16V, 0.75A
Regulation:	
Zero load to full load	0.75%
At full load with line-voltage swing	0.25%
Ripple	0.20 mV rms max.
Overload Protection:	
Current Foldback at	1.8A
(Protected for short-circuit to common; positive to negative)	
Ambient Operating Temperature	55° C max.
Dimensions	4-13/16" H, 4¾" W, 11-3/16" D
Weight (approx.)	12 lbs.

Accessories

Guide Assembly	MI-11593-8
Rack-Mount Shelf, Type BR-22	MI-11597

Ordering Information

Console Power Supply, Type BX-100 (less Guide Assembly)	MI-141590
--	-----------



Cabinet Racks, Jack Panels, Patch Cords, Rack Accessories

- Three cabinet-rack styles
- Rack-mount equipment shelves
- Blank panels—electrical shields
- Power distribution—circuit breakers
- Terminal boards—patch panels and cords

Described in these pages is a line of cabinet racks and various rack-associated accessories useful in the installation of both audio and video systems. There are five styles of cabinet racks, rack-mount shelves for amplifier and switcher modules, terminal blocks and boards, blank panels, trim strips, electrostatic shields, jack panels, cords and plugs, ground-bus kits, power circuit-breakers, wiring kits and so on.



De Luxe
Cabinet Racks

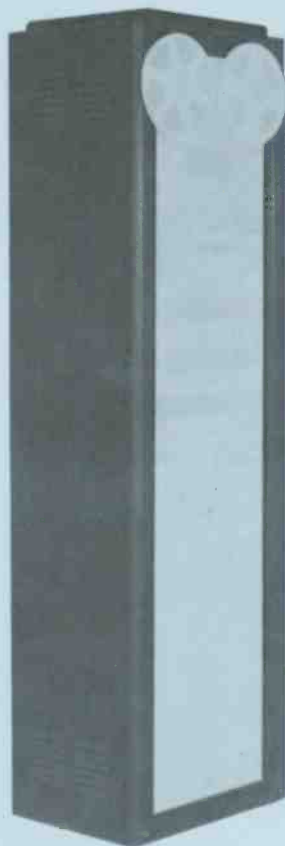

Standard
Cabinet Racks

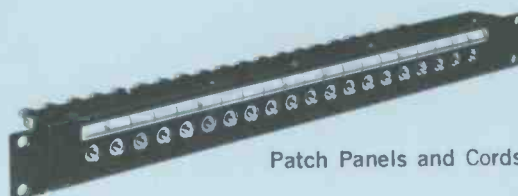

Patch Panels and Cords

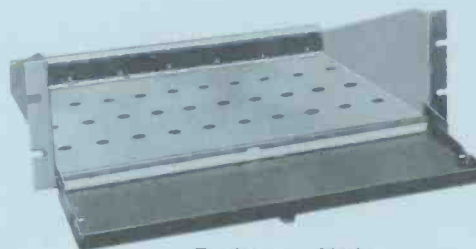

Equipment Shelves

Cabinet Racks and Accessories

Five styles of cabinet racks are offered: four de luxe units and one standard-duty unit. The de luxe racks are modular units available in two heights and two depths.

The standard-duty unit has no removable sides, no front door and is available in only one height and one depth.

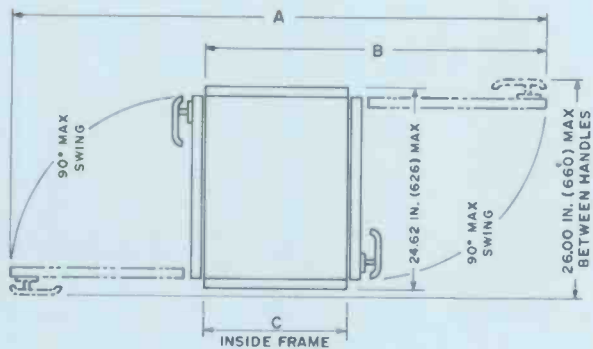
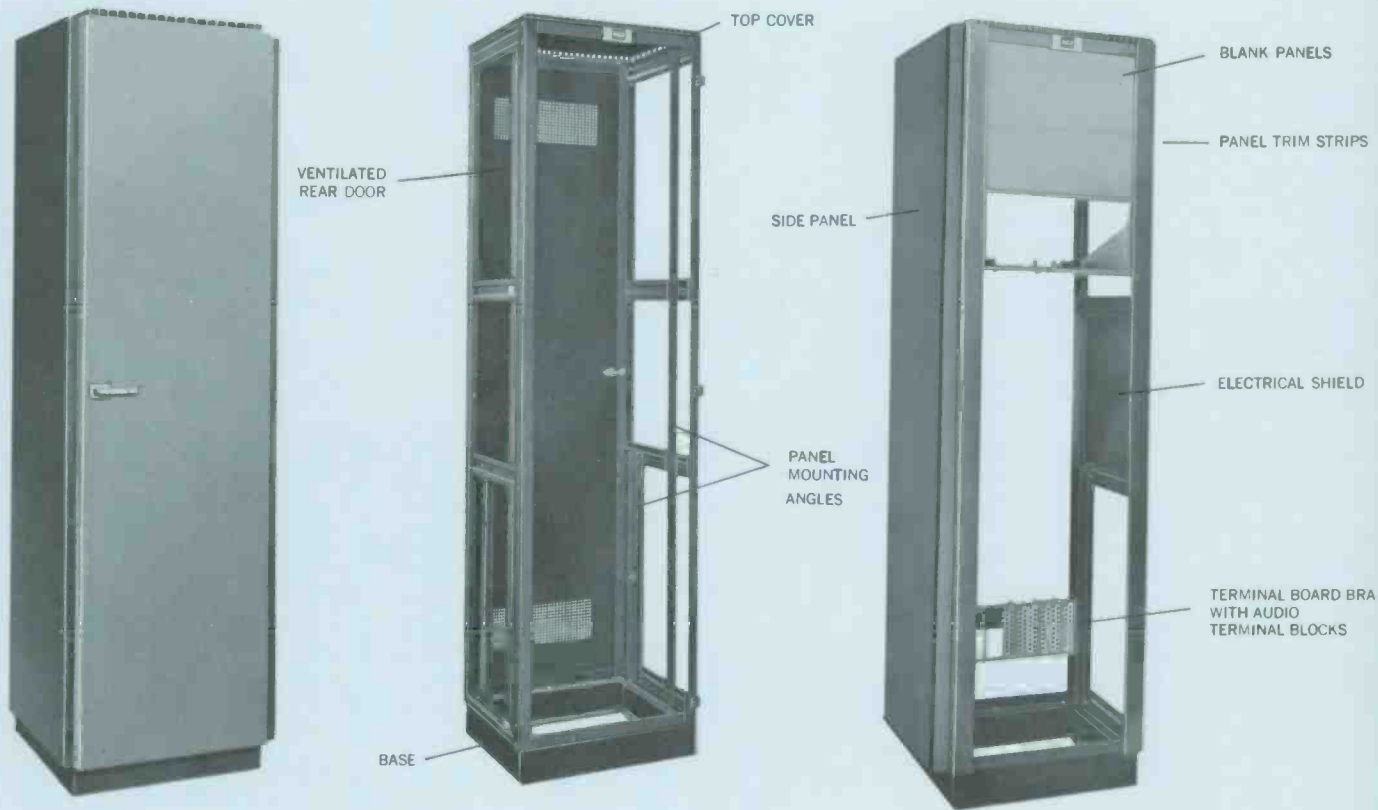

NOMINAL CABINET DEPTH INCHES (mm)	DIMENSION A (MAX) INCHES (mm)	DIMENSION B (MAX) INCHES (mm)	DIMENSION C (MIN) INCHES (mm)
18.00 (457)	64.00 (1620)	41.00 (1041)	17.82 (452)
24.00 (610)	70.00 (1778)	47.00 (1194)	23.82 (605)

Specifications

	BR-84 Series		BR-77 Series		BR-19
	18" Depth	24" Depth	18" Depth	24" Depth	18" Depth
Height:					
Frame	80" (2032 mm)	80" (2032 mm)	73" (1854 mm)	73" (1854 mm)	—
Frame with base	84" (2134 mm)	84" (2134 mm)	77" (1956 mm)	77" (1956 mm)	—
Frame with base and top	85" (2159 mm)	85" (2159 mm)	78" (1981 mm)	78" (1981 mm)	84" (2134 mm)
Panel Mounting Area:					
Width	19" (483 mm)	19" (483 mm)	19" (483 mm)	19" (483 mm)	19" (483 mm)
Height	77" (1956 mm)	77" (1956 mm)	70" (1778 mm)	70" (1778 mm)	77" (1956 mm)
Depth	18" (457 mm)	24" (610 mm)	18" (457 mm)	24" (610 mm)	18" (457 mm)
Color	2-Tone Blue; Vinyl Alum.	2-Tone Blue; Vinyl Alum.	2-Tone Blue; Vinyl Alum.	2-Tone Blue; Vinyl Alum.	Midnight Blue

Ordering Information

	BR-84 Series		BR-77 Series		BR-19
	18" Depth	24" Depth	18" Depth	24" Depth	18" Depth
Complete Cabinet Rack (Rack, side covers, top cover, front door and ventilated rear door)	ES-36591-G84	ES-36591-N84	ES-36591-G77	ES-36591-N77	Note 1
As Above—Less front door	ES-36591-H84	ES-36591-P84	ES-36591-H77	ES-36591-P77	MI-11550
As Above—Less side panels	ES-36591-J84	ES-36591-R84	ES-36591-J77	ES-36591-R77	Note 2
Cabinet Rack— with rear door only	ES-36591-K84	ES-36591-S84	ES-36591-K77	ES-46591-S77	Note 2
Cabinet Rack— Less doors and panels	ES-36591-L84	ES-36591-T84	ES-36591-L77	ES-36591-T77	Note 2
Basic Rack—includes base, panel mounting angles, terminal board mounting angles, hardware	MI-36551-M84	MI-36551-U84	MI-36551-M77	MI-36551-U77	Note 2
Ventilated Door—includes handle, keeper, hinges, hardware	MI-36535-S84	MI-36535-S84	MI-36535-S77	MI-36535-S77	Note 2
Unventilated door—includes handle, keeper, hinges, hardware	MI-36530-S84	MI-36530-S84	MI-36530-S77	MI-36530-S77	Note 2
Side Panels	MI-36542-B84	MI-36541-B84	MI-36542-B77	MI-36541-B77	Note 2
Top Cover (ventilated)	MI-30521-B1	MI-36521-B1	MI-30521-B1	MI-36521-B1	Note 2
Base (with electrical outlet)	MI-36511-1	MI-36511-2	MI-36511-1	MI-36511-2	Note 2
Electrical shield: top and bottom	MI-30546-A28	MI-36546-A28	MI-30546-A21	MI-36546-A21	Note 2
Electrical shield for mid-section of rack	MI-30546-A21	MI-36546-A21	MI-30546-A28	MI-36546-A28	Note 2
Trim Strip Single	MI-30566-A84	MI-30566-A84	MI-30566-A77	MI-30566-A77	Note 2
Trim Strip Double	MI-30568-A84	MI-30568-A84	MI-30568-A77	MI-30568-A77	Note 2
Terminal Board Mounting Angles	MI-30527-A29	MI-30527-A29	MI-30527-A29	MI-30527-A29	Note 2
Panel Mounting Angles	MI-30526-A84	MI-30526-A84	MI-30526-A77	MI-30526-A77	Note 2
Terminal Board Bracket	MI-4570-A2	MI-4570-A2	MI-4570-A2	MI-4570-A2	MI-4570-A2

NOTE 1: The BR-19 is a standard-duty rack cabinet. It is available in but one form: with integral side panels, top, base and ventilated rear door. Shipped unassembled, hardware included.

NOTE 2: These elements apply only to the BR-77 and BR-84 Cabinet Racks. They are incompatible with the BR-19.

Cabinet Rack Electrical Accessories

Ordering Information

Terminal Blocks

Power Connections (includes cover)	MI-4568
Audio Connections (with 80 terminals)	MI-4569
Mounting Bracket (for two MI-4568 or three MI-4569)	MI-4570

Ground-Bus Kit (for system ground connections)

MI-11728

Circuit Breakers (115/230V):

2.5 Ampere	MI-26176-1
5.0 Ampere	MI-26176-2
10 Ampere	MI-26176-3
20 Ampere	MI-26176-4
40 Ampere	MI-26176-5
Mounting Panel (For up to 3 breakers)	MI-11792

Rack Wiring Kits (include grounding and lacing bars, mounting hardware):

For 84" (2134 mm) Rack	MI-36570-1
For 77" (1950 mm) Rack	MI-36570-2

These accessories simplify the wiring of cabinet racks with terminal blocks, ground-bus connections, power-circuit breakers and rack-wiring kits.



Mounting Panel MI-11792 with one breaker installed

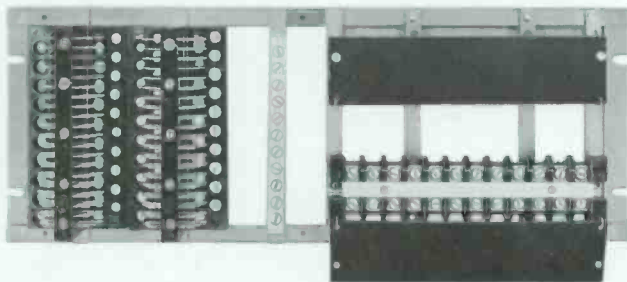

Mounting bracket MI-4570 with two MI-4569 Blocks, one MI-11728 Kit and two MI-4568 Blocks mounted

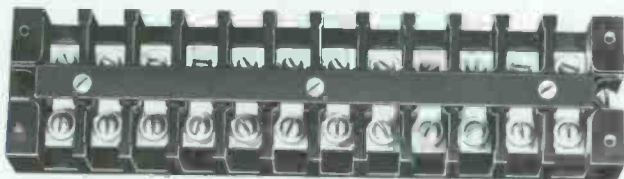

Power Terminal Block MI-4568 (Cover Removed)

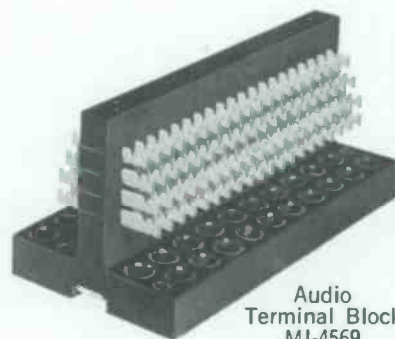

Audio Terminal Block MI-4569



Mounting Bracket MI-4570



Ground-Bus Kit MI-11728

Equipment Shelves, Type BR-22

The BR-22 Rack-Mount Shelf mounts RCA modular amplifiers. It fits any standard, 19-inch equipment rack and occupies only 5¼ inches of rack space. A removable, hinged cover provides ventilated enclosure for the equipment. One BR-22 shelf accommodates these equipment combinations:

- 10 Preamplifiers (BA-71 or BA-41)
- 3 Program Amplifiers (BA-73, BA-43)
- 3 Monitor Amplifiers (BA-74, BA-44)
- 5 Cue/Intercom Amplifiers (BA-78)
- 2 Power Supplies (BX-71)
- 10 Distribution Amplifiers (BA-40)
- 5 AGC Modules (BA-45)
- 5 Limiter Modules (BA-46)
- 5 Peak-Clipper Modules (BA-47)
- 2 Monitor Amplifiers (BA-48)

Specifications

Dimensions19" W; 5-7/32" H; 13¼" D (483, 133, 337 mm)
 Mounting Space17½" W; 4-11/16" H; 11-3/16" D
 (435, 119, 284 mm)
 Weight (Approx.)10 lbs. (45 kg)
 FinishAluminum Color Epoxy Enamel
 Packed Dimensions10" x 17" x 22" (254, 432, 559 mm)
 Packed Weight13 lbs. (6 kg)

Ordering Information

Rack-Mount Equipment Shelf, Type BR-22MI-11597



Blank Panels

All panels are fabricated of 0.18-inch (4.5 mm) aluminum or steel and finished in aluminum-color epoxy enamel. The aluminum panels are available in four widths; the steel, six widths (see *Ordering Information*).

Ordering Information

Panel Width	Aluminum	Steel
1¾" (44 mm)	MI-3090	MI-36547-1
3½" (89 mm)	MI-3091	MI-36547-2
5¼" (133 mm)	MI-3092	MI-36547-3
7" (178 mm)	MI-3093	MI-36547-4
8¾" (222 mm)	N/A	MI-36547-5
10½" (267 mm)	N/A	MI-36547-6

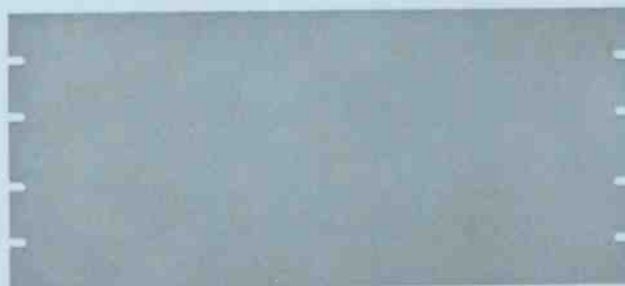

Patch Panels, Mats and Cords, Type BJ-12, BJ-20, BJ-24

The BJ-12 Jack Panel is a single row of 12 double jacks. The BJ-24 offers two rows of 12 double jacks. Both include individual cord holders for each jack pair. The jacks mate to cords fitted with PJ-1 or WE-241A plugs (see below).

The Type BJ-20 Jack Panel is a single row of 20 tip-ring-sleeve jacks, spaced 0.75 inches (18 mm) center-to-center.

Jack Mats

Jack mats are dress panels for jack fields. Two styles are available: one for a single (BJ-24) panel and another for two (BJ-24) panels. The single mat measures 17 by 3-5/32 inches (432 by 80 mm) and the double, 17 by 5-7/32 inches (432 by 133 mm).

Specifications

	BJ-12	BJ-24	BJ-20
Jack Type	Double	Double	Tip, Ring, Sleeve
Panel			
Dimensions	1¾" x 19" (44 x 438 mm)	2½" x 19" (54 x 483 mm)	1¾" x 19" (44 x 438 mm)
Mating Patch Cord	PJ-12, -14, -16	PJ-12, -14, -16	PJ-72
Weight (Approx.)....	3 lbs. (1.4 kg)	5½ lbs. (2.5 kg)	3 lbs. (1.4 kg)

Ordering Information

Jack Panels:

12 Jack Pairs, Type BJ-12	MI-11646
24 Jack Pairs, Type BJ-24	MI-11645
20 Tip-Ring-Sleeve Jacks, Type BJ-20	MI-11666

Jack Mats:

For single BJ-24 Panel	MI-11647-1
For double BJ-24 Panel	MI-11647-2

Patch Cords

RCA Patch Cords are available in 2-, 4- and 6-foot lengths with single or double plugs. Cards are jacketed in tough black braided nylon for extra wear.

Ordering Information

Patch Cord (Double-Plug Cords):

Two Feet (610 mm) Long, Type PJ-12	MI-4652-2
Four Feet (1220 mm) Long, Type PJ-14)	MI-4652-4
Six Feet (1830 mm) Long, Type PJ-16	MI-4652-6

Patch Cord (Tip-Ring-Sleeve Plugs):

Two Feet (610 mm) Long, Type PJ-72	MI-4652D-2
--	------------

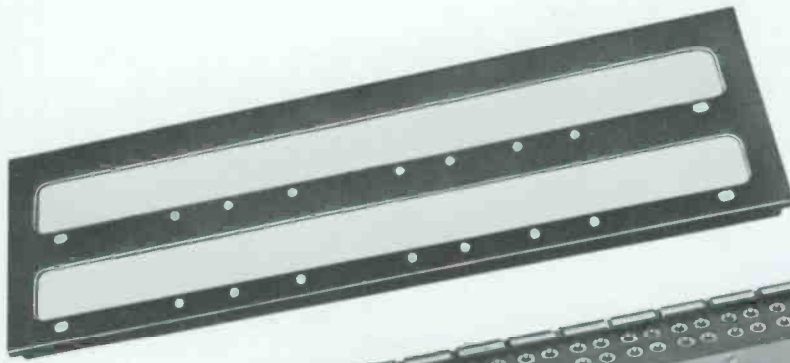

Double Jack Mat, MI-11647-2

Type BJ-24
Patch Panel



Type BJ-12
Patch Panel

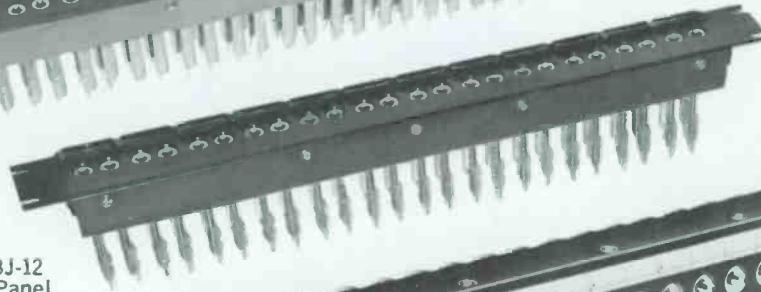

Type BJ-20 Patch Panel

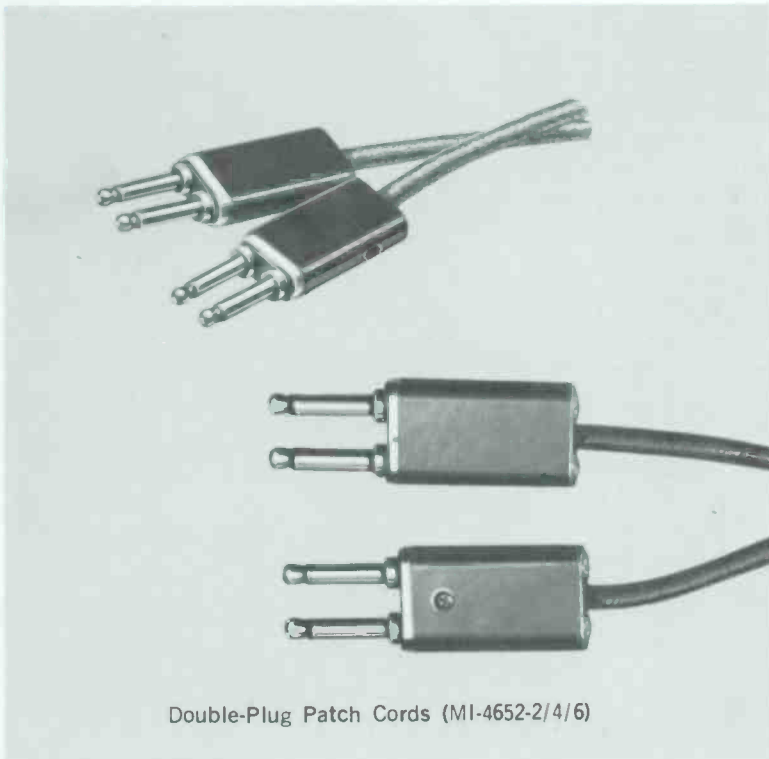
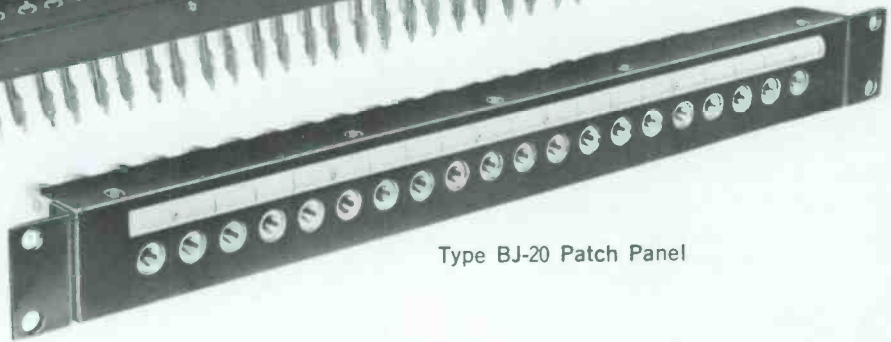

Double-Plug Patch Cords (MI-4652-2/4/6)

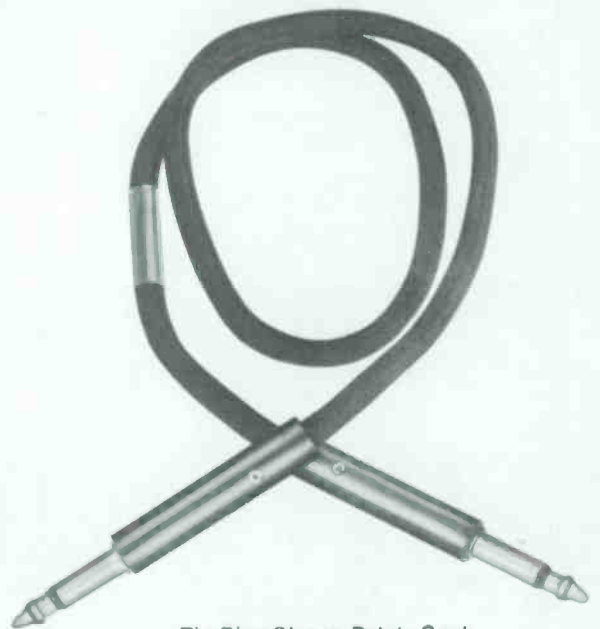

Tip-Ring-Sleeve Patch Cord
(MI-4652D-2)

Switches, Panels and Housing

- Six-gang, Form-C leaf switches
- Nine-place panels
- Sloped-front housings
- Mounting adapters for console and rack

Switches, panels and housings for general studio use in the routing of program audio or a-c power. The items shown in the photo are available individually to allow assembly of the unit that best fits the need at hand.

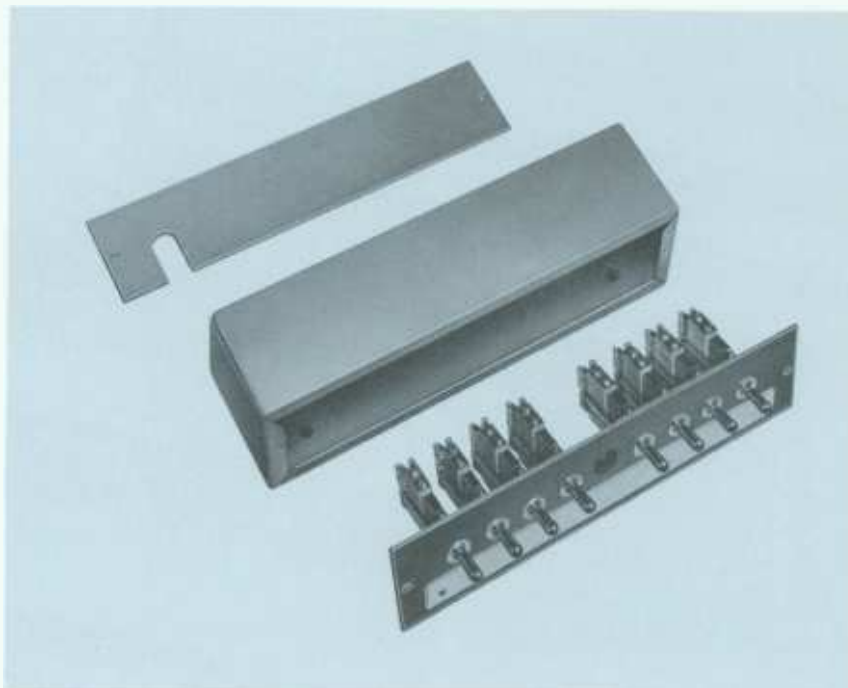

Switches

Switches are lever-type, low-capacitance leaf devices with a total of six form-C contact stacks (single-pole, double-throw) with a center-off position. The switches are arranged for lever lock on one side and non-locking on the other. However, they are adjustable for lock or non-lock on either side. The lever uses a Nylon hub for extended life and the contacts are plated with palladium. Maximum current is 3A at 120Vac to a non-inductive load. Two cable clamps included.

Panels

Made of reverse-etched aluminum, the panel is punched with nine 15/32-inch holes to accommodate the switches described above or other appropriate devices such as indicator lamp, toggle switches, etc. An erasible, write-in strip is included for labelling. The panels fit the housings described below or two adapters (see *Accessories*) for mounting the panel in a console or in a 19-inch equipment rack.

Housings

A sturdy steel box with a 15-degree sloped front, the housing includes four rubber feet to allow use on fine finishes without mar. The rear panel is removable to provide access to internal connections. Finished in umber gray enamel.

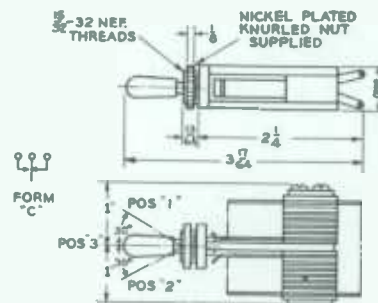

Dimensional drawing, MI-11755-2 Switches

Specifications

Switches

TypeSix Form-C (SPDT) circuits
 Contact Rating (Non-inductive load)3A at 120Vac
 DimensionsSee drawing

Panels

Dimensions2 5/8" W; 11 1/2" L (67, 292 mm)

Hole Diameter15/32" (12 mm)
 Write-in Strip Dimensions (Approx.)1" x 10" (51 x 254 mm)
 Weight (Approx.)1 lb. (454 g)

Housings

Dimensions2 5/8" H; 11 1/2" W; 3 1/2" D (67, 292, 89 mm)
 Panel Slope15 degrees
 Weight (Approx.)5 lbs. (2.3 kg)

Accessories

Rack-Mount Adapter (for Panel)MI-26254
 Adapter for 13 1/2" Console Housing (for Panel)MI-26252

Ordering Information

SwitchMI-11755-2
 Panel (Includes plug for each hole)MI-11754
 Housing (Includes rear panel)MI-11756



Studio Furniture

- Pleasant styling
- Designed especially for the studio
- Sturdy construction
- Facilltates Installation
- Provides ample, orderly storage



A line of studio furniture designed especially to meet audio requirements is now available from RCA. A series of tables, turntables cabinets, cartridge machine cabinets and storage racks complements the line of cabinets, racks, panels and other accessories. The new line of equipment increases station efficiency, facilitates installation, and provides ample, orderly storage space.

Each item of furniture is semi-customized to meet specific needs. Tables with wire ducts for audio consoles and their attendant wiring; one-, two- or three-unit turntable cabinets provide new ease of operation while cabinets and storage racks provide new ease in cartridge handling.

Square steel framework, sheet steel and high pressure laminate are the materials used. Satin chrome finish and colors that match other RCA studio equipment let them fit in most anywhere.

Console Tables



Tables with movable wire ducts are ideal for mounting audio consoles and other studio equipment. Convenient levelers, left-center-right mounting provisions for the ducts, protective one-inch aprons are construction features.

Specifications

Construction.....	Steel and high-pressure laminate
Finish.....	Walnut grain and light gray with satin chrome
Table Top Dimensions.....	36 x 44 or 64 or 84 inches (914 x 1117 or 2225 or 2733 mm)
Table Height	29" (733 mm)
Leveler Range	1¼"
Wire Duct.....	18" W, 12" D, 27-½" H (457, 305, 694 mm)
Weight (Approximate):	
44-Inch Table.....	35 lbs. (16 kg.)
64-Inch Table.....	45 lbs. (21 kg.)
84-Inch Table.....	65 lbs. (30 kg.)

Ordering Information

44-Inch Table	MI-141030-1
64-Inch Table	MI-141030-2
84-Inch Table	MI-141030-3

Turntable Consoles

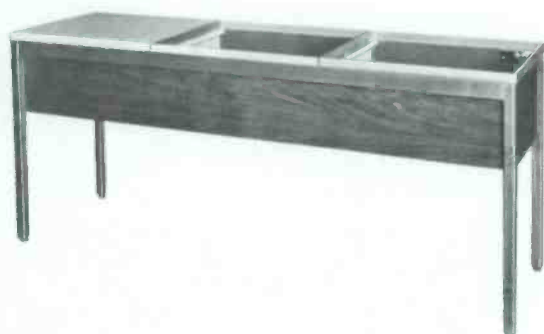

Functionally designed turntable consoles afford a simplified mounting for one or more Type BQ-50 or BQ-51 Turntables. Top panels (see below) convert the console into a table. Shown above is a single-unit console; at right, a triple-unit model with one blank top panel in place.

Specifications

Construction.....	Steel and high-pressure laminate
Finish.....	Walnut and light gray with satin chrome
Top Dimensions.....	9⅞ x 23 or 46 or 69⅞ inches (486 x 584 or 1171 or 1757 mm)
Leveler Range.....	1¼" (32 mm)
Turntable Console Height.....	29" (737 mm)
Turntable Blank Panel	23" x 19⅞" (584 mm x 486 mm)
Weight (Approximate):	
One-turntable Unit	25 lbs. (11 kg.)
Two-turntable Unit	40 lbs. (18 kg.)
Three-turntable Unit	60 lbs. (27 kg.)
Turntable Blank Panel	6 lbs. (3 kg.)

Ordering Information

Turntable Console for one BQ-50 or BQ-51 Turntable.....	MI-141026-1
Turntable Console for two BQ-50 or BQ-51 Turntables.....	MI-141026-2
Turntable Console for three BQ-50 or BQ-51 Turntables.....	MI-141026-3
Blank Top Panel.....	MI-14127

Tape Cartridge Consoles

Convenient two-unit console mounts one tape cartridge playback unit and one recording amplifier or two playback units.



Four-unit console with tape cartridge storage cabinet on top.

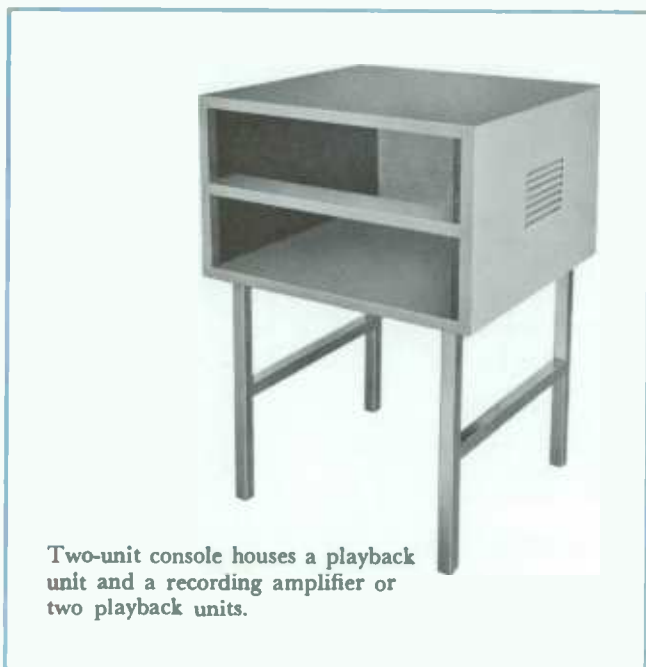

Two-unit console houses a playback unit and a recording amplifier or two playback units.

Tape Cartridge consoles provide mountings at a convenient operating height for the RT-7/17/27/37 Cartridge Playback Units and BA-7/17/27/37 Tape Cartridge Recording Amplifiers. One is a console designed to mount two playback units, or one playback unit and one recording amplifier. The other is a four-unit cabinet to mount four playback units or one recording amplifier and three playbacks. A cartridge storage cabinet provides ten shelves to accommodate tape cartridges.

The consoles are sturdily constructed of metal with a midnight-blue finish. Holes in the cabinet accommodate interconnection cables and louvers afford ventilation. Protective screens, attached to the rear frames provide additional ventilation.

The Cartridge Storage Cabinet stores eighty five-minute tape cartridges. The storage cabinet fits nicely on top the consoles. Two can be accommodated placed back-to-back. The cabinet may be placed on the floor beneath the console. There is room for two storage cabinets, one either side of the cross bar.

Specifications

ConstructionMetal
 FinishMidnight Blue
 Legs (removable).....17" L (432 mm)

	2 Unit Console	4 Unit Console	Storage Cabinet
Dimensions (overall)			
Width	20 ³ / ₄ " (527 mm)	40 ³ / ₄ " (1035 mm)	35 ⁷ / ₈ " (911 mm)
Depth	19 ⁵ / ₈ " (503 mm)	19 ⁵ / ₈ " (503 mm)	9" (229 mm)
Height (less legs)...	13" (330 mm)	13" (330 mm)	16" (406 mm)
Height (with legs)...	30" (762 mm)	30" (762 mm)	—
Weight (approximate)	25 lbs. (11 kg.)	40 lbs. (18 kg.)	30 lbs. (14 kg.)

Ordering Information

Two-Unit Console Cabinet.....MI-11984-A
 Four-Unit Console Cabinet.....MI-11983-A
 Tape Cartridge Storage CabinetMI-11985-A



Audio Relay Switcher Module

- "Custom" switcher for audio installations
- Solid-state modules form unlimited switcher configurations
- Seven inputs, one output per module
- Plug-in, unitized construction
- Switching level 0 to +18 dBM in 600 ohms



The Audio Relay Switcher Module is a primary component for use in custom relay switching systems. The basic module is a seven-input by one-output switcher and offers a true building block in the development of unlimited audio switcher configurations.

Electronic Expansion

The Switcher Module may be combined in numerous combinations to fit the needs of individual systems. A typical switcher (see diagram) has 21 inputs each switchable to either or both of two outputs, such as preview and program bus. Such a switcher utilizes six modules mounted in a Standard Frame Assembly. Up to nine audio switcher modules can be mounted in the frame to provide combinations such as the following: two modules for 14x1 or 7x2; three modules for 21x1 or 7x3; four modules for 28x1, 14x2 or 7x4; five modules for 35x1, or 7x5; 6 modules for 42x1, 21x2, 14x3 or 7x6; seven modules for 49x1 or 7x7; eight modules for 56x1, 28x2, 14x4 or 7x8; nine modules for 63x1, 21x3 or 7x9. Systems beyond these configurations are assembled with additional frames and modules.

The use of standard plug-in modules greatly reduces the cost of custom-built switching systems, provides reliable performance and allows for future expansion requirements. The switcher may be controlled either by a custom-designed bank of individual push buttons or by pulses generated in automation or preset switching equipment.

DC Power Supply

A 24-volt d-c power source is required. Two module connector units are available as accessory items, a connector assembly and connector kit (see *Accessories*).

The connector assembly consists of three connectors wired for use with three relay modules in a 7x3 switcher configuration. The assembly, if desired, reconnects for a 21x1 switcher. All audio, tally and control circuits are wired to an audio terminal block on the assembly. Also included are three transformer mounting plates and hardware for securing the assembly to the rear of the frame assembly. Numerous connector assemblies may be cross-connected to obtain any desired switcher configuration.

Specifications

Input/Output Impedance.....	Dependent upon associated circuit (usually 600 or 150 ohms)
Insertion Loss	Essentially zero in the module (Normal loss through external bridging transformer 20 dB)
Crosspoint Activation	Pulse or continuous voltage
Switching Level	0 to +18 dBm, 600 ohms
Switching Time (Break before make)	5 ms (approx.)
Signal-to-Noise Ratio	Better than 60 dB; with 0-dBm, 600-ohm input
Relay Contacts	Gold plated; two form "C" and three form "A" (each relay)
Control Cable (Max. Length)	300 ft. using #22 AWG wire
Power Requirements	24 volts, dc; at 135 ma (including pilot lamp but excluding tally lamps)
Fuse	1/2 amp, 3 AG
Pilot Lamp	Type 327
Dimensions (Overall)	4 3/4" high, 1 1/4" wide, 13" deep (120 mm, 45 mm, 330 mm)
Weight	2 1/2 lbs. (1.13 kg)

Mounting Accessories

The mating connector kit includes one connector housing, solder-type terminals, one transformer mounting plate, and all hardware required for securing the connector and mounting plate to the rear of the frame assembly. One connector kit is required when installing a single relay module.

Gap switching

The Audio Relay Switcher Module utilizes a transistor-latch circuit. The circuit design and relay characteristics are chosen so that relay drop-out is faster than pickup, hence gap switching is assured. Each Module contains a pilot light to indicate presence of control voltage and fuse continuity. The lamp is operated at low voltage for extended life.

Printed Circuitry

The latest printed circuitry techniques are employed including two-sided printed wiring on glass epoxy boards. The board contacts as well as the contacts of the mating receptacle are gold plated for

maximum reliability. All audio circuits are wired with two conductor twisted pair cable, individually shielded and insulated to minimize crosstalk as well as hum and noise pickup. Each module contains seven plug-in relays held in place by spring retaining clips. Each relay is equipped with gold contacts and a clear plastic dust cover to assure long life and quiet operation.

The Switcher is designed for switching balanced audio circuits at levels of 0 dBm (up to +18 dBm) in 600 ohms, or equivalent levels at other impedances. An external bridging transformer is normally used to provide 20,000 ohms impedance at the switcher crosspoints, with a choice of either 150 or 600 ohms output bus impedance. The Bridging Transformer mounts on either the Connector Kit or the Connector Assembly. Back loading of the input source is not required when using a bridging output, unless many outputs simultaneously connect to one input. However, each relay crosspoint has "C" contacts, and the terminals are arranged so that back loading resistors may be conveniently installed if required.

Optional and Accessory Equipment

Standard Frame Assembly (holds up to nine modules)	MI-557300
24-volt DC Power Supply	MI-11318
Mating Connector Kit	MI-11789
7x3 Connector Assembly	MI-11790
Bridging Transformer	MI-11791

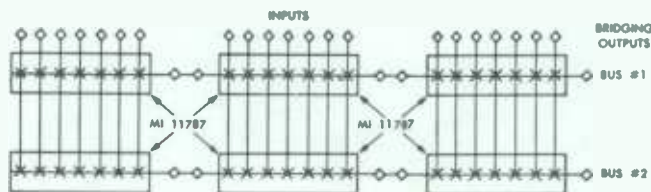

Ordering Information

Audio Relay Switcher, Positive Pulse Actuated	MI-11787
Audio Relay Switcher, Negative Pulse Actuated	MI-11787N



Studio Accessories

- Pads and networks
- VU-meter panels
- Lighted studio signs—studio clocks
- Line equalizers
- Sound-effects filters

Described here are a series of attenuator and bridging pads, divider networks, a pair of VU-meter panels, several lighted studio signs, two studio clocks, a line-equalizer unit and a sound-effects filter.



Pads and Networks

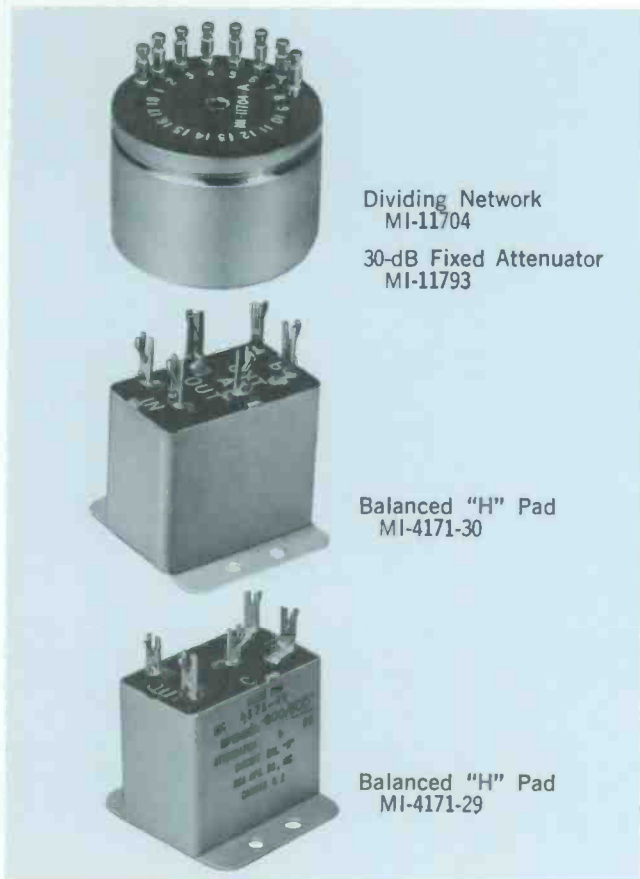

Dividing Network
MI-11704
30-dB Fixed Attenuator
MI-11793

Balanced "H" Pad
MI-4171-30

Balanced "H" Pad
MI-4171-29

RCA offers a comprehensive selection of attenuator pads, bridging pads and dividing networks. The pads and networks are constructed with precision resistors. The terminals are securely mounted with stencilled nomenclature. The fixed, balanced-*H* type is available in four forms; introducing 6-, 10-, 20- or 40-dB insertion loss. The dividing networks are available as shown below:

Specifications

Dimensions:

Balanced H Type (MI-4171-)1 5/8" x 1 1/2" x 1 7/8" H (41 x 38 x 48 m)
Dividing Networks (MI-11704)1 3/4" Dia. x 1 5/8" H (44 x 41 mm)
Isolation Pad (MI-11705)1 5/8" x 1 1/2" x 1 7/8" H (41 x 38 x 48 m)
Fixed Attenuator (MI-11793)1 3/4" Dia. x 1 1/4" H (44, 32 mm)

Ordering Information

Balanced H Pads (Input/Output Z: 600 ohms):

6 dB Insertion LossMI-4171-29
10 dB Insertion LossMI-4171-30
20 dB Insertion LossMI-4171-32
40 dB Insertion LossMI-4171-39

Dividing Networks, 600-ohm, balanced:

Two-Way, 6-dB lossMI-11704
Three-Way, 9.5-dB lossMI-11704A
Four-Way, 12-dB lossMI-11704B
Six-Way, 15.6 dB lossMI-11704D

Isolation Pad, 600-ohm, balanced, 45-dB isolation:

Two-Way, 10-dB lossMI-11705
---------------------	---------------

Fixed Attenuator, 30 dB:

10 k to 600 ohms or 600 to 600 ohmsMI-11793
-------------------------------------	---------------

VU-Meter Panels

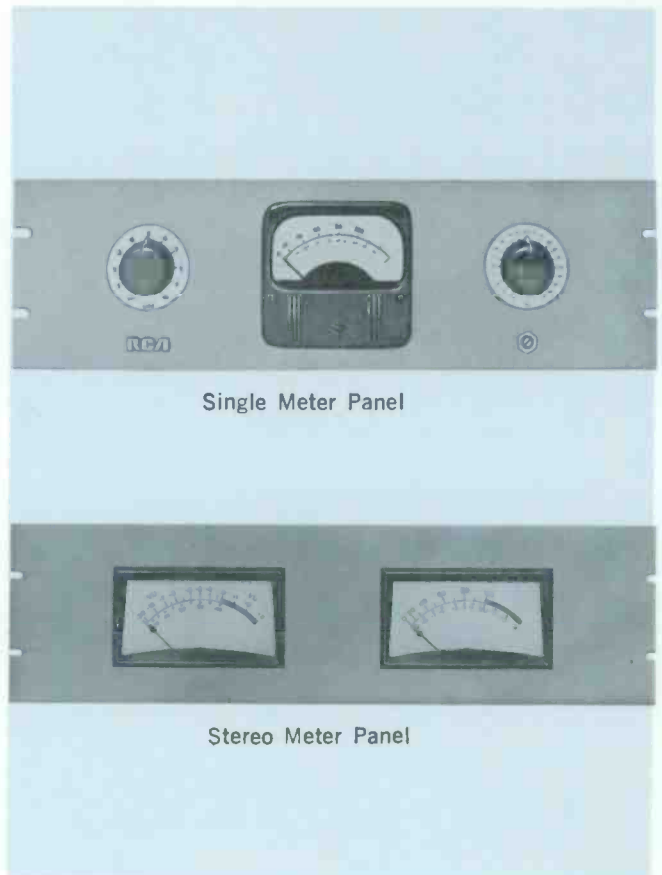

Single Meter Panel

Stereo Meter Panel

Two VU-meter panels are available: a single-meter and a double-meter panel. The single-meter panel is equipped with a ten-position switch and a step attenuator; the double-meter panel is intended for stereo or dual-channel mono operations without selector switch or front-panel attenuator. It does, however, include a fixed-value attenuator, see below.

The single-meter panel's attenuator provides up to 40 dB attenuation in 2-dB steps. The attenuators on the double-meter panel provide up to 24 dB attenuation in 1-dB steps. Both panels mount in 19-inch racks and require 5 1/2 inches of space.

Specifications

	1-Meter	2-Meter
Input Impedance (Bridging)7500 ohms*	7500 ohms
No. of Input Connections10 pair	2 pair
Attenuator4 to 40 dB	4 to 24 dB
Attenuator Steps2 dB	1 dB
Dimensions19" W; 5 1/4" H; 4" D (483, 136, 101 mm)	
Weight7 1/2 lbs. (3.5 kg)	6 1/2 lbs. (3 kg)
FinishEnamel	Enamel

*Except in 1-mW attenuator position.

Ordering Information

Monophonic VU-Meter Panel, Type BI-5MI-12265
Stereo/Dual-Channel VU-Meter PanelMI-141921

Bridging Level Controls

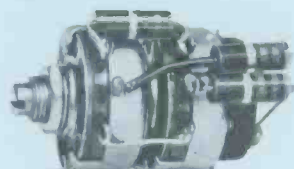
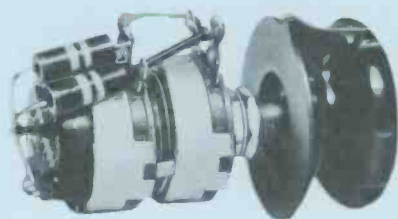

Dual-gauged composition potentiometers wired as volume controls for bridging 600- or 150-ohm balanced lines. The output matches a 600- or 150-ohm balanced line. MI-11278E includes a 1 $\frac{1}{4}$ -inch knob while MI-11278F has a short, slotted shaft for screwdriver adjustment. Bushing fits $\frac{3}{8}$ -inch (10 mm) hole in panels up to $\frac{1}{8}$ -inch thick. Nuts included.

Specifications

Input Impedance	20,000/10,000 ohms
Output Impedance	600/150 ohms
Insertion Loss	32/24 dB
Maximum Input Level	+40 dBm
Dimensions	1 $\frac{3}{8}$ " Dia.; 2 $\frac{3}{16}$ " or 3" Long (35, 55, 76 mm)
Weight	4.5 oz. (128 g)

Ordering Information

Volume Control, Panel Mounting	MI-11278E
Volume Control, Chassis Mount	MI-11278F

Lighted Studio Signs

Constructed of satin-finished, cast-aluminum, these lighted studio signs use an opaque, dark-brown glass insert with frosted, 2-inch letters. The light source is a 40-watt, 12-inch Lumaline (incandescent) lamp for operation on 117 V power. Operation on 230-volt, a-c power requires a stepdown transformer (see *Accessories*).

Accessories

Stepdown Transformer* (230/117 V, 50/60 Hz)	MI-141010-85
Signal-Light Relay (24 V coil)	MI-11702
Replacement Lamp	Stock No. 45946

Specifications

Lamp (Lumaline incandescent)	117 V, 40 W
Dimensions	14" L; 3 $\frac{1}{2}$ " H; 2 $\frac{3}{4}$ " D (355, 89, 69 mm)



Ordering Information

Lighted Studio Sign (Lamp included):	
Sign, less glass	MI-11717
With "On-Air" glass (MI-11718-1)	ES-11706-1
With "Rehearsal" glass (MI-11718-2)	ES-11706-2
With "Audition" glass (MI-11718-3)	ES-11706-3
With "Standby" glass (MI-11718-4)	ES-11706-4
With "Silence" glass (MI-11718-5)	ES-11706-5
With "Recording" glass (MI-11718-6)	ES-11706-6

*Power capacity sufficient for two lamps.



Studio Clocks

These are self-starting electric clocks for general use. Two models are available: one for operation on 117 V, 60-Hz power and another for operation on 234 V, 50-Hz power (not illustrated).

Ordering Information

Studio Clocks:	
117 V, 60-Hz Operation (13 $\frac{1}{2}$ " dia., 2 $\frac{3}{4}$ " deep) (346, 70 mm)	MI-11758
234 V, 50-Hz Operation (11 $\frac{5}{8}$ " dia., 2 $\frac{3}{4}$ " deep) (292, 70 mm)	MI-11788-3

Line Equalizer, Type BE-2

The Type BE-2 Line Equalizer reshapes the non-linear frequency-response characteristics of a non-loaded telephone pair. It is suitable for 15,000-Hz FM-broadcast circuits. The unit is recommended for use on lines that are permanently installed and used continuously such as studio-transmitter or remote-program lines.

The equalizer uses a parallel-resonant circuit. A rotary selector switch selects different resistance values in series with the inductance of the resonant circuit. The resonant frequency is just above 15 kHz so that the characteristics of the lower passband are used to equalize the line (see drawing).

Accessories

Rack-Mount Panel (3½" x 19") (89 x 483 mm) MI-4591
Line-Match Transformer MI-11713

Specifications

Source Impedance 150/600 ohms
Equalization Frequency Limit 15 kHz
Insertion Loss (at 1000 Hz) 7 dB min.
Dimensions 3" W; 2½" H; 3¾" D (73, 64, 86 mm)

Ordering Information

Line Equalizer, Type BE-2 MI-11752

Frequency characteristic of Type BE-2A Line Equalizer.

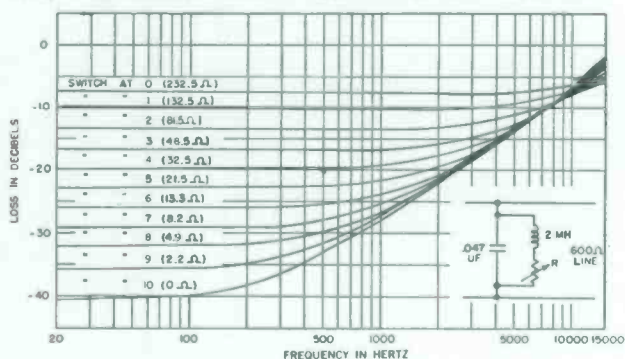

Sound-Effects Filter, Type BE-21



No-Loss Equalizer, Type BE-100R

An equalizer with separate low-, high- and peaking-frequency (presence) equalization without insertion loss. Equalization exceeds 18 dB boost or cut at 40 Hz; 15 dB boost or cut at 10 kHz and 16 dB boost at any frequency between 800 and 10,000 Hz.

Specifications

Input/Output Level +10 dBm max.
Input Impedance 50/150/600 ohms bal.
Output Impedance 600 ohms, unbal.*
Insertion Loss 0.75 dB max.
Power Requirements 117V†, 50-60 Hz, 2W
Dimensions 1¾" H; 19" W; 6¾" D (34, 483, 171 mm)
Weight (Approx.) 4 lbs. (1.8 kg)
Shipping Data (Approx.) 4" x 24" x 10" (101, 610, 254 mm); 5 lbs. (2.3 kg)

*Accessory plug-in transformer (MI-141001) converts output to balanced 600 ohms.
†Available for 234V operation on special order.

Ordering Information

Zero-Loss Equalizer, Type BE-100R ES-11466

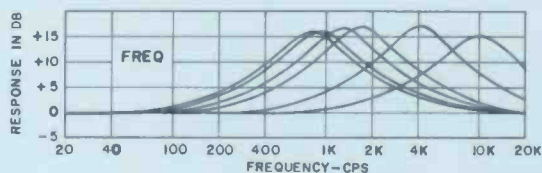
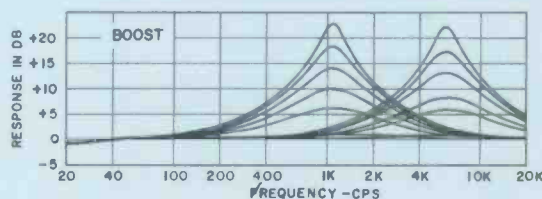
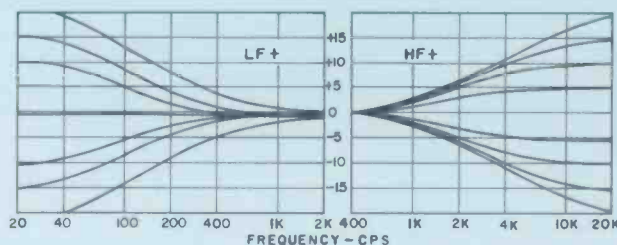

The BE-21 produces a variety of special or unusual sound effects through control of the audio bandwidth of the transmitter program. It is particularly useful in making programming sound "muffled" or "tinny" or for simulation of the sound of a telephone conversation, short-wave radio or a portable radio.

Specifications

Source Impedance (unbalanced) 600 ohms
Load Impedance 600 ohms
Input Level -60 to +18 dBm
Output Level +18 dBm max.
Insertion Loss (at center of passband) 1 dB max.
Dimensions 19" W; 5¼" H; 5" D (483, 134, 127 mm)
Weight 15 lbs. (6.8 kg)
Finish Light Umber Gray Enamel

Ordering Information

Variable Sound-Effects Filter, Type BE-21 MI-11723

RCA

Phono Equipment:
 Turntables, Tone Arms, Cartridges,
 Equalizers, Amplifiers, Cabinetry

- High performance—low maintenance
- Extra flexibility
- Easy stylus replacement
- "Flat-less" turntable drives



In the pages that follow, several of the RCA products intended for high-quality record reproduction are described.

Two-Speed Turntable, Type BQ-51
 Our finest turntable, the Type BQ-51 features a heavy platter and a deep-well pivot. Very low rumble, wow and flutter give it a quality of performance difficult to surpass at both 45 and 33 rpm speeds.

Three-Speed Turntable, Type BQ-50
 For applications where three speeds are useful, the Type BQ-50 Turntable combines enviable performance characteristics with a moderate purchase price.

Turntable Pickup System, Type BDR-1
 Our finest pickup system, the Type BDR-1 is an extremely light weight, low inertia device with the kind of ruggedness essential to reliable duty. Designed as a matched system—arm-cartridge-stylus.

Lightweight Tone Arms
 Available for either twelve-inch or sixteen-inch discs, these tone arms feature accurate stylus force adjustment, plug-in cartridges, quick-change stylus assemblies and a "stylus-saver" adjustment.

Moving-Magnet Stereo Pickup Cartridge
 Featuring superior performance and simplified stylus replacement, this cartridge fits any EIA-standard phono arm and simply plugs into the RCA Lightweight Arms described above.

Pickup Equalizer/Preamplifier, Types BA-26 and BA-36
 Offered in mono and stereo versions, the Type BA-26 (mono) and Type BA-36 (stereo) equalize and amplify the output of pickup cartridges to mixer level.

All-Metal Turntable Cabinet
 A rugged, all-steel unit designed specifically for broadcast turntable duty, this cabinet makes a turntable a self-contained unit with considerable storage space inside.

Dual-Speed Turntable Type BQ-51



- Precision, 2-speed rim-drive
- Individual idler wheels for each speed
- Provision for two tone arms
- Smooth and rapid starts

The RCA BQ-51 turntable is a high-quality mechanism for disc recordings at speeds of 33-1/3 and 45 rpm. The BQ-51 is available for mounting in custom-built arrangements or as a complete assembly with a styled cabinet.

Space is provided on the top panel of the BQ-51 for mounting one or two standard pickups that conform to EIA standards.

There are three RCA tone arms suitable for the BQ-51 Turntable: two 12-inch and one 16-inch. For highest quality reproduction the Type BDR-1 Arm is recommended.

The Type BQ-51 is a rim-drive mechanism, using a hysteresis-synchronous motor. It is available for 60 or 50 hertz operation. A two-position speed selector switch is provided on the turntable assembly. An "off-on" selector control operates a mercury switch and simultaneously engages the appropriate rubber idler wheel. This feature eliminates the idler "flat" when set to the "off" position.

Specifications

Turntable Speed	33 $\frac{1}{3}$ and 45 rpm \pm 0.3%
Rumble	40 dB below 1.4 cm/s at 100 Hz
Wow or Flutter	0.1% of mean speed
Motor	1/100 h.p., at 60 Hz; 1/125 h.p., at 50 Hz
Power	105-125 V, 50/60 Hz, 40 W
Power Cord	8 ft. long (2.44 m)
Overall Dimensions	22" W, 18 $\frac{1}{4}$ " D, (559 x 459 mm)
	depth below top surface 9" (228 mm)
	height above surface 1 $\frac{1}{2}$ " (38 mm)
Weight	31 lbs. (14.06 kg)

Accessories

Studio Furniture (Walnut Finish)	
Turntable Console, for one turntable	MI-141026-1*
Turntable Console, for two turntables	MI-141026-2*
Turntable Console, for three turntables	MI-141026-3*
Stepdown Transformer 230/115-volt, 85 W	MI-141010-85

Ordering Information

Dual-Speed Turntable, Type BQ-51	
for 60 hertz power	MI-11810-D
Dual-Speed Turntable, Type BQ-51	
for 50 hertz power	MI-11810-E

* See page B.1504 for complete information.

Three-Speed Turntable Type BQ-50



- Low flutter performance
- Simple, rugged construction
- Heavy-duty synchronous motor
- Fast acceleration

The BQ-50 Three-Speed Turntable meets precision requirements for fine music reproduction. The 16-pound unit mounts in custom-built arrangements or in turntable consoles or cabinets.

The BQ-50 is powered by a heavy duty, synchronous motor. The rim drive system is a neoprene idler wheel transmitting power directly from the stepped capstan on the motor shaft. Acceleration is extremely fast with average results of one-sixteenth revolution at 33; one-tenth revolution at 45; and one-half revolution at 78 rpm.

Oilite bronze bearings assure long, maintenance free service. The solid, cast-aluminum platter has a black felt cover and the base has a midnight blue finish. Platter offset on the base permits compact turntable arrangement and free movement of the tone arm when installed side-by-side. Shock mounts isolate motor vibration for quiet performance. The turntable has a motor on off switch, light and speed-control lever. When the lever is in neutral the platter spins freely.

Specifications

Turntable Speed	33 $\frac{1}{3}$, 45 and 78 rpm
Acceleration Time	$\frac{1}{6}$ rev at 33; 1/10 at 45; $\frac{1}{2}$ at 78 rpm
Rumble	36 dB below 1.4 cms at 100 Hz
Wow or Flutter	0.3 % max.
Motor	1/70 h.p., at 60 Hz, 1/70 h.p. at 50 Hz
Power Supply	105-125 V, 50/60 Hz, 40 W
Chassis Dimensions	15 $\frac{1}{2}$ " x 15 $\frac{1}{2}$ " (394 mm)
Depth Below Surface	6 $\frac{1}{2}$ " (165 mm)
Weight:	
Platter only	5 $\frac{1}{2}$ lbs. (2.5 kg)
Entire Unit	16 lbs. (7.25 kg)

Accessories

Stepdown Transformer 230/115-volt	MI-141010-85
Turntable Console*	MI-141026-1/2/3
Adapter Plate	MI-141005

Ordering Information

Three-Speed Turntable,	
Type BQ-50 (60 Hz, 115 volts)	MI-141004
Three-Speed Turntable,	
Type BQ-50-A (50 Hz, 115 volts)	MI-141004-A

Turntable Pickup System Type BDR-1



- Integrated system
- Excellent tracking
- Selection of low mass, high compliance styli
- Set down limit adjustment

The Type BDR-1 is a twelve-inch pickup system with a nominal 15-degree cartridge and stylus intended for use with turntables such as Types BQ-51 and BQ-50.

The BDR-1 incorporates an extremely light weight, low inertia arm. This is an "integrated" design in which the arm, pickup cartridge and stylus are designed as a system.

The pickup uses a very low mass, moving-magnet cartridge with high compliance and interchangeable stylus assemblies.

The cartridge accommodates several stylus assemblies. Elliptical styli provide low distortion, wide range reproduction of stereo discs at 1.5- and 2.5-gram tracking forces.

Provision is made for the insertion of an electrical signal used for testing the system, including the cartridge, wiring, equalizer, and associated equipment. This feature eliminates test records except where the stylus assembly must be checked.

Quick-change stylus assemblies, identified by color codes, insert or remove without the use of tools. The stylus assemblies are weighted to provide the proper tracking force for each type used.

Specifications

Tracking Force of Pickup System1.5, 2.0 or 2.5 grams
Tracking Error1° max.
Weight13 oz. (368 g)
Tracking Ability at 1½ g:	
400 to 10,000 Hz22 cm/sec or greater
1,000 to 5,000 Hz30 cm/sec or greater
Frequency Response20 to 20,000 Hz
Output Level3.5 mV per channel at 1,000 Hz (5 cm/sec peak)
Channel Balance at 1 kHzWithin 1½ dB
Channel Separation25 dB min. at 1,000 Hz; 17 dB min. from 500 to 10,000 Hz
Load Impedance60 kohms optimum; 47 kohms min.

Accessories

Spare Cartridge (less stylus)MI-11472
Diamond Stylus Assemblies:	
0.2 x 0.7 mil, Bi-Radial, 1.5 gram trackingMI-11474-2
0.4 x 0.7 mil, Bi-Radial, 2.5 gram trackingMI-11474-4
0.7 mil, Spherical, 1.5 gram trackingMI-11474-7
0.1 mil, Spherical, 2 gram trackingMI-11474-10
2.5 mil, Spherical, 2.5 gram trackingMI-11474-25

Ordering Information

12-Inch Integrated Pickup Arm and Cartridge:	
With anti-skate featureMI-11473
Without anti-skate featureMI-11473-A

Lightweight Tone Arms



- Lightweight—low distortion
- Accurate stylus force adjustment
- Track properly at all times
- Plug-in pickup cartridge

The RCA Lightweight 12 and 16-inch Tone Arms, and the Universal Cartridge and Stylus fill the need for a high quality pickup combination for playing stereo and mono fine-groove records as well as transcriptions and 78 rpm records. The tone arms are designed to operate with Type BQ-50 and BQ-51 Turntables.

The advanced tone arm design incorporates a three-terminal pickup socket, with free-floating collets, to accept the plug-in "Universal" cartridge. Facilities for accepting pickups which mount on standard ½-inch mounting centers are also included.

Both models of the tone arm include the "Stylus Saver" adjustment. This limits the vertical travel of the arm so that the cartridge stylus engages only the record groove and not the turntable, to prevent accidental damage to the stylus, should the arm drop off the edge of the record.

Tone arm resonance is well outside the operating frequency range of the system. Distortion due to tracking error in the arm and pickup is reduced to a minimum. The anti-friction vertical and lateral pivots and low mass let the tone arms track properly on warped and eccentric records.

The arm is hinged at the pivot center for easy access to the pickup and wiring on the underside. An adjustable counterweight, controlled by a thumb wheel at the rear of the arm, provides accurate stylus-force adjustment.

Specifications

Tracking Error, 16-inch Record4° max.
Pivot BearingsAnti-resonant in both planes
Tone Arm Head ReceptacleQuick-lock, plug-in type
Construction of ArmAluminum casting
Length of Arm:	
16-inch arm16¾" (425 mm)
12-inch arm12" (305 mm)
Height of ArmAdjustable
Weight:	
16-inch arm2 lbs. (906 g)
12-inch arm1½ lbs. (679 g)
Mounting:	
16-inchApprox. 12" (305 mm) from spindle center
12-inchApprox. 8" (203 mm) from spindle center

Ordering Information

12-Inch Tone Arm complete with arm rest and mounting hardwareMI-11894 *
16-Inch Tone Arm complete with arm rest and mounting hardwareMI-11895 *

*Less cartridge and styli. See next page

Universal Pickup Cartridge



The Universal Pickup Cartridge and Replaceable Stylus provide a fully compatible unit for reproducing stereophonic and monophonic phonograph records. The cartridge utilizes a moving-magnet system for superior performance and simplified stylus replacement. It is completely housed in a molded plastic case. The stylus replaces without use of tools.

Specifications

Inductance	400 mH
DC Resistance	280 ohms
Output Voltage at 1000 Hz, 5 cm/sec5 mV
Channel Separation	20 dB min. @ 1000 Hz
Recommended Load Impedance	47,000 ohms
Dimensions (overall)	1 $\frac{3}{8}$ " L x $\frac{3}{4}$ " W x $\frac{1}{4}$ " H 33 x 19 x 17 mm
Weight	10.5 grams
Mounting	Plug-in (standard EIA mounting centers)
Recommended Stylus Force	4 to 8 grams

Ordering Information

Pickup Cartridge (less stylus)	MI-11865
Stereo Stylus Assembly 0.7 mil (black)	MI-11866-7
Mono Stylus Assembly 1.0 mil (red)	MI-11866-10
ET & 78 RPM Stylus Assembly 2.5 mil (green)	MI-11866-25

Pickup Equalizer-Preamplifier Type BA-26/36

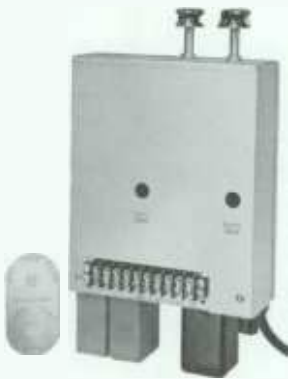

- Internal power supply
- Low distortion—high output level
- Level adjustment control
- NAB/RIAA equalization

The Type BA-26 Monophonic and Type BA-36 Stereo Pickup Equalizer-Preamplifiers provide correct equalization and amplification for records and transcriptions. They are recommended for use with Type BDR-1 Pickup Arm and the "Universal" Pickup.

Feedback Equalized Design

Both the BA-26 and BA-36 use a four-stage amplifier with selective feedback to achieve NAB and RIAA equalization.

Simplified Controls

Two control knobs and a dial plate are supplied with each unit. One control is a three-position filter switch which provides "normal equalization," "high-frequency de-emphasis" and "high-frequency cut-off." The second selects either of two tone arms or from stereo to mono.

Specifications

Power Requirements	115/230 V, 50/60 Hz, 1 W
Frequency Response	NAB or 20-20,000 Hz, ± 0.5 dB
Hum and Noise Level	30 to 15,000 Hz, -78 dBm max. (5 microvolts equivalent 1000 Hz signal at input)
Input Impedance:	
BA-26	24,000 ohms, 100 pf. (Up to 60,000 ohms)
BA-36	47,000 ohms, 100 pf. (Up to 60,000 ohms)

Load Impedance	150/600 ohms
Input Voltage (-20 dBm Output Level)	16 mV to 13 mV
Output Level	-5 dBm max.
Distortion (At -20 dBm Output Level)	
Intermodulation (40/4000 or 400/4000 Hz 4:1)	1% max.
Harmonic (30 to 15,000 Hz)	0.25% max.
Distortion (At -5 dBm Output Level)	
Intermodulation	4% max.
Harmonic	1% max.
High Frequency Compensation	0, -35, or -10 dB at 10 kHz
Crosstalk (30 to 15,000 Hz)	Below noise level
Dimensions (overall)	10 $\frac{3}{4}$ " L x 6 $\frac{5}{8}$ " W x 2 $\frac{1}{2}$ " D (273 x 168 x 64 mm)

Weight:

BA-26: 4 lbs. 10 ozs. (2.1 kg.); BA-36: 5 lbs. 4 ozs. (2.4 kg.)

Ordering Information

Mono Pickup Equalizer-Preamplifier, Type BA-26	MI-11436
Stereo Pickup Equalizer-Preamplifier, Type BA-36	MI-11441

Turntable Cabinet

Built for the Type BQ-50 and BQ-51 Turntables, the Turntable Cabinet makes the turntable and associated preamplifiers a self-contained unit. Its rugged design provides a stable platform for the turntable and tone arm while the inside volume behind the hinged door houses the equalizer-preamplifier chassis and approximately five cubic feet (0.14 m³) of storage. (See photo on page B.1600)

Included are four leveling screws as cabinet feet to simplify the task of turntable leveling. The cabinet is all-steel construction finished in blue enamel. For a complete line of Walnut Studio Furniture, see *catalog sheet B.1504*.

Accessories

Adapter Plate (for Type BQ-50 Turntable)	MI-141005
--	-----------

Ordering Information

Turntable Cabinet	MI-11809
-------------------------	----------

Specifications

Dimensions	23 $\frac{3}{8}$ " W x 19 $\frac{3}{8}$ " D x 29" H (586 x 460 x 736 mm)
Weight	47 lbs. (21 kg)
Finish	Blue enamel

RCA

Program Logger, Type RT-19

- Unattended logging and monitoring
- Solid-state components for high reliability
- Reel capacity—up to 307 hours with no reel turnover

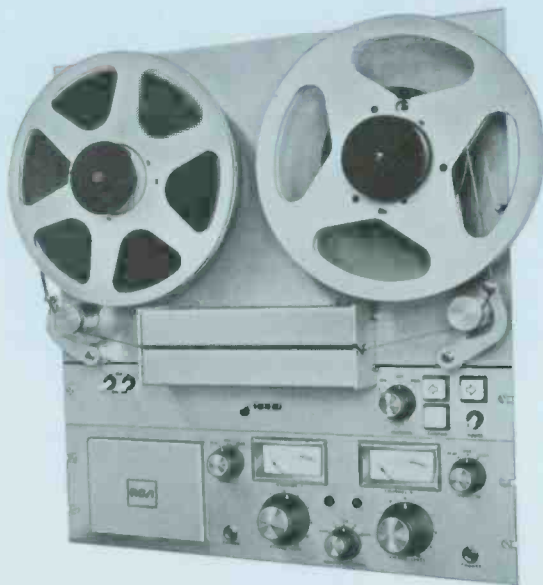

The Type RT-19 Program Logger tape recorder is designed for continuous long-duration recording. It records and plays in both directions to equal performance specifications. The logger is especially useful in broadcasting where it can serve as a complete and accurate program log and monitor to assure compliance with FCC regulations.

Four-Track System

The RT-19 makes four tracks available on quarter-inch tape, which may be used in a variety of ways. One channel of program material may be recorded on each of the four tracks in sequence, or four channels may be recorded simultaneously.

Since the basic mechanism is 4-track, a broadcast station with AM, FM and TV facilities can record the AM station on Track 1, FM on Track 2, TV on Track 3 and the 4th track can be used to record external time signals.

Good Quality Monitoring

The modular solid-state electronics provides clear recording, high reliability and long, unattended operation. Even at the slowest speed of 5/16 ips, recorded voices are clear and sharp. The signal-to-noise ratio is better than 43 dB, flutter is low, and response is within 3 dB from 200 to 2700 Hz.

Designed to Demands of Unattended Operation

The RT-19 is simple to operate. Accessibility is rapid; no point on the tape is more than 1½ to 3 minutes away. All electronic adjustments and operation are readily accessible from the front. It has such features as straight-line threading, automatic tape lifters, interlocked controls (which make it impossible to break or spill tape by improper control sequences), and editing and cueing versatility.

The modular, solid-state electronics provide quick plug-in replacement of any components requiring service. Extremely

high reliability in the transport is inherent in the basic design. The heavy-duty components and careful construction more than meet the continuous recording functions demanded of the equipment.

Low Cost Operation

The RT-19 uses standard 10½-inch NAB reels and hubs, or EIA 7-inch plas-

tic reels. Low cost tape of 1 mil plastic base will provide nearly 154 hours of continuous recording and reproducing at a low tape cost. If extremely long unattended hours of recording are desired, 7200 feet of ½ mil tape on an NAB hub will provide over 300 hours of continuous logging (twelve 24-hour days, or seventeen 18-hour days).

Rack or Console, Vertical or Horizontal Mounting

The RT-19 Logger Tape Recorder is designed for rack or console mounting or can easily be incorporated into custom installations demanding either horizontal or vertical mounting. Several models are available to provide the utmost flexibility.

Specifications

Head and Track Configurations4 track, 1 channel, 2 channel, 4 channel and multiples thereof. Erase facility included on special order.

Overall Frequency Response15/16 ips: 200 Hz -8 kHz, ±3 dB; 15/32 ips: 200 Hz -4 kHz, ±3 dB; 5/16 ips: 200 Hz -2.7 kHz, ±3 dB. Adjustable level and equalization for each head, as well as bias and calibration adjustments

Signal-to-Noise Ratio43 dB min.

Total Unattended Time204 hours 48 min. at 15/32 ips w/triple-play tape; 307 hours 12 min. at 5/16 ips w/triple-play tape

Inputs ("XL" connectors)One per channel, -15 dBm sensitivity, 100k bridging. Provision for various plug-in units, such as 200-ohm adjustable 30-60 dB mic. preamplifier, balanced line bridging or matching transformers, etc.

Outputs ("XL" connectors)0, +4 or +8 dBm into 600 ohm balanced or unbalanced (per strapping). +25 dBm undistorted capability. Monitoring jacks included

Distortion (+8 dBm output)0.25% THD max.

Power Requirements (approx.)117 V, 50-60 Hz, 100 W

Tape Counter4 digit pushbutton reset on supply reel; returns to zero on reverse tape travel.

Size and Weight:

Transport19" x 15¾", 47 lbs. (482 x 400 mm, 21 kg)

Electronics19" x 5¼", 9 lbs. (428 x 133 mm, 4 kg)

Reel Size10½" NAB, or 7" EIA reels. Independent torque switches allow intermixed sizes

Tape Size and Tape Guides¼" (6 mm) wide, ½ mil to 1½ mil thickness, acetate or polyester base. Close tolerance guides provide accurate quarter-track guidance.

Tape Speeds and Playback Timing AccuracySpeed 15/16 ips, 15/32 ips, 5/16 ips. Accuracy within 1%

Wow and Flutter (rms)1% max.

Fastwind Time3600 feet (1097 m), approx. 100 seconds

Start Time1/10 sec. max.

Remote ControlDesigned for complete adaptability to any automation system

Capstan ControlSolenoid actuated (externally controllable)

BrakesFail-safe solenoid actuated Permaband design, for smoothness and predictable action. Solid-state control eliminates relays, tape feelers, etc.

ReversingLow current conductive tape contacts reliably trigger reversing circuit for completely automatic action and maximum unattended playing (or recording) time

MotorsThree, long-life, ball-bearing suspended

Ordering Information

RT-19 Logger Tape Recorder*,
1-channel, 4-track, automatic triple reverse, 5/16 ips, 60-Hz, 115 volt power MI-141904-1

RT-19 Logger Tape Recorder*,
1-channel, 4-track, automatic triple reverse, 15/32 ips, 60-Hz, 115 volt power MI-141904-2

RT-19 Logger Tape Recorder*,
1-channel, 4-track, automatic triple reverse, 15/16 ips, 60-Hz, 115 volt power MI-141904-3

RT-19 Logger Tape Recorder*,
2-channel, 4-track, automatic reverse, 5/16 ips, 60-Hz, 115 volt power MI-141905-1

RT-19 Logger Tape Recorder*,
2-channel, 4-track, automatic reverse, 15/32 ips, 60-Hz, 115 volt power MI-141905-2

RT-19 Logging Tape Recorder*,
2-channel, 4-track, automatic reverse, 15/16 ips, 60-Hz, 115 volt power MI-141905-3

RT-19 Logging Tape Recorder*,
4-channel, 4-track, one direction, 5/16 ips, 60-Hz, 115 volt power MI-141906-1

RT-19 Logger Tape Recorder*,
4-channel, 4-track, one direction, 15/32 ips, 60-Hz, 115 volt power MI-141906-2

RT-19 Logger Tape Recorder*,
4-channel, 4-track, one direction, 15/16 ips, 60-Hz, 115 volt power MI-141906-3

*For 220-volt operation use stepdown transformer (MI-141010-175). Specify 50-Hz recorder, if required.



Reel-to-Reel Tape Recorder, Type RT-21

- Monaural or stereo
- Tape speeds:
7½ and 15 or 3¾ and 7½ ips
- Rack, console or portable
mounting



The RCA Type RT-21 Tape Recorder is designed to meet rigid specifications and requirements set forth by broadcast and studio engineers for mono or stereo tape operations.

Solid-state circuitry assures low power consumption, cool operation and small size. An etched capstan shaft is used to achieve maximum tape contact and minimize tape slippage.

The basic recorder is supplied in two sections: a tape transport and a control panel which includes one amplifier in the mono model, two in the stereo. The equipment is normally supplied for rack mounting. Console cabinet and portable carrying case are optional.

Exclusive Stereo-Phase Head Adjustment

Of particular interest to FM-stereo broadcasters, a Stereo-Phase Head Mounting Assembly allows three-axis alignment (azimuth, zenith, height) to minimize the out-of-phase components that cancel high frequencies when stereo tracks are mixed to mono.

Amplifier Controls

The record/playback amplifier modules are identical and interchangeable. Front panel facilities consist of a *record level* control, *playback level* control, *headset* jack, *bias* adjustment and meter-function selector to monitor playback, record, bias and erase signals. A light on each amplifier indicates the record mode.

Continuously Variable Cue Speed; Interlocked RECORD Operation

Operating controls consist of the following: variable *cue speed* and related *cue delegate* button, *record*, *record delegate*, *start*, *stop*, *fast forward* and *fast reverse*. The panel features an interlocked record arrangement in which the *record* button and then the *start* button must be depressed to begin record operation.

Tape Transport

The tape transport panel accommodates either 10½-inch or 7-inch reels. NAB 10½-inch reels and NAB hubs are

available as accessories. Proper tape tension for 10½ or 7-inch reels is provided by means of a toggle switch. Tape equalization is automatically selected by a speed change switch. 7½/15 ips and 3¾/7½ ips models are available. Each RT-21 is supplied with a plug-in record equalizer according to the tape speed and track width.

Velocity Brake System

The "velocity sensing brake system"

provides velvet smooth braking action by use of large surface area brake hubs. A safety feature stops the transport mechanism in the event of tape breakage.

Solenoid-Operated Tape Lifters

These lift the tape away from all magnetic heads whenever the machine is in the fast forward or fast reverse mode. When the cue mode is selected, tape is lifted from all heads except playback. This permits the operator to listen to the

audio as he "jockeys" the tape for final cueing.

Full or Dual Half-Track

Four magnetic head positions are available. Three heads normally supplied provide full or dual half-track recording, erase and playback (depending on model, see *Ordering Information*). An optional fourth head may be used for playing pre-recorded stereo tapes, of the consumer variety, with interlaced tracks.

Specifications

Tape Speed	7½ and 15 ips, 3¾ and 7½ ips
Track Width	Full- or dual half-track (80 mil tracks)
Frequency Response (Overall):	
15 ips	50-15,000 Hz ±2 dB (within 6 db at 30 Hz)
7½ ips	50-15,000 Hz ±2 dB (within 4 db at 30 Hz)
3¾ ips	40-7,5000 Hz ±2 dB (within 4 dB at 30 Hz)
Signal-to-Noise Ratio	60 dB full track 55 dB half track
Flutter and Wow (Over a band of 0.5 to 250 Hz):	
15 ips	0.1% rms, max.
7½ ips	0.15% rms, max.
3¾ ips	0.2% rms, max.
Starting Time	0.1 second, max.
Stopping Time	2" of tape at 15 ips
Playback Timing Accuracy	±3 seconds in 30 minutes
Rewind Time (Approx.)	90 seconds for 2400 ft. on 10½" reel
Tape	¼" wide
Reels	7" and 10½ EIA, NAB hubs optional
Amplifiers	Independent Record and Playback
Record Input:	
Matching	150 or 600 ohms, balanced
Bridging	20,000 ohms
Record Input Level:	
Matching	-70 to -20 dBm
Bridging	-30 to +20 dBm
Playback Output	+18 dBm, max. into 600 ohms, balanced
Distortion	1% max.
Metering	Record/playback level, bias/erase current
Monitoring	VU meter and headphone; input source or tape output
Record Selector	Track A, Track A & B, Track B

Record Equalization	NAB Standard, CCIR available
Bias frequency	80 kHz
Tape Lifters	Tape lifted from all heads, automatically during fast forward and fast reverse. Tape is lifted from the erase and record heads when in cue mode.
Remote Control	All control functions (except variable cue speed) may be remotely controlled. Optional remote panel includes tape lifter control.
Power Requirements	115/230 volts, 50/60 Hz, 115 W mono, 135 W stereo
Dimensions (Overall):	
Transport	19" W, 15¾" H, 9" D (483, 400, 229 mm)
Control Panel	19" W, 5¼" H, 9"D (483, 134, 229 mm)
Finish	Anodized aluminum overlay
Weight (Approx.)	75 lbs. (34 kg) mono; 83 lbs. (38 kg) stereo

Accessories

NAB Reel Hubs Consisting of:	
a. 2—MI-41604 NAB Reel Hubs	
b. 1—MI-11932-2 10½" Empty NAB Reel	ES-41919
Bulk Tape Eraser	MI-11992
Fourth Head Kit (Dual ¼ Track Playback)	MI-41602
220 V Transformer	MI-41605
Remote Control Panel	MI-141301
Record/Playback Amplifier Module	MI-141351
Portable Carrying Case	MI-141302
Console Cabinet	MI-141303
Remote Control Panel Housing	MI-141308
Stereo Head Mounting Kit	MI-141325

Ordering Information

Reel-To-Reel Tape Recorders, Type RT-21	115 V. 60 hertz	115 V. 50 hertz	220 V. 50 hertz
Mono, Full Track, 3¾ & 7½ ips, Less NAB Hubs	MI-41920	MI-41909	MI-41909 (220)
Mono, Dual Half Track, 3¾ & 7½ ips, Less NAB Hubs	MI-41921	MI-41911	MI-41911 (220)
Stereo, Dual Half Track, 3¾ & 7½ ips, Less NAB Hubs	MI-41921S	MI-41911S	MI-41911S (220)
Mono, Full Track, 7½ & 15 ips, Less NAB Hubs	MI-41930	MI-41910	MI-41910 (220)
Mono, Dual Half Track, 7½ & 15 ips, Less NAB Hubs	MI-41931	MI-41912	MI-41912 (220)
Stereo, Dual Half Track, 7½ & 15 ips, Less NAB Hubs	MI-41931S	MI-41912S	MI-41912S (220)

Automatic Reel-to-Reel Tape Machines, Type RT-22

- Stereo or mono models
- Automatic record/playback
- Four-head transport
- Two trip cue frequencies

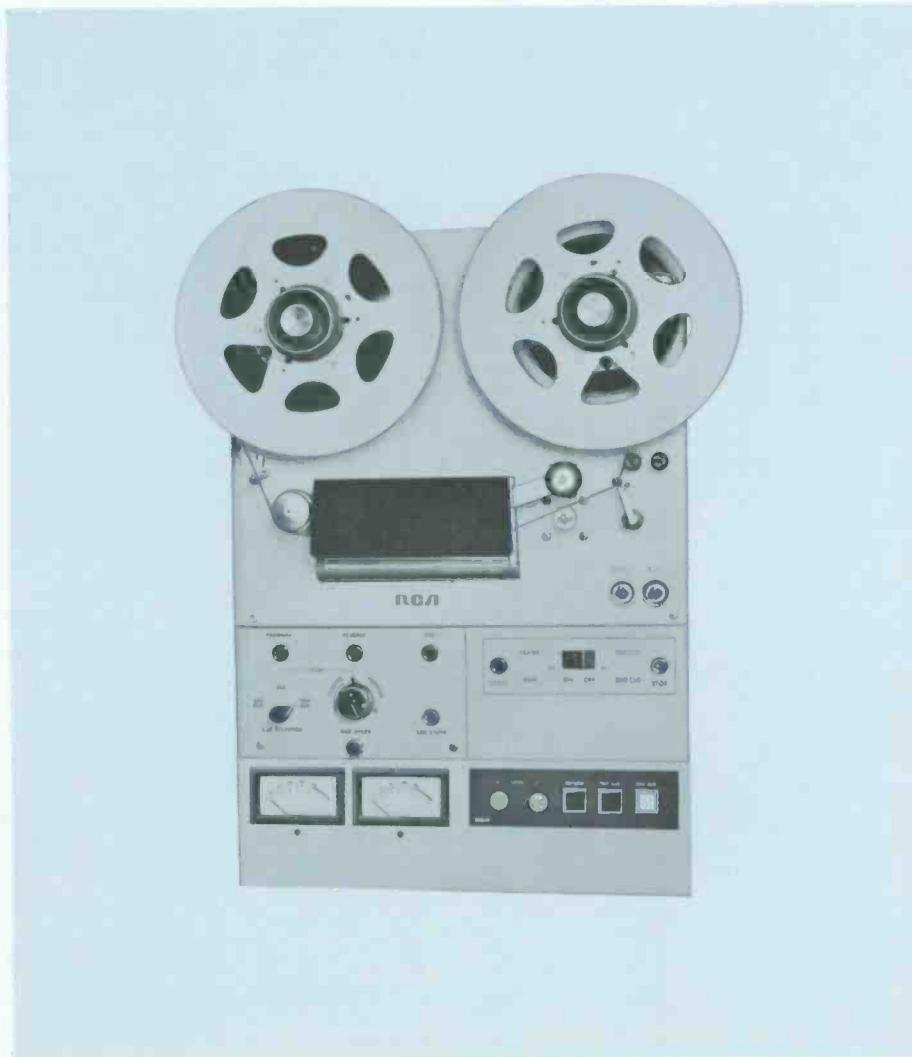

The RT-22 Automatic Tape Machine is a reel-to-reel tape handling mechanism with the electronics and cueing facilities normally found only in cartridge tape equipment.

The RT-22 is available as a playback only or complete record/playback system, in stereo or monaural models. The record/playback systems are supplied with a standard stereo or mono Record Amplifier. All units are designed for rack mounting and feature solid-state, plug-in modules.

Quality Tape Transport

The tape transport is basically the same high quality mechanism used in the RT-21 series of tape recorders. It features a heavy duty hysteresis synchronous capstan motor, integrated reel motor and brake hub, solenoid operated tape lifters, smooth action brake system, four head positions and the capability of accepting reel sizes up to 10½ inches. The RT-22 is equipped with separate erase, record, and playback heads plus a cue-track erase head.

The amplifier and control panel for the tape recorder houses the playback amplifier; power supply; cue, end cue and trip cue amplifiers; as well as the control relays and circuits. Front panel controls include *start*, *stop*, *fast forward*, *fast reverse*, *cue speed*, *cue* (mode selection), *cue selection* (tone) and *cue* (tone) *erase*. Remote control panels are available as optional accessories.

Cue Tone Automatically Recorded

At the start of the recording operation a 1000-Hz *stop* cue tone is automatically recorded on the tape. During playback, the *stop* cue is used to stop the transport mechanism, leaving the recorded program material in a cued condition.

Cue Frequencies

A 150-Hz, end-of-message tone can be automatically recorded at the termination of the recording operation. On playback, this tone activates a relay which may be used to start the next device in an automation system. The automatic record feature of the end-of-message tone may be disabled and the tone recorded manually wherever desired.

An 8000-Hz trip-cue tone is also provided and may be manually recorded anywhere on the tape. The trip-cue tone may also be used to activate external devices during playback of the recorded program information.

Cue Tone Search and Erase

Facility is included for cue tone search and erasure. The "Cue Selector" switch, located on the front panel, selects one of the three cue tones as the transport stop tone. The selector switch is normally set to the "cue" position so that the 1000-Hz tone stops the tape transport. However, when it is desired to search out the "end of message" tone on "Trip" tone, the "Cue Selector" switch allows the operator to positively locate the tones and erase them, if necessary, by depress-

ing the "Cue Erase" button. These tones may be re-recorded on the tape at any time by activating the appropriate control on the record amplifier. The 1000-Hz stop cue may also be erased in the same manner. Separate tally lamps indicate the presence of either the "End Cue" or "Trip Cue" tones and serve as an additional aid to the operator in locating them on the tape.

Audio Switching Relay

An audio switching relay is provided

in the output circuit of each playback channel and is activated only during play operation of the recorder. Stopping the unit removes the playback channel connections to the output. A number of RT-22 units may have their switching relays connected in crossbar fashion to provide audio switching to a single program line. The program information to the line is derived only from the final unit to be placed in operation.

Specifications

Tape Type.....	1/4" wide magnetic
Reels	10 1/2" dia. (NAB): 10 1/2", 7", 5", 4" EIA
Tape Speed	7.5 and 3.75 ips
Starting Time.....	0.1 sec. full speed
Stopping Time.....	2" of tape at 15 ips
Playback Timing.....	Accuracy ±3.0 sec. in 30 min.
Rewind Time.....	Approx. 90 sec. for 2400 ft. NAB reel
Frequency Response	7.5 ips ±2 dB 50-15,000 Hz 3.75 ips ±2 dB 40-7,500 Hz
Signal-to-Noise Ratio	50 dB @ 7.5 ips, 45 dB @ 3.75 ips
Distortion.....	Less than 2% at normal recording level
Cross Talk Between Channels	-55 dB @ 1 kHz
Flutter & Wow	0.15% rms @ 7.5 ips 0.25% rms @ 3.75 ips
Cueing Accuracy.....	Within 0.1 sec.
Cue Speed.....	Continuously variable either direction
Remote Control.....	Optional, all functions, except variable Cue Speed, Cue Selector.
Recording Input Level*	Microphone -70 dBm min., Matching -20 dBm max., Bridging +18 dBm max.
Input Impedance*	Unloaded input transformer for 37/150/250 Ohm microphones, or 20,000 bridging input
Cue Signal	1-kHz automatically recorded at start of recording

Auxiliary Cue Signals:

End of Message	150-Hz cue tone automatic of manually selected
Trip Cue	8-kHz manually selected
Cue Signal Search and Erase	Any one of the three cue frequencies may be located and erased
Meter*	3" illuminated, rectangular VU
Indicator Lights.....	On, Ready, Run, Trip Cue, and End Cue
Heads	Three-track stereo, two-track monaural, separate Record and Playback Heads permit simultane- ous monitoring and recording
Power Requirements	115 volts AC, 60 Hz (220-volt, 50-Hz operation available)
Power Consumption	Record, 125 watts; Playback, 120 watts; Standby, 47 watts; Fast Forward, 130 watts; Fast Reverse, 130 watts
Finish	Aluminum Epoxy Enamel
Dimensions:	
Transport.....	19" wide, 15 3/4" high, 9" deep (483 mm, 400 mm, 229 mm)
Control Panel.....	19" wide, 5 1/4" high, 16 1/4" deep (483 mm, 133 mm, 413 mm)
Record Amplifier	19" wide, 5 1/4" high, 11 1/8" deep (483 mm, 133 mm, 295 mm)
Weight	Approx. 100 lbs. (45.36 kg.)

* Applies to complete record/playback system.

Accessories

NAB Reel Hubs	ES-41919
Consisting of:	
Two MI-41604 NAB Reel Hubs	
One MI-11932-2 10 1/2" Empty NAB Reel	

Ordering Information

Automatic Reel-to-Reel Tape Machines, Type RT-22:

Playback-Only Machines:

Mono (less NAB Reel Hubs)	ES-41924
(One MI-141124 Transport; one MI-141324 Amp & Control Panel)	
Stereo (less NAB Reel Hubs)	ES-41926

Record/Playback Machines:

Mono (less NAB Reel Hubs)	ES-41925
(As ES-41924 above plus one MI-141966 Record Amp and three MI-141800-1 Plug-In Relays)	
Stereo (less NAB Reel Hubs)	ES-41927
(As ES-41926 above plus one MI-141963 Record Amp and three MI-141800-1 Plug-In Relays)	

Note: Head configurations are identical to those of cartridge machines: mono heads are two-track; stereo, three-track.



Reel-to-Reel Tape Reproducer, Type RT-20

- Mono or stereo
- Tape Speeds: 3¾ and 7½ ips
- Rack, console or portable mounting



catalog B.1710

The RCA Type RT-20 Tape Reproducer is designed to meet the specifications and requirements set forth by broadcast and studio engineers for mono or stereo tape reproduction.

Solid-state circuitry assures low power consumption, cool operation and small size. An etched capstan shaft is used to achieve maximum tape contact and minimize tape slippage.

The reproducer is supplied in two sections; a tape transport and a control panel which includes one playback amplifier in the mono model, two in the stereo. The equipment is normally supplied for rack mounting. Console cabinet and portable carrying case are optional.

Exclusive Stereo-Phase Head Adjustment

Of particular interest to FM-stereo broadcasters, a Stereo-Phase Head Mounting Assembly allows three-axis alignment (azimuth, zenith, height) to minimize the out-of-phase components that cancel high frequencies when stereo tracks are mixed to mono.

Pushbutton Operation

Operating controls consist of start, stop, fast forward and rewind.

Tape Transport

The tape transport panel accommodates either 10½-inch or 7-inch reels. NAB 10½-inch reels and NAB hubs are available as options. Proper tape tension for 10½ or 7-inch reels is provided by a toggle switch. Tape equalization is automatically selected by a speed change switch.

Velocity Brake System

The "velocity sensing brake system" provides velvet smooth braking action by use of large surface area brake hubs. A safety feature stops the transport mechanism in the event of tape breakage.

Solenoid-Operated Tape Lifters

These lift the tape away from all magnetic heads whenever the machine is in the fast forward or rewind mode.

Specifications

Tape Speed3¼ and 7½ ips
Track WidthDual half-track (80 mil tracks)
Frequency Response (Overall):
7½ ips50-15,000 Hz ±2 dB (within 4 dB at 30 Hz)
3¼ ips40-7,500 Hz ±2 dB (within 5 dB at 30 Hz)
Signal-to-Noise Ratio55 dB
Flutter and Wow (Over a band of 0.5 to 250 Hz)
7½ ips0.15% rms, max.
3¼ ips0.2% rms, max.
Starting Time0.1 second, max.
Stopping Time2" (51 mm) of tape at 7½ ips
Playback Timing Accuracy±3 s in 30 minutes
Rewind Time (Approx.)90 s (2400 ft. on 10½" reel)
Tape¾" (8 mm) wide
Reels7" EIA, and 10½" NAB hubs optional
Playback Output, (into 600 ohms balanced)+18 dBm max.
Distortion1% max.
MonitoringHeadphone jacks
EqualizationNAB Standard, CCIR available
Tape LiftersTape lifted from all heads, automatically during fast forward and fast reverse
Remote ControlAll control functions may be remotely controlled. Optional remote panel includes tape lifter control

Power Requirements115 V, 60 Hz*
Dimensions (Overall):
Transport19" W, 15¾" H, 9" D (483, 400, 229 mm)
Control Panel19" W, 1¾" H, 9" D (483, 44, 229 mm)
FinishAnodized aluminum overlay
Weight (Approx.)mono, 50 lbs. (23 kg);
stereo, 55 lbs. (25 kg)

Accessories

NAB Reel Hubs Consisting of:
a. 2-MI-41604 NAB Reel Hubs
b. 1-MI-11932-2 10½" Empty NAB ReelES-41919
Bulk Tape EraserMI-11992
220 V Transformer KitMI-41605
Remote Control PanelMI-141301
Portable Carrying CaseMI-141302
Console CabinetMI-141303
Remote Control Panel HousingMI-141308
Stereo Head Mounting KitMI-141325

Ordering Information

Reel-to-Reel Tape Reproducer, Type RT-20:
Mono, less NAB Reel HubsMI-41913
Stereo, less NAB Reel HubsMI-41912

*Units for operation on 220 V, 50 Hz power available on request.



Multicartridge Tape Playback Systems, Types RT-16 and RT-26

- Extended reliability—electronic switching
- Six or twelve decks per system
- Mono or stereo playback
- Sequential or random operation
- Status-lighted pushbutton control

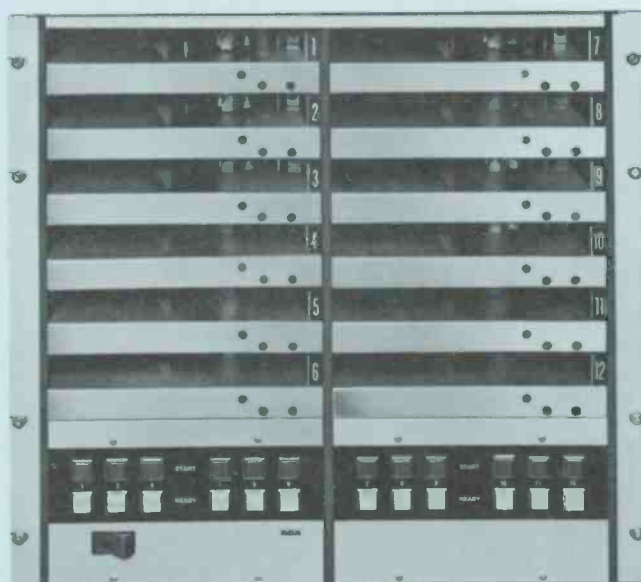

RT-26 Multicartridge System

The Multicartridge Tape Playback Systems described here offer improved technical quality, improved reliability and long life. The RT-16 has six decks while the RT-26 offers twice as many decks with no increase in vertical rack space.

Extended Reliability

Improved performance is combined with a proportionate improvement in dependability. The RT-16 offers greater operational quality and increased reliability through the elimination of electro-mechanical relays. Solid-state logic circuitry performs the switching functions faster and more faithfully.

Six or Twelve Decks Per Unit

The RT-16 unit carries six cartridge-tape decks in 17½ inches (446mm) of equipment rack space. The 12-deck unit, the RT-26, carries twice the cartridge capacity at no increase in occupied rack space. Each 6-deck unit is only half the width of a 19-inch rack and uses a common capstan. However, each deck unplugs without affecting the operation of the remaining five. The capstan is driven by a synchronous motor and twin O-ring belts to a 10-lb (4.5 kg) flywheel.

Easy Maintenance

Each tape deck slides out to expose the tape head face and the pressure-roller mechanism. This unrestricted access speeds and simplifies maintenance procedures. The deck electronics are independent. Therefore, a failure in one deck has no effect on the operation of the other decks in the system.

Mono or Stereo Playback

The RT-16 and RT-26 systems are offered in mono and stereo. The differences between the two are merely head configurations and associated amplifiers. The stereo units require no more space and only slightly more primary power.

Solid-State Reliability

Each RT-16 and RT-26 tape deck carries its own set of independent electronics. This redundant arrangement prevents an outage in one deck amplifier from affecting the operation of the other decks in the system. Each deck removes easily from the system and in no way affects the operation of the remaining decks.

Self-Sequencing— “Random” Sequence

Through use of a unique “patch panel” at the rear of the system, the RT-16 (and RT-26) becomes a self-sequencing device. Ordinarily patched so that the decks sequence in numerical order, the patch system allows any desired sequencing arrangement. In standard form, the RT-16

and RT-26 require a command (contact closure) for the start of each cartridge. Adding the End-Cue, Trip-Cue and Audio Switching Options (see *Accessories*) make the systems entirely self-sequencing.

Status-Lighted Pushbutton Control

Lighted indicators on the machine’s control panel convey the operational status

of each deck. There are two indicators for each deck: a “Start” and a “Ready.” The “Ready” indicator lights when the deck is loaded and cued. Touching the “Start” button lights a lamp behind the button and extinguishes the “Ready” lamp. Thus, the operational status of each deck in the system is displayed on its front panel.

Specifications

Performance:

Frequency Response Characteristics	±2 dB, 50 to 12,000 Hz ±4 dB, 50 to 15,000 Hz
Distortion	Less than 2% (at normal recording level)
Signal-to-Noise Ratio (Ref. 3% THD, tape limited)	55 db mono—52 dB stereo
Crosstalk Level (Head crosstalk)	—50 dB
Wow and Flutter	Less than 0.2% rms
Tape Velocity	7.5 ips (190.5 mm/s) ±0.4%
Equalization Curve	NAB Standard
Cartridge Capacity	All three NAB sizes
Cue Accuracy	±0.1 second
Start Time	50 milliseconds or less

Outputs:

Level	—20 dBm
Impedance (see <i>Accessories</i>)	600 ohms unbalanced

Cue Signal:

Stop Cue	1,000 Hz
End Cue (see <i>Accessories</i>)	150 Hz
Trip Cue (see <i>Accessories</i>)	8,000 Hz

Power Requirements:

Voltage (see <i>Accessories</i>)	117 volts ±10%
Frequency (see <i>Accessories</i>)	60 Hz
Current	4 A., max.

Ambient Operating Temperature 55°C. max. (130°F.)

Physical:

Dimensions:

Rack Model	17½" H. x 15" D. x 19" W. (446 x 381 x 483 mm)
Desk-Top Model	19" H. x 15" D. x 11" W. (483 x 381 x 279 mm)

Weight:

Six-deck, RT-16	64 lbs. (29 kg.) Approx.
Twelve-deck, RT-26	128 lbs. (58 kg.) Approx.

Accessories

Output Options:

Balanced Transformer (600 ohms)	MI-141805
Mono 40-dB Line Amplifier (600-ohm balanced output)	MI-141806
Stereo 40-dB Line Amplifier (600-ohm balanced output)	MI-141806S
40-dB Line Amplifier, Type BA-42	MI-141811
Power Supply, Type BX-42	MI-141812
Vertical Shelf (for BA-42 and BX-42)	MI-141813

Spare Cartridge Decks:

Mono Machines:

For	Order
MI-141950R & MI-141970R	MI-141978
MI-141951R & MI-141971R	MI-141979
MI-141952R & MI-141972R	MI-141980
MI-141953R & MI-141973R	MI-141981

Stereo Machines:

For	Order
MI-141954R & MI-141974R	MI-141982
MI-141955R & MI-141975R	MI-141983
MI-141956R & MI-141976R	MI-141984
MI-141957R & MI-141977R	MI-141985

Primary Power Options:

234/117 volt Transformer (for RT-16)	MI-141010-250
234/117 volt Transformer (for RT-26)	MI-141010-500
50-Hz Conversion Kit (for 50-Hz power line operation)	MI-141807

Ordering Information

Multicartridge Tape Systems (for rack mount. To order cabinet models, drop suffix “R” from MI number)

Mono, 6-Deck Machines (for 115-V, 60-Hz power*):

With Stop Cue only	MI-141950R
As above plus End Cue	MI-141951R
As above plus Audio Switcher	MI-141952R
As above plus Trip Cue	MI-141953R

Mono, 12-Deck Machines (for 115-V, 60-Hz power*):

With Stop Cue only	MI-141970R
As above plus End Cue	MI-141971R
As above plus Audio Switcher	MI-141972R
As above plus Trip Cue	MI-141973R

Stereo, 6-Deck Machines (for 115-V, 60-Hz power*):

With Stop Cue only	MI-141954R
As above plus End Cue	MI-141955R
As above plus Audio Switcher	MI-141956R
As above plus Trip Cue	MI-141957R

Stereo, 12-Deck Machines (for 115-V, 60-Hz power*):

With Stop Cue only	MI-141974R
As above plus End Cue	MI-141975R
As above plus Audio Switcher	MI-141976R
As above plus Trip Cue	MI-141977R

*All machines for operation on 115-V, 60-Hz power. Each converts to 50-Hz operation with conversion kit MI-141807; 230-V operation requires step-down transformer MI-141010-250 or MI-141010-500 for each machine; see *Accessories*.

RT-16 Multicartridge System

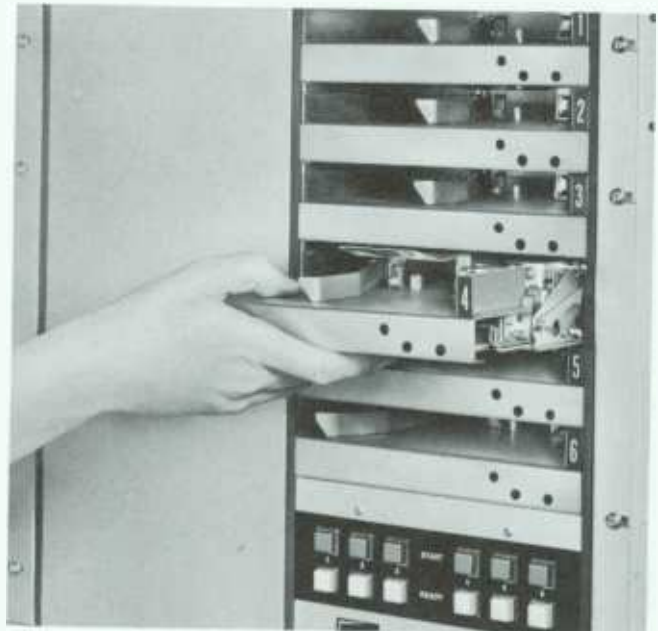



Cartridge Tape Carousel, Type RT-25

- Random or sequential tape playback
- Modular, solid-state electronics
- Unique, 24-cartridge "carousel" transport
- Excellent performance with very low distortion and noise

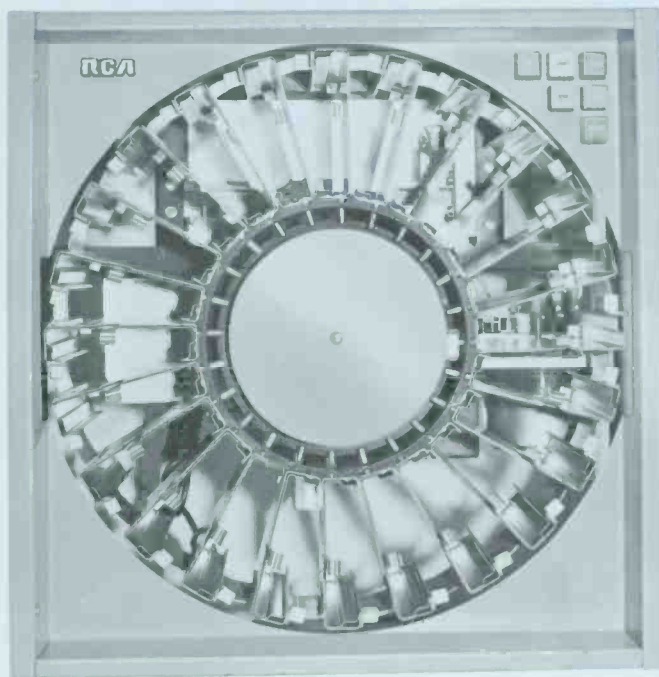

The Type RT-25 Cartridge Tape Carousel Systems offer a convenient, reliable, cartridge-tape playback system for low-cost, automation programming. The carousel stores up to 24 pre-recorded cartridge tapes in its drum; two or more carousels can be used back-to-back for multiple-spot announcements.

High Performance Audio

The carousel is compatible with any automation system, whether manually or remotely controlled. Reliable, solid-state electronics provide excellent performance with low distortion and noise. The frequency response is from 50 to 12,000 hertz ± 1.5 dB with an audio-output level (NAB reference-level tape) of +4 dBm at 600 ohms.

Sequential or Random-Select

Stereo or mono carousels are available for either sequential or random-select operation. The sequential carousel (when cued to the beginning of the endless tape loop), stops the tape drive and automatically removes the cartridge from the playing position, moves to the next cartridge and inserts it, ready for a "start" command. This sequence is repeated each time a cartridge is played. The carousel has start-stop cue (1000 Hz) and end-of-message cue (150 Hz) tone to start other units. The 150-Hz tone is pre-recorded at the end of a program segment and, when played back, is sensed by circuits in the carousel to switch additional units.

A 50-event programmer (see *Accessories*) is available to provide remote selection of any of the 24 cartridges. Automatic switching of audio output circuits is provided as well as selective starting of other carousels in a group where the 150-Hz cue tone feature is utilized.

The RT-25 Carousel system has few moving parts and single-cam adjustment of index stops. Its unique transport makes all cartridge trays accessible without revolving the drum, and simplifies operation and routine maintenance. The transport handles unbalanced cartridge loads and aligns a cartridge precisely with the stationary transport. The cartridge tape transport is solenoid operated and has many refinements: fine pressure-roller adjustment, adjustable cross shaft, a hysteresis-synchronous capstan motor, and ball thrust roller.

Vernier Head Holder

Another feature of the RT-25 playback system is the vernier head holder. Design features here include: vernier adjustment of head azimuth, tape-guide adjustment (before and after heads), vernier adjustment of head-tape parallelism, cartridge

hold-down springs, positive cartridge location, complete head shielding, and upper and lower jacks for track identification.

The RT-25 is designed for 7½ ips operation, with fast start and stop time,

and quick cartridge-transfer. The RT-25 operates from an ordinary 115-volt, 60-Hz (50 Hz on special order) power source. The equipment mounts in standard 19-inch equipment racks. Three carousels can be housed in a 66-inch high rack.

Specifications

Frequency Response	50-12,000 Hz, ±1.5 dB
Signal-to-Noise (overall record/playback from NAB Reference Level)	48 dB (55 dB Ref. 3% THD)
Distortion (0 dBm output)	1%, max.
Audio Output Level (NAB Reference Level tape, 600-ohm output)	±4 dBm
Wow and Flutter	0.2% rms max.
Time Capacity	10 sec. to 10½ mins. per cartridge
Tape Drive Control	Common motor-capstan, hysteresis-synchronous operation with precision instrument type ball bearings
Speed	7½ ips
Timing Accuracy	99.9%
Start Time	0.1 s.
Stop Time	0.1 s.
Cartridge Transfer Time (plus re-cueing time)	1.75 s., min.
Size	19¼" H, 19" W, 17" D (489 x 483 x 432 mm)
Weight (approx.)	90 lbs. (41 kg)
Power Requirements	115 V, 60 Hz, 0.8 W idle, 31 W standby, 62 W run
Shipping Data:	
Dimensions (approx.)	22" H, 22" W, 19" D (559 x 559 x 483 mm)
Weight (approx.)	115 lbs. (52 kg)

Accessories

Fifty-Event Programmer (for Automation)	MI-141923
Interface Assembly (for Automation)	MI-141924
Step-Down Transformer (234 to 117 V.)	MI-141010-125
Head Cleaner Cartridge	MI-141808
Torque-Test Cartridge	MI-141809
Strobe Cartridge (for Speed Testing)	MI-141810
Azimuth Alignment & Freq. Resp. Cartridge (Mono)	MI-11993-4

Ordering Information

Cartridge Tape Carousel, Type RT-25:	
Mono Systems	
With Random Cartridge Selection	MI-141901
With Sequential Action	MI-141911
Stereo Systems	
With Random Cartridge Selection	MI-141900
With Sequential Action	MI-141910

(Available also for operation from 115-V, 50-Hz power. For operation from 230-V power, order MI-141010-125 Step-Down Transformer for each carousel system.)



The RT-25 Carousel is compatible in any automation system. Two Carousels provide "back to back" multiple instantaneous spot announcements.

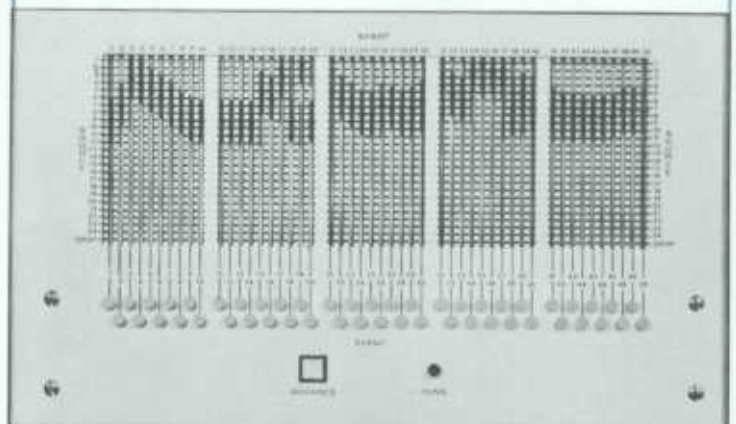

Fifty-Event Carousel Programmer

RCA

Cartridge Tape System, Type RT-27/BA-27

- Mono or stereo systems
- Three-axis head adjustment
- For all three cartridge sizes
- Removable tape decks
- Plug-in circuit boards

The Type RT-27/BA-27 Cartridge-Tape Systems provide professional mono and stereo playback and recording performance which exceeds NAB cartridge-tape requirements.

The components of the system are a playback-amplifier electronics assembly with plug-in circuit boards and a selection of tape decks. The Type BA-27 recording amplifier also uses plug-in circuit boards and operates with the RT-27 as a matched record/playback system. The RT-27 tape deck accommodates all three cartridge sizes: 300, 600 and 1200 Series.

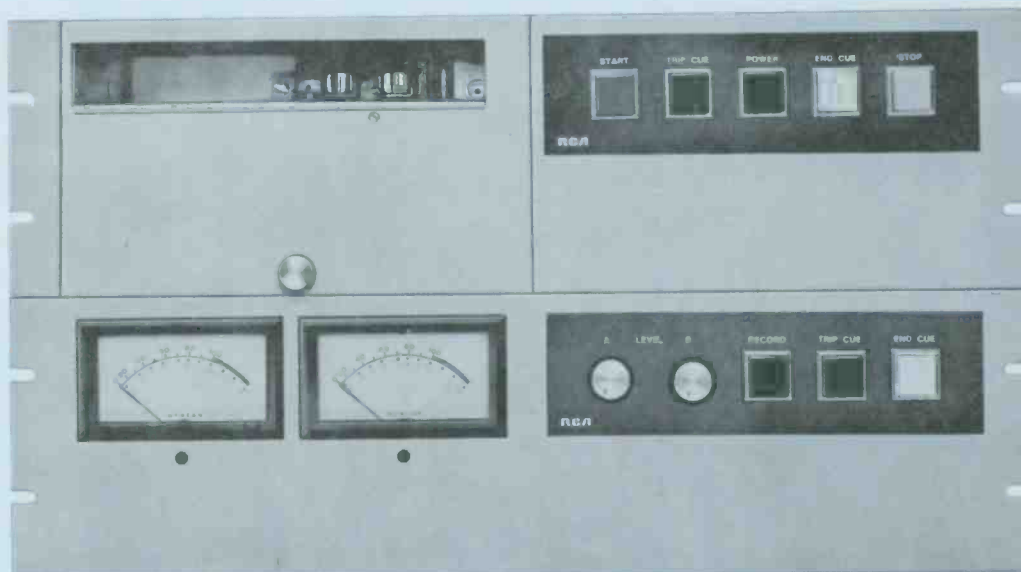

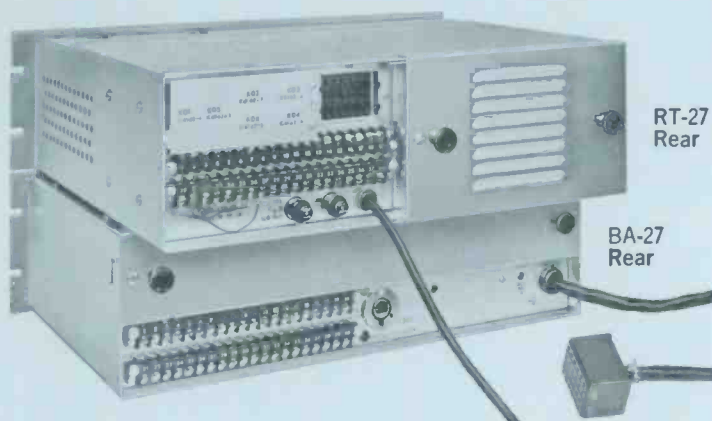

Monophonic Cartridge Tape Recorder, Type RT-27, fits neatly into 19½-inch studio rack or console and is pre-wired for conversion to stereo. The Type RT-27S stereo counterpart is shown on preceding page. Below is rear of equipment showing separate chassis construction of both RT-27 Playback Unit and the BA-27 Record Amplifiers. This building-block concept provides a variety of monophonic and stereo playback/record systems to meet virtually any requirement.

Playback Only Systems

The basic playback system consists of mono tape deck, playback amplifier, cue amplifier, power supply and stop/start relays. The tape deck contains a single playback head with two tracks, one for program-audio (which goes to the playback amplifier) and the other for a 1-kHz cue signal which operates, through the cue amplifier, the start/stop relays.

Operation of the basic RT-27 consists of inserting a recorded cartridge into the slot and pressing the "Start" button. The tape plays until either the "Stop" button is pressed or the entire length of the endless loop is played. The machine then senses the start/stop cue (1000 Hz) of the recording and stops, in a cued-up configuration. Status lights on the panel indicate "Stop" when the cartridge is inserted, "Start" while it runs, and "Trip Cue" and "End Cue" when the optional 8000- and 150-Hz features are included.

Add "Cue" and "Audio Switching"

The basic RT-27 provides for the addition of (optional) plug-in cue-amplifier and relay circuits, independent of the 1-kHz Start-Stop Cue circuit. One of these senses an end-cue tone (150 Hz) recorded in the cue track at the conclusion of the recorded program audio. This signal can trigger the start of other program sources or automation systems or, to switch the program-audio line. The 8-kHz Trip-Cue option tones provide a contact closure that could activate equipment such as TV-slide or cine projectors. Audio switching is easily added by the use of plug-in relays (see *Accessories*).

Expanding to Stereo

The RT-27 Mono Playback System is pre-wired for stereo, and can be expanded to an RT-27S Stereo Playback System. The conversion simply requires substitution of a stereo tape deck for the mono deck, the addition of a second playback amplifier board and a plug-in output transformer (see *Accessories*).

Addition of Recording Facilities

The BA-27 Recording Amplifier may be added at any time to an RT-27 Playback Unit equipped with a record/playback deck to form a complete RT-27/BA-27 Playback/Record System. The RT-27 and BA-27 are both rack-mounted units that match each other in construction and styling. The combination may be ordered as a complete mono or stereo system, with or without accessory cue and

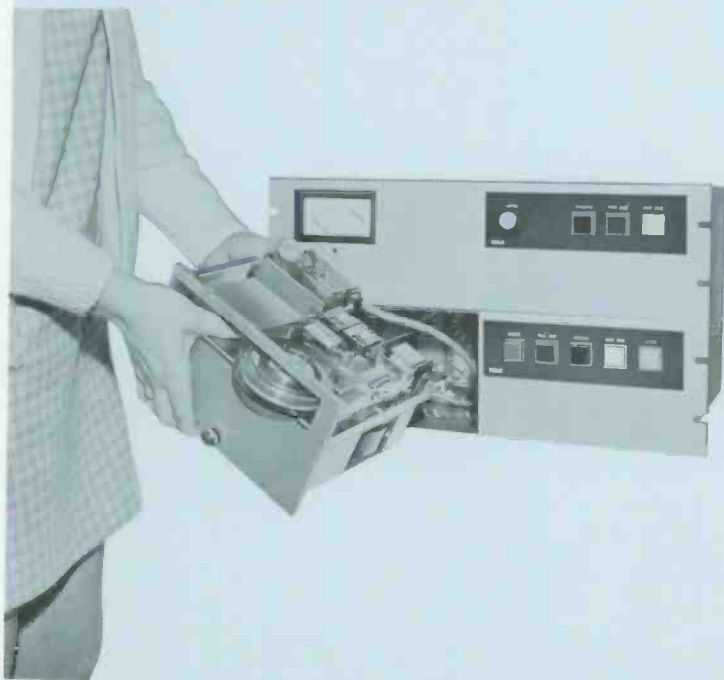

A roll-out tape deck assembly and plug-in glass epoxy circuit boards assure easy maintenance of RT-27 systems. Precision components provide quiet operation essential for on-air use. Separate record and playback heads exceed all NAB cartridge record/playback standards.

audio-switching features (see *Ordering Information*). The BA-27 Recording Amplifier receives its power from the RT-27 Playback Unit.

BA-27 Recording Amplifier Operation

The BA-27 Recording Amplifier includes a preamp for use with any low-impedance microphone. A bridging input provides for high-level (line) recording. The mike input makes the system useful for remote recording without the need for additional equipment.

100-Hz Start/Stop Cues

Cue tone is recorded automatically each time the tape starts in the recording mode. Terminals are provided at the rear of the unit to allow manual defeat of all

automatic cue facilities, if desirable. End and trip cues (150 Hz and 8000 Hz) are manually recorded at any time, whether in or out of the record mode. This lets the operator give full attention to program recording and proper placement of recorded cues in relation to the program material.

Roll-Out Deck Feature

A unique, roll-out deck design allows easy removal of the complete tape deck of RT-27/BA-27 systems from the main frame for inspection and/or adjustment. Should a mechanical component fail during the work day, this feature allows quick replacement of the faulty deck. Precision mechanical components provide reliable, quiet operation for on-air use.

Plays or Records 31-Minute Cartridges

The RT-27 accommodates all three cartridge sizes, the Series 300, 600 and 1200. Most machines available today handle only the two smaller sizes; the RT-27 provides for up to 31 minutes of program from a single cartridge.

Remote Control Facilities

Two accessory panels are available optionally for remote-control operation of RT-27/BA-27 systems. One provides remote start for up to four playback systems and, the other, remote control of a single record/playback system with functions including Start, Stop, Program Record and Cue Record.

RT. 27 CARTRIDGE-TAPE FORMAT

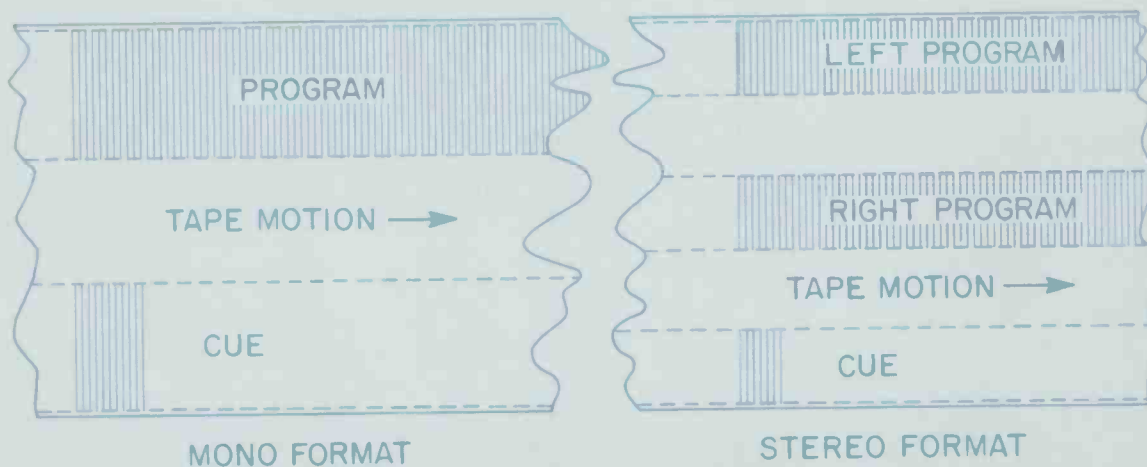

(AS SEEN THROUGH THE TAPE)

Accessories

Playback Amplifier Electronics (Playback unit with Start/Stop Cue, less tape deck)	MI-141965	Output Transformer for Conversion of RT-27 (mono to RT-27S) (stereo)	MI-141802
Mono Playback Deck (Deck only)	MI-141967-1	Remote Control Panel (Start, Record, Trip Cue, End Cue, Stop Pushbuttons)	MI-11968-2
Mono Record/Playback Deck (Deck only)	MI-141967-2	Module Extenders (four) for RT-27	MI-11495
Mono Recording Amplifier, Type BA-27 (Less Audio Switcher)	MI-141966	Module Extenders (four) for BA-27	MI-11496
Stereo Playback Deck (Deck only)	MI-141967-3	Bulk Tape Eraser	MI-11992
Stereo Record/Playback Deck (Deck only)	MI-141967-4	Head Degausser (115V, 50/60 Hz power)	MI-11995
Stereo Recording Amplifier, Type BA-27S (Less Audio Switcher)	MI-141963	Head Degausser (230V, 50/60 Hz power)	MI-11996
Plug-In Circuit Boards:		Frequency Response and Azimuth Alignment Test Tape (mono)	MI-11993-3
Power Supply	MI-11974-1	Head Cleaner Test Cartridge	MI-141808
End Cue/Trip Cue	MI-11974-2	Torque-Test Cartridge	MI-141809
Cue Amplifier	MI-11974-3	Speed-Test Cartridge (50 or 60 Hz Operation)	MI-141810
Bias and Cue Tone	MI-11974-5	50-Hz Conversion Kit	MI-11494
Record Amplifier	MI-11974-6	Tape Cartridges	MI-11988 or MI-141988 Series
Playback Amplifier	MI-11974-7	Cartridge Equipment Studio Furniture	See Catalog B.1504
Plug-In Relays:			
Relay (2 Form-C)	MI-141800-1		
Relay (4 Form-C)	MI-141800-2		
Relay (6 Form-C)	MI-141800-3		

Ordering Information

Cartridge-Tape Systems, Type RT-27:

	115V 60 Hz* With Start/Stop Cue	115V 60 Hz* Plus End-Cue/Trip Cue and Audio Switching	230V 60 Hz* With Start/Stop Cue	230V 60 Hz* Plus End-Cue/Trip Cue and Audio Switching
Mono Systems				
Playback-Only Systems	ES-41940	ES-41941	ES-41940(220)	ES-41941(220)
Record/Play Systems (less Recording Amplifier)†	ES-41940R	ES-41941R	ES-41940R(220)	ES-41941R(220)
Record/Play Systems (incl. Recording Amplifier)	ES-41942	ES-41943	ES-41942(220)	ES-41943(220)
Stereo Systems				
Playback-Only Systems	ES-41944	ES-41945	ES-41944(220)	ES-41945(220)
Record/Play Systems (less Recording Amplifier)†	ES-41944R	ES-41945R	ES-41944R(220)	ES-41945R(220)
Record/Play Systems (incl. Recording Amplifier)	ES-41946	ES-41947	ES-41946(220)	ES-41947(220)

*For operation on 50 Hz power, order one Modification Kit (MI-11494) for each RT-27 system. (Kit is factory installed when ordered as part of system.)
 †Recording Amplifier, Type BA-27, available separately. See "Accessories" List.



Tape Recorder Accessories

- Pre-loaded and empty cartridges
- Head-cleaner and test cartridges
- Bulk erasers; head degaussers
- Remote control panels
- Spare decks, amplifiers, relays

Here are a series of accessories appropriate to magnetic-tape operations: cartridges, tape bulk erasers, head degaussers, test cartridges, remote control panels and spare assemblies.



Tape Cartridges

Cartridges, empty or loaded, for use with the RCA Tape Cartridge Systems are available in playing times ranging from 40 seconds to more than a half hour. Each cart includes pressure pads and an automatic brake that prevents tape spillage when the cartridge is outside of the cartridge machine. Tape lengths other than those listed are available on special order. The tape is one-mil thick polyester base, back-lubricated for smooth cartridge performance. Two styles are available: "squareback" and "roundback".

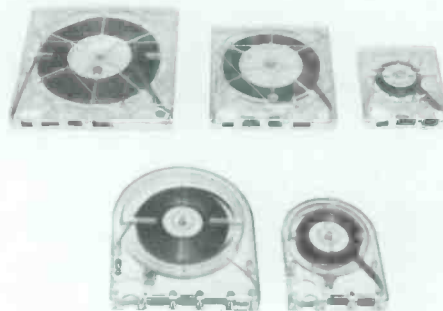

Specifications

Series 300 "Square-Back" Cartridges

Play Time at 7.5 ips (in/s)40 s to 10.5 min.
 Dimensions4" W, 5½" L, 7/8" D (102, 130, 22 mm)
 Weight (empty)2.75 oz. (78 g)
 Carts per Package6
 Package WeightSee Ordering Information

Series 300 "Round-Back" Cartridges

Play Time at 7.5 ips (in/s)40 s to 10.5 min.
 Dimensions4" W, 5½" L, 7/8" D (102, 130, 22 mm)
 Weight (empty)3 oz. (85 g)
 Carts per Package6
 Package WeightSee Ordering Information

Series 600 "Square-Back" Cartridges

Play Time at 7.5 ips (in/s)16 min. max.
 Dimensions6" W, 7" L, 7/8" D (152, 178, 22 mm)

Weight (3 oz. empty)10 oz. (284 g)
 Carts per Package2
 Package Weight1.5 lbs. (680 g)

Series 600 "Round-Back" Cartridges

Play Time at 7.5 ips (in/s)16 min. max.
 Dimensions6" W, 7" L, 7/8" D (152, 178, 22 mm)
 Weight (3 oz. (85 g) empty)10 oz. (284 g)
 Carts per Package2
 Package Weight1.5 lbs. (680 g)

Series 1200 "Square-Back" Cartridges

Play Time at 7.5 ips (in/s)31 min. max.
 Dimensions7½" W, 8¾" L, 7/8" D (194, 212, 22 mm)
 Weight (4 oz. empty)13 oz. (370 g)
 Carts per Package2
 Package Weight32 oz. (907 g)

Ordering Information

Square-Back Cartridges

Play Time	Series	Weight	Package Weight	Stock ID
40 s.	300	3 oz. (85 g)	1¼ lbs. (567 g)	MI-11988-1
70 s.	300	3½ oz. (99 g)	1½ lbs. (680 g)	MI-11988-2
2.5 min.	300	4 oz. (114 g)	1¾ lbs. (794 g)	MI-11988-11
3.5 min.	300	4 oz. (114 g)	1¾ lbs. (794 g)	MI-11988-3
5.5 min.	300	4½ oz. (128 g)	2 lbs. (907 g)	MI-11988-4
10.5 min.	300	5½ oz. (156 g)	2¼ lbs. (1021 g)	MI-11988-5
15.5 min.	600	10 oz. (284 g)	1½ lbs. (680 g)	MI-11988-6
31 min.	1200	13 oz. (370 g)	2 lbs. (907 g)	MI-11988-7
Empty	300	3 oz. (85 g)	1½ lbs. (510 g)	MI-11988-8
Empty	600	3 oz. (85 g)	1¼ lbs. (567 g)	MI-11988-9
Empty	1200	4 oz. (114 g)	10 oz. (284 g)	MI-11988-10

Round-Back Cartridges

40 s.	300	3 oz. (85 g)	1¼ lbs. (567 g)	MI-141988-1
70 s.	300	3½ oz. (99 g)	1½ lbs. (680 g)	MI-141988-2
90 s.	300	3½ oz. (99 g)	1½ lbs. (680 g)	MI-141988-3
2.5 min.	300	4 oz. (114 g)	1¾ lbs. (794 g)	MI-141988-4
3.5 min.	300	4 oz. (114 g)	1¾ lbs. (794 g)	MI-141988-5
5.5 min.	300	4½ oz. (128 g)	2 lbs. (907 g)	MI-141988-6
7.5 min.	300	4½ oz. (128 g)	2 lbs. (907 g)	MI-141988-11
10.5 min.	300	5½ oz. (156 g)	2¼ lbs. (1021 g)	MI-141988-7
15.5 min.	600	10 oz. (284 g)	1½ lbs. (680 g)	MI-141988-8
Empty	300	3 oz. (85 g)	1½ lbs. (510 g)	MI-141988-30
Empty	600	3 oz. (85 g)	1¼ lbs. (567 g)	MI-141988-60

Test Cartridges

Azimuth Alignment and Frequency Response Test

Useful whenever tape head alignment requires adjustment, this Series 300 cartridge is recorded in mono format (two-track). It provides recorded tones for head-height and azimuth adjustment, a series of tones for frequency-response test and a series of tones for cue, trip-cue and stop-cue. Not available in stereo format.

Specifications

Head-Azimuth Adjustment Track15 kHz
 Head-Height Adjustment Frequency400 Hz

Frequency-Response Test Frequencies15, 10, 12, 10, 7, 4, 2, 1 kHz; 700, 400, 200, 100, 50 Hz (All recorded 10 dB below normal "zero" level)

Cue-Facility Test:

CueOne 1 kHz tone
 Stop-Cue (End-Cue)Three 150 Hz tones
 Trip CueThree 8 kHz tones

Length of Test Recording (approx.)3:30

Ordering Information

Azimuth Alignment & Frequency Response Test Cart (Mono only)MI-11993-4

Head Cleaner Cartridge

Provides 20 seconds of automatic, programmed head cleaning and conditioning. At the end of the cycle, a pre-recorded 1000 Hz cue tone stops the tape.



Specifications

Cleaning and Conditioning Program (20 seconds total):	
Mild Abrasive Action (silicon carbide)	5s
Head Lubrication	5s
Head Polishing	5s
Final Head Lubrication	5s
Automatic Stop	Pre-recorded cue tone

Ordering Information

Head Cleaner Cartridge	MI-141808
------------------------	-----------

Torque-Test Cartridge

Valuable in determining and adjusting the tape-pulling torque of cartridge-tape machines, the Torque-Test Cartridge fits into the machine in the normal manner. As the capstan and pinch roller pull tape, the force is displayed on a calibrated scale in the cartridge. If the pulling force is more or less than the 1.5 lb. NAB spec., the pinch roller pressure should be re-adjusted.



Ordering Information

Torque-Test Cartridge	MI-141809
-----------------------	-----------

Speed-Test Cartridge

The Speed-Test Cartridge contains 50- and 60-Hz strobe discs that indicate the speed accuracy of cartridge-tape machines when viewed under the supplied strobe lamp (lamp for 115-volt operation only).



Ordering Information

Speed-Test Cartridge (50 and 60 Hz)	MI-141810
-------------------------------------	-----------

Remote Control Panels for RT-7, RT-17, RT-27, RT-37

The Remote Control Panels provide convenient means for operating from one to four cartridge-tape playback units via remote control. Connections are easily made through a rear terminal board directly to the playback units. Four momentary "Start" pushbuttons are mounted on an aluminum panel for control of up to four playback units.

Remote control of a single record/playback cartridge tape system is provided by another Remote Control Panel. Parallel operational functions of the system are controlled to the remote control panel with its five pushbutton switches, labelled "Start", "Record", "Stop", "End", and "Trip".

Specifications

Dimensions	2½" H, 6" W, 2-13/16" D (89, 152, 72 mm)
Weight	½ lb. (250 g)
Finish	Dark umber gray



Tape Head Degausser

The Tape Head Degausser demagnetizes record/playback and erase heads. The degausser is housed in a lightweight hand-grip case. A momentary-contact on-off pushbutton switch energizes the unit.

Specifications

Power Requirements	117 or 230 V, 50/60 Hz
Switch	Momentary contact
Line Cord	5 ft. long (1.52 m)
Dimensions (Overall)	9¾" L, 7/8" Dia. (251, 22 mm)
Weight	9 oz. (250 g)

Ordering Information

Cartridge Tape Head Degausser (117 V, 50/60 Hz)	MI-11995
Cartridge Tape Head Degausser (230 V, 50/60 Hz)	MI-11996

Bulk Tape Eraser

A bulk tape eraser provides erasure of any ¼-inch recorded reel of tape or tape cartridge. It is housed in a brown plastic, hand-grip case measuring only 4⅞ (124 mm) inches in diameter and 4¾ (121 mm) inches high overall. A momentary-contact, on-off pushbutton switch prevents current being applied when not in use.



Ordering Information

Bulk Tape Eraser (117 V, 50/60 Hz)	MI-11992
------------------------------------	----------

Circuit Boards for RT-8/-17/-18/-27/-27S/-37

The circuit boards are offered for service replacements and/or expansion of existing equipment in the field.

Ordering Information

Power Supply Board	MI-11974-1
End-Cue/Trip Cue Board (150 Hz; 8000 Hz)	MI-11974-2
Cue Amplifier Board	MI-11974-3
Bias and Cue-Tone Board	MI-11974-5
Record Amplifier Board	MI-11974-6
Play Amplifier Board (Replaces MI-11974-4)	MI-11974-7
150 Hz End-of-Message Cue Board	MI-11973-1



Ordering Information

Remote Control Panel for up to four RT-17, RT-27 and RT-37 Playback Units	MI-11968-1
Remote Control Panel for single record/playback systems	MI-11968-2

Plug-In Relays for RT-17/-27/-27S/-37

Stocked as spares, these relays minimize machine down time in the event of relay failure.

Ordering Information

Two Form-C Relay	MI-141800-1
Four Form-C Relay	MI-141800-2
Six Form-C Relay	MI-141800-3

Spare Cartridge Tape Decks, RT-27/-27S

Spare Cartridge Tape Decks allow rotation of decks and routine maintenance during the work day, without affecting on-air operation.



Ordering Information

Play Deck, Mono	MI-141967-1
Play/Record Deck, Mono	MI-141967-2
Play Deck, Stereo	MI-141967-3
Play/Record Deck, Stereo	MI-141967-4

Spare Cartridge Tape Decks, RT-16/-26

Spare Cartridge Tape Decks allow rotation of decks and routine maintenance during the work day, without affecting on-air operation.



Ordering Information

Mono Decks:	
for MI-141950 & 141970	MI-141978
for MI-141951 & 141971	MI-141979
for MI-141952 & 141972	MI-141980
for MI-141953 & 141973	MI-141981
Stereo Decks:	
for MI-141954 & 141974	MI-141982
for MI-141955 & 141975	MI-141983
for MI-141956 & 141976	MI-141984
for MI-141957 & 141977	MI-141985

Other RT-16/-26 Accessories

A balanced 600-ohm transformer converts the unbalanced output of the multicartridge machine to a balanced output; the mono and stereo amplifiers raise the machine's -20 dBm output to +20 dBm. The balanced transformer is provided as standard with the line amplifier.

Ordering Information

Balanced, 600-ohm Transformer	MI-141805
Mono Line Amplifier, 600-ohm, 40 dBm	MI-141806
Line Amplifier, as above but for stereo	MI-141806S

50-Hz Modification Kits

For converting tape equipment equipped for operation on 60-Hz power.

Ordering Information

50-Hz Conversion Kits for Types:

RT-8, RT-18, RT-27	MI-11494
RT-16, RT-26	MI-141807

Module Extenders

Set of Four (For use with RT-17/-27/-37)	MI-11495
Set of Two (For use with BA-17/-27/-37)	MI-11496

Reel-To-Reel Recorder Accessories (RT-20, RT-21, RT-22)

The accessories listed are unique to reel-to-reel recorders and specifically to the three RCA reel-to-reel machines. Each accessory fits all three systems, unless stated otherwise.

Ordering Information

NAB Reel Hub	MI-41604
Empty 10½-inch NAB Reel	MI-11932-2
NAB Reel Hub Kit (Two hubs plus one 10½" reel)	ES-41919
Remote-Control Panel (for RT-21 only)	MI-141301
Remote-Control Panel Housing	MI-141308
Spare Record/Play Amplifier Module (RT-21 only less equalizer)	MI-141351
Plug-In Equalizer (for half-track 3¾ & 7½ ips)	MI-141350-1
Plug-In Equalizer (for half-track 7½ & 15 ips)	MI-141350-2
Plug-In Equalizer (for full-track 7½ & 15 ips)	MI-141350-3
Plug-In Equalizer (for full-track 3¾ & 7½ ips)	MI-141350-4
Portable Carrying Case (RT-20 and RT-21 only)	MI-141302
Console Cabinet (RT-20 and RT-21 only)	MI-141303
Fourth-Head Kit (RT-20 and RT-21 only)	MI-41602
Stereo Head-Mounting Kit (RT-20 and RT-21 only)	MI-141325

Step-Down Transformers

For situations where tape equipment must operate from 200 to 240-volt power mains, RCA offers step-down transformers selected specifically for each tape machine. For 50/60 Hz power.

Ordering Information

230/115-Volt Step-Down Transformer for Types:

RT-16	MI-141010-250
RT-19	MI-141010-175
RT-25	MI-141010-125
RT-26	MI-141010-500

Loudspeakers and Enclosures

- Speakers, enclosures, systems
- Paging, monitoring, quality-listening
- Power handling: 10 to 60 watts
- Curvilinear, dioplex and coaxial cones
- Wall-, floor-mount enclosures

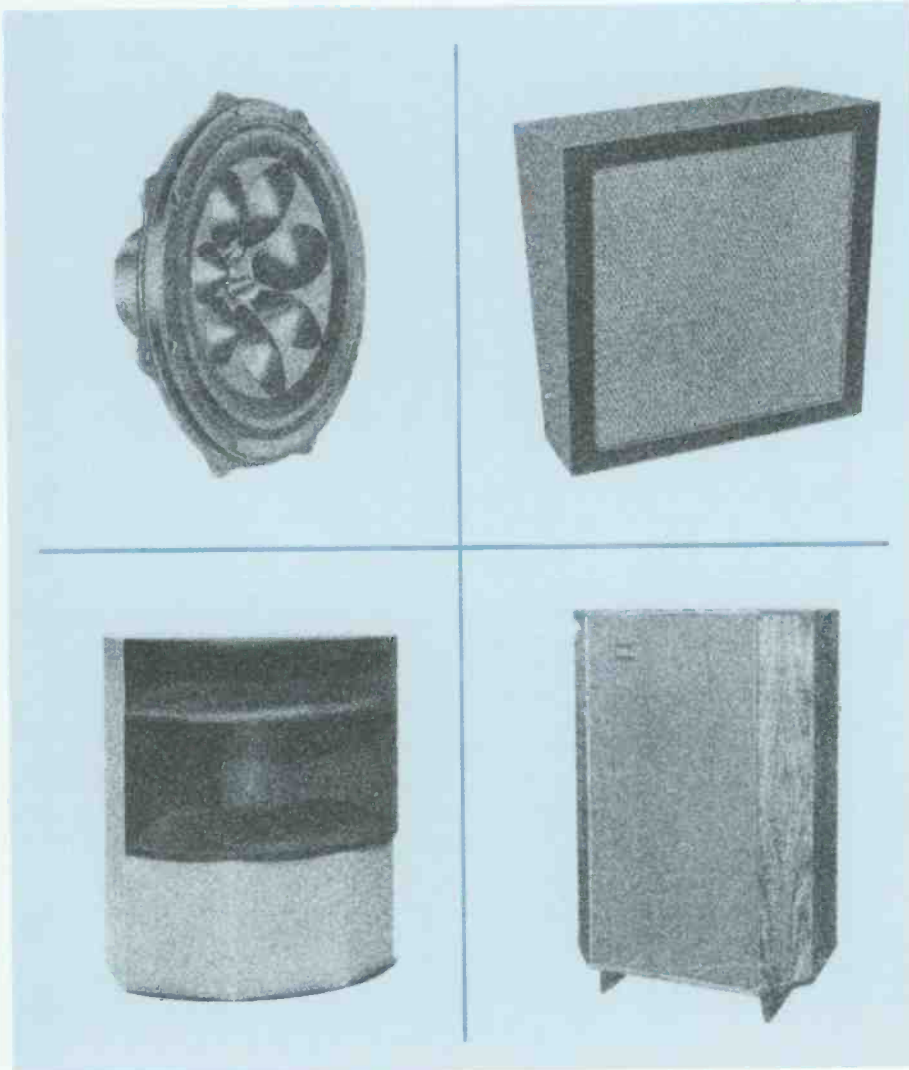

There are five cone-type loudspeakers available from RCA: three 8-inch, one 12-inch and one 15-inch. The 8-inch units feature a dioplex-type cone and oversize ceramic magnets; they are most suitable for paging, monitoring and good-quality studio listening.

The 12-inch speaker features a curvilinear cone and a 10-ounce ceramic magnet. Its larger diameter improves the bass response slightly for better-quality paging, monitoring and studio listening.

The 15-inch unit is the famous Harry Olson duo-cone speaker. This is the fourth-generation LC-1 which features improved frequency crossover, bass response and dispersion angle.

Complete Speaker Systems

RCA offers two complete speaker systems: a 60-watt column-type unit for use where beamed sound is required and a 50-watt studio-playback unit with a cone-type woofer and a horn-type tweeter.

Speaker Enclosures

RCA makes available four speaker enclosures: three wall-mount and a floor mount. Two of the wall-mount units are closed-back units for extended bass response; the third is an open-back, wedge-type paging enclosure. The floor mount cabinet is designed specifically for the LC-1 Duo-Cone Speaker.

15-Inch Duo-Cone Speaker, Type LC-1



- Wide dispersion angle: 120°
- Frequency response: 25-16,000 Hz
- Crossover frequency: 1600 Hz
- Sensitivity at 1 watt input: 94.5 dB
- Power handling capability: 40 watts

The Type LC-1 is a 15-inch duo-cone speaker designed specifically for use in recording studios, studio control rooms and wherever the finest in reproduced sound is desired.

Wide Bandwidth, Wide Dispersion

The LC-1 is a high compliance, duo-cone speaker with a 25 to 16,000-Hz frequency response and a 120-degree dispersion angle (see curves). As a result, it covers four times the area typical of other high-quality (60°) speakers. The two coaxial cones are direct radiators with separate voice coils. Crossover occurs at 1600 Hz.

The low-frequency cone is stiffened with seven acoustical domes which, because of their shape and relative location, contribute to the wide dispersion of the high frequencies from the tweeter, at the center, by spoiling the symmetry. This eliminates the interference normally characteristic of such shapes without loss of either high or low frequencies.

Alnico V Magnets; Aluminum Voice Coils

The LC-1 uses a die-cast aluminum frame with Alnico V magnets in an epoxy-cemented structure. The two voice coils are wound of copper-clad aluminum wire which improves high-frequency efficiency. High-temperature materials and extra clearances increase the speaker's power-handling capability and reduce distortion even in the crossover frequency region.

The coaxial relationship of the two cones minimizes out-of-phase components in the crossover frequency range. The shallow angle of the cones improves response smoothness.

Specifications

Frequency Response Characteristic	25-16,000 Hz
Program Power Handling Capability	40 watts*
Woofer Magnet Weight (Alnico V)	4 lbs. (1.8 kg)
Tweeter Magnet Weight (Alnico V)	6.8 oz. (193 g)
Axial Sensitivity (1 kHz at 1 W; 4 ft. [1220 mm])	94.5 dB
Dispersion Angle	120°
Input Impedance (nominal)	15 ohms
Woofer Voice-Coil Diameter	2.5" (64 mm)
Tweeter Voice-Coil Diameter	0.75" (19 mm)
Crossover Frequency	1600 Hz
Cone Resonance (in infinite enclosure)	22 Hz
Overall Diameter	17" (432 mm)

Bolt-Circle Diameter	16¼" (413 mm)
Cone Diameter	15⅝" (396 mm)
Depth (mounted)	7⅞" (189 mm)
Weight (approx.)	21 lbs. (10 kg)

*This speaker, when fused with a ¼-ampere fuse, is safe with any high-quality amplifier, regardless of power.

Recommended Enclosures

Wall-Mount Enclosure, Type LS-1	MI-11406
Olson Floor Enclosure, Type LS-11	MI-11415

Ordering Information

15-Inch Duo-Cone Loudspeaker, Type LC-1	MI-11411
---	----------

8-Inch Dioplex-Cone Speaker, Type SL-8



- 50 to 18,000 Hz frequency response
- Balanced listening characteristic
- Ten-ounce ceramic field magnet (Indox)
- Curvilinear cone with high frequency cone

The Type SL-8 is an 8-ohm, extended-range speaker for use wherever smooth, uniform response and natural reproduction of voice and music are desired. It may be used in any suitable enclosure. For full exploitation of the speaker's capabilities the enclosure should contain a volume of at least 2.5 cubic feet (0.6m³).

Balanced Listening Characteristic

The speaker's smooth frequency response is the result of a curvilinear cone of special material, a damping ring at the outer suspension and a mechanically coupled cone at the center to extend the high-frequency response.

Specifications

Frequency Response Characteristic	50-18,000 Hz
Power-Handling Capability	10 watts
Magnet Weight (Indox)	10 oz. (284 g)
Gap Flux Density	9000 gauss
Axial Sensitivity (1 kHz at 1 W; 4 ft. [1220 mm])	92 dB
Cone Resonance (in 6.5 ft. ³ [0.18m ³] enclosure)	74 Hz
Voice-Coil Impedance (at 400 Hz)	8 ohms
Overall Diameter	8 ³ / ₈ " (210 mm)
Bolt Circle Diameter	7 ⁵ / ₈ " (194 mm)
Depth	3 ¹ / ₈ " (80 mm)
Weight (approx.)	2 ³ / ₄ lbs. (1640 g)

Recommended Enclosures

Wall-Mount Enclosure, Type LS-3	MI-11407
Wall-Mount Paging Baffle	MI-11414-2

Ordering Information

Dioplex Cone 8-Inch Speaker, Type SL-8	MI-38311
--	----------

8-Inch Dioplex-Cone Speaker, Type SL-890



- 50-18,000 Hz frequency response
- 5-ounce ceramic field magnet
- Handles 15 watts of program
- Designed for wall-baffle use

The Type SL-890 is a 15-watt, 8-inch speaker designed for use with open-back wall baffles in high-quality paging and music systems. It includes a matching transformer for bridging 70-volt constant-voltage lines.

Edge-Damped Cone

The SL-890 uses an edge-damped cone and a mechanically coupled high-frequency cone to achieve its 50 to 18,000 Hz frequency response. An enclosure with volume greater than 2.5 cubic feet (0.6m³) is recommended wherever improved bass response is desired.

Mounted Matching Transformer

For simplified mounting, the SL-890 includes a 70-volt, line-matching transformer mounted and wired to the voice-coil terminals. The transformer primary is tapped at 0.25-, 0.5- and 1-watt levels.

Specifications

Frequency Response Characteristic	50 to 18,000 Hz
Program Power-Handling Capability	15 watts
Magnet Weight (Indox)	5 oz. (142 g)
Axial Sensitivity (1 kHz at 1 W; 4 ft. [1220 mm])	96 dB
Voice Coil Impedance (at 400 Hz)	8 ohms
Voice Coil Diameter	1 inch (51 mm)
Matching Transformer Primary Taps	1/4-, 1/2-, 1-watt
Overall Diameter	8 ¹ / ₈ " (206 mm)
Bolt-Circle Diameter (4 holes)	7 ⁵ / ₈ " (194 mm)
Depth	2 ⁵ / ₈ " (67 mm)
Weight, Including Transformer (approx.)	2 ¹ / ₂ lbs. (1134 g)

Recommended Enclosures

Wall-Mount Enclosure, Type LS-3	MI-11407
Wall-Mount Paging Baffle	MI-11414-2

Ordering Information

8-Inch Dioplex Speaker, Type SL-890	MI-12454
As above, less transformer	MI-38304

12-Inch High-Fidelity Speaker, Type SL-12



- Curvilinear, edge-damped cone
- 20-ounce field magnet
- 10-watt power handling capability
- 1-inch voice-coil diameter
- Smooth frequency response

Curvilinear, Edge-Damped Cone

The Type SL-12 is a third-generation speaker that features a 1-inch voice-coil diameter, a curvilinear cone with a damping ring at the outer edge. As a result, the speaker delivers wide, smooth frequency response with good dispersion. It may be used in any speaker baffle large enough to mount a 12-inch speaker. For full utilization of the speaker's low frequency response, an enclosure with a volume larger than 5 cubic feet (1.2 m³) is recommended.

The Type SL-12 is one of the finest high-fidelity speakers available in its price range. It is designed for use as a good-quality studio- or lounge-monitor speaker. Its 10-watt power-handling capability and extra sensitivity let it deliver considerable acoustic level.

Specifications

Frequency Response Characteristic	50 to 16,000 Hz
Program Power-Handling Capability	10 Watts
Magnet Weight (Inbox)	20 oz. (567 g)
Gap Flux Density	11,500 gauss
Cone Resonance (6.5 ft. ³ [10.18 m ³] enclosure)	60-70 Hz
Axial Sensitivity (1 kHz at 1 W; 4 ft. [1220 mm])	95 dB
Voice Coil Impedance (at 400 Hz)	8 ohms
Voice Coil Diameter	1 inch (51 mm)
Overall Diameter	12-7/32" (310 mm)
Bolt-Circle Diameter	11-9/16" (294 mm)
Depth	5-5/32" (131 mm)
Weight (approx.)	4 lbs. (1.8 kg)

Recommended Enclosures

Wall-Mount Enclosure, Type LS-3	MI-11407
Wall-Mount Paging Baffle	MI-11414-2

50-Watt Loudspeaker System, Type LC-9

- Excellent frequency response—
50 to 16,000 Hz
- 50 watts program input
- Wide-angle radiation at all frequencies
- Matching high- and
low-frequency wavefronts
- 500 hertz crossover frequency

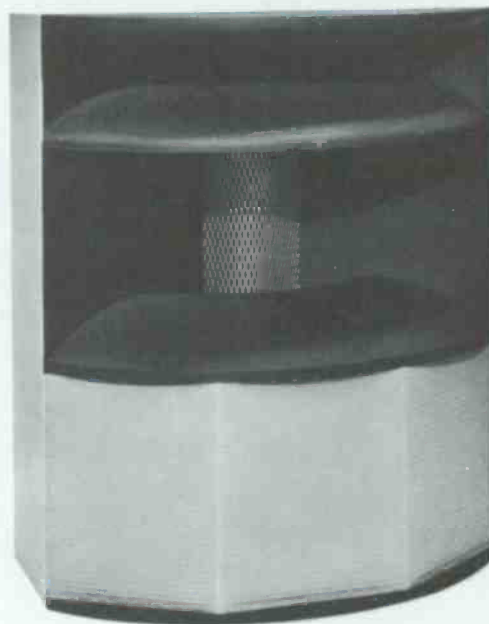

The LC-9 Loudspeaker System is designed for applications where high acoustical level, wide dispersion angle, and extended frequency response are required. The frequency range is covered by separate low and high frequency horns with a crossover point at 500 Hz. A feature of the LC-9 is the particular care with which the high and low frequency horns have been designed to provide matched acoustical wavefronts for smooth response over the entire frequency range.

Specifications

Frequency Response Characteristic	50-16,000 Hz
Power-Handling Capability	rms: 35 watts; program: 50 watts
Dispersion Angles	120° Horiz.; 45° Vert.
Impedance, Tweeter Voice Coil	16 ohms
Impedance, Woofer Voice Coil	16 ohms
Diameter, Tweeter Diaphragm	1¾" (44 mm)
Diameter, Woofer Diaphragm	15" (381 mm)
Crossover Frequency (12 dB/octave)	500 Hz
Input Impedance	16 ohms
Dimensions	44" H; 36" W; 27½" D (1118, 915, 689 mm)
Weight (approx.)	175 lbs. (79 kg)

Ordering Information

50-Watt Auditorium Loudspeaker System, Type LC-9	ES-11423
---	----------

60-Watt Column Speaker

- Wide horizontal dispersion—
narrow, vertical dispersion—
ideal for minimum reverberation
- High sensitivity 8-inch speakers
- Excellent frequency response—
80 to 16,000 Hz
- 25-watt sinewave and
60-watt program capability
- Acoustically balanced, treated interior—
exterior easily refinished
to match any decor
- Nominal impedance 8-ohms—needs no
matching transformer

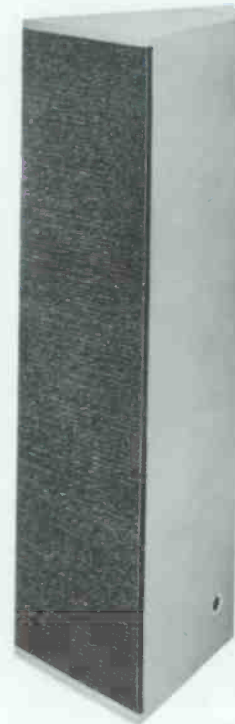

The Column Speaker System consists of five 8-inch speakers (RCA Type SL-8) mounted in a line, in a specifically designed and acoustically treated cabinet. The result of the "in line" combination is a concentration of sound into a fan-shaped beam which "aims" toward areas where sound coverage is desired. A number of column systems, properly placed, can provide large areas with high-quality sound reproduction relatively free of annoying reverberation. Side-tapered baffles allow a number of cabinets to mount in a cluster over a stage, if appropriate.

Because of the directional properties of this column speaker, relatively little sound reflects from the ceilings or floors, which, in turn reduces undesired reverberation.

Specifications

Frequency Response Characteristic	80-16,000 Hz
Power-Handling Capability:	
Program Material	60 watts
Continuous Sinewave	25 watts
Dispersion Angles:	
Horizontal Plane (200 Hz)	-6 dB at 180°; -10 dB at 240°
Vertical Plane (800 Hz)	-6 dB at 40°; -10 dB at 50°
Dimensions	45½" H; 12½" W (front) 5¾" (rear); 13" D (1156, 318, 146, 330 mm)
System Weight (approx.)	25 lbs. (11 kg)

Speaker Enclosures And Baffles, Types LS-1, LS-3, LS-11 And MI-11414-2

- Acoustically engineered
- For all RCA speakers
- Fiber glass acoustic padding
- Adapters supplied
- Sturdy plywood construction



Three of the cabinets described here are speaker enclosures as opposed to speaker baffles. The LS-1 and LS-11 are designed specifically for the Type LC-1 15-Inch Duo-Cone Speaker while the LS-3 and MI-11407 accommodate any standard 8-, 10- or 12-inch speaker. (See next page.)

Olson Floor Cabinet for LC-1 Speaker, Type LS-11

Designed specifically for the Type LC-1 Duo-Cone Loudspeaker, this floor cabinet uses the infinite-baffle principle to extend bass-frequency response without affecting the speaker unit's high-frequency capabilities. It is offered in two finishes: a utility finish, for use where some abuse may be expected, and a satin-walnut finish that harmonizes with good furnishings anywhere.

Specifications, Type LS-11

Dimensions:	
Height (4-inch legs, removable)	44" (1118 mm)
Width	28½" (724 mm)
Depth	16" (406 mm)
Weight (approx.)	64 lbs. (27 kg)
Finish	Satin Walnut or Utility Finish

Ordering Information

Olson Floor Cabinet for LC-1, Type LS-11:	
In Satin-Walnut Finish	MI-11415A
In Utility Finish	MI-11415B

Wall Speaker Enclosure, Type LS-1



A reflex enclosure designed to load the Type LC-1 Duo-Cone Speaker, this enclosure mounts on a wall at a 30- or 60-degree angle. It is finished to harmonize with any RCA-equipped studio.

Specifications

Dimensions:	
Height	22 $\frac{3}{4}$ " (553 mm)
Width	37 $\frac{1}{2}$ " (953 mm)
Depth	17 $\frac{1}{8}$ " (435 mm)
Weight	45 lbs. (20 kg)

Ordering Information

Wall-Mount Enclosure, Type LS-1MI-11406

Wall Mount Speaker Enclosure, Type LS-3



The Type LS-3 Speaker Enclosure is designed for wall-mounting any standard eight-, ten- or twelve-inch diameter loudspeaker. It is particularly suitable for the RCA Types SL-8, SL-890 and SL-12 Speakers.

Built solidly of one-half-inch plywood, the LS-3 includes a back panel, glass-fiber acoustic insulation, two speaker adapter boards and two wall-mounting brackets. The aperture in the enclosure is cut for a twelve-inch speaker. The adapter boards provide for mounting eight- or ten-inch units.

Specifications

Dimensions:	
Height	16 $\frac{1}{8}$ " (411 mm)
Width	25" (635 mm)
Depth	11 $\frac{1}{2}$ " (286 mm)
Weight (approx.)	12 lbs. (5 kg)
Finish	Textured lacquer: Midnight Blue

Ordering Information

Wall-Mount Speaker Enclosure, Type LS-3MI-11407

Paging Baffle for 12-Inch Speaker



An open-back baffle for any standard 8- or 12-inch loudspeaker, the MI-11414-2 unit is built of one-half-inch plywood finished in textured lacquer. A fiber glass acoustic pad and adapter board are included. Two slotted brackets make mounting easy.

Specifications

Dimensions:	
Height	15 $\frac{1}{4}$ " (387 mm)
Width	13 $\frac{7}{8}$ " (352 mm)
Depth	9 $\frac{1}{4}$ "; 5 $\frac{1}{4}$ " (235; 133 mm)
Weight (approx.)	9 $\frac{1}{2}$ lbs. (4 kg)

Ordering Information

Paging Baffle, Wall MountMI-11414-2



Transformers, Wire and Cable

- **Bridging and line-matching transformers**
- **Speaker-matching transformers**
- **Power-line step-down transformers**
- **Microphone cables**
- **Console and rack cable**
- **Lacing cord and tape**



Described here are line-bridging and line-matching transformers, speaker-matching transformers, microphone cables, console- and rack-wiring cables and cable-lacing material.

Bridging Transformers

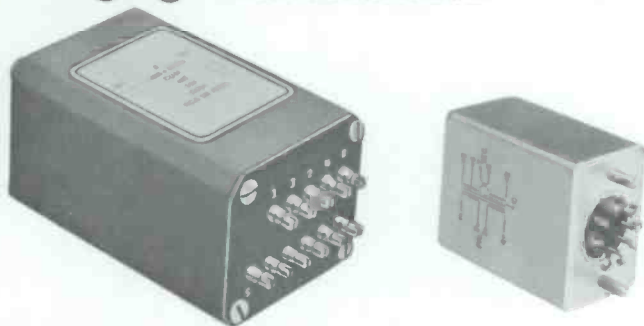

Well-shielded, chassis-mount transformers for bridging any 600-ohm program line. The differences between the two described here lie mostly in dimensions and frequency response.

Specifications	MI-11712	MI-11791
Frequency Response (Hz)	20-20k \pm 0.5 dB	30-15k \pm 0.5 dB
Primary Impedance	20,000 ohms	20,000 ohms
Secondary Impedance	150/600 ohms	150/600 ohms
Distortion (30 Hz)	0.5%	0.5%
Insertion Loss (1000 Hz)	19 dB max.	20 dB max.
Input Level (45V input)		(32V input)
Input Level (Min. to Max., dBm)	-30 to +20	-20 to +20
Output Level (Min. to Max., dBm)	-10 to 0	-20 to 0
Winding Imbalance	0.5% (100 Hz)	1% (1000 Hz)
Insulation	500V 60 Hz	500V 60 Hz
Dimensions (inches)	4 x 2.34 x 1.22	2.58 x 1.19 x 1.69
Dimensions (mm)	102 x 60 x 31	65 x 30 x 30
Weight	46 oz. (1204 g)	24 oz. (680 g)

Matching Transformers

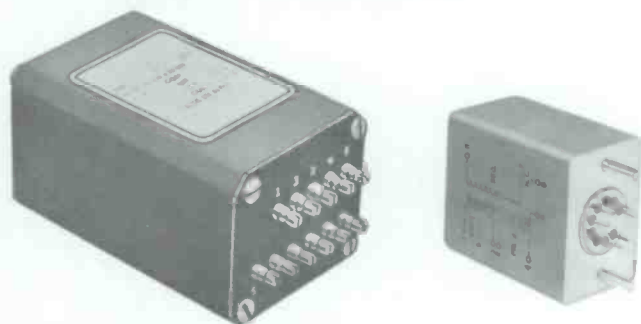

For any isolation requirement, these two transformers match 150/600-ohm lines. The difference between the two are largely in size and maximum operating level.

Specifications	MI-11713	MI-141001
Frequency Response (Hz)	20-20K \pm 0.5 dB	30-20k \pm 0.25 dB
Primary Impedance	150/600 ohms	150/600 ohms
Secondary Impedance	150/600 ohms	150/600 ohms
Distortion (30 Hz)	0.8% max. (7.5V/600 ohms)	0.5% max.
Insertion Loss	2 dB max.	1 dB max.
Input Level (Min. to Max., dBm)	-50 to +10	-40 to 0
Insulation	500V 60 Hz	500V 60 Hz
Dimensions (inches)	4 x 2.34 x 1.22	2.75 x 1.19 x 1.69
Dimensions (mm)	102 x 60 x 31	70 x 30 x 30
Weight	46 oz. (1204 g)	7 oz. (198 g)

Speaker Transformers



Autotransformers

These three transformers increase (or decrease) line impedance to match speaker impedance. The autotransformer principle provides impedance ratio without isolation between primary and secondary.

Specifications	MI-9471	MI-9472	MI-11731
Frequency Response (Hz)	50-15k \pm 2.5 dB	50-15k \pm 2 dB	60-10k \pm 1 dB
Power Level	25W	100W	8W
Distortion	0.15%	0.2%	2% (100-10k Hz)
Winding Taps	250, 125, 30, 15, 7, 5, 4, 2	250, 63, 30, 15, 10, 7, 5, 4, 2	16/8/4 ohms
Dimensions (inches)	3 $\frac{3}{8}$ x 2 $\frac{1}{8}$ x 3 $\frac{7}{8}$	4 $\frac{1}{2}$ dia., 5 $\frac{1}{2}$ H	1.66 x 2 x 0.75
Dimensions (mm)	92 x 62 x 98	114 x 140	34 x 51 x 19
Mounting Centers	3 $\frac{1}{4}$ " x 1 $\frac{3}{4}$ "	3 $\frac{1}{8}$ " x 3 $\frac{3}{8}$ "	2.38" (61 mm)
Weight	50 oz (1.4 kg)	162 oz. (1.7 kg)	10 oz. (284 g)

Ordering Information

Autotransformer Speaker Transformers:

25W	MI-9471
100W	MI-9472
8W	MI-11731

Multi-Tap Speaker Transformer

This multi-tap transformer provides isolation between primary and secondary as opposed to the autotransformers described above. Conventional strap mount with stripped and tinned pigtail leads.

Specifications

Frequency Response (Hz)	60-10k \pm 0.5 dB
Power Level	10W
Distortion	2% max.
Core Stack	0.75 x 0.825" (19 x 22 mm)
Primary Impedance (ohms)	5000/2500/1250/625
Secondary Impedance (ohms)	16/8/4
Dimensions (inches)	2.28 x 3.78 x 2.25
Dimensions (mm)	58 x 95 x 57
Mounting Centers	3.125" (79 mm)
Lead Lengths	10" (254 mm)
Weight	22 oz. 624 g

Ordering Information

Speaker Matching TransformerMI-12368

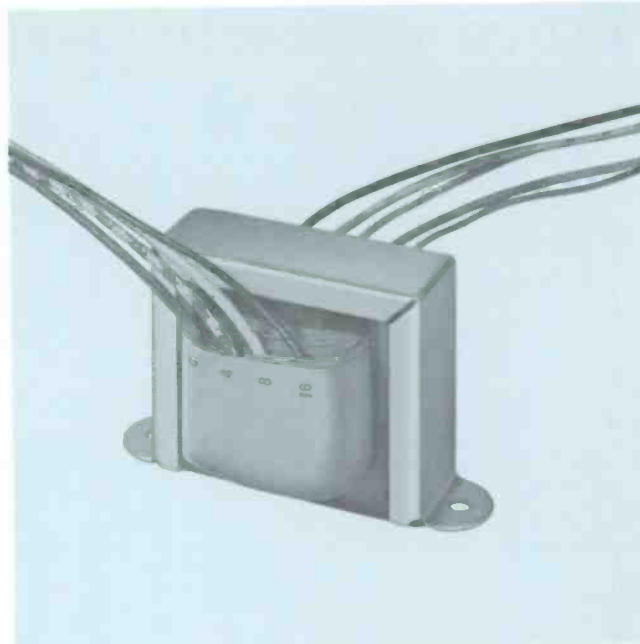

Matching Transformers for BC-14, -15 and -18 Consoles

These transformers are specially selected for use with the BC-14, -15 and -18 Consoles. The one for the BC-14 matches the 50 ohm console monitor output to a 4-, 8- or 16-ohm loudspeaker; the other converts the unbalanced, low-impedance audition output of the BC-15 and -18 into a balanced 150/600 ohm output.

Specifications

	MI-11686	MI-141011
Frequency Response (Hz)	40-20K \pm 2 dB	20-20K \pm .5 dB
Power Level	10 W	1 W
Primary Impedance	50 ohms	50 ohms
Secondary Impedance	16/8/4 ohms	150/600 ohms
Dimensions	1 3/4" W; 2 7/8" L; 2 3/8" H (44, 73, 60 mm)	2-7/16" W; 1-15/16" L; 3 1/4" H (62, 49, 83 mm)
Mounting Centers	2 3/8" (60 mm)	1-3/16"
Weight (Approx.)	14 oz. (397 g)	22 oz. (624 g)
Distortion	1% Max.	0.39% Max.



Ordering Information

Matching Transformer,
BC-14 Monitor OutputMI-11686

Matching Transformer,
BC-15, -18 Audition OutputMI-141011

Stepdown Transformers

Available in five power capabilities, these transformers allow operation of 117-volt equipment on 234-volt power lines. They are autotransformers and provide no isolation. All supplied with 5-foot, heavy-duty power cord and built-in, non-polarized outlet.

Specifications

Watts	Length (mm)	Width (mm)	Height (mm)	Stock ID
85	3.13" (80)	2.63" (67)	3.19" (81)	MI-141010-85
125	3.50" (89)	3.00" (76)	3.50" (89)	MI-141010-125
175	3.75" (95)	3.25" (83)	3.88" (99)	MI-141010-175
250	3.88" (99)	3.25" (83)	3.88" (99)	MI-141010-250
500	4.63" (118)	3.88" (99)	4.63" (118)	MI-141010-500

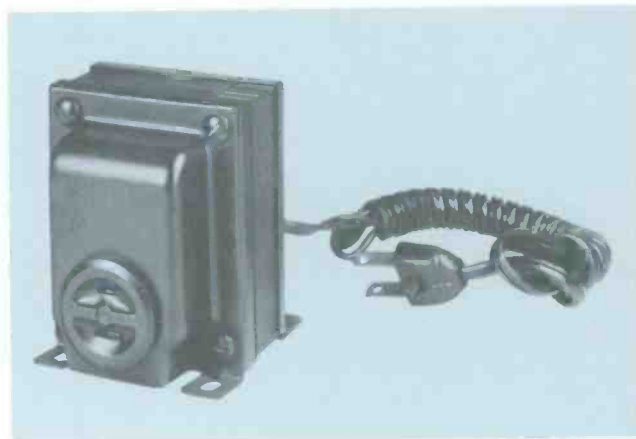

Microphone Cable: Shielded 2- and 3-Conductor

Four types of microphone cable are available: two heavy-duty and two lightweights. Rugged and flexible. Available in 100-foot (30 m) lengths only.

Cond.	AWG	Shield	Rating	OD (mm)	Jacket	Color	Stock ID*
3	#20	Braided	1000V	0.3" (8)	Rubber	Brown	MI-43
2	#16	Braided	600V	0.3" (8)	Neoprene	Brown	MI-13307
2	#24	Braided	600V	0.215" (6)	Neoprene	Brown	MI-13322
2	#28	Braided	200V	0.156" (4)	PVC	Dark Beige	MI-13373

*Stocked in 100-foot (30 m) hanks only

Audio Cabling: Stranded and Solid Conductor

General-purpose audio cable for console and equipment-rack wiring.

Stranded Conductors							
Cond.	AWG	Shield	Rating	OD (mm)	Jacket	Color	Stock ID*
2	#22	Wire	200V	0.210" (5)	Vinyl	Black	MI-13342-2
2	#22	Foil	200V	0.135" (3)	Vinyl	Black or Gray	MI-13342-4
2	#22	Braid	300V	0.166" (4)	Vinyl	Brown	MI-34
2	#18	Braid	300V	0.236" (6)	Vinyl	Brown	MI-35
2	#28	Braid	200V	0.160" (4)	Vinyl	Brown	MI-13395-1

Solid Conductors							
Cond.	AWG	Shield	Rating	OD (mm)	Jacket	Color	Stock ID*
2	#22	Braid	300V	0.170" (4)	Vinyl	Brown	MI-33
2	#22	Braid	200V	0.200" (5)	Vinyl	Black	MI-13342-1

*Stocked in 100-foot (30 m) lengths only

Lacing Cord and Tape

For general cable lacing and dressing.

Ordering Information

Linen Cord, #6, Black,
500 yards (1500 m)MI-11719A

Nylon Lacing Tape, Natural, 500 yards, (1500 m)
0.85" x 0.016" (2.2 x 0.4 mm)MI-11719B

Fungus-Proof Nylon Lacing Tape, Natural,
500 yards, (1500 m) 0.09" x 0.013" (2.3 x 0.3 mm)MI-11719C

RCA

Audio Level Meter, "Little Nipper" Type BI-100

- Range: -60 to +40 VU in 10-dB steps
- Battery powered—light weight
- Calibrated for 150- or 600-ohm lines
- Response: 30 to 15,000 Hz ± 1 dB
- For balanced or unbalanced lines



The extremely compact and light weight "Little Nipper" Audio Level meter is designed for use as a utility level meter in checking audio distribution systems, remote lines and other similar applications.

Eleven Ranges in 10-dB Steps

A selector switch provides for bridging either balanced or unbalanced audio circuits. The switch provides eleven ranges, in 10-dB steps, between -60 and +40 VU.

Battery Powered

Power for the circuitry of "Little Nipper" is provided by a mercury battery with a useful life of approximately 250 hours. The long shelf life of this type of power source minimizes battery deterioration while the unit is not in use. A spare battery is stored within the case. The unit weighs only 26 oz. (707 g). A three-wire cable, fitted with alligator clips is included. The connector is a standard two-circuit phone plug (tip, ring and sleeve). The BI-100 is supplied with two magnetic mounting strips which permit permanent or temporary mount on any steel surface.

Specifications

Input (switch selected) Balanced or Unbalanced
 Input Impedance (bridging) 20,000 ohms, min.
 Frequency Response 30 to 15,000 Hz \pm 1 dB
 Ranges -60 to +40 VU in 10-dB steps
 Battery Mercury Cell, 6.75 V
 Battery Life (approx.) 250 hours

Input Connector Two-circuit phone jack
 Dimensions 6" H; 2 $\frac{3}{4}$ " W; 2 $\frac{3}{4}$ " D (152 x 69 x 69 mm)
 Weight 26 oz. (707 g)
 Shipping Data 6" x 6" x 10" (152 x 152 x 254 mm)
 40 oz. (1134 g)

Ordering Information

Audio Level Meter, "Little Nipper", Type BI-100 MI-141022

Audio Test Equipment Available Through RCA

Literature and prices available from Radio Station Equipment Product Mgmt., RCA Bldg. 2-2, Camden, N.J. 08102 (U.S.A.) or the nearest RCA Broadcast Sales Representative.

Audio Oscillators and Generators

Waveforms	Models:	402A	471B	471F	473B
		510B	510C	512F	
Barker & Williamson	Model:	210			
Hewlett-Packard	Models:	651B	652A		
RCA	Types:	WA-44C	WA-504A		

Transmission-Line Measuring Sets

Waveforms	Models:	452A	452B	524C	54246R
-----------------	---------	------	------	------	--------

Passive Attenuators

Waveforms	Model:	454A
-----------------	--------	------

Distortion Analyzers

Waveforms	Model:	456A			
Barker & Williamson	Model:	410			
Hewlett-Packard	Models:	331A	332A	333A	334A

Noise and Distortion Test Set

Waveforms	Models:	5146P	5146R
-----------------	---------	-------	-------

Sweep Signal Generators

Waveforms	Models:	610B	610D
-----------------	---------	------	------

Audio Vacuum-Tube Voltmeters

Waveforms	Models:	520A	520D	520L	
RCA	Types:	WV-76A	WV-77E	WV-98C	WV-98CX
		WV-500B	WV-510A		

Volt-Ohm-Milliammeters

RCA	Types:	WV-38A	WV-516A	WV-517A	WV-518A
		WV-519A	WV-520A		

Audio Frequency Meters

Waveforms	Models:	620B	620D
-----------------	---------	------	------

Oscilloscopes

Tektronics	Types:	321A	323
RCA	Types:	WO-33A	WO-505A

Radio-Frequency Signal Generators

RCA	Type:	WR-52A
-----------	-------	--------

FM-Stereo Signal Simulator

RCA	Type:	WR-50B
-----------	-------	--------

Transistor Tester

RCA	Types:	WV-511A	WT-501A	WV-506A	WC-528A
-----------	--------	---------	---------	---------	---------

Power Line Voltage Monitor

RCA	Types:	WV-120A	WV-503A
-----------	--------	---------	---------



RCA Broadcast
Systems

Front and Cooper Streets, Camden, New Jersey 08102, U.S.A.

720207

Printed in U.S.A.

www.americanradiohistory.com