

December

THE NEW

25 Cents

# Science and Invention

IN PICTURES

IN  
PRIZES  
\$12,000.00  
FOR  
PICTURES

See Page  
754

A "FLOATING" RAILROAD

See Page 753



40 NON-TECHNICAL RADIO ARTICLES



# Electricity Needs You I WILL TRAIN YOU AT HOME

Stop right here. This is YOUR opportunity! Electricity is calling you, and the Electrical Business is in for a tremendous increase. But it needs more trained men—at big pay. By my Home Study Course in Practical Electricity I can train you for these positions.

## Earn \$70 to \$200 a Week

You've always had a liking for Electricity and a hankering to do electrical jobs. Now is the time to develop that talent; there's big money in it. Even if you don't know anything at all about Electricity you can quickly grasp it by my up-to-date, practical method of teaching. You will find it intensely interesting and highly profitable. I've trained and started hundreds of men in the Electrical Business, men who have made big successes. YOU CAN ALSO

BE A BIG PAID

## ELECTRICAL EXPERT

What are you doing to prepare yourself for a real success? At the rate you are going where will you be in ten years from now? Have you the specialized training that will put you on the road to success? Have you ambition enough to prepare for success, and get it?

You have the ambition and I will give you the training, so get busy. I am offering you success and all that goes with it. Will you take it? I'll make you an ELECTRICAL EXPERT. I will train you as you should be trained. I will give you the benefit of my advice and 20 years of engineering experience and help you in every way to the biggest possible success.

CHIEF ENGINEER  
COOKE  
Chicago Engineering  
Works  
Dept. 29, 2150 Lawrence Av.  
CHICAGO, ILL.

Dear Sir: You may send me entirely free and fully prepaid, a copy of your book, "How to Become an Electrical Expert," and particulars about your Home Study Course in Electricity.

Name.....

Address.....

Occupation..... Age.....

**Valuable Book Free** My book, "How to Become an Electrical Expert," has started many a man on the way to fortune. I will send a copy, free and prepaid, to every person answering this advertisement.

**Act Now!** Good intentions never get you anywhere. It is action, alone, that counts. NOW IS THE TIME TO ACT.

L. L. COOKE, Chief Engineer  
**CHICAGO  
ENGINEERING  
WORKS**

2150 LAWRENCE AVENUE  
Dept. 29 Chicago, U. S. A

## FREE!

### BIG ELECTRICAL OUTFIT

A fine outfit of Electrical Tools, Instruments, Materials, etc., absolutely FREE to every student. I will also send you FREE and fully prepaid—Proof Lessons to show you how easily you can learn Electricity and enter this splendid profession by my new, revised and original system of Training by Mail.

### RADIO COURSE FREE

Special newly-written wireless course worth \$45.00 given away free. Full particulars when you mail coupon below.

### Earn Money While Learning

I give you something you can use now. Early in my Home Study Course I show you how to begin making money in Electricity, and help you get started. No need to wait until the whole course is completed. Hundreds of students have made several times the cost of their course in spare time work while learning.

**The Cooke trained man is the "Big-Pay" man**

# NEW TRAINING PLAN IN ELECTRICITY

Takes Only

**20**

WEEKS BY



S. V. Smith  
President  
S & H Engineering  
Works

Mr. Smith is known as the "Electrical Wizard," not only because of his vast knowledge of Electricity, but also because he has been so successful in his training that many of his students are holding some of the most important Electrical positions in America.

## Amazing S&H Shop Type Method Prepare Quickly at Home for Better Jobs

Remarkable "Shop Type Home Training System" is the most complete, thorough and easily mastered Method ever devised. Trains you for the Higher Paying positions in Electricity.

Don't be satisfied to become an ordinary Electrician. Our remarkable new method enables you to *Aim Higher*, and *Get Higher*—it places the *Big Pay* jobs at the top of the profession at your disposal. It is different from all other courses.

### A MASTER COURSE

This new system was designed by S. V. Smith, called by his friends the "Electrical Wizard" because of his ability to teach Electricity and because of the reputation and high positions attained by those whom he has taught.

This *Shop-Type Home Training System*—which makes you so efficient—is an exclusive feature of *S & H Training*.

It gives you all the theoretical knowledge of electrical principles that is taught in Technical Universities. That is something the ordinary Electrician *Never* gets.

But, in addition it gives you the *Practice* that a man gets *only* from doing practical work, which is something the College student does not get. The men at the head of big Electrical Plants—the men in the \$10,000 jobs *Must* have *Both* the Theory and the Practice. *S & H Training* gives you *both*.

If you are able to read and write ordinary English, we can train you to do house wiring, central station and power house operation, automotive and tractor electricity, electric welding, armature winding, motor and generator work, etc., so that

when you are in charge of a plant you can tell every man in it what to do and how to do it.

### LEARN IN FEW MONTHS

Because Mr. Smith has devised numerous shortcuts this *Extra* training takes no longer than the ordinary courses.

### FREE OUTFIT

To all who send coupon at once, Mr. Smith offers *Free*, a complete outfit of Electrical Apparatus, Instruments and Appliances for experimental and practical home shop work. By enrolling *now* you will be entitled to this outfit—but you must send coupon immediately.

Do this today. Get our big catalog giving information about this amazingly rapid and easy course. Read in it the letters from other students who have attained big success through S & H Training. This catalog will also explain the remarkable service rendered our students by the *S & H Employment Bureau*. This service is offered absolutely free. Mail coupon now.

S. V. SMITH  
S & H ELECTRICAL WORKS

Dept. S-2 1422 W. Monroe Street, Chicago, Ill.

Mail for FREE Offer

Chief Engineer Smith, S & H Electrical Works,  
Dept. S-2, 1422 W. Monroe St., Chicago, Ill.

Please send me catalog and full information about the remarkable S & H Course, your *Free Outfit*, your Employment Bureau, etc. This information is free and does not obligate me in any way whatsoever.

Name .....

Address .....

City ..... State .....

# Science and Invention

FORMERLY  
**ELECTRICAL EXPERIMENTER**

PUBLICATION OFFICE: 542 Jamaica Ave., Jamaica, N. Y.  
EDITORIAL & GENERAL OFFICES: 53 Park Place, New York City  
Published by Experimenter Publishing Company, Inc. (H. Gernsback, Pres.; S. Gernsback, Treas.; R. W. DeMott, Sec'y).  
Publishers of SCIENCE AND INVENTION, RADIO NEWS, and PRACTICAL ELECTRICS

## Table of Contents for December

POPULAR SCIENTIFIC ARTICLES		AUTOMOBILES	
EDITORIAL	737	TEMPRESSES OF DEATH	738
THERMOCOUPLE FINDS ICEBERG	738	LICENSE LOCK	765
TEMPRESSES OF DEATH	738	ELECTRIC JACK	765
TAKING MOVIE SCENES IN MINIATURE	739	MOTOR DRIVEN SLED	766
MOVIE DOUBLE EXPOSURE TRICK	740	MOTOR HINTS	814
SELF PROPELLING WAVE SHIP	741		By Tom C. Plumridge.
STEREOSCOPIC MOTION PICTURES	741	<b>ELECTRICITY</b>	
DRIFTWOOD FINISH FOR CYPRESS	742	THERMOCOUPLE FINDS ICEBERG	738
METHODS OF PRESERVING FLOWERS	743	SELF PROPELLING WAVE SHIP	741
NEW YORK'S PHOTO BY SEARCHLIGHT	744	NEW YORK'S PHOTO BY SEARCHLIGHT	744
	By P. R. Bassett.		By P. R. Bassett.
FAKE EARTHQUAKE MOVIES	745	SIMPLE BATTERY CHARGER FOR A.C. USE	770
	By W. B. Arvin.		By Dr. Ernest Bade.
DR. HACKENSAW'S SECRETS—NO. 24. THE SECRET OF THE MEMORY OBLITERATOR	746	HOW TO MAKE A STORAGE "A" BATTERY	773
	By Clement Fezandie.	LATEST PATENTS	787
AROUND THE UNIVERSE—SIXTH AND FINAL INSTALLMENT	748	ORACLE	789
	By Ray Cummings.	<b>RADIO ARTICLES</b>	
LARGEST VEHICULAR TUNNEL	750	LOUD TALKER WITHOUT MICROPHONE	777
	By A. P. Peck.		By Dr. Alfred Gradenwitz.
INSECTS MAKE CAMERA DEBUT	751	RADIO FOR THE BEGINNER—NO. 22. A RADIO CHRISTMAS	778
	By Edwin Schallert.		By Armstrong Perry.
THE ANCIENT'S HOUSE HARDWARE	752	BROADCAST STATIONS PHOTOGRAPHS	779
	By Charles Beecher Bunnell.	THE COMPACT "SINGLE SIX" CIRCUIT	781
INVISIBLE ELEVATED RAILWAY	753		By H. E. Hayden.
	By Edwin F. Linder.	MULTI-WAVE REINARTZ RECEIVER	782
MOORING MAST FOR DIRIGIBLE	754		By Kenneth Harkness.
FAMOUS OPINIONS ON SPIRITUALISM	755	HOW TO BUILD A ROGER'S CAGE LOOP	783
FOSSILIZED EXTINCT ANIMALS	756	WELL MADE RADIO CABINET	784
	By Dr. W. A. Luz.	RADIO ORACLE	785
AIRPLANE LANDING STAGE	757	BROADCASTING STATIONS CALL LETTERS UP-TO-DATE	802
	By George F. Paul.	RADIO WRINKLES—Edited by A. P. Peck	322
THE WONDERS OF SATURN	758		
	By Isabel M. Lewis, M.A.	<b>CONSTRUCTOR ARTICLES</b>	
THE HEAVENS IN DECEMBER	760	SIMPLE BATTERY CHARGER FOR A.C. USE	770
	By Isabel M. Lewis, M.A.		By Dr. Ernest Bade.
INVENTORS TRY IT ON THE LAWYER	761	"BOBCAT" AN AIR PROPELLED SLED	771
SCIENTIFIC CHRISTMAS TOYS	762		By G. A. Luers.
MAGIC FOR EVERYBODY—NO. 9 OF A SERIES	763	COMBINATION DRILL AND LATHE	772
	By Professor Joseph Dunninger.	HOW TO MAKE A STORAGE "A" BATTERY	773
"KICK" PREVENTION FOR CIDER	764		By Dr. Ernest Bade.
	By Raymond B. Wailes.	<b>CHEMISTRY ARTICLES</b>	
BURN YOURSELF? WHAT HAPPENS?	765	"KICK" PREVENTION FOR CIDER	764
THE STARS IN 1,000 CENTURIES	766	EVERYDAY CHEMISTRY	769
	By Donald H. Menzel.		By Raymond B. Wailes.
SCIENTIFIC MATCH-BOX PUZZLES	767	CAPTURING FROST CRYSTAL FORMS	774
SCIENTIFIC PROBLEMS AND PUZZLES	768		By S. Leonard Bastin.
	By Ernest K. Chapin.	<b>ASTRONOMY ARTICLES</b>	
<b>PRIZE CONTESTS</b>		THE HEAVENS IN DECEMBER	760
WRINKLES, RECIPES AND FORMULAS—\$5.00 MONTHLY PRIZE	774		By Isabel M. Lewis, M.A.
HOW-TO-MAKE-IT DEPARTMENT—\$30.00 IN PRIZES	775	THE STARS IN 1,000 CENTURIES	766
SCIENTIFIC HUMOR—PRIZE FOR BEST JOKES	788		By Donald H. Menzel.

HOW TO SUBSCRIBE FOR "SCIENCE AND INVENTION." Send your name, address, and remittance to Experimenter Publishing Co., 53 Park Place, New York. Mention the name of the magazine you are ordering. We also publish RADIO NEWS and PRACTICAL ELECTRICS.  
RATES AND TERMS The subscription rate for SCIENCE AND INVENTION is \$2.50 per year. (12 numbers.) When remitting do so by check, money order or registered letter, if cash is enclosed. Avoid sending cash through the mail if possible. Subscriptions for less than one year are not accepted. Subscriptions may be made in combination with RADIO NEWS or PRACTICAL ELECTRICS with considerable saving. Send postal for special rates. Subscriptions start with the current issue, unless otherwise ordered.  
POSTAGE. We prepay postage in all parts of the United States, Mex-

SCIENCE AND INVENTION is published on the 25th of each month. There are 12 numbers per year. Subscription price is \$2.50 a year in U. S. and possessions. Canada and foreign countries \$3.00 a year. U. S. coin as well as U. S. Stamps accepted (no foreign coin or stamps). Single copies, 25 cents each. A sample copy will be sent gratis on request. Checks and money orders should be drawn to order of EXPERIMENTER PUBLISHING CO., Inc. If you change your address notify us promptly, in order that copies are not misrouted or lost.

All communications and contributions to this journal should be addressed to Editor, SCIENCE AND INVENTION, 512 Jamaica Avenue, Jamaica, New York, or 53 Park Place, New York City, N. Y. Unaccepted contributions

New York City.  
General Advertising Dept.,  
53 Park Place.

Western Advertising Representatives,  
Finucan & McClure,  
720 Cass St., Chicago, Ill.

Pacific Coast Advertising Representatives,  
A. J. Norris Hill Co.,  
Hearst Bldg., San Francisco, Calif.

Kansas City Advertising Representative,  
George F. Dillon,  
Republic Building, Kansas City, Mo.

ico and island possessions. For foreign or Canadian subscriptions we require 50 cents in addition to the subscription price for additional postage charges.

CHANGE OF ADDRESS. Notify us as far in advance as possible. It requires several weeks to make an address change on our records. Always write clearly, giving your old address as well as your new.

ON EXPIRATION of your subscription we enclose a renewal blank in our last number to you and notify you otherwise. Unless we receive your order for a renewal, with your remittance, we stop our delivery to you on expiration.

COMMUNICATIONS to us should always bear your full name, address and when possible the number which appears on your wrapper every month."

cannot be returned unless full postage has been included. ALL accepted contributions are paid for on publication. A special rate is paid for novel experiments; good photographs accompanying them are highly desirable.

SCIENCE AND INVENTION. Monthly. Entered as second-class matter at Jamaica, N. Y., Post Office, under act of Congress of March 3, 1879. Title Registered at the Patent Office. Copyright, 1923, by E. P. Co., Inc., New York. The Contents of this Magazine are copyrighted and must not be reproduced without giving full credit to the publication.

SCIENCE AND INVENTION is for sale at all newsstands in the United States and Canada; also at Brentano's, 37 Avenue de l'Opera, Paris. Member of the Audit Bureau of Circulation.

# New Hair for You in 30 Days -or Your Money Instantly Refunded

My amazing guarantee means just exactly what it says! I don't care how thin your hair is—I don't care if you are completely bald—if new hair fails to grow after using my method—then the test costs you absolutely NOTHING! The astonishing proof of what I have done for others is now yours—entirely free. Simply mail the coupon below

By ALOIS MERKE

Founder of Famous Merke Institute, Fifth Avenue, New York

**N**O matter how long you have been bald—no matter how many different treatments you have taken without results—I have discovered a startling new treatment for baldness which I absolutely guarantee will grow new hair in 30 days—or every penny you have paid me will be instantly—and gladly—refunded.

No one has ever dared to make such a sweeping guarantee before! But do you suppose that I could make it unless I was absolutely confident that my treatment would do all I claim? Never! I would be out of business in a week. But I KNOW what my method will do. For in most cases, its remarkable value is shown by actual statistics covering thousands of cases treated—*only three people in every hundred asking the return of their money!*

### Not One Penny's Risk!

Now I realize that you have perhaps wasted a lot of time and money on treatments which could NEVER restore your hair. Very likely you are skeptical. All right. I don't blame you. And I'll admit right here that my treatment may not help you either. For your case may be one of the three in every hundred that is absolutely hopeless. In any case, I want you to try my treatment at my risk—and if after 30 days you are not more than delighted with the results produced—then all you need do is tell me so,



and without asking a single question I'll mail you a check refunding every cent you have paid me. I don't want a cent of your money, unless I *actually grow hair on your head!* You of course, are to be the sole judge.

### Entirely New Method

My treatment is the result of 17 years of experience gained in treating thousands of cases of baldness. This included many long years which I spent in such famous centers of scientific research as Heidelberg, Berlin, Paris, Geneva, and Buenos Ayres. And my method is entirely different from anything known or used before.

There is no massaging—no singeing—no "mange cures"—no unnecessary fuss or bother of any kind. Yet results are usually noticeable even after the very few first treatments.

My treatment proves that a big percentage of baldness is caused—not by *dead* hair roots—but by *dormant* hair roots, which can now be awakened and made to grow hair again. The reason other treatments failed is because they did not penetrate to these dormant roots. To make a tree grow, you would not think of rubbing "growing fluid" on the bark. Instead you would get right to the roots. And so it is with the hair.

In all the world there is only one method I know about of penetrating direct to the roots and getting nourishment to them. And this method is embodied in the treatment that I now offer you on my positive guarantee of satisfactory results, or the trial costs you nothing.

Already great numbers of men and women who only recently were bald or troubled with thin, falling hair have, through this method, acquired healthy hair that is the envy and admiration of all their friends. As for dandruff and similar scalp disorders, these in many cases disappear so quickly that it seems almost magical. The treatment can be used in any home in which there is electricity.

### Free Booklet Explains Treatment

If you will merely fill in and mail the coupon below I will gladly send you—without cost or obligation—an interesting 32-page booklet, describing my treatment in detail.

This booklet contains much helpful information on the care of hair—and in addition shows by actual photographs what my treatment is doing for thousands of others.

No matter how bald you are—no matter if you are completely bald, this booklet will prove of deepest interest to you. So mail the coupon now—and it will be sent you by return mail.

Allied Merke Institutes, Inc.

512 Fifth Ave., Dept. 4612, New York City

Allied Merke Institutes, Inc.  
Dept. 4612, 512 Fifth Avenue,  
New York City

Please send me, without cost or obligation on my part, a copy of the new booklet describing in detail the Merke Institute Home Treatment.

Name .....

Address .....

City .....

### Actual Results

(Dozens of letters like the following are received every day by the Merke Institute.)

"In the short time I have used your treatment I have gained remarkable results. Dandruff has disappeared entirely. My scalp is now all full of fine new hair. I would not part with my treatment for 10 times its cost." A. W. B.

"The top of my head is now almost covered with new hair about one-half inch long. I have been trying five years, but could never find anything to make my hair grow until your treatment." T. C.

"Ten years ago my hair started falling. I used hair tonics constantly, but four years ago I displayed a perfect full moon. I tried everything—but without results. Today, however, thanks to your treatment, I am pleased to inform you that I have quite a new crop of hair one inch long. My friends are astonished at the result." F. H. B.

JUST OFF THE PRESS

12th Edition

# WIRELESS COURSE IN 20 LESSONS

By S. GERNSBACK, A. LESCARBOURA and H. W. SECOR

Very Greatly Enlarged

Price

**\$2.00**

Post paid

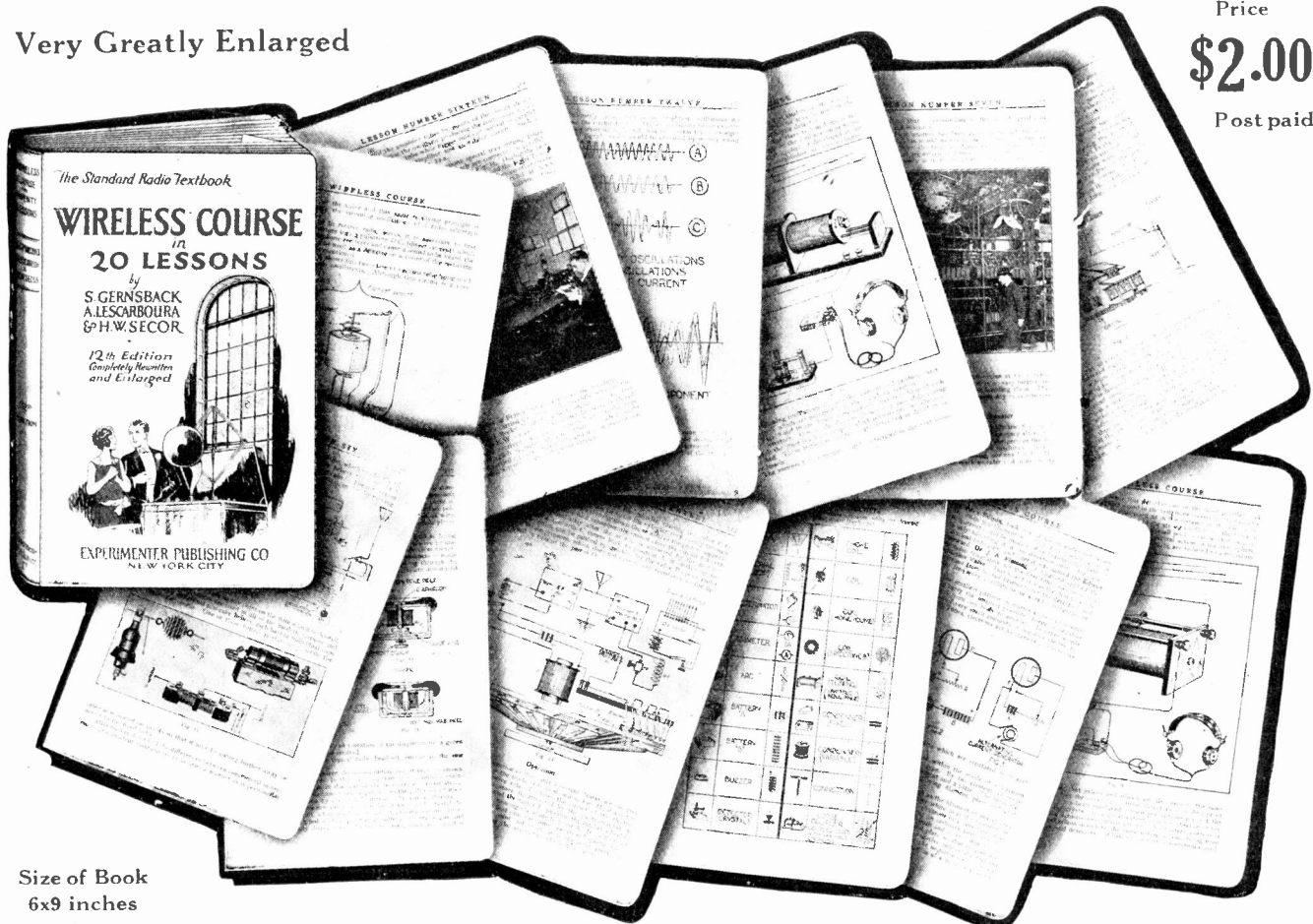

Size of Book  
6x9 inches

264 pages. 500 illustrations, diagrams and photographs. Binding de luxe; black leatherette cover, genuine gold stamped; red edges; round corners; semi-flexible covers; multi-colored jacket.

This new edition contains over 100 pages more than the previous editions, of which over 100,000 were sold. It is printed in a larger type, on better paper and has better and more illustrations.

- Lesson No. 1: Principles of Electricity:  
History and Explanation of Electricity, etc.
- Lesson No. 2: Principles of Magnetism:  
The History and Explanation of Magnetism, etc.
- Lesson No. 3: Dynamos, Motors, Generators, and Wiring.  
Explanation of Construction and Operation of each of the above, etc.
- Lesson No. 4: Principles of Wireless Telegraphy:  
History and Explanation of the Wave Transmission and those concerned in the development of early radio, etc.
- Lesson No. 5: Amateur Transmitting Sets and Apparatus:  
Apparatus and Circuits used by Amateurs in the early days of radio telegraphy, etc.
- Lesson No. 6: Transmitting Sets (Continued):  
Apparatus and Circuits of Transmitting Apparatus, etc.
- Lesson No. 7: Commercial Transmitting Systems:  
Apparatus and their operation, etc.
- Lesson No. 8: Aerials and Underwriters Installing Regulations:  
Explanation of the Antenna System and Constructional details of the various types used. Official regulations, etc.

- Lesson No. 9: Radio Receiving Apparatus:  
Description of the Various Types of Receiving Apparatus with an explanation of their operation, etc.
- Lesson No. 10: The Detector:  
An explanation of the various types of detectors used for reception purposes, including circuits, etc.
- Lesson No. 11: The Vacuum Tube as a Detector:  
Principles of operation of the vacuum tubes, etc.
- Lesson No. 12: Regenerative Receiving Set:  
Description and explanation of various vacuum tube circuits, etc.
- Lesson No. 13: The Vacuum Tube as an Amplifier:  
Operation of the types of amplifiers as in conjunction with tuners. Loud Speakers, etc.
- Lesson No. 14: Practical Vacuum Tube Circuits:  
An explanation of various up-to-date Circuits used in Radio, etc.
- Lesson No. 15: Super-Regenerative Receiver:  
Operation of the Super-Regenerative Receiver, etc.
- Lesson No. 16: Vacuum Tube Transmitter:  
Vacuum Tube Transmission and Broadcasting Systems, etc.
- Lesson No. 17: Radio Compass—The Wavemeter—Radio Control:  
The Radio Compass. Principles and operation of the Wavemeter and Radio Control, etc.
- Lesson No. 18: Learning to Operate—The Codes—The Wireless Law:  
Methods of learning the International Code. Appendix: Detailed regulations of the wireless law, etc.
- Lesson No. 19: History of the Development of Radio:  
A progressive history of radio and those concerned in its progress, etc.
- Lesson No. 20: Mathematics of Wireless Telegraphy and Appendix:  
Formulas for the Calculation of Wave-length, Inductance, Capacity, and other measurements, etc.

*Sent postpaid upon receipt of \$2.00*

If your Dealer cannot supply you, order direct from us, giving Dealer's name and address

**Experimenter Publishing Co., 53 Park Place, New York, N.Y.**

# How to Invent— What to Invent and What to Do About Protecting and Selling An Invention

**A**LTHOUGH the fact has been universally recognized that Invention is governed by a few simple, easily acquired, fundamental principles, no one ever thought of putting these principles in black and white so that everybody interested in invention could read them. In spite of the fact that Thomas A. Edison made his famous statement that invention should be taught as a science, thousands of people continued to work blindly, doggedly, haphazardly to perfect their ideas.

But now anyone can learn how to invent. Fifteen famous inventors have at last given to the world the laws and principles of Inventive Science. They have shown every ambitious man and woman how to invent. They are teaching Invention exactly as other people are teaching law, medicine, bookkeeping. Instead of spending years groping blindly, instead of wasting your time in useless, heartbreaking drudgery, you learn how to complete your ideas quickly *and what to do about them* when they are completed. You learn how to think so you are sure to succeed.

## Everybody Invents

For a long time it was commonly believed that every invention was a matter of pure luck—the result of some happy inspiration that suddenly flashed through a man's brain, and which made him fabulously rich without the slightest effort or thought. But you can prove for yourself that this is not so. You can prove for yourself that invention is the result of thinking and action along definitely exact, scientific lines.

Suppose when you went home tonight, you found a window rattling. Through your mind would flash, almost instinctively, a regular order of thoughts which characterize the conception and completion of every invention the world has ever known. First, you would recognize a problem to be solved—the rattling of the window. Then you would think of several principles of science or mechanics which would solve your problem. You might think of the scientific fact that if you poured water on the frame the wood would swell and tighten the window. You might think of using a nail. But what you most probably would do would be to use the oldest mechanical principle known to man, the wedge.

## What Invention Is

Brought down to its simplest terms, that is exactly the way every invention has been made—combining two ideas; a problem which must be solved and a fact of mechanics or science which solves the

- How to develop your imagination
  - How to develop your ideas
  - How to get the facts you need for inventions
  - How to keep legal records of ideas
  - How to use scientific principles of mechanics
  - How to avoid wasting time on impractical inventions
  - How to apply for a patent
  - How to organize a company
  - How to protect your rights
  - How to market a patent
- and hundreds of other vitally important facts which EVERY successful inventor knows and uses.

problem. So, although you may never have thought of it in just this way every time you solve a problem in your daily life—at home, traveling, or in business—you are an inventor; you use the principles of thought and action which govern the Science of Invention!

You can see, therefore, how easy it is for you to develop your natural instinct to "fix things." The same processes of thought that almost instinctively told you to fix a rattling window with a wedge can be so well developed that you can learn to invent other things almost as easily and quickly. You know, too, that every invention is made only by thinking inventively. And every inventor is agreed that the principles of Inventive Science are so simple, so easy to learn that any one, regardless of training or education, can develop himself to become a successful inventor!

With every new advance, with every new discovery that the world experiences, more problems are coming up—and more inventions are needed to solve these problems. Now, as never before, are new inventions wanted, and the world will pay a fortune to the man or woman who gives it just one of the inventions it needs.

Even little ideas can bring you a fortune. Eberhard who invented the rubber on the end of a pencil, has been paid hundreds of thousands of dollars for his simple idea. The man who invented the metal tip for shoelaces, the man who conceived the idea of the "humped" hairpin, the man who developed the metal tape measure; all have achieved success and wealth as great or greater than the inventors of large machinery.

## Learn how to invent at home

If you would like to develop your natural inventive ability along *money making* lines, instead of trifling with ideas—if you would like to DO something about your ideas instead of letting someone else patent and market them ahead of you, let this great Course in Inventive Science help

you. Get the advice and the help of the fifteen famous inventors who tell you the secrets of invention which you MUST know to be successful.

This is the first course in practical invention that has ever been devised. In simple, easy-to-understand language you are told how successful inventors work; you learn how to think along inventive lines, you learn the short-cuts to successful invention; you learn how to use the secrets of invention that convert a simple little idea into money.

No one step in invention has been omitted. Everything you want to know about invention—developing your ideas, securing information you need, how to apply for patents, how to protect your rights, how to sell your invention—are taken up step by step, so that when you have completed the course you have a wealth of information worth thousands upon thousands of dollars.

## FREE—New Book on Inventive Science

A wonderful new book has just come from the press that tells you all about the Science of Invention. It tells you how to avoid the pitfalls that have brought failure to thousands of would-be inventors. It tells you how to learn the secrets of practical invention, which famous inventors discovered only after years of heart-breaking effort and discouraging mistakes and it tells you how to do this in only fifteen minutes of your spare time each day. This fascinating book will be sent to all those who are genuinely interested. Get the advice of those fifteen famous inventors. Let them tell you how you can easily learn the secrets of successful invention. Send for this Book today as only a limited number are available for free distribution. Send the coupon below NOW, or a letter or postal card will do. There is no cost or obligation. This bureau is not connected in any way with patent attorneys or manufacturers. Our only work is to help ambitious men and women to develop their inventive ability—to become successful inventors.

**Bureau of Inventive Science**  
Dept. 712, Wisner Building, Rochester, N. Y.

**BUREAU OF INVENTIVE SCIENCE**  
Dept. 712, Wisner Building  
Rochester, New York

Please send me your free book, "The Science of Invention."

Name..... Age.....

Address.....

City..... State.....



Raymond F. Yates, who with fourteen other famous inventors, now makes it easy for you to learn how to invent in your spare time at home.







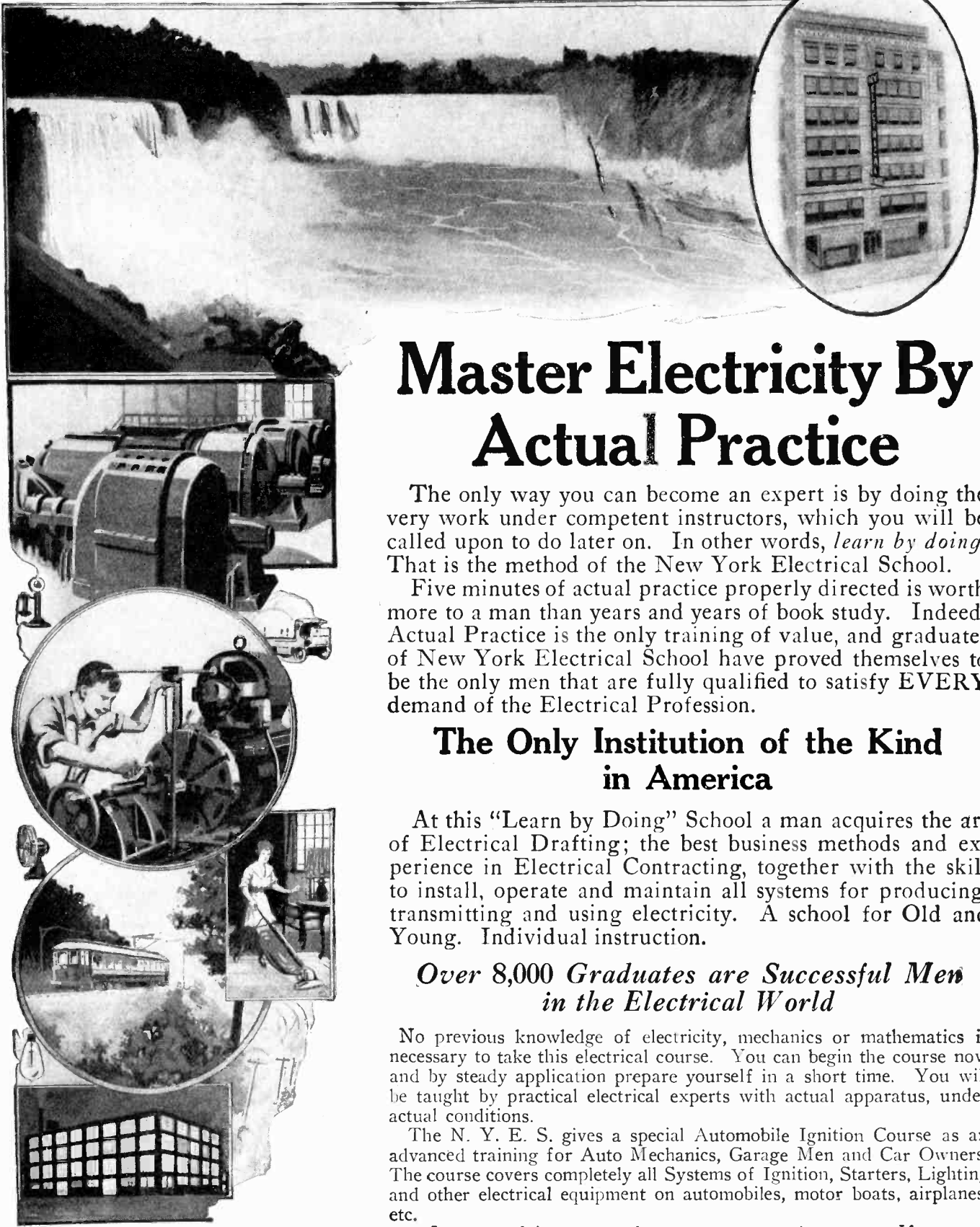

# Master Electricity By Actual Practice

The only way you can become an expert is by doing the very work under competent instructors, which you will be called upon to do later on. In other words, *learn by doing*. That is the method of the New York Electrical School.

Five minutes of actual practice properly directed is worth more to a man than years and years of book study. Indeed, Actual Practice is the only training of value, and graduates of New York Electrical School have proved themselves to be the only men that are fully qualified to satisfy EVERY demand of the Electrical Profession.

## The Only Institution of the Kind in America

At this "Learn by Doing" School a man acquires the art of Electrical Drafting; the best business methods and experience in Electrical Contracting, together with the skill to install, operate and maintain all systems for producing, transmitting and using electricity. A school for Old and Young. Individual instruction.

## Over 8,000 Graduates are Successful Men in the Electrical World

No previous knowledge of electricity, mechanics or mathematics is necessary to take this electrical course. You can begin the course now and by steady application prepare yourself in a short time. You will be taught by practical electrical experts with actual apparatus, under actual conditions.

The N. Y. E. S. gives a special Automobile Ignition Course as an advanced training for Auto Mechanics, Garage Men and Car Owners. The course covers completely all Systems of Ignition, Starters, Lighting and other electrical equipment on automobiles, motor boats, airplanes, etc.

*Let us explain our complete courses to you in person. If you can't call, send now for 64-page book—it's FREE to you.*

New York Electrical School  
29 W. 17th St., New York, N. Y.

Please send FREE and without obligation to me your 64-page book.

..... NAME  
 ..... STREET  
 ..... CITY ..... STATE

# New York Electrical School

29 West 17th Street, New York

Volume XI  
Whole No. 128

# Science and Invention

H. GERNSBACK, EDITOR AND PUBLISHER  
H. WINFIELD SECOR, ASSOCIATE EDITOR  
T. O'CONNOR SLOANE, Ph.D., ASSOCIATE EDITOR

Editorial and General Offices, - - - 53 Park Place, New York

DECEMBER  
1923  
No. 8

*"Those Who Refuse to Go Beyond Fact Rarely Get As Far As Fact" -- HUXLEY*

## Inventions Wanted

By H. GERNSBACK

**W**E have in the past mentioned editorially in these columns that great fortunes have been made in a great number of cases from simple ideas correctly worked out. The more complicated our lives become the more we are in need of simple devices; particularly those inventions that make things easier and simpler for us are in big demand. The fountain pen, the clutch pencil, the book-match, and dozens of others, not only have made fortunes for the owners of the patents, but are making fortunes right now in their further exploitation.

**I BELIEVE**  
¶ THAT we should generate power while the sun shines.

But what is to be invented? What ideas are to be worked out? The answer and the recipe are rather simple. Any inanimate objects that constantly annoy ideas are to be worked out? The answer and the recipe are rather simple. Any inanimate objects that constantly annoy

you, will annoy a million more like yourself. The annoying objects obviously have not been properly designed and other better ones might easily take their places. It is not only inanimate objects that annoy us but certain conditions arise continuously which make things uncomfortable for us, when people will gladly spend money to do away with the discomfort. What is meant by this is explained in the suggestions below.

**WINDOW CLOSER.** When a clever American invented the American window he hit upon a whale of an idea. In Europe, and before the American window was invented, there were no two separate window frames sliding vertically—instead they use in Europe even now—two frames that meet in the center and open like doors, sideways. The American window is a wonderful invention. It has been perfected to such an extent that a slight touch of the hand will raise or lower it, due to the counter-weights. What the window, however, does not do is to close itself when it starts raining or snowing. A simple invention which mechanically would open a trip the moment it starts raining or snowing when the house owner is away or in bed asleep, would probably be adopted all over the country.

**ICE-WATER GLASS.** The doctors tell us that one of the reasons why we are all becoming more and more dyspeptic is that we Americans swallow ice water in huge quantities. Cold water is all right but ice water with its microbes and other impurities from the ice are obviously not good for us. Everybody uses ice water and we all know that it is harmful. What is wanted is a glass formed in such a shape that the ice will cool the water without coming into contact with it. The glass should be simple and inexpensive and not too complicated. Neither should it be a freak. One of these days such a glass will make its appearance and will net its inventor a fortune.

**DINING CAR INDICATOR.** If you travel much about the country and have occasion to eat in dining cars, you will often find yourself huddled up with dozens of other travelers somewhere in the corridor of the dining car; the reason being that the diner seats only so many people and you have to await your turn. Suppose an electrical or a mechanical device were installed at the end of each of the coaches throughout the train. Let us say that a red color appearing in a box would mean that the diner is full, while green would mean that seats are to be had. Such a device if it can be made right would do

away with the present nuisance of keeping men, women and children waiting, sometimes for hours, standing in the corridors of the dining car.

**AUTO CAR HEATER.** Driving in the winter is one of the best pastimes we have. When it is very cold, extended trips out into country become uncomfortable as our feet and legs become extremely cold. What is needed is a cheap auto heater. To be sure, there are a number of these on the market today, particularly the ones that work from the exhaust of the car. They are, however, not very easy to install. A mechanical, electric, or chemical car heater that need not be attached to the exhaust pipe and can be sold for a few dollars would soon find twenty million customers. The device must be simple to operate and must not be messy, and the heat should be reasonably inexpensive.

**I BELIEVE**  
¶ THAT an idea well worked out is worth three ideas patented in a hurry.

**BOTTLE CAP.** The present steel bottle cap was a wonderful invention. It has just one fault. It requires some sort of a tool to open the bottle, and very often just when you want to open it most you are not able to find a bottle-opener. The milk people have solved the problem by using paraffine cardboard disks which serve very nicely for milk. But they will not do for ginger ale or other charged liquids. There must be some way to produce a bottle cap that can be opened, using nothing but your hands. We are all waiting for it and are willing to pay the inventor a fortune for the idea.

**SUGAR DISPENSER.** Every time you go into a restaurant, particularly the popular price ones, you will find a bowl of sugar with a spoon. Like as not, the customer preceding you has been careless, having put the spoon into his coffee, or milk, or what not, and let its contents drip all over the sugar. This does not look very appetizing to you when your turn to use it comes. Also flies that are holding mass meetings around the sugar bowl in the summer are not welcomed enthusiastically, nor are they desired. Some mechanical sugar bowl without a spoon, which is normally closed hermetically, is badly needed. It can be made so that at the touch of the hand or by turning the bowl otherwise, just one spoonful of sugar will be dispensed. Such a device will find its way into every restaurant and every home, if it can be made cheaply.

**SALT SHAKER.** The world is still waiting for a salt shaker that you do not feel like throwing out of the window in rightful wrath every time you use it. To be sure, there is a whole carload of patents on salt shakers, but somehow either the inventors were lax or the devices were impractical because we are still using the old timer which we shake hard but which refuses obstinately to give us salt. One of these days a genius will tackle the problem in an entirely different manner and his invention will give us salt when we want it without strenuous exercise and without the caking of the salt.

Powdered salt which will "shake out" of a salt-shaker is necessarily dry salt. Cannot a salt-shaker be devised which will keep salt dry and powdery in the dampest weather? Even the aspect of the dry, floury condiment is more appetizing than lumps of damp material, which will not yield to distribution. And when occupied with a salt-shaker do not forget the pepper castor which also clogs up.

**I BELIEVE**  
¶ THAT in radio, we have not even scratched the surface as yet. Radio's greatest wonders are still to come.

### THE GOLDEN AGE OF SCIENCE

is now symbolized by the golden cover of SCIENCE & INVENTION. LOOK FOR THE GOLD COVER every month!

# Thermocouple Finds Iceberg

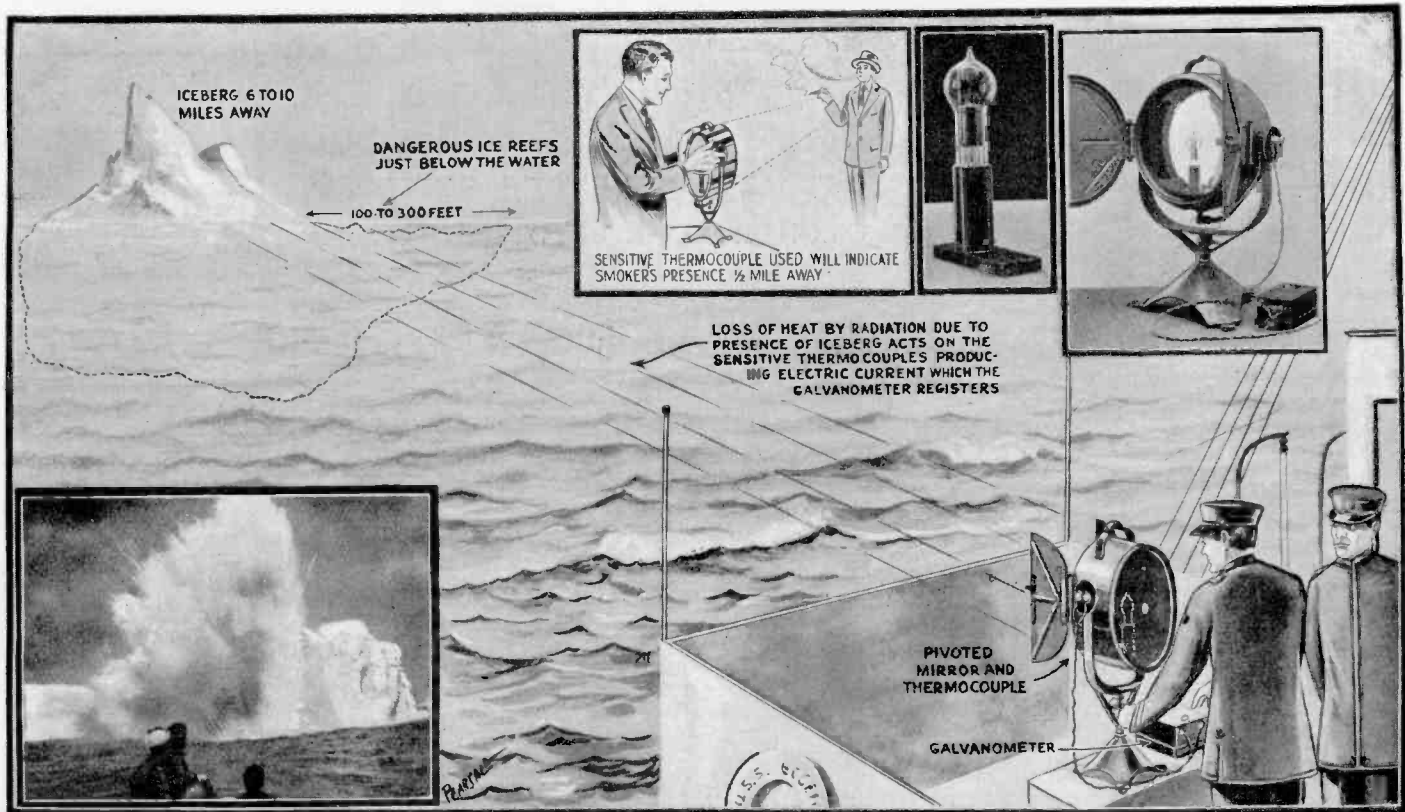

The thermocouple, encased in a vacuum tube, shown in the top inset, is placed in front of a mirror in a searchlight-like case: it is so sensitive that galvanometer readings will indicate changes in temperature so accurately

that the presence of an iceberg can be located by it at a distance of ten miles. The instrument is manufactured by Carl Zeiss, Jena. The mirror is silvered on the front side so the glass will not absorb any of the heat.

## Tempresses of Death

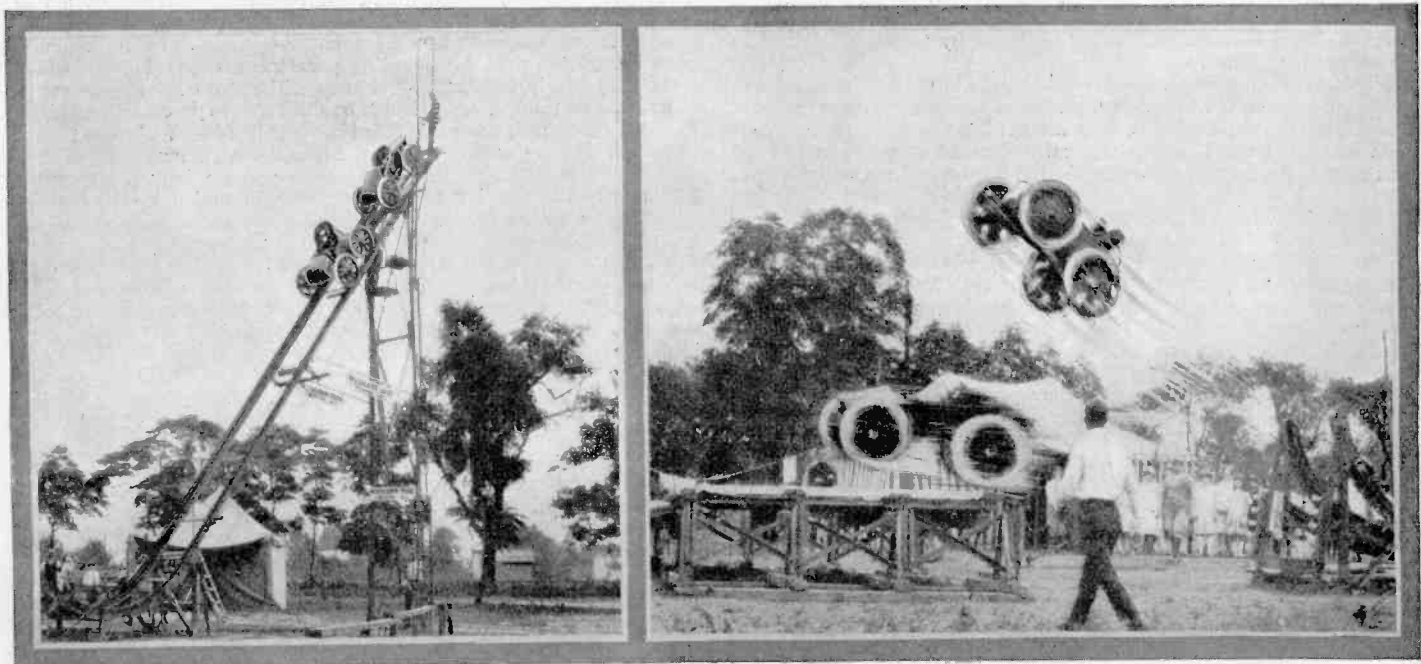

By driving the cars down the incline at 130 miles an hour, Sisters Betty and Peggy Gregg, speedway drivers, give spectators the thrill of a lifetime. The cars are of different gages. One takes the heavy curve at the bottom of the

incline with the result that it loops-the-loop three times in the air. The other, which starts afterwards, takes a lighter curve and so shoots out onto the runway under the looping car.

This is an invitation. **SCIENCE AND INVENTION** has \$1,000 which it is going to use, beginning with the January issue (and every month for a year) for relief work—relief of the mechanical and observant brain. You see something, you have an idea, you know a friend who has a novel device. You are, of course, very anxious to tell the world about it. Well, **SCIENCE AND INVENTION**, will relieve you of your idea, and if it conforms to the editorial policy will send you a handsome new check, perfectly signed and endorsed as one of the prizes it is offering for articles, pictures and sketches. For details see page 754.

# Taking Movie Scenes in Miniature

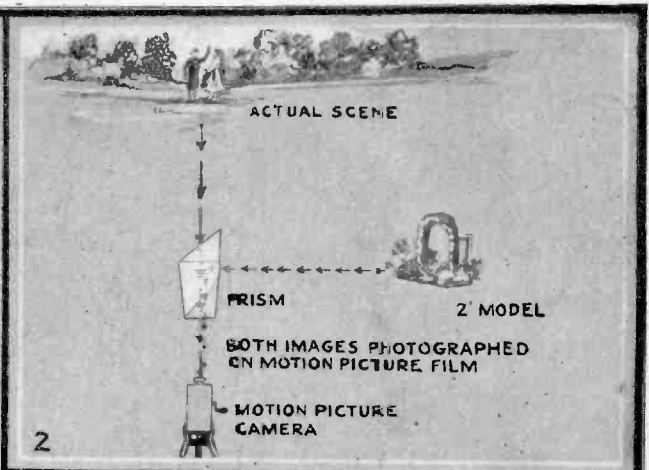
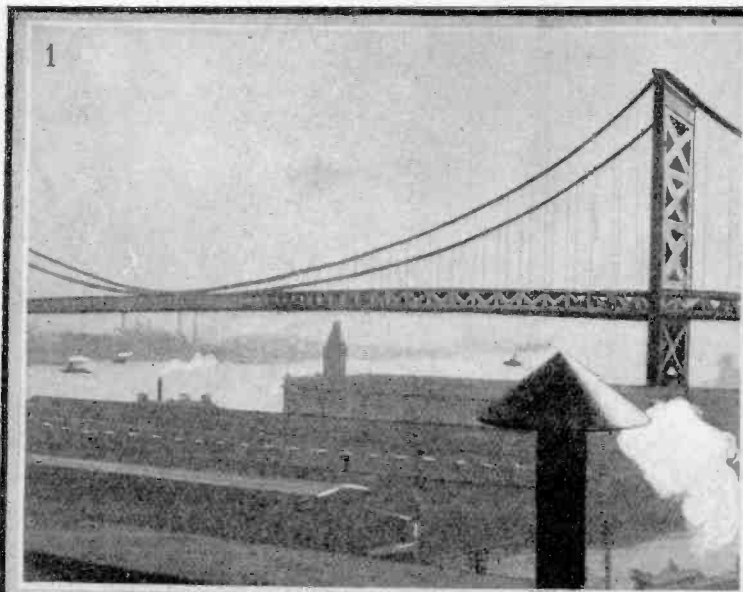

At (1) is shown a photo of the Delaware river bridge at Philadelphia as it will appear in 1926 when it is completed. The photo was taken with a new device invented by Rex Stovel to enable movies to be made with miniature "sets." Although the actual process is still a secret, pending patenting, the sketch at (2) shows how it may be accomplished by using a prism. The two lower pictures show an actual movie scene made with the device. The

one to the right shows the inventor holding the "set" which appears larger than the actors in the scene actually made. The inventor claims that with this scheme practically all "sets" for movies use may be made of papier mache at a small cost instead of the costly life-size products used today. It will be possible to run an automobile into a doll's house or to march an army across a six-inch bridge with the aid of the device.

## Windshield Wiper

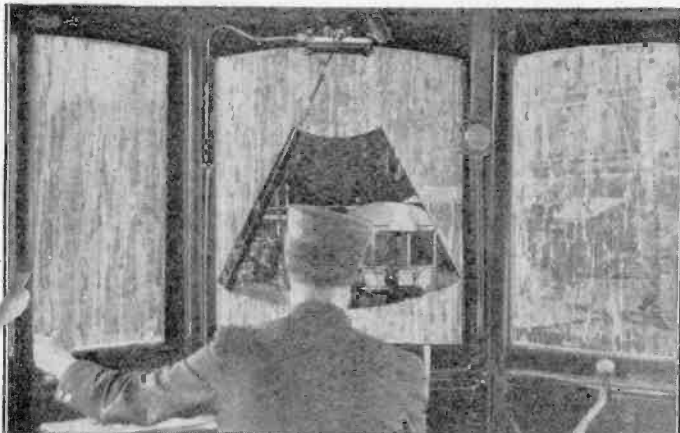

A Cleveland firm has just brought out a wind-shield wiper for use on trolley cars. It is made on the same principle to a similar device used on automobiles. The long arm with the rubber wiper attached is operated by a small piston and compressed air.

## Helicopter Model

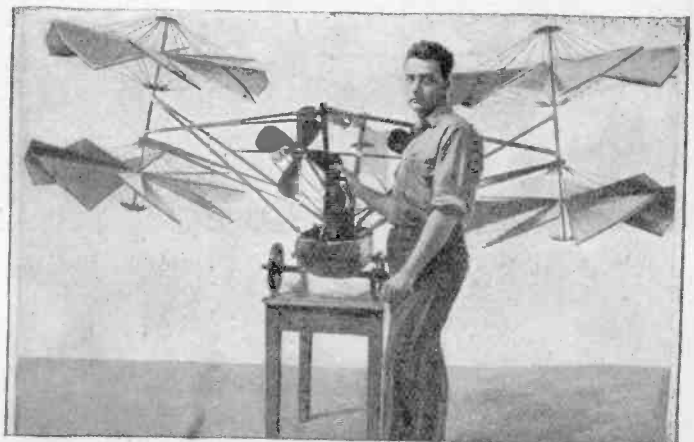

The general idea that the helicopter is a new development in aircraft is false as will be seen by the picture above which shows a model of one designed by Sir George Cayley in 1843. Photo shows Paul Garber of the U. S. National Museum, Washington, D. C., who built the model.

# Movie Double Exposure Trick

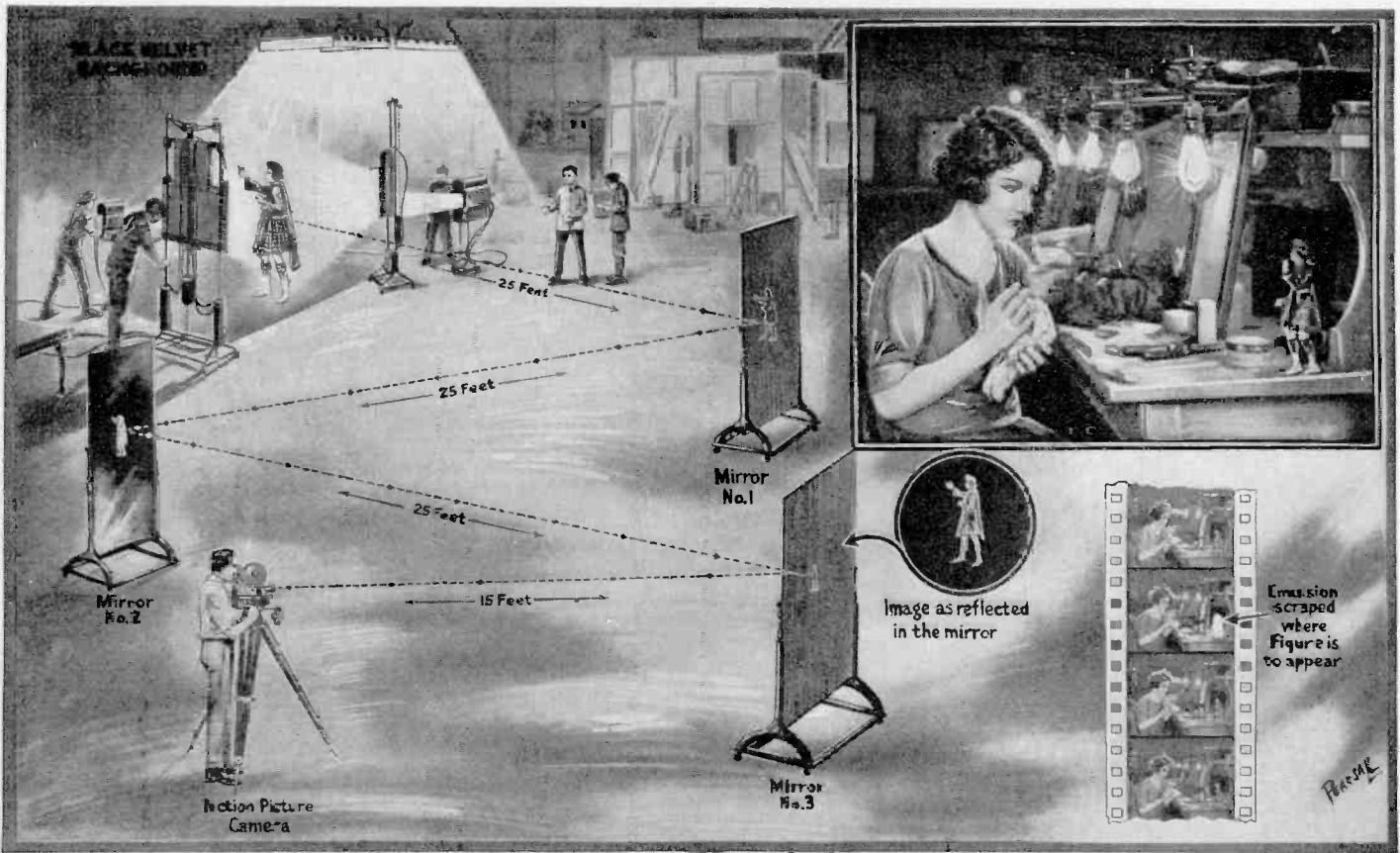

In Metro's "Rouged Lips," Viola Dana's Scotch inheritance of thrift rises and stands on her dressing table in the form of a small figure to hide her while she contemplates some extravagance. The small figure is obtained by reducing the size of a regular figure with the assistance of mirrors as shown. Then

the film is re-exposed to the small figure. Note that it appears against an almost black background, where the emulsion is hardly affected. A part of the film is developed and the position of the small figure scraped clean so the photographer may accurately focus his camera. —Phil. Gersdorf.

## TABLE TOP LANDSCAPE PHOTOGRAPHY

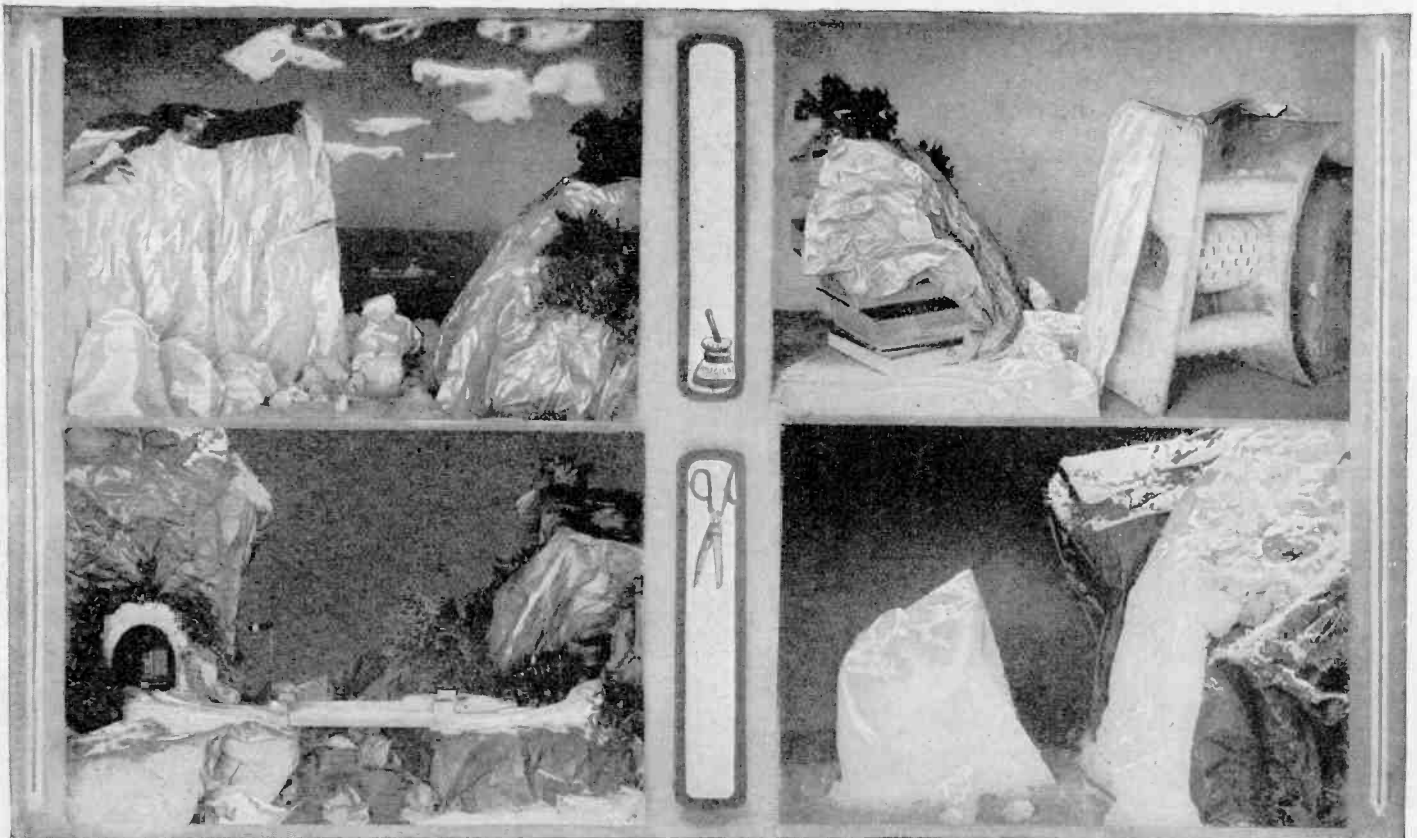

Cliffs of salt and paper with some cotton clouds stuck on a dark background, the whole supported by books, ink-bottles or whatnot—erected on the top

of the library table and photographed gives very realistic landscape photographs. Other ideas will suggest themselves. —S. Leonard Bastin.

# Self-Propelling Wave Ship

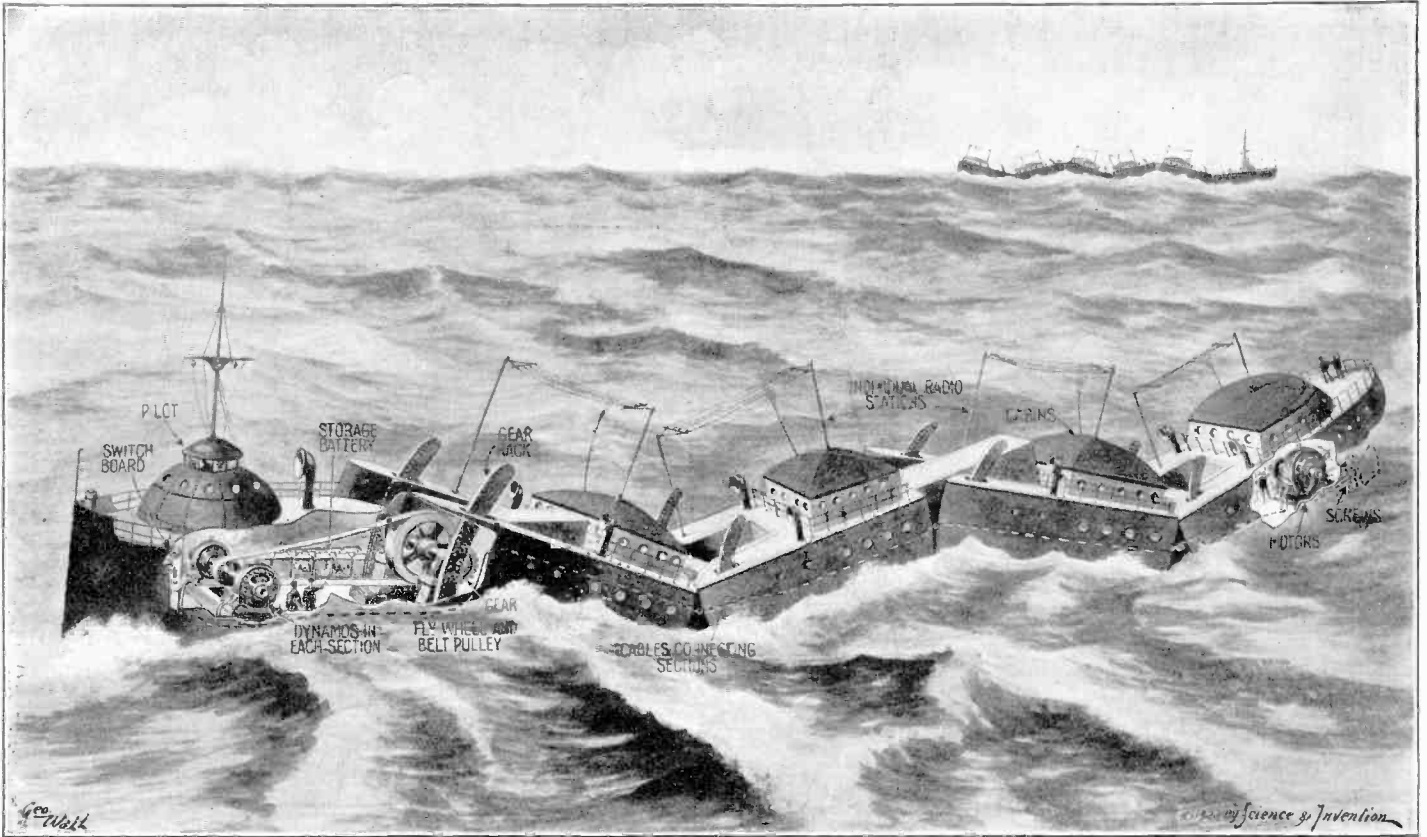

The ship shown in the illustration above is built in sections so that they rock up and down with the motion of the waves. This motion runs electric generators in each section. The current generated in this way is carried to the rear of the ship where it runs motors connected with the

propellers thereby propelling the ship. There are storage batteries also that collect the surplus current so it may be used when the sea is quiet. The gears are made so that both the up and down motion of the waves are used.

# Stereoscopic Motion Pictures

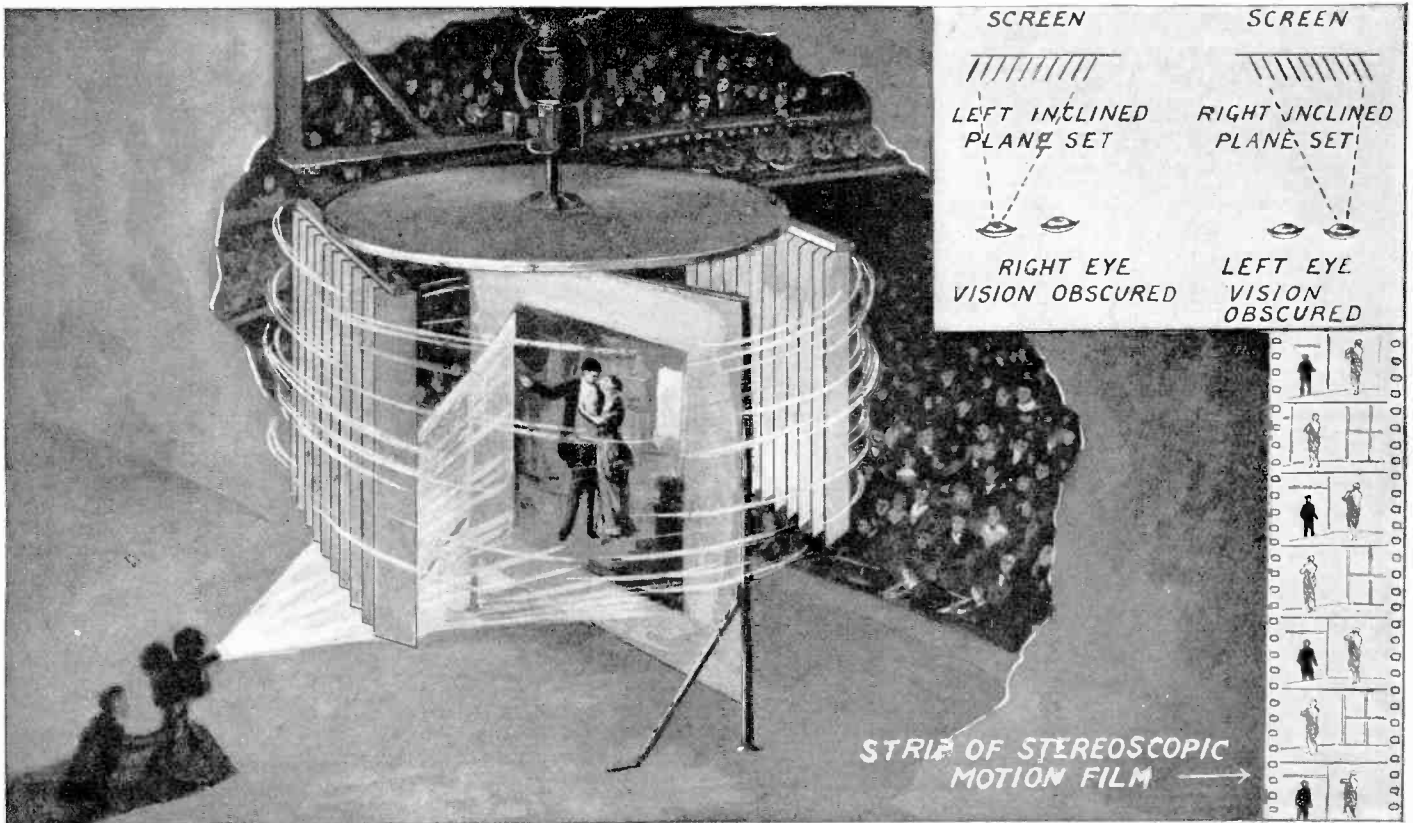

By means of revolving shutters that pass before the screen an English inventor has found a means of producing stereoscopic movies—movies in which the figures stand out in bold relief as they do naturally. The special film used with this method is taken with a stereoscopic movie camera that

exposes one side for one frame and the other for the next. The revolving shutters that allow the scenes to be viewed first with the right eye and then the left works in synchronism with the camera. The projector is behind the transparent screen. —Cedric Marshall.

# Driftwood Finish for Cypress



The Japanese method of obtaining a "driftwood" finish synthetically is extremely simple though the secret has been so closely guarded since its first discovery that it is almost unknown. The finish is effected by burning the surface of cypress with a blowtorch and then removing the charred particles. Take the piece to be finished and pass the torch's flame quickly from top to bottom of the board with the grain on a strip not greater than three inches wide at a time. Do not burn all the way across the board. The point of the heat must be moved quickly. After the burning has been finished set the board aside for three days. Then take the char off with a wire bristle brush, rubbing with the grain or directly across it, never diagonally. Follow this with a small dry scrubbing brush. Never use varnish for best effect. The surface may be waxed or dyed. Be sure to get dry wood. It probably will warp after the heating, but by letting it stand the time designated it will return to its normal position.

—Robert H. Moulton.

## An Improved Toddle-Top

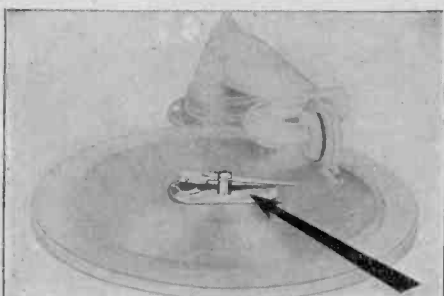

This repeater consists of an arm to lift the reproducer and a spring to throw it back.



The three concentric disks fastened to a common shaft and arranged with numbers is the latest in gambling devices. The illustration above shows how it designates the "put and take."



# Methods Of Preserving Flowers

Simple methods of preserving the freshness of flowers after picking—

Rhododendron as a thermometer.

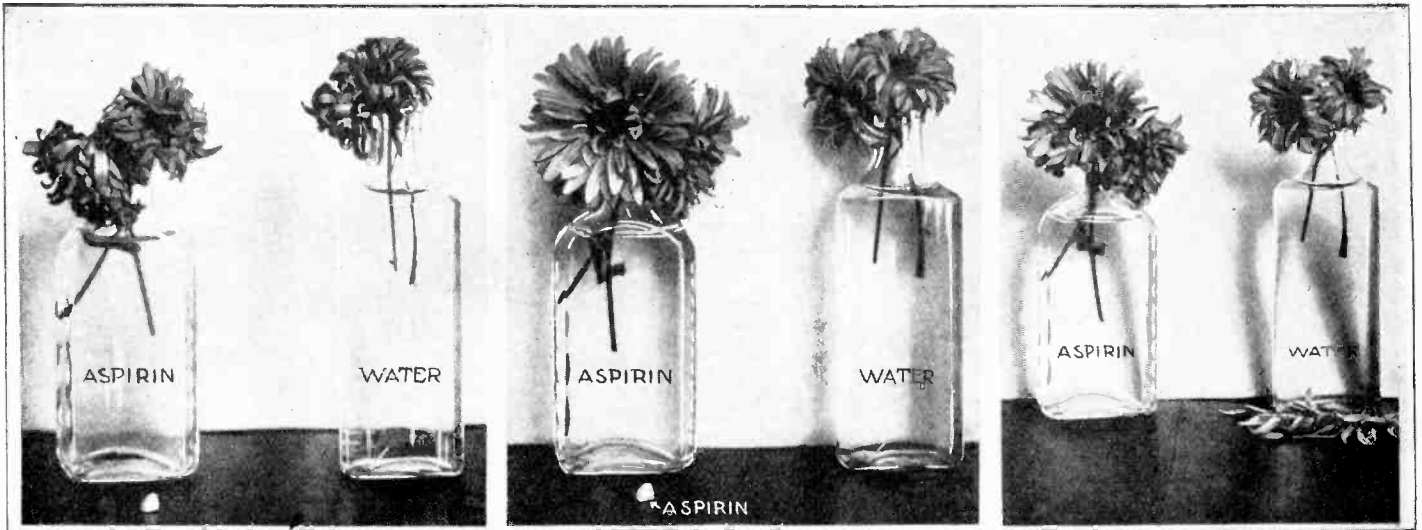

Wilted flowers can be revived and their former bloom brought back by simply placing in water in which a quarter tablet of aspirin is dissolved, as shown by the pictures above. Note that the aspirinated flowers revived while those in water remain wilted. Last photo 48 hours after first.

## Insertion of blooms in glass tubes keeps them fresh for two years.

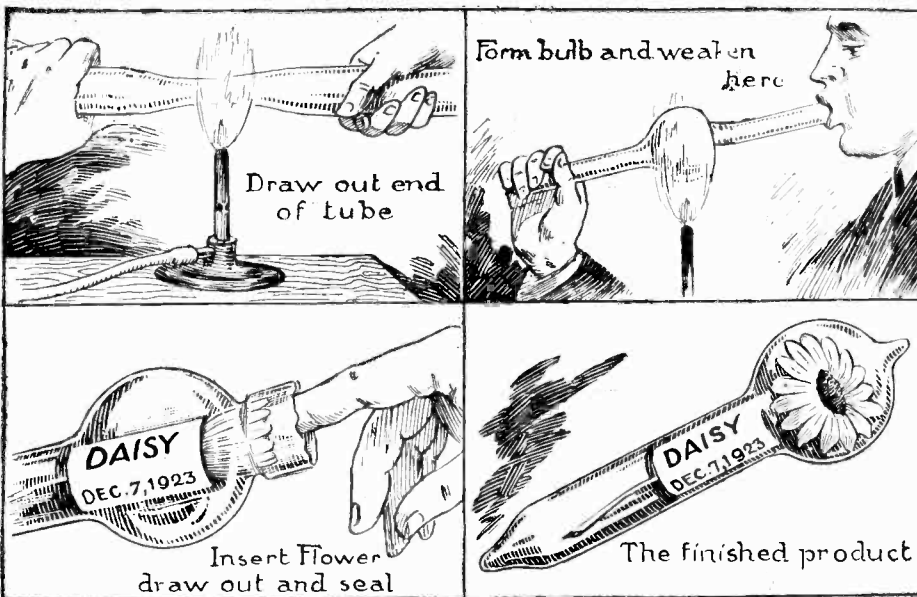

By placing a bloom in a sealed glass tube blown as shown above they may be preserved in their original state for two years. The paper with the name and date helps support the stem of the plant. If the tube is filled with an inert gas like nitrogen the flower will remain fresh much longer. After sealing the tube it should not be allowed to remain in the sun light on account of the deteriorating effects of the ultra-violet light. —H. O. Bernstrom.

## Sand and Shade Method

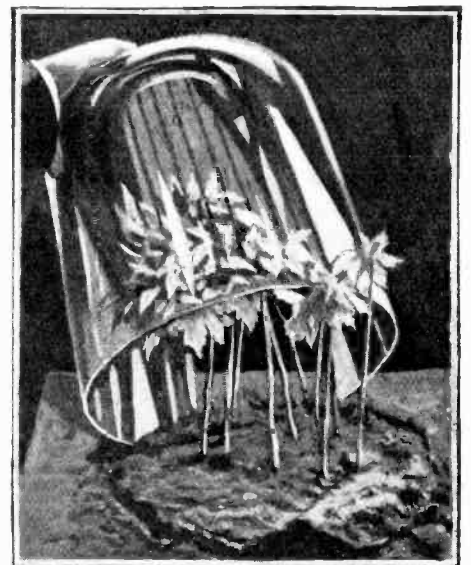

By placing the stems of fresh blossoms in a few inches of moistened sand and covering the whole with a glass shade, if kept in a cool, shady place, the flowers will remain fresh for weeks. At the first sign of mold place a piece of cotton-wool soaked in formalin beneath the shade. —S. Leonard Bastin.

## RHODODENDRON MAKES A GOOD THERMOMETER

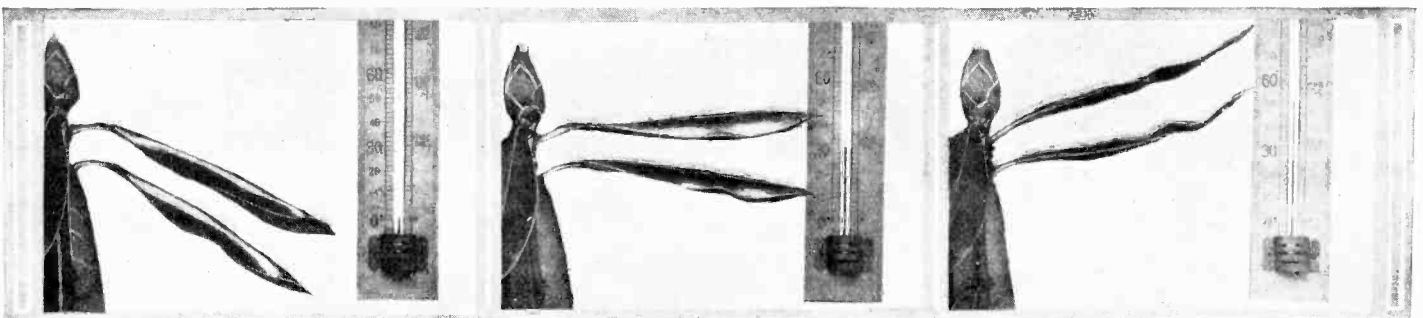

The Rhododendron gives clear indications of temperature. Its leaves form a natural thermometer. When the temperature is at about 50 deg. F. the leaves are held up. If the cold increases to freezing point the foliage becomes horizontal while at zero the leaves droop and roll inward.—S. Leonard Bastin.

# New York's Photo by Searchlight

By P. R. BASSETT



The above photo of the New York skyline was made from the top of a Brooklyn skyscraper with the aid of a Sperry searchlight of one billion candle-power. It was located on the roof of a building about one and one-half miles from the sky-line. The camera was set up on an adjacent roof. The beam

was played up and down the surface of each building. Twenty minutes was required to "wash" the whole sky-line in light. The light recorded on the plate from which this picture was developed equaled 35 billion candle-power. The method of playing the searchlight is evident by the contrast.

## A French Work-Bench

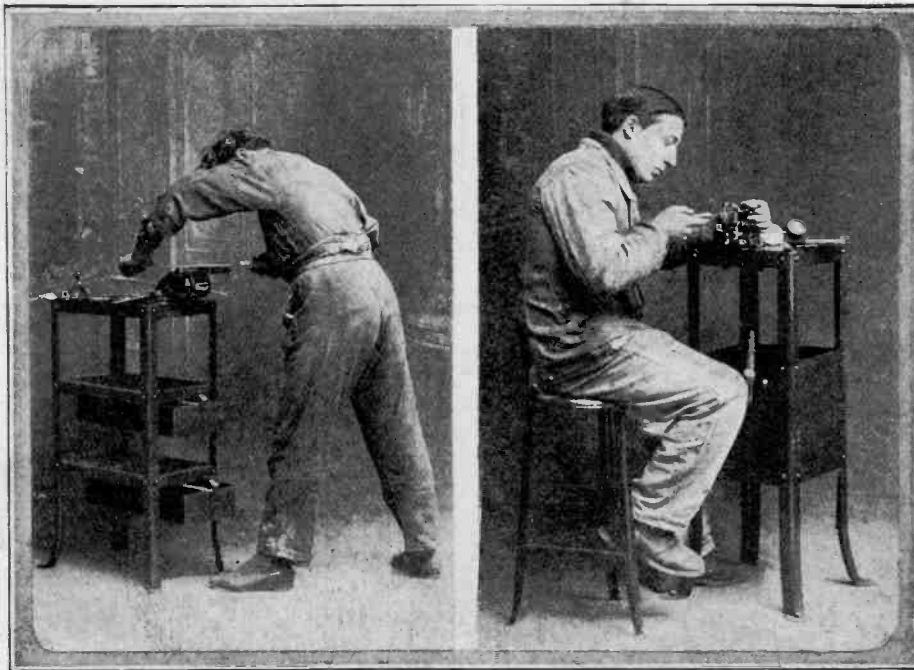

The combined work-bench and vise shown above is the French idea of the acme in home shop equipment. The whole thing is made of light sheet steel with the legs bored so that the whole may be

secured to the floor. There are two principal designs manufactured. One is equipped with drawers and the other with a large metal box for holding the tools. A stool is supplied also.

## Extinguisher



The little extinguisher shown above is the regular chemical type put up in a glass bulb. It breaks when thrown into the base of the flames.

# Fake Earthquake Movies

How Jaded Broadway Got a View of the Earthquake Three Days After It Occurred.

BY W. B. ARVIN

IRREGULAR JAGGED CUTS HINGED TOGETHER WITH COURT PLASTER, JARRING OF BASE MAKES BUILDINGS APPEAR TO COLLAPSE, ONE PORTION AT A TIME.

Brooklyn wants its movie news quick, so the Bray studios performed the Japanese earthquake—in miniature—and gave Broadway its thrill ten days before the real pictures reached the American shores. A still picture of sections in the devastated region was taken and the buildings and landscape of the foreground reproduced in miniature. The whole was placed on springs as shown so the quaking effect could be obtained.

SPRINGS

DUST

AS BUILDING COLLAPSES MAN IN REAR BLOWS CLOUD OF DUST UP FROM UNDER THE RUINS

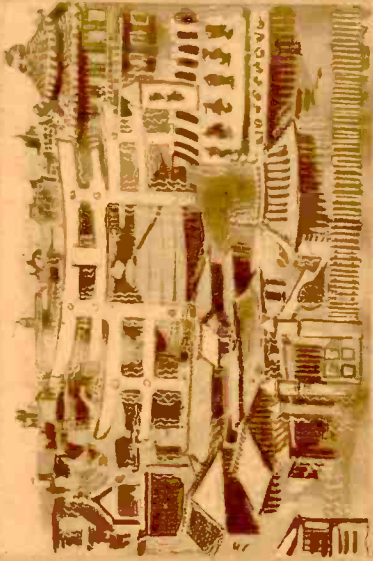

AS EARTHQUAKE APPEARS ON SCREEN

BUILDINGS MOUNTED ON CARDBOARD AND CUT OUT

WOODEN STRIP ON BACK SLIGHT TAP WITH FOREFINGER ON BASE OF SET MAKES PERCEPTIBLE VIBRATION, BUILDINGS BEING MOUNTED ON SPRINGS. (BACKGROUND IS ALSO TAPPED)

PAN FILLED WITH CHARCOAL WHICH HAS ABSORBED A QUANTITY OF ALCOHOL

SULPHUR AND SALT PETRE SPRINKLED ON, MAKING FLAME SPRING UP HERE AND THERE

BITS OF "SPARKLERS" TOSSED IN TO SIMULATE EXPLOSIONS

The quake scene was made first with the ground trembling and the houses falling, with the camera light slightly dimmed. The negative was then rewound and the flames from the charcoal pan, as shown, were taken on the same negative under very dim light. The resulting picture was very realistic and full of thrills. It was, of course, portrayed under the caption of "How it probably happened," and not as authentic.

IN MAKING EFFECT OF FLAME-SWEPT CITY, BIRDSEYE VIEW PHOTOGRAPHIC PRINT FIRST RETOUCHEE - SOME BUILDINGS PAINTED OUT AND MANY PARTIALLY REMOVED AND REPLACED BY MARKS INDICATING DEBRIS, PLACED BEFORE CAMERA AND FILMED IN HALF LIGHT. FILM REWOUND IN CAMERA AND THEN

© 1923 BY SCIENCE AND INVENTION

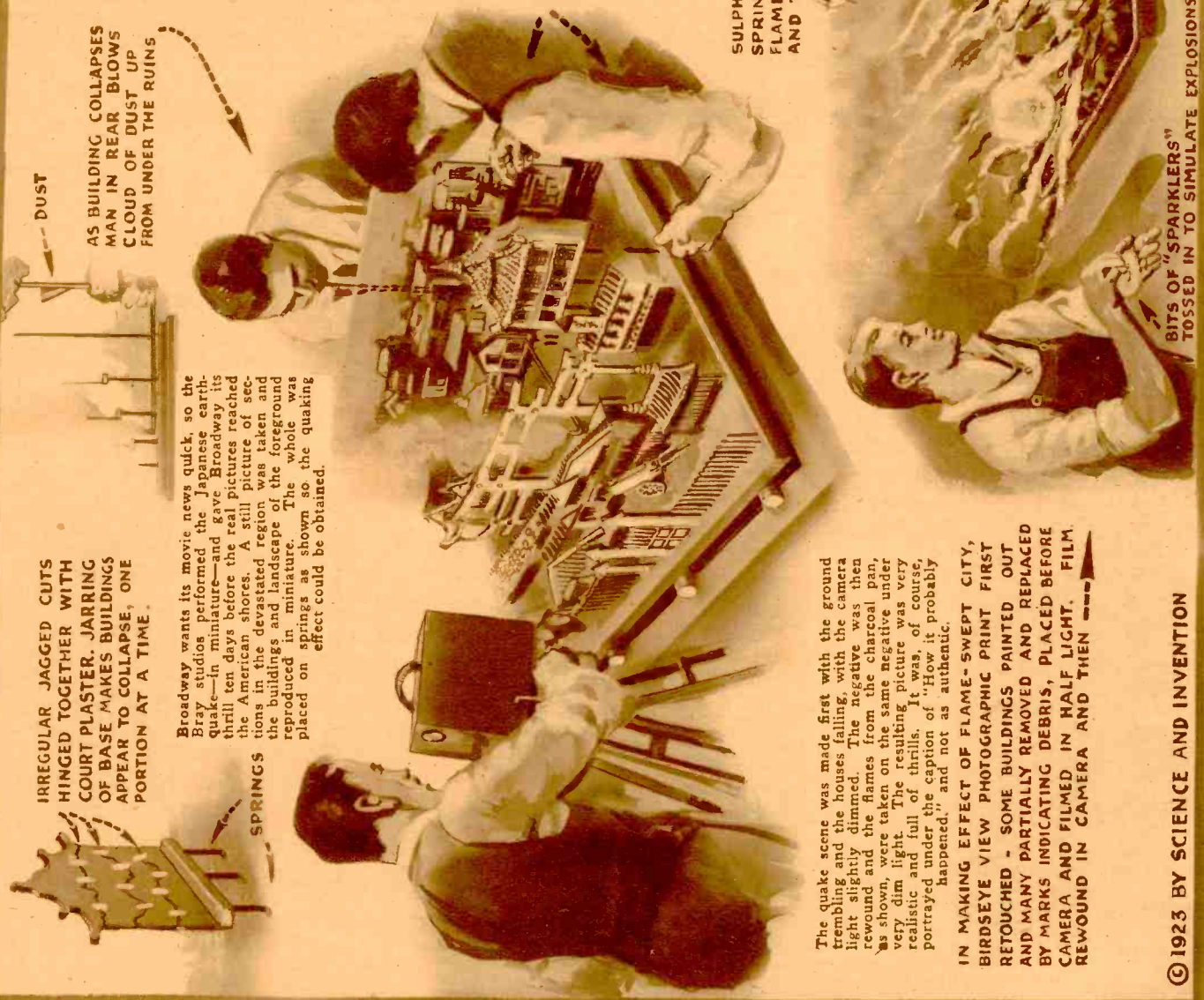



"Not exactly—Magnifying the features helps a little, but not much. I get my best results by distorting the features, that is to say by magnifying the one trait I am examining, whether anger, jealousy or some other passion.

In a word these mirrors produce caricatures—One is designed to intensify a man's looks of envy, another his sensuality, etc.—I sit a man in the middle of this room and look into each of these analyzing mirrors in turn.

## Doctor Hackensaw's Secrets

By CLEMENT FEZANDIÉ

[Author's Note. The fabled "Waters of Lethe" possessed a curious power. Any one who drank of the water at once lost all memory of his former life. Nature, too, has her Waters of Lethe. As we grow old, the memories of recent events fade from our mind, only those of our earlier years remaining with any degree of clearness. Diseases of the brain, too, can blot out the memories of past years. Some day, when our scientists understand better what memory is we may hope to find the means of thus blotting out certain of our recollections artificially. In this story I have endeavored to show how this power of obliterating memories might be made use of in the reformation of criminals.]

"DOCTOR HACKENSAW," cried Pepita Perkins, gaily, "Why don't you invent some means of preventing people from spitting in the street cars? Couldn't you make some contrivance that would rap the spitter on the head, or blow a strong puff of wind in his face when he tries to spit?"

Doctor Hackensaw laughed. "I have already invented such a device, Miss Pep," said he. "Moreover, my invention is simple, inexpensive and I will guarantee it. It is nothing more than to hang up the following sign in the street cars:

**"ONLY HOGS SPIT ON THE FLOOR!"**

"When a man disregards the sign and expectorates, his neighbor will naturally look at the sign and laugh. The most hardened spitter could not stand such ridicule. He will leave the car at the first opportunity, and, it is safe to say, the lesson will never have to be repeated.

### No. 24

#### The Secret of the Memory Obliterator

"Understand me, Miss Pep, I am not, as a rule, in favor of ridicule as a means of education—in fact, I believe ridicule is used far too much already by both parents and teachers—especially in Europe, but it is a powerful weapon, and there are times when its use is justified."

"Is it to make people look ridiculous that you use those horrid mirrors on the wall? They make me look like a fright! They're worse than any of those at Coney Island!"

#### DISTORTION MIRRORS IN READING CHARACTER

"Those," said Doctor Hackensaw, smiling, "are my distorting mirrors, and I am very proud of them. You must know, Miss Pep, that at present I am engaged on the problem of reforming criminals, and before reforming a man I must know something about him. These mirrors tell me what I want to know, they enable me to read a man's soul!"

"What!" cried Pep, thinking the doctor must be jesting.

"Sit down, please, and I will explain myself. Of course you will understand that the words 'crime' and 'criminal' are very elastic, and often apply to things that in reality have nothing criminal about them. However, you will understand me when I say that my efforts are directed toward nullifying the vicious tendencies in men, and strengthening the good ones. But, in order to accomplish anything, I must be able to read a man's character accurately. And a man's face is an index to his character."

"Not always," interrupted Pep. "I've known some scoundrels that looked like honest men, and some honest men that looked like villains."

"True, but that is because you did not use scientific methods. Science demands instruments of precision, not mere guess-work. I don't suppose you know, Miss Pep, that Darwin made a careful study of the expression of the emotions in man and in animals, and showed that the same emotion is expressed in the same way by animals of the same species. Any man familiar with dogs knows that a dog's tail can express a variety of different emotions. Watch the meeting of two strange dogs. At sight of each other their tails remain stationary—mute. They are on the alert. Then one dog wags his tail tentatively, and the other answers, Friendship is declared. Then along comes the master of one of the animals and the dog slinks away with his tail between his legs. Could any language be plainer?"

"No, but they're only dogs."

"Man too," continued the doctor didactically, "expresses his emotions by means of gestures, but principally by the expression of his features. I am safe in saying that every emotion a man experiences, whether fear, anger, hate, jealousy, sensuality, or joy, is expressed to a certain degree in his face. Of course, he has learned to school himself and keep his features more or less under control, but the expression is in his face, however imperceptible it may be to a casual observer."

"Well?"

#### MAN'S FACE REVEALS HIS EMOTIONS

"Well, the wrinkles that appear in our faces with age, are the result of such expressions of emotion, often repeated. A man who

continually frowns, or who is stern and cold will have wrinkles that betray him. An experienced observer can often tell at a glance a man who is cruel, vindictive, envious, lascivious or dangerous, merely by the expression of his face. We all of us express these passions by much the same play of features. And every such emotion leaves its trace . . . barely perceptible, but each repetition strengthens it. A man's character is thus indelibly stamped upon his face. The difficulty consists in reading it correctly. It is for the purpose of reading this facial expression that I use these distorting mirrors that you see here. By means of these I can read any man's character without a mistake. Of course, in a boy or girl, the character is not so deeply impressed on the face as in an adult, but it is there all the same, and I can read a person as if he were a book."

"I see—you magnify the features."

**HOW EACH TRAIT IS MAGNIFIED FOR STUDY**

"Not exactly—Magnifying the features helps a little, but not much. I get my best results by distorting the features, that is to say by magnifying the one trait I am examining, whether anger, jealousy or some other passion. In a word these mirrors produce caricatures—One is designed to intensify a man's looks of envy, another his sensuality, etc.—I sit a man in the middle of this room and look into each of these mirrors in turn, and after these observations I know the man better than he knows himself."

"Gee!" cried Pep. "You ought to turn phrenologist, doctor, give a man a chart of his character, and tell him what vocation he is best fitted for. Or you could examine candidates for office and accept or reject them at a glance, without need of a written examination."

"Yes," replied the doctor, gravely—"there are many uses to which these distorting mirrors may be put, but the greatest one is undoubtedly that of reforming criminals."

At this moment the pair were interrupted by the entrance of the office boy.

"Inspector Fox is below, Doctor Hackensaw, and wishes to see you."

**SIX-FINGERED PETE**

"Come along with me, Miss Pep," said the doctor. "I am going with Inspector Fox to



Pep and the doctor entered the operating room, where the patient was stretched motionless under the powerful electrical machine that was to destroy his memories of a life of crime and make a new man of him. An anaesthetic had been administered and all was in readiness. Doctor Hackensaw rapidly divested himself of his coat and carefully adjusted the micrometer screws that regulated his "Memory Obliterator."

visit Six-Fingered Pete, one of my subjects. Come along and you will see some of the practical results I have obtained."

Six-Fingered Pete, so-called because he was born with six fingers on one hand, was, at the time, under sentence of death for murder. He was a criminal of the worst type, having been, so to speak, born to crime. His father had been a burglar and his mother a thief and drunkard of the lowest class. Pete himself had been reared in the slums amid all that was vilest and foulest of New York, in what was at the time known as Mulberry Bend. This plague-spot has fortunately been abolished, a park now occupying its place. It was the haunt

of the thief and the prostitute, and stories were current that, for the modest sum of thirty dollars, you could hire any one of a dozen men to rid you of a troublesome rival or for a few more dollars have a policeman killed.

Naturally enough, in this foul place, Pete soon grew to be a rogue. In fact, he rapidly outstripped his fellows. At ten he was a clever pick-pocket, and even assisted the local gangs of crooks in their burglaries, his small size rendering him valuable for entering houses through transoms, and unlocking the door for the older members of the gang. As he grew older and bolder, he became himself a leader, starting a gang of his own, which was a terror to the neighborhood. He was suspected of several murders, but nothing could be proved against him. Finally, however, he was caught red-handed after murdering a member of his own gang. The fellow had turned traitor and his testimony had sent Pete to prison for a term of years. Pete had sworn vengeance and had obtained it immediately upon his release.

This was the man whom Doctor Hackensaw was about to visit.

"You see, Miss Pep," explained the doctor, "It's no sinecure I've undertaken. If I can succeed in reforming Pete, it's a proof that my method is a good one. Eugene Sue in one of his books, recommended blinding criminals to reform them. The loss of their eyesight would render them powerless to commit new crimes. My method is more humane, however, and more efficient."

Six-Fingered Pete was not a pleasant personage to look at. A coarse, brutal, sensual face told its story without need of the doctor's distorting mirrors. A dangerous man, evidently, with a large muscular body that made him look strangely menacing.

"There, Miss Pep," said the doctor, "that is the man whom I have undertaken to reform. He is condemned to death, but I have succeeded in obtaining a promise of his pardon if I can really succeed in reforming him. The fellow has consented to let me try my hand. It is his last hope, and be-

(Continued on page 792)



Pete had awakened none the worse physically, but his mind had become a complete blank. It was curious to watch him as he tried to rise from his bed. He was more helpless than a babe, for his muscles had lost all power of co-ordination.

# Around the Universe

By RAY CUMMINGS

6TH AND FINAL INSTALLMENT



The new asteroid—five hundred miles in diameter, a white-hot core with flames hundreds of miles in height leaping from it, plunged for the Sun. But Mars also lay beneath it though slightly off to one side—Mars, now a huge reddish, smug-looking crescent across the lower firmament.

## CHAPTER XI.

IN WHICH THE MATHEMATICAL GENIUS OF SIR ISAAC PLAYS HAVOC WITH THE MINOR PLANETS, BUT SAVES THE EARTH FROM DISASTER.

**T**HE vehicle had passed within the orbit of Jupiter on its return voyage before Sir Isaac deemed it expedient to explain to his fellow voyagers his mathematical plan for the salvation of the Earth. It was the morning of the day before Mars was to be in opposition with the Earth. To be exact, just thirty-four hours remained at the moment the orbit of Jupiter was crossed.

The return trip—of a little less duration than the voyage out—had been devoid of any exciting events chiefly owing to the unflagging vigilance of Sir Isaac. His genius for astronomy—by some method which he did not see fit to explain to his friends—enabled him unerringly to find his way back to the proper Universe, and thence to the Solar System.

During these days and weeks, sleeping little, Sir Isaac had remained almost constantly at his post at the instrument room floor window, or at the table beside the keyboard, verifying over and over again, his gigantic calculations; or writing on his now very bulky manuscript. Tubby and Ameena, left thus to their own devices, passed the time pleasantly enough, singing their duets whenever Sir Isaac would let them, and always cooking the meals and washing the dishes together. The wedding had now been set to take place on the Earth, immediately upon their arrival, with a honeymoon trip to Venus.

At meal time which the three friends occupied principally with argument and with scientific dissertations from Sir Isaac, Tubby had once remarked:

"Them inhabitants of the Edge of Space must have been awful big, professor. Big

as anybody could get. Ain't I right?"

Sir Isaac, in a manner that now was becoming quite habitual, smiled condescendingly.

"My dear fellow, those inhabitants of the Inner Surface of our Atom may be, possibly, several hundred times larger than ourselves. But, like us, they are merely denizens of an infinitesimal Atom. The inhabitants of that outer world are so much larger that their most powerful microscopes—assuming they have microscopes—would be necessary even to see our Atom itself much less see us or the planets in it!"

### SYNOPSIS OF THE FIVE PRECEDING INSTALLMENTS

**W**ATCHING a game of cards, "Tubby" suddenly finds himself out in the open under the stars, endowed with a power of wishing. He wishes for a knowledge of astronomy and is confronted by a Professor Isaac Swift DeFoe Wells-Verne. They start for Venus in the Professor's space flyer.

Arriving, they meet Ameena, an inhabitant of Venus and she tells them that the earth is going to be attacked by Martians and the Twilight People of Mercury. The three decide to set out to the various planets to solicit aid, in behalf of the earth. They land on Jupiter and are interviewed by the Great Mogul who laughs at them and refuses help.

Leaving Jupiter they head out into space, passing near the rings of Saturn. Arriving at Uranus, they find that it is not inhabited. The same condition is found on Neptune. Therefore, in hopes that some of the stars are inhabited, they head toward Alpha Centauri.

In passing Alpha Centauri they find no possibility of habitation. Sir Isaac then informs his companions that he has very nearly completed calculations which will save the earth from destruction and, he continues, he is going to visit the "Edge of Space." He believes that by the time they conclude the trip his problem will be solved and he can save the earth. For nearly a week they travel, attaining a velocity of 5,593,056,000 miles per second. Sir Isaac then goes on with his calculation and finally announces that he is successful.

"Tubby" and Ameena become engaged to be married, having fallen in love with each other.

Soon they sight beneath them what seems to be a cliff and proceed toward it. As they descend along the side of it a huge ball of fire flashes past. In size it was ten times larger than the space traveler itself. A shock is felt and the travelers are hurled to the floor. Sir Isaac announces that they have reached the inner surface of the atom containing our universe and solar system, and that the ball they saw was a street light in one of the cities on the inner surface and that the vehicle collided with the coat sleeve of a pedestrian, causing the shock.

Within the orbit of Jupiter—they were heading for Mars and had passed a very considerable distance from Jupiter itself—Sir Isaac materially checked their velocity. The region of the Minor Planets lay ahead.



Past the side window, very close outside, a gleaming white object flashed! Sir Isaac, Tubby and the girl leaped to their feet in fright. A glance upward out of the side window was enough. It was that same Mercurian vehicle, hovering here between Mars and Jupiter, awaiting their return! The glistening white cube was receding rapidly above them. Suddenly it turned, and as they hurried into the store room to observe it from there, it came rushing toward them again. "It's runnin' into us!" Tubby cried in terror.

It was among them that he planned to operate.

**SIR ISAAC EXPLAINS HIS PLAN TO SAVE THE EARTH**

After breakfast that morning he called Tubby and the girl into the instrument room and very quietly but solemnly announced that he was ready to explain his plan. Tubby and Ameena sat together in the huge easy chair, she perched on his lap, and hand in hand they prepared to give Sir Isaac their closest attention.

"My dear friends and fellow voyagers," Sir Isaac began, with something of the tone of a public lecturer, "we come now to the most important, most remarkable, and I may say the most awe-inspiring event of our scientific adventure around the Celestial Universe."

"I wish he did not have such long prefaces," Ameena whispered to Tubby.

"Sh! you'll make him mad," Tubby whispered back. "He don't mean nothin'. He gets that way from writin' so much."

"As you both know," Sir Isaac went on, ignoring these whispered asides, "at 6:15 P. M. tomorrow evening the Planet Mars will be at its closest point to the Earth. We anticipate then that the combined Martian and Mercurian armies will voyage to our Moon, which already they have conquered, there to prepare to attack the Earth. It is necessary, therefore, for us to prevent this migration. If we can keep the armies on Mars their small force now occupying our Moon will be powerless for offensive movement. We could even send armies from Earth to destroy them; or, at the next opposition doubtless they would return to Mars of their own volition."

"Right," Tubby agreed impatiently. "But please tell us how we're goin' to stop the Mars armies from movin' over to our Moon."

"I will," stated Sir Isaac. "But first you must understand the scientific laws governing what we are about to do. A poet once said, 'Thou canst not touch a flower without troubling of a star.' He did not mean it scientifically perhaps, but its scientific application is very pertinent. It means that if you so much as pick a



"I wish the Earth was revolvin' ten times as fast! I wish—" Sir Isaac's body left the ground, hurtling into the air like a bullet. Tubby grasped one arm around Ameena, and one about the tree-trunk. He felt like a balloon tugging at its leach. The wind was a cyclone. A house went sailing off through the air—Bill Hawkins' house.

flower anywhere in the Universe, you alter, by some minute fraction, the course of every star—every celestial body, no matter how distant, or how gigantic.

**THE UNIVERSE DELICATELY BALANCED**

"I see you do not quite understand me. The celestial Universe is very delicately balanced. Every force acting upon the celestial bodies has another force to counteract it. Now since every body attracts every other body directly as the mass, you will realize that a daisy growing in a field on Earth attracts Neptune or Mars just as much in proportion to its mass, as they attract the daisy. And since attraction is inversely as the square of the distance, it follows that if you pick the daisy, thus altering its position, you alter its attraction.

And therefore—very minutely, of course—you disturb the movements of every body in the Universe."

"I think we understand you," Ameena said. Sir Isaac had paused, and this time Tubby had failed to make any comment. "It is really very interesting. Do go on, Sir Isaac."

Sir Isaac continued:

"Well, I propose to do just that very thing. To—"

"Pick a daisy?" Tubby put in. He glanced at Ameena for approval of this quip, but she frowned.

"To so alter the course of some very small celestial body—by using the attraction of our vehicle upon it—that a series of collisions, progressively greater in the masses of the colliding bodies, will rapidly occur among the Minor Planets."

"Oh," said Tubby, somewhat abashed. "Then what?"

"I have figured it out very carefully," declared Sir Isaac. "You may appreciate possibly the abstruseness and the delicacy of such a calculation. The collisions will climax at 5:34 P. M. tomorrow afternoon, by—"

The sentence was never finished. Past the side window, very close outside, a gleaming white object flashed! Sir Isaac, Tubby and the girl leaped to their feet in fright. A glance upward out of the side window was enough. It was that same Mercurian vehicle, hovering here between Mars and Jupiter, awaiting their return!

"Say—what the—did they try an' run into us?" Tubby gasped.

The glistening white cube was receding rapidly above them. Suddenly it turned, and as they hurried into the store-room to observe it from there, it came rushing toward them again.

**ATTACKED BY THE MERCURIANS**

"It's runnin' into us!" Tubby cried in terror. "Hey pefessor! Let's do somethin'—let's get a-goin' somewhere!"

Sir Isaac rushed back to the keyboard. The horrible meaning of the situation became clear. The Mercurian vehicle, manned by "suicide volunteers," was endeavoring to destroy them and itself simultaneously by a collision in Space!

(Continued on page 794)



It came at 5:51 P. M.—as Sir Isaac had calculated—a soundless flash, and then a new, larger celestial body, the fused mass of the other two bodies, wavering in Space, plunging diagonally toward the Sun, and at last finding its new orbit by that delicate balancing of forces which is the marvel of Celestial Mechanics. Sir Isaac was jubilant. He took several observations of the new asteroid. "Perfect, my dear friends. The new orbit is identical with my calculation. There will be another collision, with a much larger planetoid, at 7:19 P. M. Let us have dinner."

# Largest Vehicular Tunnel

By A. P. PECK

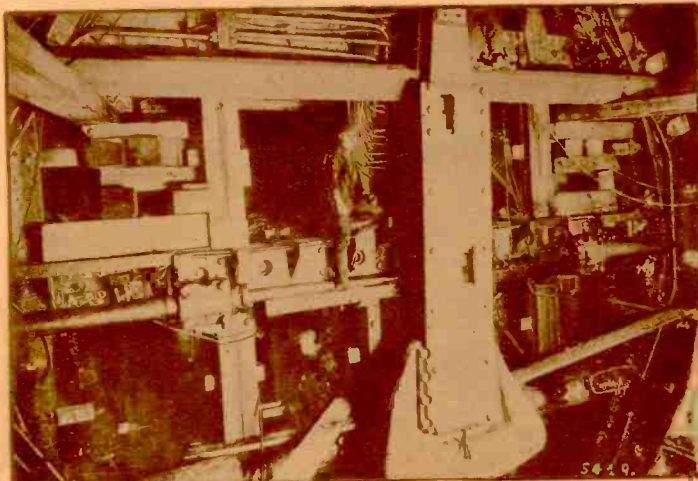

A rear view of the digging face of the shield used in constructing the New York-New Jersey vehicular tunnel under the Hudson River is shown above. The jacks which are used to force the shield ahead may be seen at the side. The large upright arm is used to place the sections of the tunnel in position, after the shield has been moved forward.

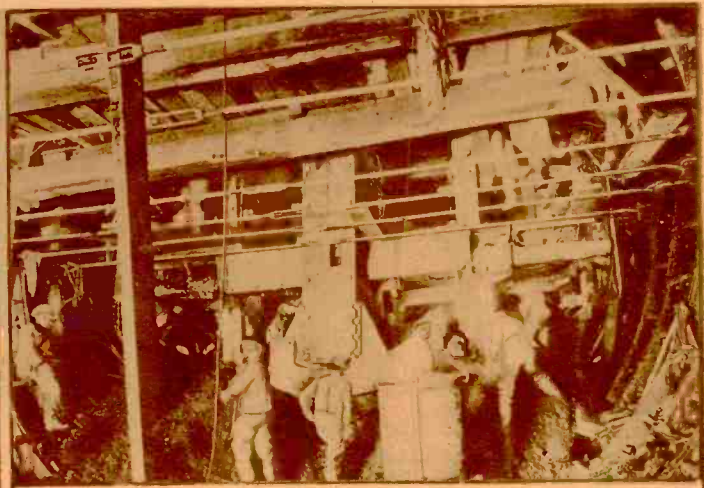

Another view of the same portion of the shield showing laborers at work digging through the doors in the face. These men work under an air pressure of twenty-nine pounds per square inch. Occasionally it is necessary to increase this pressure in order to keep the earth from forcing its way into the tunnel.

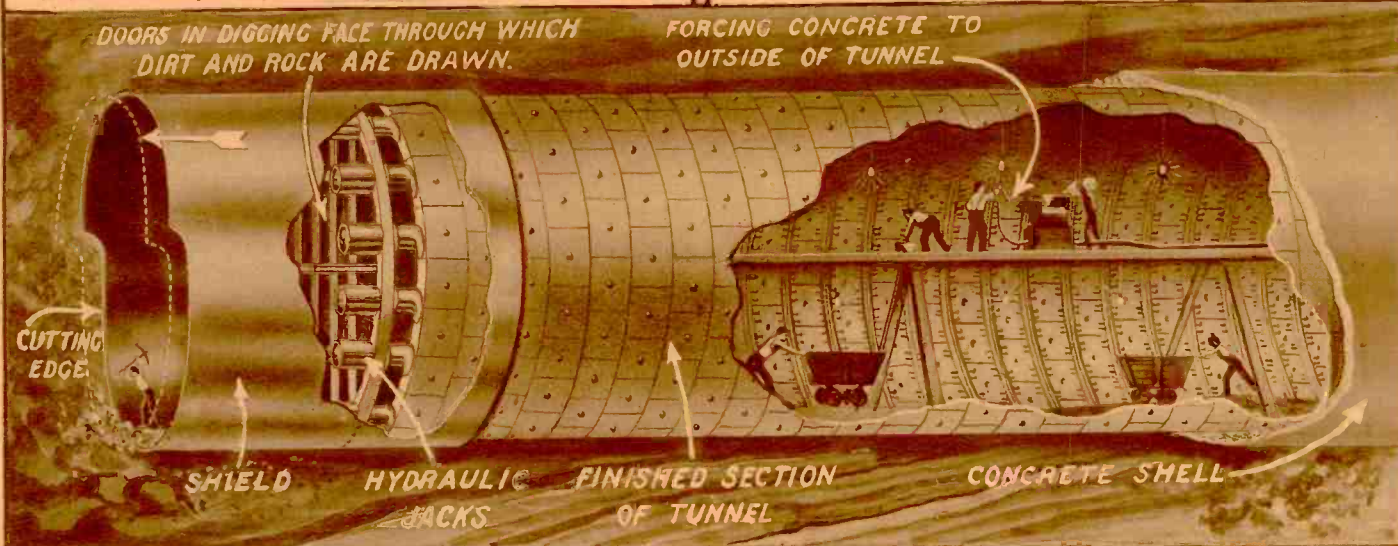

A diagrammatic view of the shield and a finished section of the tunnel will be seen above. The hydraulic jacks force the shield forward and the dirt and rocks are removed through the finished tunnel after being taken in through the digging face. When rock is struck, the dirt in the forward part of the shield is removed,

and blasts are set to break up the rock. The concrete shell, in semi-liquid form, is forced out under air pressure through holes in each section of the steel wall. When the shield can be forced forward by the jacks this is done until the shield has advanced. Then two or three jacks are removed and a steel section is set in place.

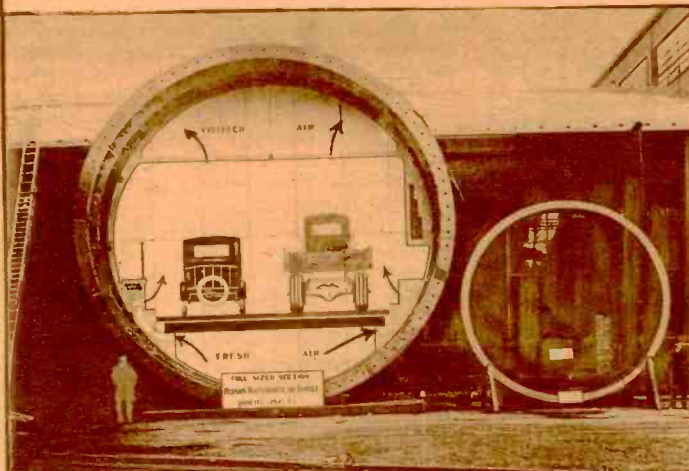

At the left is shown a cross-section of one of the finished segments of the steel tunnel. The system of ventilation can be plainly seen. To the right is shown a section of what was formerly the largest under-river railroad tunnel in the world. The pleasure car and truck indicates how fast and slow moving vehicles will be divided to prevent congestion.

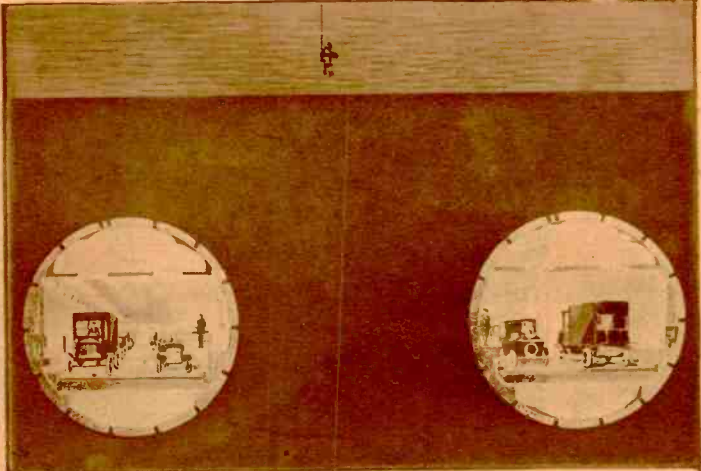

Referring to the above diagram it will be seen how east and west bound traffic will be taken care of by the twin tubes under the river connecting New York and New Jersey. Note the depth of the tubes below the river bed and their distance apart. Pedestrians are taken care of by the walks on the sides. Fresh air will circulate in the tubes.



# Insects Make Camera Début

By EDWIN SCHALLERT



SINCE the invention of a new motion picture device, insects as well as microscopic forms of life may be shown on the screen as they appear in their native haunts. The new invention's success depends upon the fact that the strong light which must be played over the subject can be cooled before it strikes them. Formerly it was impossible to make motion pictures of insects because the intense heat of the light killed them almost instantly. A picture of the invention with its inventor, Louis R. Tolhurst is shown at the right. At the left is the profile of a spider, taken with the invention.

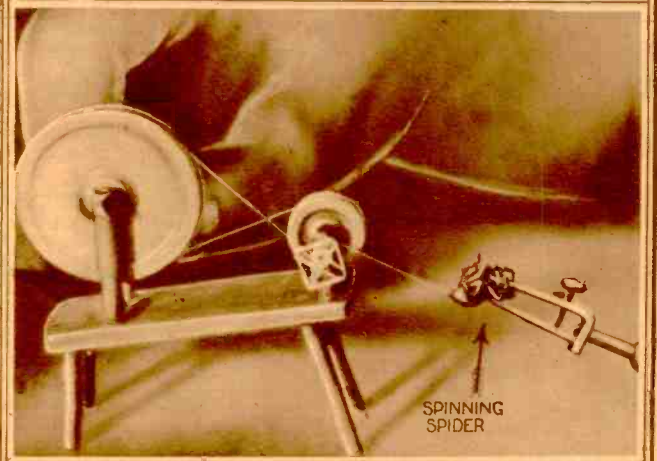
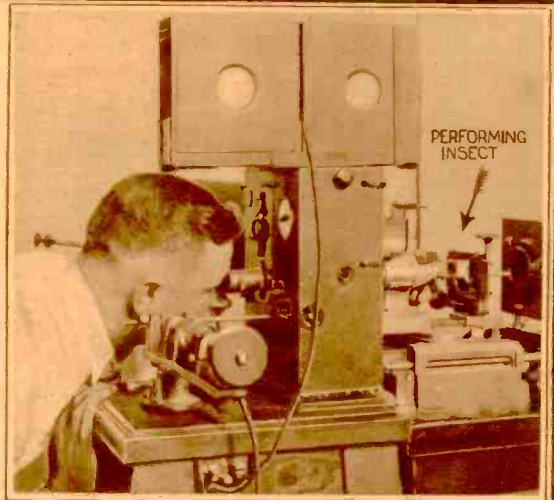

ABOVE is shown a close-up of the same spider in a mood of vengeance. In fact, he is just ready to leap at his opponent, whom he ate with hearty gusto a few seconds after this picture. Here he is crouched for the spring. As spiders and insects generally do not heed a director's megaphone to any great extent, the job of the camera man is a hard one, since he has to be ready at all times and then await the pleasure of Mr. Spider or Beetle before he begins "shooting." On account of the short distance of the subject from the lens focussing is hard.

AFTER a number of days of careful waiting and just as careful handling, spider in the above photo was induced to spin her web onto a spool device as shown above. All insects are so quirk in their movements—as well as temperamental—that by the time the camera man gets to clicking away the whole show may have passed. This difficulty was overcome in the new apparatus by making its starting and stopping practically instantaneous. The operator, of course, must necessarily be at his post constantly, waiting for the royal insect play to start.

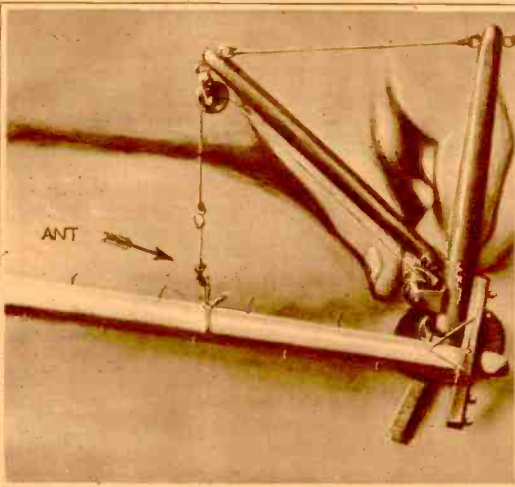

IT has long been known that the lower forms of life were much stronger in relation to their size than the human race or the larger vertebrates. Here is shown a common ant, such as the pedestrian might kill without the slightest knowledge of his act. The ant, however, in fighting his own kind or others of the lower world of life is a giant greater than any of those in the tales of the justly famous Jack the Giant Killer. The ant caught in this photo is holding with her mandibles a miniature telephone pole weighing a thousand times more than herself. A man to be equally strong would have to lift three railroad cars of coal, one on the other. In the center is shown a close-up of the ant with the cord suspending her and the cord over her mandibles on which the miniature telephone pole is tied.

ANT'S jaws are not such pleasant things to deal with, it would seem from the above close-up picture of them. The directors who got out the present film are contemplating making a picture in which the insects and men will appear in the same proportion. The insects and the men will fight—and they will be the same size. Of course, the double exposure system in printing the films will be used to make the picture.

# The Ancients' House Hardware

By CHARLES BEECHER BUNNELL

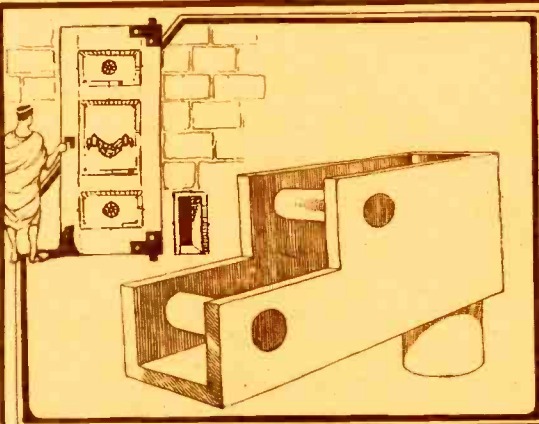

The door of the ancient Pompeians. Instead of hinges as we know them today, the richer homes used bronze key pieces with sockets. They were made of solid bronze and were made fast to the doors by rivet-like bolts through the pieces and the door. The key pieces fitted in sockets countersunk in the lintel of the door. To the right may be seen the cat and dog door.

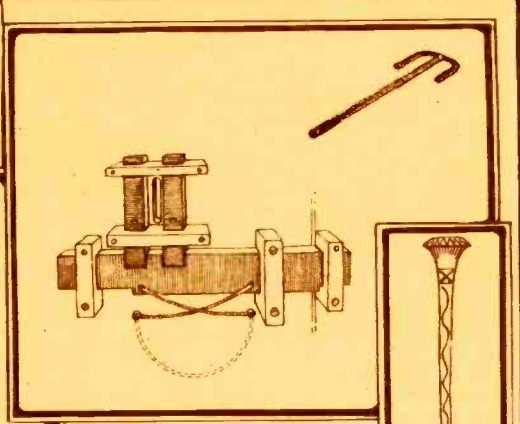

Here is the lock spoken of by Homer in his *Odyssey* when he tells of one Penelope having inserted a pin and raised the two plungers which held the lock in place. The plunger that held the door fast is plainly seen in the sketch. The two pins that fit into the top of the plunger held it fast when the occupants of the house were absent. These pins were held in their slots in the bolt by gravity. The above illustration, as most of the others on the page are made from pieces of apparatus now preserved in the British Museum in London.

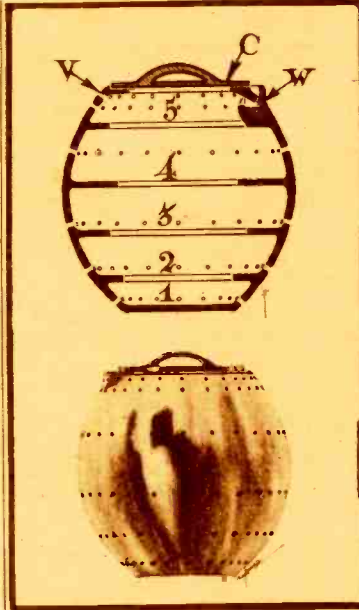
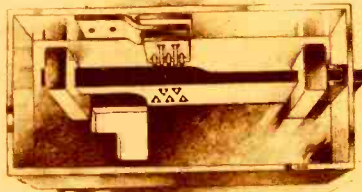

That the Romans were very fond of honey is shown by the fact that they made such elaborate beehives to be placed in their gardens. Above is shown one made completely of bronze, with inlay work. It will be seen that it was made in stories and had ventilators at the top. (Marked "V.") and a pan of water shown at "W."

Above is shown a lock of ancient Pompeii. The bolt of the lock was held in place by the pins. In order to open the door it was necessary to have a key with pins on its face corresponding to the perforations in the plunger. These keys dislodged the pins and took their place. By moving it ninety degrees the plunger of the lock could be withdrawn, releasing the door.

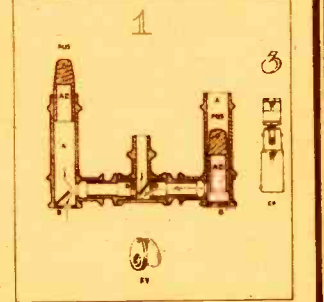
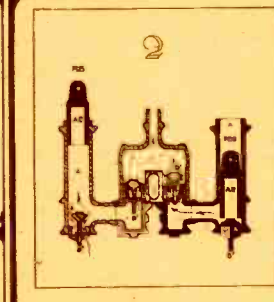

A complete pump with valves and plungers 2,203 years old! These two pumps, shown in the above sketch were found on the site of the ancient Etruscan city of Velesna, which was captured and entirely destroyed by the Romans in 280 B. C. The pumps were found by scientists of the British Museum. In the case of both pumps the plungers were operated by rocker arms. It will be noted that the design of the pistons is practically the same in both cases and that the only difference in the two is in the valves. It is generally conceded that the one with the flap valves is the older. In the latter pump the delivery chamber is also much more elaborate.



We of the modern day prate about the multitude of our new inventions many of which are simply adaptations of earlier ones that flourished thousands of years ago. The fireless cooker is thought by many to be new. That it is not is shown above; it is nothing other than a form of the cooker that was used in ancient Rome.



Alexander the ancient and glorious Monarch used the above disk with its raised letters as a means of rapid communication. The disk with its message was put into a catapult and thrown. In this case its general name forms the inscription.

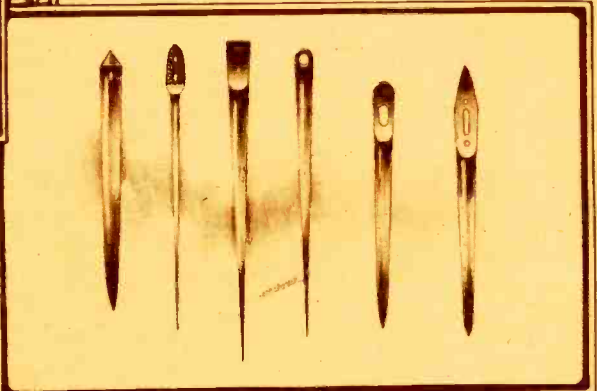

Has the sewing needle fallen from its high estate? Here are needles of the First Roman Empire, wrought in gold, bronze and silver with inlay work in some cases. Before they were made in metal the same shapes were made in bone.



# Invisible Elevated Railway

Carrying Structure in Buildings at Side of Street.

BY EDWIN F. LINDER

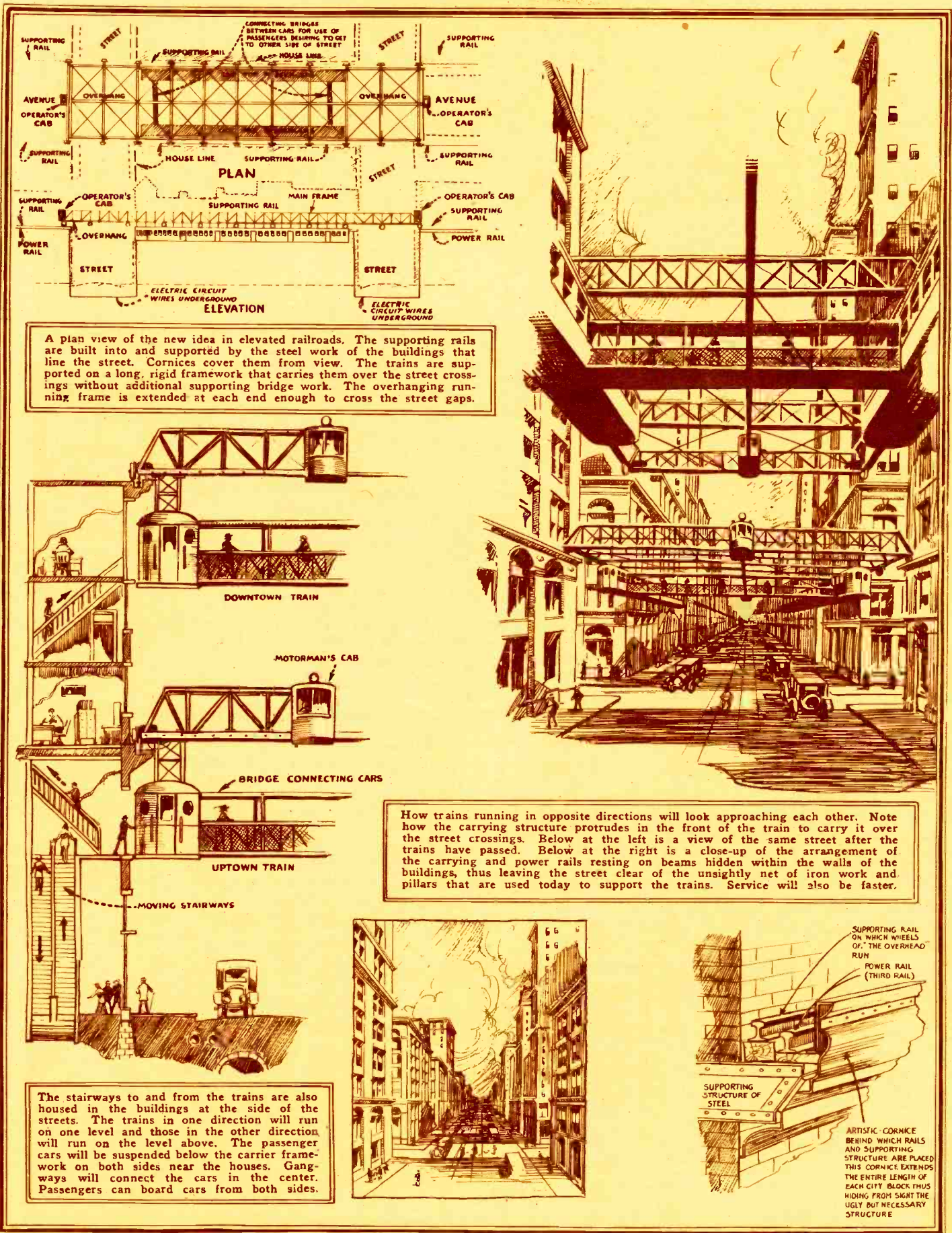

A plan view of the new idea in elevated railroads. The supporting rails are built into and supported by the steel work of the buildings that line the street. Cornices cover them from view. The trains are supported on a long, rigid framework that carries them over the street crossings without additional supporting bridge work. The overhanging running frame is extended at each end enough to cross the street gaps.

How trains running in opposite directions will look approaching each other. Note how the carrying structure protrudes in the front of the train to carry it over the street crossings. Below at the left is a view of the same street after the trains have passed. Below at the right is a close-up of the arrangement of the carrying and power rails resting on beams hidden within the walls of the buildings, thus leaving the street clear of the unsightly net of iron work and pillars that are used today to support the trains. Service will also be faster.

The stairways to and from the trains are also housed in the buildings at the side of the streets. The trains in one direction will run on one level and those in the other direction will run on the level above. The passenger cars will be suspended below the carrier framework on both sides near the houses. Gangways will connect the cars in the center. Passengers can board cars from both sides.

SUPPORTING RAIL ON WHICH WHEELS OF THE OVERHEAD RUN  
 POWER RAIL (THIRD RAIL)  
 SUPPORTING STRUCTURE OF STEEL  
 ARTISTIC CORNICE BEHIND WHICH RAILS AND SUPPORTING STRUCTURE ARE PLACED THIS CORNICE EXTENDS THE ENTIRE LENGTH OF EACH CITY BLOCK THUS HIDING FROM SIGHT THE UGLY BUT NECESSARY STRUCTURE

# Mooring Mast for Dirigible

Tower Station Without Landing Field Allows Aircraft to Stop For Passengers

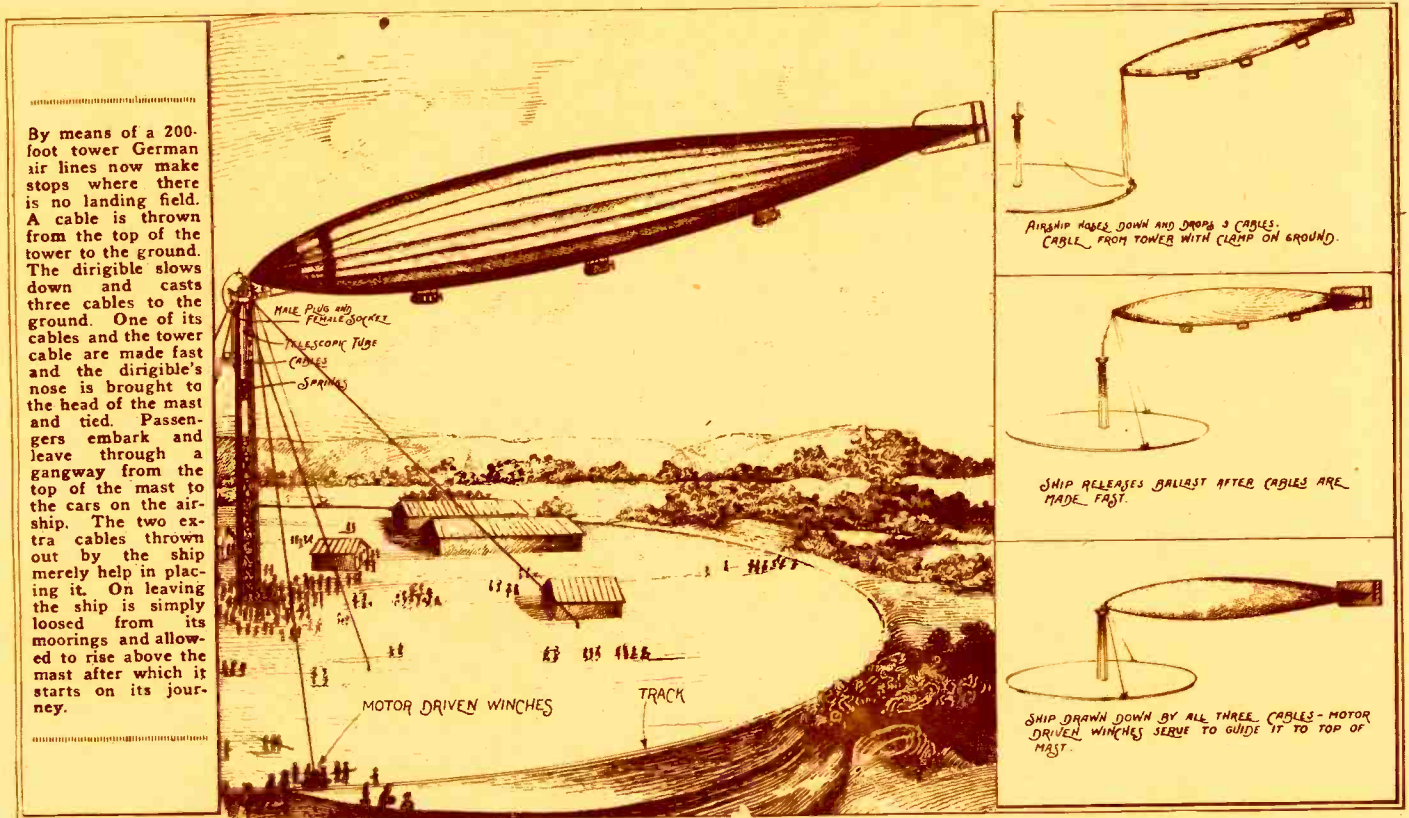

By means of a 200-foot tower German air lines now make stops where there is no landing field. A cable is thrown from the top of the tower to the ground. The dirigible slows down and casts three cables to the ground. One of its cables and the tower cable are made fast and the dirigible's nose is brought to the head of the mast and tied. Passengers embark and leave through a gangway from the top of the mast to the cars on the airship. The two extra cables thrown out by the ship merely help in placing it. On leaving the ship is simply loosed from its moorings and allowed to rise above the mast after which it starts on its journey.

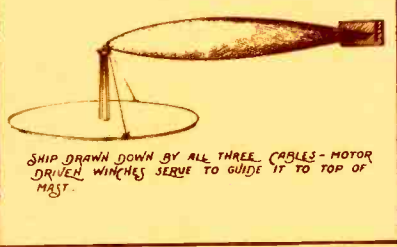
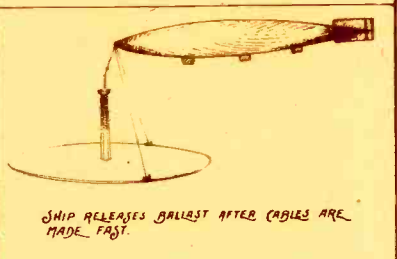
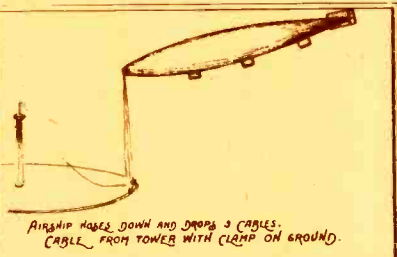

## \$12,000 or More in Gold

Beginning with the January issue, SCIENCE AND INVENTION will pay \$1,000.00 or more each month of the year in prizes. Every article published in the regular news section will receive one of them. (The departments have awards of their own which they will continue to give.)

Ideas are what the editors want. They must be told simply—so your mother or sister can understand them—in pictures and sketches. Be sure they are NEW and have something to do with science or invention. The editors want pictures and sketches—

88 monthly prizes will be given as follows:

<b>FIRST PRIZE \$100.00</b>			
<b>2 PRIZES of \$50.00 each</b>			
10	"	"	25.00 "
5	"	"	20.00 "
10	"	"	15.00 "
20	"	"	10.00 "
10	"	"	5.00 "
20	"	"	2.00 "
10	"	"	1.00 "

## \$12,000 or More in Gold

must have them—but ideas are wanted most of all.—And they will be handsomely paid for. The rules of the contest will be found on page 534 of the October issue. If you haven't a copy, one will be mailed you free on receipt of your name and address. It will give full details of the rules and hints on submitting articles. The closing date for all prize contributions will be the 15th of the month preceding date of issue, i.e., 15th of December for the February number; the 15th of January for the March number, etc.

### WILL YOU BE OUR REPORTER?

IN connection with our \$12,000.00 prize contest announced last month, it goes without saying that you will have to hustle to win a prize. The Editors do not wish to make it hard for you; quite the contrary. We want the pictures and want them badly. Herewith is reproduced our reporter's card. We shall be glad to send it to anyone who makes an application. By means of this card, you will be able to secure entré into industrial plants, business houses, motion picture studios, steamships, mines, etc. This card will prove an open sesame to you in many instances. Each card is numbered and only one is given to a correspondent. A postal card from you and a request for this reporter's card is all that is necessary for obtaining one. It will be sent you by return mail. Address Field Editor, SCIENCE AND INVENTION, 53 Park Place, New York City.

**REPORTER**

## Science and Invention

CORRESPONDENT  
REPORTER'S  
IDENTIFICATION

NO. 999

*John Doe*

THE BEARER OF THIS CARD IS AN AUTHORIZED CORRESPONDENT REPORTER OF SCIENCE and INVENTION MAGAZINE THE PUBLISHERS OF SCIENCE AND INVENTION WILL APPRECIATE ANY COURTESY EXTENDED THEIR REPRESENTATIVE.

EXPERIMENTER PUBLISHING CO.  
*H. Jones Balk*  
PRESIDENT

(over)

# Opinions on Spiritualism

## VIEWS OF WORLD-FAMOUS MAGICIANS ON MEDIUMS

### Our Spiritism Contest

SCIENCE AND INVENTION herewith reviews its offer, first made in the June, 1923 issue, that we will duplicate the spirit manifestations of any spiritist or medium under the same conditions and with purely natural means. We offered \$1,000 which was to be forfeited in case the magazine failed to make good its claims. This offer was to run for the term of one year, ending May 1, 1924. The conditions of the award are as follows:

The contestant must be a practising medium and must perform her acts through the aid of so-called spiritistic power.

Contestants must come to the New York office of the magazine for tests—53 Park Place.

Subjects must consent to present their offerings before the magazine's staff of investigators, the general press and Mr. Joseph Dunninger.

Mr. Joseph Rinn, member of the American Society for Psychical Research has added another \$10,000 to the offer of the magazine. His awards are as follows:

"A thousand dollars for successfully making any of the following tests:

"Reading a book, opened at random by me behind the medium's back.

"Spelling an intelligible message on a ouija board, the letters of which have been transferred from their regular places, the medium to be blindfolded and cotton to be put in the ears by me.

"Causing writing to appear on slates furnished and bound together by me and placed within my shirt bosom while the writing appears.

"For proving mental telepathy, or the power of two persons to communicate with each other after they have been bound, blindfolded, mouth and ears stuffed with cotton by me.

"For describing any event to take place in the future. Such event to be of a nature that the medium would be without the power to bring it to pass. Details to be so clear as to leave no doubt as to nature or place of the happening. Must be of a nature that the medium can have no fore-knowledge of its happening. Or to any person who will produce a picture on a negative furnished by me while the plate is locked in a safe.

"I will give \$5,000 to the person who, after being searched and secured by me, shall produce from their mouth or body the substance called ectoplasm, and shall cause it to take definite shapes.

#### OR TO ANY PERSON

who will prove under scientific conditions, laid down by me, that the spirit of the dead can communicate with the living.



JOSEPH F. RINN—"Spiritualism is all bunk. I back my opinion by offering \$10,000 through this magazine to anyone who will prove it is anything else."



DUNNINGER—Chairman of this magazine's investigating committee says it is all bunk; that he is prepared to duplicate all phenomena of mediums.



THURSTON—"Although I believe in spiritualism, I believe that all phenomena done in public is trickery."



HOUDINI—"Am anxious to be convinced but have seen nothing I could accept as genuine."



WILLIAM KRIEGER—"Ectoplasm and other such phenomena, my experience has shown, is just another way of presenting a conjurer's performance."



FRANK DUCROT—"All medium performances I've seen employed magical principles that are well known."



A. M. WILSON—"All is fraud and mediums fakirs or self-hypnotized which is a form of hysteria."



LA FOLLETTE—"Spiritual phenomena consist of tricks known to the illusionist."



GREAT LEON—"In every case on a second demonstration, I was able to discover that the effects were brought about by trickery purely and simply."



AL BAKER—(No Photo). "I have witnessed many mediumistic performances and find that all their weird effects and phenomena are brought about by methods used by magicians for years."

CAESAR—"Although a believer in spiritualism, I am opposed to so-called mediums, because they employ trickery to convince."

# Fossilized Extinct Animals

By DR. W. A. LUZ,  
Of Stuttgart, Germany



On the Northern Slopes of the Swabian Alps in South Germany, Not Far from Stuttgart, the Capitol of Wurtemberg, Lies the Village of Holzmaden Where Fifty Feet Below the Surface Lie Reptiles in Fossil Form. Here Countless Petrified Fishes, Such as the One Illustrated at the Left (Lepidotus Elvensis), Which is Three Feet Long, Have Been Discovered. The Texture of the Stratum in Which the Fossils Were Found Leaves the Markings Well Preserved.

The Immense Petrified Monster in the Photograph at the Right Is Ten Feet Long. It is Called the Teleosaurus. This Animal, Like the Fishes and Corals on This Page, Was Found by Dr. Hauff, Who Lives in the District Where the Excavations Are Made. Although the Output of Slate from the Holzmaden Quarries is Not So Very Great, No Less Than One Hundred Ichthyosaurs Are Found Yearly, and at Least Ten Per Cent of These Are Perfect Enough to be Prepared for Museums.



The Fish at the Left Appears to be a Hybrid Between a Crocodile and a Dolphin. It is Called the Ichthyosaurus. Even the Skin of the Specimen Was Perfectly Obtained by Dr. Hauff Through a Secret Process. Our Knowledge of These Beasts Has Been Established to an Extraordinary Degree. This Breed Frequently Devour Their Own Young, and as Many as Eleven Have Been Found in the Belly of an Adult Ichthyosaurus. This Specimen Was Four Feet Long.

Recently a Magnificent Group of Sea Lilies, (Pentacrinini), One of the Largest Ever Found, Which Settled on a Drifting Trunk Covered With Sea Shells Was Discovered. This Petrified Growth Illustrated in the Photo Below is Ten Feet High and Eleven Feet Long. However, in Another Specimen a Log Fifty Feet Long with Sea Lily Foliage Spreading Out to Fit a Rectangle Sixty Feet by Twenty Feet Was Found. It Was Necessary to Employ Three Workmen for a Period of Four Years to Chisel This Growth Out. Scientists Today Believe That the Waters of the Bay Were Deficient in Oxygen and Poisoned by the Presence of Sulphur Dioxide. It is Thought, Shoals of Spawning Fish, Hard Pressed by Rapacious Amphibians, Turned into the Bay Where Both Chasers and Those Chased Were Asphyxiated. These Were Swiftly Covered by Mud and So Preserved. Similar Conditions Prevail in the Black Sea. The Fable of Submarine Eruptions Killing These Animals Has Been Discarded.



# Airplane Landing Stage

By GEORGE F. PAUL

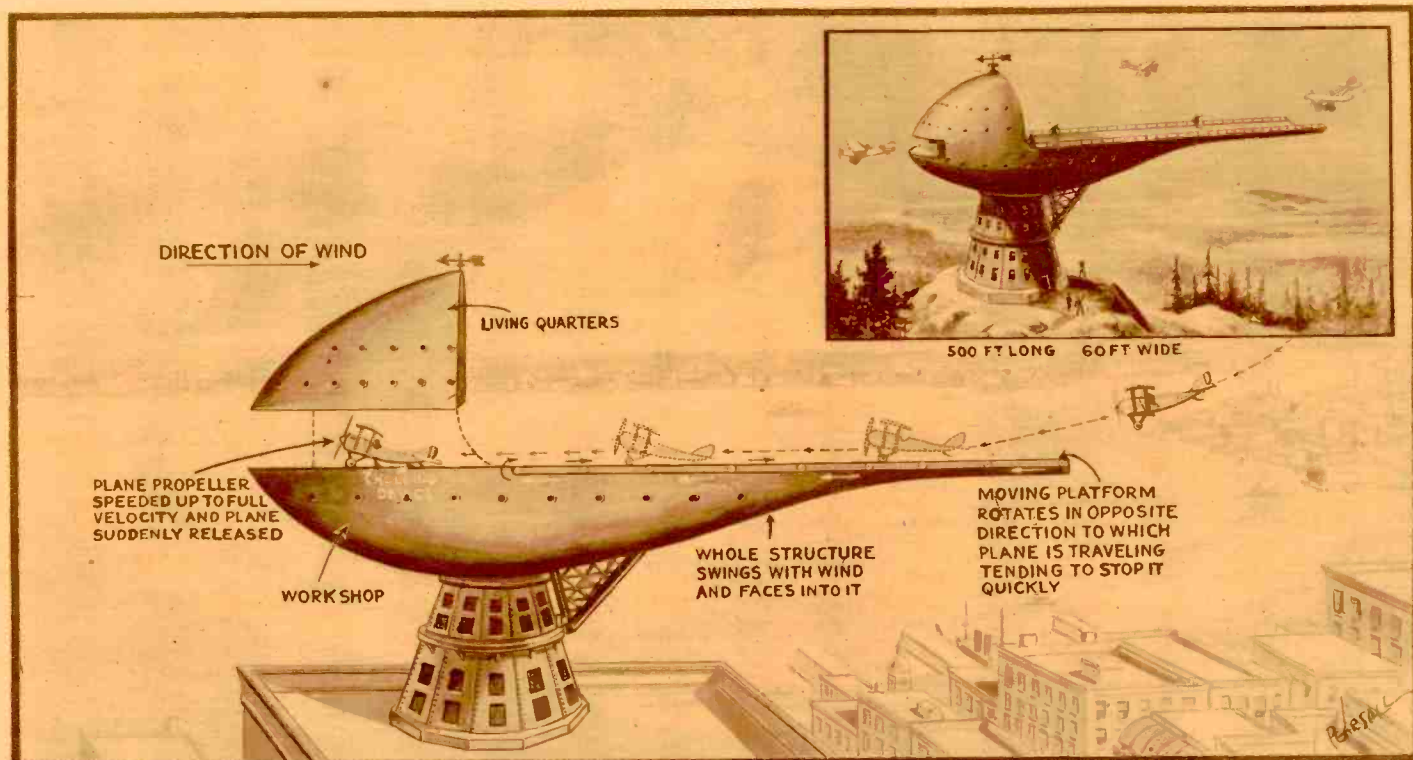

The new landing stage shown in the above drawing can be constructed anywhere, regardless of physical conditions surrounding it. It will accommodate landing in any weather and allows planes to hop off without a runway. The structure is of fabricated steel and automatically faces itself into the wind.

# Safety Gas Mask for Miners

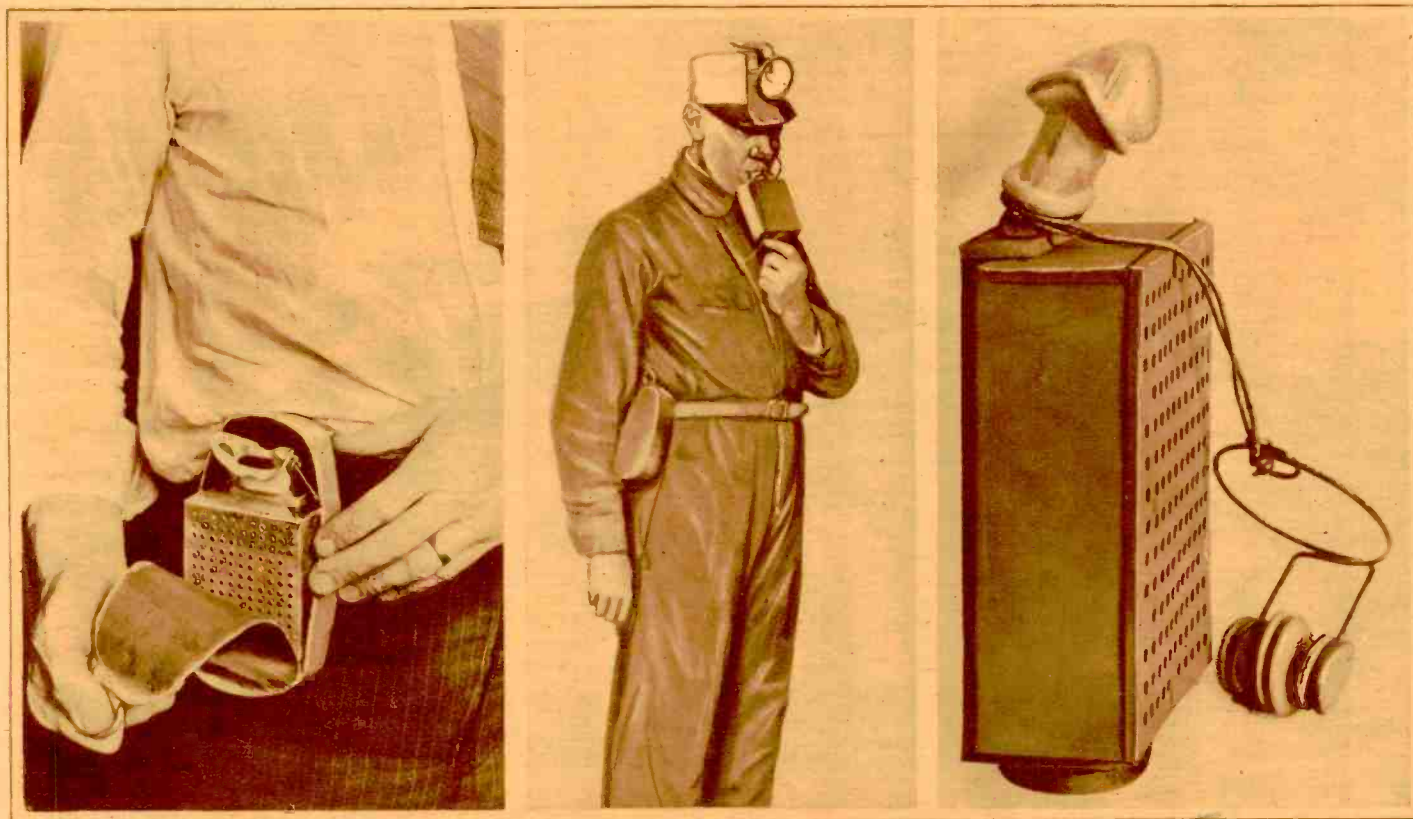

The gas mask shown above was found to be very effective against poisonous mine gases. Ordinarily it is carried in the small metal container shown at left. For use the miner clamps tips over his nose and grips mouthpiece with

his teeth. The perforated box contains hopcalite which counteracts carbon monoxide, the most deadly of mine gases. The chemicals will give relief for seventy minutes, allowing miner time to reach safety.—John M. Schalek.

## POPULAR

BY ISABEL

OF THE U. S.

## THE WONDERS

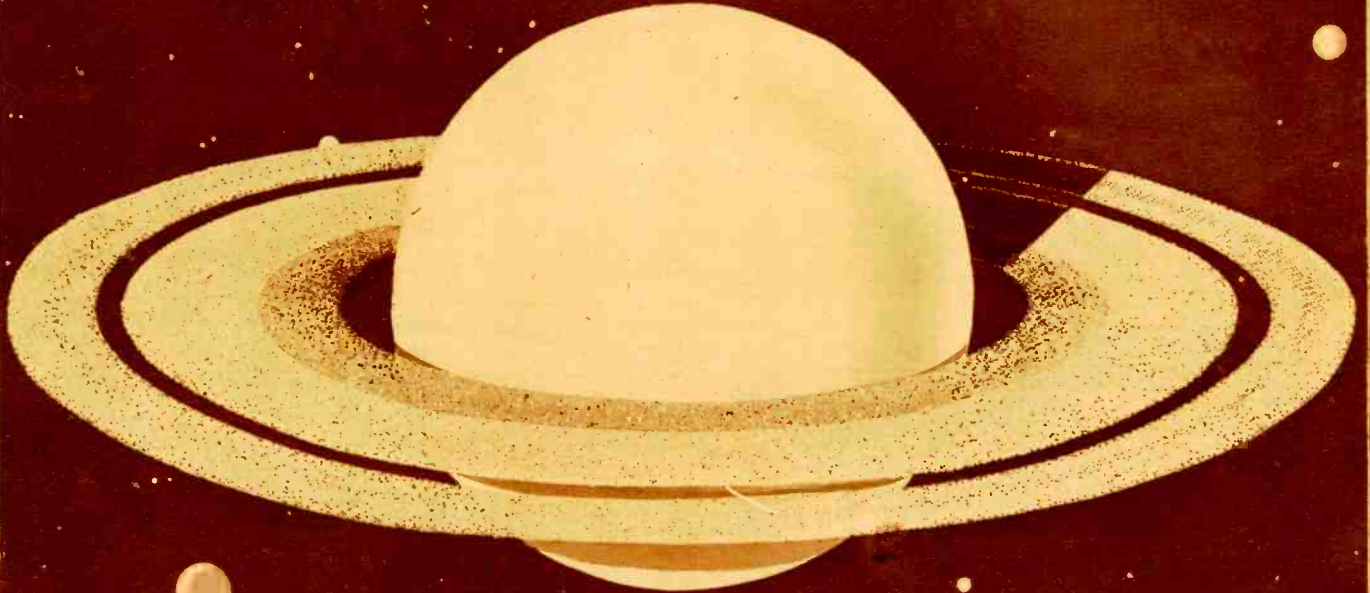

A full view of the planet Saturn with its system of rings as seen through a large telescope. The thickness of the planet and the rings from outer edge to outer edge is about 172,500 miles. The diameter of the planet itself is 76,460 miles at the equator. The first ring's inner edge is 5,900 miles from the surface of the planet. The first, or dusky ring itself is 10,900 miles in diameter. Very

little is known as to the composition of the rings. It is said, however, that some of the particles in them may be as large as three miles in diameter while it is entirely possible that they may be composed of gaseous clouds. It is thought that the particles are the thickest at the outer edge of the second ring. Also, some think that the rings may be composed of large masses of dust particles.

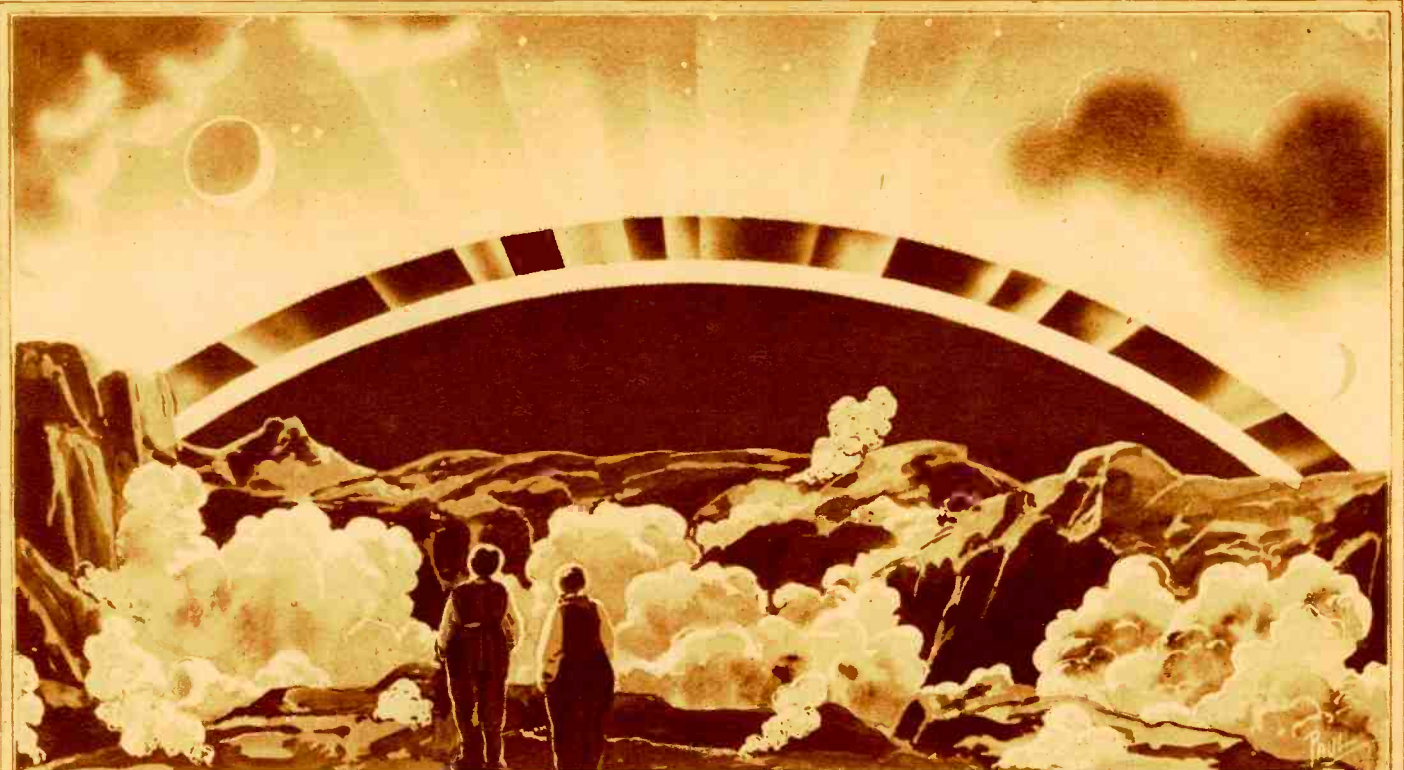

This is as the rings would appear to visitors of the planet on a Winter's mid-day were they in Latitude fifty degrees North. The gap between the second and third rings now becomes an area of light through which the sun filters since it is on the opposite side of the rings from the observer. Here, though it is mid-day stars can be seen above the rings at all times. In these latitudes there

is only a small segment of the first ring visible above the horizon. Of course, the sun being on the opposite side of the northern surface of the planet, that part of its surface is in darkness, or semi-darkness, most of the time. If the rings are composed of dust particles, as some think, it is thick enough to obscure the sun. Some think that the rings are composed of gaseous clouds.



# ASTRONOMY

M. LEWIS, M. A.

NAVAL OBSERVATORY

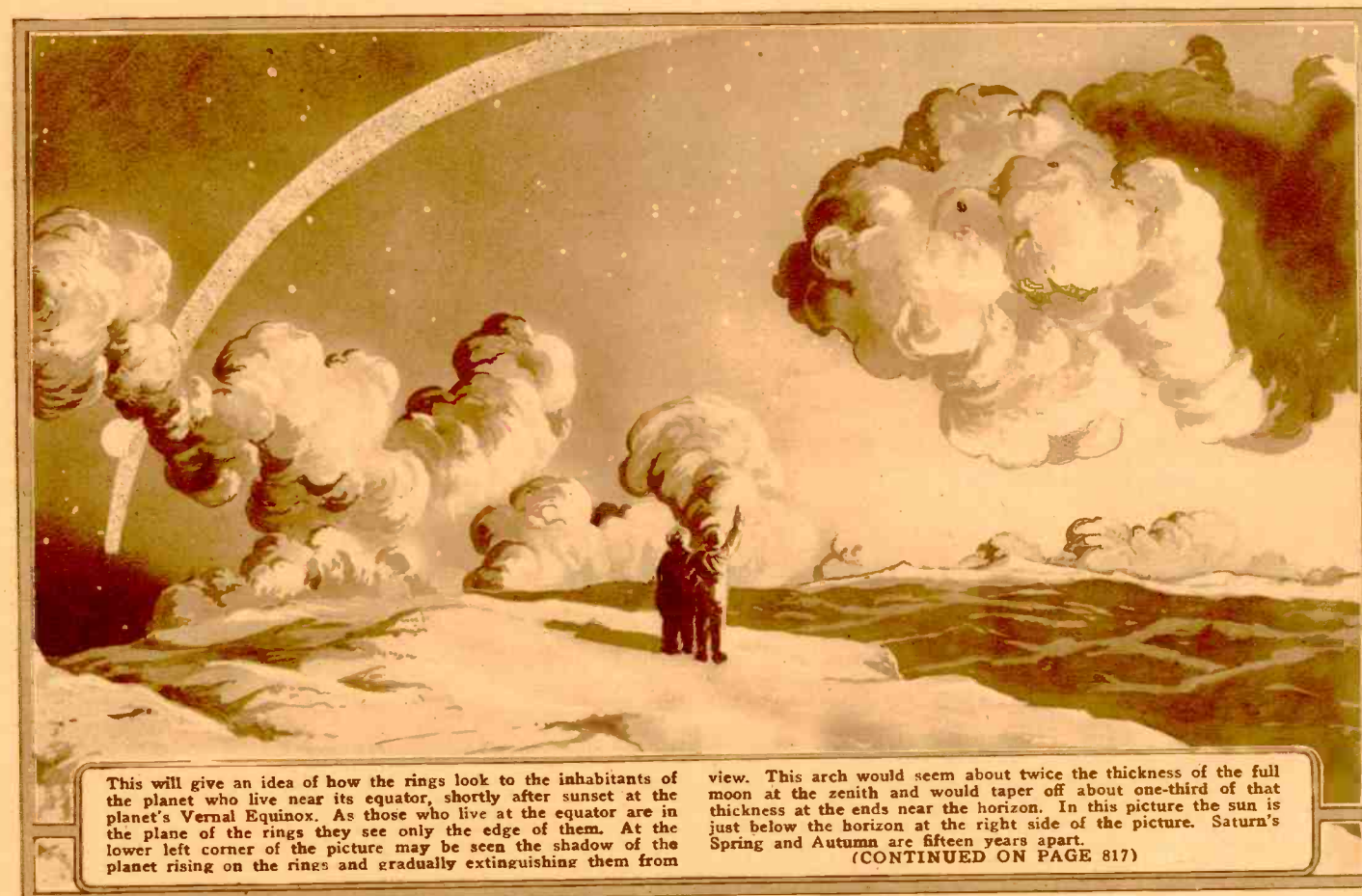
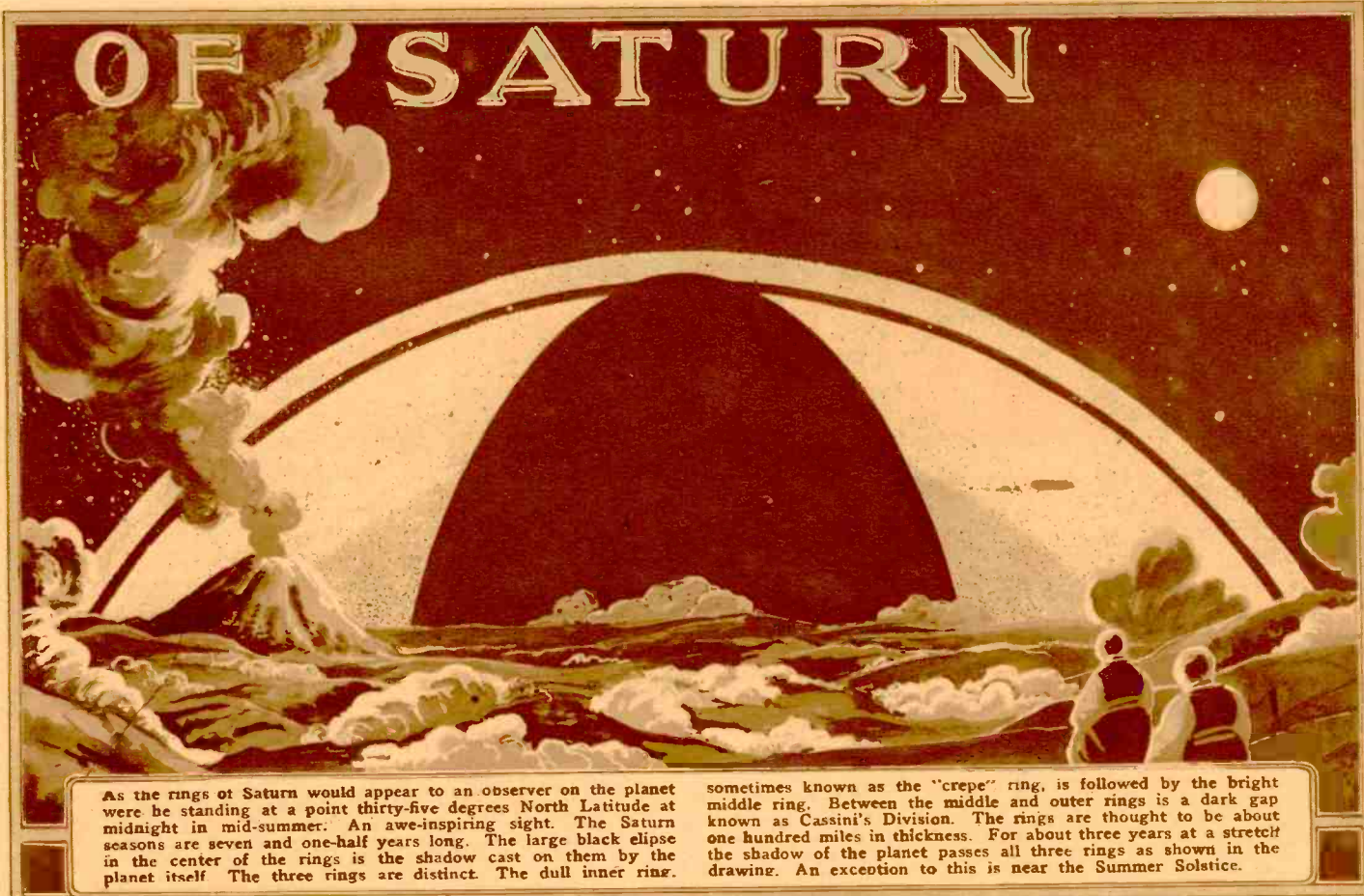

# The Heavens in December

By ISABEL M. LEWIS, M.A.  
of the U. S. Naval Observatory

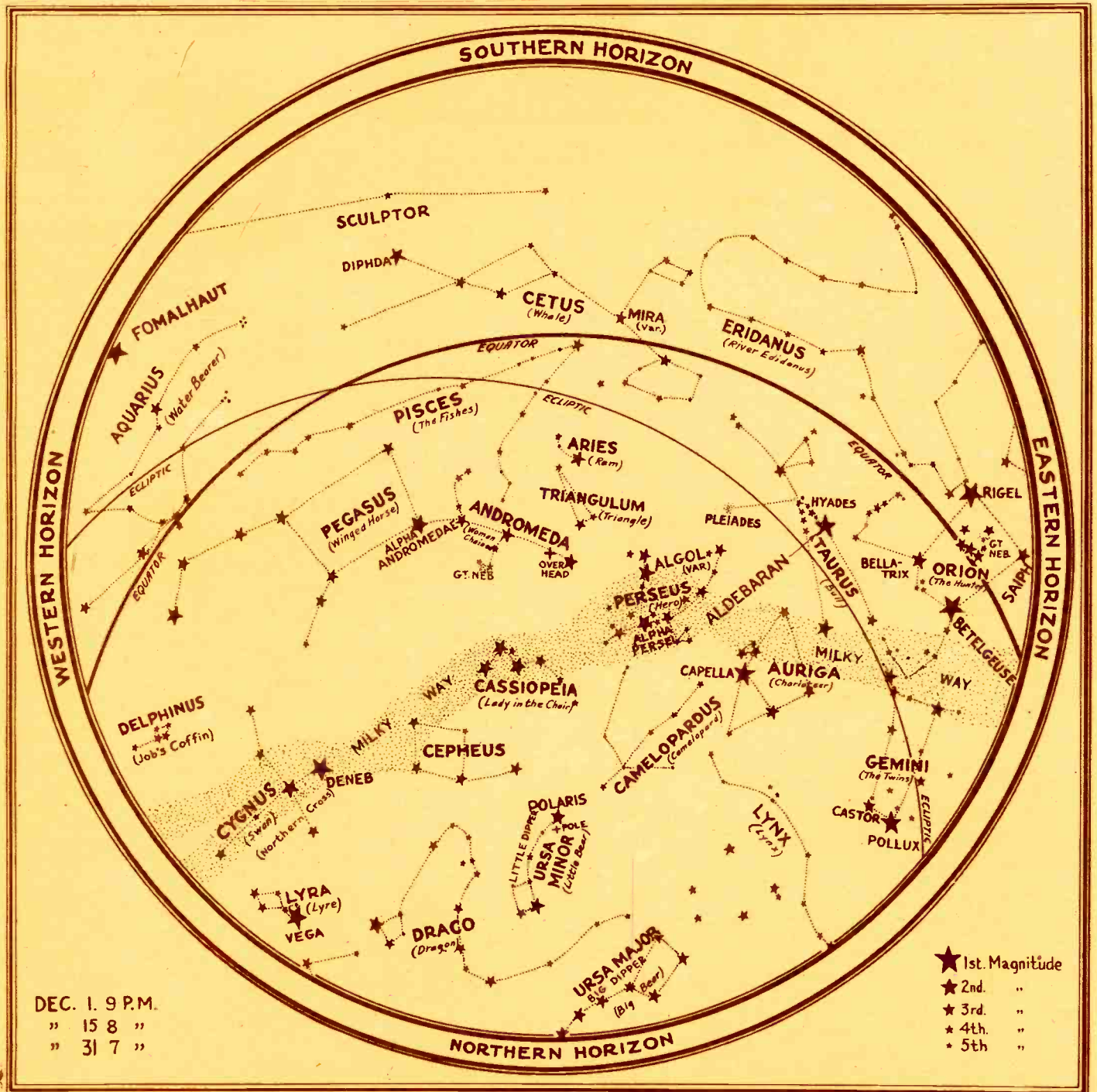



Above is the star map for the month of December. If the chart is held over the head with the "Northern Horizon," north, at nine P. M. December first or eight P. M. December fifteenth the location of the stars in the heavens will coincide with their position on the map.

THE leaders of the brilliant constellations of winter, Taurus, The Bull, containing the famous clusters of the Pleiades and the Hyades; and Auriga, The Charioteer, with its beautiful Capella and The Kids, or Haedi, close by. Aldebaran, the fiery, red star that marks the eye of the Bull in the v-shaped group of the Hyades is estimated to be about fifty light years from the earth. It is, therefore, one of the nearer stars and it is also one of the giants of the universe for, according to reliable estimates, its diameter is in excess of 30,000,000 miles. It is equal in bulk to more than sixty thousand suns as large as our own. Its surface temperature is about that of

the sun spot regions of our own sun or approximately 3,500 degrees. Very few of the luminous stars in the heavens have surface temperature below 3,000 degrees. Capella is also one of the nearer stars. Its distance is approximately 52 light years. Though it is a star of the same type as the sun its diameter is estimated to be nearly ten times as great, or over 8,000,000 miles. The meaning of the word Capella is she-goat and the small group of stars of the fourth magnitude nearby are known as "Haedi" or The Kids. The magnificent constellation of Orion with its two stars of first magnitude, Rigel and Betelgeuse, and its distinctive belt of

three evenly spaced stars of the second magnitude is now visible in the southeast. Also the well-known constellation of Gemini with its twin stars Castor and Pollux. Perseus has now come conspicuously into view. At the time indicated on the chart, it will be found just to the east of the meridian. One of the richest fields of the Milky Way abounding in nebulae clusters and double stars is to be found in this constellation. Algol, The Demon Star, which ordinarily is of the second magnitude, but which suddenly every third day drops to the third magnitude within a brief period of three and a half hours, and then within an  
(Continued on page 809)

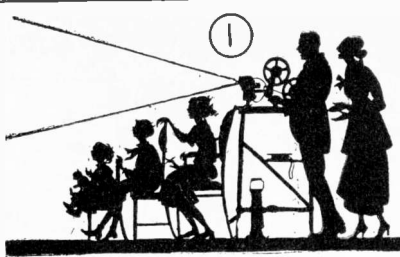
# Do You See What You Look At?

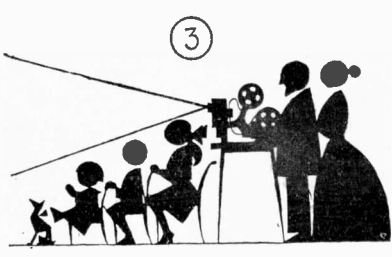
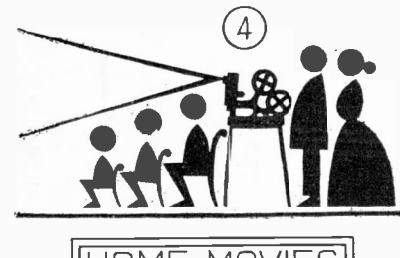
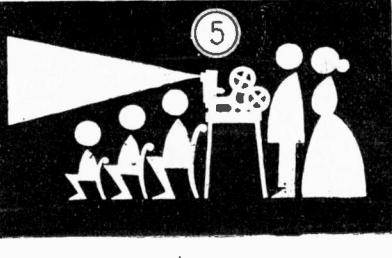
 <p>① HOME MOVIES</p>	 <p>② ~Home Movies~</p>	 <p>③ -HOME MOVIES-</p>
 <p>④ HOME MOVIES</p>	<p>Evidently, people do not see much of the things they look at, according to some experiments carried on by a German advertising firm. The first four pictures shown above were inspected by fifty people selected at random. They were allowed to look at each design for one-fifth of a second and were then asked to describe what they had seen. Only ten people out of the fifty could name the correct number of figures in the illustrations 1 to 4. Thirty named the correct number in picture number 5. Only nine of them told correctly what the picture concerned. Many kinds of mistakes were made. The first picture was voted the most attractive and the last to be the most easily understood. — Praktische Psychologie, Leipzig.</p>	 <p>⑤ = HOME MOVIES =</p>

# Trying It On the Patent Lawyer

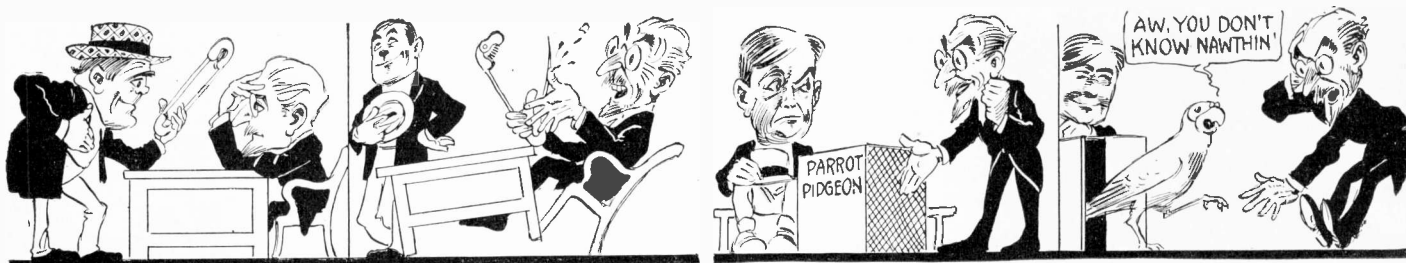

A lot of inventive genius is inventive bunk, according to Franklin J. Foster, who, after many years of helping struggling geniuses, was forced to retire or be retired by the genius he was helping. He said he knew from his interview with his first client that matters would come to just such a pass. His shingle

was bright and new when the budding young genius asked advice on a safety pin. The doctor of laws obtained a small fee and a split thumb for his trouble. Another genius was going to do away with writing messages for carrier pigeons by crossing them with parrots so they could speak the message.

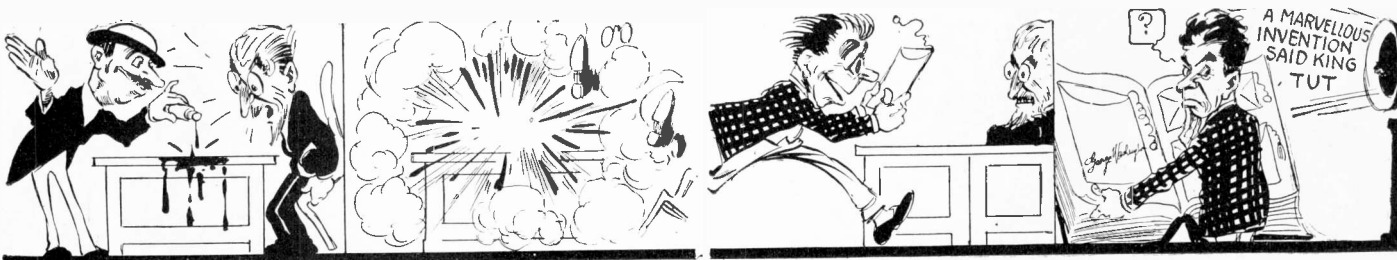

Dr. Foster, still altruistic to genius, suffered a slight surprise when an inflammable furniture polish took the mahogany off his desk-top, removed his eye lashes and was finally subdued only with the aid of the city fire department.

Inventing envelopes with wires or strings to tear the flaps is a form of insanity, he thinks. He uses a phonograph to tell the inventors when the first one appeared and shows them 79 like patents autographed by G. Washington.



He was about to do the God of War a service when the inventor of the device mistook the doctor's zeal for interest, and turned the thing on. Foster did the round of his office thirty-seven times in just slightly over nothing flat. The rotating machine gun, it might be added, did the same rotation as the doctor

in just slightly less time. This pleasant little incident was one of the outstanding reasons for his retirement from nursing impecunious inventors—this and the fact that he hated to speak about such trifles as fees and that the inventors chronically suffered a lapse of memory concerning them.

# Scientific Gifts for the Children

The Engineers and Shops of Santa Claus



AT the Yuletide all men and things unite and bend their efforts toward peace and goodwill. Here are the offerings of the shops, ingenious engineers and clever designers, built to give joy to the hearts of thousands of kiddies—and the grown-ups—in celebration of the great and wonderful spirit that grows out of the celebration of the birthday of the world's most wonderful hero.

This pair of electric racing cars started by the sound of the voice or a clap of the hands will furnish sport for many a long winter's evening. The cars are pulled to the top of the plane where a catch holds them in place before starting.

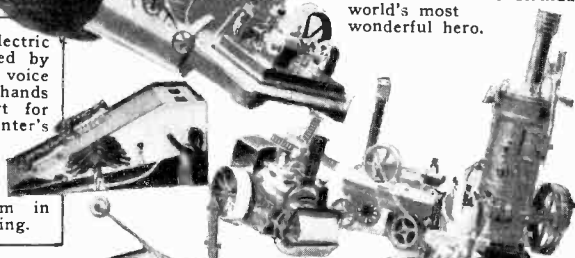

For the embryo house-keeper. An electric washing machine made just like its life-size model. It has the motor below the tub, the rotor in the tub, the spigot on the side, and everything. The plug attachment for connecting the machine, through a low voltage transformer, of course, to the lighting circuit is shown in the photo.

Quite the de luxe in tops is shown here. On the top of the body is an arrangement that throws out great bursts of harmless sparks as the top spins. It is started like most other mechanical tops with a special spring device that winds up on the spindle. It also emits a deep humming note.



"The trolley, the Toonerville trolley, the trolley that meets all the trains." Here it is with its wheels off center and the driver ever working the brakes—all operated by a spring motor, going through antics more ridiculous than even the cartoon makes it.

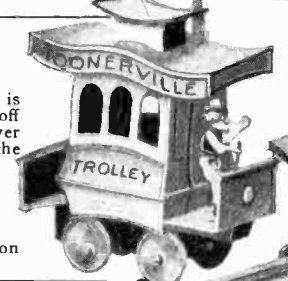

A real gun that bangs, shoots out a tongue of flame and, does all that a gun should do and yet is harmless. The secret is, it works with a chemical and water. It shoots several times on one charge and sells for fifty cents.

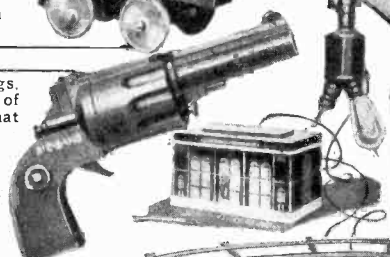

Try to put the jockey on his horse. Release the board on which he stands and then move the horse so that he will light on its back.

From a leading toy concern comes word that they have a new loom. One that any child can operate and one that will make real designs for doll's house rugs, very simply.

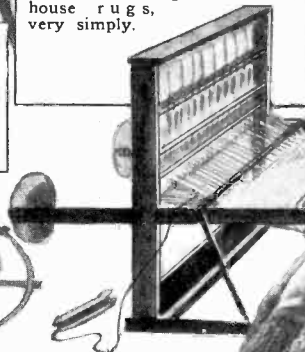

Below, in the doll shown, we hark back to the days of the First Napoleon. A Dresden doll of the early Eighteenth century.



This train must be dispatched. It stops and starts with a sound of the voice. Connected to the lighting circuit through a transformer the current passes through the dispatcher's office where there is a relay, sound operated, that acts on the same principle as the Radio Rex toy. When the child speaks the circuit is made or broken and the train stops or starts.

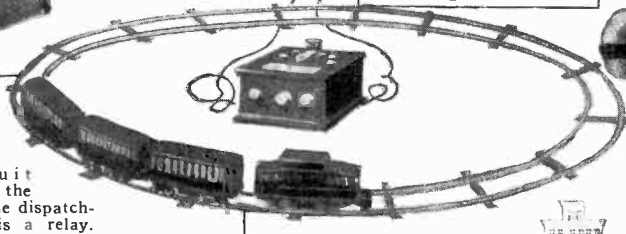

Here is a toy that will thrill the heart of the future builder of skyscrapers. Made of tin, the window, door, archway, cornice and wall pieces can be put together to form a perfect replica of the world's most famous buildings. There are two different designs of windows, three of doors and a number of cornice, balcony and roof designs. At all four of the edges of the pieces there are slits where thin friction plates are inserted and the next piece put on. There are also plain structural steel imitation pieces for building bridges, towers or other such structures. The pieces are a little more than two inches square. Twelve of them make a building more than two feet high! A real sky-scraper for the children. Designs for a large number of buildings are furnished with each set.



# Magic for Everybody

By PROF. JOSEPH DUNNINGER

NO. 9 OF A SERIES

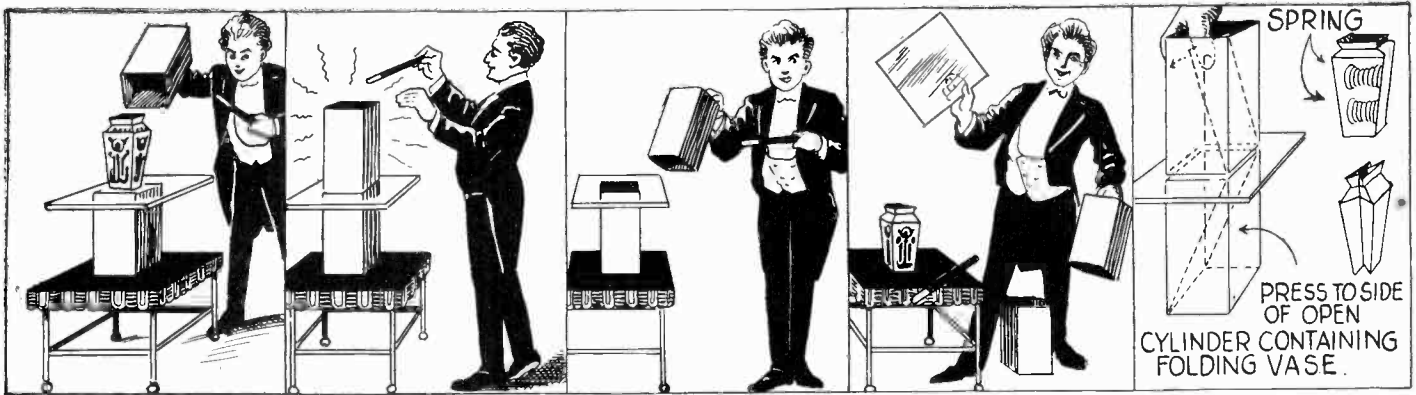

A wooden box open at both ends is shown to the audience and then placed upon a table. The open top is then covered with plate glass sheets. A vase is placed on the glass. This vase is covered with a duplicate box. A moment later the top box is removed and the vase has disappeared. The

plate glass is taken away and the bottom box is picked up. The vase is found on the table. The boxes are made with a flap while the vases are of cloth opened by springs. When it is desired to disappear one of them, the wooden leaf is pressed to one side, folding and concealing the vase.

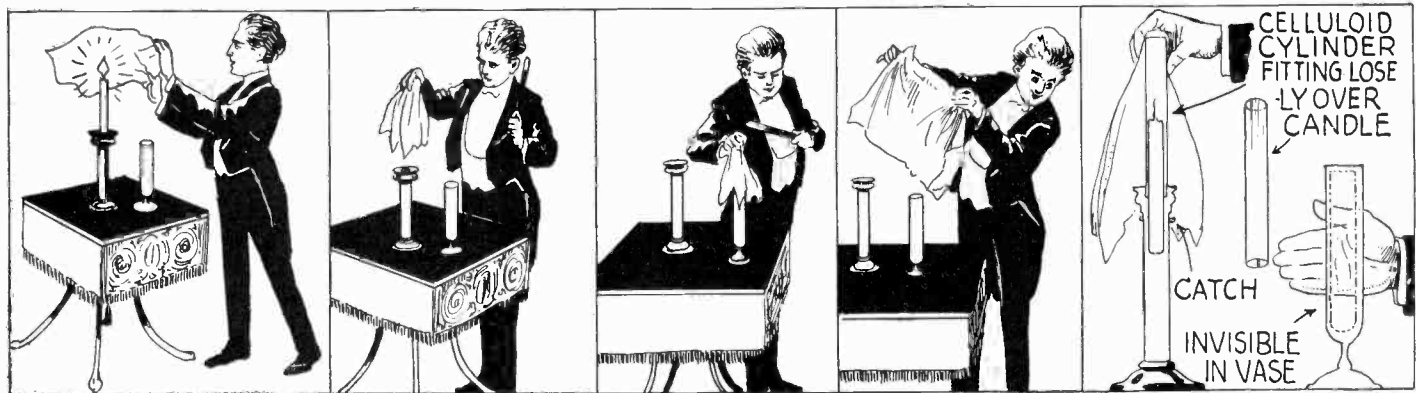

A lighted candle is seen in a candle-stick. A silk handkerchief is placed over it. The candle, whose shape can be easily seen beneath the handkerchief, is put into a tall glass. Snapping the kerchief away, it will be found that the candle has completely disappeared. A celluloid tube surrounds the candle

in the candle-stick. A catch in the candle-stick holds the candle in position. When the magician covers the candle he releases the catch, permitting the tallow taper to slide into the candle-stick. The celluloid cylinder is removed and placed in a glass vase, where it is invisible.

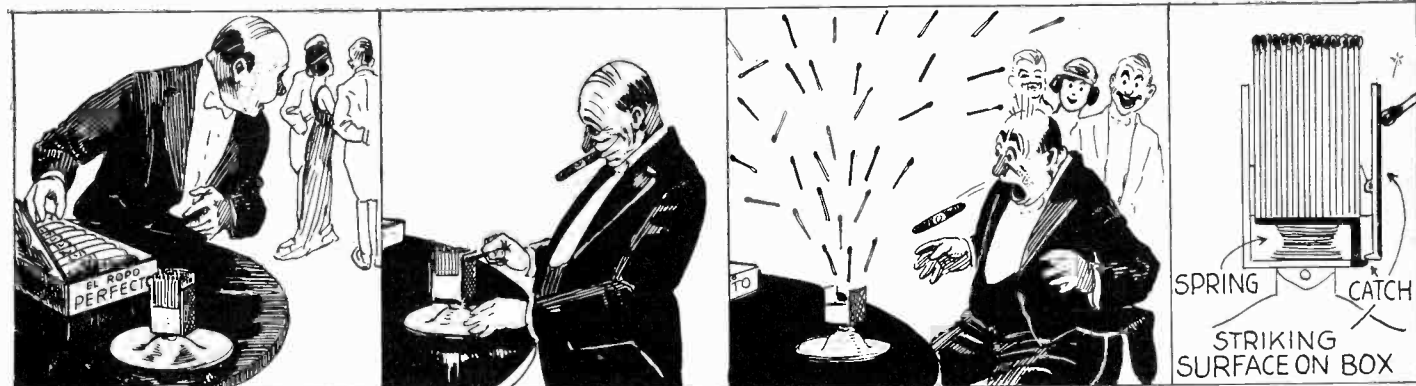

Although not a magical trick, the above novelty if constructed, will repay the slight amount of work required. When one sees a choice box of cigars open and no one else looking, he will undoubtedly step over, extract one and then take a match. He strikes a match on the box, and then with a

sudden snap the entire contents of the match box fly all over the table and floor. The construction of the device is made clear in the diagram. The side of the match box is hinged so that a catch on the bottom will be released when the striking surface is touched.

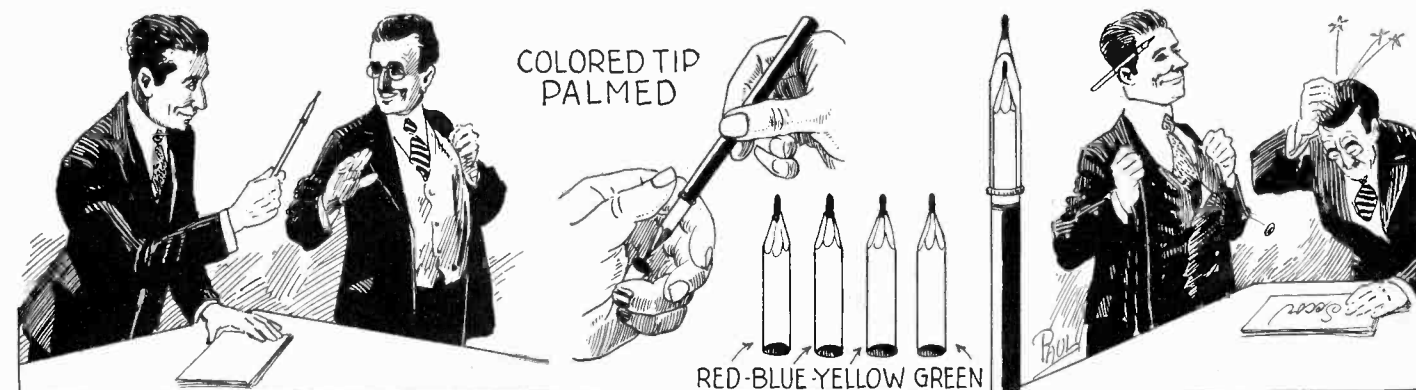

The magician passes an ordinary pencil to his audience for examination and tells them that the pencil will write in colors, and asks them to name a color in which he desires the writing to appear. One of the audience says "green." Grasping the pencil he writes a name in the chosen color on a sheet of

paper and then returns the pencil and paper to the spectators. The magician has a series of colored crayon pencil-tips resembling the end of the regular pencil. The tip of the color requested is palmed, and when the pencil is returned to the magician the tip is put on the end.

# "Kick" Prevention for Cider

By RAYMOND B. WAILES.

**1 LEGAL METHOD**  
4 OUNCES OF BENZOATE OF SODA  
WATER  
42 GAL. BBL.

**2 LEGAL METHOD**  
BENZOATE OF SODA SOLUTION  
FRUIT JUICE  
FRUIT JUICE SHOULD BE TREATED WITH BENZOATE OF SODA OR STERILIZED

**3 LEGAL METHOD**  
ALL CONTAINERS FOR FRUIT JUICES SHOULD BE BOILED IN WATER

**4 ILLEGAL METHOD**  
WATER SEAL  
FRUIT JUICES AND YEAST

**5**  
FERMENTED JUICES NOT DISTILLED NEVER CONTAIN MORE THAN 16% OF ALCOHOL

**6**  
TREATING FRUIT JUICES WITH BENZOATE OF SODA ACTS LIKE A GERMICIDE

YEAST CELLS GROW BY BUDDING

FIRST A MINUTE CONSTRUCTION FORMS

WHICH FINALLY NARROWS

TERMINATING IN TWO YEAST CELLS

To prevent souring and fermenting in cider, add four ounces of soda dissolved in water to a barrel. Another method is to sterilize the containers by boiling and pouring the hot juice into them and corking immediately. The water seal method is illegal since after fermentation has

started the seal prevents it from going further into the vinegar stage. The sketches at the top of the page show how the yeast cells grow by becoming narrow and splitting into two parts. The benzoate of soda acts as a germicide and kills them. This information is of value just now.

## World's Smallest Multi-plate Camera

This small camera that can easily be concealed in the palm of the hand holds forty-eight plates. It is of French manufacture. The plate magazine is in two parts, one above the other. As a plate is exposed it passes to the bottom compartment and an unexposed plate takes its place on the top row. Two very fine lenses are used, and, with the extremely short focal length of one and five-eighths inches, very sharp photos may be taken. Four focusing pins bring the lens to the proper distance from the plate.

FOCUSING PINS

LENS

SHUTTER

SHUTTER LEVER

SPRINGS

48 PLATES IN MAGAZINE

PLATE MOVING UP

PLATE MOVING DOWN

With its smallness and the sharp pictures it makes from which quite large enlargements may be made the little camera is invaluable in police work, for taking pictures secretly. —C. A. Oldroyd.

# Burn Yourself? What Happens?

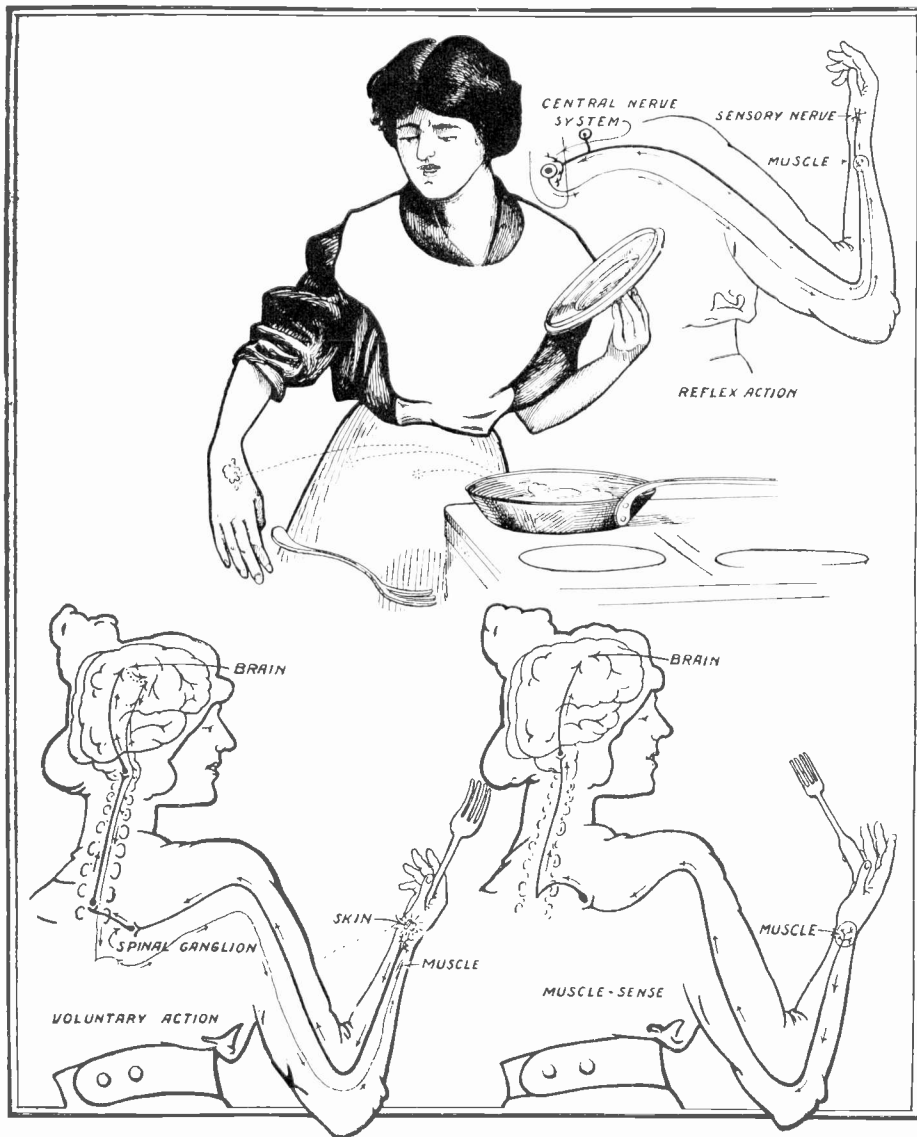

# Electric Jack

The electric power jack shown here is capable of lifting a load of 150 tons. Power is furnished by a one-half horse-power motor directly connected to a lighting circuit. The motor is connected to the jack through a series of reducing gears. The power is applied to a gear

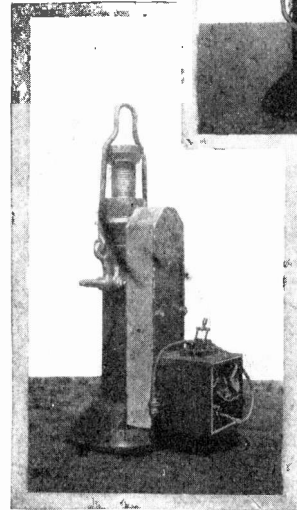

at the top of the jack-stand. All bearings throughout are of steel ball-bearings. A brake-control is installed to take up the weight in lowering the jack. This brake works on the gears after reduction giving perfect control of the load while it is descending.

Geo A. Cosgove.

The illustration at the left shows graphically what happens when we burn ourselves. The burning sensation affects the sensory nerve at the spot where the hot grease falls on the arm of the woman (at the top). This sensation is carried to the central nerve system where a connection is made to a motor nerve which forces the arm to be jerked away. This happens instantly and without the knowledge of the woman. Just a fraction of a second later, however, the impulse is carried on to the brain. Following this, another nerve, the muscle sense nerve, leading from the arm tells the brain that the arm has moved. All this happens in a fraction of a second.

## License Lock

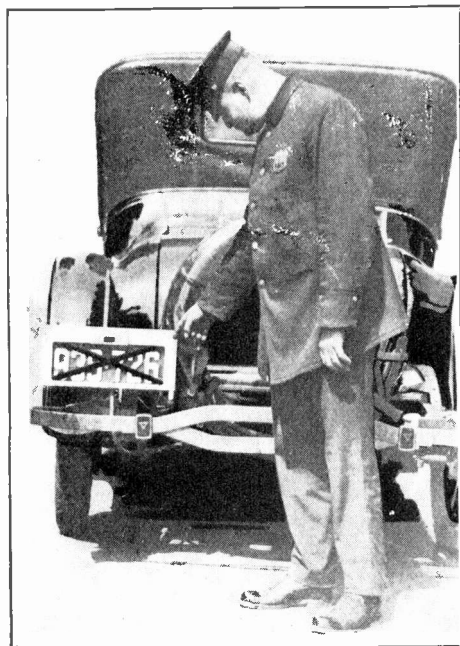

By locking a cross over the license plate while the car is parked, the all-steel apparatus shown above makes the car thief-proof.

## The Omnivator

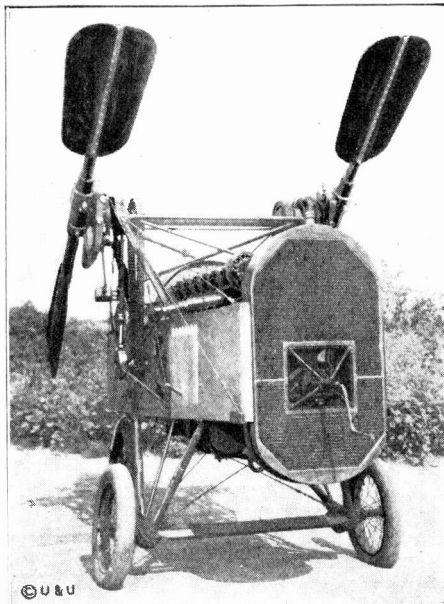

The inventor of this machine, E. R. Johnson, claims it will ascend, descend, move forward, backward, or remain stationary in the air. It will compete in the British helicopter contest.

## Double Aquarium

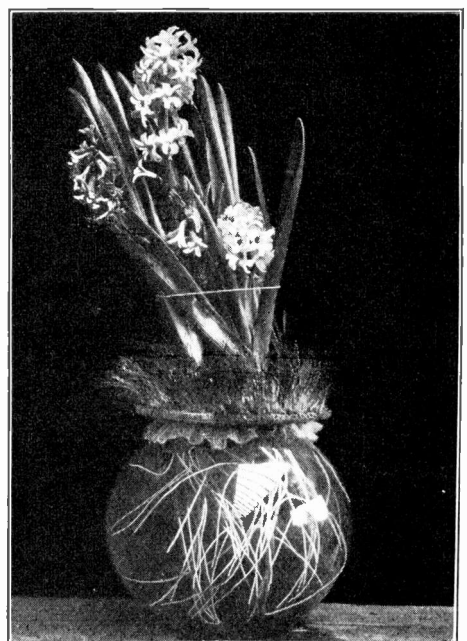

By placing a cloth across the top of the goldfish bowl and planting it with bulbs and seeds—a double aquarium result! —S. L. Bastin.

# The Stars In 1000 Centuries

DONALD H. MENZEL, Princeton University

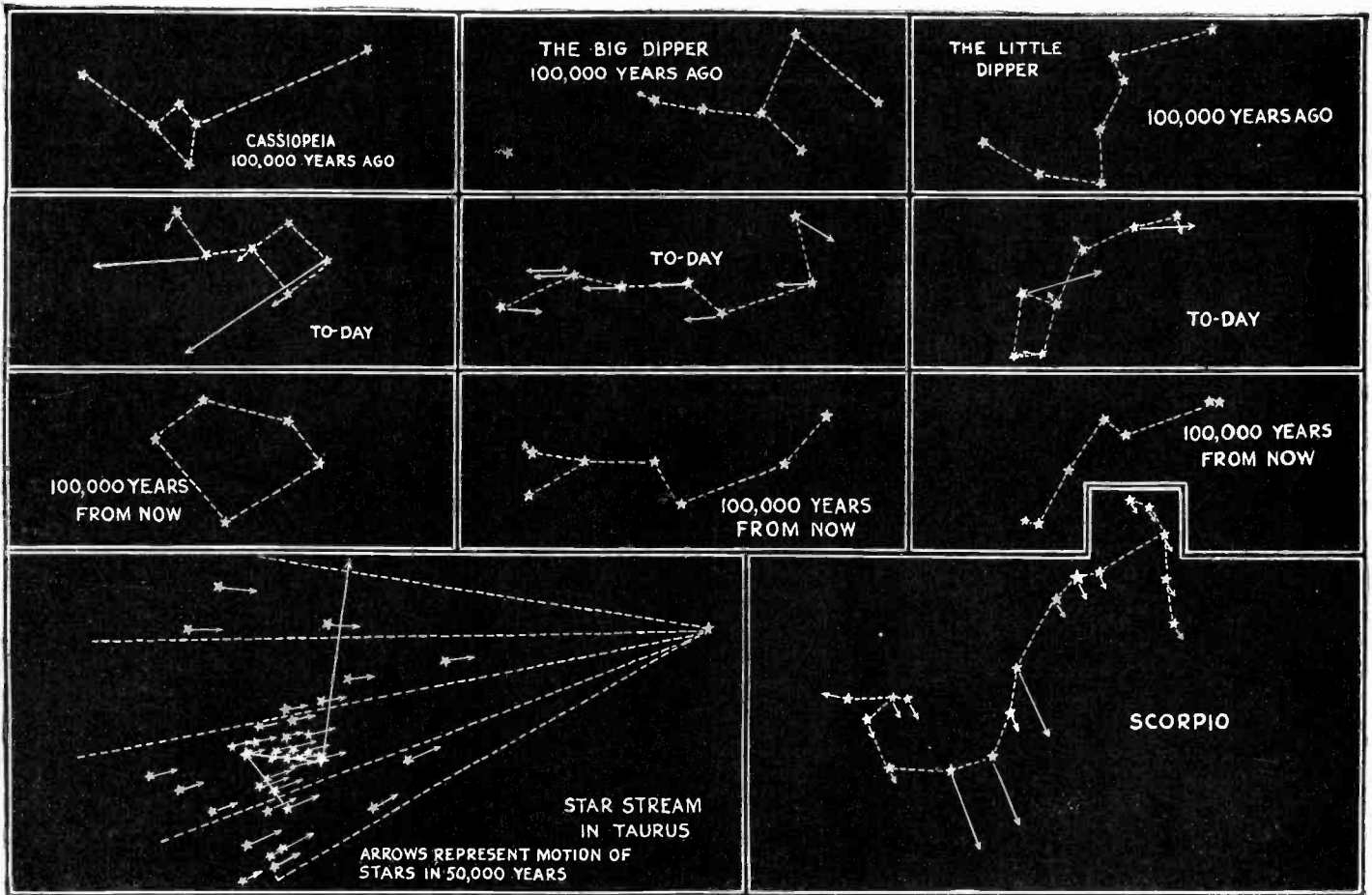

Here, with what is known of the direction and rate of travel of the stars in the major constellations, is constructed a map of what possibly will be the face of the groups of stars 1,000 centuries hence. To the astronomers of those days, the constellations in their present form will be entirely unknown. These figures will also be altered by the movement of our own

solar system in relation to the constellations. Then the mariners will have to find some other star by which to set their course since Polaris is moving out of its position along with the remainder of the stars in its constellation. It is not moving as fast as some of the others but in a thousand centuries it will no longer point to the pole.

## Motor Driven Sled



Equipped with caterpillar treads and a husky motor, the sled shown in the above illustration is capable of carrying its passengers over hill and dale at the rate of twenty-five to forty-five miles an hour. The large wheel at the front rests on springs and is used to steer the sled. It was shown at the Winter Carnival at Montreal, Can.

## Portable Stove for Winter Sports



A very simple and useful portable skating stove that can be used with charcoal is shown in the above photo. The kettle that forms the bottom is riveted to the bucket that serves as a grate. Holes are punched through the bottom of both to admit draught. The handle of the bucket will be found very serviceable in carrying the stove. —Dale R. Van Horn.



# Scientific Match-box Puzzles

Several Simple Entertainments from Safety Matches

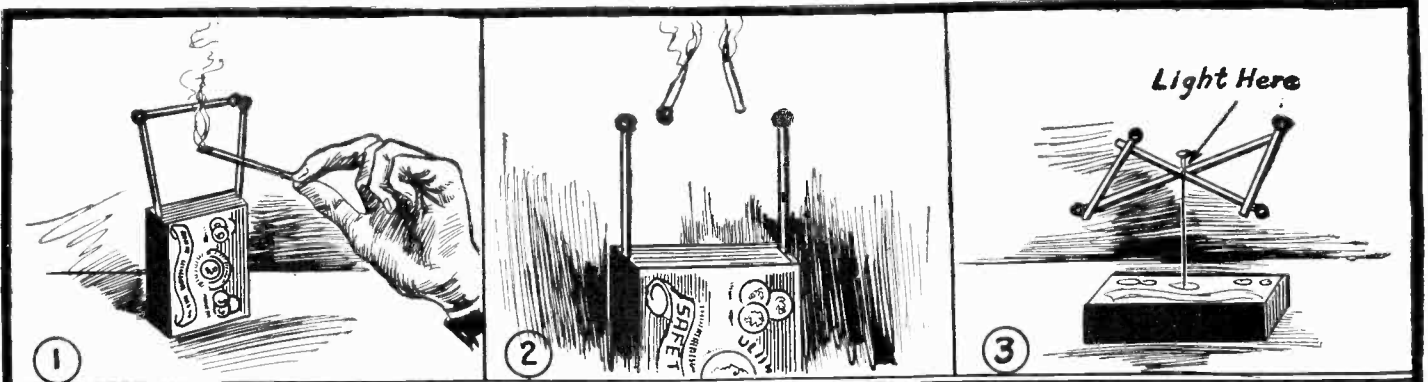

1 Place three matches as shown in the sketch above, two of them thrust in between the drawer and the sides of the box. Light the cross match in the middle and ask which will ignite first.

2 After all the opinions and bets are in light the central match and watch the fun. The pressure of the other two matches will throw the burning stick in the air. The others do not light.

3 A simple variation of this stunt is to pin two matches in the form of a cross as shown above and lay two other matches across to ends of the cross. Light the center. The matches fall off.

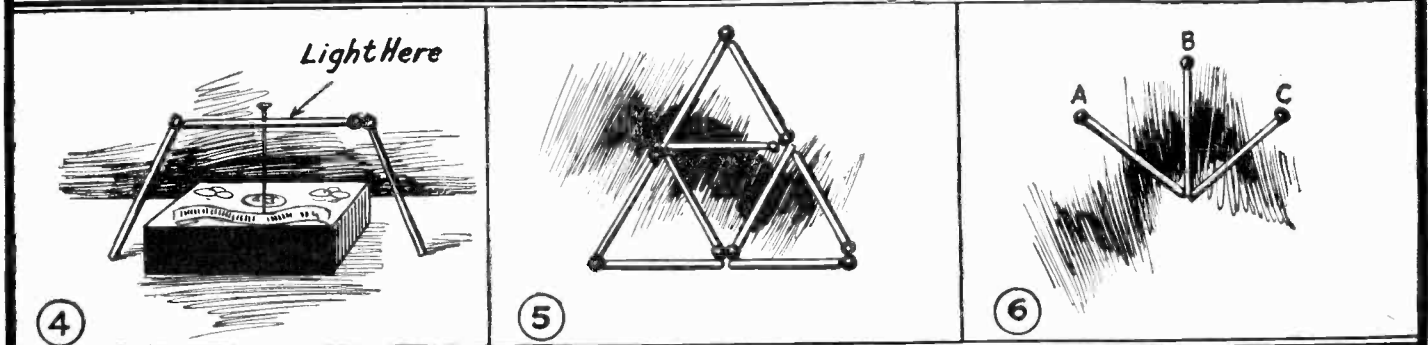

4 This is a third variation of the same stunt, shown above. Instead of the cross use only one match as the support and stand the other two at its end. They, as before, fall to safety and are not ignited. The supporting pin will become warm.

5 Ask your audience to form five triangles with nine matches. Give them the matches and let them try it. All the triangles are equilateral and none of the sticks must be broken. The solution of the puzzle is shown in the sketch.

6 Place three matches in the sketch as shown above and ask someone in the crowd to form an equilateral triangle with them by moving only the match marked "B." The other two must not be moved. Be sure that the ends are square.

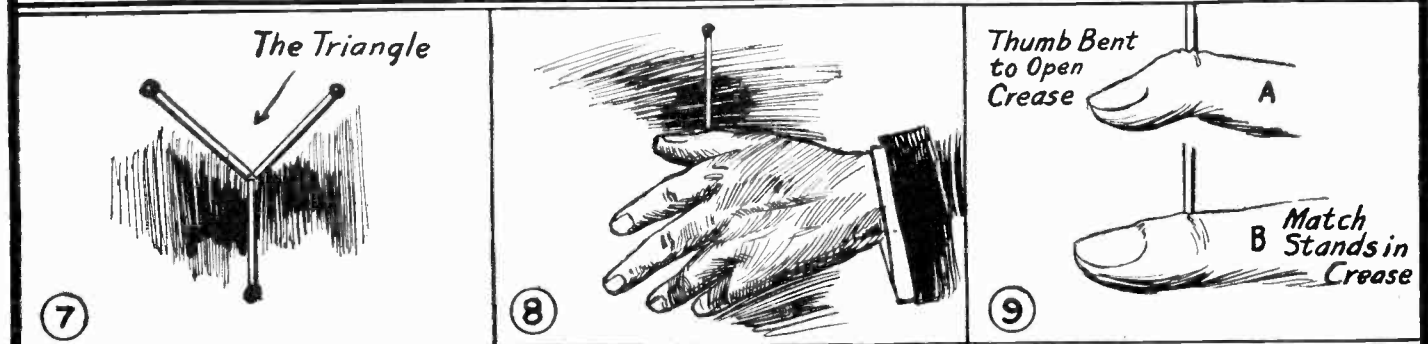

7 The solution to the problem is simple. Simply put the match "B" at the bottom of the other two and a very small equilateral triangle will be formed by the square bases of the matches as shown in the sketch.

8 This is a great feat of equilibrium. Place the small match stick on the thumb and make stage play of great difficulty to keep it balanced. Unless some one knows the trick they will say you should be on the Keith Circuit.

9 They will change their mind, however, when the explanation is given them. The thumb is bent down as shown in the above sketch and the match is inserted in the wrinkle of flesh where it is firmly held in the upright position.

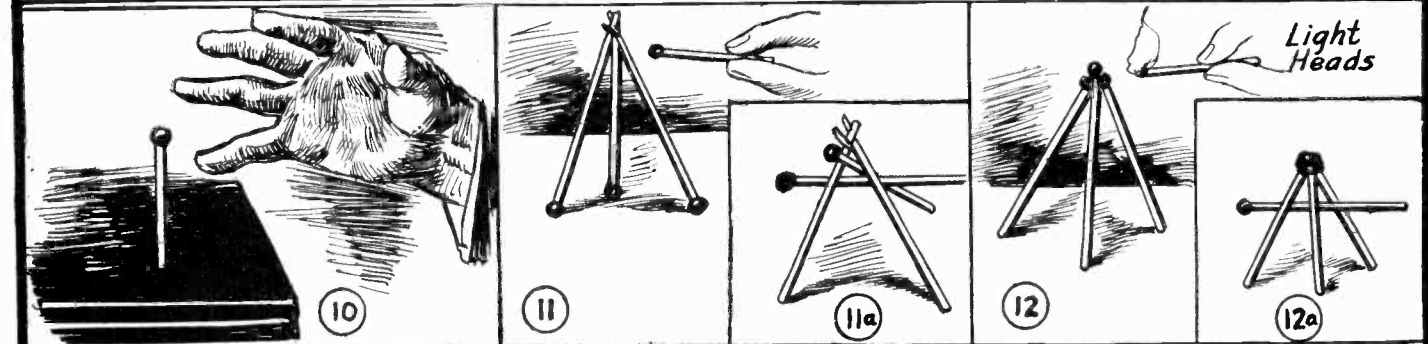

10 Then balance the match on the table surface. While the audience isn't looking moisten the end of the match. When placing it on the table use some force in standing it upright. After the feat secretly remove the moisture with the finger.

11 Split the ends of two matches and wedge them together. Then place a third one next them forming the tripod as shown above. Ask someone to lift the three with one match. The solution is to let the loose match fall between the lifting stick and the two wedged ones.

12 To lift three matches with their heads together, light them and extinguish the flame with a breath. The heads will be found to be welded together so that they may be easily lifted from the table. —WALTER B. GIBSON.

# Can You Answer These Problems?

Problems of Scientific Interest Involving Well-Known General Physical Laws.

By ERNEST K. CHAPIN.

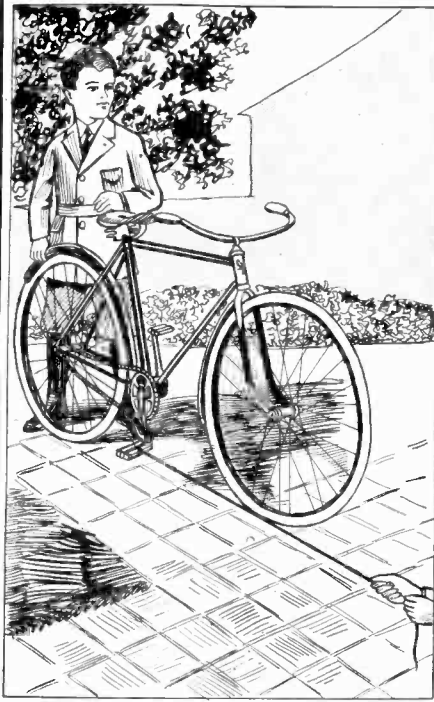

For the first problem take an ordinary bicycle. It must be without a coaster brake attachment. Set it so one of the pedals is down, as shown in the above sketch. Rest both of the wheels on the ground. Tie a rope to the pedal nearest the ground and pull it forward. Which way will the bicycle move and how far?

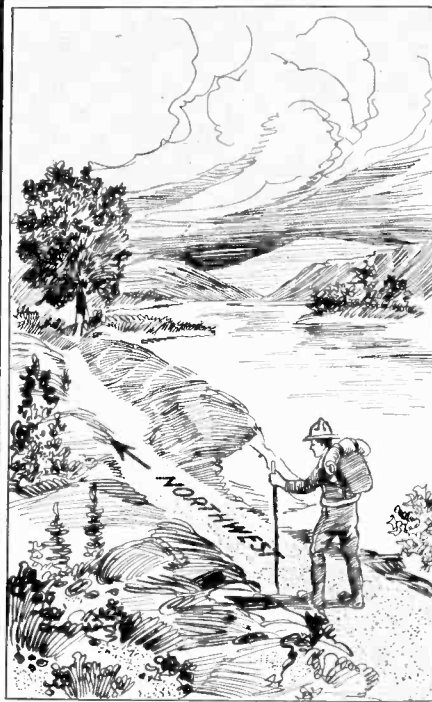

Traveling is an epidemic, it seems. Some people are pushing wheelbarrows around the continent and others are traveling the railroads—walking. Suppose someone set out to travel northwest only. Working from town to town but only going northwest. How far could the traveler go?

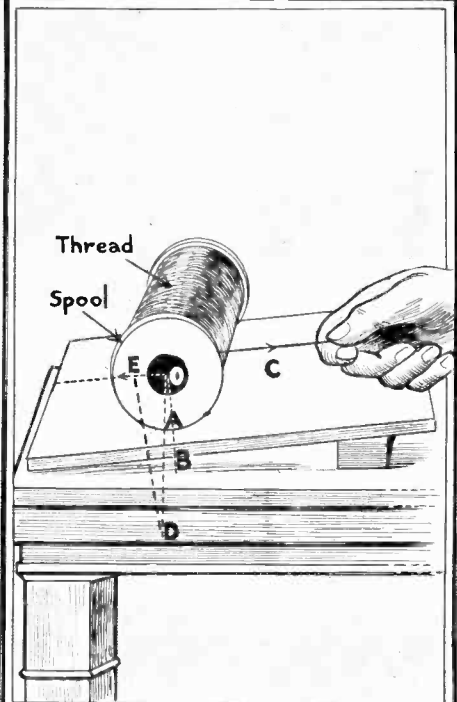

The rolling spool test shown in the above is a variation of the bicycle problem. Place the spool on an inclined plane and unroll one end of the thread, holding it. The end of the thread should come out from under the spool at the center. If a light spool is used better results can be obtained.

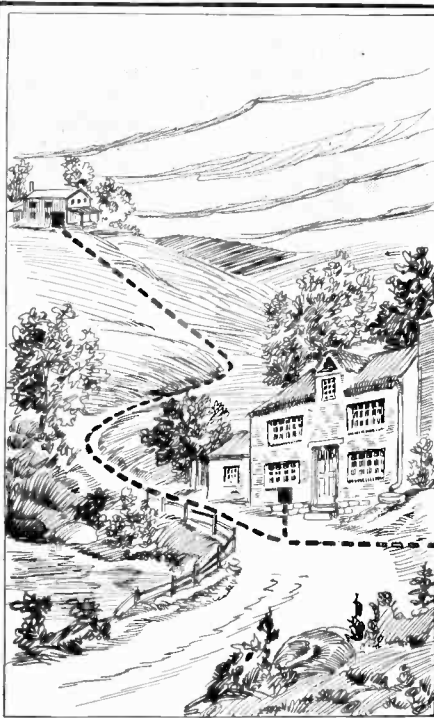

Of two houses, both taking gas from the same main, one situated at the bottom of a hill and the other at the top, which would receive the gas at the highest pressure? Would the fact that gas is lighter than air cause the most pressure at the top; or the fact that it has weight make the pressure largest at the bottom of the hill?

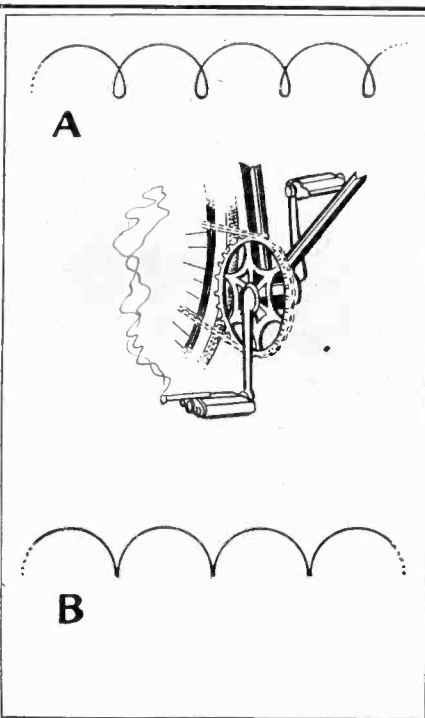

If a lighted cigarette were tied to the pedal of a bicycle as shown and the smoke from the cigarette remained stationary, what sort of a figure would be made by the smoke as the bicycle traveled. Of the two figures above and below the pedal in the illustration, which is right—if either of them, and why?



Stand near a picket fence and, walking down beside it, clap the hands. At some spots along the fence a musical echo note will be heard. What causes this and why can it only be heard in spots?

ANSWERS ON PAGE 813

# Everyday Chemistry

By Raymond B. Wailes.

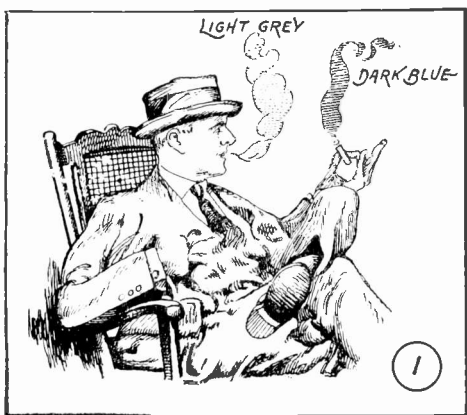

1 Tobacco smoke that comes directly from flame is dark blue. That coming from the smoker's mouth is light grey because the tar is filtered out.

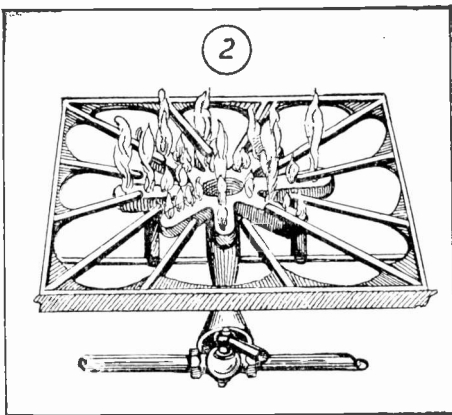

2 A blue gas flame turns yellow when washing powders are used around it because the sodium contained in them colors the flame.

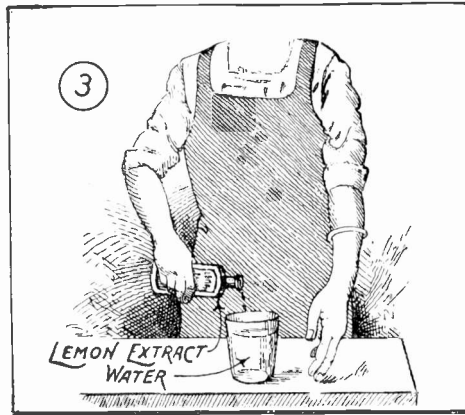

3 To test real and artificial lemon extract pour a little into a glass of water. If it is real a white cloud of lemon oil will appear.



4 To test butter for oleomargarine boil samples of both. The butter will boil slowly while the artificial product will sputter and splash vigorously.

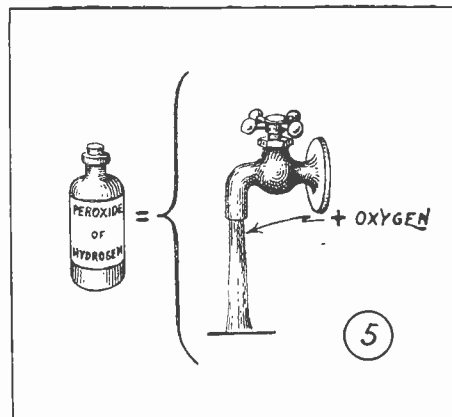

5 Hydrogen peroxide is simply water with an added molecule of nascent oxygen held in it. When poured on a wound this oxygen attacks impurities.

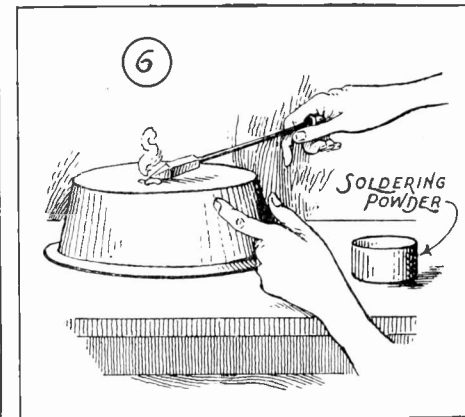

6 The difficulty encountered in soldering aluminum is caused by the swiftness with which it oxidizes as fast as the tinsmith scrapes it.

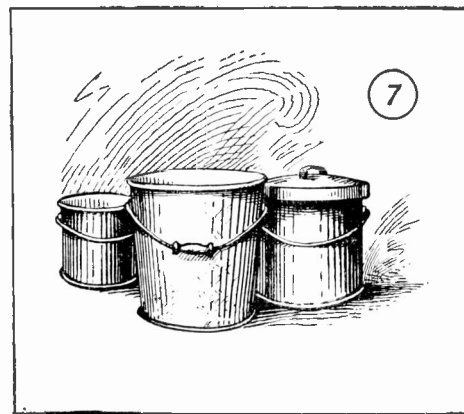

7 Galvanized pails are sheet iron coated with zinc. The whole finished pail is dipped into a bath of melted zinc to coat it.

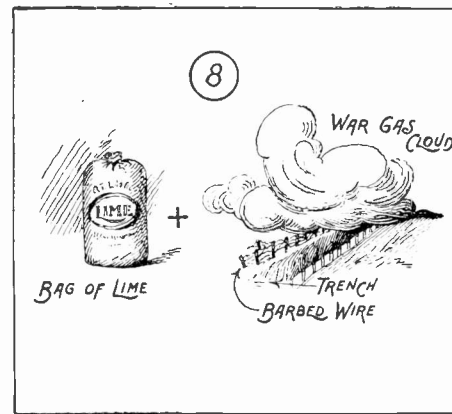

8 Chlorine, a war gas, and exposed moist lime join and form the every-day bleaching powder known to science as calcium hypochlorite.



9 The changes of color caused by pouring oil on water is caused by the interference of light due to the thin film of oil.

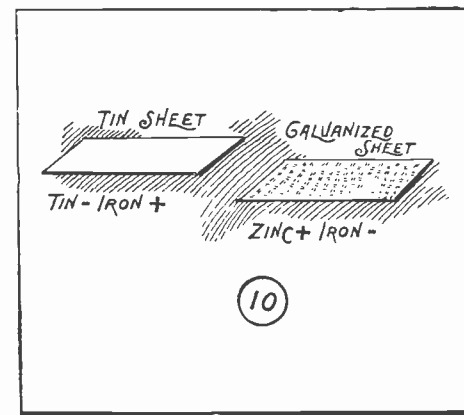

10 So-called tin sheet is iron coated with a thin layer of tin. The tin protects the iron as would paint. Galvanized iron is iron coated with zinc.

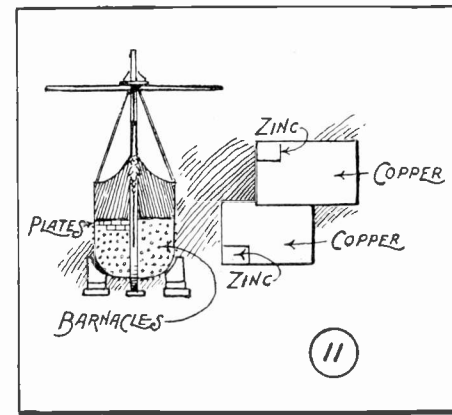

11 To keep the copper on ship bottoms clean bits of zinc were nailed on the surface. The method failed as clean copper did not keep barnacles off.

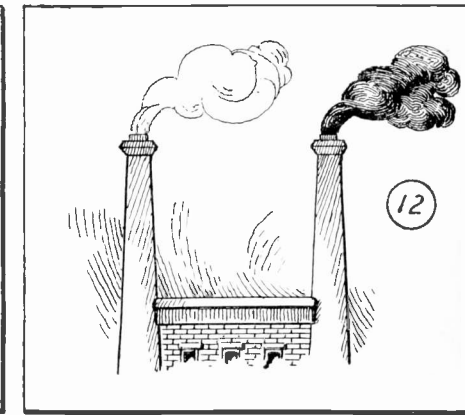

12 Black smoke from a chimney indicates incomplete combustion. No smoke, on the other hand, may indicate far too much air and a greater loss.



# THE CONSTRUCTOR



## Simple Battery Charger for A. C. Use

Complete electrolytic unit drawing one ampere

BY DR. ERNEST BADE

**1** **2** **3**

100 WATT LAMP  
TO 110V. LAMP SOCKET  
A.C.

STG BATT

**4** **5**

**A**N inexpensive rectifier-charger for storage batteries can be made of four mason jars and some bits of scrap aluminum and lead. Make a suitable box for the four pint jars and construct a cover for it. After making the cover, drill two holes for each jar. These should be arranged so that the metals will not touch while in the solution. Two binding post holes are then drilled at each end of the cover. For the electrodes use four pieces of lead and four pieces of aluminum rod. These should be long enough to reach almost to the bottom of the jar and should be made fast in the holes in the top of the box. The four jars are then filled three-fourths full with a saturated solution of sodium phosphate and water. If this chemical cannot be obtained, plain sodium bicarbonate may be used. To make a saturated solution continue adding the chemical to the water until no more will be absorbed. Then syphon off the solution, leaving the surplus chemical in the bottom of the mixing vessel. After the solution is poured into the jars mount a lamp socket on the outside of the case as shown, in which a 100-watt lamp is used.

## KIT BOX MADE OF TWO CIGAR BOXES

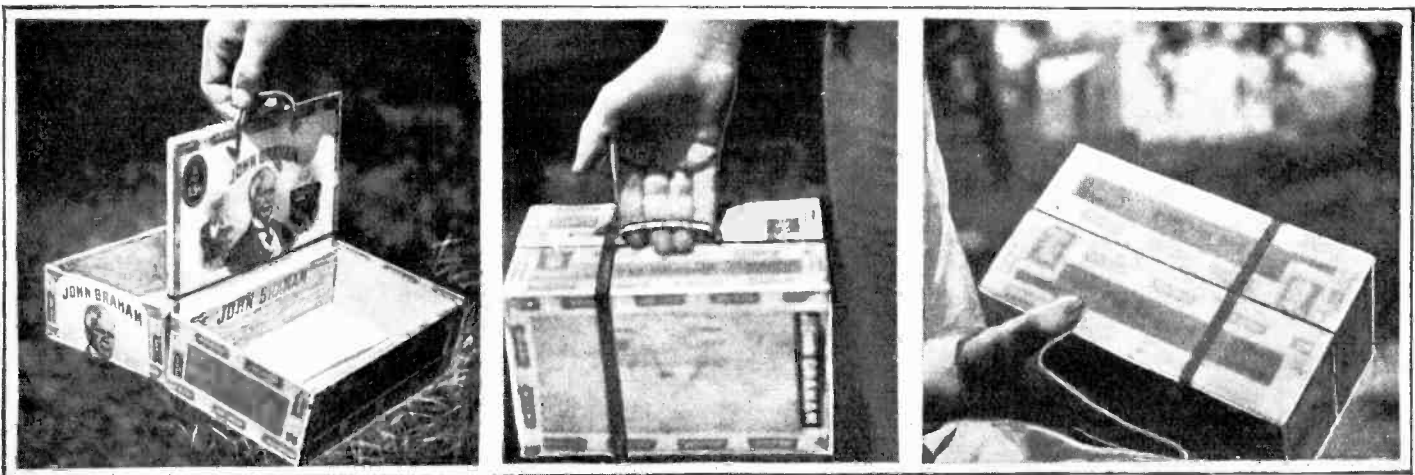

A very handy tool box or lunch kit can be made with two empty cigar boxes, a bit of heavy wire and a couple of heavy rubber bands. The boxes are laid down with their backs raised next to each other as shown in the first picture. Then the first rubber band is passed around the backs holding them together. The heavy wire is then bent in the form of a handle and made

fast to the top of the lids by passing it through holes drilled in them. Notches are then cut in the edges of the boxes so they will close tightly over the handle. The second rubber band is then passed around the boxes in the closed position and the kit is complete.

—DALE R. VAN HORN.

# "Bobcat"--An Air-Propeller Sled

Capable of Fifty Miles Per Hour On Ice

By G. A. LUERS.

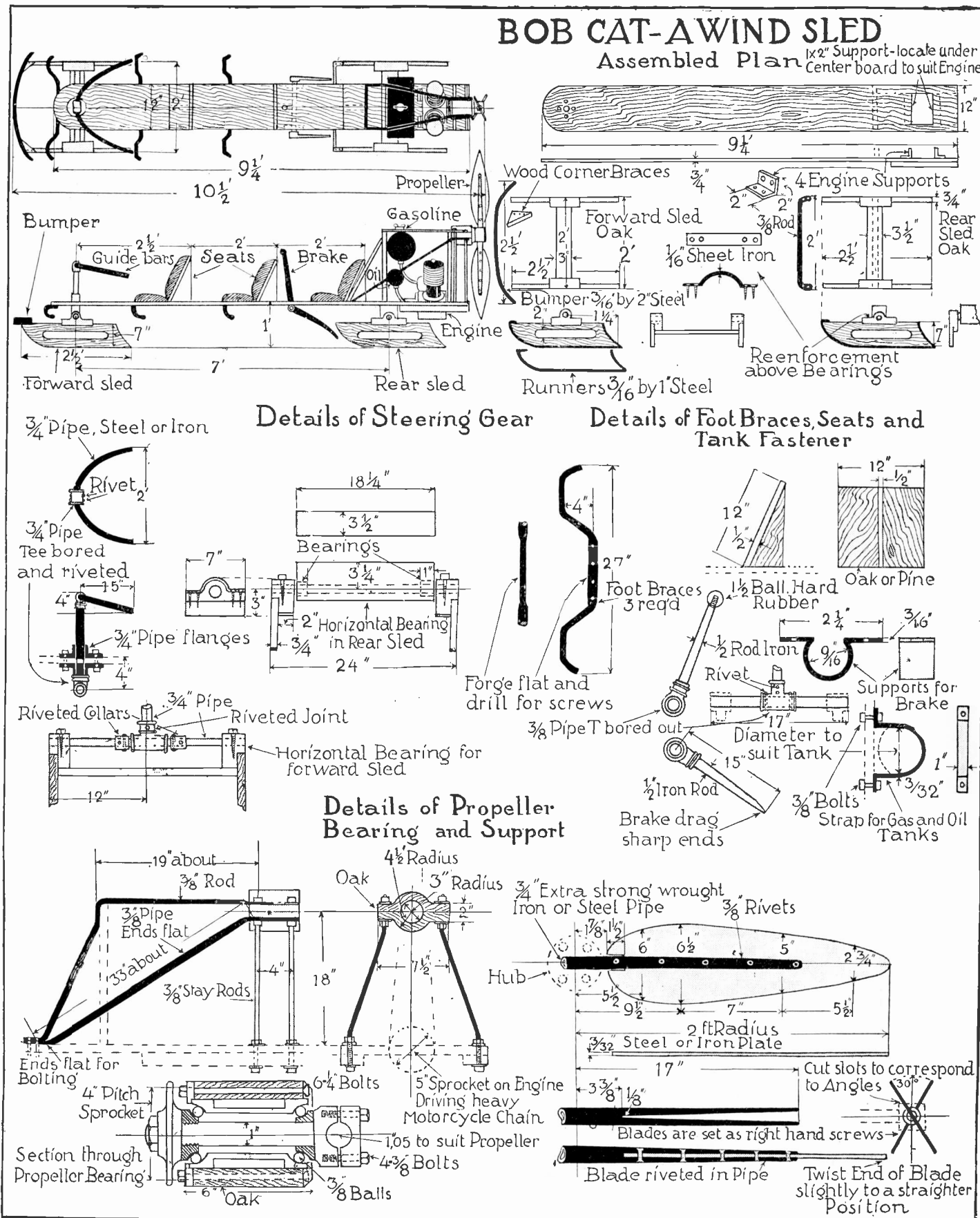

Equipped with a twin cylinder engine of the motorcycle type developing between seven and ten horsepower, the wind sled whose structural details are shown above, will work over pack snow and moderate hills, fully loaded. On ice it will develop upwards of fifty miles per hour. The method of constructing the body is shown in the plans. The cost is very moderate since

the engine can be procured at from ten to thirty dollars. It need not be in the best of condition. A motorcycle sprocket shaft and bearings supply the propeller journals. The propeller is made of sheet steel and is firmly riveted into the steel tubing which carries it. The weight of the completed sled is just slightly over 200 pounds if the details given above are followed.

# Combination Drill and Lathe

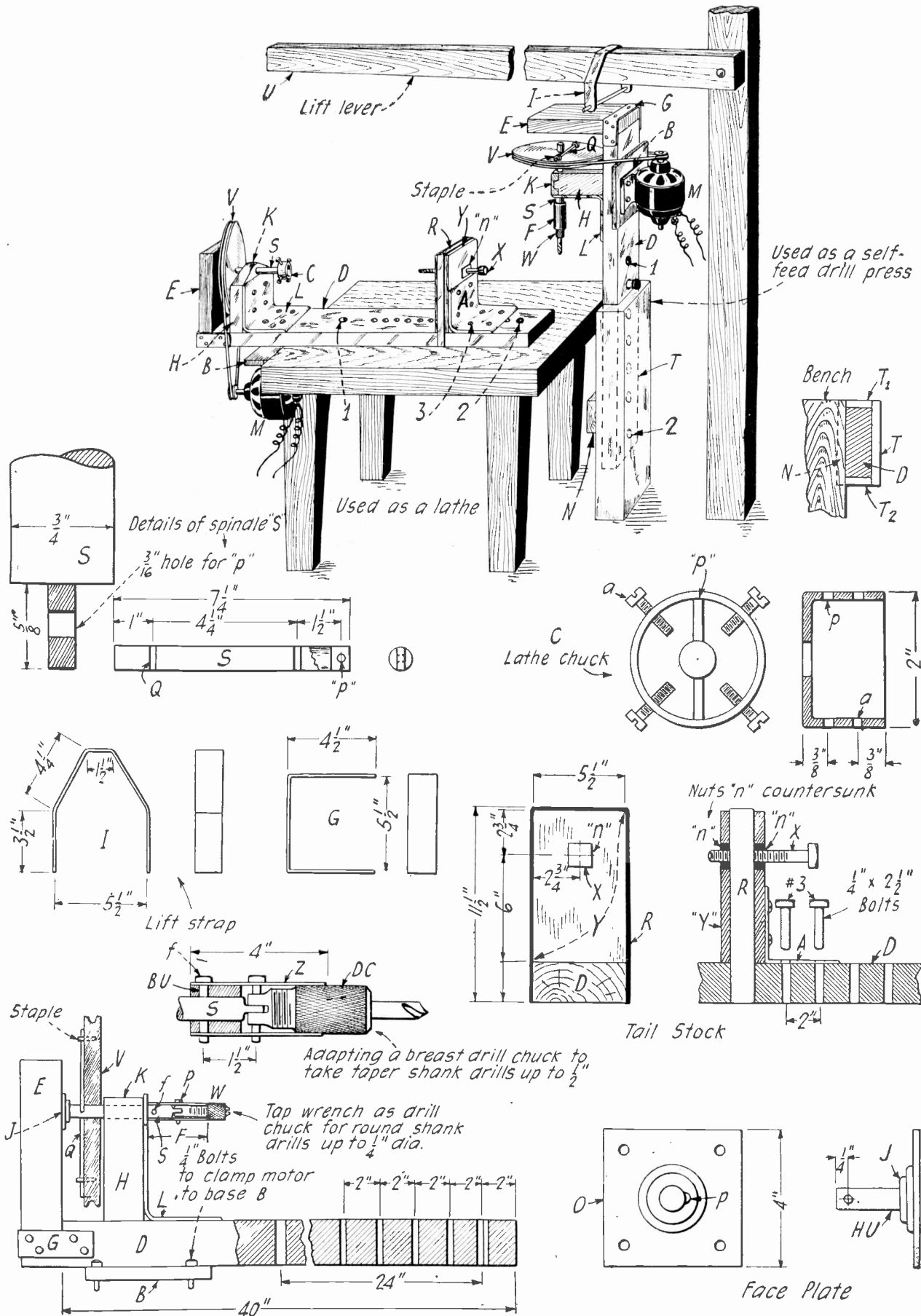

THE cheaply and simply constructed combination drill and lathe shown above might be considered too flimsy for real work. The author has, however, used one similar to it for six months and it has given good service. Most of the structural details are shown. The drill chuck is taken from a discarded breast drill. The slot in the chuck which takes the shaft tongue is made at right angles to the pin holes, which take the pin holding the chuck to the staff. The motor used is of the one-quarter horse-power A.C. variety. The relation of the pulleys is one to eight. The shank of the face-plate is slotted to take the tongue of the shaft and it is used with the sleeve and bushing the same as the drill chuck attachment.

—F. J. Marsa.

# How to Make a Storage "A" Battery

BY DR. ERNEST BADE

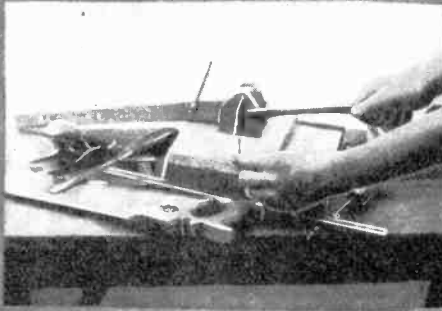

In making the storage "A" battery shown here the first step is the manufacture of a puncher. Attach a heavy nail to a stick fulcrum as shown and drill a hole in the baseboard for a guide for the nail. Another board nailed to this serves as a guide for the plates.

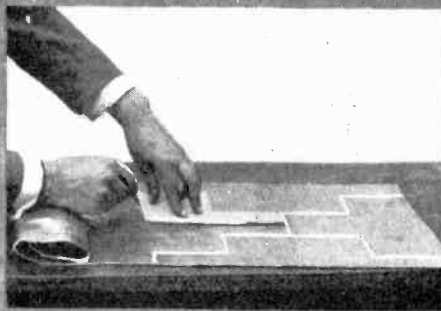

The next step is marking the size of plates. They are made of lead about 5-64 inch (2 mm.) thick. If the plate is to be four by six inches cut it eight by twelve leaving ample material for the lug. The finished plate is double the thickness of the original lead.

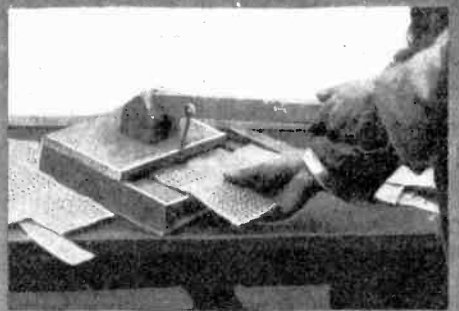

The third step is punching the blank plate. Place the blank on the bench and mark it in half-inch squares. Put a hole at the corner of each square with the punch. Of course, only the body of the plate is thus punched, the lugs being left solid as shown above.



Fourth—Bend the punched plate in the middle of the lug as shown in the picture above, being careful to see that one edge laps over the other about three-sixteenths of an inch. This lap is to be left for clinching the completed plates in one of the later steps in the process.

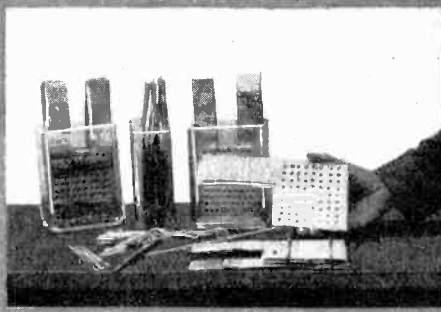

The bent plates are then placed in a bath of half nitric acid and half water and allowed to stand for twenty-four hours. In making the acid solution be careful to add the acid to the water by pouring it into the water very slowly, while stirring the mixture with a glass rod.



Wash the plates thoroughly after removing them from the acid. Place two glass rods on top of one and then lay another on the rods with the lug on the opposite side. Continue this until there is a total of five plates. Then bind them with rubber bands as shown above.

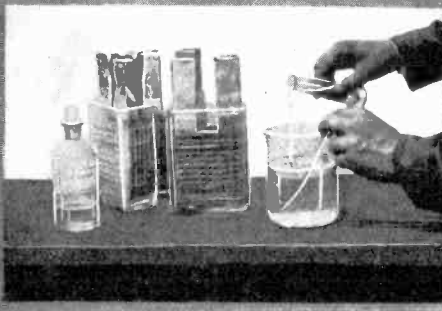

Place these units in glass battery jars and cover them with a solution of one part concentrated sulphuric acid and nine parts water, being careful to add the acid to the water while stirring. The solution will heat.

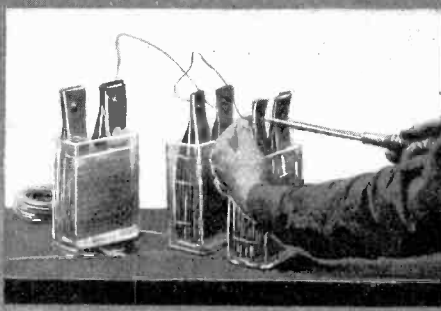

Drill the lugs for copper or brass bolts as shown in the above illustration. The three plates of the unit are the negative, the others positive. Connect in series and the negative lead to the positive of the charger.



Leave the plates in circuit until the negative plates turn a dark brown. Then short-circuit the battery with a piece of No. 14 iron wire about thirty feet long until the negative plates resume their normal color.

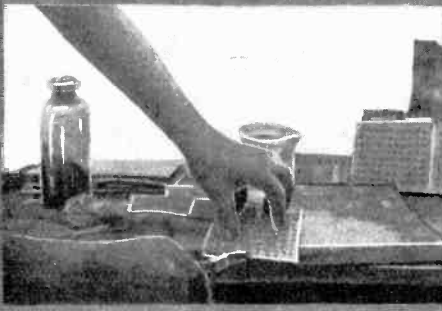

Then charge again connecting the positive of the battery to the positive of the charger until the plates bubble at the same rate. Then remove and dry them. Cover the negative plates with a paste of litharge and the sulphuric acid solution. Moisten plates with solution first.

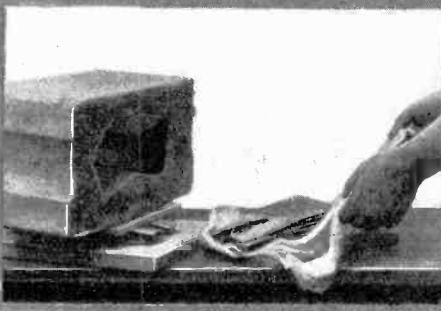

Cover the positive plates with a paste made of the solution and red lead in the same way. Then refold the plates, clinching the edges as shown and place them under a heavy weight for twenty-four hours. Remove all excess paste with a cloth moistened with the acid.

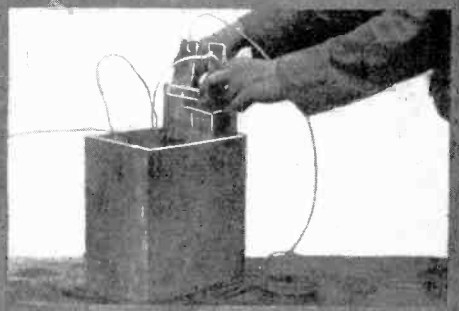

Reassemble the plates in packs, insulating and binding as before, and return them to the acid solution. Connect them in series and charge by connecting the positive lead to the positive pole of the charger and negative to negative. Each cell will develop two volts.



# WRINKLES

## RECIPES & FORMULAS



### Capturing Frost Crystal Forms

Simple method of fixing frost designs on glass

THIS MONTH'S \$5.00 PRIZE TO S. LEONARD BASTIN

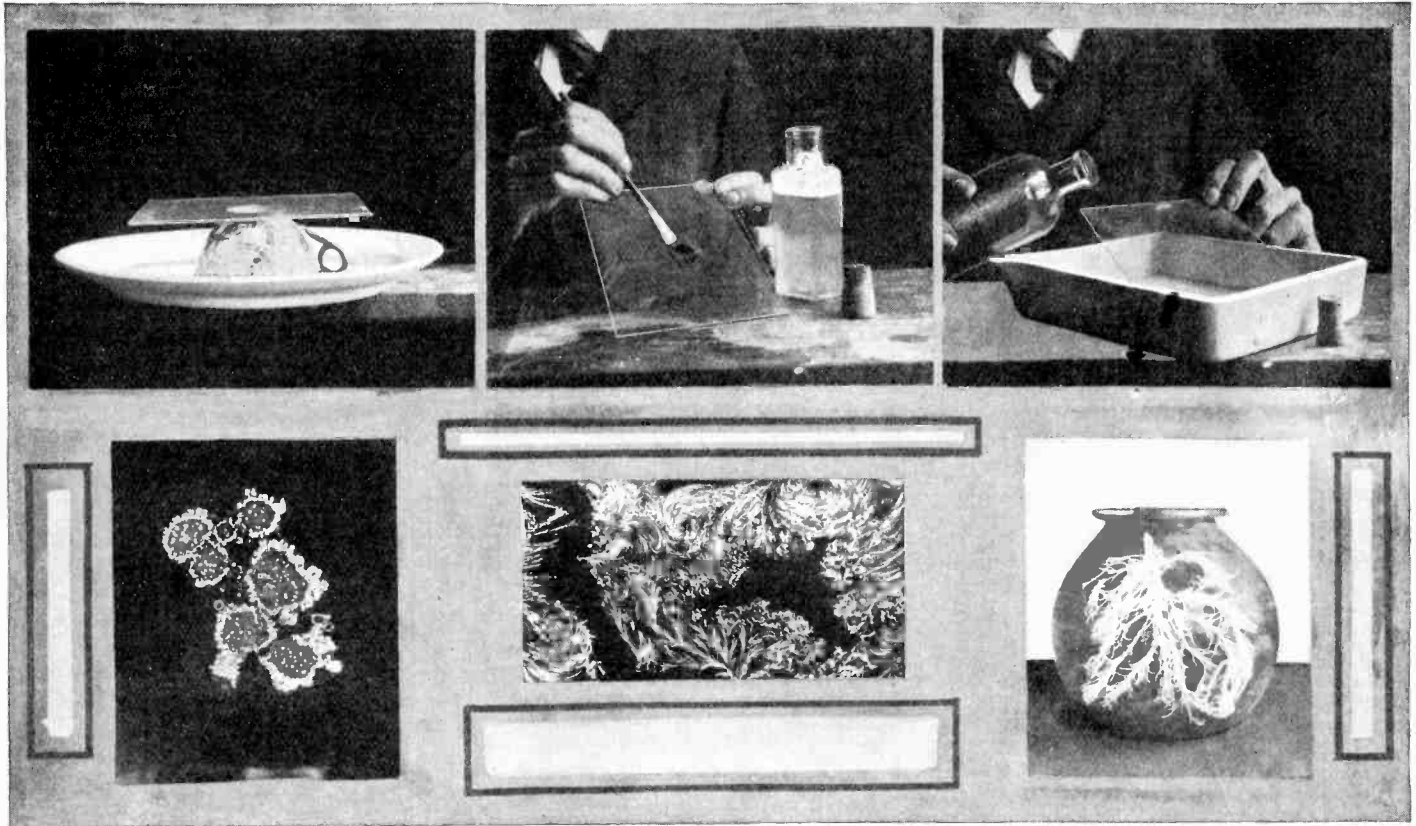

A novel method of obtaining decoration designs is that of fixing the flower-like figures made by frost. A simple method of placing such designs on glass is shown above. The vessel to be decorated is covered with a thin coat of a solution made of two per cent of gelatin added to distilled water. This is brushed evenly over the surface and the piece to be coated is left out in

freezing weather for the formation of the crystals. After their formation, the work is rinsed in methylated spirits which removes all but the figures. The whole is then covered with a coat of clear varnish. If the designs are desired in colors it is only necessary to add a dye of the preferred tint to the gelatin solution.

#### Brush Softener

Keep Handles out of Solution

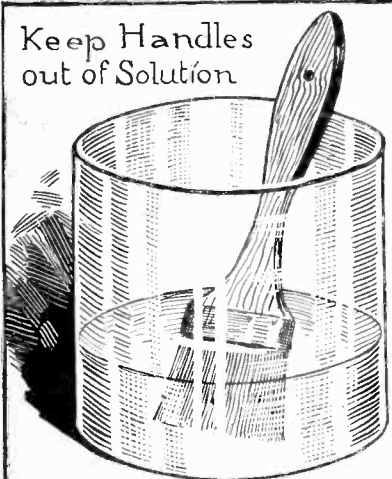

Solution Sodium Hydrogen Phosphate 1oz to 1 pint Water

To remove dried paint in brush bristles, soak them three days in a solution of Sodium Hydrogen Phosphate, being careful that the handle is not in the solution. Then wash well with soap-suds and water. Rinse in clear water.

—ALDEN JOHNSON

#### Chemical Stunt



To a solution of 1 teaspoon of cornstarch in a pint of boiling water add one drop of iodine tincture. Bottle the blue liquid and heat the bottle in water until the solution clears. Cork and seal with wax. When the bottle is brought to room temperature, the color returns.

#### Water and Oil Experiments

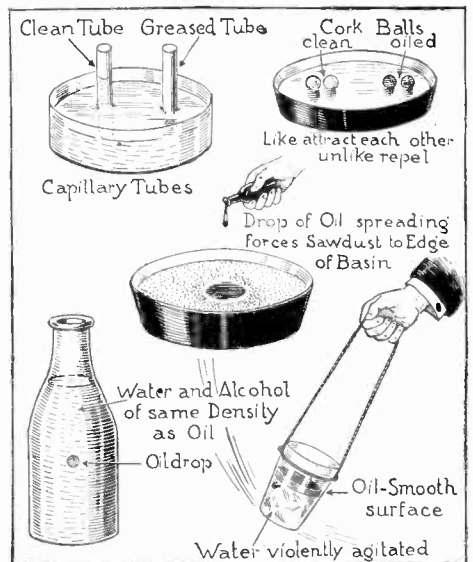

No capillary action in greased tube. Oiled and clean balls repel. Sawdust on water repelled by oil. Oil drop will stay suspended in solution as shown. Oil unaffected by centrifugal force.

—CHAS. D. TENNEY.





# HOW-TO-MAKE-IT



This department will award the following monthly prizes: First prize, \$15.00; second prize, \$10.00; third prize, \$5.00. The purpose of this department is to stimulate experimenters toward accomplishing new things with old apparatus or old material, and for the most useful, practical and original idea submitted to the Editors of this department a monthly series of prizes will be awarded. For the best idea submitted a prize of \$15.00 is awarded; for the second best idea a \$10.00 prize, and for the third best a prize of \$5.00. The article need not be very elaborate, and rough sketches are sufficient. We will make the mechanical drawings. Use only one side of sheet. Make sketches on separate sheets.

## Drain Repair

FIRST PRIZE \$15

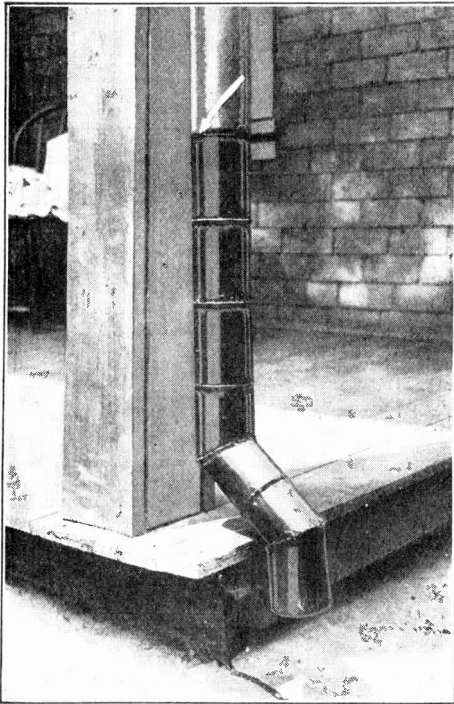

Remove the top and bottom of condensed milk cans and use to repair old drain pipes. They fit the 3-in. pipe. —J. H. Shalek.

## Stove Lighter

SECOND PRIZE \$10

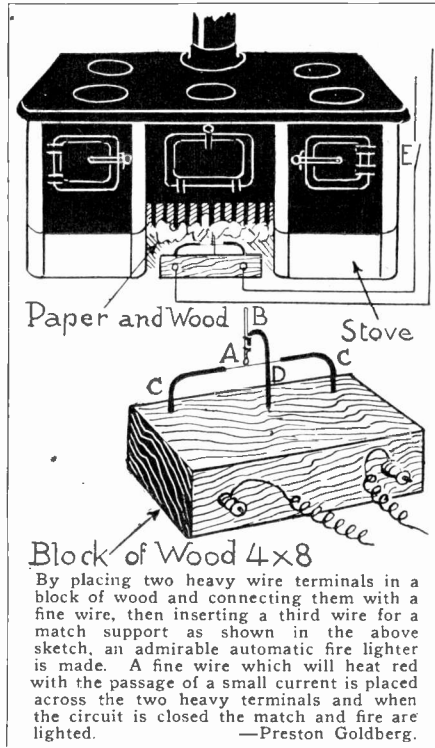

## Wind Indicator

THIRD PRIZE \$5

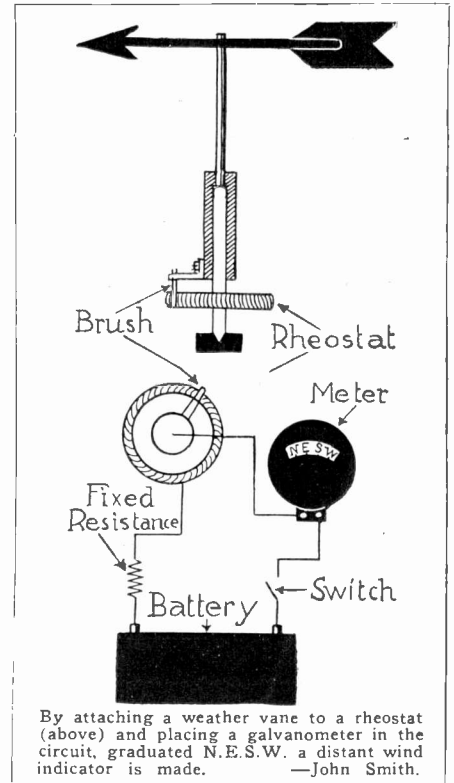

## Water Control

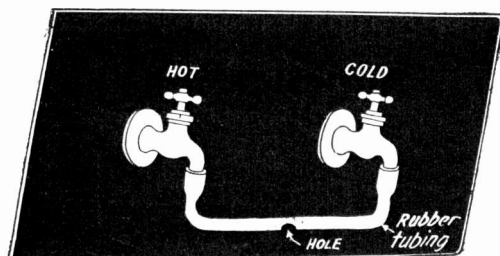

By attaching a piece of rubber tubing, notched in the center, to the hot and cold water taps the temperature of the water is controlled. —Geo. Frederick.

## Fish Trap

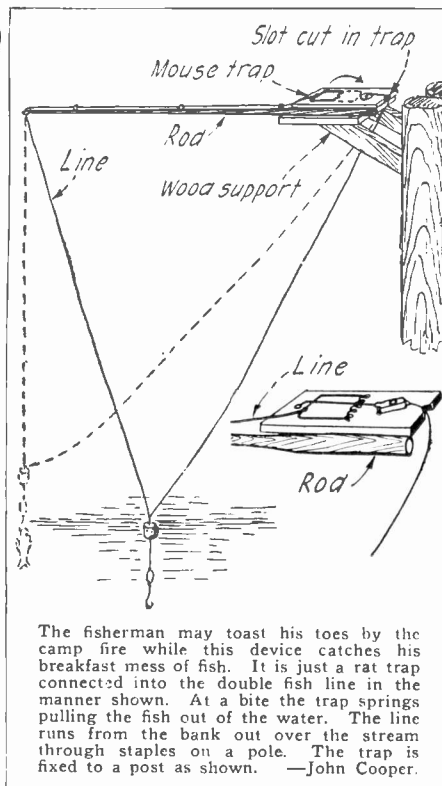

## Tack Hammer

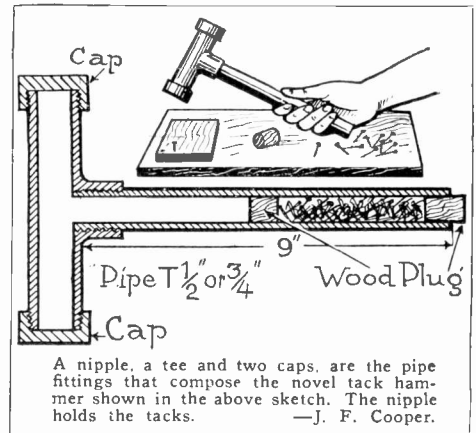

## GLASS TUBE CUTTER

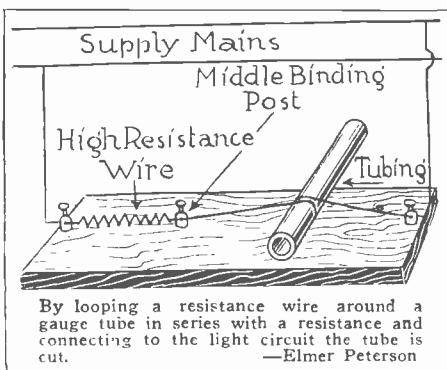

## BOW SHAPER

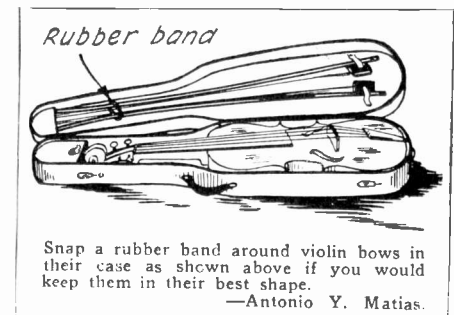

### Bottle Cutter

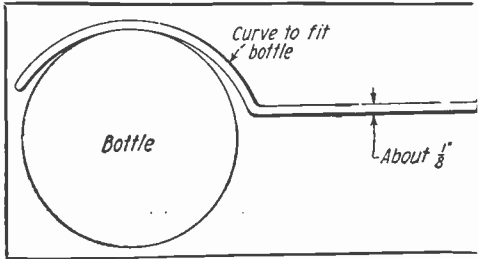

This Tool for Cutting Bottles is Made of Iron or Copper Wire Bent So It Is in Contact with About an Inch of the Bottle's Surface at a Time. Mark the Point Where the Bottle is to be Cut with a File Scratch. Then Place the Wire, Heated to Redness, on the Crack. In About Thirty Seconds it Will Crack. Continue Around the Bottle Until Top Comes Off.—Harry Lubcke.

### Faucet Protector

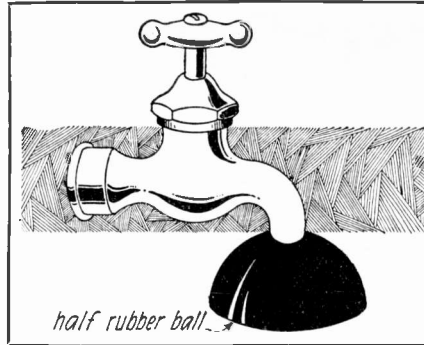

The Above Shown Faucet Protector, Made from Half a Rubber Ball, Will Save Fifty Times Its Cost in Broken Crockery. It Does Not Interfere With the Water.—S. L. Bastin.

### Glass Working Flame

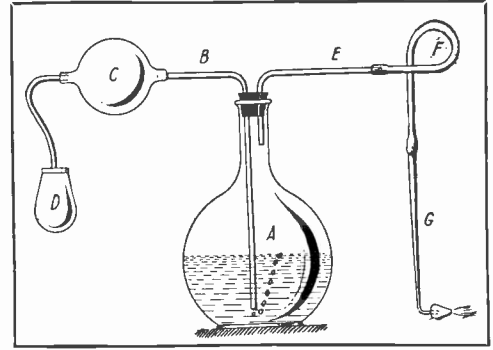

A Flame Hot Enough to Melt Glass Can Be Obtained from This Flask Filled with Alcohol, Through Which Air is Circulated from Bulb (D) Through Toy Balloon (C) Into Blow Pipe (G).—Arthur S. Clark.

### Fat-Oil Extractor

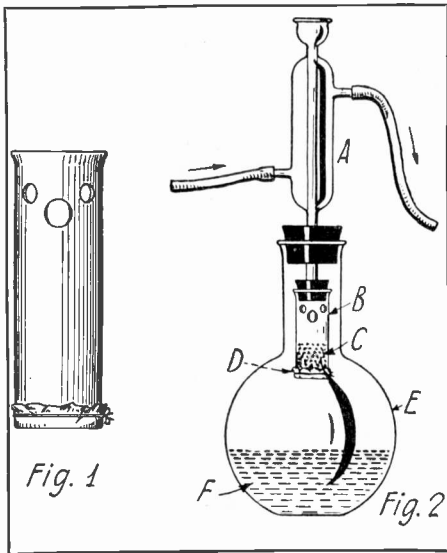

By Halving a Test Tube and Cutting Holes at Its Top and Attaching It to Liebig Condenser as Shown in Sketch, Fat-Oil from Milk, Etc., Can Be Extracted. (C) is Dehydrated Milk. (F) is Either Ether or Carbon Disulphide, Kept Almost Boiling, Which Dissolves Oil.—S. B. Seeley.

### Match Box Trick

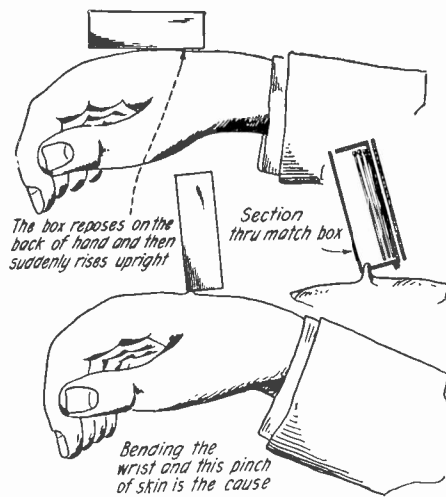

This Trick is Easily Performed by Pinching a Small Bit of Skin Between the Box and the Container of a Safety Match Box. If the Hand Is Now Bent, the Box Will Immediately Fly Upright.—G. A. Luers.

### Shutter Attachment

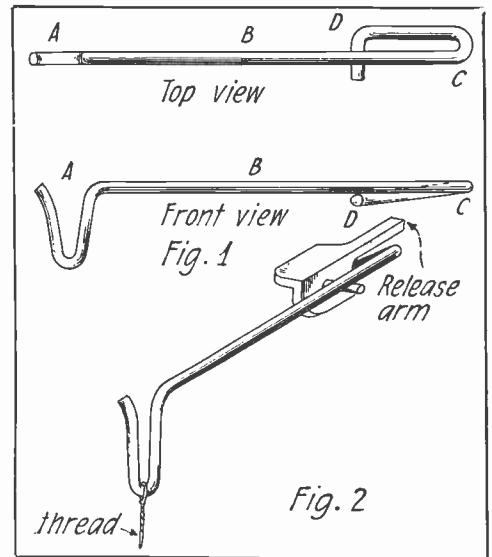

This Camera Shutter Attachment for Self-Portraiture is a Bit of Stiff Wire Bent as Shown. To Attach, Spring Open Bend, Place Under Release Arm and Over Pin Shown in Fig. 2.—F. M. Weston, Jr.

### Hero's Fountain

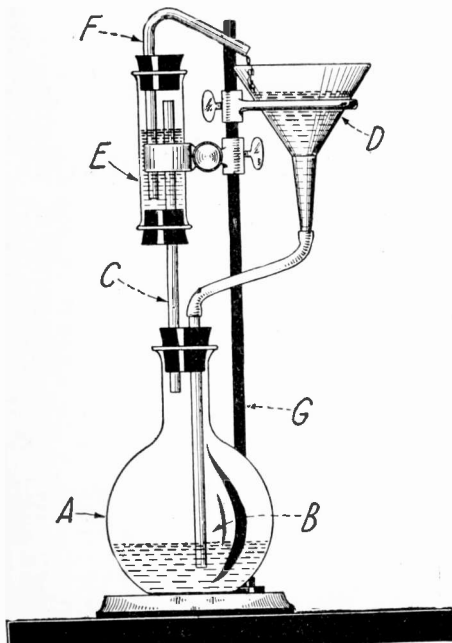

To Operate Model Hero's Fountain Shown in Sketch, Fill (E) and (A) Nearly Full of Water. Then Quickly Fill (D), Thus Forcing Water in (E) out at (F).—C. D. Tenney.

### Heater Model

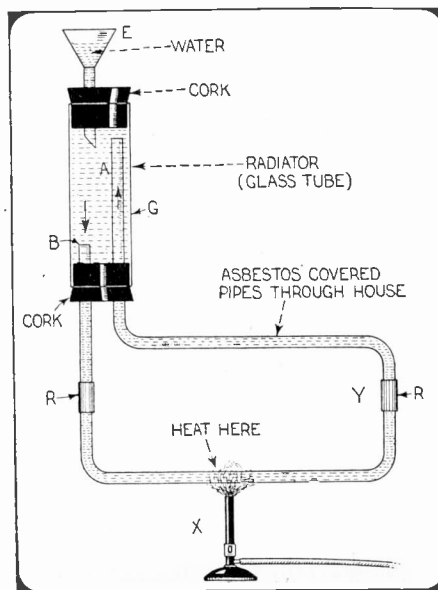

This Model of the Hot Water Heating System Can Be Constructed from Apparatus in Any Laboratory. Be Certain to Equip with Funnel Which Acts as the Expansion Tank. If a Drop of Ink is Put in the Water the Circulation Can Be Seen.

### Square Hole Punch

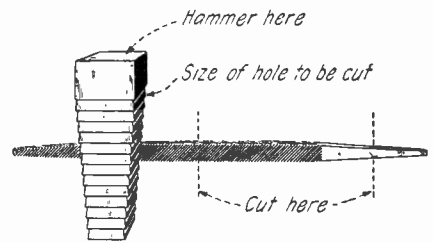

To Make Square Hole Punch Shown, Draw Temper in Square File, Cut Notches with Fine Abrasive and Retemper.—D. R. Van Horn

### Water Cooler

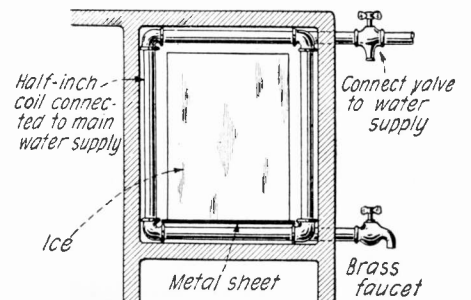

This Water Cooler is of Half Inch Pipe Coiled in Bottom or Side of Ice Chest. No Filling is Necessary but the Coil Should Be Flushed at Least Once a Day to Be Sanitary.—M. Benjamin.

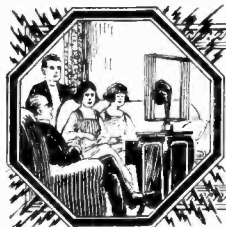

# RADIO

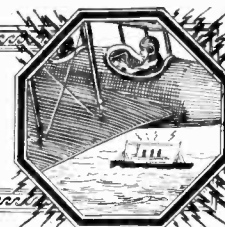

## Loud Talker Without Microphone

Absence of Iron Diaphragms Gives Perfect Reproduction

BY DR. ALFRED GRADENWITZ

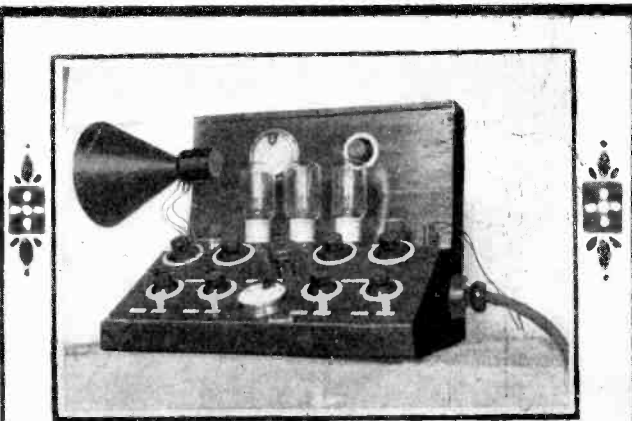
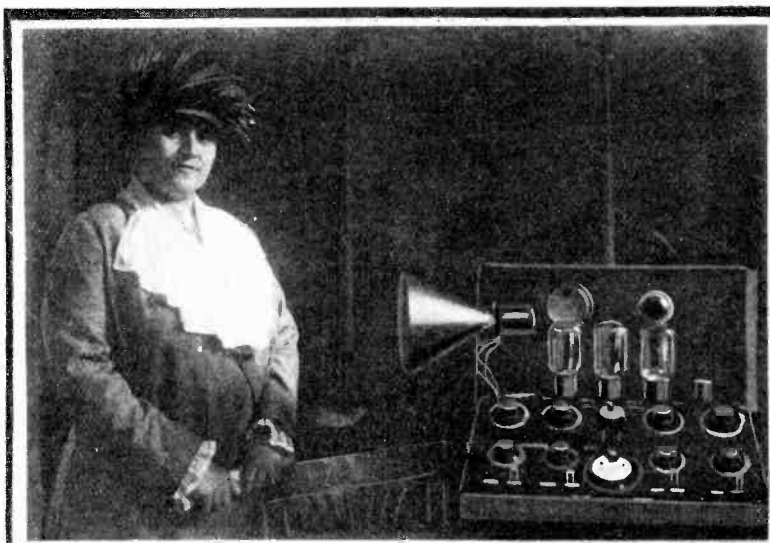

Above: The transmitting apparatus connected with broadcasting radio apparatus. To the left below is shown the reproducing units installed in a hall for a concert. At the left is shown an opera singer standing before the transmitter in operation.

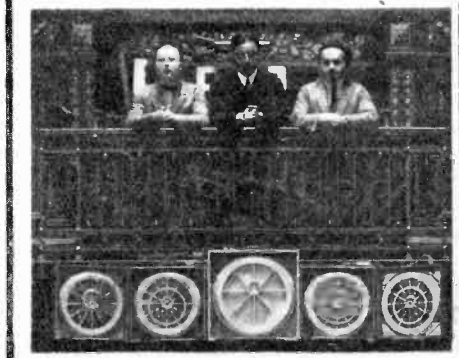

Below: Close-up of unit of the reproducing apparatus.

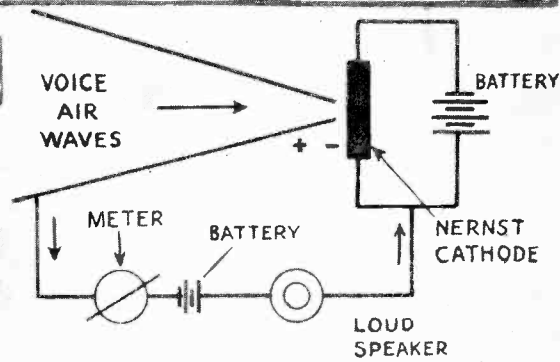
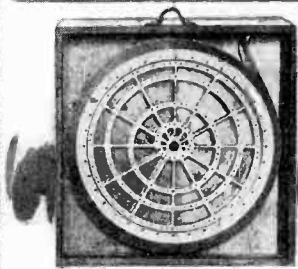

German inventors have evolved the recording and loud-speaking device shown above which gives perfect reproduction. In the sketch at the right is shown the diagram of the recording apparatus which operates

by the effect of the voice on a stream of ions flowing from the incandescent rod of a Nernst lamp. The reproducer depends on the varying attraction of electrostatic charges a metal plate and a mica diaphragm.

### \$12,000 or More in Gold

Beginning with the January issue, SCIENCE AND INVENTION will pay \$1,000.00 or more each month of the year in prizes. Every article published in the regular news section will receive one of them. (The departments have awards of their own which they will continue to give.) Ideas are what the editors want. They must be told simply—so your mother or sister can understand them—in pictures and sketches. Be sure they are NEW and have something to do with science or invention. The editors want pictures and

88 monthly prizes will be given as follows:

<b>FIRST PRIZE \$100.00</b>			
<b>2 PRIZES of \$50.00 each</b>			
10	"	"	25.00 "
5	"	"	20.00 "
10	"	"	15.00 "
20	"	"	10.00 "
10	"	"	5.00 "
20	"	"	2.00 "
10	"	"	1.00 "

### \$12,000 or More in Gold

sketches—must have them—but ideas are wanted most of all.—And they will be handsomely paid for. The rules of the contest will be found on page 534 of the October issue. If you haven't a copy, one will be mailed you free on receipt of your name and address. It will give full details of the rules and hints on submitting articles. The closing date for all prize contributions will be the 15th of the month preceding date of issue, i.e., 15th of December for the February number; the 15th of January for the March number, etc.

### WANTED!!! RADIO ARTICLES

WE want descriptions of new radio ideas which you have worked out in practice. Take photographs of the important parts and make pencil or pen and ink sketches of the hook ups or mechanical details, et cetera. We are particularly

desirous of obtaining new hook-ups and descriptions of single tube sets, reflex and other types which have proven satisfactory. We want articles on the latest single tube receptors which require a minimum current from the filament battery.—Editor.

# Radio for the Beginner

Suggestions for useful gifts to "radio bugs"

BY ARMSTRONG PERRY.

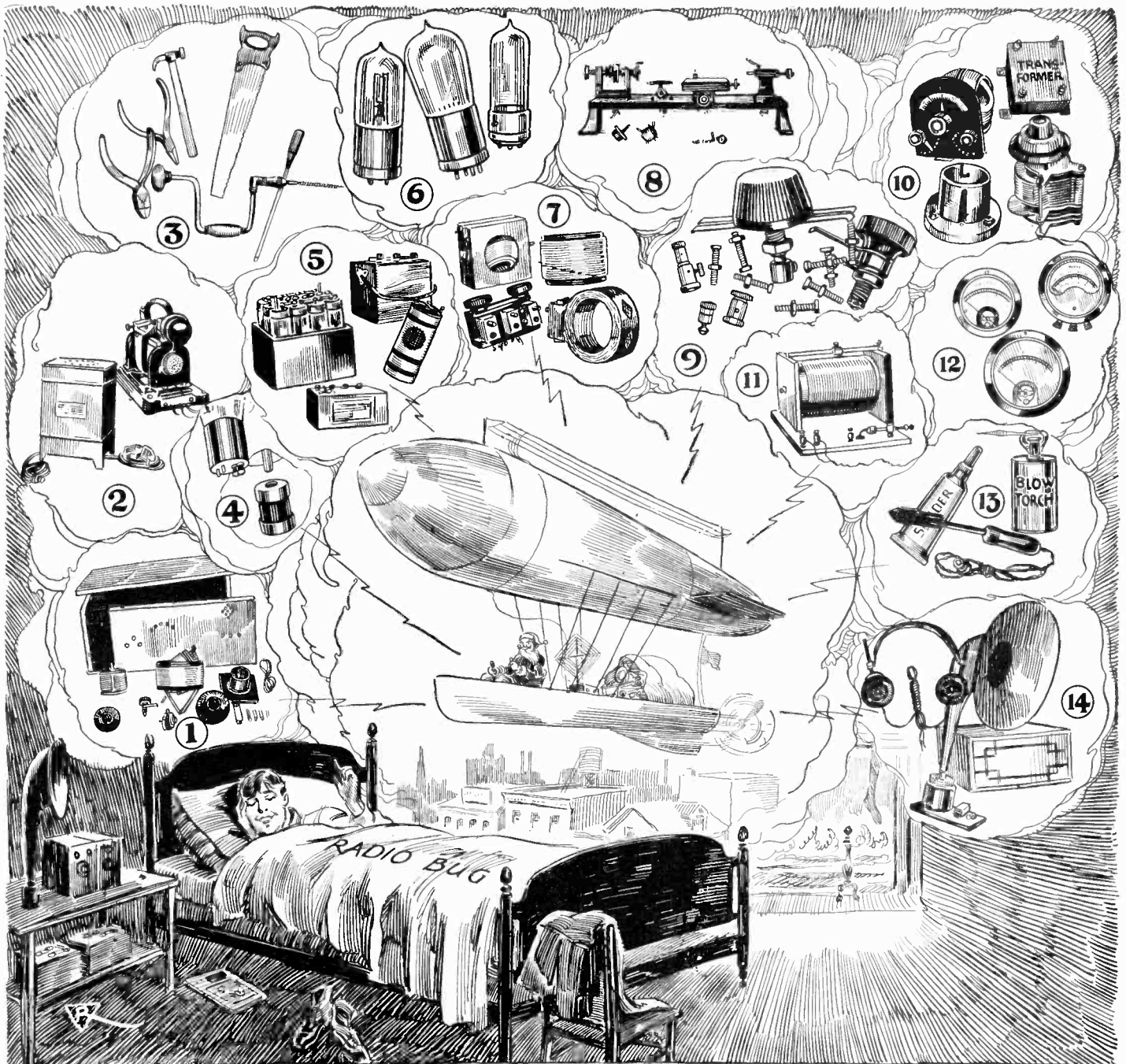

## NO. 22, A RADIO CHRISTMAS

**T**HE S. P. U. G. (Society for the Prevention of Useless Giving), is with us again. This time it is dealing with the matter of radio, something which is in the minds of everyone at the present time. Above, in the Radio Bug's Dream, will be seen a few suggestions for gifts.

His apparatus on hand at present must be taken into consideration so that duplicates will not be given, and in order that the recipient shall find himself in possession of material which will be of use to him in expanding his present set. If the radio enthusiast has only a crystal set, do not present him with a loud speaker (Fig. 14), or some other useless instrument. Rather, present him with a vacuum tube (Fig. 6), so that his range can be extended and in this way bring joy and happiness to his home.

To the man or boy, or for that matter, the woman, who likes to build radio sets, there are many tools (Fig. 3), which will be greatly appreciated. A lathe (Fig. 8) is something desirable but usually unattainable to the average amateur. Batteries and chargers (Figs. 5 and 2) can always be used, the latter, however, only when A.C. is available. Parts (Figs. 1, 7, 9, 10 and 12) can be used for additions to present sets. The beginner would appreciate a crystal set (Fig. 11). Soldering materials (Fig. 13) are useful. A simple but welcome present is a set of vacuum tube fuses (Fig. 4). An extra pair of phones (Fig. 14) will always find favor. To our mind radio apparatus makes the best present that anyone can give to those interested in the most fascinating of all hobbies.

# BROADCAST STATIONS

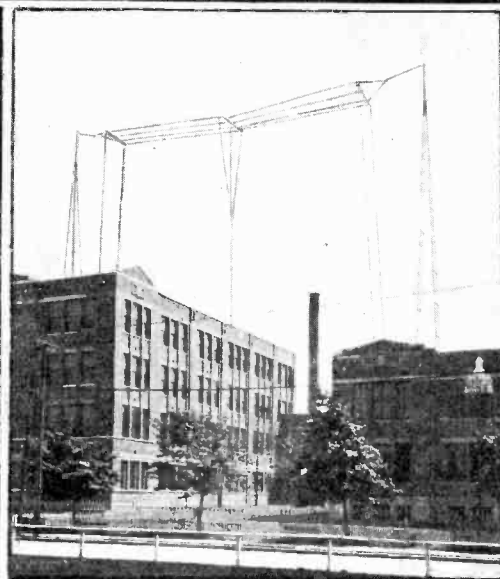
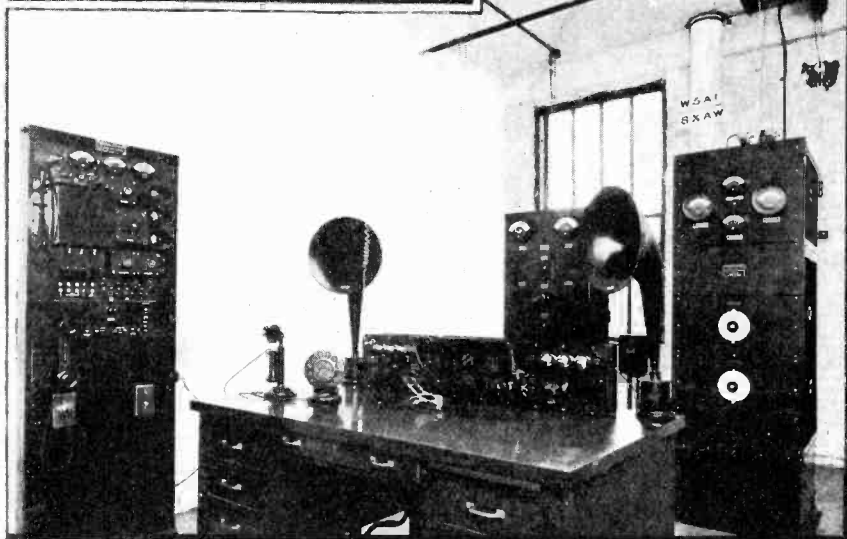

The Upper Left Hand Photograph Shows Mr. P. A. Green, Radio Engineer of Station WSAI of the United States Playing Card Company of Cincinnati, Ohio. Lower Left: The Radiophone Broadcasting Apparatus of WSAI Can Be Seen in the Background, with the Voice Amplifier on the Extreme Left. On the Desk is Located the

Monitoring Apparatus for Checking Up on the Programs. Announcements May Also Be Made from This Desk. Above, at Right: The Antenna System of WSAI Supported on Two Steel Towers 167 Feet Above the Street Level. The Active Antenna Length is 65 Feet with a Lead-in of 137 Feet.



On the Right May Be Seen Miss Vaughn de Leath, Managing Director of Station WDT of the Ship Owners' Radio Service and Premier Grand Piano Corporation, New York City. Miss de Leath Makes Claim to the Title of the "Original Radio Girl," on the Grounds that She Was the First Young Lady to Have Ever Broadcasted from a Radiophone Station. This Took Place in 1920, and the Transmitting Was Done by Dr. Simon, from the World Tower Building in New York City.

Miss de Leath is Also known to Every Song Writer and Singer, Having Done Some of This Work Herself. She Has a Remarkable Contralto Voice and Very Often Entertains the Radio Fans from Station WDT.

This Latter Station Has Established Quite a Record of Late, Having Been Heard in Every State East of the Mississippi, and Several West of That River. The Transmitting Apparatus of WDT May Also Be Seen in the Photo at the Right.

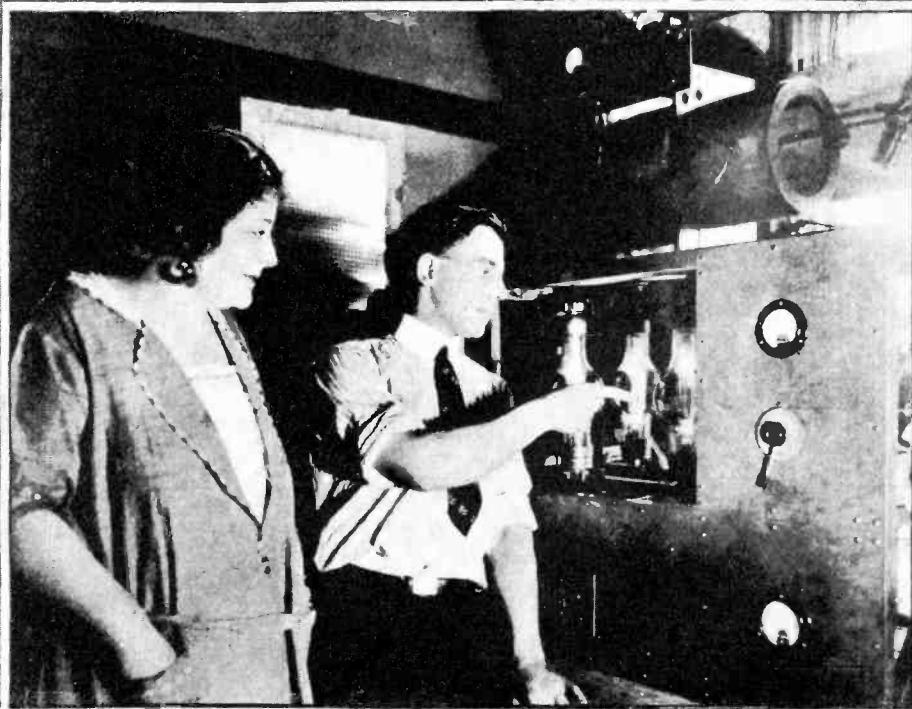

# BROADCAST STATIONS



The studio of the newly opened WOAW, broadcasting station of the Woodmen of the World, is shown in the photo directly above. Despite the unfavorable time the station began work—last April 2nd—reports have already been received by the operating staff that the station has been clearly heard over a great part of the United States. The most outstanding report so far received was a card signed by the operator aboard the S. S. White to the effect that he picked up the station clearly while his vessel was proceeding 1,700 miles south of San Diego, Cal. The insert in the center of the page shows a corner of the building on which the aerial is installed. The masts that carry the antenna reach more than 170 feet above the level of the street. The regular broadcast program is carried on from this station, including weather reports, lectures, and musical concerts.

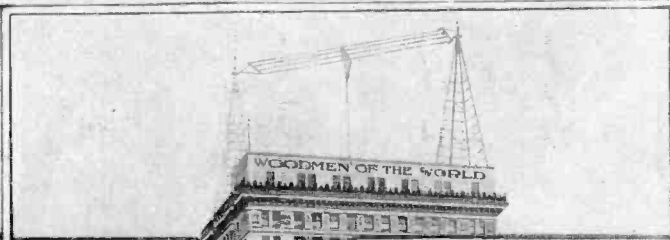

Above is shown Engineer Stenback of Station WOAW at the transmitting instrument board of his station. Below is shown the instrument room of Station WOC, owned and operated by the Palmer School of Chiropractic, Davenport, Iowa. The two panels at the left are the controlling units of the public address system through which addresses given in the school are broadcast while they are being made. Through it, speakers in any part of the institution may make public a lecture at the same time they are giving it to a class. The power control board may be seen beneath the monitoring horn in the center. The transmitting apparatus proper is housed in the panel to the extreme right.

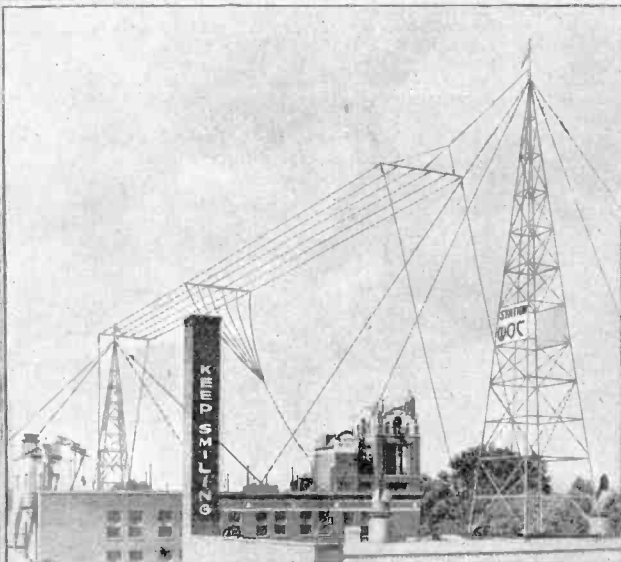

Above is shown the antenna system of WOC. The towers are placed atop one of the buildings of the school. Their total height is 130 feet above the street level. They are more than 300 feet above the level of the Mississippi River. On account of the severe winds that hit the city in the winter months special care had to be taken in the construction of the masts to make them proof against the gales. At night the towers are outlined by flood lights which make them visible for miles around the tri-cities. This station has a good distance record to its credit and has given great satisfaction in its operation. It was installed as a means of advertising the chiropractic system of healing.

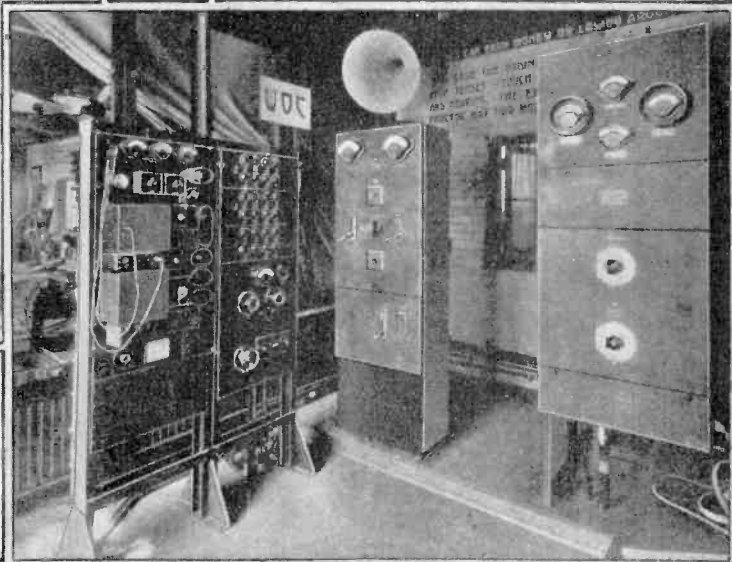

# The Compact "Single Six" Circuit

Operated With One No. Six Dry Cell Supplying the Filament Circuit

By H. E. HAYDEN

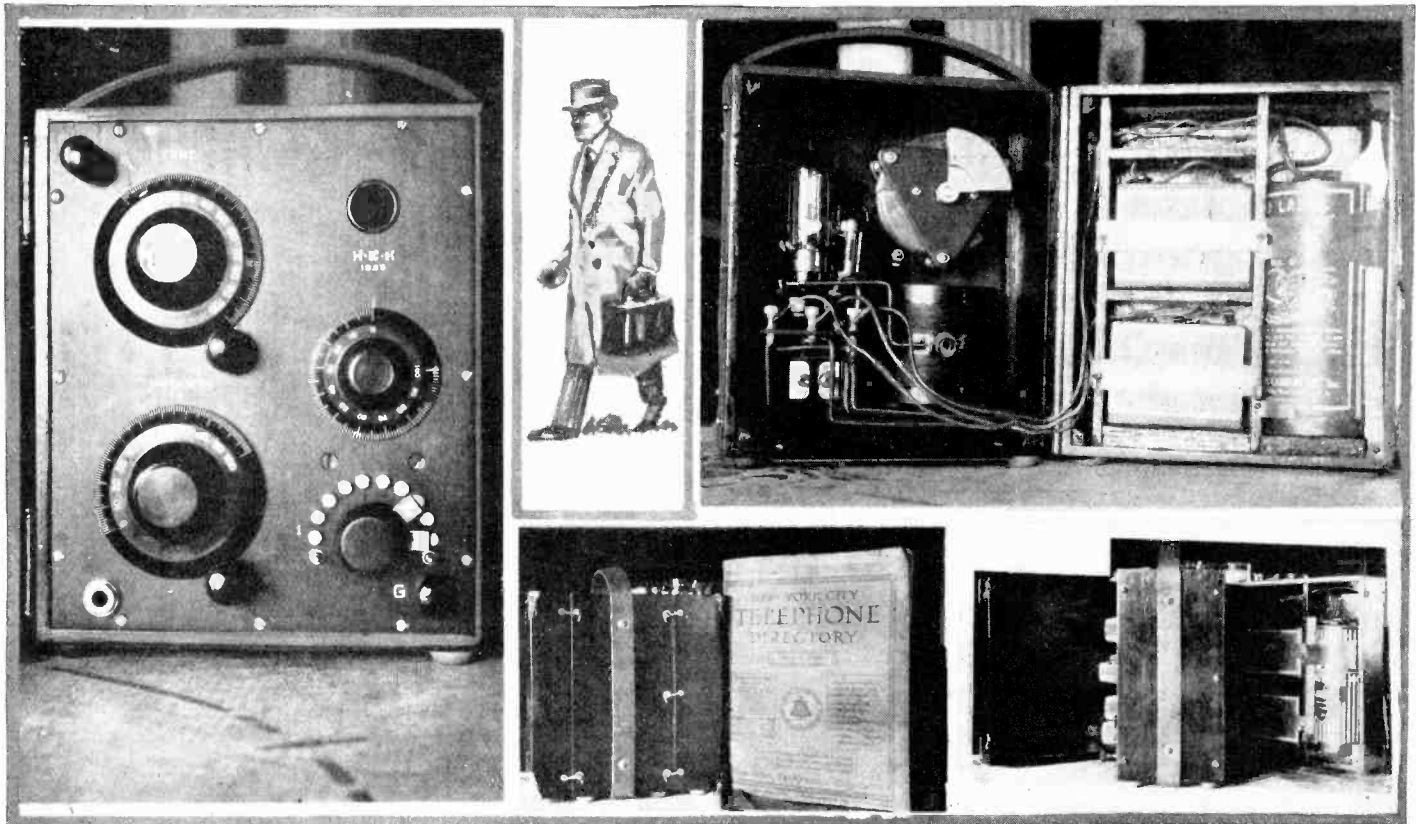

This set, called the "Single Six" receiver by the author, because the "A" battery is a single No. 6 dry cell, is illustrated in its completed form above at the left. In the lower center, the set is shown in comparison with a standard telephone directory, illustrating its compactness.

Upper right: An interior view of the set showing the compact wiring and placement of the "A" and "B" batteries. Lower right: Illustrating the construction of the cabinet enclosing the entire "Single Six" receiving set and batteries.

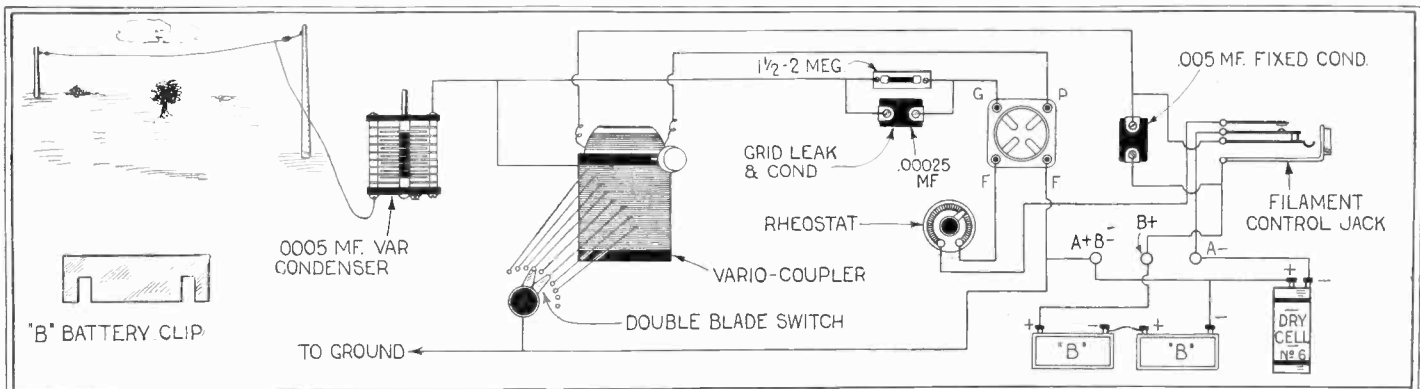

The circuit diagram of the "Single Six" receiving set is shown in simplified form above. Note the filament control jack, by the use of which the filaments will be extinguished upon removing the phone plug from the jack. This set will give fair selectivity and excellent volume under all conditions.

The use of tickler feed-back in the "Single Six" circuit makes possible amplification by means of regeneration and the auto-transformer effect in the primary reduces losses. At the extreme left will be seen the form of the "B" battery clip used for connecting the "B" battery together.

## RADIO VISION

AT LAST the instrument that will make sight at a distance possible has been invented. If you are an old reader of the ELECTRICAL EXPERIMENTER and SCIENCE AND INVENTION, you will remember all the different articles we had on the Telephot and various television schemes. But now an instrument has been invented which is fully described in the December issue of RADIO NEWS by Mr. H. Gernsback, Editor, who saw it in operation at Washington recently. Mr. Gernsback has actually seen a picture of his hand transmitted by radio while he was moving the hand to and fro.

Dr. Lee De Forest, inventor of the Audion, comes forward with his latest invention, "The Radio Chauffeur Call."

Last, but not least, John V. L. Hogan, I. R. E., famous radio expert, tells us all about the new super-sensitive vacuum tube, the "Sodion." This is an exclusive feature for RADIO NEWS.

List of principal articles to appear in RADIO NEWS for December:

The Clariphone, a New Static Eliminator  
By S. R. Winters

The Radio Controlled Aeroplane,  
By Maurice Percheron

Construction of Super-Heterodyne Receivers,  
By F. de Willy and R. E. Lacault.

Simplifying the Radio Receiving Set.

By John Ashton Greig.

A New High Power Tube,

By Laurence S. Lees

Commercial Possibilities of Wired Radio for

Central Stations,

By Bert T. Bonaventure

Canadian Station 9BP Reaches Arctic,

By Jack Barnsley.

Notes on the Autoplex Circuit,

By M. L. Muhleman

Observations at the Receiving End of the

Radiophone,

By W. A. Knight.

# Multi-Wave Reinartz Receiver

By KENNETH HARKNESS

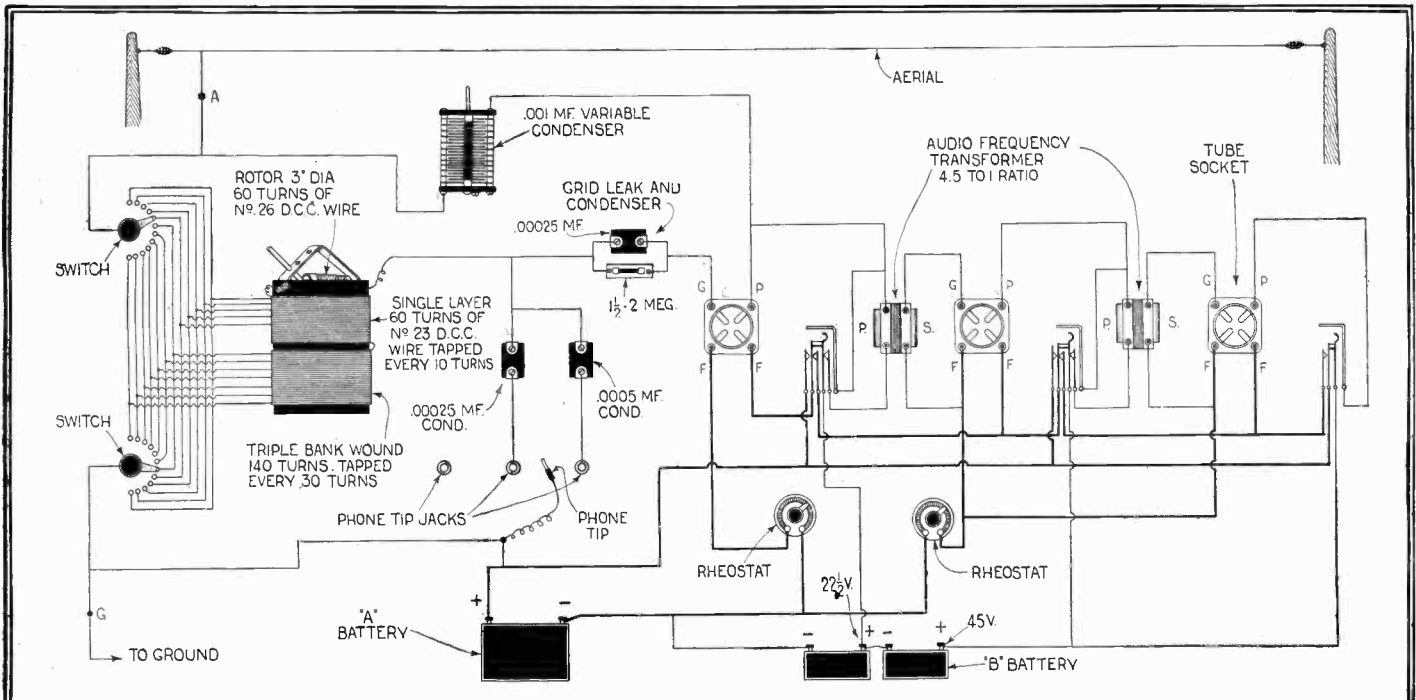

The Reinartz Tuner is without a doubt the best type for the reception of C.W. and I.C.W. signals. It gives excellent results on radiophone reception. The data on a Reinartz coupler of 3000 meters is given above.

The top end of the stator, in the diagram, is connected to one side of the rotor, and the other side of the rotor to the grid. The jacks plug the two small fixed condensers into the circuit as shown above.

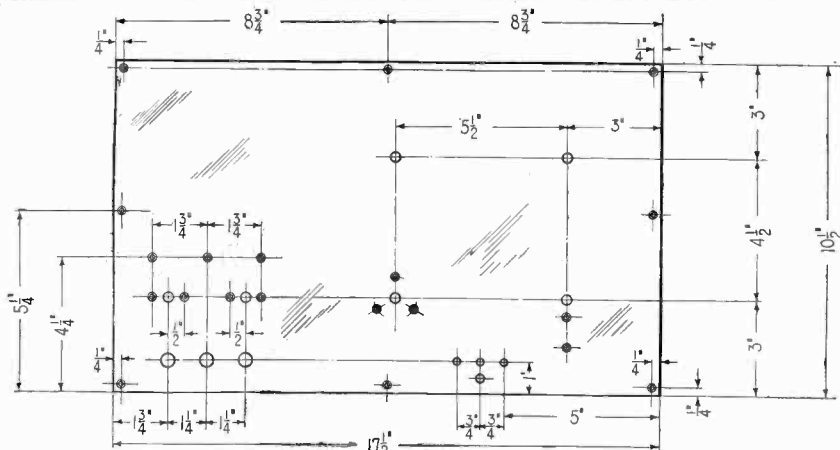

### MATERIAL REQUIRED FOR THE MULTI-WAVE REINARTZ

- 1 .001 m.f.d. variable condenser.
  - 1 multi-wave coupler (details of winding in Fig. 1).
  - 2 12 point (back of panel) inductance switches.
  - 2 rheostats.
  - 2 vacuum tube sockets.
  - 2 double circuit automatic filament control jacks.
  - 1 single circuit automatic filament control jack.
  - 2 .00025 m.f.d. fixed condensers.
  - 1 .0005 m.f.d. fixed condenser.
  - 1 panel 17 1/2 x 10 1/2 x 3-16.
  - 1 panel 5 1/2 x 7 x 1/4.
  - 5 binding posts.
- It is well to remember in selecting apparatus for use in this circuit that the better the apparatus you purchase, the better your results will be and the more satisfactory service your set will give.

Above is shown the panel lay-out for the multi-wave Reinartz receiver. This panel is used with a standard all-wave coupler such as shown at the right, second illustration from the bottom of this page. The two switch sets are to be connected in parallel so that any section of the

coils may be used as desired. The coupler used in this circuit may be wound on a 4-inch bakelite tube for the stator, following the data given. The finished coupler may be purchased ready made or may be wound as shown at the top of this page. Either one will give good results.

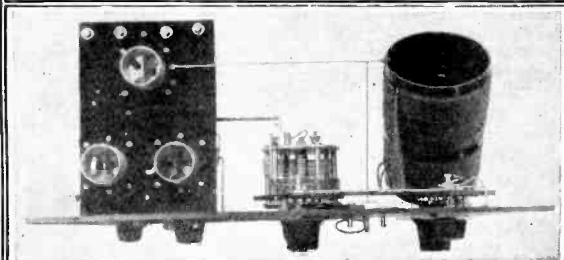

At left is a top view of the assembled all-wave Reinartz receiver, showing the position of the coupler, the variable condenser, and the three tube sockets.  
At right a photograph of the finished all-wave coupler. The rotor should be placed so that it may rotate through 180 deg.

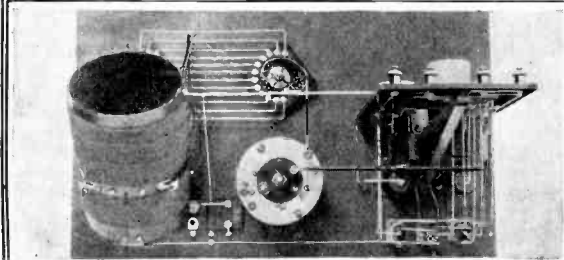
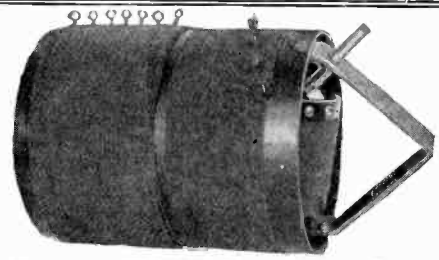

At left is a rear view of the tuner, showing the locations of the jacks, transformers and other apparatus.  
At the right is a front view of the finished tuner. In the placing of the instruments it is necessary to exercise great care so as to be sure that the bus bar wiring can be run the shortest way.

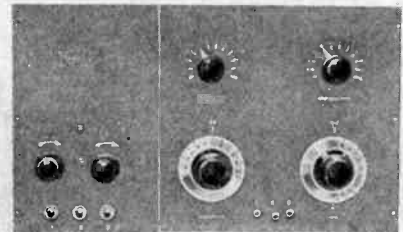



# How to Build a Rogers' Cage Loop

Full Details of Cage Loop Aerial Designed by Dr. James Harris Rogers.

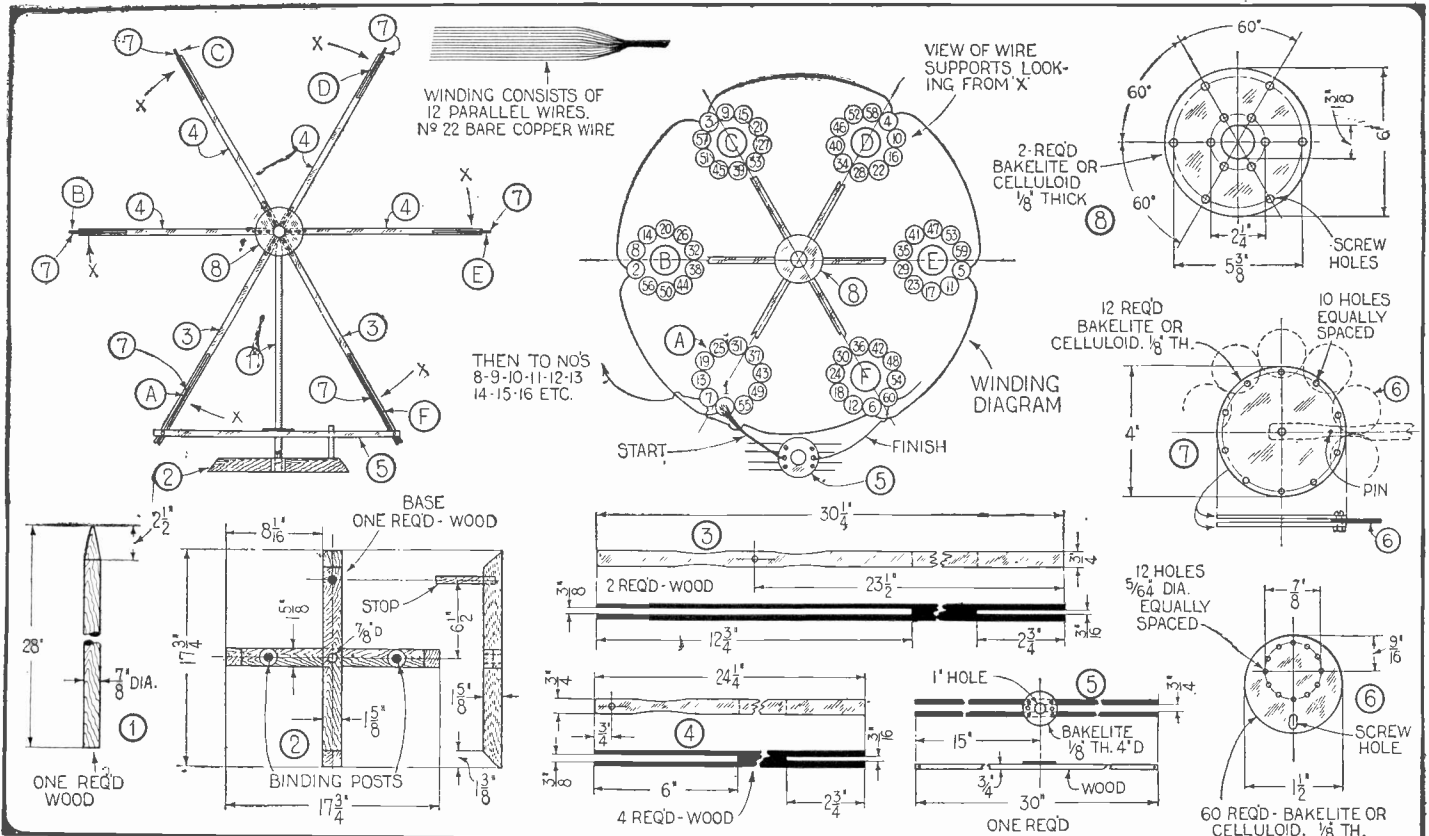

## A Business-Like Radio Table

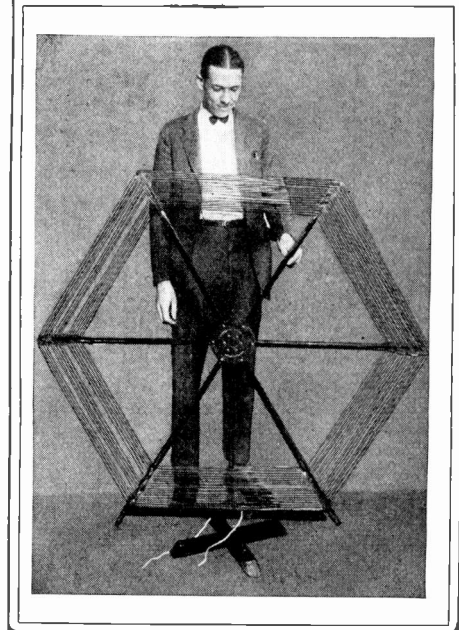
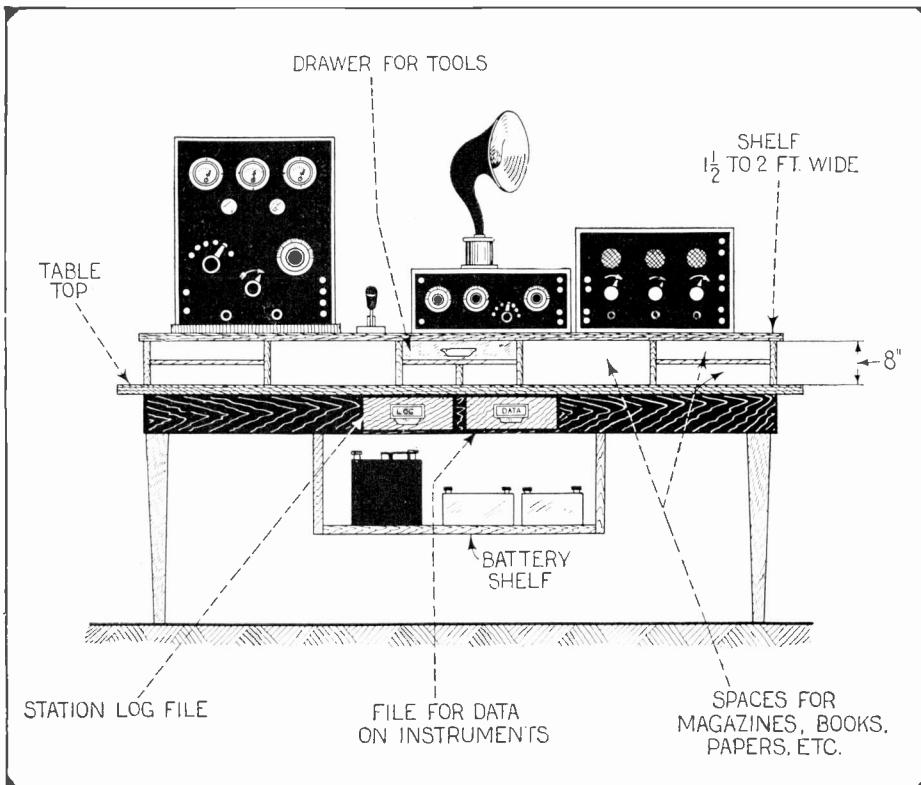

The drawings and photo above show exact details for building the Rogers' cage loop antenna. This loop has been tested in the Radio News Laboratories, and has proven very efficient. It brings in signals approximately twice as strong as a single wire loop of the same size. This loop has a natural wave length of 246 meters. When it is shunted by a .0005 variable condenser, it has a wave-length range from 260 to 550 meters. When shunted by a .001 M. F. condenser, its wave-length runs to about 700 meters. The main advantages of the new loop are very low radio-frequency resistance, owing to the cage construction, and low distributed capacity due to the spacing of the wires. The results obtained with this loop show that even the ordinary loops can be greatly improved by winding them with the largest stranded or woven copper ribbon or tubing available.

Above will be seen a suggestion for the arrangement of a table with spaces provided for the filing of magazines, papers and other equipment which usually clutters up the table of amateur Radio stations. Drawers may be provided with card indexes for call letters and other data. Under the table, a shelf should be provided upon which may be placed the "A" and "B" batteries and the battery charger. This keeps them off the floor and prevents a tangle of wires in which one's feet are liable to be caught.

—By Thomas W. Heine.

# Well Made Radio Cabinet



At the left is shown the radio cabinet of Harry Huntley. The receiver with its detector and two stages of amplification is housed in the top of the cabinet. The storage and "B" batteries, together with a battery charger and a bottle of distilled water are housed in the bottom of the cabinet. There is a voltmeter and a series of switches mounted in the center panel. The loud speaker sits on the shelf at the side.

At the right is shown the cabinet closed. In this position it makes a piece of furniture of which anyone might be proud. The switches along the center panel operate the batteries and the loud talker. A push button throws the voltmeter in circuit. The circuits are so arranged that the storage battery is thrown from the set into the charging circuit by means of a double-pole double-throw switch. Changes from detector, to one stage of amplification or two stages of amplification are also made by throwing switches on the center panel. The bottom of the cabinet also contains a hydrometer.

At the bottom is shown the composite connections in this extremely well constructed set. Note the diversity of the circuits, even to the dash light, and how they are all controlled through the central panel, an idea many amateurs might do well to copy.

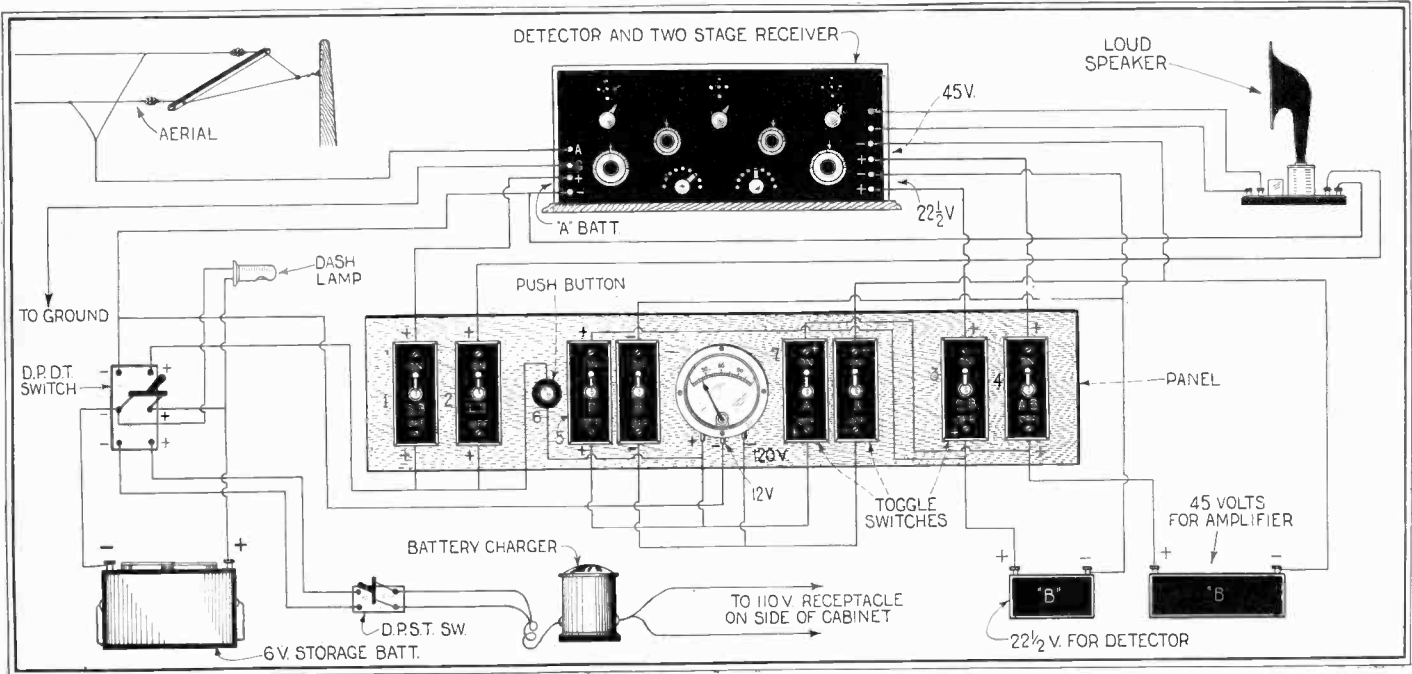

# Liquid Air In Vacuum Tube Work

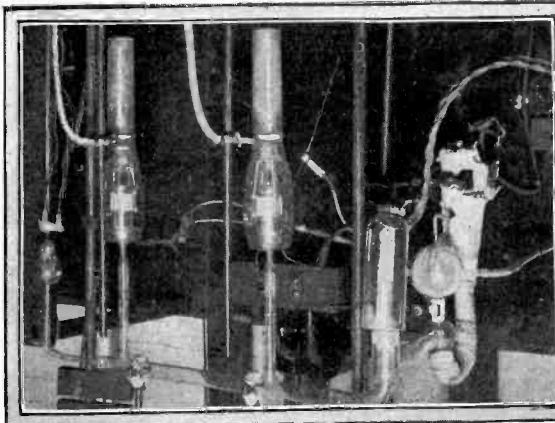

In manufacturing radio vacuum tubes, using mercury vacuum pumps the Western Electric Co. uses a liquid air trap to freeze and keep mercury vapors from returning to the tubes. (Above.) At the right is shown the liquid air "still" in operation.

# Radio Oracle

In this Department we publish questions and answers which we feel are of interest to the novice and amateur. Letters addressed to this Department cannot be answered free. A charge of 25c is made for all questions where a personal answer is desired.

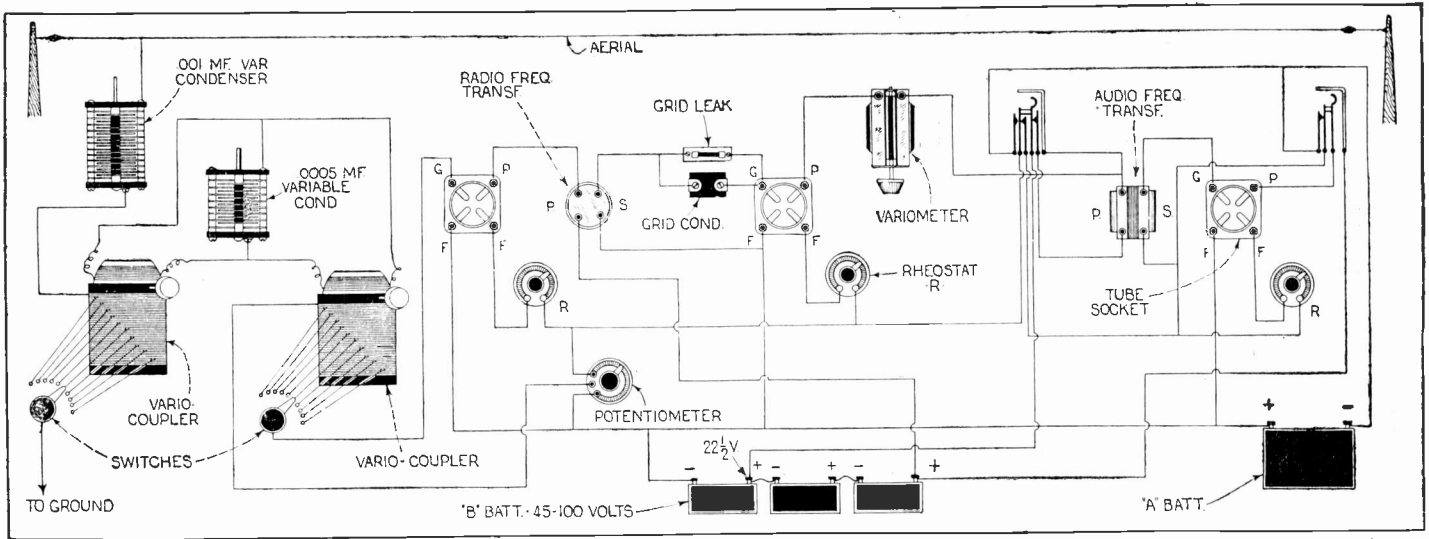

Q. 196. The selective tuner which was illustrated in the February, 1923, issue of this magazine may be used in connection with one stage of radio frequency amplification, a vacuum tube detector, and one stage of audio frequency amplification, using the circuit illustrated above. This method of connecting the instruments will give extremely sharp tuning under all conditions and regeneration is accomplished by means of the variometer.

## ONE STAGE R. F. AND STAGE A. F. AMPLIFICATION

(196) Joseph C. Haggbart, La Crosse, Wisconsin, asks:

Q. 1. Can you show me how to connect one stage of radio frequency and one stage of audio frequency amplification to the circuit diagram shown in Fig. 4 on page 990 of the February, 1923 issue of SCIENCE AND INVENTION, using filament control jacks?

A. 1. You may connect your instrument as shown in the diagram in these columns.

## VARIABLE GRID LEAK

(197) A. K. Force, Middletown, N. Y., wants to know:

Q. 1. How can I make a fairly serviceable variable grid leak which will give a constant variation such as is not obtained in those leaks using switch points?

A. 1. You will find in these columns an

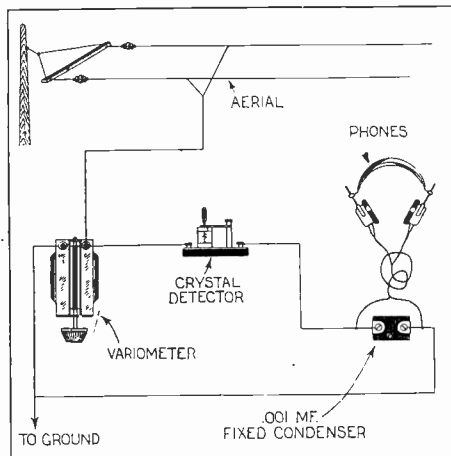

Q. 199. A crystal receiving set using only one tuning control may be connected as illustrated above. Selectivity is not very high, but the volume obtained is very good.

illustration which will aid you in constructing such a variable grid leak. The basis of the instrument is an old rheostat of the type making use of a fibre ring upon which the resistance wire was wound. The wire is removed and the upper edge of the fibre ring filed smooth. This edge is then coated with several coats of India ink, each coat being allowed to soak into the fibre. This process will be assisted greatly if the ink is applied while warm.

## DATA ON TWO-SLIDE TUNER

(198) Lawrence Higgins, Chicago, Ill., requests:

Q. 1. Kindly give accurate data for the construction of a two-slide tuner capable of tuning to 600 meters when shunted by a variable condenser with a capacity of .0005 mf.

A. 1. You will find a diagram in these columns giving all the necessary data on the instrument you mention.

## SINGLE CONTROL RECEIVING SET

(199) George C. Stewart, Cincinnati, Ohio, asks:

Q. 1. Can you give me a circuit diagram showing how to connect up the instruments

necessary for a single control receiving set using a crystal detector?

A. 1. In these columns there is a diagram showing how to connect up a variometer with a crystal detector and a fixed condenser. This probably is the simplest type of receiving set that it is possible to construct and operate. The only control is the variation of the variometer.

## 5 MIL-HENRY INDUCTANCES

(200) Arthur M. Van Wick, Richmond Hill, N. Y., requests:

Q. 1. Can you give me accurate data on the construction of a 5 mil-henry inductance or radio frequency choke coil, both single layer and double layer wound?

A. 1. A diagram in these columns gives all the necessary information. The method of bank winding a double layer coil is also indicated.

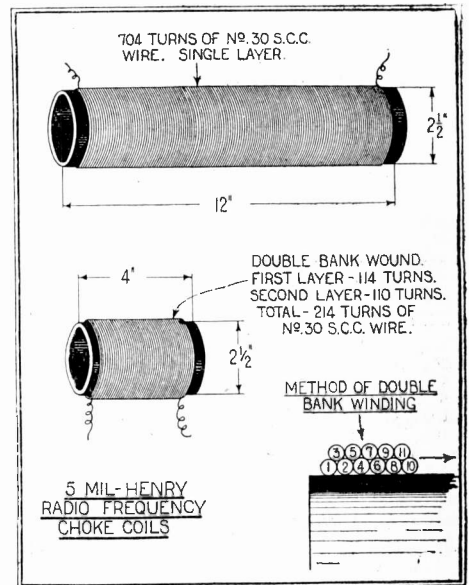

Q. 200. In various radio receiving and transmitting circuits, it is necessary to use radio frequency choke coils. Two methods of winding a 5 mil-henry choke coil are shown above, one using only a single layer of winding and the other two layers, bank wound.

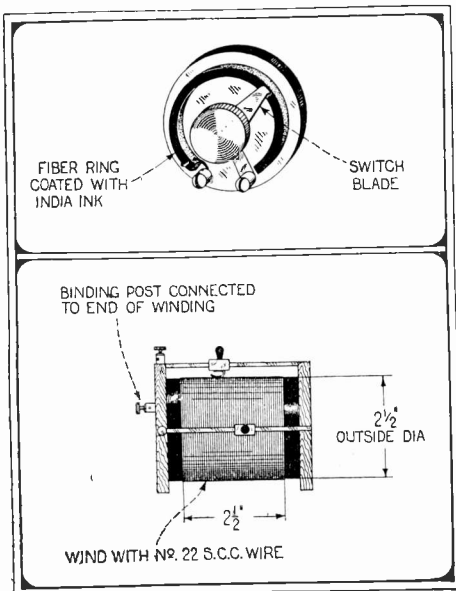

Q. 197. The top illustration shows the construction details of a variable grid leak.  
Q. 198. The lower diagram gives all the necessary data for a two-slide tuner, for use on the lower wave-lengths.

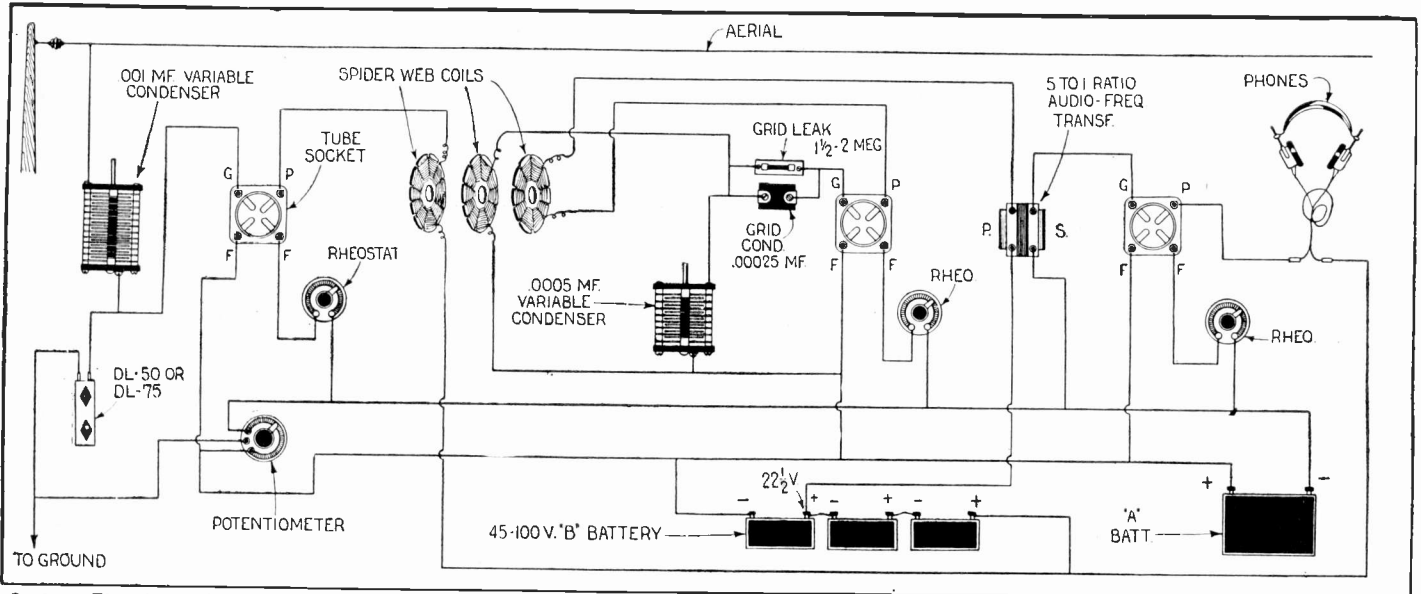

Q. 201. The circuit diagram of a radio receiving set employing one stage of tuned radio frequency amplification, a vacuum tube detector and one stage of audio frequency amplification, appears above. The tickler coil pro-

vides regeneration in the detector circuit only. The sizes of the coils must be determined by experiment and be adapted to the wave-length it is desired to receive. This circuit gives excellent selectivity and is good for D.X.

**R. F. AND A. F. AMPLIFICATION**

(201) Harold C. Vender, Sacramento, Cal., wants to know:

Q. 1. Can you show me how to connect up one stage of radio frequency and one stage of audio frequency amplification using three spiderweb coils between the radio frequency amplifier and the detector?

A. 1. In order to do this, it is necessary to tune the antenna circuit by means of a variable condenser and a fixed or variable inductance. A diagram is shown in these columns putting forth all the necessary connections and all the data will be found thereon.

**VARIOMETER AND TICKLER COIL**

(202) Frank Prell, Osceola, Nebraska, wants to know:

G. 1. What would be the best way to use a variometer for the tuning inductance and a honeycomb coil for the tickler coil so as to produce regeneration?

A. 1. A honeycomb coil placed in inductive relation to your variometer as illustrated in these columns, could very readily be used to obtain regeneration in a radio receiving circuit. If the bracket used for supporting the honeycomb coils was so arranged that the inductive relation between the variometer and the tickler coil could be changed at will, better results would be obtained.

Q. 2. Should a switch be used in the "B" battery circuit so that the current may be cut off when the set is not in use?

A. 2. A switch in the "B" battery circuit is advisable in order to eliminate any chance of short-circuiting the "B" battery while changing connections or otherwise working on the set.

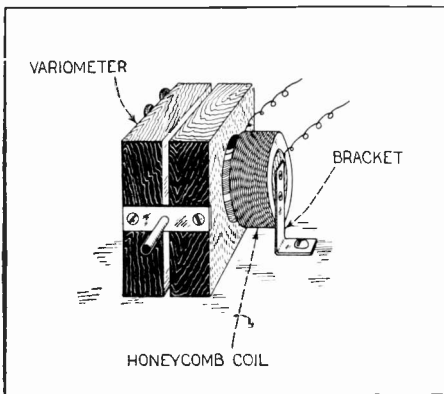

Q. 202. By placing a honeycomb coil in inductive relation to a variometer as shown above, regeneration by the feed-back principle will be obtained.

**CRYSTAL RECEIVING SET CIRCUIT**

(203) W. M. Riggs, Cincinnati, Ohio, asks:

Q. 1. How can a short wave regenerative

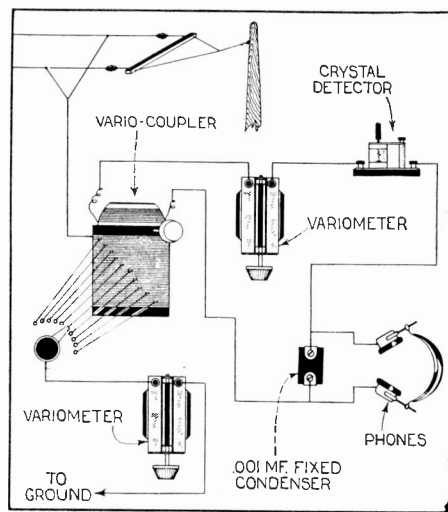

Q. 203. A selective and efficient hook-up using a crystal detector is shown above.

tuner, employing two variometers and a variocoupler be used with crystal detector?

A. 1. The circuit diagram found in these columns shows the necessary connections. This circuit is, of course, not regenerative.

**VARIOMETER CONNECTIONS**

(204) Ward Stanley, Oakes, North Dakota, requests:

Q. 1. How are the two coils of a variometer wound, and how are they connected together?

A. 1. The two coils of a variometer are always wound in the same direction and they are connected in series with each other, as illustrated in these columns.

**LIMIT TO WAVE-LENGTH**

(205) J. E. Peters, Hartman, Ark., requests:

Q. 1. Can you tell me what the limit of the wave-length of a tuning coil is and does the wave-length to which it will tune affect the receiving range?

A. 1. The limit of the wave-length for a tuning coil depends upon the size of the core, the amount of wire and the size of the wire wound thereon. Increasing the wave-length will not increase the receiving range in the least. These two factors are entirely distinct from each other.

**VARIOCOUPLER QUERY**

(206) Joseph Scafede, Pittsburgh, Pa., asks:

Q. 1. Should the secondary of a variocoupler be wound on a tube of the same size as the primary, or of different size?

A. 1. In constructing a variocoupler, the secondary must be wound on a tube much smaller than the primary tube, in order that it may rotate. Wooden standards or supports may be fastened on the outside of the primary, through which a brass rod is passed, to which rod the secondary is fastened.

**BUZZER TEST**

(207) Fred H. Sander, Malden, Mass., wants to know:

Q. 1. What is the best way to test the minerals used in a radio receiving set?

A. 1. The best system for testing radio receiving crystals is to use a high-pitched buzzer. This buzzer should be placed in a box, and packed in with cotton, so as to reduce the amount of mechanical sound produced. Leads are brought out from the two binding posts of the buzzer and connected to a battery and switch, and a third lead is brought out from the contact point of the buzzer. If a single circuit tuner is used, connect this third lead to the ground connection of the set. If an inductively coupled tuner is used, connect the third lead directly to one post of the detector. Now, by turning on the switch, and adjusting the cat whisker over the surface of the mineral, a loud buzz will be heard when the cat whisker is on a sensitive spot.

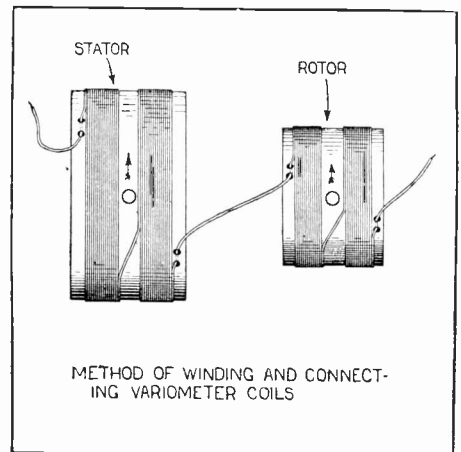

Q. 204. The rotor and stator of a variometer are always wound in the same direction and connected as shown above.



# LATEST PATENTS

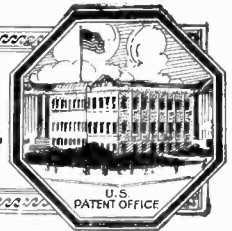

## Oscillating Fan

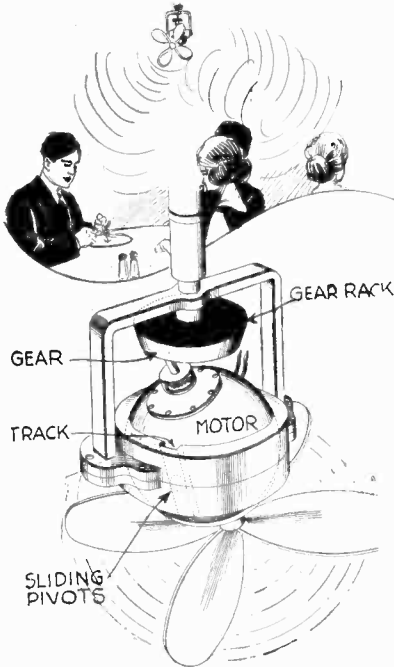

No. 1,456,433 issued to Maurice M. Glasser. This arrangement for a ceiling fan causes the fan to oscillate. The motor rocks up and down in a slot where a sliding pivot guides it. Opposite the fan on the shaft of the motor is a gear and rack, which causes the fan to swing in a circle.

## Advertising Device

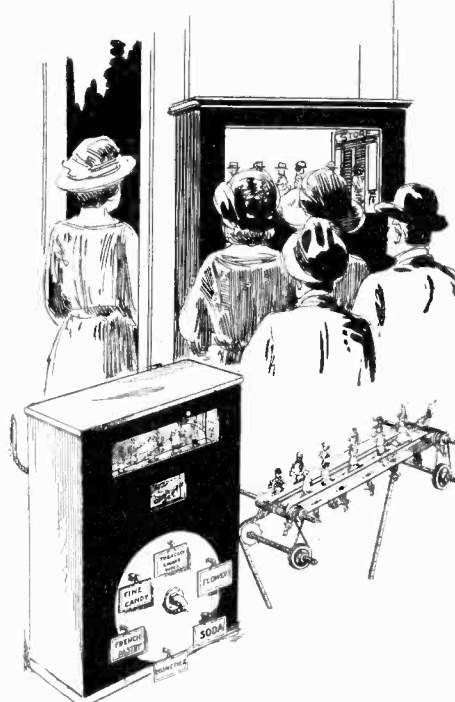

No. 1,446,680 issued to Ned Winkler. In this window display a number of figures are mounted on two endless belts traveling in opposite directions. The figures enter a store, and then leave the store laden with bundles. A disk rotates below and display placards are exposed.

## Wind Wheel

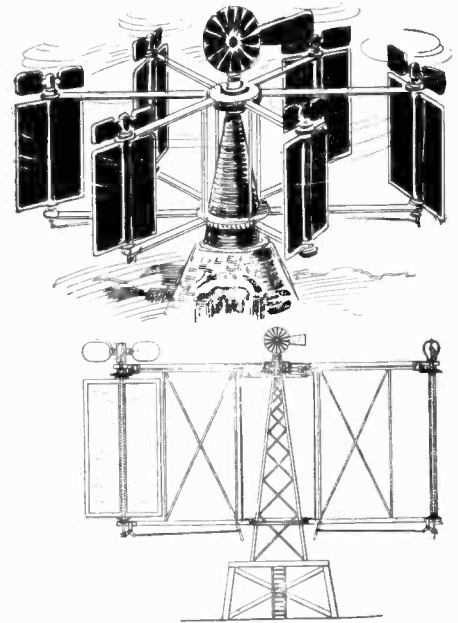

No. 1,445,367 issued to Frank A. Stirtan. The invention illustrated obtains a maximum efficiency from wind wheels. The invention contemplates the use of a vertically pivoted rotor carrying a number of sails which act in synchronism as the rotor revolves to present the maximum sail surface.

## Airship Mooring

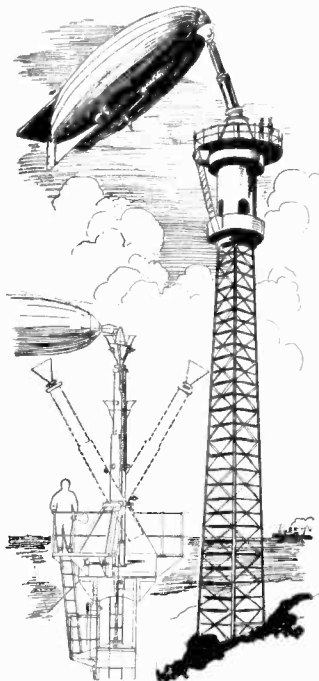

No. 1,448,088 issued to George Herbert Scott. The mooring mast illustrated is fitted with an arm on top of the mast head, which is telescopic in nature and which has complete azimuthal freedom. It is thus able to assume any inclination within limits of course. The airship nosing down to the top of the mast is coupled to it by means of male and female plugs, and the shock of the landing taken up by the swinging tube and by springs which tend to maintain this in a horizontal position.

## Automobile Fender

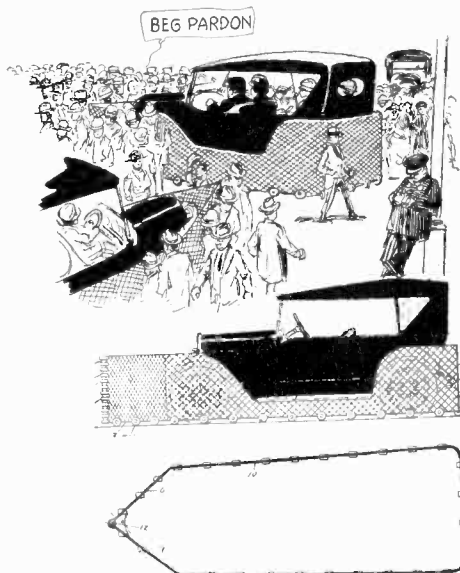

No. 1,444,558 issued to Max Scheffel. Perhaps if the traffic gets much more dense than it is at present in some of the larger cities, we may find it necessary to drive around in automobiles equipped as illustrated in the above drawing. The inventor has designed a fender which runs along the ground on tiny rubber tired wheels. It is entirely made of wire screening and surrounds the automobile completely. It is evident that an automobile equipped with such a fender could not possibly severely maim or injure anyone in its path; particularly would this be true if the device was sufficiently heavy to prevent the automobile from increasing its speed. It cannot be doubted that such a device affords perfect protection to the car itself.

## Cigarette Extinguisher

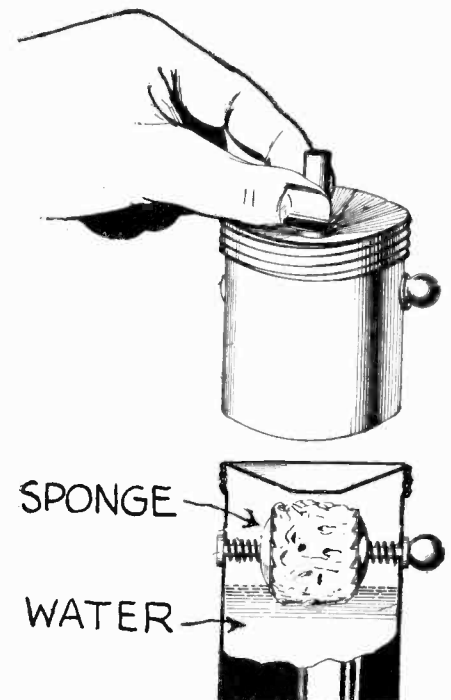

No. 1,464,998, issued to Charles F. Pratt. This is an interesting little novelty for extinguishing cigarettes. A sponge is supported on either side in a receptacle containing water. When placing a cigarette or cigar into the hole in the top of the container, the water on the sponge automatically extinguishes it. The cigarette may then be dropped into the container.

# Scientific Humor

**The Short Sir Quit.**—REMUS: "Whar yo' all g'wine wid dat baby food, Mose?"

MOSE: "Mah wife Dinah give me a son las' night."

REMUS: "Dasso, what you g'wine call him?"

MOSE: "Lectricity."

REMUS: "Am he as shockin' as dat?"

MOSE: "No, but what ailse can we call him when he comes from Dinah-Mose?"—*Bison.*

**We Want to Know.**—What makes a pison ring?

How much does the Milky Way?

Where does the Gulf Stream?—*Rice Owl.*

**A Befitting Answer.**—RASTUS: "Ah can't get dis spot off'n yo' trousers."

STUDENT: "Have you tried gasoline?"

RASTUS: "Yas, suh."

STUDENT: "Have you tried ammonia?"

RASTUS: "Naw suh, but I'm almost sure they'll fit."—*Yellow Jacket.*



**Some Distance.**—FIRST RADIOPHAN: "Just think, I got Paris last night."  
SECOND RADIOPHAN: "And I got London."  
THIRD RADIOPHAN: "And I listened in until two o'clock this morning and got h—l."—*Carl C. Sattell.*

**A Direction Finder.**—LITTLE JACK: "Say Ma, what did pa mean when he said he was the captain of this ship?"

MA: "Oh that's a polite way of letting us know that he is the head of the house."

LITTLE JACK (after a few moments' silence): "Well, if he's the captain, Ma, you're the pilot and I'm the compass."

MA: "Why the compass?"

LITTLE JACK: "Well ain't the captain and pilot always boxing the compass?"—*Harry Rowe, Jr.*

**Let's Get At 'Em!**—PROFESSOR: "Tell about atoms."

STUDENT: "Why—er—Adam was the first man!"—*Frank Gibson.*



**Yes, Without Aerials.**—MRS. DORCAS: "Women are more clever than men."

DORCAS: "In some ways. At any rate, they used to broadcast things from the housetops long before we'd ever heard of the radio."—*Jas. J. O'Connell.*

**Wisdom at Large.**—PROFESSOR (to Biology class): "Now these bacteria are largely very small though a small number of them sometimes grow to be very large for their size."—*Randolph Howorth.*

**Wired Wireless.**—CRAWFORD: "Mrs. Snooper quarreled with her husband about having a wireless?"

CRAWSHAW: "He told her he was sure she could listen in all right without going to the expense of a radio set."—*Jas. J. O'Connell.*

**The Merry Go Round.**—PROFESSOR: "Describe centrifugal motion."

STUDENT: "That's the way your head feels after drinking some of this Anti-Prohibition hooch!"—*Frank Gibson.*

## First Prize \$3.00



### An Eye Opener.

The Henry F

Co. was

holding an executive meeting.

They were trying to devise a new door for their car, which would look a little different from the present one, because D..... Bros. had just put out a car with doors that looked like theirs. Nobody had any suggestion to offer. Finally the chairman decided to send a telegram to their absent assistant engineer.

Next day back came an answer to the telegram: "Build it solid and send a can opener."—*William J. Murphy.*

**A Noisy Transmitter.**—IRATE CITIZEN (from his bedroom window): "Say you down there; who are you talking to?"

INTOXICATED ROMEO: "Nobuddy n'perticler. I'm jesh broadcastin'."—*Agwan.*

**WE** receive daily from one to two hundred contributions to this department. Of these only one or two are available. We desire to publish only scientific humor and all contributions should be original if possible. Do not copy jokes from old books or other publications as they have little or no chance here. By scientific humor we mean only such jokes as contain something of a scientific nature. Note our prize winners. Write each joke on a separate sheet and sign your name and address to it. Write only on one side of sheet. No letters acknowledged unless postage is included.

All jokes published here are paid for at the rate of one dollar each, besides the first prize of three dollars for the best jokes submitted each month. In the event that two people send in the same joke so as to "tie" for the prize, then the sum of three dollars in cash will be paid to each one.

**Wrong (.) Indigestion.**—TEACHER: "Is there any connecting link between the animal and vegetable kingdom?"

WILLIE: "Yes, ma'am. Hash."

**Impossible to Exterminate Them.**—STOREKEEPER: "No, we don't sell radio powder, what do you want it for?"

CUSTOMER: "For radio bugs."—*Sidney Lang.*



"Wal, ye seen that yeller dog a chasin' ye, didn't ye?" inquired Constable Slackputter amicably. "When that dog can't keep up with a feller, the feller's a goin' more'n thutty miles an hour."—*Fred Brewster.*

**A Light Tale.**—SHE: "What is the smallest tail light you have ever seen?"

HE: "Oh! The one on a Ford."

SHE: "Not on your life. What about the tail-light of a firefly."—*Randolph Howorth.*

**A Super-Expert.**—"You say the efficiency expert you hired is cutting down every salary except his own. Do you think that fair?"

"It will be," replied the manufacturer. "As soon as he gets through I'm going to fire him."—*Jas. J. O'Connell.*

**Broadcasting a Joke.**—"That's a pretty good joke," exclaimed the radio operator after somebody had sprung a hot one.

Then, reaching for his instruments he added thoughtfully, "I'll tell the world."—*Harry Richter.*

### He'll Ring Her Neck.

Modern inventions play an important part in our every-day life. A telephone, for example, is an innocent looking tool yet it causes many complicated situations.



Friend wife was visiting her mother and dear "hubby" was endeavoring to survive as best he could. Each evening by means of the telephone they learned the good or bad news of the day. On a certain eventful evening during the course of the conversation the wife inquired of her devoted mate as to his actions of the present moment. Being a truthful chap our hero replied that, if the truth was demanded, he was washing his B. V. D.'s. At this juncture Central sung out in an awe-inspiring voice, "I'm ringing them for you!" Whereupon the family cat turned a back somersault and another divorce case was in the offing.—*Tiger.*

**Correct.**—BOY (Pointing to an Electric Meter): "Pop, what's that thing?"  
POP: "Oh! that's an Electric Racer."—*Carl C. Sattell.*

**A Shirt-Waste**—In a small town a resident calls central for a number. Central does not answer promptly, so the man forgets the number while waiting.

CENTRAL (At last): "Number."

RESIDENT (In his long wait): "I forgot the number, so keep your shirt on until I find it."

This makes central very angry and she tells the manager, who next day tells the resident that he must call central and apologize or his phone will be removed.

The culprit calls central, saying: "Is this the lady whom I told yesterday to keep her shirt on?"

CENTRAL (Snappy): "Yes, I am."  
RESIDENT: "Well you can take it off now."—*Fisher H. Carlile.*

**Hooched Up.**—FIRST INEBRIATE: "Shay, Bill, what do they call a connection for a radio set, a— a— what?"

SECOND DITTO (Staring blankly): "Hic-up!"

FIRST INEBRIATE: "Thash it—Hook up!"  
—*F. T. Peterson.*





# THE ORACLE



The "Oracle" is for the sole benefit of all scientific students. Questions will be answered here for the benefit of all, but only matter of sufficient interest will be published. Rules under which questions will be answered:

1. Only three questions can be submitted to be answered.
2. Only one side of sheet to be written on; matter must be typewritten or else written in ink, no penciled matter considered.

3. Sketches, diagrams, etc., must be on separate sheets. Questions addressed to the department cannot be answered by mail free of charge.

4. If a quick answer is desired by mail, a nominal charge of 25 cents is made for each question. If the questions entail considerable research work or intricate calculations a special rate will be charged. Correspondents will be informed as to the fee before such questions are answered.

## THE PIN-HOLE CAMERA AGAIN.

With reference to the pin-hole camera described in this department in the October, 1923, issue, one of our correspondents, Mr. Allen B. Garratt, has offered further information on the same.

He states that instead of drilling or punching a hole directly in front of the box used, that a

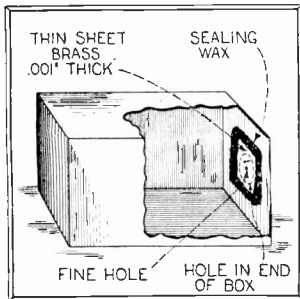

An improved design pin-hole camera is shown here. Instead of punching the hole directly in the front of the box the hole is made by running a needle through a very thin piece of brass or foil.

piece of very thin sheet brass, tinsel or tinfoil should be used, in the center of which is punched a fine hole with a needle. Both sides of the plate sheet are then to be rubbed down on a fine oil-stone, taking off any burr, whereupon a very nearly perfect hole will result. This strip of brass is to be fastened on the inside of the camera box as illustrated herewith, after a hole about one inch in diameter has been bored in the box. The sheet of metal is to be fastened on with sealing wax, making sure that a perfectly light-tight joint is obtained.

Mr. Garratt also stated that both sides of the brass sheet should be blackened, as well as the edges of the hole. He advises the use of lamp black in turpentine with a few drops of varnish added.

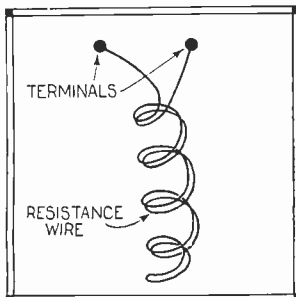

Here is shown a method of winding a non-inductive resistance. By winding the turns back over each other as shown in the sketch the self-inductance of the coil is practically eliminated.

## THE ELECTRIC CARILLON

ALSO called electric Chimes, can be made by any experimenter within a few hours. Most of the material will be found about the house as all you need are a few bells and some old bottles. Beautiful music can be played upon the Carillon. This instrument is described fully in the December issue of PRACTICAL ELECTRICS together with the following interesting articles.

- TRICK SHUFFLE BOARD
- ECHO DEEP-SEA SOUNDING.
- ELECTRIC BASEBALL SCORE BOARD  
By Samuel Fariss
- MAMMOTH FAN
- HIGH VOLTAGE TRANSMISSION  
By F. W. Peek, Jr., Consulting Engineer, General Electric Company
- VOYAGING BEYOND THE VISIBLE  
By M. R. McCabe
- HOUSE BELL AND ALARM CIRCUIT  
By J. M. Bellaire, Paris Correspondent

## NON-INDUCTIVE RESISTANCE

(1584) J. C. Thomas, Arlington, New Jersey, wants to know:

Q. 1. What is meant by a non-inductively wound resistance and how is such a coil to be made?

A. 1. A non-inductive resistance is one in which successive turns have little or no inductive effect on each other. Such a coil is wound as illustrated herewith. The wire is measured off for the required resistance, doubled, and wound in coil shape from either end, connecting the two ends of the wire to suitable terminals, according to the type of apparatus in which the resistance coil is to be used.

This method of wiring resistance is used where non-inductance is desired such as in the resistance coils of a Wheatstone bridge or a standard resistance box used in calibrating other instruments in the laboratory.

## MODEL MARINE ENGINE

(1585) E. Edmunds, Hoboken, New Jersey, asks:

Q. 1. Can you tell me where to obtain actual working drawings for the construction of a model marine engine suitable for propelling a hydroplane or other model boat about four feet long?

A. 1. Upon receipt of a stamped addressed envelope we will supply the name and address of a company who supplies such a set of complete drawings at a nominal price.

## SOLENOID TYPE OF METER

(1586) R. D. Sloane, Chicago, Ill., asks:  
Q. 1. What is the principle of the common ammeter and volt-meter such as those known as the watch-case type?

A. 1. The illustration herewith shows such a meter, which depends upon solenoid action. The

Here is illustrated a solenoid type of volt-ammeter. The variation in the strength of the current affect the power of the solenoid's action upon the iron plunger to which the indicator is attached.

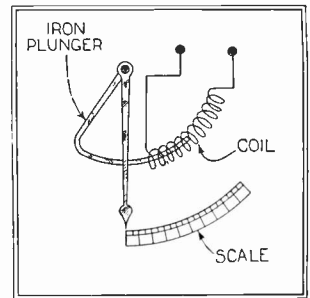

coil of wire is the solenoid and the curved strip of iron is the plunger. When current passes through the coil, the iron plunger is drawn within it, by the magnet action, to a greater or lesser extent. This, of course, indicates on a scale as the shaft carrying the iron plunger is firmly affixed to the pointer. In common practice, ammeters are wound with comparatively heavy wire on the solenoid coil, while volt meters have a very fine wire.

## DIVIDED CIRCUIT

(1587) L. K. Kennedy, Plainfield, N. J., wants to know:

Q. 1. What is meant by a divided circuit in electrical work?

The amount of current carried by each of two conductors in a common circuit where the circuit is divided, as shown in the sketch, is in inverse ratio to the resistance of each conductor.

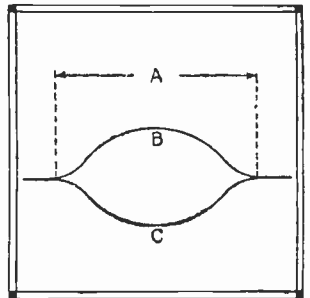

## OUR \$12,000 PRIZE CONTEST

THE next issue of SCIENCE AND INVENTION will witness the first issue in which we will award prizes to our correspondents and contributors for the best articles submitted during the month. From the way the manuscripts have been pouring in, we feel sure that the January issue will eclipse all former ones; and we have been receiving some mighty good material too. Our correspondents are scouting the field far and wide, and those that stay at home have thought up a host of novel things, many of which you will find in the January issue.

### ARTICLES TO APPEAR IN JANUARY SCIENCE AND INVENTION.

- How to Make Butterfly Trays, By Dr. Ernest Bade.
- Heat From the Stars—How It Is Measured by Sensitive Thermo-Couples, By Edison Pettit, Astronomer, Mt. Wilson Observatory.
- Facts About Oil and Coke Fuel for House Furnaces, By H. Winfield Secor.
- The Latest Developments in Automobiles.
- Raising Sunken Ships by Freezing Them in a Block of Ice.
- The Latest Attempts at Perpetual Motion.
- The New Contra-Propeller for Airplanes and Ships.
- At the County Fair—How Scientific Gambling Devices Separate the Public From Their Money, By W. C. Kelly.
- New Reflected Stage Lighting Approaches Daylight, By A. P. Peck.
- The Secret of the Submarine City—No. 25 of Dr. Hackensaw's Secrets, By Clement Fezandie.
- Largest Artificial Lightning Machine for the Movies, By Phil Gersdorf.
- Wireless Energy for Autos and Trains.
- Two Remarkable New Steam Turbines.
- Over Forty Radio Articles—Giving the Latest Developments in Commercial Apparatus and How-to-Make-it Ideas.

## FREE INFORMATION

IF you want additional information concerning any of the subjects illustrated and described in this number of SCIENCE AND INVENTION, we shall be glad to give you other data we have at our command. To make this work as easy as possible for our editors, please be brief. Write only on one side of the paper and state exactly in a few words just what it is you desire further information on. We have the original manuscripts and drawings of many of these articles in our files and can furnish much additional data in most cases. Please do not fail to send stamped and self-addressed envelope.

Address all inquiries of this nature to INFORMATION EDITOR c/o Science and Invention, 53 Park Place, New York City.

A. 1. When two conductances of certain resistances, either equal or unequal in value are joined in parallel, as illustrated in these columns, the current passing through the entire circuit will divide itself between the two conductors. The amount of current passing through each one will be in inverse proportion to the resistances of the wires B and C.

The ability of any circuit to conduct an electrical current is represented by its conductance, which is the reciprocal of the resistance. The conductance of a divided circuit is equal to the sum of the conductances of its various parts. Suppose that A is the sum of the resistances of the wires B and C. Then the joined conductance of the entire circuit equals  $\frac{1}{A} = \frac{1}{B} + \frac{1}{C} = \frac{B+C}{BC}$

Now that we have the joint conductance, we can find the joint resistance by taking the reciprocal of the conductances we have for the resistance  $A = \frac{BC}{B+C}$

From this we can state a rule as follows: The joint resistance of a divided circuit, or of resistances in parallel is equal to the product of the two separate resistances divided by their sum.

**COMPARATIVE SIZES OF THE PLANETS**

(1588) Frank Mayo, Boston, Mass., asks the Oracle:

Q. 1. What is the diameter of the smallest and of the largest planet of our solar system?

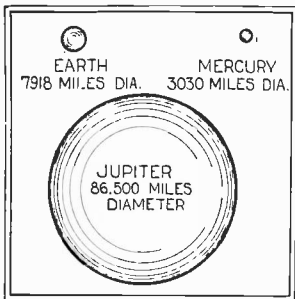

Mercury is the smallest planet in our Solar System and Jupiter is the largest. Their relative sizes together with the comparative size of the Earth is shown in the sketch. Mercury is the nearest planet to the sun.

A. 1. Mercury, the nearest planet to the sun is the smallest, of the planets usually so-called, measuring 3,030 miles in diameter. Jupiter is the largest, measuring 86,500 miles in diameter. The illustration herewith shows the comparative sizes of the Earth, Mercury and Jupiter.

**NICKEL PLATING ANODES**

(1589) Ben Benoit, Pasadena, Cal., asks: Q. 1. What kind of anodes must be used in nickel electro-plating?

A. 1. The anodes used for this work must consist of nickel which is at least 99% pure. If there is a greater percentage of other metals present, the plating will be discolored and will not take a high polish.

**WIRELESS POWER**

(1590) J. G. Benoit, Montreal, Que., Canada, asks:

Q. 1. Has anyone ever succeeded in running small machinery at a distance by wireless, in other words, without having any metallic connection between the source of power and the apparatus?

A. 1. Nikola Tesla has succeeded in running a small motor by wireless, and also in lighting several lamps. His experiments have been described from time to time in various past issues of SCIENCE AND INVENTION.

**THE AMOEBIA**

(1591) Louis Hoffmeister, Bronx, New York, asks:

Q. 1. What is the simplest form of animal life?

A. 1. The Amoeba, a microscopically small animal, is probably one of the simplest types of all animals, consisting of a single mobile cell-like structure and a nucleus. This tiny animal, illustrated herewith, moves by pushing out out-flowing lobes, which are merely a part of the body elongated, and then drawing itself up. Food is taken into the organism in much the same manner, the entire body of the Amoeba wrapping itself around the food, forcing it into the food vacuole. After assimilating the food, waste matter is thrown off through the contractile vacuole. This tiny animal resembles an irregularly shaped speck of grayish colored jelly and is about one one-hundredth of an inch in diameter.

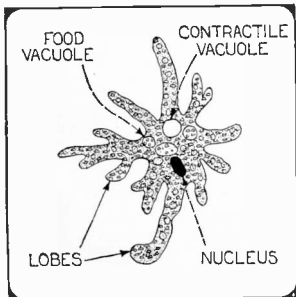

This is the Amoeba, the simplest form of animal life. It is a mobile cell-like animal with a central nucleus. It propels itself with out-flowing lobes which are a part of its body. It resembles gray jelly.

One method of soldering—and a very good one, too since it will withstand a great amount of strain, is shown here. The soldering iron must be very hot for this method, which is called "sweating a seam."

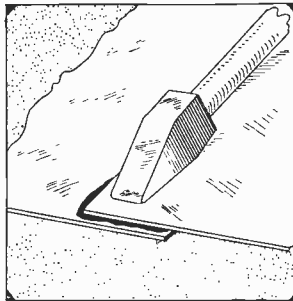

**SWEATING A SEAM**

(1592) Jack Wilbur, Roscoe, N. Y., wants to know:

Q. 1. What is meant by "sweating a seam" in soldering and how is it done?

A. 1. This term is used to designate the soldering of two metal strips or edges such as illustrated herewith. In doing this, a very hot soldering iron is used and is pressed on the top of the joint until the metals are hot. Solder is then allowed to flow between the faces of the metals to be united and the iron is held on the seam, so that literally, the solder sweats into the seam. The iron for this work must be very hot and the work done carefully in order to insure complete soldering of the joint. This makes a very tight joint and one which will withstand considerable strain.

**IMPORTANT**

**TO NEWSSTAND READERS**

IN order to eliminate all waste and unsold copies it has become necessary to supply newsstand dealers only with the actual number of copies for which they have orders. This makes it advisable to place an order with your newsdealer, asking him to reserve a copy for you every month. Otherwise he will not be able to supply your copy. For your convenience, we are appending herewith a blank which we ask you to be good enough to fill in and hand to your newsdealer. He will then be in a position to supply copies to you regularly every month. If you are interested in receiving your copy every month, do not fail to sign this blank. It costs you nothing to do so.

To ..... Newsdealer

Address .....

Please reserve for me ..... copies of SCIENCE & INVENTION every month until I notify you otherwise, and greatly obliged,

Name .....

Address .....

**REMOVING SCRATCHES FROM GLASS**

(1593) E. G. Adams, Rochester, N. Y., wants to know:

Q. 1. How can scratches be removed from plate glass without marring the surface?

A. 1. It is impossible to remove scratches from plate glass without grinding down the surface of the glass to a level with the bottom of the scratch.

Q. 2. Can hydrofluoric acid be used for this purpose?

A. 2. Any attempt to use hydrofluoric acid will leave a surface similar to ground glass, which must necessarily be polished thereafter.

**EXPANSION OF AIR**

(1594) Dominic Addeo, Long Branch, N. J., asks:

Q. 1. If a liter flask is heated from 50° F. to 70° F., what amount of air will be expelled therefrom by expansion?

A. 1. If a flask containing 1 liter of air is heated from 50° F. to 70° F., the volume of the gas will expand .05 liters and this amount will be expelled.

**MAGNETIC ATTRACTION**

(1595) R. S. Alexander, Avalon, Cal., wants to know:

Q. 1. Can you tell me of a chemical or a compound of chemicals that could be mixed into a paste with which an object could be painted, so that a person could be guided to this object by means of a compass being attracted by the composition used in the paint?

A. 1. The best and most reliable way for you to obtain the results you desire, would be to install a powerful permanent magnet at the point you desire a compass to be attracted to.

A magnet such as used on magnetos in automobiles and motorcycles, would attract a sensitive compass over a distance of probably five

or six feet. This would be the only way that you could obtain this result, but if you made a mixture of iron filings and glue, you could paint objects with it, and probably obtain an attraction over a distance of a fraction of an inch. This would be the very best you could do with any such paint or paste.

**SIMPLEST ELECTRIC CELL**

(1596) Jack Morrell, Long Island City, N. Y., says that he wishes to construct the simplest type of electric cell for demonstration. It must be one which does not require charging in order to deliver current.

A. 1. The voltaic cell illustrated herewith is probably the simplest type of electric cell which can be used for successful demonstration. It merely consists of a strip of copper and a strip of zinc immersed in an acid solution. Usually sulphuric acid is used. This cell will deliver about 1.05 volts, but will become polarized very rapidly under use. The polarization takes place when bubbles of hydrogen gas cover the surface of the copper plate. In order to restore the action, which is interrupted by polarization, the copper plate may be wiped off and replaced in the solution. The zinc must be amalgamated.

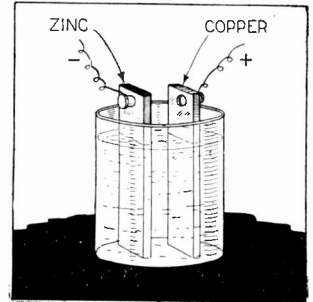

The simplest form of electric cell is shown here. It is merely a strip of copper and a strip of zinc immersed in a solution of sulphuric acid. Although the cell polarizes quickly it will deliver a little over one volt.

**RECTIFIERS**

(1597) John H. Barnes, Norwich, Conn., says that he understands that a crystal detector such as used in radio reception allows the current to pass through in only one direction. He asks:

Q. 1. Is it possible to fix a copper or other wire with some chemical compound so that the wire in question will allow a fairly large current to pass through in one direction and not in the other?

A. 1. Any of the rectifiers on the market today will perform the results you desire, but to our knowledge there is no way of obtaining the same result with some chemical or compound in the form of a wire. Many different kinds of substances used in radio work have the property of rectifying alternating currents, but only to a very slight degree. While they will rectify the extremely minute currents handled in radio telegraphy and telephony still they will not normally rectify any very great amount of current.

There is an experimenter in this city who has constructed a modification of the radio crystal detector, using a piece of the well-known crystal silicon, through which he claims that he is able to pass nearly one ampere A.C. and obtain D.C. on the output.

Not knowing just how you desire to use such an arrangement, we are unable to give you further information, but will be only too glad to advise further if the above will not suit your purpose.

**PUNCHING GASKET HOLES**

(1598) Leonard Bastin, Kansas City, Mo., asks: Q. 1. What is the simplest way to make holes in gaskets for use on automobiles in such places as between the crank case and the cylinder casting?

A. 1. First, a sheet of gasket material of the required size must be obtained and cut to the shape of the top edge of the crank case. The resulting rectangular strip is then placed over the crank case and by means of two ball hammers, placed as shown herewith, a neat hole of exactly the right size will be cut in the material. Care must be taken to do this work carefully, in order that the material of the gasket will not be torn unnecessarily. By careful manipulation the same results may be obtained with a single ball hammer by tapping on the gasket material carefully around the edges of the hole until the sharp corners of the metal cut the hole in the gasket.

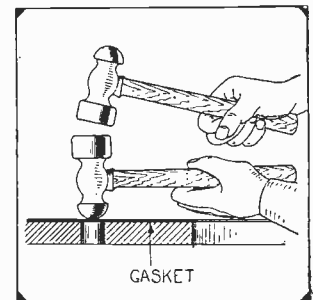

The simplest method of punching gasket holes is to place the blank gasket over the part which it is to fit and then place the ball peen hammer over the hole as shown and then tapping this hammer with another one.





# Tighten Your Grip on a Trade

## Be An Electrical Expert

At \$75 to \$200 a Week

Every up-to-date fellow knows what a future there is in electricity.

Big pay—fascinating work on land or sea—rapid advancement in a field where jobs are ten times more numerous than trained men to fill them, where \$75.00 a week is just a fair starter, where top notchers pull down ten thousand dollars or more a year—in a field, where any man if he wishes, can easily have a business of his own, have men working for him, **be his own boss!**

But what the average young man does NOT know, is what a simple, easy, A-B-C sort of a job it is to get started.

### You Can Start Right Now!

Yes, you. You don't need a thing you don't already have! You can read. You can write. You can figure. You can think. And in your breast is the fire of ambition—the desire to get ahead! All right, that's all you need—we can help you just as you are—just as we have helped scores, yes, thousands of other two-fisted young fellows determined to get out of the rut and into the electric field—into work that will be pleasant—easy—and all in your home, during spare time.

### Fascinating Home Study As You Hold Your Old Job

With the help we will give you, you can slip right into one of these big pay—he-man jobs and never lose a day's work. After a few weeks' start, you can earn enough in installation and electric repair jobs alone to more than pay for the Course and lay a foundation for an Electrical Contracting or Repair Shop Business of your own. When the proper time comes, we will tell you the easy way to go about doing it.

### The Most Practical, Thorough and Condensed Electrical Course Ever Written

This is the only home study electrical course that gives you the combined practical and theoretical training you must have before you can be a successful electrician without which you cannot succeed—with which you cannot fail.

Written not by ONE man, with the narrow one-man viewpoint, but by 22 of the brainiest, most successful, electrical experts ever drawn from the field of practice and theory. Gives you the complete mastery of the subject—qualifies you as electrical expert to boss jobs—fits you right into the kind of a job you want—and does it in shortest time—at lowest cost—with the

### Most Binding Guarantee of Results Ever Offered!

Satisfaction guaranteed or no sale! We not only SAY we can make you an electrical expert, we Guarantee it! If you are not absolutely satisfied when you have finished our Practical Electrical Course, we will refund every nickel you sent us.

**FREE!** Experimental Outfit Worth \$30 Find out all about our offer. Find out about the thousands who have taken this course in preference to all others and MADE GOOD. Find out about the Electric Library—four elegant volumes—worth \$25, but free. About the free Drafting Course worth another \$30. The free Experimental and Demonstration Outfit, including a real, not a make-shift Electric Motor, Wheatstone Bridge, etc.—the most scientific, high-grade and complete Experimental Outfit ever supplied with a Course in Electricity. Get all the facts without obligation, without expense! Just send the coupon!

## American School

Dept. E-926

Drexel Ave. and 58th Street, Chicago

**FREE**  
Electrical  
Coupon

American School,  
Dept. E-926, Chicago  
Please rush all information relative to your Course in Electricity. This obligates me in no way whatever.

Name.....

Address.....

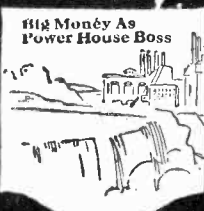
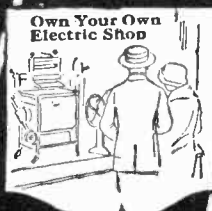

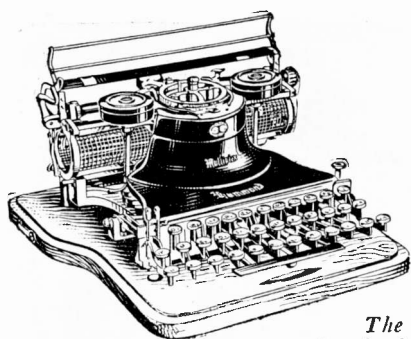

The  
Standard  
Hammond

Also made in Folding Portable Model

# The Greatest Invention

SINCE the development of visible writing 30 years ago

A typewriter that can use an almost unlimited number of types and languages.

*Many Sizes of type  
Many Styles of type  
Over 50 Languages  
all on the same Hammond!*

## VARIABLE SPACING

ON every Hammond Typewriter now made, you can change the spacing in width to fit the different SIZES of type; 11 characters to the inch for the large sizes, 14 characters to the inch for the medium sizes, and 18 characters to the inch for the tiny types—exclusive to the Hammond—which condense writing in less than one-third the space of ordinary typewriting.

THE NEW  
**Hammond**  
TYPEWRITER  
VARIABLE SPACING  
CHANGEABLE TYPE

Send for New Booklet

which explains many more wonders of the Hammond typewriter and illustrates its special usefulness for every profession.

**Write Today**

There is a Branch Office or Dealer near you. We will tell you where you can see the Hammond.

**Hammond Typewriter Corp.**  
544-A East 69th St., New York

## Dr. Hackensaw's Secrets

By CLEMENT FEZANDIÉ

(Continued from page 747)

sides, he imagines he will be able to hood-wink me."

"Do you think you can cure him? He looks like a pretty bad case."

"He is a hard case. In fact he is a resumé of the three classes of criminals: Those who receive their criminal instincts through inheritance, those who acquire them through evil training in their youth, and those who, through some physical cause that affects the brain, acquire a partial insanity or have their moral faculties warped."

"PEP" FEARS LOSING HER JOB

"Gee, doctor!" observed Pep, smiling, "If you cure all the criminals, you'll spoil my job as a reporter. Our newspapers would be pretty tame if everybody were good!"

"Not only the newspapers, Pep," replied Doctor Hackensaw, laughing, "but all our books, plays, and movies. What would a movie be without a villain? We owe more to the criminals than we are apt to imagine. The world would be somewhat monotonous without them. But I guess it will be some time before we get rid of the last of them."

"How do you set to the work of reform, doctor?"

"It all depends. If I can get hold of a baby I can do a great deal to eliminate undesirable inherited instincts. Oliver Wendell Holmes declared that early training would accomplish wonders, provided you began early enough. He added, however, that you might have to begin several thousand years before the baby was born. Personally, I believe that inherited instincts are of minor importance. Physical, mental, and moral inheritance can be controlled by proper means. Education is the important thing. Place the child of respectable parents in criminal surroundings, and he will almost certainly grow up a criminal. Take, on the other hand, the baby of criminal parents, give him into the custody of proper guardians, and he will become a virtuous man."

"The criminal is the product of poor education and poor conditions. Of course, physical defects play their part. Vicious cravings and appetites arise from morbid conditions. Disease of the brain may also lead to crime. To cure a criminal, you must first cure his body, including, of course, his brain. Then you must counteract his early vicious training."

"How can you do that?"

"Well, our knowledge of the brain is as yet at a rudimentary stage. Certain indications lead us to believe that each part of the brain has some definite function. Touch a certain portion of an animal's brain, and the animal will move its right leg. Touch another portion and it will move its right arm. The same thing seems to be true of the mental and moral faculties. Certain areas of the brain seem to be the seat of memory, others of the reasoning-power, others of the will-power. Of course, I am aware that these 'regional controls,' as they are called, are far from proved. In fact, modern experiments seem to show that if one portion of the brain is cut out, some other portion after a time is able to take up the functions of the portion removed. But normally we may assume that each area of the brain has some special function, and injury to that area will disturb the function."

REFORMATION BY OBLITERATING  
VICIOUS MEMORIES

"Taking this as my starting-point, I began my experiments. If, as I believe, it is a man's early training that is the principal cause of his going wrong, then if we could blot out that early training and start afresh,

we ought to be able to make a new man of him. In a word, I became convinced that all criminals could be cured if we could erase from their minds the memories they had acquired during their early life, the bad habits they had formed, and all knowledge of their vicious companions.

"Of course all of us have memories we should wish to destroy—memories of things done or left undone, or of ridiculous situations in which we have been placed, or superstitions we have acquired in youth.

"Unfortunately I have not yet found means of destroying separate memories—the task is far beyond my powers. I am obliged to obliterate practically everything that is in the mind and start again from the very beginning. This I accomplish by means of my 'Memory Obliterator,' a device that enables me to make a fallen woman forget her old life and begin anew; and that makes a criminal forget his crimes and his associates and leaves him free to start afresh. I can even make a drunkard forget his craving for drink."

"How does your machine work?"

"You must know, Miss Pep, that memory is a most peculiar thing—in fact every part of the body seems to possess a memory of its own. What we call habit is a sort of memory of the body. Take for example the stenographer working the keys of her typewriter. Her fingers seem to know just what distance to go to strike a certain key. She could work blindfold. This is the result of practice. Every action often repeated becomes a habit, and these habits constitute a kind of memory. A very strange fact is the persistence of memory. If you learned how to skate or how to ride a bicycle twenty years ago, and have never practiced since, you will be surprised to find that you have not forgotten the trick. In all probability every particle that composes your body has changed in those twenty years, but the habit remains. To explain this we must assume that the new particles in some way inherit the memories or habits of the old ones. The brain, as you may perhaps know, contains millions of microscopic neurones connected irregularly with each other by filaments—My theory was that these connections between the neurones must explain the association of ideas which is the basis of memory, one idea calling up the other ideas associated with it by means of the connecting filaments. Working on this theory I made experiments on the effect of X-rays, radium emanations, and wireless waves on these filaments. I struck the right method and found means of destroying the associations between the neurones without injuring them. In this way I am able to destroy past memories and so leave a clean page for the formation of new ones. It is this method that I am about to apply to the reformation of Six-Fingered Pete."

As the doctor finished speaking, Inspector Fox entered the room.

READY FOR THE OPERATION

"Pete is all ready for the operation," said he.

Pep and the doctor entered the operating room, where the patient was stretched motionless under the powerful electrical machine that was to destroy his memories of a life of crime and make a new man of him. An anaesthetic had been administered and all was in readiness.

Doctor Hackensaw rapidly divested himself of his coat and carefully adjusted the micrometer screws that regulated his "Memory Obliterator."

(Continued on page 794)

# Radio Catalogue Free—

**Write us  
a post card—**

**Address Dept. 40-R**

and we will send you free this 52 page catalogue of radio sets and parts. It also contains explanation of radio terms, map and list of broadcasting stations and much radio information, including an explanation of successful hook-ups and circuits.

You will be amazed at the low prices Ward's quote. A complete tube set having a range of 500 miles and more, including tubes, head set, batteries, and antenna equipment, as low as \$23.50.

This catalogue contains everything for the expert and amateur. Complete sets and every improved part for building sets, all the most up-to-date devices—at the lowest possible prices.

## Headquarters for Radio

Montgomery Ward & Co. is headquarters for Radio, selling everything direct by mail without the usual "Radio-profits." Why pay higher prices? Ward quality is the best and the prices will often save you one-third. Everything sold under our Fifty Year Old Guarantee,—Your Money Back if You Are Not Satisfied. Write today for your copy of this complete 52-page Radio Book.

**Write to our house nearest you. Address Dept. 40-R**

**Chicago Kansas City St. Paul Portland, Ore. Ft. Worth**

# Montgomery Ward & Co.

**The Oldest Mail Order House is Today the Most Progressive**





Let me send you this great book. Learn all about the wonderful electrical industry and how you can easily learn to earn \$3,500 to \$10,000 a year.

**BE A CERTIFICATED  
Electrical Expert  
EARN \$70 to \$200 A WEEK**

No matter what kind of work you are doing now, or how much you earn, electricity offers you more—a better job and bigger pay is waiting for you. Trained Electrical Experts (not common screw driver electricians) are in great demand at the highest salaries ever known. The opportunities for advancement and a real success are amazing. The enormous growth of the electrical industry snaps up men faster than they can be trained.

**EASY TO GET \$3,500.00 to \$10,000.00 A YEAR**

I will train you at home in your spare time to earn this fine big pay. In just a few short months you will be ready for a wonderful job that I will help you get. Lack of education or experience doesn't bar anyone. My simplified, up-to-the-minute, easily learned course, backed up with my 20 years of engineering experience, guarantees your success.

**—Outfit Free—  
Electrical Tools and Material**

I will give you free a whole outfit of electrical tools, material, measuring instruments and a real electric motor—not toys, but the real things, such as no other school has ever offered before. I will start you right in after your first few lessons doing practical work, in a practical way—work that will pay you extra money while you are learning and from \$3,500 to \$10,000 a year when you are trained.

**SATISFACTION GUARANTEED**

I don't merely promise you these things—I guarantee them. I send you a signed bond guaranteeing to return your whole tuition fee—every penny you pay me—if you are not 100% satisfied after finishing my course.

**MAIL COUPON NOW**

Send me this coupon and I will mail you a \$45.50 credit check, (for limited time only). My big illustrated book and the "Vital Facts of the Electrical Industry," including my Free Outfit Offer. Mail the coupon today while the special reduced price is in effect.

**L. L. COOKE, Chief Engineer**  
Chicago Engineering Works

Dept. 529 CHICAGO

L. L. COOKE, Chief Engineer  
Chicago Engineering Works  
Dept. 529, 2150 Lawrence Ave., Chicago, Ill.

Send me free and without obligation on my part, your book "How to Become an Electrical Expert," your Free Outfit Offer, Proof Lesson, and all particulars of your course, including the \$45.50 Credit Check.

Name .....  
Address .....  
Occupation ..... Age.....

**Dr. Hackensaw's Secrets**

(Continued from page 792)

"Now then, Miss Pep," said he, "just turn that switch. In less than an hour Pete's mind will be a blank. He will have completely forgotten every incident of his past life, and will be ready to start afresh and become an honest man."

\* \* \* \* \*

Three years had passed since the date on which Doctor Hackensaw had performed the marvelous operation on the brain of Six-fingered Pete. The operation had been entirely successful. Pete had awakened none the worse physically, but his mind had become a complete blank. It was curious to watch him as he tried to rise from his bed. He was more helpless than a babe, for his muscles had lost all power of co-ordination. Walking was of course out of the question, for he had forgotten how to balance himself. He had forgotten how to talk, and he had even forgotten how to see. Like a new-born babe he was unconscious of what was going on around him. Everything had to be learned over again, just as a baby has to learn. He had this advantage, however, that his brain and his muscles were fully developed, and some vague remnants of memory remained. His progress was therefore extremely rapid. What it takes a child ten years to learn, Pete was able to master in a few months.

He was naturally bright and energetic, but his training was rendered difficult by the fact that he was a strong man instead of a helpless baby, and hence not so easy to control. Doctor Hackensaw was obliged to keep him in a padded room with six strong attendants continually on the alert. Otherwise he would have walked out of the window or into a fire just as a baby would have done. As new memories were formed, however, and he learned to take care of himself, he was allowed more liberty, and finally the day came when he could go about as he pleased. His cure seemed complete for he gave no evidence of any of the criminal traits which had formerly rendered him a menace to society. His pardon had been secured and Doctor Hackensaw kept him at his New Jersey cottage where he was employed on the farm.

Doctor Hackensaw, on his return from his trip to the moon, had kept his promise to Miss Pep Perkins. The proofs of her innocence were so complete that the warrant for her arrest was never served. She was a

frequent visitor at the doctor's summer cottage, and one hot Sunday she started out for a stroll through the woods, and unfortunately chose a short cut through a pasture where some cattle were feeding. Pep was not aware of the fact that a vicious bull was pastured with the herd. And it happened that this bull, on that particular day, was wild from a tussle with a hornets' nest—an encounter in which the bull was not victorious. While smarting from the pain of his stings, what should the bull see but a young lady coming tripping through the pasture. It was a direct challenge. The bull lowered his head and came rushing at her with a threatening bellow.

Pep was no country girl, but she was a good sprinter and turned to run. But she could not have made good her escape had not a third actor appeared on the scene. This was Six-Fingered Pete, who had come to drive the cattle to the barn. He took in the situation at a glance, and rushed to head off the bull.

Now in Spanish bull-fights, the toreador seems to have an easy task dodging the excited beasts. But, in the arena the bull is first tired out by the picadors or men on horseback. Moreover the toreador has helpers to divert the attention of the bull, and there are aisles of safety as retreats. In a country pasture the thing is not so easy. Pete had no jacket to wave at the bull, but he did what was probably the best thing under the circumstances. He picked up a double handful of earth and threw it in the eyes of the infuriated animal just as the latter was on the point of goring Pep.

Half blinded, the bull swerved from his course, and Pep was saved, but the animal came straight for Pete and the poor man was thrown to the ground and gored unmercifully.

\* \* \* \* \*

By the time the farm-hands, armed with pitch-forks, had rescued him, he was past all help.

The life that Doctor Hackensaw had saved was thus sacrificed before the results of the experiments with the "Memory Obliterator" could be fully realized. But to Doctor Hackensaw the proof was convincing that the reformation of criminals was a possibility if their minds could only be washed clean of all their criminal memories and a fresh start made.

**Around the Universe**

By RAY CUMMINGS

(Continued from page 749)

Sir Isaac, his blood running cold in his veins, shook himself together, and with deliberate care depressed two of the keys. The Heavens turned over swiftly, dizzily.

Tubby, who was standing in the center of the room, clutched Ameena for their mutual support.

"Don't look at them windows!" he cautioned. "Close your eyes. Perfessor, which way we goin'? What'll I do to help? Where's them Mercurians? Are we duckin' 'em?"

Nothing could be distinguished through the windows save the rapidly shifting firmament. Sir Isaac gritted his teeth.

"That tiny asteroid!" he muttered. "We were near it, the first asteroid in my calculation."

A blinding white glare burst through the

side window; Sir Isaac, desperately pressing other keys, finally brought the Heavens to rest.

"It's—all right," he panted. "That burst of light—that—"

Through the side window a tiny blazing globe was receding above them; from none of the windows was the Mercurian vehicle to be seen.

**THE ENEMY ANNIHILATED**

"We are safe," said Sir Isaac a moment later, when they had all calmed down a little. "The Mercurians collided with that little asteroid. They are annihilated."

Sir Isaac's face was as sober as though this were personally a great misfortune to himself—which indeed it was. He added:

(Continued on page 796)

# NATIONAL Apparatus of Simplicity and Perfection

The Monodyne circuit is one of the most radical advances in Radio engineering. Parts heretofore considered essential are omitted. One simple tuning control gives selectivity, equal if not superior to sets costing hundreds of dollars.

## All Wave Lengths

2 coils are furnished with each set.

## NATIONAL INTERFERENCE ELIMINATOR

The National Interference Eliminator can be used with any and all radio outfits no matter what make, tube or crystal sets. Will bring in stations you never heard before. Nothing else required with set as illustrated. Just connect it with two short wires to your outfit.

**\$7.50**

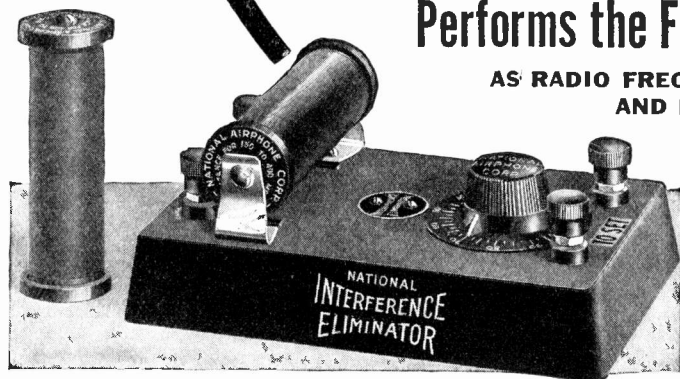

**An Absolute Necessity to Clear Reception**  
Eliminates broadcasting and code-signal interference  
Can be used to increase or shorten wave lengths

Dealers, Jobbers and Distributors—Send for Samples and Prices

**NATIONAL AIRPHONE CORPORATION**  
20 HUDSON ST. NEW YORK

For Reflex and Crystal Sets

## NATIONAL "GOLD-GRAIN" DETECTOR



**\$1.00**



Actual Size FOR PANEL MOUNTING

Entirely New Circuit  
No Storage Batteries

## NATIONAL MONODYNE TUBE SET MODEL GT-1

**\$10.00**

Including Two Inductance Coils Without Tube



Amplifies As It Detects  
ONLY ONE CONTROL!

THE SINGLE TUBE Performs the Function of 2-Tubes  
AS RADIO FREQUENCY AMPLIFIER AND DETECTOR

OVER 1000 Miles

Dear Sirs:—When your Monodyne sample arrived, to be entirely frank, we did not believe it capable of doing very much on long distance work. After carefully testing the set, we feel that we owe you an apology.

The National Monodyne naturally percolated all over the place; we heard Davenport, Chicago, Dallas, Texas and Atlanta, Ga. The next night we took it to the home of Mr. McCreary, President of the Western Radio Company here, and we heard another string of stations, using the WD-12 tube with two 22½ "B" batteries.

Your Monodyne is certainly a wonder and we should be very glad to stock and advertise it locally.

We are enclosing our initial order, which kindly rush. Yours very truly,

The Radio-Electric Shop, Inc.  
225 East Tenth St., Kansas City, Mo.

### SEND NO MONEY

National Airphone Corporation  
20 Hudson Street, New York City, N. Y.

B. I. 12-23

Gentlemen:

Please send me prepaid the articles crossed, for which I will pay postman upon delivery the advertised price.

- One  National Monodyne
- One  Interference Eliminator
- One  Panel Detector

NAME .....

STREET .....

CITY ..... STATE .....

## Around the Universe

(Continued from page 794)



### Give Him His Finest Christmas

Give your boy the thrill of a lifetime and win his everlasting gratitude by presenting him with a Conn instrument! For a Conn not only enables him to develop his musical talent; it gives him wholesome fun and companionship with fellows of his kind, develops a real spirit of team-work; in a word, *builds character*. Besides this pleasure and popularity, many boys earn their college expenses and more with their musical ability.

His Conn instrument inspires a boy to do his best, because he knows it's exactly the same as those used by the foremost artists in the world. And the easy playing qualities of the Conn, the beautiful tone, perfect scale and reliable action make practice a pleasure, speeding his progress. With all their exclusive features Conn instruments cost no more. Send now for

**FREE BOOK** and details of **Free Trial, Easy Payment** plan on any Conn instrument—cornet, saxophone, trombone, clarinet, flute, any wind instrument. Conn is the only maker of every instrument used in the band. Mention instrument.

Conn Dealers and Agents Everywhere

C. G. CONN, Ltd., 1256 Conn Bldg.,  
Elkhart, Ind.



# CONN

WORLD'S  
LARGEST MANUFACTURERS  
OF HIGH GRADE BAND AND  
ORCHESTRA INSTRUMENTS

CULTIVATE YOUR MUSICAL BUMP

"That asteroid was the first in my calculation—the one on which I was to begin operations. This unforeseen collision has changed its course—the whole fabric of my calculations has been altered." Tears welled into his eyes. "I—I tried so hard to have it mathematically perfect. And now it's ruined! Now we are powerless to save our world!"

The unfortunate man was overcome for a moment. Tubby and the white faced girl sat beside him.

"You can figure it out again," Tubby said consolingly. "Try, professor. Maybe it ain't ruined at all."

Under the influence of Ameena's gentle fingers stroking his hair, and her soft words of courage in his ear, Sir Isaac suddenly braced up.

"I'll do it!" he cried. "Give me my pencil and paper . . . Ameena, make me some strong, black coffee. Bring it here . . . with my lunch . . . Tubby, give me my cigarettes, and let me alone. Go away. I must rectify this terrible error."

He dashed the damp locks of hair from his eyes; and while Ameena hurried into the kitchen, he lighted a cigarette, pushed Tubby away, and plunged feverishly into his ruined computation. Ten minutes later he was altering the vehicle's course and, with his array of delicate scientific instruments, was making careful observations of the asteroid's present direction and rate of flight.

Tubby kept out of the instrument room. At noon, Ameena took Sir Isaac's luncheon into him on a tray. He smiled up at her, momentarily suspending his flying pencil.

"I do hope your computation isn't ruined, dear Sir Isaac," she murmured gently.

"Oh no," he said. "In fact I am beginning to think quite the contrary." He seemed wholly cheerful. "The Mercurian vehicle colliding with my asteroid altered its course, naturally. But I am beginning to discover that the alteration is favorable to my plans rather than the reverse."

He patted her shoulder. "Thank you, Ameena . . . That stew looks delicious . . . I shall have my new calculation completed in an hour, I hope. That Mercurian collision was a blessing in disguise."

So it proved, for by two o'clock in the afternoon Sir Isaac called his friends into the instrument room and triumphantly displayed his new set of figures.

"Very good indeed," approved Tubby. "Let's get to usin' 'em. What do we do first?"

"At 3:57 P. M. this afternoon we shall approach that same asteroid," Sir Isaac announced. "Just leave everything to me. It is all quite simple now!"

#### COAXING AN ASTEROID FROM ITS COURSE

At 3:57 P. M. exactly they were encircling the asteroid at a distance of some ten miles—speeding around it in a circular orbit as though they were its satellite. But with each revolution they paused on one side and drew away slightly, coaxing it from its path by their attraction.

It was a tiny celestial wanderer indeed—not more than three or four thousand feet in diameter Sir Isaac said—nothing but a boulder flying alone through Space.

At 4:17 P. M. the vehicle withdrew. Tubby was anxious to have something happen; but for nearly an hour nothing did. It was 4:45 P. M. when Sir Isaac pointed through the side window to another, somewhat larger asteroid approaching. With careful work at the keyboard he swooped

the vehicle toward it—around it twice—and then slowly away again in the opposite direction.

"There," he murmured. "I think I have done my part correctly. The laws of Celestial Mechanics must do the rest."

He sat at the side window, watching. Tubby and Ameena saw the first asteroid far above them. The other was obviously nearing it. Both had been deflected from their normal course by Sir Isaac's skill; a collision was inevitable.

#### THE ASTEROIDS COLLIDE

It came at 5:51 P. M.—as Sir Isaac had calculated—a soundless flash, and then a new, larger celestial body, the fused mass of the other two, wavering in Space, plunging diagonally toward the Sun, and at last finding its new orbit by that delicate balancing of forces which is the marvel of Celestial Mechanics.

Sir Isaac was jubilant. He took several observations of the new asteroid.

"Perfect, my dear friends. The new orbit is identical with my calculation. There will be another collision, with a much larger planetoid, at 7:19 P. M. Let us have dinner."

"Very good idea," approved Tubby with relish.

Tubby and Ameena still had only a vague idea of how all this was to save the Earth; but they trusted Sir Isaac implicitly. Besides, they did not dare ask any advance details, which would have offended Sir Isaac's sense of the dramatic.

The second collision—another, larger flash—took place exactly at the appointed time. And all during the evening and far into the night, other collisions occurred. Each involved larger bodies—and after each, from the vehicle which followed in their train, Sir Isaac computed the orbital elements of the new celestial body.

"You had better go to sleep," he said, at two o'clock. "There will not be another until 4:35 A. M. It involves a very considerably larger body—I shall wake you up in time to see it."

He added solemnly:

"I trust this next Minor Planet is not inhabited. I do not think so, though it is over two hundred miles in diameter. I did not want to involve it—but I had to."

At 6:03 P. M. the following evening, just twelve minutes before the long-anticipated opposition of Mars with the Earth, the climax came. There had been two gigantic collisions during the day. The last one—at 2:23 P. M.—involved two bodies of almost equal mass which approached each other from diametrically opposite directions. A head-on crash ensued. A new body, fused into a molten mass by the created heat of arrested motion, hung for an instant suspended—completely devoid of orbital velocity. Then it moved downward—slowly at first, then swiftly, with constant acceleration plunging down toward the center of mass of the Solar System—the Sun.

The vehicle followed it cautiously. Watching this enormous, fiery derelict created by the mathematical genius of Sir Isaac, it was nearly six o'clock before Tubby and Ameena grasped the true significance of what was taking place before their very eyes.

The new asteroid—five hundred miles in diameter, a white-hot core with flames hundreds of miles in height leaping from it, plunged for the Sun. But Mars also lay beneath it though slightly off to one side—Mars, now a huge reddish, smug-looking crescent across the lower firmament.

(Continued on page 798)

# "BUILD YOUR OWN" WITH "RASCO" PARTS!

THE Radio Specialty Company—"RASCO" for short—now in its third year, is unquestionably the oldest and most unique radio parts supply house in the United States, if not in the whole world. This Company makes a specialty of small orders. No order is too small to get immediate and prompt attention. The reason is simple: 80% of our orders are small. The reputation of this house was built upon service. Ask any of your radio acquaintances what they think of "RASCO" service. "RASCO" promptness. Thousands of unsolicited testimonials are in our files, to prove that we serve the public as it has never been served in radio merchandise before. Be sure to get our great 84-page catalog, containing over 550 different parts. Catalog contains over 350 illustrations. "WE CAN ONLY DISAPPOINT YOU ONCE." Try us with a 50c. order and make us prove what we say. Prices include delivery to your door.

We pay all transportation charges in U. S.

ALL GOODS SENT PREPAID IN 24 HOURS

Order direct from this page.

**NOTE BIG PRICE REDUCTIONS THIS MONTH**

Money refunded if goods do not satisfy



**LOOP AERIAL**  
The loop aerial you have been waiting for. Made entirely of well seasoned hard wood. Complete with all parts and base; No. 22 enamelled wire used. Total height of loop 36", 2 feet on the side; loop is 10 convolutions. Can be put together by anyone in less than 5 minutes.

Satisfaction guaranteed. D2600 Two foot loop aerial, complete. \$1.15

**STORAGE BATTERIES**  
New! New! New! Two volt, 40 ampere hour storage battery for use with WD11, 12, and U.V. 199 tubes. Don't keep on buying dry cells continuously. This storage battery will pay for itself in two months. Only best materials used. Guaranteed for 2 years. You can connect up to 6 dry cell tubes on a single one of these batteries. Can be recharged for a few cents. Hard rubber container encased in impregnated wood case. Due to low price and large weight of batteries, shipped express collect.

D2400 Two volt, 40 ampere hour storage battery, size 2 1/4"x8x9" ..... \$3.90  
D640 Six volt, 40 ampere hour storage battery, size 4 3/4"x7 1/4"x9" ..... 7.25  
D660 Six volt, 60 ampere hour storage battery, size 6x7x9 1/4" ..... 9.50

**WOOD CABINETS**  
Highest grade mahogany cabinets made. Best hand rubbed finish. Top is hinged. Front of cabinet rabbeted to fit panel. Price delivered to your door; no panel included in these prices.

Entire cabinet made of 1/2" well seasoned stock.  
D714 Wood cabinets, panel size 7x14" ..... \$3.35  
D718 Wood cabinets, panel size 7x21" ..... 4.40  
D724 Wood cabinet, panel size 7x10" ..... 2.60  
D710 Wood cabinets, panel size 7x12" ..... 3.00  
D712 Wood cabinets, panel size 7x12" ..... 3.00  
D721 Wood cabinets, panel size 7x21" ..... 3.90

**"RASCO" BEZELS**  
The finest Bezel on the market. Best brass used. The Bezel comes entirely nickel plated. Will improve looks of your panel 100 per cent. Outside diameter 1". Can be used on 3/8" or 3-16" panel.

D1700 Rasco bezel ..... \$1.15  
D1701 Bezel 1 1/2" diam. ..... .20

**UNIVERSAL BEARING**  
THE bearing to hold variometer and variocoupler in place. Total length of bearing 2 1/4". Outside shaft, 1 1/4". Length of thread 1". Length of threaded sleeve, 3/4".

D1375 Bearing ..... \$2.25

**COPPER FOIL**  
Thinnest copper foil made. .001" thick. Comes 4" wide. D5025 Copper Foil per ft. \$1.80 10 ft. length ..... \$18.00

**FORMICA PANELS**  
Clearance Safe. This sheeting is positively the best grade on the market. High Finish on both sides. Too well known to require much explanation. Due to the fact that we are discontinuing these particular sizes, this material is now offered practically at cost. Prices are about 40 per cent lower than our catalogue list. Note also that we ship these panels prepaid.

D350 6"x12"x3-16" thick, each ..... \$1.50  
D352 9"x12"x3-16" thick, each ..... 1.75  
D353 12"x18"x3-16" thick, each ..... 4.00  
D354 6"x10 1/2"x3-16" thick, each ..... 1.90  
D356 6"x14"x3-16" thick, each ..... 1.60  
D357 6"x4"x3-16" thick, each ..... .65

**RASCO 180° VARIOCOUPLER**  
This Coupler while extremely low in price will do anything and everything that the more expensive ones accomplish. Silk Wire wound on bakelite tubes. There are six taps. Wave length of coupler from 150 to 600 meters. Coupler is made for panel mounting. 1/2" shaft. Your money refunded if it is not as claimed.

D3100 Variocoupler, prepaid ..... \$1.50



**MELOTONE LOUD SPEAKER**  
The best popular loud speaker on the market. Has tuned feature the same as all "Rico" phones. Fibre horn, heavy metal base, five foot cord. Nickle goose neck. Greatest tuned talker. Compares favorably with most expensive speakers. Size overall 1 1/2"; horn length 1 1/2"; bell 6"; total height 9".

D255 Melotone Speaker ..... \$4.90

**RICO TUNED RECEIVERS**  
No better phones made. Supersensitive. Awarded Radio News Laboratories Certificate of Merit. The only tuned phone on the market. Can be tuned for any intensity and sensitivity. Magnetic pole of phone is in mathematical center of diaphragm.

D666 2000 ohms, double head set, not adjustable \$3.50  
D2020 2000 ohms, double head set, TUNED. \$4.45  
D3030 3000 ohms, double head set TUNED. \$5.50

**"RASCO" VERNIER**  
Cleverest vernier made. Can be used with any dial. Soft rubber ring engages dial. Does away with vernier condenser. We guarantee results. All metal parts moulded in best black composition. Nothing to come apart. Biggest hit of the season.

D1450 Vernier ..... \$0.30

**"RASCO" POSTS**  
D650 Post made entirely of best black composition—8-32 screw—each ..... \$0.08  
D202 Post has nickel-plated bottom part, each ..... .08  
Dozen, each style ..... .90

**JUST OUT AUTOPLEX CIRCUIT**  
The famous Autoplex circuit described in RADIO NEWS has taken the country by storm. The only single tube outfit that works a loud-talker. Results guaranteed.

D1714 Mahogany Cabinet, 7x14" ..... 1.20  
D-25353 Moulded Variometers ..... 6.00  
2-D3076 4" Dials ..... .80  
1-D5014 1250 turn Honeycomb coil ..... 1.95  
1-D6500 Vacuum Tube Socket ..... .35  
1-D4310 5 ohm Rheostat ..... .45  
8-D201 "Rasco" Binding Posts ..... .80  
8-Assorted Binding Post Name Plates ..... .18  
5-D6400 Feet Bus Bar Wire ..... .25  
1-D5209 Consolidated Autoplex pattern ..... .50  
Total \$15.83  
Our special price, complete ..... \$15.25  
Complete with Melotone Loud-speaker \$20.00

**"RASCO" SOCKETTES**  
Substitute for Vacuum Tube Socket. Four of these take one Vacuum Tube. Grasp tube firmly. Best contact possible. Take less room. Are better.

D1550 Sockettes, nickelled, set of 4 ..... \$2.50  
D1551 Sockettes, nickelled, set of 4 (to take WD-11 Tube) ..... .25  
Note: Set of 4 sufficient to hold 1 tube.



**PHONEHORN**  
Fills a new and distinct want. Base consists of D1310 Phonodapter described on this page into which fits a fine enameled fibre horn. Size of horn 12"; bell 6 1/2". Slip Phonodapter end on a single telephone receiver and you have the lowest priced loud talker ever made. Mounted in your set or hung in corner of room it will bring sound all over the room. A most useful article. Welcome by all radio fans.

D1321 Phonehorn, prepaid ..... \$1.45

**AUDIO FREQUENCY TRANSFORMERS**  
No better Transformer on the market. Highest class materials. Impregnated coils. Silicon steel stampings used. Save 50 per cent by assembling it yourself.

D1100 A.F. Transformer, ratio 4 1/2 to 1 ..... \$2.00  
D1150 A.F. Transformer, ratio 6 1/2 to 1 ..... \$2.00

**RADIO FREQUENCY TRANSFORMERS**  
The best Radio Frequency Transformer developed so far. Designed for us by Mr. R. E. Lacault, Associate Editor of RADIO NEWS. Air core. Guaranteed to do the work. This Transformer brings in the long distances.

D2800 Radio Frequency Transformer, size 1 1/2"x2 1/2" ..... \$1.50

**RHEOSTATS AND POTENTIOMETERS**  
Highest grade Rheostat made. High heat dielectric composition base. Wound with best non-corrosive resistance wire. Comes with tapered, knurled knob. Diameter, 2 1/2". Complete with pointer.

D4310 6 ohm, each \$1.45  
D4311 30 ohms, for 30la and 20la tubes, each ..... .65  
D4312 Potentiometer, 200 Ohms, each ..... .85

**JUST OUT Cat. No. 10**  
At last! Fine forms to wind your spider webs. Made from hard, well seasoned fibre. 1-16" thick, center and side holes for wiring. 3200 has 13 slots, 3201, 11 slots, both 5" diameter. 3201 has projection for mounting.

D3200 Spider web form, each ..... \$1.25  
D3201 Spider web form, each ..... \$1.25

**BRASS RODS**  
Sold in 6" lengths only.

D8032 Brass Rod 5/32" thread, per length ..... \$1.08  
D6032 Brass Rod, 6/32" thread, per length ..... .06  
D1425 Brass Rod, plain 1/4" round, per length ..... .10  
D3616 Brass Rod, plain 3/16" round, per length ..... .06

**"RASCO" NAME PLATES**  
The circular plate is our new Binding Post Name Plate. Diameter, 3/4". These denominations: PHONES GROUND, OUTPUT, "A" BATTERY, "B" BATTERY, LOUD SPEAKER, GRID, LOAD, "C" BATTERY, AERIAL, INPUT, "A" BATTERY, "B" BATTERY, LOOP, TICKLER, PLATE, "C" BATTERY, FILAMENT.

D6000 to 6019 Binding Post Name Plates, each denomination ..... \$1.30  
Dozen ..... \$15.60



**REINARTZ DUO-SPIDERWEB COIL**  
Here is a very fine inductance for Reinartz circuit, 200-600 meters. 19 taps. Size 4 1/2" diam.; 1 1/2" center opening. Can be used in nearly all new circuits. Construction: duo-spiderweb throughout. Coil is firm and will not fall apart as is case with many inferior makes. A few of these coils will work wonders in your set.

D2650 Spider-web Reinartz coil ..... \$1.15

**PHONODAPTER**  
The Phonodapter will fit any phone. Metal tube fits any standard phonograph. Make your phonograph a loud talker. Fits Columbia, Victor and Sonora phonographs. Is made entirely of pure soft rubber with brass tube insert.

D1310 Phonodapter ..... \$1.40

**DOUBLE PHONODAPTER**  
The Double Phonodapter fits all phonographs and will take any standard double head set, thereby making your phonograph a loud talker. Made of cast metal, nickel plated and highly polished. Has three generous soft rubber bushings.

D1320 Double Phonodapter ..... .85

**PLUGS**  
RASCO Telephone Plug. This is the plug that is sold from 75c to \$1.00 everywhere. Has hard rubber composition shell and patented cord tip holder. Must be seen to be appreciated. Finest workmanship throughout.

D1030 Rasco Telephone Plug, each ..... \$3.35

**LITZ WIRE**  
D823 equals No. 25 B&S, per foot ..... \$0.02  
D880 equals No. 28 B&S, per foot ..... .01  
D891 equals No. 21 B&S, per foot ..... .03  
D892 equals No. 20 B&S, per foot ..... .04  
Discounts of 10 percent in 100 foot lots.

**PANEL MOUNTING VARIABLE CONDENSERS**  
This condenser presents the latest word in precision mechanics. Plates, washers, and all other parts are accurately machined. Positively no better condenser on the market. Shafts 1/4". Save from 40% to 60% by assembling condenser yourself. A child can do it in a few minutes' spare time. Capacity guaranteed.

D1111 21 plate condenser, .00125 mfd. \$1.10  
D1211 21 plate condenser, .0005 mfd. 1.22  
D4343 45 plate condenser, .001 mfd. 1.50

**The "Rasco" Catalog**  
CONTAINS 75 VACUUM TUBE HOOK-UPS. 350 ILLUSTRATIONS No. 10 550 ARTICLES, 84 PAGES

All Armstrong Circuits: These important circuits are explained clearly, all values having been given leaving out nothing that could puzzle you. Just to name a few of the Vacuum Tube circuits: The V.T. as a detector and one-step amplifier; Armstrong circuits; one-step radio frequency amplifier and detector; three stage audio frequency amplifier; short wave regenerative circuits; 4-stage radio frequency amplifiers; radio and audio frequency amplifier; inductively coupled amplifier; Armstrong superautodyne, etc.



**Radio Specialty Co.**  
106-98 Park Place, New York  
"RASCO PAYS THE FREIGHT"

**Radio Specialty Co.**  
100 Park Place - New York City  
Oldest and Original Exclusive Radio Parts House in U. S.  
Factories: Brooklyn, N. Y. Elkridge, Md.

**DEALERS**  
Get Our Special Proposition



## HIGH SCHOOL COURSE IN TWO YEARS

### You Want to Earn Big Money!

And you will not be satisfied unless you earn steady promotion. But are you prepared for the job ahead of you? Do you measure up to the standard that insures success? For a more responsible position a fairly good education is necessary. To write a sensible business letter, to prepare estimates, to figure cost and to compute interest, you must have a certain amount of preparation. All this you must be able to do before you will earn promotion.

Many business houses hire no men whose general knowledge is not equal to a high school course. Why? Because big business refuses to burden itself with men who are barred from promotion by the lack of elementary education.

### Can You Qualify for a Better Position?

We have a plan whereby you can. We can give you a complete but simplified high school course in two years, giving you all the essentials that form the foundation of practical business. It will prepare you to hold your own where competition is keen and exacting. Do not doubt your ability, but make up your mind to it and you will soon have the requirements that will bring you success and big money. **YOU CAN DO IT.**

Let us show you how to get on the road to success. It will not cost you a single working hour. It costs you nothing but a stamp.

### American School

Dept. H-926 Drexel Ave. & 58th St., Chicago

#### American School

Dept. H-926 Drexel Ave. and 58th St., Chicago  
Send me full information on the subject checked and how you will help me win success.

- |                              |                            |
|------------------------------|----------------------------|
| .....Architect               | .....Lawyer                |
| .....Building Contractor     | .....Machine Shop Practice |
| .....Automobile Engineer     | .....Photoplay Writer      |
| .....Automobile Repairman    | .....Mechanical Engineer   |
| .....Civil Engineer          | .....Shop Superintendent   |
| .....Structural Engineer     | .....Employment Manager    |
| .....Business Manager        | .....Steam Engineer        |
| .....Cert. Public Accountant | .....Foremanship           |
| .....Accountant and Auditor  | .....Sanitary Engineer     |
| .....Bookkeeper              | .....Surveyor (& Mapping)  |
| .....Draftsman and Designer  | .....Telephone Engineer    |
| .....Electrical Engineer     | .....Telegraph Engineer    |
| .....Electric Light & Power  | .....High School Graduate  |
| .....General Education       | .....Fire Insurance Expert |
| .....Vocational Guidance     | .....Wireless Radio        |
| .....Business Law            | .....Undecided             |

Name.....

Address.....

## Around the Universe

(Continued from page 796)

### BLAZING ASTEROID PLUNGES TOWARD MARS

Minutes passed. The three watchers crouched tense at the lower window of the instrument room. The blazing asteroid plunged on. Its course for the Sun would take it half a million miles to the side of Mars! Five minutes more! The asteroid, feeling Mars' attraction as it approached, began turning gradually aside, deflected by this other attraction which at such proximity was greater than the Sun's.

Then at last Tubby understood! He gripped Ameena—breathless.

"Look! Mars is pullin' it! Look!"

It was 6:03 P. M. exactly when, with a gigantic, soundless flash, the molten asteroid collided squarely with the Planet's upper surface!

### CHAPTER XII

IN WHICH TUBBY'S WONDERFUL GIFT, REVIVED ON EARTH, BRINGS ABOUT A CATAclySM, AND HIS ASTRONOMICAL ADVENTURES ARE ABRUPTLY TERMINATED.

WHAT a triumph, even for the genius of a super-mathematician! A blazing, molten mass of matter five hundred miles in diameter had fallen upon the surface of Mars at almost the very moment of its anticipated triumph over an inoffensive neighboring planet! No wonder Tubby and Ameena were overjoyed! No wonder Sir Isaac's pale, intellectual countenance could not but reflect the pride in his heart!

Tubby shook his friend's hand warmly; Ameena kissed him.

"Well," declared Tubby, "I guess that settles them Martians. Some excitement for them right now!"

"Did it kill many of them, do you think, Sir Isaac?" Ameena asked anxiously. "Women and little children—"

"I'm afraid it did," Sir Isaac said soberly. "I could not help that—the innocent must everywhere suffer for the guilty. I had to do the best I could for our own world."

He sat down, pondering. Then he added:

"I have no idea what such a collision would do or what may be the result of it to the orbit of Mars and thus to the other planets. The heat generated may have roasted every living creature on the globe. Or perhaps not. But I rather imagine those armies will have enough to do at home without undertaking an invasion of the Earth for some time to come."

"I should guess yes," Tubby declared enthusiastically. He threw his arms around Ameena and kissed her vigorously. "Now all we got to do is hurry right home so you an' me can get married. Ain't I right, kid?"

The girl agreed that this was logical.

"I shall have you there tomorrow," said Sir Isaac. "We need not bother with the Moon—let us leave that little Martian army marooned there. We will let it alone—it cannot harm us."

"Sure," agreed Tubby. "Let it alone. Come on, let's eat an' then play poker."

On this last leg of the journey, Sir Isaac insisted on going slowly. In the first place he was thoroughly exhausted and demanded twelve solid hours' sleep; and also, with Tubby and Ameena thus in continuous command, he felt it was advisable to make haste slowly. It was therefore not until 9:45 P. M. the following evening that the vehicle landed again upon the Earth from which it had departed some sixty days previously.

### THE LAST EVENING ABOARD

The last evening in the vehicle was a solemn one. Tubby and Ameena were to part from their friend and take their honeymoon trip alone in it to Venus. A hazardous voyage, doubtless! But youth and inexperience are always confident.

"You're a very wonderful man, Sir Isaac," Ameena said during that last supper.

"You sure are," Tubby confirmed. He hesitated, scratching his head. "But say, professor, there's one or two things about this here voyage of ours I ain't quite got clear."

Sir Isaac nodded encouragingly.

"For one thing," Tubby began, "I ain't got this gravity part very straight. Why is it when we're in this vehicle don't we personally feel all these here changes of gravity? If the gravity is cut off from under us why don't we get lighter?"

It was a stupendous bit of logical reasoning on Tubby's part. It surprised Ameena; it amazed Sir Isaac.

"Why—why—" he stammered. Then he smiled frankly.

"I really cannot explain exactly," he confessed. "The thing surprised me very much. I've been worrying over it for my manuscript. It is a fact that we do not feel any changes of gravity until we actually land upon some celestial body. But why, I cannot say. I think it's because of our velocity, the constant acceleration or changes of velocity of the vehicle. Motion and gravity are very closely related. If it's that, Einstein would know all about it. He disagrees with me on almost everything, but still he's a nice sort of chap. I think I shall have to consult him."

"I would," said Tubby. "Then there's another thing. You got this here vehicle built wrong. You got the observatory on top an' we're always goin' the other way. You never onc't used that little telescope. An' then there's—"

"Tubby!" cautioned Ameena. And, in deference to the feelings of their friend, who after all was only human and therefore liable to err, Tubby took the hint and stopped.

### THE SKY-TRAVELERS ON EARTH AGAIN

They landed, after a careful reconnoiter, within a few hundred feet of where they had started. As they stepped from the vehicle to that earth upon which Ameena had never before set foot, Bill Hawkins' apple trees were in plain sight in the moonlight. Instantly Tubby remembered his wonderful gift which had brought Sir Isaac's Inter-planetary vehicle into material being. The thought of it had never crossed his mind since the first few minutes after their departure from Earth. How foolish all their perturbation over the Martian attack! Why all they need have done was come home, and Tubby could have wished that all the Martians and Mercurians would drop dead as fast as they landed!

Tubby explained all this excitedly to his friends. Sir Isaac frowned.

"I thought of that," he said. "But I could not be concerned in trickery like that. My public would not stand for it. We had a scientific problem to solve, and we solved it with science—quite reasonably and properly."

Tubby nodded acquiescence; but his eyes were sparkling as he regarded Bill Hawkins' apple orchard.

(Continued on page 800)



# A Chemistry Laboratory for \$7.00

Think of it, fellows! Here is a *real* chemistry outfit with regular chemical apparatus that performs those fascinating, actual chemical experiments. This outfit is not a toy, put up merely to amuse, but a practical laboratory set, with all the chemicals, apparatus and reagents necessary to perform real work and to teach the beginner all the secrets of inorganic chemistry.

## DESCRIPTION OF THE OUTFIT

The outfit consists of 44 Chemicals and Reagents all C. P. put up in appropriate wooden boxes, glass bottles, and hermetically closed jars. The acids are put up in glass bottles, with ground-in glass stoppers, and there is a sufficient quantity of chemicals supplied (mostly one to two ounces) to make dozens of experiments with each.

The apparatus furnished are all of the best obtainable make and of standard laboratory size and shape.

The Instruction Book is a real Chemistry Course for the Beginner. Some of the Contents are: Division of Matter; This is a Treatise on Elementary Chemistry and deals with the theory of the Elements, Molecules and Atoms, etc. Chemical Nomenclature: This explains in simple language the derivation of the chemical names of the elements and their compounds. There is a chapter on Laboratory Operations; Glass Working; First Aid; Fire Extinguishers; Experimenters' Aphorisms, etc.

A good part of the book is devoted to Weights and Measures. The Metric System, The English System and the U. S. System are fully explained.

The following tables are furnished: Symbols and Atomic weights of the Elements; Measures of Weights, Volume, Capacity and Length; per cent solutions; Conversion of Measure expressed in parts; poisons and their antidotes; technical and common name of chemical substances; formulas for cleaning various substances, etc., etc.

Among the 100 Experiments are:

How to make chemical tricks; How to make invisible and magic inks; How to test flour; How to test soil; How to make chlorine gas and smoke (German War Gas); How to bleach cloth and flowers. How to produce Oxygen and Hydrogen; How to make chemical colors; How to test Acids and Alkalies and hundreds of interesting hints and formulas.

Complete, \$7.00 Sh. Wght, 10 lbs. (Shipped by Express only)

(We guarantee shipment within 24 hours after your order is received.)

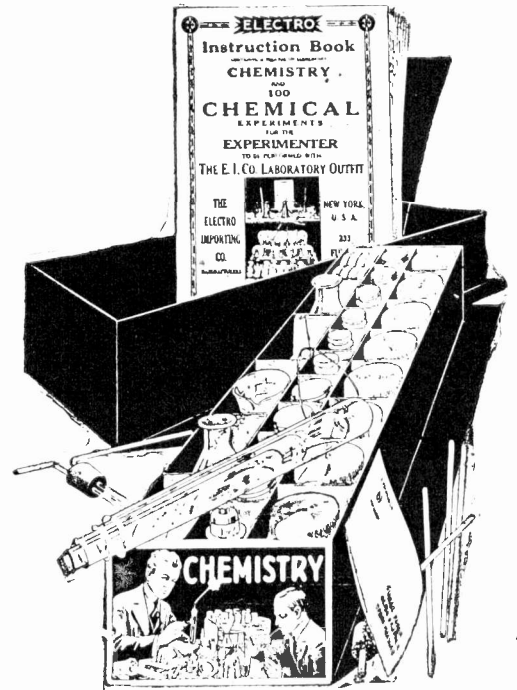

\$7.00



Every Fellow Wants the  
**BOY'S ELECTRIC TOYS**

The Boys' Electric Toy contains: Enough material to make and complete over twenty-five different electrical apparatus without any other tools except a screw-driver furnished with the outfit. Student's chromic plunge battery, compass-galvanometer, solenoid, telephone receiver, electric lamp, etc. Enough various parts, wire, etc., are furnished to make the following apparatus:

Electromagnet, electric cannon, magnetic pictures, dancing spiral, electric hammer, galvanometer, voltmeter, hook for telephone receiver, condenser, sensitive microphone, short distance wireless telephone, test storage battery, shocking coil, complete telegraph set, electric riveting machine, electric buzzer, dancing fishes, singing telephones, mysterious dancing man, electric jumping jack, magnetic geometric figures, rheostat, erratic pendulum, electric butterfly, thermo-electric motor, visual telegraph, etc., etc.

With the instruction book we furnish one hundred experiments that can be made with this outfit, nearly all of these being illustrated with superb illustrations. No other materials, goods or supplies are necessary.

The outfit contains 114 separate pieces of material and 24 pieces of finished articles ready to use at once.

The size over all of the outfit is 14 x 9 x 2 3/4. Shipping weight, 8 pounds.

"The Boy's Electric Toys" outfit as described, \$7.00 Immediate shipment.

**SEND NO MONEY**

We have so much confidence in these sets that we desire to ship either one to you by express C.O.D. with the privilege of inspection. In other words, we ship on approval. It does not cost you one cent to take a good look at whichever outfit you want, and see if it comes up to your expectations. If it does, pay the express man \$7.00, plus express charges. If not, you need not accept it, and we will pay the return charges as well.

ELECTRO IMPORTING CO., 233 Fulton Street, New York City

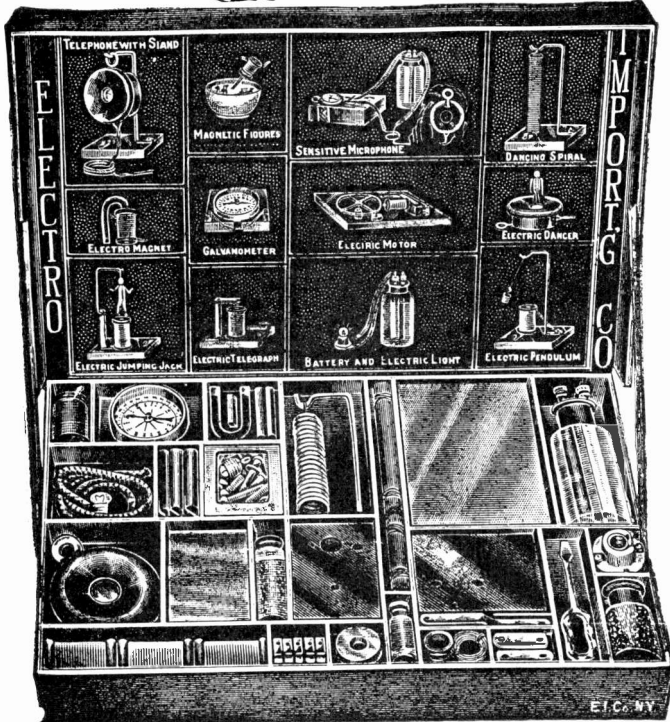

ELECTRO IMPORTING CO.,  
233 Fulton St., New York  
Please send me by express THE CHEMICAL LABORATORY. If I don't like it I need not accept it. If I want it I only pay \$7.00 plus the few cents express charge.

ELECTRO IMPORTING CO.,  
233 Fulton St., New York  
Please send me by express THE BOY'S ELECTRIC TOYS. If I don't like it I need not accept it. If I want it I only pay \$7.00 plus the few cents express charge.



# How This Man Won Success As an Electrical Expert

General Manager of his company at 28 years of age! His own boss—owns his home—married and happy and prosperous—that's the remarkable success achieved by Wallace H. Rohrschneider, now General Manager, Secretary and Treasurer of the Hustisford Light, Power and Manufacturing Company of Hustisford, Wisconsin.

Mr. Rohrschneider got his start toward his quick and brilliant success at School of Engineering of Milwaukee. There he received the practical, intensive and specialized training that enabled him to make good in a big way.

## Why Don't You Get Into This Big Pay Field?

The same kind of training that put Mr. Rohrschneider into the ranks of the highly-paid Electrical Specialists will qualify you for brilliant success in this fascinating field of unlimited opportunities. Come to America's Greatest Institution of Electrical Education. Learn by actual practice in our big laboratories with their magnificent equipment, including motors, dynamos, switchboards, ignition and lighting systems, etc. Recognized experts give you personal instruction every step of the way.

## Earn Your Way Through This Great College

You can earn money to help defray your expenses while you are learning. Our wonderful co-operative plan brings an Electrical Career within the reach of every ambitious man. Our Free Employment Department secures positions for those students who wish to earn part or all of their expenses. In addition, the Department will help you get a good position in the Electrical industry when your training is completed.

**BIG BOOK FREE**—Mail the coupon today for our big new illustrated catalog. Check the course that interests you most and we will send you special information. Read about the School that trains men for practical and quick success. See how easy it is for you to get the training that will enable you to step to a splendid position and a handsome income. Mail the coupon right NOW. No cost or obligation.

## SCHOOL of ENGINEERING of Milwaukee

Dept. S&I-12, 415 Marshall Street, Milwaukee, Wis.  
MAIL COUPON NOW

### SCHOOL OF ENGINEERING OF MILWAUKEE

Dept. S&I-12, 415 Marshall St., Milwaukee, Wis.

Please send me without any cost or obligation, full particulars of the electrical course I have checked and your big Free Book telling about your institution and how it will fit me for a big position in the electrical field. Also tell me about your Earn-While-You-Learn plan.

(Check courses interested in, and be sure to give your education.)

- School of Practical Electricity—6 months or 1 year course. Complete general course, covering entire electrical field.
- Institute of Electrotechnics—12 to 30 months' course. Practical electrical training combined with thorough Academic education.
- College of Electrical Engineering—3 years' course. Regular collegiate work granting B. S. Degree. 14 High School units or diploma from our Institute of Electrotechnics required for entrance.
- Commercial Electrical Engineering—1 year course. Thousands of Trained Men wanted in this new profession. 11 High School units or diploma from our Institute of Electrotechnics required for entrance.
- School of Automotive Electricity—3 to 6 months. Covers all systems of starting, lighting, ignition, and storage batteries for automobiles, tractors, air-craft, etc. Intensive practical course.
- Armature Winding and Motor Generator Repair Course—3 to 6 months' course. Brief, but intensely practical, leading to well-paying positions.
- Electrical Home-Servic Training with laboratory facilities, for those who cannot come to Milwaukee.

Name .....

Street .....

City ..... State .....

Age ..... Education .....

## Around the Universe

(Continued from page 798)

"All right, professor. But I'm goin' to get revenge on this guy Hawkins anyway. You do things your way—I do them my way. Come on over an' let's see them apples turn rotten."

Sir Isaac was greatly annoyed. "I beg you not to. It is childish. To engage in such foolishness, after all our scientific adventures—"

"You did that onc't," Tubby suddenly accused. "An' when you wrote how you did it, you signed that there Wells name. I read it."

Sir Isaac flushed. "Yes, I did," he admitted with some heat. "I did descend once to such an unpalatable trick—and I've been sorry for it ever since. I've been trying to live it down. I—Tubby, you'll only bring disaster upon yourself—upon all of us. Forget that ability you have. Don't ever—"

"I ain't goin' to forget it," Tubby persisted doggedly. "I wish all Bill Hawkins' apples was rottin' on the trees. I wish—"

A diabolical memory of that similar situation Sir Isaac had once conceived under his favorite "Herbert George" name came to Tubby.

### TUBBY'S WISHING POWER GETS HIM INTO TROUBLE.

"I wish the Earth was revolvin' twice as fast as usual, so Bill Hawkins' house would fly off in the air," he intoned.

Ameena flung her arms about his neck; Sir Isaac gave a cry of terror. A fearful gale of wind came roaring down upon them. Stones, sticks, every manner of flying missile, whistled by.

Sir Isaac, shouting something incoherent, flung himself prone upon the ground. Tubby gripped a tree-trunk to hold himself from blowing away; Ameena clutched him in terror.

In the midst of the hurricane Bill Hawkins' house was standing firm. Sudden madness possessed Tubby.

"I wish the Earth was revolvin' ten times as fast! I wish—"

Sir Isaac's body left the ground, hurtling into the air like a bullet. Tubby grasped one arm around Ameena, and one about the tree-trunk. He felt like a balloon tugging at its leash. The wind was a cyclone. A house went sailing off through the air—Bill Hawkins' house.

"Tubby! Don't Tubby!"

The girl's appealing cry frightened Tubby. A flying billet of wood struck him viciously on the shoulder. He tried desperately to think of something to stop this horrible cataclysm.

"I wish—" he murmured. "I wish I hadn't never been able to wish nothin'. I wish I'd forget all about havin' done this. I wish—"

The clink of the poker chips was incessant—annoying. Tubby stared across the smoke laden room at the three men under the circle of light. He remembered dimly that they had been arguing, and sat up abruptly.

"As I was sayin', Jake," he announced. "I got a idea that this here Edge of Space—"

THE END.

# We Teach COMMERCIAL ART

**Meyer Both Company, the largest Commercial Art Organization in the World** offers you an unusual opportunity for practical training, based upon twenty-three years of success. This nationally known organization each year produces and sells to advertisers over 15,000 commercial drawings. Meyer Both instruction is the difference between successful fact and experimental theory. This well paid profession equally open to men and women. Home study instruction.

## Get Facts Before You Enroll in Any School

Ask the Advertising Manager of the leading newspapers in your city, anywhere in the United States, Canada, England or Australia about the Meyer Both Company—let them tell you about us. Write for our illustrated book, telling about the success of our students—for one-half the cost of mailing—four cents in stamps

**MEYER BOTH COMPANY**  
Department of Art Instruction

Michigan Ave. at 20th St., Dept. 64 CHICAGO, ILL.

Note—To Art and Engraving Firms: Secure practical artists among our graduates. Write us.

# MASTER ELECTRICITY AT HOME

Send for my FREE Book—a STRAIGHT-FROM-THE-SHOULDER TALK about your future in the Electrical Field. It contains no misleading promises such as "EARN \$10,000 A YEAR," or "BECOME AN ELECTRICAL EXPERT IN A FEW MONTHS." You are far too intelligent to believe such rot. If you are seeking to better yourself, let me help you as I have helped thousands to reach their goal. My instructions are easily understood and right to the point. My book speaks volumes to any one who wants to be a success in the electrical field.

## Buy Success With Burgess Training

Our close connection with International Association of Electrical Engineers gives you unusual chances. Experts everywhere indorsed this course as unequalled leader. All branches of electricity covered. Slide Rule and Slide Rule Course of 30 lessons and Electrical Hand Book given FREE if you ACT NOW. Write for our fully illustrated Book TODAY.



New Radio Course Now Ready

**BURGESS ELECTRICAL SCHOOL**  
YORKE BURGESS, Superintendent  
Dept. 12, 745 E. 42nd St. CHICAGO  
Canadian Branch: 201 B. Crawford Street, TORONTO

## ELECTRICAL HANDBOOK

We have prepared a pocket size note book for practical men. Contains drawings and diagrams of electrical machines and connections; over 200 formulas, with problems worked out. "THE BURGESS BLUE BOOK" contains drawings for Motor Starters, Controllers, Transformers, Reversing Switches, Lighting Circuits, Calculations including Electrical Mathematics, Units, Resistance, Wire Gauge Rules, Ohm's Law, Unknown Resistance, Dynamo Troubles. Also Alternating Current Calculations, finding Impedance, Frequency, Speeds, Power Factor, Formulas for Line Transformers. Price only \$1.00 postpaid on money back guarantee.

AGENTS WANTED: Write for special proposition to THE BURGESS COMPANY, Consulting Electrical Engineers 745 East 42nd St. Radio Apparatus and Supplies Chicago, Ill.



## MAKE YOUR OWN Radio Receiving Set

Enjoy the concerts, baseball scores, market reports, latest news, etc., as sent out by large broadcasting station.

This NEW copyright book, "EFFICIENT RADIO SETS," shows how to make INEXPENSIVE sets for receiving wireless broadcastings. Sent postpaid for 25c. Address J. C. DORN, 725 So. Dearborn St., Dept. 117, Chicago

## STAMMER NO MORE

Kill the fear of stammering. Re-education the key. The widely famed Hatfield Method fully outlined in an accurate, dependable, worthwhile book—"HOW TO STOP STAMMERING." It has inspired thousands. Free copy today.

THE HATFIELD INSTITUTE, 109 N. Dearborn, Chicago, Ill.

## SALESMEN

Largest radio publishing organization in the world, wants salesmen, either whole or side line, to sell an assortment of 20 books to the trade.

Liberal Commission to Hustlers.

Box 233, Science & Invention, New York City

# BARGAIN OFFERS

## The Best Magazines in Clubs at Prices Not Surpassed Anywhere

**B**ECAUSE of special arrangements, we can offer you the following extraordinary bargains in desirable and popular magazines.

These amazing offers enable you to obtain, for a small sum, a veritable feast of fact and fiction; of fashions, recipes and household hints — reading matter worth many times its cost. You may order more than one of these combinations, if you wish. The extremely low prices at which these magazines are offered do not permit our paying any agent's commission on any combination. Send your orders to us direct. Otherwise, you cannot obtain the magazines at these prices. Remit by check or money order.

Club No.		Regular Price		Our Price	You Save
757	Physical Culture and American Fruit Grower	\$3.50	both 1 year for only	\$3.05	45c
758	Physical Culture and American Magazine	5.50	both 1 year for only	5.00	50c
759	Physical Culture and American Needlewoman	3.50	both 1 year for only	3.05	45c
760	Physical Culture and Baseball Magazine	5.00	both 1 year for only	4.25	75c
761	Physical Culture and Beautiful Womanhood	3.50	both 1 year for only	3.05	45c
764	Physical Culture and Boys' Life	5.00	both 1 year for only	4.25	75c
765	Physical Culture and Boys' Magazine	4.00	both 1 year for only	3.35	65c
766	Physical Culture and Brain Power	3.50	both 1 year for only	3.05	45c
767	Physical Culture and Capper's Weekly	4.00	both 1 year for only	3.05	95c
768	Physical Culture and Child Life	6.00	both 1 year for only	5.00	\$1.00
769	Physical Culture and Christian Herald	5.00	both 1 year for only	4.00	1.00
770	Physical Culture and Collier's Weekly	5.50	both 1 year for only	4.50	1.00
771	Physical Culture and Delineator	5.00	both 1 year for only	4.00	1.00
772	Physical Culture and Designer	4.50	both 1 year for only	3.75	75c
773	Physical Culture and Etude (Music)	5.00	both 1 year for only	4.25	75c
774	Physical Culture and Farm & Fireside	3.50	both 1 year for only	3.05	45c
775	Physical Culture and Farm & Home	3.25	both 1 year for only	3.05	20c
777	Physical Culture and Farm Life	3.25	both 1 year for only	3.05	20c
778	Physical Culture and Farm Mechanics	4.00	both 1 year for only	3.35	65c
781	Physical Culture and McCall's	4.00	both 1 year for only	3.10	90c
782	Physical Culture and McClure's	6.00	both 1 year for only	5.00	\$1.00
783	Physical Culture and Metropolitan	6.00	both 1 year for only	4.65	1.35
784	Physical Culture and Modern Priscilla	5.00	both 1 year for only	4.35	65c
785	Physical Culture and Movie Weekly	8.00	both 1 year for only	7.00	\$1.00
786	Physical Culture and Pathfinder	4.00	both 1 year for only	3.10	90c
787	Physical Culture and People's Home Journal	4.25	both 1 year for only	3.50	75c
789	Physical Culture and Pictorial Review	4.50	both 1 year for only	4.00	50c
790	Physical Culture and Review of Reviews	7.00	both 1 year for only	5.50	\$1.50
791	Physical Culture and Sunset Magazine	5.50	both 1 year for only	4.50	1.00
792	Physical Culture and Today's Housewife	4.00	both 1 year for only	3.10	90c
793	Physical Culture and True Romances	6.00	both 1 year for only	4.65	\$1.35
794	Physical Culture and True Story Magazine	6.00	both 1 year for only	4.65	1.35
795	Physical Culture and Woman's Home Comp'n	4.50	both 1 year for only	4.00	50c
796	Physical Culture and Woman's World	3.50	both 1 year for only	3.05	45c
797	Physical Culture and Youth's Companion	5.50	both 1 year for only	5.00	50c
802	Physical Culture and Fruit, Garden & Home	3.35	both 1 year for only	3.05	30c

-----COUPON-----

.....1923.                      Send both to:

Macfadden Publications, Inc.                      Name .....

    1926 Broadway,                                      Address .....

    New York.    State .....

Herewith \$..... for Club No.....

made up of the following magazines:

Name of Magazine:.....

    "            "                      .....

    "            "                      .....

Remit by Check, P. O. Money Order or Express  
Company Order. Cash or Stamps should be sent by  
registered mail.

# Learn COMMERCIAL Electrical Engineering in One Year

To fill the ever increasing demand for electrically trained business men, consulting and efficiency engineers, men who can handle commercial engineering problems, we offer a thorough, condensed, and very practical course to high school graduates.

We teach by practical work and scientific methods under practical working conditions. Specialists for 18 years in training young men for

## Electrical Engineering with B. S. Degree in 3 years



Electrotechnics 1 to 2 years. Electrical and Mechanical Drafting 9 months. Automotive Electricity 3 months. Armature Winding and Motor Generator Repair 3 months. Practical Electricity 6 months.

A place for every student regardless of age or education. Up-to-date laboratories, faculty of experts, individual instruction. Students' Activities. Radio Broadcasting Station. Winter Term opens January 2, 1924.

## SCHOOL of ENGINEERING of Milwaukee

Founded 1905

School of Engineering of Milwaukee, Dept. S&I-12, 415 Marshall Street, Milwaukee, Wis. Without obligating me in any way, please mail free illustrated book and further particulars on the course I have marked with an X.

- ...Commercial Electrical Engineering
- ...Electrical Engineering
- ...Practical Electricity
- ...Drafting
- ...Electrotechnics
- ...Automotive Electricity
- ...3 mo. Armature Winding Course
- ...3 mo. Light and Motor Wiring Course

Name .....

Address .....

City ..... State.....

Education ..... Age.....

# Radio Broadcast

Revised and corrected to date.

First group of figures indicate the power in watts in the antenna of the transmitting station. The second group gives the wave-length.

Call Letters	Name	Location	Power & Wave Length	Call Letters	Name	Location	Power & Wave Length
KDKA	Westinghouse Electric & Mfg. Co., East Pittsburgh, Pa.		100—326	KFAW	The Radio Den (W. B. Ashford), Santa Ana, Calif.		10—280
KDPM	Westinghouse Electric & Mfg. Co., Cleveland, Ohio		250—270	KFAY	Virgin's Radio Service, (W. J. Virgin), Medford, Ore.		100—360
KDPT	Southern Electric Co., San Diego, Calif.		50—244	KFBB	F. A. Buttrey & Co., Havre, Mont.		50—360
KDYL	Telegram Publishing Co., Salt Lake City, Utah		50—360	KFBC	W. K. Azbill, San Diego, Calif.		20—278
KDYM	Savoy Theatre, San Diego, Calif.		50—252	KFBE	Reuben H. Horn, San Luis Obispo, Calif.		10—360
KDYQ	Oregon Institute of Technology, Portland, Oregon		5—360	KFBG	First Presbyterian Church, Tacoma, Wash.		50—360
KDYS	The Tribune, Great Falls, Montana		50—360	KFBK	Kimball-Upson Co., Sacramento, Calif.		100—283
KDYW	Smith Hughes Machinery Co., Phoenix, Ariz.		20—360	KFBL	Leese Bros., Everett, Wash.		10—224
KDYX	Star Bulletin, Honolulu, Hawaii		100—360	KFBS	Trinidad Gas & Electric Supply Co., and Chronicle News, Trinidad, Colo.		15—360
KDZB	Frank E. Siefert, Bakersfield, Calif.		100—240	KFBU	The Cathedral (Bishop N. S. Thomas), Laramie, Wyo.		50—283
KDZE	The Rhodes Co., (Dept. Store), Seattle, Wash.		100—455	KFCB	Nielsen Radio Supply Co., Phoenix, Ariz.		10—238
KDZF	Automobile Club of Southern Calif., Los Angeles, Calif.		500—278	KFCD	Salem Electric Co., (F. S. Barton), Salem, Oreg.		20—360
KDZI	Electric Supply Co., Wenatchee, Wash.		50—360	KFCF	Frank A. Moore, Walla Walla, Wash.		50—360
KDZK	Nevada Machinery & Electric Co., Reno, Nevada		25—360	KFCH	Electric Service Station, Inc., Billings, Mont.		10—360
KDZQ	Nichols Academy of Dancing, (Hal G. Nichols), Denver, Colo.		10—360	KFCK	Colorado Springs Radio Co., Colorado Springs, Colo.		10—242
KDZR	Bellingham Publishing Co., Bellingham, Wash.		50—261	KFCL	Los Angeles Union Stock Yards, San Antonio, Calif.		500—360
KDZT	Seattle Radio Association, Seattle, Wash.		10—360	KFCM	Richmond Radio Shop, (Frank T. Doeing), Richmond, Calif.		100—360
KFAD	McArthur Bros. Mercantile Co., Phoenix, Ariz.		100—360	KFCP	Ralph W. Flygare, Ogden, Utah		25—360
KFAE	State College of Washington, Pullman, Wash.		500—360	KFCV	Fred Mahaffey, Jr., Houston, Tex.		10—360
KFAF	Western Radio Corporation, Denver, Colo.		500—360	KFCY	Western Union College, Le Mars, Iowa		100—360
KFAJ	University of Colorado, Boulder, Colo.		100—360	KFCZ	Omaha Central High School, Omaha, Nebr.		100—258
KFAN	The Electric Shop, Moscow, Idaho		50—360	KFDA	Adler's Music Store, Baker, Oreg.		5—360
KFAP	Standard Publishing Co., Butte, Mont.		100—360	KFDD	St. Michaels Cathedral, Boise, Idaho		10—252
KFAR	Studio Lighting Service Co., (O. K. Olsen), Hollywood, Calif.		200—280	KFDH	University of Arizona, Tucson, Ariz.		150—360
KFAU	Independent School District of Boise City, Boise High School, Boise, Idaho		150—270	KFDJ	Oregon Agricultural College, Corvallis, Oreg.		50—360
KFAV	Abbot Kinney Co., Venice, Calif.		5—224	KFDL	Knight-Campbell Music Co., Denver, Colo.		5—360
				KPDO	H. Everett Cutting, Bozeman, Mont.		50—248
				KFDP	Hawkeye Radio & Supply Co., Des Moines, Iowa		100—278

### Common Objects Magnified 225 Diameters

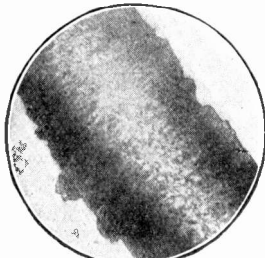

Human Hair

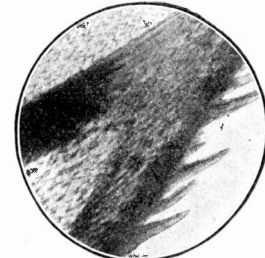

Edge of Fly's Wing

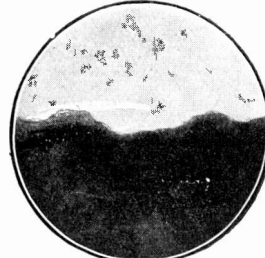

Edge of Razor

# Wonderful New Ultralens MICROSCOPE

A remarkable scientific discovery now makes it possible to manufacture a perfect lens of high magnifying power at about one-twelfth the usual cost. After years of research we have been able to bring the price of the Ultralens Microscope within the reach of all who wish to study and experiment with the vast world of minute objects that are invisible to the naked eye.

Magnifies 225 Diameters or 50,625 Times  
Surface Area

The illustration, at the left, gives an idea of the extraordinary magnification and the clear definition secured through the Ultralens objective. The instrument, shown at the right, comes complete in bakelite case and includes everything necessary to conduct numberless experiments. A 225 diam. objective is standard equipment. Extra Ultralens objectives of 125 or 325 diams. can be had for \$1 each.

## Easy to Use

at Home, in the Field, or in the  
Scientific Laboratory

Amateurs and Scientists alike will find that research with the Ultralens is both pleasant and profitable. The instrument is a marvel of simplicity and cannot get out of order. Handsomely finished, solid construction, accurate focusing adjustment. A perfect microscope for all purposes—only \$5.

One-Twelfth Usual Cost!

Order your Ultralens Microscope today at the special low price. Interesting descriptive booklet sent free on request.

**Scientific Apparatus Corp.,**  
Dept. 101, Milton, Pa.

\$5

A Splendid  
Christmas Gift

No present will be more appreciated than an Ultralens Microscope. It is interesting, useful, and highly instructive.

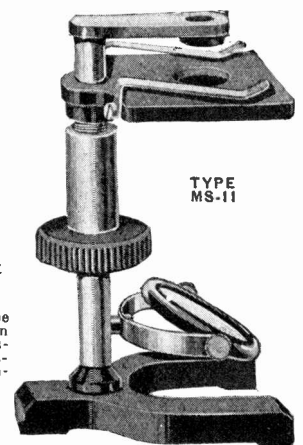

Order on this Coupon  
or Send for Descriptive Booklet

SCIENTIFIC APPARATUS CORP.,  
Dept. 101, Milton, Pa.

Please send to me, fully prepaid, the complete Ultralens Microscope, MS-11, including full outfit for experiments. I enclose \$5. You guarantee the instrument to do all you claim in this advertisement.

Name .....

Address .....

Call Letters	Name	Location	Power & Wave Length
KFDR	Bullocks Hardware & Sporting Goods. (Robert G. Bullock), York, Nebr.		10-360
KFDU	Nebraska Radio Electric Co., Lincoln, Nebr.		20-240
KFDV	Gilbrech & Stinson, Fayetteville, Ark.		200-360
KFDX	First Baptist Church, Shreveport, La.		100-360
KFDY	South Dakota State College of Agriculture and Mechanic Arts, Brookings, S. Dak.		100-360
KFDZ	Harry O. Iverson, Minneapolis, Minn.		5-360
KFEC	Meier & Frank Co., Portland, Ore.		50-360
KFEJ	Guy Greason, Tacoma, Wash.		10-360
KFEL	Winner Radio Corp., Denver, Colo.		50-360
KFEP	Radio Equipment Co., (Jos. L. Turre), Denver, Colo.		10-240
KFEQ	J. L. Scroggin, Oak, Nebr.		150-360
KFER	Auto Electric Service Co., Fort Dodge, Iowa		20-231
KFEV	Radio Electric Shop, Douglas, Wyo.		100-263
KFEX	Augsburg Seminary, Minneapolis, Minn.		100-261
KFEY	Bunker Hill & Sullivan Mining and Concentrating Co., Kellogg, Idaho.		10-360
KFEZ	Amer. Society of Mechanical Engineers, (F. H. Schubert), St. Louis, Mo.		100-360
KFFA	Dr. R. O. Shelton, San Diego, Calif.		50-242
KFFB	Jenkins Furniture Co., Boise, Idaho.		10-240
KFFC	Eastern Oregon Radio Co., Pendleton, Ore.		10-360
KFFD	First Baptist Church, Moberly, Mo.		100-275
KFFE	Marksheffel Motor Co., Colorado Springs, Colo.		100-360
KFFG	Dr. E. H. Smith, Hillsboro, Oreg.		5-229
KFFH	Nevada State Journal (Jim Kirk), Sparks, Nev.		10-226
KFFI	Graceland College, Lamoni, Iowa		100-360
KFFJ	McGraw Co., Omaha, Nebr.		250-278
KFFK	Pincus & Murphey, Alexandria, La.		100-275
KFFL	Al G. Barnes Amusement Co., Dallas, Tex. (portable)		20-226
KFFM	Louisiana State University, Baton Rouge, La.		100-254
KFFN	Chickasha Radio & Electric Co., Chickasha, Okla.		20-248
KFFO	Leland Stanford University, (P. O.) Stanford Univ., Calif.		500-360
KFFP	Missouri National Guard, 138th Infantry, St. Louis, Mo.		250-266
KFFQ	Arlington Garage, Arlington, Oreg.		5-234
KFFR	Cheney Radio Co., Cheney, Kans.		10-229
KFFS	Crary Hardware Co., Boone, Iowa.		20-226
KFFT	Heidbreder Radio Supply Co., Utica, Nebr.		10-224
KFFU	First Presbyterian Church, Orange, Tex.		500-250
KFFV	Gjelhangs Radio Shop, Bandette, Minn.		20-224
KFFW	Emmanuel Missionary College, Berrien Springs, Mich.		10-268
KFFX	Colorado State Normal School, Gunnison, Colo.		50-360
KFFY	Rialto Theatre, (P. L. Beardwell), Hood River, Oreg.		5-280
KFFZ	Utz Electric Shop Co., St. Joseph, Mo.		20-226
KFGA	Central Christian Church, Schreveport, La.		150-266
KFGB	Ambrose A. McCue, Neah Bay, Wash.		50-253
KFGC	Charles V. Dixon, Wichita, Kans.		20-224
KFGD	Fallon & Co., Santa Barbara, Calif.		100-360
KFGE	Curtis Bros. Hardware Store (Alfred E. Fowler), Los Gatos, Calif.		5-242
KFGF	Star Electric & Radio Co., Seattle, Wash.		100-270
KFGG	Clifford J. Dow, Lihue, Hawaii		30-275
KFGH	M. G. Sateren, Mayville, N. Dak.		50-261
KFGI	Robert W. Nelson, Hutchinson, Kans.		50-229
KFGJ	R. S. McEwan, Trinidad, Colo.		50-242
KFGK	Earle C. Anthony, Inc., Los Angeles, Calif.		500-469
KFGL	Franklin W. Jenkins, St. Louis, Mo.		10-244
KFGM	Ross Arbuckle's Garage, Iola, Kans.		20-246
KFGN	Benson Polytechnic Institute, Portland, Oreg.		100-360
KFGO	Gladbrook Electrical Co., Gladbrook, Iowa		20-234
KFGP	Windsch Electric Farm Equipment Co., Louisburg, Kans.		30-234
KFGQ	North Central High School, Spokane, Wash.		50-252
KFGR	Yakima Valley Radio Broadcasting Association, Yakima, Wash.		50-224
KFGS	Alaska Elec. Light & Power Co., Juneau, Alaska		10-226
KFGT	Y. H. Broyles, Pittsburg, Kans.		20-240
KFGU	Reorganized Church of Jesus Christ of Latter Day Saints, Independence, Mo.		500-240
KFGV	Brott Laboratories, Seattle, Wash.		15-236
KFGW	Daily Commonwealth and Oscar A. Huelsman, Fond du Lac, Wis.		100-273
KFGX	Central Power Co., Grand Island, Nebr.		100-244
KFGY	Marshall Electrical Co., Marshalltown, Iowa		10-248
KFGZ	Seattle Post Intelligencer, Seattle, Wash.		100-233
KFHA	Weld County Printing & Publishing Co., Greeley, Colo.		50-236
KFHB	National Radio Mfg. Co., Oklahoma City, Okla.		20-252
KFHC	The Sugar Bowl, (H. R. Shaw), Selma, Okla.		10-273
KFHD	Liberty Theatre, (E. E. Marsh), Astoria, Oreg.		10-252
KFHE	Carrollton Radio Shop, Carrollton, Mo.		50-236

# No Matter What Your Vocation

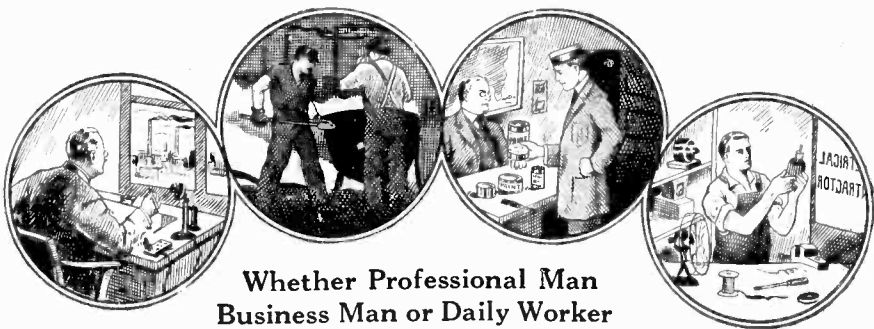

Whether Professional Man  
Business Man or Daily Worker

## A Thorough Training In **CHEMISTRY** Will Help You To Get Ahead

**T**O be successful today is to know Chemistry! Every line of business, every branch of industry depends upon Chemistry in some form. You may not realize it, but your own proficiency in whatever work you are doing would be increased by a knowledge of Chemistry. In many lines such knowledge is absolutely essential. In others it is a guarantee of promotion and more money.

The keen competition that exists in every commercial activity today requires that a man know all there is to know about his vocation. If you have something to sell—no matter what—Chemistry enters into its make-up. The salesman who knows the chemical composition of his article can talk about it more intelligently than the one who lacks this information, and his sales are proportionately larger. In the building trades Chemistry is of prime importance. The mason, electrician or painter who knows something about Chemistry can do better work and command more money than the one who does not. Through Chemistry a shop-keeper learns how to attract the most trade, and even in clerical positions one can capitalize his chemical skill.

Chemistry should be as much a part of your mental equipment as the ability to calculate or to write correct English. The world is paying a thousandfold more for ideas than for actual labor. The big rewards go to the man who can show how to turn out a little better product at a little lower cost. And Chemistry will give you the ideas that will save money for yourself or your firm in the very fundamentals of your business. There is nothing remarkable about this; it is going on every day. If you have not heard of it before, it is because the general public has been slow to recognize the tremendous value of chemical training. People have been content to leave Chemistry in the hands of a few trained chemists who could not possibly develop the subject to anywhere near its greatest extent.

Now we are on the eve of a great awakening. Our heritage from the World War has been an intense development of the chemical industries in the United States and a tremendous interest in all the applications of Chemistry. People are taking up the subject merely for the good it will do them in their own line of business.

It is no longer necessary to enter college in order to learn this fascinating science. Our Home Study Course trains you just as thoroughly, and with the same assurance of success, as those who took the longer way. And our methods are so simple that we can teach you no matter how little previous education you may have had. Many of our graduates now hold responsible positions or have materially increased their incomes from private enterprises as a result of taking our course. Hundreds of letters from students testifying to the benefits they have derived from our training are here for your inspection.

Remember that you do not need to study Chemistry with the idea of actually practicing as a chemist, although a great many of our students are taking our course with this object in view. If you want to know more about what Chemistry will do for you, if you want to know what our home study course offers, sign and mail the coupon today for FREE BOOK "Opportunities for Chemists."

**DR. T. O'CONOR SLOANE Will Teach You Chemistry In Your Own Home**

The Chemical Institute of New York, of which Dr. T. O'Conor Sloane is Educational Director, was founded to fill the need of ambitious, far-sighted men who realize and recognize the splendid future Chemistry offers them, but who cannot spare either the time or the money to attend college. Dr. Sloane, a foremost authority on Chemistry, will teach you and will give you any individual help you may require. He will personally go over your papers, correct them, point out your faults, teaching you in a practical and interesting way. No special education required other than the ability to read and write English. One student has characterized our lessons as "The course that takes the mystery out of Chemistry."

**Read What One of Our Recent Graduates Reports**

"I thought I would let you know of my success. I finished your course about two months ago and now have a fine position as chemist at the DuPont Dye Works. I am getting along fine with my work and like it very much. It was through your course alone that I have been so successful. It is wonderful and I hope you have great success with it."

(Name and Address on request).

**Easy Monthly Payments**

You do not have to have even the small price of the course to start. You can pay for it in small monthly payments—so small that you won't feel them. The cost is very moderate, and includes everything, even the Laboratory Equipment—there are no extras to buy with our course. Our plan of monthly payments places a chemical education within the reach of everyone.

**Laboratory Equipment Given To Every Student Without Additional Charge**

We give to every student without additional charge his chemical equipment, including forty-two pieces of laboratory apparatus and supplies, and seventeen different chemicals and reagents. These comprise the apparatus and chemicals used for the experimental work of the course.

**Special 30-Day Offer**

For a short period we are making a special offer that will be worth your while to take advantage of. Write for particulars, using the coupon below or simply a postal card. This will not obligate you in the least. Do not wait until to-morrow. Send the coupon now while you think of it.

**Sign and Mail the Coupon for FREE BOOK**

CHEMICAL INSTITUTE OF NEW YORK, Inc.  
Home Extension Division 12,  
66-D—West Broadway, New York City.

Please send me at once without any obligation on my part, your Free Book "Opportunities for Chemists," and full particulars about the Laboratory Equipment furnished to every student. Also please tell me about your plan of payment and your special 30 day offer.

NAME .....

ADDRESS .....

CITY .....

STATE .....

S. & I. 12-23

**Chemical Institute of New York, Inc.**  
HOME EXTENSION DIVISION 12  
66-D West Broadway, New York City



### "I'm Going to Make More Money!"

"I'm tired working for a small salary. I know I have just as good a head on me as Fred Moore and Bob Roberts, for we used to work side by side. But they've gone far ahead of me.

"Why? Because they saw the value of special training, and I didn't.

"But I know better now. If the International Correspondence Schools can raise the salaries of men like Fred Moore and Bob Roberts, they can raise mine, too!

"If they have helped others to advance, they can help me. To-day—right now—I'm going to send in this coupon and at least find out what the I. C. S. can do for me."

#### INTERNATIONAL CORRESPONDENCE SCHOOLS

Without cost or obligation on my part, please tell me how I can qualify for the position or in the subject before which I have marked an X:

##### BUSINESS TRAINING COURSES

- Business Management
- Industrial Management
- Personnel Organization
- Traffic Management
- Business Law
- Banking and Banking Law
- Accountancy (including C.P.A.)
- Cost Accounting
- Bookkeeping
- Private Secretary
- Spanish
- French
- Salesmanship
- Advertising
- Better Letters
- Show Card Lettering
- Stenography and Typing
- Business English
- Civil Service
- Railway Mail Clerk
- Common School Subjects
- High School Subjects
- Illustrating

##### TECHNICAL AND INDUSTRIAL COURSES

- Electrical Engineering
- Electric Lighting
- Mechanical Engineer
- Mechanical Draftsman
- Machine Shop Practice
- Railroad Positions
- Gas Engine Operating
- Civil Engineer
- Surveying and Mapping
- Metallurgy
- Mining
- Steam Engineering
- Radio
- Architect
- Blue Print Reading
- Contractor and Builder
- Architectural Draftsman
- Concrete Builder
- Structural Engineer
- Chemistry
- Pharmacy
- Automobile Work
- Airplane Engines
- Agriculture and Poultry
- Mathematics

Name.....  
 Street.....  
 Address.....  
 City..... State.....

Occupation.....  
 Persons residing in Canada should send this coupon to the International Correspondence Schools Canadian, Limited, Montreal, Canada

## EARN MONEY AT HOME

YOU can make \$15 to \$60 weekly in your spare time writing show cards. No canvassing or soliciting. We instruct you by our new simple Directograph system, pay you cash each week and guarantee you steady work. Write for full particulars and free booklet.

**WEST-ANGUS SHOW CARD SERVICE LIMITED**  
 Authorized Capital \$1,250,000.00  
 67 Colborne Building Toronto, Can.



Wonderful, new device, guides your hand; corrects your writing in few days. Big improvement in three hours. No failures. Complete outline FREE. Write C. J. Ozment, Dept. 44 St. Louis, Mo.

Call Letters	Name	Location	Power & Wave Length
KFJK	Delano Radio & Electric Co.	Bristow, Okla.	100-233
KFJL	Hardsag Mfg. Co.	Ottumwa, Iowa	10-242
KFJM	University of North Dakota	Grand Forks, N. Dak.	100-229
KFJQ	Electric Construction Co.	Valley Radio Division, Grand Forks, N. Dak. (portable)	5-252
KFJR	Ashley C. Dixon & Son	Stevensville, Mont. (near)	50-258
KFJV	Thomas H. Warren	Dexter, Iowa	10-224
KFJW	Le Grand Radio Co.	Towanda, Kans.	10-226
KFJX	Iowa State Teachers College	Cedar Falls, Iowa	50-229
KFJY	Tunwall Radio Co.	Fort Dodge, Iowa	50-246
KFJZ	Texas National Guard Cavalry	112th Port Worth, Texas	20-254
KFKA	Colorado State Teachers College	Greeley, Colo.	50-248
KFKB	Brinkley-Jones Hospita. Association	Milford, Kans.	500-286
KFKH	Denver Park & Amusement Co.	Lakeside, Colo.	10-226
KFLE	National Education Service	Denver, Colo.	10-268
KFKX	Westinghouse Electric & Mfg. Co.	Hastings, Nebr.	500-286
KGB	Tacoma Daily Ledger	Tacoma, Wash.	50-252
KGK	Hallock & Watson Radio Service	Portland, Oreg.	50-360
KGN	Northwestern Radio Mfg. Co.	Portland, Oreg.	100-360
KGU	Marion A. Mulrony	Honolulu, Hawaii	250-360
KGW	Portland Morning Oregonian	Portland, Oregon	500-492
KGY	St. Martins College	Lacey, Wash.	5-258
KHJ	Times Mirror Co.	Los Angeles, Calif.	500-395
KHQ	Louis Wasmer	Seattle, Wash.	100-360
KJFU	Central Power Co.	Kearney, Nebr.	10-234
KJO	C. O. Gould	Stockton, Calif.	5-360
KJR	Northwest Radio Service	Seattle, Wash.	100-270
KJS	Bible Institute of Los Angeles	Los Angeles, Calif.	750-360
KLN	Monterey Electric Shop	Monterey, Calif.	10-261
KLS	Warner Bros. Radio Supplies Co.	Oakland, Calif.	250-360
KLX	Tribune Publishing Co.	Oakland, Calif.	250-360
KLZ	Reynolds Radio Co.	Denver, Colo.	500-360
KMJ	San Joaquin Lt. & Power Corp'n.	Presno, Calif.	250-360
KMO	Love Electric Co.	Tacoma, Wash.	10-360
KNJ	Roswell Public Service Co.	Roswell, N. Mex.	500-250
KNT	Grays Harbor Radio Co. (Walter Hemrich)	Aberdeen, Wash.	250-263
KNV	Radio Supply Co.	Los Angeles, Calif.	100-256
KNX	Electric Lighting Supply Co.	Los Angeles, Calif.	100-360
KOB	New Mexico College of Agriculture and Mechanic Arts	State College, N. Mexico	500-360
KOP	Detroit Police Dept.	Detroit, Mich.	500-423
KPO	Hale Bros.	San Francisco, Calif.	500-286
KQI	University of California	Berkeley, Calif.	500-360
KQP	Apple City Radio Club	Hood River, Oreg.	10-360
KQV	Doubleday Hill Electric Co.	Pittsburgh, Penn.	500-360
KQW	Chas. D. Herrold	San Jose, Calif.	50-360
KRE	Berkeley Daily Gazette	Berkeley, Calif.	50-278
KSD	Post Dispatch (Pulitzer Pub. Co.)	St. Louis, Mo.	500-546
KSS	Prest & Dean Radio Co. & Radio Research Society of Long Beach	Long Beach, Calif.	20-360
KTW	First Presbyterian Church	Seattle, Wash.	500-360
KUO	Examiner Printing Co.	San Francisco, Calif.	150-360
KUS	City Dye Works & Laundry Co.	Los Angeles, Calif.	100-360
KUY	Coast Radio Co.	El Monte, Calif.	50-256
KWV	Portable Wireless Telephone Co.	Stockton, Calif.	100-360
KWH	Los Angeles Examiner	Los Angeles, Calif.	500-360
KXD	Modesto Herald Publishing Co.	Modesto, Calif.	10-252
KYQ	Electric Shop	Honolulu, Hawaii	20-360
KYW	Westinghouse Electric & Mfg. Co.	Chicago, Ill.	500-345
KZM	Preston D. Allen	Oakland, Calif.	50-360
KZN	The Deseret News	Salt Lake City, Utah	500-360
KZV	Wenatchee Battery & Motor Co.	Wenatchee, Wash.	50-360
WAAB	Valdemar Jensen	New Orleans, La.	100-268
WAAC	Tulane University	New Orleans, La.	400-360
WAAD	Ohio Mechanics Institute	Cincinnati, Ohio	25-360
WAAF	Chicago Daily Drover's Journal	Chicago, Ill.	200-286
WAAG	Commonwealth Electric Co.	St. Paul, Minn.	100-360
WAAL	Gimbel Bros.	Milwaukee, Wis.	100-280
WAAM	I. R. Nelson Co.	Newark, N. J.	250-263
WAAN	University of Missouri	Columbia, Mo.	50-254
WAAP	United Electric Co.	Wichita, Kans.	150-360
WAAW	Omaha Grain Exchange	Omaha, Nebr.	200-360
WAAZ	The Hollister-Miller Motor Co.	Emporia, Kans.	100-360
WABB	Dr. John B. Lawrence	Harrisburg, Pa.	10-266

Call Letters	Name	Location	Power & Wave Length
WABC	Fulwider-Grimes Battery Co.	Ander-son, Ind.	10-229
WABD	Parker High School	Dayton, Ohio	10-283
WABE	Young Man's Christian Association	Washington, D. C.	250-234
WABF	Mount Vernon Register-News Co.	Mount Vernon, Ill.	100-234
WABG	Arnold Edwards Piano Co.	Jackson-ville, Fla.	10-248
WABH	Lake Shore Tire Co.	Sandusky, Ohio	100-240
WABI	Bangor Railway & Electric Co.	Bangor, Me.	50-240
WABJ	The Radio Laboratories	South Bend, Ind.	10-240
WABK	First Baptist Church	Worcester, Mass.	10-252
WABL	Connecticut Agricultural College	Storrs, Conn.	100-283
WABM	F. E. Doherty Automotive & Radio Equipment Co.	Saginaw, Mich.	100-254
WABN	Waldo C. Grover	La Crosse, Wis.	250-244
WABO	Lake Ave. Baptist Church	Rochester, N. Y.	20-252
WBAA	Purdue University	West Lafayette, Ind.	250-360
WBAD	Sterling Electric Co.	Minneapolis, Minn.	100-360
WBAF	Fred M. Middleton	Moorestown, N. J.	100-360
WBAH	The Dayton Co.	Minneapolis, Minn.	500-360
WBAN	Wireless Phone Corporation	Pater-son, N. J.	100-244
WBAO	James Mullikin University	Decatur, Ill.	50-360
WBAP	Wortham-Carter Publishing Co. (Star-Telegram)	Port Worth, Tex.	500-476
WBAV	Erner & Hopkins Co.	Columbus, Ohio	500-390
WBWA	Marietta College	Marietta, Ohio	250-246
WBAX	John H. Stenger, Jr.	Wilkes-Barre, Pa.	20-360
WBAY	Western Electric Co.	New York, N. Y.	500-492
WBBA	Newark Radio Laboratories	Newark, Ohio	20-240
WBBC	Sterling Radio Equipment Co.	Sterling, Ill.	50-229
WBBD	Barbey Battery Service	Reading, Pa.	50-234
WBL	T & H Radio Company	Anthony, Kansas	100-261
WBS	D. W. May (Inc.)	Newark, N. J.	20-360
WBT	Southern Radio Corp.	Charlotte, N. C.	50-360
WBU	City of Chicago	Chicago, Ill.	500-286
WBZ	Westinghouse Electric & Mfg. Co.	Springfield, Mass.	250-337
WCAD	St. Lawrence University	Canton, Ohio	250-280
WCAE	Kaufman & Baer Co.	Pittsburgh, Pa.	500-462
WCAJ	Clyde R. Randall	New Orleans, La.	50-268
WCAH	Entrekin Electric Co.	Columbus, Ohio	100-286
WCAI	Nebraska Wesleyan University	University Place, Nebr.	500-360
WCAK	Alfred P. Daniel, Asst. Division Mgr.	A.R.R.L., Houston, Texas	50-360
WCAL	St. Olaf College	Northfield, Minn.	250-360
WCAM	Villanova College	Villanova, Pa.	150-360
WCAO	The Sanders and Stayman Co.	Baltimore, Md.	50-360
WCAP	Chesapeake & Potomac Telephone Co.	Washington, D. C.	500-469
WCAR	Alamo Radio Electric Co.	San Antonio, Texas	150-360
WCAS	Wm. Hood Dunwoody Industrial Institute	Minneapolis, Minn.	100-246
WCAT	South Dakota State School of Mines	Rapid City, S. Dak.	50-240
WCAU	Durham & Co.	Philadelphia, Pa.	250-286
WCAV	J. C. Dice Electric Co.	Little Rock, Ark.	20-360
WCAX	University of Vermont	Burlington, Vt.	50-360
WCAW	Kesselman O. Driscoll Co.	Mil-waukee, Wis.	250-261
WCAY	Carthage College	Carthage, Ill.	50-246
WCBA	Charles W. Humbach	Allentown, Pa.	5-280
WCBB	K & K Radio Supply Co. (Charles H. Katzenberger)	Greenville, Ohio	100-240
WCBD	Wilbur G. Voliva	Zion, Ill.	500-345
WCE	Findley Electric Co.	Minneapolis, Minn.	250-360
WCK	Stix Baer & Fuller Dry Goods Co.	St. Louis, Mo.	100-360
WCM	University of Texas	Austin, Texas	500-360
WCX	The Detroit Free Press	Detroit, Mich.	500-517
WDAD	Central Kansas Radio Supply Co. (Wm. L. Harrison)	Lindsborg, Kans.	10-360
WDAE	Tampa Daily Times	Tampa, Fla.	250-360
WDAF	Kansas City Star	Kansas City, Mo.	500-411
WDAG	J. Laurance Martin	Amarillo, Texas	100-263
WDAH	Trinity Methodist Church (South)	El Paso, Texas	100-288
WDAI	Hughes Radio Corp.	Syracuse, N. Y.	100-246
WDAK	The Courant	Hartford, Conn.	100-261
WDAL	Florida Times-Union	Jacksonville, Fla.	100-360
WDAO	Automotive Electric Co.	Dallas, Texas	50-360
WDAP	Board of Trade	Chicago, Ill.	500-360
WDAR	Lit Bros.	Philadelphia, Pa.	500-395
WDAS	Samuel A. Waite	Worcester, Mass.	5-360
WDAU	Slocum & Kilburn	New Bedford, Mass.	100-360
WDAX	First National Bank (Appomoosee County Farm Bureau)	Center-ville, Iowa	100-360
WDAY	Fargo Radio Electric Co.	Fargo, N. Dak.	50-244

Call Letters	Name	Location	Power & Wave Length
WDBC	Kirk Johnson & Co., Lancaster, Pa.		50-258
WDBF	Robert G. Phillips, Youngstown, Ohio		50-261
WDM	Church of the Covenant, Washington, D. C.		50-360
WDT	Ship Owners' Radio Service, New York, N. Y.		500-405
WDZ	J. L. Bush, Tuscola, Ill.		10-278
WEAA	Frank D. Fallain Police Building, Flint, Mich.		150-280
WEAB	Standard Radio Equipment Co., Fort Dodge, Iowa		500-360
WEAF	American Telephone & Telegraph Co., New York, N. Y.		500-492
WEAG	Nichols-Hineline-Bassett Laboratory, Edgewood, R. I.		10-231
WEAH	Wichita Board of Trade & Lander Radio Co., Wichita, Kansas		100-244
WEAI	Cornell University, Ithaca, N. Y.		500-286
WEAJ	University of South Dakota, Vermillion, S. Dak.		200-360
WEAK	Julius B. Abercrombie, St. Joseph, Mo.		15-360
WEAM	Borough of North Plainfield, (W. Gibson Buttfeld), North Plainfield, N. J.		100-252
WEAN	Shepard Co., Providence, R. I.		100-273
WEAO	The Ohio State University, Columbus, Ohio		500-360
WEAP	Mobile Radio Co., Mobile, Ala.		100-360
WEAR	Baltimore American News Publishing Co., Baltimore, Md.		50-360
WEAS	Hecht Co., Washington, D. C.		50-360
WEAU	Davidson Bros., Company, Sioux City, Iowa		100-360
WEAY	Will Horwitz, Jr., Houston, Texas		250-360
WEB	Benwood Co., St. Louis, Mo.		500-360
WEV	Hurlburt-Still Electrical Co., Houston, Texas		250-360
WEW	St. Louis University, St. Louis, Mo.		100-261
WFAD	The Dallas News, The Dallas Journal, Dallas, Texas		500-476
WFAB	Carl F. Woese, Syracuse, N. Y.		200-234
WFAF	H. C. Spratley Radio Co., Poughkeepsie, N. Y.		20-360
WFAH	Electric Supply Co., Port Arthur, Texas		150-360
WFAJ	Hi-Grade Wireless Instrument Co., Asheville, N. C.		50-360
WFAM	Times Publishing Co., St. Cloud, Minn.		20-360
WFAN	Hutchinson Electric Service Co., Hutchinson, Minn.		100-360
WFAQ	Missouri Wesleyan College, Cameron, Mo.		10-360
WFAT	The Daily Argus-Leader, Sioux Falls, S. Dak.		100-360
WFAV	University of Nebraska, Dept. E. E., Lincoln, Nebr.		100-360
WFI	Strawbridge & Clothier, Philadelphia, Pa.		500-395
WGAL	Lancaster Elec. Supply & Const. Co., Lancaster, Pa.		10-248
WGAN	Cecil E. Lloyd, Pensacola, Fla.		50-360
WGAQ	Glenwood Radio Corp., (W. G. Patterson), Shreveport, La.		100-360
WGAR	Southwest American, Fort Smith, Ark.		20-360
WGAU	Radio Mfg. & Service Co., (Marcus G. Limb), Wooster, Ohio		20-226
WGAW	Ernest C. Albright, Altoona, Pa.		100-261
WGAY	North Western Radio Co., Madison, Wis.		100-360
WGAZ	The South Bend Tribune, South Bend, Ind.		100-360
WGF	The Register & Tribune, Des Moines, Iowa		100-360
WGI	American Radio & Research Corp., Medford Hillside, Mass.		500-360
WGL	Thomas F. J. Howlette, Philadelphia, Pa.		500-360
WGR	Federal Telephone and Telegraph Co., Buffalo, N. Y.		500-360
WGV	Interstate Electric Co., New Orleans, La.		100-360
WGY	General Electric Co., Schenectady, N. Y.		1000-380
WHA	University of Wisconsin, Madison, Wis.		500-360
WHAA	State University of Iowa, Iowa City, Iowa		100-283
WHAB	Clark W. Thompson, Galveston, Texas		200-360
WHAC	Cole Bros. Electric Co., Waterloo, Iowa		10-360
WHAD	Marquette University, Milwaukee, Wis.		100-280
WHAG	University of Cincinnati, Cincinnati, Ohio		200-222
WHAH	Hafer Supply Co., Joplin, Mo.		250-360
WHAJ	Radio Equipment & Mfg. Co., Davenport, Iowa		50-360
WHAK	Roberts Hdw., Co., Clarksburg, W. Va.		15-258
WHAL	Lansing Capital News, Lansing, Mich.		20-360
WHAM	University of Rochester, (Eastman School of Music), Rochester, N. Y.		100-360
WHAO	Frederic A. Hill, Savannah, Georgia		100-360
WHAP	Otta & Kuhns, Decatur, Ill.		50-360
WHAQ	Semmes Motor Co., Washington, D. C.		10-360
WHAR	Paramount Radio & Electric Co., (W. H. A. Paulus), Atlantic City, N. J.		15-231
WHAS	Courier-Journal and Louisville Times, Louisville, Ky.		500-400
WHAV	Wilmington Electrical Specialty Co., Inc., Wilmington, Del.		50-360
WHAZ	Rensselaer Polytechnic Institute, Troy, N. Y.		500-380

**Your Copy of this great book**

**FREE**

**Send for it TODAY**

*You can Boss the Job*

**Mark These 9 Feature Points of A.E.E. Service**

- 1 Life Membership in the Associated Electrical Engineers
- 2 Our exclusive and copyrighted method of training
- 3 Unlimited Placement Service throughout your career
- 4 Unlimited Consultation Service
- 5 A wonderful Laboratory and Experimental Outfit
- 6 A Complete Course in Automotive Electricity
- 7 A Complete Course in Radio
- 8 A Complete Course in Business for the Electrical Expert
- 9 A Legally Binding Guarantee of Satisfaction



*This is the mark of the Associated Electrical Engineers Follow it to SUCCESS!*

This handsome, profusely illustrated book will tell you of the astonishing growth of the great Electrical Industry, and of the thousands of big money jobs and opportunities waiting for trained men.

More important, it will tell you of the great Associated Electrical Engineers—chartered by the State of Illinois, as an institution for the advancement of every phase of Electrical Science. Not a mere school, but a great National Organization of Electrical Experts and Specialists, who have developed the MOST REMARKABLE SYSTEM ON EARTH for HOME TRAINING IN ELECTRICITY.

**We Train You at Home**

in your spare time, quickly and surely, by our EXCLUSIVE AND COPYRIGHTED METHOD to qualify to

**Earn \$75 to \$200 a Week**

as an Electrical Expert or in business for yourself—and

**We Help You "Cash In"**

through our Placement Department and our great FREE BUSINESS COURSE, which will show you how to get the big-money Electrical jobs and how to establish your own independent, profitable Electrical business.

**Our Book Tells the Story**

Our BIG 64-PAGE ILLUSTRATED BOOK will tell you fully about every one of the 9 remarkable features of Associated Electrical Engineers Service, and how they will be the stepping stones for you from futureless, low-pay jobs up into the limitless, big-money opportunities in Electricity.

**You Have Education Enough**

If you have the AMBITION to succeed and make big money as an Electrical Expert, we will guarantee the rest.

**Mail the Coupon NOW**

Get this remarkable book. It is FREE. You will incur no obligation in asking for it. We want every ambitious man in America to have one and receive this great message. Your copy is ready. Send for it TODAY.

**ASSOCIATED ELECTRICAL ENGINEERS**  
Dept. C-2 537 South Dearborn Street, CHICAGO, ILL.

**Here's Opportunity's Wide Open Door**

**Associated Electrical Engineers**  
Department C-2  
537 South Dearborn Street, Chicago, Ill.

Without obligation, send me your 64-page illustrated book on Electricity, together with full details of your remarkable plan of home training and membership in the A.E.E.

Name .....

Address .....

**Associated Electrical Engineers OF AMERICA**

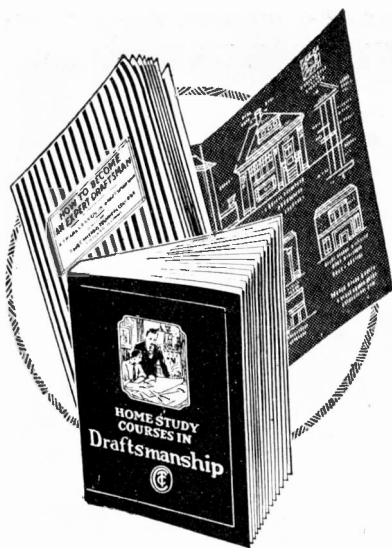

# FREE Trial Lesson DRAFTING

Mail the coupon and we will send you this Free Trial Lesson which will show how well prepared you are to master Drafting. No obligation on your part, nothing to pay. While other schools ask you to enroll and pay a fee at once, we send you this lesson first. Before you pay a cent or even decide about enrolling—test your ability and learn about the Chicago Tech. Method of teaching Drafting by mail.

## Double Your Earnings

Big concerns everywhere are seeking expert Draftsmen. Top notch salaries are paid to experts. This is your chance to step ahead just as R. L. Cory did who reports 300% salary increase since training with Chicago Tech.; or as J. A. Da Costa did who was doing manual labor and rose to an executive position.

## Train by Mail

By the Chicago Tech. Method you can become an expert Draftsman by home study. Practical men will give you the training that brings highest pay. No useless theories—you learn how to handle actual problems. Direct personal instruction. We furnish full size professional FREE Drawing Outfit (retail price \$25) free or credit you on fees if you already have an outfit.

## Send the Coupon

Ask now for the Trial Lesson. We will send catalogs and full information about the Chicago Tech. Method. No obligation—no promise on your part. Send today.

CHICAGO TECHNICAL COLLEGE  
1245 Chicago Tech. Bldg., Chicago, Ill.

Without cost or obligation on me please send instructive matter about opportunities in line I have marked with "X".

- DRAFTING. (The Big Salary Course). No experience necessary. Free Lesson sent now.
- BUILDING TRADE COURSE. For: men in the building lines.

Name .....

Address .....

Post Office ..... State .....

# Be an Expert Repairman

ON MOTORS AND GENERATORS  
Repair and Maintenance Men in Big Demand  
LEARN IN THREE MONTHS

Insure yourself permanent income and bigger opportunities—here at this Great Electrical School you actually wind D. C. and A. C. armatures under expert instructors. Write today for 72-page illustrated Book. It's FREE.

SCHOOL OF ENGINEERING OF MILWAUKEE  
S 1-12, 415-17 Marshall St., MILWAUKEE, WISCONSIN



**SENSATIONAL SALE**  
GUARANTEED TYPEWRITERS  
Limited quantity fully guaranteed standard make typewriters. Five Days Free Trial. Lowest prices ever offered. Easy monthly payments. Send today for FREE booklet of Valuable Typewriter Information and Special Sale Bulletin.  
SMITH TYPEWRITER SALES CO.  
303-360E, Grand Ave. Chicago, Ill.

Call Letters	Name	Location	Power & Wave Length
WHB	Sweeney School Co., Kansas City, Mo.		500-411
WHD	West Virginia University, Morgantown, W. Va.		250-360
WHK	Radiovox Co., (Warren R. Cox), Cleveland, Ohio		500-360
WHN	George Schubel, New York, N. Y.		100-360
WIAB	Joslyn Automobile Co., Rockford, Ill.		50-252
WIAC	Galveston Tribune, Galveston, Texas		100-360
WIAD	Ocean City Yacht Club, (Howard R. Miller), Ocean City, N. J.		10-254
WIAP	Gustav A. DeCortin, New Orleans, La.		10-234
WIAH	Continental Radio & Mfg. Co., Newton, Iowa		10-360
WIAI	Heer Stores Co., Springfield, Mo.		20-252
WIAJ	Fox-River-Valley Radio Co., Nunah, Wis.		100-224
WIAK	Journal-Stockman Co., Omaha, Nebr.		200-278
WIAO	School of Engineering of Milwaukee, Milwaukee, Wis.		200-360
WIAQ	Chronicle Publishing Co., Marion, Ind.		100-226
WIAR	Paducah Evening Sun, Paducah, Ky.		100-360
WIAS	Home Electric Co., Burlington, Iowa		100-360
WIAT	Leon T. Noel, Tarkio, Mo.		15-360
WIAU	American Trust & Savings Bank, Le Mars, Iowa		20-360
WIAY	Woodward & Lothrop, Washington, D. C.		100-360
WIK	K & L Electric Co., McKeesport, Pa.		500-234
WIL	Continental Electrical Supply Co., Washington, D. C.		5-360
WIP	Gimbel Bros., Philadelphia, Pa.		500-509
WJAB	American Electric Co., Lincoln, Neb.		500-360
WJAD	Jackson's Radio Engineering Laboratories, Waco, Texas		150-360
WJAF	Press Publishing Co., Muncie, Ind.		10-360
WJAG	The Norfolk Daily News, Norfolk, Nebraska		200-360
WJAK	Clifford L. White, Greentown, Ind.		30-254
WJAM	D. M. Perham, Cedar Rapids, Iowa		20-268
WJAN	Peoria Star, Peoria, Ill.		100-280
WJAO	Capper Publications, Topeka, Kansas		100-360
WJAR	The Outlet Co., (J. Samuels & Bro.), Providence, R. I.		50-360
WJAS	Pittsburgh Radio Supply Co., Pittsburgh, Penna.		500-360
WJAT	Kelley-Vawter Jewelry Co., Marshall, Mo.		10-360
WJAX	Union Trust Co., Cleveland, Ohio		500-390
WJAZ	Chicago Radio Laboratory, Chicago, Ill.		1000-273
WJD	Howe, Richard H., Granville, Ohio		50-229
WJH	Wm. P. Boyer Co., Washington, D. C.		50-273
WJX	De Forest Radio Telephone & Telegraph Co., New York, N. Y.		500-360
WJY	R. C. A., New York, N. Y.		500-405
WJZ	R. C. A., New York, N. Y.		500-455
WKAA	H. F. Paar, Cedar Rapids, Iowa		100-268
WKAD	Charles Loeff, (Crescent Park), East Providence, R. I.		10-240
WKAF	W. S. Radio Supply Co., Wichita Falls, Texas		100-360
WKAN	United Battery Service Co., Montgomery, Ala.		15-226
WKAP	Dutree W. Flint, Cranston, R. I.		200-360
WKAQ	Radio Corp. of Porto Rico, San Juan, Porto Rico		100-360
WKAR	Michigan Agriculture College, East Lansing, Mich.		100-280
WKAS	L. E. Lines Music Co., Springfield, Mo.		10-360
WKAU	Laconia Radio Club, Laconia, N. H.		50-360
WKAU	Turner Cycle Co., Beloit, Wis.		10-242
WKAX	William A. MacFarlane, Bridgeport, Conn.		15-231
WKAY	Brenau College, Gainesville, Ga.		20-360
WKC	Joseph M. Zamoiski Co., Baltimore, Md.		20-360
WKY	W. K. Y. Radio Shop, Oklahoma City, Okla.		100-360
WLAC	North Carolina State College, Raleigh, N. C.		750-360
WLAG	Cutting & Washington Radio Corp., Minneapolis, Minn.		500-417
WLAH	Samuel Woodworth, Syracuse, N. Y.		250-234
WLAJ	Waco Electrical Supply Co., Waco, Texas		150-360
WLAK	Vermont Farm Machine Corp., Belknap Falls, Vt.		500-360
WLAL	Naylor Electrical Co., (Sim Naylor), Tulsa, Okla.		100-360
WLAN	Putnam Hardware Co., Houlton, Me.		250-283
WLAP	W. V. Jordan, Louisville, Ky.		15-360
WLAQ	Arthur E. Schilling, Kalamazoo, Mich.		20-360
WLAT	Radio & Specialty Co., Burlington, Iowa		10-360
WLAV	Electric Shop, Pensacola, Fla.		20-360
WLAU	Police Dept., New York, New York, N. Y.		500-360
WLAX	Putnam Electric Co., Greencastle, Ind.		10-231
WLB	University of Minnesota, Minneapolis, Minn.		100-360
WLW	Crosley Manufacturing Co., Cincinnati, Ohio		500-309
WMAB	Radio Supply Co., Oklahoma, Okla.		100-360
WMAC	J. Edw. Page (Clive B. Meredith), Cazenovia, N. Y.		200-261
WMAF	Round Hills Radio Corp., Dartmouth, Mass.		500-360
WMAH	General Supply Co., Lincoln, Neb.		100-254

# Make Money Taking PICTURES



Tremendous, big-paying opportunities are open for ambitious men in Modern Photography. This is the picture age. Magazine and newspaper publishers buy thousands of photographs each year. Every manufacturer sends out high priced pictures of his portraits. Every home wants portraits. Photography is a business running into millions of dollars each year. And there is a great shortage of trained photographers.

Got \$100 for Flood Pictures  
"I took pictures of a flood and sold them for \$100. I have been able to buy my house and lot from the sale of pictures."  
C. M. Cole, Washington.

EARN \$3,000 to 10,000 a Year  
Hundreds of men are earning big money and establishing their own businesses. Even during spare time, while training, you can make \$75 a week easily—no matter where you live!

\$97 in Two Days!  
"I made \$285 in December. Went out two days last week on home portrait work and made \$97."  
A. G. Hughes, Kentucky.

Amazing New Easy Method  
I show you, at home, how to do the kind of work turned out by the big studios in New York and (Chicago)! I show you how to make big money within 30 days! C. M. Cole bought a home with money he had made when only half way through his training. So well do I know what I can do for you that I guarantee under bond to return every cent of your tuition if you are not thoroughly satisfied.

Send to return every cent of your tuition if you are not thoroughly satisfied.

## Professional View Camera FREE!

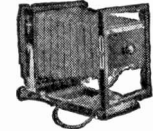

Write at once for Free CAMERA Offer— I give you, free, a splendid professional view camera. You will be astonished and delighted. This offer open for short time only—so act quick! No obligation.

INTERNATIONAL STUDIOS, Inc.  
Dept. 7459  
3601 Michigan Ave., Chicago, U.S.A.

# Why Good Dancers Are Popular

EVERYONE admires and wants to dance with the person who knows the latest steps. There's no need to envy others. You can enjoy the pleasures and popularity of a really good dancer. Arthur Murray, America's foremost teacher of social dancing, has developed a remarkable new easy method which enables anyone to learn all the latest popular steps at home—in a few hours—at very little cost!



No music or partner is needed. More than 90,000 have learned by mail. Your success is positively guaranteed!

## Five Dancing Lessons Free

To prove you can learn any step in a few minutes, and all of the dances in a few hours, Arthur Murray will send you free, in plain cover: 1—A lesson in Fox Trot; 2—the Secret of Leading; 3—How to Follow; 4—How to Gain Confidence; 5—How to Avoid Embarrassing Mistakes, and other dancing helps.

These valuable lessons will show you how easily and quickly you can become an accomplished dancer and how you can be more popular by dancing well! Learn at home and surprise your friends. This offer of free instruction may be withdrawn at any moment. Write for your lessons today! To pay the cost of mailing, handling, etc., send 10c. Money back if not delighted.

ARTHUR MURRAY, Studio 924, 290 Broadway, N.Y.

# Automobile Makes 27 Miles On Air

An automobile goes 27 miles on air by using an automatic device which was installed in less than 5 minutes. The automobile was only making 30 miles on a gallon of gasoline but after this remarkable invention was installed, it made better than 57. The inventor, Mr. J. A. Stransky, 195 Eleventh Street, Pukwana, South Dakota, wants agents and is willing to send a sample at his own risk. Write him today.—Adv.

**ANYBODY CAN PLAY**

So simple a child can play—by numbers instead of notes.

**Fun** at parties, entertainments, etc. **"FUN"**

SEND NO MONEY. Just your name. Pay postman only \$2.75 on arrival. No postage.

**PUBLIC TRADING CO.** New York  
263-5th Ave., Dept. 446

**FREE—15 SONGS!**

**"BECOME A LIGHTNING TRICK CARTOONIST"**

Make money chalk talking. Send \$1.00 for snappy program of trick drawings, with instructions by a professional cartoonist. Satisfaction guaranteed. Circular free.

Balda Art Service, Dept. 4, Oshkosh, Wis.



Call Letters	Name	Location	Power & Wave Length
WMAJ	Drovers Telegram Co.	Kansas City, Mo.	250-275
WMAK	Norton Laboratories	Lockport, N. Y.	500-360
WMAL	Trenton Hardware Co.	Trenton, N. J.	15-256
WMAM	Beaumont Radio Equipment Co.	Beaumont, Texas	100-360
WMAN	First Baptist Church	Columbus, Ohio	10-286
WMAQ	Chicago Daily News	Chicago, Ill.	500-448
WMAV	Alabama Polytechnic Inst.	Auburn, Ala.	500-250
WMAZ	Kingshighway Presbyterian Church	St. Louis, Mo.	100-280
WMAZ	Mercer University	Macon, Georgia	50-268
WMC	Commercial	Memphis, Tenn.	500-500
WMH	The Precision Equipment Co.	Cincinnati, Ohio	10-248
WMU	Doubleday-Hill Electric Co.	Washington, D. C.	100-261
WNAC	Shepard Stores	Boston, Mass.	100-360
WNAD	University of Oklahoma	Norman, Okla.	100-360
WNAL	R. J. Rockwell	Omaha, Nebraska	20-242
WNAM	Ideal Apparatus Co.	Evansville, Ind.	500-360
WNAN	Syracuse Radio Telephone Co.	Syracuse, N. Y.	100-286
WNAP	Wittenberg College	Springfield, Ohio	100-360
WNAQ	Charleston Radio Electric Co.	Charleston, S. C.	20-360
WNAZ	C. C. Rhodes	Butler, Mo.	20-231
WNAS	Texas Radio Corp. & Austin Statesman	Austin, Texas	100-360
WNAT	Lennig Bros. Co. (Fred'k Lenning)	Philadelphia, Penna.	250-360
WNAV	People Telephone & Telegraph Co.	Knoxville, Tenn.	500-360
WNAX	Dakota Radio Apparatus Co.	Yankton, South Dak.	100-244
WNAW	Peninsular Radio Club	Fort Monroe, Va.	5-360
WNJ	The Shotton Radio Mfg. Co., Inc.	Albany, New York	55-360
WOAA	Dr. Walter Hardy	Ardmore, Okla.	100-360
WOAB	Valley Radio	Grand Forks, N. Dak.	5-441
WOAC	Maus Radio Co.	Lima, Ohio	100-266
WOAD	Friday Battery & Elec. Co.	Sigourney, Iowa	10-360
WOAE	Midland College	Fremont, Neb.	20-360
WOAF	Tyler Commercial College	Tyler, Texas	100-360
WOAG	Apollo Theatre (Belvidere Amusement Co.)	Belvidere, Ill.	100-224
WOAH	Palmetto Radio Corp.	Charleston, S. C.	100-360
WOAI	Southern Equipment Co.	San Antonio, Texas	500-385
WOAJ	Ervins Electrical Co.	Parsons, Kansas	15-258
WOAK	Collins Hdwe. Co.	Frankfort, Ky.	20-240
WOAL	Wm. E. Woods	Webster Groves, Mo.	500-229
WOAN	Vaughn Conservatory of Music	Lawrenceburg, Tenn.	150-360
WOAO	Lyradion Mfg. Co.	Mishawaka, Ind.	50-360
WOAP	Kalamazoo College	Kalamazoo, Mich.	50-375
WOAQ	Portsmouth Kiwanis Club	Portsmouth, Va.	15-360
WOAR	Henry P. Sundskow	Kenosha, Wis.	50-360
WOAT	Boyd M. Hamp	Wilmington, Del.	50-360
WOAV	2nd Battalion, 112th Inf.	P. N. G., Erie, Penna.	100-242
WOAW	Woodmen of the World	Omaha, Neb.	500-526
WOAX	Franklyn J. Wolff (Monument Pottery Co.)	Trenton, N. J.	100-240
WOAZ	Penick Hughes Co.	Stamford, Texas	100-360
WOC	The Palmer School of Chiropractic	Davenport, Iowa	500-484
WOI	Iowa State College	Anes, Iowa	100-360
WOK	Pine Bluff Co.	Pine Bluff, Ark.	500-360
WOO	John Wanamaker	Philadelphia, Penna.	500-509
WOQ	Western Radio Co.	Kansas City, Mo.	500-360
WOR	L. Bamberger & Co.	Newark, N. J.	500-405
WOS	Missouri State Marketing Bureau	Jefferson City, Mo.	500-441
WPAB	Pennsylvania State College	State College, Penna.	500-360
WPAC	Donaldson Radio Co.	Okmulgee, Okla.	200-360
WPAD	W. A. Wieboldt & Co.	Chicago, Ill.	500-360
WPAF	Peterson Radio Co.	Council Bluffs, Iowa	10-360
WPAH	Wisconsin Dept. of Markets	Wau-paca, Wis.	250-360
WPAJ	Doolittle Radio Corp.	New Haven, Conn.	10-268
WPAK	North Dakota Agricultural College	Agricultural College, N. Dak.	250-360
WPAL	Superior Radio & Tel. Equipment Co.	Columbus, Ohio	100-286
WPAM	Auerbach & Guettel	Topeka, Kansas	100-360
WPAP	Theodore D. Phillips	Winchester, Ky.	35-360
WPAQ	General Sales & Engineering Co.	Frostburg, Md.	10-360
WPAR	Ward Battery & Radio Co.	Beloit, Kansas	10-360
WPAT	St. Patricks Cathedral	El Paso, Texas	20-360
WPAU	Concordia College	Moorhead, Minn.	20-360
WPAZ	John R. Koch, Dr.	Charleston, W. Va.	20-273
WPG	Nushawg Poultry Farm	New Lebanon, Ohio	50-234

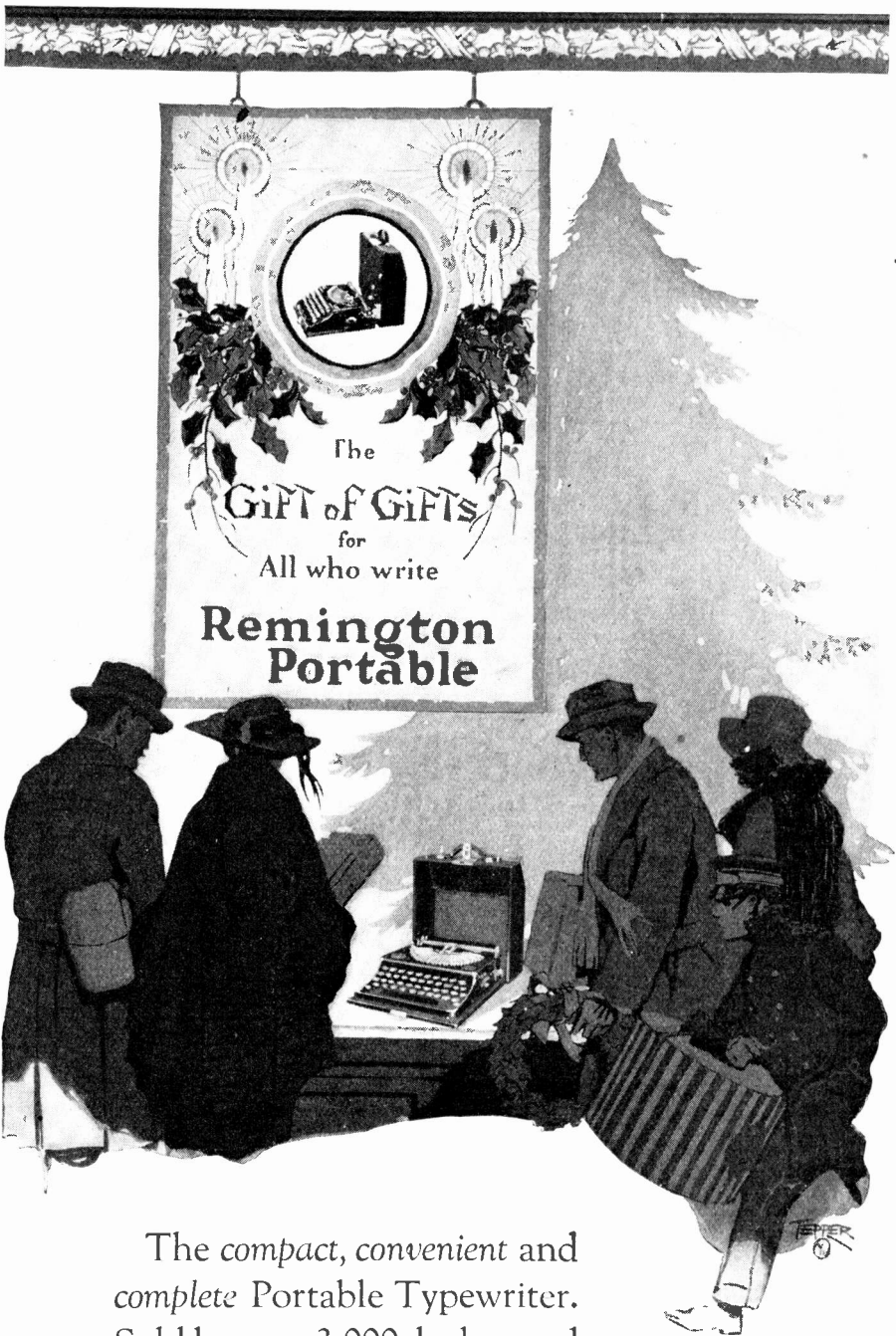

The compact, convenient and complete Portable Typewriter. Sold by over 3,000 dealers and Remington branches everywhere. Easy payment terms if desired. Send for our illustrated "For You—For Everybody". Address Department 14.

We believe we make the best typewriter ribbon in the world—and its name is PARAGON

# Remington Portable

Remington Typewriter Co., 374 Broadway, New York

**FREE \$500<sup>00</sup>**

**Electrical Laboratories**

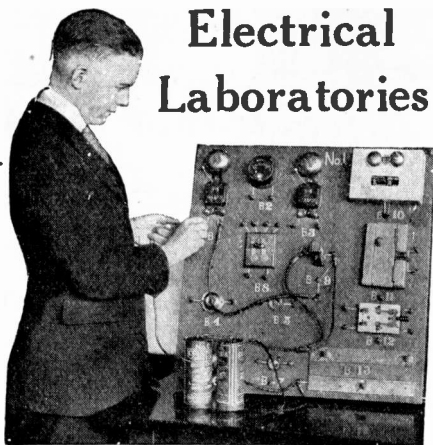

**9 Laboratories**

**Sent to Your Home**

Real actual-size, expensive units of electrical apparatus are mailed to you without extra charge while learning. The illustration shows one of the 9 new home-laboratory outfits. As fast as you have completed the work of one laboratory, another is sent, until you have mastered the entire field. You, therefore, advance step by step, from simple electrical experiments to complicated, intricate, important practical work.

**Learn Electricity this New Quick Way**

You can get the finest electrical training at home in your spare time. You need not leave your job, your friends, your home. This wonderful new home-laboratory training course in Practical Electricity brings this great, big technical school to your very door—into your very room. It develops ability, step by step, and leads you to every reward the great field of electricity can offer.

**Just Like Going to School**

Our large faculty of experts offer you a short cut that combines theory and practice, eliminating all the non-essentials. The plan is so simple—so logical—so carefully arranged, and also so interesting, that in a surprisingly short time you will have made yourself a master of technical electricity.

**Earn Big Pay**

Billions of dollars are invested in this great industry. Trained experts are in demand and handsome salaries are paid. You can easily master the work through our personal coaching and "home-laboratory" plan so that you can step immediately into the industrial field. **WE ASSIST ALL OUR GRADUATES TO POSITIONS WITH THE LEADING ELECTRICAL FIRMS IN THE UNITED STATES.**

**Free—Electrical Apparatus**

In addition to the free use of our 9 large electrical experimental hoards we will give you all materials and apparatus needed for experimental work with the 9 outfits, absolutely free and ship it with the first laboratory shipment. No materials to be purchased by you. We furnish everything needed.

EXTENSION-DIVISION  
**SCHOOL OF ENGINEERING**  
of Milwaukee

415 Marshall Street Milwaukee, Wis.

Extension-Division,  
School of Engineering,  
Dept. F-12, 415 Marshall St., Milwaukee, Wis.

Please send me full details of your "new wonderful laboratory method" of home-study in Practical Electricity. This request obligates me in no way.

Name .....

Address .....

Town ..... State .....

Call Letters	Name	Location	Power & Wave Length
WQAA	Horace A. Beale, Jr.	Parkeburg, Penna.	500—360
WQAB	Southwest Missouri State Teachers College,	Springfield, Mo.	10—236
WQAC	E. B. Gish,	Amarillo, Texas.	100—360
WQAD	Whitall Electric Co.,	Waterbury, Conn.	50—242
WQAE	Moore Radio News Station,	Springfield, Vt.	50—275
WQAF	Sandusky Register,	Sandusky, Ohio.	5—240
WQAH	Brock-Amerson Electrical Eng., Co.,	Lexington, Ky.	10—254
WQAK	Appel Higby Electric Co.,	Dubuque, Iowa.	50—360
WQAL	Coles County Telephone & Telegraph Co.,	Mattoon, Ill.	10—258
WQAM	Electrical Equipment Co.,	Miami, Fla.	100—360
WQAN	Scranton Times,	Scranton, Penna.	250—280
WQAO	Calvary Baptist Church,	New York, N. Y.	100—360
WQAQ	West Texas Radio Co.,	Abilene, Texas.	100—360
WQAS	Prince-Walter Co.,	Lowell, Mass.	100—266
WQAV	Huntington & Guerry (Inc.),	Greenville, S. C.	15—258
WQAW	Catholic University,	Washington, D. C.	5—236
WQAX	Radio Equipment Co.,	Peoria, Ill.	10—360
WQAZ	Greensboro Daily News,	Greensboro, N. C.	30—360
WRAA	Rice Institute,	Houston, Texas.	200—360
WRAD	Taylor Radio Shop,	Marion, Kansas.	10—248
WRAP	The Radio Club (Inc.),	Laporte, Ind.	10—224
WRAH	Stanley N. Read,	Providence, R. I.	10—231
WRAL	Northern States Power Co.,	St. Croix Falls, Wis.	100—248
WRAN	Black Hawk Electrical Co.,	Waterloo, Iowa.	20—229
WRAP	Radio Service Co.,	St. Louis, Mo.	100—360
WRAP	Winter Park Electrical Construction Co.,	Winter Park, Fla.	20—360
WRAR	Jacob C. Thomas,	David City, Nebraska.	20—226
WRAS	Radio Supply Co.,	McLeansboro, Ill.	10—360
WRAU	Amarillo Daily News,	Amarillo, Texas.	10—360
WRAV	Antioch College,	Yellow Springs, Ohio.	100—360
WRAX	Flaxon's Garage,	Gloucester City, N. J.	100—268
WRAW	Avenue Radio Shop,	Reading, Penna.	10—238
WRAY	Radio Sales Corp.,	Scranton, Penna.	50—280
WRAZ	Radio Shop of Newark,	(Herman Lubinsky), Newark, N. J.	50—233
WRC	Radio Corp.,	of America, Washington, D. C.	500—469
WRK	Doron Bros. Elec. Co.,	Hamilton, Ohio.	200—360
WRL	Union College,	Schenectady, N. Y.	500—360
WRM	University of Illinois,	Urbana, Ill.	500—360
WRR	City of Dallas Police and Fire Signal Dept.,	Dallas, Texas.	20—360
WRW	Tarrytown Radio Research Laboratory,	(Koenig Bros.), Tarrytown, N. Y.	500—273
WSAB	South East Missouri State Teachers College,	Cape Girardeau, Mo.	100—360
WSAC	Clemson Agricultural College,	Clemson College, S. C.	500—360
WSAD	J. A. Foster Co.,	Providence, R. I.	50—261
WSAG	City of St. Petersburg,	(Loren V. Davis), St. Petersburg, Fla.	10—244
WSAH	A. J. Leonard, Jr.,	Chicago, Ill.	500—248
WSAI	United States Playing Cards Co.,	Cincinnati, Ohio.	500—309
WSAJ	Grove City College,	Grove City, Penna.	100—360
WSAK	Foster Emer,	(Daily News Pomeroy, O.), Middleport, Ohio.	70—258
WSAL	Franklin Electric Co.,	Brookville, Ind.	10—246
WSAN	Allentown Radio Club,	Allentown, Penna.	10—229
WSAP	Seventh Day Adventist Church,	New York, N. Y.	250—360
WSAR	Doughty & Welch Elec. Co.,	Fall River, Mass.	10—254
WSAT	Plainview Elec. Co.,	Plainview, Texas.	20—268
WSAU	Camp Marienfeld,	Chesham, N. H.	100—229
WSAW	Curtice & McElwee,	Canandaigua, N. Y.	100—275
WSAX	Chicago Radio Lab.,	Chicago, Ill.	20—268
WSB	Atlanta Journal,	Atlanta, Ga.	500—429
WSL	J. & M. Electric Co.,	Utica, N. Y.	100—273
WSY	Alabama Power Co.,	Birmingham, Ala.	500—360
WTAB	Fall River Daily Herald Pub. Co.,	Fall River, Mass.	10—248
WTAC	Penn. Traffic Co.,	Johnstown, Penna.	150—360
WTAD	Robert E. Compton,	(First Presbyterian Church), Carthage, Ill.	50—229
WTAF	Louis J. Gallo,	New Orleans, La.	20—242
WTAG	Kern Music Co.,	Providence, R. I.	10—258
WTAH	Carmen Ferro,	Belvidere, Ill.	10—236
WTAJ	The Radio Shop,	Portland, Me.	50—236
WTAL	Toledo Radio & Elec. Co.,	Toledo, Ohio.	10—252
WTAM	Willard Storage Battery Co.,	Cleveland, Ohio.	1000—390
WTAN	Orndorff Radio Shop,	Mattoon, Ill.	100—240
WTAP	Cambridge Radio & Elec. Co.,	Cambridge, Ill.	50—242
WTAQ	S. H. Van Gorden & Son,	Osseo, Wis.	100—226
WTAR	Reliance Elec. Co.,	Norfolk, Va.	70—226
WTAS	Charles E. Erbstein,	Elgin, Ill. (near)	500—279
WTAT	Edison Electric Illuminating Co.,	Boston, Mass. (Portable)	100—244

**YOU CAN LEARN NEWSPAPER WORK**

**Experienced Editor Will Teach You How to Become a Reporter**

**FASCINATING WORK--GOOD PAY**

**Only a Few Months' Work Required To Qualify You for a Better Position**

Regular reporters earn from \$40 to \$125 a week. Good deskmen on a daily paper are paid from \$60 to \$100 a week. A "Star" Reporter can command his own salary. Hundreds of ambitious men and women enhance their income materially by corresponding for newspapers or writing for magazines in their spare time.

**We Will Teach You at Home**

We can develop your talent for writing and lead you into this well paying profession. Our Practical Course in Journalism was personally prepared by Henry J. Brockmeyer, Assistant City Editor of the New York Evening Post. Mr. Brockmeyer has trained hundreds of men and women, many of whom have, under his guidance, developed into front rank reporters or feature writers.

Mr. Brockmeyer's course will teach you what it would take years of actual newspaper work to learn. It consists of six comprehensive lessons just brimful of everything a reporter must learn. The following are only a few of the subjects covered.

Starting in Journalism. What is a Newspaper? What is News? Start and Finish of a News Story. Technical Terms. The Type Point System. Styles of Type, Proof Reading. Capitalization and Punctuation. A Late Fire Bulletin. Court Stories. Libel Laws, Copyright. Hints to Reporters. Personal Conduct. Re-Writing and Condensing Stories. Paragraphs and Short Items. Good and Bad Styles. Broadening the Vocabulary. Aids to Good Style. Special Stories. Suggestions for Stories. Rhetoric. Preparing Your Story. Don'ts for Writers. Office Organization. Syndicated Matter. Business Office. Mechanical Department. Hints for Headline Writers. The Make-Up. The Country Correspondent, etc., etc.

**This Complete Course For \$10**

The price for the entire course is only \$10, and entitles the student to full consulting services which are directed by Mr. Brockmeyer personally, including any questions in connection with journalistic work.

**Five Days' Trial**

Just pin a check, money order or ten dollar bill to the coupon below and mail. Then take five days after the course arrives to decide whether you want to keep it. If not, return it at our expense and your money will be immediately refunded.

**Or Write For Free Circular "S"**

THE PRESS GUILD, Inc., 66-D—West Broadway, N. Y.

THE PRESS GUILD, Inc.,  
66-D—West Broadway, New York City

Enclosed find \$10 for which you are to ship me at once, prepaid, Henry J. Brockmeyer's complete course in Practical Journalism with the distinct understanding that if I return the course in five days my full \$10 will be refunded and no questions asked.

(Name) .....

(Address) .....

(City) ..... (State) .....

Call Letters	Name	Location	Power & Wave Length
WTAU	Ruegg Battery and Electric Co., Tecumseh, Neb.		10—360
WTAW	Agricultural & Mechanical College, College Station, Texas.		50—254
WTG	Kansas State Agricultural College, Manhattan, Kansas.		1000—435
WWAC	Sanger Bros., Waco, Texas.		50—360
WWAD	Wright & Wright, Inc., Philadelphia, Penna.		50—360
WWAX	Wormser Bros., Laredo, Texas.		50—360
WWB	Daily News Printing Co., Canton, Ohio.		100—268
WWI	Ford Motor Co., Dearborn, Mich.		50—273
WWJ	Detroit News (Evening News), Detroit, Mich.		500—517
WWL	Loyola University, New Orleans, La.		100—280
WWZ	John Wanamaker, New York, N. Y.		100—360

## The Heavens in December

BY ISABEL M. LEWIS, M.A.  
(Continued from page 760)

equal period regains its former brightness, is one of the most interesting variable stars in the heavens. Its peculiar light variations are due to periodic eclipses of the brighter star by a close faint companion of nearly equal size, as the two stars revolve around their common center of gravity.

Algol with the few faint stars near it form the Head of Medusa which Perseus carries in his hand as he comes to the rescue of Andromeda, daughter of Cassiopeia and Cepheus, who has been chained to the rocks to be devoured by the sea-monster, Cetus.

Andromeda and Pegasus are conspicuously in view in the western heavens. Gamma Andromeda, the most easterly of the three second-magnitude stars nearly in a straight line that are the characteristic feature of this constellation, is now very nearly in the zenith in 40° North latitude. Alpha Andromedae, which is the farthest west of the three stars, marks the northeast corner of the Great Square in Pegasus.

At this time of year when "The Pointers" of the Big Dipper, which point to the pole star are so close to the northern horizon that they are generally hidden from view behind trees or buildings, we turn to the stars of Andromedae and Cassiopeia to direct us to the Pole star, Cassiopeia lies almost exactly midway between Andromeda and the north pole.

A line drawn from Alpha Andromedae, the star in the northeast corner of the Great Square, through Beta Cassiopeiae, the star farthest west in Cassiopeia, and prolonged an equal distance will bring us to Polaris. We can also find the Pole-star by drawing a similar line from Gamma Andromedae, the star farthest east in Andromeda, through the star farthest east in Cassiopeia, which is also the faintest of the five stars that outline the W of Cassiopeia.

Early risers this month will find Mars well up in the eastern sky at sunrise.

Saturn is also in the eastern heavens now and the two planets will be in conjunction on the second of the month, and close to the first magnitude star Spica in Virgo. Saturn will remain in the constellation of Virgo near Spica throughout the month but since Mars, as well as the sun, is moving eastward, Saturn will be higher in the eastern heavens than Mars by the end of the month.

Venus, after being in the eastern sky from the beginning of the year to the tenth of September, may now be found in the western sky at sunset where it will remain for some months to come. It can be readily distinguished by its brilliancy which far surpasses that of any other planet or star in the heavens.

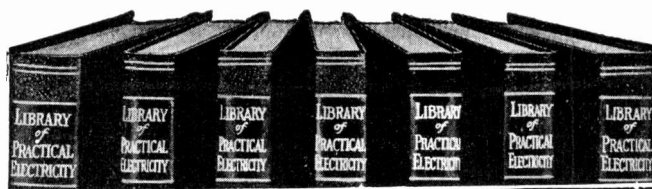

**If these books were \$25 each they would still be a good investment for you!**

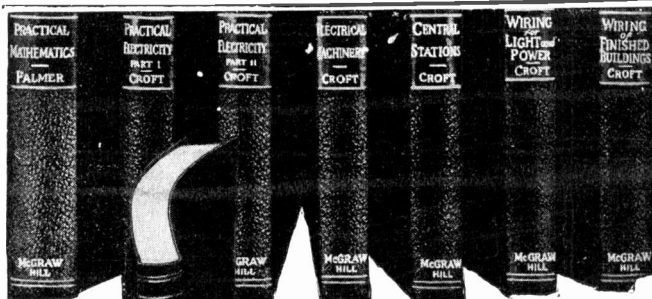

Eight times \$25 is \$200. Put \$200.00 in the bank at 4% interest and you get a little over \$8 a year interest. Put only one-tenth of \$200.00 into the Croft books, together with a little spare-time study, and you should get back anywhere from ten to several hundred times \$8.

## Practical Electricity

By Terrell Croft

8 volumes—3000 pages—2,100 illustrations—flexible binding

OPPORTUNITIES in the electrical field have always been abundant, but today there are more big-paying positions open than at any time in the history of electricity. New uses are being found for electricity every day, and the progress of the world more and more depends upon it. Terrell Croft is doing his share in teaching men the correct principles of electrical practice. He knows the game from experience. He has poured out all his secrets, all the short cuts, all the time savers, in language that anyone can easily grasp. Yet the text is so scientifically correct that thousands of the highest paid electrical engineers are using the books as a reference set.

Free Examination. No money down. Only \$2 a month.

## The Sure Way to Bigger Pay

BIG salaries are paid in the electrical field for expert knowledge. The man who knows electricity in all its many phases—the man who has completely mastered the subject from A to Z—can pick his own job and name his own salary. Fit yourself for a bigger position by knowing electrical practice complete—inside and outside work—central stations, electrical illumination and the whole subject. Croft will teach you. He will take you in quick, easy steps from the simplest principles to the complete and economical operation of a great central station. The Croft-trained man wins because he knows the "why" and the "how" of modern electrical practice.

### Practical Electricity Taught by an Expert

No course, no set of books, offers a quicker, surer method of mastering electricity than the Croft Library. It is founded on practice—on work as it is actually done. It is jammed from cover to cover with the kind of hard-headed, pay-raising facts you want. Written so that the beginner can easily understand it, yet so sound, so thorough, that it is the daily guide of thousands of highly paid electrical workers and engineers.

Croft has been through the mill. His knowledge has been gained by shirt-sleeves contact with electrical problems. He has worked his way up from the bottom to the top—from apprentice lineman to electrical engineer for one of the great electrical companies. Now he heads his own consulting company, and his name is known in every corner of the electrical world. He is the one man above all others who can show you the way to permanent success.

#### What the Books Contain

Volume One — Practical Mathematics, 358 subject headings. Tells you how to use mathematics as a tool.

Volume Two — Practical Electricity, 1,000 subject headings. The basic principles of all electrical practice.

Volume Three — Practical Electricity, 1,100 subject headings. A continuation of Volume Two.

Volume Four — Electrical Machinery, 1,100 subject headings. Contains what every electrical man wants to know.

Volume Five — Central Stations, 509 subject headings. All phases of central station operation are covered.

Volume Six — Wiring for Light and Power, 1,700 subject headings. Tells how to do the big and little jobs right.

Volume Seven — Wiring of Finished Buildings, 1,100 subject headings. The very meat of wiring practice.

Volume Eight — Practical Electric Illumination, 1,000 subject headings. Lamps and the art of lighting properly.

Easy Payments Pay for these books as you go along. We have made the payments so low that any man can meet them. Only \$1.50 in ten days and the balance at the rate of \$2 a month for nine months. These are the lowest—the easiest—terms ever made on a high-grade electrical library.

Just Send the Coupon We want you to test our statements—send me the CROFT books with others. Fill in and mail the coupon attached and we will send you the entire set of eight volumes for ten days' Free Examination. You assume no obligation—you pay nothing unless you decide to keep the books. Send the coupon NOW (shipping charges prepaid) for 10 days' free examination. If satisfactory, I will send \$1.50 in ten days and \$2 per month until \$19.50 has been paid. If not wanted, I will write you for return shipping instructions. (Write plainly and fill in all lines.)

Send No Money—Just the Coupon

Name .....  
Home Address .....  
City and State .....  
Company or Employer .....  
Occupation ..... S & I-12-23

10 Months to Pay!

# U.S. PATENTS



**SEND FOR THIS FORM**

## Don't Lose Your Rights

Before disclosing your invention to anyone send for blank form "Evidence of Conception" to be signed and witnessed. A sample form together with printed instructions will show you just how to work up your evidence and establish your rights before filing application for patent. As registered patent attorneys we represent hundreds of inventors all over the U. S. and Canada in the advancement of inventions. Our schedule of fees will be found reasonable. The form "Evidence of Conception" sample, instructions relating to obtaining of patent and schedule of fees sent upon request. Ask for them,—a post card will do.



255 OURAY BLDG.,  
WASHINGTON, D. C.

"Originators of form Evidence of Conception"

# PATENTS

## TO THE MAN WITH AN IDEA

I offer a comprehensive, experienced, efficient service for his prompt, legal protection and the development of his proposition.

Send sketch, or model and description, for advice as to cost, search through prior United States patents, etc. Preliminary advice gladly furnished without charge.

My experience and familiarity with various arts frequently enable me to accurately advise clients as to probable patentability before they go to any expense.

Booklet of valuable information and form for properly disclosing your idea, free on request. Write today.

**RICHARD B. OWEN, Patent Lawyer**  
164 Owen Building, Washington, D. C.  
2276-B Woolworth Bldg., New York City

# PATENTS

Hand Books on Patents, Trade Marks, etc., sent free. Our 77 years of experience, efficient service, and fair dealing assure fullest value and protection to the applicant. The Scientific American should be read by all inventors.

## MUNN & CO.

618 Woolworth Building, New York  
Tower Bldg., Chicago, Ill.  
Scientific American Bldg., Washington, D. C.  
Hobart Bldg., 582 Market St., San Francisco, Cal.

# PATENTS

Trade-Marks, Copyrights and Patent Litigation  
Write for advice and instructions how to proceed, costs, etc.  
Hand Book with illustrations of 100 Mechanical Movements sent free on request.

**ALBERT E. DIETERICH**  
Patent Lawyer and Solicitor  
Successor to Fred G. Dieterich & Co.  
601 OURAY BLDG. WASHINGTON, D. C.



Edited by  
**Joseph H. Kraus**

In this Department we publish such matter as is of interest to inventors and particularly to those who are in doubt as to certain Patent Phases. Regular inquiries addressed to "Patent Advice" cannot be answered by mail free of charge. Such inquiries are published here for the benefit of all readers. If the idea is thought to be of importance, we make it a rule not to divulge all details, in order to protect the inventor as far as it is possible to do so.

Should advice be desired by mail a nominal charge of \$1.00 is made for each question. Sketches and descriptions must be clear and explicit. Only one side of sheet should be written on.

**NOTE**—Before mailing your letter to this department, see to it that your name and address are upon the letter and envelope as well. Many letters are returned to us because either the name of the inquirer or his address is incorrectly given.

### SPARE TIRE AND RADIATOR LIGHT

(751) R. I. Black, Orcutt, Calif., asks our advice on a spare tire and a lighting suggestion for the radiator.

A. We would not solicit a patent upon either of your ideas. The spare tire device which you have designed is entirely too expensive and cannot be placed upon the market.

The lighting suggestion is relatively poor, a far better means being to attach a small bulb to the back of the bumper, and direct its light beam upon the radiator.

### WINDOW DISPLAY STAND

(752) L. Z. Plebank, Chicago, Ill., requests our advice on a window display stand made as shown so that passers-by can see how a certain article of wearing apparel would appear on them.

A. We believe that your suggestion for a win-

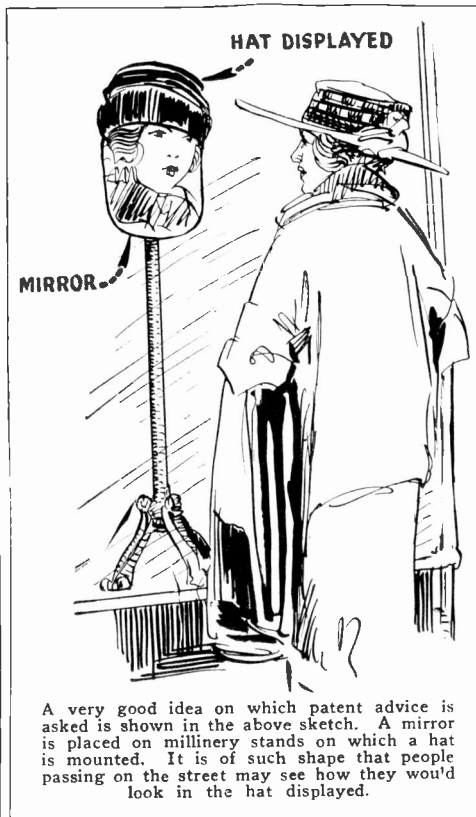

dow hat display stand is unique, and if you can manage to force this upon the market, which should be relatively easy to do, we are of the opinion that the device would make a very fine saleable article.

We would suggest that you have a patent search made, and if the attorney claims that your device can be patented, that you proceed with an application for such patent, with the avowed intention of placing this device in the hands of various milliners. Provision should be made, if possible, to cover mirror attachment for the ordinary stands now found in millinery stores.

### SEPARABLE FINGER RING

(753) A. Kurzawski, Gilroy, California, says that sometimes a ring placed upon a finger cannot be removed—for that reason he has designed a ring which can always be taken from the finger even if the finger should swell or grow heavier. He points out its similarity to a bracelet.

A. We are quite confident that the finger ring

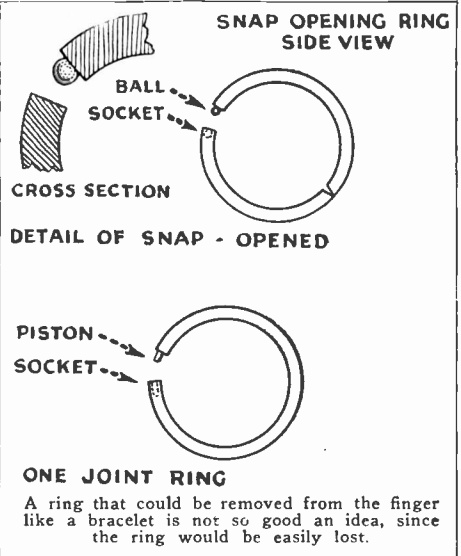

which you have designed has considerable merit but, like a bracelet, it may open when least expected. Usually, a ring receives more wear and tear than a bracelet. Consequently such a jointed ring as you show is subject to loss sooner than a bracelet.

### CURRENT INTERRUPTER

(754) Isaac Margolis, New York City, has submitted the idea for interrupting current for a spark coil or transformer shown herewith.

A. Your suggestion of an intermittent beam of light falling upon a selenium cell to produce an interrupted current for spark coil or transformer

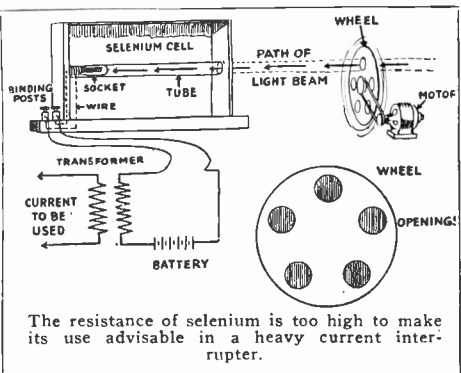

The resistance of selenium is too high to make its use advisable in a heavy current interrupter.

use, is absolutely worthless, in that a selenium cell will not conduct enough current in order to do this, its resistance being excessive.

(CONTINUED ON PAGE 812)



**EXPERIENCE SERVICE**

# CLARENCE A. O'BRIEN

## PATENT ATTORNEY

REGISTERED IN UNITED STATES PATENT OFFICE  
 MEMBER OF THE BAR OF  
 SUPREME COURT OF UNITED STATES, COURT OF APPEALS DISTRICT OF COLUMBIA,  
 SUPREME COURT DISTRICT OF COLUMBIA, UNITED STATES COURT OF CLAIMS.  
 PRACTICE CONFINED TO PATENTS AND TRADE MARKS.



# PATENTS

## PROTECT YOUR IDEAS

*ANY NEW* article, machine, design or improvement thereof, or any new combination of parts or improvements in any known article which increases its efficiency or usefulness, *may be patented*, if it involves invention.

### IF YOU HAVE ANY NEW IDEAS

which you feel are useful, practical and novel, *take prompt action to protect your rights*. If you have invented any new machine, or new combination of parts of improvement, or any new design or process, **SEND DRAWING, MODEL OR DESCRIPTION** of it for information as to procedure to secure protection.

**WRITE TODAY FOR BLANK FORM**  
**"Record of Invention"**

USE THE COUPON attached, and immediately upon its receipt I shall send you this form to be returned to me with drawing, description or model of your idea; promptly upon receiving your idea I shall write you fully as to procedure and costs.

**NO CHARGE FOR THE ABOVE INFORMATION**

*All communications are held in strict confidence. My personal, careful and thorough attention is given to each case. I offer you efficient, reliable and prompt service—based upon practical experience. Highest references.*

**WRITE TODAY** for free book "*How to Obtain a Patent.*" This book will give you valuable information, and it may save you much time and effort. *Send for it, NOW.*

My practice is devoted *exclusively* to United States and Foreign Patents and Trade Marks. Write me freely, frankly and with full confidence; it is very probable that I can help you. **Write TODAY.**

**CLARENCE A. O'BRIEN, Registered Patent Attorney**  
 304 Security Savings & Com'l Bank Bldg., Directly across street from Patent Office, Washington, D. C.

---

CLARENCE A. O'BRIEN, Patent Attorney, 304 Security Savings & Com'l Bank Bldg.  
 Directly across street from Patent Office, Washington, D. C.

Please send me your free booklet "*How to Obtain a Patent*" and blank form "*Record of Invention*" without any obligation on my part.

Name .....

Address .....

(IMPORTANT: WRITE OR PRINT NAME CLEARLY)

SCIENCE

INVENTION

INDUSTRY

ECONOMY

EFFICIENCY

INITIATIVE

**HOW TO OBTAIN A PATENT**

**CAN YOU**

think of a simple, practical idea that will fill one of the many requests we have on file for new inventions? It may mean a fortune for you. Thousands of things are needed Right Now. Your brains can help. Send today for our great new book—"Inventions and Trade Marks, Their Protection and Exploitation" and learn more about making money from ideas than you ever knew before. It tells many things that are wanted, too.

A postal will do—  
it is free.

We help our clients, without charge, to get the dollars out of their ideas—having facilities none others possess.

Advice Free. Don't delay—get the book at once.

**PATENTS ADVERTISED For SALE FREE**

In Invention and Manufacturing Supplement.

Published for the man with an idea. Send for free sample copy. One year's subscription 50c.

**AMERICAN INDUSTRIES, INC.**  
225 Patent Dept., WASHINGTON D. C.

**PATENTS**

If you have an invention and desire to secure a patent, send for our Free Guide Book, **HOW TO GET YOUR PATENT**. Tells our Terms, Methods, etc. Send model or sketch and description for our opinion of its patentable nature.

**RANDOLPH & CO.**  
Dept. 172 Washington, D. C.

**PATENTS**

BOOKLET FREE HIGHEST REFERENCES PROMPTNESS ASSURED BEST RESULTS  
Send drawing or model for examination and report as to patentability.

**WATSON E. COLEMAN, Patent Lawyer**  
624 F Street N. W., Washington, D. C.

**INVENTORS**

who derive largest profits know and heed certain simple but vital facts before applying for Patents. Our book *Patent-Sense* gives those facts free. Write **Lacey & Lacey, 644 F St., Washington, D. C.** ESTABLISHED 1869.

**PATENTS**

**C. L. PARKER**  
Formerly Member Examining Corps, U. S. Patent Offices.  
**PATENT LAWYER**

McGill Bldg., Washington, D. C.

Patents, Trade Marks, Copyrights, Patent Litigation

Handbook for Inventors, "Protecting, Exploiting and Selling Inventions," sent upon request.

**PATENTS TRADE-MARKS AND COPYRIGHTS**

Before disclosing an invention, the inventor should write for our blank form, "RECORD OF INVENTION." This should be signed and witnessed and if returned to us together with model or sketch and description of the invention we will give our opinion as to its patentable nature. Radio and Electrical cases a specialty.

Our illustrated Guide Book, "HOW TO OBTAIN A PATENT," sent Free on request. Highest References Prompt Attention Reasonable Terms

FREE COUPON

**VICTOR J. EVANS & CO., Patent Attorneys**

Chicago Offices: 1114 Tacoma Bldg. Pittsburgh Offices: 514 Empire Bldg. Philadelphia Offices: 714-715 Liberty Bldg. San Francisco Offices: Hobart Bldg. New York Offices: 1001 Woolworth Bldg.

MAIN OFFICES: 779 NINTH, WASHINGTON, D. C.

Name..... Address.....

**TWINE REEL**

(755) N. J. LeGrande, Jr., New Ramburg, Mo., has designed a twine reel which will hold twine taken from packages, unknotted and wound upon the drum. He desires our opinion of its marketability.

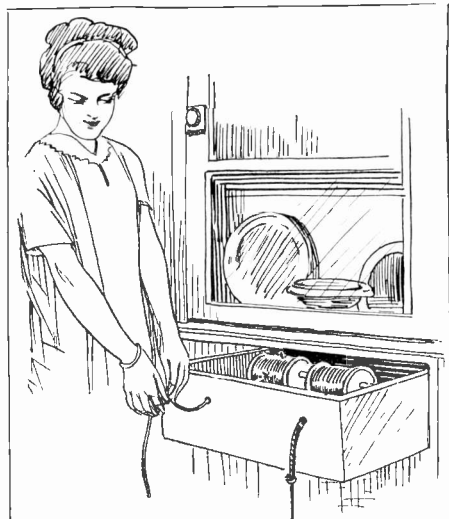

As shown above, the idea here is a spool for waste twine. The idea is thought impracticable since the housewife has little repacking to do and therefore would have little use for such an arrangement.

A. Although the device designed by you would be of a slight benefit in the ordinary household, you must remember that the twine, which is received from packages, comes in varying sizes, in varying qualities, and different thicknesses. Consequently, if the housewife tied the pieces of twine together as she removes them from the packages, and wound them up on one of these spools, when the twine is to be used again, she may desire a rather thin piece and have to unwind a whole lot of heavy material, and vice versa. The employment of three or four of these spools, so that various sizes of twines could be wound upon them, will not overcome this difficulty. For the rather heavy twine, a large sized spool would have to be used. For thinner material, a small sized spool could be employed. Still, the device does not, in this amended form, change its general features.

A canvas of women in your neighborhood will show, that they stand fifty to one against the use of your proposed device. This canvas should be carried out in the following manner. A model of the device, or half a dozen models should be built, and loaned to various individuals, or given to them. Six months later, or, even three months later, the inventor could go to these houses and inquire whether or not the device was being employed.

**SHOE BOX HANDLE**

(756) S. S. Kahn, Ardmore, Cal., desires to put a handle on shoe boxes (containing shoes ready to deliver) in shoe stores so that all a person would have to do is to order his shoes, pay for them and walk out with them.

A. The editor is of the opinion that your device would not meet a long-felt want. On the contrary the handle of the shoe box will be prac-

tically worthless. We do not believe that there is a person in the United States today who purchases his shoes without trying them on, which necessitates the handling of the shoes and also boxes. Even though the shoe may conform to all measurements and sizes, it may not fit or may not appear well in the eyes of the wearer and that is the reason why we like to see the new shoes which we intend to purchase on our feet before we buy the same. We do not advise applying for patent upon this idea.

**PORTABLE WATER STILL**

(757) William B. Minuse, East Setayket, L. I., asks our opinion on a water still for campers made as shown and supplied with fuel bricks.

A. The water still which you have designed is a rather novel application of the still principle, and if handled correctly, could undoubtedly command a sale. We wish to state that a patent upon such a device will not be of any great value if the patent is to be sold, but manufacturing the device and placing it on the market yourself would undoubtedly attract attention.

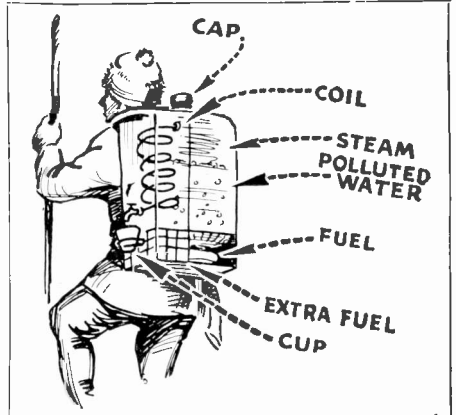

A still for campers that is small, compact and light in weight is offered here for patent advice. The idea is good, since the still operates with compact fuel in the form of bricks. It is considered a fair proposition for manufacture but a patent search is advised.

If you find yourself financially able to manufacture or have these stills manufactured, and if you can place the same upon the market at prices commensurate with other stills, we believe you will have a fairly good paying proposition.

**TOOTH PICK HOLDER**

(758) William E. King, Monessen, Pa., asks for our opinion of a tooth pick holder made as shown.

A. We believe that your tooth pick holder as a novelty, would probably find a fair sale. In our opinion, it would be better to make the device a trifle smaller, and permit three receptacles for the tooth picks to extend downward into the roots of the tooth itself. In this way there will be three distinct compartments and the device will contain a greater number of tooth picks.

The entire device could be made of bisque, enamelware, or porcelain, the latter probably the best. But under no circumstances make the holder look gruesome.

If you find it difficult to secure the necessary

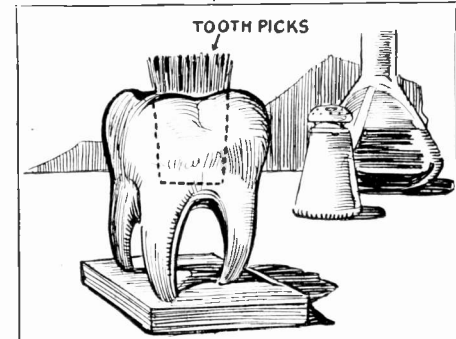

An inventor here offers a new form of toothpick holder. It is also advised that this is a good idea for manufacture and if manufactured by the inventor might be sold with ease. The container might be made from enamel or porcelain. The design should not be gruesome.

financial aid to help in manufacturing this device, we would suggest that you put a few hundred dollars into the manufacture of these devices, or have them manufactured and then attempt to sell the same.

**READ!!**

## WORLD OF INVENTION

A Monthly Magazine  
**INSTRUCTIVE and ATTRACTIVE**

THE MARKET PLACE—a department of immense possibilities—aids the sale of inventions and furnishes information of inventions needed—it is here that the minds of the seller and buyer meet.

Interesting contributions from scientists, inventors and prominent writers.

ENGINEERING DEPARTMENT is especially valuable to inventors.

Many other very desirable features.

Subscription \$2.50 for one year  
Advertising rates on request.

For full particulars address

**World of Invention Company**  
Three Thirty-four Fifth Avenue  
New York City, U. S. A.

## FREE RADIO

VACUUM TUBE SET



Receives 100 Miles or More  
Send name and address. Learn HOW you can get a Vacuum Tube Radio Set **ABSOLUTELY FREE**  
Write today for Free Radio Plan. **RELIABLE SALES CORP.**  
434 Broadway, N. Y. City, Dept. 588

### \$4.00 ADDING MACHINE

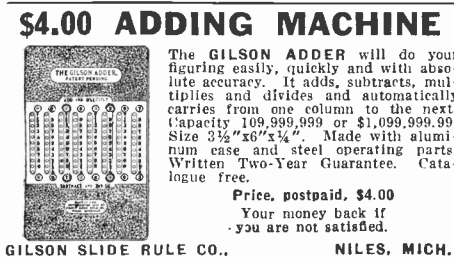

The GILSON ADDER will do your figuring easily, quickly and with absolute accuracy. It adds, subtracts, multiplies and divides and automatically carries from one column to the next. Capacity 109,999,999 or \$1,099,999.99. Size 3 1/2" x 6" x 1 1/4". Made with aluminum case and steel operating parts. Written Two-Year Guarantee. Catalogue free.

Price, postpaid, \$4.00  
Your money back if you are not satisfied.

GILSON SLIDE RULE CO., NILES, MICH.

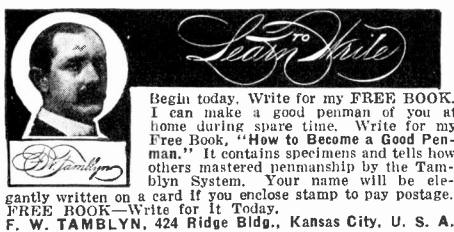

Begin today. Write for my FREE BOOK. I can make a good penman of you at home during spare time. Write for my Free Book, "How to Become a Good Penman." It contains specimens and tells how others mastered penmanship by the Tamblin System. Your name will be elegantly written on a card if you enclose stamp to pay postage. **FREE BOOK**—Write for it Today.  
F. W. TAMBLYN, 424 Ridge Bldg., Kansas City, U. S. A.

### Print Your Own

Cards, circulars, labels, book, paper, Press \$12. Larger \$35 Job press \$150. Save money. Print for others, big profit. All easy, rules sent. Write factory for press catalog, TYPE, cards, etc. **THE PRESS CO., D-47, Meriden, Conn.**

### DRAWINGS

Inventions developed to commercially practical shape. Working drawings for models, Machine designing. Patent drawings. Reasonable rates.  
H. WETTSTEIN, M. E.  
150 Nassau St. New York City

### Scientific Questions on Page 768 Answered.

By ERNEST K. CHAPIN.

THE answers to all the questions are arrived at through the laws of physics and mathematics. The problems are comparatively simple when they are studied, although the final answer is, in many cases, just the opposite of the first conclusion drawn as to the results of the tests.

#### THE BICYCLE PROBLEM

THE bicycle will move forward in the direction of the pull without skidding. This is explained by the fact that although the pedal is turning backwards (with reference to the axis of the sprocket) when the bicycle is going forwards the pedal is at every instant progressing over the ground.

#### TRAVELING NORTHWEST

A MAN could not travel northwest indefinitely but would circle closer and closer to the pole, until finally he reached it.

#### THE ROLLING SPOOL

IT is natural to jump to the conclusion that the spool will roll down hill unwinding the thread as it goes. On the contrary it will remain stationary as long as the thread is held fixed. For if the spool unrolled to the extent, say, of one revolution it would travel down the incline a distance equal to the circumference of the rim on which it rolls, but in the same time the thread would unwind by an amount only equal to the circumference of the drum—which is obviously impossible.

Still more surprising, perhaps, is the effect of pulling on the thread. In this case the spool actually rolls uphill winding up the thread as it goes. To understand this consider the relation of the forces represented in the diagram. The spool may be thought of as a lever with its pivot at the point of contact with the table. Let AC represent the force applied to the thread and OD the weight of the spool. Then OE is the component of OD down the plane of the table. The moment tending to roll the spool up the table is equal to AC x AB. The moment tending to roll the spool in the opposite direction is OE x OB. If these two moments are equal the spool remains stationary. But if AB x AC exceeds OE x OB the spool must move upward.

#### ALTITUDE AND GAS PRESSURE

THE pressure of street or illuminating gas at a house on top of a hill would be slightly less than the pressure at the bottom. Gas, like water and everything else material, has weight and hence the pressure at the top would be less than the pressure at the bottom. Ordinarily this would mean a trifling difference which would not be noticed.

#### CIGARETTE LOCUS

REMEMBERING that the pedal never goes back with reference to the ground, we get a series of curves from the lighted cigarette such as shown at the bottom of the illustration.

E. D. BLODGETT, BROOKLYN, N. Y.

#### THE MUSICAL ECHO

A SINGLE clap of the hands sends out practically a single pulse of sound through the air. Since the pickets are progressing farther and farther from the source the sound reaches them in succession and is in succession reflected to the ear. The train of sound pulses thus reaching the observer is then heard as a musical note whose pitch depends principally upon the spacing of the pickets.

# Learn Electricity



In the Great Shops of  
**Coyne**

Student Winding a Stator

## Chicago

**The Electrical Center of the World**

Come to Coyne—learn electricity in 3 1/2 months in the largest electrical school in the country. Get a complete training so you can make big money as Power Plant Operator, Superintendent, Telephone man, Construction worker, auto, truck or tractor electrician, battery man, radio expert, or you can go into business for yourself as electrical contractor, dealer, auto ignition or battery expert and make from \$8,000 to \$20,000 a year. Hundreds of our graduates today are making big money and you can do the same if you grasp this opportunity—act now.

## Learn in 3 1/2 Months

No books or useless theory. You are trained on \$200,000 worth of electrical equipment. We give you FREE a complete course in Radio—the marvel of the age, Constructing, installing and operating. We also give you FREE a life Membership which enables you to stay as long as you want or come back for further training at any time without charge.

## Earn \$150 to \$400 a Month!

You work on motors, generators, housewiring, autos, batteries, radio, switch-boards, power plants—everything to make you an expert ready to step right into a position paying from \$45 to \$100 a week. You get a complete practical training in Circuits, Housewiring, D. C., A. C. Armature and Stator Winding, Drafting, Auto, Truck and Tractor Electricity, Battery Building and Repairing, and Radio.

### Earn While You Learn!

We help students to secure jobs to earn a good part of their expense while studying.

## Send Coupon Now

Don't delay a minute—send that coupon right now for our big free catalog and full particulars of special offer. Act now!

**COYNE**  
Electrical School  
Endorsed by Electrical Industry

1300-1310 W. Harrison St., Dept. 53-39, Chicago

Coyne Electrical School, Dept. 53-39  
1300-1310 W. Harrison St., Chicago

Dear Sir: Please send me free your big catalog and full particulars of your special offer.

Name .....

Address .....

.....

*Why haven't you clipped this coupon*

**INTERNATIONAL CORRESPONDENCE SCHOOLS**  
Box 6215-C, Scranton, Penna.

Without cost or obligation on my part, please tell me how I can qualify for the position or in the subject before which I have marked an X.

**BUSINESS TRAINING COURSES**

- |   |   |
|---|---|
| <input type="checkbox"/> Business Management            | <input type="checkbox"/> Salesmanship           |
| <input type="checkbox"/> Industrial Management          | <input type="checkbox"/> Advertising            |
| <input type="checkbox"/> Personnel Organization         | <input type="checkbox"/> Better Letters         |
| <input type="checkbox"/> Traffic Management             | <input type="checkbox"/> Show Card Lettering    |
| <input type="checkbox"/> Business Law                   | <input type="checkbox"/> Stenography and Typing |
| <input type="checkbox"/> Banking and Banking Law        | <input type="checkbox"/> Business English       |
| <input type="checkbox"/> Accountancy (including C.P.A.) | <input type="checkbox"/> Civil Service          |
| <input type="checkbox"/> Cost Accounting                | <input type="checkbox"/> Railway Mail Clerk     |
| <input type="checkbox"/> Bookkeeping                    | <input type="checkbox"/> Common School Subjects |
| <input type="checkbox"/> Private Secretary              | <input type="checkbox"/> High School Subjects   |
| <input type="checkbox"/> Spanish                        | <input type="checkbox"/> French                 |
| <input type="checkbox"/> Illustrating                   |   |

**TECHNICAL AND INDUSTRIAL COURSES**

- |   |  |
|---|--|
| <input type="checkbox"/> Electrical Engineering | <input type="checkbox"/> Architect               |
| <input type="checkbox"/> Electric Lighting      | <input type="checkbox"/> Blue Print Reading      |
| <input type="checkbox"/> Mechanical Engineer    | <input type="checkbox"/> Contractor and Builder  |
| <input type="checkbox"/> Mechanical Draftsman   | <input type="checkbox"/> Architectural Draftsman |
| <input type="checkbox"/> Machine Shop Practice  | <input type="checkbox"/> Concrete Builder        |
| <input type="checkbox"/> Railroad Positions     | <input type="checkbox"/> Structural Engineer     |
| <input type="checkbox"/> Gas Engine Operating   | <input type="checkbox"/> Chemistry               |
| <input type="checkbox"/> Civil Engineer         | <input type="checkbox"/> Automobile Work         |
| <input type="checkbox"/> Surveying and Mapping  | <input type="checkbox"/> Airplane Engines        |
| <input type="checkbox"/> Metallurgy             | <input type="checkbox"/> Agriculture and Poultry |
| <input type="checkbox"/> Steam Engineering      | <input type="checkbox"/> Radio                   |
| <input type="checkbox"/> Mathematics            |  |

Name.....  
Street.....  
Address.....  
City..... State.....

Occupation.....  
Persons residing in Canada should send this coupon to the International Correspondence Schools Canadian, Limited, Montreal, Canada

**Can You Draw This?**

If you can write you can learn to draw. The famous artist Chas. Lederer, founder of the Lederer School of Drawing, and author of the Lederer Home Study Course in Drawing, Art and Cartooning—has always said that by the use of his course, it was easier to learn to draw than to learn to write. Thirty thousand students, without a single complaint, prove that he is right. The Lederer Course was formerly a high-priced course, sold in the old expensive way. To eliminate this expense, and just as an experiment on our part, we will send you the complete course of 34 lessons upon receipt of \$2.98. Order now, offer may be withdrawn. LEDERER SCHOOL OF DRAWING, Dept. 64-B Chattanooga, Tenn.



**Send To-day for the "Electrical Worker's Friend" \$3.00**

An electrical book of 66 motor drawings with complete instructions for rewinding and reconnecting A. C. motors. Special at...  
Or write for full particulars of this valuable book. SMITH & SMITH PUBLISHING CO. Dept. B., 7428 Hermitage St., Pittsburgh, Pa.

**Motor Hints**  
Oil Pumping—Causes and Cures  
By TOM C. PLUMRIDGE

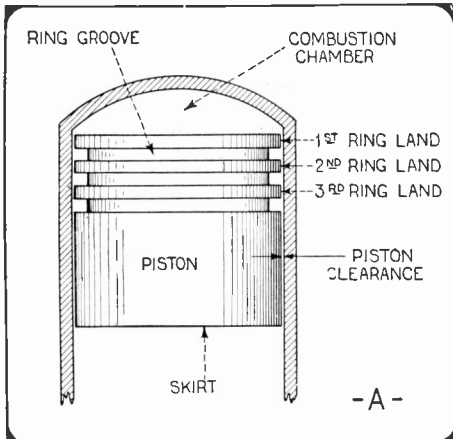

Here is shown an illustration of piston play. Also the sketch shows the correct names of the parts of a piston. All measurements should be made with micrometers.

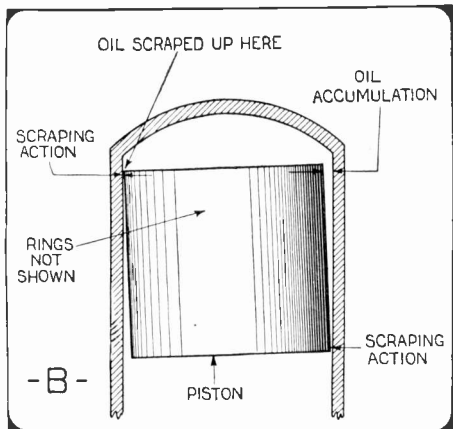

When a piston cocks in a cylinder it is caused by a warped or strained connecting rod. Such a piston pumps much oil as well as scores the cylinder wall.

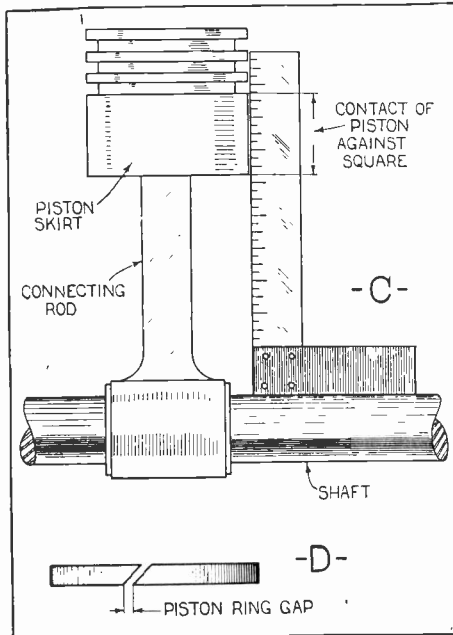

Above is shown a method of testing a piston for alignment. The connecting rod is bolted to a mandrel and the piston tested with a square as shown above. Both skirt and top of the piston should touch the square. To test the wear of a piston ring, place it in the cylinder and measure the gap. A gap should never be more than .002 to .003 inch for each inch of piston diameter.



**PLAY THIS JAZZY SAX**  
*Without Practice No Lessons Sweet Jazzy Tone*

**"Easy to Play"**

"This is easy. I played tunes after fifteen minutes and am delighted." V. D. Beatty, Chicago, Ill. "I find your Jazzy Sax is very easy to play."—Clara Lemke, Appleton, Wis. "A friend of mine got your Jazzy Sax and I just think it is a great instrument so I am writing to get one myself."—Wm. Ellis, Fil-tonville, Ohio.

Anyone can play this imported Jazzy Sax right away. No knowledge of music required, no lessons. Play by numbers instead of notes—play by notes or ear if you wish. All directions and 80 songs with each sax. Be popular at parties, dances, picnics.

Not a toy—but a real musical instrument. Glistening, polished brass with nickel mouthpiece. Looks like a regular saxophone the same size. Weighs over 3 lbs.

Beautiful, clear, ringing tones and delightful harmony. No need to spend \$85 when you can own a Jazzy Sax.

**Send No Money**

Just fill out the coupon below. When the Sax and the 30 Songs arrive, pay the postman only \$5.98 plus a few pennies postage. Play the songs right away. You don't risk a penny. Satisfaction guaranteed or money refunded. But the supply is limited—so don't delay. Mail the coupon today.

**Send This Coupon Today**

FERRY & CO., 75 W. Van Buren Street, Dept. 1258, Chicago, Ill.

Please send me at once your Jazzy Sax and 30 Songs. On arrival I will deposit \$5.98 plus postage with the postman. If I am not satisfied, I will return the instrument and you will refund my money.

Name.....  
Address.....  
City..... State.....

**DANCE And be Popular**

**Learn In ONE HOUR at Home**

There's now no need of being a wall-flower. In one hour—at home—by mail—I can make you an easy, confident dancer—popular in any ballroom.

**NEW EASY METHOD**

No Partner Needed—No Embarrassment  
Over 60,000 men and women have become popular dancers of Fox Trot, One Step, Waltz and all the latest up-to-the-minute society dance steps through my new Foto-tell and Fono-tell Method set to music. Amazingly easy—fascinating. No other course like it. I teach you perfect time and rhythm—the secret of good dancing. Your success Guaranteed.

**SENT FREE ON TRIAL**

Convince yourself at my expense how amazingly easy it is to learn modern dancing with my new method. For a short time only I'll send the first six lessons of my course (in plain wrapper), including 10-inch dance instruction record, free and prepaid for five days trial. See, test and prove this remarkable new method in your own home. Then, if not delighted at your success, simply return record and lessons within five days and you'll owe me nothing. Write quick before this unusual offer expires. Please mention make of phonograph you have.

**WILLIAM CHANDLER PEAK, M. B.**  
Studio 252  
4601-4611 Broadway Chicago, Ill.





# A Wonderful Brain Building Course

## Your Success Depends Upon Brain Energy

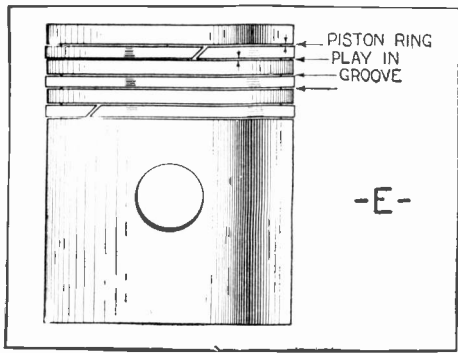

A ring loose in its groove is the cause of oil pumping and lack of compression. Even new engines sometimes show such trouble.

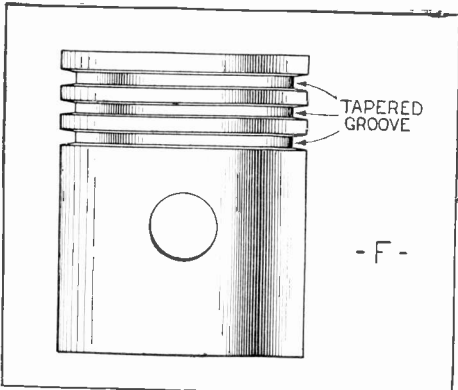

Before installing new rings in a piston examine it for groove taper. If the groove resembles the one above it should be re-turned.

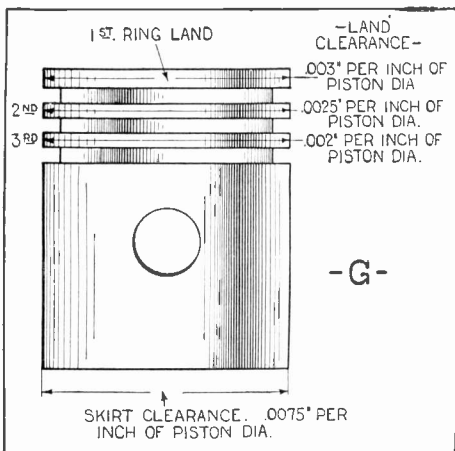

Here is shown a good rule for piston clearance. The piston should be placed in the cylinder and tried, for if it is too tight scoring will result.

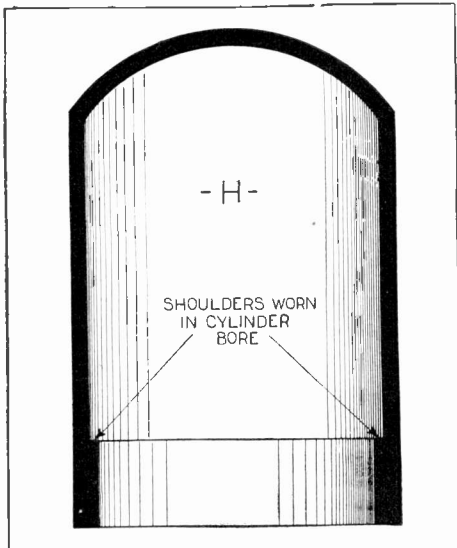

If a shoulder has been worn in the bottom of the cylinder as shown above, there is nothing to do but regrind the cylinder. This trouble also invariably causes a slight knock in the engine.

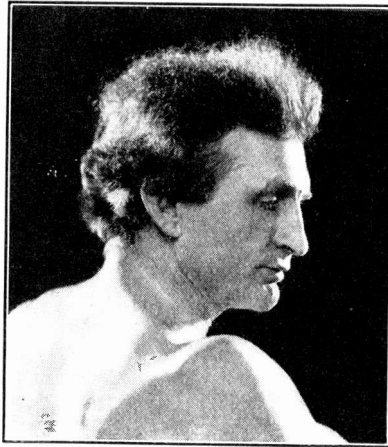

BERNARR MACFADDEN

**Y**OU, too, are striving, longing, aching for success. You would give an arm or a leg, or half your life, for the kind of success you dream of in your day-dreams.

But have you the very first essential for such success—a six-cylinder mentality? Have you sufficient power for your think-machine? That's the big thing. Talent will not go very far if you lack the steam to back it up, the driving force, the mental energy.

Do you realize that an increase of brain energy would mean boarding the express train on the road to success? That more brain energy would mean not only a greater capacity for work, but a better quality of work? And what is more to the point, do you know that it is possible to build this increase of brain energy?

*A human dynamo of energy*—expressed in thinking power and will power—that is what you ought to be. And you can be. It is simply a matter of right methods of training and self-development.

How to make your brain do more work.

There is your problem.

Bernarr Macfadden has been studying this very problem for the best part of a lifetime, with the result that he has finally written an extraordinary course of training in vitalizing the nerves and building brain energy, a course that is bound to revolutionize many current theories on training for mental efficiency. With his customary originality and freshness of mind, this forceful writer has attacked the question of success and failure from an entirely new viewpoint, going to the very root of the problem, and the result is that this remarkable course is the greatest success guide ever written. In this course Mr. Macfadden has brought out both the physical factor and the mental factor in building increased brain power.

Among the striking features of Mr. Macfadden's new philosophy as expressed in this course, is the demonstration that not only does mental ability depend upon brain energy, which is nothing more nor less than nerve-force translated into terms of mental activity, but that character, the foundation of success, is likewise inseparably dependent upon the same underlying human force. He has shown that courage, self-confidence, power of will, personality and the elusive quality known as magnetism, all depend very largely upon building and maintaining that inexhaustible reserve of nerve-force that is back of exceptional brain power.

Whatever may be the weak points in your mentality or character, this broad and comprehensive new course by Mr. Macfadden will interest you and help you. You don't need to be a failure, a slow thinker, a mere average mentality, a commonplace personality, a characterless, weak-willed nonentity, a slacker, a quitter or a loafer. It is your business to realize your best destiny, to develop your latent powers. Cultivate your forces; become magnetic, forceful, successful; learn to concentrate, to think energetically, to act decisively and irresistibly.

Energy, brains, will power, personality—these and related factors in a high degree of development, all contribute to the building of success. Where do you stand in these respects? Do you know how to develop these qualities? You should know. You have possibilities in you that you have never fully brought out. You have never made the most of your natural powers, or of your opportunities. Few men do. But can you afford to waste your life? Be honest with yourself. Give yourself a square deal. You will be here only once. Why not be master of your destiny?

Success! Think what it means. It is the basis of the larger happiness—the satisfaction of achievement. It means everything. Is it worth while? It is up to you. It is your next move. This new Brain Energy Building, Nerve-Vitalizing Course by Bernarr Macfadden was written to help you in the very way in which you most need help. If you are interested, you can secure a brochure of further information about this course by writing to the publishers.

## Macfadden Publications, Inc.

Macfadden Building

Dept. SI 11

1926 BROADWAY

NEW YORK

MACFADDEN PUBLICATIONS, Inc., Macfadden Building, Dept. SI 11

I am interested in Bernarr Macfadden's Brain Energy and Nerve-Vitalizing Course. Please send me full information regarding it. It is fully understood that I incur no obligation by signing this coupon.

Name .....

Address .....

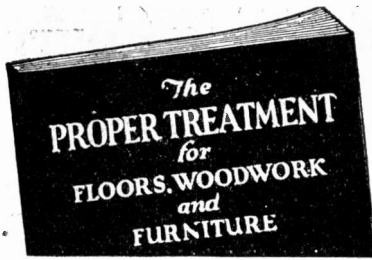

**FREE-This Book on Home Beautifying**



THIS book tells how to finish wood in artistic stained and enameled effects. Gives practical suggestions on making your home artistic, cheery and inviting. Tells just what materials to use and how to apply them. Includes color card—gives covering capacities, etc. Use coupon below.

**JOHNSON'S WOOD DYE**

With Johnson's Wood Dye inexpensive soft woods, such as pine, cypress, fir, etc., may be finished so they are as beautiful and artistic as hardwood.

Johnson's Wood Dye is very easy to apply—it goes on easily and quickly, without a lap or a streak. It penetrates deeply, bringing out the beauty of the grain without raising it—dries in 4 hours and does not rub off or smudge.

Full instructions for finishing all wood—old or new, soft or hard, are given in the booklet.

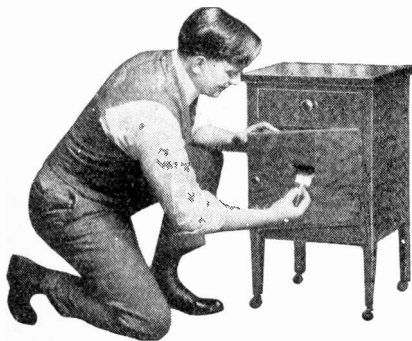

S. C. JOHNSON & SON, Dept. S. 1, 12, Racine, Wis. (Canadian Factory—Brantford)

Please send me free and postpaid your Instruction Book on Home Beautifying and Wood Finishing.

The best dealer in paints here is.....

MY NAME .....

MY ADDRESS .....

CITY & STATE.....

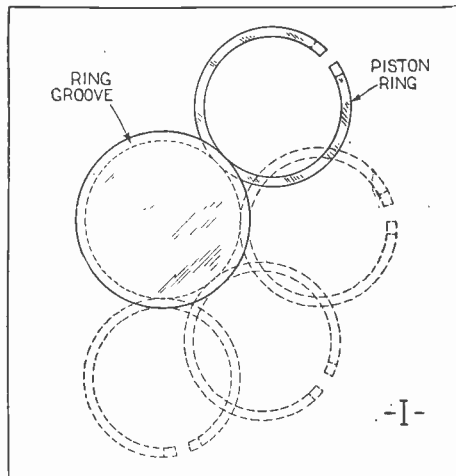

In fitting new rings into pistons roll them around the groove to see that they fit on all sides. If the ring is tight reduce it with emery paper.

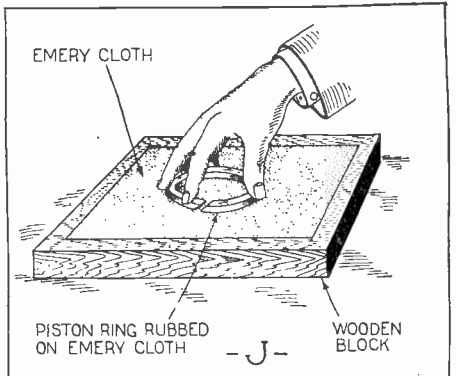

Here is shown a method of reducing a ring to fit a piston. On all rings it will be found that one side has been accurately ground. This side should be to the bottom of the groove. This will reduce leakage on the compression stroke. If the ring has to be reduced, do the reducing on the roughly finished side. Mark rings so they fit their own grooves.

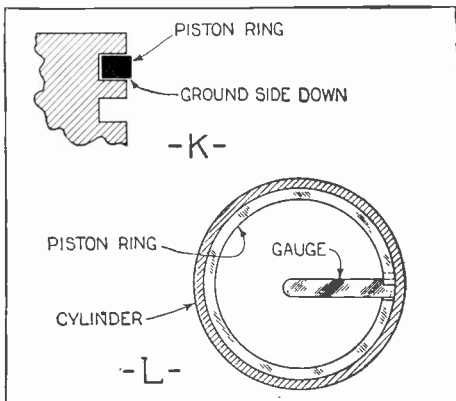

After placing a ring on a piston, test the gap for size. This is done with a feeler gauge. If the gap is too close the ends should be filed.

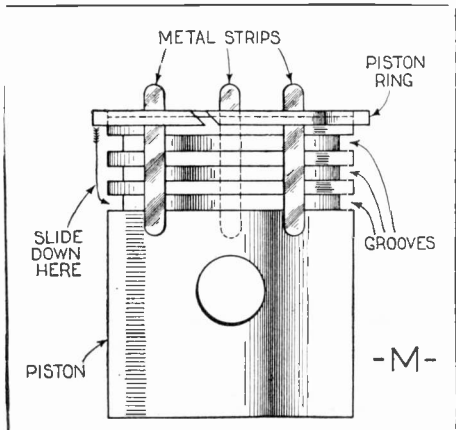

Here is given the method for placing the rings on the piston. Put on bottom ring first.



**A Merry Christmas for that Boy of Yours!**

Your boy's Christmas will be the happiest ever, if you will send him THE BOYS' MAGAZINE. It is a gift that lasts a whole year. This splendid magazine is chock full of just the kind of reading you want your boy to have. Clean, inspiring stories by the world's best writers. Practical and instructive departments devoted to Radio, Mechanics, Electricity, Athletics, Physical Training, Stamp Collecting, Cartooning, etc., etc. Beautiful big pages with handsome covers in colors. A big lot of jokes and comic drawings.

We give away \$132.00 in Cash Prizes for the best amateur short stories, drawings, cartoons, articles on radio, mechanics, electricity, etc. There is no reason why your boy should not win some of these Cash Prizes. These Prize Contests are continuous and each issue of THE BOYS' MAGAZINE gives full particulars regarding them. Subscribe for this great magazine for your boy or for some boy in whom you take a particular interest. It will mean for him a whole year of pleasure, entertainment and instruction.

**Special Offer!** For only \$1.00 we will send THE BOYS' MAGAZINE for a full year beginning with the big December (Christmas) issue. We will send FREE to each subscriber a copy of our book "Fifty Ways for Boys to Earn Money." We will also send the subscriber a handsome Christmas gift card with your name as donor. (Satisfaction or money refunded.)

THE SCOTT F. REDFIELD CO., Inc., 8228 Main St., Smethport, Pa.

I enclose \$1.00 for which enter the following name for a whole year's subscription to THE BOYS' MAGAZINE. Send him his first copy of THE BOYS' MAGAZINE, a Christmas gift card and a copy of your book, "Fifty Ways for Boys to Earn Money," all to reach him on Christmas morning.

Name .....

Street or R. F. D. ....

City ..... State .....

Your Name .....

**Tycos Thermometers**

All the Family feels Better when the Temperature is at **68°**

Taylor Instrument Companies  
Rochester, N. Y.

There's a Tycos and No. Thermometer for Every Purpose

**LATHES**

9 to 18-inch Swing

List price \$135.00 and up, according to size. When ready to buy, send for Lathe Catalog and prices.

W. F. & John Barnes Co,  
442 Ruby Street  
ROCKFORD, ILLINOIS

# The Wonders of Saturn

BY ISABEL M. LEWIS

(Continued from page 759)

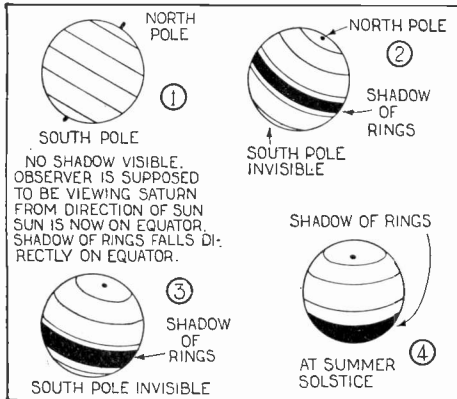

The shadow of the rings fall in different places over the surface of the planet with the passage of the seasons. At 1, the observer is viewing the planet from the side next the sun at the Vernal Equinox. The sun is in the plane of the rings so their shadow falls directly on the equator. At 2, the shadow is seen growing shorter as the equinox approaches. At 3, is its position near the Summer Solstice—mid-summer. At 4, is its position at the Solstice. The rings always fall on the side of the planet that is having winter.

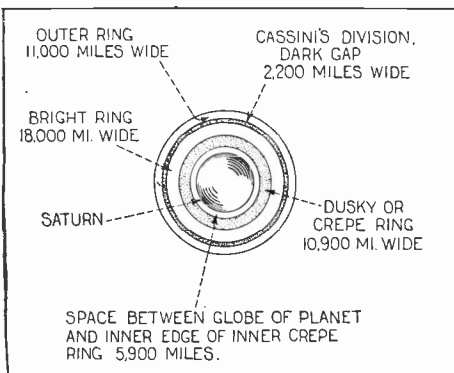

As Saturn and his rings would look from a point directly above her north pole, showing the division of rings and their width.

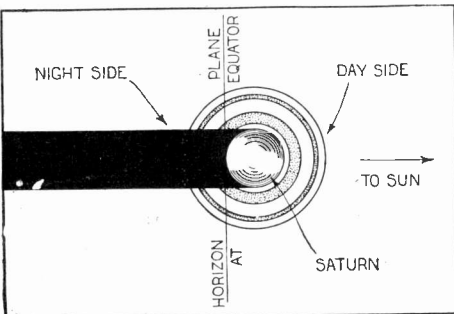

At the Equinoxes the planets shadow cuts a dark rectangle out of the rings leaving only a segment of them at each side of the horizon.

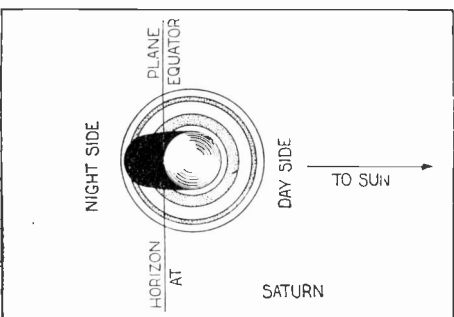

At the Solstices the shadow is shortened by the rise of the sun to the tropics so that the whole shadow of the planet is on the rings cutting a dark ellipse from them.



## Crossroads of Conversation

Could the telephone directory in the hands of each subscriber be revised from hour to hour, there would be no need for the information operator. But even during its printing and binding, thousands of changes take place in the telephone community. New subscribers are added to the list. Old ones move their places of business or of residence.

Though their names are not listed on the directory, these subscribers must be connected by the highways of speech with all others in the community. To supplement the printed page, there must be guides at the crossroads of conversation.

Such are the information operators, selected for their task because of quickness and accuracy, courtesy and intelligence. At their desks, connected with the switchboards in central offices, they relieve the regular operators from answering thousands of questions about telephone numbers that would otherwise impede the rendering of service. If they are unnecessarily asked for numbers already in the directory, service is retarded.

"Information" stands for the most complete utilization of telephone facilities.



**"BELL SYSTEM"**  
AMERICAN TELEPHONE AND TELEGRAPH COMPANY  
AND ASSOCIATED COMPANIES

*One Policy, One System, Universal Service,  
and all directed toward Better Service*

## BE A RAILWAY TRAFFIC INSPECTOR

EARN UP TO \$250 PER MONTH. Expenses Paid  
Big demand for trained Railway Traffic Inspectors; excellent opportunities for advancement. Meet prominent officials, travel, something new every day. Pleasant, healthful, out-door work.  
Position Guaranteed or money refunded. We prepare you in 3 months' spare time study at home. Non-technical; easy to master. Start at \$110 per mo. expenses paid, or more. Hundreds of successful graduates. More positions than we can fill now open. Act NOW—No Risk!  
Send coupon today for Booklet No. D-83, giving full details. Don't delay.

Standard Business Training Institute, Buffalo, N. Y.  
Send me entirely free, booklet No. D-83, giving full particulars about course in Railway Traffic Inspection.  
Name .....  
Street .....  
City .....



## VACCU-PUMPS

Needed by every Doctor, Dentist, Chemist, Mechanic, garage repair shop, radio experimenter, college and laboratory.

### Many Uses

Will exhaust vacuum tubes, start a syphon, empty auto gas tanks by suction, draw liquid from inaccessible places, transfer acids, and supply a vacuum for any medical or laboratory use. Price with gauge, hose, and bottle, \$10.00. Without gauge, \$6.00. Circulars on request.

**A. B. C. LABORATORIES CO.**

100 Lawrence St., N. Y.  
West 126th St.

# Look Here!

Are you ambitious? Are you looking for the way to Success? Do you want an easy, pleasant job? Do you want to make from \$60 to \$100 a week? Do you want to enjoy the luxuries of life?

**Then Read My Offer!**



## I Guarantee

to make you an EXPERT DRAFTSMAN right in your home, in your spare time! My "Job-Method" instruction prepares you to hold down any job at TOP PAY! I train you with Draftsmen's INSTRUMENTS, not books—until you can design and draw the plans of any machine or structure, until you are earning at least

**\$250 a Month!**

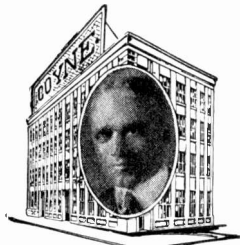

Men like EDISON, McADOO, GOETHALS, STEINMETZ have used DRAFTING to climb the ladder of success to dizzy heights. You can't find pleasanter, more interesting or easier work—nor will you find any other profession that pays such big salaries after only a few months of training!

**FREE!**

Make up your mind right now to be an EXPERT DRAFTSMAN and you can stop worrying about the future for ever! Mail coupon TODAY for inducements you cannot resist! Get my limited offer of big \$19 Drafting Outfit FREE—prices reduced, terms made easier! Get my 2 FREE books quick!

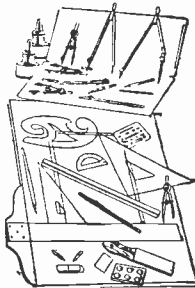

**Mail Coupon Today!**

Address B. W. Cooke, President



Dept. E-13, 552-598 So. Throop Street, Chicago, Ill.

Coyne School of Drafting  
B. W. Cooke, President  
Dept. E-13 552 to 598 So. Throop Street, Chicago

Without obligating me in any way please send me your 2 books, "Drafting, the foundation of industry" and "Learning Drafting by the Job-Method"—all absolutely free. Also complete information of your rapid home-study Drafting course and Free Instruments

Name.....  
St. No.....  
City..... State.....

## Book Review

**THE SCIENCE OF INVENTION.** A course in invention consisting of an introduction and twenty-five lectures. Published by the Bureau of Inventive Science, Rochester, New York. Each of the separate lectures and the introduction bound in paper. Also includes numerous problem cards, catalogs of reference works. Complete list of Libraries, as well as engineering and professional Association Libraries.

This course in invention is rather pretentious in its realm. It cannot be said that it does not cover the field. Beginning with a discussion on the nature of genius and the inventive trend of mind it follows on through a short course in concentration and memory with special attention toward creating, in the mind of the budding young inventor the right sort of mental habits.

Then there are lectures on what the inventor should know about mechanics, electricity, chemistry, physics, and sketching. These set out very briefly some of the more common laws of the branches of science under discussion in the chapter.

Then there are chapters on such subjects as "What not to invent," "Development of the labor saving device" and "Manufacturing Methods." But by far the best parts of the course are those dealing with the methods and practices in carrying out research work in connection with the ideas on which the inventor is working. In these lessons the course goes so far as to set out lists of libraries and bureaus where information may be obtained and the general procedure in obtaining books and literature from them.

The latter part of the course is given up to the intensely practical side of inventing such as designing the complete machine or device, with an eye toward making its manufacture the cheapest possible consistent with quality, with the obtaining of patents both U. S. and foreign with a discussion of what ideas should be patented and where.

At the back of each lecture there are practical problems in invention designed to give the inventor the proper trend of mind that will allow his imagination to work.

One of the most admirable things about the course is the more or less complete bibliography given with it to be used in connection with the course. It is a hopeless task to try to cover physics or chemistry in a booklet of a dozen pages so the author appends this rather good list of reference books.

The course may not enable the student to evolve a vacuum tube but it certainly will not leave him in the dark as to the practical way in which to go about his exploits in the field of discovery and design.

**THE RADIO PATHFINDER.** By Richard H. Ranger. 155 pages, illustrated, hard cloth covers, size 7½"x5¼". Published by Doubleday Page and Company, New York City.

This is one of the clearest books written on the subject of radio reception. In it the author makes use of little characters, such as we used to find in our nursery rhyme books which he calls positive ions, king electrons and negative electrons. These little figures enter into the explanations in the forms of diagrams and make very interesting reading. These little figures come in quite handy in explaining the action of the radio vacuum tube as the same can be clearly put forth with their use. In all explanations of the action of electrical currents in the various radio instruments, these figures are used to great advantage.

The text of the book is written in a very engaging and entertaining manner and at the same time gives authoritative information on the different phases of radio reception. The writer confines himself solely to this subject, that is reception, and in this manner presents a book which is of great interest to all classes of radio receiving fans.

A useful chapter, covering a phase of radio work which is usually omitted in other books is that on batteries. Storage batteries are thoroughly discussed and the necessary precautions in caring for them are taken up. Methods of charging storage batteries are also illustrated, making the chapter particularly of interest to the experimenter.



**You and your support —both are needed**

THE battle against tuberculosis is your battle. The organized fight against consumption protects you, and makes your community a cleaner, more healthful place to live in.

You support the war upon tuberculosis when you buy Christmas Seals. The life-saving campaign of the Tuberculosis Association is largely financed by the sale of these seals. Protect yourself and help others. Buy Christmas Seals.

Stamp out Tuberculosis with Christmas Seals



THE NATIONAL, STATE AND LOCAL TUBERCULOSIS ASSOCIATIONS OF THE UNITED STATES

## BLANK CARTRIDGE PISTOL

PRICES 50c. \$1.00



Well made and effective; modelled on latest type of Revolver; appearance alone is enough to scare a burglar. When loaded it may be as effective as a real revolver without danger to life. It takes standard .22 Cal. Blank Cartridges obtainable everywhere. A Great Protection Against Burglars, Tramps and Dogs. You can have it lying about without the danger attached to other revolvers. PRICE 60c Postpaid; Better make and superior quality for \$1.00. Blank Cartridges .22 cal., shipped express 60c per 100. JOHNSON SMITH & CO., Dept. 34, Racine, Wis.

## Wrestling Book FREE

Be an expert wrestler. Learn at home by mail. Wonderful lessons prepared by world champions Farmer Burns and Frank Gotch. Free book tells you how. Secret holds, blocks and tricks revealed. Don't delay. Be strong, healthy. Handle big men with ease. Write for free book. State agent Farmer Burns School, 1259 Railway Bldg. Omaha, Neb.

**RAILROAD ELECTRIFICATION.** By Arthur J. Manson. Illustrated, 332 pages, hard cloth covers, size 8 3/4"x 5 3/4". Published by Simmons-Boardman Publishing Company, New York City.

In this book is outlined the principles involved in railroad electrification, in a manner meant for students of that subject and those actively engaged in the work. An explanation of Ohm's law is given and inductance and capacity are thoroughly explained. Various types of electric motors are then taken up and instruction is given on how to read the characteristic curves of motors. The operation of trains is then entered into and various phases of the running of electrical locomotives are treated carefully. Tables are given showing the general data on the operation of electrical trains in the United States and throughout the world. Electric and steam locomotives are compared as to efficiency.

The book can very well be considered as a text book for anyone desiring to study electrical transportation and its future.

**THE AMERICAN BOY'S BOOK OF BUGS, BUTTERFLIES AND BEETLES.** By Dan Beard. Illustrated. board 8 1/4"x5 1/2", 304 pages, Lippincott, Philadelphia.

Dan Beard, the great naturalist and woodcraftsman of the American boy, has written this treatise on some branches of entomology, as specified in the title. All the way through the book he maintains a simple style, and a reduction of terms and words to their simplest forms that makes the subject matter perfectly clear, even to the veriest layman. Full directions for the collection and mounting of specimens are given and great care is taken to show the young student the why and the wherefore. The subject matter is divided into three divisions. They are: The beetle family, the butterfly and moth family and the lower forms of insects. Full description is given of each of the species described. Several of the fundamental facts of biology are brought out in the course of these descriptions. Special attention is given to distinguishing those insects that are harmful and those that are helpful to man and his work.

The whole subject is set out clearly so the boy—or man, for that matter—who hasn't any training in science may read the text, follow the illustrations, and finish this enjoyable book without failing to understand a single sentence or thought the author has set down. He will learn a great deal about the life, habits and formation of the insect kingdom.

**THE WEB OF DESTINY.** By Max Heindel. Frontispiece, 7 3/4"x5 1/4", 187 pages, including blurbs. Board. The Rosicrucian Fellowship, Oceanside, Calif.

This may be termed another one of those Spiritualistic things now prevalent. The author, evidently, has heard of such things as instincts, lower nerve centers, brain cortices, et. al. He looked upon them and decided they were good for another religion. It seems that a great many men, once they find something new to their mind, something exotic in the field of science, or some branch of study in its infancy, must immediately set to get the known facts, under different names, into some sort of religion.

It must be because a certain type of intelligence is very impressionable. Immediately they fall on something that is rich in theory and rather shy on fact, they proceed to fill the deficiency in fact by supplying a wealth of imaginative detail.

Heindel, however, has a quite interesting arrangement of bodies which seem to take the place of the instincts, the spiritual and the intelligence, in the works of the more conservative religionists.

It is worth reading just for the sake of his point of view of psychology—that is, if it is not taken too seriously.

**DIESEL AND OIL ENGINE HAND-BOOK.** Julius Rosebloom. Illustrated with diagrams, plans and photos. 5"x7". 376 pages, bound in imitation leather. Published by the Technical Publishing Co., Los Angeles, Calif.

A long felt need for a volume such as this one has been, at last, filled. It is written from the point of view of the actual operating engineer, the one who stops and starts the engines and who cares for them. It contains an explanation of the working principles of the machines, but the emphasis is placed on a thousand and one little things that the draughtsman and engineer never think about. Those little things that cause the hard pressed engineer to make the air blue with swearing and bring him to a premature grave, those little worries that only the actual operator knows.

It deals with both the marine and stationary types, fully, but never profusely; sets out in plain language easily understood the weak and strong points of each type and gives many hints that may prove extremely useful. The auxiliary apparatus is also fully covered. An appendix with calculations follows, which is a very useful addition to the text.

# Learn Cartooning at Home

## Earn \$100 a Week

### In This Fascinating Business

**CASH** in on the amazing ever-increasing popularity of cartoons! Thousands of cartoonists are needed to draw the vast number of political, religious, international, seasonal and human-interest cartoons. There is a crying demand too for men able to produce humorous cartoons, comic strips and sport cartoons. Advertising and animated cartooning offer two wonderful new and almost untouched fields. Never before have the opportunities in cartooning been so many or so varied. Never have cartoonists had such a wonderful chance to make big money. Now indeed is the time to study cartooning!

### New Methods Makes Cartooning Easy to Learn

Regardless of how little ability you have in drawing, you can now easily qualify for this attractive highly-paid business. Through a wonderful new method you can learn right at home in your spare time. Learning this way is more than easy—it is actually as fascinating as a game.

First you learn the important fundamental principles of cartoon-making. Then you learn the little secrets of originating ideas of action, exaggeration and expression—the little tricks which make cartooning easy to those who know them. Step by

step you advance through every branch of cartooning until almost before you realize it you are drawing cartoons that **SELL**. Many of our students have sold enough work while studying to pay for the course many times over.

Just think of earning a splendid salary for such pleasant work. Successful cartoonists earn from \$3,000 to over \$100,000 a year. Yet enough cartoonists cannot be found to meet the tremendous demand. Right now there is a wonderful opportunity for *you* in this fast-growing uncrowded field.

### Send for FREE BOOK

WASHINGTON SCHOOL OF CARTOONING,  
Room 2612, 1113—15th St., N. W., Washington, D. C.  
Please send me without obligation your illustrated booklet on cartooning.

Name .....  
(Print Name Plainly)

Address .....

City ..... State .....

If under 16 years, please give age .....

Find out more about the wonderful opportunities open to you in this attractive field. Learn more about this easy home-study method of learning cartooning. A handsome booklet has just been prepared which is crammed full of interesting information about cartooning, and describes in detail this remarkable method. It will be sent to you without cost, without obligation. Mail coupon for it **TO-DAY!**

**Washington School of Cartooning**  
Room 2612  
1113—15th St., N. W., Washington, D. C.

# RUSONITE

**CRYSTAL RECTIFIER**  
(Patent Pending)

**THE PERFECT SYNTHETIC CRYSTAL DETECTOR SENSITIVE OVER ENTIRE SURFACE**  
No Hunting for "Spots," Loud and Clear.  
Endorsed by Thousands of Satisfied Users.

Sensitiveness Guaranteed Price Mounted **50c**

14 K. Gold Supersensitive RUSONITE CATWHISKER Price **25c**  
Permanent. Will not Oxidize.

RUSONITE REFLEX CRYSTAL  
Manufactured Expressly for Reflex Circuits  
Will Stand Up Under Heavy Plate Voltage

Guaranteed Price Mounted **\$1.00**

Order from your dealer or direct from  
**RUSONITE PRODUCTS CORP.**

15 Park Row New York, N. Y.

The Real Metal Solder in Paste Form

## SOLDERALL

Introducing Our New  
**SOLDERALL BLOW TORCH**  
of Heavy Solid Brass

Indispensable in the Home, Garage and to the Electrician. For Soldering Radio, House Wiring, Jewelry, Ignition, Kitchen Utensils, Etc.



**SOLDERALL CO. Dept. S Newark, N.J.**

## Are You Contented?



**A**N enterprising publication recently asked thousands of farmers' wives this most personal question: "Are you contented with your lot?" In 94 per cent of all cases the answer was "Yes, decidedly."

Yet, only a decade ago farm life meant drudgery. To-day the washing-machine and electric iron make quick work of what used to be a formidable task. New utensils speed up the preparation of meals. Dish washing is disposed of in short order. Vacuum cleaners lend their most effective aid. Running water, better cleansers and innumerable household helps lighten, quicken and improve the work.

That is what advertising means to women on the farm. It has brought them countless appliances which help in their work, better conditions in their homes, add to their pleasure and increase their interest in life.

Advertising means as much to you. Advertisements published in these pages continually tell of many conveniences and comforts that you might otherwise miss.

*Read the advertisements. It pays.*

## Help Wanted

We require the services of an ambitious person to do some special advertising work right in your own locality. The work is pleasant and dignified. Pay is exceptionally large. No previous experience is required, as all that is necessary is a willingness on your part to carry out our instructions. If you are at present employed, we can use your spare time in a way that will not interfere with your present employment—yet pay you well for your time. If you are making less than \$150 a month, the offer I am going to make will appeal to you. Your spare time will pay you well—your full time will bring you in a handsome income. It costs nothing to investigate. Write me today and I will send you full particulars by return mail and place before you the facts so that you can decide for yourself.

ALBERT MILLS, Gen. Mgr. Employment Dept  
4819 American Bldg., CINCINNATI, OHIO.

## HEALTH

is the Greatest Joy of Life. Only the robust, vigorous and healthy can enjoy life to its fullest. The complaining, ailing, sickly ones are unhappy, discontented, dejected, failures. For many years I have been making people well through Strongfortism. I have helped tens of thousands to become strong. No matter what ails you, write me fully about it, and I will prove to you I can help you. The experience and research of a lifetime are contained in my wonderful FREE BOOK "Promotion and Conservation of Health, Strength and Mental Energy." Send a ten cent piece (one dime) to cover postage.

**LIONEL STRONGFORT**

Physical and Health Specialist  
1317 Strongfort Institute, Newark, N. J.



Lionel Strongfort  
Perfect Man

## STRONGFORTISM

Insure your copy reaching you each month. Subscribe to Science and Invention—\$2.50 a year. Experimenter Publishing Co., 53 Park Place, N. Y. C.

**THE PLANET MARS AND ITS INHABITANTS.** By Iros Urides (A. Martian). A Psychic Revelation written down by J. L. Kennon. 102 pages, paper binding, 5"x7½". Published by the author.

We poor earth worms will have to struggle along as best we can, according to Mabel J. McKean, the medium who says she saw the wonderful things which appear in this little volume, for several thousand years before we will reach the spiritualistic heights that permit the Martians to enjoy their perfect communism. As a matter of fact, we earthly people cannot understand the great spiritual truths that enable the Martians and Mrs. McKean to get at the foundational facts of life and science. They are much nearer a speaking acquaintance with the Almighty than we poor benighted souls. But, Mrs. McKean says to just bear with us a little while, to give us a little time and we may learn to enjoy life, like the Martians, if we follow the right leaders. The Martian who made the revelation to the lady in question says that Christ visited that planet several thousand years ago and told them to build the canals. The Martians, by the way, didn't crucify him, according to Iros.

**LIGHTING CIRCUITS AND SWITCHES.** By Terrell Croft. 472 pages. Board bound, profusely illustrated with diagrams and photos. McGraw-Hill Book Company, New York.

There is no reason why another book should be written on lighting circuits. This book covers the field from the smallest one-lamp circuit to the method of wiring a theatre for illumination. It covers the field thoroughly. In the preface the author states that the book is designed primarily as a hand book for the practical men. For that purpose it is excellent. But all contractors, designers and engineers would do well to have a copy of this volume on their shelves. There are few problems that may arise in connection with illumination circuits on which something is not included.

The National Electric Code rules and regulations are fully discussed in connection with the various pieces of apparatus, and the best methods of installation are shown. Proper location of leads and the placement of the various subsidiary devices is treated of.

**PLASTICS AND MOULDED ELECTRICAL INSULATION.** By Emile Hemming. Illustrated with drawings and photos. 310 pages, 9¼"x6". Board bound. The Chemical Catalog Co., New York.

The first half of this volume is devoted to one of the oldest arts of the earth—plastics. The study the book makes of plastics is not what might be called exhaustive but it will give a very good general idea of the chemistry employed in making the various cements and refractory substances so much in use today. At times it almost drops to the level of a book of formulas. The amateur will find a great many helpful hints and the value of the book to the professional laboratory man and experimenter is undoubted.

The latter half of the book is given over to the modern art of making electrical insulation. The whole field from the porcelain cleat to bakelite is covered.

**THIRTY YEARS OF PSYCHICAL RESEARCH.** By Charles Richet, Ph.D. Translated from the French by Stanley DeBrath. 6"x8½", 629 pages. Board. The McMillan Co., New York.

The French Doctor of Philosophy under whose name this book is brought out has collected together pretty much all the recent developments in the psychical field. The book doesn't take on so much the form of a history as it attempts to show the development of the alleged phenomena over the stage covered. By staying close to scientific terms and keeping the language and style dry and matter-of-fact the author or the translator one or the other is guilty of making the book lack life.

It mulls along for all the 600 pages without a great deal of organization—stating observations here, fancies and theories there, in such a manner as to leave the reader in the dark most of the time.

It has the advantage, however, of being as close to a true scientific discussion of the matter as has come from the presses in late months.

**LIGHT, COLOR TONES AND NATURE'S FINER FORCES.** By Ernest J. Stevens, M. Sc., Ph.D., 7¾"x5¾". Frontispiece. 268 pages. Published by the author.

This treatise is a semi-religious affair which attempts to disclose the secrets of life through the medium of vibration. It hooks up the shorter vibration of light and color, picks up some copy from the experimenters with ultra-violet and infra-red rays, uses some of the radio wave lengths, then seeks to fill the gap between the radio and the light waves by finding what it calls the life waves.



## King of 'Em All Means Auto Wheel

Here come Bill and his Auto-Wheel Coaster Wagon. They are old friends—Bill and the Auto-Wheel. Bill wouldn't give up his Auto-Wheel unless he was sure that he could get another just like it, for in his choice of coaster wagons, Bill knows that "King of 'Em All" means

## Auto-Wheel Coasters and Auto-Carts

Bill and thousands of others like him are proud to own an Auto-Wheel because it has these fine mechanical features: rubber-tired disc wheels (over-size tires on three largest), or steel-tired disc or wood spoke wheels; mortised joints; self-contained friction-reducing roller bearings; hound brace; hand brake; hub cap and locking pin; and solid maple bolsters.

Write for catalog showing all models of the Auto-Wheel and also all models of the Auto-Cart, the Auto-Wheel's junior companion. If you send the names and addresses of three coaster wagon dealers in your town, telling which ones sell the Auto-Wheel, we will give you FREE a year's subscription to the "Auto-Wheel Spokes-man"—a dandy little magazine for a boy like you.

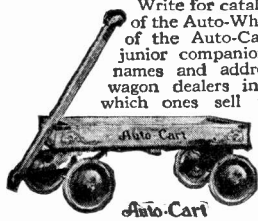

**AUTO WHEEL COASTER CO. Inc.**  
North Tonawanda, N. Y.

## FORDS run 34 Miles

on Gallon of Gasoline  
**Low Gear Seldom Used**  
with Air Friction Carburetor

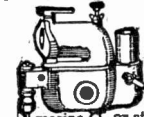

We guarantee all other cars nearly double present mileage, power and flexibility, make hills on high formerly difficult on low. Models for any car, truck, tractor, or stationary engine. Makes old cars better than new. See wonderful mileage guarantees for other cars.

Ford..... 34 ml.	Reo..... 24 ml.	Chevrolet... 32 ml.
Chalmers... 23 ml.	Maxw(25) 30 ml.	
Buick 4... 24 ml.	Olds 6... 23 ml.	Nash 6... 23 ml.
Paige 6... 20 ml.	Lincoln 8... 17 ml.	
Hudson... 25 ml.	Oakland 6... 24 ml.	Std Bk L 16 23 ml.
Dodge... 28 ml.	Over'd 4... 32 ml.	Colo 8... 17 ml.

If your car is not mentioned here send name and model for particulars and our guarantee on it. **AGENTS WANTED SENT ON 30 DAYS FREE TRIAL** You can drive any car in heaviest traffic without shifting gears. Starts off on high in any weather without priming or heating—no jerking or choking. No more foul spark plugs or carbon in cylinders. No leaking of gas into crank case. Try it 30 days on our guarantee of money back if not entirely satisfied. No strings to our guarantee. **YOU ARE THE JUDGE.** Anyone who can handle a wrench can attach it. No boring of new holes or changing of operating mechanism. Write today. **AIR-FRICTION CARBURETOR CO.**  
191 Raymond Bldg. Dayton, Ohio, U. S. A.

## New 1/4 H. P. 110 Volt Guaranteed Motors

Complete with Cord, Plug and Pulley



60 cycle A.C. 1740 speed	\$13.00
60 cycle A.C. 1160 speed	16.50
25 cycle A.C. 1450 speed	16.50
Direct current 1740 speed	17.25
Direct current 1160 speed	19.75

All makes and sizes up to 100 h.p., both new and rebuilt. Motors bought, repaired, exchanged. Let us quote on your needs.

**ONE YEAR GUARANTEE**

Satisfaction guaranteed or money refunded  
Illustrated Catalog of Motors and Supplies FREE

**HYRE ELECTRIC CO.**

631-X So. Dearborn St., Chicago, Ill.

The book is given in the form of lessons. There are fifty of them and each deals with some sort of waves. The author has found several new varieties, it would seem. It is not quite clear what it is all about, but then some things are clear to the obstinate mind that likes to take its religion in the good old-fashioned way.

**THE RIDDLE OF THE RHINE.** By Victor Lefebure. Illustrated, 8 1/4"x5 1/2". 274 pages with introductions by Marshal Foch and Field-Marshal Sir Henry Wilson. E. P. Dutton, New York.

To those of us who had to rely on newspaper accounts alone of the happenings at the front during the war, this little book will be of great interest as to the methods of chemical warfare. The study begins with the developments of gases as combatant elements early in the late Great War and traces the advances made to a place high in importance among the instruments of war. It is surprising how very little has been published on this new method of warfare, a method which promises to vie with the airplane in the next war, if it does not exceed the methods of aerial warfare in importance.

The author goes into the types of gases used and their effect on plants, animals and man. He gives most interesting data on the lethal and other effects, the durability and transportation of the various gases used. Then follows a detailed history of the use of gas in the work of the great opposing generals.

There are two chapters at the end of the book dealing with the problem of gas disarmament. The author's point of view is surprisingly clear of bias and he discusses the subject with intelligence and logic. After finishing these final two chapters, one is left to think that the statesmen who gathered at Washington for the Disarmament Conference should have given more attention to gas and less to battle cruisers. It is one of the best books on the scientific side of the war that has been published, to the mind of the reviewer.

**THE PSYCHIC LIFE OF INSECTS.**

By E. L. Bouvier. Translated by L. O. Howard, M.D., Ph.D. Illustrated, 377 pages, size 5" x 7 1/2". Published by The Century Co., New York City.

This book, which is devoted to the intelligence of insects, is really quite a remarkable treatise. Numerous individual instances of insect intelligence are given with its very definite limitations. Some very interesting examples of hereditary habit are given, and among the authorities cited, it is interesting to find the great Fabre, whose books are charming, but whose biography as written by one of his friends, showing the man's great amiability and his simplicity of life, is still more interesting. The present is a book of rather concentrated information and hardly can be called light reading, but is very well put and comes from a very eminent patriot of Prof. Fabre. A good deal of very interesting material has been written on the subject of insects; and Thoreau's description of the battle of the ants with its allusion to a preceding description of many years before is a sort of classic. Most vivid descriptions of the ants in the tropics have appeared in our periodical literature and a vivid realization is afforded of how terribly dangerous they are.

**HOUDINI'S PAPER MAGIC.** By Houdini.

Fully illustrated, 206 pages, size 5 1/4" by 7 3/4". Published by E. P. Dutton Co., New York City.

This book is a veritable treasure of parlor amusements. We do not mean to say that the celebrated author does not tell tricks worthy of production on the stage, but the book will be found an exhaustive treasure house for the home circle. We were interested in noting a number of chapters on paper folding, and some years ago SCIENCE AND INVENTION published an article with numerous illustrations on the special application of paper folding for the solution of geometrical problems, which is one of the most entertaining applications, but here we have many of the things we used to make out of paper when we were children, and on page 130 we find the famous "Trouble Wit." This is one of the oldest paper folding amusements known. It will be found very incompletely described in old time books on amusements, and it would be interesting really to run it down to earth, as they say, and find out who originated it and where. The writer has prepared the folded paper himself a number of times, and found that it required a considerable amount of care in its preparation, and he has found it advantageous after the folding to dampen it and put under very heavy pressure, as between wood clamps, or between boards in a vise. The paper, too, wants to be of good quality, and above all wants to be large enough. Another old friend we find in the book is the paper rings. The most curious effects are produced by pasting bands of paper into rings and cutting them into two, all sorts of interlacings being producible by simply cutting with the scissors. Besides old friends, we believe that most people will find in this book considerable that is new to them, for so much can be done with paper that it supplies almost an exhaustless field of the lighter type of amusement.

## Price Cut 1/2 On World's Greatest Reference Books

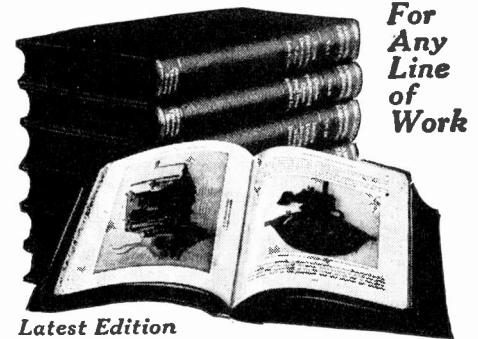

For Any Line of Work

Latest Edition

Let experts work for you—in these books you will find the most remarkable collection of practical job experience and vital knowledge that was ever assembled in book form. More than 200 of the greatest engineers, lawyers, business men, and practical experts—all of them men who have gone through the mill—give you in these books a life-time of valuable inside information on the line of work in which you want to get ahead. Make their knowledge and experience your own. Let them show you all the newest methods—the best ways of doing things. This very minute you may be up against some tough problem—if you had these books you would solve it instantly. Send the coupon for

## A Week's Free Trial

Just fill out the coupon and we will immediately send you any one of these libraries express collect. Read the books over carefully. Test them out thoroughly for seven days. If you do not want them, send them back at our expense. If you decide that they will do for you what they have done for 280,000 other men to whom they brought more money and success, pay \$2.80 within one week and \$3.00 a month thereafter until the special price is paid. This amounts to only 10c a day. Mail the coupon NOW if you want a bigger, better job and bigger pay.

## Free Consulting Membership

A resident staff of from 15 to 20 practical experts is waiting to solve for you any difficulty that you may have.

## Your Choice 75c a Week

- 5 vols. Carpentry and Contracting—was \$37.50 now... 19.80
- 12 vols. American Law and Practice (including free reading course and 250 page book of standard legal forms)—was \$97.50 now... 49.80
- 8 vols. Applied Electricity—was \$60.00 now... 29.80
- 6 vols. Auto Engineering—was \$45.00 now 21.80
- 9 vols. Civil Engineering—was \$67.50 now 34.80
- 8 vols. Business Management—was \$52.50 now 29.80
- 7 vols. Steam Engineering—was \$52.50 now... 24.80
- 4 vols. Sanitation, Heating and Ventilating—was \$30.00 now... 14.80
- 4 vols. Fire Prevention and Insurance—was \$30.00 now... 14.80
- 6 vols. Modern Machine Shop Practice—was \$45.00 now... 21.80
- 4 vols. Telephone and Telegraphy—was \$30.00 now... 14.80
- 4 vols. Drawing—was \$30.00 now... 14.80

A letter or a wire to American Technical Society will bring you an immediate answer and the solution to your problems. This advisory staff of practical men plus your working and reference library will enable you to handle successfully any job in your line. These men know all the latest methods and the newest and best ways of doing things. Let this pay-raising consulting staff be YOUR SILENT PARTNER.

**This free consulting membership offer is good for a limited time only and can be withdrawn without notice.**

## Send No Money

Here is your opportunity if you want to earn more money. Remember we are taking all the chance—you pay nothing until you are thoroughly convinced that these books will help you to greatly increase your pay. Isn't this about the fairest proposition that was ever made you?

## American Technical Society

Dept X-925 Chicago, Ill.

© A.T.S. 1922

## AMERICAN TECHNICAL SOCIETY,

Dept. X-925 Chicago,

Please send me a set of for seven days' FREE EXAMINATION, shipping charges collect. I will examine these books thoroughly, and if satisfied will send \$2.80 within seven days and \$3.00 a month until I have paid the special price of \$... If I decide not to keep the books, I will return them within one week at your expense. It is understood that if I keep the books I am entitled to a FREE Consulting Membership in the American Technical Society.

Name.....

Address.....

Reference (Please fill in all lines, give local merchant, banker, or employer as reference.)

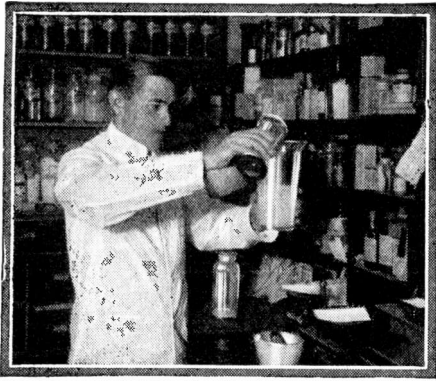

## An Easy Way to Learn PHARMACY AT HOME

Graduate pharmacists are always in demand. The work is interesting and pleasant and salaries are good. Many young men open drug stores of their own and become independent.

There's an easy way to learn pharmacy right in your own home in spare time, without losing a day or a dollar from your present work.

The International Correspondence Schools course in Pharmacy supplies the knowledge which it will be necessary for you to have in order that you may pass your State Board Examination.

Just mark and mail the coupon printed below to the International Correspondence Schools, Box 6213-C, Scranton, Pa., and full particulars about the Pharmacy Course or any other work of your choice will come speeding to you by return mail.

TEAR OUT HERE

INTERNATIONAL CORRESPONDENCE SCHOOLS  
Box 6213-C, Scranton, Penna.

Without cost or obligation on my part, please send me full particulars about the subject before which I have marked an X in the list below:

**TECHNICAL AND INDUSTRIAL COURSES**

- |  |  |
|--|--|
| <input type="checkbox"/> PHARMACY                | <input type="checkbox"/> Civil Engineer                                  |
| <input type="checkbox"/> Chemistry               | <input type="checkbox"/> Surveying and Mapping                           |
| <input type="checkbox"/> Automobile Work         | <input type="checkbox"/> Mine Foreman or Engineer                        |
| <input type="checkbox"/> Agriculture and Poultry | <input type="checkbox"/> Steam Engineering                               |
| <input type="checkbox"/> Mathematics             | <input type="checkbox"/> Gas Engine Operating                            |
| <input type="checkbox"/> Electrical Engineering  | <input type="checkbox"/> Airplane Engines <input type="checkbox"/> Radio |
| <input type="checkbox"/> Electrician             | <input type="checkbox"/> Architect                                       |
| <input type="checkbox"/> Mechanical Engineer     | <input type="checkbox"/> Contractor and Builder                          |
| <input type="checkbox"/> Mechanical Draftsman    | <input type="checkbox"/> Architectural Draftsman                         |
| <input type="checkbox"/> Machine Shop Practice   | <input type="checkbox"/> Concrete Builder                                |
| <input type="checkbox"/> Railroad Positions      | <input type="checkbox"/> Structural Engineer                             |

**BUSINESS TRAINING COURSES**

- |   |   |
|---|---|
| <input type="checkbox"/> Salesmanship           | <input type="checkbox"/> Business Management                              |
| <input type="checkbox"/> Advertising            | <input type="checkbox"/> Industrial Management                            |
| <input type="checkbox"/> Better Letters         | <input type="checkbox"/> Personnel Organization                           |
| <input type="checkbox"/> Foreign Trade          | <input type="checkbox"/> Traffic Management                               |
| <input type="checkbox"/> Stenography and Typing | <input type="checkbox"/> Business Law                                     |
| <input type="checkbox"/> Business English       | <input type="checkbox"/> Banking and Banking Law                          |
| <input type="checkbox"/> Civil Service          | <input type="checkbox"/> Accounting (including C.P.A.)                    |
| <input type="checkbox"/> Railway Mail Clerk     | <input type="checkbox"/> Nicholson Cost Accounting                        |
| <input type="checkbox"/> Common School Subjects | <input type="checkbox"/> Bookkeeping                                      |
| <input type="checkbox"/> High School Subjects   | <input type="checkbox"/> Private Secretary                                |
| <input type="checkbox"/> Illustrating           | <input type="checkbox"/> Business Spanish <input type="checkbox"/> French |

Name.....

Street Address.....

City..... State.....

Occupation.....

Persons residing in Canada should send this coupon to the International Correspondence Schools Canadian, Limited, Montreal, Canada.

### MAKE MONEY AT HOME

**YOU CAN** earn \$1 to \$2 an hour writing show cards at home in your spare time. Quickly and easily learned by our new simple "Instructograph" method. No canvassing or soliciting. We show you how, guarantee you steady work at home, no matter where you live, and pay you cash each week. Full particulars and booklet free. Write to-day.

**AMERICAN SHOW CARD SYSTEM LIMITED**  
Authorized and Fully Paid Capital, One Million Dollars  
110 Adams Bldg. Toronto, Canada.

### 5 Master Keys

Work like magic in emergencies or prove whether your door or padlocks are burglar-proof. Open and test thousands of different locks. Recommended by users in ten different nations. Most wonderful and only keys of their kind. Send \$1 today. Novel key chain FREE with set.

**MASTER KEY CO., 78 West Water St., Milwaukee, Wis.**

## RADIO WRINKLES

EDITED BY  
A. P. PECK,

Associate Member Institute Radio Engrs.

UNDER this heading we are going to publish items of interest to everyone who likes to build radio instruments. In order to continue this department it is necessary for our readers to tell us about their latest experiments. Write us a short description of some time- or money-saving kink you have discovered and send it to us along with a few sketches. Our regular prizes will be paid for this material. Be brief and try to put everything in the drawing. Don't be too elaborate. Address "RADIO WRINKLES" editor, care of Science and Invention.

### CRYSTAL DETECTOR HINTS

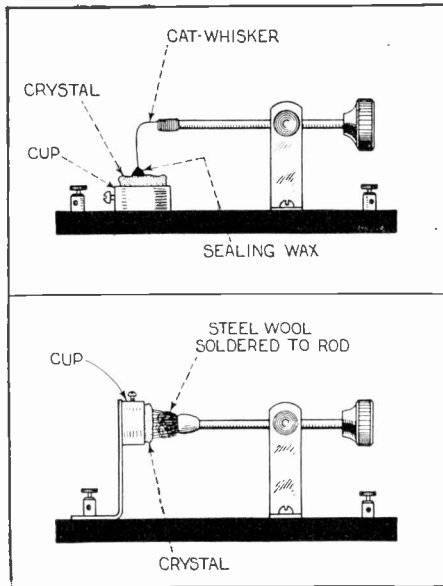

Upper: A drop of wax will hold the cat-whisker on a sensitive spot. Lower: Steel wool makes an excellent substitute for a cat-whisker.

—W. T. Markowski.

### FASTENING ROTOR BALL

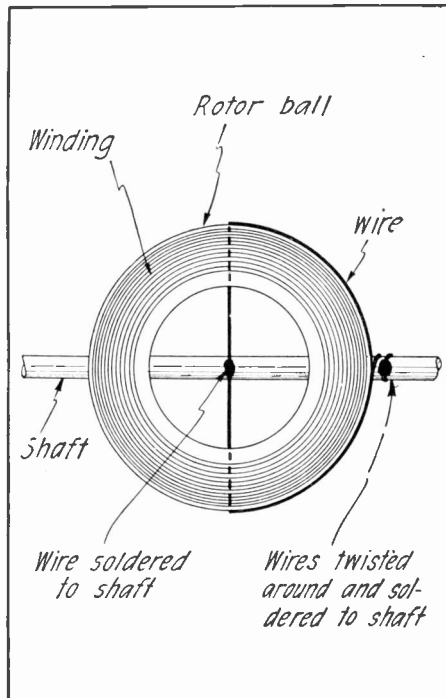

Drill two holes in opposite sides of the rotor ball, as shown. Pass a stiff wire through them around one-half the ball and solder to center and end of shaft. The rotor will be held rigid.

—Fritz Vanderwerth.

## How to Hook - Up A Transmitter Button to Make an Efficient Loud Talker

A Transmitter button with a few dry cells and a telephone receiver will make a remarkably simple and efficient loud talker. A Microphonic amplifier of this type is just the thing for use with a radio set. The weak music and signals may be amplified many times their original value. It is possible to entertain a large audience with a simple radio equipment if a transmitter button is used in the circuit as explained in diagram A.

The cost is extremely low and the results are comparable with those produced by highest grade of expensive loud talkers.

As may be seen in the diagram, two dry cells or a small storage battery are connected in series with the transmitter button and a 4 to 75 ohm telephone receiver. The transmitter button is secured to the diaphragm of the telephone in the radio receiving set. To accomplish this properly, scrape off the enamel (if diaphragm is enameled) on the face of the diaphragm and solder the small hexagon nut supplied with the button to the exact center. Care should be taken that the thin diaphragm is not bent or otherwise

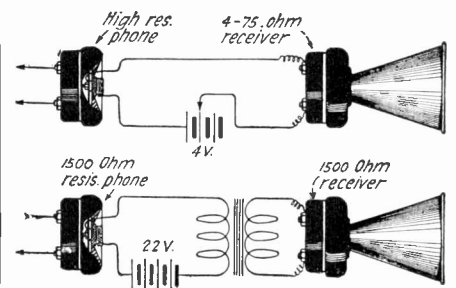

harmed. The transmitter button is then screwed into place. Connections, as shown in the diagram, are made with flexible wire. A horn may be placed over the low resistance receiver if desired. When the radio set is properly tuned and signals are being received, the transmitter button is operated by the vibration of the diaphragm of the receiver. As the receiver diaphragm vibrates, the mica diaphragm on the transmitter button also vibrates. The carbon grains are compressed at varying pressure; the current flowing through the local battery circuit is thus varied and results in an amplification of the sounds in the low resistance telephone loud-talker.

Diagram B, which includes a step-up transformer, is to be used with loud talking receivers of high resistance. The primary of the transformers should have a resistance of about 75 ohms. An ordinary telephone induction coil will serve as the transformer in this circuit.

You can get the above-described transmitter button FREE in subscribing to "Practical Electrics Magazine" at \$2.00 per year (12 months). Send your subscriptions today.

Make all remittances payable to Practical Electrics Co., 53 Park Place, New York City.

—Adv.



Science and Invention for December, 1923

**SEND NO MONEY**

**THE WILD CAT**

Regular Swing-Out, Hand-ejecting, Left-Hand Wheeler Revolver

32.20 or 38 Cal. 6 Shot

**\$13.50**



A powerful six shot gun, made specially for Rangers, mountaineers and men working in unprotected places, requiring a safe and efficient weapon. Quick as a flash, with great penetrating power and true marksmanship. Carry this gun with you, and you will feel fully protected. Made of best blue steel, rifled barrel. Hammer with safety. Fires regular, short and long 32.20 or 38 caliber ammunition \$13.50.

**20 Shot Automatic Pistol**



**\$8.50**

20 Shot—32 Cal.

The biggest bargain ever offered. Built of best fine steel, checkered grip, safety. Every one brand new and inspected. Shoot all standard 32 cal. cartridges. 10 shot, with extra magazine, making 20 quick, hard and straight shots. Buy several while they last, at our unheard of price, \$8.50 (regular \$35). Pocket size, .25 cal. 7 shot, \$7.80. 32 cal. short, \$8.50.

Send No Money Pay on arrival, our bargain price, plus few cents postage. Satisfaction guaranteed or money back. Order today. NOW.

THE PRICE CUTTING CO., Dept. 726, 55 B'way, N.Y.

**For Pleasure or Profit**

Every man has a hobby from which he derives either pleasure or profit—or both. Through a better job, more quickly, more easily done, the man whose hobby is working in wood or soft metals can get more pleasure and more profit from work done on a

**Boice-Built Bench Machine**

The Pony Bench Machine shown here combines six machines in one: saw, sander, drill, grinder, polisher and buffer. It saws 1 1/2" stock with ease, and does mitering, dadiing, tenoning, etc. Easily driven by 1/4 hp. or 1-3 hp. motor. Boice-Built machines are in use in thousands of shops, both industrial and private.

**An Excellent Gift for Man or Boy**

As a gift nothing could be more appreciated by the man or boy who likes to work with wood and soft metals. It will bring years of pleasure and profit to the recipient.

**Sold on a Positive Guarantee**

Every Boice-Built Machine is sold with a ten-day trial money back guarantee.

The complete line of Boice-Built Bench Machines includes larger Bench Saws, Bench Band Saws, Bench Lathes, Bench Drills, Bench Jointers, and Motors. Write today for completely descriptive circular on any of these machines.

W. B. & J. E. BOICE, Toledo, Ohio. Dept. S. I.-12.

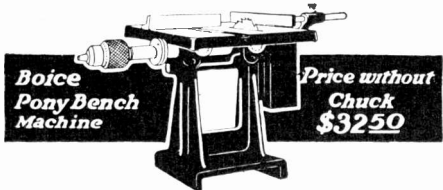

Boice Pony Bench Machine

Price without Chuck \$3250

**13 WEEKS FOR 15 CENTS**

*The Pathfinder*

You've heard your neighbor praise the Pathfinder, the wonderful weekly news and story magazine with over half a million subscribers. Unbiased digest of national and world affairs. Check full of just the kind of reading you want. Fun, fashions, question box, books, health-entertainment and instruction for all. Exciting serial and short stories. Send 15c (coin or stamps) today for this big \$1 paper 13 weeks. Money back if not satisfied. \* Sample copies free. **PATHFINDER, 555 Langdon Sta., Washington, D. C.**

**Electrical Engineering** men with training are in demand. For more than a quarter of a century this school has been training men of ambition and limited time for the electrical industries. Condensed course in Electrical Engineering enables graduates to secure good positions and promotions. Theoretical and Practical Electricity. Mathematics, Steam and Gas Engines and Mechanical Drawing. Students construct dynamos, install wiring and test electrical machinery. Course with diploma complete

**In One Year**

Over 3000 men trained. Thoroughly equipped fireproof dormitories, dining hall, laboratories, shops. Free catalog. First year begins Sept. 28, 1923. **ELISS ELECTRICAL SCHOOL, 108 TAKOMA AVE., WASHINGTON, D. C.**



**POSITIVE CONTACT POINTS**

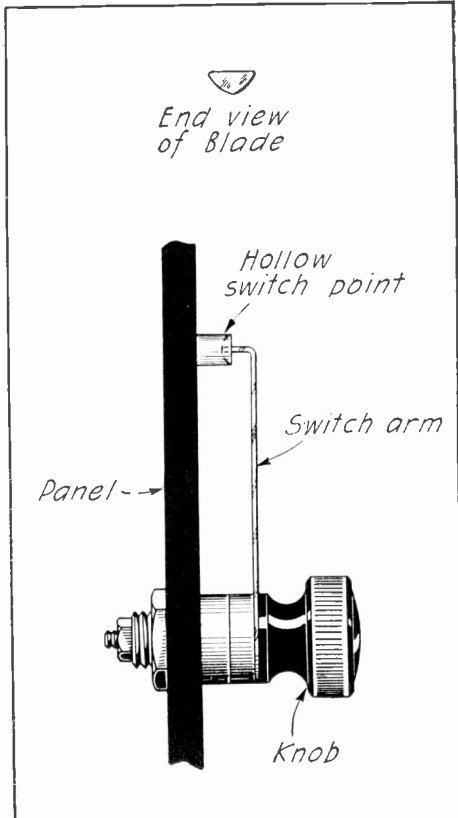

By setting up switch points in a vise, and countersinking slightly with a drill about the same diameter as the switch point, an excellent contact surface will be formed. The end of the switch arm should be curved as illustrated, so as to fit into the end of the contact point.

—Lloyd Jacquet.

**MICROMETER COIL SET**

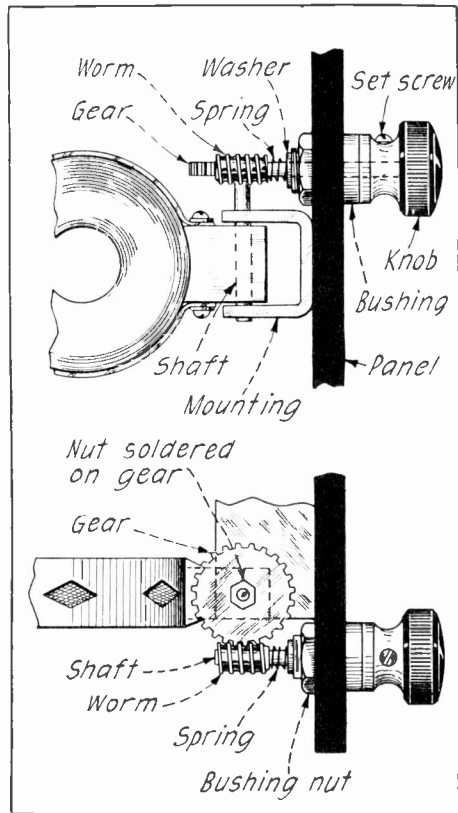

One of the greatest bugbears attending the use of honeycomb coils is satisfactory adjustment. This can be overcome by mounting a gear wheel such as found in toy engineering sets on a shaft running through the mounting, and turning it with a worm gear. The lay-out of such an arrangement is shown above. The spring holds the worm in position and prevents loosening of the shaft. The primary and tickler coils may be mounted in this way, with the secondary stationary between them. The entire mounting may be placed behind the panel.

—John Skerbits.



Any boy can learn to play a Saxophone. 3 first lessons sent FREE

**"SOME PRESENT" FROM "DAD"**

What a wonderful thing it will be for any boy whose Dad makes it possible for him to take his first lesson on Christmas Day on his very own

**BUESCHER**

**True-Tone Saxophone**

Every boy should play some musical instrument. Of all musical instruments, the Saxophone is the easiest to master. It is a boy's ideal instrument, one to which he takes naturally, for it fully satisfies that craving every boy has to personally produce music. It fascinates him, it tempts his ambition and brings out and develops his latent musical talent.

With the aid of the first three lessons, which are sent free (upon request) with each new Saxophone, it is possible for your boy to learn to play the scale in an hour and in a few weeks be playing popular airs. If he wishes, he may join a band or orchestra in 90 days, or get up a neighborhood orchestra and have a lot of wholesome fun, besides earning some extra money from engagements.

Nothing can take the place of the Saxophone for home entertainment, church, lodge or school. Saxophone players are always in demand for dance or band work.

\$100 to \$250 weekly is not uncommon for musicians of ability to earn. Buescher True-Tone Instruments have helped to make famous Paul Whiteman, Tom Brown, Jascha Gurewicz and many others. Your boy might develop equal ability.

**Free Trial--Easy Payments**

You may order any Buescher Saxophone, Cornet, Trumpet, Trombone or other Band or Orchestra Instrument and try it six days in your own home. Easy terms of payment may be arranged if preferred. Mention the instrument interested in and a complete catalog will be mailed free.

**Free Saxophone Book**

It tells which saxophone takes violin, cello and bass parts, and many other things you would like to know. Also illustrates first lesson. Send coupon for your free copy.

**Buescher Band Instrument Co.**

Everything in Band and Orchestra Instruments

6044 Buescher Block, Elkhart, Ind.

**BUESCHER BAND INSTRUMENT CO.,**  
6044 Buescher Block, Elkhart, Ind.

Gentlemen:

I am interested in the instrument checked below:  
Saxophone... Cornet... Trombone... Trumpet...  
(Mention any other instrument interested in)

Name .....

Street Address .....

Town ..... State.....



# \$10,000 or Death!

Millionaire Blair had laughed at the first threat of the blackmailer. The next night his lumber yard burned to the ground. A \$5,000 reward brought a score of detectives, but not a clue. Then came Wilson, the Finger Print Expert. He examined the death letter. A few minutes in his laboratory—a few more at his files.

"Pick up Markaroff," he said to the chief, "and send the reward to my office." How did he do it? Easy enough for the Finger Print Expert. He is the leader, the cream of detectives. Almost daily the newspapers tell of his marvelous exploits.

## More Trained Men Needed

The demand for trained men is becoming greater every day. Here is a real opportunity for YOU. Can you imagine a more fascinating line of work than this? Often life and death depend on finger print evidence—and big rewards go to the expert. Many experts earn regularly from \$3,000 to \$10,000 per year.

Learn the secrets of this science at home in your spare time. Any man with common school education and average ability can become a Finger Print Detective in surprisingly short time.

## FREE Course in Secret Service

For a limited time we are making a special offer of a Professional Finger Print Outfit, absolutely free and Free Course in Secret Service Intelligence. Mastery of these two kindred professions will open a brilliant career to you.

Write quickly for fully illustrated free book on Finger Prints which explains this wonderful training in detail. You assume no obligation. Mail the coupon now.

University of Applied Science  
Dept. 53-39 1920 Sunnyside Ave., Chicago, Ill.

University of Applied Science  
Dept. 53-39 1920 Sunnyside Ave., Chicago, Ill.

Gentlemen:—Without any obligation whatever, send me your new, fully illustrated, FREE book on Finger Prints and your offer of a FREE course in Secret Service Intelligence and the Free Professional Finger Print Outfit.

Name .....

Address .....

Age .....



**FREE** Fine Tone Musical Instruments  
\$20  
We have a wonderful new copyrighted system of teaching note music by mail. To first pupils in each locality we will give free a \$20 superb Violin, Tenor Banjo, Ukulele, Hawaiian-Guitar, Banjo, Mandolin, Banjo-Ukulele, Banjo-Mandolin, Cornet or Banjo-Guitar absolutely free. Also teach Piano and Organ. Very small charge for lessons only. Four lessons will teach you several pieces. Over 100,000 successful players. We guarantee success or no charge. Complete outfit free. Write today, Dept. 149. No obligation. Slingerland School of Music, 1815 Orchard St., Chicago, Ill.

## STUDY AT HOME

Directed by  
**The University of Chicago**

Courses in English, History, Chemistry, Business, Mathematics, Education, Psychology, and 35 other subjects command credit toward a Bachelor degree. Begin any time. Address 27 Ellis Hall, University of Chicago, Chicago, Ill.

### THE SIMPLEST VERNIER

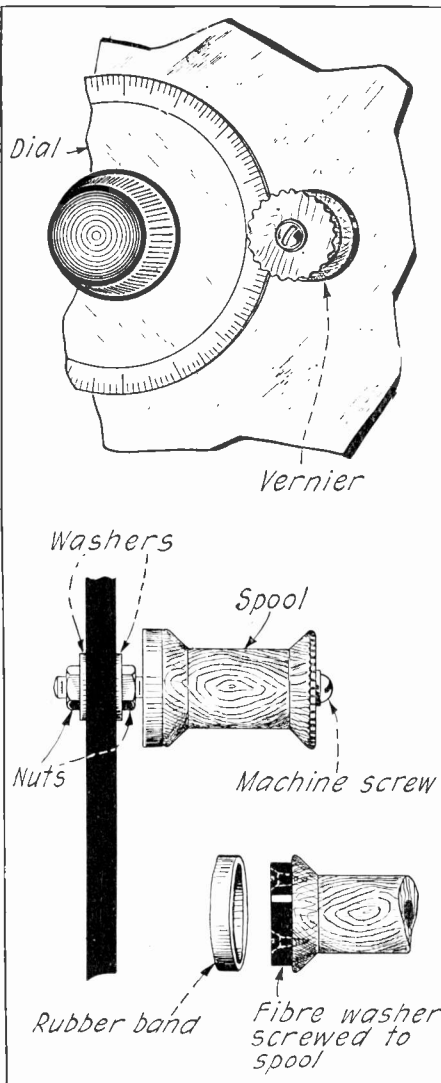

An exceedingly simple yet efficient vernier for use on any instrument may be made as illustrated above. A fibre washer is attached to an ordinary spool and a rubber band slipped over the edge of the washer. A machine screw supplies the mounting. The vernier should not be drawn up so tight that the edge of the spool cannot be slipped away from the edge of the dial when coarse tuning is desired. —L. B. Robbins.

### CHEAP INSULATORS

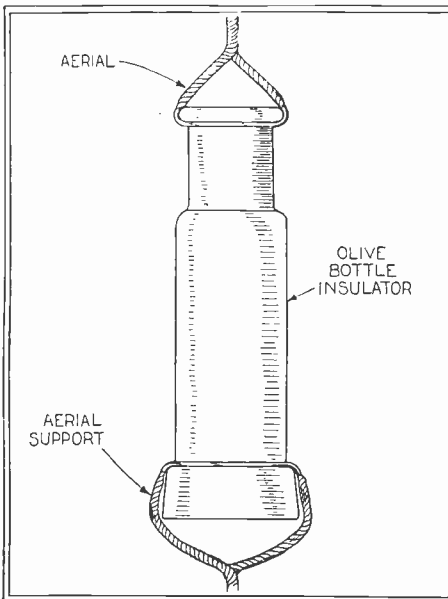

Olive or pickle bottle with a flange at each end make cheap and efficient antenna insulators. Bridles are fastened to each end as illustrated above. These insulators will stand quite a strain and at the same time furnish adequate insulation.

—Willard R. Balbou.

## YOU CAN BE A \$5000 AUTO EXPERT

Learn At Home

### THE C. A. I. "JOB-WAY"

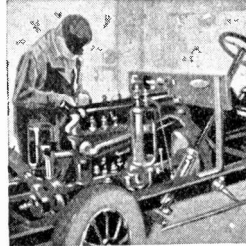

Get into the world's greatest industry. Get into it right. Earn big money. Trained men are in demand. You can pick your own job at practically your own price. Field is unlimited and growing every day.

The C. A. I. Job-Way system of training will make you an expert in a few short months.

### There Is Big Money for You in This Great Field

Know Automotive Work and your fortune is made. The C. A. I. course covers every phase of this industry. Easy to master. Our students are enthusiastic. Money back after you finish course if you want it. Write today for our big, illustrated Free Book.

### FREE KIT OF TOOLS

You get a set of fine tools free. We show you how to make quick money with them. Tools worth \$15 or more. Surely you want them.

CHICAGO AUTOMOTIVE INSTITUTE  
J. R. Bayston, M. S. A. E., Pres.  
Dept. 108, 536 S. Clark St. Chicago, Ill.

## LEARN AT HOME THE C.A.I. JOB-WAY

### Play TENOR BANJO Same Day You Get It!

I have taught thousands to play in 21 years as head of Music department at New York University, and now I have worked out a way so simple that you can play this Tenor Banjo the same day you get it, and afterwards learn all the popular songs quickly and easily.

#### You Don't Have to Know Music

All you need to learn is three easy motions, of which I show you pictures. You can't go wrong. Easiest, quickest way there is.

#### Free Phonograph Records

So you can see you are playing correctly I send you Free Phonograph Records of myself playing the songs you are learning. This is the only course giving these records. It makes all the difference in the world.

#### BE POPULAR

Very soon you will be playing Lee's Knees, Crying for You, You've Got to See Mama Every Night, and all the popular airs. Great demand for people who can play Tenor Banjo. They're always the center of every gathering. Others have learned easily—why not you?

For a limited time only to students who enroll in our conservatory we will give absolutely free this \$18.00 full size professional tenor banjo.

Send us your name and address on a postcard for circular giving full particulars on just how Professor Six has been able to teach thousands to play—and how he can teach you so you will play from the first lesson on. Send the postcard today, as Professor Six can give his personal attention to a limited number only, and you want him.

NEW YORK CONSERVATORY OF MUSIC  
Desk D4, 212 5th Ave., New York

## YOU TOO CAN PLAY THE HAWAIIAN GUITAR JUST AS THE HAWAIIANS DO! PLAY ALL THE LATEST HITS

After Your FIRST LESSON You Will Play a Complete Selection. We Guarantee That—

Our method is so simple, interesting and appealing that you begin in your first lesson to learn the famous Hawaiian Folk Song "ALOHA". Think how happy you will be when you surprise your friends by playing the fascinating Hawaiian Guitar.

#### Only Four Motions-- and You Master Them Quickly!

In a few minutes you acquire the four motions necessary to play any piece—after that short period of practice and you will have mastered this weirdly sweet music. Complete course of 52 lessons includes music Beautiful Hawaiian Guitar, necessary picks, steel bar, etc. No extra.

No Previous Musical Knowledge Necessary  
If you never read a musical note in your life—if you haven't even the slightest knowledge of music, we can quickly and positively teach you "step by step" when you can easily be the center of interest among your friends. Over 40,000 successful students.

Just Mail a Post Card for Details of our remarkable FREE Hawaiian Guitar Offer—simply write: "I am interested"—but do it today.

First Hawaiian Conservatory of Music, Inc.  
Desk 49, -2337 (4way)  
(Woolworth Bldg.)  
New York City

## FREE A Beautiful Hawaiian Guitar



\$18.00 Tenor Banjo FREE

IMPROVED CAT WHISKER

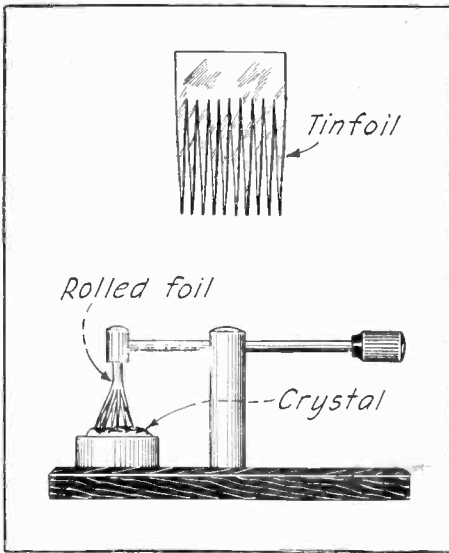

A strip of tin-foil cut as shown and rolled into a cylinder at the top makes an excellent cat whisker. —A. W.

ANTI-VIBRATION SOCKET

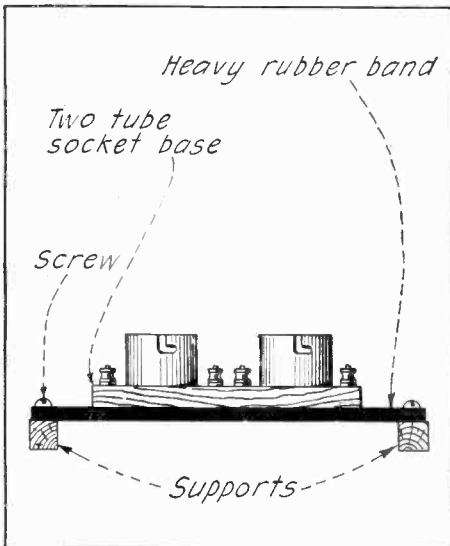

Two or three heavy rubber bands stretched between two wooden supports and fastened with clamps or screws make an excellent base for mounting tube sockets. —L. J.

ANTI-BODY CAPACITY

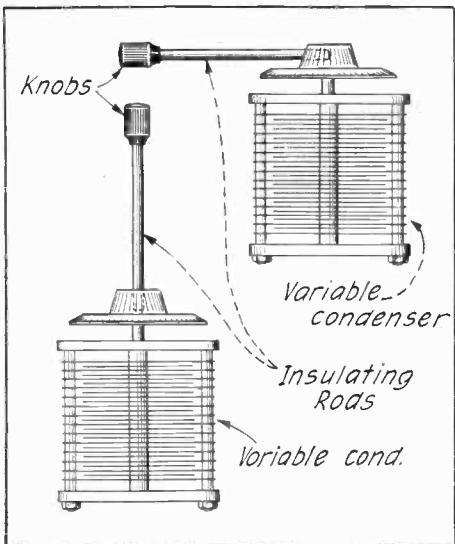

It is often desirable to tune condensers from a distance so the capacity of the body will not affect them. This may be done by drilling and tapping holes in the knobs of the condensers and attaching threaded rods as illustrated above. The condenser can then be tuned by means of the small knob. —L. J.

# Smashing Reduction!

**BOXING,  
Jiu-Jitsu,  
Wrestling**

**Now  
\$1.97**

"Had I studied this course before I took up boxing would have saved myself a few hard knocks. I have knocked out two local boys—best scrappers in town. Charles P. Ball, Potlatch, Idaho"

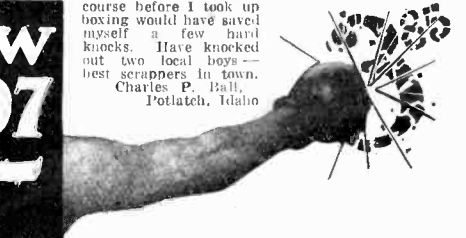

Down goes price again. Now you can get the complete Marshall-Stillman Course for \$1.97. It teaches you how to feint, duck, block and hit like a professional. It contains all the secrets of the ring.

A pugilist says: "Your course is a most valuable assistant to any one who wishes to become either a real prize fighter or an amateur boxer."

All that is needed to master the Marshall Stillman Course is persistence. Every movement is described so clearly you have no difficulty in understanding it. You are taught expert blows such as Corbett's Left Hook; Fitzsimmon's Shift; the McCoy Corkscrew; the Dempsey Triple.

Jiu Jitsu and Wrestling are also included. You are taught bone-breaking holds, how to take a gun, club or dagger from a ruffian and break his arm, how to render an opponent help-

less, break a grip on your throat, or baffle a man who tries to kick you.

A 96-page book containing the lives of famous pugilists with many little known stories is included FREE.

**SEND NO MONEY**

Fill out coupon and we will send you course. Hand the postman a temporary deposit of \$.97 and send us the remaining \$1.00 in 10 days if satisfied. Otherwise return the course and we will return your deposit.

**COUPON**  
MARSHALL STILLMAN ASSOCIATION  
Dept. 1423-M, 42nd St., and Madison Ave., New York

You may send me on approval the Marshall Stillman Course. I will deposit 97 cents (plus actual postage) with the postman with the understanding that if, after 10 days, I wish to return the course I may do so and my money will be instantly refunded. If I keep the course I am simply to send you \$1 in final payment.

Name .....

Address .....

Canadian and foreign orders must be accompanied by cash (\$1.97 U. S. funds) subject to money back guarantee if not entirely satisfactory.

## SAVE YOUR BODY

Conserve Your Health and Efficiency First

"I Would Not Part With It for \$10,000"

So writes an enthusiastic, grateful customer. "Worth more than a farm," says another. In like manner testify over 100,000 people who have worn it.

### THE NATURAL BODY BRACE

Overcomes WEAKNESS and ORGANIC AILMENTS of WOMEN and MEN. Develops erect, graceful figure. Brings restful relief, comfort, ability to do things, health and strength.

**Wear It 30 Days Free At Our Expense**

Does away with the strain and pain of standing and walking; replaces and supports misplaced internal organs; reduces enlarged abdomen; straightens and strengthens the back; corrects stooping shoulders; develops lungs, chest and bust; relieves backache, curvatures, nervousness, ruptures, constipation, after effects of Flu. Comfortable and easy to wear.

**Keep Yourself Fit**

Write today for illustrated booklet, measurement blank, etc., and read our very liberal proposition.

**Howard C. Rash**

Pres. Natural Body Brace Co.  
286 Rash Bldg., Salina, Kansas

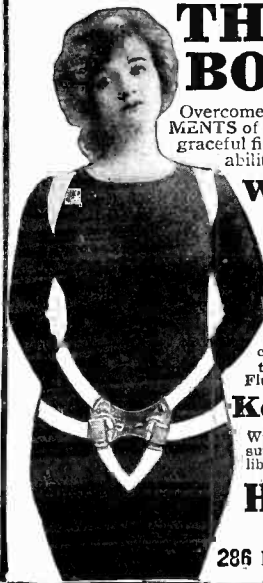

**For Boys and Girls Also**



### GERMAN MAUSER

Reg. price \$25.00

**\$11.50**

32 cal. \$12.50  
WITH PERFECT SAFETY DEVICE

Guaranteed Genuine Latest model 9 shot automatic. 8 shoots standard cartridges—lies flat in the pocket—World's famous Luger. 30 Cal. \$15.50. Hand Ejector Revolver, swing out cylinder 32 cal. \$15.50, 38 cal. \$16.50. All brand new latest models—guaranteed genuine imported. Pay postman on delivery plus postage. Satisfaction guaranteed or money promptly refunded.

**SEND NO MONEY**  
**\$6.00** 25 Cal. Vest Pocket Automatic—25 cal. Blue Steel Army Automatic \$7.85. 32 Cal. \$10.25. Military Trench Automatic—32 cal. 20 shot, extra magazine FREE. \$9.50. Imported Top Break Revolver, 32 Cal. \$8.25, 38 Cal. \$8.25.  
UNITED SALES CO., 12 East 22nd St., Dept. 267 New York

### Pants Always Pressed

**STAYPREST TROUSER PRESSER** puts a real master-tailor crease in pants. Takes the bag out of knees and removes wrinkles. Easy to use—takes only a few seconds. Always a like-new press without delay or trouble. A real convenience. Saves many dollars in pressing bills, and trousers always look like just from the tailor. Makes them last longer. Saves nap of cloth which ironing ruins. Every man should have at least one or two.

← **Stay Prest**

Made of selected hardwood, fabric covered, canvas lined. All metal parts heavily nickel plated. Fits any size trousers. Folds into small pack to fit handbag. Strong, but light. Easy collapsible coat hanger. Lasts a lifetime. Thousands in use. Well dressed men have several to keep all trousers well pressed. Sold through dealers, agents or direct by mail. Mailed postpaid on receipt of \$2.50. C.O.D. if desired. Attractive, Useful Gift. Xmas Package If Desired. Satisfaction or money back. Order today. Book free.

**The Getgey-Jung Company**  
2012 G. & J. Bldg. Cincinnati, Ohio



**\$3 brings genuine UNDERWOOD**

Yes, only \$3 down puts this genuine standard Shipman-Ward Rebuilt Underwood in your home. Then—small monthly payments, or if convenient, pay cash. Either way you get the world's standard typewriter at a big cash saving.

**WHY PAY RENTAL?**

Think of it! You pay little more than rental, and the machine is yours! We offer the same three models of the Underwood Typewriter which are being made and sold by the Underwood Company today. The only difference is that Shipman-Ward machines are priced lower and are rebuilt like new by experts. You can't tell them from brand new machines. Visible writing—the FULL LINE of typewriting is visible at all times. STANDARD 4-ROW SINGLE SHIFT KEYBOARD. Two color ribbon, back spacer, stencil device, automatic ribbon reverse, tabulator, etc.

**TEN DAYS' FREE TRIAL**

See for yourself! Try the typewriter ten days. You must be satisfied or the entire transaction won't cost you a penny. Act today. Get our big illustrated catalog and full particulars. Write NOW.

**FREE TRIAL COUPON**

**Typewriter Emporium SHIPMAN-WARD MFG. CO.**  
2169 Shipman Bldg., CHICAGO

Send by return mail Bargain Offer No. 2169 of a Standard Visible Writing Underwood. This is not an order and does not obligate me to buy.

Name.....  
Street or R. F. D. No.....  
Postoffice..... State.....

**NEW-TREAD TIRES AT 40¢ ON THE DOLLAR**



**Send No Money!**

Here is a real opportunity to cut your season's tire bill notwithstanding advances in prices. For a limited period only we offer our famous New-Tread Tires—as illustrated—at less than 1/2. Made of NEW LIVE RUBBER and built on the best carcasses money can buy.

**Special Sale Prices**

Size	Tire	Tube	Size	Tire	Tube
28x3	\$4.95	\$1.25	36x4	\$8.65	\$2.35
30x3	4.95	1.35	32x4 1/2	8.85	2.40
30x3 1/2	5.85	1.40	33x4 1/2	9.00	2.45
32x3 1/2	6.50	1.50	34x4 1/2	9.15	2.50
31x4	7.00	1.60	35x4 1/2	9.25	2.60
32x4	7.50	1.85	36x4 1/2	9.45	2.70
33x4	7.85	2.15	35x5	9.75	2.80
34x4	8.10	2.25	37x5	9.85	2.90

ALL OUR TUBES ARE NEW FRESH STOCK and Guaranteed for One Year. Shipment made same day order is received. Pay on arrival and if not satisfied, return AT OUR EXPENSE. Specify whether straight side or clincher wanted. FIVE PER CENT DISCOUNT when cash accompanies order. DEALER AGENTS WANTED IN EVERY LOCALITY.

STANDARD TIRE & RUBBER CO.  
3280 S. Morgan St., Chicago, Illinois

**LOOK 50¢ LOOK**



Wonderful instrument. Greatest thing yet. Nine separate articles in one. Everybody delighted with it. Odd, curious and interesting. Lots of pleasure as well as very useful. It is a double Microscope for examining the wonders of nature, a Reading Glass, a Telescope, a Compass, a Pocket Mirror, and a Laryngoscope—for examining eye, ear, nose and throat. It is worth all the cost to locate even one painful cinder in the eye. Folds flat and fits the pocket. Something great—you need one. Don't miss it. Sent by mail, with 300 page Novelties Catalog, ONLY 50c or 3 for \$1.25

JOHNSON SMITH & CO., Dept. 34, Racine, Wis.

**SERIES-PARALLEL JACK**

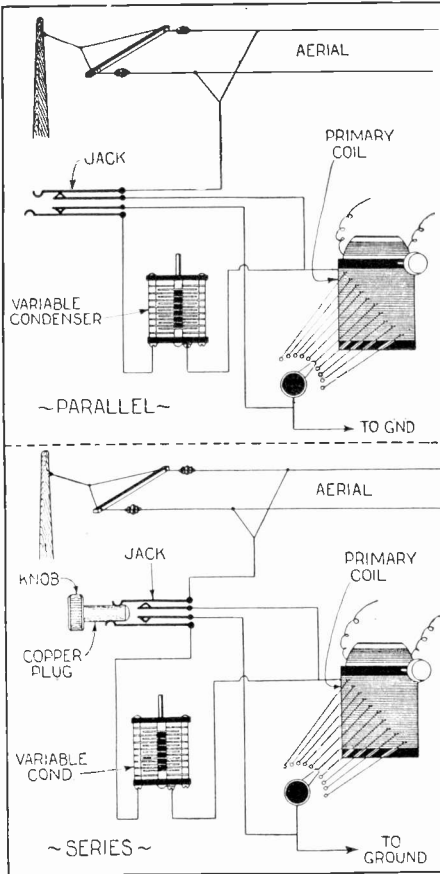

A very handy arrangement to be used in place of a series-parallel switch consists of an ordinary two-circuit jack and a piece of copper rod with a knob. The rod should be the same diameter as the telephone plug and the connections are made as shown. The insertion of the plug will connect the condenser in series with the inductance and withdrawing the plug places the condenser in parallel.

**A TIN CAN VARIABLE**

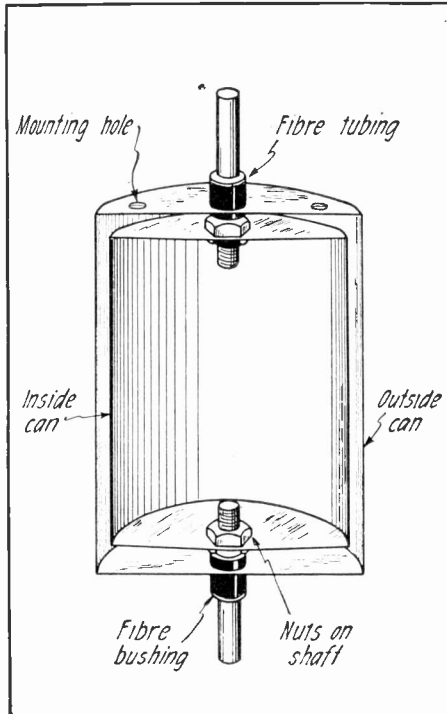

To make this very simple variable condenser, obtain two circular tin cans, one slightly shorter and smaller in diameter than the other. Cut each one in half, longitudinally, as shown. Drill two holes in the smaller one for clamping the shaft and insert sections of shaft, threaded on one end as illustrated. By clamping the shafts to the inner can with two nuts, a very serviceable variable condenser capable of being mounted on a panel will be obtained.

—Edgar Smothers.

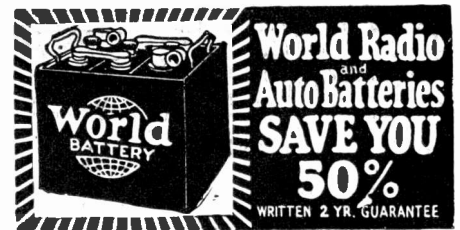

World prices are possible because it costs the World Battery Company only one-half as much to sell World batteries. That is the reason we can spend just as much to build our batteries as any other big company. That is the reason we can stand behind every battery we put out with a written 2-year guarantee. You take no risk when you buy a World battery—service is certain.

**COMPARE THESE PRICES**

Auto Prices	Radio Prices
6 Volt, 11 plate ... \$12.25	Special 2-volt Storage Battery ..... \$5.00
Ford, Chev., Mitchell, Hud., Grant, Elgin, Velie, Saxon.	For WD11 and WD12 tubes. Will run 200 hours on one charge. Rechargeable.
6 Volt, 13 plate....\$14.00	Special 4 volt Storage Battery ..... \$8.00
Overland, Bulck, Reo, Paige, Hudson, Nash, Stude., Dorr.	For UV199 tubes. Same features as 2 volt.
12 Volt, 7 plate ... \$17.00	6 volt, 60 amp. .... \$8.50
Maxwell, Dodge, Regal, Franklin, Briscoe and Crow-Elkhart. Give year and model of car.	6 volt, 80 amp. .... 10.00
	6 volt, 100 amp. .... 12.50
	6 volt, 120 amp. .... 14.50
	6 volt, 140 amp. .... 16.00

**SEND NO MONEY!**

We ship C.O.D. subject to inspection, or will allow 5 percent discount for cash with order. Shipment made same day order is received. Save 50 percent on your next battery and get better service and longer life. Written 2-year guarantee is your proof of satisfaction. Order NOW!

WORLD BATTERY CO.,

Dept. 19, 1219 S. Wabash Ave., Chicago, Ill.

**FREE RADIO CATALOG**

CONTAINING

**LATEST HOOK-UPS**

14 UP-TO-DATE HOOK-UPS AND LIST OF STANDARD QUALITY PARTS AT REDUCED PRICES

Service and Quality Goods Built This House

**GREAT LAKES RADIO CO.**

136 W. LAKE ST., Dept. S, CHICAGO, ILL.

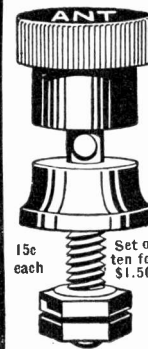

**"Read'em" Binding Posts**

Simplify Complicated Hook-ups. Tell at a glance whether it is Antenna, Ground, Fones, A or B battery, etc. Name neatly engraved for keeps on top of each post. (See illustration.)

Knobs Can't Come Off. The irremovable knobs save time, trouble and petty annoyances. "Read'em's" add to the appearance of any set. Don't be without them. Price 15c each. Set of ten \$1.50. If your dealer can't supply you with "Read'em's" order direct.

Look for the name "Read'em." The Marshall-Gerken Co., Dept. G, 27 N. Ontario St., Toledo, Ohio.

**IMPROVED GROUND CLAMP**

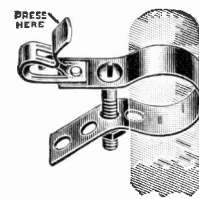

Equipped with Fahnstock Patent Wire Connectors Easily Attached

No Soldering—For Radio Use Only

AT YOUR DEALERS.

**FAHNESTOCK ELEC. CO.**

Long Island City, N. Y.

**ARE YOU SELF-CONSCIOUS?**

Embarrassed in company, lacking in self-control? Let me tell you how you can overcome these troubles. VERITAS, Desk 15, 1400 Broadway, New York City



**The Improved MIRACO GETS 'EM FROM COASTS TO COASTS**

Clearly and distinctly, too! For our users tell us that Cincinnati hears Frisco, Denver hears Schenectady, New York hears Havana! Scores of long distance records were made on these instruments last year so with the many new refinements incorporated the result obtained now will be far better than ever.

**HIGHEST QUALITY AT LOWEST PRICE**

This has always been the MIRACO key-note and the thousands of sets now in use are a fitting tribute to MIRACO'S excellent performance. Many new improvements, such as new sockets resting on shock-absorbing pads—a refinement found only in the most expensive sets—rheostats with multiple resistance windings, making it possible to use either dry cell or storage battery tubes, and a new aluminum shield that prevents annoying body capacity effects, are embodied.

Cabinet is of solid mahogany—workmanship the finest—operation extremely simple yet always dependable.  
 2 tube outfit shown above ..... \$29.50  
 1 tube outfit ..... 18.50  
 4 tube outfit shown below ..... 54.50  
 Write for our new bulletin today.

**DEALERS—JOBBER**  
 Write for our proposition quickly.  
**AGENTS!**

There's still some territory open—write or wire.

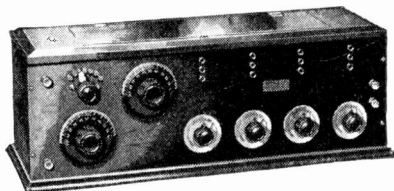

THE MIDWEST RADIO COMPANY,  
 809 Main Street, Cincinnati, Ohio.

**NEON SIMPLEX RECEPTOR**

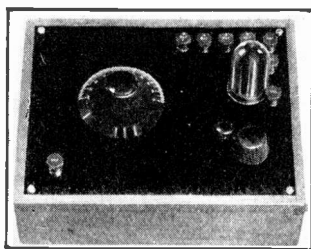

**\$9<sup>75</sup>**  
 WITHOUT TUBE  
 Value \$20

**Vacuum Tube Receiver for Price of Crystal Set**  
**NEW INVENTION REVOLUTIONIZES RADIO**

Range 1800 Miles. Can be used with a Loud Speaker, in connection with our 2 step amplifier. This set after a rigid test by the New York Tribune Institute was given the Certificate of Approval. One dial controls everything. Uses an ordinary dry cell battery. So simple can be worked by a child. Start receiving 10 minutes after arrival.

Neon set for....\$9.75 Book of instructions  
 Neon Phones...\$5.00 with each set.  
 Tube .....\$5.75 Satisfaction guaranteed

**SPECIAL OFFER** Send \$17.75 and we will send you complete outfit, including phones and tube.  
 We Carry Complete Line of Standard Radio Parts.  
 Catalogue on Request.

ROYAL MFG. CO., Dept. 24 World Bldg., New York

**The Newest Simore Tool**  
**"Lightning-Change"**



**\$225**  
 Prepaid

Combination KNIFE and screwdriver—a keen steel knife blade and two screwdriver blades in the handle. Blades are selected and produced by gravity action; the knife blade can never turn or fold and injure you. Change blades in two seconds.

This combination KNIFE and screwdriver will be sent you post prepaid for only \$2.25, money order or check. The only tool of its kind, ideal for work with radio sets, bicycles, motorcycles, guns, and for household work.

Dealers are invited to write for proposition on this and other Simore tools.

The SIMON & SKIDMORE MFG. CO.  
 Dept. 912, Santa Ana, California

**PHONE CONNECTION**

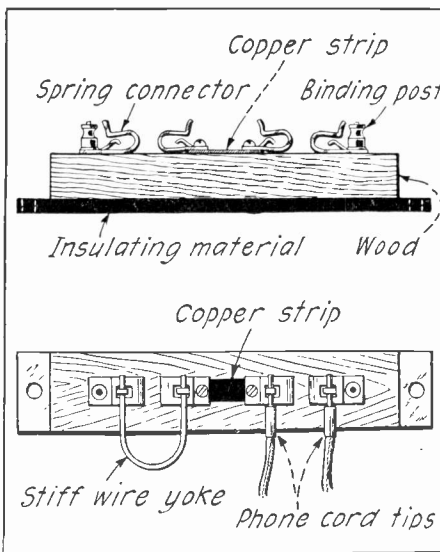

A strip of wood, a strip of insulating material and several spring binding posts with miscellaneous screws and bits of copper, make an excellent yet inexpensive connection block for connecting various pairs of phones in series. The stiff wire yoke is to short-circuit adjacent clips when phone tips are not used. Such a block may be extended as much as necessary. —L. B. R.

**BACK-MOUNTING SWITCH**

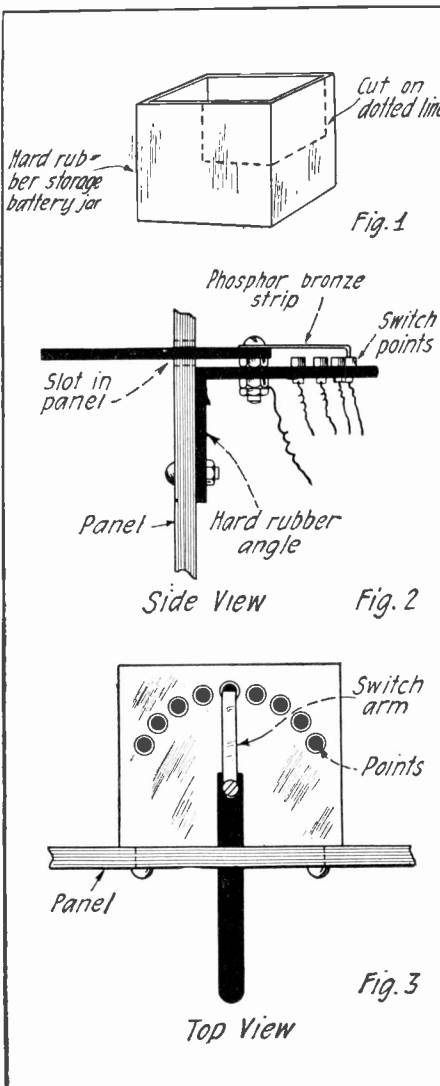

By sawing out a section of a storage battery jar, a right-angular strip of hard rubber will be obtained. On one arm of this angle may be mounted switch points and contact arm. The other is bolted to the back of a radio panel. A slot may then be cut in the panel and an extension insulated arm run through it. —John N. Quinton.

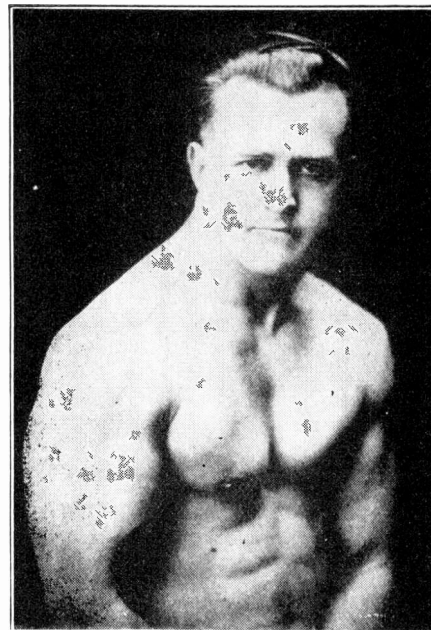

Earle E. Liederman  
 as he is today

**Call the Undertaker!**

What's the use of living when you're only half alive? You get up in the morning and you don't have the pep of a jelly fish. Your work is a burden and life has ceased to give you a thrill. You don't seem to get anywhere and nobody cares whether you do or not. What's the use, fellows? Call the Undertaker, for you're dead and you don't know it.

**A New Life**

Stop! It's all wrong. There is another life right here before you. A new and a better one. A life that is full of thrills and sunshine. Every day opens new worlds to conquer, new joys, new friends and lasting ones. Come with me and let me guide you to it.

I have a system that knocks those gloom bugs higher than a kite. I'll put pep in your old backbone that will make you feel like a jack rabbit. I'll put a spring to your step and a flash to your eye so that your own friends won't know you.

**Health and Strength**

That's what you need and that's what you get. Come on now, pull in your belt and throw out your chest. Take a good deep breath of that pure air that's all about you. Give your heart a treat with some rich blood. You will feel so good you will think it's your birthday. Drop me a line and I'll show you how to do it. I'm going to put a chest on you that will make your old ribs strain with the pressure. I'm going to change those skinny arms and legs of yours to a real man's size. You will have the strength and vitality to do things you never thought possible. Come on, fellows! Get busy. I don't promise these things—I guarantee them. Are you with me?

**Send for My New 64-Page Book**

**"MUSCULAR DEVELOPMENT"**

It contains forty-three full-page photographs of myself and some of the many prize-winning pupils I have trained. Some of these came to me as pitiful weaklings, imploring me to help them. Look them over now and you will marvel at their present physiques. This book will prove an impetus and a real inspiration to you. It will thrill you through and through. All I ask is 10 cents to cover the cost of wrapping and mailing and it is yours to keep. This will not obligate you at all, but for the sake of your future health and happiness, do not put it off. Send today—right now, before you turn this page.

**EARLE E. LIEDERMAN**

Dept. 212, 305 Broadway, New York

**EARLE E. LIEDERMAN**

Dept. 212, 305 Broadway, New York City

Dear Sir:—I enclose herewith 10 cents, for which you are to send me, without any obligation on my part whatever, a copy of your latest book, "Muscular Development." (Please write or print plainly.)

Name .....

Address .....

City ..... State .....

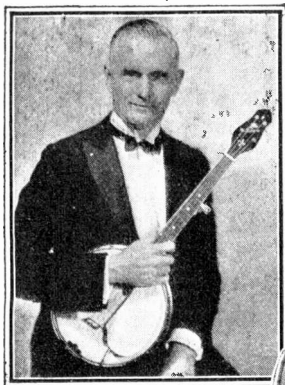

*Charles McNeil,*

**WITH ISHAM JONES, USES THE NEW GIBSON MASTERTONE**

Instantly recognizing the superior qualities of the New Mastertone—marvelous tone, absolute dependability, and “easy playing”—Mr. McNeil, a real banjo artist, has adopted it for all his dance and recording work.

All the tang of real banjo tone with a new musical quality and great carrying power due to the exclusive Gibson Rim and Ball Bearing Tone Tube Construction, the biggest improvement ever made in banjos. Gibson Tone Projector takes the place of resonator attachments. Scientifically correct scale makes easier playing and eliminates string breakage.

Send coupon for Free Book and details of Easy Payment plan on any Gibson instrument, including Tenor Banjo, Mandolin Banjo, Guitar Banjo, Cello Banjo, Mandolin, Mandola, Mando-Cello, Guitar, Harp-Guitar, and Mando Bass. Send coupon NOW for Free Book and complete information, mentioning instrument.



GIBSON MANDOLIN-GUITAR CO.  
1210 Parsons Street, Kalamazoo, Mich.

Please send me complete information about

(Instrument)

Name \_\_\_\_\_  
Street or R. R. \_\_\_\_\_  
P. O. \_\_\_\_\_  
If interested in becoming a teacher-agent check ( )



**\$1**



Postpaid with Instructions

**Transmitter Button For Loud Speaker — Experiments — Amplification — Radio — Etc.**

**K ELECTRIC CO.**

15 Park Row New York

I have used the Skinderviken Button for many years, it gives good results.

E. Boudreault, Ottawa, Canada.

Works fine for a detectiphone and loud talker, etc. C. Roth, Winthrop, Minn.

It's a wonder for radio work. Geo. Tarnon, Chicago, Ill.

**FREE LITERATURE**

**FREE VACUUM TUBE RADIO SET**

Can receive 100 miles and more.



**RUSH** your name to learn how you can get a Vacuum Tube Radio Set **ABSOLUTELY FREE** Don't delay, write today for **FREE RADIO PLAN**.

**HOME SUPPLY CO.**  
Dept. 21  
131 Duane St., N.Y.C.

**UNIT PANELS**

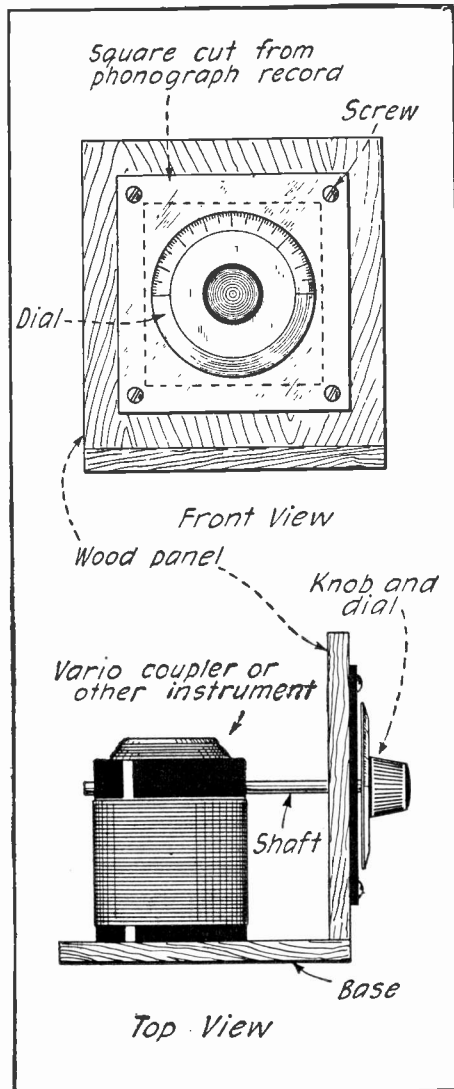

Phonograph records are made of a composition which is a very good insulator. If squares are cut from them and mounted as illustrated above a neat and efficient unit panels will result. Switches or other apparatus may also be mounted on these panels. A large square hole is cut in the wooden panel and the square cut from the phonograph record screwed thereon. —D. Adams.

**BINDING POSTS**

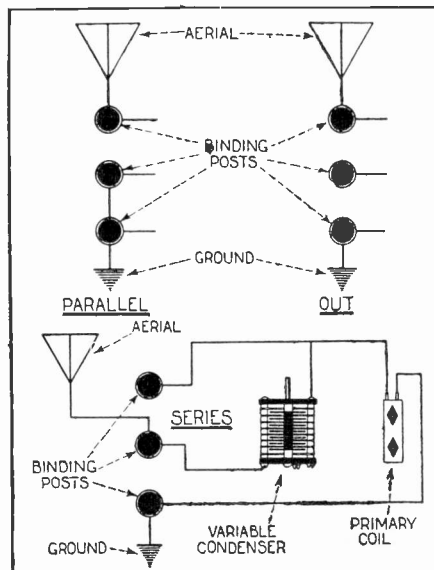

A jumper is used as shown for parallel connection but is removed when the condenser is not used in the circuit. The aerial and ground are connected to the center and bottom binding posts respectively for series connections.

—Thomas L. Robinson.

**Radio Bargains**

**for THIS MONTH**

- Hedgehog Transformer .....\$3.15
- Reflex Crystal ..... .89
- Battery Test Clips (each) ... .05
- 199 Tube Adapter ..... .49
- Licensed Neutrodyne Parts...19.98
- Rheostats, 6, 25, 40 ohm..... .69
- Variocoupler or Variometer (180 degree) each..... 1.28
- Erla Reflex Transformer ..... 4.65
- Murdock 2000 Ohm Phones... 3.65
- Jewell Lightning Arrester.... .98
- Cico Two-way Plug..... .49
- Cockaday Coil, each..... 1.89
- Contact Points or Switch Stops, per dozen..... .10
- Special Prices on Tubes, Magnet Wire, etc.

Clip this list—Check items you want Enclose with Money Order. Your order will be filled by return mail, postage free—Satisfaction or money back.

FANS List of Bargains FREE

**RADIO BARGAINS**  
17 N. LA SALLE ST-CHICAGO

**EDSON**

**Tone Tested Radio Headsets**

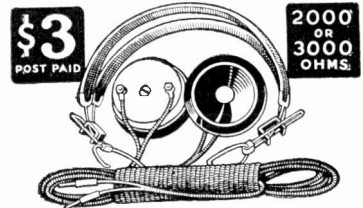

THE lowest-priced first quality headset on the market today. Compare with headsets costing twice our price. Return ours if not satisfied. Our written guarantee protects you. Send \$3 by registered mail or money order. Buy direct of us and save the difference. We ship, postage prepaid, same day order is received. Ask for our

Free Catalog of Radio Parts  
**EDSON RADIO SALES COMPANY**  
4 Elmwood Providence, R. I.

**CATALOG E19-100 PAGES FREE**

**EVERYTHING IN RADIO**

One of the largest complete stocks in the world. 40 diagrams of latest Hookups.

**DEALERS ALL OVER THE U.S.**

Making big profits handling our supplies. 24-hour service. Goods shipped same day order received.



**WHOLESALE RADIO DISTRIBUTORS**  
Dept. F. 6 West 14th St. Kansas City, Mo.

**LEARN RADIO**

Here's your opportunity. Radio needs you. Win success in this fascinating field. Trained men in demand at highest salaries. Learn at home, in your spare time.

**Be a Radio Expert**

I will train you, quickly and easily, to design, construct, install, operate, repair, maintain, and sell all forms of Radio apparatus. My new methods are the most successful in existence. Learn to earn

**\$1,800 to \$10,000 a Year**

**FREE** Wonderful, home-construction, tube receiving set, of latest design. Write for "Radio Facts" free. Engineer Mohaupt. **American Electrical Association**  
Dept. J 612 4513 Ravenswood Ave., Chicago

**GRID CONDENSER**

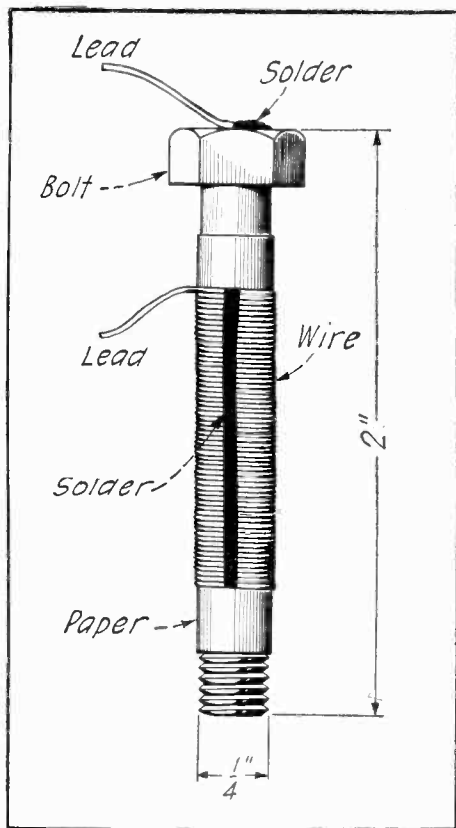

A semi-variable grid condenser is made as illustrated. By winding more or less turns of wire over the waxed paper, the desired capacity is obtained. The bolt used should be of brass. The wires are soldered as shown so as to hold adjacent turns together. L. J.

**FIXED COUPLING TUNER**

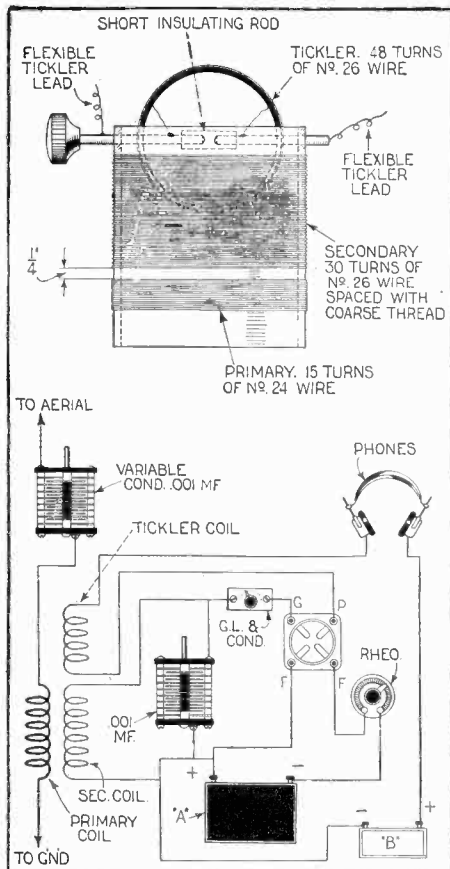

A very simple receiving tuner, consisting of primary, secondary and tickler coils, is made from an old vario-coupler following the data given above. This circuit gives excellent results and the tickler coil provides regeneration. Only three controls are used, thereby simplifying the operation of the set. —Jack W. Morton, Jr.

**—and Now a Complete Radio Receiving Set**

Consisting of  
**Radiogem Phone and Aerial \$2.50**

Shipping Charges Prepaid to Any Point in the U. S. This outfit is absolutely complete. It includes everything you need to hear the Broadcast Programs, market reports, time signals, ship calls or land station messages. Nothing more to buy—no batteries or tubes needed—no upkeep cost of any kind.

The Complete Outfit Consists of Three Parts

(One)  
**The RADIOGEM**

The simplest radio outfit made—yet as practical as the most expensive. A crystal receiving set that you can operate and enjoy even though you know absolutely nothing about radio. You receive the RADIOGEM unassembled, together with a clearly written instruction book, which shows you how to quickly and easily construct the set, using only your hands and a scissor. The outfit comprises all the necessary wire, contact points, detector mineral, tube on which to wind the coil, etc., etc. The instruction book explains simply and completely the principles of radio and its graphic illustrations make the assembling of the RADIOGEM real fun.

(Two)  
**The GEMPHONE**

An adjustable, 1,000-ohm phone complete with 3-ft. cord—the first inexpensive adjustable receiver made. The Gemphone is of standard type and made of the very best grade of materials throughout. The case is made of turned wood, an exclusive feature with the "GEMPHONE." This is responsible for its exceptionally rich, and mellow tone. Like RADIOGEM, the GEMPHONE is sold unassembled. Our instruction pamphlet shows how to assemble it in two minutes, using only a screw driver.

(Three)  
**The AERIAL OUTFIT**

Consisting of 100 ft. of standard copper aerial wire and two porcelain insulators.

Complete Radiogem Outfit	..... \$ 2.50
The Radiogem, only	..... 1.00
The Gemphone, only	..... 1.00
Aerial outfit, only	..... .50



\$2.50 Complete  
\$1.00 Without Phone or Aerial

(Patents Pending)

**What They Say About RADIOGEM**

I am enclosing herewith \$1.00 to pay for the Radiogem. I had it carefully wound by our wireless operator and find that it works beautifully—fully as good as any crystal set we know of.

Radiogem received, which we assembled and were very much astonished at results obtained and the clearness and volume of tone produced.

The greatest distance I heard on one of your sets is 1000 miles, having heard WGY at Schenectady, N. Y. I think your set is the best I have ever sold at any price.

Herewith P.O.M.O. amt. \$1.00 for another "RADIOGEM." The one received is O.K. Placed about 15 ft. of picture cord under front porch and grounded to a gas meter, and heard the Sacramento Bee and Sacramento Broadcasting Union much better than with my large crystal set.

Your RADIOGEM RECEIVER is a wonder. I have received every station in Philadelphia with it much louder than with a high-priced crystal set.

Your two Radiogem sets received last night, and one was wired up for testing. WGY is about 40 miles away, and their signals could be heard with headphones on table. After they quit KYW at Chicago about 170 miles east was heard. Every word could be plainly heard here.

You claim a radius of 30 miles over your "Radiogem" is sometimes a possibility. You should adhere to the truth. I constructed one for my mother, installed it with an aerial, and she listens not once in a while, but at her will, to Schenectady, Newark, New York, or Providence, R. I., and her home is Athleboro, Mass. I can't give your set too much praise.

(Names and Addresses on Request)

**Order Direct or From the Following Dealers:**

- |  |  |  |  |
|--|--|--|--|
| Astoria, Ore.<br>Cook & Foster   | Dallas, Texas<br>Cullum & Boren Co.<br>Texas Furniture & Storage Co. | Laurel Springs, N. J.<br>Stone & Kean                          | Philipsburg, Pa.<br>A. O. Curtis                       |
| Atlanta, Ga.<br>Miller's Dollar Store                                  | Freeport, L. I.<br>Alexander Gold                                    | Los Angeles, Cal.<br>Lester's Radio Shoppe                     | Poughkeepsie, N. Y.<br>Chas. P. Raymond                |
| Baltimore, Md.<br>A. A. A. Co.   | Hamilton, Ont., Canada<br>Radio Supply Co.                           | Medford, Ore.<br>Virgins Radio Service                         | Providence, R. I.<br>The Outlet Co.                    |
| Boston, Mass.<br>Radio Specialty Co.                                   | Hartford, Conn.<br>Sage Allen Co.                                    | Media, Pa.<br>Media Elec. Co.                                  | Pullman, Wash.<br>Electric Supply Store                |
| Brooklyn, N. Y.<br>Levy Brothers<br>Weber Talking Mach. Co.            | Hawera, New Zealand<br>H. H. Blake                                   | Newark, N. J.<br>L. Bamberger & Co.                            | Saginaw, Mich.<br>J. A. Loubert & Co.                  |
| Buffalo, N. Y.<br>Elec. Sup. & Equip. Co.                              | Havana, Cuba<br>Compania Radiotelefonica de Cuba                     | New York City, N. Y.<br>Dixie Supply Co.                       | St. Louis, Mo.<br>United Auto Supply Co.               |
| Chicago, Ill.<br>Baravik Co.<br>Home Supply Co.<br>Levitus & Flansberg | M. Missana<br>Manuel Nodar, Jr.<br>Radio Novelty                     | Eastern Radio Corp.<br>Radio Specialty Co.<br>Harold M. Schwab | St. Paul, Minn.<br>Hill District Radio Sheet Metal Co. |
| Cleveland, Ohio<br>Anderson Elec. Co.<br>Service Publishing Co.        | Hoboken, N. J.<br>C. R. Prieman Co.                                  | Northampton, Mass.<br>Parsons Elec. Shop                       | Seattle, Wash.<br>Frank B. Wilson                      |
|  |  | Oregon City, Ore.<br>Singer Hill Radio Service                 | Springfield, Mass.<br>Johnsons Book Store              |
|  |  | Philadelphia, Pa.<br>Jos. J. Miller                            | Washington, D. C.<br>Chas. Klaben Co.                  |

**THE RADIOGEM CORP., 66-S-West B'way, N. Y. City**

**\$20 Monthly Brings Big Battery Charging Profits**

Start your own big money-making business now with HB 8 Hour Battery Charging. No experience needed. HB outfit comes complete ready to connect and operate. Small cash payment puts an HB 8 Hour Battery Charger in your shop. Your profits easily carry small \$20 monthly payments on balance. 30 days' free trial, absolute money-back guarantee. HB users everywhere making big monthly profits—you can, too. Write today for Bulletin 321.

**HOBART BROTHERS COMPANY, Box S-12, TROY, OHIO**

**Pays For Itself ~ Earns Big Profits**

Insure your copy reaching you each month. Subscribe to Science and Invention—\$2.50 a year. Experimenter Publishing Co., 53 Park Place, N. Y. C.

# A New **RICO** Product

CAPACITY EQUALS 43 PLATE CONDENSER  
REQUIRES 1/4 THE SPACE

## THE "RICO" STRAIGHT LINE CONDENSER

This condenser marks a revolution in condenser building. It is the simplest and most practical type of condenser as yet developed for broadcast and amateur work. This condenser has been developed by our engineers after considerable research work and has been pronounced perfect by experts.

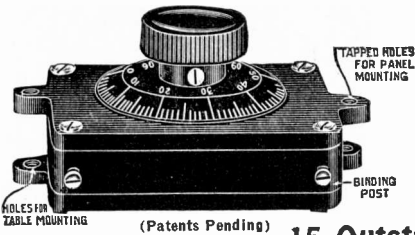

(Patents Pending)

### 15 Outstanding Features

- 1—Large capacity (.001 Mf.).
- 2—Replaces a 43-plate condenser.
- 3—Uses a minimum of space, size 3 1/4" x 2 1/4" x 1 1/4".
- 4—For panel mounting or for table mounting—universal in its scope.
- 5—One complete revolution of dial adjusts condenser from minimum to maximum.
- 6—Vernier effect.
- 7—Absolute straight line curve.
- 8—Accumulates no dust between plates as is the case with air condensers entirely enclosed.
- 9—Light weight. Condenser only weighs 3 oz.
- 10—Less than 1-30th amount of parts as used in old style mesh plate condenser.
- 11—Can never get out of order.
- 12—Impossible to short circuit. Finest India Mica dielectric used.
- 13—Works in any position, vertical or horizontal. No counterweights needed.
- 14—Lowest in price for high class condenser.
- 15—Compactness. Size only 3 1/4" x 2 1/4" x 1 1/4" over all. The Rico Straight Line Condenser must be seen to be appreciated. Made of the best materials that money can buy. Stands in a class by itself. All metal parts finished in nickel plate. Money refunded if this condenser is not all we claim for it. No. 450 "Rico" Straight Line Condenser complete with molded dial, \$1.75. No. 451, same condenser but without dial (shaft is for 1/4 inch), \$1.50.

SEND NO MONEY

S. & I. 12

Radio Industries Corp., 131 Duane St., New York City  
Gentlemen: Please send me by Parcel Post No. ....  
..... "Rico" Condenser for which I will  
pay the postman the amount of .....

Name .....

Street .....

City .....

**RADIO  
INDUSTRIES  
CORPORATION**  
131 DUANE STREET, NEW YORK CITY  
Cable Address: Ricotrade, New York

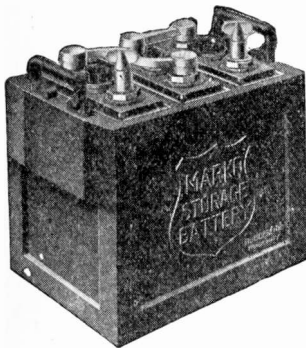

## MARKO "A" BATTERY

90 AMP. HRS.  
IN RUBBERLITH CASE

Ornamental As Well As Efficient

The Rubberlith case is a composition case with a high gloss giving the appearance of ebony. It is moulded in one piece, including handles and cells—no jars to break—and is practically indestructible. A worthy addition to your set.

ALL SIZES, FROM 2 VOLT BATTERIES UP, CARRIED IN MAHOGANY FINISH CASES

DISTRIBUTED BY

MARKO STORAGE BATTERY CO., 210 West 54th St., New York, N. Y.  
MARKO STORAGE BATTERY CO., 102 Jefferson Ave., Brooklyn, N. Y.  
E. M. WILSON & SON, 11 Lafayette St., Newark, N. J.  
ALBANY RADIO CORPORATION, 356 Broadway, Albany, N. Y.

Sold by Radio Supply Stores and all Marko Service Stations

MADE BY

## MARKO STORAGE BATTERY CO.

1402 ATLANTIC AVENUE, BROOKLYN, N. Y.

## "THERE'S MONEY IN IT" AT HOME LEARN TELEGRAPHY AT HOME MORSE AND WIRELESS

### TEACH YOURSELF

in half usual time, at trifling cost, with the wonderful Automatic Transmitter THE OMNIGRAPH. Sends unlimited Morse or Continental messages, at any speed, just as an expert operator would. Adopted by U. S. Government, and leading Universities, Colleges and Telegraph Schools. 3 styles. \$14 to \$30. Catalog free.



If you own a Radio Phone Set and don't know the Code, you are missing most of the fun.

OMNIGRAPH MFG. CO. 22 Hudson St., NEW YORK

## LEARN WATCH REPAIRING



You can learn by our modern and original system of instruction every part of the Watch Repairing Trade at home as good or better than at a shop. You can earn money while learning and secure a well paying position or start in business after completing our course of instruction. Good watch repairers are always in demand and earn from \$20 to \$65 per week. For particulars apply to the

MILWAUKEE SCHOOL OF WATCH REPAIRING, 166 Mason St., MILWAUKEE, WIS

1.25¢  
By MAIL



## QUESTIONS and ANSWERS

Electricians' Examinations Diagrams, symbols, tables, notes and formulas for preparation for license.  
READE PUB. CO., 296 Broadway, N. Y. City

### EFFICIENT POTENTIOMETER

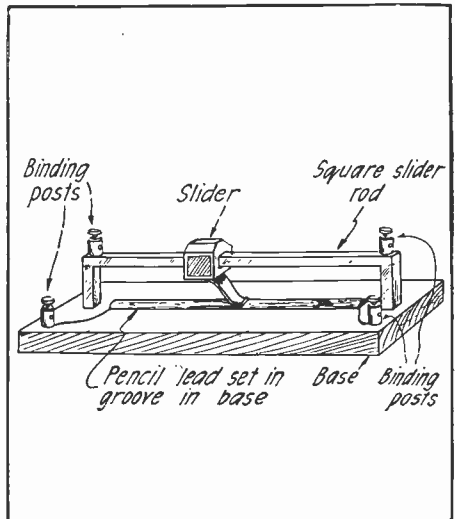

Some scraps of square brass rod, a slider, a piece of soft pencil lead and binding posts comprise a very good yet cheap potentiometer when assembled as shown above. The pencil lead should be fastened in the groove with glue.

—Charles J. Coward.

### SERIES-PARALLEL SWITCH

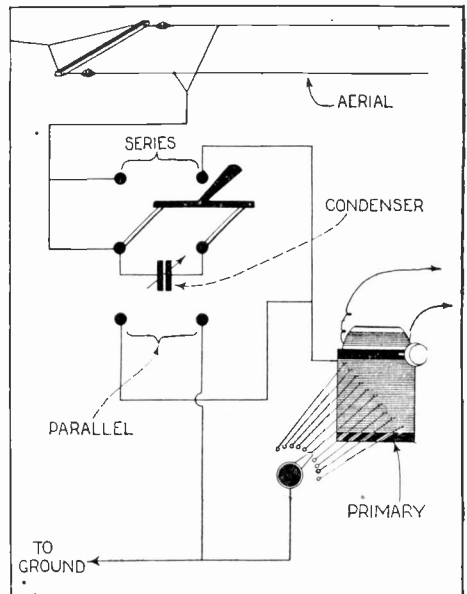

A double-pole double-throw switch makes a very effective series-parallel connection on any receiving tuner. The hook-up is given above. It is advisable to use a small switch which can be mounted on the front of a panel.—S. H. Cornell

### VERNIER TUNER

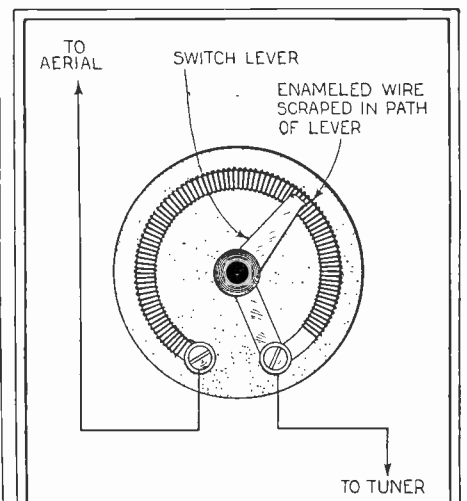

A vernier tuner to be connected in series with the primary of the regular tuner may be made from the rheostat.

—Ernest Kocak.



BALANCING DIALS

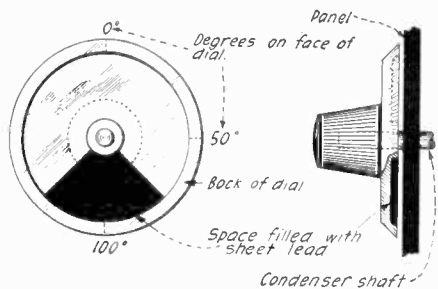

By filling up a part of the countersunk space in the back of a dial with a piece of sheet lead as shown, a counter-balance for the rotary plates of a variable condenser may be formed.  
—Stanley G. Mitsuo.

HOT-WIRE AMMETER

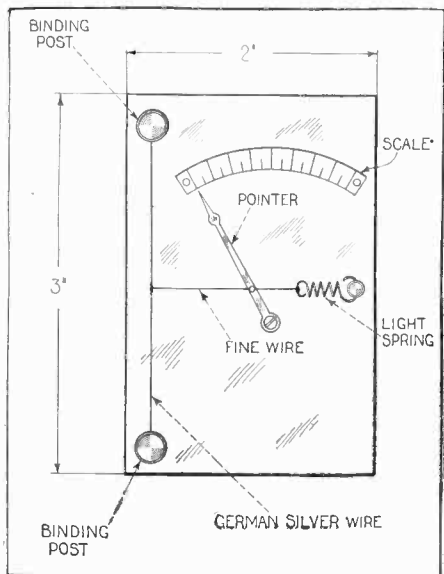

A fairly accurate ammeter operating on the principle of the expansion of a hot wire may be constructed as shown above.  
—John R. Good.

INDUCTANCE SWITCH

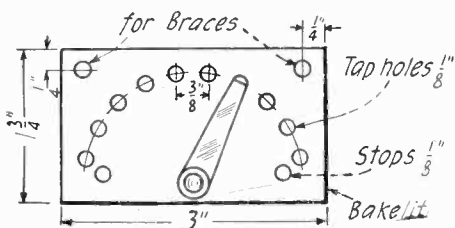
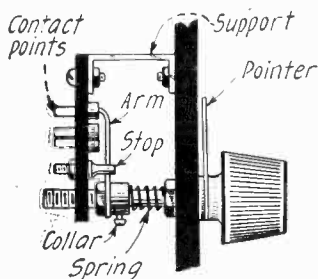
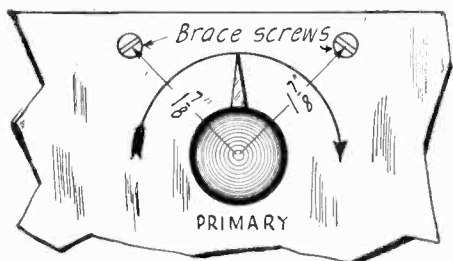

Above will be found the constructional details for an inductance switch to be mounted back of a panel.  
—George A. Sherwood.

*Natural*  
**Re-PRODUCTION**

**Atlas**  
**AMPLITONE**  
**LOUD SPEAKER**

FOR Christmas give the radio enthusiast his fondest expectation—a perfect radio re-PRODUCER, the *Atlas Loud Speaker*. Natural re-PRODUCTION, identical with the original in the broadcasting studio, is completely achieved. The “double diaphragm”, responds uniformly to the full range of sound intensities. Adjustable to each individual set and receiving conditions. The *Atlas Loud Speaker* is a gift not only to an individual but to an entire home, an unmistakable sign of your regard and thoughtfulness.

Hear the *Atlas Loud Speaker* at your dealer's. Its amazing naturalness will convince you. **\$25**

Write for Booklet “T”  
Contains a great deal of helpful information.

Sole Canadian Distributors  
**THE MARCONI WIRELESS TELEGRAPH COMPANY OF CANADA, LIMITED**  
Montreal, Canada

MANUFACTURED BY  
**Multiple Electric Products Co. Inc**  
ORANGE ST. RADIO DIVISION NEWARK, N. J.

**SEND NO MONEY FOR THESE AUTOMATICS**

LOWEST PRICES IN THE COUNTRY

**20 SHOT MILITARY MODEL \$8.95**  
32 cal. with Extra Magazine FREE

25 Cal. 6-shot Blue Steel.....\$6.25  
25 Cal. 8-shot Mauser.....\$11.95  
32 Cal. 7-shot Mauser.....\$12.95  
30 Cal. 9-shot Luger.....\$16.25

38 or 32.20 Cal. \$17.25  
**HAND EJECTOR**

32 or 38 Cal. \$8.25  
**BREAK-OPEN REVOLVER**

32 cal. 6 shot \$16.25  
**HAND EJECTOR** Brand New Guns Use Standard Ammunition.

Satisfaction Guaranteed or Money Back.  
Pay Postman Our Price, Plus Postage.  
**EDWARDS IMPORT TRADING CORP.**  
258 Broadway Dept. 942 New York

**You Can Play These IMMEDIATELY!**  
*A Remarkable Bargain for Lovers of Music*

Here's your chance to own a musical instrument you can really play. No lessons necessary; anyone can play at once and become popular at parties and dances. This handsome clarinette is the latest European invention. A sensation everywhere. Imported to sell at \$2.33. Do you like Jazz? Then send for this handsome new Saxophone. No need to pay \$85 when you can own this handsome nickel plated instrument for

**ONLY \$5.28**  
Plays real music in clear mellow tone. No lessons required. Popular songs and Easy Instructions FREE.

Send No Money —merely your name and address —and pay the postman on delivery. Mail your order today and receive either one of these bargains by return mail. Payments must be sent with all Canadian and foreign orders. Special Combination Offer \$6.61 for both. Free Catalog of Theaters, Banjos, Mandolins, Guitars, Accordions, Violins and others.



Only \$2.33  
Money Back if Not Satisfied



Only \$5.28  
The Bensbrage Studios, Dept. 19D 212 Fifth Ave. New York

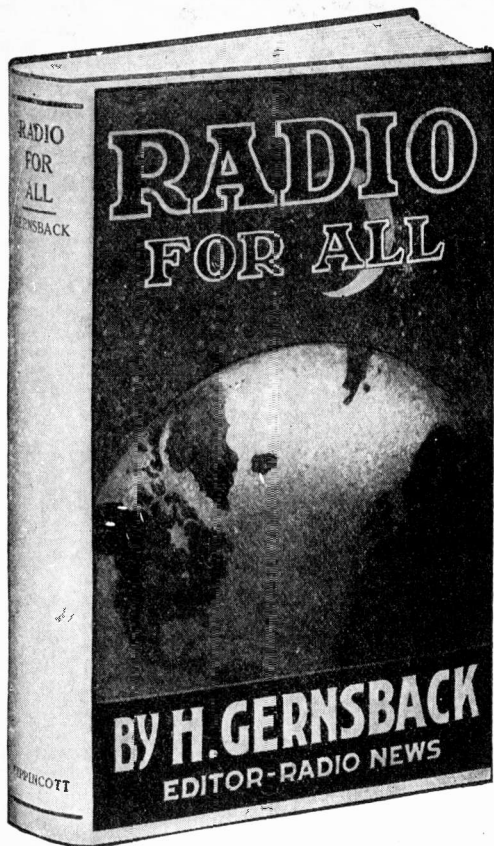

# RADIO FOR ALL

By H. GERNSBACK

Editor "Radio News," "Science and Invention" and "Practical Electrics"

With over 130 illustrations and diagrams, and 12 photographs, 300 pages, size 8 1/4" x 5 1/2".

What the novice in radio needs is a book in which he can get all the information necessary for him to understand radio telephony and telegraphy, to make or buy a receiving set suitable to his means, to know how to operate his set, and after he has an understanding of the radio art, information that will enable him to advance and get the most out of his outfit. All this must ordinarily be dug out of text-books, pamphlets and government publications, but the aim of this book is to have all the data and information that the beginner will need from the time that he takes up radio. It is a permanent, comprehensive reference book for the dyed-in-the-wool dabbler in Radio.

### What the Book Is.

A combination of a radio course for the novice in radio telegraphy and telephony with a reference book for the more experienced amateur. Half a dozen books in one.

### For the Beginner.

- The theory of radio carefully explained with drawings.
- Description of and instruction for operating instruments of receiving and sending sets, with all picture diagrams of the wiring of the apparatus.
- How to make your own receiving set, costing from \$3.00 to \$50.00.
- How to read diagrams; for every picture diagram there is a corresponding technical diagram using the symbols instead of drawings.
- How to tune sharply and eliminate interference from other stations.
- How to protect your set from lightning and the laws regarding installation.
- Explanation of time and weather signals.

### For the More Experienced Amateur.

- How to make a practical vacuum tube detector, two stage amplifier set costing less than \$50.00, that will work.
- How the radio compass works.
- All about underground aeriels, loop aeriels and directional aeriels.
- Formulae for finding wave length; miscellaneous formulae for finding capacity of condenser and other instruments. Tables of wire resistances, wave lengths and their corresponding frequencies, approximate wave lengths for different aeriels, tuning coil data, and much more invaluable information.

### Special Features.

- Lists of all the broadcasting stations in the United States and Canada for concerts, time signals, weather reports, press, stock market reports, etc., with their call, wave length and time of sending.
- Detailed description of Washington weather signals and their translation.
- Description of a modern broadcasting station and its operation.
- Large map showing location of all U. S. radio telephone broadcasting stations suitable for hanging up in radio room.
- Collection of miscellaneous radio information for the amateur.

### In Other Words.

The information that you ordinarily have to dig out of government publications, text-books, pamphlets, etc., is handily combined in this one book.

The Complete Book of All Radio Information  
**PRICE POSTPAID \$2.00**

**PRACTICAL ELECTRICS COMPANY**

::

::

**53 PARK PLACE, NEW YORK CITY**

# Each a Leader In Its Field

## Science & Invention

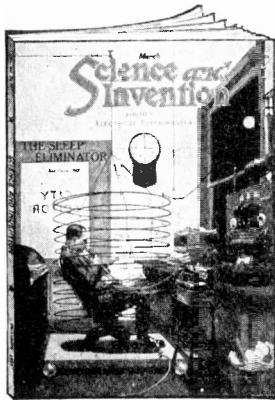

Is one of the most interesting magazines published. It is more interesting than fiction.

It is profusely illustrated and covers in word and picture the latest achievements in the sciences—in Invention, Astronomy, Physics, Chemistry, Electrics, Mechanics, etc.

It has a large section devoted exclusively to Radio. SCIENCE & INVENTION has the distinction of being more often quoted than any other magazine in the world.

More than 100 large pages—with over 300 illustrations, drawings, etc.

Special prize contests are offered each month.

On all newsstands, 25c a copy.

## Subscription Prices

Science & Invention	} One Year 12 Issues \$2.50 Each
Radio News	

(Add 50c to the cost of each magazine for Canada or Foreign)

## Radio News

"The 100 Per Cent Wireless Magazine"

The Largest Radio Magazine in the World

Is read by more than a million Radio enthusiasts each month.

Its position as the leader of all Radio publications is universally recognized by dealers, radio manufacturers and every branch of the radio industry and its pages reflect their confidence.

RADIO NEWS contains more articles by Radio Experts—more specific information—detailed drawings—illustrations and news—than is published in any other magazine.

More than 200 large pages monthly. Profusely illustrated.

On all newsstands, 25c a copy.



**FREE PRESENTS FOR SUBSCRIPTION RAISERS.**

Write for our Premium Catalog containing valuable rewards given away **FREE.**

Premium Dept.  
**Experimenter Pub. Co.**  
 53 Park Place, N. Y.

**Experimenter Publishing Co., Inc., 53 Park Place, New York, N. Y.**

## NEW PISTON RING OF DUAL METALS

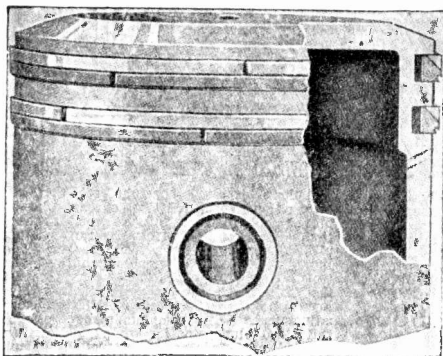

In the manufacture of the ring shown above, the outer section which presses against the cylinder wall is made of a soft, non-resilient iron compound that resists wear as well as the ordinary ring and at the same time does not bore. The inner ring is made of an entirely different compound and is equiradial in expansion, thus delivering an equal pressure at all points around the cylinder wall. The face of the inner and outer rings meet at an angle of fifty degrees. The outer section of the ring is called the packing section and the inner the spring section. The new ring does away entirely with pins.

STATEMENT OF THE OWNERSHIP, MANAGEMENT, CIRCULATION, ETC., REQUIRED BY THE ACT OF CONGRESS OF AUGUST 24, 1912.

OF SCIENCE AND INVENTION, published monthly at Jamaica, New York, for October 1, 1923.

State of New York )  
County of New York ) ss.

Before me, a notary public in and for the State and county aforesaid, personally appeared H. Gernsback, who, having been duly sworn according to law, deposes and says that he is the Editor of the SCIENCE AND INVENTION and that the following is, to the best of his knowledge and belief, a true statement of the ownership, management (and if a daily paper, the circulation), etc., of the aforesaid publication for the date shown in the above caption, required by the Act of August 24, 1912, embodied in section 443, Postal Laws and Regulations, printed on the reverse of this form, to wit:

1. That the names and addresses of the publisher, editor, managing editor, and business managers are:

Publisher, Experimenter Publishing Co., 53 Park Place, New York City. Editor, H. Gernsback, 53 Park Place, New York City. Managing Editor, H. Winfield Secor, 53 Park Place, New York City. Business Manager, R. W. DeMott, 53 Park Place, New York City.

2. That the owners are: (Give names and addresses of individual owners, or, if a corporation, give its name and the names and addresses of stockholders owning or holding 1 per cent or more of the total amount of stock.)

Experimenter Publishing Co., H. Gernsback, S. Gernsback, H. Winfield Secor, R. W. DeMott, Dr. T. O'Connor Sloane, Mrs. Catherine Major (All of 53 Park Place, New York City), and M. M. Finucan, 720 Cass St., Chicago, Ill.

3. That the known bondholders, mortgagees, and other security holders owning or holding 1 per cent or more of total amount of bonds, mortgages, or other securities are:

None.

4. That the two paragraphs next above, giving the names of the owners, stockholders, and security holders, if any, contain not only the list of stockholders and security holders as they appear upon the books of the company but also, in cases where the stockholder or security holder appears upon the books of the company as trustee or in any other fiduciary relation, the name of the person or corporation for whom such trustee is acting, is given; also that the said two paragraphs contain statements embracing affiant's full knowledge and belief as to the circumstances and conditions under which stockholders and security holders who do not appear upon the books of the company as trustees, hold stock and securities in a capacity other than that of a bona fide owner; and this affiant has no reason to believe that any other person, association, or corporation has any interest direct or indirect in the said stock, bonds, or other securities than as so stated by him.

5. That the average number of copies of each issue of this publication sold or distributed, through the mails or otherwise, to paid subscribers during the six months preceding the date shown above is.....(This information is required from daily publications only.)

H. GERNSBACK,  
Sworn to and subscribed before me this 28th day of September, 1923.

[SEAL]

JOSEPH H. KRAUS,  
(My commission expires March 30, 1925.)



An Appreciated Gift

### Charges Radio and Auto Batteries at Home Over Night - For a Nickel!

For a friend who owns a radio set or automobile, what could be more appropriate than a gift which would eliminate the inconvenience and expense of taking his battery to a service station every time it requires recharging? The

**GOLD SEAL HOMCHARGER**  
The World's Most Popular & Batteries Charger

is such a gift, appropriately dressed up in a beautiful Christmas package, too. It charges any AUTO, RADIO or "B" storage battery in the simplest, quickest and most efficient manner possible. Connects to any lamp socket—operates silently—requires no watching. Fully automatic in operation—absolutely safe.

#### HOMCHARGER'S TEN POINTS OF SUPERIORITY

1. **Simple**—Only one moving and wearing part, replaceable after thousands of hours use for \$1.00. Will last a lifetime.
2. **Efficient**—Uses less than one-half the current of any bulb or liquid type rectifier. Will charge any radio or automobile battery for a nickel.
3. **Quick**—Its high charging rate of 7 amperes eliminates long waiting for battery to become charged. Will charge any "A" or "B" battery over night, or three times as fast as a 2-ampere machine.
4. **Clean**—No expensive bulbs to break or acids to spill or replace. No acid fumes. Charges without muss, fuss or bother.
5. **Dependable**—Tungsten contacts insure continuous operation—prevent sticking and stopping.
6. **Fool-Proof**—Can be operated by anyone. Attach to lamp socket and connect battery either way, it will always charge. High-grade ammeter eliminates guess work.
7. **Safe**—No danger of shock or fire. Tested and approved by Fire Insurance Underwriters everywhere. Gives tapering charge—will not overheat or injure battery.
8. **Beautiful**—Mahogany and Gold Finish.
9. **Unqualifiedly Guaranteed.**
10. **Popularly Priced**—Retail at \$18.50 complete (\$25.00 Canada). No extras to buy. Sold by all dealers.

**FREE BROADCASTING LIST.** Ask your dealer or write direct for Free Homcharger List of Broadcasting Stations, and Circular Describing the Gold Seal Homcharger.

DEALERS!

JOBBERS!

GOLD SEAL HOMCHARGERS in their attractive Xmas packages are going to be "best sellers" to the holiday trade. Write for our elaborate merchandising plans and then prepare to get your share of this big "Homcharger Xmas business".

#### Insist on the GOLD SEAL

ACCEPT NO SUBSTITUTE. Like all good products, the HOMCHARGER has been widely imitated. No other charger is just as good. INSIST on seeing our registered trade-mark, the "GOLD SEAL," on nameplate and carton before purchasing.



The Automatic Electrical Devices Co., 116 West Third St., Cincinnati, O.

Largest Manufacturers of Vibrating Rectifiers in the World

**WANTED**  
Railway Postal Clerks  
**\$1600 to \$2300 Year**  
MEN—BOYS 18 or Over  
Mail Coupon Immediately



Steady work. No layoffs. Paid vacations.  
Common education sufficient.  
Travel—See the country.  
Send coupon today—SURE

Franklin Institute, Dept. D183, Rochester, N. Y.  
Six: Send me without charge, (1) Specimen Railway Postal Clerk Examination questions, (2) List of U. S. Government jobs obtainable, (3) Send free illustrated book, "How to Get Government Jobs."

COUPON  
Name .....  
Address .....

# "Make Your Own" with CONSRAD PATTERNS



**How to Make a Short Wave Regenerative Receiver**  
 This set was designed by a foremost radio engineer to fulfil the wants of an all-round broadcast receiver. It covers wave-lengths up to 800 meters. . . . . **50c.**

**How to Make a Detector and Amplifier Units**  
 This pattern was designed for detector and amplifying units especially adapted for use with our regenerative receiver. It is strongly recommended when the attachment of a loud speaker to that set is desired. **50c.**

**How to Make a Cockaday Receiver**  
 The Cockaday four-circuit tuner is one of the latest advancements in radio. Its main advantage lies in the fact that the set can be adjusted to the highest point of regeneration, and tuning accomplished over a wide band of wave-lengths without the necessity for readjusting the regeneration control. All dimensions, size of wire, number of turns, etc., are given leaving nothing to the imagination. . . . . **50c.**

**How to Make a Radiophone Crystal Set**  
 Designed for those without technical knowledge. This set has a range of 30 miles. Packet consists of 4 page illustrated direction pamphlet and full size blue print for drilling and wiring. . . . . **50c.**

**20 Radiophone Diagrams and Hook-Ups**  
 These diagrams show how to get the best possible efficiency from the instruments you make or purchase. They cover hook-ups from the simplest to the most complicated, in a way that any amateur can understand and follow without difficulty. Printed on heavy paper, 8 1/2 x 11 1/2 inches, and together with KEY CHART OF SYMBOLS and pamphlet "How to Read Diagrams", are contained **50c.** in a heavy two-color envelope. . . . .

**How to Make a Reinartz Receiver**  
 The original Reinartz Receiver is the most popular type of set in existence today due to its simplicity of operation and capability of long-distance reception. Full directions for building this receiver are given in this folder. Two blue prints and instruction pamphlet in two-color manilla envelope. The connections of the set are shown plainly. . . . . **50c.**

**All About Aerials and their Construction**  
 These blue prints were made after practical erection of each aerial, and point out how simple it is to erect not only the proper aerial for your particular need, but how to erect this aerial in the most practical manner and at the least expense. Consists of 12 blue prints 8 1/2 x 11 inches and one of four-page instruction pamphlet **50c.**

**14 Radio Formulae and Diagrams**  
 With this packet you need never worry about schematic wiring diagrams, measurements and radio tables. All formulas and diagrams are printed on heavy paper. **50c.**

**How to Make an Autoplex Receiver**  
 The long expected one-tube set that will work a loud speaker. Will operate wherever placed and requires but a ground connection. Every station within its range is amplified sufficiently for a loud speaker. Tuning is very simple, there being but two controls. Any tubes from the "peanuts" up to the "big ones" can be used. This receiver knows no such thing as "critical filament adjustment." The complete plans consist of full sized blue print for wiring and drilling and also a four-page instruction pamphlet giving complete details even as to tuning. . . . . **50c.**

**How to Make a Neutrodyne Receiver**  
 This pattern gives the complete assembly, wiring, adjusting and tuning of a five-tube Neutrodyne receiver. This type of receiving outfit was brought out after extensive experimenting and is noted for its very efficient radio frequency amplification. All the disadvantages of ordinary radio receivers, such as distortion and re-radiation are eliminated. The circuit is also noted for keeping the tubes from oscillating. Put up in packet, with full size blue prints for drilling and wiring and four-page instruction pamphlet. . . . . **50c.**

**How to Make a Reflex Receiver**  
 The plans for the reflex receiver were gotten out only after considerable research work by our engineers. Most people have trouble with reflex receivers. It takes an expert to build one that will work satisfactorily. The trouble lies in the values of condensers, etc., in the circuits. If they are incorrect, the set is a dismal failure. The construction details of a reflex receiver, contained in this folder, are the results of their successful efforts. . . . . **50c.**

## Order Direct From These Dealers—Or If Your Dealer

- Abilene, Kans. Union Elec. Co.
- Albany, Ga. Lonsbergs Book House
- Akron, O. Radioart Supply Co.
- Albany, N. Y. Havens Elec. Co.
- Ignition Service Supply Co.
- Couper & Hotchkiss
- Kimball Bros.
- Peoples Radio Store
- Standard Elec. Co.
- Wagner Bros.
- Amsterdam, N. Y. Anderson Elec. Co.
- Allentown, Pa. Hess Bros.
- Huchman Book Store
- Altoona, Pa. Altoona Elec. Supply Co.
- Anthony, Kans. Letroy Hughbanks Rad. Co.
- Astoria, O. Astoria Radio Shop
- Atchison, Kans. Low & Blythe Elec. Co.
- Atlanta, Ga. Capital Elec. Co.
- Millers Book Store
- Atlantic City, N. J. Paramount Radio Co.
- Eastern Hdwe. & Sup. Co.
- Sport Shop
- Just Elec. Co.
- Sea Coast Radio Co.
- Auburn, Me. G. L. Foss
- Baltimore, Md. Jos. A. Becker
- Jos. M. Zamolski
- Wilbur Elec. Co.
- Bacharach Raslin Co.
- W. W. Hentzel
- S. B. Berkowich
- Joel Gutman
- Herdas Elec.
- Little Joes Dept. Store
- C. D. Kellert
- J. Meyer
- Murdock Co.
- E. I. Rosenfeld & Co.
- Batavia, N. Y. H. F. Smith
- Bethlehem, Pa. Lehigh Radio Co.

- Billings, Mont. Torterson Bros.
- Birmingham, Ala. Interstate Elec. Co.
- Bluefield, W. Va. Burgess Elec. Co.
- Boston, Mass. Atlantic Radio Co.
- Cutter & Wood Supply Co.
- Seth Fuller Co.
- International Radio Corp.
- Lewis Elec. Supply
- F. D. Pitts Co.
- New Eng. Elec. Spec. Co.
- Williams Book Stores
- J. B. Hunter & Co.
- Samuel J. Berkwith
- Chandler & Farquhar Co.
- A. P. Merchant Co.
- Eugene Proctor Co., Inc.
- Radio Sales & Service Co.
- Farrington & Clark
- Berman Radio
- Bridgeport, Conn. Morison Radiophone Parts
- Flynn & Power
- Conn. Radio Supply Co.
- Brooklyn, N. Y. Arthra
- Brooklyn Radio Serv. Co.
- O. Olsen
- Tollner Elec. Co.
- Iklyns Radio Center
- Bohs Radio Service
- Bklyn Elec. Lamp & Nov.
- Boro Hall Radio
- Globe Radio & Bat. Shop
- Haag & Vince Co.
- G. Kleinteich
- C. G. Rosewall
- J. Streiff
- Denmarks
- American Phon. Exch.
- Arlington Radio Service
- Barneys Radio Shop
- Bengo Elec. Co.
- J. D. Cunningham
- Delta Elec. Co.
- H. A. Dietz
- Duchmans Music Store
- Kelley & Feist
- Hatpen Elec. Co.
- Kensington Radio
- E. C. & H. B. Lagerholm
- G. Moskowitz
- G. Scharff Sons

- H. Schur & Son
- Victor Radio Sport Shop
- Walker Elec. Co.
- Breuer Bros.
- 20th Century Radio Co.
- Morch Radio
- M. Ulrich
- B. Haupt
- David M. Isaac
- Star Radio
- Buffalo, N. Y. McCarthy Bros. & Ford
- Robertson Cataract
- O. Ulbrich Co.
- Burlington, N. J. Burlington Elec. Co.
- Butte, Montana Montana Elec. Co.
- Cambridge, Mass. Chapp-Eastham Co.
- University Book Store
- Canton, Ill. Frank White & Bros.
- Camden, N. J. Neisner Bros.
- Carrollton, Mo. Carrollton Radio Shop
- Centerville, Ia. H. E. Luther
- Champaign, Ill. H. C. Swannell & Son
- Charleston, W. Va. John R. Koch
- Charlestown, S. Car. S. C. Radio Shop
- Charlotte, N. C. Smith Novotny Elec. Co.
- Caroline Radio Co.
- Chester, Pa. Neisner Bros.
- Chicago, Ill. Harry Alter & Co.
- Barawik Co.
- Beckley-Radston Co.
- Chicago Radio App. Co.
- Elec. Appliance Co.
- Inland Elec. Co.
- Marshall-Field & Co.
- A. C. McClurg & Co.
- Montgomery Ward & Co.
- Newark Elec. Co.
- Henry Paulson & Co.
- Sears-Roebuck & Co.
- Chicago Cut Rate Book

- Community Book Store
- Izenstark Radio Co.
- Follett Book Co.
- McArthur Elec. Co.
- P. O. News Co.
- Max Stein
- E. J. Stringos
- Fireside Radio Co.
- Cincinnati, O. Midwest Radio Co.
- Milnor Elec. Co.
- Reuter Elec. Co.
- Cleveland, O. Radio Electric Shop
- Radio Eng. & Sales Co.
- H. Lesser & Co.
- Oliver C. Schroeder
- Radio Sales & Rep. Co.
- Columbus, O. Hall Elec. Co.
- Corapolis, Pa. T. C. O'Donovan
- Cumberland, Md. J. A. Fulton & Co.
- Dallas, Texas Huey & Phillip Hdwe. Co.
- Southwest Radio Sup. Co.
- Radio Equip. Co.
- Denton, Tex. Ever Hdwe. Co.
- Iowa Radio Co.
- Denver, Colo. Electrical Auto App. Co.
- Pratt Book Store
- Reynolds Radio Co.
- Des Moines, Ia. H. W. King
- Iowa Radio Co.
- Detroit, Mich. Federal Elec. Supply Co.
- Twentieth Century Radio Co.
- Crowley Milner Co.
- McAulay Bros.
- Detroit Elec. Co.
- Wolverine Radio Co.
- Northeastern Radio Co.
- Duluth, Minn. Kelley Duluth Co.
- Easton, Pa. F. & W. Grand Stores
- E. Orange, N. J. Essex Radio Shop
- United Radio & Sport Shop
- Elizabeth, N. J. H. Richmond & Son
- Elizabeth Elec. Sup. Co.

- Eureka, Ill. Klaus Radio Co.
- Fergus Falls, Minn. Grande & Seiber
- Far Rockaway, L. I. Dunlap Spitz Goods Co.
- Scientific Radio Co., Inc.
- Flushing, L. I. The Electric Shop
- Ft. Worth, Tex. H. C. Meacham Co.
- Galveston, Tex. Galveston Wireles Sup. Co.
- Gardner, Mass. Gardner Hdwe. Co.
- Gloucester, N. J. Lenny's Variety Store
- Granite City, Ill. Rosenberg Dept. Store
- Great Bend, Kans. Great Bend Radio Co.
- Greensburg, Pa. H. Hamilton
- Hamilton, O. Radio Co.
- Hartford, Conn. Elec. Sup. & Equip. Co.
- F. & W. Grand Stores
- G. Fox & Co.
- Havana, Cuba Diamond News Co.
- Liberia de Jose Albebe
- Helena, Mont. Van Parleum Co.
- Hoboken, N. J. International Book Store
- Eaganas Radio
- Holyoke, Mass. Haskell Elec. Co.
- Independence, Mo. The Melodion Co.
- Hackensack, N. J. Wurtz & Fuchs
- Jacksonville, Fla. Southern Elec. Co.
- Holt Elec. Co.
- Jamestown, N. Y. Willis Switch & Inst. Co.
- Jamaica Plain, Mass. Concord Radio Co.
- Jamaica, L. I. Scientific Radio Co., Inc.
- Merrick Elec. Co.
- Jersey City, N. J. Arrow Elec. Co.

- M. Schlein
- Guarantee Elec. Co.
- Johnson City, Tenn. Bishop Elec. Co.
- Johnstown, Pa. W. T. Grant Co.
- Joliet, Ill. Joliet Book & Sta. Co.
- Kansas City, Mo. Vulcanizers Supply Co.
- Donaldson Radio Co.
- Lancaster, Pa. Radio Outfit & Sup. Co.
- Lawrence, Mass. Schwarzenberg, W.
- Schwarzenberg, W. Los Angeles, Cal. Leo J. Meyberg
- S. California Elec. Co.
- West Radio Elec. Co.
- Radio Concert & Equip.
- Natick Book Store
- Prode Elec. Co.
- Lewiston, Montana Chas. Williams
- Lock Haven, Pa. Burkett Bros.
- Louisville, Ky. Sutcliffe Co.
- Lowell, Mass. G. A. Hill Co.
- Lyons, Kans. R. L. Case
- Macon, Ga. J. W. Burke Co.
- Memphis, Tenn. Street Elec. Co.
- McKeesport, Pa. F. C. Wampler & Son
- Milwaukee, Wis. Julius Andrae & Co.
- Dewey Sport Goods Co.
- Badger Radio Co.
- Minneapolis, Minn. Jacob Andresson Co.
- Findley Elec. Sup. Co.
- Nagel Hdwe. Co.
- Reinhard Bros. Co., Inc.
- Sterling Elec. Co.
- Peerless Elec. Co.
- Missoula, Mont. Missoula Elec. Sup. Co.
- Montgomery, Ala. Alabama Radio Mfg. Co.
- R. P. Reeves



**233 Fulton Street**  
 Publishers of Consolidated Patterns  
 Formerly The Consolidated

# Solve Your Radio Problems with E. I. Co. Books

## How to Make Radio-Phone Receiving Sets

A non-technical book for the beginner. Gives complete constructional data on the building of a complete Crystal Detector Set, Tuning Coil, Loose Coupler and a Single Audion Tube Set with Amplifying Units. It furnishes all dimensions and working drawings of every part that must be constructed by the amateur. 48 pages, 26 illustrations. Bound in beautiful two-color cover. Size, 5 1/2 x 7 1/2 in. Prepaid... **25c.**

## Loud Talkers

### How to Build Them

Gives complete data for building two distinct types of loud talkers. One chapter deals with improvised loud talkers, and gives complete instructions on how to build suitable horns for use in loud speakers of the Baldwin and other types. With this book anyone can build a successful loud talker, equivalent to the commercial types, costing \$30.00 or more. 48 pages, profusely illustrated. Prepaid... **25c.**

## Radio Questions Answered

This book is proving as welcome to the radio public as our "100 Radio Hook-ups", which is now the fastest selling radio publication on the market. "Radio Questions Answered" was gotten up after a thorough canvass of dealers to find out which topics troubled most of the amateurs. Almost 100 questions are answered very fully and in language so simple that even the most inexperienced layman can easily understand. Put up in the style which has made the E. I. books famous all over the world. 52 pages, 2 color cover, 25 illustrations. Prepaid... **25c.**

## How to Tune Your Radio Set

Covers in comprehensive form, the fundamental principles of tuning. The characteristics of radio waves are fully described and illustrated. Several chapters are devoted to the use and functions of all radio apparatus. The book describes how to tune such sets as the Reinartz, Flewelling, Neutrodyne, radio frequency amplifier receivers and others. 52 pages, 25 illustrations. Prepaid... **25c.**

## 100 Radio Hook-Ups

Contains a varied selection of hook-ups from the simple crystal to the more elaborate circuits, with a circuit for every requirement. Crystal hook-ups, combined crystal with radio and audio frequency amplifiers, non-regenerative, and regenerative vacuum tube circuits with and without radio and audio amplifiers. Amplifier units, with straight jacks, filament and switching arrangements, power amplifiers, choke coil, resistance coupled and transformer coupled radio frequency amplifiers. Includes all the latest types of Reflex, super-regenerative, super-heterodyne, Neutrodyne, Reinartz, Flewelling, and Bishop. 52 pages, two-color cover. **25c.**

## Radio Frequency Amplifiers

Shows the construction of the Radio Frequency Amplifying Transformer and gives complete constructional data. It shows the application of Radio Frequency to amplifying units that the amateur may already possess and gives 15 hook-ups showing practically every use Radio Frequency Amplifying Transformers can be put to. 32 pages, 15 illustrations. Bound in beautiful two-color cover. Size, 5 1/2 x 7 1/2 in. Prepaid... **25c.**

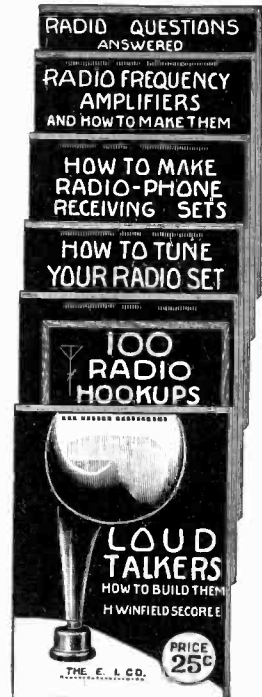

**\$1.97** Here is Your Chance. Learn All You Can About **RADIO** The \$10.00 "RADIO READING COURSE" Special at **\$1.97**

All the technical details and a thorough explanation of radio reception, written in easily understood, non-technical language by a foremost radio engineer and inventor. The five Lecture Books with over 100 graphic drawings give you the knowledge to intelligently buy, design, build, operate and maintain radio receiving apparatus. Tells you how to locate and correct troubles, how to make your apparatus more efficient and gives you a thorough knowledge of radio science. This set of five handsome Lecture Books are a complete radio library. To own them is like having a trained engineer or instructor at your side, answering questions, pointing the way. No matter what your interest in radio, take advantage of this attractive special offer and be the owner of this fine set of books.

**SEND NO MONEY**  
By special arrangement you can own this \$10 Course comprised in the set of five books for only \$1.97—if you act at once. Simply send us your name and address. Upon receipt pay the postman only \$1.97 plus postage and the books are yours. The supply is limited so order at once.

## Cannot Supply You Send Us his Name and Address

- |   |   |  |   |  |  |
|---|---|--|---|--|--|
| <p>Mt. Vernon, N. Y.<br/>Stephens Shop<br/>Nashville, Tenn.<br/>Zibart Bros.<br/>Newark, N. J.<br/>Bamberger &amp; Co.<br/>Bassett Radio Sup. Co.<br/>Davis Elec. Co.<br/>Eddies Wireless Ex.<br/>Bannister &amp; Pollard<br/>Essex Mfg. Co.<br/>W. T. Grant Co.<br/>United Elec. Sup. Co.<br/>Friedmann Music Shop<br/>New Brunswick, N. J.<br/>Schneider Bros.<br/>The Elec. Shop<br/>Newburgh, N. Y.<br/>Rouss &amp; Davis<br/>New Orleans, La.<br/>Interstate Elec. Co.<br/>Nola Radio<br/>Newport, R. I.<br/>Geo. H. Chase<br/>New Haven, Conn.<br/>W. W. Gale &amp; Co.<br/>New York City<br/>Fenno &amp; Co.<br/>Frank Radio Co.<br/>J. J. Kelleher<br/>David Kilcho &amp; Co.<br/>Liberty Radio Co.<br/>R. H. Macy &amp; Co.<br/>Manhattan Elec. Sup.<br/>Overland Radio &amp; Equip. Co.<br/>Peerless Light Co.<br/>Radio Specialty Co.<br/>Stanley &amp; Patterson<br/>Viking Radio Co.<br/>The Winchester Store<br/>Army &amp; Navy Dist. Co.<br/>Chamberlain Elec. Co.<br/>Economy Radio<br/>Elec. Service Eng. Co.<br/>Goldfinger Bros.<br/>Gimbel Bros.<br/>R. G. Haslinger<br/>Herbert &amp; Huesgen<br/>Allied Radio Co.<br/>J. Belmont<br/>J. H. Bunnell &amp; Co.<br/>Butler Bros.<br/>Carnahan &amp; Dalzell, Inc.<br/>Bway. Radio Corp.</p> | <p>P. M. Dreyfuss Co., Inc.<br/>Delta Elec. Co.<br/>Fordham Radio Spec. Co.<br/>F. &amp; W. Grand Stores<br/>J. L. Lewis &amp; Co.<br/>Lowe Motor Sup. Co.<br/>Rova Radio Stores<br/>Live Wire Elec. Co.<br/>Marks Radio<br/>Medelis—3 Stores<br/>Williams Sport Shop<br/>Wellman Bros.<br/>A. &amp; A. Elec. Co.<br/>Acme Radio Co.<br/>Am. Elec. Tech. App.<br/>Atlas Elec. Supply Co.<br/>Atlas Radio Co.<br/>Franklin Radio Shop<br/>J. Gabler<br/>Globe Radio Shop<br/>Hygrade Elec. Co.<br/>International Radio Store<br/>J. Kelleher<br/>Marlen Hdve. Co.<br/>Nassau Radio Co.<br/>Times Sq. Auto Sup. Co.<br/>Triggers<br/>Ace Elec. Co.<br/>Baker &amp; Taylor Co.<br/>Borough Elec. Co.<br/>Columbia Elec. Co.<br/>J. Edelson<br/>Keystone Battery Service<br/>S. S. Kresge &amp; Co.<br/>Langers Radio Store<br/>A. Marcus<br/>G. H. Masten &amp; Co.<br/>Mentz Store<br/>Milbro Radio &amp; Elec. Co.<br/>Radio &amp; Mech. Trad. Corp.<br/>Radio Parlor<br/>Radiophone Equip. Co.<br/>Rialto Elec. Radio St.<br/>St. Marks Radio Co.<br/>K. R. Schullstrom<br/>P. E. Silverman<br/>Woeffer<br/>M. Workman<br/>Perfection Radio<br/>Corlandt Radio<br/>James Gear<br/>A. J. Goldman</p> | <p>T. Eaton &amp; Co.<br/>Progressive Book Store<br/>S. Astor<br/>M. &amp; P. Elec. Co.<br/>Borough Elec. Co.<br/>Marvel Elec. Sup. Co.<br/>O. R. R.<br/>A. E. Zimmerman<br/>Davidson Radio Co.<br/>Mogul Elec. Co.<br/>Brunswick Supply Co.<br/>Stuyvesant Radio Co.<br/>Osborn Radio Co.<br/>Fordham Sup. Co.<br/>M. H. Elec. Co.<br/>The Heights Radio Sup. Co.<br/>Relipse Elec. Co.<br/>Fordham Radio Co.<br/>Crescent Radio Co.<br/>Terminal Rad. &amp; Mus. Shop<br/>United Anchor Tire Co.<br/>Inter City Radio Co.<br/>Josephson<br/>Relifon Corp.<br/>Greenwich Radio Co.<br/>H. Goldstein<br/>Isador Fajans, Inc.<br/>Grand Radio<br/>M. Rubin<br/>Hannes &amp; Co.<br/>Madison Hdve. Store<br/>American Radio Co.<br/>Electrical Eng. &amp; Con. Co.<br/>Niagara Falls, N. Y.<br/>H. Messersmith &amp; Sons<br/>Norristown, Pa.<br/>E. M. Law<br/>Oakland, Cal.<br/>Warner Bros.<br/>E. M. Sargent Co.<br/>Omaha, Nebr.<br/>Wolfe Elec. Co.<br/>Onset, Mass.<br/>W. C. Spring<br/>Passaic, N. J.<br/>J. L. David<br/>Simon Bros.<br/>Passaic Radio Shop<br/>Perth Amboy, N. J.<br/>Smerling, J.<br/>Amboy Lighting Co.<br/>Amboy Radio</p> | <p>Paterson, N. J.<br/>Federal Radio &amp; Elec. Co.<br/>Pawtucket, R. I.<br/>Delancey Felch &amp; Co.<br/>Peoria, Ill.<br/>Peoria News Stand<br/>Philadelphia, Pa.<br/>Gimbel Bros.<br/>H. C. Roberts El. Sup. Co.<br/>Sayre Level Radio Co.<br/>Goetz Music Stores<br/>F. &amp; W. Grand Stores<br/>E. P. Noll &amp; Co.<br/>Trilling &amp; Montague<br/>Neisner Bros.<br/>Schimmig Elec. Co.<br/>Radio Sales Co.<br/>John Wamamaker<br/>Phoenix, Ariz.<br/>Nielsen Radio Sup. Co.<br/>Poughkeepsie, N. Y.<br/>C. P. Raymond<br/>Pittsburgh, Pa.<br/>Goldsmith &amp; Son Co.<br/>Ludwig Hummel &amp; Co.<br/>Gain-a-Day Elec. Co.<br/>Liberty Incan. Sup. Co.<br/>Pitts Radio &amp; App. Co.<br/>U. S. Radio Co. of Pa.<br/>Doubleday Hill Co.<br/>Pittsfield, Mass.<br/>W. T. Grant Co.<br/>Plainfield, N. J.<br/>H. E. Gayle Hdve. Co.<br/>Pittsburgh, N. Y.<br/>H. E. Atwater<br/>Portland, Me<br/>Chisholm Bros.<br/>Portland, Oreg.<br/>E. L. Knight Co.<br/>Hynson Elec. Co.<br/>Hylands Old Book Store<br/>Pottstown, Pa.<br/>T. S. Reidenhour &amp; Son<br/>Pottstown Radio Sup. Co.<br/>Princeton, N. J.<br/>Princeton Cycle Shop<br/>Providence, R. I.<br/>B. &amp; H. Supply Co.<br/>R. I. Elec. Equip.<br/>The Shepard Co.<br/>The Outlet Co.</p> | <p>Boston Store<br/>Reading, Pa.<br/>F. &amp; W. Grand Stores<br/>Rochester, N. Y.<br/>Hickson Elec. Co.<br/>Rochester Elec. Sup. Co.<br/>Wiessler Green El. Sup. Co.<br/>Eastman Radio Co.<br/>R. Schmidt &amp; Co.<br/>E. C. Sykes &amp; Co.<br/>Neisner Bros.<br/>Miller Drug &amp; Elec. Co.<br/>Ridgewood, L. I.<br/>Ridgewood Radio Shop<br/>Rock Island, Ill.<br/>H. E. Gehart &amp; Co.<br/>Beardsley Specialty Co.<br/>Valle Co.<br/>St. Joseph, Mo.<br/>Empire Elec. Co.<br/>Mannsbrooks Book Stores<br/>St. Louis, Mo.<br/>The Bonwood Co.<br/>Linza Elec. Supply Co.<br/>Foster Book &amp; Cigar Co.<br/>St. Paul, Minn.<br/>North West Elec. Eq. Co.<br/>Premier Radio Mfg. Co.<br/>Pioneer Elec. Co.<br/>St. Paul Book &amp; Sta. Co.<br/>Crist Hook Shop<br/>San Francisco, Cal.<br/>Reichter, Conrad<br/>Schenectady, N. Y.<br/>Albany St. Radio Store<br/>J. Tigar<br/>Seattle, Wash.<br/>F. B. Wilson<br/>Stamford, Conn.<br/>Arthora<br/>Stillwater, Okla.<br/>Stillwater Elec. Shop<br/>Syracuse, N. Y.<br/>Grant's Alexander Sons<br/>Hughes Radio Corp.<br/>M. H. Salmon Elec. Co.<br/>Toledo, O.<br/>Kuebier Radio Co.<br/>W. J. Nagel Elec. Co.<br/>Aitken Radio<br/>Toronto, Ont., Can.<br/>H. M. Kipp<br/>T. Eaton &amp; Co.</p> | <p>Trenton, N. J.<br/>Pieron &amp; Son, Inc.<br/>Radio Chain Stores<br/>Troy, N. Y.<br/>L. H. Cooper &amp; Son<br/>Tyler, Tex.<br/>R. E. Bryan<br/>Union Hill, N. J.<br/>N. W. Friedman<br/>Uniontown, Pa.<br/>Frederick Pismo Co., W. F.<br/>Utica, N. Y.<br/>Dent, Co., M. F.<br/>Olds Book Store<br/>Utica Elec. App. Co.<br/>Utica Elec. Sup. Co., Inc.<br/>Waco, Tex.<br/>Jackson's Radio Eng. Lab.<br/>Washington, D. C.<br/>Continental Elec. &amp; Sup. Co.<br/>Radio Auto Sup. Co.<br/>Watertown, Wis.<br/>D. &amp; P. Kusel Co.<br/>Watertown, N. Y.<br/>F. A. Emisall &amp; Co.<br/>W. Hoboken, N. J.<br/>The Heraco Exchange<br/>W. New York, N. J.<br/>W. N. Y. Heraco<br/>Wheeling, W. Va.<br/>Gee Electric Co.<br/>Wapakoneta, Ohio<br/>Helm &amp; Nagel Elec. Co.<br/>Waupaca, Wis.<br/>Waupaca Radio Sales Co.<br/>Wausau, Wis.<br/>Janke, Kurth Co.<br/>Wilkes-Barre, Pa.<br/>Foster Radio &amp; Elec. Co.<br/>Wilmington, Del.<br/>I. X. L. Radio<br/>L. P. Moore<br/>Wilmington Elec. Spec. Co.<br/>Worcester, Mass.<br/>Neisner Bros.<br/>Williamsport, Pa.<br/>Wilhelm Book Store<br/>Yonkers, N. Y.<br/>Knefer, F.<br/>Westchester Elec. Eq. Co.<br/>York, Nebr.<br/>Bullocks<br/>Youngstown, Ohio<br/>Robert F. Phillips</p> |
|---|---|--|---|--|--|

**New York City**  
and Sales Agents for E. I. Co. Books  
Radio Call Book Company, Inc.



## Opportunity Ad-lets

**Y**OU will find many remarkable opportunities and real bargains in these columns. It will pay you to read and investigate the offerings made every month by reliable firms, dealers and amateurs from all over the country. No matter what you may be seeking, whether supplies, automobile accessories, the opportunity to make money, or anything else, you will find listed here the best and most attractive specials of the month.

Advertisements in this section twelve cents a word for each insertion. Name and address must be included at the above rate. Cash should accompany all classified advertisements unless placed by an accredited advertising agency. No advertisement for less than 10 words accepted.

Ten per cent. discount for 6 issues. 20 per cent. discount for 12 issues. Objectionable or misleading advertisements not accepted. Advertisements for the February issue must reach us not later than December 15.

**The Circulation of Science and Invention is over 160,000 and climbing every month**

EXPERIMENTER PUBLISHING CO., INC., 53 Park Place, New York City, N. Y.

### Agents Wanted

**Agents—Best seller:** Jem Rubber Repair for tires and tubes; supercedes vulcanization at a saving of over 800 per cent; put it on cold. It vulcanizes itself in two minutes, and is guaranteed to last the life of the tire or tube; sells to every auto owner and accessory dealer. For particulars how to make big money and free sample, address Amazon Rubber Co., Dept. 601, Philadelphia, Pa.

**Big money and fast sales.** Every owner buys gold initials for his auto. You charge \$1.50; make \$1.35. Ten orders daily easy. Write for particulars and free samples. American Monogram Co., Dept. 71, East Orange, N. J.

**Make \$25 to \$50 week** representing Clows' Famous Philadelphia Hosiery, direct from mill—for men, women, children. Every pair guaranteed. Prices that win. Free book "How to Start" tells the story. George Clows Company, Desk 27, Philadelphia, Pa.

**Success in Business and Personal Affairs!** Read character by handwriting and features. Conlin System. Low price for entire course. Write, H. E. Conlin, Dept. G, 21 St. John's Place, Buffalo, N. Y.

**Wonderful Invention—Eliminates all needles** for phonographs. Saves time and annoyance. Preserves records. Lasts for years. 12,000,000 prospects. \$15.00 daily. Free sample to workers. Everplay, Desk 127, McClurg Bldg., Chicago.

**We want Salesmen and Agents,** either whole or side line, to sell our low priced radio books to the trade. Excellent proposition for live wires. The E. I. Company, Publishers, 233 Fulton Street, New York City.

**Write and learn how to start profitable business** without capital or experience. Silvering mirrors, refinishing auto headlights, tableware, plating. Outfit furnished. International Laboratories, Dept. 25, 309 Fifth Ave., New York.

**Earn big money fast** applying gold initials to autos. Every owner buys—\$1.35 profit on \$1.50 sale—particulars and samples free. Write quick. Lithogram Co., Dept. 19, East Orange, N. J.

**Only one sale a day means \$200 per month!** Five sales, \$1,000 per month! Marvelous new adding machine. Retail \$6. Work equals \$350 machine. Adds, subtracts, multiplies, divides automatically. Speedy, accurate, durable, handsome. Five-year guarantee. Offices, stores, factories, garages, buy one to dozen. A fortune for live agents. Write quick for protected territory and free trial offer. Lightning Calculator Co., Dept. W., Grand Rapids, Mich.

**\$60—\$200 a week.** Genuine Gold Letters for store windows. Easily applied. Free samples. Liberal offer to general agents. Metallic Letter Co., 441 B, North Clark, Chicago.

**Agents—\$15 a day—Easy, quick Sales—Free Auto—Big weekly bonus—\$1.50 premium** free to every customer. Simply show our Beautiful, 7-piece, Solid Aluminum Handle Cutlery Set. Appeals instantly. We deliver and collect. Pay daily. New Era Mfg Co., 803 Madison St., Dept. 88F, Chicago.

**Agents—Big returns, fast office seller;** particulars and samples free. One Day Pen Co., 12 Daily Record Bldg., Baltimore, Md.

**Rummage Sales make \$50.00 daily.** We start you. Representatives wanted everywhere. Wholesale Distributors, Dept. 32, 609 Division Street, Chicago.

**Earn \$10 daily** silvering mirrors, plating and refinishing metalware, chandeliers, bedsteads, headlights. Outfits furnished. N. Deete Laboratories, 1133 Broadway, New York.

**Agents—Our soap and toilet article plan** is a wonder; get our free sample case offer. Ho-Ro-Co., 2719 Dodler, St. Louis.

**\$10 daily silvering mirrors, plating and refinishing lamps, reflectors, autos, beds, chandeliers** by new method. Outfits furnished. Write Gunmetal Co., Ave. D, Decatur, Ill.

**Boys and Agents** make big profit selling Xmas seals. Start now, send for particulars. G. W. Amberg, 1311 N. State St., Chicago, Ill.

**Agents.** Write for free fall catalog 200 sure sellers. Blankets, Flannels, Hosiery, Slippers, House Dresses, Novelties, etc. Economy Sales Co., Dept. 307, Boston, Mass.

**We want men taking orders** for Insyde Tyres. Positively prevent punctures and blowouts. Give double tire mileage—any tire, old or new. Use over and over again. Old worn out casings give 3 to 5 thousand miles more service. Enormous demand. Low priced. Spare time or full time \$6 to \$12 a day. Write for agency. American Accessories Co., B-584, Cincinnati, Ohio.

**Agents—90c an hour** can be made advertising and distributing samples to consumer. Write quick for territory and particulars. American Products Co., 8864 American Bldg., Cincinnati, Ohio.

**We start you without a dollar.** Soaps, Extracts, Perfumes, Toilet Goods. Experience unnecessary. Carnation Co., Dept. 232, St. Louis.

### Agents Wanted—(Continued)

**A business of your own:** Make sparkling glass name plates, numbers, checkboards, medallions, signs, big illustrated book free. E. Palmer, 313, Wooster, Ohio.

**Fords Get 25-45 Miles** with Reids Automatic Air-Friction Vaporizer. Something New, Guaranteed. Send today. Price \$3.00. Agents Wanted. R. A. Reid, 19 Burget Ave., Medford, Mass.

**Formulas, Processes, Trade-Secrets—Different, Dependable, profitable, catalog free.** D. Thaxley Co., Washington, D. C.

### American Made Toys

**Manufacturers on large scale, also homeworkers,** wanted to manufacture Metal Toys and Novelties, Barking Dogs, War-Fall Pups, Wild Animals, Automobiles, Indians, Cowboys, Baseball Players, Cannons, Toy Soldiers, Crowing Roosters, Statues of Liberty, Miniature castings of Capitol, Bathing Girl Souvenirs and others. Unlimited possibilities. Guaranteed Casting forms furnished manufacturers from \$3.00 up, with complete outfit. No experience or machinery necessary. Hundreds made complete per hour. We buy goods all year and pay high prices for finished goods. Cash on Delivery. Contract orders placed with manufacturers. Enormous business waiting to be taken care of in 1924. Catalog and information free. Correspondence invited only if you mean business. Metal Cast Products Co., 1696 Boston Rd., New York. Established since 1912.

### Automobiles

**Automobile owners, garagemen, mechanics,** send for free copy America's popular motor magazine. Contains helpful, money-saving articles on repairing, overhauling, ignition, carburetors, batteries, etc. Automobile Digest, 541 Butler Bldg., Cincinnati.

### Battle Photos and War Relics

**For Dens:** Relics Collected from Europe's Battlefields. Firearms, medals, helmets, etc. Illustrated catalogue and sample War Photographs 25c. Lieut. Welch, 2117 Regent Place, Brooklyn, N. Y.

### Books

**Free—Upon request** will send you my literature illustrating the following books: Astrology, Character, Clairvoyance, Concentration, Healing, Hypnotism, Magnetism, Mediumship, Personal Magnetism, Personality, Physiognomy, Salesmanship, Seership, Success, Sex, Will, Yogi Philosophy, Gazing Crystals, etc. A. W. Martens, E.E. 6, Burlington, Iowa.

**"Lights, Colors, Tones and Nature's Finer Forces"** including: Vibrations, Odic-Auras, Electro-Magnetics, Coldlights; Radio; Coming Inventions, 270 pages. Satisfaction Guaranteed; \$2.00, Circulars Free. Stevens Research Laboratories, 242 Powell Street, San Francisco, Calif.

**Perpetual Motion, by Percy Verance.** A history of the efforts to discover same from earliest days to the present, together with a scientific discussion regarding the possibility of its ultimate achievement. Profusely illustrated. 337 pages. Price postpaid, \$2.00. The Enlightenment Specialty Co., 305 Fourth St., Edwardsville, Ill.

**Diseases and Their Innate Healer.** Book 50 cents. Arthur Stevens, Wauseon, O.

**New and Original Magic.** Massey. 205 page, 28 page plates. \$3.15 postpaid. Spon & Chamberlain, 1228 Liberty Street, New York.

**The How and Why of Radio Apparatus,** by H. W. Secor, E. E. This newest book on radio matters fulfills a distinct gap in wireless literature in that, while the treatment is made as understandable and as free from mathematics as possible, it at the same time incorporates a wealth of technique and instruction for the Radio Amateur—the Radio Operator—the Installation and Designing Expert—as well as teachers and students of the subject in general. A very broad field has been covered by the author, at the same time giving a great deal of information not found in other text books. If you are engaged in any branch of the Radio or allied arts at all you will surely need this latest contribution to radio literature, which is destined to be found on every radio man's book shelf before long. A glance at the following list of chapters gives but a very scant idea of the extensive and useful radio knowledge provided in its text: The Induction Coil; The Alternating Current Transformer; Radio Transmitting Condensers; The Spark Gaps; Radio-Transmitting Inductances; Radio Receiving Tuners; Radio Receiving Condensers; Detectors; Telephone Receivers; Radio Amplifiers; Construction of a Direct Reading Wavemeter and Decimeter; Antenna Construction; The Calculation and Measurement of Inductances; Appendix containing very useful tables, covering all subjects treated in this very unusual book. This newest of Radio Works, cloth bound in Vellum de Luxe, Gold Stamped and Hand Sewed, has 160 pages. Size of book, 6x9 inches. The How and Why of Radio Apparatus. Postpaid, \$1.75. Experimenter Publishing Co., Book Dept., 53 Park Place, New York City.

### Business Opportunities

**Sell us your spare time.** You can earn Fifteen to Fifty dollars weekly writing show cards at home. No canvassing; pleasant profitable profession, easily, quickly learned by our simple, graphic block system, artistic ability unnecessary; we instruct you and supply work. Wilson Methods, Limited, Dept. 51-M, Toronto, Canada.

**You can have a business-profession** of your own and earn big income in service fees. A new system of foot correction: readily learned by anyone at home in a few weeks. Easy terms for training, openings everywhere with all the trade you can attend to. No capital required or goods to buy, no agency or soliciting. Address Stephenson Laboratory, 18 Back Bay, Boston, Mass.

**Stop Plodding! Be Successful.** Operate a Tire Repair Shop. Make big profits in any locality. We teach you and furnish complete equipments \$100 up. Book of Opportunity free. Haywood's 1312 South Oakley Avenue, Chicago.

**Money Making Opportunities—particulars free.** Lemke, Box 572, Cincinnati, Ohio.

**Wanted—County Distributors** for World's Fastest Selling Automobile Accessory. Write A. Benross Co., 384 East 114th Street, New York.

**\$50 to \$150 Weekly Writing Jokes, Epigrams and Humorous Stories** for publications. Write for details. American Institute of Humor, Office E, 414 Park Bldg., Cleveland, Ohio.

**Establish your own cash business.** Capital \$100 upwards. Dept. X, Paul Kaye, 149 Broadway, N. Y.

**Dollars yearly in your backyard.** No mushroom dope. Particulars free. Metz, 313 East 89th, New York.

### Chemistry

**Experiments—Book of over 100 chemical experiments** only 25c. Oliver Stalter, Oshawa, Ontario, Canada.

**Learn Chemistry at Home.** Dr. T. O'Connor Sloane, noted educator and scientific authority, will teach you. Our home study correspondence course fits you to take a position as chemist. See our ads on pages 803 and 808 of this issue. Chemical Institute of New York, 66 W. Broadway, New York City.

**"Popular Chemistry," "The Experimenter's Monthly,"** Six months' trial—50c. A. Wright Laboratory, Caldwell, New Jersey.

**Chemical analysis of your ore samples,** determining the presence of any commercially valuable metal except gold. Fifty cents each sample. Prompt, accurate service. Terms cash. Thor Laboratory, 1739 E. Villa, Pasadena, Calif.

### Correspondence Courses

**Used correspondence courses** bought and sold. Bargain catalogue 1000 courses free. Students' Exchange, Dept. 4, 47 West 42d St., New York.

**Dollars Saved.** Used correspondence courses of all kinds sold, rented and exchanged. List free. (Courses bought.) Leo Mountain, Pisgah, Alabama.

**Correspondence Courses** sold complete 1/3 usual prices because slightly used; easy terms; money back guarantee. All schools and subjects. Write for special Free Catalog. Courses bought for cash. Economy Educator Service, H202, West 49th Street, New York.

### Duplicating Devices

**"Modern" Duplicators** save Time, Labor and Money. Gets Business. Reproduces Typewritten or penned letters, Drawings, Lessons, Music, Menus, Bids, Notices, Specifications, Maps or anything in one or more colors. Prints two per minute. Special Sale On. 30 Days' Free Trial. \$2.25 up. Booklet Free. B. J. Durkin-Reeves Co., Pittsburgh, Pa.

### For Inventors

**Get your own patents.** Application blanks, complete instructions \$1. Cutting Bros., Campbell, Calif.

**Your Chemical problem** solved and working process furnished for Five Dollars. Write me. W. Stedman Richards, Consulting Chemist, Box 2402, Boston, Mass.

**Patent Application** involving one sheet drawing prepared for \$15. Arthur M. Benner, Olympia, Wash.

**Invention and Patent Promotion Magazine.** Interesting information and helpful advice. Send for circular. Burckett, Box 38-1, Station S, New York City.

**Ford Owners**

Sport Cars. Fast, saucy, hug the turns and stick to the road—make you glad you're a Ford owner. Can easily be built by aid of life size "Red-I-Kut" patterns and picture instructions. The "Pal" system delivered complete with pressed metal streamlines tall for \$6.40. Garage men make big money building them. Send for prospectus on making sport cars—Jifty Tops and Gosum windshields. Kuempel Co., 1100 Kuempel Bldg., Guttenberg, Iowa.

**Formulas**

Moneymaking Books, Plans, Formulas. Catalog Free. Ideal Book Shop, 5501-E, North Robey, Chicago.

**For the Photographer**

Have you a Camera? Write for free sample of our big magazine, showing how to make better pictures and earn money. American Photography, 118 Camera House, Boston, 17, Mass.

**Games and Entertainment**

Tricks, Puzzles, Jokes, Magical Apparatus, Plays, Stage Supplies, Mind-Reading, Acts and Sensational Escapes. Send 10c for 150-page illustrated 1923 professional catalogue. Oaks Magical Co., Dept. 549, Oshkosh, Wis.

Greatest mind reading act ever sold. Not a toy. Easily mastered. Cannot be detected. Postpaid for \$1.00. The Bonwills Co., Box 797, Macon, Pa.

**Health**

Free to Men—Information of a scientific nature that has brought physical vigor and happiness to thousands. No charge, no obligation. Enclose stamp for reply. C. I. Wood & Co., Colorado Springs, Colorado.

Asthma and Hay Fever Cured to Stay Cured. Write for particulars. A. Butterworth, 374 DeWitt, Boileville, N. J.

Study Sexology—Publication dealing forcefully with the vital problems of intimate marital sex life will be sent on receipt of 20c—Health and Life Publications, Dept. 107, 333 S. Dearborn Street, Chicago, Illinois.

Only twenty cents for copy "How to obliterate Tuberculosis within 48 hours." Also latest discovery, how old weak bodies may be made strong and healthy almost overnight. Positive proof submitted. Dr. Hartmann, 282 West 70th, New York.

**Help Wanted**

We want Salesmen and Agents, either whole or side line to sell our low priced radio books to the trade. Excellent proposition for live wires. The E. I. Company, Publishers, 333 Fulton Street, New York City.

Detectives Earn Big Money. Travel. Excellent opportunity. Great demand everywhere. Experience unnecessary. Particulars free. Write, American Detective System, 1974 Broadway, N. Y.

Be a Mirror Expert. \$3 to \$10 a day; spare time home at first; no capital; we train, start you making and silvering mirrors French method. Free prospectus. W. B. Derr, Pres., 26 McKinley St., Baldwin, N. Y.

Be a Detective; Excellent opportunity; good pay; travel. Write C. T. Ludwig, 1417 Westover Bldg., Kansas City, Mo.

Make Money in spare time mailing letters. Rare opportunity now. Men, send addressed envelope for special plan. Normande R., 147 W. 23d St., New York.

All men, women, boys, girls, 17 to 65, willing to accept Government positions, \$117-\$250, traveling or stationary, write Mr. Ozment, 293, St. Louis, Mo., immediately.

Silvering Mirrors, French plate. Easily learned, immense profits. Plans free. Wear Mirror Works, Excelsior Springs, Mo.

Earn \$25 Weekly, spare time, writing for newspapers, magazines. Experience unnecessary; details free. Press Syndicate, 5665 St. Louis, Mo.

Railway Postal Clerks—Start \$133 month. Railroad pass; expenses paid; questions free. Columbus Institute, H-6, Columbus, Ohio.

Men Wanting Railway Station-Office positions with transportation furnished, experience unnecessary write quick. Baker, Supt. Dept. 78 Wainwright, St. Louis.

Wanted—Men 18 up. Commence \$133 month. Steady. Railway Mail Clerks. Travel—see country. Schedule examination places—free. Write immediately. Franklin Institute, Dept. D24, Rochester, N. Y.

Firemen, Brakemen, Baggage-men, Sleeping car, train porters (Colored), \$140-\$200. Experience unnecessary. 897 Railway Bureau, E. St. Louis, Ill.

**Instruction**

Instruct Yourself for desired Successes. Illustrative chart shows Success (19c) Steps. Postpaid 50 cents. J. E. Morrey, Box 304, Madison Sq. Sta., N. Y.

Learn Chemistry at Home. Dr. T. O'Connor Sloane, noted educator and scientific authority, will teach you. Our home study correspondence course fits you to take a position as chemist. See our ads on pages 803 and 808 of this issue. Chemical Institute of New York, 66 W. Broadway, New York City.

**Languages**

World-Romio System. Masterkey to All Languages. Primers, 23 languages, \$1.94 each language: English, French, German, Italian, Portuguese, Spanish. Pronunciation—Tables, 103 languages, 30c each language. Languages Publishing Company, 3 West 40th Street, New York.

**Improved Made Toys**

Wanted Manufacturers and Houseworkers to manufacture Metal Toys and Novelties. Wonderful opportunity. Millions needed. In Whistling Birds, Wild Animals, Wag Tail Pups, Crowing Roosters, Automobiles, Baseball Players, Statue of Liberty, Indians, Toy Soldiers, Barking Dogs; and 50 others. No experience or tools necessary. Guaranteed casting forms with complete outfit, at cost. From \$5.50 up. We buy goods all year. Cash on delivery. Higher price for finished goods. Contract orders placed. Send for catalog and information free. The Improved Metal Casting Co., 342 East 145 St., New York.

**Machinery and Tools**

Concrete Building Block Machines and Molds. Catalogue free. Concrete Machine Co., 305 South Third St., St. Louis, Mo.

**Manufacturing**

Something special in metal? Models. Tools. Patterns. Experimenting. Manufacturing. Inventions developed. Parma Engineering Works, Brooklyn Station, Cleveland, Ohio.

**Miscellaneous**

Questions Answered on any subject. One dollar each. Money returned if answer cannot be given. Fee for elaborate investigations and reports arranged by correspondence. Technical Associates, P. O. Box 1478, Boston, Mass.

Kodak + Hospital. Camera-Exchange. Used Cameras sold, exchanged, bought (any condition). Expert Camera Repairing a specialty. Send your broken Camera. Turner, 1679 Ave. A, N. Y.

Only \$9.85 men's heavy solid gold ring. Beautiful 1/2 K. African Whitestone gem setting. If you can tell it from a genuine diamond, will refund your money. Send \$1.00. Balance, (\$8.85), when delivered. Williams Co., 538 N. Carrollton Ave., Baltimore, Md.

Moon-O-Light radium paint shines in darkness; 25c per bottle. Gray & Greely Co., Dept. 50, 1448 St. Lawrence Avenue, Bronx, N. Y.

Complete course in Photoplay writing, for \$1 money order. Henry Gardner, Box 581, Little Rock, Ark.

Want to hear from owner having farm for sale; give particulars and lowest price. John J. Black, Chippewa Falls, Wisconsin.

Patented Articles, Models, Brass Work, Machine Construction; Dies Made. Baum's Metal Specialties, 1020 Wyandotte St., Kansas City, Mo.

Free—Complete price list of radio parts. Write Aitken Radio Co., 504 Superior St., Toledo, Ohio.

**Motion Picture Business**

\$35 Profit Nightly. Small capital starts you. No experience needed. Our machines are used and endorsed by Government institutions. Catalog free. Atlas Moving Picture Co., 470 Morton Bldg., Chicago, Ill.

**Motorcycles—Bicycles**

Don't buy a Bicycle Meter Attachment until you get our catalogue and prices. Shaw Mfg. Co., Dept. 6, Galesburg, Kansas.

**Novelties**

Magic goods, cards, books, novelties, Catalogue free. Clifford Fenner, 2401 Jefferson, Louisville, Ky.

**Orchard Lands**

Big returns from Pecan, Orange, and Fig Groves. Guaranteed care. Small monthly payments. Dept. 1, Suburban Orchards Co., Biloxi, Mississippi.

**Personal**

Exchange Interesting Letters with new friends. Write Dolly Gray Club, Box 186K Denver, Colorado.

Exchange Cheery Letters with new friends. Write Betty Lee, Inc., 4254 Broadway, New York City. Stamp appreciated.

Exchange jolly letters with new friends. Lots fun! Send stamp. Eva Moore, Box 908, Jacksonville, Fla.

Correspondence Club—Many wealthy members everywhere. Fascinating particulars free. Smith, Box 1167Y, Denver, Colo.

Your horoscope. Business, changes, social, matrimonial prospects. Send birthdate and 10 cents (stamps) for remarkable test reading. Zanya, 202-J West 105th Street, New York.

Lonely Hearts, join our Club, be happy, correspondence everywhere, many wealthy, descriptions, photos free; either sex, most successful method, 23 years' experience. Standard Corr. Club, Grayslake, Ill.

**Phonographic Supplies**

Build Your Phonograph. Quality phonoparts. Famous Herando Motors. Also original Perfection Motors. Electric Motors, tonearms, reproducers, amplifiers, case material, accessories. Free blueprints and building instructions. Big Saving. Wonderful results. Prompt delivery. Catalogue mailed for ten cents. Hooster Mfg. & Supply Company, 321 Baldwin Block, Indianapolis, Indiana.

**Publishers Choices**

Radio Fans send for radio price list of bargains. Satisfaction guaranteed. H. J. Frank, Box 950, East Pittsburgh, Pa.

**Patent Attorneys**

Inventors: Protect your invention by Experts, skilled in Radio-Electrical, Chemical, and Mechanical fields. New illustrated Booklet, giving much necessary and very useful information which every inventor should know, sent free upon request. Write today to A. M. Wilson, Inc., (Radio 3ARR) 312 Victor Building, Washington, D. C.

Inventors—Send for form "Evidence of Conception" to be signed and witnessed. Form, fee schedule, information free. Lancaster and Allwine, 242 Ouray Bldg., Washington, D. C.

Millions spent annually for ideas! Hundreds now wanted! Patent yours and profit! Write today for free books—tell how to protect yourself, how to invent, ideas wanted, how we help you sell, etc. 212 Kresge Bldg., American Industries, Inc., Washington, D. C.

Patents. Send for free booklet. Highest references. Best results. Promptness assured. Send model or drawing for examination and opinion. Watson E. Coleman, Patent Attorney, 624 F Street, Washington, D. C.

Inventors write me about patents. My fees payable monthly. Booklet free. Frank Fuller, Washington, D. C.

Herbert Jenner, Patent Attorney and Mechanical Expert, 624 F Street, Washington, D. C. I report if patent obtainable and exact cost. Send for circular.

Lacey Patent-Sens. "The book the inventor keeps." Free. See page 812.

Patents Procured, Trade Marks Registered. A comprehensive, experienced, prompt service for the protection and development of your ideas. Preliminary advice gladly furnished without charge. Booklet of information and form for disclosing idea, free on request. Richard B. Owen, 130 Owen Bldg., Washington, D. C., or 273-T Woolworth Bldg., New York.

Inventors! Record invention legally before disclosing to others. Our Invention Record and Data Sheet shows how. Sent free and valuable information given on patent procedure, costs, etc. Report on patentability includes copies of patents nearest your idea. O'Connell & O'Connell, 409 Jenifer Building, Washington, D. C.

Monroe Miller, Ouray Building, Washington, D. C., patent attorney, mechanical and electrical expert. Best quality of work and results. Moderate charges.

Before or after filing your application for patent, it will pay you to read over my "Inventors Advisor No. 4." Free for asking—Write: M. Labiner, Registered Patent Attorney, 3 Park Row, New York.

Patents Procured. Send sketch or model today for examination, prompt report and advice. No charge for preliminary advice. Write for free booklet and blank form on which to disclose your idea. Highest references. Promptness assured. Clarence A. O'Brien, Registered Patent Lawyer, 319 Security Bank Building, Directly across the street from Patent Office, Washington, D. C.

M. P. Laughlin, Patents. Engineer-Attorney, 48 East 41 Street, New York.

Commercialize your ideas according to My Cooperative Plan. Booklet free. Ralph Burch, Patent Lawyer, Jenifer Building, Washington.

H. F. Lowenstein, Registered Patent Attorney, Radio Expert, 825 McLaehen Building, Washington, D. C.

"Inventors' Guide" free on request; gives valuable information and advice for all who have original ideas or improvements. Frank Ledermann, Registered Attorney and Engineer, 15-E Park Row, New York.

**Patents**

Unpatented Ideas can be sold. I tell you how and help you make the sale. Particulars free. Write W. B. Greene, Jenifer Building, Washington, D. C.

**Patents For Sale**

Brush's Pad for cleaning and spotting any garments, etc. No. 1,224,581 for \$16,000.00. C. B. Twyford, 617 Bailey, Zanesville, Ohio.

Automobile tire perfected, guaranteed to stand test. Bonus and royalty. Might sell. Investor of merit given prompt attention. J. J. Krudwig, 225 1/2 W. 13th St., Fort Worth, Texas.

**Photoplays, Stories, Etc.**

Wanted. Men and women ambitious to make money writing Stories and Photoplays. Send for wonderful Free Book that tells how. Authors' Press, Dept. 131, Auburn, N. Y.

\$\$\$ For Ideas. Photoplay Plots accepted, any form; revised, criticized, copyrighted, marketed. Advice free. Universal Scenario Corporation, 233 Security Bldg., Santa Monica & Western Ave., Hollywood, Calif.

Big Money in Writing photoplays, short stories, poems, songs, etc. Send today for free copy America's greatest magazine for writers. Filled with practical help in writing and selling. Writer's Digest, 637 Butler Building, Cincinnati, Ohio.

**Salesmen Wanted**

\$742 Last Month for Beck of Buffalo introducing latest advertising plan; nothing else like it; every merchant wants it; easy sales; no deliveries; no collections; specialty salesmen write quick for offer. National Adv. Service, P.O. Box 43, La Grange, Ind.

"Salesmen Wanted." Amazing Invention—almost human. The Little Draft-Man—a wonderful labor-saver, automatically opens furnace or boiler while owner sleeps. Pays for itself in fuel saved. Simple, efficient, can be installed by anyone in five minutes. 100 percent profit. Thousands being sold. \$25 daily easily made. Act quick. Address: Little Draft-Man Co., Dept. C, Grand Rapids, Michigan.

## Fat Can Be Reduced in Just Two Ways

Medicines Are Worthless and Generally Harmful

Fat cannot be sweated out—the first drink of water you take after perspiring restores the lost weight—Fat cannot be rubbed off—If rubbing did break it up it would simply float around in the blood and be re-deposited elsewhere—It cannot be squeezed out by rubber bands or corsets—massage furnishes a little exercise but squeezing has no effect at all.

The Real Solution Is Simple and It Works

Fat enters the body when food is consumed in excess of one's needs; it can be removed by lessening the fat making food intake or by muscular exercise. There is no other way for it to get in or get out. All other pills of the body may sometimes fail to respond even when the best known methods are applied. Not so with obesity. The cause and elimination of obesity is a matter of mathematics and there is no argument about it.

In his new book entitled **"HOW TO REDUCE WEIGHT"** **Bernarr Macfadden**

gives you the complete recipe for weight reduction including full dietary instructions, actual menus, food classifications and reduction exercises.

It is by all odds the most thorough and effective work on weight reduction that we have ever seen. Only 50c post-paid—send for it today.

Clip this ad—enclose with 50c and mail to us. Or we will enter your subscription to **PHYSICAL CULTURE Magazine** and mail you a copy of "How to Reduce Weight" for \$3.10.

MACFADDEN PUBLICATIONS, INC.  
Dept. S.I.-11

Macfadden Building, 1926 Broadway, New York City

## PIMPLY SKIN made WELL

When a few applications of this wonder working lotion has cleared faces of pimples, blackheads, acne eruptions on the face or body, enlarged pores, oily or shiny skin, you can realize why CLEAR-TONE has been tested and approved in over 100,000 Test Cases.

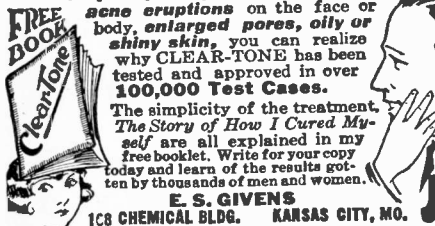

**FREE BOOK**  
The simplicity of the treatment. *The Story of How I Cured Myself* are all explained in my free booklet. Write for your copy today and learn of the results gotten by thousands of men and women.

**E. S. GIVENS**  
108 CHEMICAL BLDG. KANSAS CITY, MO.

## DON'T WEAR A TRUSS BE COMFORTABLE

Wear the Brooks Appliance, the modern scientific invention which gives rupture sufferers immediate relief. It has no obnoxious springs or pads. Automatic Air Cushions bind and draw together the broken parts. No salves or plasters. Durable. Cheap. Sent on trial to prove. Mr. C. E. Brooks its worth. Beware of imitations. Look for trade-mark bearing portrait and signature of C. E. Brooks which appears on every Appliance. None other genuine. Full information and booklet sent free in plain, sealed envelope.

**BROOKS APPLIANCE CO., 172 State St., Marshall, Mich.**



## SEX

Facts other sex books don't dare discuss are plainly told in "Where Knowledge Means Happiness." Creates a new kind of married love. One reader says: *It contains more real information than all other sex books put together.*

From "Where Knowledge Means Happiness" turn mail, for \$1.00, cash, money order, check or stamps  
Copyright 1921  
Dept. 39 COUNSEL SERVICE, 257 W. 71st St. N.Y.



**DEAFNESS IS MISERY**  
I know because I was Deaf and had Head Noises for over 30 years. My invisible Antiseptic Ear Drums restored my hearing and stopped Head Noises, and will do it for you. They are Tiny Megaphones. Cannot be seen when worn. Effective when Deafness is caused by Catarrh or by Perforated, Partially or Wholly Destroyed Natural Drums. Easy to put in, easy to take out. Are "Unseen Comforts." Inexpensive. Write for Booklet and my sworn statement of how I recovered my hearing.

**A. O. LEONARD**  
Suite 369, 70 5th Avenue -- New York City

**ADULTS! SEX KNOWLEDGE BOOKS**  
Instructive, authoritative, profusely illustrated in natural colors, etc. Not the cheap sort. Contains everything one should know both before and after marriage to insure health and happiness. Large catalog free. **M. F. SMETANA & COMPANY, OWOSSO, MICH.**

### Radio Equipment

Genuine Edison Elements (new) for making "B" Batteries, obtained from U. S. Government. A positive and negative element—6c; glass tube—3c; all other parts at reasonable prices. Postage, etc. 50c extra per order. Free instructions. Todd Electric Company, 109 West 23rd St., New York.

### Short Stories, Manuscripts Wanted

Earn \$25 Weekly Spare Time writing for newspapers, magazines. Experience unnecessary; details free. Press Syndicate, 566 St. Louis, Mo.

Stories, Poems, Descriptive Articles, Plays, etc. Are Wanted for Publication. Monthly cash prize. Submit Mss. or write Literary Bureau, 165, Hannibal, Mo.

### Song Poems Wanted

Write the Words for a Song. We compose music. Our Chief of Staff wrote many big song-hits. Submit your song-poem to us at once. New York Melody Corp., 412 Romax Bldg., New York.

Prominent London Music Publisher is open for available songs by American Writers, Amateur or Professional; Songs judged on merit—not writers' reputations. For further particulars write to American Representative, Jack Mahoney Dept. 1, 145 West 45th St., New York.

### Stammering

St-Stu-t-t-tering and Stammering cured at home. Instructive booklet free. Walter McDonnell, 105 Potomac Bank Bldg., Washington, D. C.

### Stamps and Coins

Stamps—50 varieties, Brazil, Peru, Cuba, etc., 10c. 50 different U. S., 25c, 1,000 hinges, 10c, 1,000 mixed, 40c. 1st free. C. Stegman, 5955 Cote Brillante, St. Louis, Missouri.

Stamps—20 Unused. All different. Free. Postage 3c. Mention paper. Quaker Stamp Co., Toledo, Ohio.

California Gold, quarter size, 27c; half-dollar size, 53c. Columbian nickel and catalogue, 10c. Norman Schulz, Box 146, Colorado Springs, Colo.

Free a Set of two flume tryangles to approval applicants sending two cents for postage. Mohawk Stamp Co., Hackensack, N. J.

### Typewriters

Typewriters sold on payments. Free trial. Payne Company, Rosedale, Kansas.

All standard makes, \$10 up. Fully guaranteed. Free trial. Write for complete illustrated lists. Northwestern Exchange, 320 Goethe St., Chicago.

### Wanted

Detectives Earn Big Money. Work home or travel. Experience unnecessary. Particulars free. American Detective System, 1974 Broadway, N. Y.

### Wireless

Attention! 50 Vacuum Tube Hook-Ups. The greatest collection of Vacuum Tube Circuits ever brought under two covers at such insignificant cost. These diagrams will be found in the great "Rasco" catalogue which contains raw materials and parts in a greater profusion than any other catalogue. 15c in stamps or coin will bring the catalogue to you. Radio Specialty Company, 100 Park Place, New York City.

Boys, don't overlook this! The "Rasco" Baby Detector. Greatest detector ever brought out with molded base. Fully adjustable. See former advertisements in this publication or our catalogue. Detector with Galena Crystal complete, 50c; the same Detector with Radiocite Crystal, 75c. pre-paid. Send for yours today. Radio Specialty Co., 100 Park Place, New York City.

Radio Generators—500 Volt 100 Watt \$28.50 each Battery Chargers \$12.50—11gh Speed Motors, Motor-Generator Sets all sizes. Motor Specialties Co., Crafton, Penna.

Motors—G. E. 1/4 HP. \$15.00—1/2 HP. \$32.50—1 HP. \$62.50. Generators 8 volt 10 amp \$15. 32 volt 500 watt \$30. Other sizes. Low prices. Motor Specialties Co., Crafton, Penna.

The How and Why of Radio Apparatus, by H. W. Secor, E. E. This newest book on radio matters fulfills a distinct gap in wireless literature in that, while the treatment is made as understandable and as free from mathematics as possible, it at the same time incorporates a wealth of technique and instruction for the Radio Amateur—the Radio Operator—the Installation and Designing Expert—as well as teachers and students of the subject in general. A very broad field has been covered by the author, at the same time giving a great deal of information not found in other text books. If you are engaged in any branch of the Radio or allied arts at all you will surely need this latest contribution to radio literature, which is destined to be found on every radio man's book shelf before long. A glance at the following list of chapters gives but a very scant idea of the extensive and useful radio knowledge provided in its text: The Induction Coil; The Alternating Current Transformer; Radio Transmitting Condensers; The Spark Gaps; Radio-Transmitting Inductances; Radio Receiving Tuners; Radio Receiving Condensers; Detectors; Telephone Receivers; Radio Amplifiers; Construction of a Direct Reading Wavemeter and Decimeter; Antenna Construction; The Calculation and Measurement of Inductances; Appendix containing very useful tables, covering all subjects treated in this very unusual book. This newest of Radio Works, cloth bound in Vellum de Luxe, Gold Stamped and Hand Sewed, has 160 pages. Size of book 6x9 inches. The How and Why of Radio Apparatus, Postpaid, \$1.75. Experimenter Publishing Co., Book Dept., 53 Park Place, New York City.

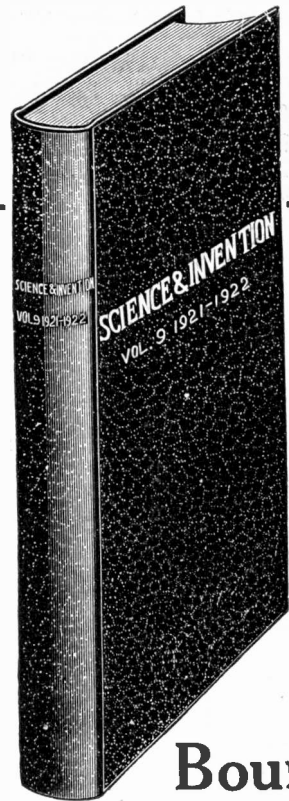

## Bound Volume No. 9

May, 1921—April, 1922

CONTAINS

1200 Pages with over 1500 Illustrations

and Over 700 Articles by the Foremost American and Foreign Writers

We have also a limited amount of the following Bound Volumes of *Science and Invention* (Electrical Experimenter):

Vol. No. 6—May, 1918, to April, 1919.

Vol. No. 8—May, 1920, to April, 1921.

Each volume bound in stiff board covered with green vellum and gold stamped.

Price for vol. No. 9.....\$2.25

Price for vol. 6 or 8..... 2.00

ALL THREE VOLUMES 6.00  
Send Express Collect.

EXPERIMENTER PUBLISHING Co.  
53 Park Place, N. Y.

Gentlemen:  
Enclosed find \$.....for which send me bound vol. of S. & I. No. 6 ( ), No. 8 ( ), No. 9 ( ), by express collect.

Name .....

Address .....

Town ..... State .....



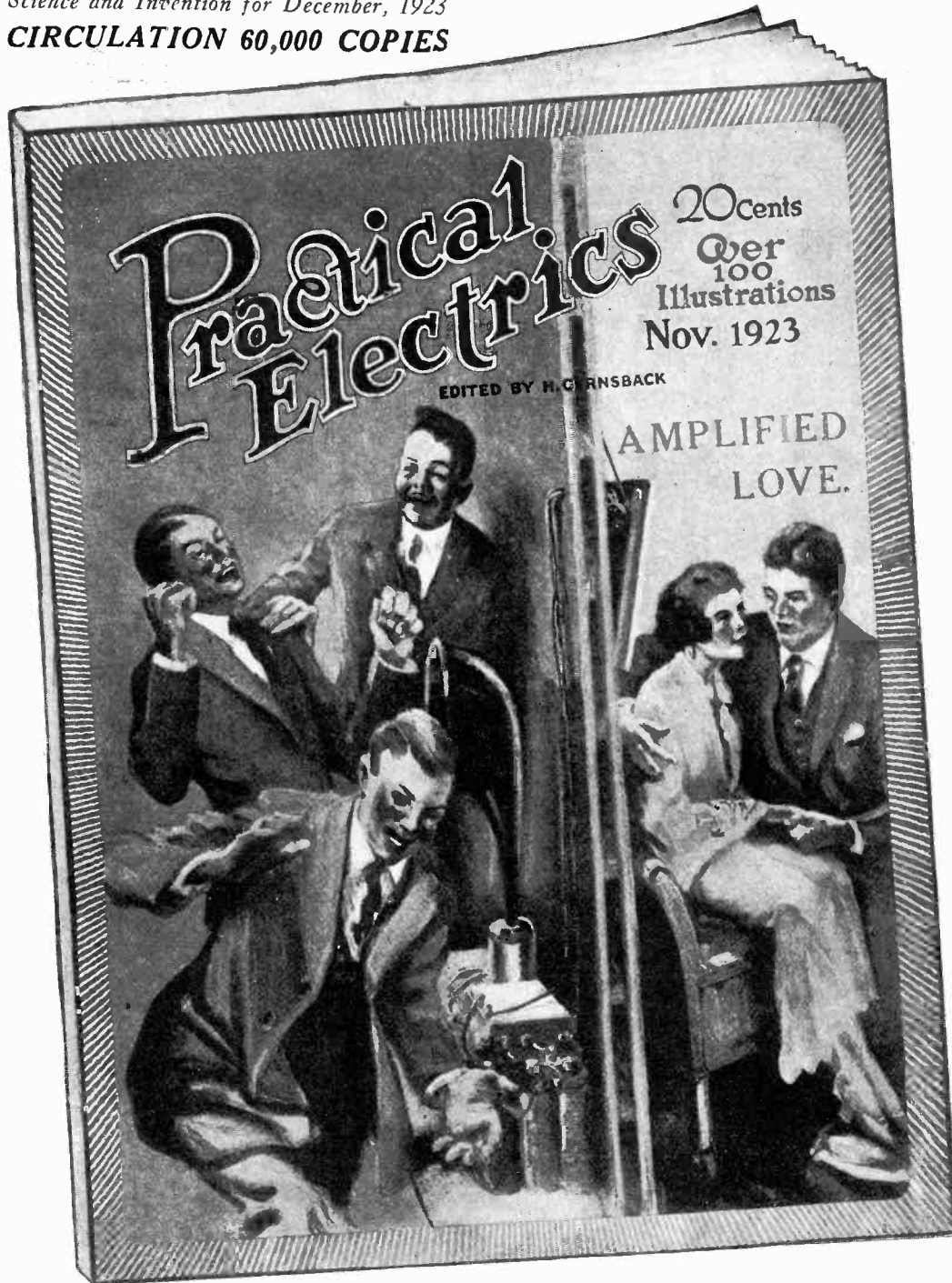

This magazine is  
 edited by  
**H. GERNSBACK**  
 also Editor of  
**RADIO NEWS**  
 and  
**SCIENCE and  
 INVENTION**

**100 Articles  
 Over  
 100 Illustrations**

**FOR SALE AT  
 ALL NEWS STANDS**

**20c. the Copy  
 \$2.00 a Year  
 Canada and Foreign  
 \$2.50 a Year**

SEND FOR  
**FREE**  
 SAMPLE COPY  
 TODAY

See Coupon Below  
 for **SPECIAL OFFER**

## “The Electrical Magazine for Everybody”

**P**RACTICAL ELECTRICS is probably the most novel magazine of its kind ever conceived. It is personally edited by H. Gernsback, editor of **SCIENCE & INVENTION** and **RADIO NEWS**. Mr. Gernsback, who founded the old “Modern Electrics” as well as the “Electrical Experimenter,” knows thoroughly what his readers want and have wanted for many years. **PRACTICAL ELECTRICS**, the 100% electrical magazine eclipses the best that was in “Modern Electrics” and “Electrical Experimenter.”

Electricity covers such a tremendous field that the man who does not keep abreast of it does himself a great injustice. **PRACTICAL ELECTRICS** covers that field from every angle. It is written in plain every-day language that all can understand. It portrays the entire electrical development of the month faithfully in non-technical language. It caters to everyone interested in electricity, be he a layman, an experimenter, an electrician or an engineer—each will find in this magazine a department for himself and plenty more.

The December issue now on the news-stands contains 48 pages, over 100 different articles and over 100 illustrations, with an artistic cover in three colors. Professor T. O’Conor Sloane, Ph.D., is associate editor of the magazine.

### INTERESTING ARTICLES IN DECEMBER “PRACTICAL ELECTRICS”

- Thermostat System, By Edward Dowis.
- Trick Shuffleboard, a gambler’s plant exposed. By Walter B. Gibson
- Electric Baseball Scoreboard, of general interest at the present time. By Samuel Fariss
- High Voltage Transmission, how 220,000 volts are taken care of on a power line. By F. W. Peek, Jr., Consulting Engineer, General Electric Co.
- Voyaging Beyond the Visible. By M. R. McCabe.
- Electric Halloween, also of timely interest at present. By Paul Valliere, Quebec.
- Army Loud Speaker.

### PRIZES

This magazine offers a number of prizes, as follows:  
 Our \$50.00 Prize Contest for Junior Electricians and Electrical Experimenters includes as its elements simplicity, as great a degree of novelty as possible, and practicability.  
 Also a new prize contest giving four prizes amounting to \$37.50 for the best account of an odd electrical experience.  
 \$3.00 for the best article on Elec-Tricks, the new department.  
 \$3.00 for the best “short-circuit,” the semi-humorous department.  
 In addition to this, the magazine pays high prices for all electrical experiments, electrical articles, etc. See current issue for full details.

This issue also contains articles by some of the greatest electrical writers, workers and students. The magazine will prove a revelation to any one interested in electricity.

Every issue besides its many other features contains the following departments:

- “New Things Electric”
- “Experimental Electrics”
- “Electrical Digest”
- “Junior Electrician”
- “Elec-Tricks”
- “Motor Electrics”
- “Short Circuits”

“How and Why” (Questions and Answers.)

Make all checks payable to: “Practical Electrics Co.”

S. & I. 12-23

### SPECIAL OFFER

Gentlemen:

Although your regular price is \$2.00 per year, you will accept my subscription at \$1.75 per year (Canada and foreign \$2.25). I enclose the money herewith and I have written my name and address in margin below.

**PRACTICAL ELECTRICS CO., 53 Park Place, New York**



# By Merit Alone, Chiropractic

has grown from an idea in the mind of one man in 1905, to the second largest health profession in the world.

There are now approximately 25,000 practitioners, more than a hundred schools and about 15,000 students.

Twenty-six state governments have recognized the science as distinct and different from anything else on earth.

In less than eighteen years, this growth has been effected, not only without the aid of other professions engaged in getting the sick well, but in spite of their utmost efforts to prevent it.

Chiropractic has never had a single dollar of endowment from state or national governments. It has overcome the prejudice of the public, the opposition of other professions intent on its extermination, and adverse laws in every state in the Union.

It has recruited its patients from among those upon whom other methods failed, and with these failures of other methods upon which to prove its efficiency, it has made the most phenomenal growth of any health profession in the history of the world.

Employ none but a competent chiropractor.

**DEFINITION**  
The practice of Chiropractic consists of the palpation and adjustment, with the hands, of the movable segments of the spinal column to normal position for the purpose of releasing the prisoned impulse.



Write for information regarding Chiropractors or Schools to the

*Universal Chiropractors' Association, Davenport, Iowa, U.S.A.*

All Rights Reserved



# ENGINEERS

## JUST OUT

### A \$10,000

#### MASTER SET

##### ON LATEST

###### ENGINEERING



**AUDEL'S ENGINEERS & MECHANICS GUIDES** 4750 pages—8754 Illustrations—Pocket Size—Flexible Binding

**\$1** Per Month

Every Engineer, Mechanic and Electrical Worker will welcome this new Master Set. It will answer your problems. It will help you with your daily work. A sure source of advancement and higher pay. Complete up-to-date information that is thoroughly and easily explained on every branch of Modern Engineering and Electrical Practice.

A dollar a month is all it costs to have in your possession all the latest information on engineering.

**\$12** Complete

**THE GUIDES TELL YOU ALL ABOUT**

Theory, Practice and Operation of ALL Steam Engines, Valve, Motions, VALVE SETTING; CORLISS ENGINES, UNIFLOW and POPPET VALVE ENGINES, LOCOMOBILES—Locomotive—Marine Engines; Turbines; Rotary Engines—the Indicator—Lubrication—PRACTICAL MANAGEMENT. How to use Indicator—GAS, OIL and DIESEL ENGINES—Aeroplanes, Aviation—HOW TO SELECT AN ENGINE. STEAM ENGINE DESIGN. Theory and Construction of ALL Steam Boilers; Heat-Combustion; Fuel and Flue Gas Analysis—CO<sub>2</sub> Recorders—Characteristics of Boilers—

Materials. Boiler Construction—Mechanical Stokers—Oil Burners—Setting—Chimneys—Mechanical Draught—HOW TO SELECT A BOILER. BOILER DESIGN based on A. S. M. E. BOILER CODE—OPERATION of Steam Boilers—Pipes and Pipe Fitting—Heating and Ventilation—Refrigeration—Cooling Towers—Condensers—Distilling Apparatus—Elevators—Cranes and Hoisting Machinery—Ropes and Cables—Splicing—Compendium of Practical Electrical Engineering—Ready Reference Index, covering entire field of Modern Electricity.

**SHIPPED TO YOU FREE!**

Not a cent to pay until you see the books. No obligation to pay unless you are satisfied. Send coupon now—today, and get this new Master Set for Engineers and see if it is not worth \$100 to you. Pay only \$1.00 a month.

Theo. Audel & Co., 72 Fifth Ave., New York City. Please submit me for free examination Audel's "New Eight" Master Set for Engineers and Mechanics. If satisfactory I agree to send you \$1 within seven days, and to further mail you \$1 each month until \$12 is paid.

Name.....  
 Occupation.....  
 Employed by.....  
 Home Address.....  
 S.-I. Dec.

# "Tune In" on a Real Job and Get the Pay of a Specialist

*This Free Book Will Show You  
How to Earn \$1,500 to \$10,000  
Yearly as a Radio Expert*



**T**HE man who would be a success in business today must be a specialist. The market is already crowded with clerks, stenographers, accountants and detail men of every description. And as the number of applicants increases, the pay and opportunities diminish. Not that these men are unnecessary, for their work is important and essential. But the competition has always been keen in general work of this kind and it is bound to increase in proportion to the number of good men available.

For that reason Radio needs good men. It is ready to treat them right and pay them well. And for the men who "get in" NOW, the best is none too good.

## Get Into This Big Paying Profession

Consider for a moment the possibilities of Radio. The shores of every continent are dotted with transmitting and receiving stations. Practically every vessel is now equipped for communication with land and other ships. Hotels, railroad terminals, public buildings and Government stations are flashing their business messages across cities, rivers, mountains and seas. At night, millions of men, women and children are "listening in" to music, speeches, news, important events and business reports, broadcast for their amusement and education. Factories, stores, banks, laboratories, business houses and newspaper offices are employing Radio experts in every branch of the profession. Yet the demand for good men is far greater than the supply. If YOU are sick of plugging along in the daily grind of monotonous office routine—held down by the thousands of men who are doing the same work as you—get out of the rut into this big paying profession.

## You Can Qualify at Home Easily and Quickly

On land and sea, the news of the world's progress is flowing under the skilled fingers of Certified "Radio-tricians"—men who are well-paid, honored and respected for their specialized knowledge and important work. A short course of training at home for the enjoyable work of Radio, will quickly enable you to be independent, to travel and see the world if you wish, or establish yourself in a permanent position in your own town. Radio will take you out of the rut of a bare existence, into the enviable standing of a specialist—with unlimited opportunities for honor, power, wealth and satisfaction. It will make you a doer of real things, a vital force in the world and an important factor in your own community. Start to train NOW for a Radio position while the profession is growing. You can start TODAY.



**This  
FREE  
BOOK  
Will Tell  
You How**

men, in their spare hours at home, for every important branch of the big Radio industry. To any man who is eager to better his conditions and make a place for himself in this fascinating and profitable profession, we will gladly send a copy of this timely, helpful book—*absolutely free*. It is called "Your Opportunities in Radio" and it will open up a chain of opportunities that you will do well to carefully consider.

You assume no obligation whatever in sending for this interesting, helpful book. It is yours for the asking—FREE. For that reason you can hardly afford to miss it. Ask for a copy today and learn the tremendous opportunities that are open in Radio, how we are preparing men at home to take advantage of these opportunities, and how we aid them in securing the kind of positions that lead to independence and success, "Tune in" on a real job—mail the coupon for this Free Book today—and then "stand by" until it arrives by return mail. It will PAY you! National Radio Institute, Dept. 14M, Washington, D. C.

## This Will Bring It

NATIONAL RADIO INSTITUTE,  
Dept. 14M, Washington, D. C.

Without any obligation on my part, please send me a FREE copy of your book, "Your Opportunities in Radio." Also tell me how your Free Employment Service will help me secure a position, and send me details of your special short-time offer.

Name .....  
Street .....  
City ..... State .....

### PICK OUT THE JOB YOU WANT WE WILL HELP YOU GET IT

This is a brief list of the positions in the Radio field today, and the salaries paid—

Radio Mechanic, \$1,500 to \$4,000 a year.

Radio Inspector, \$1,800 to \$4,500 a year.

Radio Salesmen, \$2,000 to \$10,000 a year.

Radio Engineer, \$3,500 a year and

Radio Executives, up to \$15,000 a year.

Radio Instructor, \$200 to \$500 a month.

Radio Draftsmen, \$7 to \$15 a day.

First Class Ship Operator, \$105 a month, all expenses paid.

Second Class Ship Operator, \$95 a month, all expenses paid.

Radio Operator, \$85 a month.

Radio Communication Operator, \$75 a month.

Radio Technician, \$100 a month.