

Science and Invention

MAY
25 CENTS

Giants of
Industry
See Page 19

Riding the
Thunder Clouds
—in a Motorless Plane

Los Angeles' Traffic Plan
Scientific Wonders
of Chicago

Snow-Capped
Equatorial Africa

By
Carveth
Wells



42 Miles on 1 Gallon of GAS

WILL YOUR CAR DO IT ?

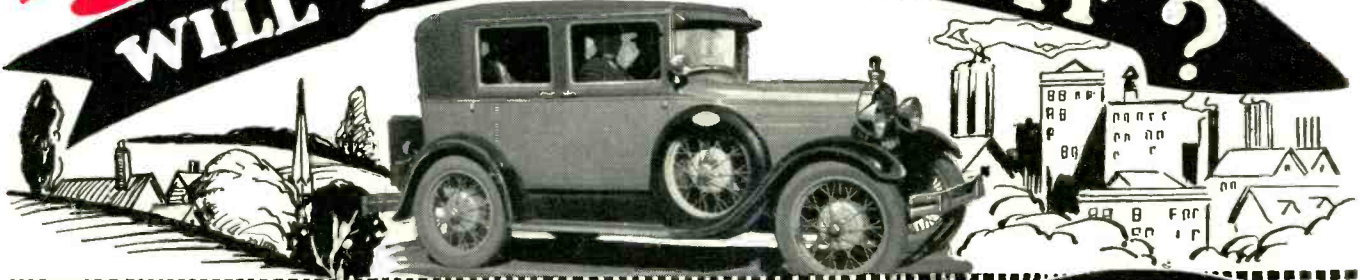

New Moisture Humidifier & Carbon Eliminator

for all Makes of Cars, Trucks, Tractors and Engines

An amazing Scientific Humidifier has been patented throughout the World that beats any ever got out. It makes engines run ALL THE TIME with the same wonderful efficiency they do on a cool moist night. It gives MORE pep and power, HIGHER top speed, eliminates hard carbon, and gives AMAZING mileage. Fords report 28 to 42 miles per gallon. Other makes (both American and Foreign) report marvelous increases of 1/4 to double mileage. Some of the best records are:

Miles	Miles	Miles	Miles
Buick.....28 1/4	Essex.....32	Nash.....30	Pierce Arrow.....22
Cadillac.....21 1/2	Ford (Model T).....42	Oakland.....31	Pontiac.....31
Chevrolet.....41	Ford (Model A).....40	Oldsmobile.....34 1/2	Reo.....26 1/2
Chrysler.....30 3/4	Hudson.....23 1/2	Packard.....21 1/2	Studebaker.....29
Dodge.....31 1/2	Hupmobile.....24 1/2	Plymouth.....29	Whippet.....41
Durant.....41 3/4	Marmon.....21 1/2	Graham-Paige.....23 1/2	Willys-Knight.....29

And Hundreds of Other Wonderful Records on ALL American and Foreign Makes

Big Profits

to Man with Car Spare or Full Time

\$350 to \$1500 a month
 1 man \$4,939.66 in 3 1/2 months.
 Another \$1,656.60 in 58 days.
 \$5,150.00 in 5 months to another.
BIG MONEY can be—IS being made.

Fitting Motors With Vix

One man sold 8 first morning.
 Another sells all 3 men can install.
 Another's profits as high as \$100.00 a day.

VIX sells itself by 8 STARTLING demonstrations — BIG, STUNNING, ASTOUNDING DEMONSTRATIONS. Successful VIX men make MORE MONEY than they ever made before.

Free Trial Try This New Principle Gas Saver AT MY RISK

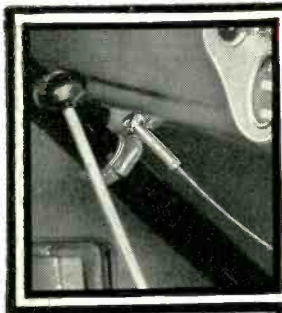

Try this wonderful VIX Moisture Humidifier and Carbon Eliminator AT MY RISK on YOUR OWN CAR to prove that VAPOR MOISTURE (drawn from Radiator to Engine) gives you that wonderful night driving effect ALL THE TIME with MORE mileage from gas and oil—eliminates hard carbon accumulation — gives MORE power, a SNAPPY, PEPPY motor. FASTER acceleration, a SMOOTHER, QUIETER running engine and HIGHER top speed.

VIX will PROVE ITS MONEY SAVING MERIT on your own car by 8 DEMONSTRATIONS—conducted by yourself AT MY RISK—the most SENSATIONAL, most ASTOUNDING, most CONVINCING DEMONSTRATIONS you ever saw. If you don't find from your tests that it does MORE than I claim, return it and it COSTS YOU NOTHING. I want wide-awake, hustling, County, State, Province and National Agencies everywhere, part or full time, to make \$350 to \$1500 per month filling the great DEMAND for this wonderful invention wherever introduced. Write for my FREE TRIAL and MONEY MAKING OFFER. Use coupon below.

WALTER CRITCHLOW

Inventor and Manufacturer, 863-C Street, WHEATON, Ill., U. S. A.

FREE VIX offer Mail Now

WALTER CRITCHLOW
 INVENTOR and MANUFACTURER
 863-C Street, Wheaton, Ill., U. S. A.

Please send me without obligation or charge your FREE TRIAL and MONEY MAKING VIX OFFER.

Name.....
 Address.....
 Town.....State.....

Pictures here and at top show Model "B" VIX attached to my own New Model A Ford. This car is wonderfully improved in performance with the VIX Moisture Humidifier. So is every Auto, Truck, Tractor, Taxi, Bus, Marine, Stationary and Aircraft Engine, both American and all Foreign makes.

GUARANTEED TO SAVE { 1/4 to 1/2 Gas
 Carbon Cleaning
 Engine Repairs
or Costs You Nothing

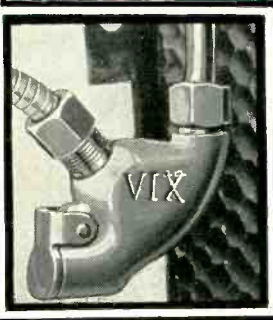



MEN!

Get Your Copy of My *New* Book

It shows you

How to get a good job in the Radio Industry

Hundreds of Jobs paying \$50, \$60, \$75, \$100 a week are opening in Radio every year.

J. E. SMITH, Pres
NATIONAL RADIO INSTITUTE

I showed these men how to get *Big Pay* jobs like these



Seldom Under \$100 a Week

"My earnings in Radio are many times bigger than I ever expected they would be when I enrolled. In November I made \$577. December \$645, January \$465. My earnings seldom fall under \$100 a week. I merely mention this to give you some idea of what a Radio man can do who has the training."

E. E. WINBORNE,
1414 W. 48th St., Norfolk, Va.



\$3000 a Year in Own Business

"I cannot give N. R. I. too much credit for what I have been able to do in Radio. I can safely say that I averaged \$3000 a year for the past three years. I am in the Radio business here. Any man who really wants to advance cannot go wrong in Radio. There is certainly a lack of trained men."

FRED A. NICHOLS,
P. O. Box 207, Eaton, Colo.

If you are earning a penny less than \$50 a week, send for my book of information on opportunities in Radio. It is free. Radio's amazing growth is making hundreds of fine jobs every year. My book shows you where these jobs are, what they pay, how I can train you at home in your spare time to be a Radio Expert.

You have many Jobs to choose from

Broadcasting stations use engineers, operators, station managers and pay \$1,800 to \$5,000 a year. Manufacturers continually need testers, inspectors, foremen, engineers, service men, buyers for jobs paying up to \$15,000 a year. Shipping companies use hundreds of operators, give them world-wide travel with practically no expense and \$85 to \$200 a month besides. Dealers and jobbers (there are over 35,000) are always on the lookout for good service men, salesmen, buyers, managers and pay \$30 to \$100 a week for good men. Talking Movies pay as much as \$75 to \$200 a week to men with Radio training. There are openings almost everywhere to have a spare time or full time Radio business of your own—to be your own boss. Radio offers many other opportunities. My book tells you about them. Be sure to get it at once.

My New 8 Outfits of Parts give you extensive Practical Radio Experience

With me you not only get the theory of Radio—you also get practical Radio experience while learning. You can build over 100 circuits—build and experiment with the circuits used in Atwater-Kent, Majestic, Crosley, Eveready, Stewart-Warner, Philco, and many other sets. These experiments include A. C. and screen grid sets, push pull amplification and other late features. When you finish my course you won't need to take "any old job" just to get experience—you will be trained and experienced ready to take your place alongside men who have been in the field for years.

Back view of 5-tube A. C. screen grid tuned Radio frequency set—only one of many circuits you can build with the parts I give without extra charge.



I Will Train You at Home in Your Spare Time

Hold your job until you are ready for another. No need to leave home. All I ask is part of your spare time. I have doubled and tripled the salaries of hundreds through my practical home-study training. You don't have to be a high school or college graduate. My course is written in easy, simple terms that most anyone can understand.

My course includes Talking Movies, Wired Radio, Television

My course is up-to-date with Radio's latest uses and improvements. It includes Radio's application to Talking Movies, Television and home Television experiments, Wired Radio, Radio's use in Aviation, in addition to fitting you for many other lines. When you finish you won't be a "one job" man. You will be trained for many jobs.

Money Back If Not Satisfied

I will agree in writing to refund every penny of your tuition if you are not satisfied with my Lesson Texts and Instruction Service when you have finished my course. This agreement is backed by the Pioneer and World's Largest organization devoted entirely to training men and young men for good jobs in the Radio industry, by correspondence.

Find out what Radio offers you Get My Book

This book gives you the facts on Radio's opportunities and the many features and services of N.R.I. training. It gives you 100 letters from actual students who have proved that my methods are successful. Get your copy today. There is no obligation.

J. E. SMITH, President,
National Radio Institute, Dept. OES
Washington, D. C.

THIS COUPON IS GOOD FOR ONE FREE COPY OF MY NEW BOOK



J. E. SMITH, President
National Radio Institute, Dept. OES
Washington, D. C.

DEAR MR. SMITH:—Send me your book. I want to see what Radio offers and what you offer in Radio training. This request does not obligate me in any way.

Name.....

Address.....

City..... State.....

Lifetime Employment Service to all Graduates

In This Issue . . . May 1930

SCIENCE *and* INVENTION Offers You

Sky-High Pioneers	4
<i>A glimpse of riggers working far above Manhattan</i>	
Science in the Home	8
<i>An editorial by Arthur H. Lynch, Editorial Director</i>	
Speeding the World's Words	11
<i>Modern telegraphy, as explained by Herbert W. Drake, of Western Union, to Mary Jacobs</i>	
Arctic Fever and Tropic Frostbite	12
<i>Carveth Wells tells a tall, true tale of his trip to the African Mountains of the Moon</i>	
Wings for Us All!	14
<i>The gliding map of the U. S. A. is mapped by Karl S. Betts, N. G. A.</i>	
Riding the Thunderclouds	15
<i>A thrilling picture of glider soaring technique, by Martin H. Schempp, soaring pilot and instructor</i>	
Los Angeles Says "Stop" to Traffic Congestion	16
<i>Arthur G. Arnoll sketches the situation in this western city</i>	
Eyes Across the Sea	17
<i>Dramatic close-up of an instant of success in trans-oceanic television, by William Watts Chaplin</i>	
Behind the Human Front	18
<i>Everyone is a psychologist, says Edward J. Beck, and pretty well proves it</i>	
Giants of Industry	19
<i>About machines like the one on the cover (in size), by J. Kay London</i>	
Does Your Home Need an Umbrella	20
<i>Roofing is the subject of this article in the Home Improvement series by S. Gordon Taylor</i>	
"Outboard Busters"	22
<i>A great western pastime transferred to marine settings</i>	
Air Lanes of Dots and Dashes	23
<i>George R. Brown describes plane dispatching by radio</i>	
Chicago—A Scientific Glimpse	26
<i>Seven informative and picturesque shots at a great inland city</i>	
We'll Motor Across the Atlantic	27
<i>Marguerite Kujawska inventories the motorship Britannic</i>	
Foods That Fight Your Stomach	32
<i>Dr. Frederic Damrau identifies our gastric enemies and tells how science outwits them</i>	

The cover this month is based on a scene in the River Rouge plant of the Ford Motor Company, Dearborn, Mich.

A Forecast of SCIENCE AND INVENTION Features Will Be Found on Page 86

Other Articles

General

Gunning for Lightning	25
<i>By J. N. Wirt</i>	
Diesel Car Makes Début	25
<i>By A. E. LeBlanc</i>	
The Big Bridges Rise	28
In the Spotlight of Science	33
How Giant "Moles" Bore Under Streets	40
<i>By Josef W. Von Stein</i>	
The Way I See It	42
<i>By the Editor</i>	
Cook While You Play	46
<i>By Mrs. Christine Frederick</i>	
Novel and Convenient Aids to Comfort	47
The Safety Valve	52
<i>Conducted by Joseph H. Kraus</i>	
Let's Laugh	54
The Oracle	55
Rustless Steel to the Fore	79
<i>By W. A. Simmons</i>	
Book Reviews	82
New Devices	89, 90, 91
<i>Gas-making machine; home movie camera; water softeners; key-making machine; rotary hand duplicator</i>	
Index to Advertisers	94
The Gold Mine of Chemistry	95
<i>By Alfred M. Caddell, Financial Editor</i>	

Construction, Amusement, Experiment

Feed Your Plants With Chemicals	24
<i>By Raymond B. Wailles</i>	
Your Glider's Flying Clothes	39
<i>By Lieutenant H. A. Reynolds</i>	
Build a Boat for \$3.62	41
<i>By H. Sibley</i>	
Hints for the Home Workshop	43
<i>By Our Readers</i>	
Wrinkles and Recipes	44
A Pole Screen—Useful and Decorative	48
<i>By H. L. Weatherby</i>	
Helps for the Owner and Driver	49
<i>By George A. Luers</i>	
Magic	50
<i>By Dunninger</i>	
Solve These Brain Teasers	51
<i>By Sam Loyd</i>	
Hand-Side-Before Crossword Puzzle	88
<i>By Richard H. Tingley</i>	

Radio

On the Short Waves With a Super-Wasp	30
<i>By Robert Hertzberg</i>	
Pull Them in With a Heterodyne	31
<i>By George R. Brown</i>	

For Inventors

Patent Advice	56
<i>By Joseph H. Kraus</i>	
Yankee Brains at Work	58

Astronomy

Get Out Your Smoked Glasses	29
<i>By Donald H. Menzel, Ph.D.</i>	

Aviation

"Both Ends of the String"	29
<i>By Augustus Post, Aviation Editor, and Arthur H. Lynch, Editorial Director</i>	
Rotary Ailerons and Other Novel Control Devices	87
<i>By Augustus Post</i>	

Home Improvement

Digest of Rules for SCIENCE AND INVENTION'S Basement Plan Contest	63
List of Manufacturers' Booklets for our Home Service	84

R. T. I. R. T. I. QUALIFIES YOU TO MAKE MONEY AND ITS SERVICE KEEPS YOU UP-TO-THE-MINUTE ON THE NEWEST DEVELOPMENTS IN RADIO, TELEVISION, AND TALKING PICTURES **R. T. I.**

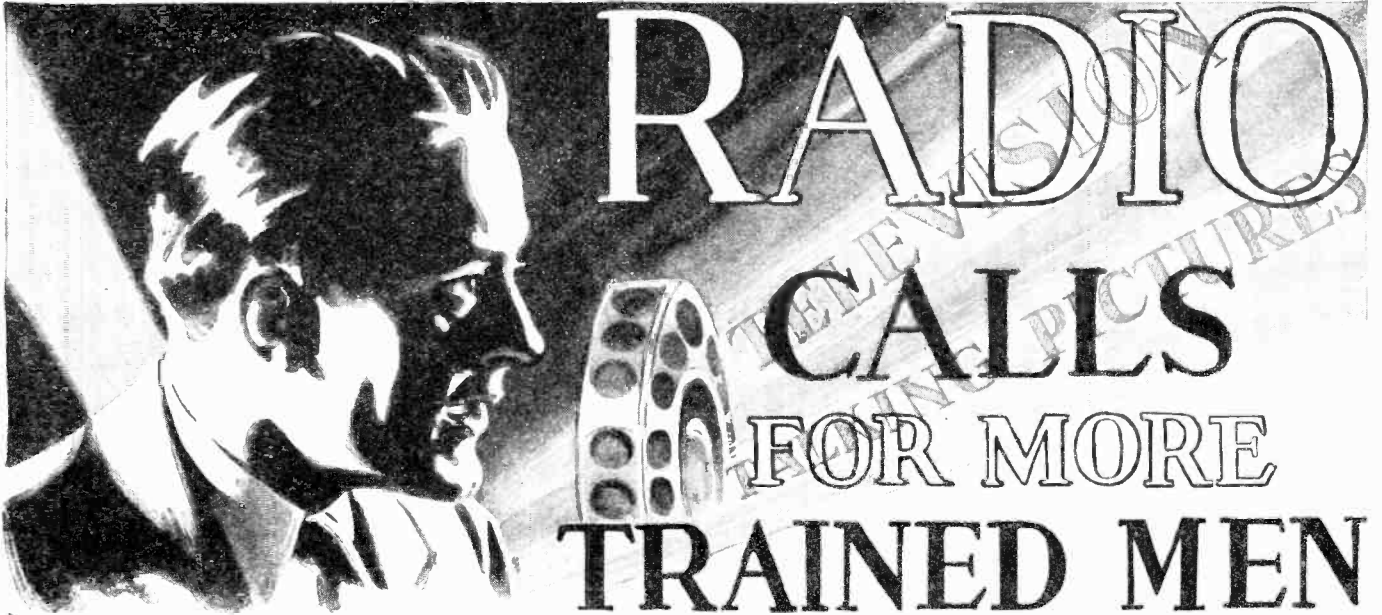

Big Money quick—the chance to more than double your salary—is offered to you now. RADIO has leaped from the experimental stage to a gigantic industry, employing many, many thousands and loudly calling for MORE TRAINED MEN to fill the Big-Pay jobs.

TALKING PICTURES have taken the larger cities by storm and will sweep the entire country, opening up many new good jobs everywhere. TELEVISION now comes with even greater promise of a large number of good paying jobs and big profits for those who are prepared.

Big Money Now! More to Come

Here is an entirely new field of profitable employment—Big-Money Jobs—\$2500—\$3500—\$5000 and up, right now—lots of money easily made in spare time—increasing pay for you and more and more money as this new industry grows bigger and bigger.

Answer the Call—Get Into This Money-Making Industry Now!

The "R. T. I." famous "3 in 1" Home Training in Radio, Television and Talking Pictures makes it easy for men, young men and boys to get into this new field quickly. R. T. I. home training is practical and easy to understand. It trains your head and hands at the same time. Your opportunities for money-making are unlimited. Your age, amount of education, or experience make no difference. If you are interested and ambitious you can succeed. Are you willing to use a little spare time at home? That is all you need to quickly start making money with R. T. I. material and home training. You will be ready for a good job or profitable business of your own, even before you finish the training. Remember—you learn *at home* in your spare time on actual equipment included in fine, big outfits sent you by R. T. I. R. T. I. with all its connections in the industry, keeps you up-to-date and pushing forward all the time.

R. T. I. Wonderful Free Book Nothing Like It Ever Published

No one can fully realize the amazing size and future growth of the Radio, Television, and Talking Picture industries unless they know all the facts revealed in this R. T. I. book. No exaggeration is necessary—the plain truth is astounding. It will open your eyes to the dawn of the greatest development in the history of the world—the vast number of new money-making jobs—enormous spare-time profits—all within easy reach of ambitious men. Send for your copy before this edition is exhausted.

Big R. T. I. Book Free—While They Last



Let F. H. Schnell and R. T. I. Advisory Board Help You

Mr. Schnell, Chief of the R. T. I. Staff, is one of the ablest and best known radio men in America. He has twenty years of Radio experience. First to establish two way amateur communication with Europe. Former Traffic Manager of American Radio Relay League. Lieutenant Commander of the U. S. N. R. Inventor and designer of Radio apparatus, Consultant Engineer to large Radio manufacturers. Assisting him is the R. T. I. Advisory Board, composed of men prominent in the Radio Industry.



Is Now Radio Engineer Through R. T. I. Training

Today I am able to class myself as a Radio Engineer along with the leaders, and this is all due to the help of R. T. I. I have been able to handle efficiently every radio problem with which I have come in contact. I cannot say too much in praise of R. T. I., and any man desiring to improve himself can do nothing better than find out what this institution has to offer, and get started with their training.—H. P. SATTERFIELD, Chief Radio Engineer, Western Air Express, Amarillo, Texas.

RADIO & TELEVISION INSTITUTE Dept. 915, 4806 St. Anthony Ct., Chicago



\$500 in 2 Months Hasn't Finished the Course
Your radio course enabled me to earn over \$200 in two months spare time work.—J. Koflinger, R. I. Box 37, Greenville, Ky.



\$20 a Week—Through R. T. I. Training
I am earning \$20 per week and another \$20 a week in spare time Radio Work. My course is the best investment I ever made.—W. S. Mead, 915 W. 28th St., Indianaapolis, Ind.

STEP UP QUICK TO A BIG MONEY JOB THROUGH R. T. I. training in Broadcasting, Sales, Service, Manufacturing, Repairing, Ship and Station Operating, Installing, in business for yourself.

R. T. I. R. T. I. TRAINS YOU AT HOME FOR A GOOD JOB OR A PROFITABLE PART TIME OR FULL TIME BUSINESS OF YOUR OWN



RADIO & TELEVISION INSTITUTE Dept. 915, 4806 St. Anthony Court, Chicago

Send me Free and prepaid your BIG BOOK "Tune In On Big Pay" and full details of your three-in-one Home Training (without obligating me in any way).

Name
Address
City State

Sky-High Pioneers



Ewing Galloway

Silhouetted against the upper midtown district, these riggers are shown erecting scaffolding on the forty-fourth story of the Lincoln Building, New York, for the riveters and bricklayers who will follow. The Grand Central Building in the middle ground is actually three blocks distant from the camera.

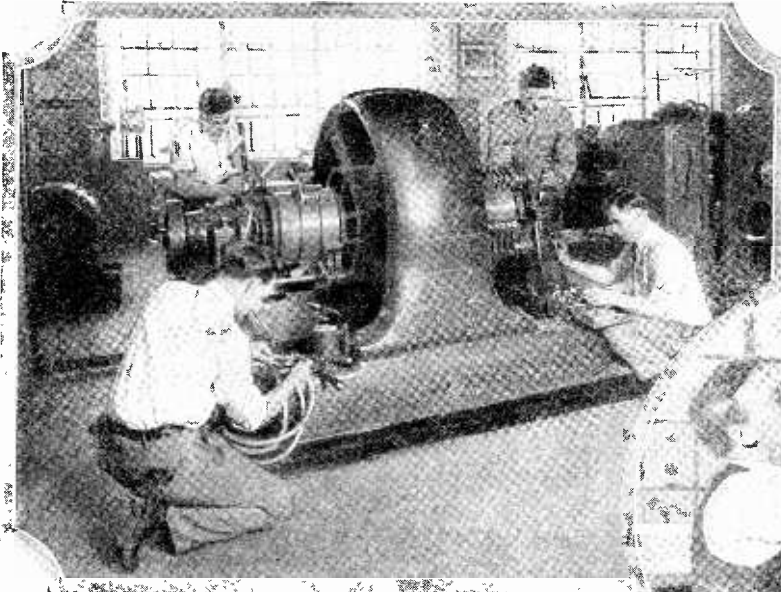

Learning about the converter used to change alternating to direct current at the great Coyne Shops

Coyne men working on the valves and timing of a Velle Radial Aircraft Engine

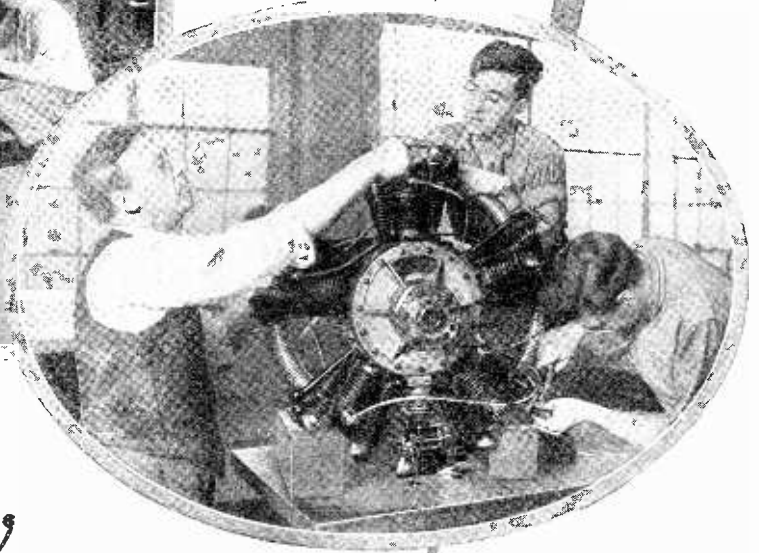

Follow this amazingly easy way into

ELECTRICITY

-and you're through in 90 DAYS!

SAY good-bye to 25 and 35 dollars a week. Let me show you how to qualify for jobs leading to salaries of \$50, \$60 and up, a week, in **ELECTRICITY** — NOT by correspondence, but by an amazing way to teach, **RIGHT HERE IN THE GREAT COYNE SHOPS**. You become a practical electrician in 90 days! Getting into Electricity is far easier than you imagine!

LEARN—by doing the work with your own hands IN 90 DAYS

The secret of Coyne-training is that it is **ALL PRACTICAL** work. No books—no dry lessons—no useless theory. In the great shops of Coyne you learn the "ins and outs" of Electricity by actual work on real electrical equipment—the finest outlay in the country. And best of all—experts work right with you every step of the way, showing you all the electrical secrets that are essential to your success!

NO BOOKS—NO PRINTED LESSONS

COYNE
ELECTRICAL SCHOOL
500 S. Paulina St., Dept. 50-83
Chicago, Ill.

Experience not required I don't care if you don't know an armature from an air brake—I don't expect you to! I don't care if you're 16 years old or 48—it makes no difference! Don't let lack of money stop you either. Most of the men at Coyne have no more money than you have.

Big pay jobs are waiting Our employment bureau gives you lifetime service. Two weeks after graduation, Clyde F. Hart got a position as electrician for the Great Western Railroad at over \$100 a week. That's not unusual. We can point to Coyne men making up to \$600 a month. You can go into radio, battery, or automotive electrical business for yourself and make up to \$15,000 a year.

Railroad fare allowed Make up your mind today to get into one of these big pay electrical jobs. If you act now—I'll allow your railroad fare to Chicago and give you these courses free! **AVIATION ELECTRICITY, RADIO and AUTOMOTIVE ELECTRICITY!** And besides that, I help you to a part time job while learning! Don't lose another minute—make this the turning point in your life. Send this coupon **RIGHT NOW**.



Get this FREE BOOK

This school is 30 years old—endorsed by many large electrical concerns. Simply mail the coupon and let me tell you all about it in the big, free Coyne book.

USE THE COUPON

Mr. H. C. Lewis, President
COYNE ELECTRICAL SCHOOL, Dept. 50-83
500 S. Paulina St., Chicago, Ill.

Dear Mr. Lewis:

Without obligation send me your big free catalog and all details of Railroad Fare to Chicago, Free Employment Service, Radio, Aviation Electricity, and Automotive Courses, and how I can "earn while learning."

Name.....
Address.....
City.....State.....

Free ~

1000 Page Encyclopedia of Facts!

3000 Subject Headings

Most Widely Consulted Reference Book in America!

Now, for the first time, **SCIENCE & INVENTION** offers you this triumph in book-making—this complete and unabridged

WORLD ALMANAC and BOOK OF FACTS

FREE!

Contents Virtually Limited Only by the Extent of Man's Knowledge!

Has Outsold Any Similar Volume the World Over!

ENTIRELY at our own risk, we have arranged to ship you **ABSOLUTELY FREE** this 1,000-page "1930 **WORLD ALMANAC AND BOOK OF FACTS**"—the veritable storehouse of information in daily demand in every workshop, home and office—the world's most famous reference library which no busy mechanic, experimenter, business man, educator, or man or woman in any walk of life can afford to be without!

An Unprecedented Indispensable GIFT

The contents treated is virtually limited only by the extent of man's knowledge. More than 3,000 subjects! A glance at the following gives but a faint conception of its vast completeness, scope and amazing interest:

- | | |
|--|--|
| All About Radio and the Wireless | Elements of Physics |
| What Eclipses Will Occur in 1930 | Marriage and Divorce in Various States |
| Law of Contracts, Wills and Business Procedure | How Many Tons in a Carload of Wheat? |
| Tables of Time and Distance | The Great Disasters of History |
| What Produces the Aurora Borealis? | How Can You Avoid Lightning? |
| How Does Bankruptcy Law Operate? | What Are the Known Elements? |
| What Is the World's Fastest Train? | What Is the World's Greatest Bridge? |
| What Is New York's Costliest Building? | What Is the Metric System? |
| Tables of Temperature and Precipitation | How Fast Does Light Travel? |
| Complete Chronology of the Past Year | How Long Do Animals Live? |
| | Hanging Gardens of Babylon |
| | Seven Wonders of the World |
| | Women—Interesting Facts About Them |

Complete chapters are devoted to Aviation, Radio, Scientific Progress, Intrepid Explorers, Chemistry, Biographies, Noted Inventions, etc. Science, Banking, Commerce, Industry, Sports, Countries and Governments—production of Factory, Field and Mine—Aeroplane data, Astronomical Tables, Velocity Tables, Poison Antidotes, Zodiac, Weather Forecasting . . . nothing has

escaped the corps of editors who searched the whole field of human activity for every mite of information useful to you.

Entertainment that Brings Bigger Pay

Of course you are vitally interested in all the amazing news, new inventions, discoveries, patents, ideas and stories as they forecast the astounding world of the future in **SCIENCE & INVENTION** every month.

Radio, Aviation, Electricity, Carpentry, Engineering, Auto Mechanics, Television, Projection and Filming Talkies, Magic, Still Photography, New Patents, Chemistry . . . **SCIENCE & INVENTION** shows you the miracles of their latest developments and gives you a liberal education in all fields. With its more than 200 highly instructive pictures in every issue, it will fascinate you, teach you, and pave the way to fatter pay envelopes!

Send for your FREE Copy at ONCE!

To persuade you merely to try it entirely at our risk, we offer you the new complete "WORLD ALMANAC AND BOOK OF FACTS" **FREE** with Eleven big issues, almost a full year's subscription to **SCIENCE & INVENTION**, at the special introductory price of only \$2. You risk nothing. If you are not more than delighted with both the magazine and gift we absolutely guarantee to refund your money.

There are only 5,000 of these 1,000-page Gift Almanacs left. To make sure of getting your copy—

---Mail Coupon Before It's Too Late!---

SCIENCE & INVENTION, Dept. 2505-Q
Published by **MACKINNON-FLY PUBLICATIONS**, Inc.
381 Fourth Avenue, New York, N. Y.

Please send me **ENTIRELY FREE** the 1,000-page "1930 **WORLD ALMANAC AND BOOK OF FACTS**" postpaid by return mail and enter my Special Introductory Subscription for Eleven Months of **SCIENCE & INVENTION** at only \$2.00. I save 75c on the regular single copy price and get the complete "WORLD ALMANAC" **FREE**. If not more than delighted, you will cheerfully refund my money.

Name

Address

City and State

FREE—The Book You Need Most

5,000



Radio Service Men Needed Now!

The replacing of the old battery operated receivers with all-electric Radios has created a tremendous country-wide demand for expert Radio Service Men. Thousands of trained men are needed quick!

30 Days of R.T.A. Home Training
... enables you to cash in on this latest opportunity in Radio

\$40 to \$100
a week
Full Time
\$3.00 *an hour*
Spare Time

Ever on the alert for new ways of helping our members make more money out of Radio, the Radio Training Association of America now offers ambitious men an intensified training course in Radio Service Work. By taking this training you can qualify for Radio Service Work in 30 days, earn \$3.00 an hour and up, spare time; prepare yourself for full-time work paying \$40 to \$100 a week.

hour spare time or \$40 to \$100 a week full time, this R. T. A. training offers you the opportunity of a lifetime.

We furnish you with all the equipment you need to become a Radio Service Man!

Radio Service Work a Quick Route to the Big-Pay Radio Positions

Radio Service Work gives you the basic experience you need to qualify for the big \$8,000, \$10,000 to \$25,000 a year Radio positions. Once you get this experience, the whole range of rich opportunities in Radio lies open before you. Training in the Association, starting as a Radio Service Man, is one of the quickest, most profitable ways of qualifying for rapid advancement.

More Positions Open Than There Are Trained Men to Fill Them

If you were qualified for Radio Service Work today, we could place you. We can't begin to fill the requests that pour in from great Radio organizations and dealers. Members wanting full-time positions are being placed as soon as they qualify. 5,000 more men are needed *quick!* If you want to get into Radio, earn \$3.00 an

hour spare time and cash in on Radio quick, investigate this R.T.A. training and the rich money-making opportunities it opens up. No special education or electrical experience necessary. The will to succeed is all you need.

Mail Coupon for No-Cost Training Offer

Cash in on Radio's latest opportunity! Enroll in the Association. For a limited time we will give to the ambitious man a No-Cost Membership which need not . . . should not . . . cost you a cent. But you must act quickly. Filling out coupon can enable you to cash in on Radio within 30 days, lift you out of the small-pay, no-opportunity rut, into a field where phenomenal earnings await the ambitious. You owe it to yourself to investigate. Fill out coupon NOW for details of No-Cost Membership.

The Radio Training Association of America
 4513 Ravenswood Ave. Dept. RN-5, Chicago, Ill.

THE RADIO TRAINING ASSOCIATION OF AMERICA
 4513 Ravenswood Ave., Dept. RN-5, Chicago, Ill.

Gentlemen: Please send me details of your No-Cost training offer by which I can qualify for Radio Service Work within 30 days. This does not obligate me in any way.

Name

Address

City State

Published by Experimenter Publications, Inc., 381 Fourth Ave., New York City, N. Y.

B. A. Mackinnon
President

H. K. Fly
Vice-President

Arthur H. Lynch, EDITORIAL DIRECTOR

MURRAY GODWIN
Managing Editor

JOSEPH H. KRAUS
Field Editor

T. O'CONNOR SLOANE, Ph.D.
Associate Editor

ALFRED M. CADDELL
Financial Editor

AUGUSTUS POST
Aviation Editor

GEORGE R. BROWN
Radio Editor

Editorial

Science In The Home

NO matter how great our interest is in any other subject, most of us derive a great deal of satisfaction from those little things which go to make our homes more livable. Whether we be men, women, boys or girls; whether we be interested in mechanics, electricity, economics, or any other subject, if we are normal humans we get a great deal of satisfaction out of improving and beautifying our dwelling places. Attractive surroundings assist us materially in enjoying our particular hobbies.

It is surprising to find the difference we can bring about in the bathroom, for instance, by the application of the contents of a ten-cent can of white paint. Similarly, a few cents worth of curtain material in the hands of a capable woman can transform the appearance of a bedroom or kitchen in an astonishingly short time. Old, dilapidated, and discarded furniture can be given a new lease on life by the intelligent application of a little paint, lacquer or varnish.

The more ambitious among us find it desirable, as well as handy, to accept the offers of some of the wood manufacturing companies which provide us with such useful items as kitchen cabinets, bookcases, tables of one sort or another, or even complete breakfast nooks, furnished in knock-down form and sent us through the mail. Cost of furniture of this kind is quite low. It is very simple to assemble and with the artistic application of just a little paint it can be used to add to the effectiveness of almost any home.

More and more we are coming to realize the real saving that can be effected in our coal bills as a result of properly installed insulating material which may be applied with almost equal ease to existing homes or those under construction. Figures covering this situation, prepared by the Bureau of Standards of the Department of Commerce, indicate very definitely that the saving in

fuel effected by properly installed insulating material pays for the latter within a period of two or three years, to say nothing about the more comfortable living conditions for winter and summer which the installation of this material brings about.

Just a little plaster of paris, whitewash, or cement can result in effecting savings in our garrets, cellars and garages which amply warrant the few minutes necessary for their application.

Quite contrary to the general belief, the carrying out of simple schemes for improving the appearance of our abodes do not require a very expert knowledge, or a very practiced familiarity with tools. Some of the most effective small repairs, or small additions, may be made without any previous knowledge of tools whatever.

We feel that there is plenty of opportunity for the practical application of science in our homes and that a great majority of our readers will derive much satisfaction from the application of inventive ideas.

Articles of this nature appear continuously in SCIENCE AND INVENTION and it is our purpose in the future to increase their number. We are making a serious effort to make articles of this character as completely worth while as possible and shall greatly appreciate any cooperation which any of our readers feel they can give us in this connection.

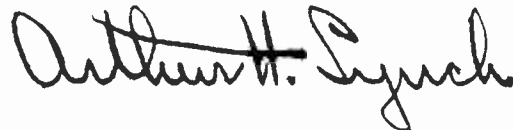

"Those Who Refuse to Go Beyond Fact Rarely Get as Far as Fact" - - - - HUXLEY



“Select the car you like . . . then try it out for 5 days!”

“That should give me time enough to make sure I like the car.”

“Yes sir. And every used car backed by the famous Studebaker Pledge carries the same privilege—five days’ driving trial!”

1 1 1

The privilege of trial by the jury of your family—and *five days* to reach a verdict! That’s what the famous Studebaker Pledge permits when you choose a used car under its protection!

You drive it—your wife can drive it—you can test it in any reasonable manner for five days. Then, if you’re not satisfied, you may return it and apply your payment on *any* car in your Studebaker dealer’s stock—*new or used!*

The Studebaker Pledge also provides a 30-day guarantee on all Certified cars, as well as the assured protection of plainly marked prices—one price for every buyer!

More than 150,000 thrifty motorists bought Pledge-backed used cars last year. They knew that a good used car is a better buy than a cheap car bought new.

INVEST 2c

you may save \$200

Spend 2c now for your copy of this interesting and instructive booklet, “How to Judge a Used Car”—it may save you as much as \$200 on the used car you buy. Mail the coupon—*now!*



Pledge to the Public on Used Car Sales

- 1 Every used car is conspicuously marked with its lowest price in plain figures, and that price, just as the price of our new cars, is rigidly maintained.
- 2 All Studebaker automobiles which are sold as CERTIFIED CARS have been properly reconditioned, and carry a 30-day guarantee for replacement of defective parts and free service on adjustments.
- 3 Every purchaser of a used car may drive it for five days, and then, if not satisfied for any reason, turn it back and apply the money paid as a credit on the purchase of any other car in stock—new or used. (It is assumed that the car has not been damaged in the meantime.)

© 1928 The Studebaker Corporation of America

STUDEBAKER
Builder of Champions

THE STUDEBAKER CORP. OF AMERICA
Div. 175, South Bend, Indiana

Please send me copy of “How to Judge a Used Car.”

Name

Street

City.....State.....

The *proof* that Ethyl develops more power

Right: This is the instrument board of a "knock" demonstration machine. The wattmeter (at the left) registers power. The tachometer (at the right) records engine revolutions per minute. When this picture was made, the engine was running on ordinary fuel.

Below: When the lower picture was taken, Ethyl had been fed into the carbureter. The wattmeter shows that the power has risen to the maximum; the tachometer shows a corresponding increase in revolutions per minute.

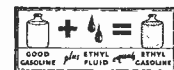
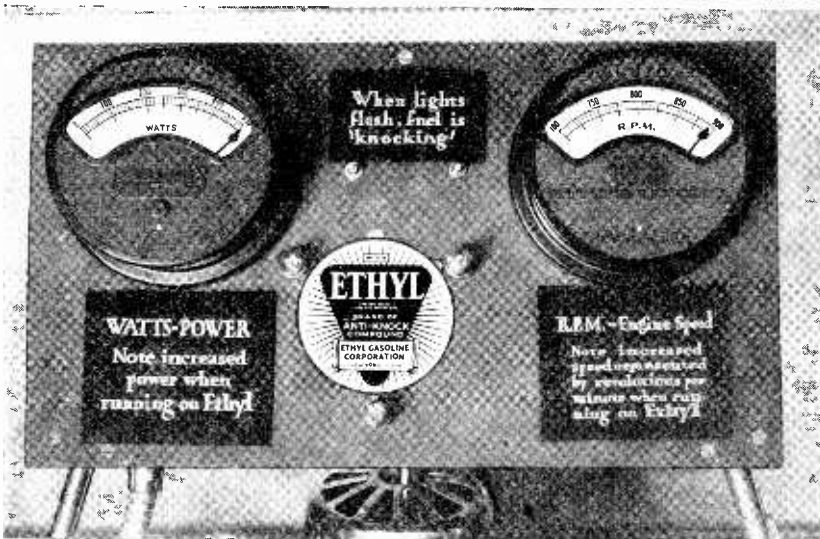

ETHYL GASOLINE

"SEEING is believing." These pictures of a "knock" demonstration machine let you *see* how Ethyl Gasoline will increase the speed and power of your motor.

A simple valve switches the fuel from ordinary gasoline to Ethyl and back again. When Ethyl goes in, "knock" goes out, R.P.M.'s (engine revolutions per minute) increase, power goes up. That is how Ethyl improves motor car performance.

It is the Ethyl anti-knock compound in Ethyl Gasoline that makes the difference. This remarkable fluid was developed by General Motors Research Laboratories after years of experiment to find an ingredient which would make gasoline a better fuel. Make this convincing

experiment in your own car. Use up the ordinary gasoline in the tank; then fill up with Ethyl. You'll see and feel the difference.

Wherever you drive—whatever the oil company's name or the brand associated with it—*any* pump bearing the Ethyl emblem represents quality gasoline of anti-knock rating sufficiently high to "knock out that 'knock'" in cars of average compression and bring out the additional power of the new high-compression cars. Ethyl Gasoline Corporation, New York City.

© E. G. C. 1930

The active ingredient now used in Ethyl fluid is tetraethyl lead.

SCIENCE *and* INVENTION

Volume XVIII. Number 1

MAY 1930



Speeding *the* World's Words

An Interview with Herbert W. Drake of Western Union on the Marvels of Modern Telegraphy

By Mary Jacobs

THE day of the lone inventor has passed. No longer does a solitary individual tear his hair, lock himself in his workshop or attic, and burst forth a few months later, shouting 'Eureka. I've found it!' says Herbert W. Drake, Apparatus Engineer of the Western Union Telegraph Company. "Today a group of scientists, each a specialist in his field, comes together and talks matters over. Each considers the problem from his individual angle—and in time the invention emerges—the joint work of many."

It is for this reason that Mr. Drake, who has been working for his company nearly forty years, considers himself only partially the inventor of various telegraph systems, and of the 100-wire concentration unit recently developed to expedite the handling of telegrams. This latest mechanism enables a single operator, without changing her position, to send or receive messages on any of 100 lines; enables her to tell at a glance which lines are busy, which ones require attention. How was this achieved? That is the story, and one must begin at the beginning.

"Telegraphy," says Mr. Drake, "has been changing rapidly in the last decade from the older manual systems to those where automatic printing machinery is used. The Morse dot-and-dash method circuits have been replaced by those with super-typewriters at both receiving and sending ends, until now more than eighty percent of the telegraph business is handled automatically. Of course, many more messages may be transmitted now in less time. Under present conditions, trunk lines connecting big cities can carry as many as eight messages, simultaneously, over the same wire, each at a rate of 50 to 60 words a minute. Their speed is limited to a great extent by the desire for absolute accuracy. It's quite conceivable that one or even two thousand words per minute might be handled on a circuit—but, if we did so, the proportion of errors might be increased.

"Using the old Morse system, an



Herbert W. Drake, Apparatus Engineer, who sees telegraphic advance as the result of joint intelligent effort.

operator who could master the code of dots and dashes and receive them at the rate of thirty or forty words per minute was 'good.' In printing telegraphs we use the five-unit code devised by Baudot late in the nineteenth century. In this code each character is represented by five electrical impulses and therefore occupies the same time in transmission as any other character. A great saving in time and ease of operation results—for example, to transmit the letters E and J equal fractions of a second are required now. But under the Morse code system, E would occupy four time units and J would occupy fourteen, and thus it would take three and a half times as long to telegraph a J as an E." For

operation of both Multiplex and Simplex printers, this five-unit code is essential.

"About twenty years ago, the Multiplex machine was developed to speed messages between large city terminals. It provided duplex communication channels which work simultaneously in both directions. . . . Four messages may be sent each way at a rate of about a word a second per channel, or 480 words per minute over one trunk line! The machines are constantly in operation at both ends—no starting or stopping impulses are required—these are supplied automatically by synchronous machinery.

"The Multiplex took care of our large city-to-city telegraph business, but what about the feeder circuits, those short circuits that bring messages to the large city terminals for transmission? We had to devise apparatus to make these feeders keep pace with the main transmission service. So we experimented, and finally adopted the Simplex printer, a long distance typewriting machine. As the letter of the typewriter keyboard is depressed, electrical impulses go directly to the telegraph line, and instantaneously the corresponding type bar registers at the receiving end. Letters are hurled from one point to another with a speed approaching that of light."

Installation of these machines in customers' offices connected with local Western Union headquarters made it necessary to develop a method for handling the business at the wire headquarters with the greatest possible efficiency. The answer to this problem was the invention of the 100-wire concentration unit, which presents the spectacle of a complicated system operating with what would impress the average person as almost human intelligence.

When a patron wants to send a telegram in, the light corresponding to his wire flashes. The operator plugs in, and her machine automatically records the message. As she takes the call, a

(Continued on page 62)

Arctic Fever

By *Carveth Wells*

*Fellow of the Royal Geographical Society and
the American Geographical Society*



CARVETH WELLS was born in 1887. Before he was six he could sew, knit, crochet and make baskets, while his hobby was the breeding of silkworms and white mice.

At seven he won prizes for swimming and Latin, and his school report for his seventh year states: "He is making good progress, but is inclined to be talkative!" He is now one of the most famous lecturers in America, and is internationally known.

After receiving a classical education at St. Paul's School, he graduated from London University as a Civil Engineer and practised his profession for a time.

He is now a professional explorer, has led expeditions to the Arctic, Desert and Jungle, and has demonstrated the fact that it is far more profitable to talk about engineering than to practice it.

Tell these people the truth, and they become annoyed. Show them pictures of Arctic Lapland sweltering in the summer sun, inhabited by people who have never even heard of an eskimo or a polar bear, and they shake their heads and say "I don't think." Gently whisper that hippopotami do not rush through flaming forests and leap recklessly over precipices into a river hundreds of feet below; that lions are harmless and do not hunt Boy,



The Elena is one of several great glaciers found in Central Africa at an elevation of 15,000 feet.

THESE are the days of Ripley, Lowell, Horn and Halliburton—but believe it or not, no one has ever yet found me guilty of making a single misstatement of fact.

President Thwing of Western Reserve University says that I have an uncanny knack of making the truth sound like a lie, but this is not purposely done—it is natural.

As far back as 1918 I brought to America, from the Malay jungle, amazing stories of fish that climbed trees, singing earth-worms and bouncing fish balls. For six years I had lived in Topsy Turvy Land where monkeys wash their teeth, birds sleep upside down, animals fly, crabs eat cocoanuts, fish eat coral, rats live on the tops of tall trees, and people dress and undress without undressing!

I soon discovered that the world was full of people who knew everything and became rather annoyed when they heard of something they never knew before.

It is a strange fact that most people have very fixed ideas concerning the rest of the world which they have only read about. To them, the Arctic is freezing cold, and swarms with Eskimos, seals and polar bears chasing one another about enormous icebergs.

Deserts are sandy places as hot as Hades, full of romantic sheiks.

Central Africa is a steaming jungle full of lions and swarming with snakes, where one takes one's life in one's hands, and where brave men take movies of wild animals, risking all for the sake of science and in order to provide Broadway with a few real thrills.



Porters walking through snow on the equator insisted on carrying their boots around their necks as ornaments.

At an altitude of 12,000 feet lobelias grow ten feet high and the ground is covered with everlasting flowers.

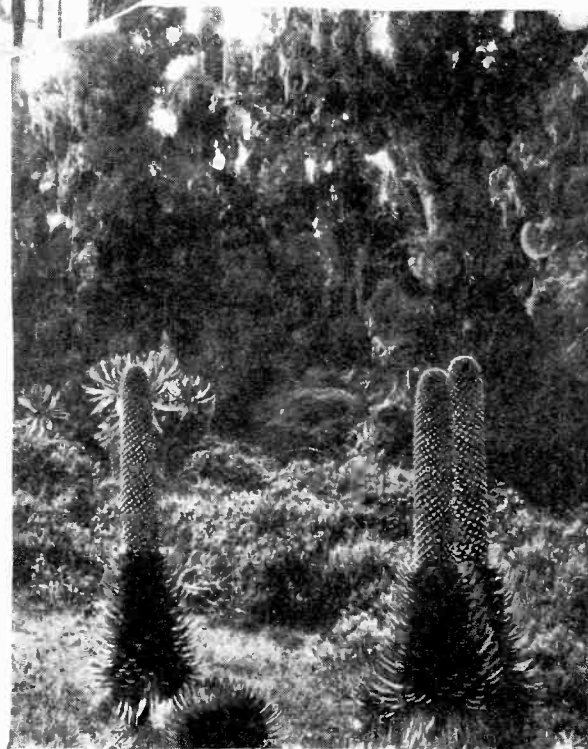

and Tropic Frostbite!

Lightning Flashed, Thunder Crashed, While the Wells Expedition Struggled on in a Blinding Equatorial Snowstorm . . . and Reached the Enchanted Forest Where Heather Grows Fifty Feet High . . . That Is Africa, as Carveth Wells Found It on His Trip to the Mountains of the Moon

Scouts; that headhunters do not capture inoffending travelers; that the so-called "Jungle of Africa" looks like Central Park and is just as dangerous, and they will say, "I don't believe you, I've actually seen it in the Movies!"

Finally inform them that Central Equatorial Africa is as truly arctic as the North Pole, and that the great danger is *not* from wild animals, but from *freezing to death*, and they say "Liar!"

Nevertheless, such is the fact. I have suffered intensely from Arctic heat and Tropic cold. I have seen fish living in water that was hot enough to cook them if they had been dead, and I know of live fish being shot from active volcanoes and from artesian wells in the middle of the Sahara, but it



A forest of gigantic birdseed in the Butago Valley, at an elevation of 14,000 feet, in the Mountains of the Moon.

At the left is a piece of parsley nine feet high and the explorer is standing alongside a piece of groundsel in blossom. Groundsel normally grows to a height of four inches. This plant is 25 feet high.



Central Africa is not at all an impossible place for skating and tobogganing the year round. Here the party was delayed two days by a snow storm. The temperature was 22 degrees.

takes a Ripley to make the man in the street believe it. I certainly hand it to Ripley; he is one of the world's most useful educators.

It was with the definite object of proving that Central Equatorial Africa was not at all an impossible place for winter sports, that I recently led an expedition to the Mountains of the Moon, for the Geographic Society of Chicago and the Milwaukee Public Museum.

Before I had been a week in Africa I found that the word "jungle" was never used, but in its place the word "blue," because the country was so open that the horizon in any direction fades away into a haze of blue.

On the way to the mountains I saw Boy Scouts chasing lions with bows and arrows, the only danger being from jiggers—and even they had been imported by some thoughtless person from

South America (the jiggers, not the scouts!)

I actually went fishing for lions, using for bait a dead zebra which was used as a spinner, and trailed behind a seven-passenger Buick! I saw positively and photographed millions of fly swatters attached to the tails of gnus. I timed the animals sprinting about in the "jungle" at forty miles an hour—but that is all the gnu that's fit to print.

As I made my way across Kenya Colony, I disturbed a colony of thirty million flamingoes, those bright pink birds whose method of feeding has earned for them the popular name of "Vacuum Cleaner birds."

For hundreds of miles I motored along the equator, huddled up in my winter overcoat, shivering with (Continued on page 59)



Captain Frank Hawks pioneered airplane-towed glider flight in the United States, when he hitched on behind a powered ship for a ride between Orion, Mich., and Cleveland

Wings for Us All!

The Task of Making a Nation of Flyers Is Off to a Gliding Start

GLIDER activities throughout the United States will reach their peak in September of this year with the staging of the first National Gliding and Soaring Contest somewhere in the vicinity of New York City, according to officials of the National Glider Association in Detroit. Aircraft makers and civic organizations have joined in a nationwide effort to interest thousands of persons in aviation through the new sport of motorless flying. William B. Mayo, Chief Engineer of the Ford Motor Company, and President of the National Glider Association, estimates that there will be one million glider pilots in America by 1935. Charles L. Lawrence, William B. Robertson, Admiral William A. Moffett, Amelia Earhart, and other aviation leaders concur with this view and are lending their efforts to carry through an ambitious expansion program.

By March of this year, thirty-five glider clubs had been organized and had affiliated with the national association, and approximately fifty more were

By Karl S. Betts, N.G.A

RECOGNIZING that 1930 is the first great American gliding year, Augustus Post, Aviation Editor of SCIENCE AND INVENTION, and gliding pioneer, has pulled the shock cord on a campaign for municipally owned gliding fields throughout the country. . . . The Exchange Club is co-operating with Mr. Post in his project for making the next generation a flying generation, to the last boy—and girl—in the land.

in process of organization. Many of these clubs have been sponsored by Boards of Commerce, Exchange Clubs and other organizations, and have pur-

chased gliders for training. Girls' glider clubs have been formed in Buffalo, New York and Cincinnati, and the Universities of Utah, Detroit and Michigan are actively engaged in teaching students to fly. The Bowls Glider Club (Continued on page 61)



Up at Orion, Mich., the budding aviator is instructed in motorless flight by Gliders, Inc.

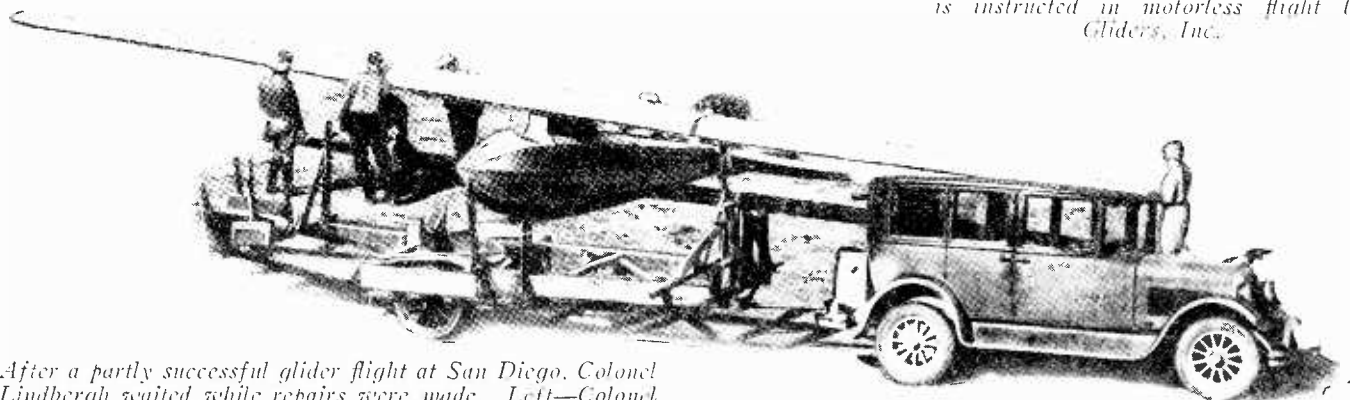

After a partly successful glider flight at San Diego, Colonel Lindbergh waited while repairs were made. Left—Colonel Lindbergh. Right—Mrs. Lindbergh.

Riding *the* Thunderclouds

Martin H. Schempp is a graduate of the University of Stuttgart, where he also studied gliding under the pioneer international gliding champion, Wolf Hirth. Continuing in aviation, he won his international sport pilot's license, and gained a manufacturing knowledge of both gliders and power planes. He landed in New York last year, and became instructor of the Syracuse, N. Y., Glider Club, one of the most active in the country.

By Martin H. Schempp
Pilot and Instructor

ALTHOUGH successful gliders are being built and flown in the United States, soaring gliders and soaring flight are still rare. Germany, with ten years of experience in motorless aviation, still leads the world in the advanced phases of this form of flight.

I know that the enthusiasm of this country for gliding will overcome the Germany advantage within a short time, and that the art of soaring flight will reach a high development on this side of the Atlantic. Meantime, as an intimate associate of Germany's soaring aces, and as a holder of a German soaring license, I should like to tell you something of the methods by which

Robert Kronfeld soared to altitude and distance records on the wings of a thunderstorm.

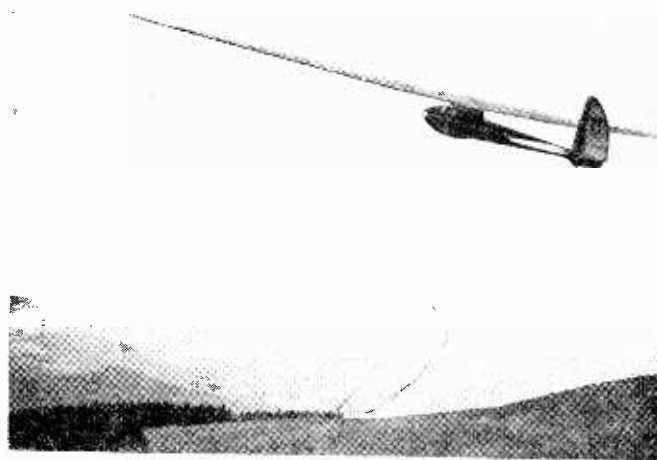
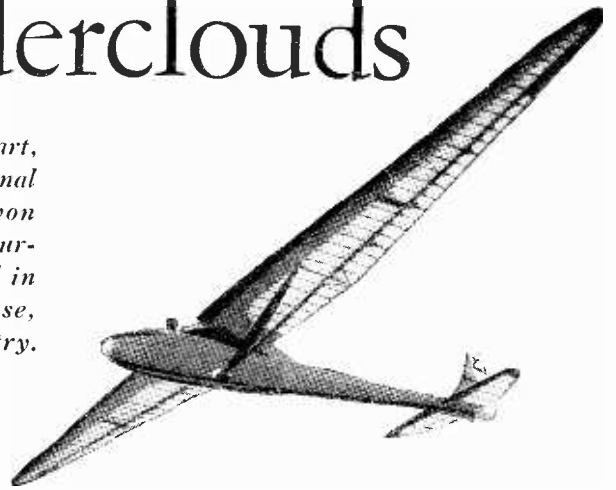

tude of 4000 feet, over a distance of 40 miles. The flight lasted three-quarters of an hour.

Kegel told afterward of his thrilling ride on the wings of that mountain storm. Caught in an aerial whirlpool, he was pitched about by violent crosscurrents, while visibility went to zero in a dense mass of turbulent foam.

Perhaps something of the ancient seafaring adventurers of the Baltic survives in our German glider pilots. At any rate, no sooner had the news of "Max's stormflight"—it became known at once by that name—reached them than they began an intense study of cloud formations. No other thought seemed to occur to them than that here

The shock cord is pulled, and a soaring plane starts from the "Häusser Kuppe," highest peak in the Rhoen district.

Max Kegel, the German veteran who took the first "storm ride," cherishes the Elida, his soaring ship, with which he is shown in this view.



Wolf Hirth, pioneer international champion, takes off in his favorite soaring ship

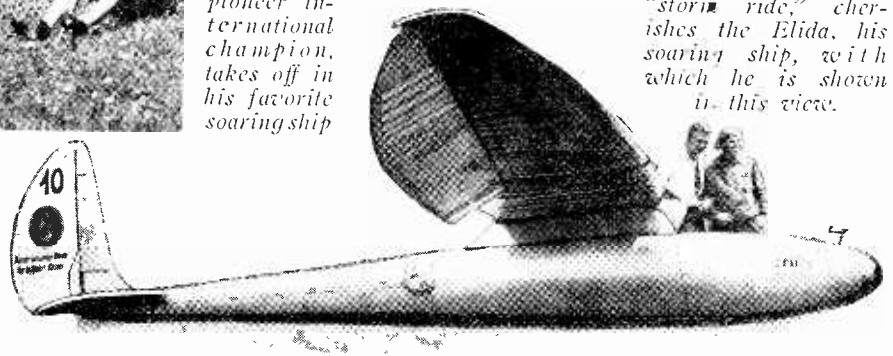

motorless flights to altitudes up to 6000 feet, for distances of 100 miles, and of 15 hours' duration, have been achieved in my native land.

Until 1926, German glider pilots depended on hill upwinds for successful soaring flights. Nevertheless, flights lasting several hours had been made by pilots who cruised to and fro in these ascending currents caused simply by the physical characteristics of the earth itself.

During the glider meet of July, 1926, however, in the Rhoen Mountains, there took place an event which produced a vital change in the technique of soaring flight. The veteran pilot, Max Kegel, was making a flight in the ordinary way when he was caught in a suddenly rising

thunderstorm. Threatening clouds came rolling upward toward the mountain tops, and Kegel drove directly into the blow. Traveling at a terrific rate, he disappeared from the view of the amazed spectators. Later it developed that the upwash carried him to an alti-

was a source of power which they could utilize for flights to altitudes never previously reached. Out of hand, they determined to make a steed of Thor!

You have noted those characteristic woolpack clouds, with a dome-shaped upper surface (*Continued on page 66*)

Los Angeles

says: **STOP**

to Traffic
Congestion
and Accidents

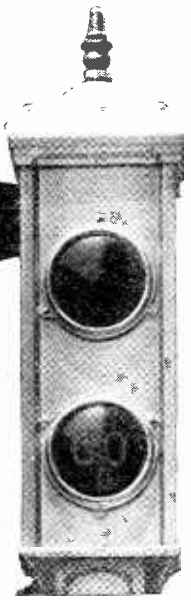

By Arthur G. Arnoll

General Manager, Los Angeles Chamber of Commerce.

FACED with an adverse total of about 400 traffic fatalities yearly, and with a traffic frequency at certain intersections of 41,000 vehicles per eight-hour day, Los Angeles is exerting itself vigorously to solve the twin problems of congestion and accidents.

A notable feature of Los Angeles' persistent campaign for safety and freedom from congestion is the emphasis placed on the drivers of tomorrow — the children in the city's schools.

Advanced physical and mechanical safety and traffic aids are being installed. And at the same time, a continual campaign is kept up for the education of the individual from both the driver and pedestrian point of view.

Los Angeles has carried out the use of one modern safeguard to an extent observable in few cities of its size. In all there have been forty underground passageways, costing an average of \$10,000 each, constructed beneath dangerous street crossings. Crossings thus guarded of course afford absolute protection for the school child while permitting the free flow of traffic as well. Where streets must be crossed at grade, police officers are detailed to protect the children. An interesting experiment is being tried with the "cafeteria" type

Los Angeles has built forty pedestrian tunnels like the one above at a cost of \$10,000 each.

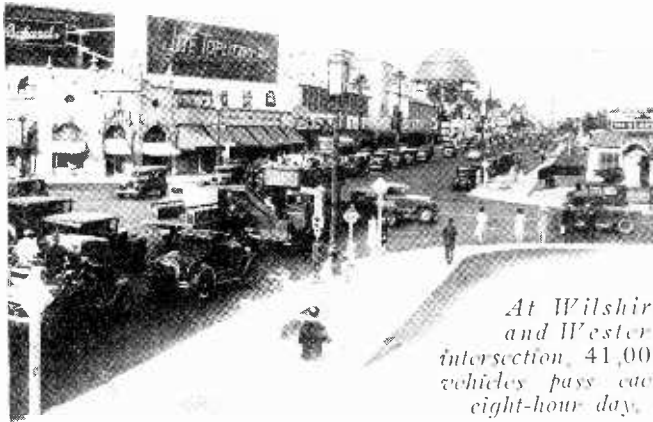

Auto Club, So. Calif.

At Wilshire and Western intersection, 41,000 vehicles pass each eight-hour day.

of stop signal, which is operated by the child himself, but results with these devices are not yet regarded as either conclusively satisfactory or the opposite.

The importance of pedestrian protection and education is apparent in the accident statistics for the city, which show that 50 per cent of all fatalities occur to persons on foot.

Automatic signals are employed at 491 intersections. In addition to bells and lights, these signals are equipped with



A continuous poster campaign is a feature of the safety activity in the schools.

semaphore arms carrying "stop" and "go" signs, which raise and lower in synchrony with the corresponding colored lights. Metal markers and painted lanes help the motorist at busy intersections. Los Angeles uses the four-button marking system instead of the single-button method employed in many cities. Only 30 percent of the total accidents occur at intersections thus equipped.

The educational campaign among school children includes talks by teachers and traffic experts, the organization of school safety committees, and the award of badges, buttons, and citations for meritorious effort. Posters pointing out traffic perils (Continued on page 62)



Drive-in markets offer shopping facilities that keep the streets clear of parked cars.

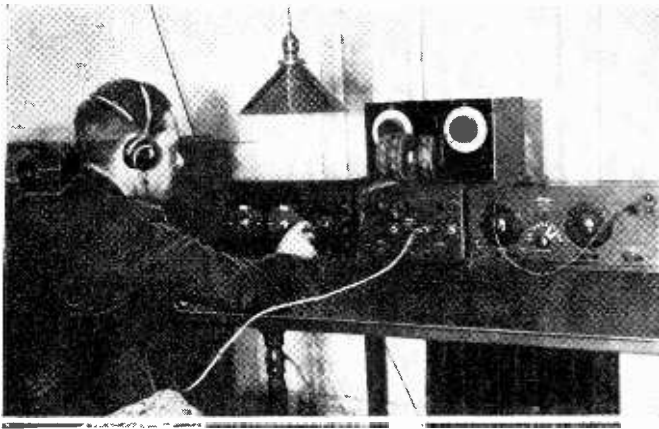

With this set contact was kept with the London transmitting station during the first attempt at trans-oceanic television. The radio photograph at the right shows Mrs. Mia Howe sitting before the London transmitter; it was "received" in the United States on the day of the event.



Photos courtesy Associated Press

Eyes Across the Sea

S UDDENLY in the dark cellar, as three men knelt on the dusty floor and held their breath, a woman's face appeared in shifting light to grin distortedly, grimace and smirk and nod, fading then back to oblivion.

It was the face of a woman who was not actually present, was not for the matter of that even in America, and yet this was no spiritualistic seance. What the three men in that cellar had just seen was the first demonstration of transatlantic television.

In ten years of reporting this was one of the biggest thrills I ever encountered, and now looking back over the reportorial experiences of that decade I am surprised to realize that with few exceptions it was the assignments with at least some scientific flavor that held the biggest emotional moments, the truest romance, the most exciting "kick."

I had seen something of television before that trans-oceanic experiment. But by a wide margin the most dramatic was that far from perfect test between London and New York in the Winter of 1928.

Captain O. W. Hutchinson, a promoter for the English Baird interests, had come over here to stage the demonstration largely for publicity purposes—to dramatize television for the public just as aviation was dramatized by the first Atlantic flights; and I arranged with him to be the only reporter present. Several papers and news services had got wind of the fact that something of the sort was in the making, and keeping the story "under the hat" during the month of preparation was a difficult task.

Capt. Hutchinson was preceded to this country by a month by Edward Clapp, a radio mechanic who conducted the preparatory work with Robert M. Hart of Hartsdale, N. Y., a radio amateur who had offered his short wave

By William Watts Chaplin

William Watts Chaplin returned from service with the Yankee Division to a career of freelance writing and reporting. For seven years he worked on the staff of the Associated Press, specializing in reporting events of vital significance in television, air transport, naval aeronautics, and other scientific fields. Time after time he saw at close range a great experiment in its initial instant of success. Thus he is particularly equipped to write for us this dramatic close-up of trans-oceanic television.



set for the experiments. At last everything was in apparent readiness and I went to the Hart home on a blustery cold night to find the house imbued with an air of nervous expectancy. Hutchinson and Clapp down in the cellar where the portable televisior was set up on a kitchen chair and Hart on the second floor at his radio.

But all the worry went for naught. Atmospheric conditions were unfavorable and the result of repeated trials was only disappointment. Twice more I went to the Hart home to no avail, but then came the big night and the thrill of a lifetime.

When I went down to the cellar Capt. Hutchinson was talking on a house telephone with Hart upstairs and raised a hand in greeting under a red light.

"Hart's talking to London now," he said, hanging up the receiver. "It

looks pretty good. Baird is just going to try sending the image of Mrs. James Howe." Jim Howe was an A. P. man in London and the only reporter present at that end.

Hutchinson slipped a pair of ear-phones on my head and I heard a rhythmic hum like the lazy song of a honey-laden bumble bee—the carrier wave. And then came a different sound, high, squeaky, constantly changing in tone—the image.

The red light was extinguished. The mechanic moved levers. Flickering radiance appeared in the televisior's opening, much the sort of opening into which you press your face in one of those machines in a penny arcade. There was a feeling of tension, expectancy. The mechanic kicked away his stool and we knelt beside him.

The lights whirled and danced, clotted and disintegrated, formed in strange patterns and burst like a shower of sparks. And then suddenly they arranged themselves in orderly fashion and before our eyes there grew into being the illuminated face of a woman. She smiled with a grotesque widening of the mouth, moved her head from side to side, nodded. It could hardly have been more startling if she had suddenly called us by name.

Capt. Hutchinson, the typically well-groomed and suave-mannered Englishman, scrambled to his feet and slapped me on the back. We all laughed and exclaimed and the little mechanic groped about to shake our hands in the darkness relieved only by that face of light.

"I must tell Hart," the Captain said excitedly and rang the buzzer on the house phone. "Hart," he yelled. "Clip down here jolly quick, will you? It's a blinking success."

We heard Hart's feet pounding the carpeted stairs to the ground floor and then the (Continued on page 63)

Behind *the* Human Front

By

Edward J. Beck

We're All Psychologists. Each of Us Has His Own Way of Detecting What Goes on in the Minds of Others. This Article Recounts Acute Psychological Observations by Ordinary Folks



A HUSBAND and wife were pouring out their grief over the counter of the taxidermist's shop. It seems that King Tut had died. There had never been a dog like him and would never be another. The woman was audibly sobbing and the man stopped short in the midst of his canine eulogy to wipe some tears from his cheek.

Would my friend, the taxidermist, send a man out at once to pick up the remains and stuff them? It would be such a comfort to have even the *image* of the dog around the house, now that his friendly soul had passed on.

The taxidermist listened with sincere sympathy. He loved dogs himself and understood. However, on work like that, he stipulated, full payment in advance was required. No, a deposit would not do. The customer was finally pinned down to writing out a check and after some parting instructions—"You won't forget this, will you? Or neglect that?"—the tearful couple left the shop.

"Why were you so insistent about cash in advance? That fellow is good for the money," the taxidermist was informed. "That's old man Smith's son, of the Smith paint and varnish plant. He's in line to inherit a million dollar business."

"I know that," was the reply. "I was just trying to save myself some grief."

"What do you mean?"

"Just this. There are secrets in every trade and I got wise to one that applies to my line years ago. Whenever a customer comes in to have a pet dog, cat, parrot or what not mounted and he weeps when he tells you about it, be sure and get your money in advance. Otherwise you'll never get it. Even

the rich boys will try to welch on you.

"You can take a chance on the fellow who gives you an order in a matter-of-fact way. He, too, mourns his pet—otherwise he wouldn't want to have him mounted. But he knows his own mind. He'll call for the finished job when it's done and pay you. The weepy ones won't."

"How do you make that out?"

"Well, I figure that anybody that will weep before strangers about a dog or cat has his feelings on the surface. He's excitable. Today he feels one way and the next time you see him he'll be just the opposite. His mood is easy come, easy go. You can't afford to stake any cash on his intentions. He forgets them. The dry-eyed customer is more apt to run on an even keel. I can't do like a laundry man—sell the shirts that aren't called for. Nobody will take somebody else's mounted dog for a gift. So I've got to protect myself against the crying kind. It cost me a thousand dollars to learn that."

It is really too bad that there isn't a learned journal to which the butcher, the baker and the malt extract maker could contribute their discoveries about human nature as the professors do. Because they do make such discoveries. The taxidermist had probably heard of William James or Sigmund Freud, and if you sounded him out on the "emotional instability" that the psychologists talk about, he'd give you a stare as glassy as the eyes he installs in elk-heads. Just like the Frenchman who had talked prose all his life without knowing it, this craftsman who understood how to turn fish and antlers into interior decorations had the real low-down on some of this psychological stuff with the big names. But he lacked the highbrow shipping tag that would

get his observations to the reviews. And he didn't realize that he was using psychology as well as papier-mâché and plaster of Paris in his business.

People collect almost everything else today—street car transfers, photographs of misspelled signs, coal oil lamps, pictures of Robinson Crusoe—so why would it not be a superior hobby for any person with a background of psychological theory to collect bits of insight into human nature from grocers, bell hops and merry-go-round ticket-takers?

Of course, you must not expect the grocer to "know his groceries" about anything but his groceries. He qualifies as an expert only in that little sphere where human nature and groceries meet. But every one of us watches the game of life through a vocational knot-hole and we get to know about some fine points of the game in the part of the back-field near our knot-hole that are completely overlooked by the experts in the press box.

A hotel clerk, for example, was complaining that guests swiped all sorts of things out of their rooms—even rugs and window curtains.

"Only one thing they never carry off," he added, "and that's the Gideon Bibles. I used to think they swiped them but I (Continued on page 68)

The Giants of Industry

By
J. Kay London

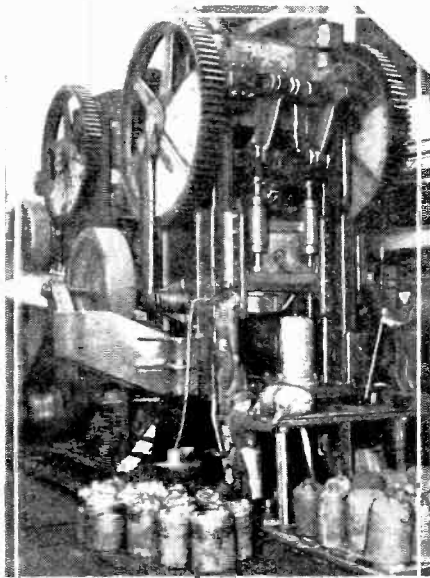

Photo—E. W. Bliss & Co.
A triple-gear, twin-driven toggle drawing press making heater fire pots.

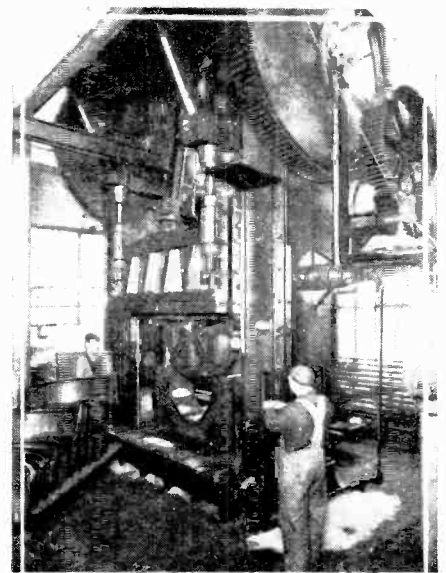

Photo—E. W. Bliss & Co.
A drawing press producing a pressure of 400 tons making auto fenders.

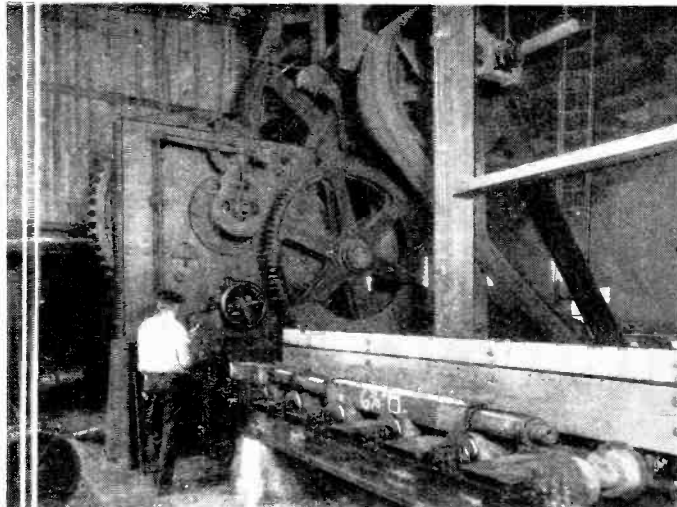

Photo—Henry Pels & Co.
A machine that will shear round billets up to 7 3/8 inches and square billets up to 7 1/8 inches in operation.

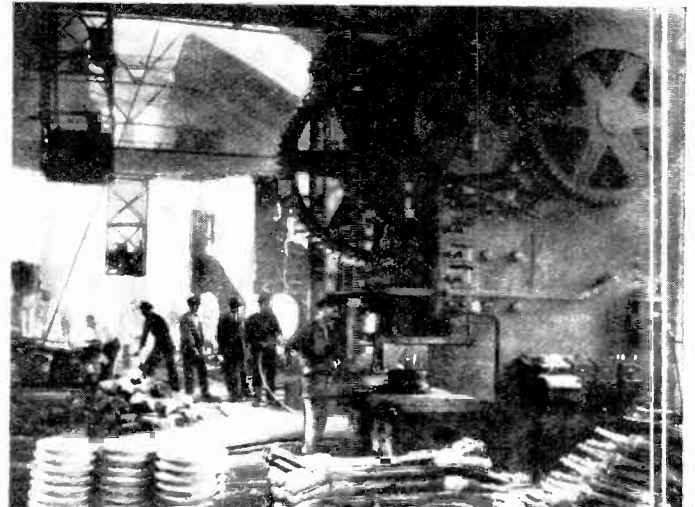

Photo—Henry Pels & Co.
This press develops a pressure of 660 tons and is used for stampings of all kinds and trimming heavy forgings.

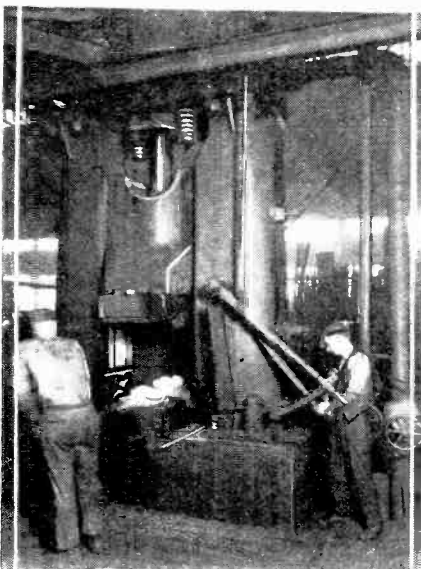

Photo—International Harvester Co.
A drop-forge hammer capable of striking a blow of from 10,000 to 12,000 pounds, forging a crankshaft.

MACHINERY replaces man power. This, after all, is a machine age, but one must remember that for every machine that is manufactured, hundreds of men are employed in the building of that machine and in the design of its component parts. Yet, are there any amongst us who believe that we could do the work of some of the giants of industry? Let us take, for example, some of the large presses, power shears, and drop-forge hammers. Even Vulcan himself could not be given credit for striking a blow of 12,000 pounds or for exerting a pressure of 1,500 tons.

On this page there is shown a machine for cutting billets. It has a knife five inches thick, made of high-grade tool steel, and it will bite off a piece of round rolled steel billet up to 7 3/8 inches in diameter with a knife that exerts a pressure of about 1,300 tons. Now compare the gigantic press for making car ends, shown with the occupants in a motor car on the bed of the press, and then imagine if any of the giants of mythology could duplicate in fable the results that these giants daily produce. The motors operating them vary from 40 to 100 horsepower and the pressures from 800,000 to 3,000,000 pounds.

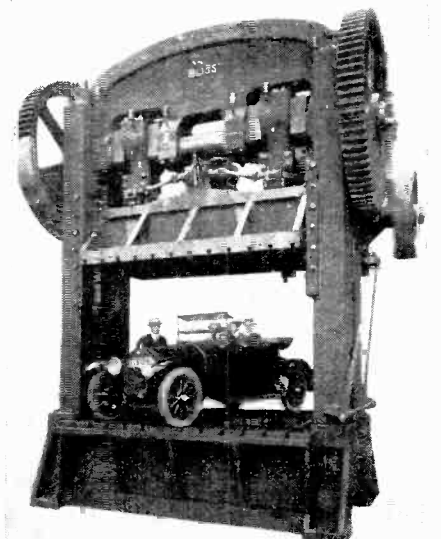

Photo—E. W. Bliss & Co.
This giant press, capable of exerting a pressure of 1,500 tons, is used for stamping out freight-car ends.

Does Your Home Need

*Take It From S. Gordon Taylor—There Is
head Is Likely to Assay Almost Clear Profit;
Roof of Your Home. . . . Read His Views
Roofing—and Start to*

By S. Gordon Taylor



Our Filipino cousins make the roof of their homes first and then transport it to the site where the home is to be built. We could do much worse than give the roofs of our homes first consideration instead of last. (Ewing Gallorway.)



The Spanish tile roof perfectly caps this duplex house, which is located in Milwaukee. (Milwaukee Corrugating Company.)

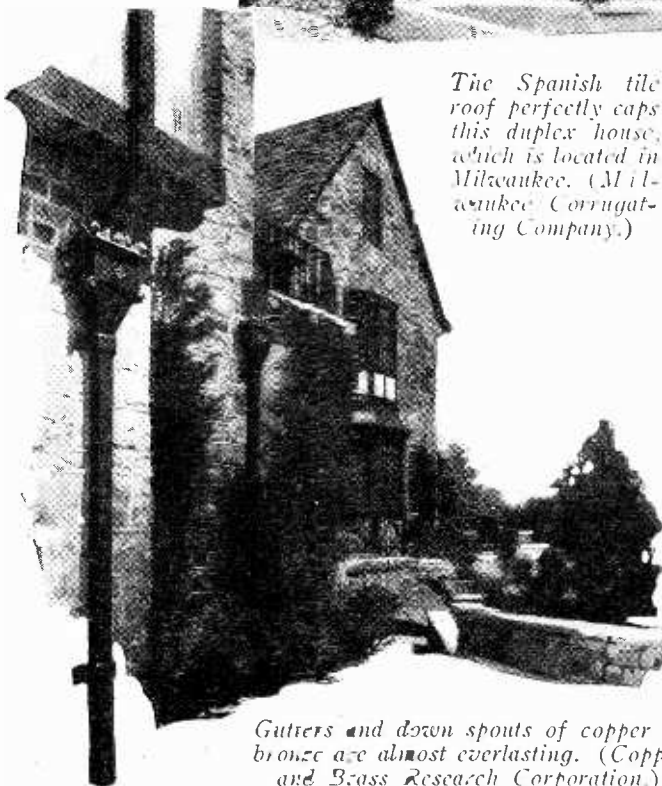

Gutters and down spouts of copper or bronze are almost everlasting. (Copper and Brass Research Corporation.)

AT the head of this article you'll find a picture illustrating the Filipino maxim for home-builders: *Always start with the roof.*

The Filipino way of working is to construct the roof first of all and then to carry it to the home-site. That's how important the roof of the home is to our island cousins.

And it might be better in a good many cases if we'd take a leaf from the island cousins' book. It might be better if we'd think of the roof first, for by thinking of it last we sometimes get a very dubious covering for our heads, health, and possessions.

We are too apt to regard the roof of our home as a permanent feature. Rarely is this feeling warranted by the facts. . . . A recent study of the roofing market indicates that 60 to 80 per cent of all roofing sold is destined for replacement purposes, and that the average life of a roof is only fifteen years.

When a roof reaches the end of its efficient life, it requires replacement immediately. Delay means not only discomfort, but damage to interior finish and household goods. The result too often is a hurried selection of materials and a hurried application of those materials to their purpose. Under these conditions, a satisfactory roofing job is hardly possible.

The home-owner who wants his next roof to be right in every particular will study the subject before his present roof reaches the stage for emergency measures. When the time comes for re-roofing, he will be fully decided on the type of cover that, best suits his needs.

There are four primary considerations in selecting the roofing for a home. First there is the factor of protection from the elements which, of course, is the basic function of a roof. Almost any roofing material can be depended upon to shed water but an extremely important question is how long it will continue to do so. This brings up the second consideration which is that of long life. The third feature for consideration is economy and finally there is the matter of appearance.

The waterproof quality of a roof depends upon more than the surface roofing material alone. The roofing may shed water perfectly, yet it will not be effective unless proper

PRIZE COMPETITION

\$400 in Cash Awards for the
18 Best Answers on—

How I Would Utilize Waste Basement Space

Open to All Readers. See Page 63 for Details

an UMBRELLA?

One Place Where Over- and that Place Is on the on the Subject of Good Profit Now

provision is made in the form of adequate flashings, gutters and downspouts to carry off the drainage. In modern homes copper and brass are being used very extensively for the flashing around the base of chimneys, dormer windows, and other structures protruding from the roof. Also, for valleys, gutters and downspouts. The reason for this is that copper has almost infinite life even on exposed areas such as roofs, and further, particularly in the case of gutters and downspouts, is itself attractive in appearance and does not require any painting or other maintenance attention. Freedom from deterioration and leakage is particularly important in the roof flashings because a large portion of the flashings are concealed under the main surface material and if the flashing becomes defective it is frequently a difficult matter to locate the source of the trouble. Also, replacement of flashings requires dismantling a good part of the roof and is likely to be an expensive operation.

As for protection against heat and cold the surface roofing material plays a comparatively small part, even when laid over wood sheathing. In winter a good part of the heat losses occur through the roof and the proper roof insulation is therefore doubly important. This can best be provided by installing a layer of insulation material. This may go between the sheathing and roofing, under the sheathing or on the under side of the rafters. The last of these three is the (Continued on page 70)

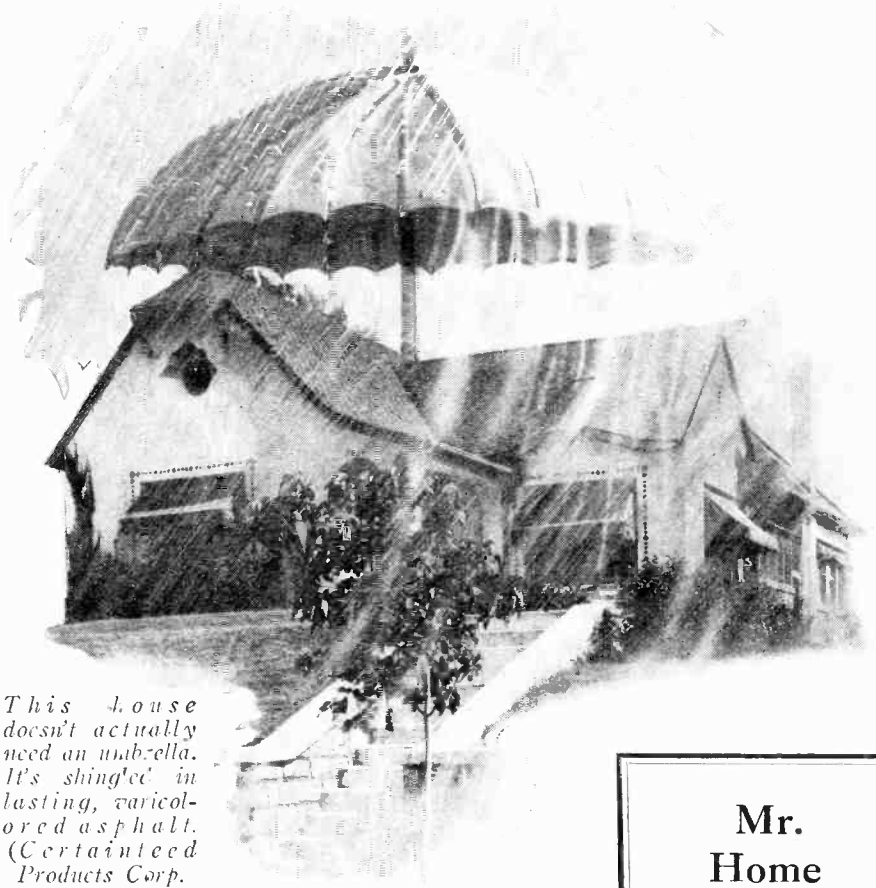

This house doesn't actually need an umbrella. It's shingled in lasting, varicolored asphalt. (Certain-teed Products Corp.)

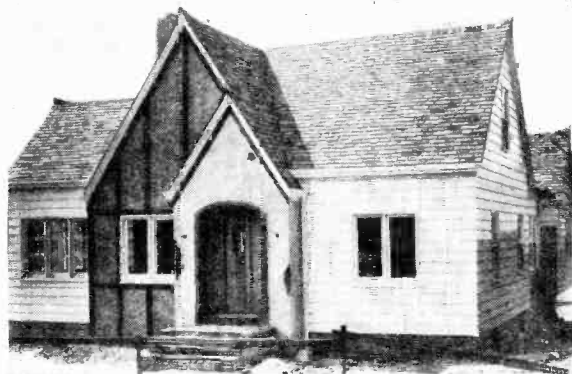

Shingles of mineral-covered asphalt provide rough and ready charm. (Flintkote Company.)

**Mr.
Home
Owner**

On page 84 SCIENCE AND INVENTION offers a new service which will be of inestimable value to readers who are home owners or some day hope to build or buy their own homes. Through this service a vast fund of information on building materials and equipment is yours for the asking.



The roof above is of rock-like shale tile. The picture to the right shows how new roofing materials can be applied over the old roof. (Ludowici-Celadon Company; Johns-Manville Company.)



"Outboard Busters"

Broncho Wrangling Is Tame in Comparison with Outboard Busting, a New Sport for Marine Acrobats

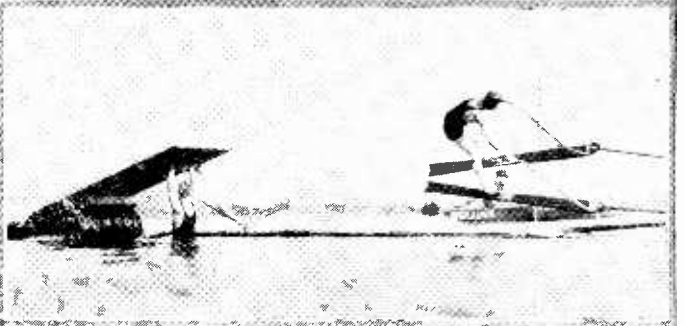
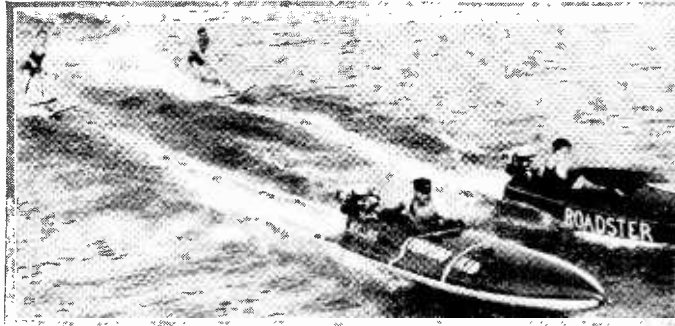

Aqua-skiing takes the place of aqua-planing in Florida now. The skiers make their leaps from a spring-board in the water.

Water skiing is full of spills. In another moment this jumper will not land on the skis. Top: An aqua-glider doing his stuff.

SPEEDY outboard motorboats are now being put through antics that would make even an experienced broncho buster look upon them with envy. With aquaplanes flying through the air; with riders skiing at forty or more miles an hour behind fast outboard motor craft; with humans serving as hurdles; and with motorboats that actually take to the air from a raised platform, one can imagine the difficulty a cowboy

on this page shows such a racing event in progress.

At Winterhaven, Florida, several new sports have been evolved. One of these is aqua-gliding and the second aqua-skiing. The former requires an ordinary aquaplane to which a small glider has been rigged. The wing of the glider is not large enough to keep

Aqua-skiing is different from aquaplaning in that the riders equip themselves with a pair of skis which are towed by boats driven with outboard motors. It requires more skill to operate the aqua-skis than is necessitated in aquaplaning. Devotees of this ski sport have erected a spring-board which is held up by a swimmer. As the outboard motorboat rushes by the spring-board, the skier guides his direction toward the



Breaking his own speed record, Philip Turner sent his 47-pound outboard motorboat along at a speed of 55.76 miles an hour.



Society jockeys racing their outboard motor craft in the narrow confines of the Deauville Pool, Miami Beach, Florida.

would have in attempting to duplicate the effect on land.

Even noted society girls have taken to the sport of racing these tiny speed boats in a series of events in the Deauville Pool at Miami Beach, Florida. The confines of this pool are rather narrow, but the society jockeys find great delight in taxiing their vessels to position and opening the motor fully at the sound of the gun. One of the photographs

the occupant in the air, but it does present enough of a resistance to create many thrills, a few spills, and to induce excitement in the crowds watching the aqua-glider go through his stunts. The device is the invention of Harrison Frazer, who has been noted for his outboard achievements.



It is quite difficult to balance an outboard motorboat when it is flying through the air, and flops are frequent.

board and leaps into the air. It requires more than unusual skill to land on the skis.

Similar spring-boards are also used to catapult such motorboats as the *Flying Rug* into space. Careful balancing is necessary to prevent a nose-dive or a side slip. Recently Philip Turner, a famous racing motorist, set a new world's outboard motorboat speed record of 55.76 miles per hour on the river Thames.

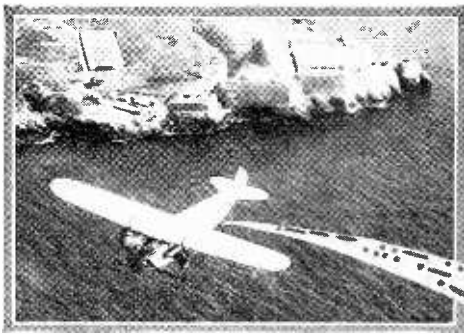

Air Lanes of Dots and Dashes

From Miami to Havana and along the South American Coast Telegraphic Code Messages from Land Stations Guide Giant Air-Liners Safely into Port.

By
George R. Brown

THE morning dawned bright and clear in Havana. None of the American pleasure-seekers in that great Cuban city knew that a short distance from land, on the turbulent waters of the South Atlantic, a cyclonic storm was brewing. Nor could a group of travelers bound for Miami in a huge tri-motored plane of the Pan-American Airways find any obvious reason for their pilot's sudden about-face back to Havana. They thought only of the delay and discomfort; they could see no storm. But the pilot of that huge ship heard a stream of wireless waves which brought to him warning of impending danger. He knew that twenty-eight land stations of this great aerial transportation system were at that moment pounding brass in order that he and several other pilots might not venture into the teeth of a turbulent storm. He knew that at the touch of a key his radio operator could secure for him the latest weather reports and even check up on his position. Without that key he would be flying in uncertainty; he might know of no storm; he could not tell his position if any unforeseen accident should occur.

Of course the pilot might have fought his way through the storm successfully. But that introduces the element of chance to a very great degree. That, according to the Pan-American Airways, is the factor that they are seeking to remove, and so they have insisted on providing all their planes on all their routes with adequate radio communication apparatus in an effort to make aerial travel dependable.

This company's ideas of reliable apparatus did not include manufactured sets which were available. A communication department was organized under the direction of H. C. Leuteritz as Chief Communication Engineer. After careful research amid the tech-

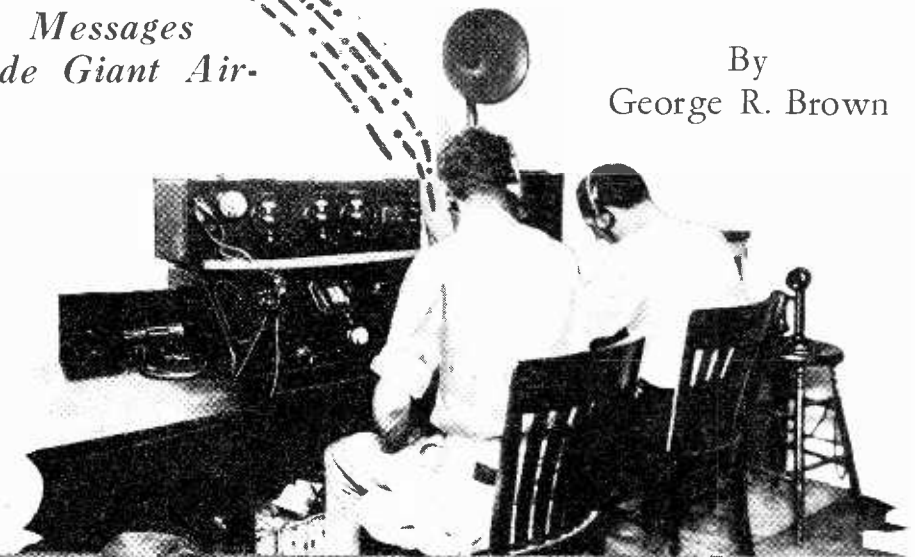

From the time he takes off every pilot on the Pan-American route receives a series of messages and directional signals from land stations of the organization. At the left—H. C. Leuteritz, chief communication engineer, operating the two-way, high-frequency apparatus.

nical snarls surrounding the efficiency of radio communication with planes, a receiver and transmitter were designed which have proved their capabilities under the trying tests of fog, storms and damaged navigating apparatus.

The apparatus has been primarily designed for transmission and reception of telegraphy by continuous waves, but it can be adapted for telephony. The entire installation is mounted within reach of the radio operator and is directly controlled, thus taking full advantage of the flexibility and wave

length range of the equipment with maximum simplicity in circuit design.

The transmitter employs a master oscillator neutralized power amplifier circuit using two UX 210 tubes and is capable of furnishing from 10 to 25 watts of unmodulated radio frequency energy to the antenna. Plug-in coils are used in order that operation may be obtained on wavelengths of 32.4, 52.8, 600 and 900 meters. Power is supplied by a small dynamotor, mounted in the plane, entirely enclosed to protect (Continued on page 67)

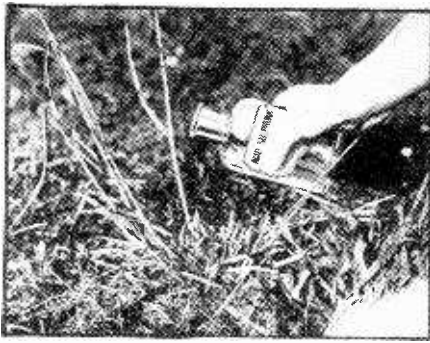

One will go to extremes to rid his lawn of crab grass. Here is one way to do it. Pour a dessertspoonful of strong sulphuric acid on the crown of the plant.

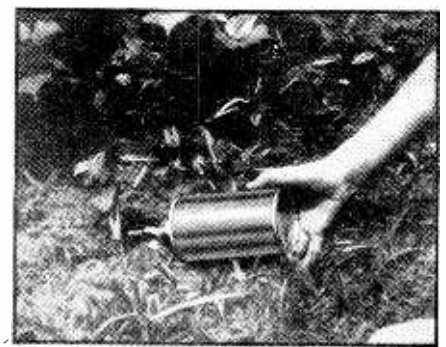

A can with an oiler-spout can be used for treating spindly young plants with the liquid fertilizer.

You can add a pinch of the chemical mixture directly to the soil, if desired. Work in and loosen the soil with a fork.

Feed Your Plants with Chemicals

HOW about some nitrogen? Have you any phosphorus cakes? Gee, I wish I had a dish of potash! I like my food seasoned with zinc and manganese."

If your plants could talk, they would say just such things as these. And why wouldn't they—with nothing but water to help them grow? We ourselves cannot exist on an unbalanced diet. Why then feed our plants as we would not feed ourselves? Why not balance *their* "diet"?

One can make a balanced fertilizer for house plants and garden flowers by mixing sodium nitrate, 1½ lbs; sodium phosphate (tertiary) 1 lb; and potassium sulphate 1 lb. The powdered chemicals, which are not at all harmful, are mixed well and stored in an airtight jar for use throughout the season. For liquid fertilizer, take a rounded tablespoonful of the mixture and dissolve it in a gallon of water. This solution is used directly upon plants once a week. It should not be sprinkled on the foliage. The liquid is odorless, colorless and balanced as to the needs of plants. One may stir a pinch of the mixed chemicals into the soil around the plant. For house plants an old kitchen fork makes a good cultivator for this purpose.

Urea is a white crystalline chemical which can be used for plants both indoors and out. The price of this substance at wholesale sources is about sixty cents a pound, and it provides growing things with the substance which most of them lack—nitrogen. It is applied at the rate of a teaspoonful to nine square feet of growing area, or a small pinch to a potted plant. It can be scattered over the plot in the dry

By Raymond B. Wailes

condition, mixed with finely powdered dry earth to spread it evenly; then the covered area is watered. Or, it may be dissolved in water and used directly.

Here's a month's "dose" of home-made fertilizer.



One tablespoonful of three inexpensive chemicals mixed makes a gallon of odorless, safe fertilizer.

Sodium nitrate is another chemical which can be used to supply nitrogen to the soil. One tablespoonful dissolved in two or three gallons of water will prove itself a valuable liquid fertilizer. It can be applied to plants which have just been watered without burning their roots if the suggested solution is used.

Sodium nitrate can also be used on trees and shrubs showing a lack of nitrogen foods. Deficiency of nitrogen in springtime is usually shown by a yellowish hue in the soil or in the newly sprouted leaves, and later by the dwarfed character of the plant. A quarter-pound of sodium nitrate for every year of the tree's age should be worked into the soil or dissolved in

some water and applied to the ground.

The potassium or "potash" content of wood ashes provides potassium for the plant. Soapsuds and dishwater also have been applied as fertilizer. When soaps were made from wood ashes or caustic potash, this was a wise thing to do; but now, when caustic soda is used, the dishwater might do more harm than good.

The majority of soils can do without lime. It is used mainly because it is alkaline in the presence of moisture and supplies calcium to the soil. But practically all soils contain sufficient calcium for plant needs. Weeds love alkaline soils and any application of lime promotes their growth. On lawns, lime should never be applied. Crab grass will increase itself bountifully when lime is applied, and acid—and alkaline—tolerant grasses lose out in their struggle for supremacy of the lawn.

Ammonium sulphate gives an acid reaction in the presence of water and will be found very good in lessening the growth of weeds. The right mixture is five pounds of ammonium sulphate to ten gallons of water per thousand square feet of lawn surface. Watering the lawn after sprinkling will help the chemical penetrate the soil. In applying the dry chemical, five pounds can be mixed with sand and broadcast over the area; a good soaking should follow. One very good method of keeping the quantity right is to take the garden hose and shape it on the lawn to form a square fifteen by fifteen feet, and apply one pound of the ammonium nitrate, mixed with sand, to this specific area. Several applications should be given at intervals of two or (Continued on page 65)

Gunning for Lightning

By
J. N. Wirt



This mobile generator can impress surges of more than 1,000,000 volts on a transmission line.

EQUIPPED with the latest type of Norinder-Du Four cathode-ray oscillographs, Westinghouse engineers carry on a continuous investigation of the effects of lightning on power transmission lines. These special oscillographs act even faster than lightning and are capable of accurately recording every detail of a lightning flash, including the polarity, voltage, and time required for the voltage to rise and fall. They have been installed in field experimental stations scattered throughout the lightning-infested areas of Illinois, Tennessee, West Virginia and New Jersey. A portable lightning laboratory is used to study lightning disturbances on a ten-mile section of a 220 kv. transmission line.

Many new electrical features are incorporated in the design of the new oscillograph. This instrument can be readily changed from a laboratory instrument to a type which, when connected to a transmission line, will automatically record the complete story of a lightning shock in terms of millions of volts and millionths of a second.

A typical lightning flash.

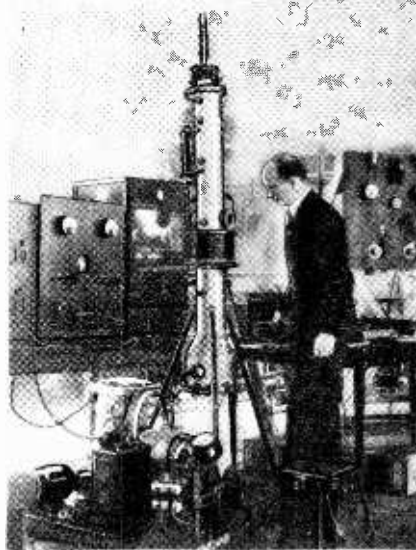
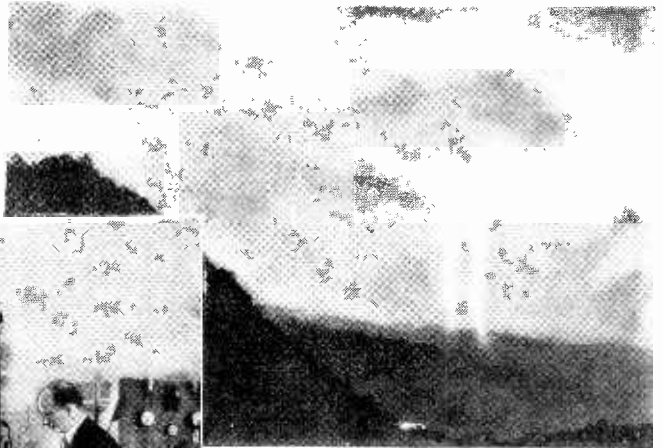

The elements that work together to insure clear photographic records are an electron filter, which removes the slow moving electrons that tend to fog the film, and an improved method of magnetic focusing of the beam.

A surge generator, capable of delivering a million volts, is used in conjunction with the tests, so that artificial transients may be studied.

The latest type of Norinder oscillograph works faster than lightning itself.

Diesel Car Makes Debut

By A. E. LeBlanc

TRUCK, bus, and tractor users soon may be operating units equipped with Diesel engines.

Outstanding economy and practicability for commercial haulage were definitely demonstrated by a Diesel powerplant installed in a large motor car on a trip of 2,500 miles made early this year.

Fuel cost per mile for the Diesel-powered car came to about one-thirteenth of that for the vehicle as originally equipped. The gasoline motor burned fuel costing about 21 cents per gallon at the point where the Diesel installation was made, and turned up from six to eight miles per gallon on the road. Though the

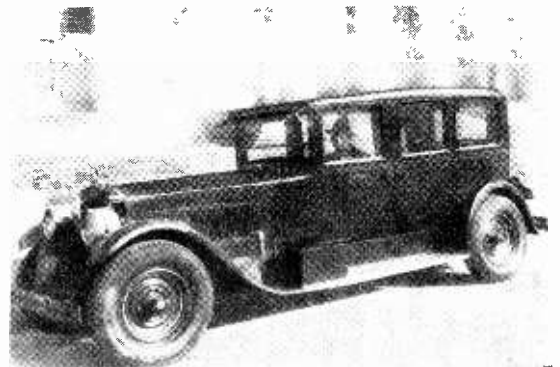

C. L. Cummins piloted the Dieselizeed Car over its 2,500-mile course.

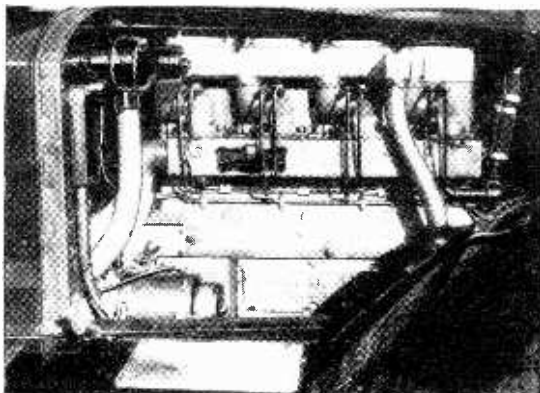

A standard Model U Cummins engine was used in the demonstration drive.

Diesel motor added 600 pounds to the weight of the car, it delivered about 26 miles per gallon of fuel consumed, and the fuel cost at the point of installation came to but $4\frac{3}{4}$ cents per gallon.

The Diesel motor was a standard Model U manufactured by the Cummins Engine (Continued on page 68)

Chicago — a Scientific Glimpse

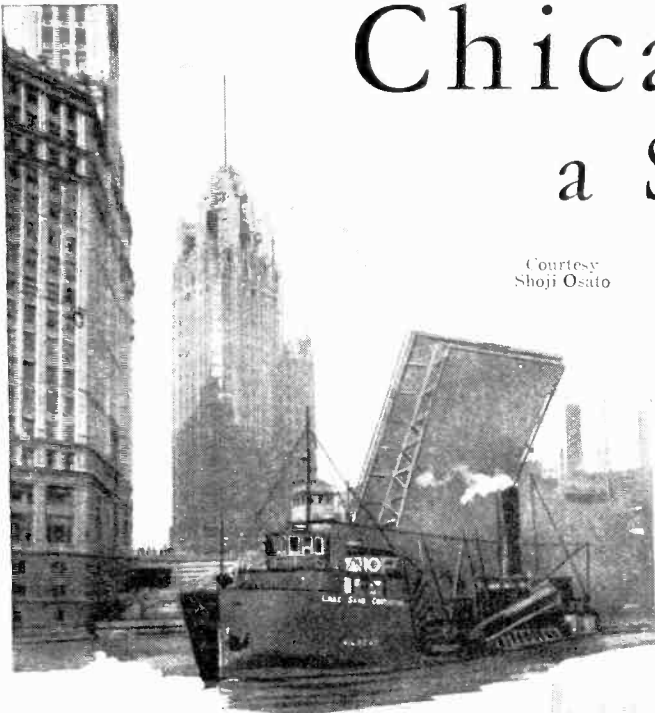

Courtesy
Shoji Ozato

Almost at the foot of the great Tribune Tower a bridge parts and rises to admit steamers of various types from Lake Michigan, which lies at Chicago's door. The Tribune Tower is one of the most interesting adaptations of the Gothic to the skyscraper form.

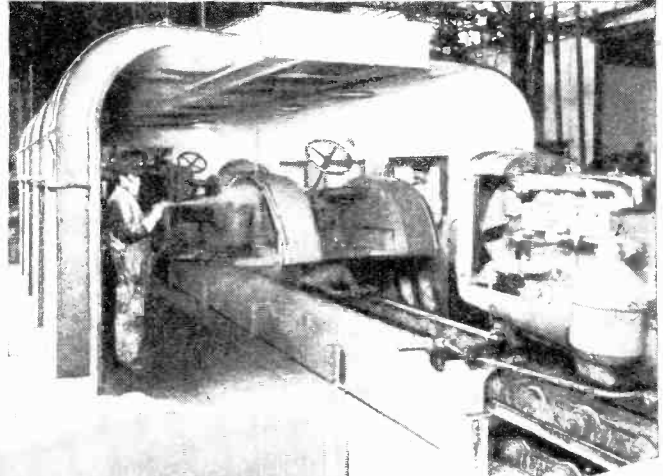

The International Harvester Company's range of products embraces farm implements, from the simplest ploughs to the complex "combine." The picture above shows a workman spraying an International tractor with paint on the continuous assembly line. . . . The picture below is of the Merchandise Mart, the largest building for merchandise display in the world.



Chicago Aerial Surveys Company



This night view of Chicago features in the foreground the tower of the Wrigley Building, while beyond can be discerned Wacker Drive, one of the most unique boulevard construction projects in the world. . . . On the left is an aerial idea of the task involved in taking the kinks out of the Chicago River—the old course of the river is to the left, the new one to the right.

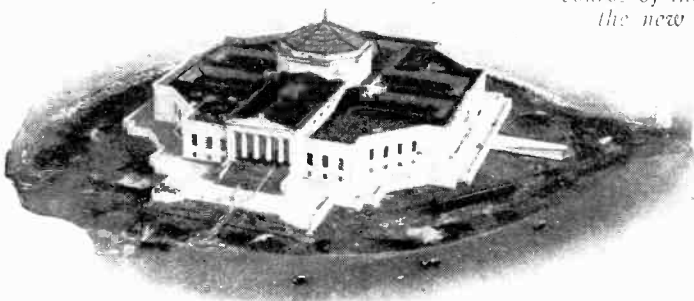

The new Shedd Aquarium adds another repository of living scientific knowledge to the Field Museum and other distinguished achievements of this type. The water for the aquatic creatures in this aquarium is to be conditioned to their needs as air is conditioned for human needs in theaters and auditoriums.

In Chicago's Adler Planetarium a representation of the firmament will be projected for instructional purposes as it is in Jena and other advanced centers of astronomical study.

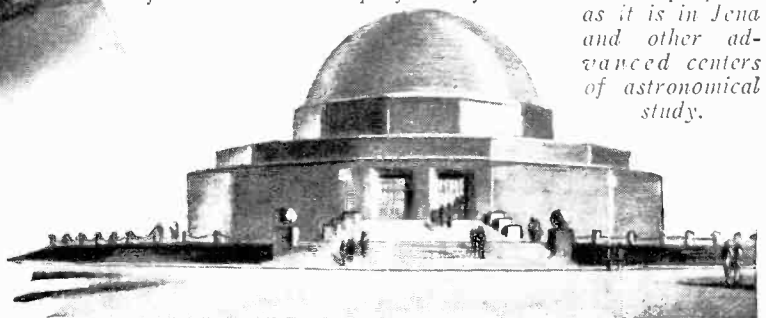

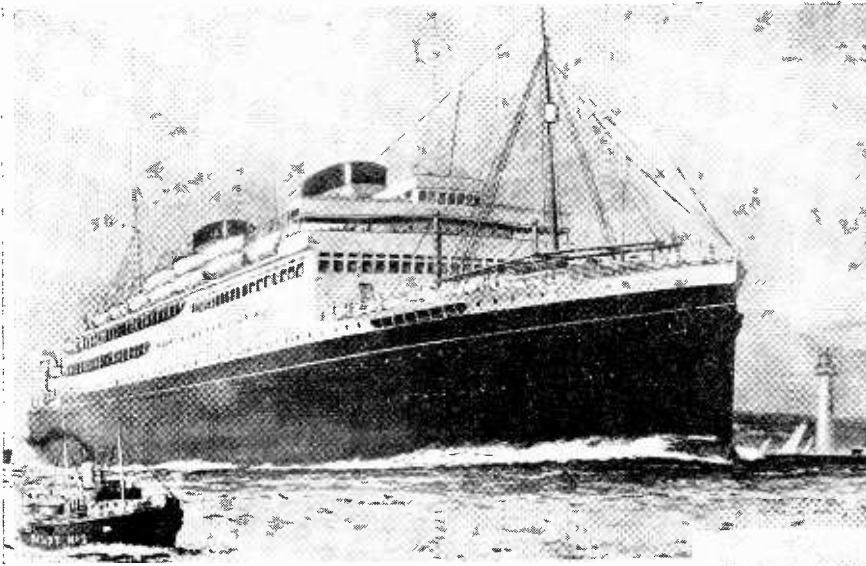

The White Star Line's Britannic is the largest motor-driven liner in the world.

We'll Motor Across *the* Atlantic

Displacement of Steam-driven Liners by Dieselized Ocean Motor Ships Forecast by Construction of M. S. Britannic

By Marguerite Kujawska

THE tourist of the future will be carried across the Atlantic by the same kind of powerplant that whisks him along the Lincoln Highway at the present time. This is the probability that has been given vastly increased support by the construction of the White Star's Britannic, largest motorship in the world.

Fifteen hundred and fifty passengers are provided for in the new motorship, which will be placed in the New York-Liverpool service of the line, and the luxury of the accommodations will be surpassing.

The Britannic is 680 feet long, 82 feet in breadth, and 43 feet 9 inches deep. Her gross tonnage is 27,840. Thus she compares well in size with such liners as the Belgenland. Two ten-cylinder double-acting Diesel engines—the largest and most powerful ever installed in any vehicle—will drive her through the deep.

To supply air for starting and fuel injection, and also for actuating the machinery for maneuvering the ship, the Britannic is equipped with four compressors, each driven by a four-cylinder motor of the Diesel type. For emergency, a small steam-driven compressor is included. Four other Diesels—six-cylinder units—will drive generators which will furnish electrical current for engineering and general ship use, and there is an emergency genera-

tor, also Diesel-driven, above the margin line. The combined capacity of the four generator sets for regular duty is 2,000 kilowatts, and that of the emergency set is 75.

The connected load of current in the Britannic will be equivalent to that required for a town of 30,000 people. Nearly 200 electric motors, ranging in horsepower from one to 170, are included.

Steam for ship use at sea will be generated in four boilers fired by exhaust gas from the propulsion motors. Gas from the auxiliary motors will fire one boiler to furnish steam for heating and cooking, and two oil-fired boilers will also be available.

TWELVE motor cars could be parked within the area of the bed-plate of one of the motors. By removing an inlet valve an engineer can climb bodily into one of the cylinders. . . . Daily consumption of fuel oil, 80 tons. Each inlet, exhaust, and fuel valve will function 70,000 times. Each piston will travel a distance of 280 miles. . . . Thirteen thousand tons of water will pass through the cylinder jackets, and 16,000 tons of seawater will circulate through the various coolers. . . . Exhaust gas will generate steam at 100 pounds' pressure for ship use . . . The Britannic's motors can be reversed in nine seconds.

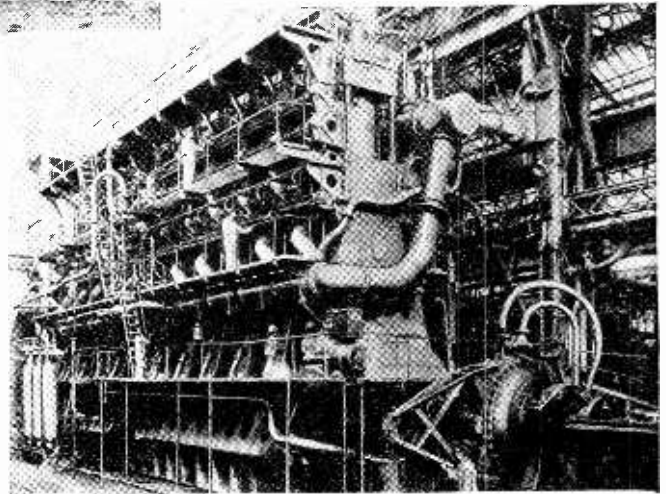

This starboard motor and its twin are the largest and most powerful ever installed in any vehicle on land or sea.

Father Neptune himself would have a job cranking the Britannic; each of her crankshafts weighs 185 tons. Note size of workmen.

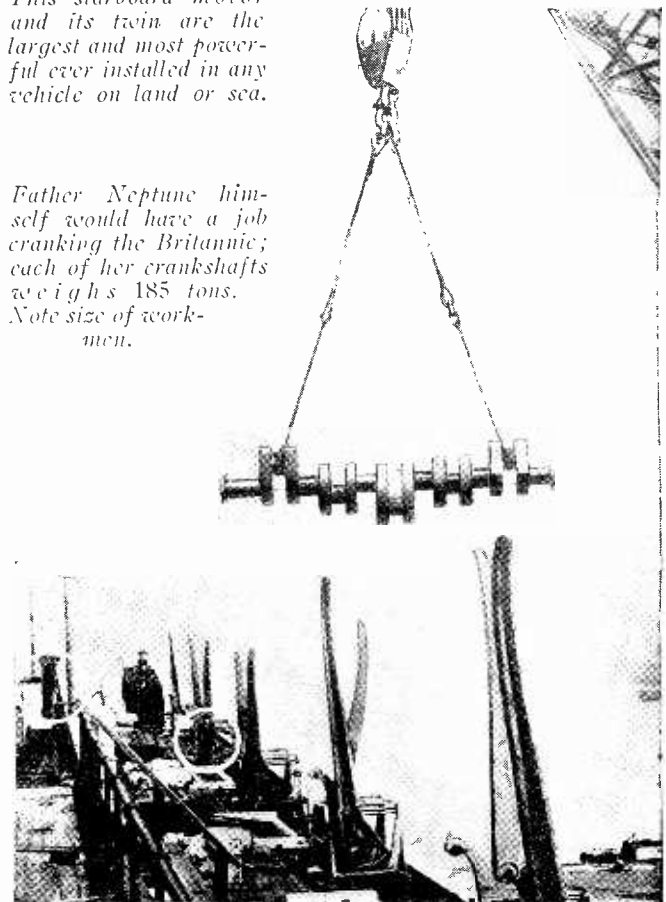

The Big Bridges Rise



\$60,000,000 will be the cost of the proposed Liberty Bridge, which will span the Narrows and link Brooklyn with Staten Island. The towers will be 800 feet high—taller than the Woolworth Building—and the main span 4,500 feet long—1,000 feet longer than that of the Hudson Bridge. Original features will be a carillon of bells and a beacon light. (Robinson and Steinman, Engineers.)

Across the rivers and harbors of the world man throws his expert webs of steel. . . . Once a tremendous task, conceived in trepidation and watched with wonder, the construction of a suspension bridge has become a systematized process, progressing from stage to stage with orderly regularity. . . . Yet can any appearance of order and system overcome the element of the marvelous in the spectacle of matter-of-fact men laboring on swaying catwalks in a high wind, weaving shore to shore?

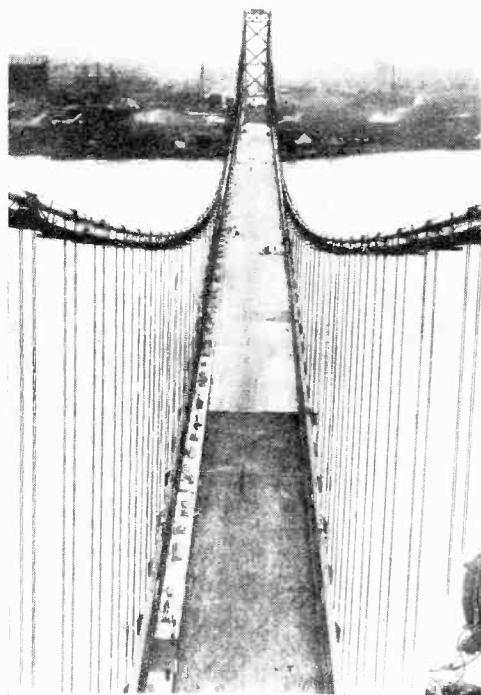

An idea of the height of the Hudson Bridge across the Hudson River at New York City, is shown in this downward shot of an arch under construction.

Connecting Detroit with the Border Cities, Ontario, is the Ambassador Bridge, with a span between towers of 1,850 feet—at present the longest in the world. The mid-span clearance is 152 feet—more by 20 feet than that needed for any vessel now plying the Great Lakes.

The proposed Golden Gate Bridge, of combination suspension and cantilever type, will connect San Francisco and Marin counties.

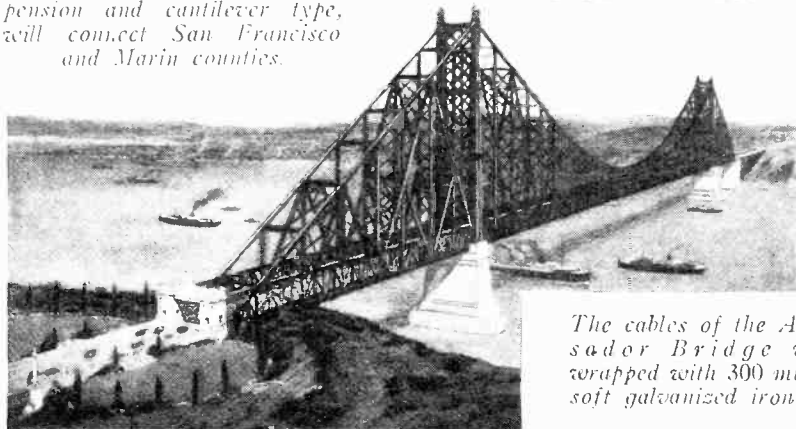

The cables of the Ambassador Bridge were wrapped with 300 miles of soft galvanized iron wire.

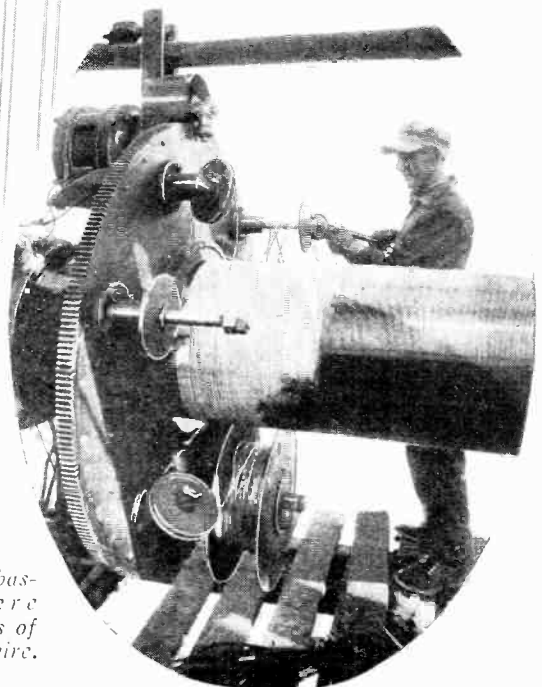

Get Out Your Smoked Glasses

ON the 28th of April will occur an eclipse of the sun, visible generally as a partial eclipse throughout the North American continent. As a preliminary I should like to remind the reader that an eclipse of the sun occurs when the moon gets in line between the earth and sun. The latter is about 400 times as

By Donald H. Menzel, Ph. D.

Lick Observatory



When the moon intercepts the light from the sun, the sun may look as it does in this photograph. The sun is much larger than the moon, but also much farther away, so the latter can hide the sun.

the eclipse will be annular or ring-like.

The April 1930 eclipse is a sort of freak because it is total, annular, or partial—according to the place it is viewed from. The moon and sun are so nearly the same size that the curvature of the earth is the factor that decides which appears to be the larger. Figure 1 is a schematic diagram (not to scale) of the condition that obtain at that time. (Continued on page 60)

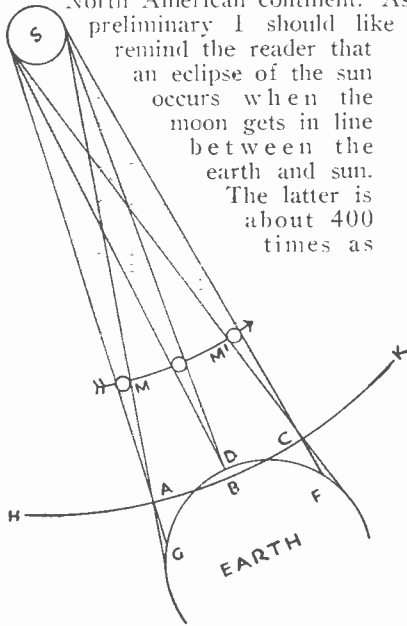

The conditions that obtain on April 28 are schematically indicated in the diagram here, not drawn to scale.

large as the moon, but since it is 400 times farther away, the two objects appear to be about the same size in the

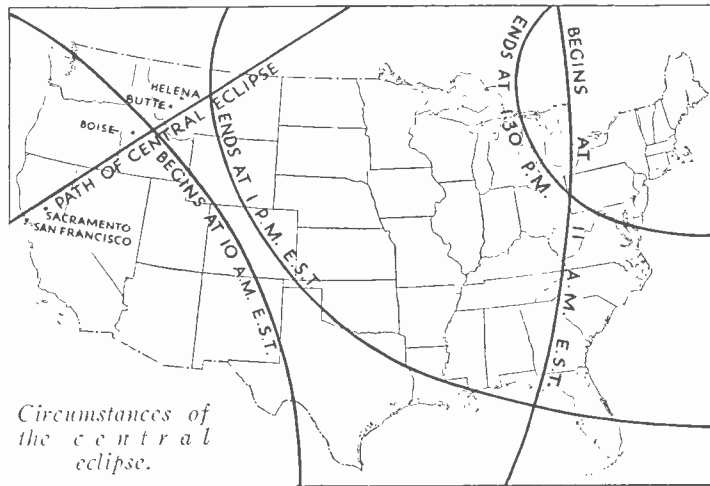

Circumstances of the central eclipse.

sky. The lunar orbit is far from circular. When the moon is nearer than the average its disk is larger than the sun's and a total eclipse will occur when the two bodies come exactly into line with the earth. When the moon is farther away than usual, it will not be able to cover the sun completely and

partial—according to the place it is viewed from. The moon and sun are so nearly the same size that the curvature of the earth is the factor that decides which appears to be the larger. Figure 1 is a schematic diagram (not to scale) of the condition that obtain at that time. (Continued on page 60)

“Both Ends of the String”

By Augustus Post and Arthur H. Lynch

Aviation Editor

Editorial Director

Says Mr. Post—

Early in the Spring of 1908 a few of the members of the Aero Club of America who had been studying the subject of gliding, decided to make some real experiments and to build gliders after the model of those constructed by Octave Chanute, an engineer who lived in Chicago, and who was one of the authorities on Aeronautics at that time. We were fascinated (Continued on page 60)

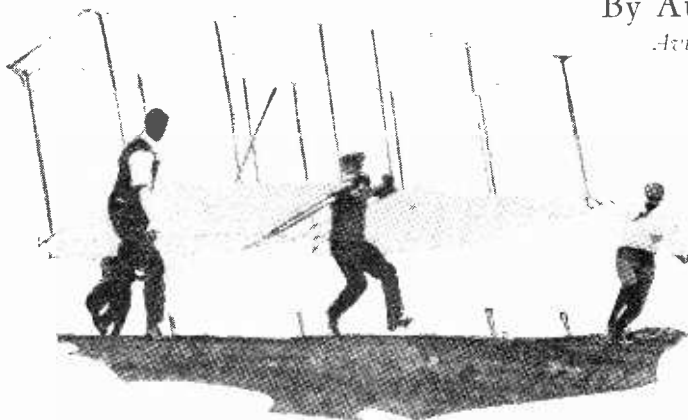

When Mr. Post (on the right) took to gliding in 1908, he galloped down a slope and was wafted aloft in this glorified boxkite—

While Mr. Lynch gets a shock-cord start and does his motorless flying sitting down.

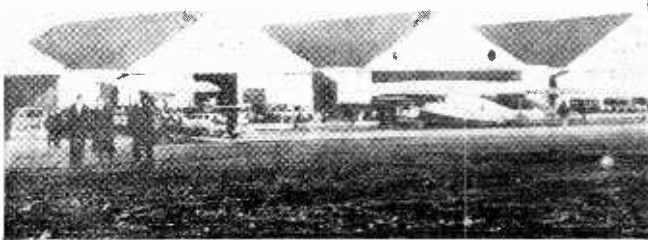
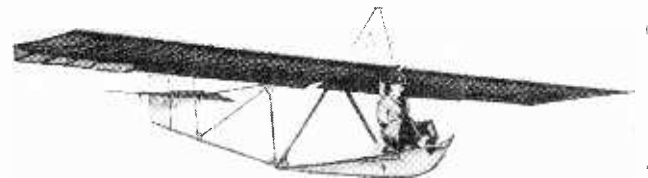

THE staff of SCIENCE AND INVENTION is connected with glider progress in America at “both ends of the string.” In Augustus Post, Aviation Editor, it has an active glider experimenter of the days when gliding was a field containing far more unknown than known quantities. Arthur H. Lynch, Editorial Director, is a glider enthusiast and a flier of motorless ships as they are today. He made the first paid-for glider flight taken at Roosevelt Field. In connection with the pictures published with this article, Mr. Post and Mr. Lynch offer illuminating comments.

On The Short Waves

with a

Super-Wasp

You Won't Have a Thrill in Radio Until You Play Around with the High Frequencies

By Robert Hertzberg



The Super-Wasp in a radio transmitting station. This is W2XC1, the television station of the Pilot Radio & Tube Corporation.

THERE is nothing in radio more thrilling than the short waves. Radio fans who have constructed the most expensive and complicated of broadcast receivers and who think there

these days of high-power stations and super-sensitive receivers, for a man in New York to hear West Coast broadcasting direct, even on a seven or eight-tube receiver. The New York

at seven o'clock in the evening, New York time, by broadcasting the midnight chimes from Big Ben in London; or station PCJ, Holland, from which the announcements are made in six languages; or little NRH, in Costa Rica, Central America, over which the owner broadcasts the chirpings of his delightful two-year-old baby; or station VK2ME, in Sydney, Australia, which broadcasts football games in the best McNamee manner.

In a spirit of truthfulness, the writer does not want to create the impression that such reception can be accomplished at the mere flip of a switch. Short-wave work is still quite tricky, and it takes a few hours of practice to learn where the important stations come in on the dials. The usual difficulties with fading and signal distortion are experienced, but the short-wave channels are

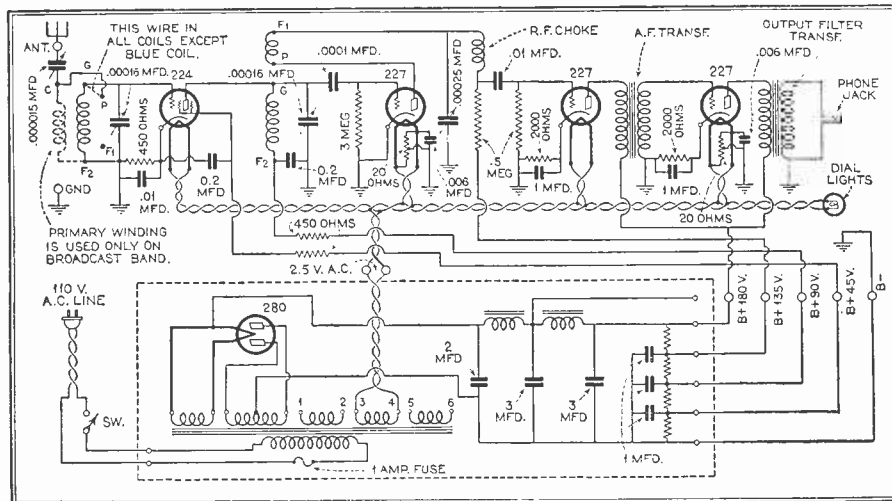

is nothing left in the "game" to interest them are discovering a new and fertile field of amusement in the regions below 200 meters, where hundreds of stations are now broadcasting at all hours of the day and night. Short waves have the peculiar habit of "skipping" over the earth's surface in such irregular fashion that even tiny transmitters deliver wallopingly strong signals at antipodal points, and owners of short-wave receivers enjoy truly phenomenal reception.

The writer wishes to distinguish between short-wave broadcasting and short-wave amateur telegraphy. The former is a comparatively recent development and is of interest to broadcast fans because the announcements are made in *voice*. Amateurs have been telegraphing to each other all over the world for many years, but this work is done in the dots and dashes of the Continental Code. It is much more difficult to pick up a distant short-wave broadcast station than a telegraph station, and therein lies most of the sport. If such reception were easy there would be no "kick" to it.

It is still an accomplishment, even in

The circuit of the AC Super-Wasp employs a -24 tube for the tuned r. f. stage, and three -27 tubes for detector and audio stages.

Compact and well shielded is this efficient set with all parts cleanly mounted on base-board.

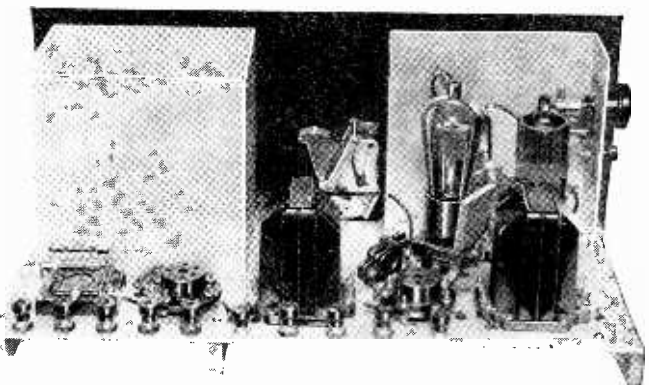

owner of a good short-wave receiver using only three or four tubes considers W6XN, in Oakland, California, a nuisance because of its strength, and reaches for Khabarovsk, Siberia, where the Soviet maintains a fine short-wave station, or for Bandoeng, on the island of Java, where the enterprising Dutch operate a whole string of short-wave transmitters. Thousands of fans who have "discovered" the short wave amuse their friends by tuning in, on the loud speaker, mind you, station G5SW, in Chelmsford, England, which signs off

so active now that distant stations can be heard almost any time. The Australian, Javanese and other East Indian stations float in early in the morning, conveniently around breakfast time. The Dutch, English, French and German stations operate right through the afternoon. The Central American and South American stations put on special programs for the United States during the early evening hours, as do the Dutch stations. There are also plenty of American transmitters. To take
(Continued on page 69)

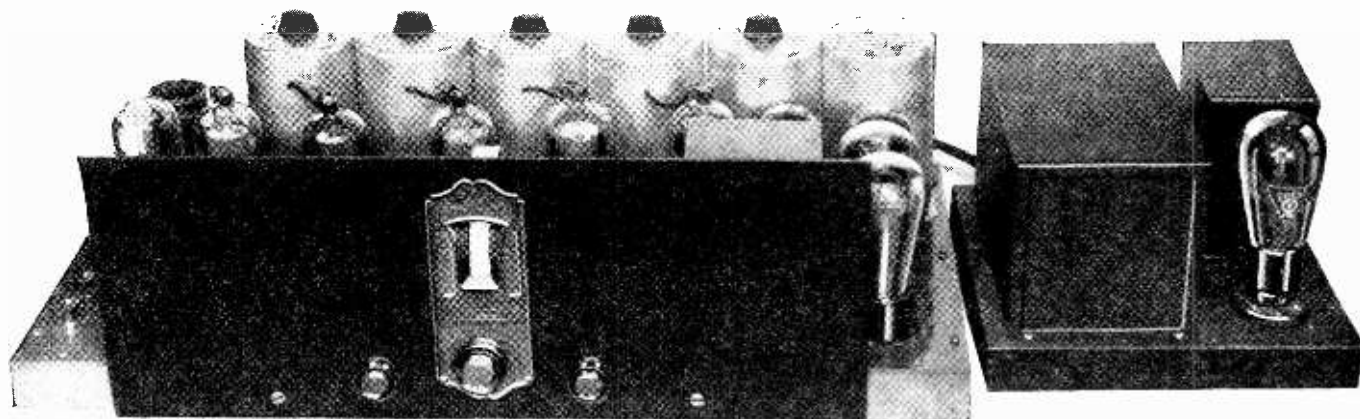

The Lincoln Super with power pack to the right.

Pull Them In with a Heterodyne

By George R. Brown

If You're Interested in Broadcast Reception, Here Is a Set Which Will Bring in Stations with a Bang.

IF you knew of a super-heterodyne set which pulled in stations without peaking, stayed on ten kilocycles, and had good audio system, you'd probably be interested in it—provided you played around with super-heterodyne circuits in the radio days beyond recall.

The Lincoln Super-Heterodyne is a set which has these qualifications. We know. We've tried it out. We sat in a room in a house eight miles out of New York and logged stations that are the despair of every radio owner in the metropolitan area. We played around with the dial and went right up the scale, stopping only long enough to hear call letters and incidental announcements. We listened to a total of thirty stations—only

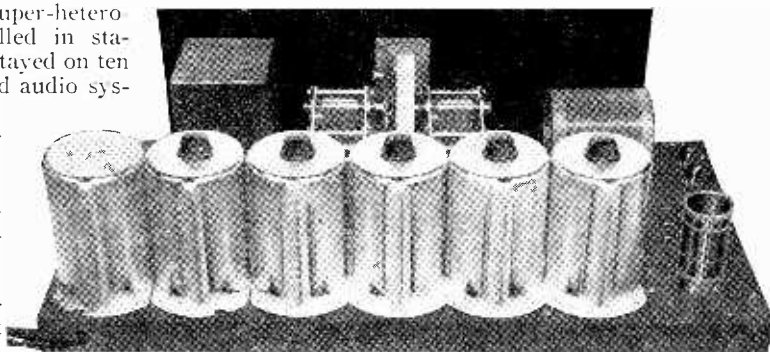

Here is the Lincoln Super from the rear. It is a well-designed set and compact in spite of its eleven tubes.

three of them local. We even got as far as Havana and pulled in KHJ in Los Angeles without batting an eye. . . .

We were interested very greatly in this hook-up, and knowing that the readers of SCIENCE AND INVENTION would be interested in an explanation, we obtained the following information from W. H. Hollister of Lincoln Radio Company concerning the intermediate frequency amplifying transformers, which are the important part of this set.

"It is not possible to get all of the gain out of a transformer, when used between three-electrode tubes, because a condition of instability and a

(Continued on page 93)

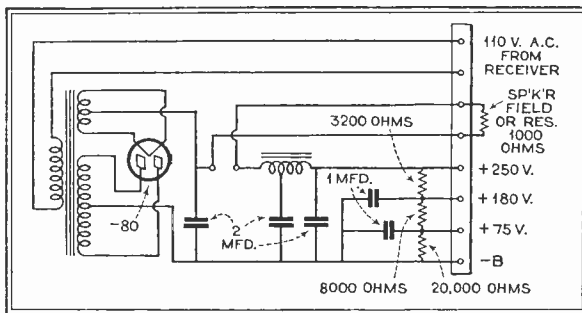

The schematic diagram of the power pack for the Lincoln.

The circuit of the Lincoln Super is shown below.

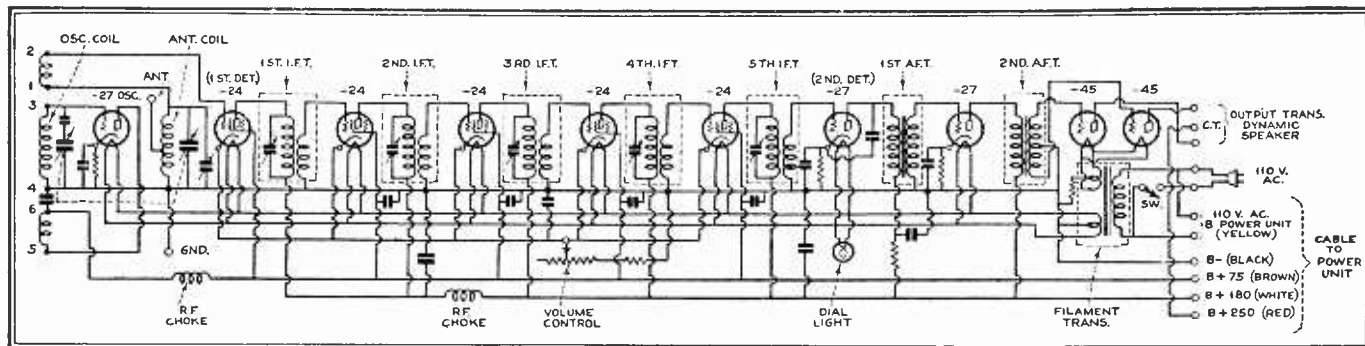

Foods that Fight Your Stomach

Science Now Makes Your Skin Tell Which Elements of Your Diet Disagree With You

By Frederic Damrau, M.D

IT is a remarkable fact that foods which are ordinarily quite nutritious and entirely harmless may cause sudden illness in the case of susceptible persons. These unfortunates are said to have an *idiosyncrasy*; which means that they have a queer habit of becoming sick after eating some particular food that nourishes other people. The old proverb, "one man's food is another's poison," has a scientific foundation.

When it comes to food idiosyncrasies, every man is a law unto himself.

There are seventy-two foods in the rogues' gal-

lery for disorderly conduct in the human stomach. Most of them are rather common articles of diet, such as milk, eggs, beef, cheese and various kinds of beans. They all contain *protein*, which is an organic combination of carbon, nitrogen, hydrogen, oxygen and sulphur. It is the protein element of the food to which persons with an idiosyncrasy are sensitive.

We could not live without these seventy-two foods. If the doctor attempted to eliminate all the foods that may cause trouble, there would be nothing substantial left to eat.

Luckily there are scientific tests by which the exact food at fault in a given case may be determined. We must bear in mind that there is no way of deciding by the symptoms whether milk or spinach, or in fact, any one of the seventy-two suspects, is to blame. Food *allergy*, or the condition of sensitiveness to the protein of some par-

ticular food, acts pretty much the same whether the illness occurs in a lobster-sensitive man after a cabaret supper or in a cabbage-sensitive fellow after a dinner with his wife.

When one is sensitive to a food, his whole body fights against its introduction into the system. The body passes a prohibition law against this food, which is more rigidly enforced than the Volstead act. Then *antibodies*—the body's prohibition agents—are sent out by the central tissues with instructions to raid the stomach and other organs and destroy the forbidden food on sight.

But the human appetite

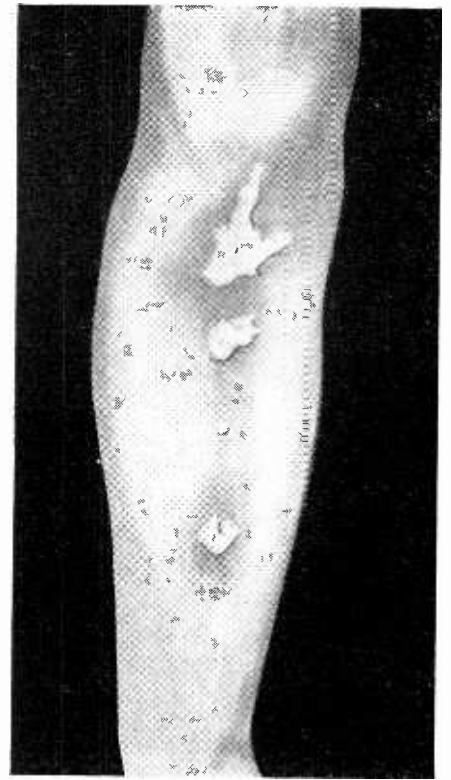
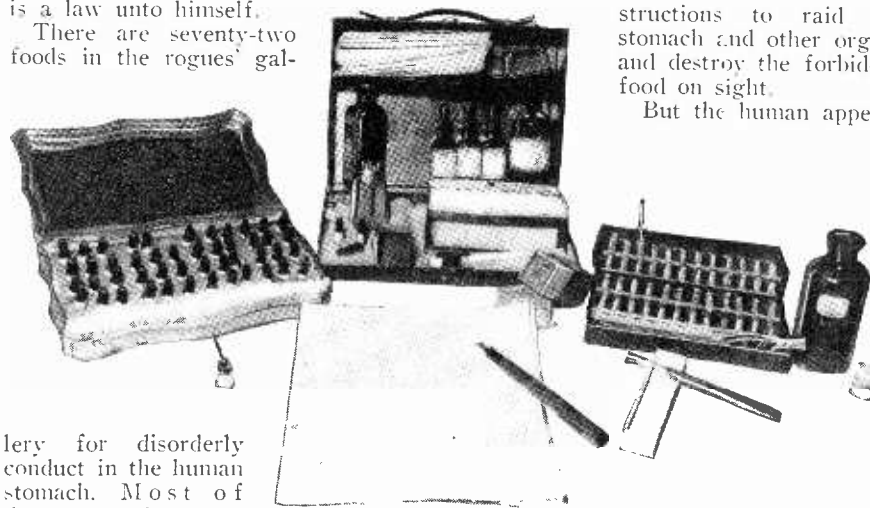

Photo courtesy Arlington Chemical Company.

This person cannot eat eggs until he is desensitized. The upper large reaction was obtained with egg white protein; the reaction next below was obtained with the same in dilution; the next was the negative control—small white dot; and the lowest reaction came from chicken protein.

plays the rôle of the bootlegger. And a very successful smuggler it is! The man whose mission in life is to have hundreds of lobsters boiled alive will defend the honor of the Crustacean family to the last claw. And so, if he happens to be sensitive to lobsters, he

(Continued on page 73)



The diagnostic set used in making cutaneous tests for food allergy, with the fountain pen ready for recording on the diagnostic sheet. Proteins are available in the form of pollen extracts, animal epidermal proteins and others.

Food sensitivity test. The forearm is cleansed with 40% alcohol and scratches about 1/8-inch long and an inch or more apart are made, but only a trace of blood is drawn. The protein is then applied.



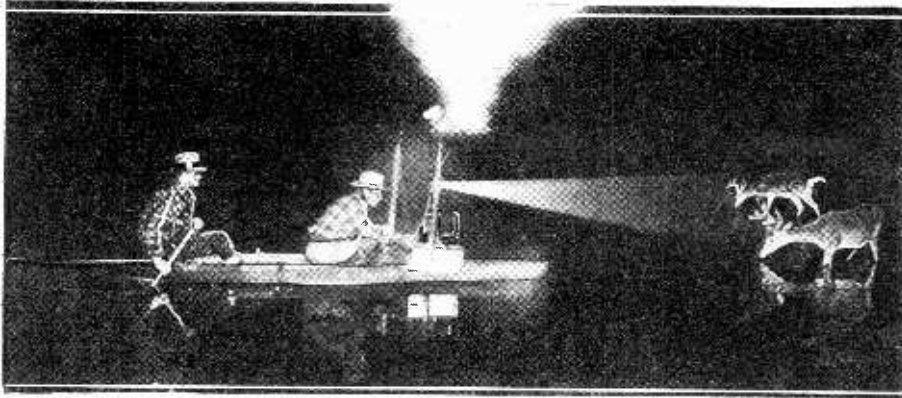

Photographing Wild Life at Night

HOBART V. ROBERTS of the New York State College of Forestry used a novel rig for taking photographs of wild animal life at night. This consisted of a pair of up-rights mounted on a canoe and a camera suitably set in the bow. When an ordinary electrical flashlight penetrated the darkness and disclosed the animal feeding or drinking, the flash-

light powder was set off and the camera shutter clicked. The first photograph reveals a pair of fawns calmly enjoying a nocturnal drink. They did not get a chance to become startled. A second fawn became terrified at the approach of the canoe and leaped for safety. At that moment the camera was again operated, with the strikingly beautiful result shown at the right.



In the

Spotlight of Science

Acetylene-Driven Automobile

ACETYLENE was used as a substitute for gasoline in a recent experiment in Pittsburgh, Pa. The tank of acetylene was mounted in the front of the automobile and a tube conveyed the gas to a mixing chamber where water and air were added. This fuel proved to have many advantages, among which are lightness, power, and quick starting in any kind of weather. There is a total absence of deadly carbon monoxide gas. The photograph shows the inventors, Frederick Keitel, G. C. Jones (who first used this form of fuel in 1923), W. C. Duve, and their car.



New Plane Flies Like a Bird

A NEW development of the ornithopter type of machine was recently announced by Captain Sarin, who won the Clifford Harmon trophy for aviation in 1929. The ornithopter is a flapping-wing type of airplane. This one uses no propeller. A successful test caused enthusiasts to predict the new plane would revolutionize power flight.

Glider Launched from Zeppelin

IN order to demonstrate that a glider can be launched from a zeppelin and land exactly where the pilot plans it should, Lieutenant Ralph S. Barnaby dropped from the U. S. Navy dirigible, Los Angeles, when the big airship was at an altitude of 3,000 feet over Lakehurst, N. J., on January 31st. The glider came to a perfect landing on the snow-packed field after flying in wide circles and crossing the terrain a dozen times.

The flight took twelve minutes and demonstrated the feasibility of releasing a man from a zeppelin for the purpose of directing ground crews in mooring a dirigible of large size. Because the pilot of the glider can accurately settle down in a relatively small area, the method is far superior to a parachute drop. A special rig was fitted to the Los Angeles to hold the glider until the descent was made.

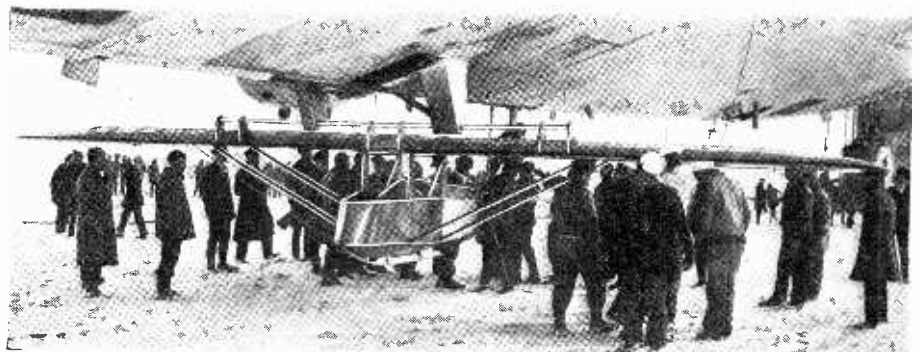

Tri-Motor Monoplane Is Repaired in Flight



IN an experimental flight over Miami, Florida, James Terry proved that he could repair a rudder cable control in four minutes should it break while the plane was in flight. A cable was stretched between two points along the fuselage for Terry's exploit. This dem-

onstration blazes another trail in safe flying and indicates that it is now possible to remove hazards from passenger flying by making repairs in midair. Captain Goodsell was the pilot in this experimental flight and the plan used was an all-metal tri-motor ship.

Truck Has Moving Floor

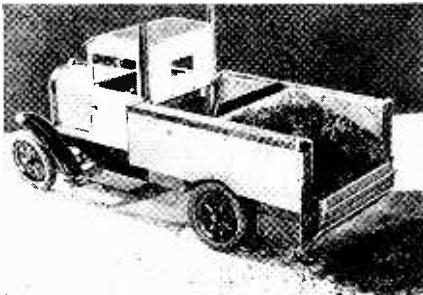

AFLEXIBLE floor, electrically operated, is a salient feature of an English motor truck. The floor moves backward and coils beneath the vehicle as it discharges its load. So far the device has been demonstrated in model form only.

Testing Automobile Headlights

AWILLYS-KNIGHT Great Six has been especially fitted with almost every type of motor-car lighting device for the research and development work now being carried on by the Westinghouse Lamp Co. The lamps will take practically all types of lenses and are equipped with micrometer adjustments for correct focusing.

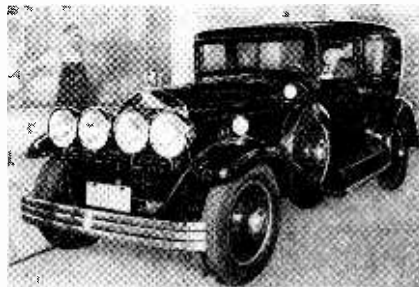

Airplane Ferry Service for 'Frisco

AN air ferry between San Francisco, California, and Oakland, California, operates on a fifteen-minute schedule, with six minutes' flying time. It is believed that this is the first air ferry installed between any two cities in the United States. A whole fleet of Loening amphibians is used in this service and the passengers have no more difficulty embarking on the air ferry than they would on any of the regular ferryboats.

This experiment may be a forerunner of many other air ferries that will be started in different parts of the country. No expensive docks are needed because a simple slop-

ing platform permits the amphibian to pull up out of the water and set its passengers ashore on perfectly dry land. We can look upon this experiment with a keen degree of interest and await its adoption throughout the country.



Alcohol, Not Frost, Colors Autumn Leaves

ACCORDING to Samuel G. Hibbon, a lighting specialist of the Westinghouse Lamp Co., alcohol, not frost, is responsible for the autumnal colors in forest foliage. When the leaves reach the turning point in their natural life, their powers of absorption begin to change, and a chemical action takes place in the leaf tissues. The change in chemical composition involves a slight fermentation, and when alcohol appears, the leaves gradually turn red. It is a well-known fact that plants require sunlight, but even in those sections to which the sun does not penetrate it is possible to produce vegetables and flowers if there is an abundance of cheap electric power. Mr. Hibben declared that by excluding natural sunlight from growing plants and substituting various colors of the spectrum, man can exercise a great control over nature. This fact, but not in detail, has been known to farmers who exclude daylight from certain vegetables so as to make the leaves more tender and the vegetables more appetizing. Sunlight is practically excluded from all celery grown for table use.



Looping the Loop in a Glider

AFTER being towed to a considerable height, Mr. E. Heath, one of the pioneers in the airplane industry, looped the loop four times before landing his glider. The Heath experiment was conducted at Chicago and this photograph was taken immediately after performing this remarkable feat.

Half-Tones Are 50 Years Old

ON the 4th of March a luncheon was given by William Gamble and other European authorities on picture printing, in celebration of the anniversary of the invention of half-tones, at which Stephen H. Horgan, the inventor of the process, was the guest of honor. Mr. Horgan, who is a pioneer in various forms of illustrated journalism, first proved in 1897 that the half-tone could be reproduced by the modern newspaper press. The first half-tones that were ever printed appeared in a newspaper called the *New York Daily Graphic*. This was on March 4, 1880.

With the half-tone process it is possible to get the photographic results portrayed on this page. Before that time etchings, woodcuts, and line illustrations were the vogue and, of course, they left much to the imagination. Picturization in those days depended entirely on the skill with which the artist depicted a scene or event.

Award Made for Long-Range Aerial Photograph

THE Mackay Trophy for 1929 has been awarded to Captain A. W. Stevens, Army Air Corps, for his outstanding aerial photography, which includes an aerial photograph of Mount Rainier made from a plane 227 miles away. This distance exceeded by more than 50 miles Captain Stevens' own previous record for long-range photography. Mount Rainier is in the state of Washington, but the photograph was taken from well south of the center of the state of Oregon. The 227-mile picture shows, quite clearly, mountains far beyond the distance that the human eye can see. Even on clear days the atmosphere contains sufficient haze to limit vision to much less than 227 miles, but the long distance pictures were made possible on film sensitive to the invisible infra-red rays that penetrate haze and smoke.

Captain Stevens could not see his objective and was obliged, on the various days when he attempted the picture, simply to point his camera in the direction of Mount Rainier and then await the development of his films to learn whether or not he had been successful. When the negative showed that Mount Rainier had been recorded, the distance was measured, on a map. When the photograph was taken the plane was at an altitude of 17,000 feet.

It is expected that scientists employed by the Eastman, Bausch and Lomb, and Folmer companies will co-operate with Captain Stevens in an attempt to increase the camera's range.

Captain Stevens and one of his 227-mile aerial photographs.

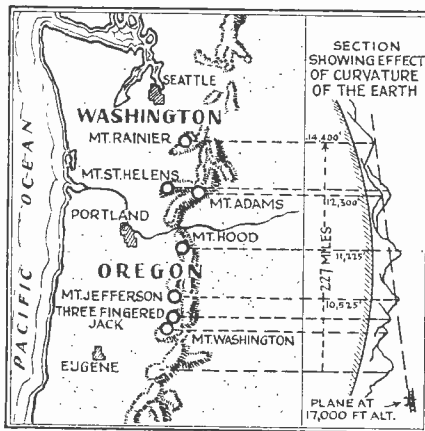
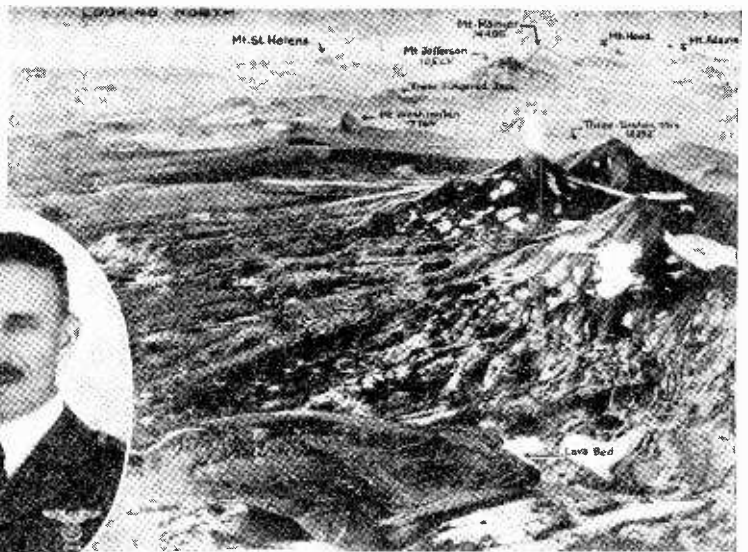

Machine Makes Record of Faulty Brakes

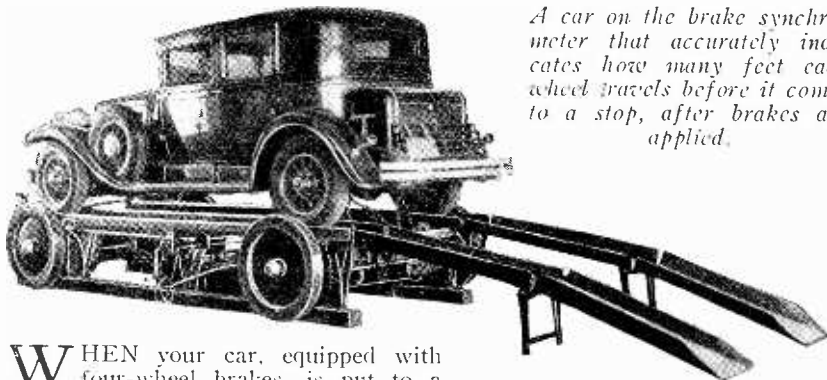

A car on the brake synchronometer that accurately indicates how many feet each wheel travels before it comes to a stop, after brakes are applied.

WHEN your car, equipped with four-wheel brakes, is put to a test, do you ever find that the car has a tendency to swerve to the right or left? If so, you know that the brakes are not properly adjusted. When you attempt to regulate them yourself, you usually make a hit-or-miss job of it, but a brake synchronometer will actually tell you which brakes are at fault. This is a mechanical device that permits you to duplicate the energy of a vehicle moving at a selected speed and then to dissipate this energy by the application of the vehicle's brakes. At the same time you automatically record the results of the braking effort afforded by each wheel. The testing power is supplied by the vehicle itself. The synchronometer consists of two axles, on each of which are mounted

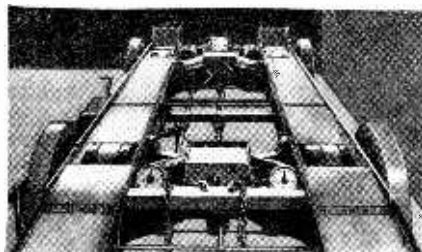

two flywheels. The axles are connected by a shaft and worm gears. The vehicle to be tested is brought up to the required speed by its own motive power, the energy being transmitted to the drums which rotate the flywheels. The brakes are then applied

and a dial records the exact number of feet traveled by each wheel, from the time the brake is applied to the time the wheels come to a stop. Adjustment is thus made accurate and easy.

Thawing the Earth for Gold

ALASKA'S latest gold strike is in the vicinity of Poorman. The Poorman placer vein was discovered by Mike Kovas, Tom Gallagher and James August, and is in the west central part of the territory. The latest man to stake a claim was Sergeant William M. Growden of the Signal Corps Unit at Ruby, Alaska, who took five days' furlough so that he and his companion, Chief Harry Pitka of the Kokrine Indians, could pan for dust. The temperature at Poorman being at 40° below zero, it was necessary to break off pieces of frozen earth, hold them in a pan containing water, and then boil the water to thaw the earth out. In two pans \$2.96 worth of gold was obtained.

A Spider-Line Fire Escape

A PORTABLE apparatus by means of which occupants of upper floors can escape in case of fire was recently demonstrated in London, England. The photo shows Miss Paddy Naismith testing the apparatus at the new Y. M. C. A. building at Hornsey. The speed of descent is regulated by the device containing the reel of wire



Tiny Motor Car Has Speed

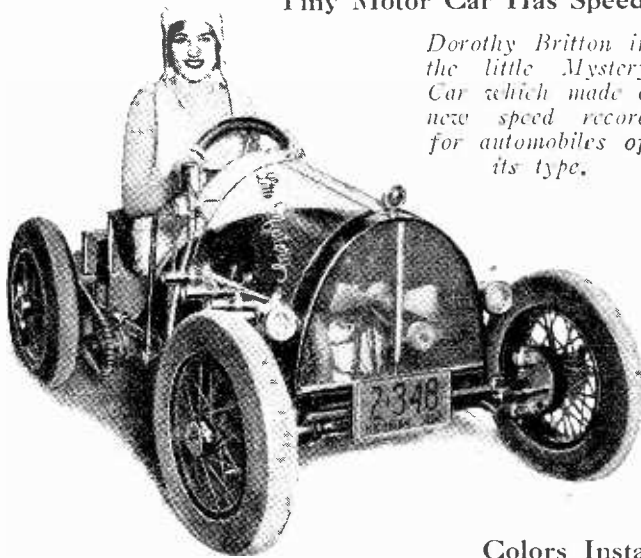

Dorothy Britton in the little Mystery Car which made a new speed record for automobiles of its type.



The Bowlus glider which established a new American flight record.

Soaring Glider Sets New American Record

W. HAWLEY BOWLUS, an expert at handling and building gliders, recently established for the second time in seven days a new American record for duration of flight in a motorless plane. He remained in the air for two hours, 47 minutes and 13½ seconds, and thereby surpassed his own former record of an hour and twenty minutes.

The design of the Bowlus record glider makes it particularly suitable for sustained soaring flights, and the mountainous country in the vicinity of Los Angeles, California, is admirably suited for the establishment of new flight records. This is the same glider which Colonel Charles A. Lindbergh flew so successfully and regarding which he stated that flying a glider is comparable with setting sail in a yacht. One need not worry about the motor, nor does one hear the constant throb of the engine or feel its vibration.

Colors Instantly Analyzed

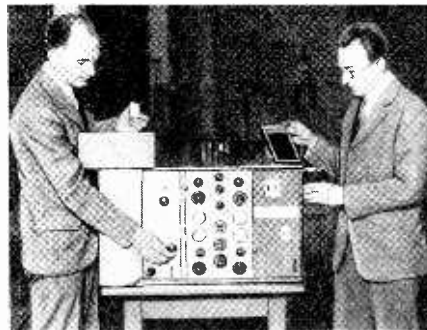

In the University of Pennsylvania's Department of Physics, Joseph Razek and Peter J. Mulder developed this machine which analyzes colors almost instantly. At right is a graph of a color analysis.

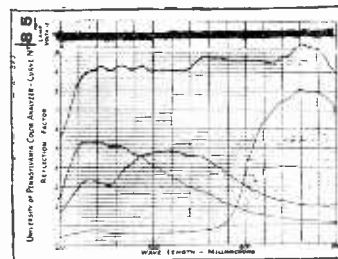

Find New Depth in Carlsbad, New Mexico, Cave

F. RANK EARNEST NICHOLSON, of New York, the leader of the Carlsbad cavern expedition, has discovered a new low level about 1,350 feet below the surface. This new depth is 325 feet lower than what was formerly considered the deepest level of the Carlsbad caverns. The heat here was stifling and there seemed hardly enough air to permit breathing. Marvelous formations known as cave pearls were found and a nest of white crickets was discovered.

Eliminating Blanketing Effect from Transmitters

S. TATION KDKA of the Westinghouse Electric and Manufacturing Company has erected a new antenna near Saxonburg, Pa., which will not send a "blanketing" signal over the surrounding territory, but will reach distant points. This will enable receiving sets near the station to tune in on distant programs. The antenna is formed by a huge circle of wooden poles 800 feet in diameter and 110 feet in height bearing a bird-cage aerial.

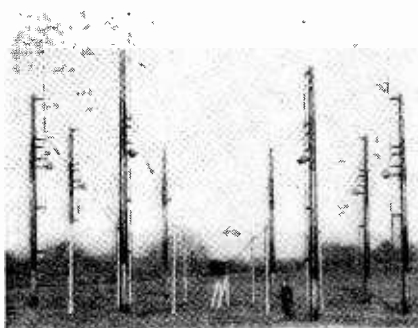

AN automatic apparatus with which the colors of transparent and opaque objects can be analyzed with scientific accuracy in less than 10 seconds has been developed in the graduate laboratories of the University of Pennsylvania's Department of Physics, under the direction of Dr. Charles B. Bazzoni, professor of experimental physics. The method was perfected by Joseph Razek and Peter J. Mulder, instructors in the department. The sample to be tested is placed over a small rectangular opening at the top of a box, about the size of a large suitcase, where the sample is illuminated by a powerful source of light. Light is reflected from the sample to a spectroscope which separates it into its component colors and then passes into a photo-electric cell. The current is amplified, then indicates on a sensitive galvanometer and records on a photographic film. By turning a crank, the operator admits different portions of the spectrum to the photo-electric cell, until the entire spectrum has been completed. The machine is expected to find wide application.

An All-Metal Flying Wing

P. OWERED with a sixty-horsepower engine, and experimental all-metal monoplane, involving radical changes in aero-dynamic features and combining wing and fuselage, has been flown faster than 100 miles an hour. The plane was developed by the Northrop Aircraft Corporation, a division of the United Aircraft and Transport Corporation.

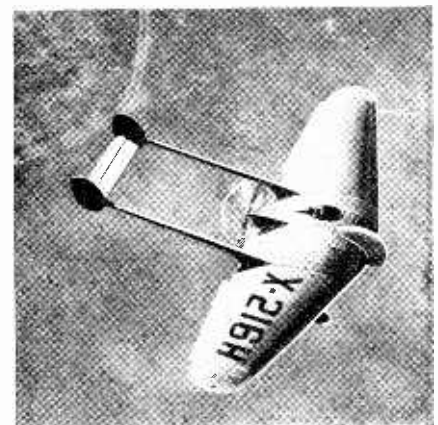

Floating Church

SEAFARING men have for 25 years sought comfort and religious guidance in a unique ship which is the only floating church in the world. This church recently celebrated its 25th anniversary and is here shown tied up in port in Berlin, Germany. It has a congregation made up largely of fishermen and was first opened on January 12th, twenty-five years ago.



Sea Bike Crosses Channel in Eight Hours

EUROPE'S latest sensation is a bicycle boat which crossed the English Channel in eight hours. It consists of two pontoons fourteen feet long connected by suitable braces which also serve to support a kind of bicycle frame. The pedals are geared to a shaft and propeller and the handle bars control the rudder by which the contraption is steered. The width of the entire boat is 3½ feet and it weighs only 100 pounds. This boat attracted a great deal of interest at the New York Motor Boat Show where Miss Marguerite Schiels demonstrated its operation. The boat is adapted for use on rivers, lakes and streams. It draws but little water and is capable of being driven forward by foot power at a fair rate of speed. Its ruggedness was proved when it successfully crossed the English Channel.

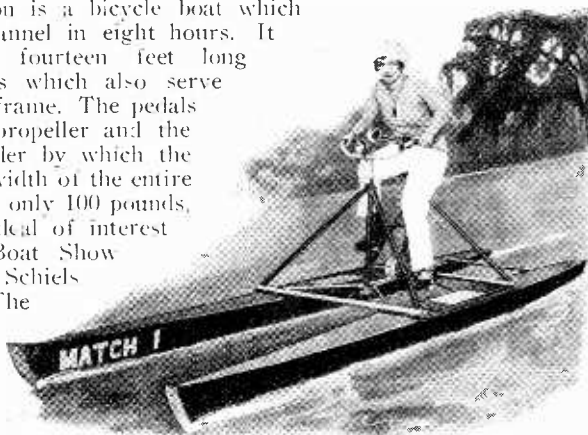

Hardening Copper—A Lost Art?

MOST people mistakenly imagine that the art of hardening copper has been lost. Such is not the case. Copper today is much harder and stronger than the copper of the ancients. W. H. Bassett, lecturer in the School of Mines in Columbia University, says that research workers who seek the magic process by which ancient metallurgists hardened copper are simply wasting time. When copper is heat-treated by a method of treatment which ancients could not apply by their crude methods, it has a tensile strength of 108,000 pounds per square inch and a high elastic limit resembling that of medium carbon steel. By alloying it with various metals Professor Bassett claims that the tensile strength can be raised. When alloyed with silicon it can be welded with as much ease and certainty as steel, but such an alloy produces a wire of high electrical resistance and is, therefore, not used in electrical circuits.

The progress made by science in metal alloys for special purposes is practically revolutionizing the industrial world.

Growing Plants Without Sun or Soil, Under Colored Lights

AN experimenter of the Smithsonian Institution, Frederick S. Brackett, in charge of the division of radiation, has been growing plants without sun or soil to discover the effect of radiation obtained with various colors of light. The plants are placed in an artificial growth chamber where a certain temperature is maintained and they are illuminated by banks of lamps above. Different colors of light are provided, but otherwise the conditions in various test chambers are identical. Not only are the effects of visible light upon plant growth being studied, but also the rays of infra-red and ultra-violet are under investigation in so far as they affect plant growth. The results of the experiments are being eagerly awaited.



Radio Station at Top of World Faces Isolation

THE United States Army's radio station at Point Barrow, Alaska, the most northerly in the world, is faced with an "all-ice" year, according to Staff Sergeant Stanley H. Morgan of the Signal Corps, in charge of that station. His report to the War Department indicates that there may be a serious food and fuel shortage. The old-timers at Point Barrow stated that unless there was a change of wind and ice conditions within the next two months, it would be impossible for ships to break through with annual supplies.

In normal years the winds here are enough to keep large packs in motion and the northeasterly current carries the packs north in the spring. Sergeant Morgan reports "All indications point to a similar period a number of years ago when no boats reached Point Barrow, forcing discharge of all supplies at Wainwright, with essentials freighted by dog teams during winter."

Science Measures Dust in City Air

DUST calculations are taken hourly in practically every large city. Efforts are being made to keep cities clean. In New York, David Morris makes an hourly observation in a little-known weather observatory stationed in a sequestered section of Central Park, New York City. For this purpose several mechanisms are employed, one of which is being held in Mr. Morris' hand while he sucks in the air against a microscopic slide and then proceeds directly to count the dust particles. Records are made of these compilations. An average, as struck by the scientist, revealed that there were

38,508 dust particles for each cubic foot of air in the city of New York during the year 1929. Another device, an automatic air filter, automatically records the impurities in the air at all hours of the day.

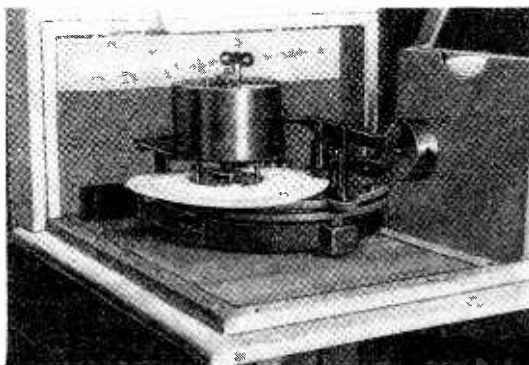

Measuring city dust.

An Early Front-Wheel Drive

IT is not generally known that an automobile with a front-wheel drive ran in the Vanderbilt Cup races in 1908, but such was the case. Here is a rare photograph of the car quite well stripped so as to show the mechanism. By even a casual examination one will see that it differs vastly from front-wheel drives as they are

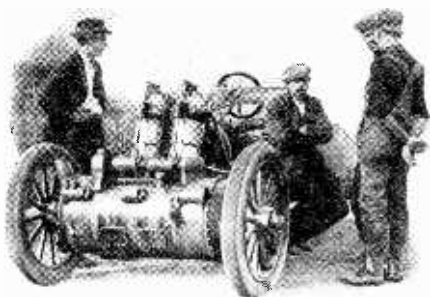

now known, but then there is a vast difference in most features between the automobile of 1908 and the automobile of 1930. This car, the Chrystie, possessed but two cylinders.

Gold Stronger Than Steel

ACCORDING to Professor R. C. Brumfield, gold alloys three times as strong as bridge steel have been developed at the Cooper Union Institute in New York. The announcement follows the results of three years of research in the field of dental gold, and Dr. Brumfield has developed nearly 60 new gold alloys. It is a known fact that the alloys used in the filling of teeth have to be extremely hard when they solidify. The constant wear and tear destroys present day alloys so there is always a need for the superior types. Dr. Brumfield is shown testing the tensile strength of one of his alloys.

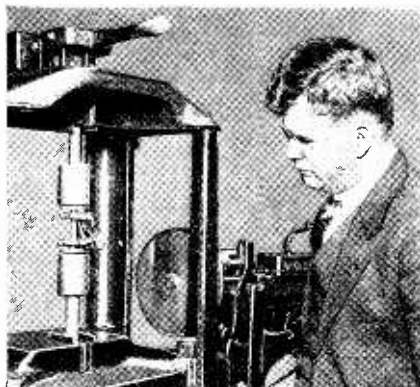

Radium Treats Eye Defects

DR. WILLIAM H. WILMER, head of the Wilmer Eye Institute of Johns Hopkins Hospital now uses radium in small quantities to treat obscure vision blurred through the formation of scar tissue in the cornea. Such treatment hastens the absorption of scar tissue.

When Short Waves Fail, Blame the Sun

IN the experiments in trans-Atlantic broadcast, both engineers and radio listeners were disappointed when the programs did not come across as announced. When asked as to the reason, C. W. Horn, the general engineer of the National Broadcasting Company, blamed magnetic disturbances due to unusual sunspot activity. He explained that the extreme rapidity with which such disturbances become acute makes it impossible to foretell conditions and live up to the rebroadcast schedule.

If sunspot activity is the cause, we can hope for an improvement in conditions for the next five or six years, after which they again become worse. The sunspot cycle is about eleven years.

A Strange Plane

A NEW amphibian of the Aero Marine Corporation has two wheels set one behind the other in each pontoon. Its flight amazed experienced pilots, who had expected to see the plane crash when making a landing.



Rubber Bumpers for Autos

DRIVING an ordinary stock touring car head-on into poles, pillars, and stationary or moving automobiles, at speeds of from 10 to 30 miles an hour, Captain Franz Carl Schleiff, a one-armed former ace of the German air forces, demonstrated his new crash-absorber to newspaper men, scientists, engineers, safety experts, policemen and insurance officials. In general appearance the crash absorber resembles a usual metal automobile bumper. It consists of a three-inch bar of solid rubber attached horizontally to the chassis by two pairs of claws suggestive of forwardly pointed partly opened scissors. When a crash occurs

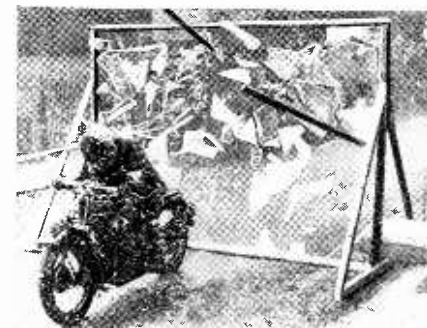

Motorcycling Through Plate Glass

A DARING British cyclist, Harry Lorrain, demonstrated before crowds his ability to dive right through a plate glass window without even being scratched. The plate glass was set in a frame directly in the path of the speeding cyclist. His hands were covered with leather gloves and a large hat protected his head and ears from the flying pieces of glass. At a speed of approximately 50 miles an hour the motorcycle ran right through the plate glass without in the least injuring the driver. Bystanders were thrilled at the performance, which was given in London, England. No one seems to have recorded the reactions of the cyclist as he heard the glass crashing about him at the instant the impact occurred.

much of the impact is absorbed before it reaches the chassis.

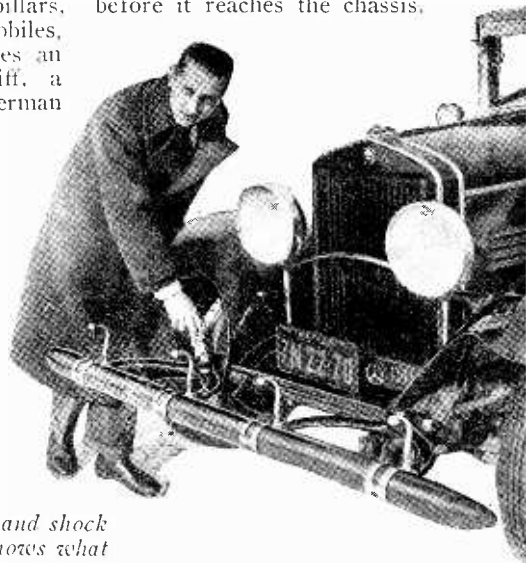
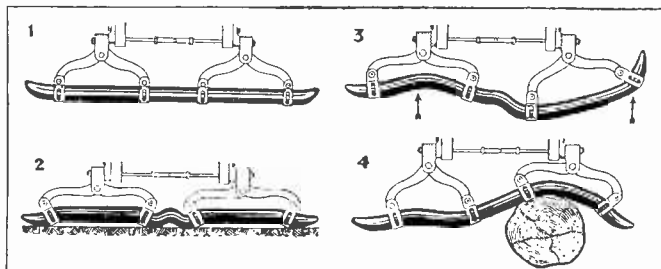

Fig. 1 illustrates a rubber bumper and shock absorber, and 2 diagrammatically shows what happens when a flat surface is hit. Note the way the tongs separate and the rubber stretches. Figs. 3 and 4 show what occurs when irregular bodies are met. Much of the impact is spent in the absorber.



Your Glider's Flying Clothes

The first article in this series (published in February) described the construction of wing framework and ailerons. The second (March) took up the elevator, stabilizer, rudder, and the main skid section. Controls and launching hook were considered in the third (April). In the present article the wings are covered and the ship is made ready for the air.

By
Lieut. H. A. Reynolds

IN the preceding articles we have described the construction of the glider framework and are now ready to cover the wings and controlling sections with cloth. There are many varieties of cloth that can be used for this purpose. A good grade of unbleached muslin or No. 100 cambric serves this purpose very well. The Heath Airplane Company, 1721 Sedgwick St., Chicago, Ill., sells a special close weave cotton fabric for 30 cents a yard that is designed for motor plane wing covering and has been found suitable for glider wings.

The covering of a wing with cloth has always presented one of the most difficult problems to the home builder. This difficulty, in the opinion of the writer, is mostly mental, caused by the fact that most mechanically inclined men seldom have had experience in cutting and fastening cloth. After the first bit of cloth is fastened into place the fact becomes very evident that no tailoring or sewing ability is needed to produce a smooth good-looking job.

Some builders make up a huge bag of cloth which they slip over the wing tip and pull along towards the butt end, thus covering both surfaces as they go along. This method requires quite a bit of sewing and critical measuring in constructing the bag so that it will fit the wing.

The writer employed the panel method which is very simple and requires little sewing. With this method the builder has complete control of the cloth at all times during the covering.

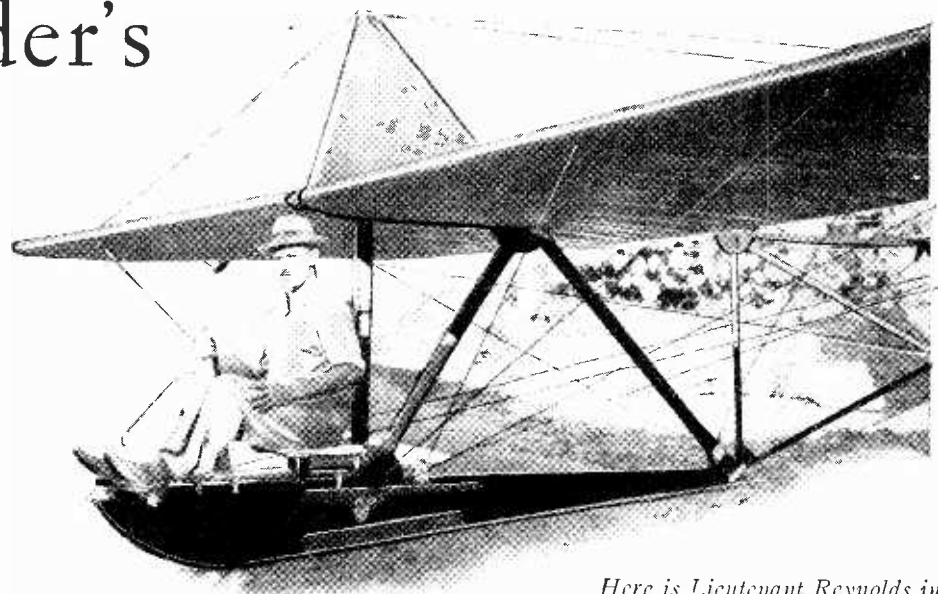

Here is Lieutenant Reynolds in the primary glider he has built according to the SCIENCE AND INVENTION plans.

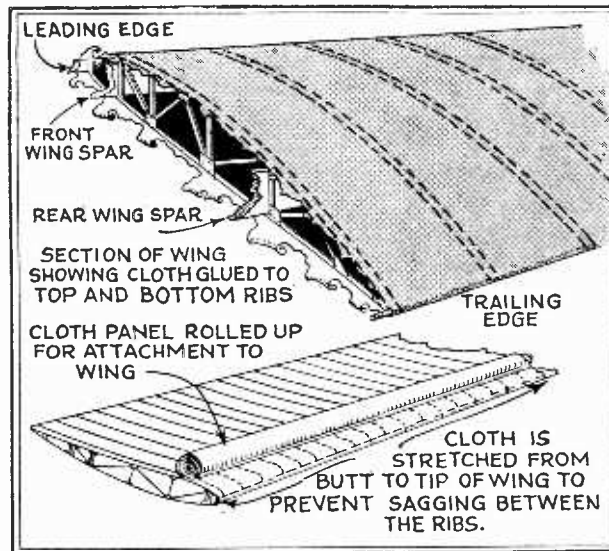

Covering a wing is easy when you follow directions. How the glider is balanced is shown below.

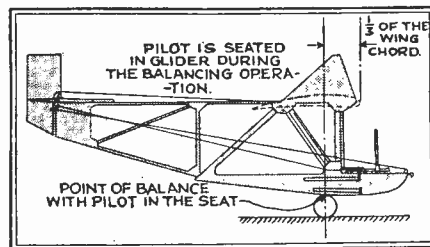

Martin H. Schempp, instructor, demonstrated the Reynolds glider at the Syracuse club's gliding field.

The only sewing required can be done on the household sewing machine before the cloth is placed on the wing.

Sew your yard wide strips side by side so that you will have a large panel of a width that will reach from the leading edge around the width of the wing over the trailing edge with about two inches to spare. The length of this panel should consist of enough of these strips sewed side by side to extend from the butt end to the tip end of the wing. In sewing up this panel have all the seam ends or edges of the strips on one side. When the cloth is laid on the wing with all of these

seam ends on the inside a smooth outside surface is presented for the dope treatment later. Use No. 40 thread and sew each seam at least twice. Two of these panels of cloth should be prepared at this time.

The wing framework to be covered is set up on two saw horses with its bottom surface up. Provide a large quantity of casing glue with an easy flowing brush. You will also need a large quantity of push pins. The panel to be used is rolled up so that the roll will extend from the butt rib to the wing tip with the sewed seam edges protruding towards the inside of the wing. Spread a liberal quantity of glue all along the leading edge and fasten the long edge of your cloth panel to this, holding it in place with thumb tacks. The cloth should be stretched tightly from end to end along the leading edge to prevent it from being pulled down between the ribs when the dope is applied later. Next spread glue along each rib for about one-third of the distance to its trailing edge and fasten the cloth with push pins to the two ribs at the (Continued on page 75)

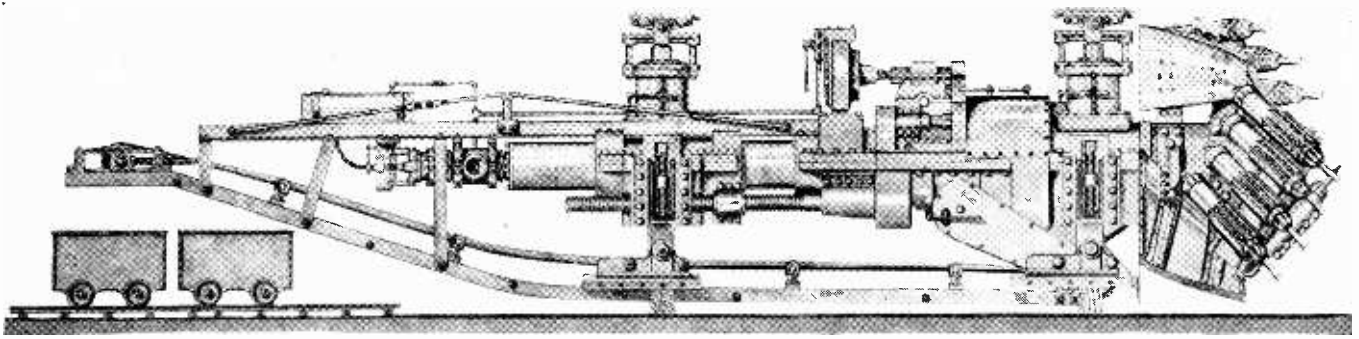

The revolving head chips its way through rock and soil by means of pneumatic hammers and chisels. The resistance met by any or all of the chisels automatically regulates the revolutions and forward speed of this head, which is mounted on a main shaft extending the length of the horizontal carriage. The cutting head is forced forward by a feed screw. A stationary vertical supporting carriage is rigidly braced against the interior of the tunnel and forms the abutment for the thrust of the head.

How Giant "Moles" Bore Under Streets

By
Josef W. Von Stein

A VIVID picture arose in my mind as Mr. Oliver O. App, mining and mechanical engineer, explained the intricacies of the automatic tunneling machines which he has evolved after years of experimentation.

Experience has shown that the efficient method of working through rock is cutting by chisel and hammer. The powerful pneumatic hammers used in this machine compare with the hand hammer and chisel as the modern steam shovel compares with the hand shovel. Tunneling and excavating is accomplished without the danger generally attendant upon the use of explosives. Rock is chipped away by the action of eighteen or more powerful pneumatic hammers and

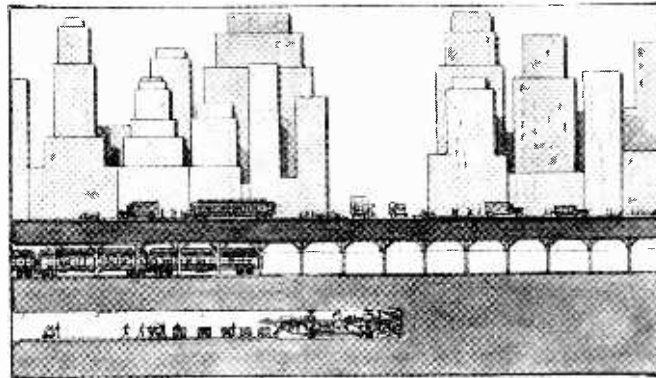

Tunnels may be bored under all existing structures without any external disturbance or interference.

chisels assembled on the head, which head turns on a longitudinal axis. The hammers and chisels are so arranged that they cut in concentric circles. With an air pressure of 80 to 100 pounds per sq. in., the hammers strike a tremendous blow, each hammer being capable of delivering 500 or more strokes a minute with a force approximately from 1 to 50

tons to each impact. The entire operation of the machine is automatic, cutting and loading simultaneously.

As Mr. App says: "The secret of the greater measure of success of this machine is contained in the fact that there is a distinct relation between the character of cutting and the action of the hammers. The point of control is where the chisel touches the rock. When there is no contact, the hammer does not act, but the instant resistance is encountered the individual hammer begins its work. The amount of resistance

automatically regulates the force and speed of the hammer action—the harder the rock the more powerful and the more rapidly the blows are delivered, each hammer acting independently. As the revolving head advances, all the hammers may be working at once or one only may be in action for a time. The speed of (Continued on page 80)

The head carries a number of pneumatic chisels, so arranged that the chisels cut in concentric circles, producing a vertical, circular face.

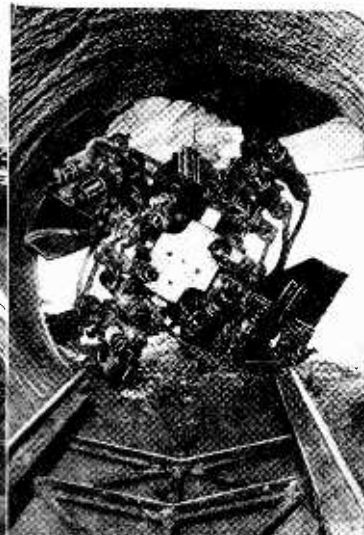
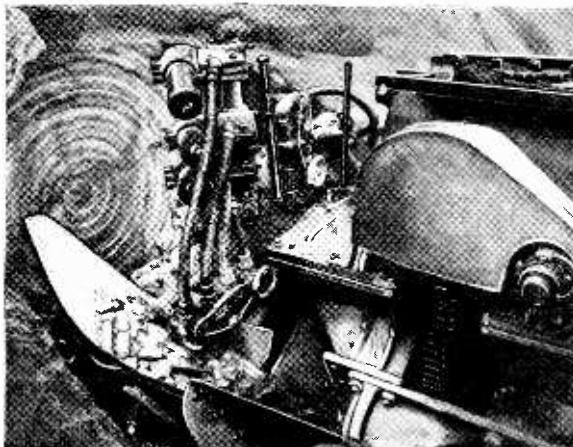

Center, the head of a machine in a tunnel in New York subway. Below, aqueduct tunnel cut through a mountain in Pennsylvania.



Build a Boat for \$3.62

Here's Your Chance to Get a Sailboat
for Less Than a Five-Dollar Bill

By Hi Sibley



ONE of the boys of the neighborhood was going to the beach within two days. He had three dollars for spending money, but no boat. And he told the world that he wanted a boat. So we organized and planned, and within twenty-four hours from the time we set out for the lumberyard after material, his boat was successfully launched in the neighborhood pool. The cost exceeded his finances by only 62 cents.

Here's the way we went about it. A rough sketch was laid out like the accompanying drawings, boards were purchased and brought home in the car, each piece marked and one boy set to sawing to size. As fast as they were cut another boy was assigned to drilling screwholes, and two more assembled the bottom.

All the edges, as indicated, had first been beveled with a plane to make v-shaped cracks into which the cotton was caulked. The bottom was made of two finished pine boards 7 ft. long, 3/4 in. thick and 12 in. wide (finished size for the latter is 11 1/2 in., but the drawings are made on a 12 in. basis). These bottom boards were fastened together by means of six cross cleats 24 in. by 3 in., set approximately 1 ft. 5 in. apart on centers. No. 5 flathead wood-screws, 1 3/8 in. long, were used. Next the side boards were put on, using the same size screws as in the cleats. Temporary thwarts or cross-pieces were nailed to the top edges to hold them in place while assembling.

Next came the transom, or stern board and then the sloping bow pieces. The most difficult job of all was fitting the joint between the bow board and the front end of the bottom. It must fit snugly, with the usual v-crack for caulking. It is covered by a cross-cleat on the top side, which has been planed to a

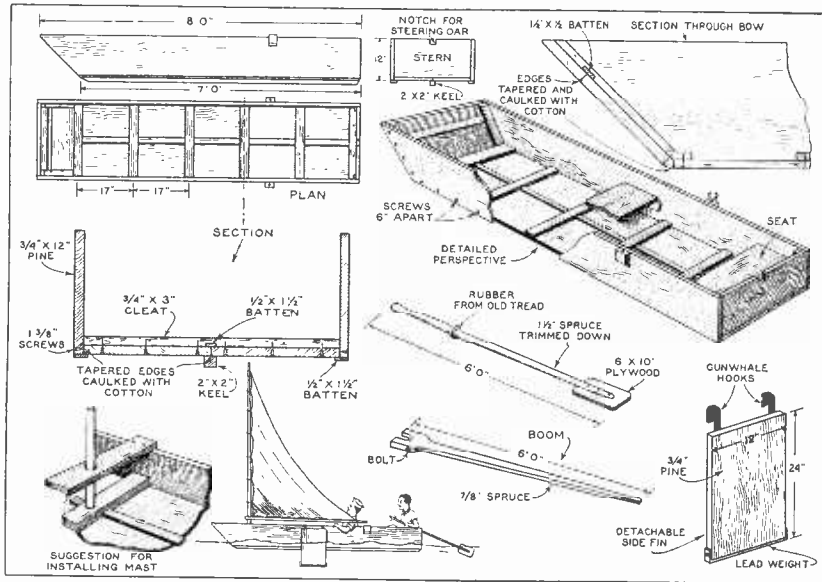

Six passengers and almost room for one more.

Here are the complete plans for the construction of this inexpensive and easily made boat. It will provide much pleasure when the spring winds fill its tiny sail. A list of materials will be found in the article.

bevel to allow for the angle at this point. In each of the four corners was screwed a 3/4 in. by 2 in. piece to reinforce these points. Between the cross-cleats 1/2 in. by 1 1/2 in. battens were screwed over the crack in the center of the bottom.

Caulking is easy, but takes considerable time for a proper job. However, with four boys at work it was accomplished in less than two hours. Cotton

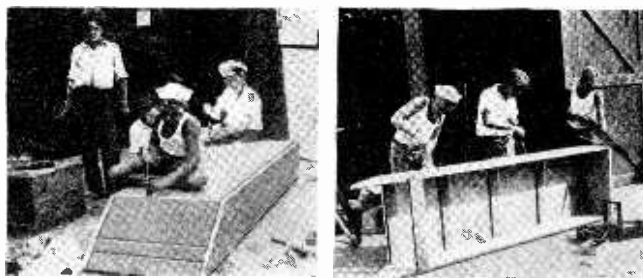

One hand sawed, another drilled screwholes, while a third put in the screws, and four boys caulking finished the job in less than two hours.

was rolled into strips and driven into the cracks by means of tapping a screw-driver with a block of wood. The cotton was necessarily forced well below the surface of the boards.

By four o'clock in the afternoon we were ready for painting. A light green appealed to the skipper, and light green it was. This ordinary house paint was sloshed generously into the cracks over



the caulking, after which outside and inside were covered all over, and the boat left to dry over night.

Next morning the crew was on hand early to complete the job, screwing on the 2 x 2 in. keel and bottom skids, or battens (which had been painted the day before). And then the triumphant launching. Of course the water seeped in here and there through a crack at first, but in a short time the wood had swelled and the hastily made craft became water-tight, as it has been ever since.

While no seats nor sails were made at first, it is the skipper's intention to add this equipment, as per the drawings. The mast was planed round and tapering, from an 8 ft. length of 2 by 2 in. spruce, and set in sockets as shown.

In place of a centerboard and the center well, (Continued on page 81)

The way I see it—

By Murray Godwin

Medaille d'Honneur

AUGUSTUS POST has been awarded the Medal of Honor of the International League of Aviators, that brotherhood of the air which in its four years of life has grown to embrace the aeronauts of nearly forty nations. . . . Each year the League bestows tokens of its high esteem on those who have distinguished themselves by outstanding accomplishment in the aeronautic field. Juan de la Cierva, Sir Alan Cobham, Colonel Lindbergh, and Baron Huenefeld are among those previously honored. . . . Mr. Post has been recognized by the League, not for any single achievement, but for a long and rare record of devotion to the advance of aviation. Not that he has no outstanding feats to his credit. With the founder of the League, Clifford B. Harmon, he went aloft years ago in a free balloon, and together they set a record which has never been surpassed. But it is for his patient, active service in behalf of aviation in its every phase that the League has chosen to award him its Medal of Honor, and in congratulating Mr. Post we make bold to say that, in our judgment, on no one could the distinction more fitly have been bestowed.



The Lifting Power of Rents

RETAIL merchants who once occupied shops on Manhattan's principal thoroughfares have in many cases found themselves forced into side streets by the pressure of increasing rents. The new Fuller Building is designed to offer the retailer a chance to keep his front on a main avenue of commerce at the cost of a partial vertical move, instead of a complete horizontal one which may take him around the corner into an undistinguished street. . . . Fronting on 57th Street at Madison Avenue, the Fuller Building has its six lower floors divided vertically into seven independent units, each six stories high. Each has its own entrance and an elevator joining its six vertical parts, all of which front on 57th Street. The merchant whose mounting rental forbids his lease of a ground-floor expanse for his whole establishment, now can place five-sixths of it in vertical order above the ground-floor unit, and see the rental per floor go down as the shop expands upwards.

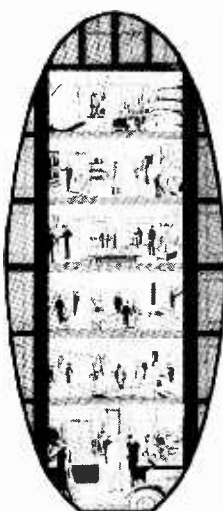

Sterilizing Crime Cultures

WHILE more prosperous cities exert themselves to combat crime with (figuratively speaking) serums, sanitariums, and surgery, Vienna in its poverty is striving to eliminate it by hygienic measures at its source. In the filth and gloom of the traditional slums, Vienna thinks, the germs of future felonies find their most favorable breeding ground. Sterilize the breeding ground today, and you will prevent contagion tomorrow. So Vienna, acting on this theory, has applied its housing taxes collected from 1925 to 1928 to the elimination of old tenements and their environs, and to replacing them with communal houses of the cleanest, brightest, most modern type, surrounded by park spaces where sunshine can be had in plenty and where flowers can grow. . . . Now six thousand families of the lower economic stratum are housed in Vienna's



communal dwellings, and the work of replacement still goes on. . . . Perhaps defeat, after all, is not the worst thing that can happen to a nation. Denmark, when its chances for conquest were cut off by the growth of other European states, developed an agricultural coöperation which has placed Danish dairy products in an enviously high position throughout the world, and an educational system which seems destined to make its people the most cultured of any. And now Vienna, center of an impoverished territory, is applying itself to improvement with a vigor which under other conditions might have been directed to intrigue and preparation for war.

High Art Moderne

RENTS have been lifting retail establishments into vertical form. It is said that the urge for exclusiveness in thick-settled Manhattan is the force which has elevated the Chanin auditorium to its position on the fiftieth floor of the building called by that name. . . . In any case, the auditorium is a fine example of the playhouse furnished and decorated in art moderne. There are checkered chairs for 200 people. The stage curtain is of extremely modern conception. A rainbow lighting effect is given the proscenium arch, and filagree panels over the stage are illuminated in a variety of colors, when the theater is in use. On the sidewalls are fountain designs in silver against a background of bakelite. Black and silver predominate throughout.

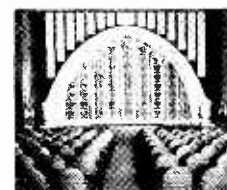

Just an Atom of Oxygen

BY ADDING an atom of oxygen to each atom of motor exhaust gas, Professor J. C. W. Frazer of Johns Hopkins intends removing from automobile drivers everywhere the danger of sudden death by carbon-monoxide poisoning. The transformation is to be effected by an exhaust attachment, in which a catalytic agent will act upon the gas before it is discharged into the atmosphere. . . . Back in the early 1900's, American motorists had a slow, puzzled awakening to the dangers of carbon monoxide in a closed garage. One owner wrote in high dudgeon to an automotive magazine, complaining that the maker of his car should be prosecuted for selling a motor the exhaust gas from which rendered people ill. Another followed up with a supporting statement in which he declared he had tried the effects of the vapor on two occasions, and both times had been rendered unconscious! And since that time the lack of the vital "atom of oxygen" has too often resulted in death.

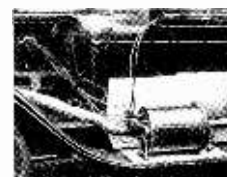

Time, Space, and Relativity

AS CONTROVERSY over the truth of the Einstein Theory has gone on, many of us have come to realize that we have never really believed in the factual existence of time at all. . . . We remember, for instance, hours of excited leisure which have lasted not more than fourteen minutes at the most, and minutes of suspense which have endured for at least a day and a half. For time at best is only a measuring stick with which we try to keep in order the endless succession of events and sensations, and one may achieve an age of 150 in terms of things experienced, and still be on this side of the forty mark. Sixty or seventy years loom up large on the tax records, but it is age in terms of phenomena seen, felt, and participated in which represents the only truth that counts.

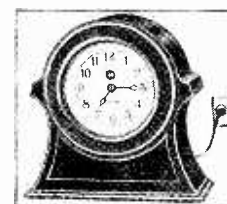

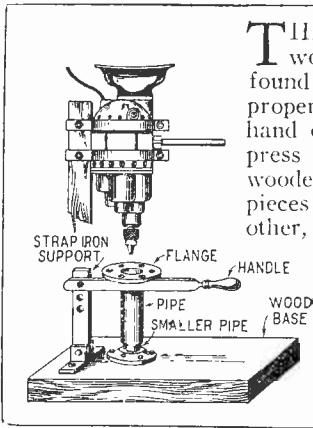

THERE are many young home workshop enthusiasts who have found difficulty in obtaining a proper drill press for their electric hand drill. Here is a simple drill press which may be made with a wooden base, two pipe flanges, two pieces of pipe, one to fit over the other, and one flange for each piece. A few pieces of strap iron complete the press. To operate simply hold work to be drilled on the flange, which serves as work rest, then raise handle.—*William Sharpwinkel.*

WHILE this little kink cannot strictly be called a hint for the home workshop, it may find use around that part of the household where the amateur photographer does his developing. To keep one's fingers out of the hypo solution, a pair of wooden clothespins with straight-grained strips of wood attached to them, as shown to the right, have been found very useful—and are comparatively easy to make.—*Lester P. Young.*

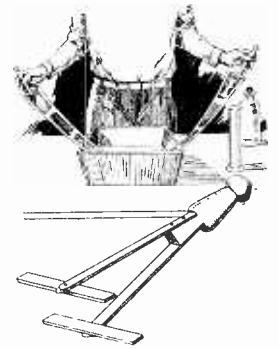

Hints for the Home Workshop

Boring Holes in Hard Wood

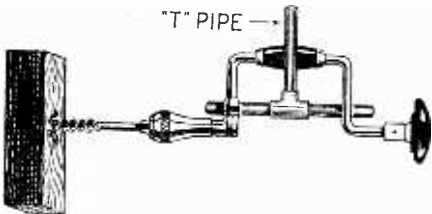

BY using a "T" pipe, that is, three pieces of gaspipe fitted together in the form of a letter "T," the bit of a drill will go through the hardest wood with ease. This novel method increases the leverage and enlarges the efficiency of the applied power. This arrangement will offset the difficulty sometimes encountered due to lack of leverage on the part of the drill.—*Louis Andrews.*

Renewing Brace Knobs

OCCASIONALLY a carpenter or electrician will break the knob from a perfectly good brace. He naturally hates to discard it. All one has to do is to procure a glass or porcelain

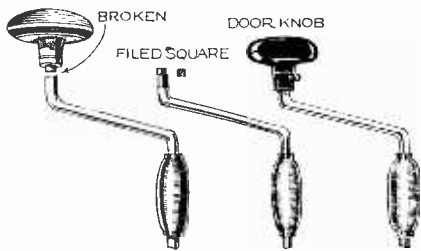

door knob and file the top of the shaft on the brace so that it is four-sided, such as the shaft on a door knob. Then the door knob may be attached to the brace by the screw which is usually used to fasten it on the shaft running through the door. This arrangement has been tried on several occasions in a home workshop and has been found to be of much practical value. We think this method will find much favor in the eyes of the young mechanic.—*Leslie F. Carpenter.*

A Practical Electrical Furnace

A SMALL furnace of the resistance type may be easily built at home, which, with a little care and patience,

will easily be suitable for the average amateur. The cost of such a furnace should not exceed two or three dollars at the most.

The materials needed are as follows: About two pounds of dry asbestos, two or three pounds of fire clay, a heating element such as used in an electric stove (the size about 12 inches long

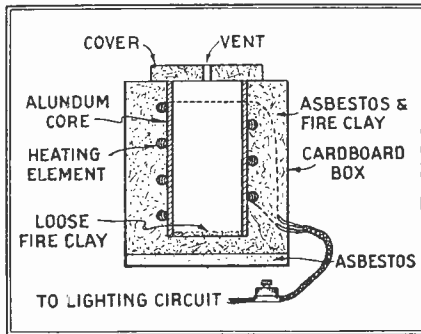

First Prize \$10.00

before stretching), an alundum core about 3" dia. and 6" long, a small can of water-glass such as is used for preserving eggs.

A cardboard box should first be made from cardboard seven inches square and eight inches deep. Make a mixture of asbestos and water of a stiff, doughy consistency and pack in the bottom of the box to the depth of one-half inch. Mixture of equal parts of asbestos and fire clay, mixed to a stiff consistency with a solution of water-glass and water, make another layer of half to three-quarters inch. The alundum core is placed in the center of the box and connections made with short pieces of copper wire. The connections should be about half way between the core and the side of the box or even outside the entire furnace. Now carefully pack the fire clay-asbestos mixture around the core to about one-fourth inch above its top. After it has dried this excess permits smoothing down to an even top. The top is made by packing a layer of the mixture in the lid of a round mush box, the vent being made with an ordinary lead pencil.

The furnace can be dried out quickly with its own heat. When the furnace

is quite dry, smooth the top by rubbing with a flat board and round the corners.—*Wendell O. Rich.*

Pulling a Bushing

GET a bolt with a head larger than the hole in the bushing and smaller than the outer diameter and one which will pass through the bushing. Put the bolt through the bushing with the threaded end pointed in the direction of the moving bushing. Slip a piece of pipe over the projecting end large enough so that the bushing may pass through. Put a nut on the bolt

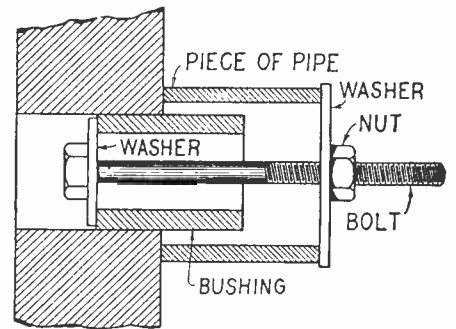

with a washer to keep it from going into the pipe. Now screw the nut with a wrench, applying pressure and gradually pulling the bushing out.—*Leo Placeriar.*

\$10.00 MONTHLY FOR BEST HINT

SEND us a photograph or sketch of your own hint for the home workshop. \$10.00 is paid monthly for the best hint accepted and published. Others that we publish are paid for at regular rates. Here is a chance for you to win a prize for a useful workshop hint.

Clothes Hanger as Catch

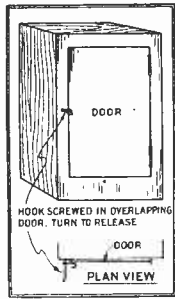

A CLOTHES hanger or rather clothes hook can be used as a catch on a wardrobe or closet door, which refuses to stay shut without being held shut. — *Henry Buchtel.*

Damp-Froof Mucilage

MACERATE five parts of good white glue in twenty parts of soft water for twenty-four hours. Then add nine parts of rock candy and three parts of gum arabic. This can be laid on with a brush before the labels are used and they will not stick together when dry. — *Miss Emily Dinsmore.*

Emergency Jack Handles

First Prize, \$5.00

OFTEN one wishes to raise a car to change a tire, and finds that his jack handle does not reach out far enough for him to get good leverage. If he will place a long board, rail, or even a piece of old pipe over the end of the jack handle and the other end on the ground away from the car he may then, by stepping on the board easily raise the car. — *Wendel B. Nester.*

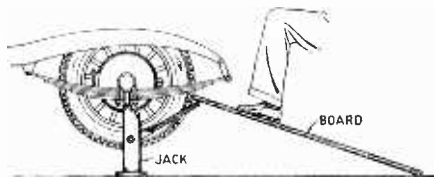

A Convenient Memo Holder

BELOW you will find sketched a small device I have used for some time on my car; it merely consists of a spring clip screwed at some easily seen part of the interior of a car; its chief purpose being the holding of papers, memo, notes, or addresses that one might have to refer to while driving; this scheme saves trying to fish through one's pockets while driving, and also eliminates the possible hazard of letting loose of the steering wheel or looking around over the inside of the car for memo that may have dropped on the floor or behind the cushions. — *F. L. Reynolds.*

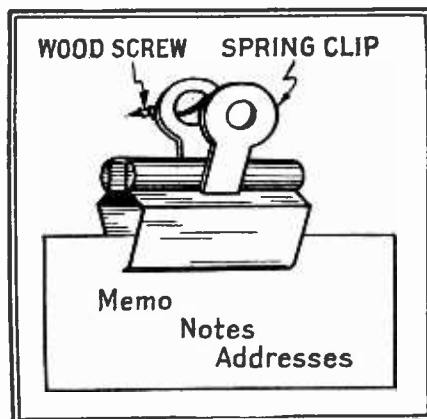

WRINKLES

Broom Aids

HERE are two suggestions which will add to the life of the humble broom: Get a rubber cap of the kind used on the ends of crutches, at almost any druggist's and fit this to the top of the broom handle. Then when leaned against a door or wall, it will not slide and fall down, nor will it mark papered walls, varnished woodwork, or anything else with which it comes in contact. The working end is improved with a section of inner tube, selected so as to be a snug fit around the top of the broom part, and with the two upper ends shaped so as to have a hole to go over the handle. This is put on from the top with the two ears of the rubber lapping over one another. — *Mrs. H. E. Chrisman.*

Sagged Doors

IF a door sags and sticks at the bottom front corner, open it wide, take out the screws that fasten the top hinge to the casing and fold the hinge back against the door. Drive a wedge under the door at the bottom front corner. With hammer and wood chisel, or screwdriver, deepen the mortised opening in the casing about 1/16 inch to let the hinge lie a bit deeper. Get some burnt match sticks, drive them into the screw holes and break them off even with the surface. Open the hinge back into place and replace the screws, using screws a little larger and longer if possible. It is well to glue the matches. The hinge should be put in very tight and solid. See that the screws that secure the hinge to door are tight also. — *Fred W. Roc.*

Remove Iodine Stains

A SIMPLIFIED method to remove iodine stains from cloth is first, wet the stained spot with aromatic spirits of ammonia, then add a few drops of hydrogen peroxide. The stain will quickly vanish. — *Fred F. Edwards, Jr.*

An Ornamental Bowl

DON'T throw away old victrola records. You can make them flexible by heating, and then bend into various shapes, suitable for bon-bon dishes or fruit bowls. The center hole of the record serves as a good point for the exact middle of the bottom. After it has hardened, the bowl may be bronzed and tinted. — *James Dean.*

A Table Pad

TO protect a highly polished table from hot dishes, use a pad of standard plaster board, which costs about 4 cents a square foot. This can be cut into any desired shape or size with a saw. 80 cents will buy enough to cover a dining room table with two extra leaves. — *Thos. P. Milburn.*

Low Vacuum Pump

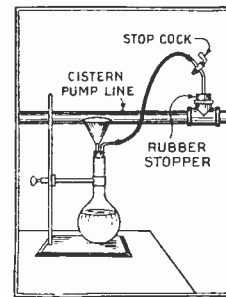

A VACUUM pump suitable for filtering, distilling, and other home laboratory uses can be had if the home is using a cistern pump. Tap the pipe or remove a plug and put a one hole rubber stopper in its place. Insert a small stopcock in the stopper and work the pump until all air is removed from the pipe and water begins to come out. The stopcock may now be opened and regulated to get the desired vacuum. Of course the pump must be worked every so often to expel the air and renew the vacuum. With the stopcock closed, the pump may be used as usual. — *Howard Dietrich.*

Keep Your Eye Glasses Clear

JUST rub eye glasses with a little soap and polish with tissue paper. This will remove steam and prevent their being clouded. — *Mrs. J. M. Frisco.*

Uses for Spools

AN empty thread-spool, chopped off at one end, may restore a very efficient base to a wine glass, (Fig. 1) or can be used in experiments as a cork for inserting tubings, (Fig. 2) or may be usefully employed as a bottle opener (Fig. 3). — *Scavax Framrose Desai.*

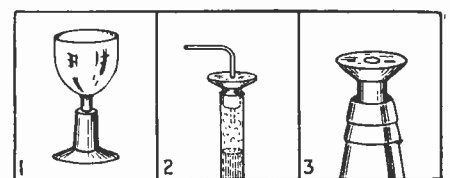

Pole Supports Rug for Cleaning

A RUG may be handled easily for cleaning if the pole on which it is rolled when purchased is used as a support, as shown in the illustration. Two stout wires are fastened into the ends

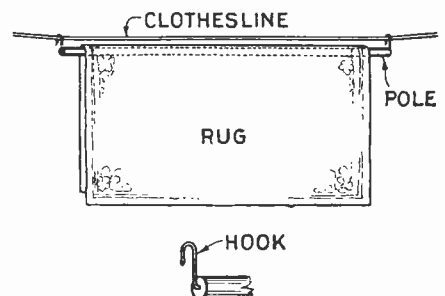

of the pole and hooked over the tightly stretched clothesline. The rug is suspended on the roller and is thus kept straight. — *Alfred J. Kafoury.*

and RECIPES

Drying Films

THE drying of photographic film in full lengths without scratching or curling is quite difficult. The illustration shows a simple and inexpensive device constructed of common wood clothespins without any metal pins to come in contact with the film and cause rust streaks. A pair of pins are fastened at each end of the film by pushing one pin over the other which in turn is clamped on the film. A string tied to the heads of one pair of pins provides a way to hang the whole on a nail.—*Alfred J. Kafoury.*



Improved Surface Gauge

THE needle is simply a piece of wire forced through a heavy cork which in turn is pushed down over a long spike driven through the center of a small block of wood, perhaps four inches square. This device can be made in a few minutes and gives quicker results (also better) than attempting close work with a rule.—*August Jeffers.*

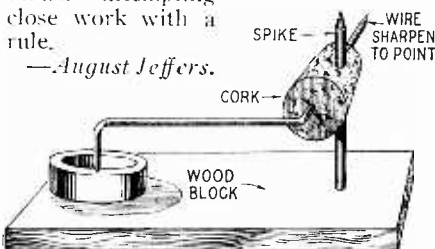

To Remove Bolts and Nuts

AN old file cut off about one inch from the end will prove useful as an "easy-out" for removing bolts and long nuts. Most of us are familiar with the form sold in the stores. All that is necessary to remove a troublesome bolt that is stuck is to bore a hole in it large enough to insert the "easy-out." Tap it lightly and it can be easily turned with a pair of pliers.—*Clyde Snoke.*

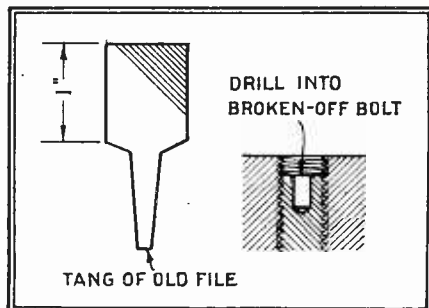

To Mend a Crack in Stove

WHEN the stove is cracked, it can be made as smooth as the surface, even though the crack is quite broad. Make a cement with egg, the yolk and white beaten together, a teaspoonful of powdered stove polish, worked into a paste with finely sifted coal ashes. This will also cover holes in stove pipes. The egg cooks making a strong cement that lasts and can be polished when cement is perfectly dry.—*Miss Emily Dinsmore.*

An Easy Repair Method

WHEN some appliance is loose and keeps loosening quickly on account of the screw hole having become too large, proceed in this way.

Remove the screws so as to be able to get at the screw hole. Fill the opening with plastic wood which when it hardens, can be hammered into or sawed. While the plastic wood is still soft, put the appliance in place and screw firmly. Superfluous plastic wood which is putty-like before it hardens in the air, will be forced out and the screws will be held solidly.

The weight of a hanging appliance should be taken off the screws until the plastic wood sets. In many cases the article to be fixed firmly in place, will be held down by its own weight, as the upright metal stand on a stenographer's desk.—*Bruce F. Richards.*

For Nails in Shoes

PAD a nail in the heel of your shoe with cotton wool and fasten with a cross section of adhesive tape. The shoe can then be worn without discomfort.

\$5.00

will be paid each month for the best wrinkle or recipe submitted to the editor's and which they accept and publish in these columns. All other ideas accepted and published in this department will be paid for at regular rates. Address your ideas to—*Editor Wrinkles and Recipes.*

A Simple Wood Preservative

WOODEN fenceposts often do not last long, when set in ground. To make them last, apply the following mixture all over with a brush. Powdered charcoal with boiled linseed oil—have it the consistency of paint. It costs but 2 cents apiece to preserve posts in this manner.—*J. Fischer.*

For Washing High Windows on the Outside

TAKE a pole about 14ft. long and make a handle on one end. Take some staples and some rope. Put the piece of rope around top end of pole. Drive in the staples to hold the rope in place. About 6 inches above the handle, take a garden hose and tie the ropes around it, turn on the water and direct the hose.—*Fred Allen.*

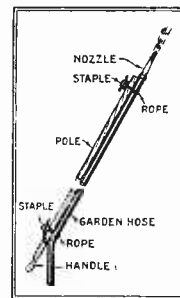

Screen for Stemming Elderberries

TAKE a foot square of heavy screen such as one buys for frames with 1/4 inch size mesh, galvanized is best. Tack on a square frame and lay over a deep crock.

Rub berry stems over this and berries will come off perfectly stemmed at rate of 1 bu. in ten minutes, where a person would otherwise work for hours to prepare a basket for canning by hand.—*Mrs. B. W. Fluker.*

Six Volt Electric Soldering Iron

TAKE a carbon core from an old flashlight battery, leave the brass cap on while the other end is pointed.

Solder 10 gage copper wire to top of cap. Then solder the end of the wire to the old battery clip, which is secured to handle by a screw. Counter set clip and wire for a neat job. The wood handle may be turned or whittled out, if you desire.—*Clarence Price.*

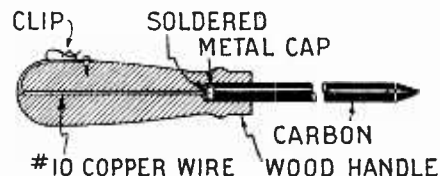

Carpenter's Combination Bench

A COMBINATION bench, step and door jack can be easily made from slabs of wood around the workshop. The top step is 20" from the floor, 12" wide, and 30" long. Three drawers for nails may be made underneath it. The lower step projects 10" and is 10" high. It is as long as the top step. The shelf on the level with the lower step forms a space for tools. The top step is notched to hold the door or sash while dressing.—*Herman F. Schneider.*

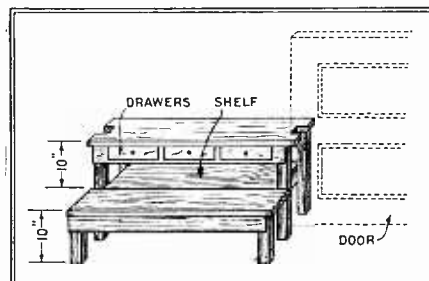

Cook While You Play



By Mrs. Christine Frederick

UNTIL the war new utensils made their way into the kitchen very slowly. Women were not "sold" on the home use of machinery. They didn't like to operate machines and didn't understand them. Servants refused to use these labor-saving devices. I have had some who preferred the washboard to my new electric washer!

But the war and the high cost of servants forced a new order of things. Women are now accustomed to machinery and "new-fangled" methods in the kitchen. They do not fear that a pressure cooker will explode, as they once did; nor are they skeptical of the value of the fireless cooker or the



Courtesy The Kitchen Craft Co.

A thick layer of chemically treated asbestos prevents heat from striking the aluminum-bodied waterless cooker directly, and supplies uniform heat.

waterless cooker. They perform marvels of efficiency in their kitchens with the aid of modern equipment, and feel perfectly at home using it. They do not have the ideas of an aunt of mine, who on seeing my modern, well-equipped kitchen, said grudgingly, "it's all very up-to-date and all that, but I wouldn't like to cook in it; it seems too much like a machine shop!" She likes her old coal stove, her oil cloth-covered table and her iron pots!

Just as laundering and sweeping have been revolutionized by modern devices, so has cookery. Every new development is in the direction of less time spent by the stove, less time spent in preparing the food, and a more nutritious and tasteful menu. Not long ago someone started a "society for the prevention of cruelty to good foods," which means that intelligent people realize food should not be mistreated by bad

cooking. Nor should the cook herself—so often the wife with many duties and no servant—have to spend so many hours in the kitchen.

What are some of these new aids to cooking efficiency? At the top of the list I should place the steam-pressure cooker and the "waterless" cooker. The steam-pressure cooker brings to the aid of the housewife the physical fact that either steam or boiling water *under pressure* is hotter than boiling water in an open vessel or steam at atmospheric pressure, the more pressure, the higher the temperature. Water boils at 194° F. instead of 212° F. on top of a mountain 10,000 feet high. In a sealed pressure boiler under 25 pounds of steam pressure it boils at 267° F., 55° F. higher than in an open vessel. A pressure cooker therefore saves fuel. A pot roast can be cooked with less than 10 cubic feet of gas, and one shovelful of coal will cook a chicken beautifully. It makes use of a low fire instead of a hot fire. And more important still, tough chickens are made tender and makes of a cheaper cut of meat a delicious dish. Cheap foods, like navy beans, hominy and corn meal mush become cheaper still because of the lower cost of cooking them. Nor does a steam-pressure cooker ever let things burn; no "pot-watching" is needed. Moreover, steam breaks down the connective tissues of the food so that it is more readily assimilated.

Courtesy The Pressure Cooker Co.

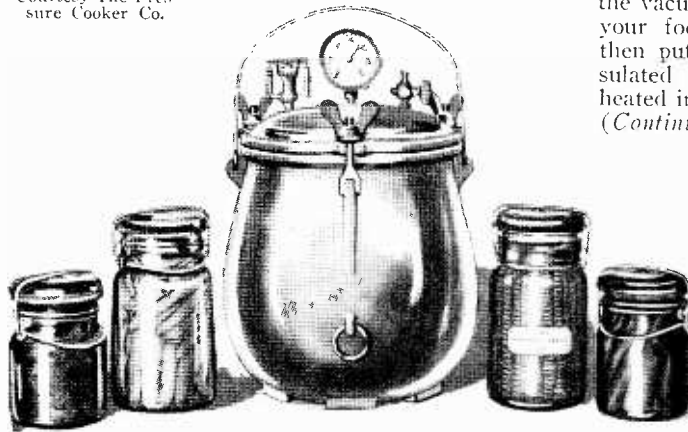

A heavy aluminum steam-tight pressure cooker can be used over any type of fire. This one is vase-shaped to provide space and strength, particularly for canning.

This fireless gas range has a heavily insulated hood to provide top-store cooking.

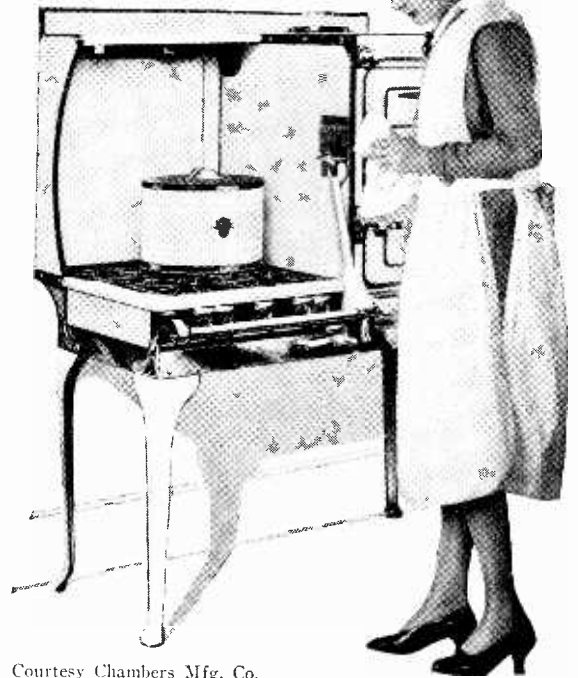

Courtesy Chambers Mfg. Co.

The waterless cooker is another modern marvel of the kitchen. It makes use of the principle that heat and not water is needed for perfect cooking, water being really a detriment to the food—washing out, as it does, the important and nourishing mineral salts of the vegetables.

The waterless cooker has a heavy insulated base which distributes the heat so evenly that it does virtually what the steam-pressure cooker does. The water in the food makes it unnecessary to put any water in the cooker. And the result is that the flavor is not washed out, and tough meats become tender with the slow cooking. You can cook three or four vegetables *all at one time over one burner* in a waterless cooker. It saves and provides better-tasting food.

The "fireless" cooker has been with us a long time, but surprisingly few women have used it, although the Indians used it centuries ago. The principle is simple, like that of the vacuum bottle. You heat your foods thoroughly and then put it in a highly insulated box, with two heated iron disks at top and

(Continued on page 64)

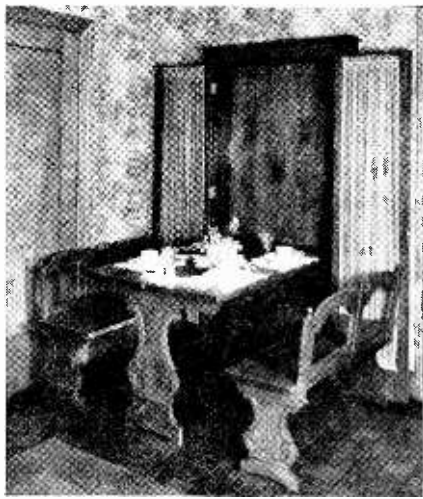

Eliminate the Dining Room

BEAUTIFUL French doors open to reveal a table that literally falls from the wall, and benches to either side with collapsible backs. At the close of a meal, these fold up and silently steal away. Such an arrangement will enable you to save space and time, with a combination dining alcove and living-room.

Perpetual Motion, Almost

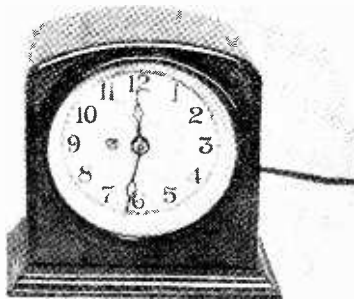

NEVER mind worrying about being late because you forgot to wind the clock. Use this electric one, just start it and it will go as long as you have credit with the lighting company.

Let Your Eggs Time Themselves



COOK your eggs without watching the clock. Just put the eggs inside the bowl (four at a time), and pour a few teaspoonfuls of water into the top porcelain cup. When the current is turned on, the water runs inside and turns to steam which cooks the eggs. When the steam stops, they are done.

Novel and Convenient Aids to Comfort



It's a Searchlight

REALLY, he's not taking his fountain pen from his vest pocket—he's taking out the latest flashlight, a *penlight*. If you're tired of lugging the standard-size flash on hikes, if you've searched in vain for the house number on a dark street at night, why not try this young man's brand of lighter? It's equipped with a powerful flashlight, complete with battery and all. You can put it in your pocket, your purse, anywhere.

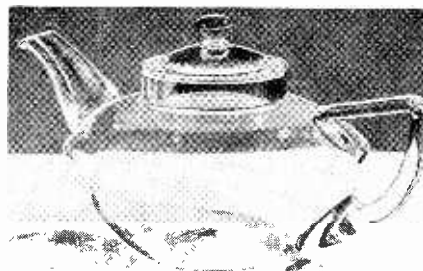

Tea to Taste

EVER wondered why you just couldn't make tea weak or strong enough to suit individual tastes? Or had so many individual tastes to suit? Ever wished you could just see through the teapot? Well, now you can, with this transparent pot, made of heat-resisting glass. Boiling water will not crack it—put in your tea ball or tea and you can just see when it's steeped enough.

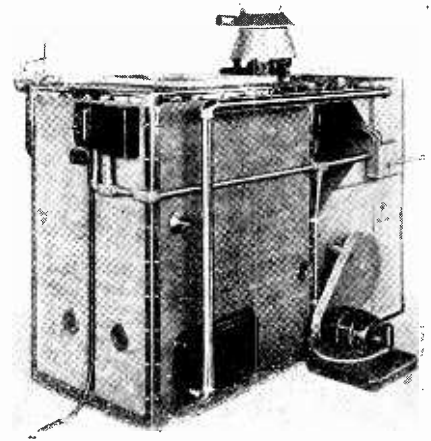

Windowless Ventilation

SOUNDS funny, but it's true. This weather-maker works independently of windows and eliminates drafts. Heating is accomplished by gas and circulation by means of an electric blower. It combines four services—warms, filters, humidifies, and circulates air through the house at the same time.

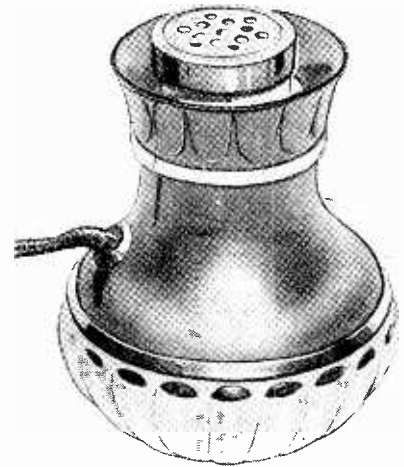

Cigarettes Again!

MANUFACTURERS are certainly turning their attention to making smoking comfortable. This lighter can be used wherever there's access to an electric switch. Just lift the lighter and press your favorite cigar or cigarette against the top—it's lit.

Toast to Order

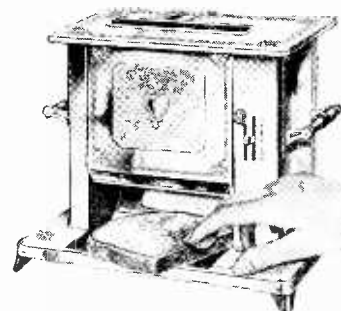

TIRIED of unevenly done toast? Half-done toast? Burnt toast? Well, this device gives you toast as brown and dry as you want it to be. And it's automatic. Press the lever to adjust heat and drop in your bread. When it is done the toast drops down the slide to the tray at the base.

A Pole Screen

Useful, Decorative and Easily Made

To Give Yourself Comfort as Well as Warmth, Follow These Constructional Details

By H. L. Weatherby



On chill spring nights, this charming pole screen will protect your face from the too warm rays of your open fire.

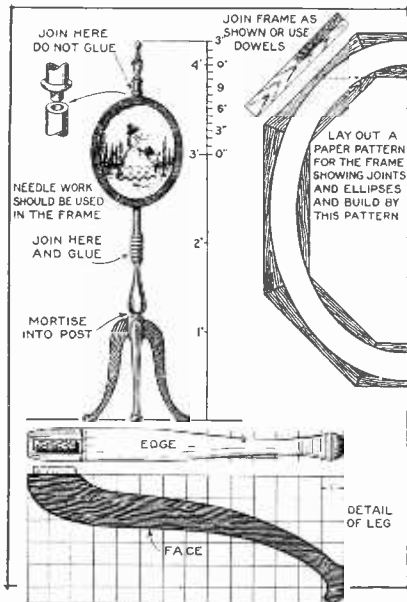

Detailed layout and dimensions for this beautiful screen are shown to the left and right

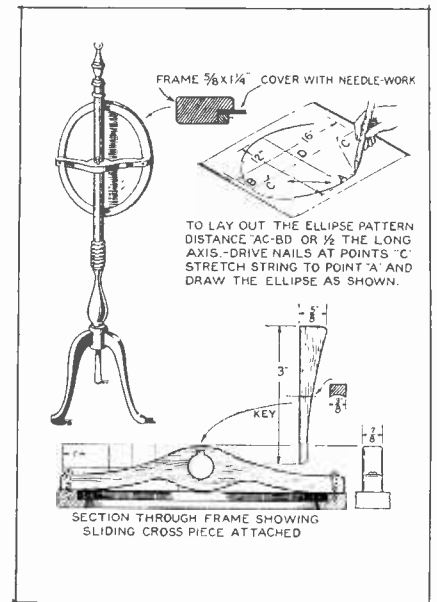

shown for the oval frame will prove highly satisfactory, and the work involved will well repay the builder.

Joining and building the frame will be rather difficult and can best be done by working from or over a full sized paper pattern showing all joints. When the joints have been carefully fitted, all the pieces should be clamped to a perfectly level surface, such as the bench top, and the gluing pressure applied to the joints with bar clamps. Plain butt

TO quote from a book on antiques: "The pole screen was designed to protect the fair lady's face from the devastating heat of the open fire."

The construction is easy to follow from the drawings. The frame is designed for a choice

needle-work design which originally was done on black satin in cross-stitch. The frame, however, can be used with a small tapestry, a bit of oriental embroidery, or even an etching or other type of picture, and may be square or rectangular in shape. It is entirely possible to buy the frame ready-made from houses specializing in picture frames; but for the craftsman who desires to make his own, the methods

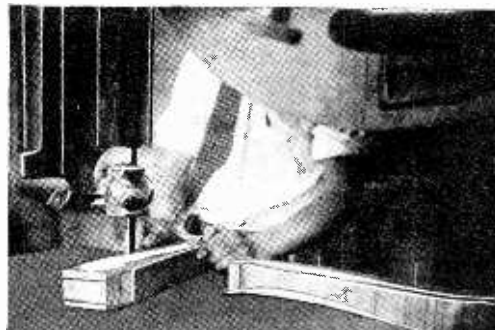
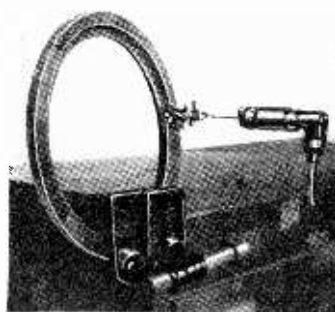

It is a simple matter to cut a rabbet in the frame of the screen as shown at the left. A bandsaw can be used to cut the desired curves in the legs

joints are not strong enough, and should be reinforced by lapping the pieces. Dowels, if carefully fitted, will strengthen the sections. After the frame has set, the outline for the two ellipses should be drawn, and the frame cut to shape. This can be done by hand, but

a jig saw or a bandsaw will be a big aid.

The rabbeting of the back is clearly illustrated. After boring to the correct depth, the rabbet should be smoothed out with a chisel, the outside and inside of the frame filed smooth and well sand-papered.

The next most difficult feature of construction is shaping the legs. The method is illustrated. Each leg calls for two sets of cuts with a turning saw, after which considerable smoothing with file, scraper, and sandpaper is necessary. Fitting the legs into the post requires tenons or dowels with concave shoulders on the leg pieces.

From his own experience in building the pole (Continued on page 82)

Helps for the Owner and Driver

If You're Interested in Your Car, You'll Find These Articles Invaluable.

By George A. Luers

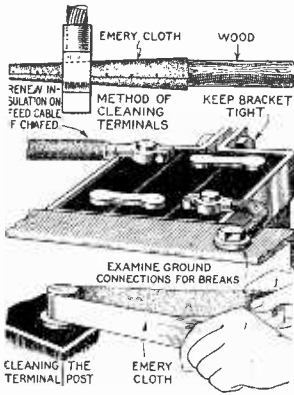

Doctoring the Battery

SO many instances of car failure are attributed to defects in battery care, that it is well to check up periodically to avoid trouble at some inconvenient time and place. The cleaning of terminals is important. The tightness of the battery in the bracket is an item that should not be neglected. The ground lead should be unbroken and the connections tight. The main feed cable should be free from chafing and properly insulated. There is no better time to check up on the battery than in the Spring.

For the Old Swimming Hole

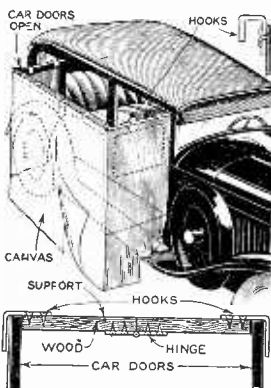

MANY times the motorist and friends could enjoy a Saturday afternoon or Sunday swim if dressing facilities were more convenient.

A three sided canvas closure is made to be supported by the closed car doors. The canvas extends from the tops of the doors to the ground. A folding wooden support for the outside edge is made to hold the doors open. Hooks on the canvas provide for hanging the canvas. Stowage is simple as the canvas folds and may be carried under a seat, along with the folded prop. The car is kept clean and dry when this is used.

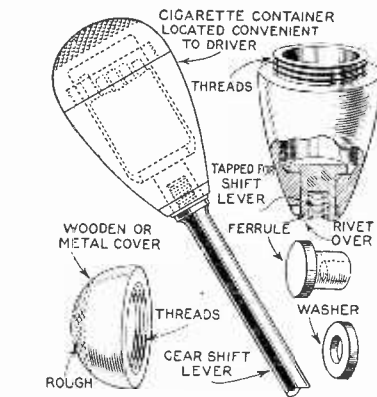

Reach for a "Lucky" Instead of a Gear Shift

A CASE for carrying cigarettes, convenient to the driver, is one consisting of a gear shift container right at the driver's hand. This arrangement permits of handling cigarettes while driving, without detracting from observations of the road ahead.

The container shown by the drawing was made from wood, fashioned similar to a hand drill handle; that is, the part in which drills are carried. The top of the container is roughened for the striking of matches.

Helping the Little Folks to Drive

TO provide adjustability of the seats of a coach, so that the smaller members of the family could drive the car, one owner made the alteration shown below.

In this alteration the front seats are fitted with extra swivels several inches to the rear of the regular equipment. The lugs on the floor were slotted so

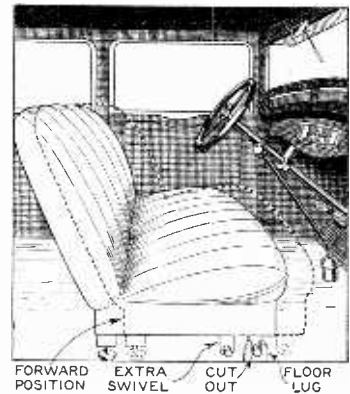

the seats could be lifted and placed quickly on either swivels. The forward position brings the driver closer to the pedals, steering wheels and controls, allowing shorter persons to drive the car freely. Additionally, when one or both seats are moved forward, the foot room for the rear seat passengers is greater.

If Brake Rods Rattle—Try This

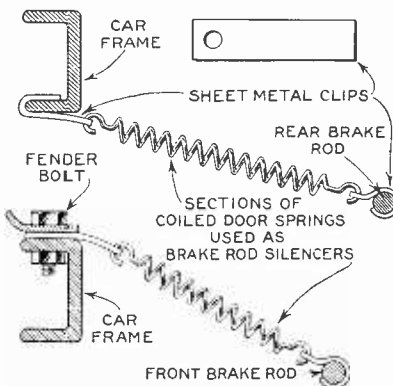

WITH the four-wheel brake system, the additional brake rods produce more than usual noises, especially after the links and supports are worn enough to rattle.

Silencing of brake rods is possible through use of coiled springs fastened jointly to the rods and car frames.

Springs such as are used for screen doors are servicable and cheap. Sections of these attached by pieces of sheet iron, cut off, punched and bent to form hooks, make effective silencers.

Two will be required for the emergency brake rods, two for the foot front brake rods and two for the foot rear brake rods.



MAGIC

By *Huminger**

New Production Box

A BOX with no top and the bottom working on hinges is exhibited for examination. It is entirely empty and quite unprepared. The magician lets down the flap so that everybody can see through it; then, replacing the bottom, puts the box on the seat of a chair. He then lifts the box and promptly proceeds to withdraw yards and yards of ribbons, flags, silks and a large white rabbit. Secret: The load is contained in a black bag suspended in back of a chair as shown. As the box is lifted, the load is hoisted into place.

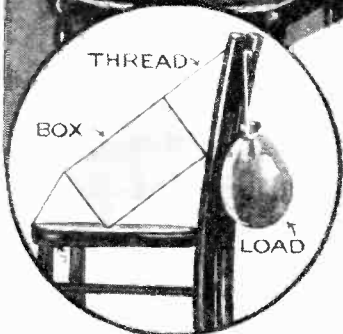

Spirit Ropes

THE magician passes an unprepared rope for inspection. He then shows a pail,

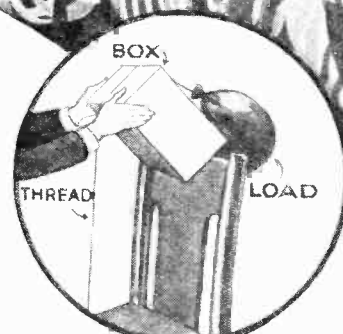

The Vanishing Cane

THE magician enters, sporting a high-polished ebony walking stick. As his assistant

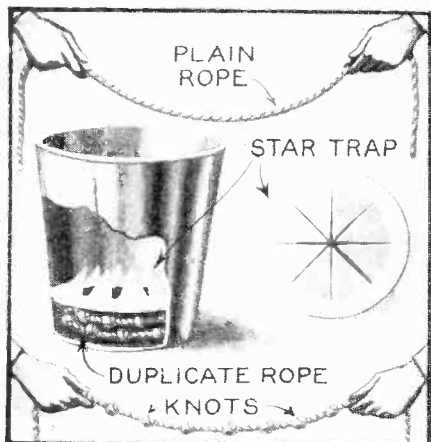

unquestionably empty. He then slowly drops the center of the rope into the pail and asks two spectators to hold the ends. After a bit of by-play, the rope is removed and found to be knotted. The secret lies in the fact that a star trap is formed in the bottom of the pail. This permits the plain rope to be exchanged for the knotted rope. The audience does not observe that the plain rope is concealed for but a fraction of a minute.

The Enchanted Buddha

THE magician shows a small brass Buddha which possesses enchanted properties. He claims that if it is held by an unbeliever it becomes intensely hot. To demonstrate he gives the Buddha to a spectator, who drops it with an exclamation of surprise. The magician then suggests that someone else pick it up, but the attempt is usually not made. The secret lies in the fact that the Buddha is mechanically constructed, the bottom of the figure being threaded to fit tightly. Near the top a small perforation is made to allow the gases to escape. A tube for water is soldered to the bottom and the surrounding area is heaped with calcium carbide. Chemical reaction started by tipping the figure produces the heat.

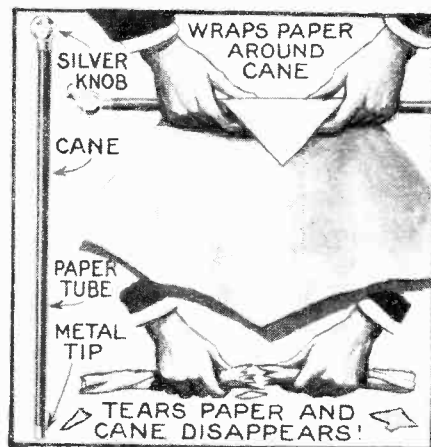
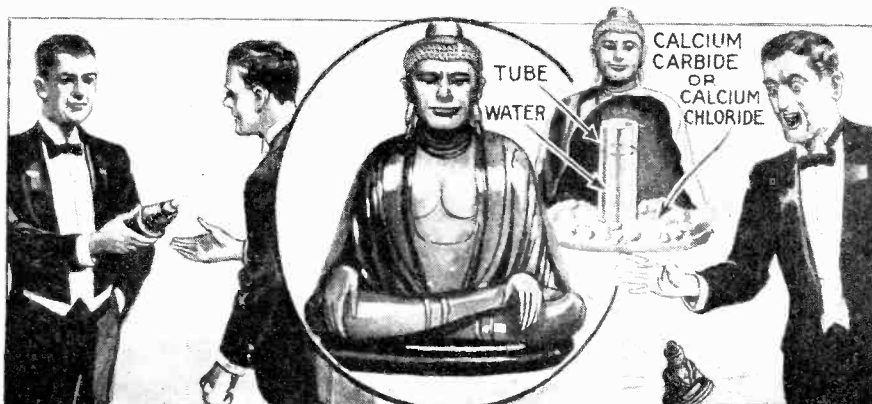

is not there to take the cane, he removes a sheet from an ordinary newspaper and, beginning with one corner of the newspaper, he wraps the cane up. When completely covered, he tears his parcel to pieces and rolls the remnants between his palms. Secret: The cane is made of paper, painted to give it an ebony appearance. The tip and knob are genuine. When rolling up the cane in the paper, the two ends are vanished and the entire is torn up.

Solve these Brain Teasers and Win a Prize

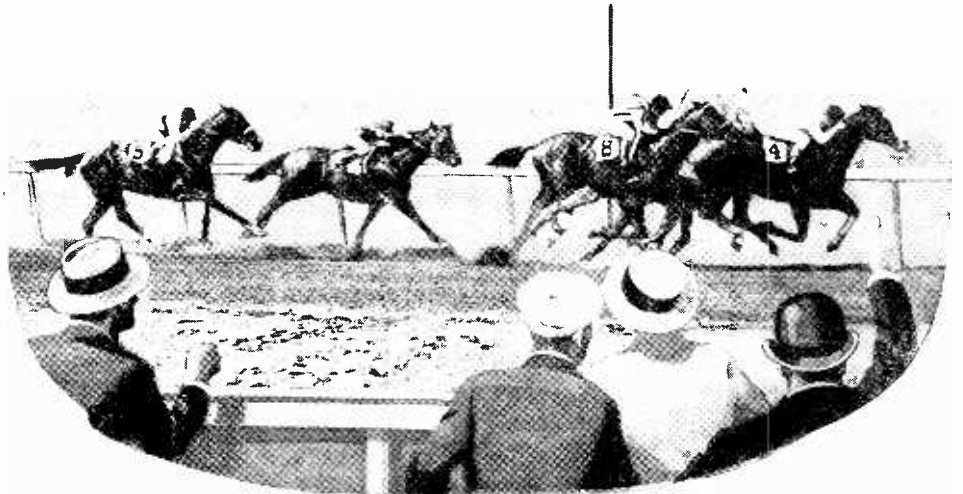

“A Game That
Can't Be Beat”

By *Sam Loyd*

THE Puzzle King presents the fifth of a series of problems, the solving of which will show if your mathematical ability is bolstered up by logical reasoning. Prize winners of the February puzzles will be found listed on page 64.

Twenty-five Dollars in Prizes

A FIRST PRIZE of \$10 will be awarded to the person sending correct answers to the two puzzles accompanied by the best expressed analysis of the *Horse Race Problem*.

A SECOND PRIZE of \$5 will be awarded for the next best analysis and correct answers to the two puzzles.

TEN PRIZES of \$1 each will be awarded to the ten persons who send the next best analysis of the *Horse Race Problem*, together with correct answers to the two puzzles.

Answers must be received not later than noon, May 15th, addressed to “Puzzle Editor,” SCIENCE AND INVENTION, 381 Fourth Avenue, New York City.

All contestants must abide by the decisions of Sam Loyd, who will examine all papers and award the prizes.

Papers of identical merit, tying for any one of the prizes, will each receive the full amount of the prize tied for.

BOOKMAKERS, in offering the public opportunity to back their choices at the racetracks, naturally take measures to assure themselves profits.

The collective chances of the horses in a race, of course, represent 100%. For example, in a three-horse race, where the candidates are considered of equal merit, each would have 1 out of 3 chances, or 33 and 1/3%. The odds should be 2 to 1 against each entry.

Calculating “bookies” sell anywhere from 110 to 150%, instead of the 100% which exists. Thus they acquire an advantage over the bettors of from 10 to 50% to start with. For example, the odds of a 150% book in a three-horse race, might be even money against each horse.

Now, let us see who understands the bookmakers’ methods, by working out the following proposition:

In a five-horse race, a bookmaker offers \$2 to the bettor’s \$1 on the horse A. On horse B he offers 3 to 1. On C he offers 4 to 1. On D he offers 5 to 1. If he wants to make a 125% book on that race, what odds must he offer on the fifth horse, E?

Scissoring Linoleum

MRS. SIMPKINS brought home a piece of linoleum from the big fire-sale, and after her good man had scissored out the damaged sections, the salvaged piece appeared as in our sketch.

“There, that will repave the kitchenette nicely,” chirped Mrs. S.

“Oh, yeah,” gloomed Simpkins. “Well, if you can cover a square floor with that jig-saw remnant, I’ll cable Einstein that you have proved his Fourth Dimension theory to be O. K.”

Now, the situation is not so hopeless as Simpkins implies.

First, counting the little squares, we find them to total 121; just enough to form an 11 by 11 square; so the problem resolves itself into the question:

What is the least number of pieces into which the remnant can be divided in order to construct an 11 by 11 square, and preserving the pattern of alternating dark and light squares?

Utilize the printed diagram, or a copy of it, to demonstrate your solution, and above your constructed square state the number of pieces in its composition.

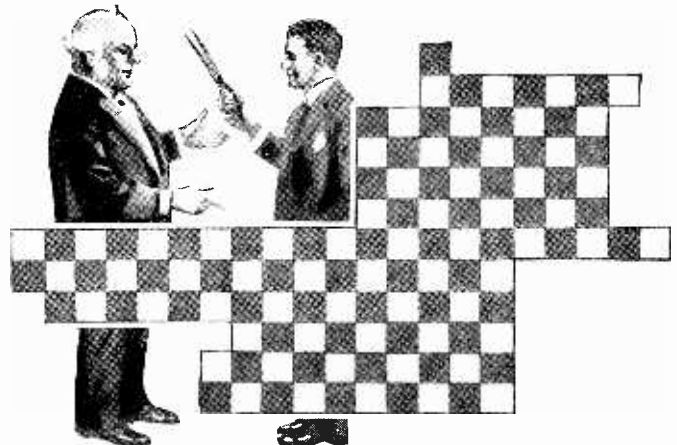



THE SAFETY

Conducted by
Readers' Opinions and Comments

Magnets For Defective Eyesight

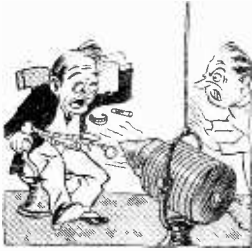

I HAVE recently read an old book on Suggestive Therapeutics in which the author has advocated the use of an electro-magnet for the cure of defective eyesight.

It stated that color blindness and near sightedness were effectually cured in a Paris hospital through this means.

I would like to have your opinion on the authenticity and efficacy of this, to me, novel idea.

If it is effectual, I would like you to print a diagram of such a magnet along with full constructional details, as I am sure it would be of interest to many of your readers.

I am a constant reader of SCIENCE AND INVENTION, and would be greatly obliged for this information.

FREDERIC SHELLEY,
Philadelphia, Pa.

(It has been quite definitely proven that magnetism, per se, has no effect on the human organism. It is not and cannot be of benefit to the eyesight and will not in any way cure defective eyesight.)

Where a psychic factor is involved, faith in any form of a cure-all, whether that be a magnet or the hind foot of a rabbit may aid the individual in regaining health. The quack's greatest asset is the testimonial letters that he receives, so no doubt there are testimonials backing up magnetic devices for all sorts of ills.—EDITOR.)

Stop Medical Frauds

IN the December number of your magazine I read an article by a reader claiming your attacks on fraudulent "curative" devices are not justified. In my opinion, this man must be a crook himself, or he has been bitten badly by one and his disposition is such that he would like to see others share his own fate. Misery loves company.

In my case I have been defrauded a number of times with cure-all devices, but I don't care to see others defrauded. The people who buy these devices are usually poor. They spend their hard-earned money looking for help and can ill afford to be swindled by crooks. I am glad that there is such a magazine as yours, that has backbone enough to expose these wolves in sheep's clothing. I only wish there was an organization that would round them all up and send them down to the hottest part of Satan's kingdom where they will eventually arrive.

TOM J. CLARK,
Willows, Sask.,
Canada.



(It is only because the vast majority of our readers believe as you do about the work of our magazine that we have maintained a ruthless campaign against fraudulent systems and practices of all kinds and we intend to continue doing so.—EDITOR.)

Suspended Animation

I AM only seventeen, but your Science Questionnaire has helped me out a great deal in my biology, physiology and physics classes at High School.

I have a few questions that I would like to have answered.

1. Would you give me an outline on what work or experiments have been done in the way of suspended animation?

2. Can you give me any information (such as drawings, etc.) that will give me some light on the fourth dimension?

ALVIN FICKEWIRTH,
Los Angeles, Calif.

(Quite a number of experiments have been conducted along the lines of suspended animation. About five years ago the editors of SCIENCE AND INVENTION Magazine took some gold fish, eels, and various other animals and attempted to freeze them in blocks of ice in refrigeration machines.

Our experiments indicated that these animals, when frozen in ice, did not come back to life after they were thawed out. As a result of the publication of this article, a great many letters were sent to the editors, stating that persons had actually found fish frozen in ice and after cutting them out of the ice and melting the ice, the fish came back to life. The subject is still open for discussion. There is no other way of suspending animation other than perhaps by the use of narcotics, which render an individual comatose.

It is impossible to portray the fourth dimension in the form of drawings, unless you intend to use time as a fourth dimension. If we move a point we produce a line. If we move this line at right angles to itself, we then produce a plane, either rectangular or square in shape. If we again move the plane at right angles to itself, we produce a solid. Now, in order to be absolutely correct in our form of reasoning, we would have to move this cube at right angles to itself to produce a figure of four dimensions. Our limited understanding does not permit us to grasp the situation.—EDITOR.)

More Chemistry?

I AM a constant reader of your science magazines and would like to see the chemistry section grow a little more. How about some more short wave articles? I know most of the readers who like adventure and thrills are interested in them.

In the November 1929 issue of SCIENCE AND INVENTION John P. advanced the

thought that perpetual motion exists in the molecule. This maybe true, but a more visible example than that is the celestial bodies; yet this is not a terrestrial machine and I am not submitting it in the contest.

M. F. RAWLINGS,
Sanford, Texas.

The Radium Cure-Alls

FOR some time I have been contemplating purchasing a container for water which would charge the water with radium emanations. Drinking its contents is supposed to improve the secretions from the various glands in the body and in this way help an invalid to regain health. Can you also give me any information regarding radium pads and the like? Are they beneficial?

G. WINTERS,
Philadelphia, Pa.

(For more than five years SCIENCE AND INVENTION Magazine has contended that radium given in large enough doses to improve the human constitution can also do harm. On February 4th, the United States Department of Agriculture issued a press release headed "Concoctions claiming to contain radium are fakes in many cases." One of the radium water crocks which was examined was found actually to charge the water and produce radio-activity, but in order to get a minimum daily dosage of radio-activity, it would be necessary to drink 1,957 gallons of water each day. Such articles as hair tonics, bath compounds, tissue creams, tonic tablets, face powders, ointments, mouth washes, demulcents, healing pads and other preparations in solid, semi-solid and liquid forms were examined for radium content.

It must always be remembered that radium in active dosage should only be administered under the guidance of a physician who is trained in its application. Our advice is to keep your hands off anything advertised as containing radium, whether it has a small or large quantity or none of that element in its composition.—EDITOR.)



Increase Perpetual Motion Prizes?

IF you think that perpetual motion, as you call it, is impossible, why don't you double or triple the reward that you now offer? By the way, it hasn't appeared in the last issue of the magazine. It is possible that you are getting cold feet? I have another plan. Why don't you offer a large amount of money, say \$50,000.00, with the understanding that upon commercialization of such a machine you are to receive your money back or ten per cent of the profits, the choice resting with the inventor! Place the whole thing in third hands, so that

VALVE

Joseph H. Kraus

Will Be Welcomed by the Editors

there won't be anything that might look phoney about it.

The writer has something up his sleeve and it isn't that he wants your money that he writes this; he needs the money to begin with and is trying to make sure he doesn't get cheated out of anything.

This is all for the present—you will hear from me again.

N. C. T.,
New York City.

(The SCIENCE AND INVENTION prize of \$5,000.00 for receiving a working model of a perpetual motion machine has two purposes. The first is to give to the inventor of a working model, coming within the contest conditions, a sufficient sum of money to enable him to patent the device in the United States and in foreign countries. The second and equally as important, is to limit the sale of shares of stocks in mechanisms that do not exist and that cannot be made to operate. We are in no way interested in the outcome of the invention, and desire no rights to the patent.)

We have no desire to increase the monetary prize award so that inventors working along these lines can dangle a large prize before the eyes of suckers, and use it as an argument for the selling of stock. Every magazine that circulates through the mails is duly obligated to pay any awards publicly announced. Failure to do so might mean the loss of entry in the Post Office Department, which would amount in financial loss to a great deal more than the prize itself.

When a magician has something up his sleeve, he shows it. It is up to you now to build your working model and demonstrate the same.—EDITOR.)

You Are Welcome

I AM slightly late in acknowledging the fact that you awarded me the fourth prize in the Dunninger Buzz Saw Illusion Contest.

So I am taking this opportunity to thank both Mr. Dunninger and you for your consideration. Needless to say, it was greatly appreciated by me.

NEILSON C. HAHNE,
Dayton, Ohio.

Tear Gas

IN your January issue, a question as to the technical name for tear gas. The question was No. 2345 and your answer was 'benzyl bromide.'

While the same common name is often applied to two



or more different chemical compounds, the writer believes that for the most part a different chemical compound is known as tear gas.

This compound is 'chloropicrin.' Its methods of preparation should not be attempted by one not experienced in the realm of organic chemistry. Also, it is not a very pleasant compound to handle.

This gas, 'chloropicrin,' is used very extensively as a fumigating material. The liquid, rapidly vaporizes and fills infested areas, penetrates all storage spaces, even packaged goods. The results are that very little insect life is left.

The writer subscribed to your magazine about two months ago. I find it a very interesting and instructive book. My boy, who is twelve years old, reads it too. And you know the results, when he reads stories about space being curved, under the ocean in a bell, and the like, there are a million questions.

LAWRENCE MAHER, Chemist,
Clinton, Missouri.

(We wish to thank you very much for your kind compliments and appertaining to your reply on the subject of tear gas, would advise as follows:

During the early part of the war, benzyl bromide usually mixed with bromoacetone was used as a lachrymator. This material was not pure benzyl bromide, but the reaction product of bromine upon xylene. It was known as "Green T Stoff" by the Germans and while relatively non-toxic, French troops were rendered unconscious by it during certain bombardments in the Argonne in the Summer of 1915.

It was not until the spring of 1917 that reports came from the Italian front that the Germans were using a new type of tear gas that also caused vomiting. Analysis later proved this to be chloropicrin.

There are many lachrymators, the most powerful of which is bromobenzyl cyanide and the least powerful of which is chloropicrin. They are listed in the following order:

Bromobenzyl cyanide, Martonite, Ethyl Iodoacetate, Chloroacetone, Xylol bromide, Benzyl bromide, Bromo ketone, Bromoacetone, Chloropicrin by Major General Amos A. Fries, former Chief of Chemical Warfare Service and Major Clarence J. West in their book, *Chemical Warfare*.—EDITOR.)

Health Shoe Plates

I HAVE seen devices such as electric belts, electric insoles and the like made of copper and zinc strips advertised for sale, that were supposed to cure various ailments. A friend of mine tells me that he has been able to grow a new head of hair by wearing electric heel-plates. Is there any truth in such a statement?

JOSEPH C. BALL,
London, England.

(Perspiration cannot strictly be considered an electrolyte of a strength to produce a good current from a copper and zinc plate. Dry feet will produce no current. Even if current is produced, the pressure is about one volt and the resistance of the human



Postal Inspector D. F. Angiers examining heel plates against which a fraud order was issued by the Postal Authorities.

body is such that the amount of current would not even register on the most sensitive milliammeter made today. There is a good deal more current generated by muscular movements, or by the beating of the heart than could be produced by a pair of heel-plates. On January 29, 1930, the Postal Department exposed another group of these heel-plates which were supposed to be health appliances and issued a fraud order against the Electrifiable Company of Atlanta, Georgia, which had been selling metal heel-plates to be worn in the shoes and which were alleged to cure a number of diseases by raising the temperature of the blood by an electrical effect. Experts

found the heel-plates to be absolutely worthless. The photograph here shows D. F. Angiers, Postal Inspector, examining a pair of these plates.

We would advise you not to purchase any products of this general type. They are worth less.—EDITOR.)



Garlic Winners

PLEASE let me add my ideas to those outlined by J. G. Q. pertaining to "Other Contests" in the January issue. I don't want to suggest anything in particular, because I think that has been your failing in the past and up until now. Model-making is a fine thing, but what is the fellow going to do that can't afford to equip a shop for such things? Just one small lathe means a lot of money for the average person. And then, I have a suggestion regarding the prize. I believe my suggestion beats J.G.Q.'s. The loving cup is absolutely useless. A bouquet of garlic blossoms would do as well. A microscope would be much better, but what would a lot of people want with it? For the most of us it would be a great curiosity and that is all.

(Continued on page 76)

Let's Laugh

ALL jokes published here are paid for at a rate of \$1.00 each; \$3.00 is paid for the best joke submitted each month. Jokes should be scientific. Write each joke on a separate sheet of paper and add name and address to each sheet of paper.

NO WONDER

ENGLISHMAN TO AMERICAN — In England we have a building that's so big it takes three hours to go through it.

AMERICAN—That's nothing. We have bigger buildings than that. I know someone who went into a building ten years ago and hasn't come out yet—and it's called the "pen."

—Charles Osborn.

WELL PAID



An ancient automobile chugged painfully up to the gate of the races. The gate-keeper, demanding the usual fee for cars, called, "A dollar for the car."

The owner looked up with a sigh of relief. "Sold," he said.

—Bernard Proctor.

HE'S RIGHT

PROFESSOR—When were you born?

STUDENT—April 2nd.

PROFESSOR—Late again!

—Joe Sterling.

PAGE WEBSTER!

DOC—Your son is suffering from voluntary inertia.

MOTHER—And Joe said he was just lazy.

—Eunice Beard.



UNDER PROHIBITION

CHEM. PROF.—If you put some yeast in a mixture of honey and water and let it set in your house for a week, what would be the result?

STUDENT—A raid, \$1,000 fine, and 90 days.

—Burt Knutson.

THAT BATTERED LOOK!

First Prize \$3.00

SCIENCE TEACHER—Exercise kills germs.

BOY ON BALL TEAM—How do you get them to exercise?

—Mrs. J. R. Carson.



A LONG CIRCUIT

SWEET YOUNG THING—Why don't you turn on the electric lights?

SUAVE SHEIK—I have, but you see it's like this. The power house is so far away it takes a bit of time for the electricity to arrive.—L. F. Carpenter.

TRUE ENOUGH

1ST FLAPPER — I'm taking a mail order course in typing, do you think it will do me any good?

2ND FLAPPER—I guess so, I've made a lot from taking male orders.

—Clyde Snoke.

NEVER MIND EAR-MUFFS

It was necessary to decide for taxation purposes whether a border farm lay on Canadian or United States territory. Surveyors finally announced to the old lady who had just purchased it, that it just came within the American side.

The old lady smiled with relief. "I'm so glad to know that," she said. "I've heard that winters in Canada are terribly severe." —Louise Wright.

ANY APPRECIABLE DIFFERENCE?

LAYMAN—I don't believe all this talk about these mechanical robots.

ENTHUSIASTIC SCIENTIST—It's all true, man—why in a few years I expect they'll be running for president of the United States.—M. S. Batson.

Scienty Simon—Scientist

BOTH GET HOT

JIM—What is the difference between phosphorus and a match?

JOHN—Well?

JIM—One gets lit when hot, and one gets hot when lit. —Robert Klink.

ARITHMETIC LITERALLY APPLIED

Jack's mother looked out of the window and saw Jack holding his pet rabbit by the ears, saying, "Two plus two!"

"Why, what are you doing, Jack?" she cried.

"Well, our teacher said that rabbits multiplied rapidly and this dummy can't even add." —Mrs. Pearl Blari.



TRY IT

HE—What can you put in a barrel to make it lighter?

SHE—And wot?

HE—Why, just fill it full of holes. —Jack Eedes.

AN APPROPRIATE DEFINITION

TEACHER—Billie, what's your father's occupation?

BILLIE—He's a worm's substitute.

TEACHER—What on earth is that?

BILLIE — He bores holes in furniture for an antique dealer. —Vernon Field.



CORRECT!

SCIENCE PROF.—This gas is deadly poison, what steps would you take if it escaped?

BRIGHT STUDENT—Long ones.

—Paul Arduin.



SCIENCE LESSON
No. 42
NEWTON'S LAW STATES THAT "TO EVERY ACTION THERE IS AN EQUAL AND OPPOSITE REACTION." THE WIND CREATED BY SIMON'S BELLOWS PUSHES AGAINST THE SAIL WITH A CERTAIN FORCE WHICH WOULD TEND TO MAKE THE BOAT GO FORWARD... BUT, IN LEAVING THE BELLOWS, THE AIR PUSHES BACK WITH AN EQUAL FORCE... THIS FORCE OF REACTION IS TRANSMITTED TO THE BOAT, AND OPPOSES ITS FORWARD MOTION... THE RESULT IS THAT THE BOAT REMAINS STATIONARY.

Mr. Loyd Solves An Intricate Problem

(2353) Harold Keller, Portland, Oregon, writes:

Q. 1. I am enclosing a problem which

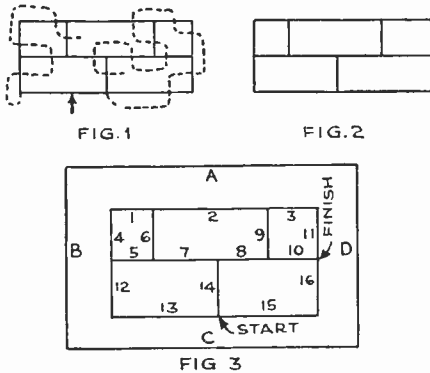

I have been unable to solve. Could you tell me whether or not this problem has a solution.

A. 1. According to Mr. Sam Loyd, our puzzle expert, this problem cannot be solved. He sent us the following reply:

"Originally the puzzle was called the 'Brick Problem' and was presented as follows (Figure 2):

"Directions: Copy the design by drawing three separate, continuous lines which do not cross one another at any point.

"The proposition seems simple enough, and the fact that an endless variety of 'tries' comes within an ace of accomplishing the feat kept people at it for many a long day. Of course, nobody succeeded, for the reason that analysis proves that the design containing eight odd junctions requires four separate lines in its construction.

"A rule applying to continuous line designs established that while there may be any number of points where an even number of lines comes together, no continuous line which does not cross can produce more than two junctions of an odd number of lines.

"Rule: Disregard the even junctions, count the odd ones and divide the total by two—the result will be the number of lines required.

"It will be seen that the line goes through the section where the arrow is pointing, rather than across (Figure 1). In my own answer to the puzzle, I prefer to resort to a method of folding the paper and consistently 'go through' all sixteen sections, thus reproducing the design with a continuous line. There it is (Figure 3).

"Directions: Cut out rectangle A-B-C-D and proceed as follows: Start from arrow and trace short line 14. Hold pencil at point between 7 and 8 and fold edge A over to line 5-7-8-10. Continue pencil line over on folded end A and carry to point between 8 and 10. Hold pencil on point and move folded edge A to line 1-2-3. Trace line 9 and continue over folded edge around to point between 1 and 2. Trace line 6 and hold pencil at point between 5 and 7. Move edge A to line 5-7-8-10. Continue line over on fold and carry it to



point between 4 and 12. Now flatten out fold, it having served its tricky purpose. We have now described lines 6, 9 and 14, and pencil has not been lifted from the paper. Now trace lines 5, 7, 8, 10, 16, 15, 13, 12, 4, 1, 2, 3 and 11 and the design is complete.

"Like the old 14-15 Block Puzzle, the fascination of this tracing puzzle lies in the fact that the variations are endless and sufficiently close to the desired result to keep one everlastingly at a hopeless task, unless, like Alexander the Great, in his cutting of the Gordian knot, we use original strategy."

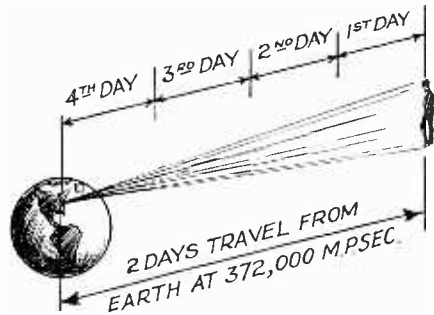

Einstein Again

(2354) George S. White, Chicago, Ill., writes:

Q. 1. Is it quite true that if a man were projected from the earth at a speed twice that of light, after two days' flight he would be looking back on the earth at events which occurred four days previously?

A. 1. According to Mr. Einstein, such a state of affairs would occur. He claims that time is not relative. That events pass on our earth at the rate of light (186,000 miles per second). If a man were shot from this earth at twice that speed (372,000 miles per second), after two days' travel he would be look-

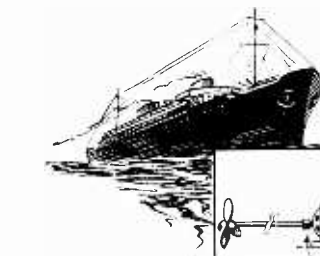

Schematic arrangement of geared turbine and turbo-electric drives.

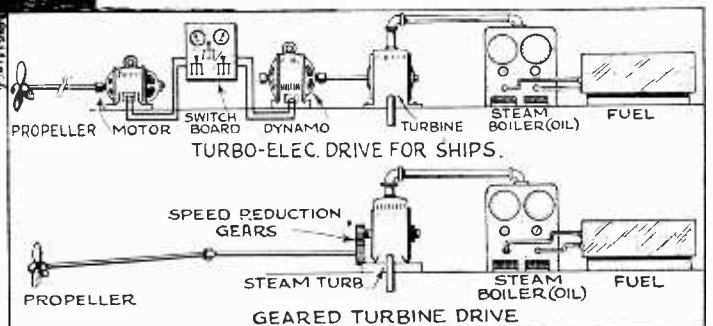

ing back on events which had occurred two days before he left earth. In other words, he would see events which had occurred four days previous. Mr. Einstein might object to this interpretation of his comprehensive theory, but this explanation has been given many times in both lectures and, recently, in a movie of the Einstein theory.

Turbo-Electric vs. Geared Turbine

(2355) James S. Jackson of Kansas City, Kansas, writes:

Q. 1. Some of my friends and I recently had an argument about the advantages of turbo-electric drives and gear-reduction turbine drives. I claim that the turbo-electric drive is the most efficient. Can you settle this question?

A. 1. In order to receive an expert opinion on this matter, we called on D. S. Niven of the Federal Marine Department of the General Electric Company. We received the following answer:

"An analysis of the two forms of drive, based upon statements of Dr. Bauer and his associates of the Bremen, shows that the total machinery weight with electric drive is practically the same; that it will take up no more room, and that the all-electric ship will be from 8 per cent. to 10 per cent. more efficient. The characteristics and performance of turbine-electric drive are even better for the higher powered vessels.

"Installations made with this typical form of American drive, as exemplified by the airplane carriers *Lexington* and *Saratoga* and the International Mercantile Marine vessels *California* and *Virginia*, prove conclusively that vibration and noise are very much less with any other form of drive and, from a passenger point of view, it is obvious that these two points are tremendously important.

"Maintenance of electric drive based on service results to date would be less than on geared turbines, particularly when it is considered that, in an installation of the capacity of the *Bremen*, electric drive would have four high-speed turbines operating at a speed of 2,300 R.P.M. as against twelve ahead turbines and eight reversing turbines operating at a speed of 2,000 R.P.M.

"It is practical from an engineering point of view for this country, to place in service super-transatlantic liners which, if they are equipped with turbine electric machinery, can far exceed any performance made to date."

PATENTS SECURED TRADE-MARKS REGISTERED

High-class professional services for Inventors and Trademark users is necessary for **Proper Protection**. We offer you our facilities on reasonable terms. If you have an invention send us a model or sketch and description and we will give you our **Opinion** whether your invention comes within the provisions of the Patent Laws. Our book **"HOW TO GET YOUR PATENT"** and Record of Invention Certificate sent on request. *Delays are Dangerous in Patent Matters.* We Assist our Clients to Sell their Patents. **TERMS REASONABLE. BEST REFERENCES.**

RANDOLPH & CO.

PATENT ATTORNEYS

Dept. 172, Washington, D. C.

Name

Street

City



**PATENTS
TRADE-MARKS**
**DO NOT LOSE YOUR RIGHTS
TO PATENT PROTECTION**
Before disclosing your invention to anyone send for blank form "EVIDENCE OF CONCEPTION" to be signed and witnessed.
LANCASTER, ALLWINE & ROMMEL
Registered Attorneys
255 OURAY BLDG. WASHINGTON, D. C.
Originators of forms
"Evidence of Conception"



PATENTS
TRADEMARKS—COPYRIGHTS
Before showing your idea to anyone, send for new—"DUPLICATING INVENTION RECORD"—you keep a copy for evidence and send me a copy for advice and exact cost of patent. Prompt Personal Service. Advice and Record free on Request.
JOHN J. LYNCH, Registered Patent Attorney
41-C Park Row 704-C International Building,
New York City Washington, D. C.

Have You An Idea?

**Would You Like
To Get It Patented?**

**—Is the Delay Due To
LACK of FUNDS?**

If so, we can help you

WRITE us immediately for free information regarding our time payment plan for the benefit of inventors which should enable you to proceed without further delay.

—MAIL THIS COUPON NOW—

INVENTORS FINANCE CORPORATION
Dept. C, Union Trust Bldg., Washington, D. C.
Please send no particulars with reference to above plan, and information about the way to proceed.

Name

Address

City State

PATENT ADVICE

CONDUCTED BY JOSEPH H. KRAUS

In this Department we publish such matter as is of interest to inventors and particularly to those who are in doubt as to certain patent phases. Regular inquiries addressed to "Patent Advice" cannot be answered by mail free of charge. Such inquiries are published here for the benefit of all readers. If the idea is thought to be of importance, we make it a rule not to divulge all details, in order to protect the inventor as far as it is possible to do so.

Should advice be desired by mail, a nominal charge of \$1.00 is made for each question. Sketches and descriptions must be clear and explicit. Only one side of sheet should be written on.

NOTE:—Before mailing your letter to this department, see to it that your name and address are upon the letter and envelope as well. Many letters are returned to us because either the name of the inquirer or his address is incorrectly given.

Selling a Patent

(1214) John B. Guerra, Chicago, Ill., submits a copy of patent No. 1,733,874, issued on October 29, 1929. He advises that the invention is patented in the United States and Canada, and he wants to know the best way to sell the patent on an outright basis.

A. Had you taken advantage of the Patent Advice columns of SCIENCE AND INVENTION Magazine before applying for a patent on the battery charger, we would have advised against such procedure.

We believe you will have very great difficulty in selling an idea of this nature. First, your device is nothing more than a lamp connected in series with the battery and can only be used on direct current circuits. Secondly, most of this country is electrically supplied with alternating current, and your battery charger cannot possibly be used. Thirdly, the day of batter charging is passé. All modern radio sets are operated directly from the line. Your device is not very practical for

manufacturers of battery chargers and then submit your plan to them. We further suggest that you take anything you can possibly get for this invention. It has but little value.

Remote Radio Control

(1215) Herman N. Kittredge, Rockland, Me., asks for advice about remote control for radio sets.

A. Many remote control systems have been designed and developed in which the dial is controlled by a motor. Whether or not you can get a patent on your device depends largely on the means of control. A motor connected with a drum dial through gears or otherwise is not necessarily a basis for a patent. Inasmuch as you have given us no information upon which we can base a comment, we regret that we cannot give further advice.

Lock for Doors and Windows

(1216) Jose Vignes, Nuevitas, Cuba, writes:

I am enclosing a drawing of my idea for a lock for doors and windows. I should like to sell this patent to a manufacturer.

A. We do not see that your lock for doors is in any way different from the very simple latch, yet it is just as costly to produce. Latches that are available on the market today at a cost of from 5 cents to 25 cents are even superior to your device because they do not require the fuss necessitated in your scheme to set the latch in position for fastening the door. We advise no action.

(1217) W. Thomas, Jerome, Arizona, asks a great many questions regarding the possibility of producing colored television images.

A. If we were able to answer all of the numerous questions which you have put to us, we would be inventing the idea of transmitting television images in color. There are several systems for doing that now. One of them employs the usual red, blue and yellow discs, driven synchronously with a similar set at the transmitting end. There are no gases with which tubes can be filled that will give you every color of the rainbow. If such a system were operative you could secure a very broad patent on your idea, but the United States Post Office requires that the patent be so worded that those gifted in the art can build and operate a similar device. The government protects you because you disclose your idea instead of keeping it a secret. An inoperative disclosure is worthless. Until you are in a position to demonstrate by a working model that your system will produce the results you expect of it, we are doubtful that there is any organization that would be interested in the purchase of an interest in the idea.

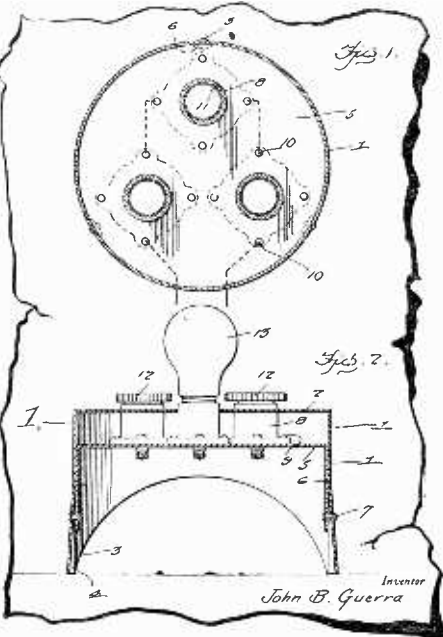

storage battery charging because the lamp, even if of 100 watts capacity, will pass less than one ampere. This means that it will take about 150 hours to charge an ordinary 100 ampere hour storage battery.

There is no excuse for the two fuses in the circuit. Should the two leads to the battery become short-circuited, the only thing that can happen is for the lamp to burn brightly. The pair of fuses do not protect the battery against being over-charged, even though the patent specifications say so.

We would suggest that you go to your local library and look up Dun's or Bradstreet's and copy down the names of the

At the right is a view of my drafting and specification offices where a large staff of experienced experts are in my constant employ.



All drawings and specifications are prepared in my offices.

PATENTS

My Offices
Just Across Street
From U. S. Pat.
Office



Protect Your Ideas

Take the First Step Today—Action Counts

If you have a useful, practical, novel idea for any new article or for an improvement on an old one, you should communicate with a competent Registered Patent Attorney AT ONCE. Every year thousands of applications for patents are filed in the U. S. Patent Office. Frequently two or more applications are made for the same or substantially the same idea even though the inventors may live in different sections of the country and be entirely unknown to one another). In such a case, the burden of proof rests upon the last application filed. Delays of even a few days in filing the application sometimes mean the loss of a patent. So lose no time. Get in touch with me at once by mailing the coupon below.

Prompt, Careful, Efficient Service

This large, experienced organization devotes its entire time and attention to patent and trademark cases. Our offices are directly across the street from the U. S. Patent Office. We understand the technicalities of patent law. We know the rules and requirements of the Patent Office. We can proceed in the quickest, safest and best ways in preparing an application for a patent covering your idea. Our success has been built on the strength of careful, efficient, satisfactory service to inventors and trademark owners located in every state in the Union.

Strict Secrecy Preserved—Write Me in Confidence

All communications, sketches, drawings, etc., are held in strictest confidence in strong, steel, fireproof files, which are accessible only to authorized members of my staff. Feel free to write me fully and frankly. It is probable that I can help you. Highest references. But FIRST—clip the coupon and get my free book. Do THAT right now.

No Charge for Information On How to Proceed

The booklet shown here contains valuable information relating to patent procedure that every inventor should have. And with it I will send you my "Record of Invention" form, on which you can sketch your idea and establish its date before a witness. Such evidence may later prove valuable to you. Simply mail the coupon and I will send you the booklet, and the "Record of Invention" form, together with detailed information on how to proceed and the costs involved. Do this NOW. No need to lose a minute's time. The coupon will bring you complete information entirely without charge or obligation.

Clarence A. O'Brien

Registered Patent Attorney

Member of Bar of: Supreme Court of the United States;
Court of Appeals, District of Columbia; Supreme Court,
District of Columbia; United States Court of Claims.

PRACTICE CONFINED EXCLUSIVELY TO
PATENTS, TRADEMARKS AND COPYRIGHTS

Inventors Write for these Free Books



Mail this Coupon Now

CLARENCE A. O'BRIEN
Registered Patent Attorney

534 Security Savings & Commercial
Bank Bldg., Washington, D. C.

—or—
Suite 1106, Woolworth Bldg.
New York City

Please send me your free book, "How to Obtain a Patent," and your "Record of Invention" form without any cost or obligation on my part.

Name

Address

(Important! Write or print plainly, and address office nearest you)

This Needed Invention Paid \$135,000



A YEAR. Beverage manufacturers immediately adopted this simple crimped tin cap. This invention would have made you independently wealthy. Fortunes await inventors working along right lines. Concentrate on things that are NEEDED. Get Raymond Yates' new book.

"1000 NEEDED INVENTIONS" Costs only \$1.50 and may lead to a big idea. Find out what industry needs and the public wants. That's where the money is! Mr. Yates' book tells you what these things are. Send no money. This revised 1929 edition contains valuable chapters on Aviation and Television. Just write postal. Pay mailman \$1.50 plus postage when book arrives. Your money back if you want it. This offer limited. Write now and get on the right track. (Outside U. S. \$1.70 cash with order.)

BUREAU OF INVENTIVE SCIENCE
75 Wisner Building Rochester, N. Y.

INVENTORS

We have been in business 30 years. If your invention or patent has merit, send details or model, or write for information. Complete facilities. References. Adam Fisher Mfg. Co., 205-D Enright, St. Louis, Mo.

NEW YEAR - NEW IDEA
PATENT YOUR IDEAS
Call or send me a sketch of your invention. Phone LONGacre 3088
FREE Inventors' Recording Blank
Confidential Advice
U. S. and Foreign Patents secured by
Z.H. POLACHEK Reg. Patent Attorney
Consult. Engineer
1234 Broadway, New York

PATENTS
BOOKLET FREE HIGHEST REFERENCES
PROMPTNESS ASSURED BEST RESULTS
Send drawing or model for examination and advice.
WATSON E. COLEMAN, Patent Lawyer
724 9th Street, N. W., Washington, D. C.

INVENTORS who derive largest profits know and heed certain simple but vital facts before applying for patents. Our book, Patent Sense, gives these facts; sent free. Write
LACEY & LACEY
614 F STREET WASHINGTON, D. C.
Established 1869

PATENT YOUR INVENTIONS
EDWARD GOTTLIEB
Attorney in Patent Causes
5 Beekman Street
New York
Inventions Developed—Representative for Blair Tool and Machine Corp.

INVENTORS MODELS
Mechanical Specialists for over 20 years. Rendering Complete Service to the man with an idea
Labor-Saving Machinery Designed & Built
Circular References—Guarantee—Free
BERNARD E. HELLER - 31 East 17th St. N.Y.C.

PATENTS
WRITE FOR FREE INSTRUCTIONS
Send drawing or model for examination.
CARL MILLER, Patent Attorney
Former member Examining Corps, U. S. Patent Office
261 McGill Building, Washington, D. C.

Yankee Brains at Work

Notice to Readers:

AN appreciable period of time elapses between the filing of a patent and the date upon which the patent is granted. During this interval inventors frequently move. We regret that it is quite impossible for us to supply the correct addresses of persons whose inventions appear on this page, nor can we furnish information about when the product may appear on the market. Attorneys who prosecuted the patent cases can furnish the most reliable data. Copies of patents are available at ten cents each from the U. S. Patent Office, Washington, D. C.

Another Ancient Prejudice Removed

No. 1,728,864, issued to Henry A. Kramer. Refers to a device for efficiently releasing a hook from fish. Comprises a shank having a means for engaging hook and controlled trigger means for releasing the hook and housing it after its release.



Check That Door!

No. 1,730,646, issued to Elizabeth Danner. Relates to a simple and inexpensive means of providing an efficient door-check. Consists of two hollow tubes, each open at one end and telescoped in sliding contact with each other. One tube is fastened to the door frame; the other to the door itself. Air resistance encountered in sliding provides means of checking door.

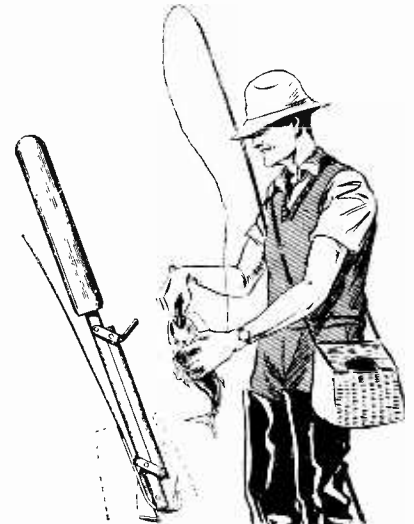

Junior Becomes Air-minded

No. 1,729,007, issued to Harry Tracy Nelson. Relates to new and useful improvements in helicopters or flying toys. Consists of a toy having a parachute connected to the lower end, the cords of the parachute are so attached to a sliding member so that on ascent the parachute is kept closed; on descent the sliding member permits the air to open the parachute.

Comfort for the Open Road

No. 1,707,270, issued to Frederick B. Lichtenberg. Pertains to a tent or camp accessory designed especially for use in touring with a closed automobile of the sedan type. Consists of a canopy body, ridge pole means for supporting the canopy, a roller means about which the canopy body may roll and be held in complete tension at time of use. The tent may be folded down on top of the car while touring and not in use.

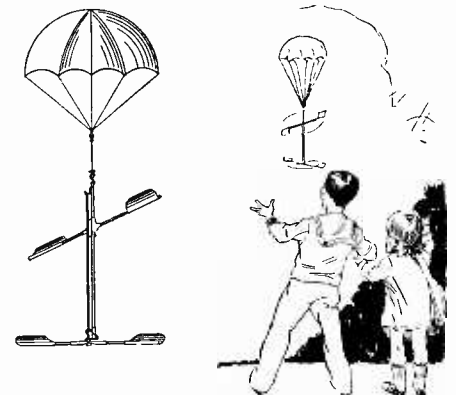

Arctic Fever and Tropic Frostbite

By Carveth Wells

(Continued from page 13)

tropical fever in a terrific hailstorm.

At one spot on the equator, the car skidded along the ice and into the ditch that runs alongside that imaginary line. Eventually I reached the source of the River Nile at Rippon Falls, crossed Lake Victoria Nyanza and went on through Uganda, finally arriving at the foothills of the most important range of mountains in Africa, the Mountains of the Moon, seventeen thousand feet high and absolutely invisible. But in spite of the mist which for thousands of years has hid from the rest of the world these magnificent mountains, I plunged on and up, higher and higher, accompanied by fifty faithful Bakonju natives, who carried living fire in long cigar shaped bundles, and at meal times huddled round big bonfires to keep warm on the equator, and feasted on blackberries.

Day after day lightning flashed and thunder crashed while we struggled on in a blinding snowstorm. Trees disappeared while weeds became gigantic.

We crossed the Fallen Forest where a false step would have meant a fall into bottomless pits lined with great jagged spikes of almost petrified wood and on into the Enchanted Forest, where lobelias grew ten feet high, groundsel (canary food, see Encyclopedia Britannica) thirty feet high, and heather fifty feet high. This forest is indeed a paradise for Scotsmen and canaries!

We had no need for weather bureaus, as we controlled the weather by a flute played by a Bakonju witch doctor. If the sun went behind a cloud, our safari stopped while the witch doctor played upon his flute until it shone again!

At 14,000 feet, our porters were walking through equatorial snow, with their boots slung around their necks as ornaments.

Down dropped the temperature to twenty degrees, and on we climbed with sun helmets to protect our heads from the sun, and thick woolen stockings to ward off frostbite. What a life! Our worst camp was at Freshfield Col, where our tent was pitched in snow, under which was a layer of moss, and under that three feet of icy black mud, into which we continually plunged up to our waists; but to cheer us up, we were surrounded by acres of everlasting flowers—the kind that undertakers use.

When we entered the Belgian Congo, still at great altitude, we discovered parsley bushes nine feet high. If African parsley were used for garnishing beef steak, dishes would have to be fifteen feet in diameter with a nice roast ox in the middle.

Finally, after climbing through a forest of gigantic birdseed at fourteen thousand feet, we were overcome by a terrific blizzard, and for two days we huddled on a little ledge while the witch doctor tried to stop the storm with his flute.

It was a lovely August morning in Central Africa, with snow covering the tropical vegetation, when we crossed the huge Elena Glacier and reached the Scott Elliot Pass. On every side were Africa's eternal snows.

When Aristotle said that there were snow-capped mountains on the Equator in Central Africa, he certainly knew his oats. On the top of one was resting the calling card of the famous Duke of the Abruzzi, left there by him in 1906.

Africa was turned upside down. I had shaken the truth out of it at last!

PATENTS TRADE-MARKS AND COPYRIGHTS



VICTOR BUILDING

Our New Building Nearly Opposite U. S. Patent Office Specially Erected by Us for Our Own Use

OUR OFFER: FOR THE PRODUCTION OF YOUR INVENTION

YOUR FIRST STEP—The inventor should write for our blank form, "RECORD OF INVENTION." Before disclosing your invention, a sketch and description should be made on our "Record of Invention Blank", signed, witnessed, then returned to us and we will place it in our fireproof secret files. **We will also give our opinion** as to whether the invention comes within the Patent Office definition of a patentable invention. This "Record of Invention" will serve as "proof of conception" until the case can be filed in the Patent Office. **There is no charge or obligation for this service.**

Write for Our Five Books Mailed Free to Inventors

Our Illustrated Guide Book

HOW TO OBTAIN A PATENT

Contains full instructions regarding U. S. Patents, Our Methods, Terms, and 100 Mechanical Movements illustrated and described.

OUR TRADE-MARK BOOK

Shows value and necessity of Trade-Mark Protection. Information regarding TRADE-MARKS AND UNFAIR COMPETITION IN TRADE.

OUR FOREIGN BOOK

We have Direct Agencies in Foreign Countries, and secure Foreign Patents in shortest time and at lowest cost.

PROGRESS OF INVENTION

Description of World's Most Desirable Inventions and Pressing Problems by Leading Scientists and INVENTORS.

DELAYS ARE DANGEROUS IN PATENT MATTERS

TO AVOID DELAY: YOU SHOULD HAVE YOUR CASE MADE SPECIAL IN OUR OFFICE to save correspondence, secure protection and early filing date in Patent Office. You should send us a model, sketch or photograph with a description of your invention together with \$25.00 on account. We will make an examination of the U. S. Patent Office records and if it is Patentable we will prepare the official drawings immediately and forward them for approval. If the invention is not patentable we will return the fee less the cost of the examination.

PAYMENT OF FEES IN INSTALLMENTS

It is not necessary that the total cost of a patent be paid in one payment. We permit our clients to pay for their applications in three installments as the preparation of the application progresses in our office.

ALL COMMUNICATIONS AND DATA STRICTLY SECRET AND CONFIDENTIAL. INTERFERENCE AND INFRINGEMENT SUITS PROSECUTED. Our Large, Comprehensive Organization has been established for 30 years and offers Prompt, Efficient and Personal Service by experienced Patent Lawyers and Draftsmen. We shall be glad to have you consult us or to answer any questions in regard to Patents, Trademarks or Copyrights without charge.

WE ASSIST OUR CLIENTS TO SELL THEIR PATENTS

Highest References—Prompt Service—Reasonable Terms

WRITE TODAY

VICTOR J. EVANS & CO.

Registered Patent Attorneys: Established 1898

MAIN OFFICES: 715 Ninth St., Washington, D. C.

BRANCH OFFICES: 1007 Woolworth Bldg., New York City; 1640-42 Conway Bldg., Chicago, Ill.; 514 Empire Bldg., Pittsburgh, Pa.; 828 Fidelity Phila. Trust Bldg., Philadelphia, Pa.; 1010 Hobart Bldg., San Francisco, Calif.

Gentlemen: Please send me FREE OF CHARGE your books as described above.

Name.....

Address.....





The Boss—Could You Handle His Job?

SUPPOSE the Boss should leave tomorrow—who would they put in his place? Could you handle his job? It's worth thinking about because such things happen—every day. Would you have the background—the technical knowledge—to carry on his work? In an hour a day of your spare time, right in your own home, the International Correspondence Schools can give you exactly the training you need. And when you are ready, the opportunity will surely come. Choose now the job that you would like to hold a year—two years—five years from now. Then prepare yourself for that job through I. C. S. study. Thousands of men—starting where you are today—have advanced to better positions and bigger pay in just this way. You can do it too. There is no cost or obligation in finding out how. Just mark and mail the coupon and we will gladly send you full details at once.

INTERNATIONAL CORRESPONDENCE SCHOOLS "The Universal University" Box 6217-F, Scranton, Penna.

Without cost or obligation on my part, please send me a copy of your 48-page booklet, "Who Wins and Why," and tell me how I can qualify for the position, or in the subject, before which I have marked an X.

TECHNICAL AND INDUSTRIAL COURSES

- | | |
|--|--|
| <input type="checkbox"/> Architect | <input type="checkbox"/> Automobile Work |
| <input type="checkbox"/> Architectural Draftsman | <input type="checkbox"/> Aviation Engines |
| <input type="checkbox"/> Building Foreman | <input type="checkbox"/> Plumber and Steam Fitter |
| <input type="checkbox"/> Concrete Builder | <input type="checkbox"/> Plumbing Inspector |
| <input type="checkbox"/> Contractor and Builder | <input type="checkbox"/> Foreman Plumber |
| <input type="checkbox"/> Structural Draftsman | <input type="checkbox"/> Heating and Ventilation |
| <input type="checkbox"/> Structural Engineer | <input type="checkbox"/> Sheet-Metal Worker |
| <input type="checkbox"/> Electrical Engineer | <input type="checkbox"/> Steam Engineer |
| <input type="checkbox"/> Electrical Contractor | <input type="checkbox"/> Marine Engineer |
| <input type="checkbox"/> Electric Wiring | <input type="checkbox"/> Refrigeration Engineer |
| <input type="checkbox"/> Electric Lighting | <input type="checkbox"/> R. R. Positions |
| <input type="checkbox"/> Electric Car Running | <input type="checkbox"/> Highway Engineer |
| <input type="checkbox"/> Telegraph Engineer | <input type="checkbox"/> Chemistry |
| <input type="checkbox"/> Telephone Work | <input type="checkbox"/> Pharmacy |
| <input type="checkbox"/> Mechanical Engineer | <input type="checkbox"/> Coal Mining Engineer |
| <input type="checkbox"/> Mechanical Draftsman | <input type="checkbox"/> Navigation |
| <input type="checkbox"/> Machine Shop Practice | <input type="checkbox"/> Assayer |
| <input type="checkbox"/> Toolmaker | <input type="checkbox"/> Iron and Steel Worker |
| <input type="checkbox"/> Patternmaker | <input type="checkbox"/> Textile Overseer or Supt. |
| <input type="checkbox"/> Civil Engineer | <input type="checkbox"/> Cotton Manufacturing |
| <input type="checkbox"/> Surveying and Mapping | <input type="checkbox"/> Woolen Manufacturing |
| <input type="checkbox"/> Bridge Engineer | <input type="checkbox"/> Agriculture |
| <input type="checkbox"/> Gas Engine Operating | <input type="checkbox"/> Fruit Growing |
| | <input type="checkbox"/> Poultry Farming |
| | <input type="checkbox"/> Mathematics |
| | <input type="checkbox"/> Radio |

BUSINESS TRAINING COURSES

- | | |
|--|--|
| <input type="checkbox"/> Business Management | <input type="checkbox"/> Business Correspondence |
| <input type="checkbox"/> Industrial Management | <input type="checkbox"/> Show Card and Sign |
| <input type="checkbox"/> Personnel Management | <input type="checkbox"/> Lettering |
| <input type="checkbox"/> Traffic Management | <input type="checkbox"/> Stenography and Typing |
| <input type="checkbox"/> Accounting and C. P. A. | <input type="checkbox"/> English |
| <input type="checkbox"/> Coaching | <input type="checkbox"/> Civil Service |
| <input type="checkbox"/> Cost Accounting | <input type="checkbox"/> Railway Mail Clerk |
| <input type="checkbox"/> Bookkeeping | <input type="checkbox"/> Mail Carrier |
| <input type="checkbox"/> Secretarial Work | <input type="checkbox"/> Grade School Subjects |
| <input type="checkbox"/> Spanish | <input type="checkbox"/> High School Subjects |
| <input type="checkbox"/> Salesmanship | <input type="checkbox"/> Cartooning |
| <input type="checkbox"/> Advertising | <input type="checkbox"/> Lumber Dealer |

Name.....
Street.....
Address.....

City..... State.....

Occupation.....

If you reside in Canada, send this coupon to the International Correspondence Schools Canadian, Limited, Montreal, Canada

MAKE YOUR INVENTIONS PAY

Millions have been made from ideas properly developed and protected by inventors. One of the first steps is the development of a practical working model. Send us rough sketch or model of your idea. We will submit complete report backed by 30 years' experience in model making. Confidential service. Modern equipment. Bank referral. CRESCENT TOOL COMPANY, Dept. D, Cincinnati, Ohio

WANTED

Large manufacturing concern is in the market for patent rights either by exclusive royalty or outright purchase of articles that can be manufactured in wood-working and finishing plant or in special machine shop. Box No 5, Science and Invention, 381 Fourth Ave., New York.

Get Out Your Smoked Glasses

By Donald H. Menzele, Ph.D.

(Continued from page 29)

During the progress of the eclipse the moon moves from M to M'. As seen from anywhere along the curved line HABCK the bodies will be identical in size. Hence, along ADC, the actual surface of the earth, the eclipse will be total. Between CF and AG it will be annular.

This "freakishness," incidentally makes it rather difficult for the professional astronomer to observe the eclipse. Even at the most favorable position on the earth (D in the diagram) the excess of the apparent lunar diameter is so small that the line of totality is but three quarters of a mile wide and the duration about a second and a half, instead of 60 or 70 miles and several minutes, as in the average eclipse. The moon is noted for its erratic behavior. In spite of our best endeavors it refuses to follow exactly the orbit we calculate for it, which may prove embarrassing in the present instance. With so little leeway, we shall be agreeably surprised if we are fortunate enough to find ourselves inside the totality belt on April 28th.

The eclipse begins as an annular one in mid-Pacific, changes to total just off the coast of California, and back to annular a little south of Butte, Montana, as indicated by the bar across the line of central eclipse in figure 2. The approximate times of beginning and ending may be estimated from the curves drawn on the map. In the following table, the magnitude of the eclipse, i.e., the percentage of the sun's disk covered by the moon at maximum, is given for a few selected cities. By comparing your distance from the central path with that of the plans noted in the table you can figure out how the eclipse will look anywhere in the country.

Albany, N. Y.	59
Ann Arbor, Mich.	62
Augustus, Me.	64
Austin, Tex.	41
Berkeley, Calif.	99
Boise City, Idaho	99
Chicago, Ill.	59
Denver, Colo.	76
Flagstaff, Ariz.	76
Honolulu, Hawaii	74
Juneau, Alaska	52
Louisville, Ky.	51
Los Angeles, Calif.	85
New Orleans, La.	30
New York City, N. Y.	54
Omaha, Nebr.	69
Salt Lake City, U.	88
Seattle, Wash.	83
St. Louis, Mo.	56
Tallahassee, Fla.	26
Washington, D. C.	49

"Both Ends of the String"

(Continued from page 29)

by the book which he wrote "Progress in Flying Machines," telling of his experiments made with gliders launched from the sand dunes along the south shore of Lake Michigan.

Mr. Braine, a very enthusiastic member of our party, Louis R. Adams, president of the aeronautical society, Carl Dienstbach, a noted German aviation authority, and myself took the machine, which we all helped to build and repair, down to my brother-in-law's estate at

Locust Valley, Long Island, not far from today's Roosevelt Field. From one of the ridges nearby we made gliding flights, taking turns in sailing off the hilltop where the wind was strong and keeping up as long as we could, balancing by shifting our weight from one side to another or forward or back on the padded side bars which went under our arms.

We made glides of about 100 yards and found it great sport, though the neighbors predicted that we would break our necks in the "consarned contraption."

You could count on the fingers of your hands the men who had made successful gliding flights in 1908; while today an adding machine would have to run at full speed to keep track of the numbers who daily are experiencing the sensation of flight.

Says Mr. Lynch—

Today's motorless plane embodies a most effective means of training the power plane pilot of tomorrow. And in the future the glider stands forth as an ultimately common means of individual aerial transport.

The glider pilot learns to fly by feel. In the primary glider there is no structural or other feature between the pilot and the horizon which can be used to determine whether the ship is gliding normally, stalling, or diving. There are no instruments to help the pilot regulate his flight. And later, when the glider-trained pilot flies a power plane, he will fly by instinct, in contrast to the graduate of a regular flying course, who flies by art. Naturally, the glider-trained man will act to meet an emergency while the more conscious flier is wasting precious seconds figuring what to do.

Training in a glider is a safe method. Out of a thousand flights by novices and near-novices at a Cape Cod school last summer, not one brought forth an accident which resulted in more than a scratch or bruise.

The hydroglider, towed by a motorboat, promises further interesting developments in glider technique. Glider economy in any case is outstanding, since a glider can be built at a tithe of the cost of a power ship.

Glider can now be bought for from \$200 to \$400 and for \$150, a primary course, including board and lodging for training period, can be had. A glider can be built at home from blueprints for fifty dollars.

Today glider clubs are forming throughout the United States, and seventeen organizations are already building gliders for the market. At the rate the sport is developing, we shall soon have our full quota of pilots for power plane work, and they will be pilots of the instinctive type—the best.

Among the Features of June SCIENCE AND INVENTION will be "The City of Tomorrow—Today," by Don Bennett. . . . A story of a New Kind of Town, Built for the Motor Age, with complete separation of pedestrian and Automotive Traffic.

Wings for Us All!

By Karl S. Betts

(Continued from page 14)

of San Diego now boasts several first-class soaring pilots within its membership, including Colonel and Mrs. Charles A. Lindbergh. Colonel Lindbergh qualified for his first-class license with a fine thirty-minute flight at Point Loma, and Mrs. Lindbergh secured her three star insignia the following day with a six-minute flight.

William B. Stout, Lieutenant Ralph Barnaby, Dr. Wolfgang Klemperer of the Goodyear-Zeppelin Corporation, Eddie Stinson, Captain Frank Hawks and scores of other well known flyers have taken up gliding enthusiastically and have qualified for licenses as glider pilots. William Hawley Bowlus, of San Diego, has established several American records within the past few weeks, and his last flight of six hours and twenty-five minutes stands at present as the official American duration record.

Several glider meets are scheduled for this year by the national association, and official sanction has been granted the Western Glider Meet to be held at San Diego, California, on April 10, 11, 12, and 13. The New York Glider Carnival, which will be managed by the writer, will be staged at the Queensboro Golf and Country Club on Long Island, on April 26 and 27. Several feature demonstrations are planned for this meet, including another exhibition of cutting loose a glider from the dirigible Los Angeles, with Lieutenant Ralph Barnaby, United States Navy, at the controls. Edward P. Warner, Editor of *Aviation Magazine* and formerly Assistant Secretary of Aeronautics of the Navy Department, has been named Chairman of the carnival committee and has organized a strong group of New York aviation leaders to supervise it.

Another preliminary to the National Gliding and Soaring Contest to be held in September will be the Frank Hawks Trans-continental Glider Flight, which, it is announced, will be staged in the near future. This flight will take Captain Hawks to San Diego and back in a glider towed by an airplane. The date of this flight and the route to be followed have not yet been announced, but the arrival in San Diego and in New York is expected to coincide with the glider meets arranged for in both places.

\$5,000 FOR PERPETUAL MOTION

The editors have received thousands of different designs of perpetual motion devices, and have received hundreds of circular letters soliciting finances for the building of perpetual motion machines.

The editors know that if they receive these letters, there are thousands of others in this country who get similar letters and who fall for the claims made in the numerous prospectuses giving the earning capacities of the various machines.

Most of the shares of stock for these perpetual motion machines are being sold at a rate of \$1.00 per share, although some inventors are trying to sell shares of stock at \$100.00 per share.

Therefore, the editors of this publication say, "Just come in and show us—merely SHOW us—a working model of a perpetual motion machine and we will give you \$5,000.00. But the machine must not be made to operate by tides, winds, waterpower, natural evaporation or humidity. It must be perpetual motion."

SUCCESS IN RADIO Depends Upon Training

...You Get that Training with RCA Institutes, Inc.

REGARDLESS of who you are... how old you are... where you live or what you do... You, too, can make a success in radio because RCA Institutes trains you for success. This is the *only* school backed by the Radio Corporation of America... the foremost radio organization in the world today!

"A Serious Shortage of Trained Men Exists Right Now"

Thousands of men are needed. Broadcasting stations, manufacturing plants, retail and wholesale dealers, as well as ships at sea and planes in the air are now waiting for men like you... men who have the will as well as the knowledge to make good. They know that the graduate of RCA Institutes has the knowledge and ability to hold a good position in radio.

Inside Information about Radio... Quickly and Easily Yours

See how easy it is to learn at home in your spare time... Mr. Lawrence A. Aicholtz says:

"Your course is without a doubt the very best of its kind and the training I received has enabled me to work up to the position of Chief Remote Operator of WSAI."

We have received hundreds of letters similar to this... Each letter a "true story" of success in radio. You get your lessons and criticisms direct from RCA... the very source of radio achievement... the organization that made Radio what it is today... that sponsors every lesson in this course.

Remarkable Outlay of Apparatus Included with this Famous Laboratory Training Course

You learn radio by actual experience with the famous RCA Institutes outlay

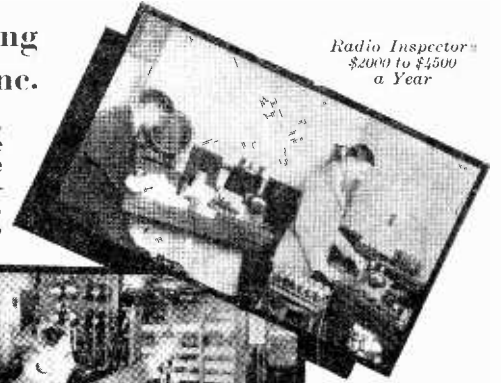

Radio Inspector \$2000 to \$4500 a Year

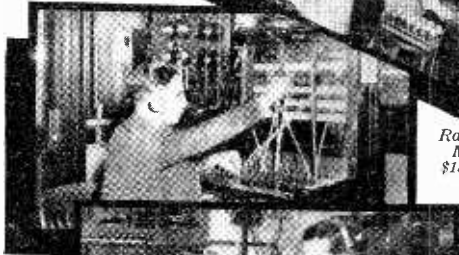

Radio Repair Mechanics \$1800 to \$4300 a Year



Radio Operators \$90 to \$200 a Month (Board Free)

of apparatus... A complete assortment of parts assembled for your help and instruction by RCA experts. See for yourself how easy it is to solve every radio problem such as repairing and servicing fine sets. Here is the training that you cannot duplicate elsewhere, at any price. Students learn by actual experience, under the direction of nationally known instructors.

RCA Graduates Find It Easy to Fill Good Radio Jobs

For more than 20 years, there has been a radio job for practically every graduate who wished one. RCA Institutes students are actually trained for success in Radio... That is the *only* purpose of this organization and that is why students make such rapid progress in Radio. Every student receives an agreement signed by the president of this school assuring absolute satisfaction upon completion of the course... or money refunded.

Clip this Coupon NOW!

RCA INSTITUTES, INC.

Formerly Radio Institute of America

SPONSORED BY



RCA INSTITUTES, Inc.
75 Varick Street,
New York, N. Y.

Gentlemen: Please send me your FREE 40-page book which illustrates the brilliant opportunities in Radio and describes your laboratory-method of instruction at home!

Name.....

Address.....

Exp. 7

Speeding the World's Words

By Mary Jacobs

(Continued from page 11)

distributing clerk's chart of 500 lights shows the wire is in use and in which of the five groups of operators it is being used.

"As messages come in for subscribers to direct lines in the unit, the process is reversed. The distributing clerk sorts these messages into the proper slots. Girls note by the chart whether the wire is busy. If it is she takes the message to the machine working that wire. If it is not she notes by the room chart lights the location of idle operators and takes the message to the nearest one for transmission.

"In developing the 100-wire unit we first tried a modified telephone switchboard. This gave better service than individual lines, but was not good enough. So we worked out tentative designs for handling 1,000 lines at once. We finally agreed that a 100-wire concentrator would suit present needs best, so we perfected such a machine."

It wasn't easy. Provision had to be made for but one conductor per line, so that the terminals of each line would take up a small space. (They occupy only 1/16 of a square inch). The depth of panels containing these terminals was brought down to a few inches as against the telephone measurement of about a foot. The engineers had to work out a system whereby an operator at any position could get a busy signal—quite essential in dealing with 100 lines combined! The vacuum-tube rectifier which permits the current to go one way and not the other was employed here, together with suitable relays and lamps.

According to Mr. Drake, this concentrator is a development in telegraphy of greater importance than can be easily realized by the man who does not come in personal contact with it.

As to the future developments—"I'm afraid we engineers have our noses too deeply buried in our work to make good prophets," Mr. Drake said with a smile. "We're too much interested in meeting immediate problems to devote much time to the distant future. There is the possibility that telegraphy will be used for flashing whole page, facsimile reproductions of newspapers from city to city, scanned with an electric eye. So far, however, the means available for such facsimile transmission cannot compete commercially with the printing telegraph machines. With the latter, some experiments have been made in transmitting a large amount of news matter by telegraph on perforated tape, fed into a monotype machine.

"Telegraphic photographs are now delivered. Already we have had one of King George opening the Naval Conference in London sent over Western Union cables to newspapers in this country. Any symbols, words or characters which may be photographed may be sent by wire. We transmit messages in Chinese from coast to coast.

"There is a possibility that some day a regular telegraph receiver may be in each home. Or perhaps each office will be equipped with pneumatic tubes for dropping messages. We can do this now, but few homes have enough business to justify it. Perhaps some day a pocket telegraph set will be invented with which individuals may receive messages at many given points."

But all this is in the future. Meanwhile Mr. Drake continues his research work. His province includes the testing equipment on switchboards to determine the conditions of wires. For years he has been working on the protection of wires between cities against lightning and other forms of interference. This guards the accuracy of transmission and protects employees from injury. He has also done considerable work on telegraph repeaters and the systems used for the transmission of time and messenger call signals.



The distributing clerk is taking a message for transmission from her file, working with the 100-wire concentration unit.

Los Angeles Says Stop

By Arthur G. Arnoll

(Continued from page 16)

and their remedy from the viewpoint of the child pedestrian are regularly distributed and displayed. Safety patrols, chosen from among the children themselves, keep a lookout for violations, and there are suitable demerits for flagrant cases. Hitch-hiking and begging for rides have been almost eliminated by consistent appeals to the child's pride, and the general success of the campaign may be seen in the fact that accidents to school children in the city show a reduction of eleven percent against the average for the rest of the country.

As a means of facilitating the flow of traffic through the busiest streets, Los Angeles officials favor a wide application of the over-and-under type of intersection. It is hoped that this form can be introduced at points like the Wilshire-Western Avenue intersection, where 41,000 motor cars pass each eight-hour day.

An article describing how CLEVELAND is treating its traffic problems will appear in SCIENCE AND INVENTION for June.

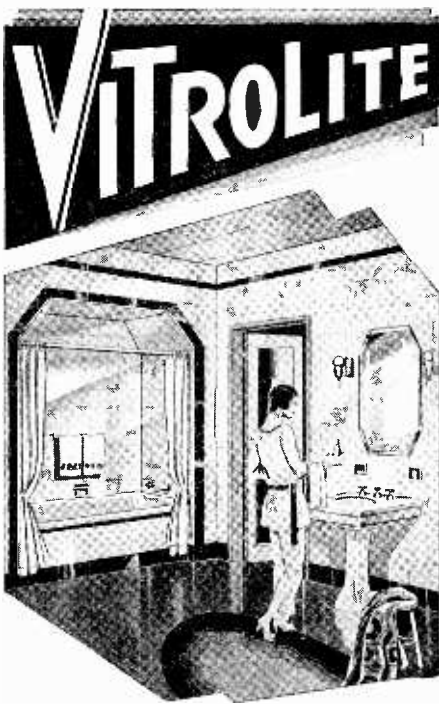

BEAUTIFIES



Charming, Colorful Interiors

The great variety of colors including black makes Vitrolite so flexible in design that simple or ultra-modern effects can be produced as in no other material. It does not discolor, stain, or deteriorate. It does not craze, scratch or absorb odors because it is a fused rock material—hard, sanitary and imperishable. Its beauty and structure last indefinitely. The trade mark on each slab of Vitrolite is your assurance of quality.

Vitrolite can be installed easily and quickly, either for original installation or for remodeling. It can be used for walls and ceilings or for decoration—wainscoting, baseboards, etc.

Write for free catalog, illustrated in colors. Mention in what special use you are interested.

THE VITROLITE COMPANY

Room 1106, 120 S. La Salle St., Chicago
Branches in all principal cities

Eyes Across the Sea

By William Watts Chaplin

(Continued from page 17)

cellar door slammed. He had worked for two months all toward this one moment and he was anxious to see the results. But as his feet began groping down the dark stairs the lady of light, as though she heard him coming and did not wish her audience increased, went all to pieces.

An ear unbinged and floated away. The mouth opened so wide that there was nothing of the face left but an irregular outline and that broke suddenly into a thousand pieces to scatter like snowflakes in a storm. When Hart got to a place where he could see there was nothing left to be seen.

"Static," the mechanic said with disgust. "I'll try to get her back." But Mrs. James Howe was staying in London for the rest of that night, and no repetition of the experiment was achieved. Shortly afterward Hutchinson and his mechanic took their televisior back to England, incidentally giving a demonstration on the way of television from London to a liner in mid-ocean, so the man who had given his time and skill and equipment and worked as hard as anyone else never did actually see the transmitted vision.

Before he left I asked Capt. Hutchinson about the televisior, which during his stay in the country he had carefully guarded from inspection, carrying it each night to his hotel room in New York. What special development was there, I asked, in this set over any of the other television machines.

"It is merely a simple set," he replied, "using the same principles as all the others, except for one thing. There is a photoelectric cell, amplifiers, and a scanning disc with spiralled perforations. At the transmitting end an 'electric eye' views the subject through these perforations and the degree of light on each small segment of the subject is translated into electric energy. This is transmitted and received just as sound is, and then turned back into light, thus forming an image. The only secret we have is our means for synchronizing the discs at the transmitting and receiving terminals and that cannot be divulged."

By the time I got back to the office in New York from Hartsdale about an hour after the experiment, the story I had telephoned in from the Hart home had already been cabled to Europe and a story by Mrs. Howe, telling her feelings at being the first woman ever to have her face lifted across the Atlantic, had already been received.

I got a good laugh out of her reactions, because she said that when she was told to place herself before the television she went first to a mirror and arranged her hair. Yet all the image had for hair was a half circle of light.

The newspapers gave the story of the first transatlantic television a big play and once more a new phase of science was dramatized so that the man in the street could visualize its eventual application to the purposes of everyday life.

WE OFFER \$400 IN AWARDS FOR BASEMENT PLAN

THE SCIENCE AND INVENTION Basement Utilization Contest is in full swing, but there is still time to work out and send in the plan that may get you a share in the \$400 cash awards.

The idea is to present a practical plan for converting waste basement space into attractive, comfortable rooms for work, relaxation, or recreation. The basement may be yours, someone else's, or nobody's—it may be real, imaginary, or proposed.

The contest is open to all readers. You can send in as many plans as you please. Each plan should be made the subject of a separate letter. No letter should exceed 1,000 words.

A drawing will help the jury to understand your idea. Make a rough sketch showing the approximate dimensions of the basement, location of doors and other openings, permanent equipment, etc. For a planned remodeling, send two drawings, one showing the basement as is, the other showing the changes you propose. In this case, divide your letter into three parts. In the first describe the existing basement; in the second describe the changes you propose; in the third describe the materials and methods you propose for its transformation: wall, floor and ceiling treatments; kind and purpose of partitions, if any; provisions for damp-proofing, heating, ventilation, lighting, etc.

For a basement already remodeled, limit your letter to the basement as is, describing the means and methods used to make it comfortable and attractive. For a proposed new basement, describe the materials and methods you intend using to make it dry, comfortable, and attractive, also the equipment you mean to install.

Interesting hints on materials, methods, and equipment are available in the booklets listed on page 84 of the present issue. Order by number. For other information see S. Gordon Taylor's article on basement conversion in the March number of SCIENCE AND INVENTION, also the article on damp-proofing your cellar, in the same issue, by J. W. Von Stein.

Typewrite your letter if possible. However, this is not essential. Use only one side of each sheet and place your name and address on each.

The jury will select as the winning plans those which are best from the standpoint of comfort, attractiveness, and ingenuity of arrangement, allotting them prizes in the order of their merit. But to be considered on these grounds, a plan must be capable of being worked out in practice.

The decision of the jury will be final. The full amount of the prize involved will be awarded each tying contestant in case of a tie. Not more than one prize will be given any one contestant.

The Contest opened February 10 and will close at midnight on May 31. All entries, to be eligible, must be received by SCIENCE AND INVENTION, 381 4th Avenue, New York, N. Y., before that time.

Prize winners will be notified approximately two weeks after the closing date. Their names will be announced also in the September issue of this magazine.

Duplicate copies of plans should be held by readers desiring them.

SCIENCE AND INVENTION reserves the privilege of publishing any idea received. Entries thus published will be paid for on publication at the rate of five dollars each, if they have been awarded no regular prizes.



IS PERMANENT



Many Beautiful Designs with This Life-Time Material

Vitrolite—today's mode for unusual and colorful interiors—owes its wide popularity to its flexibility of design, due to its many colors, various slab sizes, and to the fact that it endures a life-time. Vitrolite will not stain, craze, warp, discolor, or absorb odors. Its original newness and beauty is restored with a damp cloth, for Vitrolite is a fused rock material, as enduring as nature's vitreous formations. Vitrolite is used everywhere—for bathroom and kitchen walls and ceilings, hotel, apartment, hospital and office building corridors and lobbies, meat markets, barber shops and restaurants—in fact, you will see it wherever you go.

Vitrolite is enthusiastically endorsed by architects, builders, and interior decorators. It is easily installed and can be plain or especially designed or etched to give either traditional or contemporary effects. A Vitrolite installation is economical and the trade-mark on each slab is your assurance of quality.

Write for free catalog, illustrated in colors. Mention in what special use you are interested.

THE VITROLITE COMPANY

Room 1106, 120 S. La Salle St., Chicago

Branches in all principal cities

BRAND NEW
GENUINE Model 3
CORONA
LOWEST PRICE EVER OFFERED



\$200 DOWN
BALANCE EASY TERMS

Here's your chance to own that brand new Genuine Model 3 Corona you've wanted—on the easiest terms ever offered—at **LOWEST PRICE** ever offered! Complete in every detail; back spacer, etc., **MANUFACTURER'S GUARANTEE**. Recognized the world over as the finest, strongest, sturdiest, portable built. Only a limited number of these splendid machines available. To get one, you must act now!

Yours for 10 Days FREE—
Send No Money

Experience the joy this personal writing portable typewriter can give you! Use 10 days free! See how easy it is to run and the splendidly typed letters it turns out. Ideal for the office desk, home, traveling. Small, compact, light, convenient. Don't send out letters, reports, bills in poor handwriting when you can have this Corona at such a low price or on such easy terms. Remember these are brand new machines right out of the Corona factory.

Carrying Case Included
—If You Act Now

Leatheroid carrying case, offer, instructions free on this offer. Send no money—just the coupon. Without delay or red tape we will send you the Corona. Try it 10 days. If you decide to keep it, send us only \$2—then \$3 a month until our special price of \$39.90 is paid. Now is the time to buy. This offer may never be repeated. Mail coupon now.

MONEY SAVED
By Using This Coupon

Smith Typewriter Sales Corp.
(Corona Division)
469 E. Ohio St., Chicago, Dept. 915
 Ship me the Corona, F. O. B. Chicago. On arrival I'll deposit \$2 with express agent. If I keep machine, I'll send you \$3 a month until the \$37.90 balance of \$39.90 price is paid; the title to remain with you until then. I am to have 10 days to try the typewriter. If I decide not to keep it, I will repack and return to express agent, who will return my \$2. You are to give your standard guarantee.

Name

Address

Employed by

AN
EASIER Way
to Popularity

PLAY your way to favor with a sweet-toned, easy-playing Pan-American. You learn popular music quickly. Fun, popularity, increased income! Choose any instrument—Pan-Americans are the only complete line of nationally-advertised, factory guaranteed, moderately priced instruments made. **Free Trial!** write for literature; mention instrument.

PAN-AMERICAN
 Band Instrument and Case Co.
 505 Pan-American Bldg.
 Elkhart, Ind.



Answers and Prize
Awards in February
Puzzle Contest

By Sam Loyd

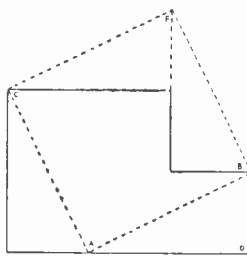

The diagram for the solution to "The Accommodating Metal Dealer" problem illustrates how the metal should be cut to form a square

Solution to "Jack London's
Puzzling Ride"

JACK LONDON went a distance of 133 $\frac{3}{4}$ miles from Skagway to his camp. He traveled 33 $\frac{3}{4}$ miles the first day. Then he went the remainder of the journey at three-fifths speed, 20 miles per day, which brought him in two days late. Had the two dogs remained with him for a further 50 miles, he would have reached his goal one day sooner.

Since it was stated that a further distance of 50 miles at full speed would save him one day, it follows that a further distance of 100 miles would save him the two lost days. Therefore, the remaining distance after his first day's travel must have been 100 miles.

In the same time that he went 100 miles at three-fifths speed, he would go 166 $\frac{2}{3}$ miles at full speed, which establishes his schedule speed as 33 $\frac{3}{4}$ miles per day.

Solution to "The Accommodating
Metal Dealer"

THE diagram shows how the piece of copper is reformed into a square by rearrangement of its three parts. We cut from A to B to produce a triangle whose base and elevation are similar to the sides of the two squares. The line of the hypotenuse, therefore, shows the dimension of the large square, which will equal the two. Then from A to C we clip off another triangle of the same dimensions. Thus the two cuts have produced four edges of the required length for the sides of the prospective square, and all that remains is to place them in position to produce the square A, B, E, C.

The perimeter of the figure is equal to ten times the side of the small square. Its area is five times the area of the small square.

It being told that the perimetrical length, figured at 72 cents per foot, would amount to the same as the area figured at 60 cents per square foot, we arrange the equation: $5N^2 = 1\frac{1}{2} (10X)$, which solved, gives the value of X as 2 $\frac{2}{3}$; 28 $\frac{2}{3}$ square feet at 60 cents amount to \$17.28. Likewise, 24 running feet, at 72 cents, amount to \$17.28.

Prize Winners in February
Contest

First Prize of \$10 is awarded to Gerald G. Decker, Chamber of Commerce, Mission, Texas.

Second Prize of \$5 is awarded to E. A. Cuellar, 204 Bay State Road, Boston, Mass.

The ten prizes of \$1 each are awarded to the following:

Thomas Petre, c/o Arthur Judson Concert Management, Steinway Hall, West 57th Street, New York City.

- William Zborowski, 6251 Bereniece Avenue, Chicago, Ill.
- C. R. Wylie, Jr., 77 Parkhurst Place, West, Detroit, Mich.
- J. Dentraygues, 319 Commercial Street, Los Angeles, Calif.
- H. V. Nyland, 402 La Porte Avenue, Whiting, Ind.
- Helen W. Shuman, 353 Harrison Street, Portland, Oregon.
- Donald Culver, Laurel, Del.
- E. J. Kinleyside, R. D. 3, Jefferson, Ohio.
- Cecelio Delgado, Department of the Interior, San Juan, Porto Rico.
- Harry R. Reckwerd, 3503 Carlisle Avenue, Covington, Ky.

Cook While You Play

By Mrs. Christine Frederick

(Continued from page 46)

bottom to help hold the heat. The result is that your food goes on cooking slowly for hours without any fuel cost. A roast of beef, for instance, will require only 25 percent of the usual time in the oven—it will cook the other 75 percent of the time without any fire.

A bright gas stove manufacturer supplies the insulated cover for the pot right on the stove; you simply turn off the gas at the right point and pull down the cover. It is splendid gas economy.

One of the newest things is a "vapo-seal cooker" which gives the effects of the waterless cooker without the heavy insulated base, using simply super-thick aluminum. Like the waterless cooker, it makes possible cooking four foods at one time over the same burner; it is of 12-quart capacity, and made of rustproof chromium alloy, with thermoplas trimmings.

Another new wrinkle is a "thermostove cooker." The food is placed in the aluminum utensil and set in the cooking well, which is sealed with a steamtight plunger. When the food reaches the boiling point and live steam is blown out through the aluminum vent, a strip of the thermostat metal curls and trips a trigger which turns off the current. Heat stored in the

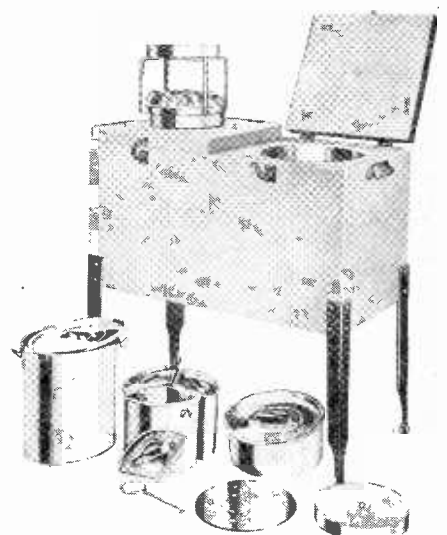

Courtesy The Durham Mig. Co.

The deep-well fireless cooker provides ample room for preparing your entire meal simultaneously.

heavy porcelain heating element in the bottom of the well finishes the cooking.

A portable oven, lined with aluminum and heavily insulated, is available for use on the top plate of the cooker.

Feed Your Plants With Chemicals

By Raymond B. Wailes

(Continued from page 24)

three weeks. Iron, or copper sulphate can be applied to rid lawns of weeds, especially dandelions. One pound dissolved in a gallon of water treats 400 square feet of lawn.

To rid the lawn of crab grass apply about ten drops of strong sulphuric acid to the crown of the plant in between the shoots. In one minute the effects of this corrosive acid will be seen. Charring occurs, due to the formation of uncombined carbon, and is followed by the utter destruction of the root system of the plant.

One drawback to the sulphuric acid method is that the lawn must be made absolutely impassable to any living thing for several days afterward. By the end of this time the acid will have abstracted enough water from the air to make its way into the top soil by dilution. Rains or the garden hose will drive the remaining acid into the soil, so that the surrounding grasses will not be affected. Of course one should be careful not to spill the acid on the clothes or hands. Rubber gloves and rubber overshoes will outfit one for this "acid cure of crab grass." The brown and unsightly clumps of crab grass can be pulled up about a week later or allowed to remain as humus. The writer has used this acid method with very good results. Carbolic or muriatic acid can also be used, but for absolute destruction strong sulphuric acid is best. All three are virulent poisons.

Weeds on tennis courts or similar places can be removed with dry calcium chloride. This substance rapidly absorbs water from the air and the resulting solution destroys vegetable growth. Common salt will do the same, but calcium chloride will be found to be far better. The calcium chloride should be kept in an airtight container or it will "turn to water," or go into solution by taking the moisture from the air.

The basis for some of the artificial manures which are on the market is: ammonium sulphate, sixty pounds; superphosphate, thirty pounds; potassium chloride twenty-five pounds, and ground limestone, fifty pounds. The whole is to be applied to one ton of dry straw, grass or other similar material. Certain micro-organisms present in the strawy material thrive upon the straw when the mineral conditions are right. The added chemicals supply this condition, with the result that the bacteria go to work making artificial manure for the flower-lover.

It is well known that blue hydrangeas are produced on acid soils. Such soils can be made by adding tannic acid, alum, ammonium sulphate, or even soot to the soil about the base of the plant. A tablespoonful of the chemicals dissolved in a gallon of water and applied every week or so will maintain the soil in an acid condition.

The plant lover can also use chemicals to cause early germination of certain seeds. Such hard seeds as *musa ensete*, or Abyssinian banana, grown for their ornamental foliage, will sometimes respond to soaking in a glass of water containing three or four drops of saturated copper sulphate solution. After being soaked in solutions of magnesium chloride, manganese sulphate and sodium nitrate, the seeds of peppers, spinach and parsnips were found to give a higher percentage of germination than untreated seeds.

Men who work with their HANDS . . . Make the BEST Draftsmen



We have placed machinists, carpenters, masons, plumbers, railroad men, office clerks, farmers and even laborers in fine Drafting Jobs under this plan. Mail coupon for details of our remarkable offer.

—and we'll back them with this EMPLOYMENT CONTRACT

We are looking for more ambitious young fellows with factory, building-trade or any other kind of mechanical experience to prepare for and help place in well-paid Drafting positions. Such men, we find, are unusually successful as Draftsmen, because they know how things are done, and that's a priceless asset to the man who makes the blueprint plans. Get in touch with me and I'll tell you how you can cash in on your entire past mechanical experience.



Drafting is Logically Your Next Move!

Of course you realize the biggest handicap to mechanical work is that you're limited in earning capacity to the output of your two hands, as long as you live. Even the skilled mechanic earning \$50 to \$60 a week has reached his limit. He can never earn more and when he gets old he will earn less. So I don't blame any man for wanting to get away from this futureless outlook. For wanting to get into something where he can use his head as well as his hands—where he will be paid for what he knows, instead of only for what he does. . . . You know enough about blueprints to understand that PLANS govern every move in factory and construction job. The Draftsman who makes them is several jumps ahead of the workman who follows them. And so I want you to know that DRAFTING is a logical, natural PROMOTION from mechanical and building work—better-paid, more interesting—just the kind of work you'd enjoy doing.



"I have landed a job with the Pacific Tel. and Tel. Co. in Seattle, and I must say that I am greatly indebted to the American School for my success. You have done all that you promised in helping me obtain employment."
T. C. White, Seattle, Wash.

Get Our No-Risk Plan

The way to a fine Drafting job for you—is easier than you think. It takes no "artistic talent" or advanced education. Thousands of men no smarter than you, with no more education or ability, have learned it quickly and you can, too. With the co-operation of some of the biggest employers and engineers in the U. S., we have worked out a plan to prepare you for Drafting work in your spare time at home—then to help you get a fine position when you're only half way through the course. Mail the coupon and we'll be glad to tell you all about this lifetime chance.



"I have obtained a position as a junior draftsman with the Muncie Oil Engine Co., and so far I like the work real well. I appreciate your aid in obtaining this position very much."
M. S. Braham, Muncie, Ind.

THE AMERICAN SCHOOL

DEPT. D-553 DREXEL AVE. AND 58th ST., CHICAGO, ILL.

AMERICAN SCHOOL, Dept. D-553, Drexel Ave. & 58th St., Chicago, Ill. Please tell me, without cost or obligation, about your training and employment service in line marked X below.

- **DRAFTING**
- Architecture
 - Building
 - Civil Engineering
 - Auto Engineering
 - Electrical Engineering
 - Business Management
 - Accounting
 - Mechanical Engineering
 - Shop Superintendent
 - Foremanship
 - High school in 2 Years
 - Structural Steel

Name.....
Street No.....
City..... State.....
Age..... Occupation.....

36-page Drafting Book—FREE

Tells how easy Drafting is to learn—how interesting the work is—what remarkable opportunities are open for Draftsmen right now. Mail coupon for a copy—without cost or obligation.

EXCELLO RADIO



Style No. 154

Genuine Screen Grid radio with dynamic speaker and high grade cabinets for radio or radio-phonograph combinations.

Write today for free illustrated catalog of Radio and Radio Cabinets

EXCELLO PRODUCTS CORPORATION
4832 West 16th Street
CICERO, ILLINOIS

TYPEWRITER 1/2 Price

Best World's Underwood, Remington, Royal—also portables—prices smashed to below half. (Easy terms.)
SEND NO MONEY!
All late models completely rebuilt and refinished brand new. Guarantee for ten years. Send no money—big Free catalog shows actual machines in full colors. Get our direct-to-you easy payment plan and 10-day free trial offer. Amazing values—send at once.



Free Trial

International Typewriter Exch. 231 W. Monroe St. Dept. 521 Chicago

AGENTS WANTED

For Patented **HOLDZIT** Screwdrivers



It Holds the Screw

Profitable Sales Appeal

Special Purpose Small Tools Fill a Definite Shop Need. Insulated, Rigid, Less Room, No Adjustment, Save Time and Labor. No Competition.

Price \$1.50. Guaranteed Satisfaction or Money Refunded

Wire or Write for Information

THE ABCO MFG. SALES CO.
PAINESVILLE, O., U. S. A.

Riding the Thunder-clouds

By Martin H. Schempp

(Continued from page 15)

and horizontal base, that appear suddenly on a warm summer day. Do you know how they are formed? The atmosphere is heated, not by the sun direct, but from the heat radiated by the earth. And even on a hot day the air above a woodlot will remain much cooler than that above an open field. So the air above the field will ascend and expand until its moisture content reaches its dewpoint and turns to water vapor, thus forming a so-called cumulus cloud.

Whenever we see a cumulus cloud, we know it marks the top of a thermal vertical air-current. Therefore one has only to reach a point a few feet below a cloud of this type to take advantage of a strong upward wind on which to soar one's glider toward a record!

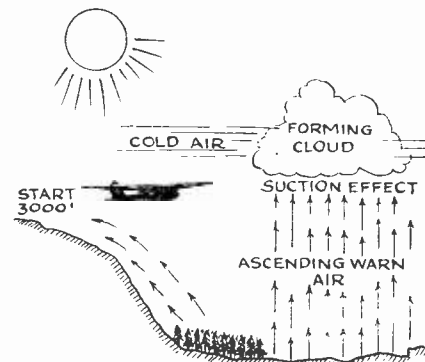

The process by which a cumulus cloud is formed.

Three thousand feet up on the slopes of the Rhoen Mountains, the glider pilots can see cumulus clouds forming above the plain below. They take off and soar aloft on the mountain upwinds. They wait their chance. Then, when they sight a cumulus cloud within their gliding range, they desert the mountain current, steer across the intervening space, and "hang their ship upon a cloud!" And there they stay until another comes within range and furnishes them with a further sustaining force. Or they may glide on to another mountain upwind, which in turn will bring them within range of a new cumulus cloud. . . . A fine and thrilling method of "hitch-riding!" And the art of the soaring pilot is the art of knowing the moment when he can desert one cloud-current or mountain upwind for another. In 1927, Bachem and Dittmar thus made their record flights.

This is not quite "riding the thunder-clouds." But do not think that our glider pilots are backward about following Kegel's involuntary example of this art. On the contrary, our master soaring men wait for nothing more anxiously than for a thunderstorm to give them a lift. Still it takes nerve and ability to negotiate a storm of this kind, as the report of Robert Kronfeld on his world record flight (altitude, 6000 feet; distance 95 miles) will show.

"It was on a hot afternoon during this year's soaring meet," says the report, "in the Rhoen. When I reached the starting point, Pilot Wolf Hirth already was soaring with clouds 3000 feet above. Just then there was no wind whatever. It began to sprinkle and the spectators dispersed. Suddenly the anemometer's hand went to 12, to 18, to 21, to 24 feet a second—and kept going higher. I gave the command. The crew stretched the shock cord, and I was up. . . .

"I have no time to stay on the slope.

The rain pours over the fuselage and wings. There is thunder everywhere. The race starts. Shall I be able to keep ahead of the storm. . . . The altimeter climbs without cessation. That may save me. The higher I get the more quiet it seems. On both sides I can see over the storm-clouds. Small white clouds rise like pigeons below me. Wrecked clouds whirl around my ship. They pile up denser and denser. I am trying hard to keep a course straight east. It seems impossible. The compass goes in a circle. My speedometer jerks up to 70 miles an hour, and by pulling the machine I try to lower the speed. "Suddenly it grows very quiet. My speedometer goes to zero! I try to bring the ship to normal speed. I have the feeling of tumbling forward, head over heels. My vision becomes as in a fever dream, first faint, then distinct. . . . Fields and gardens are circling around me. It is light. I restore again the balance of the machine. There is a town below, and I keep on. Again the compass indicates a course to the east. My hair and shirt are drying, emphasizing the coolness of a 6000-foot altitude.

"Time passes. It is growing dark. There are wide, empty fields below. I glide down to a field suitable for landing, and after a few curves the ship slips through the grass. . . ."

That is what it means to ride a thunder-storm.

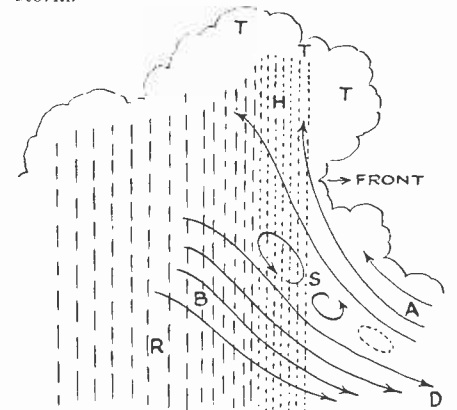

Cross-section of a thunder-storm—A, ascending air B, descending air; S, roll scud; D, wind gust; H, hail; T, thunderheads; R, rain.

Watch for "How to Make a Glider Release Trap," by Martin H. Schempp, in **SCIENCE AND INVENTION** for June.

\$21,000.00 for Spirits

For more than six years this publication has offered prizes totaling \$21,000.00 for genuine demonstrations and proofs of spirit manifestations which we cannot duplicate by scientific and well-known means.

Up to the present time not one manifestation has been presented which by even the greatest stretch of the imagination could be considered genuine.

How many more years must this prize be offered? Spiritualists, please answer!

Air Lanes of Dots and Dashes

By George R. Brown

(Continued from page 23)

against the weather and fire hazards. This dynamotor derives its power from the regular 12-volt 65-ampere-hour storage battery, thus rendering it suitable for full emergency operation. A small 5-ampere 15-volt wind-driven generator is used to charge the battery continually while in flight.

The receiver uses a UX 222 aperiodic coupling tube, one tuned circuit, a UX 112A regenerative detector, a high gain space charge UX 222 audio amplifier, and a UX 112A output tube. Plug-in coils are provided to cover 17, 32, 54, and 590 to 900 meters. The complete receiver weighs 10½ pounds, while the total weight of receiver and transmitter and dynamotor is 42½ pounds.

All important adjustments of performance and wavelength are made at the airport before the plane leaves the ground. With the aid of a test set designed especially for the purpose this operation is reduced to simple routine, and expensive test flights are thus eliminated. This system has the important advantage that the adjustment of the apparatus can be properly carried out by a competent and qualified service man. Thus the number of cases of failure on the part of the apparatus is considerable reduced. This becomes even more important when it is considered that during nine months of use the average two-way communication was 98.4 percent.

The problems involved in creating this apparatus were many. Such factors as size, economy of weight, bad conditions in airplanes due to noise and vibration, and the fact that in many cases the apparatus had to be installed in aircraft where no provision had been made for its proper arrangement had to be considered.

These difficulties were all overcome in due time. The result was a complete apparatus weighing but 42 pounds, completely installed and mounted on spring cushions to offset noise and vibration.

This apparatus had been extremely successful not only in the transportation system of the Pan-American Airways, but in many other airplane ventures. After completing his airplane flight through the Mayan jungles last year, Colonel Lindbergh wired the Pan-American engineers, "Radio communication has been one hundred percent efficient on entire flight—Lindbergh." It has recently been used by the Army Air Service at Wright Field. Here the radio apparatus was used as a means of instruction for student pilots. Again, the Marine Corps used it on their flight from Philadelphia to Nicaragua during the recent uprisings in that stormy country. In addition it has been used by the Arctic Patrol of the First Pursuit Group, Army Air Service, in its flight from Selfridge Field to Seattle, Washington.

William Watts Chaplin contributes another Great Close-Up of Modern Science—"The Sky Talkers"—to SCIENCE AND INVENTION for June.

Why Are We Nervous?

By A. Griffiths, M.D.

The principal causes of nervousness can be explained in simple language. They are two: First, Nerve Weakness; Secondly, Derangement of the Nerves.

Nerve Derangement can be explained crudely as follows: Our nervous system is somewhat like a great telephone system, in that it transmits messages from one part of the body to the other; the brain being the central office. It is the character of the messages sent through the nerves that cause nervousness; messages that flash from the mind to the vital organs and muscles, and back again to the mind. Therefore, anything that disturbs or irritates the mind causes irritating messages to be sent through the nerves to the entire body, especially to the vital organs. This explains why worry, anxiety, fear, anger, grief, jealousy and kindred mental turmoil cause nervous indigestion, heart palpitation, high or low blood pressure, constipation, etc. Worst of all, this cycle of mental and physical upheaval may lead to insanity or suicide. Our insane asylums are crowded to the doors because of conditions that owe their origin to nothing more than simple nervousness. Thousands of sufferers commit suicide every year, and millions of people are unhappy because of their nerves, that is, because of the irritating messages that are transmitted through the nerves. Nerve weakness is entirely different from nerve derangement. It is a condition known as "Neurasthenia," meaning, Nerve Exhaustion. As the noted scientist, Wm. Osler, described it, our nervous system stores a mysterious something, which for the want of a better term, we must call "Nerve Force." This stored force represents our nerve capital. If we squander this force through excesses and undue strains, we naturally become Nerve Bankrupt, that is, the nerves become exhausted, and we have what is known as neurasthenia. Or, as another great scientist very vividly expresses it, "Think of a cut in your arm from which your life's blood is trickling away. Yet millions of people live on from day to day, permitting a loss of vitality which is even far more precious than their blood; namely, they ruthlessly waste their Nerve Force."

Nervousness, then, is due to two major causes: (a) Crazy Messages transmitted through the nerves, which disturb the mind and vital organs; (b) Nerve Exhaustion, due to abuse of the nerves and ruthless waste of Nerve Force. Paul von Boeckmann, who during the last thirty years has carefully studied the mental and physical characteristics in over 400,000 people with high-strung nerves, has proved by actual statistics that at least 90 per cent. of these people are nervous or suffer in some way through their nerves, because of the two nerve abuses mentioned. We see evidence of nervousness about us everywhere, among our friends, in trains, street cars, yes, right in our own homes, and it requires no expert in nerves to see plainly the misery and unhappiness that come from nervousness. He says, further, "It is difficult to imagine anything but perfect health if the nerves are in order." That is, with calm nerves, and abundant Nerve Force, the

stomach can digest any kind of food, for digestion depends directly upon the "stomach nerves." And so, too, would the body be free from colds, for a cold can only be contracted during low nerve pressure, i. e., lowered disease resistance. The same is true with constipation, and scores of other complaints with which the average person is afflicted. Beard, the great authority on the Nerves, who originated the term, "Neurasthenia," agrees with him in this statement almost word for word.

Nervousness, and the train of evils that result therefrom, may be said to develop in three stages, which may vary greatly, according to individual characteristics; namely:

First Stage: Nervousness, restlessness, sleeplessness, lack of energy, poor circulation, and other minor symptoms of low vitality.

Second Stage: Nervous indigestion, belching, sour stomach, gas in the bowels, constipation, shallow breathing, decline in power of reproductive functions, high or low blood pressure, hot or cold flashes, heart palpitation, mental uneasiness, irritability, undue worry, despondency, self-consciousness, etc.

Third Stage: As nerve weakness advances, the symptoms mentioned before become more severe. It is then the more severe mental symptoms appear; namely, fears, melancholia, dizziness, loss of memory, hallucinations, suicidal thoughts, and, in many cases, INSANITY.

If only a few of the symptoms mentioned here apply to you, especially those indicating mental uneasiness, you may be certain that your nerves are weak and deranged. Fight this weakness as you would fight for your life. *Conquer it, or it will conquer you.* To correct nervousness demands, first of all, that the sufferer understand his own condition—the "Why and How" his nerves act as they do. The cause of the trouble must be understood to be corrected. No medicine ever concocted can correct nervousness. There are drugs that deaden the nerves and make them calm. These are very dangerous. There are other drugs that stimulate exhausted nerves. These act similarly to dragging a tired horse behind an automobile to give him "pep." All "nerve drugs" are dangerous and unnatural.

Many books have been written, intended as a guide for keeping up the nervous forces and calming the nerves. In nearly every public library one or more practical treatises on this subject are on file. The most concise and practical of all these books the writer has so far come across is one by Paul von Boeckmann entitled, "Strengthening Your Nerves," which may be found in many public libraries and at the National Medical Library at Washington, D. C. I advise earnestly that the sensible advice given in this practical little book be given careful consideration by any one whose nerves show signs of irritability, instability and exhaustion. The concise, understandable and non-technical information contained in this book is by far the most useful of any I have read. In these days of High Pressure my advice is: Guard Your Nerves.

NOTE:—von Boeckmann is a high authority on the subject of nerve culture, and with the advice given in his book, any one can in a short time improve his control of the nerves 100 per cent. Far over a million copies of this excellent work have been sold during the last twenty years. Every reader should avail himself of this offer, for as stated, we are all nervous, more or less. The book, "Strengthen Your Nerves," by Paul von Boeckmann, may be obtained direct by addressing him, Studio 1800, Cellini Building, 48 West 48th Street, New York City. Enclose 25c in coin or small denomination stamps. It will be forwarded promptly in plain wrapper, postpaid.—*Advt.*

Get Into Business this Easy Way

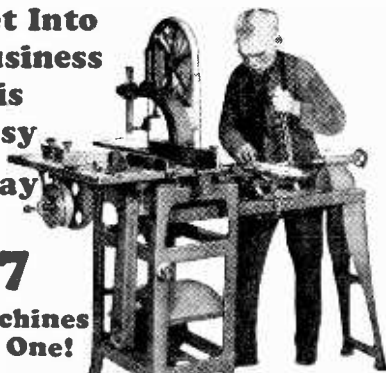

7 Machines in One!

Ball Bearing Throughout Weight 520 lbs.

Sent you for **\$65** FREE trial on deposit of A whole year to pay.

The Electric Carpenter

Make money on screens, trellises, furniture, toys, etc. 8" Circular Saw; 14" Band Saw; 38" Lath, 10" swing; 47" Jointer; Reversible Shaper; 1/2" Hollow Chisel Mortiser; Sander. Does 35 wood-working operations. NOT a toy!

Write Today for Illustrated Folder

We also build a complete line of single-purpose machines.

The Woodworking Machinery Co., Inc.
260 N. Eleventh St. Philadelphia, Pa.

BUILD THINGS!

EARN—LEARN—HAVE GREAT SPORT

We furnish plans for the construction of this Airsled or for Speed Boats, Gliders, etc. Also finest and cheapest plans and materials for model Air-planes. Catalogs 25 cents.



INTERNATIONAL ENGINEERING CORPORATION
Westory Bldg. Washington, D. C.

Learn to PAINT SIGNS and SHOW CARDS

We quickly teach you by mail, or at school, in spare time. Enormous demand. Big future. Interesting work. Oldest and foremost school. **EARN \$50 TO \$200 WEEKLY**



Otto Wiegand, Md., home-study graduate, made \$12,000 from his business in one year. John Yanson, N. Y., gets \$25 for a show card. Crawford, B. C., writes: "Earned \$200 while taking course." Write for complete information.
DETROIT SCHOOL OF LETTERING
179 Stimson Ave. Est. 1899 DETROIT, MICH.

RADIO BARGAINS

Short Wave sets, 1 tube; receives from 30 to 550 meters. \$ 6.45
7 tube A. C. sets. 26.50
A B C power packs. 8.75
Power and Filament transformers. 4.00
Tubes: UX type, Fully Guaranteed, No. 250, \$2.35; No. 281, \$2.00; No. 245, \$1.25; No. 224, \$1.75; No. 227, 75c; No. 220, 65c; No. 171, 75c. Audio transformers, 75c. Variable condensers, 50c.

CHAS. HOODWIN CO.
4240 Lincoln Ave. Dept. E-3 Chicago, Ill.
Dealers in Bankrupt Radio Stocks

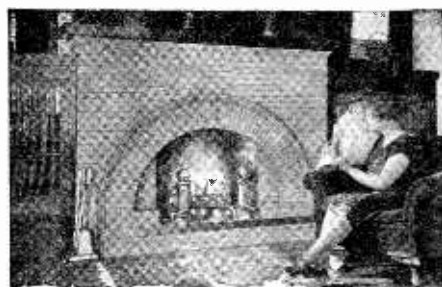

Contentment and Happiness Certain with the COLONIAL DAMPER IN YOUR FIREPLACE

Avoids smoking and cracks in facing that ruin a fireplace. Happiness and contentment in front of an open fire assured when your fireplace is equipped with this perfected draft control. Product of firm famous for twenty-five years. Your architect, contractor or dealer will assure you of the recognized superiority of the Colonial Damper—the only damper made that takes up heat expansion.

Send 10c in stamps for Fireplace Plan Book and Helpful Information.

COLONIAL FIREPLACE CO., 4631 Roosevelt Road, Chicago

Diesel Car Makes Debut

By A. E. LeBlanc

(Continued from page 25)

Company of Columbus, Indiana, normally used for marine and industrial work. It was installed with practically no change in the original equipment of the motor car. The electric starter proved able to perform its function as readily for the Diesel engine as for the gasoline power-plant. A small push-and-pull device for compression release during the starting operation was added to the controls on the dash. The original muffler was found satisfactory in every way for the Diesel-equipped car.

A maximum speed of 55 miles an hour was obtained during the demonstration trip. Getaway was particularly rapid, according to those who took the drive; it is claimed that no gasoline motor car of today could surpass the Diesel automobile in acceleration from a standing start. While the speed of the vehicle is somewhat too slow for individual passenger transport, it seems certain that the Diesel powerplant can be applied efficiently to commercial goods and passenger work and also to tractor propulsion. C. L. Cummins, president of the engine company, who drove the car, found that it handled well in traffic—even in New York—and that a heavy snowstorm failed to hinder the efficiency of operation. The car made the entire journey without adjustments or repairs.

Behind the Human Front

By Edward J. Beck

(Continued from page 18)

was deceived. They merely stuck them into a bureau drawer. The black books were not gone."

Then the hotel clerk contributed a specimen of psychology to a growing collection that ought to be good for a page, or at least a footnote in any book of Drs. Freud, Jung or Adler.

"Guests hide the Bible in bureau drawers, usually the bottom one, to get it out of sight," he theorized. "Now it's apparent that for some reason they don't want to see a Bible on the table. Why?"

"I have a pretty good hunch it's a matter of conscience. Some of these guests are here for a vacation, coming from some small town. They're out to paint the town red and have their fling. Naughty! Naughty! A Bible in plain view disturbs their consciences and so they deliberately hide it."

A druggist friend who happened to drop the remark that collapsible tooth-paste tubes were one of the minor causes of divorce also had the makings of a psychologist in him. It may or may not be true but anyhow he observed that women, as a rule, "milk" a tube of tooth-paste while their husbands prefer to "wind up" the empty end as the directions advise. Hubby gets peeved and thus mangled tubes lead to marital feuds.

"A measly milk can has been the cause of a lot of similar squabbles," he added. Again the druggist took in a lot of territory when he asserted that women are inclined to punch holes in a milk can (at least one hole) at the center or some distance from the edge. Here also hubby may get on his high horse, and sneer that any fool ought to know that both holes ought to be punched at the edge to prevent dribbling and messing up the can."

Any man whose function it is to size

strangers up for their honesty and reliability is likely to have arrived at some interesting conclusions. The writer quizzed the branch manager of a bonding company and asked him if he had ever run across any tell-tale signs whereby one can tell whether the other fellow is lying or not.

"Certainly," he answered. "That's part of my stock in trade. Most of my judgments are intuitive, based on a general impression, but I can give you a couple of rules that usually work out.

"We issue bonds for employes in responsible positions. Our blanks have to be filled out with details of a man's history. I don't know why, but many men lie when we question them as to their past jobs even though they have no particular reason for twisting the facts.

"One little sign often betrays them. They repeat the last part of my question. For example, I ask: 'Where were you working in 1918?' The person being written up replies: 'Where was I working in 1918? I was working for the Brown Wire Co.' 'What were your duties there?' 'My duties there? I was payroll clerk.'

"This practice of repeating questions or parts of questions is one of the commonest devices of the off-hand liar. He seems to be stalling until he can make up a reply. Just listen to a girl at a telephone trying to get out of a date sometime and you'll be able to check up this rule.

The pitch of the voice, continued the surety man, also offers a clue sometimes.

"If I doubt a statement, I induce the speaker to repeat his assertion," he explained. "If he repeats his former statement without raising the pitch of his voice, I gather that he is insincere or untruthful.

"For example, he will say: 'I caught a bass that weighed four pounds.' Then to test him I counter with: 'How much did you say it weighed?' If he answers 'four pounds' in the same pitch, I know he is lying. If he raises his voice as compared with its former level, I am inclined to believe him. Merely increasing the volume of the second statement does not show truthfulness or sincerity but tones in a higher pitch do point that way."

Do you know why a person who "talks like a streak" makes you nervous? A sales-manager, who was giving advice to some of his men called in for a sales-conference, cautioned them against such Gatling-gun delivery. He propounded a theory or observation that the mind of a listener can successfully tune in only 20 wave-lengths of thought per minute. More than that produce "static," he said.

"Where do you get an exact figure like 20, one of his staff interrupted, 'and what are wave-lengths of thought?'"

"I was just ready to go into that," resumed the sales chief. "You eat beef-steak in bites and you pause between bites. The human mind works the same way. It absorbs thoughts by units. And it demands at least a split-second rest between the units.

"Now here's where I get the number 20. We breathe about 20 times a minute. A sentence or unit of thought should be as long as the expiration period of the lungs.

"Thus, you see, the normal wave of attention does not last more than a few seconds. If you're talking to a prospect, 'come up for air'—pause—once in a while.

"If you jabber away, without stopping for these pauses, your listener gets fidgety and irritable. He can only take in 20 idea-units a minute.

"Too short waves of attention, those that are shorter than a full second, are likewise displeasing. Too choppy sentences make the speaker seem nervous and put his listener in the same state."

(Continued on page 80)

GET LEGS LIKE THIS!

Newly Invented Device Gives Quick Results

How would you like to have a pair of legs like the one shown here? You bet you would. Strong legs mean more than strong arms. 90% of body builders spoil their physique with poor legs. Don't be half built. The new **PEERLESS LEG DEVELOPER** will grow inches on your calf, and build powerful thighs. The only leg Developer perfected. Positively guaranteed to give results.

BOW LEGS, KNOCK KNEES, WEAK ANKLES are quickly corrected and transformed into pillars of power. The **PEERLESS LEG DEVELOPER** is a foot corrector as well as a leg builder. Will help build a wonderful upper body and give a grip of steel. New method of exercise requires only 10 minutes a day to build your legs from hip to heel in beautiful shaped muscle of might.

5 DAYS' FREE TRIAL

Send for free descriptive illustrated information, concerning the marvelous **PEERLESS LEG DEVELOPER** and Special Offer. No obligations.

American Athletic Appliance Co.,
3817 N. 9th St., Phila., Pa. Dept. SC-5

Please send me free information about the Peerless Leg Developer Special Offer and 5-day free trial.

Name

Address

A GENUINE 240 POWER MICROSCOPE!
Sent for Only \$100 DOWN



An educational and entertaining instrument that enables all to see and know life invisible to the naked eye. Thrills and fun galore! See tiny bugs grow to proportions of great elephants. See plant and mineral life reveal amazing wonders in form and color. Made just like microscopes used by physicians, scientists, etc. Now only \$2.00. Could easily sell for \$10 and \$20 more. Adjustable lens of 240 power. Send only \$1.00. Pay balance (\$2.00 plus postage) when postman delivers. If not satisfied return within 5 days and your money will be promptly refunded.

Ideal for Students!

A wonderful help in studying science, botany, etc. Never before has such a wonderful instrument been offered at the amazingly low price of \$2.00.

DEALERS AND TEACHERS WRITE FOR OUR PROPOSITION!

R. B. SPECIALTY COMPANY
Dept. E-360 220 E. 3rd St., Cincinnati, O.

WANTED MEN

To Manufacture Metal Toys and Novelties

Big demand for 5 and 10c store Novelties, Ashtrays, Toy Soldiers, Animals, Auto Radiator Ornaments, etc. We co-operate in selling goods you make; also buy these from you. Small investment needed to start and we help you build up. **WE FURNISH COMPLETE OUTFITS** and start you in well-paying business. Absolutely **NO EXPERIENCE** and no special place needed. A chance of a lifetime for man with small capital, and who means strictly business and want to handle wholesale orders now being placed.

METAL CAST PRODUCTS COMPANY
DEPT. E 1696 Boston Road New York City

DEAFNESS IS MISERY

Multitudes of persons with defective hearing and Head Noises enjoy conversation, go to Theatre and Church because they use **Leonard Invisible Ear Drums** which resemble Tiny Megaphones fitting in the Ear entirely out of sight. No wires, batteries or head piece. They are inexpensive. Write for booklet and sworn statement of the inventor who was himself deaf.

A. D. LEONARD, Inc., Suite 685, 70 5th Ave., New York

MAKE MUCH MONEY

Making and Selling Your Own Goods. Formulas by experts. Manufacturing Processes. Trade Secrets. All kinds. All lines. Automobile Specialties. Cleaning and Polishing Compounds. Food Products. Toilet Preparations, etc. Send for interesting catalog, special circulars, FREE.

D. THAXLY CO., Washington, D. C.



SOMETHING DIFFERENT
No Flint. No Friction.
MAKE UP TO \$40 A DAY

Showing My Mystery Lighter to Men. What Makes It Light? All Guaranteed. No Flint or Friction. New Principle of Ignition. Sample With Sales Plan 25c. Sample Gold or Silver Plated, \$1.00. Agents write for proposition.

NEW METHOD MFG. CO.
Desk SI-5. New Method Bldg., Bradford, Pa.

On the Short Waves

By Robert Hertzberg

(Continued from page 30)

advantage of the opportunities the short waves offer, radio fans until recently were forced to use critical battery-operated straight regenerative receivers, innocent of shielding or the benefits of tuned R.F. amplification, and utterly lacking the conveniences of lamp socket operation. This situation discouraged many ex-broadcast fans who had disposed of their batteries with the advent of the A.C. broadcast receiver and who naturally did not want to take a step backward by buying batteries all over again.

Now, however, there is available in kit form a completely A.C. operated short-wave receiver having a *tuned* screen-grid R.F. stage, double shielding and a wavelength range of 14 to 500 meters. This kit was designed particularly for the man who wants to get into the short-wave game at little expense and with little trouble. The set can be assembled and wired in two evenings with the aid of a screw-driver, a Spintite wrench, and a soldering iron, all necessary parts down to the last washer and lug being supplied. The front and sub-panels are accurately drilled, and everything goes in place with gratifying smoothness. This set, known as the "Super-Wasp," has been on the market for about seven months, and has established an international reputation for general effectiveness.

The use of a tuned screen grid R.F. stage gives sensitivity and selectivity far beyond anything obtainable from a straight regenerative outfit, while the double shielding absolutely eliminates hand capacity effects even down to 14 meters. Many problems were encountered in the effort to make this tuned R.F. stage work properly, but they were ironed out by an orderly process of experimentation. Many radio men still doubt the effectiveness of T.R.F. on the short waves, but they forget that not so many years ago T.R.F. on waves as high as 300 meters was considered impracticable, and engineers were forced to use beat-frequency receivers in which the wavelength of the signal was raised, in effect, to a higher value at which R.F. amplification could be accomplished more easily. This was the super-heterodyne idea, if you recall. Radio engineers have learned a few things, and R.F. amplification on 14 or 15 meters is no longer an uncertainty. The R.F. short-wave receiver is just as far ahead of the hay-wire straight regenerator as the modern R.F. broadcast receiver is ahead of the old three-circuit tuner.

The schematic diagram of the "Super-Wasp," along with several views of the completed set, are shown on these pages. You will note that the components of the R.F. and detector stages, respectively, are enclosed within individual shield cans, which in turn are mounted behind a metal panel. The tuning inductances take the form of coils which plug into regular tube sockets. The parts of the two tuned circuits are so laid out that most of the connections are made directly from terminal to terminal, the longest wire being hardly 1½ inches long. The R.F. currents are confined entirely within the can, none of them roaming off into the shielding or the connecting leads. The mechanical arrangement of the parts is to a large extent responsible for the success of the circuit.

A question that naturally arises is: "How much hum is there present?" The answer is that the hum has been reduced to the point where it is hardly noticeable.



Sending in the coupon below may mean the difference between going on struggling and striving—or it may mean that with a few minutes a day properly applied, you can fit yourself for a bigger job.

Thousands of men have done just this—increased their knowledge, increased their earning power, increased their chances of profit. You can do the same. Big things are ahead in the electrical field. The electrical expert has first call, and can name practically any salary and get it. You can do this, if first you fit yourself for a "big-pay" job by knowing electricity, as the experts know it.

THE CROFT LIBRARY OF PRACTICAL ELECTRICITY

You do not need to go to college, you do not need to waste a lot of time learning unnecessary things. The Croft Library (59,000 sets now in use) gives you the practical side in condensed form. Just a few minutes a day of pleasant, interesting reading will teach you all you should know to step into the expert's shoes and into his salary. Thousands upon thousands have done just this—have sent the coupon, started on the high road of success.

LIMITED OFFER—SEND NO MONEY

It is impossible to describe all of the information contained in these books—or tell you of the condensed way in which the hundreds of subjects are handled—such as circuits, armatures, commutators, transformers, switch boards, distribution systems, electrical machinery—in fact, how to do a complete job from estimating to completion. The books are filled with plans, pictures. They furnish a continual source of ready reference. They are handsomely bound in flexible Keratol. The edition we offer amounts to a complete course in electricity. Not in a lifetime could you gain by experience alone the knowledge that has been brought together by Ferris Croft in these seven books.

You must see them and you can see them—absolutely FREE of all cost. Send no money. You are obligated in no way. We will ship the books to you for free examination and trial. Then if you decide to keep this library, and use it to fit yourself for a bigger job, send only \$1.00; the balance in small monthly payments. You will never miss the money, and you will see as thousands of others have, that it is the best investment you ever made. Just clip the coupon, mail it, and the books will be forwarded to you immediately.

FREE 10 DAY TRIAL



McGraw-Hill FREE EXAMINATION COUPON

McGraw-Hill Book Co., 370 Seventh Avenue, New York
Send me the seven volumes of the New Croft Library of Practical Electricity on approval for 10 days' free examination. At the end of that time I will either return the books, or remit in full, or pay in installments of \$1.00 and \$2.00 a month for 9 months.

Name

Home Address

City and State

Position

Name of Company



**AN ECONOMICAL
MOTOR-BOAT
STURDY AS A STEAMER**

Economy — speed — safety — and durability — you get these in an "Old Town" square-stern sponson powered with an outboard motor. She skims the water — shoots along as stoutly as the staunchest cruiser.

The extra-strong stern cares for the weight of the motor. Rigidity is wrought into the ribs . . . no vibration or shaking. This and the heavy, non-leak canvas means she won't "loosen up" and need soaking or caulking. An "Old Town" doesn't require going over for a long, long time.

Free catalog shows many outboard craft, including big, fast, seaworthy, all-wood family boats; dinghies; rowboats; speedy step-planes; and also all canoe types. Write today. Old Town Canoe Co., 1145 Main St., Old Town, Maine.

"Old Town Boats"

Automobile Radio?

Yes, we can tell you something interesting.

Write Us About It Today!

NATIONAL CO., Inc. MALDEN, MASS

Send To-day for the

"Electrical Worker's Friend"

An electrical book of 66 motor drawings with complete instructions for rewinding and reconnecting A. C. motors. Special at **\$3.00**
Or write for full particulars of this valuable book.

SMITH & SMITH PUBLISHING CO.
Dept. B, Valencia, Pa.

YOU will be doubly welcome everywhere when you learn to play a Conn. Chances to join a band or orchestra, to travel, to make extra money. Conns are the choice of Sousa and the world's greatest artists. Easiest to play. Recommended to beginners for quicker progress.

FREE TRIAL, EASY PAYMENTS on any Conn. No matter which band or orchestra instrument interests you most, Conn will send you a special booklet on that instrument giving valuable facts.

C. G. CONN, Ltd., 556 Conn Bldg. Elkhart, Ind.

CONN
World's Largest
Manufacturers of
BAND INSTRUMENTS

Write for FREE BOOK
Mention Instrument

**Does Your Home Need
An Umbrella**

By S. Gordon Taylor

(Continued from page 21)

most effective location because the added insulating value of the air space between the rafters is taken advantage of. This subject was discussed in considerable detail in the last issue of SCIENCE AND INVENTION, in an article on insulation in the home.

The life of roofing materials varies anywhere from six or eight years up. There are records of copper roofs which have been in service for over 500 years and are still in perfect condition, while on the other hand, one occasionally finds a roof in need of repairs after service of only two or three years. The selection of roofing material which will provide long service not only results in freedom from maintenance expense but definitely eliminates the expense involved in repairing plaster or decorations ruined as a result of a leaking roof.



Modern slate shingles of odd dimensions beautify this house. (Penna. Slate Institute.)

Long life and economy are naturally very closely related. If short lived material is employed its subsequent replacement involves not only the added cost of the material for re-roofing, but also a duplication of the original labor cost for installation. Thus, material which can be depended upon to stand up through 20 years of service is worth far more than twice the cost of material which would render only 10 years of useful service. Economy is therefore obviously not a question of first cost but rather one of ultimate cost. This applies whether the material is to be employed for roofing a new home or for re-roofing an existing dwelling.

From the standpoint of appearance, the roofing on a house plays a decidedly important part. Today more than ever before this fact is being realized and as a result owners are giving careful atten-



The charm of a thatched roof is gotten with stained cedar shingles. (Weatherbest Stained Shingle Co.)

**3 Amazing
BOOKS**

Only 50c Each

While They Last!



**1001 RADIO
QUESTIONS
AND
ANSWERS**

If you own a radio, you need this book. Everything you want to know about radio is in it, from "How to Kill Outside Radio Noises" to a clear description of the newest tubes and how to

use them. If you have a question on radio, here is your answer and a thousand more. 100 large, 9 x 12 inch pages in beautifully colored cover. Shipped direct to your home for only **50c**

**POPULAR
MAGIC and
CARD
TRICKS**

Mystify your friends: charm the ladies; be the life of any party. Make glass bowls vanish, cards fly, coins disappear. Do hundreds of other magic tricks and games as easily as a professional magician. Over 200 clever stunts described and illustrated in this big book on magic. Countless evenings of fun and popularity await you. Order it shipped direct to your home, prepaid, for only **50c**

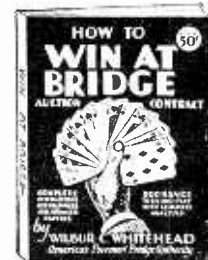

**HOW TO
WIN AT
BRIDGE**

By Wilbur C. Whitehead

Surprise your friends! Get the habit of winning! Let Wilbur C. Whitehead, famous bridge expert, show you his new short-cut method to complete mastery of this fascinating game. By his easily understood new picture method—show-

ing 500 hands to bid and play with analyses and solutions—he makes you master of the fine art of finessing, ruffing, sluffing, placing the lead and dozens of other clever plays. Worth more than any \$2.50 book on Bridge. Shipped, prepaid, to you for only **50c**

Mail TODAY!

Experimenter Publications, Inc.
Dept. 2505-aa
381 Fourth Ave., New York, N. Y.

Gentlemen: Please ship me, prepaid, the big books I have checked below. I enclose only 50c in full payment for each book ordered.

- 1001 Radio Questions and Answers
- Popular Magic and Card Tricks
- How to Win At Bridge

Name

Address

City and State

tion to the use of colors and pleasing textures in roof surfacings. In the old days when wood shingles were used almost exclusively, roofs were for the most part rather drab, monotonous affairs because of the absolute regularity of the shingle surface. In sections of the country where slate was prevalent many of the roofs were more attractive in appearance. While they may have been somewhat lifeless as to color, still they offered a variety of shingle width and thicknesses which lent a pleasing variety of shadows. Nowadays any desired effect may be obtained in these and other types of roofing.

This matter of fine appearance will affect the cost to a certain extent, but the owner will usually find that the additional cost is more than justified by the added attractiveness, particularly where the roofing is of long lasting high quality. If color is desired in the roof, the coloring



Waterproof concrete tile in color is used here. (Hawthorne Concrete Products Co.)

should be an integral part of the roofing material—not just a surface dye, stain or paint. Also it should be a fast coloring which will not assume a washed-out appearance in a short time; otherwise the occasional painting or stain required to maintain its good appearance will add to the expense of maintenance.

The choice of roofing materials for the past several years has been almost unlimited. We no longer have to depend upon the "natural" roof, such as wood shingles but in addition have an almost endless variety of composition shingles employing asbestos, asphalt, cement, metal and clay or other mineral products. Some of the manufactured shingles are little if any more expensive than plain wood shingles and lend themselves readily to roofs that are attractive in appearance.



Wood shingles impregnated with preservative stain are moderate in cost. (Creo-Dipl Company.)

Obviously the home owner will be interested in knowing something of the make-up of some of these roofing materials. Wood is undoubtedly still the most commonly used of the shingles, and they are offered in considerable variety. In order to increase the normal life of the old unfinished wood shingle, present day manufacturers are for the most part impregnating the wood with a preservative

Make Things Quickly and Easily with the NEW 1930 Delta Electric Handi-Shop

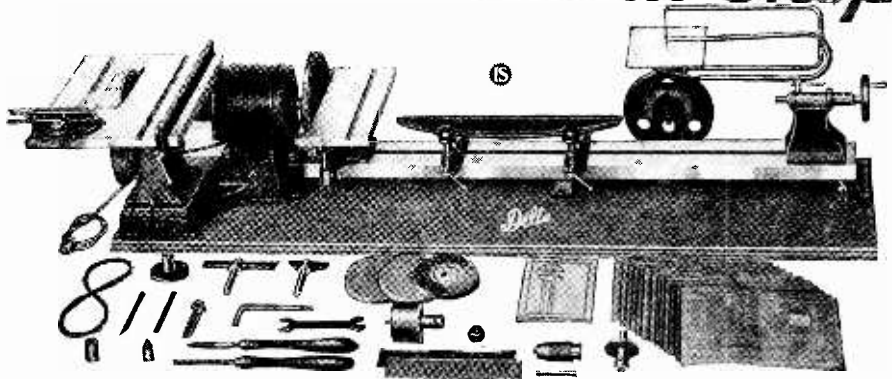

Craftsmen, artisans, farmers, mechanics—all who use wood in their daily labors or spare-time hobbies—are delighted with the sturdy construction, splendid efficiency, and moderate cost of this Delta equipment. They appreciate keenly in the "Handi-Shop" such exclusive constructional features as the Patented Tilt- ing Tables, Automatically-Oiled Bronze Bearings, Heavy U-Shaped Lathe Bed, Circular Saw Raising Lever to mention but a few. Send coupon for complete description of this remarkable workshop. You will understand then why men who know prefer "Delta."

New Woodworking Units

The introduction of the Delta Jointer and Circular Saw Units marks a new era in moderately priced wood-working equipment. Now, for the first time, are available sturdy, practical machines in compact, convenient form at price levels astonishingly low. The individual units are built ruggedly to give years of heavy service. Both incorporate many special features of great value. The combination unit affords a compact, convenient arrangement which permits sawing and planing in one quick operation. Either Jointer or Saw can be operated separately or both together. Welded steel stand of convenient height. All three units are furnished with or without motor, as desired.



Make the things you have always wanted to make, with this sturdy, full-sized equipment. Save money on repair work—earn money in spare time. It is so easy—so quick with the "Delta." Complete Handi-shop includes all necessary equipment for Circular Sawing, Wood Turning, Scroll Sawing, Sanding, Drilling, Grinding and Buffing. Full Instructions and complete set of working blue-prints furnished.

10 DAY TRIAL EASY TERMS

For complete details and full description of the new 1930 Delta line, send coupon for FREE illustrated literature. Shows many items of interest to those who work with wood. You will learn, also, how you can try any Delta equipment for 10 days under actual working conditions at our risk. Choice of three convenient payment plans. Mail coupon TODAY!

Delta Specialty Co.

Division of

DELTA MANUFACTURING CO.

1661-67 Holton St. Dept. C-530 Milwaukee, Wis.

DELTA SPECIALTY COMPANY, Dept. C-530
Division of "Delta Manufacturing Co."
1661-67 Holton St., Milwaukee, Wis.

Please send me FREE, illustrated literature describing 1930 model "Delta" Woodworking Units. Also details of 10-Day Trial Offer and Easy Payment Plans. (Check special information desired.)

- Handi-Shop
- 4" Jointer Units
- Combination 4" Jointer and 8" Circular Saw
- I am interested particularly for home use
- I am interested for shop and professional use
- Moulding Cutter
- 8" Circular Saw Unit

Name.....
Address.....

FREE THE NEW WORLD ALMANAC 1930

SEE PAGE 6

SPORS GUARANTEED NO. 1 FOUNTAIN PEN

SELLS FOR \$1.25

SEND ONLY

39¢

"Writes Like a \$7 Pen"

Use 60 Days — Money Back

If Not Pleased

(Sent Post-Paid)



AGENTS! CHANCE TO MAKE \$10 to \$20 A DAY

Write for Free Wholesale Catalog Showing Over 400 Articles

F. SPORS & CO., 230 AGATE ST., LESUEUR CENTER, MINN.

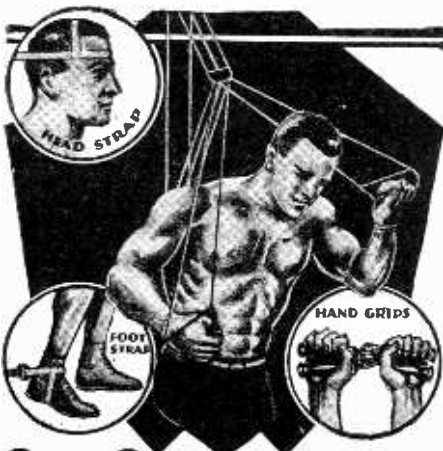

GET STRONG with these 6 Improved Muscle Builders—All for \$5.00 With Illustrated Course

Realize your ambition and develop muscles of a super-man: **GET STRONG!** Easily master feats which now seem difficult—or if you want physical culture for your health's sake, this equipment is what you need. With this special offer you **SAVE AT LEAST HALF.** We furnish 300 cable chest expander adjustable to 200 lbs. resistance. Made of new live extra strength spring rubber so as to give resistance you need for real muscle development. You also get a pair of patented hand grips for developing powerful grip and forearm. We include wall exercising parts which permit you to develop your back, arms and legs—a real muscle necessity. The head strap permits you to exercise muscles of your neck. Develop leg muscles with foot strap furnished. This gives speed, endurance. In addition you get especially written course containing pictures and diagrams showing how to develop any part of your body. **ACT NOW!**

Send No Money

Give name and address to coupon and rush to us. We send everything by return mail. Pay postman \$5.00 plus postage. (If you desire, send money order now and we pay postage.)



GUARANTEE MONEY BACK IF NOT SATISFIED

CRUSADER APPARATUS CO., Dept. 405, 44 Parker Ave., Maplewood, N. J.

I accept your offer. Send me everything described in your advertisement by return mail. I will pay postman \$5.00 plus postage on arrival. It is understood if I am not entirely satisfied after examination, I can return the goods and you will refund my money.

Name.....
 Street.....
 City.....State.....
 Note—No C. O. D. orders to Foreign Countries Except Canada

THIN HEAD MODEL 15° HINSDALE CHROME VANADIUM WRENCH SET Only \$1.95

Plus Parcel Post C.O.D.



Polished Nickel Heads Openings Accurately Milled

This "thin-head" set of wrenches is invaluable for work on modern automobiles. Made of S.A.E. 6130 heat treated chrome vanadium steel. Kit-pack holds each wrench individually.

Hinsdale Thin Jaw Pliers FREE—if you order from this ad. **SEND NO MONEY**

Just write "Send C. O. D. parcel post one Hinsdale 15° angle Chrome Vanadium Wrench Set and free pair of Hinsdale Pliers." Pay postman \$1.95 plus parcel post charges. Money cheerfully refunded if you're not satisfied.

HINSDALE MFG. CO.
 Established 1919 223 N. Desplaines St., Chicago, Ill.

stain. The best of these are treated under pressure so that the preservative is forced into the structure of the wood itself. The shingles are cut to various thicknesses and widths to provide the popular random effect when installed on a roof. This type of shingle is for the most part inexpensive although some of the special shapes run into the moderate cost class.

The so-called asphalt shingle is rapidly growing in popularity. It is also relatively cheap and is put out in an almost unlimited variety of colors, shapes and textures. Most of the asphalt shingles consist of a base of felt which is completely saturated with asphalt and then given an all-over coating of asphalt. Crushed mineral matter is then applied to one surface. The minerals are selected for their color and in addition protect the asphalt from the action of sand and light thereby greatly increasing its durability.

The Next Article in this Home Improvement Series by S. Gordon Taylor will be on Paints and Decorations for the Home. It will be published in the June issue.

Asbestos shingles are long lived, fire-proof and many of them are relatively inexpensive, but at the same time are available in a variety of forms, colors and shapes. They are made of a mixture of cement and asbestos fibre thus combining the durable features of these two minerals into a rigid shingle form which is practically everlasting. Colors are put into the mixture before the shingle is formed and are therefore permanent.

The qualities of slate shingles are so well known that there is little need for discussion of this type except to say that slate shingles are now available in a great many more different forms than in years gone by. Many extremely attractive roof patterns are made possible by the variety of colors in which slate is quarried. Also, pleasing random effects are obtained with this material through mixing slates of different colors, and by employing shingles of varying lengths and thicknesses.

Tile roofing, while generally rather expensive, is finding more and more extensive use in the better class dwellings. It has found increasing use since the popularization of the Spanish and Italian type houses. Good quality tile roofing will outlast any ordinary house and requires no attention of any kind.

Copper is another form of roofing which is as near everlasting as a roof can well be. The Copper and Brass Research Association made an investigation to find out how long a copper roof might be expected to last. They discovered, among other examples, a temple in Japan which had been erected in 1411, the copper roof on which is still intact after 519 years of service. Copper roofing is available in various forms including shingles, tile and sheet. It is naturally rather expensive, as would be expected of such a material but is comparatively light—considerably lighter than many of the other better grade roofing materials.

For one who is interested in the subject of roofing, it will be found well worthwhile to obtain booklets offered by various roofing manufacturers. A list of some of these booklets will be found on page 84 of this issue.

Summer Days Are Comfortable... Here

SUMMER days in Chicago are comfortable...at THE DRAKE. Pleasant... spacious... airy rooms and an ideal location... overlooking Lake Michigan... Beach, bridge paths... Lincoln Park... and other attractions immediately accessible. Rates begin at \$5 per day. Permanent Suites at Special Discounts.

THE DRAKE HOTEL, CHICAGO
 Under Blackstone Management

"AN ADDRESS OF DISTINCTION"

"STAMMERING"

Its Cause and Cure

You can be quickly cured if you stammer. Send 10 cents, coin or stamps, for 288 page cloth bound book on Stammering and Stuttering. It tells how I cured myself after Stammering and Stuttering for 20 years.

BENJAMIN N. BOGUE
 12954 Bogue Building, 1147 N. Illinois St., Indianapolis

Learn Advertising at HOME

Send your name and address for free booklet giving interesting information and vital facts about Advertising. Find out how we prepare you at home, in your spare time, for the opportunities open in this fascinating business. Practical work. No text books. Old established school. Successful graduates everywhere. Just the Plan you have always wanted. Write today. No obligation.

PAGE-DAVIS SCHOOL OF ADVERTISING
 Dept. 1425, 3601 Michigan Ave., Chicago, U. S. A.

Let Us Be Your Factory

EXPERT makers of Dies, Tools and Models. Complete machinery equipment; excellent work, moderate prices, low overhead. Send model or drawing for manufacturing estimate.

Backus Novelty Company, Smethport, Pa.

MODEL AIRPLANES

Construction Sets to build 2 ft. flying models. Sikorsky — \$2.75. Vought-Corsair — \$3.00. Curtiss-Hawk — \$3.00. Savoia-Marchetti — \$2.50. Full size blue-prints included. If ordered separate, 50¢ piece. National Moth latest R. O. G. 60c. 32-page catalog 5c. More models and all supplies described.

National Model Aircraft & Supply Co.
 29 North Ave., Dept. S, New Rochelle, N. Y.

Write for Information About the NEW

H-F-L MASTERTONE

Laboratory-Made Receiver

The year's outstanding Radio Achievement

HIGH FREQUENCY LABORATORIES
 28 N. Sheldon St., Dept. 27, Chicago, Ill.

MAGIC

Learn at Home—by Mail! Easily! Quickly!

New! Different! Teaches you Big Tricks, Illusions, Stage Stunts, "Patter" and the Principles of Magic. Learn at home. Astonish your friends. Write today for full information. Please tell us your age.

TARBELL SYSTEM, INC.
 1926 Sunnyside Ave., Studio 14-25
 Chicago, Illinois

Foods That Fight Your Stomach

By Frederick Damrau, M. D.

(Continued from page 32)

continues to bootleg them into his stomach and the industrious antibodies do their best to destroy the lobster protein. The result is a lifetime of guerrilla warfare between lobster proteins and anti-lobster antibodies.

One person in every seven is abnormally sensitive to some form of protein, whether it be animal dandruff protein, plant pollen protein, or protein food. In such cases cat, dog or horse dandruff may cause asthma; ragweed, timothy, lamb's quarters or wormwood pollen, hay fever and asthma. Food allergy may produce a number of troubles.

I knew an asthmatic old maid who was proved to be sensitive to cat's dandruff. She had a pet cat of which she thought the world, but I didn't. Once, when I was called to see her during a severe attack of asthma, the animal clawed me viciously. Revenge was sweet! When I discovered what caused her asthma, I asked my patient to kill the cat.

Soon afterward I received another hurry call. The cat was still there, but it was stuffed. The stuffed cat was ostracized, but still the asthma continued. It was not until the family in an adjoining apartment, who maintained two very virile tomcats, were bribed to part with their pets that I was able to relieve my patient of her asthmatic attacks.

This experience illustrates how very sensitive some people may be to the inhalation of animal dandruff. In some cases persons susceptible to horse dandruff have suffered from asthma although they lived almost a block away from the nearest stable.

In the case of hay fever, sensitiveness to certain plant pollens may also be extreme. During the season when the guilty weed or grass is in bloom, the victims must either put up with the sneezing and irritation or migrate to sections where the plant does not grow. However, a *desensitization* treatment is now available, by which most of them may be relieved of their pollen sensitiveness.

Food proteins act in sensitive people much like the proteins contained in animal dandruff and in pollens. A number of illnesses may result when susceptible persons eat foods which their bodies have prohibited. Among them are upsets of the stomach and intestines, attacks of sick headache, hives and asthma.

A young stenographer came to me with the story that she suffered periodically from excruciating headaches, at which times she thought she saw "the white lights of Broadway" even in the daytime. She had noticed that these attacks of migraine came whenever she ate a banana and that she would frequently have an outbreak of hives at the same time.

Bananas were tabooed, and then the headache and hives stopped. When the girl's arm was gently scratched with a needle and a little banana protein rubbed in, a large red hive promptly appeared. When proteins other than those of banana were used, such as milk and egg proteins, no hive formed. Simply by avoiding bananas this young lady has been able to remain free from attacks of migraine.

How the doctor picks out the particular protein food (or dandruff or pollen) to which his patient is sensitive is a matter of much interest and importance to the unlucky one in seven who happens to suffer from protein sensitiveness.

If one is made sick by banana protein, for example, the skin as well as the rest

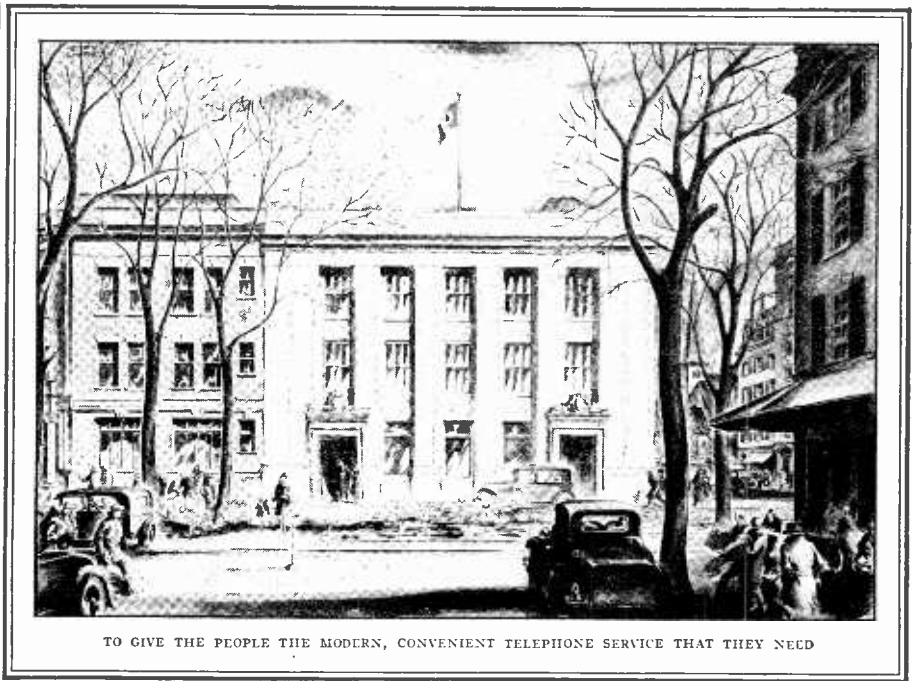

The Bell Telephone Company ... of your town

An Advertisement of the American Telephone and Telegraph Company

IT HAS its home in your town. Its operators are the daughters of your neighbors. Its various departments are in the hands of your own citizens, with years of training in telephone engineering and management. Who owns the Bell System? 450,000 people scattered over the United States own the stock of the American Telephone and Telegraph Company and 250,000 own other securities of the Bell System.

No matter how small the part of the Bell System that serves you, it has behind it research, engineering and manufacture on a national scale. The Bell System operates through 24 companies, each designed to fit the particular area it serves—to furnish the highest standard of service in a manner personal to the needs of every user.

Serving each of these 24 operating companies is the staff of the American Telephone and Telegraph Company, which is

constantly developing better methods of telephone communication. Each draws on the findings of the Bell Laboratories, one of the greatest institutions of its kind in the world, for the continual scientific improvement of telephone service. Each has the benefit of the buying power and specialized manufacturing processes of the Western Electric Company, which supplies telephone apparatus of the highest quality and precision for the entire Bell System. Each takes advantage of every improvement in practice, equipment and economy.

The Bell System's ideal is to give all of the people of this nation the kind of modern, convenient telephone service that they want, over its wires to connect them one with another and with the telephones of the rest of the world. It is your telephone company, at your service with every resource that it commands.



See the Craters in the MOON!

Astronomical and Terrestrial TELESCOPE

Own a genuine Astronomer's Telescope. See thousands of miles away. Make Sun, Moon Planets. Stars your next door neighbors. Moors, Centers Sun Spots, Red pen enlarged 30 times. Strange thrills!

Hours of fun looking at scenery, games, bathing beauties. Great for trips and voyages. Made like telescopes used in observatories. Gerding wrote: "Moon seemed 10 yards away."

Price Only \$2.95

EARN \$10 A DAY
Charge 25c to look at the moon

ROLL-O SPECIALTY CO.,
Dept. E-335
220 E. 3rd St., Cincinnati, O.

Learn AVIATION
WHERE LINDBERGH STARTED!

Come to Lincoln—where "Lindy" learned. Come to the famous Lincoln School!

No other civilian airplane school in America offers mechanical and flying training on such elaborate equipment at anywhere near our reasonable charge. Over \$250,000 worth of buildings and equipment. A modern \$100,000 airport. Expert instructors. Plenty of new production, government-licensed training planes, including a new Travel Air transport cabin ship. Mechanical School is tied in with a large airplane factory. Pilots government-licensed. Write today for details, stating age!

LINCOLN AIRPLANE & FLYING SCHOOL
221 Aircraft Bldg. Lincoln, Nebr.

MOLDING A MIGHTY CHEST



Get a 46 Inch Chest
Complete Course on Chest Building
ONLY 25c

Learn the real secret of powerful chest building. Know all about the muscles that lift, widen and deepen the chest and broaden the shoulders. Practice the specialized exercises which will make YOUR chest massive and powerful. The greatest analysis of vital, vigorous chest development ever written. Learn the Hindoo religious system of exercises that makes their wrestlers and strong men invincible. A Hindoo strong man and wrestler threw Zybyso in two seconds. Many other methods unknown to the American body builder, are explained. Complete with illustrations. You can build for yourself a Herculean chest. The author, George F. Jovett, built his chest from 32 inches of weakness to 48 inches of colossal muscular strength. Develop your chest with straps of big steel muscle. Fill it full of vital strength energy.

WORTH ITS WEIGHT IN GOLD—GET IT TODAY
To each purchaser will be given a COPY of **THE THRILL OF BEING STRONG**—a priceless book to the strength fan and muscle builder. Full of pictures of marvelous bodied men who tell you decisively how you can build symmetry and strength the equal of theirs.

REACH OUT—GRASP THIS SPECIAL OFFER

Jovett Institute of Physical Culture

422 Poplar Street, Dept. 30-E, Scranton, Penna.

Dear Mr. Jovett: I am enclosing 25c. Please send me the course "MOLDING A MIGHTY CHEST" and a copy of "THE THRILL OF BEING STRONG."

Name

Address

BIG MONEY IN ELECTRIC REFRIGERATION



etc. Many jobs open in production, installation, service and sales which ordinary mechanics can't fill without special training in electric refrigeration.

EASY TO LEARN AT HOME

Learning electric refrigeration is now amazingly simple through a new easy home training endorsed by authorities. Highly praised by Serrel, Kelvinator, and other leading refrigerator manufacturers. GET FREE BOOK. Utilities Engineering Institute, 4403 Sheridan Road, Dept. 550, Chicago.

UTILITIES ENGINEERING INSTITUTE
4403 Sheridan Road, Dept. 550, Chicago, Ill. **FREE!**

Without obligation, send me free information book.

Name

Address

City State

of the body is irritated by it. A gentle scratch is made on the skin of the arm, not so deep as for vaccination. Then a tiny bit of the protein of the banana is rubbed gently into the skin. Should the patient not be susceptible, no inflammation follows; but, if the banana really is the trouble-maker, a large red hive soon forms over the scratch.

In some cases the physician is led to suspect from the patient's account which of the seventy-two foods in the protein rogues' gallery is responsible. Unfortunately, the patient's story may prove misleading, as he is only too likely to shift the blame to some food which he dislikes. Moreover, one may be sensitive to two, three or more proteins. Therefore, it is usually necessary to run the patient through the whole scale of protein skin tests in order to have a complete understanding of the case.

Patients going through the skin tests have a humorous habit of saying that they are being "tattooed." The repetition of scratches may indeed suggest an enlistment in the Navy, but the irritation lasts only a few days and no scar results.

To reduce the required number of scratches to a minimum, the various protein substances have been arranged in groups by some workers. For instance, the shellfish group contains clam, oyster, crab, lobster, scallop and shrimp proteins; the bean-and-pea group: kidney bean, lentil, lima bean, navy bean and pea proteins. If the skin test for the group is negative—that is, no hive forms after the group of proteins has been rubbed in—we know that the patient is not sensitive to any of the members of the group.

Desensitization

Having discovered by the skin tests which food or foods disagree with his patient, the doctor must next turn his attention to treatment. Sometimes the problem is very simple. I am acquainted with the case of a "grass widower" suffering from hives who proved susceptible to garlic protein and was, in fact, in the habit of eating raw garlic. His halitosis was devastating. By simply eschewing garlic he was cured simultaneously of both hives and halitosis, and his wife returned to live with him. A happy ending for what threatened to be a garlic tragedy!

Suppose, on the other hand, one should prove sensitive to a group of essential foods, such as eggs, wheat and milk. It would be almost impossible to forbid these articles of diet and still sustain life.

In that event we should have to resort to *desensitization*, another of the marvels of medical science. Let us suppose that the theatrical producer whose case I have mentioned had proved susceptible to lobsters, as I suspected at first. It would have been a waste of words to ask him to stop eating lobsters.

"Consider my career," he might have answered. "The Follies cannot go on without the midnight lobster."

And so, in the interests of "the white lights of Broadway," the correct procedure would have been to desensitize against lobster protein. The technique would have been as follows: An extremely tiny amount of lobster protein—not enough to produce a hive or cause illness—would be injected with a fine hypodermic needle. Subsequent injections would be made with increasing amounts of lobster protein, but never enough to produce illness. Under this treatment resistance to lobster protein would gradually be increased. Finally the desensitization would become so complete as to allow the impresario to eat all the lobster that his profession required.

NEW LOW PRICES ON GOOD YEAR FIRESTONE-FISK AND OTHER U.S. TIRES

Lowest Prices in History!
This big company, because of its immense buying power, will supply you with reconstructed standard make tires at these unheard of low prices—whole year's service guaranteed. Thousands of satisfied customers reorder year after year.

ORDER NOW—SAVE MONEY

REGULAR CORD PRICES			
Dealers Wanted	Size	Tires	Tube Size
30x3 1/2	\$2.25	1.00	35x5 \$3.60 \$1.75
30x3 3/4	2.25	1.00	35x5 4.45 1.75
31x3 1/2	2.25	1.18	35x5 4.45 1.75
31x3 3/4	2.25	1.18	35x5 4.45 1.75
32x4	2.25	1.18	35x5 4.45 1.75
32x4 1/2	2.25	1.18	35x5 4.45 1.75
32x4 3/4	2.25	1.18	35x5 4.45 1.75
33x4 1/2	2.25	1.18	35x5 4.45 1.75
34x4 1/2	2.25	1.18	35x5 4.45 1.75
30x5	3.60	1.75	All Balloon Sizes

Send only \$1.00 deposit with each tire ordered balance C.O.D. if you send cash in full. Deduct 5%. You are guaranteed a year's service or replacement at half price. **MIDLAND TIRE AND RUBBER COMPANY**
Dept. 179, 1000 West Sixty-third St., Chicago, Ill.

Feel 10 Years Younger In 6 Days

SCIENCE now knows that the tiny prostate gland frequently causes health and strength, night rising, constipation, pains in back, legs, feet, etc., in men past 40. Unless corrected this may lead to miserable old age and grave surgery. Now an amazing drugless treatment is giving swift, permanent relief to thousands. Used and endorsed by physicians, hospitals and sanitarians. Sent on trial. Feel 10 years younger in 6 days or pay nothing. Write for offer and free book of daring facts about men past 40.
W.J. KIRK, Pres., 4529 Morris Ave., Steubenville, O.

LEARN CARTOONING

At Home—In Your Spare Time
The famous Picture Chart Method of teaching original drawing has opened the door of success for hundreds of beginners. Whether you think you have talent or not, send for sample chart to test your ability, and examples of the work of students earning from \$50 to \$300 per week. Please state your age.
THE LANDON SCHOOL
1460 National Bldg., Cleveland, O.



BOW LEGS?

THIS GARTER (PAT'D)
Makes Trousers Hang Straight
If Legs Bend In or Out
Free Booklet, Plain Sealed Envelope
The T. Garter Co., Dept. 16
South Bend, Ind.

Be A Detective

Make Secret Investigations
Earn Big Money. Work home or travel.
FASCINATING WORK. Experience unnecessary
DETECTIVE Particulars FREE. Write
GEO. STEVE WAGNER, 2190 Broadway, N. Y.

"Concentration"

Learn how to keep your mind on one subject despite interruptions. Great possibilities through thought control. Companion book "How to Conquer Fear," shows how to avoid worry, doubt, anxiety, nervousness; gain contentment. Both wonderful books, by F. W. SEARS, \$1 postpaid. Satisfaction or money back.

CENTRE PUBLISHING CO.,
1123 Broadway—A-45 New York

48 PP. CATALOG FOR MODEL BUILDERS

Most complete listing of parts, materials, fittings and supplies for Model Airplane Builders; also full information on IDEAL Model Airplanes. Sent anywhere for 5 cents.
Ideal Aeroplane & Supply Co.
22-24 West 19th Street New York City

SONG WRITERS!

Substantial Advance Royalties are paid on work found acceptable for publication. Anyone wishing to write either the words or music for songs may submit work for free examination and advice. Past experience unnecessary. New demand created by "Talking Pictures", fully described in our free book. Write for it Today—Newcomer Associates
764 Earle Building, New York, N. Y.

Your Glider's Flying Clothes

By Licut. H. A. Reynolds

(Continued from page 39)

butt end of the wing. Next draw the cloth to smoothness (not stretched tight) and fasten it with glue and pins to the 3/4-inch half round strip at the wing tip. Rub each glued rib with your hands so that the cloth absorbs some of the glue and occasionally put in a push pin to hold the cloth in position. Next apply more glue to each rib and continue fastening the cloth back towards the trailing edge by unrolling your panel as you go. Do not spread the glue over too large a section of ribs at one time. If you cover too large a section with the glue it will become too dry before you can fasten all the cloth needed to cover it. As you proceed in this manner and the glue first applied dries, you can pry out the push pins in this dry section and use them over again. The push pins will not split the spruce rib battens and are easily pried out leaving the cloth securely glued to the surface of the wing. Continue covering the bottom surface of the wing, but do not glue the trailing edge or rib tips at this time. A small slit can be cut in the cloth at each wire connection as an outlet for the wire. These wire outlets can be reinforced with cloth patches cut to shape and glued in place later when the true course of the wire can be estimated. Trim away the excess cloth so that the aileron horn will slip through and cover the bottom of the aileron. The trailing edge of the aileron must be in line with the trailing edge of the wing during this covering process. After all of the glued cloth connections are dry the push pins may be removed and the wing turned over right side up on the sawhorses. The top surface of the wing and aileron can be covered in the same manner starting at the trailing edge and working slowly towards the leading edge. The aileron can be cut out from the wing and removed so that its butt rib can be covered on the side. This is done by gluing in a shaped piece of cloth. The side of the wing rib next to the aileron should also be covered with a piece of cloth cut to shape and glued in place. Do not be discouraged if slight depressions should appear in the cloth here and there between the ribs for the shrinking caused by the dope will make this disappear later. Cover both wings in the same manner. Trim off the excess cloth which will overlap along the leading edge and wing tips.

The triangular stabilizer framework can be laid on a double thickness of cloth and its pointed outline marked for sewing. Do not sew the spar edge of the stabilizer covering. After sewing the two sides leading to its pointed front the cloth can be turned inside out and the stabilizer inserted through the open back side. The stabilizer framework should be well covered with glue and the triangular shaped cloth bag covering drawn over it. Fasten it temporarily with push pins.

The outline of the elevators can be drawn on double layers of cloth so that they may be sewed into tight fitting bag-shaped covers which when turned inside out can be drawn over the elevator framework and glued fast. Turning these sewed-up coverings inside out places the sewed seams on the inside and presents a smooth good looking surface on the outside. The cloth should be cut away at the horn positions so that no wrinkles will be present in the finished covering.

(Continued on page 77)

ELECTRICITY OFFERS BIG PAY



NOW YOU CAN LEARN AT HOME

HUNDREDS OF COOKE TRAINED MEN ARE MAKING \$60 to \$100 A WEEK

Why don't you get into Electricity, too? It's today's great Opportunity for you and every other man who is sick and tired of struggling along on small pay. Hundreds of "Cooke Trained Men" who were no smarter than you when they started now make \$3,000 to \$5,000 a year—and some make even more.

LEARN AT HOME IN SPARE TIME

Learn with the famous L. L. COOKE "Work Sheet and Job Ticket" Method. It's simple, it's thorough, it's practical. It's just like actual shop experience, yet it's all done right in your own home with the Big Complete Outfit of Tools and Apparatus given to you without extra cost. And it's done in your spare time, without quitting your present job or losing a single hour's pay.

PREVIOUS EXPERIENCE NOT NEEDED

You don't need previous experience—you don't need higher education to learn Electricity the L. L. COOKE Way. If you can read and write, that's enough. This great Training is amazingly clear and simple. There's nothing like it anywhere. It's the Training with hundreds of successful graduates; it's the Training that has put many men on Easy Street; it's the Training for YOU.

GET STARTED—MAIL COUPON

"Cooke Trained Men" are the "Big Pay Men" everywhere. \$60 to \$100 a week is what many of them are making. That's the kind of a job for you. Get started under the famous L. L. COOKE Money Back Agreement. Act today to increase your pay. Send coupon for Big FREE Book, "Secrets of Success in Electricity." Mail coupon now.

L. L. COOKE SCHOOL OF ELECTRICITY
Dept. 405, 2150 Lawrence Ave., Chicago, Ill.

FREE BOOK COUPON!

L. L. Cooke School of Electricity, Dept. 405, 2150 Lawrence Ave., Chicago, Ill. Send me entirely free and fully prepaid, your book "Secrets of Success in Electricity," with particulars about your Home Study Course in Electricity.

Name.....
Address.....
City..... State.....
Residents of Canada may send coupon to R. A. Farrow, Special Representative, 7 Medbury Lane, East, Windsor, Ont., Canada.



\$13 A Day
"When I enrolled as a laborer at small pay, now I make \$13 a day in Electricity. Book, Home Study Course, 200 5th Ave., New York, N.Y."

\$65 A Day
"But for your course I would still be on small pay instead of making as high as \$65 a day in Electricity. Jacob Lenth, 1225 1st Ave., Bore, Oregon."

LEARN BY DOING



The "Cooke" Trained Man is the "Big Pay Man"

Who Wants a Sedan FREE?

STUDEBAKER—BUICK—NASH! TAKE YOUR CHOICE!

or \$2000.00 Cash

Thousands of dollars in new autos and grand prizes will positively be given free to advertise and make new friends for my firm. Choice of Studebaker or Buick or Nash new 4-door sedan delivered free, or \$2000.00 cash. Also Oldsmobile, Pontiac, Chevrolet, Fords, diamonds, other fine prizes and cash will be given free. No problems to do. No fine writing required. No words to make. No figures to add. Bank guarantees all prizes.

PICK YOUR LUCKY STAR!

All the stars in the circle are exactly alike except one. That star is different to all the others and it may be a lucky star for you. Can you pick it out? If you can, mark the different star and send the circle to me at once along with your name and address. A prompt answer can start you on the way to win the great \$2000.00 free prize.

BE PROMPT—WIN \$650.00 EXTRA

Someone like you who will write me at once can get \$650.00 cash just for being prompt, so you may thank your lucky stars if you send your answer right off. No risk. Nothing to buy. Nothing hard to do. Over \$7000.00 in valuable prizes will be given free of cost. Send today and I will show you just how you can get your free choice of these splendid new sedans or \$2000.00 cash, without cost or obligation of any kind. All win plan! A reward for everybody. SEND NO MONEY. Answer AT ONCE.

GEO. WILSON, DEPT. 212, AUGUSTA, MAINE



MARK YOUR STAR

Mail the Circle

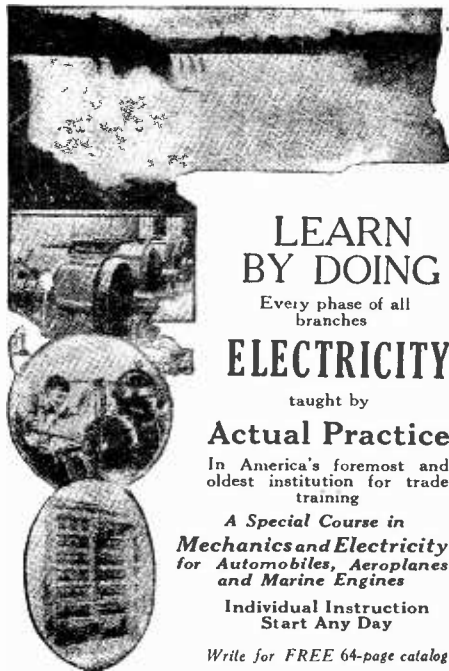

LEARN BY DOING
Every phase of all branches

ELECTRICITY
taught by
Actual Practice

In America's foremost and oldest institution for trade training

A Special Course in
Mechanics and Electricity for Automobiles, Aeroplanes and Marine Engines

Individual Instruction
Start Any Day

Write for FREE 64-page catalog

THE NEW YORK ELECTRICAL SCHOOL

29 West 17th Street New York City

✓ FREE BOOKS of BUSINESS HELPS

We publish over 200 Home Study Books, each a complete treatise of its subject. We have one or more for you. Books on

- | | |
|--|---|
| <input type="checkbox"/> Commercial Art | <input type="checkbox"/> Decoration |
| <input type="checkbox"/> Lettering | <input type="checkbox"/> Automobiles |
| <input type="checkbox"/> Advertising | <input type="checkbox"/> Battery Work |
| <input type="checkbox"/> Sign Making | <input type="checkbox"/> Electricity |
| <input type="checkbox"/> Radio | <input type="checkbox"/> Carpentry |
| <input type="checkbox"/> Aviation | <input type="checkbox"/> Building |
| <input type="checkbox"/> Painting | <input type="checkbox"/> Contracting |
| <input type="checkbox"/> Silk Screen Process | <input type="checkbox"/> Sheet Metal Work |
- and many other subjects. All fully described in our FREE CATALOG. Check the subjects in which you are interested and write today.

FREDERICK J. DRAKE & CO., Publishers
Room 510—179 No. Michigan Blvd., Chicago
Drake books are for sale in all book stores

Every Household Needs a Bartlett Snip
(Compound Lever)

A special snip for repair work about the house or shop. Cuts screen, stove pipe, picture wire, paper, wallboard, tin, cloth, and sheet metals.

7-inch, stamped, \$2.70; 8-inch, forged, \$4.00;
10-inch, \$6.00; 12-inch, \$8.00;
14-inch, \$9.50.



Postpaid. Sold by dealers or direct. Every tool guaranteed.
BARTLETT MFG. CO., 3023 E. Grand Blvd., Detroit, Mich.

Complete WOODWORKING SHOP FOR INCOME OR HOBBY

FIVE FOOT WORKSHOP INCLUDES:
Planer, Circular Saw, Lathe, Disc Sander, Buffer, Grinder, Drill Chuck, Motor, V Belt Pulleys, Sub Base, Cable with Plug. Under the magic of Workace Electric Woodworker raw lumber is easily converted into useful and valuable articles. Man or boy will enjoy Workace. Simply plug into electric light socket. \$9.00 down will bring it. Send now for offer.

J. D. WALLACE & CO.
California & Wilcox, Chicago
11 W. 42nd St., New York
268 Market Street, San Francisco

WORKACE Electric WOODWORKER

The Safety Valve

(Continued from page 53)

Now suppose we determine the value of the prize. Is it going to be \$250.00 or \$500.00 or only \$100.00? Decide that first and then maybe it would be better to have a first, second and third prize. Then notify the winners and find out what they want for a prize. For instance, a radio amateur (me) would select such articles as 1, quartz crystal. 1. UX852 tube. 2. UX866's, etc. until the selections amounted to that amount which he won as a prize. In no case send the actual cash as a prize, but only merchandise, and the merchandise must be of a scientific, experimental or practical nature, other than groceries, fuel, clothing and such necessities of life. You can readily see the logic in this. The financially poor winner would, through duty to his family, select merchandise that would in no way aid him in his chosen hobby or profession, but would aid his family instead.

As to contests, let them pertain to such things as mechanical skill, wood-craft, puzzles, powers of observation, intelligence tests, and hobbies such as pictures of the den, laboratory, home shop, or radio station.

Don't you think this would work a lot better? The model builders have grabbed the gravy for a long time now, so why not let someone else have a chance at a nice prize?

AMOS UTTERBACK,
Whiting, Ind.

(Lathes can now be obtained at the price of a couple of square meals. Will some of those who have won cups in the Model Contest of SCIENCE AND INVENTION Magazine answer Mr. Utterback's letter stressing the garlic inference?)

We are perfectly willing to let anybody enter our contests and we want to make their appeal as universal as possible. See answer to Kepplinger's communication.—EDITOR.)

IN RADIO NEWS for May

Lieutenant Wenstrom, in another of his illuminating articles, tells how by means of short wave radio and observation of sunspots, it is possible to attempt the forecasting of weather and radio conditions.

Full construction details for a one-tube tuner to go with the Loftin-White amplifier are contained in an article by John B. Brennan. Specially designed for the job, this simple tuner is amazingly selective and sensitive.

For the serviceman, George Fleming tells how to build a simple set analyzer and tube tester. The construction is such as to make the assembly entirely portable.

Walter S. Bullock, in the second of a series of articles, gives full constructional details for a compact auto-radio receiver.

Messrs. Loftin and White present another of their highly interesting articles on the Loftin-White system of audio frequency amplification.

How to build a fly-weight receiver for plane, glider, or outboard motor boat. "A Tube Story." by Dr. Lee DeForest; "Radio In Every Room." by S. Gordon Taylor, another automobile radio receiver article by Gilbert Brown, are only a few of those contained in the May issue of RADIO NEWS.

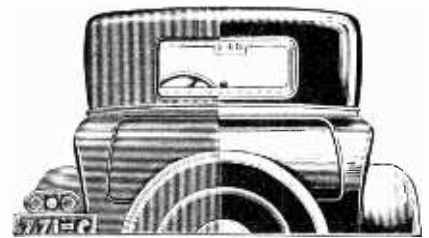

New Fluid Restores Finish of Old Autos

Unquestionably this is one of the greatest discoveries in the automobile field. Think of it! A marvelous liquid called NUREX, almost magical in its effect, does away entirely with all polishes and waxes.

WITH A SWEEP OF THE HAND

NUREX requires no rubbing, painting, cleaning nor waxing. Just a sweep of the hand and the drab, dull surface vanishes before your eyes and the hidden color gleams forth with wonderful lustre. Your car then looks like it just came from a paint shop and the beautiful new finish will last indefinitely.

PAYS YOU EASILY \$100 PER WEEK

By merely showing NUREX you will make big money. Every car owner to whom you demonstrate will buy. Sales rapidly multiply. Every sale brings you enormous repeat business. In your spare time you can easily make from \$5 to \$10 an hour with little effort.

REFINISH YOUR OWN CAR FREE

We are now appointing men in various localities to take care of the big demand. A simple supply of NUREX is furnished FREE to workers. Just write and say: "Send me your FREE sample and big money making offer."

Nurex Products Co., Sta. C, Dept. 210, Milwaukee, Wis.

TOBACCO HABIT BANISHED QUICK, SURE, LASTING RESULTS

In most cases, *Tobacco Redeemer* relieves craving for tobacco completely in a very few days. An absolutely safe, dependable, and thoroughly reliable treatment. No matter how long the habit, or in what form used, all craving for tobacco usually vanishes when this pleasant, inexpensive treatment is used according to simple directions. Your money returned without argument or question if not satisfied. Write for free explanatory booklet and proof of what *Tobacco Redeemer* has done for men addicted to the tobacco habit. Send post card or letter today.

NEWELL PHARMACAL CO.,
Dept. 894 Clayton Station St. Louis, Mo.



CHEMISTS

Catalog illustrating 2500 Chemist's Supplies, 5,000 Chemicals, Minerals, Drugs, etc., and listing 1,000 scientific books sent for 50c. Glass Still as illustrated. Capacity of flask 1 qt. Complete \$8.

LABORATORY MATERIALS CO.
635 East 71st St., Chicago, U.S.A.

AVIATION Information FREE

Send us your name and address for full information regarding the Aviation and Airplane business. Find out about the many great opportunities now open and how we prepare you at home, during spare time, to qualify. Our new book "Opportunities in the Airplane Industry" also sent free if you answer at once.

AMERICAN SCHOOL OF AVIATION
Dept. 1425 3601 Michigan Ave. CHICAGO

Factory to Rider

Save \$10 to \$20 on the Mead Bicycle you select from 4 styles, colors and sizes.

30 Days' Free Trial We ship on approval. If not satisfied after trial return the bicycle. We make no charge for wear and tear during trial period.

Tires—lamps, wheels, equipment at half usual prices. Write for marvelous new prices, wonderful 30 day trial offer and terms.

Mead CYCLE COMPANY DEPT P-107 CHICAGO



ELECTRIFY YOUR RADIO FOR ONLY \$6.85 COMPLETE

Why discard your present good set when you can electrify it for only \$6.85, and banish the annoyance and expense of buying new "B" batteries?

Over 150,000 Townsend "B" Power Units In Use Hooked up in a few minutes. Use same tubes—no changes. You'll be amazed at the improvement in reception and distance getting. Send name and address today for full details, proof and Free Trial Offer.

TOWNSEND LABORATORIES
725 Townsend Street Chicago, Illinois

Your Glider's Flying Clothes

(Continued from page 75)

The rudder can be covered in the same manner as the wings. The plywood top of the rudder can be left uncovered if the builder desires.

It will require about 10 gallons of clear nitrate wing dope to render the wing and tail surfaces airtight and smooth. The Phenix Aircraft Products Company, Wilkamsville, N. Y., sells a No. 560 clear nitrate dope for \$1.55 a gallon which proved very satisfactory to the writer. Wing dope may be procured from nearly all of the aircraft supply firms in the country. Aluminum pigment for coloring the dope can be supplied by the Heath Company at \$1.25 a pound. Most builders do not color the cloth as the doping job usually leaves the wings nearly white and smooth. The builder will discover that he will have a little dope left from the ten gallons advised and this will come in very conveniently for sticking repair patches in place later. Nitrate dope is a fast drying adhesive for cloth and holds as firmly as the casein glue.

The brush method of applying dope is much more convenient than spraying, which requires special equipment. A good brush is needed of about four or five inch bristle width. Pour a small quantity of dope into a deep wide-topped basin and brush it along the surface covering a small area each time the brush is dipped. Avoid flame as the dope is highly explosive and keep the main supply tightly corked to avoid evaporation. In this manner the dope does not come in contact with the air long enough to thicken before it is applied to the cloth. After all the cloth surfaces of the glider have been given a first coat of dope trim up the ragged edges that were left when gluing the cloth during the covering operation. Strips of the wing covering cloth may be cut for this purpose. They should be cut as long as possible and be about 1 1/4 inch in width. If a real good looking job is desired the Marvin A. Northrop Airplane Company, 730 Washington Avenue, North, Minneapolis, Minn., can supply a 2-inch pinked edge cloth tape at 5 cents a yard that is made for this special purpose. About 100 feet of this trimming tape will be required. These cloth strips must be thoroughly saturated with the wing dope and stuck to the wing covering by brushing down with the doping brush. The leading edge must be trimmed in this manner and also the spar edges of the aileron openings at the back of the wings can be outlined with tape at this time.

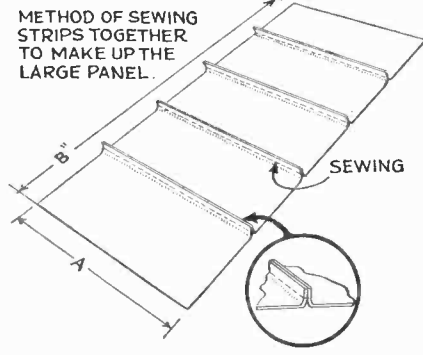

The ailerons, stabilizer, elevators, and rudder are all trimmed with this finishing tape. By fastening these strips of finishing cloth over the unsightly seams you

(Continued on page 93)

Airplane Blueprint

FREE!

If you copy this sketch

If you are ambitious—want to earn big money as a draftsman—copy this sketch and mail to me. If I think you show talent I will send you, direct from my drafting room, a handmade Airplane blue print in three views with all main parts named and explained. Also FREE my two books, "My Pay Raising Plan," and "Successful Draftsmanship." They tell all about this fascinating profession and my working method by which I train you right in your own home. No matter what your schooling or what you are doing now, clip the coupon and learn what I can do for you.

AVIATION DRAFTING AND DESIGNING COURSE

Included—No Extra Charge!
To meet the demands of the Airplane industry for designers, I have prepared a complete course on Airplane drafting. To those who act quickly, I will include this special training without any extra charge.

LEARN DRAFTING

Earn Up to \$100 a Week!

Automobiles, Electricity, Aviation, Building Construction—There are good jobs for draftsmen in these industries and in hundreds of others. Everything that is made—must first be planned and drawn in the drafting room. No wonder there is such a big demand for trained men. You can prepare for one of these fine positions—without leaving home—without quitting your present job. I'll give you practical training. I have trained men who are making \$3,500 to \$9,000 a year. There is a big future for draftsmen because you plan and supervise the work for others, or you go into business for yourself. Get started today. Copy the sketch and mail with coupon!

EMPLOYMENT SERVICE

After training you, I help you get a good job without charging you a cent for this service. Employers come to me for men because they know that Dobe Trained Men make good.



I Train You At Home

No need to leave home or quit your job. Not only do I give you complete practical drafting room training at home—but I show you how to earn while you are learning—in a few short weeks after you start.

Get These Pay Raising TOOLS

Engineer DOBE
1951 Lawrence Avenue
Div. 14-25 CHICAGO

I furnish you all tools AT ONCE, with my training, NO EXTRA CHARGE.

FREE

My Pay-Raising Plan
Mail coupon for this book that has started hundreds of men on the road to success.

My Pay-Raising Plan

MAIL THIS COUPON

If You Earn Less Than \$70 a Week

Engineer Dobe, Div. 14-25
1951 Lawrence Ave., Chicago

I am attaching sketch of Airplane. Send me the three-view blue print, as offered. Also your two books—all free to me.

Name _____ Age _____
Address _____
Town _____ State _____

Now! Do Your Own Electric Nickel Plating

Introductory Offer ONLY \$6.50 Plus Postage

A REAL MONEY-MAKING OPPORTUNITY

Nickel, Brass, Copper, Silver, Gold, etc.

No experience required. Do YOUR OWN Electro-Plating in Your Home, Garage, Office, or Place of Business. Electrically Deposit Metal—Nickel, Brass, Copper, Silver or Gold. You can Successfully do all the plating on your Automobile, Electric Fixtures, Pendants, Spoons, Forks, Chandeliers, Tools, Coffee Urns, Surgical and Dental Instruments, Utensils large or small, Iron Stoves, Music Instruments; recondition worn plating or plate New Work; do it Instantly without interrupting the Service or without removing the parts to be plated with the

ALADDIN PORTABLE ELECTRO-PLATER

Simple and Economical to operate. Not a toy, but a practical Plating Outfit with which Perfect and Durable Work can be done. Positively Guaranteed to do as we claim. BE YOUR OWN BOSS! Build up a Profitable Aladdin Electro-Plating Business of your Own. This offers wonderful ECONOMY to users and BIG MONEY-MAKING possibilities to AGENTS. Thousands in Service. Write for FREE Booklet, Testimonials and 30-Day Trial Offer Today. AGENTS and DEALERS WANTED EVERYWHERE. P. J. F. BATENBURG CO., Dept. 163, RACINE, WISC.

Thousands in Service since 1924

Get Into A Business of Your Own—EARN \$150 to \$300 Monthly

8 HOUR BATTERY CHARGING

Start a BIG PROFIT-MAKING BUSINESS of your own—"8 Hour Battery Charging." Requires SMALL SPACE AND PRACTICALLY NO INVESTMENT. Anyone can successfully operate. Charges batteries in 1/3 the time at 1/2 the cost. EVERY CAR OWNER A CUSTOMER. 20 minute Car Washing, Electrical Service, Spray Painting and Auto Waxing offer same opportunity. HB shouldn't cost you a cent—it will pay for itself on EASY MONTHLY PAYMENT PLAN, with practically no expense and with a handsome profit for you. WRITE NOW for details stating what you're interested in to Hobart Brothers, Box 8-50, Troy, Ohio.

30 DAYS TRIAL—Pay Out of Income Terms

Find Radio Troubles in 30 Seconds



FREE

Send for Your Gift Copy NOW

The Easiest Way to Learn Radio!

HAVE you ever invited friends to listen to a good radio program and then been keenly embarrassed because your radio wouldn't work? Has your radio reception ever been distorted or imperfect just when you wanted to hear every word distinctly? Most of us *have had* such experiences, and most of us *will have them* for years to come.

That's why our staff of expert radio engineers has especially prepared this RADIO TROUBLE FINDER volume for you. In times of need, it's worth its weight in gold. In simple words and easy-to-understand pictures and diagrams, it shows you just how to find and correct any radio trouble *quickly*.

Simple Charts Show You How

In the fastest form of reading—*by charts*—you learn at once what to do when tubes do not light; when tubes light and you get no reception; when your reception is weak. What to do when you get a hum or whistle; when your reception fluctuates; when

your reception is distorted; or when your power device overheats.

After you have read this RADIO TROUBLE FINDER volume, you will know how to locate any kind of radio difficulty, and how to repair it in a jiffy!

Over a hundred thousand set owners already have the RADIO TROUBLE FINDER constantly at their elbows. They know that with it at hand they can depend on getting whatever radio programs they want, *when they want them!* Thousands have used the knowledge gained from this handy volume to make marked improvements in the reception of their sets, and in repairing the sets of friends. In many cases it has been the basis for starting a very profitable radio repair business.

These good people have had to pay real money for the RADIO TROUBLE FINDER. **BUT**, we have set aside a copy to be shipped to you, prepaid, **ABSOLUTELY FREE!**

A Gift from RADIO NEWS

We are offering you this remarkable volume FREE as an unprecedented reward for your merely accepting a six months' cut-rate introductory subscription to RADIO NEWS, the world's greatest radio magazine that no set owner should be without.

Do you want to know all about new sets and latest improvements? Would you like to know what goes on behind the scenes of the big broadcast stations and the inside stories of broadcast programs and artists? Do you know how to tell a good loud-speaker from a bad one? How to construct the latest power-supply unit? How to save money in servicing your set? *It's all in RADIO NEWS!*

If you are a DX fan, you'd probably like to have a list of every broadcasting station in the world. Or perhaps you'd like to experience the thrill of hearing foreign continents direct with a modern short wave receiver. Or perhaps it's television, auto radios, aviation radio telephony, or the projection and filming of talkies that interests you? *Frankly, whatever it is, if it's radio news you will find it in RADIO NEWS!*

That's why RADIO NEWS has practically twice as many readers as any other radio magazine. That's why you should read it too!

Send for Your FREE

TROUBLE FINDER Volume TODAY!

Simply mail the coupon below and we will ship you your copy of the complete TROUBLE FINDER volume by return mail ENTIRELY FREE—at the same time entering your subscription to RADIO NEWS for the next six months at only \$1, saving you 50c on its regular newsstand value!

You risk nothing! If you are not more than satisfied, we will refund your \$1 immediately and you keep the TROUBLE FINDER book with our compliments. **BUT**, mail the coupon at once—while we still have books in stock!

A PROFITABLE RADIO REPAIR BUSINESS

This book will help you lay the foundation for a radio repair business in which hundreds of men earn as high as \$3.00 an hour. In many cases such a profitable side line has grown into a worthwhile full-time business. If you'd like to be your own boss, if you're searching for financial independence, send for this book today. It's FREE!

RADIO NEWS, (A MACKINNON-FLY PUBLICATION),
 Dept. 2505, 381 Fourth Avenue, New York, N. Y.

Gentlemen: Ship me ENTIRELY FREE, postpaid, a copy of your RADIO TROUBLE FINDER volume—at the same time entering my subscription for the next 6 big issues of RADIO NEWS at only \$1 which I enclose. (Regular newsstand value \$1.50.) If I am not more than satisfied with my first issue of RADIO NEWS, you will refund my \$1 but I may keep the TROUBLE FINDER volume whether I remain a subscriber or not.

Name

Address

City and State

Are you a serviceman ? Dealer ? Engineer ? Experimenter ?

Rustless Steel *to the* Fore

By W. A. Simmons

ALLEGHANY metal is a rustless steel which, though several years old, is one of the latest steel alloys made available in quantity for wide industrial and building use.

It was a World War discovery and was developed by German armament makers for gun lining. It contains 18 percent of chromium, 8 percent nickel, and smaller proportions of carbon, manganese, phosphorus, sulphur and silicon, which are combined with refined steel by a complicated method.

One of the hardest metals in the steel industry, it is also rustless, untarnishable, non-corrosive, impervious to weather, and needs only be washed in soap and water to keep its brightness.

The Ford Motor Company is the first large commercial plant to feature rustless steel. In the redesigned Model A Ford it is used for exterior polished sections, displacing plated parts. About 1,000 tons a month are used by Ford—two-thirds of the entire output of the United States and one-third of the world's!

Before its adoption for use on motor cars, rustless steel was subjected to exhaustive tests and intensive fabricating experimentation. Several hours of exposure to brine spray, about the severest rust and corrosion test known, produced no ill effects; Ford officials state that tests for tensile strength under varying conditions showed its resistance to be greater than that of steel. Several million dollars' worth of equipment installed for use with the nickel exterior of the original Model A have been scrapped.

Previously, rustless steel had been used on a limited scale for bridge construction, building ornamentation and other purposes

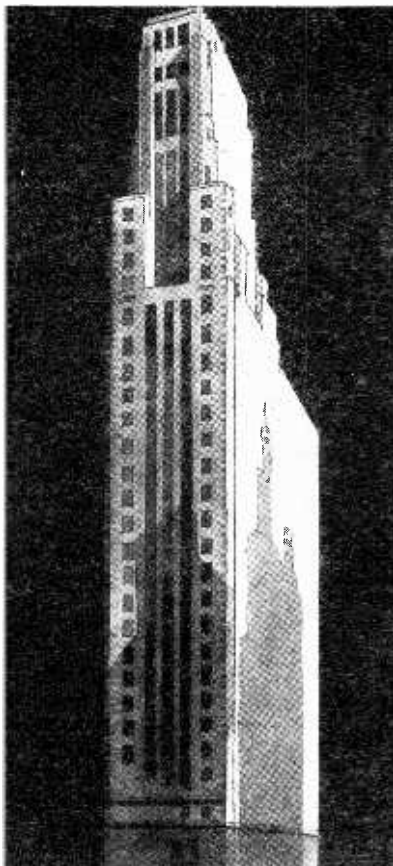

Before long we may have buildings made entirely of rustless steel.

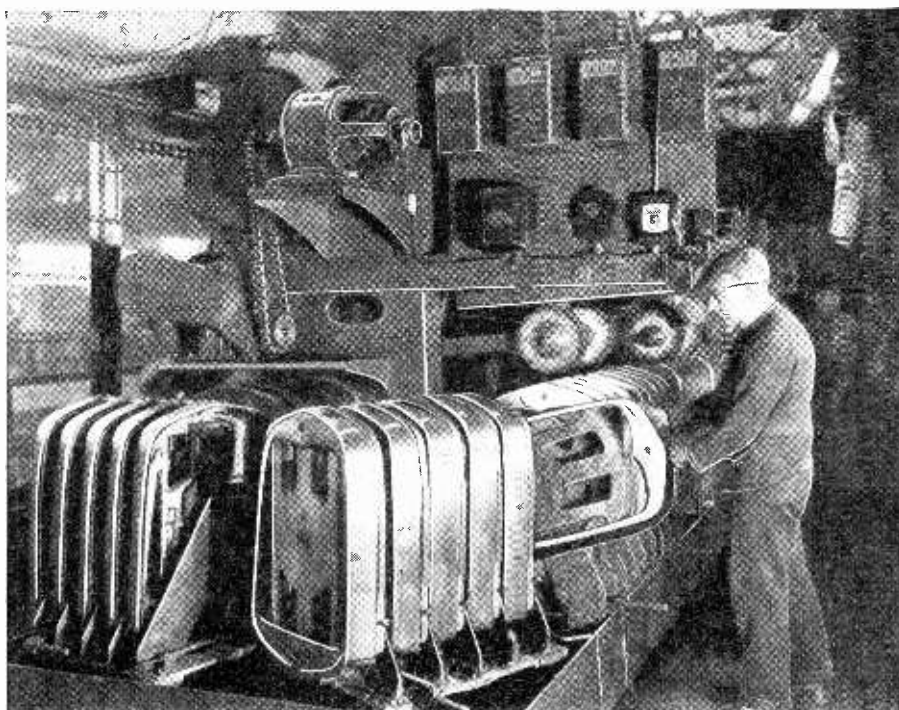

Conveyers carry Ford Model A rustless steel radiator shells past the polishers.

requiring a bright, extra strong, non-corroding metal.

Now it is being adopted for hospital operating room equipment and cooking

utensils because its comparative immunity to organic acid reactions makes it especially suitable from the hygienic standpoint.

\$ 500⁰⁰ REWARD

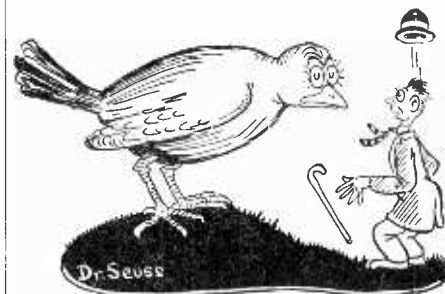

WANTED John Sparrow

(alias "Nuisance," alias "English")

John Sparrow—one of the most brazen of outlaws—is sought on two major offenses.

He roosts on housetops, defaces gables, ledges, windows and awnings, and nests in drain pipes.

This culprit's open hostility drives away welcome song-birds, replacing their musical notes with his "cheep, cheep, cheep."

John Sparrow should be tarred as well as feathered. Or, better still, he should be shot with a CROSMAN SILENT .22—the most amazing gun ever invented for shooting targets and killing small game, furred or feathered. Hence the

\$ 500⁰⁰ REWARD

for making such criminals, now at large, as silent as the Crosman Silent .22 itself, the rifle that has six features found in no .22 firearm. For full information on the Crosman Rogues' Gallery and the valuable rewards for the capture of the outlaws, write us now or see your Crosman dealer.



Crosman Silent .22 Repeater

Crosman Pell

CROSMAN ARMS COMPANY
409 St. Paul St., Rochester, N. Y.

CROSMAN RIFLES
SILENT .22
"POWER WITHOUT POWDER"

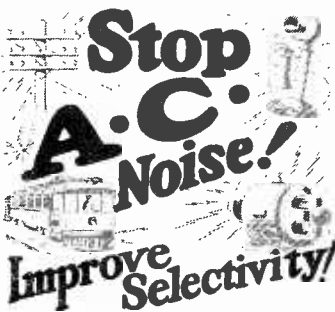

RADIO reception may be made much more enjoyable by plugging in a Falck Claroceptor between the light socket and your set. By blocking out the line interference noises, this wonderful device also helps selectivity and distance. Tested, proved. Thousands now in successful use all over America. No change required in your set. Only equipment of the kind. Compact size: $3\frac{1}{2} \times 5\frac{1}{2} \times 2\frac{1}{2}$ ". Made by pioneer radio manufacturer. At radio parts dealers, or write us for new free folder.

Falck \$7.50
(With Cord and Plug)
CLAROCEPTOR
Manufactured by **ADVANCE ELECTRIC CO.**
Dept. S-1, 1260 W. Second St., Los Angeles, Calif.
JOBBER AND DEALERS—GET OUR PROPOSITION

LAW STUDY AT HOME
Become a lawyer. Legally trained men win high positions and big success in business and public life. Be independent. Greater opportunities now than ever before. Big corporations are headed by men with legal training. Earn **\$5,000 to \$10,000 Annually**. We guide you step by step. You can train at home during spare time. Degree of LL. B. conferred. LaSalle students found among practicing attorneys of every state. We furnish all text material, including fourteen-volume Law Library, Law Code, easy terms. Get our valuable 64-page "Law Guide," and "Evidence" books FREE. Send for them NOW. LaSalle Extension University, Dept. 5384-L. Chicago. The World's Largest Business Training Institution

Complete Muscle Building \$1
Course including exercisers

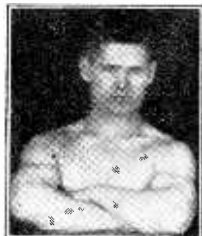

I POSITIVELY GUARANTEE
to increase your arms one-half inch in size, chest one full inch, strength 25%, health 100% in one week's time, by following my instructions and using my exerciser 10 minutes mornings and at night. Send \$1 for complete course and exerciser. Satisfaction guaranteed or \$1 refunded.
PROF. J. A. DRYER
Box 1850-L Chicago, Ill.

NOW—Become an Electro-Technician
By this Amazing New Method



Train the NEW PRACTICAL WAY! Prepare to meet the tremendous demand for Electro-Technicians in all branches of electricity. Splendid opportunities. **BIG PAY** for trained men. Now is the time to start.

BRINGS SCHOOL TO YOUR HOME
Home Shop-Laboratory worth over \$60.00 yours without extra cost. Enables you to "learn by doing." Not by texts alone—but with patented new Unit Board System. Brings full-size Electrical Equipment right into your home. Train this fascinating new way under supervision of engineers of America's great Electrical School.

FREE 48-PAGE BOOK

Write today for FREE illustrated 48-page book giving full details of how you can become an **ELECTRO-TECHNICIAN** by the wonderful new Home Shop-Laboratory Method. No obligations. Mention age.
Dept. 29. EXTENSION DIVISION

SCHOOL of ENGINEERING
of Milwaukee

How Giant "Moles" Bore Under Streets

By Josef W. Von Stein
(Continued from page 40)

rotation of the cutting head (which is adjustable for various diameters) and the forward feed of the machine is automatically controlled by the character of the material through which the machine is cutting its way, the compressed air supply being used only as and when needed. The carriage consists of two parts. The horizontal carriage carrying the revolving head is moved forward one, two or three inches per revolution. This part is interconnected by means of a giant feed screw with a rigid vertical supporting carriage or frame held stationary by being braced against the interior of the tunnel or being otherwise securely held rigid. After the head has advanced five feet, the feed screw is reversed and this carriage is then moved forward to a new starting position. The main shaft, which rotates the head, is twelve inches in diameter and twenty feet long.

The excavated material is automatically deposited on an endless belt conveyor, which carries it to the rear and loads in into wheeled conveyors, to be taken away and dumped.

Behind the Human Front

(Continued from page 68)

Perhaps this same theory explains why the "came-the-dawn" school of writers, those who write in mangled sentences and wear out the exclamation points on their typewriters, get on your nerves. There is no rhythm, or pleasing thought-grouping in their sentences.

Diagnosing bores and how they get that way is a profitable exercise for the amateur psychologist who is cultivating his powers of analysis.

You know when you're being bored—so ask yourself why?

If it's simply that you don't know what the other fellow is talking about or that you are fed up on or not interested in his subject, that's too easy a case to wonder about. Take the fellow who *does* have an interesting subject, and still bores you.

George Garton, who sits behind a desk in the reception room of a big newspaper, has learned to look pleasant even though he does often suffer from acute fatigue in the ears.

He's the man to whom the cranks and fanatics sputter their panaceas and grievances. George says they're not half as hard to listen to—they're often amusing—as certain intelligent callers with something worth saying on their chests but trying bores nevertheless.

"What makes them bores? I'll tell you," George contributed to this collection of psychological lowdowns. "A fellow often bores you because his tongue doesn't keep up with your brain. He goes into so many details that your mind is always three jumps ahead of his story. You tug at his leash of words and he pays it out so slowly.

"A conversation has to have some suspense in it, just like a movie. You'll be kept interested if you are kept guessing from sentence to sentence what is coming next. A lot of people who come in here don't seem to give me credit for any imagination at all. They advance their propositions like a fellow paying an election bet by pushing a peanut along the street with his nose. It tires you all out following them so slowly."

Earn \$3.00 An Hour in Spare Time!

RIGHT in your own neighborhood there is a pleasant, profitable, ready-made business awaiting you. A business that will bring you immediate cash rewards—that you can build up in spare time—and that requires no capital or experience!

Office and factory workers, students, teachers, store clerks, people in every walk of life are finding our easy money-making plan an ever abundant source of funds. This type of business has enabled hundreds to build their own homes, swell their family incomes, buy automobiles and secure the luxuries they have always wanted.

If you are earning less than \$3.00 an hour now, clip and mail the coupon below today and let us show you how you may make your leisure time bring that much, and possibly even more!

Immediate Big Profits!
Your profits start just as soon as you do. Within 10 minutes after you receive our plan you can turn idle moments into good hard cash! And never again need a day pass that does not see more money added to your bank account.

If you feel at all interested—send the coupon below. It costs only a 2c stamp, but may lead to a substantial income. We're so sure you will find our plan immensely profitable that we supply everything you need free of charge. Every day you delay is a money-making opportunity lost, so

Mail this Coupon NOW!
Mackinnon-Fly Publications, Inc.
Dept. 2505-W, 381 Fourth Ave.
New York, N. Y.
Without obligation to me, please send me your easy spare-time money-making plan immediately.
Name
Address
City and State

WE MATCH PANTS
To Any Suit!
Double the life of your coat and vest with correctly matched pants. 100,000 patterns. Every pair hand tailored to your measure; no "readymades." Our match sent FREE for you O. K. before pants are made. Fit guaranteed. Send piece of cloth or vest today.
SUPERIOR MATCH PANTS COMPANY
115 So. Dearborn Street, Dept. 390 Chicago

MAKE BIG MONEY
Just out. Lights gas instantly without sparks or flame. Sells like wildfire wherever gas is used. Retail for 25c.
MYSTERY GAS LIGHTER
Packed on individual cards with instructions. Sample 10c or rush \$9.00 per Gross or \$1 per Dozen. New Method Mfg. Co., Desk S1-5, New Method Bldg., Bradford, Pa.

JOKER'S DELIGHT
A package of laugh-provoking, happiness ammunition, containing eight irresistible fun-makers, including The Famous Safety Pea Knife, the latest and greatest laugh invention—not a cut in a carload; Noiseless Soup Spoon for soup serenaders—a scream; Story of Three Monkeys, etc. Send ONE DOLLAR for complete package, postpaid. Satisfaction guaranteed.
LOVE SALES CO., 4741 N. KEOZIE AVE., CHICAGO, ILL.

Learn Photography at HOME
Make money taking pictures. Prepare quickly during spare time. Also earn while you learn. No experience necessary. New easy method. Nothing else like it. Send at once for free book, Opportunities in Modern Photography, and full particulars.
AMERICAN SCHOOL OF PHOTOGRAPHY
Dept. 1425 3601 Michigan Ave. Chicago, U. S. A.

Build a Boat for \$3.62

By Hi Sibley

(Continued from page 41)

which is hard to make watertight, a sort of lee board was used, hung on the gunwale of the leeward side. This is simply a board with iron hangers at the top and a lead weight along the bottom edge. It can be readily shifted from side to side, as required. The oars are easily made from spruce and thin wood, one of them used as a rudder.

Here is the bill of material:

Bottom—2 boards, 7'x12"x $\frac{3}{4}$ "	
Sides —2 " 8'x12"x $\frac{3}{4}$ "	
Stern —1 " 2'x12"x $\frac{3}{4}$ "	
Bow	
1 " 2'x12"x $\frac{3}{4}$ "	
1 " 2'x 6"x $\frac{3}{4}$ "	
Cleats —6 " 2'x 3"x $\frac{3}{4}$ "	
Battens—21 feet 1 $\frac{1}{2}$ "x $\frac{1}{2}$ " allowing for waste	
Corners—6 feet 2"x $\frac{3}{4}$ " allowing for waste	
Keel—1 piece 7'x2"x2"	\$2.67
(Mast, boom, seats and oars not included.)	
1 pint outside paint.....	.50
1 gross No. 5 1 $\frac{3}{8}$ " flathead wood screws45
	<hr/> \$3.62

MODEL BLUEPRINTS

Correct—Easy to Follow

1-2 Horizontal Steam Engine details..set	\$1.00
3-4 Boiler construction for above....set	1.00
5 880-Ton Bark50
6-7 Twin Cylinder Steam Engine and Boiler	1.00
8-9 Gasoline Fired Locomotive.....set	2.00
10-11 U. S. S. Constitution, "Old Ironsides"	1.00
12 13th Century Man-of-War50
13-14 Chinese Junk50
15-16 Electrically Driven Automobile..set	1.00
17 Roman Ballista50
18-19 Simple Steam Engine50
20-21 How to Build a Reflecting Telescope. 1.00	
22 "Santa Maria," complete.....	.50
23-24 Model U. S. S. Portsmouth.....set	1.00
25 Building a Model Tugboat.....	.50
26 Twin Cylinder Marine Engine.....	.50
27-31 U. S. S. Truxton.....	2.00
32 Sopwith Biplane50
33 Speed Boat50
34 Airplane Engine50
35-36 Motor Winch75
37-38 Vertical Steam Engine.....	1.00
39 Cannon50
40 Steam Roller50
41 Prairie Schooner50
Lincoln Sport Biplane (man-carrying)	6.75
Gerber Monoplane (man-carrying)...	1.00

Anyone who can read blueprints and is at all handy with tools, will find no difficulty in following the simple explanatory diagrams. Many sport planes and monoplanes built from our plans are flying daily, thus attesting to the accuracy of the blueprint details. Satisfaction guaranteed.

Send Orders to

BLUEPRINT DEPARTMENT
SCIENCE AND INVENTION

381 FOURTH AVENUE

NEW YORK CITY

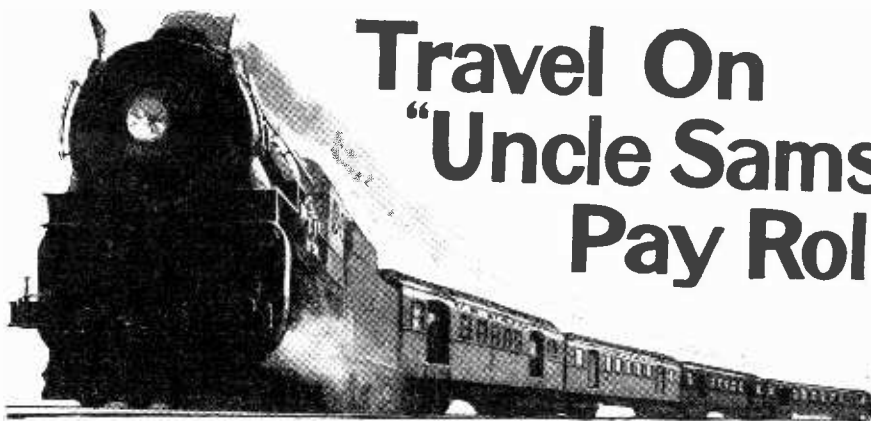

Travel On "Uncle Sams" Pay Roll

RAILWAY POSTAL CLERKS

Commence \$1900 Year

Many other U. S. Government Jobs open to Men and Boys 18 up

POSTOFFICE CLERKS
RURAL CARRIERS
IMMIGRANT INSPECTOR

CITY MAIL CARRIERS
GENERAL CLERKS
INSPECTOR OF CUSTOMS

These are all steady positions. U. S. Government employees get their pay for full twelve months every year.

RAILWAY POSTAL CLERKS

Railway Postal Clerks now commence at \$1900 a year, being paid on the first and fifteenth of each month. \$79.16 each pay day. Their pay is quickly increased, the maximum being \$2700 a year, \$112.50 each pay day. They get extra allowance for hotel expenses when away from home.

PAID VACATIONS

Railway Postal Clerks, and all Government employees, get a yearly vacation of 15 working days (about 18 days). On runs they usually work 3 days and have 3 days off duty, or in the same proportion. During this off duty and vacation, their pay continues just as though they were working. When they grow old, they are retired with a pension.

CITY MAIL CARRIERS—POST OFFICE CLERKS

Clerks and Carriers get \$1700 the first year regular and automatically increase \$100 a year to \$2100 with further increase to \$2300. They also have 15 days' vacation. Examinations are frequently held. City residence is unnecessary.

GENERAL CLERKS

(Open to men or women 18 or over)

Salary \$1260 to \$2100 a year. Pleasant clerical work in the various departments and offices at Washington, D. C., and throughout the country.

Get Free List of Positions

FILL OUT THE COUPON. Tear it off and mail it TODAY—NOW.

MAIL COUPON TODAY

Name

Address

Use this coupon before you mislay it

FRANKLIN INSTITUTE
Dept. H 477,
ROCHESTER,
N. Y.

Rush to me without charge (1) a full description of the position checked below; (2) Free copy of 32-page illustrated book, "How to Get a U. S. Government Job"; (3) Tell me how to get the position checked.

- ..Railway Postal Clerk (\$1900-\$2700)
- ..Post Office Clerk..(\$1700-\$2300)
- ..City Mail Carrier..(\$1700-\$2100)
- ..Rural Mail Carrier...(\$2100-\$3300)
- ..Inspector of Customs.....(\$2100 up)
- ..General Clerk
- ..Immigration Inspector

\$80 to \$150 A WEEK MOTION PICTURE OPERATORS EARN THIS - and MORE

E the man in the projection booth—it is one of the big, important jobs in the great billion-dollar movie industry. The hours are short, the work is light, fascinating—and most important of all—you can earn from \$4,160 to \$7,800 a year and more—easily, quickly!

Picture Operating Easily Learned!

With our simplified system of home study your training is practical and complete—it includes all types of projecting machines and their operation, Electricity, Stage and Theatre Lighting, Color Films, and the new *Talking and Sound Movies!*

Earn two to three times your present salary—have a glorious future before you! Thousands of others have found this work interesting—fascinating—one of the best paid professions open today! And right at home, in your spare time, you can learn all there is to know about moving picture projection—can start on the road to high pay and an unlimited future.

Send today for FREE descriptive book
Our new FREE book tells you about this wonderfully attractive profession. Shows how you can quickly qualify for a well-paid position as **Motion Picture Cameraman or Projectionist, Commercial Photographer or Photo-Finisher.** Send for it TODAY—NOW! It may be the turning point of your career!

New York Institute of Photography
Dept. L-1813, 8 West 33rd St., New York, N.Y.

Without cost or obligation send me a copy of your FREE book and details about how I can qualify as

- Motion Picture Cameraman
- Motion Picture Projectionist
- Commercial Photographer
- Photo-Finisher

Name

Address

City

State

SUCCESS COUPON



Low-Priced Fire Extinguisher! Easy to Sell!

Just what the world has been waiting for. A real fire extinguisher at a low price! Quenches every kind of fire—even gasoline. Puts out fire from safe distance. Just turn on valve and the Extinguisher shoots a stream of chemical 35 feet. Will not harm or stain furniture, fabrics or any kind of material. Does not corrode or evaporate.

UNLIMITED MARKET

Every home, store, school, church, hotel, factory, garage, etc., is a prospect for this faster and safer fire extinguisher. Every home needs at least six. A life-time position with big earnings and repeat business. Send today for Exclusive Territory Offer. No obligation.

WELDON MANUFACTURING CO.
55 Cottage Grove Ave. Grand Rapids, Mich.



Magnified 225 Diameters
This is what the tip of a fly's leg is like when seen through the

Ultralens Microscope

At last a high powered microscope is within the means of all who wish to study, observe and experiment with the vast world of minute objects invisible to the naked eye. Such fun it is, as well as educational. No technical training required, yet hundreds of scientists and teachers are using this instrument. Gives enormous magnification and perfect definition. Send \$5.00 for complete outfit. Send for descriptive literature.

ROAT & LOHMAN, Dept. 203, Milton, Pennsylvania

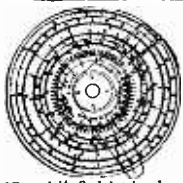

THE MIDGET SLIDE RULE

Instantly adds, subtracts, multiplies, divides, solves proportion, gives all roots and powers. Logarithms, Sines, Cosines, Tangents, Cotangents, etc. Also gives decimal equivalents, lettered and numbered drill and tap sizes.

The Engine-divided scales are on whitefinished aluminum and are grease and waterproof. Diameter 4". Price with Instruction Book, \$1.50. Pocket Carrying Case, 50c extra. Cash or C.O.D. Catalogue free. Your money back if you are not satisfied.
GILSON SLIDE RULE COMPANY, Stuart, Florida
(SLIDE RULE MAKERS SINCE 1915)

LEARN TELEGRAPHY WITH TELEPLEX

TELEPLEX, the master instructor, teaches you the telegraph code (Morse or Radio) right in your own home. You can become an expert telegraph operator after a few short weeks of practical study. NOT A SCHOOL. Amazing instrument works automatically. No knowledge needed—beginners learn at once. Free 10 days' trial. Write to-day for FREE booklet.



TELEPLEX CO.
72 Cortlandt Street Dept. R-11 New York, N. Y.



GEARS

In stock—immediate delivery
Gears, speed reducers, sprockets, thrust bearings, flexible couplings, pulleys, etc. A complete line is carried in our Chicago stock. Can also quote on special gears of any kind. Send us your blue-prints and inquiries.

Write for Catalog No. 40
CHICAGO GEAR WORKS
769-773 W. Jackson Blvd., Chicago, Ill.



Learn Public Speaking
Begin Today—Write for My FREE BOOK. I can make a good penman of you at home. Write for my FREE BOOK, "How to Become a Good Penman." It contains specimens and tells how others mastered penmanship by the Taft-Hall System. Your name will be elegantly written on a card if you enclose stamp to pay postage. Write today for book.
E. W. Taft-Hall, 224 Rialto Bldg. Kansas City, Mo.

A Pole Screen

By H. L. Weatherby

(Continued from page 48)

screen, the writer recommends that the pole part be turned in three sections, as suggested in the drawings. The vibration on a slender piece, if the length is great, will become excessive and the quality of the work will suffer. Mortises fitting the legs should be cut or holes bored for dowels before the turning is done.

The brace or piece that makes possible the sliding frame is clearly shown in the drawings. Its shape may be altered to permit the frame to slide either higher or lower by making it deeper in the middle, and throwing the frame farther from the pole to permit it to pass the thick portions. A hole with a keyway is cut, and a small wooden key for locking the frame is made to fit.

In assembling the legs to the post it would be well to drive small finish nails into the post at an angle, instead of using clamps, which are difficult to place on the curved legs.

A coat of filler, a couple of coats of white shellac, two or more coats of varnish rubbed to a velvety finish, a piece of beautiful needle work in the frame—and the job is done. And it will be prized and treasured as a true piece of handi-craft deserves to be.

For its practical use, set it where it will shield the face as you sit by the fire, or protect the eyes from a glaring light in the room as one reads; and you will find that it has its practical as well as ornamental value.

Book Reviews

THE NEW WORLD OF PHYSICAL DISCOVERY. by Floyd L. Darrow. The Bobbs-Merrill Co., Indianapolis, 358 pages.

This is a sister book to Mr. Darrow's "Story of Chemistry," and parallels the function of the latter in the field of physics. It provides a bird's eye view of the entire field of physical research, from the early primitive races to the present time, when man has to a great extent obtained a mastery of physical laws and forces which enable him to dominate the earth.

Within comparatively few pages the author has outlined the physical discoveries which have resulted through accident and persevering research. He has showed good judgment in the material selected—particularly clear are the chapters on "Heat," "The Rise of Electricity," and "Relativity for Everybody." The last mentioned, of course, is a popularized version of Einstein's Theory of Relativity, and explains simply why "two observers of the same event may arrive at totally different judgment of what has happened, and both be right," and why "the relative motion of one body with respect to another is all we can ever observe."

Due credit is given the Egyptians, Babylonians, Greeks for their discoveries, and the Mesopotamians for their mastery of hydraulic engineering. The practical significance of the scientist's work is brought out wherever possible. For example, Black's discovery of the latent heat of vaporization is shown as the forerunner of pressure cookers. The present research work in laboratories is correlated with our latest means of communication, transportation and living in general.

Naturally, the book is written in popular

PISTOL SLING SHOT!

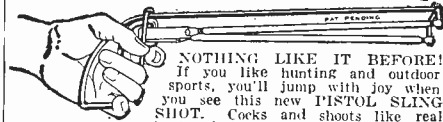

NOTHING LIKE IT BEFORE!
If you like hunting and outdoor sports, you'll jump with joy when you see this new PISTOL SLING SHOT. Cocks and shoots like real pistol. Special aiming sights and extra heavy pure gum rubbers enable you to shoot with power and accuracy of the best air rifles. Ideal for indoor and outdoor target practice. Shoots stones, marbles, lead balls, etc. Sample shot FREE! Scientifically and practically made to last a lifetime! Pin a dollar bill or money order to this advertisement and mail today. Stamps accepted. If not satisfied return within 5 days and your money will be promptly refunded.

ONLY \$1.00
R. B. SPECIALTY CO.
Dept. E-359, 220 E. 3rd St., Cincinnati, Ohio

CORRECT Your NOSE

Improve your appearance with the ANITA Nose Adjuster. Shapes flesh and cartilage—quickly, safely and painlessly, while you sleep. Results are lasting. Doctors praise it. 68,000 users. Write for 30-Day Trial Offer and FREE BOOKLET.
ANITA INSTITUTE, 573 Anita Bldg., Newark, N. J.

STAMMER

Write for my free book "Millard's Advanced Natural Corrective Course" and a free copy of my speech magazine. 11,000 cases successfully treated. Est. 28 years. Largest school for stammerers in world.

MILLARD INSTITUTE OF NORMAL SPEECH
2315 Millard Bldg., Milwaukee, Wis.

AUTO RADIO

Designed specially for operation in automobiles, motor boats and airplanes. Compact. Tremendous volume. Wonderful tone. Single dial control. Will fit any car. Easily installed by anyone. Fully guaranteed. Be among the first to have an auto radio. Price including tubes **\$39.50**

CHAS. HOODWIN CO.
4240 Lincoln Ave., Dept. E-35, Chicago, Ill.

HB PAINT SPRAY
DOES THE WORK OF FIVE MEN.
Paint Spraying Brings Quick, Easy Profits—HB does work of 5 brush painters. Paints autos, furniture, houses, at lowest prices, with big profits for you. Pays for itself—only \$20 monthly. Easy lowest terms brings it. Practically no investment. 30 days' trial. Write for valuable bulletins. **Hobart Brothers Co., Box S-501, Troy, Ohio.**

Moulds as low as \$1.50 each.
Cast Your Own Lead Soldiers, Indians, Hunters, Wild and Farm Animals
222 Wonderful "True to Life" Models. Easy and inexpensive to make. I furnish all necessary material including enamel. Send 5c Stamp for Illustrated Catalogue A.
H. C. Schiercke, 1034-72nd St., Brooklyn, N. Y.

I CHALLENGE

you that I will teach you, by mail, in one lesson, the simplest, shortest method. All for \$1.00. Not telepathy. You can read one's mind to a dot, by only looking in the eyes of partner, chum, sweetheart, etc. Praised by New York, Boston, Montreal Police chiefs; colleges; Thurston; Blackstone, etc. If fake, let them arrest me.

A. HONIGMAN, Dept. Inv-XX
Sta. E. P. O. B. 85 Montreal, Can.

Learn Public Speaking
At home—in spare time—20 minutes a day. Overcome "stage fright," gain self-confidence, increase your salary, through ability to sway others by effective speech. Write now for free booklet, **How to Work Wonders With Words.**
North American Institute, Dept. 1425, 3601 Michigan Avenue, Chicago, Ill.

style and is free of all mathematical formulae and complicated reasoning. While it serves for the layman and casual inquirer, it is neither deep nor thorough enough for the real student of physics.

THE MASTER OF DESTINY. a Biography of the Brain, by Frederick Tilney, M.D., Doubleday, Doran & Co., Inc., New York, 343 pages.

Dr. Tilney has been studying the brains of human and lower animals for more than twenty years, and in this book summarizes his findings, as well as those of others in the field. He traces the development of the brain from its beginning in the single-celled unit of life to the present time—and points out that we are in an intermediate stage of development at present.

The brain evolved with the need for a central controlling body. It definitely provides a link in the evolutionary theory for our brain "gives numerous signs indicating its primitive origin from the lowest of the vertebrates, the fish. It bears identifying marks of intimate association with animals of its own class, the mammals," and "it has a large number of details in its special mechanism possessed in common with all of the primate order, to which man belongs, together with the lemurs, tarsiers, monkeys and apes."

Dr. Tilney believes that the brain, hand, and foot are one functional unit, and that the four-handed stage of animal existence led to the highest brain development. The development of the human foot to establish erect posture, the freeing of the hand in consequence of such a position, the expansion of sight and hearing, the development of speech and the establishment of higher mental faculties come in natural sequence.

The greatest possibilities of further progress lie in the expansion of the frontal lobe, our sense combiner. But, granting future development of this organ, Dr. Tilney is not optimistic. He believes that the average person uses about one-fourth of his brain under normal conditions. And, during times of stress, such as our recent World War, man's veneer of control over his own nature cracks, and in spite of centuries of training he shows himself to be little above his lower brothers.

Dr. Tilney writes in a clear, interesting style. He treats his subject with proper dignity and does not abbreviate material which requires detailed explanation.

IN AMAZING STORIES FOR MAY

THE UNIVERSE WRECKERS. by Edmond Hamilton. (A serial in 3 parts.) Part I. There is no absolute assurance that the sun should continue to turn at its present speed. What would be the result if the sun started to turn more rapidly? Mr. Hamilton needs no introduction, but we want to say that this is the best interplanetary story by him that we have yet published.

MADNESS OF THE DUST. by R. F. Starzl. Although this story was written some time ago, an extract taken from *The New York Times* of December 21, 1929, gives almost word for word a similar description of an operation performed by a ship's Captain, following radio instructions from a physician. But this is only an incident in an unusual story, excellently told.

THE IVY WAR. by David H. Keller, M.D. Here is a new story by Dr. Keller, based on the always interesting subject of botany, dealing with a subject that is little known as yet. The "Ivy War" goes on in the good old Keller manner.

SYNTHETIC. by Charles Cloukey. Mr. Cloukey has become a familiar author in **AMAZING STORIES.** In this story, he offers us an exceedingly clever, swift-moving aviation exploit of the future that shows good imagination and excellent knowledge. **AND OTHERS.**

You can buy the "DRIVER" Home Workshop a part at a time—as you need it!

Length 30"
Between Centers 28"
Swing 6½"

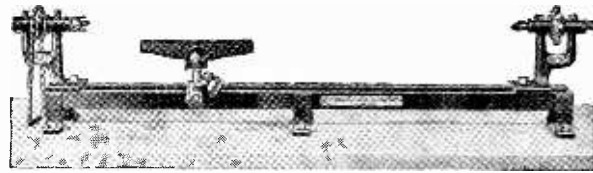

Lathe Complete \$4.00 Ready to Run

Approved by Popular Science Institute

"Driver" Power Tools are no toys. They are thoroughly tried and practical machines—efficient, sturdy and economical. They bear the Popular Science Institute of Standards Seal of Approval.

Make Your Hobby Pay Dividends

"Driver" Power Tools are designed particularly for the home craftsman. Thousands of users—from professional men, lawyers, doctors, clergymen, and engineers who make wood-working their hobby, to the school boy who operates his set to earn money—all are deriving pleasure and profit from the "Driver" Workshop.

A guaranteed, woodturning power lathe, 30" long with a 6½" swing, complete for \$4.00! A jic saw, bench saw and dado, belt sander, disc and drum sanders, flexible shaft, polishing and grinding head, shafting and pulleys—all available at correspondingly low prices. This is what the "Driver" Line offers you, made possible through quantity production and modern manufacturing methods.

Price Limit of \$1.00 Per Part!

Excepting the motor, every "Driver" machine can be bought by parts—at not over \$1.00 each. For instance the lathe is sold in four parts each retelling at \$1.00. The same holds true with the other tools. Besides, many of the parts are interchangeable so that in some instances more than one tool can be made up from the same parts.

Your local dealer will supply you with a circular giving full details.

"DRIVER" Tools Sold Nationwide Through the Following Retail Outlets:

- Chain Stores:**
W. T. Grant Co.
S. S. Kresge Co.
F. & W. Grand Co.
Schulte-United, Inc.
McLellan Stores
Neisler Brothers
Green Stores
J. J. Newberry Co.

Mail Order:
Sears, Roebuck & Co., Chicago, Illinois and retail stores.

Also sold by thousands of department stores and hardware dealers.

Buy from dealers—Not sold direct



WALKER-TURNER CO., INC. Manufacturers, JERSEY CITY, NEW JERSEY

SELL ROSECLIFF SHIRTS

Make Steady Money

Showing Samples Men's Shirts Ties, Underwear brings you big cash commissions. One Year Guarantee. No substitutions. Free silk initials. More exclusive Rosecliff features establish leadership. Write for your FREE Outfit NOW!

ROSECLIFF SHIRT CORP.
Dept. X-5
1237 Broadway, N. Y.

YOUR OWN SHIRTS AND TIES

Outfit Free

BE A RAILWAY TRAFFIC INSPECTOR

EARN UP TO \$250

per month, plus expenses
Trained men needed in this important profession. Fascinating work plenty of variety; chances to travel. Advancement rapid with experience. Report to high officials. WE ASSIST YOU TO A POSITION paying \$120 to \$150 per mo. plus expenses, upon completion of few weeks spare time home instruction—or refund your tuition. Advance rapidly to \$175, \$200, \$250 per mo. Cost moderate, terms if desired. Write today for free booklet which tells all about Traffic Inspection and what we can do for you. **Standard Business Training Inst., Div. 27, Buffalo, N. Y.**



To those who think Learning Music is hard-

Perhaps you think that taking music lessons is like taking a dose of medicine. It isn't any longer!

As far as you're concerned, the old days of long practice hours with their hard-work exercises, and expensive personal teacher fees are over with.

You have no alibis whatsoever for not making your start toward musical good times now!

For, through a method that removes the boredom and extravagance from music lessons, you can now learn to play your favorite instrument entirely at home—without a private teacher—in half the usual time—at a fraction of the usual cost.

Easy As Can Be

The lessons come to you by mail from the famous U. S. School of Music. They consist of complete printed instructions, diagrams, and all the music you need. You're never in hot water. First you are told how a thing is done. Then a picture shows you how, then you do it yourself and hear it. No private teacher could make it clearer or easier.

Over half a million people learned to play this modern way—and found it easy as A-B-C. Forget that old-fashioned idea that you need special "talent." Just read the list of instruments in the panel, decide which one you want to play, and the U. S. School will do the rest. No matter which instrument



you choose the cost in each case will average the same—just a few cents a day.

Send for our free Book and Demonstration Lesson

If you really do want to play your favorite instrument, fill out and mail the coupon asking for our Free Booklet and Free Demonstration Lesson. These explain our wonderful method fully and show you how easily and quickly you can learn to play at little expense. Instruments are supplied when needed—cash or credit. U. S. School of Music, 305 Brunswick Bldg., New York City.

U. S. SCHOOL OF MUSIC, 305 Brunswick Bldg., New York City
Send me your amazing free book, "Music Lessons in Your Own Home," with introduction by Dr. Frank Crane; also Free Demonstration Lesson. This does not put me under any obligation.

Name

Address

Instrument this Inst.?

LEARN TO PLAY BY NOTE

- Mandolin
- Piano
- Organ
- Violin
- Banjo
- Saxophone
- Cello
- Ukelele
- Coronet
- Trombone
- Or any other instrument

Cut the Family Barber Bills



Home Electric Hair Clipper

Anyone can trim or bob hair, shorten bangs, clip neck or underarms in a shape almost impossible with hand clippers or shears. Operates on direct and alternating current. Will not clog or cut the skin, and cuts as cleanly as a razor. Thousands in use. Rigidly guaranteed.

Ten Days' Free Trial

If your hardware or electrical dealer can't supply you, write for interesting booklet, or order from this ad. Send no money—pay postman \$8.75. Return it in 10 days if not satisfactory. State whether 110, 220 or 32 volt current or 6 volt storage battery is used.

Dealers and Representatives Wanted
Belle City Appliance Co., Dept. 51 1022 12th St., Racine, Wis.

Electricity!

Learn in Los Angeles

Be an electrical specialist. Gain quick success in this most fascinating and profitable field. Learn at National in the center of tremendous electrical projects costing more than \$100,000,000.00—unlimited opportunities now.

Practical, intensive training by National's job-experience method in 6 to 9 months. All technical essentials included. School endorsed by leaders in electrical industry. You learn all branches of electricity; radio. Million dollar institutions; all modern equipment and training facilities. Life scholarship. No age limit. Free employment service. Over 17,000 successful graduates. 23rd year. Big, illustrated 84-page catalog sent FREE. Write today.

FREE BOOK

NATIONAL ELECTRICAL SCHOOL
Dept. 307-EE, 4006 So. Figueroa, Los Angeles, Calif.

Home-Study Business Training

Your opportunity will never be bigger than your preparation. Prepare now and reap the rewards of early success. **Free 64-Page Books Tell How.** Write NOW for book you want, or mail coupon with your name, present position and address in margin today.

- | | |
|---|--|
| <input type="checkbox"/> Higher Accountancy | <input type="checkbox"/> Business Corres. |
| <input type="checkbox"/> Mod. Salesmanship | <input type="checkbox"/> Credit and Collection |
| <input type="checkbox"/> Traffic Management | <input type="checkbox"/> Correspondence |
| <input type="checkbox"/> Rail. Station Mgmt. | <input type="checkbox"/> Modern Foremanship |
| <input type="checkbox"/> Law, Degree of LL.B. | <input type="checkbox"/> Personnel Mgmt. |
| <input type="checkbox"/> Commercial Law | <input type="checkbox"/> Expert Bookkeeping |
| <input type="checkbox"/> Industrial Mgmt. | <input type="checkbox"/> C. P. A. Coaching |
| <input type="checkbox"/> Banking and Finance | <input type="checkbox"/> Business English |
| <input type="checkbox"/> Telegraphy | <input type="checkbox"/> Commercial Spanish |
| <input type="checkbox"/> Business Mgmt. | <input type="checkbox"/> Effective Speaking |
| <input type="checkbox"/> Railway Accounting | <input type="checkbox"/> Stenotypy—Stenog'y |
| <input type="checkbox"/> | <input type="checkbox"/> Paper Salesman's Training |

LaSalle Extension University, Dept 594-R, Chicago



FREE CATALOG

Shows the finest Tool Chests in America. They are better in every way for Machinists and Tool Makers. Get your copy now.

H. GERSTNER & SONS
677 Columbia Street
Dayton, Ohio

Electrical Engineering

Training for men of ambition and limited time. Concise, comprehensive course in Theoretical and Practical Electrical Engineering including Mathematics and Mechanical Drawing. Students construct motors, install wiring, test electrical machinery. A thorough course designed to be completed in one college year.

THIRTY-SEVEN YEARS of successful experience assures you maximum training in minimum time.

Send for free catalog

BLISS
ELECTRICAL SCHOOL
145 Takoma Ave., Washington, D. C.

SCIENCE AND INVENTION'S Service to Home Owners and Prospective Home Owners

Whether the reader's interest lies in materials and equipment for building a new home or for modernizing his present one, he will find in this list one or more booklets which will be helpful. These booklets are not just catalogues. Many contain full data on installing and using the products described. SCIENCE AND INVENTION provides this list as a service to readers, and will add to it from month to month as new booklets are received. To obtain any of the booklets listed, simply use the coupon at the foot of the list, and order by number.

NOTE TO MANUFACTURERS

In order to make this list as complete as possible, SCIENCE AND INVENTION invites manufacturers to submit copies of their booklets or other literature. No obligation is involved. Simply address the materials to SCIENCE AND INVENTION, 381 Fourth Avenue, New York City, with a brief note authorizing inclusion of the booklets in future lists.

INSULATION

2. ALL WINDOWS AND DOORS LEAK LIKE SIEVES. Advantages of weather strips.
25. THE COST OF COMFORT. Handbook on economies of dwelling insulation. with full data.
61. THERMAL INSULATION OF BUILDINGS. Non-technical treatment of principles of insulation for homes. Five cents.
55. JUST BETWEEN YOU AND THE WEATHER. Insulation for the home.
56. INSULATION SPRAYED ON PROCESSES. Application of insulation by gun.
49. CELOTEX CANE FIBRE INSULATION. Uses of this type of insulation.
50. YEAR ROUND COMFORT AND FUEL SAVING FOR EVERY HOME. Advisability of complete insulation.
51. FLINTKOTE ASPHALT EMULSION AND PLASTICS. Particularly with reference to refrigeration.
52. FLINTKOTE ASPHALT EMULSION FLOORING MASTIC. For flooring, floor patching, and resurfacing.
53. FLINTKOTE ASPHALT EMULSIONS FOR WATER PROOFING AND DAMP PROOFING. Specifications for use of this product.
63. CARRIER WEATHERMAKER. Demonstrating the importance of air conditioning systems in the home.
64. INCREASING HOME ENJOYMENT. The advantages of insulation in homes.
65. ROOF INSULATION AND PREVENTION OF CONDENSATION. Importance of insulating roofs.
86. A GUIDE TO HOME COMFORT THAT PAYS ITS OWN WAY. Greater comfort and economy in the home through insulation.

INCINERATORS

4. THE DECENT WAY. This booklet discusses the advantages of disposing of garbage with a gas-burning incinerator.

ROOFING AND SHINGLES

16. REAL ROOFING. Booklet showing the advantages of a copper roof from an economical standpoint as well as that of beauty.
17. RUST-PROOFED. Booklet setting forth the economical reasons for using brass and copper for such as roofs, gutters, rain pipes, plumbing fixtures, etc.
27. WHAT CONSTITUTES ROOFING QUALITY? The facts about asphalt shingle and roofing products.
28. COLOR. Colored photographic samples of asbestos shingles.
73. GALVANIZED IRON FOR ROOFS AND ROOF DRAINAGE. Details and specifications.

FURNITURE

43. THE HOME MAGNET. Billiard tables in the home.

SURFACE MATERIALS AND FINISHES

54. ZENITHERM DEFINED. Exterior and interior uses of this product.
23. WOOD FLOORS. Floors of beauty and use.
30. MONEY SAVED FOR BUILDERS. Red cypress wood for home building.
31. SPECIFICATION DATA FOR STRUCTURAL USES OF TIDEWATER CYPRESS. Self-explanatory.
40. OIL CLOTH. THE MODERN CINDERELLA. Varied uses in the modern home.
41. WALL DECORATIONS IN THE MODERN MANNER. Sanitas—a modern wall covering.
42. SANITAS. MODERN WALL COVERING. How to use this product.
32. BEAUTIFUL FLOORS. Rubber flooring.
36. ENDURING BEAUTY IN YOUR HOME THROUGH CERAMIC TILES. Self-explanatory.
62. A NEW KIND OF HARDWOOD FLOOR. Information about a new and unusual flooring.
67. PORTLAND CEMENT STUCCO. Vari-

ous surfaces of stucco and application to styles of architecture.

68. RECOMMENDED PRACTICE FOR BUILDING WATERTIGHT BASEMENTS WITH CONCRETE. Folder with information on making the basement watertight.
69. BEAUTIFUL HOMES OF CONCRETE MASONRY. Complete plans of homes using concrete masonry.
70. ATTRACTIVE SMALL HOMES OF CONCRETE MASONRY. Plans and photographs for small homes and their interiors.
71. CONCRETE IMPROVEMENTS AROUND THE HOME. Self explanatory.
80. THE FIFTH INGREDIENT. Uses of surface hardener for concrete.
81. COLORMIX. Color hardener and waterproofer for concrete floors.
82. CABOT'S BUILDING SPECIALTIES. Data on stains for wood, wood preservatives, waterproofing, damp-proofing and insulating materials.
83. ROOMS OF HAPPINESS. Improving waste space through wood-fiber insulating board.
84. SWIMMING POOLS. Styles and plans of swimming pools.
85. TENNIS COURTS FOR ALL-YEAR SPORT. Plans and specifications for making.

HARDWARE

74. BROWN & SHARPE SMALL TOOLS. Full line of small tools described.
75. ATKINS SILVER STEEL SAWS—SAW SENSE. Saws and their uses.
76. CORBIN LOCKS AND HARDWARE FOR THE HOME. Locks, window and door hardware, etc.
77. THE CORBIN CONCEALED CASEMENT OPERATOR. Operator for window opening outward.
78. SCREEN DOOR HARDWARE. Door and window screens, both treated.
79. HELPFUL INFORMATION ON CORBIN DOOR CHECKS AND THEIR MECHANISM. Self explanatory.
87. BARTLETT PRODUCTS. Mechanics' snips and bench shears.
88. YANKEE TOOLS. Various tools and uses.
89. TWELVE-IN-ONE TOOL. Describing one tool and its twelve uses.

PLUMBING

12. THE END OF RUST TROUBLES. Advantages of brass pipe.
13. BLASS PIPE AND HEALTH. Hygienic aspects of this product.
19. WATER SERVICES THAT SERVE. Copper and brass pipes for water service.

BATHROOMS AND BATHROOM ACCESSORIES

57. SPARTAN CERAMICS PORTFOLIO. This illustrated portfolio demonstrates the beauty and practicability of tiles.
58. ARCHITECTURAL HANDBOOK OF ROMANY TILES. Illustrated booklet demonstrating uses, plans, and designs of tiles.
59. PLUMBING FIXTURES FOR THE HOME. Illustrated pamphlet giving plans for bathrooms and necessary fixtures.
60. HOMES OF COMFORT. Illustrated booklet showing plans and illustrations of bathrooms with complete material concerning fixtures for the modern bathroom.
39. BATHROOM INDIVIDUALITY AND CHARM. Illustrated folder showing bathroom accessories in modern color.
38. CHURCH IMPROVED SANI-BLACK SEATS. Illustrated booklet demonstrating an important accessory for the bathroom.
37. BATHROOM ACCESSORIES, MEDICINE CABINETS, MIRRORS, ETC. Complete catalogue of these articles.
66. PLANNING THE SMALL BATHROOM. Facts about plumbing with a complete plan for a small bathroom.

WIRING AND LIGHTING

14. WIRING AND RE-WIRING TO MODERNIZE THE HOME. Practicability of correct wiring.
15. HOME FIXTURES. The beauty of modern fixtures in brass.

LUMBER

- 21. **YOU CAN MAKE IT.** Pamphlet illustrating uses of odd pieces of lumber. Ten cents.
- 22. **TRANSFORMATION FROM AN OLD HOUSE TO A NEW HOME.** Illustrated pamphlet.
- 24. **MODERN HOME INTERIORS.** Plans for building breakfast alcoves, kitchen cabinets, bookcases, etc.
- 34. **MANUAL OF SUPERCEDAR PRODUCTS.** Suggestions for installation of cedar closets and vaults.
- 44. **DUBOIS WOVEN WOOD FENCE.** Showing adaptation of this type of fence to interior uses.
- 45. **SOUTHERN PINE—THE SUPREME STRUCTURAL WOOD OF THE WORLD.** Booklet of information on using Southern pine in the home.
- 46. **WESTERN RED CEDAR, THE ENDURING WOOD OF THE AGES.** Interior and exterior uses of red cedar.
- 47. **WEST COAST HEMLOCK, ITS QUALITIES AND USES.** Title self explanatory.
- 48. **SITKA SPRUCE, A QUALITY WOOD OF HIGH SERVICE.** Uses of wood named in home building.

HEATING EQUIPMENT

- 1. **IDEAL HEATING.** Heaters for homes and water.
- 5. **OIL HEAT KILLS FURNACE SLAVERY.** Automatic oil burners for domestic heating.
- 6. **COLD CORNERS ARE COZY CORNERS NOW.** Portable electric radiators and humidifiers for the home.
- 7. **IDEAL GAS BOILERS, A.I.A.** File No. 29f4. Data on domestic gas boilers.
- 3. **THE MODERN HOME DEMANDS HOT WATER SERVICE.** Automatic hot water heaters.
- 72. **THE STORY OF GAS.** Story of gas and development to modern home appliances.

WINDOWS, SCREENS, DOORS

- 26. **CRITTALL METAL WINDOWS.** Installations and description of windows of this type.
- 33. **SOUND-PROOF DOOR, A.I.A.** File 17a5. Doors that are sound-proof, odor-proof, weather-proof, air-tight.
- 11. **WHAT GOOD IS A SCREEN THAT RUSTS?** Bronze or copper screens.

HOME BUILDING MATERIALS

- 9. **DONLEY BOOK OF SUCCESSFUL FIREPLACES.** Illustrated from constructive angle.
- 35. **THE WOOD-FRAMED FIREPLACE.** Period mantels in wood.
- 29. **BEAUTY IN BRICK.** Adaptability of brick to home beauty. Fifty cents.
- 10. **THE DONLEY CATALOG.** Coal chutes, package receivers, laundry chutes, etc.
- 18. **A REAL HOME.** Brass and copper for domestic building.

SCIENCE AND INVENTION
381 Fourth Avenue
New York, N. Y.

Gentlemen:
Please send me booklets

No.
Name
Address

IMPORTANT

TO NEWSSTAND READERS

IN order to eliminate all waste and unsold copies it has become necessary to supply newsstand dealers with the actual number of copies for which they have orders. This makes it advisable to place an order with your newsdealer, asking him to reserve a copy for you every month. Otherwise he will not be able to supply your copy. The dealer will then be in a position to supply copies to you regularly every month. If you are interested in reserving your copy every month, do not fail to do this. It costs you nothing to do so.

**Win Nash Sedan and \$500
or \$1,845 Cash
Seven Brand New 6-Cylinder Cars Given**

For advertising purposes I am going to give absolutely free a brand new six-cylinder "Special Six" Nash four-door Sedan, an Oldsmobile two-door Sedan, a De Soto two-door Sedan, a Pontiac two-door Sedan, an Essex two-door Sedan, a Whippet two-door Sedan, and a Chevrolet two-door Sedan, all six-cylinder latest model Sedans; also 4 splendid new console type radios, a Victor Orthophonic Victrola and other valuable prizes. Any person living in the United States outside of Chicago may enter an answer to this puzzle except employees of the W. D. Boyce Company or members of their families, or winners of automobiles or first prizes in any of our previous offers, or members of their families.

**SOLVE
THIS
TRAFFIC
PUZZLE**

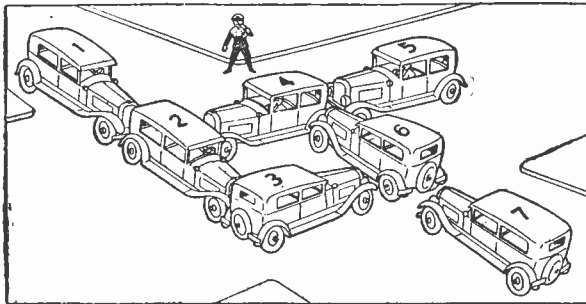

In the picture there are 7 cars in a bad traffic jam. None of them can move forward, for each car is blocked by the one in front of it. One of these cars will have to be backed out. Which one? The traffic policeman seems to be stumped. Can you straighten up this tangle for him? Only one car may be moved backward, and if you pick out the right one, you will see that it is not necessary to back up any of the others. Send the number of the car which when backed out will relieve this traffic tie-up, and if your answer is correct you will be qualified for this opportunity.

\$500.00 for Promptness

We are not only giving the Sedans, radios and so forth in our big prize list amounting to over \$6,800.00, but are also giving an additional \$500.00 in cash for promptness to the winner of first prize if he or she has been prompt. Thus, the first prize winner will receive the Nash Sedan and \$500.00 in cash, or \$1,845.00. Find the car which when backed out will relieve this traffic tangle and send the number of it in a letter or on a post card, or you can mark the car on the picture and send it to me. Be sure to write or print your name and address plainly. All who answer correctly can share in the prizes or cash. **ANSWER TODAY.** In case of a tie for any prize duplicate prizes will be paid.

ARTHUR MESKE Dept. 13, 510 N. Dearborn St., Chicago, Ill.

ADDS TO ANY INCOME

Costs Next to Nothing. No Personal Selling Required. Make immediate, immense, and endless profits. Become a Vacuum Cleaner Builder and Service Expert. New, ever-growing field. Readily mastered under our expert advice and full instructions which are **entirely free.** Valuable secrets revealed for first time. We can supply all needs. Using spare time, start a home branch factory **all your own.** End uncertainty forever. **Be your own boss.** Pay your own salary. Underseal all. Lead all. Literature tells how and why. Join us, the originators. **URON ASSOCIATED INDUSTRIES, 1305 Engineers Bldg., Cleveland, Ohio, U. S. A.**

BURN YOUR NAME ON TOOLS

WITH THE ARKOGRAF
Protect Your Tools From Theft. Write with electricity any name or design on the hardest and finest tools, ornate metal, like writing with a pen. **Outfit \$3.50 Prepaid Anywhere.** Illustrated circular free. Write today. Agents wanted. **ARKOGRAF PEN CO., 1171 1/2 E. Stark St., Portland, Ore.**



Step INTO A BIG-PAY HOTEL JOB

EARN \$2,500 to \$10,000 A YEAR

In America's 3rd Largest Industry comprised of Hotels, Apartment Hotels, Clubs, Restaurants, Institutions, Schools, Colleges, Hospitals, etc. Daily calls for Lewis Trained Men. Over 70,000 high-class positions as Manager, Assistant Manager, Steward, Room Clerk, Purchasing Agent, Bookkeeper, Auditor, Cashier and scores of other executive positions paying \$2,500 to \$10,000 a year open annually in hotels alone. Salaries up to \$3,500 to start.

We Put You in Touch with Positions

Without cost let us show you how big pay, fascinating work, quick advancement can be yours in the great hotel industry. Age is no obstacle—young and old alike have equal chance for success. A common school education is all you need with the amazing Lewis System of Spare-time Training in Hotel Operation.

HOTELS NEED TRAINED MEN

Previous Experience Unnecessary

Hundreds of Lewis Students are winning success. Totally unacquainted with hotel work before taking the Lewis Course, N. Frank Hill is now Assistant Manager of a \$200,000 Apartment House, Elwood V. Matlack rose from Elevator Boy to Manager of a big hotel, in less than two years, due to training he received from Lewis Schools. **YOU can do as well. Low cost—easy terms—money back agreement. Write today for Free Book, "Your Big Opportunity"** and complete details, mailed without obligation. **Lewis Hotel Training Schools Room CG-3439, Washington, D. C.** The Original and Only School of its Kind in the World

SEND FOR FREE BOOK



Lewis Hotel Training Schools
Room CG-3439, Washington, D. C.
Send me the Free Book, "Your Big Opportunity" without obligation.

Name
Address
City State

OPPORTUNITY COUPON

A Complete New \$2.00 Detective Novel In Magazine Form---Only 25c!

"He picked up the heavy foot-stool, took aim at the cat, and let fly without a thought of the dire consequences of such petty cruelty. . . ."

—Scene from the
"Montreal Murder
Mystery" in the May
issue of COMPLETE
DETECTIVE NOVEL.



DO you know that you can buy a New Complete Detective Novel at your nearest newsstand at a price that is only one-eighth the cost of the same novel when put out in bookbinding? Well, you can!

Every month your newsdealer has a brand new Complete Detective Novel waiting for you—a rip-snortin' thriller, tense with mystery, crowded with exciting, puzzling action. Just the kind of crime mystery that will bring you keen, intriguing, mind-exercising recreation—just the kind thousands of people gladly buy at \$2.00 per in bookstores! And it will cost you—not \$2.00—but only 25c!

Get the May COMPLETE DETECTIVE NOVEL today. It

contains a full book-length \$2.00 novel by that world-famous master of crime literature, EDWIN DIAL TORGERSON—

"THE MONTREAL MURDER MYSTERY"

Aubrey Alcock, notorious despoiler of women, is discovered mysteriously murdered. Did a jealous husband kill this philandering Montreal bachelor? Or was the murderer a maddened fiancé? Or a spurned mistress? A cat's footprints, leading from his open door, are the only clew. Follow these up and see if you are clever enough to solve this strangest of all crimes as you read "THE MONTREAL MURDER MYSTERY." A powerful, fast-moving story which you dare not lay down until you have read the last gripping word.

Complete in the May Issue of

COMPLETE DETECTIVE NOVEL MAGAZINE

A \$2 Novel for 25c - Buy It TODAY

Or order the next 12 Complete Detective Novels sent direct to your home for only \$3. Mail order to MACKINNON-FLY PUBLICATIONS, Dept. 2505-X, 381 Fourth Ave., New York, N. Y.

FORECAST

By the Official Forecaster

EVER hear of Norman Bel Geddes? Designer of Toledo scales and of the cathedral scenery for The Miracle? Builder of complicated miniature race-tracks and writer of plays? . . . SCIENCE AND INVENTION for June will carry an interview with this **craftsman-artist-engineer** of our time—an interview as fascinating as an interview with Leonardo da Vinci might be, were he alive today.

AND William Watts Chaplin will come through with another of his **dramatic close-ups** of great moments in modern science. This one will be called "The Sky Talkers," and will recount the success of airplane-to-earth-telephony as it seemed to a man who through an assignment and a lucky break had the good fortune to experience it at close range.

S. GORDON TAYLOR continues his Home Improvement series with a discussion of **paints and decorations** for the home—a subject which will prove absorbing to everyone who realizes what an important factor in attractiveness color has come to be. . . . And supplementing this article will be one on the merchandising value of color by our financial editor, Alfred M. Caddell.

DON'T overlook the fact that the SCIENCE AND INVENTION **Basement Plan Contest** closes May 31 at midnight—which means that every plan must have been received at our office by that hour. So if you have a basement conversion plan in mind, put it on paper at once and give it to the air-mailman. That's the only way to avoid regrets and connect with your share of the \$400 we are offering in cash awards for the best plans submitted. . . . You'll find a digest of the contest rules on Page 63 of the present number of this magazine, and a list of manufacturers' booklets which may help you with the material and equipment part of your plan on Page 84.

MARTIN H. SCHEMP, author of "Riding the Thunderclouds," is slated in the June number for a how-to-make-it article describing the construction of a **one-man glider release trap**—an article of first-rate importance to the generation learning to fly by motorless means. Pilot Schempp knows gliders from the Rhoen soarers to the motor-towed primaries of the Michigan flats. You can put down odds now, without second thought, that his trap will prove a practical piece of equipment for any glider club that wants it badly enough to build it. . . . And the June number will carry other glider features, too, of the most pertinent and interesting sort.

TRAFFIC in Cleveland and the scientific wonders of Philadelphia are scheduled as the contributions for June in these extremely vital fields. We have an idea that what is most needed right now is a series that will picture comprehensively the progress being made throughout the country in solving the traffic problem, and it is our hope that our group of traffic articles will promote a helpful interchange of methods and equipment which have proved effective.

Rotary Ailerons and Other Novel Control Devices

By Augustus Post, *Aviation Editor*

What we call flying is far from perfect. It resembles Baron Munchausen's famous trip into and out of a besieged fortress, riding on a cannon ball. "Shooting" mails and passengers is speedy transportation and can be performed safely by an expert, but it is not the kind of flying that we see when a pair of swallows build their nest.

What is it that enables birds to fly with such ease? Birds' wings are not solid, but have many joints, muscles and nerves. They can bend them into many forms and increase and decrease the lifting surface beside obtaining direct lift by beating the air.

Positive control has long been desired as a means of keeping an airplane in the proper condition when it is "stalled" or has lost headway on account of climbing at too steep an angle, or when flying too slowly for the ordinary type of ailerons to function in their proper manner and to keep the airplane in balance.

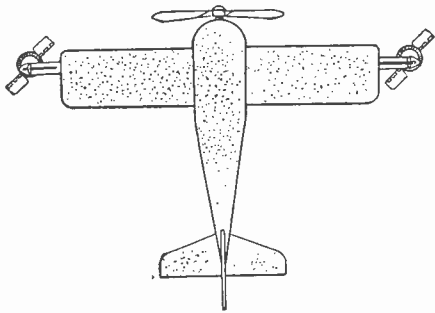

The method of using small revolving propellers, mounted at the wingtips, provided with variable pitch blades, as shown in the above diagram, has been patented by Mr. Carl Dienstbach, one of the noted German authorities on aeronautics and an expert on the subject of aerodynamics. The German patent papers cover the method of constructing the variable pitch blades of the propellers which enables them to be adjusted with accuracy and facility, giving immediate positive dynamic control as well as delicate and sensitive adjustment of the airplane at extremely slow speeds and even in stalling positions of a plane, and at times where the standard method of control by ordinary ailerons which depend upon forward motion of the airplane for their efficiency, would not apply at all.

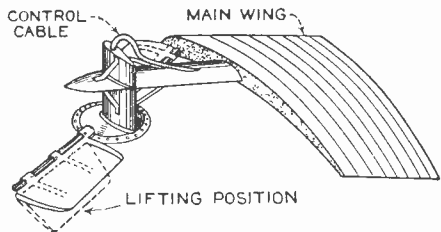

The propellers revolve continuously, being driven by the motor of the plane either by cable, shaft or an electric motor to be used only when the main motor fails, to enable a forced landing to be made in safety.

The blades of the horizontal propellers, placed at the wing tips, are so connected to the control stick that their pitch may be varied while running, causing either end of the airplane wing to be lifted at will.

When not in use they run idle without any pitch, absorbing very little power.

They are brought into use after the ailerons become inefficient through the airplane stalling, spinning or in flight at such a slow speed that ailerons become useless. This appliance would enable an airplane to fly very slowly because if the ailerons are used to increase the lift, by being depressed on both sides simultaneously, positive control by means of these variable pitch horizontal propellers can be used.

This is a way to enable an airplane to approach the bird's ability to get along without "airports." It can start and stop practically everywhere. This means you can use an airplane like an automobile and can start and land on an ordinary large roof. This positive control is what the Guggenheim Competition aimed at. Increased control and high lift at slow speeds can be obtained in this way with very simple means, without changing the present structurally perfect airplane which combines the greatest strength and the most efficient form with the least weight.

Wing slots are air guides used to keep up the smooth flow of the air over the upper wing-surface of an airplane, even when it is at the "burble point" or point when it would otherwise "stall" or be inclined so steeply that the air flow cannot continue. "Spoilers" are flaps on the top surfaces of the wing which are raised to destroy the smooth flow of the air over the upper wing-surface or cause it to lose its lift. They act in the opposite way to slots and when one side is too high, the spoiler is used to bring it down.

Slots and spoilers help, but rotary ailerons work even when slots and spoilers have reached the limit of their action. Rotary ailerons function even when the plane stands still. They should be used as the climax to other means of control. An ordinary airplane, as it has been developed, is remarkably strong and light but it must have better control than it has now; yet not at the expense of the perfection the plane has reached in aerodynamical efficiency.

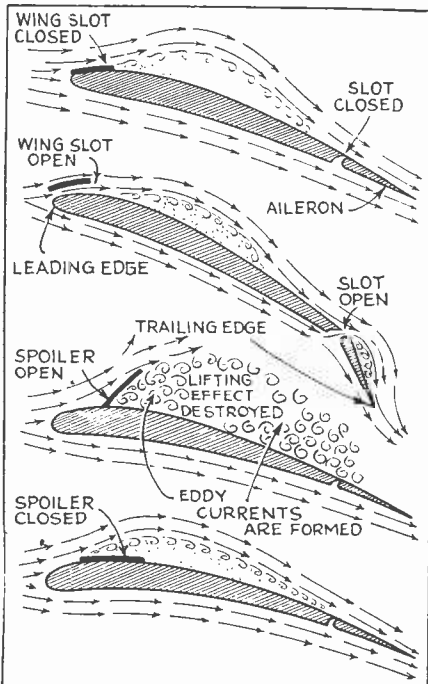

LOOK!



We'll Loan You This "SAX"!

With it a complete Home Instruction Book for beginners. It's so easy you will play "America" in 30 minutes, and all popular airs in a short time. In a few weeks you can join band or orchestra or play solos and duets at home. Be popular. This offer is FREE. Send no money. It's a beautiful new **Holton** factory guaranteed instrument. You keep saxophone and Easy Instruction Method 10 days. Return at our expense, or keep and pay only \$8 on easy payment plan. Same remarkable FREE LOAN offer on any Holton trumpet, trombone, clarinet or other band instrument. Send no money. No obligation to buy. Just **Send This Coupon**

FRANK HOLTON COMPANY, 526 Church St., Elkhorn, Wisconsin. Send on 10 days FREE loan a Holton Saxophone with Complete Easy Method book, or..... (Other Instrument)

Name _____ Address _____ City _____ State _____

FREE INSTRUCTION BOOK

Complete information on construction and repair of all radio receivers

HERE is a practical set of books which meets alike the needs of the radio dealer, serviceman and amateur. Every phase of building, repairing and "trouble-shooting" on modern radio sets and equipment is covered.

Written by two widely known radio engineers, the material is presented in an authoritative and yet entirely understandable manner. The books are illustrated with actual working diagrams.

RADIO CONSTRUCTION LIBRARY
Three Volumes 6x9 —993 pages, 561 illustrations



McGraw-Hill
FREE EXAMINATION COUPON

McGraw Hill Book Company, Inc., 370 Seventh Avenue, New York.

Send me the new RADIO CONSTRUCTION LIBRARY, three volumes, for 10 days' free examination. If satisfactory I will send \$1.50 in 10 days and \$2.00 a month until \$7.50 has been paid. If not wanted, I will return the books.

Name _____ Home Address _____ City and State _____ Position _____ Name of Company _____ S&I 5-30

See this Library FREE!

No Money Down



High School Course in 2 Years

This simplified, complete High School Course—specially prepared for home study by leading professors—meets all requirements for entrance to college, business, and leading professions.

20 Other Courses

Over 200 noted Engineers, Business Men, and Educators helped prepare the special instruction which you need for success. No matter what your inclinations may be, you can't hope to succeed without specialized training. Let us give you the practical training you need.

American School
Drexel Ave. & 58th Street
Dept. H-574, Chicago

Money Back When You Finish If Not Satisfied

American School, Dept. H-574 Drexel Ave. and 58th St., Chicago
Send me full information on the subject checked and how you will help me win success in that line.

-Architect
-Electrical Engineer
-Building Contractor
-General Education
-Automobile Engineer
-Lawyer
-Civil Engineer
-Mach. Shop Practice
-Structural Engineer
-Mechanical Engineer
-Business Manager
-Steam Engineer
-C. P. A. & Auditor
-Sanitary & Heating
-Bookkeeper
-Surveyor & Mapping
-Draftsman & Designer
-High School Graduate

Name.....
Address.....

"Dependable 'B' Battery Power"

For long and short wave receivers. Prices reasonable. Also batteries, A & B operating from 32 to 110 volt farm lighting systems.

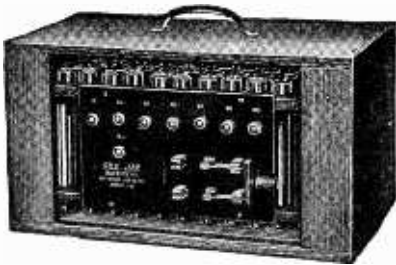

Write for our free interesting booklet.
See Jay Battery Co., 911 Brook Ave N. Y. C.

Book on Law Free

Write today for this new book. It tells you how a law training will shorten your road to success. It also carries a vital and inspiring message to every ambitious man. Find out about the opportunities that await the law trained man. Find out how you can learn law right in your own home. No obligations. The book is absolutely FREE. Write Today—is in force.

American Correspondence School of Law
3601 Michigan Ave. Dept. 1425 Chicago, Ill.

AMAZING NEW CHAIN SELLING SYSTEM

Brings Beginner a year's pay in 4 summer months!

Here is W. H. Schoen of Ohio—who made \$1,500 in 4 months last summer—as much as he earned the entire year before! Now Schoen is averaging \$90 a week in 1930—he says that's easy with the Progress line backed by wonderful new CHAIN SELLING SYSTEM.

PAINT DIRECT FROM MILLION-DOLLAR FACTORY

Why not go after "big game" while you're at it? Roofing pays you \$24 a barrel—average paint order commission \$16—cash in advance. Just as easy to sell on our credit terms as thinks paying a dollar or two. You can sell every home owner, factory, dairy, store, farmer by CHAIN SELLING method.

DOUBLE PAY for your "over-time"—write today!

Hurry—big season just starting—big earnings for you right off the bat. Clever "demonstrator" free—weighs only a few ounces—write immediately for Chain Selling Plan, stating territory, etc.

The PROGRESS PAINT CO. Cleveland, O. Dept. 151

Hind-Side-Before

A Cross-word Puzzle by RICHARD H. TINGLEY, C.E.

ACROSS

1. Calls loudly to.
6. Conventional form of respectful address to men.
9. City in Prussia where the "Big Berthas" were made.
14. To put or keep apart.
15. To do a thing habitually.
16. Fishing net.
17. The title of Col. Lindbergh's book.
18. Above zero; the reverse of minus.
20. Exceeding.
22. One or any.
23. Female deer.
25. The droings of the people.
26. To anoint.
27. A unit of work and energy rate in the Centimeter-gran-second system.
28. Yields a clear profit above all expenses.
30. Vanishes gradually.
32. Any smooth, unspirated consonant.
33. Met in assembly for deliberation.

DOWN

1. Prophets.
2. Altar cloth.
3. The square root of thirty-six.
4. The swell of the ocean.
5. Small tree-like plant.
6. Disposition to become angry.
7. The seventh note of the musical scale.
8. A large marine seal-like mammal.
9. Heated chamber for cooking.
10. A single thing or person.
11. Exists.
12. Sea eagles.
13. Demise.
19. The fifth note of the musical scale.
21. An interjection of disapproval.
24. Leagued.
27. Deviating from the true course.
29. An advance guard.
31. Took rest.
32. A suffix denoting "of the nature of."

1	2	3	4	5	6	7	8	9	10	11	12	13	
14					15			16					
17			18		19		20	21			22		
23		24		25			26				27		
28			29		30		31			32			
		33		34		35			36				
37	38				39			40			41	42	
43				44							45		
46			47					48		49			
		50				51		52		53			
54	55				56			57		58		59	60
61				62				63		64		65	
66			67					68		69		70	
71		72				73	74			75		76	
77						78				79			

35. Saturated.
36. Belonging to an object of the neuter gender.
37. The "Sage Brush State."
40. An orderly arrangement of things one after another.
43. A skein of yarn of 120 yards.
44. Places by influence or force.
45. Strong resentment.
46. Imprisonment.
48. The two hind quarters of a carcass of mutton, venison, etc.
50. Excited beyond self-control.
51. An anarchist.
53. The short fibers on the surface of flannel or a silk hat.
54. Such as mentioned, and no more.
56. Cauteurized (variant in spelling).
58. A "U" or an "S" bend in a drain pipe.
61. Given something to eat.
62. To humbug, or to deceive in a joke (slang).
63. Perch.
65. Recently produced.
66. Fourth note of the musical scale.
67. A marsh-hunting, wading bird.
68. Gamins.
70. To have actuality.
71. Scolder.
73. The constellation of the "Altar."
75. To provide for the gratification of a need or taste.
77. Two pieces.
78. A man affectedly fastidious in dress.
79. Any soft, sticky, dirty substance.

34. The nine goddesses presiding over poetry, art and the sciences.
36. Works steadily.
37. A mineral spring.
38. Dejected.
39. Cavern occupied by wild animals.
40. The squares of a body of type used in printing (plural).
41. A metric measure of 119.6 square yards.
42. A little girl.
47. Deface.
49. Large floating leaf of a pond-lily.
51. Placed your car aside temporarily.
52. More speedy.
54. Customary pursuit or occupation.
55. Allude.
56. Assistance.
57. Roman god of the underworld.
59. More crippled.
60. Scarcely enough.
62. Dry.
64. Notable epochs.
57. Chum.
69. Encountered.
72. Near.
74. Either.
76. A thing.

Solution on page 90

MEN
protect
yourselves

WIDE-AWAKE
men to-day know
how to protect
themselves
against those in-
fectious diseases
to which they are pec-
uliarly susceptible.
They use **SANITUBES**,
an efficient germ-killer
in handy form, endorsed
by physicians every-
where. You can buy
SANITUBES, in pocket
packages, at any drug store.

Clip Coupon for Interesting Booklet FREE
Sanitube Company, Dept. S.,
P. O. Box 515, Newport, R. I.

Name _____
Address _____

TRUSS USERS

Learn how to close the rupture opening, so the rupture can't come down. Get a Ten Day Test of the herbal muscle-tonic "Plapao", and 48 page illustrated book describing the effective home treatment used by satisfied thousands without delay from work. Awarded Gold Medal, Rome, Grand Prix, Paris, and other proofs of merit. You can make this test which started many others on the road to better health without cost—FREE. Write TODAY to Plapao Co., 375 Stuart Building, Saint Louis, Missouri.

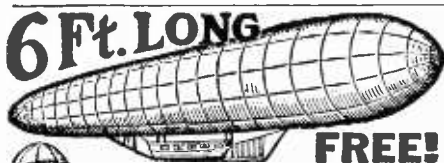

6 Ft. LONG FREE!
Boys! Here's the great Navy model Airship. Large 6-foot air bag with inflators, parachute with automatic release and complete instructions for flying. Will fly for miles at height of 1000 feet. Great chance to study aerial navigation. Send name and we'll send 6 of our new art pictures to dispose of an special 25c offer. Send the \$1.50 you collect and as a reward for this service we will send this wonderful Airship with full instructions free.
C. M. THOMAS, 337 W. Madison St., 5-K-22, Chicago

**HOW TO OBTAIN
A Better Looking Nose!**
[Improve your personal appearance]

My new Model 25 Nose Shaper is designed to improve the shape of the nose by remoulding the cartilage and fleshy parts, safely, and painlessly. This is accomplished thru the very fine and precise adjustments which only my patented Model 25 possesses. Results are lasting. Can be worn at night, or during the day. Money refunded if not satisfied after thirty days' trial. Write for free booklet to
M. TRILETY
Pioneer Nose Shaping Specialist
Dept. 136 Binghamton, N. Y.

QUIT TOBACCO

Don't try to banish unaided the hold tobacco has upon you. Thousands of inveterate tobacco users have, with the aid of the Keeley Treatment, found it easy to quit.
KEELEY TREATMENT FOR TOBACCO HABIT Quickly banishes craving for tobacco. Successful for over 50 years. Write today for FREE BOOK and particulars of our MONEY-BACK GUARANTEE.
THE KEELEY INSTITUTE, Dept. L-603, Dwight, Ill.
Home of the famous Keeley Treatment for Liquor and Drugs. Booklet Sent on Request. Correspondence Strictly Confidential.



Home Made Gas

By Don Bennett

THE man in the country may now make his own gas for both cooking and lighting purposes. And the cost is said to be less than that of city gas—seventy cents per thousand cubic feet, as against a dollar.

The device for manufacturing this gas, the "Gasolier," is said to be safer than the ordinary kerosene and gasoline stoves in use, for the fumes do not paralyze the olfactory nerves as is the case with illuminating or coal gas. The apparatus may be placed in the cellar or the kitchen—is compact enough to fit in a small space.

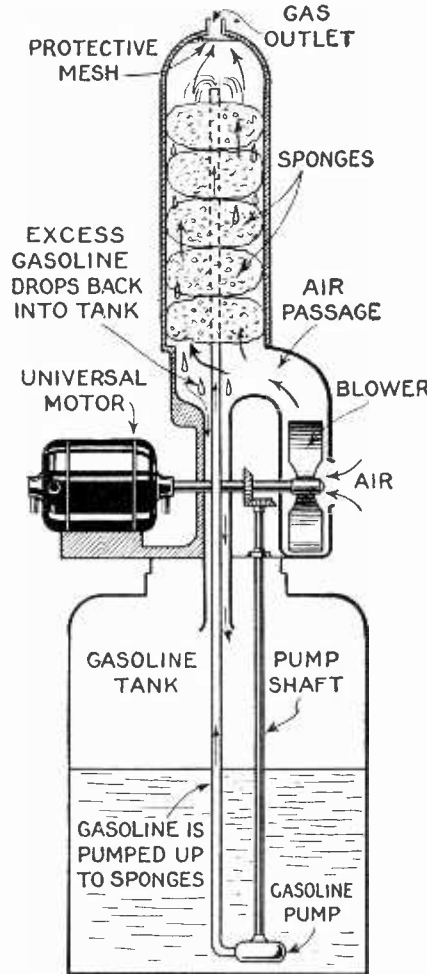

This diagram explains how the gasoline is pumped into the reservoir, mixes with air from the blower, and rises as gas in the collector.

A one-quart jar—the maximum size container approved by fire underwriters for use inside dwellings—comes with the outfit. But a large storage tank for gasoline, outside your house, will provide a reserve supply.

The principle of operation is easily understood by referring to the drawing. Gasoline is forced by a pump into a reservoir containing several layers of sponges, which become saturated, presenting a large surface for evaporation. Air from the blower mixes with the gasoline in the reservoir, and the gas thus formed rises into a collector. Excess gasoline flows back to the storage tank.

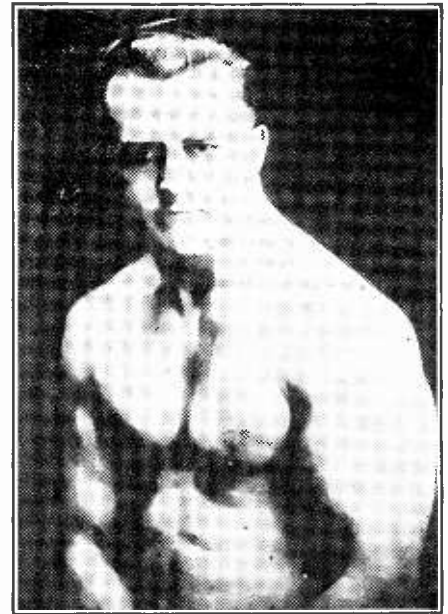

EARLE LIEDERMAN, "The Muscle Builder"
Author of "Science of Wrestling," "Muscle Building," "How's Health," "Secrets of Strength," "Endurance," etc.

The Power of Truth

Truth is often stranger than fiction. That is a fact. Sometimes the truth is unbelievable, nevertheless strange as truth may seem, there is a mighty convincing unseen power behind it, from which you cannot flee. Sometimes we dread to face the truth, but only blindfold ourselves? Let us face facts—truthful facts—right now.

The Truth About Development

You may imagine that a thin sickly individual cannot develop himself to massive muscular proportions, but the truth of the matter is HE CAN. He should, during the first month, gain one inch to his upper arms and two inches to his chest and every month thereafter, increase those parts of his body in proportion to nature's laws—and it is a law of nature to progress through activity. And while the arms and chest are gaining, every muscle throughout the entire body will respond in similar proportions. That is the truth about development.

The Truth About Strength

Your strength can be doubled in a very short time. That is an actual fact. If you, for example, are only capable of lifting 75 lbs. overhead today, in a month or two you should very easily be able to lift twice that weight, or 150 lbs. You will be amazed at how rapidly your strength will increase under proper guidance. In some cases the strength can be doubled in a few weeks' time. That is the actual truth about strength.

The Truth About Health and Vitality

Some have an erroneous idea that exercise exhausts and takes away from the stamina and energy. On the contrary, Exercise is nature's way of stimulating the internal organs and, remember, for every action there is a reaction. Each time you affect the respiratory system you are benefiting your lungs. Each time you perform proper abdominal movements you are stimulating most of your internal organs and when the lumbar region, which is the seat of the central nervous system, receives systematic and scientific work, you positively stimulate your vital energy, which in turn fills you with that mysterious power—"vitality," and arriving with this is perfect robust health. That is the truth about health and vitality.

The Truth About Earle Liederman

In conclusion, you should make sure that your instructor is one who is qualified in every respect to guide you. He should be one whom you can respect and like and one who will take a personal interest in your individual welfare. He should be a college man of wide experience in travel, for remember, the exercises performed by tropical students should not correspond with those in the far north. He should have 20 or more years of experience and have at least 100,000 students to enlarge his practical knowledge. Such a man is Earle Liederman. He tells you things straight from the shoulder and he has a system of muscle building that has become almost a household throughout the entire world. He guarantees every promise and will refund all money if he cannot live up to his word. That is the truth about your future instructor, Earle Liederman.

Send for His New Book

"Muscular Development"

64 pages and—IT'S FREE

This most interesting book contains 48 full-page photographs displaying the magnificent muscles of some of his enthusiastic pupils.

"Muscular Development" is yours for the asking—yours to keep, just as soon as you fill out the coupon requesting it. This book will tell you just what you can do with your own body and if the statements on this page have interested you, this book will double your interest, for it is just the kind of a book you have always wanted. It will grip you from cover to cover and tell you just what Earle Liederman can do for you.

Why not send for a copy today? Write now while it is on your mind.

EARLE LIEDERMAN, Dept. 2705, 305 Broadway, New York

EARLE LIEDERMAN, Dept. 2705, 305 Broadway, N. Y. City

Dear Sir: Please send me, without any obligation on my part, what-ever, a copy of your latest book, "Muscular Development."

Name _____ Age _____
Street _____
City _____ State _____
(Please write or print plainly)

Our advertising

As you turn the pages of this magazine, you see the advertising of things you need. Food, clothing, home equipment . . . all the necessities and luxuries that go to make up the fullness of modern living.

Has it ever occurred to you to wonder just how far you could trust these advertisements as reliable guides to the selection of worthy products?

We can answer your question in one broad statement. *Any product or service that you see consistently advertised in the pages of this publication is worthy in quality, honestly priced and truthfully presented.*

Why? For the very simple reason that to the maker and the seller of an unworthy product, advertising presents the quickest and surest road to failure. To the misrepresented product, advertising brings a sudden and fatal storm of public disapproval. To the dishonest maker, advertising brings a constant public reminder of his dishonesty.

Truth in advertising has come to stay . . . its use is no longer dependent on the *integrity* of the advertiser, but on his *business ability*. *Nothing else pays.*

And, in addition, the publishers of your magazine make every effort to disbar from these pages any advertising that might prove objectionable or unprofitable in any way to its readers.

Read the advertisements here. They offer you a dependable short cut to the kind of merchandise you would select if you spent your day in shopping for it.

Motion Picture Camera Cuts Operating Costs

A NEW motion picture camera, priced within the range of the average amateur home movie equipment owner, has been evolved after many years of experimenting. It is called the "Homovie," and is said to cut operating costs seventy-five percent.

Home motion picture cameras use 16 millimeter film rolls, 100 feet in length, which provide four minutes of screen entertainment. Only lengthwise motion of the film is employed.

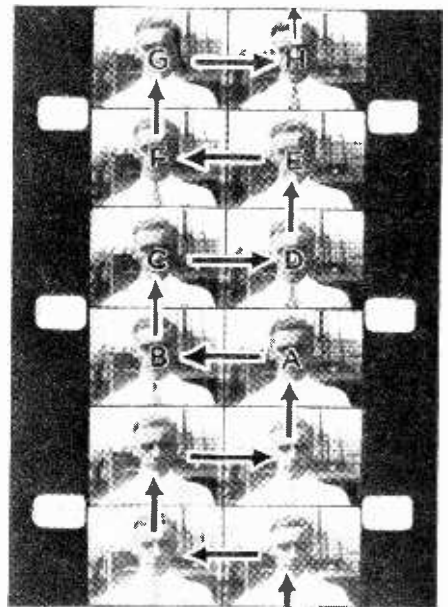

The arrows indicate the path of the film past the Homovie camera lens.

In the Homovie camera, the film moves both longitudinally and laterally across the lens, alternately, and the composite movement of film and shutter mechanism produces a series of views arranged in two columns on the film.

Operation of the Homovie camera is simple—focus through a view-finder, press a button which releases a spring, and the horizontal and lateral motion begins.

Besides the camera proper, a Homovie projector and daylight recreator are provided. The latter permits showing pictures in broad daylight. A mirror at an angle of 45 degrees, shielded from light, reflects the pictures through a translucent glass screen. A special heat-absorbing glass shutter prevents breaking or blistering the film.

Solution to Puzzle on Page 88

S	L	I	A	H	R	I	S	N	E	S	S	E
R	E	V	E	S	E	S	U	E	N	I	E	S
E	W	S	U	L	P	R	E	V	O	N	A	
F	O	D	B	O	M	L	I	O	G	R	E	
S	T	E	N	S	E	D	A	F	E	N	E	L
		T	A	S	T	E	W	S	T	I		
A	D	A	V	E	N	S	S	E	I	R	E	S
P	A	R	S	E	S	O	P	M	I	E	R	I
S	S	E	R	U	D	P	E	L	O	D	A	S
		D	A	M	D	E	R	P	A	N		
F	R	E	M	D	E	R	E	S	P	A	R	T
D	E	F	D	I	K	T	I	S	W	E	N	
A	F	L	I	A	R	S	D	A	T	M	A	
R	E	T	A	R	A	R	A	R	E	T	A	C
T	R	A	P	A	P	O	F	E	M	I	L	S

BUICK 4-DOOR SEDAN CARS GIVEN! 5

Ever win a prize? Here's your chance! Every year we spend over \$150,000.00 on prize offers to advertise our business. In this new offer 150 grand prizes totaling \$6555.00 will be given to the fortunate ones who solve our puzzle correctly and win. Here it is—

FIND THE "DIFFERENT" AUTO!

The 16 cars in the circle all look alike. 15 of them are exactly alike—but one is different from all the rest. That's the trick for you! Find this "different" car if you can—and mark it. The difference may be in the fenders, bumper, name plate, radiator, or top. Be careful now—because winner must solve puzzle correctly in order to qualify for this opportunity to

WIN BUICK SEDAN OR \$2035.00 CASH

A magnificent list of 150 Grand Prizes—\$6555.00 in all! Lucky first prize winner has choice of new 1930 Buick 4-door Sedan or cash if preferred. Also four other, fine new Sedans, radios, victrola, etc., in big prize list. Duplicate prizes awarded in case of ties. All actively interested who have answered correctly will receive prizes or cash rewards.

\$705.00 FOR PROMPTNESS

Don't delay—act this minute! Solve the puzzle correctly and receive at once Certificate good for \$705.00 if you are prompt and win first prize, making total first prize worth \$2035.00. This is the only puzzle to solve. Any man, woman, boy, or girl in the U. S. A., outside of Chicago, may submit an answer. 150 of the people who take up this offer are going to win these splendid prizes. Be one of them. Send the number of the "different" auto in a letter or post card today. Nothing to buy, so send no money. But act promptly! **B. A. SLACK,**
500 N. Dearborn St., Room 210
Chicago

SEND NO MONEY! REPLY TODAY! \$705.00 PROMPTNESS!

Water Softeners

DO you try to make a lather and find it difficult? Does your drinking water taste limy? Are your hot water pipes clogged and rusty?

These conditions indicate that your water is hard. And when there are so many advantages in having soft water, and it is comparatively easy and inexpensive to remove the hardening compounds from your water, soft water should be used.

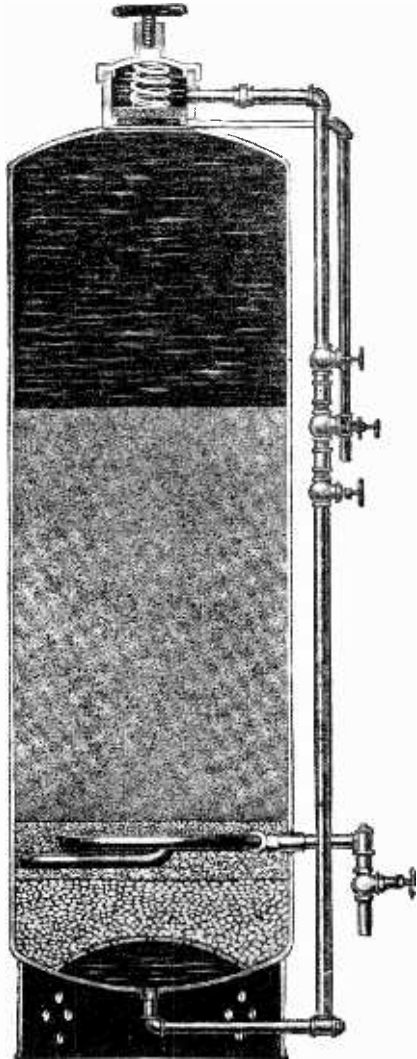

Reiter Co. Elgin Water Softener

A triple strata of filtering material at the base and a refilter at the top are features of this softener.

Water softeners are available which soften both permanent and temporary hard water. Non-corrosive tanks, seamless and equipped with a minimum of valves and caps are used. A synthetic softening material, such as "zeolite," is employed to attract the elements of hardness from the water. Then the softened water flows into the service pipe.

Softeners are equipped to purify a certain grain capacity of hardness per gallon. When the quota is absorbed, the zeolite loses its force unless regenerated. The introduction of common salt or brine usually is sufficient for this process. The Hardin-Lavin softener operates on the upflow principle, which is claimed to facilitate the regenerating process.

Filters are provided in the tanks to aid in purification and to collect the suspended matter which is dropped from the softener. One type, the Elgin, has

a special backwasher which permits cleansing the filter at the base of the tank without passing the wash water through the zeolite or interfering with the softener's operation.

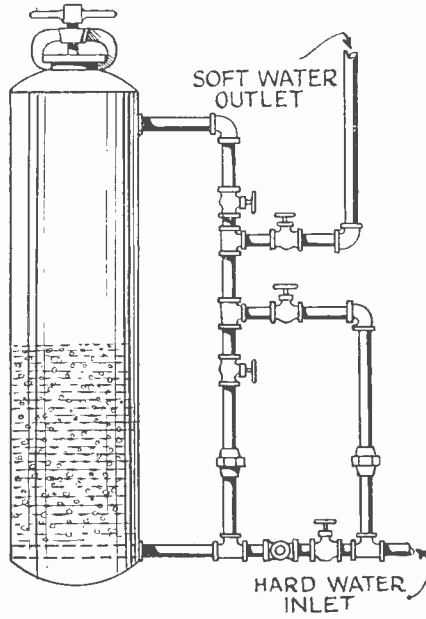

Hardin-Lavin Co.

Hard water enters at the bottom, flows upward through the softening material, and out, as soft water.

A Key-Making Machine

FIRST keys to steering wheels, tire locks, padlocks, house keys, bitted and doubled-bitted keys with side and upper groves may be made in less than one minute with the latest key machine, it is claimed.

This contrivance is said to do away with taking locks apart and to eliminate hand filing and changing gears. An internal shaft controls the speed cutters.

To make almost any type of key—four flat keys may be cut at one time—the number of the lock desired is selected through a code and the proper blank and guides are clamped on the machine. Seventeen sets of guide keys stamped of pressed hard steel are provided in the equipment. The machine itself has an adjustable thumb screw for cutting deep or shallow wards.

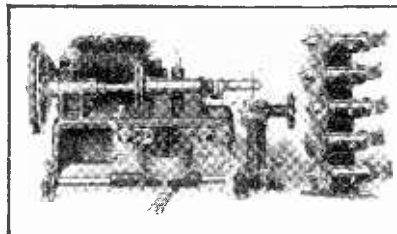

Beisser Key Machine Co.

Rotary Hand Duplicator

A SIMPLE rotary hand duplicator, called the Radiograph, for reproducing both type and drawn patterns, has been put on the market.

The stencil containing the copy is placed on the machine, which is then inked and rolled over the paper. The roller automatically returns to its starting position. The printed copy is removed, and the machine rolled across the next paper on the pile.

ELECTRICAL ENGINEERING

BOOKS SENT FREE

New Edition Containing 100 Pages on

A-C RADIO!

8 FLEXIBLE MAROON VOLUMES
4300 pages, 3200 illustrations, deluxe gold stamped binding, index in each book, general index in Vol. 8. Covers every subject in Electricity—Light, Power, Transmission, Generators, Motors, Switchboards, Radio, Telephone House Wiring, Railways, etc.

We're glad to send a set to your home to examine and use as your own for 10 days—to show you that here is the most up-to-date and complete work on Electricity ever published. Written by CROCKER of Columbia U.—MILLIKAN of Calif. "Tech."—HARRISON of General Electric and 26 other noted Electrical Engineers. Starts off with elementary Electricity in simple, non-technical language for the beginner and includes every Engineering branch for use of experts on the job.

Complete Electrical Reading Course

Electricity, the biggest industry in the world, continues to grow the most rapidly. And it offers better jobs, bigger salaries and a brighter future than any other field. Every dollar, every hour invested in learning Electricity will come back to you a thousand-fold. Learn in spare time with these books at one-fifth the cost of trade

Look it up!

Thousands of these sets are used as REFERENCE books by men employed in electrical, building construction and allied lines. The JIFFY INDEX puts the answers to 20,000 questions right at your finger tips.

courses. Outline for organized study, quiz-questions and a year's free consulting membership in the American Technical Society included without extra cost, if you mail coupon immediately.

AMERICAN TECHNICAL SOCIETY
Dept. E-525
Drexel Ave. & 58th St., Chicago

American Technical Society

Dept. E-525 Drexel Ave. & 58th St., Chicago

Please send for 10 days' free trial 8-volume set of Electrical Engineering just off the press, subject to return if I wish to. (I pay the few cents express charges on receipt of books, you pay express if returned.) If I decide to keep them, I will pay \$2.00 after 10 days trial, then \$3.00 a month until \$34.80, special advertising price, is paid, after which books become my property. Year's Consulting Membership to be included free.

Name.....

Address.....

Employed by.....

Employer's Address.....

\$10,000

Protection Against

ACCIDENT

and

SICKNESS

For Only **\$10. year** No Dues or Assessments

Men, Women 16 to 70 accepted

NO MEDICAL EXAMINATION

Policy Pays

\$10,000 for loss of life, hands, feet or eyesight. Many unusual protecting clauses, \$25 Weekly benefits, pays doctor and hospital bills. Covers Automobile, Travel, Pedestrian and many common accidents. Covers many common sicknesses, including typhoid, appendix operation, lobar pneumonia, etc., etc. Largest and oldest, exclusive Health and Accident Insurance Company. Don't delay, you may be next to meet sickness or accident. Mail coupon today for free descriptive literature.

North American Accident Insurance Co. [Chicago] 409 Wallach Bldg., Newark, New Jersey

Name.....

Address.....

City and State.....

AGENTS WANTED for Local Territory

Read Classified Advertising—It Pays!!!

Advertisements in this section fifteen cents a word for each insertion. Name and address must be included at this rate. Cash should accompany all advertisements unless placed by an accredited advertising agency. Not less than 10 words accepted. Objectionable or misleading advertisements not accepted. Advertisements for these columns should reach us not later than 1st of 2nd month preceding issue.

Classified Advertising Manager—Experimenter Publications, Inc., 381 Fourth Avenue, New York City

Advertising

Get into Advertising. Learn quickly at home. Experience unnecessary. New, easy plan. No text-books used. Practical work. Old established school. Send name and address for interesting free booklet. Page-Davis School of Advertising, Dept. 538-A, 3601 Michigan, Chicago.

Agents Wanted

Gold Leaf Window Letters and Script Signs; no experience; 500% profit; samples free. Consolidated, 69-14, West Van Buren, Chicago.

BIG MONEY applying Gold Initials on Automobiles. Easiest thing today. No experience needed. \$1.45 profit every \$1.50 job. Free Samples. "RALCO," R-1043 Washington, Boston, Mass.

250,000 ARTICLES AT WHOLESALE PRICES. Supply Sources 10c. J. Patterson Co., 4111 University, Des Moines, Iowa.

Strange Battery Compound charges instantly. Eliminates old method. Gives new life and pep. Big profits. Gallon free. Lightning Co., St. Paul, Minn.

\$10 daily silvering mirrors, plating and refinishing lamps, reflectors, autos, beds, chandeliers by new method. Outfits furnished. Write Gunmetal Co., Ave. D, Detroit, Ill.

Free Booklet describes 67 Plans for making \$20-\$100 weekly in home, or office Business of your own. Elite Co., 84-B, Elizabeth St., N. Y.

Make your own products. Employ agents yourself. Toilet articles, soap, extracts. We furnish everything. Valuable book free. National Scientific Laboratories, 1432W Broad, Richmond, Va.

Big money and fast sales. Every owner buys gold initials for his auto. You charge \$1.50; make \$1.35. Ten orders daily easy. Write for particulars and free samples. American Monogram Co., Dept. 71, East Orange, N. J.

Men Wanted—To demonstrate and take orders direct from motorists. Amazing Magnetic Trouble Light. Stripes on metallic surfaces. Our men earn as high as \$75.00 weekly. Write for demonstrator. Magna, Beacon Bldg., Dept. 495, Boston, Mass.

\$20 a day easy, all or part time selling greatest line of shirts, underwear, hosiery, neckwear. Lowest prices. Big commissions. Write today for big free outfit. Carter Welch, Mgr., 227 W. Van Buren, Dept. 517, Chicago.

Don't sell for others—Employ agents yourself. Make your own products. Toilet articles, household specialties, etc. 500% profit. Valuable book free. National Scientific Laboratories, 1432W Broad, Richmond, Virginia.

AGENTS WHO WORK HARDEST don't always make the most money. It's a case of picking the most profitable line. Zanol Products offer you a wonderful opportunity to make \$15 profit a day. New FOLD Sedan free to producers. ALBERT MILLS, 5221 MONMOUTH, CINCINNATI, O.

YOU ARE WANTED TO RESILVER Mirrors at home. Profitable business plating auto parts, tableware, etc. Write Shrinkle, Plater, 955, Marion, Indiana.

\$60-\$200 a week. Genuine Gold Letters for store windows. Easily applied. Free samples. Liberal offer to general agents. Metallic Letter Co., 441 B., North Clark, Chicago.

AMAZING PROFITS SELLING NEW Tablecloth. Looks like linen. Wash like Oldcloth. Free. Samples, Restexer Co., 147, Irving Park Station, Chicago.

BIG MONEY EASY, simply showing new Polly Wrench. 10 Wrenches in one, guaranteed fast seller. Samples furnished. GELLMAN MFG., Dept. 2-8, Rock Island, Ill.

350% PROFIT. New magic gasifiers \$1.00 dozen. \$8.00 gross, retail, 25c. ZIP-LITE'S, Kosuth Ave., New York.

Daily cash! \$25.00 sale. \$15.00 is yours. Merchants amazed at wonderful results! Big repeat commission income. Free kit. Sales Stimulators, Inc., 339 W. Madison, Chicago.

Airplanes—Aviation

Biggest. Best Catalog Model Airplanes, Parts, Supplies; 5c postpaid. Ideal Company, 23 West 18th Street, New York.

Business Opportunities

Screw-holding screw driver! Amazing new patent! Factories, garages, electricians, mechanics, auto, radio, owners, buy one right! Removes, inserts screws instantly! Your profits 75c each. Exclusive territory. FREE trial offer! Millenco, 1568 Spring Lane, Boston.

Sell By Mail!—Books. Novelties. Bargains! Large Profits! Particulars Free! E-Elfeo, 525 South Dearborn, Chicago.

Amateur Cartoonists: Sell Your Cartoons New Plan. Smith's Service, Ex. 1194, Wenatchee, Wash.

Be the LICENSED RADIO DOCTOR of your community. Earn \$7 to \$10 spare time evenings. Write now for free booklet: "Why the Radio Doctor." Radio Doctors, Inc., Dept. 1, 131 E-sex Street, Salem, Massachusetts.

Free Book. Start little mail order business. Hadzil, 53-74 Cortlandt Street, New York.

BIG MONEY AWAITS YOU HERE. 250 Signs and pictures an hour without press, type or machinery. Samples and particulars 10c. Straco, 1015 Mulberry, Springfield, Ohio.

Chemicals

"Handbook for Chemical Experimenters." Hundreds of experiments: Illustrated 50c. Booklet of experiments, 15c. Chemical price list, 2c. General Chemical Company, Box 397, Reading, Penna.

Chemistry

Your Chemical problems solved and working process furnished for Five Dollars. Write me. W. Stedman Richards, Consulting Chemist, Box 2402, Boston, Mass.

EXPERIMENTERS—Chemical & Apparatus Catalog—Fifty cents. Union Laboratories, 182 Berkenline Ave., Union City, N. J.

Correspondence Courses

Used correspondence school courses sold on repurchase basis. Also rented and exchanged. Money-back guarantee. Catalog free. (Courses bought). Lee Mountain, Pisgah, Alabama.

CORRESPONDENCE COURSES—Sold. Bought. Exchanged. Rented. Bargain Catalogue Free. Handline, B-799 Broadway, New York.

Detectives

Detectives work home or travel. Experience unnecessary. Particulars free. Write George Wagner, 2190 Broadway, N. Y.

Electricity

Electric Fun! Seventy stunts, 110 volts, \$1. Kutling Bros., Campbell, Calif.

For Inventors

Get Your Own Patents. Legal Forms, complete instructions \$1. Cutting Bros., Campbell, Calif.

INVENTORS: Send for complete names and addresses of over 800 manufacturers looking for new inventions. With suggestions from each on "What To Invent." Only \$2.00 prepaid. Inventor's Syndicate, 101 Palladium Bldg., St. Louis, Mo.

Inventors, use our special service for pre-enting your inventions or patent to manufacturers. Adam Fisher Mfg. Co., 205 Enright, St. Louis, Mo.

FREE BOOKLET ON PATENTING New inventions. Sterling Book, S-629-F, Washington, D. C.

Unpatented Ideas Can Be Sold. I tell you how and help you make the sale. Free particulars. (Copyrighted.) Write W. T. Greene, 908 Barrister Bldg., Washington, D. C.

Inventions Commercialized. Patented or unpatented. Write, Adam Fisher Mfg. Co., 205 Enright, St. Louis, Mo.

Help Wanted

MAKE BIG PROFITS SILVERING Mirrors. Easily learned patented process. Plans free. Wear Mirror Works, S.T.-5, Excelsior Springs, Mo.

Help Wanted—Instruction

WORK FOR "UNCLE SAM." \$105.00-\$280.00 month. Life jobs. Steady work. Vacations. Men-Women. 18-50. Thousands 1930 appointments. Many Spring Examinations. Common education usually sufficient. List positions and full particulars—FREE. Write today sure. Franklin Institute, Dept. J-4, Rochester, N. Y.

WANTED IMMEDIATELY. Men-Women 18-55, qualify for permanent Government Positions. \$105-\$250 month; experience not required; Vacation with pay; common education; many needed soon. Write, Instruction Bureau, 293, St. Louis, Mo. quickly.

RAILWAY POSTAL CLERKS. \$158.00-\$225.00 month. Steady. Spring examinations 1930. Common education sufficient. Men—18-35. Particulars free. Write immediately. Franklin Institute, Dept. J-15, Rochester, N. Y.

How to Entertain

Plays, Musical comedies and revues, minstrels, comedy and talking songs, black-face skits, vaudeville acts, monologs, dialogues, recitation, entertainments, juvenile plays and songs, musical readings, make-up goods. Catalog free. T. S. Denton & Co., 623 So. Wabash, Dept. 99, Chicago.

Inventions Wanted

INVENTIONS WANTED. We have large plant—Can make any article from metal stampings, or metal and wood combined. Will manufacture on royalty basis—take over invention and assist in developing, or market it ourselves. M. Rogers, Highland Body Company, Desk 3, Station P., Cincinnati, O.

Inventions Commercialized. Patented or unpatented. Write, Adam Fisher Mfg. Co., 205 Enright, St. Louis, Mo.

Inventions Wanted—patented, unpatented. If you have an idea for sale write, Hartley, Box 928, Bangor, Maine.

BIG MONEY made with good inventions. Get yours into action by sending full details to manufacturer with two large plants. G. W. MacDow, 209 Dartmouth St., Boston, Mass.

Machinery and Tools

CONCRETE Building Block Machines and Molds. Catalog free. Concrete Manufacturing Co., 5 N. Main, St. Louis, Mo.

Magic

Magic Catalog 20c. Lynn, 105 Beach, Dept. 6 Jersey City, N. J.

Male Help Wanted

Firemen, Brakemen, Baggage-men: colored Train or Sleeping Car Porters, \$1.50-\$2.50 monthly. Experience not necessary. 897 Railway Instruction Bureau, East St. Louis, Ill.

Miscellaneous

Agents, Canvassers, Salesmen, Merchants, etc., who are seeking direct contact with manufacturers for live propositions; 100% satisfaction guaranteed; send me 25c (coin or stamps) for one pound of direct contact literature of over 200 unexcelled offers. Ted Armour, 136 East 28th Street, New York, N. Y.

LET US BE YOUR FACTORY. Expert makers of Dies, Tools and Molds. Complete machinery equipment; excellent work. Moderate prices, low overhead. Send model or drawing for manufacturing estimate. Backus Novelty Company, Smetport, Pa.

"PROTECTION"—GAMBLING SWINDLES EXPOSED. Systems; Methods; Devices. 200 Articles. 200 Illustrations. Price \$3.00. Descriptive circular FREE. P. O. Box 392-A, Torrington, Conn.

Latest Classified business directory, any city, U. S. and Canada, \$8.00. E. Perry, City Harbor, Washington.

MICROMETERS one-inch, lock nut, rubber, 1/10,000. Guaranteed perfect. C.O.D. \$3.00. J. B. Witmer, 19 Clement St., Worcester, Mass.

Patents

Inventions Commercialized. Patented or unpatented. Write, Adam Fisher Mfg. Co., 205 Enright, St. Louis, Mo.

Patent Attorneys

Patents—Write for Free Instructions. Send drawing or Models for Examination. Carl Miller, Registered Patent Attorney (former Patent office examiner), 258 McGill Building, Washington, D. C.

Patents. Time counts in applying for patents. Don't risk delay in protecting your ideas. Send sketch or model for instructions or write for Free book, "How to Obtain a Patent" and "Record of Invention" form. No charge for information on how to proceed. Communications strictly confidential. Prompt, careful, efficient service. Clarence A. O'Brien, Registered Patent Attorney, Security Bank Building (directly across street from patent office), Washington, D. C. See page 51.

Patents Procured; Trade-Marks Registered—Preliminary advice furnished without charge. Booklet and form for disclosing idea free. Irving L. McArthur, 703 International Building, Washington, D. C.

Inventions patented; confidential advice; inventions developed—representative for Blair Tool and Machine Corp.; trade-marks registered. Edward Gottlieb, Patent Attorney, 5 Beekman Street, New York.

"Inventor's Adviser." Valuable Patent-book sent free. Labitur, 15 Park Row, New York.

Patent Sense. As one of the oldest firms in America we give inventors, at lowest consistent charge, a service noted for results, evidenced by many well-known patents of extraordinary value. Book, Patent-ense, free. Lacey & Lacey, 644 F Street, Washington, D. C., Estab. 1869.

JAPAN: Yoshijiro Nakane, Registered Patent Attorney. 24, Ishigat-suicho, Tenpojiku, Osaka.

Unpatented Ideas Can Be Sold. I tell you how and help you make the sale. Free particulars. (Copyrighted.) Write W. T. Greene, 908 Barrister Bldg., Washington, D. C.

"Inventors' Guide" free on request; gives valuable information and advice for all who have original ideas or improvements. Frank Lederman, Registered Attorney and Engineer, 233 Broadway, New York City.

PATENTS—Send for form "Evidence of Conception" to be signed and witnessed. Form free schedule. Information free. Lancaster, Alvine & Rommel Registered Patent Attorneys in the United States and Canada, 242 Ouray Building, Washington, D. C.

Patents or Inventions

Inventions Commercialized. Patented or unpatented. Write, Adam Fisher Mfg. Co., 205 Enright, St. Louis, Mo.

Personal

TOBACCO HABIT OVERCOME OR NO PAY. Over 500,000 used Suerba Remedy to help stop Cigarettes, Cigars, Pipe, Chewing, Snuff. Write for full treatment on trial. Costs \$2.00 if successful, nothing if not. Suerba Co., 1-82, Baltimore, Md.

Photoplays Wanted

\$\$\$ Photoplay Ideas For Both Silent and Talking Pictures. Accepted any form for revision, criticism and submission to studios. Estab. 1917. Booklet free. Universal Scenario Co., 223 Western & Santa Monica Bldg., Hollywood, Calif.

Printing Outfits and Supplies

Print Your Own cards, stationery, circulars, advertising, etc. Junior press, \$5.90; job presses, \$11; rotary, \$149. Print for others; big profit. Easy rules furnished. Write for catalog presses, type, paper, etc. Kelsey Company, Q-6, Meriden, Conn.

Radio

No Batteries, No Tubes. Marvelous new scientific crystal radio will bring you endless enjoyment. Introductory price, \$1.00, postpaid. Agents proposition included. MUSIC SALES CO., INDEPENDENCE, MO.

Real Estate

PECAN. Orange-Fig groves "On the Gulf." Monthly payments. Guaranteed care. Big quick returns. Suburban Orchards, Dept. S., Biloxi, Miss.

Salesmen Wanted

Punchboards—Hottest, largest money-making line ever offered. Season starting. Best commissions. Nothing to carry. Catalog FREE. Act! M & L Sales, 301 N. Adams, Chicago.

Color Craze Sweeping the Country! Make big money taking orders for hand painted fadeless tablecloths, bed-spreads, etc. Castle-Pond Co., AE-230 S. Wells, Chicago.

Punchboard Salesmen. Up to \$10,000 Yearly. New Line. All fast sellers. Lowest prices. Full commission on repeat business. Catalog Free. Puritan Novelty Co., 149 Jackson, Chicago, Ill.

Songwriters

Songwriters—substantial advance royalties are paid on publisher's acceptance. New Booklet. "Song Requirements of Talking Pictures," sent free. Newcomer Associates, 793 Earl Bldg., New York.

COMPOSERS—Verse or Music. Brilliant opportunity. Write Van Buren, 1942 McHugh Bldg., Chicago.

SONGWRITERS—Arranging, Composing. Free folder—"Giving Your Songs The Right Start." Stan Tucker, 330-B, Waldworth Ave., New York.

Stamps

Zanzibar! Packet. Queer freakish stamps from Zanzibar, Holkar, Antioquia, Congo, Hyderabad, Goldcoast, Newfoundland, British colonials, Soumaricarians. Don't delay! Don't wait! This whooping packet free for 5c postage! Gray Stampco, Toronto, Canada.

Telegraphy

Learn Morse and wireless telegraphy. Big salaries. Tremendous demand. Expenses low, can earn part. Catalog free. Dodge's Institute, Stone Street, Valparaiso, Indiana.

Your Glider's Flying Clothes

(Continued from page 77)

not only improve the appearance of your work but at the same time strengthen the covering against tearing. Some builders outline each rib by running a strip of tape around the wing over each of the rib positions. This tape is very handy to have on hand later for use in quick repairing of small tears in the wing fabric.

Two more coats of dope should next be applied to the covered surfaces allowing at least four hours drying between coats. It is permissible to apply a coat of good Spar Varnish to the finished wings if a more glossy surface is desired.

Next assemble the whole glider and connect all the wiring. You will have a complete glider without a seat or back rest for the pilot. The proper placing of the seat and back rest is one of the most important factors in making your glider control easily in the air. A fire place log or similar round wood piece of about six or seven inches in diameter is placed on the ground in front of the runner. With the help of two or more assistants lift the glider and roll the log under the runner so that it will serve as a pivot for balancing the whole ship from this point under the ash skid. The two seat brackets may be fastened to their position on the top of the runner and the seat itself should be set temporarily on these brackets. Measure back 21 inches from the leading edge of the wing near the butt end wing connection and attach a small line with a weight attached to its free end. With a man at each wing tip level the glider so that the weighted line will indicate a position for the log to be placed under the runner directly under the cord attachment to the wing. Tie the back rest with its attaching pieces to your own back and seat yourself in the glider. By moving your seat forward or backward you will find a position where you can balance the glider for a second or two. Have one of your assistants mark the positions for mounting the seat and back rest. In this manner you are placing your weight so that the point where the glider balances is practically under the center of lift of the wings. A man lighter than you should be seated farther to the front and a heavier man should be placed farther back. This is the experimental and easiest way to adjust a new glider for flight. When the glider with its pilot in position has a point of balance directly under the center of lift of its wings it will practically glide itself in still air.

Some adjustment for the differences in weight of pilots can be made by raising or lowering the back edge of the stabilizer, raising it for a heavier load and lowering it for a lighter load. If the glider is carefully adjusted to an average loading it is not absolutely necessary to change the stabilizer from its original position.

A Correction

In the April issue in the article headed "One More Step to the Take-off," by Lieutenant H. A. Reynolds, there is a diagram captioned "Cable Control Diagram" in which the cable on the left side goes to the bottom horn of the left aileron, and the cable on the right side to the bottom horn of the right aileron. The connections should be made as indicated in the diagram captioned "Front View Showing Aileron Control." The latter is correct; the control cable from the left side of the control stick should go to the top horn of the left aileron, and the cable on the right side of the control stick to the top horn of the right aileron.

Pull Them In With a Heterodyne

By George R. Brown

(Continued from page 31)

tendency for oscillation appear when the gain reaches a certain value per stage. The maximum gain would, of course, be reached with good shielding, by-passing of each stage to eliminate coupling by common impedance, and neutralizing. No purpose would be served by using a tuned secondary transformer for coupling three-electrode tubes, because all of the gain obtained by tuning only the secondary cannot be used even with perfect shielding and neutralization.

The four-electrode shield-grid tube, however, has radically different properties from the three-electrode tube. The presence of a shield between the grid and the plate reduces the capacity between the grid and the plate. The shield does not materially change the input grid-to-filament capacity—on the other hand, the plate-to-filament capacity is considerably increased.

In such tubes the short-circuiting effect of the output capacity is several times the short-circuiting effect of the input capacity. Since tuning either the primary or the secondary of a transformer has the effect of removing either the output capacity or the input capacity respectively, the idea is immediately suggested to tune the primary.

After determining that the primary of the transformer must be tuned, there is left one remaining possibility, namely: tuning both the primary and secondary. Tuning the secondary would, of course, eliminate the short-circuiting effect of the input capacity of the tube. When both the primary and secondary are tuned, a maximum transfer of energy no longer takes place with close coupling. The condition for maximum transfer of energy is, to the contrary, a very loose coupling. Since space limitations eliminate the possibility of separating the primary and secondary by a space of six or more inches, depending upon the type of coil used, it was necessary to turn one of the coils so that it was practically at right angles to the other. It was found, however, that there is no such thing as perfect shielding. The gain which can be obtained with the tuned primary transformer is more than can be successfully used. The tuned primary transformer gave a gain of 75 per stage at a frequency of 475 kilocycles with complete copper shielding and by-passing. It was found, however, that this gain had to be reduced for stable operation. For this reason the tuned primary and secondary transformer was found to offer no advantages from a standpoint of the amount of amplification which could be used in the set, and it had the distinct disadvantage of an additional adjustment for each stage.

Utilizing a correctly designed type of solenoid coil in the intermediate amplifier transformers has produced a very high gain per stage. It was the natural supposition that with the tremendously high gain obtained it would not be practicable to use many stages of this type. Contrary to this belief, in the Lincoln de Luxe 10 five tuned intermediate stages are successfully used, building up a total i.f. amplification exceeding anything previously known to our experience.

Combined in this system, each stage is accurately tuned by a high-grade low-loss stator and rotor type condenser, tuning the plate circuit of the screen-grid tubes. The over-all of the five operative tuning units produces a high degree of reactivity from the frequency desired.

"LINDY" BIG MUSCLE BUILDER

A Genuine 10-Cable Chest Expander



Makes Strong Virile Men

Only \$5.00 Postpaid worth \$14.50

Read our LIBERAL OFFER

- 10-Cable Chest Expander, for upper body and course of Exercises, worth... \$5.00
 - Head Harness for spine, neck and head muscles worth... 2.50
 - Foot Strap, for foot, ankle and leg, worth... 1.00
 - Grip Machine, for wrists, fingers and forearms, worth... 1.00
 - Equipment for transforming Expander to Wall Exerciser and Instruction Course, "How to develop the entire body, etc.," worth... 5.00
- Total Real Value... \$14.50

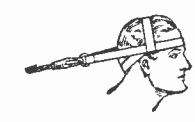
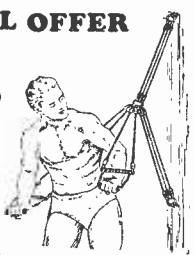

A month or two steady use of this exhilarating exerciser will put "pep" and vigor into you; makes men of 50 feel as active as at 20.

For over 30 years famous men of Athletic history have used our Exercisers.

BUSINESS and PROFESSIONAL MEN

Eliminate nervousness, irritation and constipation; build sinew, circulation and health; on our gradual system of exercising.

Clip This Adv. and Order NOW! LIND-HENDRICKSON CO. 321 Broadway, (130) N.Y.C. Originators and Mfrs. for 30 Years

25 POWER \$1 GERMAN POCKET MICROSCOPE

A marvelous German 25 power microscope, size of pencil. Enlarges diameter 25 times. Area 825 times. Fine lenses give extra large field and great light. Only 4 3/4 inches x 3 3/4 inches weighs but 7 1/2 ounces. Used in schools and colleges throughout the country. Fine for biology, geology, botany, nature study, examining stamps, finger prints, insects, cloth, metals, photographs and thousands of other things. Equip with handy fountain pen clip.

\$1 prepaid. Money back guarantee. Discount for 6 or more. Over 200 Glasses BINOCULARS All makes—\$1-\$110 Everything in binoculars, field glasses, telescopes and optical instruments. The finest and largest assortment in America. Catalog gives all information how to choose the best for your individual needs at the LOWEST PRICE. Try America's Leading Binocular House First DuMaurier Co., Dept. 175, Elmira, N. Y.

Play the Hawaiian Guitar like the Hawaiians!

Only 4 Motions used in playing this fascinating instrument. Our native Hawaiian instructors teach you to master them quickly. Pictures show how. Everything explained clearly.

Play in Half Hour Easy Lessons After you get the four easy motions you play harmonious chords with very little practice. No previous musical knowledge needed. Even if you don't know one note from another, the 52 printed lessons and clear pictures make it easy to learn quickly. Easy as you play.

GIVEN when you enroll HAWAIIAN GUITAR, Carrying Case and Playing Outfit Value \$18 to \$20 No extras—everything included

WRITE AT ONCE for attractive offer and easy terms. A postcard will do. ACT! and other courses. The same thorough instruction on Tenor BANJO, Banjo, Violin, Tiple, Tenor Guitar, Ukulele, Banjo Ukulele. Well-known instructors. Write for full information. FIRST HAWAIIAN CONSERVATORY OF MUSIC, Inc. 9th Floor, Woolworth Bldg., Dept. 240, New York, N. Y. Approved as a Correspondence School Under the Laws of the State of New York—Member National Home Study Council.



Herschel Logan with drawings made (1) before and (2) after Federal School training.

DRAWING turns INK to GOLD

HERSHEL LOGAN'S first drawings (1) were very poor. But he was determined to succeed. Obtaining a beginner's position in a publishing house, he studied his Federal Course at night. Today his drawings are seen in National Exhibits. Recently he made \$100.00 over his regular monthly salary. Do you like to draw? Logan did, so he answered an ad like this. Now compare his recent drawing (2) with the small, crudely drawn heads he made before he took the Federal Course. Then follow his example and develop your talent.

Mr. Logan is just one of hundreds of young people making good money because of Federal Training. Opportunities in illustrating have never been better. Publishers buy millions of dollars worth of drawings every year. Illustrating is fascinating as well as profitable. The Federal Course includes illustrating, cartooning, lettering, poster designing, window card illustrating, etc. Instructions are written by a specialist in each subject.

Fifty of the nation's leading artists contribute lessons and drawings especially prepared by themselves; all are included in the Federal Home Study Course.

Do you like to draw? A liking for drawing usually indicates talent which can be developed. Send for our free booklet, "A Road to Bigger Things." It explains the details of illustrating and includes a chart to test your ability. Profit by Logan's success. Send for it now.



Federal School of Illustrating

FEDERAL SCHOOL OF ILLUSTRATING, 5330 Federal School Bldg., Minneapolis, Minn. Please send your free book, "A Road to Bigger Things," together with Test Chart.

Name..... Age.....
 Present Occupation.....
 Address.....

INDEX TO ADVERTISERS

A	PAGE	PAGE	
Abeo Mfg. Sales Co.	66	Lancaster, Allwine & Rommel	56
Advance Electric Co.	80	Landon School, The	74
American Athletic Appliance Co.	69	La Salle Extension University	80-84
American Correspondence School of Law	88	Leonard, A. O.	69
American School	65-88	Lewis Hotel Training Schools	85
American School of Aviation	76	Liederman, Earle E.	89
American School of Photography	80	Lincoln Airplane & Flying School	73
American Technical Society	91	Lind-Hendrickson Co.	93
American Telephone & Telegraph Co.	73	Love Sales Co.	80
Anita Institute	82	Lynch, John J.	56
Arkograp Pen Co.	85		
Arudel, Theo. & Co.	Inside Back Cover	M	
		McGraw-Hill Book Co., Inc.	69-87
B		Mead Cycle Co.	76
Backus Novelty Co.	72	Meske, Arthur	85
Bartlett Mfg. Co.	76	Metal Cast Products	69
Batenburg Co., P. J. E.	77	Midland Tire & Rubber Co.	74
Belle City Appliance Co.	84	Millard Institute of Normal Speech	82
Bernard & Heller	58	Miller, Carl	58
Black, B. A.	90		
Bliss Electrical School	84	N	
Bogue, Benjamin N.	72	National Co., Inc.	70
Bureau of Inventive Science	58	National Electrical School	84
		National Model Aircraft & Supply Co.	72
C		National Radio Institute	1
Centre Publishing Co.	74	Newcomer Associates	74
Chicago Gear Works	82	Newell Pharmacal Co.	76
Classified Advertising	92	New Method Mfg. Co., Inc.	69-80
Coleman, Watson E.	58	New York Electrical School	76
Colonial Fireplace Co.	68	New York Institute of Photography	81
Conn, C. G., Ltd.	70	North American Accident Ins. Co.	91
Cooke, L. L., School of Electricity	75	North American Institute	82
Coyne Electrical School	5	Nurex Prod. Co.	76
Crescent Tool Co.	60		
Critchlow, Walter	Inside Front Cover	O	
Crosman Arms Co.	79	O'Brien, Clarence A.	57
Crusader Apparatus Co.	72	Old Town Canoe Co.	70
D		P	
Delta Specialty Company	71	Page-Davis School of Adv., The	72
Detroit School of Lettering	68	Pan-American Band Instr. & Case Co.	64
Dobe, Engineer	77	Plappo Co.	89
Drake & Co., Frederick J.	76	Polachek, Z. H.	58
Drake Hotel, The	72	Progress Paint Co., The	88
Dryer, Prof. J. A.	80		
Du Maurier Co.	93	R	
		R. B. Specialty Co.	69-82
E		R. C. A. Institute, Inc.	61
Ethyl Gasoline	10	Radio & Television Institute	3
Evans & Co., Victor J.	59	Radio Training Association of America	7
Excello Products Corp.	66	Randolph & Co.	56
		Roat & Lohman	82
F		Roll-O Specialty Co.	73
Federal School of Illustrating	94	Rosecliff Shirt Corp.	83
First Hawaiian Cons. of Music	93		
Fisher, Adam Mfg. Co.	58	S	
Franklin Institute	81	Sanitube Co.	88
Funk & Wagnalls Co.	95	Schiercke, H. C.	82
		School of Engineering of Milwaukee	80
G		See-Jay Battery Co.	88
Gerstner & Sons, H.	84	Smith & Smith Publishing Co.	70
Gilson Slide Rule Co.	82	Smith Typewriter Sales Corp.	64
Gottlieb, Edward	58	Spors & Co., F.	71
		Standard Business Training Inst.	83
H		Studebaker Corporation of America, The	9
High Frequency Laboratories	72	Superior Match Pants Co.	80
High School Home Study Bureau, Inc.	Back Cover		
Hinsdale Mfg. Co.	72	T	
Hobart Bros.	77-82	T. Garter Co., The	74
Holtan Co., Frank	87	Tamblin, F. W.	82
Hongman, A.	82	Tarbell System, Inc.	72
Hoodwin Co., Chas.	68-82	Teleplex Co.	82
		Thaxly Co., D.	69
I		Thomas, C. M.	89
Ideal Aeroplane & Supply Co.	74	Townsend Labs.	76
International Correspondence Schools	60-95	Triletty, M.	89
International Engineering Corp.	68		
International Typewriter Exchange	66	U	
Inventors Finance Corp.	56	U. S. School of Music	83
		Uron Associated Industries	85
J		Utilities Engineering Co.	74
Jowett Inst. of Physical Culture	74		
		V	
K		Vitrolite	62-63
Keeley Institute	89	Von Boeckmann, Paul	67
Kirk, W. J.	74		
		W	
L		Wagner, George Steve	74
Laboratory Materials Co.	76	Walker-Turner Co., Inc.	83
Lacey & Lacey	58	Wallace & Co., J. D.	76
		Weldon Mfg. Co.	82
		Whirlwind Mfg. Co.	96
		Wilson, George	75
		Woodworking Machinery Co.	68

(While every precaution is taken to insure accuracy, we cannot guarantee against the possibility of an occasional change or omission in the preparation of this index.)

The Gold Mine of Chemistry

By Alfred M. Caddell, *Financial Editor*

WE have heard a lot about this being an electrical age. It is. Electricity is fast remaking the world. But so also is chemistry.

During the last several years some enormous chemical industries have come into being. As an industrial group chemical concerns have no specific birthday. The science itself dates back to the remotest antiquity, but modern chemistry, as differentiated from the works of the alchemists, dates from the time of Lavoisier, about 1770. The World War period, however, ushered in the gigantic chemical combines, or at least nourished their growth into enormity, so that today we have industries capitalized at hundreds of millions of dollars, the equities of which are held by several million American and foreign stockholders. Truly, *via* stock ownership, no less than by the products of chemistry, each and everyone of us has become vitally and most favorably affected—chemistry is also remaking the world.

Let us look at a few of the outstanding chemical concerns whose equities are widely held by the public. Eastman Kodak, although thought of primarily as a camera concern, is the maker of film for the universally known kodak, for natural-color home motion-picture cameras, movie projectors, films, check-copying devices, educational film libraries, to say nothing of the chemicals used in developing and allied work. Since 1902, net profits have amounted to about \$365,000,000, of which \$260,000,000 has been disbursed in preferred and common dividends. Union Carbide & Carbon, makers of 116 different products ranging from electric light batteries to synthetic alcohol, is another giant in the chemical world. Air Reduction, producers of nitrates, etc., Allied Chemical, American Agricultural, American Cyanamid, Columbian Carbon, Commercial Solvents, Davison Chemical, Texas Gulf Sulphur, Tennessee Copper & Chemical, Corn Products, the great du Pont de Nemours companies and the innumerable industries founded on basic cellulose total tremendously in size and, what is more, an analysis of the whole chemical structure suggests that the present status, stupendous though it is, is really but the beginning. Indeed, chemistry bulks so largely on the immediate horizon that ten years from now it may look even bigger. It is transforming the automobiles we ride in, the clothes we wear, the houses we live in, the food we eat, to say nothing of our daily habits and modes of living.

Take a look at cellulose, for instance. If you are a girl and your thoughts run to silk stockings, dainty underthings, fancy hats and the innumerable dudads that enter into feminine life, think of the chemists who convert corn stalks, trees, straw and such like into "silk." Give paper a thought, too, and motion picture film carrying the likenesses of your favorite screen stars; and mosaics, statues, neckties, stockings, undies, laces, twine, sausage casings, Bakelite, artificial leather, lacquers, solvents, gum cotton, billiard balls, insulating board (which is fast displacing much lumber) and countless other things. All are chemical products.

Coal-tar products offer the basis for innumerable other phenomena. The great dye industries, the basis of all colorings in clothing, wall papers and such like, have their foundation in this branch of chemistry. The alcohols provide another basis, and so on throughout the whole list of enterprises.

Need we cite a few figures to drive home the import of the chemical industries? We'll look over some export figures only, which cover but a small part of the internal consumption of chemicals that go into the processes of manufacture.

In 1929 the exports of chemicals alone amounted to \$152,162,000. Pigments, paints and varnishes led with a total of \$29,199,000. Industrial chemicals were second with \$28,194,000; medicinals and pharmaceuticals third, with \$21,282,000, and fertilizers and materials fourth, with \$20,194,000. Export totals of other groups were: Coal-tar products, \$18,059,000; soap and toilet preparations, \$16,059,000; industrial chemical specialties, \$14,457,000. Imports run almost as big—methanol from Germany, cosmetics, powders, creams, soap ingredients, shellac, crude rubber from other parts of the world provide a cross-section of the great chemical picture that is constantly undergoing change and enlargement—now so large in fact, that economists throughout the world have attempted to encompass its bigness by pronouncing our era, the Chemical Age.

Questions and Answers

Conducted by Alfred M. Caddell

Information on securities will be furnished readers of "SCIENCE AND INVENTION" free of charge by mail and through these columns. A 2-cent stamped, self-addressed envelope should be included in your letter. Address your inquiries to the Financial Editor, Science and Invention, 381 Fourth Ave., New York City.

Question—Please give me some information on Baldwin Locomotive and tell me what you think of this stock. A. B. B., Toledo, Ohio.

Answer—This company is one of the two largest locomotive manufacturers in the United States; also owns some steel plants and other properties which add greatly to the company's assets. Funded debt consists of \$5,798,850 first 5s, due 1940. Capitalization consists of \$20,000,000 7% preferred and 800,000 shares of no par common. Earnings have been somewhat irregular. From 1921 to 1923 earnings on the old common (before the four-for-one split-up last year) averaged \$20.94 per share. In 1924, 1925 earnings did not cover preferred dividends, but, since then payments have been regular. In 1926 the net income amounted to \$22.42 per share; in 1927, \$5.21; in 1928, \$1.66. The rate on the new stock (800,000 shares no par common) is \$1.75 a share. The stock must be regarded as somewhat speculative.

Question—I bought twenty shares of Crocker-Wheeler at higher levels than the present market. Would you advise holding or selling? G. W. C., Pelham, N. Y.

Answer—It is impossible for anyone to accurately forecast the market regardless of their self-alleged ability, but a few facts might enlighten you upon the status of this stock. Earnings for the years ending Dec. 31, 1929, were \$1.75 a share as against 36 cents a share for 1928. The company is long established and manufactures generators, motors, transformers and other electrical apparatus. In Sept., 1929, the old stock was split ten-for-one and no dividends have been paid up to this writing on the new stock—in fact, nothing has been paid since April, 1925, although dividends were paid on the old \$100 par common from 1891 to that date. All arrears on the cumulative preferred from 1891—there were but two years' interruption—were paid up at the time of the capital split-up and the stock retired last November. It is my opinion that this stock represents a speculation, and at this writing it is not possible to stay what the outlook is.

Question—Is the \$5 dividend for American Safety Razor safe? Mrs. G. M. C., Topeka, Kansas.

Answer—I think it is safe to say that it is. This company is firmly entrenched in its field, ranking second among the safety razor companies. Company's business is rapidly expanding. The year 1929 was the best in the company's history, showing about 27% increase over previous year. This gain in net income would mean \$7 per share after all charges on the 200,000 shares outstanding. Sales are showing steady growth and the company is in a strong financial position, having more than \$3,000,000 in cash after having purchased 28,112 shares and retiring them from the market.



Col. Edw. V. Rickenbacker and a 30-passenger Fokker



This Spring get into

AVIATION!

EDDIE RICKENBACKER had the right idea! Twenty-five years ago he was just a boy working in a garage. He took the International Correspondence Schools Automobile Course—studied in spare time and learned the fundamentals of gasoline engines. That was the groundwork of his famous career—first as an automotive engineer and race driver—then as America's foremost ace in France—now as Vice-president of the great Fokker Aircraft Corporation.

Aviation holds the greatest future of any career a young man can choose today. Get into it now, by the shortest, most practical route—from the ground, as a mechanic. *Study engines!*

The new I. C. S. Course in Aviation Engines offers you a marvelous opportunity. You don't have to have experience or a large amount of capital. You don't have to give up your present job.

Find out today, without cost or obligation, just how this course will prepare you for a career. Mail the coupon now!

INTERNATIONAL CORRESPONDENCE SCHOOLS

Box 6216-F, Scranton, Penna.

"The Universal University"

Without cost or obligation on my part, tell me how I can qualify for the position or in the subject before which I have marked an X:

AVIATION ENGINES

- | | |
|--|--|
| <input type="checkbox"/> Complete Automobile Course | <input type="checkbox"/> Gas Engine Operating Course |
| <input type="checkbox"/> Automobile Electric Equipment | <input type="checkbox"/> Complete Gas Engine Course |
| <input type="checkbox"/> Electrical Engineering | <input type="checkbox"/> Architect |
| <input type="checkbox"/> Electric Lighting | <input type="checkbox"/> Architects' Blueprints |
| <input type="checkbox"/> Mechanical Engineering | <input type="checkbox"/> Contractor and Builder |
| <input type="checkbox"/> Mechanical Draftsman | <input type="checkbox"/> Architectural Draftsman |
| <input type="checkbox"/> Machine Shop Practice | <input type="checkbox"/> Concrete Builder |
| <input type="checkbox"/> Railroad Positions | <input type="checkbox"/> Structural Engineer |
| <input type="checkbox"/> Civil Engineer | <input type="checkbox"/> Pharmacy |
| <input type="checkbox"/> Mining | <input type="checkbox"/> Chemistry |
| <input type="checkbox"/> Surveying and Mapping | <input type="checkbox"/> Agriculture |
| <input type="checkbox"/> Plumbing and Heating | <input type="checkbox"/> Navigation |
| <input type="checkbox"/> Steam Engineering | <input type="checkbox"/> Mathematics |
| | <input type="checkbox"/> Radio |

BUSINESS TRAINING COURSES

- | | |
|---|---|
| <input type="checkbox"/> Business Management | <input type="checkbox"/> Advertising |
| <input type="checkbox"/> Industrial Management | <input type="checkbox"/> Business Correspondence |
| <input type="checkbox"/> Personnel Management | <input type="checkbox"/> Show Card and Sign Lettering |
| <input type="checkbox"/> Traffic Management | <input type="checkbox"/> Stenography and Typing |
| <input type="checkbox"/> Accounting and C. P. A. Coaching | <input type="checkbox"/> English |
| <input type="checkbox"/> Cost Accounting | <input type="checkbox"/> Railway Mail Clerk |
| <input type="checkbox"/> Bookkeeping | <input type="checkbox"/> Common School Subjects |
| <input type="checkbox"/> Secretarial Work | <input type="checkbox"/> High School Subjects |
| <input type="checkbox"/> Salesmanship | <input type="checkbox"/> Illustrating |
| <input type="checkbox"/> Spanish | <input type="checkbox"/> French |
| | <input type="checkbox"/> Cartooning |

Name.....

Street Address.....

City..... State.....

Occupation.....

If you reside in Canada, send this coupon to the International Correspondence Schools Canadian, Ltd., Montreal

HOW TO BECOME A MASTER OF ENGLISH

is a valuable FREE booklet which proves that the Kleiser Mail Course in Practical English and Mental Efficiency will teach you to Write Stories that Sell—Literature that will Compel Attention. It will show you how to Enlarge your stock of Words—Use the Right Word in the Right Place—Prepare Sermons, Addresses, Advertisements, Letters, etc.

BOOTH TARKINGTON

Distinguished Novelist:
Your Course is almost painfully needed by many professional writers and speakers. A student who intelligently follows your Course will know what he is talking about when he talks or when he writes.

FUNK & WAGNALLS COMPANY
Dept. 1287
New York, N. Y.

Over the Mountains from Los Angeles

559 Miles
on

11

Gallons of GAS

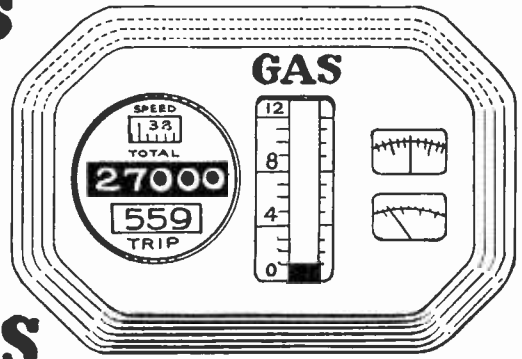
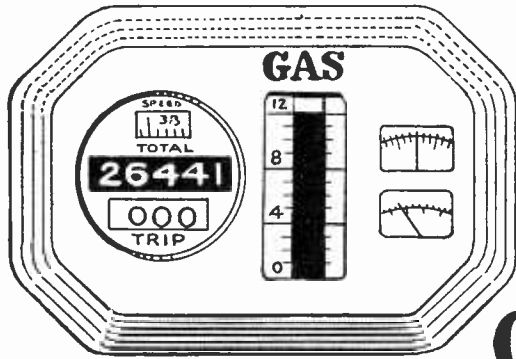

Think of it! FIVE HUNDRED FIFTY-NINE MILES over rough mountainous country burning only ELEVEN GALLONS OF GASOLINE. Imagine more than FIFTY MILES to the GALLON. This is what the WHIRLWIND CARBURETING DEVICE does for D. R. Gilbert, enough of a saving on just one trip to more than pay the cost of the Whirlwind.

THE WHIRLWIND SAVES MOTORISTS MILLIONS OF DOLLARS YEARLY

Whirlwind users, reporting the results of their tests, are amazed at the results they are getting. Letters keep streaming into the office telling of mileages all the way from 22 to 59 miles on a gallon, resulting in a saving of from 25 to 50% in gas bills alone.

Mark H. Estes writes: "I was making 17 miles to the gallon on my Pontiac Coupe. Today, with the Whirlwind, I am making 35 5/10 miles to the gallon. Am I glad I put it on? I'll say so!"

P. P. Goerzen writes: "I made an actual test both with and without a Whirlwind, getting 13 1/2 miles without and 34 6/10 miles with the Whirlwind, or a gain of 21 miles to the gallon. The longer the Whirlwind is in use on the machine, the better the engine runs, has more pep and quicker starting. It makes a new engine out of an old one, and starts at the touch of the starter button."

R. J. Tulp: "The Whirlwind increased the mileage on our Ford truck from 12 to 26 miles to gallon and 25% in speed. We placed another on a Willy's Knight, and increased from 12 to 17 miles per gallon.

Arthur Grant: "I have an Oakland touring car that has been giving me 15 miles to the gallon average, but I can see a great difference with the Whirlwind, as it climbs the big hills on high and gives me better than 23 miles to the gallon of gas, which is better than 50% saving in gas."

W. A. Scott: "I had my Whirlwind for three years. Winter and summer it gives the same perfect service, instant starting, smoother running, and what I saved in gasoline these last few years has brought other luxuries which I could not have afforded previously."

Car owners all over the world are saving money every day with the Whirlwind, besides having better operating motors. Think what this means on your own car. Figure up your savings—enough for a radio—a bank account—added pleasures. Why let the Oil Companies profit by your waste. Find out about this amazing little device that will pay for itself every few weeks in gas saving alone.

FITS ALL CARS

In just a few minutes the Whirlwind can be installed on any make of car, truck, or tractor. It's actually less work than changing your oil, or putting water in the battery. No drilling, tapping or changes of any kind necessary. It is guaranteed to work perfectly on any make of car, truck or tractor, large or small, new model or old model. The more you drive the more you will save.

SALESMEN AND DISTRIBUTORS WANTED

Free Sample and \$100.00 a Week Offer

Whirlwind men are making big profits supplying this fast-selling device that car owners cannot afford to be without. Good territory is still open. Free sample offer and full particulars sent on request. Just check the coupon.

WHIRLWIND MANUFACTURING CO.

999-232-A Third Street Milwaukee, Wisc.

GUARANTEE

No matter what kind of a car you have—no matter how big a gas eater it is—the Whirlwind will save you money. We absolutely guarantee that the Whirlwind will more than save its cost in gasoline alone within thirty days, or the trial will cost you nothing. We invite you to test it at our risk and expense. You are to be the sole judge.

FREE TRIAL COUPON

WHIRLWIND MANUFACTURING CO.
999-232-A Third Street, Milwaukee, Wisc.

Gentlemen: You may send me full particulars of your Whirlwind Carbureting device and free trial offer. This does not obligate me in any way whatever.

Name

Address

City

County State

Check here if you are interested in full or part time salesmen position.

WHAT EVERY ELECTRICIAN WANTS TO KNOW!

JUST OUT!—Latest Exact Information from A to Z!

We take pleasure in announcing: "AUDELS NEW ELECTRIC LIBRARY"

New and More Uses for Electricity offer great opportunities to men who can handle this power correctly. Modern electrification of industry calls for trained men who know how to handle electricity accurately.

Simple as A. B. C.—"Audels New Electric Library" gives latest, exact information from foundations of electrical practice to latest modern applications. This is a NEW practical and theoretical course in electricity for home study and ready reference.

Here are the answers to your questions, giving you the real dope that every electrician must know. They chart your knowledge, taking away the uncertainty of guess work.

NEW!

As Easy As ABC



Latest information, fully illustrated, covering:—

Fundamental Principles and Rules of Electricity, Magnetism, Armature Winding, Repairs, Dynamos, D-C Motors, Construction, Installation, Maintenance and Trouble Shooting, Tests and Testing Instruments, Storage Battery, Construction and Repairs, Alternating Current Principles and Diagrams, Power Factor, Alternators, Transformers, A-C Motors, Windings, Reconnecting, Converters, Switches & Fuses, Circuit Breakers, Relays, Condensers, Regulators, Rectifiers, Meters, Switchboards, Power Station Practice, House Light & Power Wiring, Circuits, High Tension, Transmission, Plans, Calculations, Code, Electric Railways, Signals, Elevators, Hoists & Cranes, Gas Engines, Auto & Aero Ignition, Starters, Radio, Telephone, Telegraph, Bells & Signals, Motion Pictures, Talkies, Lighting, Illumination, Electric Refrigeration, Heating, X-Ray, Plating, Welding, Pumps, Compressors, Domestic & Farm Appliances, An Electric Calculator for Engineers and Mechanics, Practical Mathematics for Ready Reference, A New Electric Dictionary & Encyclopedia of Words.

7 Books Now on Sale 5 in Preparation

The Library contains 12 books—the first 7 books containing 3600 pages with thousands of diagrams and illustrations are now ready; the remaining 5 books are in preparation. A pocket-size, flexibly bound series that is valuable wherever electricity is used.

Beautiful, timely books for service—pocket size; completely illustrated with diagrams and charts; simplified, easy to read and understand. No electrical man can afford to pass up this opportunity. Extremely low price; buy on your own terms.

BUY ON YOUR OWN TERMS

- PLAN 1—ONE BOOK A MONTH**
Please enter my subscription to "Audels New Electric Library" (consist of twelve volumes, price \$1.50 a volume (\$10.50 for the seven volumes now ready). Mail one volume each month and as they are received, I will mail you \$1.50 promptly.
- PLAN 2—PAY 50c OR MORE A WEEK**
Please ship me for one week's free trial the first seven volumes of "Audels New Electric Library," \$1.50 each (\$10.50 for the seven volumes now ready). The remaining five volumes to be mailed as issued at \$1.50 a volume. If satisfied, I will mail you 50c or more each week as payment for the first seven books and I will pay for the last five numbers as I receive them at \$1.50 each.
- PLAN 3—CASH PRICE \$9.98**
Please ship me postpaid "Audels New Electric Library" for which I enclose remittance \$9.98 in full payment for the seven volumes now ready. You are to ship me on one week's trial the remaining five volumes as they are issued for which I will either pay \$1.50 each as received or return to you. This price is based on 5% cash discount.

THEO. AUDEL & CO.,
65 West 23rd St., New York, N. Y.

Please ship me the NEW "Audels Electric Library" on the plan marked (X).

NAME

ADDRESS

OCCUPATION

EMPLOYED BY S. I. May

Beautiful, Timely Books



Read for Profit

QUESTIONS AND ANSWERS
AUDELS NEW ELECTRIC LIBRARY ILLUSTRATED

NEW!

SATISFACTION GUARANTEED!
"Audels New Electric Library" is backed by our 50-year record as helping hand publishers. Satisfaction always guaranteed.

Here is YOUR High School Education!



Let these fifteen books fill your spare time with pleasure and entertainment as they prepare you easily and quickly in your own home for bigger pay, broader culture, and both social and business success.

DID you miss your chance to go to high school? You need no longer be handicapped! Now you can have your high school education—in your spare time at home. An amazingly easy, new plan has been developed as simple as a-b-c, as fascinating as a game! No tedious study—no laborious lessons! Just a few minutes of pleasant reading a day. Every high school subject is covered in the most entertaining and effective way—**By Questions and Answers.**

In little time, with little effort, you can acquire the equivalent of a **FOUR-YEAR High School Training**—a training fulfilling the requirements of the State Board of Regents and the College Entrance Examination Board.

The Surest Way to Earn More Money

Without a high school education you cannot hope to get far in life. The better positions, the bigger salaries, are barred from you. Why chain yourself to a low-pay, blind-alley job, when a few minutes of pleasant reading a day will open the door to **BIG** opportunities?

A high school education is the surest way to increase your earning power. It gives you culture, enables you to meet and know educated, worth-while people.

How often have you said, "I wish I had gone to high school"? Now your wish is answered. Now, with less effort than you ever thought possible, you can learn every subject taught in high school—learn it just as it is taught in the classroom by the

question and answer method. These fifteen handy volumes, the famous "Blue Books," quickly give you a command of English, History, Literature, and all the other subjects every educated person should know.

12,000 High School Teachers Use These Books

Principals, teachers, and students the country over recognize the merit of these practical books—use them in their school work. Students preparing for college entrance find them invaluable.

Each book covers one subject—boiled down, presented in a delightfully easy series of questions and answers. This is the oldest teaching method known—and recognized today as the most effective. It is the simplest, most interesting, liveliest way to acquire knowledge.

With these fifteen books in your hands, you have at your command fifteen expert instructors, each one teaching you in your own home exactly as if you were attending a modern million-dollar high school. Approximately 625 days' attendance, or 3,840 hours, required for a four-year high school diploma, are condensed into these compact, convenient, comprehensive volumes. You save time and money.

Certificate Awarded

By answering the examination questions that supplement these books, you can qualify for a High School Certificate. This Certificate stamps you as an educated man or woman. It is invaluable to you in applying for a position or gaining advancement with your present firm.

Greatest Bargain in Brain Power Ever Offered!

Never before has there been such a bargain in education. Never before has it been possible to obtain a high school educa-

Can YOU Answer These Questions?

Who was Marie Antoinette?
How can a man be elected President though he receives a million votes less than his opponent?
Why is the sky blue?
Is this sentence correct? *He doesn't feel good.*
Who was Homer?
By what rule of economics does Charlie Chaplin earn more money than ex-President Coolidge?
Who said, "Give me liberty or give me death"?
Which freezes quickest—water, mercury, alcohol?
Do fish sleep?
What is a pentameter?
Who wrote *Virginius Puerisque*?
What nation first divided time into months, weeks, hours, minutes and seconds?
Where was the Pantheon?
Why is glass transparent?

tion in so easy and rapid a way, and at so little cost. The price of these fifteen handy volumes, embracing a complete high school education, is actually less than you probably fritter away in spending money in a couple of weeks. By taking advantage of this sensational offer, your high school education costs you a total of only \$19.85, payable on easy monthly terms.

FREE EXAMINATION Send No Money

Before you pay a penny, see for yourself how easy it is to acquire high school training this new, easy way. The coupon will bring you the fifteen famous Blue Books to examine free. Keep them and enjoy them for 5 days. Then decide. You take absolutely no risk; you assume no obligation by mailing the coupon. You miss a wonderful opportunity by NOT doing so. Tear it off now, before you turn the page.

HIGH SCHOOL HOME STUDY BUREAU
Dept. 3795
31 Union Square
New York City

- Subjects Covered**
- Biology
 - Civics
 - Ancient History
 - American History
 - Arithmetic
 - Elementary Algebra
 - Physics
 - Geography
 - Physiography
 - Modern History
 - Literature
 - Economics
 - Latin
 - English Grammar
 - Spelling

High School Home Study Bureau
Dept. 3795, 31 Union Square, New York City

Gentlemen: You may send me, for **FREE EXAMINATION**, the 15 famous Blue Books, containing the equivalent of a four-year High School Education. Within 5 days I will either return the books or remit \$3.85 as first payment and then \$4 a month for four months, a total of \$19.85.

Name

Address

Town State