

Electronic Design[®] 8

VOL. 24 NO.

FOR ENGINEERS AND ENGINEERING MANAGERS

APRIL 12, 1976

Today's world of communications contains an incredible variety of hardware, ranging from the simple tin-can telephone to the latest μ P-controlled data-transmission

system. Areas of major progress include optical communications, packaged microwave oscillators, microwave test equipment and active components. See p. 40.



**A
LOT
MORE
FOR A
LITTLE
LESS**



BOURNS®
NEW

SINGLE-TURN CERMET TRIMMER

- VASTLY IMPROVED ADJUSTABILITY
- TWELVE TERMINAL STYLES
- SEALED FOR WAVE SOLDERING

45¢

in quantities of 5000 per individual resistance



Meet Bourns new Model 3386, a product that both buyer and engineer can love . . . with super adjustability that makes for easy, accurate trimming, AND at a budget balancing price. Most importantly, it's a BOURNS product . . . and that means QUALITY and PERFORMANCE you can believe-in, and SERVICE you can depend-on.

SIGNIFICANT SPECIFICATIONS

- typical CRV less than 1% • infinite resolution • TC of $\pm 100\text{PPM}/^\circ\text{C}$ to 200K ohms • power of .5 watt at 85°C • thin $\frac{3}{8}$ " square size



For complete details, contact your local Bourns representative or distributor, or the factory direct.



TRIMPOT PRODUCTS DIVISION • 1200 COLUMBIA AVE., RIVERSIDE, CALIF. 92507

CIRCLE NUMBER 246

Are you using your \$20,000 mainframe set-up wisely? If you're using it to sweep anywhere in the 1 MHz to 1.4 GHz range, then you know it's only doing a fraction of the job you bought it for.

But think about this: if you used a Wavetek Model 2001 Sweep/Signal Generator instead of a plug-in to work below S-Band, your mainframe would be free for other high frequency testing at the same time.

Besides its range of 1 MHz to 1.4 GHz,

the Model 2001 has an output of 10mW that's flat to within 0.5dB. This solid-state designed unit features excellent linearity and low spurious content. Plus, the 2001 is programmable — with remote control of center frequency, bandwidth and output level over the 20dB range of its PIN diode attenuator. Not to mention its start/stop mode of operation, (in addition to Δf), or its flexible birdy by-pass marker system.



Now let's get down to prices. An equivalent low-frequency sweep plug-in will run you at least \$2,200. And it'll tie up your mainframe while you're using it.

On the other hand, you can get a Model 2001 for just \$1,850*. And untie your mainframe at the same time. It's like having your cake and eating it, too. WAVETEK Indiana, Inc. P.O. Box 190, Beech Grove, Indiana 46107. Phone (317) 783-3221. TWX 810-341-3226.

*US domestic price only

WAVETEK®

CIRCLE NUMBER 2

Don't tie up your microwave mainframe.



The only Double-Balanced Mixers with a 2-YEAR GUARANTEE*

featuring Hi-Rel tested diodes-

still only

\$7.95

(500 pieces)

\$9.95 (1-49)

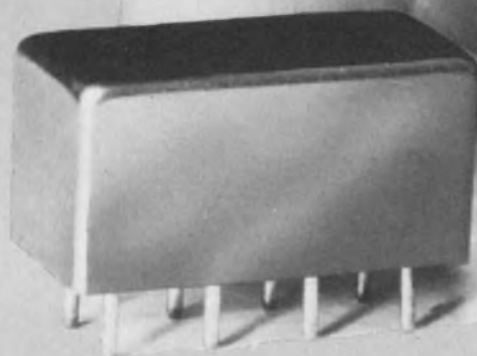

*including diodes!

Yes, a two-year guarantee for DBM's is now a reality . . . made possible by an accelerated-life diode screening program adopted at Mini-Circuits.

Each Schottky diode used in Mini-Circuits' SRA-1 mixers is now preconditioned by the HTRB (High Temperature Reverse Bias) technique, previously reserved almost exclusively for semiconductors assigned to space applications. With HTRB testing, each diode is operated for 168 hours at 150°C with one volt reverse bias applied.

To screen out "infant mortality", the diodes are deliberately stressed to accelerate aging and to force time-related failure modes to take their toll. In conventional testing or "baking", the diode does not experience anywhere near the stress encountered with the HTRB program. Hence, the ability at Mini-Circuits' to locate the potentially-unreliable diodes before they are assembled into SRA-1 units. And, with double-balanced mixers, the overall reliability hinges almost entirely on the diodes used.

Yes, the HTRB procedure costs us more and screens out more devices. But our goal is to improve reliability to a level unmatched for off-the-shelf DBM's at no increase in cost to our customers. You — our customers by your overwhelming confidence in our product line have made us the number one supplier of DBM's in the world.

To earn your continuing support, we are now employing HTRB Hi-Rel testing for every diode used in the SRA-1, at no increase in cost to you. So, for the same low price of \$7.95, you can purchase our SRA-1, with a two-year guarantee, including diodes.

To ensure highest system reliability demand highest quality diodes on your source-control drawings and purchase orders. Specify SRA-1 mixers, with HTRB tested diodes from Mini-Circuits'... where low price now goes hand-in-hand with unmatched quality.

MODEL SRA-1

Freq. range (MHz) LO - 0.5-500 RF 0.5-500 IF dc 500

Conversion loss (dB)	Typ	Max.
One octave from band edge	5.5	7.5
Total range	6.5	8.5
Isolation (dB)	Typ	Min.
Lower band edge to one decade higher	LO-RF 50	35
Mid range	LO-RF 45	30
	LO-RF 45	30
	LO-IF 40	25
Upper band edge to one octave lower	LO-RF 35	25
	LO-IF 30	20

Min. Electronic attenuation (20 mA) 3 dB

Signal, 1 dB compression level + 1 dBm

Impedance all ports 50 ohms



Mini-Circuits Laboratory

A Division Scientific Components Corp

International Representatives: AUSTRALIA General Electronics Services, 99 Alexander Street, New South Wales, Australia 2065 ENGLAND Dale Electronics, Dale House, Wharf Road, Frimley Green, Camberley Surrey; FRANCE S. C. I. E. D. I. M. E. S., 31 Rue George Sand, 91120 Palaiseau, France GERMANY, AUSTRIA, SWITZERLAND Industrial Electronics GMBH, Klüberstrasse 14, 6000 Frankfurt/Main, Germany ISRAEL Vectorics, Ltd., 69 Gordon Street, Tel Aviv, Israel JAPAN Densho Kaisha, Ltd. Eguchi Building, 8-1-1 Chome Hamamatsucho Minato-ku, Tokyo EASTERN CANADA B. D. Hummel, 2224 Maynard Avenue, Utica, NY 13502 (315) 736 7821; NETHERLANDS, BELGIUM, LUXEMBOURG Coimez, Veldweg 11, Haltem, Holland NORWAY Datamatik AS, Ostensjoveien 62, Oslo 6 Norway

US DISTRIBUTORS: NORTHERN CALIFORNIA Cain White & Co., Foothill Office Center, 105 Fremont Avenue, Los Altos, CA 94022 (415) 948 6533; SOUTHERN CALIFORNIA, ARIZONA Crown Electronics, 11440 Collins Street, No. Hollywood, CA 91601 (213) 877 3550

For complete product specifications and U.S. Rep. listing see MicroWaves "Product Data Directory," Electronic Designs "Gold Book" or Electronic Engineers Master "EEM"

837-843 Utica Avenue, Brooklyn, NY 11203

(212) 342-2500 Int'l Telex 620156

Domestic Telex 125460

NEWS

- 19 **News Scope**
- 25 **Washington Report**
- 40 **Communications '76 special issue**, featuring major trends in communications technology. Topics covered include new developments in transmitting data and telephone information via fiber optics, improvements in digital and analog communication devices; the increasing use of microprocessors in voice and data networks; the trend to more automatic and smarter radio-frequency and microwave test equipment; the latest design advances in packaged microwave-oscillators; a profile of Harold Wheeler, an innovator in the world of communications.

TECHNOLOGY

- 31 **MICROPROCESSOR DESIGN**
- 90 **Use optical fibers for long-range data communications.** They provide interference-free operation and better performance than coaxial cables.
- 98 **Design transistor oscillators** with either bipolar or field-effect devices using admittance data. Here are some circuits and design equations.
- 104 **Select mixer frequencies painlessly.** With a simple, graphical method, you can sidestep long trial-and-error sessions and determine bandwidth, too.
- 112 **Annual Index**
- 122 **Ideas for Design:**
Circuit detects incoming data to turn on teletypewriter.
A digital high/low-pass filter features voltage-adjustable cut-off points.
Digital circuit detects frequency-modulated signals.

PRODUCTS

- 131 **Integrated Circuits:** Impedance converters buffer signals without loading.
- | | |
|-----------------------------|-------------------------|
| 136 Discrete Semiconductors | 152 Microwaves & Lasers |
| 140 Packaging & Materials | 155 Components |
| 146 Power Sources | 164 Instrumentation |
| 148 Modules & Subassemblies | 170 Data Processing |

DEPARTMENTS

- | | |
|--------------------------|--------------------------------|
| 87 Editorial: Sin | |
| 7 Across the Desk | 184 Vendors Report |
| 178 Application Notes | 190 Advertisers' Index |
| 178 Evaluation Samples | 192 Product Index |
| 180 New Literature | 192 Information Retrieval Card |
| 183 Bulletin Board | |

Cover: Photo by Art Director Bill Kelly. Models Paul and Billy courtesy of Mrs. Kelly.

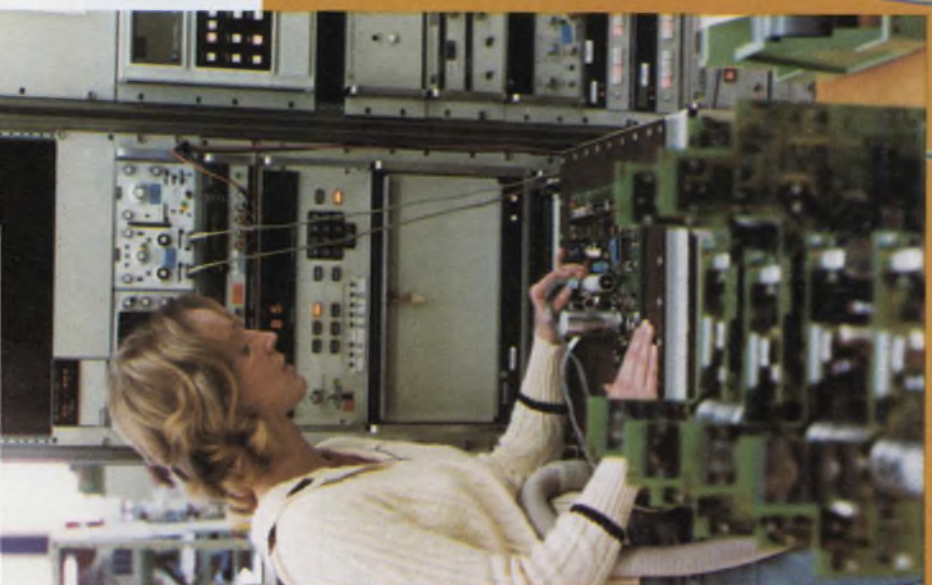
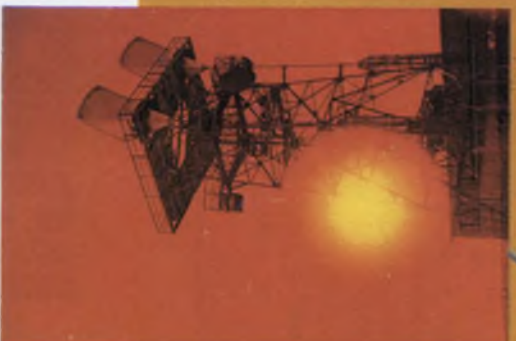

Automate your instruments.

Our new computing controllers make the connection friendly.

The new HP 9815 and HP 9825 computing controllers make interfacing practical and inexpensive. If you haven't automated your instruments yet, hook them up to one of these HP controllers and upgrade your system's performance. You'll get results and reports faster and easier. Increase your system's throughput. Control variables in real-time. Free yourself from manual readings, adjustments, and calculations.

No matter what your interfacing requirements are—simple data logging, dedicated instrument control, data communications or large-system integration—you'll find these controllers can save you time and money while increasing your productivity.

Interface cards and simplified programming make interfacing easy.

You can choose from the commonly used interfaces—BCD, bit-parallel/byte-serial, RS-232C, or HP-IB (the inter-

face bus that conforms to IEEE Standard 488-1975). You simply connect your instrument or black box to the cable of the appropriate HP interface card and plug the card into the controller. Then, using simple high-level commands, you program the computing controller to monitor and control your instruments and analyze the data. You don't have to hire a computer programmer to set up and use an automated instrumentation system. That's the friendly, direct approach to interfacing.

The HP 9825: unexpected power for systems control

Though the 9825 retains the friendliness and programming simplicity of a calculator, it has the power and performance of a minicomputer. Features

like vectored priority interrupt, buffered I/O, live keyboard, and direct memory access allow it to do several interfacing jobs simultaneously: transferring data and commands, accepting inputs, analyzing data and printing or plotting results. And the 9825 can run application programs and solve keyboard calculations at the same time. Using HP-IB, it can control as many as 42 instruments and peripherals at once. That's big system performance.

Let an HP 9815 supervise your instrument.

The 9815 at a base price of \$2,900* (I/O option and interface cards/cables extra), is the inexpensive alternative to manual monitoring of an instrument or small system. It can even run control appli-

cations unattended. And it can handle a variety of sophisticated computations as well. Truly, the 9815 provides a lot of performance for the price.

Improve your system and become more productive, too.

No matter what kinds of instruments you use—scanners, counters, spectrometers, meters, converters, chromatographs or your own black box—an HP computing controller can help you utilize them and their outputs more effectively. And in the process, free you for more productive, creative work.

We have a brochure that details the features and techniques of simplified interfacing using HP computing controllers. Call your local HP representative for your copy, or circle our number on this publication's reader service card.

*Domestic U.S.A. price only

HP computing calculators put the power where the problems are.



Sales and service from 172 offices in 65 countries
P.O. Box 301, Loveland, Colorado 80537

CIRCLE NUMBER 4



Thin-Trim[®] capacitors

Tucked in the corner of this Pulsar Watch is a miniature capacitor which is used to trim the crystal. This Thin-Trim capacitor is one of our 9410 series, has an adjustable range of 7 to 45 pf, and is .200" x .200" x .050" thick.

The Thin-Trim concept provides a variable device to replace fixed tuning techniques and cut-and-try methods of adjustment. Thin-Trim capacitors are available in a variety of lead configurations making them easy to mount.

A smaller version of the 9410 is the 9402 series with a maximum capacitance value of 25 pf. These are perfect for applications in sub-miniature circuits such as ladies' electronic wrist watches and phased array MIC's.

Johanson

Johanson Manufacturing Corporation
Rockaway Valley Road
Boonton, New Jersey 07005
(201) 334-2676 TWX 710-987-8367

Sr. Vice President, Publisher
Peter Coley

Editors

Editorial Offices
50 Essex St.
Rochelle Park, NJ 07662
(201) 843-0550
TWX: 710-990-5071
Cable: Haydenpubs Rochellepark

Editor-in-Chief George Rostky

Managing Editors:

Ralph Dobriner
Michael Elphick

Associate Editors:

Dave Bursky
Samuel Derman
Morris Grossman
John F. Mason
Stanley Runyon
Michael Shunfenthal
Edward A. Torrero

Contributing Editors:

Peter N. Budzilovich, John Kessler
Alberto Socolovsky, Nathan Sussman

Editorial Field Offices

East

Jim McDermott, Eastern Editor
P.O. Box 272
Easthampton, MA 01027
(413) 527-3632

West

David N. Kaye, Senior Western Editor
8939 S. Sepulveda Blvd., Suite 510
Los Angeles, CA 90045
(213) 641-6544
TWX: 1-910-328-7240

Jim Gold, Western Editor
1454 Burrell Court
San Jose, CA 95126
(408) 246-6094

Editorial Production

Marjorie A. Duffy, Production Editor
Tom Collins, Copy Editor

Art

Art Director, William Kelly
Richard Luce, Anthony J. Fischetto

Production

Manager, Dollie S. Viebig
Helen De Polo, Anne Molfetas

Circulation

Manager, Barbara Freundlich
Trish Edelman, Gene M. Corrado

Information Retrieval

Peggy Long

Advertising Promotion

Paul K. Hogue

Promotion, Creative Layouts

Manager, Albert B. Stempel
Maxine Correal, Nancy Gordon

Across the Desk

A sad spoof of PC artwork

I will start by saying that I enjoyed the laughs I got from Donald P. Dattilo's article, "Improve Your PC Artwork Techniques" (ED No. 25, Dec. 6, 1975, p. 72). My first comment is a generality: the article is of little technical value to a PC designer.

I am a supervisor of a PC design group for a company that manufactures batch terminals. About 90 percent of our boards are done at 4:1 because of registration problems at 2:1. We do not use paper for a grid because of its poor stability. We use a ghost grid that is printed on Mylar, and which drops out when the artwork is reduced. We never measure components for size because of variations among vendors. A company spec or data sheet that indicates largest size should be used.

I would question the ability of a designer if he constantly used cut-outs or designated leads on transistors. The use of jumpers is costly and should be avoided.

All slashes, cuts and pinholes tend to catch and hold dust and dirt, which will photograph as a line or spot. Therefore, avoid marring the Mylar in any way.

The 0.062-in. minimum UL spacing is for high voltages. Putting tape in your mouth is poor taste, but it fits in with breaking off your Exacto blade to lift the stick-ons; waiting for your ballpoint pen to run dry so you can apply transfer lettering; sloshing down the artwork with lacquer thinner; using the flip method for registration (that has to be a flop); or spraying the artwork with Krylon. (Was that before or after the talcum powder dusting?)

Oh well, tape your reds and blues

on opposite sides and keep your jumper straight.

Roger Anderson

592 Lincoln
Saint Paul, MN 55102

The author replies

I must honestly state that I enjoyed your satire. Your thoughts do show some degree of creativity.

But I am sorry to hear that your people are having problems with artwork done at a 2:1 scale. Maybe they should use a red/blue tape method to reduce their errors. All registration errors are eliminated with red/blue taping. Your comment on the use of a paper grid is correct; paper does have poor stability. Critical applications should make use of grids fused into temperature-stable glass.

The fact that you never measure components to obtain size information indicates a closed mind. Manufacturers' specifications have been known to be wrong.

I suggest re-reading the article without such a superior attitude; if you take the time to try some of the techniques described you might learn something new.

Donald P. Dattilo
President

Dattilo Enterprises, Inc.
9405 Doral Ct.
Louisville, KY 40220

More bits might be less good than less bits

The quote attributed to Dr. Gary Nelson ("If you're doing a job that requires 16 bits of precision for the computation, then, of course, that eliminates all the 8-bit processors.") in the February 2 issue (ED No. 3, p. 44)

(continued on page 14)

The smallest*



re-lampable indicators are



Illuminated Products' QT Series incandescent, neon, and LED indicators

- Long-life reliability
- Simplified press-in panel mounting
- All popular lens colors and styles
- Distributor on-shelf availability now

*Actual size shown

Lighten your decisions
contact...

ILLUMINATED PRODUCTS INC.

A subsidiary of OAK Industries Inc.

2620 South Susan St., P.O. Box 11930
Santa Ana, California 92711
Tel: (714) 540-9471 • TWX 910-595-1504



COMPONENTS GROUP

CIRCLE NUMBER 6

Electronic Design welcomes the opinions of its readers on the issues raised in the magazine's editorial columns. Address letters to Managing Editor, Electronic Design, 50 Essex St. Rochelle Park, N.J. 07662. Try to keep letters under 200 words. Letters must be signed. Names will be withheld on request.

DAIK

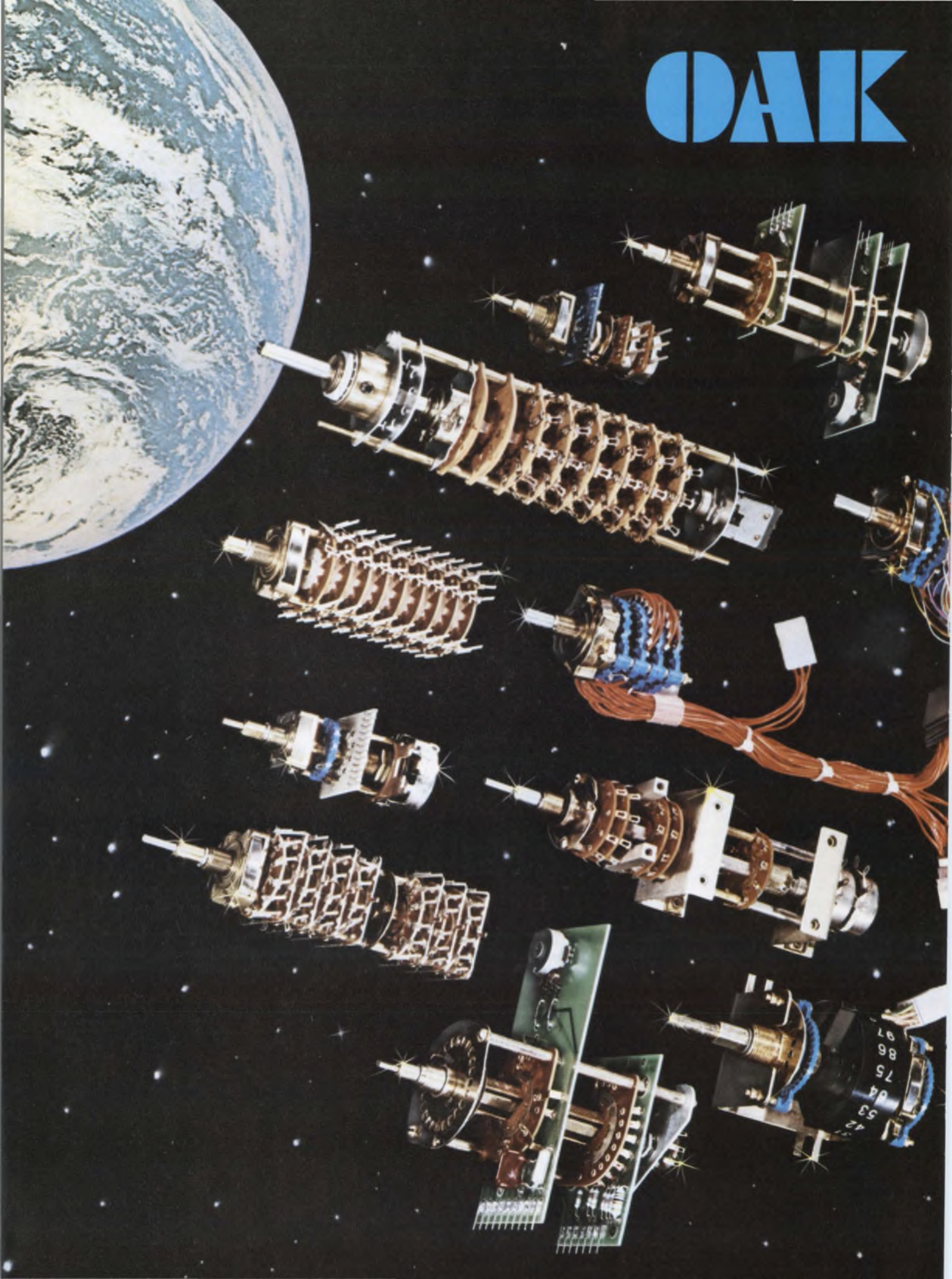

does more than provide the industry's most complete line of rotary switches

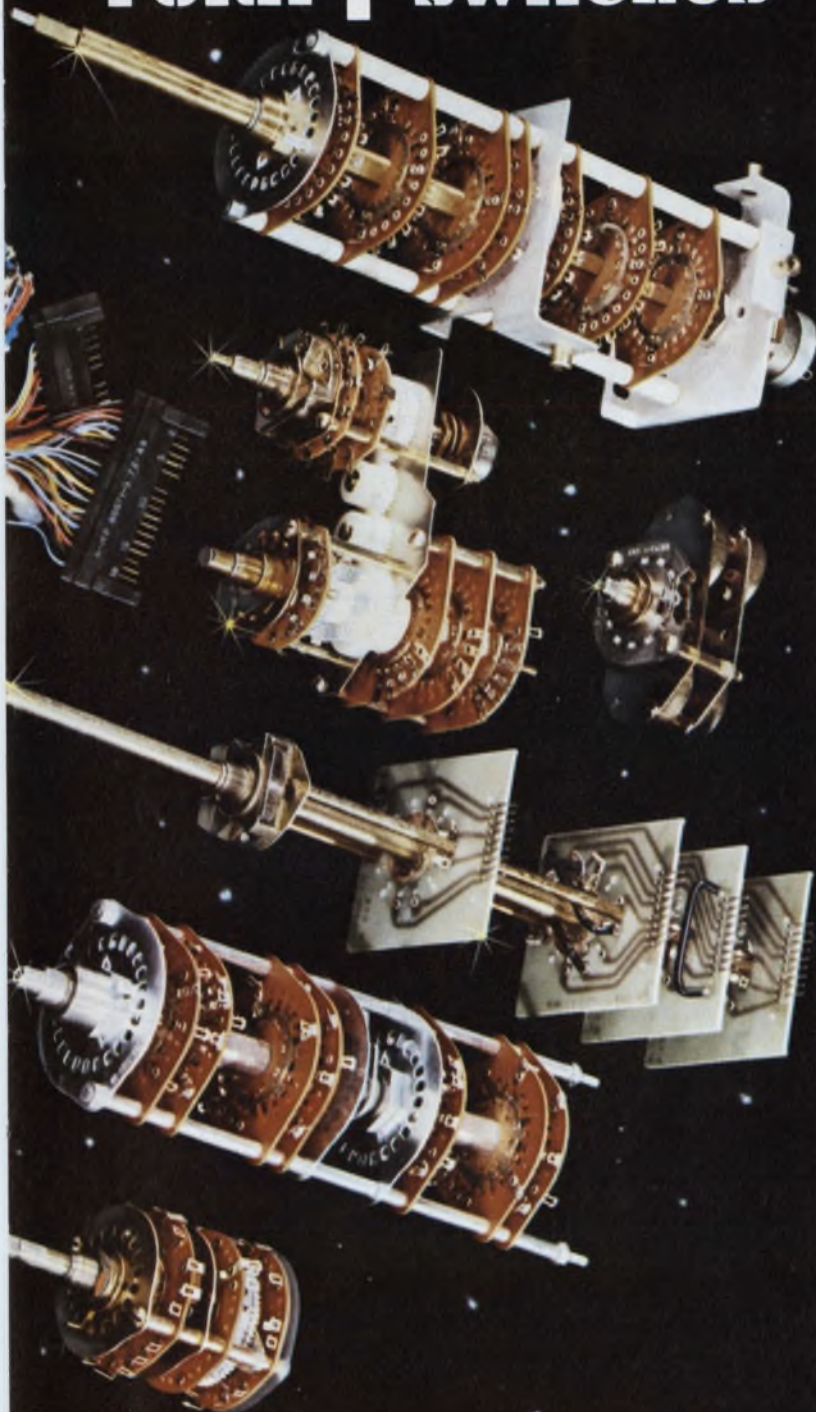

Supplying any rotary switch—from the simplest single wafer to complex multiple section types isn't enough.

We will build our switches into almost any mechanical or printed circuit sub-assembly that you specify—with parts fabrication and special testing performed in-house.

Oak has internal metal-working facilities for all metal-forming, machining and attachment operations. Of course, we'll incorporate and/or terminate any components that are required—either supplied by you or purchased by us.

Some typical examples are described below. If your requirements are not represented, call us toll-free—(800) 435-6106—or provide prints—for a prompt quotation.



1. Combination push-button/rotary switch. Rotation can occur only after shaft is pushed in to activate push-button. Special hardware designed and built by Oak.

2. PC Board assembly with Unidex detent concentric shaft and PC switch section, with two variable resistors controlled from center shaft.

3. Test equipment assembly, combining phenolic switch sections, resistors and capacitors attached to PC boards, with concentric shafts, brackets and potentiometer.

4. Nine section Unidex switch with PC terminals at opposite sides for attachment to parallel PC boards.

5. Connector and harness assembly attached to four section, 24 position Multidex switch.

6. Five section Multidex switch wired and terminated with customer supplied connectors.

7. Triple concentric shaft with dual detent, with potentiometer on inner shaft, rear bank of 3 sections on center shaft and 4 front sections on outer shaft.

8. Switch assembly for electronic test equipment assembled by Oak. Includes six switch sections, gear system, potentiometer and special brackets.

9. Compact assembly controlling four 7.5A, 32V snap switches.

10. For PC board insertion, this Unidex dual concentric switch combines a PC board switch section, standard switch section and shielded variable resistor.

11. Stamped and machined mounting brackets and shielding hardware on multi-section switch with variable resistors controlled by center shaft.

12. Glass epoxy PC board switch sections with added components, solder terminals, special brackets and shielding for hi-fi equipment.

13. Seven section dual concentric Unidex switch with PC board terminals and shielding between sections.

14. Printed circuit section switch with additional wiring and components; for attachment to PC mother board.

15. Dual concentric switch with bracket and special counting dials, wired sections and attached connector.

16. Dual-concentric, 7 section switch, with shielding and special locking mechanism for use in test equipment.

17. Three 18-position sections, dual concentric switch with counting gear mechanism used for airborne equipment. Special brackets and gears assembled at Oak to customer's specifications.

OAK Industries Inc.

SWITCH DIVISION/CRYSTAL LAKE, ILLINOIS 60014
TELEPHONE: 815-459-5000 TWX: 910-3353 TELEX: 72-244

CIRCLE NUMBER 7

Sprague puts more passive component families into dual in-line packages than any other manufacturer.

Call Sprague First!

				HIGHER PACKAGING DENSITY
			LOWER PRODUCTION COSTS	

plus improved performance and compatibility with DIP microcircuits



**DIP
MULTIPLE
TANTALUM CAPACITORS**

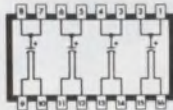

Solid-electrolyte tantalum capacitors with 2 or 4 sections per package. 8- or 16-pin configurations. Standard ratings are 6.8 μF @ 35V, 15 μF @ 20V, 22 μF @ 15V, 33 μF @ 10V. Capacitance tolerance, $\pm 20\%$. Operating temperature range, -55C to $+85\text{C}$. Write for Bulletin 3542 or circle 151 on reader service card.

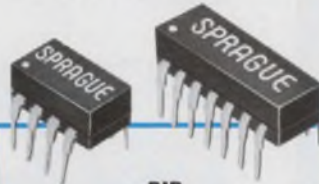

**DIP
MULTIPLE
CERAMIC CAPACITORS**



Monolithic[®] construction . . . alternate layers of ceramic dielectric material and metallic electrodes are fired into a solid homogenous block. 2, 4, 7, or 8 capacitor sections per package. Standard ratings, 18 pF to 0.1 μF @ 100V. Capacitance tolerance, $\pm 20\%$. Write for Bulletin 6242 or circle 152 on reader service card.



**DIP
TANTALUM/CERAMIC
CAPACITOR ASSEMBLIES**



Solid tantalum and Monolithic[®] ceramic alternating isolated sections. Choice of 4 or 8 sections per package. Standard tantalum ratings, 6.8 μF @ 35V, 15 μF @ 20V, 22 μF @ 15V, 33 μF @ 10V. Ceramic ratings .01, .047, .1 μF @ 100V. Cap. tol., $\pm 20\%$. Write for Engineering Bulletin 6642 or circle 153 on reader service card.



**DIP
RESISTOR/CAPACITOR
NETWORKS**

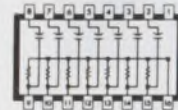

(1 of 3 designs)

Metanet[®] metal-film resistors and Monolithic[®] ceramic capacitors in bypassed pull-up, R-C coupling, speed-up, and active terminator networks. Resistor ratings, 100 to 6800 Ω with 125mW power dissipation. Capacitor ratings, 100 pF to .01 μF @ 100V. Write for Engineering Bulletin 6612 or circle 154 on reader service card.

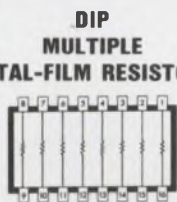

**DIP
MULTIPLE
METAL-FILM RESISTORS**



Noble metal film resistors encased in protective glass. Choice of 7 or 8 resistors per 14- or 16-pin package. Resistance values, 50 Ω to 100,000 Ω . Power dissipation, 125mW. Standard resistance tolerance, $\pm 5\%$. Operating temperature range, -55C to $+70\text{C}$. Write for Bulletin 7042 or circle 155 on reader service card.

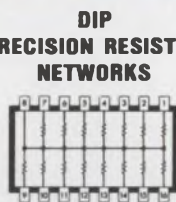

**DIP
PRECISION RESISTOR
NETWORKS**

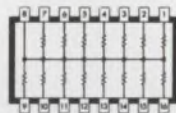

(1 of 5 designs)

Noble metal film resistors in pull-up, pull-down, interfacing, and terminating configurations, for applications requiring repetitive resistance patterns. 14- or 16-pins. Up to 28 resistors per package. Individual resistors from 50 to 100,000 Ω . Dissipation, 125 mW. Write for Bulletin 7042 or circle 156 on reader service card.

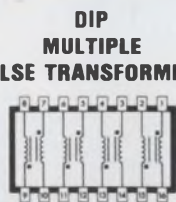

**DIP
MULTIPLE
PULSE TRANSFORMERS**

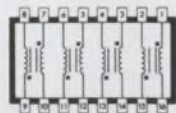

(1 of 2 designs)

Four transformers in 16-pin package. All cores have exclusive protective coating. Inductance values from 10 to 1000 μH . ET product values of 5 volt- μsec . Choice of four turns ratios . . . 1:1, 2:1, 3:1, 4:1. Operating temperature range, 0 C to $+70\text{C}$. Write for Engineering Bulletin 40400 or circle 157 on reader service card.

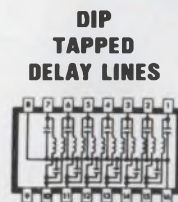

**DIP
TAPPED
DELAY LINES**

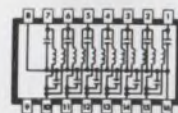

Lumped constant delay lines . . . ideal for timing and pulse synchronization circuits. 14- or 16-pin packages with delays of 50, 100, or 150 nanoseconds at a characteristic impedance of 100 Ω . Working voltage, 50VDC. Operating temp. range, 0 C to $+70\text{C}$. Write for Bulletin 45004 or circle 158 on reader service card.

Popular Types Now Available OFF-THE-SHELF From Your Sprague Industrial Distributor.

For complete technical data, write for any of the above-mentioned Engineering Bulletins to: Technical Literature Service, Sprague Electric Company, 347 Marshall Street, North Adams, Mass. 01247.

THE BROAD-LINE PRODUCER OF ELECTRONIC PARTS





Increase Reliability and Performance with Custom Quartz Crystals.

MCCoy Electronics offers a larger variety of Quartz Crystals than any other supplier. With a frequency range of 700 Hz to 250 MHz and a variety of housings available such as solder seal, glass, and cold weld, MCCoy crystals have found broad uses in commercial, industrial, military, and high reliability applications.

MCCoy specializes in applications where strict control of motional parameters is dictated, tight stabilities are needed, or in any program requiring experienced technological resources.

In addition, MCCoy crystals are proven to be economical for the buyer in terms of consistent performance and high quality, thereby eliminating the costly burden of replacement.

We invite your use of MCCoy's expert engineering and marketing staffs in developing specifications for custom crystals individually tailored to meet your needs.

Please write for our free catalog.

lmc **MCCOY**
ELECTRONICS COMPANY

a subsidiary of **OAK Industries Inc.**

MT. HOLLY SPRINGS, PA. 17065 • 717-486-3411 - TWX: 510-650-3548

CIRCLE NUMBER 8

Who provides the industry's broadest line of electronic packaging hardware ... including IC Sockets?

SAE does! And in most cases, we'll deliver right off the shelf, because SAE makes all kinds of IC sockets to satisfy a wide variety of applications.

You can choose side or edge wipe styles; dual-in-lines or single-row strips. Standard or low-profile configurations (.150" high). One, two or three-level wrap terminals; dip-solder types in 8 through 40 pin sizes, all on .100" contact centers. Or if you prefer, select individual contacts or carrier strips; and even discrete assemblies.

Plating thicknesses range from 10 to 50 mils gold; and all the low-profile components have an anti-wicking feature that eliminates solder wicking entirely. So for your next requirement ... whether prototype or by the thousands ... give us a call. We'll deliver! Our new 128 page packaging handbook gives complete details, and also describes our entire line of electronic packaging and interconnection hardware.

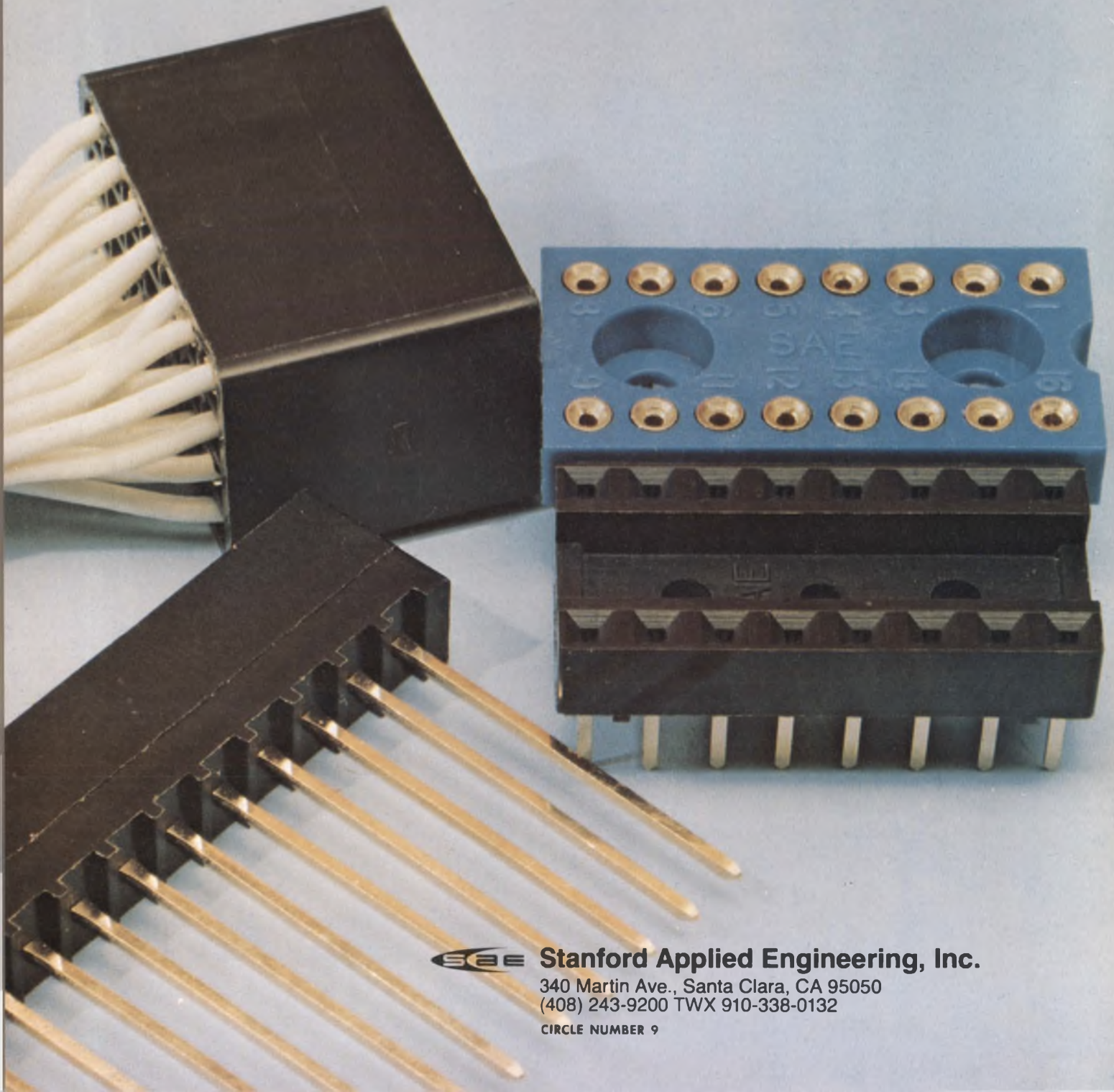

Stanford Applied Engineering, Inc.

340 Martin Ave., Santa Clara, CA 95050
(408) 243-9200 TWX 910-338-0132

CIRCLE NUMBER 9

*If you buy
a prom programmer
before you read this
you're making a
big mistake!*

You can spend a lot of money and get practically nothing if you aren't careful.

Here's what to test for:

1. Is the programmer universal? Does it equip you for "tomorrow?" Will it program every available PROM type? (At last count there were over 165.)
2. Are programming techniques approved by the semiconductor manufacturers?
3. Can the programmer be calibrated? By you? Can performance be verified to PROM manufacturers' current specifications?
4. Is the programmer supported by direct sales, installation, training and service?

If the programmer is from Data I/O, it passes the test. Today, more than 1500 companies use Data I/O programmers. We build a complete range of machines including the Programmer V which has outsold every other automatic programmer in the world (including the former world champ, the Data I/O Programmer I).



Data I/O total three point service.

1. Every Data I/O customer receives a quarterly update on currently available PROMs.
2. Through our direct (computerized) mailing program, Data I/O customers are kept constantly up-to-date on PROM specification changes and technological innovations.
3. Nine field offices in the U.S.A. and 22 distributors worldwide provide our customers with direct sales support, installations, operator training and service.

Get the facts ■■■■■■

If you would like to know more about our products, or want copies of our quarterly PROM Comparison Chart and PROMBiTS (our periodic technical bulletin on PROM applications and innovations), mail this coupon or call one of our offices. Data I/O Corporation, P.O. Box 308, Issaquah, Washington 98027.

Name _____
Title _____
Company _____
Address _____
City/State/Zip _____



Data I/O

CIRCLE NUMBER 10

Now
you have
a choice!

RCL

...A SECOND
SOURCE FOR

BW's

Molded
Wire-Wound Resistors



...AS LOW AS 5¢ EACH!

"SPECIALS" AVAILABLE

△ VALUES AS LOW
AS .01 OHMS!

△ TCs AS LOW AS
10 PPM!

△ TOLERANCES AS
LOW AS 1%!

Send For New '76 Catalog Or
Call our Hotline For Name
Of Your Local Representative
Or Stocking Distributor.
(603) 627-3831

AMF

RCL Electronics

195 McGregor Street
Manchester, N.H. 03102

CIRCLE NUMBER 11

ACROSS THE DESK

(continued from page 7)

tends to reinforce the misconception that more bits are necessarily better than less bits.

Actually, of course, word size bears little, if any, relation to the precision achievable on a particular processor. An 8-bit processor can provide 8, 16, 24, 32 or even higher bit precision. The word size does play some part in determining the speed with which a desired precision can be achieved, but the instruction set and instruction execution time are far more important factors.

With regard to benchmarks, I tend to agree with the view that holds that "standard" benchmarks are of little value, because in most cases they bear little relation to the specific application at hand.

Alex Goldberger
Manager

Microprocessor Applications

Signetics

811 E. Arques Ave.
Sunnyvale, CA 94086

'Success story'— The Czar's sequel

"The Czar's Consultant" (ED No. 1, Jan. 5, 1976, p. 75) was very interesting. Have you considered the sequel, in which his successors make a career out of obtaining information from the grass roots? One might call it "Success Story":

Following the breakup of the Czar's family-owned monopoly, there flourished a very brief period of competition. It was succeeded by a market takeover by Lenin & Co., a giant corporation, with representatives in all population centers, however small. Its many and varied sources of information were a key factor in acquiring a complete monopoly in the Russian market.

In fact, acquisition of information on possible competition became a major national industry. Even rumored possible competitors, however small, were quickly disposed of by tactics some of the foreign competition enviously called "ruthless."

Board chairmen came and went, but the monopoly, bolstered by the excellently developed market research techniques and a large and effective sales force, prospered for more than a half a century. Oh, it

was true that the vast resources of the country were being inefficiently employed. The agriculture was unable to feed the people adequately. And the standard of living was suppressed.

But the mastery of information-gathering and advertising, the continually improved tools of persuasion that were in the hands of the sales force, the high level of investment in the training of an export sales force—and firm barriers against foreign competition—not only enabled them to convince the domestic customer base that it felt satisfied, but also made for an increasing foreign market.

Although there are stresses and strains, the successors of Lenin & Co. are creeping up on the unwary foreign competition, who are foolishly cutting off their sources of information (which they deem unethical), and tools for their sales force (which they consider immoral). Their competitors will learn a lesson—too late—when they find their market has been undercut and they are about to share the fate of Nicholas.

Dan Sheingold

Analog Devices, Inc.

Misplaced Caption Dept.



How many times do I have to tell you to put circles around discrete device symbols?

Sorry. That's Michelangelo da Caravaggio's "St. Matthew," which hangs in the Church of S. Luigi dei Francesi in Rome.

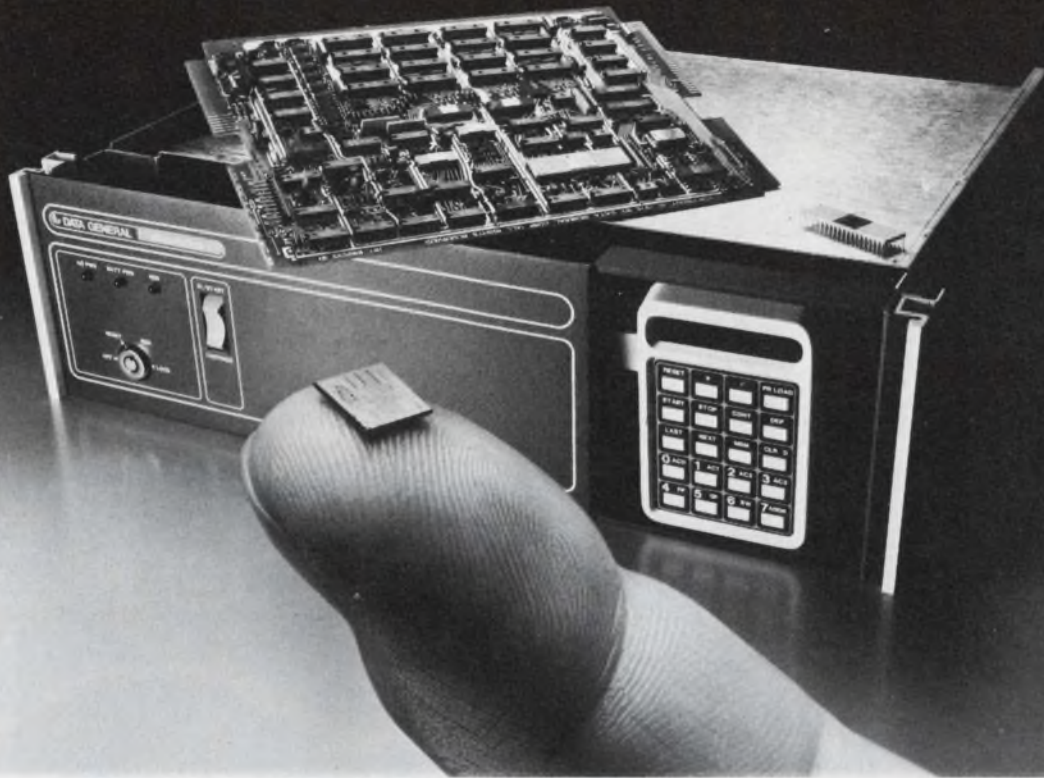

Announcing a giant reduction in the Nova line.

You're looking at a whole new family of NOVA[®] computers. microNOVA. A microprocessor chip, a microcomputer board and a complete MOS mini-computer. All based on the little thing on the tip of the finger.

mN601. The microNOVA CPU.

It's a full-blown, 16-bit NOVA computer. Manufactured by Data General. And fully supported by NOVA software.

And it's not a NOVA computer in name only. This chip has all the NOVA registers, internal data paths and computational elements. The NOVA multifunction instruction set. The NOVA multiple addressing modes. And the NOVA 3 hardware stacking. Plus things that used to be NOVA options: multiply/divide, real-time clock and power fail/auto restart. All standard at no additional cost.

The difference is, all that NOVA has been reduced to a single chip that measures only 225 mils by 244 mils.

Which was no small accomplishment.

For those who need more than a chip, there's the microNOVA computer-on-a-board. A complete, fully-buffered microcomputer that comes with 2K or 4K words of RAM on a single 7½" by 9½" board. You can add on more RAM in either 4K or

8K increments, or PROM boards with up to 4K words. Plus terminal interfaces, general purpose interfacing boards, card frame, power supply and PROM burner.

And for those who need more than a board, there's a fully-packaged 4K word MOS microNOVA mini. It comes with power supply and turnkey console. In 9 and 18 slot versions. Into which you can place as much as 32K words of RAM or PROM. And still have plenty of room left over for I/O.

There's even a microNOVA system specifically for program development. A complete system, with dual diskette drive, terminal and our RDOS-compatible Disc Operating System. Or you can use a Nova 3 system with RDOS. The best development software you can get.

And no matter which microNOVA product you get, you get to use NOVA software like FORTRAN IV. Software that's in use in over 20,000 installations all over the world. So you know it's going to work right the day you get it.

Want to know something else?

Call our toll free number.

800-225-9497.

microNOVA

Nova is a registered trademark of Data General Corporation.

DataGeneral

• Data General, Route 9, Southboro, Mass. 01772 (617) 485-9100. Data General (Canada) Ltd., Ontario.
Data General Europe, 15 Rue Le Sueur, Paris 75116, France. Data General Australia, Melbourne (03) 82-1361/Sydney (02) 908-1366.

DigiTec creates a 'counter' revolution... with two new revolutionary 'counter' features.

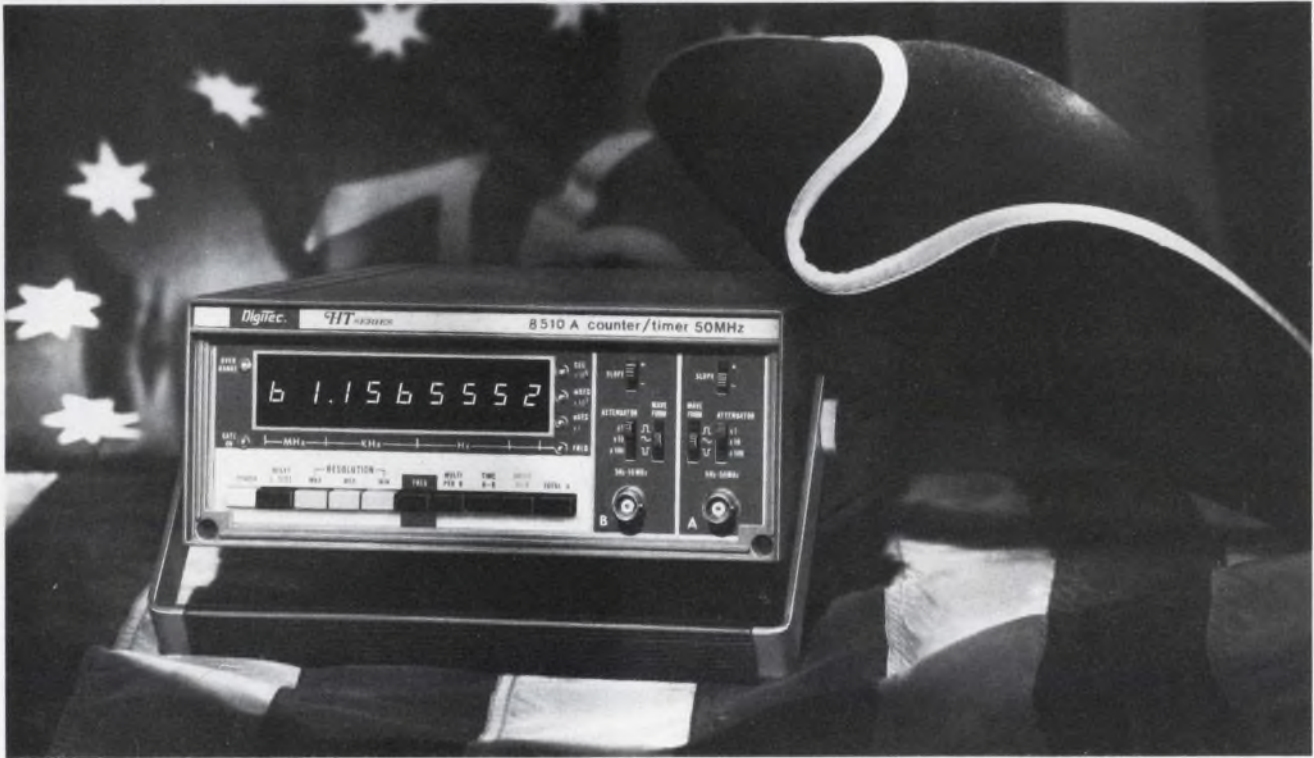

1. OPTI-RANGING: DigiTec's exclusive display technique is an improved auto-ranging that actually organizes the data before you see it. With Opti-ranging, there is no need for lights or indicators to indicate MHz, kHz or Hz since the display position is fixed regardless of the time base (resolution) selected.

All our Opti-ranging counters are augmented by a standard LED display of 9 full digits that shows your complete measurement.

2. INPUT SHUTDOWN: Another DigiTec exclusive, prevents the display of erratic or erroneous data. Based on the input sensitivity of each instrument, this system shuts down the display if the incoming signal drops below a reliable measurement level. A single zero is displayed to indicate such a condition while preserving maximum measurement confidence.

COMPARE BEFORE YOU BUY!

These counters are not partial-function. All our UNIVERSAL COUNTERS feature two separate channels for complete time interval measurements. Each channel has a separate set of input controls, including slope, waveform and attenuators for extra precision.

Every counter is housed in a rugged diecast and extruded aluminum case for lightweight convenience and total protection.

8500A Series Universal Counter/Timers

consist of 4 models for measurements from 5Hz thru 1GHz

Start at **\$725.**

8700A Series Frequency Counters

consist of 3 models for measurements from 5Hz thru 1GHz

Start at **\$625.**

We also offer 15 other counters from which to choose.

DigiTec

UNITED SYSTEMS CORPORATION

918 Woodley Road • Dayton, Ohio 45403 • Ph: (513) 254-6251 • TWX: (810) 459-1728

These instruments available under GSA Contract GS-OOS-27741

This one resistor can shrink your inventory costs

TYPE CC RN55D

- 10 ohms to 10 megs (1/4w size)
- high stability cermet film
- multiple wattage ratings
 - 1/8w at 125°C
 - 1/4w size 1/4w at 70°C
 - 1/2w at 70°C (max 250 v)
- tolerance 1%
- dual resistance marking
- available now, off-the-shelf
- **Now RLR07 approved**
 - 10 ohms to 1 meg
 - tolerance 2%



Quality in the best tradition.



ALLEN-BRADLEY

Electronics Division
Milwaukee, Wisconsin 53204

EC119C

CIRCLE NUMBER 14

Introducing Model 9300

Quality that's Quick & Quiet

Model 9300 Vacuum Column digital tape transport has characteristics common to all Kennedy recorders — and a few new ones. It's quick (125ips); quiet (noise level of less than 70db), and it has the built-in quality of all Kennedy products.

Utilizing side-by-side vacuum columns and a capacitive tape-location detector for improved tape life; air bearings and Tribaloy coated read-after-write heads to reduce tape wear and improve data integrity, Model 9300 is ideal for minicomputer and data collection applications requiring complete reliability at high tape speeds.

Model 9300 comes complete with all the operational features of the 9000 Series. Performance is guaranteed by crystal controlled timing, read threshold scanning, our

read-after-write shortened skew gage and other exclusive Kennedy features. Operation is simplified by such operator-oriented features as a front-accessible test panel, quick-release hubs and simplified tape loading.

Model 9300 has a standard tape speed of 125ips, with data densities of 200/556cpi or 556/800 on the 7-track unit and 800cpi, 1600cpi or 800/1600cpi on the 9-track transport. The format is NRZI/PE.

Model 9300 is not only quick and quiet — it's very competitive. That's quite a lot, considering the Kennedy quality.

KENNEDY CO.

540 W. WOODBURY RD., ALTADENA, CALIF. 91001
(213) 798-0953



KENNEDY · QUALITY · COUNT ON IT

APRIL 12, 1976

Wang introduces a mini, drum plotter and printer

In a continuing effort to become a significant factor in the small computer business, Wang Laboratories, Tewksbury, MA, has announced a host of new additions to its product line. These include:

- The 2200 PCS "plug-in" series of portable minicomputer systems, which are designed to compete with IBM's Model 5100, the Tektronix 4051 and Hewlett-Packard's 9825.

- A μ P-based "virtual drum" plotter, the Model 2272, and a 120-character-per-second serial matrix printer, the Model 2231W.

Wang's 2200 PCS series consists of full minicomputers completely contained within a 55-pound desktop console that plugs into a wall socket.

The PCS consists of 8-k bytes of random-access memory and 42.5-k bytes of read-only memory, a 9-in. CRT display with full alphanumeric (upper and lower case) keyboard and a tape cassette for data storage or program loading. The 8-k system will sell for \$5400 and is expandable to 32-k bytes of RAM (\$9000).

The Wang plotter, which is priced at \$2900, is somewhat unusual in that the drum does not rotate. On most drum plotters, the drum rotates with the paper attached, according to senior marketing VP Ned Chang.

Because of the physical inertia of the drum, faster plots can be obtained by rotating only the end sprocket mechanisms, which secure the plotting paper. The Wang plotter moves the paper instead of the drum. In this design approach, Chang says, the company was able to use small motors in its plotter.

Most drum plotters also use analog servo motors and linearizing circuitry that requires frequent calibration. Chang explained, "Since the source of the X and Y coordinates is digital anyway, we



Trio of new products from Wang Laboratories consists of (from left to right): 2200 PCS minicomputer, μ P-based "virtual drum" plotter and 120-cps serial matrix printer.

decided to send the coordinates directly into an 8080 μ P that digitally linearized the motion by controlling small dc stepping motors."

By adding a ROM to the μ P, Chang added, it was possible to generate an alphabetical character set for labeling plots, thus relieving the processor that drives the plotter.

The 2272 plotter can accept paper up to 17-in. wide and can optionally plot up to three colors, with a resolution of 0.005 in.

Wang's new serial printer forms characters with a 7×9 dot matrix compared with a 5×7 dot matrix on most other printers. Chang says the printer is designed to appeal to users that are driving 30-cps printers beyond the product's limits but who could not justify the expense of a 165-cps unit.

Wang's 2231W printer will sell for \$2900.

CIRCLE NO. 319

Test modules with LEDs check out PC connects

A set of low-cost 14 and 16-pin IC test modules outfitted with one LED for each pin, provide a superior means of testing PC-

board wire-wrap interconnections.

Using these modules, it is possible to verify the continuity of a wiring chain (a sequence of common connections to a pin), according to Ralph Curtis, electronic engineer at the Naval Research Laboratory (NRL), Washington, DC.

It is also possible to detect missing wires or open connections, as is possible with standard methods of continuity checking. And unlike regular methods, the NRL test can indicate whether there are short circuits or extra wires, Curtis says. He was aided in the development of the LED test-module system by NRL engineers Alan Pezzulich and William Byrne.

The NRL approach is simple, as Curtis explains it. One terminal of each of the 14 or 16 LEDs on a module is connected, through a dropping resistor, to an individual pin. The other ends of the LEDs are tied together in a common connection.

One side of a 5-V battery is connected to the common LED termination, and the other side of the battery is connected to a probe.

The PC card to be checked is filled with the appropriate test modules. Then using the probe and the special list, which was developed from the basic wire-wrap list, the connections common to each chain on the list can be verified.

If all connections are good, all the LEDs tied to that chain will light up. If there is an open, the LED remains dark; when LEDs light up that should be dark, an extra wire or short is indicated.

150-V Schottky power diodes developed at GE

Schottky rectifier diodes developed by General Electric Co., Schenectady, NY, are reported to operate as high as 150 V—a maximum voltage more than four times higher than that of Schottky rectifiers now on the market. In addition, the diode's specifications are now more reproducible from one diode to the next.

Both improvements have been achieved by a new technique, developed by GE, to form platinum silicide on a silicon mesa base. A sputtering process is now used, in contrast to the conventional method of evaporation and heating in a

furnace.

Power rectifiers have been built that exhibit a forward voltage drop of less than 0.70 V at 50 A, a switching time of less than 50 ns and a reverse breakdown voltage exceeding 100 V.

In the sputtering technique, a heated inert gas, argon, bombards a platinum anode. Platinum atoms are released for evaporation onto the heated silicon. Sputtering, as well as heating, is accomplished in a single step, resulting in increased control of the process and improved diodes.

Generally pn-junction power-rectifier diodes in current use have a forward-voltage drop approximately 50% higher, and a longer recovery time (by a factor of about two) than the GE Schottky diodes.

Although the diodes are still in the developmental stage, samples of low-voltage units (about 50 V) are available, a GE spokesman reports.

The research was supported in part by the NASA Lewis Research Center, Cleveland, OH.

Latent fingerprints matched to databank

A system has been developed that can match fingerprints picked up at the scene of a crime (latent prints) to prints stored in a databank. This is the first system of its kind with automatic print-matching and the ability to match from partial, imperfect prints.

"We don't even have to have the central features of the print to make a pretty good match," says Lou Waggoner of the Identification Systems Organization at Rockwell International in Anaheim, CA. The system looks for matches of print minutiae (points where fingerprint ridges end or fork).

An operator seated at the system's console places the latent print in front of a TV camera. An enlarged view of the print is displayed on a TV monitor and the operator uses an electronic vector-ed cursor to mark the minutiae of interest.

A two-level search is then initiated. The first level takes two to three seconds and breaks down the file to be searched according to a variety of descriptors, such as

finger-pattern type, sex, crime, year of birth and others.

The second level takes about six seconds per finger and includes a minutiae match. Each print is scored by the system on a 0-to-1600 scale ranging from worst to best match.

A 1029-line high-resolution monitor is used for the display. The system includes a Data General Eclipse C/300 computer with 128 k of core, a 90-M byte moving-head disc drive, a 1-M byte fixed-head disc drive, a magnetic tape drive and a 300-lpm line printer.

It takes about 10 k of memory to store a single print.

Waggoner points out that a hardware matcher is under development that will eliminate the need for the operator picking out the minutiae at the CRT. It will upgrade the system speed to about 200 to 300 matches per second.

The first system has just been installed at California's Dept. of Justice in Sacramento. Initial tests will use a 13,000-person fingerprint file.

Largest solar-energy plant to be built

The largest solar energy installation in the world will soon be constructed by Sandia Laboratories, Albuquerque, NM, under a grant from the United States Energy Research and Development Administration (ERDA).

The facility will consist basically of a boiler mounted atop a 200-ft high tower surrounded by an array of more than 300 large tracking mirrors. The mirrors, or heliostats, will reflect the sun's rays onto the boiler, producing about 5 MW of thermal energy, which will be con-

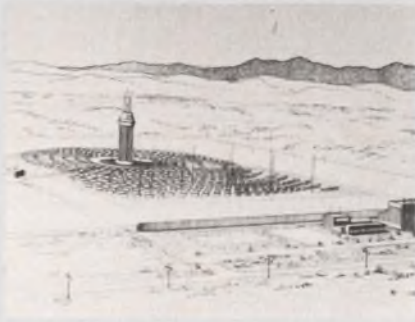

Conceptual drawing of five-megawatt solar thermal test facility.

verted to about 1.5 MW of electricity.

Currently, the largest operating solar installation is a research solar furnace at Odeillo, France, which produces 1 MW of thermal energy.

The Sandia facility will initially be used to test components for a much larger solar-power pilot plant now being designed. This plant would generate about 10 MW of electricity, an amount sufficient to supply the electrical needs of a town of 10,000 people.

The Albuquerque test facility is expected to be operating at 1 MW by late 1977 and at full power in 1978. It will be located adjacent to Sandia's environmental testing area, about six miles south of the Labs' main tech area on Kirtland AFB.

30-second diagnostic test developed for cars

An automotive diagnostic system that requires no engine connections and that can check out vehicle malfunctions in 30 seconds has been designed by L. Robin Hulls and two fellow engineers at RCA's Automated Systems Div., Burlington, MA.

The system uses a sensor that can be placed either in or near the vehicle's exhaust pipe. It is connected to a special electronic tracking filter that processes the received signals. The unit can also be used at such other vehicle points as the air intake to the manifold or the crankcase breather, Hulls says.

The test is performed by accelerating and decelerating the engine to determine its speed and acceleration rate. This information is fed into a diagnostic unit with a built-in microprocessor, which automatically computes engine horsepower. If when testing a diesel engine, for example, you learn that you're not developing the proper horsepower you know immediately that something is wrong and you need further tests, Hulls says.

Part of the further testing might be to look at harmonic signals generated in the exhaust pipe which would indicate a bad cylinder.

If the engine did give you the proper horsepower you'd know there was no point in testing the compression or fuel rate.

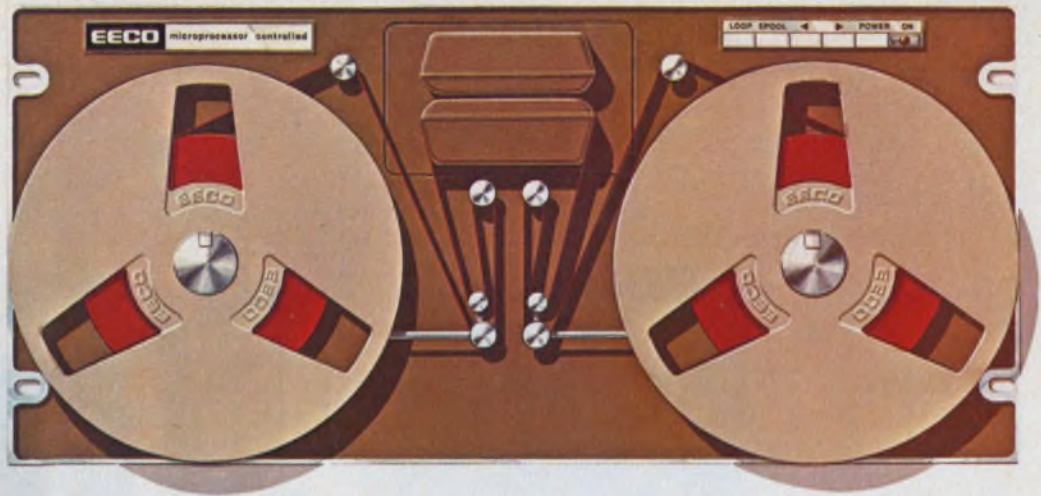

This new microprocessor controlled

reader/spooler will read 1000 characters per second, and still provide *stop on character*. All of its reader/spooler functions, such as starting, stopping, rewind speed (1500 c/s), data output, and interface timing are controlled by a program stored in its microprocessor memory. Its other advantages lie in the areas of reading reliability, high speed stopping, programmed soft stopping, the spooler system, and equipment reliability. It also includes step and slew modes, and

a priority interrupt mode. And like other EECO readers it boasts LED and phototransistor optoelectronics, a step motor drive, a full tape-width barrel sprocket, handshake interface logic, and TTL and DTL compatible electronics. But wait, we can't sell you one now, because it won't be shippable until after the National Computer Conference*. We're telling you now just so you can make plans. The best is yet to come.

*First public showing.

EEECO
READERS/PACKAGING/SWITCHES

1441 East Chestnut Avenue, Santa Ana, California 92701 Phone 714/835-6000

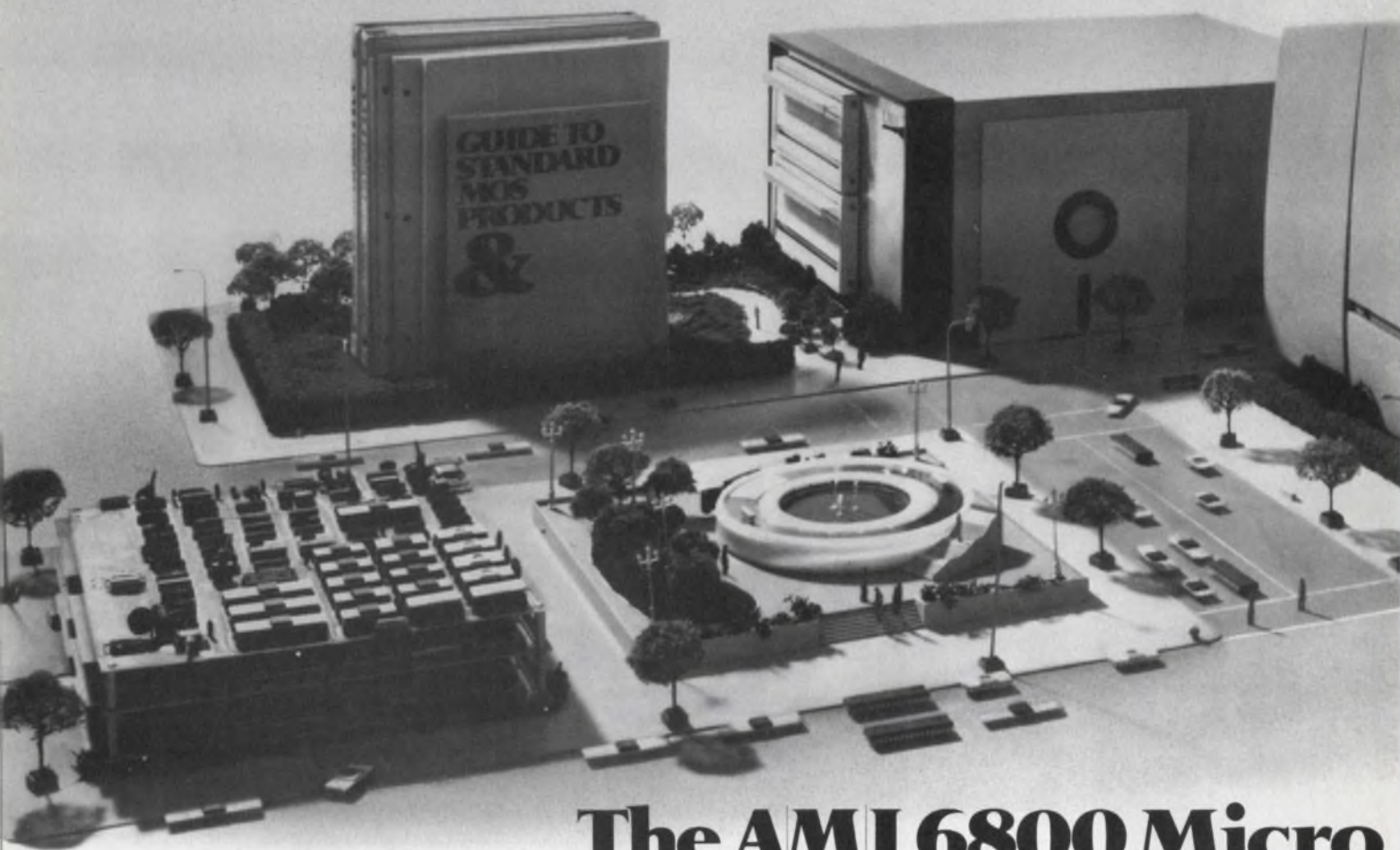

The AMI 6800 Micro

**We started by redesigning a CRT.
And ended with the fastest, easiest
way to build microcomputer systems.**

The AMI 6800 MDC architecture is so far ahead of the competition they'll have to change their whole development philosophy to catch up.

Unlike their multiple box approach, with lights and switches, our grand plan is centered around a very smart CRT, with full debug software.

There's a 6800 system in the terminal, so the processor you're working with is the same one you're developing. That cuts your learning time in half.

And you can forget about those long hassles with paper tape, front panels, teletype or cassettes. Put your hands on our keyboard and

you never have to let go. You modify information instantaneously. Interrupt a program after every instruction, and get a complete snapshot of the state of the machine. Look at all the registers and change their values, simply by pressing a key. And you never have to translate addresses into binary to get information.

Our 6800 MDC not only cuts programming time in some cases from hours to minutes, it can also be configured as a test center for incoming 6800 parts. And it adapts easily to a powerful, one megabyte microcomputer for a variety of uses, such as inventory control.

The standard AMI Microcomputer Development Center consists of the 80 char. x 25 line CRT, the dual floppy disk with disk operating system, S6834 EPROM programmer,

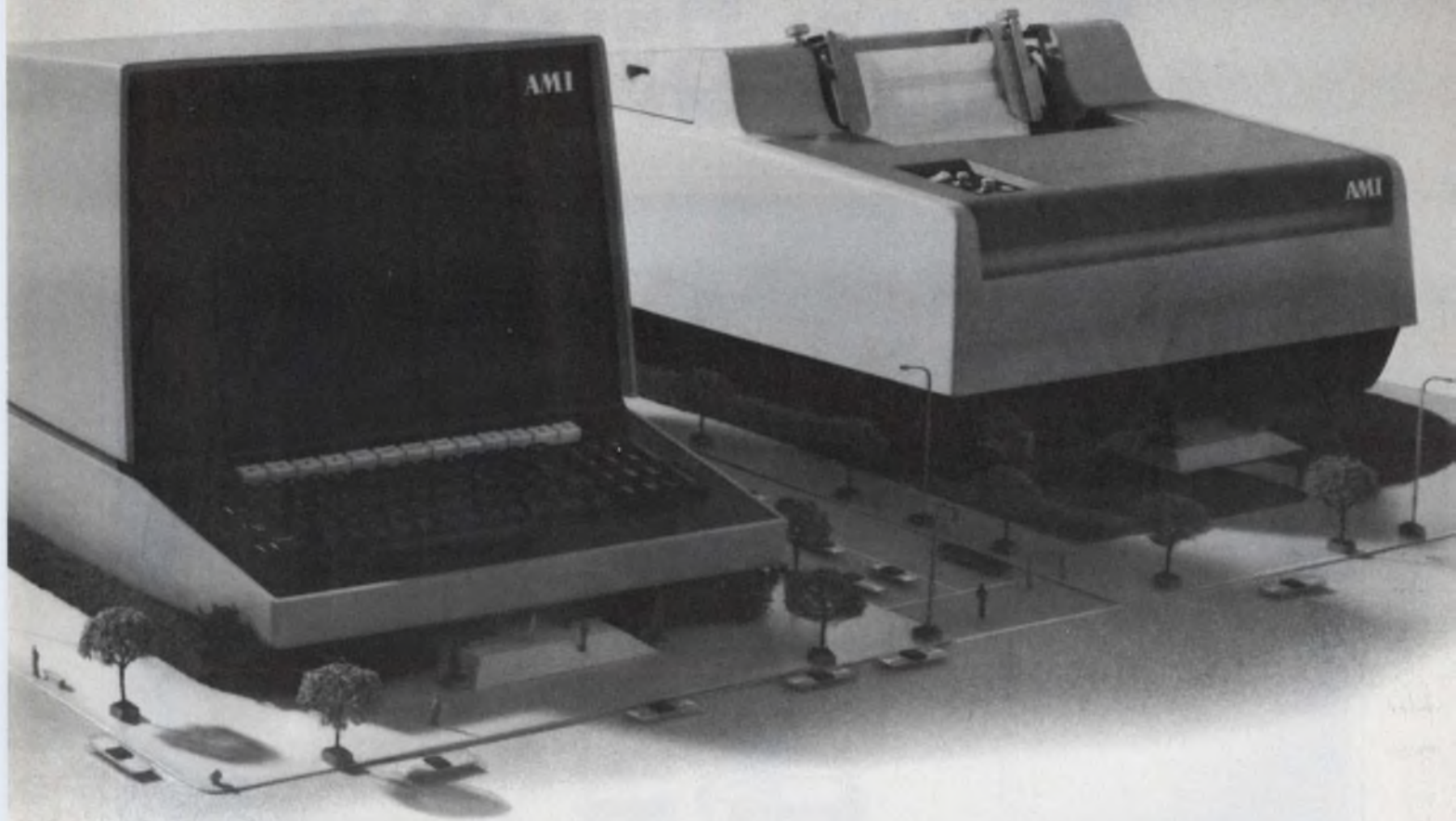

computer Development Center.

RS232 interface and 16K words of RAM memory. The many options will include a character printer, an in-circuit emulator so you can use the CRT like a front panel, EPROM and RAM memory modules.

So now the most flexible, easiest-to-use microprocessor family, the AMI 6800, has taken another giant step ahead of the others. The AMI 6800 Microcomputer Development Center can get you to the market faster, with a better product. Ask your AMI sales office, distributor or representative for our brochure. Or write to AMI, 3800 Homestead Road, Santa Clara, CA 95051. Then see how fast things develop.

**it's
standard
at AMI**
AMERICAN MICROSYSTEMS, INC.

This is the way to the Center:

SALES OFFICES

Manhattan Beach CA • (213) 379-2452
San Jose CA • (408) 249-4550
Altamonte Springs FL • (305) 830-8889
Elk Grove Village IL • (312) 437-6496
Norwood MA • (617) 762-0726
Livonia MI • (313) 478-9339
Minneapolis MN • (612) 559-9004
Monsey NY • (914) 352-5333
Cleveland OH • (216) 292-6850
Ambler PA • (215) 843-0217
Richardson TX • (214) 231-5721

DISTRIBUTORS

ALTA ELECTRONICS
Utah - Salt Lake City (801) 486-7227
ARROW ELECTRONICS
Minnesota - Bloomington (612) 888-5522
CENTURY ELECTRONICS
New Mexico - Albuquerque (505) 292-2700
Utah - Salt Lake City (801) 487-8551
INTERMARK ELECTRONICS
Washington - Seattle (206) 767-3160
SCHWEBER ELECTRONICS
California - Costa Mesa (213) 924-5594 and (714) 556-3880
Connecticut - Danbury (203) 792-3500
Florida - Hollywood (305) 927-0511
Georgia - Atlanta (404) 449-9170
Illinois - Elk Grove Village (312) 593-2740
Iowa - Cedar Rapids (319) 393-0100

Maryland - Rockville (301) 881-3300
Massachusetts - Waltham (617) 950-8484
Michigan - Troy (313) 583-9242
Minnesota - Edina (612) 941-5280
New Jersey - Somerset (201) 469-6008
New York - Rochester (716) 461-4000
Westbury (516) 334-7474
Ohio - Beachwood (216) 464-2970
Texas - Austin (512) 837-2890
Dallas (214) 661-5010
Houston (713) 784-3600
Canada - Mississauga, Ont (416) 678-9050
SEMICOMP CORP.
California - Newport Beach (213) 971-5253 and (714) 833-3070
STERLING ELECTRONICS
Arizona - Phoenix (602) 258-4531
Louisiana - Metairie (504) 887-7610
Massachusetts - Watertown (617) 926-9720
New Jersey - Perth Amboy (201) 442-8000
New Mexico - Albuquerque (505) 345-6601
Texas - Dallas (214) 357-9131
Houston (713) 627-9800
Virginia - Richmond Meridian (804) 335-6521
R V WEATHERFORD CO
Arizona - Phoenix (602) 272-7144
California - Anaheim (714) 547-0891
Glendale (213) 849-3451
Palo Alto (415) 493-5373
Pomona (714) 623-1261
San Diego (714) 278-7400
Colorado - Englewood (303) 761-5432
New Mexico - Albuquerque (505) 842-0868

Texas - Dallas (214) 243-1571
Houston (713) 688-7406
Washington - Seattle (206) 243-6340

REPRESENTATIVES

AMMON & RIZO
Oklahoma - Oklahoma City (405) 373-2748
Texas - Dallas (214) 233-5591
Texas - Houston (713) 781-6240
BARNHILL FIVE
Colorado - Denver (303) 426-0222
BENEKE & McCAUL
Missouri - Grandview (816) 765-2998
Missouri - St. Louis (314) 567-3399
CANTEC REPRESENTATIVES, INC.
Ontario - Ottawa (613) 225-0363
COULBOURN DEGREIF, INC.
Maryland - Baltimore (301) 247-4646
HADDON ASSOCIATES
California - San Diego (714) 565-9445
HECHT HENSCHEN & ASSOCIATES, INC.
Arizona - Phoenix (602) 275-4411
LOWREY & ASSOCIATES
Michigan - Brighton (313) 227-7067
NORTHWEST MARKETING ASSOCIATES
Washington - Bellevue (206) 455-5846
PRECISION SALES COMPANY
New York - Syracuse (315) 458-2223
REP. INC.
Alabama - Huntsville (205) 881-9270
Georgia - Tucker (404) 938-4358

LED Super-Brights

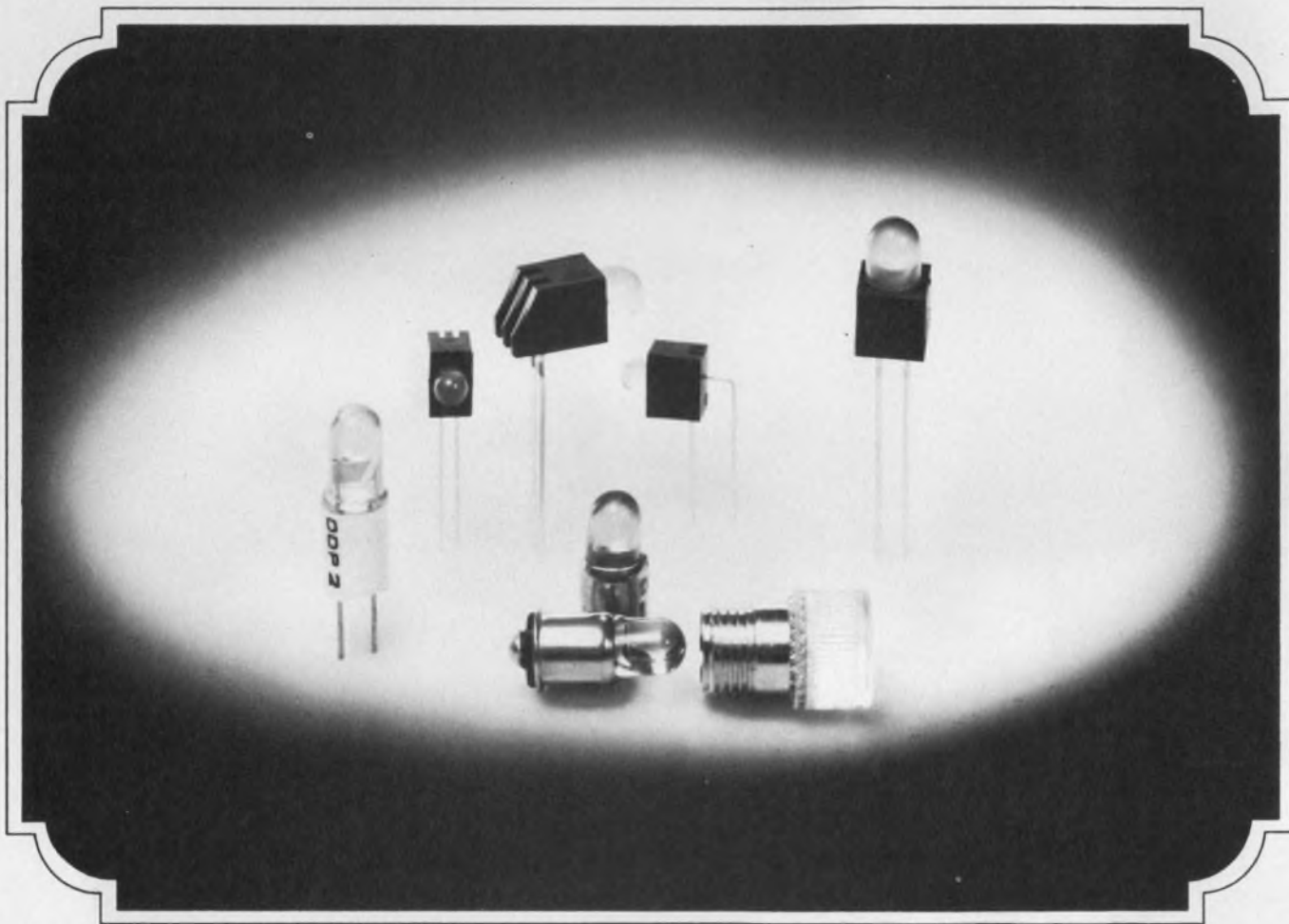

Ideal replacements for incandescents!

Here come the LED Super-Brights . . . red, amber and green. Their high brightness (50 MCD @ 20mA — typical clear red) make them the perfect cost and power saving replacements for incandescents. Available with built-in resistors for all popular voltage ranges.

PCB LED's — Horizontal or vertical viewing . . . optional built-in resistor for 5V applications.

Bi-Pin (T1-3/4) LED's — Ideal for dead front panel applications, e.g. DEC's PDP Series computers.

Midget-Flanged (T1-3/4) LED's — Direct replacements for incandescents in panel light and switch applications.

Replacement Lenses — Specially designed for use with Midget-Flanged LED's.

There's lots more too, Send for our Catalog today: Data Display Products, 5428 W. 104th Street, Los Angeles, Ca. 90045, (213) 641-1232.

We're the original "little light" people.

DATA DISPLAY PRODUCTS

Washington Report

USAF warns on spread of Soviet satellite stations

The spread of Soviet Molniya satellite-communication systems was among strong warnings to Congress delivered recently by a Pentagon spokesman at hearings on the fiscal-1977 budget.

The first Molniya satellite was launched in the mid-60s for the Russian ICBM system; three others were orbited later.

Hardened command and control stations are now being deployed throughout the USSR, East Europe and Mongolia, but the most important top-level centers are still dispersed within an 80-mile radius of Moscow.

Among system improvements reported by USAF Gen. George Brown, chairman of the Joint Chiefs of Staff, are the use of Zhdanov and Admiral Senyavin, both Sverdlov-class light cruisers, as seaborne command-and-control centers. And Brown says airborne command posts have already been used in crisis situations. The general predicts they will grow in importance with Soviet communication and computer-technology advances.

Military inches into fiber optics

The military is beginning to convert to fiber optics, says H. Tyler Marcy, assistant secretary of the Navy for research and development.

He told Congress the Navy is presently rewiring the navigation and weapon-delivery system of an A-7 aircraft, replacing 302 wire connectors—totaling 4832 ft of wiring—with 260 feet of multiplexed fiber-optic conductors. The number of cables will be reduced from 300 to 13. The weight of the cable and connectors will be reduced from 82 lb to 3.6 lb and parts cost from \$7900 to \$1100.

The major obstacle to the use of fiber optics, he reported, has been the unavailability of affordable, off-the-shelf components with suitable performance. To offset this deficiency, the Navy is encouraging industry to increase fiber-optic development efforts.

Noting that connectors, couplers, detectors and pressure-bulkhead penetrators are being produced, he says the application of multimode-optical-bundle technology offers a low-risk approach to military applications in the shortest possible time. A decided plus, according to the Navy, is that only a minimal level of skill is needed for maintenance.

Integrated IR-system for satellites may detect aircraft

Integrated infrared-sensor systems to detect aircraft by satellite may soon be made possible by silicon charge-coupled devices, according to Dr. Charles Heilmeyer of the Department of Defense.

The director of the DOD's Advanced Research Projects Agency, Heil-

meier made the prediction in Congressional testimony on behalf of the record \$246 million budget his agency has requested for fiscal 1977.

"The same mass-production technology used for silicon ICs can be applied to the production of integrated infrared sensors," Heilmeier said. "Thousands of single chips can be packaged into multimillion-element systems.

"Integration of signal processing into detection chips allows clutter discrimination to be performed automatically at the IR receiver, and will eliminate the costs and time delays caused by using large, ground-based computers."

He said the agency had recently developed such a device, called a CCD², that contained hundreds of detectors.

Even though the sensors are scanning wide areas, the large number of detectors can spot very small signals, making it possible to spot not only ballistic-missile launchings, but individual aircraft, he said.

New procedures for closing military bases

In the wake of the politically-motivated closing of military bases that was widely alleged during recent years, new procedures have been drawn up. No longer can Pentagon brass summarily close a base as they could in days of yore.

The National Environmental Policy Act now requires that environmental impact statements be drawn up first. Employment, housing, public schools, the tax base, and so on must all be considered along with pollution, population and traffic factors.

Capital Capsules: The General Accounting Office, in a recent review of material shortages, looked at the electronic component situation and found producers saying **government contracts, once their number one source of income, are now a minor portion.** This, GAO warns, will compound problems for government contractors: they'll have less leverage with producers in the future. . . . The Air Force says **air tests of the Air Force Boeing E-3A airborne warning-and-control-system aircraft will be finished in April,** nine months ahead of schedule, and then the AWACS aircraft will go into the avionics test phase. One of the four already equipped began extensive tests of surveillance and command and control last year. A major question of aircraft performance was flight behavior with the 30-foot diameter radome atop the modified 707's fuselage. . . . The Energy Research and Development Administration is seeking proposals to conduct an **18-month research program for communications systems** that are capable of automating load-management and power-distribution systems. . . . The Defense Communications Agency is seeking sources for a **study and test validation of the characteristics of jitter accumulation in a pulse-stuffing time-division multiplexing network.** Wanted are sources familiar with the analysis of the response of phase lock-loop circuitry to time-variant stimuli and application of PCM digital multiplexing to large-scale communications systems. . . . Another well-known Defense Dept. agency is slated for the history books by September. That's the date **the Weapons Systems Evaluation Group will cease to exist,** although it could come sooner. The Defense Dept. says that the group is no longer needed since the military services are now structured to perform the analyses and evaluation. About 65 people will be shifted to other jobs, DOD says.



Tektronix Minis...

Eight oscilloscopes that go anywhere

Now you can take oscilloscope measurement capability anywhere, even to remote or hard to reach places. This means faster, more thorough on-site repairs of electronic equipment and fewer callbacks. To the top of the ladder, into a utility access tunnel, onto an industrial catwalk, to the site of small or medium scale office or computer equipment, into a moving transportation system, to a remote research site—ultra-portable TEKTRONIX Miniature Oscilloscopes go virtually anywhere you can go.

Only Tektronix offers you a choice of eight miniature oscilloscopes for the performance/weight combination best suited to your application. Bandwidths range from 500 kHz to 35 MHz for servic-

ing equipment as sophisticated as mini-computers or complex industrial control systems. Model 335 offers by far the highest performance of any 10-pound oscilloscope: 35 MHz, dual-trace, delayed sweep, 1mV/div sensitivity, delay lines on vertical inputs, variable trigger hold-off and more. Two models (3½ pounds, 500 kHz and 10 pounds, 10 MHz) feature storage, a unique capability among miniature oscilloscopes. One 3½ pound model combines an oscilloscope with a precision digital multimeter. All 3½-pound models and two of the 10-pound models operate on internal batteries as well as ac. Unique two-level insulation between case and earth ground makes the 3½-pound models excellent choices for waveform measurements at elevated voltages. And proven Tektronix quality, ruggedness, reliability, and service mean more trouble-free measurements, few problems, and fast, reliable service if you need it.

For on site assistance in selecting the best miniature oscilloscope for your application, contact your local Tektronix Field Engineer. Or, for a descriptive brochure on our comprehensive portable oscilloscope family, write Tektronix, Inc., P.O. Box 500, Beaverton, Oregon 97077. In Europe, write Tektronix Limited, P.O. Box 36, St. Peter Port, Guernsey, Channel Islands.

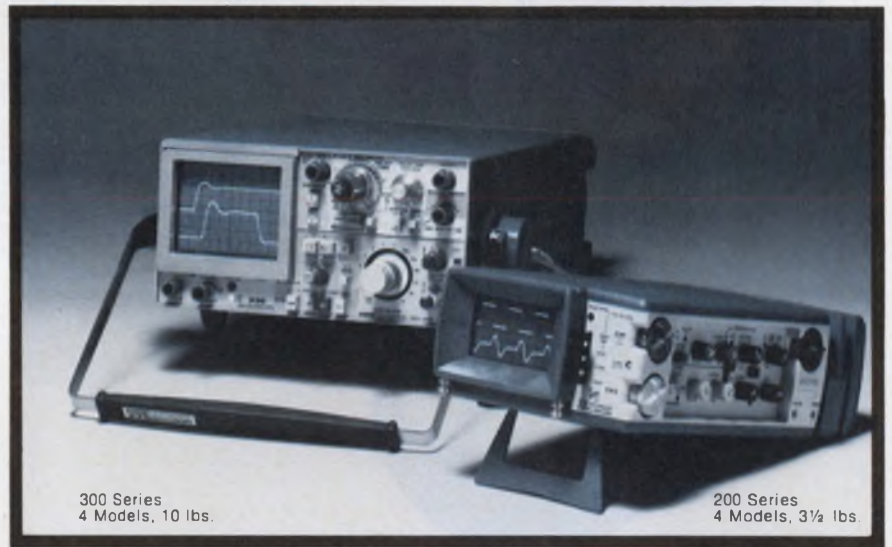

300 Series
4 Models, 10 lbs.

200 Series
4 Models, 3½ lbs.



FOR TECHNICAL DATA CIRCLE # 281

FOR DEMONSTRATION CIRCLE # 282

BME™ Capacitors- Proven Reliability For Automotive Applications

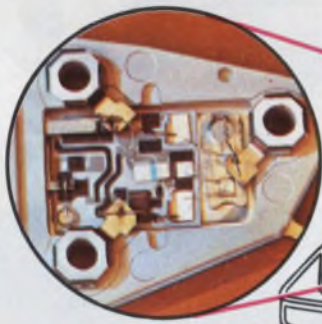

Voltage Regulators

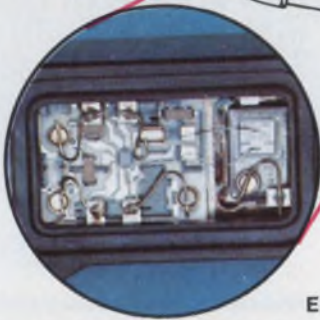

Electronic Ignition Systems

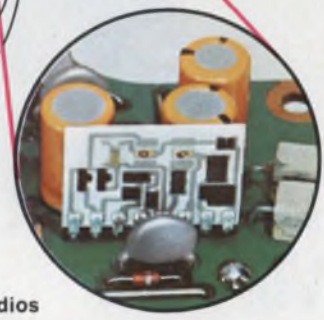

Radios

USCC/Centralab, the major supplier of monolithic ceramic capacitors to the largest manufacturers of automotive hybrid electronics.

The automotive environment can be considered the ultimate proving ground for component reliability. Under-the-hood systems provide a hostile environment where moisture, temperature extremes, shock and vibration are constant. It is a tremendous challenge to supply a component economical enough for an automotive application which can stand up to their rigorous specifications.

And Centralab is there, providing over 3.9 million BME-Chip™ Capacitors which are in 2.25 million domestic cars and light trucks. Over 11 billion unit life hours in ignition systems, voltage regulators and radios, without a single known failure. That's reliability!

Compare your requirements with those of the automotive industry. We're sure you'll choose BME™ Capacitors . . . reliability and availability at a low cost.

Please write on company letterhead for complete technical test reports.



USCC/CENTRALAB Electronics • GLOBE-UNION INC.

4561 Colorado Boulevard • Los Angeles, Ca. 90039 • (213) 240-4880

FOR LITERATURE ONLY CIRCLE 251

FOR FREE SAMPLE, CIRCLE 252

ELECTRONIC DESIGN 8, April 12, 1976



It also comes assembled.

If you need dials, we have dials. If you need handsets, we have handsets. If you need Touch Calling keysets, we've got 'em by the thousands. Ringers and hookswitches, too. Or, if you need complete telephones, we have them for you in all the latest styles and colors.

You get communications components faster from GTE Automatic Electric because, outside of the Bell System, we're the largest manufacturer of telephone equipment in the U.S. If you need it, we have it.

Use the coupon below for a complete

catalog. Or if you're in a real hurry, call John Ashby at (312) 562-7100, extension 250.

When it comes to quality components, call THE SOURCE: GTE Automatic Electric.



- Please send your catalog of communications components.
- Please send more information and prices on _____ of _____
(Quantity) (Product)

Name _____ Title _____

Company _____

Address _____

City _____ State _____ Zip _____

Telephone _____

Mail to: Mr. J. D. Ashby, B-4, GTE Automatic Electric, Northlake, Illinois 60164.

GTE AUTOMATIC ELECTRIC

Amphenol® trimmers. and Scot Pot™ potentiometers. Two bargains your competitors may not know about... YET.



Scot Pot



3810 wirewound



6034 cermet

The word is out—Bunker Ramo offers a big selection of Amphenol precision pots and trimmers. They can replace what you're using now—in form, fit, and function—and save you money in the bargain.

Our Scot Pot is as good as (or better than) any other 10-turn wirewound miniature precision pot on the market. It has improved electrical, mechanical, and environmental characteristics. Yet Scot Pots cost as much as 25% less than other equivalent pots.

And that's news that won't stay secret for very long.

Our 3/4" rectangular trimmers come in a full range of resistances and in all popular pin spacings. They're sealed to withstand automatic board cleaning. And they're highly stable—no drift. Two series to choose from: 3810 wirewound (available with Vista-Trim for fast, approximate visual settings). And 6034 cermet trimmers. Both series save you plenty. Ask for a quote and see how much you can beat the competition by.

For off-the-shelf delivery, call your local Amphenol Industrial Distributor. Your competitors may have already discovered his great service—so should you. Give him a call. Or for more information (and spec sheets on our pots and trimmers) contact: George Boyd, Connector Division, Bunker Ramo Corporation, 2801 South 25th Avenue, Broadview, Illinois 60153. Phone: (312) 261-2000.

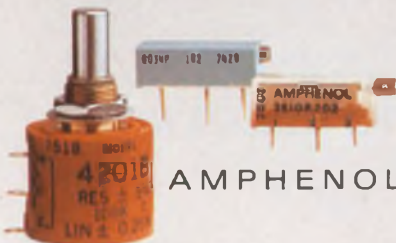

*When you can connect it
and forget it...that's quality.*

AMPHENOL POTENTIOMETERS FROM

**BUNKER
RAMO**

Microprocessor Design

A mini manufacturer warns, 'Beware the microcomputer'

Dave Methvin, president of Computer Automation, Irvine, CA, presents his views here for ELECTRONIC DESIGN readers.

A couple of years ago many experts, particularly in the financial community, thought that microcomputers would eventually wipe out the minicomputer business. Well, of course, that didn't happen. A year later they thought the microcomputer would wipe out the low-end of the minicomputer business. And, of course, that didn't happen either. Here we are a year later, still chugging along, and people are beginning to realize, I think, that the micro isn't really a minicomputer and that it has a limited capability.

The minicomputer companies, DEC, Data General and ourselves, for example, we're not about to run away from the low end of the business. For

a time there was even some discussion of the possibility that minicomputer companies will have to move up into bigger machines and start nipping at IBM's heels and so on.

Well my attitude is a little different in that we, and I think DEC and Data General felt that way also, would move our product farther and farther down that price curve and put a lid on how far microcomputers could go before they bump into the minicomputer companies with their established product lines, their software services, sales force, etc.

In fact, that's happened with Data General's recent introduction of its low-end microNova line.

It turns out that if used properly, there is no

(continued on page 32)

Complete development system for 8080 priced under \$4000

A stand-alone development system for writing, debugging, and executing programs on the 8080 μ P, the Model 8/16 costs \$3850 and is offered by Microkit (2180 Colorado Ave., Santa Monica, CA 90404. 213-828-8539).

The system comes with 8-k bytes of memory (expandable to 32-k), alphanumeric CRT display, an ASCII keyboard and two cassette-tape units. A special recording technique used in the 8/16 permits data transfer to the cassettes at the rate of 2000 bps. Software includes a monitor debugger, editor and assembler.

The CRT display holds 960 characters formatted as 24 lines of 40 characters. Since the display is refreshed directly from the main memory, the screen can be updated at a 20,000 character-per-second rate. The video terminal's keyboard is a full 53-key reed-switch unit.

Other features of the system include memory-write protect (for each 1-k page of memory and under software control), a crystal-controlled programmable real-time clock (with 32- μ s resolution) and interrupt-driven I/O. All I/O devices including real-time clock can interrupt the CPU and all interrupts can be masked under software control. The system also has 8-level vectored interrupt.

In addition, the development system has a bootstrap loader in PROM, two EIA RS-232C serial interfaces (one for a modem and one for teleprinter), and a 1-Mbyte/s DMA mode.

Delivery is 15 days.



CIRCLE NO. 501

MICROPROCESSOR DESIGN

(continued from page 31)

conflict at all between a μ P and a minicomputer, as far as I'm concerned. Microprocessors, such as the 8080 or some of the other popular μ P chips, are extremely powerful for very small tasks where you don't get into massive programming systems. They're a little bit difficult to program as compared with the traditional minicomputer, but work hand in glove with minicomputers when used properly. In fact, we have customers who use both μ Cs and minicomputers.

Accepting μ P limitations

If you understand what the limitations are on a micro and use it within those limitations you can be happy with it. Where we have seen a lot of grief is where users don't really understand what a micro is and what it is not.

A company starts out thinking its task is not very difficult, partly because its engineers are so excited about the idea of getting their hands on these little chips and playing games. Technical people love to diddle. So they have a tendency to be a little over-optimistic on the programs they're going to embark on. After awhile things start to grow on them. And that "one-time engineering charge," that "one-time software charge" they were talking about isn't one-time at all. It's continuing. Not only is it continuing, it's growing.

We've seen instances where companies have just sunk a bundle of money into this approach, only to have to scrap it entirely and start over using a minicomputer. They simply underestimated the task completely.

They learned the hard way. The next time they may be able to use a μ P properly and a minicomputer properly and know the difference between the two and where to stop with one and start with the other. Designing with microcomputers turns out to be more expensive than some people think. We have had customers who've been that route and use minis now. In fact, a bit of a backlash has developed. A few weeks ago I ran across a company where the edict was, "Thou shalt not use a micro for anything." The engineering departments were flatly told, you don't use μ Cs, period. The guys who sell those μ Ps aren't going to point out all the pitfalls you can get into. I think part of the reason they're not going to point them out is that when the customer gets into trouble, there's only one solution—namely, add a little more software and a little more memory.

The μ P is nothing more than a vehicle to sell memory chips. If you add up the total market for CPU chips, it's pretty damn small. But if

you add up the market for the memory chips they want to hang onto those μ Ps, it's pretty big. And so we have silence on one side and a whole lot of optimism on the other.

Sometimes if you get back and talk to the engineering people (and it's off the record) you'll find that in many cases they have really been burned using μ Ps. One of our customers actually fired their engineering group—on one of the programs using an 8080, I believe.

They went on and on and just couldn't get it to do the job. Not because of the μ P, I'm not knocking that at all. The group was just trying to make it do something it was never designed to do. The program was started over again using one of our minicomputers. In fact, that mini cost them about \$10,000. Now that's a pretty big price gap.

What it really means is that those guys should never have even looked at μ Cs. It wasn't a matter of price. It's just that the μ C couldn't do the job. And that was the engineering group's mistake. It had nothing to do with the μ C's quality.

An awful lot of guys who haven't used computers in their products before see this little hundred or two-hundred dollar μ C and say: "Gee, how can we go wrong? It's so cheap. We really ought to do it." So they step in with both feet. Now that's good and bad. It's bad in the sense that they can really get burned. And it's a costly way to learn a lesson. On the other hand it's good, because it drags guys into the industry and gets them acquainted with computers.

There is quite a difference between micros and minis in another respect.

Upward-compatible minis

Minicomputer houses sell relatively low-cost minis. If the customer's task outgrows that mini, he can step up to the next model. And when that one is outgrown, he can step up to the next one. He doesn't have to scrap anything he's done in the past.

With micros what you are seeing is a customer starting out with, say, an 8080. And if his task grows a little bit, or he has underestimated it, where does he go? When he runs out of gas on the 8080, what's next? Incidentally, now that there are 16-bit μ Cs on the market, that's what I would use if I were going to try to come up with a computer product of some sort.

I think the minicomputer houses will continue to bring their product down in price. When we announced the Naked Mini, the world thought that was the end of the road for minicomputers. They thought we couldn't make them any cheaper. And, of course, that hasn't happened. I've been saying all along that we'll continue to lower

(continued on page 34)

Is our new HP-91 an engineering work of art?

Or just a beautiful investment?

Time will tell. For the moment, let's just say it's an original. The first battery-operated (AC-DC), fully portable (40 oz.) printing scientific.

It performs all math, log and trig calculations.

The latter in radians, degrees or grads. It does hours/minutes/seconds arithmetic and conversions, rectangular/polar coordinate conversions, and more.

It performs many stat calculations.

Factorials, accumulations, 2-variable mean and standard deviations, linear estimates and regressions.

You can scarcely notice the 3-mode thermal printer.

One switch lets you decide to print everything, data entries and operations only, or nothing. For occasional printing, there's a PRINT x key.

The keyboard's buffered.

The printer catches virtually everything, no matter how fast you play the keys. (The number keys are set up just

like adding machine keys, by the way, so you can work them without looking.)

You can calculate up to five hours on battery power,

assuming you use the printer 20% of the time. And you can count on trouble-free performance.

You can print the contents of all registers:

the stack only (the HP-91 uses our RPN logic system with 4-register stack); the six stat registers only; or all 16 storage registers.

The 10-digit display glows like a firefly.

The characters stand almost twice as tall as those on our pocket models.

You get uncompromising design, assembly, support.

Three things that have made believers of the million+ people who own personal-sized HP calculators. Three things that might turn the HP-91 into an engineering work of art. Over time.

Meanwhile, at \$500.00* it's a beautiful investment.

800-538-7922

(in Calif. 800-662-9862).

The toll-free numbers to call for complete specs and a nearby dealer. Or send the coupon.

HEWLETT  PACKARD

Sales and service from 172 offices in 65 countries
Dept. 232T, 19310 Pruneridge Avenue, Cupertino, CA 95014.

616/05

Hewlett-Packard
19310 Pruneridge Avenue
Dept. 232T
Cupertino, CA 95014

Please send me HP-91 specs and your magazine with buyer's guide.

Name _____

Company _____

Street _____

City _____

State _____ Zip _____

*Suggested retail price, excluding applicable state and local taxes - Continental U.S., Alaska & Hawaii.

CIRCLE NUMBER 23



Actual size: 8" (203mm) length x 9" (229mm) width x 2.5" (63.5mm) height.

(continued from page 32)

the price of minis and that will tend to put a lid on how far μ C houses can operate before they

bump into minicomputers. I consider that end of the market ours. Here we've showed the world how to do it. We're not about to run away from it.

Advanced 8080-type μ P boasts improved instruction set

The latest 8-bit NMOS μ P, the Z-80 from Zilog (170 State St., Suite 260-A, Los Altos, CA 94022. 415-941-5055), uses 25 to 50% less memory for program storage and has much higher throughput than the 8080A—the μ P that most resembles the Z-80.

The new CPU chip features 158 instructions and 18 internal registers including two index registers. Also, the Z-80 boasts instructions for bit manipulation and for memory-to-memory and memory-to-I/O block transfers and searches. Further the μ P offers a wide range of addressing modes for tight and efficient coding.

Other CPU features include 8080A software compatibility; 4, 8, and 16-bit operations; 1.6- μ s instruction execution speed; single 5-V supply, and single-phase TTL clock. The CPU costs \$200 in sample quantities.

Peripheral and support circuits for the Z-80 feature the following: a programmable parallel I/O controller, counter timer, programmable parallel-serial I/O controller, and direct memory access controller. Except for the counter timer, which comes in a 28-pin DIP, all circuits including the CPU come in 40-pin DIPs.

Systems based on the new μ P can be designed with the Z-80-based Development System, which includes a debug module, floppy-disc subsystem, and optionally, a CRT terminal, line printer or hardcopy terminal. Standard software packages available for the Z-80 system include assembler, editor, and file-maintenance system.

The development system costs \$8990 and

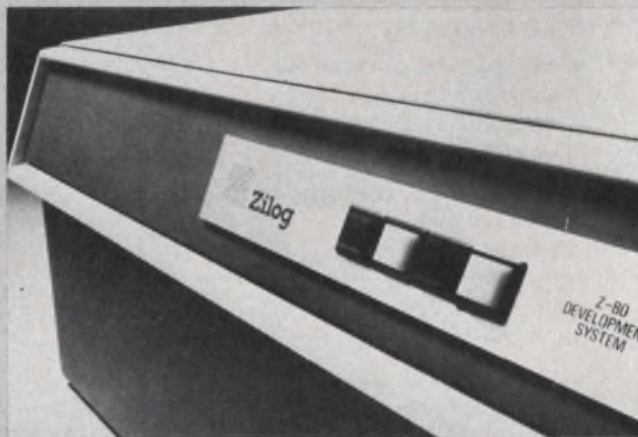

employs a single Z-80 for both the user's hardware (user mode) and the system resident monitor (monitor mode). The single CPU chip performs all functions offered by competitive systems, which require two or three processors.

The system's debug module allows pertinent user-mode transactions to be stored in real time and in an independent memory. The user can also cause any type of system transaction to suspend user operation and make the system re-enter the monitor mode. The complete record of all transactions preceding this suspension can then be conveniently displayed on the system terminal or listed on the line printer.

Other support tools encompass resident μ C software, time-sharing programs, libraries and a PL/M-type of high-level language.

CIRCLE NO. 502

μ C resident assembler comes on four PROMs

Microcomputer Associates (P.O. Box 304, Cupertino, CA 95014. 408-247-8940) now has a single-pass, resident assembler for the company's Jolt microcomputer systems. The compact assembler, totaling 1024 bytes, comes on four 1702A-type PROMs and costs \$99.50. The four PROMs alone, according to the company, are priced at more than \$60. With the low-cost resident assembler, JOLT users no longer need to incur the potentially high costs of time-sharing services.

CIRCLE NO. 503

NATIONAL ANTHEM



A Review of New Products and Literature

from National Semiconductor

WOW! 12-Bit Binary and 3-Digit BCD DACs

Brand new from National . . . a family of precision, low-cost, digital-to-analog converters for a wide range of industrial and military applications. Our DA1200 Series is self-contained in a 24-pin DIP (molded or hermetic); just turn them on and they're ready to go to work for you.

General features of the new DACs include both current- and voltage-mode outputs (0-2 mA, 0-10 V, ± 10 V); $\pm 1/2$ LSB (binary), $\pm 1/2$ LSD (BCD) linearity; 1.5- μ s current-mode, 2.5- μ s voltage-mode settling times; precision, buffered, internal references (10.240 V binary, 10.000 V BCD); standard power supplies (± 15 V, +5 V); TTL/CMOS-compatible, complementary binary or BCD input-logic formats; and expandability to 14 or 16 bits.

The DA1200/DA1201 are the 12-bit binary devices; the DA1202/DA1203 are the 3-digit BCD devices. Terrific specs, terrific parts. Ask for the data sheet and you'll see what we mean. #

LM117-Series Regulators Adjust to Your Needs

Announcing the one and only three-terminal adjustable voltage regulator on the market today! To change an output voltage, change a resistor value. Our LM117/217/317 regulators are exceptionally easy to apply, easy to mount (TO-3, TO-5, and TO-220 packages), and feature line and load regulations better than those of fixed regulators.

Look at these specs:

- Output adjusts from +1.2 to +37 V
- Guaranteed 1.5-A output current
- Line regulation, 0.01%/V, typ.
- Load regulation, 0.1 %, typ.
- Ripple rejection, 80 dB, typ.

And the chip includes full overload protection—current limiting, thermal overload, and safe-operating-area circuitry—which remains functional even when the adjustment terminal is disconnected. Even high-voltage supplies may be regulated because the chip floats; don't exceed a 40-V output-input differential and you stay in business.



So . . . ECL users, TTL users, supply diddlers (optimize, optimize!) . . . let purchasing stock *one* part—the LM117—and everyone will come up smiling. #

TELEPHONE RELAY DRIVERS



Our high-voltage/high-current positive and negative voltage relay drivers have many features that make them nearly ideal devices. For example, we specify output leakage, over temperature, at an output of ± 54 V (the polarity depends on the device). Again, we specify over temperature and at 5 mA, the minimum output breakdown; there's even an internal reference, which doesn't allow the output breakdown latching you'll find in all other

Our LM148: The Only True Quad-741 You Can Buy

Yep, we've gone and done it and, in this case, more is definitely better. Our LM148 Series is a true quad-741. It consists of four independent and well-isolated (120 dB), high gain, compensated op amps, and provides functional characteristics identical to

relay drivers, and which generally eliminates the usual need for external, inductive-transient protection; yet the output transistor is still *fully* protected.

TTL/DTL/CMOS compatibility; high-impedance pnp inputs; low power dissipation (typ., 90 mW with both outputs on); high output-voltage breakdown (typ., ± 65 V); high output current (300 mA, max.) . . . all these and more make our DS3686 (positive) and DS3687 (negative) voltage relay drivers ideal in telephone relay applications. Check them out for yourself; see what you've been missing. #

those of the 741. Yet the LM148's total supply current (2.4 mA, typ.) is less than that of a single 741; and input offset and bias currents are very much less (typ., 4 nA and 30 nA respectively) than those of a 741. Input offset voltage of the LM148 is 1 mV (typ.); all inputs and outputs are overload protected; and it's pin-compatible with the LM124.

The gain-bandwidth product of the LM148 is 1 MHz at unity gain; the other member of the family, the LM149, is a decompensated, wideband amp—4 MHz for $A_{v(\min)} = 5$. Stability? Super; 60° phase margin for both parts at the gain figures just mentioned.

To sum up: the LM148 and LM149 quads are just what you've been waiting for. Multiple-741 and 1558-type amplifier applications cry out for this part. Wherever you need matched amps or a high packing density, the LM148/LM149 will do the job; where before you had to settle for one or the other, now you get both. That's a little like having your cake and eating it too. Really. #

A Review of New Products and Literature from National Semiconductor

New Bipolar PROMs Ideal for High-Speed Systems

Our new 1024-bit PROMs are Schottky clamped; and this means high speed—a 30-ns (max.) enable-to-output delay and a 50-ns (max.) address-to-output delay into 30 pF across 300Ω. Organized as 256 4-bit words, the memories feature pnp inputs to reduce input loading, and two memory-enable inputs to control the output states.

When both enable inputs are at logic zero, the outputs present the selected

word; if either or both of the enable inputs are at logic one, all four outputs go to their high-impedance (off) state.

The memories are available in a Tri-State® version as the DM54S287/DM74S287, and in an open-collector version as the DM54S387/DM74S387. Both versions are available as either ROMs or PROMs, and are packaged in 16-pin molded and cavity DIPs.

⚡

Fast Access Featured in Tri-State®, Si-Gate CMOS RAMS

National's first silicon-gate CMOS RAMs are here. Ideal in microprocessor, minicomputer, and mainframe memory applications, these Tri-State® memories are very-low-power devices with high performance: access times are only 250 ns, maximum. Intended for operation from a single +5-V supply, the memories retain their data at $V_{CC} = 2$ V. All inputs and outputs are TTL compatible; data outputs are of the same polarity as the inputs; and on-chip registers are provided.

The MM54C920/MM74C920 (22-pin DIP) and MM54C921/MM74C921 (18-pin DIP) are organized as 256 4-bit words; the MM54C929/MM74C929 (16 pins) and MM54C930/MM74C930 (18 pins), intended for larger systems, have a 1024 x 1 organization. ⚡

qualified on MIL-S-19500/195 (2N2608), /375 (2N3823), /431 (2N4091 series), and /476 (2N5114 series).

All this shouldn't surprise you. After all, we've had, for many years, a fine reputation for MIL-M-38510 parts. We're simply expanding. So whatever your REL FET needs, consider National to be your prime source. Tie in with the leader. ⚡

Clock Modules



JUST WHAT THE DOCTOR ORDERED FOR A REALLY GOOD 'MOVEMENT'

National's MA1002 Series electronic clock modules get it all together for you on a single PC board; a MOS/LSI clock circuit; a bright, 4-digit, 0.5-inch LED display (hours, minutes, and blinking colon for seconds); and all necessary discrete components. All you add are a transformer, switches, and an ear-phone alarm-output to form a complete, pre-tested movement that's ideal for desk clocks, alarm clocks, clock-radios, TV or stereo clocks, instrument panel clocks, etc.

Features of the MA1002 Series include a 12- or 24-hour format; 50- or 60-Hz operation with power-fail indication; brightness control; sleep and snooze timers; alarm-on and PM indicators; and fast and slow set controls. Additionally, direct (non-multiplexed) LED drive eliminates RFI, and the module's size—0.93-inch max. thickness x 1.375 H x 3.05 W—allows the finished clock a very compact design. ⚡

NSC's REL FETs: Now You Know Where to Go

National is now a REL FET supplier, a simple fact that many of you will be happy to know. We've received qualification on MIL-S-19500/428 for the JAN/JANTX/JANTXV 2N4416A, a part that's been very difficult to get ('til now).

You'll also like to know that we're qualified on MIL-S-19500/385 for the JAN/JANTX 2N4856 through 2N4861—the most popular JAN FETs in today's marketplace—and will soon be



CMOS-Compatible Interface Components

We designed our DS3631/32/33/34 Series of dual peripheral drivers to be a universal set of interface components for CMOS circuits. This means that each circuit has CMOS-compatible inputs (high-impedance pnp transistors); high-voltage outputs (minimum breakdown, 56 V at 250 μA); high-current operation (300 mA, max.) at low internal V_{CC} current levels, with base drive for the output transistor derived from the load proportionate to the needed loading—essential to reduce the load on the CMOS logic

supply; and low V_{CC} dissipation (28 mW, both outputs on at 5 V). An additional bonus is that this family of peripheral drivers is also TTL-compatible at $V_{CC} = 5$ V.

Note, too that we've made the pinouts the same as those of our very popular DS75451, DS75461, and DS3611 parts. All of which means that with our DS3631 Series you can directly convert your present systems to our MM74C CMOS family, and end up with a terrific saving of power. ⚡

A Spinning Wheel Doth a Tachometer Need

While originally designed for vehicle tachometer applications, our new monolithic frequency-to-voltage converters turn out to have a wide number of uses. Besides tachometer-related applications in vehicle engines and motors in general—over/under speed sensing and control, speed switches, cruise controls, and automotive door lock, clutch and horn controls—our LM2907/17 ICs make dandy touch and sound switches, capacitance meters, and delay switches (it's not magic; to see how it's done, see the data sheet).

These circuits use the charge pump technique and offer frequency doubling for low-ripple and full-input protection. The load (to 50 mA) may be ground- or supply-referenced. Versions available offer single-ended or differential tach inputs, with or without an on-chip Zener regulator.

The transfer function of the circuits is easy to use: $V_{out} = f_{in} V_{CC} RC$, where R and C are external to the chip; linearity is 0.3% typ., $\pm 1\%$ worst case. New, interesting, and unique, our LM2907/17 will definitely make your life easier. \approx

APPLICATIONS CORNER Low-Voltage Reference Sources

We've had a number of inquiries from readers asking us how to use a three-terminal regulator as a low-voltage reference source, and how to make that source bipolar.

Our answer to these questions is that three-terminal regulators can be used in such a way, but to produce a lower-than-nominal regulator output requires a rather cumbersome amount of external circuitry.

A far better method makes use of our recently-announced LM117, a three-terminal regulator with an output that is adjustable from 1.2 V to 37 V (story on Page 1). Its use as a low-voltage reference source is shown in Figure 1.

By connecting the 'Set V' pot to a negative reference the unipolar source of Figure 1 becomes the bipolar source of Figure 2. Pre-loading the output to a negative voltage is necessary because the LM117 is a positive-output regulator and cannot sink current.

Still another scheme—this one taken from our LM199 data sheet and shown here as Figure 3—uses the LM199 temperature-stabilized Zener in combination with an LM108A op amp to provide output voltages to ± 6.9 V. \approx

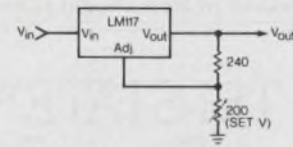

Figure 1. 1.5V to 2.0V Reference

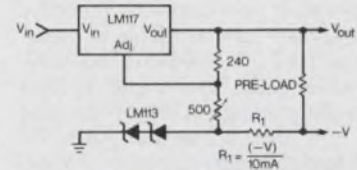

Figure 2. -2.4V to +2.7V Reference

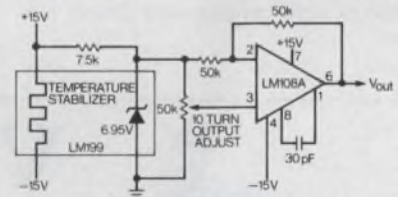

Figure 3. -6.9V to +6.9V Bipolar Reference

CLOCK CIRCUITS: Night and Day, These are the Ones

These MOS ICs provide all the logic needed to build many types of digital clocks and timers, notably desk and auto clocks, alarms, clock-radios, stop-watches, timers for industrial, photographic and appliance uses, sequential controllers, etc. The circuits have four display modes—time, seconds, alarm, sleep—and interface directly to LED displays.

The timekeeping function operates from either a 50-Hz or a 60-Hz input, and a power fail/return indication is provided. Outputs consist of display drive signals, a 59-minute presettable sleep timer (which can be used to turn off a radio), and a nine-minute snooze alarm. The display format is either 12 hours (with leading-zero blanking and AM/PM indicator) or 24 hours. These circuits, designated MM5384/5/6/7, operate from a single, unregulated supply (either 8-26 V or 18-26 V), and are packaged in 40-lead DIPs.

MM74C908/918: OLDIES BUT GOODIES

We'd like to remind you about some very popular parts we've been making. They are the MM74C908/918; CMOS, dual, high-voltage drivers that are super parts now being offered at lowered prices.

The MM74C908/918 differ only in power dissipation. At a 70°C ambient, maximum dissipation for the 908 ($\theta_{JA} = 110^\circ\text{C/W}$, max.) is 0.7 W, while the 918 ($\theta_{JA} = 55^\circ\text{C/W}$, max.) will handle 1.4 W. Both parts feature a supply range of 3 to 18 V; a low output on-



resistance of 8Ω (typ.); they can withstand 30 V in the off state; they will source 250 mA (min.) at $V_{OUT} = V_{CC} - 3$ V, $T_J = +65^\circ\text{C}$; and have proved invaluable when interfacing normal CMOS voltage levels to relays, regulators, lamps, etc. \approx



NEW TRI-STATE® OCTAL BUFFERS Use Low-Power Schottky Technology

Four new Tri-State® octal buffer ICs that employ low-power Schottky technology are now available in quantity from NSC. The DM81LS95/96/97/98 provide eight, two-input buffers in a single package. One of the two inputs is a control line that gates the output into the high-impedance state, while the other input passes the data through the buffer. Typically, power consumption is less than 80 mW per package with propagation delays less than 13 ns.

The DM81LS95 and 97 present true data at their outputs; the DM81LS96 and 98 invert the data. The DM81LS95 and 96 have eight common Tri-State enable lines, accessed through a two-input NOR gate. The DM81LS97 and 98 have two groups of four buffers each, each enabled by its own common line. Both commercial- and military-grade versions are available from stock.



A MICROPROCESSOR HANDBOOK FOR LOGIC DESIGNERS

We've just published a new book. It's called *A Logic Designer's Guide to Program Equivalents of TTL Functions*, and it's intended to help system designers make the transition from design in hardware to design in software.

While written primarily for current and potential PACE users (PACE is National's single-chip, 8/16-bit microprocessor), much of the text will be useful to anyone unfamiliar with microprocessors and software in general.

The handbook begins with the basics of microprocessing and software, then explains, in detail, the PACE instruction set and its use. More than two dozen simulations are described from both the hardware and software points of view. These simulations range from simple logic (AND gates, etc.) to complex subsystems (digital servo, digital tach, etc.), and are written in language familiar to TTL designers. A series of appendices—a glossary, a description of the hexadecimal number system, powers of two, and many more—concludes the handbook.

A Logic Designer's Guide to Program Equivalents of TTL Functions will be a unique and useful addition to any bookshelf of modern technology. The handbook costs \$5.00, and may be ordered directly from National. ☛

VIP CARD



Complete card and mail to
NATIONAL SEMICONDUCTOR
Attn: Marketing Services
2900 Semiconductor Drive
Santa Clara, CA 95051

INDEX

Please send me the literature that I have checked:

- | | |
|---|---|
| <input type="checkbox"/> LM117 Regulator, Page A, Col. 2 | <input type="checkbox"/> JANTX FETs, Page B, Col. 2 |
| <input type="checkbox"/> DA1200 Series DACs, Page A, Col. 1 | <input type="checkbox"/> DS3631/2/3/4 Drivers, Page B, Col. 2 |
| <input type="checkbox"/> LM148/9 Quad Op Amps, Page A, Col. 2 | <input type="checkbox"/> LM2907/17 Tachs, Page C, Col. 1 |
| <input type="checkbox"/> DS3686/7 Relay Drivers, Page A, Col. 1 | <input type="checkbox"/> MM5384/5/6/7 Clocks, Page C, Col. 1 |
| <input type="checkbox"/> DM74S287/387 PROMs, Page B, Col. 1 | <input type="checkbox"/> MM74C908/18 Drivers, Page C, Col. 2 |
| <input type="checkbox"/> MM74C920/21/29/30 RAMs, Page B, Col. 3 | <input type="checkbox"/> DM81LS95/6/7/8 Buffers, Page D, Col. 1 |
| <input type="checkbox"/> MA1002 Clock Modules, Page B, Col. 1 | |

A Compendium of Recently-Issued Literature (i.e., stuff to file)

- | | |
|--|---|
| <input type="checkbox"/> AN-141 Designing with the IMP Chip Set | <input type="checkbox"/> DB-4 Driving Burroughs' Bar Graph Display |
| <input type="checkbox"/> AN-152 Communications Interfaces for the IMP-16 | <input type="checkbox"/> μSpec 3 Floppy Disc Operating System (and CRT Interface) |
| <input type="checkbox"/> AN-153 Constant-Current LED | <input type="checkbox"/> μSpec 14 IMP-16 Utility Programs |

Your End Product or Application: _____

Have Salesman Call YES NO

ED-4/12/6

Please print clearly; this information will be used for our mailing list.

NAME _____ TITLE _____

COMPANY _____

ADDRESS _____

CITY _____ STATE _____ ZIP _____

PMI-Variety Store for DACs.

When you go shopping for D/A Converters, please swing by PMI. Ever since we opened our doors six years ago, we've been working hard to spice up our distributors' shelves with the widest line of monolithic DACs in the industry. 6-, 7-, 8-, 9-, and 10-bit DACs. Current or voltage outputs. Internal or external references. Routine MIL-STD 883A Level B processing, with Level A available. Guaranteed specs over full MIL Temp range. PMI pioneered monolithic DACs. It's only natural to find more here than anywhere.

And if DACs are new to you, lean on PMI's experience. We've helped designers and project managers put dependable PMI monolithic DACs to work in the most unusual spots. How can we help you?

Also, our price list, DAC data sheets and Ap. Notes are yours for the asking. Ask your distributor or call us at our store.



Precision Monolithics Incorporated
 1500 Space Park Drive, Santa Clara, CA 95050
 (408) 246-9222. TWX 910-338-0528.
 Cable MONO.

CIRCLE NUMBER 24

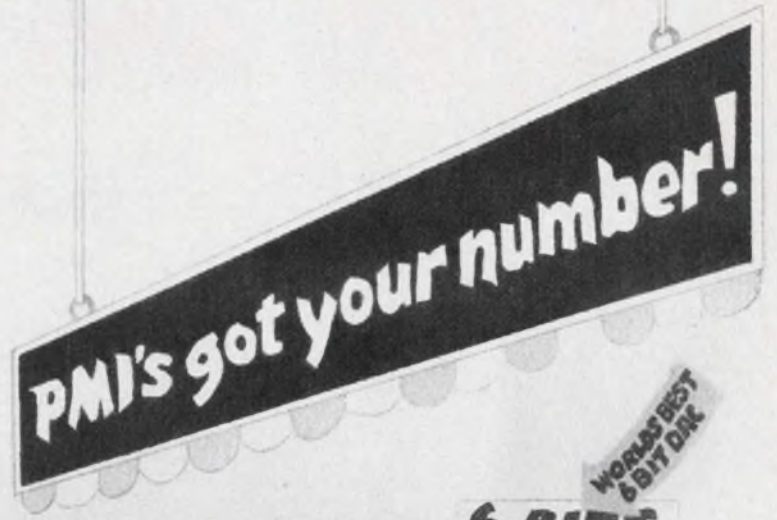

WORLD'S BEST
6 BIT DAC

6 BITS Vout
INTERNAL REF.
from \$9.25

10 BITS Vout
INTERNAL/EXTERNAL
REF. FROM

8 BITS Vout
INTERNAL/EXTERNAL
REF.
from \$10.00

8 BITS I out
EXTERNAL REF.
from \$3.95

8 BITS
I OUT
INTERNAL REF.
FROM
\$9.95

more
SOLD!
MORE MONOLITHIC
DAC'S SOLD THAN
BIG MAC'S (almost)



Optics and μ Ps begin to affect system design



Two relatively new technologies—microprocessors and optics—have begun to dramatically influence the design and performance of communication systems, components and test equipment.

Such giant organizations as Bell Telephone Laboratories, General Telephone and Electronics and International Telephone and Telegraph are currently investing millions of dollars in research and development on fiber-optic, voice and digital-data communications systems. In fact, testing of experimental optical telephone communications will begin this spring and summer.

Why fiber optics over conventional copper-wire systems? For one thing, they are lighter, have broader bandwidth capabilities, are smaller for the equivalent information handling capability. And they are potentially much cheaper. Besides, fiber-optic systems are practically immune to electromagnetic and radio-frequency interference.

In almost every fiber-optic link under development, solid-state light sources are used to generate the fast pulses used to transmit the data. The most promising source to date appears to be light-emitting laser diodes fabricated using a double-heterostructure aluminum gallium arsenide material. One problem that still needs to be solved is how to maintain the light-emitting efficiency of solid-state-laser light sources. Work is under way to extend the usable lifetime of these devices from about 10,000 hours today to over

100,000 hours—a period needed to make fiber-optic communication links a reality.

In addition to fiber-optic activity, more and more microprocessors are finding their way into telephone and data-network systems. These tiny chips are being used in such applications as network controllers, diagnostic tools, digital filters, store-and-forward-devices, and front-end processors.

A μ P-based message-switching system has recently been installed by the New York City Police Dept. And microprocessors are also being actively considered by the military for use in such applications as back-pack radios, field-data terminals, mobile-switching centers, portable satellite communication terminals and mobile relay links.

The dynamic growth of communications in recent years has also focused attention on a key system-component element—the packaged microwave oscillator. The search for a greater spectrum capacity in long-haul telephone and data links, and the spread of land mobile radio has brought demands for tighter specs on these packaged oscillators. These demands are being met by the development and production of a variety of microwave integrated-circuit designs that have improved performance.

The increasing demand for better performance and tighter specs in communication systems and components is putting an equal burden on manufacturers of specialized test equipment. This is particularly true in rf and microwave test gear where systems are now designed to be “smarter” and to have a greater range of operation than ever before.

For an inside look at the exciting developments in today’s fast-growing communications world, turn to the pages of this special section.

The photo depicts the several metamorphoses of glass as raw materials are transformed into optical fibers. The powdery substance at bottom is melted to make glass discs. The cylindrical blocks are formed into a rod and tube and the combination is pulled into a clad fiber.

Contents

Telephone and data transmission via fiber optics is being pursued by major organizations	42
Improvements continue to be made in digital and analog communications devices	50
Microprocessors are helping to communicate by voice and by data-bit stream	58
Radio-frequency and microwave test equipment is getting more automatic and a lot smarter	64
The spectrum squeeze is being eased by solid-state packaged microwave oscillator design advances	74
Harold Wheeler —An innovator in the world of communications	80

Telephone and data transmission via fiber optics is being pushed

Off-the-shelf fiber-optic systems now transmit and receive data at rates ranging from 1 to over 100 Mb/s. The transmission of thousands of conversations over a single beam of light has become feasible.

Like microprocessors, fiber optics is a new technology with great promise. There is a potential for data to be carried on a single hair-thin fiber at upwards of 100-Gb/s, and for optical fibers to displace wire and cable in literally thousands of data-transfer applications.

The unique advantages of fiber-optic systems are the solution to the problems of today's wire system. These advantages include:

- Substantially lighter weight and smaller size for the same or greater information-carrying capability.
- Potentially much lower system cost.
- Immunity to electromagnetic and radio-frequency interference (EMI and RFI) as well as to the electromagnetic pulses of a nuclear explosion (EMP).
- Virtual elimination of cross-talk.
- High degree of system information security.
- Lower signal attenuation than comparable copper-conductor systems.
- Broad bandwidth capabilities ranging from over 100-Mb/s for present LED-driver systems to greater than 100-Gb/s for future optical-IC systems.

Fiber-optic communications development is being pushed by a broad group of users. A major investment has been made by organizations like Bell Telephone Laboratories, General Telephone and Electronics Corp. and International Telephone and Telegraph. Companies in Canada, England, Europe and Japan are pursuing the same objectives.

Tests of optical telephone communication systems will be conducted this spring and summer

by both GTE and Bell Labs.

At Bell Labs' Atlanta, GA, facility, a 2000-ft cable containing over 100 single fibers will be installed in ducts and manholes. Testing of a simulated miles-long transmission line will be effected by joining individual fibers at the cable ends.

Fibers supplied by both Western Electric and Corning will be used to evaluate digital transmission for use between switching offices in metropolitan areas.

Light pulses at rates of 1.544 Mb/s and 44.7 Mb/s will be supplied by both LEDs and solid-state lasers packaged in standardized modules.

Fiber optics carry video signals

An operational optical-communication system was installed last fall in the Command Room of the Dorset County Police in Bournemouth, England after a multiple-terminal video-display system had been disabled by a lightning surge. A 10-Mb/s PPM system was installed by ITT/Standard Telecommunications Laboratories, Ltd., London, to prevent a recurrence of the outage. The fiber-optic system transfers information from the data bank of a main computer that contains criminal and other records, to video terminals on which it is displayed to supervising inspectors.

The U. S. Department of Defense is funding a number of projects. Using a 20-Mb/s system, the Army is currently investigating the use of fiber optics in medium and long-line tactical and strategic systems.

The Navy is investigating the use of fiber-optic systems both in aircraft and on board ship. For example, in an avionics interface system for the Navy A-7 Attack Aircraft, fiber-optics cables replaced the conventional wiring that transmitted data between the on-board AS91 tactical computer and its peripheral avionics. In this case, 224 ft of fiber optics weighing 1.52 lb replaced 1900 ft of copper wire weighing 30 lb. The system was delivered by IBM to the Naval Elec-



Fiber-optic communication has reached the practical stage for systems in the kilohertz to 100-Mb/s range.

System advances have been aided by the development of hardware like these ITT/Cannon optical connectors.



A six-fiber optical cable, Corning's Corguide, was developed for military field use. The tiny central fibers are protected by a tough, extruded jacket, shown in cross-section. Each fiber has a max 20 dB/km loss.

tronics Laboratory Center (NELC) in San Diego.

A six-station fiber-optic telephone system is in its third year of operation aboard the Flagship U.S.S. Little Rock. The voice is digitized in a pulse-position-modulation system that was developed by NELC for the ship. The optical cables are PVC-jacketed bundles, with a maximum length of 120 ft. Of interest is the fact that MIL-spec snap-action switches, TTL-integrated circuits and power supplies have failed during this period. But the fiber-optic links—LEDs, photo-detectors and cables—have performed reliably.

The Air Force has developed a 10-Mb/s multiple fiber-optic system with eight remote terminals that have optical switching between them. A second AF program is now investigating the performance of a system designed for transmission rates of higher than 100 MHz using existing technology.

Considering its potentially high performance, a fiber-optic communication system is surprisingly simple. It is comprised of the following elements:

- A fiber-optic transmission cable to carry the optical data a few feet or a few miles. The cable may be a single, hair-like fiber or it may be a small bundle of hundreds of such fibers.
- A source of visible or invisible IR radiation—a LED or a solid-state laser—that can be modulated to impress optical data on the fiber.

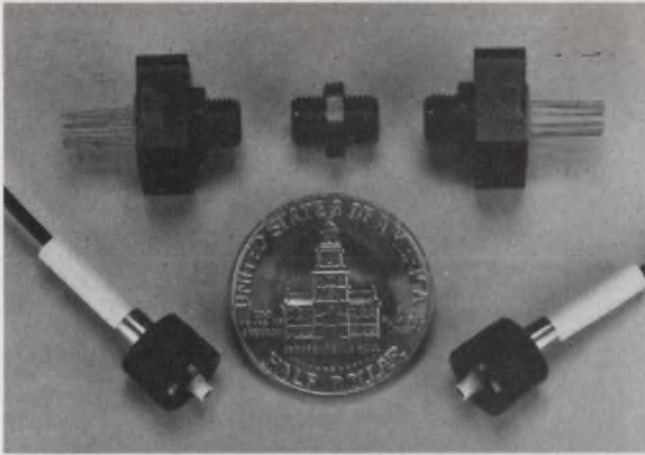

A special connector for a 45-mil fiber-optic bundle, by AMP, can be used as an end termination or as a center splice. Only the fittings need be changed to alter its function from an end to a center connector.

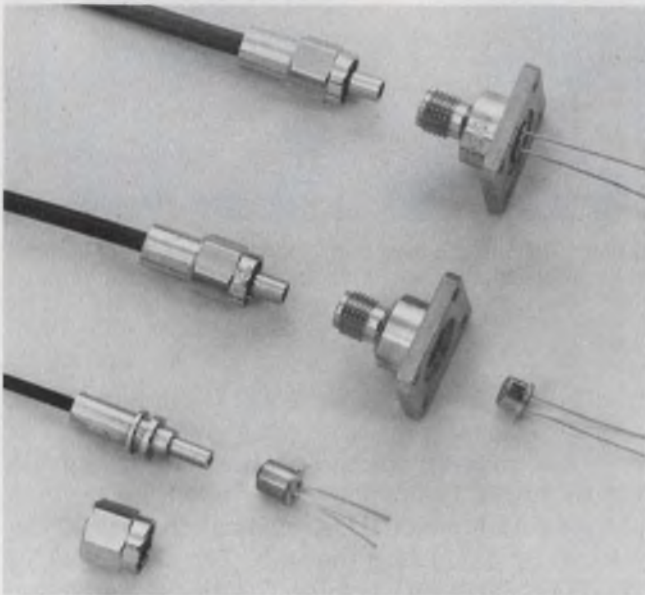

Subminiature optical-cable plugs, by Amphenol, are designed to accommodate fiber-bundle cables by Corning, Galileo, Valtec, DuPont, Poly-Optics and Pilkington. The mating receptacles hold LEDs and phototransistors.

- A photosensitive detector to capture the optical information at the receiving end of the optic cable and translate it into an electronic signal.

- Efficient optical connectors at the LED-to-cable interface, at the cable-to-detector interface, and between the interfaces of joined portions where the cables are spliced.

Optical fibers for communication systems are unique in that they transmit light efficiently by acting as optical waveguides. To achieve this performance, the lower-cost fibers are constructed of a solid core that is coated with an optical cladding. The refractive index of the cladding is less than that of the core, hence the name "stepped-index fiber." This fiber is used in multimode transmission. That is, the radiation source

(usually a LED) has a fairly broad optical bandwidth, and its energy propagates down the fiber in literally hundreds of modes.

The least lossy but highest cost fiber has no discrete cladding. Instead, the fiber is doped, during manufacture, so that the refractive index varies in a nonlinear gradient, from a maximum at the center to a minimum at the outside. This is a "graded-index" fiber.

With LEDs, the graded-index fiber is used as a multimode fiber. But with a laser (such as a neodymium-YAG) of high spectral purity the energy travels down the fiber in a single mode that gives the hundred-gigahertz bandwidth.

Both glassy and plastic fibers are commercially available for fiber-optic systems.

Typical glassy fibers range from about 2 to 5 mils in diameter. Losses range from 10 to 600 dB/km (1 km = 3280 ft). The numerical aperture (N.A.) varies from about 0.25 to 0.66. It expresses the ability of a fiber to capture or project light in a cone whose apex is centered at the fiber axis. N.A. is the sine of the maximum half-angle the fiber end is capable of accepting.

Glassy fibers are used singly or in bundles. A principle problem is concentrating the broad radiation pattern of the LED onto the small input area of a bundle or of a single fiber. This has been accomplished by the use of special LED packages containing lenses. A second lens is on the fiber.

Single fibers have own LEDs

For single fibers, LEDs have been constructed with the fibers directly attached to a tiny emitting junction. Bell Northern Research; Plessey Semiconductors, Santa Ana, CA; and RCA, Somerville, NJ, have produced variations of these devices.

Optical plastic fibers available are typically 15 mils in diameter and have losses of less than 500 dB/km. But these are used only in bundles. The N.A. is 0.53.

A variety of analog and digital fiber-optic communications equipment has reached the practical stage. With existing technology and hardware, data rates in excess of 100-MHz analog or 100-M bits of Manchester digital can be achieved, according to Kenneth C. Trumble, Air Force Avionics Laboratory, Wright Patterson Air Force Base, Dayton, OH.

Systems and hardware that have been developed under independent in-house programs or under military sponsorship are now available off the shelf from suppliers like Harris Electronic Systems Div., Melbourne, FL; Meret, Inc., Santa Monica, CA; Spectronics, Inc., Richardson, TX; American Laser Systems, Inc., Goleta, CA; Valtec Corp., West Boylston, MA; and Bell North-

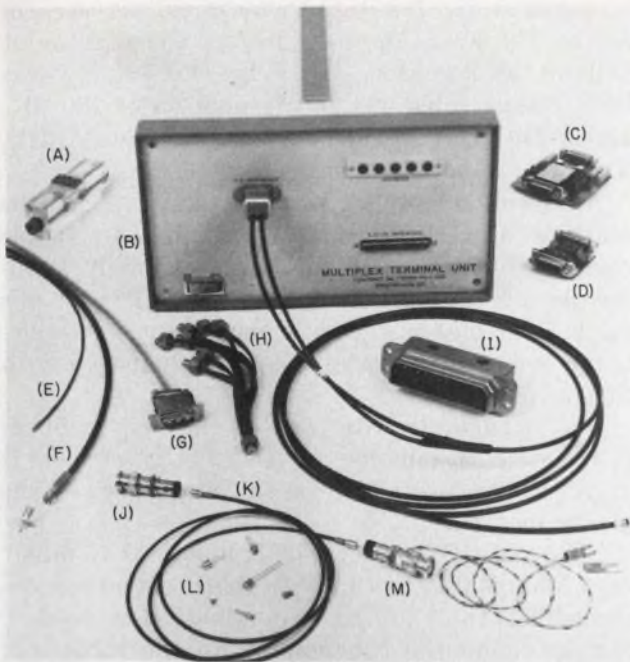

Fiber-optic systems and components developed for the Air Force by Spectronics include the following: (B) an 8-station, 10-Mb/s multiplex terminal; (A) a T-coupler; (H) an 8-arm flexible-radial coupler; (I) a 9-arm solid-radial coupler; (C, D) a 3-channel receiver and transmitter; (J, M) LED and photodiode-to-cable adapters; (K) fiber-optic cable with lens terminations; and (L) LEDs and photodiodes packaged for fiber optics.

ern Research, Ottawa, Canada.

Harris is currently marketing a 32-channel digital-data link that provides EMI-free computer-to-computer and computer-to-peripheral interconnections up to 1500 ft apart. It operates at a 16-M bit rate. The system, originally developed for the military and now being used at a SAC installation, employs a six-fiber Corning Corguide cable for data transfer. One fiber is used to transmit, another to receive, and four spares are available for either growth or redundancy.

A 10-Mb/s digital system with a standard 150-

ft cable is available from Spectronics. It consists of transmitter and receiver modules with built-in power supplies. Inputs and outputs are compatible with TTL levels.

A digital optical link offered by Corning uses either a 19-fiber bundle or a Corguide optical cable to carry the information. Error-free transmission of 10^{11} bits at clock rates of 25-Mb/s is claimed. Links up to 500-m long are available.

The key development that originally made fiber-optic systems feasible was the production of the first low-loss (20 dB/km) "doped-deposited" silica fiber—by Corning, in 1970. Before that, typical plastic and glass-fiber losses were in the area of 1000 dB/km, or more. These losses were gradually lowered by other companies that began to produce medium-loss fibers in the range of 300 to 600 dB/km.

Although Corning's low-loss fiber was useful in laboratory studies it was too fragile for military or other field operations. This problem was overcome by Corning in a two-year collaborative effort with the Army's Electronic Command at Ft. Monmouth, NJ. The result was development of a unique, "ruggedized" optical cable called Corguide that looks much like coaxial cable. Valtec is producing a less-rugged version of Corguide.

Corguide has six optical-fibers, each having a maximum loss of 20 dB/km at the 820-nm wavelength of gallium arsenide LEDs. Each fiber is plastic coated. The six of them are twisted around a central supporting fiber. For added tensile strength, two bundles of plastic fibers are embedded in a tough, extruded outer jacket.

In May, 1975 Corguide was released for commercial sale. It is now available at \$13.50/m. This price corresponds to less than 70 cents per foot per fiber channel and is competitive with high-grade coax.

Some users prefer single-fiber cables because of the lower cost. A new unjacketed multimode single-fiber with a 10-dB/km loss and a 20 MHz



This 32-channel digital data link, by Harris, is suitable for computer-to-peripheral installations up to 1500 feet apart. The system uses Corguide and operates at 16

Mb/s. Two of the six available fibers are used, leaving four free, for either growth or redundancy. The system is installed at SAC installations.

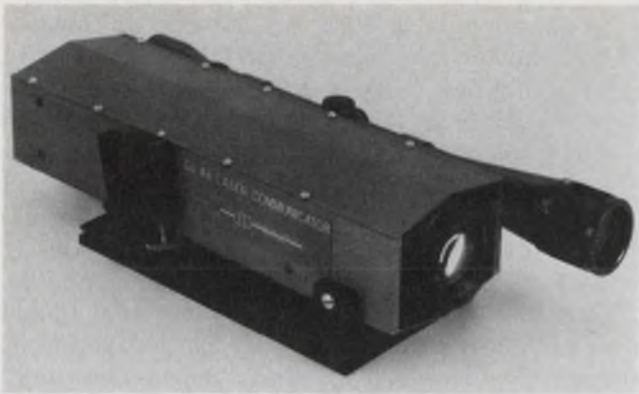

Free-space optical communication systems are useful for transmitting data over short-range links. This terminal, by American Laser Systems, operates at megabit rates.

digital-data bandwidth is available from Corning at \$1/m. The fiber is coated with a 50- μ m layer of ethylene vinyl acetate to protect it during handling. The user is expected to supply his own protective outer jacket.

When high-volume applications become practical the price of these kinds of fibers is expected to drop to 10 cents or less per meter.

Other fabricators who provided fibers for current military programs are now in open competition with Corning for the commercial market. These suppliers include the Galileo Electro-Optics Corp., Sturbridge, MA, and the Valtec Corp., West Boylston, MA.

Plastic optical cables have also been developed by suppliers like DuPont and Poly-Optics, Santa Clara, CA. They are suitable for nonmilitary en-

vironments and for links of 50 m or less, according to Dr. Fred Mannis, project coordinator at DuPont, Wilmington, DE. The DuPont low-loss PFX plastic cable has an attenuation of 480 dB/km at 66 nm, the wavelength of a visible LED. The cable is both tough and low cost.

Another advantage Mannis sees is that the plastic's highest transmission is in the visible region, which makes it possible to visually monitor the operation of circuits "wired" with this cable. A prime limitation is the plastic's relatively low temperature rating (80 C), compared with the ratings of glassy fibers.

One important advantage of the plastic fibers is the ease of bundle-end preparation, which is as yet a controversial problem with users of the glassy materials.

"The effective area of a PFX bundle is 45 mils," says Mannis. "It fits into an AMP connector designed for this cabling. No adhesive is needed. Simply clamp the connector onto the cable, cut the fiber end off with a razor blade and you have a low-loss interface termination."

Other connector manufacturers, including Amphenol, ITT Cannon and Selectro are approaching the optical-connector problem for glassy fibers by modifying existing wire connectors that have previously met military standards.

For example, Amphenol has converted an SMA connector (see photo) to a device for the 45-mil multiple-fiber bundle used by NELC.

The fiber bundle is inserted inside the connector ferrule and secured with epoxy. Then the ends must be optically finished by grinding and

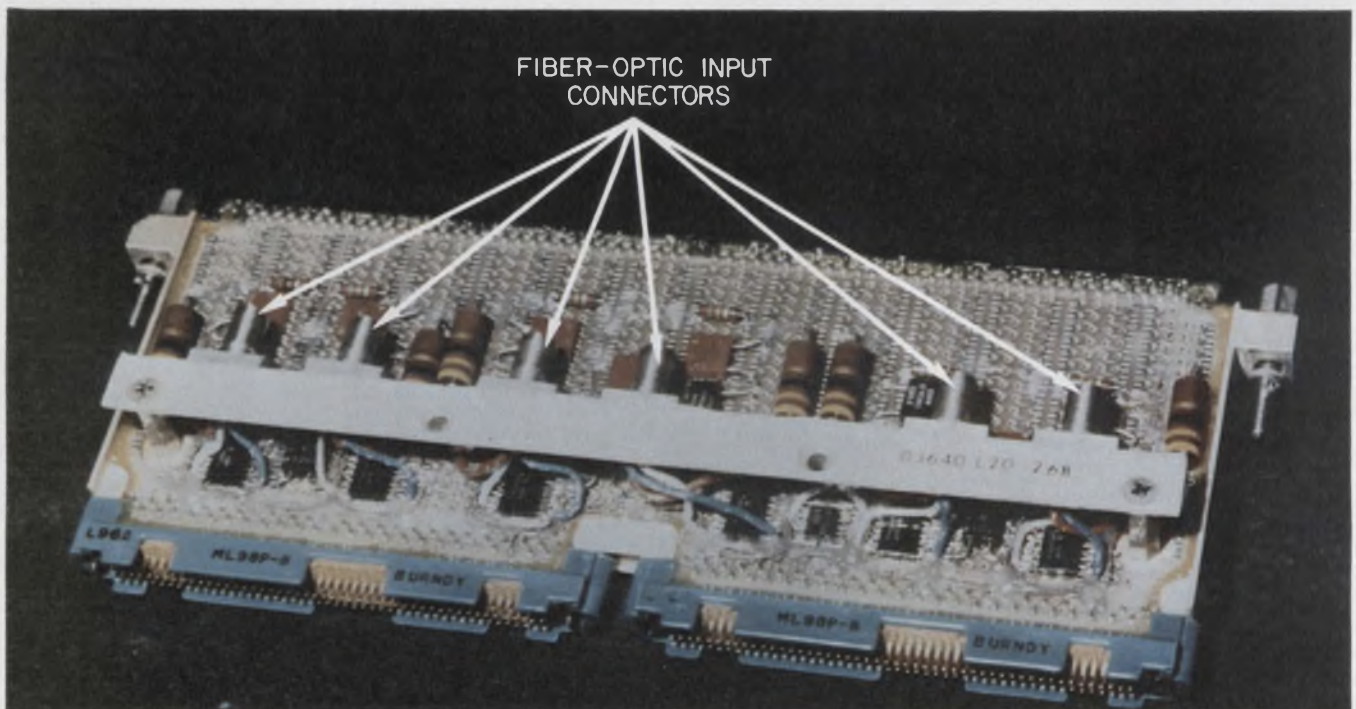

Time-division multiplexed inputs are converted, by circuits on this card, into signals that modulate six optical-data channels. These channels are a part of the fiber-

optic avionics/computer interface system that replaced cabling on the Navy's A-7 attack aircraft. The optical cables weighed but 1/20th of the copper wiring.

polishing, as with other competing types of optical connectors.

The process is generally unsatisfactory, points out Allen Kasiewicz, product manager of Amphe-nol's RF Division, Danbury, CT, which produces the SMA-type connector, particularly if it has to be done for telephone cabling down a manhole, or in the cramped confines of an aircraft.

Techniques have been developed to scribe and break the optical fibers cleanly, producing a planar face that needs no polishing, he points out. Crimping techniques have been successfully tried.

Kasiewicz believes that both active-end and fiber-to-fiber connectors will eventually be terminated quickly and efficiently because of the development of special tools.

One key sign that fiber-optics has matured is the announcement of a series of nation-wide field-training courses to update engineers on the new technology. The courses, given by Spectronics, are slated to start in San Diego in April.

Standardization a problem

The widespread application of systems in the kilohertz to megabit range is expected to be seen within the next two or three years. But at present progress is being slowed by an old malady of developing technologies—the lack of component and hardware standardization. Fortunately, standardized designs are being produced, by both in-house and military efforts, on the following system elements:

- Fiber-optic cables and their terminations.
- Cable-to-cable, cable-to-LED and cable-to-detector connectors.
- Radiation sources including LEDs and solid-state lasers.
- Radiation detectors.
- Optical routing elements such as multiport couplers and switches.
- Modular packages for LEDs, lasers and photosensors and their driving or amplifying electronics.

Standardization is a prime objective of the Tri-Service Fiber Optic Coordinating Structure, a joint effort of the Army, Navy and Air Force. The three services seek to avoid the vast proliferation of types, sizes, shapes and ratings that has plagued wire technology.

Special standards committees are now in operation. One committee, under the sponsorship of the Society of Automotive Engineers, is responsible for the development of airborne optical-system standards. Another committee, monitored by the Electronic Industries Association, is to generate standards for ground-based equipment.

Other standardization efforts are under way. At NELC contracts for the development of

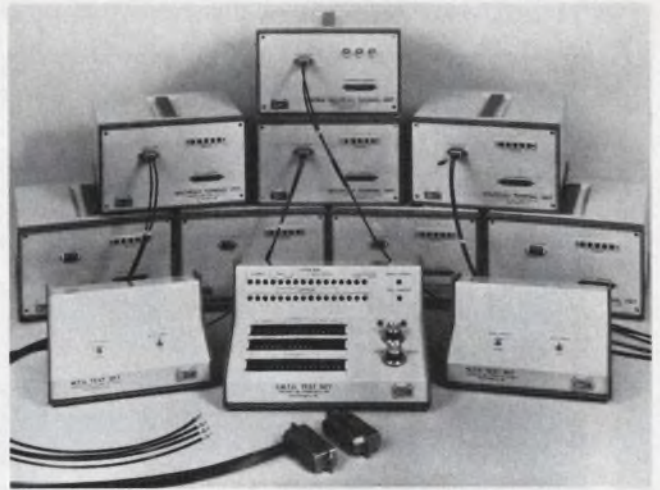

Hardware for a 10-Mb/s fiber-optics data-transfer system developed by the Air Force includes eight remote multiplex terminal units (rear) plus system test sets (center, front). Fiber-optics cables and coupler are also shown.

hybrid modular optical-transmitter and optical-receiver packages have been awarded. These modules will have digital electrical interfaces compatible with standard TTL logic at rates up to 20-M baud. They will be packaged for panel mounting.

The transmitter module will contain a Texas Instruments LED and the electronic circuits to convert the TTL input to LED drive current. The receiver will contain a silicon p-i-n diode, plus amplifiers, bias-voltage converter, and TTL outputs capable of driving 10 standard TTL loads.

The modules will be qualified to MIL-E-5400P Class II, for airborne environments and will also meet the requirements of MIL-E-16400G for fixed-station and shipboard use.

The optical-interface connectors for the LED driver and photodiode sensor will mate directly with standard cable connectors already developed for the standard 45-mil fiber-optic bundle.

Future modules planned by NELC include a video-baseband transmitter-and-receiver family for circuit board mounting, and a family of transceiver modules for full duplex operation on a single fiber-optic channel.

Developments in fiber-optic technology have overshadowed parallel efforts in commercially available optical communication systems using free-space as the transmission medium. A number of operational systems have been produced for free-space analog and data communications for outdoor and indoor environments in simplex or duplex short-haul transmission links.

These free-space systems use LEDs and solid-state and helium-neon lasers. Companies producing these systems include: American Laser Systems; Computer Transmission Corp., El Segundo, CA; Meret, Inc.; and International Laser Systems, Inc., Orlando, FL. ■■

**Monolithic capacitors have been
our business for nearly three decades.**

We build them better.

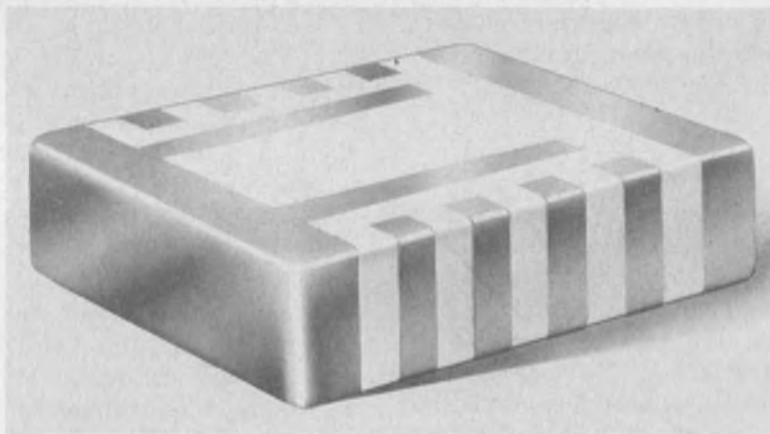

The new 'Vee Cal' Chip is one of our best.

We've been building better monolithic capacitors since 1948 — meeting your constant demands for technological and cost improvements.

Last year alone we introduced the first standard chip capacitor marking system . . . offered leaded chips . . . added X7R and Z5U dielectrics to chips and leaded ceramic parts . . . doubled and tripled the capacitance ranges of all NPO and BX components . . . produced the unique 'Vee Cal' Adjustable-Fixed Chip

Capacitor.

Now we're offering 'VK' NPO Ceramic Capacitors with low $\pm 0.25\%$ tolerances.

We've also expanded our 'Vee Cal' Adjustable-Fixed Chip series — capacitors you can adjust in or out of circuit. 'Vee Cal' is now available in a *smaller .120" x .100"* size, with values 1-55 pF, and *0.5 pF* steps. (Nearly 100 values in one part.)

In short, we're building ceramic and porcelain capacitors better than ever before — and delivering what we offer.



Vitramon[®]

**Vitramon North America
Division of Vitramon, Incorporated
Box 544, Bridgeport, Conn. 06601**

Subsidiaries: Vitramon Limited (London) • Vitramon GmbH (Stuttgart) • Vitramon France S.A.R.L. (Paris) • Vitramon Pty. Limited (Sydney) • Vitramon Japan Limited (Tokyo)

You spent a month thinking about power Darlingtonts.

Now spend a minute choosing the best ones.

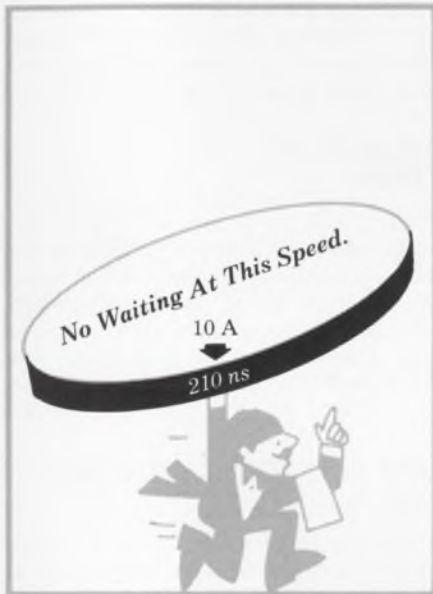

400 V 20A Switchmode* Darlingtonts

The best-spec'd switching Darlingtonts for high-efficiency power supplies, inverters, motor drives and switching regulators. *25°C inductive fall time is typ 210 ns at 10 amps.* 20 A MJ10000/001 and 10 A MJ10002/003 state-of-the-art 100°C case inductive switching speeds are fully characterized. Designers* data sheets spec max T_j at 200°C...50°C better than any other.

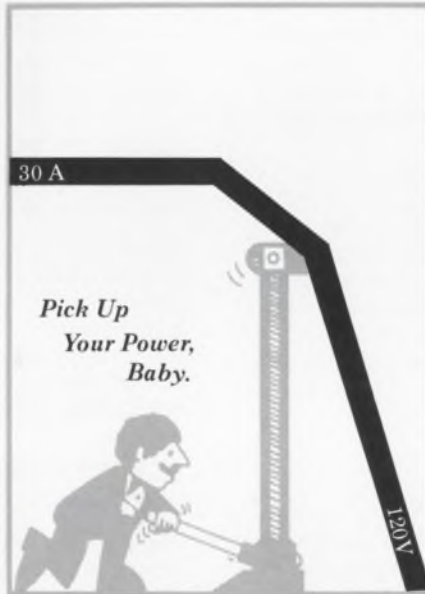

30A Complementary Darlingtonts

The industry's only 30 amp Darlington in TO-3 offers state-of-the-art SOA: 200 W at 30 V! Plus typical gain of 500 at 30 amps. Use the 60-120V MJ11011-11016 in complementary designs for motor drives, speed control and high-current, general purpose amplifier applications where "rugged" is the prime parameter.

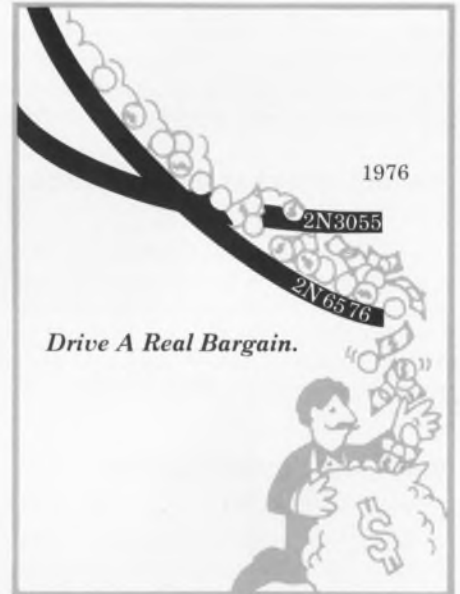

91¢ "2N3055" Darlingtonts

That's right — the 2N6576 is a complete 2N3055-type-plus-driver for just 91¢, 100-999... less than half what a '3055 plus 2N3054 driver cost. Drop the 2N6576-78 into audio, regulator and switching circuits and get 2,000 min gain at 4 amps... 4 MHz f_T ... 60 to 120 V... excellent SOA... and drive capability off low-level logic.

Motorola pioneered Darlington technology — Motorola offers the latest capability — Motorola provides the most types through field, factory or authorized distributor. Box 20912, Phoenix, Arizona 85036.

Just ask and we'll send you all the data you need to put the newest power Darlington transistors into your action. Or use your in-plant VSMF data center. It'll be time well spent.

*Trademark Motorola Inc.



SUPERPOWER

unlimited

The best talents in your business can be bought...

PRACTICAL DESIGN FOR ELECTROMAGNETIC COMPATABILITY

edited by ROCCO FICCHI

A complete guide to electromagnetic compatibility for electronic systems and equipment. Includes the current techniques for analyzing, predicting, controlling and reducing unwanted signals, along with numerous charts, graphs and nomographs. Recent advances in filtering and shielding, and exhaustive treatment of the special problems encountered in computers, semiconductors and solid-state devices. #5685-0, \$17.20

PRACTICAL VALUE ANALYSIS METHODS

by JOHN H. FASAL

This step-by-step guide transforms sophisticated VA-VE theory into concrete techniques and methods enabling you to literally take apart and scrutinize every facet of your operation—streamline everything from product costs to worker efficiency. An unlimited planning tool in the hands of today's ambitious executive or manager. #5845-4, \$13.75

MODERN DATA COMMUNICATION

by WILLIAM P. DAVENPORT

An on-the-job handbook mapping out the latest techniques, systems and services for the most efficient data transmission. Includes simplified coding techniques; ways of dealing with distortion, distraction, interference; efficiency and control techniques; modulating and multiplexing methods; and advice on using today's commercially available services. #5810-1, \$10.30

BASIC TELEPHONE SWITCHING SYSTEMS

by DAVID TALLEY

Offers the full array of switching techniques—from the early step-by-step type, through the common electro-mechanical group, to today's sophisticated electronic system. Special attention given to the No. 1 ESS type being installed by many companies. Here's a versatile, clearly-written handbook for the engineer, executive, and trainee alike. #5750-4, \$6.60

RELIABILITY, MAINTAINABILITY AND AVAILABILITY ASSESSMENT

by MITCHELL O. LOCKS

All the techniques and formulas you need for calculating the reliability, maintainability and availability of your repairable and non-repairable systems and components. You'll find sample models using point and interval values, and time-to-failure and time-to-repair data; binomial and other bernoulli-type distributions; simplified goodness-to-fit techniques, and much more. #9204, \$15.95

VIBRATION AND ACOUSTIC MEASUREMENT HANDBOOK

edited by MICHAEL BLAKE & WILLIAM S. MITCHELL

This giant, field-tested, 680-page manual enables you to master today's vibration equipment and techniques—shows you how to spot up to 90% of equipment problems months in advance and take corrective action before trouble starts. Uses scores of actual industrial problems and solutions in outlining specific procedures and techniques. #9195, \$34.50

on a 15-day money-back guarantee.

I'm buying! Please send me the books listed below to read and use FREE for 15 days. At the end of that time I will send payment, plus postage, or return the book(s) and owe nothing.

Number	Title	Price
_____	_____	_____
_____	_____	_____
_____	_____	_____
_____	_____	_____
	TOTAL	_____

Name _____

Firm _____

Street _____

City/State/Zip _____

I want to save money! Payment enclosed. Publisher pays postage. Same 15-day guarantee. 75-50



Hayden Book Company, Inc., 50 Essex St., Rochelle Park, N. J. 07662



UNIVERSAL MODEMS

Making data move is the name of the game in today's switched or dedicated line networks. If you're moving it at any speed up to 2400 BPS, Universal Data Systems has the proper modem for reliability, economy and efficiency in your system.

UDS has more than 20,000 modems in active field service, and that total is growing by more than 1000 units per month. Our product line includes CMOS 201s, plus 103s, 202s and the multiple-modem RM-16 which contains up to 16 units in any configuration mix you desire.

In addition to our products, we're extremely proud of our customer service. Check us out: Call us on the telephone. You'll like what you hear.



universal data systems

member of
IDCMA

4900 Bradford Drive • Huntsville, Alabama 35805 • Telephone (205) 837-8100 • TWX 810-726-2100

Created by Hall & McKenzie Advertising Winter Park, Florida

CIRCLE NUMBER 26

Improvements continue in digital and analog communications devices

For the past decade, many of the advances in communications circuits and components have been made in the digital area. However, important analog circuit and device developments have also occurred. Improvements are being made in bandwidth, power output and efficiency.

For example, the efficiencies of high-frequency bulk-effect devices such as Gunn and Impatt diodes have been doubled in many cases when the silicon was replaced with gallium arsenide or indium phosphide. GaAs field-effect transistors that operate at microwave frequencies are starting to appear on the designer's workbench; so are the amplifier modules containing them.

In the digital area, ICs are finding wide application in all types of communications equipment. Manufacturers have now incorporated microprocessors into public-service frequency-scanning receivers, digital frequency synthesizers into citizens-band transceivers and solid-state switches into equipment for telephone signal switching.

Other significant developments of circuits and devices in the communications area include:

- Monolithic circuits for the telecommunications industry, including companding circuits that reduce channel bandwidths and ease transmission requirements; electronic telephone-dialing circuits to replace the mechanical dial with keyboards; tone-generating circuits for multifrequency dialing.

- Solid-state crossbar switches that can handle signal-routing requirements for telephone exchanges.

- Impatt diodes that still provide useful power at operating frequencies of up to 170 GHz.

- GaAs FET amplifiers capable of delivering 2.2 W at frequencies of over 8 GHz.

- Specialized ICs for such consumer-oriented equipment as television receivers and citizens-band transceivers.

- Specialized data-communications ICs, including single-chip modems, multiplexers and peripheral interface circuits.

- Devices such as power transmitting tubes and specialized receiving tubes for the radio and TV broadcast industry.

Communicate we must

The art of communicating takes on many forms, but the telephone is surely one of the most common. Once the signal leaves the telephone in electrical form, there are many electronic transformations performed upon it. Telephone companies also manipulate basic signals, such as the dial tone and the tones used for touch dialing in many of the newer telephone exchanges.

As an alternative to the mechanical dial, General Instrument Corp. of Hicksville, NY, offers several ICs that combine to simulate the push-button tone telephone. The AY-5-9100 accepts pushbutton keyboard inputs and converts the contact closures into rotary dial pulses that, with the aid of a relay, can dial the desired number. The chip can also store the entered number for as long as power is applied to the circuit. Upon the press of a button it can redial the entire number—up to 20 digits.

To complement the dialer circuit there are the AY-5-9200 repertory dialer memory that can store up to 10 telephone numbers of 22 digits each, and the AY-5-9500, a clock circuit that generates the necessary timing signals for the 9100 and 9200.

For those areas with tone signalling, GI has the AY-3-9400, a dual-tone multifrequency generator in a 14-pin DIP, which can supply all necessary tones for dialing. Motorola Semiconductor, Austin, TX, offers a similar tone generator—the MC14410.

Several other companies have digital dialer chips

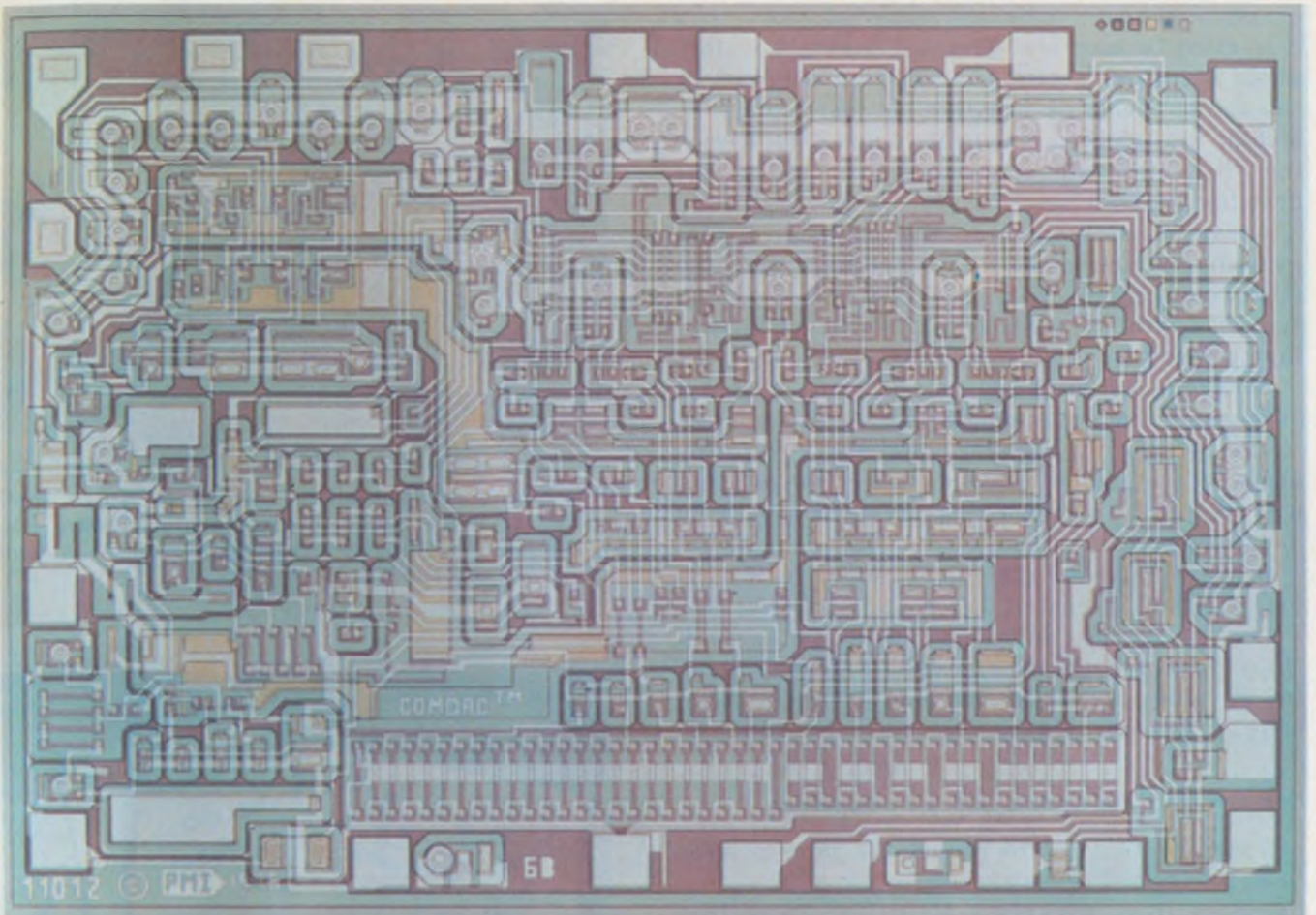

A **companding d/a converter**, when used as part of an a/d converter, logarithmically weights each bit to com-

press a signal. Antilog weighting expands the signal. The unit is made by Precision Monolithics, Inc.

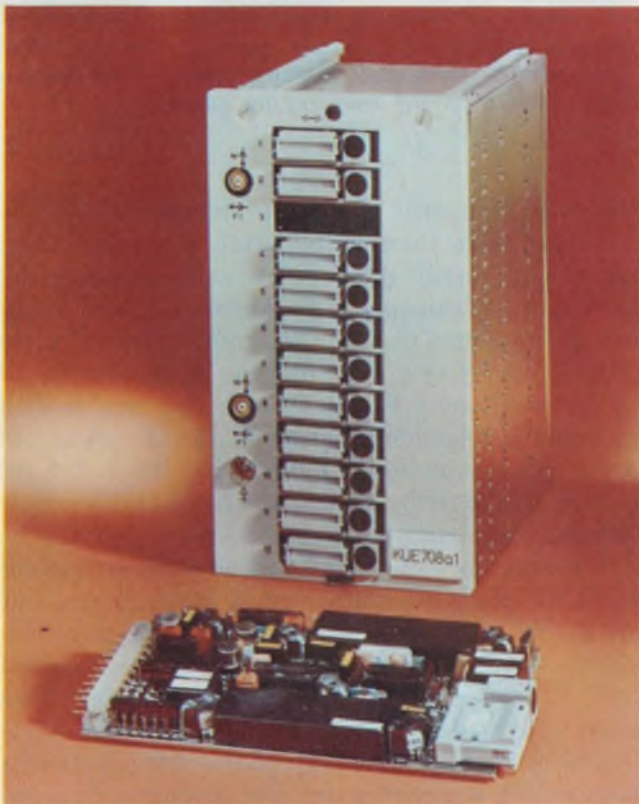

available for the designer—LSI Computer Systems in Plainview, NY; Motorola Semiconductor; and the Collins Div. of Rockwell International in Newport Beach, CA. None of these circuits perform identically, so match the best one to your application.

Once past the telephone, the signals go through a maze of switching gear, amplifiers, conversion equipment and relay stations to get to their destination. Much work has been done in the past few years on solid-state switches to route signals.

Solid-state switches offer tremendous advantages over the older, but proven, relay switches. For instance, there are no parts to wear. They have faster switching times and require less operating power. And they are much more compact than relay crosspoint switches.

Still, they are not ideal. Solid-state switches continue to suffer isolation problems—that is,

Channel translating equipment, such as this made by Standard Elektrik Lorenz, a wholly owned subsidiary of ITT in Stuttgart, West Germany, is widely used in the telecommunications industry for frequency-division multiplexing of telephone signals.

crosstalk between adjacent semiconductors on a chip must be kept low. The best results to date—about 60 dB of isolation—have been obtained by the use of dielectric isolation between devices on a chip. This method is expensive and is still keeping the solid-state crosspoint switches on the drawing boards.

Array sizes, limited by the number of pins available on the package, are not too large; the most commonly available size is only $4 \times 4 \times 2$. But arrays can be stacked to make larger switching systems.

Motorola currently has the MC3416—a dual 4×4 monolithic crosspoint switch that uses SCRs to do the signal switching. OFF and ON resistances of the switch crosspoints are 100 M Ω and 6 Ω , respectively. Switching times of the SCRs are a low 1 μ s.

Other companies, such as Signetics in Sunnyvale, CA, and, of course, different divisions of Bell Telephone are also doing heavy research in solid-state signal switching. The work Signetics is doing revolves about the company's DMOS field-effect transistor process.

Compressing the signals eases transmission

Once the signals are routed, the next process to be performed is the packing of the signals onto telephone lines, which are noisy. To get the best performance in the presence of noise, emphasis and de-emphasis networks are used. To do the signal manipulation, companies like SGS-ATES in Milan, Italy, Precision Monolithics, Santa Clara, CA, and Signetics are all working on monolithic companding circuits that will compress analog signals on the transmitting end of the line and expand the signals on the receiving end.

The Signetics circuit compresses a 2-dB-input-level change into a 1-dB change for transmission; the circuit's expander half changes the 1-dB signal back to 2 dB on the receiving end. The compandor is designed to operate from a 6-to-18-V supply and has only 0.5% distortion at a 0-dBm input level.

SGS-ATES has developed an expander circuit that can double the dynamic range of an audio signal. When coupled with a complementary compression circuit on the transmitting side, the compandors are supposed to improve tremendously the quality of audio transmission.

The digital method used by PMI, on the other hand, compresses the signal logarithmically into an eight-bit data word on the transmitting end and on the receiving end takes the antilog of the digital signal and converts it back into analog form. This method provides a 72-dB dynamic accuracy with only eight bits of data. Accuracies of 0.01% near the low-voltage regions are possible.

The multitone signal frequencies generated by

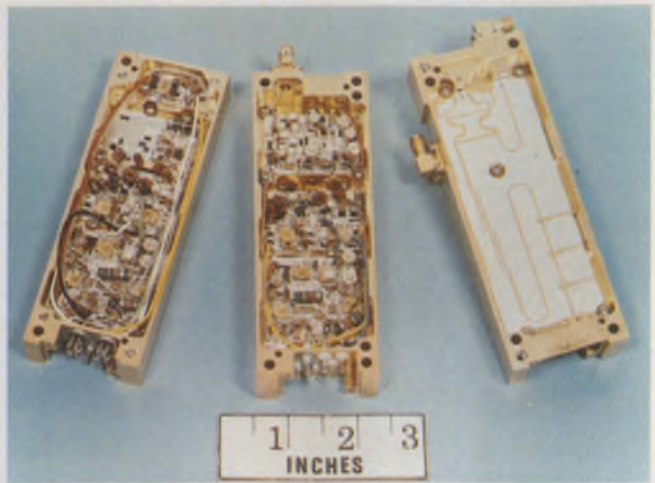

This S-band communications receiver for space applications combines hybrid, discrete and microwave integrated circuit technology to keep size small. It is made by AEL in Lansdale, PA.

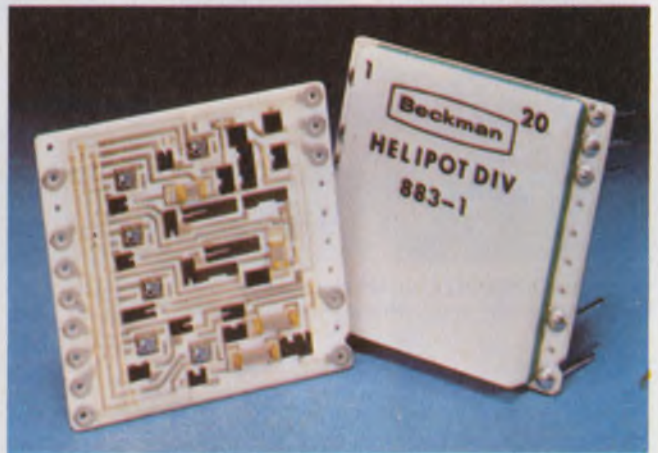

Complex telephone tone filters, such as this unit made by Beckman, require many circuits to recover the original digits entered on the transmitting keypad.

the tone keyboards (pads) of telephones can be used for more than just dialing a number. Just connect an array of circuits, such as made by Beckman Instruments of Fullerton, CA, and many other companies to filter the tones. Several companies offer single ICs that can generate the 12 or 16 multitone frequency pairs that are needed to dial the telephone, but to do the decoding, an array of as many as 13 hybrid circuits on the receiving end must be used to derive back the original numbers from the tones.

Not only does the telephone serve as an instrument for communicating verbal instructions, but with the additional decoding circuits the telephone serves as a miniature data-entry terminal and controller for simple digital systems. This control feature of the tone telephones is just starting to be realized by many of the manufacturers and will be a growing market in data-entry, se-

curity, and control applications.

The major drawback with the tone control is that complex decoding circuitry is needed. A complete array of circuits to decode the 16 tones can cost between \$100 and \$150 in large quantities. Work is being done to shrink the size of the circuits needed.

Motorola Semiconductor in Phoenix, AZ, expects to have part of the answer to the simplified decoding problem with its series of three ICs—the MC8522, 8523 and 8524. In large quantities these circuits are expected to cost about \$40, total, and contain all the circuitry necessary to decode the multifrequency tones.

Transmission frequencies on the increase

To transmit information from one point to another you have a choice of three major types of relay systems: the old microwave relay links, earth-station-to-satellite communication links and the fiber-optic "wired" links.

New semiconductors and tubes for these important communications links are appearing in ever-increasing numbers. Most of the development work, though, is aimed at the earth-station and fiber-optic links. Fiber-optic links are the most exotic, with information carried on a beam of light in a glass fiber (see p. 42).

Solid-state light sources are used in almost every link to generate the fast pulses used to transmit data. Light-emitting laser diodes fabricated using a double-heterostructure aluminum gallium arsenide material grown by liquid-phase epitaxy have shown much promise as the light source for optical communication links. These diodes provide radiances as high as 100 watts/steradian-centimeter² for a drive current of only 150 milliamps.

Most solid-state laser light sources have had problems in maintaining their light-emitting efficiency. Lifetimes of about 10,000 hours are commonly available, but for many applications these aren't long enough. Usable lifetimes of over 100,000 hours are needed to make fiber-optic communication links a reality.

On the receiving end of the fiber-optic link are solid-state photodetectors such as avalanche and p-i-n photodiodes. These devices are readily available from many manufacturers.

Rf semiconductor developments span a range that generates frequencies as high as 170 GHz with usable signal levels. The first microwave semiconductors were built from silicon and had efficiencies of up to about 15%. With the development of GaAs material technology several years ago, efficiencies for many microwave devices have improved to over 30%.

Along with the improvements came some problems. GaAs is a difficult material to manufacture

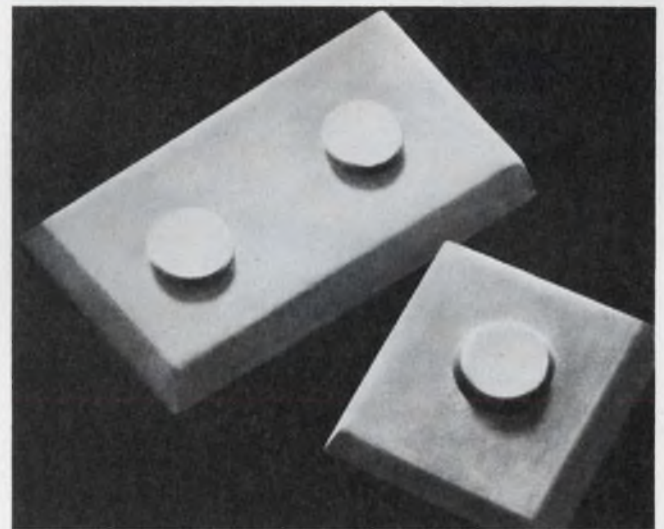

These tiny double-drift Impatt diodes (top) are used in many communications transmitters to deliver several watts at frequencies of up to 14 GHz. The actual diode chips (bottom) must have good heat sinks to obtain maximum power efficiency. The diodes are made by Hewlett-Packard.

and handle, thus making the final devices hard to produce uniformly. Aging of the semiconductors also tended to change the device parameters, and thus the circuit characteristics of whatever the devices were built into. The parameter change is most critical for devices, such as FETs, that must be biased for operation.

Avantek, in Santa Clara, CA, claims to have solved much of the aging problem with a process that surface passivates the FET chip with a coating of silicon nitride.

Whether a diode or transistor is used in an amplifier or an oscillator, power gain is an important factor in device use. Amplifier modules with small-signal gains of 63 dB are possible at frequencies as high as 13.525 GHz with bandwidths of 250 MHz.

As digital control takes over more and more of the communications gear, electronic tuning

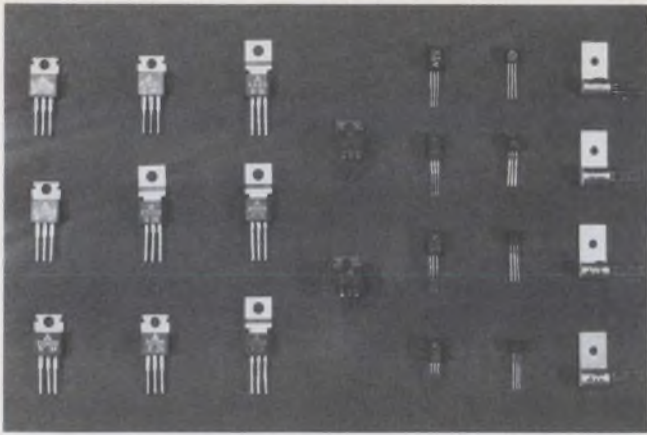

Plastic-molded transistors, like these made by Panasonic, are finding their way into more and more consumer-oriented communications gear.

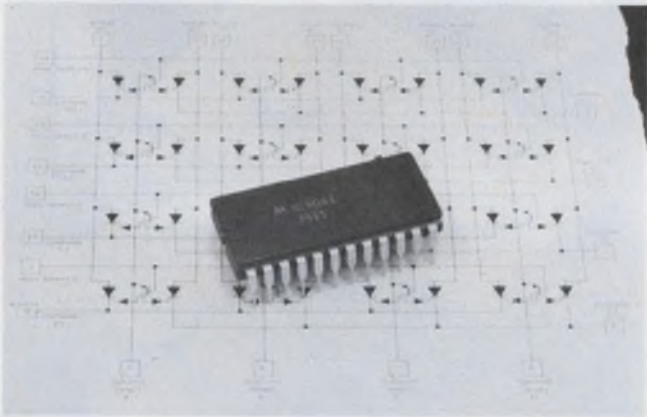

Monolithic crosspoint switches made by Motorola offer dual 4×4 switch arrays. Although Motorola uses SCRs to switch the signals, other companies are trying out field-effect and bipolar transistors.

methods are becoming an increasingly essential part of any system. Work being done by Thomson CSF has produced electronically tunable Gunn-oscillator circuits that have a tuning range of 6.4 GHz, centered around 14 to 15 GHz.

Most electronically tunable oscillators use varactor diodes to change the tank capacitances and thus the frequency. Electronic tuning isn't all roses, though. Obtaining varactor diodes with high Q s to prevent circuit loading requires careful device and circuit design to make the most of the available Q . Hewlett-Packard in Palo Alto, CA, has recently announced a process that promises to double the available Q from varactor diodes—thus bringing Q s of 13,000 and higher to the designer's workbench.

Gunn and Impatt diodes are also under constant improvement. They are, though, two-terminal devices and therefore difficult to bias and control. Three-terminal microwave devices, until several years ago, were not commercially available. Today, you have a choice of either bipolar or field-effect transistors to provide power gains

at frequencies of up to 17 GHz. Hughes Corp., Malibu, CA, has developed a 17-GHz GaAs FET using ion implantation. Noise figures for the device are 2.7 dB at 8 GHz and 5 dB at 17 GHz, with associated gains of 9 and 4.6 dB, respectively. Japanese companies, including Fujitsu and Nippon Electric are also in the forefront of FET development research and have recently announced products. GaAs FETs offer the best gain-bandwidth products of any solid-state microwave amplifying device.

Tubes—devices rarely in the spotlight today—used in communications equipment are not all being phased out. There are many applications where solid-state signal sources cannot meet the power-output requirements. Travelling-wave tubes are still undergoing active redesign to boost efficiency and reduce size. Power outputs of TWTs can reach well over 100 W at frequencies of over 10 GHz.

To boost the tube efficiency, manufacturers are considering the use of multiple collectors within the tube to capture more of the emitted electrons. However, additional collectors add to the circuit designer's problem because complex biasing networks must be included to provide optimum graded potentials.

The radio and television broadcast industries are also improving the efficiency of their transmitters by upgrading them with improved tubes. Most communications transmitters are completely solid-state up to the final output stage. But the final stage, which delivers 25 or 50 kW, still uses tubes.

RCA Electro-Optics and Devices in Lancaster, PA, has just introduced what it claims to be the industry's largest air-cooled tetrode, with a power output of 55 kW at vhf-TV frequencies. The tube offers cost savings to many stations because it eliminates the need for two 25-kW tubes and a power combiner. This makes possible a single-tube final stage for circular polarization transmitters. The tube has an efficiency of 75% and a gain of 17 dB.

Consumer communications leans on digital

Many of the communications developments of the data-processing industry have found their way into consumer communications gear. The citizens-band transceiver, for instance, has incorporated digital circuits to make it lighter and more efficient.

Some of the latest innovations include the use of a microprocessor to control the scanning and frequency-selection capabilities of a public-service-frequency receiver made by Tenelec of Oak Ridge, TN. The receiver uses a PPS-4/2, 4-bit microprocessor to search out frequencies, digitally generate them, store them in memory and recall

them at your convenience. FM frequencies in the 30 to 50 MHz, 150 to 170 MHz or 450 to 470-MHz bands are covered and any of 4096 possible frequencies in each band can be selected. The scanner costs under \$400.

There has recently been some discussion by the FCC and CB transceiver manufacturers of doubling the channel allocation from the present 23. If crystals were used in every transceiver to generate all the possible channel frequencies, the price and size of the units would probably jump to an unmanageable amount for the average consumer. Many companies are thus looking at the possibility of using a single crystal and some form of digital-synthesizer IC to generate all the transmit and receive frequencies.

Hughes, Newport Beach, CA; Nitron in Cupertino, CA; Fairchild in Mountain View, CA; National Semiconductor in Santa Clara, CA, Nippon Electric and Motorola are all introducing specialized ICs that will cut the parts count and generate up to 1023 possible channels. The Hughes HCTR0320 synthesizer, originally developed for the U.S. Army's Manpack radio, has been modified for CB applications. On the chip is a divide-by-N counter, an adder, a three-digit BCD register, a seven-bit binary register and a phase frequency detector. All that's needed is an external voltage-controlled oscillator—and the crystal—to make a complete frequency synthesizer.

Discrete devices for consumer communications equipment are also undergoing close manufacturer scrutiny. The main object of the study is to lower the manufacturing cost of the final product by lowering the cost of the internal components. The power transistors used to deliver an rf signal to the CB antenna are finding themselves housed in plastic packages, as opposed to the metal cases used several years ago. Panasonic and many other companies have pioneered low-cost, reliable plastic transistors.

Since the power devices in CB sets usually serve a dual function (both power output and audio amplifier) they must work under a wide range of bias and operating conditions.

CB transceivers are not the only growing personal communications market. The 900-MHz industrial-communications market has opened a new range of circuit design problems and device requirements. High-frequency power transistors that can deliver several watts at 900 MHz are needed, as well as specialized filtering circuits.

Hybrid power amplifiers and gold-metallized transistors are just some of the devices that the portable communications requirements are spawning. Modularized circuits are almost an absolute requirement for high-frequency transceivers because parts placement can actually affect the performance of the radio. Beam-leaded discrete devices help in the critical circuit designs since

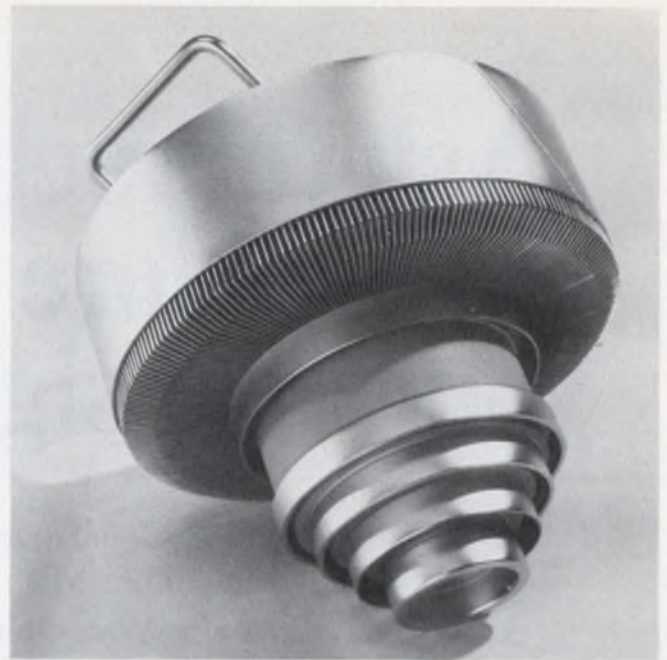

Power-transmitting tubes for the broadcast industry have gone to air cooling for lower cost and, where possible, to larger power handling capabilities. This tube, made by RCA, handles 55 kW and has a power gain of 17 dB.

they practically eliminate the package inductances and capacitances. Since there are no bulky packages to mount, the finished circuit is smaller.

Digital communications: a growing need

With the advent of low-cost data-processing equipment, the need for these devices to communicate with one another has grown into a major product area. Microprocessor-based equipment, for instance, uses many different types of digital communications circuits to transmit and receive data. Data links built using both modems and serial data transmitters are used when these digital computers talk over long distances.

Much work is being done to simplify the communications circuits. Motorola has introduced monolithic ICs that serve as modem, bit-rate generator and serial-data transmitter. The MC14412 single chip modem offers a simple solution for telephone-line data links, and the MC14411 bit-rate generator offers the multifrequency timing outputs needed to control the modem transmission rates.

Universal synchronous and asynchronous receiver/transmitters are also part of the digital communications scene, with at least one of these devices incorporated into almost every digital machine. These devices, commonly called UARTs, accept the parallel data from computer busses and transform the data into serial form (synchronous or asynchronous, as the case may be) for transmission on a two-wire or telephone data link. ■■

Ask yourself 5 questions before you buy your next signal generator.

1. How much spurious signal output will my receiver test tolerate?
2. Do I require calibrated AM & FM?
3. Is continuous tuning along with phase lock best for my test procedure?
4. Do I need a separate, low RFI counter?
5. Could my transceiver be keyed during test?

1. Fundamental L-C type oscillator gives spectrally pure signals from 10-520 MHz in 6 bands. Sub-harmonic and non-harmonic spurious outputs are >100 dB down. No spurious "cross-overs" typical of synthesized or heterodyned generators.

2. Accurate, calibrated, metered modulation, both AM and FM. Internal source 400, 1000 Hz. AM: 0-90%. FM: 0-3, 10, 30, 100 kHz deviation. FM possible during phase-lock.



8654B with Option 003, 8655A

3. Continuous tuning along with phase-lock stability gives best human interface for many receiver tests. No step-tuning jumps typical of synthesized generators. Push 8655A Counter/Synchronizer phase-lock button for 0.1 ppm/hr. stability.

4. Well shielded counter circuits exhibit RFI less than $1.5\mu\text{V}$ for use near high-sensitivity receivers. Also use for external counting of transceiver output to 520 MHz.

5. Reverse power protect (Option 003) ensures against possible damage from accidental keying of transceiver to 25W. Output is levelled, calibrated, and adjustable from +10 to -130 dBm (0.7V to $0.07\mu\text{V}$).

After you analyze your receiver test procedures, we think you'll find that the HP 8654B Generator can fill most, if not all, of your requirements. It has good spectral purity, low spurious, and calibrated AM and FM. The 8654B is really hard to beat for price and performance in an economy signal generator.

Add the 8655A Synchronizer/Counter and get high frequency accuracy, 500 Hz resolution, low drift, and low RFI. For most transceiver testing, this combination may answer all your questions.

HP 8654B, \$2275*; Option 003 (reverse power), \$300*;
HP 8655A, \$2075*; HP 8654A (FM uncalibrated), \$1900*
For more information, give your nearby HP field engineer a call, or write.

*Domestic US prices only.

HEWLETT  PACKARD

Sales and service from 172 offices in 65 countries.
1501 Page Mill Road, Palo Alto, California 94304

04508

ERIE RESPONDS. that's why WE'RE NO. 1 WORLDWIDE in Ceramic Capacitors



Forty years ago, ERIE foresaw a need and introduced the first ceramic capacitor to U.S. markets. Today, ERIE is still dedicated to fulfilling customer needs. Our state-of-the-art ceramic technology continues to lead the way in the development of smaller, more efficient ceramic capacitors, both fixed and variable. And ERIE's line of high quality components is as broad as the markets we serve. So when knowledgeable people think ceramic capacitors, increasingly, they think ERIE. To remain number one in our competitive industry, we have to be responsive to your needs. We think we are. Try us.

ERIE TECHNOLOGICAL PRODUCTS, INC.
Erie, Pennsylvania 16512



Microprocessors help to communicate by voice and bit stream

Throughout the fields of telephony, data networking and satellite and military communications, companies are designing equipment with μ Ps in them. Chips serve as network controllers, diagnostic tools, digital filters, store and forward devices, front-end processors, tariff computers and more.

Most applications are being handled by MOS μ Ps, but a few use bipolar bit-slice processors instead.

μ Ps find use in telephony

Telephony was one of the first areas of communication to feel the influence of the μ P. Among the initial products to reach the market were the BCS-50 Private Automatic Branch Exchange (PABX) from Chestel Corp., Chester, CT, and the Transaction Telephone from AT&T, Shreveport, LA.

Chestel's PABX system, which uses time-division multiplexing, employs a single 8008 μ P from Intel, Santa Clara, CA. The 8-bit, PMOS μ P searches for data during time slots. It checks on terminals for on-hook, off-hook or other status, sets up conference calls, keeps track of over-all system status and gives instructions to the terminals. The features or restrictions for each terminal are stored in PROMs.

A μ P-controlled accessory—the SMDAS Message Accounting System—is also being built for the BCS-50.

The SMDAS plugs in and keeps track of any traffic on the system. It uses an M6800 μ P from Motorola Semiconductor, Phoenix, AZ.

The Transaction I and Transaction II telephones from AT&T incorporate a PPS-4 μ P from Rockwell International, Anaheim, CA. The main functions are credit card authorization, check

verification and other electronic funds transfer functions. The μ P is used to store information and release it at the appropriate time on a coded signal. Multitone or rotary telephone sets can be programmed by a plastic dial-up card.

The μ P also provides character checking and sets up the required line protocol. The set can be used either for direct dialing or in branch exchanges.

"Soon the μ P will be used for almost every function available in telephony—and used more efficiently," says Martin Fletcher, vice president of ComQuest Corp., Palo Alto, CA. "Even now, more sophisticated use of the devices is being designed into 2-way concentrators, central office switching equipment, PABX, tariff rate computers, paging equipment for multiterminals, message accounting systems, message switchers and scramblers."

Since 10 to 50 μ s per instruction is all the speed necessary for most of these applications, he says, NMOS μ Ps of the type now available will be able to handle them.

Diagnosing telephony

What happens when something goes wrong in a switching system? Lynch Communications, Reno, NV, says diagnosing problems in its B280 electronic subscriber switching system was a tedious task. Now, it has designed a μ P-based instrument, the B280 Maintenance Monitor. Using an Intel 8008 μ P the unit is plugged into the switching system to monitor 128 points. If a fault occurs, the μ P analyzes the problem and isolates it down to PC-board level.

"Newer switching systems will use internal μ Ps to perform fault diagnosis as a routine function," says Lynch's Alan Hutcheson. He also expects the next generation of switching systems and line concentrators to all use μ Ps. The concentrators use space-division switching to concentrate many lines onto a smaller number of trunk lines.

In these systems, the μ P will handle faults, take traffic data and control the switching.

Microprocessors are being designed into a variety of central office switching equipment. The μ P may eventually monitor traffic, handle memory control, perform line scanning to determine the proper routing for best economy, maintain internal control and accounting and handle inter-office tones.

Rolm Corp., Cupertino, CA, and AT&T recently introduced minicomputer-controlled PABXs. Although initial products in this field may be controlled by minicomputers or custom LSI circuits, ultimately the μ P is expected to win out as the dominant PABX control element.

PABX goes digital

Once the PABX is digitally controlled it can readily handle a variety of digital transmissions as well as voice. Once the exchange is made programmable, the lines it controls can accept data in a variety of line protocols and speeds. The exchange can then translate the protocols as required and transmit the data in the most economical manner. It can even provide error checking and correction, or scrambling for secure communications. All features that were once hard-wired can be duplicated through software.

Microprocessors in digital networks

Microprocessors are on the verge of finding wide use in various parts of digital data-communication networks. The first important product in this field is the Model 6000 Intelligent Network Processor from Codex, Newton, MA, a multiprocessing network processor. It uses an Intel 3000 bipolar μ P as a controller for up to eight Motorola M6800s.

The 6000 handles network management, can support a throughput of 50 to 60-kb/s, does error checking, handles up to 252 terminal ports, does automatic channel assignment, dynamic network reconfiguration, data compression, system diagnostics and handles intermixed data rates and protocols.

Terminals can be intermixed with synchronous data rates of up to 9600 b/s and asynchronous data rates of up to 1200 b/s.

"In the communication environment, an eight-processor mainframe has approximately the processing power of two middle-sized minicomputers of the Digital Equipment PDP-11/40 class," according to John Pugh of Codex.

A rather sophisticated network processor, "an automatic terminal controller," is under development at the Multigraphics Div. of Addressograph-Multigraph Corp. It will be a node

controller for one part of a larger data communications network. The heart of the system is a microcomputer based on the Intel 8080A.

Most of the terminals in the system will transmit either 300 or 1200-baud data, according to M. Glen Looney, manager of systems and software development. The terminal controller will be connected to a large number of terminals where it will handle polling, message transmission and retransmission, diagnostic testing, buffering, error checking (with automatic retransmission) and line protocol. The data out of the terminal controller will then go to a host controller for communication back to the main computer. The system should be available for delivery

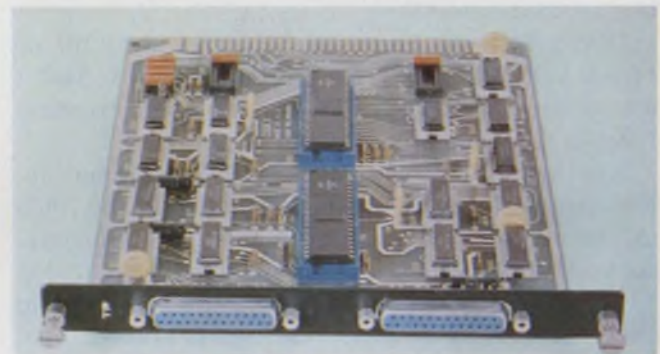

An intelligent network processor with several μ Ps inside is the Codex 6000. It uses an Intel 3000 as an executive processor to control up to 8 Motorola M6800s.

around midyear, Looney says. He expects main applications will be in point-of-sale and electronic-funds-transfer systems.

A μ P-based message-switching system has recently been installed by the New York City Police Dept. Up to 4 National Semiconductor IMP-16 μ Ps and a 32×16 -k National 2102 semiconductor memory are used to handle synchronous and asynchronous data from up to 16 lines. One IMP-16 writes asynchronous data into the memory while the other reads synchronous data from memory. The other pair of processors perform the same function.

The devices also calculate cyclic redundancy

check numbers for the data. The μ Ps serve to convert asynchronous data from inquiring terminals to synchronous data, which is fed to a host minicomputer. They then reverse the process to feed data back to the terminals.

Built by Action Communications of Dallas, TX, the system is marketed under the name Telecontroller.

A front-end processing function is also being performed by an Intel 8080A in an Energy Saver system. Developed by Systems Technology Corp., Detroit, MI, it manages the power usage in one or more buildings. A host minicomputer is used in the system. The μ P front-end uses a proprietary protocol with error detection and correction for transmission of data over a twisted pair or modem. "We can also send control signals to other μ Ps in different locations. The result is a distributed computing system," says William Buyers, president.

The Systems Technology equipment is one of many using an 8080A-based microcomputer designed by Process Computer Systems of Flint, MI.

"It is useful for data communications applications because our I/O structure is very flexible," according to Arthur Harmala of PCS. "All I/O is treated as memory locations. We can handle up to 40-kbaud in an asynchronous manner and can do cyclic redundancy code or BCH error checking at that speed."

PCS offers the computer in either an 8-bit or 16-bit version. The I/O is organized in a 16-bit manner by splitting up 16-bit words and treating them 8 bits at a time.

Another PCS customer is Interautomation, Mississauga, Canada. They are using the PCS μ C to make a digital multiplexer for industrial control applications. It can handle both analog (4 to 20 mA) and digital inputs and outputs and can deal with up to 1000 total inputs and outputs.

Into the modem

Microprocessors in the view of many do not offer any advantage over conventional circuitry for low-speed modems. But they can be very useful for controlling high-speed programmable modems. Another possible use for μ Ps is for digital filtering and adaptive equalization in high-speed modems. In time they will also be able to handle UART functions through software instead of hardware.

Processing a satellite

"We are expecting to get an order of magnitude improvement in reliability, size and power consumption when we use μ Ps in our systems," says Richard Cooperman of Comsat Laboratories,

Clarksburg, MD.

"We are now looking at the use of a μ P on board the satellite for an attitude control application," he says. Funded by INTELSAT, the attitude controller needs a flexible I/O structure to handle a large number of sensors. Since speed is not a concern the firm will probably use either an NMOS or CMOS μ P. A 12 or 16-bit processor is optimum.

Comsat is also looking at a μ P as an on-board power system controller.

For earth-station applications Comsat has built μ P-based hardware for adjusting the polarization of the beams in a dual-polarization transmission system. The Intel 8080 μ P optimizes the quadrature angle of the two polarized beams. It has this equipment currently operating in the laboratory.

Using μ Ps for telemetry encoding, random logic replacement for improved reliability, and distributed processing of satellite data are currently under study at such companies as Hughes Aircraft, El Segundo, CA; TRW Systems, Redondo Beach, CA; and Lockheed Missiles and Space, Sunnyvale, CA.

Securing the data

Security of voice and data transmissions is a primary concern of the military. In each of the services a number of classified programs are underway to explore the use of μ Ps in secure communications systems.



The Transaction II Telephone from AT&T is a μ P-based credit-authorization and check-verification device. It uses its Rockwell PPS-4 μ P for storage, forwarding, line protocol set-up, and error checking.

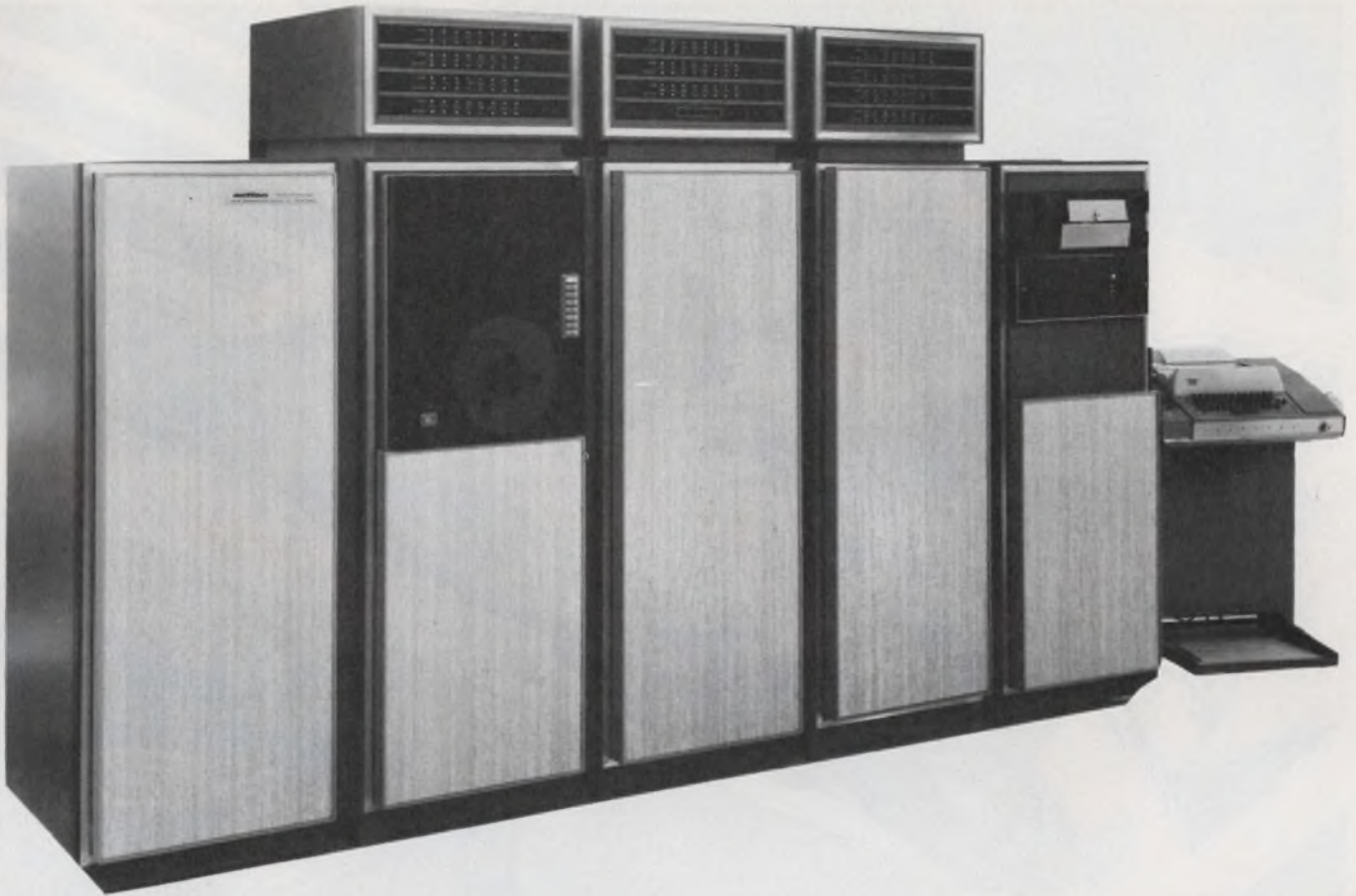

The Telecontroller from Action Communications uses up to four IMP-16 μ Ps from National Semiconductor to translate asynchronous data from remote terminals into

synchronous data that is fed to a host minicomputer. The IMP-16s also retranslate the data and distribute it back to the terminals from the mini.

One of the most widely accepted methods of obtaining a secure communications link, spread-spectrum communications, increases the frequency spectrum of the transmitted signal so the signal is hidden far below the background noise. The received signal is correlated with signal-compression circuitry at the receiver. The information, which is often coded before being spread, must also be decoded at the receiver.

Two primary methods of frequency spreading are used. The first is called frequency hopping. Here the carrier is rapidly changed so that only a small portion of the coded signal is contained on any single channel. The more frequencies (channels) used, the less information that can be detected if a single channel is received by the enemy.

Direct sequencing is the second technique. Here, the desired signal is blended with a known pseudo-noise code. The resulting combined data stream is transmitted using an rf bandwidth far larger than the information bandwidth. The message being transmitted resembles the background noise level and is thus hidden. At the receiving end, a μ P-based correlator strips the message from the pseudo-noise code and, if necessary, decodes it.

These techniques are being looked at for back-pack radios, field data terminals, mobile message-switching centers, portable satellite communication terminals, mobile relay links and a variety of other applications.

Soon μ Ps may also find their way into the communication and navigation systems of remote pilotless vehicles and cruise missiles.

What of office products?

There are now a great many office products that communicate. Examples are word processing systems and facsimile equipment.

Companies such as Xerox, IBM and 3M are known to be actively developing μ P-based office products, but none of them will comment on the subject.

One of the most promising areas for using μ Ps is facsimile. Rapifax of Santa Clara, CA, may be the farthest along with this technology. According to Norman Peterson, executive vice president: " μ Ps might have a place in both control and imagery aspects of facsimile."

Xerox and 3M are rumored to be nearing the product stage with μ P-based facsimile systems of their own. ■■

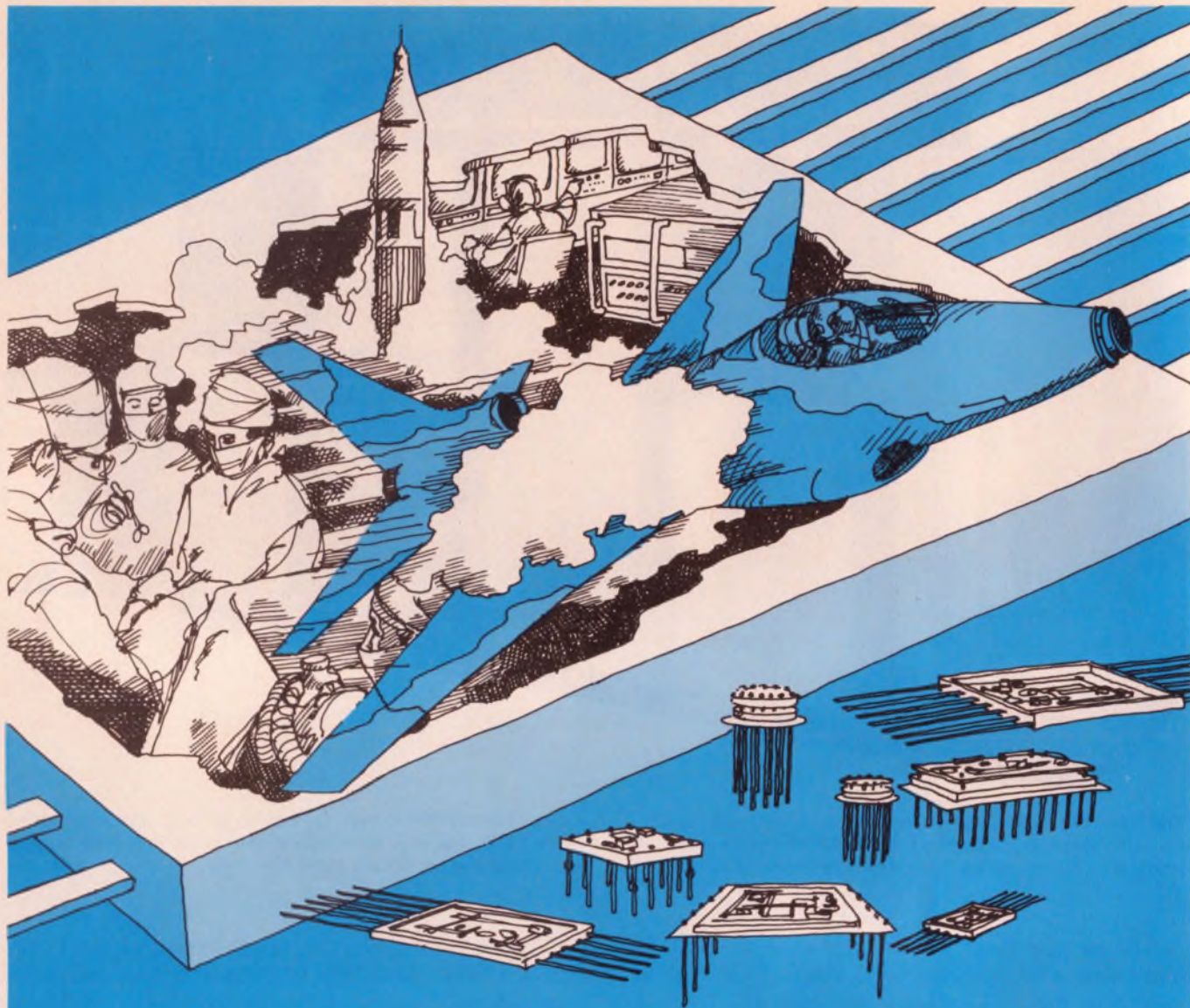

CTS puts a lot into hybrid circuits. And hybrid circuits into a lot!

Sixteen years experience in cermet circuitry and eleven in active hybrids add up to a lot of sophisticated capability. And it all goes into CTS hybrid circuits.

With that experience guiding our design activity, the CTS technical team can create an active hybrid circuit that meets your requirements, *whatever the application...*

At CTS, exacting standards beyond MIL STD 883 are a way of life used in the production of High Reliability im-

plantable grade Medical Electronics. The same exacting standards are used in all Hi Rel airborne and military applications and can benefit your applications.

This Hi Rel capability also complements and enhances the *known* CTS capability in commercial and industrial active hybrids and cermet resistor/trimmer networks.

CTS Microelectronics is dedicated to its single specialty: active & passive

hybrids. This dedication, based on the wealth of experience and capability already achieved, is your finest assurance that CTS is here to stay... in hybrid circuits.

Find out NOW how your Hybrid Circuit can benefit from CTS capability.

For full information contact
CTS MICROELECTRONICS, INC.,
Dept. ED, 1201 Cumberland Avenue,
West Lafayette, Indiana 46906.
Phone (317) 463-2565.

CTS CORPORATION
ELKHART, INDIANA
A world leader in cermet technology



New snap-in rockers with Cutler-Hammer reliability.

Here's a completely new line of snap-ins, each engineered with the kind of solid dependability you expect in Cutler-Hammer Rockette® switches. Bright metal bezels, illuminated and non-illuminated, A-c and D-c capabilities up to 20 amps.

Sub-panel rockers in a variety of colors, rocker or paddle designs in standard, special, or proprietary models.

Switches snap in and stay in permanently. Speed up assembly time, cut costs.

Flush-mounted rockers in the same wide range of designer-oriented colors and styles. One- and two-pole models.

Illuminated single-pole rockers. Choice of red, green, amber, white, or clear. Hot-stamped legends indicate switch functions.

For more information, call your Cutler-Hammer Sales Office or Switch Distributor.

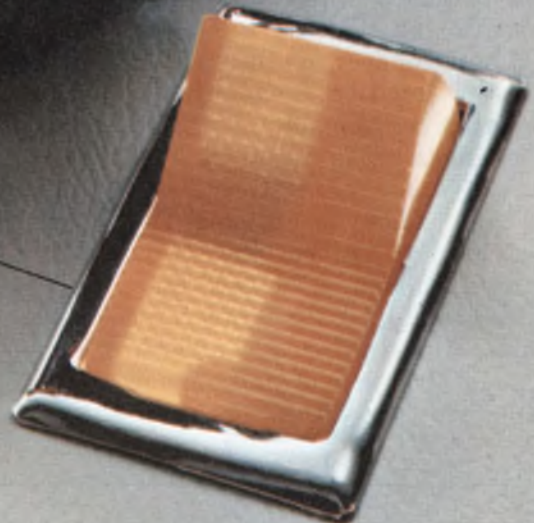

CUTLER-HAMMER
SPECIALTY PRODUCTS DIVISION, Milwaukee, Wis. 53201

 **Switch to No.1**

Rf and microwave test equipment getting more automatic and smarter

In rf communications, measurements that once took 15 to 20 minutes and required elaborate calculations can now be performed almost automatically.

Rf and microwave test equipment is now being designed to be "smarter" and have a greater range of operation than ever before. In addition, remote programming and readout capabilities are being included.

In frequency synthesizers, spectral purity has increased, frequency range extended, and provision included for remote, computer-controlled operation.

In power meters, bandwidth and dynamic range have been stretched and standing-wave ratio (SWR) decreased.

Frequency counters are being pushed to measure higher frequencies, and network analyzers appear in the background seemingly capable of doing anything.

A new breed of frequency synthesizers

Engineers who recall working with signal generators—where frequency, signal amplitude, and modulation level all had to be set by cranking knobs manually while carefully eyeing an array of monitoring meters—will appreciate the new breed of frequency synthesizer now available.

Current models range from very versatile remotely-programmable synthesizers capable of generating a wide spectrum of frequencies, to units designed for testing specific items—citizens-band radios, for example. The newest models have not only become more versatile but have acquired "smartness" as well thanks to the capabilities of the ubiquitous microprocessor.

John Minck of Hewlett-Packard, Palo Alto, CA, suggests a note of caution, however, for those planning to use synthesizers.

"No matter how attractive synthesized signal generators look from the standpoint of programmability, stability, or even price, the user would be well advised to carefully match his tests to the specs," Minck cautions.

For example, in testing receivers for spurious response, the engineer must be careful that the synthesizer itself does not emit significant levels of nonharmonic spurious signals. For such signals, a level even 70 dB down (from the main signal) may be too high.

Frequency synthesizers, rather than the more conventional cavity or LC-tuned signal generators, are generally used where signals must not only be programmed and set, but have high resolution and long-term stability.

A considerable increase in versatility is becoming available through the use of the IEEE 488 standard interface. This is an instrument-interconnection system that allows controls to be set and data to be taken automatically—all under the control of a minicomputer or a calculator.

The Fluke Model 6010A from John Fluke Co., Mountlake Terrace, WA, is reported to be the first commercial frequency synthesizer to include a microprocessor. The μ P gives the 6010A the ability to store and recall data programmed by the operator. Up to ten items of information, including frequency, modulation, and attenuation settings can be stored and recalled at the push of a button.

By means of a front-panel keyboard similar to that of a standard pocket calculator, the operator can select both the frequency (in the range 10 Hz to 11 MHz with 0.1-Hz resolution) and the desired output voltage from 0.25 mV to 5 V.

In addition to its ability to remember, the 6010A demonstrates its "smartness" in other ways. Whenever the synthesizer is turned on, it automatically starts out at minimum output, to ensure that whatever is being tested won't be accidentally damaged.

And should the operator try to program the unit to provide output conditions that are impossible for the machine, the ever-watchful micro-



Frequency coverage from 500 kHz to 1.3 GHz in one sweep gives the Hewlett-Packard Network Analyzer

8505A the widest frequency coverage of any network analyzer on the market today.



Microprocessor control of the Fluke 6011A Frequency Synthesizer allows storage and recall of frequencies and signal amplitudes—all at the push of a button.

processor will alert him to this fact.

The accuracy of this device is 3 parts in 10^6 per year. The tight control of frequency, coupled with the μ P-based memory, enables the 6010A to be used for repetitive testing. Moreover if automatic operation is desired, the microprocessor permits interfacing of the 6010A to an external system through byte-serial, bit-parallel interfacing. Other interface options are also available.

A frequency synthesizer that extends the frequency range up to 500 MHz is the 1062 from GenRad Co., Concord, MA (formerly General Radio). This signal source features especially high spectral purity and stability, making it possible to up-convert or multiply the output signal into the microwave-frequency bands.

Nonharmonics are down more than 80 dB be-

low the signal, with harmonics down more than 25 dB. Residual phase noise is -100 dB at 10-Hz offset from the carrier.

In keeping with the trend toward automatic or remote operation, the levelled output signal of the 1062 may be varied (from -7 dBm to $+13$ dBm) either by an externally applied dc signal or by manual front-panel control.

Even more significant, the signal frequency may be programmed remotely via standard 8-4-2-1 binary-coded-decimal (BCD) signals. Switching speed—from one frequency to the next—is an extremely fast $50\text{-}\mu\text{s}$. This allows, for example, the scanning of 100 points (in a digitally swept system) in 50 milliseconds, with $400\ \mu\text{s}$ of dwell time allowed for each measurement.

As a further indication of the trend toward remote-programming capability, the basic models of the 1062 now come without front-panel controls, although they are available as a standard option.

Hewlett-Packard offers a new laboratory synthesizer, the 8672A. This unit, called a synthesized-signal generator, offers highly stable, very-low-noise signals covering the 2-to-18-GHz range, with provision for internal FM or AM.

Frequency resolution of the 8672A is 1 kHz in the frequency range 2 to 6.2 GHz, 2 kHz in the interval 6.2 to 12.4 GHz, and 3 kHz for frequencies above 12.4 GHz.

Spurious signals, excluding power-line related noise, are 60 dB or more below the carrier level at 18 GHz and more than 70 dB below at 6 GHz. Single-sideband phase noise in a 1-Hz bandwidth typically exceeds 78 dB below carrier (dBc) 1 kHz away from a 6-GHz carrier signal. At 110

kHz from the carrier, the noise is less than 109 dBc.

All front-panel controls of the 8672A are remotely programmable, and the unit is compatible with the Hewlett-Packard Interface Bus System.

The 8671A, a similar, lower-cost synthesizer covering 2 to 6.2 GHz range, is also available. It does not provide a calibrated output, however.

For lower frequencies, HP's 8660 (10 kHz to 2600 MHz) still remains a broad-capability synthesizer that features AM, FM, and phase modulation.

A new, specialized frequency synthesizer called the Receiver Test Set Model 980 is available from LogiMetrics Inc., Plainview, NY.

The synthesizer provides a fully levelled output capable of being switched to any of the present 23 citizens-band (CB) channels (frequency range 26.995 to 27.255 MHz), with provision for up to 64 channels as requirements increase. These additional channels are available via a programmable read-only memory (PROM) and can be connected by the user once the FCC assigns frequencies for these channels.

The 980 is designed for maximum simplicity so that a less-skilled production person, rather than a technician, can use it.

The 980 is designed to test transceivers. Should the user inadvertently connect the transmitter portion of the transceiver to the synthesizer output the expensive attenuator would be damaged. The 980 protects against this occurrence for transmitter power levels up to 5 W.

Frequency coverage from 0.1 to 26.5 GHz (using appropriate plug-ins) is provided by Model 1250 frequency synthesizer introduced last June by Watkins-Johnson Co., Palo Alto, CA.

This is a phase-locked fundamental-oscillator synthesizer that offers low single-sideband noise and low nonharmonic spurious noise.

Frequency counters are becoming smarter

Universal frequency counters measure a number of parameters in addition to frequency. These include period, time, and the ratio between two input frequencies. Nonuniversal types are restricted mainly to frequency measurements.

Frequency counters have come a long way since their first appearance over two decades ago. During this time they have evolved from machines that could measure only up to 10 MHz, to today's versions, which offer standard capabilities up to 24 GHz with sensitivities down to 20 and 30 dBm.

In keeping with current trends in rf and microwave test instruments, many of the latest counters are also provided with interface capabilities for remote programming and remote readout. This provision also permits computer



One of a series of 30 compact modular test instruments, the Tektronix DC 502 Frequency Counter can be used alone or in combination with other test equipment.

control and readout.

"Smartness," in the form of internal microprocessor control, also enables some models to perform a number of difficult timing measurements almost automatically; rise time determination is an example. Robert Metzler of Tektronix, Beaverton, OR, points out, however, that while microprocessors can make things easier for the operator and can provide savings in power, cost and design time, they do not actually advance the range of operation of frequency counters. That is, they can't provide a higher frequency-measurement capability or greater sensitivity.

Some recently-introduced models are the following:

A frequency counter offering the highest dynamic range (60 dB for frequencies up to 10 GHz) and one of the highest frequency-counting capabilities (24 GHz) is Systron-Donner's Model 6054B, introduced just last month, (Systron-Donner Corp., Concord, CA).

This unit measures frequencies as low as 20 Hz, and provides sensitivities of -30 dBm for frequencies up to 10 GHz, -25 dBm from 10 to 18 GHz and -20 dBm from 18 to 24 GHz.

Other features of the 6054B include an 11-digit display, a single input connector (50 Ω) for the entire frequency range, selectable resolution from 1 Hz to 1 MHz, high FM tolerance, and input overload protection up to 1 W.

For automatic or computer-controlled opera-

tion, an optional feature allows complete programming of all front-panel controls except the main power switch. Also, all information on the front panel, such as control settings and digital readout, can be accessed in parallel 8-4-2-1 BCD format via a rear-panel connector.

Dana Laboratories' (Irvine, CA) Series 9000 universal counter/timer features μ P control for such measurements as pulse width and rise and fall times, and has keyboard-pushbutton function controls. It measures frequencies in the range from near dc to 100 MHz.

Four different interfacing options allow a variety of arrangements for remote, computer-controlled operation.

The Dana 9000 provides all the capabilities of a timer, counter, reciprocal counter, and calculator.

An example of how the μ P controls the operation of complex measurements is as follows:

Determination of pulse rise and fall times—measurements that usually require skill and good eyesight (for scope measurement)—can now be accomplished with a single keyboard command, using the 9000.

To make a rise-time measurement, the microprocessor scans the pulse to determine the appropriate voltage range. The microprocessor then measures the peak amplitude, computes the 10% and 90% voltage levels (the traditional values for computing rise time), and makes the measurement, all in less than 1 s.

The 9000 provides both high resolution and high accuracy for low and high-frequency measurements—a near-impossible feat for conventional counters.

The counter's sensitivity is as follows: 25 mV for frequencies to 1 MHz, 50 mV to 50 MHz, and 100 mV to 100 MHz. For the 9035, sensitivity is 15 mV. All voltages are rms.

Full 9-digit resolution is reported for this counter for any frequency from near dc to 100 MHz. Higher frequency counting is possible with the 9035, which uses a prescaler (basically a divider) to extend the frequency to 512 MHz.

For remote operation, this unit provides the following interface capabilities:

- Connection via the general-purpose interface bus.
- High-speed computer interface with parallel-bit format for maximum data-transfer rate.
- Serial ASCII-system interface for direct hookup to a keyboard printer (teletypewriter for example). The terminal can be used in turn as an I/O device for entering data to a remote computer.
- Parallel BCD output. TTL-compatible outputs are provided.

The Series 700 digital universal counters marketed by Newport Laboratories, Santa Ana, CA,

can directly measure up to 100 MHz; up to 1 GHz can be counted with a prescaler. A BCD output allows remote readout as well as remote control of all counter functions.

The sensitivity for direct measurements is 50 mV for frequencies up to 100 MHz. A unique feature of the 700 is that programmable read-only memories (PROMs) rather than conventional wafer switches are used for changing the time base.

A frequency counter aimed especially for the communications industry is the Tektronix Model DC502. It covers the frequency range 10 Hz to 550 MHz.

This unit is one of a series of 30 compact plug-in test and measurement instruments designed to be used individually or in combinations to suit the user's special needs.

A 100-ps resolution universal counter, the DC505A, is also available as part of this series. It covers the frequency range to 225 MHz on both input channels.

Network analyzers sweep up to 1.3 GHz

Network analyzers in their present form made their appearance on the instrument market only about ten years ago. But in that short time they have established a secure position for themselves as an essential piece of test gear for rapidly measuring the transmission and reflection parameters of a variety of electrical networks and components.

Not so long ago amplitude and phase characteristics were determined by making difficult point-by-point measurements using either cumbersome, manually-adjusted high-frequency bridges, or more recently, the RX meter. Network analyzers now perform all these measurements almost instantly by sweeping through an entire frequency range and presenting the amplitude and phase information graphically.

Current models can sweep through frequencies up to hundreds of MHz, and in one case (the HP8505A), up to 1.3 GHz.

The genealogy of these analyzers, short as it is, already shows a trend toward more extensive frequency coverage, greater dynamic range, and a wider use of digital techniques. This last attribute implies capability for remote computer-controlled operation.

In November, 1975 Hewlett-Packard introduced its 8505A network analyzer ("Analyzer Brings New Power to Network-Behavior Measurement," ED No. 23, Nov. 8, 1975, p. 113). By doing so, they extended the capability for automatic swept-frequency measurement of network characteristics into frequency ranges higher than ever before—to 1.3 GHz.

Providing a continuous 100 dB of displayed

dynamic range, this device presents a CRT plot, in either polar or cartesian form, of many signal parameters. These include transmission, reflection, group delay, deviation from linear phase, and S-parameters of active devices.

Every function on the 8505A is digitized—even those functions that would normally be analog controlled. For example, the sweep limits have an analog “feel” but are actually digital encoders. Because the functions are all digital, the 8505A analyzer can be controlled by a calculator or computer via a standard interface bus.

One version of this analyzer, the 8507A, comes configured with a programmable calculator, the HP 9830A, that provides the network analyzer with a number of unique capabilities.

If the analyzer is put into “learn mode” the operator can set all the controls in the normal fashion. These settings are memorized by the calculator, and at any time in the future can be reset to these positions by a remote signal.

Or, the analyzer can be set to correct for the normal transmission errors unavoidably encountered in high-frequency measurements. Signal losses or mismatch caused by the interconnecting rf hardware are measured by the analyzer and stored in memory. These errors are then subtracted from the measured parameters of the device being tested.

A printer and an optional plotter are available with this system to provide hard-copy readout.

General Radio's entry into the field is its Model 1710 rf-network analyzer. This unit covers a frequency range extending from 400 kHz to 500 MHz, has a dynamic range of 115 dB (with switching), and resolution capability to 0.005 dB.

Even though the 1710 provides complete control over all measurement parameters it is human-engineered to provide maximum simplicity of operation. It is capable of making a variety of measurements, including admittance, impedance, group delay, amplifier gain, and filter attenuation.

The 1710 solves a special problem of growing importance today, that of measuring the passband of devices (such as crystal or surface-wave filters) that have very narrow bandwidths. Such testing requires signals that have great stability and spectral purity. But the sweep frequency generator used in network analyzers usually cannot provide the low-noise qualities necessary for such accurate measurements.

Instead of frequency sweeping through the passband of interest, the GR 1062 frequency synthesizer (together with the companion 1062-P1 tracking synthesizer) traverses, point by point, the passband of interest. The result is a measurement similar to that provided by a network analyzer but with the frequency, precision,

and stability of a synthesizer, and none of the noise limitations of a sweeper.

By adding a General Radio 1167 frequency programmer, the operator can perform this measurement nearly automatically. Through a pushbutton keyboard, he simply sets the frequency limits and the increments. The synthesizer then automatically sequences through the desired range of frequencies.

Another network analyzer currently available in the American market is the Rohde and Schwarz (Fairfield, NJ) Sweep Diagraph ZWD. This unit, which measures the signal reflection and transmission characteristics for both active and pas-

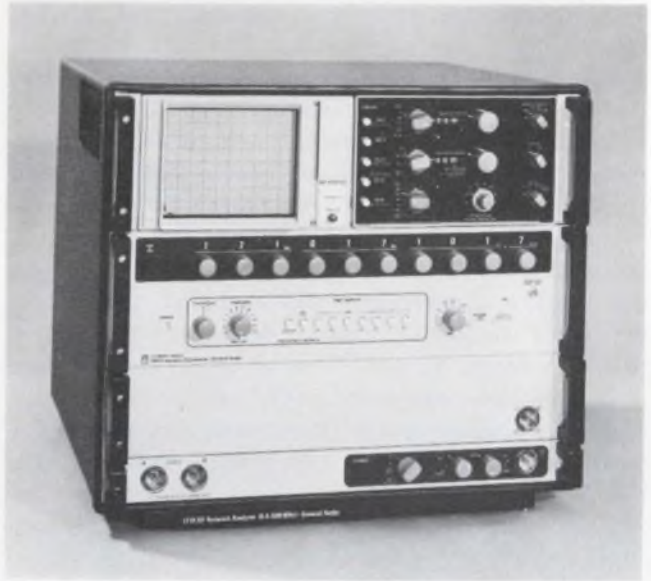

The 1710 GenRad (formerly General Radio) Network Analyzer measures a variety of parameters of active and passive networks.

sive devices, covers the frequency range 10 to 1000 MHz in one sweep. To cover this broad range, the ZWD uses electronic switchover at a frequency somewhere between 480 and 520 MHz; the exact point can be selected by the user.

The ZWD has an over-all signal-dynamic range of 120 dB with display capability of 90 dB. The information can be presented in either polar or cartesian form.

The unit is built and sold in modular form so that only those components required for the user's particular tests need be purchased. There is a version that measures only complex reflection coefficients, and one that determines only transmission factors.

For testing narrowband filters the ZWD can be configured to use a frequency synthesizer in place of the swept frequency generator. This arrangement is similar to that used with the General Radio analyzer.

(continued on page 70)

The Right DMM Decision Means Five-Function Autoranging for only \$225*

Introducing HP's 3476A DMM

The price is a big story in itself. But performance and reliability play a large part too. Take a look at the 3476A:

Autoranging — a big plus in a low cost DMM. It lets you concentrate on the point of measurement... minimizes reading errors... and speeds readings too. All readings are made directly in volts, kilohms, or amps — on an LED display. And there's a rangehold button to speed and simplify repetitive measurements.

Five functions — all the functions you want and need in a low cost DMM. Simply push the appropriate button to read AC volts, DC volts, AC or DC current, and ohms. There's no worry about polarity or zero... they're both automatic.

Advanced design — both circuit and packaging. And both contribute to high reliability. One circuit board contains all the electronics.

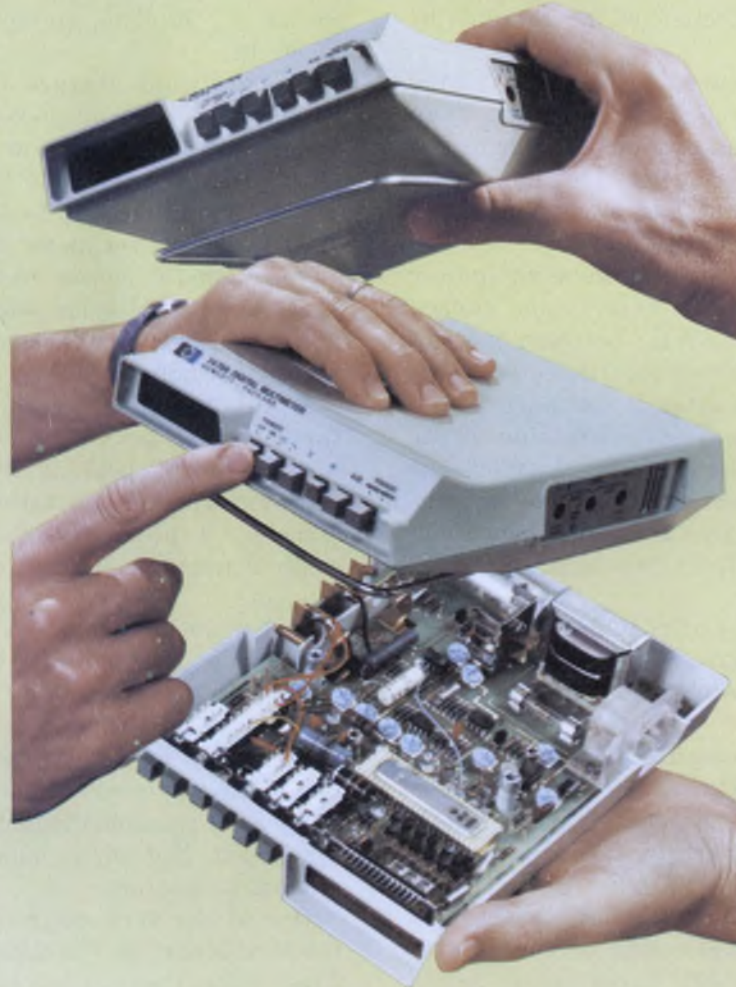

Tantalum nitride on sapphire processing allows replacement of all front end precision resistors by a single chip. That means greater reliability and better temperature stability. Of course it's input protected.

Convenient size — just right to hold in your hand... take with you in a brief case... or use on your bench. An optional carrying case and probe kit let you hang the instrument from a strap for "no-hands" operation. The "A" version (\$225*) operates from the AC line for lab use. And for portable applications, the "B" version (\$275*) has built-in batteries and recharging circuitry.

The 3476A is backed by HP's service organization... another big plus for a low-cost DMM. With these prices and features, why not put your hands on the 3476A for your 3-1/2 digit measurements? Your local HP field engineer can tell you how.

*Domestic U.S.A. prices only.

**HP DVM's—
the right decision**

Actual Size

065-62

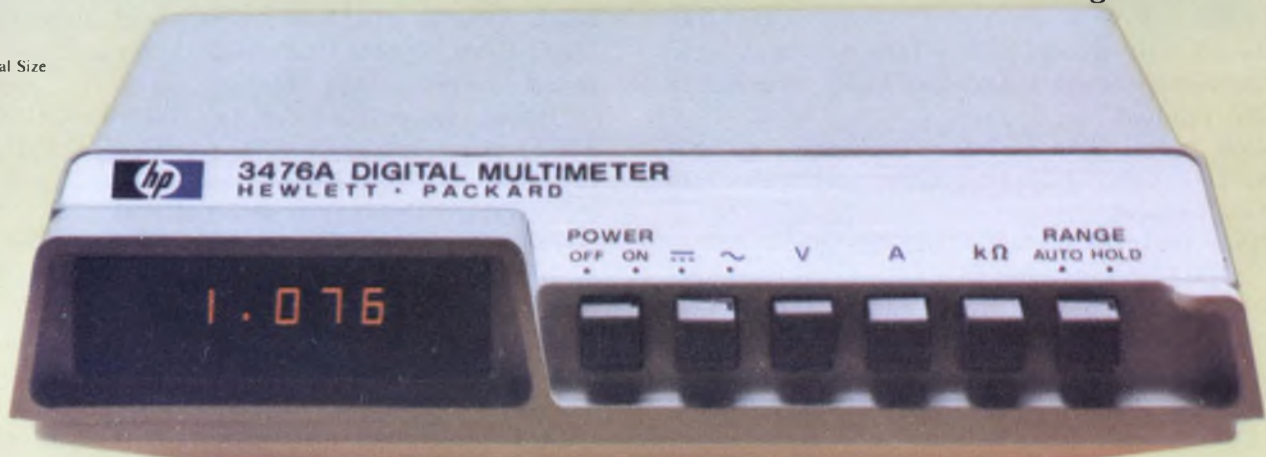

HEWLETT  PACKARD

Sales and service from 172 offices in 65 countries.
1501 Page Mill Road, Palo Alto, California 94304

CIRCLE NUMBER 31

Sweep width can be varied by an external dc voltage, and the output-signal level very precisely remote-controlled by a separate programmable attenuator, the Rohde and Schwarz DPVP.

Power meters are more versatile

Power meters, long considered to be one of the simpler pieces of rf and microwave test equipment, have also been affected by the currents of change.

Power meters today cover a greater dynamic range and a broader frequency spectrum, than did their predecessors, and provide a better match in the form of lower SWR. In addition, many units offer digital readout and a capability for remote programming and readout.

One of the greatest problems in using power meters is the measurement uncertainty caused by the imperfect match (SWR) between the signal source and the power-meter detector. This uncertainty or error can often be as much as ten times greater than the instrumentation error (meter movement error etc.), so much effort has gone into SWR improvement. One note of caution: spec sheets often give the instrumentation error and the input SWR in two separate places on the sheet.

The Boonton 42B series of rf microwatt-meters (power meters) embodies many of these new features (Boonton Electronics Corp., Parsippany, NJ).

The 42B meters can measure power down to a minuscule 1 nW (-60 dBm). The upper limit is 10 mW (+10 dBm) for a total dynamic range of 70 dB. A 300 mW overload tolerance is also provided.

As in most power meters, the detector head is a separate unit that electrically connects with the main body. For the 42C three power heads are available, all with a low-frequency limit of 200 kHz, and with the high frequency extending up to 18 GHz. Model 42B offers a conventional analog-meter readout and the 42BD provides a digital readout.

SWR is less than 1.12 for frequencies up to 4 GHz, 1.18 from 4 to 12.4 GHz, and 1.28 from 12.4 to 18 GHz.

Other features of the 42BD include:

- Solid-state switches that activate each power range. These allow the meter to be ranged manually, automatically, locally, or remotely.

- Computer-controlled test systems, printers and comparators that can be interfaced by using the power-meter BCD output.

Zero drift of these power meters is reported to be less than 1 nW per hour, thus reducing the necessity for frequent zero adjust, one of the perennial headaches of early units. Above 1 μ W no zero adjust is necessary.

Frequency coverage from a low 100 kHz up to 18 GHz with a 50-dB dynamic range is offered by the HP power meter Models 435A (analog readout), and 436A (digital readout).

An assortment of sensor heads is available to allow measuring from a low of 3 μ W full scale up to 3 W full scale. The newest power head, Model 8484A, pushes the power-measuring limit even lower, to 100 pW (-70 dBm). The highest power is -20 dBm, giving a total dynamic range of 50 dB.

A significant feature of the new head, the 8484A, is its use of low-barrier Schottky-diode technology to achieve low SWR without loss of detector sensitivity. The SWR is 1.3 at 18 GHz and 1.2 from 30 MHz to 10 GHz.

The 436A power meter offers features such as:

- Automatic sensor recognition. This recognizes which particular one of the 8480 series of power sensors is connected, and scales the reading accordingly.

- Automatic zero sensor. This permits zeroing the device by pushing a button.

- An analog peaking indicator. This tells the operator whether a reading is increasing or decreasing, a piece of information which is not easily discernible from a rapidly changing digital readout.

- Instrument accuracy of $\pm 0.5\%$.

- Provision for digital output and for remote, automatic programming of the mode, power range, and zero functions.

Engineers of an earlier generation who may feel somewhat overwhelmed by the onslaught of today's ultra-sophisticated test equipment can take heart. Not all the older equipment has been put out to pasture.

One of the very early warhorses of test gear, the Bird Model 43 Thruline Wattmeter from Bird Electronics Corp., Cleveland, OH, conceived in the 1950s, not only is still being used, it is still being manufactured and actively sold. Bird Electronic Corp. reports that the 76,000th unit recently left the production line.

One of the reasons for this instrument's enduring popularity is that it is self-contained (no batteries, no line voltage). It uses microwatts of energy from the transmission it measures.

The 43, which weighs 3 lb, is an insertion instrument for measuring rf power flow. It measures both forward and reflected CW power in coaxial transmission lines. Maximum frequency measurable with appropriate plug-in units, is 2.3 GHz.

Bird Electronics also manufactures the 4371 high-power digital rf power meter. This insertion meter measures net power flow under any load conditions from 25 to 520 MHz and from 1 W to an astronomical 1 kW. The lowest indication on this meter is 1 mW. ■■

**COSMAC ARCHITECTURE
HIGH SPEED**

CMOS FEATURES

DESIGN EASE

SUPPORT CIRCUITS

DEVELOPMENT AIDS

LOW PRICE

**Now for the first time:
this entire spectrum of
microprocessor benefits
in one package.**



**The expanded
RCA Microprocessor Family.**

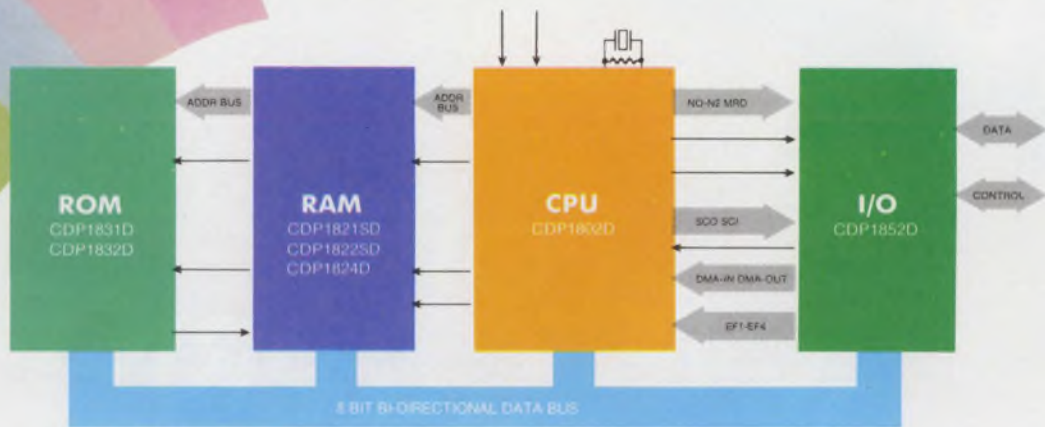

Your RCA 1800 payoff: a CMOS system, outstanding performance, unsurpassed cost effectiveness.

Now there's a new CPU in the RCA 1800 Series. The CDP1802: COSMAC on one chip. We believe and want to prove that this new 8-bit CPU, more than any other, fulfills the microprocessor promise of unprecedented system cost effectiveness and flexibility.

RCA supplies the whole system: CPU, ROM, RAM and I/O devices. Everything you need including complete design support. All from the first house in CMOS.

CMOS and low cost

CDP1802, like the original CDP1801, has the inherent CMOS tolerance to noise and power supply variations, and low power dissipation. But the 1802 is on a single, densely packed chip, made possible by a new RCA self-aligned silicon gate technology. CDP1802 is up to three times

faster: 2.5-3.75 microseconds for any instruction. And cost is way down: \$23.50 for the CDP1802 in 100 piece quantities.

In addition, we've further simplified control signals. And you get the single-chip benefits of simpler assembly and less design time, plus an expanded instruction set.

All this on top of other things you liked about the 1801. Especially its COSMAC architecture, simple yet powerful. Plus its easy learning and programming.

COSMAC architecture lowers memory costs

The big advantage is 1-byte instructions: less to store, less to fetch — which means less memory to buy. Simple subroutine calls can take just one byte.

Instructions need no addresses because the 16 internal general purpose registers act as pointers. You can point these registers at data areas or program areas. They can also be used to store data directly, reducing the need for RAM. One register even acts as a built-in DMA address generator — an RCA first.

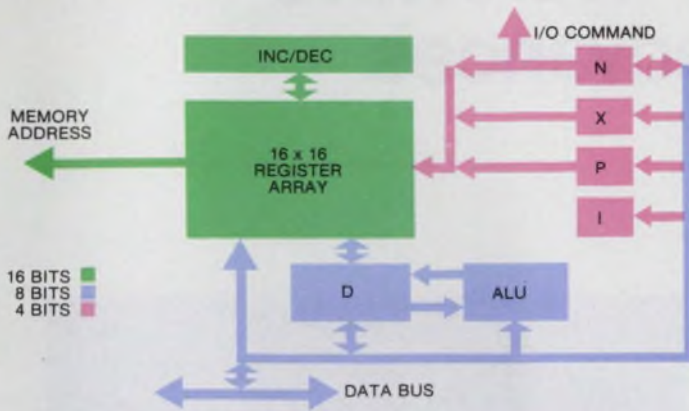

RCA offers ROMs and RAMs as standard support. But if you have reason to use memories from other manufacturers, you can use almost any industry standard in x1, x4 or x8 configurations.

I/O costs less, too

You'll find much of what you need in our line of standard I/O devices — some available now, many more in development. Or if you need special interfaces, design your own with our industry-leading CD4000 line of logic devices. If you want, we'll build a custom LSI I/O part for you. In any case, COSMAC architecture can greatly simplify your system design.

Result: system cost effectiveness

For all the reasons given, we challenge any other microprocessor to match the 1800's system cost effectiveness. Figure in, too, the other CMOS economies. One power supply. A single-phase clock, which can be implemented by an external crystal to work with the on-chip oscillator. Also consider the cooling and other equipment you *don't* have to buy because of CMOS low power dissipation and tolerance to noise, power-supply and temperature variations.

What about design time?

CMOS also makes it easy and inexpensive to assemble a prototype. Then, static logic makes your prototype easy to debug. Data exchange is carefully strobed. Everything about our 1800 Series helps make system design less time-consuming.

Use your 1801 programs

Any 1801 programs you may already have will run on the new 1802. So your program investment is safe. In fact, we offer a new emulation board that you can simply plug into COSMAC Development System to adapt it to the new CPU.

From RCA: a total system—all CMOS!

Available now:

- CDP1802D CPU
- CDP1821SD 1024x1 CMOS SOS RAM
- CDP1822SD 256x4 CMOS SOS RAM
- CDP1824D 32x8 CMOS RAM
- CDP1831D 512x8 CMOS ROM COSMAC Interface
- CDP1832D 512x8 CMOS ROM
- CDP1852D Byte I/O

Note: recommended operating range for above parts is 3 to 12 volts. They are also available in "C" versions (e.g. CDP1802CD) with recommended operating range of 4 to 6 volts.

In development:

- UART (Universal Asynchronous Receiver/Transmitter)
- MDU (Multiply-Divide Unit)
- 3- to 8-bit Latch-Decoder
- Bus Buffer Separator
- 128x8 RAM
- 1024x8 ROM
- Programmable Bit I/O part
- A/D Converter

Design support

- Microtutor (CDP18S011): a minimum computer for learning microprocessing.
- Evaluation Kit (CDP18S020): kit of parts including printed circuit board.
- COSMAC Development System with 1802 Emulator (CDP18S004) for easy breadboarding and resident software development. Includes chassis, power supply, simple control functions, CPU, RAM, byte I/O, terminal interface, utility routines, plus the capability of editing, assembling and debugging software programs.
- Floppy Disc for COSMAC Development System (CDP18S801).
- COSMAC Software Development Package (CDP18S910, CDP18S911): assembler, editor and simulator/debugger programs available on GE Time-Share or in Fortran IV for purchase.
- Manuals, seminars and application notes. Plus applications assistance by RCA engineers.

Consider RCA 1800 now

It all boils down to this: RCA offers cost and performance competitiveness with any other microprocessor — plus the special advantages of CMOS. And we're ready to prove it.

For more information, contact your local RCA Solid State distributor. Or RCA.

Write: RCA Solid State. Box 3200, Somerville, New Jersey 08876; Ste. Anne de Bellevue 810, Canada; Sunbury-on-Thames, U.K.; Fuji Bldg., Tokyo, Japan.

RCA

Spectrum squeeze eased by solid-state microwave oscillator advances

Spurred by the explosive growth of communications in recent years, packaged microwave oscillators are moving to high-frequency bands and higher power levels.

Increased traffic over long-haul telephone and data links has led to insufficient spectrum capacity. Further, the spread of mobile land communications has brought demands for tighter specs on these packaged oscillators. These demands are now being met by development and production of microwave integrated-circuit (MIC) designs.

To extract the maximum capacity out of systems, users are abandoning lower-frequency 4-GHz bands for bands in the 12-GHz area. Ultimately, 18-GHz bands are a real possibility.

Cavity tuning the oscillators

Solid-state microwave oscillators use transistors or bulk-effect diodes, such as the Gunn and Impatt devices, for signal-generating elements.

For narrow-band, low-noise communication applications these oscillators are tuned by microwave cavities having relatively high Qs of 400 to 700 or more. The higher the Q, the narrower the bandwidth.

To obtain high stability the microwave rf output of the cavity is phase-locked to a selected harmonic of a crystal oscillator that is operating in the region of 100 MHz. The harmonic is obtained by multiplying and filtering the crystal output. The oscillator's output frequency is shifted within its microwave band by changing the crystal and by mechanically retuning the cavity.

For broadband operations where it may be desired to shift the oscillator output over a range of 30% to 200% of its basic microwave frequency, cavities with low Qs, of about 10 to 100, are



Small, light and rugged packaged oscillators that can survive a launch environment and outer space are used in communications satellites like this RCA Satcom.

used in the oscillator. In this case the oscillator can be electrically tuned using varactor diodes.

The broad-band oscillator may also be crystal stabilized. Or it may be purely varactor controlled to achieve modulation bandwidths of hundreds of megahertz with slew rates approaching a gigahertz in nanoseconds.

The performance of packaged communication-system oscillators is being continually improved, but at the cost of increased complexity. For example, a phase-locked-loop oscillator operating in the 12-GHz region and using a transistor oscillator and multipliers, typically contains 400 to 500

parts—or more.

The oscillator has been developed to the level of a subsystem that has been substantially refined with the addition of the phase-locked loop and a number of protection and control features.

For example, because the varactor is a square-law device, varactor voltage-tuned oscillators are highly nonlinear in respect to change of frequency with applied voltage. In terms of oscillator frequency change it approximates a fourth-law device.

To linearize a varactor sweep, an amplifier with a variable-gain curve that is the reciprocal

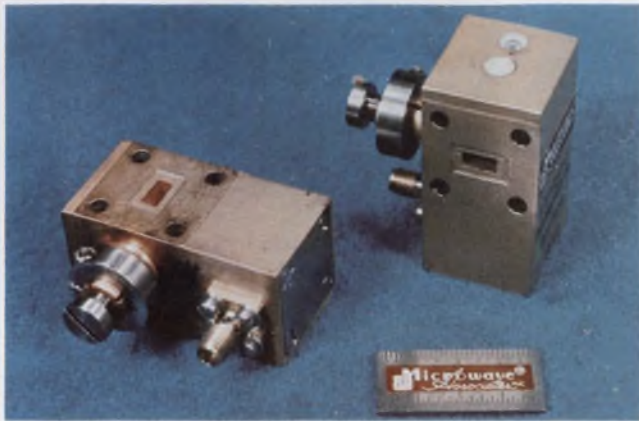

This parametric-amplifier pump oscillator produces 100 mW from 50 to 60 GHz. The oscillator, by Microwave Associates, is used for communication-satellite receivers.

of the nonlinear variation is added to the package. To compensate for low-input sweep-control voltages from a customer's equipment, an additional IC amplifier may be integrated into the assembly.

To prevent output frequency from changing with supply-voltage variations, a regulator is incorporated. To limit frequency changes due to rf-load variations, an isolator is designed into the package. To compensate for frequency drift due to ambient temperature changes, a heater and temperature controller are normally included also.

Some of these features are offered as options by oscillator manufacturers. Watkins-Johnson, Palo Alto, CA, offers hybrid heaters and sweep-linearizer assemblies as add-ons to its line of solid-state VCOs.

Upper frequency limits raised

Improvements in pushing back the upper frequency limits at which transistors produce useful microwave-oscillator power outputs is a continuing effort. Three years ago the upper frequency limit for transistor fundamental oscillators and frequency-doubled transistor configurations was

about 4 GHz, says Bruce Malcolm, chief microwave engineer at Texscan, Indianapolis, IN.

Today, through the use of improved microwave transistor technology, higher-frequency devices have pushed the range upward to 8 GHz. Transistor fundamental oscillators are now built up to 6 GHz with wide-bandwidth tuning and an output of 0.5-W cw which, Malcolm points out, is a significant increase.

Up to 12 GHz of useful power can be obtained using push-push transistors. The bases are fed in push-pull and the collector outputs are tied together. This produces second harmonic energy.

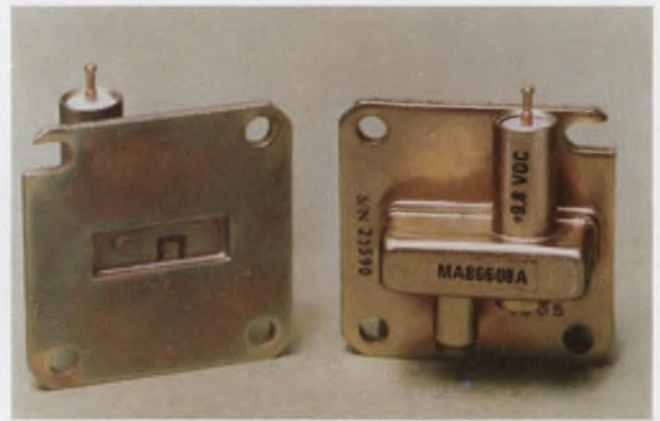

A Gunn diode generates power in the X-band, 10.525 GHz cw oscillator shown. Developed for use as a local oscillator in a receiver, it can be tuned over ± 25 MHz.

With a full-wave multiplier that energy can be further doubled to the 12-GHz limit. The outputs of the push-push arrangement can also be directly multiplied by step-recovery diodes to produce signals at up to 22 GHz.

GaAs FETs have the potential for making oscillators with less noise than there is with bipolar devices, but at present the cost is inhibiting their use in practical oscillator assemblies.

In the 8 to 12-MHz region it is possible to buy transistor, Gunn or Impatt-device oscillators. Transistor oscillators are generally more frequency-stable than are the bulk devices, but bulk oscillators use only a single active element and are both lower in cost and smaller in size.

Gunn oscillators popular

Gunn oscillators are the workhorses of the bulk-device microwave-oscillator field. They compete directly with transistor fundamental oscillators of up to 8 GHz; above that the Gunn oscillators predominate for fundamental-signal generation.

The highest power presently available from a single Gunn-diode oscillator at X band is about

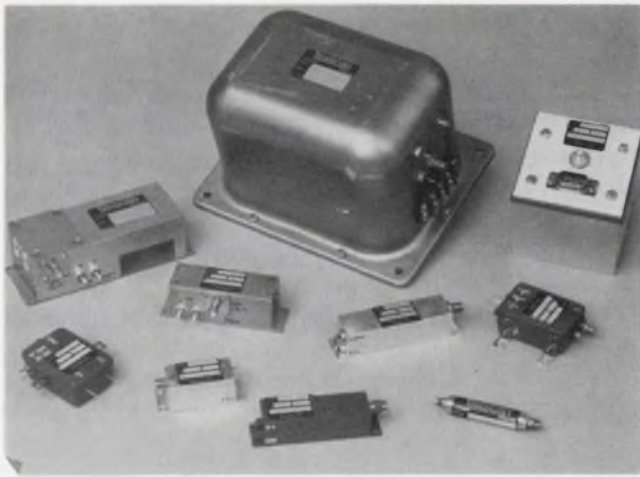

Packaged oscillators are designed in a variety of shapes, often to fit a customer's configuration. These Texscan oscillators include built-in test-equipment (BITE) units.

0.5 W. But the power barrier has been upped by combining several diodes in the same oscillator so that their outputs add in phase, according to Ken Kawakami, staff engineer at Addington Laboratories, Sunnyvale, CA, and holder of patents on this technique.

Multiple-Gunn-diode oscillators that will produce 3 or 4 W in the 8 to 12.4 and the 12.4 to 18-GHz bands are now available from suppliers like Varian and Litton, both in Palo Alto, CA. Litton, for example, produces high-powered L-band oscillators using multiple diodes in a high-Q cavity package.

Impatt oscillators traditionally have higher outputs than the Gunn units, but the Impatts tend to be substantially noisier than Gunns using equivalent rf circuits. Impatts have produced useful power at up to 100 GHz, but such devices are not available commercially.

Probably the greatest breakthrough in practical GaAs Impatt devices has been the development, at Raytheon Solid State Products, Waltham, MA, of high-powered, Read-profile Impatt diodes.

"These Read diodes produce about 4 W at X band compared with 1 W for conventional, flat-profile Impatts and 0.1 W for Gunn devices," says Jerry Simpson of Raytheon.

"We're producing saleable Read diodes with 15% efficiency at 2-W output and 20% efficiency at 4-W output in the region of 1.5 GHz."

These Read diodes have only been applied by Raytheon within the last year in both packaged oscillators and amplifiers. The Read devices are currently used in a new injection-locked, packaged oscillator that has an output of 4 W cw or pulsed, in the 6 to 8-GHz band. Components of the Raytheon oscillator include a fixed-tuned Impatt-diode oscillator, a p-i-n diode switch and two high-efficiency Read-diode amplifier stages.

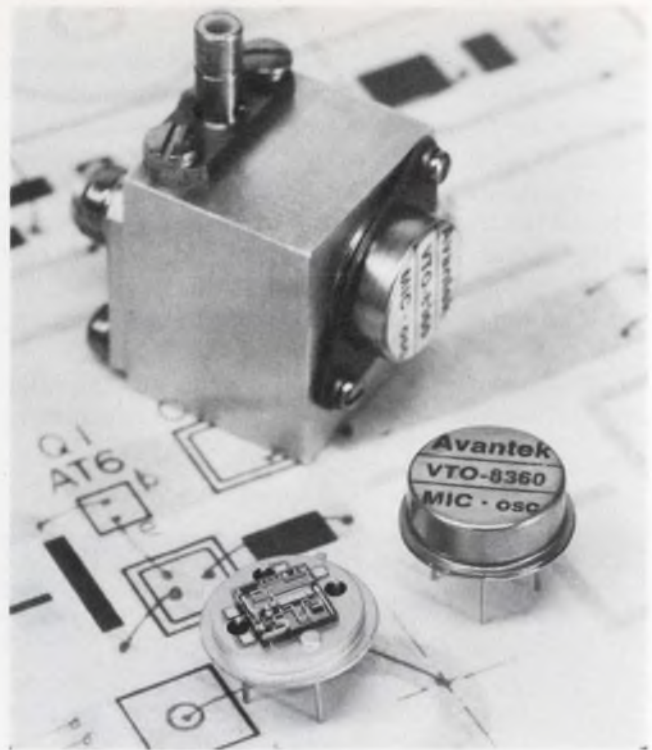

A thin-film hybrid microwave oscillator is hermetically sealed in a TO-8 can. The oscillator, by Avantek, is compatible with 50- Ω stripline.

Development of the GaAs Read diodes, originally a Raytheon in-house project, has been also supported by Wright Patterson Air Force Base, Dayton, OH, and the U.S. Army Electronics Command, Ft. Monmouth, NJ.

Gunn oscillators are pump sources

Gunn-effect oscillators are being used as pump sources in parametric amplifiers for low-noise front ends in satellite-communication receivers.

"These Gunn oscillators are mechanically tuned," says Jim Bybokas of Varian. "The pump oscillators produce up to 100 mW and operate in the 40, 50 and 60-GHz regions."

But quality-control specialist Paul Koskos at Comsat Laboratories, Clarksburg, MD, is looking for new pump sources operating at frequencies as high as 150 GHz for future communications satellite ground-station receivers.

"The capacity of our present Intelsat down-link at 4 GHz is being strained and to get relief we plan to go upward to 12, 20 and 30 GHz in future satellite-system designs," Koskos says.

"This means that although a pump source now operates at 45 GHz for the 4-GHz down-link, its frequency will have to be raised substantially for future higher frequencies. For Intelsat V, which is now in the proposal stage, we are looking at 12 and 14-GHz transponders."

An important area of Gunn-diode-oscillator applications is in varactor-tuned local oscillators for

point-to-point communication-system receivers. These oscillators are typically tunable over the 10.7 to 11.7-GHz band, according to Varian's Bybokas. Provisions for automatic frequency control are designed in.

For the output stages of telecommunications point-to-point transmitters, 1-W Gunn packages are used in the X and kU bands as injection-locked oscillators.

Advance in oscillator packaging

The most significant development in microwave oscillator packaging that occurred in the last few years is the development and production of hybrid MICs. Manufacturers like Avantek in Santa Clara, CA, Watkins-Johnson, and Trak Microwave, Tampa, FL, are drastically shrinking the size of the oscillator packages while still providing improved performance by using added circuitry tucked onto the hybrid substrates.

An example of the advantages offered by MIC technology is found in Avantek's VTO 8000 series varactor-tuned oscillators, which are hermetically sealed in TO-8 cans (see photo). Eight of them provide total coverage of the 0.6 to 6.6-GHz range.

These oscillators employ Avantek's own silicon bipolar transistors, bonded to gold-metallized pads on high-dielectric substrates to eliminate parasitic reactance and thermal resistance. The varactor chips are bonded in similar fashion.

The Avantek oscillators use a negative-resistance transistor network coupled to a thin-film microstrip resonator. The oscillator output is compatible with a 50-ohm microstrip, and consequently has eliminated conventional connectors.

Power required is 15 V at 50 mA. The rf output ranges from 20 mW in the 0.6 to 1-GHz band, to 5 mW in the 5.8 to 6.6-GHz band.

A varactor-tuned oscillator and integral buffer amplifier, also produced by Avantek, is packaged in a hermetic dual-in-line can. The internal buffering serves, essentially, to make the source immune to the frequency pulling that results from a variation in load over the tuning range.

Four units in this VTD series are required to cover the range of 2 to 6.1 GHz. They all produce 20 mW of rf power.

These VTD units have a small thermal mass. Consequently, the effects of ambient-temperature variations on frequency can be minimized by providing a small heater to keep the case temperature at its design value of 80 C. The VTD packages operate from a 12-V supply at a 125-mA current drain.

Varactor-tuned oscillators suffer, in general, from some drawbacks. One is the nonlinearity of the frequency change with varactor-voltage variations. This, however, can be substantially com-

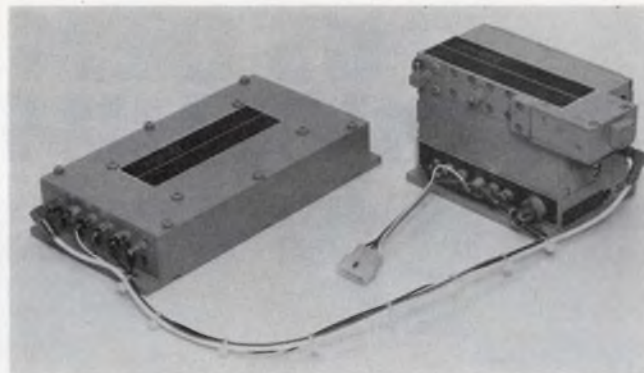

A crystal-controlled, phase-locked loop cavity oscillator, by California Microwave, up-converts 300 to 1800 telephone voice channels to the 1 to 12 GHz region.

pensated for by the use of linearizer-amplifier circuits.

A second limitation is post-tuning drift, which shows up as an undesirable frequency shift some time after a step-change in the tuning voltage has been applied. The shift is due to the heat-transfer lags across the thermal impedance of the varactor junction and its package.

Yttrium-iron-garnet (YIG) spheres are excellent as magnetic tuning elements for applications requiring high linearity, low noise, and low frequency drift with temperature change. Both transistor and GaAs-Gunn-diode oscillators are available with YIG tuning.

The change in frequency of these YIG oscillators is directly proportional to the current applied and is stated as MHz/mA. Linearity of the YIG sweep across an octave band is generally on the order of 0.1 or 0.2% or better. Because the YIG oscillator is a high-Q device, it is less noisy than its varactor-tuned counterpart. This lower noise is desirable in communications receivers.

YIG-tuned oscillators are generally applied in the 0.5 to 8-GHz range for both the military and commercial user. A typical application might be as a local oscillator in a sophisticated superheterodyne receiver, for accurate frequency tracking of the oscillator and a YIG-tuned preselector.

From 8 GHz upwards, Gunn diodes, rather than transistors, are used in YIG oscillators. For example, standard GaAs-diode oscillators from Watkins-Johnson cover the following ranges: 6 to 8; 8 to 12.4; 12.4 to 18.8; and 18 to 26. Higher ranges require special design.

Because most YIG-device users prefer to supply a tuning voltage rather than a current, voltage-to-current converters are specified to provide the necessary tuning amperage.

To provide for output-frequency modulation an FM or tickler coil—as contrasted to the primary tuning coil—can also be supplied in a YIG-oscillator design. The tickler provides a second tuning input that can vary the output frequency slightly, but at a much faster rate than can be done with the main tuning coil. ■■

THIS OEM ASKED US TO GIVE HIM THE WORKS.



Brownout proof power supply.
No extra cost.



Extra memory and I/O capacity.
No extra cost.

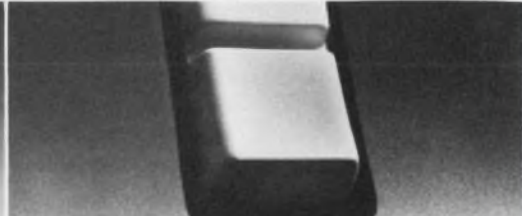

ROM bootstrap loader.
No extra cost.



Display panel.
No extra cost.

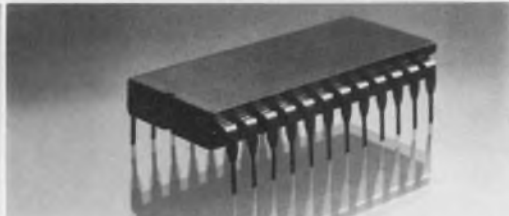

Parity, EAU, floating point.
No extra cost.



The Hewlett-Packard 21MX Minicomputer.
One low cost.

“You say it's a bargain at the price. But what do we get for our money?” Canadian Marconi asked. They were planning systems that would use 20 to 250 of our minicomputers each.

“A lot more than you'd expect,” we replied.

Even the smallest Hewlett-Packard 21MX minicomputer uses solid state 4K RAM memories. Then we include floating point and extended arithmetic as standard items. From other suppliers these are extras that might add \$1,000 to \$4,000 to your bill.

Next there's parity. It's standard too — not the usual surcharge of up to \$1,000 per memory module.

Or consider the brownout proof power supply — one of the best in the industry. Standard again. As is a ROM bootstrap loader. As is power-fail interrupt capability. Extra memory

slots. A full front panel that lets you display or change contents of data registers.

“Standard” too is low power consumption and compact size, allowing more equipment to be put in each rack.

Even our options are surprisingly low in

cost. Want to add memory for example? It's just \$1,500 per 8K words. Want better throughput? You can microprogram custom routines using a Writeable Control Store (\$1,000).

In fact, if you add up what it costs to bring a “bargain” mini up to our standard capability,

don't be surprised if it adds up to a lot more than the \$4,059* you'll pay for the Hewlett-Packard 21MX.

So, if you need the works, call us. Canadian Marconi did.

*DOMESTIC USA OEM QUANTITY 50 WITH 8K MEMORY.

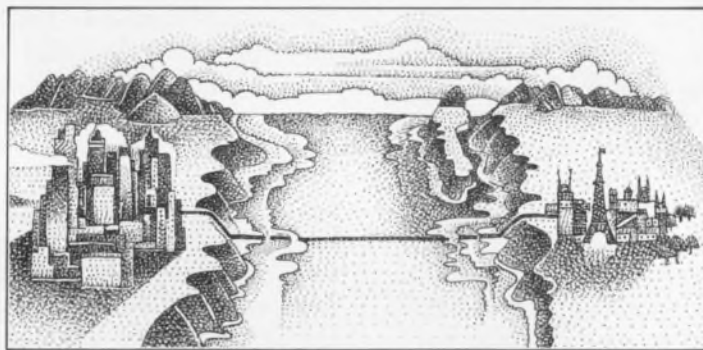

Canadian Marconi Company uses a minimum of 20 Hewlett-Packard 21MX minicomputers in each modular Telex switching system they build. These systems gather and switch Telex traffic for international transmission.

22607

NOW WHAT CAN WE DO FOR YOU?

HEWLETT  PACKARD

Sales and service from 172 offices in 65 countries.
1501 Page Mill Road, Palo Alto, California 94304

CIRCLE NUMBER 33

Dialight sees a need:

(Need: A switch for all reasons.)

Reason 1: Dialight offers three switch configurations to meet all your needs—*snap-action switches with silver contacts* for moderate-level applications, *snap-action switches with gold contacts* for intermediate-level applications, and *wiping-action switches with gold contacts* for low-level applications.

Each of these ranges is served by two switching actions—momentary (life: 600,000 operations) and alternate (life: 250,000 operations).

Reason 2: Dialight's snap-action and wiping-action switches come in a new modular design concept . . . a common switch body for either high or low current operation. All 554 series switches and matching indicators have the same rear-panel projection dimensions.

The snap-action switching mechanism guarantees a fast closing and opening rate. This insures that contact force and contact resistance

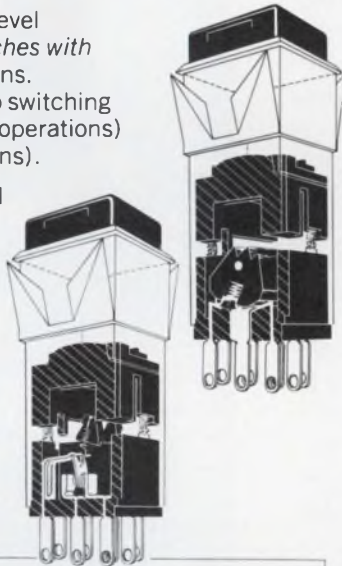
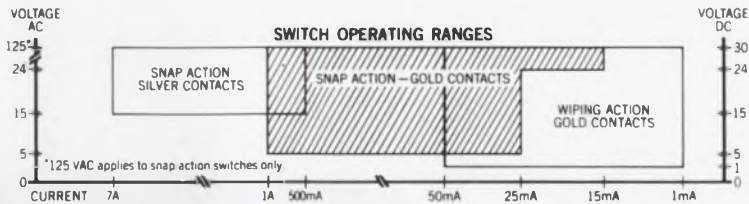

Reason 3: Dialight offers a wide variety of panel and snap-in bezel mounting switches with momentary and alternate action configurations in SPDT and DPDT types. There are over 240 switch variations to choose from.

The 554 illuminated switch, designed for front of panel lamp replacement, gives you a choice of five different bezel sizes . . . 3/4" x 1", 5/8" x 3/4", 3/4" square, 5/8" square, and 1/2" square. The first four sizes are also available with barriers. You also get a choice of six cap colors . . . white, blue, amber, red, green, and light yellow . . . four different underlying filter colors . . . red, green, amber, and blue and a variety of engraved or hot-stamped legends . . . over 300 cap styles . . . over 100,000 combinations.

There is also a variety of terminal connections . . . solder blade, quick connect, and for PC board insertions.

Reason 4: Dialight's 554 series is designed as a low cost switch with computer-grade quality.

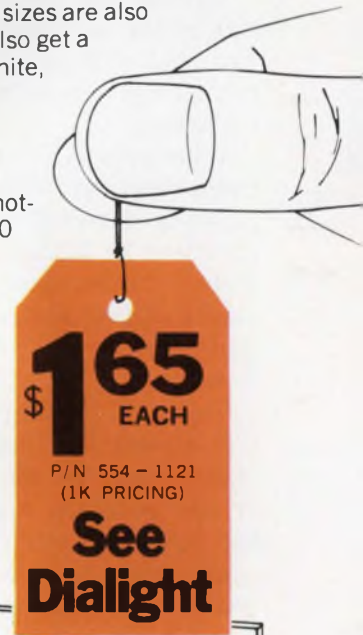

PRODUCT SELECTOR GUIDE						
SWITCHING ACTIONS	Snap-Silver contacts		Snap-Gold contacts		Wiping-Gold contacts	
	SPDT	DPDT	SPDT	DPDT	SPDT	DPDT
MOMENTARY	○	○	○	○	○	○
ALTERNATE	○	○	○	○	○	○
OPTIONS						
	PUSH BUTTON CAP SIZES					
	1/2" Sq.	5/8" Sq.	5/8" x 3/4"	3/4" Sq.	3/4" x 1"	
BEZEL MOUNTING TO ACCOMMODATE	○	○	○	○	○	
BEZEL MOUNTING WITH BARRIERS TO ACCOMMODATE		○	○	○	○	
PANEL MOUNTING TO ACCOMMODATE	○	○	○	○	○	
MATCHING INDICATORS	○	○	○	○	○	

are independent of the switch's actuation speed.

In the wiping-action switch, the contacts are under constant pressure (A unique Dialight design). This insures long life with a minimum build-up of contact resistance.

Both switch types are tease-proof.



DIALIGHT

A North American Philips Company
203 Harrison Place, Brooklyn, N.Y. 11237
(212) 497-7600

Harold Wheeler: An innovator in the world of communications

Holidays have always been important times for Harold Alden Wheeler. It was during his first summer vacation from college that he invented a neutralizing circuit that took the squeals out of radio broadcast receivers and made them easier to tune. That was in 1923.

During the 1925 Christmas holidays he designed the automatic volume control (AVC) circuit that eliminated the need for a third dial on home receivers as well as constant, irritating adjustments.

Wheeler's AVC removed a serious defect in radio receivers which gave a boost to the already growing interest in home radio, provided rich royalties to Hazeltine Corp. from 1932 to 1941 (when the Supreme Court declared the patent invalid) and established Harold Wheeler as a major innovator in the world of electronic communications.

The AVC or more general automatic gain control, circuit is still used in all AM-radio and television receivers. Since designing the AVC, Wheeler has acquired approximately 180 US patents, and at 73 he is still actively solving problems, both engineering and management, as chairman of the board of Hazeltine Corp. in Greenlawn, NY.

Simultaneous invention

Wheeler wasn't the only one to conceive the neutralizing circuit that was to become known as the Neutrodyne. Professor Alan Hazeltine of the Stevens Institute of Technology had come up with the same idea shortly before Wheeler did, though neither had been aware of the other's work.

"By tremendous coincidence," Wheeler recalls from his Spartan office at Hazeltine, "I met the professor. He invited me to visit his laboratory and in about 15 minutes we discovered we were working on the same thing. He was ahead of me in design-

John F. Mason
Associate Editor

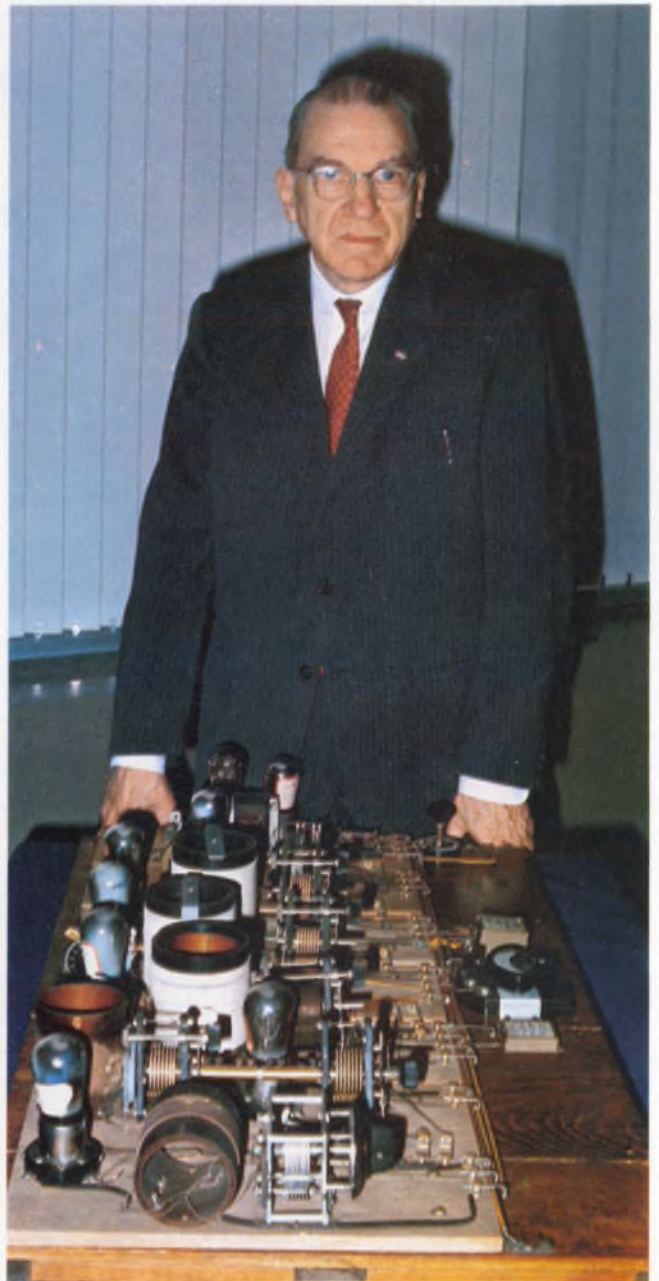

Harold A. Wheeler, Hazeltine's Chairman of the Board, displays the superheterodyne receiver with automatic volume control that he designed in 1925. The circuit is still used in all AM-radio and television receivers.

Photo by John F. Mason

ing the circuit, but I had actually built one."

Was he disappointed to find that Hazeltine had already designed it? "No. I think I was just glad to find someone else who could talk the same language, and I believe he felt the same. He immediately asked me to work summers in his laboratory. My salary, plus a small share of the royalties for the Neutrodyne, put my sisters and me through school. And, of course, I stayed on with the company after graduation." (Hazeltine incorporated the company in 1924.)

Wheeler points to a copy of the original Neutrodyne receiver, which is displayed on a table at one end of the room. The long black console looks impressive with its three large dials. "Hazeltine was just beginning to build the Neutrodyne when I went to work for him," Wheeler says. "It was the first radio-broadcast receiver ever designed on paper; all the others were done by 'cut-and-try'—by witchcraft.

"The Neutrodyne captured the market from RCA in 1923, superseding the Armstrong regenerative receiver, which was the historic introduction to sensitive receivers." The Armstrong was being built by RCA, General Electric and Westinghouse.

Simple solutions to complicated problems

As with all of Wheeler's inventions, the development of the Neutrodyne circuit came as the result of solving a practical problem. "I owe whatever success I might have had to finding problems that have simple solutions," Wheeler says. "That is literally true, and I learned that from Hazeltine."

Hazeltine may have emphasized the point, but it also emerged independently as a result of Wheeler's inherent curiosity, his strong desire to solve problems, and his need to communicate the solutions in simple terms.

"I have functioned on two levels," Wheeler explains. "I've solved engineering problems, such as the Neutrodyne circuit and the AVC circuit. Both were obvious, practical needs. But my greatest contributions have been as a theorist and mathematician; it's for these that I'm actually best known."

Wheeler says he still meets people who say: "Oh yes, I remember your paper on 'paired echos'"—a paper he wrote in the late thirties. "Its title has very little headline appeal, I'm afraid: 'The interpretation of amplitude and phase distortion in terms of paired echoes.'

"I wrote it in the early days of television when certain circuits were poorly understood. The problem of paired echos had been a very elusive topic until I reduced it to simple terms.

"I've enjoyed both levels of innovation," he adds, "but probably the more satisfying is the

theoretical."

The practical problem that led to the Neutrodyne circuit was one inherent in vacuum tubes, Wheeler explains. "The capacitive coupling between grid and plate caused a feedback, which made it difficult to make a stable amplifier for radio frequencies as well as high audio frequencies. The solution was a circuit that would neutralize the coupling. And the result was the first stable high-frequency amplifier operating at broadcast-band frequencies."

The automatic volume control was another practical solution to a troublesome problem. With existing receivers, the volume fluctuated drastically when the station was changed and whenever a station's signal faded.

"In the summer of 1925 I saw the need for some kind of automatic volume control," Wheeler recalls. "You already needed two hands to dial a station, and I just couldn't see asking people to use a third to control volume."

Other engineers were beginning to think about AVC, Wheeler says, "but they didn't go about it the right way. Their circuits were too complicated."

Wheeler—after a number of trials—used a single triode electron tube connected as a diode to detect the signal and develop the bias voltage needed to control the amplification.

The detector's function was to rectify the modulated carrier signal, to separate the ac-modulation component for further amplification at audio frequency, and to separate the dc-rectified carrier component for use as a bias voltage in controlling the preceding rf amplification.

The diode circuit performed the first function with both high efficiency and linearity, neither of which was common in the detectors then in use. Because of the linearity, the dc component was dependent only on the steady carrier and not on the full, fluctuating modulation—a result not obtained in earlier proposals for AVC.

"As with many improvements, such as air conditioning, a lot of people couldn't see any immediate need for it, even chief engineers," Wheeler remembers. "But in 1929, Hazeltine needed a new source of revenue; the Neutrodyne was obsolete due to technical developments. Philco's radio business was flourishing and needed a new product. They got our lab to design their sets—one of them with AVC. This was the Philco 95. It came out in 1929 and captured the market—not as dramatically as the Neutrodyne had six years before, but its royalties supplied the company a good income till World War II."

Wheeler's original superheterodyne receiver, using diode linear detection and automatic volume control, is on display in his office on a table near the Neutrodyne.

(continued on page 82)

With characteristic frankness Wheeler admits that his education was not remarkable. In fact, he wonders how his life might have been different if he had gone to MIT instead of George Washington University and Johns Hopkins. Wheeler received a BS in physics in the engineering school at George Washington and did graduate work in physics at Johns Hopkins.

"I don't know," he says in answer to his own question. "But I suspect that I might have had less time for early creative work with the more rigorous engineering course I would probably have become involved in at MIT."

Wheeler never wasted opportunities anywhere.

Born in Mitchell, SD, in 1903, he had read nearly every book that interested him in the public library by the time he and his family moved to Washington, DC.

"I went to high school in Washington. Washington was just emerging from a 'hick town' to being a city. But I was not very well advised in some areas in which I should have been prepared, such as Latin. I'm sorry I wasn't.

"But life was much simpler in those days," he points out. "Less demanding. Seven scholarships were given to the high school graduating class for George Washington University and I won one of them. A few days later I dropped by and

94
Jan. 2, 1925⁶ Detector-control scheme

above -
effective at r.f.:

effective at a.f.:

$R_3 \gg R_2$
 C_1, C_2 discharged by $\{ R_1, R_3 \}$

effective at d.c.:

C_1, C_2, C_3 discharged by R_1
 also $\{ C_2 \text{ then } R_2, C_3 \text{ then } R_3 \}$

Jan. 3, 1925⁶ Demonstration of "Audiosat" or "Amplisat"
 An 8-tube superheterodyne-neutrodyne set with automatic
 volume regulation.
 Walter A. MacVain Jan. 3, 1925
 J. M. Defendorf Jan. 3, 1925
 V. E. Whitman Jan. 3, 1925

Jan. 4, 1926
 Cut off analysis (see Dec. 2, 1925)
 (data on DV-199 tube, $E_b = 40v, E_c = ?$)

Demonstrated to me on 4/5/26
 J. F. Dwyer Jr.

These notes and drawings in Harold Wheeler's engineering notebook led to the invention of automatic volume control.

registered. There was no line, no trouble getting in. And I lived 30 minutes away."

Four years later, after graduating with a BS in physics in the engineering school, Wheeler went to Johns Hopkins, "the nearest good graduate school."

"I had several definite advantages going for me," Wheeler reflects: "I was an early bloomer. At 13 I knew I wanted to be a consulting engineer. I had early exposure to engineering—my father got me a job in the Bureau of Standards Radio Laboratory my first and second summers after high school, which was a tremendous opportunity; I saw things I'd never have seen otherwise. And my father gave me encouragement throughout my schooling and early career days."

The need to innovate

"In 1946 I decided there were some things I wanted to do that I didn't have the freedom to do in a big company, so I left Hazeltine and formed one of my own, Wheeler Laboratories. You can't imagine how easy it is to make decisions when you don't have stockholders to worry about. My objective was to provide manufacturers with specialized engineering services ranging from consultation to advanced development and experimental models.

"But if you think I really had a definite plan, I didn't. I only knew I wanted to do innovative work, and at that time Hazeltine had shifted from engineering to production. The laboratories prospered beyond anything I had any right to expect."

Friends at Bell Laboratories in Whippany, NJ, kept Wheeler and his group of engineers busy, subcontracting to them part of Bell's work on radar and guided missiles.

"It was government work, but we were still able to operate with more freedom than we had at Hazeltine—or could have had at Bell Labs, for that matter. We were free, working under contract, managing ourselves as we liked.

"I gave my engineers enough freedom to develop the group to its maximum. Credit to me goes only for selecting the right men and giving them freedom."

In 1959, however, Hazeltine's president made Wheeler an offer to come back with his laboratories, and Wheeler went. "Work was tapering off anyway at Bell Labs," Wheeler explains, "and military work in general was getting slack."

The golden era ends

"In 1959 the Air Force sent a memo around to contractors saying not to expect them to pay their bills promptly anymore. This was the beginning of the end of a golden era in innovative

effort for defense. The end was the Robert McNamara era, which did the Defense Department more harm than we'll ever know," he says.

"The low-bid procedure is insurance against quality, reliability and innovation; it has no place in the field of high technology.

"But during most of the fifties the Defense Department was a fertile field for encouraging innovation; this was right at the beginning of the guided-missile phase and the expansion of radar—starting with the Truman administration. It was the greatest period of innovation we have ever had, before or since."

The system ties your hands

Wheeler says engineers never find it easy to do creative work. "Someone's got to pay them, and it's an exception for management to be receptive to innovation."

What can a young engineer do?

"I don't know," Wheeler says. "I think one of the great opportunities today exists with Bell Laboratories. Why? It's a monopoly—a good monopoly." Wheeler pauses a moment. "This isn't to say that Bell Labs always utilizes all its engineering talent in the best way possible, but the opportunities there for innovative work are the greatest of any place in the world."

What about universities? "They're short of money. And again, the labs have more continuity, more far-sighted plans."

NASA? "It came and went."

FAA? "FAA covers a multitude of sins; which one shall we discuss?"

What qualities must a creative engineer possess?

"He's got to be wired up the right way. You can't attribute his creative ability to education. He's got to have an inquiring mind, deductive reasoning, and abstract reasoning.

"Of course there are all kinds of engineers: innovative and cook-book engineers, and we need both in our society."

New engineers are trained by professors who are out of date, Wheeler feels. "There was a time when a professor could grow along with the advances in society and technology. Now, he can't grow that fast. When I was born, areas of technology and people grew at about the same rate. Technology has got way beyond me now."

The solution? "I wish I knew. Electronic training devices would help. A system that calls for taking notes off a blackboard is too old."

Technology may have gone beyond Wheeler, but no more than it has other engineers. And more important, he's "wired up right." He continues to offer his expertise and invaluable experience to the world of communications and the engineering profession. ■■

Need DEC Memory?

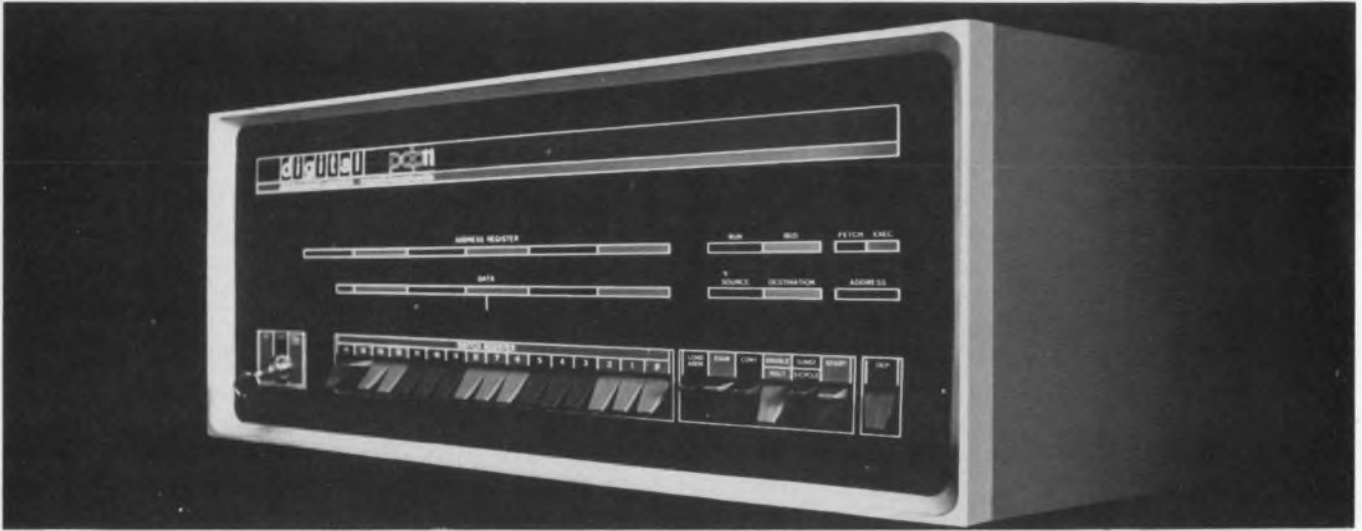

You'll get more for your money from EMM

More bits for your buck. Up to twice as much memory for your dollar from EMM. And you have a choice of core or semiconductor technology.

Improved reliability. EMM's totally engineered memory and interface mean high MTBF, low MTTR.

Proven quality and performance. EMM has been building memory since 1961. We bring all those years of experience and proven performance to the design of memory for your DEC minicomputer.

A year's warranty. When you buy Add-in/Add-on memory from EMM, you get a one year unconditional warranty against defects in workmanship and performance.

So when you need more DEC memory, take a long look at what EMM has to offer . . . buy direct from "the memory company" and save.

Want to know more about our Add-on and Add-in memories for DEC and most other major minicomputers? Call your nearest EMM office or contact us at:

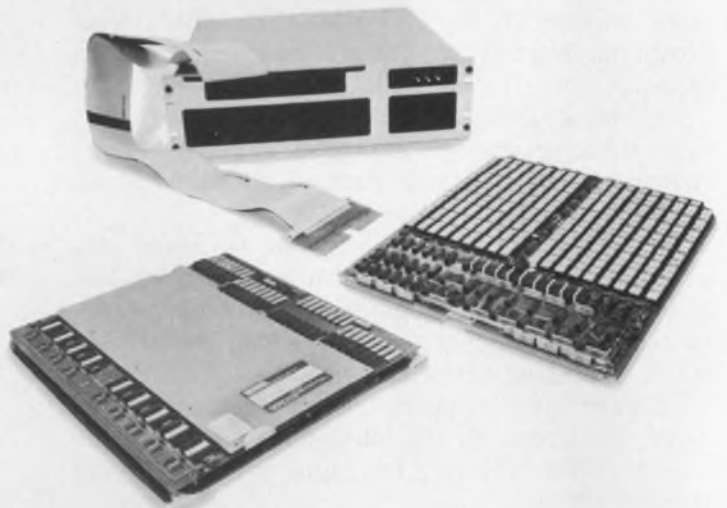

EMM Model	Increment and Type	Used With	Advantages	Price Qty One
7405	16K/32K Core in Add-on Chassis	PDP-11 UNIBUS	Up to 128K in 5 1/4" Chassis. Interleave and Parity Options	\$8500 (64K words)
7805	16K NMOS in Add-on Chassis	PDP-11 FASTBUS	Up to 128K on the FASTBUS (64K in 5 1/4" Chassis) Includes Parity	\$19,000 (64K words)
7711	8K/12K/16K NMOS Add-In	LSI-11	High density, High Performance	\$1590 (16K x 16)

EMM ELECTRONIC MEMORIES
COMMERCIAL MEMORY PRODUCTS

A Division of Electronic Memories & Magnetics Corp.
12621 Chadron Ave., Hawthorne, Calif. 90250

EMM OFFICES: WESTERN REGION, Regional Office, San Francisco (408) 247-9711, Los Angeles Area (213) 644-9881, Orange County Area (714) 639-5811, EASTERN REGION, Regional Office, Boston (617) 861-9650, Chicago Area (312) 297-7090, New York Area (516) 423-5800, INTERNATIONAL OFFICES, European Headquarters, United Kingdom (01) 751-1213, West Germany (089) 714.30.40.

REPRESENTATIVES: BFA Corporation: Scottsdale, Ariz. (602) 946-4215, Las Cruces, N.M. (505) 523-0601, Denver, Colo. (303) 344-3800, Albuquerque, N.M. (505) 292-1212, Salt Lake City (801) 466-6522, Electronic Marketing Specialists: Sherman Oaks, Calif. (213) 990-4244, San Diego, Calif. (714) 566-1000, Sunnyvale, Calif. (408) 245-9291. In Canada: Cantec, Toronto (416) 457-4455, Montreal (514) 620-3121, Ottawa (613) 225-0363. In Japan: Nissho Electronics (03) 544-8396.

"SEE US AT COMPDESIGN '76 IN CHICAGO, APRIL 13-15"

CIRCLE NUMBER 37

Amperex has what it takes to be Number One in RF Power Semiconductors...

The Line • The Book • The Boards

The line has been expanded with the addition of all the popular 2N types to the standard in-house types that have been available all along; there are new supplements to the book, available at no charge of course, to every recipient of the original edition... and our applications assistance has kept pace by the addition of many more prototype sample boards

Yes, we are still going all out to support our state-of-the-art line with a state-of-the-art program of applications engineering assistance.

Today, there's an Amperex RF power transistor for virtually every fixed or mobile transmitter application from 1.6 MHz to 2300 MHz, from ¼ watt to 150 watts, in 25 different packages and operating at any standard voltage from 6V to 50V.

As new RF transistors are added to our product line, we publish supplements that keep the application manual right up to date. But the engineering assistance doesn't end with the manual—it only starts there. You won't even have to build the prototypes to get these circuits into production! We will supply sample boards, built for you, here in the Amperex applications laboratory. Use them to test, to evaluate, to demonstrate your system. Typical of the sample boards now being made available to Amperex customers is a 100 watt, 1.6 to 18 MHz, 12.5 volt Marine Radio Amplifier (illustrated below).

For more information... on the line, the book, the boards, contact Marty Burden, Group Product Manager, Amperex Electronic Corporation, Hicksville Division, Hicksville, N.Y. 11802. Tel. 516-931-6200.

Amperex

TOMORROW'S THINKING IN TODAY'S PRODUCTS

Sold through
North American Philips Electronic Component Corporation

Marine Radio Amplifier
100 W output, 1.6 to 18 MHz,
12.5 V operation

... now —
all these popular
2N types as well
as our standard
in-house types:

2N4040	2N5862
2N4041	2N5913
2N4127	2N5914
2N4128	2N5915
2N4428	2N5916
2N4429	2N5917
2N4430	2N5918
2N4431	2N5919
2N4933	2N5922
2N5016	2N5923
2N5070	2N5924
2N5071	2N5925
2N5090	2N5941
2N5102	2N5942
2N5108	2N5992
2N5177	2N5993
2N5178	2N5994
2N5589	2N5995
2N5590	2N5996
2N5591	2N6080
2N5635	2N6081
2N5636	2N6082
2N5637	2N6083
2N5641	2N6084
2N5642	2N6094
2N5643	2N6095
2N5644	2N6096
2N5645	2N6097
2N5646	2N6104
2N5687	2N6105
2N5688	2N6136
2N5689	2N6166
2N5690	2N6197
2N5691	2N6198
2N5697	2N6199
2N5698	2N6200
2N5699	2N6201
2N5700	2N6202
2N5701	2N6203
2N5702	2N6204
2N5703	2N6205
2N5704	2N6206
2N5705	2N6207
2N5706	2N6208
2N5707	2N6255
2N5708	2N6256
2N5709	2N6265
2N5711	2N6266
2N5712	2N6267
2N5713	2N6268
2N5714	2N6269
2N5773	2N6361
2N5774	2N6362
2N5775	2N6363
2N5776	2N6364
2N5846	2N6369
2N5847	2N6368
2N5848	2N6368
2N5849	2N6369

... our standard
in-house types:

BFS22A	BLX95
BFS23A	BLY87A
BGY22	BLY88A
BGY23	BLY89A
BGY24	BLY90
BLX13	BLY91A
BLX14	BLY92A
BLX15	BLY93A
BLX65	BLY94
BLX66	2N3375
BLX67	2N3553
BLX68	2N3632
BLX69	2N3924
BLX92	2N3926
BLX93	2N3927
BLX94	

5 ways to trim trimmer needs.

1/4" Round Trimmer Type 170.
Cermet element offers essentially infinite resolution. Built-in standoffs permit washing and flux removal. All units sealed to withstand hot water immersion.

3/4" Rectangular Trimmer Type 960. High performance. Low cost. Maximum reliability insured by minimum parts. Completely sealed against dust and humidity.

3/8" Square Multi-Turn Trimmer Type 75. Operation to + 100°C. Self-locking shaft for stable settings. Readily solderable pins make wave soldering easier. Low cost unit for commercial applications.

1/4" Square Trimmer Type 180. Polyester case material withstands high-temperature environments. Tinned pins make soldering easier. All design parameters assured by constant in-process quality control.

3/8" Square Trimmer Type 76. Low cost units for industrial and commercial applications. Space-saving miniature configuration reduces circuit board size requirements.

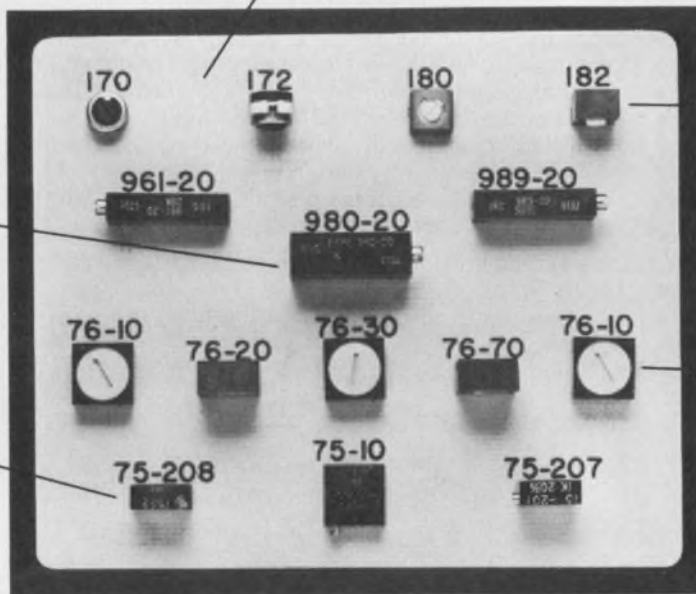

All cermet trimmers sealed against dust and humidity

The Fantastic 5

Today just 5 series of cermet trimmers from TRW can handle 85% of your trimmer requirements.

In a few years, they'll handle just about all your trimmer needs. Fantastic.

For high performance at a low cost, fast delivery and quality service you can depend on, check into the fantastic 5 from TRW.

See your TRW distributor or write or call: TRW/IRC Potentiometers, 2801 72nd Street N., St. Petersburg, Florida 33733. Telephone (813) 347-2181.

TRW IRC POTENTIOMETERS

CIRCLE NUMBER 39

Sin

When I was very young I learned, or rather, I was told, that sin was bad. My friends got the same story and, as you might suppose, we looked forward to our first taste, lest we have nothing to repent.

Whatever our feelings might have been, and they were mixed, we knew deep down that sin was bad—especially, we learned later, if discovered.

But now the world is upside down. Opposition to sin has become suitable for Sunday School lessons. But it's out of place anywhere else. We accept with amusement the proposition that a pastry is sinfully delicious. And we avoid motion pictures that feature lust and sin, only because they tend to be boring.

While objection to sin is socially accepted on week-ends, such an objection during the week is often a mark of communist leanings, or at the least, laughable naivete in the ways of the business world.

Isn't it only natural that leaders of our business community should bribe government officials? If they didn't bribe—or make illegal campaign contributions—they might lose business to an unsophisticated competitor. And losing business would be a disservice to stockholders. Should not business leaders bribe—or pay "commissions" to—representatives of other governments so that they can get more business and provide jobs for American engineers? Aren't government officials (paid with our tax dollars) perfectly justified—on the grounds of protecting the reputation of individuals—in withholding the names of Lockheed officials whose activities include corruption of others?

Further, Lockheed employs many engineers. And if Lockheed's management feels it must bribe to get business, and get taxpayer-backed loans to stay in business, then these actions must be proper and wise. For Lockheed's management must surely be wise or it couldn't command high salaries.

I was almost shocked the other day when I learned that Hewlett-Packard had discovered some minor cases of bribery within its company and promptly discharged the offenders. "Don't they know anything about business?" I asked myself. "That's un-American."

Then I realized that the ancient moral edict might perhaps be outdated. Maybe it should be modernized to read: "Thou shalt not sin—except in the interests of business."



A handwritten signature in dark ink, which appears to read "George Rostky". The signature is written in a cursive, flowing style.

GEORGE ROSTKY
Editor-in-Chief

Rockwell is support for

SOFTWARE

At Rockwell, we've been designing software for equipment based on programmable MOS-LSI CPU's since 1967. (During 1975, we shipped our 1,000,000th microcomputer!)

Because of this experience, the assembly/simulation programs we offer for our modern parallel processing system (PPS) microprocessors are powerful, seasoned, debugged and practical.

HARDWARE



For your own computer, you can purchase our assembly/simulation programs in Fortran IV, or you can use them via time-sharing networks.

But computer or not, the design aids we think you'll use most are our Assemblators—microcomputers equipped with our assembly/simulation programs.

They're designed to rapidly translate your equipment specs into powerful, multi-function PPS instruction codes.



there with system your microcomputer development.

Assemblers also serve you in debugging software by examining CPU, I/O or memory address registers by the bit; in real-time software check-out of systems with peripherals; and in generating your PROM and, finally, ROM masked codes. You can emulate any chip in your system board. And you can even use our Assemblers to test our devices or boards during your incoming inspection.

And best of all, our Assemblers cost far less than a good oscilloscope.

Finally, of course, Rockwell offers you all the evaluation boards you need for prototype development, plus comprehensive, easily understood technical literature and manuals.

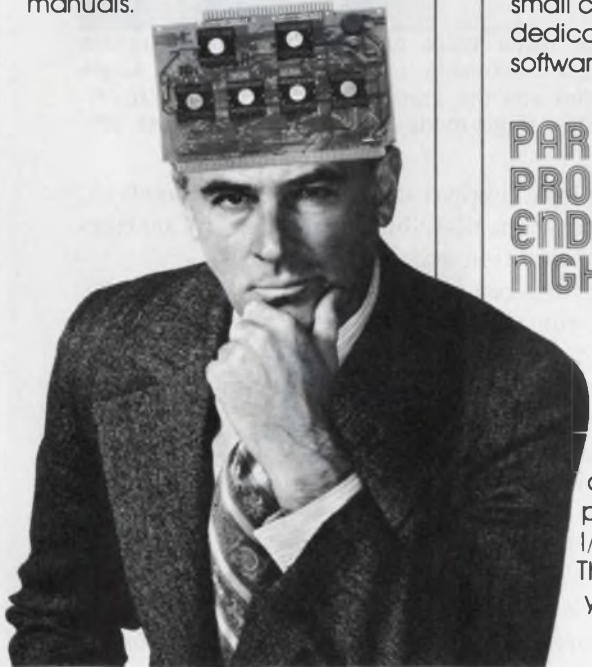

BRAINWARE

Our applications engineers all have backgrounds in software and system design. They're ready to help you

with specific answers to your microcomputer development questions. They're as near as your telephone.



Real Seminars

Better yet, you can meet them in person at one of our designers' seminars where you'll receive intensive training, in small classes, from instructors dedicated to teaching you software design skills.

PARALLEL PROCESSING ENDS DESIGNERS' NIGHTMARES.

In our parallel processing system microcomputers, the CPU synchronously executes overall processing and control while independently intelligent LSI I/Os control peripherals. This means that, when you change or add a peripheral in your

design, you need redo only a portion of your software—not the whole program—and your overall program is smaller to begin with.

**Support
is
wherever
you are.**



Rockwell support is as close as your phone. It starts with your first call to our distributors — Hamilton/Avnet or Schweber — or to our home office. Rockwell representatives are also available locally. For addresses, write or phone:
Microelectronic Device Div.
Rockwell International
P.O. Box 3669
Anaheim, California 92803
(714) 632-3729



Rockwell International

...where science gets down to business

Use optical fibers for long-range data communications. They provide interference-free operation and better performance than coaxial cables. Here are some fiber basics.

Consider fiber optics for the design of your next long-distance communications system. Fiber-optic links offer performance that coaxial cables can't match, and don't have the failings of wire systems. Presently available coaxial cables for, say, a 102 Mbit/s system have losses that run as high as 33 dB/km. In contrast, a multimode, graded-index fiber has a loss of only 4 dB/km.

Even though fiber-optic cables may cost more initially, repeater-spacing distances can be increased by more than five times, or, in short runs, can be eliminated. (Suggested repeater spacing is about 2 km for coaxial cable.) In addition to the reduced repeater cost, cable sizes are smaller (diameters are usually less than 0.5 in. for optical cables), crosstalk is almost negligible (isolation is usually better than 60 dB) and there is no interference from nearby electromagnetic or radio-frequency fields.

Before you start to design a fiber-optic system, though, let's look at the different types of cable, their specs, and the different transmitting and detecting devices. The performance limit for a long-distance system is, of course, set by both the characteristics of the transmission medium and the signal format. System costs and required performance are the two factors most often traded off.

Let's look at fiber-optic performance

In a fiber-optic system, there are many general specifications that you should consider:

- Source optical power (expressed in milliwatts or dBm). It represents the total amount of optical power emitted by the light source used.
- Spectral width (expressed in Angstroms). This depicts the wavelengths of the light emitted by the source.
- Coupling loss (expressed in decibels). It tells how much power in the fiber-optic link is lost at such discrete junctions as the one between the light source and the cable end.

Tom A. Eppes, Jim E. Goell and Charles Kao, Systems Engineers, ITT Electro-Optical Products Div., Roanoke, VA 24019.

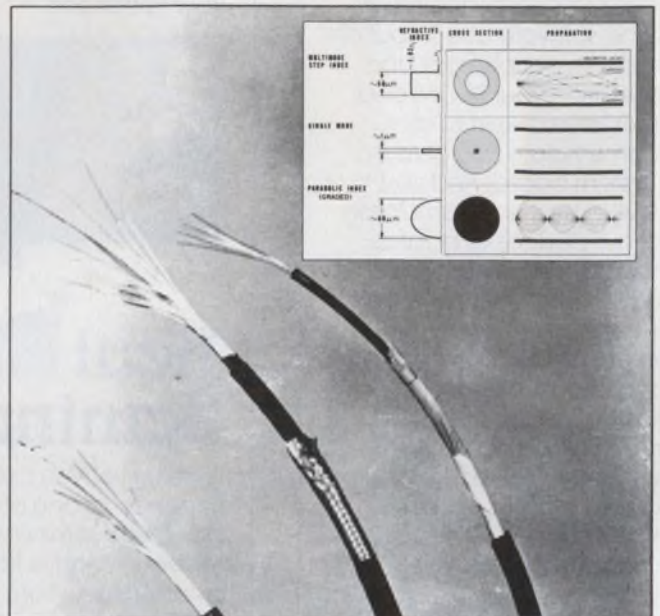

1. The three major types of fiber-optic cables include the step-index multimode (left), the step-index single mode (middle) and the graded-index multimode (right). The step-index single-mode fiber has the highest efficiency.

- Cable loss (expressed in decibels/kilometer). This represents a distributed loss due to scattering and attenuation within the cable.

- Cable dispersion (expressed in nanoseconds/kilometer, the reciprocal of this spec is a rough estimate of the maximum frequency transmitted over a specified length). It defines how much the transmitted pulse broadens (widens) as the signal propagates in the fiber, and is a combination of multimode, waveguide and material-dispersion effects.

- Receiver sensitivity (expressed in dBm). This tells how much optical power the photodetectors must receive to achieve a specified base-band performance, such as a specified bit-error rate or signal-to-noise ratio.

There are currently three major types of optical fibers in use: step-index multimode, step-index single-mode and graded-index multimode (Fig. 1). The step-index and graded-index multimode fibers are the least expensive, and presently the most widely used. Aside from cost considerations, the choice of fiber type depends on band-

width needed, pulse format and transmission distance.

For long-distance applications at a high data rate, the most important fiber parameters include loss (attenuation), numerical aperture (NA) and dispersion. The loss of a cable reduces the optical power that the detector receives. NA defines the light gathering property of the fiber and can be expressed as

$$NA = \arcsin \theta,$$

where θ is the light-gathering acceptance half angle, and the dispersion defines how the transmitted pulses will widen between repeaters and thus create intersymbol interference.

Know the fiber problems

Light can be attenuated in fiber-optic cable by any of three major factors—absorption, scattering and cabling. Absorption is caused by such cable impurities as transition-metal ions and hydroxyl radicals. Material scattering stems from impurities in the fiber core material. The dominant scattering loss in good fibers varies in proportion to the λ^{-4} (wavelength⁻⁴). Cabling attenuation is also caused by radiation from microbends in the material itself.

Scattering attenuation depends on the composition of the fiber material. The lowest loss is available from fused SiO₂ (glass); loss increases for materials with higher refractive indices. Highest quality cables are available with attenuations of only 1 or 2 dB/km for a transmission wavelength of 0.82 μm .

The fiber's NA determines the maximum angle from the fiber axis at which light rays can enter the fiber and be transmitted through it. The NA primarily affects the coupling efficiency and the pulse dispersion. The larger the aperture, the greater the coupling efficiency—and, unfortunately, the wider the pulse dispersion too. For low-loss fibers, the NA can be as high as 0.3.

Pulse dispersion stems from three main sources—material, waveguide and multimode. Since the effect of dispersion is to widen the transmitted pulses, it limits the maximum repeater spacing for a fixed data rate.

In single-mode fibers, only material and waveguide effects are present and the total dispersion is mainly controlled by the material properties. The material dispersion depends on the light source's spectral width and emission wavelength.

When the core is large compared with the wavelength, the number of modes increases as the square of the diameter. The spread of an impulse over a distance can be related to the time-arrival difference between the various modes. The delay spread for multimode step-index fibers vs NA, plotted in Fig. 2, shows almost a three-order-of-magnitude difference for different types of

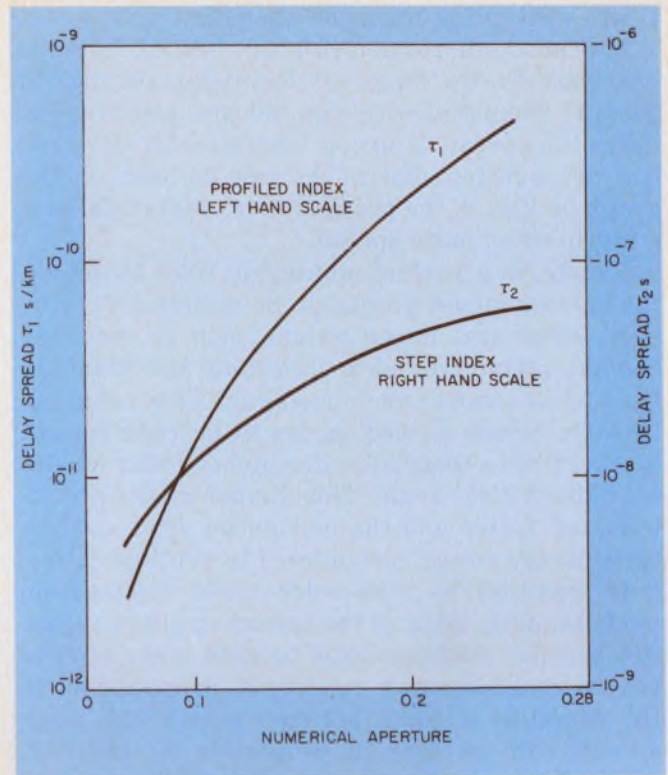

2. Profiled-index optical fibers offer a thousandfold performance advantage over step-index fibers. Of course, you'll pay for the decreased delay in the higher cost of the graded fibers.

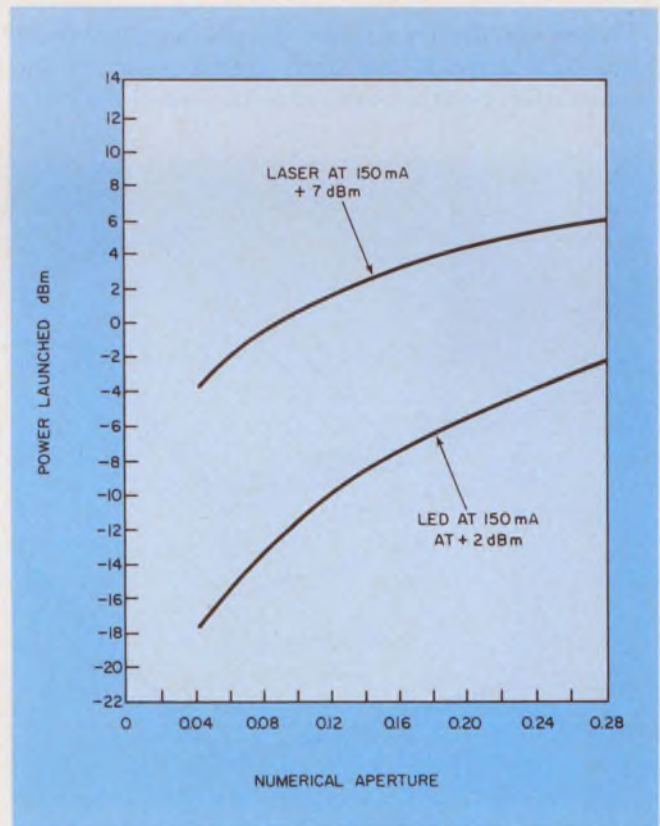

3. For the same amount of drive current, an injection-laser diode can deliver more light power to a fiber than a LED. This is because the light from the laser is totally coherent and thus passes through the cable easier.

fibers, depending upon the aperture.

Multimode dispersion in graded-index fibers is governed by the shape of the index profile. In general, compared with step indexes, profiling reduces the spread of group velocities for the various propagating modes. As can be seen on the graph of Fig. 2, the profiled index materials have a much lower pulse spread.

Ideally, in a perfect multimode fiber structure, the various modes propagate independently. However, structural imperfections such as direction change, refractive-index variations and diameter fluctuations cause mode coupling. This coupling, in turn, causes guided modes to be radiated out of the fiber—especially the higher-order modes near the critical angle. Thus higher modes are attenuated faster and the multimode delay characteristics are rarely encountered in profiled cables.

In addition to high-order mode attenuation, mode coupling reduces the spread in group velocities because modes coupled to each other tend to have a common mean velocity of propagation. If the coupling is equal between modes, the pulse spread will increase in proportion to $(LL_0)^{1/2}$, where L_0 is the length at which mode coupling reaches equilibrium. L_0 will probably be greater than 1 km for low-loss fibers, and, L is the total length of the fiber.

Select the light sources carefully

When you design a fiber-optic system, you must take into account the light source used in the transmitter. Source requirements depend upon the

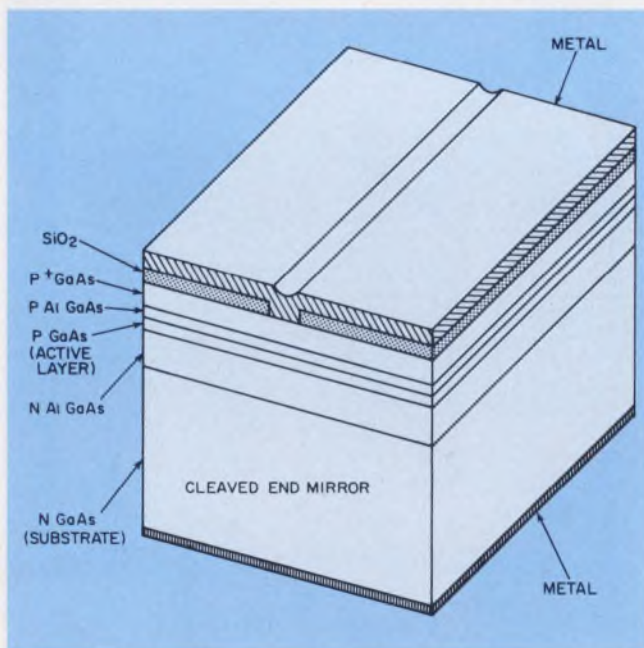

4. A typical double-heterojunction injection-laser diode built using GaAs offers the top performance of any semiconductor light emitter. Nd:YAG lasers top laser diodes but they require special modulators.

specific application and must usually be custom selected. The main characteristics you should consider during selection include brightness, size, output spectrum, efficiency, life, modulation rate and cost.

The three primary sources available to designers are gallium arsenide LEDs, GaAs injection lasers and Neodymium: Yttrium-Aluminum-Garnet (Nd:YAG) lasers. Presently, much research work is being done on AlGaAs, and it is expected that these devices will fill many of the fiber applications.

Both LEDs and injection lasers use the basic GaAs diode structure and the wavelength of the radiated light depends on the device material and the dopant.¹ The typical emitted radiance of LEDs currently available can be as high as 100 W/cm²-steradian (unit of solid angle) for a drive current of 150 mA and an emission area of 2×10^{-5} cm². The half-power spectral width of these diodes is typically 350 to 400 Å, and their quantum efficiency about 3 percent.²

Coupling efficiency for these diodes is very poor with fibers because of the diode's larger incoherent solid-angle emission. Power launched vs NA is much better if you use a coherent light source such as a laser (Fig. 3). LEDs can be easily modulated by directly varying the injected current. Modulation rates of over 100 Mbit/s are possible.

Life expectancies are presently the only limiting factor in LED usage. Current lifetimes of several thousand hours are not sufficient for many applications. Improvements are starting to

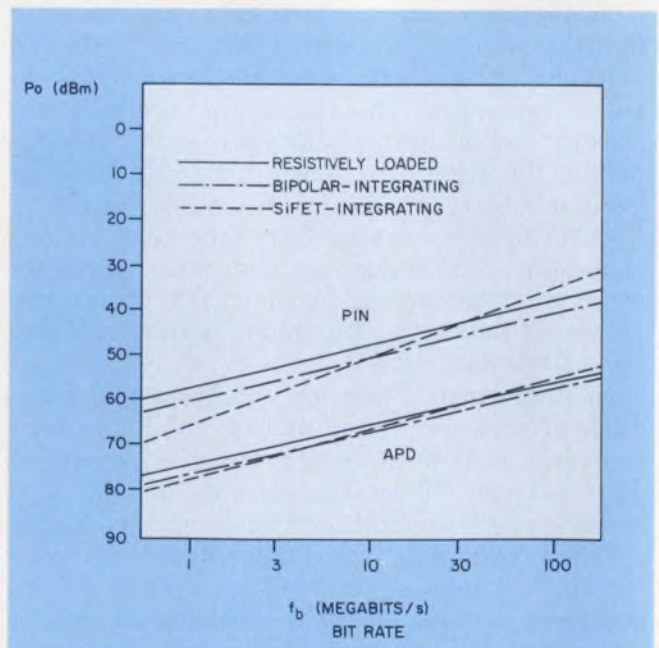

5. P-i-n and avalanche photodiodes are the two most often used detectors in fiber-optic data links. The p-i-n diodes are lower in cost than APDs, but are slightly noisier and slower.

appear and lifetimes of over 100,000 hours will be available shortly. And diode costs should follow the typical price patterns of most other semiconductors—decreasing as the product matures.

Semiconductor injection lasers are well suited for optical-fiber transmitters.^{3,4} Low-current continuous operation at room temperatures has been achieved and is a necessity for reliable source operation. Specially designed devices like the double-heterostructure device shown in Fig. 4 permit the light-output region to be matched to the fiber-core diameter.

For a single transverse-mode laser, the output wavelengths range from 0.7 to 0.9 μm , for optimum device design. Injection lasers can also be easily modulated by controlling the input current. However, in current-modulated injection lasers a phenomenon similar to resonance is caused by the phase relationship between the photon and electron densities, and may excite damped oscillation.⁵ This leads to a relatively flat frequency-dependent modulation efficiency, out to some frequency where severe peaking may occur. Typical peaking frequencies range from tenths of a gigahertz to several gigahertz. Modulation rates of up to 2 Gbit/s are possible, though.⁶

The power coupling from a semiconductor laser to an optical fiber depends on the fiber geometry and also on the geometry of the laser-emitting area.⁷ Pulse modulation of injection lasers can offer some advantages over current modulation. For example, higher peak optical powers can be obtained and the laser lifetime can be increased. If the laser is pulse modulated without any forward bias, however, a prepumping time is required before lasing action will begin.⁸

In the past, the reliability of injection lasers has been poor, but improved theoretical knowledge and material control have boosted reliability so that devices will soon be available that have a

mean-time-between-failure of 100,000 hours.

The Nd:YAG laser offers several advantages over both the LED and injection-laser light sources in transmission systems:

- Its emission wavelength of 1.06 μm coincides with one of the low-loss regions of silica fibers.
- Its longer wavelength also means less scattering loss since scattering is a function of λ^{-4} .
- Its emission spectral width is narrower than that of injection lasers which, in turn, means less material dispersion.
- Its output is a single-mode, single-frequency light beam and easy to handle.
- Its LED pumping source has a long life; therefore, the over-all life expectancy of the unit is long.

Recently, an experimental unit delivered an output of 52 mW in TEM₀₀ modes at an operating temperature of 269 K when pumped by an array of AlGaAs diodes. Short lengths of fused-silica fibers with Nd-doped cores have been operated as end-pumped lasers and hence, provide extremely high coupling efficiency.

However, Nd:YAG lasers can't be directly modulated at megahertz rates; an optical modulator is therefore a necessary companion for communications applications. The cost of the Nd:YAG laser is higher than the LED or injection sources, but the higher efficiencies will eventually compensate for the difference.

Match the photodetector to the application

Once the light signal reaches the end of the cable it must be strong enough to cause a reaction in the detector. A typical optical receiver consists of a photodetector, a front-end amplifier, an equalizer, a filter and demodulation circuitry.

For most fiber applications, the detector is usually a p-i-n or avalanche photodiode. Unlike

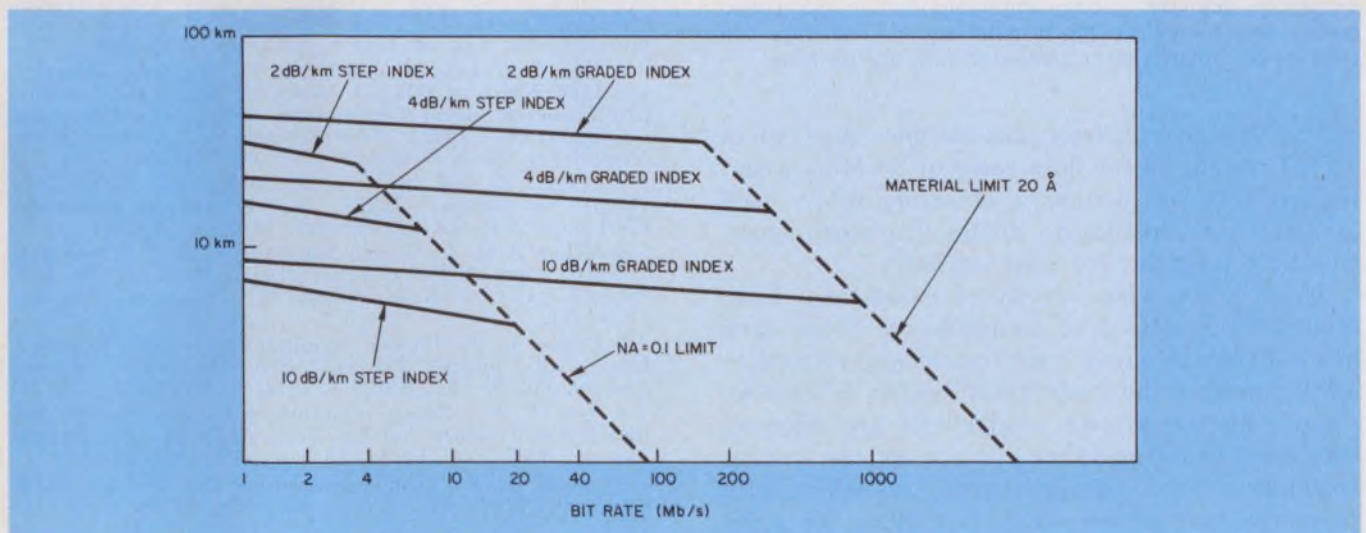

6. This simple graph can help determine the necessary repeater spacing in a fiber optic link. You must specify

the bit transmission rate, the fiber type and the light source to determine the spacing.

conventional electrical signals, optical signals have an inherent noise that is signal dependent. To calculate performance, the unique characteristics of optical signals and optical detectors must be taken into account.

In a receiver, there are several noise sources that can be modeled as parallel current sources at the receiver input. The five primary noise sources include quantum noise, background noise (including dark current), surface leakage-current noise, beat noise and amplifier noise.

For applications that use PCM (pulse-code modulation) and have high bit rates and a good detector, the total noise may be closely approximated by the sum of the quantum noise and the amplifier noise.^{9,10} Fig. 5 shows the required average power at the receiver input for a bit-error rate of 1×10^{-9} . With a p-i-n detector, the bipolar-integrating front-end has a response that is about 3 dB better than a resistively-loaded front end.

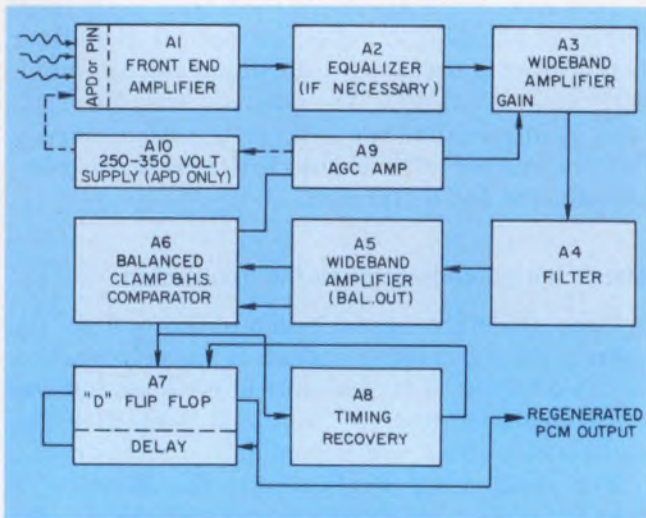

7. A typical PCM receiving system uses either p-i-n or avalanche detectors, some amplifiers and a high-speed comparator to restore the original signal. The data can then be retransmitted or converted into analog form.

The bipolar transistor also becomes superior to a FET amplifier for data rates of 30-Mbit/s and higher with an avalanche detector. When used in amplifiers, avalanche diodes are more sensitive than p-i-n devices used similarly.

There are a wide variety of modulation techniques for digital-data transmission. Since each has a different power requirement and reliability level, choosing the modulation method is critical.

Once all the system components are selected, they must be put together into a workable system. Depending upon the end-to-end system length, repeaters may be necessary to restore the pulse width and boost signal strength. To determine the repeater spacing, first specify the system bit

rate and calculate the repeater spacing by using the maximum acceptable dispersion value or loss.

There are some tradeoffs, though, that should be considered. For instance, if the repeater spacing is limited by multimode dispersion, the NA of the fiber may be reduced, which can increase cable losses even though it increases the possible repeater spacing. If material dispersion limits repeater spacing, reduce the spectral width of the source to boost performance. Or use a better grade of fiber.

If the repeater spacing is loss-limited, the NA spacing—and hence the coupled power—can be increased, which cuts dispersion in multimode fibers. Several tradeoffs are shown in Fig. 6. A typical PCM receiver, shown in block diagram form in Fig. 7, uses standard circuitry to recover the transmitted signal.

The incoming signal can be detected using an avalanche or p-i-n detector, and an amplifier in the front-end. If signal integration occurs as a result of input capacitance, an equalizer must be used to restore the pulse shape. Additional wideband amplifiers can increase the signal even more. A filter following the amplifier limits the noise and then the prepared signal feeds a high-speed comparator that feeds a D flip-flop. A timing-recovery circuit accepts the comparator's output and provides clock signals to the D flip-flop to retime the incoming signal. The regenerated PCM can then either be converted into analog form or reconverted into light form as done in a repeater. ■■

References

- Berolo, O. and Wooley, J. C., "Electro Reflectance Spectrum of $Al_xGa_{1-x}As$ Alloys," *Canadian Journal of Physics*, Vol. 10, April-June, 1971, pp. 1335-1339.
- Burrus, C. A. and Miller, B. I., "Small-Area Double Heterostructure (AlGa) As Electro-luminescent Diode Sources for Optical Fiber Transmission Lines," *Optical Communication*, Vol. 4, December, 1971, pp. 307-309.
- Paoli, T. L., Hakki, B. S. and Miller, B. I., "Zero-order Transverse Mode Operation of GaAs Double-heterostructure Lasers with Thick Waveguides," *Journal of Applied Physics*, Vol. 44, March, 1973, pp. 1276-1280.
- Iida, S., Takata, K. and Unno, Y., "Spectral Behavior and Line Width of (GaAl) As GaAs Double-heterostructure Lasers at Room Temperature with Stripe Geometry Configuration," *IEEE Transactions on Quantum Electronics*, Vol. QE-9, February, 1973, pp. 361-366.
- Ozeki, T. and Ito, T., "Pulse Modulation of DH-(GaAl) as Lasers," *IEEE Transactions on Quantum Electronics*, Vol. QE-9, February, 1973, pp. 388-391.
- Miller, S. E., Li, T. and Marcetili, E. A. J., "Research Towards Optical Fiber Transmission Systems, Pt II," *Proceedings of the IEEE*, Vol. 61(12), December, 1973, pp. 1726-1751.
- Cohen, L. G., "Power Coupling from GaAs Injection Laser into Optical Fibers," *Bell Systems Technical Journal*, Vol. 51 (3), March 3, 1972, pp. 375-594.
- Lee, T. P., "Effect of Junction Capacitance on the Rise Time of LEDs and the Turn-on Delay of Injection Lasers," *BSTJ*, Vol. 54(1), January, 1975, pp. 33-68.
- Goell, J. E., "Input Amplifiers for Optical PCM Receivers," *BSTJ*, Vol. 53(9), November, 1974, pp. 1771-1793.
- Personick, S. D., "Receiver Design for Digital Fiber Optic Communication Systems, Pt I," *BSTJ*, Vol. 52(6), July-August, 1973, pp. 843-874.

DELCO'S NEW FAS HIGH-GAIN TRANSIS

MAJOR PARAMETER LIMITS

TYPE	h_{FE} @ 10A	V_{CBO}	V_{CEO} (sus)	V_{CE} (sat) @ 7A	t_f (typical) @ 5A
DTS 515	3.5	300V	250V	5.0V	0.25 μ sec
DTS 516	4	400V	250V	1.9V	0.25 μ sec
DTS 517	5	500V	250V	1.6V	0.25 μ sec
DTS 518	5	600V	275V	1.4V	0.25 μ sec
DTS 519	5	700V	300V	1.4V	0.25 μ sec
2N6573	5	500V	250V	1.5V	0.25 μ sec
2N6574	5	600V	275V	1.5V	0.25 μ sec
2N6575	5	700V	300V	1.5V	0.25 μ sec

NPN triple diffused silicon transistors. Packaged in solid copper cases conforming to JEDEC TO-3 outline dimensions.

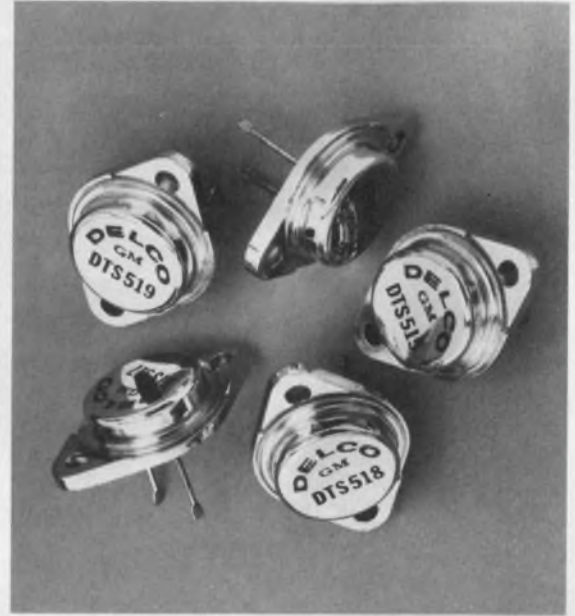

Our newest high-energy silicon power transistors have increased capabilities over our earlier types in current ratings, gain and switching speeds. These improvements were achieved without sacrificing the useful peak power handling capacity that is characteristic of Delco's transistors.

Fall time of these transistors is typically 0.25 microseconds. Their biggest advantage, however, is their high current gain as shown on the accompanying beta curves.

A new characterization feature offered with the DTS-515 series is a graph of capabilities for reverse bias clamped inductive switching. Parameter variables, dealt with in the graph, are voltage, collector current, temperature, and forward and reverse base current. As can be seen in the

" V_{BE} (reverse) \geq 5V" notation, emitter diode avalanche is recommended under certain conditions.

And, of course, these high-energy silicon power transistors come in Delco's solid copper TO-3 packages to ensure low thermal resistance.

The accompanying curves, charts and circuits tell part of the story. Prices, applications literature and electrical data from your nearest Delco sales office or Delco distributor can supply another part.

But the most important part of the story is how well these new transistors function in your applications.

You can order them today; they're in stock at your Delco distributor's.

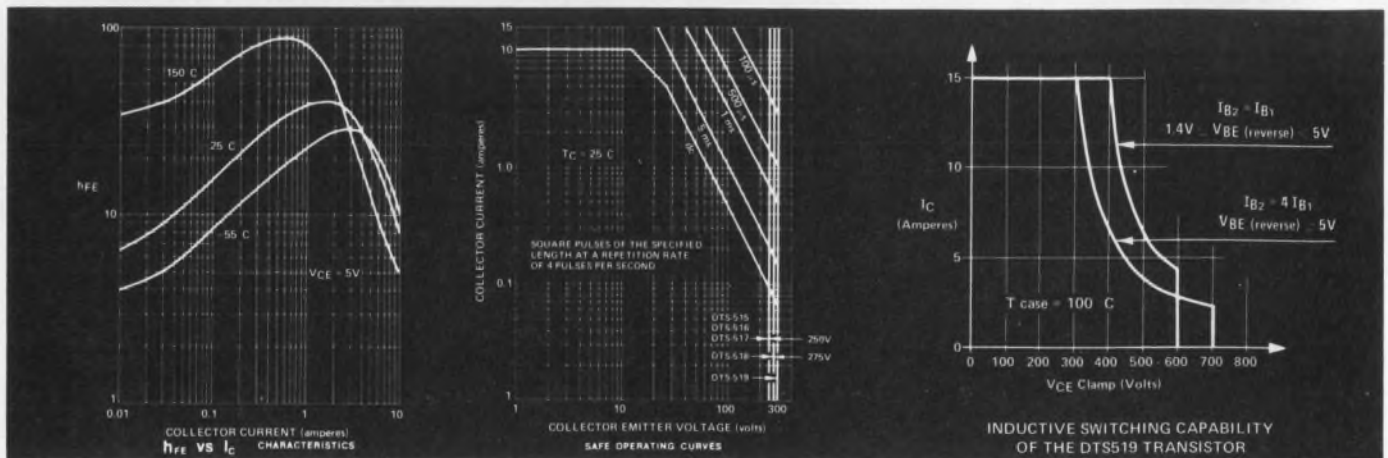

TER SWITCHING, TORS NOW IN STOCK.

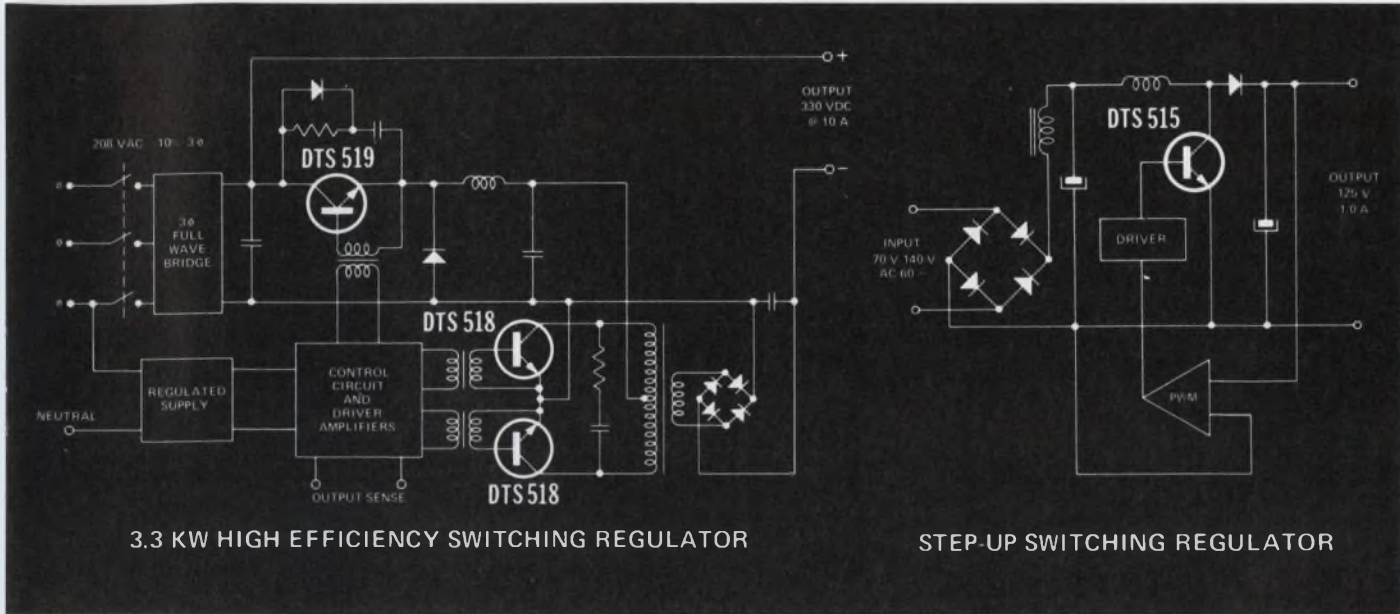

NOW AVAILABLE FROM THESE DISTRIBUTORS IN PRODUCTION QUANTITIES.

ALABAMA, Birmingham
Forbes Distributing Co., Inc.
(205) 251-4104

ALABAMA, Huntsville
Powell Electronics
(205) 539-2731

ARIZONA, Phoenix
Sterling Electronics, Inc.
(602) 258-4531

CALIFORNIA, Gardena
Bell Industries
Electronics Distributors Div.
(213) 321-5802

CALIFORNIA, Goleta
R.P.S. Electronics, Inc.
(805) 964-6823

CALIFORNIA, Los Angeles
Kierulff Electronics, Inc.
(213) 685-5511

CALIFORNIA, Los Angeles
R.P.S. Electronics, Inc.
(213) 748-1271

CALIFORNIA, Palo Alto
Kierulff Electronics, Inc.
(415) 968-6292

CALIFORNIA, San Diego
Kierulff Electronics, Inc.
(714) 278-2112

CALIFORNIA, San Diego
R.P.S. Electronics, Inc.
(714) 292-5611

CALIFORNIA, Sunnyvale
Bell Industries
(408) 734-8570

COLORADO, Denver
Kierulff Electronics, Inc.
(303) 371-6500

CONNECTICUT, Norwalk
Harvey Electronics
(203) 853-1515

FLORIDA, Clearwater
Diplomat/Southland
(813) 443-4514

FLORIDA, Miami Springs
Powell Electronics/Florida
(305) 592-3260

ILLINOIS, Elk Grove Village
Kierulff Electronics, Inc.
(312) 640-0200

ILLINOIS, Skokie
Bell Industries
Electronics Distributors Div.
(312) 282-5400

INDIANA, Indianapolis
Graham Electronics Supply, Inc.
(317) 634-8202

MARYLAND, Baltimore
RESCO/Baltimore
(301) 823-0070

MARYLAND, Beltsville
RESCO/Washington
(301) 937-5890

MASSACHUSETTS, Billerica
Kierulff Electronics, Inc.
(617) 935-5134
(617) 667-8331

MASSACHUSETTS, Newton
The Greene-Shaw Co., Inc.
(617) 969-8900

MICHIGAN, Livonia
Pioneer/Michigan
(313) 525-1800

MINNESOTA, Minneapolis
Stark Electronics Supply Co.
(612) 332-1325

MISSOURI, Kansas City
Walters Radio Supply, Inc.
(816) 531-7015

MISSOURI, St. Louis
LCOMP-St. Louis
(314) 647-5505

NEW JERSEY, Cinnaminson
Wilshire Electronics/Philadelphia
(609) 786-8990 (215) 627-1920

NEW JERSEY, Clifton
Wilshire Electronics/New Jersey
(201) 340-1900 (212) 244-8930

NEW MEXICO, Albuquerque
Sterling Electronics
(505) 345-6601

NEW YORK, Binghamton
Harvey Electronics
(607) 748-8211

NEW YORK, Buffalo
Summit Distributors, Inc.
(716) 884-3450

NEW YORK, Farmingdale
Wilshire Electronics/Long Island
(516) 293-5775

NEW YORK, Freeport
Milgray/New York
(516) 546-6000

NEW YORK, Woodbury
Harvey Electronics
(516) 921-8700 (212) 895-9260

OHIO, Cincinnati
United Radio, Inc.
(513) 761-4030

OHIO, Cleveland
Pattison Supply Co.
Industrial Electronics Division
(216) 441-3000

OHIO, Dayton
Pioneer/Dayton
(513) 236-9900

PENNSYLVANIA, Philadelphia
Almo Electronics
(215) 698-4000

PENNSYLVANIA, Pittsburgh
CAM/RPC Electronics
(412) 288-2600 (412) 782-3770

SOUTH CAROLINA, Columbia
Dixie Radio Supply Co., Inc.
(803) 253-5333

TEXAS, Dallas
Sterling Electronics
(214) 357-9131

TEXAS, Houston
Harrison Equipment Co., Inc.
(713) 652-4700

TEXAS, Houston
Sterling Electronics
(713) 627-9800

WASHINGTON, Seattle
Kierulff Electronics, Inc.
(206) 763-1550

IN CANADA: ONTARIO—Toronto
Zenronics Ltd.
(416) 787-1271

OVERSEAS: EUROPEAN INQUIRIES:
European Parts & Accessories
Marketing Group
General Motors Continental
Plant 2, Noorderlaan, Postbus 9
B-2030 Antwerp, Belgium

ALL OTHER OVERSEAS INQUIRIES:
General Motors Overseas
Operations
Parts & Accessories Dept.
767 Fifth Avenue
New York, N.Y. 10022
(212) 486-4412

Delco Electronics Regional Sales Offices
Charlotte, North Carolina 28209
4600 South Park Road
(704) 527-4444
Van Nuys, California 91404
Box 2968
(213) 988-7550

General Sales Office
700 E. Firmin, Kokomo, Ind. 46901
(317) 459-2175

Delco Electronics



Division of General Motors

Design transistor oscillators with either bipolar or field-effect devices, using admittance data from spec sheets. Here are some circuits and design equations.

By using transistor admittance parameters, you can design bipolar or field-effect transistor oscillators that provide stable, accurate frequencies. Colpitts, Clapp, Hartley, tuned-collector (drain) and tuned-base (gate) oscillators have similar design procedures, once you know the circuit basics and the equations.^{1,2,3,4,5}

Whether you use bipolar transistors or FETs in the high frequency oscillators, data sheets never give you enough information about the hybrid parameters. In most circuit-design courses you are taught how to use the parameters, but they usually are measured at 1 kHz and not the 1 or 10 MHz you really might need.

And most designs are approximate, since only the real part of the complex hybrid terms is used; the influence of the imaginary part (reactive factors) is neglected.

Admittance parameters, though, are given in most transistor handbooks and are specified at high frequencies with both real and imaginary components.

The basic oscillator design

The simplest feedback oscillator circuit uses a transistor and has feedback elements arranged in a π network (Fig. 1). The elements Z_1 , Z_2 and Z_3 are impedances, and there is also a mutual coupling between elements Z_{1L} and Z_{2L} . The basic equation that determines the frequency of oscillation,

$$f = 1 / (2\pi\sqrt{LC}) \tag{1}$$

dates to well before electronic communications became a reality.

If you replace the transistor with its common-emitter equivalent circuit and the feedback impedances with their corresponding admittances, you get the circuit in Fig. 2. Here the internal feedback of the transistor is considered negligible, and its output admittance, y_{oe} , is included in the admittance of y'_{2C} , where $y'_{2C} = y_{2C} + y_{oe}$.

You can use the modulus of the forward trans-

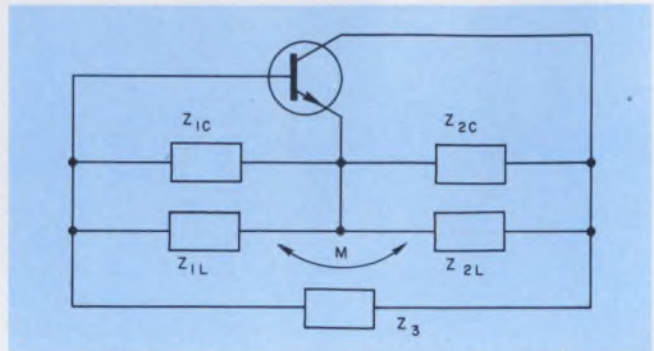

1. The basic oscillator circuit uses an active element with multipath feedback loops.

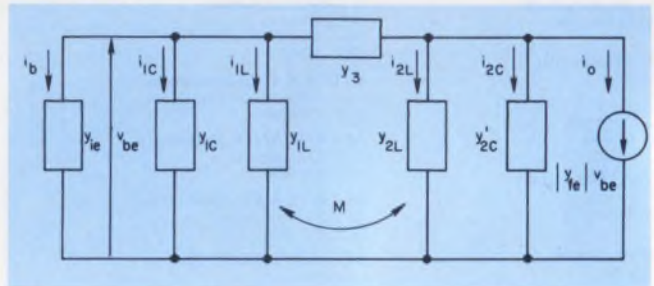

2. After you change the actual circuit into its π equivalent, you can use the admittance parameters to determine the frequency of operation.

fer admittance in the circuit since the transistor operates at a frequency at which $\cos \phi_{re}$ is close to unity. If you apply Kirchoff's Law, you obtain the following system of equations:

$$\begin{aligned} i_b + i_{1C} + i_{1L} + i_{2L} + i_{2C} + i_o &= 0 \\ (i_{1L}/y_{1L}) - (i_{2L}/y_M) &= i_b/y_{ie} \\ i_{1C}/y_{1C} &= i_b/y_{ie} \\ (i_{2L}/y_{2L}) - (i_{1L}/y_M) &= \\ (i_b/y_{ie}) + (i_{1L} + i_{1C} + i_b)/y_3 & \\ (i_{2L}/y_{2L}) - (i_{1L}/y_M) &= i_{2C}/y'_{2C} \end{aligned} \tag{2}$$

Now calculate the transfer function of the feedback circuit, $\bar{\gamma} = i_b/i_o$, where the current gain is defined by $\bar{A}_i = |y_{re}|/y_{ie}$. Once the feedback circuit transfer function and the current gains are found, you can apply Barkhausen's oscillation criterion:

$$\begin{aligned} \bar{A}_i \bar{\gamma} &= -|y_{re}| (y_3 y_M^2 - A - y_{1L} y_{2L} y_M) \\ &\times \{ y'_{2C} [(y_{1C} + y_{ie} + y_3) (y_M^2 - y_{1L} y_{2L}) + y_{1L} y_M^2] \\ &+ y_M^2 [(y_{1L} + y_{1C} + y_{ie}) (y_{2L} + y_3) + y_{2L} y_3] \end{aligned}$$

George Bajeu, Scientific Researcher, Institute of Atomic Physics, Bucharest, P.O. Box 5206, Romania.

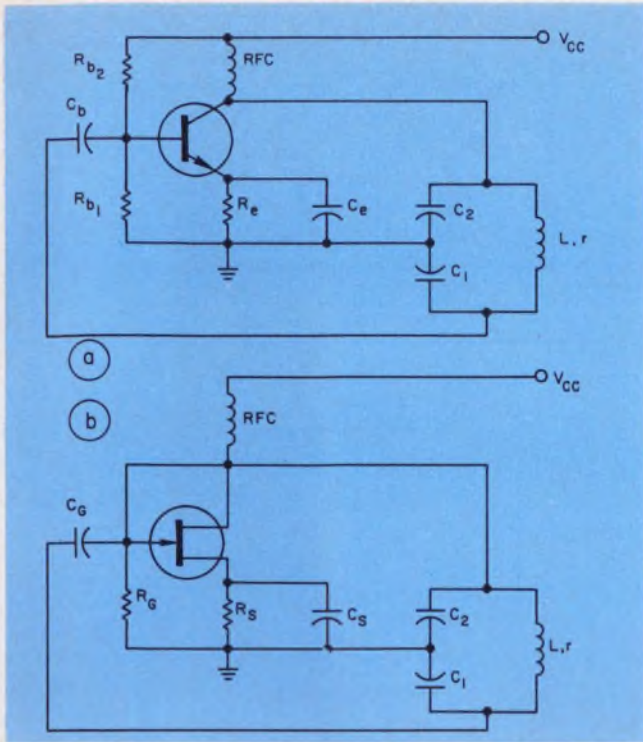

3. The bipolar (a) and the FET (b) Colpitts oscillators use center-tapped capacitors in the tank circuit to determine the frequency of oscillation.

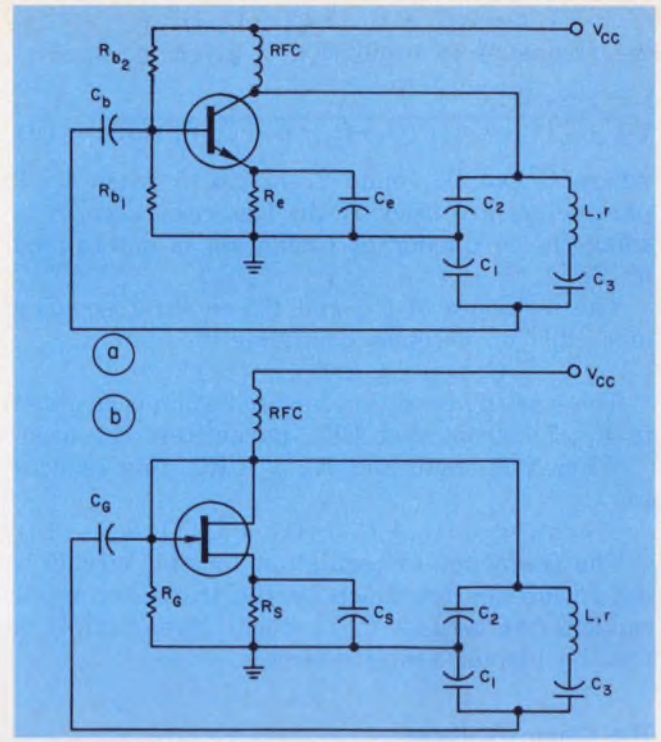

4. The bipolar (a) and FET (b) Clapp oscillators are variants of the Colpitts. They have an additional capacitor in the resonant tank circuit.

$$-A(y_{1c} + y_{ie} - 2y_M)\}^{-1} = 1 \quad (3)$$

where $A = y_{11}y_{21}y_3$.

The basic circuit of the bipolar transistor oscillators (Figs. 3a, 4a, 5a, 6a, 7a) has a thermally stable operating point. Also, the resistance of the divider (R_{b1}/R_{b2}) should be much larger than R_{ie} . When the divider resistance is small, you can make it appear large by inserting an rf choke between the meeting point and the transistor base.³

The FET oscillators (Figs. 3b, 4b, 5b, 6b, 7b) work either with a gate self bias or a source self bias. The gate bias of the FET is based on the rectifying effect of the gate-source junction, the starting point for oscillation (zero V_{GS}). This bias can be created by a parallel resistance (Figs. 5b and 6b) or with a series resistance (Fig. 7b). Usually the value of R_g is about 1 M Ω . Resistor R_s develops the source bias (Figs. 3b, 4b).

For the load impedance of the oscillator, R_L , to have a negligible effect on the parameters, R_L should be much greater than R_{oe} or R_{os} . When the oscillator is used as a power source, change R_{oe} or R_{os} with their equivalent resistances R_{oe}/R_L or R_{os}/R_L . By making this substitution in the equation that gives the starting conditions for oscillation you avoid any loading problems.

The Colpitts oscillator

The basic Colpitts oscillator circuit (Fig. 3a) has admittances in the feedback network that can

be represented by equations

$$\begin{aligned} y_{1L} = y_{2L} = 0 & \quad y_M = \infty \\ y_{1c} = j\omega C_1 & \quad y'_{2c} = j\omega C_2 + j\omega C_{oe} + 1/R_{oe} \\ y_{ie} = 1/R_{ie} + j\omega C_{ie} & \quad y_3 = 1/(r + j\omega L) \end{aligned}$$

To obtain the frequency of oscillation, set the imaginary part of Eq. 3 equal to zero and solve it after substituting in the component values:

$$f = (1/2\pi) \sqrt{(1/LC) + (A + B) r/L + AB} \quad (4)$$

$$\begin{aligned} 1/C &= [1/(C_1 + C_{ie})] + [1/(C_2 + C_{oe})] \\ A &= [(C_1 + C_{ie}) R_{ie}]^{-1} \text{ and } B = [(C_2 + C_{oe}) R_{oe}]^{-1} \end{aligned} \quad (5)$$

If the inductance has a low resistance, r , and $L \ll (C_1 + C_{ie} + C_2 + C_{oe})R_{ie}R_{oe}$, the frequency of oscillation is given by Eq. 1.

Choose $C_1 \gg C_{ie}$ and $C_2 \gg C_{oe}$ so that the influence of the transistor input and output capacitances of the frequency is negligible.

The real part of Eq. 3 represents the starting condition of oscillation:

$$|y_{ie}| \geq A(C_2 + C_{oe}) + B(C_1 + C_{ie}) + (C_1 + C_{ie} + C_2 + C_{oe})r/L \quad (7)$$

The bipolar transistor has $R_{oe} \gg R_{ie}$, and if the loss resistance, r , is small, the starting condition simplifies to

$$|y_{ie}| \geq [(C_2 + C_{oe})/(C_1 + C_{ie})]/R_{ie} \quad (8)$$

The FET Colpitts oscillator circuit (Fig. 3b) uses the same equations established for the bipolar Colpitts oscillator. Just replace the Y parameters of the bipolar device with the Y parameters of the FET.

The FET has $R_{is} \gg R_{os}$, and when

$L \ll (C_1 + C_{i_s} + C_2 + C_{o_s})R_{i_s}R_{o_s}$,
the frequency of oscillation is given by

$$f = \frac{1}{2\pi} \sqrt{LC} \times \frac{1}{\sqrt{1 + [(C_1 + C_{i_s}) / (C_1 + C_{i_s} + C_2 + C_{o_s})] r / R_{o_s}}} \quad (9)$$

where C can be found from Eq. 5 when FET parameters are used. If the loss resistance, r , is small the frequency of oscillation is determined by Eq. 1.

The influence of C_{i_s} and C_{o_s} on the frequency of oscillation becomes negligible if

$$C_1 \gg C_{i_s} \text{ and } C_2 \gg C_{o_s}$$

The starting condition for oscillation is as given in Eq. 7, except that FET parameters are used.

When r is small and $R_{i_s} \gg R_{o_s}$, this reduces to

$$|y_{fs}| \cong [(C_1 + C_{i_s}) / (C_2 + C_{o_s})] / R_{o_s} \quad (10)$$

The frequency of oscillation for this circuit is not influenced too much by the transistor input capacitance, because C_1 is much larger than it is for the bipolar Colpitts circuit.

The Clapp oscillator

A variant of the Colpitts oscillator, the Clapp, has better frequency stability (Fig. 4a). Thus the admittance, y_3 , of the feedback network is

$$y_3 = [r + j(\omega L - 1/\omega C_3)]^{-1}$$

The frequency of oscillation can now be found:

$$f = \frac{1}{2\pi} \left\{ \frac{1}{2} \left[\frac{1}{LC} + (A + B)(r/L) + AB \right] + \left[\frac{1}{4} \left(\frac{1}{LC} + (A + B)(r/L) + AB \right)^2 - AB/LC_3 \right]^{1/2} \right\}^{1/2}, \quad (11)$$

where A and B are as defined in Eq. 6 and

$$1/C = (C_1 + C_{i_e})^{-1} + (C_2 + C_{o_e})^{-1} + 1/C_3. \quad (12)$$

When r is small and

$$LC \ll (C_1 + C_{i_e})(C_2 + C_{o_e})R_{i_e}R_{o_e},$$

the formula for frequency of oscillation simplifies to Eq. 1.

If the value of C_3 is much smaller than the values of C_1 and C_2 , the frequency of oscillation is not influenced by C_{i_e} and C_{o_e} . It becomes equal to the resonant frequency of series circuit LC_3 and is defined by Eq. 1.

The starting condition for oscillation is given by

$$|y_{fs}| \cong \frac{A(C_2 + C_{o_e}) + B(C_1 + C_{i_e})}{(C_1 + C_{i_e})(C_2 + C_{o_e})r/LC} \quad (13)$$

where A and B are as defined in Eq. 6.

This simplifies to the same form as that in Eq. 8, if the assumptions in Eq. 7 are used.

The FET Clapp oscillator circuit (Fig. 4b) takes into account that $R_{i_s} \gg R_{o_s}$. If

$$LC \ll (C_1 + C_{i_s})(C_2 + C_{o_s})R_{i_s}R_{o_s},$$

where $1/C$ is defined by the FET equivalent of Eq. 12, the frequency of oscillation is determined by

$$f = \frac{1}{2\pi} \sqrt{LC} \sqrt{1 + rCB}, \quad (14)$$

where B is defined in Eq. 6.

As with the Colpitts oscillator, if r is small the frequency of oscillation is given by Eq. 1.

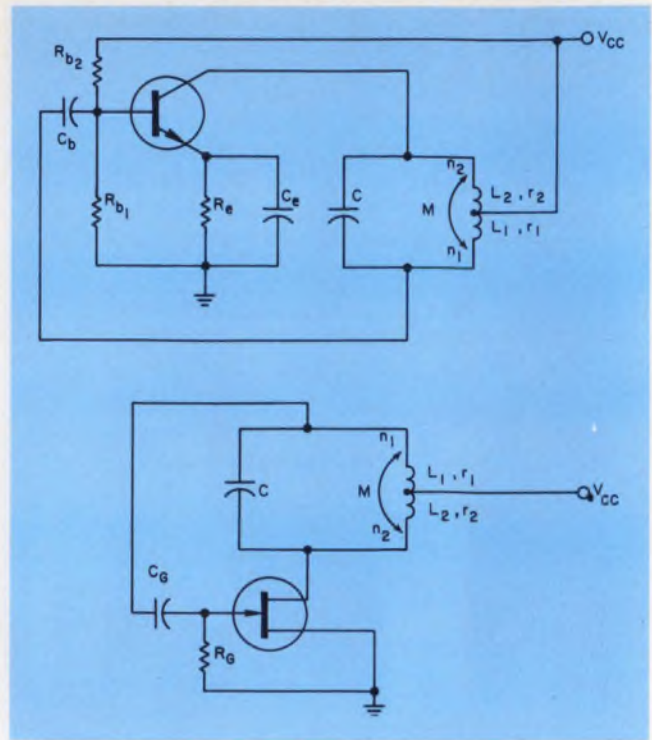

5. The bipolar (a) and the FET (b) Hartley oscillator circuits use center-tapped inductors to determine the resonant frequency.

When the value of C_3 is much less than C_1 and C_2 , the frequency of oscillation is determined by LC_3 substituted into Eq. 1.

The starting condition for oscillation is given by Eq. 13, with the equivalent FET parameters substituted. Again, if you make the same simplifications, the equation reduces to Eq. 10.

The Hartley oscillator

The admittances of the feedback network in the Hartley oscillator circuit (Fig. 5a) can be represented by

$$\begin{aligned} y_{1C} = y_{2C} = 0 & & y'_{2C} = y_{o_e} \\ y_{1L} = (r_1 + j\omega L_1)^{-1} & & y_{2L} = (r_2 + j\omega L_2)^{-1} \\ y_M = (j\omega M)^{-1} & & y_3 = j\omega C \end{aligned}$$

The coupling coefficient between L_1 and L_2 is given by

$$K = M(L_1 L_2)^{-1/2}$$

If the coil is built on a ferrite core, K can be considered equal to unity. You can also assume that $R_{o_e} \gg R_{i_e}$, so that the frequency of oscillation becomes

$$f = \frac{1}{2\pi} \left\{ \left[1 + r_1/R_{i_e} \right] \times [LC + L_1 C_{i_e} + L_2 C_{o_e} + (L_1 r_2 + L_2 r_1) |y_{ef}| C]^{-1} \right\}^{1/2} \quad (15)$$

where

$$L = L_1 + L_2 + 2M$$

The resonant frequency of the parallel circuits $L_1 C_{i_e}$ and $L_2 C_{o_e}$ affects the frequency of oscillation. If the value of C is much larger than C_{i_e} and C_{o_e} , and the inductor loss resistances r_1 and r_2 are small, the frequency of oscillation is rep-

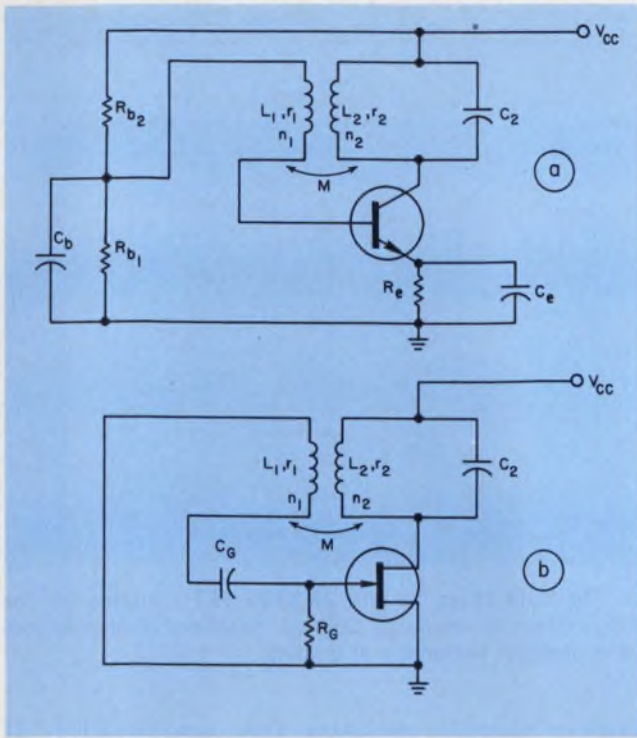

6. Tuned-collector (a) and tuned-drain (b) oscillators have the tank circuits connected in the collector or drain circuits and are coupled to the base or gate.

represented by the simplified Eq. 1.

The starting condition for oscillation of the Hartley circuit is

$$|y_{fe}| \geq \frac{E}{FR_{ie}} + \frac{F}{ER_{oe}} + L[r_1(C + C_{ie}) + r_2(C + C_{oe})]/EF + L(L_1r_2 + L_2r_1)/EFR_{ie}R_{oe} \quad (16)$$

where $E = L_1 + M$ and $F = L_2 + M$.

When r_1 and r_2 are small and $R_{oe} \gg R_{ie}$, this equation becomes

$$|y_{fe}| \geq [(L_1 + M)/(L_2 + M)]/R_{ie} \quad (17)$$

If you introduce the transformer ratio

$$n = n_2/n_1 = \sqrt{L_2/L_1}$$

and $K = 1$, you obtain

$$|y_{fe}| \geq 1/n R_{ie} \quad (18)$$

The FET Hartley oscillator circuit (Fig. 5b) takes into account that $R_{is} \gg R_{os}$. The frequency of oscillation can then be written as:

$$f = (1/2\pi) \{ [1 + r_2/R_{os}] \times [LC + L_1C_{is} + L_2C_{os} + (L_1r_2 + L_2r_1) |y_{fs}| C]^{-1} \}^{1/2} \quad (19)$$

If similar simplifications can be assumed for Eq. 19 as with Eq. 15, the frequency can be determined from Eq. 1.

The starting condition for oscillation is given by Eq. 16, except for substitution of equivalent FET parameters for the bipolar. This equation simplifies to

$$|y_{fs}| \geq n/R_{os} \quad (20)$$

The tuned-collector (drain) oscillator

The admittances of the feedback network of the tuned-collector oscillator circuit (Fig. 6a)

are given by the equations

$$\begin{aligned} y_{1C} &= 0 & y_3 &= 0 \\ y_{1L} &= (j\omega L_1)^{-1} & y_{2L} &= (r_2 + j\omega L_2)^{-1} \\ y_M &= (j\omega M)^{-1} & y'_{2C} &= R_{oe}^{-1} + j\omega(C_2 + C_{oe}) \end{aligned}$$

When the coupling coefficient, K , equals 1 and $L_2/L_1 = n^2/n_1^2 = n^2$ and $R_{oe} \gg R_{ie}$, the frequency of oscillation can be found from

$$f = (1/2\pi) \{ [1 + r_2/R_{oe}] \times [L_2C + L_1r_2(C_2 + C_{oe})/R_{ie}]^{-1} \}^{1/2} \quad (21)$$

where

$$C = C_2 + C_{oe} + C_{ie}/n^2 \quad (22)$$

C_{ie}/n^2 represents the reflected capacitance from the base circuit. When r_2 is small and

$$C_2 \gg C_{oe} + C_{ie}/n^2 \quad (23)$$

the frequency of oscillation becomes equal to the resonance frequency of the parallel circuit L_2C_2 , which can then be found from Eq. 1.

The following equation gives the starting condition:

$$|y_{fe}| \geq M/(L_2R_{ie}) + L_2/(MR_{oe}) + r_2(C_2 + C_{oe})/M + L_1r_2/(MR_{ie}R_{oe}) \quad (24)$$

You can make assumptions comparable to those in Eq. 7 to reduce Eq. 24 to

$$|y_{fe}| \geq M/(L_2R_{ie}) \quad (25)$$

For the coupling coefficient equal to 1, you can rewrite the equation as:

$$|y_{fe}| \geq 1/n R_{ie} \quad (26)$$

The tuned-drain oscillator circuit (Fig. 6b) takes into account that $R_{is} \gg R_{os}$. Thus the frequency of oscillation is

$$f = (1/2\pi) \sqrt{(1 + r_2/R_{os}) / (L_2C + L_1r_2C_{is}/R_{os})} \quad (27)$$

When r_2 is small and C is defined by Eqs. 22 and 23, the frequency can be found from Eq. 1.

The starting condition is the same as that used for the tuned-collector oscillator (Eq. 24) and can be simplified to

$$|y_{fs}| \geq n/R_{os} \quad (28)$$

Thus for n greater than 1, the frequency of oscillation will hardly be influenced by the transistor input capacitance.

The tuned-base (gate) oscillator

The admittances in the feedback network of the tuned-base oscillator circuit (Fig. 7a) are given by these expressions:

$$\begin{aligned} y_{1L} &= (r_1 + j\omega L_1)^{-1} & y_{2L} &= (j\omega L_2)^{-1} \\ y_{1C} &= j\omega C_1 & y_3 &= y_{2C} = 0 \\ y_M &= j\omega M & y'_{2C} &= y_{os} \end{aligned}$$

If the coupling coefficient is unity and we replace $L_1/L_2 = n_1^2/n_2^2 = n^2$ the frequency of oscillation is given by

$$f = (1/2\pi) \{ [1 + r_1/R_{ie}] \times [L_1C + L_2r_1(C_{oe}/R_{ie} + (C_1 + C_{ie})/R_{oe})]^{-1} \}^{1/2} \quad (29)$$

where

$$C = C_1 + C_{ie} + \frac{C_{oe}}{n^2} \quad (30)$$

Similar assumption as those that follow Eq. 22 can be made for this equation, and the fre-

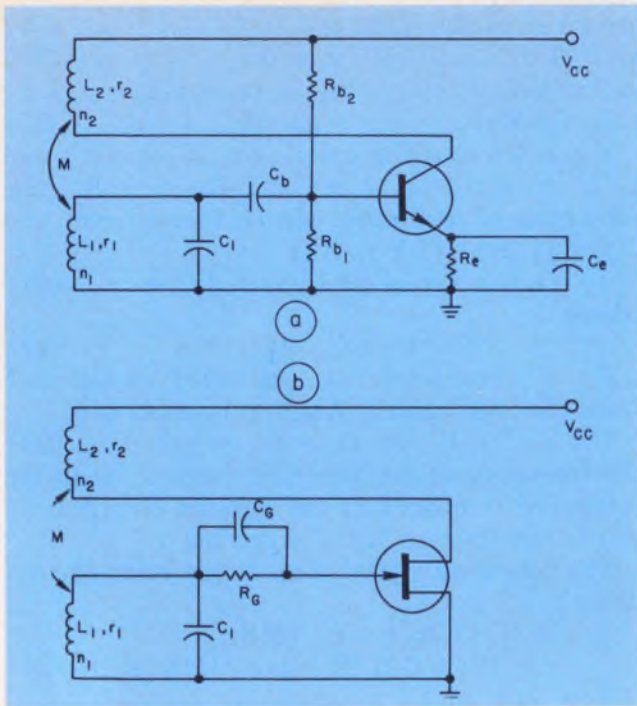

7. Tuned-base (a) and tuned-gate (b) oscillators have the tank circuit in the base or gate and are coupled either to the collector or drain, respectively.

quency of oscillation becomes equal to the resonant frequency of parallel circuit L_1, C_1 and can be found from Eq. 1.

The following equation gives the starting condition for oscillation:

$$|y_{fe}| \geq M/L_1 R_{ov} + L_1/MR_{ie} + r_1(C_1 + C_{ie})/M + L_2 r_1/MR_{ie} R_{ov} \quad (31)$$

If r_1 is small and $R_{ov} \gg R_{ie}$

$$|y_{fe}| \geq L_1/(MR_{ie}) \quad (32)$$

If the coupling coefficient equals unity the equation simplifies to

$$|y_{fe}| \geq n/R_{ie} \quad (33)$$

In the tuned-gate oscillator circuit (Fig. 7b) you can assume $R_{is} \gg R_{os}$. The frequency of oscillation then becomes

$$f = 1 / (2\pi \sqrt{L_1 C_1 + L_2 r_1 (C_1 + C_{is}) / R_{os}}) \quad (34)$$

where C is the same as in the tuned-base oscillator, except for substitution of FET parameters. When r_1 is small and

$$C_1 \gg C_{is} + C_{os}/n^2$$

the frequency of oscillation can be found from Eq. 1. The starting condition for oscillation of the tuned-gate circuit has the same form as that for the tuned-base oscillator, except for FET parameter substitutions.

Since $R_{is} \gg R_{os}$, r_1 is small and the coupling coefficient is unity, this equation simplifies to

$$|y_{fs}| = 1/n R_{os} \quad (35)$$

Designing the oscillator

To design an oscillator, select the type and the active element. Assume, for example, that you

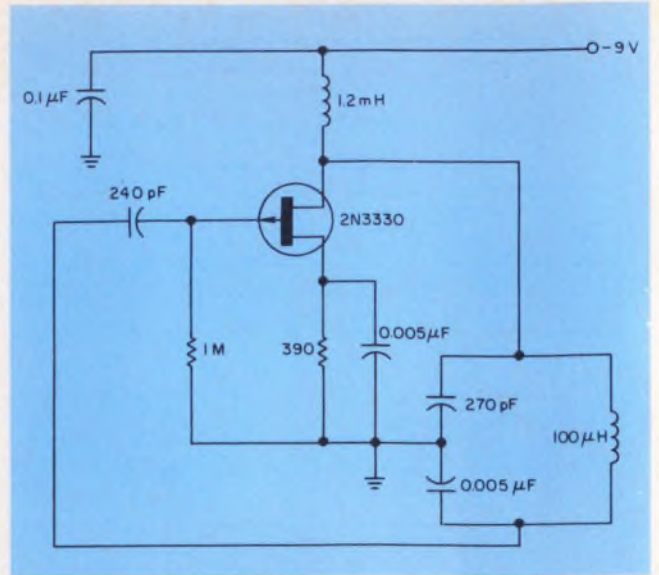

8. The data sheet for the 2N3330 FET contains all the information to design a Colpitts oscillator that operates at a nominal frequency of 1 MHz.

have a Colpitts oscillator that uses a FET. If you arbitrarily select a FET—in this case a 2N3330—and a frequency of oscillation of 1 MHz along with a supply voltage of 9 V, you need only the FET data sheet.

From the data sheet, you can extract the following: $P_{Dmax} = 300$ mW, $y_{fs} = 1.5$ mmhos at an I_D of 2 mA, $C_{is} = 20$ pF and $g_{os} = 1/R_{os} = 40$ μ mhos. Now assume a value for the inductance—say, $L = 100$ μ H. If you rearrange the basic formula for frequency of oscillation (Eq. 1), the total value of C is found to be

$$C = 1 / (6.28 \times 10^6)^2 (100) (10^{-6}) = 254 \text{ pF.}$$

To satisfy the starting condition for oscillation—taking into account the distributed static characteristics of the transistor—you can assume

$$|y_{fs}| = 2C_1/C_2 R_{os}, \text{ and} \\ 1/C = 1/C_1 + 1/C_2$$

Solving these equations for C_2 or C_1 , you get

$$C_2 = [(2 + |y_{fs}|R_{os}) / |y_{fs}|R_{os}] C \cong 270 \text{ pF} \\ \text{and } C_1 = [(2 + |y_{fs}|R_{os}) / 2] C = 5000 \text{ pF}$$

The circuit of Fig. 8 shows the FET Colpitts oscillator with the calculated values. Ten FETs of the same type number were used to determine experimentally the spread of oscillation frequencies. The spread ranged from 1.0011 to 1.0029 MHz. And the oscillator output at the drain was measured to be 6 V. ■■

References:

1. Gartner, W., "Transistors: Principles, Design and Applications," Van Nostrand, New York, NY, 1960.
2. Reich, H. J., "Functional Circuits and Oscillators," Van Nostrand, New York, NY, 1961.
3. "Transistor Circuit Design," Prepared by the Engineering Staff of Texas Instruments, McGraw Hill, New York, NY, 1963.
4. Ristenbatt, M. P., Riddle, R. L., "Transistor Physics and Circuits," Prentice Hall, Englewood Cliffs, NJ, 1966.
5. Farrell, C., "FET Oscillators, FET Applications Handbook," TAB Books, Blue Ridge Summit, PA, 1968.

12 reasons why *only* Buchanan® Terminal Blocks provide **Lowest Total Applied Cost!**

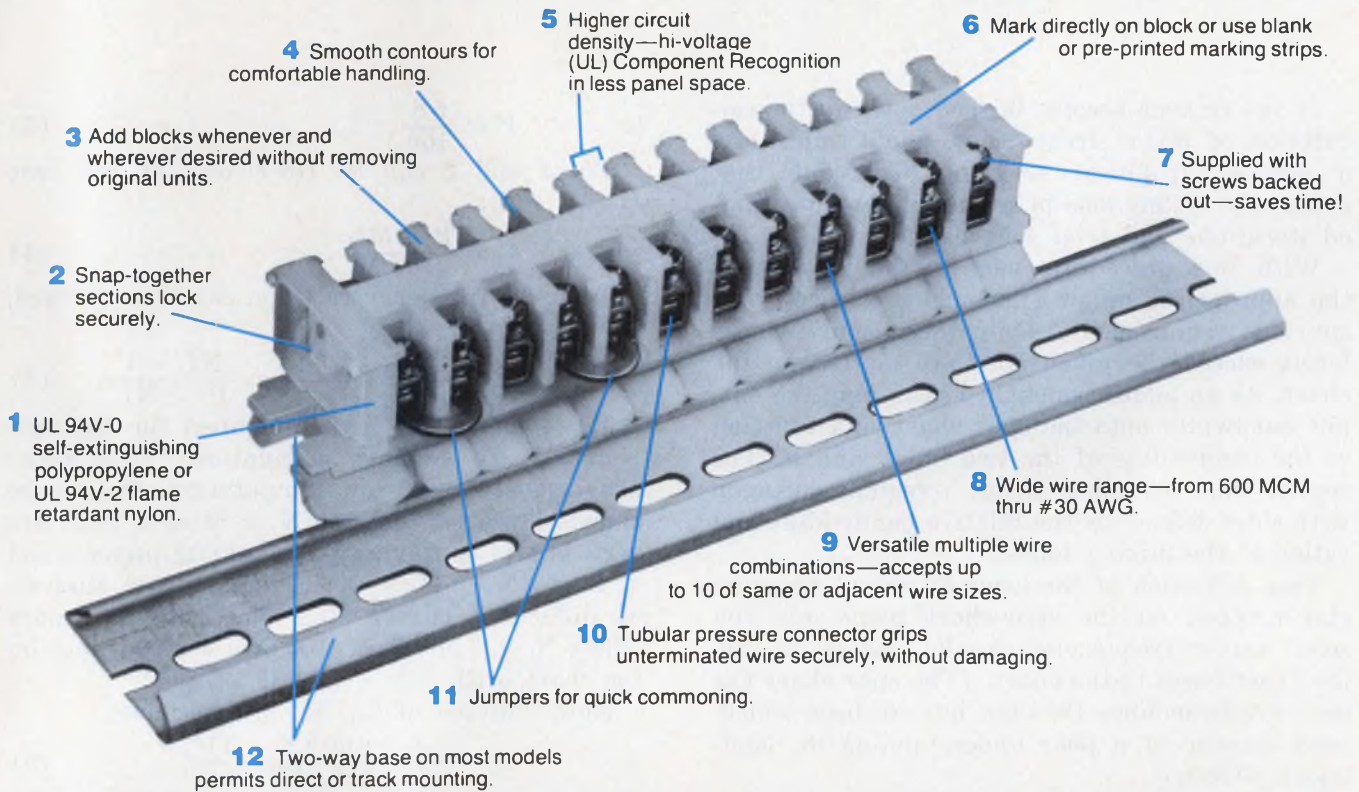

AND—you can get 'em when you need 'em!

No matter how many advantages offered by a specific terminal block, you can't get the advantages if you can't get the block!

Which is why we make sure Buchanan blocks are stocked in ample quantities throughout the country. Buchanan has anywhere from twice to eight times as many stocking distributors as other manufacturers—so you can get the blocks you need *when* you need them.

And only Buchanan distributors can give you *all* the advantages shown above.

Copper tubular contacts that really grip . . . higher circuit density . . . ease of assembly and add-on . . . everything that works together to provide Lowest Total Applied Cost!

Next time you order terminal blocks, specify Buchanan and be sure of *all* the advantages, *plus* prompt delivery. In the meantime, send for our handy Selector Chart and Catalog. Use the Reader Service Card. (If you have a special application, call one of our Regional Offices shown below.)



**CONTROL PRODUCTS
DIVISION**

Amerace Corporation
Control Products Division
Union, New Jersey

16

Select mixer frequencies painlessly.

With a simple, graphical method, you can sidestep long trial-and-error sessions and determine bandwidth, too.

If you've ever become bogged down in the calculation of mixer frequencies, you'll appreciate a simple, graphical selection technique that avoids the voluminous printouts of computer aided iterations and trial solutions.

With this procedure, you can visually select the appropriate mixer frequencies to meet your spurious requirements. Only those spurs whose levels exceed the given spec are plotted on the chart. As an added benefit, you can map the output bandwidth onto the spur chart as a function of the bandwidths of the two input signals. The region thus described is an irregular hexagon with sides defined by the relative bandwidths and ratios of the mixing tones.

This definition of the locus of output frequencies mapped on the spur-chart plane lets you select mixer frequencies rapidly and lends further usefulness to the chart. (The spur chart has been available since 1966 but has not been widely used because of a poor understanding of bandwidth effects.)¹

Derivation of equations

Typical spurs of high and low-level mixers are shown in Figs. 1 to 4. The ordinate is the frequency ratio f_1/f_2 , and the abscissa is the percentage bandwidth with respect to the desired output frequency, f_0 , where $f_0 = f_1 + f_2$ for the sum charts, and $f_0 = f_2 - f_1$ for the difference charts ($f_2 > f_1$).

To derive the equations that generate the graphs, note that the spurs, or cross-modulation products, have the general form

$$P = Mf_1 + Nf_2, \quad (1)$$

where M and N are positive or negative integers. The frequency ratio, $n = f_1/f_2$, is always less than 1. Percentage separation is given by:

$$S = \frac{P - f_0}{f_0} \times 100 \quad (2)$$

$$\text{or} \quad P = \frac{f_0 S}{100} + f_0. \quad (3)$$

Eq. 1 and 2 can be rewritten for the case $f_0 = f_1 + f_2$:

$$f_2 = \frac{P - Mf_0}{N - M}. \quad (4)$$

Then the frequency ratio, n , can be expressed, with use of Eq. 4, as

$$n = \frac{f_1}{f_2} = \frac{f_0 - f_2}{f_2} = \frac{Nf_0 - P}{P - Mf_0}. \quad (5)$$

Eq. 4 and 5 are both undefined for the case $N = M$. To simplify calculations, such spurs are deleted from this computation. It can be shown, however, that the $N = M$ spur lines are vertical and appear on the summing mixer chart at $S = (N - 1) \times 100$. Similarly the analysis of difference mixing does not consider spurs where $N = -M$. These, too, are vertical lines on the chart, with $S = (N - 1) \times 100$.

Now, with use of Eq. 3, Eq. 5 becomes

$$n = \frac{-S + 100(N - 1)}{S - 100(M - 1)}. \quad (6)$$

This equation relates n , the frequency ratio, to S , the percentage separation, for $f_0 = f_1 + f_2$ and is used to plot the sum charts.

Similarly, for $f_0 = f_2 - f_1$, Eq. 1 can be rewritten

$$f_2 = \frac{P + Mf_0}{N + M}. \quad (7)$$

Again, the frequency ratio, n , can be expressed, with use of Eq. 7, as

$$n = \frac{f_1}{f_2} = \frac{f_2 - f_0}{f_2} = \frac{P - Nf_0}{P + Mf_0}. \quad (8)$$

Now, using Eq. 3, we see that Eq. 8 becomes

$$n = \frac{S + 100(1 - N)}{S + 100(1 + M)}. \quad (9)$$

Eq. 9 relates n and S for $f_0 = f_2 - f_1$ and is used to plot the difference charts.

Calculator does the plotting

A program written for the HP 9810 calculator uses Eqs. 6 and 9 to plot spurs for any M and N . If all the spurs to the seventh order are plotted, the graphs are seen to be identical to those in reference 1. However, many of the spurs that are plotted with this procedure are very small in

M. Y. Huang, Section Head, R. L. Buskirk, Member of the Technical Staff and D. E. Carlile, Member of the Technical Staff, Communications Satellite Transponder Dept., TRW Systems Group, One Space Park, Redondo Beach, CA 90278.

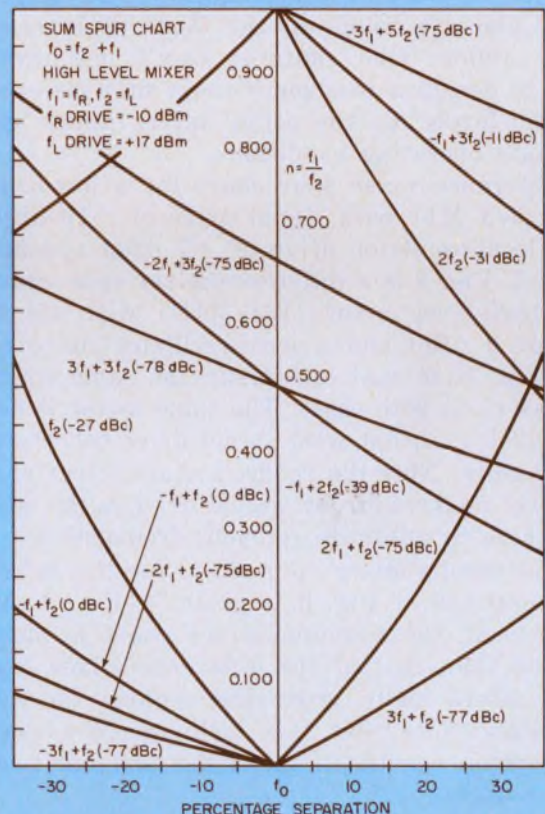
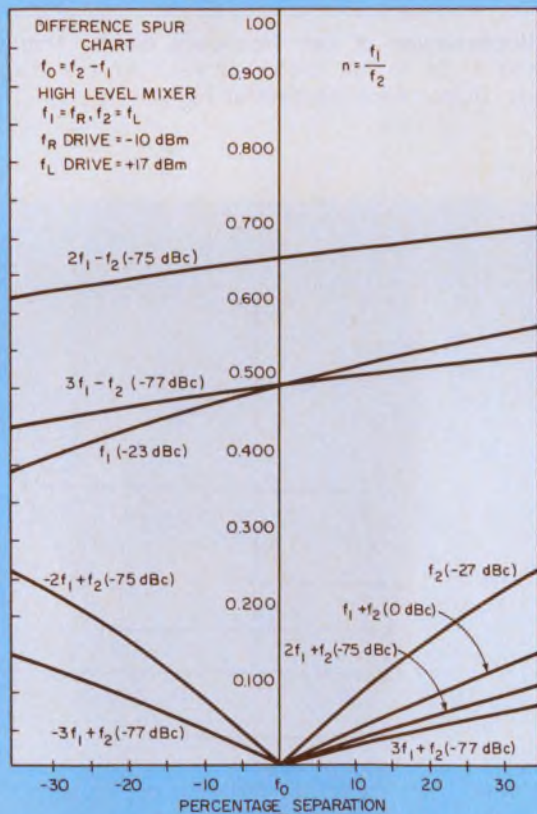
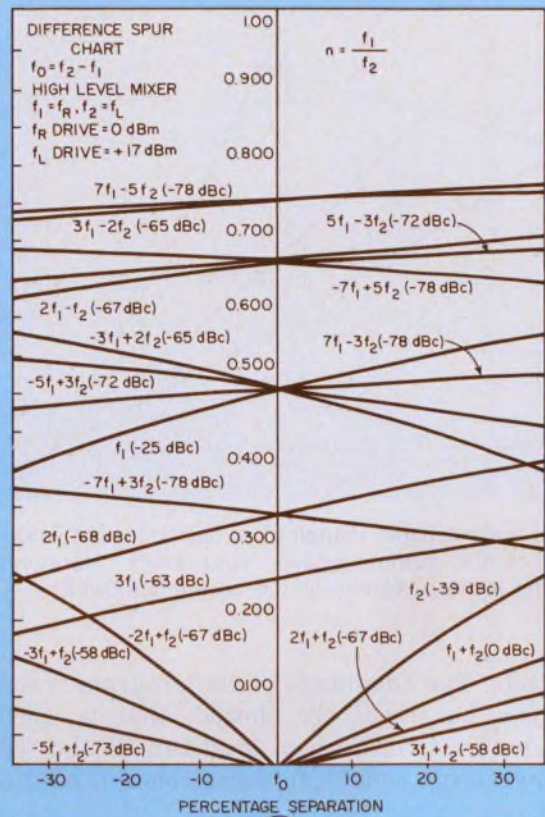
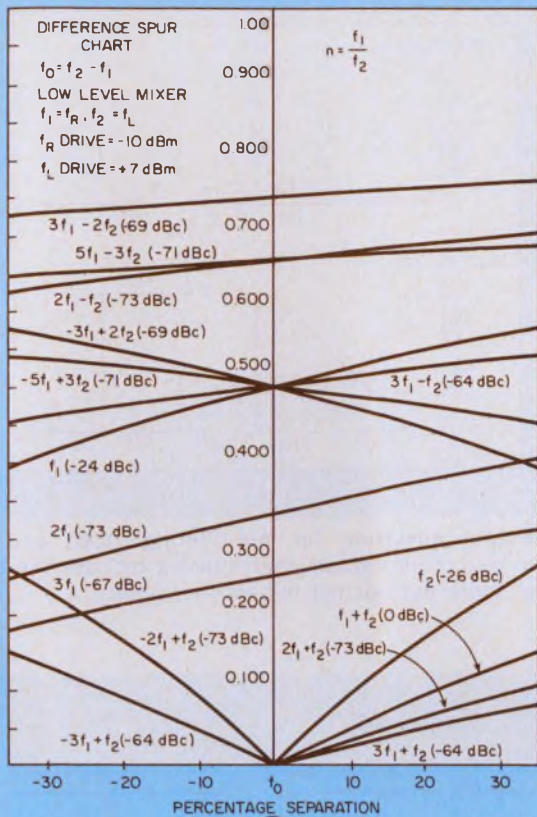

1-4. Harmonic spurs of mixers can be charted as a function of output bandwidth for differences (1 to 3) and sums (4). Note that about the same spurs appear in

both low and high-level mixers (1 and 2). When signal drive is decreased in the high-level mixer, however, the spurs are reduced (3).

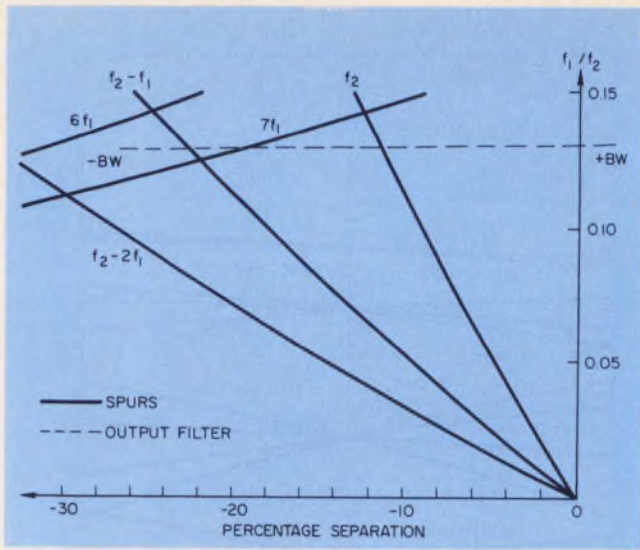

5. Filter output-band mapping is demonstrated with a section of the summing-mixer spur chart. Harmonics are easily located relative to the output bandwidth.

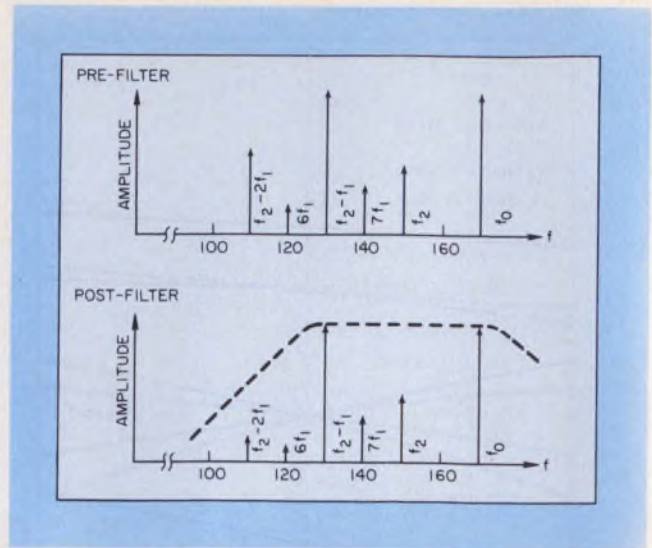

6. Output spectrum for pre-filtering (top) and post-filtering (bottom) shows that filtering reduces the out-of-band spurs but not the in-band harmonics.

magnitude. The advantage of the program is that spurs can be selectively plotted, that is, those spurs smaller than a given level can be omitted; only those large enough to cause concern need be plotted.

The levels of the spurs for the various orders listed are typical of low-frequency (50 MHz) mixers and are found in the Watkins-Johnson mixer catalog. One caution: Don't use these charts to design a receiver without first measuring spur levels for the actual mixer under approximate operating conditions.

A difference-mixer spur chart for a low-level mixer (WJ M1) with signal drive of -10 dBm and a local-oscillator drive of $+7$ dBm appears in Fig. 1. Fig. 2 is a difference-mixer spur chart for a high-level mixer (WJ M1D) with signal drive of 0 dBm and a local-oscillator drive of $+17$ dBm. Note that essentially the same spurs are present in both cases. The same mixer is depicted in Fig. 3, but with signal drive decreased to -10 dBm. Note the reduced spurs. Clearly, a high-level mixer with low signal drive is the best choice here to minimize spurious frequencies.

The summing-mixer spur chart for the mixer and conditions of Fig. 3 is given in Fig. 4. As can be seen, the summing-mixer chart is more cluttered than that of the difference mixer, but it still offers many promising regions for up-conversion. Note that this technique considers only harmonic spurs in the mixer and not two-tone products.

These charts are used for a single-frequency local oscillator and a single-frequency signal with modulation. The frequency ratio must be chosen so that no spur is found within the bandwidth of the modulation. However, a mixer is normally used not just for circuits that combine fixed fre-

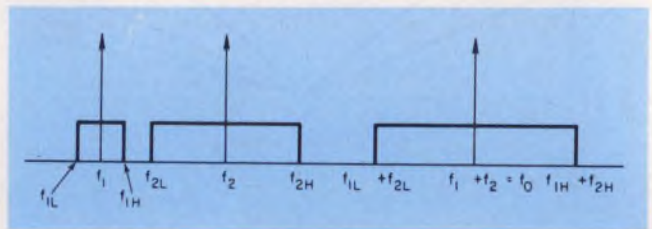

7. Upconversion of two frequency bands: frequencies f_1 and f_2 lie at the center of each of the respective bands. Output band appears at right.

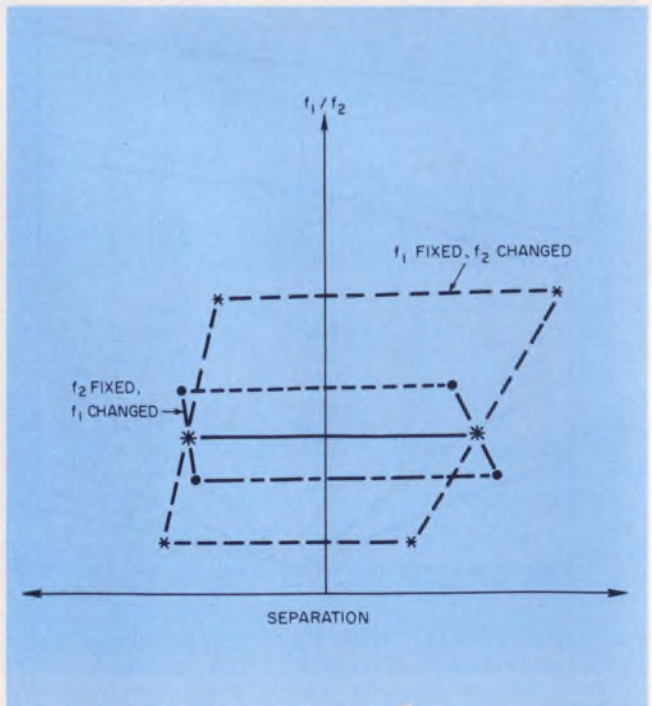

8. The upconverted output of Fig. 7 appears on the spur-chart plane distributed about the f_1/f_2 point. Incremental effects of frequency changes are easily spotted.

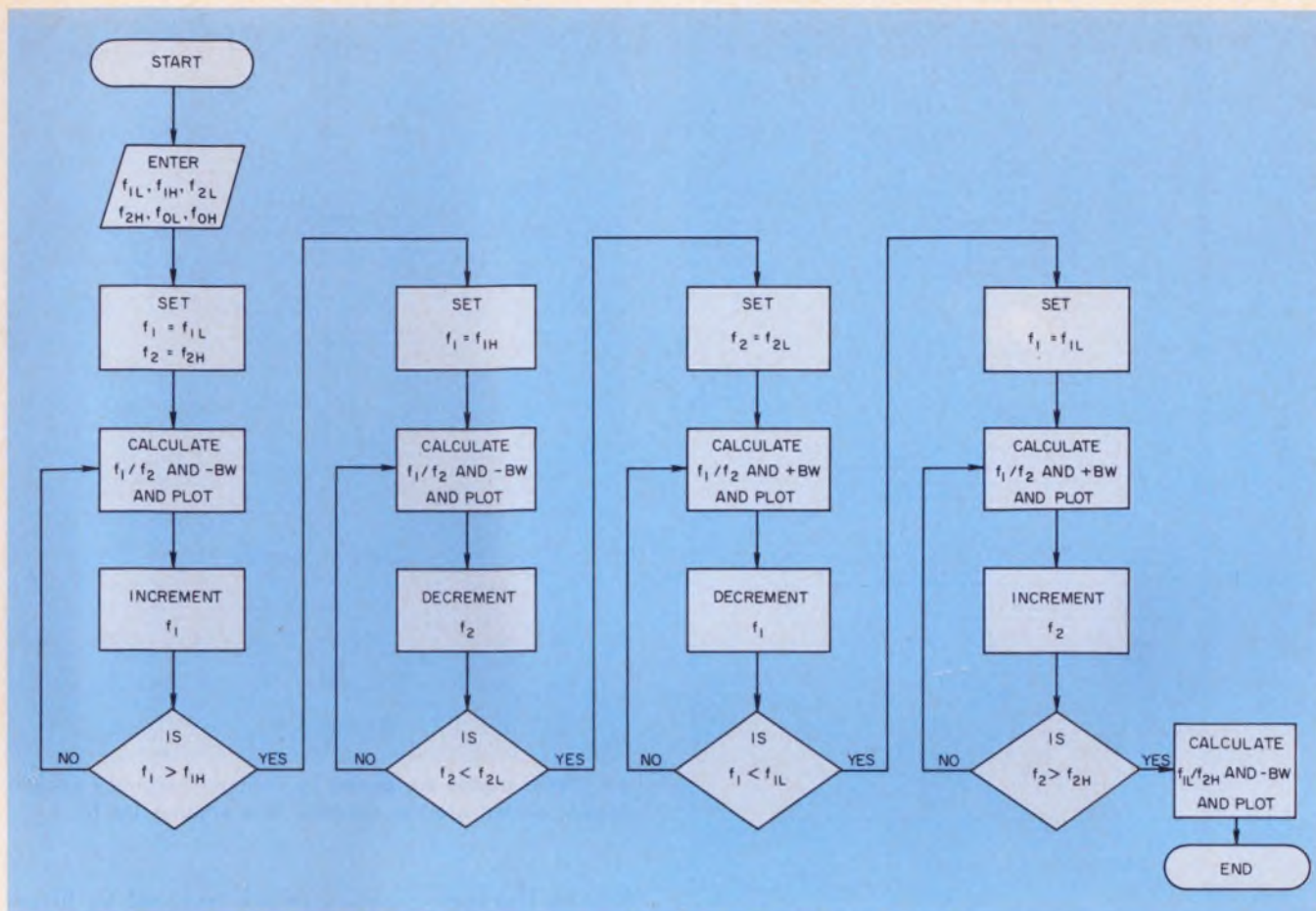

9. Calculator program plots the hexagonal locus of points resulting from variations in the values of f_1 and f_2 . The dimensions of the hexagon vary with the ratio of the

input bandwidths: For zero bandwidth, the hexagon becomes a quadrangle. The hexagon can be plotted onto the spur chart with an HP 9810 calculator.

frequencies but for those that mix one frequency band with another—as in a synthesizer or receiver design. To design this type of system, you must map the output filter onto the coordinate system of the spur chart to produce an easily read graphic representation of harmonic spur location relative to the output bandwidth.

How to use the charts

To accomplish such a mapping, consider first the simple case of mixing two fixed frequencies. Given the two input frequencies and an output frequency range, you can plot a line for the function of percentage separation vs f_1/f_2 . (The value of f_1/f_2 corresponds to the ratio of signals producing the selected output tone $f_1 + f_2$ or $f_2 - f_1$.) The end points of the line can be called $-BW$ and $+BW$ and are calculated from Eq. 2:

$$+BW \equiv \frac{f_{BW} - f_0}{f_0} \times 100, \quad (10)$$

$$-BW \equiv \frac{f_{BW} - f_0}{f_0} \times 100 \quad (11)$$

where f_{BW} is the upper edge of the output filter

passband, f_{BW} is the lower edge, and f_0 is the desired instantaneous output frequency.

The points along this straight line correspond to frequencies within the filter passband. The curves for various orders of harmonic spurs are displayed similarly—that is, each point on the line corresponds to a frequency. (This frequency is determined by the specific values of f_1 and f_2 , thus defining a specific point on the ordinate.)

The use of these graphic definitions can best be explained with an example. A small portion of the summing-mixer spur chart may look as shown in Fig. 5. Let $f_1 = 20$ MHz and $f_2 = 150$ MHz. (This will quickly prove to be a poor frequency assignment.) Then $f_1/f_2 = 0.133$. Also, define the output filter bandwidth to span 125 to 175 MHz. The spur chart indicates that for this f_1, f_2 value, the filter bandwidth extends from 3% above f_0 to 26% below f_0 . The chart also shows the $f_2, 7f_1$, and $f_2 - f_1$ spurs intersecting the filter line. These points indicate in-band harmonics, as can be verified numerically.

Plots of the output spectrum (prefiltering and postfiltering) for this example are shown in Fig. 6. The in-band spurs—those intersecting the filter

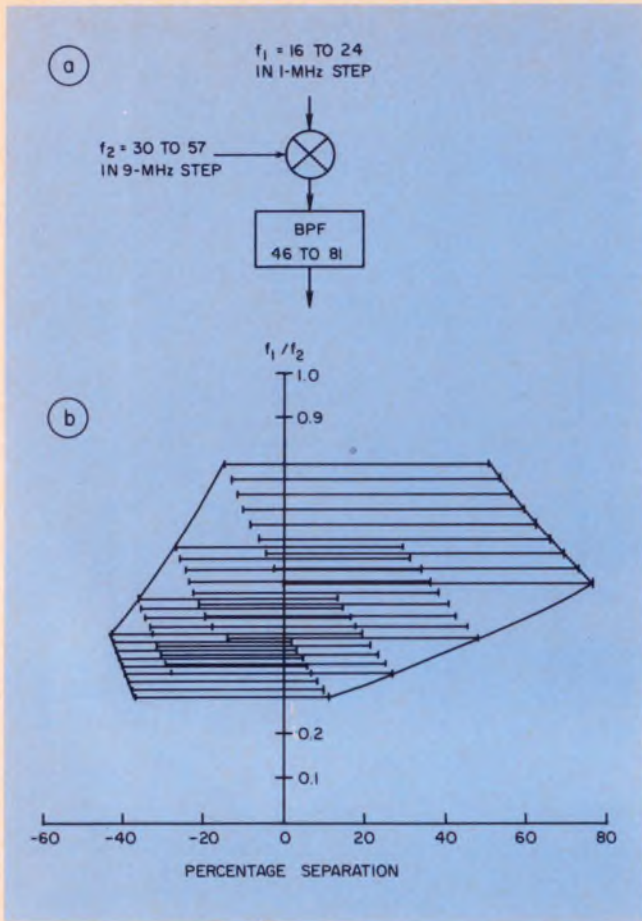

10. **Calculator program** for the circuit in (a) maps a "hexagonal" perimeter when f_1 and f_2 vary in infinitesimal steps (b).

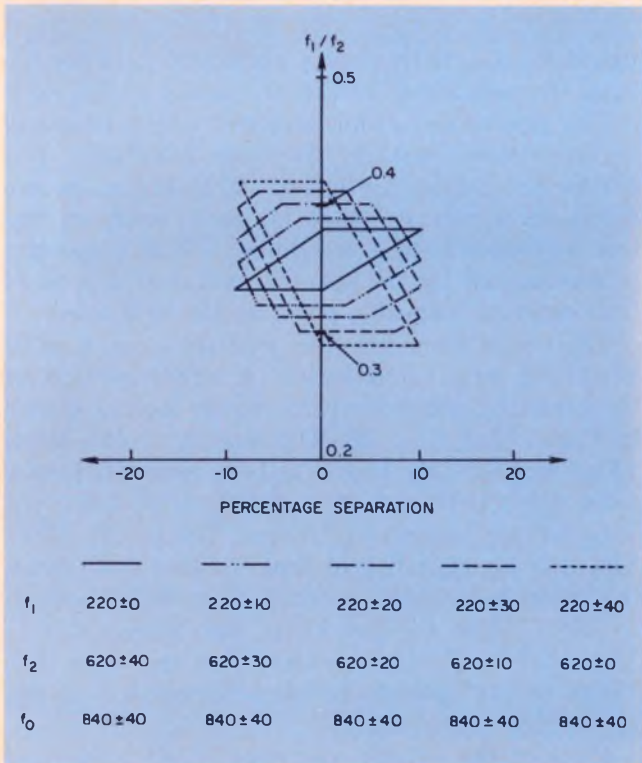

11. **Design example:** Figures generated by five different bandwidths show the advantage of a small bw at f_1 .

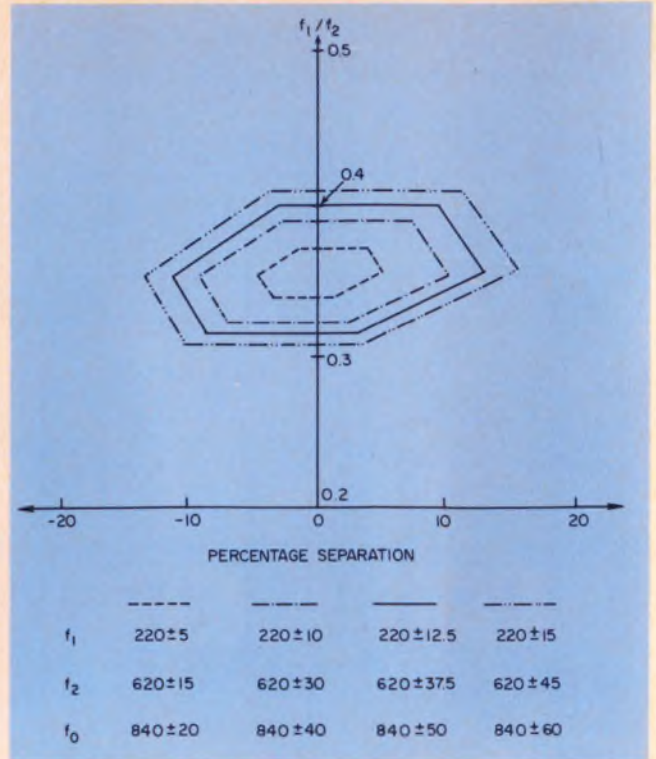

12. **Other trends** are shown by various frequency assignments. Shown are the benefits of a smaller bw for f_1 .

line on the spur chart—are not reduced by filtering and will be present at whatever amplitude the mixer propagates. Out-of-band spurs will be attenuated.

In fact, since the horizontal scale of the spur chart is a measure of frequency, you can use the horizontal distance from the filter band edge to a spur line to estimate the position of the spur in the filter skirt and thus its attenuation.

Consider, then, upconversion of two frequency bands as shown in Fig. 7, and assume that the bandwidth of f_1 is less than that of f_2 . If you fix f_1 and f_2 at the center of their respective bands, the output appears on the spur-chart plane, as shown by the solid line in Fig. 8: The bandwidth is equally distributed about the f_1/f_2 point and normalized by $f_1 + f_2 = f_0$.

If f_1 increases to f_{1H} , then n increases. Simultaneously the band shifts to the left, as shown by the dotted line. Also, since the new f_0 is larger, the percentage bandwidth decreases slightly. If f_1 decreases to f_{1L} , the reverse occurs, as shown by the dot-dash line. If f_1 is held fixed and f_2 is increased to f_{2H} , n decreases and the bandwidth shifts left and decreases (dashed line).

Locus approximates a hexagon

Again, a decrease in f_2 causes the reverse to occur. Now for each value of f_2 , you can also vary f_1 ; this results in a region bordered by a hexagon. Because of the normalization by the

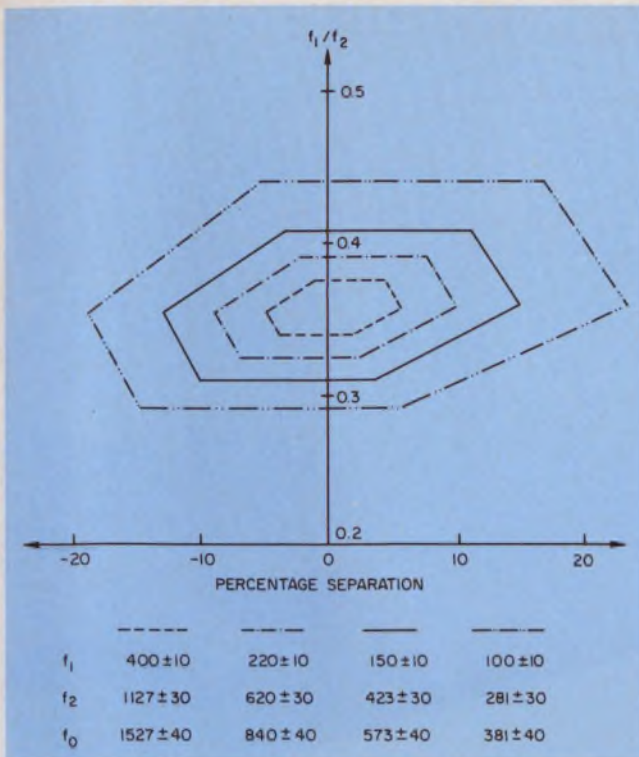

13. With f_1/f_2 constant, the spur map shows that a smaller percentage bw (or higher f_0) is better.

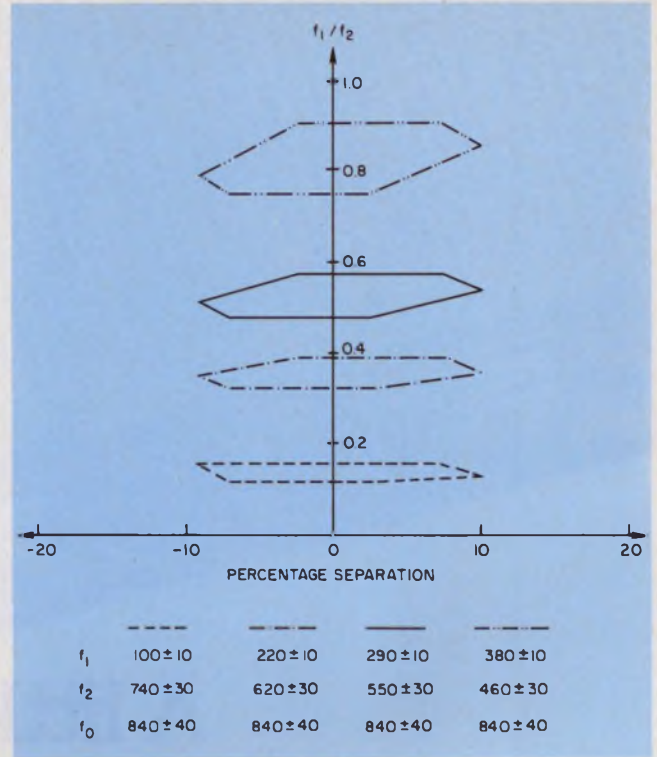

14. This map for a constant output bandwidth suggests that f_1/f_2 should be kept low.

local value of f_0 , the sides of the hexagon are not straight lines but hyperbolic arcs. However, the curvature is very slight, and for all practical purposes, the sides can be thought of as straight lines.

Another program for the HP 9810 calculator plots the hexagon on the spur chart (Fig. 9). Fig. 10 shows an example generated by this program. To help illustrate the earlier discussion, the mapping of the output bandwidth for each set of f_1 and f_2 values is also superimposed ($f_1 = 16, 17, 18, \dots, 24$; $f_2 = 30, 39, 48, 57$). If you change f_1 and f_2 in infinitesimal steps, rather than the 1 and 9-MHz steps of the example, you end up with a region whose perimeter is defined by the hexagon shown.

An example outlines the use of this program as a design tool. For a proposed output bandwidth spanning 800 to 880 MHz, choose input frequencies between, say, 220 and 620 MHz to give a favorable f_1/f_2 value on the summing-mixer spur chart. Fig. 11 is a plot of the areas (through which spur lines cannot be tolerated) for five different bandwidth assignments for f_1 and f_2 . This graph clearly shows several important features.

As mentioned previously, the dimensions of the hexagon change with the ratio of input bandwidths. In the two cases of zero bandwidth, the hexagon degenerates to a quadrangle. The total horizontal excursion of the figures remains constant for a constant percentage output band-

width. Thus, for a given acceptable harmonic spur level and absolute output bandwidth, a minimum center frequency for the output signal is defined for either sum or difference mixing.

Furthermore areas free of spurs for various ranges of f_1/f_2 indicate suitable ratios of the input signals. Minimum f_1/f_2 ranges are obtained when the lower input signal is given the smaller bandwidth. (This is also a favorable condition for realizable filters in a network of mixers.) In some applications the shape of the hexagon may be important in the elimination of spurs. Again, this can be adjusted with the ratio of the absolute bandwidths of the input signals.

Exact relations between frequency assignment parameters have not been established. But Figs. 12 through 14 provide examples of the trends. These confirm what intuition suggests. The smallest region is of general interest when you map the output bandwidth on the spur chart.

Fig. 11 shows that it is preferable to have wider bandwidths with the higher mixing frequency than vice versa. Figs. 12 and 13 show that a smaller percentage output bandwidth is superior. Fig. 14 suggests that you should choose low f_1/f_2 ratios, but this suggestion is tempered by the actual bandwidths and the spurs that appear, as shown in Figs. 1 to 4. Graphs for difference mixers exhibit similar trends. ■■

References

1. Olson, W. R. and Salcedo, R. V., "Mixer Frequency Charts," *Frequency*, March-April, 1966.

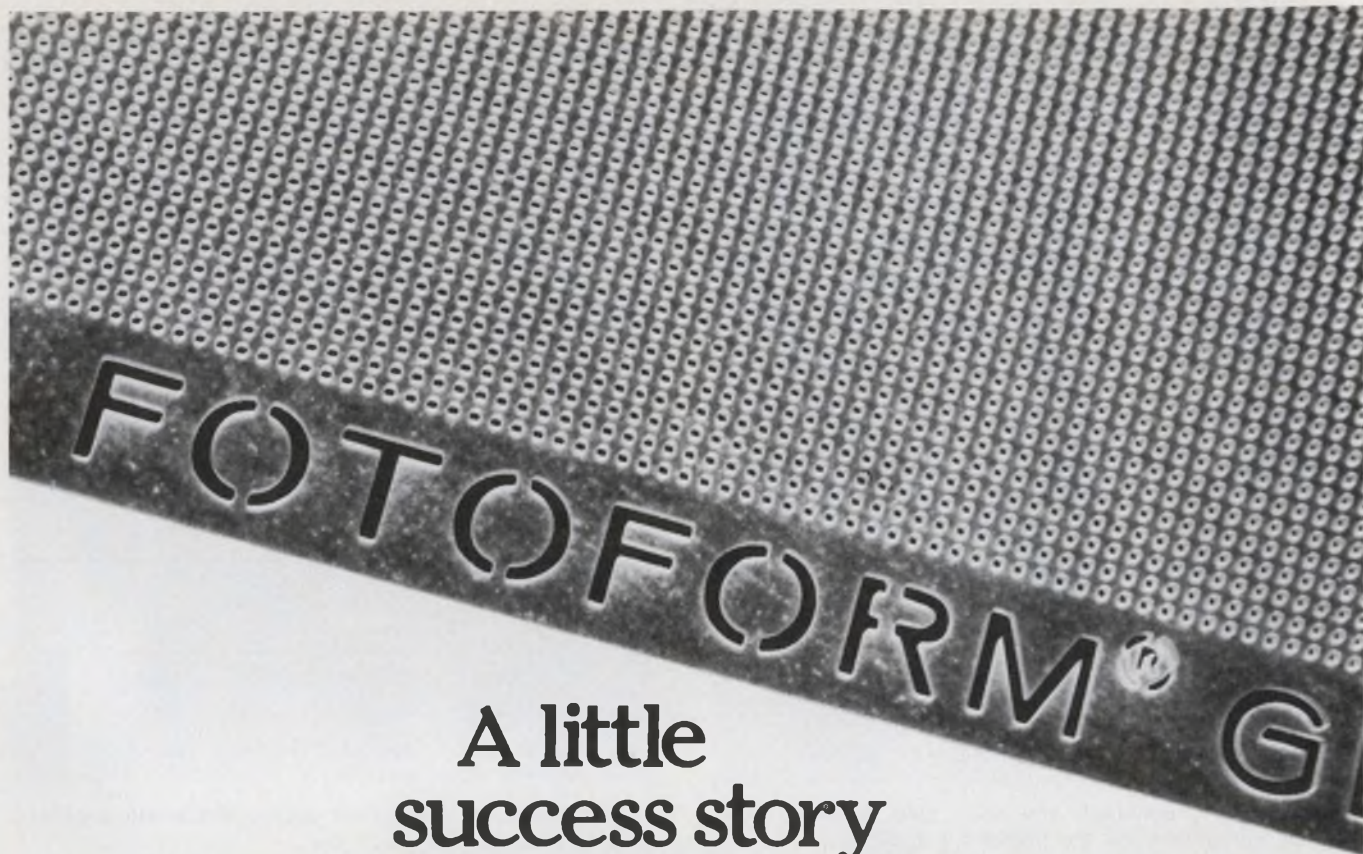

A little success story with holes in it...

Holes of almost any shape and size. Up to 10,000 holes per square inch, in pieces as thin as 0.10 inch. Holes, slots, and channels, as small as 0.005 inch. And with tolerances as close as ± 0.001 inch.

We're talking about Corning FOTOFORM® and FOTOCERAM® materials. Unique, photosensitive materials that can be precision-etched, machined, cut, milled, chamfered, ground, lapped, polished, sealed to glasses or ferrites. And even metalized.

The real beauty of FOTOFORM and FOTOCERAM materials is they offer you engineering flexibility—the flexibility to do it your way.

And at Corning, your way is the only way. That's why we developed FOTOFORM and FOTOCERAM materials. They may help you write your own success story. We'll help. We're the Fotoform Products Group, Corning Glass Works, Corning, New York.

You ought to get to know us better. Find out more about FOTOFORM and FOTOCERAM materials. Write, under your letterhead, for a free sample depicting the 1776 Bennington Flag and complete specifications to:

FOTOFORM Products Group Dept. ED-46
Corning Glass Works, Corning, New York 14830
(607) 974-8583

CORNING
CORNING GLASS WORKS



Write for free sample today!

Burr-Brown's 8-bit ADC'82 gives you a 2.8 μ sec conversion speed, adjustment free operation, low cost, and much more...

*Our new ADC82 successive-approximation
A/D converter offers both parallel
and serial data outputs, output-status signals, and conversion
speeds of 2.8 μ sec, maximum. It's complete
and self-contained with its own internal clock,
comparator and reference. No external gain or offset adjustments
are needed for 0 to +10V or $\pm 10V$ signal ranges at accuracies
of better than $\pm 0.2\%$, ± 1 LSB.*

All this means money saved in production and testing.

*But we've saved the best for last: The ADC82 uses IC's
and laser-trimmed thin-film components to bring you
this kind of performance for as little as \$36*.*

*And the ADC82 is packaged in a
metal (ADC82AM) or ceramic (ADC82AG)
24-pin DIP that measures only 1.4" by 0.8"
and less than 1/4" high.*

*For details on this or other conversion
products, contact Burr-Brown,
International Airport Industrial
Park, Tucson, Arizona
85734. Telephone
(602) 294-1431.*

**ADC82AG in orders of 100.*

*Attending Electro '76?
See us in Booths 1731, 1733*

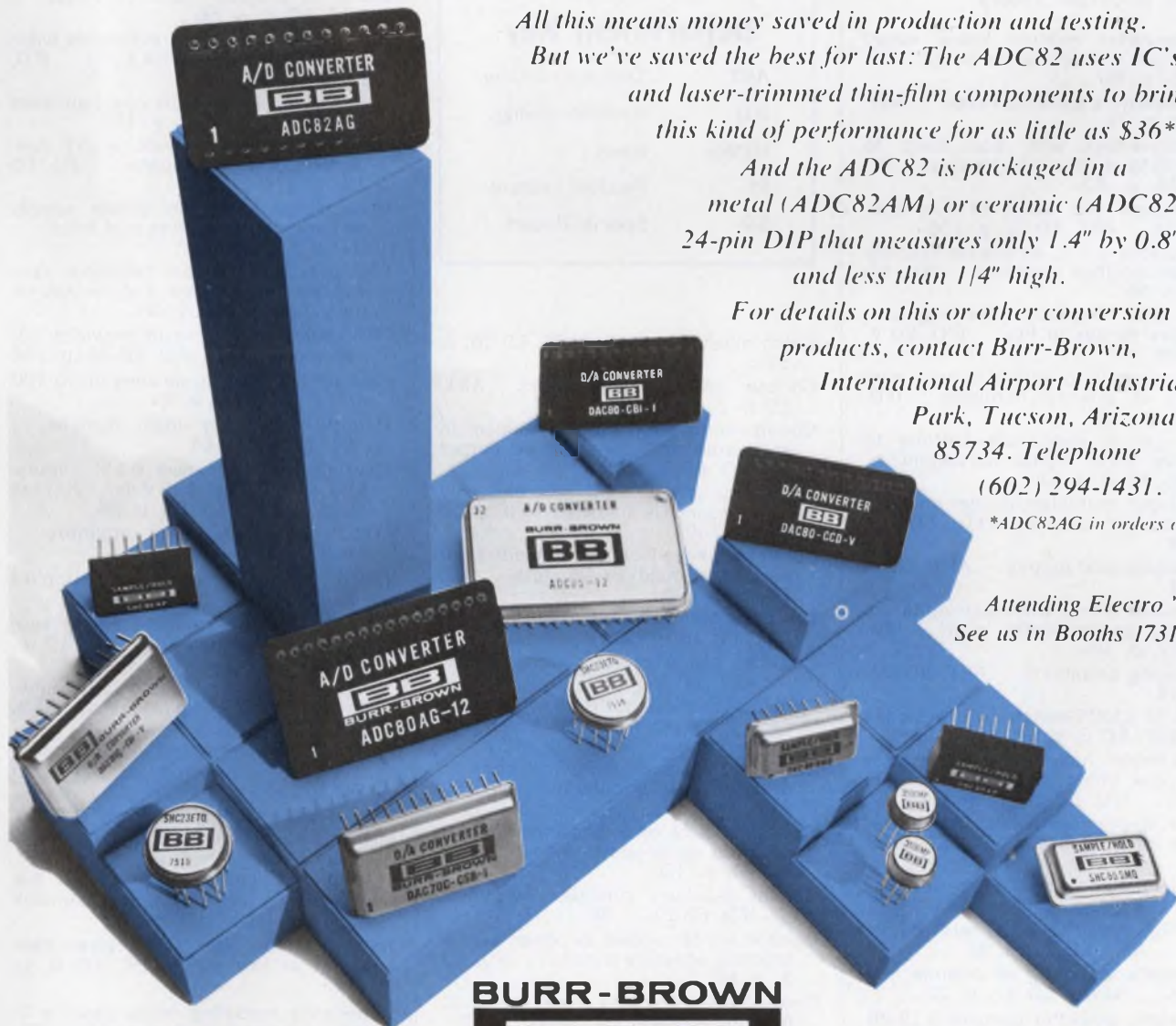

BURR-BROWN
BB

**Fifty-four
conversion
choices**

CIRCLE NUMBER 45

Electronic Design

1975

Annual Index of Articles

Circuits & Circuit Theory

- A/d converter module keeps speed high but cuts costs by 50% . . . PF, ED 5, p. 80
- A/d converter's dynamic range . . . ART, ED 3, p. 76
- A/d converters with accuracies to 0.0015% drop prices sharply . . . PF, ED 26, p. 82
- Agc extends the range of a/d converters . . . ART, ED 22, p. 108
- Agc provides 0.1% amplitude stability for Wein-bridge oscillator . . . IFD, ED 11, p. 94
- Active filter improves tracking and capture ranges of PLL . . . IFD, ED 7, p. 128
- Add-to-accumulator circuit uses a minimum of external hardware . . . IFD, ED 1, p. 120
- Analog circuit specialists battling to survive the digital onslaught . . . NEWS, ED 6, p. 32
- Analog-input multiplier/divider provides 3-1/2 digit output . . . IFD, ED 12, p. 92
- Apply topological graphs . . . ART, ED 9, p. 84
- Audible alarm tells when car lights are on and ignition switch is off . . . IFD, ED 12, p. 94
- Autoranging amplifiers . . . ART, ED 22, p. 114
- Beware of CMOS-switch failure modes . . . ART, ED 6, p. 68
- Build a linear, high-frequency detector with low offset and wide dynamic range . . . IFD, ED 12, p. 98
- Build a multiphase clock that never loses its sequence . . . IFD, ED 6, p. 95
- Build dc/dc converters that work . . . ART, ED 11, p. 82
- Build high-speed sync-pattern detectors . . . ART, ED 21, p. 82
- CAD speeds matching of antenna networks . . . NEWS, ED 22, p. 22
- CMOS audio amplifier features ± 15 -dB bass/treble control range . . . IFD, ED 11, p. 98
- CMOS switch inverts analog signal under control of digital logic . . . IFD, ED 25, p. 92
- Calculate capacitor tap impedance with correct expression and avoid errors . . . IFD, ED 8, p. 82
- Capacitor drops voltage with little heat for low-cost, low-voltage power supply . . . IFD, ED 24, p. 148

Department Key

ART	Technical Article
IFD	Ideas for Design
NEWS	News
PF	Product Feature
SR	Special Report

- Catch missing codes . . . ART, ED 16, p. 58
- Choose switching regulators . . . ART, ED 6, p. 54
- Circuit eliminates switch bounce in keyboards and gives latched output . . . IFD, ED 1, p. 118
- Circuit turns on tape recorder only when sound is detected . . . IFD, ED 20, p. 100
- Complete phase-locked loop made from part of a quad EX-OR gate . . . IFD, ED 7, p. 130
- Consider MSI for tape controllers . . . ART, ED 16, p. 50
- Consider using resolvers and synchros . . . ART, ED 17, p. 70
- Constant period with variable duty cycle obtained from 555 timer with single control . . . IFD, ED 14, p. 72
- Convert 7-segment numerical code to decimal or BCD outputs . . . IFD, ED 4, p. 96
- Crystal control of a one-shot ensures accurate pulse-width output . . . IFD, ED 24, p. 150
- Crystal oscillator provides low noise . . . IFD, ED 21, p. 98
- Current limiter added to power supply protects sensitive circuits . . . IFD, ED 3, p. 86
- Current sinks increase the range of IC function generators . . . IFD, ED 26, p. 74
- Dc/dc converter shrugs off 6:1 input voltage changes . . . PF, ED 21, p. 133
- Dc/dc converters tolerate 2:1 input-voltage swing . . . PF, ED 8, p. 102
- Damper diodes: Do you need them? . . . ART, ED 6, p. 62
- Deglitching modules attenuate glitches on current-output d/a's by over 70 dB . . . PF, ED 24, p. 162

- Design a precision a/d converter . . . ART, ED 8, p. 66
- Digital circuit detects frequencies within adjustable difference band . . . IFD, ED 14, p. 70
- Divide a digital signal by any digit from 1 to 9 . . . IFD, ED 1, p. 120
- Drift-free integration with a v/f converter and digital counter . . . IFD, ED 18, p. 110
- Dual-voltage regulated power supply has adjustable outputs that track . . . IFD, ED 25, p. 94
- Easy-to-build FM signal generator uses a phase-locked loop and an AM input . . . IFD, ED 4, p. 94
- FET analog-switch circuit provides 63-dB on-off ratio . . . IFD, ED 24, p. 146
- Fast settling op amp delivers up to 100 mA . . . PF, ED 7, p. 80
- Field-PLAs simplify logic designs . . . ART, ED 18, p. 84
- Floating regulator gives 0.1% regulation over 0-to-100-V-dc, 200-mA range . . . IFD, ED 19, p. 94
- FOCUS on Operational amplifiers . . . SR, ED 14, p. 44
- FOCUS on Switching power supplies . . . SR, ED 20, p. 52
- FOCUS on Uninterruptible power supplies and inverters . . . SR, ED 10, p. 100
- Function generator produces sine, square and triangular waves . . . IFD, ED 3, p. 88
- High-isolation amplifiers handle up to ± 2500 V, common-mode . . . PF, ED 13, p. 124
- High-speed switch handles ± 400 -V peak and is controlled by logic levels . . . IFD, ED 2, p. 74
- High-voltage power supply from 5-V source regulated by timer feedback circuit . . . IFD, ED 7, p. 132
- Hybrid IC converter series gives high speed at low cost . . . PF, ED 6, p. 112
- Impedance matching made easy: a 3-step uncomplicated method . . . IFD, ED 17, p. 76
- Improved voltage-to-frequency converter has automatic polarity inversion . . . IFD, ED 11, p. 96
- Inexpensive TTL chip makes a versatile oscillator circuit . . . IFD, ED 12, p. 90
- Inverter uses ferrite transformer to eliminate cross-conduction . . . IFD, ED 22, p. 130

Keep your op-amp circuits quiet... ART, ED 20, p. 88

LED used as voltage reference provides self-compensating temp coefficient... IFD, ED 4, p. 92

Linear VCO made from a 555 timer... IFD, ED 21, p. 96

Low-cost dedicated divider comes trimmed to within 0.25%... PF, ED 18, p. 134

Low-cost temperature controller built with timer circuit... IFD, ED 17, p. 82

Low-distortion modulator and carrier source made at low cost with single dual op amp... IFD, ED 14, p. 68

Lowered feedthrough lets d/a performance shine through... PF, ED 19, p. 124

MOS alarm-clock chip drives gas-discharge display directly... IFD, ED 22, p. 128

Match antenna over 1.5-to-30-MHz range with only two adjustable elements... IFD, ED 19, p. 96

Mate synchros with computers... ART, ED 19, p. 72

Microvolt comparisons made with pre-amp and comparator... IFD, ED 16, p. 90

Modular v/f converter series offers choice of six models... PF, ED 22, p. 142

Motor control by PLL... ART, ED 9, p. 54

Multiplying d/a converters meet MIL specs at low cost... PF, ED 23, p. 124

Need a small keyboard?... ART, ED 2, p. 56

Need to operate SCRs in parallel?... ART, ED 18, p. 94

Operate a 555 timer on a ± 15 -V supply and deliver op-amp compatible signals... IFD, ED 2, p. 76

Optocoupler is zero-crossing detector and isolator in triac power control... IFD, ED 20, p. 104

Peak-holding analog memory can store data for 3 months... PF, ED 18, p. 136

Phase-control power modules handle 25 A at up to 240 rms... PF, ED 22, p. 146

Phase-locked loop generates clock from nonreturn-to-zero data... IFD, ED 9, p. 90

Power failure alarm operates a long time on a single 1.5-V cell... IFD, ED 23, p. 108

Power op amp provides ± 100 -mA output and up to 100-V/ μ s slew rate... IFD, ED 10, p. 146

Power op amps drive dc motor from single-ended power supply... IFD, ED 17, p. 80

Precision reference source eliminates power-supply regulation errors... IFD, ED 18, p. 108

Precision voltage reference easily converts to a current limiter... IFD, ED 2, p. 72

Prevent low-level amplifier problems... ART, ED 4, p. 62

Program multichannel audio gain... ART, ED 3, p. 68

Programmable sawtooth generator settable at high and low output levels... IFD, ED 23, p. 106

Programmable shaft-angle encoder works with any rotating shaft... PF, ED 10, p. 168

Subject Listing

Circuits & Circuit Theory	Industrial Electronics
Communications, Microwaves & Lasers	Management
Components	Materials & Packaging
Computers & Data Processing	Medical Electronics
Consumer Electronics	Microprocessors
Displays & Electro-Optics	Military & Aerospace
General Industry	Semiconductors
	Test & Measuring

Programmable unijunction transistor protects op amp from overvoltages... IFD, ED 3, p. 88

Pulse amplifier can deliver over 500 V with frequencies to 100 KHz... IFD, ED 20, p. 102

Ratiometric dual-slope a/d converters offered in 14-bit or 4-1/2-digit models... PF, ED 16, p. 102

Regulated power source drives low-power devices... IFD, ED 5, p. 72

Series-regulated supplies hurdle efficiency barrier... PF, ED 15, p. 84

Simplified three-phase generator has improved characteristics... IFD, ED 1, p. 122

Simplify acoustic surface-wave designs... ART, ED 16, p. 74

Single-chip pulse generator provides 50 MHz with adjustable duty cycle... IFD, ED 26, p. 72

Single potentiometer adjusts op-amp's gain over bipolar range... IFD, ED 15, p. 68

Speedy a/d converts input signals in less than 2 μ s... PF, ED 19, p. 126

Square-wave frequency divider provides symmetrical output for odd divisors... IFD, ED 13, p. 100

Squeeze more data onto mag tape... ART, ED 21, p. 76

Squelch RFI in switching supplies... ART, ED 20, p. 96

Switch out microwave phase errors... ART, ED 13, p. 92

Switch your high-power supply... ART, ED 7, p. 116

Triple-output dc source protects against brownouts... PF, ED 12, p. 131

Triple-output dc supply ignores ac power failures... PF, ED 11, p. 107

Two components added to CMOS flip-flop convert it to one-shot or level detector... IFD, ED 17, p. 76

Ultrasonic transmitter/receiver generates a 20-ft beam that detects objects... IFD, ED 16, p. 88

Use v/f converters... ART, ED 7, p. 110

Voltage comparator circuit gives audio alarm when tripped... IFD, ED 10, p. 148

Voltage-controlled attenuator provides linear variation in decibels... IFD, ED 16, p. 86

Voltage-controlled music oscillator has linear control properties... IFD, ED 5, p. 66

Voltage-reference LED also provides visual indication of overload condition... IFD, ED 13, p. 98

Which multiplier?... ART, ED 21, p. 88

Wide-range voltage-to-frequency converter uses only one dual op-amp IC... IFD, ED 12, p. 96

16-bit d/a converter claims highest accuracy, lowest drift... PF, ED 19, p. 128

18-pin DIP houses speedy 8-bit hybrid a/d converter... PF, ED 20, p. 107

200-A motor controller provides high power in a small package... PF, ED 2, p. 85

400-Hz power supply for servos delivers up to 0.5 A at 11.8-V rms... IFD, ED 19, p. 98

Communications, Microwaves and Lasers

Acoustic radar helping FAA study wind shear... NEWS, ED 22, p. 21

Better radar antennas tested by the FAA... NEWS, ED 11, p. 23

Coax and microstrip packaging edging out microwave waveguides... NEWS, ED 9, p. 26

Designers adapt as traffic begins to shift to a mix of speech and data... SR, ED 13, p. 44

Designers cramming more traffic into satellite communications net... SR, ED 19, p. 34

Digital methods and ICs are making receivers and transmitters smarter... SR, ED 13, p. 36

Dome radar cuts cost of phased-array system... NEWS, ED 13, p. 20

Dr. Ernst Alexanderson: A pioneer to remember... SR, ED 13, p. 68

FAA pushing new electronic aids to prevent flight into the ground... NEWS, ED 11, p. 30

Feedback laser emits several wavelengths... NEWS, ED 20, p. 24

Flat, flexible TV antenna offers high gain... IFD, ED 6, p. 98

Green-light laser maps stretch of ocean floor... NEWS, ED 25, p. 26

Improvements forecast in microwave gear... NEWS, ED 14, p. 23

Land-mobile radio designs push to 900 MHz to ease crowding... SR, ED 13, p. 54

Laser and radar systems speed pinpointing of targets... NEWS, ED 10, p. 19

Laser filter promises cheaper nuclear fuel... NEWS, ED 13, p. 20

Laser printer transfers data to ordinary paper... NEWS, ED 5, p. 19

ANNUAL INDEX

- Laser 'thermometer' to detect 80 million C... NEWS, ED 26, p. 16
- Laser-TV bomb sight likely to raise accuracy... NEWS, ED 23, p. 20
- Lasers help engineers to locate dummy position in auto crash tests... NEWS, ED 1, p. 61
- MW system to help space shuttle land... NEWS, ED 12, p. 39
- Near real-time imagery from side-looking radar... NEWS, ED 5, p. 20
- Need an 'invisible' vhf antenna in a vehicle? Open the door a bit... NEWS, ED 8, p. 32
- New microwave semi fabrication pushing power and reliability up... NEWS, ED 2, p. 34
- New OTH-B radar to be cw bistatic... NEWS, ED 8, p. 19
- Over-the-rainbow radar to aid weather forecast... NEWS, ED 16, p. 22
- Power levels reported rising for I-F to microwave elements... NEWS, ED 25, p. 28
- Radar energy absorber eliminates 'ghosts'... NEWS, ED 4, p. 33
- Satellites and fiber optics gain favor for the transmission of digital data... SR, ED 7, p. 61
- Semi laser pulser delivers 1000 W from 27-V battery... NEWS, ED 5, p. 19
- Solid-state amplifiers crowd low-level TW's... NEWS, ED 2, p. 19
- Stop burnout in rf power amplifiers... ART, ED 1, p. 110
- Waveguide transmitting speed boosted threefold... NEWS, ED 12, p. 26
- YIG switch to handle high power radar pulse... NEWS, ED 19, p. 20

Components

- Bypass and feedthrough filters... ART, ED 17, p. 62
- Placemat about resistor reliability?... ART, ED 23, p. 92
- Consider electromechanical counters... ART, ED 21, p. 70
- Consider hollow-rotor motors... ART, ED 11, p. 76
- DIP relay is small in size and price... PF, ED 10, p. 164
- Ferrites halve core loss in inverter applications... PF, ED 16, p. 97
- FOCUS on Miniature relays... SR, ED 11, p. 56
- FOCUS on Pots and trimmers... SR, ED 17, p. 52
- FOCUS on Pulse transformers... SR, ED 13, p. 78
- FOCUS on Snap-action switches... SR, ED 5, p. 44
- Get to know digital shaft encoders... ART, ED 11, p. 68
- Losses in flyback transformers halved by new ferrite cores... PF, ED 1, p. 127
- Mini resistor chips offer the tops in accuracy and stability... PF, ED 23, p. 120
- Mini time-delay relays are available in fixed, variable and flasher models... PF, ED 11, p. 110
- New push-button switch called world's smallest... NEWS, ED 16, p. 22

- Process improves plastic-bound magnets... NEWS, ED 24, p. 23
- Relay coil replaced by thermal actuator... NEWS, ED 14, p. 24
- Smaller, cheaper passive chips spurring hybrid-circuit advances... NEWS, ED 23, p. 26
- Stepping motor curbs unwanted shaft motion... NEWS, ED 7, p. 22
- Stretch electrolytic capacitor life... ART, ED 7, p. 124
- Switch inside knob saves valuable space... NEWS, ED 10, p. 20
- Switching contacts causing problems... ART, ED 5, p. 60
- Transducer simplifies image processing... NEWS, ED 10, p. 19
- Transient suppressor protects RF lines... NEWS, ED 12, p. 26

Computers & Data Processing

- Algorithm said to guarantee data security for 100 years... NEWS, ED 9, p. 21
- Analog signal processing moving to challenge digital... NEWS, ED 3, p. 21
- Bucket brigade aids word processing... NEWS, ED 4, p. 20
- Build compact modems... ART, ED 1, p. 74
- CDC challenges IBM on mass-storage tape... NEWS, ED 13, p. 19
- Calculators taking over jobs once done by minicomputers... SR, ED 24, p. 58
- 'Classified ads' put into computer system... NEWS, ED 21, p. 23
- Combine multichart Karnaugh maps into single, easy-to-handle versions... IFD, ED 15, p. 70
- Computer keeps tabs on 20 engine test points... NEWS, ED 5, p. 20
- Computer series offers low cost, high performance... PF, ED 23, p. 116
- Cram data through voice-grade lines... ART, ED 4, p. 76
- Data throughput doubled with new IBM link control... NEWS, ED 14, p. 23
- Dazzling, dizzy Disney World is run by computer... NEWS, ED 4, p. 24
- Dedicated systems giving rise to once 'far out' applications from sports scoring to security... SR, ED 10, p. 56
- East German computer proves better than expected... NEWS, ED 26, p. 15
- 'Electronic checkbook' a specialized calculator... NEWS, ED 9, p. 22
- Floppy disc/controller for \$200 envisioned... NEWS, ED 18, p. 22
- Floppy discs, cartridges and fixed-hard discs rise in use at savings to you... SR, ED 22, p. 54
- FOCUS on CRT terminals... SR, ED 22, p. 86
- Full APL computer delivers mainframe power in mini size... PF, ED 24, p. 171
- Growing family of small machines at \$50 and up does complex math... NEWS, ED 2, p. 24
- Harris offers new line of 24-bit computers... NEWS, ED 10, p. 20
- High-school lab using floppy-disc time sharing... NEWS, ED 2, p. 19

- Hot-air printer sears characters on paper... NEWS, ED 9, p. 21
- How long a wait for computer response?... ART, ED 22, p. 120
- 'How to' emphasized at computer parley... NEWS, ED 6, p. 19
- IBM desk computer designed for novices... NEWS, ED 3, p. 22
- Improve analog data transmission... ART, ED 1, p. 94
- Insecure computer problem: Ways sought to foil unlawful entry... NEWS, ED 5, p. 26
- Keeping fast minis busy... ART, ED 10, p. 130
- LSI to help create a new range of smaller, less expensive minis and mini peripherals... NEWS, ED 1, p. 38
- Laser-computer system rejects defective POS codes at the press... NEWS, ED 8, p. 34
- Latest scientific calculators displayed at conference... NEWS, ED 2, p. 19
- Launch control for space shuttle to lean heavily on minicomputers... NEWS, ED 3, p. 21
- Look at calculator languages... ART, ED 12, p. 80
- Mass memories raising speed, dropping cost and storing billions of bytes... SR, ED 22, p. 46
- Medium-speed printers are on the way up—but the 'ideal' isn't here yet... SR, ED 22, p. 62
- Mini's most important part... ART, ED 14, p. 52
- Navy system pinpoints computer transients... NEWS, ED 22, p. 22
- Network processor has unusual structure... NEWS, ED 21, p. 23
- New computer aims to set speed record... NEWS, ED 2, p. 20
- Next computer era: A gradual shift seen... NEWS, ED 22, p. 22
- Novel ways of entering data are under study, including the power of positive thinking... SR, ED 10, p. 46
- Productivity increased in new minicomputer... NEWS, ED 6, p. 19
- Recognize hand-printed characters... ART, ED 3, p. 80
- Reverse-Polish or algebraic entry... ART, ED 2, p. 50
- Sensor-minicomputer network tells when lightning will strike... NEWS, ED 26, p. 28
- Serial printer shuns the costly electronics... NEWS, ED 3, p. 22
- Simplify add-on peripheral controllers... ART, ED 10, p. 22
- Small, nonimpact printer to cost less than \$25... NEWS, ED 9, p. 32
- 'Smart' cable links computer to peripherals... NEWS, ED 3, p. 21
- Speed microcomputer multiplication... ART, ED 9, p. 44
- Talking calculator is new aid for blind... NEWS, ED 25, p. 26
- Tomorrow's big computers are taking shape today; the changes are radical... SR, ED 22, p. 36
- Top computer show unfolds in Anaheim with spotlight on new directions in design... SR, ED 10, p. 90
- With new, powerful software, designers can 'see' a system work before it's actually built... SR, ED 10, p. 80
- Wraps come off a Naked Milli... NEWS, ED 4, p. 19

- 2 large computers join Univac line... NEWS, ED 7, p. 21
- 2 new calculator chips offered by Rockwell... NEWS, ED 4, p. 20
- 32-bit mini with 1 megabyte of core cycles at 450 ns average, 300 ns min... PF, ED 8, p. 87

Consumer Electronics

- CCD television camera sensitive to low light... NEWS, ED 24, p. 24
- Computers to shop by beginning to turn up... NEWS, ED 20, p. 24
- Consumer products to grow in sophistication with SOS and I²L and DMOS... NEWS, ED 1, p. 52
- Electronic music incorporating the high notes of IC technology... NEWS, ED 4, p. 26
- First IC ignition system in cars offers better engine performance... NEWS, ED 7, p. 34
- Flick of wrist gives time in new Pulsar... NEWS, ED 17, p. 20
- Holographic memory checks credit fast... NEWS, ED 21, p. 24
- Home printer to extend capabilities of cable TV... NEWS, ED 1, p. 22
- Memory incorporated in electronic tuner... NEWS, ED 14, p. 24
- Project giving all homes access to a computer... NEWS, ED 18, p. 22
- RCA video-disc entry gives hour of inexpensive viewing... NEWS, ED 6, p. 19
- Radiophones and precision gear make a splash at boat show... NEWS, ED 5, p. 24
- TV industry disputes U.S. on power-saving proposals... NEWS, ED 11, p. 23
- Time marches on—and you can even see the displays now... SR, ED 18, p. 58
- Two video disc systems to be marketed in 1976... NEWS, ED 8, p. 37
- Zenith offers closeups in 1976 color TV sets... NEWS, ED 13, p. 20
- 50-mph electric car has lead-cobalt battery... NEWS, ED 14, p. 24

Displays & Electro-Optics

- Acousto-optics pushes up laser-recording standards... NEWS, ED 20, p. 23
- Advance reported in optical modulators... NEWS, ED 17, p. 19
- Baggage X-ray system features real-time image... NEWS, ED 16, p. 22
- Consider LCDs for your next design... ART, ED 19, p. 66
- Display inverter circuit eliminates upside-down readout problems... IFD, ED 5, p. 68
- Display show sees a future for electrochromic readouts... NEWS, ED 7, p. 21
- Evolutionary growth helps CRTs keep pace with newer displays... NEWS, ED 2, p. 36
- Fiber-optic communications seen approaching applications stage... NEWS, ED 14, p. 30
- Fiber-optic gyro called navigation-improvement... NEWS, ED 15, p. 22
- FOCUS on Displays... SR, ED 19, p. 52

- Hitachi cites advance in optical IC work... NEWS, ED 23, p. 20
- How fast does your CRT write?... ART, ED 14, p. 58
- Improvements claimed with GaAs LED... NEWS, ED 17, p. 19
- Infrared device detects ice before it forms... NEWS, ED 25, p. 36
- Know the optocoupler... ART, ED 12, p. 66
- Low-cost IR detectors... ART, ED 12, p. 84
- Measure CRT spot size... ART, ED 15, p. 58
- Micro-optic devices show advantages over optical ICs... NEWS, ED 15, p. 34
- OIC performance is improved with use of silicon substrate... NEWS, ED 25, p. 29
- Optical reader scans coded copy at 400 characters per second... NEWS, ED 23, p. 53
- Optical scanning improved with unusual mirror technique... NEWS, ED 20, p. 33
- Opto-electronic switch handles 100 V in 10 ps... NEWS, ED 8, p. 20
- PLZT may challenge established displays... NEWS, ED 8, p. 20
- Plasma-panel displays modified to transmit images via telephone... NEWS, ED 7, p. 36
- Simpler circuitry due for flat-panel displays... NEWS, ED 11, p. 24
- Strong growth seen for optoelectronics... NEWS, ED 21, p. 24

General Industry

- Advanced sensing used to study causes of fog... NEWS, ED 10, p. 20
- Alexanderson, pioneer of voice radio, is dead... NEWS, ED 12, p. 26
- IEEE balloting pits Dillard against a maverick, Feerst... NEWS, ED 18, p. 21
- Independent entered in IEEE election... NEWS, ED 17, p. 20
- R&D rise forecast in U.S. this year... NEWS, ED 2, p. 20
- TV-compatible CCD camera ready to make the scene... NEWS, ED 4, p. 19
- U.S. metric conversion is called 'disjointed'... NEWS, ED 15, p. 21
- U.S. seeking a wrist transmitter for citizen use in emergencies... NEWS, ED 8, p. 26
- Wescon exhibitors see business upturn... NEWS, ED 13, p. 20
- Wireless power-transmission test aims at harnessing sun one day... NEWS, ED 25, p. 32
- 2 security systems screen body responses of people... NEWS, ED 8, p. 19

Industrial Electronics

- Automated industrial controls not yet ready to go it alone without guidance of humans... SR, ED 10, p. 72
- Coherent rf energy beam easily melts ceramics... NEWS, ED 19, p. 20
- Conference to feature offshore drilling aids... NEWS, ED 5, p. 19
- E beam tested as nuclear-power trigger... NEWS, ED 12, p. 36

- Electronic devices displacing the hydraulic and mechanical... SR, ED 24, p. 96
- Engine sensor-telemetry system hailed as the new racer's edge... NEWS, ED 12, p. 34
- Gun fells intruders with electrical current... NEWS, ED 17, p. 20
- New sensors spur 2nd try to gasify unmined coal... NEWS, ED 7, p. 31
- New workers for factories promised: Intelligent robots that 'feel' and 'see'... SR, ED 7, p. 62
- Refinements reported in ultrasonic imaging... NEWS, ED 7, p. 21
- Stop that bugging of your phone! Here's how to do it simply... maybe... NEWS, ED 21, p. 28

Management

- Bill Terry and Jack Lieberman of Hewlett-Packard Speak On Challenges To the Instrument Designer... ART, ED 24, p. 66
- Bill Walker of Tektronix Speaks on Getting Engineers to Work Harder and Enjoy it More... ART, ED 15, p. 62
- From managerial viewpoint, efficiency will be a key word in production and in hiring... NEWS, ED 1, p. 45
- Gordon Moore of Intel Speaks on Moving from Lab to Production... ART, ED 18, p. 100
- Henk Bodt of Philips Speaks on Challenges to the European Instrument Designer... ART, ED 24, p. 88
- How to make R&D payoff... ART, ED 8, p. 72
- Jerry Sanders of AMD Speaks on Making Your Engineers Profit Conscious... ART, ED 16, p. 80
- Job ratings hinge on mutual commitment... ART, ED 2, p. 68
- Joe Keithley of Keithley Instruments Speaks on Planning Your Projects... ART, ED 19, p. 86
- John Fluke of Fluke Mfg. Speaks on Training Engineering Managers... ART, ED 11, p. 88
- Level with your staff... ART, ED 6, p. 78
- When phase-downs and layoffs come... ART, ED 4, p. 86
- Ze'ev Drori of Monolithic Memories Speaks on Coping With Engineer's Weaknesses... ART, ED 14, p. 64

Materials & Packaging

- Better materials and equipment trim costs and raise reliability... NEWS, ED 15, p. 24
- Bond chips with conductive epoxies... ART, ED 20, p. 82
- Choosing the best enclosure... ART, ED 23, p. 100
- Circuits and substrates separated to make bigger, cheaper hybrids... NEWS, ED 3, p. 21
- Connector resists corrosion in water... NEWS, ED 24, p. 23
- Cool through turbulence... ART, ED 9, p. 60
- Design maintainability into equipment... ART, ED 4, p. 70
- Flat cable combines twisted pairs and flat sections... PF, ED 18, p. 118

ANNUAL INDEX

FOCUS on Component sockets... SR, ED 4, p. 48
FOCUS on Printed circuits... SR, ED 25, p. 62
GE's aim: top producer of PC boards in 1 year... NEWS, ED 16, p. 21
IC circuits in plastic DIPs provide the reliability of hermetic packages... PF, ED 9, p. 97
Improve your PC artwork techniques... ART, ED 25, p. 72
Magnetic monopole may be discovery of century... NEWS, ED 19, p. 19
Niobium tin offered in flexible cable... NEWS, ED 11, p. 23
Polymeric solid made superconductive... NEWS, ED 9, p. 22

Ribbon coax-cable design allows gang stripping and easy assembly... PF, ED 3, p. 95

Slash monolithic ceramic capacitor prices with base-metal electrodes and terminations... PF, ED 18, p. 117

Static electricity discharged from quick-access panels... PF, ED 1, p. 128

Study doubts wide use of multilayer PCs... NEWS, ED 7, p. 22

Superconducting wire gives 'superior' results... NEWS, ED 12, p. 25

Thin Si film on metal substrate promises low-cost solar power... NEWS, ED 11, p. 38

Welded wire chassis keeps CRT terminal light and cool... NEWS, ED 12, p. 38

Wrapping and unwrapping wiring tools are easily made from tubing... IFD, ED 23, p. 104

Medical Electronics

EEG unit worn by patient records data for 12 hours at 7000 bpi... NEWS, ED 12, p. 30

Fluorimeter detects lead in human blood... NEWS, ED 5, p. 20

Microcomputers giving rise to new medical instruments... NEWS, ED 23, p. 19

Portable X-ray 'lifts' fingerprints from victim... NEWS, ED 12, p. 26

The $\alpha\beta\gamma$ of bioelectric measurements... ART, ED 16, p. 68

THE SPECTRUM ANALYSIS

Select normal or variable persistence display, choose economy or high-resolution IF module. Then pick or change your frequency range by simply plugging in the appropriate tuning module.

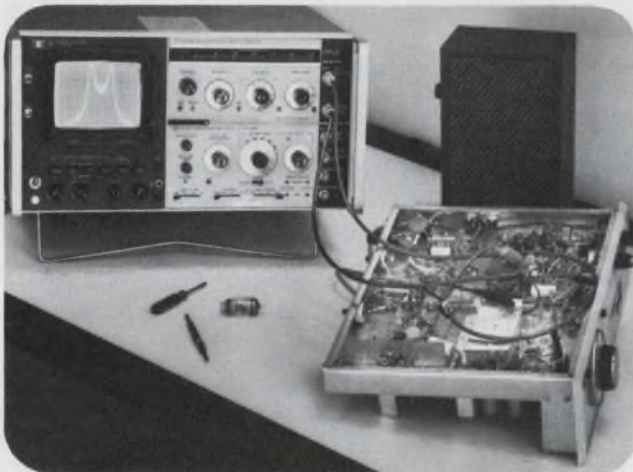

20 Hz to 300 kHz

The 8556A tuner covers 20 Hz to 300 kHz and comes with a built-in tracking generator. It's calibrated for measurements in both 50 and 600 ohm systems, with accuracies better than ± 1 dB.

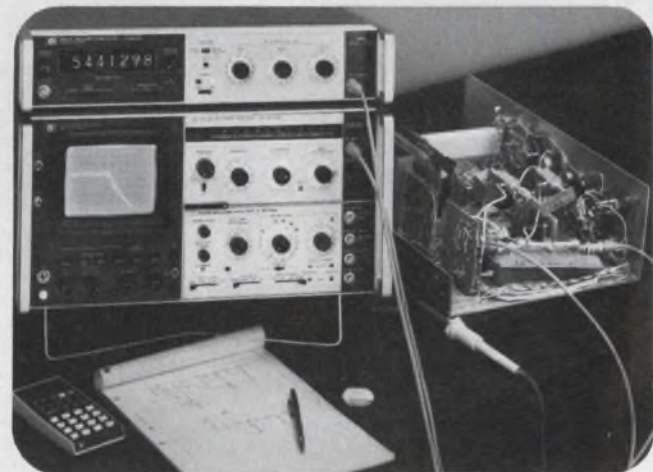

1 kHz to 110 MHz

The 8553B takes you from 1 kHz to 110 MHz with -140 dBm sensitivity. Signals can be measured with $\pm 1/4$ dB accuracy. Choose the companion tracking generator/counter for wide dynamic range swept frequency measurements and precise frequency counting.

No matter what range you're working in, you need reliable unambiguous answers. HP's spectrum analyzers give you accurate measurements over wide, distortion-free dynamic ranges, time after time. Easy operation too, with front panel markings that really help reduce the possibility of operator error.

But there's much more. Call your nearby HP field engineer or write for the full story on HP's spectrum analyzer spectrum.

Typewriter for handicapped uses special solenoid unit... NEWS, ED 7, p. 39

Microprocessors

Assemble or buy it? A look at the 'how to' with micros... SR, ED 18, p. 54

Assembly language for μ Ps... ART, ED 26, p. 58

Checking microprocessors... ART, ED 22, p. 102

DEC develops a micro and an expanded mini... NEWS, ED 4, p. 20

Debug that microcomputer system with a mini... ART, ED 12, p. 74

Design your own microcomputer... ART, ED 20, p. 72

Employ μ P software tools properly... ART, ED 26, p. 50

Experts tell how to hold down high cost of processor programs... NEWS, ED 26, p. 20

Explore microcomputer I/O capabilities... ART, ED 10, p. 114

First true computer on chip finally reaches marketplace... NEWS, ED 13, p. 19

Increase microcomputer efficiency... ART, ED 23, p. 70

Join micros into intelligent networks... ART, ED 5, p. 52

Keyboard circuit saves time, needs no microprocessor scanning software... IFD, ED 26, p. 70

Let a μ P keep track of your process... ART, ED 26, p. 66

Mating microprocessors with converters... ART, ED 18, p. 76

Microcomputers to be permanent riders on Toronto's transit system... NEWS, ED 20, p. 34

Microprocessor emphasis swings from chip specs to aids for designers... SR, ED 22, p. 74

Microprocessor shunned for TV tuning systems... NEWS, ED 24, p. 23

Microprocessors are making the 'impossible' possible... SR, ED 24, p. 52

Microprocessors helping police cut the cost of communicating... NEWS, ED 21, p. 37

Microprocessors making medical equipment 'smart'... SR, ED 19, p. 26

Microprocessors simplify industrial control... ART, ED 22, p. 96

SPECTRUM

The HP 140 family covers it.
Precisely. Conveniently.
Completely.
From 20 Hz to 40 GHz.

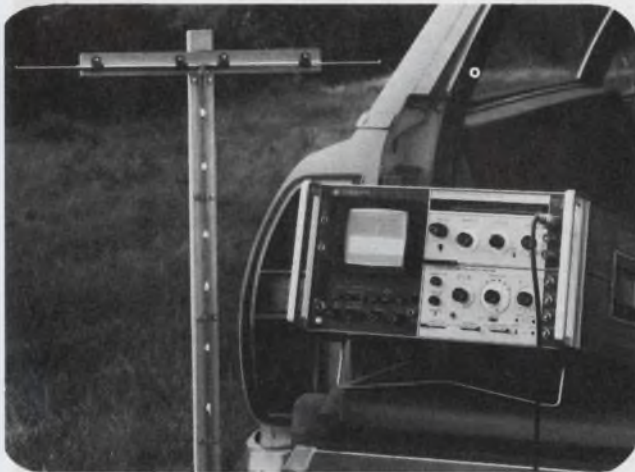

100 kHz to 1250 MHz

Use the 8554B tuning section to cover the 100 kHz to 1250 MHz range. Measure with $\pm 1\frac{3}{4}$ dB accuracy. Its companion tracking generator (500 kHz to 1300 MHz) also works with the 8554A tuning section.



10 MHz to 40 GHz

For 10 MHz to 40 GHz, choose the 8555A. Its internal mixer covers to 18 GHz, accessory mixer for 18-40 GHz. Maximum resolution is 100 Hz. Measure with $\pm 1\frac{3}{4}$ dB accuracy to 6 GHz, $\pm 2\frac{3}{4}$ dB to 18 GHz. For wide scans free from unwanted response between 10 MHz and 18 GHz, add the automatic preselector.

HEWLETT  PACKARD

Sales and service from 172 offices in 65 countries.
1501 Page Mill Road, Palo Alto, California 94304

45509

ANNUAL INDEX

- Micros future rosy for analytical instruments NEWS, ED 19, p. 19
- Micros or large mainframes, advances in ICs are producing radically improved machines SR, ED 10, p. 34
- Minicomputer speed at microprocessor cost NEWS, ED 22, p. 21
- Motorola processor to have 55-ns micro-instruction time NEWS, ED 12, p. 25
- Pick a microprocessor, a mini or anything in between NEWS, ED 16, p. 26
- Processor family debuts: 16 bit μ P to full blown mini, with software support PF, ED 22, p. 137
- Rise of microprocessors is cutting data processing and memory costs SR, ED 7, p. 54
- Rockwell and National sign processor pact NEWS, ED 20, p. 24
- Sellout show with heavy interest in microprocessors SR, ED 18, p. 50
- Speed microprocessor responses ART, ED 23, p. 78
- TV course schedule on microprocessors NEWS, ED 6, p. 19
- Two-phase clock generator and driver synchronize the 8080 microprocessor IFD, ED 9, p. 88
- Under-the-hood microprocessors could turn up in 1979 U.S. cars NEWS, ED 20, p. 28
- Will the micro KO the mini? Not if the mini manufacturers counterpunch, says Ely of HP SR, ED 10, p. 68
- With the microprocessor, industrial electronics will be working a lot smarter NEWS, ED 1, p. 56
- 4-bit bipolar/LSI processor slice cuts microcycle time to 100 ns PF, ED 15, p. 77
- \$15 microprocessor coming for simpler applications NEWS, ED 17, p. 19
- 16-bit microprocessor operates at 5 MHz NEWS, ED 6, p. 19

Military & Aerospace

- Accurate inertial system developed by Rockwell NEWS, ED 24, p. 24
- Digital controls are taking wing in emerging military aircraft NEWS, ED 11, p. 40
- EIA forecasts a 33% rise in Government spending for electronics over 5 years NEWS, ED 1, p. 58
- FAA close to breakthrough in mid-air collision detector NEWS, ED 25, p. 25
- F-16: A multibillion bonanza for the makers of avionics NEWS, ED 15, p. 21
- Hand-held control unit to monitor artillery NEWS, ED 23, p. 19
- 'Inside-out' generator mounts in plane's wing NEWS, ED 7, p. 22
- Military turning to CMOS/SOS for radiation-hardened circuitry NEWS, ED 7, p. 26
- Portable radar set to survey battlefields NEWS, ED 23, p. 20
- Satellite altimeter to measure wave heights to 10% accuracy NEWS, ED 8, p. 28
- Small concerns push for more defense jobs NEWS, ED 13, p. 19

- U.S. weighs cutbacks at WWV and WWVH NEWS, ED 5, p. 20
- 3-D radar improves target resolution NEWS, ED 26, p. 15
- 13 radio navigation systems urged instead of present 77 NEWS, ED 21, p. 23

Semiconductors

- ABCs of CCDs ART, ED 8, p. 58
- Ac/dc voltage source offers programmability & precision PF, ED 2, p. 87
- AF space computers to use bubble memories NEWS, ED 16, p. 21
- Advances in bipolar LSI yielding faster, denser low-power devices NEWS, ED 6, p. 22
- Are buffered CMOS gates right for you? ART, ED 15, p. 52
- Avoid CMOS noise-sensitivity problems ART, ED 25, p. 80
- Better analog ICs are matching discrete modules in performance NEWS, ED 17, p. 28
- Beware those FET op-amp specs ART, ED 1, p. 104
- Bipolar ICs due for broad advance with improved LSI technologies NEWS, ED 1, p. 26
- Broad-foil lead increases p-i-n diode switch power NEWS, ED 5, p. 33
- CCD memories step up from 16 k to 64 k NEWS, ED 25, p. 25
- CCD serial-memory capacity climbs to 16-k bits of storage PF, ED 4, p. 100
- Data-communication ICs have 500-MHz bandwidth PF, ED 12, p. 108
- Data General builds its own MOS chip NEWS, ED 23, p. 20
- Electron-beam system cuts IC-mask production time NEWS, ED 19, p. 19
- FET-input hybrid op amps match modules for performance at low cost PF, ED 26, p. 77
- FPLAs: If you haven't heard of them yet, you will in time SR, ED 18, p. 56
- Finally, space-saving bipolar ICs for microwave signal processors NEWS, ED 14, p. 32
- FOCUS on Field-effect transistors SR, ED 21, p. 58
- FOCUS on IC analog switches and multiplexers SR, ED 18, p. 64
- FOCUS on Semiconductor memories SR, ED 7, p. 98
- Fully monolithic 12-bit a/d contains all active elements PF, ED 21, p. 126
- GaAs cell produces 10 W from sunlight NEWS, ED 15, p. 22
- GaAs varactor gets natural passivation NEWS, ED 18, p. 21
- Gate turn-off SCRs handle up to 8.5 A PF, ED 4, p. 118
- HD/CMOS II features small cells, low power NEWS, ED 2, p. 20
- Hughes reports beam-lead ICs fail reliability and cost tests NEWS, ED 14, p. 26
- 12 L densities shooting up as speed power declines NEWS, ED 1, p. 21
- Low-power diodes at low prices come in a top-grade package PF, ED 21, p. 108

- Low-power rectifiers get better packages NEWS, ED 20, p. 23
- MOSFET power soars to 60 W with currents up to 2 A PF, ED 21, p. 103
- Microwave transistor operates at 20 GHz NEWS, ED 18, p. 22
- Monolithic v/f converters deliver 0.05% linear signals PF, ED 22, p. 164
- New entries heat up injection-logic race NEWS, ED 16, p. 21
- New MOS cell offers nonvolatile memory NEWS, ED 21, p. 24
- PLL ICs taking on dedicated jobs as temp and voltage ills recede NEWS, ED 6, p. 38
- Power Darlington transistors challenge thyristors for high-power control PF, ED 25, p. 101
- Programmable voltage regulators handle high power in a mini, 4-pin package PF, ED 4, p. 104
- Quiet JFET op amps keep inputs matched within 2.5 mV PF, ED 11, p. 103
- Rf and microwave semis rising in power and declining in noise SR, ED 18, p. 34
- ROM capacity cut in voice synthesizer NEWS, ED 26, p. 16
- Semiconductor makers push new technologies to raise performance and drop costs NEWS, ED 1, p. 42
- Semi firms speed up drive to develop new logic circuits NEWS, ED 17, p. 24
- Silicon transistor hits 1 W at 8 GHz NEWS, ED 9, p. 21
- Slowly but surely, power semis are getting faster, heftier, cheaper SR, ED 18, p. 28
- Soft-recovery test cuts cost of diodes 30% NEWS, ED 26, p. 15
- Speed of CCD memory is boosted tenfold NEWS, ED 26, p. 16
- Standard CMOS ICs due for custom designs NEWS, ED 3, p. 21
- Standard PROM family starts with 2-k and 1-k units PF, ED 11, p. 104
- Two memories coming for ECL 10,000 logic NEWS, ED 1, p. 22
- UV erasable PROMs storing up to 8-k bits NEWS, ED 5, p. 20
- Yield, density, performance increasing through new trends in chip fabrication SR, ED 7, p. 58
- 4-k RAM race still wide open as designers try different paths NEWS, ED 6, p. 26
- 4-k static RAM bids for memory-chip lead NEWS, ED 4, p. 19
- 8-bit IC DAC settles fast and has adjustable threshold PF, ED 5, p. 75
- 8-k RAM, due out in 1976, to defy 'rule of four' trend NEWS, ED 22, p. 21
- 10-bit CMOS a/d converter chip interfaces with LSI microprocessors PF, ED 2, p. 81
- 16-k RAM and reprogrammable ROM races begin to heat up NEWS, ED 17, p. 36
- 16-k RAMs make debut in computer NEWS, ED 25, p. 26
- 1024-bit NMOS RAM offers bipolar speed at low power PF, ED 19, p. 105
- 9216-bit CCD memory a market trail blazer NEWS, ED 3, p. 22

Test & Measuring

- Active-probe system adds new dimensions to time-interval studies... PF, ED 12, p. 105
- Airline gets automatic PC tester... NEWS, ED 9, p. 32
- Analyzer brings new power to network-behavior measurement... PF, ED 23, p. 113
- Automatic testing of LSI devices favored, despite some problems... SR, ED 7, p. 54
- Autoranging counter handles 40 MHz, costs just \$230... PF, ED 7, p. 70
- Avoid I_{CEO} measurements... ART, ED 24, p. 134
- Be kind to your pulse generator... ART, ED 1, p. 84
- Broadband power amplifier delivers 700 mW at 1 GHz... PF, ED 21, p. 110
- Circuit converts single-trace scope to dual-trace display for logic signals... IFD, ED 8, p. 80
- Controller converts monitor to strip-chart 'recorder'... PF, ED 4, p. 111
- Convert your pocket calculator into a programmable counter... IFD, ED 6, p. 100
- Cryogenic flux meter detects atomic field... NEWS, ED 21, p. 37
- Custom tests offered for logic diagrams... NEWS, ED 7, p. 22
- Design for fault isolation... ART, ED 23, p. 86
- Determine transmitter noise figure... ART, ED 13, p. 86
- Dielectric field probe replaces metal... NEWS, ED 11, p. 24
- Digital counting logic... ART, ED 2, p. 62
- Direct synthesizer programs in 20 μ s, is inexpensive... PF, ED 13, p. 107
- Dual-trace battery-powered scope weighs 10 lb and operates to 10 MHz... PF, ED 6, p. 105
- Dynamic power-supply load tests dual supplies to 1.25 A at 45 V... IFD, ED 18, p. 106
- Extra-safe VOM provides self-test... PF, ED 6, p. 106
- FOCUS on Graphic recorders... SR, ED 3, p. 54
- FOCUS on Scopes and scope cameras... SR, ED 8, p. 48
- FOCUS on Sweep generators... SR, ED 12, p. 54
- Function generators offering more capability at less cost... SR, ED 24, p. 82
- Gas-pressure sensor offers ultra precision... NEWS, ED 17, p. 20
- Hand-held IR thermometer has digital and analog displays... PF, ED 14, p. 77
- IEEE standard found weak for instrument interfacing... SR, ED 19, p. 30
- Increase current-probe range up to 10 times for 15 Ω with wire-and-lug assembly... IFD, ED 15, p. 72
- Instruments with improved 'minds' will be taking over dedicated jobs... NEWS, ED 1, p. 34
- Ion microprobe bares inner cell structure... NEWS, ED 24, p. 24
- It looks like a logic analyzer, it's also a word generator... PF, ED 26, p. 80
- Keep Newton on your side... ART, ED 19, p. 80

- Laser setup analyzes metals in components... NEWS, ED 24, p. 24
- Linear bar graph constructed with sequentially lighted LEDs... IFD, ED 22, p. 132
- Logic analysis: The door opens to digital domain... SR, ED 24, p. 104
- Low-cost digital setup measures horsepower... NEWS, ED 9, p. 33
- Make simple voltage-level detectors with CMOS inverters... IFD, ED 13, p. 102
- Microprocessor DVMS, with new features, to hit the market shortly... NEWS, ED 16, p. 32
- Microvolt probe traces PC current paths to help locate those defective ICs... IFD, ED 25, p. 90
- Monitor circuit detects and shows voltage excursions outside set limits... IFD, ED 10, p. 150
- Op-amp scale expander allows high-resolution with ordinary voltmeter... IFD, ED 21, p. 94
- Oscillators calibrated with TV color signal... NEWS, ED 1, p. 21
- Passive low-pass filter recovers signals buried in high ripple... IFD, ED 9, p. 92
- Phase-meter specs can fool you... ART, ED 24, p. 112
- Roll-your-own electronics can cut costs of high-quality equipment... NEWS, ED 3, p. 31
- Select pin drivers cautiously... ART, ED 4, p. 82
- Simple power-frequency meter built with only a few passive components... IFD, ED 5, p. 68
- Simpler and cheaper testers are urged for logic... SR, ED 18, p. 52
- Small \$10 magnetometer reported a rival of bulky kilobuck units... NEWS, ED 8, p. 30
- Solve your measurement problems... ART, ED 15, p. 46
- Squaring circuit generates second harmonic for controlled-distortion test signal... IFD, ED 8, p. 78
- Systems DMM slashes price, yet holds performance... PF, ED 24, p. 153
- Take oddball pulses in stride... ART, ED 24, p. 138
- Test a/d converters digitally... ART, ED 25, p. 86
- Test and measuring equipment growing in complexity to keep pace with brainier computers... SR, ED 10, p. 62
- Test equipment proving its worth in ensuring transmission quality... SR, ED 13, p. 60
- Test hybrid PC boards... ART, ED 24, p. 120
- Test semiconductors... ART, ED 24, p. 128
- Test that SCR turn-off time... ART, ED 6, p. 76
- Test those LSI chips: Watch out for 'ifs' and 'buts'... SR, ED 24, p. 74
- Uncover data-acquisition errors... ART, ED 10, p. 138
- Voltage-to-frequency converter preserves polarity of input... IFD, ED 22, p. 120
- 3-digit DPM reads rms of complex waveforms... PF, ED 4, p. 106
- 3-3/4-digit panel meter is accurate to within 0.25%... PF, ED 7, p. 68
- 5-MHz spectrum analyzer averages signals digitally to cut noise... PF, ED 7, p. 66

System soothers... from Wiley-Interscience

PHASED-LOCKED LOOPS:

Application to Coherent Receiver Design
Alain Blanchard

Here are the answers to all probable questions an engineer may face when designing and upgrading the operation of phase-locked loops. The author presents complete, systematic coverage of PLL and their direct application in communication, radiolocalization, time and frequency control, and instrumentation. Includes many useful graphs, formulas, and diagrams.

0-471-07941-3 1976 \$22.50

FREQUENCY SYNTHESIZERS:

Theory and Design

V. Manassewitsch

Here is a thorough, analytic treatment of system and circuit design information with descriptions of current design tools, recommendations for system design procedures, and an examination of synthesizer design problems. Features coverage of phased noise, spurious outputs analysis, measuring techniques, rf and digital circuits, numerous definitions, and more.

0-471-56635-7 1976 \$27.50

MICROPROCESSORS & MICROCOMPUTERS

Branko Souček

With special focus on detailed descriptions of representative microprocessor families, MICROPROCESSORS & MICROCOMPUTERS describes the application, programming, and interfacing techniques common to all microprocessors. Topics examined range from digital codes, logical systems, organization, and high-level programming to Input/Output transfer modes, 4-, 8-, 12-, 16-bit microprocessors, and addressing modes. Many programming and interfacing examples are also included.

0-471-81391-5 1976 \$23.00

Rush me title(s) indicated.

Mail to:

Customer Information, A5604WI

WILEY-INTERSCIENCE

a division of John Wiley & Sons

605 Third Avenue

New York, N.Y. 10016



Payment enclosed, plus sales tax. Wiley pays postage/handling. We normally ship within 10 days. If shipment cannot be made within 90 days, payment will be refunded.

Bill me.

NAME _____

AFFILIATION _____

ADDRESS _____

CITY _____

STATE _____ ZIP _____

Prices subject to change without notice

092 A 5604-WI

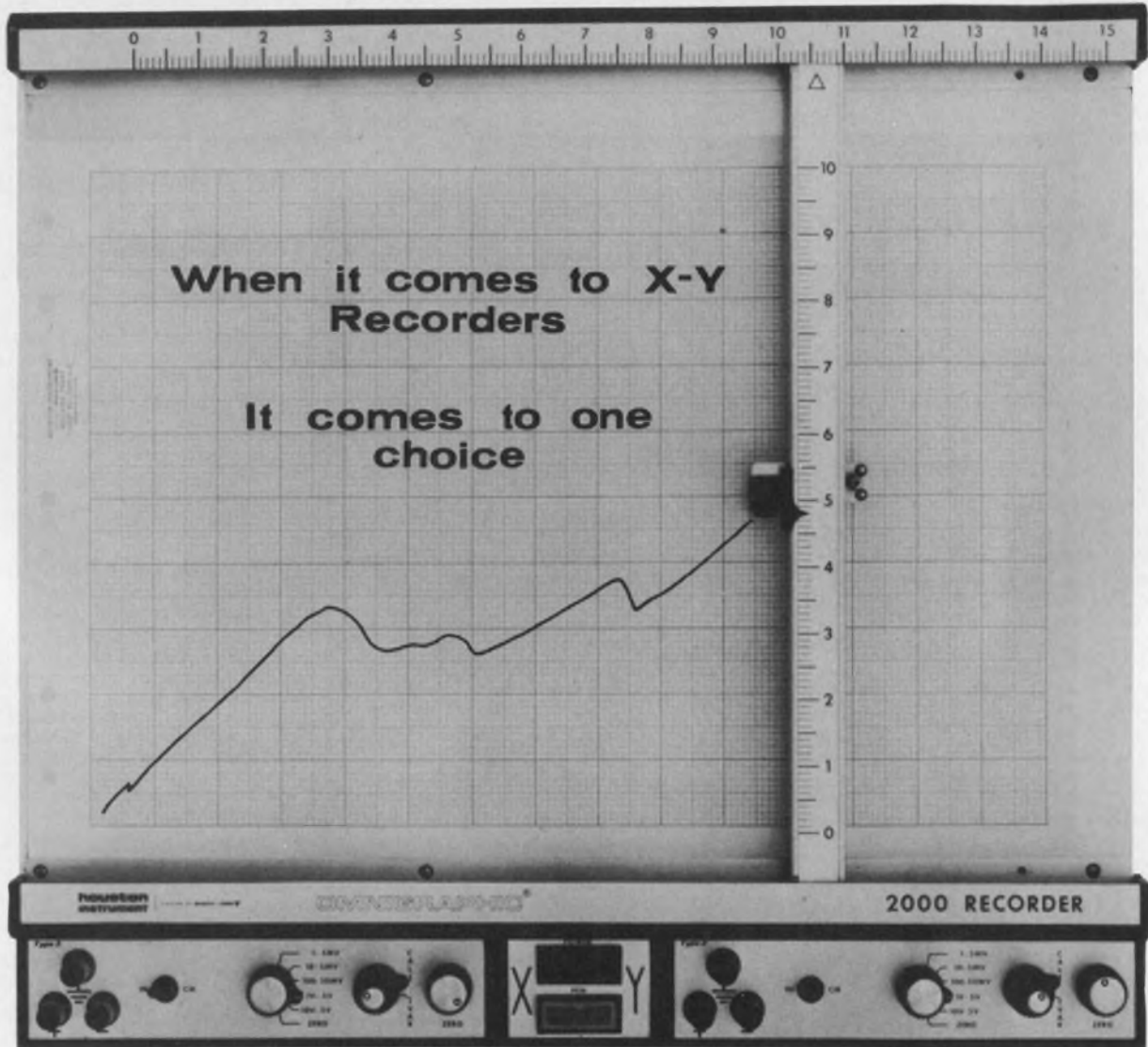

When it comes to X-Y
Recorders

It comes to one
choice

BEST VALUE - MOST FLEXIBILITY

This versatile 11" x 17" recorder is adaptable for laboratory or field, production or process, OEM (with or without modules) or dedicated applications in either bench or rack mounted. Inch/centimeter scaling by front panel switch.

Differential input is potentiometric with no less than 2 megohms slewing resistance. High common mode rejection. Acceleration, slewing speed, phasing and damping of X and Y axes drives are matched for

minimum error under dynamic conditions. Amplifiers are interchangeable as are input modules.

Overall accuracy $\pm 0.2\%$. Linearity $\pm 0.1\%$ full scale. Repeatability $\pm 0.1\%$ full scale. Resetability $\pm 0.05\%$ full scale. Overshoot is less than 1%. Basic sensitivity 1 mv/inch (0.5 mv/cm). Zero is fixed or can be remotely controlled. Local or remote control electric pen lift. Dozens of selections for input modules.

OEM discounts available.

Need more information? Call or write:

**houston
instrument**

DIVISION OF **BAUSCH & LOMB** 

ONE HOUSTON SQUARE (at 8500 Cameron Road) AUSTIN, TEXAS 78753

(512) 837-2820

TWX 910-874-2022

cable HOINCO

TELECOPIER

EUROPEAN OFFICE Rochesterlaan 6 8240 Gistel Belgium
Phone 059/277445 Telex Bausch 81399

"the recorder company"

® A registered trademark of Houston Instrument.

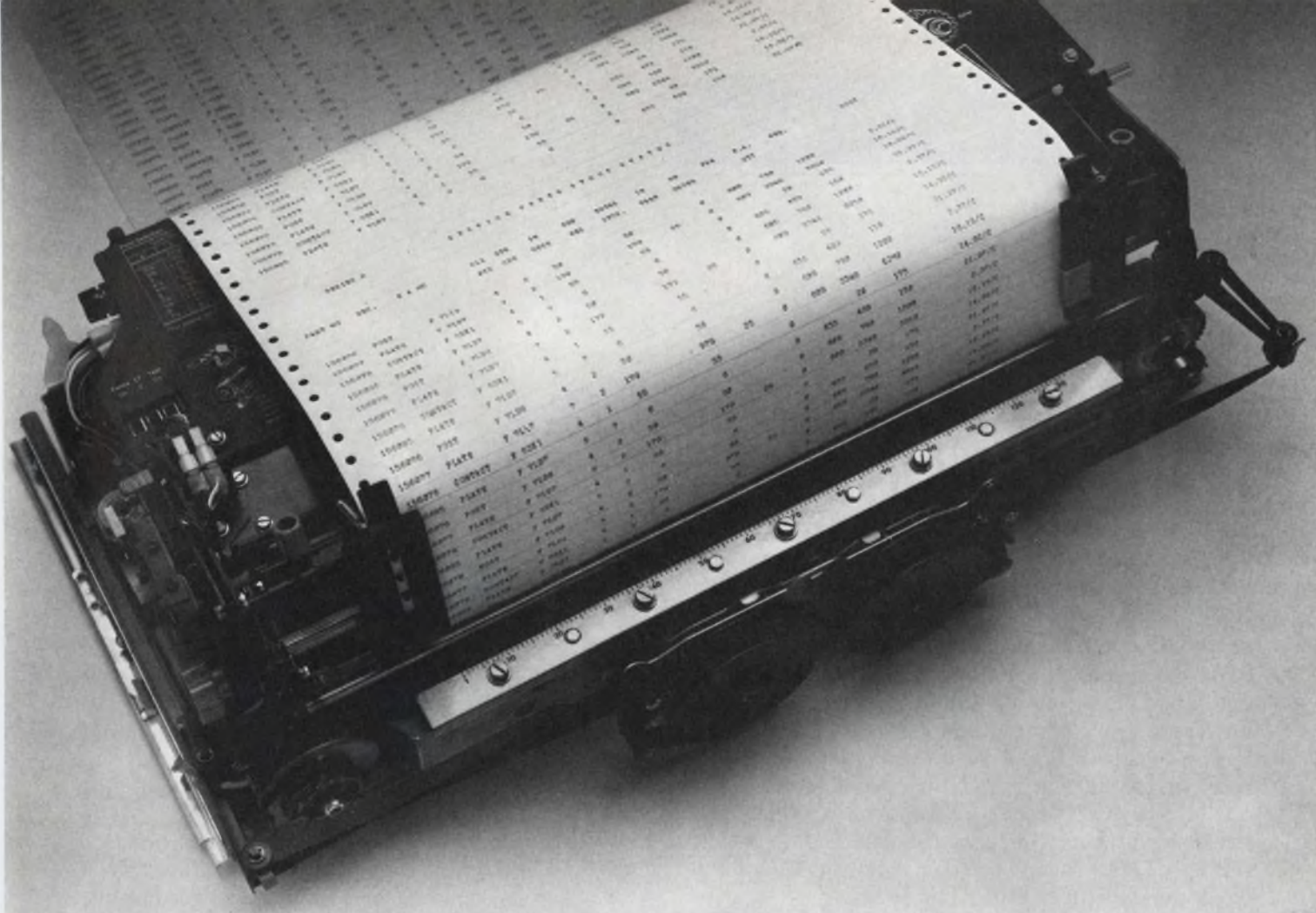

**The Teletype® model 40 OEM printer.
When you look at it from price and performance,
you'll find it difficult to look at anything else.**

The fact of the matter is simply this:
We don't think any other printer can even come close to the model 40.

And that's no idle boast. Not when you consider the facts.

Consider: Where else can you get a 132-column, heavy-duty impact printer that delivers over 300 lines per minute for less than \$2000, or an 80-column printer for under \$1400?

The big reason behind the model 40's price/performance advantage is our unique design.

Even though it operates at speeds of more than 300 lpm, wear and tear is less than you'd find in a conventional printer operating at considerably slower speed. Fewer moving parts and solid-state components add up to greater reliability and reduced maintenance.

Here's something else to consider: Where else can you get a printer that delivers the kind of flexibility and reliability the model 40 offers?

For complete information, please contact our Sales Headquarters at: 5555 Touhy Ave., Skokie, Ill. 60076. Or call Terminal Central at: (312) 982-2000.



**The Teletype model 40 OEM printer.
Nothing even comes close.**

Circuit detects incoming data to turn on teletypewriter

Teletypewriter printouts for minicomputers, data loggers and alarm monitors are frequently short and infrequent; thus, to save wear, the teletypewriter unit should be switched on only during data reception. If a computer-operated relay is available, of course it's simplest merely to use it; however, it is often not available.

The circuit in Fig. 1 senses when data are available, turns the teletypewriter on and keeps it on until data arrival ceases for 100 s. Since the teletypewriter motor requires 300 ms to reach full speed, the first three characters in each data block must be in nonprinting codes.

The circuit is coupled to the teletypewriter's data-input with an optical coupler connected in series with the teletypewriter's code coil. The teletypewriter is turned on and off by a relay contact in series with the power to the teletypewriter's Line/Off/Local switch, with the switch set to the Line position.

The code coil is continuously energized when data are not being received; with no data, LED₁, Q₁ and Q₂ are on. However, the first bit in a data

block de-energizes the code coil, and LED₁, Q₁ and Q₂ turn off. Since triac Q₄ turns off together with Q₂, relay K₁ drops out and closes the teletypewriter power circuit via a normally closed contact on K₂. The on-off action of the incoming data, and consequently of Q₃, keeps C₂ in a discharged state, which prevents the unijunction transistor, Q₅, from firing and turning on Q₄. Consequently, the teletypewriter remains switched on.

When data reception ends, Q₃ remains off; C₂ charges through R₃ and R₁ and after about 100 s fires Q₅ to energize K₁ and open the power circuit.

Capacitor C₁ provides an initial surge current to help fire Q₄. After Q₄ turns on, D₂ keeps the voltage on C₂ low to prevent Q₅ from oscillating. The 100-s delay in turning off the teletypewriter eliminates unnecessary starts and stops.

J. R. Saltvold, Reactor Analysis Branch, Atomic Energy of Canada Ltd., Pinawa, Manitoba, Canada, ROE 1LO. CIRCLE NO. 311

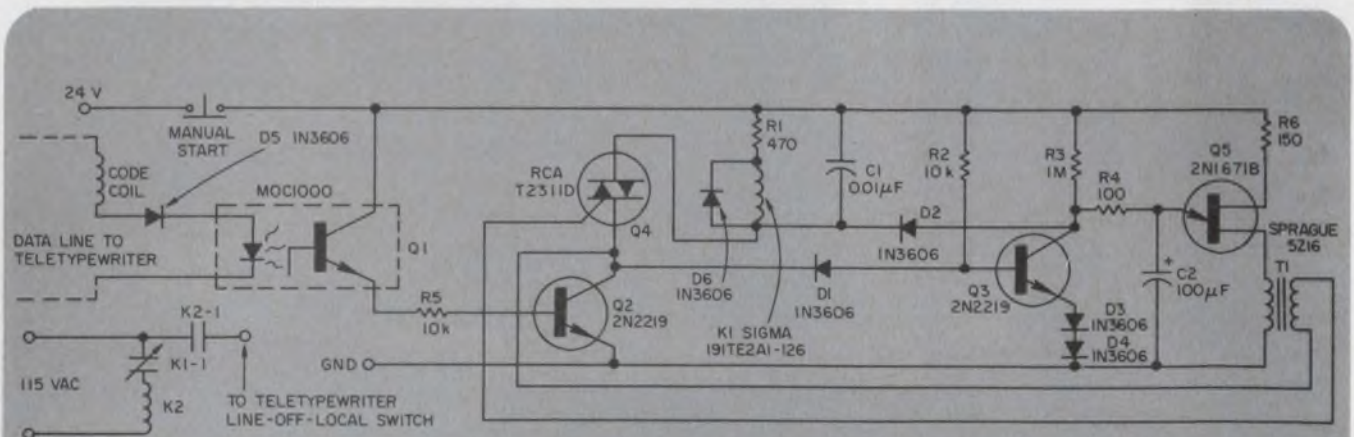

1. A teletypewriter is turned on only when data are being received. This prevents unnecessary wear on

the mechanism, especially where printouts are infrequent and short.

There's a reason why we're so open about our **Q Series** Open Frame Power Supplies. We want you to know everything about them. Like our one year warranty. And stock delivery. And our socketed semiconductors which makes field spares support a snap.

About our thermal design, the best around, making our heat sensitive parts run cooler and operate longer. And we're the *only* maker of Open Frame Power Supplies where *all* components operate well within mfrs. specs.

That's why Deltron "Open Frames" save you money three ways: When you buy them. By avoiding costly downtime. And by lasting longer.

We want you to compare Deltron "Opens" with others. In fact, we'll send you our Comparative Engineering Reports matching Deltron against other major mfrs. You'll find as others have that Deltron is unsurpassed for quality and performance.

For some more open talk about Deltron Q Series and a copy of our Comparative Engineering Reports, write or call collect to Deltron, Inc. Wissahickon Avenue, North Wales, Pa. 19454. Telephone: 215-699-9261, TWX 510-661-8061.

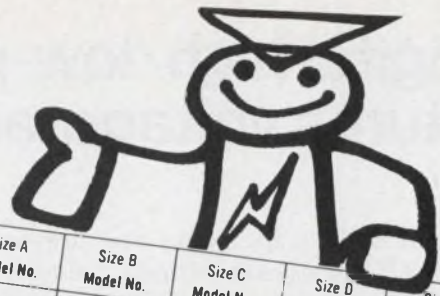

Size A Model No.	Size B Model No.	Size C Model No.	Size D Model No.	Size F Model No.
volts — amps	volts — amps	volts — amps	volts — amps	volts — amps
Q 5 — 3.0	Q 5 — 6.0	Q 5 — 9.0	Q 5 — 12.0	Q 5 — 18.0
Q 6 — 3.0	Q 6 — 6.0	Q 6 — 9.0	Q 6 — 12.0	Q 6 — 18.0
Q 12 — 1.7	Q 12 — 3.4	Q 12 — 5.7	Q 12 — 7.0	Q 12 — 10.8
Q 15 — 1.5	Q 15 — 3.0	Q 15 — 4.8	Q 15 — 6.3	Q 15 — 9.5
Q 18 — 1.3	Q 18 — 2.6	Q 18 — 4.0	Q 18 — 5.2	Q 18 — 7.8
Q 20 — 1.3	Q 20 — 2.6	Q 20 — 4.0	Q 20 — 5.2	Q 20 — 7.8
Q 24 — 1.2	Q 24 — 2.4	Q 24 — 3.3	Q 24 — 4.8	Q 24 — 7.2
Q 28 — 1.0	Q 28 — 2.0	Q 28 — 3.1	Q 28 — 4.2	Q 28 — 6.0
Dimensions: 4 7/8 x 4 x 1 1/8	Dimensions: 5 1/2 x 4 7/8 x 2 1/2	Dimensions: 7 x 4 7/8 x 2 3/4	Dimensions: 9 x 4 7/8 x 2 3/4	Dimensions: 14 x 4 7/8 x 2 3/4
Price: 1 — \$32.00 100 — \$26.00 250 — \$24.00	Price: 1 — \$54.00 100 — \$44.00 250 — \$41.00	Price: 1 — \$67.00 100 — \$54.00 250 — \$51.00	Price: 1 — \$87.00 100 — \$70.00 250 — \$66.00	Price: 1 — \$113.00 100 — \$ 91.00 250 — \$ 85.00

Some open talk about open frame Q SERIES power supplies

Forward and reverse voltage protection.
Barrier block interface.
Infinite resolution adjustments.
Full interchangeability.
115/230 vac, 47-440 hz.

Socketed IC regulation system.
Filters meet mfrs. ripple ratings.
Glass epoxy PC boards.
Loss of sense protection.
Designed for U.L. Recognized
Component Index.

Socketed power semiconductors.
Iridited aluminum chassis.
Computer grade electrolytics.
Special circuits to protect IC.

For some more open talk
about Deltron Q Series and a copy
of our Comparative Engineering Reports,
write or call collect.

Deltron inc.

A digital high/low-pass filter features voltage-adjustable cut-off points

You can build a high-pass and low-pass filter circuit for TTL signals without inductors or the need for complicated circuit networks. Inputs below a selected frequency appear at a low-pass output and those above at a separate high-pass output (Fig. 1). The cut-off frequencies are adjustable over a wide range and controlled by only a level. This allows for easy remote operation.

The basic frequency discriminator element is IC₁, an SN-54161 asynchronous counter. The input TTL signal feeds into the counter's clock input, which is enabled only when the clear is HIGH. If during this enable period the input frequency can generate 16 or more leading edges, the counter delivers a carry output that is inverted by G₁ and used to reset the R-S flip-flop, G₂ and G₃. The G₂/G₃ flip-flop is set by any pulse to G₃ from the Q₃/Q₄ voltage-controlled free-running multivibrator output. The G₄/G₅ flip-flop outputs control gates G₇ and G₈ to provide a smooth decision criterion and to separate the low and high-pass outputs.

Because of the asynchronous operation of the counter, a possible one-count ambiguity in 16 counts results in a frequency indeterminacy, or "knee," equal to about 6% of the set frequency. For 100 kHz, this would be ±3 kHz. The knee could be made smaller by use of a counter with more stages.

The multivibrator output has a fixed-period portion, and the period of the other portion is

voltage controlled by the current-source circuit of Q₁ and Q₂. The variable portion is wider and its width, PW, varies linearly with the current supplied from the voltage-controlled current-source. As V_{in} is raised, the current to the base of Q₁ increases, C₂ charges at a more rapid rate and time interval PW becomes narrower. The counter is enabled during the PW intervals; thus the pass frequencies are inversely proportional to PW.

The filter's cut-off, or trip, points and ambiguity range can be expressed by the relationship

$$\frac{1}{15 PW} \leq f_{trip} \leq \frac{1}{16 PW}$$

where

$$PW = K \frac{C_1}{I_{R2}}$$

Constant K has been experimentally determined to be approximately 3.6, and since

$$I_{R2} = \frac{V_{cc} - V_{in}}{R_2}$$

then

$$\frac{V_{cc} - V_{in}}{15(3.6)C_1R_2} \leq f_{trip} \leq \frac{V_{cc} - V_{in}}{16(3.6)C_1R_2}$$

For the circuit values shown in Fig. 1 the trip points are adjustable over 25 to 120 kHz.

Michael F. Black, Advanced Engineering Branch, M/S 295, Texas Instruments Inc., 13500 N. Central Expressway, Dallas, TX 75222.

CIRCLE NO. 312

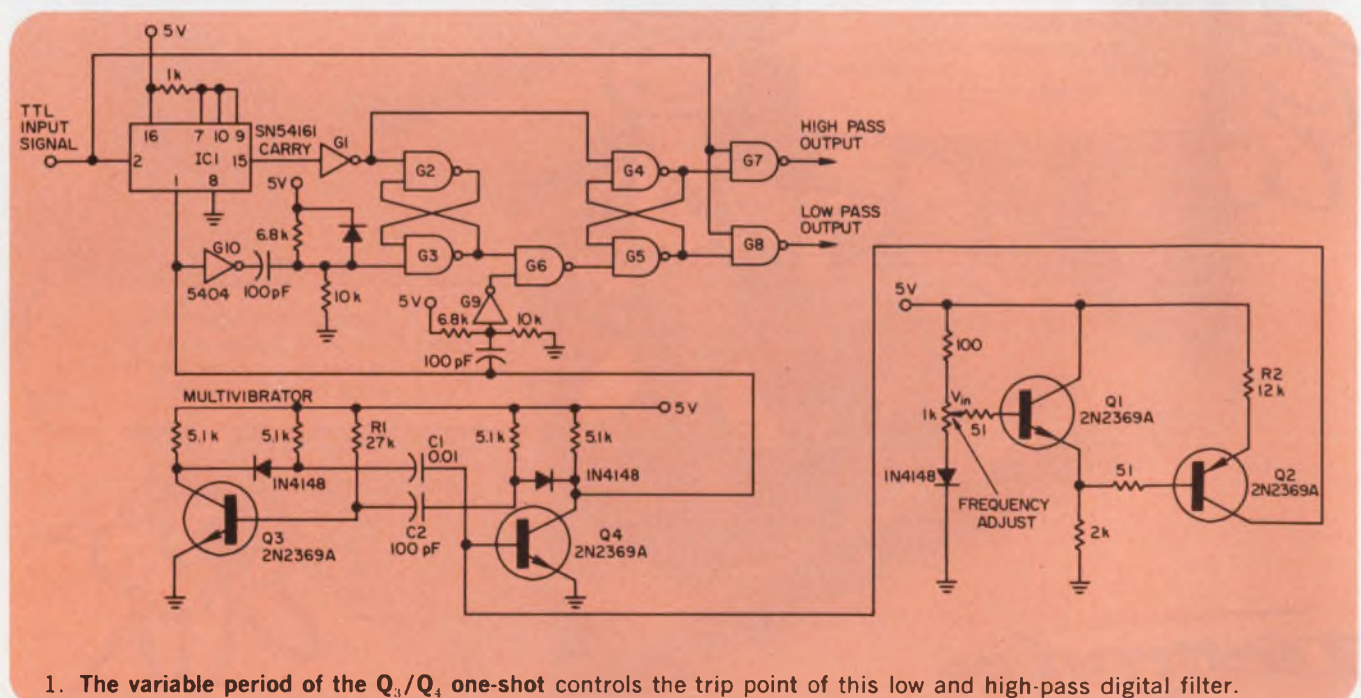

Memories are made of this.

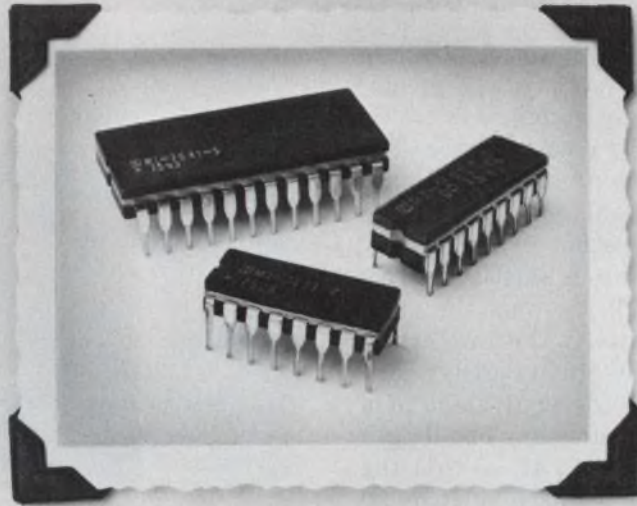

The Harris family of GENERIC PROMs

Once you know about the Harris family of GENERIC PROMs, stand-alone PROM designs are easy to forget. That's because the diverse requirements for density, modularity and performance within a system can be completely satisfied by our one GENERIC family.

As a result, there are many advantages of the Harris GENERIC PROMs to keep in mind. Like compatible DC electrical specifications and common programming requirements.

Fast programming speed (guaranteed 1 ms per bit max.). Equivalent I/O characteristics for easy upgrading. Fast access time, guaranteed to meet worst case N^2 sequencing over temperature and voltage. And improved testability.

Right now, our entire family of GENERIC PROMs is in volume production (see table). With 100 and up pricing at less than 1/2 cent per bit on the popular 1K, 2K and 4K configurations.

So remember, if you want PROMs with common programming requirements, low system costs, and the highest performance, get the Harris family of GENERIC PROMs.

It'll give you plenty of great memories.

Device #	No of Bits	Organi- zation	No of Pins	Max Access Time*		Price 100 up	
				Com	Mil	Com	Mil
HM-7602 (open coll)	256	32x8	16	40ns	50ns	\$2.95	\$5.95
HM-7603 (three state)	256	32x8	16	40ns	50ns	\$2.95	\$5.95
HM-7610 (open coll)	1024	256x4	16	60ns	75ns	\$4.95	\$9.95
HM-7611 (three state)	1024	256x4	16	60ns	75ns	\$4.95	\$9.95
HM-7620 (open coll)	2048	512x4	16	70ns	85ns	\$9.95	\$19.95
HM-7621 (three state)	2048	512x4	16	70ns	85ns	\$9.95	\$19.95
HM-7640 (open coll)	4096	512x8	24	70ns	85ns	\$19.95	\$39.95
HM-7641 (three state)	4096	512x8	24	70ns	85ns	\$19.95	\$39.95
HM-7642 (open coll)	4096	1024x4	18	70ns	85ns	\$19.95	\$39.95
HM-7643 (three state)	4096	1024x4	18	70ns	85ns	\$19.95	\$39.95
HM-7644 (active pullup)	4096	1024x4	16	70ns	85ns	\$19.95	\$39.95

* Access time guaranteed over full temperature and voltage range Industrial ($T_A = 0^\circ\text{C}$ to 70°C , $V_{CC} \pm 5\%$)

Military ($T_A = 55^\circ\text{C}$ to 125°C , $V_{CC} \pm 10\%$)



HARRIS
SEMICONDUCTOR
A DIVISION OF HARRIS CORPORATION

P.O. Box 883, Melbourne, Florida 32901 (305) 724-7412

WHERE TO BUY THEM: OEM SALES OFFICES: CALIFORNIA: Long Beach (213) 426-7687; Palo Alto (415) 964-6443 **FLORIDA:** Melbourne (305) 724-7430 **ILLINOIS:** Hinsdale (312) 325-4242 **MASSACHUSETTS:** Wellesley Hills (617) 237-5430 **MINNESOTA:** Minneapolis (612) 835-2505 **NEW YORK:** Endwell (607) 754-5464 **MEVILLE, LI.** (516) 249-4500 **OHIO:** Dayton (513) 226-0636 **PENNSYLVANIA:** Wayne (215) 687-6680 **TEXAS:** Richardson (214) 231-9031

SALES REPRESENTATIVES: ARIZONA: Scottsdale (602) 948-5590 **CALIFORNIA:** Los Angeles (213) 870-9191; Mountain View (415) 961-8121; San Diego (714) 565-9444 **COLORADO:** Denver (303) 773-0666 **CONNECTICUT:** Trumbull (203) 261-2183 **FLORIDA:** Boca Raton (305) 395-6108; Oviedo (305) 365-3283; Tampa (813) 933-3183 **ILLINOIS:** Elk Grove Village (312) 640-1850 **KANSAS:** Wichita (316) 943-6221 **MARYLAND:** Randallstown (301) 922-1248 **MASSACHUSETTS:** Burlington (617) 273-1313 **MICHIGAN:** Farmington (313) 476-2446 **MISSOURI:** Hazelwood (314) 731-5799; Kansas City (816) 761-6543 **NEW JERSEY:** Keasbey (516) 567-5900 **NEW MEXICO:** Albuquerque (505) 265-5655 **NEW YORK:** Albany (518) 489-7408 or 4777; Huntington Station (516) 567-5900 **NORTH CAROLINA:** Raleigh (919) 828-0575 **OHIO:** Cleveland (216) 831-8292; Dayton (513) 890-2150 **OREGON:** Beaverton (503) 643-1644 **PENNSYLVANIA:** Allison Park (412) 487-4300; King of Prussia (215) 265-0634 **TENNESSEE:** Shelbyville (615) 684-4544 **TEXAS:** Dallas (214) 691-4592; Houston (713) 661-3007 **VIRGINIA:** Falls Church (703) 534-1673; Lynchburg (804) 237-4740 **WASHINGTON:** Bellevue (206) 454-0300 **CANADA:** Montreal (514) 626-6723; Ottawa (613) 749-0740; Toronto (416) 676-1042

NATIONAL DISTRIBUTORS: Hamilton/Avnet; The Harvey Group, Inc.; Schreiber Electronics; R.V. Weatherford Company

Digital circuit detects frequency-modulated signals

A digital circuit can be used to demodulate frequency-modulated (FM) signals (Fig. 1). First, a sinusoidal FM input signal, $f_0 \pm \Delta f_m$ is converted to a square wave by a comparator. The output of the comparator is then divided into two digital signals. One signal goes directly to an Exclusive-OR circuit; the other is sampled by a clock and entered serially into a shift register.

The frequency of the clock, f_c , must be sufficiently high to preserve faithfully the zero crossings of the square wave. The shift register provides a fixed delay, which is the equivalent of a phase shift proportional to frequency. The length of the shift register must equal $f_c/4f_0$, so that the center frequency, f_0 , receives a phase shift of 90 degrees. If $f_c = 40f_0$, only 10 register stages are needed.

Frequencies higher than f_0 receive phase shifts greater than 90 degrees; frequencies lower, receive less.

The shift-register output is combined with the direct signal in the Exclusive-OR circuit to obtain an output whose average value is proportional to the input frequency. This signal is then low-pass filtered to remove the high-frequency carrier components. If the input frequency is FM, the filter's output reproduces the modulating signal, f_m .

Fig. 2 shows typical waveforms at the inputs and output of the Exclusive-OR circuit for frequencies $f = f_0$, $f > f_0$, and $f < f_0$.

David Ludington, Engineer, General Electric Company, Aircraft Equipment Div., Utica, NY 13503. CIRCLE NO. 313

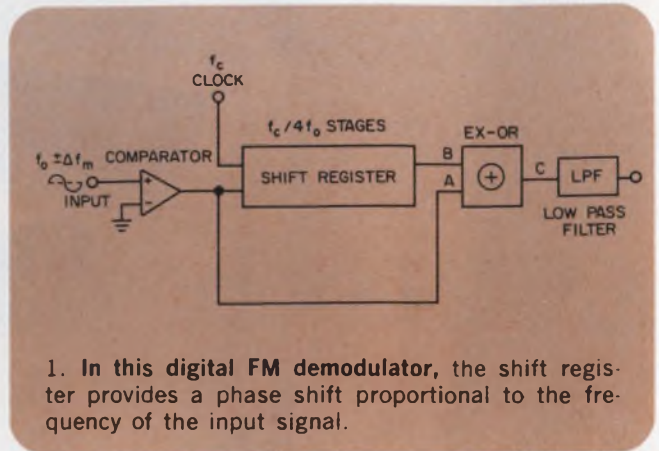

1. In this digital FM demodulator, the shift register provides a phase shift proportional to the frequency of the input signal.

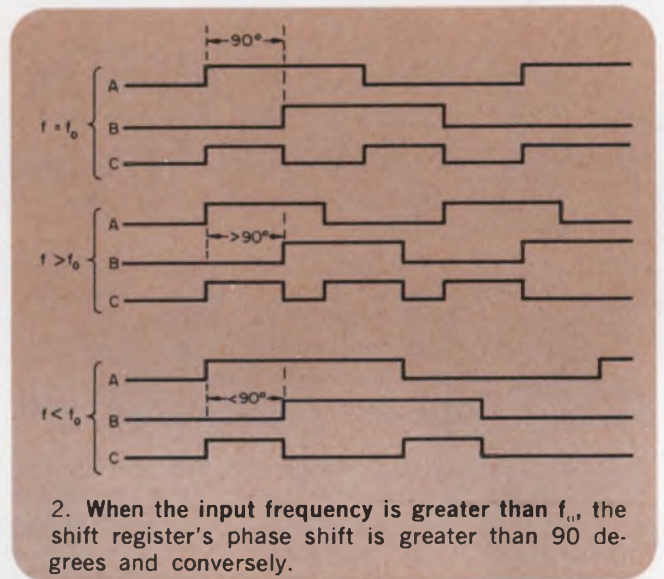

2. When the input frequency is greater than f_0 , the shift register's phase shift is greater than 90 degrees and conversely.

IFD Winner of December 6, 1975

Roy A. McCarthy, Production Engineer, GYYR Div., Odetics, Inc., 1845 S. Manchester Ave., Anaheim, CA 92802. His idea "Microvolt Probe Traces PC Current Paths to Help Locate Those Defective ICs" has been voted the Most Valuable of Issue Award.

Vote for the Best Idea in this issue by circling the number of your selection on the Reader Service Card at the back of this issue.

SEND US YOUR IDEAS FOR DESIGN. You may win a grand total of \$1050 (cash)! Here's how. Submit your IFD describing a new or important circuit or design technique, the clever use of a new component or test equipment, packaging tips, cost-saving ideas to our Ideas for Design editor. Ideas can only be considered for publication if they are submitted exclusively to ELECTRONIC DESIGN. You will receive \$20 for each published idea, \$30 more if it is voted best of issue by our readers. The best-of-issue winners become eligible for the Idea of the Year award of \$1000.

ELECTRONIC DESIGN cannot assume responsibility for circuits shown nor represent freedom from patent infringement.

Greater RFI/EMI shielding in new, narrow-width contact strips from Instrument Specialties

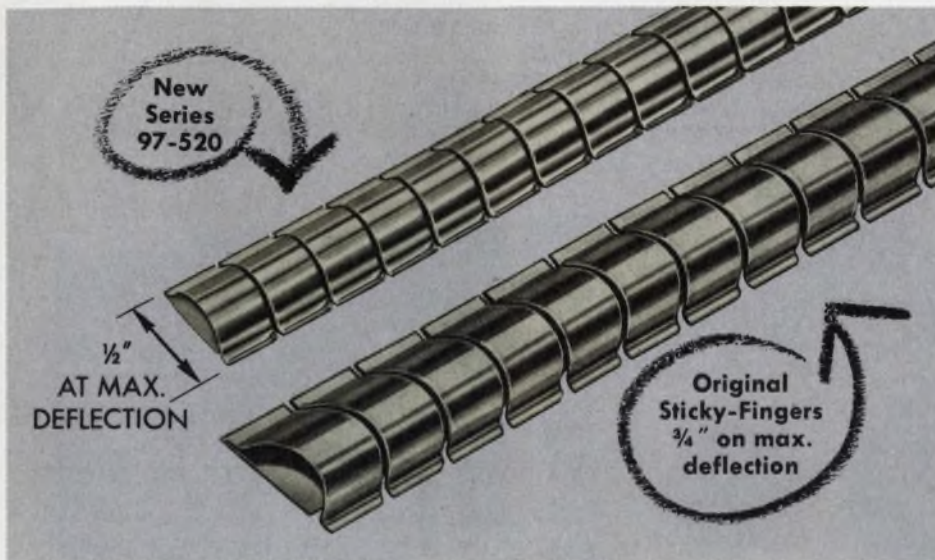

Latest addition to *sticky fingers*® line!

Instrument Specialties now offers Sticky-Fingers self-adhesive, beryllium copper contact strips in three variations to solve your most critical RFI/EMI problems.

Comparable to the shielding effectiveness of the original Sticky-Fingers, our newest series 97-520* offers shielding effectiveness of 92 dB at 10 GHz plane wave or greater than 92 dB at 1 MHz magnetic, and has a dynamic range of 0.10". Yet, it measures a scant $\frac{3}{8}$ " wide, and $\frac{1}{2}$ " at maximum deflection.

Supplied in standard 16" lengths, series 97-520 is ideal for metal cabinets and electronic enclosures where variations exist in the space to be shielded, and where high shielding effectiveness must be maintained in narrow spaces, even with frequent opening and closing of the cabinet.

Select the exact series that fits your application best. Write today for a complete catalog, list of finishes available, and our latest Independent Shielding Evaluation Report. Address: Dept. ED-68.

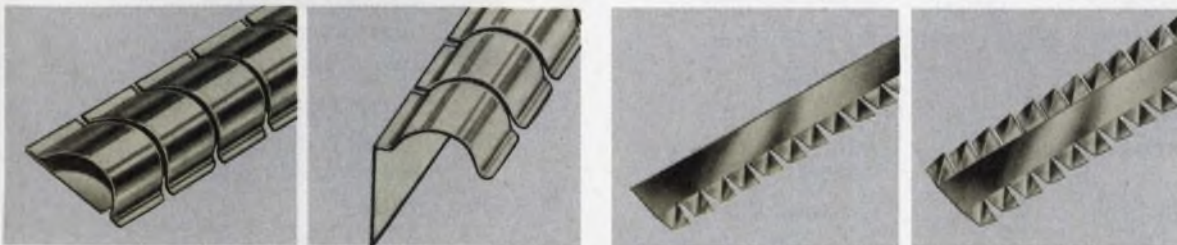

Series 97-500*—the original $\frac{3}{4}$ " wide Sticky Fingers. For greatest possible shielding and where space permits. Also available: Series 97-505—90° configuration of Series 97-500; same shielding effectiveness.

For those all-purpose applications where economy and space are both factors, specify the $\frac{3}{8}$ " wide single-twist series 97-555, or $\frac{1}{2}$ " wide double-twist series 97-560 Sticky-Fingers.

Specialists in beryllium copper springs since 1938

*Patented

CIRCLE NUMBER 52

ELECTRONIC DESIGN 8, April 12, 1976

INSTRUMENT SPECIALTIES CO., INC.
Little Falls, New Jersey
Phone 201-256-3500



MHz

4

RADIO NAVIGATION
 MARITIME MOBILE
 10 AERONAUTICAL MOBILE
 24 FIXED LAND MOBILE
 25 C.B. - BUSINESS - GOVERNMENT
 70 PUBLIC SAFETY
 75 INDUSTRIAL
 88 F.M.
 100 COMMON CARRIER
 170 TV - CATV
 200 AMATEUR
 215 FLIGHT LINE TELEMETERING
 400 METEOROLOGICAL
 450 LAND TRANSPORTATION
 500 STANDARD BROADCASTING
 600 TV LINKS
 800 STUDIO - TRANSMITTER LINKS
 960 UHF TV



ONE CLEAN SWEEP

For under \$1200

FROM 1 MHz TO 960 MHz IN ONE SWEEPER

WB-713 SPECIFICATIONS

- Frequency Range - Band I: 1 to 500 MHz
- Frequency Range - Band II: 450 to 960 MHz
- Sweep Width - Bands I and II: 0.1 to 500 MHz
- Output: +10 dBm
- Flatness: ± 0.25 dB
- Distortion - Band I: -35 dB
- Distortion - Band II: -30 dB
- Residual FM: Less than 10 kHz
- Sweep Rate: 0.01 to 100 Hz variable
- Linearity: 1%
- Markers: Provisions for up to 7 plug-in harmonic or single frequency markers.
- Marker Tilt Control
- Marker Clip Control
- Marker Width Control from 20 kHz to 300 kHz
- Weight: 15 lbs.
- Size: 9" x 4 3/16" x 12 5/8"

Texscan has sweep generators covering from Audio to 2350 MHz. Please contact your local Texscan representative for a demonstration.

Texscan

Texscan Corporation 2446 North Shadeland Ave. Indianapolis, Indiana 46219 (317) 357-8781

CIRCLE NUMBER 53

When battery life is critical, there's nothing even close to a TRW LVA zener

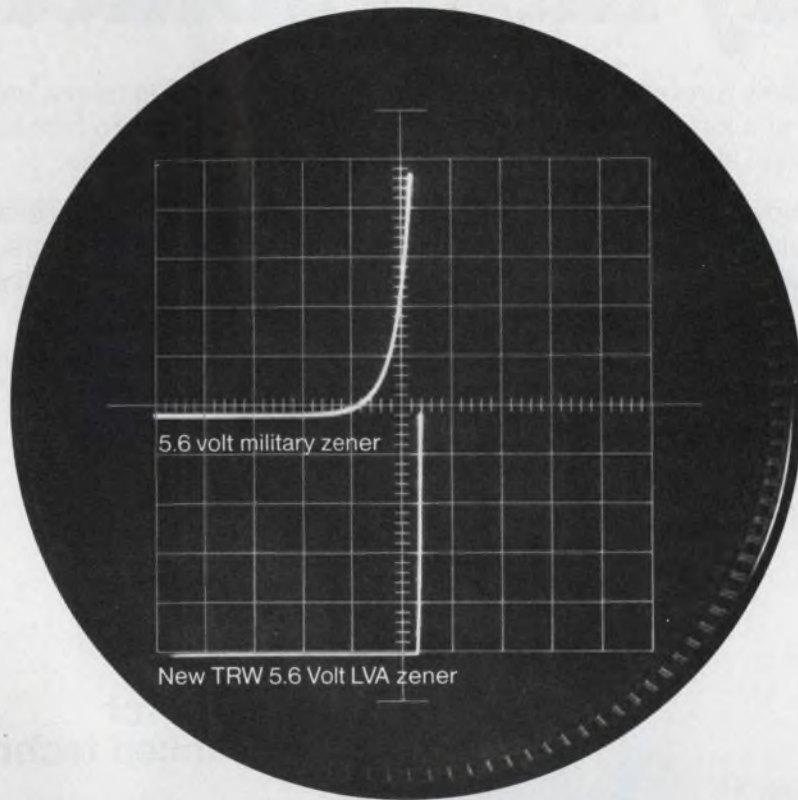

**The sharpest knee below 10 volts
for up to 10 times the battery life.**

In medical equipment, testing devices, watches, pocket pagers—wherever battery life is critical—no other zener can approach a TRW LVA.

TRW's Low Voltage Avalanche zeners are also ideal for instrumentation and logic circuitry where as highly stable zeners they provide extremely constant reference voltage yet draw as little as 50 microamps. True, they cost more. But where battery life is more important than a dollar or so, or when you have to load in transistors and resistors to minimize battery drain, it pays to use TRW LVA's. For your convenience, they're available in several package configurations and chips.

For immediate action and applications assistance, call John Power (213) 679-4561.

TRW Power Semiconductors,

An Electronic Components Division of TRW, Inc.,
14520 Aviation Boulevard, Lawndale, California 90260

- Please send me data sheets on TRW's LVA zeners.
- I would like a quote on _____ of _____ volt devices.
(Quantity) (Voltage)
- Please have representative call _____
(Phone Number)

Name _____
Company Name _____
Address _____
City _____ State _____ Zip _____

TRW[®] POWER SEMICONDUCTORS

Arrow-M Amber Relays eliminate costly hand soldering.

Only Arrow-M manufactures gas-filled plastic sealed relays, proven to have top reliability over a long life. They're applicable from very low level to high capacity contact loads and maintain highly stable contact resistance, even after long use.

Now here's the really big news: by using Arrow-M Amber Relays on your PC board and using automatic wave soldering, you can substantially reduce your labor costs. And since Arrow-M Amber Relays cost less than sealed metal can relays, the savings are even greater.

Arrow-M Amber Relays. When you want maximum reliability *and* maximum savings. And only Arrow-M makes them.

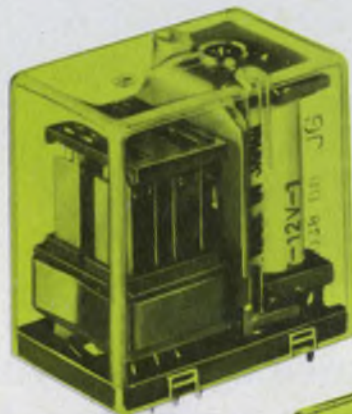

Type KE

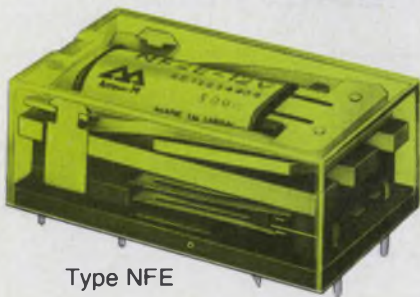

Type NFE



Type HCE

**Relays for
advanced technology.**

For more information on exact specifications of our Amber Relays, write or call your nearest Arrow-M office.

Arrow-M Corporation
250 Sheffield St.
Mountainside, N.J. 07092
(201) 232-4260

Western Office:
22010 South Wilmington Ave.
Suites 300 & 301
Carson, California 90745
(213) 775-3512



Arrow-M
Member of Matsushita Group

New Products

Impedance converters buffer signals without loading

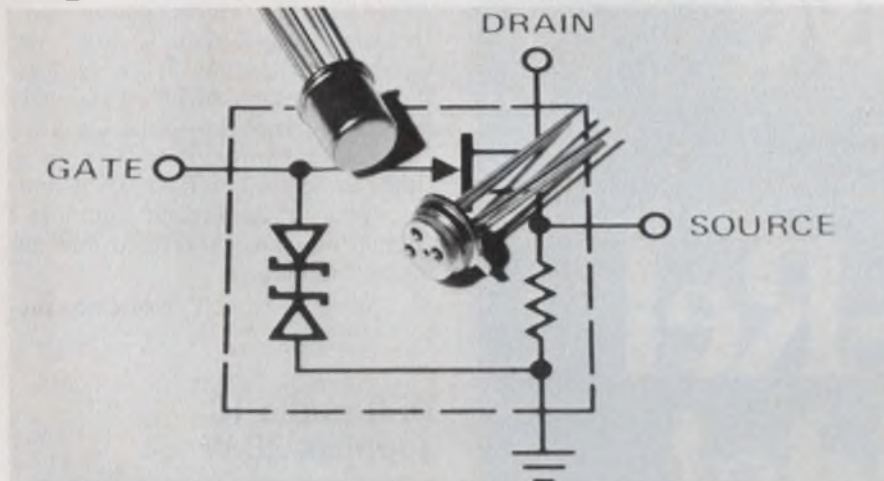

Siliconix, 2201 Laurelwood Rd., Santa Clara, CA 95054. (408) 246-8006. P&A: See text.

Got a signal you want to amplify and afraid of loading it down? Fret no more—Siliconix has just introduced a single-chip JFET impedance-converting preamplifier with internal biasing. The preamp can buffer high-impedance signals with its minimum input resistance of 200 M Ω (typically 5 G Ω).

There are two versions of the impedance converter available—the T100 and T300. Both are four-terminal units housed in TO-72 packages, or they are available as chips. The T100 unit is a micropower preamp that draws a minimum drain current of 10 μ A and a maximum of 50 μ A. The T300 requires from 70 to 350 μ A.

Both converters have an operating supply-voltage range of 1.3 to 30 V and can handle input signals (with respect to ground) that span -2 to $+2$ V. Total harmonic distortion for either preamp is typically 1%. Input capacitance for the units is typically 3 pF and is guaranteed to be 4 pF, max. Output capacitances are typically 4.4 pF and are guaranteed to be 6 pF, max.

Aside from the supply current differences, the T100 has an output resistance that can be between 1.5 k Ω , minimum and 3.5 k Ω , maxi-

mum. It also has a maximum broadband output noise of 4 μ V. The T100 has a voltage gain of 0.4, minimum, and 0.6 typical.

The T300 offers an output resistance that ranges from 500 Ω , minimum, to 1300 Ω , maximum, and has a broadband output-noise voltage of 2 μ V, maximum. It has a voltage gain of 0.3, minimum, and 0.45, typical.

The maximum forward gate current for the impedance converters is 1 mA and the total unit dissipation at 25 C is 180 mW. For operation at higher temperatures the preamps must be derated by 3 mW/ $^{\circ}$ C. The units have an operating range of -25 to $+85$ C.

Comparable circuits can be built with discrete components but a larger package would then be required. The total cost would be more than double that of the T100 or T300. With discrete-component versions such as the Model 320 from Eltec (Daytona Beach, FL), though, you can get different input bias levels, output resistances and transistor types.

Prices for the Siliconix preamps start at 60¢ for the T300 and 67¢ for the T100, both in 100-up quantities and TO-72 packages. Delivery is from stock.

Siliconix
Eltec

CIRCLE NO. 301

CIRCLE NO. 302

Schmitt trigger combines with flip-flop

RCA, Solid State Div., Route 202, Somerville, NJ 08876. (201) 722-3200. 95¢ to \$1.10 (100).

A programmable Schmitt trigger with an internal flip-flop to assure positive switching, the CA3098 provides a precision level-detector hysteresis switch with a dual input for performing over/under or high/low control functions. It can be operated with either a single power supply—16-V max—or dual supply— ± 8 -V max. It can directly control currents up to 150 mA, and operates with microwatt standby power dissipation when the current to be controlled is less than 30 mA.

CIRCLE NO. 303

3-state transceiver extends busses

Motorola, P.O. Box 20924, Phoenix, AZ 85036. (602) 244-3251. \$2.95 to \$3.95 (100).

A Schottky-TTL quad transceiver extends the data-bus capacity of systems using the M6800 processor or other comparable MOS microprocessors. Each M6880/MC-8T26 contains four 48-mA inverting drivers and four 20-mA inverting receivers. Both drivers and receivers are short-circuit protected and feature three-state capability.

CIRCLE NO. 304

IC simplifies data comm systems

Etude et Fabrication de Circuits Integres Speciaux, 17, Avenue des Martyrs, 28 Grenoble, France.

A universal biphase receiver/transmitter (UBRT) offers baseband modulation and demodulation, half and full-duplex modes and rates up to 75,000 bits per sec. The UBRT is compatible with Intel's 8080 interface module, and it can be programmed to have 8 to 64 synchronization bits in transmission and 4 to 32 bits in reception. The MOS chip comes in a 28-pin package and uses 5 and -12 -V supplies. In 1000 quantities, the the UBRT costs 110 French Francs.

CIRCLE NO. 305

We have your High-Rel Hybrids!

At RAYTHEON/QUINCY. And if you want them produced in the most advanced designs and packages available, just tell us your specific needs. We'll custom design *your* high-rel hybrids just as we do for all our customers.

100% of our business is custom high-rel designs. 98% of that is military and medical electronics. So that means more than just high-rel. It means high performance and high technology, too. And both beam-lead and chip-and-wire packaging.

Of course we have your high-rel hybrids. At Raytheon/Quincy it's a custom. Ask K. Singh. At Raytheon Company, Industrial Components Operation, 465 Centre Street, Quincy, Mass. 02169. (617) 479-5300.

RAYTHEON

CIRCLE NUMBER 56

INTEGRATED CIRCUITS

S-TTL octal buffers dissipate 80 mW

National Semiconductor, 2900 Semiconductor Dr., Santa Clara, CA 95051. (408) 732-5000. \$1.35 (100); stock.

Four three-state octal buffer ICs, employing low-power Schottky-TTL, have a typical power consumption of less than 80 mW and typical propagation delay of less than 14 ns. Each device in the new DM81LS95 through 98 series provides eight two-input buffers in a single package. The DM81LS95 and 97 present True data at their outputs, while the DM81LS96 and 98 invert the data.

CIRCLE NO. 306

Hi-fi audio IC supplies 20 W

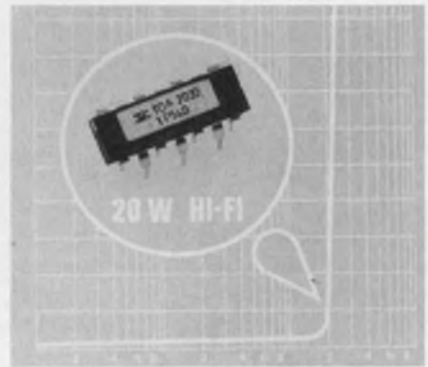

SGS-ATES Semiconductor Corp., 435 Newtonville Ave., Newtonville, MA 02160. (617) 969-1610. \$5.20 (100); stock.

A monolithic audio IC that provides hi-fi performance, the TDA 2020 supplies 20 W of rms output power into a 4- Ω load with less than 1% THD over the frequency range of 40 Hz to 15 kHz. The output power with an 8- Ω load is 16.5 W under the same conditions. With 10 W of output power into an 8- Ω load the distortion is typically between 0.1 to 0.2% over the 40-Hz-to-15-kHz frequency range. The device incorporates a proprietary overload-protection scheme that automatically limits the peak dissipated power so as to keep the working point of the output transistors within their safe operating area. The device also incorporates a conventional thermal shutdown system.

CIRCLE NO. 307

16-pin 4-k RAM has 200-ns access

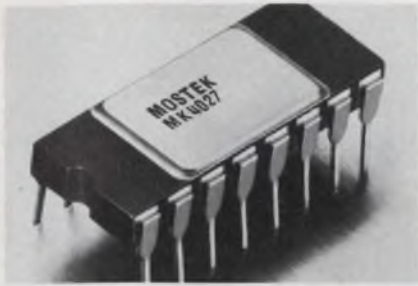

Mostek Corp., 1215 W. Crosby Rd., Carrollton, TX 75006. \$24.20 (100); stock.

The company's latest 4-k bit RAM entry features 200-ns access time and 10% tolerance on all supplies. Packaged in a 16-pin DIP, the new MK 4027 features Schottky-TTL compatibility, and allows memory-system performance to match that of 160 ns, 22-pin 4-k's; the MK 4027 eliminates the 40-ns delay of a 12-V clock driver. Other features include low-capacitance inputs and output, on-chip address and data registers, two methods of chip selection, simplified refresh operation ($\overline{\text{RAS}}$ only) and gated-CAS to compensate for system-timing skews in the column-address timing. Also the MK 4027 offers page-mode operation with page access of 135 ns. Active power for the MK 4027 is under 470 mW with standby power under 27 mW.

CIRCLE NO. 308

Quad analog gate turns on fast

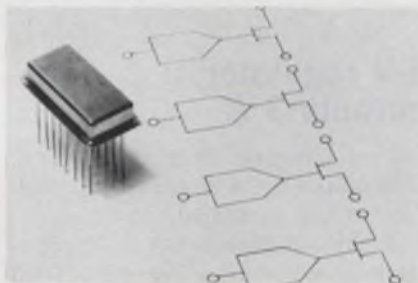

Teledyne Crystalonics, 147 Sherman St., Cambridge, MA 02140. (617) 491-1670.

The CAG-49 high-speed four-channel analog gate has a turn-on time of 20 ns and ON resistance of typically 35 Ω . The CAG-49 costs about half the price of four switches purchased independently. In quantities of 100 to 999, the quad analog gate costs \$62. Delivery is from stock.

CIRCLE NO. 309

This is an echo chamber?



Yes, and much more! It is the first N-channel Bucket Brigade Device designed with the audio engineer in mind. The **SAD-1024 Serial Analog Delay** will provide reverberation, echo, tremolo, vibrato and chorus effects in electronic organs and musical instruments. It will equalize speaker systems in an auditorium, or can be used in speech compression or voice scrambling systems. The SAD-1024, which contains two independent sections of 512 analog storage elements will accomplish all of these with a signal-to-noise ratio in excess of 75 dB. The two sections may be used independently or they may be connected in sequence to provide 1024 clock periods of delay. The delay provided by the device can be continuously varied by the clock rate from less than one millisecond to more than one second.

Other performance characteristics include: Signal bandwidth from 0 to 200 KHz, less than 1% total harmonic distortion, 0 dB insertion loss, and less than 5 mW power requirements from a single 15V power supply.

You get all of these features for less than 1¢ per storage element in OEM quantities.

We also offer a complete circuit card to help you evaluate this exciting new device. Other devices for applications such as time base correction in the video bandwidth are also available.

There are over 70 salesmen and 16 distributors to serve you worldwide.

RETICON®

910 Benicia Avenue
Sunnyvale, California 94086
(408) 738-4266 • TWX: 910-339-9343

CIRCLE NUMBER 57

MORE POWER MORE BANDWIDTH

Our Model 503L is an ultra-wideband RF power amplifier whose wide range of frequency coverage and power output provides the user with the ultimate in flexibility and versatility in a laboratory instrument. Easily mated with any signal generator, this completely solid state unit amplifies AM, FM, SSB, TV, pulse and other complex modulations with minimum distortion.

Constant forward power is continuously available regardless of the output load impedance match, making the 503L ideal for driving highly reactive loads.

Unconditional stability and instantaneous failsafe provisions in the unit provide absolute protection from damage due to transients and overloads.

This low cost instrument, covers the frequency range of 1.6 to 540 MHz with a linear power output of 3 watts . . . and there's no tuning. Priced at \$995.*

Applications include:

- Laboratory instrumentation
- Communication systems
- Laser modulation
- RF/EMI testing
- Spectroscopy

*USA and Canada



For further information or a demonstration contact

ENI, 3000 Winton Road South,
Rochester, New York, 14623.

Call 716-473-6900.

Or TELEX 97-8283 ENI ROC.

ENI

The World's Leader
in Solid State
Power Amplifiers

SEE
Electronic Design's
GOLD BOOK
FOR COMPLETE
PURCHASING
INFORMATION

CIRCLE NUMBER 58

INTEGRATED CIRCUITS

Chroma demodulator simplifies color TVs

RCA, Solid State Div., Route 202,
Somerville, NJ 08876. (201) 722-
3200. \$2.95 (100).

A linear IC for color-TV receivers—called the CA3137E and designed to function compatibly with the company's CA3126Q chroma processor—contains chrominance demodulators with three color-difference outputs, a dynamic "flesh-correction" circuit, a hue control, and a saturation control. Only a few external components are required to complete the circuit, and no tuning adjustments are necessary.

CIRCLE NO. 310

13-bit a/d converter costs only \$25

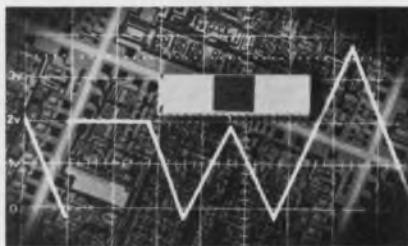

Analog Devices, Route 1 Industrial
Park, P.O. Box 280, Norwood, MA
02062. (617) 329-4700.

The AD7550 a/d converter combines 13-bit accuracy and 1-ppm/°C offset and gain tempcos with a price tag of \$25 in hundreds. The AD7550 contains an amplifier, comparator, clock, and digital logic on its 118 × 125-mil chip, and it requires only an external resistor and capacitor, for integration, and a reference supply, for ratiometric operation. The chip draws a maximum of 2 mA and converts at the typical rate of 40 conversions per second with a 1-MHz clock. The clock input (up to 1 MHz) can be driven externally or self-generated through an external capacitor. Also, the three-state output of the AD7550 allows it to be directly interfaced with the 8-bit bus line of μ Ps through the use of the ADC's "high byte enable" (5 MSBs), "low byte enable" (8 LSBs) and "status enable" lines.

CIRCLE NO. 320

12-bit DACs have long-term stability

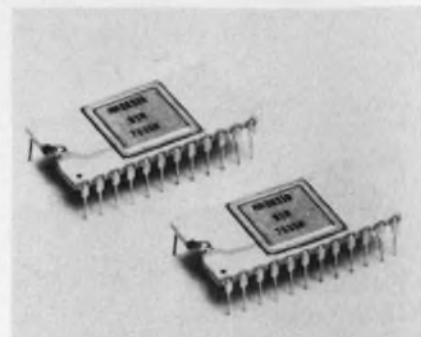

Analogic, Audubon Rd., Wakefield,
MA 01880. (617) 246-0300. \$39 to
\$42 (100); stock to 30 days.

Two 12-bit d/a converters—the internally referenced MN563 and the externally referenced MN562 series—are guaranteed not to have an error exceeding a fraction of an LSB over a six-month period. They have maximum relative accuracy ranges from $\pm 0.006\%$ to $\pm 0.012\%$ FSR. Gain and differential linearity tempcos are less than 3 ppm/°C for the MN562 series, and less than 10 ppm/°C for the MN563 series. Monotonicity is guaranteed over the operating temperature range of 0 to 70 C, -25 to 85 C, or -55 to 125 C, depending on the model. Settling time to 1/2 an LSB is 1.2 μ s with the MN563 series, and 1.5 μ s with the MN562 series. Both series have a current output of 0 to -2 mA, or ± 1 mA, and programmable output voltage ranges of ± 2.5 through ± 10 V.

CIRCLE NO. 321

5-V regulator outputs 3 A

Silicon General, 7382 Bolsa Ave.,
Westminster, CA 92683. (714) 892-
5531. \$9.35 to \$52.50; stock.

A three-terminal 3-A, 5-V regulator, supplied in a hermetic TO-3 package, provides current limiting, power limiting and thermal shutdown protection. No external components are required. The 5-V output level is preset internally. Minimum input voltage is 7.5 V and typical output impedance is 0.01 Ω . Power dissipation is 30 W. Worst-case regulation is ± 100 mV for combined effects of input voltage, load, temperature and power dissipation.

CIRCLE NO. 322

NEW SIMPSON

SERIES 2850 DIGITAL PANEL METER



NOW... at the right price...
a single DPM for popular
domestic and IEC/DIN cutouts



STANDARD CUTOUT
1.682" x 3.622"
(42.72 mm x 92 mm)



IEC/DIN CUTOUT
1.77" x 3.622"
(45 mm x 92 mm)

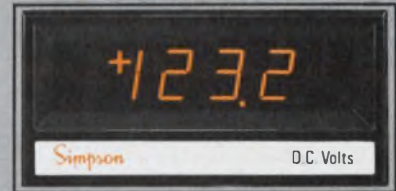

OTHER DOMESTIC CUTOUT
1.682" x 3.92"
(42.72 mm x 99.57 mm)

- 3½ digit readout
- Automatic zero and polarity
- 0.1% of reading accuracy
- BCD output is standard
- Input/output edge connector included
- Highly reliable LSI circuitry
- Choice of 120/240 VAC, 50-400 Hz or 5 VDC operation
- OEM quantity prices available upon request.

ORDER FROM YOUR ELECTRONICS DISTRIBUTOR

Model 2850 120/240 VAC input; 0.55" planar gas discharge display complete with panel mounting clips, edge connector and manual. **\$138**

Model 2851 5 VDC input, 0.55" planar gas discharge display complete with panel mounting clips, edge connector and manual. **\$138**

Model 2852 120/240 VAC input, 0.43" LED display complete with panel mounting clips, edge connector and manual. **\$138**

Model 2853 5 VDC input, 0.43" LED display complete with panel mounting clips, edge connector and manual. **\$138**

STOCK DC CURRENT RANGES: 20 & 200 μ A; 2, 20 & 200 mA
STOCK DC VOLTAGE RANGES: 200 mV; 2, 20 & 200 V
OTHER RANGES ON SPECIAL ORDER



SIMPSON ELECTRIC COMPANY

853 Dundee Avenue, Elgin, Illinois 60120 • (312) 697-2260

CABLE: SIMELCO • Telex: 72-2416

IN CANADA: Bach-Simpson, Ltd., London, Ontario

IN ENGLAND: Bach-Simpson (U.K.) Ltd., Wadebridge, Cornwall

IN INDIA: Ruttonsha-Simpson Private, Ltd., Vikhroli, Bombay

KATY INDUSTRIES



INDUSTRIAL
EQUIPMENT
GROUP

DISCRETE SEMICONDUCTORS

Microwave transistors have pnp and npn types



California Eastern Labs, One Edwards Court, Burlingame, CA 94010. (415) 342-7744. From \$3 (100-up); stock.

The "Micro-X" package line of microwave transistors includes npn and pnp silicon devices that have f_T 's of up to 9 GHz. All transistors use high-reliability gold, titanium, platinum-silicide metallization techniques. Typical of the devices is the NE02135, with an f_T of 5 GHz and a noise figure of 216 dB at 2 GHz. The transistor operates at currents of 50 mA for low-distortion applications. Other available units include the NE-57835 with an f_T of 7 GHz and the NE88935, a pnp transistor with an f_T of 3.5 GHz.

CIRCLE NO. 323

Solid-state noise source comes in TO-18 package

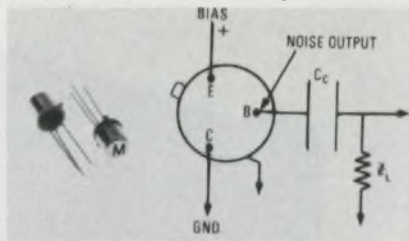

Micronetics, Inc., 36 Oak St., Norwood, NJ 07648. (201) 767-1320. \$20 to \$40 (1 to 99); stock.

A solid-state noise-source in a TO-18 transistor package has a current-limiting resistor built-in for optimum output performance. The source is hermetically sealed to satisfy the environmental requirements of MIL-S-19500 over the operating range of -55 to $+125$ C. For a limited time only, units will be available from stock at prices ranging from \$20 to \$40, in quantities from 1 to 99. Introductory evaluation units will also be available at 1/2 price (C.O.D. only) with a minimum three-unit order in any mix. This offer expires September 30, 1976.

CIRCLE NO. 324

LED lamps come with midget flange bases



Dialight, 203 Harrison Pl., Brooklyn, NY 11237. (212) 497-7600. From \$0.79 (1000-up); 2 to 3 wks.

The 521 series of LED lamps is interchangeable with filament lamps that have midget flange bases. These T-1-3/4 lamps are available in red, green and yellow with a variety of lens styles. The lamps have luminous intensity of 2 mcd at 20 mA, typical (the green and yellow are at 10 mA). Maximum ratings for the red lamp include: forward dc current of 50 mA, reverse voltage of 3 V, power dissipation of 100 mW and a storage and operating temperature range of -40 to 100 C.

CIRCLE NO. 325

POWER MINI'S FOR LOGIC OR OP AMPS

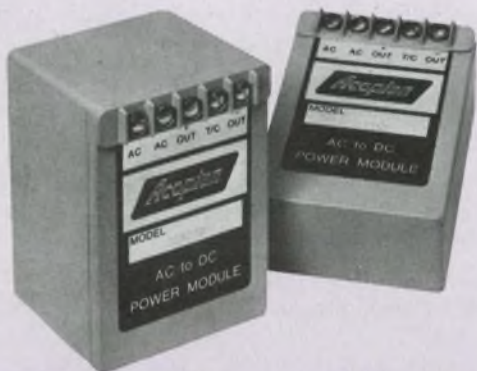

Terminal strip input/output connections on these miniature power modules eliminate the need for sockets or soldering. They mount in an area only 3.5" x 2.5". Ratings: 5 volt models to 2.5 amps, ± 15 volts to .5 amps. Other models from 1 to 75 volts, all with 3-day shipment guaranteed.

Acopian Corp., Easton, Pa. 18042 Tel: (215) 258-5441

CIRCLE NUMBER 60

SUPPLIES THAT FIT IN THIN SPACES



Measuring only 1.68" high, Acopian narrow profile power supplies fit where many others cannot. Available in a wide range of ratings from 1 to 150 volts, to 4 amps. Regulation to $\pm 0.005\%$. Tracking dual output models for op amps also available. Guaranteed 3-day shipment.

Acopian Corp., Easton, Pa. 18042 Tel: (215) 258-5441

CIRCLE NUMBER 61

Limiter diodes protect over 0.1-to-20-GHz range

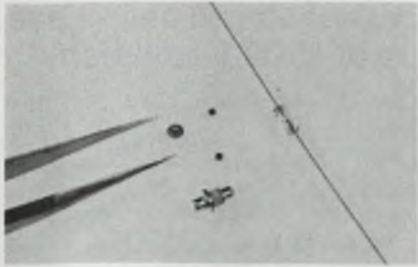

Alpha Industries, 20 Sylvan Rd., Woburn, MA 01801. (617) 935-5150. From \$6 to \$8 (1 to 9); stock to 30 days.

The CLA series of limiter diodes can handle incident pulses of up to 4 kW peak power. Their leakage power is as low as 10 mW. The Models CLA3131, CLA3132, and CLA3133 series are p-i-n silicon chips that provide passive protection from 100 MHz to beyond 20 GHz. The diodes have a peak input power range, max, at 1 μ s of 50 to 66 dBm, a peak output leakage power range of 22 to 44 dBm, an insertion loss of 0.1 dB and a recovery time of 10 to 50 ns.

CIRCLE NO. 326

Numeric LED displays have up to 9 segments

Bowmar Canada Ltd., 4900 E. Indian School Rd., Phoenix, AZ 85018. (602) 959-4760. See text.

Watch and instrument designers may now choose different character styles for their 4-digit LED displays. The R7H-12W-4 displays use hybrid construction to eliminate the thick magnifying lens required by earlier devices. The displays are available with a range of segment configurations from the 3.5-digit 12-hour display to the complex 8 and 9-segment, 4-digit units required for day-of-the-week presentations. All displays are available with optional continuous bar or evenly spaced dot segments. Custom-tailored digit fonts, insignia and logos are also possible. Each display is encapsulated for mechanical and environmental protection and is internally connected for common-cathode, multiplexed operation. Mounting can be either with conductive epoxy or reflow solder. R7H-12W-4 1000-piece prices range from \$4.75 to \$5.00.

CIRCLE NO. 327

Stackable LEDs come in red, green and yellow

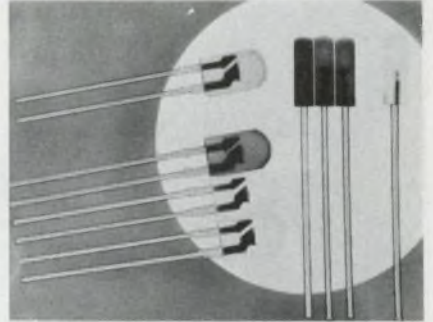

AEG-Telefunken, 570 Sylvan Ave., Englewood Cliffs, NJ 07632. (201) 568-8570. From \$0.27 (1000-up); 4 to 6 wks.

The V 146 P, V 147 P and V 148 P long-life red, green and yellow LEDs are encapsulated in a flat plastic package. The package permits stacking so that compact visual displays can be made. All three devices have an 80° viewing angle between half luminous intensity points. The luminous intensity of the red, green and yellow units at 20 mA is 1.6, 2 and 3 mcd, respectively.

CIRCLE NO. 328

SINGLE, DUAL PLUG-IN POWER



A plug-in power module can be installed in seconds. Simply plug it into a standard octal-type socket. Single output models from 1 to 200 volts. Duals combining two matched or dissimilar outputs in one case available in over 10,000 combinations. Warranty: 5 years. Shipment: 3 days.

Acopian

Corp., Easton, Pa. 18042 Tel: (215) 258-5441

CIRCLE NUMBER 62

ELECTRONIC DESIGN 8, April 12, 1976

GUARANTEED 3 DAY SHIPMENT

ACOPIAN

**POWER
SUPPLY
CATALOG
1976-1977**

Every power module listed in the Acopian 48-page catalog is shipped within 3 days of order. Guaranteed! Miniaturized supplies, narrow profile and plug-in modules, premium performance models, and a wide choice of other types are described in detail. Ask for your copy.

Acopian

Corp., Easton, Pa. 18042 Tel: (215) 258-5441

CIRCLE NUMBER 63

137

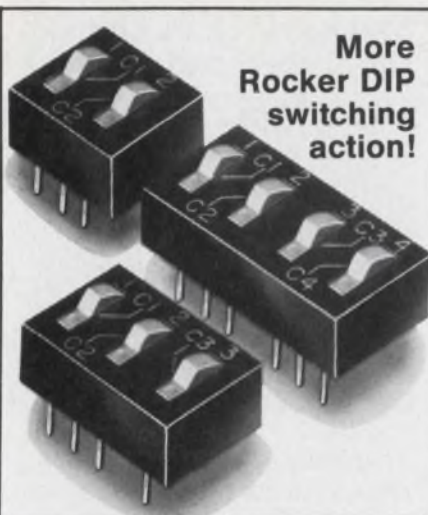

More
Rocker DIP
switching
action!

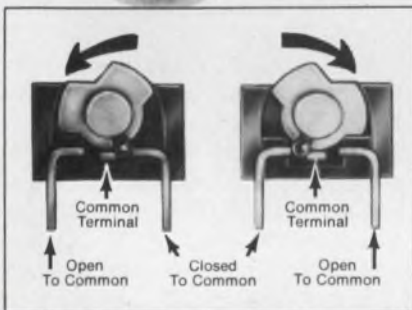

Grayhill DIP-C™ Switch

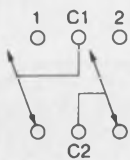

Single Pole/DOUBLE Throw circuitry under each rocker

- 2,3,4 rocker versions in the standard DIP package
- Simpler, more positive actuation than bridging SPST positions
- Satisfies logic '0' and logic '1' input requirements with single rocker

For cost-effective double throw (Form C) on-board switching, Grayhill's DIP-C Rocker DIP Switch offers the important advantages of IC compatibility, compact high-density design and ease of mounting by direct wave soldering or insertion into standard DIP sockets.

Like all Grayhill DIP switches, the DIP-C provides positive positioning through the exclusive spring-loaded sliding ball contact system, immunity to shock and vibration, molded-in terminals and 50,000 operation life as standard.

Detailed specifications and pricing are contained in bulletin #249. Contact Grayhill, 561 Hillgrove, La Grange, Illinois 60525 or phone (312) 354-1040 for your free copy.



CIRCLE NUMBER 64

DISCRETE SEMICONDUCTORS

Tunnel diodes available for most applications

Custom Components, P.O. Box 334, Lebanon, NJ 08833. (201) 236-2128. From \$9; stock to 2 wks.

Tunnel diodes, supplied in accordance with MIL-5-19500 requirements, are suitable for use in low-noise amplifiers to 25 GHz, high sensitivity detectors, with a TSS to -60 dBm, and switching circuits to 30 ps. Diode types are available with virtually any parameter combinations needed by the circuit designer.

CIRCLE NO. 329

Varactor tuning diode designed for Ka band

Microwave Associates, South Ave., Burlington, MA 01803. (617) 272-3000. From \$34; stock.

The MA-46600 series of GaAs tuning varactors can be used for both broad and narrowband tuning through Ka-band. The varactors have Q_s greater than 4000. Standard capacitance matching is $\pm 10\%$ but closer matching is available on request. All diode types are available in a wide selection of ceramic packages as well as in chip form. The series is available in three minimum breakdown voltage ranges: 30, 45 and 60 V.

CIRCLE NO. 330

Power transistors handle currents of up to 100 A

Solitron, 1177 Blue Heron Blvd., Riviera Beach, FL 33404. (305) 848-4311. From \$25 (100-up); 3 wks.

High-current industrial power transistors in the 2N5250 family handle currents of up to 100 A. Typical specs of the 100 A, TO-3 cased unit (Model SDT-96301-2-3) include 60 to 140 V, V_{CE0} ; an 80 to 160 V, V_{CBO} ; a 120-A max collector current; and an h_{FE} of 10 min at 70 A and 5 V. A 70-A TO-3 unit, the SDT-96304-5-6, has a V_{CE0} of 200 to 300 V, V_{CBO} of 225 to 325 V and an h_{FE} of 8 to 40 at 40 A and 10 V. All transistors are also available in TO-63 and TO-68 cases.

CIRCLE NO. 331

LED-photocell pairs have up to 1500-V isolation

Clairex Electronics, 560 S. Third Ave., Mount Vernon, NY 10550. (714) 664-6602. 1-to-99 prices: \$4.40 (8500 HV), \$3.55 (8600); stock.

Two LED-photoconductive cell opto-isolators, the CLM-8500 HV and CLM-8600, have decay times of 40 ms. The CLM-8500 is designed for line voltage operation, and its photocell output is rated for 400-V peak ac. The isolator has 1500-V peak isolation capability, a maximum output resistance of 5 k Ω when I_f is 16 mA, and a dark resistance of 10 M Ω . The CLM-8600 has a 500-V-ac peak output rating and a 2-k Ω output resistance at an I_f of the 16 mA. Input-to-output isolation is 2500-V peak.

CIRCLE NO. 332

Microwave transistors operate at 4 GHz

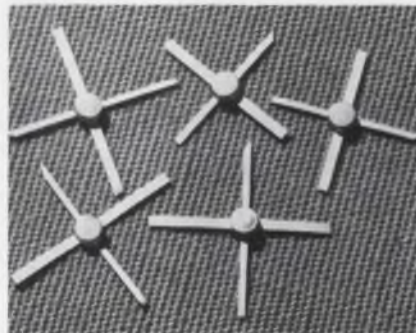

Hewlett-Packard, 1501 Page Mill Rd., Palo Alto, CA 94304. (415) 493-1501. 1-to-24 prices: \$36 (E), \$50 (L); stock.

Repeatability of transistor parameters is guaranteed for the Models 35868E and 35868L microwave transistors. These transistors are npn bipolar devices optimized for low noise and high gain at 4 GHz. Minimum-guaranteed tuned gain for both units is 8 dB at 4 GHz. In addition to the tuned-gain guarantee, the Model 35868L also has a guaranteed low noise spec of 4.5 dB at 4 GHz and 7-dB minimum associated gain. Both devices meet environmental requirements of MIL-S-19500 and the test requirements of MIL-STD-750/883.

CIRCLE NO. 333

Opening new frontiers with electro optics

Solid state laser breakthrough: CW output at room temperature!

You get at least 5 mW of continuous lasing in a solid state package. RCA's new AlGaAs CW injection lasers have a rise time of less than 1 ns—allowing modulation rates beyond 100 MHz. This plus small source size (13x2 μ m typical) and 820 nm wavelength make the C30130 and C30127 well suited to optical communications, facsimile, fiber-optic transmission, document reading, flying spot scanning. RCA also offers complete solid state systems (C30125 and C30131), which include a regulated DC power supply and a thermal stabilization network.

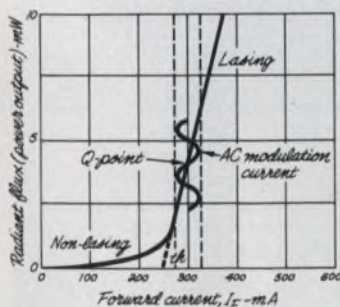

Circle 291

New PMT looks for oil at temperatures as high as 150°C.

To help geophysicists in their search for oil and minerals, RCA has produced new, long-life photomultipliers designed for repeated cycling at temperatures up to 150°C (302°F). They're being operated at depths as far down as 20,000 feet. These tubes can take the heat because of a special alkali (NaKSb) photocathode. The 1" dia. C31016G for gross counting systems meets MIL-STD-810B. Larger sizes 1 1/8", 1 1/2" and 2" for differential counting systems.

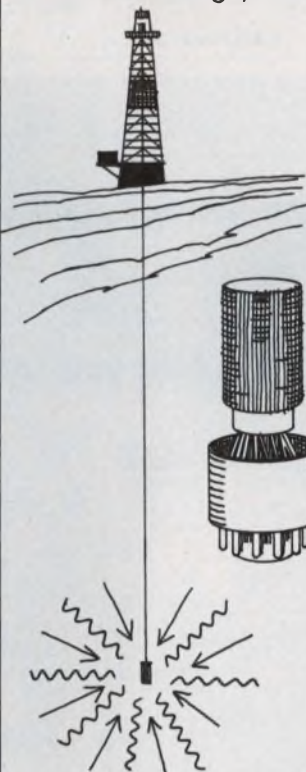

Circle 292

RCA lowers the bloom in S-T camera tubes. New Si target the key.

RCA has developed a new target that limits charge leakage between diodes. The result: bloom is dramatically reduced to provide more picture information in the presence of bright highlights. You can get low-bloom plug-in replacement versions of the popular 1" 4532 S-T vidicon series and 4804 silicon intensifier target (SIT) camera tubes.

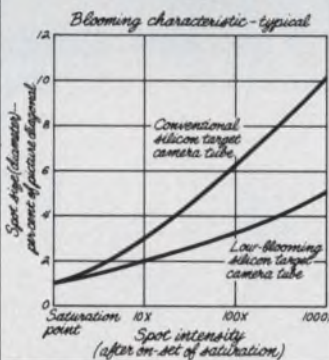
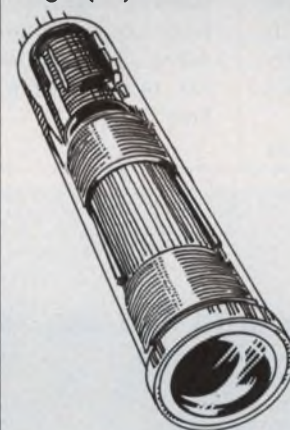

Circle 293

Low-cost IR emitting diodes from RCA: 940 & 1060 nm types.

When you think IR for fire and smoke detection, auto ignition, sorting, counting or reading—think RCA. Our mass-produced, off-the-shelf diodes have high power outputs (see table) and can replace many types you may be using. Other GaAs emitters have outputs from 1.1 to 3 mW at 940 nm, 20 to 50 mA drive. Packages to suit your needs. And our 1060 nm InGaAs emitter has typical rise time of less than 10 ns with a minimum continuous output of 100 μ W, making it an excellent simulator for Nd: YAG systems.

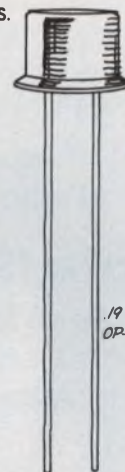

1.9" dia.
OP-17 package

Power output		
Types (940 nm)	CW with 100 mA drive	Pulse with 1 A drive
SG1009 SG1009/F	3.5 mW Typ.	2.6 mW Typ.
SG1009A SG1009A/F	7 mW Typ.	50 mW Typ.

Circle 294

If electro optics can solve your problem, remember: EO and RCA are practically synonymous. No one offers a broader product spectrum. Or more success in meeting special needs. Call on us for design help or product information. RCA Electro Optics, Lancaster, PA 17604. Phone 717-397-7661.

RCA

Flat cable switch can handle up to 50 lines

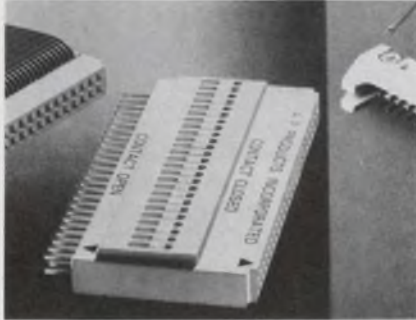

AP Products Inc., Box 110, 72 Corwin Dr., Painseville, OH 44077. (216) 354-2101. From \$12; stock to 4 wk.

The Intraswitch provides instant open or closed switching of individual lines in flat ribbon cable systems. The multiline switch mates with standard dual-row connectors and sockets with contacts on 0.1-in. centers. Recessed individual slide switches are easily actuated with any pointed device such as a pencil or probe tip.

CIRCLE NO. 334

Decapping tool opens up TO metal packages

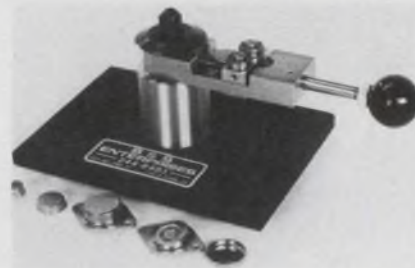

B&G Enterprises, Box NMKER, 1250 Norman Ave., Santa Clara, CA 95050. (408) 244-8483. \$250, \$45 (replacement cutting wheel); stock.

Semiconductor metal-can packages can be opened without damage to the internal chips with the Can Opener. The Can Opener can remove any size cover from TO-3 to TO-46 cases. To remove a can, the semiconductor is placed between the driver body and cutting wheel of the opener. Both the semiconductor and driver body are then rotated around the cutting wheel while pressure is applied with a turn screw. In a matter of seconds the can is removed with a clean, burr-free cut.

CIRCLE NO. 335

Hot tweezers and knives strip wire insulation

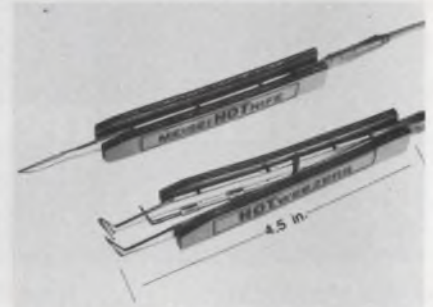

Meisei Corp., 2226 Stoner Ave., Los Angeles, CA 90064. (213) 478-2123. From \$85 (with supply).

The Hotweezers thermal wire stripper and Hotknife thermal knife have special alloy heads that resist oxidation and wear. There are three Hotweezer models: The 4A has holes from 24 to 36 AWG and can strip conductors as fine as 42 AWG, the 4B has holes from 18 to 28 AWG and the 4C has flat blades to strip larger conductors and cables. The Hotknife can depot, de-flash and handle other applications. The M-10 power supply can be adjusted so that the tip temperatures are variable from 200 to 1500 F.

CIRCLE NO. 336

Problem:

Finding a local source that stocks the cabinets, racks and accessories you want now.

Solution:

One of Bud's 327 stocking distributors is near you. Call us, get his name and get what you want now.



Bud has more than 1,000,000 cabinets, racks, enclosures and accessories in stock. Right now our distributors have over two million dollars worth of additional Bud products on hand. **YOUR PROBLEM IS SOLVED!**

Call toll free:

(800) 321-1764; in Ohio, (800) 362-2265.



BUD RADIO, INC.
Willoughby, Ohio 44094

On May 11 Boston becomes the electronics capital of the world!

That's the day 25,000 "delegates" will gather for the opening of ELECTRO/76, the new IEEE international electronics convention in Bicentennial Boston.

Just about everything new and significant in electronics will be there — more than 500 hands-on product and systems demonstrations; more than 130 hours of solid, useful professional programming.

It's All Live and Direct

Everything at ELECTRO/76 is up-front and in-person. More than 300 leadership companies presenting the newest high-technology hardware, from micro-processors to "smart" instruments, and from raw materials to complete systems. ELECTRO/76 is the biggest all-electronics event in the eastern United States in many years.

All exhibit space in Hynes Auditorium has been sold out for months, and world-wide electronics industry attention is clearly focused on beautiful, springtime Boston.

Programming by Objective

35 half-day professional program sessions have been selected and refined from more than 100 proposals, by a committee of leaders in electronics technology.

This program is designed for immediate impact — direct usefulness to pro-



professionals in their job assignments with strong emphasis on new-technology applications.

All sessions will be held in ballrooms of the Sheraton-Boston Hotel, immediately adjacent to the Hynes Auditorium exposition halls.

A single low registration fee gives you all four days of ELECTRO/76 — 500 exhibits, strong sessions, and a fine technical film program. All this, and Bicentennial Boston, too!

A Very Special Event

ELECTRO/76 is a brand-new, all-industry activity. It combines the best of the Nerem and IEEE Show traditions — and adds much more.

Examples: Fully illustrated and complete session manuscripts will be

available on-the-spot; audio tapes of most sessions will be available within a couple of hours. Visitor registration is computerized — it's quick, silent, and it gives each visitor an embossed Inquiry Badge for use in requesting technical literature.

There's an exclusive special exhibit of "famous firsts" in electronics — historically significant devices and systems. And a continuous showing of award-winning technical and scientific films.

Suburban Bostonians can use our special "Mass Pike-128 Flyer" — a continuous bus system from either of two free-parking lots, direct to ELECTRO/76. (\$1 round-trip.) Air and rail transportation to Boston from other eastern cities is frequent and plentiful.

ELECTRO/76 is for you!

If you are reading this ad in this magazine, ELECTRO/76 is for you!

If you design, develop, test, measure, fabricate, inspect, assemble, package, or use electronics, ELECTRO/76 is a very important week for you.

Registration for ELECTRO/76 — for all of it — is just \$6 for IEEE members, \$9 for non-members. You'll find that's a very modest price to pay for the dozens of new ideas you'll discover for yourself. Make your plans now to join the leaders in Boston — and take home some great ideas!



Electro76

The IEEE Convention in Bicentennial Boston May 11-14
Hynes Auditorium and the Sheraton-Boston

For further information: ELECTRO/76 31 Channing Street, Newton, Massachusetts 02158 (617)527-6944

FREE



MICROWAVE CAPABILITY GUIDE



For complete information on General Electric's line of microwave tubes and devices, use the Reader Service Card to order Condensed Catalog... or contact:

Microwave and Imaging Devices Products Section, General Electric Company, 316 E. Ninth Street, Owensboro, Kentucky 42301. (502) 683-2401.

GENERAL  ELECTRIC

CIRCLE NUMBER 67

PACKAGING & MATERIALS

Mini connectors have from 1 to 100 contacts

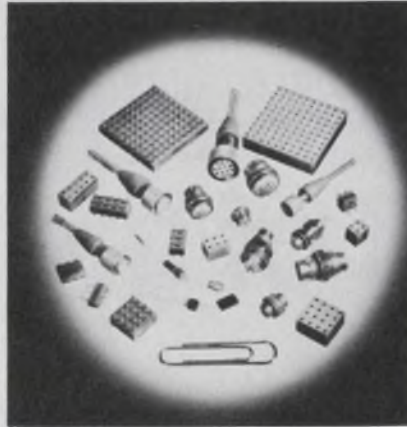

Microtech Inc., The Park Square Bldg., 777 Henderson Blvd., Folcroft, PA 19032. (215) 532-3388. From \$0.45; stock.

Miniature and microminiature co-axial, 4, 7 and 12-contact connectors are available along with a 1 x 1 in. 100-contact matrix board. The boards are designed so that they can be cut in rows and columns of any configuration from 100-contacts down to a single contact. The units are constructed of gold plated brass bodies and contacts with FEP Teflon inserts. Co-axial and special multiconductor cables are designed specifically for the connectors to give optimum miniaturization. The dielectrics and jackets are also made from Teflon.

CIRCLE NO. 337

Epoxy casting compound is self-extinguishing

Hightemp Resins, 225 Greenwich Ave., Stamford, CT 06902. (203) 325-4124. See text.

Hightemp 5600, a general-purpose, low-cost epoxy-casting compound, is self-extinguishing. A 1-lb. amount of the resin, when cured at room temperature, will set overnight to a strong, tack-free solid with an exotherm peak below 100 F. Other features of Hightemp 5600 include: a cost of \$0.95/lb in 50 gal. lots, a viscosity of less than 3500 cps, a pot life of 2 to 3 h; a shrinkage of less than 0.1% and a water absorption of only 0.1%. The epoxy is normally white and is claimed to have good thermal conductivity.

CIRCLE NO. 338

Wrapped-wire panels speed μ P breadboarding

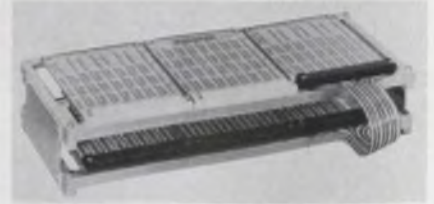

Mupac Corp., 646 Summer St., Brockton, MA 02402. (617) 588-6110. \$57 (10-up); stock.

Wrapped-wire panels have a variety of different size sockets for breadboarding systems using μ Ps, LSI circuits, semiconductor memories and other ICs. Panels mount on a predrilled frame. A 108-pin connector may be mated with standard box-type connectors and flat-ribbon or twisted-pair cable assemblies to connect to peripheral devices.

CIRCLE NO. 339

Card and file systems hold up to 2106 ICs

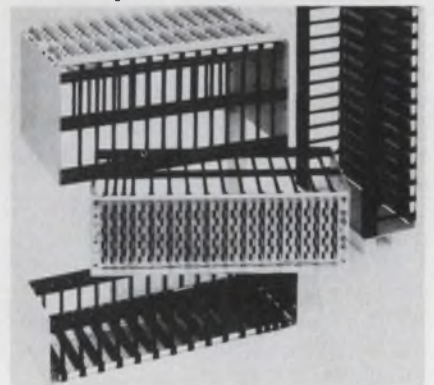

Teradyne Components, 900 Lawrence St., Lowell, MA 01852. (617) 454-9195. For 10-up lots; From \$40 (cards), \$125 (files); 1 to 2 wks.

The module library, a wrapped-wire interconnection system, is available in many different configurations. The library consists of two basic units: the module interconnect file and the pluggable module cards. The files come in single and double row configurations. Each configuration is available in two heights and two connector spacings. The modules cards are available in various etched configurations to hold 14- and 16-pin DIP ICs, various MSI and LSI packages and discrete components. Packaging densities range from 264 to 2106 ICs per file.

CIRCLE NO. 340

The Universal Counter.



Everything you're likely to need. The HP 5328A.

Here's a counter so versatile, it can really be called universal. You get high accuracy, operating ease and a low price tag of just \$1300*. It's modular so you can buy the capability you need. Not more. Not less. Start with the basic 8-digit instrument with 100 MHz frequency range and 100 ns single shot T.I. resolution. You also get period, 10 ps time interval averaging, ratio, scaling and totalizing. Then you can add more: 512 MHz with 9 digits and 15 mv sensitivity; time base aging $< 5 \times 10^{-10}$ /day; and 10 ns single shot time interval with improved averaging. But look what else you get:

UNIQUE TRIGGER LIGHTS

tell you what's happening. They're on when the input is greater than trigger level and vice versa. And they blink when the input channel is triggering from 0 to 100 MHz. Standard.

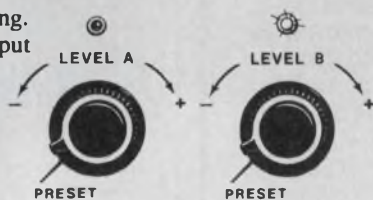

UNIQUE BUILT-IN DVM gives an instant accurate digital display of trigger levels. Or use this option to measure external voltages 10 μ V to 1100V auto-ranged, integrating, full floating, high common-mode rejection with switchable input filter. Optional.

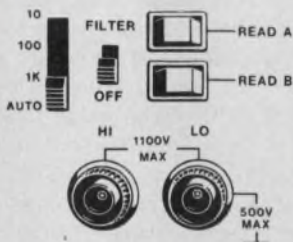

HIGH SPEED MARKERS

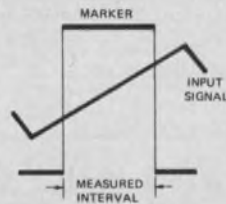

show just what your counter is doing with your input waveform. Use the markers on the second channel of your scope to see where the counter is triggering. Really useful thanks to the 5328A's 100 MHz ECL outputs. Standard.

EASY SYSTEMS INTERFACE

with the HP Interface Bus simplifies integration of the counter into a system. You get this program-mability plus standard format data output with a single connector. Optional.



ARMED MEASUREMENTS

solve difficult dynamic measurement problems. The counter goes to work when your command tells it to. Ideal for burst frequency or sweep generator linearity measurements. Standard.



These are just a few things, of course. There are many more thoughtful engineering innovations that combine to give you everything you're likely to need in a general purpose, medium-priced counter for a long time to come. We talk about them in our 12 page booklet. Write for one or ask your nearby HP field engineer for a copy. We want you to find why we call this universal counter universal.

*Domestic US Price only.



Sales and service from 172 offices in 65 countries.

1501 Page Mill Road, Palo Alto, California 94304

CIRCLE NUMBER 68

our quiet one

Our low noise, punched tape I/O desktop unit, is designed to satisfy numerical control, graphic arts, data communications and computer peripheral applications.

It accommodates oiled paper, dry paper, metallized mylar, sandwich paper/mylar/paper and polyester... 5, 6, 7 or 8-level tapes. And, it's TTL/DTL compatible.

Asynchronous punching at up to 60 characters per second.
Photoelectric reading at up to 150 characters per second, start/stop. Synchronous reading at up to 250 characters per second.
Via a highly reliable stepping motor tape transport. At OEM prices.

For full details, write or call us.



SWEDA INTERNATIONAL
Litton OEM Products

34 Maple Avenue, Pine Brook, N.J. 07058/(201) 575-8100

IN U.K. — ADLER BUS SYSTEMS/OEM PRODS., Airport House, Purley Way, Croydon, Surrey, England

IN FRANCE — SWEDA INTERNATIONAL/OEM, 103-107 Rue de Tocqueville, 75017 Paris, France

CIRCLE NUMBER 69



ROYTRON Model 1560 Reader/Punch

High speed, compact, with integral electronics and power supply self-contained in a quietized housing



PACKAGING & MATERIALS

Metal foil shields enclosed areas

Emerson & Cuming, Inc., Canton, MA 02021. (617) 828-3300. \$3: WP-3SS, \$2.25; WP-3CU, \$1.75; WP-2AL, per ft² (10 ft²-up); stock.

Eccoshield WP materials are specially developed metal foils used to make rf-shielded areas. The foils are stapled or bonded to the walls, ceiling and floor of an enclosed space. The material is used in conjunction with the firm's line of adhesive-backed metal-foil tapes, conductive adhesives, surface coatings and caulking compounds to produce enclosures that have an insertion loss in excess of 80 dB over the range of 200 kHz to 35 GHz. Three types of WP material are available. In decreasing order of cost and effectiveness they are Eccoshield WP-3SS, a stainless-steel foil; WP-3CU, a copper foil; and WP-2AL an aluminum foil.

CIRCLE NO. 341

Fiber optic cable comes with many options

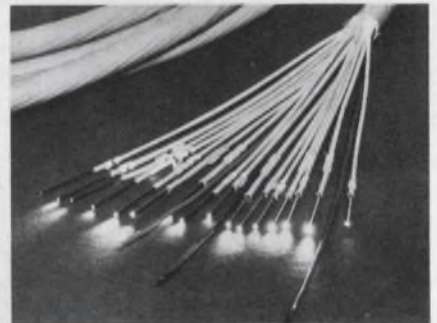

Rank Precision Ind., 411 E. Jarvis Ave., Des Plaines, IL 60018. (312) 297-7720. See text; stock to 30 days.

A multi-core fiber optic communications cable is available in various combinations of optical and electrical channels. Designated "Fibroflex 400X," the cable uses a multi-core fiber optic communications cable that contains 96 fibers jacketed in PVC. It has an operating temperature range of -40 to 105 C (-40 to 221 F). The cable attenuation is less than 400 dB/km at a wavelength of 800 nm. Typical price for a cable with 16 optical conductors and three electrical conductors is \$30/meter.

CIRCLE NO. 342

A WIDEBAND AMPLIFIER WITH WIDEBAND FEATURES

It's IFI's Model 5100. Exclusive features include automatic remote leveling and remote level control. Also prominent in its broad performance spectrum: auto pulse and auto limit to confine amplifier current to safe levels in pulsed operation... Operates into any load from open to short... Frequency range, 10 KHz to 250 MHz... Peak RF input, 1 V; 40 dB gain; output, 10 W... Model 5100 was designed primarily as a preamplifier for IFI and other high power wideband amplifiers. As such, it's a direct replacement for IFI's Model 5000—with all of that unit's proven performance AND the advanced features you will find only in Model 5100. Write for technical data.



instruments for industry, inc.

151 TOLEDO STREET • FARMINGDALE, N.Y. 11735

516-694-1414 Cable: Electronic Hallendale, Fla. Telex: 51-43-32

CIRCLE NUMBER 70

Clip-on heat sink holds TO-202 and 220 cases

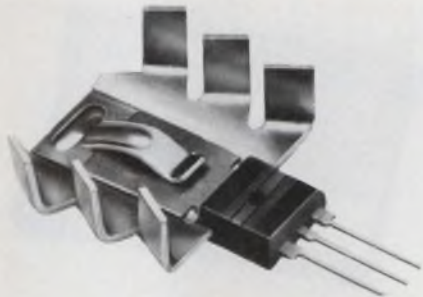

Wakefield Engineering, 77 Audubon Rd., Wakefield, MA 01880. (617) 245-5900. \$0.04 (lge. qty.); stock.

The Series 291 Clip-Cooler heat sink is claimed by the manufacturer to have double the heat transfer capability of competitive units. The unit has a one-piece construction and can hold TO-202, TO-220 or other plastic tab devices. The clip-on design guarantees secure fastening without chance of slipping. Clip-Coolers are available in 0.36 and 0.75-in. heights with a choice of black, gold or plain finishes.

CIRCLE NO. 343

Stamped PC boards cut costs vs etched boards

Rogers Corp., Electro Components Div., Rogers, CT 06263. (203) 774-9605. See text.

Mektron stamped circuits are claimed to offer significant cost savings for companies that purchase over \$10,000 of PC boards a year. The all-mechanical production technique permits the designer almost limitless combinations of conductive and resistive foils, and substrate materials. Production-capability-limits of the process, include conductor thicknesses between 0.007 and 0.0068 in. (for copper, 0.5-to-5-oz.) and a minimum line width of 0.02 in. with a minimum spacing of 0.025 in. The die-stamped circuit minimizes the possibility of chemical contamination, making possible the use of less expensive, even semi-absorbent substrate materials. A typical 2.25 × 2 × 0.062 in., 1 oz. copper board with 79 holes costs about 15¢ in 25,000 pc lots, excluding tooling.

CIRCLE NO. 344

Enclosures molded from high impact plastic



Vero Electronics, Inc., 171 Bridge Rd., Hauppauge, NY 11787. (516) 234-0400. See text.

Instrument cases molded of ABS plastic provide high strength. They contain built-in mounting guides for vertical or horizontal mounting of printed-circuit boards. The boxes are formed in two sections with separate anodized aluminum front and rear panels for mounting of controls. The standard color is two-tone gray, but custom colors are available at no extra cost when at least 1000 units are ordered. A typical box with dimensions of 4.3 × 8.1 × 5.5 in. (Model 75-1412 K) costs \$7.32 in single quantities.

CIRCLE NO. 345



WORLD'S SMALLEST TOGGLE SWITCH

made SPECIFICALLY for PC APPLICATIONS

- 60% smaller in volume than existing miniatures.
- 3/8" Max. Height compatible with PC components.
- Terminals match 1/10" centers X-Y axis.
- Gold plated contacts and terminals for dry circuit.
- Available in 1 and 2 poles, On-On or Center-Off.
- Upright or Right Angle mounting.

Call (617) 685-4371 or write for additional info.

ALCO ELECTRONIC PRODUCTS, INC.
1551 OSGOOD STREET, NORTH ANDOVER, MA 01845 U.S.A.
TEL: (617) 685-4371 TWX: 710 342-0552 A SUBSIDIARY OF AUGAT INC.

CIRCLE NUMBER 71

ELECTRONIC DESIGN 8, April 12, 1976

MICROPROCESSOR SERIES NO. 1

OUR EASIEST-TO-USE 2650: NOW MULTI-SOURCED.

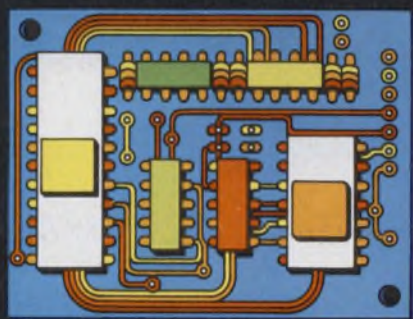

All the 2650's you need, in stock at Signetics, authorized distributors, Advanced Memory Systems (AMS) and Philips, too

Clip coupon to letterhead. Or call (408) 739-7700, Ext. 2982/3. Please rush me my FREE 2650 Short Form Catalog.

Name _____ Title _____

Tel. _____ M.S _____

811 E. ARQUES, SUNNYVALE, CA. 94086

THINK
signetics μ P
a subsidiary of U.S. Philips Corporation

CIRCLE NUMBER 72

POWER SOURCES

Supply allows control of plating process

Leighton Electronics, RD# 1, Box 374, Leighton, PA 18235. (717) 386-4156. \$1980; 8 wks.

Improved plating of semiconductor parts, wafers, etc., with greater control over amount deposited,

porosity, adhesion and smoothness is achieved with this solid-state ac-dc power supply, the PD01. In the ac mode, the output is continuously adjustable for both the plating and deplating portion of the cycle with four independent current-regulated power supplies. Dc output is filtered so that maximum ripple is merely 25 mV at 100 mA. Any of three adjustable output ranges can be selected.

CIRCLE NO. 346

It looks like a DMM; it's a lab source



Boston Electronics, 109 Massachusetts, Lexington, MA 02173. (617) 861-8620. \$199; stock.

Model 131 multisource, designed for use as a general laboratory instrument, is housed in a compact case and provides outputs of 5 V dc at 1 A and ± 15 V dc at 100 mA. Optional ac and dc test signals are available for use with most analog and digital circuits. Options include test signals and higher current capability. Accessories available include dust covers, carrying cases and rack mount kits.

CIRCLE NO. 347

125-W supply measures just 1.7-in. high



Ro Associates, 3705 Haven Ave., Menlo Park, CA 94025. (415) 322-5321. \$320; stock.

Model 325 20-kHz switching power supply produces 5 V at 25 A in a unit only 1.7-in. high. The total package operates at 1.3 W per cubic inch, traceable to the high efficiency of 75%. The unit offers many innovations such as all-plug-in, functionally isolated control cards, as well as easy access to all of the power components for field repairability. It will take either 115 or 230-V input without any switching or without any changing of taps or straps. Brownout protection is included, so that line dips below 95 V still provide usable outputs.

CIRCLE NO. 348

Give 'em hell.

They can take it. And come back for more. Beautifully.

You've spent a great deal of time and money designing your equipment to work in the field. That means unpredictable conditions, rough handling and plenty of abuse. And when your product is 200 miles from the nearest service center, it had better work.

Give it the extra protection of Zero Centurion™ carrying cases, combining the best in classic styling with rugged durability. Durability that's been proven by people like yourself in environmental extremes around the world.

Choose from 59 standard sizes for two week delivery A.R.O., with unlimited modification capabilities. And the price is surprisingly low. Consider it low cost life insurance on your equipment.

Write for your free catalog today.

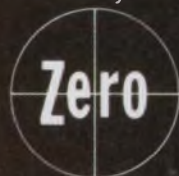

The Final Touch



ZERO MANUFACTURING CO.

Burbank, CA 213/846-4191 · Monson, MA 413/267-5561 · Clearwater, FL 813/531-8991

CALL ME, I'M INTERESTED CIRCLE #272
146

FOR MAIL CATALOG CIRCLE #271

Got a printer? Here's a power source for it



Boschert Associates, 1031 E. Duane, Suite C, Sunnyvale, CA 94086. (408) 732-2441. \$225 to \$235 (100s).

Models OL150 and OL151 are four-output, switching power supplies designed to power daisy wheel printers and the associated logic in computer terminal applications. In addition to the voltages needed for the printer, +5 and ± 15 V, a fourth output voltage is available and can be selected by the customer. These supplies have overvoltage, overcurrent and reverse-polarity protection. Currently models are available to drive the Diablo HY Type I and HY Type II (fits inside) and the Qume Q30, 45 and 55.

CIRCLE NO. 349

Dc supplies receive performance facelift

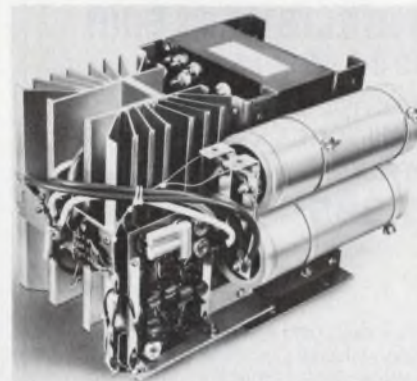

Tele-Dynamics, 525 Virginia Dr., Fort Washington, PA 19034. (215) 643-3900. Starts at \$215; stock.

The Brute series has been enhanced in performance and versatility with no change in price. The supplies are rated to 1200 W, and they can be set for either constant-current or constant-voltage operation. Remote sensing and coarse-and-fine voltage adjustments cover 2-to-25 and 5-to-50-V ranges. The Brute units produce no output spikes, and their power efficiency exceeds 75%.

CIRCLE NO. 350

Supply aims at μ Ps, interchanges with others

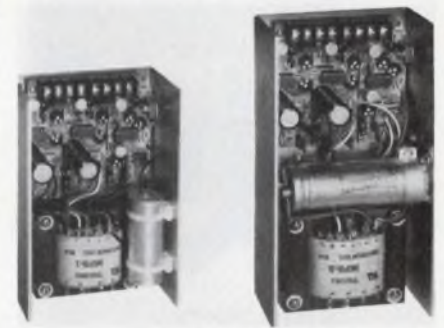

Deltron, Wissahickon Ave., North Wales, PA 19454. (215) 699-9261. \$77, MPS-1; \$88, MPS-2.

"MPS" Series is interchangeable with Lambda's MPU Series and is said to sell for less than half the price. The series consists of two models: MPS-1 is rated at 5 V dc at 3 A, 12 V dc at 0.6 A, and 9 to 12 V dc at 0.6 A or 5 V dc at 0.38 A. Model MPS-2 is rated at 5 V dc at 7.0 A, 12 V dc at 1 A, and 9 V dc at 1.2 A, or 5 V dc at 0.75 A. Both units are fully protected against overload and overvoltages and are mechanically interchangeable with other competitive units.

CIRCLE NO. 351

10 amps of switching in a 1" cube

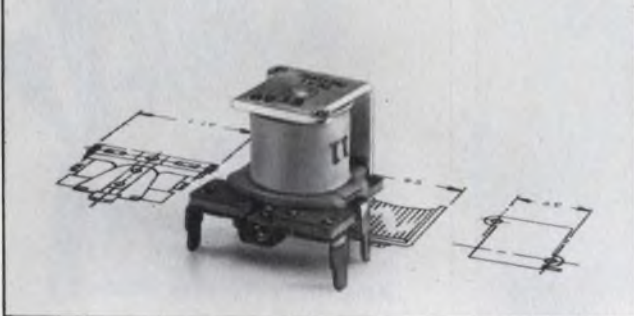

Series 19 Relay. One of the most compact and reliable relays you'll ever use.

In just one cubic inch, the remarkable Series 19 relay combines the advantages of miniaturization with a capacity to handle heavy switching loads. Result: more performance in a smaller overall package. Yet the cost is low — less than \$2.00 each in 100-piece quantities.

Contact arrangement is SPDT. Rating is 10 amps, 28 vdc or 115 v, 60 hz. Available coil voltages range from 3 to 24 vdc.

Consider the Series 19 relay for low level to 10 amp switching applications such as remote control, alarm systems and similar industrial and commercial uses.

Send for information now!

NORTH AMERICAN PHILIPS CONTROLS CORP.

Frederick, Md. 21701 · (301) 663-5141
FOR IMMEDIATE NEED CIRCLE #73

FOR INFORMATION ONLY CIRCLE #74

ELECTRONIC DESIGN 8, April 12, 1976

MICROPROCESSOR SERIES NO. 2

2650

DEVELOPMENT HARDWARE FOR ALL COST/CAPABILITY LEVELS.



Here now:

- PC1001 Prototyping Card
- PC2000 4K Byte RAM Card
- DS2000 Demo Base with P.S.
- PC3000 Smart Typewriter Democard
- KT9000 Prototyping Kit

More Soon!

Clip to your letterhead. Send me the Short Form Catalog including the foregoing data sheets.

Name Title

Tel. M.S.

811 E. ARQUES, SUNNYVALE, CA. 94086

THINK SIGNOTICS μ P

a subsidiary of U.S. Philips Corporation

CIRCLE NUMBER 75



UNBELIEVABLE!!!!
The Intecolor® 8001
A Complete 8 COLOR
Intelligent CRT
Terminal
\$1,995*

"Complete" Means

- 8080 CPU • 25 Line x 80 Character/Line • 4Kx8 RAM • PROM Software
- Sockets for UV Erasable PROM • 19" Shadow Mask Color CR Tube
- RS232 I/O • Sockets for 64 Special Graphics • Selectable Baud Rates to 9600 Baud • Single Package • 8 Color Monitor • ASCII Set
- Keyboard • Bell • Manual

And you also get the Intecolor® 8001 9 sector Convergence System for ease of set up (3-5 minutes) and stability.

Additional Options Available:

- Roll • Additional RAM to 32K • 48 Line x 80 Characters/Line • Light Pens
- Limited Graphics Mode • Background Color • Special Graphic Characters
- Games

*OEM quantity 100 (OEM Unit Price \$2,495.)

ISC WILL MAKE A BELIEVER OUT OF YOU!



Intelligent Systems Corp. © 4376 Ridgeway Drive, Duluth, Georgia 30136
 Telephone (404) 449-5961

CIRCLE NUMBER 76

Electronic Cabinets & Cases by
PREMIER METAL PRODUCTS CO.

381 Canal Place, Bronx, N.Y. 10451/(212) 993-9200

OVER 1300 ITEMS IN OUR CATALOG

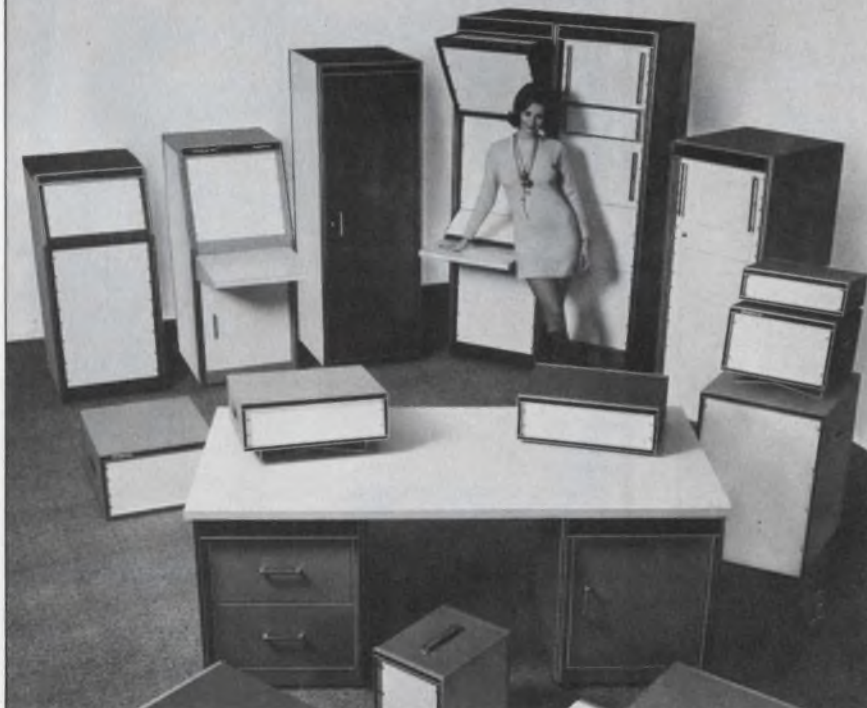

CIRCLE NUMBER 77

MODULES & SUBASSEMBLIES

Multiplier & log modules
have wide ranges

TAU Systems, Box F, Newton, NH 03858. (603) 382-7218. \$18.90 (either unit); 1 to 3 wks.

The USC 1220 transconductance multiplier has a four decade range and a response to better than 0.3%. The multiplier has a built-in FET operational stage so that the USC 1220 can be used for voltage or current-controlled active filters, oscillators and amplifiers. Another module, the LAM 1212 log/antilog unit, has multiple outputs which are capable of simultaneous log and anti-log output signals, from 500 μ A to 500 pA. The 1212 outputs are directly capable of driving the 1220 multiplier to obtain non linear control of linear signal voltages. Both devices are housed in 1 x 1 x 0.6 in. 10-pin plastic cases.

CIRCLE NO. 352

High power amplifier
delivers up to 250 W



Technical Research & Mfg., Grenier Field, RFD #3, Manchester, NH 03103. (603) 668-0120. \$275 (1 to 4); 4 wks.

The AP-150 power amplifier has a fixed gain of 28 dB. It can deliver 160 W into an 8 Ω load and 250 W into 4 Ω over a -3 dB bandwidth of 1 Hz to 60 kHz. The amplifier has a full, push-pull complementary-symmetry circuit, low distortion, (0.03% TDH at 1 kHz), high slew rates (25 V/ μ s) and peak output currents of \pm 14 A. The module, with integral isolated heat sink measures 9 x 4.8 x 2.3 in. with cover.

CIRCLE NO. 353

Frequency synthesizer has 1-to-32-MHz range

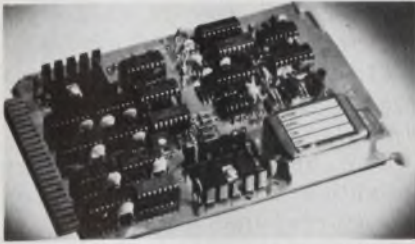

Syntest, 169 Millham St., Marlboro, MA 01752. (617) 481-7827. \$429; stock.

The SM-105 frequency synthesizer card offers a 1-to-32-MHz range. The output frequency can be set in 500-Hz steps. Direct BCD (parallel load, TTL-compatible) programming can be used. Outputs are both TTL and ECL-compatible and have logic-controlled enable lines. Spurious outputs are greater than 60 dBc. It takes 50 ms for the output to settle within 10% of a frequency step. Power requirements are 8 V at 700 mA and 24 V at 20 mA. The synthesizer is built on a 6.5 × 4.5 × 0.75 in. board and has an operating temperature range of 0 to 50 C.

CIRCLE NO. 354

8 and 10-bit DACs fit in 16-pin DIP-like case

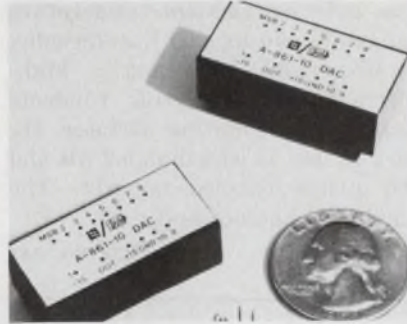

Intech, 1220 Coleman Ave., Santa Clara, CA 95050. (408) 244-0500. For 1 to 99 units: \$15 (861-8), \$22 (861-10); stock.

The A-861-8 and A-861-10 d/a converters are designed to be pin-compatible to the Hybrid Systems 371 converter family. These 8 and 10-bit converters are packaged in 16-pin DIP-like cases that measure 1.3 × 0.6 × 0.5 in. The A-861-8 operates from a +15-V supply and uses 52 mW. The A-861-10 requires ±15-V supplies. Both converters have a maximum nonlinearity error of 0.5 LSB and a worst-case nonlinearity error of 20 ppm/°C.

CIRCLE NO. 355

Phase sensitive detector spans 0.01 Hz to 1 MHz

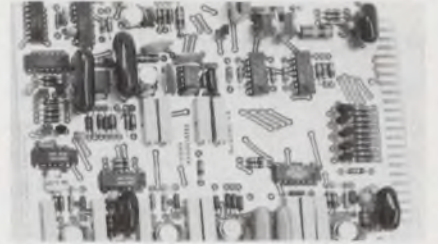

Evans Associates, P.O. Box 5055, Berkeley, CA 94705. (415) 848-6839. \$175; 2 to 4 wks.

The phase-sensitive detector card, Model 4110, is intended for measuring the amplitude of phase-coherent periodic signals. It provides lock-in amplifier circuit functions from 0.01 Hz to 1 MHz. The analog output is compatible with meters, recorders, DPMs and a/d converters. Input-output sensitivity of the 4110 ranges from 10⁻⁵ to 10⁻¹ V/V in decade steps. The detector is constructed on a 4.5 × 6.5 in. (11.4 × 16.5 cm) board, mating to a standard 2 × 22-pin edge connector. It requires ±15-V-dc supplies and has an on-board regulation for isolation.

CIRCLE NO. 356



**SINGLE
& DUAL**

McLEAN CENTRIFUGALS

Std. or Mil. Spec. Over 25 models with airflows from 50 to 2000 CFM. Static pressures from 0." to 3.0". Motors and wheels precision balanced — quiet, vibration free. UL approved motors for any AC frequency or power, single or three phase. Custom-built units available.

SEND FOR CATALOG

McLEAN ENGINEERING LABORATORIES

P.O. Box 127D PRINCETON JUNCTION, NEW JERSEY 08560
PHONE 609-799-0100 • TELEX 84-3422

CIRCLE NUMBER 78

ELECTRONIC DESIGN 8, April 12, 1976

MICROPROCESSOR SERIES NO. 3

**2650
HIGHER LEVEL LANGUAGE
SPEEDS
YOUR DEVELOPMENT.**



Available:
(A) PL_μS
Compiler for
16- & 32-bit
computers and on
Time-share, (B) 16-
& 32-bit Assemblers
and Simulators.

Clip to letterhead.
Send me quickly the 2650 Short
Form Catalog including data
sheets on the foregoing software.

Name _____ Title _____

Tel. _____ M.S. _____

811 E. ARQUES, SUNNYVALE, CA. 94086

**THINK
SINOTICS μP**
a subsidiary of U.S. Philips Corporation

CIRCLE NUMBER 79

149

MODULES & SUBASSEMBLIES

Power multicoupler handles 1 kW sources

Electronic Navigation Ind., 3000 Winton Rd. S., Rochester, NY 14623. (716) 473-6900. \$295 (5 to 49); 30 days.

The Model PM1777 four-port,

power multicoupler can combine or split power levels of 1 kW over a 20-to-80-MHz range. The unit operates over an ambient temperature range of -50 to +90 C. Internally, a silicone-oil bath and a high-thermal-mass heat sink conducts heat to the mounting surfaces. Insertion loss is less than 0.2 dB and the phase balance is $\pm 1^\circ$. The amplitude balance is 0.1 dB.

CIRCLE NO. 357



New low-profile, high-performance crystal oscillator.

Here's a completely new ceramic packaged crystal oscillator that can add more performance per dollar to your time base application.

The new MXO-40 is only .200" high, .800" long and .500" wide. Frequency range: 31.5 KHz to 26 MHz. Frequency stability (calibration, environment and aging for 5 years): $\pm .01\%$ and $\pm .1\%$ standard; as low as $\pm .0025\%$ available upon request. Temperature range: 0° to 70°C . Symmetry: 45/55. TTL Compatible square wave output. Guaranteed startup of 2 msec. assured

by bias feedback circuitry. Input voltage: +5 VDC $\pm .5$ VDC. 96% alumina ceramic case compatible with 14 pin dual-in-line layouts. Newly developed fully hermetic, epoxy seal. Solder seal available.

A good example of CTS Knights research which produces a continually expanding line of precision frequency control products. Write **CTS Knights, Inc.**, 400 Reimann Ave., Sandwich, IL 60548, phone: (815) 786-8411.

CTS CORPORATION

Elkhart, Indiana



CIRCLE NUMBER 80

Message weighting filter has 60-Hz-to-5-kHz span

Frequency Devices, 75 Locust St., Haverhill, MA 01830. (617) 374-0761. For unit quantities: \$65 (581-1), \$55 (581-2); stock to 4 wks.

The 581 series C-message weighting filters provide a frequency response characteristic simulating the perceived response of the human ear to telephone noise. The 581-1 provides a ± 1 dB approximation to the theoretical C-message weighting function. It is intended for use where a tight tolerance is required over a full 60-Hz-to-5-kHz range. The 581-2 has a looser tolerance below 300 Hz and above 3 kHz. Both models are housed in $2 \times 2 \times 0.4$ in. modules that require no external adjustments.

CIRCLE NO. 358

Telephone autodialler stores up to 96 numbers

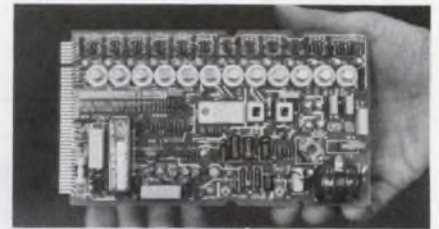

PYE TMC Ltd., Martell Rd., Dulwich, SE 21 8 EF, England.

The PYE TMC modular autodialler can store and access 96 different telephone numbers, each of which can be up to 21 digits long. The module has facilities for single-key dialling of prerecorded numbers; keypad dialling of any other number; and automatic recording of the last number entered via the keypad (for redialling). The module has a printed-circuit edge connector for plugging into OEM equipment and is shielded from mechanical damage by a metal cover. Any number of modules can be banked to provide the desired storage. Other circuitry on the board allows for connection of a 96-address button keypad for key dialling and programming, dial-tone pause button, double-pause interdigit button, finish button or cancel button, on/off/record switch, in-use lamp, telephone handset, power supply and exchange line.

CIRCLE NO. 359

Temperature controller handles 3 A loads



Elma Engineering, 1066 East Meadow Circle, Palo Alto, CA 94303. (415) 494-7303. \$40 (100-up); stock.

The Series 400 millivolt control accepts all standard ISA thermocouple calibrations. The output for ac inductive or non-inductive loads is a 3 A, 120 V ac single-pole-double-throw relay. The relay has adjustable hysteresis and on-off or, optional, time proportioning circuitry. Temperature setpoint is adjustable by an integral or remote potentiometer. Calibrated scales with temperature ranges to 2000 F or C are available. The control operates from a 120 V ac, 50/60 Hz supply. It has a frequency response of 100 kHz and a linearity of 0.1% of span.

CIRCLE NO. 360

CRT memories show 16 lines x 32 characters



Matrox Electronic Systems, P.O. Box 56, Ahuntsic Stn., Montreal, Que., H3L2S0, Canada. (514) 481-6838. \$243 (10-up); 4 to 8 wks.

The MTX-1632 video random-access memory can display 16 lines of 32 characters. On the input side, the VRAM looks like a 512 x 8 RAM but on the output it delivers a video signal that can directly drive a CRT monitor. The display modules need no external refresh, have a bidirectional data bus, have an access time of less than 650 ns and can drive up to 25 CRT monitors. The 4.4 x 3.9 x 0.45-in. module operates from a +5-V supply and draws 600 mA, maximum.

CIRCLE NO. 361

Low-cost a/d converter spec'd for MIL temp



Micro Networks, 324 Clark St., Worcester, MA 01606. (617) 852-5400. See text; stock.

The MN5120H 8-bit a/d converter combines a fast conversion speed of 6 μ s, full military-temperature (-55 to +125 C) operating range and low cost (\$98 in quantities of 100). Operating over the full temperature range, the MN5120H is guaranteed to maintain ± 2 LSB absolute accuracy (± 1 LSB at 25 C), ± 0.5 LSB linearity, and to have a zero error of no more than 1 LSB. The converter consumes only 680 mW. The MN5120H series has four models: the MN5120H, with 0 to -10 V input range; MN-5121H, ± 5 V; the MN5122H, ± 10 V; and the MN5123H, 0 to ± 10 V. Power supply requirements are ± 15 V and +5 V for all units.

CIRCLE NO. 362

SOUTH BAY CABLE SOLVES TOUGH CABLE PROBLEMS!



For computer applications, business machines... or a custom design to fit your particular requirement. Write for catalog or send details of your needs.

Manufacturers of cable for electronic use both military and commercial.

SOUTH BAY  **CABLE CORP.**

Idyllwild, California 92349 • Tel. (714) 659-2183

CIRCLE NUMBER 81

ELECTRONIC DESIGN 8, April 12, 1976

MICROPROCESSOR SERIES NO. 4°

2650 SUPPORT CKTS ARE ALL MULTI-SOURCED.



Available: interface, ROM, RAM, PROMs/EROMs. Coming: PPI, PCI, A-D Converters, SDLC. Specials from AMS, too.

Attach to your letterhead. Put me on your reservation list for the first mailing on upcoming 2650 Interfacing Circuits.

Name _____ Title _____

Tel. _____ M.S. _____

811 E. ARQUES, SUNNYVALE, CA. 94086

THINK

Signetics μ P
a subsidiary of U.S. Philips Corporation

CIRCLE NUMBER 82

151

Low Cost Reliability

Applications for sub-miniature ceramic capacitors requiring stringent specifications in critical frequency areas for accuracy and stability have made Centre Engineering an excellent source of supply.

Technological advancements have enabled Centre Engineering to manufacture ceramic capacitors in high volume for low cost applications. The processes are the same as used in manufacturing ultra-high reliable sub-miniature ceramic capacitors.

The widest range of ceramic capacitors in the industry are available from Centre, including multi-layer or single layer chip capacitors, polymer coated leaded devices and glass sealed devices. Over 40 different formulations to meet your requirements with a capacity range of 1pF to 10mF. Catalog available upon request.

CENTRE ENGINEERING
 2820 E. COLLEGE AVE., STATE COLLEGE, PA. 16801
 814-237-0321 - TWX 510-691-2634

CIRCLE NUMBER 83

Meet the top new analyzer.

Quan-Tech introduces a high-frequency wave and spectrum analyzer with a range of 1 KHz to 1.5 MHz.

The Model 2525 is a new, high performance Wave and Spectrum Analyzer with many features including electronic sweep. This portable unit offers unequaled capabilities for accurate harmonic measurements, fourier amplitude analysis of complex signals and spectral density analysis of random signals.

Quan-Tech
 Division of SCIENTIFIC-ATLANTA, INC.

RANDOLPH PARK WEST, ROUTE 10, RANDOLPH TOWNSHIP, NEW JERSEY 07801
 PHONE (201) 361-3100 TWX 710-987-7946

CIRCLE NUMBER 84

MICROWAVES & LASERS

4-output multiplier uses small package

Trak Microwave, 4726 Eisenhower Blvd., Tampa, FL 33614. (813) 884-1411. \$2700; 90-120 days.

The Model 3850-1610 multiplier provides outputs of 100, 300 and 500 MHz, and a 4-to-8-GHz comb line. The unit measures only $3 \times 1.75 \times 0.6$ in. and weighs 3-1/2 oz. Powers of the respective outputs are 5, 17, 10, and -25 dBm. A 25-MHz input is required, and the multiplier operates from 15-V-dc, 200-mA supply.

CIRCLE NO. 363

Laser rangefinder measures up to 2 miles

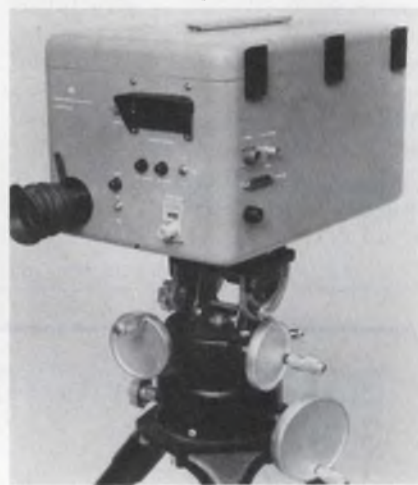

International Laser Systems, 3404 N. Orange Blossom Trail, Orlando, FL 32804. (305) 295-4010. \$25,000; 120 days.

The Model GR-5000 laser rangefinder can measure target distances up to 10,600 ft. with an accuracy of ± 5 ft. Using a GaAs laser diode as the optical source, the system produces an eye-safe output in 40-ns pulses at repetition rates up to 2000 pps. Range-output indication is provided via a four-digit LED display. An internal sighting telescope enables the user to locate and track the desired target. First-pulse logic selects the first return. Transmitter beam divergence can be varied from 5 to 50 mrad by adjustment of an external control. The rangefinder comes in a weather-resistant enclosure, measuring $11 \times 9.5 \times 16$ in. and weighing 22 lb. The unit operates from a 24-V-dc source and draws about 1.1 A.

CIRCLE NO. 364

WG circulator handles 3 kW

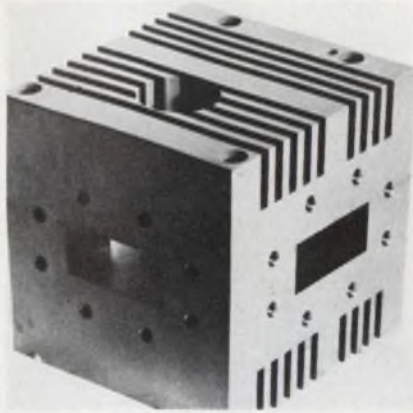

Merrimac Industries, 41 Fairfield Pl., West Caldwell, NJ 07006. (201) 228-3890. \$450; 45 days.

A high power, air-cooled waveguide junction circulator—the FCW-1528—handles more than 3 kW average power and operates over the 5.925 to 6.425 frequency range. The unit specs an isolation of 20 dB, insertion loss of 0.15 dB, VSWR of 1.2:1, and cooling flow rate of 25 ft³/min. Waveguide size is WR 137 and waveguide flange is CPR 137F.

CIRCLE NO. 365

Mixer/preamp spans 1 to 18 GHz

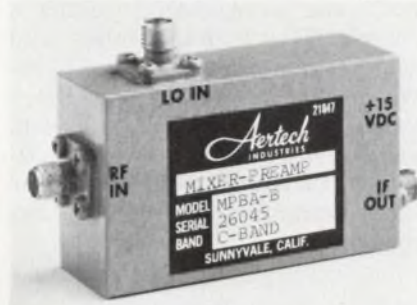

Aerotech Industries, 825 Stewart Dr., Sunnyvale, CA 94086. (408) 732-0880. \$695 up; 45 to 60 days.

A series of octave-band integrated mixer/preamplifiers covers the 1-to-18-GHz frequency range with several options of i-f frequency. Conversion gain is 25 dB, and LO-to-rf isolation is 20 dB minimum. Units have an output power at 1-dB compression point of up to +20 dBm, and its SSB noise figure is 8 to 10 dB. Gain flatness is ± 1 dB, and the mixer/preamp can operate from 15, 20, or 24-V-dc supply. Temperature range is -40 to 81 C.

CIRCLE NO. 366

Ion laser outputs 40 W

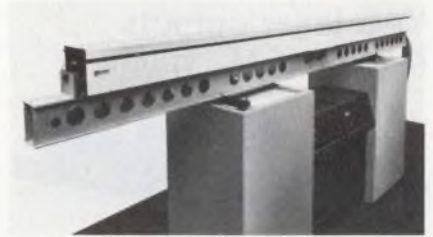

Spectra-Physics, 1250 W. Middlefield Rd., Mountain View, CA 94042. (415) 961-2550. \$44,900 to \$47,900.

An ion laser, the Model 921, offers more than twice the output power of earlier commercial models. In all-line mode operation, output is specified at 40 W for a period of one year; operation in excess of 46 W is typical. Individual lines are specified at 15 W for 514.5 nm and 14 W for 488.0 nm. All output powers are TEM₀₀ mode. The Model 921 laser has two high-power plasma tubes mounted in tandem in an optical resonator structure. Only two mirrors are used in the cavity for minimum optical loss.

CIRCLE NO. 367

NOW—A FAIL-SAFE SOLID-STATE RELAY

A unique combination of dv/dt snubber, fusible-link protection, and an oversized triac makes the new optically-coupled Heinemann SSRs fail-safe. Now, the worst thing that can happen to your system in the event of relay failure is the simple need to replace the relay. That's a lot better than having to reprogram your entire control sequence, isn't it?

We make our new SSRs for either zero-voltage or non-zero-voltage switching, and both types are rated for maximum ac load currents of 5A or 10A. Any control voltage from 3Vdc to 32Vdc; all models compatible with TTL, DTL, and CMOS logic.

And you have a choice of solder-pin, quick-on, and screw terminals.

Talk with Bob Kusek (609-882-4800) or write for further information. Heinemann Electric Company, Brunswick Pike, Trenton, NJ 08602.

HEINEMANN

We keep you out of trouble.

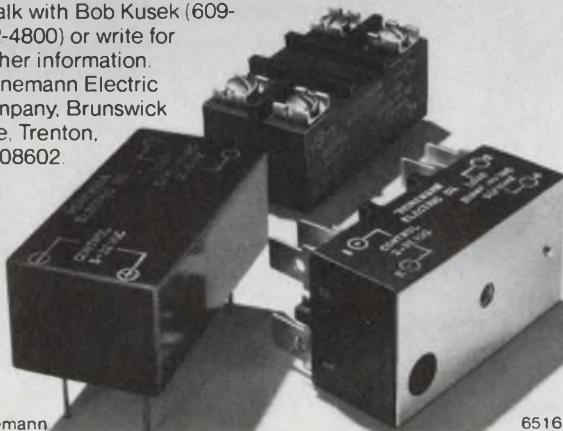

© Heinemann

6516

CIRCLE NUMBER 85

ELECTRONIC DESIGN 8, April 12, 1976

MICROPROCESSOR SERIES NO. 5

2650 CRASHPROOF DEVELOPMENT SYSTEM: TWIN WITH DUAL FLOPPY DISKS.

TestWare INstrument (TWIN) lets you develop software and hardware together in an actual environment.

Clip to letterhead. Mail now. Please send me 2650 Short Form Catalog full data on TWIN.

Name _____ Title _____

Tel. _____ M.S. _____

811 E. ARQUES, SUNNYVALE, CA. 94086

THINK

SIGNETICS μ P

a subsidiary of U.S. Philips Corporation

CIRCLE NUMBER 86

MICROWAVES & LASERS

YAG laser outputs 4-W in TEM₀₀ mode



Hadron, 2520 Colorado Ave., Santa

Monica, CA 90404. (213) 829-3370.

A YAG laser system for industrial or laboratory use—the Model KY3—can be operated in either a cw or Q-switched mode, and achieves power outputs of up to 30-W multimode and 4-W TEM₀₀. Priced at \$8920 for the cw system and \$12,935 with acousto-optic Q-switch, the system consists of laser head, power supply and heat exchanger.

CIRCLE NO. 368

Yig oscillators span 7 to 19 GHz

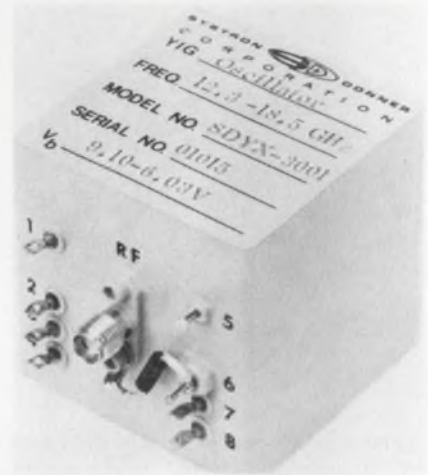

Systron-Donner, 735 Palomar Ave., Sunnyvale, CA 94086. (408) 735-9660. \$1020; stock to 45 days.

Yig-tuned Gunn-diode oscillators consist of the Model SDYX 3000, which covers the 7-to-12.4-GHz frequency range with 25 mW of output power, and the Model SDYX 3001, covering the 12.3-to-18.5-GHz band with 30 mW of output power. The oscillators hold spurious signals to 60 dBc and harmonics to 30 dBc. Residual FM is less than 10 kHz peak-to-peak. Other specs include wide tuning bandwidth of 3 kHz, narrow tuning bandwidth of 10 kHz with 2 dB/decade rolloff to 250 kHz, and linearity of 0.2%. Units measure 1.7 on each side.

CIRCLE NO. 369

You can't beat our high voltage ceramic capacitors' quality... at any price!

Experience can't be bought at any price and with over 30 years in the design and manufacture of high voltage ceramic capacitors, Murata has experience that's unsurpassed in the field. This experience has made Murata the world's largest producer of high voltage ceramic capacitors and generated a reputation for quality and performance second to none. What's more, our line covers virtually every high voltage application requirement. Check some of the brief features listed below and we're sure you'll want to

know more. Our complete information package is yours for the asking. Write or call today.

DH, DHL, DHG Types. For Power Supplies and Power Distribution Systems: 10-30 KVDC WV. 40, 50 & 60 KVDC WV also in DH. 500-5,000 pF. Z5V, Y5P & N4700 Temp. Char. Epoxy Resin Encapsulation. **DHR Type. For Color TV Doublers and Triplers:** 500-1,000 pF. 10, 12 and 15 KVDC WV. Z5P & N4700 Temp. Char. Extremely Low Noise Level. (Higher Capacities are also available.)

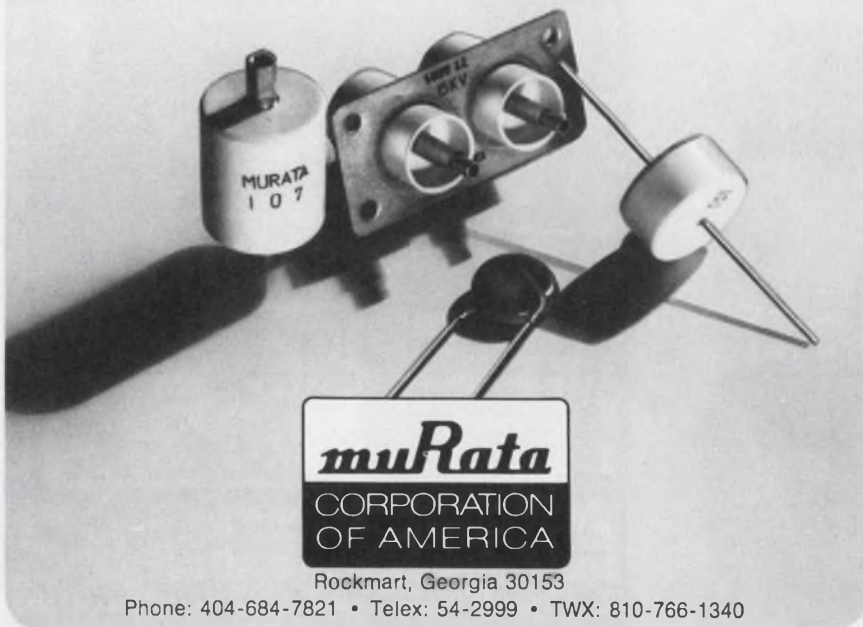

muRata
CORPORATION
OF AMERICA

Rockmart, Georgia 30153

Phone: 404-684-7821 • Telex: 54-2999 • TWX: 810-766-1340

CIRCLE NUMBER 87

Modulator features 2000- μ s pulse widths

Polard Electronic Instruments, 5 Delaware Dr., Lake Success, NY 11040. (516) 328-1100. \$550; 30 days.

The Model 1020A Modulator provides pulse widths from 0.2 to 2000 μ s. The solid-state unit can be employed with the company's modular microwave signal generators and signal sources in the band from 800 MHz to 21 GHz. The modulator's output signals typically have less than 100 ns pulse-rise times. Other specs include pulse rates of 10 Hz to 10 kHz, sync delay of 0.3 to 2000 μ s and internal or external synchronization. The Model 1020A also provides FM and square-wave modulation. The compact unit is only 1-3/4 in. high.

CIRCLE NO. 370

COMPONENTS

Motor claimed world's tiniest

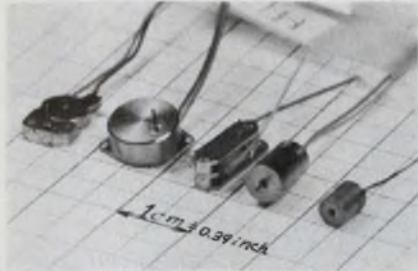

Seiko Instruments, Inc., 2990 W. Lomita Blvd., Torrance, CA 90505. (213) 530-3400.

Five new ultra-small motors include a two-pole stepping motor, a three-phase stepping motor and a dc brush motor. The three-phase motor is only 0.0036 in.³, which makes it one of the smallest in the world, according to Seiko. The motors are equipped with a ruby bearing as used in wristwatches. The motors can turn either clockwise or counterclockwise.

CIRCLE NO. 371

Lock selector switches added to oiltight line

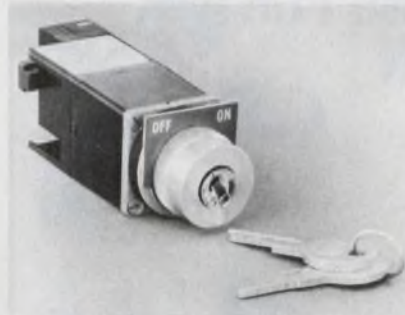

Allen Bradley, 1201 S. Second St., Milwaukee, WI 53204. (414) 671-2000.

Allen-Bradley has added cylinder-lock switches to its Bulletin 800M line of small oiltight push-buttons. The units mount on 1-1/4-in. centers. They are NEMA Type 13, oiltight and dust-tight, when mounted in suitable enclosures. Cylinder-lock selector switches help restrict operation to authorized personnel. Two, three and four-position switches are available with a variety of locking positions and contact configurations.

CIRCLE NO. 372

Precision potentiometer at semiprecision price

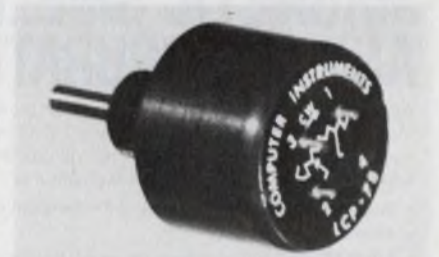

Computer Instruments Corp., 92 Madison Ave., Hempstead, NY 11550. (516) 483-8200. \$9.50 (10 up); stock.

The LCP-78 Series potentiometers provide precision potentiometer construction and performance at semiprecision prices. In all-metal 7/8-in. diameter cases, the units come with threaded bushings, or servo mounts with optional ball or bushing bearings. Other features include infinite resolution, linear or functional outputs and precious-metal multiple-fingered wipers to yield life in excess of 20-million revolutions over a wide range of environments.

CIRCLE NO. 373

INTRODUCING



VERY LOW COST **TRANSIT CASES**

ECONOMIC: These plastic cases are cheaper than wood crates when the cost is amortized. Prices start at \$30.49 ea.

INDESTRUCTIBLE: Made of high-density polyethylene giving very high impact resistance.

PROTECTIVE: Custom foam cushioning is available for your delicate equipment.

SUPER TOUGH: They withstand 100 trips by air and meet Air Transport Assn. Specification 300-CAT-1.

VARIETY: 56 standard sizes

THREE GRADES: 1) rain-tight 2) air-tight 3) military (vapor seal).

THERMODYNE INTERNATIONAL LTD.

12600 YUKON AVE
HAWTHORNE
CALIFORNIA 90250
(213) 679-0411



CIRCLE NUMBER 88

ELECTRONIC DESIGN 8, April 12, 1976

MICROPROCESSOR SERIES NO. 6

2650. APPS ENGINEERS: IN STOCK NOW.



Dozens of people to support systems, hardware, testware, devices in USA and Europe. More coming.

Attach to your letterhead. Mail. Send me the list of 2650 Applications Engineers with addresses & phone numbers.

Name _____ Title _____

Tel. _____ M.S. _____

811 E. ARQUES, SUNNYVALE, CA. 94086

THINK

Signetics μ P
a subsidiary of U.S. Philips Corporation

CIRCLE NUMBER 89

MAGNETIC SHIELDING FOR ANY CONFIGURATION

Ad-Vance reduces your shield costs because it already owns tooling for most standard shields. Or, our Magnetic Shielding Specialists will custom fabricate shields to your exact specifications.

- Magnetic Shields for 312 Types of Photomultiplier Tubes.
- AD-MU Sheet Stock.
- AD-MU Tape Data Protectors assure full fidelity of valuable tapes.
- Unequaled engineering & design service.
- In-house quality control.
- Fast delivery, competitive pricing.



2 Modern Plants with complete facilities for quality shield manufacturing

Ad-Vance Magnetics, Inc., the Old Firm with the New Name, is the industry's largest, oldest and most experienced independent firm exclusively manufacturing magnetic shielding.



AD-MU Foils Cut, Wrap Easily & Quickly



Typical Custom Fabricated Shields For Components & Systems



Send for 16-page catalog

AD-VANCE MAGNETICS, INC.

226 E. SEVENTH ST., ROCHESTER, IND. 46975

(219) 223-3158 TWX 810 290 0294

The Magnetic Shielding Specialists



CIRCLE NUMBER 90

IS A DETECTOR WITH SUB NANOSECOND RISE-TIME OF VALUE TO YOU?

IF YES-

Can you live with an S-1, S-5, S-13, S-20, or S-25 cathode?

IF YES-

Will you pay \$190 for it? Or \$520 in a housing?

IF YES-

Write, or call me personally (Ralph Eno) and let's talk about it.

IF NO-

But you do need quality detectors such as Photomultipliers, InAs, Vidicons, Silicon Detectors, InSb, and others ranging in price from \$1 to \$6,000, send for our full catalog.

HAMAMATSU CORPORATION
120 Wood Avenue
Middlesex, New Jersey 08846
(201) 469-6640

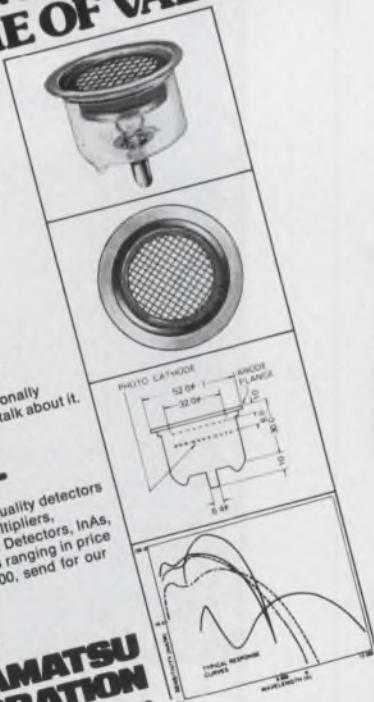

CIRCLE NO. 374

COMPONENTS

Decade resistor network holds 0.05% tolerance

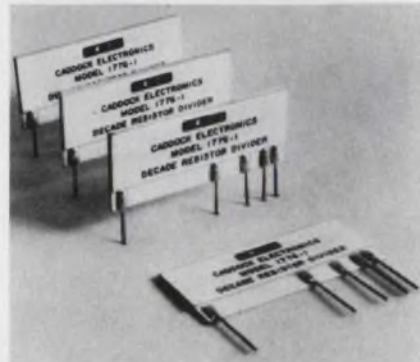

Caddock Electronics Inc., 3127 Chicago Ave., Riverside, CA 92507. (714) 683-5361. \$4.92 (1000 up); prototypes in stock.

Series 1776 edge-mounted precision decade-resistor networks can provide improved stability and accuracy in the input-voltage divider circuits of multimeters, oscilloscopes and other range-switching laboratory instruments. The standard version includes individual resistor values of 9 M Ω , 900 k Ω and 10 k Ω —values most commonly used in scaling the input signals of laboratory instruments. Ratio tolerances between resistors are held within 0.05%. The TC of the ratios holds to less than 10 ppm over 0 to 70 C. The maximum voltage-coefficient of the ratio is less than 0.02 ppm/V; the typical value is 0.003 ppm/V.

High-temp thermistors operate ac or dc modes

Fenwal Electronics, Div. of Walter Kidde & Co., Inc., 63 Fountain St., Framingham, MA 01701. (617) 872-8841.

Ionic-conduction Hi-Temp thermistor units are designed for high-temperature measurement and control from 500 to 1000 C in either ac or dc modes. In the dc mode, the unit's resistance is 10 k Ω at 750 C; in 60-Hz ac, 6300 Ω . Typical temperature coefficient is -1% at 750 C. Special order units are available in resistance values from 3 to 12 k Ω at 750 C, with body lengths from 1/4 to 2 in.

CIRCLE NO. 375

CIRCLE NUMBER 91

Micromotor features ironless rotor

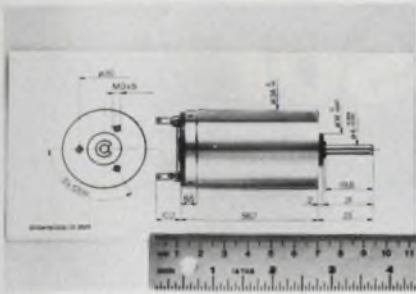

Portescap US, 730 Fifth Ave., New York, NY 10019. (212) 245-7716.

The new 34 L dc-micromotor series in a 34-mm case, at rated voltages, has a typical no-load speed range from 4700 to 5900 rpm and a range of stall torques to 14.8 oz-in. The torque constant is 8.1 oz-in/A and the unloaded mechanical time constant is 13 ms. The motor series uses an ironless rotor that features a low moment of inertia. Maximum operating temperature is 100 C. Linear relationships between voltage, speed and torque, as well as a low starting voltage make this series particularly suitable for servo applications.

CIRCLE NO. 376

Sealed relay provides mercury-wetted contacts



Fifth Dimension Inc., 707 Alexander Rd., Princeton, NJ 08540. (609) 452-1200. \$2.50 (OEM qty); stock to 6 wks.

The LC2RE SPST relay is epoxy encapsulated and features the use of a welded LC2 switching capsule that has only one moving part. Mercury films give mercury-wetted contact performance in all mounting positions. The initial contact resistance of 0.15 Ω is kept stable to $\pm 0.015 \Omega$ over the relay's lifetime of over 500-million cycles for either dry-circuit or power loads. The contacts operate and release in approximately 2.5 ms without contact bounce. Standard temperature limitations are -38 to 85 C.

CIRCLE NO. 377

Mechanical filters reject adjacent channels

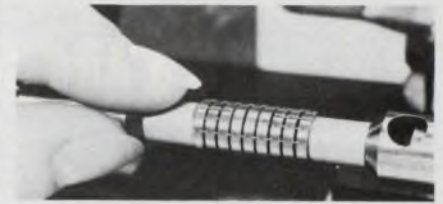

Collins Radio, Rockwell International, 4311 Jamboree Rd., Newport Beach, CA 92663. (714) 833-4632. \$11 (5000 up).

A new single-sideband mechanical filter, PIN 526-9877-010, for the CB market (455-kHz carrier) features stability and excellent adjacent-channel rejection, according to Collins. Disc resonators are made from specially processed Ni-Span "C," so that the total frequency shift over the temperature range of -30 to 50 C is typically only 35 Hz at the carrier 3-dB points. Either filter end may be used as input or output, but only one end is balanced. Both ends should be terminated with 2700 $\pm 10\%$ Ω shunted by a capacitance of 360 $\pm 10\%$ pF.

CIRCLE NO. 378

Stress test our strain reliefs.

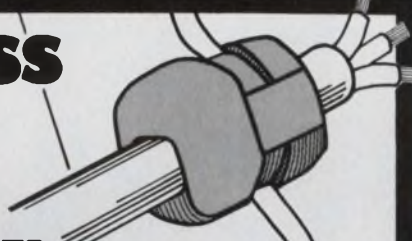

See for yourself how Heyco's nylon bushings provide instant strain relief and insulation for your wires. They absorb any push, pull or twist, so you get complete protection for electrical products. U.L. recognized, C.S.A. approved, for wires up to 5/8" diameter.

Send for Free sample pack and catalog.



HEYMAN MANUFACTURING COMPANY

KENILWORTH, NEW JERSEY 07033 WAUKESHA, WISCONSIN 53186
(201) 245-2345 • TWX: 710-996-5986 (414) 542-7155 • TWX: 910-265-3668

CALL TOLL-FREE (800) 558-0917 • IN WISCONSIN CALL (800) 242-0985



250

CIRCLE NUMBER 92

ELECTRONIC DESIGN 8, April 12, 1976

MICROPROCESSOR SERIES NO. 7

BY SEPTEMBER THE 2650 IS OVER 30% FASTER.

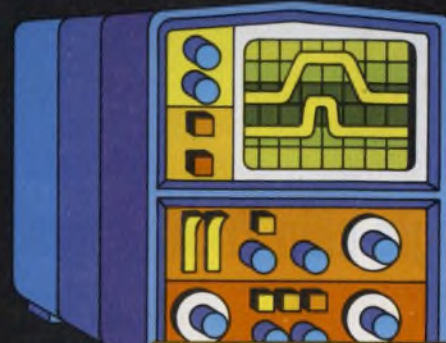

Your system's features can be extended with the speedier 2650. Current 2650 software will apply.

Clip to your letterhead. Put me on your reservation list for the first mailing of the faster 2650 data sheet.

Name _____ Title _____

Tel. _____ M.S. _____

811 E. ARQUES, SUNNYVALE, CA. 94086

THINK

Signetics μ P

a subsidiary of U.S. Philips Corporation

CIRCLE NUMBER 93

157

The easiest-to-use microprocessor

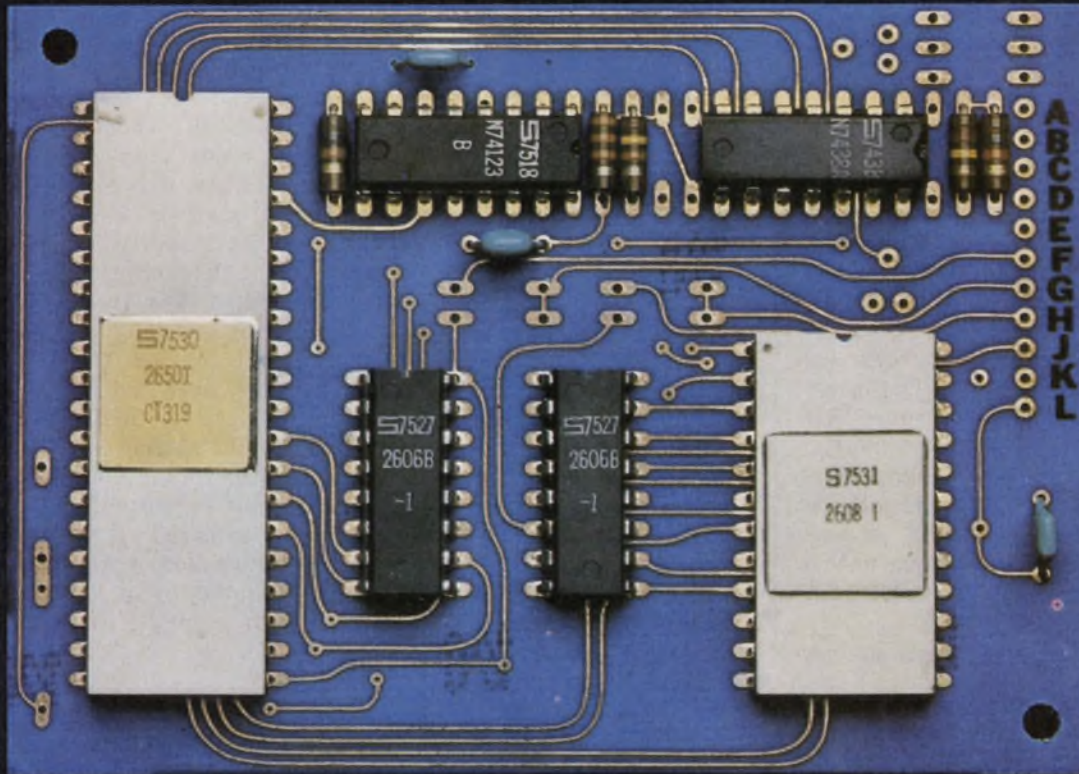

(Photograph approximately 2x actual size.)

The single-chip 2650 is easiest-to-buy, too. Now only \$21.50 (100-up).

Full support of customer and product is the key to ease of development with the 2650. Applications engineers in the U.S. and abroad are at your beck and call at every stage. Software for almost anyone's requirements and machines. Development hardware is versatile and inexpensive. All circuits are multi-sourced.

Flow Chart: How to travel safely and quickly from spec sheet to your μ C.

- 1 Applications Engineers — in the field now, more coming. Specific assistance to you is available around the USA, and in Belgium, Holland, Germany, France, Sweden, Britain, Italy, etc.
- 2 Multi-sourced 2650 — available in any quantity from Signetics, at the unprecedented low price of \$21.50. Also available from AMS and Philips, and from Signetics' authorized distributors.

- 3 Development Software — includes the PL μ S, an extremely efficient High Level Language (compiler) that reduces programming effort and cuts development time. ANSI standard Fortran IV executes on most machines without alteration. 2650AS1000/1100 Assembler and 2650SM1000/1100 Simulator are available in both 32- and 16-bit, on GE and NCSS time-sharing.

- 4 Multi-sourced Support Circuits — You'll need MOS and/or Bipolar Memories, Interface and Logic. Signetics has *everything* for a complete system. Back up any item from other sources. Coming soon from Signetics are: Programmable Peripheral Interface and Communications Interface, A-D Converters, Synchronous Data Link Controller, 16k NMOS & Bipolar ROMs, 4k & 8k NMOS EROMs, and 8k Bipolar PROMs.

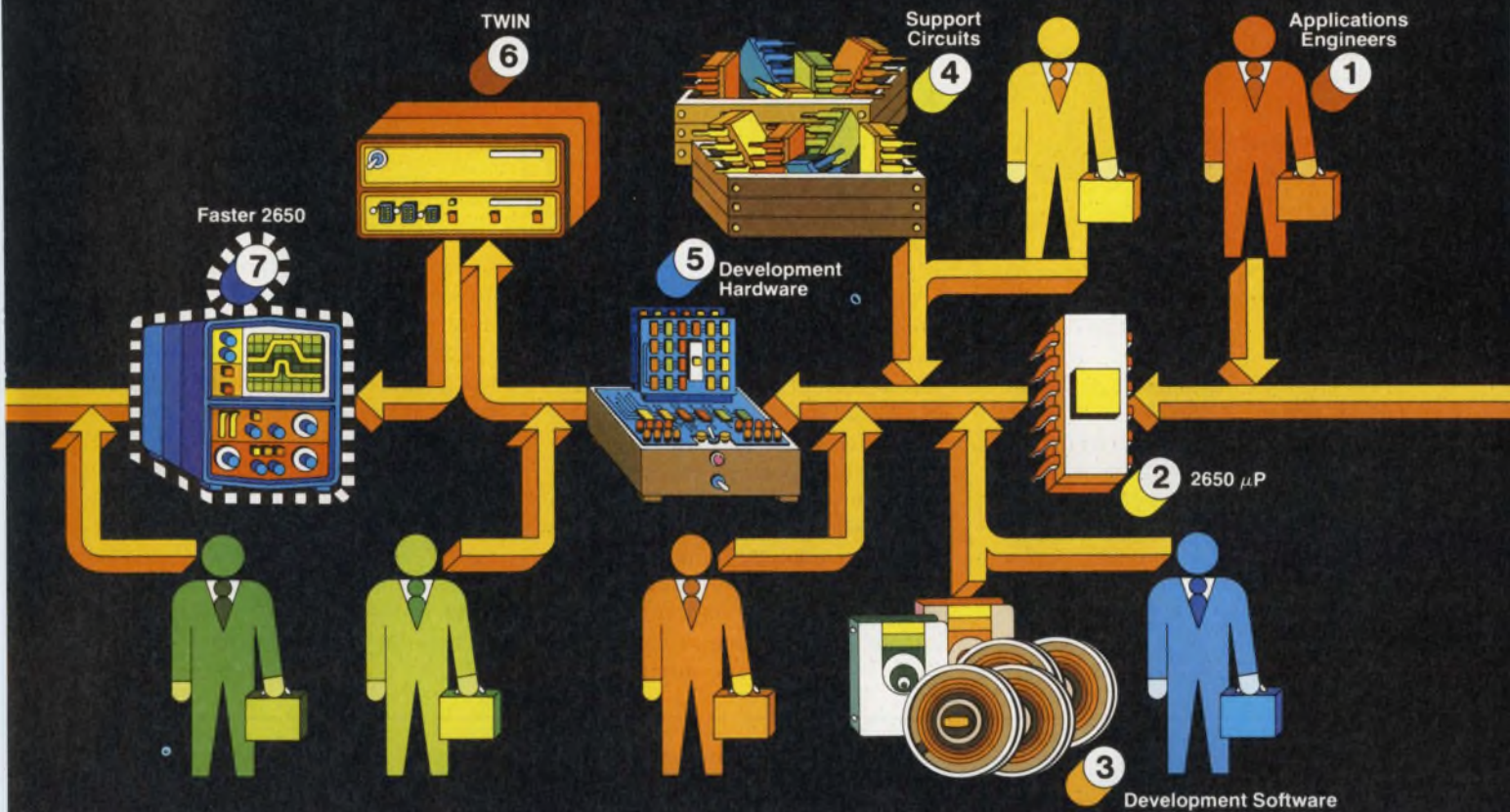

makes the easiest-to-develop microcomputer.

5 Development Hardware — Design/develop/prototype with a variety of cost/capability levels of hardware support. Including prototyping cards and kits, smart typewriter demo card, 4k-byte RAM card, and more. Applications help if you need it.

6 TWIN With Floppy Disks — “crashproofs” your system checkout. With DOS, Resident Assembler, and Text Editor. You develop programs and circuits together in an actual system environment with TWICE (TestWare In Circuit Emulator). PROM programming, too.

7 Over 30% Faster 2650 — By the time you’ve proven out your μC , you’ll have available a faster 2650 if you want it. Uses the same software. For still higher speeds, call Signetics Bipolar Microprocessor Marketing about our 2650 emulator using 3000 series μP .

You go from gleam-in-your-eye to proven prototype in less time for less cost, and the μC you develop is easier and cheaper to produce in quantity, when you start with the 2650. Start now by mailing the coupon.

Attach this to your letterhead for fast response.

Send me complete 2650 short form catalog.

Have a Field Applications Engineer call me for appointment.

My need is: immediate 6 months information only

My application is _____

Name _____ Title _____

Telephone _____ Mail Stop _____

THINK Signetics μP
a subsidiary of U.S. Philips Corporation

811 E. Arques Ave., Sunnyvale, Ca. 94086

COMPONENTS

Lighted pushbutton operates on 120 V

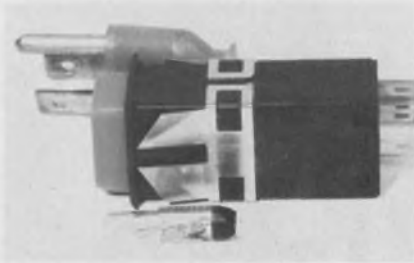

Micro Switch, Div. of Honeywell, 11 W. Spring St., Freeport, IL 61032. (815) 232-1122. \$3.65 (1000 up).

A UL-listed commercial pushbutton added to the Series-4 lighted pushbuttons can be wired directly into 120-V circuitry without transformers or resistors. A T2 lamp with slide-base construction, rated at 120 V and 0.025 A for 5000 h, is used. A locked-in button retainer prevents front-of-panel tampering.

CIRCLE NO. 379

Optical-encoder kit provides 256 pulses/rev

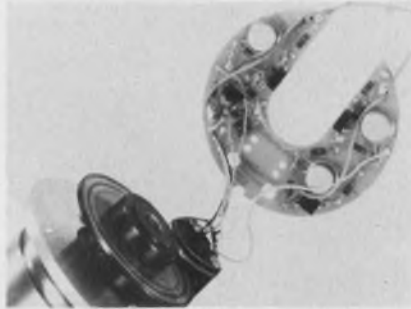

Vernitech Div., Vernitron Corp., 300 Marcus Blvd., Deer Park, NY 11729. (516) 586-5100. \$25 (10,000 up); stock to 4 weeks.

The OADC-023/256P/INC incremental optical-encoder kit for industrial applications features 256 pulses/revolution, a single output, an all-solid-state light assembly and modular construction. Its LED light assembly has a guaranteed life expectancy of 100,000 h. Other kit encoders are available with two channel outputs, indexing channels, up to 1000 pulses/revolution squared output and operating voltages from 5 to 15 V dc.

CIRCLE NO. 380

DIP resistor networks hold up to 15 resistors

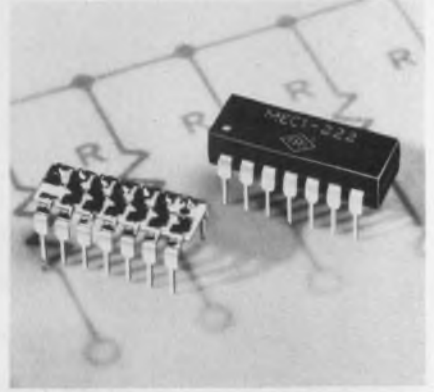

Centralab, 5757 N. Green Bay Ave., Milwaukee, WI 53201. (414) 228-2911. See text; stock.

Off-the-shelf DIP resistor networks are available in four popular configurations. The thick-film networks consist of 7, 8, 13 or 15 resistors in 14 or 16-pin DIPs. The networks have a $\pm 2\%$ resistance tolerance, 2.5-W package power rating and ± 200 ppm/ $^{\circ}\text{C}$ resistance tempco. Price for a typical seven resistor, 14-pin unit is \$0.61 each in lots of 1000 pieces.

CIRCLE NO. 381

**NEW LOW COST REED RELAY
ROCK HARD EPOXY COATED**

\$1.85 to 49¢

Depending on coil voltage, contact level and volume.

Blue Boy Reed Relays offer:

- Protection from handling, solvents, tough environments
- 1 pole normally open contacts up to 10 watts
- General purpose or logic level contacts
- Coil voltages 5 through 48 VDC; .35" H x 1" L

Available from distributors.

26477 Golden Valley Road • Saugus, California 91350
(805) 252-8330 • (213) 788-7292 • TWX 910-336-1556

ELEC-TROL, INC.



CIRCLE NUMBER 96

**DIP REED RELAYS
35 MODELS**

Your choice of:

- SPST, DPST & SPDT dry reed contacts, 3 to 10 watts.
- SPST mercury wetted reed contacts, 28 watts.
- 5 to 24 VDC coils, 4, 8, or 14 terminals, TTL compatible.
- Optional clamping diodes and electrostatic shielding.

Available from distributors. Or contact us today.

26477 N. Golden Valley Road • Saugus, Calif. 91350
(805) 252-8330 • (213) 788-7292 • TWX 910-336-1556

ELEC-TROL, INC.

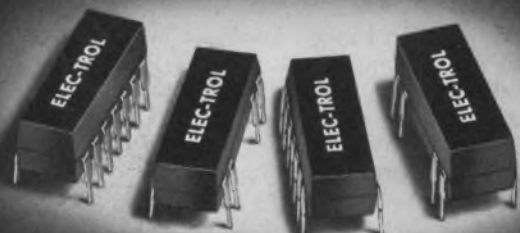

eem

CIRCLE NUMBER 97

Front panel components should look good.

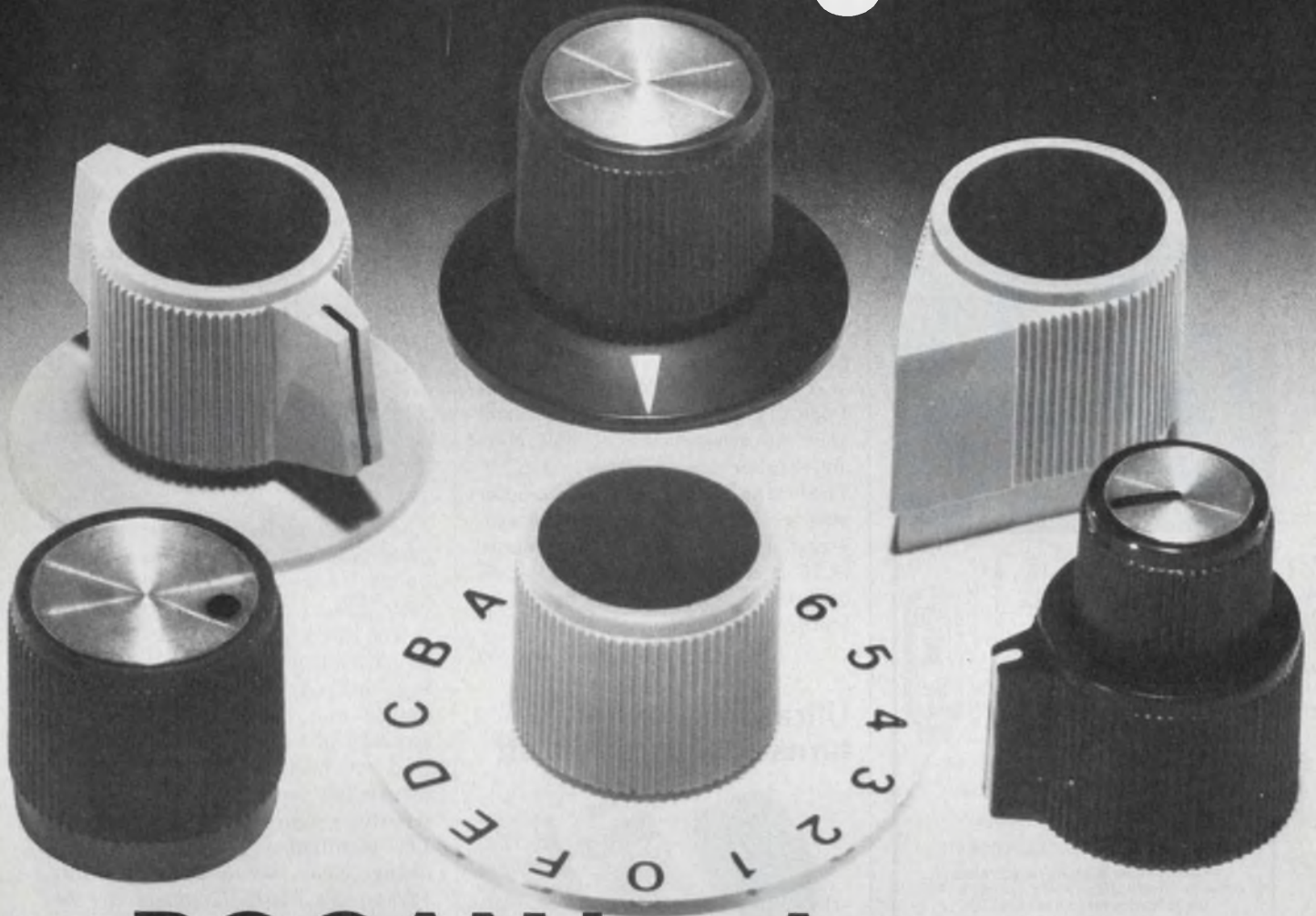

ROGAN knobs and dials do.

Today's market is aesthetics-conscious. An attractive front panel adds to the acceptance of your product. Front panel components, including control knobs and dials, must contribute to the overall design. Some knobs and dials simply look better than others. We think that the Rogan line illustrates superior styling details, while offering the largest selection of functional shapes and sizes available.

Obtain a copy of our catalog by contacting Rogan . . .
the control knob and custom dial company.

ROGAN
CORPORATION

3455 Woodhead Drive, Northbrook, Illinois 60062
Phone: (312) 498-2300 · TWX: 910-686-0008

CIRCLE NUMBER 98

AMPERITE

Thermostatic RELAYS - LONG DELAY -



240 & 300 Seconds

New! For applications requiring long delays. Hermetically sealed — not affected by altitude, moisture, or climate changes. . . SPST only — normally open or normally closed. . . Compensated for ambient temperature changes from -55° to +80°C. . . Rugged, explosion-proof, long-lived. . . Standard radio octal base only.

Price, under \$6.00 ea.

Write for Bulletin No. LD-73.

DELAYS: 2 to 180 SECONDS*

Same rugged construction, hermetic sealing and stability as the long Delay Relays described above. . . For standard radio octal and 9-pin miniatures.

Price, standard or min., under \$4.00 ea.

*Miniatures delays: 2 to 120 seconds.

PROBLEM? Send for Bulletin No. TR-81.

All Amperite Delay Relays are recognized under component program of Underwriters' Laboratories, Inc. for all voltages up to and including 115V.

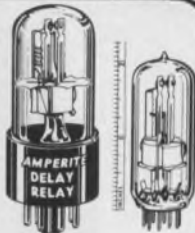

DIFFERENTIAL RELAYS

For automatic overload, over-voltage or under-voltage protection. . . Made only to specifications for 70V, 80V, 90V and 100V.

Price, under \$6.00 ea.

AMPERITE BALLAST REGULATORS

Automatically keeps current and voltage at a definite value. For AC or DC. . . Hermetically sealed, rugged, vibration-resistant, compact, most inexpensive.

Price, under \$3.00 ea.

Write for 4-p. Bulletin No. AB-51.



AMPERITE

600 PALISADE AVE., UNION CITY, N.J. 07087

Telephone: 201 UNION 4-9503

In Canada: Atlas Electronics, Ltd.,
50 Wingold Ave., Toronto 19

OUR COMPLETE PRODUCT LINE CAN BE FOUND IN ELECTRONIC DESIGN'S GOLD BOOK.

CIRCLE NUMBER 99

COMPONENTS

Bridged-T-pad trimmer operates in CATV range

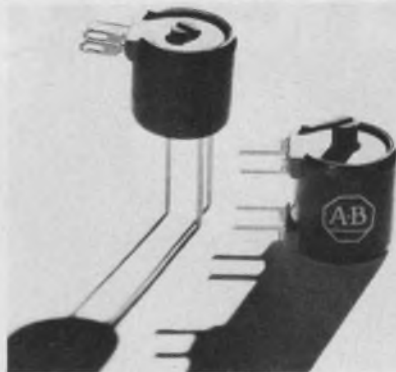

Allen-Bradley Co., 1201 S. Second St., Milwaukee, WI 53204. (414) 259-2062.

A dual molded-carbon trimmer Type BT offers superior performance at frequencies of 300 MHz and higher encountered in CATV. The single-turn 0.5-in.-diameter plastic unit is designed for bridged-T-pad applications. The impedance is $75 \Omega \pm 20\%$ over its entire 295-degrees of rotation. The operating temperature range is -40 to 120 C.

CIRCLE NO. 382

Ultrasonic control turns appliances on/off



Mark Engineering Inc., 34 Towers St., P.O. Box 308, Hudson, MA 01749. (617) 562-7883. \$18.95 (unit qty).

A wireless ultrasonic remote-control device can turn televisions, lights and appliances on and off at the squeeze of a finger. Called Whistle Switch, the receiver part of the system plugs into any 110-V outlet along with the appliance to be controlled. A hand-held transmitter is then squeezed to turn the power on or off.

CIRCLE NO. 383

Toroidal cores can cut Xformer weight by 1/3

International Commerce Aid Ltd., Horii Bldg 501, 3-5-3 Misaki-Cho, Chiyoda-ku, Tokyo 101, Japan.

Nippalloy-S core materials made from 78.5% Ni, 4% Mo and 17.5% Fe can cut toroidal transformer weight by 33-1/3%. The cores are designed for operation at frequencies above 2000 Hz. The material has a density of 8.65 g/cm³, a resistivity of 50 $\mu\Omega$ -cm, a curie temperature of 400 C and a saturation induction of 8.2 gauss.

CIRCLE NO. 384

Gas-discharge displays upper/lower decimal



Cherry Electrical Products Corp., 3600 Sunset Ave., Waukegan, IL 60085. (312) 689-7702. \$6.95: display, \$1.02: connector (2000 up).

The new Plasma-Lux 16-digit gas-discharge display, W16-0002, has both upper and lower decimal points and commas. The display has 0.25-in. high characters. A unitized connector, W30-1602, with bifurcated contact tabs assures positive connection to the display's PC terminals. The unit's neon-orange color provides easy visibility and the display's image can be readily filtered.

CIRCLE NO. 385

Stacked-film extended to metallized-Mylar caps

Siemens Corp., 186 Wood Ave. S., Iselin, NJ 08830. (201) 494-1000, Ext. 338. \$0.11: 0.01 μF (100 up); stock.

The space efficiency afforded by stacked-film construction has been extended to a new line of metallized-Mylar capacitors, heretofore restricted to polycarbonate-film capacitors. Constant lead spacing for all capacitor values simplifies mechanical layout. Designated B32560, B32561 and B32562, the new capacitors are available in 100 or 250-V ratings. Capacity range is from 0.001 to 2.2 μF with a $\pm 5\%$ standard tolerance.

CIRCLE NO. 386

9 questions and 8 answers about Fairchild's microprocessor kit.

What exactly is an F8 kit?

Put simply, it's a package designed to help you get better acquainted with microprocessors in general and our F8 in particular.

What's in it?

Each kit contains a fully assembled microprocessor which includes an F8 CPU, a preprogrammed Program Storage Unit, an F8 Memory Interface Circuit, and 1k bytes of static RAM. You'll also get a wired edge connector - one end for the board, another for your TTY and three wires for power. And it all comes on a fully assembled and tested PC board.

The board is a complete microcomputer with CPU, memory, 32 I/O bits, two levels of interrupts, two programmable timers, and all the necessary control circuits. I/O signals are TTL compatible. And have been brought out to the edge connector. Internal signals have also been brought out to connectors for possible system expansion.

Unlike most other kits there's no additional assembling. Just add power. No soldering. No wiring. Compare that with the assembly time you'll spend getting other kits up and running.

What if I don't really know all that much about microprocessors?

No problem. We've included everything you'll need. The F8 Programming Manual, the F8 Data Book, and the Fairbug program.

Will they really help me get on the air?

They sure will. The F8 Programming Manual contains all the basic programming information you need even if you've never written a program before. And, if you're already acquainted with programming, it contains some very sophisticated techniques.

Fairchild F8 microprocessor kit. What's in it for you?

The Data Book completely characterizes the F8 parts, both internal functions and the electrical characteristics of all the pin-outs.

With the aid of these two manuals you'll be writing and running programs in a couple of hours.

And don't forget Fairbug.

What's Fairbug?

The kit's PSU has the Fairbug program on it. It's a series of user oriented subroutines to make your job as a designer a little easier. For instance, entering a program into RAM can be a difficult process. But our Fairbug handles the problem quickly and easily with a "bootstrap loader" that loads data from a terminal and stores it in RAM.

What else will Fairbug do?

The Fairbug contains 1,000 bytes of programming and the "bootstrap loader" is only a small part of it. The remaining functions allow you to communicate with virtually any terminal or TTY at speeds from 10 to 300 cps; dump memory from RAM for future loading or to create a PROM and to read from a high speed paper tape reader.

It also lets you examine and alter any register or memory location in an F8 system from a terminal. Suppose you've erred

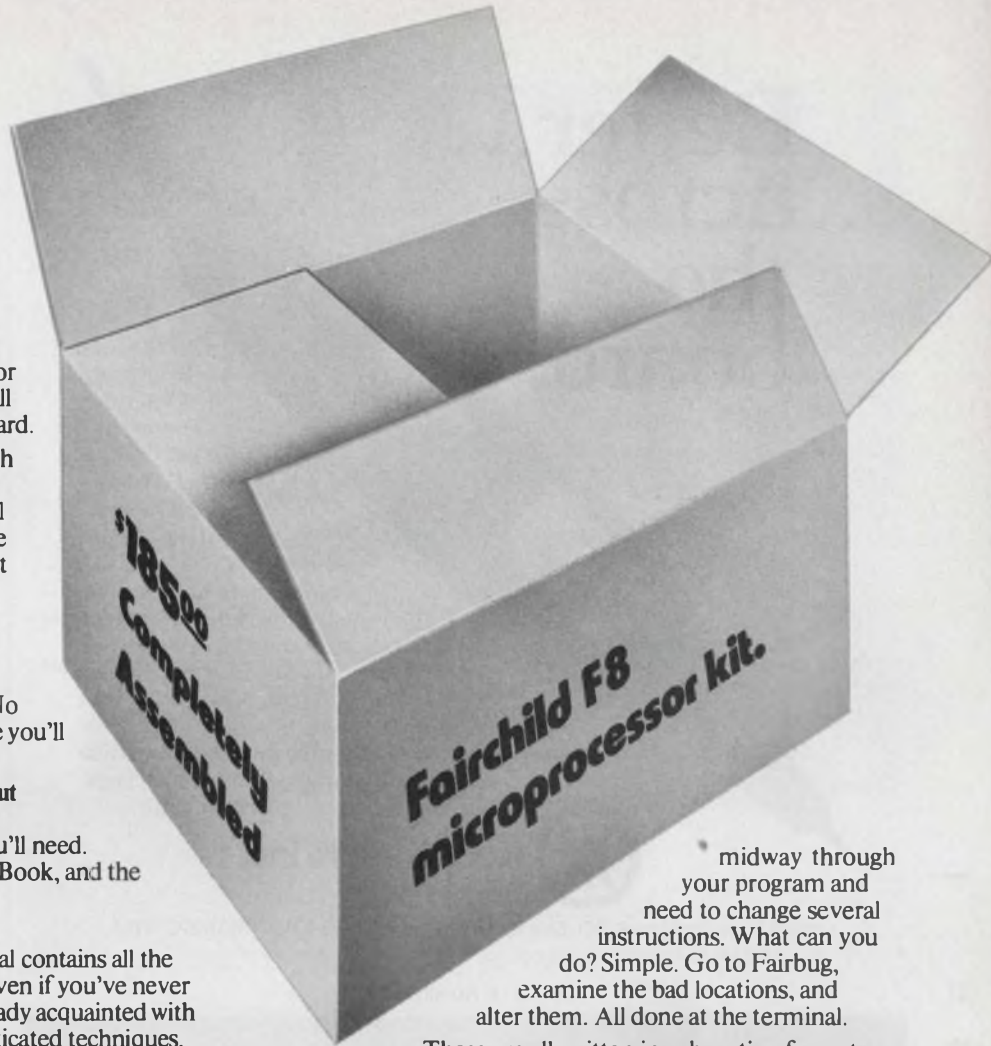

midway through your program and need to change several instructions. What can you do? Simple. Go to Fairbug, examine the bad locations, and alter them. All done at the terminal.

These are all written in subroutine format. So you can use them both as the Fairbug package, and as part of a subroutine library.

Sounds pretty impressive. What does the whole kit cost? Would you believe \$185.00 for a fully assembled microcomputer? That's a lot less than the bag of unassembled parts offered by most other manufacturers. Then add our powerful Fairbug user's program and twice as much RAM as most kits.

Where can I get a kit?

Kits are available for immediate delivery from your local authorized Fairchild distributor. Or, if you prefer, use the coupon below, and we'll process your order from the factory.

Last question. How effective will Fairchild's F8 kit be in my application?

We thought you'd never ask. That's one you'll just have to answer yourself after you've tried it, and the first step is to get the kit.



I'm sold. Fairchild Microsystems Division of Fairchild Camera & Instrument Corporation, 1725 Technology Drive, San Jose, California 95110. Please rush me Fairchild's F8 microprocessor kit today. Here's my: check money order P.O. number for \$185.00 (add sales tax where applicable) have a salesman call

NAME _____ TITLE _____

COMPANY _____

ADDRESS _____

CITY _____ STATE _____ ZIP _____

SIGNATURE _____

PHONE NUMBER _____ EXT _____

Better...
...across
the
board.



Our PLP-550 logic probe is internally programmed to select C-MOS, HTL, TTL/DTL logic. Stretch memory catches single, short pulses you can't see. Unique three lamp system gives you duty cycle information you'd otherwise need a scope to see. Next time out, take the Kurz-Kasch PLP-550 with you... and leave your scope back at the shop. Soon to be available are single and dual family probes in the same rugged, functionally designed package. Call or write.....



Kurz-Kasch, Inc.
Electronics Division

1501 Webster Street, P.O. Box 1246, Dayton, Ohio 45401 (513) 223-8161

CIRCLE NUMBER 101

INTRUMENTATION

Keyboard controls precision calibrator



Digitec, 918 Woodley Rd., Dayton, OH 45403. (513) 254-6251. 3210, \$1795; 3220, \$1595.

Expanding its High Technology series instrumentation line, Digitec has introduced two new models in its precision calibrator family—the Model 3210 keyboard-controlled unit and the Model 3220 programmable unit. The units are designed to function as both constant-voltage and constant-current sources. Model 3210 has a keyboard that replaces conventional front-panel controls and permits operation from remote locations or by semi-automatic testing systems. Model 3220 is designed for fully automatic systems and can be programmed to accept TTL/BCD logic, or other codes. Both models provide a precise LED digital display of the output voltage to ± 200 V and current to ± 200 mA.

CIRCLE NO. 387

Data Display: YOUR Way



Ann Arbor makes over 1000 standard RO and KSR display terminal models. Alphanumeric. Graphics. Or both.

We also thrive on *tough* CRT display applications. Unique character sets. Unusual graphics. Difficult interfacing. Custom keyboards. Special packaging. You name it.

Standard or custom, *every* terminal produced is based on a field-proven Ann Arbor engineering concept. DESIGN III desktop terminals to complement any office decor. Compact, rugged Series 200 modular terminals that defy industrial environments. Or barebones board sets for OEMs who prefer to roll their own.

Many companies sell CRT terminals. But Ann Arbor sells creative solutions to CRT display problems, as well.

Probably at lower cost than anyone else in the business.

Contact us at 6107 Jackson Road, Ann Arbor, MI 48103. Tel: 313-769-0926 or TWX: 810-223-6033. Or see our catalog in EEM, Volume One.

**ANN ARBOR
TERMINALS, INC**

... creating new ways to communicate

CIRCLE NUMBER 102

True-rms meter offers high accuracy

UFAD Corp., 700 36th St. S.E., Grand Rapids, MI 49508. (616) 241-6000. \$345; stock-30 days.

True-rms 733 series voltmeters offer converter accuracies of $\pm 0.25\%$ and full-scale meter accuracies of $\pm 1\%$. The units can convert inputs of any wave shape, including noise up to 1 MHz at rated accuracies over ranges from 3 mV to 300 V. Additional features include a crest factor of 5.5:1 and two selectable response times.

CIRCLE NO. 388

HP displays.

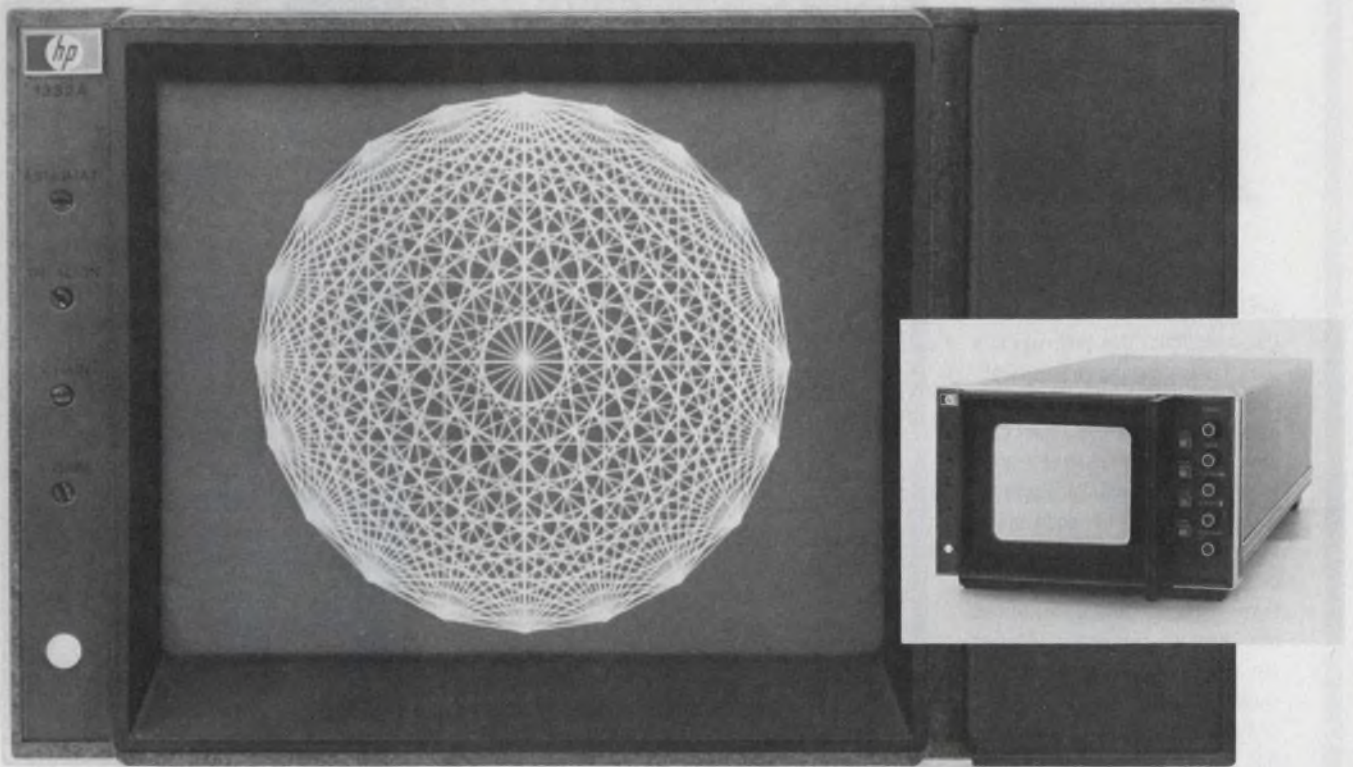

Because your system deserves a bright, sharp image.

You put a lot into each OEM system: good circuit design, quality components, careful testing. But end users will judge it by the information they get from the display. They expect bright, sharp images. That's why HP's 1332A, 1333A, and 1335A CRT displays make excellent choices for all types of systems—from spectrum, network, and chemical analyzers, to automatic test systems.

Each display has a very small spot size that focuses uniformly over the complete viewing area, regardless of writing speeds or intensity level. This eliminates the need to refocus at each intensity setting and assures crisp images, even around the outer edges of the screen. Fine image detail with excellent contrast and uniformity make them particularly well suited for applications involving complex graphics, especially those with alphanumeric data.

The 1335A, a variable-persistence, storage, and non-storage display, introduces a totally new CRT design optimized exclusively for information display. It offers exceptionally good resolution over the entire 8 x 10 cm screen. And the 1335A is versatile too. Any operating mode—erase, store, write, conventional, or variable persistence—can be selected with manual front-panel controls, remote program inputs, or a combination of both. Manual controls can be inhibited entirely during remote operations. The 1335A is a welcome

addition to medical and instrumentation systems.

OEMs who need a larger viewing area and a brighter image at faster scan rates like the 1332A. They appreciate its 9.6 x 11.9 cm viewing area, its superior performance, and the ease with which the 1332A, like the others, integrates into a variety of racks and cabinets.

For photographic recording of displayed data, the new 1333A offers new performance levels. Its extremely small spot size of 0.20 mm (0.008 in.) provides the exceptional quality necessary for easy and accurate photo evaluation. And its 8 x 10 cm screen allows reproduction on Polaroid film with very little optic reduction. For convenience, all frequently used controls on all of these displays have been placed on the front panel for maximum accessibility.

Which display best fits your requirements? Let your local HP field engineer help you decide. Or write for specific details. We'll help you pick a display that makes your system look as good as it actually is.

085/9 A

HEWLETT  PACKARD

Sales and service from 172 offices in 65 countries
1501 Page Mill Road, Palo Alto, California 94304

MONOLITHIC CRYSTAL FILTERS



SPEAKING TO THE DEAF

Our monolithics find their way into some fascinating and unusual applications. For instance — a narrow-band FM system which allows children with severely impaired hearing to participate in normal classroom activities. One of the requirements of the system was that both the students' receivers and the teacher's transmitter allow unhindered movement by the wearer. Another was freedom from interference, including interference from other systems in nearby classrooms. Cost was also an important factor. One of our standard 10.7 MHz tandem monolithic crystal filters in each receiver takes care of the interference. Its size is consistent with the needs of the wearer. Its cost is consistent with educational budgets.

HAVE IT YOUR WAY

As regular readers of this column know by now, we offer the broadest line going of standard monolithic crystal filters. It may be worth mentioning that we're just as interested in helping you with a custom monolithic as we are in showing you new ways to use our regular models. We've done hundreds of production "specials" from 5 to 180 MHz. May we do one for you?

What's your production application? Talk with us about it. We may be able to help. And if your interests include teaching the deaf, we'd be happy to put you in touch with the manufacturer of this equipment.



Piezo Technology Inc.

2400 Diversified Way Orlando, Florida 32804
305 425-1574

The Standard in monolithic crystal filters.

CIRCLE NUMBER 104

INSTRUMENTATION

Ultrasonic units fit modular instrument line



Metrotek, Inc., 1313 Acacia Blvd., Richland, WA 99352. (509) 946-4778. MP203, \$525; MR101, \$535; 8 wks.

MP203 and MR101 are part of a modular, plug-in ultrasonic system, designed to operate with Tektronix TM-500 system power modules. M-series is TTL-compatible. The MP-203 is a variable output ultrasonic pulse generator. It generates a negative spike pulse with a typical rise time of 7 ns and a peak amplitude of 230 V into 50 Ω . Rep rate is adjustable to over 10 kHz. MR101 is a receiver-amplifier with a calibrated gain of 40 dB.

CIRCLE NO. 389

Chart recorder offers remote control



McKee-Pedersen Instruments, P.O. Box 322, Danville, CA 94526. (415) 937-3630. \$695.

MP-1027-MR recorder is a general-purpose, flat-bed unit for laboratory use. The recorder features a six-speed, digital chart drive and electric pen lift. Both can be remotely controlled by contact closures. The chart drive can also be stepped by logic pulses. It is possible to slave the chart drive to the pen lift so that only one contact closure is required to drop the pen to the writing position and start the chart. A major feature is the wide range of calibrated full-scale spans: from 1 mV up to 100 V.

CIRCLE NO. 390

EAGLE



SINCE

1843

PICHER

Carefree[®]
RECHARGEABLES

LEAD-ACID BATTERIES

- SEALED ● RUGGED
- NO MAINTENANCE
- SAFE ● SPILL-PROOF
- WIDE TEMPERATURE OPERATING RANGE
- LONG LIFE



RELIABLE ECONOMICAL RECHARGEABLE POWER
for

- Alarm Systems
- Emergency Lighting
- Electromedical Apparatus
- Telephone Carrier Equipment
- Portable Television
- Communication Equipment
- Portable Instrumentation
- Computer Standby Systems
- And Many More

To Find Out How to Make Your Battery System

Carefree[®]

Call or Write

EAGLE-PICHER INDUSTRIES, INC.
Commercial Products Dept. ED
P.O. Box 130, Seneca, Mo. 64865
Telephone (417) 776-2258

CIRCLE NUMBER 105

ELECTRONIC DESIGN 8, April 12, 1976

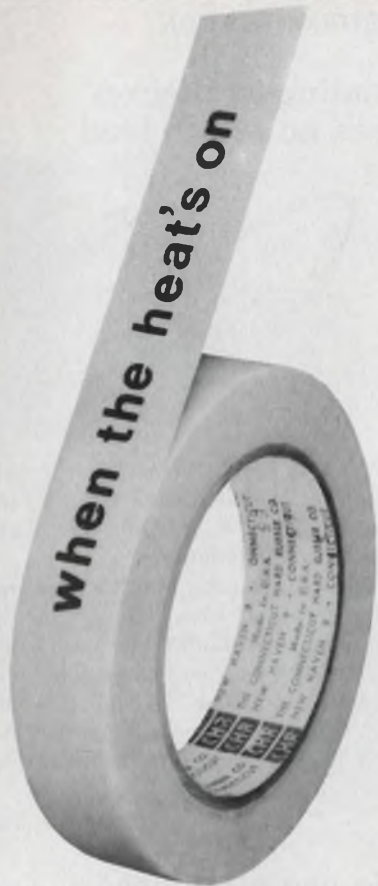

use pressure sensitive
TEMP-R-TAPE of fiberglass
for quick relief.

Excellent electrical properties plus most anything else you want in fiberglass tapes like high tensile and tear strength, dimensional stability, good conformability, thermal endurance, abrasion resistance, non-corrosiveness, Temperature to 180°C. Available with several adhesive systems. Low unit cost.

Find your nearest Distributor in the Yellow Pages under "Tapes, Industrial" or in Industrial Directories or write for complete specification kit and sample offer. The Connecticut Hard Rubber Company, New Haven, Conn. 06509

CHR

an ARMCO company

CIRCLE NUMBER 106

ELECTRONIC DESIGN 8, April 12, 1976

Speed indicator displays digitally



Servo-Tek Products, 1086 Goffle Rd., Hawthorne, NJ 07506. (201) 427-3100. \$290; stock.

A new digital speed indicating system consists of a 3-1/2-digit panel meter and a precision, permanent-magnet, dc tachometer generator. Also available are 2-1/2 and 4-1/2-digit meters. The system provides a continuous updated reading of rpm and allows any reading to be displayed indefinitely, regardless of speed, through the actuation of a hold signal. Three bidirectional ranges are offered as standard: 0 to 100 rpm, 0 to 1000 rpm and 0 to 10,000 rpm. Other ranges and engineering units are also available, as are BCD outputs.

CIRCLE NO. 391

DMM/thermometer linearizes sensor inputs



Takeda-Riken, 1-32-1 Asachi-Cho, Nerima ku, Toyko, Japan.

Model TR-2112 thermometer/multimeter measures dc V, ac V, resistance and dc and ac current in addition to temperature. The unit digitally linearizes the sensor input to cover a temperature range from -100 to +1600 C with five kinds of thermocouples and an accuracy of $\pm 0.3\%$ of rdg ± 1 digit. With a CC thermocouple, resolution is 0.1 C. As a DMM, the TR-2112 counts to 1999, with automatic ranging and resolution of 10 μ V on dc V.

CIRCLE NO. 392

Get the scope you need-Now!

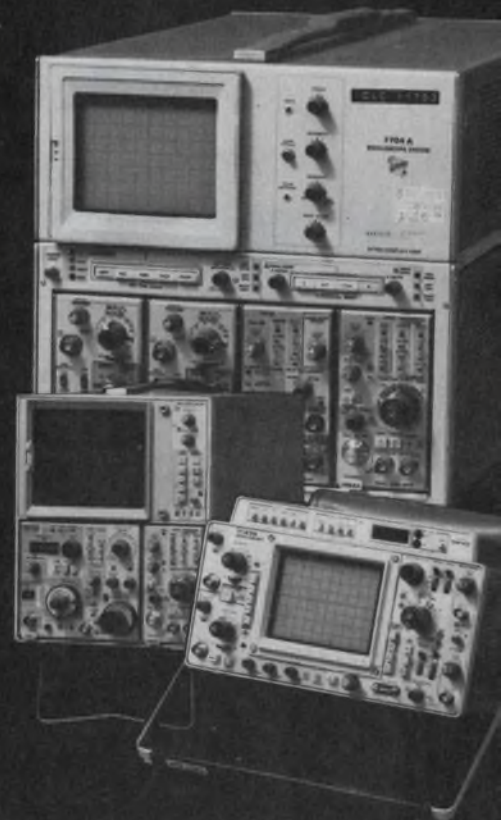

Our "Instrument Professionals" will tell you which scope will do the job best, at the lowest cost, make immediate delivery and guarantee performance.

Write or call for data on our other specialties: Instrument Leasing • Computer Peripherals • Equipment Sales • Instrument Service.

Call  Get our
FREE
Catalog

Continental Rentals

Div. Continental Leasing Co., Inc.
175 Middlesex Turnpike, Bedford,
MA. 01730 (617) 275-0850

Metuchen NJ, (201) 549-8500; Rockville,
MD, (301) 881-7997; Dallas, TX, (214)
357-1779; Elk Grove IL, (312) 439-
4700; Costa Mesa, CA (714) 540-6566;
Santa Clara, CA, (408) 735-8300;
Los Angeles, CA, (213) 477-7521

CIRCLE NUMBER 107 ►

What's your Mu IQ?

A QUICK QUIZ ON MAGNETIC SHIELDS

1	2	3	4	5	6
Who has the most complete magnetic shield facility in the U.S.?	How many ways can a magnetic shield be fabricated?	Who gives you design help, prototypes, drawings, testing and quality assurance?	How many layers of .004" Hiper-nom foil will attenuate a 4 oersted field by a factor of 10?	Why are Amuneal magnetic shields cooked 22 hours in 99.9% dry hydrogen?	What is "Mu" anyway?



Answers: 1. Amuneal; 2. six; spot welded, heliarc welded, drawn, spun, wrapped or hydroformed; 3. Amuneal; 4. two layers; 5. to restore the optimum magnetic shielding properties of the metal destroyed during fabrication; 6. the Greek letter denoting permeability, the ability of the shield to carry the field.

For all the answers, send for your free Magnetic Shield Source Book today.

amuneal
MANUFACTURING CORP.

4737 Darrah St., Philadelphia, Pa. 19124 Telephone: 215-535-3000

CIRCLE NUMBER 108

The finest switches are also the easiest to install

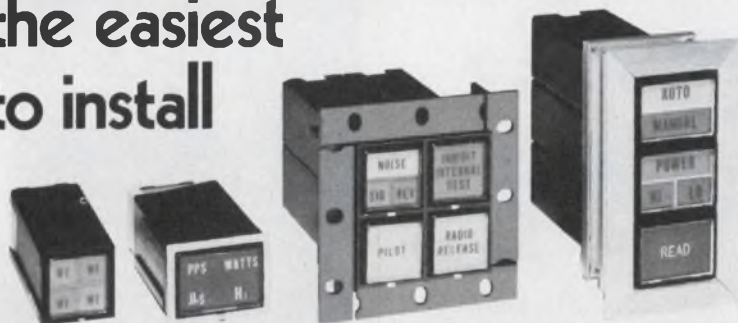

Quick and easy to mount, Stacoswitch individual and matrix illuminated push-button display switches save installation time and cost. Matrix available with rear mounting flanges or a new front mounting dress bezel that will enhance the most modern panel design. And where dependability is a prime requirement Stacoswitch will keep working long after lesser switches have failed. Choice of switch action and contact arrangement, 2PDT or 4PDT. Wide selection of display colors and legend styles. You can't do better than with Stacoswitch. Write today for General Catalog giving complete description and specifications. When you think switch... think Stacoswitch.

STACOSWITCH
a STACO, INC. company
1139 BAKER STREET, COSTA MESA, CALIF. 92626
(714) 549-3041 TWX: 910/595-1507

Other STACO Company products:
Custom Transformers, STACO, INCORPORATED, Richmond, Indiana; Variable Transformers, STACO, INCORPORATED, Dayton, Ohio.

CIRCLE NUMBER 109

INSTRUMENTATION

Continuity checker uses no return lead



X-Tronics Electronics, 15500 Trask River Rd., Tillamook, OR 97141. (503) 842-7296. \$12.50 w/o batteries; stock-30 days.

This continuity checker has no ground-return lead. The circuit is completed through the hand and body of the user and the component being tested. The checker is completely portable and can be carried in a pocket. The output indication is visual.

CIRCLE NO. 393

Sig gen stretches range of scope cal unit



Tektronix, P.O. Box 500, Beaverton, OR 97077. (503) 644-0161. \$1995; 10 wks.

Model SG 504 leveled sine-wave generator is said to extend the frequency range of the company's TM 500 oscilloscope calibration package far beyond that of any other on the market. The unit provides a regulated, constant-amplitude sinusoid over a 245-to-1050-MHz range. The unit indicates frequency on a high-resolution tape dial that expands each band over 28 in. It produces internally selectable amplitude reference signals of 0.05 MHz for real-time bandpass measurements, or 6 MHz for sampling.

CIRCLE NO. 394

MINIATURE
LAMPS



OUR HELPING HAND

If the prosaic nature of miniature lamps leaves you a little cold, maybe you'll warm up to our price and delivery.

Not being one of the "big" little lamp people—at least not yet—means Inter-Market has to do some attractive things on pricing and shipping to compete.

We aren't running this ad to ask to be your second source, but we'll accept this for openers. So if you're being kicked around by one of the "big," let's talk. You're important to us and we respond accordingly.

Complete lines of ImLec miniature and subminiature filament lamps, neon glow lamps, Green Glow lamps and accessories. Lamps only or packaged assemblies.

WRITE FOR LITERATURE



INTER-MARKET, INC.

1920 Waukegan Road • Glenview, Ill. 60025
Telephone: (312) 729-5330

CIRCLE NUMBER 110

environmental simulation

controlled temperature
chambers . . .

from
-200°
to
+600° F

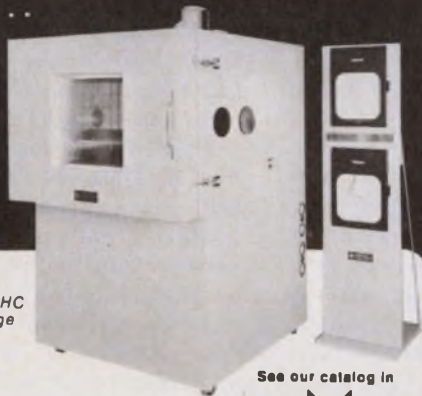

Model HU-120-12HC
Temperature range
-120 to +500°F

See our catalog in
THOMCAT

Environmental chambers custom engineered. Models for electrical, electronic and physical testing of parts or components can simulate most in service environments: high and low temperature, altitude, humidity, and moisture.

Write for FREE
booklet, "Controlled
Temperature
Chambers"

**CINCINNATI
SUBZERO
PRODUCTS INC.**

2612 Gilbert Ave., Cincinnati, Ohio 45206
(513) 751-8810

CIRCLE NUMBER 111

ELECTRONIC DESIGN 8, April 12, 1976

decitrak[®]

OPTICAL ABSOLUTE SHAFT ENCODER

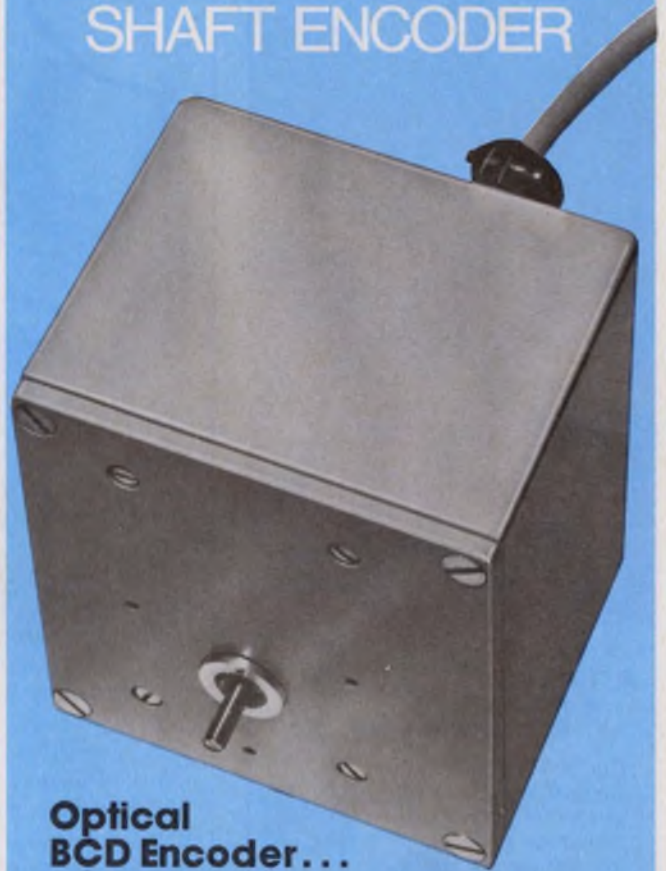

**Optical
BCD Encoder . . .
LED Light Source Heavy
Duty Industrial Design . . .
BCD Output at DTL/TTL
Compatible Levels High
Speed . . . Low Torque
Operation**

Accurate electrical output in BCD format is yours with the Decitrak Optical Absolute Shaft Encoder . . . range to 999999 . . . non-contacting optical design provides high speed, low torque operation . . . uses long life LED light source . . . one power requirement, 5 VDC . . . no external electronics required. A Theta Applications Engineer is always ready to help you with your special application or system requirement.

LITERATURE: Write for descriptive literature and your free copy of Digital Solutions to Automatic Control.



Theta

INSTRUMENT CORPORATION

Fairfield, New Jersey 07006 • 201-227-4700

CIRCLE NUMBER 112

Here's the answer
to your
Miniature
Switch needs

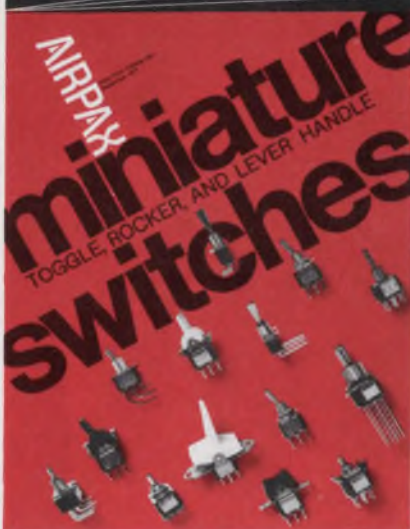

- TOGGLE
- ROCKER
- LEVER HANDLE

Get full information on Airpax competitively priced, American made miniature switches . . . the product of years of experience in the design and manufacture of electromechanical devices.

Airpax Short Form Catalog 3001 describes the basic switching functions, contact ratings, terminations, handle types, and hardware options; all

arranged to simplify the selection and ordering of the specific switches you require.

Send for your catalog today

AIRPAX

Airpax Electronics/CAMBRIDGE DIVISION
Cambridge, Maryland 21613
Switches, Circuit Breakers,
Glass/Ceramic-to-Metal Seals

Other Airpax Divisions:
CONTROLS DIVISION,
Ft. Lauderdale, Fla.
Instruments for Industry
AMERICAN DATA,
Huntsville, Alabama
TV Products

CIRCLE NUMBER 113

DATA PROCESSING

Printer for calculators enhances programming



Texas Instruments Inc., P.O. Box 5012, M/S 84, PC-100, Dallas, TX 75222. (214) 238-2011. \$295 (retail).

The new PC-100 print cradle allows any TI hand-held programmable calculator to become a desktop printing unit. The user is able to print anything shown in the display, or to print the step-by-step execution of a program. A 2.5-in. thermal tape has room for 20 char./line with each character printed in a 5 × 7 dot matrix. The printer is fully controllable from the calculator keyboard or card program.

CIRCLE NO. 395

Drum memory suits military users

Datum Inc., RMS/Timing Div., 1363 S. State College Blvd., Anaheim, CA 92806. (714) 533-6333. From \$25,000; 120 days.

Called the 300 Series, this ruggedized drum memory is supplied with a controller to mate with the Honeywell H316 computer. It is a fixed head-per-track unit with a capacity of up to 4.65 Mbits, a data rate of 2.5 MHz and an average access time of 17 ms. It withstands 10-G shock, 2-G vibration, 0 to 55 C and up to 90% relative humidity. A complete system consists of a controller in an ATR package that measures 10.125 in. W × 7.625 H × 15.5 in. D and the drum, which measures 13-1/4-in. dia. × 14-1/2 in. height, and has a total weight of 72 lb.

CIRCLE NO. 396

Floppy-disc controller uses single-chip μ P



Scientific Micro System, Subsidiary of Corning Glass Works, 520 Clyde Ave., Mountain View, CA 94043. (607) 974-8147. \$320 (100 up).

The SMS FD0300 is one of a series of complete IBM-compatible floppy-disc controller systems. All the controllers use single-chip bipolar microprocessors developed by SMS. The FD0300 requires less than 50 IC packages and occupies less than 100 in.² of PC board. It can interface floppy-disc drives with CRT terminals, instruments, microprocessors or other byte-oriented systems, and can interface up to four floppy-disc drives in series.

CIRCLE NO. 397

Disc drive accesses track-to-track in 6 ms



Orbis Systems Inc., 14251 Franklin Ave., Tustin, CA 92680. (714) 838-1491. \$528 (OEM qty).

Model 76 low-cost diskette drives for OEM use are offered in standard or double-density versions with up to 5.4 million bits, a 250-kbps transfer rate and an access time of 6-ms track-to-track. A door interlock eliminates operator error and data corruption; no job restarts are required. A self-centering lotus-petal clutch gently eases the diskette into registration position. And a uniball head positioner provides zero backlash. Options include sector generator and write enable, which can expand system flexibility and performance better than IBM-3740-specification requirements.

CIRCLE NO. 398

High performance you can really see.

Look to Motorola CRT modules for sharper, brighter displays.

Motorola's 12 and 15 inch CRT modules deliver! 80 sharp characters by 24 lines, with a 7x9 dot matrix display. Video response to 22MHz. Horizontal scan frequency up to 19KHz. TTL separate sync or composite video input. And all at a lower cost than you may now be paying for CRT's with lower performance.

Other screen sizes are 5, 9, 19 and 23 inches. All are optimized for data display applications. All are adaptable for U.S. or European operation. All circuitry is completely solid state. In fact, up to 99% of the module circuitry comes on easily removed printed circuit boards . . . for quick and easy maintenance.

Readable. Economical. Versatile. Serviceable. Why not look us over? Send today for our free Design Kit with complete specs and application notes.



MOTOROLA Data Products

Domestic 455 East North Avenue
Carol Stream, Illinois 60187
312-690-1400 TWX: 910-252-4404

International Airport Center
4250 Veterans Memorial Hwy.
Holbrook, L.I., NY 11741 U.S.A.
516-588-4700 TWX: 510-228-1096

CIRCLE NUMBER 114

To find a fault fast... "QUIK-FREEZE IT!"

Drops surface temperature
to -50°F. in seconds

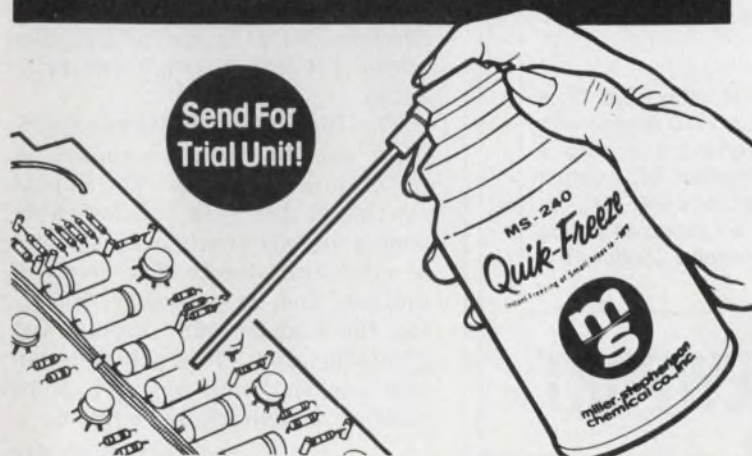

Few things waste more time than locating an intermittent circuit component. Isolate off-again on-again resistors, capacitors, etc., by quick-freezing them during testing. Remember: MS-240 "Quik-Freeze" is not only a circuit cooler, but also a full-fledged freezer. It can drop surface temperature to -50°F. — (-45°C.) in seconds. A handy extension nozzle confines the chilling spray to the suspected component. Use MS-240 also to prevent undesirable heat transfer to delicate circuit elements during soldering or welding.



**miller-stephenson
chemical co., inc.**

ED-4U Danbury, Connecticut 06810 • (203) 743-4447

- Enclosed is \$2.00, please send my "Trial Unit" (MS-240).
- Please send FREE literature and prices.

Intended Use

Name Dept./Title

Company

Address

CHICAGO • LOS ANGELES • TORONTO / Dist. in • ITALY • GERMANY • FRANCE
• GREAT BRITAIN • SWITZERLAND • LEBANON • SPAIN • NETHERLANDS

CIRCLE NUMBER 115

DATA PROCESSING

Unit scrambles data for RS-232C modems

Datotek, Inc., 13740 Midway Rd., Dallas, TX 75240. (214) 233-1030. \$4900: half duplex; \$6400: full duplex.

The DS-138 scrambles synchro-

nous data at any rate up to 9600 baud. A method of code generation is used that will not repeat a scrambling pattern until 10^{65} bits have been transmitted. The scrambler has 10^{32} code settings available and the provision for visual and audible failure warnings to ensure secure operation. The unit is housed in a locked steel case that measures $5\text{-}1/4 \times 17 \times 16$ in.

CIRCLE NO. 399

Tape-recorder system for industrial use

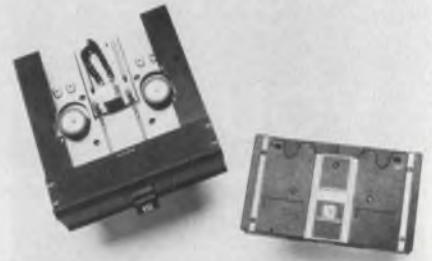

Emerson Electric Co., 3300 S. Standard St., Santa Ana, CA 92702. (714) 545-5581. \$2295: Model 2005 (unit qty); \$70: Model 2004 (OEM qty).

The 2000 Series Tape Pac system includes a 1/2-in. computer-compatible magnetic tape that can work in industrial environments. Tape is protected from temperature and humidity variations. The standard system consists of a Model 2005 tape drive and a Model 2004 Tape Pac. The Tape Pac is plug-to-plug compatible with conventional tape drives using industry-standard tape formatters that handle phase-encoded (PE) or NRZI data. The tape drive has a bidirectional read/write speed of 25 in/s and a search/rewind speed of 240 in/s. No reel motors or associated complex servos are needed. Recording densities include 7-to-9-track NRZI at 556 and 800 bpi, or 9-track PE at 1600-bpi recording density. Also, a special recording format in serial PE can record at 3200 bpi. The data transfer rate is 40-k bytes/record at 25 in/s with a recording density of 1600 bpi.

CIRCLE NO. 400

The first, accurate digital pyrometer that measures thermocouple and RTD ranges for \$165.00

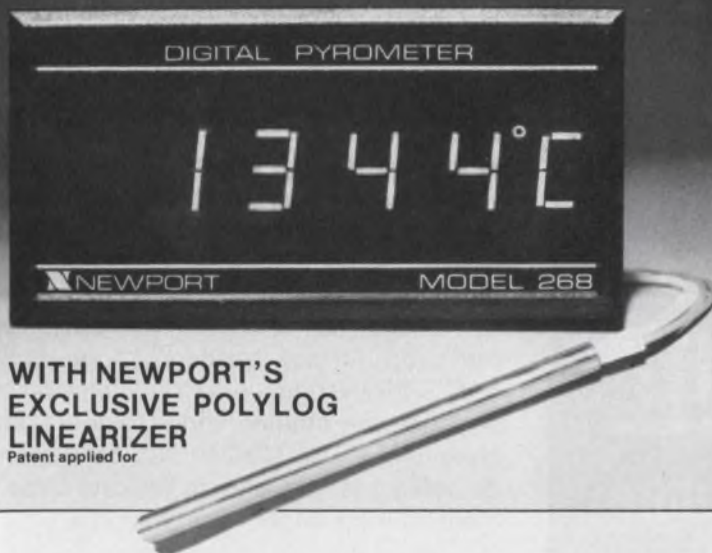

WITH NEWPORT'S EXCLUSIVE POLYLOG LINEARIZER
Patent applied for

Newport's Model 268 Digital Pyrometer gives you 19 optional bipolar ranges. It can be adapted to almost any application where temperature is measured. Power and signal inputs are attached to a convenient screw terminal barrier strip, while digital signals are handled through a PCB connector.

OTHER OUTSTANDING FEATURES:

- Large 13mm (1/2 inch) LED digits
- Bipolar ranges in either °C or °F
- Less than 0.3% error with five TC ranges
- Platinum RTD ranges with less than 0.15% error
- Reference junction mounted in barrier strip
- 3 μV /count sensitivity
- DIN standard case
- Parallel BCD output standard
- Open TC indication
- 100/115/230VAC power (5VDC optional)
- Lowest parts count for highest reliability
- Linearized analog output (optional)
- One or two digital set point controller (optional)
- NMR 60dB
- CMR 120dB

Newport Laboratories, Inc.
630 E. Young St., Santa Ana, CA 92705
Call Collect: (714) 540-4686
In Netherlands, Call:
Amsterdam (20) 45-20-52

NEWPORT

CIRCLE NUMBER 116

Data logger monitors processes

Doric Scientific Div., Emerson Electric Co., 3883 Ruffin Rd., San Diego, CA 92123. (714) 565-4415. \$2495.

The Digitrend 200 digital multi-point data logger can monitor up to 24 process points. The inputs can be in the form of low level analog signals from thermocouples or other transducers. The unit will digitize, and, if necessary, linearize the signals and display and print the data. The printout can also include time of day, point number, magnitude and symbol.

CIRCLE NO. 401

**\$250 PAPER-TAPE READER
HAS ONE MOVING PART**

This paper-tape reader comes with TTL interface and has only one moving part. It reads any standard tape at 150 cps, asynchronous. Bi-directional, the unit stops on character and automatically detects taut tape and end of tape. The reader's user-furnished clock input is a positive-going pulse that advances tape at the input's negative-going edge and

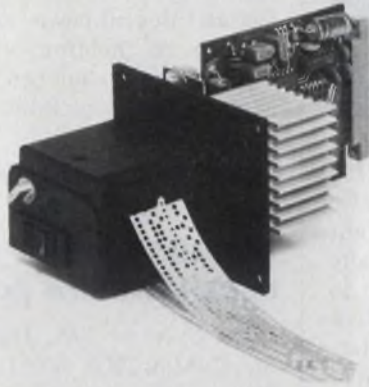

may also strobe the output data. Power requirements are + 5 V at 200 mA and 24 V at 600 mA. Stand alone versions with parallel or serial RS 232 outputs, fanfold box and spooler are also available. Price \$250 (1-99 units). Addmaster Corporation, 416 Junipero Serra Drive, San Gabriel, CA 91776. (213) 285-1121.

CIRCLE NUMBER 117

**SP-G10, H-10 SPEEDEX
RECORDER**

3 different power supplies available!!

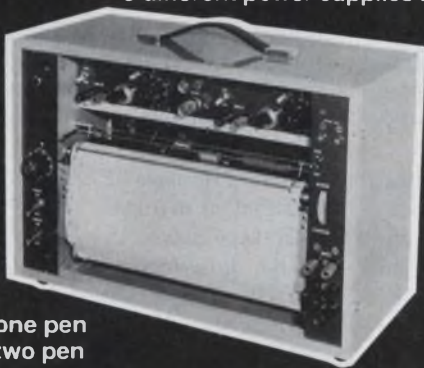

G10...one pen
H10...two pen

FEATURES

- | | |
|---|---|
| 1. High sensitivity Switchable from 0.5mV/250mm full scale to 500V in 12 steps. | 3. Easy to operate |
| 2. 3 different power supplies.
a) Internal battery
b) AC power line (110, 220V 50/60Hz)
c) External 12V power supply | 4. Durable plastic potentiometer. |
| | 5. All solid-state circuitry. |
| | 6. Pulse motor chart feed also permits chart feed by external pulse. Chart can be freely wound and un-wound |

● Please write us on your letterhead for detailed information

Riken Denshi Co., Ltd.

5-5-2, Yutenji, Meguro-ku, Tokyo, Japan TEL: 711-6656 TELEX: 0246-8107

CIRCLE NUMBER 118

ELECTRONIC DESIGN 8, April 12, 1976

**Penril Modems
offer the OEM
and End User
advantages in . . .**

CUSTOM DESIGN

Our facilities and capabilities enable us to provide both OEM and End Users with low, medium and high-speed modems tailored to meet their specific system requirements and cost objectives.

RELIABILITY

Our modems use hermetically sealed semiconductors and ceramic integrated circuits exclusively. Vibration, burn-in, and complete electrical and mechanical testing is performed on every unit prior to shipment. Perhaps these are the reasons our modems are experiencing MTBF's ranging from 35,000 hours to 200,000 hours.

DIAGNOSTICS

No special tools or equipment are required to install, operate or maintain our modems. Built-in diagnostics obviate the need for test equipment and minimize the time and labor involved in performing system fault isolation. Many of our units feature a unique telemetric test capability whereby non-technical personnel can test the entire link and isolate faults therein all from one site.

PERFORMANCE

The bit error rate probability of our modems is 1×10^{-6} or better over leased lines or the dial network. Our units are virtually unaffected by the major line impairments affecting data transmission.

AND MUCH MUCH MORE

If you'd like to know more of what Penril modems have to offer, ask for our modem brochure, or let us know of your specific requirements.



5520 Randolph Road • Rockville, Maryland 20852
301/881-8151

CIRCLE NUMBER 119

Highest energy ...
lightest weight ...
most compact ...
rechargeable battery
on the market!

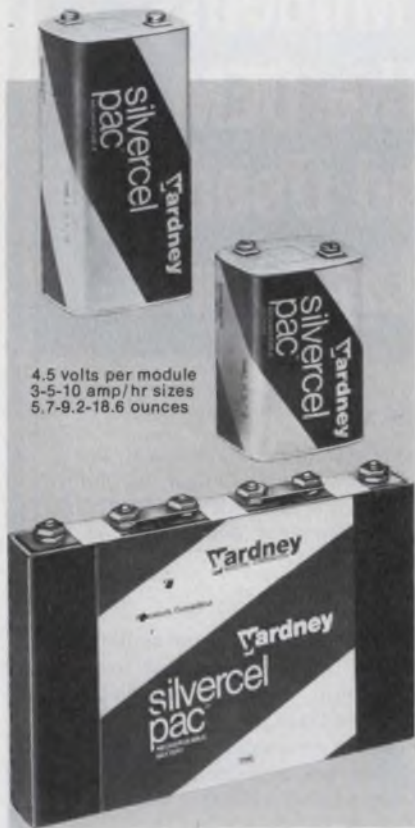

Yardney silvercel

If you have to carry batteries ... depend on batteries ... or design with them ... you'll appreciate Yardney!

Our Silvercel rechargeable batteries pack the most useable power into the smallest and lightest weight modular package now commercially available. In fact, per unit of weight Silvercel delivers 3 to 4 times the energy of common rechargeable batteries and does it with flat, non-tapering discharge voltage characteristics.

Whether you are an OEM development engineer, a supplier or a battery user, we invite your inquiry. Our technical assistance and advice are yours for the asking.

Write or phone
for complete information.

COMMERCIAL/INDUSTRIAL SALES

Yardney
ELECTRIC CORPORATION

82 MECHANIC STREET,
PAWCATUCK, CONNECTICUT 02891
(203) 599-1100

CIRCLE NUMBER 120

DATA PROCESSING

Erases PROMs with UV radiation



Technitrol Inc., 1952 E. Allegheny,
Philadelphia, PA 19102. (215)
426-9105. \$128.50; stock to 3 wks.

The Model 2537 erase-light module can erase any electrically programmable memory designed to be erased by UV. It uses a 2537-Å source, and is equipped with interlocks to protect the user against accidental exposure. A timer provides up to 30-min of exposure in 5-min increments.

CIRCLE NO. 402

Optical lines used in severe locations



Spectronics, Inc., 830 E. Arapaho
Rd., Richardson, TX 75080. (214)
234-4271. Qty. 1-9; SPX 2672,
\$750; 2673, \$900; and 2674,
\$1000; 6 wks.

Three optical transmission lines, Models SPX 2672, 2673, 2674, provide communication in severe environments. They accept electrical signals at one end, and transmit, with no electrical attenuation, to the other end 150 ft away. The SPX 2672 is designed for standard TTL levels and will handle input data from dc to 100-k bits/s. The SPX 2673 handles 1-V pk-pk video signals, and the SPX 2674 handles TTL levels from dc to 10 Mbits/s. These lines are immune to EMI and other adverse atmospheric conditions, and produce no electrical noise. They also have complete isolation from input to output.

CIRCLE NO. 403

Core memory board achieves double density

Fabri-Tek Inc., 5901 S. County Rd.
18, Minneapolis, MN 55436. (612)
926-2721. \$2650; single qty.

Core-memory boards with twice the capacity of the company's earlier Model 696 are now available. Each stores 32 k × 18 bits and plugs into an enclosure that has an integral power supply and is capable of holding up to eight boards. The system can be configured for a 512-k × 9-bit to 128-k × 36-bit format.

CIRCLE NO. 404

Digital recorder system uses ultra-low power

Datel Systems Inc., 1020 Turnpike
St., Canton, MA 02021. (617) 828-
8000. \$325; transport, \$90; card
cage, \$125; write card (unit qty).

Because individual data-recording requirements can vary widely, Datel introduces the ICT series of ultra-low power, write-only incremental cassette transports and a family of compatible circuit-card modules that sequence and drive the transport stepping motor and format the tape heads. Extensive use of CMOS circuitry minimizes power drain. A building-block approach enables the engineer to custom design the system he needs. The ICT-series transport can begin writing data within 20 ms from a standing start. Power is consumed only during motor stepping, and the transport and card modules remain turned off when not writing data. Forerunner of the new series is the Model ICT-WZ incremental system. It uses Philips or other certified computer-quality magnetic-tape cassette intended for CNRZ data formatting. With a bit density of 615 b/in., the transport records at 100 b/s and uses only 100 mA at 12 V dc. Word length can be user programmed to 8, 10, 12, 14 or 16 bits long, and depending on jumpering of the circuit cards, files can consist of 1, 2, 4, 8, 32, or 64 words, or an externally controlled file length. Optional circuit cards include an EOT/BOT sensor, motor drive, clock and head drive and formatter—an 8-bit, CMOS parallel input/serial output encoder.

CIRCLE NO. 405

TAKE THE STING OUT OF YOUR EMI AND DECOUPLING PROBLEMS . . .



with Gulton's versatile line of ultra-miniature, Hi-Rel feedthru capacitors for your critical EMI and decoupling applications, featuring:

- 50 to 200 Volts operation
- 100 pF to 5000 pF range
- Solder and Projection Weld Mounting
- Hermetic Seal and Center Hole Feedthru Terminals

Call Gulton . . .
before you get stung!

gulton

Electronic Components Division
212 Durham Ave. Metuchen, NJ 08840, (201) 548-2800

CIRCLE NUMBER 121

Tough! Flexible! Protective!
Inexpensive! Shrinks down in hot water above 140°F. Good electrical and mechanical strength. Resists corrosion and chemicals and will not support a flame. Used for electrical insulation on wires, mechanical protection for pipes and fittings. Effective as scuff resistant jacketing for electrical cables and harness . . . and much more. Sizes 1/4" to 4". Black only.

PENNTube Plastics Co., Inc.



Madison Ave. & Holley St.
Clifton Heights, Pa. 19018
(215) 622-2300

Export Div. • 5710 Empire State Bldg., N.Y. 10001
*Du Pont Reg. TM. †Penntube Plastics Co. Reg. TM.

SEND FOR
FREE SAMPLE
and Bulletin #71SN-B

CIRCLE NUMBER 122

ELECTRONIC DESIGN 8, April 12, 1976



There Goes Your Reputation --Up In Smoke.

Here's how to protect your product, your customer—and yourself!

Just add MICROTEMP® safety thermal cutoffs to your plans. The millions already in use are your assurance of positive, yet low cost protection against overheating caused by malfunctions in electrical circuits and components.

MICROTEMP is a reliable, accurate, easy to install, "one shot" thermal limiter. Because of its patented design and construction, it won't derate. And, it's unaffected by age or extended use.

Compare this data:

- opening tolerance — ± 3° F.
- temperature range — 58 to 242°C. (136 to 468° F.)

- compact — diameter, .157"; length, .457" (exclusive of leads)

- economical — priced as low as 9¢

- proved reliable in millions of on-the-job applications

- installation ease — assorted terminations, mounting packages and insulations are available

Recognized under the Component Program of Underwriters' Laboratories, Inc. UL File #E40667A. CSA and BSI Certificate #5041 approved. Recognized by MITI and VDE. Military approval.

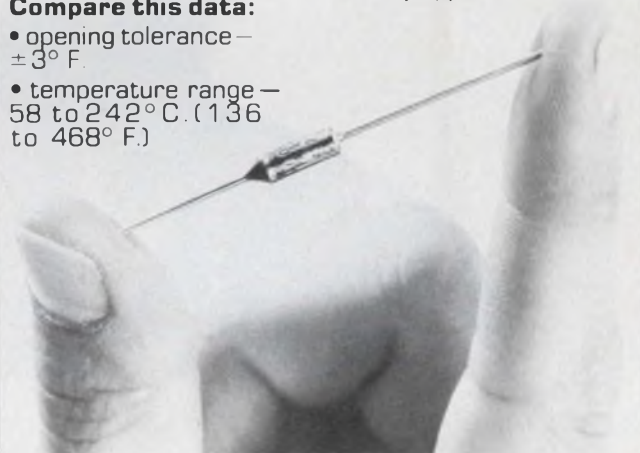

For additional information, check the reader service card, or call or write:



MICRO DEVICES CORP.

1881 Southtown Blvd., Dayton, Ohio 45439
Ph: (513) 294-0581 Telex: 28-8087

CIRCLE NUMBER 123

"The majority of can



Richard D. Vance
President
AD-VANCE MAGNETICS, INC.

Tell us what you think about the GOLD BOOK. (If it's good, we'd like to hear it. If it's bad, we want to improve it.)



our new business be attributed to the GOLD BOOK."

"*Electronic Design* has done one hell of a job in getting the GOLD BOOK to the places it should be," says Richard D. Vance, President, Ad-Vance Magnetics, Inc., Rochester, Indiana. Ad-Vance describes itself as the industry's largest, oldest, most experienced independent firm exclusively manufacturing magnetic shielding. Mr. Vance continues:

"We're an old company with a new name, so not too well known in the field. Our two-page spread in the GOLD BOOK has made us much better known.

"The GOLD BOOK gave us opportunities to bid from firms who had never heard of us before they saw our GOLD BOOK ad. For example, just today we got to bid on 1,000 CRT magnetic shields for a midwest firm who found us in the GOLD BOOK.

"Engineers don't hesitate to tell us they saw our ad in the GOLD BOOK when they call. I do a lot of sales work in the field, and I run into the GOLD BOOK almost everywhere our magnetic shielding has an application, both in purchasing and engineering. You've done one hell of a job in getting the GOLD BOOK to the places it should be."

Ad-Vance states that over 90% of past and present magnetic shield designs have been fabricated in the Ad-Vance plant during the past 20 years. Its magnetic shielding is used off-planet in spacecraft and satellites, and worldwide in precision industrial, laboratory, military and consumer applications.

Because the GOLD BOOK goes primarily to *Electronic Design's* audience of specifiers, Ad-Vance gets the benefit of 78,000 engineers, engineering managers, purchasing agents and distributors throughout the U.S.A., not to mention 13,000 overseas. These are the men who are ready to talk shielding—the men who have the authority to buy.

**ELECTRONIC DESIGN'S GOLD BOOK IS WORKING
...IT'S WORKING FOR READERS...AND IT'S
WORKING FOR ADVERTISERS, TOO.**

HAYDEN PUBLISHING COMPANY, INC.

WORLD LEADER IN ELECTRONICS PUBLISHING

50 Essex Street, Rochelle Park, N.J. 07662 • (201) 843-0550

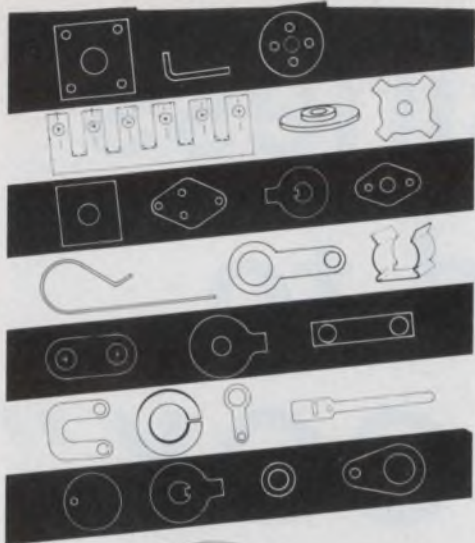

seastrom wants you!

... to join the thousands of companies relying on Seastrom quality products.

Washers—all types
Spring Clips
Military Standards
Electronic Hardware

FREE... Illustrated Catalog.
250 pages with complete
description by part number.
All stocked for immediate
delivery.

Seastrom Manufacturing Co., Inc.
701 Sonora Avenue / Dept. E2
Glendale, California 91201
Phone: (213) 245-9121

CIRCLE NUMBER 124

Application Notes

Semi measurements

Valid vs erroneous conclusions based on semiconductor parameter measurements made with a VOM is the topic of the newest Tech Tip. Westinghouse Electric, Semiconductor Div., Youngwood, PA

CIRCLE NO. 406

D/a converters

A wide range of applications possible with a universal d/a converter is covered in an application note. Precision Monolithics, Santa Clara, CA

CIRCLE NO. 407

Microwave freq counter

"Understanding Microwave Measurements" starts with a description of three common down-conversion techniques: prescale, heterodyne and transfer oscillator. Measurement speed, accuracy, dynamic range and tolerance to modulation and unwanted noise of each technique are discussed in detail in the 10-page note. Hewlett-Packard, Palo Alto, CA

CIRCLE NO. 408

Spring connectors

"How to Improve Performance of Spring Connectors," a six-page brochure, is illustrated with tables, flow diagrams and photographs. It is designed to aid the designer in selecting material, testing, and specifying requirements for springs made from high strength beryllium copper alloys. Instrument Specialties, Little Falls, NJ

CIRCLE NO. 409

Solid-state relays

"Introduction to Solid State Relays," a 16-pager, details the specifications, advantages and applications of solid-state relays for switching power in electrical equipment. A glossary of terms is included. International Rectifier, Crydom Div., El Segundo, CA

CIRCLE NO. 410

Evaluation Samples

Programming pins

Individual programming of DIP sockets is possible with the company's Dipatch. For the ON position, the pins are inserted into the opposing socket contacts. For storage in the OFF position, the Dipatch is simply turned upside down and the plastic ears are inserted into the socket contacts. The device stacks on 0.1-in. centers and is 0.4 in. wide. Pins have diameters of 0.018 in. and are gold over nickel plated. Aries Electronics.

CIRCLE NO. 411

Circuit-board support

Series SCBS circuit-board support with a #8-32 thread for speedy screw fastening to a nut or receiver is available in eight spacing heights from 0.25 to 1.406 in. It has a top locking tab, which laps over the board after insertion for secure fastening in either an upright or inverted position. The support comes in UL-rated V-2 and V-0 nylon flame retardant materials. Richco Plastic.

CIRCLE NO. 412

Knurled pins

Cold formed, knurled pins with diameters as fine as 0.029 in. easily pass industry standards for pull-out torque. Knurls available include diamond, straight, diagonal, annular groove and undercut. Parts come plated or unplated to specs. Art Wire and Stamping Co.

CIRCLE NO. 413

Conductive fabrics

Electrical resistance for high-performance, electrically conductive fabrics measures $10^4 \Omega$. The fabrics also feature exceptional strength and inherent flame-resistant properties. For a sample, send a letterhead request to Herculite Protective Fabrics, 1107 Broadway, New York, NY 10010.

INQUIRE DIRECT



6th international exhibition MESUCORA 76

Measure • Analysis • Control • Testing • Automation

10th - 17th JUNE 76 - PARIS

Parc des Expositions
Porte de Versailles (France)

551 groups
of Measurement, Analy-
sis, Control, Regulation and
Automation instruments form in
Paris a

unique confrontation

between the 900 best well-known
manufacturers from 23 Countries.
400 French, 500 Foreign Companies
covering the various techniques :

Acoustic, Automation, Chromatic,
Electronic, Electrotechnic, Flow
Control, Computing, Magnetic,
Nucleonic, Optic, Pneu-
matic, Thermic

Full information for: FRENCH TRADE SHOWS - French Chamber of
Commerce in The United States Inc. 1350 Avenue of the Americas
NEW YORK N.Y. 10019 TEL : (212) 582-4960

CIRCLE NUMBER 125

Processing analog signals?

Use the Panasonic 512-stage BBD for 25.6 m/sec. delay with
wide frequency range and excellent S/N ratio of 70 dB.

The Panasonic MN 3001 contains two
BBDs with independent input, output
and clock terminals. Uses a common
power supply. Pair of output terminals
allows the clock component to be cancelled.

The BBD MN 3001 gives you wide
frequency response. Up to 0.3 x fcp.
Clock frequency range from 10 kHz to
800 kHz. S/N ratio of 70 dB.

Use the Panasonic MN 3001 BBD for
variable speech speed control in tape
recorders, tremolo and vibrato effects for
musical instruments, plus telephone
time compression and voice scrambling.
Any place you design to process analog
signals.

Panasonic[®]
just slightly ahead of our time

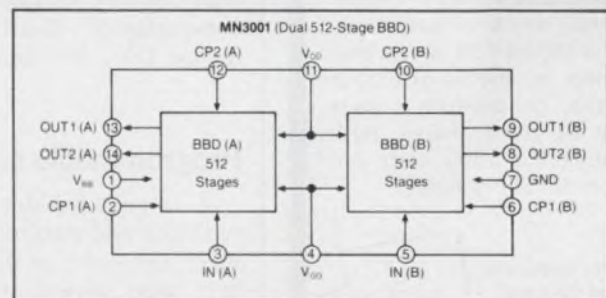

For free data on all our BBDs, mail to:

Panasonic Electronic Components
One Panasonic Way, Secaucus, N.J. 07094.

Name _____

Title _____

Company _____

City _____ State _____ Zip _____

CIRCLE NUMBER 126

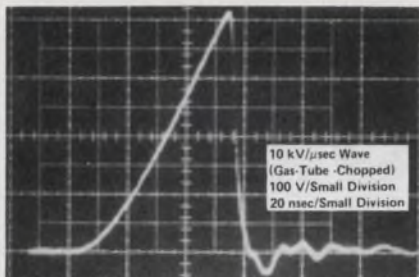

NOW... Precision SURGE TESTING

of TELECOM, POWER
& AUXILIARY NET-
WORKS, CIRCUITS,
COMPONENTS, ETC.



Keytek's new Model 424 Surge Generator/Monitor is the first commercially - available, self-contained instrument for generating and measuring the peak values of classic transient pulse forms. Designed to produce waveshapes such as 8x20, 1.2x 50, 10x1000, 10x50 and 0.1 to 10 kV/usec, it simultaneously measures and displays, digitally, peak applied voltages and currents. Test circuits, varistors, silicon avalanche devices, gas tubes and networks of all types. Ideal for engineering, QC and production.

Programmable Pulses — Simple to operate and extremely versatile, the Model 424 can be programmed, by means of plug-in networks, to produce a wide variety of pulse shapes, with amplitudes to 1500 volts and currents to 500 amperes.

Send for complete product data and new article on surge protection and testing... yours FREE

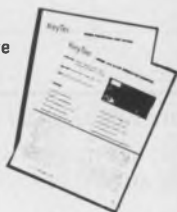

KeyTek
INSTRUMENT CORPORATION
220 GROVE STREET, BOX 109
WALTHAM, MASS. 02154
TEL. (617) 899-6200

CIRCLE NUMBER 128

New Literature

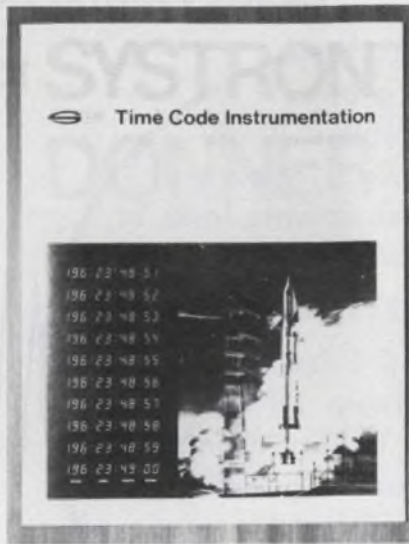

Time-code instrumentation

Precision time-code and time-keeping instrumentation, such as time-code generators, readers, digital clocks, and complete tape-search systems, are featured in a 22-page catalog. Systron-Donner, Concord, CA

CIRCLE NO. 414

Inverter SCRs

Fast switching 450-A rms, inverter SCRs in the 250RM series are described in a six-page data sheet. The literature contains 20 graphs, four dimensional-outline drawings and a photograph. Specifications and ratings are included. International Rectifier, Semiconductor Div., El Segundo, CA

CIRCLE NO. 415

Programmable calculators

A 12-page booklet describes how, with the addition of HP's EE software pacs and an X-Y plotter, the HP 9800 series of desktop programmable calculators are capable of such important tasks as the design of analog networks, simulation of logic designs, prediction of system response in the time domain, simplification of microwave circuit design and interactive modeling for transformer design. Hewlett-Packard, Palo Alto, CA

CIRCLE NO. 416

TWT amplifiers

Features and specifications of the company's medium-power TWTAs are given in an eight-page brochure, "Commercial Traveling Wave Tube Amplifiers." Varian, Microwave Equipment Operations, Santa Clara, CA

CIRCLE NO. 417

Semiconductor devices

"The Semiconductor Problem Solver" explains in detail problems of obsolete devices, custom hybrid circuits, specials and assembly, custom monolithic and testing and screening. The brochure indicates the company's solutions. Custom Devices, Fern Park, FL

CIRCLE NO. 418

Microwave products

Active microwave products such as crystal, phase locked, cavity and Gunn-diode sources are covered in a 26-page catalog. Specifications, technical data and prices are shown for each device featured. Microwave Technology, Mechanicsburg, PA

CIRCLE NO. 419

Racks

Vertical and sloped racks are described in a 20-page catalog. Optima Enclosures, Tucker, GA

CIRCLE NO. 420

Double-balanced mixer

Double-balanced MIC "drop-in" mixers are described in a two-page data sheet. Detailed outline drawings and mounting data are shown. RHG Electronics Laboratory, Deer Park, NY

CIRCLE NO. 421

Comm test equipment

A 480-page communications test equipment catalog provides a comprehensive review of the company's test equipment for telecommunications systems. The catalog features the equipment according to the main field of application. Letterhead requests only. Siemens Corp., Communications Equipment Div., 186 Wood Ave. S., Iselin, NJ 08830.

INQUIRE DIRECT

Switches

Covered in a 36-page brochure are 10 standard types of switches, including lever, pushbutton, pushbutton slide and multi-pushbutton switches as well as rocker, rotary, rotary slide, slide and toggle switches. Shigoto Industries, New York, NY

CIRCLE NO. 450

Ceramic capacitors

A 20-page ceramic capacitor catalog includes expanded and extended range capacitance values, MIL-C-20 ultra-stable capacitors and additional dielectric and voltage selections in chip capacitors. Union Carbide, Greenville, SC

CIRCLE NO. 451

Signal generator

Photos, a schematic diagram and specifications in a six-page foldout cover the Model 3000 signal generator. Wavetek Indiana, Beech Grove, IN

CIRCLE NO. 452

PC & solderless terminals

"Printed Circuit and Solderless Terminal Brochure," a two-pager, includes up-to-date drawings and over-all dimensions dealing with PC extensions, PC clips, PC "T" slugs and wrapped-wire extensions for plugging into a PC board. Standard-Grigsby, Aurora, IL

CIRCLE NO. 453

Dye outputs for lasers

An up-to-date listing of dyes used in both the DL series and Spectroscan 10 dye lasers is included in a brochure. Curves show typical outputs in both the fundamental (360 to 750 nm) and frequency doubled (260 to 360 nm) modes. Molelectron, Sunnyvale, CA

CIRCLE NO. 454

Wire terminals

The geometric and metallurgical characteristics of crimp-type terminals are described in a 12-page booklet. Application tooling from simple hand-held crimping tools to fully automatic lead-making machines is also illustrated. AMP, Harrisburg, PA

CIRCLE NO. 455

Imaging devices

Imaging devices for military, space and scientific applications are described in a 10-page catalog. An explanation of the design, operation and advantages of each tube type is given, along with the specification tables and dimensional diagrams. Westinghouse Electric, Industry & Government Tube Div., Horseheads, NY

CIRCLE NO. 456

Filter characteristics

"Phase Response Characteristics of a Butterworth Filter" provides a basic understanding of the phase vs frequency relationship of a Butterworth filter, and provides step-by-step examples for calculating gain and phase shift through a high-pass, low-pass, bandpass or band-reject filter. Krohn-Hite, Avon, MA

CIRCLE NO. 457

Our Standard Power Supplies Don't Always Come In Standard Packages!



For special electrical and/or mechanical power supply needs, Arnold Magnetics is hard to beat. Our unique modular concept allows us to mix our standard modules with specials to meet custom design requirements. The result is reduced engineering costs, fast deliveries and proven performance. And with over 1200 possible standard configurations a special from someone else may be just another standard for us.

- Single or dual inputs: 115 VAC, 47-500 Hz, 12, 28, 48, 115, 150 VDC.
- Multiple isolated and regulated DC outputs from 4.2 to 300 VDC.
- Line & load regulation to 0.1%.
- Up to 400 watts per output.
- Efficiencies to 85%.
- Completed units provided in tested and encapsulated, conduction cooled packages.

Call or write for more information today!



ARNOLD MAGNETICS CORPORATION

11520 W. Jefferson Blvd., Culver City, CA 90230 • (213) 870-7014

CIRCLE NUMBER 127

CONNOR-WINFIELD'S

NEW

LOW PROFILE

DIP OSCILLATOR



ACTUAL SIZE

TTL AND CMOS COMPATIBLE

Model S14R4:

AVAILABLE AT ANY FIXED FREQUENCY FROM 32 kHz to 70 kHz

FREQUENCY ACCURACY: $\pm 0.003\%$
AT AMBIENT TEMPERATURE

FREQUENCY STABILITY: $\pm 0.02\%$
FROM -25°C to $+70^{\circ}\text{C}$ AT
FIXED SUPPLY VOLTAGE

DRIVES CMOS OR 1 TTL GATE

DUTY CYCLE: 30/70

SUPPLY VOLTAGE IS ANY FIXED
VOLTAGE FROM 5 Vdc to 15 Vdc

SUPPLY CURRENT: 10 mA to 15 mA

DIMENSIONS: 0.2" HIGH x 0.49"
WIDE x 0.78" LONG

AVAILABILITY: 4 to 6 WEEKS ARO

CONNOR-WINFIELD CORP.



West Chicago,
Illinois 60185 U.S.A.
Ph.: (312) 231-5270

CIRCLE NUMBER 132

NEW LITERATURE



Resistor networks

Thick-film resistor networks and chip resistors are described in a brochure. Basic information on specifying custom networks, examples of custom circuits and a glossary of terms is included. Dale Electronics, Columbus, NE

CIRCLE NO. 422

Microwave test programs

High reliability test programs offered by the company for its entire microwave devices product line are included in a brochure. GHZ Devices, Chelmsford, MA

CIRCLE NO. 423

Battery/charger consoles

Design features, specifications and ordering information for transistor-controlled, mag-amp charger consoles for lead-acid and nickel-cadmium batteries and gellcells are given in a two-page bulletin. LaMarche Manufacturing, Des Plaines, IL

CIRCLE NO. 424

Process instruments

General information on more than 35 key process instruments is given in a 16-page booklet. The booklet groups the instrumentation by end application. Beckman Instruments, Process Instruments Div., Fullerton, CA

CIRCLE NO. 425

Knobs

Aluminum and molded phenolic knobs are illustrated in a 24-page catalog. Alco Electronic Products, North Andover, MA

CIRCLE NO. 426

Instrumentation amps

TWT and transistor instrumentation amplifiers are covered in an eight-page brochure. The catalog includes a selection chart, specifications and outline drawings. Hughes Electron Dynamics, Torrance, CA

CIRCLE NO. 427

Power supplies

Laboratory benchtop power supplies that include single, dual and triple-output models are featured in a 48-page catalog. Included are applications, a selection guide, and electrical and mechanical specifications. Acopian, Easton, PA

CIRCLE NO. 428

Triggered spark gaps

Performance specifications and application notes on over 20 types of triggered spark gaps are contained in a 12-page brochure. EG&G, Salem, MA

CIRCLE NO. 429

Plastic ICs

Life tests and screens on plastic integrated circuits are described in "Reliability of Plastic-Encased Integrated Circuits." The major failure modes of plastic-encased ICs, the causes and preventative measures and associated screening and testing are tabulated. Sprague Electric, North Adams, MA

CIRCLE NO. 430

Solenoids

Twenty-six solenoid models are discussed and illustrated in a 62-page "Solenoid Engineering Manual." Over 200 photos, drawings, schematics and charts are provided. Deltrol Controls, Milwaukee, WI

CIRCLE NO. 431

Capacitors

Four bulletins cover monolithic ceramic capacitors, high-dielectric disc ceramic capacitors, temperature-compensating ceramic disc capacitors and reduced-titanate ceramic disc capacitors. Specifications and diagrams are shown for each group. Murata, Rockmart, GA

CIRCLE NO. 432

Bulletin Board

Interdata has developed a multi-tasking operating system called OS/16 MT2, which optimizes the use of its 16-bit minicomputers in real-time, program development and computational applications.

CIRCLE NO. 433

United Systems has expanded the Digitec data logger line. Six new models widen the temperature measurement capabilities of the data loggers to include thermistor and platinum resistance probes with readings in °C or °F.

CIRCLE NO. 434

Signetics has announced the qualification of nine low-power Schottky IC devices, which have met Mil Spec MIL-M-38510A.

CIRCLE NO. 435

GE's Hermetic Sealed Relay Operation has announced that its half-sized crystal rf relay is now qualified to MIL-R-39016/33A. Typical rf characteristics up to 500 MHz are 1.1:1 VSWR, 36-dB crosstalk and insertion loss of 0.34 dB.

CIRCLE NO. 436

Rockland Systems has announced a new frequency range extension option to its line of 2-MHz frequency synthesizers. Option 13 extends the frequency range of the Models 5100 and 5110 to 3 MHz, with no sacrifice of resolution.

CIRCLE NO. 437

CODI has added the JAN1N5518B series of diodes to its list of QPL products. The unit price for the JAN1N5518B through JAN1N5528B is \$3.30 (100 qty.) and \$4.90 (100 qty.) for the JAN1N5518B through JAN1N5528B.

CIRCLE NO. 438

Price cuts up to 52% in the low-cost DAC80 line have been announced by Burr-Brown. The

DAC80 was formerly \$46 in single quantity (voltage output) and is now \$26.50 (1-24), \$24.50 (25-99) and \$19.50 (100-999).

CIRCLE NO. 439

Analogic has announced a price reduction on the MP2600 12-bit binary, 3-1/2 digit BCD a/d converter. Single unit price is now \$89, which is less than 60% of the previous \$149 unit price.

CIRCLE NO. 440

Price reductions of 16 to 40% on its new series of 8-bit a/d converters, 12-bit a/d converters and data-acquisition system has been announced by Micro Networks.

CIRCLE NO. 441

Texas Instruments has reduced prices up to 75% of its TMS8080 μ P. New pricing is \$34.25 (1-24) and \$21.15 (100-up).

CIRCLE NO. 442

You know our reputation in DC to DC

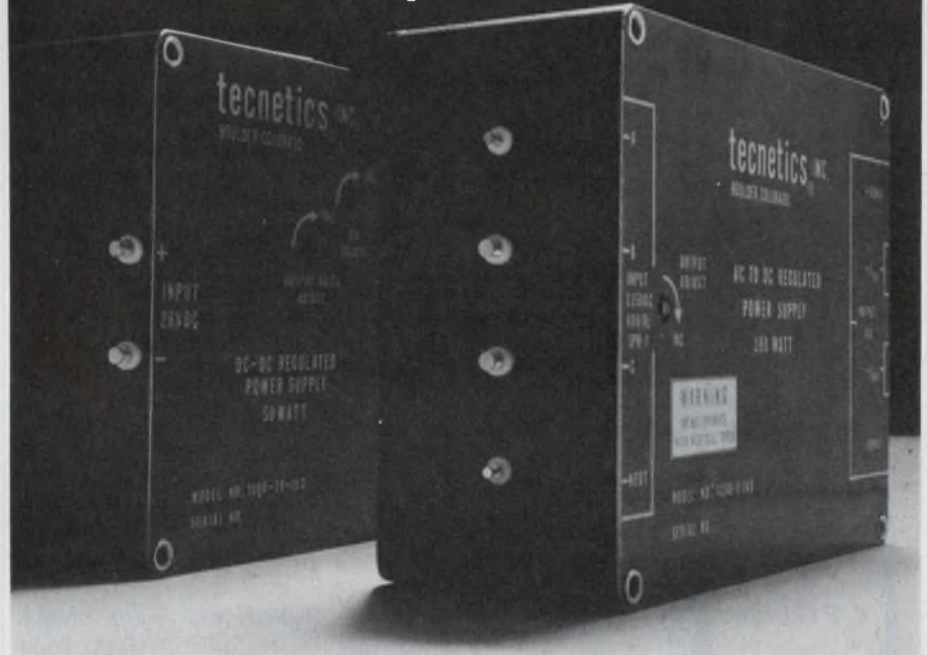

Wait till you see Tecnetics' new 400 Hz AC power supply

We earned a reputation with our line of DC to DC power supplies. Now, we add to it with a new 400 Hz AC power supply. Like our 28VDC power supplies, the AC model features extremely high packaging density, high efficiency and reliability. Most important, it's small, measuring in at only 4x4x2 inches and weighing 36 ounces fully encapsulated.

These power supplies are designed to meet

the rugged vibration, shock, humidity and altitude specs of the aerospace industry (Mil-E-5400). They also have separate, remote error-sensing terminals to compensate for voltage loss, assuring that the voltage level remains constant at the load.

Write for our 26-page catalog that gives full specs and prices on these and over three hundred other power supplies.

SPECIFICATIONS	3000 SERIES - DC TO DC	4000 SERIES - 400 Hz AC TO DC
Output Power	150, 100, 50, & 25 watt models	100, 50, & 25 watt models
Output Voltages	13 standard outputs from 5 to 48V	13 standard outputs from 5 to 48V
Input Voltages	28VDC or 48VDC (48VDC only on 150 w units)	115VAC \pm 10%, 400 Hz (Single or 3 phase)
REGULATION		
Line	(LL to HL) 0.3%	(115V \pm 10%) 0.2%
Load	(1/2 to FL) 0.1%	(1/2 to FL) 0.1%
Load	(NL to FL) 0.4%	(NL to FL) 0.5%
Temp	0.01%/°C	0.01%/°C

tecnetics® The Power Conversion Specialists P.O. Box 910,
1625 Range Street, Boulder, Colorado 80302 (303) 442-3837 TWX 910-940-3246

CIRCLE NUMBER 133

CRYSTAL CONTROLLED DIP OSCILLATORS

\$20.90 EACH
(25 UNITS)



**MODEL ZY-7409
TTL COMPATIBLE
10 MHZ**
(other frequencies available)

CALL OR WRITE



**Greenray
Industries, Inc.**

840 West Church Rd.
Mechanicsburg, PA 17055
Phone 717-766-0223

CIRCLE NUMBER 134

PROFESSIONAL DISCOUNT PRICES AVAILABLE ON

HEWLETT  PACKARD

Engineering Calculators

**PHONE TOLL FREE
800-638-8906**

FOR THE CURRENT LOW DISCOUNT
PRICE OF THE LATEST MODEL
CALCULATOR OF YOUR CHOICE

THE GUARANTEE

10 day money back trial. If you are not completely satisfied you may return the Hewlett-Packard calculator you order within 10 days for a cash refund or charge cancellation. In addition Hewlett-Packard and Capital Calculator Co. Inc. warrant each calculator for a period of one year against defective parts and workmanship.

Capital Calculator Company

Maryland residents phone:
(301) 340-7200

**701 East Gude Drive
Rockville, Maryland 20850**

CIRCLE NUMBER 135

Vendors Report

Annual and interim reports can provide much more than financial-position information. They often include the first public disclosure of new products, new techniques and new directions of our vendors and customers. Further, they often contain superb analyses of segments of industry that a company serves.

Selected companies with recent reports are listed here with their main electronic products or services. For a copy, circle the indicated number.

Electronized Chemicals. Electrical insulation products.

CIRCLE NO. 443

Sangamo Electric. Energy management products, electronic components, data instrumentation, communication products, aviation services and products, and commercial vehicle instruments.

CIRCLE NO. 444

Cetec Corp. Computer peripherals, marine communications and navigation gear, components, plastics and microphones, AM and FM broadcast equipment, high-fidelity equipment and TV broadcast antennas.

CIRCLE NO. 445

Cooper Industries. Hand tools, aircraft parts and services, compressor units and systems, and engines.

CIRCLE NO. 446

Comten. Communications and message-switching computer systems.

CIRCLE NO. 447

Spar Aerospace Products Ltd. Aerospace and military electronics, gears and transmissions, aircraft repair and overhaul.

CIRCLE NO. 448

Hoffman Electronics. Navigation systems, audio-visual education systems, solderless electronic terminals and connectors, closed-circuit TV systems, video tape recorders and indoor and outdoor antennas.

CIRCLE NO. 449

Electronic Design

Advertising Sales Staff

Tom W. Carr, Sales Director
Jean Bunfield, Sales Coordinator

Rochelle Park, NJ 07662

Robert W. Gascoigne
Daniel J. Rowland
Thomas P. Barth
George Mortimer
Stan Tessler
50 Essex St.
(201) 843-0550
TWX: 710-990-5071

Philadelphia

Thomas P. Barth
(201) 843-0550

Boston 02178

Gene Pritchard
P.O. Box 379
Belmont, MA 02178
(617) 489-2340

Chicago 60611

Thomas P. Kavooras
Berry Connor, Jr.
Harry Marshall
200 East Ontario
(312) 337-0588

Cleveland

Thomas P. Kavooras
(312) 337-0588

Los Angeles 90045

Stanley I. Ehrenclou
Burt Underwood
Neil Canavin
8939 Sepulveda Blvd.
(213) 641-6544

Texas

Burt Underwood
(213) 641-6544

San Francisco

Robert A. Lukas
3579 Cambridge Lane
Mountain View, CA 94040
(415) 965-2636

London, Amsterdam, Tokyo, Seoul

Malcolm M. Thiele
Wood Cottage, Shurlock Row
Reading RG 10-QE, England
Phone: Shurlock Row 302 & 619
S.T.D. 073 581

Sanders, B. V.

Raadhuisstraat 24
Graft-De Ryp, Holland
Phone: 02997-1303
Telegrams: Euradteam-Amsterdam

Haruki Hirayama

Electronic Media Service
5th Floor, Lila Bldg.,
4-9-8 Roppongi
Minato-ku, Tokyo, Japan
Phone: 402-4556
Cable: Electronicmedia, Tokyo

Mr. O-kyu Park, President
Dongbo Intl Corp.—

World Marketing
C.P.O. Box 4010
Seoul, Korea
Tel. 76-3910/3911
Cable: DONGBO SEOUL
Telex: EBKOREA K27286

 ABP

 BPA

Get CUSTOM MOS

in any quantity

7
YEARS
OF SUPPLYING QUALITY PRODUCTS

ALL APPLICATIONS

★ Industrial ★ Commercial ★ Consumer ★ Military

FOR IMMEDIATE ACTION, CALL 516-293-3850

LSI computer systems, inc. • 22 Cain Drive, Plainview, N.Y. 11803

CIRCLE NUMBER 129

HEATH
Schlumberger **NEW!**

SR-207 X-Y Recorder



only \$700
With built-in features others charge extra for!

- Built-In Sweep
- Vacuum Paper Hold Down
- TTL Compatible remote controls
- Individually Floating X-Y Inputs
- Uses standard 8½ x 11" Chart Paper
- Less than 1 second balance time
- Electric Pen Lift • Metric Conversion

Read about the SR-207 and other proven values in our NEW Assembled Instruments Catalog.



FREE! SEND FOR IT TODAY!
Heath Company, Dept. 511-160
Benton Harbor, Michigan 49022

EK-480A

CIRCLE NUMBER 130

ELECTRONIC DESIGN 8, April 12, 1976

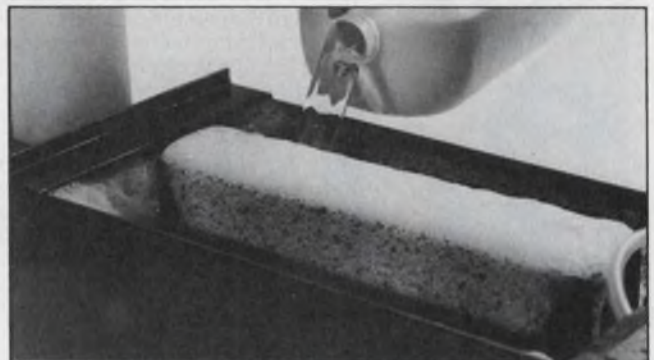

Supersafe, Superflux

Superior's new formula of No. 30 for use in foam fluxers is clean, safe, water soluble with absolutely no fire hazard.

With No. 32, you will be certain of the best results on the finest electronic production lines. Its foaming qualities are consistent and will meet or exceed your needs.

An Opportunity

To prove No. 32's capabilities, we make this unusual offer: we will send you your first gallon of No. 32 for only \$8.00 including freight. Put our No. 32 through its paces. You'll find the results topnotch and your costs will be lower along with your soldering safety hazards. Also available as #3298 where faster moisture removal is required.

Send check to: Dept. ED



The Superior Flux
and Mfg. Co.

95 Alpha Park, Cleveland, Ohio 44143

CIRCLE NUMBER 131

Design Data from Manufacturers

Advertisements of booklets, brochures, catalogs and data sheets. To order use Reader-Service Card
(Advertisement)

Electronic Design

GIANT FREE CATALOG



New 172 page catalog! Packed with 1,000's of hard-to-find buys in Optics, Science, Electronics. Loaded with optical, scientific, electronic equipment available from stock. Rare surplus buys. Many "one-of-a-kinds". Ingenious scientific tools. Components galore: lenses, prisms, wedges, mirrors, mounts, accessories. 100's of instruments: pollution test equipment, lasers, comparators, magnifiers, microscopes, projectors, telescopes, binoculars, photo attachments, alternate energy sources. Shop, save by mail! Request free Catalog "DA".

Edmund Scientific Co.

America's Largest Science-Optics-Electronics Mart
300 Edscorp Bldg., Barrington, New Jersey 08007 (609) 547-3488

CIRCLE NUMBER 171

Share in the nation's top managerial policies, strategies, techniques . . .

MANUFACTURING MANAGEMENT SYSTEMS

New Challenges and Opportunities Edited by Fred Gruenberger



By crystallizing the results of the 1973 Informatics/UCLA Symposium, this book offers a powerful blend of technical and managerial expertise for enhancing the overall success and profitability of today's manufacturing management systems. Some of the nation's top industrial and technical leaders speak freely and in depth of their organization's objectives and specific operations, as well as their personal strategies and methods. You'll find the newest computerized tools available to manufacturers . . . crucial managerial skills for directing progressive systems . . . the tact and care needed for the sensitive human problems of system implementation, and more. #5940-x, 160 pages, \$10.50. Circle the Info Retrieval No. to order a 15-day exam copy. When billed, remit or return book. No obligation.

CIRCLE NO. 172

Hayden Book Company, 50 Essex St., Rochelle Pk, N.J. 07662

Are you using the #1 training courses in electricity & electronics?

BASIC ELECTRICITY and BASIC ELECTRONICS

By Van Valkenburgh, Nooger & Neville, Inc.



Derived from the COMMON-CORE Training Program initially developed for the U.S. Navy, these unique texts are now about to enter their third decade of use in schools, industries, and communication utilities. They continue to be exemplary training texts in their subjects. Carefully integrated illustrations comprise almost half the course material. These perform a remarkable job of visualizing complex theory and applications. Readers are able to grasp essential concepts right away without having to wade through pages of wordy explanation. Thorough, comprehensive coverage. Available in separate paperbacks or one cloth volume. Write for FREE brochure.

Hayden Book Company
50 Essex St. Rochelle Pk, N.J. 07662

CIRCLE NUMBER 173

ELECTRONIC DESIGN's function is:

- To aid progress in the electronics manufacturing industry by promoting good design.
- To give the electronic design engineer concepts and ideas that make his job easier and more productive.
- To provide a central source of timely electronics information.
- To promote communication among members of the electronics engineering community.

Want a subscription? ELECTRONIC DESIGN is sent free to qualified engineers and engineering managers doing design work, supervising design or setting standards in the United States and Western Europe. For a free subscription, use the application form bound in the magazine. If none is included, write to us direct for an application form.

If you do not qualify, you may take out a paid subscription for \$30 a year in the U.S.A., \$40 a year elsewhere. Single copies are \$1.50 each.

If you change your address, send us an old mailing label and your new address; there is generally a postcard for this bound in the magazine. You will have to requalify to continue receiving ELECTRONIC DESIGN free.

The accuracy policy of ELECTRONIC DESIGN is:

- To make diligent efforts to ensure the accuracy of editorial matter.
- To publish prompt corrections whenever inaccuracies are brought to our attention. Corrections appear in "Across the Desk."
- To encourage our readers as responsible members of our business community to report to us misleading or fraudulent advertising.
- To refuse any advertisement deemed to be misleading or fraudulent.

Microfilm copies are available of complete volumes of ELECTRONIC DESIGN at \$19 per volume, beginning with Volume 1, 1952 through Volume 20. Reprints of individual articles may be obtained for \$3.00 each, prepaid (\$.50 for each additional copy of the same article) no matter how long the article. For further details and to place orders, contact the Customer Services Department, University Microfilms, 300 North Zeeb Road, Ann Arbor, Michigan 48106 telephone (313) 761-4700.

Want to contact us? If you have any comments or wish to submit a manuscript or article outline, address your correspondence to:

Editor
ELECTRONIC DESIGN
50 Essex Street
Rochelle Park, N.J. 07662

ELECTRONIC DESIGN 8, April 12, 1976

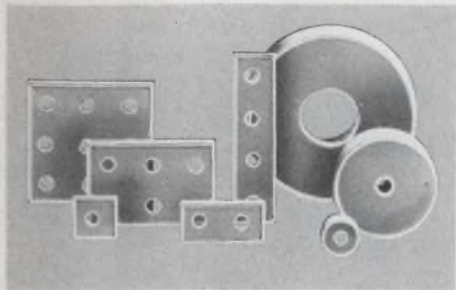

CIRCLE & MULTI-FEED-THRU CAPACITORS, available in a wide range of sizes and configurations, with NPO, BX, Z5U and Y5V characteristics. For use as feed-through elements, where volume efficiency of capacitance performance is required. Applications also include filter networks, pulse and logic circuitry, and signal bypass to ground elements in broadband circuits. Available in configurations suited to customer needs. Johanson/Dielectrics, Inc., Box 6456, Burbank, CA 91510 (213) 848-4465.

CIRCLE/MULTI-FEED CAPACITORS 181

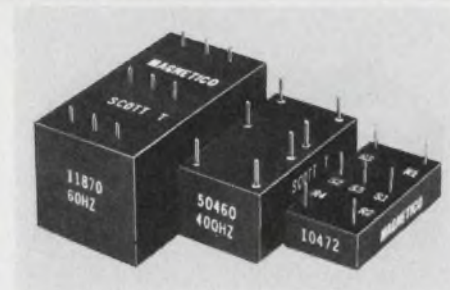

Scott T Transformer. 11870: 60HZ, 90v, L-L in. 1.1x2.1x1.1. 50460: 400 HZ, 90v, L-L in. 7/8x1-5/8x11/16. 50642: 400HZ, 11.8v, L-L in. 7/8x5/8-11/16. 10472: 400-HZ, 11.8v, L-L in. 3/4x1-1/2x3/8. All with 6v RMS sine & cosine output. MAGNETICO, INC., 182 Morris Ave., Holtsville, N.Y. 11742 516-654-1166.

TRANSFORMER 184

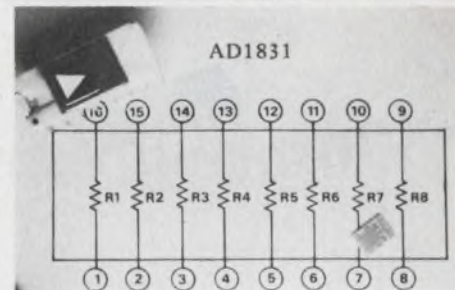

Precision Thin Film Resistors: The AD1831 has 8 precision resistors, with -55°C to +125°C operating range in "S" (0.1%) and "U" (0.01%) absolute accuracy grades. Packaged units are available in 16 DIP, FLATPAK, and a 4.064mm x 5.334mm chip. "S" prices - \$3.60 in 100's (DIP). Processing to MIL-STD 883A, Class B also available. Analog Devices, Norwood, Mass. 02062 617-329-4700.

THIN FILM RESISTORS 187



"Short-Stop" short-circuit locator uses near-field magnetic phenomena for fast, efficient PCB troubleshooting. LED read-out positively locates short as probe passes over it. Easy to use; operators qualify in 15 minutes! \$495 in single units, lower in quantities. "Short-Stop II" (\$675 single unit) can also be used to exercise and control ICs and for on-board data bus diagnostics. Testline Instruments, 1625 White Drive, Titusville, Fl. 32780.

AUTOMATIC SHORT FINDER 182



PROGRAMMING PROVERBS, H. F. Ledgard. A unique collection of "proverbs", or rules and guidelines, for upgrading the quality of your work, improving your skills in *program organization* and *logical thinking*. Sample programs in PL/1, ALGOL, and others. #5522-6, 144 pages, \$5.95. Circle the Info Retrieval Number to order 15-day exam copy. When billed, remit or return book with no obligation. Hayden Book Co., 50 Essex Street, Rochelle Park, N.J. 07662.

PROGRAMMING PROVERBS 185



Low-cost tape reader is fast—up to 300 cps—and quality-built. Dual sprocket drive, a state-of-the-art fiber optic light source and photo transistor read head. Simplicity of design makes it easy to adapt to specific OEM requirements. Decitek, 250 Chandler Street, Worcester, MA 01602 (617) 798-8731

SAM[®] TAPE READER 188

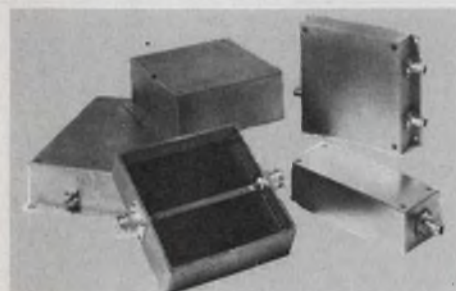

LOW COST RFI SHIELDED CASES. COMPAC line includes blank case assemblies without connectors in 13 sizes, standard cases with flange mounted RF connectors and RFI filter feedthroughs, and custom made cases. Effective from 60 dB to ≥ 100 dB at 100MHz. Greater shielding with available gaskets. Cases are made from extruded aluminum alloy, completely finished with a chemical film per MIL-C-5441B for excellent conductivity. (From \$9.85) COMPAC, 222 Middle Country Rd., Smithtown, N.Y. 11787, 516-979-7100

RFI SHIELDED CASES 183

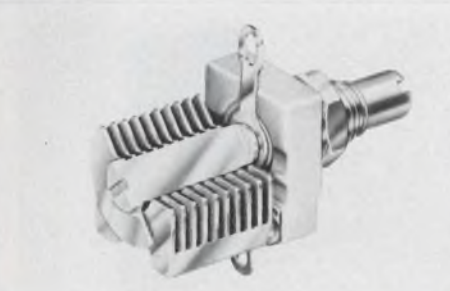

Small, high capacity Type V air variable capacitors. Printed circuit and panel mount types mount in less than 0.3 sq. in. Rotors and stators machined from solid brass extrusions provide reliability and stability. Metal parts are silver-plated and Iridized. Ceramic is steatite. High torque (2-1/2 to 10 oz./in.) Low temperature coefficient (+50 \pm 20 ppm/°C). Uniform delta C and voltage characteristics. E.F. Johnson Co., Waseca, Mn., 56093. (507) 835-5222

TYPE V CAPACITORS 186

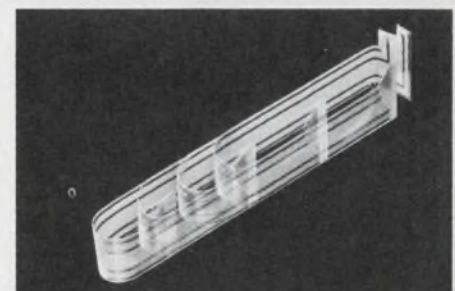

When you want a flexible circuit that doesn't just sit there, but really flexes—millions of times with complete reliability—then you want an R/flex flexible circuit from Rogers. Rogers has the know-how to make *flexible* flexible circuits to do your job. For help, write or call Rogers Corporation, Chandler, AZ 85224. Telephone: (602) 963-4584.

FLEXIBLE FLEXIBLE CIRCUITS 189

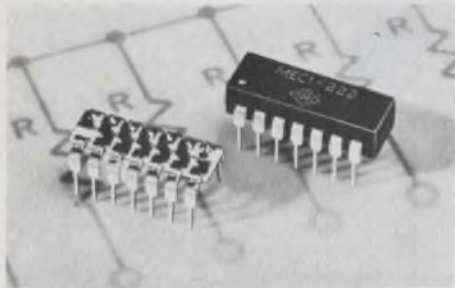

DUAL-IN-LINE, RESISTOR NETWORKS for such typical applications as pull-up and pull-down networks or line terminators.
• 7 or 13 resistors, 14 pin • 8 or 15 resistors, 16 pin • Resistor values: 100 ohm to 10K ohm. • TCR: $\pm 200\text{ppm}/^\circ\text{C}$
• Thick film resistor tolerance: $\pm 2\%$. All are available for off-the-shelf delivery from over 200 Centralab Distributors. For the name of your local Distributor call 414-228-2911.

RESISTOR NETWORKS

190

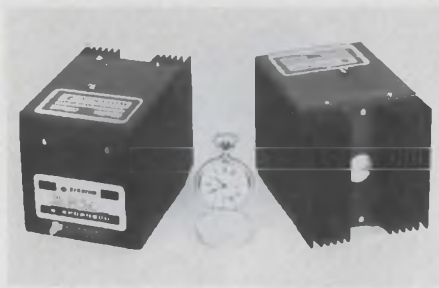

Rubidium Oscillators. Models FRK-H and -L feature typ. stab. $1 \times 10^{-11}/\text{mo}$. Fast warm-up < 10 min., power 12W, wgt. 2.9 lbs. Warranty 5 yrs. lamp/cell. For nav/comm in aircraft/ship. Price \$3480/5100, OEM avail. EFRATOM CA., INC., 3303 Harbor Blvd., El, Costa Mesa, CA 92626 Tel: (714) 556/1620

TIME/FREQUENCY/STANDARDS

193



Model 433 Random Time Delay Module is a solid state device for the Generation of random timing. Activating the device by an electrical command results in an output pulse, the duration of which is unpredictable and may with equal probability be any value in a preset range. Time ranges from a fraction of a second to as long as one hour are set by the user by connecting a resistor and capacitor external to the module. Call Frank Jomini, W-P Instruments, Inc., Box 3110, 60 Fitch St., New Haven, CT 06515, 203-389-2183.

RANDOM TIME DELAY MODULE

196

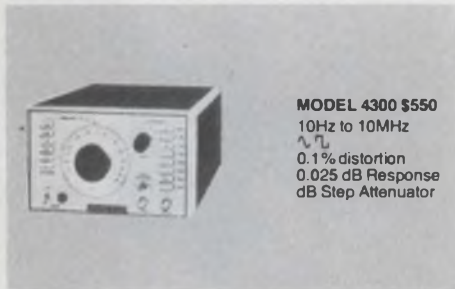

MODEL 4300 \$550
10Hz to 10MHz
0.1% distortion
0.025 dB Response
dB Step Attenuator

10 Hz to 10 MHz Sine/Square Generator features 0.025 db frequency response .10VRMS output. Distortion less than 0.1%. Calibrated push-button attenuator. Wein Bridge oscillator generates true sine waves without discontinuities or peaks. Model 4300A \$550. KROHN-HITE, AVON INDUST. PARK, AVON, MA 02322.

SINE/SQUARE GENERATOR

191



PROGRAMMING PROVERBS FOR FORTRAN PROGRAMMERS, H. F. Ledgard. These 26 unique "proverbs," or rules and guidelines, are specially designed to help FORTRAN programmers upgrade the quality of their work. Comes with many sample programs. #5820-9, 144 pages, \$5.95. Circle the Info Retrieval Number to order 15-day exam copy. When billed, remit or return book with no obligation. Hayden Book Co., 50 Essex Street, Rochelle Park, N.J. 07662.

PROGRAMMING PROVERBS

194



OPTICAL GLASS COMPONENTS—Color filters, substrates, fiber optics and radiation shielding windows are some of the specialty components available from America's most modern optical glass plant. From Led display enhancement to piping light, Schott can assist you in applying their years of optical material research to this year's product. From concept to production, on time and to specification. SCHOTT OPTICAL GLASS INC., Duryea, Pa. 18642. (717) 457-7485

OPTICAL GLASS COMPONENTS

197

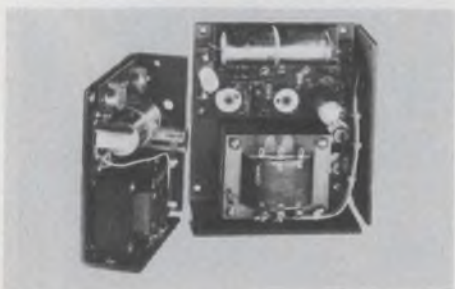

New "Slim Line" Industry Standard DC Supplies offer narrow silhouette interchangeability with other makes. Competitively priced, the SPS 32/42 are fully rated from 47 to 440Hz, 115/230Vac $\pm 10\%$ inputs. Nom. outputs are 5, 12, 15 and 24/28Vdc at 3.0, 1.8, 1.6 and 1.2/0.9A(max) for the SPS 32; and, 6.0, 3.5, 3.0 and 2.3/1.8A(max) for the SPS 42. Vdc adj. to $\pm 10\%$. For data, prices and local distr: Standard Power, Inc., 1400 So Village Way, Santa Ana, CA 92705 (714) 558-8512, or in east: (516) 420-0944.

DC POWER SUPPLIES

192



Custom made cases, cabinets and enclosures. Exceptionally rugged construction, laminated Formica-wood-Formica. Internally reinforced corners. Attractive wood grain or solid color exteriors. Superb workmanship, competitive prices, small or quantity lots. W. A. Miller Co., Inc., 306 Mingo Loop, Oquossoc, Maine 04964. Telephone: 207/864-3344.

CASES AND ENCLOSURES

195

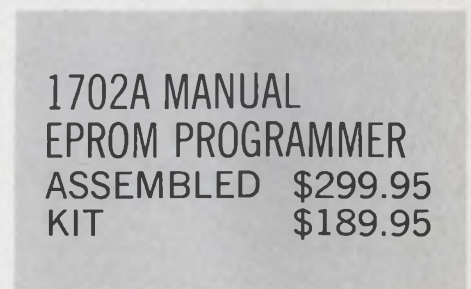

**1702A MANUAL
EPROM PROGRAMMER**
ASSEMBLED \$299.95
KIT \$189.95

Features hex keypad, two digit hex address and two digit hex data display. Controls include load, clear, go!(step), key/copy, data in/data out, and counter up/down. Profile card includes high voltage pulse regulator, timing, 8 bit address and 8 bit data drivers/receivers. Two 6 1/2" X 9" stacked cards with spacers. Allows programming in 20 minutes—copying in 5 minutes. Requires +5, -9, and +80 volts. 30 days for delivery. Associated Electronics, 17855 Sky Park Circle, Irvine, CA 92714 (714) 549-3830

1702A PROGRAMMER

198

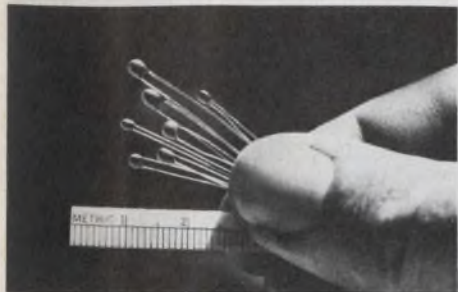

Chip Thermistors with leads and coating are highly reliable, exceptionally predictable, low cost components with small and miniature dimensions more compatible with modern circuit design. R @ 25°C 10 ohms to 10 meg ohms, tolerances $\pm 10\%$ to $\pm 1\%$. Curve matched interchangeables $\pm 1^\circ\text{C}$ to $\pm .2^\circ\text{C}$. Point matched interchangeables for temperature control R, to $\pm 1\%$. WESTERN THERMISTOR Corporation, 403 Via El Centro, Oceanside, CA 92054. (714) 433-4484.

THERMISTORS

199

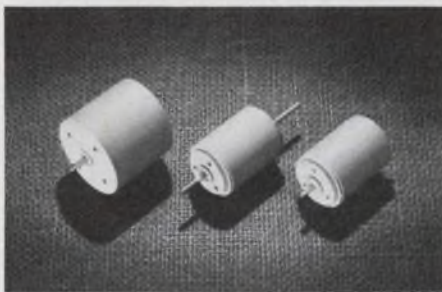

MINIATURE IRONLESS ROTOR DC MOTORS offer efficiencies to 80%, low inertia, rapid response and high starting torque. 24 and 12 VDC models available. Motor time constants are 17 and 23 MS respectively. Rotor torque is 100 and 50 gcm and starting torque 600 and 230 gcm, respectively. 12 VDC units can be ordered with either a single or extended double shaft. Tach versions also available. For reel and capstan drives, chart and pen drives, etc. North American Philips Controls Corp., Cheshire, Conn. 06410. (203) 272-0301.

IRONLESS ROTOR

202



The **AMP Hexadecimal Rotary Switch** can be programmed with a screwdriver. Costs less than an ordinary DIP switch. It's a fast, 16-pin DIP-type performer with four Form 'C' switches mounted on a bi-directional binary-encoded cam. Input/output pins are spaced on .100" x .300" centers. Fully-enclosed design protects gold plated phosphor bronze contacts. Call (717) 564-0100, or write: AMP Incorporated, Harrisburg, Pa. 17105.

HEXADECIMAL SWITCH

205

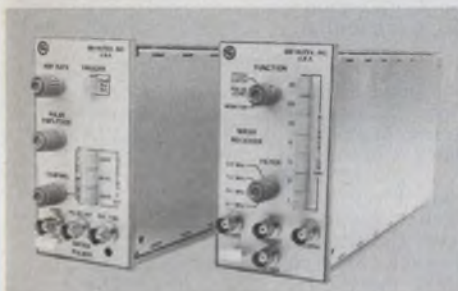

New modular M-series plug-in ultrasonic system designed to operate with Tektronix TM-500 power supply modules. TTL compatible sync, triggering for easy interface with digital logic. MP203 pulser features variable amplitude spike pulse to 230 volts into 50 ohms at 10 kHz pulse rate, 5 nsec. risetime. MR101 low noise receiver amplifier has 40 db gain, precision attenuator adjustable to 62 db in 1 db steps, high pass filter. MetroTek, Inc., P.O. Box 101, Richland, WA 99352. (509) 946-4778.

ULTRASONIC SYSTEM

200



PRACTICAL DESIGN FOR ELECTROMAGNETIC COMPATIBILITY, ed. by R. Ficchi. A complete guide to elec. compatability for electronic systems and equipment, including semiconductor, microelectronic, and digital computer equipment. Numerous charts, graphs, and nomographs. #5685-0, 272 pages, \$17.20. Circle the Info Retrieval Number to order 15-day exam copy. When billed, remit or return book with no obligation. Hayden Book Co., 50 Essex Street, Rochelle Park, N.J. 07662.

DESIGN GUIDE

203

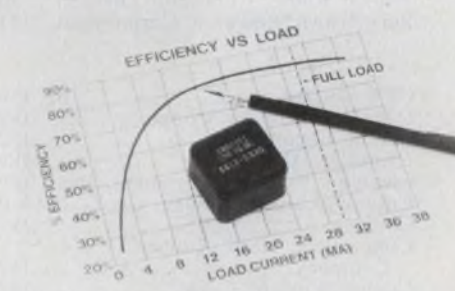

Activate gas discharge readouts! DC-to-DC power supplies convert low DC line voltages of 5, 9, 12 or 15 volts to nominal 200 and 250 volt DC levels required to run gas discharge information displays. Ideal for battery powered applications! Both regulated and unregulated. Ask about our custom power supplies, too! Free literature. Endicott Coil Co., Inc., 31 Charlotte Street, Binghamton, N.Y. 13905. (607) 797-1263

POWER SUPPLY

206

MICROPROCESSOR PROGRAMMING BREAKTHROUGH!

First Data Corporation's new line of interactive time-sharing cross-assemblers can be used to develop software faster and cheaper than other development systems. It can actually save users up to 90% of the cost of competitive systems.

First Data presently offers microprocessor assemblers for Intel 4004, 4040, 8008 and 8080. Texas Instrument TMS 8080. Motorola 6800. Fairchild F8. MOS Technology 6500 Series. TI TMS 100 Series; and all DEC PDP-8 and PDP-11 compatible microprocessors.

Cross-assemblers and simulators for the following minis are also available: PDP-8 family; PDP-11 family; Nova/Rolm family and GRI-909/99.

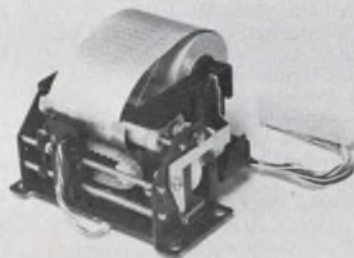

Hycom has introduced an improved 16 column Electro Discharge Printer that is faster, more reliable, and costs less than previously available units. (\$69 per unit in 100 quantity.) Designed to enhance the performance of remote terminals, microprocessors, and other low cost terminal applications, the Printer, Model DC-1606B, prints 8 lines per second very quietly, using a 5x7 dot matrix to form alpha-numerics. HYCOM INCORPORATED, 16841 Armstrong Ave., Irvine, Ca. 92714 (714) 557-5252

ELECTRO DISCHARGE PRINTER

204

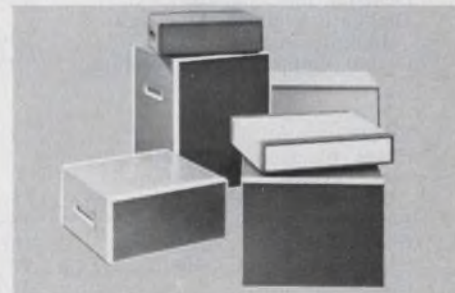

Optima Instrument Cases available in 72 sizes for 19 and 24 panel-mounted instruments. Accessories include: Doors, slides, tiltstands, detachable tops, chassis, side handles, support angles and perforated panels. Choose from 16 colors. Delivered assembled. Optima Division, Scientific-Atlanta, Inc. 2166 Mountain Industrial Blvd. Tucker, Ga. 30084

CABINETS

207

Advertiser's Index

Advertiser	Page	Advertiser	Page	Advertiser	Page
AMP, Incorporated	189	First Data Corporation	189	Penril Corp., Data Communica- tions Division	173
Acopian Corp.	136, 137	GTE Automatic Electric	29	*Philips Industries, Test and Measuring Instruments Dept.	136, 137
Ad-Vance Magnetics, Inc.	156	General Electric Company, Tube Products Department	142	Piezo Technology, Inc.	166
Addmaster Corporation	173	Gold Book, The	176, 177	Precision Monolithics, Incorporated	39
Airpax Electronics, Cambridge Division	170	Grayhill, Inc.	138	Premier Metal Products Company	148
Alco Electronic Products, Inc.	145	Greenway Industries, Inc.	184		
Allen Bradley Co.	17	Gulton Electronic Components Division	175	Quan-Tech, Division of Scientific Atlanta, Inc.	152
American Microsystems, Inc.	22, 23	Hamamatsu Corp.	156		
Amperex Electronic Corporation	85	Harris Semiconductor, A Division of Harris Corporation	125	RCA Electro Optics	139
Amperite Co., Inc.	162	Hayden Book Company, Inc. *17, 48B, 186, 187, 188, 189	189	RCA Solid State	71, 72, 73, Cover IV
Amuneal Manufacturing Corp.	168	Heath Company	185	RCL Electronics, Inc.	14
Analog Devices, Inc.	187	Heinemann Electric Company	153	Raytheon Company, Industrial Components Division	132
Ann Arbor Terminals, Inc.	164	Hewlett-Packard	4, 5, 33, 56, 69, 78, 116, 117, 143, 165	Reader Service Card	192A-B
Arnold Magnetics Corp.	181	Heyman Manufacturing Company	157	Reticon	133
Arrow-M Corp.	130	Houston Instruments, A Division of Bausch & Lomb	120	Riken Denshi Co., Ltd.	173
Associated Electronics	188	Hycorn	189	Rockwell International	88, 89
				Rogan Corporation	161
Bourns, Inc., Trimpot Products Division	Cover II	Illuminated Products Co.	7	Rogers Corporation	187
Bud Radio, Inc.	140	Instruments for Industry, Inc.	144	Schott Optical Glass, Inc.	188
Bunker Ramo, Connector Division	30	Intelligent Systems Corp.	148	Scientific-Atlanta, Inc.	189
Burr-Brown Research Corporation	111	Inter-Market, Inc.	169	Seastrom Manufacturing Co., Inc.	178
		Instrument Specialties Company	127	Signetics Corporation	145, 147, 149, 151, 153, 155, 157, 158, 159
CTS Corporation	62, 150	Johanson Manufacturing Corp.	6	Simpson Electric Company	135
Capital Calculator Company	184	Johanson/Dielectrics Inc.	187	South Bay Cable Corp.	151
Centre Engineering	152	Johnson Company, E. F.	187	Sprague Electric Company	10
Centralab Distributors	188	Kennedy Co.	18	Stacoswitch, A Staco Inc. Company	168
Cincinnati Sub-Zero Products, Inc.	169	Keytek Instrument Corp.	180	Standard Power, Inc.	188
Communications Survey Card	112A-B	Krohn-Hite Corporation	188	Stanford Applied Engineering, Inc.	12
Compac	187	Kurz-Kasch, Inc.	164	Superior Flux and Mfg. Co.	185
Connecticut Hard Rubber Company, The	167	LSI Computer Systems, Inc.	185	Sweda International OEM Products	144
Conner-Winfield Corp.	182				
Continental Rentals, Division of Continental Leasing Co., Inc.	167	3M Company	Cover III	TRW/IRC Potentiometers, An Electronic Components Division of TRW, Inc.	86
Control Products Division, Amerace Corporation	103	Magnetico, Inc.	187	TRW Power Semiconductors, an Electronic Components Division of TRW, Inc.	129
Corning Glass Works	110	McCoy Electronics Company	11	Tecnetics, Inc.	183
Cutler-Hammer, Specialty Products Division	63	McLean Engineering Laboratories	149	Tektronix, Inc.	27
		Mesucora 76	179	Teletype Corporation	121
Data I/O	13	MetroTek, Inc.	189	Testline Instruments	187
Data Display Products	24	Micro Devices Corp.	175	Texscan Corporation	128
Data General Corporation	15	Miller Co., Inc. W. A.	188	Thermodyne International, Ltd.	155
Decitek	187	Miller-Stephenson Chemical Co., The	171	Theta Instrument Corp.	169
Delco Electronics, Division of General Motors Corporation	96, 97	Mini-Circuits Laboratory, A Division of Scientific Components Corp.	2	U. S. Capacitor Corporation	28
Deltron, Inc.	123	Monsanto, United Systems Corporation Subsidiary	16	United Systems Corporation, A Subsidiary of Monsanto	16
Dialight, A North American Philips Company	79	Motorola Data Products	171	Universal Data Systems	49
Digital Equipment Corporation	95	Motorola Semiconductor Products, Inc.	48A		
		MuRata Corporation of America	154	Vitramon North America Division of Vitramon Incorporated	48
EEOC	21	National Semiconductor Corporation	35, 36, 37, 38	W-P Instruments Inc.	188
EMM Electronic Memories, A Division of Electronic Memories & Magnetics Corp.	84	Newport Laboratories, Inc.	172	Wavetek Indiana Incorporated	1
Eagle-Picher, Inc.	166	North American Philips Controls Corp.	147, 189	Western Thermistor Corporation	189
Edmund Scientific Company	186	Oak Industries, Inc.	8, 9	Wiley-Interscience	119
Efratom California, Inc.	188	Panasonic Electronic Components	179		
Elec-Trol, Inc.	160	Penntube Plastics Co., Inc.	175	Yardney Electric Corporation	174
Electro 76	141			Zero Manufacturing Co.	146
Electronic Design	*29, 191				
Electronic Navigation Industries	134				
Endicott Coil Co., Inc.	189				
Erie Technological Products, Inc.	57				
Fairchild Microsystems, A Division of Fairchild Camera and Instrument Corporation	163				

*Advertisers in non-U.S. edition

MAIL TO:

Electronic Design

P.O. BOX 13803, PHILADELPHIA, PA. 19101

FREE SUBSCRIPTION APPLICATION

Do you wish to receive (continue to receive) **ELECTRONIC DESIGN?** Yes No

Date: _____

Signature: Does not obligate me or my company

I wish to receive (do not wish to receive) other solicitations. Yes No

ALL SUBSCRIBERS: Please fillout completely, the name and address portion, even if the information on your label is the same. (For prompt, accurate processing remember to affix label in the space provided above.) Do not use periods, commas etc.

To qualify please answer all questions carefully. Independent consultants must attach business card.

MR. MS. Area Code Office Telephone

1st Initial	2nd Last Name	Title
Company Name (Do not abbreviate if possible)		Division
Parent Company (if subsidiary) (Do not abbreviate if possible)		
Department		Internal Mail Code
Company Street Address or P.O. Box No.		
Company City	State/Country	Zip Code/Postal Code
Home Address		
Home City	State/Country	Zip Code/Postal Code

8 Products you specify or authorize purchase of:
(Check all codes that apply.)

<input type="checkbox"/> 1 Resistors and Capacitors	<input type="checkbox"/> 12 Computer Peripherals
<input type="checkbox"/> 2 Connectors	<input type="checkbox"/> 13 Computer Components
<input type="checkbox"/> 3 Switches and Relays	<input type="checkbox"/> 14 Cabinets and Enclosures
<input type="checkbox"/> 4 Function Modules, Op Amps, Converters, etc	<input type="checkbox"/> 15 Panel Meters, Analog or Digital
<input type="checkbox"/> 5 Potentiometers	<input type="checkbox"/> 16 Readout and Display Devices
<input type="checkbox"/> 6 Test and Measurement Equipment	<input type="checkbox"/> 17 Rotating Components
<input type="checkbox"/> 7 Computers, Medium and Large	<input type="checkbox"/> 18 Cooling Products
<input type="checkbox"/> 8 Electronic Power Supplies	<input type="checkbox"/> 19 Printed Circuits
<input type="checkbox"/> 9 ICs and Semiconductors	<input type="checkbox"/> 20 Calculators
<input type="checkbox"/> 10 Microwave Devices	<input type="checkbox"/> 21 Indicators including LEDs
<input type="checkbox"/> 11 Minicomputers	<input type="checkbox"/> 22 Materials, Plating and Stripping
	<input type="checkbox"/> 23 Communications Equipment

1 Title: (Insert letter)

A President	J Project Engineer
B Vice President	K Senior Engineer
C Vice President of Engineering	L Group Leader
D Technical Director	M Dept. Head
E Chief Engineer	N MTS
F Principal Engineer	O Engineer
G Research Director	P Consultant
H Section Head	R Scientist
	S Physicist

2 Your principal job function: (Insert code)

- 1 General and Corporate Management
- 2 Design and Development Engineering (circuits, components, equipment systems)
- 3 Engineering Services (evaluation, quality control, reliability, standards, test)
- 4 Basic Research
- 5 Manufacturing and Production
- 6 Engineering Assistants (draftsman, lab assistant, technician)
- 7 Purchasing and Procurement
- 8 Marketing including Sales
- 9 Other Personnel (explain)

3 Plant Your own work

The primary end product (or service performed) at your plant, and the product (or service) that is your own work. (Insert code in each box even if the same)

<table style="width: 100%;"> <tr><td>A</td><td>A Large Computers</td></tr> <tr><td>B</td><td>B Mini-Computers</td></tr> <tr><td>C</td><td>C Computer Peripheral Equipment</td></tr> <tr><td>D</td><td>D Data Processing Systems (Systems Integration)</td></tr> <tr><td>T</td><td>T Office and Business Machines</td></tr> <tr><td>E</td><td>E Test, Measurement and Instrumentation Equipment</td></tr> <tr><td>F</td><td>F Communications Systems and Equipment</td></tr> <tr><td>H</td><td>H Navigation and Guidance Systems and Equipment</td></tr> <tr><td>J</td><td>J Consumer Entertainment Electronic Equipment</td></tr> <tr><td>G</td><td>G Consumer Electronic Appliances</td></tr> <tr><td>N</td><td>N Other Consumer Electronics</td></tr> <tr><td>K</td><td>K Industrial Controls, Systems and Equipment</td></tr> <tr><td>L</td><td>L Components and Sub Assemblies</td></tr> <tr><td>M</td><td>M Materials and Hardware</td></tr> <tr><td>Q</td><td>Q Aircraft, Missiles, Space and Ground Support Equipment</td></tr> <tr><td>P</td><td>P Oceanography and Support Equipment</td></tr> <tr><td>R</td><td>R Medical Electronics</td></tr> <tr><td>U</td><td>U Industrial Companies within the OEM incorporating Electronic Equipment in their end product, not else where classified</td></tr> <tr><td>V</td><td>V Independent Research, Test and Design Laboratory and Consultant. (Only if you are not connected with a manufacturing company.)</td></tr> <tr><td>X</td><td>X Government Agency and Military</td></tr> <tr><td>2</td><td>2 Industrial Companies using and/or incorporating any Electronic products in their manufacturing, research or development activities.</td></tr> <tr><td>1</td><td>1 Commercial Users of Electronic Equipment</td></tr> <tr><td>3</td><td>3 Distributor</td></tr> <tr><td>4</td><td>4 School, University or Library</td></tr> <tr><td>5</td><td>5 Other (explain)</td></tr> </table>	A	A Large Computers	B	B Mini-Computers	C	C Computer Peripheral Equipment	D	D Data Processing Systems (Systems Integration)	T	T Office and Business Machines	E	E Test, Measurement and Instrumentation Equipment	F	F Communications Systems and Equipment	H	H Navigation and Guidance Systems and Equipment	J	J Consumer Entertainment Electronic Equipment	G	G Consumer Electronic Appliances	N	N Other Consumer Electronics	K	K Industrial Controls, Systems and Equipment	L	L Components and Sub Assemblies	M	M Materials and Hardware	Q	Q Aircraft, Missiles, Space and Ground Support Equipment	P	P Oceanography and Support Equipment	R	R Medical Electronics	U	U Industrial Companies within the OEM incorporating Electronic Equipment in their end product, not else where classified	V	V Independent Research, Test and Design Laboratory and Consultant. (Only if you are not connected with a manufacturing company.)	X	X Government Agency and Military	2	2 Industrial Companies using and/or incorporating any Electronic products in their manufacturing, research or development activities.	1	1 Commercial Users of Electronic Equipment	3	3 Distributor	4	4 School, University or Library	5	5 Other (explain)	
A	A Large Computers																																																		
B	B Mini-Computers																																																		
C	C Computer Peripheral Equipment																																																		
D	D Data Processing Systems (Systems Integration)																																																		
T	T Office and Business Machines																																																		
E	E Test, Measurement and Instrumentation Equipment																																																		
F	F Communications Systems and Equipment																																																		
H	H Navigation and Guidance Systems and Equipment																																																		
J	J Consumer Entertainment Electronic Equipment																																																		
G	G Consumer Electronic Appliances																																																		
N	N Other Consumer Electronics																																																		
K	K Industrial Controls, Systems and Equipment																																																		
L	L Components and Sub Assemblies																																																		
M	M Materials and Hardware																																																		
Q	Q Aircraft, Missiles, Space and Ground Support Equipment																																																		
P	P Oceanography and Support Equipment																																																		
R	R Medical Electronics																																																		
U	U Industrial Companies within the OEM incorporating Electronic Equipment in their end product, not else where classified																																																		
V	V Independent Research, Test and Design Laboratory and Consultant. (Only if you are not connected with a manufacturing company.)																																																		
X	X Government Agency and Military																																																		
2	2 Industrial Companies using and/or incorporating any Electronic products in their manufacturing, research or development activities.																																																		
1	1 Commercial Users of Electronic Equipment																																																		
3	3 Distributor																																																		
4	4 School, University or Library																																																		
5	5 Other (explain)																																																		

4 Your design function: (Insert each letter that applies)

A I do electronic design or development engineering work
B I supervise electronic design or development engineering work
C I set standards for, or evaluate electronic design components, systems and materials

5 Your principal responsibility: (Insert code)

1 Management other than Engineering	3 Engineering
2 Engineering Management	

6 Please estimate: (Insert letter)

The number of electronic engineers at this address:
(A) 1 **(B)** 2-5 **(C)** 6-19 **(D)** 20-49 **(E)** 50-99
(F) 100-249 **(G)** 250-499 **(H)** 500-999 **(I)** Over 1000

7 Please write in box total number (other than self) to be served by this subscription at this address and list individuals and their titles below. If no other person is served please indicate "0" in the box at left.

Name (Please Print)	Title

9 Do you specify or buy through distributors?
 YES NO

10 Minicomputers at this address:

	Model	Qty.	Model	Qty.
3 Cincinnati Milacron				
C Computer Automation				
D Control Data				
E Data General				
F Digital Equipment				
I General Automation				
K Hewlett Packard				
M Honeywell				
O IBM				
N Interdata				
7 Microdata				
	Modular Computer			
V Systems Engineering Labs				
9 Texas Instruments				
x Varian				
	Other			



This questionnaire conforms to the guidelines of the Business Publication Audit of circulation for eliciting comparable data. The publisher reserves the right to serve only those individuals who qualify for a free subscription.
ELECTRONIC DESIGN is sent free to qualified engineers and engineering managers doing work, supervising design or setting the standards in the United States and Western Europe.

Use this form for Change of Address or New Subscription Only.

Product Index

Information Retrieval Service. New Products, Evaluation Samples (ES), Design Aids (DA), Application Notes (AN), and New Literature (NL) in this issue are listed here with page and Information Retrieval numbers. Reader requests will be promptly processed by computer and mailed to the manufacturer within three days.

Category	Page	IRN	Category	Page	IRN	Category	Page	IRN
Components			transistors, power	138	331	Microwaves & Lasers		
capacitors	6	5				microwave guide	142	67
capacitors	154	87	Instrumentation			oscillators	154	369
capacitors, ceramic	152	83	amplifier, wideband	156	91	rangefinder	152	364
capacitors, monolithic	48	25	calibrator	164	387			
capacitors, stacked-film	162	386	communications equip.	110	44	Modules & Subassemblies		
display, gas discharge	162	385	counter	16	261	control, temperature	151	360
fan	149	78	DMM	69	31	converter, a/d	151	362
filters, mechanical	157	378	Electro '76	141	66	converters, a/d	111	45
miniature lamps	179	127	oscilloscopes	27	281	converters, d/a	149	355
networks, DIP	160	381	rf power amplifiers	134	58	filters, C-message	150	358
passive components	11	151	recorder	173	118	hybrid circuits	62	29
pushbuttons	160	379	recorders, X-Y	120	48	hybrid circuits	132	56
reed relays	162	99	rental instruments	167	107	memory, CRT display	151	361
relay	147	74	signal generator	56	27	multicoupler, power	150	357
relay, solid-state	153	85	signal generator	168	394	oscillator, crystal	150	80
relays	130	55	spectrum analyzers	116	46	oscillator, DIP	182	130
relays	160	96	speed indicator	167	391	oscillators, DIP	184	134
relays, reed	162	98	strip-chart recorder	185	137	synthesizer, frequency	149	354
resistor	17	14	surge-generator/monitor	180	128			
resistors	14	11	sweep/signal generator	1	2	Packaging & Materials		
rocker, snap-in	63	30	sweeper	128	53	cabinets, racks & acces.	140	65
selector switch, lock	155	372	test chambers	179	126	cable	151	81
switch, miniature	170	113	ultrasonic generator	166	389	cable/connector systems	III	247
switch, toggle	145	71				cables, fiber optic	144	342
switches	138	64	Integrated Circuits			carrying cases	146	271
switches	168	109	a/d converter	134	320	cases, transit	155	88
switches, rotary	9	7	analog delay	133	57	circuit cooler	171	115
trimmer, bridged-T	162	382	analog gate	133	309	connectors, miniature	142	337
			audio circuit	132	307	contact strips	127	52
Data Processing			buffer	131	301	electronic hardware	178	124
CRT modules	171	114	buffer, octal	132	306	enclosures	145	345
CRT modules	148	76	chroma demodulator	134	310	enclosures	148	77
calculator	165	103	converters, d/a	39	24	fiberglass tapes	167	106
calculator	170	395	DAC, 12-bit	134	321	foam fluxer	185	138
calculators	184	135	MOS custom	185	136	heat-sink, clip-on	145	343
controller, floppy-disc	170	397	PROMs	125	51	IC sockets	13	10
data logger	172	401	RAM, 4-k	133	308	knobs	163	100
memories	84	37	regulator	134	322	magnetic-shielding	144	70
memory, core	174	404	Schmitt trigger	131	303	magnetic shields	168	108
memory, drum	170	396	transceiver	131	304	nylon bushings	157	92
minicomputers	78	33	UBRT	131	305	PC boards, stamped	145	344
modems	49	26	512-stage BBD	183	133	photographic masks	12	9
modems	173	119				prototype breadboards	142	339
paper-tape reader	173	117	Microprocessor Design			shrinkable tubing	175	122
reader/punch	144	69	assembler	34	503	switch, flat cable	140	334
recorder, tape, digital	174	405	development system	31	501	systems, card	142	340
tape transport	18	15	microprocessor	23	17	terminal blocks	103	43
			microprocessor chip	34	502			
Discrete Semiconductors			microprocessor kit	161	97	Power Sources		
detector	185	136	microprocessors	145	71	dc supply	147	350
diodes, light-emitting	137	328	microprocessors	147	75	lab source	146	347
displays, alphanumeric	137	327	microprocessors	149	79	lead-acid batteries	166	105
electro-optics	139	291	microprocessors	151	82	plating supply	146	346
isolators, opto	138	332	microprocessors	153	86	power supplies	123	50
LEDs	24	18	microprocessors	155	89	power supplies	136	60
lamps, LED	136	325	microprocessors	157	93	printer source	147	349
rf power semiconductor	85	38	microprocessors	159	94	rechargeable battery	174	120
transistors, high-gain	97	42	microprocessors	89	40	switcher	146	348
transistors, microwave	138	333	μ C system support			μ P supply	147	351

Design with the complete flat cable/connector system.

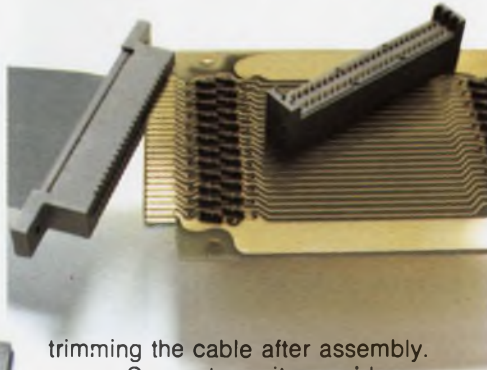

trimming the cable after assembly.

Connector units provide positive alignment with precisely spaced conductors in 3M's flat, flexible PVC cable. The connector contacts strip through the insulation, capture the conductor, and provide a gas-tight pressure connection.

With cable, connectors and assembly tools from one design and manufacturing source, you have added assurance the connection will be made surely, with no shorts or "opens."

And "Scotchflex" now offers you more design freedom than ever. From stock you can choose shielded and non-shielded 24-30 AWG cable with 10 to 50 conductors, and an ever-increasing variety of more than

The 3M DELTA pin and socket connector.

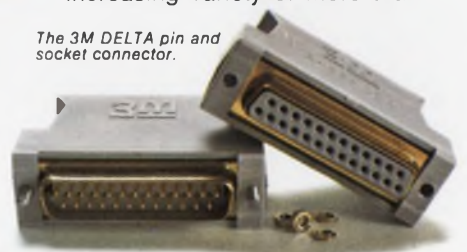

Assembly-cost savings are built in when you design a package with "Scotchflex" flat cable and connectors. But more important, 3M Company offers you the full reliability of a one-source system: cable *plus* connectors *plus* the inexpensive assembly aids that crimp the connections quickly and securely (with no special operator training required).

The fast, simple "Scotchflex" assembly sequence makes as many as 50 simultaneous multiple connections in seconds, without stripping, soldering or

100 connectors to interface with standard DIP sockets, wrap posts on standard grid patterns, printed circuit boards, or headers for de-pluggable applications. 3M's DELTA "D" type pin and socket connectors are now also available. For full information, write Dept. EAH-1, 3M Center, St. Paul, MN 55101.



3M
COMPANY

3M's "Scotchflex" line.

See our catalog in EEM 2-1034.

"Scotchflex" is a registered trademark of 3M Co.

What's new in solid state...

RCA breaks another SOS speed barrier with 90 ns 1K RAMs.

Now more than ever, RCA is making good on the speed/power promise of SOS. As the table shows, you now have much more design flexibility. Two organizations to choose from. Two levels of performance. All with very low operating power. Both of the 1024x1 devices are pin compatible with CMOS 6508 and bipolar 93415 types. And our 256x4 devices are pin compatible with CMOS 5101.

Moving fast, RCA has fully geared up to produce SOS. So we're ready now to bring you the dramatic system savings and wide usefulness made possible by our advanced SOS/CMOS technology.

For more information, contact your local RCA Solid State distributor. Or RCA.

Type	Organization	Access Time	Power Supply	Power @ 1 MHz
*MWS5001D	1024x1	150 ns typ.	5 V	4 mW
MWS5501D	1024x1	90 ns typ.	10 V	20 mW
MWS5040D	256x4	150 ns typ.	5 V	4 mW
MWS5540D	256x4	90 ns typ.	10 V	20 mW

*Previously announced

Write: RCA Solid State, Box 3200, Somerville, New Jersey 08876; Ste. Anne de Bellevue 810, Canada; Sunbury-on-Thames, U.K.; Fuji Bldg., Tokyo, Japan.

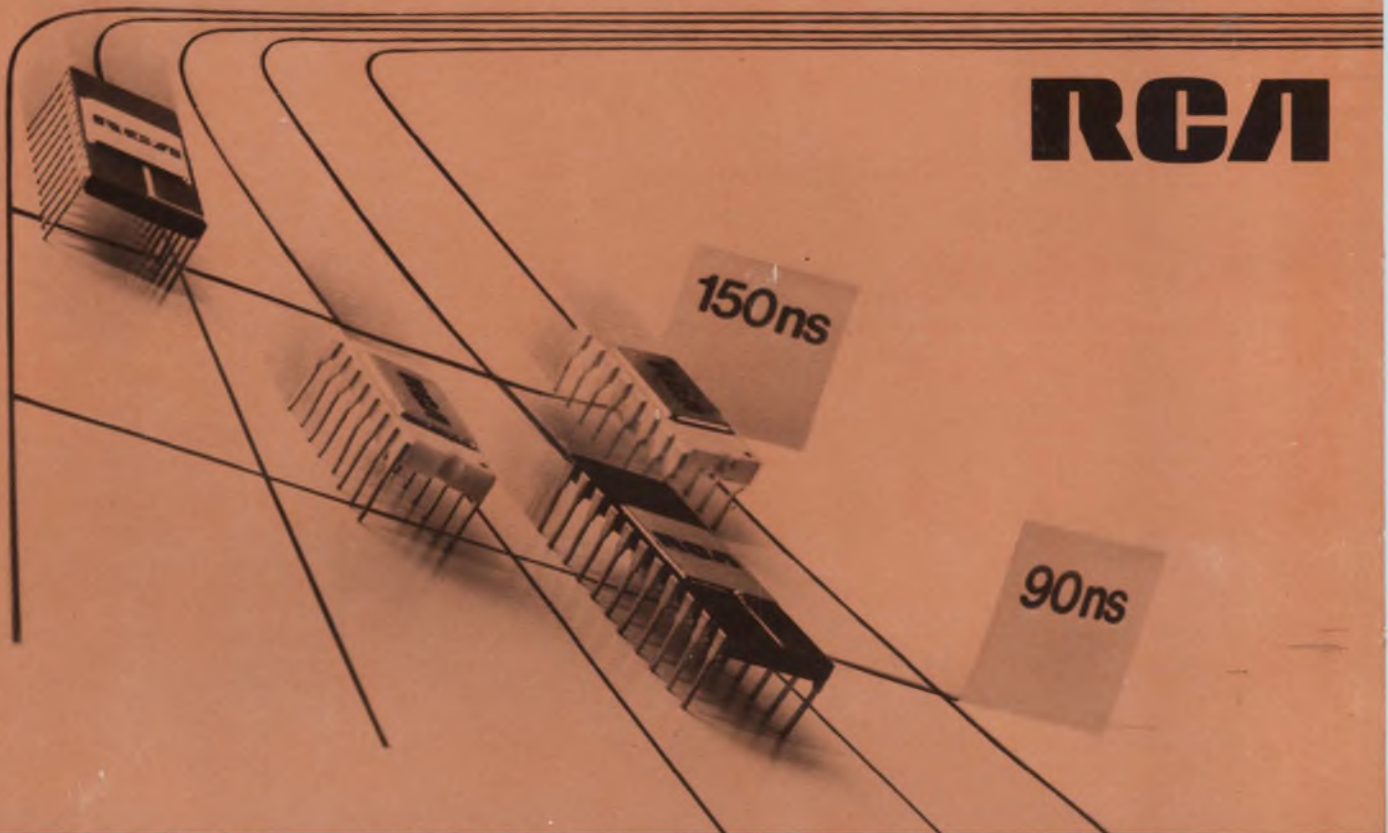

RCA. Fastest moving house in memory.