

July 21, 1961

electronics

Surgically implanting pacemaker to control heartbeat (below). See p 63

One-megawatt r-f generator for resonant heating of plasma, p 70

Designing automatic gain control into superregenerative amplifiers, p 76

A McGraw-Hill Publication 75 Cents

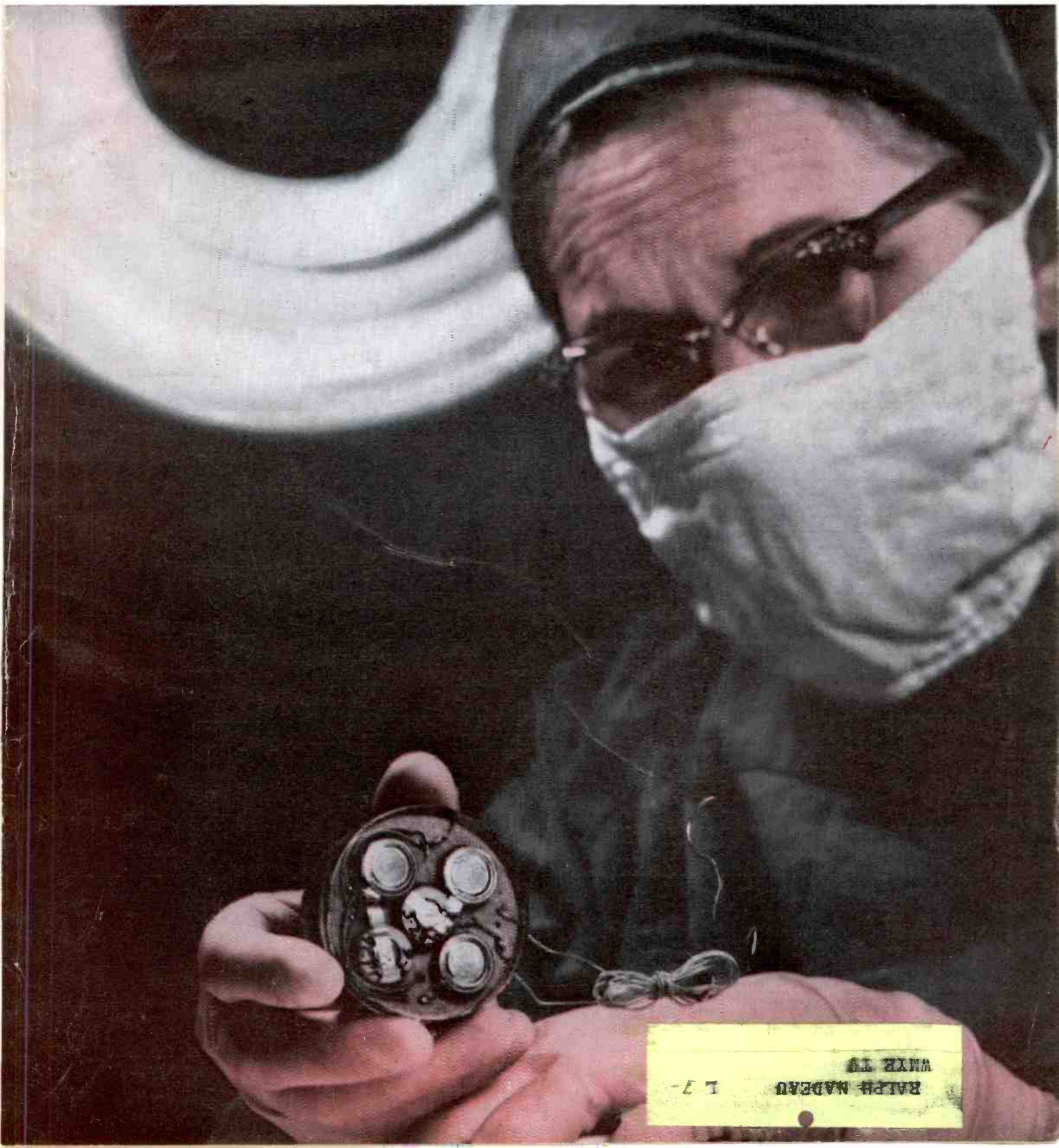



PULSE TRANSFORMERS

FROM STOCK

MINIATURE STABLE WOUND CORE

HERMETIC MIL-T-27A TYPE TF5SX36ZZ

UTC miniature, wound core, pulse transformers are precision (individually adjusted under test conditions), high reliability units, hermetically sealed by vacuum molding and suited for service from -70°C . to $+130^{\circ}\text{C}$. Wound core structure provides excellent temperature stability (unlike ferrite). Designs are high inductance type to provide minimum of droop and assure true pulse width, as indicated on chart below. If used for coupling circuit where minimum rise time is important, use next lowest type number. Rise time will be that listed for this lower type number . . . droop will be that listed multiplied by ratio of actual pulse width to value listed for this type number. Blocking oscillator data listed is obtained in standard test circuits shown. Coupling data was obtained with H. P. 212A generator (correlated where necessary) and source/load impedance shown. 1:1:1 ratio.

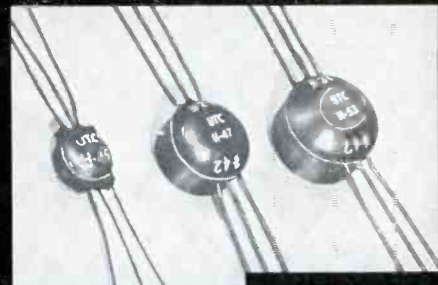

DEFINITIONS

Amplitude: Intersection of leading pulse edge with smooth curve approximating top of pulse.
Pulse width: Microseconds between 50% amplitude points on leading and trailing pulse edges.
Rise Time: Microseconds required to increase from 10% to 90% amplitude.
Overshoot: Percentage by which first excursion of pulse exceeds 100% amplitude.
Droop: Percentage reduction from 100% amplitude a specified time after 100% amplitude point.
Backswing: Negative swing after trailing edge as percentage of 100% amplitude.



APPROX. DCR, OHMS | BLOCKING OSCILLATOR PULSE | COUPLING CIRCUIT CHARACTERISTICS

Type No.	1-2	3-4	5-6	Width μ Sec.	Rise Time	% Over Shoot	Droop %	% Back Swing	P Width μ Sec.	Volts Out	Rise Time	% Over Shoot	Droop %	% Back Swing	Imp. in, out, ohms
H-45	3	3.5	4	.05	.022	0	20	10	.05	17	.01	20	0	35	250
H-46	5.5	6.5	7	.10	.024	0	25	10	.10	19	.01	30	10	50	250
H-47	3.7	4.0	4	.20	.026	0	25	8	.20	18	.01	30	15	65	500
H-48	5.5	5.8	6	.50	.03	0	20	5	.50	20	.01	30	20	65	500
H-49	8	8.5	9	1	.04	0	20	10	1	24	.02	15	15	65	500
H-50	20	21	22	2	.05	0	20	10	2	27	.05	10	15	35	500
H-51	28	31	33	3	.10	1	20	8	3	26	.07	10	10	35	500
H-52	36	41	44	5	.13	1	25	8	5	23	.15	10	10	45	1000
H-53	37	44	49	7	.28	0	25	8	7	24	.20	10	10	50	1000
H-54	50	58	67	10	.30	0	20	8	10	24	.25	10	10	50	1000
H-55	78	96	112	16	.75	0	20	10	16	23	.40	5	15	20	1000
H-56	93	116	138	20	1.25	0	25	10	20	23	.6	5	10	10	1000
H-57	104	135	165	25	2.0	0	30	10	25	24	1.5	5	10	10	1000
H-60	.124	.14	.05	.05	.016	0	0	30	.05	9.3	.012	0	0	20	50
H-61	.41	.48	.19	.1	.016	0	0	30	.1	8.2	.021	0	0	15	50
H-62	.78	.94	.33	.2	.022	0	0	18	.2	7.4	.034	0	5	12	100
H-63	1.86	2.26	.70	.5	.027	2	10	20	.5	7.5	.045	0	20	25	100
H-64	3.73	4.4	1.33	1	.033	0	12	25	1	7	.078	0	15	23	100
H-65	6.2	7.3	2.22	2	.066	0	15	25	2	6.6	.14	0	10	20	100
H-66	10.2	12	3.6	3	.087	0	18	30	3	6.8	.17	0	10	20	100
H-67	14.5	17.5	5.14	5	.097	0	23	28	5	7.9	.2	0	18	28	200
H-68	42.3	52.1	14.8	10	.14	0	15	28	10	6.5	.4	0	15	30	200

Note: 0 = Negligible

Vacuum Tube Type Ratio 1:1:1

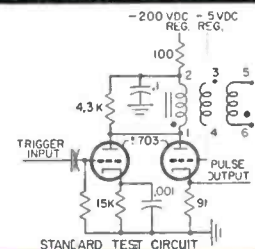

Transistor Type Ratio 4:4:1

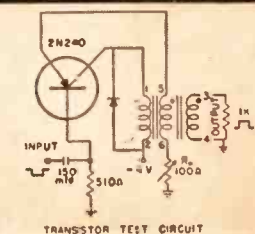

H-45, 46, 60 thru 68 are 3/8 cube, 1 gram

H-47 thru 52, 9/16 cube 4 grams

H-53 thru 57, 5/8 cube 6 grams

AND SPECIAL UNITS TO YOUR SPECS

While stock items cover low level uses only, most of UTC's production is on special units to customers' needs, ranging from low levels to 10 megawatts.

Write for Catalog for full details on these and 1000 other stock items

UNITED TRANSFORMER CORPORATION

150 Varick Street, New York 13, N. Y.

PACIFIC MFG. DIVISION: 4008 W. JEFFERSON BLVD., LOS ANGELES 16, CALIF.
 EXPORT DIVISION: 13 EAST 40th STREET, NEW YORK 16, N. Y. CABLES: "ARLAB"

electronics

A McGraw-Hill Publication 75 Cents



W. W. MacDONALD, Editor

J. M. CARROLL, Managing Editor

SENIOR ASSOCIATE EDITORS: Samuel Weber, Roland J. Charest. ASSOCIATE EDITORS: Michael F. Tomaino, George Sideris, Sylvester P. Carter, William P. O'Brien, John F. Mason, William E. Bushor, Thomas Emma, Sy Vogel, Leslie Solomon, M. M. Perugini, George J. Flynn.

ASSISTANT EDITORS: Michael F. Wolff, Nilo Lindgren, Stanley Froud, Stephen B. Gray, Roy J. Bruun, George V. Novotny, Leon H. Dulberger.

REGIONAL EDITORS: Harold C. Hood (Pacific Coast, Los Angeles), Thomas Maguire (New England, Boston), Cletus M. Wiley (Midwest, Chicago).

ART DIRECTOR: Harry Phillips; Howard R. Berry. PRODUCTION EDITOR: John C. Wright, Jr. EDITORIAL ASSISTANTS: Gloria J. Meurer, Bernice Duffy, Lorraine Rossi, Virginia T. Bastian, Lynn Emery, Avis Pomeranz, Florence Hajastron, Laura W. Smith, Bette H. Snyder.

JAMES GIRDWOOD Publisher

Surgeon at Miamonides Hospital, Brooklyn, prepares to implant an artificial pacemaker developed by GE. See p 63	COVER
Plans for Dyna-Soar's Ground Net Revealed. Communications and data link (CADL) subsystem handles six general classes of telemetry data	24
Closely-Defined Magnetic Field Measures Wear on Metal Surfaces	26
Soviet Electronics? All's NOT Well. Cybernetics being neglected	28
Infrared System Tracks Missile Reentry. Unit uses optical head	31
New Antenna System Includes Data-Processing	32
MEDICAL ELECTRONICS PART V: Prosthetics—Touch Hearing Devices, Blind Readers, and Artificial Organs and Limbs. Techniques and equipment for replacing or augmenting non-functional organs and limbs. By W. E. Bushor	63
RESONANT PLASMA HEATING: Equipment Delivers Megawatt R-F Pulses. A key part of Stellarator nuclear fusion experiments. By H. M. Hill, Jr.	70
Transient Recorder Monitors Power Lines to Protect Circuits. Records time and frequency of overvoltage transients. By F. Trainor	74
AGC FOR SUPERREGENERATIVE AMPLIFIERS. Technique produces high-gain stable amplifier from i-f to microwave frequencies. By J. H. Kuck	76
Smith-Diagrams Unit Display Uses Microwave Phase-Directional Coupler. Cathode-ray tube display. By S. Tsuchiya	80
Designing Emitter-Coupled Monostable Multivibrators. Short-cut method saves design and bench time. By L. L. Kleinberg	86

Crosstalk	4	Components and Materials	92
Comment	6	Production Techniques	96
Electronics Newsletter	9	New on the Market	102
Washington Outlook	14	Literature of the Week	109
Meetings Ahead	34	People and Plants	110
Research and Development	88	Index to Advertisers	115



TWA flies where the **BUSINESS** is!

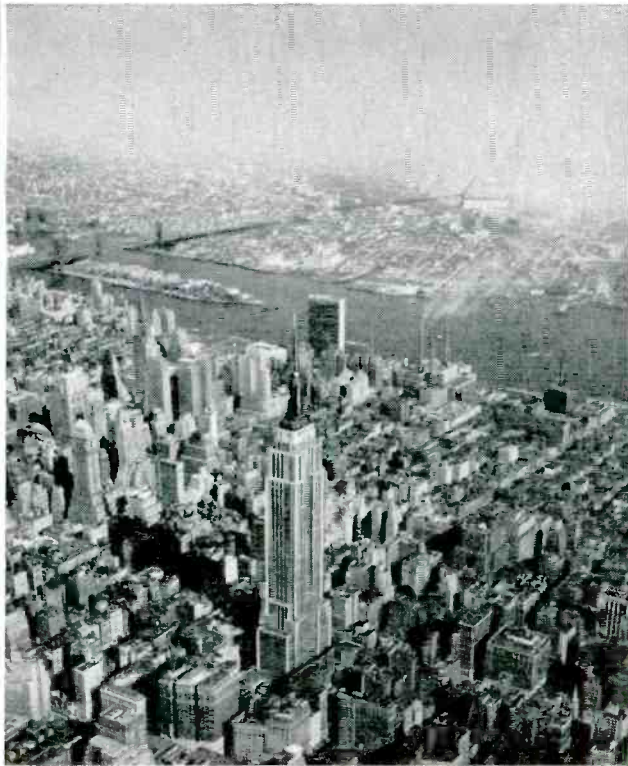

New York... major East Coast Air Freight center.



Paris... destination for U.S. products by the ton.

ONLY TWA carries freight between 70 thriving U. S. cities and 23 busy world centers overseas. Daily **JETSTREAM EXPRESS** flights...world's most dependable, longest-range all-cargo service ...fly your shipments non-stop coast-to-coast and to Europe. Next time you ship, call your freight forwarder...or TWA Air Freight,

TWA
AIR FREIGHT

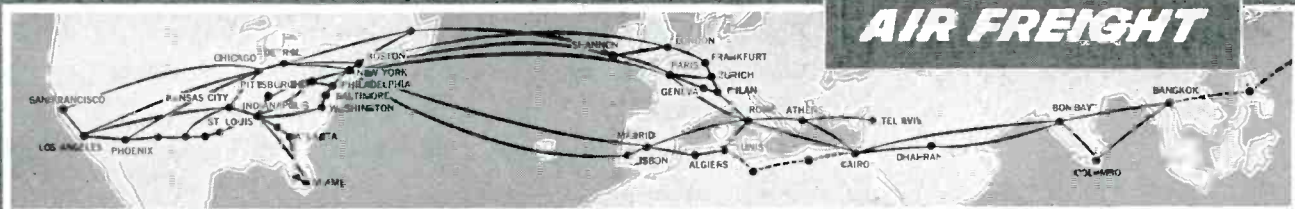

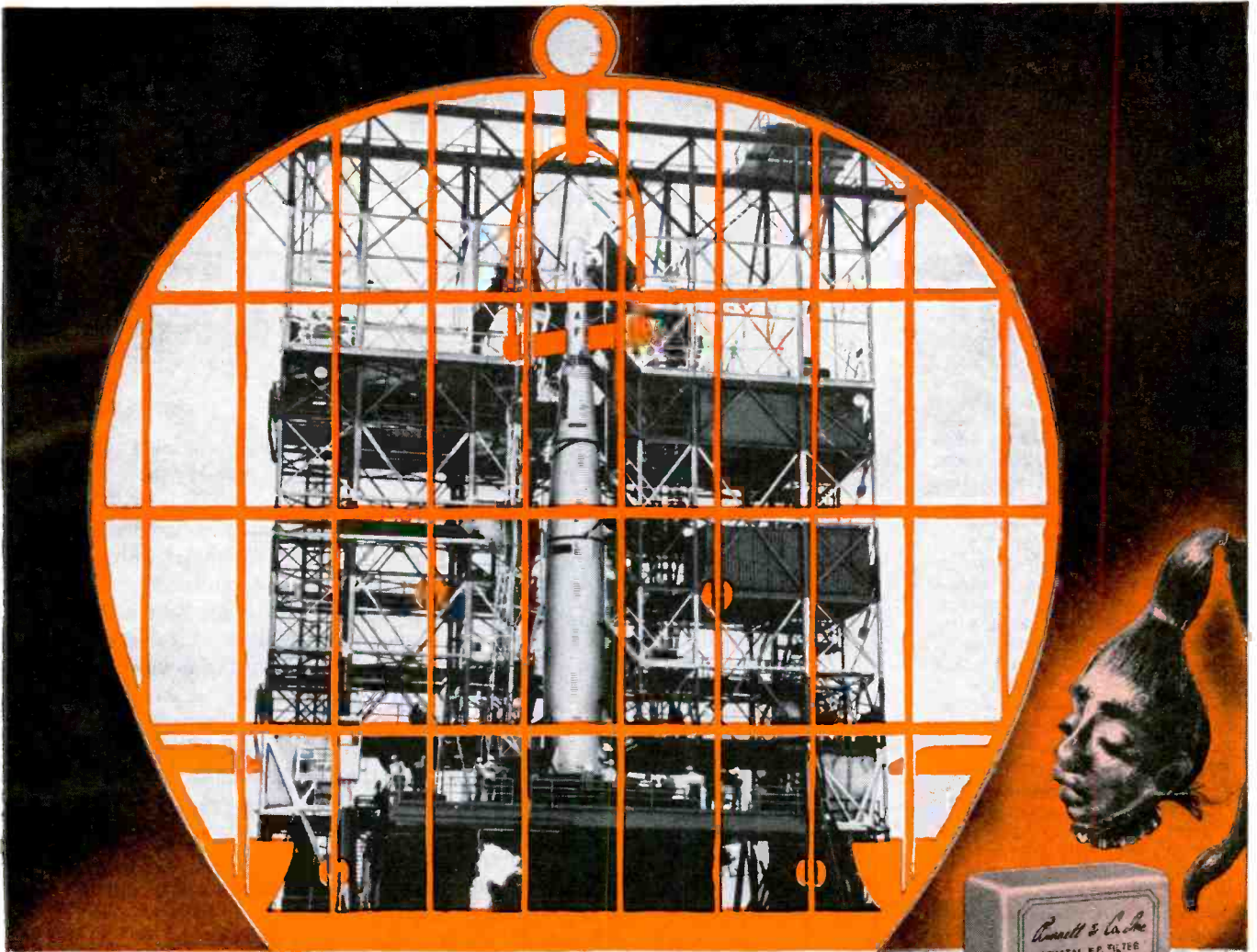

Only a Bird in a Gilded Cage

As succeeding generations of missiles penetrate the curtain of space that separates Earth from other planets, the importance of electronic guidance, control and airborne telemetry systems becomes obvious. For, without new engineering design techniques to provide reliable communication and control, the most advanced missile is but a bird in a gilded and very expensive cage.

As typical examples of what can be accomplished to insure maximum performance in missile telemetering, communication, data processing and other applications, Burnell & Co. has developed two new filters—a miniature 3 kc crystal filter and, employing modern synthesis techniques, a miniature 500 kc LC toroidal filter possessing low transient distortion characteristics.

COPYRIGHT BURNELL & CO., INC. 1961

TECHNICAL DATA 3 kc Crystal Filter

Attenuation—3 db B/W—2 cps
Shape Factor—30/3—5:1
Impedance—500K in and out
Temp. Coeff.—.021 cps °C
Size— $3\frac{1}{2}$ x $2\frac{5}{16}$ x $1\frac{1}{16}$
Insertion Loss— $3\frac{1}{2}$ db
Also available in any impedance from 500 ohms to 500K

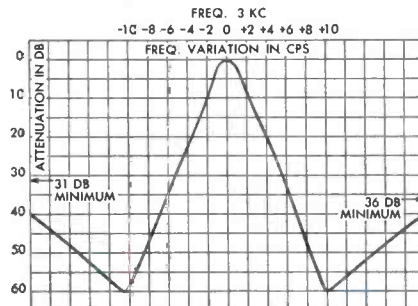

TECHNICAL DATA 500 kc LC Toroidal Filter

Attenuation—B/W 40 kc at 3 db
—200 kc at 50 db
Impedance—50 ohms in and out
Insertion Loss—4.5 db
Over and undershoot—
(for a step modulated
500 kc carrier)—less than 1%
Size— $\frac{7}{8}$ x 3 x $1\frac{1}{2}$

Other Burnell filters are available in frequencies up to 30 mcs over a wide range of impedances.

Write for new catalog.

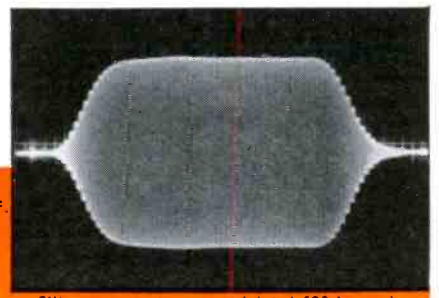

Filter response to step modulated 500 kc carrier

Burnell & Co., Inc.

PIONEERS IN microminaturization OF
TOROIDS, FILTERS AND RELATED NETWORKS

DIVISIONS: Gray & Kuhn, Inc., Westbury, L. I., New York • Guillemain Research Laboratory, Cambridge, Mass.

EXECUTIVE OFFICE
AND PLANT
DEPT. E-37
PELHAM, NEW YORK
PELHAM 8-5000
TELETYPE PELHAM 5633



PACIFIC DIVISION
SOUTH PASADENA, CALIF.
MFD. IN CANADA
BY EDO (CANADA) LTD.
CORNWALL, ONT.
WELLINGTON 2-6774

Published weekly, with Electronics Buyers' Guide and Reference issue, as part of the subscription, by McGraw-Hill Publishing Company, Inc. Founder: James H. McGraw (1860-1948).

Title registered U.S. Patent Office; Copyrighted 1961, McGraw-Hill Publishing Company, Inc. All rights reserved, including the right to reproduce the contents of this publication, in whole or in part.

Executive, editorial, circulation and advertising offices McGraw-Hill Building, 330 West 42nd Street, New York 36, N. Y. Telephone Longacre 4-3000. Teletype TWX N.Y. 1-1636. Cable McGrawhill, N. Y. Printed in Albany, N. Y.; second class postage paid.

OFFICERS OF THE PUBLICATIONS DIVISION: Nelson L. Bond, President; Shelton Fisher, Wallace F. Traendly, Senior Vice Presidents; John R. Callahan, Vice President and Editorial Director; Joseph H. Allen, Vice President and Director of Advertising Sales; A. R. Venezian, Vice President and Circulation Coordinator.

OFFICERS OF THE CORPORATION: Donald C. McGraw, President; Joseph A. Gerardi, Hugh J. Kelly, Harry L. Waddell, Executive Vice Presidents; L. Keith Goodrich, Vice President and Treasurer; John J. Cooke, Secretary.

Subscriptions are solicited only from those actively engaged in the field of the publication. Position and company connection must be indicated on orders. Subscription rates: United States and Possessions, \$6.00 one year; \$9.00 two years; \$12.00 three years. Canada, \$10.00 one year. All other countries \$20.00 one year. Single Copies, United States and Possessions and Canada 75¢; Buyers' Guide \$3.00; Single Copies all other countries \$1.50; Buyers' Guide \$10.00.

The Publisher, upon written request from any subscriber to our New York Office, agrees to refund that part of the subscription price applying to copies not yet mailed.

Subscribers: Please address all correspondence, change of address notices, subscription orders or complaints to Fulfillment Manager, Electronics, at above address. Change of address notices should provide old as well as new address, including postal zone number if any. If possible, attach address label from recent issue. Allow one month for change to become effective.

Postmaster: Please send Form 3579 to Fulfillment Manager, Electronics, 330 West 42nd Street, New York 36, New York.



Audited Paid Circulation

CROSSTALK

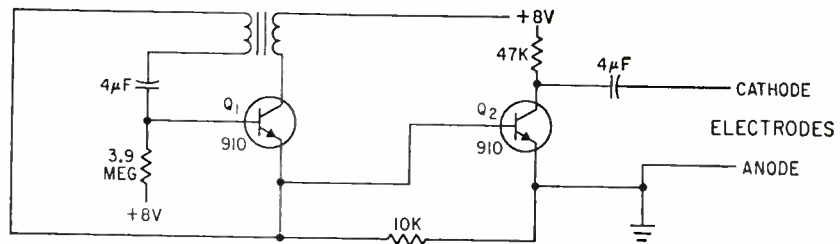

MEDICAL ELECTRONICS. Hearing aids are the most common electronic prosthetic device worn by the handicapped in everyday life. Another device fast gaining similar acceptance by the medical profession and the public is the artificial pacemaker—an electronic substitute for the normal nervous pathways in the heart responsible for maintaining correct pumping rhythm. The various types of devices, both externally carried and surgically implanted, are discussed in detail by Associate Editor Bushor in Part V of his medical electronics series appearing in this issue (p 63).

Shown above is the circuit of an internal pacemaker developed by the University of Buffalo and consultant Wilson Greatbatch, and now being manufactured by Medtronic. The unit, including the mercury cell batteries, is roughly the size of a receiver in a telephone set and is expected to perform adequately for at least five years before replacement is necessary. Transistor Q_1 functions as a blocking oscillator, generating a low-power pulse. The output signal triggers Q_2 , which acts as a switch. This action drains a capacitor, charged from the power supply, which delivers a 1-millisecond pulse with positive and negative peaks. These pulses are applied to a bipolar electrode sutured into the heart muscle.

Pulse rate is set when device is assembled by selecting an appropriate value for the 3.9-megohm resistor. The entire unit is potted in epoxy resin to eliminate motion between components, breakage of wires and solder points, and prevent seepage of body fluids.

Pacemakers will find application both as life-long substitutes for permanently damaged natural pacemakers and as temporary aid to sustain life until the body can make necessary repairs. The device is a practical demonstration of the strides that can be made toward alleviating human suffering and prolonging life when medicine and electronics work together effectively.

MEGAWATT PULSED R-F GENERATOR described in this issue by H. M. Hill, Jr., is used for resonant heating of plasma in the B-66 Stellarator at Princeton University Plasma Physics Laboratory. This is the third article ELECTRONICS has carried on the various Stellarator heating circuits. Our July 3, 1959 issue had a description of the 250-Kc generator by R. L. Gamblin (p 50), and ohmic heating was described by Gamblin on Oct. 9, 1959 (p 57). Hill's article begins on p 70.

Coming In Our July 28 Issue

FEATURE MATERIAL to appear next week includes: electron beam technology by R. Bakish of Alloyed Electronics Corp; a voltage-tuned oscillator that uses a varistor network by M. Uno of Chiba University, Japan; a tunnel-diode fast-step generator that produces positive or negative steps by R. Carlson of Hewlett-Packard Co; design of a short high-power balun that is continuously variable by J. T. Coleman of RCA; and a servo-driven bridge that measures analog voltage ratios by S. Shenfeld and H. R. Manke of U.S. Navy Underwater Sound Laboratory.

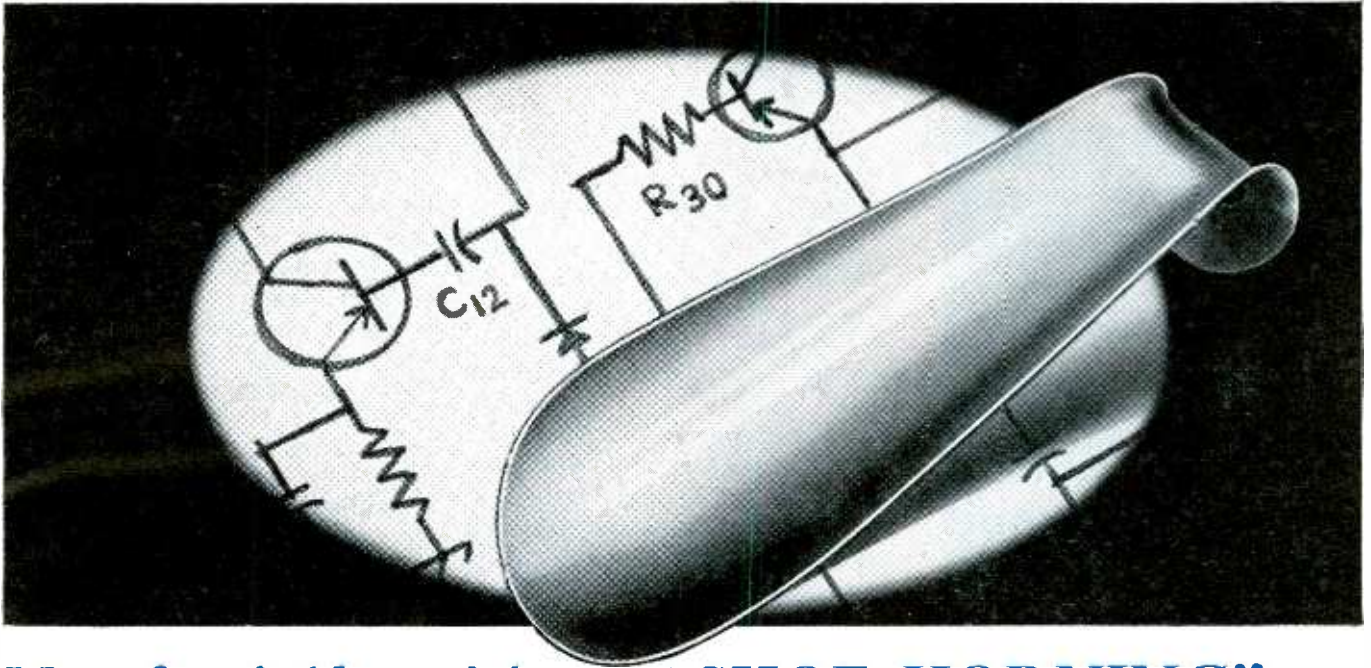

Now! minify without "SHOE-HORNING"...

TANTALEX® Solid-electrolyte Capacitors Can Help!

Big boast? No! Plain fact. You need no shoe horn to get high capacitance values into your transistorized circuits. Sprague's ultra-miniature, solid-electrolyte TANTALEX Capacitors let you minify to the hilt without sacrificing performance or reliability! This one,  for example, is only $\frac{1}{8}$ " in diameter by $\frac{1}{4}$ " long, yet packs a whopping $6.8 \mu\text{F}$ at 6 volts!

A Reliable Source of Supply!

Sprague Electric Company pioneered in the development of solid-electrolyte tantalum capacitors. Unmatched experience has enabled us to establish the largest production facilities in the capacitor industry. Producing more solid-electrolyte tantalum capacitors than all other suppliers combined, it stands to reason that Sprague Electric offers . . . in addition to reliability of product . . . *reliability of source of supply!*

Type 150D Capacitors can be furnished to meet all of the requirements of Military Specification MIL-C-26655A. Sprague, the pioneer in the solid tantalum capacitor field, is your first source for Types CS12 and CS13.

Polar and Non-Polar Types Available

The famous Type 150D polarized capacitor, outstanding for miniature size, excellent characteristics, and reliable service life, is now joined by non-polarized Type 151D, which is useful in many new applications, such as phase-splitting in small low-voltage motors, in servo systems, in low-frequency timed circuits, in crossover networks, and in bypass applications where high ripple voltages are encountered.

● We'll be happy to send you complete performance data covering the full range of sizes and ratings of Tantalex Capacitors. For information on Type 150D Capacitor, request Bulletin 3520D. For data on Type 151D Capacitors, specify Engineering Bulletin 3521. Address Technical Literature Section, Sprague Electric Company, 35 Marshall Street, North Adams, Massachusetts.

You can get off-the-shelf delivery of Type 150D capacitors at factory prices on pilot quantities up to 499 pieces from your local Sprague Industrial Distributor

SPRAGUE COMPONENTS

CAPACITORS

RESISTORS

MAGNETIC COMPONENTS

TRANSISTORS

INTERFERENCE FILTERS

PULSE TRANSFORMERS

PIEZOELECTRIC CERAMICS

PULSE-FORMING NETWORKS

HIGH TEMPERATURE MAGNET WIRE

CERAMIC-BASE PRINTED NETWORKS

PACKAGED COMPONENT ASSEMBLIES

FUNCTIONAL DIGITAL CIRCUITS



'Sprague' and '©' are registered trademarks of the Sprague Electric Co.

COMMENT

Patent Legislation

In regards to the editorial "Harmful Patent Legislation," appearing in *Crosstalk*, (p 4) June 2, if one should substitute "present practice" for "proposed legislation," "industry" or "companies" for "U. S. Government," "engineer" for "company," etc., one can make out a very good case condemning the "Patent Agreements" that are required by many companies as a condition of employment. These agreements, as you are no doubt aware, require that an engineer assign to the company all patent rights to inventions made while in the employ of, and sometimes for a period after termination of employment, which are in some general way related to any field in which the company might consider itself engaged.

The clear injustice of this practice is that it can grant to the company property for which the company has not paid. Companies rarely employ for an invention; they usually employ for skills or services. If inventions are made by an engineer to provide the services or results more efficiently, this is, philosophically, an accident. Throughout the long history of letters patents, they have traditionally been privately held, and only recently have they been assigned in great numbers to corporate or public entities.

Reaction to the practice indicates that in the future companies could hurt themselves by being thus acquisitive. Some engineers have already indicated that they hesitate to accept employment at companies engaging in this practice. Undoubtedly there will be other engineers who will react identically. The result may be a net reduction in brainpower and manpower.

It would be healthier if this practice were eliminated before it resulted in a universal sapping of initiative.

DAVID A. BEAN

1603 HESS ROAD, APT. 1
REDWOOD CITY, CALIF.

Tissue Resistance Monitor

We have been unsuccessful in getting a copy of the paper entitled "An Improved Tissue Resistance Monitor" and given at the April 30, 1959 annual meeting of the Aero Medical Association by W. E. Tolles and W. J. Carberry of Airborne Instruments Laboratory. L. E. Larsson, an assistant professor at the Umea Medical School, is interested in the paper. We learned of its existence from the medical electronics article (Part I) "Diagnostic Measurements," p 55 in the Jan. 20 issue of *ELECTRONICS*.

INGA BOETHIUS

UMEA MEDICAL LIBRARY
KUNGSATAN, SWEDEN

We have asked Messrs. Tolles and Carberry to provide Umea with a copy of their paper which was privately printed and hence not generally available.

Therapeutic Devices

We were very surprised to see Giarzol (not Gearsol), an ultrasonic atomizer, mentioned on the sixth page of Part III of your medical series (February 24). In contradiction to the information given, this unit has never been commercially marketed by our firm, remaining in the experimental field.

A. GUEULETTE

SOPHYA
BRUSSELS, BELGIUM

Information in question was obtained from reference 23 listed in Part III. Typographical error was ours.

Low Level Switch

I would like to call your attention to an error in a new product release published in the May 12th issue of *ELECTRONICS*. The release was entitled "Low Level Switch" (p. 104).

In the subhead and in line 3, "resolution of 5 mv" should be "... 5 μ v;" and in line 8, "less than 50 mv" should be "... 50 μ v." As you can see the changing of the word *microvolts* to *millivolts* makes the product seem almost worthless. I realize this mistake was unintentional.

LOIS DE BOTTARI

ALPHA-TRONICS
TORRANCE, CALIF.

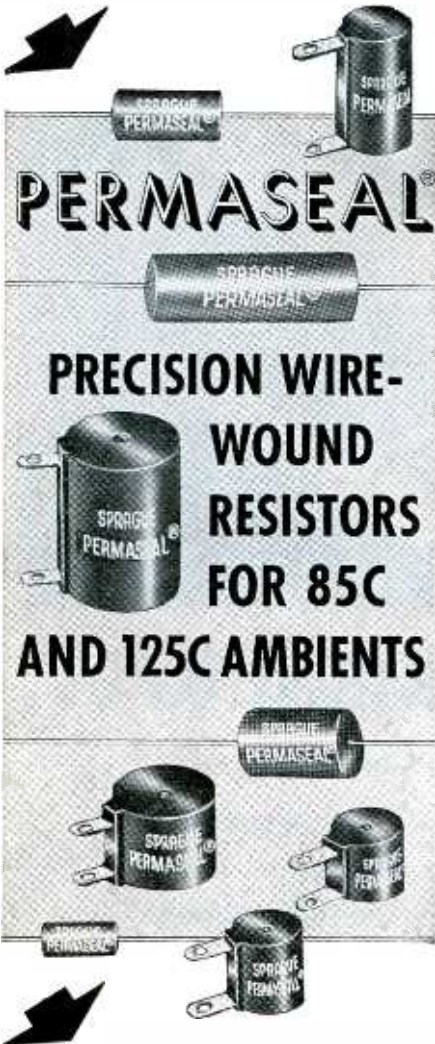

A COMPLETE LINE OF DEPENDABLE ENCAPSULATED RESISTORS

PermaSeal resistors are designed for extreme stability and long life in military and commercial applications requiring highly accurate resistance values in small physical sizes. To achieve this, winding forms, resistance wire and embedding materials are carefully matched. The completed resistors are then aged by a special Sprague process for long-term stability.

They're plastic embedded for mechanical protection and humidity resistance, meeting exacting requirements of MIL-R-93B and MIL-R-9444A (USAF).

PermaSeal Resistors are available in close resistance tolerances down to 0.05%. Permanent identification marking is available to withstand all environmental conditions. Write For Engineering Bulletins 7500 and 7501 to: Technical Literature Section, Sprague Electric Company, 35 Marshall Street, North Adams, Mass.



This
 Solid-State 1 MC
 Counter/Timer
 Frequency Meter*
 has

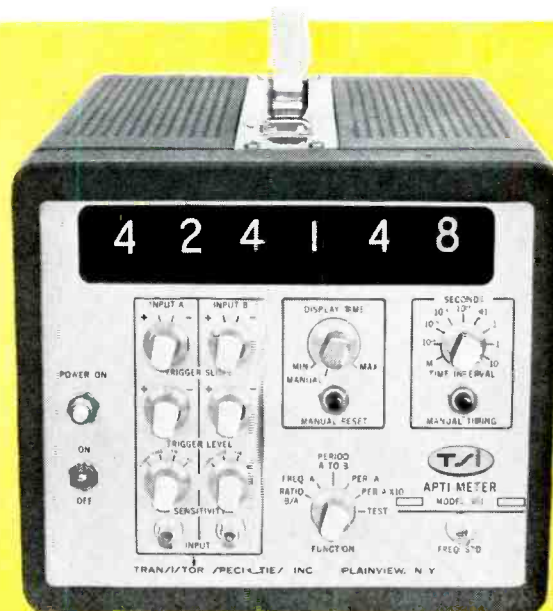

Proven Reliability

Eighteen months ago, TSI introduced the Model 361 as the industry's first completely transistorized 1 MC digital Counter/Timer. It won immediate acceptance. The integrity of the original design has been preserved through eleven successive production runs.

Field reports on the 361 are consistently impressive. We have rarely received a valid report of malfunction due to a manufacturing or design defect.

There are good reasons for this record of proven reliability. The NOR-logic design of the 361, for example, drastically reduces its semiconductor count over that of conventional instruments. Our inflexible attitude toward derating, and our refusal to use "selected" components or transistors add significantly to the performance margins this instrument will maintain over wide ranges of power line voltage and ambient temperature. Like all TSI instruments, the 361 is 100% solid-state. It runs *cool*, despite its compact design.

Engineers who use it tell us that the 361 has the best amplifier of any 1 MC Counter/Timer . . . sensitive, wideband, and unaffected by noise and jitter. They also compliment the straightforward readout, the flexibility provided by its dual-channel logic, and its crystal-clock stability.

It will pay you to consult TSI when you need digital instrumentation in the real-time domain.

* Model 361 Solid State 1 MC Counter/Timer/Freq. Meter. 10 MV sensitivity. 3 parts in 10^7 /week stability. Six-digit in-line Nixie readout. 0.1 cps - 1 MC freq. standard outputs in decade steps. Modes: Count, frequency, frequency ratio, period A, period

A - B, freq. st'd, self-check. Dual amplifiers with unique "level-sampling" design. Available in 3 1/2" rack (Model 361-R). Bench version shown. Available from stock.

One of 17 Solid State Instruments by TSI.

TRANSISTOR SPECIALTIES
 INCORPORATED

Sophisticated Digital Instrumentation



TERMINAL DRIVE, PLAINVIEW, NEW YORK • WELLS 5-8700

Familiar product . . . new use

In the hands of experts, a well-known product has found a new use, brought about by today's fast moving technology. A spacer with electrical insulating and special mechanical properties was required for this stud-mounted power transistor. CDF solved the problem with paper phenolic rolled tubing, a long-established grade. Fabrication of the spacer is accurate and low cost on automatic screw machines.

Result: Reliability is assured through use of a time-tested and proven material, while costs are kept to the minimum.

A few facts on the tubing: (1" x 1 1/8")

Dielectric strength, perp., vpm . . . 400
Min. density 1.12
Water absorption, % 3.0
Axial compression, psi 13,000



CONTINENTAL-DIAMOND FIBRE

CONTINENTAL-DIAMOND FIBRE CORPORATION, NEWARK, DELAWARE • A SUBSIDIARY OF THE *Budd* COMPANY

ELECTRONICS NEWSLETTER

Soviet Patents Coming to U.S.

MOSCOW—An American firm has signed contracts with the Soviet government which could open the way to a major interchange of American and Soviet technology.

Jerome Feldman, president of National Patent Development Corp. signed contracts with Amtorg—Soviet trading corporation headquartered in New York City—under which the firm is receiving exclusive licenses for 50 to 70 Soviet patents.

National Patent in turn will sublicense patents to its customers, who include American Machine and Foundry, AVCO Manufacturing Co., International Latex Corp. and Thiokol Chemical.

National Patent went to Moscow upon official invitation and hoped to arrange cross licensing deal under which it could be middleman for technology moving both directions. But Feldman and his associates found the Soviets more interested in licensing their technology than in taking license on American patents.

The American firm isn't ready to disclose details of patents that are being licensed, but the fields are known to include electronics, ultrasonics, medical instruments and machine tools. What we are getting is the cream of Soviet technology, said Feldman. It is known that items covered include microwire drawing method, transistors, thermo elements, diffusion welding process and fine wire.

from 40 1N830 Sylvania diodes delivering 18 volts, 10.8 watts at 2,440 Mc.

Diodes, mounted in quarter-inch plate, are clamped between flanges of 10-inch tapered section connecting S band to 4.75-by-4.25-inch waveguide equipped with tuning plunger. Completed device will parallel 18 diodes in five bands connected in series as each arm of a full-wave bridge—360 diodes in all.

Other, simultaneous, approaches to microwave conversion—useful as power source for satellites and space vehicles—include researches into direct rectification using hot cathode-high vacuum diodes, new model lighthouse diodes as half and full-wave rectifiers, varistors, non-linear capacitors and resistors and 2,450-Mc klystron for which high-vacuum system has just been completed.

Shows New Approaches For Data Retrieval

TWO NEW APPROACHES to information retrieval were announced by IBM at San Jose, Calif., last week.

A system for channeling publications and current information selectively to the people most interested in it, called Selective Dissemination of Information, uses "profiles" based on key words describing the nature of a publication, or an individual's area of interest.

H. P. Luhn, senior scientist and consultant, said the system uses a computer to match interest profiles against publication profiles, has been in use experimentally with 500 engineers within the company, and has been proven superior to other existing methods.

An instant random access information retrieval system named WALNUT has been built for use by the CIA. The equivalent of 990,000 pages of information, or 3,000 books, are stored in one cabinet as permanently recorded images on Kelvar film. Project manager N. A. Vogel said up to 100 such cabinets can be linked in a system, each cabinet potentially containing 10^{12} bits of digital information.

On command, a particular image is instantly located by its digital address (magnetically stored), brought out and reproduced on a Kelvar film window in a punched

Biomagnetics—A New Interdisciplinary Field

INTENSE INTEREST is developing at widely scattered laboratories in a new interdisciplinary field called biomagnetics—the study of biological effects of magnetic fields. Some of the work is being sponsored by the Air Force because of implications for space medicine. Increasing interest has led to additional session on biomagnetics at first International Conference on High Magnetic Fields, scheduled Nov. 1 through 4 at MIT, Cambridge, Mass. Papers will be presented on effects of magnetic fields at organismic, cellular, subcellular and macromolecular levels.

Micromodule Symposium Hears Latest Trends

LAST WEEK, at a symposium sponsored by the Signal Corps and RCA, representatives of over 50 companies cooperating in the micromodule program, were brought up to date on developments in and the outlook for the program.

J. J. Newman of RCA's Semicon-

ductor and Materials division indicated any low-power transistor circuit can be made available in micro-module form today. A projected overall military communications system involves 17 million microelements, he said. The market for all types of microminiature components was estimated as \$470 million for 1961 and \$740 million for 1965. These figures compare to projected component sales of \$1,092 million in 1961 and \$1,720 million in 1965. No estimate was given as to what portion of the total microminiaturization figure the micromodule approach would command.

By the end of this year five new families of transistors and two new families of diodes may be available in microelement form, firm says. Other areas discussed involved the reliability, costs and applications of the micromodule.

85% Microwave Energy Conversion Now Likely

MICROWAVE ENERGY conversion efficiency of 85 percent is aim of a Purdue University research team. "Very promising" 60 percent efficiencies have already been achieved

card. This can be examined in a viewer with controls, with access to information in files, documents and correspondence. R. B. Johnson, manager of the Advanced Systems division, predicted such equipment would eventually eliminate almost all paper work from management offices.

Use M-F Ground Waves to Overcome Blackouts?

THE AIR FORCE is investigating the possibility of using medium-frequency ground waves for communications during blackout caused by natural or man-made ionospheric storms. Medium frequencies from 500 Kc to 2 Mc are believed usable for ground-wave transmission up to about 1,500 miles. A study is now being made by AVCO Research and Advanced Development division.

AVCO, meanwhile, is intensifying investigation of a technique for sneaking through Arctic h-f communications blackout (ELECTRONICS, p 35, Aug. 5, 1960). Rome ADC will sponsor stepped-up study of plan for switching to optimum propagation routes and modes, taking advantage of changing phases of magnetic storms. Experimental field tests are expected to begin within a year. The AVCO plan was recently presented to NATO Ionospheric Conference in Europe.

Slot Antenna Voltage Breaks Down at 250 Mc

QUANTITATIVE measurements of antenna breakdown during a rocket flight were made recently by Air Force Cambridge Research Laboratory during a series of three Nike-Cajun rocket firings at the Eglin Gulf Test Range. The purpose of the flights was to obtain new information concerning the voltage breakdown of antennas at high altitudes.

Definite evidence was obtained of voltage breakdown of a slot antenna at 250 Mc. In addition, the following parameters related to breakdown were measured throughout the flight: static charge on the vehicle, atmospheric pressure at the nose cone and heat inputs to the surface of the vehicle at four locations.

Voltage breakdown occurs at low atmospheric pressure because of the loss of the atmosphere's insulating property surrounding the antenna. The signals received from electronic systems in various rockets have shown antenna voltage breakdown to exist at altitudes from 59,000 to 300,000 feet at vhf, uhf and microwave frequencies.

When voltage breakdown occurs, several things happen. Radio frequency noise is produced, antenna input impedance is altered, total radiated power is decreased, radiation pattern may be modified, and, in pulse systems, pulse shape is distorted.

Integrated Patent Monitor for Hospitals Introduced

DIAGNOSTIC, surgical and recovery room units that can be integrated into a hospital-wide medical electronics system were demonstrated at the fourth annual International Medical Electronics Conference held in New York this week. Built by the Heiland division of Minneapolis-Honeywell, the system consists of three expandable modular units.

One unit measures and records physiological phenomena including: heart, brain, muscles and nerve potentials; pulse rate; respiration flow, rate and volume; heart sounds; body movement, body temperatures, blood pressures, oxygen content of the blood and chest expansion. Plug-in blocks change a four or five-channel system into a 10 or 12-channel one.

The second unit is an electronically controlled heart/lung machine for surgery. It contains a double blood pump and heating and refrigeration mechanism. Surface or profound hypothermia can be induced in a patient, pumping and oxygenation of the blood can be maintained during heart surgery, or both can be handled simultaneously.

The third unit automatically measures and records a patient's temperature, pulse rate, respiration rate, and diastolic and systolic blood pressure at two-minute intervals. It can be used as a recovery room or critical patient monitor. A one-cabinet version contains all the elements in a single package, and another has a remote recorder.

In Brief . . .

ITT's FEDERAL ELECTRIC CORP. receives a \$37.1-million Air Force contract to operate, maintain and support a land-based segment of the Distant Early Warning (DEW) Line during 1962 fiscal year.

SENATE passage last week sent to President Kennedy a bill permitting duty-free importation of electron microscopes and apparatus using radioactive substances.

ADMIRAL CORP. government electronics division gets contracts totaling \$2.2 million for 2,000 pack-carried transceivers; radar switchboards and radar test sets; airborne high frequency radio equipment.

COLLINS RADIO CO. receives two Air Force contracts: \$1 million for delivery of vhf airborne communication systems; \$1.5 million for airborne transceivers.

NEW RADIO MODELS presented last week by German industry were 10 to 15 percent more expensive than last year's sets. Reasons: higher wages and a greater variety of models resulting in smaller production numbers and higher manufacturing costs.

COLORADO RESEARCH CORP., Broomfield, Colo., an electronics subsidiary of Bell & Gossett Co., gets a \$157,226 subcontract from GE for microwave refractometers for a new missile trajectory measurement system.

SIEGLER CORP. receives a \$725,000 contract from the Martin Company to produce video systems for operational sites of the Air Force Titan ICBM.

ELECTRONIC SPECIALTY CO., Los Angeles, gets \$1-million contract from Avions Fairey, Belgian aircraft manufacturer, for fighter jet aircraft equipment including timers, relays, sensors and actuating systems.

LANSDALE DIVISION of Philco Corp. forms a microelectronics department for the development, manufacture and marketing of highly miniaturized semiconductor circuits.



plenty
plus
one

equals the ever growing family of CAPITRON® Capacitors

And plenty doesn't say enough! Now Capiton adds this silicone rubber encapsulated Wafer Capacitor to its more than 2,500 special capacitor designs, available as standard in our line. When your requirements go beyond this . . . we will create a capacitor to fit your requirements. If you're working in advanced areas of design—atomic energy, radar, communications and control—there's no need to let ordinary "off-the-shelf" capacitors freeze your design creativity . . . you may find exactly what you want in the big Capiton line. From single wafers to encapsulated multiple capacitors . . . whatever your choice or requirement . . . you can depend on Capiton products for:

- high resistance to thermal extremes (−65°C to +125°C)
- maximum stability, reliability and longevity with AMPLi-film® dielectric
- choice of waxdipped, encapsulated or armored types

Complete information on Capiton Capacitors available upon request.

®Reg. U.S. Pat. Off.

CAPITRON DIVISION
AMP INCORPORATED
Elizabethtown, Pennsylvania

Capiton products and engineering assistance are available in Canada through Aircraft-Marine Products of Canada, Ltd., Toronto, Canada

KLYSTRON AND TWT ACCESSORIES

FOR LITTON AND OTHER TUBES

Klystron Focus Coils
TWT Solenoids
Water Loads
Radiation Shields
Cathode Sockets & Fingers



Litton microwave tube accessories have largely been confined in the past to those required by Litton tube users. Now, Litton develops and produces a variety of tube accessories to customer specifications, *regardless of tube manufacturer or application.*

Focus Coils and Solenoids: Foil or wire wound in any size — from low-noise TWT's to super-power klystrons. Epoxy impregnated by vacuum or pressure. One terminal board. One coolant input/output manifold. Leak-resistant cooling systems. Integral lead shielding.

Water Loads: For L through C bands. Seamless aluminum guide construction. Light, short, versatile. Excellent pressure integrity to 50 psia. Super or medium power. Low VSWR with high peak and average power ratings. Typical L-band unit tested to 20 megawatts peak power, 50 KW average power.

Other Litton tube accessories are radiation shields, differential thermopiles, and cathode sockets and contact fingers.

For more data, write to: Litton Industries, Electron Tube Division, San Carlos, California. Or telephone LYtell 1-8411.



LITTON INDUSTRIES
Electron Tube Division

MICROWAVE TUBES AND DISPLAY DEVICES

High-Performance Commercial Potentiometer—Under \$1

NUMBER 16—NEW PRODUCT SERIES

Now—solve the quality-price dilemma with Bourns E-Z Trim® commercial potentiometers. These subminiature thoroughbreds are direct descendants of the time-proven Trimpot® potentiometer, and their performance shows it. They stand up to steady-state humidity and fully satisfy the requirements for such demanding applications as industrial controls.

Settings you make with E-Z Trim units are pinpoint-sharp, thanks to the superior angular resolution afforded by the 15-turn shaft. They stay that way, too, because the shaft is self-locking. Adjustments are fast and simple—an ordinary screwdriver does the job.

Take your choice of wirewound or Resistor® carbon units. Wirewound Model 3067 handles a hefty ½ watt at room temperature, is available with resistances of 100 ohms to 20K. Carbon Model 3068 offers resistances of 20K to 1 Meg. Both units have either printed circuit pins or solder lug terminals.

Order in production quantities of 1000 or more, and these exceptional potentiometers are yours for under \$1 each. Tell us you're in a hurry, and you'll have them within 48 hours—they're on the shelf from coast to coast. Write now for complete data and list of stocking distributors.

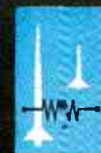

BOURNS

BOURNS INC., TRIMPOT DIVISION
6135 MAGNOLIA AVE., RIVERSIDE, CALIF.
PHONE: OVERLAND 4-7000 • TWX: RZ 9222
CABLE: BOURNSINC

Manufacturer: Trimpot® potentiometers; transducers for position, pressure, acceleration. Plants: Riverside, California; Ames, Iowa; and Toronto, Canada

JERROLD®

SWEEP GENERATORS

NEW!

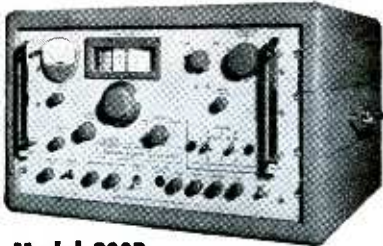

Model 900B

Very narrow to very wide sweep widths in one sweep SIGNAL generator

\$1880.00

Unusual stability in sweep widths from 10 kc to 400 mc. Frequency range 500 kc to 1200 mc. Built-in crystal-controlled harmonic markers, direct coupled scope pre-amplifier, and attenuators. The ultimate instrument for your IF-VHF-UHF requirements.



Model 900A

Wide-band sweep generator

\$1260.00

Center frequency: VHF, 0.5 to 400 mc; UHF, 275 to 1000 mc. Sweep widths from 100 kc up to 400 mc. Flatness: ± 0.5 db over widest sweep.



Model 707

Ultra-flat sweep generator

\$795.00

Featuring $\pm 5/100$ db flatness; plug-in oscillator heads*; variable sweep rates from 1/min. to 60/sec.; all electronic sweep fundamental frequencies; sweep width min. of 1% to 120% of C.F. *Heads available within the spectrum 2 to 265 mc. Narrow-band heads on request.

For applications bulletin and complete catalog (including wide-band comparators, precision attenuators and accessories), write.

JERROLD® ELECTRONICS CORPORATION

Industrial Products Division, Dept. IIE-103

The Jerrold Building, Philadelphia 32, Pa.

Jerrold Electronics (Canada) Ltd., Toronto

Export Representative: Rocke International, N. Y. 16, N. Y.

WASHINGTON OUTLOOK

PRESSURES ARE MOUNTING on the Kennedy Administration to order another round of increased defense spending. The Berlin crisis, the Kremlin's truculent plan to boost its military budget by 35 percent, and the revelations of Soviet airpower advances at the Moscow Airshow are being used to put the heat on the White House.

But the Administration is moving cautiously so far. The Pentagon has been ordered to make a new review of military needs in light of Moscow's latest saber-rattling. The upshot, however, is likely to be some shifts in tactical plans and deployment rather than any costly long-range program to buy more military hardware over and above current budget plans. These measures could add several hundred millions to the \$2.2 billion already tacked on to the Pentagon's appropriation request by Kennedy. But little if any extra electronics and other major procurement would be involved.

NATIONAL AERONAUTICS AND SPACE ADMINISTRATION has selected RCA to build seven space capsules costing around \$200,000 each to flight test ion engines, starting in 1962. Designed to power space vehicles by electrically charging atoms, five different types of ion engines are currently being developed. Four are for NASA and one for the Air Force.

Between 1962 and 1965, some 14 flight tests are slated to increase gradually the size of ion engines up to a 60-kilowatt engine to be used for interplanetary space experiments.

Most of the first seven ion space capsules will be used in ballistic flight tests using a Scout launching vehicle. First engines to be tested are a cesium fueled engine under development by Hughes Research Laboratory and a mercury fueled engine being developed by NASA's Lewis Research Center.

Ion engines may be used to keep commercial communications satellites in programmed orbits to extend their useful life and cut operating cost. New recommendations on ownership of such a system have been sent to the White House by Vice-President Johnson's Space Council.

WHITE HOUSE sources say the Space Council spelled out in more detail than has been done before just what areas of the world must be serviced by a commercial satellite system. Primarily, this was expanded to include such areas as Africa and South America where the economic returns will not be as immediate as servicing Europe, for example.

Private ownership is still considered the first choice of the Administration for the system. But, it is now up to industry to say whether it will meet the government servicing requirements. Thinking is that an ad hoc industry committee will be formed soon to study the matter and come back to the Administration with an ownership proposal.

WESTERN ELECTRIC, General Electric, North American Aviation, Boeing, The Martin Co., RCA and United Aircraft Corp. have signed agreements with the government to bar racial or religious discrimination in employment. The companies will set up formal programs to push efforts to promote equal employment opportunities. The agreements, signed with the President's Committee on Equal Employment Opportunity, stem from Washington's intensified drive to wipe out job bias on defense projects.

WITHIN THE NEXT WEEK OR SO, the Weather Bureau will decide if it can technically maintain two meteorological satellites in orbit at the same time. The recent success in putting the Tiros III into a near circular 425-mile-high orbit forces a decision on whether Tiros II should be commanded to cease transmitting. The reason: communication interference and inability to handle the volume of data.

The two satellites are orbiting 180 degrees apart, thus providing full coverage in both the northern and southern hemispheres. This is highly desirable during the forthcoming hurricane season.

95%

OF YOUR
SPECIALIZED
DIGITAL
SYSTEMS..
READY
TO GO

If you have special requirements in digital data handling equipment, format conversion, special purpose computers or airborne and ground timing systems . . . Temco Electronics can deliver any part or all of the system with speed and economy. ■ The digital equipment design section of Temco Electronics has already developed printed circuit cards that meet 95% of all standard digital requirements. Remaining circuits can be provided with a minimum of design effort and time. All of these logic modules are designed and tested to meet or exceed MIL-E-5272 specifications, through a temperature range of from 71°C to -55°C. ■ Use of these pre-engineered, off-the-shelf "building blocks". . . plus quick reaction capabilities, wide range of experience and talent . . . gives Temco a significant head-start in producing equipment for your special needs. For quick action on your inquiries, write or call Temco Electronics today.



LING-TEMCO ELECTRONICS, INC.

TEMCO ELECTRONICS DIVISION • DEPT. 221N • P. O. BOX 6191 • DALLAS 22, TEXAS



**SCOTCH® BRAND MAGNETIC INSTRUMENTATION TAPES
OFFER A RIGHT TAPE FOR EVERY APPLICATION**

Knowledgeable tape users realize that magnetic tapes are not all alike—that it takes specific constructions to meet the needs of specific applications. And they've learned to rely on "SCOTCH" BRAND to supply the one right tape for each application. Not only does "SCOTCH" BRAND offer a complete line, it offers that something extra that makes all the difference in performance—the uniformity and reliability that result from 3M's experience, technical skill, and continuing research. Make the "SCOTCH" BRAND label your guide in buying instrumentation tapes. Your 3M Representative is close at hand in all major cities—a convenient source of supply and information. For details, consult him or write Magnetic Products Division, 3M Co., St. Paul 6, Minnesota.

© 1961, 3M Company

The wide "SCOTCH" BRAND line provides many tapes, including these broad classifications:

SANDWICH TAPES 488 and 489—exclusive with "SCOTCH" BRAND, offering 30 times the wear of standard tapes, drastic reductions in head wear, elimination of oxide rub-off. In standard or extra-play lengths.

HIGH RESOLUTION TAPES 458 and 459—offering superior resolution in high frequencies, greater pulse density in digital recording. In standard and extra-play lengths.

HEAVY DUTY TAPES 498 and 499—offering exceptional life, good resolution, high resistance to temperature and humidity, reduction in the build-up of static charge. In standard and extra-play lengths.

HIGH OUTPUT TAPE 428—offering top output in low frequencies. Performs well even in temperature extremes.

STANDARD TAPES 403 and 408—offering the good all-round performance at low relative cost which has made them the standards of the instrumentation field.

MINNESOTA MINING AND MANUFACTURING COMPANY
... WHERE RESEARCH IS THE KEY TO TOMORROW



"SCOTCH" BRAND MAGNETIC TAPES FOR INSTRUMENTATION

"Scotch" and the Plaid Design are registered trademarks of 3M Company, St. Paul 6, Minnesota. Export: 99 Park Avenue, New York, N.Y. In Canada: London, Ontario.

Engineers in electronics and allied fields are invited

to join the roster of regular readers of the

hp JOURNAL

published throughout the year, presenting factual reports on new measurement techniques, new instrumentation.

TYPICAL SUBJECTS

- Improved sweep frequency techniques for broad band microwave testing
- Square wave and pulse testing of linear systems
- Effect of μ -circuit non-linearity on the amplitude stability of RC oscillators
- A new frequency counter plug-in unit for direct frequency measurement to 510 MC
- Two versatile new power supplies for high power semiconductor work
- An improved method for measuring losses in short waveguide lengths

YOURS WITHOUT CHARGE Just check box in white area on card below and mail.

Please send these **APPLICATION NOTES**:

#2, #6, #15, #36, #42, #43, #44A, #44B,

#44C, #48, #50, #52, Complete Index



Put me on the mailing list for the **hp** JOURNAL

Inform my **hp** representative that I would like to receive the new 1961 **hp** general catalog.

Name _____ Title _____

Company _____ Bldg. or Mail Sta. _____

Address _____

City _____ Zone _____ State _____

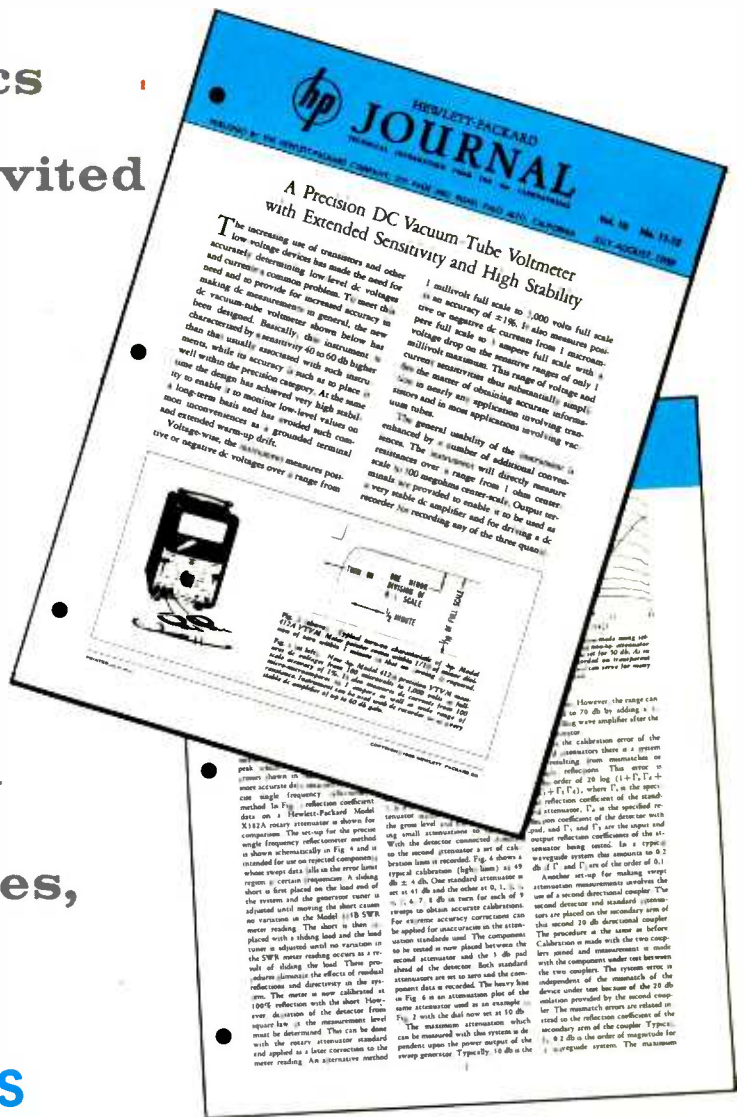

Now available! The new 1961 **hp** catalog giving complete information on the more than 400 precision electronic instruments manufactured by Hewlett-Packard. Just contact your nearest **hp** representative for your copy — or check the appropriate box on the postcard.

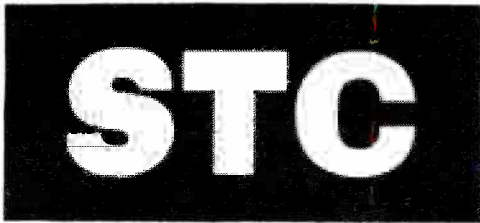

TRAVELLING WAVE TUBES

● used in communication networks in 18 different countries

● several types suitable for use in S-band radar equipment

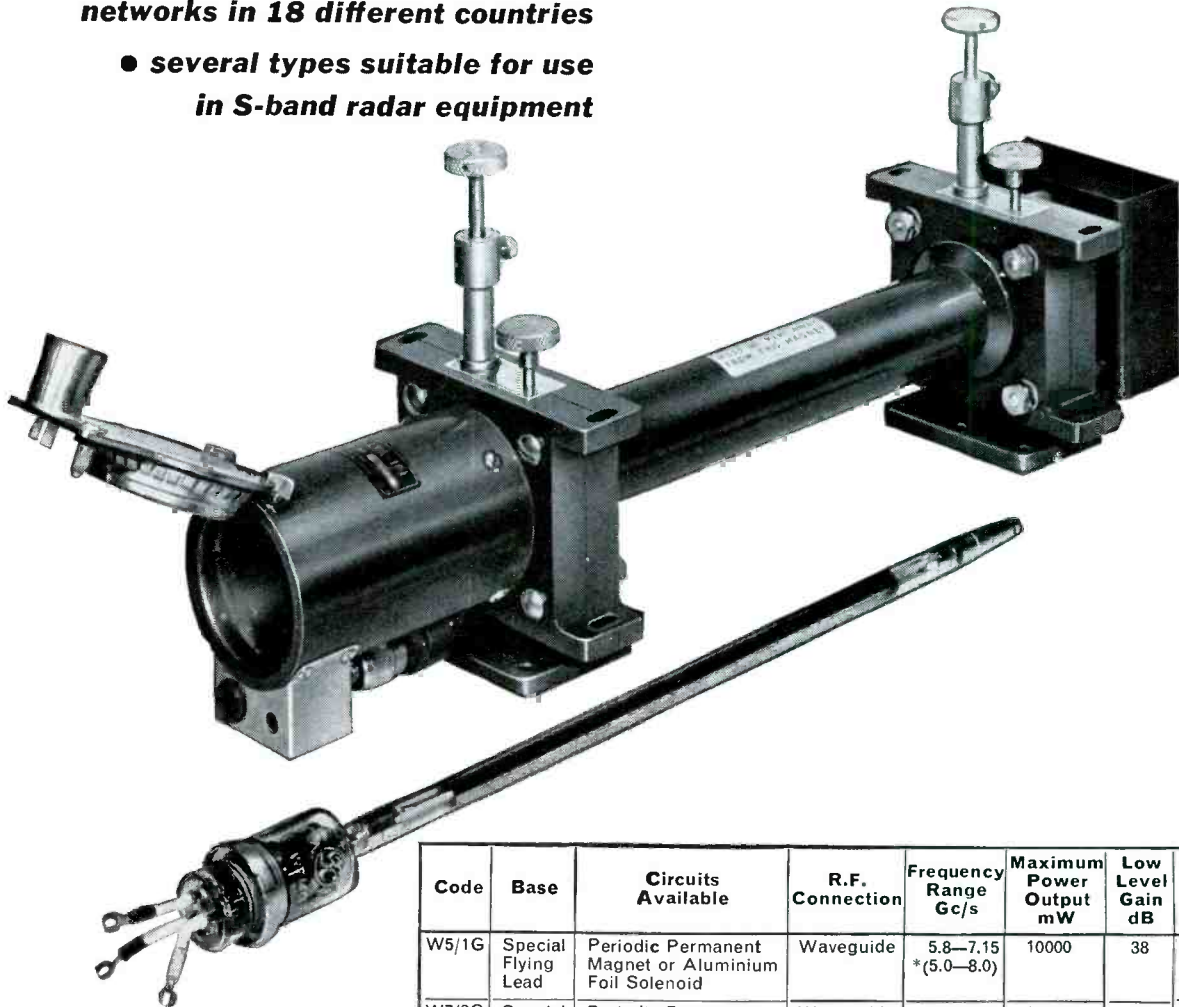

Code	Base	Circuits Available	R.F. Connection	Frequency Range Gc/s	Maximum Power Output mW	Low Level Gain dB	Noise Factor dB
W5/1G	Special Flying Lead	Periodic Permanent Magnet or Aluminium Foil Solenoid	Waveguide	5.8—7.15 *(5.0—8.0)	10000	38	—
W7/3G	Special Flying Lead	Periodic Permanent Magnet or Aluminium Foil Solenoid	Waveguide	3.6—4.2	10000	28	25
W7/4G	Special Flying Lead	Periodic Permanent Magnet	Waveguide	3.6—4.2 *(3.6—5.0)	10000	42	25
			Coaxial	2.6—3.7	8000	36	25
W9/1E	Special B9A	Aluminium Foil Solenoid or Permanent Magnet	Coaxial	2.5—4.1	120	36	18
W9/2E	Special B9A	Aluminium Foil Solenoid	Coaxial	2.5—4.1	10	40	8.5
W9/3E	Special B9A	Aluminium Foil Solenoid	Coaxial	2.5—4.1	0.3	15	16
W10/3E	Special B9A	Copper or Aluminium Foil Solenoid	Waveguide	2.7—3.3	3	23	6.5
			Coaxial	2.8—3.7			

* Bracketed frequency limits indicate extension or range for reduced performance.



61/5MS

Standard Telephones and Cables Limited

Registered Office: Connaught House, Aldwych, London W.C.2

VALVE DIVISION: FOOTSCRAY

SIDCUP



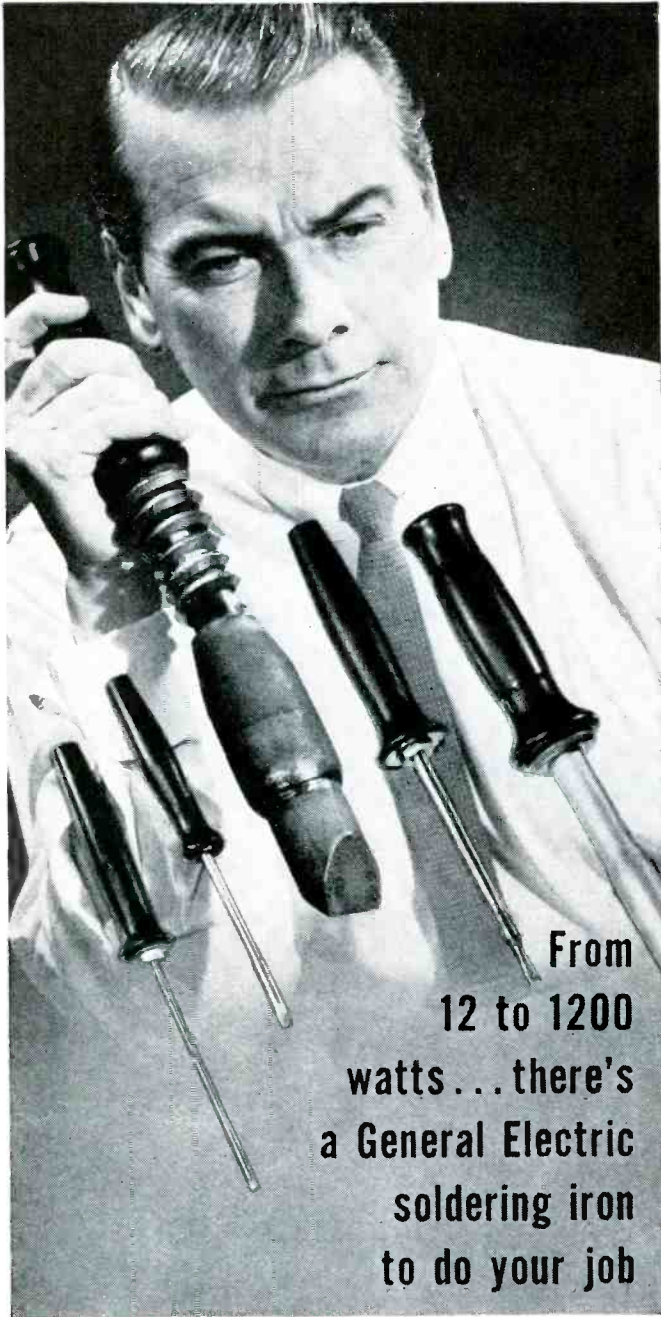

From
12 to 1200
watts... there's
a General Electric
soldering iron
to do your job

... AND GENERAL ELECTRIC WILL HELP YOU
CHOOSE THE EXACT IRON YOU NEED

Whatever your soldering requirements may be—from complex miniature electronic sub-assemblies to heavy-duty industrial uses—one of the high-speed soldering irons in General Electric's complete line will do the job. The G-E irons shown above include (left to right):

MINIATURE for production-line soldering of sub-miniature assemblies.

MIDGET for pinpoint soldering of hard-to-reach joints.

EXTRA HEAVY-DUTY for industrial high-wattage soldering.

LIGHTWEIGHT for soldering of most electronic components.

INDUSTRIAL for general industrial soft-solder applications.

For expert assistance in choosing the exact iron you need, contact your General Electric distributor or local G-E Apparatus Sales Office; or write Section 758-03, General Electric Co., Schenectady 5, N. Y.

Progress Is Our Most Important Product

GENERAL  ELECTRIC

HEART OF THE CIRCUIT

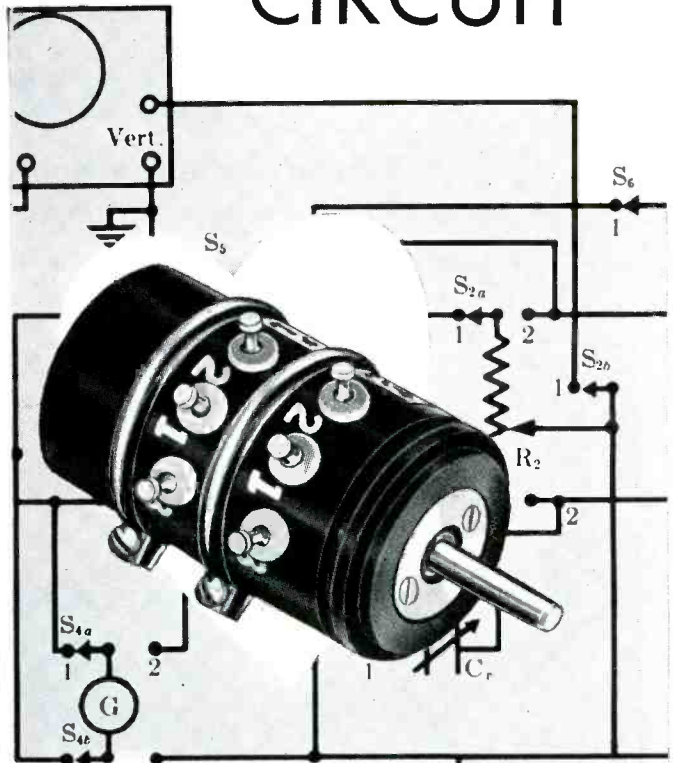

PRECISION POTENTIOMETERS

by New England Instrument

WIRE WOUND — CONDUCTIVE PLASTIC

Whatever your potentiometer requirement may be, N.E.I. has the answer. Since we produce both wire wound and conductive plastic types our engineers can impartially evaluate your problem and come up with the proper solution.

CONDUCTIVE PLASTIC

- Infinite resolution
- Unsurpassed reliability
- Negligible noise level
- Standard resistance values 1K, 2K, 5K, 10K and 20K, 0.5 linearity.
- Specials from 500 ohms to 1 megohm — 0.1% linearity
- Single or multigang construction.

WIRE WOUND

- Meet performance specs of MIL5272A, and NAS710 and applicable portions of JANR-19
- Maintain excellent characteristics from -55° to 150° C
- Available from $\frac{1}{2}$ " single and 10 turn types to 3"
- Standard resistances from 1K to 100K, special designs from 25 ohm to 250K
- Single or multigang construction.

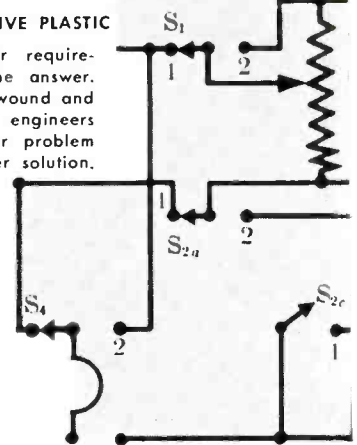

SEND FOR COMPLETE CATALOG



New England Instrument Company
39 Green Street, Waltham, Massachusetts

CIRCLE 200 ON READER SERVICE CARD
electronics

TEMCO AEROSYSTEMS



DEPOT LEVEL MAINTENANCE



..GIANT SIZE

For almost a year the C-133 Cargomaster has received complete depot level maintenance at Temco Aerosystems. Accommodation of the gigantic aircraft . . largest Air Force 4-engined turboprop cargo transport in service . . tells Temco Aerosystems' size story, both in capabilities and physical installation. Long one of SAC's principal maintenance depots for the Command's tanker fleet, Temco Aerosystems' selection by the Air Force to perform PARC on the MATS C-133 is further recognition of its across-the-board capabilities in the field of complete depot level maintenance. ■ Because of this division's systems integration, installation and flight testing capabilities, and electronic systems development, it has been the choice for work in several fields. The current conversion of a C-130 into a down range missile tracker for Cape Canaveral is a case in point. Another is the conversion of a C-130 into an airborne ECM laboratory for White Sands. Through the union of basic airframe and electronic capabilities Temco Aerosystems has established a major position as a versatile and efficient producer, economical and on time.

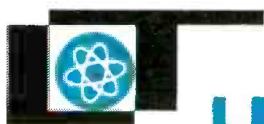

LING-TEMCO ELECTRONICS, INC.

TEMCO AEROSYSTEMS DIVISION • P. O. BOX 1056 • GREENVILLE, TEXAS

The industry's most thoroughly characterized and medium power silicon Mesa transistors...2N497A,

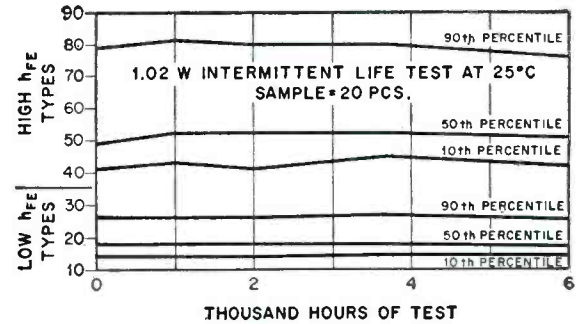
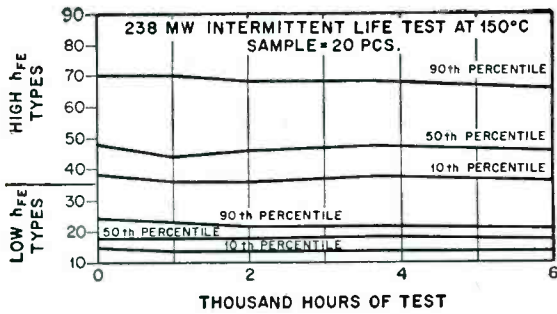
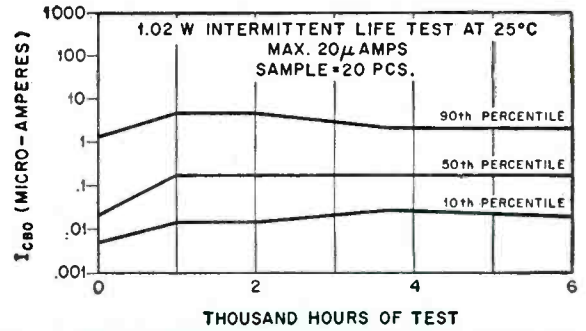
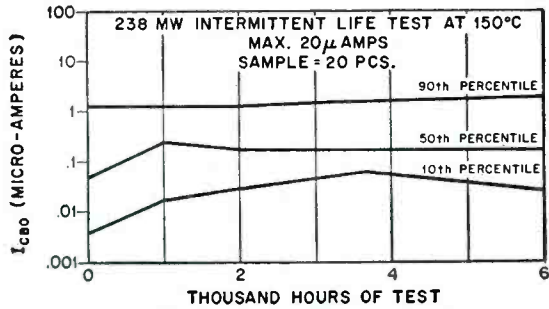

Absolute Maximum Ratings (25°C)

Voltages
Collector to Base
Collector to Emitter
Emitter to Base

	2N497A	2N498A	2N656A	2N657A	
V _{CB0}	60	100	60	100	volts
V _{CE0}	60	100	60	100	volts
V _{EB0}	8	8	8	8	volts
T _{STG}	-65 to 200°C				
T _J	-65 to 200°C				

Temperatures
Storage
Operating Junction

Total Dissipation
Free Air @ 25°C — 1 watt*
Case Temperature @ 25°C — 5 watts**

*Derate 5.72 mw/°C increase in ambient temperature above 25°C
**Derate 28.6 mw/°C increase in case temperature above 25°C

Electrical Characteristics (25°C)

unless otherwise specified

D-C Characteristics

	2N497A		2N498A		2N656A		2N657A			
	Min.	Max.	Min.	Max.	Min.	Max.	Min.	Max.		
Collector to Base Voltage (I _c =100 μa, I _e =0)	V _{CB0}	60	100	60	100	volts				
Collector to Emitter Voltage (I _c =250 μa)	V _{CE0}	60	100	60	100	volts				
Collector to Emitter Voltage (I _c =16 ma)	V _{CE0}	60		60		volts				
Collector to Emitter Voltage (I _c =10 ma)	V _{CE0}		100		100	volts				
Emitter to Base Voltage (I _e =250 μa, I _c =0)	V _{EB0}	8	8	8	8	volts				
Forward Current Transfer Ratio* (I _c =200 ma, V _{CE} =10V)	h _{FE}	12	36	12	36	30	90	30	90	
Base Input Resistance* (I _b =8 ma, V _{CE} =10V)	h _{IE}	200		200		200		200		ohms
Saturation Resistance* (I _b =40 ma, I _c =200 ma)	r _{CE (sat)}	10		10		10		10		ohms
Collector Current (I _E =0, V _{CB} =30V)	I _{CO}	10		10		10		10		μa
Collector Current (High Temperature) (I _E =0, V _{CB} =30V, T _A =150°C)	I _{CO}	250		250		250		250		μa

*Pulse Test: 300 μsec. 2% Duty Cycle

Specifications also available for 2N497,498, 2N656,657 mesa transistors

tested

98A, 2N656A, 57A...come from General Electric

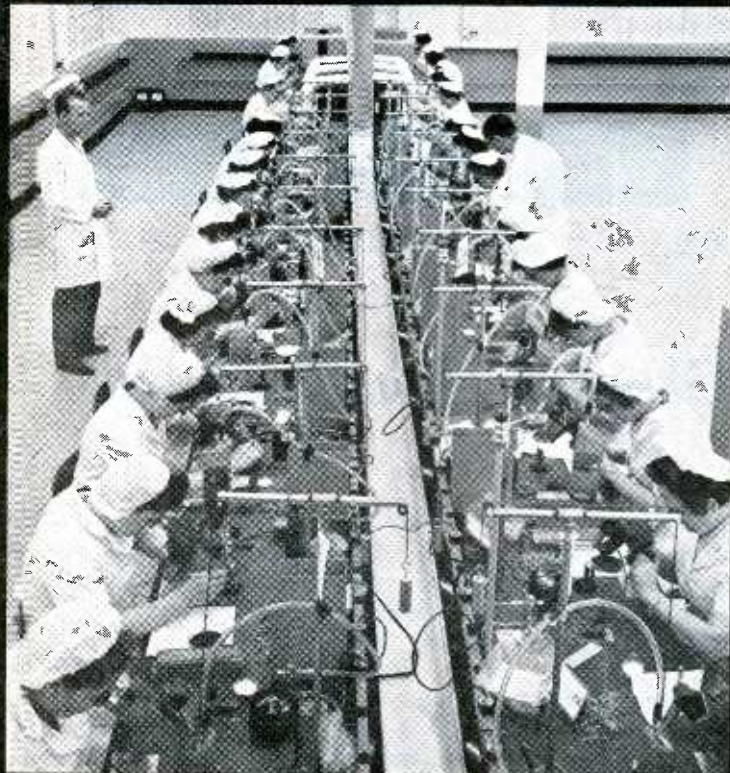

All assembly is done on a super-clean, super-reliability line similar to that which produces transistors for missile applications.

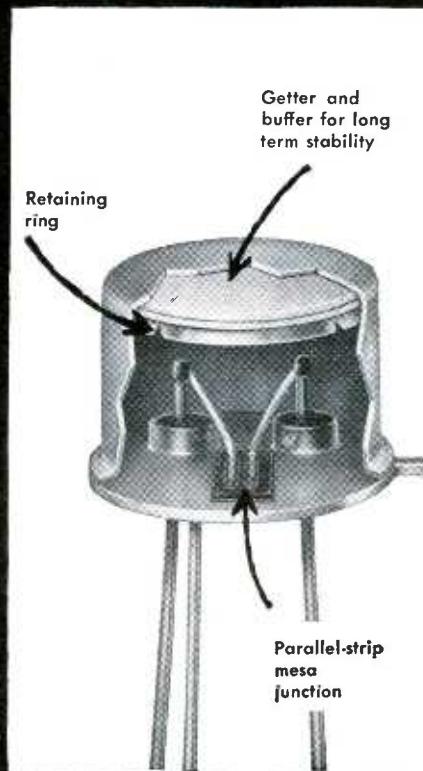

Positive internal atmospheric control achieved through the use of General Electric's buffered-sieve encapsulation technique, higher power dissipation with lower saturation resistance and lower input impedance are important features of this line of top quality one to five watt audio switches. Especially well suited for either high level linear amplifier or switching applications, these are the industry's most thoroughly characterized and tested medium power silicon double diffused NPN transistors available today. Just take a look at the extended life test charts illustrated for convincing evidence of long term stability and reliability.

Semiconductor Products Department, Section 25G96, Electronics Park, Syracuse, New York.

For fast delivery of medium power Mesa transistors at factory-low prices in quantities up to 999 call your G-E semiconductor distributor.

Progress Is Our Most Important Product

GENERAL  **ELECTRIC**

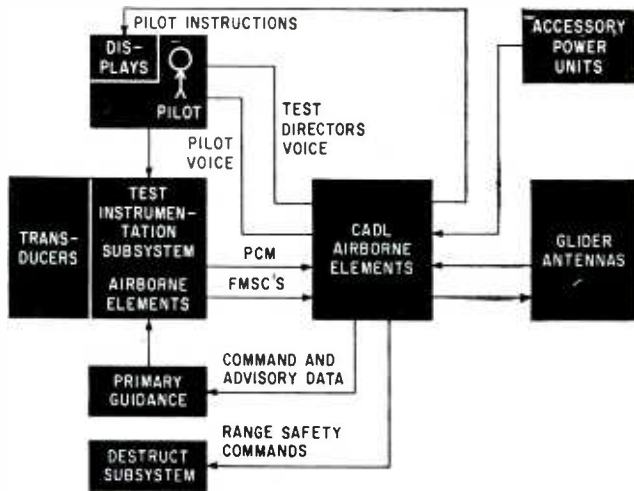

Fig. 1—Major airborne communications and data link (CADL) users

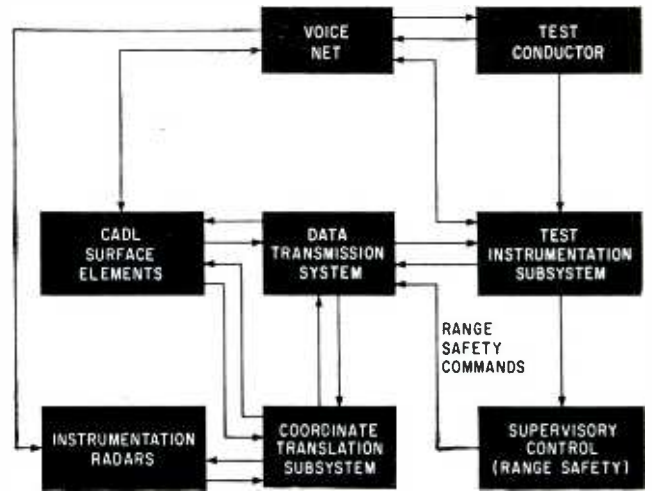

Fig. 2—Glider test range instrumentation surface elements

Plans for Dyna-Soar's Ground Net Revealed

By JOHN F. MASON,
Associate Editor

DESIGNERS OF THE communications and data link (CADL) subsystem for Dyna-Soar, the manned orbital glider project (ELECTRONICS, p 26, Feb. 3), are meeting and solving new engineering problems.

"Communicating with vehicles entering the earth's atmosphere at hypersonic speeds (5,000 to 18,000 mph) presents formidable obstacles," C. K. Law, project director for the CADL subsystem, told ELECTRONICS at RCA's Communications and Aerospace facility in Camden, N.J.

"These problems are further complicated by the strict weight limitations for onboard gear," Law said. "Also, the communications

facilities for Dyna-Soar must be integrated with existing equipment in the already-crowded Atlantic Missile Range where the first missile-launched test flights will be made."

As associated contractor in the joint USAF/National Aeronautics and Space Administration project, RCA will provide surface-air-surface transmission facilities required by the Dyna-Soar glide reentry vehicle for radio communication and tracking.

System contractor for the entire program is Boeing. Martin is associate contractor for the Titan II booster; Aerojet General for the propulsion units; and Minneapolis-Honeywell for guidance and navigation.

To date, RCA has named two

principal subcontractors: Radiation, Inc. to design and develop antenna systems—for communications tracking and telemetry; and Sprague Electric, responsible for radio interference environment control.

RCA's \$2½ million contract covers work for Step I only of the three-step Dyna-Soar program. The first step calls for air drops from a B-52 at Edwards AFB. This will be followed by unmanned and manned launches from Cape Canaveral, Fla.

At Edwards AFB, RCA will install enough equipment to handle communications, tracking and data link only for what would normally be the terminal phase of the glider's flight. For the unmanned, and later manned Titan-boosted sub-orbital flights, the Atlantic Missile Range will require from eight to 11 sites—up to four of which might be on ships.

Besides new gear to be developed by RCA, existing range equipment will be used plus possibly some gear provided by the National Aeronautics and Space Administration for Project Mercury.

Conceivably, some of Mercury's global net (ELECTRONICS, p 30, Oct. 7, 1960) will be used for Dyna-Soar—point-to-point communications, data processing and tracking radar. Ultimately, a vehicle like

AS FOR FUNDS . . .

THE HOUSE VOTED \$185.8 million in fiscal year 1962 "available only for" the Dyna-Soar program. A plan called Project Streamline will accelerate the program by three years and save \$300 million.

The speed-up is based on two major program changes: (1) use of the Saturn booster to place the glider in orbit (Boeing says Titan II can't push glider into orbit); and (2) substituting in the early flights available subsystems for some of the more complex subsystems that are to be developed for Dyna-Soar later.

The cost savings, according to the House report, will result because: "When a development program is pursued at a less than optimum pace costs mount up. Personnel are on the payroll for a longer period of time and minor changes are multiplied."

Streamline proposal now goes to the Senate

Dyna-Soar will not need a network to monitor its flights. The guidance subsystem and pilot will achieve sufficient autonomy to accomplish unaided reentry and landing.

Information the CADL system will communicate to the surface originates with the transducer and conditioning system built by Boeing. This is passed on to the Test Instrumentation System (TIS) to be built under a Boeing subcontract by Electro-Mechanical Research Inc.

CADL handles six general classes of telemetry data. One is flight safety data and the remaining five are test and scientific data (see Fig. 1).

Besides data from TIS, the CADL also transmits pilot voice messages.

The CADL also provides surface-to-air communication of the test director's voice (intended for the pilot) and digital command data. The pilot carries an emergency vhf voice system and a beacon in the event he must leave the vehicle.

The CADL surface elements contain the complements to the airborne elements (see Fig. 2). The transmitted signals are received by tracking antennas, demodulated by low noise receivers, converted to vhf, amplified and sent by coaxial cable to four vhf receivers at each site.

The demodulated subcarriers are routed via the data transmission subsystem to demultiplexers, subcarrier discriminators, and demultiplexers in the TIS. Demodulated pilot voice signals are fed into the voice network for distribution.

A communications console displays the operational status of the receivers, transmitters, multiplexers, and antennas and provides manual override of the automatic fail-over switching for redundant elements. The tracking console monitors antenna tracking performance, selection of tracking signal, and controls for manually assisting automatic signal acquisition. The tracking antenna must pick up the glider within 30 seconds after it rises above the horizon (or about two degrees altitude above the horizon).

In addition to communications tracking, radar for skin or beacon tracking, such as FPS-16 and possibly the FPQ-6, will be used.

Because of the glider's weight limitations, surface elements of CADL use high gain transmitting and receiving devices, narrow beam antennas, high powered transmitters for the surface-to-air link and low-noise receivers for air-to-surface link.

Special communications problems for Dyna-Soar which result from the vehicle's hypersonic speeds are the creation of high skin temperatures which produce ionized shock waves.

A big problem for the entire Dyna-Soar program is to develop materials to withstand extreme temperatures. The glider antennas are mounted flush with the glider skin and must withstand several thousand degrees F.

To prevent the high skin temperatures from passing through the metallic portions of the r-f conductors to the terminals inside the vehicle, thermal isolation is required. This results in some radio energy absorption. Another source of loss is the dielectric window used to hermetically seal, while passing r-f energy.

"High temperature dielectrics in the antenna and in the thermal barrier will absorb between 20 and 30 percent of the r-f signal," according to L. B. Garrett, CADL systems engineering leader.

"The worst offender in the glider," Garrett said, "appears to be the metallic components themselves. Materials capable of providing adequate structural integrity in the temperature environment have a conduction loss for both reception and transmission approaching 40 percent.

"Received energy is further degraded by electromagnetic noise energy emitted by the heated metallic and dielectric materials. The glider radio receiver desensitization caused by such noise can result in a loss up to 60 percent of the ground transmission captured by the glider antenna."

The biggest communications problem in the Dyna-Soar project is to get through the ionized shock wave that envelopes the glider during reentry into the earth's atmosphere. The high speed of the glider compresses and heats the otherwise cool low-pressure gas forming an electrostatic sheath around the vehicle. This sheath attenuates radio

signals in certain bands. Uhf, for example, may be totally blacked out.

The electron density of the sheath, or resonant frequency, varies with the glider's altitude, attitude, velocity and area of the glider itself. The worst angle is head-on; the best is at 90 degrees.

Although there is little data on sustained communications during reentry, commuter runs of simulated trajectories indicate that super-high frequencies will penetrate the sheath at all times. Shf frequencies are higher than the ion sheath resonant frequencies and lower than the band absorbed by the atmosphere.

The problem is economic, Law said. There is a limited amount of tube development at these shf frequencies. The Atlantic Missile Range, for example, is instrumented for uhf. There is also the problem of effects of subsystem equipment on other gear within the glider.

There could be some unexpected problems, Law said. No one knows precisely what will happen during an actual reentry flight. There could be distortion, noise generation or multipath signals. The sheath problem is important in the Dyna-Soar projects since the glider may well be enclosed in this ionized envelope throughout the entire mission.

Automatic Wiring

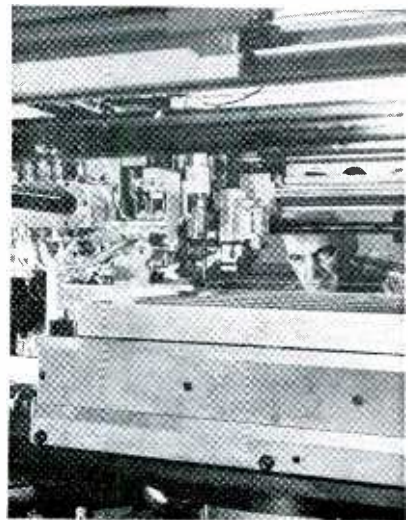

Circuit modules for General Electric Ordnance Dept.'s Mark 84 Polaris fire control system are manufactured by new machine

Closely-Defined Magnetic Field Measures Wear On Metal Surfaces

By F. H. BAER.

McGraw-Hill World News

BUDAPEST—International Measurement Conference (IMEKO) held here recently aimed to improve technical information exchange. Observers had mixed views on its success, but tell *ELECTRONICS* the event made an important stride by having its shortcomings spelled out.

Among technical developments observed by *ELECTRONICS* at the meeting were:

- Metal surface wear method, using closely-defined magnetic field principles, described by H. Macura, Poland.

- Electronic measuring potentiometer using strain gages. This was described by T. Kemeny of Hungary.

- Test bench for batch quality control of tubes, capacitors and resistors which will register batch quality on a digital voltmeter and include automatic feed. This was described by A. Ambrozy of Hungary.

- Analog/digital converter system for automatic power station control, described by C. Penescu of Rumania.

- Nonelectric quantity measurement by simultaneous variation of capacitance and conductance. This was described by N. Rakoveanu, Rumania.

- Novel method of measuring a-m to p-m conversion and a-m compression, by T. Sakarny, Hungary.

The greatest obstacle cited this year was the late delivery of lecture preprints and the almost insurmountable language barrier. Eastern and western delegates agreed that too many papers had been chosen at random and lacked concentration on important subjects. Lecture readings were overly lengthy at the cost of discussion time.

On the positive side, delegates cited the increasingly international aspects of the event. The first



Budapest's House of Engineering, site of this year's second International Measurement Conference

IMEKO held in 1958 was organized for Eastern European countries only. This second one had 138 papers read by men from 22 countries to 438 delegates from both East and West.

The nine-man U. S. delegation,

headed by Harry Burke of the Instrument Society of America, praised the substance of some papers although they said the content of some lectures did not get through to many in the audience.

The U. S. industry delegation left Budapest with the intent to attend the next IMEKO. Unless another nation offers to play host in 1964, the event again will be held in Budapest. Stockholm and Leipzig reportedly are interested. The next conference will see 10-minute limitations on lectures and 20 minutes on discussion time, as well as more communication among delegates.

Main focus of this year's conference was on individual measurement results and novel instrument design. In general, papers steered away from any heavy discussion on design philosophy, industrial instrumentation and measurement and economics.

More than half the exhibit space was taken by Hungarian displays. Nine Western and four Eastern countries also displayed equipment. Some were prototypes, others were commercially available.

IMEKO was established as a per-

Digital System Runs Connector Test

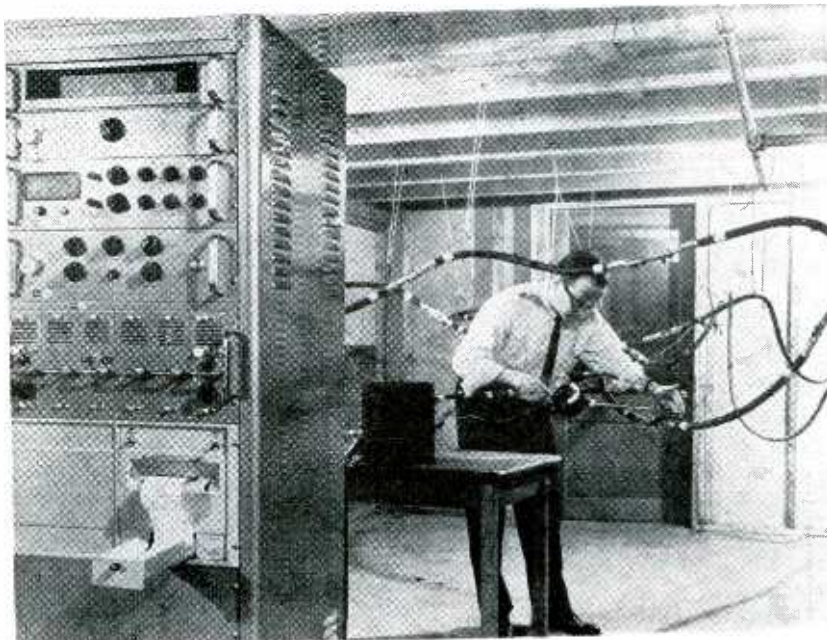

Digital voltmeter system (left) at Thomas & Betts Co. puts cable connectors through performance tests, eliminating manual monitoring and supervision (right). Device tests heating effects of high current loads

manent organization with a 20-man steering committee.

A-Powered Station Reads Weather Automatically

SIXTY PAIRS of lead telluride thermocouples are arranged like spokes around the cylindrical heat source in the atomic-powered automatic weather station soon to be shipped to a barren location north of the Canadian mainland, where it will make possible year-round observations. It is capable of transmitting over distances up to 1,500 miles.

The unmanned station derives its power from pellets of a strontium-90 compound which generate heat spontaneously by radioactivity decay.

The heat is transformed directly into a continuous five watts of electricity by the thermocouples connected in series to a single outlet. The electrical energy is stored in rechargeable batteries until time for transmission—every three hours.

The station was designed and built for the Atomic Energy Commission by the Nuclear division of the Martin Company in Baltimore.

Temperature, wind speed and barometric pressure are received from the automatic device by radio.

Using More Electronics For Medical Diagnosis

MORE ELECTRONICS are slated to be used for medical diagnosis. The Public Health Service will soon begin a two-part research program aimed at developing a system where electrocardiographic wave forms can be programmed through a computer to convert them for clinical use.

A nine-month feasibility study of the system has just been completed with good results. The first phase of the program will concentrate on developing a practical method of measuring the electrocardiographic waveforms.

The second part of the program consists of programming this information through computers so that it can be used by physicians. The program will take about two years to complete.

have you tried BIRD?

READ RF WATTS DIRECTLY

Today everyone who measures RF power in coaxial systems wants the answer in watts. The BIRD Model 43 THRULINE reads watts!

Connect the Model 43 between transmitter and antenna or load. The meter reads RF power directly. Measure forward or reflected power instantly.

No calibration charts. No adjustments. No calculations. No auxiliary power.

Plug-in elements are used to cover 2 to 1000 mc, and powers to 1000 watts.

BIRD Quick-Change (QC) Connectors eliminate adapters. Any standard series of coaxial line fittings may be accommodated.

Write, TWX or call us for complete specifications on the Model 43 and other BIRD products.

Price:

Instrument only \$95.00 each

Plug-in elements \$30.00 each

FOB, Factory

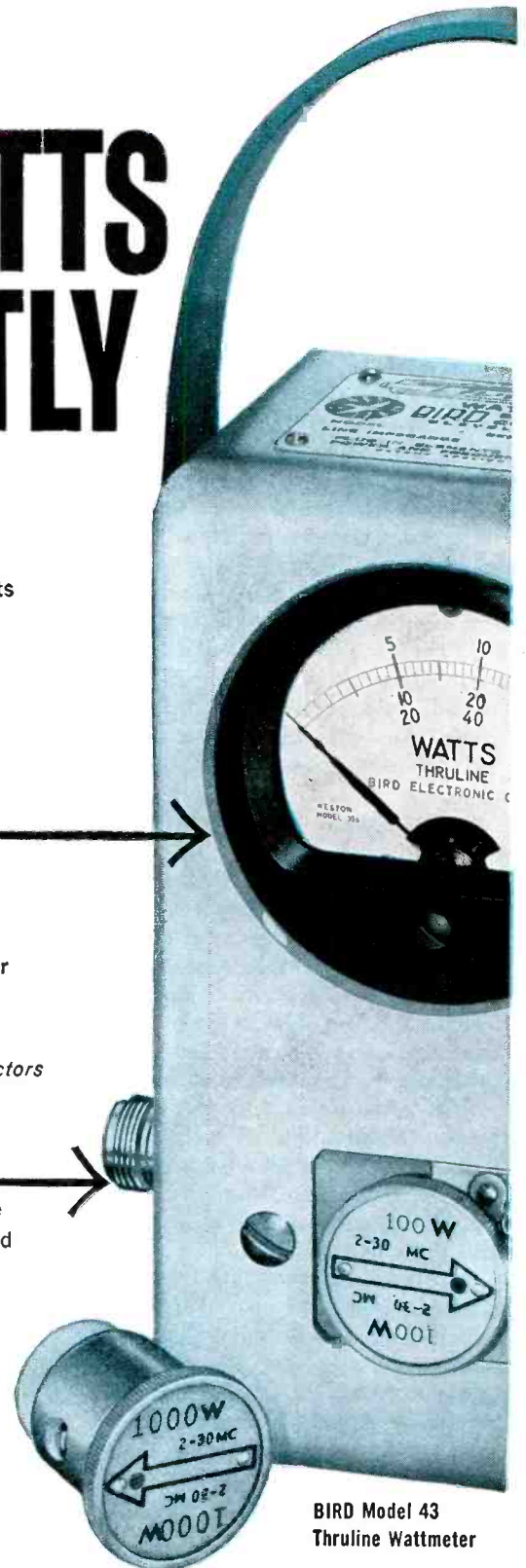

BIRD Model 43
Thruline Wattmeter



ELECTRONIC CORPORATION
30303 Aurora Rd., Cleveland 39 (Solon), Ohio
Churchill 8-1200 TWX CGN F5 679
Western Representative:
VAN GROOS COMPANY, Woodland Hills, Calif.

Soviet Electronics? All's NOT Well

MOSCOW—Soviet scientists this week are claiming great strides in electronics and automation. They are, however, under new orders from the Kremlin to narrow the gap between scientific discovery and practical application.

At the recently-held all-Union conference of scientific workers here, the new president of the USSR Academy of Sciences, M. V. Keldysh, claimed: "The principles of radar were first advanced and introduced in our country in the 1930's." Other speakers pointed to Soviet space successes as examples of how advanced the USSR is in the field of automation.

Despite these and other positive statements, however, deputy premier Alexei Kosygin flatly told an audience of some 2,000 scientists and administrators there is a serious Soviet lag in the sphere of semiconductors and a number of areas of radio electronics. He also cited a need for more progress in applications of electronic computer devices.

Some other sore spots were ticked off by Keldysh:

- In 1954 a new principle was evolved in the USSR for using semiconductor devices as nonlinear capacitors. Yet, the Soviets started working on improvement and utilization of the devices only after the foreign press reported about their use in parametric amplifiers.

- At a number of Soviet enterprises introduction of automation is being retarded because of inadequate coordination between designers of factories, machines and control systems.

- Too much duplication in research has created one situation in which some 150 establishments are elaborating on digital programming control systems with the main attention usually directed not at elaborating operational sequences for automatic control but at creating computers which are often similar in design.

- By contrast, other areas of research, such as cybernetics, are receiving insufficient attention.

- Supply of scientific instruments and equipment is unsatisfactory.

Scientific organizations devise a number of instruments in the process of research but many of them never reach other users who could benefit from them.

- Test installations are not properly organized and utilized. In a number of cases when institutes lack experimental equipment, investigations are not completed. At times a number of different institutes build similar test installations which are not loaded to capacity, rather than having available large concentrated establishments which could cater to the needs of other research and design bodies.

These and other comments indicate that government and party leaders feel Soviet research and development programs have suffered from too little coordination and guidance and that the USSR Academy of Sciences has dispersed its energies in too many directions.

Because of this situation, the Academy will turn over half its institutes to other bodies in order to concentrate on vital research areas.

Also, it will advise the newly established State Committee for the Coordination of Scientific Research.

The Committee, which replaces the State Scientific and Technical Committee, will have responsibility for coordinating research, providing cross-flow of information and drawing up unified state plans for scientific research.

The unified plan, according to Soviet spokesmen, includes three sections: major problems still in the experimental design stage (such as automation); long-range investigations directed at solving already defined problems (such as thermonuclear fusion, thermoelectric conversion and others); fundamental research.

The last is described by the Committee as extremely difficult and requiring handling by the most qualified experts in the country to avoid wasted effort in areas that won't pay off. Group suggests research in high energy physics, cybernetics, nuclear physics, etc.

Keldysh outlined several areas as

Air Force to Upgrade Interceptors

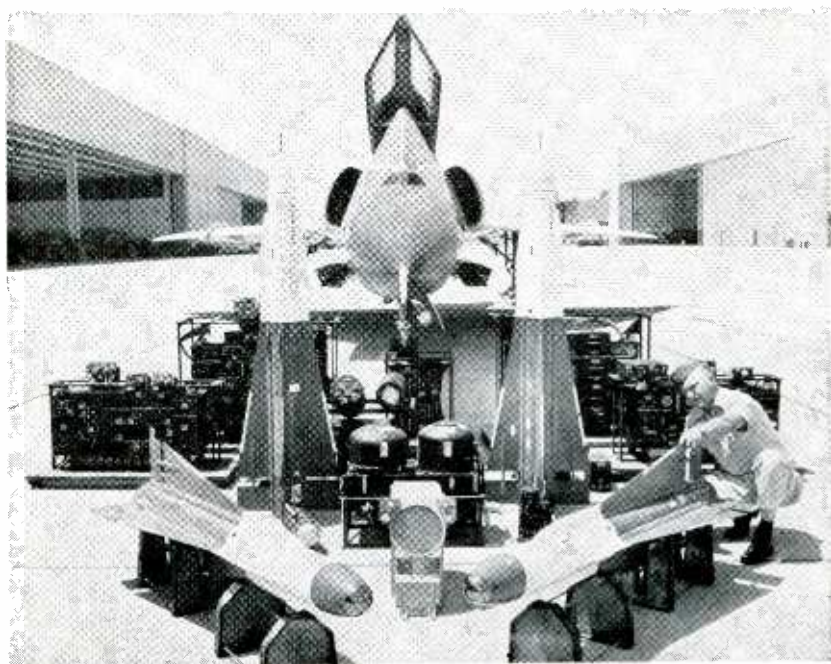

Convair's F-102A (above) and F-106A, McDonnell's F-101B will get some or all five modifications: ir search and track for low altitude, redesigned radar antenna, ecm capabilities, parametric amplifier. All three jets carry Hughes Falcon missiles and 200-box armament control system above

FERRITE ISOLATORS

by **D-B**

-for exceptionally high performance... a full range of sizes... 30-day deliveries



DE MORNAY

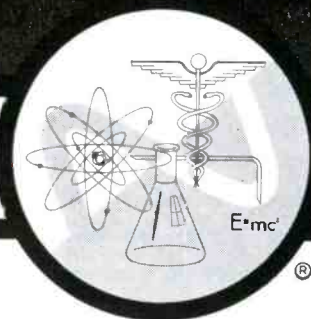

BONARDI

D-B supplies ferrite isolators covering a range from 2.6 to 18.0 kmc. Units will soon be available to 140 kmc. All units in the line have the following high-performance features:

High isolation—a minimum of 30 db at X Band, and 24 db at Ku Band.

Low insertion loss—a maximum of 1.0 db in *all* sizes.

DeMornay-Bonardi isolators are resonance absorption type units, employing a low-loss ferrite developed especially for this application.

Low VSWR—a maximum of 1.15 in either direction.

Short insertion lengths—only 5 $\frac{7}{8}$ " in X Band size.

Complete data in Bulletin DB-487.

Other ferrite units manufactured by DeMornay-Bonardi include: Frequency Converters, Circulators, and Harmonic Rectifiers using unique D-B ferrite compounds.

D-B

- a reliable supplier

As the oldest manufacturer of microwave equipment, we have the talents to design reliable instruments...the skills to manufacture them, and the complete equipment for checking and calibration. You'll find deliveries prompt now at D-B, and, as always, every instrument backed by a firm replacement guarantee.

DE MORNAY-BONARDI 780 South Arroyo Parkway, Pasadena, California

Lapp

ANTENNA STRAIN INSULATOR

The Lapp porcelain rod insulator shown at the top of the illustration develops 12,000 lb. strength, and is suitable for the most severe electrical and mechanical duty. It is available with rain shield and/or corona rings. All hardware is silicon aluminum alloy. Smaller insulators, in porcelain or steatite, are suited to lighter duty for strain or spreader use. Lapp engineering and production facilities are always ready for design and manufacture of units to almost any performance specification. Write for Bulletin 301, with complete description and specification data. Lapp Insulator Co., Inc., Radio Specialties Division, 181 Sumner Street, LeRoy, N. Y.



fundamental. Among them was automation. He called for wide-scale development of automated production processes, with special attention to self-tuning and self-learning systems. He said attention must be paid to using such control systems over long distances on earth as well as in space. He also called for more work in nuclear physics and thermoelectric conversion.

In radio electronics, the Academy head asked for greater miniaturization and reliability, utilization of shorter wave ranges that would make it possible to transmit large amounts of information through waveguides, and concentration of radiation streams in narrow beams with moderate-sized antennas.

He said this would open up great opportunities for radio location, radio navigation and communications over even cosmic distances. He told the conference still greater opportunities are promised in the infrared and optical wave ranges, and added that the solution of problems in these ranges is of vast importance to the development of quantum mechanical generators and optical range amplifiers.

Developing this topic, acamedician Lev Artsimovich said so-called atomic radio stations should be able to produce a beam of electromagnetic lightwaves able to transmit for billions of miles.

Government to Explain Undersea Gear Needs

AN INDUSTRY CONFERENCE will be held August 14-15 in Washington, D. C. The government will lay out electronic instrumentation requirements for underwater research. Over the next decade, an estimated \$4 to \$5 billion will be spent by the federal government in this field, including oceanography and Navy's antisubmarine warfare program.

A survey is being made now on instrument requirements for undersea research by the Interagency Committee on Oceanography of the Federal Council for Science and Technology.

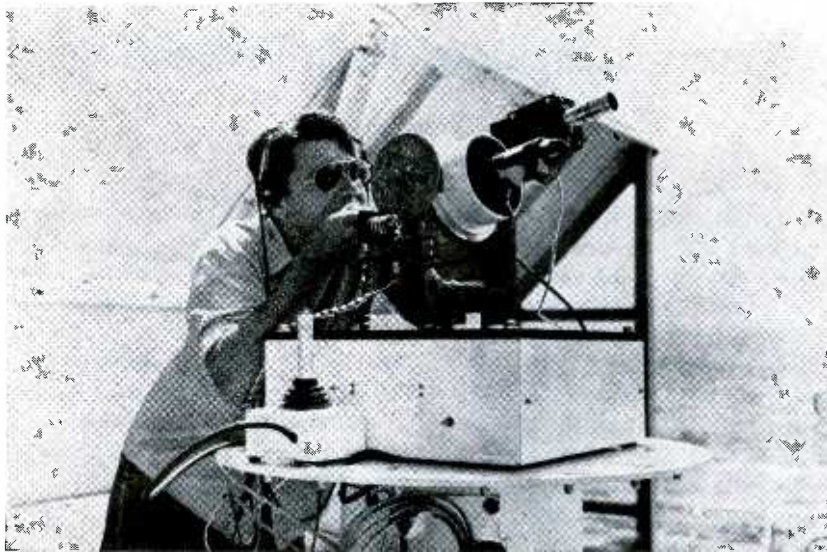

Infrared tracking system on USAS American Mariner seeks ir emitted by reentering missile. Joystick on pedestal manually aims instrument at start of test. Servos lock on when target enters field of view

Infrared System Tracks Missile Reentry

OPTICAL TRACKING system installed on the new *USAS American Mariner* floating laboratory tracks missiles by detecting infrared radiation emitted during reentry. Ship is conducting extensive reentry research as part of the Downrange Antimissile Measurements Program.

System was developed by Army Rocket and Guided Missile Agency and modified for shipboard use by Barnes Engineering Co.

Tracking system includes an optical head, servo driven pedestal and associated amplifiers and control units. Infrared radiation is collected by a mirror system in the optical head and focused on an infrared detector.

A manually operated joy stick points the instrument in the general direction of the reentering missile; the servo system takes over when the target enters the tracker's field of view. Incoming radiation is encoded by a rotating reticle mounted just ahead of the detector. Alternate clear and opaque spokes on the reticle frequency modulate the beam adding information on radial and angular target position with respect to the center of the control head.

Detector output is amplified and discriminated, and positional information is converted to elevation and

azimuth error signals. These signals are amplified and fed to servo system to keep the tracker centered on the target.

The tracker pedestal may be slaved to other optical instruments to keep them pointed at the missile.

Computers, Bionics Get NEC Billing

SYNOETICS, new computer science, will be discussed by a panel at the 17th Annual National Electronics Conference Oct. 9-11 in Chicago's International Amphitheatre.

A workshop equipped with several operating computers will update delegates on state of computer art. Improved transistor neuron models and speech recognition by analog neural networks will be part of four-paper session on bionics. There will also be a three-day tutorial workshop on computers.

Total of 85 papers will cover newest electronic development areas from multiple sessions on antennas, low-frequency solid-state amplification and solid-state devices and circuits through optical communications—including papers on applications of masers and lasers—to parametric devices and techniques and space communications.

SELECTIVE *Gas-Damped* SENSITIVITY

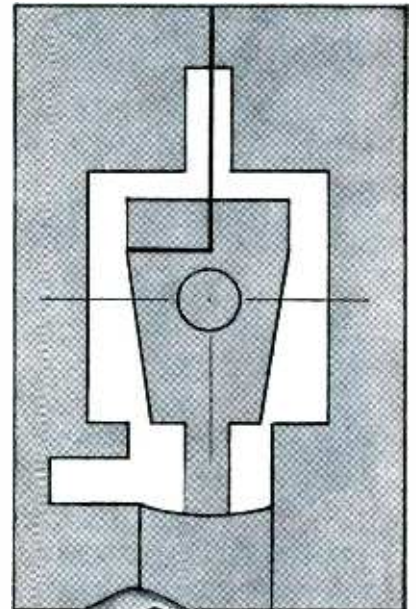

GENISCO GMB SERIES ACCELEROMETERS

for airborne applications

- CONSTANT DAMPING
- POTENTIOMETER PICKOFF OR SWITCH CONTACTS

Genisco's GMB Series Accelerometers feature the advantages of gas damping which remains constant over wide temperature ranges for extreme accuracy and consistency. These units are ruggedly designed and constructed to operate reliably under conditions of high vibration and shock. The GMB Series Accelerometers are hermetically sealed units, available with either precision potentiometer pickoff or switch contacts... Standard or custom models.

Genisco
INCORPORATED

2233 Federal Ave., Los Angeles 64, California

SPRAGUE PIEZO- ELECTRIC CERAMIC ELEMENTS



**ELEMENTS
FOR ALL
APPLICATIONS
AS WELL AS
COMPLETE**

**TRANSDUCER ASSEMBLIES
FOR MOST APPLICATIONS,
SUCH AS UNDERWATER
SOUND AND
VARIOUS ORDNANCE AND
MISSILE DEVICES.**



Sprague-developed mass production and quality-control techniques assure lowest possible cost consistent with utmost quality and reliability. Here too, complete fabrication facilities permit prompt production in a full, wide range of sizes and shapes.

Look to Sprague for today's most advanced ceramic elements—where continuing intensive research promises new material with many properties extended beyond present limits.



**YOUR INQUIRIES
ARE INVITED**

**WRITE FOR
LITERATURE**

SPRAGUE ELECTRIC COMPANY
35 Marshall Street, North Adams, Mass.

SPRAGUE®
THE MARK OF RELIABILITY

Antenna Includes Data-Processing

A DATA-PROCESSING antenna system—that does not use an increase in aperture size—has been developed at Air Force Cambridge Research Laboratories in Bedford, Mass.

The interferometer-type antenna system, using 16 elements, synthesizes a given pattern with the same resolution that would ordinarily be possible only with an interferometer containing 80 elements. The complex antenna array incorporates interferometer and slotted waveguide techniques and data-processing circuits such as phase shifts, multipliers and filters. The 16 elements are spaced with an ordered, but increasingly wider separation from one end to the other. In an interferometer, elements are spaced with a regular half-wavelength separation.

Because of the increased spacings between elements as more interferometers are added, it is possible to achieve an even greater reduction in the percentage of elements needed to simulate a given

aperture. All the data-processing such as phase-shifting and the first multiplications are done in X-band waveguide. The multiplied and detected output of the waveguide system is an audio frequency which can be filtered and again multiplied by simple audio techniques. The experimental model operates at 9,375 Mc and scaling to other frequencies will present no problems, AFCRL says.

The system was developed by Lt. L. C. Davenport of AFCRL and based on earlier theoretical work of C. J. Drane, also of AFCRL.

This antenna can be used only as a passive system—not for transmitting. It would be used largely for locating sources that can be considered essentially points in space or for mapping the surface of incoherent self-luminous sources such as active satellites or radio stars.

The system may also study the influence of partially ionized plasmas on electromagnetic energy.

Document Data Relayed By Television

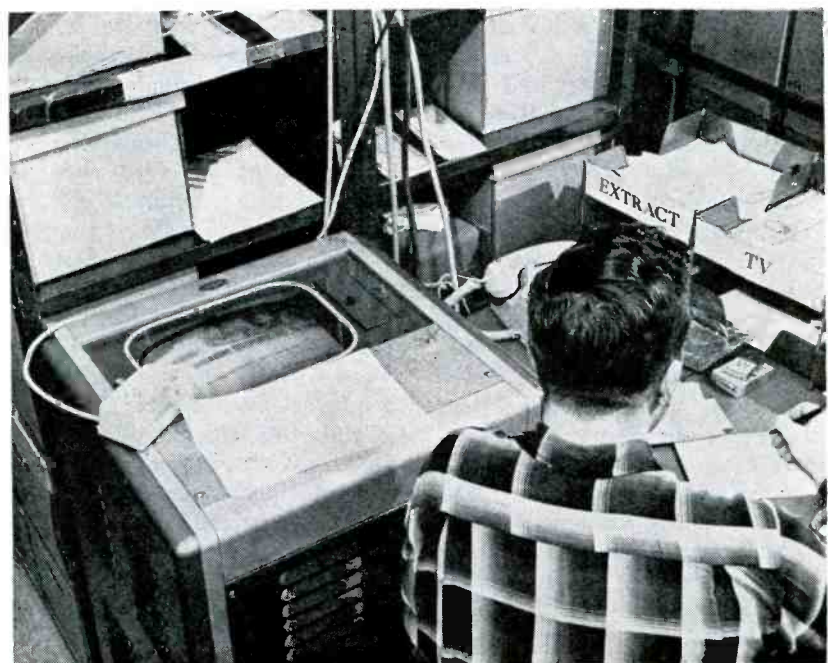

Special tv installation made for AT&T by GPL division of General Precision uses two 14-in. monitors to send visual data between offices

Raytheon Transformer Talk

New techniques reduce size of 2.5 megawatt

AIRBORNE PULSE TRANSFORMER

to only .45 cu. ft.

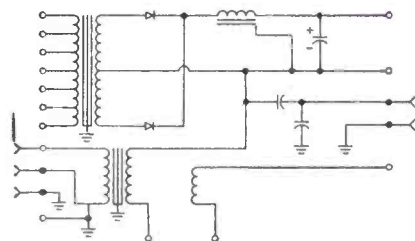

A high-voltage pulse transformer tested at 180kv and rated for pulsed operation at 90kv that measures just $9\frac{1}{2} \times 9\frac{1}{2} \times 8\frac{3}{4}$ inches!

This ruggedized unit—typical of Raytheon's new compact pulse transformers—is designed to operate under the extreme environmental conditions encountered by high-speed aircraft. It contains an insulated DC filament supply and internal provision for -50° to $+100^{\circ}$ centigrade operation. For flexibility in mounting, it features a space-saving, bifilar-type, epoxy terminal that is eight inches shorter than previous models. Overall, the new .45 cubic-foot unit is 60% smaller than its predecessors.

Raytheon pulse transformers are designed to work with specific microwave tubes. Standard designs include open, resin encapsulated, enclosed, and oil-filled types.



WRITE FOR 16-PAGE BOOKLET on Raytheon transformers or for specific help on your particular requirements to Magnetics Operations, Microwave and Power Tube Division, Raytheon Company, Foundry Avenue, Waltham 54, Mass.

FEATURES of new Raytheon high-power pulse transformer include: (1) 2-inch-high, truncated, bifilar-type klystron high-voltage terminal operating under external and internal liquid environment, (2) high-voltage primary input connector, double shielded to eliminate cable interference, and (3) 30kw traveling-wave-tube high-voltage output.

RAYTHEON

RAYTHEON COMPANY

MICROWAVE AND POWER TUBE DIVISION

WHAT'S YOUR TRANSISTOR COOLING PROBLEM?

Whatever it is, you can probably find the solution with a Birtcher Radiator. Available in sizes and designs to most efficiently cool all popularly used (and many special) transistors. Test reports show up to 27% more transistor efficiency!

AVAILABLE FROM AUTHORIZED BIRTCHER DISTRIBUTORS

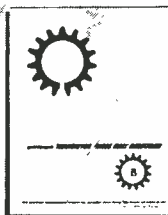

NEW!
TRANSISTOR
RADIATOR
CATALOG 1-HR

Just off the press - write for it

B

THE BIRTCHER CORPORATION

INDUSTRIAL DIVISION

745 S. MONTEREY PASS ROAD, MONTEREY PARK, CALIFORNIA

CIRCLE 201 ON READER SERVICE CARD

MEETINGS AHEAD

Aug. 13-18: Magneto-hydrodynamics, Seminar, Penn State Univ., University Park, Pa.

Aug. 16-18: Electronic Circuit Packaging Symposium; Univ. of Colorado, Boulder, Colo.

Aug. 22-25: WESCON, L.A. & S.F. Sections of IRE, WEMA; Cow Palace, San Francisco.

Aug. 23-Sept. 2: National Radio & TV Exhibition, 1961 British Radio Show; Earls Court, London.

Aug. 28-Sept. 1: Heat Transfer Conf., International; Univ. of Colorado, Boulder, Colo.

Aug. 30-Sept. 1: Semiconductor Conf., AIME; Ambassador Hotel, Los Angeles.

Sept. 4-9: Analog Computation, International Conf., International Assoc., for Analog Comp., and Yugoslav Nat. Comm. for ETAN, Belgrade, Yugoslavia.

Sept. 6-8: Computing Machinery, National Conf., ACM; Statler-Hilton Hotel, Los Angeles.

Sept. 6-8: Nuclear Instrumentation Symposium, PGNs of IRE, AIEE, ISA; N. C. State College, Raleigh, N. C.

Sept. 6-8: Space Elec. & Telemetry, PGSET of IRE; Univ. of New Mexico, Albuquerque, N. M.

Sept. 6-13: Electrical Engineering Education, Internat. Conf., ASEE, AIEE, PGE of IRE; Sagamore Conf. Center, Syracuse Univ., Adirondacks, N. Y.

Sept. 8-10: High-Fidelity and Home Entertainment Show, Chicago, Crystal Ballroom, Palmer House, Chicago.

Sept. 11-15: Instrument-Automation Conf. and Exhibit, ISA; Sports Arena, Los Angeles.

Sept. 13-15: Technical-Scientific Communications, PGEWS of IRE, Bellevue-Stratford Hotel, Phila.

Oct. 9-11: National Electronics Conf. IRE, AIEE, EIA, SMPTE; Int. Amphitheatre, Chicago.

Nov. 14-16: Northeast Research & Engineering Meeting, NEREM; Commonwealth Armory and Somerset Hotel, Boston.

Name it in

HIGH TEMPERATURE CERAMICS



We have it!

- Extruded sections; intricate press parts; tapped, threaded and machined shapes
- Heating Appliance Insulators
- Porcelain Insulation
- Thermocouple Wire Insulators
- Crushable Insulation Tubing
- Refractory Porcelainware
- Electronic Insulation
- High-Fired Alumina Ceramics
- High Voltage Transformer Insulation
- Foundry Cores

We will quote from your prints or samples. Write or phone today.

"Proud to Serve You"



DU-CO CERAMICS CO.

203 Main Street

Saxonburg, Pa.

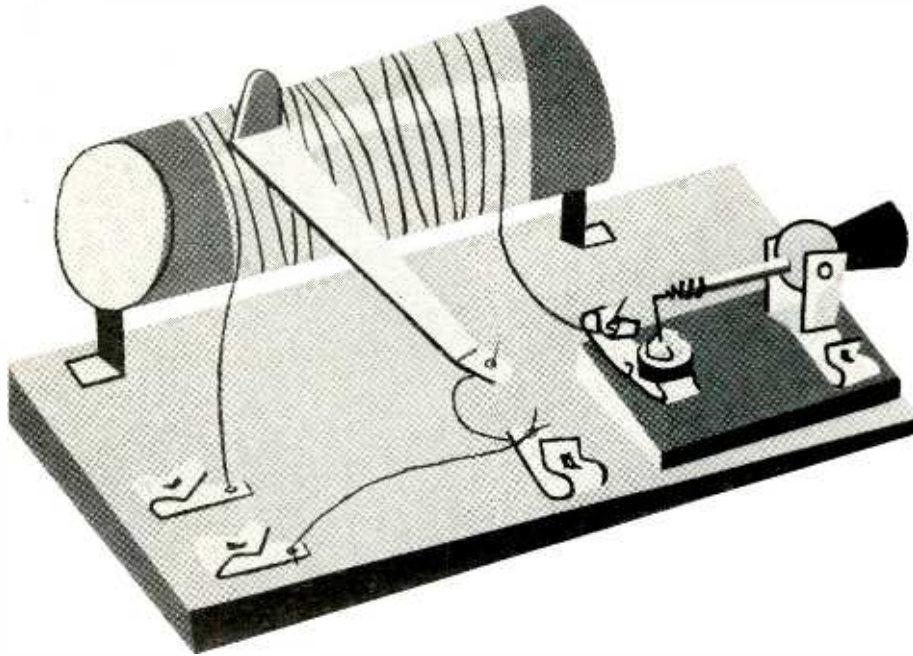

REMEMBER?

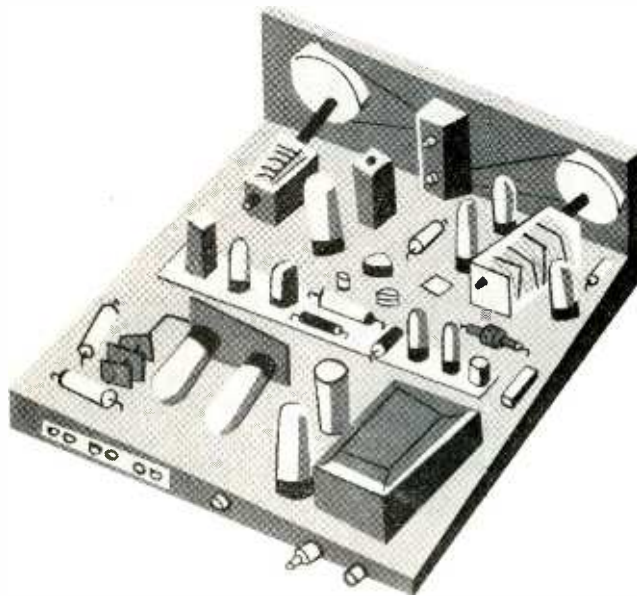

Remember when all ears were tuned to the feeble, squeaky sounds that came from the radio wonder of the '20's . . . the crystal set, a simple instrument combining little more than a crystal, wire windings and a crude mounting? The modern tuner and other electronic equipment, by comparison, is a far cry from the crystal set.

To simplify production of the complex metalwork for most of today's electronic industry WIEDEMANN Turret Punch Presses are used. Piercing the many holes and openings of varying sizes and shapes is simple and fast.

All metal fabricators can as easily justify a WIEDEMANN Turret Punch Press because it will solve the big problem of locating and piercing openings in sheet metal in low-run quantities from 1-1000 and more.

The "WIEDEMANN METHOD" cuts piercing costs 60% to 90%. It eliminates setup and layout; permits unlimited engineering changes; reduces tool cost, inventory of punched parts, material handling and assembly cost. This can be proved by comparative time studies. We will analyze your work and send you a detailed picture of production times you can expect on a WIEDEMANN.



From the versatile 150 ton R-15 down to the hand operated R-2, there's a Wiedemann for your short run piercing requirements.

WIEDEMANN

WIEDEMANN MACHINE COMPANY
Dept. E-7, Gulph Road • King of Prussia, Pa.

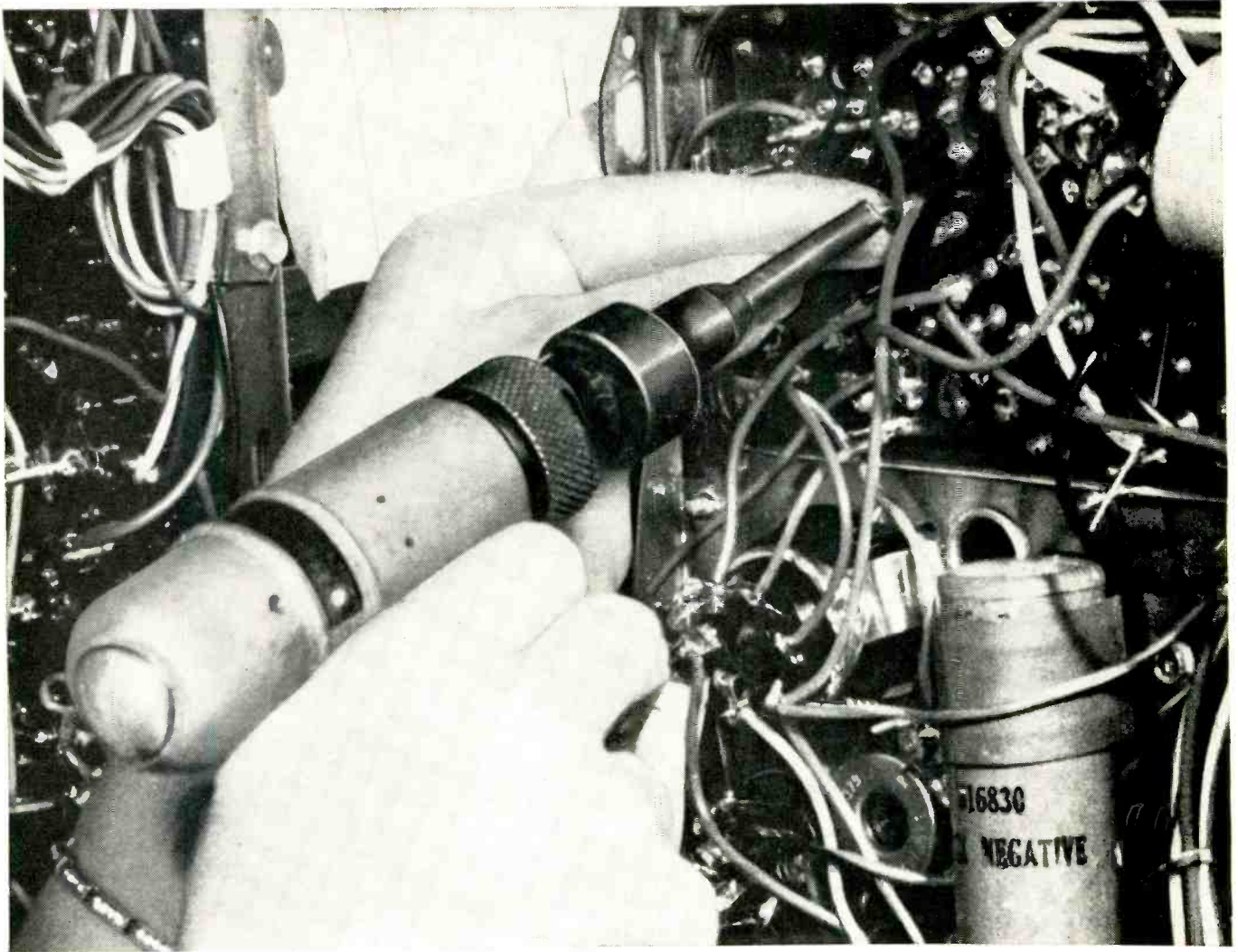

With "Wire-Wrap"[®] tools these hands make 3-second connections

Make expensive hands more profitable. Put your electrical connections on a 3-second production schedule with Gardner-Denver "Wire-Wrap" tools. That's all the time it takes to make a permanent electrical connection using the solderless wrapping method, and absence of heat means greater reliability of your component.

Proof of superiority? Over a billion permanent, solderless wrapped connections with no reported failure. And only Gardner-Denver offers a complete line of equipment for making such connections—including custom-designed, automatic "Wire-Wrap" machines to solve special problems in multiple operations. Write for bulletins.

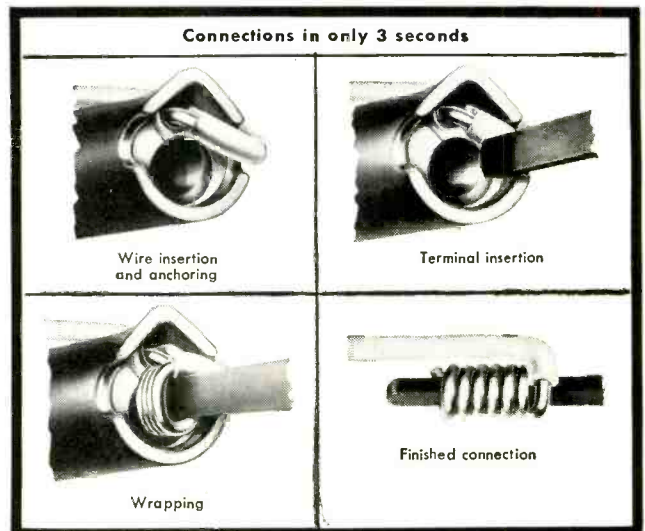

EQUIPMENT TODAY FOR THE CHALLENGE OF TOMORROW **GARDNER - DENVER**

Gardner-Denver Company, Quincy, Illinois—Offices in principal U.S., Canadian and Mexican cities
In Canada: Gardner-Denver Company (Canada) Ltd., 14 Curity Avenue, Toronto 16, Ontario
International: Gardner-Denver International Division 233 Broadway, New York 7, N.Y.
International Offices: Buenos Aires, Argentina; Artarmon, N.S.W. Australia; Brussels, Belgium; Rio de Janeiro, Brazil;
Santiago, Chile; Barranquilla, Colombia; Lima, Peru; Ndola, N. Rhodesia; Salisbury, S. Rhodesia; Johannesburg, Transvaal

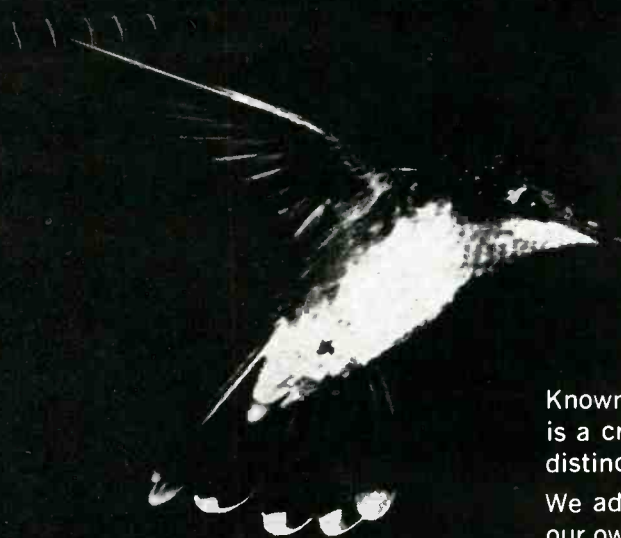

Known to rout hawks a hundred times his size, the hummingbird is a creature of courage. But when he takes this risk, it is with a distinct advantage. His powers of flight are matched by none.

We admire his style. And we share the philosophy. Knowing that our own capabilities are highly distinctive, we too believe that they are a thing to be used with boldness. Two years ago, Fairchild pioneered commercial production of diffused silicon Mesa transistors. They became the industry's most widely copied types. But we developed direct replacements — silicon PLANAR transistors (PLANAR diodes too were developed) — another step forward. Our newly introduced PLANAR EPITAXIAL devices and MICROLOGIC elements continue the progress.

We have many ambitious programs ahead. If you like our approach and have a relevant background, we would like to hear from you.



545 WHISMAN ROAD • MOUNTAIN VIEW, CALIFORNIA
A Division of Fairchild Camera and Instrument Corporation

To Contractors and Subcontractors
on U. S. Government Projects

Western Electric offers high reliability semiconductors from Laureldale

- Western Electric's Laureldale, Pennsylvania, plant is now in its ninth year of producing semiconductor devices of ultra-high quality and reliability for government applications.
- Devices designed by a resident Bell Telephone Laboratories group have performance standards exceeding specification requirements which are based on MIL-S-19500B.
- Mechanized production facilities and a comprehensive statistical quality control program assure uniformity and contribute to obtaining ultimate process capabilities.
- Reliability requirements specify 1000-hour elevated temperature life storage tests on all products shipped from Laureldale.

Typical High Reliability Laureldale Semiconductors:



2N559

Diffused Base Germanium p-n-p Mesa Transistor. For ultra-high reliability in large computer systems. Rise times of 1-2 nanoseconds and storage and fall times of 3-4 nanoseconds obtainable.

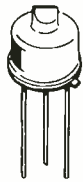

2N1195

Diffused Base Germanium p-n-p Mesa Transistor. Excellent for video or rf applications and as a non-saturating switch. 100 MC gain is ≥ 12 db. Alpha cut-off frequency is ~ 750 MC.

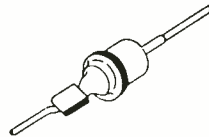
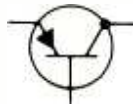

1N696

Diffused Silicon Junction Diode. Outstanding high-speed, low-capacity diode, with a maximum recovery time of 5 nanoseconds and a maximum capacitance of 4 picofarads.

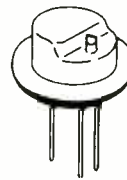

2N1645

Diffused Base Germanium p-n-p Mesa Power Transistor. This transistor is designed to provide 1 watt of power output at 100 megacycles with an efficiency of 50%.

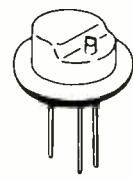

2N1072

Double Diffused Silicon n-p-n Mesa Transistor. This switches a current of 1 ampere with rise and fall times of 50 nanoseconds. The 2N1072 is an excellent core driver.



Western Electric and Bell Laboratories have an applications engineering group in residence at Laureldale. The codes shown above (and a complete range of other high reliability semiconductor devices) can be purchased in quantity from Western Electric's Laureldale plant. For technical information on these and other codes, please address your request to Mr. F. A. Mark, Regional Sales Manager, Room 102, Western Electric Company, Incorporated, Laureldale Plant, Laureldale, Pa. Telephone—Area Code 215—Walker 9-9411.



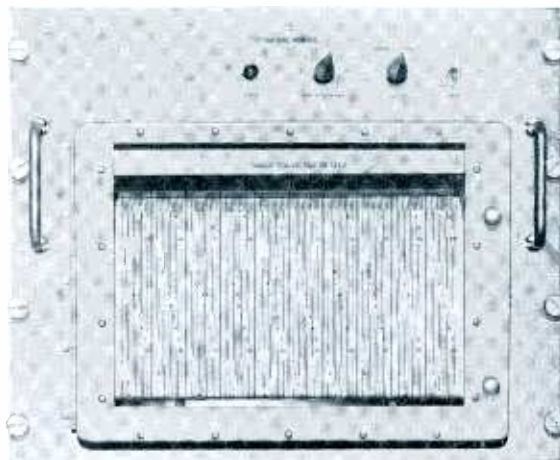
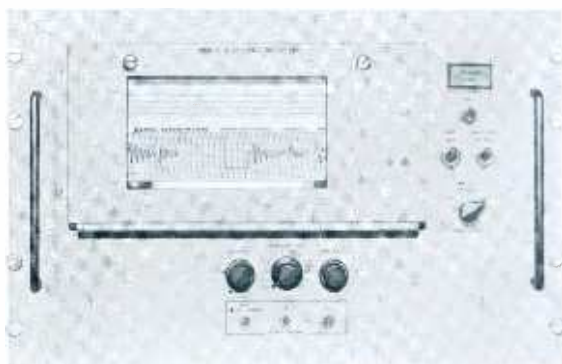

in direct writing recording systems

only **Brush**
designs

specifically for **mil specs**

From every nut and bolt to the shipping crate, fully militarized Brush Direct Writing Recording Systems are *originally* built to meet military specifications.

That's why they are performing every imaginable task of data acquisition and recording at U. S. and NATO installations throughout the world. These electric writing systems have proved their unexcelled reliability . . . from the Operations Monitor that will record 120 separate operations at the instant they occur . . . to the Analog and Sequence Recorder that simultaneously records both analog data and sequential events. And, they are built for maximum performance in the hands of non-technical personnel.

Brush equipment is already at work putting evaluation data in writing for a whole new generation of weapons. When the weapons become operational, Brush MIL Recorders are a vital part of the system. This experience is unique in the industry. *Before* prototype design becomes a problem—call, write or wire Brush for complete details.

brush INSTRUMENTS
DIVISION OF



Milestones in Engineering

Benjamin Franklin made history in 1752 when he established the fact that "lightning is electricity." He fastened sharp pointed wires at the angles of the frame of a silk kite and at the free end of a long cord tied to the kite he fastened an iron key. During a thunder storm, with the help of his son, he sent up the kite. When it reached the storm clouds the rain-wet cord stiffened—Franklin put his finger near the key and felt a distinct shock. Grabbing a Leyden jar he directed the current into the jar and stored it there. "Our proof is in that jar," he shouted.

Thus was sparked the way to further progress in the science of electrical engineering—a new era of electro-technics was born.

Today, North Electric continues such progress with many significant developments that make life more enjoyable and fruitful.



North Electric multi-contact multi-purpose connectors provide a maximum number of positive contact connections in a minimum of space. Designed for a wide range of electronic applications, they are available in multiples of 20 contacts and in a variety of mounting hardware. Moderately priced, yet designed for heavy duty, these connectors feature "Floating Action" pressure with a knife-edge male connection making positive 2 point contact in an angled bifurcated female. With locking bolt ("D" type) or with handle ("E" type). For detailed specifications on 20, 40, 60, 80, 100 pin sizes write...

ELECTRONETICS DIVISION

NORTH ELECTRIC COMPANY

147 S. MARKET ST., GALION, OHIO



JONES & LAMSON OPTICAL COMPARATORS

the man who needs
a new machine tool is
already paying for it

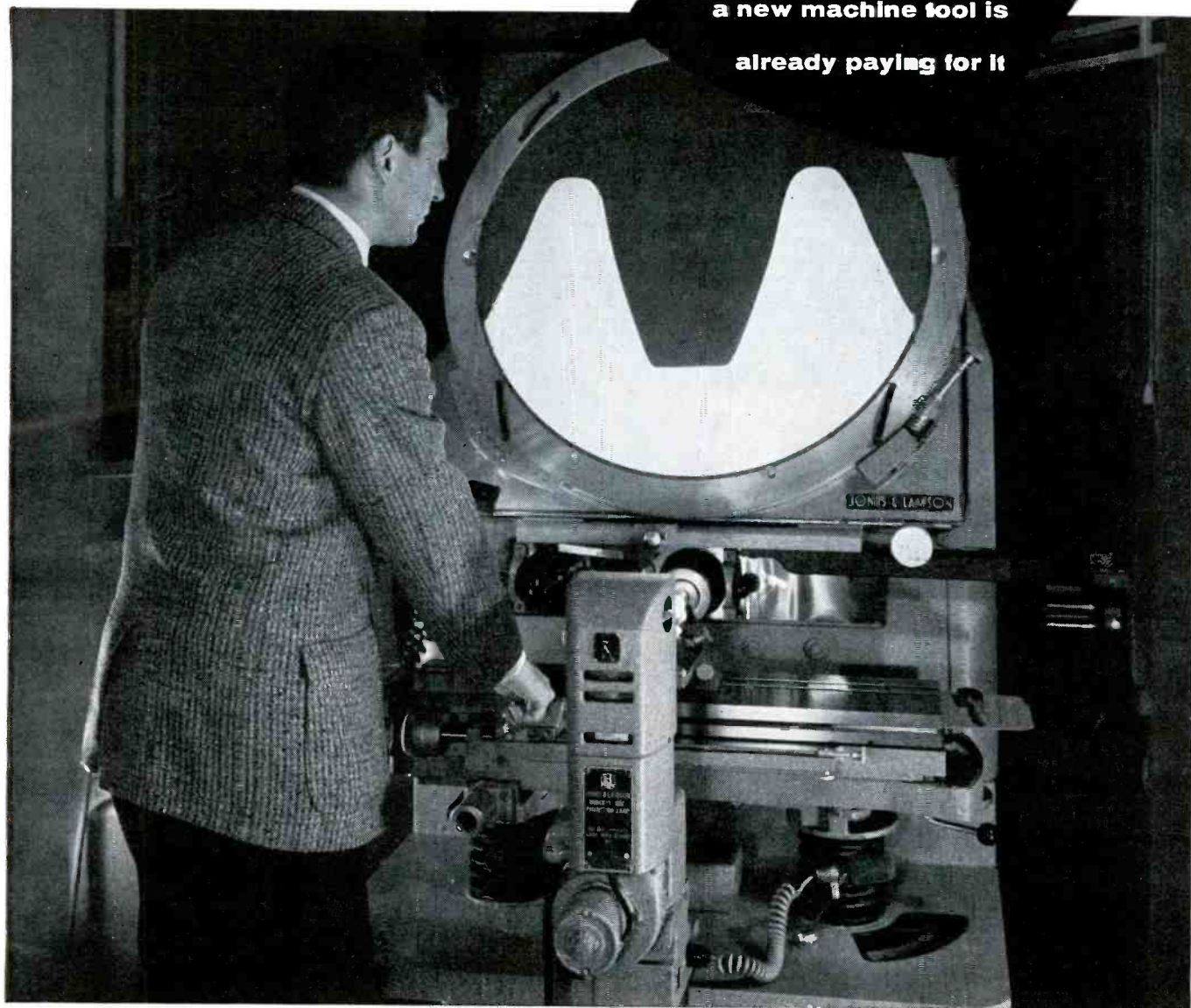

This revolutionary new light source makes optical inspection more efficient than ever

Jones & Lamson now offers the J & L Mercury Arc Lamp, an entirely new light source unit that gives *more than 5 times the intensity of the best filament light source available today.*

This new unit, designed for use with any J & L 14-inch or 30-inch screen Comparator, actually gives a *new* kind of light . . . an extremely bright, *steady* arc, with *no* flickering. Its high intensity produces an incomparably bright screen with razor-sharp black shadow, even at highest magnifications.

Thus, you can greatly increase the accuracy of your inspection and measuring with the J & L Comparator, even to the point of actu-

ally "splitting tenths". (For use at low magnifications, the light can be filtered readily.)

The J & L Mercury Arc Lamp comes as a complete, compact packaged unit, which plugs into any 110 volt outlet. It is quickly interchangeable with the standard light source of any Jones & Lamson 14-inch or 30-inch screen Comparator, and is a universal device which accommodates various standard makes of mercury arc lamps.

For detailed information and specifications, or a demonstration, contact your local J & L representative or write direct to Jones & Lamson Machine Company, 539 Clinton Street, Springfield, Vermont.

now

low-cost Tektronix Oscilloscopes with 5-inch CRT's
...require only 7 inches of standard rack height

Tektronix Type RM561

A new, rack-mount, laboratory oscilloscope—basically an Indicator which accepts a wide range of plug-in units in both channels—the Type RM561 offers the type and degree of performance demanded for particular applications in the dc-to-4 mc region.

Indicator Unit f.o.b. factory \$450.00
(without plug-in units—which range from \$50 for a basic amplifier to \$250 for the versatile dual-trace unit.)



Besides the 5-inch rectangular crt, other features of the Indicator Unit include: 3.5 KV accelerating potential, 8 cm by 10 cm viewing area, Z-axis input, 6 calibrated square-wave voltages from 1 mv to 100 volts (available at the front panel), regulated dc heater voltage thru separate regulator circuitry, regulated dc supply—which operates between 105 to 125 volts or 210 to 250 volts, 50-60 cycles to provide 85 watts of power for the plug-in units.

The plug-in units drive the crt deflection plates directly, house approximately 2/3 of the circuitry, contain minimum components and controls.

Eight plug-in units are presently available. These include two time-base units—one with 21 calibrated sweep rates from 1 μ sec/cm to 5 sec/cm, 5X magnifier, extremely adaptable triggering facilities, external input to sweep amplifier, 1 v/cm sensitivity—and also six signal-amplifier units. The signal-amplifier units range from basic units (with passband from dc to 400 kc at maximum sensitivity, sensitivity approximately 1 v/cm with attenuation provided by variable potentiometer at the input) to more complex units including those for differential-input, dual-trace, and wide-band applications.

In addition, plug-in units under development include those for pulse-sampling, four-trace work, high-gain measurements, strain-gage and other transducer applications.

You can even design your own circuitry into skeleton units available.

For a demonstration of either of these versatile low-cost rack-mount oscilloscopes, please call your Tektronix Field Engineer.

Tektronix Type RM503

A new, complete-unit, rack-mount oscilloscope, the Type RM503 features practically identical horizontal and vertical amplifiers, 21 calibrated sweeps, five degrees of sweep magnification, extremely adaptable triggering facilities.

A differential-input X-Y Oscilloscope, the Type RM503 ideally suits curve-plotting applications using the X-Y method of operation, as well as most other laboratory applications in the dc-to-450 kc region.

Type RM503 f.o.b. factory \$640



Vertical and Horizontal Amplifiers

Frequency Response—dc to 450 kc (at 3 db down).

Sensitivity—1 mv/cm to 20 v/cm in 14 calibrated steps, variable uncalibrated from 1 mv/cm to 50 v/cm.

Differential input and constant input impedance at all attenuator settings.

Sweep Range and Magnification

Linear Sweeps—1 μ sec/cm to 5 sec/cm in 21 calibrated rates, variable uncalibrated from 1 μ sec/cm to 12 sec/cm.

Sweep Magnification—2, 5, 10, 20, or 50 times.

Triggering Facilities

Fully automatic, recurrent, or amplitude-level selection on rising or falling slope of signal, with AC or DC coupling, internal, external, or line.

Tektronix Cathode-Ray Tube

5-inch crt at 3KV accelerating potential provides bright trace on 8 cm by 10 cm viewing area.

Amplitude Calibrator

500 mv and 5 mv peak-to-peak square-wave voltages available.

Regulated Power Supplies

All critical dc voltages—and the input-stage heaters of both amplifiers—are electronically regulated.



Tektronix, Inc. P. O. BOX 500 · BEAVERTON, OREGON / Mitchell 4-0161 · TWX—BEAV 311 · Cable: TEKTRONIX

TEKTRONIX FIELD OFFICES: Albuquerque, N. Mex. · Atlanta, Ga. · Baltimore (Towson) Md. · Boston (Lexington) Mass. · Buffalo, N.Y. · Chicago (Park Ridge) Ill. · Cleveland, Ohio · Dallas, Texas · Dayton, Ohio · Denver, Colo. · Detroit (Lathrup Village) Mich. · Endicott (Endwell) N.Y. · Greensboro, N.C. · Houston, Texas · Indianapolis, Ind. · Kansas City (Mission) Kan. · Los Angeles, Calif. Area (East Los Angeles, Encino, West Los Angeles) · Minneapolis, Minn. · Montreal, Quebec, Canada · New York City Area (Albertson, L.I., N.Y. · Stamford, Conn. · Union, N.J.) · Orlando, Fla. · Philadelphia, Pa. · Phoenix (Scottsdale) Ariz. · Poughkeepsie, N.Y. · San Diego, Calif. · San Francisco, Calif. Area (Lafayette, Palo Alto) · St. Petersburg, Fla. · Syracuse, N.Y. · Toronto (Willowdale) Ont., Canada · Washington, D.C. (Annandale, Va.).

TEKTRONIX ENGINEERING REPRESENTATIVES: Hawthorne Electronics, Portland, Oregon · Seattle, Washington. Tektronix is represented in twenty overseas countries by qualified engineering organizations. In Europe please contact Tektronix International A.G., Terrassenweg 1A, Zug, Switzerland, Phone (042) 4-91-92, for the address of the Tektronix Representative in your country.



For Printed Circuit Plug-In Modules

Smallest connector with 40 contacts in only $1\frac{1}{16}$ " molding. .050" center-to-center spacing of patented "Bellowform" contacts. Accept $\frac{1}{32}$ " printed circuit board or printed circuit cable.



For Rack & Panel Plug-In Modules

Ruggedized, micro-miniature plug and socket connector with 44 contacts in $1\frac{1}{2}$ " molding. Polarized guide pins and guide sockets or screwlock hardware assure positive mating. Also available in 5, 7, 9, 11, 14, 20, 26, 29 and 34 — contact sizes. .094" center-to-center spacing.

*New! from
Continental
Connector . . .
your choice of
micro-electronic
applications*

Continental Connector's development program on miniaturization includes production of connectors for printed circuitry and rack and panel applications. Two samples of this activity are illustrated here. However, others are available and in various stages of research and test. Contacts used in these connectors are spring temper phosphor bronze with gold plate over silver plate. Moldings are available in various materials including glass reinforced Diallyl Phthalate.

Complete technical specifications and outline drawings are available free on request. Write to Electronics Division, DeJur-Amsco Corporation, Northern Boulevard at 45th Street, Long Island City 1, N. Y. (exclusive sales agent) and ask for Forms MM22 and 600-2.

 **CONTINENTAL
CONNECTOR
CORPORATION**

AMERICA'S FASTEST GROWING LINE OF PRECISION CONNECTORS

150 mw
POWER DISSIPATION

MADT

NEW LINK
in Industry's Strongest Chain of Transistor Performance

PHILCO
2N2048
GERMANIUM
SWITCH

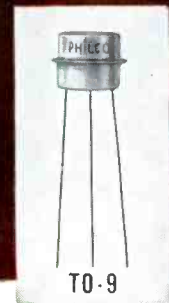

ABSOLUTE MAXIMUM RATINGS

Storage Temperature	-65 to +100°C
Collector Voltage, V_{CB}	-20 volts
Collector Voltage, V_{CES}	-20 volts
Collector Voltage, V_{CEO}	-15 volts
Collector Current, I_C	-100 ma
Total Device Dissipation @ 25°C	150 mw

ELECTRICAL CHARACTERISTICS (@ 25° C)

Characteristics	Conditions	Min.	Max.	
Collector Cutoff Current, I_{CBO}	$V_{CB} = -5v$		3	μa
DC Current Amplification Factor, h_{FE}	$V_{CE} = -0.5v$ $I_C = -50 ma$	35		
DC Current Amplification Factor, h_{FE}	$V_{CE} = -0.5v$ $I_C = -10 ma$	50	300	
Collector Saturation Voltage, $V_{CE(SAT)}$	$I_C = -10 ma$ $I_B = -0.5 ma$.050	0.140	volt
Base Input Voltage, V_{BE}	$I_C = -10 ma$ $I_B = -0.5 ma$	0.25	0.35	volt
Hole Storage Factor, K's	$I_B = -2.5 ma$		100	nsec
Gain Bandwidth Product, f_T	$V_{CE} = -10v$ $I_E = -6ma$	150		mc

Philco's new 2N2048 is the forerunner of a broad line of 150 mw MADT switching transistors. The new power dissipation capability is available in uniformly reliable high-speed units, at surprisingly low cost, via proven MADT automation.

Intended for both saturated and non-saturated logic circuits, the Philco 2N2048 gives you more than comparably priced transistors—more drive per transistor, more switching speed per dollar invested in transistors, and the extra capability of extra power dissipation for applications that require it.

Philco 2N2048 features include minimum h_{FE} of 50, maximum $V_{(SAT)}$ of 0.14V., minimum f_T of 150 mc., and tightly controlled V_{BE} ranging from 0.25V. minimum to 0.35V. maximum. For complete information write Dept. E-72161.

Immediately available in quantities 1-999 from your Philco Industrial Semiconductor Distributor

PHILCO



Famous for Quality the World Over

LANSDALE DIVISION, LANSDALE, PENNSYLVANIA



Poliomyelitis patient is linked by two plastic tubes to 56-lb transistorized Barnet Ventilator, built by W. Watson & Son in England. Number of respirations a minute, ratio of respiratory-to-expiratory times, and air volume entering and leaving lungs can be instantly and precisely adjusted

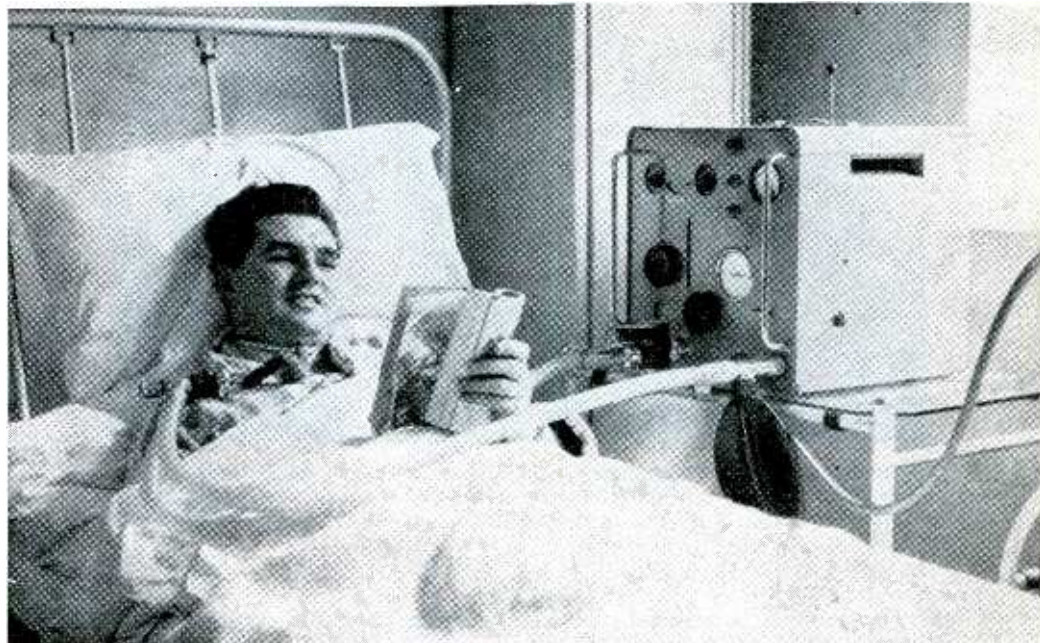

MEDICAL ELECTRONICS Part V: Prosthetics—Substitute Organs and Limbs

Electronic devices for helping the deaf to hear by touch and the blind to read by sound are described. Also discussed are aids to replace lost function of the larynx, heart, lungs, muscles and arms

By WILLIAM E. BUSHOR,
Associate Editor

IMPORTANT as hearing aids and blind guidance devices are (see Part IV) these do not represent the only approaches to making life more interesting and profitable for the deaf and blind. Two demonstrably practical ideas, which are discussed here, are hearing through the sense of touch and reading through the sense of hearing. Two other more blue-sky concepts, direct replacement of the eyes and ears by artificial devices, will be discussed in Part VI.

Hearing by Touch—Devices that apply vibrations to the skin to permit the deaf to hear by their sense of touch were developed by the Franklin Institute more than 30 years ago.¹ The difficulty with this approach was that it is not usually possible to distinguish between changes of frequency and changes of intensity, because the touch sense cannot perform frequency analysis.

Finer analysis is provided by a speech-interpretation system developed at the U. of Cape Town, Union of South Africa.² Here words spoken into a microphone are converted into tactile stimuli, which

are then applied to the fingers of one hand. The position of mechanical vibrators along the fingers indicates the frequency, thus direct frequency discrimination does not have to be made through the sense of touch.

A vibration on the thumb means a low frequency and on the little finger a high frequency; the other fingers are graduated accordingly. Differences between vowels, lengths of words, vowels and consonants, ascending and descending movement by liphthongs (sounds produced by combining two vowels into single syllable) and consonants of



By passing photoelectric stylus of Battelle Memorial Institute's reader along a line of print, blind subject is presented with aural representation of letter scanned. Subjects have learned to read at 15 words a minute⁷

various groups were also recognizable.

Rome Air Development Center researchers are working on a communications system using the hearing-by-touch principle. Here sound is converted into mechanical vibrations felt by placing a small plate on the skin. An area on the chest has been found most responsive. Ultimately, it is hoped to use this technique to channel information to a pilot when his hearing or sight has been impaired by injury or environmental conditions.

Reading Machines for the Blind—Although a blind person can have someone read to him or can listen to recorded versions of books, he much prefers to be self-reliant. Efforts to give him an all-important tool in obtaining that self reliance has resulted in the lengthy and somewhat tortuous development of electronic reading machines.

At present the blind can read in braille, but the books are bulky and content selection is limited—also, braille is difficult to learn as is attested to by the fact that only 30 percent of the blind now use it. Talking books (magnetic or disk recording of the spoken word) are even more limited in selection than braille.³

What is needed is a reading machine which can produce intelligible sounds from the printed page of the average book, magazine or typewritten page. That is, the device should use printed mate-

rials designed for sighted readers, not specially prepared material. Of course, the factor of cost, so critical throughout prosthetics, is important, as are portability (because reading is likely to take place anywhere), easy operation and low learning time. Also, the device must read rapidly; below 50 to 60 words a minute is inadequate, 100 words a minute is about the average minimum requirement and 200 words in minute is the desired rate.¹

Historically, many approaches have been tried (see the Table). Least expensive of these machines are those which leave the interpretation of embossed images, impulses or tones to the user. Unfortunately, this is most unsatisfactory since many blind people are unable to make the necessary interpretation.

Only modified versions of the Optophone and Visagraph have been carried to the advanced stage of engineering necessary for user tests. They exemplify the two principal approaches to the problem, both utilize ordinary printed materials prepared for sighted readers and both extract information (in instrument terms) by scanning the text with a photosensitive element. The information is presented to the user by sound (Optophone) and touch (Visagraph). Neither machine has been sufficiently useful to justify its adoption on a wide scale, nor have these machines been able to compete with their counterparts,

the talking book and braille, despite the fact that these are restricted to specially prepared materials.^{5, 6}

Artificial Larynx—Surgical removal of the larynx (voice box) or paralysis of the vocal cords has caused the loss of normal speaking ability of over 40,000 people in the U.S. Many of these people can learn esophageal speech—controlled vibration of tissues at the top of the esophagus produced by expelling swallowed air—but at least one third cannot learn to speak effectively in this way.

Last year, a transistorized artificial larynx developed by Bell Labs in cooperation with the National Hospital for Speech Disorders (N. Y. C.) and manufactured by Western Electric became available.^{8, 9, 10} The small hand-held unit consists of a modified telephone receiver used as a vibrating driver that is placed in contact with the throat, a transistorized pulse generating circuit and a mercury battery power supply. In operation, sound waves are transmitted through the throat wall into the larynx cavity, replacing those sound waves normally produced by air passing over the vocal cords. Words are formed with the lips and tongue just as in normal conversation.

A completely intra-oral artificial voice appliance has been outlined by R. V. Tait in England.¹¹

Externally Mounted Pacemakers—In addition to their use in surgery (Part III), artificial pacemakers are also carried by ambulatory patients with heart conditions. These devices serve to initiate cardiac beating in cases of arrest, that is, when the natural electrical stimulus which keeps the pumping in proper rhythm is not functioning correctly. In the natural pacemaking system, the beat rate of the pumping chambers of the heart (the right and left ventricle) is controlled by the receiving chambers (the right and left atrium). The electrical stimuli are generated at nodes, or dense networks of fibers in the conduction system of the heart. Interrelationship of the elements in the natural pacemaking system is shown in Fig. 1.

Nervous pathways regulating the heart rate terminate at the sino-auricular (SA) node. Contraction

HIGH POINTS IN DEVELOPMENT OF READING DEVICES FOR THE BLIND^{5,6}

- 1902—Photophonic books for blind devised. Transparenc square representing letter is scanned by opaque mask with apertures matching squares. Whenever aperture passes over square, light rays illuminating page are sensed by selenium cell behind mask. Electrical signal developed is converted into coded sounds designating printed letter.
- 1912—Exploring Optophone invented by Fournier d'Albe for reading white letters on black background. Light reflected from page falls onto one of two selenium cells connected to a Wheatstone bridge. A rotating disk with hole interrupts light beam periodically. This action generates a buzz tone in earphones whose character depends on letter scanned.
- 1915—Photopticon, similar to Optophone, invented by F. C. Brown. Two selenium cells scan letter image; one cell receives illuminations from upper part of letter, the other from lower part. These cells form arms of Wheatstone bridge, thus changes in light cause intensity variations of interrupted current fed to earphones.
- 1920—Optophone that could read black characters on white background developed by Barr, Stroud and d'Albe.
- 1921—Typophone developed. User listens to slow-playing phonograph records containing subject matter in Morse code form.
- 1924—Mertens firm in Germany devised machine using special symbols written with conductive ink. A moving mechanical finger scans the page; symbols are sensed when electrical contact is made with inked areas.
- 1926—Photoelectrograph invented by M. Thomas. Book on rolling carriage is moved under fixed scanning unit. Illuminated letter is projected on matrix of selenium cells each controlling the vertical position of a retractable stylus with an electromagnet. A group of these styli present a relief image of illuminated areas in book.
- 1928—Visagraph invented by R. E. Naumberg. Book is fixed in a mechanical holder, light projected on page and reflected to selenium cell connected to a buzzer. User draws stylus along guides directing spot of light across letter. Light and dark areas are distinguished by vibration or lack of it, respectively, in the stylus.
- 1930—More sensitive Optophone developed by R. S. Rosing. Device uses oscillatory circuits containing selenium cell as a circuit element.
- 1932—Patent issued to Snook for device that scans printed page by mechanical-optical means. (U.S. patent 1,889,576). Output of a photocell produces tactile stimulus by controlling solenoid-driven plungers.
- 1933—G. Schutkowski described machine that would recognize a scanned letter as one of the 26 letters to the alphabet by principle of optical congruence (German patent 570,403). Image of letter is projected on sheet of film carrying image of complete alphabet. When unknown letter coincides with its counterpart on the matrix, a minimum amount of light falls on the photosensitive cell causing relays to operate which either sounds the letter or picks out the corresponding type in a blind alphabet.
- 1936—Device similar to Photoelectrograph developed by E. Ranssen of Northern U.
- 1941—A. R. Sharples granted patent on system similar to Schutkowski's (U.S. patent 2,228,782).
- 1942—G. Ukovic of Germany develops device where intensity of incident light detected by optical probe varies frequency of tone in earpiece (German patent 717,223).
- 1943—W. O. Sell granted patent on device that focuses an image of an object placed in its field on a matrix array of photocells (U.S. patent 2,327,222). This photocell array controls a similar array of points that give electrical stimulation to the skin.
- 1946—Zworykin and Flory invent Optophone-type device in which small spot of light is manually caused to move up and down along vertical line corresponding to vertical scanning slit. In synchronism with motion of light spot, an audio oscillator is frequency modulated so that when the spot is at top of line the frequency is high and when at bottom it is low. Reflected light is detected by phototube driver amplifier that feeds earphone. Audible sound indicates number, size and position of black areas under scanning slit.
- 1947—Faximile Visagraph developed by Committee on Sensory Devices of National Research Council. This is essentially an updated version of original Naumberg device.
- 1949—Zworykin, Flory and Pike develop letter reading machine that recognizes and actually pronounces letters. Device divides line of type into number of horizontal bands each of which it explores with a spot of light. Reflected light from each band is converted to an electrical signal by a phototube. Counting circuits connected to the scanner count number of times each light spot encounters part of a letter. From this information, other circuits in the device recognize the letter or letters scanned and cause magnetic recordings of correct letter sounds to be played back to user.
- 1950—Davis and Hinton receive patent on method of using black of letter to control position of light pencil illuminating a motion-picture-type sound track. Photoelectric system converts sound track image into spoken letter.
- 1954—A. Rubbiani of Italy demonstrated tactile reader to E. Murphy of the Veterans Administration. Photozell scanning is done by a Nipkow disk. The electrical output controls solenoids that drive long wires which converge on a small area under a single finger tip.
- 1956—B. Henke of Pomona College develops improved Optophone. Rotating photographic tone disk modulates light passing through a slit into 11 to 15 channels. A comparison between white paper and printed material is made by balanced photosensitive elements. Several audio frequencies corresponding to successively higher positions on a letter are fed to earphones. Copy is mounted in ordinary typewriter which provides controlled alignment and movement past slit.
- 1956—Audiavis (simple optical probe device similar to Ukovic's) described by C. M. Witche of MIT.
- 1957—Frank of Franklin Institute invents tonal braille system. Separate tones associated with upper, middle and lower braille dots are generated. Combinations of tones are sounded for various braille letters.
- 1957—Autophone patented by S. Pantages and E. N. Pantazis (U.S. patent 2,817,706). System is related to Frank's but uses specially prepared punched material.
- 1958—C. M. Surber gets patent on optical-to-tactile system (U.S. patent 2,866,279). Printed material is scanned by a matrix consisting of 30 channels each consisting of a photocell, relay and pin. Device produces tactile raised-pin presentation.
- 1959—H. A. Mauch gets patent on system that scans an entire letter, integrates the information obtained at each of five levels, and produces a single complex sound (U.S. patent 2,907,833). Single element sound per letter avoids three sounds produced on Optophone as beginning, middle and end of letter is passed.
- 1959—Battelle Memorial Institute develops aural reading device of the Optophone type. This device uses 11 frequency channels, spanning a vertical section of a letter from bottom to top with 11 tones. Probe is rolled along lines of type with help of mechanical tracking device.⁷
- 1961—Moon (U. of Chicago) suggests optical-to-tactile transducer. Photozell and tactile stimulator are mounted on same finger which, as they pass over black marks on page, generate tactile sensation

of the heart commences when the SA node sends an electrical impulse to the right and then the left atrium. Eventually this pulse triggers the atrioventricular (AV) node which spreads the charge to the ventricle system (by way of a slender group of fibers called the Bundle of His) triggering the idioventricular (IV) pacemaker.¹²

If normal conduction between the atrium and ventricle is disrupted, a condition known as heart block occurs. Since SA stimuli are missing, the ventricle will contract at its own intrinsic, fixed and much slower rate. The pulse rate can now fall as low as 22 to 30 pulses a minute causing fainting or convulsions from poor circulation of blood in the brain. Sometimes the heart stops beating entirely (Strokes-Adams seizure) and the victim blacks out, has convulsions and goes into a coma. Temporary or permanent heartblock can also be caused by accidentally severing the Bundle of His during surgery, by

arteriosclerosis, by infection or by drug administration.

There are two general types of externally carried artificial pacemaker; the external stimulator in which impulses are applied between two electrodes placed on the outside of the body, and the internal stimulator in which the electrode is brought into direct contact with the heart.

In external pacemakers, the stimulating electrodes are placed over the chest wall and deliver electric impulses with currents from 50 to 200 ma and voltages from 20 to 100 v. In internal pacemakers, the stimulating wire is directly attached to the heart muscle. Advantages of the internal over the external pacemaker are that it is effective with smaller currents, does not entail contractions of chest muscles, does not produce pain or local skin burns and, because of its small size, can be carried.

Medtronic's transistorized Cardiac Pacemaker is designed for in-

ternal applications with at least one wire attached directly to the myocardium (muscular tissue of the heart) for temporary stimulation or with a bipolar patch for prolonged stimulation.¹³ Shaped like an oversized package of cigarettes and weighing 10 ounces, the unit uses a self-contained 9.4-v mercury battery having a flat voltage discharge curve so that for a given setting the pacemaker stimulation is relatively constant for the 1,000-hour battery life. It is normally carried on the belt or in a shoulder holster.

A neon flasher on the Cardiac Pacemaker indicates the frequency of the stimulating pulse, which can be varied from 60 to 180 pulses a minute. The output is a 2-millisecond square wave current pulse that is variable in amplitude from 1 to 20 ma when applied to a 1,000-ohm load. This is enough current to cause stimulation without triggering the ventricles into fibrillation (independent beating of heart



Electronic larynx developed by Bell Labs weighs only seven ounces, closely resembles a modern electric shaver. Power is supplied by Mallory 5.4-v mercury batteries

without rhythm).

Braided tantalum or stainless steel electrodes insulated with Teflon are implanted in the ventricular myocardium. This wire is connected to the negative pole of the pacemaker. A flat metallic electrode is inserted into the subcutaneous tissue of the chest wall and connected to the indifferent pole of the pacemaker.

An alternative method which is frequently used is to apply two electrodes to the myocardium and stimulate the ventricle in bipolar fashion. Bipolar stimulation appears to have the advantage that the ventricles are slightly more responsive to it than to unipolar stimulation. Recently a bipolar electrode with terminals 5 mm apart and imbedded in silastic silicone rubber mold has been developed for Medtronic's pacemaker by the Research Laboratory of St. Joseph's Hospital in St. Paul, Minn." This configuration is advantageous for long term stimulation because only a single small wire need emerge through the chest wall. Another technique of placing the electrode is to insert a braided wire through a vein in the neck and into the heart. (See cutaway photo of heart.)

A companion unit, the Cardiac Monitor, can be inserted into the same circuit with Medtronic's Cardiac Pacer to activate the pacer

maker automatically should the patient's rate suddenly fall below a predetermined level. It also contains an audio alarm.

Atronic's pacer, developed in close cooperation with the Philadelphia General Hospital, is attached to the heart by a wire inserted in the jugular vein in the neck and running through the vein to the lower right chamber of the heart.¹⁵ The ground electrode is imbedded in the skin of the chest over the heart. By using the jugular vein insertion method, the piercing of the heart muscle is eliminated as are the occasional complications that result, that is, hemorrhage, fibrosis and infection. Such electrodes can be maintained in position with effective cardiac stimulation for many weeks, even in the ambulatory patient. Wire electrodes are sewn directly to heart for long periods of use. Also a special spinal needle can be used to pierce the intact chest wall and the wire electrode inserted through it into the myocardium.

The instrument, which is the size of a small book and weighs less than two pounds, is a combination simplified PQRS polarity and wave rate monitor, impedance meter and artificial pacemaker. It can be used for monitoring and internally stimulating cardiac activity in the event of an emergency or as a precautionary measure during an operation.

Pulses produced are 2.5 millisecond long, current is continuously variable from 0 to 24 ma when applied to impedances ranging from 50 to 1,500 ohms. Pulse rate is continuously variable from 25 to 120 pulses per minute.

In event of heart failure, electrical signals can be started instantaneously to stimulate the heart back to its normal beat. Batteries provide an independent source of power with an expected life of 120 days. An audio output jack provides audible stimulate and monitor signals for use with external earphones or accessory amplifier and loudspeaker.

Westinghouse is marketing a transistorized Cardiac Resuscitation System consisting of a cardiac pacer and a bedside monitoring unit. Although it also generates periodic electrical stimuli, this system will respond to indications of

heart arrest by switching the pacer on and by signalling an alert to the doctor via radio. The self-powered pacer, which weighs two pounds, generates voltages adjustable over a 0 to 25 volt range at an output current of 0.1 amperes and a pulse rate of 25 to 250 beats a minute.

Two disks are clamped to patient's chest at critical points. Electrodes from the pacer are plugged into the disks. The pacer is self-powered by mercury batteries so that it can be used in places where electrical outlets are not available. A small bright lamp that flashes in synchronism with pulse rate also serves as a performance guide.

The cardiac monitor listens to patient's heart beat and switches on the pacer immediately if the heart beat becomes irregular or stops. Built into the monitor is a tiny radio transmitter that broadcasts a coded alarm signal on the Citizens' Band (27 Mc) over a distance of 2½ miles. The alarm signal can be picked up by a special receiver, about the size of a cigarette package, carried in the doctor's or attendant's pocket. The doctor then tunes the patient in and listens to his heart beat, prescribing emergency treatment as necessary.

Russian workers at the Moscow Surgical Instrumentation Research Institute have developed what they call an electric cardiostimulator. The device, described as compact, foolproof and simple to operate, has a pulse repetition frequency that can be adjusted from 20 to 200 pulses a minute. Electrodes can be applied either directly to the heart or sunk into the pericardium, a closed sac enveloping the heart. It is claimed the electrodes, which can be left in the body for years if necessary, can be introduced into the heart within 20 or 30 seconds in an emergency. Presumably the patient suffering from heart block can press the button on the pocket sized pacemaker at any moment and stimulate his heart at will.

Implanted Pacemakers—Artificial pacemakers that are connected to the heart by means of wire connections through the skin always present the danger of infection, as well as being an impediment to mobility. These problems are overcome by implanting the artificial

pacemaker within the chest cavity. Although not yet developed to the point where they can be used routinely, many implantable artificial pacemakers have been built which are practical. It may only be a matter of a few years before they're in widespread use.

Doctors at the University of Buffalo School of Medicine and the Buffalo VA Hospital together with Wilson Greatbatch Electronics Consultants in Clarence, N. Y. have developed a miniaturized, implantable cardiac pacemaker for long term correction of heart block.^{16, 17, 18} Recently Medtronics has been licensed to make and market the device (see Crosstalk, p 4).

The pacemaker, which measures 6 x 9 x 2 cm including battery, uses only nine components and has an estimate life of 50,000 hours—or more than 5 years. By potting the unit in epoxy resin and then encapsulating it in silicon rubber, satisfactory biological neutralism can be attained. A bipolar electrode is used because unpleasant side effects from monopolar electrodes due to rise in threshold currents with time have been observed. Fixed stimulation rates are between 50 and 60 pulses a minute, the simplicity of device far outweighing the loss of adjustability of rate.

When batteries near the end of their capacity, warning is given by a very slow rise in the pulse rate. The pacemaker is then replaced by a simple operation under local anesthesia without disturbing the electrode in the heart. This device has been tested for more than two years by the Experimental Surgical Lab of the VA Hospital in Buffalo.

An implanted pacemaker which

uses a receiver-coil arrangement to receive radio waves transmitted through the skin externally has been developed by Glenn and Mauro.¹⁹ The signal is rectified and the stimulus applied to an electrode in the myocardium. This technique permits the rate and amplitude of the stimulating signal to be controlled externally.

A similar device, which is implanted in the stomach area just below the breastbone, has been built by Swedish workers.²⁰ They use a transistorized pulse generator, powered by rechargeable nickle-cadmium cells to produce stimulating pulses at a rate of 80 a minute. A blocking oscillator and amplifier combination generates two-volt pulses of $\frac{1}{2}$ microsecond duration which are R-C coupled to the stimulating electrodes. Every few days the batteries are recharged using the magnetic induction technique.

Researchers at Boston's Beth Israel Hospital have also developed an implantable pacemaker. Highly stable silicon transistors are used together with special mercury batteries with a shelf life of five years. As the batteries run down, the pulse rate of the patient slowly decreases and surgery is required to replace the batteries.

Last March, GE's Electronics Laboratory in cooperation with Dr. Kantrowitz of Miamonides Hospital in Brooklyn surgically implanted their first internal pacemaker (see cover). External control of pulse rate was provided to permit temporary increase in pulse rate for occasions when the patient is engaged in strenuous activities. Completely self-contained, the pacemaker uses simple circuits with high-reliability solid-state devices as active compo-

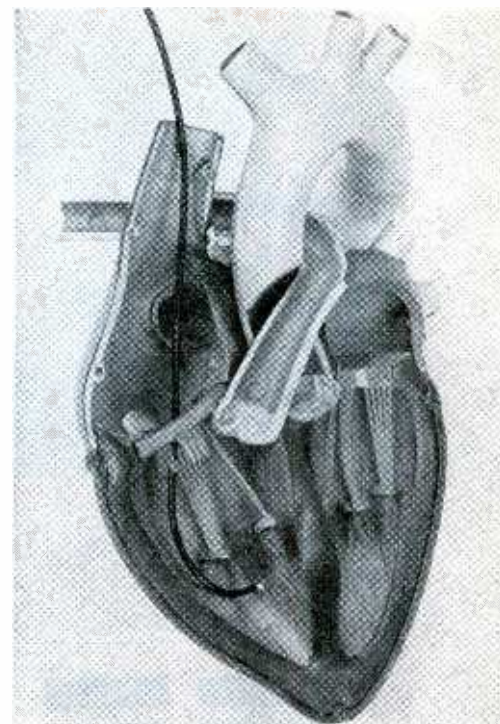

Thin, stainless steel wire covered with plastic links externally carried pacemaker to heart. Necessary flexibility and strength has been built into braided wire by National Standard Co. for the United States Catheter & Instrument Corp.

nents and batteries with lives of three to five years.

Regular pulse rate is set at 65 beats a minute. The rate can be increased by use of a second unit containing a calibrated potentiometer that can be set anywhere from 70 to 125 pulses a minute. This output signal is inductively coupled to the pacemaker by a flat circular antenna which is placed over the implant area.

Respirators—In recent years artificial respirators have kept patients alive who would have been doomed to certain death but a quarter of a century ago. These devices provide or assist in providing proper venti-

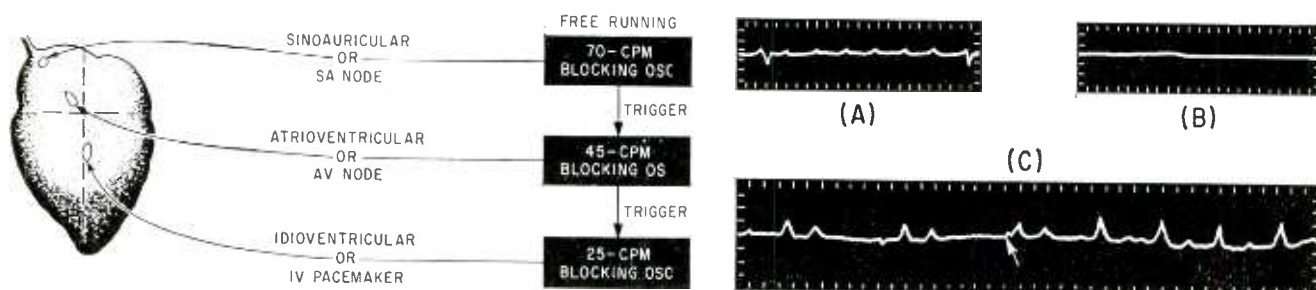
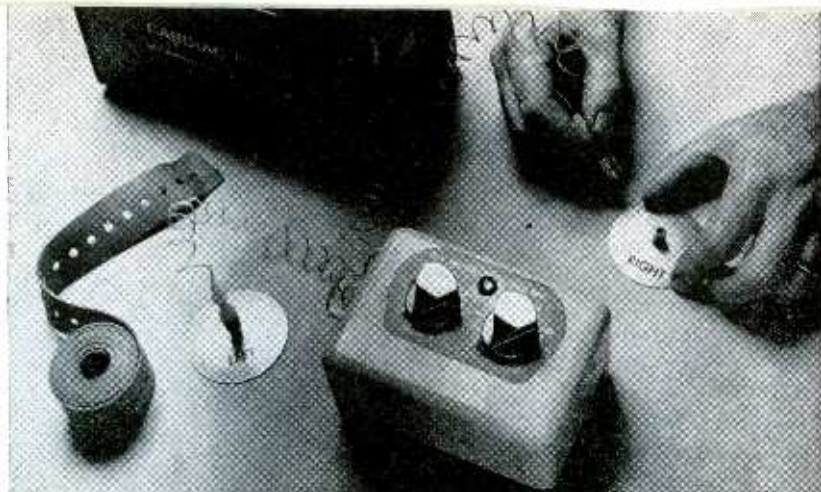

FIG. 1—Electrical analog of natural pacemaker (left) shows that all blocking oscillators are locked to 70-cpm SA node. If SA signal is lost, AV node becomes free-running at 45-cpm as does the IV pacemaker. If SA and AV signals are lost, the IV pacemaker drives the ventricle at its 25-cpm free running rate. Electrocardiograms of patient under treatment (right) shows initial condition of only 20 heart beats a minute (A), complete heart block during Stokes-Adams seizure lasting 2½ minutes (B) and, with Medtronic's pacemaker attached, normal heart rate of 80 beats a minute restored at point shown by arrow (C)



Electrodes from Westinghouse's cardiac pacer are being fitted into disks which will then be clamped to patient's chest with band on left. Pulses generated by unit cause heart to beat at any selected rate from 25 to 250 times a minute

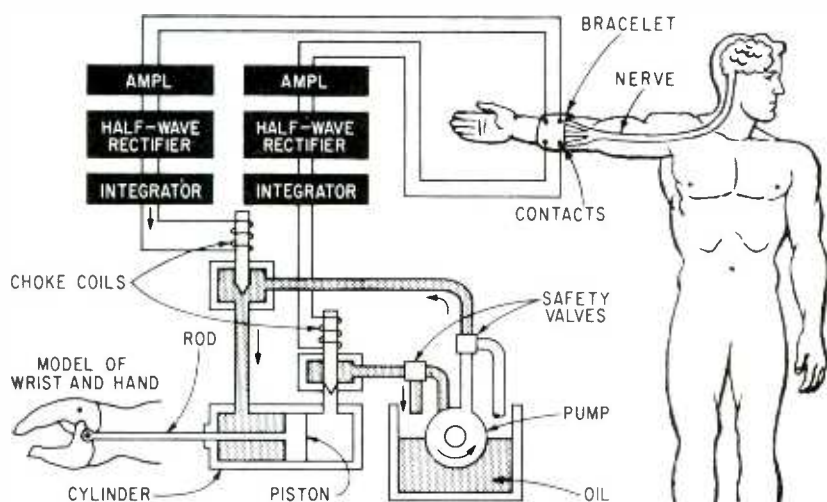

FIG. 2—Experimental model of a Russian artificial hand. A practical prosthetic device using this principle of operation would be worn on remaining portion of injured arm. Device would be operated by biocurrents coming from the central nervous system through the leftover part of severed muscles. Instead of hydraulic pump, compressed air from containers carried on the belt would serve as mechanical drivers

lation on an emergency or short term, prolonged recovery or maintenance basis.

Three types of artificial respiration can be applied: pressure changes exerted primarily on the chest wall, abdomen or diaphragm; pressure changes through the airway; and electrical stimulation of the phrenic nerve in the diaphragm through an electrode in the neck. The later method has limited use because of the extremely unpleasant sensations experienced by the patient.²¹ Rocking bed, jacket and cabinet (iron lung) respirators are used to produce chest wall, abdomen or diaphragm pressure changes and have been controlled electronically to varying degrees. From the point of view of electronics the most important, however, is the intermittent positive pressure respirators

in which machine or ambient air is introduced to the lungs through the air passage. The object of this type of ventilation is rhythmical movement of gases into and out of the lungs at adequate volume and optimum velocity to supply required oxygen and remove the necessary amount of carbon dioxide.

The Barnet Ventilator, built by W. Watson and Sons, Ltd, a member of the Pye Instrument Group in England, uses transistorized circuits, built-in batteries capable of 20 hours of operation without recharging, and weighs only 56 lbs.²² The patient is connected to the device by two plastic breathing tubes. Air is pumped into the lungs during the positive phase and extracted during the negative. The number of respirations a minute, the ratio of inspiratory to expiratory time

and the volume of air entering and leaving the lungs can be instantly and precisely adjusted within physiological limits.

Addition of an electronic triggering device subject to any dominant rhythm between 12-60 respirations a minute increases the scope of the machine. This feature permits it to be used when spontaneous respiration is desired or on the conscious patient where he can control its operation at will. By setting the multivibrator to the longest expiratory period, the patient can trigger the machine continuously and weak inspiration efforts can be assisted. The device is readily portable and operable from the power line.

The Pneumotrom, built by British Oxygen Gases, Ltd., incorporates two switch-selected circuits. One is a patient-demand circuit which provides assisted respiration for the patient who can make a slight attempt at inspiration and is synchronized with patient's rate of breathing. The other is automatic, giving forced respiration to the near moribund patient and permits ventilation of a severely paralyzed patient over long periods without constant attention.²³

Artificial Muscles—Replacement of nonfunctioning muscles with mechanical devices controlled by amplified muscle potentials has been investigated at Vanderbilt U.²⁴ Although originally developed to assist respiration of polio patients²⁵ the technique is now being used experimentally to operate artificial hands and arms. Electrodes in the arm pick up the muscle potentials. After amplification, these signals operate an electromagnetic valve that controls the flow of compressed gas from a cylinder. The gas pressure pulse thus created activates a mechanical muscle consisting of a woven sleeve of fine steel wires. As the gas pressure increases, the sleeve expands in diameter. When the weave angle of the wires changes, the sleeve contracts longitudinally operating a mechanical brace system.

A lightweight electronic muscle has been developed by Theratron Corp. This commercially available device is battery-operated, weighs less than eight ounces, and is worn

either on the belt or strapped to the upper leg. Reportedly it can be used in place of a lower leg brace by electronically activating muscles rendered useless by disease or injury.

The Engineering Design Center at Case Institute of Technology is developing a minute wireless unit that is implanted in a muscle and which may ultimately supplant the present wired techniques of measuring muscle potentials. This micro-miniaturized f-m unit (employing tunnel diodes) transmits radio signals indicating muscle behavior to a conveniently located receiver, from inches to a few hundred feet away. Initially, the device will be implanted in animal muscle tissue and tested over a long period of time. Necessary power will be produced by the muscle itself or supplied from an external radio source. It is hoped signals broadcast from transmitters implanted in selected muscles near a lost member can be used to operate an artificial limb.

A similar electronic receiver is being developed by the Center to actuate a muscle which has lost its nervous connection to the brain. A computer memory will be used to supply signals similar to those provided by the brain.

Artificial Arms — Unfortunately, two mutually exclusive requirements for developing natural functioning of an artificial arm exist — there should be as many non-patient powered motions as possible

and yet the manipulation and control must be kept simple. Less tangible but no less important are the human engineering factors of the patient's physiological, psychological and social problems.

The first real attempt to develop an electric arm was by IBM in 1945. Previous attempts resulted only in the development of crude electromagnetic hands.²⁶ These arms were not too successful because of excessive concentration and mental strain of the patient, frequent control error and robotlike quality of motion.

Researchers at the Engineering Design Center at Case Institute of Technology are working on an artificial arm that can be controlled by a tape recorder to perform specific functions such as eating. Amounts of movement required by a normal arm to perform the act are first measured and then recorded on magnetic tape. When played back, an artificial arm is caused to reproduce the original motions. The patient will also be able to operate a small feedback control that will permit him to move the artificial hand at will in any direction during or after arm movement.

The Russians claim they have a device capable of operating an artificial hand by thought control. Theoretically, this fantastic system was created in 1957 at the Central Scientific Research Institute for Prosthetics in Moscow.²⁷ The system operates by strapping a metal

bracket on the arm as shown in Fig. 2. When the subject wills the hand to close, it supposedly does.

The system consists of a strap with four electrodes, an electronic device to amplify and transform potentials to a form suitable for operation and a mechanism to execute the commands. The bracelet contains four small metallic-cup electrodes filled with a current conducting jelly. The cups are connected by wires to an amplifier from which the amplified biopotentials are fed to two half-wave rectifiers. The rectified outputs enter an integrator whose output intensity is approximately proportional to the value of the power of the bio-currents. This output signal is applied to coils of electromagnetics controlling the choking coils in a hydraulic drive system.

Cavities on each side of the piston are fed, through separate channels controlled by the choke coils, by a pump. Transmission of liquid through each channel is controlled by one of two muscles in the subject's arm. Movement of the piston from side to side causes the hand to open and close.

Efforts to produce hands with a sense of touch are underway at the Institute. It is hoped the subject can be given a sensation of temperature, hardness and condition of the surface of a compressible object. Russians also hope to produce arms capable of moving at the shoulder and elbow joints by dint of will power.

REFERENCES

- (1) Hearing Through the Sense Organs of Touch and Vibrations, *J. Franklin Inst.*, 204, p 329, 1927.
- (2) R. W. Guelke and R. M. J. Huyssen, Development of Apparatus for the Analysis of Sound by the Sense of Touch, *J. Acous Soc Am.*, 31, June 1959.
- (3) W. Blum, Current Efforts to Design Reading Machines, *Meet of World Council for the Welfare of the Blind*, Paris, France, August 4, 1954.
- (4) Summary of Fourth Technical Session on Reading Machines for the Blind, Veterans Administration, Washington, D. C., Aug 23 and 24, 1956.
- (5) P. A. Zahl, "Blindness—Modern Approaches to the Unseen Environment," Princeton University Press, Princeton, N. J., 1959.
- (6) H. Freiberger and E. F. Murphy, Reading Machines for the Blind, *IRE Trans PGHP, HPE-2*, No. 1, Mar 1961.
- (7) J. S. Abma and R. S. Laymon, The Development and Evaluation of an Aural Reading Device for the Blind, *paper presented at 67th Ann Conv of Am Psycho Assoc*
- (8) Barney, H. L., Unitary Transistorized Artificial Larynx, *1959 IRE Conv Rec, Part 8*, p 26, Aug 18-21, 1959.
- (9) Barney, H. L., F. E. Haworth and H. K. Dunn, An Experimental Transistorized Artificial Larynx, *The Bell System J.*, 38, p 1337, Nov. 1959.
- (10) F. E. Haworth, An Electronic Artificial Larynx, *Bell Laboratories Rec.*, p 362, Oct. 1960.
- (11) Tait, R. V., Artificial-Voice Appliances for Medical Use, *Third Int Conf on Med Electronics*, July, 1960.
- (12) D. G. Kilpatrick and S. Bellet, Cardiac Pacing/Stimulation by Very Portable Equipment, *1959 IRE Conv Rec.*, March 1959.
- (13) C. W. Lillehei, et al, Transistor Pacemaker for Treatment of Complete Atrioventricular Disassociation, *J Am Med Assoc.* 1172, p 2006, April 30, 1960.
- (14) S. W. Hunter, et al, The Clinical Use of a Permanently Implanted Bipolar Myocardial Electrode for Complete Heart Block, *Min Med*, p 16, Jan., 1961.
- (15) S. Bellet, O. F. Muller, A. C. deLeon, Jr., L. S. Sher, W. M. Lemmon and D. G. Kilpatrick, The Use of an Internal Pacemaker in the Treatment of Cardiac Arrest and Slow Heart Rates, *AMA Arch of Int Med.*, 105, p 361, March, 1960.
- (16) W. Greatbatch and W. M. Chardack, A Miniaturized and Subcutaneously Implantable Cardiac Pacemaker for Long Term Correction of Heart Block, *Dig of Tech Papers, 13th Ann Conf on Elect Tech in Med and Bio.*, Oct.-Nov., 1960.
- (17) W. Greatbatch, W. M. Chardack and A. A. Gage, A Transistorized, Implantable Cardiac Pacemaker, *IRE Int Conv Rec.*, 8, Part 9, p 107, Mar., 1960.
- (18) W. M. Chardack, A. A. Gage and Wilson Greatbatch, A Transistorized, Self-Contained, Implantable Pacemaker for the Long-term Correction of Complete Heart Block, *Surgery*, 48, p 643, Oct., 1960.
- (19) W. W. L. Glenn, A. Mauro, E. Longo, P. H. Lavietes and F. Mackay, Remote Stimulation of the Heart by Radiofrequency Transmission, *New Eng J. Med.*, 261, p 948, 1959.
- (20) A. Semming, Discussion of paper by Stephenson, *J. Thoracic Surg.*, 38, p 639, 1959.
- (21) J. R. Rockford, Artificial Respiration, *Gen Anaesth.*, 2, p. 79.
- (22) J. Rockford, R. F. Welsh and D. P. Winks, A Electronic Time Cycled Respirator, *Brit J. Anaesth.*, 30, p 23, 1958.
- (23) M. Garbe, "Medical Electrical Equipment," Section 17, p 218, Philosophical Library, Inc, New York, 1958.
- (24) L. H. Montgomery and S. E. Stephenson, Muscle Potential Amplifiers and Their Application to Supportive Procedures, *Second Int Conf on Med Electronics*, 1959.
- (25) L. H. Montgomery, Muscles Control Iron-Lung Operation, *ELECTRONICS*, p 180, July 1, 1957.
- (26) P. E. Klopstey, P. D. Wilson, et al, "Human Limbs and Their Substitutes," McGraw-Hill Book Co., N. Y., 1954.
- (27) M. Breydo and V. Gurfinkel, Machine is Operated by Thought, *Tekhnika Molodchshi*, April, 1958.

Delivering Megawatt R-F Pulses

Generator operating from 16 Mc to 24 Mc delivers pulsed power

By HOMER M. HILL, JR.,

Plasma Physics Lab.,
Princeton University, Princeton, N. J.

HIGH POWER r-f equipment is used to heat ionized plasma. The equipment described here produces long pulse power of over 1 megawatt without the complexities and expense of large high-voltage and high-current pulsing components ordinarily used.

Presently, experiments in controlled thermonuclear reactions are taking place at several places in the U.S. A portion of this basic research is devoted to the Stellarator approach at Princeton University at the Plasma Physics Lab of the James Forrestal Research Center.

The Stellarator consists of a gas-

filled nonmagnetic tube of race-track or figure eight configuration plus accessories to ionize, confine and heat the gas. The gas presently used is either helium or deuterium and is injected into the Stellarator after the tube has been evacuated to an extremely low base pressure. The problems are confinement and heating. Confinement is accomplished by a longitudinal magnetic field, while heating has been attempted by a variety of methods.

These heating methods may be divided into two general types. One is electron heating, the other, ion heating. In electron heating, an accelerating field passes a current through the plasma. The ion temperature is raised by collisions. The method is limited by the decreasing value of plasma resistance as temperature increases.

Ion heating has been done by magnetic pumping in which the confining field is modulated at a low r-f rate and by resonant heating, which involves exciting the plasma at a rate close to the ion cyclotron resonance frequency. In this experimental work, the latter method has produced the highest ion temperature—above 100 ev.¹

This article describes equipment designed and built for resonant heating on the B66 Stellarator at Princeton.

The ion cyclotron resonance frequency for fully ionized atoms is

$$f_o = \frac{ZeB}{2\pi m_i} = 1.52 \times 10^7 \frac{Z}{A} B$$

where Z is the atomic number, e is 1.60×10^{-19} coulomb, B is the magnetic field in webers per sq meter, A is the atomic mass number, m_i is the ion mass in Kg.

For deuterium Z/A is approximately 1/2, and if B is expressed in kilogauss the resonance frequency in Mc is close to $\frac{1}{2} B$.

The confining field on the B-66 Stellarator ranges from 22 kilogauss to 32 kilogauss. This determines an r-f range for ion cyclotron resonance as 16 Mc to 24 Mc.

The field is constant over a four-millisecond portion of the confining field pulse. The constant period starts after a rise-time of approximately twelve milliseconds. The resonance heating must take place during this 4-msec interval. The Stellarator may be pulsed at a maximum rate of one pulse per minute at maximum confining field, and more rapidly as the confining field is decreased.

The r-f electromagnetic energy is coupled into the Stellarator by a water-cooled work coil surrounding a glass portion of the Stellarator tube. A tapped capacitance network tunes the coil to resonance.

Since a large r-f magnetic field must be generated, the current through the coil must be large and the inductance as low as feasible. Otherwise, intolerably high r-f voltages are required. The stray inductance must be kept low if a reasonable portion of the available volt-amperes is to be used at the work coil. In the B-66 installation the coil inductance is approximately $0.4 \mu\text{h}$ and the stray inductance is about $0.1 \mu\text{h}$. Thus voltages of the order of 50 Kv must be generated, only 80 percent of which appears across the work coil. The coil v-a are thus only 64 percent of that available from the source.

Loading effect of the plasma is variable with time and with machine parameters such as gas pressure, confining field strength and impurity level. Thus, it is necessary to provide an adjustable impedance matching network between the coil and the generator. The tapped capacitance network of Fig. 1A is used. The capacitors are vacuum variable types. This network matches the input to a 50-ohm source over a relatively large range of frequency and loaded Q of the work coil.

The capacitors are mounted in a cylindrical silver-plated brass container over the work coil section of the Stellarator. The enclosure and the coil section are pressurized

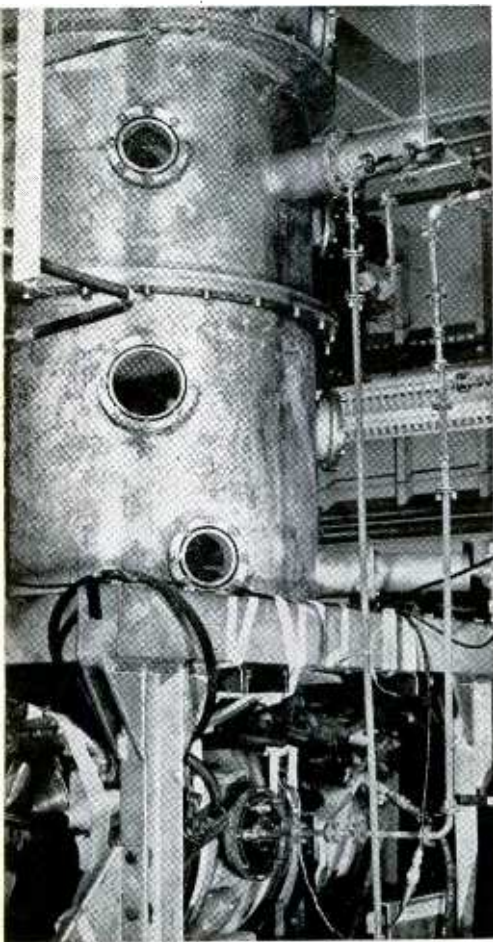

Matching network enclosure and Stellarator work coil section

For Resonant Heating of Plasma

that provides resonant heating of plasma in a Stellarator

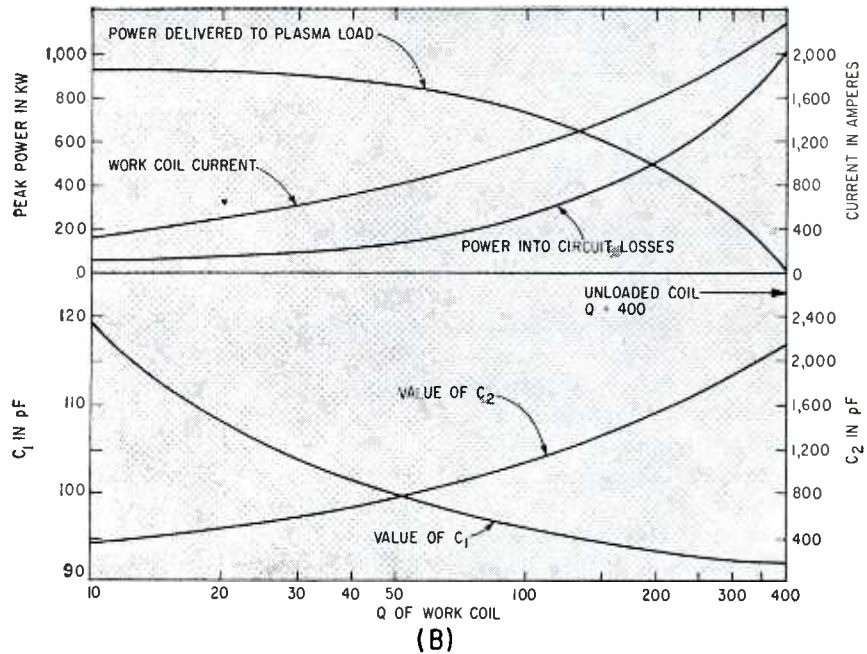
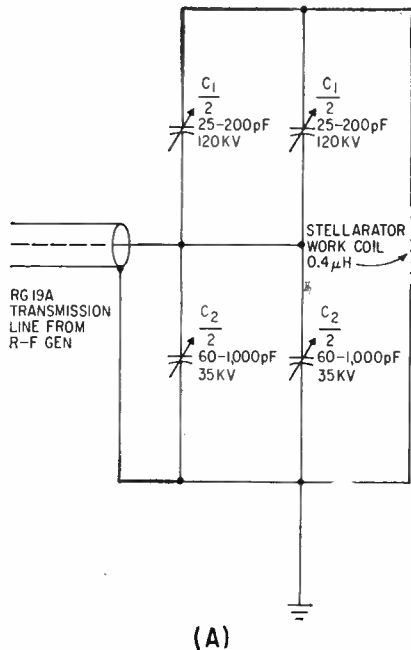

FIG. 1—Network (A) adjusts for variable loading effect of plasma. Power division is related to Q of work coil (B)

and filled with sulfur hexafluoride to insure maximum resistance to high r-f voltage breakdown.

Resonant frequency of the work coil circuit is affected by the presence of the plasma. Thus it is not possible to maintain resonance both prior to breakdown and after breakdown. The capacitors are normally adjusted for resonance after ionization. However, under some operating conditions the r-f voltage before ionization is not sufficient to start the breakdown. Then the circuit is tuned slightly off the plasma resonance. No attempt has been made to alter tuning during the r-f pulse interval.

Relations existing at the output circuit for matched load and 1 megawatt input at 24 Mc are shown in Fig. 1B. Curves for frequencies ranging from 16 Mc to 24 Mc are similar except for absolute values of coil current and the two capacitors if the unloaded coil Q is assumed nearly constant.

Operation at high loaded Q with full input results in voltage limitation such that at 24 Mc the 120-Kv rating of the vacuum capacitors of

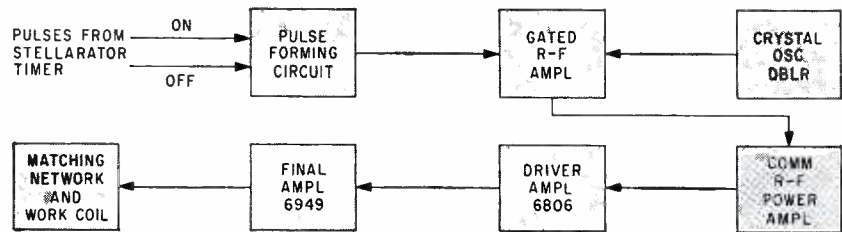

FIG. 2—Pulses from Stellarator timer determine pulse duration

C_1 is exceeded for Q values greater than 100. At 16 Mc, operation with full input is possible with Q values up to 150.

The curves of Fig. 1B are plotted from calculated values and do not include stray shunt capacitance existing directly across the work coil. In practice the voltage limitation is somewhat worse because of the higher apparent inductance. This also results in lower C_1 and C_2 values to maintain resonance.

Figure 2 is a block diagram of the pulsed r-f generator. The generator operates over a frequency range of 16 Mc to 24 Mc and can deliver over 1 Mw into a 50-ohm resistive load. Pulse duration may be varied from about 20 μ sec to 15

msec by pulses from the Stellarator electronic timer.

The final amplifier is an RCA super-power water-cooled, shielded-grid beam triode, type 6949. The tube has a rated plate dissipation of 400 Kw and a peak emission of 300 amp at rated filament temperature. Peak emission is over 450 amp at increased filament temperature and decreased life.

The tube is operated as a class C r-f amplifier at d-c plate voltages of from 10 Kv to over 30 Kv. Plate voltage is supplied from a capacitor-bank and d-c grid bias is adjustable from 0 to -2 Kv.

Features of the tube include a system of electron-optical focused beams and shielded-grid construc-

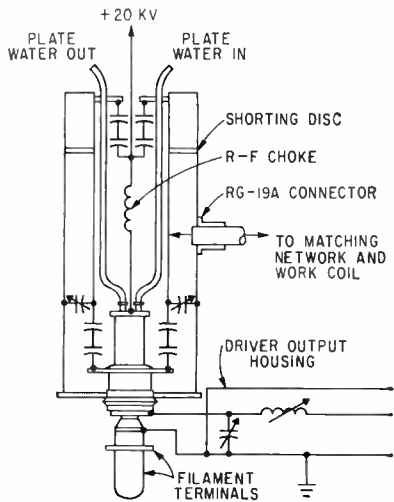

FIG. 3—Filament of 6949 amplifier consumes 8 Kw

tion. The small grid-plate capacitance and low drive power requirement make the tube suitable for operation over an extended frequency range under variable loads.

Using lumped inductance in the plate output circuit of the 6949 is not feasible at frequencies above a few Mc because of the tube's physical size and the low values of inductance required for optimum loaded tank circuit impedance. At 24 Mc, about $0.15 \mu\text{h}$ is the maximum useable inductance for resonance with the tube and stray circuit capacitances. Thus a shorted coaxial line is used as the plate tank inductor (Fig. 3). This line consists of a 27-in. diameter outer conductor and a 15-in. diameter inner conductor and has a maximum effective length of approximately 42 in. The line is tuned to quarter-wave resonance with three vacuum-variable capacitors. The inner conductor of the cable is connected to the 6949 plate connector through 10 stacks of 20 Kv ceramic capacitors. Each stack contains two 500-pf capacitors, resulting in a total value of 2,500 pf for the blocking capacitance. The d-c supply voltage is shunt-fed through the center of the inner conductor. A shorting disk with spring finger contacts provides for changing the line length. Unloaded Q of the shorted line is over 10,000.

The r-f output is taken from a variable tap on the inner conductor, through the outer conductor wall to a $\frac{1}{2}$ wavelength of RG 19 A/U transmission line. A spring strip maintains contact with the outer conductor wall as the tap position

changes. Contact to the inner conductor is by spring-loaded shoes against a flat portion of the conductor wall.

The grounded beam-forming structure of the 6949 causes the input capacitance of the tube to be relatively high. This value, about 1,350 pf, results in a large circulating current in the input tank circuit. Furthermore, the inductance to resonate this capacitance at 24 Mc is only about $0.03 \mu\text{h}$. Therefore, a resonant π network is used between the driver and the grid of the final amplifier. The network consists of a variable inductance coil and two variable vacuum capacitors, allowing adjustment of the matching over the frequency range. Bias is supplied to the 6949 grid through an r-f choke.

The high plate voltage used with the 6949 and the low-impedance energy storage features of the plate power supply necessitates high-speed protection against prolonged high currents resulting from internal tube breakdowns. This is done by connecting a low resistance (about 0.05 ohm) between the negative terminal of the d-c storage supply and the tube, using the fault-current voltage across it to initiate the firing of an ignitron to crowbar the storage bank. The system used removes the supply voltage within 10 μsec after a fault starts.

A demineralized water system supplies cooling water for the 6949. Interlocks and flow sensing devices prevent tube damage from inadequate water flow.

The final amplifier is driven by a

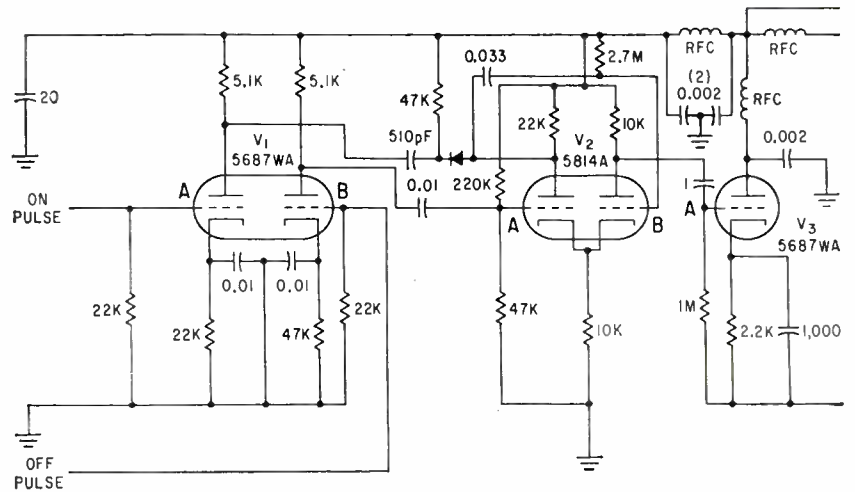

FIG. 4—Low-level unit has pulse-forming circuit and provides gated r-f

type 6806 water-cooled beam power tube. This tube, capable of 40 Kw output, is usable into the uhf range. Advantages of the 6806 for this application are its high perveance, small size and freedom from neutralization problems. The 6806 also features electron-optical principles that result in low drive-power requirements. The tube operates at a d-c plate voltage of 8 Kv, a screen-grid voltage variable from 0.5 Kv to 1 Kv and a fixed bias of -175 volts. The two-section filament has its center connected to r-f ground. A two-phase transformer supplies filament voltage—1.35 v, 1,000 amp per section. Water-cooling requirements are satisfied from the water supply for the final amplifier. The tube and circuit components are mounted in a silver-plated brass cylindrical enclosure.

Drive for the 6806 is supplied by a commercially available r-f power amplifier capable of 1-Kw output when excited with 20 watts over a frequency range of 3.5 Mc to 30 Mc. This amplifier has adjustable input and output matching networks.

The amplifier stages have no pulsing circuits in them. These stages are all supplied with fixed d-c voltages and draw no cathode current in the absence of r-f drive. Furthermore, the d-c operating potentials do not change in the presence of r-f drive. All pulsing is accomplished at an r-f power near 1 w. This does away with the high-voltage high-current equipment usually required for pulsing the high level stages of an r-f amplifier.

The commercial r-f power am-

Transient Recorder Monitors Power Lines to Protect Circuits

Continuous monitoring of nominal line voltage, and recording of all overvoltage transients makes possible protection of electronic equipment connected to line

By FRANK TRAINOR,
Engineering Dept.
Admiral Corp., Chicago, Ill.

ELECTRONIC EQUIPMENT connected to power sources common to electrical machines may be subjected to overvoltage transients capable of destroying components and interfering with operation. Semiconductor voltage limits are rigid, and may not be exceeded by transient pulses of even short duration. A single transient can destroy a silicon rectifier or transistor. The use of expensive semiconductor components therefore, imposes the responsibility for protection against stray transients on the equipment designer.

The design engineer has under his control all circuit elements that generate transients except the power source. Transients generated within equipment can be anticipated and compensated for. Limiting diodes may be connected across inductive elements, while switching transients can be eliminated by many techniques. Transients produced beyond the equipment, in the power source, are unknown quantities, unless a particular study is made. Even shipboard or aircraft power sources can generate transients of unknown amplitudes.

Although a laboratory power source can not be made to represent all possible field sources to which equipment may be connected, knowledge gained from simulated conditions in the lab can be useful in prescribing corrective measures for field sources. Conventional display equipment, such as an oscillo-

scope, is useless for detecting random transients. A synchroscope with a long-persistence screen can be used in certain cases, but it does not provide a permanent record of data. What is needed is a device that responds to a single transient, and leaves a permanent record of the time and frequency of occurrence.

The transient recorder described here responds to a single pulse having a rise time of 1 μ sec. It also records the average value of the line voltage, which may be read as rms values.

Operation is illustrated in Fig. 1. An isolation transformer and bridge rectifier drive a strip chart recorder that writes the rms value of the line voltage. Transient pulses

greater than a preset trigger level pass through a diode gate and trigger a monostable multivibrator. Output of the multivibrator is a current pulse that drives the chart recorder pen.

Trigger level is set by an adjustable bias supply in series with the bridge rectifier output, the diode gate and the multivibrator trigger input.

The center scale position of the recorder pen represents nominal line voltage; slow excursions of the line voltage are recorded as a continuous trace. Multivibrator current pulse output drives the pen to full-scale deflection. Recovery time of the pen after a transient trace is fast enough to cause rise and recovery traces to overlap.

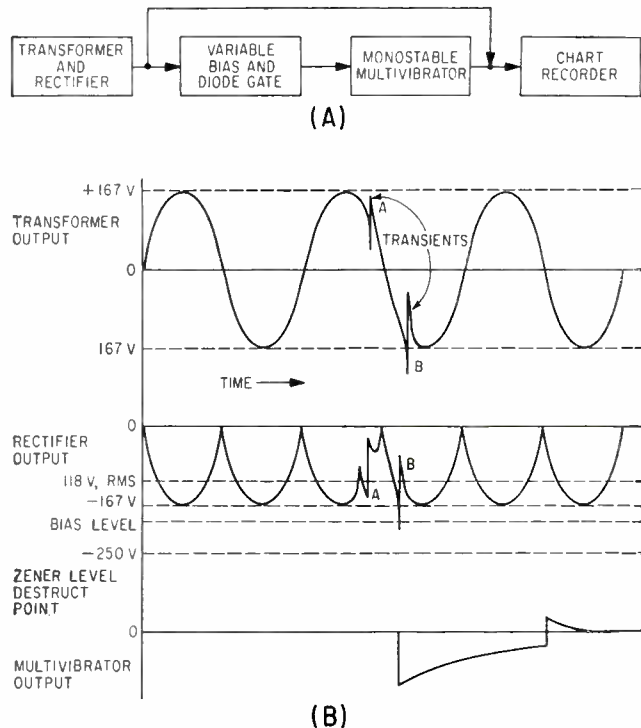

FIG. 1—Block diagram (A), and characteristic waveforms (B) show recorder operation. Unit will record only transient B, having peak greater than preset bias level

By JOHN H. KUCK,

Applied Physics Laboratory,
The Johns Hopkins University,
Silver Springs, Maryland

THE SUPERREGENERATIVE amplifier can achieve high gain with a single stage. Since it is inherently a gated device, and is sensitive for only a short time at the beginning of each oscillation interval, it is useful for applications requiring a gated receiver for pulsed signals.

However, if no agc circuit is provided, this amplifier requires critical adjustment and will give linear amplification of only a narrow range of input signal levels. This has limited its usefulness as an r-f or i-f amplifier.

Previous agc circuits^{1,2} that controlled the grid bias, d-c anode voltage or amplitude of the quench voltage, affected the bandwidth and the duration of the gating interval. This agc circuit transforms the superregenerative amplifier into a noncritical circuit that is stable for long periods. Because the gain can be adjusted, it can accept a wide dynamic range of input signal levels without saturation, thus permitting linear detection and substantially constant output. One disadvantage is that the amplifier is inherently a gated device. While it can handle c-w input signals, the circuit produces an output that consists only of amplified and stretched samples of the input. The gaps between the sampling intervals must be large compared with the duration of the sampling interval, to allow time for the buildup and decay of the oscillations after each sample. In addition, amplifier selectivity will not be as good as that of a conventional multistage i-f amplifier unless a bandpass filter having a sharp cut-off is provided in the amplifier input.

The most likely applications are in miniaturized equipment such as i-f, r-f or microwave amplifiers for satellites, beacons, missile guidance and tracking circuits where simplicity and reliability are important. The design of transistor superregenerative amplifiers using this agc principle is simple. As it is difficult to obtain satisfactory

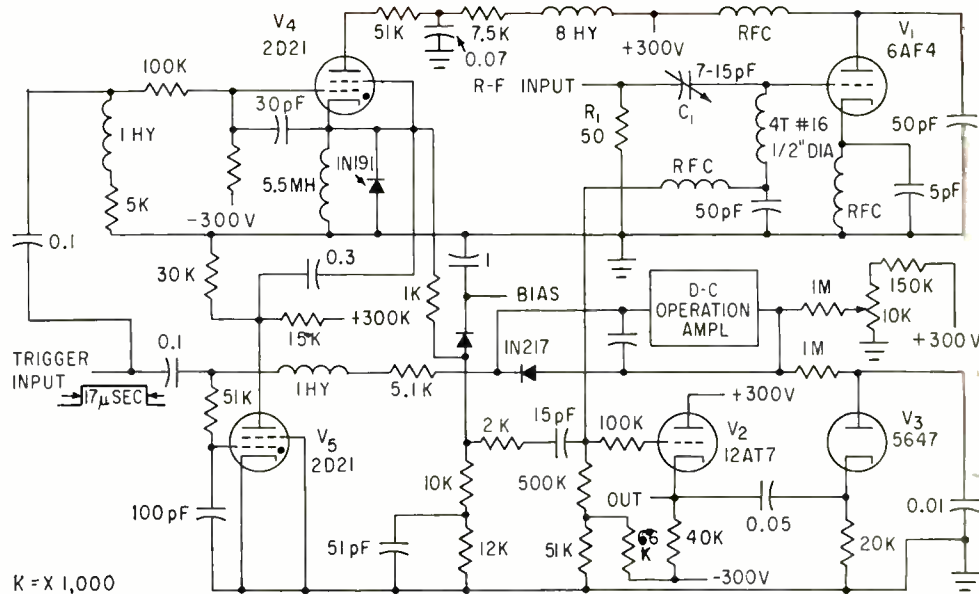

FIG. 1—Grid-pulsed superregenerative amplifier V_1 is controlled by pulse generator V_4 , and V_5 which are controlled from an external pulse source

Automatic Gain Control

This circuit enables a superregenerative amplifier to operate stably over long periods of time while maintaining output pulses substantially constant over a 90-db dynamic range of input signals

performance in more conventionally designed transistorized i-f amplifiers having wide-range agc because of the influence of the gain control voltage on the transistor parameters that affect the amplifier bandwidth, this agc circuit could find application in transistor equipment.

The circuit can also be used to apply pulse modulation to klystrons or magnetrons. If such an oscillator is placed in the pulse-width-control agc loop, the pulse amplitude may be modulated by injection of the modulating signal into the loop at the point where the threshold control voltage is introduced. A low-level, constant amplitude r-f signal should also be injected into the r-f input to eliminate pulse jitter that is present if the oscillator is allowed to start on noise.

There has been increasing interest in experimentation with the applications of the principle of superregenerative amplifiers in travel-

ing-wave tubes, klystrons, and the newer semiconductor devices such as parametric amplifiers, tunnel diodes and masers³⁻⁸. This method of agc should be applicable to these devices. The circuit is not restricted to simple rectangular-pulse quench voltage waveforms, but could also be applied in the more optimum waveform discussed by Bradley⁹ in which a step occurs ahead of the keying pulse. This step provides a long listening interval at zero damping ahead of the buildup period and improves the signal-to-noise ratio.

The agc circuit features gain control by control of the width of a rectangular keying pulse that turns the superregenerative oscillator on and off. This circuit converts the superregenerative amplifier into a stable device that will operate in the linear mode without critical adjustments and will permit linear detection of signal modulation over a wide range of input signal levels.

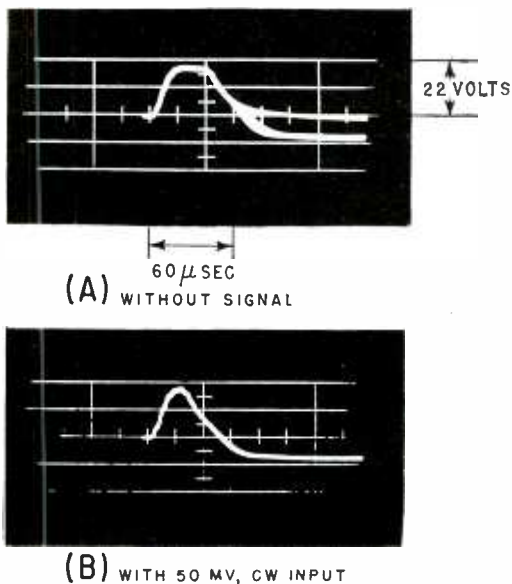

FIG. 2—Effect of r-f input signal on the grid pulse of the amplifier

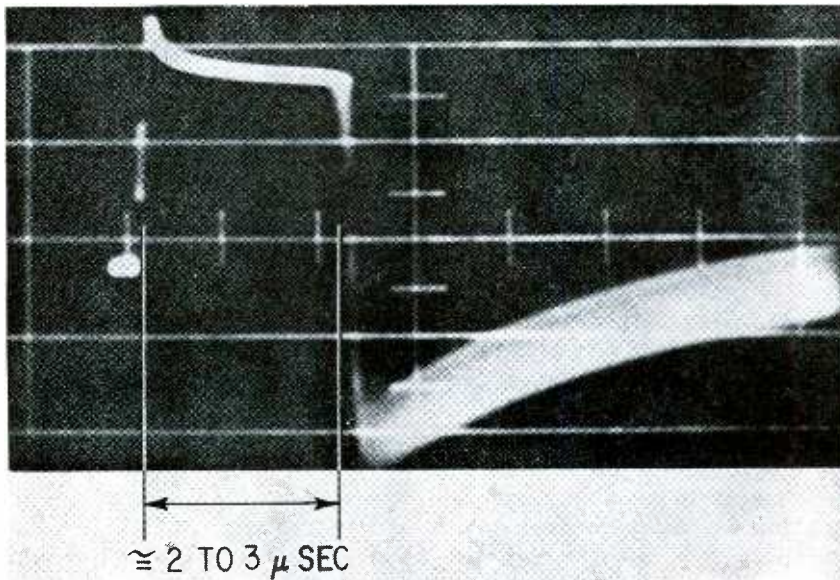

FIG. 3—Grid pulse of narrowband circuit without an input signal showing solid band of noise

for Superregenerative Amplifiers

Satisfactory age action has been experimentally demonstrated for input signals having a dynamic range as great as 90 db.

With this automatic gain control, the bandwidth and shape of the frequency response curve and the gate rejection characteristic are relatively independent of input signal level. The flexibility of the circuit has been demonstrated by its application to grid and plate-pulsed oscillators at 150 Mc and to a klystron oscillator at X-band.

A pulsed superregenerative amplifier, operating in the linear mode, is an oscillator that is gated on by a keying pulse sufficiently short that the oscillation amplitude does not have time to build up to saturation level during the on-time. Thus, the peak amplitude to which the oscillation builds up is directly proportional to the amplitude of any externally applied signal existing in the tank circuit during a short interval. This interval lasts from the instant the keying pulse is first applied until the oscillation has built up to an amplitude which is large compared to that of the external signal.

The oscillator is a high-gain amplifier for signals present during the sensitive interval and the maxi-

mum amplitude of oscillation increases exponentially with on-time. If amplifier gain is defined as the ratio of the maximum amplitude of buildup to the amplitude of the initiating signal, the gain in decibels is a linear function of the on-time. If the keying pulse is supplied from a pulse generator so that the pulse width can be varied by a control voltage, a gain-control mechanism is available that can vary the amplifier gain over the full range from unity to maximum gain.

If the peak amplitude of the oscillation is detected, filtered amplified, and then used as the pulse-width control voltage input to the keying pulse generator, an agc loop is formed. This loop will hold the average level of the output very nearly constant while the average input signal level is slowly varied over a wide range. Signal modulation at higher frequencies than those to which the agc circuit responds will appear unattenuated in the detected output, just as in a conventional agc amplifier.

Figure 1 is a schematic of one of the circuits that has been experimentally demonstrated. Filtering and amplification of the detected output is accomplished by a d-c

amplifier connected as an integrator. The integrator contains a diode limiter in the feedback circuit to prevent the integrator output voltage from going negative.

A reference voltage of opposite polarity from the detected output voltage is added to the integrator input. This voltage determines the threshold level of detected output above which agc action begins. If the incremental open-loop gain of such an agc loop is high, the average detected output will remain nearly constant at this threshold value, even though there are large variations of input signal above the threshold level. When the detected output is below the threshold, the diode limiter in the integrator feedback circuit clamps the integrator output and prevents agc action from taking place.

The circuit shown in Fig. 1 shows a loop containing a 150 Mc, grid-pulsed superregenerative oscillator. The oscillator is a Colpitts in which the interelectrode capacities of oscillator V_1 form the capacitive portion of the tank circuit. Positive polarity keying pulses from the variable-width, keying-pulse generator are injected into the grid circuit. Negative

pulses of detected output voltage proportional to the amplitude of the oscillation pulses are also present in the oscillator grid circuit as a result of the increased grid current caused by the oscillation.

The summation of the positive keying pulse and the negative detected output pulse produce the waveform shown in Fig. 2 at the input to cathode follower V_2 . The cathode follower is coupled to diode V_3 , which functions as a peak rectifier and pulse stretcher for the negative detected output pulses. The stretched, negative output pulses are amplified and filtered by the d-c integrating amplifier, and the resulting d-c voltage is used as the control voltage input to the variable-width, keying-pulse generator.

Pulse generator V_1 and V_2 contains two thyratrons triggered from a multivibrator not shown in Fig. 1. The trigger is a rectangular pulse with a width of 17 μ sec, an amplitude of 90 v and a repetition frequency of 1 Kc. Because of different R-C time delays and grid biases of the two thyratrons, they fire at different times after the start of the trigger pulse. In normal operation, V_1 fires first and generates a positive step voltage across the load impedance in its cathode circuit. This positive step has a slow decay time compared to the keying pulse width. The subsequent firing of V_2 generates a negative step across the same load impedance terminating the keying pulse. Firing time of V_2 is varied by the pulse width control voltage coupled into the grid circuit of this stage. A clipper circuit in the output of the thyatron generator clips the top of the keying pulse and gives it a flat top. Clipper circuit bias is supplied from an external battery.

The output of the thyatron pulse generator is coupled to the grid circuit of the superregenerative oscillator to close the agc loop. When the amplitude of the detected output from the superregenerative oscillator increases, this increase is carried around the loop to the control input of the thyatron pulse generator. In response to the change in control voltage, the thyatron generator reduces the width of its output pulse and this, in turn, reduces the peak amplitude to which the superregenerative oscil-

lation pulses build up.

Figure 2 shows the grid voltage pulse of the superregenerative oscillator at the input to cathode follower V_2 . Without an input signal, the inherent noise in the oscillator causes the output to fluctuate and two horizontal lines appear in the region following the positive pulse—one at the maximum and one at the minimum level of the negative detected output voltage as shown in Fig. 2A. The mean frequency of occurrence of intermediate values of output between the two limiting levels is not high enough to register these traces on the photograph.

The application of the r-f input has a quieting effect on the superregenerative oscillator, and a single output level is obtained as shown in Fig. 2B.

During the experimental work on the superregenerative oscillator, difficulty was experienced with shock excitation of the oscillator by the keying pulse. When this condition is present, the sensitivity of the oscillator to small signals is reduced. The effect is accompanied by the characteristic that as the input signal level is increased, the output noise level increases to a maximum and then decreases, instead of decreasing monotonically. Considerable work was spent on the input filtering network to minimize the shock excitation effects. It was found that the desired condition of noise level decreasing monotonically with increasing signal level could be achieved, and that this condition coincided with maximum sensitivity.

The oscillator shown in Fig. 1 operated at 150 Mc. A narrowband, grid-pulsed oscillator, operating at 183 Mc was also tried. The narrow bandwidth was obtained by a low-inductance, high-Q tank

circuit. External capacitors of 50 and 15 pf were placed in parallel with the internal grid-to-cathode and plate-to-cathode capacitances of the oscillator tube respectively, to obtain operation in about the same frequency range as the wideband circuit. The appearance of the grid pulse of the narrowband circuit, shown in Fig. 3, is different from that of the wideband circuit in that the region between the maximum and minimum output levels is filled in with a solid band of noise.

The performance of the agc loop of the wideband circuit is indicated by Fig. 4, which shows the change in agc voltage as a function of the amplitude of the applied r-f signal. The curve is linear over the measured range of 50 db. With the narrowband circuit, an agc range of 90 db was measured.

The input signal required to reduce the noise voltage in the detected output to one-half of its value in the absence of signal is a measure of the input noise and an indication of the sensitivity of the circuit as a receiver. The c-w input to produce this effect is estimated to be about -80 dbm. This figure is uncertain because the input impedance of the superregenerative amplifier is unknown. However, -80 dbm is the power that the signal generator would have delivered to a matched load, if this had been substituted for the receiver after the signal generator output voltage was adjusted to the level that reduced the output noise voltage of the superregenerative amplifier to half-amplitude.

Figure 5 (left) is the gate rejection of the wideband, grid-pulsed circuit. This curve shows the response of the circuit to a pulsed r-f input as a function of the time of occurrence of the signal pulse, measured from the time of initiation of the superregenerative amplifier. The curve illustrates the gating action of the superregenerative amplifier. The ordinate is plotted in terms of equivalent c-w input, which was determined from the agc voltage with Fig. 4.

The ratio of the slopes on the leading and trailing sides of the gate rejection curve is subject to control by oscillator loading adjustment C_1 , which couples the oscil-

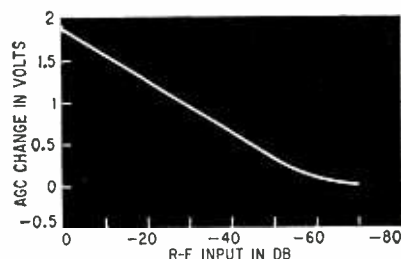

FIG. 4—Agc voltage change plotted against amplitude for a wideband grid-pulsed amplifier

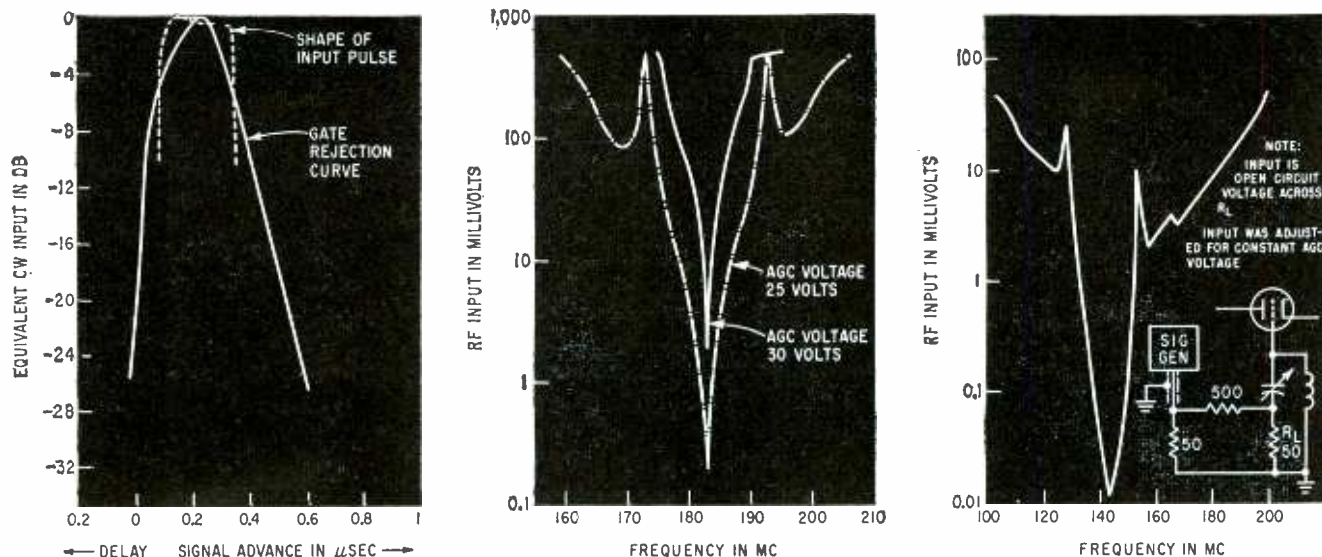

FIG. 5—Gate rejection curve of wideband, grid-pulsed superregenerative amplifier (left), frequency response of a narrow-band circuit to c-w input signals (center) and frequency response of a plate-pulsed superregenerative amplifier (right)

lator grid to resistor R_i in the input network. Increasing the load on the oscillator reduces the buildup rate and increases the decay rate of the oscillator. This reduces the slope on the signal advance side of the gate rejection curve and increases the slope on the other side.

Figure 5 (center) shows the frequency response of the narrow-band circuit. Each curve was taken with constant output (constant agc voltage) and variable input amplitude. The two frequency-response curves for different agc voltage levels have the same shape and bandwidth. This illustrates one of the advantages claimed for this method.

The lower curve (agc = 25 v), which was plotted over a wider frequency range than the upper one, shows a null and a subsidiary peak on each side of the main peak. These seemed to be characteristic of the frequency response of the superregenerative amplifier circuits that were tried. During the experimental work it was possible to observe multiple nulls and peaks at regularly spaced intervals in the skirts of the response curve. These may be due to a beat between the input signal and the natural frequency of the oscillator during buildup. This seems likely, since the constant output method of taking the frequency response curve required large input signals to obtain the skirts of the curve. These signals could be large enough to

induce a steady-state input frequency component in the oscillator tank circuit of large enough amplitude to beat with the natural oscillator frequency component at the end of buildup. The effect on the amplitude of output at this instant would depend on the relative phase between these two signals. Assuming that the two signals are in phase at the beginning of buildup, the phase difference at the end of buildup will be a linear function of the input frequency, since the constant agc voltage would keep the width of the keying pulse constant.

A plate-pulsed version of the wideband oscillator circuit was also tried in the agc loop. The results were similar to those obtained with the grid-pulsed circuit, except that the agc voltage versus db of input signal curve was slightly nonlinear. The input noise level, measured as previously described, was -86 dbm. Figure 5 (right) shows the response curve of this amplifier which shows the same subsidiary side lobes as Fig. 5 (center). Bandwidth between 3-db points is 3.5 Mc.

A modulated c-w input signal was also applied to the wideband plate-pulsed oscillator circuit. The modulation frequency of 30 cps was well above the corner frequency of the agc loop so that the modulation could be recovered at the detector output. With the modulation percentage held constant as signal level was varied,

the amplitude of the recovered modulation envelope did not vary more than ten percent over an input range of 66 db.

An X-band 2K25 klystron with a microwave crystal detector was also operated in the agc loop as a superregenerative amplifier. The agc voltage versus db of input signal curve was measured and found to be linear over a 40-db range. The input noise level was 44 dbm, and the bandwidth was 35 Mc. Noise level and bandwidth measurements were also made on two type 290 klystrons. Values of -53 and -61 dbm and 38 and 27-Mc bandwidth were obtained.

This work was supported by Navy Contract Nord 7386.

REFERENCES

- (1) J. R. Whitehead, "Superregenerative Receivers". Cambridge University Press, American Branch, New York, 1950.
- (2) Harry Stockman, Superregenerative Circuit Applications, Electronics Manual for Radio Engineers, p 617, McGraw-Hill Book Company, Inc., New York, New York, 1949.
- (3) J. K. Pulfer, Microwave Superregenerative Amplifiers, *The Microwave Journal*, p 61, Feb. 1961.
- (4) Don N. Thomson, Microwave Superregenerative Amplifiers, *Proc. NEC*, 16, p 753, 1960.
- (5) J. J. Younger, A. G. Little, H. Heffner, and G. Wade, Superregenerative Operation of Parametric Amplifiers, 1959, *IRE Wescon Conv Record*, 3, part 1, p 108.
- (6) A. G. Jordan and R. Elco, Esaki Diodes as Superregenerative Detectors, *Proc IRE*, 48, No. 11, p 1,902, Nov. 1960.
- (7) P. F. Chester and D. I. Bolef, Superregenerative Masers, *Proc IRE*, 45, No. 9, p 1,287, Sept. 1957.
- (8) B. B. Boussard, Superregenerative Reactance Amplifier, *Proc IRE*, 47, No. 7, p 1,269, July 1959.
- (9) William E. Bradley, Superregenerative Detection Theory, "Electronics Manual for Radio Engineers," p 60, McGraw-Hill Book Co., Inc., New York, New York, 1949.

Smith-Diagram Display Unit Uses

Designed for research and production of microwave components and semiconductors, this broadband electronic unit rapidly measures impedances and displays them on a cathode-ray tube



Author measures varactor quality (variation of capacitance with bias) with 6-Gc broadband impedance display unit

A BROADBAND automatic Smith diagram unit has been developed to display microwave impedances directly. It uses a phase directional coupler. The unit features high precision and simplicity of construction. The display unit is used not only in production of and research in waveguide components, but also in semiconductor production. Because it measures microwave impedances rapidly at low

power levels, such as -30 dbm, this equipment finds use in measurement of parametric diodes, varactors, Esaki diodes, and so forth.

The precision of measurement obtained by experiments in the 6-Gc and 11-Gc band is:

- (1) percentage error of $|R|$: less than ± 2 percent over 10-percent bandwidth;
- (2) phase angle error $\Delta\gamma$: less than ± 2 deg over 10-percent bandwidth;
- (3) resid-

ual vswr: less than 1.005 over 10-percent bandwidth, where the measured reflection coefficient is $R = |R| \cdot \exp(j\gamma)$.

Although the majority of experimental work has been done in WRJ-6 (6-Gc band) and WRJ-11 (11-Gc band) waveguides (TE_{10} mode), the results are equally applicable to rectangular waveguides of any frequency, for instance the S and K bands.

The important part of this equipment is the waveguide coupler. It is called a phase directional coupler. This coupler consists of two rectangular waveguides that intersect at right angles, with their broad walls in close contact. Through the common wall there is a coupling slot, whose center is on the common diagonal at the center of the circularly polarized magnetic field. This slot can be rotated about its center at high speed by a synchronous motor (Fig. 1A). A dumbbell shape, Fig. 1B, is preferred for the coupling slot for achieving greater magnetic coupling than any other shape of the same slot length, and for minimizing the coupling of electric fields.

By referring to Fig. 1A and using the symbols shown in it, the operation of the coupler is expressed concisely by an S-matrix as follows,

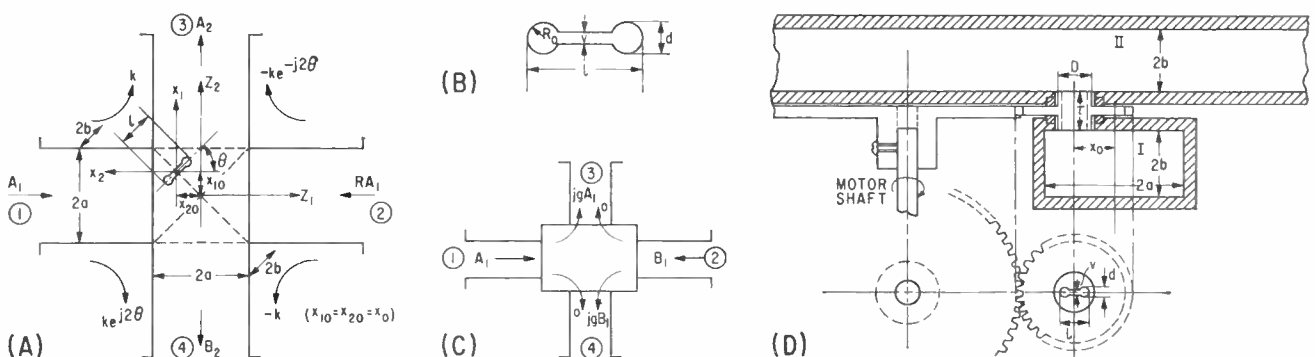

FIG. 1—Phase directional coupler (A); the dumbbell-shaped slot (B); an ordinary directional coupler (C); and details of rotatable slot in the phase directional coupler (D)

Microwave Phase-Directional Coupler

By SHOJI TSUCHIYA,

Senior Engineer,
Electrical Communications Laboratory,
Nippon Telegraph and Telephone
Public Corp., Tokyo, Japan

as the result of theoretical calculations²:

$$\begin{vmatrix} S_{13} & S_{14} \\ S_{23} & S_{24} \end{vmatrix} = \begin{vmatrix} k \left\{ 1 + j\delta \left(1 - \frac{\delta}{2} \right) \sin 2\theta \right\} & -k \left(e^{-j2\theta} - j \frac{\delta^2}{2} \sin 2\theta \right) \\ k \left(e^{j2\theta} + j \frac{\delta^2}{2} \sin 2\theta \right) & -k \left\{ 1 - j\delta \left(1 - \frac{\delta}{2} \right) \sin 2\theta \right\} \end{vmatrix} \quad (1)$$

where

$\delta = \frac{\lambda g - \lambda g_0}{\lambda g_0}$: parameter expressing errors due to frequency change,

g_0 : guide wavelength at a design frequency (center frequency of operating band),

θ : orientation of coupling slot,

k : magnetic coupling coefficient,

$K \equiv 20 \log_{10} k$

$$\begin{aligned} &= 20 \log_{10} \frac{\pi M \sin \frac{\pi x_0}{a}}{16a^2b} \\ &\quad - 20 \log_{10} \left\{ 1 - \left(\frac{\lambda_r}{\lambda} \right)^2 \right\} \\ &\quad - \frac{54.6}{\lambda_r} \tau \sqrt{1 - \left(\frac{\lambda_r}{\lambda} \right)^2} \end{aligned}$$

in db³,

λ_r : resonance wavelength of slot ($\cong 2l + 1.3d$ - $2v$: empirical relation),

$M = \phi \left(\frac{d}{l} \right) \cdot l^3$, magnetic

polarizability of slot⁴

τ : thickness of slot, and

x_0 : location of slot center,

$$x_0 = \frac{2a}{\pi} \tan^{-1} \frac{4a}{\lambda g_0}$$

In the derivation of Eq. 1, terms of higher order than δ^3 are neglected, because in general $|\delta|$ is less than 0.1 over a 10-percent bandwidth. At a design frequency, as a typical case, δ will be zero, and hence Eq. 1 becomes

$$\begin{vmatrix} S_{13} & S_{14} \\ S_{23} & S_{24} \end{vmatrix} (f=f_0) = \begin{vmatrix} k & -ke^{-j2\theta} \\ ke^{j2\theta} & -k \end{vmatrix} \quad (2)$$

An ordinary waveguide direc-

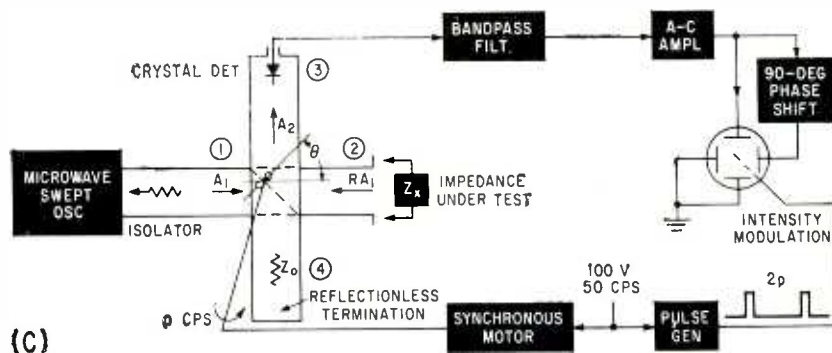
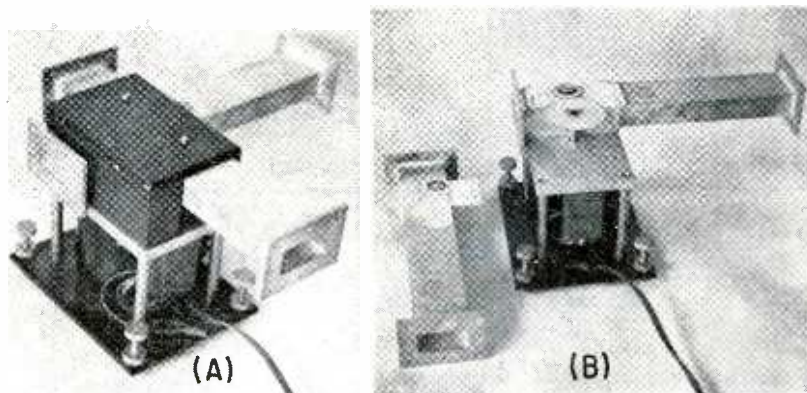

FIG. 2—Exterior (A) and interior (B) views of phase directional coupler for the 6-Gc band; and simplified diagram (C) illustrating the principle of impedance display unit using the phase directional coupler

tional coupler has a directivity as to the amplitude of the branched wave, as shown in Fig. 1C, and is expressed by an S-matrix, in an ideal state, as

$$\begin{vmatrix} S_{13} & S_{14} \\ S_{23} & S_{24} \end{vmatrix} = \begin{vmatrix} jg & 0 \\ 0 & jg \end{vmatrix} \quad (3)$$

where g is the coupling coefficient.

Comparison of Eq. 2 with Eq. 3 shows, on the contrary, that the coupler expressed by Eq. 2, according to Fig. 1A, has a directivity as to the phase of the branched wave. This is why the coupling circuit of Fig. 1A is defined as a phase directional coupler.

The phase directional coupler has a rotating slot, illustrated in Fig. 1D. The circular disk, which is common to both waveguides and is provided with a dumbbell-shape slot, is rotated by a synchronous motor through gear coupling at the rate of, for instance, 50 cps. Figures 2A and 2B show outer and interior views of the coupler for the 6-Gc band.

Design data of the coupler for the 4-Gc, 6-Gc and 11-Gc bands are shown in Tables I and II. (These three frequency bands are allocated for use of Nippon Telegraph and Telephone Public Corp.) The agreement with calculated values is good. The main reason for discrepancies between measured and calculated values is the inaccuracy in the value of λ_r . The coupling coefficients vary slightly with frequencies, due to the slot resonance λ_r and attenuation by thickness τ . This frequency dependence of coupling coefficients, however, does not become a substantial error in the equipment described below and can be easily compensated for by making the crystal detector more sensitive at lower frequencies.

The most useful application of the phase directional coupler is as a broadband automatic impedance plotter, whose principle is shown in Fig. 2C.

Referring to Eq. 1 and Fig. 2C, the r-f energy entering the crystal detector is proportional to A_2 of the

TABLE I—DIMENSIONS OF DUMBBELL-SHAPED SLOT

Freq Band	l (mm)	d (mm)	v (mm)	$\phi \left(\frac{d}{l} \right)$	$M = \phi \left(\frac{d}{l} \right) \cdot l^3$	λ_r (mm)	τ (mm)	D (mm)
4,000 Mc	16.5	4.5	1.0	0.087	391.0	41.4	4.5	18.5
6,000 Mc	12.25	3.5	0.7	0.09	165.4	31.2	4.5	14.0
11,000 Mc	7.0	2.0	0.5	0.09	30.9	17.6	3.2	9.0

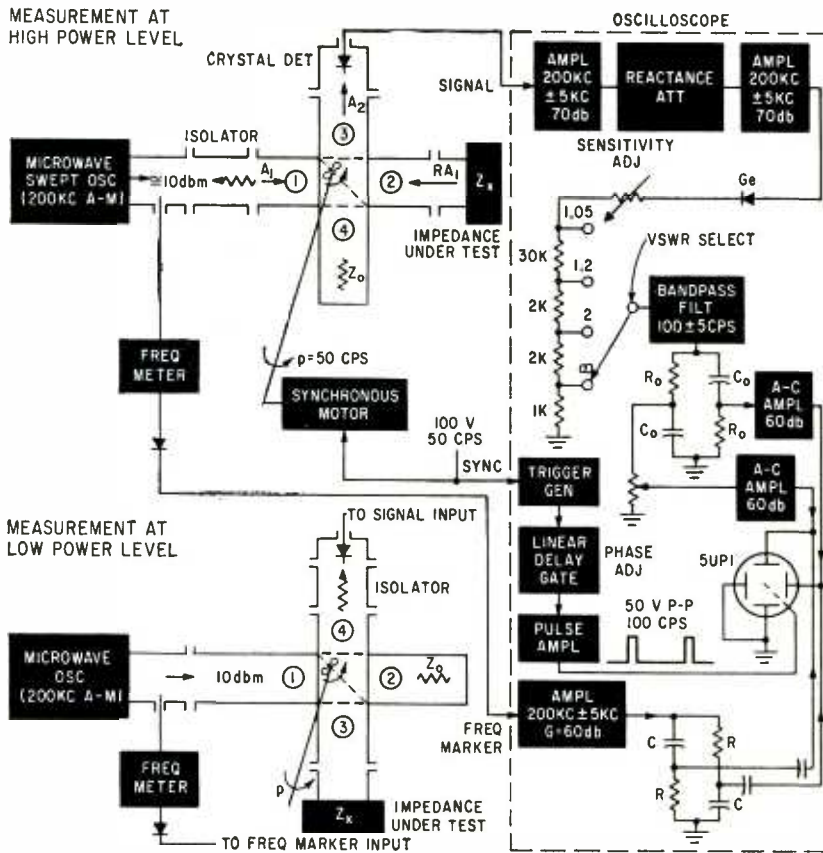
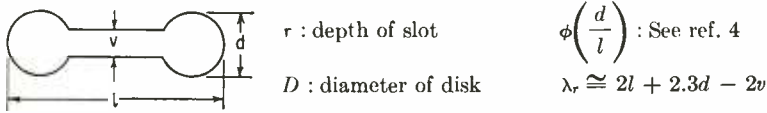

FIG. 3—Automatic impedance display unit, with arrangements for measurement at both high and low power levels

following equation:

$$A_2 = kA_1 \left\{ \left(1 + j\delta \left(1 - \frac{\delta}{2} \right) \sin 2\theta \right) + \left\{ e^{j2\theta} + j \frac{\delta^2}{2} \sin 2\theta \right\} |R| e^{j\nu} \right\} e^{j\omega t} \quad (4)$$

where A_1 is oscillator output, and $|R| e^{j\nu}$ is the complex voltage reflection coefficient of Z_x (impedance under test) at the center of the coupling slot. When the slot is rotating at the rate of p cps, θ , in Eq. 4 is

$$\theta = 2\pi p t \quad (5)$$

Now, A_2 is detected by the square-

law crystal detector and its output is picked up through the narrow-bandpass filter whose center frequency is twice the revolution frequency of the slot, that is, $2p$ cps. The output voltage V of the filter becomes:

$$V = 2k_1 k_2 |A_1|^2 \left(1 + \frac{\delta^2}{2} \sin^2 y \right) |R| \cos \left(2\pi(2p)t + \tan^{-1} \left\{ \left(1 + \frac{\delta^2}{2} \right) \tan y \right\} \right) \quad (6)$$

where k_1 means detector sensitivity

and insertion loss of the filter.

After being amplified and shifted in phase by 90 deg, V of Eq. 6 is impressed on the deflection plates of a cathode-ray tube. Bright spots on the fluorescent screen form a circle, whose radius is proportional to the reflection coefficient $|R|$. Further, positive pulses of narrow width and a repetition rate of $2p$ cps are added to the control grid to increase the intensity and to show the phase angle y .

A reflection coefficient $|R| e^{j\nu}$, consequently $Z_x (= 1 + R/1 - R Z_0)$, is represented on the screen by a bright spot.

In Eq. 6, the term $\delta^2/2$ expresses the error caused when the microwave frequency is deviated from the design frequency f_0 ; but $|\delta|$ being less than 0.1 over a 10-percent bandwidth, as shown in Table I, $\delta^2/2$ is less than 0.005, and so can be neglected with no large error.

Besides, Eq. 6 contains no term that gives rise to a residual voltage standing wave ratio. This is why the circuit arrangement of Fig. 2C has broad-band and high-precision characteristics.

This display unit, in combination with a swept frequency oscillator, can continuously indicate the frequency response of an impedance over a 10-percent bandwidth with high accuracy and speed. (The sweep frequency should be low compared $2p$ cps.)

In Fig. 2C, interchanging the positions of Z_x and Z_0 , the same result as Eq. 6 is obtained, and in this case the microwave power entering the unknown impedance Z_x is weak; for instance -30 dbm. Therefore the interchanged case is suited for measurement at low power levels, for example, for measurement of parametric diode and varactor qualities. Furthermore, this display unit will also measure negative impedances if an extended transmission-line chart is used.⁵

In Fig. 2C, a part of the TE_{10} wave (frequency f_0) traveling from left to right in the rectangular waveguide, branches into both directions of the secondary waveguide through the coupling slot; the wave directed to port 3 is not influenced at all, and the other directed to port 4 is totally influ-

enced, by rotation of the slot. Hence the former maintains its original frequency f_0 , but the latter is shifted in frequency by $-2p$; that is, the frequency is $f_0 - 2p$.

For a wave traveling from right to left (a reflected-wave from Z_c) the situation is reversed; that is, the branched wave directed to port 3 is shifted in frequency by $+2p$ (the frequency is $f_0 + 2p$), and the other directed to port 4 maintains its frequency f_0 (see Eq. 2 and Eq. 5).

Therefore, the wave entering the crystal detector consists of the following two waves: one that is proportional to the incident wave and has a frequency f_0 , and the other that is proportional to reflected wave and has a frequency $f_0 + 2p$. Therefore, after detection by a square-law detector, a voltage of beat frequency $2p$ is produced and picked up through a narrow-band-pass filter, whose center frequency is $2p$. This voltage is linearly proportional to the reflected wave both in magnitude and in phase (Eq. 6).

Accordingly, the voltage can be used as the information concerned with the reflection coefficient R under measurement, and an impedance plotter can be made.

The broad-band characteristic of the phase directional coupler may be explained as follows. Consider first an incident wave only (the state of matched termination). The center of the coupling slot is at the center of a circularly polarized magnetic field (Fig. 1A).

This is true however, only for the case of $\delta = 0$ (Eq. 1), that is, for a design frequency of f_0 . For a frequency deviating from f_0 , δ is no longer zero and the magnetic field at the slot center becomes an elliptically polarized field whose eccentricity is $\sqrt{2}|\delta|$. So if the two waveguides are parallel to each other, the ellipticity is doubled and causes an error equivalent to a residual vswr of about $(1 + |\delta|)$. Thus the use is limited to a narrow bandwidth. On the other hand, if the two waveguides intersect at right angles as shown in Fig. 1A, the major axes of elliptical polarization in both waveguides also cross at right angles. Hence the ellipticities for both waveguides compensate each other in total, and, as the

TABLE II—VALUES OF X_0 AND δ FOR THREE FREQUENCY BANDS

Freq Band	Freq Range	Design Freq	2a (mm)	2b (mm)	x_0 (mm)	$ \delta $	$\frac{\delta^2}{z} \times 100$ (%)
4,000 Mc	$f = 3700 - 4200$ Mc $\lambda g = 1134 - 90.6$ mm	$f_0 = 3920$ Mc $\lambda g_0 = 102$ mm	58	29	15.8	<0.11	<0.60
6,000 Mc	$f = 5800 - 6400$ Mc $\lambda g = 67.71 - 57.78$ mm	$f_0 = 6087$ Mc $\lambda g_0 = 62.5$ mm	40	20	11.5	<0.08	<0.32
11,000 Mc	$f = 10700 - 11700$ Mc $\lambda g_0 = 35.4 - 30.9$ mm	$f_0 = 11200$ Mc $\lambda g_0 = 32.97$ mm	22.9	10.2	6.9	<0.07	<0.25

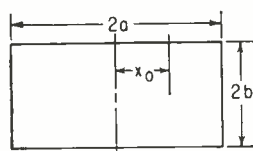

$$x_0 = \frac{2a}{\pi} \tan^{-1} \frac{4a}{\lambda g_0} \quad \delta = \frac{\lambda g - \lambda g_0}{\lambda g_0}$$

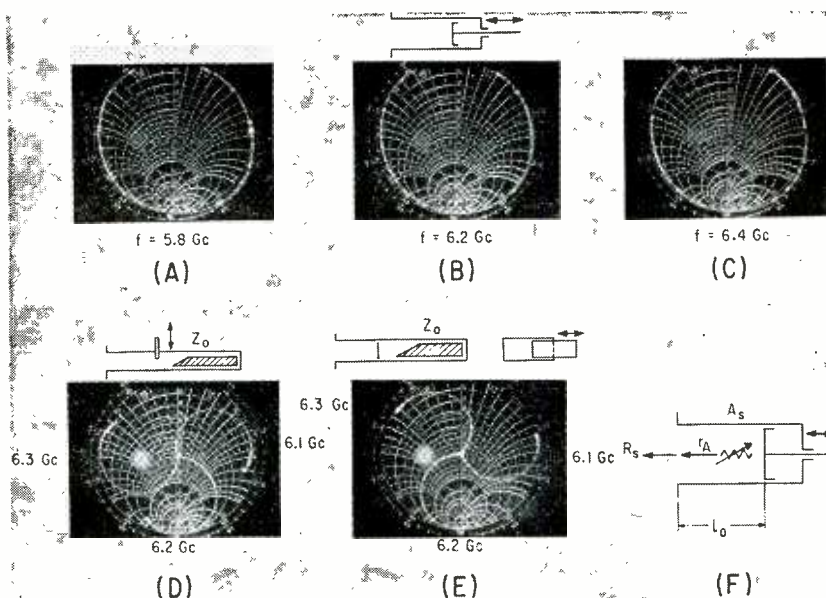

FIG. 4—Impedance loci of a movable short-circuit at 5.8 Gc (A), 6.2 Gc (B), and 6.4 Gc (C); impedance loci of a capacitive stub (D) and a reflectionless termination (E); and the standard impedance (F) consisting of a standard attenuator and a movable short-circuit

result, the same state results as for the circular polarization. Thus no error or residual vswr occurs; this is valid regardless of the value of δ . The device may thus be used over a broad bandwidth.

The practical arrangement of Fig. 2C is illustrated in Fig. 3. Most of the circuit, except for the phase directional coupler and the circuits mentioned below, is well-known or familiar. As to the nar-

row-bandpass filter, the cascade connection of parallel-T R-C selective amplifiers⁶ is used to obtain a high selectivity, such as 100 ± 5 cps and to avoid unnecessary stray magnetic fields. The linear delay gate circuit⁷ is useful for making the pulse width narrow and for adjusting the pulse phase to any desired value. The VSWR SELECT switch changes the sensitivity of the signal circuit and the scale il-

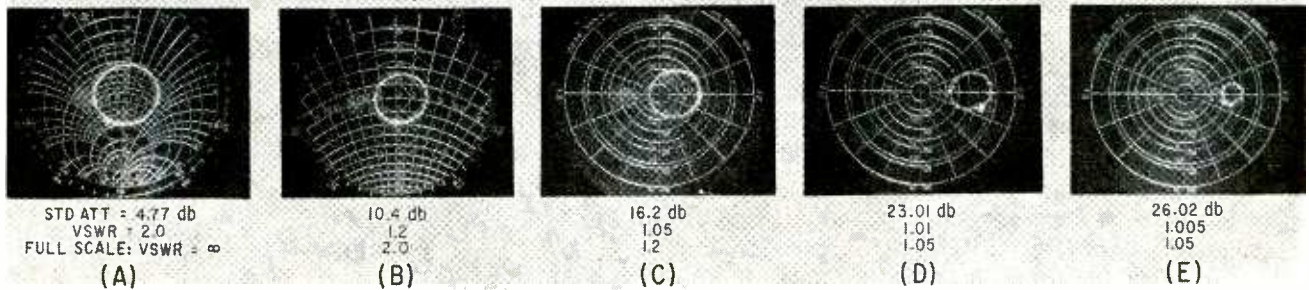

FIG. 5—Impedance loci (A through E) of the standard impedance of Fig. 4F, measured at 6.2 Gc, with the loci corresponding to the movement of the short-circuit

lumination on the face of the cathode-ray tube simultaneously, and scales of $vswr = \infty$, 2.0, 1.2, and 1.05 at full scale are displayed according to the switch position.

Calibration of the display unit is performed by short-circuiting the waveguide port that is connected to Z_r (Fig. 3), and assuming the short-circuit to be a standard of perfect reflection. As $R = 1 e^{j\theta}$, y_0 being calculated knowing λ_g and l , with l being the distance from the center of coupling slot to the short-circuit

$$y_0 = \pi - \frac{4\pi}{\lambda_g} l_0 \quad (7)$$

In a phase directional coupler, the location of center of the slot must fulfill exactly the equation $x_{10} = x_{20} \cong x_0$ (see Fig. 1A), because the state of $x_{10} \neq x_{20}$ will cause an error, or a residual $vswr$. The residual $vswr$ becomes:

$$\text{Res. } VSWR = 1 + \frac{\pi \cdot |\Delta x|}{2a \sin \frac{\pi x_{10}}{a}} \quad (8)$$

where $\Delta x = x_{20} - x_{10}$.

This amounts to about 1.01 to 1.03.

The residual reflection (Δr) of the reflectionless termination Z_0 in Fig. 3 should be made as small as possible, for this also becomes an error, or another residual $vswr$. These residual reflections caused by Δx and Δr can be compensated simultaneously by inserting a three-stub tuner ($\lambda_g/8$ interval) between the coupling slot and the termination Z_0 . In inserting the tuner nearer to the slot, the residual $vswr$ of the compensated state was made less than 1.005 for a frequency range of 5.8 Gc to 6.4 Gc without resetting the tuner at each frequency (broadband compensation).

In connection with the calibration of display unit and with the

variety of R , isolators (in Fig. 3) having a small reflection coefficient, such as $vswr = 1.02$, should be used to avoid load reactions, namely, the effect of mismatching of microwave source and crystal detector, because these mismatches will cause a large percentage error in the reflection coefficient $|R|$. By using a well-matched isolator ($vswr < 1.01$) this error is made less than 2 percent.

As to the oscilloscope (Fig. 3), the linearity of the signal circuit and especially that of the germanium-diode envelope detector must be checked carefully at the required voltage level. The non-linearity of the low-frequency circuits also causes another percentage error in $|R|$. This error, however, is easily made less than 1 percent.

Figure 4A, 4B and 4C show the impedance locus of a movable short circuit. The deviation of the locus from the circle of $|R| = 1$ on the Smith diagram becomes a measure of mismatch of microwave source and crystal detector, that is, a measure of load effect. The result shows that the load effect was greatly lessened by using a well-matched isolator (Fig. 3).

Figures 4D and 4E are the impedance loci of the capacitive stub and inductive window, followed by a reflectionless termination. The locus must be a semicircle passing through the center of the Smith diagram. The results show good agreement with the semicircle, proving the display unit error was small, both in magnitude and in phase. In varactor measurement too, nearly the same locus is obtained as in Figs. 4D and 4E, by changing the d-c bias voltage.

To test the linearity of the display unit more quantitatively, the combination of a standard attenu-

ator and a movable short-circuit was adopted as a standard impedance (Fig. 4F). The reflection coefficient becomes

$$R_s = A_s^2 e^{j\left(\pi - \frac{4\pi l_0}{\lambda_g}\right)} + r_A \quad (9)$$

where A_s is the attenuation of standard attenuator, l_0 is the distance between input flange and short-circuit, and r_A is the reflection coefficient of the attenuator itself. Hence, by setting the attenuator at 4.77, 10.4, 16.2, 23.01, 26.02 db and moving the short-circuit, the impedance loci of circles equivalent to $vswr = 2.0, 1.2, 1.05, 1.01, 1.005$, respectively may be obtained (Figs. 5A through 5E). The signal circuit was fairly linear. In the figures, the distance between the center of the impedance circle measured and the center of the Smith diagram shows r_A of Eq. 9.

There are other applications of the phase directional coupler, such as a display unit for microwave source output impedance, a display unit for small reflection coefficients of the order of 0.0005, and so on.

The author thanks the Anritsu Electric Co., Tokyo, Japan, for their aid in constructing the oscilloscope, and the Nihon-Koshuha Co., Yokohama, Japan, for their many instructive opinions.

REFERENCES

- (1) S. Tsuchiya, A broad-band impedance display unit, *J Inst Electr Commun Eng Jap*, 43, p 1317, Nov. 1960.
- (2) S. Tsuchiya, Actions of dipole in waveguide circuit (Submitted to *J Inst Electr Commun Eng Jap*).
- (3) S. B. Cohn, Microwave coupling by large apertures, *Proc IRE*, 40, p 696, June 1952.
- (4) S. B. Cohn, Determination of aperture parameters by electrolytic-tank measurements, *Proc IRE*, 39, p 1416, Nov. 1951.
- (5) H. F. Mathis, Extended transmission-line charts, *ELECTRONICS*, 33, p 76, Sept. 23, 1960.
- (6) J. J. Ward and P. V. Landshoff, Parallel-T RC Selective Amplifiers, *Electronic & Radio Engineer*, 35, p 120, Apr. 1958.
- (7) M. Kawakami, "Electronic Circuits," Kyoritsu Publishing Co., Tokyo, p 53, 1957.

NEW! from ELECTRO INSTRUMENTS

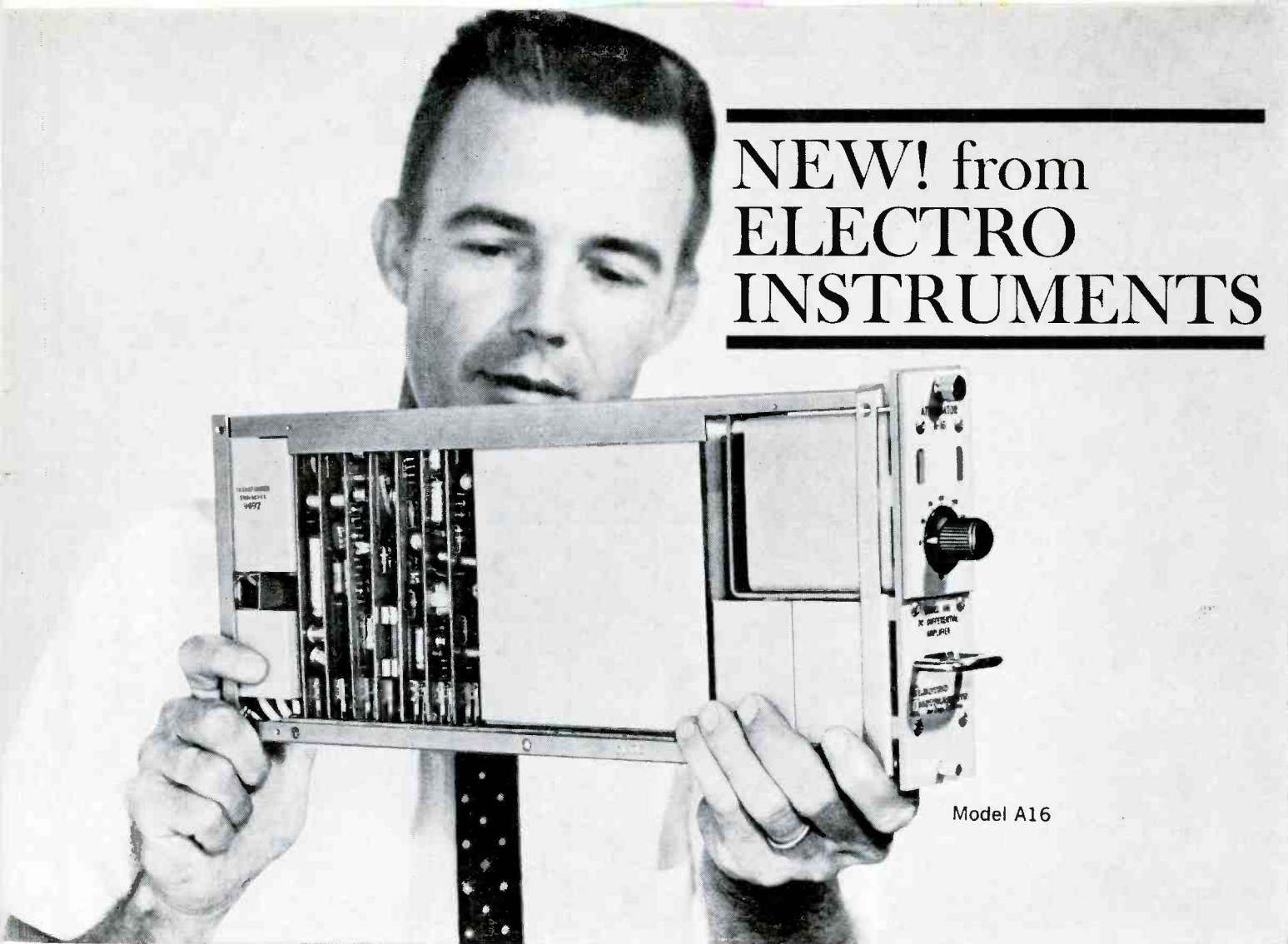

Model A16

8 fit into a 19" rack!

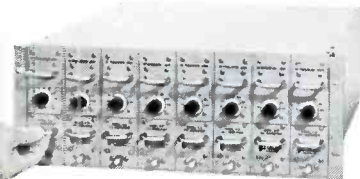

A WIDEBAND DIFFERENTIAL AMPLIFIER that combines wide bandwidth, high common mode rejection, and high input impedance!

NOW 4 precision, low level, wideband DC instruments to meet every amplifier requirement!

Entirely new in concept and design this new family of "second generation" instruments provides more of everything you want in precision, low level, wideband DC amplifiers. New design techniques represent major breakthroughs in all areas of amplifier design. Performance and versatility are unmatched. Circuits are totally transistorized to eliminate heat dissipation problems, to assure high reliability, and to minimize size and weight. Plug-in, etched circuit boards and internal modular construction simplify trouble shooting and eliminate lengthy downtimes. An actual comparative maintenance report by a major ICBM manufacturer showed the operational

reliability record of EI amplifiers to be better than competitive instruments by **8 to 1!**

Let your EI field engineer show you how this new family of amplifiers can meet your needs. EI's nationwide staff of factory sales and service men assures you of the most for your money—before, during and after the sale.

Model A14—For operational, computer and control system applications. Operates at gains of from 1 to 100 with 0.01% stability.

Model A15—A general-purpose, single-ended or differential amplifier with a noise level less than 3 microvolts rms

wideband over the gain range of 10 to 1000.

Model A16—A wideband differential amplifier that combines a 3 microvolts rms noise level, 120 db common mode rejection at 60 cps with up to 1,000 ohms unbalance in either line, DC to 50 KC bandwidth and 100 megohms input impedance.

Model A17—A low-cost, wideband differential amplifier with basically the same performance as the Model A16, including high 160 db common mode rejection at DC. Gain of 1 to 100. Substantial saving in cost through a reduction in input impedance.

Write for new EI Amplifier catalog!

Electro Instruments, Inc.



3540 AERO COURT,
SAN DIEGO 11, CALIF.

Designing Emitter-Coupled Monostable Multivibrators

This procedure solves some of the problems commonly involved in designing transistor monostable circuits. A step-by-step example is also given

By L. L. KLEINBERG,
Lockheed Electronic Co.,
Plainfield, N. J.

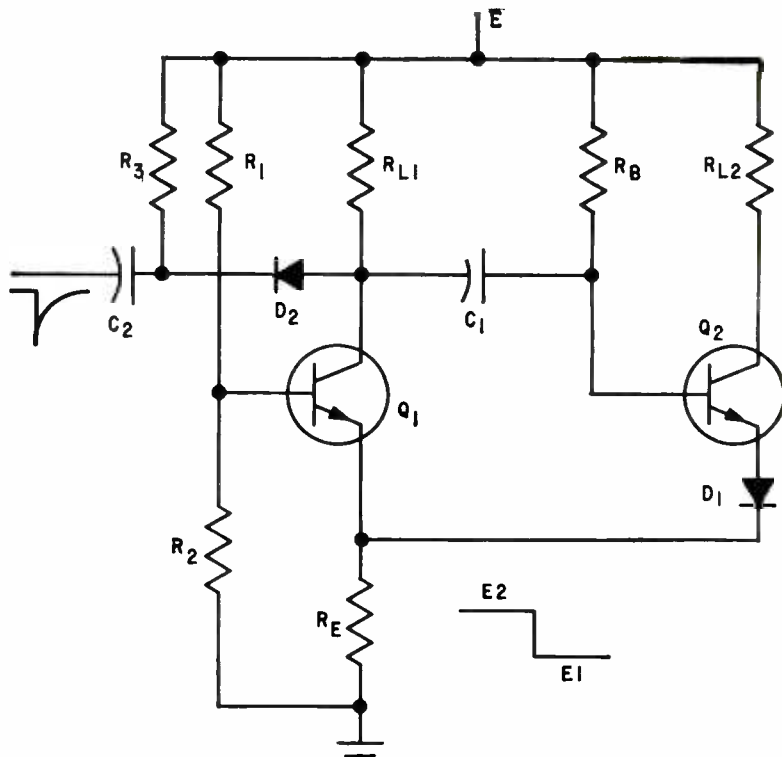

Circuit diagram of the emitter-coupled monostable multivibrator, triggered by negative voltage pulse applied to C_2

THIS ARTICLE describes a simplified method for designing the emitter-coupled monostable multivibrator, with considerable savings of design and bench time.

The circuit is shown in the diagram. Consider the initial condition, when Q_2 is conducting and Q_1 is cut off. This is described by

$$ER_2/(R_1 + R_2) = KE_2 \quad (1)$$

where K is a constant less than unity and E_2 is the voltage across R_E when Q_2 conducts. In the transitional state, Q_2 is cut off and Q_1 conducts.

$$[(E_1 + e_b)/R_2] + i_{b1} = [E - (E_1 + e_b)]/R_1 \quad (2)$$

where E_1 is the voltage across R_B when Q_2 is off and Q_1 conducts, i_{b1} is the base current of Q_1 and e_b the voltage between emitter and base of the transistor during conduction. Solving the two equations for R_1 and R_2

$$R_1 = \frac{1}{i_{b1}} \left[E - (E_1 + e_b) - \right.$$

$$\left. \frac{(E - KE_2)(E_1 + e_b)}{KE_2} \right] \quad (3)$$

$$R_2 = R_1[KE_2 / (E - KE_2)] \quad (4)$$

If Eq. 3 is set equal to zero

$$KE_2 = E_1 + e_b \quad (5)$$

Equation 5 yields the key for the design procedure. For R_1 to be nonnegative, KE_2 must be greater than $E_1 + e_b$. Once E_2 , E_1 and R_E are chosen, all components values may easily be found, assuming saturated operation.

As an example, type 2N338 transistors are used with a supply voltage of 20 v and a pulse width of 25 microseconds. Choosing $E_1 = 4$ v, $E_2 = 7$ v, $R_E = 1$ K, and $B_{min} = 40$,

Step 1:

$$(a) \quad i_{c2} \cong E_2/R_E \cong 7\text{v}/1\text{K} \cong 7 \text{ ma}$$

$$(b) \quad R_{L2} \cong (E - E_2 - E_{sat})/i_{c2} \\ \cong (20 - 7 - 0.5)/7 \text{ ma} \\ \cong 1,800 \text{ ohms}$$

$$(c) \quad i_{b2} \cong i_{c2}/B_{min} = 7 \text{ ma}/40$$

$$(d) \quad R_b \cong (E - E_2 - e_b)/i_{b2} \\ \cong (20 - 7 - 0.7)/(7/40) \\ \cong 68,000 \text{ ohms}$$

Step 2:

$$(a) \quad i_{c1} \cong E_1/R_E \cong 4\text{v}/1\text{K} \cong 4 \text{ ma}$$

$$(b) \quad R_{L1} \cong (E - E_1 - E_{sat})/i_{c1} \\ \cong (20 - 4 - 0.5)/4 \text{ ma} \\ \cong 3,900 \text{ ohms}$$

$$(c) \quad i_{b1} \cong i_{c1}/B_{min} = 4 \text{ ma}/40 \\ \cong 10^{-4} \text{ ampere}$$

Step 3:

(a) Using Eq. 3, solve for R_1 . The value of K must first be determined. Since the 2N338 has a reverse breakdown voltage of -1 volt (V_{RE}) and E_2 is 7 volts, KE_2 is chosen as 6.5 volts. See Eq. 1.

$$(b) \quad K = 6.5/7$$

$$(c) \quad R_1 = (1/10^{-4}) \{20 - 4 - 0.7 - \\ [(20 - 6.5)(4 + 0.7)/6.5]\} \\ \cong 56,000 \text{ ohms}$$

$$(d) \quad \text{Using Eq. 4,} \\ R_2 = [6.5/(20 - 6.5)]56\text{K} \\ \cong 27,000 \text{ ohms}$$

Step 4:

Solve for C_1 : $(E - E_2)/(2E - E_1 - E_2) = (1 - e)$ to the power of $-t/R_b C_1$; C_1 then equals 620 pf. Components C_2 , R_3 and D_2 comprise the triggering network; D_1 prevents reverse breakdown of the base-emitter diode of Q_2 .

Normal Metals Are Made Superconductive

METALS that are not normally superconducting can be made superconductive. Also, transition temperatures of these superconductors are predictable and subject to control within limits.

The project in which these phenomena were observed is still in the basic research stage. However, it indicates that more superconducting materials will be available to the design engineer. It also demonstrates that transition temperatures are not necessarily restricted to those provided by nature.

Results of the experiments with superconducting metals were reported by A. D. Little, Inc. The consulting firm found that, when in contact with a superconducting metal film at the proper temperature, a thin film of metal not normally a superconductor behaves like one. Moreover, the two metals films in contact act as a unit with unique superconducting properties of its own.

Silver, which is not superconducting at any temperature, was used in the experiments with lead, which becomes superconducting at 7.2 K. Both the silver and the bimetallic assembly as a whole became superconducting at transition temperatures lower than that of lead. A transition temperature as low as 1.87 K was measured in one case.

In the continuing experiments, films of the selected metals less than 0.001 mm thick are vapor deposited on top of each other on glass substrate. Typically, a silver film 10 mm long and 0.3 mm wide has a longer lead film superimposed on it that is 0.15 mm wide. Electrical connections are soldered to the ends. Several samples can be made by depositing different thicknesses of each metal simultaneously on the same substrate.

When thickness of either metal was varied, transition temperatures and other characteristics changed. In some cases, one metal completely surrounded the other; in other cases, one metal was simply deposited on top of the other to form

an open sandwich. Observed results did not change with type of construction, sequence of deposition or with time.

The experiments indicate that a film of pure nonsuperconducting metal deposited in direct contact with a superconductor depresses the transition temperature of the superconductor. Also, the depression increases with thickness of the nonsuperconducting metal.

The change in transition temperature is not attributed to contamination of one metal by the other or by impurities. All metals were at least 99.999 percent pure, and solid solubility of lead in silver or of silver in lead is quite small. Also others have shown that transition temperature of lead is substantially unaltered by the addition of silver in solid solution.

Although it is difficult to account for the observed phenomena at this time, Prof. L. N. Cooper of Brown University has developed a theory that provides a qualitative explanation of results.

Current-carrying electrons in metals can generally be handled mathematically on an individual basis. However, in a theory of superconductivity developed by Brown and others, current carrying electrons act as though they were paired.

When a superconducting and a nonsuperconducting metal are in contact at low enough temperature, some paired electrons cross the interface even through a thin insulating layer. The migrating electrons occupy some volume in the nonsuperconducting metal, which becomes superconducting to the extent that the paired electrons cross the interface.

The bimetallic assembly also acts as a superconductor with its own characteristic transition temperature in the volume where electron pair migration occurs. If the nonsuperconducting metal were more than 0.001 mm thick, presumably the region far enough from the interface would not be affected.

So far the metal films used in the experiments are too thin for an unaffected region to exist. However, using a technique of electron tunneling between superconductors reported by A. D. Little last November, existence of an electron energy gap in a silver film superimposed on a lead film was demonstrated. Such a gap is a clue to a semiconductor. The energy gap in the silver part is smaller than that in the lead part of the sandwich, indicating the predicted decreasing superconductivity.

Although the existence of this superconducting phenomenon has been indicated in earlier investigations, in the present project it has been clearly delineated in experiments and a microscopic theory has been developed to explain it.

Method Permits Tests of Nerve Impulse Velocity

MEASURING technique using a barrier-grid storage tube is helping investigators to determine velocity of afferent nerve impulses. The memory tube functions as an integrator to enable detection of very weak signals in the presence of random noise.

Nerve impulse velocity, ranging from about 60 to 80 meters per second, is being successfully measured at the Department of Medicine, St. Thomas Hospital, London, England. The special tube was produced by EMI Electronics Ltd., Middlesex, and has enabled the hospital Electronics Department to develop a compact instrumentation system for the measurements.

The equipment detects and amplifies evoked nerve impulses as they travel from the point of stimulus to the brain. After storage in the tube, the detected signals are displayed on an oscilloscope for photographic recording. Nerve impulse velocities are determined from the photographs.

To limit electrical interference, the patient is placed in a shielded

Introducing

ALSiBASE

AMERICAN LAVA CORP
A SUBSIDIARY OF MINNESOTA MINING AND MANUFACTURING CO.



ALSiBASE

**improved ceramics
result from a new method of fabrication.**

Favorable characteristics include:

- 1.** Fabrication of thin sections especially suited for substrates. Marked improvement has been made in flatness or camber control.
- 2.** Flatness and dimensional accuracy within normally accepted ranges without grinding expense, contaminants or scratches. However where especially strict requirements must be met, ALSiBase can be furnished both ground and polished at commensurate cost.
- 3.** Ability to fabricate holes, slots, serrations to tighter than usual tolerances without machining after firing.
- 4.** A superior and uniform surface especially adapted to economical coating or metalizing. Surface finish in 10-25 microinch range is available without grinding or polishing.
- 5.** ALSiBase has exceptional dielectric strength in thin sections. Measurements made to date on ALSiBase in the new thin sections indicate better dielectric strengths than those of similar ceramic formulations processed by conventional methods and tested on 1/4" thick discs in accordance with A.S.T.M. D 667-44. A typical ALSiBase design in alumina had a dielectric strength up to 2000 ACV/mil at 10 mil thickness.

May we see your prints on parts where this might apply?

A subsidiary of
Minnesota Mining and
Manufacturing Company



AMERICAN LAVA CORPORATION

CHATTANOOGA 5, TENN.
60TH YEAR OF CERAMIC LEADERSHIP

For service, contact American Lava representatives in Offices of Minnesota Mining & Manufacturing Co. in these cities (see your local telephone directory): Boston: Newton Center, Mass. • Chicago: Bedford Park, Ill. • Cleveland, Ohio • Dallas, Texas • Los Angeles, Cal. • New York: Ridgefield, N. J. • Philadelphia, Pa. • St. Louis, Mo. • St. Paul, Minn. • So. San Francisco, Cal. • Seattle, Wash.
All other export: Minnesota Mining & Manufacturing Co., International Division, 99 Park Ave., New York, N. Y.

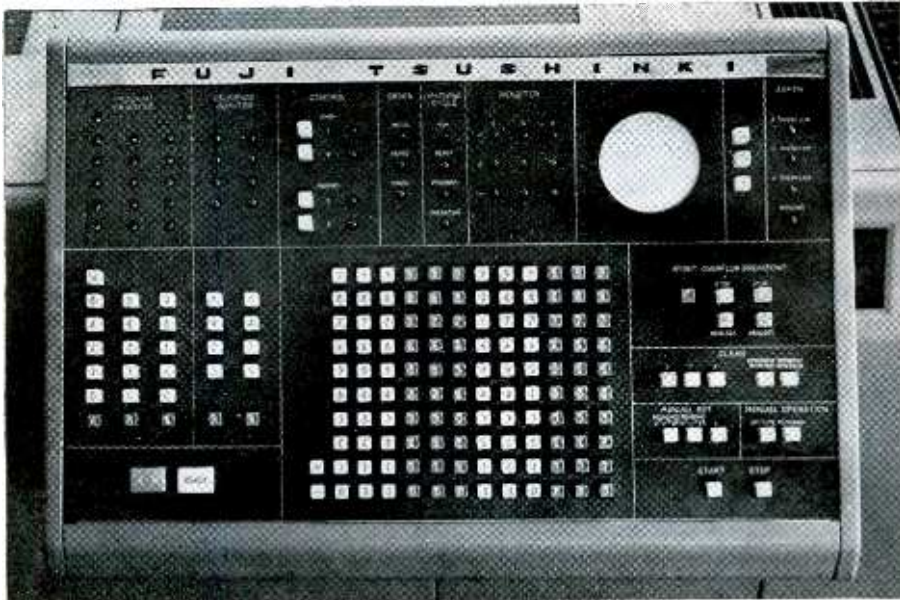

Keyboard of parametron computer designed by Fuji engineers and Mr. E. Goto of Tokyo University who developed the parametron circuit. Fuji Stycon polystyrene capacitors used throughout.

Fuji Stycon polystyrene capacitors

systems-proved in Fuji's parametron computer

Over 20,000 Fuji Stycon capacitors are used in the parametron logic and control circuits of Fuji's unique FACOM 202 digital computer. At high frequencies, the Fuji Stycon shows extreme reliability and exceptional stability of capacitance. The circuit's low operating temperature ideally suits the Stycon's $-10^{\circ}\text{C. to }+70^{\circ}\text{C.}$ range, eliminating the need for more expensive, high-temperature capacitors.

With 27 years of systems-making experience and the latest in modern component technology, Fuji is one of the world's largest suppliers of polystyrene capacitors with a monthly output of 5 million units. Complete specifications are available from Fuji's U.S. distributors.

(Stycon specifications)

Capacitance (mmf)	Standard Type		
	Capacitance Tolerance $\pm 10\%$, $\pm 5\%$, $\pm 2\%$		
	WV 125v d \times 1	WV 250v d \times 1	WV 500v d \times 1
2	6.0 \times 14		6.6 \times 19
5	6.0 \times 14		6.6 \times 19
10	6.0 \times 14		6.6 \times 19
15	6.0 \times 14		6.7 \times 19
22	6.0 \times 14		6.9 \times 19
33	6.0 \times 14		7.1 \times 19
47	6.0 \times 14		7.3 \times 19
68	6.0 \times 14		7.5 \times 19
100	6.0 \times 14		7.7 \times 19
150	6.0 \times 14		8.0 \times 19
220	6.0 \times 14		8.4 \times 19
330	6.0 \times 14		7.5 \times 24
470	6.0 \times 14		7.7 \times 24
680	6.4 \times 19		8.1 \times 24
1,000	7.0 \times 19	8.7 \times 24	8.8 \times 24
1,500	7.4 \times 24	8.9 \times 24	9.6 \times 24
2,200	7.6 \times 24	9.2 \times 24	10.6 \times 24
3,300	8.0 \times 24	9.6 \times 24	12.2 \times 24
4,700	8.5 \times 24	10.2 \times 24	13.9 \times 24
6,800	8.5 \times 35	10.5 \times 35	13.5 \times 35
10,000	9.4 \times 35	11.9 \times 35	15.9 \times 35
15,000	10.8 \times 35	13.7 \times 35	
22,000	12.7 \times 35		
33,000			
47,000			

FUJITSUSHINKI SEIZO K.K. TOKYO, JAPAN

*The Nissho American Corporation

New York 5, 80 Pine St., WH 3-7840 Chicago 3, 140 S. Dearborn St., CE 6-1950

*The Nissho Pacific Corporation

San Francisco 4, 120 Montgomery St., YU 2-7901 Los Angeles 14, 649 S. Olive St., MA 7-7691

CIRCLE 90 ON READER SERVICE CARD

TODAY YOU MUST SELL ALL FOUR!

Is your advertising selling the same four key buyers your salesmen call on? Competition demands it! Only advertising in electronics reaches and sells the electronics man wherever he is: in Research,

Design, Production, and Management. Put your advertising where it works hardest...

in **electronics**

room during the measurements. All parts of the instrumentation system that require primary line power are excluded from the enclosure.

Mild stimuli are provided to the patient in the form of constant-intensity taps applied by a small pneumatic hammer to the area above the ankle tendon. The electrical nerve impulses evoked by the hammer taps travel to the brain. Two electrodes are placed in contact with the skin above the nerve. The electrodes are located close together along the nerve path to detect the nerve impulses. The detected signals from each electrode are fed through a preamplifier to the storage tube.

The area of the ankle above the tendon is coated with silver paint. Each time the silver hammer face makes contact with the coated surface, a trigger is generated. In addition to initiating sweep voltage, the trigger switches off the photographic recording equipment.

The hammer stimulus is repeated 20 to 30 times. By storing the detected output, random noise tends to be canceled. However, the nerve impulses, which occur at constant times after the stimuli, are integrated. The reinforced pulses from the storage tube are displayed on the oscilloscope and photographed. The detected signals appear as two amplitude peaks and spacing of the peaks indicates the time difference that the nerve impulse is detected by each electrode. This information combined with physical spacing of the two electrodes is then used to compute nerve impulse velocity.

The complete instrumentation system includes two additional probes fitted to the calf muscle. These detectors permit a simultaneous reflex check.

The basic function of the equipment is that of detecting weak signals in the presence of noise. The storage tube method can be used for other applications where similar problems are encountered.

Microwave Reflector Solves Cable Problems

PASSIVE reflector for microwave signals has eliminated maintenance problems encountered with cables. A byproduct of the project is the

electronics

acquisition of data on expected losses with a passive reflector when other parameters are varied. Passive reflector losses in this particular installation were 2.8 db.

The microwave system is used by the Tennessee Valley Authority. The passive reflector is mounted on top of the smokestack of a generating plant where it intercepts microwave signals and beams them to an antenna on top of the main electrical control building.

Because of the limited data available about reflector losses in such installations, computations were made on a large digital computer. Results confirmed the findings of a limited analog computer study made nearly ten years ago and were reported to a power communications symposium during the Summer General Meeting of the AIEE at Cornell University by W. C. Jakes of Bell Labs, C. McCord of Knoxville, Tenn., and J. W. Vinyard of Chattanooga.

Seven microwave terminals in the TVA system are located at seven different steam plants. Where needed, the smokestacks have been found to be an economical location for the antenna. At five of the plants, the antenna is mounted at heights of 220 to 500 feet above the ground.

To limit transmission line losses, the microwave equipment has been located in a house at the base of the smokestack. Video cables were used to link the microwave equipment with multiplex equipment located in the communications room at the main electrical control building. However, maintenance problems were encountered with the cables.

In the alternate arrangement, the microwave and multiplex equipments are located together in the communications room. The passive reflector is used to beam the microwave signals directly to an antenna on the roof above the communications room.

In addition to solving the maintenance problem, the new arrangement provided an opportunity for studies of comparative performance of the passive reflector and the customary method. Data obtained from the computer study was sufficient to plot curves relating reflector loss to wavelength, antenna and reflector sizes, and antenna and reflector spacing.

One of a series EXPLORING THERMISTOR APPLICATIONS

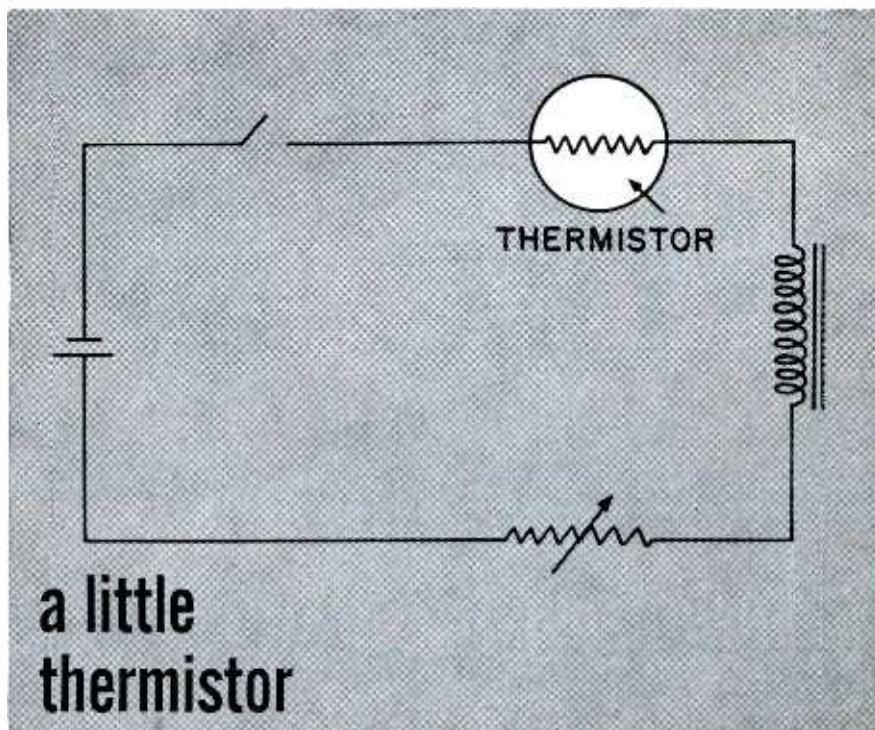

a little
thermistor

makes a big difference
in a
time delay circuit

Circuits like the one above are often used where variable or fixed delay are required. Circuit ingredients: a thermistor and a variable resistor, in series with a battery and a relay.

With the switch closed, current flow is limited by the high resistance of the thermistor. The thermistor then heats up, permitting sufficient current flow to close the relay. Delay time can be increased or decreased by increasing or decreasing series resistance.

This is just one example of putting the thermistor to work. There are hundreds more — including temperature control, liquid level measurement, remote control, switching, power measurement, voltage control — or you name it.

There are just two kinds of thermistors, really: ordinary, which are good; and FENWAL ELECTRONICS', which are a little bit better. One reason is that FENWAL ELECTRONICS has the edge in experience. We pioneered in this field. Another reason is that we can suit your application exactly — FENWAL ELECTRONICS has the most complete line of thermistors available anywhere.



For details, application assistance, and new Thermistor Catalog EMC 4, write:

51 Mellen Street, Framingham, Massachusetts

THE MOST COMPLETE LINE ANYWHERE . . . beads and glass probes . . . discs . . . washers . . . rods . . . probe assemblies . . . El matched pairs



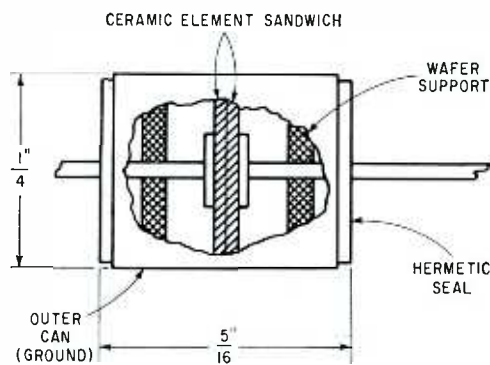

PROTOTYPE I-F FILTER PARAMETERS

PARAMETER	TRANSISTOR MODEL	VACUUM TUBE MODEL
INPUT IMPEDANCE	10K	25K
OUTPUT IMPEDANCE	1K	200K
CENTER FREQUENCY	455 ± 1KC	455 ± 1KC
POWER LOSS AT RATED FREQUENCY	1 db	—
VOLTAGE LOSS AT RATED FREQUENCY	—	1 db
WORKING VOLTAGE	500V D-C BETWEEN ANY 2 TERMINALS	500V D-C BETWEEN ANY 2 TERMINALS

FIG. 1—Cut-away sketch of ceramic i-f filter (left) shows ceramic sandwich construction. Both wafers are identical, and operation of the device is bilateral. Table (right) gives specifications for two current prototype models: A10019C, for transistor receivers; A25H4C, for vacuum tube sets

Piezoelectric Ceramic for Solid I-F Filter

RECENT INTRODUCTION of a ceramic i-f filter by U. S. Sonics, Inc.,¹ adds another electronic component to the blossoming list of piezoelectric ceramic devices. An earlier report in this column (see ELECTRONICS, p 68, June 23, 1961) discussed the role of piezoelectric ceramics as transducer materials. The simple ceramic filter, shown in a cut-away sketch above, may precede a new class of solid state passive circuit elements.

Prototype models operate at 455 kc, but the company plans to extend the spectrum down to 100 kc and up to 1.5 mc with filters based on the present design. The device is not intended as a conversion component that simply plugs in to replace conventional wire wound i-f transformers in present receivers, but rather as a new circuit element that will spark new receiver design. Engineering samples of two models are available: A10019C, for transistor receivers; A25H4C, for vacuum tube receivers. Specifications of both are shown above. Both filters have temperature stability of 0.1 percent from room temperature through 80 C, negligible spurious response within an octave of center frequency, and shock resistance to repeated 100 g shocks. Available bandwidths, at 6 db points, run from 1 to 20 percent of center frequency.

Filter consists of a hermetically sealed three layer sandwich of ce-

ramic wafer-copper electrode foil-ceramic wafer, held between two electrodes running to axial leads. A contact to the central foil electrode is brought out as a common terminal. The filter is completely bilateral as a result of its symmetrical construction, and either end lead can be used as input or output. It operates as a step-down transformer in both directions, and is insensitive to load impedance value over a wide range, as shown in Fig. 2. Power loss at the specified operating frequency is 1 db or less.

Electrical energy of an input signal applied across an end electrode and ground is transduced to mechanical energy through the piezoelectric effect by one ceramic wafer. Mechanical energy is mechanically

coupled to the second wafer and transduced back to electrical energy appearing in an output signal across the second and electrode and ground. This energy transfer process only occurs at the mechanical resonance frequency of the wafers. Proprietary right considerations have prevented the company from describing exactly the type of material used for the wafers. Company reports it is a member of the lead zirconate family, and was chosen especially for filter use because of its excellent temperature stability.

The exact process of impedance transformation is not yet understood but much research effort is aimed at understanding this process and the unique bilateral operation. A rough physical argument can be formed to explain the insensitivity to load impedance by considering one wafer of the sandwich at a time. Assume that a suitable load impedance is across the electrodes, and the ceramic wafer is being mechanically stressed. The wafer will deliver electrical power to the load. If load impedance is considerably lower than the internal impedance of the capacitor formed by the electrodes and wafer dielectric little power will be dissipated in the ceramic, and nearly all will be delivered to the load. This will hold over a fairly wide range of load impedances. Power transfer will decrease when

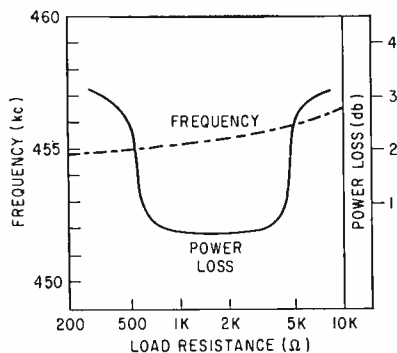
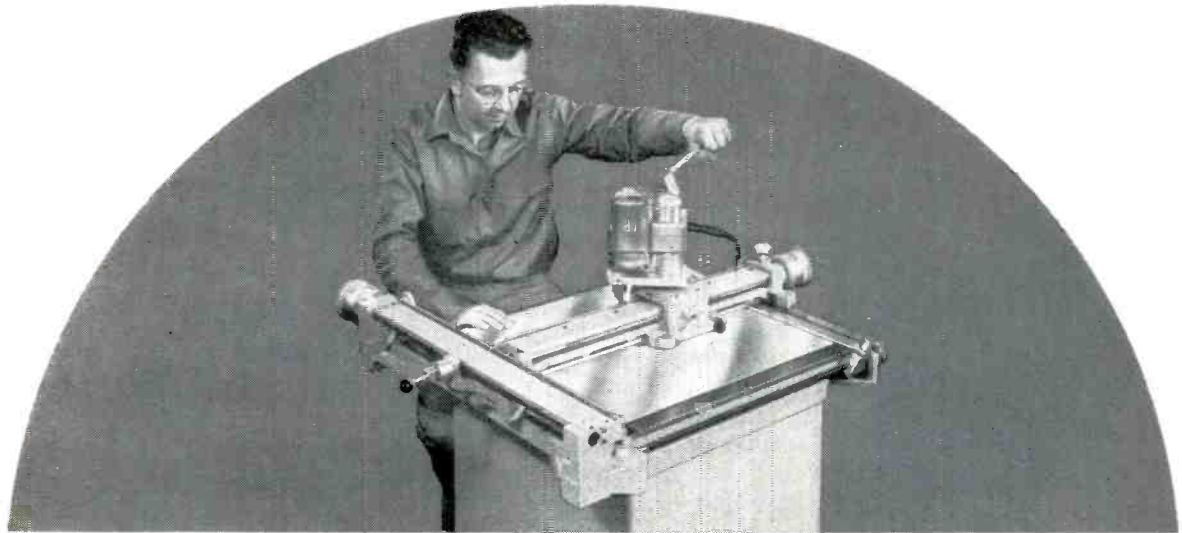
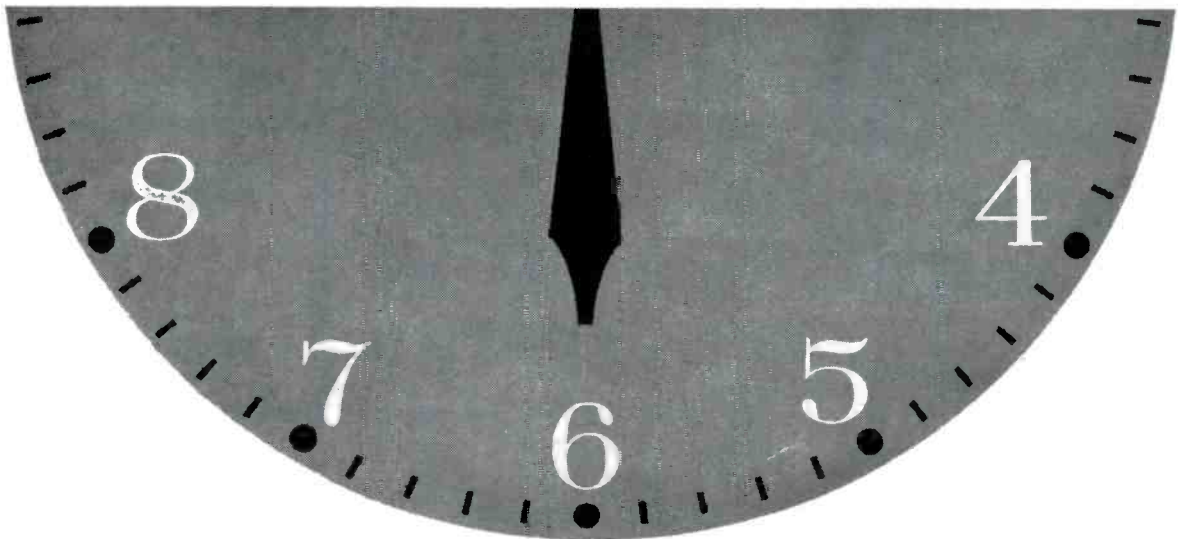

FIG. 2—Plot of power loss and resonant frequency versus load impedance. Input impedance is 10,000 ohms



STRIPPIT FLEX-O-DRILL CUTS TIME IN HALF



STRIPPIT Flex-O-Drill Drilling-Layout machine offers you low cost, quality equipment that drills, reams, center punches and scribes within $\pm .002''$ accuracy. Designed for template layout and drilling, it's also ideally suited for pilot runs and short run production. A new, inexpensive accessory utilizing a high quality optical instrument converts the Flex-O-Drill to an accurate machine for checking drawings, patterns, templates or production pieces.

STRIPPIT Flex-O-Drill permits you to work directly from a chart of x and y coordinates...no need to make base line drawings. Adjustable steel tapes quickly set up coarse dimensions. Quick-set Micrometric Gages provide fast, accurate adjustment to thousandths. Result...template making time slashed as much as 50% or more.

STRIPPIT Flex-O-Drill can be operated by anyone with only a few minutes of study. Let our STRIPPIT Tool & Methods Engineer explain the finer points of the Flex-O-Drill and demonstrate it in your plant. Or write for catalog FD.

WALES **STRIPPIT** INC.

225 Buell Road • Akron, New York

In Canada: Strippit Tool & Machine Company, Brampton, Ontario

In Continental Europe: Raskin, S. A., Lausanne, Switzerland

In the British Isles: Kearney & Trecker—C. V. A. Ltd., Hove, Sussex, England



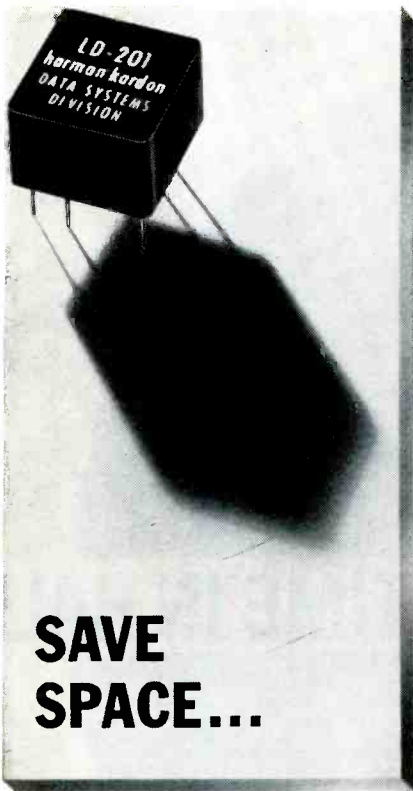

**SAVE
SPACE...**

INCREASE RELIABILITY

with
Harman-Kardon encapsulated
digital logic modules...
proven components...proven
circuits...proven packaging

These fully encapsulated modules offer increased reliability—afford a high density, fully protected package with better heat dissipation. And, you will find the cost competitive with open card construction.

The modularized Series 200 logic circuits are available now—from stock—in a variety of logic configurations for operation up to 250 Kc. Higher speed units, too, are on the way!

The application engineering staff of the Data Systems Division stands ready to serve you in the implementation of your system block diagrams.

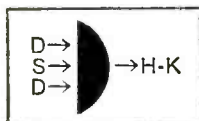

Data Systems Division

harman kardon

INCORPORATED
Plainview, N.Y.

the load impedance approaches the order of magnitude of the wafer internal impedance, or tends to short circuit the wafer.

No equivalent circuit diagram for the filter can be drawn because of its bilateral nature. Once inserted in a circuit its operation is similar to a standard i-f transformer with the addition of series capacitors in the input and output to block a d-c path. Operating power loss is only 1 db compared to up to 12 db for conventional units.

Company claims that quantity unit cost will be competitive with wire wound transformers: 31 cents per unit in quantities of 10,000.

Ceramic i-f filters have an edge over conventional wire wound i-f transformers in several areas. Overall physical size of developmental models is smaller than currently used miniature wire wound transformers. Most of the device volume is taken up by the case and hermetic seal. Hermetic sealing is necessary to prevent moisture from condensing on the wafer sandwich and altering its resonant frequency. In applications where a complete circuit is encapsulated or otherwise sealed against moisture, the ceramic elements may be installed directly.

The ceramic filter is permanently aligned and bandwidth is established during manufacture, and no further tuning or adjustment is required after installation. This will enable radio manufacturers to arrange receiver chassis without provision for access to the i-f strip, as well as simplify the lives of radio repairmen.

Prototype ceramic filters are housed in a metal case: input and output terminals are axial leads and the case is ground. The filter chassis mounts through a small metal clip. Production models are scheduled for all plastic hermetically sealed housings having a third lead as common terminal.

The company reports that the three lead arrangement is suitable for automatic insertion in printed circuit boards, and that the case will fit standard inserting machines.

Two design problems inherent in the ceramic filter are its low characteristic input impedance and lack of a d-c path. Impedance values of greater than 25,000 ohms are diffi-



Your
ingenuity

PLUS

simple
tools

can
transform

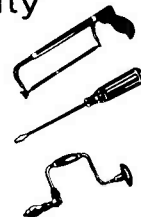

BUD IMLOK

extrusions
and
connectors



↓ into housings
like these

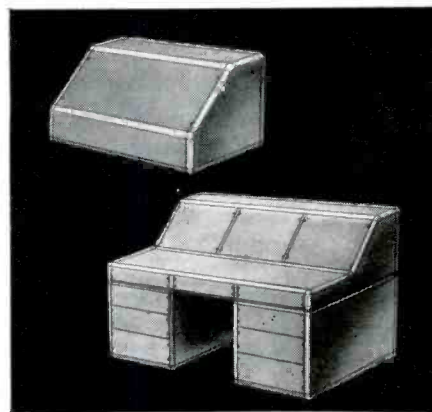

When you need cabinets, racks or cases for experimental or prototype work, make them, quickly and inexpensively with BUD IMLOK extrusions and connectors. No tooling costs or expensive labor are involved. The new BUD IMLOK manual gives complete details on this system. Write us for a copy or obtain one at your local BUD distributor.



BUD RADIO, INC.
CLEVELAND 3, OHIO

CIRCLE 205 ON READER SERVICE CARD
electronics

cult to produce. Company design engineers used shunt resistors to match impedances in several experimental transistor receiver conversions.

This technique increases the power loss in the i-f strip, and increased gain in other stages may be necessary for compensation. However, the lower initial power loss of the ceramic filter as contrasted with conventional transformers, negligible i-f mistuning losses and tolerance to impedance mismatch often negate shunt resistance losses, the company says. D-c path can be provided, again by addition of resistors and corresponding power loss.

Bandwidths as narrow as 4 kc can be achieved with single ceramic filter elements operating in the radial mode.

The ceramic filter is far less susceptible to microphonics than conventional i-f transformers.

Ladder network arrays of several single elements can be produced with a wide range of transfer characteristics.

Company spokesmen claim that a ladder filter composed of 6 ceramic elements can have characteristics comparable to currently available quartz filters. Extrapolating from quantity i-f filter prices, this indicates a quantity ladder filter price of \$2.00 per unit.

A practical upper frequency limit for radial mode piezoelectric devices is about 1.5 mc. At higher frequencies the ceramic disc is too small to be handled conveniently. Higher frequency filters will be cut to operate in the shear mode at frequencies in the tens of mc. The company is presently developing i-f units for f-m and t-v applications, where the pretuned and set bandwidth properties are exceptionally valuable.

Lower frequency filters are being developed for automobile radios which operate at an i-f frequency of 265 kc. Filters could be built to operate below 100 kc, but are too large physically to be considered practical. The company reports an auto radio manufacturer will convert its complete line to ceramic i-f transformer construction in the near future.

REFERENCE

(1) U.S. Sonics, Inc. 63 Rogers Street, Cambridge 42, Mass.

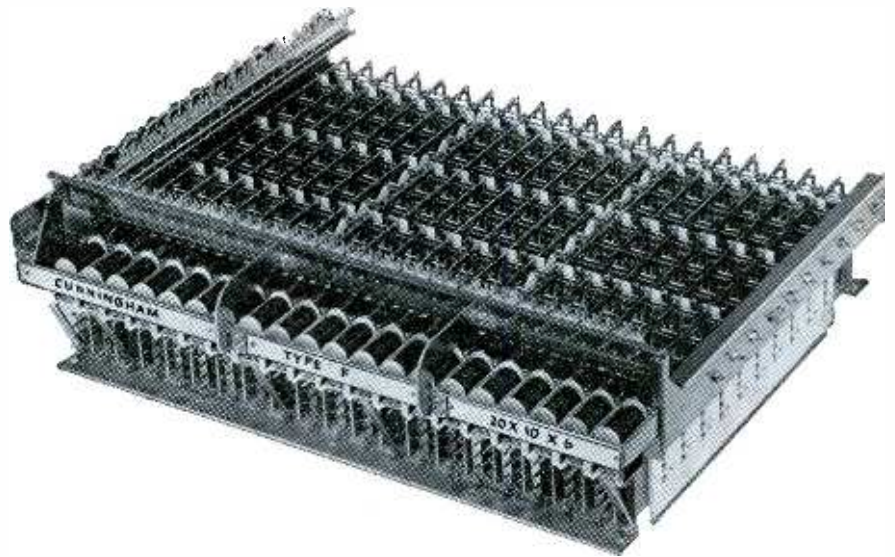

Tolerance Buildup No Bugaboo with Punched Laminated Plastics Parts

The compounding of individual tolerances on several punched holes or cutouts over the length of the piece is not the bugaboo that many designers believe. Careful die work and good working knowledge of the laminate used minimizes tolerance buildup. A good example of what can be done is the insulated pusher fabricated by Taylor for a high-performance crossbar switch manufactured by James Cunningham, Son & Co., Inc., Rochester, N.Y.

These switches are 3-dimensional conductor matrices, with from 30 to 1200 switching contacts, which bring intelligence from as many as 600 sources to one or more readout or signal points. They are basic components in computers, machine tool programming systems, high frequency scanning systems, thermocouple and strain gage monitoring, and similar equipment.

The insulated pusher, only 2.955 in. long and .031 in. thick, and fabricated from Taylor Grade GEC-500 glass epoxy laminate, is a critical part of the crossbar. It must be held flat within $\pm .005$ in., with total over-length buildup not exceeding $\pm .002$ in.

The materials used before to fabricate the pusher proved difficult to hold to the tolerances required. The success of the GEC-500 laminate fabricated by Taylor is evidenced by marked reduction in rejects and a 20% gain in production.

Taylor Fibre's Fabricating Division has the manpower, experience and equipment to produce parts to close tolerances from any of the company's raw materials. Send us your problem—we will recommend the best material for the job and quote on production runs. Write Taylor Fibre Co., Norristown 40, Pa.

Taylor
LAMINATED PLASTICS VULCANIZED FIBRE

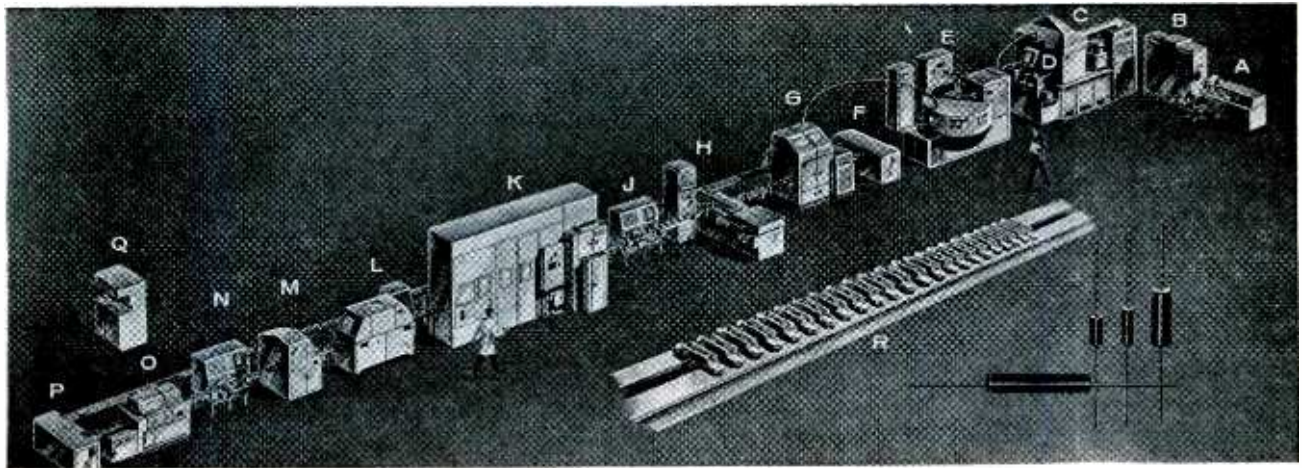

Machine parts are computer (A), input-output control (B), coating (C), inspection (D), terminating (E), conveyor control (F), capping (G), helixing (H), inspection (J), encapsulating (K), leak detecting (L), marking (M), inspection (N), packing (O) and conveyor control (P). Q represents the cap lead welder and R shows a conveyor section

Computer Controls Resistor Production Line

DEPOSITED CARBON resistors are made on a fully-automatic, 11-station production line at Western Electric Company's North Carolina Works, Winston-Salem. A digital computer with 4,096-word drum storage is used for programming, setup and feedback control of resistor values. It will accept, at random, a month's production scheduling requirements. Resistors are produced at a maximum rate of 1,200 an hour in four power ratings with almost any possible resistance value.

Statistical quality control is used. Data from three test points is analyzed to determine if there is a drift away from nominal values. If a trend is detected, new setup information is calculated for appropriate stations. In addition to feedback control, the computer provides initial setup of wattage size at eight machines and resistance values at six machines.

Unit-by-unit deposition, rather than batch coating, is employed to facilitate feedback control. The ceramic cores are transported through heating and deposition furnaces on rotating horizontal rollers, then inspected. Resistance value of the carbon coating is adjusted through computer control of the speed of core passage

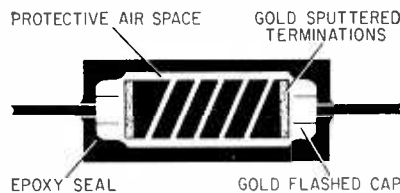

Cutaway view of encapsulated resistor

Termination sputtering machine. Engineer holds bell jar



through the furnace, pyrolysis temperature and methane gas flow. Resistance is measured by passing cores between four probes of a bridge. Analog voltage is digitized for computer analysis. This station also inserts magnetic slugs to separate lots of resistors of different size or values.

Gold contacts are sputtered on core ends in rotary indexing vacuum chambers. The first section of this machine fits the correct size mask over each core. The chamber is then evacuated and backfilled with argon. Rollers rotate cores inside the masks as the gold is sputtered.

Leads are percussion welded in advance to end caps of gold-plated brass. A capping machine presses the cap assemblies over both ends

of the core, welding them to contacts. The capping machine is triggered by each core arriving from the sputtering machine.

A helixing machine cuts a spiral groove along the carbon film to give it the desired resistance value. The resistor is chucked and rotated against a diamond-impregnated wheel. Cutting is monitored by a computer-controlled bridge, which disengages the lathe at the proper value. If the resistor reaches desired value before 75 percent of its length is grooved, or if resistance is not reached in the full length, or if non-linearity is sensed, the resistor is rejected.

The helixing is done to full value, to eliminate hand-rubbing for adjustment. The helix lathe bridge is slightly biased to compensate for

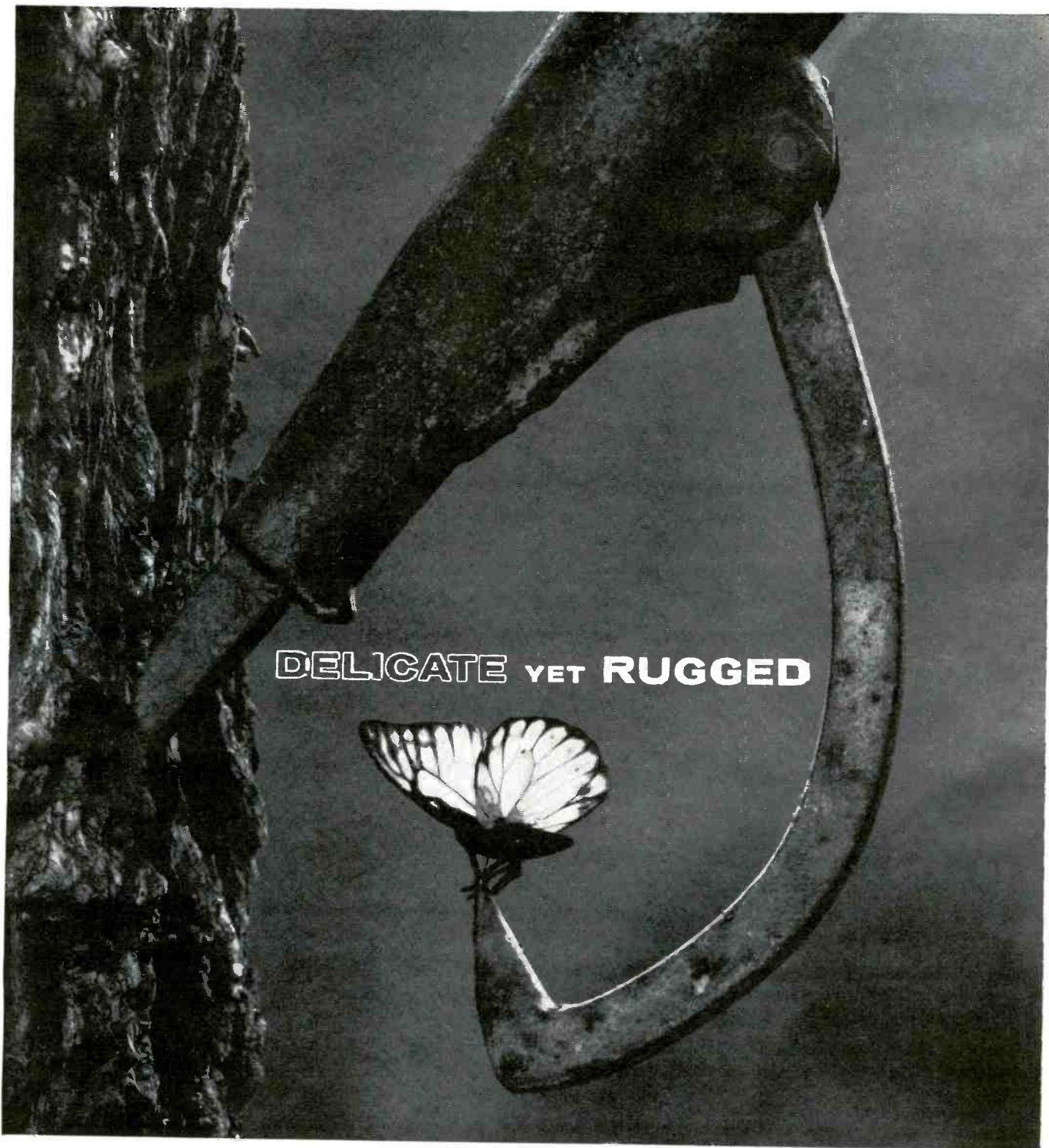

DELICATE YET RUGGED



Not a usual combination. The sensitivity and toughness included in every Honeywell panel instrument is a result of the infinite patience and superior technical know-how of our designers and engineers. Ruggedized Honeywell panel instruments are available with external zero adjuster. They are sealed, dustproof, moistureproof and immune to the hazards of climate and atmosphere. Built to withstand the most severe tests of shock, vibration and strain — and still give accurate, reliable readings — they're another reason why the name Honeywell and the word dependability are synonymous. Perhaps a quality instrument from Honeywell can help you do a job better and faster. Just get in touch with our representative in your area — he's listed in the classified pages of your telephone directory. Or contact us direct: PRECISION METER DIVISION, Minneapolis-Honeywell Regulator Company, Manchester, New Hampshire, U. S. A. In Canada, Honeywell Controls Limited, Toronto 17, Ontario. Honeywell International Sales and service offices in all principal cities of the world.

Honeywell



Precision Meters

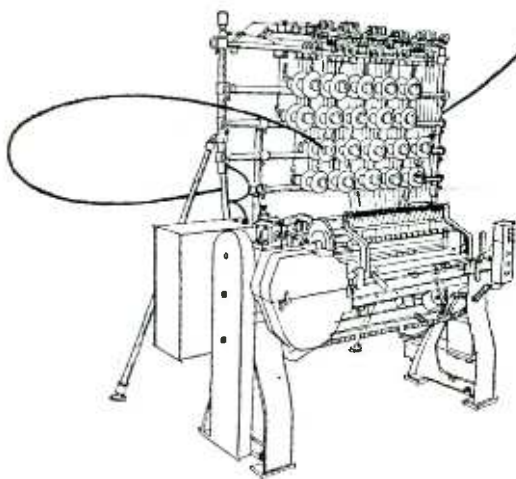
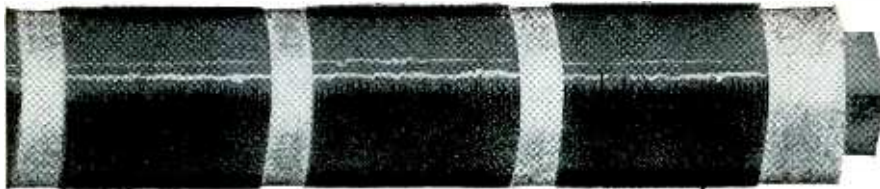

Faster, finer way to wind coils Leasona Model No. 107

Winding paper insulated coils is faster, more accurate and more economical on the fully automatic Leasona No. 107.

Here's why:

Electronic control eliminates wire breakage at start-up by gradual winder acceleration. ■ **Paper Miss Detector** automatically stops machine if a miss occurs. This permits one operator to tend several machines. ■ **Windings** are made at speeds up to 2500 rpm on paper inserts from 1 $\frac{3}{8}$ " (with short paper attachment) to 23 $\frac{1}{2}$ ". A special attachment is available for wide spacing in windings. ■ **Three methods of tension** — strap-type handles wire from No. 19 to No. 42 (B & S); Insto-start over-end type handles No. 20 to No. 44 (B & S). Pot-type wire No. 40-50 (B & S) & finer.

These are just a few of the positive advantages of the Model No. 107 that will help you wind better coils at lower cost. For full details write Leasona Corporation, P. O. Box 6088, Providence 4, Rhode Island.



23B.1.3

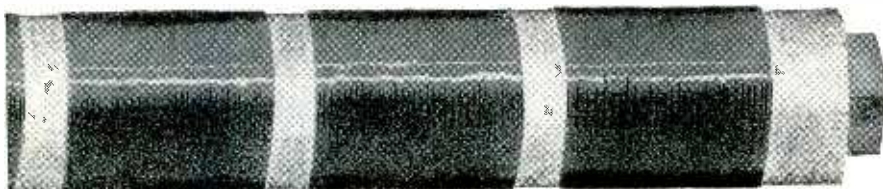

machine inertia and grinding heat. Servos adjust speed and pitch. Helixing time has been reduced to three seconds by careful balance of the rotating mechanism and the use of a magnetic counterweight to hold movable chucks against the cutting wheel.

The encapsulating machine fits a precured epoxy shell over the core. Two partially-cured epoxy pellets are fitted over the leads. As the resistor passes through a curing oven, the pellets soften and seal the shell. The resistor is held between rubber chucks, which prevent leaks by trapping the air under the shell.



Helix monitoring station



Packing station loads resistors into foam blocks in magazine

Cooling water jets terminate the cure. Detection circuits reject resistors missing shells or pellets.

Resistors are picked off the conveyor by holding clips and immersed in hot water. The water contains a wetting agent so escaping air bubbles will not cling to the resistor. Air bubbles are detected by photoelectric cells. If bubbles are detected, a mechanical memory tag on the holding clip is actuated and the resistor is rejected as it leaves the tank.

Identifying markings are stamped on the shell by an offset printer. However, the type head does not reciprocate against the

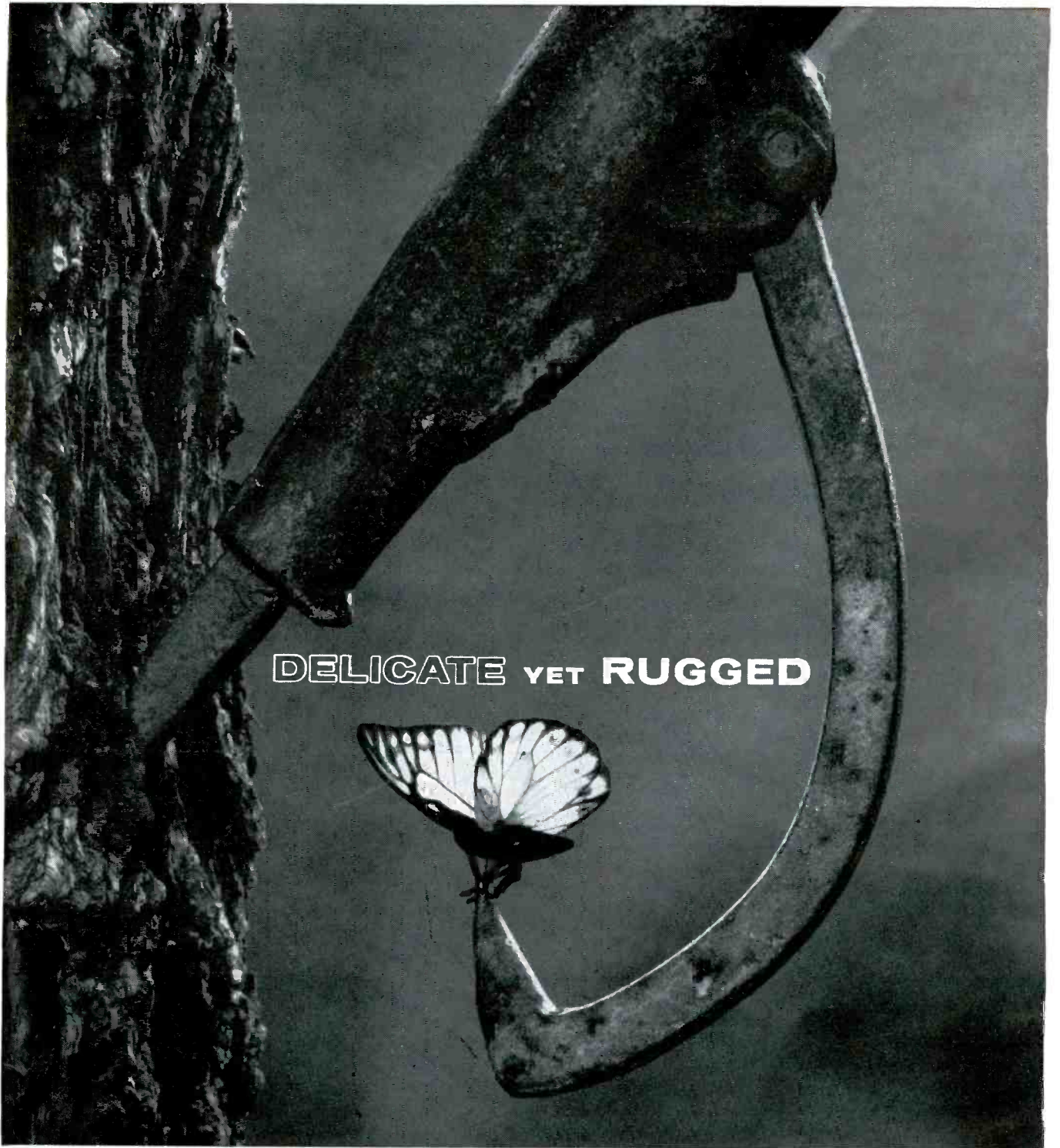

DELICATE YET RUGGED



Not a usual combination. The sensitivity and toughness included in every Honeywell panel instrument is a result of the infinite patience and superior technical know-how of our designers and engineers. Ruggedized Honeywell panel instruments are available with external zero adjuster. They are sealed, dustproof, moistureproof and immune to the hazards of climate and atmosphere. Built to withstand the most severe tests of shock, vibration and strain — and still give accurate, reliable readings — they're another reason why the name Honeywell and the word dependability are synonymous. Perhaps a quality instrument from Honeywell can help you do a job better and faster. Just get in touch with our representative in your area — he's listed in the classified pages of your telephone directory. Or contact us direct: PRECISION METER DIVISION, Minneapolis-Honeywell Regulator Company, Manchester, New Hampshire, U. S. A. In Canada, Honeywell Controls Limited, Toronto 17, Ontario. Honeywell International Sales and service offices in all principal cities of the world.

Honeywell



Precision Meters

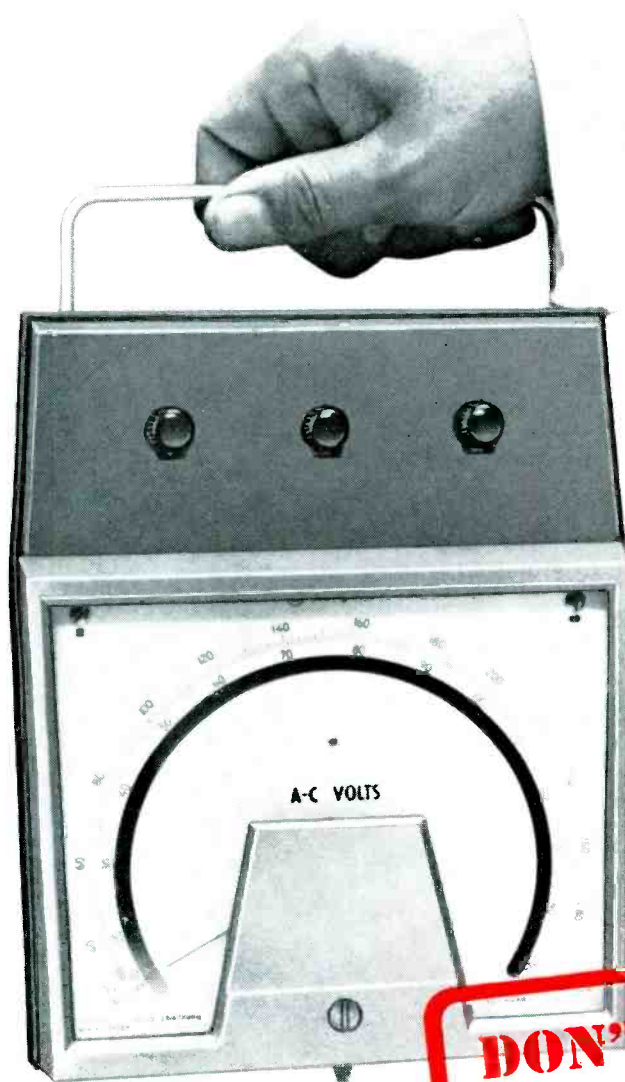

Type 161 TBS Portable Instrument—
11.2-inch scale

**DON'T HANDLE
WITH CARE**

New, rugged Westinghouse portable instruments give long-term accuracy never before possible

There's no need to treat them gently. These new Westinghouse portable instruments have neither pivots nor jewels. There is no friction in the movement—no wear—nothing to get out of adjustment. The secret is a unique development—Westinghouse Taut Band Suspension. The moving element is suspended between strong metal bands under high tension. These bands carry the current to the coil and provide torsion against rotation.

In the Westinghouse instrument laboratory, this rugged instrument movement has withstood over 200 shock tests of 2400 G's and retained accuracy within 1/2%. After 24 million full-scale deflections, repeatability remained within 1/20 of 1%. By contrast, pivot and jewel instruments, after only one million deflections, will have so much

friction their accuracy will be questionable. Conclusion: Westinghouse *tbs** portable instruments are the toughest precision portables ever made. Maintenance, recalibration and other adjustments are practically eliminated.

Westinghouse TBS portable instruments are available as a-c or d-c ammeters or voltmeters, with single or multi-range scales for practically any precision applications. Full-scale deflection as low as 1 microampere is available. Shatterproof glass window, high impact molded case and insulated retractable handle are standard features. Accuracy rating is 1/2% or 1/4%. All Westinghouse portable instruments meet or exceed the requirements of ASA standard C-39.1. Write for complete specifications and a sample of Taut Band Suspension. Westinghouse Electric Corporation, P.O. Box 868, Pittsburgh 30, Pennsylvania. *You can be sure... if it's Westinghouse.*

J-40541

*Trademark of Westinghouse Taut Band Suspension Instruments

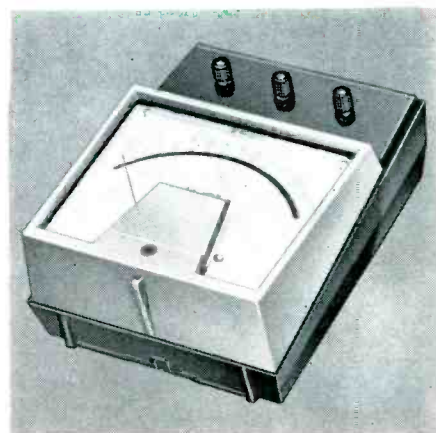

Type 151 TBS Portable Instrument—
6.0-inch scale

Westinghouse



VERY NARROW

10kc*

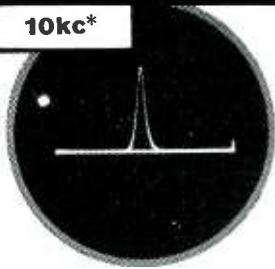

TO VERY WIDE

400mc**

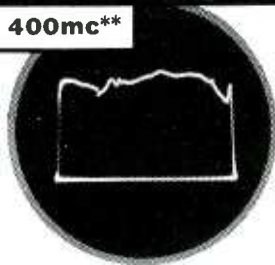

SWEEP WIDTHS
... all in one instrument

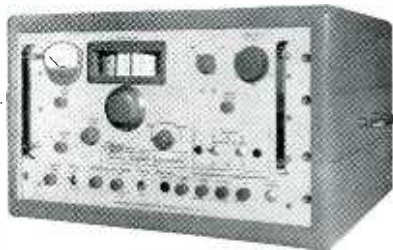

NEW JERROLD® 900B
SWEEP SIGNAL GENERATOR

The new Jerrold 900B is the last word in versatility and precision, the ultimate instrument for all your IF, VHF, and UHF sweep requirements. Bench space requirements and test set-up time are drastically cut because so much is already built in:

- Built-in crystal-controlled harmonic markers at 1, 10, and 100mc intervals.
- Built-in variable-gain dc or ac-coupled 'scope preamplifier with 200X maximum gain.
- Built-in precision attenuator from zero to 50db in 10db steps.

Generating sweeps with center frequencies ranging from 500kc to 1200mc, the 900B offers unusual stability with sweep widths as narrow as 10kc and as wide as 400mc. Write for complete technical data.

\$1,980.00 f.o.b. Philadelphia

*Typical communication receiver IF (selectivity approx. 6 kc).

**Frequency response of typical wide-band distributed amplifier (4-216 mc).

JERROLD® ELECTRONICS CORPORATION
Industrial Products Division, Dept. ITE-121
The Jerrold Building, Philadelphia 32, Pa.
Jerrold Electronics (Canada) Ltd., Toronto
Export Representative: Rocko International, N.Y. 16, N.Y.

WASHINGTON OUTLOOK



ELECTRONIC COMPANIES are scrambling for Project Apollo subcontracts now that NASA has named North American Aviation prime contractor. Subcontractor selections should start in a few weeks. Other prime contract bidders were Martin and teams headed by GE, General Dynamics and McDonnell Aircraft.

The spacecraft is to send a trio of astronauts to the moon and back by 1967-69. Apollo is expected to cost several billion dollars before the first lunar landing. NAA's share will tally well over \$1 billion, NASA experts predict.

Apollo is to be built in three modules (sketches are artist's conception of lunar landing, left, and takeoff): a command center module for the astronauts with controls, much like those used in Mercury capsules; a second carrying fuel, electrical power supplies and takeoff propulsion units; a third with landing deceleration rockets.

North American will build the first two modules. Selection of a contractor for the third module is expected within six months. Initial plans call for NAA to build 10 to 15 capsules. A mockup model, for NASA acceptance testing, is due by late 1962. Flight models to check out the system are to be ready by 1964. Circumlunar manned flight will then be made before the attempt is made to land on the moon around 1967-69.

Final negotiations of the cost-plus-fixed-fee prime contracts are underway now between NASA and NAA. The project will be handled by the company's Space and Information Systems division at Downey, Calif.

NEXT YEAR'S Pentagon budget, nearing final shape, will boost new orders for electronics procurement and R&D. This year, procurement appropriations run about \$5 billion: \$1.4 billion for "pure" electronics and communications, the remainder lumped in with aircraft and missiles. Current R&D is about \$1.2 billion.

Electronics programs likeliest to gain are Minuteman, Polaris, Skybolt and Pershing missiles; Nike Zeus anti-ICBM system; tactical battlefield equipment; Midas, Samos and Advent satellites; electronic support systems like 480-L air communication, 473-L and 465-L Air Force control, and 496-L space surveillance systems.

Aircraft budget will be heavily trimmed from this year's \$5.9 billion. Air Force will cut combat type plane procurement, increase transport planes and buy large quantities of the Navy's Douglas A4D fighter-bombers. Missile orders will be substantially higher than this year's \$4.2 billion. NASA is expected to get twice this year's \$1.7 billion.

TUNG-SOL
6977
*subminiature
 indicator triode
 saves display space*

Here's an indicator triode for computer and business machine applications that will replace neon lamps in computer circuits. It has the advantage of low voltage drain with great economy of display area.

The Tung-Sol 6977 is a filamentary, high vacuum, subminiature triode with a fluorescent anode. Especially advantageous in transistorized circuits, its high input impedance and small signal requirements do not load these circuits.

Tung-Sol design and manufacturing skills are being applied constantly to the problems of improving componentry in all fields where industrial and special purpose tubes find their specialized uses.

If you have questions regarding the application of type 6977, or any tube type, you are invited to bring them to Tung-Sol. You will be pleased with the results. Tung-Sol Electric Inc., Newark 4, N. J. TWX: NK193

TYPICAL OPERATION

Heater Voltage ^B AC	1.0	Volts
Anode Voltage DC	50	Volts
Grid Resistance	100,000	Ohms
Grid Supply Voltage for max. light output	0	Volt
Grid Supply Voltage at zero light output	- 8	Volts

TECHNICAL ASSISTANCE IS AVAILABLE THROUGH: Atlanta, Ga.; Columbus, Ohio; Culver City, Calif.; Dallas, Tex.; Denver, Colo.; Detroit, Mich.; Irvington, N. J.; Meirose Park, Ill.; Newark, N. J.; Seattle, Wash. In Canada: Abbey Electronics, Toronto, Ont.

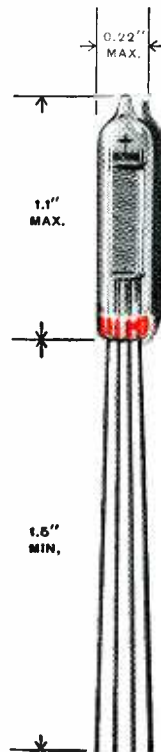

Today's most versatile 11" x 17" XY-T* Recorder

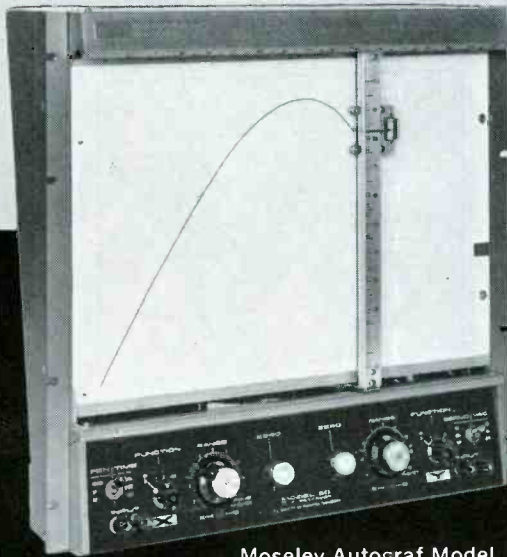

Moseley Autograf Model 2DR Recorder, today's most compact 11" x 17" rack-mount instrument!

COMPACT RACK MOUNT

*Built-in time base

Moseley Autograf Model 2DR Recorder mounts flush with rack, takes only 17½" of rack space, is only 5⅛" deep behind control panel, ideal for systems use.

Accepts ac or dc input on each axis, includes calibrated X-axis time base, scale factor vernier, 16 dc ranges, 8 ac ranges, 7 calibrated sweeps on X-axis time base. DC accuracy greater than 0.2% full scale. \$2525.

The Moseley 2D, a benchtop recorder, features the same size and flexibility advantages as the 2DR. This is today's most versatile bench instrument, has all the electronic features of the 2DR and is readily convertible to roll chart use. \$2450 (roll chart accessory, \$575 additional).

Write today for full details.



Now available! Models 2D-2, \$2,050.00, and 2DR-2, \$2,125.00, identical to above instruments, except without ac converter.

AUTOGRAF recorders

F. L. MOSELEY CO.

Dept. A-12, 409 N. Fair Oaks Avenue, Pasadena, California
MUrray 1-0208; Area Code 213 TWX PASA CAL 7687, Cable MOCOPAS

Field representatives in all principal areas • Data subject to change without notice • Prices f.o.b. Pasadena • Pioneer and leader in X-Y and and Strip-Chart Recorders



You can
FEEL
 the Difference
 in an Ohmite
 Rheostat

Sm-o-o-o-th Operation Prolongs Life...Aids in Close Control

TRY IT YOURSELF! Note the smooth, silent glide of the contact over the windings . . . and of the contact moving off and on the terminal bands. There's absolutely no raspy grinding to cause premature wear . . . no aggravating "jerk" points that make you hunt for a setting.

The smooth, close control of Ohmite rheostats doesn't just happen. It's the result of special production operations that eliminate roughness. All 11 sizes of Ohmite rheostats from 12½ to 1000 watts bring you this plus value . . . a refinement that pays dividends in your equipment, whether the rheostat is to be hand operated or motor driven.

Write on Company Letterhead for Catalog 58.

Terminal lug band is adjusted to wire diameter...no bump up or down for the contact.

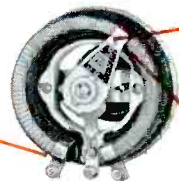

Rounded pivot gives metal-graphite contact brush flush-floating contact with wire.

Smooth, welded transitions between the different wire sizes of tapered windings.

SMOOTHNESS FROM ATTENTION TO DETAIL



OHMITE MANUFACTURING COMPANY
 3610 Howard Street, Skokie, Illinois

Rheostats Power Resistors Precision Resistors
 Variable Transformers Tantalum Capacitors
 Tap Switches Relays R.F. Chokes
 Germanium Diodes Micromodules

distribute them to the industry. The library will include U.S. and foreign patents and all available technical information.

Financing of the center was started with pledges of \$5,000 from Hawley Products and \$1,000 from Arnold Engineering.

Resonant-V Rod Antenna Gets All VHF Tv Channels

ANTENNA designed to receive all vhf tv channels equally well is reported by University of Illinois Antenna Research Lab. The inventors, Paul Mayes and Robert Carrell, say it is especially useful in fringe areas served by two or more cities and for pulling in signals over long distances.

Operational model uses 14 aluminum rods attached diagonally to two central eight-foot rods and swept forward in V configuration. The central rods are supported on a pole at right angles. Design was derived from work on log-periodic antennas.

Guided Bus Line May Go Into Operation in 1965

CHICAGO—The Transit Authority is testing an electronically-guided, driverless bus this month on an unused, one-mile stretch of road. CTA hopes to operate guided buses when an expressway with separate transit lanes is ready in 1965.

Sensing units under the test bus pick up low frequency (10Kc) signals from low-voltage cable in the road. Modified Barrett Electronics industrial self-guiding devices control the bus' hydraulic steering mechanism and at programmed intervals sound the horn, stop the bus and open and shut the doors.

Chicago Area to Create Permanent R&D Council

CHICAGO—Chicago area conference on R&D wound up last week with a decision to create a permanent R&D council, made up from university, industrial and financial communities and coordinated by the Chicago Association of Commerce and Industry.

Three-way program will be developed to improve public relations,

better the scientific atmosphere of the area and increase interest and activity in electronics and aerospace defense contracts.

Number of Midwest R&D labs has dropped from 27 percent of national total, in 1950, to 24 percent while West Coast facilities have increased 12 percent, Haldon Leedy, Armour Research Foundation said. Midwest overemphasis on hardware manufacturing and disinterest in R&D is to blame, he said. Failing to keep up with technology will affect the area's industrial growth, he said.

Experimental BWO Gives High Millimeter Power

EXPERIMENTAL backward wave oscillator developed by Varian Associates delivers 1.6 watts of c-w power in the 50-Gc to 75-Gc band. The company thinks that further development of techniques used may lead to oscillator-amplifier chains capable of hundreds of watts of c-w power at 50-75 Gc and tens of watts c-w in the vicinity of 150 Gc.

The device emits a 0.012-inch diameter beam from an impregnated tungsten dispenser cathode. The prototype uses a powerful electromagnet to confine the beam to the center of the interaction structure. Permanent magnets would be used in production units. Design reportedly enables strong interaction with the high-density electron beam without drawing excessive cathode current.

FCC Starts UHF Tv Tests in New York City

FCC TEST of uhf tv in New York got underway last week when Chairman Newton Minow flipped a switch on the 86th floor of the Empire State Building. The experiment, planned more than a year and costing \$2 million, could lead the way to an uhf television system in the U.S.

WUHF will broadcast on channel 31 in the metropolitan area. Educational and institutional programs will be monitored by home sets and professional equipment. Receivers and monitors will be relocated on a monthly schedule, to blanket the region thoroughly during a two-year period.

In Brief . . .

AEROSPACE Industries Association has selected Armour Research Foundation to direct its Automatically Programmed Tools (APT) program.

PHILCO's TechRep division will supply 84 instructors to Navy electronics school, reportedly first use of contract instructors for Navy rate training programs.

MOTOROLA has received R&D contract for the Mariner R Venus spacecraft flight command subsystem and test console.

MIT INSTRUMENTATION Lab has begun development of gyros for Apollo.

ARMY has awarded Raytheon \$5 million in contracts for ground support equipment and continued development of Hawk missiles.

AIR FORCE is awarding Space Technology Laboratory a \$10 million contract for research in detecting nuclear explosions by instruments in spacecraft.

OTHER Air Force awards include \$2 million to Bosch Arma for R&D on Atlas Guidance; \$1.8 million to IBM for production tooling for B-52 bomb-nav system; \$10.4 million to Avco for more FPS-26 radars; \$800,000 to GPL, mostly for doppler radar.

NAVY contracts include \$1.8 million to DuKane Corp for electronic components of a new type sea mine; \$1.2 million to Lear for guidance and electrical components of the antisubmarine DSN-3 drone helicopter.

RYAN Electronics has sold \$320,000 in military aircraft doppler navigation radar to Australia and Japan.

RECENT military and space contracts also include \$600,000 to Consolidated Electrodynamics for recorders for Surveyor; \$500,000 to Magnetic Amplifiers division of Siegler for airborne power supplies; \$595,000 to Taffet Electronics for mobile telephones and pulse generator sets; \$300,000 to Kin Tel for closed-circuit tv.

ELECTRONICS NEWSLETTER

ELF-VLF Propagation May Be Bomb-Proof

SURVIVAL of communications in an era of 50-megaton bombs (*ELECTRONICS*, p 9, Nov. 10)—sharpening focus on propagation methods immune to man-made ionospheric disturbances—adds significance to long-term Air Force research on elf (from a few cps to 3 Kc) and vlf (3-30 Kc) communications.

Projects Argus and Hardtack indicated vulnerability of ionosphere-dependent communications to high-altitude nuclear explosions. Elf, vlf, meteor trail facsimile, exospheric forward scatter and multi-lobe techniques may provide solutions.

Elf and vlf advantages appear to be: low transmission losses in earth-ionosphere space, relative immunity to artificial disturbances, possibility of using subsurface paths.

The ionosphere blankets elf-vlf radiation. This may provide secure communications above the ionosphere and free spacecraft from terrestrial radiation interference. Also, some vlf modes are phase-sensitive to ionosphere height changes and might aid world-wide nuclear test surveillance.

Air Force Cambridge Research Labs is experimenting with elf-vlf propagation on a short baseline network in New England. Master station is at Mt. Wachuset, Mass., and slave stations are in Vermont, New Hampshire and Rhode Island.

EIA Sees Growth in Major Markets in '62

FACTORY SALES of electronics will reach a record total of \$10.15 billion this year and climb to \$10.8 billion in 1962, L. Berkeley Davis, Electronics Industry Association president, reported at EIA's winter conference in Los Angeles last week.

Consumer electronics skidded a bit this year, to \$2 billion, but will go back up to \$2.1 billion in 1962. Other 1961 and 1962 figures—all increases from 1960—are: industrial electronics, \$1.9 and 2.1 billion; military, \$5.3 and \$5.6 billion; replacement components, \$0.95 and \$1 billion, and totals, \$10.15 and \$10.8 billion.

Other predictions: after 1964 aircraft will give way to missile and space systems as dominant military procurement category; component sales this year will match or slightly exceed 1960's \$3 billion, but price declines will probably keep transistors and diode-rectifier sales at or below 1960's \$525 million. Davis expects the upswing in the national economy to continue, providing fruitful conditions for expansion.

Burns Resigns, RCA Elects New President

ELECTION of Elmer W. Engstrom as president of RCA was announced last Friday after the regular monthly meeting of the board of directors. The resignation of John L. Burns as president, a director and as director of subsidiary companies was accepted by the board on the same day, according to an announcement by David Sarnoff, chairman.

Burns said that his resignation was based on personal reasons. He had been president since March 1, 1957. He will continue to serve RCA, on special assignments from

Hams Want 160 Meters

INDEPENDENT GROUP of radio operators in the Midwest is urging return of the 160-meter band to amateur.

Hams are being asked to send their QSL card with call, signature and comments to "160 Meters," Cleveland 33, Ohio.

Object: to obtain a hearing before the Federal Communications Commission

Sarnoff, the announcement said.

Engstrom was senior executive vice president since 1955 and has been an RCA employee 31 years. As president, he will have supervision of all company operations, reporting to Sarnoff.

Engstrom started his career with GE in 1923. When GE's radio engineering and manufacturing activities were transferred to RCA in 1930, he went along. He was active in development of tv and later headed RCA Laboratories.

Defense Supply Agency Plan Nearly Completed

DETAILED PLAN for placing procurement of electronic components under the new Defense Supply Agency will be submitted to Secretary of Defense McNamara before the end of the month.

A member of the planning staff said this week that management integration plans include more than 500,000 components, including such items as resistors, capacitors, switches, connectors, relays, coils, crystals and tubes.

Complete plans will relate organization, manpower, other resources and time schedules for absorption of the function by the agency. Maj. Gen. Charles B. Root, USAF, with a working group from Army, Navy, Air Force, Marine Corps and the Joint Staff began working on the report Oct. 23.

Loudspeaker Makers Plan R&D Foundation

CHICAGO—Loudspeaker and speaker parts section of EIA approved creation of an R&D foundation at the section's semiannual meeting here. The meeting was attended by 118 industry representatives.

Projects include: a public information program to promote sales of American-made loudspeakers, an industry R&D center, improved industry-wide credit policies, increased standardization of loudspeakers and parts, and a new marketing data program.

The center will conduct confidential studies for individual firms. It will also evaluate new ideas and

All Popular TO-36, 15-Amp POWER TRANSISTORS Compared

Tests show that internal construction differences of devices on the market are responsible for wide variation in junction-to-case thermal resistance (θ_{jc}) . . . prove big difference in device reliability and maximum possible power.

As every design engineer knows, the maximum power a transistor will dissipate and the performance of the device are directly related to its capability of removing heat from the collector junction . . . with the impedance to heat removal being the thermal resistance.

Any transistor with lower thermal resistance will naturally permit greater power dissipation, and will insure greater device reliability because of the cooler junction temperature at any power level.

KEYS TO LOWER THERMAL RESISTANCE

Variation in thermal resistance of the TO-36 power transistors on the market is due primarily to the differences in two internal components — the indium collector and the copper pedestal . . . with the major variation resulting from differences in the thickness and effective area of the indium collector.

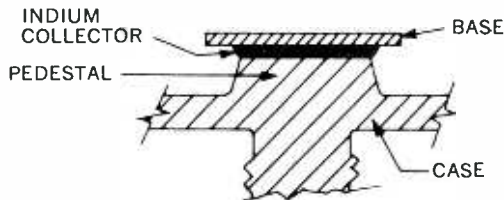

The thinner the indium through which heat must be conducted, and the better the heat conduction design of the copper pedestal — the lower the thermal resistance.

Actual measurements of the indium thickness in 15-Amp TO-36 transistors from six semiconductor manufacturers showed that the indium slab in the Motorola device was from 17% to 85% thinner than the others . . . resulting in a comparably lower thermal resistance.

Manufacturer	Indium Thickness
A	16.0
*B	4.0
C	11.0
D	14.0
E	3.0
Motorola (#1)	1.5
Motorola (#2)	1.5

*Although the indium thickness was comparatively thin, the cross-sectional area of the heat path was so small that thermal resistance was greatly increased.

To avoid the possibility of error in the results of the comparative tests, two methods of determining θ_{jc} were used: . . . by thermal-electric measurement; and by calculation of the metallic heat paths using the equation:

$$\theta_{jc} = \sqrt{1} \frac{L_1}{A_1} + \sqrt{c} \frac{L_2}{A_2} = \theta_{jp} + \theta_{rc}$$

- where . . .
- $\sqrt{1}$ = thermal resistivity — Indium
 - \sqrt{c} = thermal resistivity — Copper
 - L_1 = indium thickness
 - A_1 = effective area of indium
 - L_2 = pedestal thickness
 - A_2 = entire pedestal area
 - θ_{jp} = junction-to-pedestal thermal resistance
 - θ_{rc} = pedestal-to-case thermal resistance

Calculated Junction-to-Case Thermal Resistance (θ_{jc}) (Two Motorola devices and one each from five other manufacturers)

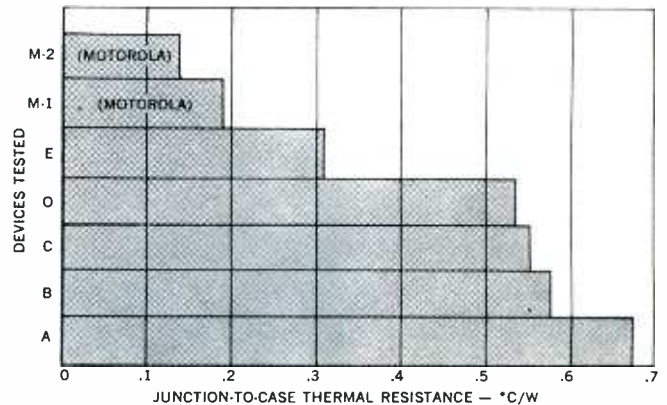

RELATIONSHIP OF THERMAL RESISTANCE TO MAXIMUM POSSIBLE POWER DISSIPATION

Examination of recent data sheets for all the power transistors tested showed that the specified maximum thermal resistance for most TO-36 transistors was established at .8°C/Watt; whereas the specified maximum thermal resistance of the standard Motorola TO-36 units is only .5°C/Watt . . . and the typical is .35°C/Watt.

The difference in performance resulting from this variation in thermal resistance is clearly illustrated in the derating curves below based on normal maximum junction temperatures (T_{jmax}) of 95°C and 100°C.

(For comparison, a derating curve is also shown for Motorola's new 2N2075 Series 15-Amp, TO-36 transistors with a thermal resistance of .5°C/W and a MAXIMUM JUNCTION TEMPERATURE of 110°C).

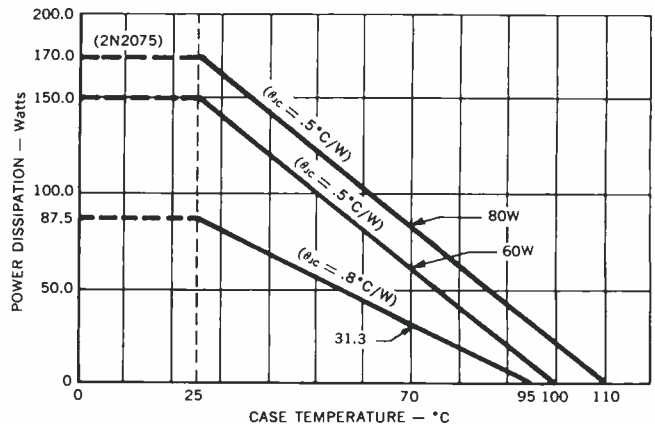

If you would like complete design and specification data for the low-thermal-resistance Motorola TO-36 devices — contact the Motorola Semiconductor District Office in your area, or write to the Technical Information Center at the address below.



MOTOROLA Semiconductor Products Inc.

5005 EAST McDOWELL ROAD PHOENIX 8, ARIZONA A SUBSIDIARY OF MOTOROLA INC.

genus: homo • species: sapiens discipline: factors engineering

At the six major RCA Defense Electronic Products facilities, teams of psychologists and design engineers are deeply involved in the highly specialized, incredibly complex study of human factors engineering—man/machine interfaces, auto-instructional methods, decision processes, read-in/read-out optimization techniques, sensory perception, the entire spectrum of psychological-physiological-

physical disciplines. Whether your requirements involve human factors study of command and control functions for defense networks, or projected life support systems for space exploration, a total RCA capability stands ready to assist you . . . from feasibility study to project completion. Write Defense Electronic Products, Radio Corporation of America, Camden, N. J.



The Most Trusted Name
in Electronics

RADIO CORPORATION OF AMERICA



*in this neat
package...*



a complete dc laboratory

The Keithley 610A Electrometer has 64 dc ranges... all you need to investigate in-circuit measurements with no loading, semi-conductor parameters, capacitor characteristics, photo-electric devices, piezo-electrics, properties of insulators and outputs of ion chambers. The 610A is line-operated and comes in bench or rack models. Brief specifications:

- **9 voltage ranges** from 0.01 to 100 volts fs with 2% accuracy on all ranges.
- **input impedance** selectable in decade steps from 1 ohm to 10^{14} ohms.
- **28 current ranges** from 3 amperes to 10^{-13} ampere fs.
- **27 resistance ranges** from 10 ohms to 10^{14} ohms fs with provision for guarding.
- **constant current source** from 1 milli-ampere to 10^{-12} ampere in decade steps.
- **gains to 1000** as a preamplifier, dc to 500 cps bandwidth, 10-v and 1-ma outputs.
- **price \$565.00.**

other ELECTROMETERS available:

Model 620	31 ranges, battery-operated	\$280.00
Model 621	37 ranges, line-operated	\$390.00
Model 600A	54 ranges, battery-operated	\$395.00
Model 603	50 kc bandwidth amplifier	\$750.00



Send for latest catalog

**KEITHLEY
INSTRUMENTS**

12415 Euclid Avenue • Cleveland 6, Ohio

COMMENT

Proprietary Rights

I enjoyed reading your editorial, *Whose Proprietary Rights?* (p 98, Oct. 27). I am pleased to see that you speak out on this subject.

In order to clear any ambiguity that there may be in my mind, what do you mean by the term *rights* in the sentence "There is no question but what the government is entitled to know-how and patent rights resulting from government-financed development and research"? I have interpreted that you mean rights to license under a privately-owned patent versus the right to own a patent resulting from government-funded work.

I feel strongly that the NASA contract provisions on patent ownership should be repealed and that the government should only have the privilege of free licensing under the privately-owned patent.

ROBERT W. GALVIN
President

Motorola Inc.
Franklin Park, Illinois

Yes, we do mean what reader Galvin means, that "the government should only have the privilege of free licensing under the privately-owned patent."

Electronics in the Midwest

As a resident of Chicago, and as a financial consultant, the current controversy as to the Midwest's lack of research, as expressed in your October 6 issue (p 22), is naturally of interest.

We certainly need research, but we also need, as the industry seems to be finally realizing, however painfully, large, solid companies who *buy* the products of others in *quantity*, *sell* in *quantity*, and are financially sound enough to pay their way, support the industry, and weather the storm.

Far from apologizing for the Midwest, I am as proud of its place as an increasingly solid electronics center as I am of its increasingly solid position as a financial center.

DAVID L. KEITH

Chicago, Illinois

Semiconductors

I have just read the recent article,

What's New in Semiconductors (p 89, Sept. 29), and I wish to relate to you some opinions on the same. I find the article informative especially on subjects such as growth techniques not generally found in technical electronics and management journals. I found particularly interesting the descriptions of construction for the various types of diodes and transistors.

With constant pressure to advance the state of the art, we are actively engaged in applied research and development toward compact, lighter, reliable and faster electronic circuits to meet our customers' needs. In this respect, I found the section on microminiature developments of great interest. It is especially timely in that we now are pursuing a packaging technique that requires the removal of cans from transistors to achieve ultimate compactness.

F. H. SHEPPHARD

Litton Systems, Inc.
Woodland Hills, California

Traveling Wave Tube

Page 114 of your Nov. 10 issue carried an announcement of our electronic tube division's new STX-186 miniature traveling wave tube.

In stating the db of the tube, 4.0 was printed instead of the proper 40 db.

We would like to call your attention to this error.

R. W. CORNES

Sperry Gyroscope Company
Great Neck, New York

Required Reading

We have selected as required reading for War College students an article by [Associate Editor] John F. Mason entitled *Our Defense Against Attack From Space*, which appeared in the May 13, 1960 issue (p 36).

Request permission to reprint and use this article for the purpose stated above, royalty free. Appropriate credit to the author and magazine will appear on the cover of each copy.

CHATHAM P. BUSSELLS
Lt. Colonel

War College
Air University
Maxwell Air Force Base, Alabama

Permission granted.

TODAY'S
 MOST RELIABLE
 SOLID TANTALUM
 CAPACITORS



**HYREL® ST Capacitors, developed and qualified
 for use in the Minuteman Missile, are
 NOW available to you in ALL RATINGS!**

- Quality *100 times greater* than that of former high-reliability components! That's the ultra-high-reliability now demanded of electronic parts in the Minuteman missile's intricate guidance and control system.

- An unmatched test history of over 111 million unit-hours backs up the design of HYREL ST Capacitors to withstand the rigorous performance requirements specified for Minuteman components.

- The pioneer in solid tantalum capacitors, Sprague is one of 12 nationally-known manufacturers chosen to participate in the

Air Force's Minuteman Component Development Program of Autonetics, a division of North American Aviation, Inc.

- All of the special processes and quality control procedures that make HYREL ST Capacitors the most reliable in the world can now help you in your military electronic circuitry. A tantalum capacitor engineer will be glad to discuss the application of these capacitors to your missile and space projects. Write to Mr. C. G. Killen, Vice-president, Industrial and Military Sales, Sprague Electric Company, 35 Marshall St., North Adams, Mass.

SPRAGUE COMPONENTS

CAPACITORS
 RESISTORS

MAGNETIC COMPONENTS
 TRANSISTORS

INTERFERENCE FILTERS
 PULSE TRANSFORMERS

PIEZOELECTRIC CERAMICS
 PULSE-FORMING NETWORKS

HIGH TEMPERATURE MAGNET WIRE
 CERAMIC-BASE PRINTED NETWORKS
 PACKAGED COMPONENT ASSEMBLIES
 FUNCTIONAL DIGITAL CIRCUITS

SPRAGUE®
 THE MARK OF RELIABILITY

'Sprague' and '®' are registered trademarks of the Sprague Electric Co.

Published weekly, with Electronics Buyers' Guide and Reference Issue, as part of the subscription, by McGraw-Hill Publishing Company, Inc. Founder: James H. McGraw (1860-1948).

Title ® registered U.S. Patent Office; Copyrighted © 1961, McGraw-Hill Publishing Company, Inc. All rights reserved, including the right to reproduce the contents of this publication, in whole or in part.

Executive, editorial, circulation and advertising offices McGraw-Hill Building, 330 West 42nd Street, New York 36, N. Y. Telephone Longacre 4-3000. Teletype TWX N.Y. 1-1636. Cable McGrawhill, N. Y. PRINTED IN ALBANY, N. Y.; second class postage paid.

OFFICERS OF THE PUBLICATIONS DIVISION: Nelson L. Bond, President; Shelton Fisher, Wallace F. Traendly, Senior Vice Presidents; John R. Callahan, Vice President and Editorial Director; Joseph H. Allen, Vice President and Director of Advertising Sales; A. R. Venezian, Vice President and Circulation Coordinator; Daniel F. Crowley, Vice President and Controller.

OFFICERS OF THE CORPORATION: Donald C. McGraw, President; Hugh J. Kelly, Harry L. Waddell, Executive Vice Presidents; L. Keith Goodrich, Executive Vice President and Treasurer; John J. Cooke, Vice President and Secretary.

Subscriptions are solicited only from those actively engaged in the field of the publication. Position and company connection must be indicated on orders. Subscription rates: United States and Possessions, \$6.00 one year; \$9.00 two years; \$12.00 three years. Canada, \$10.00 one year. All other countries \$20.00 one year. Single Copies, United States and Possessions and Canada 75¢; Buyers' Guide \$3.00; Single copies all other countries \$1.50; Buyers' Guide \$10.00.

THE PUBLISHER, UPON WRITTEN REQUEST FROM ANY SUBSCRIBER TO OUR NEW YORK OFFICE, AGREES TO REFUND THAT PART OF THE SUBSCRIPTION PRICE APPLYING TO COPIES NOT YET MAILED.

Subscribers: Please address all correspondence, change of address notices, subscription orders or complaints to Fulfillment Manager, Electronics, at above address. Change of address notices should provide old as well as new address, including postal zone number if any. If possible, attach address label from recent issue. Allow one month for change to become effective.

Postmaster: Please send Form 3579 to Fulfillment Manager, Electronics, 330 West 42nd Street, New York 36, New York.



Audited Paid Circulation

CROSSTALK

FLAT SCREEN electroluminescent displays may, when perfected, give in a solid-state device the picture clarity and definition now obtained in cathode-ray tubes. Since the viewing screen need be no more than a fraction of an inch thick, a tv screen—for example—could be hung on the wall like a painting while the circuit is hidden away in a black box in the attic. The same basic setup could be used to reduce the airplane panel volume occupied by a radar set or to ruggedize industrial monitoring equipment.

Even now, rudimentary electroluminescent screens are being used for alphanumeric display and large-scale plotting and tracking panels.

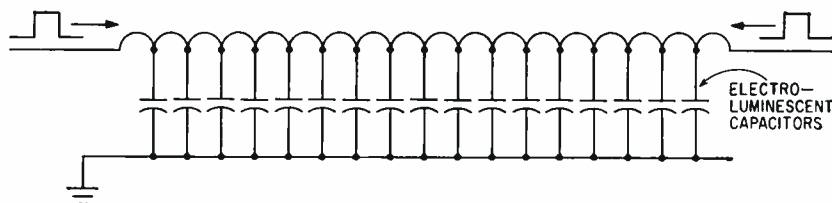

There are several approaches to designing such displays. One of the more ingenious is described in this issue on p 53 by R. W. Windebank, of G. V. Planar, Ltd. It does not need a conductor to each point to be illuminated. Instead, delay line principles are used to build up a voltage pulse at the desired spot.

Pulses are introduced at each end of the line (see sketch). Since the delay line capacitive sections are also the electroluminescent display elements, the point at which the pulses coincide is the point illuminated. The doubling of voltage turns them on. Pulse coincidence is controlled through the relative phasing of the pulses.

The basic linear display is converted fairly easily to a square or rectangular panel by folding a long delay line into parallel segments. A further sophistication is a matrix control method that permits higher pulse rates and a four-fold increase in coincident pulse amplitude, for greater brightness.

Coming In Our December 15 Issue

MEDICAL ELECTRONICS. After covering diagnostic, clinical and prosthetic medical electronics equipment in five articles published earlier this year, Senior Associate Editor Bushor now reports on the instruments being used to probe life processes. Among the instruments employed are infrared, ultraviolet, x-ray and ultrasonic microscopes, nuclear magnetic resonance and electron precession spectrometers, cell counters, gas ana-

lyzers, photometers and many more, in two more articles.

Other reports in this issue include a roundup of new electron tubes, by Associate Editor Solomon; a hybrid electronic ignition system, by H. P. Quinn, of Tung-Sol; an avalanche-detecting telemetry system, by G. Neal and S. A. Stone, of the Canadian National Research Council, and a degenerate parametric amplifier design, by R. J. Mayer, of Boeing.

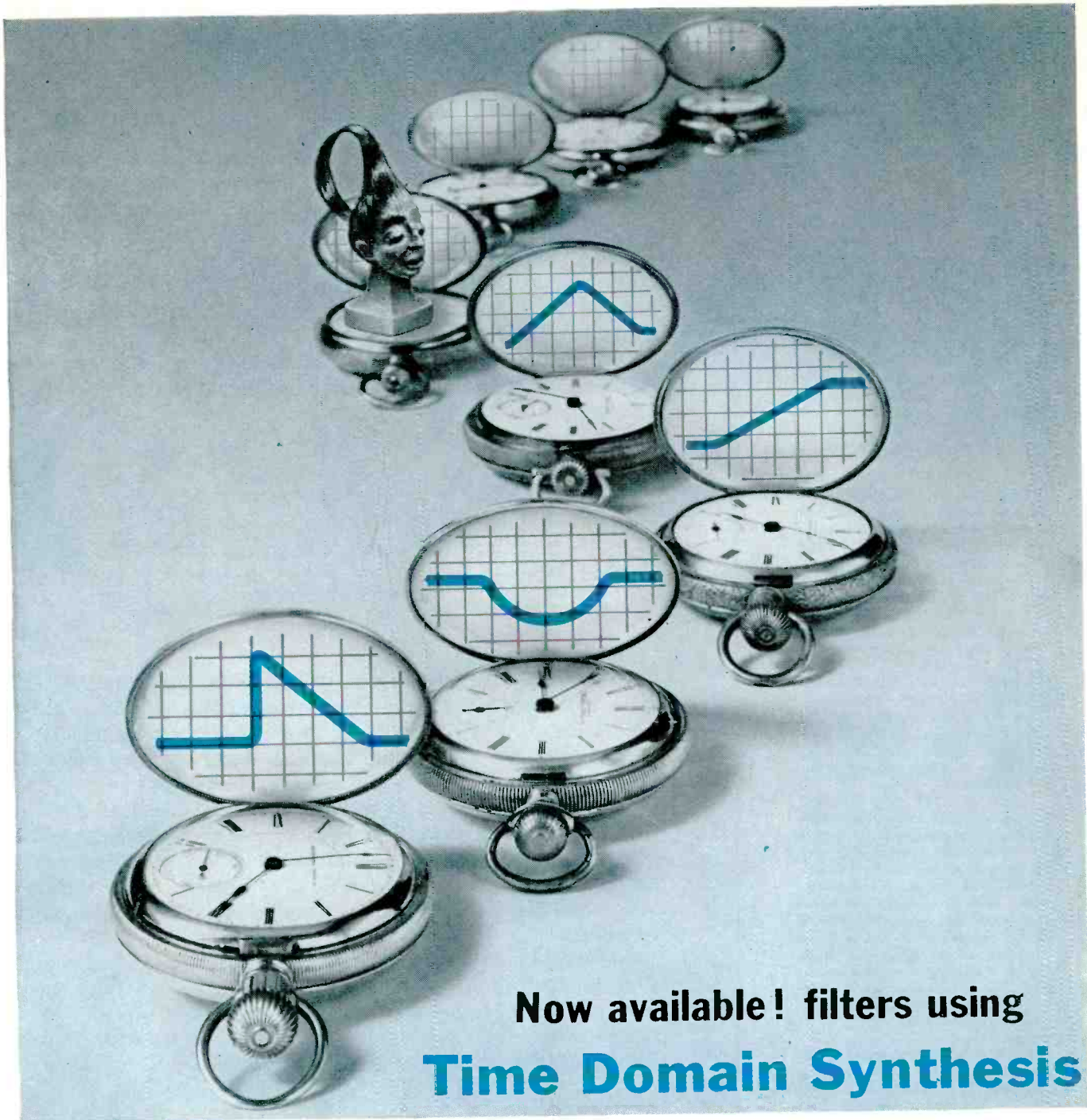

Now available! filters using Time Domain Synthesis

Imagine having access to an unlimited inventory of wave forms of every conceivable shape; some so radical that they could previously only be described graphically and attained only through complex active element circuitry.

Furthering the state of the art to suit the complexities of modern electronic systems, Burnell is now prepared to design networks through the use of the Fourth Dimension of Time Domain Synthesis.

These passive networks may be designed to produce low ringing, constant delay filters, or to produce a functional

wave shaping characteristic with or without specific attenuation requirements. Examples of a low pass characteristic pulse forming network are shown above, where the networks precisely resolve the constituents of a time function to produce a variety of wave forms, with unique properties now available as a tool for new and imaginative applications.

Break the chains of conventional design, unnecessarily complex circuitry, and wasted space by contacting your Burnell sales engineer today, with your wave form application problems.

Burnell & Co., Inc.

PIONEERS IN microminiaturization OF TOROIDS,
FILTERS AND RELATED NETWORKS

DIVISIONS: Gray & Kuhn, Inc., Westbury, L. I., New York • Guillemain Research Laboratory, Cambridge, Mass.

EXECUTIVE OFFICE
AND PLANT
DEPT. E-39
PELHAM, NEW YORK
PELHAM 8-5000
TELETYPE PELHAM 3633



PACIFIC DIVISION
SOUTH PASADENA, CAL.
MFD. IN CANADA
BY EDO (CANADA) LTD.
CORNWALL, ONT.
WELLINGTON 2-6774

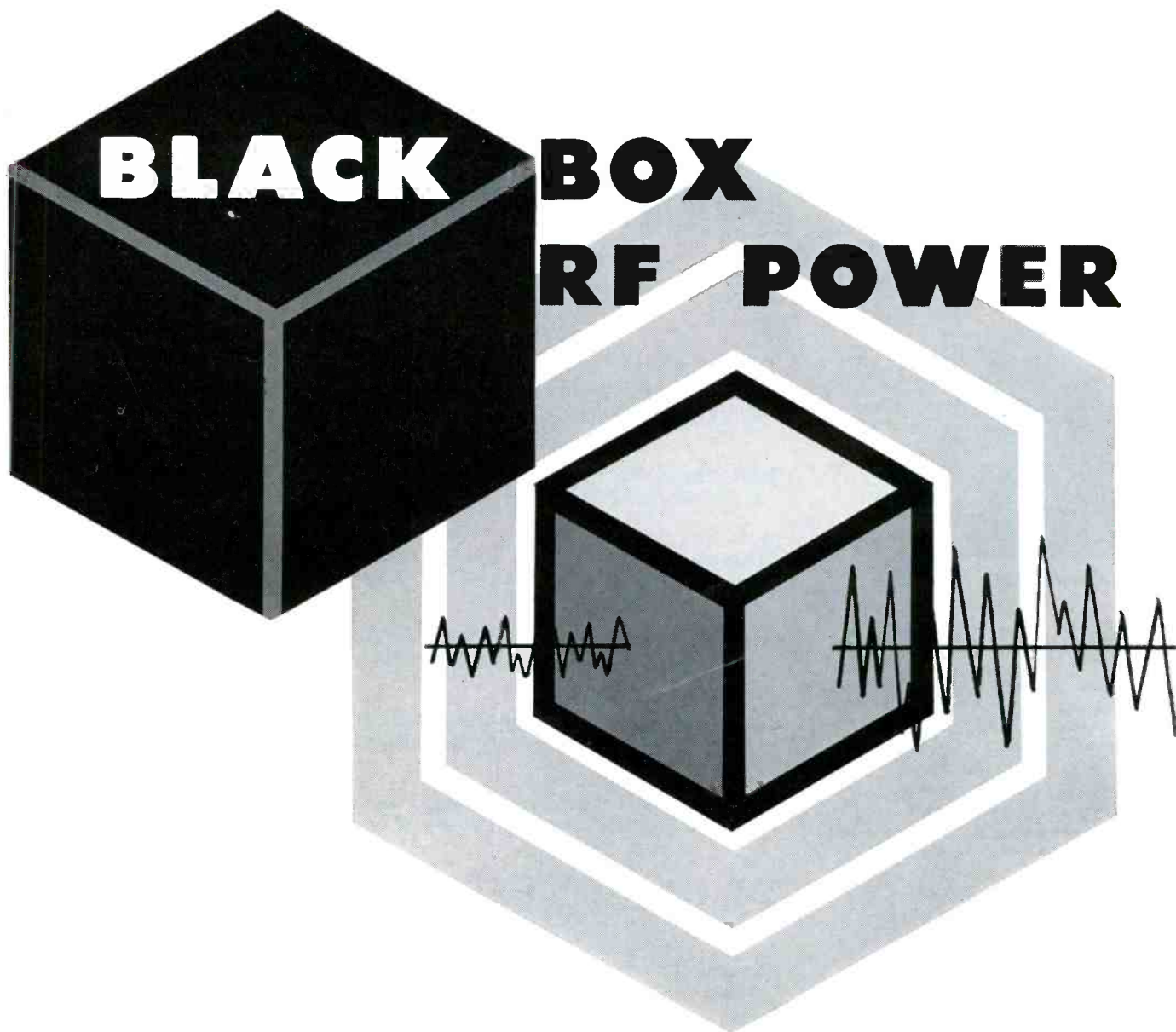

RF Generators by ITA for every power level . . . every frequency!

ITA Electronics Corporation specializes in manufacturing black box RF power generating equipment for industry and research. One of the nation's leading producers of broadcasting and communications equipment, ITA has the experience with RF equipment to supply *any* power requirement . . . design units that will meet *any* need. ITA products—30 kc to 2000 mc with power levels from a few watts to megawatts—may be modified to perform many specialized functions. Custom equipment, for highly technical applications, can be purchased at very low cost with prompt delivery assured.

For the finest in RF power generators choose ITA. It's the *best* equipment made!

ITA ELECTRONICS CORPORATION
GOVERNMENT and INDUSTRIAL DIVISION • LANSDOWNE, PENNSYLVANIA

ITA SALES OFFICES: Chicago, Ill. AN 3-3797
Cincinnati, Ohio. CH 1-6386
Dallas, Texas. FL 7-9607

Jacksonville, Fla. EL 6-0121
Kansas City, Mo. GR 1-2838
Lansdowne, Pa. CL 9-8200
Los Angeles, Cal. MA 2-8552

New York City, N.Y. CH 2-1999
Portland, Ore. CA 2-2651
Washington, D.C. 337-2884

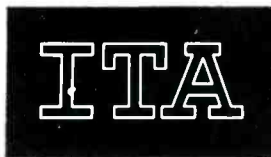

electronics

A McGraw-Hill Publication 75 Cents



W. W. MacDONALD, Editor

J. M. CARROLL, Managing Editor
 SENIOR EDITORS: Samuel Weber, George W. Sideris. SENIOR ASSOCIATE EDITORS: William E. Bushor, Michael F. Wolff. ASSOCIATE EDITORS: Michael F. Tomaino, Sylvester P. Carter, William P. O'Brien, John F. Mason, Thomas Emma, Sy Vogel, Leslie Solomon, M. M. Perugini, George J. Flynn, Laurence D. Shergalis. ASSISTANT EDITORS: Nilo Lindgren, Stanley Froud, Stephen B. Gray, Roy J. Bruun, George V. Novotny, Leon H. Dulberger. REGIONAL EDITORS: Harold C. Hood (Pacific Coast, Los Angeles), Thomas Maguire (New England, Boston), Cletus M. Wiley (Midwest, Chicago). ART DIRECTOR: Harry Phillips; Howard R. Berry. PRODUCTION EDITOR: John C. Wright, Jr. EDITORIAL ASSISTANTS: Gloria J. Meurer, Bernice Duffy, Lorraine Rossi, Virginia T. Bastian, Lynn Emery, Laura W. Smith, Bette H. Snyder, Rosemary Abbruzzese, Judy Haskins.

JAMES GIRDWOOD, Publisher

Raster-scan crt display by Aerospace Research shows six satellite tracks and other data on command. See p 74 **COVER**

More Phones for Cars, Planes. Boom in vehicular communications predicted for next decade 22

Telemetry Aids Pollution Study. Equipment use to plot water movement in Lake Michigan could be used for oceanography 28

AIR TRAFFIC CONTROLS May Use Missile Technique. Digital data links for air defense could handle radar handoff messages 29

Interlaced Heads Double Recording Density. Slow-speed, 22-channel system reduces storage needs at FAA centers 30

POLICE RADIO Integrates Telephones. Chicago speeds answers to distress calls by using exchanges as radio zones 35

ELECTROLUMINESCENT PANEL Presents Nanosecond Pulses. Technique could lead to flat-screen tv display. R. W. Windebank 53

Photoelectric Pyrometers With and Without Feedback. Two versions for measuring high temperatures. S. A. Elder 56

SEMICONDUCTOR THERMOELECTRIC POWER Measured by Hot Probe. Needs no sample preparation. N. Bobson 61

Designing Multivibrators With Stable Delay Times. How to maintain accuracy during production. D. E. Haselwood 64

MAGNETIC DESIGN of Traveling-Wave Tubes and Klystrons. Considers cooling methods and thermal requirements. A. Zack 66

REFERENCE SHEET: Voltage Needs of Power-Supply Transformers. Rapid method gives good results. W. J. Bates 72

Crosstalk	4	Components and Materials	78
Comment	6	Production Techniques	82
Electronics Newsletter	9	New on the Market	86
Washington Outlook	14	Literature of the Week	102
Meetings Ahead	36	People and Plants	106
Research and Development	74	Index to Advertisers	119



NEW

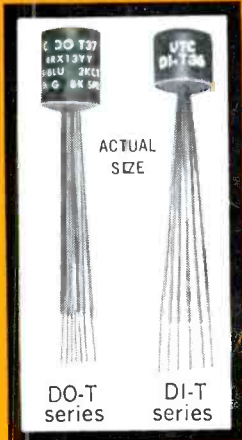

Revolutionary

DO-T & DI-T

Transistor TRANSFORMERS & REACTORS Hermetically Sealed to MIL-T-27A

There is no transformer even twice the size of the DO-T and DI-T series which has as much as 1/10th the power handling ability... which can equal the efficiency... or equal the response range. And none to approach the reliability of the DO-T and DI-T units (proved to, but exceeding MIL-T-27A grade 4).

- High Power Rating up to 10 times greater
- Excellent Response twice as good at low end
- Low Distortion reduced 80%
- High Efficiency up to 30% better ... compare DCR
- Moisture Proof hermetically sealed to MIL-T-27A
- Rugged Grade 4, completely metal cased
- Anchored Leads will withstand 10 pound pull test
- Printed Circuit Use (solder melting) nylon insulated leads
- Suited to Clip Mounting use Augat #6009-8A clip



Typical Printed Circuit Positioning

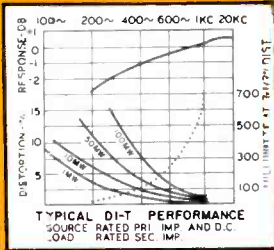
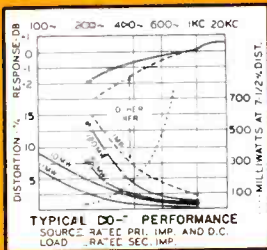

TRANSFORMERS PICTURED DO-T: 5/16" Dia. x 1/32", 1/10 Oz.; DI-T: 5/16" Dia. x 1/4", 1/15 Oz.

Write for catalog or over 1,000 STOCK ITEMS with UTC High Reliability IMMEDIATELY AVAILABLE from YOUR Local Distributor



AND CUSTOM BUILT SPECIAL UNITS TO YOUR SPECIFICATIONS

UNITED TRANSFORMER CORP.

150 VARNEY STREET, NEW YORK 13, N.Y.

PACIFIC MFG. DIVISION: 3630 EASTHAM DRIVE, CULVER CITY, CALIF.
EXPORT DIVISION: 13 EAST 40th STREET, NEW YORK 16, N. Y. CABLES: "ARL3"

IMMEDIATE DELIVERY FROM STOCK

COMPLETE STOCK LINE LISTING

DO-T No.	Pri. Imp.	D.C. Ma.† in Pri.	Sec. Imp.	Pri. Res. DO-T	Pri. Res. DI-T	Mw. Level	DI-T No.
DO-T37	2000 CT 2500 CT	3 3	8000 Split 10,000 Split	195	180	100	DI-T37
DO-T38	10,000 CT 12,000 CT	1 1	2000 Split 2400 Split	560	600	100	DI-T38
DO-T39	20,000 CT 30,000 CT	.5 .5	1000 Split 1500 Split	800		100	
DO-T40	40,000 CT 50,000 CT	.25 .25	400 Split 500 Split	1700		50	
DO-T41	400 CT 500 CT	8 6	400 Split 500 Split	46	48	500	DI-T41
DO-T42	400 CT 500 CT	8 6	120 Split 150 Split	46		500	
DO-T43	400 CT 500 CT	8 6	40 Split 50 Split	46		500	
DO-T44	80 CT 100 CT	12 10	32 Split 40 Split	9.8		500	
DO-T45	1000 CT 1250 CT	3.5 3.5	16,000 split 20,000 split	120		100	
DO-T46	100,000 CT	0	500 CT	7900		25	
DO-T1	20,000 30,000	.5 .5	800 1200	830	815	50	DI-T1
DO-T2	500 600	3 3	50 60	60	65	100	DI-T2
DO-T3	1000 1200	3 3	50 60	115	110	100	DI-T3
DO-T4	600	3	3.2	60		100	
DO-T5	1200	2	3.2	105	110	100	DI-T5
DO-T6	10,000	1	3.2	790		100	
DO-T7	200,000 500	0 0	1000 100,000	8500		25	
			Reactor 2.5 Hys./2 Ma., 9 Hy./4 Ma.		630		DI-T8
DO-T8			3.5 Hys./2 Ma., 1 Hy./5 Ma.	560			
DO-T9	10,000 12,000	1 1	500 CT 600 CT	780	870	100	DI-T9
DO-T10	10,000 12,500	1 1	1200 CT 1500 CT	780	870	100	DI-T10
DO-T11	10,000 12,500	1 1	2000 CT 2500 CT	780	870	100	DI-T11
DO-T12	150 CT 200 CT	10 10	12 16	11		500	
DO-T13	300 CT 400 CT	7 7	12 16	20		500	
DO-T14	600 CT 800 CT	5 5	12 16	43		500	
DO-T15	800 CT 1070 CT	4 4	12 16	51		500	
DO-T16	1000 CT 1330 CT	3.5 3.5	12 16	71		500	
DO-T17	1500 CT 2000 CT	3 3	12 16	108		500	
DO-T18	7500 CT 10,000 CT	1 1	12 16	505		500	
DO-T19	300 CT	7	600	19	20	500	DI-T19
DO-T20	500 CT	5.5	600	31	32	500	DI-T20
DO-T21	900 CT	4	600	53	53	500	DI-T21
DO-T22	1500 CT 600	3 5	600 1500 CT	86 —	87	500	DI-T22
DO-T23	20,000 CT 30,000 CT	5 5	800 CT 1200 CT	830	815	100	DI-T23
DO-T24	200,000 CT 500 CT	0 0	1000 CT 100,000 CT	8500		25	
DO-T25	10,000 CT 12,000 CT	1 1	1500 CT 1800 CT	780	870	100	DI-T25
			Reactor 4.5 Hys./2 Ma., 1.2 Hys./4 Ma.		2300		DI-T26
DO-T26			6 Hys./2 Ma., 1.5 Hys./5 Ma.	2100			
			Reactor .9 Hy./2 Ma., .5 Hy./6 Ma.		105		DI-T27
DO-T27			1.25 Hys./2 Ma., .5 Hy./11 Ma.	100			
			Reactor .1 Hy./4 Ma., .08 Hy./10 Ma.		25		DI-T28
DO-T28			.3 Hy./4 Ma., .15 Hys./20 Ma.	25			
DO-T29	120 CT 150 CT	10 10	3.2 4	10		500	
DO-T30	320 CT 400 CT	7 7	3.2 4	20		500	
DO-T31	640 CT 800 CT	5 5	3.2 4	43		500	
DO-T32	800 CT 1000 CT	4 4	3.2 4	51		500	
DO-T33	1060 CT 1330 CT	3.5 3.5	3.2 4	71		500	
DO-T34	1600 CT 2000 CT	3 3	3.2 4	109		500	
DO-T35	8000 CT 10,000 CT	1 1	3.2 4	505		100	
DO-T36	10,000 CT 12,000 CT	1 1	10,000 CT 12,000 CT	975	970	100	DI-T36
DO-TSH			Drawn Hipermalloy shield and cover 20/30 db				DI-TSH

† DCMA shown is for single ended usage (under 5% distortion—100MW—1KC) . . . for push pull, DCMA can be any balanced value taken by .5W transistors (under 5% distortion—500MW—1KC)
‡ DO-T & DI-T units designed for transistor application only. Pats. Pend.
* Units in tinted area newly added to series

electronics

A McGraw-Hill Publication 75 Cents

Photo at right
SATELLITE ORBITS

*traced on scope.
 Gun calls up more data. See p 74*

How to design
MAGNET SYSTEMS

for traveling-wave tubes and klystrons, p 66

SOLID-STATE PANELS

display pulse waveforms, p 53

POWER TRANSFORMERS

a quick way to select them, p 72



Now 0.25 ohm max. R_s ; min. beta of 15 @ 5 amp - 7.5 @ 10 amp

...with RCA 2N2015 and 2N2016 150-watt, 200°C Silicon Power Transistors

Outstanding as replacements for germanium power transistors of comparable power ratings in inverter, voltage-regulator and other power-supply applications, the new high-temperature RCA 2N2015 and 2N2016 feature:

- 0.25-ohm max. saturation resistance at $I_C = 5$ amp.
- Beta of 15 to 50 at $I_C = 5$ amp.
- Min. beta of 7.5 @ $I_C = 10$ amp.
- 10 amp max. collector current.
- 150 watts max. transistor dissipation at 25°C.
- 200°C max. junction temperature.
- 1.17°C/W max. thermal resistance.
- JEDEC TO-36 package.
- Immediate Availability.

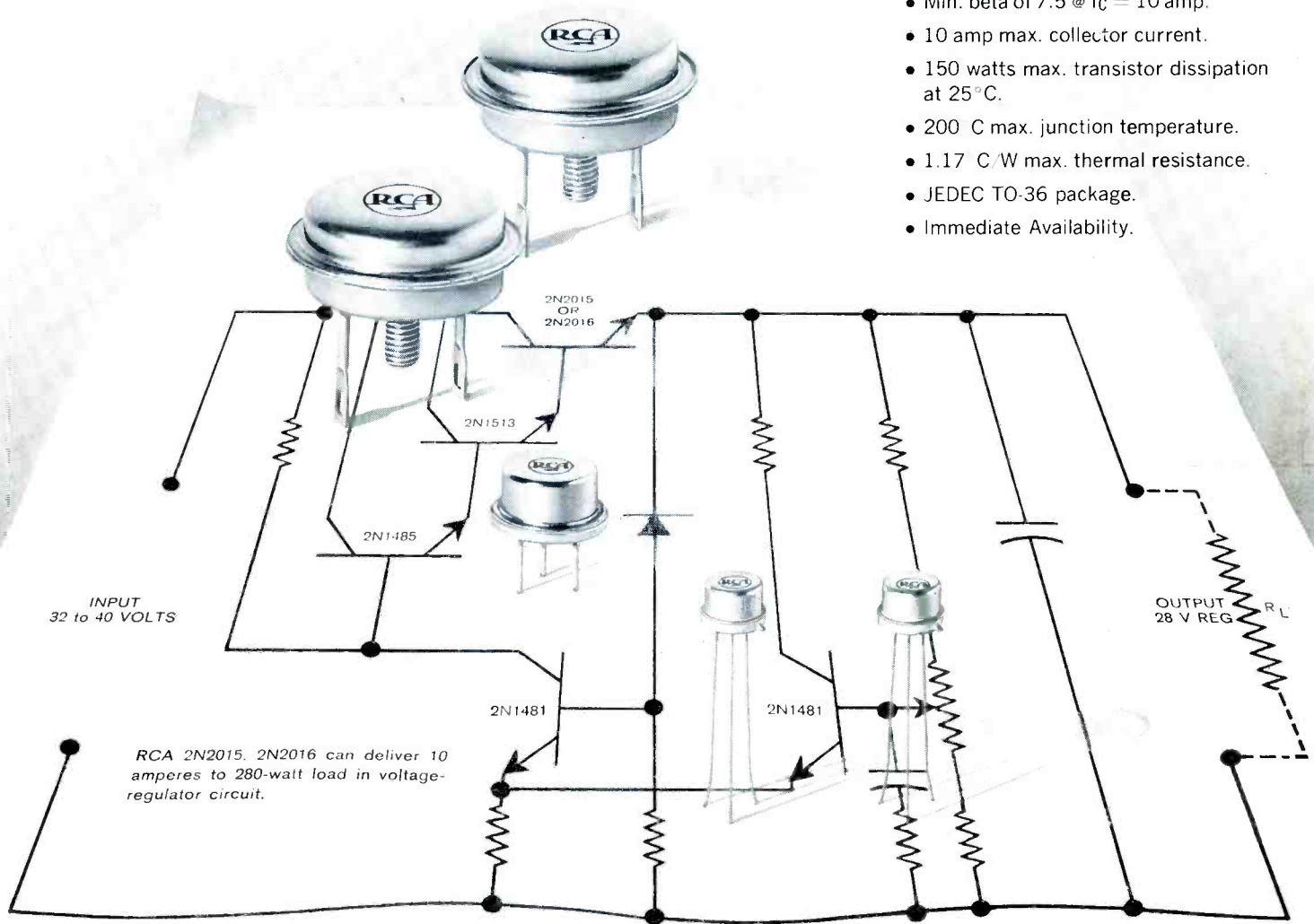

Check these superior ratings against those of the germanium types you are now using:

Type	Dissipation @ 25°C Watts	I_C Amp	V_{CEX} Volts	V_{CEO} (sus.) Volts	Typical $f_{\alpha e}$ Kc	Constr.	JEDEC Package
2N2016	150	10	130	65	25	NPN	TO-36
2N2015	150	10	100	50	25	NPN	TO-36

Call your RCA representative today for full particulars on new RCA 2N2015, 2N2016 and the entire RCA lineup of Industrial Silicon Transistors. For additional technical information, write RCA Semiconductor and Materials Division, Commercial Engineering, Section G-19-NN-3, Somerville, New Jersey.

FIELD OFFICES:

EAST: Newark, N. J., 714 Broad Street, Humboldt 5-3900 · Erlton, N. J., 605 Marlton Pike, HAZEL 8-4802 · Baltimore, Md., Enterprise 5-1850 · Syracuse 3, New York, 731 James Street, Room 402, GRanite 4-5591 · **NORTHEAST:** Needham Heights 94, Mass., 64 "A" Street, Hillcrest 4-7200 · **SOUTH-EAST:** Orlando, Fla., 1520 Edgewater Drive, Suite #1, GArden 4-4768 · **EAST CENTRAL:** Detroit 2, Mich., 714 New Center Bldg., TRinity 5-5600 · **CENTRAL:** Chicago, Ill., Suite 1154, Merchandise Mart Plaza, WHitehall 4-2900 · Minneapolis, Minn., 5805 Excelsior Blvd., WEst 9-0676 · **WEST:** Los Angeles 54, Calif., Box 54074, RAYmond 3-8361 · Burlingame, Calif., 1838 El Camino Real, OXFord 7-1620 · **SOUTHWEST:** Dallas 7, Texas, 7905 Carpenter Freeway, FLeeewood 7-8167 · **GOV'T.:** Dayton, Ohio, 224 N. Wilkinson St., BALdwin 6-2366 · Washington, D.C., 1725 "K" St., N.W., FE 7-8500

Available
through
your RCA
distributor



The Most Trusted Name in Electronics
RADIO CORPORATION OF AMERICA

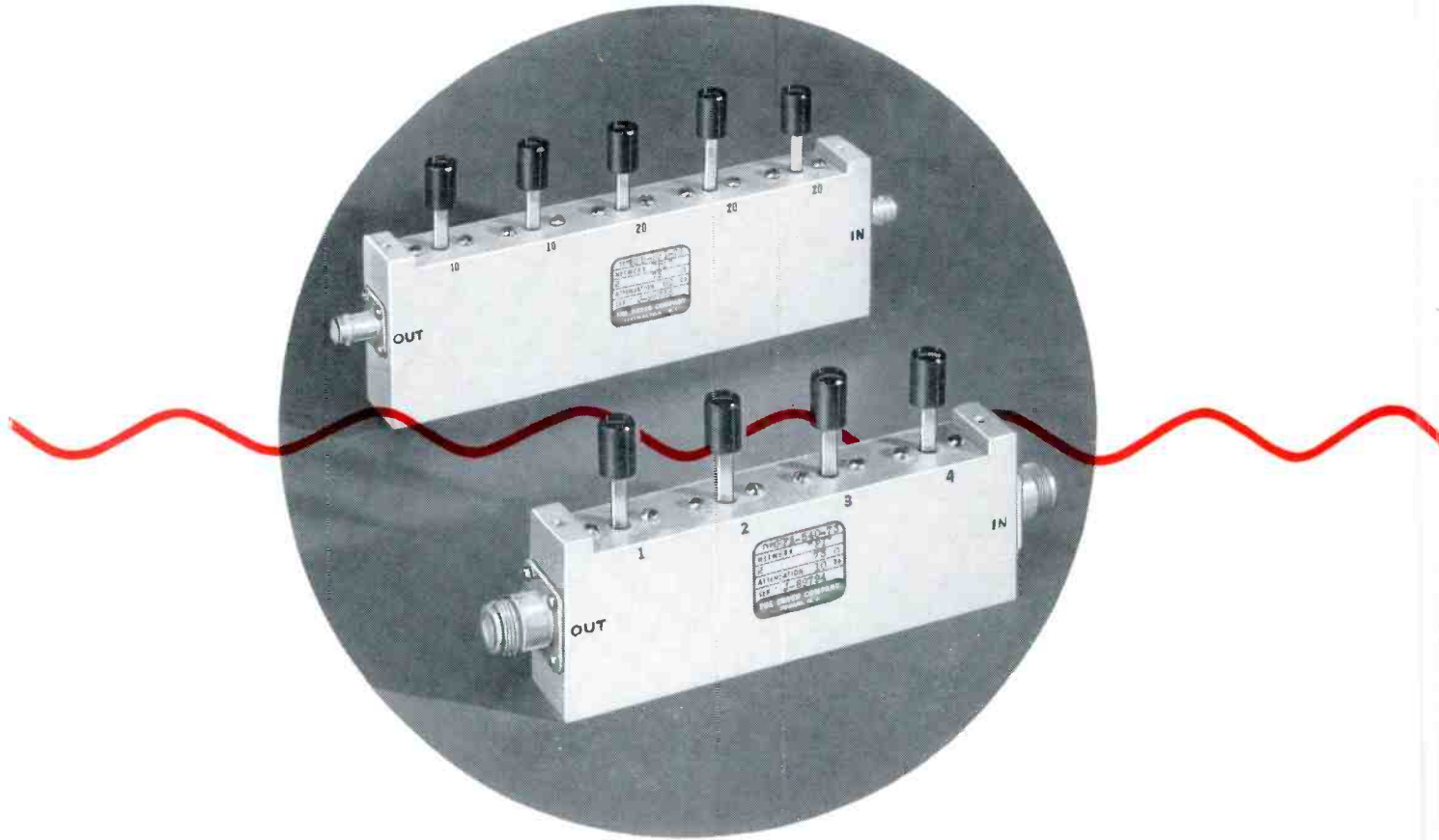

FOR ACCURATE ATTENUATION OVER A WIDE FREQUENCY RANGE...

RF Attenuators by **DAVEN**

These units are used in signal generators, wide-band amplifiers, pulse generators, field intensity meters, micro-wave relay systems, and repeater stations. They find application as laboratory standards, test equipment, and for checking out all types of instruments.

Daven RF Attenuators are available, in combination, with losses up to 120 Db in two Db steps; or 100 Db in one Db steps. Due to their internal circuitry and construction, they have a **zero insertion loss** over the frequency range from DC to 225 megacycles.

Standard impedances are 50 and 73 ohms, with special impedances available on request. Resistor accuracy is within $\pm 2\%$ at DC. An unbalanced circuit is used which provides constant input and output impedance. The units are supplied with either UG-58/U or UG-185/U receptacles or Coaxial lead terminations. Individual units with single-section cavities can be obtained.

Many of these types are available for delivery from stock.

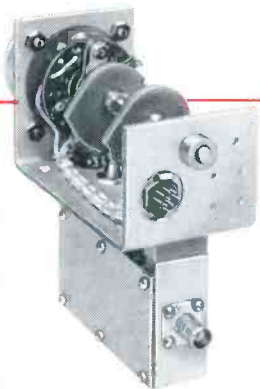

Solenoid actuated RF Attenuators are also available in various decibel combinations and any number of steps up to 5.

TYPE	LOSS	TOTAL Db	STANDARD IMPEDANCES
RFA & RFB 540	1, 2, 3, 4 Db	10	50/50Ω and 73/73Ω
RFA & RFB 541	10, 20, 20, 20 Db	70	50/50Ω and 73/73Ω
RFA & RFB 542	2, 4, 6, 8 Db	20	50/50Ω and 73/73Ω
RFA & RFB 543	20, 20, 20, 20 Db	80	50/50Ω and 73/73Ω
RFA & RFB 550	1, 2, 3, 4, 10 Db	20	50/50Ω and 73/73Ω
RFA & RFB 551	10, 10, 20, 20, 20 Db	80	50/50Ω and 73/73Ω
RFA & RFB 552	2, 4, 6, 8, 20 Db	40	50/50Ω and 73/73Ω

Other Db loss combinations are available.

Write for complete information



THE **DAVEN** CO.

530 West Mt. Pleasant Ave.
Route 10, Livingston, N. J.

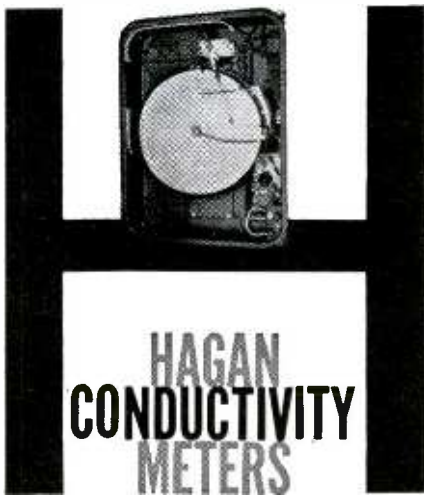

The Hagan Model H-O may be used as a single instrument, or up to four different conductivity measurements may be recorded in a single meter case. Provides continuous reliable measurement for a moderate investment.

Temperature compensation is continuous and automatic, and limit switches may be installed for applications where drastic changes in dissolved solids may damage equipment.

Write for Bulletin OE-10004



HAGAN

CHEMICALS & CONTROLS, INC.
HAGAN CENTER, PITTSBURGH 30, PA.
CIRCLE 212 ON READER SERVICE CARD



Are you selling the whole buying team

Tough competition *demands* that the electronics man be reached and *sold* wherever you find him: *Research, Design, Production, and Management.* Only advertising in **electronics** reaches all four... the same men your salesmen call on. Put your advertising where it works *hardest*....

in **electronics**

Sprague Electric Co.....5, 6, 32
Standard Telephones and Cables Limited 19
Swissair 42

Taylor Fibre Co..... 95
Tektronix, Inc. 60
• Transistor Specialties, Inc..... 7
Trans World Airlines..... 2

United Shoe Machinery Corp..... 113
• United Transformer Corp.....2nd Cover

• Wales Strippit Inc..... 93
Western Electric Company, Inc..... 56
Westinghouse Electric Corp....38, 40, 41
Wiedemann Machine Company..... 53

Manufacturers' Representatives
MacDonald, Inc., Samuel K..... 115

Professional Services 115

CLASSIFIED ADVERTISING

F. J. Eberle, Business Mgr.

EMPLOYMENT OPPORTUNITIES.... 115

EQUIPMENT
(Used or Surplus New)
For Sale 115

INDEX TO CLASSIFIED ADVERTISERS

Moss Electronic Inc..... 115
WLAC-TV 115

• See Advertisement in July 20, 1961 issue of Electronics Buyers' Guide for complete line of products or services.

This index and our Reader Service Numbers are published as a service. Every precaution is taken to make them accurate, but electronics assumes no responsibilities for errors or omissions.

electronics



Audit Bureau of Circulations



Associated Business Publications

Audited Paid Circulation

JAMES T. HAUPTLI
Advertising Sales Manager

R. S. QUINT, Assistant Publisher Buyers' Guide and Business Manager; FRED STEWART, Promotion Manager; B. ANELLO, Marketing Service Manager; RICHARD J. TOMLINSON, Production Manager; GEORGE E. POMEROY, Classified Manager; HUGH J. QUINN, Circulation Manager.

ADVERTISING REPRESENTATIVES: NEW YORK (36) Donald H. Miller, Henry M. Shaw, George F. Werner, 500 Fifth Avenue, OXford 5-5959; BOSTON (16) William S. Hodgkinson, Donald R. Furth, McGraw-Hill Building, Copley Square, Congress 2-1160; PITTSBURGH (22) David M. Watson, Four Gateway Center, Express 1-1314; PHILADELPHIA (3) Warren H. Gardner, William J. Boyle, 6 Penn Center Plaza, LOcust 8-4330; CHICAGO (11) Harvey

W. Wernecke, Martin J. Gallay, 645 North Michigan Avenue, Mohawk 4-5800; CLEVELAND (13) P. T. Fegley, 55 Public Square, Superior 1-7000; SAN FRANCISCO (11) T. H. Carmody, R. C. Alcorn, 255 California Street, Douglas 2-4600; LOS ANGELES (17) Marshall Freeman, Peter S. Carberry, 1125 W. 6th St. Huntley 2-5450; DENVER (2) J. W. Patten, Tower Building, 1700 Broadway, Alpine 5-2981; ATLANTA (9) M. H. Miller, 1375 Peachtree St. N.E., Trinity 5-0523; HOUSTON (25) Joseph C. Page, Jr., Prudential Bldg., Halcomb Blvd., Jackson 6-1281; DALLAS (1) Robert T. Wood, Frank Le Beau, The Vaughn Bldg., 1712 Commerce St., Riverside 7-9721; LONDON W1, Edward E. Schirmer, 34 Dover St.; FRANKFURT/Main, Stanley R. Kimes, 85 Westendstrasse; GENEVA Michael R. Zeynel, 2 Place du Port.

EMPLOYMENT OPPORTUNITIES

ASSISTANT CHIEF ENGINEER

Seeking college graduate electronics engineer to assist Chief Engineer of commercial VHF television station in growing market. CBS affiliate; progressive management with long broadcast experience; good record of low personnel turnover. Majority of equipment RCA; two Ampex Videotape Recorders; maximum power; 1000 foot tower. Applicant should be capable of doing design and construction work, and should have some administrative ability. Salary commensurate with experience and ability. Replies treated in confidence.

TELEVISION BROADCAST TECHNICIAN

Seeking experienced qualified television technician for maintenance and operation at commercial VHF station in growing market. CBS affiliate; progressive management with long broadcast experience. Station is well-equipped; maximum power; 1000 foot tower; two Ampex Videotape Recorders. Applicant must be ambitious, dependable, and have First-Class Phone License. Some formal schooling in electronics preferred. Salary commensurate with experience and ability. Replies treated in confidence. Write:

Chief Engineer,
WLAC-TV
Nashville, Tennessee

POSITION VACANT

Senior Electronic Engineer—Opening for an electronic engineer with experience in circuitry, instrumentation and product design with a B.S. in E.E. and at least five years of experience. Salary, \$10,000 to \$15,000 depending on qualifications. Excellent opportunity for higher degree with tuition paid. Send complete resume to Ad-Yu Electronics Lab., Inc., 249 Terhune Avenue, Passaic, N. J.



MANUFACTURERS' REPRESENTATIVES

IN THE ELECTRONIC INDUSTRY

SAMUEL K. MACDONALD, INC.

manufacturers representatives over 25 years
1531 SPRUCE STREET, PHILA. 2, PA.

Territory: Pennsylvania • New Jersey
Delaware • Maryland
Virginia • West Virginia
District of Columbia

Other Offices:
Pittsburgh
Baltimore
Washington, D.C.

SEARCHLIGHT SECTION

(Classified Advertising)

GEIGER COUNTERS

Have quantity of RCA laboratory type WF-16A Geiger Counters made to sell for \$750. Will sacrifice at \$125 each.

MOSS ELECTRONIC, INC.
3849 Tenth Avenue New York 34, N. Y.
(Phone M. Steir-TULip 2-1530)

CIRCLE 460 ON READER SERVICE CARD

PROFESSIONAL SERVICES

JOHN LESSER & STAFF ENGINEERING—DESIGN— DEVELOPMENT—PRODUCTION

For Edge Light Panels Qualified to MIL-P-7788A and Instruments Illuminated To MIL-I-25487A
BODNAR PRODUCTS CORP.
236 Huguenot St., New Rochelle, N. Y. NE 6-4664

INDEX TO ADVERTISERS



Audited Paid Circulation

• AMP Incorporated	11	• Haydon Co., A. W.	108, 109
• American Lava Corporation	89	• Hewlett-Packard Company	17, 18
Armour Research Foundation	42		
• Automatic Metal Products Corp.	106		
		• Indiana Steel Products, Div. of Indiana General Corp.	103
• Bird Electronic Corporation	27	International Business Machines Data Processing	87
• Bircher Corporation, The	34		
Bourns Laboratories, Inc.	13	Jerrold Electronics Corp.	14
• Brush Instruments, Div. of Clevite Corp.	57	Jones & Lauson Machine Co.	59
• Bud Radio, Inc.	94		
• Burnell & Co., Inc.	3		
By-Buk Company	105	Klein & Sons, Mathias	39
CBS Electronics	47	• Lapp Insulator Co., Inc.	30
• Continental Connector Corp.	61	Leesona Corporation	98
Continental-Diamond Fibre Subsidiary of the Budd Company	8	Lincoln Laboratory	50
		• Ling-Temco Electronics, Inc.	15, 21
• Daven Company, The	3rd Cover	• Litton Industries, Electron Tube Divi- sion	12
• DeJur-Amsco Corporation	61	Lockheed California Division	111
• DeMornay-Bonardi	29		
• Du-Co Ceramics Co.	34	• Minneapolis-Honeywell Precision Meters Division	97
		Minnesota Mining & Mfg. Co., Magnetic Products Division	16
• Eitel-McCullough, Inc.	43	Moseley Co., F. L.	46
Electrodynamic Instrument Corporation	105		
Electro Instruments Inc.	85	New England Instrument Co.	20
• Erie Resistor Corp. Erie Pacific Division	107	North Electric Co.	58
• Fairchild Semiconductor Corp.	55	Pacific Semiconductors Inc.	35, 36, 37
• Fenwal Electronics, Inc.	91	• Phileo Corporation	62
• Fuji Tsushinki Seigo K K.	90	• Power Designs, Inc.	113
Gardner-Denver Company	54	• Radio Corporation of America 4th Cover,	52
Garner Company, T. H.	108	• Raytheon Company	33
• General Electric Co.	20	• Royal Electric Corp.	50
Semiconductor Pmts. Dept.	22, 23		
Silicone Pmts. Dept.	106	Security Devices Laboratory	113
General Dynamics General Atomic Division	112	• Sola Electric Co.	44, 45
Genisco Incorporated	31	Sperry Electronic Tube Div. Sperry Rand Corp.	51
• Grayhill, Inc.	105		
Hagan Chemicals & Controls, Inc.	116		
Harman Kardon	94		

• See Advertisement in the July 20, 1961 issue of Electronics Buyers' Guide for complete line of products or services.

electronics

WEEKLY QUALIFICATION FORM FOR POSITIONS AVAILABLE

ATTENTION: ENGINEERS, SCIENTISTS, PHYSICISTS

This Qualification Form is designed to help you advance in the electronics industry. It is unique and compact. Designed with the assistance of professional personnel management, it isolates specific experience in electronics and deals only in essential background information.

The advertisers listed here are seeking professional experience. Fill in the Qualification Form below.

STRICTLY CONFIDENTIAL

Your Qualification form will be handled as "Strictly Confidential" by ELECTRONICS. Our processing system is such that your form will be forwarded within 24 hours to the proper executives in the companies you select. You will be contacted at your home by the interested companies.

WHAT TO DO

1. Review the positions in the advertisements.
2. Select those for which you qualify.
3. Notice the key numbers.
4. Circle the corresponding key number below the Qualification Form.
5. Fill out the form completely. Please print clearly.
6. Mail to: D. Hawksby, Classified Advertising Div., ELECTRONICS, Box 12, New York 36, N. Y. (No charge, of course).

COMPANY	SEE PAGE	KEY #
ARMOUR RESEARCH FOUNDATION Illinois Institute of Technology Chicago, Illinois	42	1
ESQUIRE PERSONNEL Chicago, Illinois	114*	2
IBM CORPORATION New York, New York	113*	3
KOLLSMAN INSTRUMENT CORP. Sub. of Standard Kollsman Industries Inc. Elmhurst, New York	114*	4
LOCKHEED California Div. Burbank, California	111	5
LOCKHEED MISSILES & SPACE DIV. Sunnyvale, California	42*	6
NORTHROP CORPORATION Beverly Hills, California	44*	7
PHILCO WESTERN DEVELOPMENT LABS. Palo Alto, California	112*	8
SANDERS ASSOCIATES INC. Advanced Systems Laboratories Burlington, Mass.	114*	9
WLAC-TV INC. Nashville, Tenn.	115	10

* These advertisements appeared in the 7/14/61 issue.

(cut here) (cut here)

electronics WEEKLY QUALIFICATION FORM FOR POSITIONS AVAILABLE

Personal Background

NAME

HOME ADDRESS

CITY ZONE STATE

HOME TELEPHONE

Education

PROFESSIONAL DEGREE(S)

MAJOR(S)

UNIVERSITY

DATE(S)

FIELDS OF EXPERIENCE (Please Check)

7211

- | | | |
|--|--|---------------------------------------|
| <input type="checkbox"/> Aerospace | <input type="checkbox"/> Fire Control | <input type="checkbox"/> Radar |
| <input type="checkbox"/> Antennas | <input type="checkbox"/> Human Factors | <input type="checkbox"/> Radio-TV |
| <input type="checkbox"/> ASW | <input type="checkbox"/> Infrared | <input type="checkbox"/> Simulators |
| <input type="checkbox"/> Circuits | <input type="checkbox"/> Instrumentation | <input type="checkbox"/> Solid State |
| <input type="checkbox"/> Communications | <input type="checkbox"/> Medicine | <input type="checkbox"/> Telemetry |
| <input type="checkbox"/> Components | <input type="checkbox"/> Microwave | <input type="checkbox"/> Transformers |
| <input type="checkbox"/> Computers | <input type="checkbox"/> Navigation | <input type="checkbox"/> Other |
| <input type="checkbox"/> ECM | <input type="checkbox"/> Operations Research | <input type="checkbox"/> |
| <input type="checkbox"/> Electron Tubes | <input type="checkbox"/> Optics | <input type="checkbox"/> |
| <input type="checkbox"/> Engineering Writing | <input type="checkbox"/> Packaging | <input type="checkbox"/> |

CATEGORY OF SPECIALIZATION

Please indicate number of months
experience on proper lines.

	Technical Experience (Months)	Supervisory Experience (Months)
RESEARCH (pure, fundamental, basic)
RESEARCH (Applied)
SYSTEMS (New Concepts)
DEVELOPMENT (Model)
DESIGN (Product)
MANUFACTURING (Product)
FIELD (Service)
SALES (Proposals & Products)

CIRCLE KEY NUMBERS OF ABOVE COMPANIES' POSITIONS THAT INTEREST YOU

1 2 3 4 5 6 7 8 9 10 11 12 13 14 15 16 17 18 19 20 21 22 23 24 25

ON PW BOARDS...

INSERT these Components

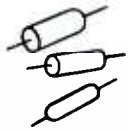

Up to 10 times
FASTER!

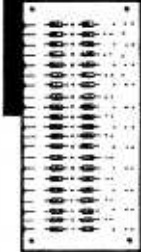

Dynasert Component Inserting Machine slashes costs even if you insert only a few hundred components a week. Equally fast on big or small boards, long or short runs, small (to .032" diameter) or large components. Model changeover in seconds. Dynasert automatically feeds, trims, bends leads, inserts, and clinches precisely and uniformly. Leads automatically clinched to follow circuit. Send for cost-saving facts and figures, today. Dynasert Dept., United Shoe Machinery Corporation, Boston, Massachusetts.

United

US1-70

DYNASERT

CIRCLE 210 ON READER SERVICE CARD

NEW LOW PRICE!

MODEL

1010T



WITH



ROBOTEC
overload and
short protection
and



HEATRAN
electronic
dissipation
control

\$339⁵⁰

FOB FACTORY
Other Models
Available. Write
for Catalog

SEMICONDUCTORIZED
POWER SUPPLY
1-100 VDC
0-1.0 AMP

High efficiency, stabilized solid state DC power supply with .05% regulation, 1 millivolt ripple, .015 ohm source impedance, 50 micro-second response time, 55-440 cycle input.

IMMEDIATE DELIVERY

Power Designs inc.

1700 SHAMES DRIVE, WESTBURY, NEW YORK
Edgewood 3-6200 (LD Area Code 516)

CIRCLE 211 ON READER SERVICE CARD
July 21, 1961

Consulting Engineers, with headquarters in Bloomfield, N. J.

Besides pioneering in television and radar, Chipp has three decades of experience in design and operation and management of electronic and communications systems.

Dunn Engineering Enters Digital Systems Field

DUNN ENGINEERING CORP., Cambridge, Mass., developer-manufacturer of electronic systems and inertial guidance and other missile test instruments, has established a digital systems department.

New department will develop advanced digital techniques for check-out of guidance equipment and for automatic control of industrial processes, Joseph M. Dunn, president, announced.

PEOPLE IN BRIEF

Adam Zittell leaves RCA to join Line Electric Co. as plant manager. David Karmann, formerly with the Southern New England Telephone Co., appointed antenna engineer for Wind Turbine Co. Thomas J. Sullivan transfers from J. Bishop Co. to International Resistance Co., plastic products division, as production control supervisor. Stanley E. Benson of General Dynamics/Electronics advances to manager of long range planning for the marketing division. Windsor H. Hunter moves up to director of development at Transitron Electronic Corp. Michael T. Trainor, previously with ITT-Kellogg, named executive engineer for Adler Electronics' military products division. Wilson M. Alford promoted by Hamilton Standard, division of United Aircraft Corp., to chief engineer of ground support equipment. Neil M. Blair of Amphenol-Borg named president of the FXR division. Chester W. Nimitz, Jr., leaves Texas Instruments to become vice-president of Perkin-Elmer Corp. and general manager of the instrument division. Howard H. Aiken, director of the Harvard Computation Lab., elected to the board of directors of WacLine, Inc. Pat Minervini promoted to engineering manager of Daystrom's military electronics division.



BF SERIES BATTERY HOLDER

Literally, BF Series Battery Holders are powerhouses... designed for use as highly stable, panel mounted cell sources of power. They will accommodate batteries and cells up to 1 3/8" diameter and lengths from 1 1/4" to 7 3/8", enabling use of different battery combinations to obtain wide selection of voltages. Batteries are exchanged simply by unscrewing holder cap. Designed for mounting up to a 1 3/8" diameter hole and 3/8" panel thickness. Inquiries for special battery holder lengths are invited. Complete data available on request.



300 SERIES: • Designed to accommodate batteries up to 1 1/4" diameter and lengths 1.300 to 5.850.

400 SERIES: • Accommodates batteries 1" to 1 1/4" diameter and lengths from 1 1/8" to 6 3/8".

500 SERIES: • Accommodates batteries ranging from 1 3/8" to 1 3/4" diameter and lengths from 2 3/8" to 7 3/8".

SDL

**SECURITY
DEVICES
LABORATORY**

ROCHESTER 21, NEW YORK

CIRCLE 113 ON READER SERVICE CARD 113

General Atomic Provides

PULSED RADIATION FACILITIES

An unusual combination of pulsed radiation facilities is now available on a scheduled basis to industry and military organizations for conducting transient radiation effects testing. These facilities include, at a single location, the **TRIGA Mark-I** and **Mark-F** reactors and the high-energy **Electron Linear Accelerator**.

In addition to the skilled personnel who operate the facilities, scientific and engineering staff members with extensive experience in transient radiation effects testing programs are available to assist in planning and executing specific research programs.

Testing can range from fundamental studies of transient radiation effects to the environmental testing of specific components and systems. The TRIGA reactors developed by General Atomic are designed to yield reproducible, pulses of neutrons and gamma rays up to a peak fast neutron flux of 4.0×10^{16} nv. The powerful 45 Mev L-band Electron Linear Accelerator provides extremely short pulses of high energy electrons, gamma rays or both.

Write now for complete information on these facilities to: Applications Group-FS, General Atomic, P.O. Box 608, San Diego 12, California.

**GENERAL DYNAMICS
GENERAL ATOMIC
DIVISION**

alloy and mesa transistors, has appointed Walter B. Mitchell to the position of director of electronics. Activities under his direction will encompass device applications, evaluation and reliability, test equipment design and fabrication.

Prior to joining NSC, Mitchell was chief, evaluation engineering at Transatron Electronics.



Webber Advances At Martin-Orlando

HUGH E. WEBBER has been named director of the technical and research staff of The Martin Company's Orlando Division.

TARS is responsible for the division's major research and development programs in technical fields related to missiles and electronics.

Prior to being named to his new position, Webber was Martin-Orlando's engineering support director.



Ortho Industries Forms Subsidiary

A NEW electronic subsidiary called Ortho Dynamics, Inc. has been established in Orlando, Fla., by the parent firm, Ortho Industries, Inc., Paterson, N. J.

William E. Lane has been named vice president and general manager of the new facility. According to

Lane, Ortho Dynamics will engage in contract work and research, design and production of a line of solid state and semiconductor devices. Products will include a power supply line and a line of telemetry signal conditioning devices.

The new firm expects approximately 60 percent sales in products; 30 percent in systems and contract work; and 10 percent in research and development of specialized equipments.

James Brophy Assumes New Position at ARF

APPOINTMENT of James J. Brophy as director of technical development for the Armour Research Foundation of Illinois Institute of Technology is announced.

A member of the Foundation staff since 1951, Brophy succeeds Richard Humphreys who recently became president of Cooper Union College in New York.



Airtron-Pacific Gets New Chief Engineer

ROLLIN H. KOONTZ has been named chief engineer of Airtron-Pacific, a division of Litton Industries, Beverly Hills, Calif.

Prior to joining Litton, Koontz was a specialist in the microwave components section of the Radiating Systems Division of Electronic Specialty Co.

Rodney D. Chipp Heads Consultant Group

UNTIL recently an engineering executive at International Telephone & Telegraph Corp., Rodney D. Chipp has left to head the new firm of Rodney D. Chipp & Associates,



THERE **IS** SOMETHING NEW UNDER THE SUN

Yes, there *is* something new under the sun. Science is proving this every day. With new discoveries. New explorations. New concepts.

Nowhere is this more evident than in the field of technology. For example: On the drawing boards of Lockheed Scientists and Engineers, new designs are constantly being born—designs in Spacecraft and Aircraft that will reinforce and enlarge our growing knowledge of Outer Space.

These new designs are rapidly developing. And their number is rapidly increasing. The pace is fast. Yet it needs to become faster. To keep pace, Lockheed needs more Scientists, more Engineers. Result? The future for Lockheed was never more promising—the opportunities never greater.

Lockheed feels that trained men will do well to examine thoughtfully the Company's current openings. Notable among

these are: Aerodynamics engineers; thermodynamics engineers; dynamics engineers; electronic research engineers; servosystem engineers; electronic systems engineers; physicists (theoretical, infrared, plasma, high energy, solid state, optics); hydrodynamicists; ocean systems scientists; physiopsychological research specialists; electrical-electronic design engineers; stress engineers; and instrumentation engineers.

Scientists and Engineers: To learn more about the opportunities at Lockheed, write Mr. E. W. Des Lauriers, Manager Professional Placement Staff, Dept. 1506, 2408 No. Hollywood Way, Burbank, California. All qualified applicants will receive consideration for employment without regard to race, creed, color, or national origin. U.S. citizenship or existing Department of Defense industrial security clearance required.





FAE Instrument Gets Larger Quarters

FAE INSTRUMENT CORP., designer and maker of precision miniature magnetic rotating devices for servo systems, computers, antenna drives and other critical commercial and military applications, recently moved into newly-constructed quarters in Huntington Station, L. I., N. Y.

Alex Onyskin, president, reports that expanding sales of the firm's line of clutches, clutch-brakes, brakes, gears, gear-heads, differentials, bellows couplings and balanced clamps, virtually forced FAE out of its space in Long Island City.

Now situated in an industrial park, the plant was built to meet the company's specific needs. It doubles FAE's production capacity. It houses completely-equipped, fully air-conditioned engineering, development, sales and manufacturing areas arranged for maximum utility and for the comfort of a contemplated full complement of 65 employees.

The 8,000-sq-ft building features an up-to-date "white room" for maximum cleanliness in assembly, an electronic test and research laboratory, and a manufacturing area designed for the greatest degree of efficiency and continuity in rotating component work-flow, company says.

Onyskin started FAE Instrument 10 years ago to build servo system components. He has also done consulting work on servo packaging for a number of large firms.

The recent move, Onyskin says, was brought on by the success of a

line of particle clutches which are about to be followed by a new type of crystal clutch.

Other officers of the concern include: Mrs. Ann Mankes, secretary-treasurer; Arthur Blake, production control manager; and Robert Goff, sales manager.



Lockheed Electronics Promotes Benzing

LOUIS H. BENZING has been appointed assistant general manager of the Military Systems/Stavid Division of Lockheed Electronics Co., Plainfield, N.J.

With the company since 1955, Benzing has been serving as assistant to the general manager since 1958.

Trak Microwave Hires Pichal

APPOINTMENT of Henri T. Pichal as staff engineer has been announced by Trak Microwave Corp., Tampa, Fla. The company was organized

last year as a subsidiary of Trak Electronics Co., Inc., of Wilton, Conn., and specializes in engineering and manufacture of miniature microwave energy sources.

Pichal comes to Trak Microwave from Electronic Communications, Inc., St. Petersburg, Fla., where he served as project and staff engineer.



GPI's Link Division Advances Timmons

KENNETH P. TIMMONS has been appointed manager of the Western Laboratory of the Link Division, General Precision, Inc., Palo Alto, Calif. With Link since 1957, he served successively as senior engineer, manager of engineering services, and business manager.

Link manufactures flight simulators, and also specializes in aircraft, fire control, radar and ground support electronics and other special fields pertinent to the development of advanced systems for industry and defense.



National Semiconductor Appoints Mitchell

NATIONAL SEMICONDUCTOR CORP., Danbury, Conn., producer of silicon

Literature of the Week

ANGULAR POSITION TRANSDUCER Baldwin - Lima - Hamilton Corp., 42 Fourth Ave., Waltham 54, Mass. The Angulator, a device that measures limited angular displacements continuously and accurately, is described in a recent data sheet. (331)

COMMUNICATIONS CATALOG Marconi Italiana S. P. A., Genoa, Via Corsica 21, Italy, offers a catalog indicating the range of radio communication and broadcasting products it manufactures. (332)

COMPONENT CONTAINERS Olympic Products Co., Inc., Alpha, N. J. A 32-page bound catalog describes a line of square, round, and rectangular cases for electronic component packaging. (333)

D-C AMPLIFIER Neff Instrument Corp., 1088 E. Hamilton Road, Duarte, Calif. Bulletin gives complete specifications for type 101A solid state dc-amplifier. (334)

TILTING INSTRUMENT PANEL TA Mfg. Corp., 4607 Alger St., Los Angeles 39, Calif., offers an engineering brochure describing Consolet portable tilt panel instrument cases. (335)

CERAMIC CAPACITORS Gulton Industries, Inc., 212 Durham Ave., Metuchen, N. J. A 16-page booklet describes a line of Glennite ceramic capacitors. (336)

COMPUTERS Philco Computer Division, 3900 Welsh Road, Willow Grove, Pa. Catalog lists all currently available material on the Philco 2000 electronic data processing system. (337)

PHOTOELECTRIC TAPE READER Omnitronics, Inc., 511 N. Broad St., Philadelphia 23, Pa. A data sheet covers model PTR-71, which incorporates a bidirectional drive with the application of chopped reflected light in the tape reading process. (338)

AIRBORNE TELEMETERING Electro-Mechanical Research, Inc., P. O. Box 3041, Sarasota, Fla. A

four-page catalog describes a line of f-m instruments and accessories for airborne telemetering. (339)

ARC SUPPRESSION RECTIFIERS Electronic Devices, Inc., 50 Webster Ave., New Rochelle, N. Y., has published a two-page bulletin on its arc suppression selenium rectifiers. (340)

PHOTOVOLTAIC CELLS Daystrom, Inc., Weston Instruments Div., 614 Frelinghuysen Ave., Newark 12, N. J. Bulletin 03-201-A discusses features, selection, and applications of selenium photovoltaic cells. (341)

SELENIUM RECTIFIERS Syntron Co., Homer City, Pa., announces a bulletin giving electrical and mechanical specifications of a line of certified selenium cells and stacks, and cartridge type selenium rectifiers. (342)

MICROWAVE COMPONENTS Caswell Electronics Corp., 414 Queens Lane, San Jose 12, Calif. Condensed catalog illustrates and describes ferrite microwave components and subassemblies. (343)

LOW PRESSURE CELL International Resistance Co., 401 N. Broad St., Philadelphia 8, Pa. A highly accurate explosion proof low pressure cell for pressure measurement applications is described in a 2-page bulletin. (344)

LOGIC BLOCKS Rese Engineering, Inc., A and Courtland Streets, Philadelphia 20, Pa. Four-page bulletin describes 200 Kc transistor-operated logic circuit plug-ins. (345)

H-V CAPACITORS Corson Electric Mfg. Corp., 540 39th St., Union City, N. J. A 4-page catalog describes h-v d-c Mylar capacitors that surpass requirements of MIL-C-25A, characteristic E. (346)

STRAIN GAGES Micro Systems Inc., 319 Agostino Rd., San Gabriel, Calif., has available a catalog on 29 new Micro-Sensor semiconductor strain gages. (347)



**tinest timer
for
reliability
studies**



This A. W. Haydon ETI is essential for applications where space is critical. We don't know of any other ETI that can touch it for size—only ¼ cubic inch. It records hours to 999.9 or 9999, with over 99.9% accuracy... runs on a half watt, 115 v, 400-cycle input... weighs 0.75 oz... exceeds requirements of MIL-M-26550. Temperature range, -65° to +250°F... altitude 80,000'... 20g vibration up to 2,000 cycles. The microminiature ETI is designed for reliability test engineering. For full details on this, and its companion events counter, write The A. W. Haydon Company today.

**AWH HAYDON
THE COMPANY**
235 NORTH ELM STREET, WATERBURY 20, CONNECTICUT

SUB MINI ATURE

ETI

**workhorse of
reliability
testing**



This A. W. Haydon ETI is ideal for applications where space is a problem. Less than 3" long, 1 1/4" dia, it's production-test-proved to record up to 9,999.9 hours at better than 99.9% accuracy—much more reliability than what it's testing. The 23200 series for 60-cycle, or the 25200 series for 400-cycle run on 3 watts of 115 v., exceed requirements of MIL-M-7793. These ETI's are tested for service from -65° to +250°F... altitude to 80,000'...20g vibration up to 2,000 cycles. To get full details, write The A.W. Haydon Company today.

THE AWH HAYDON COMPANY
235 NORTH ELM STREET, WATERBURY 20, CONNECTICUT

PRODUCT BRIEFS

CENTRIFUGAL BLOWERS rack mounted. McLean Engineering Labs, Inc., Princeton, N. J. (315)

PHOTOCONDUCTIVE CELL cadmium sulphide. National Semiconductors Ltd., 230 Authier St., Montreal 9, Canada. (316)

ROTARY-TYPE POT subminiature device. Daystrom, Inc., Archbald, Pa. (317)

EPITAXIAL TRANSISTORS high-speed. National Semiconductor Corp., Danbury, Conn. (318)

TOROIDAL WINDING MACHINE compact. Universal Mfg. Co., Inc., 1168 Grove St., Irvington 11, N. J. (319)

ATTENUATORS tuned, microwave. Maury & Associates, 10373 Mills Ave., Montclair, Calif. (320)

MOTOR-GENERATOR for lab testing. Kato Engineering Co., Mankato, Minn. (321)

SELENIUM RECTIFIER high current density. Westinghouse Electric Corp., P.O. Box 2099, Pittsburgh 30, Pa. (322)

HUMIDITY CHAMBER 6 cu ft, portable. Wyle Laboratories, El Segundo, Calif. (323)

KLYSTRON TUBES super-power. Litton Industries, 960 Industrial Road, San Carlos, Calif. (324)

TELEMETERING TRANSMITTER for short distance. Wiley Electric Products Co., 2045 W. Cheryl Dr., Phoenix, Ariz. (325)

PRESSURE TRANSDUCER low-differential. Consolidated Electrodynamics Corp., 360 Sierra Madre Villa, Pasadena, Calif. (326)

VERSATILE SEQUENCER high reliability. Alpha-Tronics Corp., 1033 Engracia, Torrance, Calif. (327)

TAPE PUNCH & TAPE READER high speed. Teletype Corp., 5555 Touhy Ave., Skokie, Ill. (328)

SHAFT POSITION ENCODER analog-to-digital. Datex Corp., 1307 S. Myrtle Ave., Monrovia, Calif. (329)

LIQUID EPOXY DISPENSER finger tip control. Kenics Corp., P.O. Box 27, Greenwood Station, Wakefield, Mass. (330)



MANUFACTURED TO YOUR SPECIFICATIONS

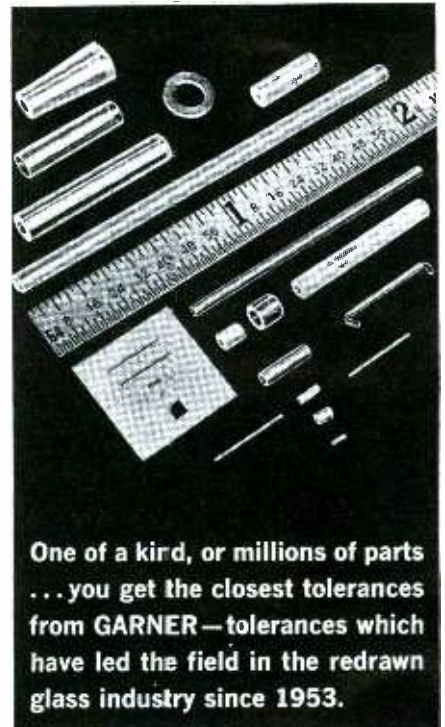

**One of a kind, or millions of parts
... you get the closest tolerances
from GARNER—tolerances which
have led the field in the redrawn
glass industry since 1953.**

Large stocks of many different glass types and sizes—including the unusual. Available for immediate redraw.

Customer minded—We constantly upgrade equipment and techniques to keep ahead of your needs. You'll find us especially helpful on difficult requirements.

On-time deliveries—GARNER is geared for volume production to tight specifications—on a day-to-day basis. You get the parts you need... when you need them.

Send for complete data.



T. H. GARNER COMPANY

177 S. Indian Hill Blvd.
Claremont, Calif. • NAtional 6-3526

CIRCLE 209 ON READER SERVICE CARD
electronics

num exceeding 5,000 lb per sq in. and offers very good adhesion to steel, copper, glass and porcelain. Material has built-in toughness combined with excellent ductility; offers good resistance to chemical attack and retention of strength even after 30 day immersion in water. It will cure in 1 hr at 300 F.

CIRCLE 312 ON READER SERVICE CARD



Wire Clippers

AIR POWERED

CHICAGO PNEUMATIC TOOL CO., 6 E. 44th St., New York 17, N. Y., announces pneumatically powered Air-Nips designed for production wire trimming. Requiring 28 times less pressure to operate than conventional hand pliers, they eliminate operator fatigue. They feature a pointed cutting head that can be rotated 180 deg to get at hard to reach leads on p-c boards. They will work off a $\frac{1}{4}$ h-p compressor.

CIRCLE 313 ON READER SERVICE CARD



Coax Attenuators

RUGGED AND STABLE

COAX DEVICES, Box V, Chelsea 50, Mass., announces attenuators with a typical vswr of 1.2. They operate over the frequency range from d-c to 2 Gc. Typical attenuator deviation is 5 db. Units are available in 3, 5, 6, 10, 15, 20, 30 and 40 db values. Standard connector types are N, C, TNC, BNC, HN, LT, LC. Price ranges from \$30-\$40.

CIRCLE 314 ON READER SERVICE CARD

July 21, 1961

ERIE *Instrumentation* **MODEL 925**
... the counter
that remembers!!

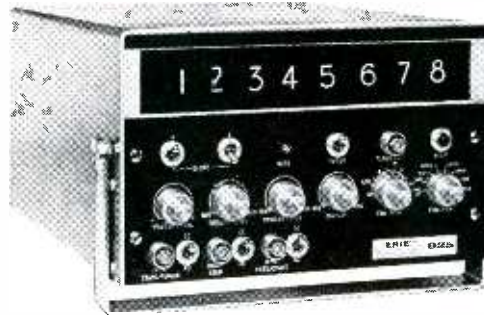

SOLID STATE
20 MC
UNIVERSAL COUNTER-TIMER

All new ... the rugged, compact Model 925 is designed to offer the ultimate in reliable counting of periodic or random electrical events and precise measurement of Frequency, Period and Time Intervals. *Built-in memory* provides readout storage, continuous display while counting, more frequent sampling and less operator eye fatigue. Modular construction.

OUTSTANDING FEATURES:

- IN-LINE NIXIE READOUT
- 8 DIGIT MEMORY – No Blinking
- SENSITIVITY – .1V RMS – All 3 Channels
- THREE DC AMPLIFIERS
- HIGH INPUT IMPEDANCE
- AUTOMATIC DECIMAL POINT
- ONLY 3 $\frac{1}{2}$ " RACK SPACE (Model 925-R)
- DECADE TIME BASE – No Adjustments
- STABILITY – 1 Part in 10⁶/Day; 5 Parts in 10⁶/Week



ONE HAND PORTABILITY

Write today for complete specifications on the Model 925 or Model 925-R (Rack Model) – the ideal instrument for laboratory or industrial applications.

Quality Where It Counts
ERIE
Instrumentation

ERIE-PACIFIC, DIVISION OF ERIE RESISTOR CORPORATION
 12932 South Weber Way, Hawthorne, Calif. • ORegon 8-5418 • TWX HAW CAL 4006

CIRCLE 107 ON READER SERVICE CARD 107

General Electric Silicone dielectric grease

An excellent electrical insulating compound that's easily applied and stays in place.

Water repellency protects terminals, connections from failure due to moisture.

Good heat transfer for transistor applications.

Maintains protection from -65°F to 400°F; won't solidify or evaporate.

Chemically inert.

Protects copper, other metals against corrosion.

For full information on G-E silicone dielectric grease, plus a free 2 oz. sample tube, write on your company stationery to: General Electric Company, Silicone Products Department, Section I, Waterford, New York.

GENERAL ELECTRIC

measurements is manufactured by Micro Systems, Inc., 319 Agostino Rd., San Gabriel, Calif. Device MPS100 is suited for applications prohibiting mechanical loading and where a controlled intensity light spot may be employed. It consists of a pair of silicon photo diodes accurately separated. Output is a differential emf, which is a measure of the difference in light incident upon the two cells. Characteristics obtained with a tungsten light source include: light sensitivity of 250 mv at 50 mw per sq cm, light displacement sensitivity of 35 mv per mw per 0.001 inch displacement. Immediate delivery at \$75 to less than \$20, depending upon quantities and specialized characteristics.

CIRCLE 309 ON READER SERVICE CARD

Ceramic Magnet

INDIANA GENERAL CORP., Indiana Steel Products Div., Valparaiso, Ind. Magnet material is designed for microwave equipment where resistance to demagnetizing forces is required.

CIRCLE 310 ON READER SERVICE CARD

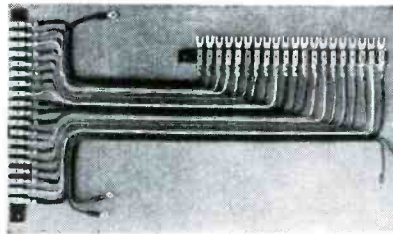

Flat Ribbon Cable MULTICONDUCTOR

SPECTRA-STRIP WIRE & CABLE CORP., P. O. Box 415, Garden Grove, Calif., introduces multiconductor, multi-colored flat ribbon cable. Advantages include light weight, flexibility, ease of handling, full visibility of color code, control of interconductor capacitance, and uniformity between one length of cable and the next.

CIRCLE 311 ON READER SERVICE CARD

Epoxy Adhesive

EXTRA BONDABILITY

CONAP, INC., 184 E. Union St., Allegany, N. Y. Conap 1222 epoxy adhesive provides bonds to alumi-

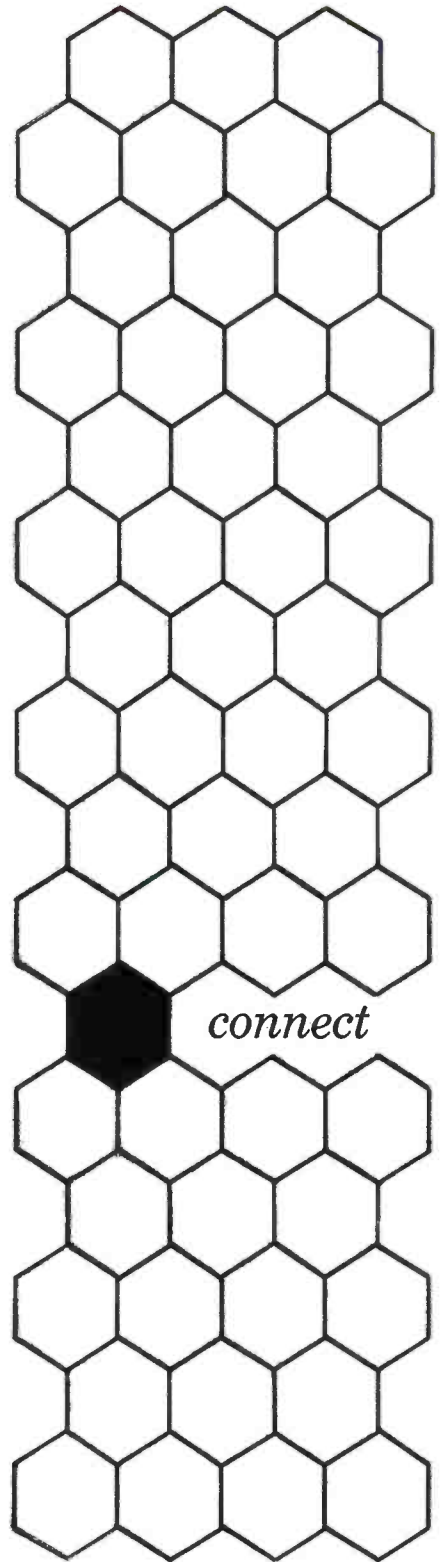

for the latest advances in design and performance always specify

Coaxial Connectors by

Automatic

METAL PRODUCTS CORPORATION
323 Berry St., B'klyn 11, N. Y. • Evergreen 8-6057

CIRCLE 208 ON READER SERVICE CARD
electronics

with an accuracy better than 0.1 percent. Since parameters *A* and *C* are completely isolated, and may differ in form from *B* and *D*, a-c and d-c signals may be mixed with no loss in accuracy. MO-1 solid-state device is equivalent to a servo-mechanism. Bandwidths match or exceed those of electromechanical servos.

Compact and rugged, the device is suited for military applications and severe environmental conditions. Because of the isolation of the parameters the unit can be used as an a-c to d-c, or d-c to a-c converter; ripple free d-c output is

available without using filters; frequency conversion can be accomplished with ease; squaring is accomplished by letting $A = B$; square root taking requires an additional amplifier. The unit consists of a computation element and a power amplifier. The multiplying element is approximately $2\frac{1}{2} \times 2\frac{1}{4} \times 2\frac{3}{4}$ inches; dimensions for the power amplifier vary, depending on the application. The unit is available on a 6-8 week basis, from Elasco Inc., 5 Prescott St., Roxbury 19, Mass.

CIRCLE 304 ON READER SERVICE CARD



Digital Counter

10-NSEC ACCURACY

TIME INTERVAL measurements in digital form with 10-nsec accuracy are available with Model 5275A counter, by Hewlett-Packard Co., 1501 Page Mill Rd., Palo Alto, Calif. Applications include measurement of explosive burning rate, timing test vehicle speed and acceleration in free-flight wind tunnels and measurement of nuclear phenomena. Range extends from 10 nsec to 0.1 second; counted frequency is 100 Mc, obtained from an external 1-Mc standard which is multiplied 100 times by an internal circuit. Neon columns give a 7-place reading in microseconds, with automatically positioned decimal point.

CIRCLE 307 ON READER SERVICE CARD



Miniature Flip-Flop

LOW FAILURE RATE

MINIATURE flip-flop has 12 components, each passivated by a silicon-oxide film, and uses ceramic substrate 0.31×0.31 in. Operating speed is in the nanosecond range. The circuits are being produced initially on order, to specification, with cost equal to conventional circuits. All components are pretested and the units have

failure rate of 0.001 percent per 1,000 hours. Components are mounted by wafer bonding; a ceramic coating provides mechanical rigidity. Manufacturer is General Instrument Semiconductor Div., 65 Gouverneur St, Newark 4, N. J.

CIRCLE 305 ON READER SERVICE CARD



Pressure Transducer

MINIATURIZED

PRECISION RESEARCH INC., 43 Westover Lane, Stamford, Conn., has developed miniaturized differential transformer pressure transducers intended to be used in problem areas where pressure of high temperature liquid metals is to be measured. Smallest probe size presently available has a sensing end diameter of 0.230 to fit a 0.250 in. i-d well at an operating temperature of 300 C. Differential transformer is sensitive to diaphragm movements of less than 0.005 in.

CIRCLE 308 ON READER SERVICE CARD

Photo-Sensor

FOR DISPLACEMENT

MICRO-PHOTO-SENSOR that provides sensitive light spot displacement



Backward Wave Tubes

12.4 TO 26.5 GC RANGE

RUGGED K-band backward wave oscillators meet severe military requirements. Frequency range of the QKB890 is 12.4 to 18 Gc; QKB-

891 range is from 18 to 26.5 Gc. Both tubes have 20-mw minimum output, control grid for low-voltage pulsing and permanent magnet focusing. Minimum space needed between tubes is 2 inches.

The tubes are suitable for space, airborne and ground-based applications, as swept local oscillators and as pump tubes for parametric amplifiers. Manufacturer is Micro-wave and Power Tube Div., Raytheon Co., Foundry Ave, Waltham 54, Mass.

CIRCLE 306 ON READER SERVICE CARD

From Indiana Steel Products Division of
INDIANA GENERAL CORPORATION

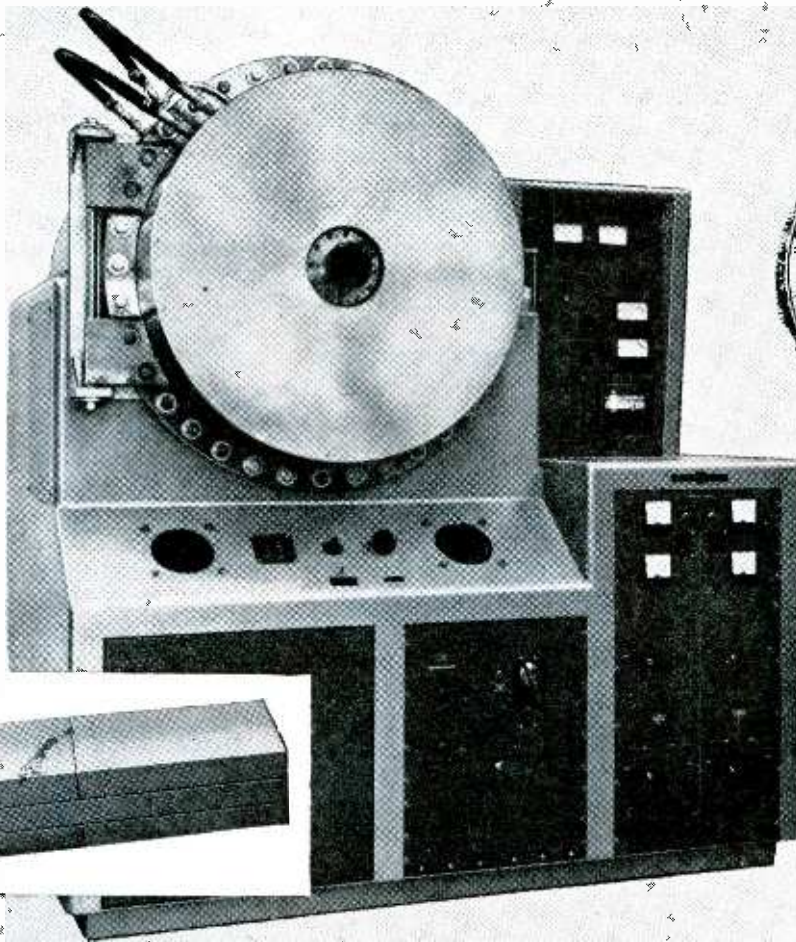

The ultra-high vacuum obtainable with this Varian Vaclon pump provides the nearest earthbound equivalent to outer space — showing effects on equipment, clothing, etc. The pump shown has a capacity of 800 liters/second and uses approx. 276 lbs. of INDOX V.

INDOX® V magnets improve space chamber vacuums

Indiana Steel's INDOX V permanent magnets are helping Varian Vaclon pumps obtain verified vacuums past 10^{-9} mm Hg. Result: better space chambers, plus many additional critical vacuum applications.

Advanced design ion pumps, manufactured by Varian Associates, Palo Alto, Calif., are providing ultra-high vacuums with greater efficiency. In fact, these pumps, using powerful INDOX V magnets, are largely replacing diffusion pumps on critical vacuum applications.

After a mechanical roughing pump removes most of the air from a given vessel, the ion pump goes into operation. High voltage is applied, ionizing some of the gas particles and forcing electrons toward the anode. The powerful magnetic field of the INDOX V permanent magnet deflects the traveling electrons into spiral paths, increasing path lengths and, therefore, the number of particle collisions and degree of ionization. Finally, the

ions bombard titanium cathode plates which frees titanium atoms to form stable compounds with the atoms of oxygen and nitrogen which are then deposited on the anode grid. Inert gases are also removed by burial in the cathode and entrapment on the anode.

Varian selected Indiana Steel INDOX V magnets both for their magnetic characteristics and their uniform quality. INDOX V is a highly oriented ceramic magnet material with a peak energy product $3\frac{1}{2}$ times greater than conventional unoriented barium ferrite materials. It is lightweight and extremely resistant to the effects of demagnetization.

Whether it's a question of choice of magnet or a design problem, why don't you take advantage of Indiana's wealth of experience, research leadership and specialized engineering "know-how"? Write today, outlining your needs. For further details on the INDOX family of magnetic materials, ask for Bulletin 18A, Dept. A7.



INDIANA STEEL PRODUCTS

Phone HOward 2-3111 • Direct Distance Dialing Code 219

VALPARAISO, INDIANA

INDIANA PERMANENT MAGNETS

New On The Market

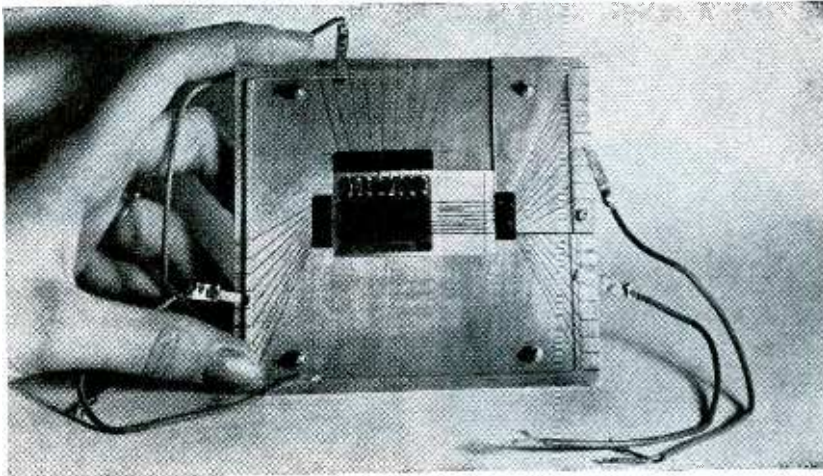

Cylindrical Film Memory 15-NSEC CYCLE TIME

THIN-WALL cylindrical film memory device has been developed by CBS Labs, High Ridge Rd., Stamford, Conn. Outputs for ONE and ZERO are several hundred mv. Material in the memory device is a composition of cobalt, nickel and iron, and can be plated without stringent controls of temperature, pH or vat

composition. Bipolar ONES and ZEROS and pure nondestruct operation are inherent in the design, with pure nondestruct operation at cycle times as low as 15 ns. Scratch-pad operation is easily achieved.

CIRCLE 301 ON READER SERVICE CARD

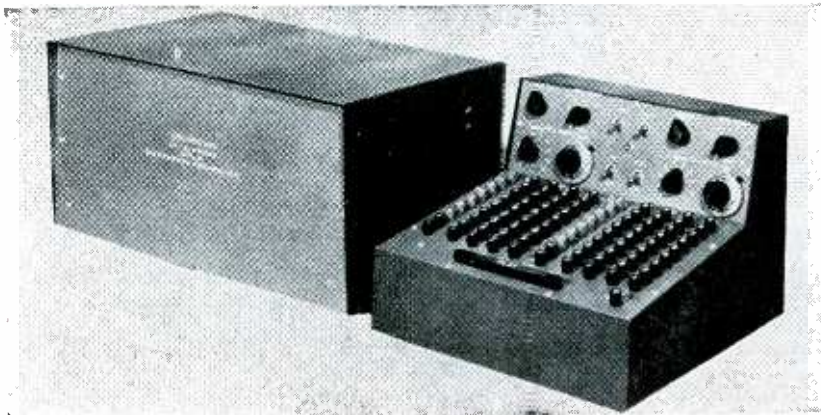

Keyboard for Manual Plotting WORKS WITH X-Y RECORDERS

KEYBOARD and converter unit are for use with any X-Y recorder or plotting table, for manual-entry point plotting. Numerical data is converted to graphical form on log-log, semi-log or linear coordinate papers. Fatigue and errors in plotting are greatly reduced. Logarithmic plotting capability of the model 110 allows high accuracy and

resolution of each point, and straight-line representation of multiplication, division, raising to powers or extracting roots.

Unit provides full-scale ranges of one log cycle plotting to seven cycles, with four-column entry for each axis. Accuracy of conversion to log analog is 0.1 percent. System response is about 1 second per

point with typical plotting tables. Conversion accuracy for linear plotting is 0.05 percent and is instantaneous with key operation. The origin of a graph can be anywhere on the paper. Plotting system is by King Scientific Co., 316 Bocknell Rd., Costa Mesa, Calif.

CIRCLE 302 ON READER SERVICE CARD

Component Tester CURRENT MODULATED

CURRENT-MODULATED testers quickly determine the d-c and a-c characteristics of Zener diodes, matching diodes, rectifiers, chokes, filters, transformers, relay coils and solenoids, as well as meter movements and power supplies. The testers are suited for field service, quality con-

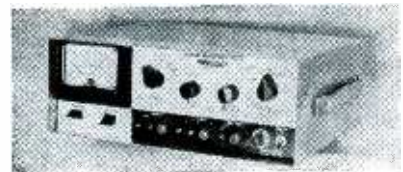

trol, receiving inspection and engineering lab check-out. They use a 60-cps internal current-modulated circuit; external modulation from 20 cps to 100 Kc is possible. An internal load makes it possible to calibrate d-c currents and modulation amplitude without applying power to the component. Damage by shorts is prevented through built in current limiting. Model MT 302 (0 to 80 volts) is ready for immediate delivery; other models will be ready in late August. Manufacturer is Modutronics, Inc., P. O. Box 368, Solana Beach, Calif.

CIRCLE 303 ON READER SERVICE CARD



Analog Computation MULTIPLIER-DIVIDER

INEXPENSIVE computing device performs the operation $D = A \times B/C$



Resistors are coded by offset printer

ink rolls. Blanking and inking rolls are mounted on a planetary gear arrangement. Keeping the type head stationary permits the addition of servo drives for automatic type changing under computer control. Blanket rolls are automatically cleaned between code changes and during idle periods.

Final inspection data is used to reset the preceding inspection station to compensate for shifts in value caused by encapsulation heat. At the packing station, the resistor is pushed into a bank between two loading jaws. When the bank fills, an anvil pushes the resistors into a block of foam plastic. This machine has computer-controlled servos which adjust it to the four resistor sizes.

Between the first four stations, the resistor core is blown through plastic tubes by low air pressure. Conveyors are used from the capping machine to the end of the line. The conveyors have individual stainless steel pallets on continuous belts. As the pallets index through each machine, the resistor is unloaded by a rubber-tipped vacuum rod. Space is allowed between each machine for a five-minute inventory. Each machine will shut off if the storage space fills on the succeeding machine.

Heat Joins Plastic Pipe

BUTT FUSION is recommended by Phillips Chemical Co. for joining high-density plastic pipe used for conduit. The ends are squared with a saw and clamped so they face each other. An aluminum plate is placed between the two ends and heated to about 400 F for 30 seconds. The heated ends are pressed together until they cool, in about 20 seconds.

July 21, 1961

square peg



round hole

You can't sell transistors to a short-order cook . . . nor a carload of frozen strawberries to a jewelry jobber.

And you don't have to waste advertising dollars trying to fit square pegs into round holes, either — not when the business publication you use is a member of the Audit Bureau of Circulations*.

Our ABC report, for example, helps you aim your advertising message directly to the audience you seek to sell . . . not only the specialized markets we reach and how well we reach them . . . but also the vocational identity of each subscriber in these markets — *who* and *how* many.

The phrase "Member of ABC" is significant to every advertiser who uses business publications. ABC reports provide him with a factual basis for reaching specialized markets . . . and the assurance that the people he wants to talk to will be there when the publication is delivered.

We are proud to be an ABC member.

electronics

A McGraw-Hill Publication

330 W. 42nd Street • New York 36, N.Y. 

* Through the reports issued by the Audit Bureau of Circulations, this publication, along with other publisher members of ABC, voluntarily and regularly give the buyers of advertising more verified factual information than is available for any other advertising media at any time.

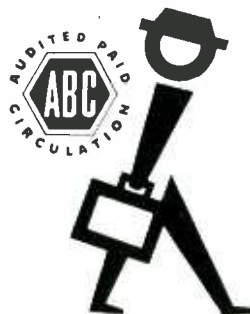

More opportunities than ever before at HUGHES SPACE SYSTEMS DIVISION

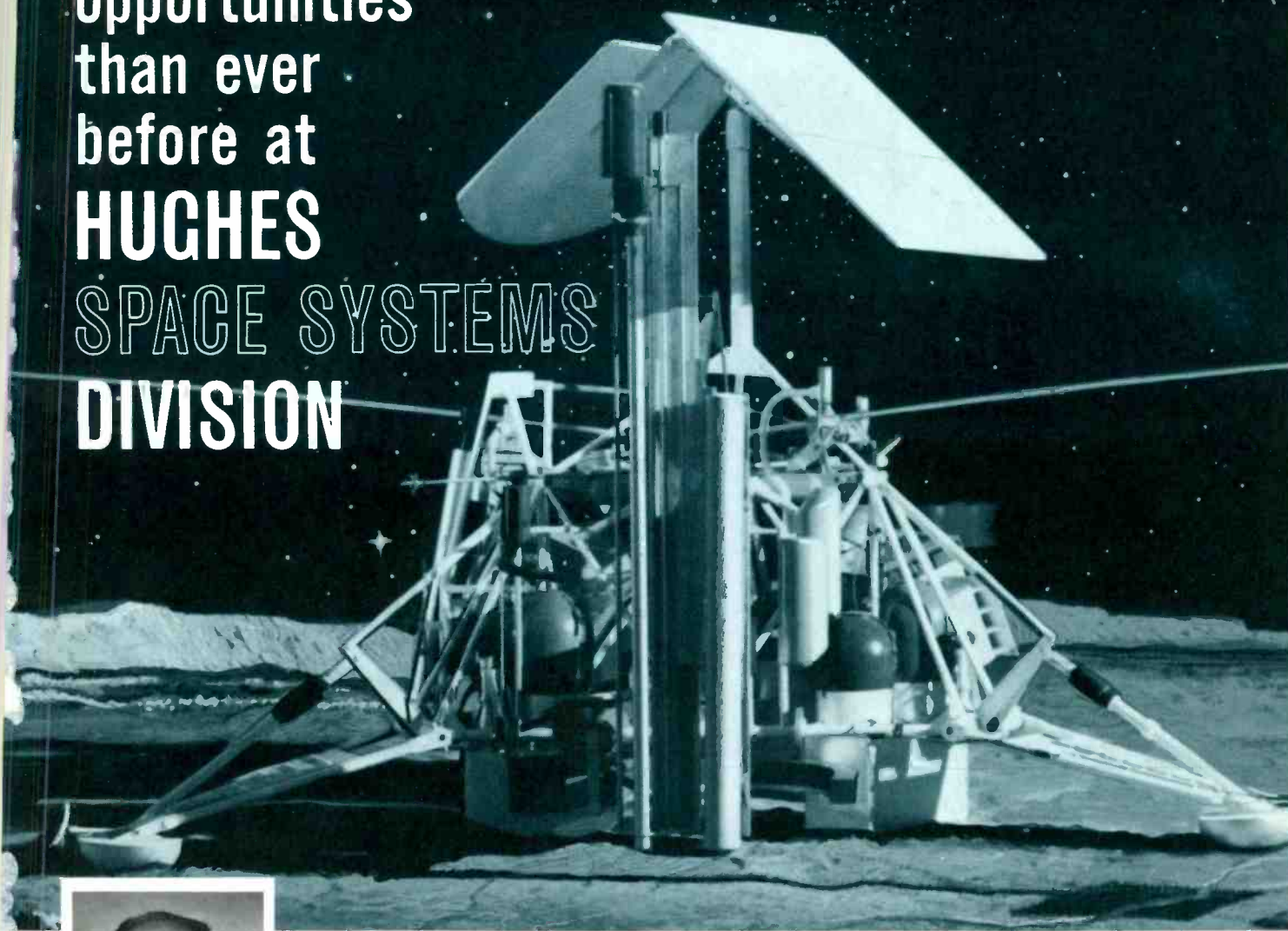

TO ENGINEERS AND PHYSICISTS WITH FORESIGHT:

The success of your professional career depends on your abilities, your training *and* the proper opportunities to apply these. Such opportunities now exist through the unusually challenging and responsible positions available in the Space Systems Division of the Hughes Aircraft Company.

This Division, expanding at an unprecedented rate, will double in size in the course of one year. Several hundred engineers and physicists will soon join Hughes to take part in Space Systems Division projects.

Among our important Government contracts are such significant and interesting programs as Project SURVEYOR, the development of spacecraft to soft land on the moon; and ARPAT, an experimental program for an advanced ballistic missile defense system. In addition the company is sponsoring a strong, forward looking program in space technology research and design of new systems. If you are interested in building an exciting and rewarding career working on growing projects and tomorrow's technology, please write to me. You will receive a reply within one week.

A handwritten signature in blue ink, appearing to read 'F. P. Adler'.

F. P. ADLER, *Manager*
Space Systems Division
Hughes Aircraft Company

AEROSPACE & WEAPONS SYSTEMS ENGINEERS

Consider these representative openings:

These are only a few of the hundreds of openings for both junior and senior graduate Physicists, Electronic Engineers, Thermodynamicists, Mathematicians, Mechanical Engineers and Aeronautical Engineers. To qualify, you should have training or experience which can be applied to space systems analysis, vehicle design, controls, propulsion, missile defense or related areas. We invite your inquiry.

Control System Analysts

Requires engineers at various levels of experience including senior men capable of taking over-all project responsibility in the synthesis and analysis of control systems.

Orbital Mechanics Analysts

Trajectory analysis and solution of problems involving conic and perturbation techniques.

Senior Dynamicists

Must be capable of performing advanced analysis in structural mechanics. Will be required to calculate response of complex elastic systems to various dynamic inputs including random excitation. Must be capable of original work in developing advanced analytical techniques.

Space Power Engineers

Openings include development of electronic propulsion systems for space probes. Positions call for capability of working in either a project or research capacity on direct energy conversion and storage systems. Openings exist for both junior and senior engineers. An advanced degree in Electronics or Physics is preferred.

Aerothermodynamicists

Experience in hypersonic gas dynamics, heat transfer, ablation, re-entry vehicle design and shock layer ionization will be most useful.

Armament Control Analysts

Experience in the synthesis of integrated fire control loops including the tie-in of sensing and guidance equipment is desirable. A strong background in target data sensing devices, particularly at optical wavelengths, is very helpful, as is experience with computers.

Systems Analysts

Senior engineers and physicists to investigate such questions as: What are the optimum guidance systems for lunar and inter-planetary space flight; how are the system choices justified considering trade-off of choice in terms of cost effectiveness; what are the IR systems requirements for ballistic missile defense; what are the optimum signal processing techniques for inter-planetary telecommunications; what are the maintenance and logistic requirements for weapon systems; what are the requirements of manned space flight?

Instrumentation Engineers

Involves the integration of advanced instruments into spacecraft such as Surveyor. Includes design for in-flight reliability; technical direction of instrument subcontractors; development of test programs and test equipment; and determining instrument interactions. Experience with subcontract procedures is also helpful.



PLEASE COMPLETE THE ATTACHED CARD so that we may become acquainted with your interests and qualifications. Or write: Dr. F. P. Adler, Manager, Space Systems Division, Hughes Aircraft Company, 11940 West Jefferson Boulevard, Culver City 49, California. We invite your inquiry and . . .

creating a new world with electronics

HUGHES

HUGHES AIRCRAFT COMPANY
SPACE SYSTEMS DIVISION

We promise you a reply within one week

An equal opportunity employer.

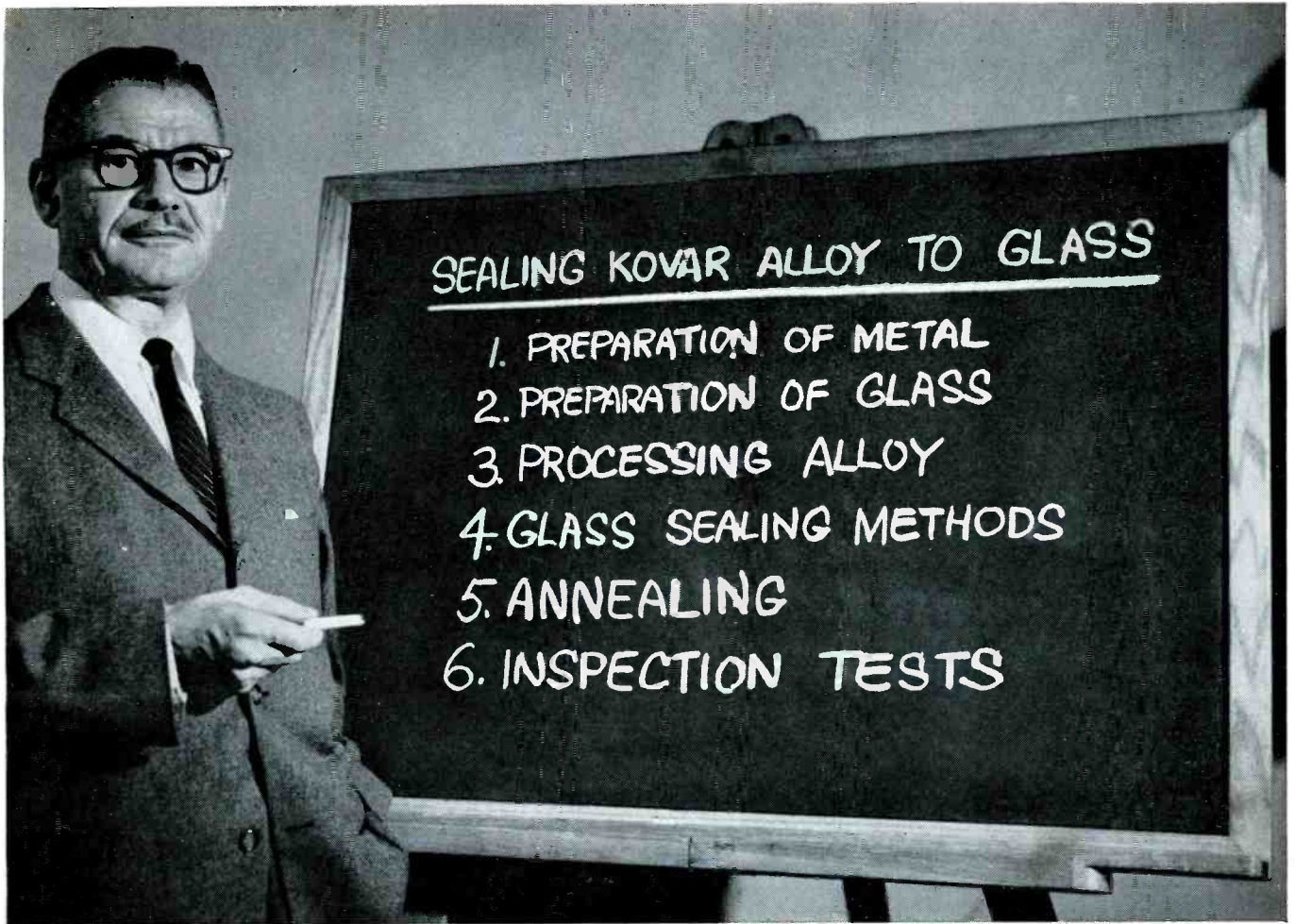

Engineering hints from Carborundum

6 steps to better glass-to-metal seals with KOVAR[®] Alloy

KOVAR[®] is the original iron-nickel-cobalt alloy with correct thermal expansion characteristics for making seals with several hard glasses. Procedures for obtaining a satisfactory seal—with optimum production yields—will vary according to the nature of the end product. This may range from large electron tubes to the smallest semi-conductor devices. The following hints typify recommendations for the more critical electron tubes; they can be modified for other products according to need.

1. KOVAR should be scratch-free. Polish with 180-grit aluminum oxide cloth, followed by 260-grit—never emery or carbide. Round edges of edge-type seals with a radius of about half metal thickness. Sand-blasted matt finish, using pure alumina, is preferable for butt type seals.
2. REMOVE DUST FROM GLASS with lint-free cloth. Rinse in 10% hydrofluoric acid solution, then in running tap water, finally in distilled water. Dip in methanol and hot air dry.
3. CLEAN KOVAR prior to sealing by trichlorethylene vapor degreasing, immersion in concentrated HCl, followed by rinses in tap and distilled water. Methanol dip and hot air

dry. Heat treat in wet hydrogen atmosphere.

4. SEALING EQUIPMENT includes gas-oxygen burner and glass lathe. Oxidize surfaces by heating metal and glass to 850° C in air. Bring parts together by pressure. For strong seal, glass edge should approach 90° angle where it meets KOVAR alloy.
5. ANNEAL SEAL using flame or furnace program, advancing to annealing temperature for 30 mins. Reduce to 50° C below strain point at 1° per minute, then 10° per minute to room temperature.
6. INSPECTION may include stress analysis by polariscope viewing or other method. Examination under 10x to 15x magnification should show that glass is free from excessive bubbles. Glass color should be grayish or mouse brown.

FIND OUT ABOUT KOVAR— WHERE IT IS USED AND WHY

Bulletin 5134 gives data on composition, properties and applications of KOVAR Alloy. For data on sealing procedures, ask also for Technical Data Bulletin 100-EB6. Write Dept. E-121, Latrobe Plant, Carborundum Co., Latrobe, Pa.



THERE IS NO TRUE SUBSTITUTE FOR KOVAR ALLOY

... supplied only by

CARBORUNDUM[®]

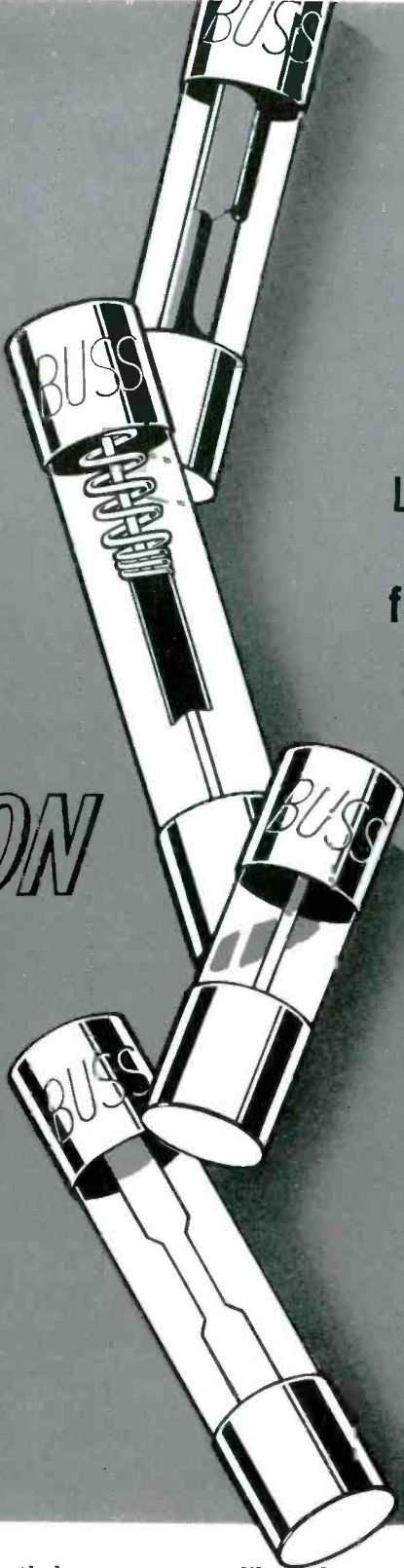

BUSS and **FUSETRON** **FUSES**

A Complete
Line of Fuses
in sizes
from 1/500
Amps. up

Plus
a companion
Line
of Clips,
Blocks
and Holders

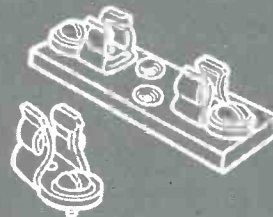

If protective devices fail to protect, costly burnouts may result. Or, if they open needlessly, equipment is put out-of-service. In either case, users may blame the trouble on the equipment and not on the faulty protective device.

To guard against this happening to your equipment, specify BUSS and FUSETRON fuses. Each and every fuse is tested in a sensitive electronic device that automatically rejects any fuse not correctly

calibrated, properly constructed and right in all physical dimensions.

Should you have a special problem in electrical protection, where you might be in doubt as to the proper fuse to use, BUSS places at your service the facilities of the world's largest fuse research laboratory and its staff of engineers.

To get full data for your files, write for the BUSS bulletin on small dimension fuses and fuseholders. Form SFB.

1261

BUSSMANN MFG. DIVISION, McGraw-Edison Co., UNIVERSITY AT JEFFERSON, ST. LOUIS 7, MO.

General Instrument is now delivering this flip-flop

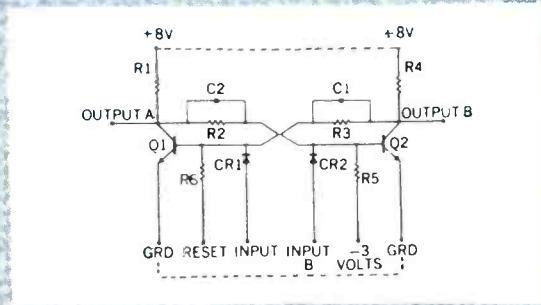

in these four different packages

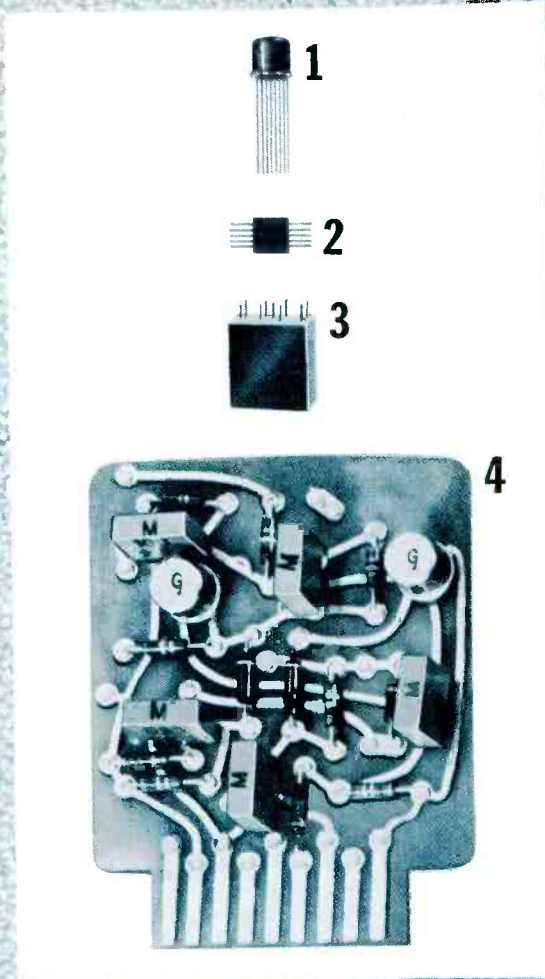

What better way to demonstrate packaging skill and versatility? Here you see the same circuit: **1** in a TO-18 can, **2** on a 0.17" x 0.17" ceramic substrate containing 2 transistors, 2 diodes, 6 resistors, 2 capacitors; **3** in all-welded or soldered-connection epoxy module 0.625" cube; **4** on a printed board 2¼" x 2½". Such capability comes easily to General Instrument. We've made components by the millions—to the most rigid standards. We offer a depth of experience as a leading supplier of packages in an infinite variety. And we can take your design—your environmental, mechanical and electrical requirements—and wrap them up in the most perfect package you can find. Call or write today for details.

GENERAL INSTRUMENT SEMICONDUCTOR DIVISION

General Instrument Corporation, 65 Gouverneur Street, Newark 4, New Jersey

More Phones for Cars, Planes

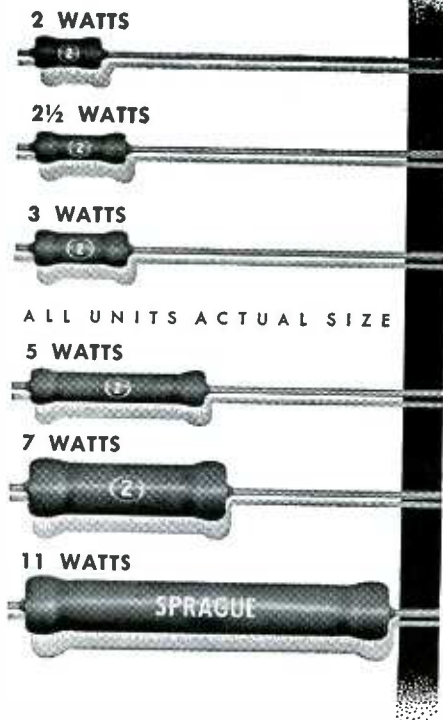

NEXT TIME ... USE TINY *Blue Jacket*[®] WIREWOUND RESISTORS

Sprague builds reliability ... efficiency ... economy right into minified Blue Jackets with these important features:

- * All-welded end-cap construction with special vitreous-enamel coating for total protection against humidity, mechanical damage, heat, corrosion gives long-term dependability under severe environmental conditions
- * Available in resistance tolerances as close as $\pm 1\%$
- * Low in cost ... quick and easy to install

Tiny axial-lead Blue Jackets are specially designed for use with conventional wiring or on printed boards in miniature electronic assemblies. Write for complete technical data in Sprague Engineering Bulletin 7410B.

SPRAGUE ELECTRIC COMPANY
35 Marshall Street, North Adams, Mass.



VEHICULAR COMMUNICATIONS boom during the next 10 years was predicted recently by A. J. Runft, director of commercial electronics engineering for AC Spark Plug division of General Motors. He thinks that the number of telephones in autos will grow from 18,000 this year to about five million.

In addition, he says that commercial aircraft will be offering air-ground telephone service to passengers as a routine travel accommodation. Plans are well underway to expand this service, now being offered on a limited basis.

Major factor in growth of the automobile radiotelephone market will be increased desire for communications as more and more people take to the roads for business, pleasure and commutation. Runft points out that there will be about 100 million autos on U.S. roads by 1970. The trend will be accelerated, he says, by an increase in FCC channel allocations for auto telephone service, a reduction in equipment size and power drain and innovations in selective signaling decoders.

AC's present auto telephone, the AChieverfone, has a decoder with a capability 25 times greater than its 1947 counterpart, for example, and is one-quarter the size. Runft expects that before 1970 a unit

with 10 million codes, occupying $4\frac{1}{2}$ cu. in. will be available.

At present, equipment gives no problems as long as calls are placed within the area intended for its use. However, if the car is driven to another area, the auto telephone might receive a call placed to a local resident with the same channel and code. Units with a great number of codes would solve this problem. Runft said that he could even conceive of the day when people would be assigned permanent telephone numbers (like a Social Security number).

More Base Stations

Expectations are that telephone companies will install many more auto telephone base stations throughout the nation, to provide complete coverage.

Other obstacles besides technical ones need to be overcome. In some states, for example New York and Massachusetts, drivers who want to use their telephones must pull over to the side of the road. The new GM phone is hands-free, using a boom-mounted microphone and a foot-actuated operating switch. Developments like this may help change driving regulations.

In the air, Runft said, some 20 commercial airplanes have been trying out the GM Skyphone. Passengers can use the telephones now within 200 miles of New York City, Washington, D. C., Pittsburgh, Chicago and Detroit, and contact virtually any phone in the world via the Bell System. Other cities will be joining the network shortly.

Telephone companies, he said, plan to add about 70 more ground stations by 1964 in the U.S. and about 12 more in Canada. Permanent frequency allocations for this service have been made by FCC. The production model of the Skyphone will be a multichannel set which will automatically tune to the channel of the proper ground station.

Runft also outlined a number of other feasible vehicular electronic systems with future market potential. These include several types of

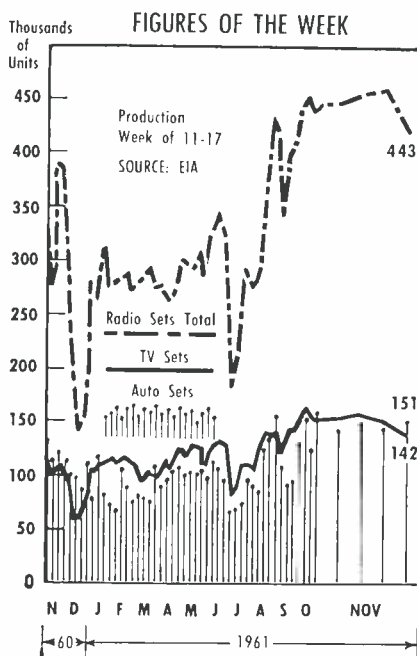

road guidance, safety and warning systems; radio and computer-controlled unmanned vehicles and heavy equipment for mining and farming; highway construction bulldozers which would grade on planes established by radio beams.

Small Firm's Best Bet Industrial and Military

STANFORD Research Institute survey conducted for the Small Business Administration finds that electronics companies with annual sales of less than \$10 million account for half of the total 1960 industry figure of \$10 billion.

Indications are that the most promising product areas for small businesses are military and industrial. The survey listed equipment for reconnaissance and surveillance, countermeasures, checkout, detection, tracking and data reduction as the most likely to catch the government's fancy. Test and measuring instruments of relatively small size and high technical complexity are the most appealing to industry.

About 30 percent of the industry's output, \$3 billion a year, is spent in government and industry R&D. Since production quantities involved are relatively low, expensive, automated equipment is less important and lower capital requirements make it possible for smaller firms to compete effectively with industry giants.

Generally, competition is based on quality or uniqueness of product rather than price.

MILITARY CONTRACTING

COMPLETE DEFENSE SYSTEMS FIRST QUARTER FISCAL 1962

	Total Prime Contractors	Total Sub- contractors
Aircraft Systems	\$1,067,508,000	\$31,704,000
Communications	161,944,000	13,028,000
Components	69,447,000	1,672,000
Data Processing	25,383,000	5,710,000
Electronic Warfare	214,160,000	7,506,000
Meteorology	1,309,000
Missiles	1,510,824,000	183,561,000
Navigation	124,286,000	1,259,000
Research	82,885,000	242,000
Services	161,702,000
Vehicles	500,616,000	13,373,000
TOTALS	\$3,920,064,000	\$258,055,000

The above figures represent prime military systems awards. They are recorded for ELECTRONICS by Frost & Sullivan, Inc., of New York City, defense marketing specialists.

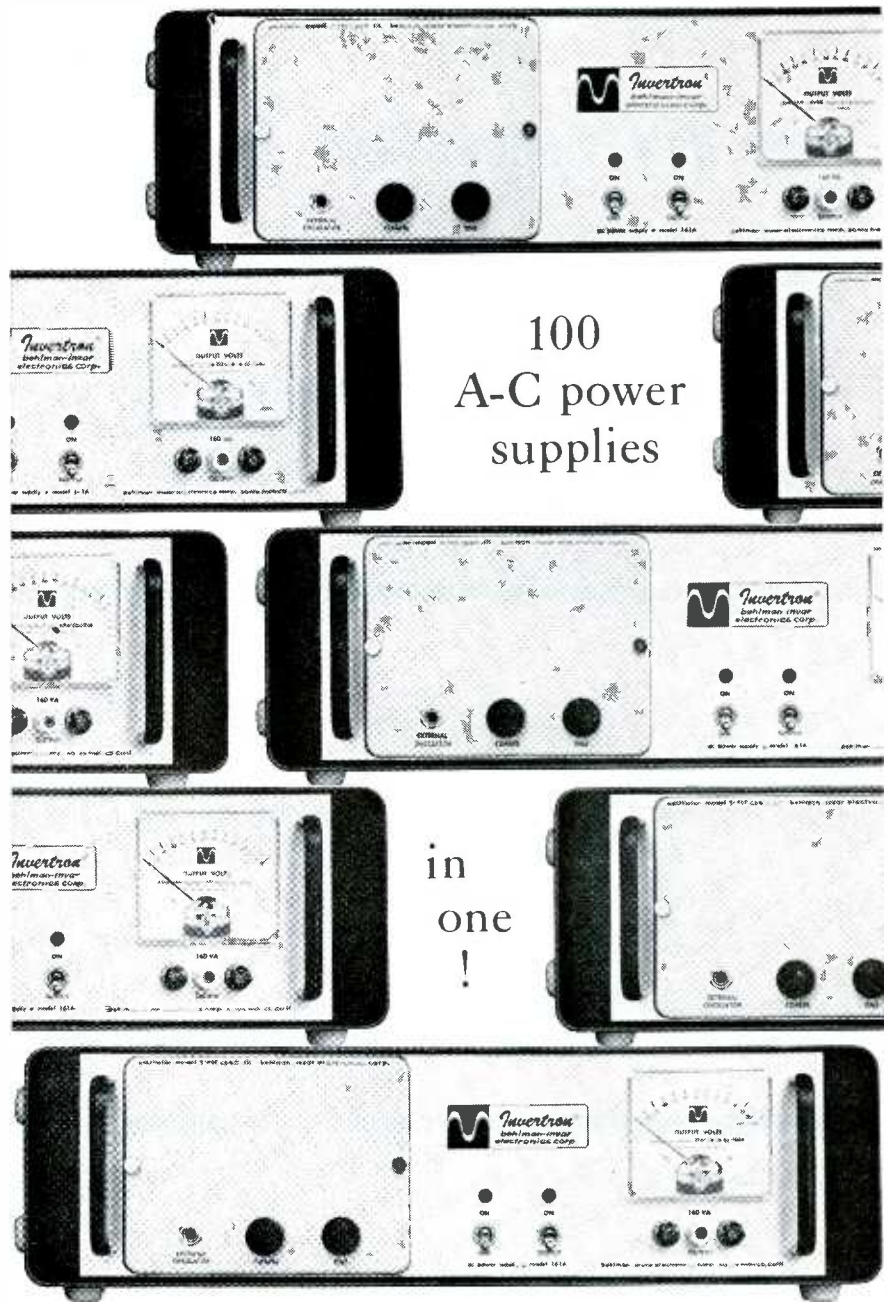

Never before has there been an a-c power source as flexible as the Behlman-Invar 161A Invertron. The unit features a wide variety of separate plug-in oscillators in both fixed and variable frequencies from 45 to 5000 cps. Finally, the electronic industry's need for a low-cost, general purpose a-c power supply has been realized.

The 161A is so flexible, in fact, that three of the units can be stacked. The three outputs can then be connected in a Y configuration, employing a 3-phase plug-in oscillator, to give 3-phase output at approximately 500 volt amperes.

The 161A is available either rack mounted or for bench use, and is only 5¼ inches high, 17 inches wide and 16 inches deep. Additional features include: extended frequency capability, excellent short term voltage amplitude stability and zero response time. The price is only \$420.00 f.o.b. Santa Monica, California. Prices on a variety of plug-in oscillators are available on request.

Behlman-Invar also manufactures a broad line of both a-c and d-c laboratory power supplies as well as modular power supplies for rack mounting. Modules may be operated in series or in parallel for maximum output and flexibility of operation.

BEHLMAN-INVAR ELECTRONICS CORP.

1723 CLOVERFIELD BOULEVARD • SANTA MONICA, CALIFORNIA

Behlman-Invar representatives are: T. Louis Snitzer Company—Los Angeles, La Jolla and Sunnyvale, California. • Cain and Company—Albuquerque; Great Neck, N.Y.; Boston, Orlando, Fla.; Philadelphia; Chicago; Dallas; Washington, D.C.

New Copper-Clad Reliability

In March, 1961, CDF Grade 614, glass-epoxy laminate, was announced . . . and met with almost overnight acceptance. Particular electronics and electrical manufacturers wasted no time in specifying this premium performance material with zero burnout and minimum "haloing."



By June, 1961, CDF Grade 614 had become the new standard of comparison for applications in critical ground and air-borne circuitry. Designers like its specifications, production men like the way it handles, management likes its reasonable price.



Now, CDF Grade 614 Copper-Clad is setting a new pace among particular producers of printed circuits . . . offering a new high in reliability for high packaging densities . . . and offering researchers a new tool in the investigation of molecular and submicro-circuitry.

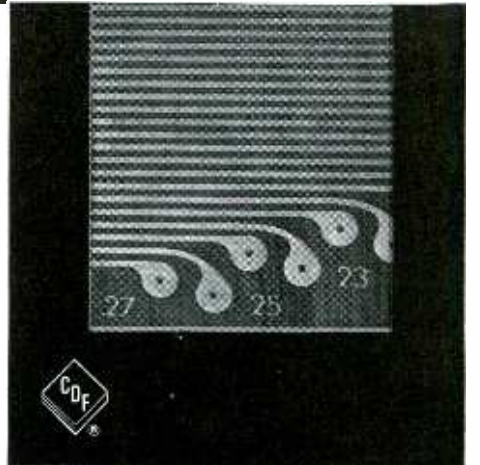

You can take advantage of 614 Copper-Clad's unique features right now . . . in research, development or production operations. Continental-Diamond Fibre Corporation, Newark, Delaware. A Subsidiary of the *Budd* Company.

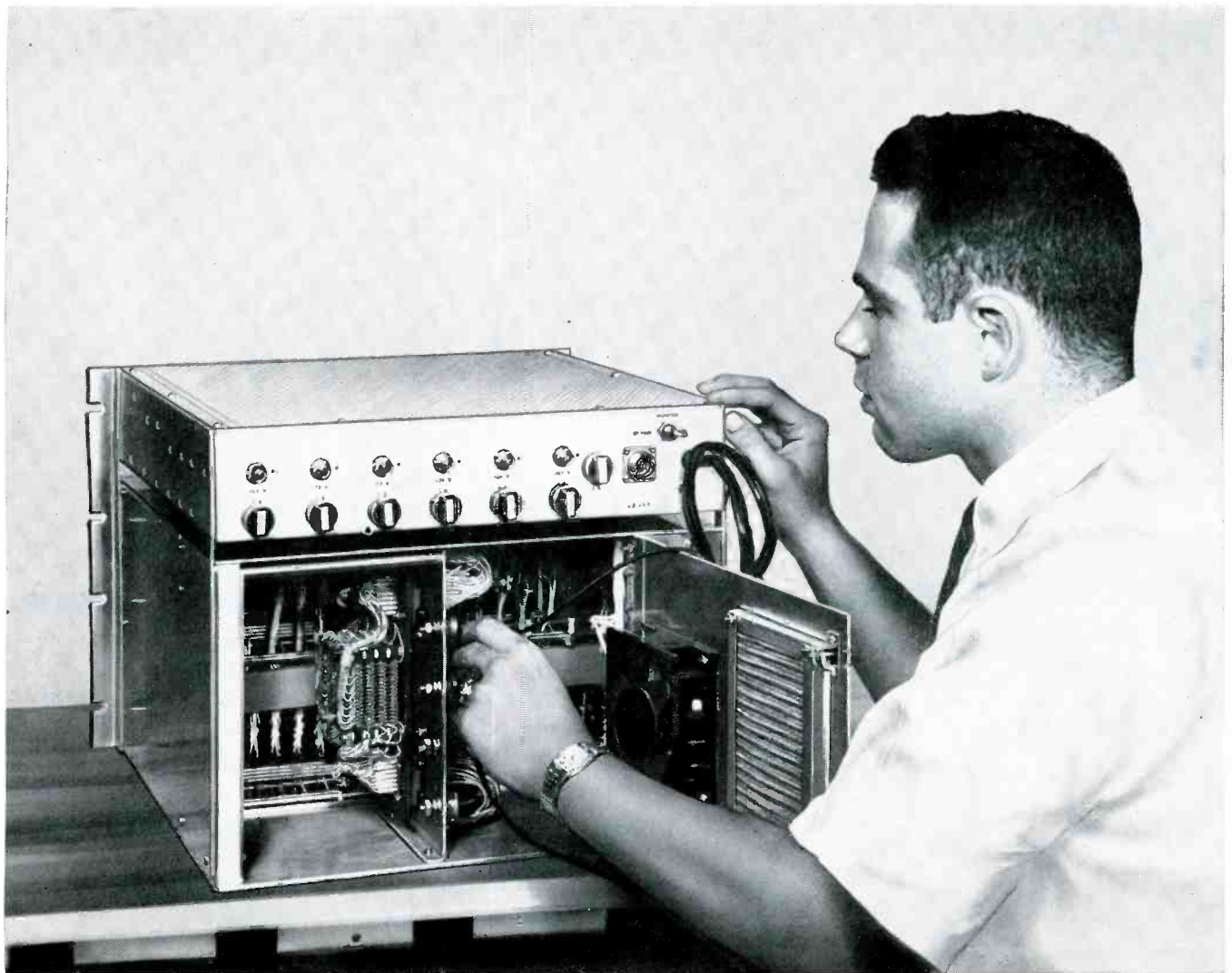

Here's Custom Memory Flexibility in a Standard Package RCA 5 μ SEC MODULAR MEMORY SYSTEM

Compact, high-capacity systems now available with the word lengths you specify—available for quick delivery

Now you can bring a new standard of operating efficiency, servicing flexibility and plug-in convenience to your computer designs with RCA's complete modular memory system. It utilizes new, compact modular design throughout. All circuits and elements, as well as the complete system plug in for easy maintenance and reduced computer down-time.

This rugged RCA memory system, encased in an aluminum cabinet, has a capacity of 256 to 2048 words and up to 20 bits per word. It incorporates RCA ferrite memory cores and planes, with specified wide margins of operation... up to $\pm 8\%$... to cope with broad variations of voltage levels over a wide temperature range.

All RCA Complete Memory Systems are available in a broad range of standard types and custom designs. RCA is ready, willing, and able to meet the most stringent custom requirements for voltage, current, temperature range, and speed of operation to make the memory system fully compatible with your equipment.

Here are some of the outstanding features of complete RCA Memory Systems:

- Specified Wider Margins of Operation... Up to ± 8 per cent... to cope with broad variations in voltage levels.
- Custom Design Service... RCA's engineering staff will custom-design a memory system to your specifications.
- Complete Information Retention... even in case of primary power loss.
- Wide Temperature Range... 0°C to 50°C .

Systems Engineering Service—Your local RCA Semiconductor and Materials Division Field Representative is prepared to provide a completely coordinated application service, covering transistors, semiconductor diodes, ferrites and memory systems. For further technical information, write RCA Semiconductor and Materials Division, Commercial Engineering Division, Section L-19-NF2, Somerville, N. J.



The Most Trusted Name in Electronics

RCA SEMICONDUCTOR & MATERIALS DIVISION FIELD OFFICES... EAST: Newark, N. J., 744 Broad St., HU 5-3900 • (Camden, N. J. area) Eriton, N. J., 605 Mariton Pike, HA 8-4802 • Syracuse, N. Y., 731 James St., Room 402, GR 4-5591 • Baltimore, Md., EN 9-1850 • NORTHEAST: Needham Heights 94, Mass., 64 "A" St., HI 4-7200 • SOUTHEAST: Orlando, Fla., 1520 Edgewater Drive, Suite #1, GA 4-4768 • EAST CENTRAL: Detroit 2, Mich., 714 New Center Bldg., TR 5-5600 • CENTRAL: Chicago, Ill., Suite 1154, Merchandise Mart Plaza, WH 4-2900 • Indianapolis 5, Ind., 2132 East 52nd St., CL 1-1405 • Minneapolis 16, Minn., 5805 Excelsior Blvd., WE 9-0676 • WEST: Los Angeles 22, Calif., 6801 E. Washington Blvd., RA 3-8361 • (San Francisco area) Burlingame, Calif., 1838 El Camino Real, OX 7-1620 • SOUTHWEST: Dallas 7, Texas, 7905 Carpenter Freeway, ME 1-9720 • GOVT: Dayton, Ohio, 224 N. Wilkinson St., BA 6-2366 • Washington, D. C., 1725 "K" St., N.W., FE 7-8500.

HIGH SPEED WITH LOWEST $V_{CE}(\text{sat})$ RATINGS

PLANAR EPITAXIAL PASSIVATED



The new G-E 2N2193-2195 and "A" series combines three of the most advanced processes in semiconductor technology to bring you new standards of silicon transistor performance, reliability and stability. This series of PEP transistors features greatly improved $V_{CE}(\text{sat.})$ ratings, and can replace standard units without basic circuit changes.

Planar Passivated 2N696-2N699, 2N1613, 2N1711, and 2N1893 silicon transistors are also available. They feature superior h_{FE} holdup at low currents, lower I_{CBO} and I_{EBO} , and remarkable reliability of performance and stability of parameters due to planar passivation.

TYPICAL PULSE GENERATOR CIRCUIT WITH PEP TRANSISTORS SWITCHES 1/2 AMP IN 25 NANoseconds

PULSE GENERATOR

Pulse Characteristics:

Amplitude	25 volts
Width	200 nanoseconds
Rise Time	25 nanoseconds
Fall Time	30 nanoseconds
Impedance	50 ohms
Repetition rate	100 kilocycles

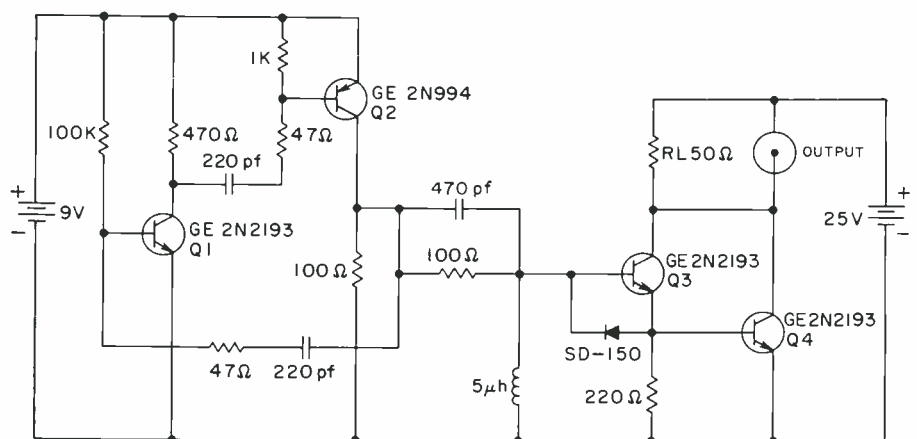

Unprecedented versatility is still another unique advantage of General Electric PEP transistors in new and/or existing applications. The pulse generator circuit shown illustrates the versatility of 2N2193 in an existing circuit, without the need for redesigning. Also, by combining low saturation resistance, high voltage, dissipation and frequency response, controlled gain over four decades of current, and low leakage, with the stability of passivation, the 2N2193 approaches "ideal" transistor characteristics. These characteristics make the 2N2193 equally effective in linear or switching applications. Examples: direct conversions of germanium transistor circuits, low level linear amplifiers, power stages, and computer type switching applications.

SILICON TRANSISTORS

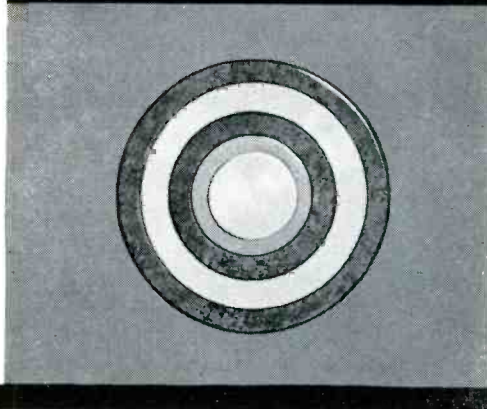
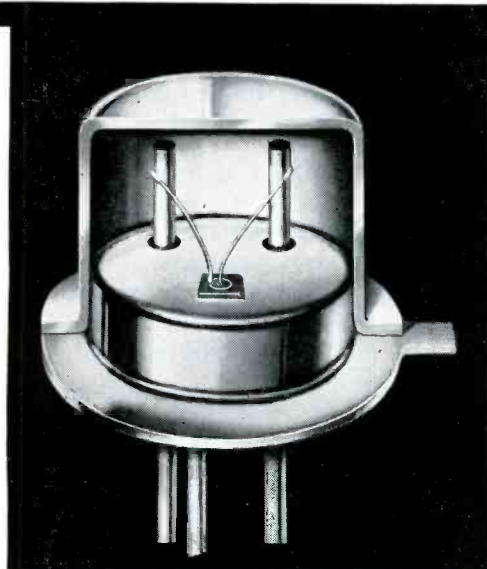

PEP (PLANAR EPITAXIAL PASSIVATED) TRANSISTORS

Type No.	Description	Notable Advantage
2N2193	Similar to 2N1613 (see chart below)	$V_{CE}(\text{sat}) = 0.35 \text{ V max.}$ (@ $I_C = 150 \text{ ma}$, $I_B = 15 \text{ ma}$) $V_{CEO} = 50 \text{ V min.}$
2N2193A	Similar to 2N1613 (see chart below)	$V_{CE}(\text{sat}) = 0.16 \text{ V Typ.; } 0.25 \text{ V max.}$ (@ $I_C = 150 \text{ ma}$, $I_B = 15 \text{ ma}$) $V_{CEO} = 50 \text{ V min.}$
2N2194	Similar to 2N696 (see chart below)	$V_{CE}(\text{sat}) = 0.35 \text{ V max.}$ (@ $I_C = 150 \text{ ma}$, $I_B = 15 \text{ ma}$) $V_{CEO} = 40 \text{ V min.}$
2N2194A	Similar to 2N696 (see chart below)	$V_{CE}(\text{sat}) = 0.16 \text{ V Typ.; } 0.25 \text{ V max.}$ (@ $I_C = 150 \text{ ma}$, $I_B = 15 \text{ ma}$) $V_{CEO} = 40 \text{ V min.}$
2N2195	General Purpose Industrial Type	$V_{CE}(\text{sat}) = 0.35 \text{ V max.}$ (@ $I_C = 150 \text{ ma}$, $I_B = 15 \text{ ma}$) $V_{CEO} = 25 \text{ V min.}$
2N2195A	General Purpose Industrial Type	$V_{CE}(\text{sat}) = 0.16 \text{ V Typ.; } 0.25 \text{ V max.}$ (@ $I_C = 150 \text{ ma}$, $I_B = 15 \text{ ma}$) $V_{CEO} = 25 \text{ V min.}$

PLANAR PASSIVATED TRANSISTORS

Type No.	h_{FE} @ $I_C = 150 \text{ ma}$ $V_{CE} = 10 \text{ V}$	$V_{CE}(\text{sat})$ (max.) @ $I_C = 150 \text{ ma}$ $I_B = 15 \text{ ma}$	$V_{CE}(\text{min.})$ @ $I_C = 100 \text{ ma}$ $R_{BE} = 10$	I_{CBO} (max.)
2N696	20-60	1.5V	40V	1 μa @ 30 V
2N697	40-120	1.5V	40V	1 μa @ 30 V
2N698	20-60	5V	80V	5 m μa @ 75 V
2N699	40-120	5V	80V	2 μa @ 60 V
2N ⁺ 613	40-120*	1.5V	50V	10 m μa @ 60 V
2N ⁺ 71	100-300*	1.5V	40V	10 m μa @ 60 V
2N1893	40-120*	5V	100V	10 m μa @ 90 V

* p us guaranteed minimum h_{FE} 's at several other currents

The silicon oxide is thermally grown during the planar diffusion process. It forms a passivated surface over the junction that provides maximum protection against contamination and degradation of characteristics during the entire life of the transistor. The thin epitaxial layer on low resistivity substrate gives negligible body drop resulting in extremely low saturation resistance and increased uniformity from unit to unit.

For complete technical data on the new PEP and Planar Passivated silicon transistors, call your G-E Semiconductor Products District Sales Manager. Or Write Semiconductor Products Department, Section 16L113, General Electric Company, Electronics Park, Syracuse, New York. In Canada: Canadian General Electric, 189 Dufferin St., Toronto, Ont. Export: International General Electric, 159 Madison Avenue, New York 16, New York.

STOCKED BY YOUR G-E SEMICONDUCTOR DISTRIBUTOR

GENERAL  ELECTRIC

Telemetry Studies Pollution

By CLETUS M. WILEY,
Midwest Editor

CHICAGO—Telemetry apparatus which, developers feel, could be applied to large-scale oceanographic experiments is being used by the Public Health Service in a long-range study of Lake Michigan pollution factors.

Basic data on water flow is recorded and transmitted to shore by an instrumentation capsule which trails a string of sensors at various depths in the lake.

Data will produce a mathematical model which can predict where currents will carry pollutants and how much debris can safely be dumped in the lake. The \$500,000 program is aimed at bringing pollution under control and making the best use of water resources in the Great Lakes basin.

The lake sampling system may eventually be coordinated with Tiros weather satellites to correlate cloud formations, surface wave patterns, temperatures and current data. This will improve accuracy of the mathematical model.

The prototype capsule, costing \$25,000, was designed at the Vicksburg, Miss., station of the Army Corps of Engineers, under direction of Francis Hanes. If the capsule proves out in tests this winter, when ice will prevent maintenance by ship, 25 more systems will be planted in the lake.

The capsule contains a modified

5-w, 170-Mc, f-m transceiver (Motorola), a seven-channel punched tape recorder (Friden) and eight 12-volt, lead-acid batteries. Weight is 700 pounds. Hanes says a 50-lb fuel cell may eventually replace the batteries.

Pods containing current and direction meters and digitizers are suspended at depths of 40, 120 and 200 feet (see sketch). Currents as sluggish as a foot a minute turn Savonius rotors. Contacts riding on printed circuits develop pulses which are digitized for recording. A magnetic compass in each pod is the direction reference. As the pod turns in the current, a disc divided into 3.6-degree segments is optically scanned. Counting away from a mirror, the number of pulses gives the heading.

This information is stored on six tape channels. The seventh channel is reserved for programming. Every four hours, a shore station signal triggers the transmitter. Accumulated data is rerecorded on shore for computer analysis. The buoy's receiver remains on briefly after each transmission, to receive instructions or repeat transmission.

Planned improvements include increasing range from the present 20 miles to 40 miles. A temperature sensor will be added.

Public Health Service reports that airborne pollution mapping experiments using military infrared gear have met with "mixed success" this year. Runs have been made



Pod parts are (from top) digitizer, direction sensor and rotor

over the Missouri, Kansas and Blue Rivers to detect sources, types of wastes and flow patterns. However, the equipment, designed to pick up land details, fail to detect half-degree differences in water temperature, needed for PHS mapping.

Advanced pollution mapping projects are also underway at the University of Michigan, Northwestern and Penn State. Sensing devices working with photographable visual displays are reported under development.

NBS Establishes Radio Refractive Data Center

NATIONAL BUREAU OF STANDARDS has established a Radio Refractive Index Data Center at its Boulder, Colo., Laboratories to assist studies of radio propagation in the earth's atmosphere. Data is made available to scientific, government and industrial groups, NBS says.

Data on meteorological parameters affecting refractivity is sent to Boulder by more than 300 weather stations and ships around the world. More than seven million punched cards recording data have been prepared to date. The center can compute index profiles for certain areas or make card sets available.

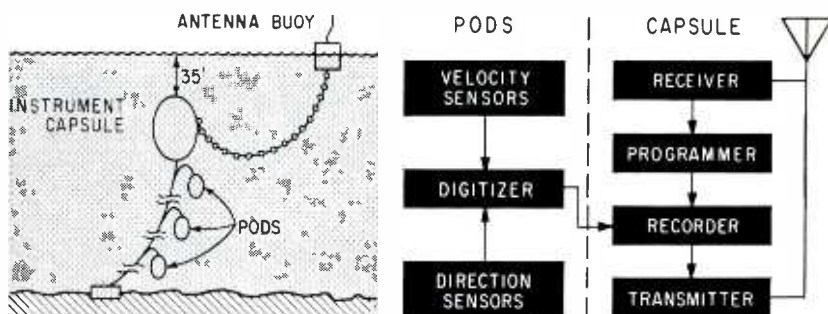

Data collected by instrument capsule (left) is transmitted on command to shore station

Missile Technique May Control Air Traffic

ADAPTATION of missile battery air defense coordination systems to civil air traffic control has been proposed to the Federal Aviation Agency by the Martin Co. Martin says digital data links like those in its AN/FSG-5 (Birdie) system could transfer radar handoff data between Air Route Traffic Control Centers (ARTCC) and their airport towers.

Transmission rate with a modified version would be 750 bits a second using pulse code modulation techniques and standard commercial private line circuits. Major system components would include special purpose computers, modulators and demodulators, telephone line switching gear and a master synchronizer.

Transmitters and receivers would use registers to store messages prior to encoding, transmission or display. Receivers would accept only data addressed to that tower. The ARTCC receiver would also transfer handoff messages to the proper tower.

Each pulse-code data frame would consist of three groups of three subframes each, with interrogation signals between each group. Each frame transmits up to six sets of handoff data from the center to the towers and three sets of data between towers. Subframes consist of x and y coordinates of the radar handoff flight and a group of 15 auxiliary bits for other flight information.

Handoff symbols would be displayed on tower radar screens. For

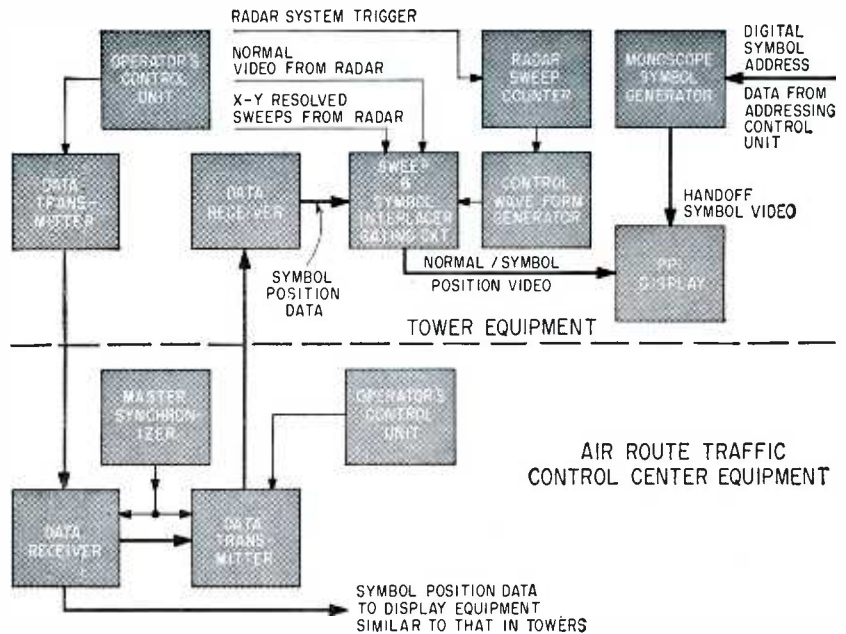

Simplified functional diagram of data link and radar handoff display

scan-converted displays, symbols would be produced by a marker generator of the type being developed for FAA by Hazeltine. Handoff data is converted to tv form and mixed with the video from the readout circuits of the scan converter. The marker generator would use dot matrices for character generation.

In ppi displays, symbols would be interlaced with radar signals. This technique of periodically inserting a character display in a radar display is used in a number of military systems.

Buffer-stored digital x and y position data establishing location of the handoff symbols are converted to d-c voltages which position the crt beam. Address information selects from a symbol generator the symbols to be displayed. Symbol generator video signals modulate the ppi beam as it traverses the symbol raster.

Martin recommends a monoscope symbol generator for ppi displays. As the electron beam scans carbon ink characters on an aluminum plate, variations in secondary emission produce modulating signals.

No modification of ASR-1 or ASR-4 radars would be needed.

ASR-2 and ASR-3 radars would have to be fitted with resolved sweep, fixed-yoke deflection instead of rotating yokes.

A report on the study made by Martin for FAA was presented at the Air Traffic Control Association's recent convention in Miami Beach, by George F. Romano. Romano pointed out that other companies have come up with similar concepts.

Three Universities Get Nuclear Research Gear

AMONG RECENT National Science Foundation grants for nuclear research are three which will underwrite purchase of particle accelerators at Michigan State, Pennsylvania and Ohio State Universities.

Michigan got \$700,000 for a 50-mev sector-focused cyclotron with a new system for extracting particles in a thin beam. It also has a \$400,000 grant for a new computer.

Penn is getting \$1.6-million for a 12-mev tandem accelerator. Ohio has purchased a 5.5-mev machine from High Voltage Engineering.

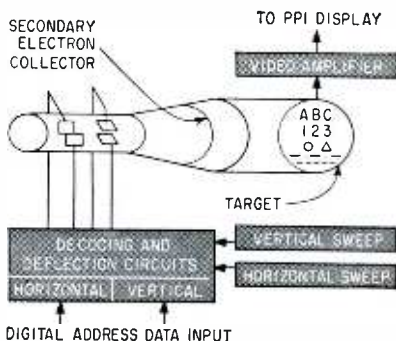

Monoscope generates handoff symbol video for ppi radar

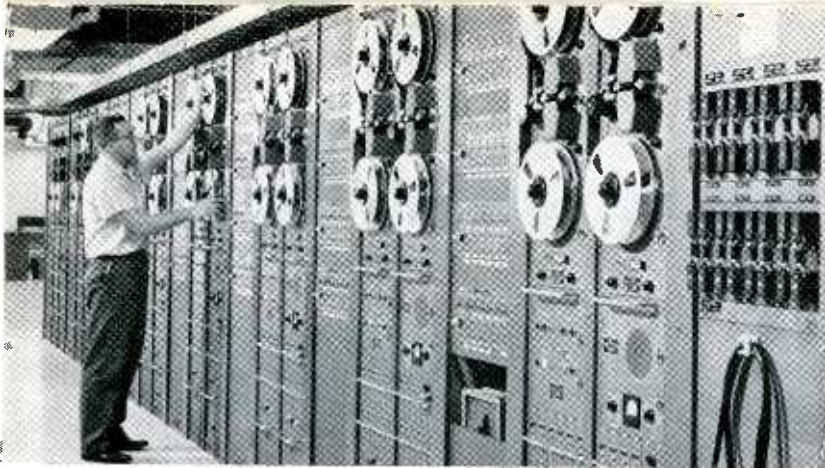

Battery of two-transport recorders at FAA center in Oberlin, Ohio



Investigator at playback console

Interlaced Heads Double Recording Density

MAGNETIC TAPE storage requirements at Federal Aviation Agency traffic control centers have been cut in half by a high-density recording system developed for FAA by Webcor. The centers must store for 30 days all low-frequency data.

Tape capacity was increased in the width (1½ in.) by recording 22 channels, and in the length by reducing speed to 15/16 ips and recording at higher density. Each recorder has two transports with a 16-hour tape supply, enabling them to record 32 hours unattended.

Each of the 22 amplifiers can supply identical audio signals to both transports simultaneously, through circuits which split the signals to the grids of each half of a single tube. Transports are linked by monitoring, failure control and automatic transfer circuits. If a tape should break or stop, transfer from the first to second transport is instantaneous.

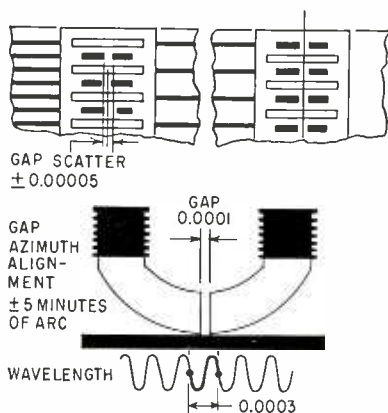

Tape passes from right to left through dual heads

Companion playback equipment will playback any three channels simultaneously. Maximum variation in signal strength is 3 db over a dynamic range of more than 35 db.

Magnetic Head Design

Crosstalk and other problems created by closeness of recording channels and slow speed were resolved by record and playback heads recently developed for this type of application by Brush Instruments, a division of Clevite Corp.

The heads are built with two cartridges, with interlaced channels, mounted on an H-block. Brush says this design nearly doubles the

number of channels which can be recorded on a tape while avoiding crosstalk.

Interlacing allows more shielding. Although energy produced at 15/16 ips is only about 200 μ v, wider track width and increased winding permitted by interlacing gives a high signal-to-noise ratio. Brush says. Track width is 0.044 in. and track spacing is 0.0624 in.

At 15/16 ips, the upper frequency recorded, 3 Kc, represents a wavelength of less than 0.0003 in. compared to 0.0005 in. for most instrumentation recorders. The slow-speed heads use a gap of 0.0001 in. to obtain high resolution.

German Tv Tricks of the Trade

THIS YEAR'S CROP of German tv receiver circuits include three apparently novel solutions to fine tuning, turnoff spot and warmup hum problems.

Grundig's method for fine tuning is shown in Fig. A. The local oscillator uses a premagnetized ferrite-coiled connected in parallel with the oscillator coil. The inductance of the second coil depends on the magnetization of the ferrite which in turn is controlled by the current flowing through the coil.

The bright spot that remains on the crt for a few moments when the set has been turned off is removed by the Telefunken circuit seen in Fig. B. Brightness control is con-

nected in series with a triode. When the set is operating, the triode conducts and has a low internal resistance. When the set is turned off, the R-C combination in the triode grid circuit differentiates the switching transient and causes a negative pulse to be applied to the triode. This cuts off the triode and the voltage at the crt control grid becomes positive thus causing a large current flow to discharge the crt anode.

Some tv sets are bothered by hum in the sound channel during the few moments of warm up after being switched on. Loewe Opta uses the build-up transient of the line deflection circuit to mute the output

audio stage during this time.

The circuit, shown in Fig. C, uses the build-up transient of line multivibrator V_1 to charge capacitor C_1 to about -10 v to -15 v. This voltage is used to cut off first audio amplifier V_2 . The negative voltage is discharged through the long time constant in the control grid so that the output stage has its normal operating bias after 30 seconds.

By this time, the line multivibrator is operating normally and its output pulses (on this muting line) are bypassed to ground through C_2 . Switching the set off causes a positive voltage pulse to appear across C_1 . R_1 is high to prevent rapid buildup of positive voltage. The positive voltage at the grid is delayed until anode voltage is zero.

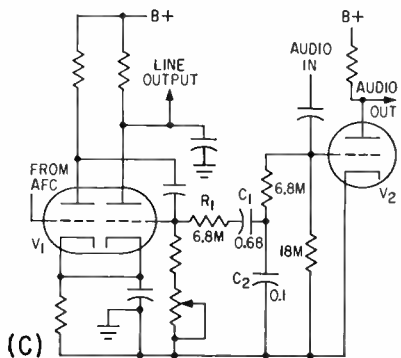
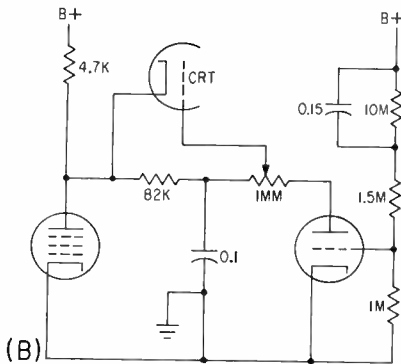
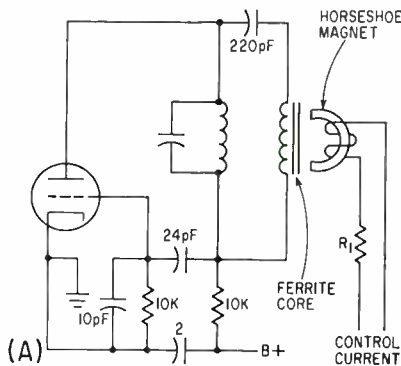

How do you talk to a man to sell him something when he can be working in any or all of the areas of research, design, production and management in the dynamic electronics industry? Obviously you can't follow him unless *he keeps in touch with you*. That's exactly what **electronics'** 52,721 subscribers do. They **PAY** to read **electronics** because they want and need it in their work. As they progress they voluntarily contact us week in and week out...more than 61,721 changes in titles, addresses, etc. during 1960...and that's where **electronics'** membership in the Audit Bureau of Circulation—where subscribers actually pay—reaps dividends for the advertiser.

Illustrated below are major steps in the career of Mr. Dorman D. Israel, a charter subscriber to **electronics**. Mr. Israel has paid approximately \$160.00 to receive **electronics** since it was established in April, 1930. Mr. Israel estimates that he spends between 60 and 100 hours a year studying the pages of the publication. (The average subscriber

he paid to read **electronics**

Mr. Dorman D. Israel
as radio design
engineer



As chief engineer

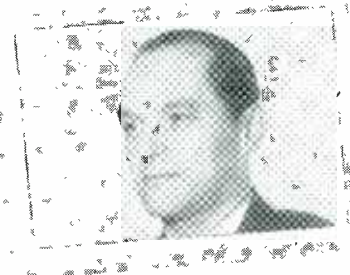

currently spends 5 hours 25 minutes every month.) Mr. Israel has obviously invested a considerable amount of time as well as his money in **electronics** over the past 31 years.

Only paid circulation has the drawing power to keep track of key people in America's most dynamic growth industry. Only **electronics** reaches so deep into the industry. And only **electronics** reaches all four major buying influences in the industry—engineers in research, design, production and management, working in any or all four areas. Place your advertising alongside editorial material for which the buyer has demonstrated a need...in ABC publications such as **electronics**.

  A McGraw-Hill Publication, 330 West 42nd Street, New York 36, N. Y.

all the way to the top

As Executive Vice President
Emerson Radio & Phonograph
Corporation



As vice president in
charge of engineering
and production



As development engineer



NOW for Subminiature Applications, too...

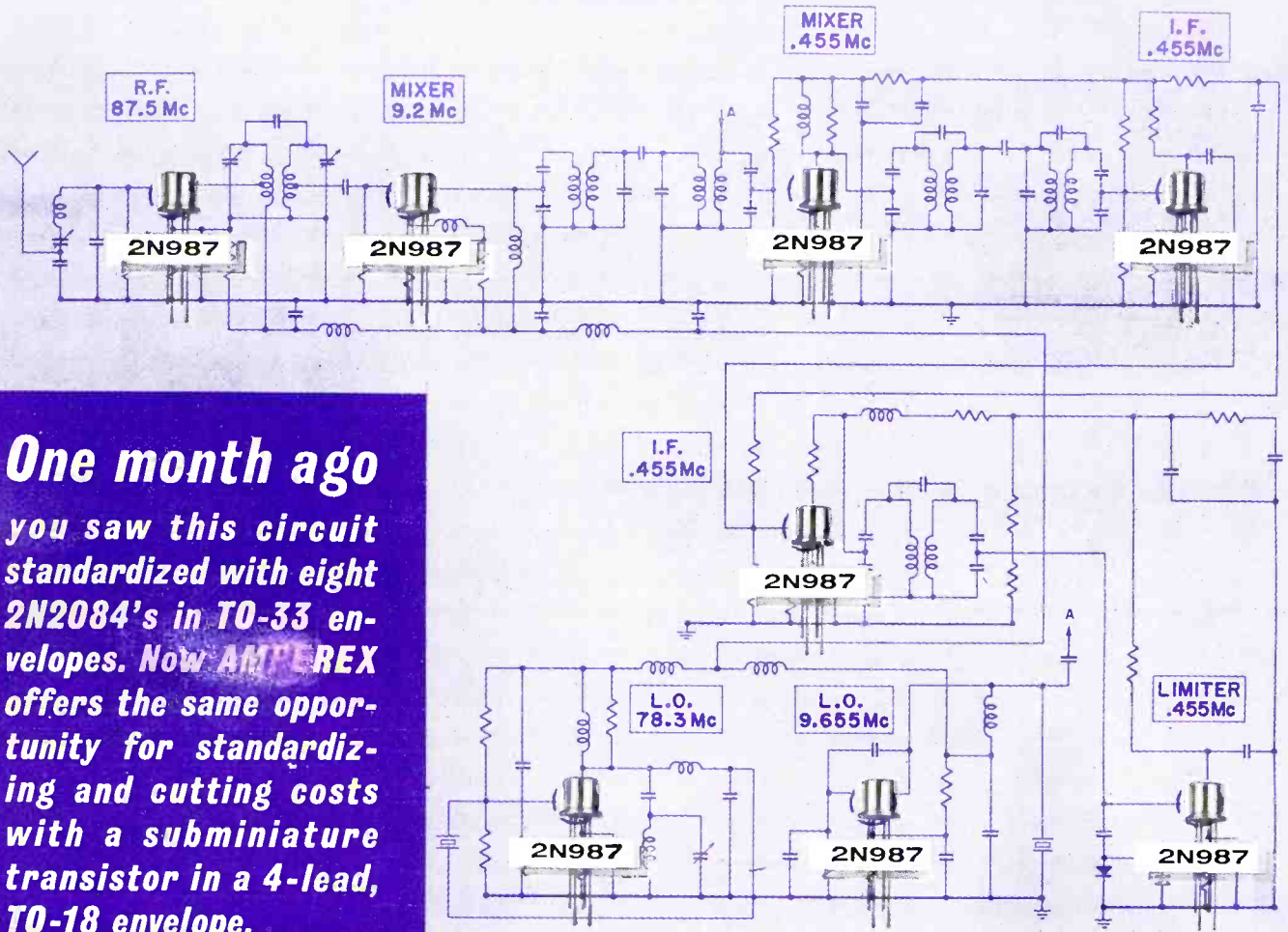

One month ago you saw this circuit standardized with eight 2N2084's in TO-33 envelopes. Now AMPEREX offers the same opportunity for standardizing and cutting costs with a subminiature transistor in a 4-lead, TO-18 envelope.

Amperex® announces the new 2N987 a Subminiature Universal Communications Transistor in a TO-18 envelope, available in production quantities and priced for universal acceptance

The new 2N987 employs the identical approach used in the development of the AMPEREX 2N2084. This revolutionary approach combining the best features—high voltage, high beta and high frequency—of many specialized front end and IF types, results in a new PADT germanium-alloy-mesa subminiature transistor that provides a distinct competitive edge to the designer of HF and VHF pocket paging systems, airborne, mobile communications and other miniaturized equipment.

Cuts costs 3 ways:

AMPEREX advanced design — plus the high yields characteristic of the PADT process — now provides to the manufacturer of miniaturized industrial equipment a *single communications transistor* with an unrivaled combination of application flexibility, high quality and low price. The long-sought degree of universality offered by the new AMPEREX 2N987 results in —

1. **Lower procurement costs:** only one type to order — with a better price break through volume purchasing.
2. **Lower designing costs:** only one type to specify — because of the wide range of desirable characteristics.
3. **Lower inventory costs:** only one type to stock — simplifies inventory control and disbursement.

It's as simple as that!

TYPE 2N987 SPECIFICATIONS AND FEATURES

Gain Bandwidth Product	$f_T = 100\text{mc}$
Typical Beta	$\beta_{FE} = 140$
Breakdown Voltage	$BV_{CEO} = 40\text{V}$
Typical Power Gain	14db (at 100mc) 27db (at 30mc)
Output Capacitance	$C_{ob} = 2\mu\mu\text{f}$
Case	TO-18, 4 lead



for complete data and applications information on universal communications transistors in both TO-18 and TO-33 envelopes.

AMPEREX ELECTRONIC CORPORATION
230 Duffy Ave., Hicksville, Long Island, N.Y.
In Canada:
Philips Electronics Industries, Ltd., Tube, Semiconductor & Component Depts., 116 Vanderhoof Ave., Toronto 17, Ontario

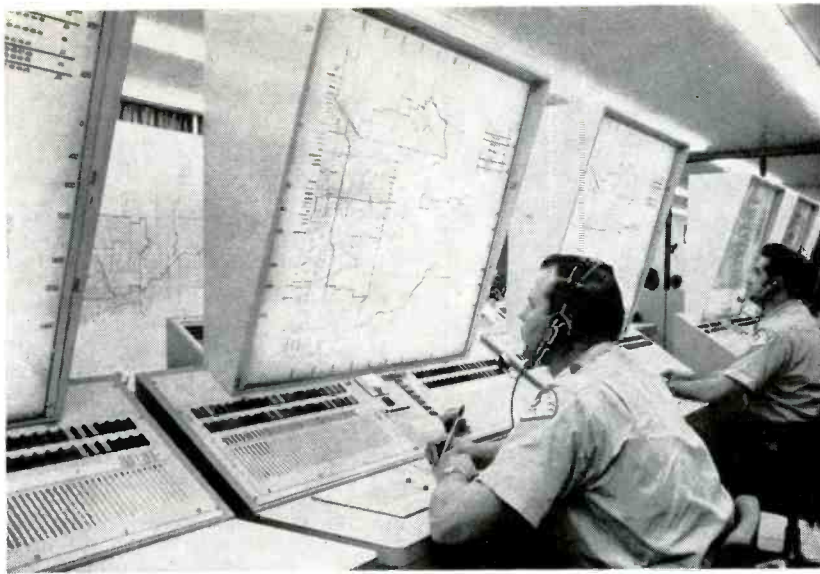

Consoles include patrol zone maps. Lights on map indicate availability of each of 80 patrol cars in the zone

System Blends Radio, Telephone

CHICAGO—Crossbanding and exploitation of telephone exchanges as radio patrol zones enable Chicago's new police communications system to transmit a call for help to a patrol car within 10 seconds. The system serves more than 1,400 vehicles in an area of 224 sq mi.

Doubling up on uhf and vhf replaced four former police channels with a new array of 22 frequencies, half in the 453-Mc range, half in the 158-Mc range.

Vehicle antennas are $\frac{1}{2}$ -wave for receiving, $\frac{1}{4}$ -wave for transmitting. Intermodulation between some adjacent bands is minimized by a squelch line set so patrol receivers won't pass a signal unless they are tripped by a coded tone.

Integrating telephone exchanges as radio patrol zones speeds toll-free incoming calls directly to one of three communications center consoles assigned each zone. Switchboard screening is bypassed. There are 36 special consoles to take zone calls, coordinate message traffic, answer overflow calls and monitor the system. One console links Chicago with suburban and state police.

Motorola, the prime contractor, worked with Illinois Bell on the telephone net switching system. Among developments were a three-stage, transistor compressor ampli-

fier which adds 50 db of gain to a dynamic microphone feeding into consoles.

Civil Defense and disaster communications provisions include means for shifting operations to any of 11 alternate base stations with standby storage battery power. Redundancy provisions extend from standby base stations at each of the eight city zones, through three city-wide channels.

The system cost \$2 million. Motorola's share, \$1.4 million, included 885 transistor mobile units and conversion kits for 604 previously in use. Automatic Electric developed a switching system to automate teletypes. Dictaphone supplied 13 five-channel recorders.



City-wide consoles coordinate police action in several zones

**NOW for
Subminiature
Applications,
too...**

**Amperex®
2N987**

**a Subminiature Universal
Communications Transistor
in a TO-18 envelope,
priced for universal
acceptance...available
in production quantities
from these and other
leading industrial electronic
distributors.**

CALIFORNIA

R. V. WEATHERFORD COMPANY
Glendale 1, Calif.
BRILL SEMICONDUCTOR CORP.
Oakland 6, Calif.
ELMAR ELECTRONICS INC.
Oakland 7, Calif.

COLORADO

INTERSTATE RADIO & SUPPLY
Denver 4, Colorado

CONNECTICUT

RADIO SHACK CORP.
Stamford, Conn.
W. Hartford, Conn.
New Haven 10, Conn.

DISTRICT OF COLUMBIA

ELECTRONIC WHOLESALERS, INC.
Washington 1, D. C.

FLORIDA

THURLOW ELECTRONICS, INC.
Cocoa, Fla. • Jacksonville, Fla.
Miami, Fla. • Orlando, Fla.
Pensacola, Fla. • Tampa, Fla.

ILLINOIS

NEWARK ELECTRONICS CORP.
Chicago, Ill.

INDIANA

RADIO DISTRIBUTING COMPANY
Indianapolis 6, Indiana

MASSACHUSETTS

RADIO SHACK CORP.
Boston, Mass.

MICHIGAN

RADIO SPECIALTIES COMPANY
Detroit, Michigan

MISSOURI

INTERSTATE INDUSTRIAL ELECTRONICS
St. Louis 32, Missouri
BURSTEIN-APPLEBEE COMPANY
Kansas City, Missouri

NEW YORK

MILO ELECTRONICS
New York, N. Y.
ROME ELECTRONICS
Rome, N. Y.

OHIO

UNITED RADIO, INC.
Cincinnati, Ohio

OREGON

UNITED RADIO SUPPLY, INC.
Portland 9, Oregon

PENNSYLVANIA

RADIO ELECTRIC SERVICE CO.
Philadelphia, Pa.

TEXAS

ADELETA COMPANY
Dallas 1, Texas
Fort Worth, Texas
BUSACKER ELECTRONIC
EQUIPMENT CO., INC.
Houston 19, Texas

UTICA TOOLS

NEW UA-200

THE VERSATILE
MULTI-PURPOSE
POWER CUTTER
FOR INDUSTRY
WITH
INTERCHANGEABLE
CUTTING HEADS

B-5 Cutter
Standard edge
diagonal cutting head



SHOWN
FULL SIZE

This latest and most versatile addition to the Utica line of production tools is available with four optional, interchangeable cutting heads. Each head is designed for a specific cutting purpose and all have electronically induction hardened jaws. The air cylinder is lightweight, shock-resistant Delrin plastic and the UA-200 is easily operated with a long trigger that fits either hand. And the UA-200 is four times more powerful. Maximum cutting speed with minimum operator fatigue assures higher production in almost any cutting operation. Each UA-200 is equipped with an 8 ft. air hose and your choice of one cutting head. Write for complete information.

OPTIONAL HEADS FOR VARIED USES

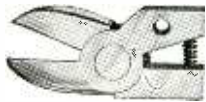

B-6 Cutter
Hairline flush edge
diagonal cutter head



B-7 Cutter
Cutter-crimper head
for printed circuits



B-8 Cutter
Diagonal cutting head
for plastics only

UTICA

UTICA TOOLS • DIVISION OF KELSEY-HAYES COMPANY, UTICA 4, NEW YORK

MEETINGS AHEAD

COMPUTER Conference, Eastern Joint, PGEC of IRE, AIEE, ACM; Sheraton-Park Hotel, Wash., D.C., Dec. 12-14.

RELIABILITY AND QUALITY CONTROL, 8th National Symposium, PGRQC of IRE, AIEE, ASQC, EIA; Statler Hilton Hotel, Wash., D.C., Jan. 9-11, 1962.

OPTICAL CHARACTER RECOGNITION Symposium, National Bureau of Standards; Department of the Interior Aud., Washington, D.C., January 15-17, 1962.

ELECTRICAL ENGINEERING Exposition for electrical-electronics industry, AIEE; New York Coliseum, N.Y.C., January 29-February 2, 1962.

REDUNDANCY TECHNIQUES FOR COMPUTING SYSTEMS, Information Systems Branch of Office of Naval Research; Department of Interior Aud., Washington, D.C., February 6-7, 1962.

MILITARY ELECTRONICS, 3rd Winter Convention PGMIL of IRE (L.A. Section); Ambassador Hotel, Los Angeles, Calif., Feb. 7-9, 1962.

SOLID STATE CIRCUITS, International Conference, PGCT of IRE, AIEE; Sheraton Hotel and U. of Penn., Philadelphia, Pa., Feb. 14-16, 1962.

APPLICATION OF SWITCHING THEORY TO SPACE TECHNOLOGY Symposium, USAF, Lockheed Missiles & Space; at Lockheed, Sunnyvale, Calif., Feb. 27-Mar. 1962.

SCINTILLATION AND SEMICONDUCTOR Counter Symp, PGNS of IRE, AIEE, AEC, NBS; Shoreham Hotel, Washington D.C. Mar 1-3, 1962.

MISSILES & ROCKET TESTING Symposium, Armed Forces Communications and Electronics Association; Cocoa Beach, Fla., March 6-8, 1962.

IRE International Convention, Coliseum & Waldorf Astoria Hotel, New York City, Mar. 26-29, 1962.

QUALITY CONTROL Clinic, Rochester Soc. for Quality Control; Univer of Rochester, Rochester, N. Y., March 27, 1962.

ENGINEERING ASPECTS OF MAGNETO-HYDRODYNAMICS, AIEE, IAS, IRE, Univ of Rochester; Univ of Rochester, Rochester, N. Y., March 28-29, 1962.

SOUTHWEST IRE CONFERENCE AND SHOW; Rice Hotel, Houston, Texas, April 11-13, 1962.

HUMAN FACTORS in Electronics, PGHFE of IRE; Los Angeles, Calif., May 3-4, 1962.

JOINT COMPUTER CONFERENCE, PGEC of IRE, AIEE, ACM; Fairmont Hotel San Francisco, Calif., May 1-3, 1962.

ELECTRONIC COMPONENTS CONFERENCE, PGCP of IRE, AIEE, EIA; Marriott Twin Bridges Hotel, Washington, D. C., May 8-10, 1962.

Quality is a quantity of built-in values

If you measure electrical connector quality as we do—that is, by adding up ALL of the extras—we talk the same language. We believe you can't stint in even the smallest detail and come up with dependable quality.

Electrical connectors are vital components. They can affect the operation of the simplest power line . . . or the success of a million-dollar missile shot, a submarine trip under the polar ice cap, or a Mach 3 aircraft test. That's why Bendix builds the utmost quality into electrical connectors. In our book, there's no place for the smallest deviation in quality. To achieve closest quality control,

we maintain one of the highest ratios of inspectors-to-production-workers in the industry.

Ask our customers about us. We're sure they will tell you that no one in the industry produces higher quality than does Scintilla Division. That's why Bendix® Electrical Connectors are most often selected for the most demanding jobs.

Integrity. Ability. Experience. Acceptance. They add up to a complete "package" of built-in quality values we think you will appreciate. And, this superior "package" is competitively priced. If you want to know more about our quality in quantity, call us at Sidney, N. Y.

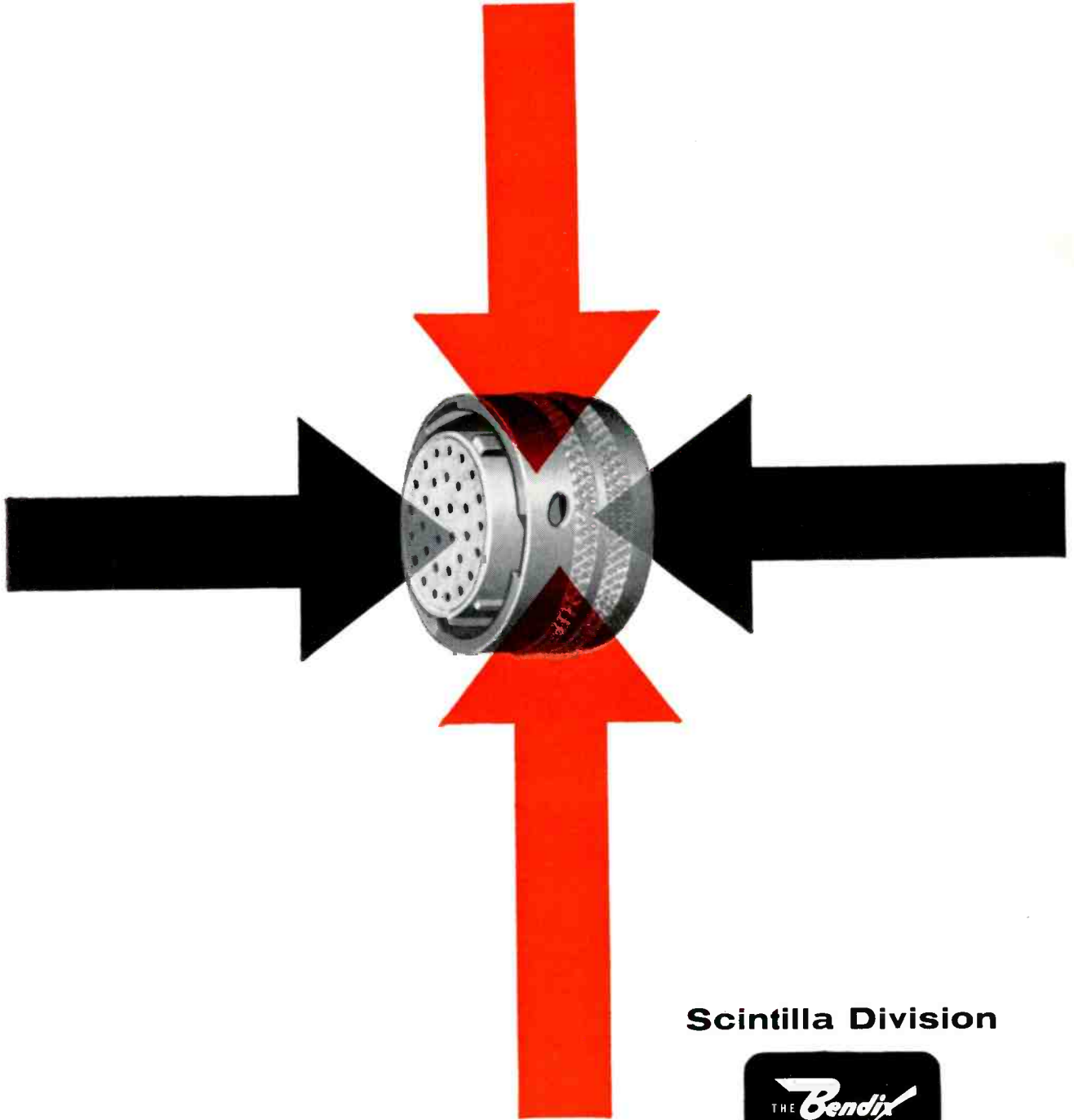

Scintilla Division



Canadian Affiliate: Aviation Electric, Ltd., 200 Laurentien Blvd., Montreal 9, Quebec. Export Sales & Service: Bendix International, 205 E. 42nd St., New York 17, N. Y.

FOR YOUR MAGNETIC SHIELDING PROBLEMS...

MUMMETAL

IS THE ANSWER!!!

Instant relief to interference caused by extraneous magnetic fields is the net result of shields made of Allegheny Ludlum's Mumetal. These shields protect components against stray external fields or prevent neighboring parts from being affected by a field-generating component inside the shield. In electronics, Mumetal and shielding are practically synonymous terms.

To develop its optimum shielding properties, Mumetal must be properly annealed in a pure, dry, high temperature hydrogen atmosphere after fabrication. When properly annealed, Mumetal has extremely high permeability and is capable of attenuating stray fields to negligible proportions.

In general, high permeability, shielding excellence and strain sensitivity go hand in hand. In the optimum condition, Mumetal is relatively soft. Shields in this condition

should be handled with care in order to preserve high permeability and optimum shielding efficiency.

In many applications, fabricating or field conditions are encountered which make it impossible to avoid straining the material after the high temperature hydrogen anneal. Even when strained, Mumetal shields remain effective, with just a small loss of permeability.

The inherent ductility of Mumetal offers fabricating advantages in forming, drawing, and spinning operations.

For all your shielding requirements, insist on Allegheny Ludlum Mumetal. And for more information, ask for a copy of EM12, a 20 page technical Blue Sheet describing Mumetal, its properties, annealing details, etc. Write *Allegheny Ludlum Steel Corporation, Oliver Bldg., Pittsburgh 22, Pa., Address Dept. E-12.*



ALLEGHENY LUDLUM

PIONEERING ON THE HORIZONS OF STEEL



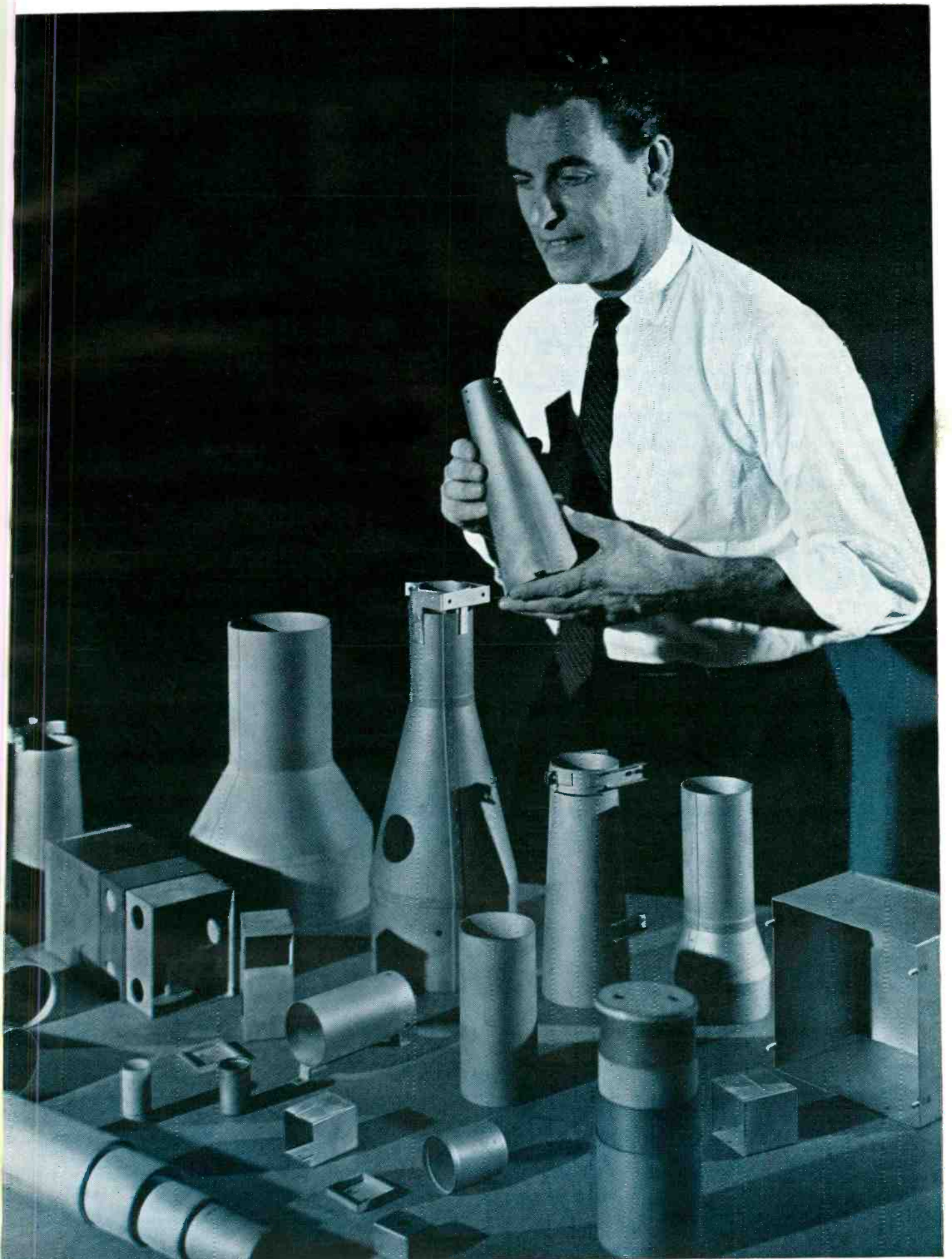

10MC FREQUENCY COUNTER/STANDARD

A NEW CONCEPT IN PRECISION MEASURING

The Model 14-20C 10MC Frequency Counter/Standard combines the features of a precision counter and a high stability frequency standard into an advanced design unit. Specifications are as follows:

- Simultaneous and independent use of both frequency standard and counter.
- Stability of 1×10^8 per day and 5×10^8 per week as calibrated against the primary time-standard "Atomichron" — 2×10^{10}
- Nine standard decade output frequency steps of 0.1cps to 10mc provided by frequency synthesizer. Gate time from 1 millisecond to 100 seconds.
- Counts any one of nine decade frequencies from 0.1cps to 10mc for period and time interval measurements.
- Self checks counting and gate circuits at any of these frequencies in all combinations of available gate times.
- Operates within all ratings over a temperature range of -20°C to $+55^\circ \text{C}$, and humidities up to 95%.
- Operates from an external 100KC or 1mc reference frequency.

Other features include:

Frequency range 10cps— Input power 115/230v,
10.1mc 50-60 cps (400 cps opt.)
Period DC— 100KC
In-line readout 8 place PRICE \$2,200

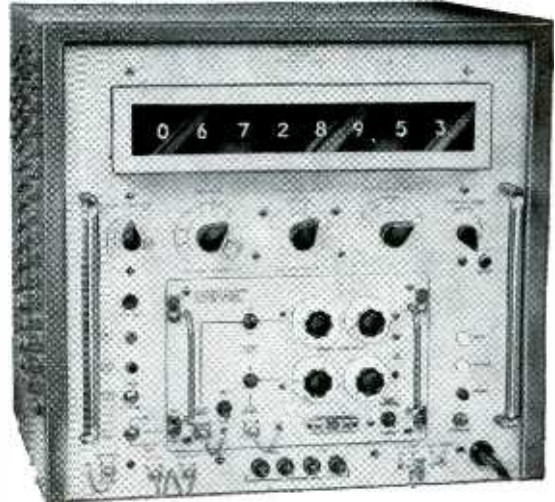

NORTHEASTERN ENGINEERING INCORPORATED

DEPT. 1C, MANCHESTER, NEW HAMPSHIRE
AFFILIATE OF ATLANTIC RESEARCH CORP.

CIRCLE 200 ON READER SERVICE CARD

Available for the first time!
AN ENTIRELY NEW CONCEPT IN

CONDUCTIVE PLASTICS

Possessing all the conductive properties of expensive silver-filled plastics while costing substantially less, this new series developed by Chomerics Inc. has excellent heat stability and resistivity of less than 0.01 ohm-cm. They are non-settling and are consistent in batch-to-batch uniformity. These conductive plastics are offered in a wide variety of formulations to meet your requirements.

\$17.⁷⁵ for a ONE POUND INTRODUCTORY KIT

Supplied as either hot-melt or epoxy.

**CONDUCTIVE
(THERMOPLASTIC)
HOT-MELT**

For soldering printed circuit component leads, prototype construction, assembly of grounded aluminum truck bodies, electroluminescent panel construction.

**CONDUCTIVE
(THERMOSETTING)
EPOXY**

For free style leads and circuitry, connections on tantalum-slug capacitors, lab repairs, conductive encapsulations.

Write today for your introductory kit and prices on commercial quantities. State any unusual requirements you may have — we welcome difficult problems. When ordering specify your choice of either hot-melt or epoxy.



chomerics, inc.

PLASTIC SYSTEMS FOR ELECTRONICS
TEL.: UNiversity 4-5104
343 VASSAR STREET • CAMBRIDGE 39, MASS.

PINPOINT PRECISION

THROUGHOUT LARGE VOLUME



MODEL 1060B
Temperature Chamber
Cabinet Optional

20" x 20" x 25"

LOWER GRADIENTS:

$\pm 1^\circ \text{C}$. over large portion of test volume

RANGE:

-100°F . to $+600^\circ \text{F}$.

CONTROL ACCURACY:

$\pm \frac{1}{4}^\circ \text{F}$.

HEATING TIME from 70° :

13 minutes to 350°F .

28 minutes to 500°F .

COOLING TIME from 70° :

6 minutes to -65°F .

9 minutes to -100°F .

Call Delta representative or write direct for specifications



3163 ADAMS AVE. SAN DIEGO 16, CALIFORNIA
ATWATER 3-3193 • CABLE: DELTA • TWX: SD 6488-U

CIRCLE 201 ON READER SERVICE CARD
electronics

Use Low Cost Allen-Bradley Type J Pots for Constant Impedance Attenuators

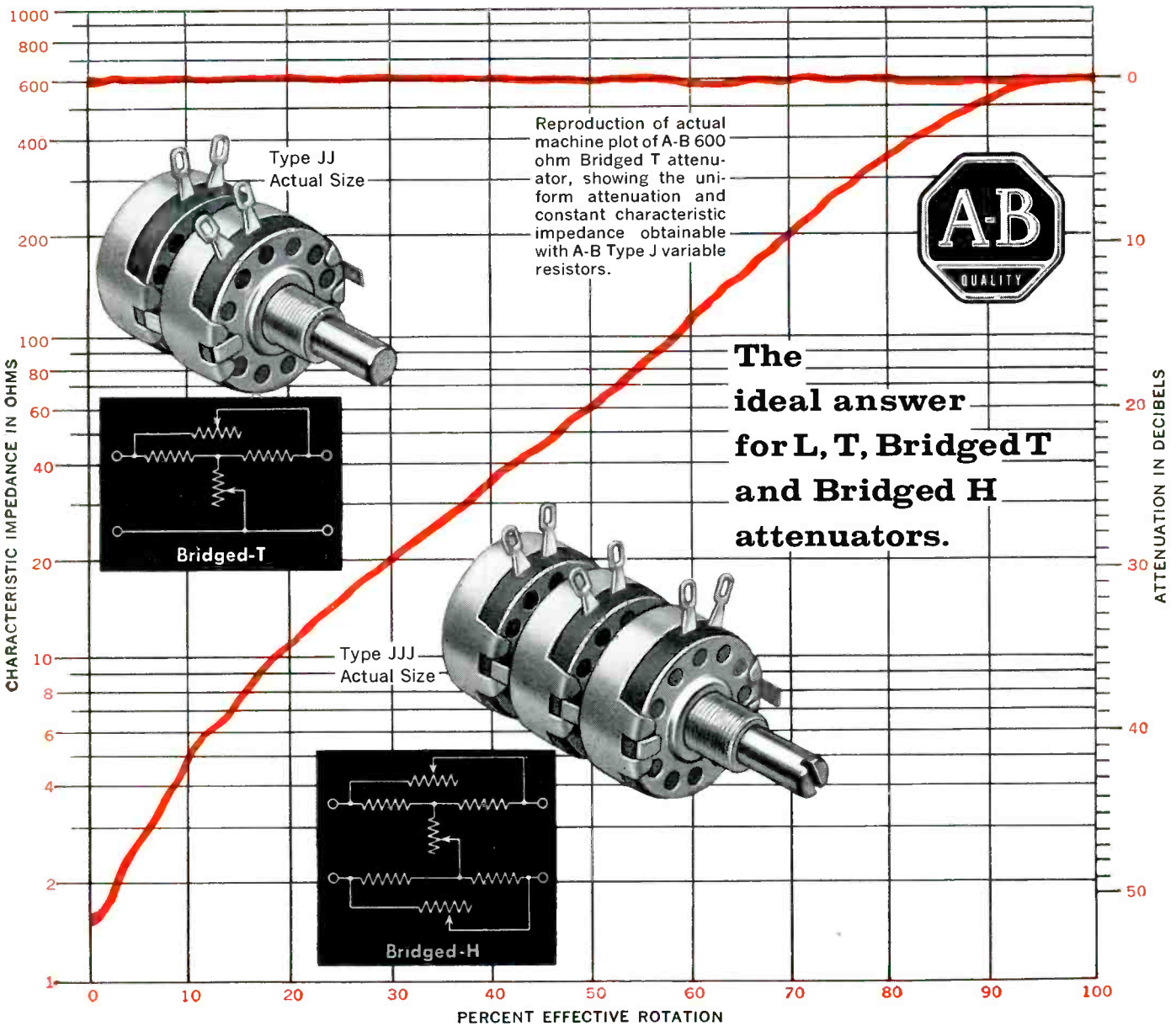

Allen-Bradley dual and triple Type J variable resistors are widely used in attenuators in electronic circuitry because they provide dependably smooth and uniform attenuation plus constant characteristic impedance.

Stability, high wattage, long life, ideal uniformity, plus remarkable compact structure are combined in the Type J to assure top performance. The solid resistance element—made by A-B's exclusive hot molding process—provides smooth control at all times.

With this precise control over the resistance-rotation characteristics during production, A-B attenuators have a consistently uniform attenuation that approaches calibration accuracy . . . and the characteristic impedance can be held to $\pm 10\%$ over *entire* rotation—*end to end*. The virtually infinite resolution eliminates the definite incremental steps of wire-wound units, while freedom from inductance insures excellent high frequency response. For full details on Type J variable resistors, send for Publication 6024.

Allen-Bradley Co., 110 W. Greenfield Ave., Milwaukee 4, Wis. • In Canada: Allen-Bradley Canada Ltd., Galt, Ont.

ALLEN-BRADLEY

QUALITY
ELECTRONIC
COMPONENTS

**10 mV - 10 V
at frequencies up
to 800 Mc/s**

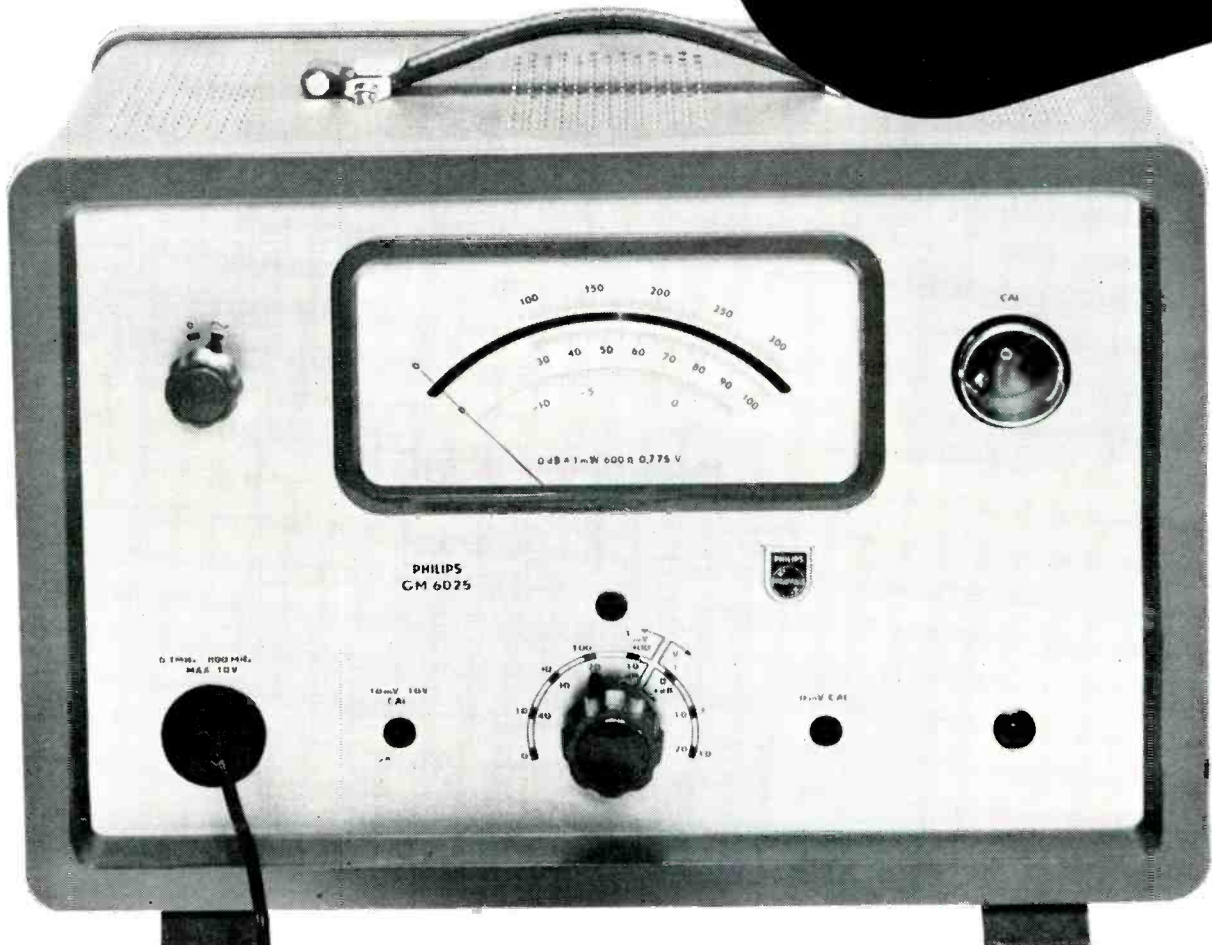

Internal calibration

It should be noted that all Philips electronic voltmeters contain calibration standards which enable the user easily and rapidly to check, and, if necessary, to re-calibrate his voltmeter at any time without the use of additional instruments.

PHILIPS *electronic measuring*

Sold and serviced by Philips Organizations all over the world

Further information will gladly be supplied by:

N.V. Philips' Gloeilampenfabrieken, EMA-Department, Eindhoven, the Netherlands

For Canada: Philips Electronics Ind. Ltd., 116 Vanderhoof Ave., Toronto 17, Ont.

VHF voltmeter, type GM 6025

Frequency range

0.1 Mc/s - 800 Mc/s flat from 1 Mc/s - 300 Mc/s (see graph)
- 1dB at 0.1 Mc/s
+ 1dB at 800 Mc/s

Measuring range

0 mV (f.s.d.) - 10 V divided into 7 ranges in a 1-3-10 sequence.

Accuracy

The overall accuracy is better than 5% with respect to full scale.

Input impedance

Input capacitance: 1 μ F
Input resistance at:
1 Mc/s 65 k Ω
100 Mc/s 50 k Ω
200 Mc/s 35 k Ω

Linear scale

Thanks to voltage-dependent feed-back the scale is linear. It is calibrated directly in the r.m.s. value of the VHF voltage and has an effective length of 5".

Calibration voltages

The frontpanel contains a calibration socket which for any setting of the range selector provides the appropriate calibration voltage for that range.

Replacement of the probe crystal

The probe crystal can be easily replaced and the instrument rapidly re-calibrated by the user.

Coaxial T-connector

For measurements on 50 Ω -coaxial lines the T-connector, type GM 6050T can be ordered separately.

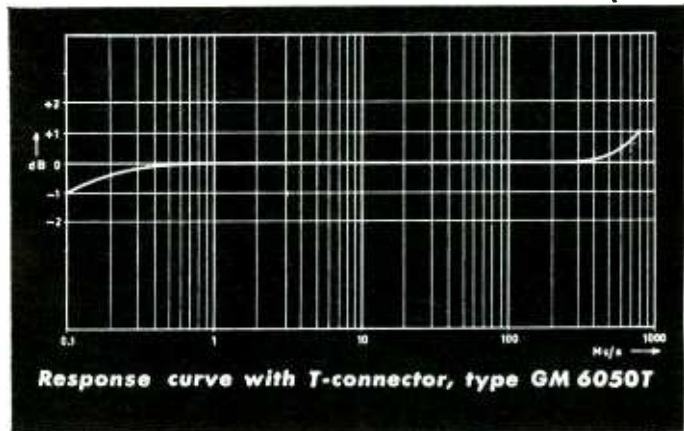

other voltmeters from our range

type GM 6012

2 c/s - 1 Mc/s
1 mV (f.s.d.) - 300 V

type GM 6014

1 kc/s - 30 Mc/s
1 mV (f.s.d.) - 30 V

type GM 6020

D.C.
100 μ V (f.s.d.) - 1000 V



instruments: quality *tools* for industry and research



NEW MINIATURIZED LONG-LIFE COMMUTATION SWITCH



ACTUAL SIZE
Plate dia. only 1³/₄"



... but 1³/₄" plate diameter and 50% space savings* in a 180-channel switch are only the start of the story. This new electromechanical switch also gives the other advantages that have made MYCALEX® units the industry standard. Noise level of less than 1 millivolt when switching 5 volts into a 150-ohm load. Up-to-a 1000 megohm resistance between rectangular contacts. Speeds as high as 1800 RPM. Metal-to-metal wiping action that prevents graphite build-up. Super-hard, gold-plated contacts. SUPRAMICA® 555 ceramoplastic plate that withstands operating temperatures to 650° F., has total dimensional stability, locks contacts in place. Plus nylon-brush mountings of new design that eliminate bounce and deliver sharp, clean signal edges.

Whether you're looking for commutation plates or complete switches, it'll pay you to investigate both of these compact, new components which give you an additional degree of design latitude. (For example, other MYCALEX switches offer up to 540 contacts on a 3"-diameter plate.) Write today for our new, comprehensive technical bulletin.

*When compared with conventional Inter-Range Instrumentation Group Telemetering Switches.

General Offices and Plant: 120 Clifton Boulevard, Clifton, N. J.
Executive Offices: 30 Rockefeller Plaza, New York 20, N. Y.



HIGH-SPEED SWITCHING



Check these

CLARE

Mercury-Wetted
Relays

against your
design needs

Choice of two basic switches

SPEED TO 200 CPS



This CLARE TYPE HGS is the fastest operating, most sensitive mercury-wetted contact relay obtainable. It will operate at speeds to 200 cps with sensitivity as low as 2.5 milliwatts with a contact rating of 2 amperes, 500 volts (100va max.). Two permanent magnets provide, single-side stable and bi-stable adjustments. Available with Form D (bridging) contacts.

LOADS TO 250 VA



This CLARE HG capsule will handle contact loads as high as 5 amperes, 500 volts (250va max.). Operating time may be as low as 3 milliseconds. It is also available equipped with two permanent magnets (HGP TYPE) for single-side stable, bi-stable or chopper operation.

The Clare Mercury-Wetted Relay Principle

The remarkably long life of CLARE mercury-wetted relays is the result of a design principle whereby a film of mercury on the contacts is constantly renewed, by capillary action, from a mercury pool. Both CLARE HGS and HG switch capsules employ this principle. Both switches are sealed in high-pressure hydrogen atmosphere. Certain construction differences, however, give greater speed and sensitivity to the HGS switch.

FOR BILLIONS OF OPERATIONS

Choice of three convenient packages

ENCLOSED MODULES



Both CLARE HGS and HG switch capsules are available in steel-enclosed modules for convenient mounting on printed circuit boards in the same manner as resistors, capacitors and similar components. The enclosure is ruggedly designed and provides both excellent mechanical protection and magnetic shielding. These modules are ideal for design and prototype work.

CONVENTIONAL PLUG-IN RELAYS

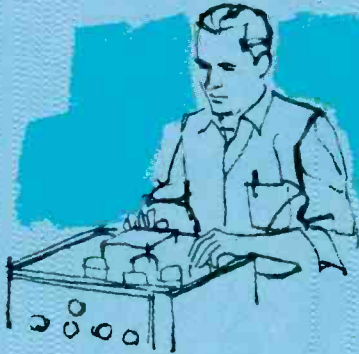

CLARE HGS switch capsules are available in single switch units, surrounded by a coil, mounted in high-melting point wax and encased in cylindrical steel containers provided with plug-in base. A smaller type (HGSS) is designed for use where space is limited. HG relays are available with one, two, three, or four capsules, surrounded by a single coil. Also with permanent magnets (HGP) for single-side stable, bi-stable or chopper operation.

PCB ASSEMBLIES

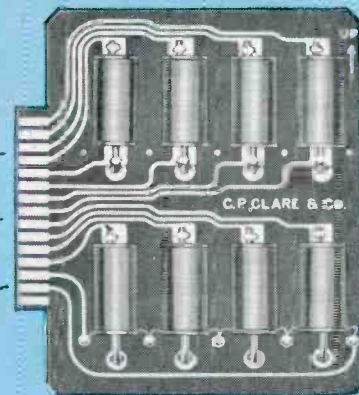

Printed circuit board assemblies are available with either HGS or HG switch capsules to meet design specifications. These may be designed to customer specifications by CLARE or mounted on boards supplied by the customer. Number of relays is limited only by the dimensions of the printed circuit board.



NEW! Design Manual 201A

Complete data on characteristics, circuitry, mountings, coil tables and information for ordering CLARE mercury-wetted contact relays.

See your nearest CLARE representative or address: C. P. Clare & Co., 3101 Pratt Blvd., Chicago 45, Illinois. In Canada: C. P. Clare Canada Ltd., 840 Caledonia Road, Toronto 19, Ontario. Cable Address: CLARELAY.



C. P. CLARE & CO.

Relays and related control components

in full bloom...Synkote[®] MULTI-CONDUCTOR CABLES

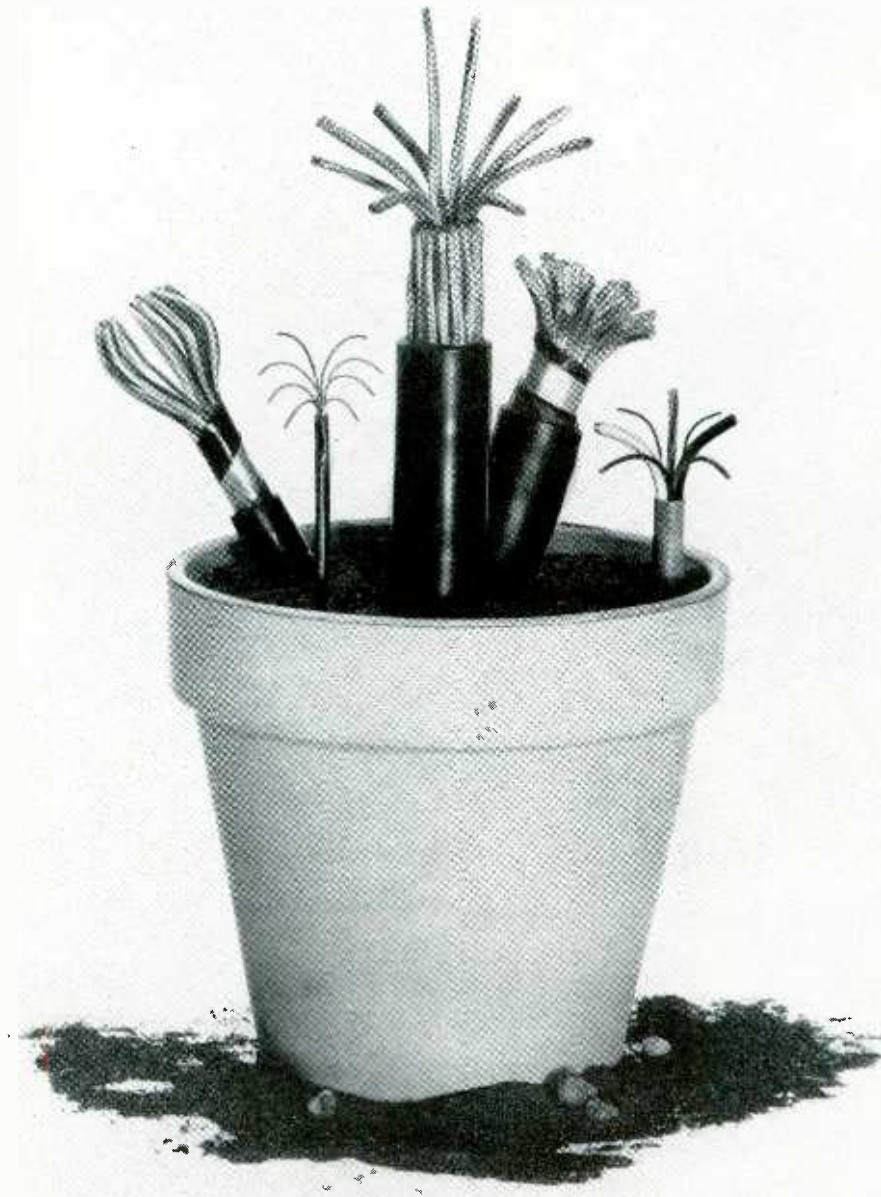

We got a "million of 'em" ...made to your design or ours! The booming Synkote[®] line of multi-conductor cables is being used for outer space, under sea, and dry land purposes. Heavy, powerful watertight cables. Light, strong aerial cables. Cables for telemetry, instrumentation, data tabulating and computing equipment. All are thoroughly tested, quality controlled, performance proven. Myriad multi-conductor cables are only part of Plastoid's growing multiplicity of cables. Write or call for detailed information today. Our application engineers are at your service.

PLASTOID
CORPORATION

42-61 24TH STREET / LONG ISLAND CITY 1, N. Y. / ST 6-6200

RECENT RAYTHEON DEVELOPMENTS
IN MICROWAVE FERRITE DEVICES

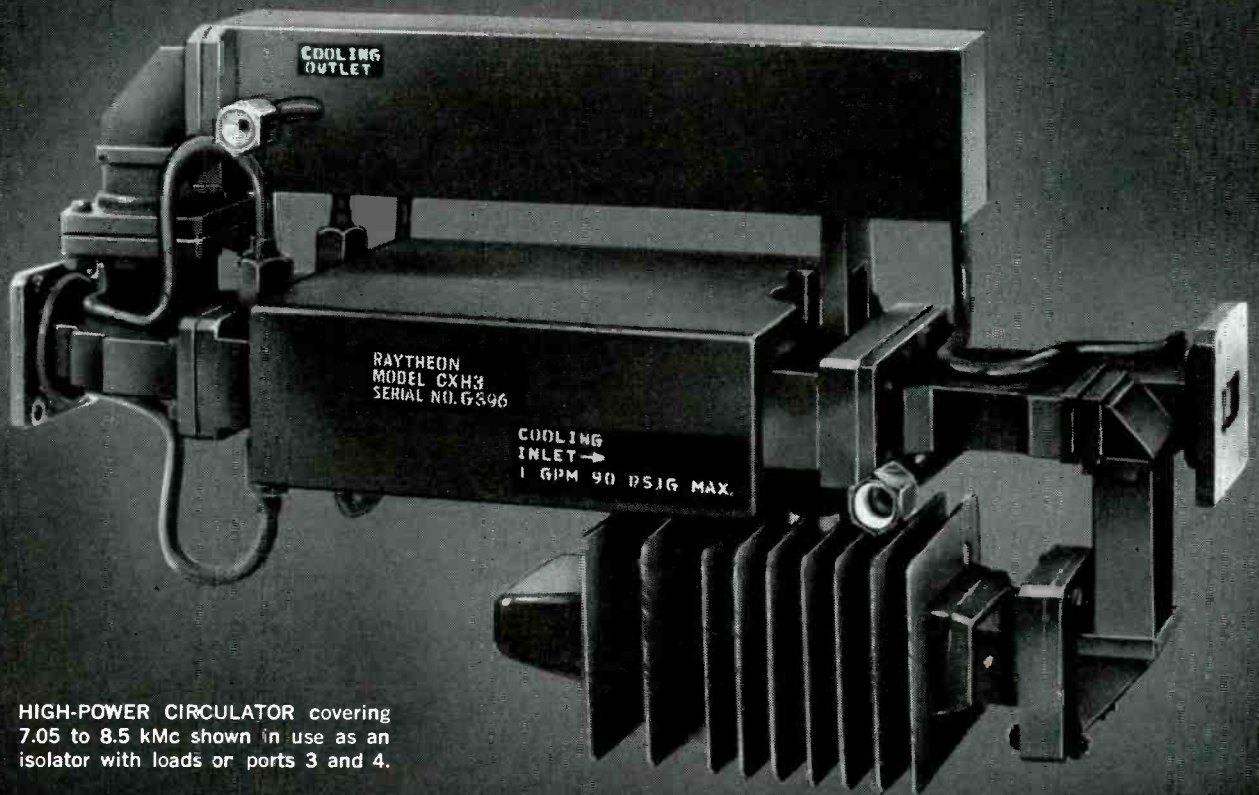

HIGH-POWER CIRCULATOR covering 7.05 to 8.5 kMc shown in use as an isolator with loads or ports 3 and 4.

X-band circulators take 20 kW CW to match state of the art in tubes

New unit tested at 20 kW continuous power; can be used as isolator or duplexer

This high-power CXH3 circulator provides greater than 20 db of isolation over the 7.05 to 8.5 kMc band with a maximum insertion loss of less than 0.3 db. The CXH3—developed under U. S. Army Signal Corps contract number DA-36-039-SC-85372—is typical of circulators Raytheon can supply for any X-band segment at power levels up to 25 kilowatts average and 2 megawatts peak.

Write for technical details on this and other significant developments in high-power microwave ferrite devices to Special Microwave Devices Operation, Raytheon Company, Waltham Industrial Park, Waltham 54, Massachusetts.

TYPICAL SPECIFICATIONS
MODEL CXH3 CIRCULATOR

Frequency Range	7.05-8.5 kMc
Power (CW)	20kW
Isolation	20 db min.
Insertion loss	0.3 db max.
VSWR	1.15 max.
Length	14.5 inches
Flanges	UG 51/U
Waveguide	RG 51/U
Weight: Incl. loads	19 lbs.
Excl. loads	12.5 lbs.
Cooling	1 gpm @ 90 psi max.
Recommended Pressurization	10-15 psig nitrogen or dry air

RAYTHEON

RAYTHEON COMPANY

SPECIAL MICROWAVE DEVICES OPERATION

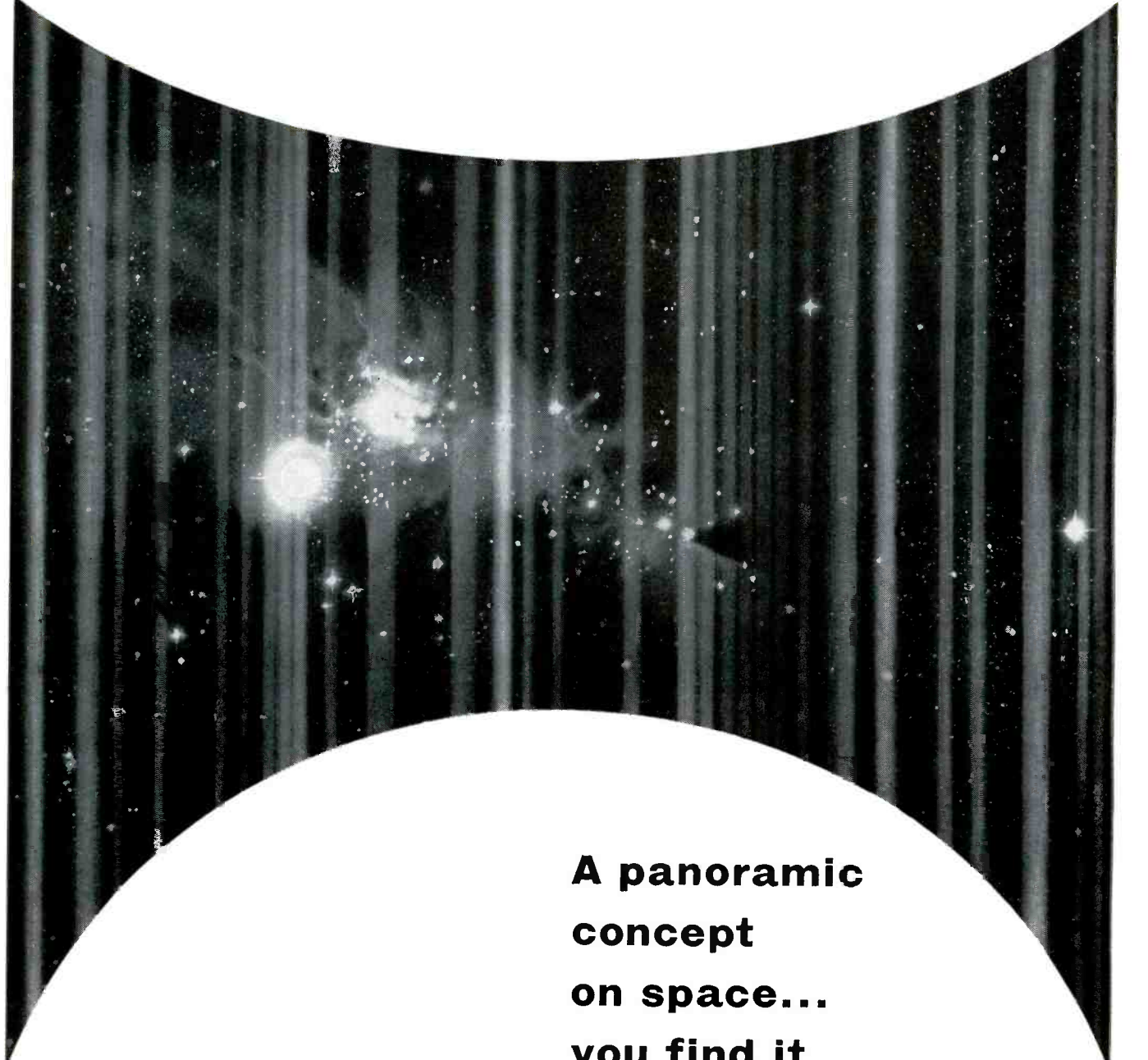

**A panoramic
concept
on space...
you find it
at Lockheed**

Long experience and proven capability give Lockheed a great advantage: perspective on space. This results in programs that cover the broad spectrum of aerospace dynamics; that present the most far-reaching technological problems; that offer endless creative challenge to Scientists and Engineers; that give them new concepts to explore—new goals to reach.

This far-ahead program in the concepts and vehicles of space creates a climate most favorable to advancement in the state of the art as well as in professional status.

Scientists and Engineers with an eye to a secure and

rewarding future will find these openings at Lockheed worthy of serious consideration: Aerodynamics; thermodynamics; dynamics; electronic research; servosystems; electronic systems; physics (theoretical, infrared, plasma, high energy, solid state, optics); electrical and electronic design; structural design (wing, empennage, fuselage); human engineering; reliability; wind tunnel design. Write today to Mr. E. W. Des Lauriers, Manager Professional Placement Staff, Dept. 1512, 2408 N. Hollywood Way, Burbank, California. An equal opportunity employer.

LOCKHEED CALIFORNIA COMPANY
A DIVISION OF LOCKHEED CORPORATION

NATVAR TUBING AND SLEEVING

For a Wide Range of
Military Electronic
and Electrical Uses.

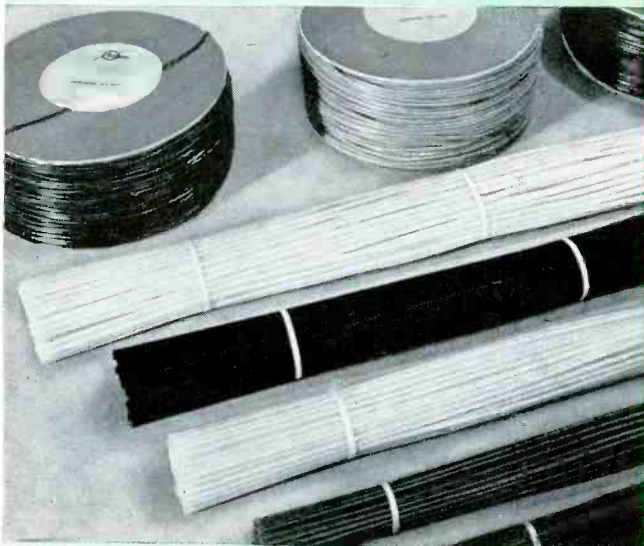

Natvar Products

- Varnished cambric—sheet and tape
- Varnished canvas and duck—sheet and tape
- Varnished silk and special rayon—sheet and tape
- Varnished papers—rope and kraft—sheet and tape
- Varnished, silicone varnished and silicone rubber coated Fiberglas*—sheet and tape
- Slot cell combinations, Aboglas®
- Teraglas®
- Isoglas® sheet and tape
- Isolastane® sheet, tape, tubing and sleeving
- Vinyl coated and silicone rubber coated Fiberglas tubing and sleeving
- Extruded vinyl tubing and tape
- Styroflex® flexible polystyrene tape

*TM (Reg. U.S. Pat. Off.) OCF Corp

We will be very happy to supply information on any of our products on request.

General Purpose Extruded Vinyl Tubing

Natvar 241	MIL-I-631C, Type F, Form U, Grade A, Class II, Category I.
Natvar 261	MIL-I-631C, Type F, Form U, Grade A, Class I & II, Category I.

Low Temperature Extruded Vinyl Tubing

Natvar 361	MIL-I-631C, Type F, Form U, Grade B, Class I & II, Category I.
Natvar 362	MIL-I-7444B, Type I, II & III, Range I, II & III.
Natvar 363	MIL-I-22076.

High Temperature Extruded Vinyl Tubing

Natvar 461	MIL-I-631C, Type F, Form U, Grade C, Class I & II, Category 1. U/L Approved for 105°C Continuous Operation.
Natvar 400	U/L Approved for 105°C Continuous Operation.
Natvar 500	Specially Formulated for Use in Transformer Oil.

Natvar Coated Fiberglas Sleeveings

Vinyl	MIL-I-21557 (Grade A Only) and MIL-I-3190B.
Isolastane (Polyurethane)	MIL-I-3190B.
Silicone Rubber	MIL-I-18057A (Grade A Only).

NATVAR is synonymous with quality throughout the world. Among the many outstanding insulations now serving the needs of the military and industry are Natvar extruded tubings and coated sleeveings.

These are made to perform in a wide range of temperatures from -68°C to 180°C and above, and to meet the electrical and mechanical requirements of applicable military and industry specifications. In addition, most have superior resistance to oil, alkali and flame; excellent flexibility, and exceptional toughness and ability to withstand abrasion.

The specially compounded formulations used in Natvar extruded tubings and coated sleeveings are subjected to systematic and rigorous quality control from raw materials to finished product. The name Natvar is your guarantee of quality and uniformity.

Shipments of standard items can be made the same day from distributor's or factory stock. Samples are available on request.

NATVAR CORPORATION

FORMERLY THE NATIONAL VARNISHED PRODUCTS CORPORATION
Telephone TWX Cable Address

FULTON 8-8800 RAHWAY, N.J., RAH 1134 NATVAR: RAHWAY, N.J.
201 RANDOLPH AVENUE • WOODBRIDGE, NEW JERSEY

GET HIGH SPEED AT HIGH CURRENT

WITH PHILCO MADT* ECONOMY!



2N1494, 2N1494A,
and 2N1496 fea-
ture 400 mw P_T in
TO-31 case.



2N1204, 2N1204A,
and 2N1495 fea-
ture 200 mw P_T in
TO-9 case.

Six Philco high current *Micro Alloy Diffused-base Transistors give you extra design latitude

Philco High Current MADT Parameters

	V_{CB0}	P_T	f_T min	V_{CE} (Sat) Max $I_C=400$ ma $I_B=25$ ma	C_{ob} Max
Ultra high speed types					
2N1204	20 v	200 mw	220 mc		8 pf
2N1204A	20	200	220	0.7 v	8
2N1494	20	400	220		8
2N1494A	20	400	220	0.7	8
High Voltage types					
2N1495	40	200	150	0.7	6.5
2N1496	40	400	150	0.7	6.5

- ... for line driving
- ... for memory driving
- ... for high current logic.

All six Philco high current MADT's—types 2N1204, 2N1204A, 2N1494, 2N1494A, 2N1495 and 2N1496—give you a high capability-to-cost ratio, outstanding uniformity, and are 100% tested for freedom from avalanche . . . all benefits of Philco MADT automation.

For complete information, write Dept. E12861.

Immediately available in quantities 1-999 from your Philco Industrial Semiconductor Distributor

PHILCO®



Famous for Quality the World Over

LANSDALE DIVISION, LANSDALE, PENNSYLVANIA

CIRCLE 52 ON READER SERVICE CARD



Electroluminescent elements are capacitive.

Their properties enable them to act as capacitance in a delay line.

Pulses sent down the line control the voltage distribution over the elements, thus selecting the regions to be excited



Operator prepares to display pulse waveforms on the small square screen

Electroluminescent Display Presents Nanosecond Pulses

By R. W. WINDEBANK,
G. V. Planer Limited, Windmill Road,
Sunbury on Thames, England

A NEW PRINCIPLE in flat-screen electroluminescent displays makes possible the presentation of short-duration pulses using a minimum of electronics and in a fashion that is easy to interpret. In common with other electroluminescent displays it is essentially robust in construction and uses no moving parts or fragile heater elements.

The display gives information about the time duration of input

pulses down to nanosecond widths, and gives the timing of these pulses relative to some fixed reference. A special form of the display can also be constructed to show pulse amplitude.

The principle of the display is to build up the voltage at selected electroluminescent elements so that it exceeds the level necessary to produce illumination. Since the electroluminescent elements also double as the capacitive elements in a delay line, the excitation voltage is produced by coincidence of oppositely travelling pulses — where

these pulses meet they produce a higher voltage than either of them could produce alone and thus illuminate the electroluminescent elements at that point.

The display element, shown in Fig. 1 uses an electroluminescent panel with its phosphor-containing layer sandwiched between a transparent electrode deposited on a glass sheet, and a counterelectrode system consisting of a number of narrow separate conductive strips. An electric delay line formed by a multi-turn winding on an insulating tube has each of its taps connected

to one of the electrode strips. In this arrangement, the inductive winding, with the series of discrete capacitances set up between the electrode strips and the transparent electrode layer, make up a conventional delay line structure.

The pulse whose time-duration is to be displayed is applied simultaneously to the two terminals of the device. The pulse inputs at each end of the line travel along the line at the predetermined rate of propagation, and by arranging the voltage amplitude of each pulse input to be somewhat greater than half the voltage required to produce a suitable luminescent display, the luminescent phosphor layer is excited to the level of visual display beneath those strips upon which the two oppositely travelling pulses coincide. Thus, there is a visual display extending over part of the central region of the panel whose width depends on the duration of the applied pulse. By making the delay time of each section of the delay line a suitable known value, say 10 nanoseconds, the length of the pulse can be readily determined by measuring the length of the resultant visual display.

Where pulse amplitude is to be measured, a modification of the device is used, in which the phosphor layer is wedge shaped in cross-section to give progressively increasing separation between the strips of one set at right angles to those of the other set (Fig. 3). The uppermost set of electrodes is preferably transparent. The strips on each side are connected to tap points of a delay line associated with each of the sets, and pulses of opposing polarity are applied to the two lines. By appropriate adjustment of the timing relationship between the applied pulses, a visual display may be produced at any chosen intersection of a strip of one set with a strip of the other set over the whole display area of the panel.

In operation, if positive pulses of amplitude V are applied across one of the delay lines, and negative pulses of equal amplitude across the other, the intersection area between the two sets of strips will have an impressed potential of $4V$ due to the coincidence of the travelling pulses. This voltage compares with a voltage of $2V$ at certain other intersection points and a voltage of

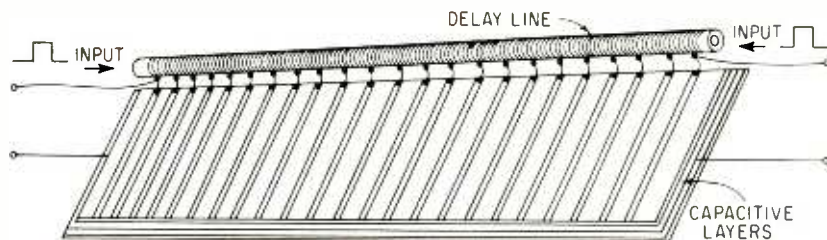

FIG. 1—Pulses fed into both ends of the delay line build up voltage at their point of coincidence and light the electroluminescent elements at that point

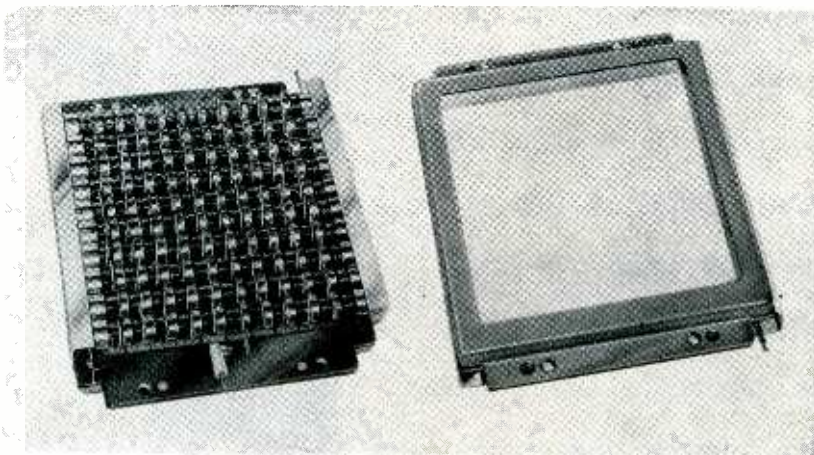

FIG. 2—A long delay-line is folded into several sections of equal length to make an area type display

only V at the remaining intersection points. By appropriate adjustment of the timing relationship between the input pulses, the $4V$ intersection can be caused to scan the entire panel. This method permits a faster pulse-rate than that of Fig. 2.

Capacitance between any of the oppositely situated strips should be small compared with the capacitive components of the delay lines, hence these strips may be of the distributed capacitance type having a common electrode as indicated in Fig. 3.

Characteristics of the electroluminescent elements are substantially those of conventional types, except that the resistance of the transparent electrode should be lower than usual, that is, about 10 ohms per sq as opposed to the usual value of 100-200 ohms per sq. To achieve this lower resistance the electrodes are applied by spraying a tin chloride solution onto the glass base and by using a small percentage of doping agent in alcoholic solution. The material is treated to form the oxide at 600 C.

In operation, if positive pulses of amplitude V are applied across one of the delay lines, and negative pulses of equal amplitude across the other, the intersection area between the two sets of strips will have an impressed potential of $4V$ due to the coincidence of the travelling pulses. This voltage compares with a voltage of $2V$ at certain other intersection points and a voltage of

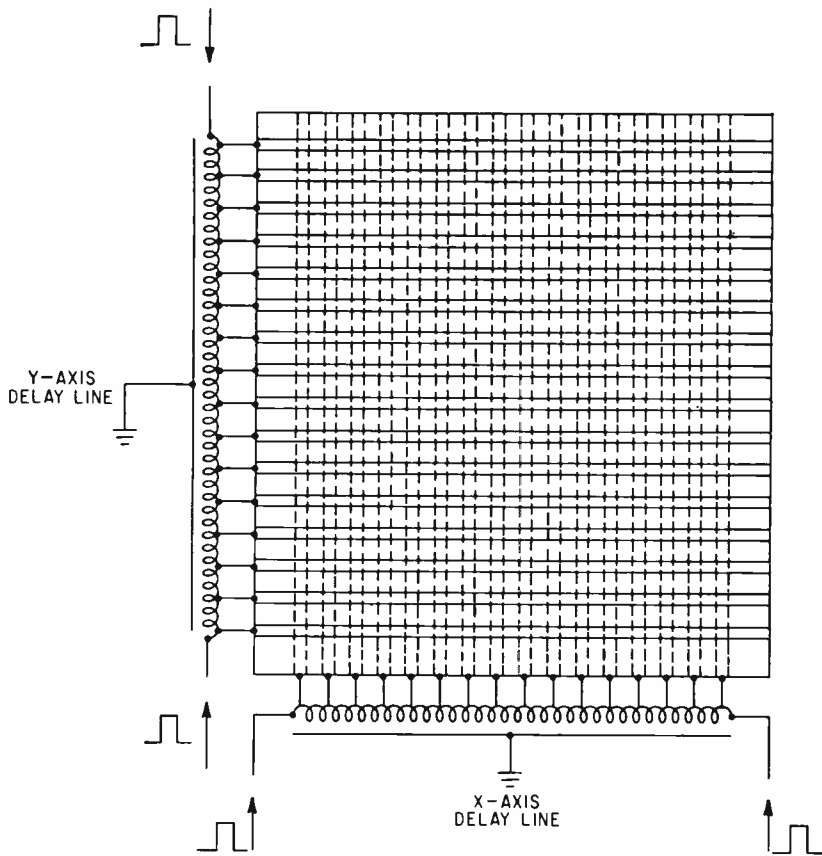

FIG. 3—Matrix type control enables higher pulse rates to be used with square panel than folded line permits

The phosphor layer is a zinc sulphide dispersion in an organic binder.

Experimental models of the basic display, Fig. 1, had 50 discrete phosphor sections each $\frac{1}{8}$ inch wide. Synchronized pulses applied to both ends of the delay line caused one section of the display to light up for every 10 nanoseconds of applied pulse. When using synchronized 50-nanosecond pulses instead of 10-ns ones, 5 consecutive sections were lit up at the center of the panel. On introducing a delay in either pulse, the luminous region could be displaced to the left or right of center.

The 100-section folded-line panel in Fig. 2, was scanned by continuously varying the delay in both applied pulses. A 2-second scan was used and pulse heights were between 300 and 1,000 V, with pulse lengths between 20 and 500 nanoseconds. The pulse repetition frequencies were varied from 10 to 1,000 cps.

Pulses of the rate of 1 to 10,000 cps could be used, while the trans-

mission line could be designed for 1 to 10-ns pulses.

The resolution obtained in the laboratory models was approximately 2 percent; that is, a ratio of line length to pulse length of 50:1. With improvements in phosphor and delay line characteristics this ratio can no doubt be increased.

With the techniques established so far, it would be possible to produce a rectangular display using X and Y delay lines each divided into 50 sections, to give 2,500 individual points. Any point could be illuminated by using two pulses of 20 nanosecond duration, each having amplitudes of 300 to 500 V and a pulse repetition frequency of 10 cps or more. Increase in the pulse repetition frequency would increase the brilliance and the scan rates.

An interesting future development would be to extend the system shown in Fig. 2 by employing a delay line of sinuous or raster-like form, disposed over the underside of the panel. With this type of construction, the delay line is preferably made up of a single conductor,

rather than a helically coiled conductor, and may be formed by normal electrodeposition methods. To obtain the correct inductance value for the line, magnetic loading with ferrite may be used. Similarly, the capacitive value could be adjusted to a suitable order by using a dielectric, with these magnetic and capacitive modifying materials applied in layer form.

Such a panel might be used to give a television-type display of either a simple pulse input or of a complex video waveform. In the latter case, the video signal would be applied to one end of the delay line structure and a single exploring pulse of short duration to the opposite end. If the electrical length of the line were equal to half the time duration of the complex waveform and the short exploring pulse applied to one end just when the leading edge of the complex waveform had reached that same end, the exploring pulse would coincide in turn with all of the separate elements of the complex waveform as both waveforms travelled in opposite directions down the line, so producing a video signal pattern.

Alternatively, two pulses suitably spaced in time can be applied to the line from the same end, provided the opposite end is not correctly terminated. Coincidence of the second pulse with the reflection of the first pulse would then produce the required visual display. If a short-circuit termination were used the pulse polarities would be opposed.

A video or equivalent display could also be built up by applying discrete pulse sections of the complex waveform in turn to the delay line in suitably timed relationship with a series of appropriately time-displaced pulses at the opposite end, so as to produce, by time coincidence, a visual marking spot at each of the different points of the line raster in turn.

For a color display, two, three or more interlaced sinuous line conductors would be used, in combination with suitable color filter strips on the viewed side of the panel.

The author is indebted to L. S. Phillips, and D. F. A. MacLachlan, both of G. V. Planer Ltd. for their assistance in the construction of the display panels.

Designing

*Two versions of measuring device
for high temperature.*

*One, without feedback, features
high threshold sensitivity
and wide dynamic range.*

*Feedback device is linear and
has good calibration stability*

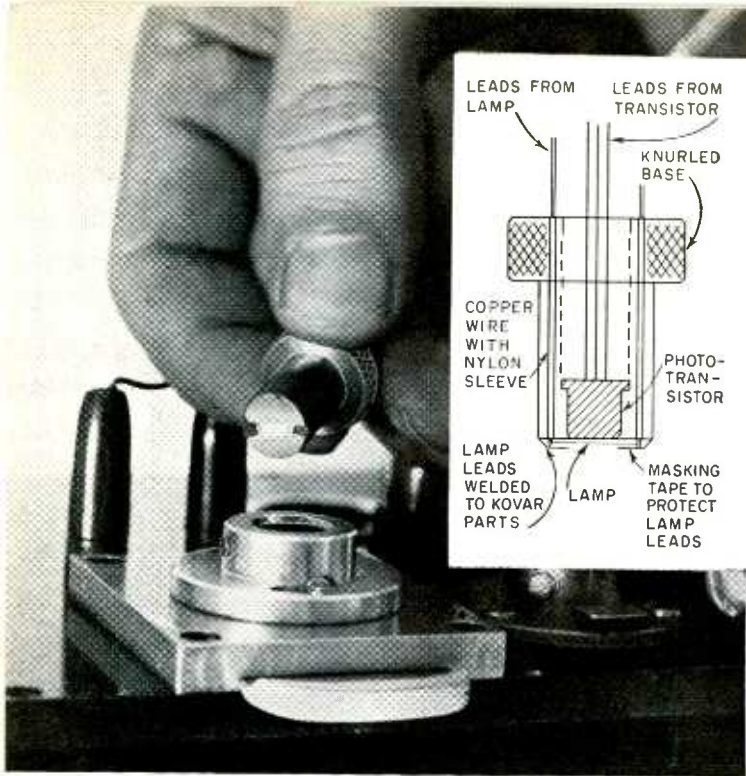

Details of phototransistor mount showing miniature lamp lying across window of phototransistor

By SAMUEL A. ELDER,

Applied Physics Lab.,
The Johns Hopkins Univ.,
Silver Springs, Maryland

AUTOMATIC RECORDING of surface temperature in missile and rocket environments requires a compact, rugged instrument. The completely transistorized recording pyrometer shown in Fig. 1 is the first version of such a device. Here, the design emphasis was on simplicity, since it was felt the instrument's reliability would be enhanced by having as few parts as possible. The control box is hand held and is ordinarily separated from the test area by a 50 ft. cable. Output of the control box may be fed directly to a d-c oscillograph.

Figure 2 is a schematic of the optical system. The telescope lens mounted in the end of a projecting tube focuses an image of a small portion of the source on a 0.020 in. field stop aperture, behind which a phototransistor is flush-mounted. Linear magnification is approximately 1. To avoid d-c drift and noise in the transistor circuit, the light beam is mechanically chopped at 750 cps by the toothed wheel placed just in front of the aperture. A silicon filter restricts the wavelength of the incoming light to a small band around 1.4μ , where

the phototransistor has maximum sensitivity.

When aligning, the phototransistor may be removed, permitting the image in the aperture plane to be examined by the microscope mounted in the lid. Field illumination is provided by the projection lamp. A standard tungsten ribbon lamp is used for calibration.

The circuits used are shown in Fig. 3. The optical box contains only seven components, including

the phototransistor and battery. The phototransistor, connected in common emitter mode, requires no preamp. A low output impedance is provided by a miniature transformer, good ground loop isolation being obtained at the same time.

The control box circuit consists of the decade amplifier and demodulator. Gain stability is assured by the application of 34 db of feedback through R_1 . The high input impedance generated by the feedback

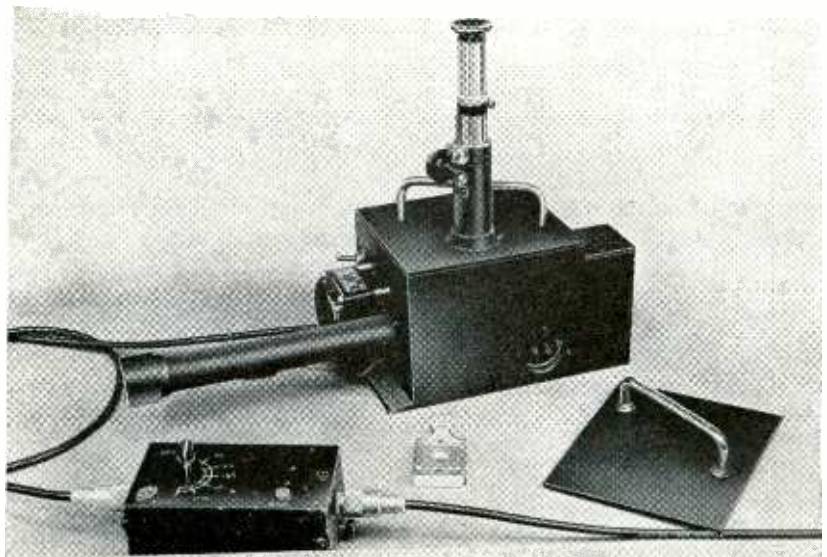

FIG. 1—Pyrometer's optical box is made from $\frac{1}{2}$ in. aluminum. Filter is in center foreground

Phototransistor Pyrometers

WITH AND WITHOUT FEEDBACK

means a simple voltage divider network can be used in the decade switch. Direct coupling is used in the common emitter cascade to reduce the phase shift at low frequency.

The diode demodulator transformer-coupled to the last transistor stage gives d-c output for recording on an oscillograph. The small bias voltage in series with the detector makes the output voltage exactly proportional to the input voltage. Minimum signal smoothing is employed, so as not to limit the rise time of the instrument any more than necessary. With the filtering shown, the device takes about 20 millisecc to come up to 90 percent of a step input. A filter with a shorter time constant could be used if the light beam were chopped at a higher rate. For low-speed oscillograph recording, 20 ms is fast enough. Output signal level for full-scale deflection of the oscillograph pen is 250 mv d-c, corresponding to a line input of 2.5 mv rms. Noise level referred to the input of the

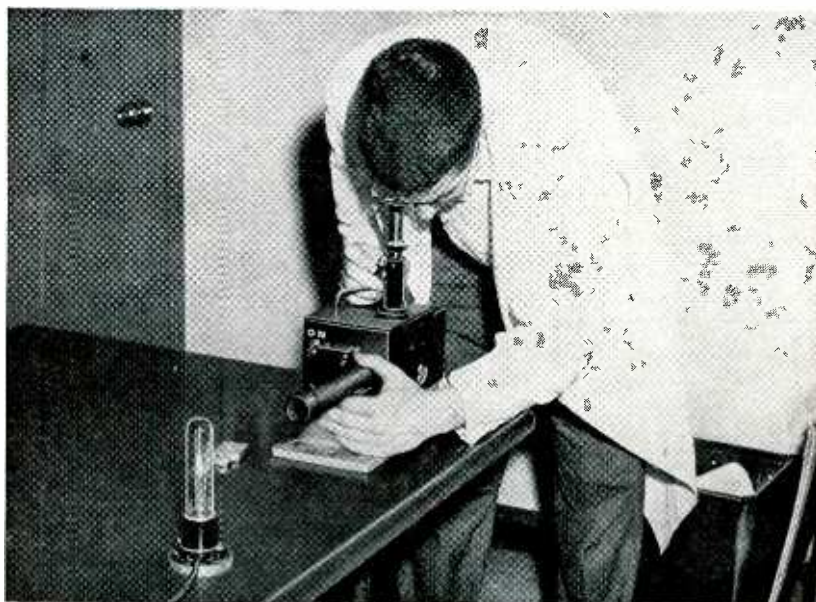

Aligning pyrometer for calibration with tungsten ribbon lamp standard

decade amplifier is about 50 μ v rms at maximum gain.

By the decade attenuator, a large linear dynamic range (about 4000 times referred to noise level) can be attained, the upper limit being

imposed by clipping in the phototransistor. The dynamic temperature range of the pyrometer is affected by the dynamic voltage range of the electronics and by the efficiency of the optical system. This is shown in Fig. 4 where typical calibration curves are plotted on log-reciprocal axes. The temperatures given are black body temperatures (that is, corrected for the emissivity of the tungsten calibration lamp.)

With wide open telescope objective (Curve C) the linear range extends from about 725 K to about 1,400 K. By stopping down the telescope opening, the temperature range may be shifted upward as shown in curve B, where it extends from 950 K to 3,000 K. The straight line portion of the curve corresponds to the linear portion of the electronic dynamic range. Over this region the output signal is nearly proportional to the light intensity, which in accordance with Wien's Law, varies exponentially with the reciprocal of the absolute

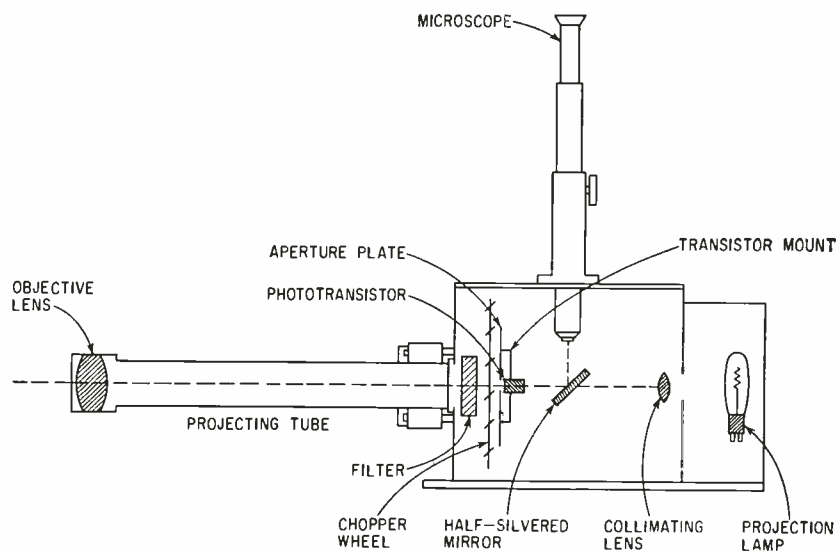

FIG. 2—In nonfeedback version the phototransistor is located near chopper wheel

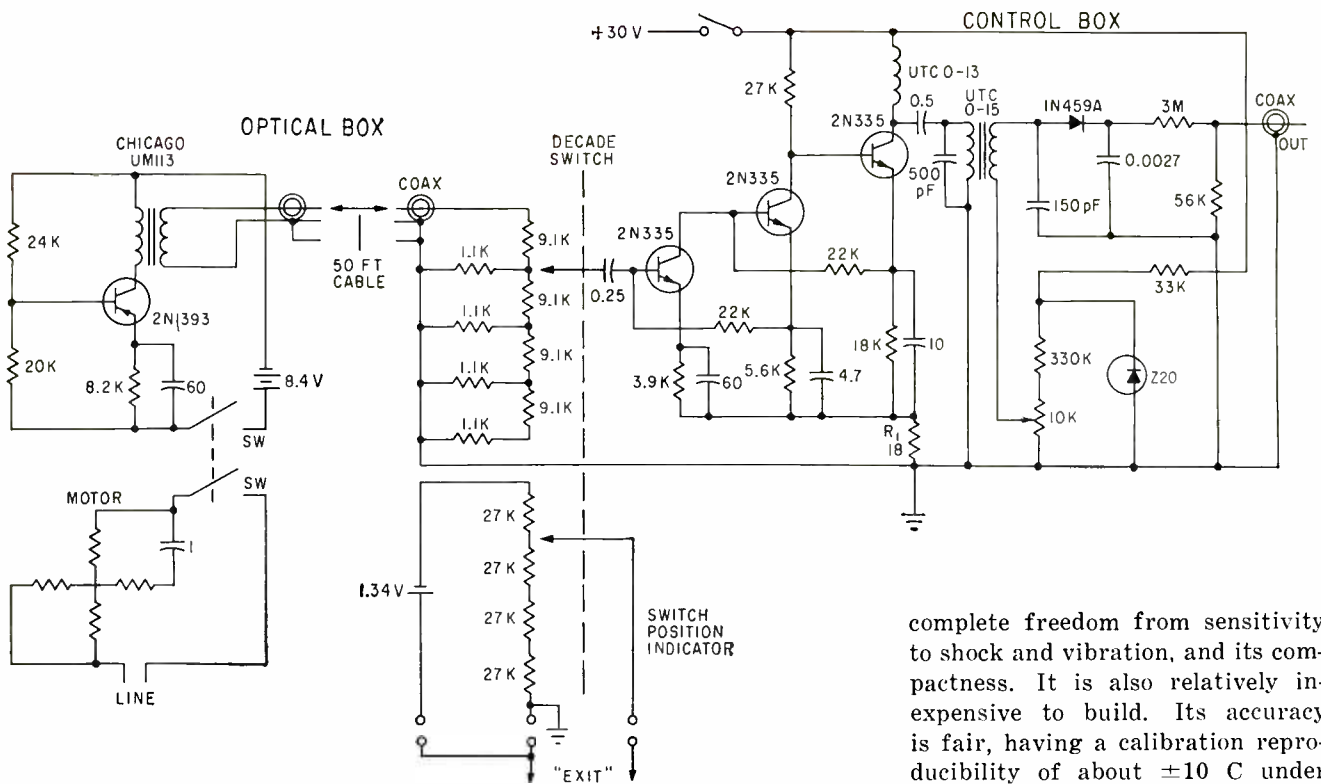

FIG. 3—Control and optical boxes are interconnected by microphone cable

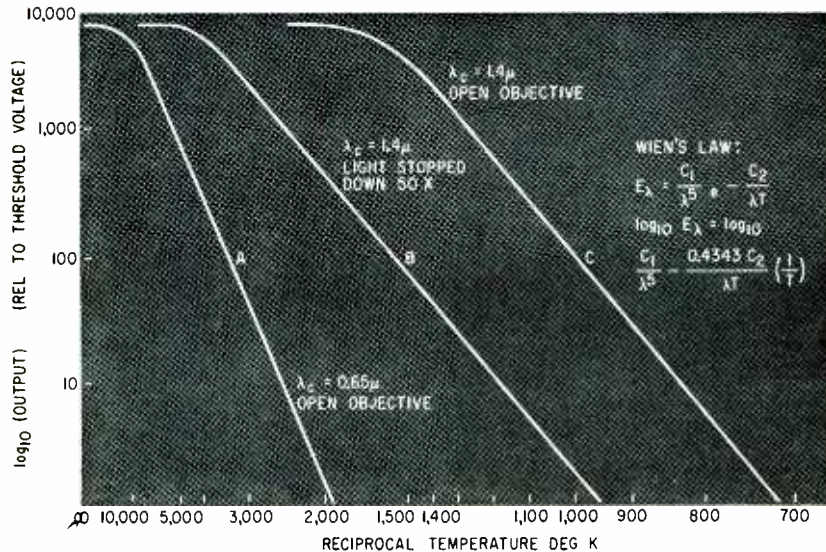

FIG. 4—Calibration curves show effects of stopping down objective lens and of changing filter

temperature. The slope of the straight-line portion depends on the center wavelength of the band-pass of light being received (curve A). Here a light filter with center wavelength in the visible spectrum was used in place of the infrared filter. Actually, the phototransistor current is not proportional to input light intensity so that the

slope of the calibration curve is off by a few percent from that which would be expected from Wien's Law. For the particular phototransistor used, at ambient temperature of about 70 F, the output current varies as the 1.1 power of the input light intensity.

The chief advantages of the pyrometer system are its nearly

complete freedom from sensitivity to shock and vibration, and its compactness. It is also relatively inexpensive to build. Its accuracy is fair, having a calibration reproducibility of about ± 10 C under ordinary laboratory conditions.

The chief disadvantage is that the response of the phototransistor varies with ambient temperature. Since both the slope and threshold abscissa of the calibration curve are affected by changes in ambient temperature, the pyrometer must be calibrated under conditions identical to that in which it is to be used. This is not always a convenient procedure for field use.

A second version of the pyrometer in which the electro-optical response of the phototransistor has been stabilized by photofeedback overcomes this disadvantage. The photofeedback is accomplished by flush mounting a subminiature tungsten-filament lamp on the window of the phototransistor. The complete circuit is given in Fig. 5. Here the phototransistor becomes part of a direct coupled common emitter cascade. Base bias for the phototransistor is supplied by the d-c component of the light from the feedback lamp. The lamp is biased at a steady 12 ma current so as to have linear transducer response.

The static transducer characteristic of the feedback lamp is given in Fig. 6A. The dynamic transducer response of the lamp at a fixed bias current of 12 ma is shown in Fig. 6B. Over most of the audio range the lamp response falls off

FIG. 5—In feedback configuration, a light bulb is flush mounted on window of phototransistor

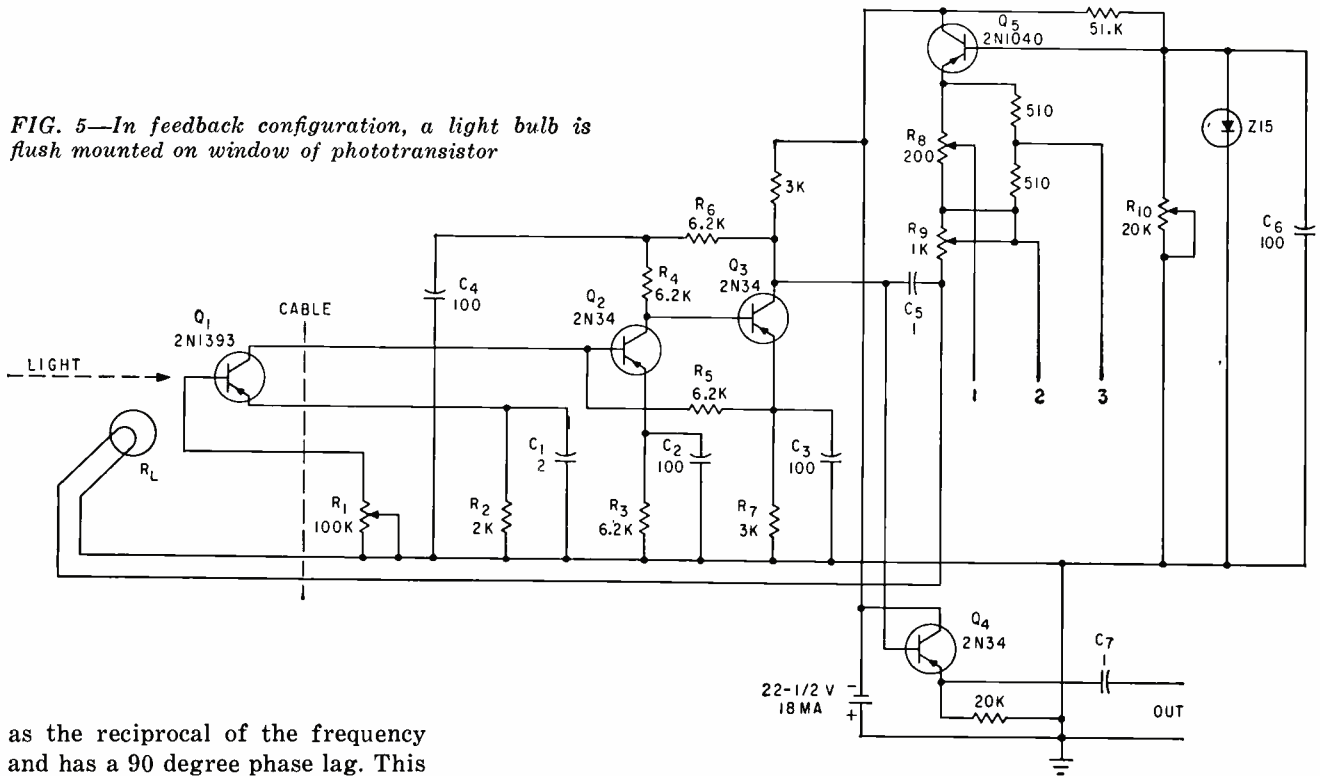

as the reciprocal of the frequency and has a 90 degree phase lag. This behavior is to be expected from elementary thermodynamic considerations. The energy equation for small perturbations in the temperature of a (lumped-parameter) light filament is

$$\frac{V_o}{R_o} \Delta V = AC_v \frac{\Delta T}{\Delta t} + BT_o^3 \Delta T \quad (1)$$

where ΔV is applied signal voltage, R_o is lamp resistance at bias voltage V_o , ΔT is temperature change of the filament, C_v is heat capacity, t is time, A and B are constants.

Equation 1 states that of the heat energy supplied to the filament by the signal current, a part raises the filament temperature while the rest is radiated away. At a large enough bias temperature, T_o , conductive

and convective heat losses may be ignored. The heat capacity term behaves like a reactance and at high enough frequency dominates the equation, producing the observed response:

$$\frac{\Delta T}{\Delta V} = \frac{V_o}{j2\pi f AC_v R_o} \quad (2)$$

$$\text{or } f \frac{\Delta I}{\Delta V} = -j \times (\text{constant}) \quad (3)$$

where ΔI is the intensity of the radiated light in the band $\Delta \lambda$ around λ_o . The corner frequency is of the order of 100 cps for the lamp used. At high audio frequencies the lumped-parameter approximation breaks down and the lamp response

begins to fall off faster than $1/f$. The upper corner is near 2200 cps, as may be seen in Fig. 6B. There is only a slight deviation from $1/f$ response up to 10 kc, however.

Both the static and dynamic lamp response are important. A steady 12 ma bias current is supplied to the lamp by a current regulator transistor Q_5 (Fig. 5). The current setting may be varied to allow for battery aging by adjusting R_{10} . The Zener diode across R_{10} protects the lamp from burnout when batteries are replaced. The maximum permissible current may be set by adjusting R_o .

Lamp current may be checked at

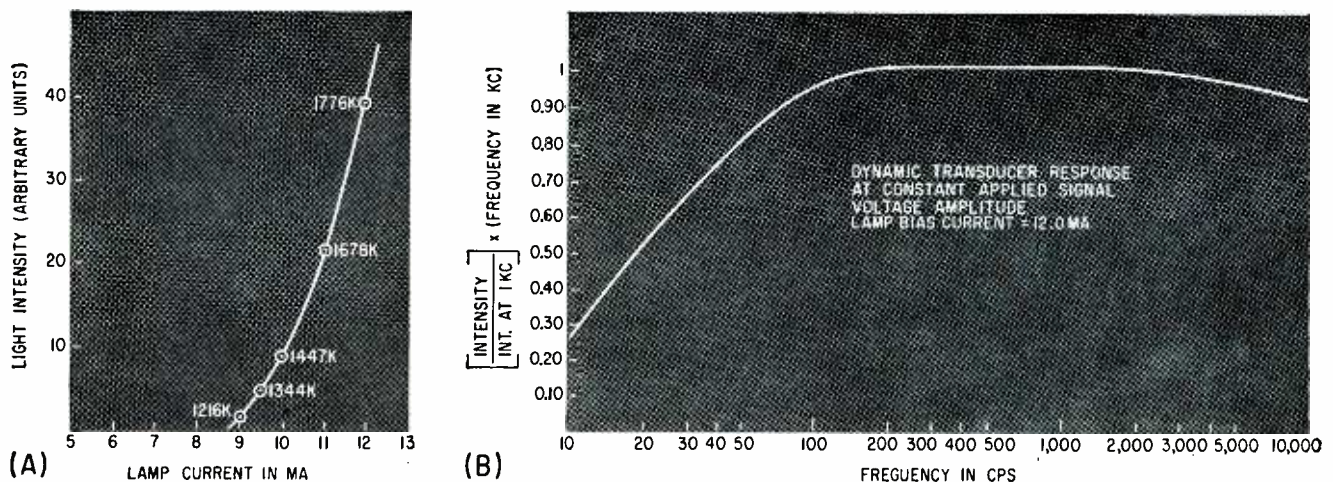

FIG. 6—Static (A) and dynamic (B) transducer characteristics of Pinlite 15-15. Curve in (B) is obtained by disconnecting C_5 in Fig. 5 and driving the feedback lamp from external oscillator

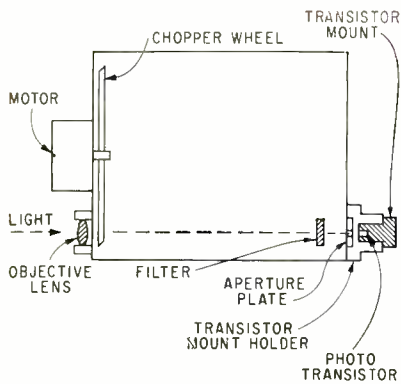

FIG. 7—Feedback version has photo-transistor mounted at rear of box

any time by inserting a potentiometer at terminal 1 and 2. The lamp current is standardized by a portable potentiometer that uses a mercury cell as reference. Aging of the mercury cell may be calibrated out by adjusting R_1 . To counter-act phase shift and sloping frequency response of the lamp, coupling capacitor C_1 is used. This gives good compensation up to about 1.7 Kc without excessive attenuation of the feedback signal. The overall feedback is 28 db at the signal frequency. This is equivalent to a 1 megohm voltage-feedback resistor.

The need for wide-band amplifier response was eliminated by mechanically chopping the light beam into a sine wave rather than the usual square wave. This was accomplished by placing the chopper blades close to the plane of the objective lens and making the lens aperture equal to blade width. The optical system is shown in Fig. 7. A 180-cps chopping frequency places the signal in the passband of the amplifier.

Low-frequency response is heavily damped by an undersized bypass capacitor (C_1 of Fig. 5) to avoid ringing due to transients. Bias current to the first stage is set by adjusting R_1 . The origin of the bias current is the photon input from the lamp itself, which behaves as an infinite impedance source. To secure low output impedance to line with minimum reaction back on the amplifier, an emitter follower stage Q_1 is added at the collector of Q_3 .

The decade amplifier in the original pyrometer was unsuitable for

the photofeedback version, since it did not have enough feedback at low frequencies. The circuit was modified by removing the output transformer and load inductor as shown in Fig. 8. To obtain linear operation of the detector without a step-up transformer, it was necessary to operate at higher supply voltage. A bootstrap emitter follower stage was added as an output buffer to improve the circuit stability.

The photofeedback version of the pyrometer gives greater precision as well as greater calibration stability. The voltage calibration of the feedback version is reproducible to better than 1 percent resulting in a temperature reproducibility of better than ± 1 C at 1,000 K and ± 4 C at 2,000 K. Precision could be improved further by redesigning for a greater amount of feedback, although the stability of the feedback lamp characteristics may impose a practical limit. The threshold temperature is about 840 K (as compared with 725 K for the nonfeedback version).

The most important advantage of the feedback pyrometer is that after an initial absolute calibration using a standard black body,

it does not need to be optically calibrated again. This makes it useful as a field instrument. Another advantage is that the feedback improves the linearity of the photo-transistor response. The photofeedback principle described here should be useful for photometric devices in general.

Compared to the feedback version, the nonfeedback pyrometer works at higher chopping frequency, has somewhat better threshold sensitivity and dynamic range, and is less affected by microphonic pickup in severe vibration environments. Refinements in the photofeedback circuit, however, may neutralize these differences.

Both instruments are currently being used in rocket tunnel experiments at the APL hypersonic research facility.

The author acknowledges the help of T. Kahn who aided in the mechanical design. This work was supported by the Bureau of Naval Weapons, Department of the Navy, under Contract NOrd 7386.

REFERENCES

- (1) S. A. Elder, A Completely Transistorized Recording Pyrometer, Delivered at the Fourth Symposium on Temperature—Its Measurement in Science and Industry, Mar. 28, 1961. To be published in the Symposium Proceedings.

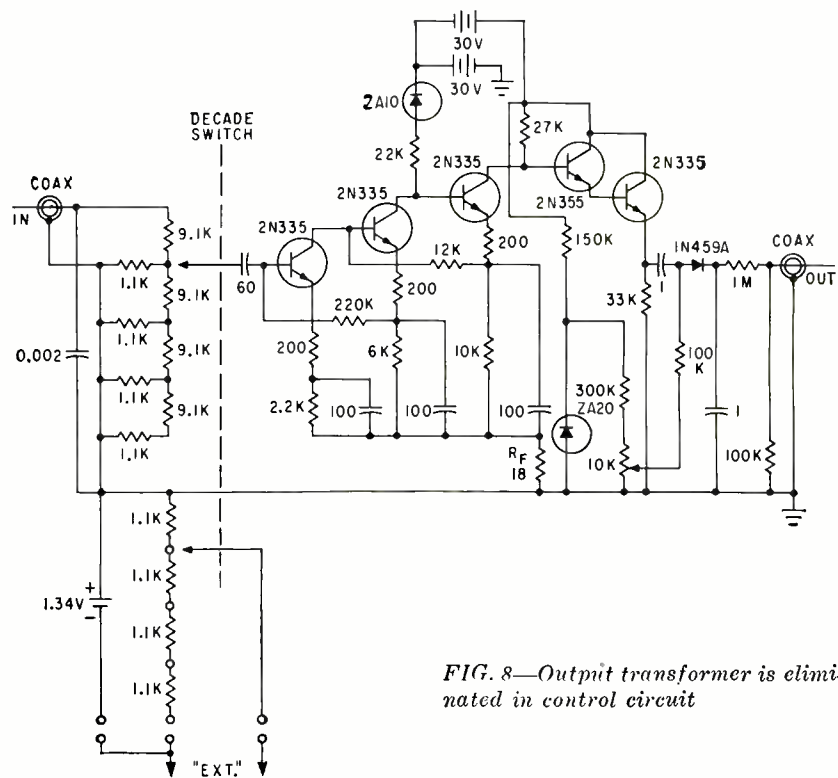
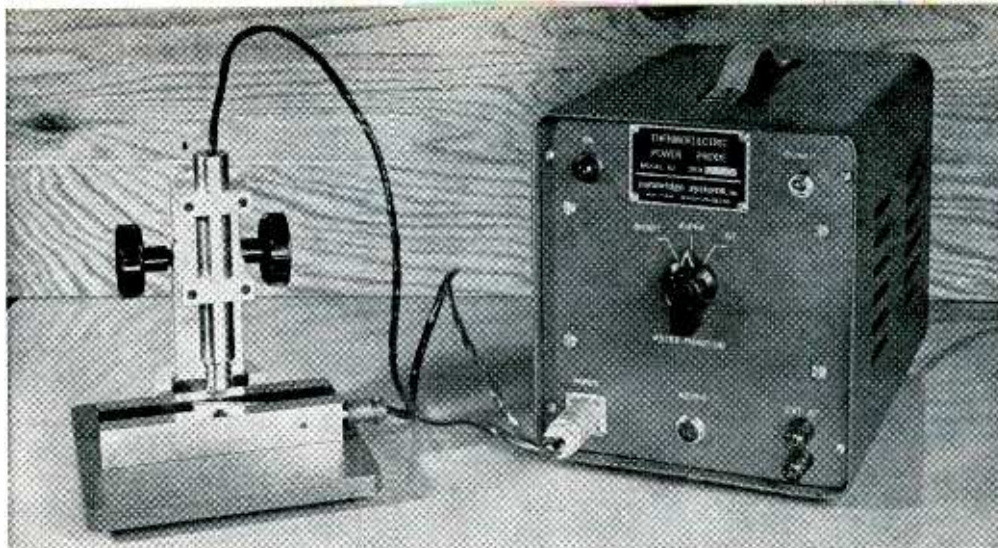

FIG. 8—Output transformer is eliminated in control circuit



Point of the heated vertical probe is applied to the sample between lower clamps. Control on right monitors probe temperature through thermistors, also feeds thermoelectric voltage to an external differential meter that indicates junction polarity

Hot Probe Measures Semiconductor Thermoelectric Power

Temperature-stabilized probe determines the thermoelectric power of semiconductor samples without sample preparation or shaping. Permits point measurement of Seebeck coefficient

By NEIL BOBSON,
Cambridge Systems Inc.,
Waltham, Mass.

THE RECENT rapid growth in semiconductors for thermoelectric energy conversion requires the basic semiconductor materials to be speedily available for production use, and available in uniform and known quality. Since thermoelectric power alone (Seebeck effect) may vary from -300 microvolts per degree C to $+300$ microvolts per degree C within a single semiconductor crystal, rapid nondestructive testing methods must be available to sort out which sections of a given semiconductor sample can be used.

Semiconductors for thermoelectric applications, have three quan-

ties of interest: electrical conductivity, thermal conductivity and thermoelectric power. These three combine to give the figure of merit for the whole semiconductor, which is a measure of its usefulness as a thermoelectric material. Electrical conductivity is measured by the two and four-probe techniques^{1,2} that permit rapid, nondestructive resistivity measurement without requiring special sample preparation or shaping.

The thermal conductivity, while equally important in the determination of the figure of merit, is the quantity least likely to be variable. Presently, several programs are developing a probe technique for measuring thermal diffusivity—a factor that is related to thermal conductivity through the specific

heat. Though this measurement has been shown to be practical, development work is still required.

The widely varying thermoelectric power coefficient on the other hand, should be measured to give a sample's thermoelectric power profile, which, coupled with the resistivity profile, indicates those portions of the sample deserving close examination. Such profiles allow selection of the more interesting sections of an ingot for detailed experiment and also provide homogeneity data on crystal growth techniques. To fill this profile need, a probe measuring-scheme has been devised to measure the thermoelectric power of a semiconductor without preliminary sample preparation.

When a hot probe is placed on

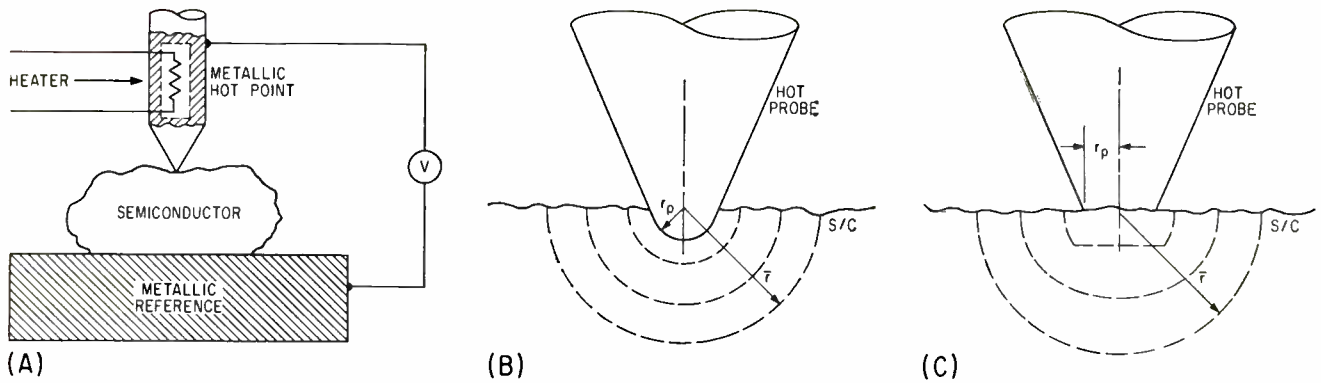

FIG. 1—Complete system (A). Hemispherical probe (B) produces hemispherical isothermal surfaces while temperature distribution of flat probe (C) assumes hemispherical shape several radii from the surface

the surface of a thermoelectric semiconductor a voltage is generated between the hot probe and some cooler reference point in an undisturbed region of the semiconductor. Since polarity of the voltage changes sign with a change from *p* to *n* conductivity, a thermoelectric probe has often been used to detect *p-n* junctions. If in addition the temperature of the probe is known and the magnitude of the thermoelectric voltage is measured, a semiconductor's Seebeck coefficient can be determined directly. Since sample preparation is not usually required, that is, no cutting or soldering of leads is necessary, a hot probe can be used for the rapid evaluation of thermoelectric semiconductors.

The experimental situation is illustrated in Fig. 1, with the specimen on a metallic reference electrode at temperature T_c . The hot probe at a temperature T_h is placed on an arbitrary point of the sample and the thermoelectrically generated voltage measured between reference and hot electrodes. It is assumed that the thermoelectric power generated by the reference and hot electrodes, as well as by the leads connected to the voltmeter, is negligible compared with the thermoelectric power of the semiconductor specimen.

The Seebeck coefficient or thermoelectric power α is defined by

$$\nabla\phi = -\alpha\Delta T \quad (1)$$

where ϕ and T are the voltage and temperature, respectively. In this simplified analysis, it will be assumed that α is isotropic, independent of temperature and independent of position. Thermal conductivity K , is likewise assumed to be

isotropic, temperature and space independent. These assumptions are restrictive and seldom realized in practice, however, the analysis carried out on this basis can lead to useful results.

The Seebeck coefficient is defined under open-circuited conditions. Consequently, the density of heat sources in the uniform bulk semiconductor with no currents flowing must be zero. This condition leads to a differential equation for the temperature distribution

$$\nabla^2 T = 0 \quad (2)$$

Equation 1, in view of the uniform α approximation, indicates that the voltage distribution is governed by the same differential equation

$$\nabla^2\phi = 0 \quad (3)$$

The metallic electrodes can be chosen so that their electrical and thermal conductivity is far greater than that of the conductor being measured to ensure identical thermal and electrical equipotentials where the electrodes contact the semiconductor. Boundaries of the specimen not enclosed by the electrodes are electrically open-circuited. Since the thermal conductivity of still air (0.00023 watts per deg C-cm-sec) is two or three orders of magnitude less than the thermal conductivity of thermoelectric semiconductors, the electrically open-circuited boundaries can be regarded as being also thermally open-circuited. Heat flow across the open surfaces could be further reduced by immersing the sample in some low thermal-conductivity medium or possibly vacuum, but this technique would destroy some of the device's facility. Even in a still-air medium, it is a valid ap-

proximation to consider the open surfaces as being completely open-circuited—both electrically and thermally. Consequently, the voltage and temperature distributions are governed by identical differential equations and identical boundary conditions.

Integrating the temperature gradient along an arbitrary path between the electrodes

$$\Delta T = \int_{T_c}^{T_h} \nabla T \cdot dl = T_h - T_c \quad (4)$$

Performing a similar integration for the E field

$$\begin{aligned} \nabla\phi &= \int_{T_c}^{T_h} \nabla\phi \cdot dl \\ &= -\alpha \int_{T_c}^{T_h} \nabla T \cdot dl \\ &= -\alpha(T_h - T_c) \end{aligned} \quad (5)$$

Therefore, the thermoelectric power is

$$\alpha = -\frac{\Delta\phi}{\Delta T} \quad (6)$$

Equation 6 demonstrates that within the limitations imposed by the assumed boundary conditions and the assumed semiconductor uniformity, the thermoelectric power is the quotient of the thermoelectrically generated voltage divided by temperature drop. This result is unaffected by electrode or sample geometry.

This conclusion is the result of some drastic over-simplifications.

The effect of temperature variations of α and K can be minimized by keeping the temperature drop ($T_h - T_c$) as small as possible. This dictates voltage-measuring equipment with a high sensitivity. It is also assumed that the semiconductor being measured is isotropic. A thermoelectric power

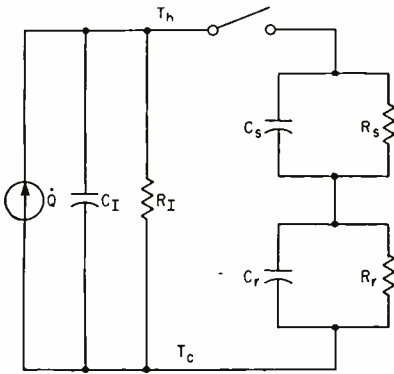

FIG. 2—Equivalent thermal circuit of hot-probe measuring technique

measurement by a hot probe on an anisotropic semiconductor would be difficult to interpret. Generally, anisotropy causes circulating currents, and additional information must be known about the thermal and electrical conductivity tensors before making conclusions about the thermoelectric power tensor. Consequently, a hot probe cannot be used to evaluate an anisotropic semiconductor. The effect of possible spatial variations of α and K can be minimized by the choice of probe geometries and dimensions.

Consider the two following probe geometries that make contact to the semiinfinite semiconductor: a hemispherical and a plane circular contact. With the hemispherical point, Fig. 1A, the temperature distribution in the semiconductor is

$$T = \frac{r_p}{r} (T_h - T_c) + T_c \quad (7)$$

where r_p is the radius of the point. The isothermal surfaces indicated by the dotted lines, of the geometry indicated in Fig. 1C are oblate spheroids, but at distances a few radii into the bulk, the isotherms become spherical and similar to those indicated by Fig. 1B. Equation 7 demonstrates that with these small point geometries the major temperature drop occurs in a small volume immediately under the point. The magnitude of the thermoelectrically generated voltage then is governed predominantly by the thermoelectric power of the semiconductor near the hot probe. This property allows α and K to be assumed spatially constant, because the point dimensions are small enough for variations in α and K over the volume being measured to be negligible. Furthermore, with

specimens of suspected grading, the hot point can be used to probe and measure the variation of α .

The size of the hot point is important. Aside from resolution there are other considerations that limit the magnitude of r_p . Large r_p 's are limited by temperature-regulation requirements. In using a hot probe, it is desirable to maintain the temperature drop ($T_h - T_c$) constant. The thermal loading produced in measuring applications can be demonstrated by the equivalent thermal circuit in Fig. 2. Here, ϕ is the heat flux supplied to the hot point, which has a thermal resistance and capacitance R_I and C_I respectively. C_r and R_r are the thermal capacitance and resistance of the reference block. In practice, C_r is large. C_s and R_s refer to the sample being measured.

The switch is closed when the hot point is applied to the specimen, and open when the hot point is removed. Although ϕ is regulated to maintain a constant ($T_h - T_c$), the instantaneous temperature will not vary with opening and closing of the switch if R_s is much greater than R_r . Analog R_I is governed by the surface area of the entire hot-probe assembly and the thermal conductivity of still air; R_s can be computed exactly for the two types of contacts.

$$R_s = \frac{1}{2\pi r_p K} \quad (\text{Hemispherical contact})$$

$$R_s = \frac{1}{4r_p K} \quad (\text{Plane-circular contact})$$

If a hot-probe-assembly length of 10 cm is convenient, then r_p must be chosen at least three orders of magnitude smaller to compensate for the lesser thermal conductivity of still air. Consequently, an r_p of 10^{-2} cm or less would result in an R_s greater than R_I .

For reasons of thermal loading, r_p 's much less than 10^{-2} cm would be advantageous. Vanishingly small points, however, are not desirable since surface properties rather than bulk properties would then be measured. Semiconductor surfaces may be covered by oxide layers or inversion layers arising from surface states. The thickness of an oxide layer is a variable factor but inversion layers are of the order of several Debye lengths thick—about 10^{-6} to 10^{-5} cm in most semiconductors. If the bulk rather than sur-

face properties are desired, the point should be made large enough so that a major portion of the temperature drop occurs in the bulk.

Thermoelectric power is measured by a three-element instrument. It includes a temperature-regulated hot probe and reference block assembly; also required is a mechanical fixture for positioning the sample and for applying the hot probe to the sample in uniform fashion. A sensitive high-impedance d-c voltmeter is needed to measure the generated emf, and this meter should preferably be of the differential type and calibrated in microvolts per degree C.

The photograph shows the instrument system. An electronic proportional controller maintains the hot probe at a fixed temperature above the ambient or reference. A 20 degree C temperature difference is adequate. The error signal for the proportional controller is developed from bridge-connected thermistors located in the probe and reference block. The probe and reference block are also equipped with differentially connected thermocouples to provide exact monitoring of the temperature difference. The probe and reference block are made of nickel-plated copper for maximum thermal stability and minimum sample contamination.

A d-c voltmeter indicates alpha (α) when the probe is depressed onto the sample. A differential meter identifies the junction polarity and eliminates continuous switching of meter leads. A switch connects the d-c meter to the thermocouples and permits the temperature differential to be monitored without an expensive potentiometer.

This information has been condensed from reports prepared by the Energy Conversion Laboratory of the Massachusetts Institute of Technology under sponsorship of the Electronics Research Directorate of the Air Force Cambridge Research Center, Air Research and Development Command, under contract number AF 19(604)-4153. Although the instruments were initially designed and developed at MIT under Air Force sponsorship this does not constitute an approval for use by either MIT or the Air Force.

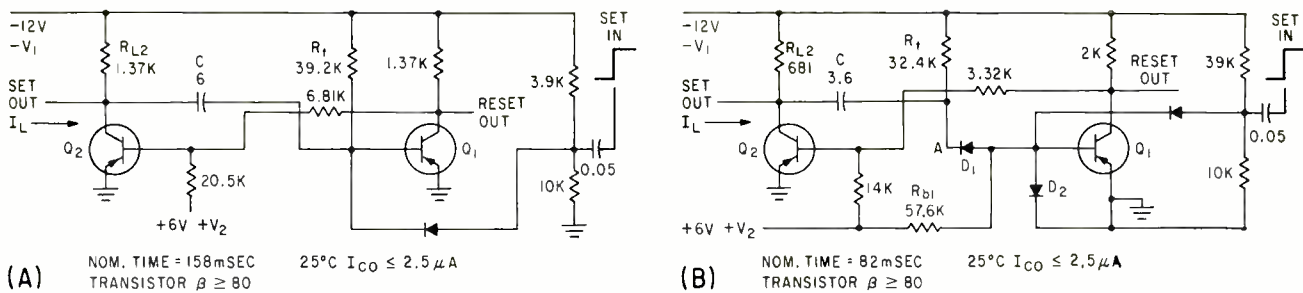

FIG. 1—Conventional monostable multivibrator (A) compared with isolating-diode type (B)

Monostable Multivibrators

GENERATING accurate delays in the 1 to 300-millisecond range with transistor monostable multivibrators is easy under laboratory conditions but difficult in production runs. Bulky capacitors and large timing resistors are the two major difficulties. Large stable capacitors are expensive, while large timing resistors accentuate the variable effects of transistor I_{co} . To design a monostable that will maintain timing within 5 percent with changes in temperature, supply voltage and component variation requires consideration of all timing parameters.

Two circuits will be analyzed. Although these circuits were analyzed with germanium transistors, the analysis holds true with silicon transistors.

The circuit shown in Fig. 1A is the common monostable and its operation is similar to the vacuum-tube type.¹ The difference is that during the timing interval, capacitor C discharges into the base of Q_1 due to I_{co} in addition to the usual path through R_1 . Large errors may result if this parameter is not considered.

Circuit operation of the isolating monostable, shown in Fig. 1B is not as obvious. Diode D_1 is added² to reduce timing variation caused by the variable I_{co} of Q_1 .² Diode D_1 disconnects C from Q_1 during t_1 of the timing period and Fig. 2 shows typical waveforms.

The reverse leakage of D_1 can be neglected if a good quality silicon diode is chosen. During time t_1 , Q_1 is off and I_{co} is supplied by base resistor R_{b1} and bias supply V_2 . Diode D_2 clamps the base of Q_1 , maintaining the uniform base-emitter voltage required to realize the benefits of isolating diode D_1 . Time t_1 ends when the voltage at point A equals the forward drop of D_2 . At this point, D_1 begins conducting. From this time until the monostable resets to its quiescent state (time t_2), the capacitor C discharge depends on the I_{co} of Q_1 , R_{b1} , R_1 , V_1 and V_2 .

Before capacitor C and timing resistor R_1 are chosen to produce the time delay, the designer must satisfy the requirements of the external circuits. Usually it is good practice to derate components and chose nominal values so that the circuit will operate with any combination of tolerances expected. This worst-case design technique is described elsewhere.³

A graphical method may also be used.⁴ In either case, the design procedure will end with R_1 specified to fall below a maximum value. It is desirable to use a resistance near this maximum so that the capacitor size (and cost) may be reduced. Capacitor C and resistor R_1 combination may be chosen to give the desired timing using the following equations. The effects of parameters varying may also be calculated from these equations.

The monostable shown in Fig. 1A uses the following timing equation

$$T = R_1 C \log_e \frac{I_{co1} R_1 + 2V_1 - V_s - R_{L2} (I_L + I_{co2}) - V_{BEon}}{V_1 + I_{co1} R_1 - V_B}$$

where C = timing capacitor, I_{co1} = I_{co} of Q_1 , I_{co2} = I_{co} of Q_2 , V_s = collector saturation voltage of Q_2 , V_{BEon} = base-emitter voltage at the quiescent state of Q_1 , V_n = base-emitter cutoff voltage of Q_1 , V_1 = negative supply voltage, R_1 = timing resistor, R_{L2} = collector resistor of Q_2 and I_L = current into R_{L2} , quiescent state, observe sign on current. Magnitudes are used on all terms except I_L .

The monostable shown in Fig. 1B has the following equations. The time period must be calculated in two steps. Figure 2 shows t_1 and t_2 .

$$t_1 = R_1 C \log_e \frac{I_{co1} R_1 + 2V_1 - V_s - R_{L2} (I_L + I_{co2}) - V_{D1} - V_{BEon}}{V_{D2} + I_{co1} R_1 + V_1}$$

definitions same as previous equation plus V_{D1} = diode drop of D_1 quiescent state, V_{D2} = diode drop of D_2 during t_1 , V_2 = positive supply voltage and I_{co1} = I_{co} of D_1 . Use magnitudes on all terms except I_L .

$$t_2 = R_{eq} C \log_e \frac{I_{co1} R_{eq} + V_{eq} + V_{D2} - V_s}{I_{co1} R_{eq} + V_{eq} - V_{D2} - V_B}$$

where $R_{eq} = (R_1 R_{b1}) / (R_1 + R_{b1})$ and $V_{eq} = [R_1 (V_2 - V_{D1} - R_{b1} I_{co1} - R_{b1} V_1)] / (R_{b1} + R_1)$ and the total period is $t_1 + t_2$.

A number of observations may be made from these equations to give further insight into circuit operation. For the circuit of Fig. 1A, the term $I_{co1} R_1$ appears in both numerator and denominator of the log term. By using typical values of components and supply voltages shown in Fig. 1A, and calculating the time period with no I_{co1} and then with

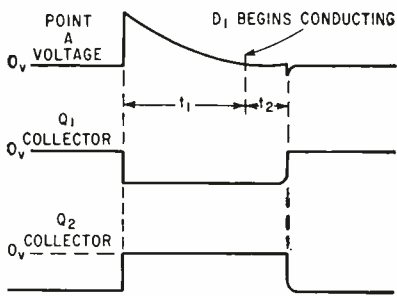

FIG. 2—Timing waveforms of isolating diode type monostable time delay

Maintaining accuracy in production-run transistor monostables often presents problems. Analysis of factors affecting timing shows how to alleviate them

By D. E. HASELWOOD,
Engineer, A. C. Nielson Co., Chicago, Illinois

With Stable Delay Times

$80 \mu\text{A } I_{co}$, the timing decreases approximately 16 percent. Varying supply voltage V_1 produces less than 1-percent timing change. These two points are typical of this monostable.

For the circuit of Fig. 1B, the equations are more complex. The major variation with change in I_{co1} comes from the second part of the time period, t_2 . During this tailout time, transistor Q_1 is connected to capacitor C via diode D_1 , therefore I_{co} does affect the time period. Using the typical values shown in the circuit, this effect has been reduced slightly more than 2:1. The interplay of R_1 and R_{b1} is important. As it is desirable to keep the tailout period small, R_1 must be small and R_{b1} large, but R_{b1} cannot be increased above the point at which insufficient I_{co} is supplied to Q_1 . Diode D_2 with a low forward drop makes t_2 occur at a later time thus reducing the variable tailout period. Since period t_3 depends on V_1 and V_2 in addition to the resistors and diodes, timing is also dependent on the supply voltages.

Using typical values from Fig. 1B, a 10-percent supply voltage change nets about 1 percent timing change. The worst case is when one supply voltage increases while the other decreases. This monostable is dependent on many variables but the major cause of timing change (I_{co1}) has been greatly reduced, even in the worst case.

Calculated and measured data were found to agree within $\frac{1}{2}$ percent when accurate values were used in the equations. Values for diode and transistor drops can be estimated from data sheets with sufficient accuracy. To obtain good agreement, I_{co1} should be measured in the setup. For design it is more useful to calculate the maximum timing change with variable I_{co} by using the maximum expected value. Two minor assumptions were made in the derivations; the period of time required to turn a transistor on and off is negligible when considering delays in the order of milliseconds, and the I_{co} of Q_1 is the reverse bias current of the transistor.⁵

To realize accurate timing from a monostable, its use in a circuit must be considered. To maintain less than 2-percent timing jitter, a recovery time of

$4R_{L2}C$ must be allowed before the next trigger pulse is applied. Cascading two monostable in series will overcome this problem in critical cases. Driving other circuits from the set output of either type monostable should be avoided. Noise pickup on a lead connected to this point may trigger the monostable. A variable load (I_L) will directly vary the time period. Still another difficulty can be the slow fall of the set output waveform when working into logic gates. This is caused by capacitor C recharging through R_{L2} . Another point which should not be overlooked is the power supply as good regulation and low ripple are requisite. Fluctuations will feed through R_{L2} and the capacitor to the base of Q_1 , causing instability or false triggering; 50 mv of this noise can cause trouble.

Equipment containing both types of monostables have been constructed. Over 350 monostables, assembled and tested on a production basis, proved the analysis. A simple production procedure was devised to adjust for the initial tolerance of the capacitors. Incoming capacitors were measured in a test monostable circuit. Standard 1-percent resistors were switched into the R_1 position. The resistor value that gave the nearest to desired timing was marked on the capacitor for later assembly. A digital time interval counter measured the time interval. With no other selections or adjustments, 99 percent of the monostables were within ± 2.5 percent from nominal. A large portion of this may be attributed to two chances for R_1 to be off from nominal. Temperature tests at 65 C proved the isolating diode circuit to be about 2:1 less sensitive to I_{co} changes than the conventional circuit. Between 2- and 4-percent decrease with temperature was typical with the isolating diode circuit and after four months of service, no signs of drift have been observed.

REFERENCES

- (1) Millman and Taub, "Pulse and Digital Circuits", McGraw-Hill Book Co., New York, p 174, 1956.
- (2) P. E. Harris, Insuring Stability in Time Delay Multi-vibrators, ELECTRONICS, 33, 15, p 73.
- (3) A. I. Pressman, "Design of Transistorized Circuits for Digital Computers", John Rider, 1959.
- (4) S. J. Osler, Graphical Procedure for Transistor Circuit Design, Electronic Design, p 40, Feb 15, 1961.
- (5) R. F. Shea, "Transistor Circuit Engineering", Wiley and Son, p 308, 1957.

Solenoids for Traveling-Wave Tubes

Survey of the principal design aspects of electromagnetic systems for microwave tubes and the mechanical techniques of cooling microwave tube solenoids

THE INCREASE in use of traveling-wave tubes and high-powered klystrons has created a demand for focusing solenoids for these tubes. Previously it was enough for the focusing solenoids to meet electrical and magnetic considerations, but packaging of electronic systems has produced additional demands with regard to the mechanical aspects, heating problems, environmental conditions and weight.

The electromagnet solenoid provides a magnetic field of sufficient intensity and length to control the path of the electron stream inside the tube. This magnetic field must be within a given intensity range; it must be uniform, of maximum length in the space allotted, and be homogeneous, that is, have a minimum of magnetic fields perpendicular to the main field. The more usual type of tube requires a constant magnetic field throughout its length. A constant field is generally identified as an unchanging plateau that the magnetic field achieves between dropoff points at each end. This is shown on a typical solenoid chart in Fig. 1A.

A variable magnetic field may be desired and is specified in field intensity at critical locations along the length of the solenoid as shown in Fig. 1B. The variable field can be obtained by varying either the number of turns in each section or the current in each section. These field changes are generally not abrupt and the pattern has been to provide the strongest field for a relatively short distance at one end. Concentration of power at one end creates a heat dissipation problem in this area, which can be handled either by using more wafers for more cooling area or by using copper wafers for these sections to reduce the power needed.

Field length of a solenoid between dropoff points is not only a func-

tion of the physical length of the unit but also depends on the internal diameter of the solenoid. As a rule of thumb, the dropoff at each end begins at a point $1\frac{1}{2}$ times the opening of the end pole pieces, see Fig. 1C. If the id of the coils is appreciably larger than the pole piece opening, then there may also be a dropoff of intensity towards the center. See Fig. 1D.

It is possible to make the end dropoff more abrupt by additional turns immediately adjacent to the end plate thereby increasing the field at this point, see Fig. 1E. The effect of too large an increase of turns in this area is to overshoot the field level beyond the normal

solenoid level. Also important are the additional losses created, which must be considered in the cooling design of the solenoid.

The magnetic field is also affected by the construction of the twt or klystron. The tubes are built with magnetic pole pieces matching the solenoid end plate holes so that the magnetic field is continued without interruption. If there is an air gap between the solenoid pole piece and tube pole piece, then the magnetic field will be altered. The tube cables or wave guides also affect the magnetic field when these are brought directly through the solenoid, (see Fig. 2). To allow room for entrances, the wafer coils are notched or holes drilled through the wafers. In most cases the effect of the cut-outs on the magnetic field cannot be detected by normal magnetic tests but may be picked up during tube operation. The openings are necessary on one side only but to minimize the magnetic-field effect, a matching notch or hole is made directly on the opposite side. This balances the transverse fields created and cross fields are nullified at the center of the solenoid.

For accurate tube focusing, solenoid cross fields must be minimum. Cross fields are created by eccentricities in the winding, variation of physical location of each turn, variations in mechanical parts, magnetic characteristics and, to some degree, heating of the windings.

The oldest method of solenoid construction uses a metal bobbin wound with the number of turns of wire to provide the desired field strength through the center hole of the bobbin. Until recently, insulated copper magnet wire was used exclusively but many designs have now been converted to aluminum. With care in winding and precision of metal parts, a uniform field can

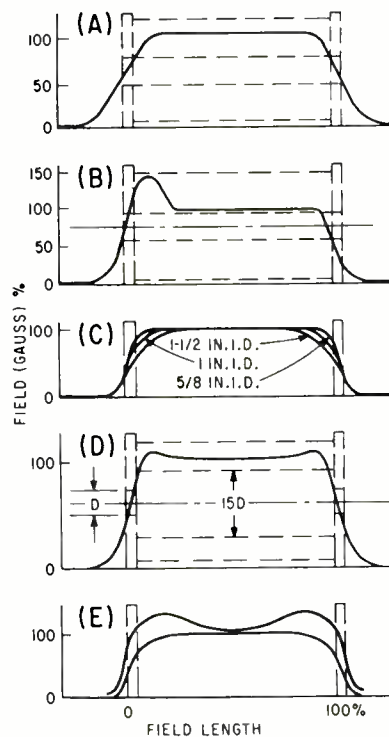

FIG. 1—Typical curve of a constant magnetic field (A); curve showing a patterned magnetic field (B); effect of the opening diameter in end plate (C); the effect of a large variation between coil i-d and end-plate i-d (D); effect of additional turns on end wafers (E)

and Klystrons

By ALBERT ZACK

Tungsten and Transformer Division,
Sylvania Electric Products Inc.,
Ipswich, Mass.

be obtained. The inherent drawback to wirewound units is inefficient heat transfer through the windings, which limits the power that can be handled or makes the unit large. To overcome the heat transfer drawback, the wafer-coil technique¹ is used for most twt and klystron solenoids.

Ocasionally the edge-wound foil technique² is considered because it is then possible to have the od at the same temperature as the id, providing a method for dissipating the heat by air flow or heat sinks around the od. The major drawbacks are the difficulty of production and the space factor of insulation between turns. This technique is limited to high current and low voltage and has not been developed for production.

The wafer technique provides versatility to match different power supplies available. Most wafer windings use laminated plastic and foil, either aluminum or copper. This technique has proven to be the most reliable and simplest to control. Occasionally units are constructed with anodized foil to eliminate the plastic insulation; drawback to anodized foil is its fragility during winding. Providing strength requires heavy layers of anodic film, and the space factor then is no improvement over plastic films. The temperature range of anodized foil is not helpful because the solenoid power increase due to higher operating temperatures is less acceptable than the increase in size necessary for reduced operating temperatures. Another drawback to higher operating temperatures is the adverse effect on twt and klystron tubes that are limited in temperature range. As tube operating temperatures are increased, higher operating temperatures for the solenoid become important. Work now being carried out on high-tem-

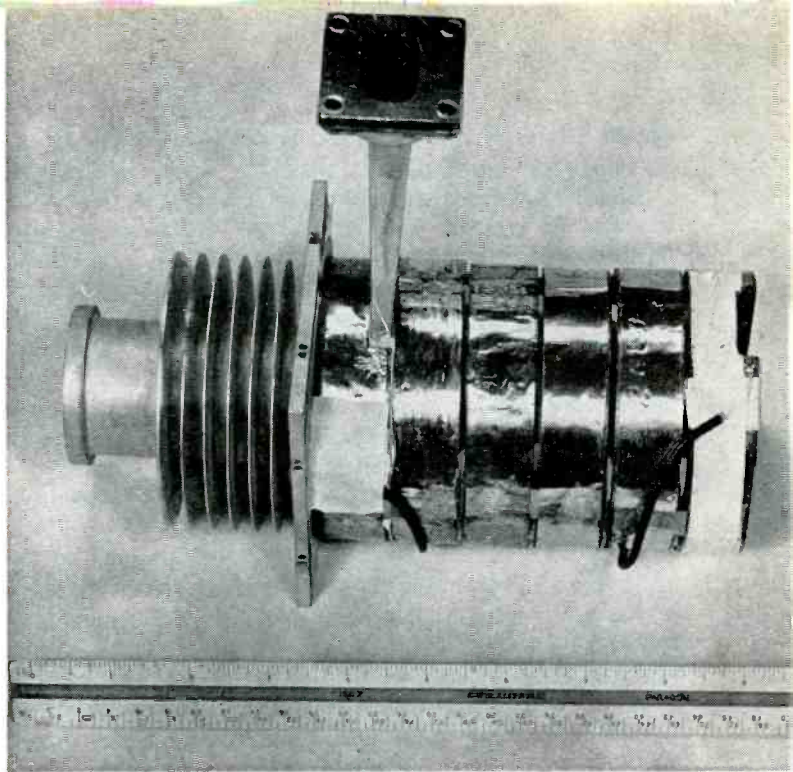
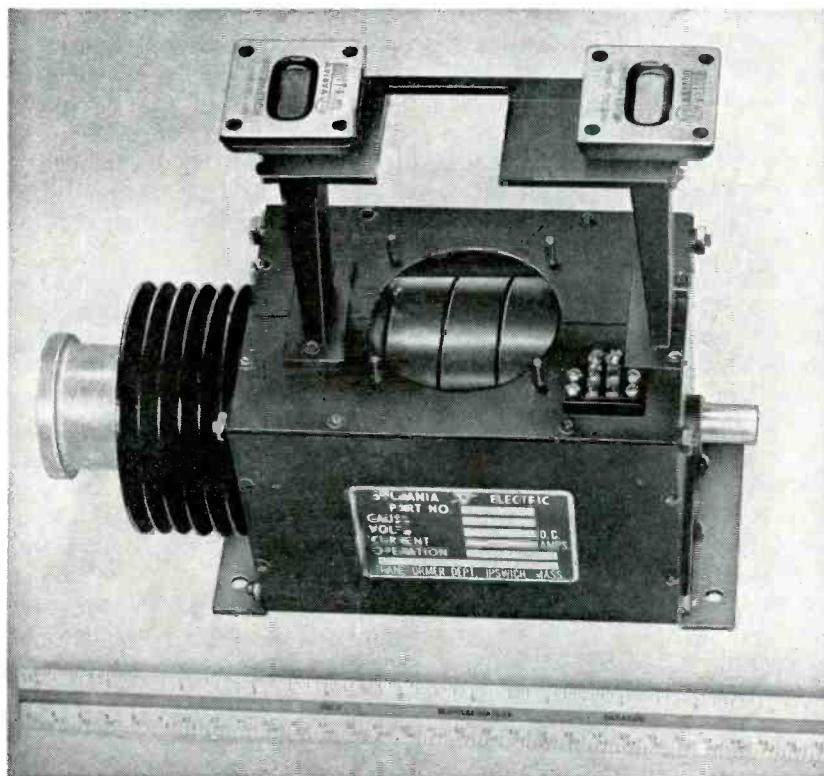

FIG. 2—Focusing solenoid with waveguides as an integral part of the assembly, shown without cover (above) and with cover, (below)



perature insulations³ up to 600 C should provide the insulations for these developments of the future.

Besides the advantage of improved heat transfer, another wafer coil detail helpful for solenoid work is that slots or openings can be machined for cables or other interferences; see Fig. 2. Thus the magnetic field can remain continuous

and still allow room for the tube construction details.

Where patterned fields are required, the wafer method provides an effective way of using copper in critical areas to minimize power losses and still use aluminum in noncritical low-power areas.

Because the construction of wafer coils is so compact with each turn

sealed internally, they can be used in immersed liquid-cooled designs.

All solenoid designs center around the cooling system. Cooling is by natural convection, forced air flow, liquid immersion with forced liquid flow, water-cooled heat sinks, or a combination. Unless other requirements override, such as limited power consumption, the goal is the smallest and lightest solenoid to produce the field required with a minimum of power and cooling.

The cooling method may be dictated by the availability of a type of cooling. For instance in many klystrons, water or liquid cooling is needed for tube operation; thus most klystron solenoids use liquid or water cooling. In airborne systems where air flow is available the designs are built around this method.

Where weight is a controlling factor, aluminum foil is generally used, the penalty being extra power consumption. As a rule, for a given size the weight of an aluminum design will be approximately half of the equivalent copper design. The power dissipation of aluminum will be about $1\frac{1}{2}$ times that of copper foil; however, if the metal parts are a large percentage of the overall weight, the coil weight savings of aluminum may be reduced. Then copper foil may be preferable because of smaller overall size. Cost is proportional to the weight of the solenoid.

In wirewound solenoids whose length is large compared to the buildup of wire layers, it is possible to force air over the od and maintain reasonable operating temperatures. In some wire designs where the layer buildup is large, additional cooling is provided by liquid cooling on the id. However, all wire designs are limited in the amount of power they can dissipate.

Wafer designs use two basic methods of air cooling—air passage over or through cooling fins placed between wafers, see Figs. 3A and 3B, and air passage through spaces between wafer coils, see Fig. 3C. Each method has advantages. Where air flow is over the od the air duct tie-in is simplified and the configuration follows the overall solenoid pattern. This type requires metal cooling plates between wafers. In spaced wafer designs, a transverse air flow is used; this

cools efficiently and has less metal parts. A disadvantage is more difficulty in packaging the wafers particularly for vibration and shock.

Air-cooled wafer designs effectively dissipate as much as 5 watts per square inch of wafer coil cooling surface. Designs are generally tailored to particular air systems with regard to maximum pressure drop across the solenoid for the amount of air available. In cooling fin designs, the amount of air space between the coil od and case id plus restrictions due to fin configuration generally determine the air pressure drop. Where a large amount of fin cooling area is required, the air pressure drop is controlled by the cooling fin design. In spaced wafer designs, the pressure drop is controlled by the air space between wafers, although the air entrance pattern is a factor.

Most air-cooled solenoid designs operate at 1 to 2 in. of pressure drop across the solenoid package, although back pressures up to 4 in. may be encountered. Back pressures beyond this are difficult to obtain, particularly if the air supply is provided by self-contained blowers. Low back pressures require an excessive amount of air space.

Solenoid designs using air cooling for sea-level operations will necessarily be less effective at high altitudes because of the change in air density. If adequate air flow is available at the high altitude, this method of cooling is satisfactory. Where individual blowers are used, the designs are aimed at the highest altitude rating where the blower is least effective.

Various types of blowers have been used to obtain air flow for cooling. Brush type motors are generally avoided because of possible noise effect on tube operation; capacitor start or inductive type motors have worked satisfactorily. Both 60-cps and 400-cps blowers are used, with 60-cps types limited by their size. The most effective types readily available are three-phase 400-cps vane axial blowers that perform well with reasonable back pressures, and are suitable for either longitudinal or transverse air flow. Propeller blowers are occasionally used for longitudinal air flow. Propeller types have poor back pressure characteristics but are cheaper.

For transverse air flow, the squirrel-cage or centrifugal type of blower is suitable. For long solenoids the dual type centrifugal blower provides a better distribution of air.

Design of cooling fins is correlated with the air flow characteristics of the blower system. The simplest types are aluminum or copper foil cut into a pattern. See Fig. 3A. Where the cooling requirement is severe, fins are designed as shown in Fig. 3B. Fins are placed between wafers to conduct the heat to the od of the wafer where the air flow pattern is established. The problems of heat exchangers are involved in cooling of solenoids: to transfer a given amount of heat from the coils to the air. The controlling factor is generally the coil temperature, which is kept to an average of 360 F or less. Temperature is monitored by measurement of the start voltage and stabilized voltage at a constant current, see Fig. 4.

The distinction between water cooling and liquid cooling is that in water-cooled designs, the wafer coils are physically isolated from the coolant, whereas in liquid-cooled designs, the coils are immersed in the coolant. Water-cooled designs may be operated with other coolants in preference to water, assuming equivalent heat transfer, but in liquid-cooled designs, the designed coolant must be used to be sure that the coil insulations are compatible.

A conventional method of water cooling is shown in Fig. 5. The cooling fins are placed between wafers and tubing is soldered to the od of the fin. The tubing around each cooling fin is connected in series creating a water-flow pattern to keep the od of the fin cool. The inlet and outlet tubing positions can be positioned wherever needed. The limitation of this cooling method is the temperature drop from the id to the od of the cooling fin which can become excessive if the coil buildup is large. Space is needed on the od for the water tubing increasing unit size. To counteract the temperature drop, thicker plates are needed but this has a limited effect. One solution is to spiral tubing, Fig. 6A, from id to od. This is limited to single or double wafer designs of only two cooling fins or where the spacing will not affect the

magnetic field. Another solution is special cooling fins as shown in Fig. 6B. Here two metal plates are fastened together with spacers to allow a sheet of water to flow, thus providing a heat sink for the entire face of the wafers. This method can handle heat densities of the order of 15 watts per square inch.

For immersed liquid cooled designs, the wafers can be spaced to allow liquid flow pattern as shown in Fig. 6C. Physical blocks prevent any coolant flow around the od, thereby forcing the liquid through the wafer spaces. Also effective are cooling fins that bring the heat to the outside thereby allowing the liquid flow to pass only over the od of the wafer. This method is less effective in cooling but has the advantage of a solid winding assembly for vibration or shock. Liquid cooling is effective for wafer coils since the coolant is in intimate contact with each turn. The cooling systems, however, are generally closed systems, requiring a second heat exchanger to remove the collected heat and therefore may not always be suitable.

Another method is a combination of cooling fins and water jacket as shown in Fig. 6D. The cooling fins move the heat to the od or id, where physical contact is made to a water jacket which is cooled by liquid flow. This method minimizes the increased dimension requirement for cooling without physically immersing the wafers.

Most solenoid designs are based on constant-current systems where variation in resistance due to heating of the wafers is reflected in voltage increase. The magnetic field in these designs is constant over the entire range of environmental conditions, assuming the current controls can handle the changes in resistance. This is the preferred method of tube operation. The disadvantage is that a current regulator is needed that is capable of handling the required currents. The range in solenoid designs uses current from 0.5 amp to over 100 amp with voltages ranging from 500 V to 10 V. The majority of designs range between 2 and 20 amp.

Where current regulators cannot be incorporated, the electrical design depends on the cooling characteristics and has to stabilize for

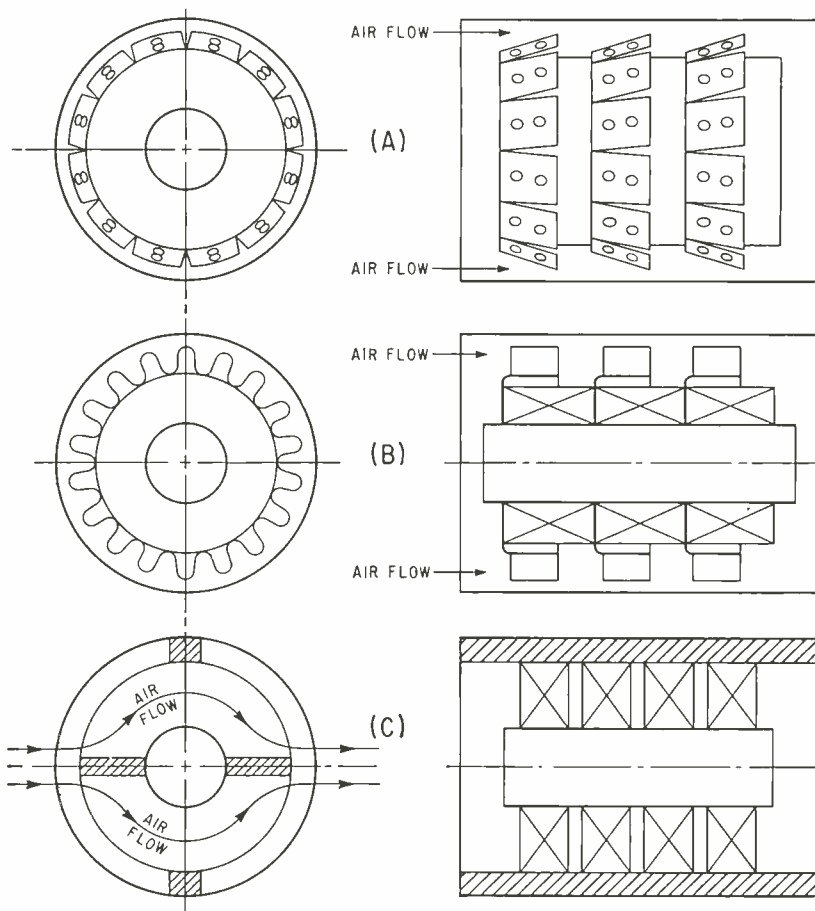

FIG. 3—Folded-tab cooling fin design (A); extended-surface cooling fins (B) spaced-wafer cooling design (C)

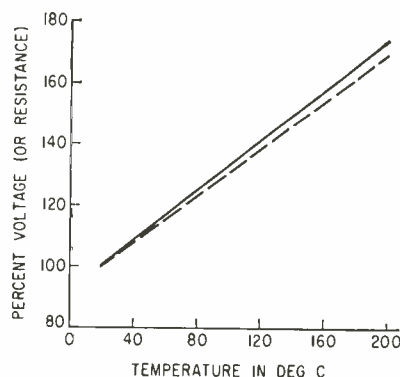
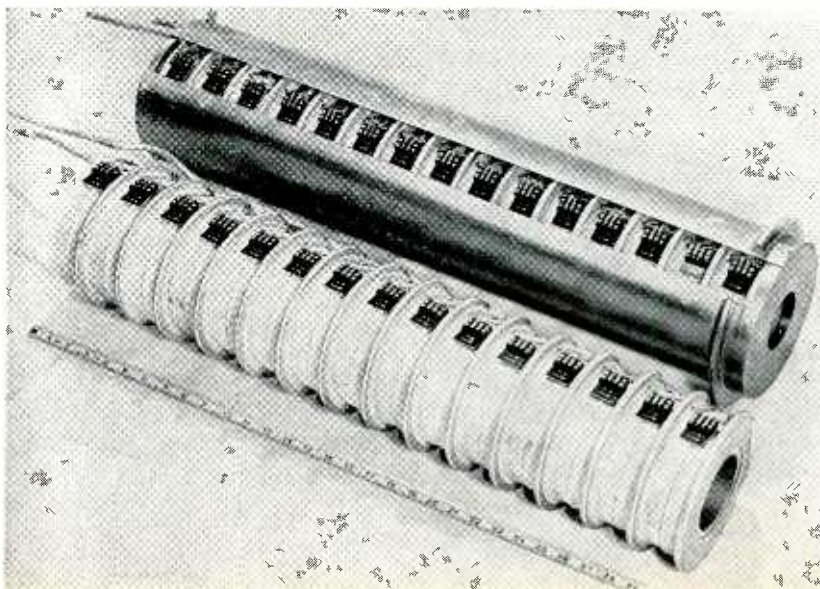

FIG. 4—Voltage increases due to temperature, plotted for aluminum (solid line) and copper (dotted line)

FIG. 5—Water-cooled solenoid using cooling fins between wafers



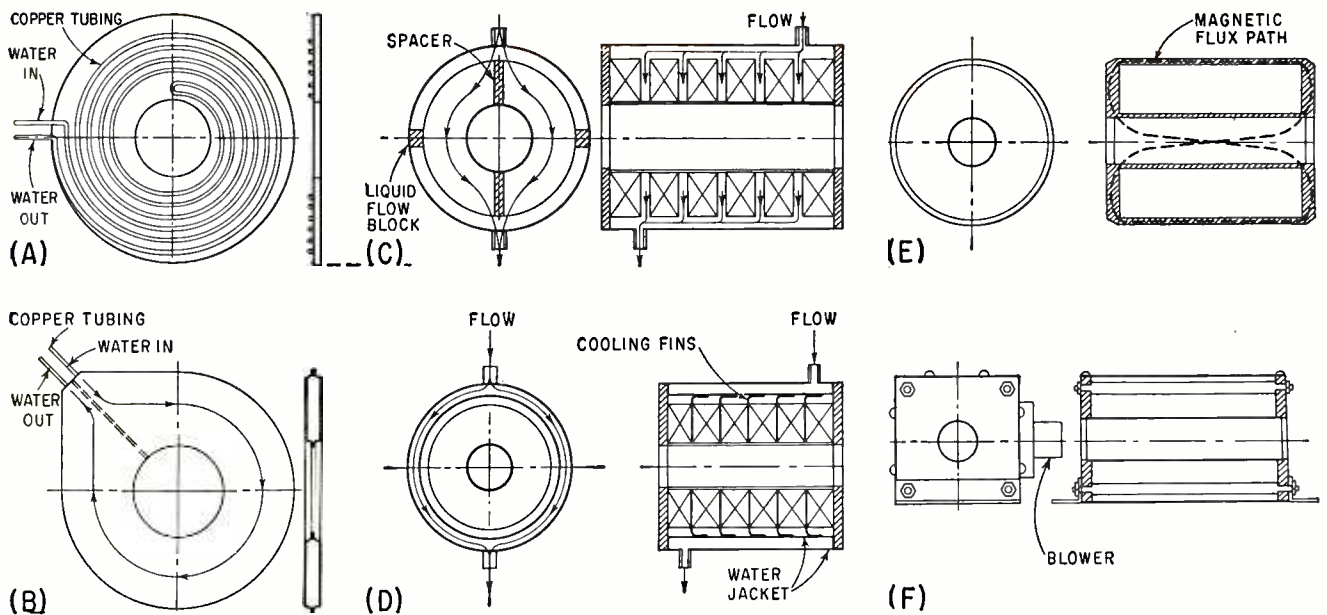

FIG. 6—Cooling fin for wafer coil using spiral tubing soldered to metal plate (A); laminated cooling fin for wafer coil (B); liquid-cooled spaced-wafer design: cooling by intimate contact with wafer sides (C); water-jacket cooling design: cooling by transfer of heat from wafer sides through cooling fin to water jacket (D); round case with case peened over on ends to eliminate screws (E); square case with spacer rods (F)

a minimum magnetic field (lowest current condition) at the worst environmental condition. These designs use a fixed voltage and allow the current to vary from a maximum at start to a minimum at the stabilized condition. Because a current regulator is not used, the fixed voltage system allows a large variation in magnetic field. For example, in a fixed voltage system that allows a variation of plus or minus 10 percent in voltage along with a plus or minus 5 percent resistance tolerance of the solenoid, an increase (or decrease) of 15 percent in current can be encountered. In addition the starting resistance of a solenoid may be up to 60 percent less than its final stabilized resistance. Thus the magnetic field can start at a level 75 percent greater than the nominal field. In certain cases this variation is not critical; in others, the high magnetic field is objectionable because it will reduce the r-f power output.

Present materials for interturn insulation are epoxy coatings or Mylar film. The operating range is approximately 180 C. Although the materials are rated at 150 C, (based on the insulation limit at the maximum temperature), the turn-to-turn voltage is less than 0.1 volt; thus the limiting factor for wafer coils is the melting or carbonizing point of the insulation.

Work is being carried out to de-

velop materials for higher operating temperatures (350 C to 600 C). Some materials for 350 C are relatively heavy (0.0006 in. thickness). Coated foils seem to be more practical.

Although increased temperature range will reduce solenoid size, it also means increased power; therefore, care must be taken to ensure system gain. Another disadvantage to high-temperature coil operation is that the tubes must be subjected to these temperatures. Present tubes will not operate above 150 C; the higher temperatures require forced cooling. New designs in ceramic tubes will undoubtedly increase the temperature range.

The physical size of solenoids requires bulky metal parts to provide mechanical stability. Thus the iron parts are adequate for carrying the flux densities. Occasionally where physical size is extremely limited, the metal parts are smaller and care must be given to saturation.

Although saturation densities are seldom reached, flux leakage can still be a problem because of air gaps at the ends. In certain applications, stray external fields can affect tube operation and must be shielded out.

The magnetic circuit for a solenoid is shown in Fig. 6E. The matching of the magnetic circuit through the tube shunts depends on the air gap allowed. The shunt may

mate with the end plate; or the tube can have an air gap between tube and end plate.

For wafer coils, a metal bobbin design can be used except that one end plate must be left free to allow mounting the individual wafer coils. This end plate is machined to allow a mechanical fit over the core tube. The outside case can be a slip fit over the end plates, or can be made with a shoulder as shown in Fig. 6E. This provides for mechanical peening of the case to the end plate and eliminating screws and adding strength.

Round shapes lend themselves to the use of conventional tubing. One disadvantage is the mounting problem; this is generally handled by providing a matching cradle and then strapping around the od to the cradle. For heavier units, it is possible to weld mounting brackets that can be mounted conventionally. Where blowers are needed, special mounting brackets are needed for round units. Thus square or rectangular units are sometimes preferred. The flat sides allow mounting both of the solenoid and the blower, Fig. 6F.

REFERENCE

- (1) A. Zack, J. Heffernan, Wafer Coil Techniques for Transformers, *Elect Mfg.*, Feb. 1955.
- (2) Edge Wound Coils for Solenoids, *Sylvania Technologist*, Photo Vol. VIII No. 3, July 1955.
- (3) B. L. Sawyer, Electrical Insulation System for 350 C Wafer Coil Transformers, *Electronic Technology*, Feb. 1961.

COMPLETE PRODUCTION

under ONE responsibility

ALSiMAG[®]

METALLIZED CERAMICS

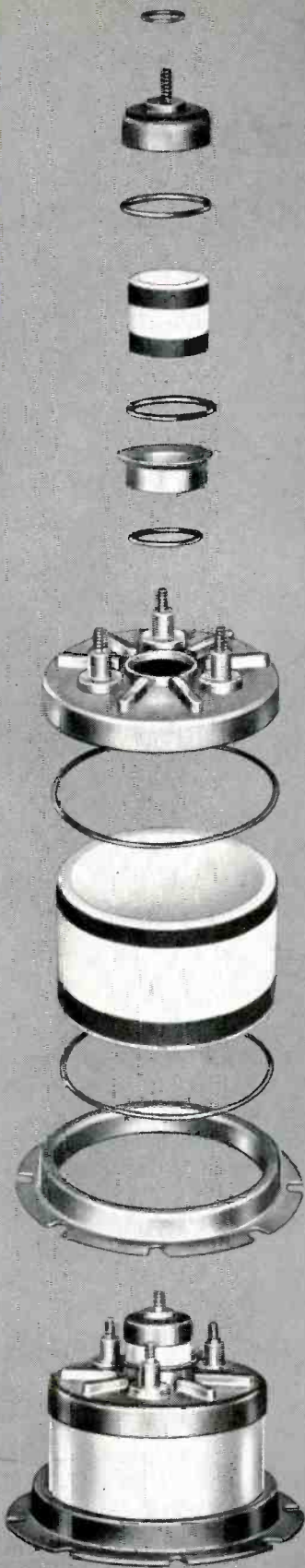

AN integrated source, American Lava Corporation offers you 60 years of experience as custom producers of the widest range of technical ceramics from a single source, plus over 10 years of metallizing experience utilizing the several metallizing processes.

Here you have maximum range of choice in ceramic body selection, in metallize method selection, in metal part composition and configuration, and in facilities for inspection and testing. Centralized responsibility saves time, permits better control of quality.

Bulletin 612 is now available on request.

Bulletin 612 has 16 pages of metallizing details to help you find just the right combination for your application.

Bulletin 613 excerpts 4 pages of stock items in low and high temperature hermetic terminals.

**FREE
ON
REQUEST**



From basic ceramics through various metallizing, plating, brazing and testing procedures in one plant under one responsibility at American Lava.

A subsidiary of
Minnesota Mining and
Manufacturing Company

AMERICAN LAVA CORPORATION

CHATTANOOGA 5, TENN.

60TH YEAR OF CERAMIC LEADERSHIP

For service, contact American Lava representatives in Offices of Minnesota Mining & Manufacturing Co. in these cities (see your local telephone directory): Boston: Newton Center, Mass. • Chicago: Bedford Park, Ill. • Cleveland, Ohio • Dallas, Texas • Los Angeles, Cal. New York: Ridgefield, N. J. • Philadelphia, Pa. • St. Louis, Mo. • St. Paul, Minn. • So. San Francisco, Cal. • Seattle, Wash. Export: Minnesota Mining & Manufacturing Co., International Division, 99 Park Ave., New York, N. Y.

CALCULATING VOLTAGE REQUIREMENTS FOR Power-Supply Transformers

By WILLIAM J. BATES,
Special Products Div.,
Zenith Radio Corp.,
Chicago, Ill.

TRANSFORMER OUTPUT VOLTAGES required to achieve given d-c output voltages can be determined accurately by a simple, rapid method. In a full-wave capacitor-input filter circuit for a d-c power supply, the magnitude of the d-c output voltage, as related to the rms value of the a-c input to the transformer, is a function of four independent variables: capacitance of the input capacitor, C , in farads; powerline frequency, ω , in radians; load resistance, R_L , in ohms; and series resistance, R_s , in ohms.

If the product of $\omega R_L C$ exceeds a certain value, it may be considered a constant, and a system of mathematics may be employed that simplifies computation. Such errors as arise from this approximation are negligible in practical applications owing to the tolerance variation in components.

The plot assumes $\omega R_L C \geq 100$. With the availability of silicon rectifiers and high-capacitance electrolytic capacitors, the product of $\omega R_L C$ can be made ≥ 100 , that is, variations in R_L may be compensated for by C .

The load resistance of the circuit is determined by the voltage and current requirements so it cannot be changed to achieve this end. Also, power-line frequency cannot be changed readily.

The series resistance is the sum of transformer resistance and rectifier forward resistance. With silicon rectifiers, the rectifier forward resistance is usually negligible compared to the transformer resistance. Transformer resistance, determined by the

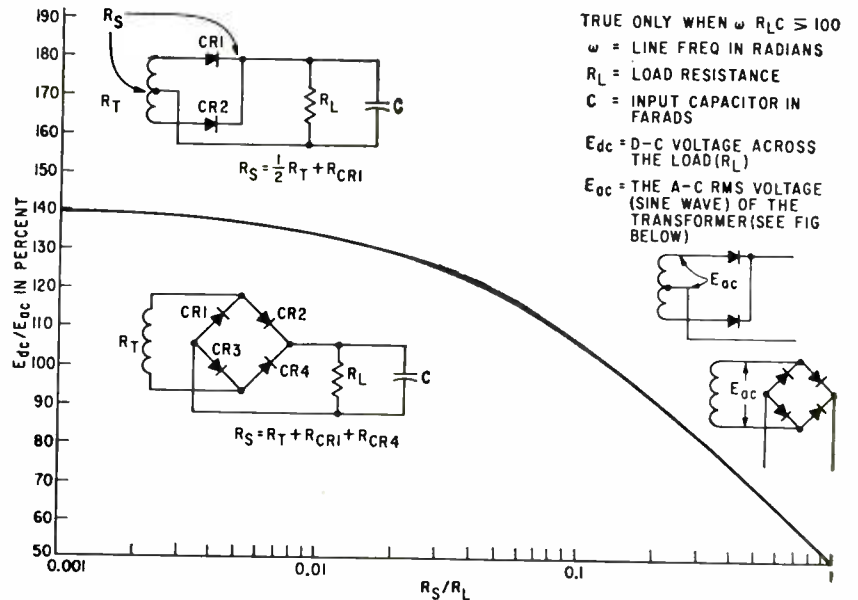

How E_{dc}/E_{ac} varies with R_s/R_L for full-wave rectifiers

turns ratio and wire size, can be predicted accurately if the transformer output current and approximate a-c voltage are given.

With the above information and with the aid of the curve, the a-c output voltage of the transformer can be specified.

Example 1: A 250-v, 50-ma source voltage is required for the unregulated portion of a regulated power supply. It is to be operated from a 60 cps source. Therefore $R_L = 250 / (50 \times 10^{-3}) = 5,000$, $\omega = 2\pi \times 60 = 377$, Minimum $C = 53 \mu\text{F}$ so that $\omega R_L C = 377 \times 5,000 \times 53 \times 10^{-6} = 100$. Experience predicts a series resistance of 40 to 80 ohms. This means R_s/R_L will vary between 0.008 and 0.06. The E_{dc}/E_{ac} ratio will vary between 1.35 and 1.31, which means that the rms transformer voltage required will be between 185 and 191 v rms. This is about 2 percent accuracy — a typical

transformer tolerance. Therefore, the center value of 188 volts would be chosen.

Example 2: Given a rectifier filter circuit with a series resistance (R_s) of 100 ohms, an output voltage of 250v at 50 ma, and with $\omega R_L C \geq 100$, what is the percent of regulation if the load is reduced to 25 ma?

$$R_{L1} = \frac{250}{(50 \times 10^{-3})} = 5,000 \text{ ohms}$$

$$R_{L2} = \frac{250}{(25 \times 10^{-3})} = 10,000 \text{ ohms}$$

The R_s/R_L ratio would vary between 0.02 and 0.01. On the curve, E_{dc}/E_{ac} will vary between 1.29 and 1.34. If transformer voltage is 188v, the d-c voltage will be $188 \times 1.34 = 251.9$ or $188 \times 1.29 = 242.5$. The regulation would be 3.7 percent with the 50 percent load change.

BIBLIOGRAPHY

O. H. Schade, *Proc IRE*, 31, p. 341, 1943.

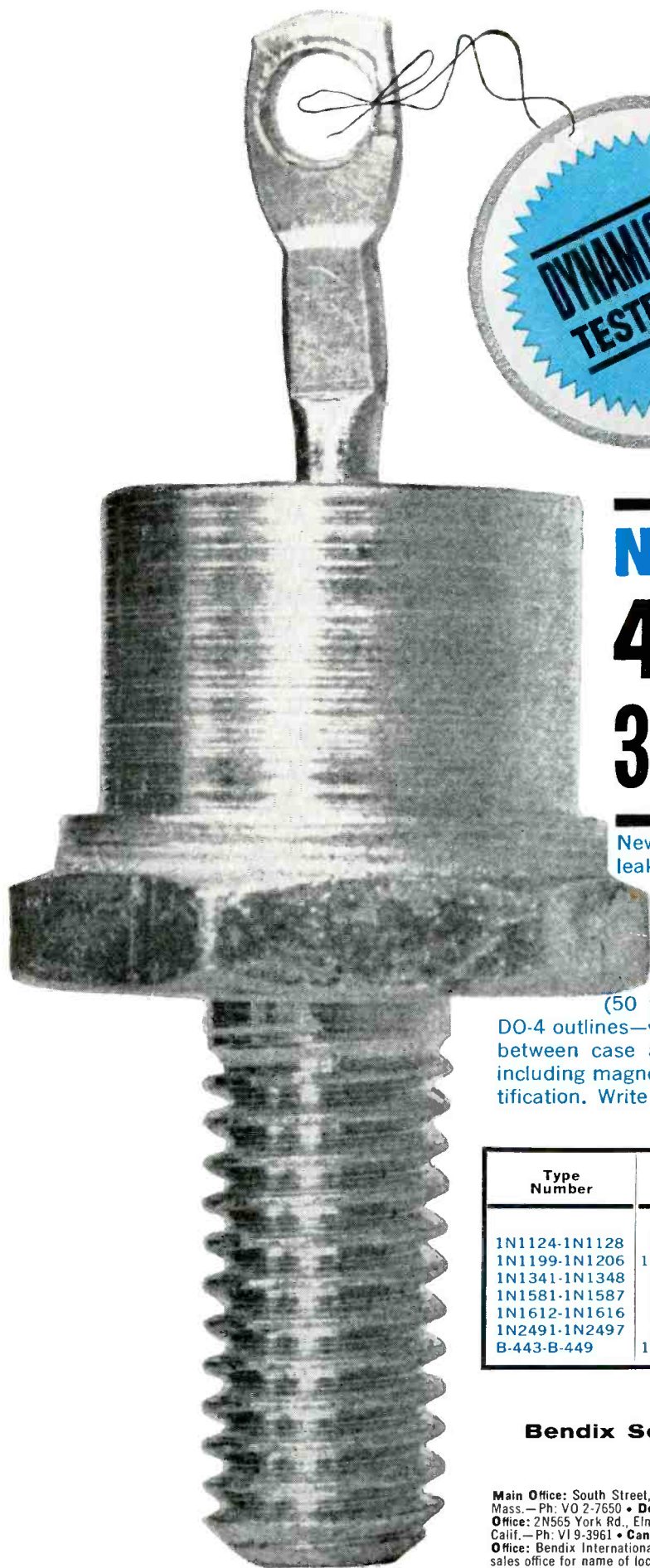

NEW FROM BENDIX 42 RECTIFIERS 3-6-12 AMP SERIES

New Bendix silicon rectifiers offer lower current leakage for greater circuit stability—as low as 10 microamps at 600 volts. They're 'Dynamically Tested', an exclusive Bendix quality control process that individually tests each unit to assure uniform reliability. The result: dependable, versatile units that offer a wide range of voltage capabilities (50 to 600 volts PRV). Designs conform to JEDEC DO-4 outlines—with welded case and glass-to-metal hermetic seal between case and anode lead. Ideally suited for applications including magnetic amplifiers, DC blocking units, and power rectification. Write Bendix Semiconductor Division for information.

MAXIMUM RATINGS

Type Number	Forward Current	Peak Reverse Voltage	Reverse Current at PRV		Forward Drop at 25°C
	Adc	Vdc	@150°C	@25°C	Vdc
1N1124-1N1128	3 @ 50°C	200-600	—	10 μAdc	1.1 @ 6 Adc
1N1199-1N1206	12 @ 150°C	50-600	10.0 mA	—	1.25 @ 12 Adc
1N1341-1N1348	6 @ 150°C	50-600	10.0	—	1.15 @ 6 Adc
1N1581-1N1587	3 @ 150°C	50-600	0.5	—	1.5 @ 6 Adc
1N1612-1N1616	5 @ 150°C	50-600	1.0	—	1.5 @ 10 Adc
1N2491-1N2497	6 @ 150°C	50-600	2.0	—	1.1 @ 6 Adc
B-443-B-449	12 @ 150°C	50-600	2.0	—	1.2 @ 12 Adc

Bendix Semiconductor Division

HOLMDEL, N. J.



Main Office: South Street, Holmdel, N. J.—Ph: SH 7-5400 • **New England Office:** 114 Waltham, Lexington, Mass.—Ph: VO 2-7650 • **Detroit Office:** 12950 West 8 Mile Road, Detroit 37, Mich.—Ph: JO 6-1420 • **Midwest Office:** 2N565 York Rd., Elmhurst, Ill.—Ph: BR 9-5050 • **West Coast Office:** 117 E. Providencia Ave., Burbank, Calif.—Ph: VI 9-3961 • **Canadian Affiliate:** Computing Devices of Canada, P.O. Box 508, Ottawa 4, Ont. • **Export Office:** Bendix International, 205 E. 42nd Street, New York 17, N. Y. **Stocking Distributor:** Contact nearest sales office for name of local distributor.

System Displays Satellite Tracks

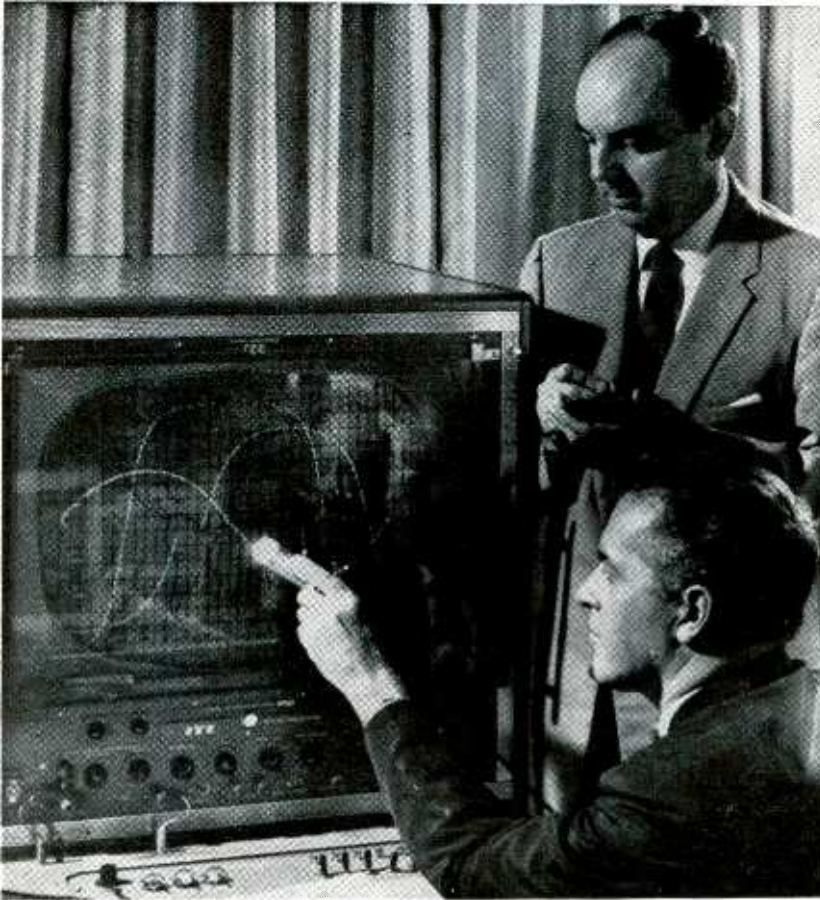

THE FRONT COVER. Final tests of prototype satellite display system are made by F. Slack (seated) and F. Mellow of Air Force Cambridge Research Laboratories

OPERATIONAL model of a display system provides up-to-the-minute positional information about orbiting earth satellites. The system is undergoing final testing at the Spacetrack R & D Facility at Hanscom Field, Mass. After final testing, the unit will be used as an aid in the development of advanced display systems for use in the space detection and tracking system of the North American Air Defense Command.

The prototype was designed at the Air Force Cambridge Research Laboratories at Hanscom. The operational model was constructed by the Pastoriza Electronics Co., Boston.

Satellite tracks are presented visually on the face of a large-screen

crt on which a transparent Mercator's projection overlay of the earth is superimposed. Six satellite tracks can be displayed simultaneously. Real-time satellite positions are shown as intensified spots on their respective tracks.

Satellite information is converted to punched teletype tape and stored in a computer. The data includes identification of a specific satellite, time and longitude of each south-to-north equator crossing, time and longitude of each degree of latitude the satellite will cross and satellite altitude at each degree of latitude.

A console operator can command information about the status of a particular satellite being shown on the screen by directing a light beam at the target of interest. Additional

information stored in the computer, such as satellite identification and altitude, then appears on the screen.

The system is sufficiently flexible to allow time to be moved forward or backward in time for periods up to nine days. This capability is particularly significant when the need exists for determining the position of a communication or surveillance satellite with reference to a specific region of the earth.

Electron Field Emission Depends on Temperature

TEMPERATURE dependence of electron emission from metals in the field emission region has been verified. In a constant field, the incremental increase in current is nearly linear with the square of absolute temperature of the emitter.

The experiments were conducted by the National Bureau of Standards over the temperature range of 4.2 to 400 K with a field emission microscope using tungsten as the emitter. Similar measurements were made with niobium, which is superconducting below 9.2 K.

In the region of thermionic emission, electrons in metals acquire sufficient thermal energy to surmount the potential barrier at the metal surface. Field emission, which can occur near absolute zero, requires a field of about 10^7 volts per cm^2 . Electron emission results from quantum tunneling through an approximately triangular barrier at the metal surface. In the transition region, both types of electron emission can take place.

The temperature range is about 0 to 400 K for field emission, 400 to 800 K for the transition region and above 1,200 K for thermionic emission. Although the thermionic and transition regions have been studied, the effect of temperature in the field emission region had not been experimentally checked with theoretical prediction.

Temperature dependence in the

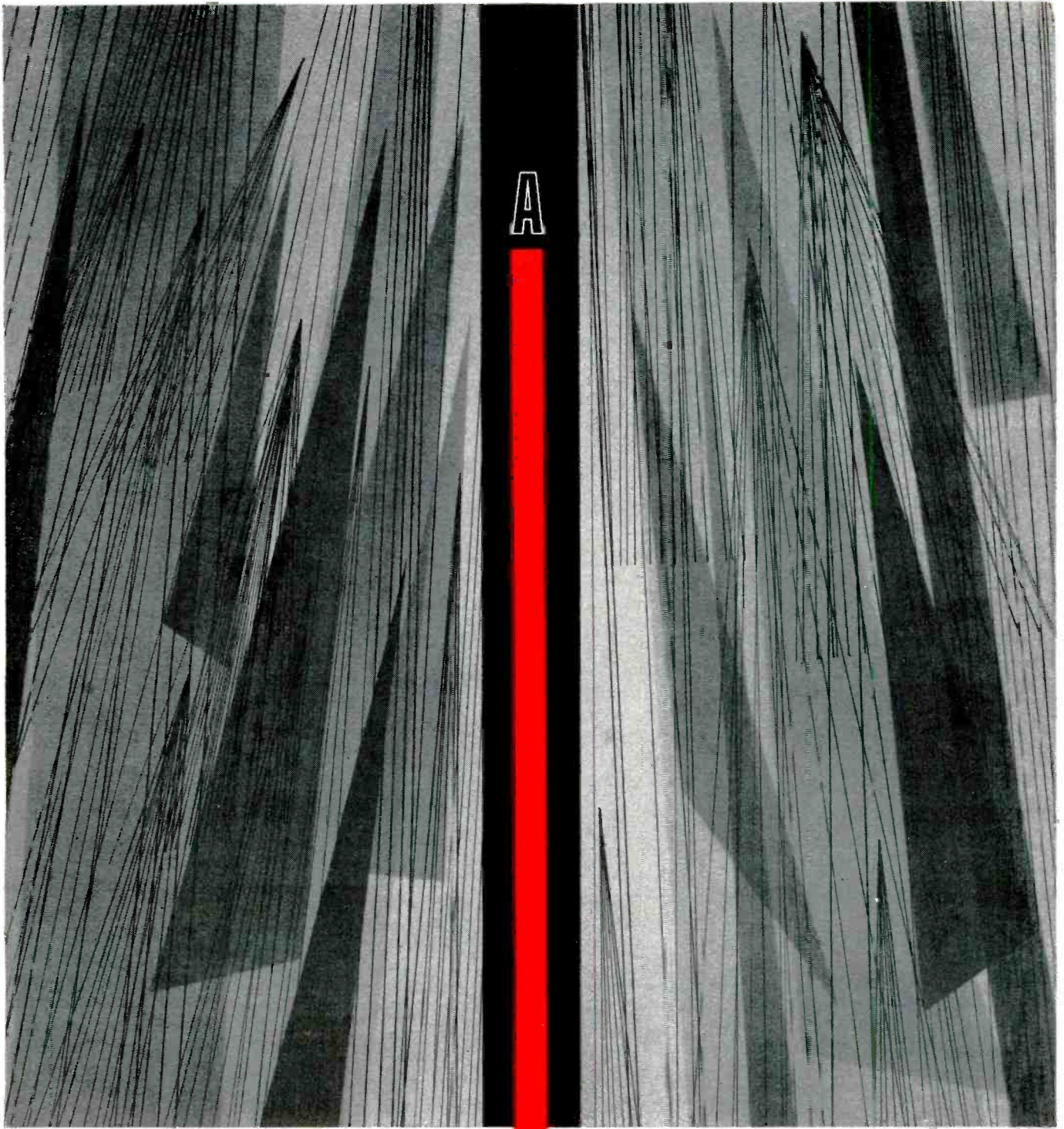

The challenge stirs the imagination and ingenuity of man perhaps more than any other in history. And in the drive to conquer the almost unthinkable infinitude of the heavens, Georgia Tech scientists joined the task early and have kept pace with space technology and developments. Notable achievements have been made in ceramics for rocket nose cones and work is being pressed forward in developing protective coatings for space ships re-entering earth's atmosphere with the speed of a shooting star. Heat-fighting nozzles are being created for uncooled solid propellant rockets. Another project may contribute to a nuclear propulsion system. Georgia

SPACE

Tech scientists have also tackled the job of finding a flexible ceramic for insulating the electrical systems in missiles and aircraft. Few earth materials have been exposed to the strange environment of space. Research at Georgia Tech will tell us which materials will stand the test before they are sent on a journey to the stars. We are proud of Georgia Tech's contributions. GASA will draw heavily on the school's resources in helping make America's space program a success. Your inquiry for information on this resource in research will be held in strict confidence.

S. Ernest Vandiver, Governor, State of Georgia
Executive Offices, State Capitol, Atlanta, Georgia

field emission region was determined using a specially designed field emission tube operated in liquid helium. The emitting tungsten tip was attached to a tantalum loop that served as the thermometer, and resistance was measured by a four-terminal network.

The resistance - temperature curve was determined by calibration at several constant-temperature points. Required temperatures were obtained by heating the loop resistively using an adjustable current source. The field applied to the tungsten emitter at 4.2 K was sufficient for an emission of 2.6×10^{-10} amp. Current flow through the measuring device was nulled and emitter temperature was raised. The current increment, which was as small as 10^{-18} amp at low temperatures, was measured as a function of the temperature. The measurements confirmed the theoretical expectation that the current increment would vary approximately linearly with the square of absolute temperature.

The investigation also showed that field at the emitter surface can be calculated from the slope of the plot of emission current as a function of temperature squared. Field determined in this way was in excellent agreement with that calculated from electron microscope pictures of the emitter. Average field can be determined in-place from the line slope, avoiding the complexities of calculation from irregularly shaped tips.

When the temperature of a niobium emitter is raised from 4.2 K to above 9.2 K, a current increment should arise from the effect of temperature on field emission and also from the elimination of the energy band gap in the superconducting-to-normal transition. This band gap, predicted theoretically, has been demonstrated experimentally in other laboratories with low field tunneling experiments. In the present investigation, calculations for the current increment of the niobium emitter resulting from the superconducting-to-normal transition indicated an easily measurable effect. However the current increment attributable to the transition was absent in the experiments, suggesting either that the emitter surface had not been superconducting even in the absence of the field, or

that superconductivity in high fields can be quenched at the surface.

Crystal Growing Process Makes Silicon Ribbons

THIN RIBBONS of silicon are being produced by a new form of crystal growth that could have a significant affect on the production of semiconductor devices. The near-perfect crystals are uniform in thickness and width.

The process, developed at Bell Laboratories by E. S. Greiner, J. A. Gutowski and W. C. Ellis, was reported at a meeting of the Metallurgical Society of AIME. The ribbons of silicon grown from vapor are so thin that they are semitransparent. Thickness is typically one micron and ranges from 0.1 to 15 microns, and the ribbons are about 0.1 mm wide and 1 to 3 cm long.

In the process, silicon is reacted with iodine and hydrogen, with small amounts of arsenic and nickel, at high temperatures in a closed tube. The ribbons, together with silicon whiskers of a hexagonal cross-section, grow rapidly in the hot tube.

The ribbons contain few or no crystal defects except for a single twin plane (junction of mirror-image crystals) parallel to the ribbon surface. The crystalline perfection makes the ribbons quite strong, and their extreme thinness makes them quite flexible.

The single twin plane existing in all ribbons observed is a central part of a theory developed by R. W. Wagner and R. G. Treuting of Bell Labs that explains some of the main mechanisms of ribbon growth. The twin plane with an apparent growth-poisoning effect of certain impurities causes rapid growth in the length of the ribbon but relatively slow growth in width and thickness.

The nearly perfect surface and the uniform thickness and width suggest the possibility of incorporating the crystal ribbons directly into semiconductor devices with little or no mechanical preparation. However, considerable development would be required before the ribbon process could be used in commercial devices.

LOOK

Constant-voltage transformers and d-c power supplies conveniently available nation-wide.

ALABAMA

Birmingham —
James W. Clary Co.
M-G Electronics & Equipment Co.

ARIZONA

Phoenix —
Midland Specialty Co.

CALIFORNIA

Glendale —
R. V. Weatherford Co.
Los Angeles —
Federated Purchaser, Inc.
Oakland —
Brill Electronics
Elmar Electronics

PALO ALTO

R. V. Weatherford Co.

PASADENA

Electronics Supply Corp.

SAN FRANCISCO

Pacific Wholesale Co.

COLORADO

Denver —
Denver Electronic Supply Co.
Inter-State Radio & Supply Co.
Radio & Electronics Supply Co.
L. B. Walker Radio Co.

CONNECTICUT

Bridgeport —
Sprague Electrical Supplies
Hartford —
Electrical Supplies, Inc.
Waterbury —
Bond Radio Supply

DELAWARE

Wilmington —
Radio Elec. Service Co. of Delaware

DISTRICT OF COLUMBIA

Washington —
Capitol Radio Wholesalers
Electronic Wholesaler, Inc.

FLORIDA

Melbourne —
Electronic Wholesalers, Inc.
Miami —
Electronic Wholesalers, Inc.
Orlando —
Hammond Electronics

PENSACOLA

Grice Electronics

TAMPA

Thurow Electronics

GEORGIA

Atlanta —
Electro Tech Inc.
Specialty Distributing Co., Inc.

ILLINOIS

Chicago —
Allied Radio Corp.
Lukko Electronics
Newark Electronics Corp.
E. H. Sargent & Co.
The Welch Scientific Co.

OAK PARK

Melvin Electronics

PEORIA

Klaus Radio & Electric Co.

INDIANA

Evansville —
Ohio Valley Sound

*the pioneer
in a-c and d-c
regulated power*

thru this nationwide network of distributors

Indianapolis —
Graham Electronics Supply
Radio Distributing Co.
South Bend —
Radio Distributing Co., Inc.
IOWA
Davenport —
TCR Distributors
Des Moines —
Gifford Brown, Inc.
KANSAS
Wichita —
Interstate Electronic Supply Corp.
KENTUCKY
Lexington —
Radio-Electronic Equipment Co., Inc.
Louisville —
P. I. Burks Co., Inc.
LOUISIANA
New Orleans —
Southern Radio Supply Co.
MARYLAND
Baltimore —
Wholesale Radio Parts Co., Inc.
Bethesda —
Empire Electronic Supply Co.
Silver Springs —
Kenyon Electronics Corp., Inc.
MASSACHUSETTS
Boston —
DeMambo Radio Supply Co.
A. W. Mayer Co.
Radio Shack Corp.
Cambridge —
Electrical Supply Corp.
MacAlaster Bicknell Co.
Newton —
Cramer Electronics, Inc.
Springfield —
T. F. Cushing, Inc.
Soundco Electronic Supply Co., Inc.
MICHIGAN
Ann Arbor —
Wedemeyer Electronic Supply Co.
Battle Creek —
Electronic Supply Corp.
Detroit —
Radio Specialties Co., Inc.
Jackson —
Fulton Radio Supply Company
Muskegon —
Western Electronic Supply Co.
MINNESOTA
Minneapolis —
Lew Bonn Co.
Northwest Electronics Corporation
Stark Electronics Supply Co.
St. Paul —
Gopher Electronics Co.
MISSOURI
Joplin —
Four State Radio Supply Co.
Kansas City —
Burststein-Applebee Co.
St. Louis —
Walter Ashe Radio Co.
NEBRASKA
Omaha —
Radio Equipment Co.
NEW JERSEY
Mountainside —
Federated Purchaser, Inc.
NEW MEXICO
Albuquerque —
Radio Specialties Co., Inc.
NEW YORK
Albany —
Ft. Orange Radio Dist. Co., Inc.

Binghamton —
Federal Electronics, Inc.
Buffalo —
Radio Equipment Corp.
Summit Distributors, Inc.
Elmira —
Brady Supply Corp.
Long Island City —
H. L. Dalis, Inc.
Lynbrook L. I. —
Peerless Radio Distributors, Inc.
Mineola L. I. —
Arrow Electronics, Inc.
New York —
Harvey Radio Co., Inc.
Milo Electronics Corp.
Terminal Hudson Electronics, Inc.
Poughkeepsie —
Chief Electronics, Inc.
Rochester —
Requa Electrical Supply Co., Inc.
Rochester Radio Supply
Rome —
Rome Electronics, Inc.
Schenectady —
Electric City Radio Supply
NORTH CAROLINA
Asheville —
Freck Radio Supply Co.
Raleigh —
Southeastern Radio Supply Co., Inc.
Winston-Salem —
Dalton-Hege Radio Supply Co.
NORTH DAKOTA
Fargo —
Bristol Distributing Co.
OHIO
Akron —
Akron Electronic Supply, Inc.
The Sun Radio Co.
Cincinnati —
Herringer Distributing Co.
United Radio Incorporated
Cleveland —
Pioneer Electronic Supply Co.
Radio & Electronic Parts Corp.
Columbus —
Hughes-Peters, Inc.
Dayton —
The John A. Becker Co.
Strepco, Inc.
Lima —
Lima Radio Parts Company
Toledo —
Warren Radio Company
Youngstown —
Ross Radio Co.
OKLAHOMA
Tulsa —
Engineering Supply Company
Radio Inc.
S. & S. Radio Supply
OREGON
Medford —
Verl G. Walker Co.
Portland —
Central Distributors
Lou Johnson Co., Inc.
Stubbs Electric Co.
United Radio Supply, Inc.
PENNSYLVANIA
Erie —
Erie Industrial Electric Supply
Warren Radio, Inc.
Indiana —
Fischer-Scientific Co.
(Instrument Div.)
Philadelphia —
Herbach & Rademan, Inc.

Pittsburgh —
Cameradio Co.
Fisher Scientific Co.
Radio Parts Co., Inc.
State College —
Alvo Electronics Distributors, Inc.
RHODE ISLAND
Providence —
Wm. Dandreta & Co.
SOUTH CAROLINA
Charleston —
Wholesale Radio Supply Co.
TENNESSEE
Kingsport —
Radio Electric Supply Co.
Knoxville —
Roden Electrical Supply Co.
Memphis —
Bluff City Distributing Co.
Nashville —
Electra Distributing Co.
TEXAS
Dallas —
Engineering Supply Co.
Wholesale Electronic Supply of Dallas
El Paso —
Midland Specialty Co.
Houston —
Busacher Electronic Equip. Co., Inc.
Harrison Equipment Co., Inc.
Sterling Electronics, Inc.
UTAH
Salt Lake City —
Standard Supply Co.
VIRGINIA
Charlottesville —
Virginia Radio Supply Company, Inc.

WASHINGTON
Everett —
Pringle Radio Wholesale Co.
Seattle —
Pacific Electronic Sales Co.
Seattle Radio Supply, Inc.
Western Electronics Co.
Spokane —
Northwest Electronics, Inc.
Tacoma —
C & G Electronics Co.
Wible Radio Supply, Inc.
Walla Walla —
Kar Radio & Electric Co.
WEST VIRGINIA
Beckley —
ChemCity Electronic Distributors
Huntington —
West Virginia Electric Supply Co.
WISCONSIN
Madison —
Satterfield Electronics, Inc.
Milwaukee —
Radio Parts Co., Inc.

S-52-61



**DIVISION OF BASIC
PRODUCTS CORPORATION**
SOLA ELECTRIC CO., 1717 Busse Road,
Elk Grove Village, Ill., HEMPSTEAD 9-2800
IN CANADA, Sola Basic Products Ltd.,
377 Evans Ave., Toronto 18, Ontario.

Ferrite Improvements Extend Core Use

By C. J. KUNZ, JR.,
Chief Engineer, Ferroxcube
Corporation Of America,
Saugerties, New York

LARGE QUANTITIES of ferrites are now being used in a variety of applications operating in a frequency range of a few hundred cycles per second to several hundred megacycles per second.

These applications include transformers, filters, delay lines, loading coils, modulation reactors, chokes, accelerators, pulse networks, pulse transformers, amplifiers, oscillators, antenna tuning devices, variable inductors, decoder and encoder discs, recording heads, memory cores, switch cores, tuning slugs, a-c d-c, and d-c d-c converters, high-frequency lighting, and other specialized electronic devices.

The growing popularity of ferrites is attributed to their desirable electrical or magnetic properties and to the ultimate cost of the component utilizing a ferrite core.

Higher Permeabilities

Continuing material advancements are succeeding in extending the frequency range over which metals offer equal or better performance. A few years ago, ferrites with permeabilities from 500 to 700 were the best that could be obtained. Today, permeabilities of ferrites range from 2,700 to 5,000. In the not too distant future, materials are promised with initial permeabilities in the range of 15,000. And it is apparent that we are at the stage where more careful evaluation should be given to ferrites before the core is selected for a particular design.

The use of a non-ferrite core in a magnetic application often results in higher associated core losses. The largest part of this total core loss is caused by eddy current flow in the core itself; in other words, the I^2R loss, where I is the effective value of the eddy current and R is the d-c resistance of the core material.

This eddy current loss becomes

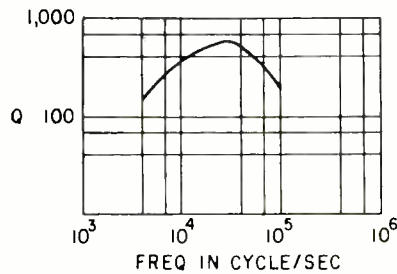

Typical Q curve for a particular pot core configuration

prohibitive as the frequency is increased—and for the non-ferrite materials, a reasonable limit is reached at a relatively low value of frequency. Extension of the useful frequency range can be obtained by laminating the core or by using powdered iron, but still a practical frequency limit is reached far below that required by fast, present day circuits.

In addition to the power losses, eddy currents can produce other undesirable effects. In recording heads, for example, they reduce the effective permeability and flux density in the region of the gap.

The outstanding advantage of ferrite is that it almost entirely eliminates these eddy current problems because its material resistivity is from 10^9 to 10^{11} higher than other present day metal type cores.

Another advantage of ferrite is that its permeability is constant as a function of frequency over a wide frequency range. Some ferrite materials have a relatively constant permeability from a few hundred cycles to several hundred megacycles and this results in a constant flux density, or constant inductance, as a function of frequency.

In most laminated or powdered iron cores, the permeability starts to drop off immediately above several hundred cycles, or a few kilocycles per second. This change in permeability, flux or inductance as a function of frequency is actually related to the eddy current flow in the core.

This eddy current flow gives rise

to an imaginary component of permeability. Although the core is driven with a constant magnetizing force, the magnitude of the real component of the permeability drops off as the imaginary component increases. Iron and steel have high losses at low frequencies and therefore, the real component of the permeability which is of interest, must start to drop off immediately at these low frequencies.

The lower losses of ferrite also give rise to higher Q components. In recording heads, and especially in erase heads, less driving power is required. Ferrites are also extremely well suited to low-power transistor applications.

In analyzing component construction costs, use of one piece of ferrite core assembly results in a considerable cost advantage over laminations. In many cases, there will also be a considerable saving in the size of the component.

Ferrite Applications

In general, there are no restrictions as to ferrite core shapes. Laminated cores are often subject to definite shape restrictions. And laminated matting surfaces, cold worked in the finishing process, can result in the loss of magnetic properties at the surface of the material. This effect is the equivalent of an enlarged inherent air gap in the magnetic path and a consequent reduction in the value of the effective permeability for the core assembly over that of the bulk material.

Certain types of steel are subject to magnetic deterioration as a result of shock, a characteristic not present in ferrite materials.

Considerable savings in wattage, reduction in required power drive and increase in efficiency occurs in the component employing a ferrite core. As the frequencies increase from the higher audio to lower r-f range, the loss reduction is particularly significant.

Special consideration should be given to the wide frequency range over which permeability of the fer-



ELECTROLYTIC CAPACITORS—Reliability is our first ingredient

Actual size 50V (1uf)

The "space saver" of Tantalytic* Capacitors

Because it packs the most uf into the smallest package, the General Electric 62F510 Porous Anode Tantalytic Capacitor frees up valuable circuit space. It's the smallest (.075" x .250"), lightest (15 grams) 85C tantalum capacitor.

Though small, it provides more V-uf than larger units. In fact, it has almost four times greater volumetric efficiency than the smallest solid type.

* Reg. Trade-mark of General Electric Co.

But it offers superior reliability because of these special features:

1. **Non-acid electrolyte.** No free liquids are used. "Gel" electrolyte eliminates acid-attack problems.
2. **Paper spacer** between case and anode prevents impurity migration and scintillation at the anode.
3. **Re-healing capability** contributes to long life in rugged applications includ-

ing high ripple and low impedance. And it's used at full-rated voltage at 85C!

Yet, this G-E unit is lower in price than other tantalum types, and the low price includes insulated sleeving.

Ask your G-E Sales Engineer about the five case sizes rated from 60V (2.5uf) to 6V (325uf). Or write for bulletin GEA-7008 to General Electric Co., Schenectady, N. Y. *Capacitor Dept., Irmo, S. C.*

430-04

Progress Is Our Most Important Product

GENERAL  ELECTRIC

General Electric also offers these reliable Tantalytic capacitors

**HIGH-RELIABILITY
FOIL AND SOLID
CAPACITORS**

Bulletin
GEA-7227



**"A CASE"
TANTALYTIC
CAPACITORS**

Bulletin
GEA-7226



**125C KSR*
TANTALYTIC
CAPACITORS**

Bulletin
GEA-6258



**HIGH-VOLTAGE
TANTALYTIC
CAPACITORS**

Bulletin
GEA-7065



**125C CYLINDRICAL
TANTALYTIC
CAPACITORS**

Bulletin
GEA-7085



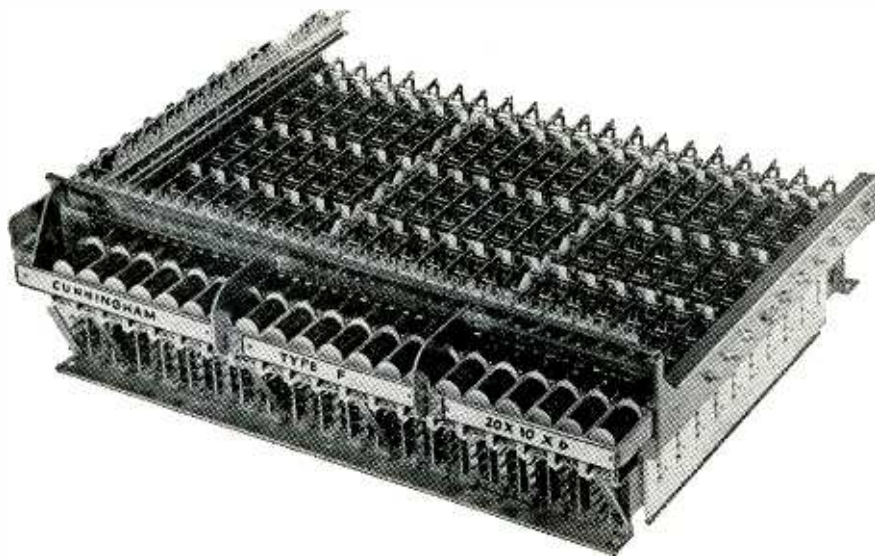

Tolerance Buildup No Bugaboo with Punched Laminated Plastics Parts

The compounding of individual tolerances on several punched holes or cutouts over the length of the piece is not the bugaboo that many designers believe. Careful die work and good working knowledge of the laminate used minimizes tolerance buildup. A good example of what can be done is the insulated pusher fabricated by Taylor for a high-performance crossbar switch manufactured by James Cunningham, Son & Co., Inc., Rochester, N.Y.

These switches are 3-dimensional conductor matrices, with from 30 to 1200 switching contacts, which bring intelligence from as many as 600 sources to one or more readout or signal points. They are basic components in computers, machine tool programming systems, high frequency scanning systems, thermocouple and strain gage monitoring, and similar equipment.

The insulated pusher, only 2.955 in. long and .031 in. thick, and fabricated from Taylor Grade GEC-500 glass epoxy laminate, is a critical part of the crossbar. It must be held flat within $\pm .005$ in., with total over-length buildup not exceeding $\pm .002$ in.

The materials used before to fabricate the pusher proved difficult to hold to the tolerances required. The success of the GEC-500 laminate fabricated by Taylor is evidenced by marked reduction in rejects and a 20% gain in production.

Taylor Fibre's Fabricating Division has the manpower, experience and equipment to produce parts to close tolerances from any of the company's raw materials. Send us your problem—we will recommend the best material for the job and quote on production runs. Write Taylor Fibre Co., Norristown 40, Pa.

Taylor

LAMINATED PLASTICS VULCANIZED FIBRE

rite remains constant. Also reasonably high Q values at relatively low frequencies are possible when ferrite cores are employed.

Compromises which are made in selecting ferrite for lower frequency applications sacrifice permeability to obtain the advantages of lower losses, constant permeability, and perhaps higher Q.

At the present time, ferrite is not the answer to all design problems. However, in the light of the present rate of industry growth and advancements which have been made in the state of the art, the ferrite application potential should be reviewed by design engineers.

A check list to consider when selecting a material for inductance or magnetic application requiring a magnetic core includes: core costs, efficiency, ease of installation, required accuracy in the duplication of parts, size of core, possible core configurations, power requirements, frequency of operation, power losses, environmental effects, mechanical requirements, cost of assembly, overall initial and long range cost of the component.

Joining Thermoelement To Ohmic Contacts



A NEW material for bonding lead telluride was announced last week by General Instrument Corporation, as a development in the field of thermoelectric power generation. Lead telluride is today's leading thermoelectric material.

Bonding lead telluride has been a major problem. Because a thermoelectric generator uses many thermocouples in series, the ohmic re-

sistance loss of the bimetal joints adds up and limits over-all efficiency. Mechanical joints are expensive and unreliable; present brazing methods tend to pollute the telluride by "doping" and thus further reduce efficiency. Because of these losses, thermoelectric generators have to be heavily over-designed.

The new material, called Generalock, makes joints with resistance of the order of 10 microohms per square centimeter; this is claimed to be an improvement of one or two orders of magnitude over present methods. The new bonds are mechanically stronger than metal, and thus reliable. Company claims there are no detrimental effects on the lead telluride.

Main effect of the new development will be to reduce the cost, size and weight of thermoelectric generators by eliminating most of the ohmic losses and thus saving thermoelectric material. Company has built generators with capacity of 150 watts per pound of material, compared to previous best of 40 watts per pound. Thermal conversion efficiencies are 7 to 8 percent.

The company predicts that it will manufacture generators to sell at \$10 per watt of capacity, a five to ten times reduction over present prices. Eventually the bonding process is to be made available under license to other manufacturers. Bonding powder is applied to basic element of thermoelectric generator. Powder melts under heat, provides strong joint. Thermocouple at rear consists of two pellets of semiconductor material joined by metallic strip.

New Getter Coatings

THE NON-FLASH getter, Ceralloy 400, is now available in the form of vacuum sintered coatings on molybdenum, kovar, and inconel, in addition to nickel which was previously available.

These products were developed at the request of vacuum tube engineers who require uniformly reproducible coatings, vacuum sintered to suitable substrates.

The new getters are available, in production quantities, as strips measuring $1 \times 0.005 \times 9.0$ in., coated on one or both sides with Ceralloy 400.

BALLANTINE True RMS VTVM model 350



Measures
wide
range of
waveforms
with

1/4% ACCURACY

For highly accurate voltage measurements, the uncertainty introduced by waveform distortion limits the use of average and peak-responding instruments. The Model 350 is a 0.25% accurate, true rms-responding instrument designed to overcome this limitation. It provides the engineer with a rugged, reliable and easy-to-use laboratory or production line instrument. It will measure a periodic waveform in which the ratio of peak voltage to rms is not over 2.

The method of measurement with the Model 350 is similar to balancing a bridge: four knobs are set for minimum indication and the unknown voltage is read directly from a 4 to 5 digit NIXIE® in-line readout. The precision exceeds the stated accuracy by 5 to 10 times. Price: \$720.

SPECIFICATIONS

Voltage Range..... 0.1 V to 1199.9 V	Frequency Range..... 50 cps to 20 kc
Accuracy. ¼%, 100 cps to 10 kc, 0.1 V to 300 V; ½% outside these limits	Max Crest Factor 2
	Input Impedance 2 MΩ shunted by 15 pF to 45 pF

Write for brochure giving many more details

— Since 1932 —



BALLANTINE LABORATORIES INC.

Boonton, New Jersey

CHECK WITH BALLANTINE FIRST FOR LABORATORY AC VACUUM TUBE VOLTMETERS, REGARDLESS OF YOUR REQUIREMENTS FOR AMPLITUDE, FREQUENCY, OR WAVEFORM. WE HAVE A LARGE LINE, WITH ADDITIONS EACH YEAR. ALSO AC/DC AND DC/AC INVERTERS, CALIBRATORS, CALIBRATED WIDE BAND AF AMPLIFIER, DIRECT-READING CAPACITANCE METER, OTHER ACCESSORIES. ASK ABOUT OUR LABORATORY VOLTAGE STANDARDS TO 1,000 MC.

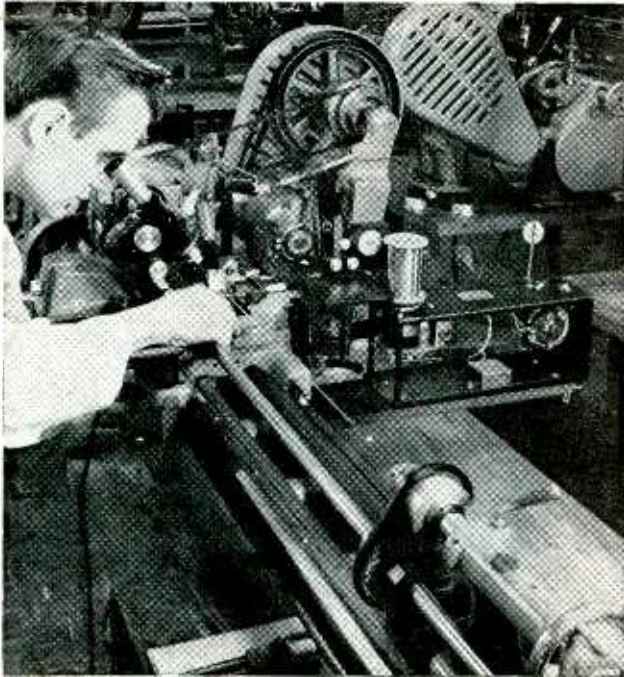

Groove-cutting and element winding machine is a specially designed lathe



Precision trimmer potentiometers are assembled in "clean room"

Diamond Cuts Groove for Linear Potentiometers

TO PRODUCE good linearity in precision trimmer potentiometers, Daystrom Potentiometer Div., Archbald, Pa., makes sure that the winding itself is highly linear. Since there are residual non-linearities in element wire stock, the problem boils down to controlling the spacing between each of the windings of the resistance element on the mandrel.

The problem in winding a highly linear element in the conventional way is the uneven surface of the insulation on the mandrel. While irregularities can be minimized, they cannot be completely eliminated. Consequently, wire spacing varies slightly and, in addition, some wires are high, some low. This can cause uneven wear and eventually an open element.

While linearity is reduced by an uneven mandrel surface, forming the element into a circle or a helix after winding allows the wire to move again. A wire not quite in a surface "valley" may slip into the valley during the bending operation. To minimize this effect, the

element wires are often cemented in position before the element is formed. If too hard a cement is used, however, strain gauge effects will be noted in the completed potentiometer and the temperature coefficient will be high and non-linear. Moreover, when the cement covers the element portion to be contracted by the wiper, it must be removed by buffing.

To remove cement from a low wire, it may be necessary to buff off part of the high wires next to it. This increases the resistance of that turn and causes more non-linearity.

To eliminate the above problems, Daystrom developed a special process for winding the element. The

insulated mandrel is fed into the winding machine where a diamond tool cuts a groove, producing an endless helix or screw thread on the mandrel. The uninsulated resistance wire is wound tightly, using electronic controls, into this continuous groove.

The tight fit between groove and wire essentially locks the wire in place. No movement is caused by forming and no cement of any sort is required. The result is an element whose linearity depends solely on the accuracy to which the circle or helix is formed; linearity of the completed potentiometer depends on its mechanical design (Square-trim or rotary). Linearity remains good through rated temperature, cycling, shock, and vibration specifications.

The wire-winding machine is a specially designed, patented lathe. The mandrel is made from copper wire, from 0.025 to 0.085 inch diameter. Mandrel insulation is Thermaleze or Teflon and the resistance wire is either Cupron, Evenohm or Karma, from 0.004 to 0.010 inch

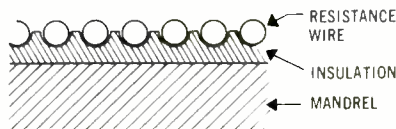

Each turn of the resistance element lies in its precision-cut groove. After the element is wound, it is formed into a circle or helix

QKB 830 O-TYPE BWO is 1¼ inches in diameter; weighs only 1½ lbs.



Electrostatically focused BWO provides smaller, lighter X-band signal source

New Raytheon tube combines advantages of backward wave oscillators in rugged compact package ideal for airborne and missile use.

The QKB 830 is especially suitable for local oscillator service in airborne, shipboard, or ground-based equipment such as anti-jam radar receivers. A wide-range tube, it can be tuned from 8.5 to 9.6 kMc by varying a single electrode voltage.

The small size and low voltages of the QKB 830 permit its use as a direct replacement for mechanically tuned klystrons in existing systems. It is also adaptable to many other applications requiring a voltage tunable source having provision for low-voltage pulsed or amplitude modulation.

Write today for technical data or application service to Microwave and Power Tube Division, Raytheon Company, Waltham 54, Massachusetts. In Canada: Waterloo, Ontario.

QKB 830 GENERAL CHARACTERISTICS (Typical CW Operation)

Power Output	15-30mW
Frequency	8.5-9.6 kMc
Voltage Requirements	
Tuning Voltage	150-250 Vdc
Focus Voltage	300 Vdc
Filament Voltage	6.3 V
Shock	50 G's
Cooling	convection
Overall Length	7.5 in.
Weight	1.5 lb. Max.

RAYTHEON COMPANY

MICROWAVE AND POWER TUBE DIVISION

RAYTHEON

CIRCLE 83 ON READER SERVICE CARD

LAPP STAND-OFF INSULATORS FOR MODERATE OR HEAVY DUTY



For years, Lapp has been a major supplier of stand-off insulators to radio, television and electronics industries. Wide knowledge of electrical porcelain application, combined with excellent engineering and production facilities, makes possible design and manufacture of units to almost any performance specification. The insulators shown on this page are representative of catalog items—usually available from stock—and certain examples of special stand-offs. The ceramic used is the same porcelain and steatite of which larger Lapp radio and transmission insulators are made. Hardware is brass or bronze; brush nickel plating is standard.

Write for Bulletin 301 with complete description and specification data. Lapp Insulator Co., Inc., Radio Specialties Division, 186 Sumner St., Le Roy, N. Y.

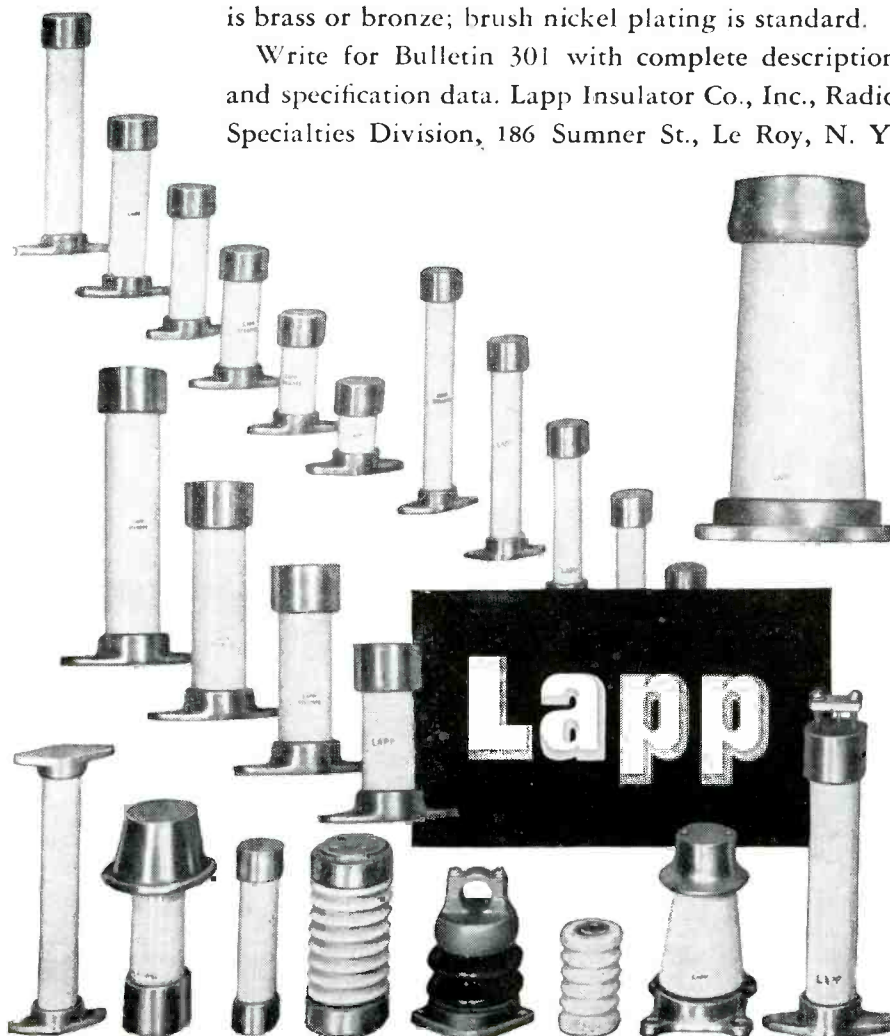

diameter. Spacing between turns runs from 0.001 to 0.005 inch.

Because of the care with which all potentiometer parts are treated, rejects at final inspection are low. Potentiometers have a guaranteed 1 percent maximum defect A.Q.L. per MIL Standard 105, proposed MIL R27208A. All potentiometers are inspected for at least 25 electrical, physical, and environmental characteristics. As a result, potentiometer A.Q.L. is only a fraction of 1 percent.

Automatic Driller For Printed Circuits



FULLY AUTOMATIC printed circuit drill for drill component fixing holes in printed circuit boards, has been developed by Ferranti Ltd., Hollinwood, Lanc., England. Two-stage positioning and drilling to a grid system speeds drilling and increases accuracy.

Machine has twin drilling heads, allowing either tandem or single spindle operation, a hydraulically operated coordinate table, and a control system that enables machine to work unattended except for loading and unloading.

Drilling table is moved on both X and Y axes by hydraulic jacks. Rough positioning is by perforated template and photocell, fine positioning by a mechanical indexing system using the meshing of a half-nut and precision rack. Positional accuracy is to 0.001 inch, and repeatability is also to within 0.001 inch. Drilling is carried out to a grid system, holes being drilled in a systematic pattern of rows and

columns. Basic spacing between rows of the grid system is determined by the pitch of the precision rack thread associated with row alignment. A similar rack is used for column alignment.

A perforated template is mounted on an extension of the 20 × 14 in. drilling table; wherever a hole in the template coincides with the light beam, the photocell is stimulated to give a signal to the control system. This signal initiates stopping the table, locking it in position and starts drilling action. When drilling is complete, the table is moved automatically for the next drilling operation. Each row of the drilling pattern has a marker hole to make the table move to the next row after one row has been completed.

The machine can accommodate a stack of boards up to 12½ by 18 in., with maximum drilling dimensions of 11½ by 17½ in., or two stacks of smaller boards for simultaneous drilling. A typical application, drilling 288 holes in each of two stacks of four boards, required 14½ minutes.

Circuit Overlay Spots Solder Bridges

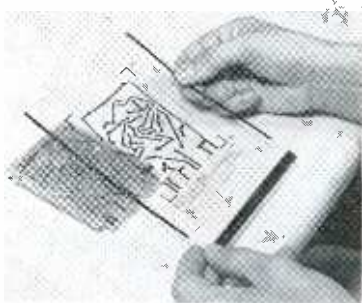

Solder bridges can occasionally pass undetected through visual inspection of printed circuit boards when inspectors develop eyestrain or fatigue, or when the solder bridge has the shape of a land. Kollsman Instrument Corporation, Syosset, New York, detects false lands by using a positive of the conductor pattern as a test pattern. When the positive, clear film, is placed over the board, the black pattern hides the conductors. Any bridges are readily seen through the clear areas of the film. The visual aid also speeds up board inspection, since, with the board known to be free of bridges, only a few seconds are needed to scan for misrouted patterns

SOME TIMERS DO ALL THEY ARE DESIGNED FOR—AND MORE. Others just make claims. A. W. Haydon's record speaks for itself. Behind each 101 "pros" pooling their timing technology...so-phisticated test labs to assure peak performance...built-in reliability reflecting years of experience. ■ A. W. Haydon makes them all: timing motors, time delay relays, elapsed time indicators and the like—electronic marvels from Culver City, electromechanical wonders from Waterbury. Shown: chronometrically governed subminiature DC motor. Literature on request. ■ When it comes to timing devices, for anything from data processing to satellite communications—miniature, subminiature or microminiature—specify A. W. Haydon, and be certain of peak reliability.



PERFORMANCE OUTWEIGHS CLAIMS

THE A. W. HAYDON COMPANY

235 NORTH ELM STREET, WATERBURY 20, CONNECTICUT

New On The Market

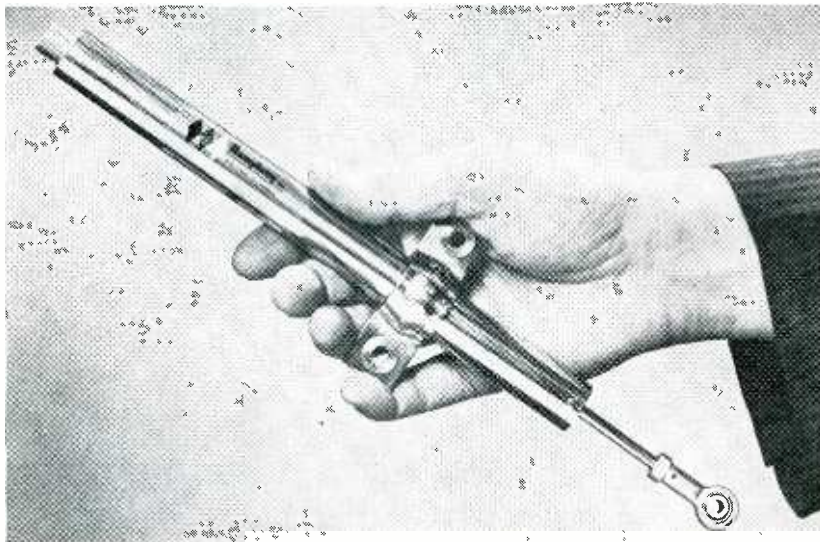

Differential Transformer FOR INDUSTRIAL AND MILITARY USE

HUMPHREY, INC., 2805 Canon St., San Diego 6, Calif. Differential transformer converts linear movement into an easily read a-c signal. Typical applications include use in hydraulic actuators, feedback devices and other servo systems used on missiles. Unit provides an integral self-aligning mounting bracket,

eliminating transformer coupling errors caused by placing a metal ring around the instrument to mount it. Characteristics include output voltage scale factor constant to within $\pm 3\text{db}$ from 60 cps to 20 Kc, low output impedance.

CIRCLE 301 ON READER SERVICE CARD

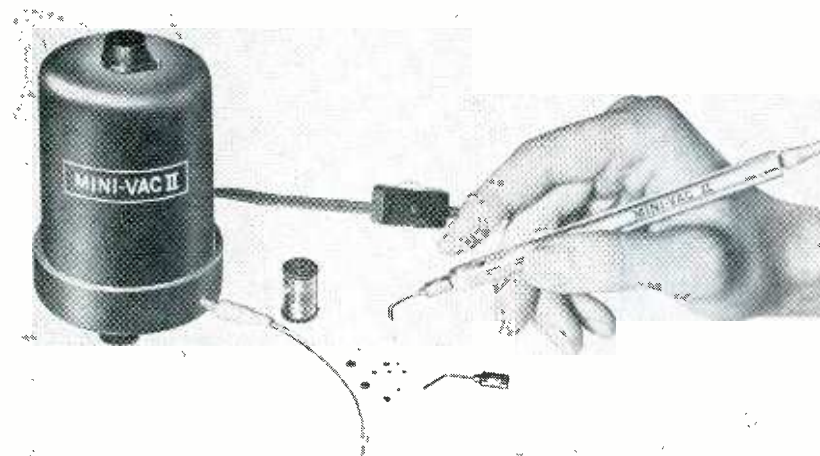

Miniature Parts Handler VERSATILE AND DEPENDABLE

MINI-TOOL INDUSTRIES, Box 84, Highbridge Station, New York 52, N. Y. The Mini-Vac II parts handling system uses vacuum suction to move and manipulate tiny, delicate components quickly and safely. Electromagnetic vacuum pump, Tygon tubing, stainless steel pickup

tips, suction cup adapters and finger-actuated pickup pencil comprise the basic system. Vacuum is finger-tip controlled by covering, or uncovering, the by-pass opening in pickup pencil.

CIRCLE 302 ON READER SERVICE CARD

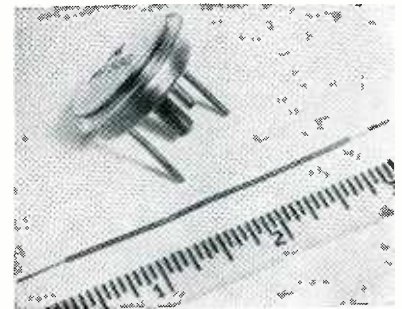

Power Transistors GERMANIUM TYPE

MOTOROLA SEMICONDUCTOR PRODUCTS INC., 5005 E. McDowell Rd., Phoenix, Ariz., announces 30 and 60 amp germanium power transistors with saturation resistance as low as 0.009 ohm, the approximate equivalent of a 3-in. length of No. 26 copper wire. Units are suited for regulator purposes in power supplies and for switching applications where only small voltage drops across the transistor can be tolerated, even at exceptionally high currents.

CIRCLE 303 ON READER SERVICE CARD

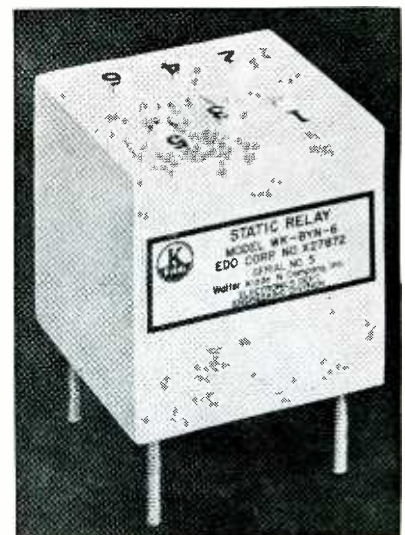

Static Relay SOLENOID-ACTUATING

KIDDE ELECTRONIC LABORATORIES, Walter Kidde & Co., Inc., Belleville 9, N. J. Model WK-BYN-6 static relay eliminates problems of arcing in the switching of heavy inductive loads. Contact employed is a bi-stable semiconductor. Its sole stable states are a low-impedance or "on" state and a high-impedance or "off" state. Absence of moving parts and elimination of arcing assure reliability and long-life operation. Relay

CIRCLE 87 ON READER SERVICE CARD →

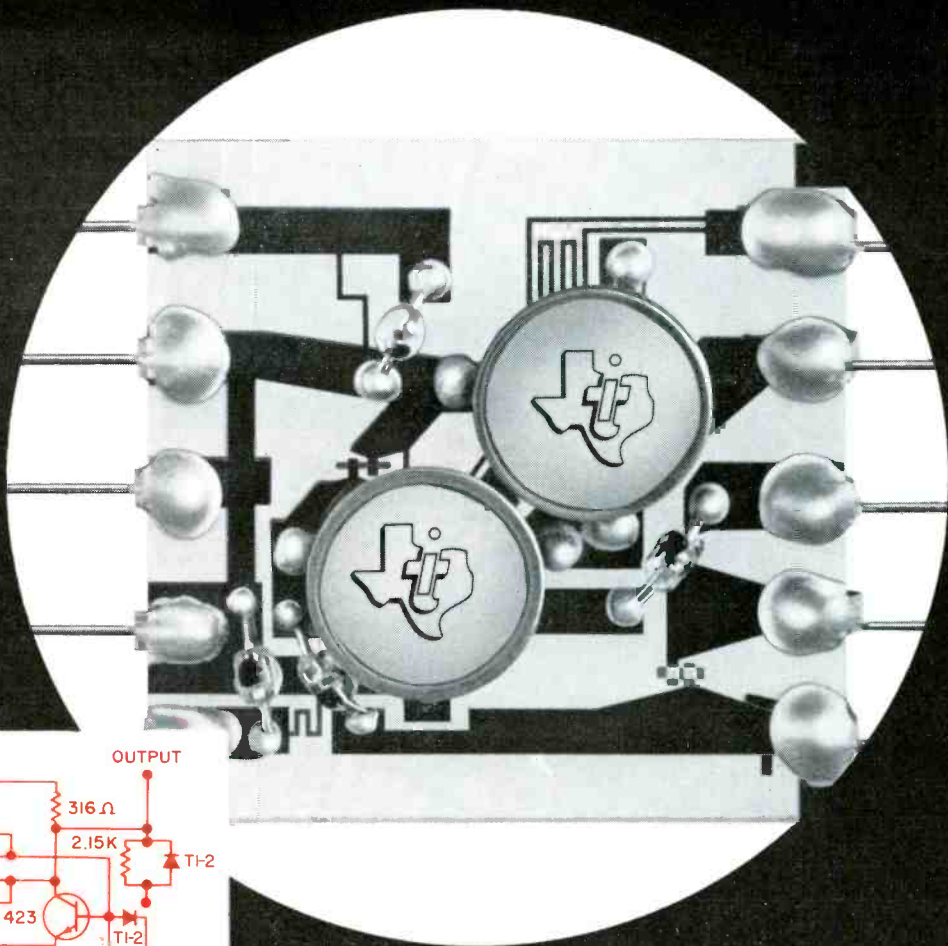

TANTALUM FILM 10 MC FLIP-FLOP CIRCUIT

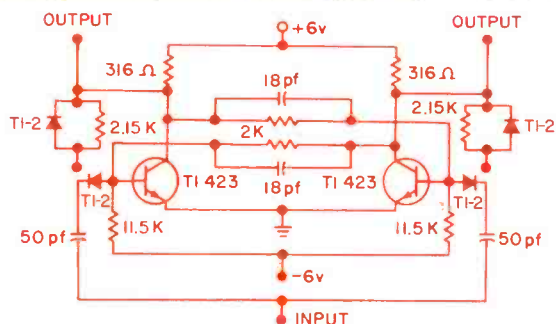

HERE'S HOW TI MICRO MINIATURIZATION CAN HELP YOU NOW!

EXTENDED PERFORMANCE—Yes, you can have extended performance TI Tantalum Film Circuits today—Circuits giving you 3 major benefits: **1. Reliable semiconductor components**— *umesa** the highest power/volume silicon transistor available today— MICRO/G* diode for space saving economics with all the electrical parameters of the famous MOLY/G* diode; **2. Passive components** are tailored precisely to your individual circuit requirements—Tantalum Film techniques allow precision control of resistor and capacitor elements; **3. TI Tantalum Film Circuits manufacturing facility** is now in production... utilizing single Tantalum Film technique and hermetically sealed active components... to give you the potential for improved circuit performance. **CIRCUIT VERSATILITY**—Your particular low-level circuit requirements can be fabricated for rapid delivery.

PRECISION CIRCUITS—TI Tantalum Film Circuits, with precise control of all components, offer you custom-quality circuits with space savings not previously available. ■ Let TI help you adapt your designs to Tantalum

Film Circuits at surprisingly low costs. Write today for more information: Texas Instruments Incorporated, Department 588, P. O. Box 5012, Dallas 22, Texas.

*Trademarks of Texas Instruments Incorporated

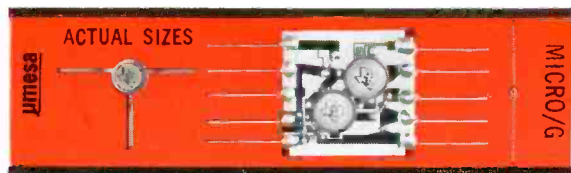

COMPONENTS DIVISION
CAPACITORS, DIODES,
RECTIFIERS, RESISTORS,
SEMICONDUCTOR NETWORKS,
SILICON CONTROLLED RECTIFIERS

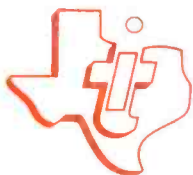

**TEXAS INSTRUMENTS
INCORPORATED**
13500 N. CENTRAL EXPRESSWAY
P. O. BOX 5012 • DALLAS 22, TEXAS

BIRD

"Termaline" DIRECT READING RF LOAD- WATTMETERS SERIES 6100



MODEL 612
Models 61 and 611
are identical in
appearance

These popular direct reading instruments measure and absorb power in 50 ohm coaxial line systems through the range of 30 to 500 mc.

They are portable and extremely useful for field or laboratory testing . . . checking installation of transmitters . . . trouble shooting . . . routine maintenance . . . production and acceptance tests . . . transmitter tune-ups . . . measuring losses in transmission lines . . . testing coaxial line insertion devices such as, connectors, switches, relays, filters, tuning stubs, patch cords and the like . . . accurately terminating 50 ohm coaxial lines, and . . . monitoring modulation by connecting phone, amplifier or audio voltmeter to the DC meter circuit.

Power scales for Model 61 Special are made to meet your requirements.

WRITE FOR CATALOG

SPECIFICATIONS

RF INPUT IMPEDANCE: 50 ohm nominal.

VSWR: Standard specification 1.1 to 1 maximum over operating range.

ACCURACY: 5% of full scale.

INTERNAL COOLANT: Oil.

POWER RANGE: Model 611—0-15, 0-60 watts full scale. Model 612—0-20, 0-80 watts full scale.

INPUT CONNECTOR: Female "N".

EXTERNAL COOLING METHOD: Air Convection.

OTHER BIRD PRODUCTS

RADIATOR STRUCTURE: All Aluminum.

FINISH: Bird standard gray baked enamel.

WEIGHT: 7 pounds.

OPERATING POSITION: Horizontal.

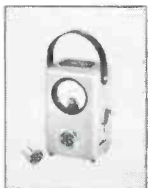

"ThruLine"
Directional
RF Wattmeters



"Termaline"
RF Load Resistor



Coaxial
RF Filters



Coaxial
RF Switches



BIRD

ELECTRONIC CORPORATION
30303 Aurora Rd., Cleveland 39 (Solon), Ohio
CHurchill 8-1200 TWX CGN FS 679
Western Representative:
VAN GROOS COMPANY, Woodland Hills, Calif.

operates in a range of line voltages from 105 to 127 v at 60 cps, over an ambient temperature range of 0 to 50 C.

CIRCLE 304 ON READER SERVICE CARD

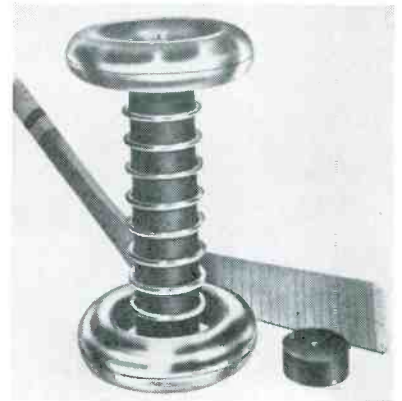

Selenium Stacks HIGHLY VERSATILE

RADIO RECEPTOR CO., INC., 240 Wythe Ave., Brooklyn 11, N. Y. A compact type of selenium rectifier package is announced. Package resembles a cylinder with a length proportionate to the voltage to be encountered—plus (for extreme voltages) corona-suppressing rings at each end, all mounted as an integral, rugged unit. Each stack is composed of a series of flat cylindrical modules, studded together through a metallic, threaded insert in the center of each face. Each cylinder is individually rated at 20,000 v.

CIRCLE 305 ON READER SERVICE CARD



Power Supply ADJUSTABLE UNIT

MATRIX RESEARCH AND DEVELOPMENT CORP., Nashua, N. H. Model AH all solid state, well regulated power supply, employing rugged high density packaging suitable for missile and space vehicle application is available, over a wide range of out-

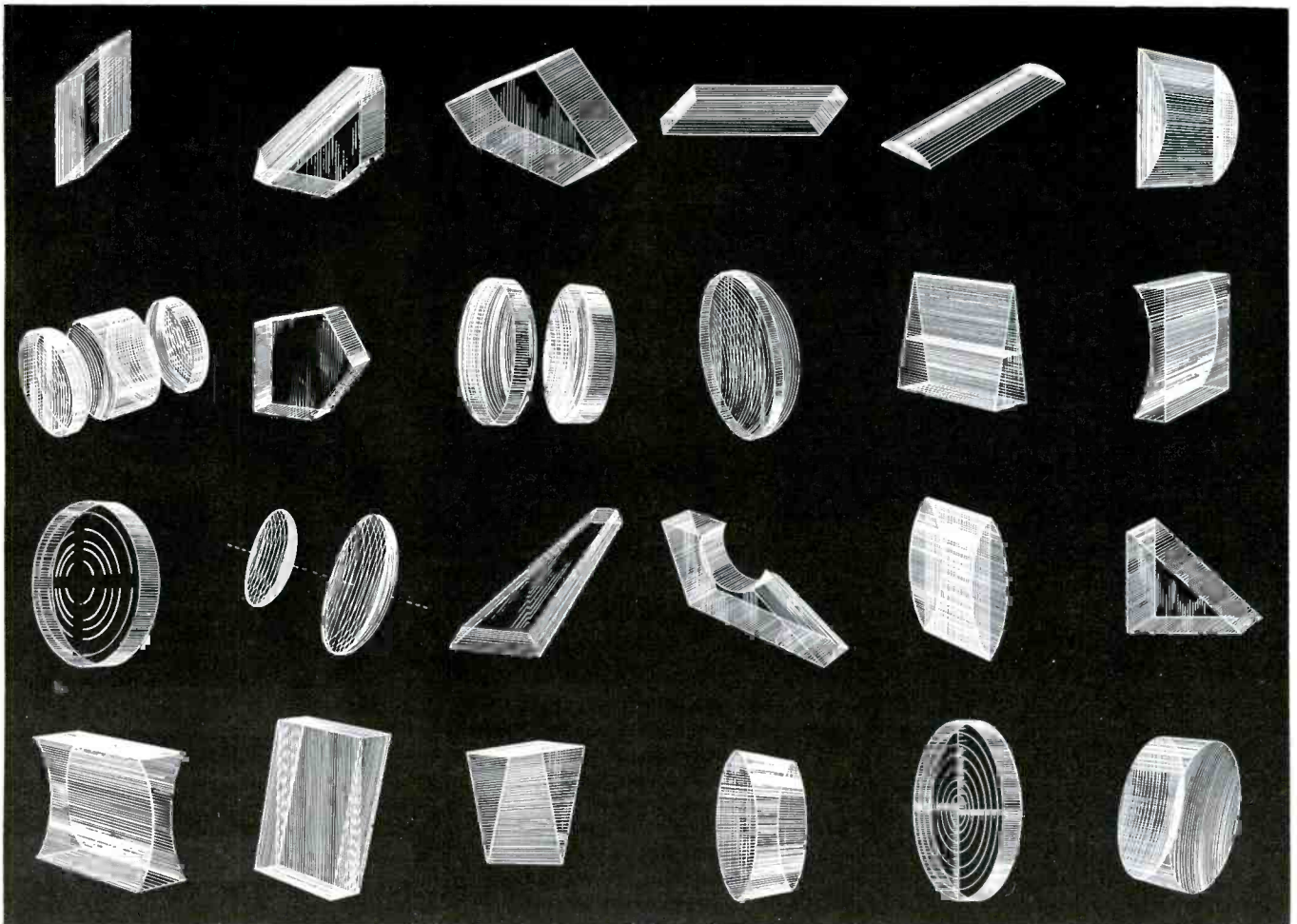

OPTICS FOR ELECTRONICS ...

Components and systems for visible, ultraviolet, and infrared radiation. GEC's Astro-Optics Division specializes in design, development, and manufacturing of optical components and systems for the ultraviolet through infrared spectrum.

Here are a few of the optical components you can order from Astro-Optics: prisms, flats, spherical, aspherical and parabolic surfaces, reticles, information choppers, encoders, precision vacuum coating, and optically polished synthetic crystals.

Also available from Astro-Optics are infrared and optical-electronic systems.

For complete information regarding your precision optical requirements, write today to:

ASTRO OPTICS DIVISION

... precision optics at work



GENERAL ELECTRODYNAMICS CORPORATION
4430 FOREST LANE • GARLAND, TEXAS



IN PARIS

PORTE DE VERSAILLES

FROM 16th TO 20th

FEBRUARY 1962

5th INTERNATIONAL EXHIBITION OF ELECTRONIC COMPONENTS

The greatest world meeting
in the field of electronics

**FÉDÉRATION NATIONALE
DES INDUSTRIES
ÉLECTRONIQUES**

23 rue de Lubeck, Paris 16^e
phone: PASsy 01.16

put voltages (700-1,500). Designed for use with photomultiplier tubes, the supply has built-in overload and protector circuits, together with multiple external taps so that different voltages are available, depending upon the particular application.

CIRCLE 306 ON READER SERVICE CARD

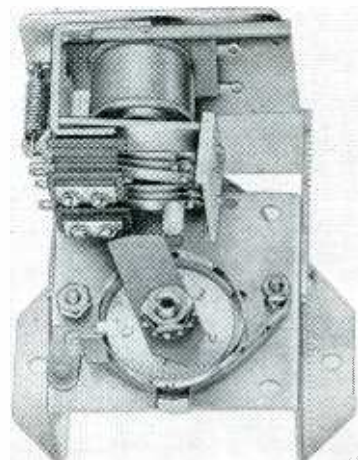

Delay Timer
SIMPLIFIED DESIGN

HAYDON DIVISION of General Time Corp., 245 E. Elm St., Torrington, Conn. Series BN21 delay timer eliminates the need for auxiliary relays and can be used for interval or delay timing. Unit measures 2.938 in. deep, 3.375 in. wide and 3.750 in. high. It is designed for rear mounting in any position, and is equipped with a calibrated dial for easy adjustment of the timing interval by lock-nut.

CIRCLE 307 ON READER SERVICE CARD



Static Inverter
D-C TO SINE WAVE

ABBOTT TRANSISTOR LABORATORIES,
INC., 3055 Buckingham Road, Los



For the man to see, go to EBG

One more reason electronics buyers' guide and Reference Issue is your most valuable reference book when you're buying:

For the first time, the 1961 EBG lists in the Green Section the actual name of the man to see in the company from which you want to buy . . . the man designated by the company who knows prices, delivery dates, specifications, etc. This valuable new feature is only one of many in this year's Manufacturers' Index. The same EBG section tells you the number of engineers, number of employees, dollar volume of business of each manufacturer, etc. And there's still more . . .

Guide to military and government procurement . . . Complete, most useful guide for the man who is doing business with the government. Lists the military and government agencies that buy electronic equipment and services, with phone numbers,

addresses, procurement officers' names, and what they buy.

Specific product listing . . . each listed under its specific heading, no matter how many products a company makes. More than 3,000 are cross-indexed.

Registered trade-name index . . . lets you find the manufacturer of a product when you know it only by its trade name.

Local sales office listing . . . gives you manufacturers' nearest sales offices, addresses and phone numbers.

These are only a few of the features that make electronics buyers' guide your "best buy" for both buying and selling in the electronics industry. Make the most of your '61 EBG. Use it every day.



electronics buyers' guide and reference issue *The Basic Buying Guide in Electronics since 1941*



A MCGRAW-HILL PUBLICATION 330 West 42nd St., New York 36, N. Y.

ENGINEERS SCIENTISTS MANAGERS

New long term diversified development and design contracts create unusually attractive opportunities at the Link Division of General Precision, Inc. Qualified men, proficient in broad systems and equipments

engineering, will be interested in these commercial and military projects. Both aircraft and space vehicle systems are involved. Excellent salaries and ideal living in the Binghamton, New York area will attract the qualified professional man or manager seeking advancement opportunity and challenging work.

PROJECT MANAGER — laboratory precision measurement, visual displays and special projects including G.S.E., simulators and checkout equipment. **PROJECT MANAGER** — electro-optical precision measurement systems. **MANAGER PRODUCT SUPPORT** — 12-15 years

mechanical design, electronic packaging, model shop construction, and department supervision in military programs. Direct product design department, model shop, product programs and advanced development.

PRINCIPAL ENGINEER

— visual systems projects.

OPTICS — optical, electro-

optical measuring, inspection and scanning systems. **OPTICS** — periscopic,

projection and relaying lens, analysis of optical problems, laboratory proposals.

DIGITAL — transistor

circuits, switching cir-

cuits, computer logic,

"NOR" logic, direct-coupled transistor logic, proposals. **VISUAL**

DISPLAYS — electronic systems project responsibility. Supervise design, test and verification of prototype model and preparation of engineering data. **SIMULATION** — analog computing devices, audio systems, transistorized amplifiers, radio aids, radio navigation, aircraft communications. **SIMULATION** — program digital computers, digital systems design. **SIMULATION** — define problems, program and solve equations

of flight simulation, specify components, initiate requirements for design and configuration of electronic and electro-mechanical systems.

MECHANICAL — systems design of servos, hydraulics, missiles, life support systems. **MECHANICAL** — systems design of mechanisms,

structures, hydraulics, electro-mechanical packaging, materials, plastics. **AERONAUTICAL** — simulation, project responsibility for computation

of equations, defining motion and engine performance of aircraft, specification interpretation, concept determination, data search and liaison, data analysis and processing, test guide inception and computation. **AERONAUTICAL** — process raw aerodynamic coefficient data and

engine data into equation form for electronic simulation, engine performance calculations, test guide to check simulator. **ELECTRONIC**

SCIENTIST — airframe and spacecraft performance, stability and control, engine performance, analog simulation and digital computations.

All positions require an appropriate degree—advanced degree is highly desirable for managerial and senior positions. Minimum experience required is 4 years—an additional 4 years experience is required for managerial and senior positions.

Qualified men are invited to phone collect (RAYmond 3-9311) or write Mr. James T. Gibbons. An equal opportunity employer.



LINK DIVISION
GENERAL PRECISION, INC.

Binghamton, New York

SENIOR & JUNIOR ENGINEERS

DEVELOPMENT · DESIGN · ANALYSIS

Angeles, Calif. Transistorized static inverter converts d-c to sine wave 400 cps power, from a 28-v source. Unit is rated up to 50 v-a with less than 3 percent total harmonic distortion. Model N3A1 is closely regulated for input variations and is protected against short circuits, polarity reversals and transient spikes. It meets environmental requirements of MIL-E-5272C, is suited for use in missile, aircraft and space fields.

CIRCLE 308 ON READER SERVICE CARD

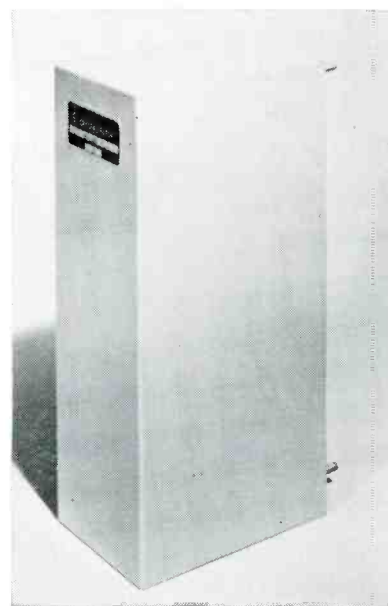

Crystal Filters

PRECISION DEVICES

SYSTEMS INC., 2400 Diversified Way, Orlando, Fla. Model BS-100-012 has a rejection of more than 100 db over a bandwidth of greater than 12 cps and a 2 db bandwidth of less than 40 cps at a center frequency of 100 Kc. Response on either side of the rejection band is essentially flat or 100 cps beyond the center frequency. Insertion loss is less than 1 db. Input/output impedance is 8,000 ohms.

CIRCLE 309 ON READER SERVICE CARD

Silicon Transistors

HIGH BETA

RHEEM SEMICONDUCTOR CORP., 350 Ellis St., Mountain View, Calif. The RT5401, -2, -3 and -4 series provides typical betas from 210 to 300 at 50 ma and from 100 to 120 at 500 ma. Beta spread is very tightly

controlled with a max/min ratio of only 2 to 1. These high betas at high current make possible design improvements in Class A and B amplifiers.

CIRCLE 310 ON READER SERVICE CARD

Full Adder

ENGINEERED ELECTRONICS CO., 1441 E. Chestnut Ave., Santa Ana, Calif. Full adder T-441, a binary circuit module for arithmetic applications, is packaged in a container measuring $\frac{1}{8}$ in. diameter by $2\frac{3}{8}$ in. seated height, and plugs into a standard 9-pin miniature tube socket.

CIRCLE 311 ON READER SERVICE CARD

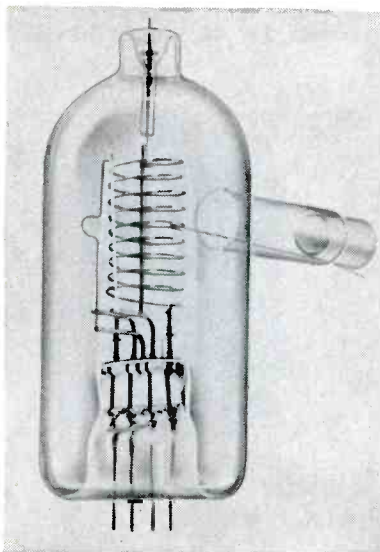

Ionization Gage Tubes BURN-OUT PROOF

NUCLEAR CORP. OF AMERICA, Central Electronic Mfrs. Division, Denville, N. J. Type CEM-75 is capable of vacuum measurement in the range of 10^{-4} to 10^{-10} mm of mercury. Filament voltage is 3-5 v a-c; filament current 4-6 amp a-c; grid voltage +150 v; collector voltage -30 v. The grid is degasable by passing current through it. The burn-out proof filament makes it desirable for use in systems that are repeatedly open to the air.

CIRCLE 312 ON READER SERVICE CARD

Magnetic Switch

MAGNETICS INC., Butler, Pa., announces a low-priced completely-

ANELEX®

Analex High Speed Line Printers are standard equipment in the data processing systems of almost every major computer manufacturer here and abroad.



Further information available upon request

ANELEX CORPORATION

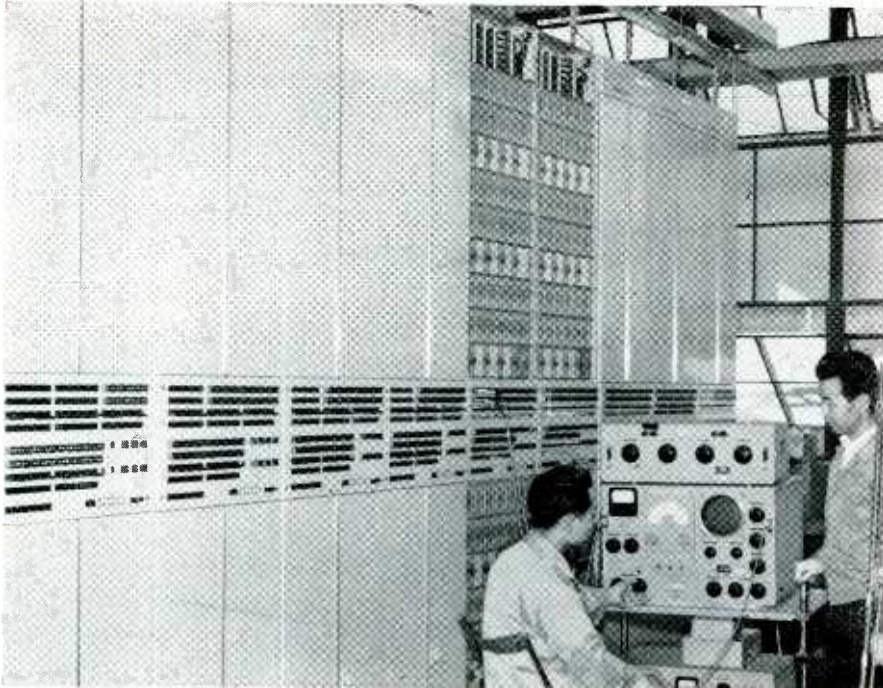

156 Causeway Street, Boston 14, Massachusetts

Channel modulator bay of Fuji's carrier transmission system contains more than 3,500 Fuji Stycon capacitors.

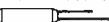
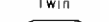

FUJI systems-proved POLYSTYRENE "Stycon" CAPACITORS

Fuji Stycon is a highly accurate and reliable capacitor backed by 26 years of systems-making experience. As one of Japan's leading systems-makers and one of the world's leading producers of polystyrene capacitors (5,000,000 monthly), Fuji is its own best capacitor customer. This "feedback" means that Fuji is constantly systems-proving and improving its components to assure you of the highest quality and uniformity.

FUJI STYCON			
Type	Voltage (D.C.)	Capacitance Range	Capacitance Tolerance(%)
Standard 	WV 125 TV 375	2-25,000mmf	2, 5, 10 %
	250 750	1,000-20,000	
	500 1,500	2-10,000	
Non-Inductive 	WV 125 TV 375	1,500-25,000mmf	10, 20 %
	250 750	1,000-20,000	
	500 1,500	500-10,000	
Twin 	WV 125 TV 375	2,000-50,000mmf	0.5, 1 %
	250 750	2,000-40,000	
	500 1,500	40-20,000	
Micro 	WV 35 TV 105	300-5,000 mmf	10 %
	125 375	2-600	
TV & Radio Broad-casting Receiver 	WV 125 TV 375	2-25,000mmf	10 %
	250 750	2-20,000	
	500 1,500	2-10,000	

Specifications

Capacitance: From 2 mmf to 50,000 mmf
 Tolerance : As close as 0.5%
 Operating Temperature: From -10°C to +70°C
 Temperature Coefficient : 150±50 PPM per °C
 Insulation Resistance : As high as 10⁶
 Stability : As close as 0.1% drift in 1 year
 Voltage Derating : None to 70°C



WRITE FUJI'S U.S. DISTRIBUTORS FOR COMPLETE SPECIFICATIONS

FUJI TSUSHINKI SEIZO K.K. Tokyo, Japan

Represented by:

■ The Nissho American Corporation □ New York 5, 80 Pine St., WH 3-7840 □ Chicago 3, 140 S. Dearborn St., CE 6-1950
 ■ The Nissho Pacific Corporation □ San Francisco 4, 120 Montgomery St., YU 2-7901 □ Los Angeles 14, 649S. Olive St., MA 7-7691

CIRCLE 94 ON READER SERVICE CARD

static switch rated at 40 w, with output of 0.4 amp at 100 v a-c.

CIRCLE 316 ON READER SERVICE CARD



Zener Diodes

VERSATILE UNITS

AMERICAN SEMICONDUCTOR CORP., 3940 N. Kilpatrick Ave., Chicago 41, Ill., announces a line of sub-miniature glass diffused Zener diodes with 2, 5, 10 and 20 percent voltage tolerances for a variety of circuits. All range from 5.9 to 300 v in 400 mw ratings at temperatures ranging from -55 to +150 C.

CIRCLE 317 ON READER SERVICE CARD

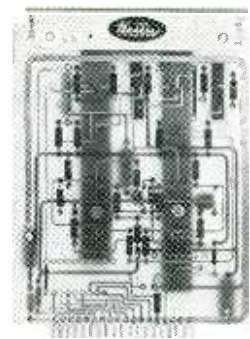

Multiplexing Modules

SOLID-STATE

NAVIGATION COMPUTER CORP., Valley Forge Industrial Park, Norristown, Pa. Models 371 (illustrated) and 372 solid-state modules multiplex information from several single-ended analog circuits. Input range is 0 to 10 v. A long-term accuracy of 1 percent is ensured by using a matched pair of transistors in the input stage of each channel, and cementing each pair in a common heat sink. The 371 contains two channels of input gates and amplifiers and an output amplifier. The 372 contains four channels of input gates and amplifiers. It is used to extend the capacity of the 371.

CIRCLE 318 ON READER SERVICE CARD

Vacuum System

ULTEK CORP., 920 Commercial St., Palo Alto, Calif. Clean vacuums

NEW IDEAS FOR SALE!

Words and pictures tell you about the top new product ideas each week in "On the Market". Who makes 'em and what they'll do for you. Easy way to keep in touch with the latest and best.

Another reason why it will pay you to subscribe to *electronics* (or renew your subscription) right now. Fill in the box on Reader Service Card. Easy to use. Postage free.

FIND WHAT
YOU NEED IN . . .

electronics

to 5×10^{-6} mm Hg in 4 hr or less, without bakeout, are achievable in a glass bell jar, with the Boostivac-equipped, ion pumped high vacuum system.

CIRCLE 319 ON READER SERVICE CARD

Integrator

GENERAL PURPOSE

TEXAS RESEARCH AND ELECTRONIC CORP., Meadows Building, Dallas, Texas. The GPI-100 utilizes a solion tetrode as the integrating element. Battery-powered and portable, it weighs $5\frac{1}{2}$ lb and measures $6\frac{1}{2}$ by 8 by 8 in. Accurate to 1 percent, it has an input impedance of 10,000 ohms, a frequency response from d-c to 10 Kc, and accepts inputs to 1 v. The integral is read out on a 1 percent meter with both a 100 v-sec and 1,000 v-sec range.

CIRCLE 320 ON READER SERVICE CARD



Pressure Switch

EXPLOSION-PROOF

CUSTOM COMPONENT SWITCHES, INC., 3137 Kenwood St., Burbank, Calif. Model 610GE explosion-proof pressure switch meets the demand for miniature industrial components. The low-priced switch is listed by UL, Inc. for use in hazardous locations Class I Groups A, B, C and D as well as Class II Groups E, F and G. The Dual-Snap switch design provides a positive setting and eliminates drifting of actuation point due to varying temperatures. The hermetically sealed unit is not affected by pump ripple or pulsation.

CIRCLE 321 ON READER SERVICE CARD

Voltage Integrator

HARVEY-WELLS ELECTRONICS, INC., 14 Huron Drive, Natick, Mass. Multi-

MASSA RECTILINEAR RECORDERS

are selected for exacting applications



Model BSA 250
(Ink Writing)

Model BSA 260
(Electric Writing)

Precision Dimension Monitor Torpedo Velocity Measurement Process and Quality Control Inspection

Among the many exacting and varied applications in which Massa Rectilinear Recorders are used are the monitoring of precision dimensions, measuring of torpedo velocities and the inspection of process and quality control. Although unrelated in ultimate function, these different end uses have one thing in common . . . the need for a reliable, two-channel strip chart recorder, easy and economical to operate and easy to interpret.

The unique feature of interchangeable plug-in preamplifiers provides a broad application range for the "Meterite". Ink or electric writing pen motors produce permanent recordings with waveforms identical to those of the input signal. The Massa "Meterite", predominantly transistorized, provides faithful long-term operation.

Massa Division manufactures a complete line of portable and rack mounting direct ink or electric writing Rectilinear Recording Systems ranging from two to twelve channels.

Write for Technical Bulletin: BSA 250/260



275 LINCOLN STREET
HINGHAM, MASSACHUSETTS

OTHER MASSA PRODUCTS
TRANSDUCERS
Sonar, Ultrasonic

ACCELEROMETERS HYDROPHONES
MICROPHONES AMPLIFIERS

COMPLETE LINE OF MULTI-CHANNEL AND
PORTABLE RECORDING SYSTEMS

-100° to +350°F
and
20% to 95% RH
-and never
a mechanical
problem



Model
 ELHH-4-LC
 (Window is optional extra)

A major advance in environmental test chamber design, Associated's Econ-O-Line Low-High Temperature-Humidity Chamber eliminates mechanical problems by eliminating the mechanical refrigeration system entirely. Breakdown, leaks, other mechanical failures can't happen, because Liquid CO₂ is used for both temperature pull-down and humidity control. Other advanced design and performance features include:

- Pull down to -100° from ambient in 15 minutes
- Heat up to +350° within 60 minutes
- Temperature control $\pm 2^\circ\text{F}$
- Humidity control $\pm 5\%$ RH
- 2 pen, 2 cam programming and recording controller
- Fan circulation with external motor
- 18" x 18" x 18" stainless steel, welded interior
- Integral demineralizer with replaceable cartridge

Price \$2675

Write today for Bulletin C-20.

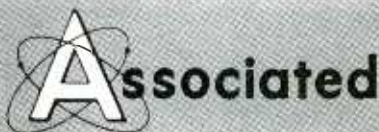

ASSOCIATED TESTING LABORATORIES, INC.
 (Manufacturing Division)
 155 ROUTE 46 • WAYNE, NEW JERSEY • Clifford 6-2800
TEST LABORATORIES
 Wayne, N.J. • Winter Park, Fla. • Burlington, Mass.

channel voltage integrator sums and prints out after specified time.

CIRCLE 322 ON READER SERVICE CARD



Waveguide Flanges
 AT C, X, AND P BANDS

MICROWAVE COMPONENTS & SYSTEMS CORP., 1001 S. Mountain Ave., Monrovia, Calif., has available waveguide flanges at C, X, and P bands. Cover, choke and butt flanges are available in either brass or aluminum in production quantities at production prices. Meeting all requirements applicable to MIL-SPEC F-3922A, the flanges are forged, broached and precision ground for flatness.

CIRCLE 323 ON READER SERVICE CARD



Voltage Reference
 SOLID STATE

DYNAGE, INC., 390 Capitol Ave., Hartford, Conn., announces d-c voltage references for satellite pcm telemetry applications. Input current is 10 ma or less with an input voltage of 20 v d-c ± 1 v d-c. Output voltage is 5.0 v d-c and output current is zero, that is for null circuit. Overall stability is better than ± 0.2 percent over a temperature range of -20 to +60 C and with an input voltage variation of ± 5 percent.

CIRCLE 324 ON READER SERVICE CARD

Pattern Generator

CYBETRONICS, INC., 132 Calvary St., Waltham, Mass. Model B digital pulse-pattern generator works

Suppress lead wire errors

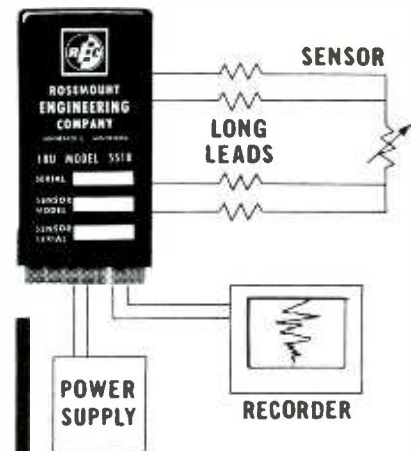

Now you can make accurate resistance temperature measurements even with long, unequal lead wires. The REC Triple Bridge Unit:

- Suppresses lead resistance changes to 5 ohms.
- Suppresses variable or unequal resistances.
- Trims out calibration differences.
- Provides standardized 10 mv. DC output.

Single units or 10 TBUs and power supply are packaged for standard 19" rack. Multiple units provide convenient change of temperature ranges and sensors. Write for Bulletin 6612.

A complete precision line

Rosemount designs and manufactures high quality precision equipment in these lines:

- Air data sensors**
 Total temperature
 Pitot-static (de-iced)
- Immersion temperature sensors**
 (including cryogenic)
- Surface temperature sensors**
- Pressure transducers**
- Accessory equipment**
- Aeronautical research**

For more information please write for the REC catalog. Specific questions welcomed.



ROSEMOUNT ENGINEERING COMPANY

4900 West 78th St. • Minneapolis 24, Minn.

in the best of circuits

more



and

more

engineers

use

HOLLINGSWORTH SOLDERLESS TERMINALS

because they

- SPEED PRODUCTION
- CUT ASSEMBLY COSTS
- ... all types ... all wire sizes
- FAST DELIVERY
- GOVERNMENT APPROVED

SEND FOR CATALOG AND SAMPLES
SOLDERLESS TERMINAL DIVISION

hollingsworth

C O M P A N Y
BOX 430 • PHOENIXVILLE, PENNSYLVANIA

CIRCLE 203 ON READER SERVICE CARD



LARGEST NUMERICAL DISPLAY AVAILABLE

WITH KEARFOTT'S DME COUNTER-INDICATOR

With numerals 5/16" in height, this Kearfott unit has a larger, more easily read numerical display than any other DME indicator. This size factor contributes greatly to speed and accuracy in reading, and it provides an added margin of insurance against navigational error.

The Kearfott Single DME Counter-Indicator shows distance (in units, tens, and hundreds of nautical miles) from the aircraft to a navigational beacon. A mask with rectangular apertures allows only the significant calibrations to be seen; and when no signal is impressed, a red flag extends across the apertures to prevent reading. The unit is hermetically sealed and is filled with dry inert gas for trouble-free dependability and maximum service life.

In addition to the Single DME Counter-Indicator (T8510-11N) shown above, a Dual DME Counter-Indicator (T8511-11N) is available which indicates aircraft distance from each of two navigational beacons. The units meet environmental requirements and other applicable portions of RTCA Paper 100-54/DO-60.

SPECIFICATIONS

		T8510-11N (SINGLE)	T8511-11N (DUAL)
ACCURACY	Units Drum	±.05 mi	±.05 mi
	Tens Drum	±1/32 in.	±1/64 in.
	Hundreds Drum	±1/32 in.	±1/64 in.
SPEED	Either Direction	15 mi/sec	15 mi/sec
	POWER		
POWER	Rotor Voltage	26 ±2v ac, 400 ±10 cps	26 ±2v ac, 400 ±2 cps, 1 ph
	Flag Voltage	28 ±2v dc, 0.3 amp max	28 ±2v ac
	WEIGHT	1¾ lbs	3 lbs

Write for complete data



KEARFOTT DIVISION
GENERAL PRECISION, INC.

Little Falls, New Jersey

CIRCLE 97 ON READER SERVICE CARD

97

**Phil
Greenstein
can
show
you...**

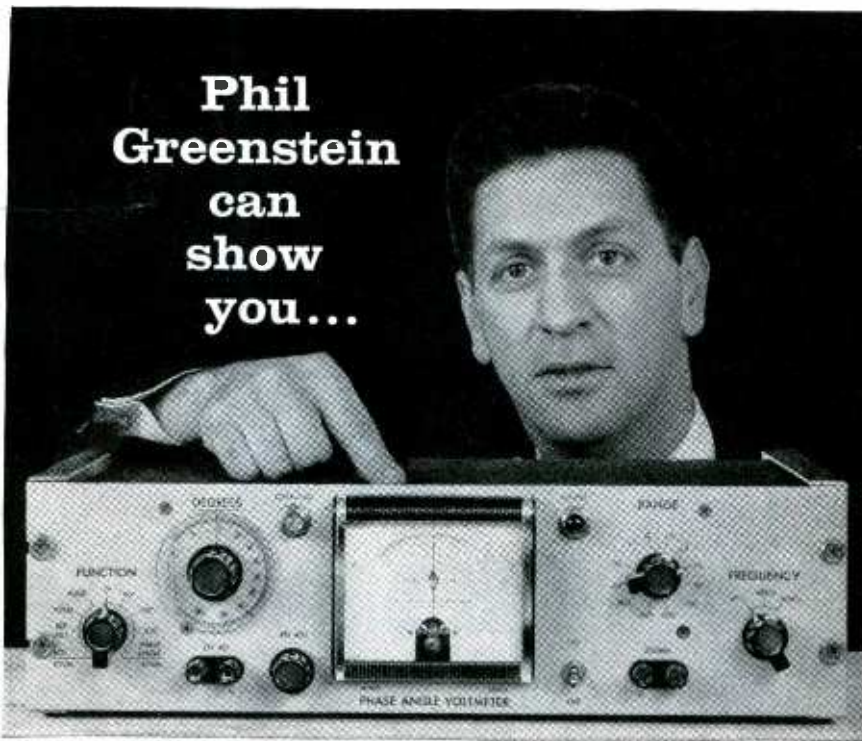

**how North Atlantic's
Phase Angle Voltmeters solve
tough ac measurement problems
... in the lab or in the field.**

Designed for critical tasks in circuit development, production and testing, North Atlantic's Phase Angle Voltmeters provide direct reading of phase angle, nulls, total, quadrature and in-phase voltages—with proven dependability even under field conditions. Your North Atlantic engineering representative can quickly demonstrate how they simplify ac measurement jobs from missile checkout to alignment of analog computers—from phasing servo motors to zeroing precision synchros and transducers.

Shown below are condensed specifications for single-frequency Model VM-202. Other models include high sensitivity, three-frequency and broadband types.

Voltage Range.....	1 mv to 300 v f.s., 12 ranges
Voltage Accuracy.....	±2% f.s.
Phase Accuracy.....	dial: ±1°; meter: ±3% of F.S. degrees
Signal Frequency.....	1 Freq., 30 cps—10 kc
Input Impedance.....	10 megohms
Reference Input.....	100 K, 0.25 v min.
Meter scale.....	3-0-3, 10-0-10 linear
Phase Angle Dial.....	4 scales, 90° (elec.) apart
Nulling Sensitivity.....	2 microvolts (phase sensitive)
Harmonic Rejection.....	55db (with filters)
Dimensions.....	5¼" h. x 19" w. x 7⅞" d.

The North Atlantic man in your area has full data on standard and special models for laboratory, production and ground support. Call today for his name, or request Bulletin VM-202.



NORTH ATLANTIC industries, inc.
TERMINAL DRIVE, PLAINVIEW, L. I., NEW YORK • OVerbrook 1-8600

without switches, contacts or patch cords.

CIRCLE 325 ON READER SERVICE CARD



MADT Transistors
VERY LOW NOISE

PHILCO CORP., Lansdale, Pa. Three MADT transistors exhibit very low noise characteristics. The T2028, T2029 and T2030 are designed for vhf-uhf, r-f amplifiers, mixers and oscillators used in military communications equipment, mobile radios and transistorized tv.

CIRCLE 326 ON READER SERVICE CARD

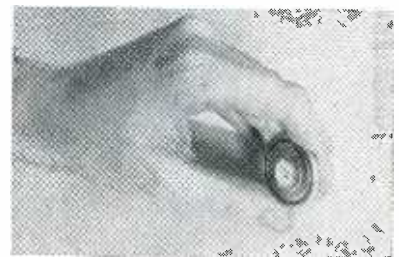

Button Cell
SILVER-CADMIUM

YARDNEY ELECTRIC CORP., 40 Leonard St., New York 13, N.Y., announces Silcad (silver-cadmium) button cells for use in all types of portable equipment requiring high energy outputs from small, light-weight power packs. The 0.25-ampere hr unit shown provides up to 75 percent more capacity than ordinary rechargeable button cells of the same weight and volume, and has a cycle life almost 60 percent greater. Open-circuit cell voltage is 1.4 v; nominal voltage under load, 1.1 v.

CIRCLE 327 ON READER SERVICE CARD

Infrared Material

SEMITRONICS, INC., P. O. Box 46, Winchester, Mass., has available

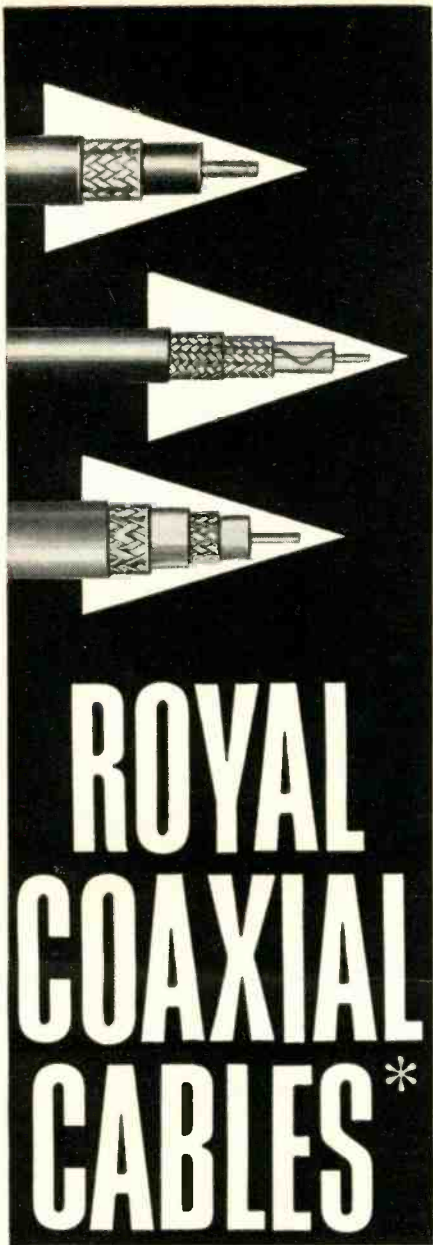

ROYAL COAXIAL CABLES*

Dependable performance is the greatest asset of Royal coaxial and multi-conductor cables. They are made to exacting standards for exacting applications. Whatever your requirements . . . for electronic equipment, the military, or community TV applications,



Royal can supply stock or special constructions with built-in satisfaction.

Ask for Bulletin 4C-3-L (stock constructions) or let us quote on your needs . . . representatives coast to coast.

ROYAL ELECTRIC CORPORATION
301 Saratoga Avenue
PAWTUCKET • RHODE ISLAND

In Canada: Royal Electric Company (Quebec) Ltd.,
Pointe-Claire, Quebec



... an associate of



CIRCLE 204 ON READER SERVICE CARD
December 8, 1961

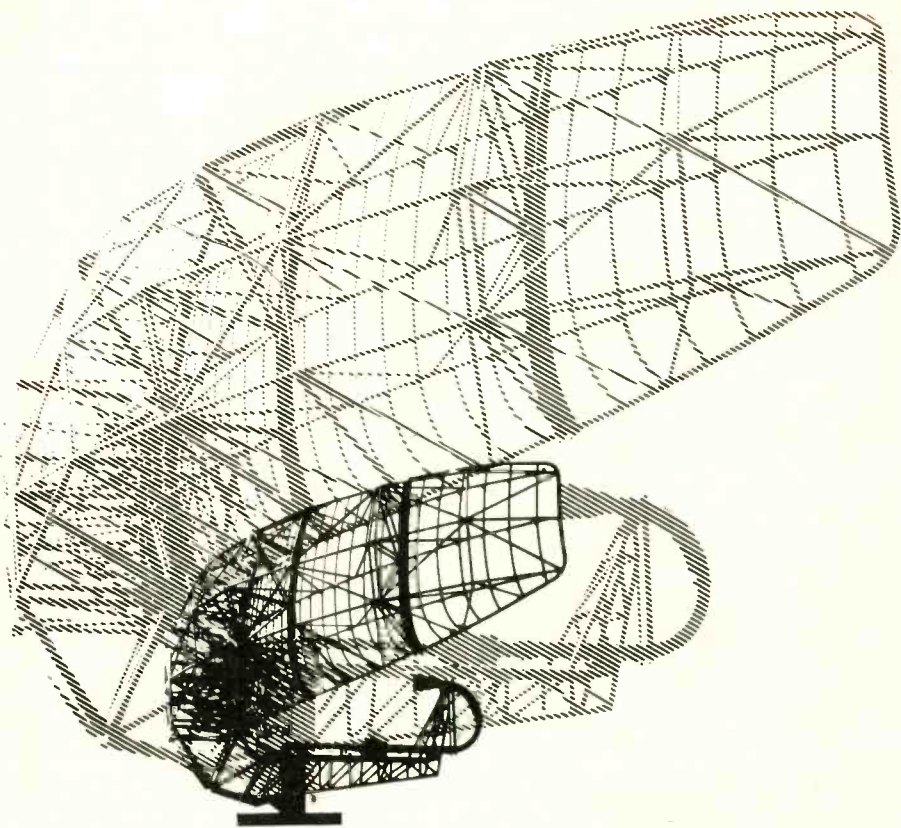

SAFETY OF LIFE IN THE AIR

SELENIA AIR TRAFFIC CONTROL RADAR OFFERS:

SOLID LONG RANGE, HIGH ALTITUDE DETECTION OF EVEN THE SMALLEST TYPES OF AIRCRAFT THROUGH THE USE OF HIGH AVERAGE POWER AND A PARAMETRIC AMPLIFIER RECEIVER.

THE MOST ADVANCED TRUE MTI SYSTEM IN THE WORLD WITH THREE PULSE CANCELLATION FOR CLUTTER-FREE PRESENTATION AND STAGGERED REPETITION RATE FOR BLIND SPEEDS ELIMINATION.

THE USE OF L-BAND ASSURES SHARP AZIMUTH DISCRIMINATION AND LOW PRECIPITATION ATTENUATION WITH REASONABLY SIZED ANTENNA STRUCTURES.

SPECIAL HIGH-LOBE ANTENNA FOR GREATLY IMPROVED SUBCLUTTER VISIBILITY FOR CLOSE-IN TARGETS AND CIRCULAR POLARIZATION FOR NEARLY COMPLETE CANCELLATION OF RETURNS FROM PRECIPITATION.

A RADAR COMPLETELY COMPATIBLE WITH JET AGE REQUIREMENTS.

A DIRECT SUCCESSOR OF THE PROVEN RAYTHEON AIRPORT AND AIRWAYS RADARS CHOSEN BY THE AIR TRAFFIC CONTROL AUTHORITIES IN CANADA, THE UNITED STATES AND SWITZERLAND.

Your inquiry is invited for more specific information
ROME ITALY
P.O. BOX 7083

MANAGED BY
RAYTHEON



Excellence in Electronics in Europe

CIRCLE 99 ON READER SERVICE CARD 99

Published by Chart-Pak, Inc., originator of the tape method of drafting

PRINTED-CIRCUIT DRAFTSMEN GET "INSTANT" SYMBOLS WITH CHART-PAK

It's a lot less work to make fast, accurate master drawings with Chart-Pak printed circuit symbols and tapes.

Chart-Pak offers circles, ovals, fillets and a variety of common shapes die-cut out of pressure-sensitive black crepe paper — available on handy backing rolls. You just press them down!

Chart-Pak circuit symbols are low in cost; accurate; reproducible; easily "correctable". Available in popular decimal sizes.

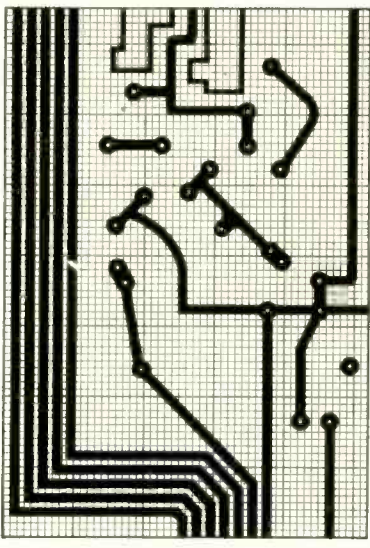
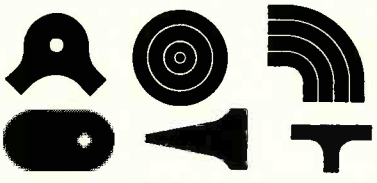

Conductor Paths "Tape" On—A Yard at a Time!

Draftsmen put down conductor paths in seconds, with Chart-Pak circuit tapes . . . Lines have unusual uniformity (width held within .002"). Chart-Pak's precision-slit tapes come in sizes down to 1/4" . . . in all-black or white-backed type (handy for registering circuits back-to-back.)



WRITE FOR NEW CHART-PAK CATALOG. It helps you take the drudgery out of drafting!

Chart-Pak Grids Pin-Point Location within .002"

Precise printed-circuit drawings are a foregone conclusion when they're "taped-up" with Chart-Pak, on a Chart-Pak Precision Grid. The distance between any two lines is guaranteed accurate within .005".

The sheet, tough, stable DuPont "Mylar"® is a pleasure to work on — can be used over and over again.

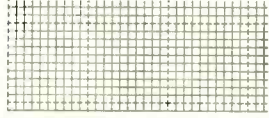

New! "Tape-Saver" Package

CHART-PAK, INC.

ORIGINATOR OF THE TAPE METHOD OF DRAFTING



CIRCLE 100 ON READER SERVICE CARD

vertically grown, single crystal indium antimonide p-n junctions for infrared detector applications.
CIRCLE 328 ON READER SERVICE CARD

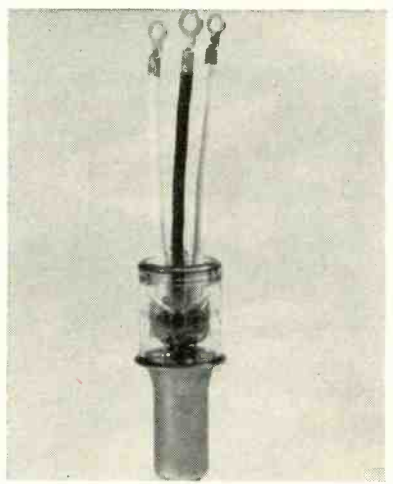

High-Mu Triode HIGH VACUUM

UNITED ELECTRONICS CO., 42 Spring St., Newark, N.J. The No. 581 is a miniature high vacuum high-mu triode designed for pulse modulator service. In this service it can deliver 13 Kw pulse power output. Maximum anode voltage is 20 Kv, peak plate current is 1.2 amperes, and grid bias is 300 v. Length of the tube is 2.75 in. and the diameter is 1.13 in.

CIRCLE 329 ON READER SERVICE CARD



D-C Power Modules HIGH TEMPERATURE

TECHNIPOWER INC., 18 Marshall St., South Norwalk, Conn. Using all silicon semiconductors and tantalum capacitors, these d-c power modules have a temperature rating of -40 C to +100 C. Over 90 models are available ranging from 2.8 to 52 v at powers of 1.0 to 20 w. Ripple is 1 mv rms for 0.05 percent regulation; 5 mv rms for 0.5 percent regulation.

CIRCLE 330 ON READER SERVICE CARD

YOUR CHRISTMAS GREETINGS AND PACKAGES WILL GET THERE FASTER IF YOU MAIL EARLY!

to Distant Points, by December 10 . . . for Local Delivery, by December 16th
Address Legibly—Include Postal Zone Number and Your Return Address—
Wrap Packages Securely—AND . . .

MAIL EARLY!

PRODUCT BRIEFS

ACCELEROMETER versatile unit. Gianini Controls Corp., 1600 S. Mountain Ave., Duarte, Calif. (331)

CHOPPER INPUT TRANSFORMER high impedance. James Electronics, Inc., 4050 No. Rockwell St., Chicago 18, Ill. (332)

DUMET WIRE CLEANER safe to handle. Fidelity Chemical Products Corp., 470 Frelinghuysen Ave., Newark 14, N.J. (333)

RIGID TRANSMISSION LINE for high power signals. Technical Appliance Corp., Sherburne, N.Y. (334)

COAXIAL SLOTTED LINE with parallel-plane design. General Microwave Corp., 47 Gazza Blvd., Farmingdale, N. Y. (335)

P-C BOARD angular construction. R. G. Circuits Co., 15216 Mansel Ave., Lawndale, Calif. (336)

MICROWAVE ATTENUATOR solenoid actuated. Hathaway Denver, 5800 E. Jewell Ave., Denver, Col. (337)

COMPUTER SIMULATOR low-cost. Scientific Development Corp., 372 Main St., Watertown, Mass. (338)

STRIPPING MACHINE for shielding braid. Ewald Instruments, Route 7, Kent, Conn. (339)

BATTERY CHARGER for space vehicle batteries. Mid-Eastern Electronics, Inc., Springfield, N.J. (340)

STRAIN GAGE POWER SUPPLY fully transistorized. Cubic Corp., San Diego 11, Calif. (341)

LONG SCALE METER limited panel space. The Triplett Electrical Instrument Co., Bluffton, O. (342)

SUPERHET RECEIVER tunes 10 to 600 Kc. Marconi Instruments, 111 Cedar Lane, Englewood, N.J. (343)

HEART MONITOR portable. Electronic Medical Systems, Inc., 1449 University Ave., St. Paul, Minn. (344)

CURRENT GOVERNOR programmable. North Hills Electronics, Inc. Alexander Place, Glen Cove, N.Y. (345)

LASER MATERIAL strontium fluoride. Semi-Elements Inc., Saxonburg Blvd., Saxonburg, Pa. (346)

For Production

Line Testing...

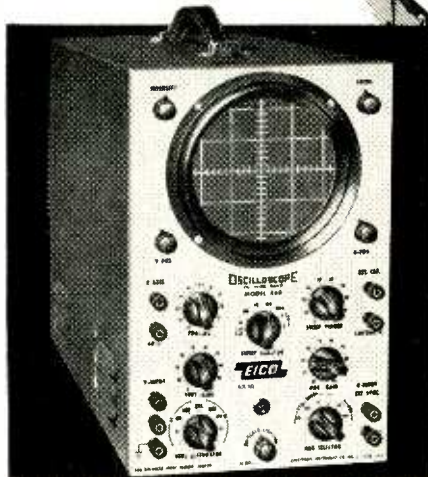

EICO SCOPES

give you:

- professional performance
- reliability
- ruggedness
- versatility

... at moderate cost

EICO's high quality standards and low initial cost add up to true economy: EICO units outperform scopes selling for two or three times EICO's prices.

With kits, the initial cost is even lower. And the experience each operator gains in building his own, increases his efficiency, and enables him to keep his scope in better condition, with less "down" time.

	prices		freq. resp. (sinusoidal)		sensitivity (rms)	
	kit	wired	vert.	horiz.	vert.	horiz.
5" Push-Pull Scope #425	\$44.95	\$79.95	5 cps to 400 kc	5 cps to 400 kc	75 mv/in	0.1V/in
5" DC-4.5 MC Scope #460	79.95	129.95	DC-4.5 mc/flat	1 cps to 400 kc flat	25 mv/in	0.6 V/in



See the 41 additional EICO test instruments helpful for your lab and production work. Write for free Catalog & name of neighborhood Distributor.

3300 NORTHERN BOULEVARD, Dept. E-12B, L. I. C., 1, N. Y.
CIRCLE 205 ON READER SERVICE CARD

add 5% in the West

PRECISION GLASS

SINCERE WISHES
FOR A
HAPPY HOLIDAY SEASON
and
thank you for your
patronage and support

Serving
the electronic and
instrumentation field
since 1953



T. H. GARNER COMPANY

177 S. Indian Hill Blvd.
Claremont, Calif. • NAtional 6-3526

PRODUCT APPLICATION

HANSEN

SYNCHRON
TIMING MOTORS



CLOCK PROGRAMMING

systems



using reset clock movements
powered by Hansen SYNCHRON motors

MINNEAPOLIS-HONEYWELL REGULATOR COMPANY incorporates Hansen SYNCHRON Clock Movements in its Indicating Clocks and Master Control Systems — for installation in schools, public buildings, in industry, or wherever accurate time must be maintained. Single-dial Indicating Clocks are coordinated by Master Clock Programming, with automatic correction — to compensate for deviations caused by current fluctuations — available either on an hourly or 12-hour correction basis. Hourly correction resets the clock which may be from 55 seconds fast to 59 minutes slow depending on current fluctuations, at two minutes before the hour. The 12-hour correction occurs between 5:00 and 5:30 o'clock, automatically resetting clocks up to 12 hours slow.

HANSEN SYNCHRON CLOCK MOVEMENTS were chosen by Minneapolis-Honeywell because of satisfactory power and dependability experienced by a previous supplier to the firm. Hansen SYNCHRON motors are connected to reset movements through a gear, clutch and cam arrangement. The clock systems operate with 60-cycle and 24-volt motors, on 115-volt current — generally most readily available on typical installations.

SEND TODAY for informative folder containing specifications and technical data on all Hansen SYNCHRON motors and clock movements.

HANSEN REPRESENTATIVES:
THE FROMM COMPANY
5150 W. Madison, Chicago, Illinois
H. C. JOHNSON AGENCIES, INC.
Rochester, N. Y. — Buffalo, N. Y. — Syracuse, N. Y.
Binghamton, N. Y. — Schenectady, N. Y.
ELECTRIC MOTOR ENGINEERING, INC.
Los Angeles, Calif. — (OLive 1-3220)
Oakland, California
WINSLOW ELECTRIC CO.
New York, N.Y. — Essex, Conn. (5Outh 7-8229)
Philadelphia, Penn. — Cleveland, Ohio

Sweet's Product
Design File



Literature of the Week

FACILITIES BROCHURE F. J. Stokes Corp., 5500 Tabor Road, Philadelphia 20, Pa., offers a brochure discussing its people, purpose and varied facilities. (347)

INSTRUMENT LIGHTING Monroe Industries, Inc., 934 Thirty-Sixth St., S.E., Grand Rapids 8, Mich. An illustrated brochure describes the company's facilities for the manufacture of precision illuminated parts for military integral lighting. (348)

ULTRASONIC FLOWMETER Gulton Industries, Inc., 212 Durham Ave., Metuchen, N.J. A 4-page bulletin describes and illustrates the Glenite ultrasonic flowmeter. (349)

HIGH RELIABILITY CAPACITORS General Electric Co., Schenectady 5, N. Y. Bulletin GEA-7240 covers high reliability Tantalytic solid capacitors. (350)

INFRARED TRANSMITTING GLASSES Bausch & Lomb Optical Co., Rochester 2, N. Y., offers a progress report on calcium aluminate infrared transmitting glasses. (351)

METALIZED ENCLOSURE TUBES Corning Electronic Components, Bradford, Pa. Metalized glass enclosure tubes that can withstand down-shock from 275 C to ice water are discussed in file CE-6.00. (352)

ENERGY DISCHARGE CAPACITORS Sangamo Electric Co., Springfield, Ill. H-V low inductance energy discharge capacitors are discussed in a 12-page bulletin. (353)

MAGNETIC HEAD ASSEMBLIES Westrex Recording Equipment division of Litton Systems, Inc., 335 No. Maple Drive, Beverly Hills, Calif. Details of 14-track in-line or interleaved magnetic head assemblies are covered in a bulletin. (354)

GLASS-TO-METAL SEALS Glass Instruments Inc., 2285 E. Foothill Blvd., Pasadena, Calif. Bulletin covers glass-to-metal seals that will withstand environmentals of from +420 C to -80 C. (355)

ELECTRICAL TAPES Johns-Manville, Dutch Brand Division, 22 E. 40th St., New York 16, N.Y. Selection

chart contains samples of 15 different insulating tapes, as well as data on each. (356)

PULSE GENERATORS, REFERENCE SOURCES Bulova Watch Co., Inc., 40-01 61st St., Woodside 77, N. Y. Two-color catalog sheet describes pulse generators and voltage reference sources. (357)

METER RELAYS Weston Instruments Div., Daystrom, Inc., 614 Frelinghuysen Ave., Newark, N. J. Bulletin 02-106 contains features and specifications of the model 1073 MagTrak double-action meter relays. (358)

EPOXY PELLETS Epoxy Products Division, Joseph Waldman & Sons, 137 Coit St., Irvington 11, N.J. Bulletin No. 8 describes the use of epoxy pellets for protecting tantalum capacitors. (359)

PHASE ANGLE VOLTMETER North Atlantic Industries, Inc., Terminal Drive, Plainview, N.Y., offers a data sheet on an all-transistorized multiple-function phase angle voltmeter. (360)

GLASS-TO-METAL SEALS Chromalloy Corp., 171 Western Highway, West Nyack, N.Y. Bulletin describes a new method of achieving hermetic glass-to-metal seals. (361)

MICROWAVE OPTICS Cenco Instruments Corp., 6450 W. Cortland St., Chicago 35, Ill. A 24-page illustrated booklet describes the company's microwave optics demonstration apparatus and outlines operating instructions. (362)

CLIP-ON CURRENT MEASUREMENTS Dawe Instruments Ltd., Western Ave., Acton, London, W.3, England. A technical leaflet illustrates and describes type 618 a-c Milliclamp from which readings can be taken without interruption of the circuit under test. (363)

BROADBAND AMPLIFIERS Applied Research Inc., 76 South Bayles Ave., Port Washington, N.Y., has published a data sheet on its 500 to 1,000 Mc broadband amplifier series. (364)

I-F AMPLIFIERS Ferrotran Electronics Co., Inc., 693 Broadway, New York 12, N.Y. Bulletin 576 gives the characteristics of cascaded amplifiers with gains as high as 80 db and operating from 455 Kc to 30 Mc. (365)

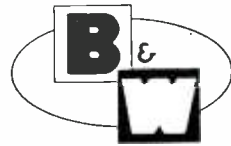

INSTRUMENTS FOR PRECISION CIRCUIT ANALYSIS

For every type of service. These quality instruments are supplied as original equipment with many broadcast station installations.

NEW B & W Model 410 Distortion Meter



- Measures: Audio distortion, noise level and audio voltage level.
- Ideal for FCC Proof of Performance Tests and laboratory measurements.
- Measures distortion as low as .1% on fundamental frequencies from 20 to 20,000 cycles.
- The sensitive vacuum tube voltmeter circuit measures AC voltage with an accuracy of $\pm 5\%$ through a frequency range of 20 to 200,000 cycles.
- The calibrated attenuator permits noise and db measurements over an extremely wide range.
- The Model 410 is a quality instrument, attractively styled and nominally priced.
- Drop us a card for a Spec Sheet.



MODEL 200 AUDIO OSCILLATOR

- Frequency Range: 30 to 30,000 cycles.
- Frequency Response: Better than ± 1 db. 30 to 15,000 cycles with 500 ohm load.
- Stability: Better than 1%.
- Calibration: $\pm 3.0\%$ of scale reading.
- Voltage Output: 10 volts into 500 ohm load.
- Distortion: Less than .2% at 5 volts output.



MODEL 600 DIP METER

- Covers 1.75 to 260 mc in 5 bands.
- Monitoring jack & B+ OFF switch.
- Shaped for use in hard-to-get-at places.
- Sturdy, color coded, plug-in coils.
- Adjustable, 500 microamp meter.

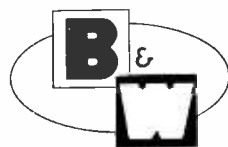

Barker & Williamson, Inc.

Canal St. and Beaver Dam Rd., Bristol, Pa.

Specialists in Designing and building equipment to operating specifications

B&W also design and manufacture filters for: ANTENNAS • RADIO INTERFERENCE • RADIO RANGE • UHF and VHF as well as many special types designed to performance specifications. Available to commercial or military standards.

CIRCLE 105 ON READER SERVICE CARD

Is your advertising selling the same four key buyers your salesmen call on? Competition demands it! Only advertising in electronics reaches and sells the electronics man wherever he is: in Research,

TODAY YOU MUST SELL ALL FOUR!

Design, Production, and Management. Put your advertising where it works hardest...

in **electronics**

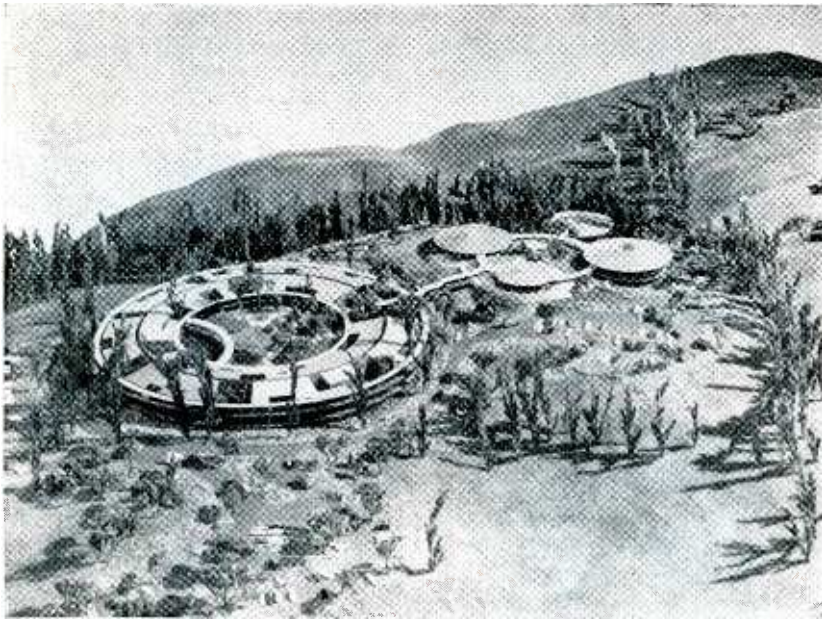

Research Center Under Construction

GENERAL TELEPHONE AND ELECTRONICS LABORATORIES, INC., a subsidiary of General Telephone and Electronics Corp., is building a new research center at Palo Alto, Calif. Facility will occupy a 77-acre site immediately southwest of the Stanford University campus.

The main building will be ring-shaped, containing laboratories and offices for the technical staff. It has been designed for quick rearrangement of office and laboratory combinations, to allow for changes in research projects and aims. A

special supported floor system allows for rearrangement of conduit, storage and ducts in connection with other changes.

Four separate round buildings will house library, auditorium, cafeteria, and administrative offices.

The facility will have a total of 67,000 sq ft at a cost of approximately \$2.6 million in its first stage (somewhat less than half of the laboratory ring), and will provide office and laboratory space for a core staff of 175.



Liquidometer Names Evans a V-P

CAREY A. EVANS has been named vice president in charge of engineering

by the Liquidometer Corp., Long Island City, N.Y.

Prior to joining Liquidometer, Evans was director of operations for the marine equipment department of the Northrop Corporation's Nortronics Division.

Pickering Elected Astrosonics President

ELECTION of Norman C. Pickering as president and director of Astrosonics, Inc., Syosset, N. Y., is announced. He was formerly vice president and technical director of

Avien, Inc., president of Charles Denning, Ltd., founder and president of Pickering & Co.

Astrosonics' laboratories and plant include advanced facilities for measurement, testing and product development, utilizing high-intensity sonic phenomena.

Sah, Ferguson Take New Posts

FAIRCHILD SEMICONDUCTOR'S Research & Development Laboratory, Palo Alto, Calif., has promoted C. T. Sah and Phillip Ferguson to section heads.

Sah will head the laboratory's physics section; Ferguson, the device development section.



General Microwave Appoints Pizzutiello

APPOINTMENT of Robert Pizzutiello to the position of applications engineer is announced by General Microwave Corp., Farmingdale, N. Y.

Pizzutiello was formerly with Microwave Dynamics Corp. as sales engineer.



Warriner Moves Up At Raytheon

BEN WARRINER has been named manager, product programs for

When you need **POWER...**

choose

NICAD[®]

**NEW
Nickel Cadmium
Rechargeable
Batteries**

SEALED CELLS

Hermetically sealed and rechargeable, Nicad batteries are small in size, require no maintenance, operate in any position. They make practical the battery operation of many types of equipment not previously suited to dry, mercury, or lead acid types.

VENTED CELLS

High surge power cells, in sintered or pocket plate types, are capable of sustained voltage at high discharge rates over a wide temperature range. They have extremely long life... little or no maintenance. For more of the POWER story, write

SEALED CELLS

VENTED CELLS



NICAD BATTERY DIVISION
GOULD-NATIONAL
BATTERIES, INC. E-1411 First National
Bank Bldg., St. Paul 1, Minn.

CIRCLE 206 ON READER SERVICE CARD

For Military and
Commercial
Applications

**Grayhill
Miniature
Rotary
Tap Switches**



These switches are designed to meet military and commercial specifications and ruggedly built to precision standards.

Grayhill No. 5000, No. 12, and No-24 Series. 1.01" dia. Break 1 amp., 115 VAC, resistive. Carry 5 amps. 1 to 10 decks, 2 to 10 positions per deck—1 or 2 poles per deck—shorting or non-shorting. Life 100,000 cycles. Also No. 24 Series, spring return switch.

Concentric Shaft. No. 6 (1 to 3 decks per shaft—Total 6 decks) and No. 36 Series (1 or 2 decks per shaft. Total 4 decks). 1.01" dia. 2 to 10 positions per deck. Break 1 amp., 115 VAC, resistive. Carry 5 amps. Two switches in one. 1/4" shaft controls 1/2 of the decks, 1/8" shaft controls the other half.

No. 45 Series Midget. .640" dia. Single deck only. 60° indexing. Break 1 amp., 115 VAC, resistive. Carry 5 amps. Life 100,000 cycles.

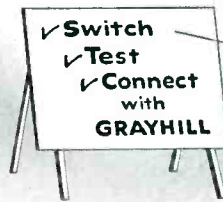

Grayhill offers a full line of Rotary Tap Switches, Push Button Switches, Test Clips, Binding Posts, and other miniature electrical and electronic components.
ASK FOR CURRENT CATALOG.

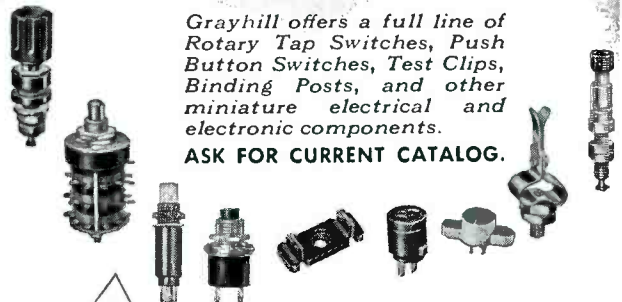

Phone: Fleetwood 4-1040
523 Hillgrove Avenue
LaGrange, Illinois

"PIONEERS IN MINIATURIZATION"

CIRCLE 107 ON READER SERVICE CARD 107



MODEL P-25



MODEL EW-16



MODEL FL-202

Around the world it's **KEW**



MODEL VO-38



MODEL VR-2P



MODEL TK-20A



MODEL TR-A



MODEL TR-B



MODEL TK-20B



MODEL VTM-500

MODEL TR-C

KYORITSU ELECTRICAL INST. WORKS, LTD.

No. 120, Nakane-cho, Meguro-ku, Tokyo, Japan
Cable Address: "KYORITSUKEIKI TOKYO"

Tel: (717) 0131~5

CIRCLE 207 ON READER SERVICE CARD

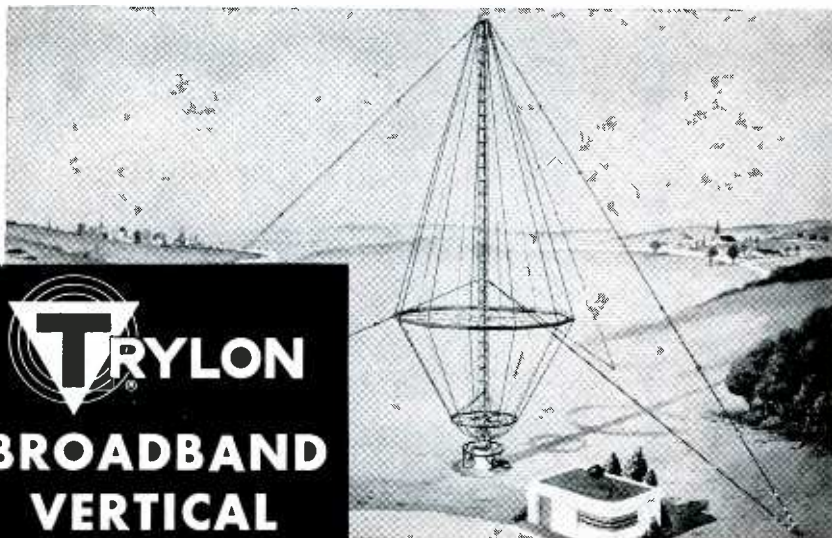

TRYLON
BROADBAND
VERTICAL
RADIATORS

for frequency ranges from 2 to 6 mc.
 4.5 to 13.5 mc.—11 to 33 mc.—or similar ranges

A multi-frequency service radiator requiring no matching equipment

ADVANTAGES

- Extremely constant input impedance over a wide frequency range.
- Power handling capacity to 150 kw. or more.
- Radiation performance equal to, or better than a conventional radiator without the need of impedance matching equipment.

WIND TURBINE COMPANY

WEST CHESTER, PA.

Phone: OWen 6-3110

TRYLON TOWER AND ANTENNA SYSTEMS

- RESEARCH
- MANUFACTURE
- DEVELOPMENT
- INSTALLATION

Write, wire or phone for information or application to your requirements.

CIRCLE 208 ON READER SERVICE CARD

Raytheon Company's Microwave and Power Tube Division, Burlington, Mass.

Warriner joined Raytheon in January of this year. Earlier he had been with Collins Radio Co. as manager of the research and development division and as its government representative at Hanscom Air Force Base, Bedford, Mass.



**Form New Company
 In Massachusetts**

FORMATION of Damon Engineering, Inc., Needham Heights, Mass., is announced. Co-founders of the new company are: David I. Kosowsky (picture), president and treasurer; Carl R. Hurtig, vice president; and Austen H. Madeson, sales manager. All were previously associated with Hermes Electronics Co.

Products of Damon Engineering, Inc. include quartz crystal filters, oscillators and other frequency selection and control networks. Custom built systems for spectrum analysis and telemetry will also be offered



**Levin Advances
 At Power Designs**

JOHN K. LEVIN is appointed vice president in charge of manufacturing at Power Designs, Inc., Westbury, L.I., N.Y. He will continue to fulfill the responsibilities of plant

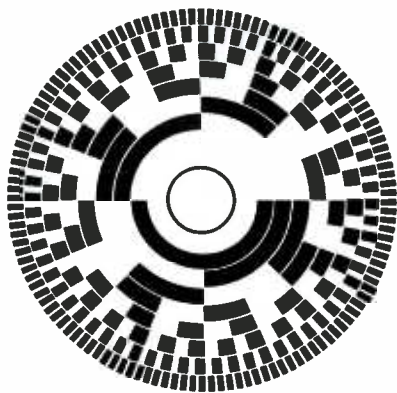

military qualified

**LITTON MINIATURE
 SHAFT ENCODERS**

8, 13, AND 18-BIT

- Twice the resolution. 32-to-1 gear ratio.
- 2⁸ count for one shaft rotation.
- 5,000,000-revolution life expectancy.
- Performance proven for:
 Temperatures within —55°C to 100°C.
 Altitude to 70,000 feet.
 Vibration of 5 to 2,000 cps to 10 g.
 Shock to 15 g.
 Humidity per MIL Standard 202A.
 Non-flammability.



Size 11 Encoder, actual size

For complete information, contact Products Marketing Department, Litton Systems, Inc., Guidance and Control Systems Division, 5500 Canoga Avenue, Woodland Hills, California.



LITTON SYSTEMS, INC.
 GUIDANCE AND CONTROL SYSTEMS DIVISION
 A DIVISION OF LITTON INDUSTRIES



Gamewell made this special completely from scratch.

Every part of this rotary switch was newly designed by Your Engineered Specials service to meet a customer's special requirements. The unit provides bi-directional operation at 160 rpm max. It is rated at 28 VDC, 60 ma . . . has high vibration and shock resistance . . . and -55° to $+150^{\circ}\text{C}$. temperature range. Although this design called for only six poles and 11 switching segments, many more could have been provided.

Gamewell's YES service has developed answers to hundreds of special "pot" problems. Interested? Write for the full story.

***your
Engineered
Specials service**

yes



THE GAMEWELL COMPANY, POTENTIOMETER DIVISION, 1418 CHESTNUT STREET, NEWTON UPPER FALLS 64, MASS. A SUBSIDIARY OF E. W. BLISS COMPANY.

CIRCLE 210 ON READER SERVICE CARD
December 8, 1961

SYNCHRO NEWS!

VERNITRON 3-MINUTE CONTROL SYNCHROS DELIVERED ON REGULAR PRODUCTION BASIS

ALL SIZES—11 through 23
ALL TYPES—Transformers, Transmitters, Differential Transmitters — Thru-Bore and Standard
ALL ENGINEERED & MANUFACTURED TO:
MIL-S-2335 MIL-S-16892 FXS-1066
MIL-S-12472 MIL-S-20708A
ALL AVAILABLE WITH MAXIMUM ELECTRICAL ERROR OF ± 3 MINUTES! A major break-through, made possible by VERNITRON specialization in precision synchro component design and manufacture.



WRITE, WIRE, PHONE NOW for complete price, delivery and specification data; ask for new Vernitron Catalog



606 Old Country Rd., Garden City, N.Y. Pioneer 1-4130 TWX: G-CY-NY-1147
West Coast Plant: 1742 So. Crenshaw Blvd., Torrance, Cal.—FAirfax 8-2504 TWX: TNC-4301

CIRCLE 209 ON READER SERVICE CARD

Acoustical Components of Superior Quality

JAPAN PIEZO supplies 80% of Japan's crystal product requirements. Here are a few examples of our capabilities.



MICROPHONE Crystal—X-29

At 20°C , 1KC/s, Sensitivity is $-58 \pm 5\text{db}$. Impedence: 100K Ω . Capacitance: 1,500 pF.



PHONOGRAPH MOTOR—DC PM—31-1

9V, 2,500 RPM: No-load current, 35 mA; load current, 80 mA. Starting torque, 13 g-cm; load torque, 5g-m. Size: 2.4cm X 4.6cm. Weight: 100 gm.

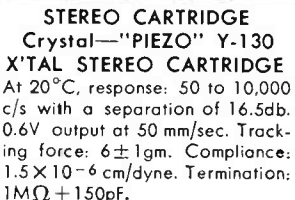

STEREO CARTRIDGE Crystal—"PIEZO" Y-130 X'TAL STEREO CARTRIDGE
At 20°C , response: 50 to 10,000 c/s with a separation of 16.5db. 0.6V output at 50 mm/sec. Tracking force: $6 \pm 1\text{gm}$. Compliance: 1.5×10^{-6} cm/dyne. Termination: 1M Ω + 150pF.



Write for detailed catalog to :

JAPAN PIEZO ELECTRIC CO., LTD.

Kami-renjaku, Mitaka, Tokyo, Japan

CIRCLE 109 ON READER SERVICE CARD 109

- the ultra
new **YOKE!**



Deflectron*
By **Celco**

**MAJOR ADVANCE IN
THE SCIENCE OF
ELECTRON BEAM DEFLECTION!**

SPOT RECOVERY

Fastest! to 1 μ S

SPOT SIZE

Smallest - by 25%

SPOT SWEEP

Straightest.....

*** DEFLECTRONS for DISPLAYS**

Where ordinary precision
yokes **FAIL** to meet your
requirements.

Write for NEW "DEFLECTRON"
Data and Standard Yoke
Catalog. 

Celco

*Constantine Engineering
Laboratories Co.*

Main Plant: MAHWAH, N. J. DAvis 7-1123
PACIFIC DIV.- UPLAND, CALIF. YUkon 2-0215
CENTRAL DIV.- LANESBORO, PA. ULYsses 3-3500

manager, a position he has held with the company since 1959.

Power Designs, Inc., is engaged in the design and manufacture of high reliability power supplies for defense, industry and research laboratories.

Donald Chrisman Takes New Post

DONALD W. CHRISMAN has been appointed director of planning for the Martin Electronic Systems and Products division, Baltimore, Md. He will be responsible for the division's operational and long-range planning.

Chrisman formerly was on the Martin corporate staff.

PEOPLE IN BRIEF

Charles Terrey, formerly with Bailey Meter Co., has joined Datex Corp. as a development engineer in the electronic products group. Harold Rind, of Republic Aviation Corp., is named chief of its Space Environment Laboratory. Robert Neyman previously with Elgin Micronics, is appointed technical manager, electronics and communications projects, at Cannon Electric Co. Paul Gallagher leaves Transatron Electronics Corp. to become section head, preproduction engineering, at Rheem Semiconductor Corp. Paul F. Radue, ex-ITT Kellogg, now applications engineer in the marketing division of Lynch Communications Systems Inc. Earl M. Underhill advances at Crucible Steel Co.'s Magnet Div. to manager of engineering. William A. Matthews moves from Kollsman Instrument Corp. to Winchester Electronics, Inc., as general mgr. Robert B. Martin from Airpax, Inc. to Colin Campbell Co. as chief engineer. Richard M. Mock, Lear Inc. executive, elected a director of Astrodata, Inc. Robert W. Brooks, former president of Computer Control Co., Inc., named product department mgr. of Adage, Inc. Sylvania Electric Products Inc. ups James O. Lawson to manager of quality control for the Parts Div. Ward C. Low, ex-Mitre Corp., joins LFE Electronics as technical director for the Systems Div.

**0 TO 1500 V
COMPLIANCE**

with **ELECTRONIC
MEASUREMENTS**



MODEL C638A

**CONSTANT CURRENT
POWER SUPPLIES**

You'll find a whole new world of application in Electronic Measurements Constant Current Power Supplies. Take the husky Model C638A shown here. It'll deliver up to 1500 V dc at any output current from a few microamperes up to 100 ma. There are other features too... a modulation input, programmability, less than 0.01%+1 μ a ripple... and the all-important voltage control that lets you set the maximum voltage compliance.

For complete information ask for Specification Sheet 3072B.

BRIEF SPECIFICATIONS

MODEL	RANGE		VOLTAGE COMPLIANCE (MINIMUM)
	MIN.	MAX.	
C612A	1 μ a	100 ma.	100 V
C631A	1 μ a	100 ma.	300 V
C638A	1 μ a	100 ma.	1500 V
C624A	2.2 μ a	220 ma.	100 V
C632A	2.2 μ a	220 ma.	300 V
C629A	2.2 μ a	300 ma.	50 V
C633A	2.2 μ a	300 ma.	300 V
C620A	5 μ a	500 ma.	50 V
C621A	5 μ a	500 ma.	100 V
C613A	10 μ a	1 AMP	50 V
C614A	10 μ a	1 AMP	100 V



**ELECTRONIC
MEASUREMENTS**
COMPANY, INCORPORATED
EATONTOWN, NEW JERSEY

CIRCLE 211 ON READER SERVICE CARD
electronics



CIRCUIT DESIGN

If this is your career interest, we have projects involving digital computers of extremely small size. Let us tell you more about this — confidentially. Write to Mr. Harry Laur — Research and Engineering Staff.

Qualified applicants will be considered regardless of race, creed, color or national origin.



LITTON SYSTEMS, INC. Data Systems Division
Canoga Park, California



looking for better than jewelry quality in precious metal tubing?

If you are a nuclear or electronics engineer looking for a supply of jewelry quality small tubing in silver, gold, palladium or their alloys, here's good news! The quality tubing you seek is available from UNIFORM TUBES with O.D.'s from 0.005" to 3/8". What's more, you can order this tubing precision drawn to any wall thickness from 0.035" down to 0.001" within tolerances of $\pm 0.0005"$. . . $\pm 0.00025"$ on the smallest sizes!

UNIFORM cuts this tubing to specified lengths with ends square and free of burrs. UNIFORM's experience in working precious metals is also available for the fabrication of tubular parts. Flaring, coining, bending and other fabricating steps are completed with the same precision and skill applied to drawing the precious metal tubing.

Where the corrosion resistance or special properties of a precious metal are needed on either O.D. or I.D. only, UNIFORM supplies COMPOSITE TUBING with the precious metal drawn over a precision tube of a less expensive base metal or vice versa.

Composite tubing meets the same close tolerances and quality standards UNIFORM sets for tubing of silver, gold, palladium or their alloys.

Phone, wire or write today for details and a quotation. Delivery is normally less than three weeks.



UNIFORM TUBES, INC.
COLLEGEVILLE 2, PA.

HUxley 9-7276 TWX-CGVL 1044

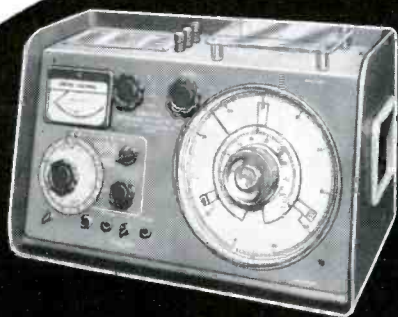

Model 1313

\$590

1/4% ACCURACY WANTED?

This new Universal Bridge adds to the wide variety from which an engineer must choose. But Model 1313 has both 1/4% Accuracy and Direct Readout; combines high discrimination with exceptional ease of use. Detector AGC, variable frequency operation and functional styling are all plus features.

L: 1 μ H to 110H, 7 decades
C: 1 μ F to 110 μ F, 7 decades
R: 0.1 Ω to 110M Ω , 8 Decades
Accuracy: 1/4%
Discrimination: 5000 div's/Decade
Frequency: 1Kc, 10Kc, 100 cps to 20Kc
with ext. osc.
Readout: Direct—no multiplying factors

MAKE NO MISTAKE
MEASURE WITH :



MARCONI
INSTRUMENTS



111 CEDAR LANE • ENGLEWOOD, NEW JERSEY

CIRCLE 212 ON READER SERVICE CARD

electronics

WEEKLY QUALIFICATION FORM FOR POSITIONS AVAILABLE

ATTENTION: ENGINEERS, SCIENTISTS, PHYSICISTS

This Qualification Form is designed to help you advance in the electronics industry. It is unique and compact. Designed with the assistance of professional personnel management, it isolates specific experience in electronics and deals only in essential background information.

The advertisers listed here are seeking professional experience. Fill in the Qualification Form below.

STRICTLY CONFIDENTIAL

Your Qualification form will be handled as "Strictly Confidential" by ELECTRONICS. Our processing system is such that your form will be forwarded within 24 hours to the proper executives in the companies you select. You will be contacted at your home by the interested companies.

WHAT TO DO

1. Review the positions in the advertisements.
2. Select those for which you qualify.
3. Notice the key numbers.
4. Circle the corresponding key number below the Qualification Form.
5. Fill out the form completely. Please print clearly.
6. Mail to: D. Hawksby, Classified Advertising Div., ELECTRONICS, Box 12, New York 36, N. Y. (No charge, of course).

COMPANY	SEE PAGE	KEY #
AMPEX CORPORATION Redwood City, California	87*	1
RICHARD D. BREW & CO., INC. Concord, New Hampshire	88*	2
ELECTRO-MECHANICAL RESEARCH INC. Sarasota, Florida	114	3
ERIE ELECTRONICS DIV. Erie Resistor Corp. Erie, Pennsylvania	116	4
GARRETT CORPORATION AirResearch Manufacturing Div. Los Angeles, California	114	5
GENERAL DYNAMICS/ASTRONAUTICS San Diego, California	17, 18*	6
GENERAL DYNAMICS/ELECTRONICS Military Products Div. San Diego, California	116	7
GENERAL ELECTRIC CO. Missile & Space Vehicle Dept. Philadelphia, Pa.	113	8
HUGHES AIRCRAFT COMPANY Space Systems Div. Culver City, California	17, 18	9
HUGHES AIRCRAFT COMPANY El Segundo, California	84*	10
HUGHES AIRCRAFT COMPANY Tuscon Engineering Lab. Tuscon, Arizona	80*	11
I B M CORPORATION New York, New York	115	12
LAWRENCE RADIATION LABORATORY Livermore, California	88*	13
LINK DIVISION General Precision Inc. Binghamton, New York	92	14
LITTON SYSTEMS INC. Data Systems Div. Canoga Park, California	111	15
LOCKHEED CALIFORNIA CO. A Div. of Lockheed Aircraft Corp. Burbank, California	50	16

CONTINUED ON PAGE 116

(cut here)

(cut here)

electronics WEEKLY QUALIFICATION FORM FOR POSITIONS AVAILABLE

Personal Background

NAME

HOME ADDRESS

CITY ZONE STATE

HOME TELEPHONE

Education

PROFESSIONAL DEGREE(S)

MAJOR(S)

UNIVERSITY

DATE(S)

FIELDS OF EXPERIENCE (Please Check)

1281

- | | | |
|--|--|---------------------------------------|
| <input type="checkbox"/> Aerospace | <input type="checkbox"/> Fire Control | <input type="checkbox"/> Radar |
| <input type="checkbox"/> Antennas | <input type="checkbox"/> Human Factors | <input type="checkbox"/> Radio—TV |
| <input type="checkbox"/> ASW | <input type="checkbox"/> Infrared | <input type="checkbox"/> Simulators |
| <input type="checkbox"/> Circuits | <input type="checkbox"/> Instrumentation | <input type="checkbox"/> Solid State |
| <input type="checkbox"/> Communications | <input type="checkbox"/> Medicine | <input type="checkbox"/> Telemetry |
| <input type="checkbox"/> Components | <input type="checkbox"/> Microwave | <input type="checkbox"/> Transformers |
| <input type="checkbox"/> Computers | <input type="checkbox"/> Navigation | <input type="checkbox"/> Other |
| <input type="checkbox"/> ECM | <input type="checkbox"/> Operations Research | <input type="checkbox"/> |
| <input type="checkbox"/> Electron Tubes | <input type="checkbox"/> Optics | <input type="checkbox"/> |
| <input type="checkbox"/> Engineering Writing | <input type="checkbox"/> Packaging | <input type="checkbox"/> |

CATEGORY OF SPECIALIZATION

Please indicate number of months experience on proper lines.

	Technical Experience (Months)	Supervisory Experience (Months)
RESEARCH (pure, fundamental, basic)
RESEARCH (Applied)
SYSTEMS (New Concepts)
DEVELOPMENT (Model)
DESIGN (Product)
MANUFACTURING (Product)
FIELD (Service)
SALES (Proposals & Products)

CIRCLE KEY NUMBERS OF ABOVE COMPANIES' POSITIONS THAT INTEREST YOU

1 2 3 4 5 6 7 8 9 10 11 12 13 14 15 16 17 18 19 20 21 22 23 24 25

ANTENNA & PROPAGATION ENGINEERS:

To carry on theoretical & experimental studies of advanced nature for all radio frequency bands. EE's. (Advanced degree preferred.) Minimum of 6 years experience. **(C)**

Ground Support Electronic Systems Engineer

Design and development of ground electronic systems through the RF spectrum for application in the support systems of re-entry or space vehicles. A technical specialist position requiring a BSEE, 6 years experience and a background in such fields as communications, telemetry or radar. **(D)**

Senior Staff Consultant

for all System Level Experimentation in Electronics for all MSVD programs

System problems include: stabilization and attitude control of satellites and re-entry vehicles; space/ground communications; orbit navigation and control; mid-course and terminal spacecraft navigation and guidance.

An advanced degree is essential for this outstanding opportunity for high level, original work; also a substantial background in systems design. Experience in radar & communications helpful. **(E)**

MANAGER

ADVANCED MISSILE & SATELLITE ELECTRONICS

A Significant Opportunity for an Engineer with a Record of Achievement. An advanced degree — MS or PhD and a minimum of 10 years applicable experience is mandatory for the highly competent and creative man required for this position. He will guide an organization responsible for the development of very advanced components for missile & satellite applications. These include encoders, command circuitry, transmitters, digital electronics, etc. **(G)**

IMMEDIATE OPENINGS AT THE MISSILE & SPACE VEHICLE DEPARTMENT PHILADELPHIA, PENNSYLVANIA

Your inquiry is invited regarding any of the positions — encompassing many areas of space science and engineering — listed on this page. Please use the INQUIRY CARD provided for your convenience. A prompt answer is guaranteed; your confidence will be respected.

Diversified Assignments for Design Engineers

Logic Circuit Design

Provide high level technical evaluation of digital techniques as applied to automatic programming systems for check-out equipment and airborne instrumentation. Requires EE with broad digital background from systems philosophy to final design. **(S)**

Digital Components & Circuits

Design and evaluate A/D and D/A converters, multiplexers, parity check generators, digital storage devices, binary counters, etc., for both airborne and ground digital equipment. EE with 2-5 years experience. **(I)**

RADAR SYSTEMS
Re-Entry Guidance & Space Navigation
Apply radar systems principles to problems of re-entry-guidance and space navigation; define parameters of the technical concept and maintain project control over full engineering effort. Requires EE, strong background in radar systems. **(H)**

ADVANCED SYSTEMS ENGINEERING

ECM SUB-SYSTEMS for Advanced Reconnaissance Vehicles

Contribute substantially to synthesis & analysis of these systems, utilizing familiarity with RF interference jammers, scanning receivers, modulation techniques, electronic decoys, etc. **(M)** Essentials for this position:

Physics or Electronics Degree plus a minimum of 5 years related experience.

TELECOMMUNICATIONS CONSULTANT

TO LEAD STUDIES AND PRELIMINARY DESIGNS INVOLVING ALL ELEMENTS OF INTERCONTINENTAL COMMUNICATIONS SYSTEMS: COMMUNICATION CENTRAL SWITCHING CENTERS, LOAD ANALYSIS, ETC. QUALIFICATIONS: PHD OR DEEP EXPERIENCE IN COMMUNICATIONS SYSTEMS SYNTHESIS AND PLANNING. THE CALIBRE MAN SOUGHT FOR THIS IMPORTANT POSITION WILL HAVE PUBLISHED PAPERS IN RELATED FIELDS. **(W)**

GENERAL ELECTRIC

PROFESSIONAL EXPERIENCE (Two most recent or most applicable jobs)

Company _____ Position _____
Years of experience (from) _____ (to) _____ Salary _____ Assigned Duties _____

Company _____ Position _____
Years of experience (from) _____ (to) _____ Salary _____ Assigned Duties _____

PERSONAL DETAILS

Name _____
Home Address _____ City _____
State _____ Telephone _____ U.S. Citizen Yes No

Education Undergraduate _____
College _____ Degree _____ Year of Graduation _____
Graduate _____
College _____ Degree _____ Year of Graduation _____

Position Objective (primary job preference, level of responsibility, salary expectations) _____

All qualified applicants will continue to receive consideration for employment without regard to race, creed, color, or national origin.

I am interested in the following position(s)

Navigation & Control E, H
Instrumentation & Communication C, E, Q, S, T, W
Systems Analysis M
Advanced Systems H, M
Ground & Space Support Y
Analog & Digital Techniques Q, S, T

Simply circle the appropriate letters of those positions that meet your professional interests and qualifications, fill in the questions to the left — attach a resume if you have one handy — and airmail to:

Mr. Frank Wendt
Missile & Space Vehicle Department
General Electric Company
3198 Chestnut Street
Philadelphia 4, Pennsylvania

GENERAL ELECTRIC

DEVELOPMENT ENGINEERS

Advanced Motors,
Generators,
Solid State Circuit Design

Several fine opportunities are now available in expanding project areas.

Generator Development Engineer

This position requires a man for design and development work on high speed alternators. A comprehensive knowledge of alternator design is needed with special emphasis on high speed, high frequency machines. BSEE and 3-5 years experience required.

Development Engineer for Advanced Motors

Prefer physicist, or EE, for work involving electromagnetic theory as applied to advanced electric motor studies. This work involves investigation of electrical, thermal and mechanical phenomena, with immediate assignment dealing with solid rotor motors.

Work will involve machine studies using modern computer techniques. Requires 3-5 years experience.

Development Engineer for Solid State Circuit Design

This work involves design and development of solid state power conversion equipment. Experience is needed in the operation of silicon controlled rectifiers in power handling circuits. Requires BSEE and 3-5 years experience.

Garrett is an "equal opportunity" employer. Send complete resume to Mr. Thomas Watson.



AIRESEARCH MANUFACTURING DIVISION

9851 So. Sepulveda Blvd., Los Angeles 45, California

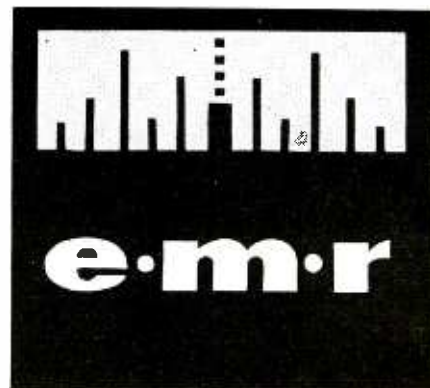

Maximum Responsibility
FOR
CREATIVE ENGINEERS
WITH
FOLLOW-THROUGH CAPABILITIES

By maintaining a reputation for technical engineering excellence and a position of leadership in research and development, Electro-Mechanical Research, Inc. (e-m-r) has become the largest of all companies specializing in telemetry systems. Today, with the space age bringing new and vital significance to the field of electronics, e-m-r affords mature engineers an environment for maximum responsibility and personal growth.

SYSTEMS ENGINEERS — DIGITAL (Telemetry)

The full weight of the e-m-r engineering approach is brought to bear on these demanding positions. A high level of engineering creativity and skill is required. Most important, there must be a real desire to participate in the entire digital systems effort, including synthesis, development and construction of "custom systems". Compensation proportionate to "follow-through" ability.

Minimum of 3 years experience in detailed design in such areas as digital circuits — using semi-conductors and magnetic elements — transistor implemented low level amplifiers, ferrite core memories, logic design of digital computer, analog to digital converters, feed-back amplifiers, servomechanisms, and RF transmitters and receivers — 100 to 1000 megacycle range.

Direct confidential inquiries to
ROLAND E. HOOD, JR.
Personnel Manager, Systems Division

**electro-
mechanical
Research, inc.**

P. O. Box 3041-C
Sarasota 2, Florida

An equal opportunity employer

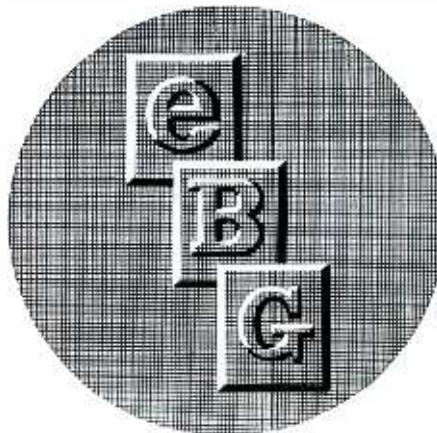

HOW TO SELL TO THE GOVERNMENT

Key reference is your 1961 electronics Buyers' Guide and Reference Issue. Your 1961 EBG Reference Section includes a survey of military and government procurement methods with phone numbers, addresses and procurement officers' names. EBG lists main government books, pamphlets, and periodicals on the subject, and the military and government agencies that buy electronic equipment and services and what these agencies buy... plus a helpful run-down on specifications for this important segment of the electronics industry. And that's only part of the Reference Section; only part of your 1961 EBG.

MORE EBG EXCLUSIVES

1. Actual name of the man to call on in each company for key information about prices, delivery dates, specifications, etc.—a first-time exclusive.
2. Company statistics—another new exclusive—that give you dollar-volume, number of engineers, number of employees, etc., for each company listed.

3. Complete index of editorial articles that have appeared in electronics during the last 12 months.

4. Abstracts of feature articles listed in the editorial index from electronics. Plus these EBG features:

- Specific product listings—accurate, complete, authentic, more than 3,000 of them cross-indexed.
- Registered trade name index—lets you find the manufacturer of a product when you know it only by its trade name.
- Local sales office listing—makes it easy to find name, address and phone number of a manufacturer's nearest sales office.

These are all factors that make your EBG the most essential buying and selling reference in the electronics industry. Keep your EBG close at hand—it will pay off in more ways than one.

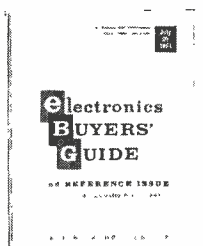

electronics buyers' guide and reference issue *The Basic Buying Guide in Electronics since 1941*



A MCGRAW-HILL PUBLICATION 330 West 42nd St., New York 36, N. Y.

SENIOR & ADVANCED-LEVEL ENGINEERS

RADAR

EQUIPMENT DEVELOPMENT AND SYSTEM DESIGN

Important assignments are immediately available to experienced radar engineers capable of assuming a high degree of responsibility. General Dynamics|Electronics is a newly formed division of General Dynamics Corporation, and the men selected to staff these positions will participate in the initial phases of organization, planning, and the creative aspects of radar systems and equipment design and development.

Specific openings are for the following specialists:

- RADAR SYSTEMS ANALYSTS
- ANTENNA SPECIALISTS
- MICROWAVE TRANSMITTER SPECIALISTS
- SERVO-MECHANISMS ENGINEERS
- ADVANCED DESIGN ENGINEERS
- SOLID STATE CIRCUIT ENGINEERS
- MATHEMATICIANS

These positions provide the opportunity to perform highly original and creative work at an advanced state of the art. Salaries and benefits are among the best in the industry. Relocation expenses will be paid, of course. For complete details or to arrange a confidential interview in your area, write:

Mr. B. L. Dobler, Industrial Relations Administrator-Engineering, General Dynamics|Electronics, 3302 Pacific Highway, San Diego 12, California

AN EQUAL OPPORTUNITY EMPLOYER

ALL INQUIRIES WILL RECEIVE A REPLY WITHIN FIVE DAYS

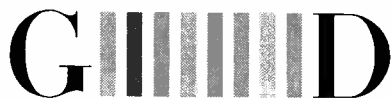

GENERAL DYNAMICS

ELECTRONICS

MILITARY PRODUCTS DIVISION SAN DIEGO 12, CALIFORNIA

SALES ENGINEER

NAVIGATION ELECTRONIC INSTRUMENTATION SYSTEMS

Engineering degree and sea-going experience desirable. Must be aggressive sales representative with a successful record, possess a thorough knowledge of navigation electronic instrumentation systems along with government procurement practices. Experience in government sales helpful.

SALARY OPEN

Our staff knows of this ad
Please send resume to:

P-7843, Electronics
Class. Adv. Div., P. O. Box 12, N.Y. 36,
N.Y.

An Equal Opportunity Employer

TRANSFORMER ENGINEER

With experience in the design and development of Hi-Frequency and Pulse transformers for commercial and military applications.

Ideal opportunity for ambitious man to develop full potential of present small department. Salary—open. Location—Erie, Pa. Call or send resume to Chief Engineer

Erie Electronics Division

Erie Resistor Corporation
645 West 12th Street Erie, Pa.
GL 6-8592

ENGINEERS—SCIENTISTS

MORE AND MORE COMPANIES

are continually coming to us for help!

WHY DON'T YOU?

S.E.E. client companies are wide in variety—large and small—with opportunities at all levels, as diverse as "the state of the art". Employers pay placement fee and relocation costs. If you are interested in advancement—

Send Resume to:

SCIENTISTS, ENGINEERS & EXECUTIVES, Inc.

1026-17th St. N.W., Washington 6, D. C.

electronics

WEEKLY QUALIFICATIONS FORM FOR POSITIONS AVAILABLE

(Continued from page 112)

COMPANY	SEE PAGE	KEY #
MICROWAVE SERVICES INTERNATIONAL, INC. Denville, New Jersey	88*	17
NATIONAL CASH REGISTER CO. Electronics Division Hawthorne, California	55*	18
NATIONAL CASH REGISTER CO. Dayton, Ohio	88*	19
NATIONAL SCIENTIFIC LABORATORY INC. Washington, D. C.	88*	20
REMINGTON RAND UNIVAC Div. of Sperry Rand Corp. St. Paul, Minnesota	83*	21
SCIENTISTS, ENGINEERS & EXECUTIVES INC. Washington, D. C.	116	22
P-7843	116	23

* These Advertisements appeared in the 12/1/61 issue.

POSITION VACANT

Experienced Production man on solid Tantalum capacitors for Calif. firm. Practical man preferred. Give complete resume—absolutely confidential. P-7851, Electronics, Classified Adv. Div., 255 California St., San Francisco 11, Calif.



MANUFACTURERS' REPRESENTATIVES
IN THE ELECTRONIC INDUSTRY

SAMUEL K. MACDONALD, INC.
manufacturers representatives over 25 years
1531 SPRUCE STREET, PHILA. 2, PA.

Territory: Pennsylvania • New Jersey
Delaware • Maryland
Virginia • West Virginia
District of Columbia

Other Offices:
Pittsburgh
Baltimore
Washington, D.C.

SEARCHLIGHT SECTION

(Classified Advertising)
BUSINESS OPPORTUNITIES
EQUIPMENT - USED or RESALE

GET IT from GOODHEART!

0.1% SORENSEN Line Voltage Regulator

±5000s. Brand new at low surplus price! Input 95-130 V, 1 ph., with taps for 50 or 60 cy. Use for any power up to 5000 watts. Output adjustable 110-120 V and holds to ±0.1% at line frequency, or to ±0.25% if line frequency drifts 5%. Regulates against line changes of 95-130V and against load changes from 0 to 5 KVA. Maximum harmonics less than 3%. Recovery time 0.15 seconds. Input to the control section can be moved to the point where you will use the power, thus compensating for line drop. In rack cabinet 28" h, 22" wd, 15" dp. Net wt 190 lbs. Shpg wt 285 lbs FOB Utica, N. Y. In original factory pack suitable for export, including SPARE PARTS group. Sorensen catalog net price is \$695.00 \$349.50 less spares. Our price, WITH SPARES. . . . \$349.50



±10,000s, same as above but 10 kva, factory-reconditioned. fob Norwalk, Conn., \$995.00. ±1000-25. 190-260 V 1 ph to 230 V, fob Los Ang., \$179.50.

Write us, stating your specific needs in Line Voltage Regulators, Receivers, Signal Generators, Transmitters, Tuning-Fork Frequency Standards, Graphic Recorders, etc., all at low surplus prices, all certified and guaranteed unconditionally.

R. E. GOODHEART CO.

P. O. Box 1220-E Beverly Hills, Calif.

CIRCLE 460 ON READER SERVICE CARD

LIFSCHULTZ
FASTEST TO BOTH COASTS

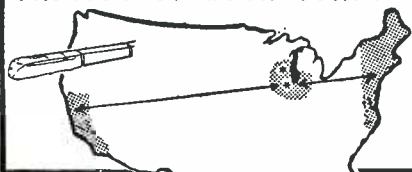

Over 62 years of dependable ON-TIME Freight Forwarding Service.

We welcome your inquiry.



PROMPT DAILY PICKUP and DELIVERY

LIFSCHULTZ
FAST FREIGHT

CIRCLE 461 ON READER SERVICE CARD

December 8, 1961

SPECIAL PURPOSE TUBES

OA2..... .80	4-1000A..... 90.00	242C..... 10.00	809..... 5.25	5845..... 4.50
OA2WA..... 2.00	4AP10..... 10.00	244A..... 2.50	810..... 15.00	5852..... 3.00
OA3..... .85	4B31..... 12.50	245A..... 2.50	811..... 2.50	5854..... 1.00
OB2..... .60	4C27..... 7.50	249B..... 10.00	811A..... 4.00	5876..... 8.50
OB2WA..... 2.00	4C35..... 12.50	249C..... 5.00	812A..... 4.75	5879..... 1.25
OB3..... .70	4CX250B..... 35.00	250R..... 10.00	813..... 12.50	5881/6L6WGB..... 2.50
OC3..... .50	4D32..... 15.00	250TH..... 25.00	814..... 3.50	5886..... 2.50
OD3..... .30	4E27..... 7.50	251A..... 50.00	815..... 2.00	5894..... 18.85
C1A..... 6.50	4J30-61..... PUR	252A..... 4.75	816..... 2.25	5896..... 1.50
1AD4..... 1.50	4J50..... 100.00	254A..... 2.00	826..... 3.50	5902..... 2.00
1B24A..... 10.00	4J52..... 25.00	257A..... 3.50	828..... 12.50	5915..... .85
1B35A..... 3.00	4PR60A..... 60.00	FG-258A..... 75.00	829B..... 9.50	5930/2A3W..... 2.00
1B63A..... 10.00	4X150A..... 15.00	259A..... 3.50	832..... 2.00	5932/6L6WGA..... 1.50
1C/3B22..... 5.00	4X150D..... 15.00	262B..... 3.50	832A..... 7.50	5933/807W..... 1.75
CTK..... 6.00	4X250B..... 20.00	267B..... 5.00	833A..... 37.50	5933WA..... 5.00
1P21..... 30.00	4X250F..... 30.00	271A..... 12.50	836..... 2.50	5948/1754..... 75.00
1P22..... 8.00	5B1A..... 9.50	272A..... 2.75	837..... 1.00	5949/1907..... 50.00
1P25..... 8.00	5C22..... 12.50	274A..... 2.00	838..... 1.00	5963..... 1.10
1P28..... 15.00	5CP1A..... 9.50	275A..... 4.00	842..... 7.50	5964..... .85
1Z2..... 1.50	5J26..... 50.00	276A..... 6.00	845..... 7.50	5965..... .85
2-01C..... 12.50	5LP1..... 7.50	283A..... 3.50	850..... 12.50	5979/BS1..... 4.00
2AP1A..... 6.50	5R4GY..... 1.10	287A..... 3.00	851..... 25.00	5980/BS2..... 6.00
2B23..... 20.00	5R4WGB..... 5.00	HF-300..... 30.00	866A..... 1.90	5981/5650..... 25.00
2BP1..... 8.50	5R4WGY..... 2.75	300B..... 5.00	869B..... 50.00	5987..... 7.50
2C36..... 22.50	5R1A..... 9.50	304TH..... 25.00	872A..... 4.00	5992..... 2.50
2C39A..... 9.75	6A4C7W..... .35	304TL..... 35.00	884..... 1.25	5993..... 5.00
2C39B..... 18.75	6AG7Y..... .90	307A..... .40	885..... .85	6002/QK-221.2500..... 1.00
2C40..... 7.50	6AK5W..... 1.00	309A..... 2.50	913..... 8.50	6005/6AQ5W..... 1.00
2C42..... 3.00	6AK5WE..... .65	310A..... 3.50	920..... 2.50	6012..... 3.50
2C43..... 7.50	6AN5..... 1.75	311A..... 3.00	927..... 1.50	6021A..... 2.00
2C50..... 4.00	6AR6..... .75	313C..... 1.50	931A..... 3.00	6032..... 10.00
2C51..... 1.50	6AS6..... .85	323A..... 6.00	1000T..... 80.00	6037/QK-243..... 50.00
2C52..... 1.50	6AS7G..... 2.75	328A..... 3.00	R1130B..... 10.00	6045..... 1.15
2C53..... 8.00	6B4G..... 3.00	336A..... 3.50	1500T..... 125.00	6072..... 1.50
2D21..... .50	6BL6..... 30.00	347A..... 1.00	1614..... 2.75	6073..... .75
2D21W..... 1.00	6BM6..... 30.00	347A..... 1.00	1616..... .50	6074..... 2.00
2E22..... 2.50	6BM6A..... 35.00	348A..... 1.00	1619..... .25	6080..... 3.00
2E24..... 2.50	6C4W..... 2.50	349A..... 4.50	1620..... 3.50	6080WA..... 5.00
2E26..... 2.50	6C21..... 17.50	350A..... 3.50	1624..... 1.00	6080WB..... 10.00
2J21-50..... PUR	6D4..... 1.25	350B..... 2.50	1846..... 50.00	6082..... 2.50
2J42..... 60.00	6G1..... 10.00	352A..... 8.50	1855..... 250.00	6087/5Y3WGTB..... 3.00
2J51..... 50.00	6G1A..... 15.00	354A..... 10.00	2050..... 1.25	6098..... 5.00
2K22..... 25.00	6G1K..... 20.00	355A..... 10.00	2050W..... 1.50	6100/6C4WA..... 1.00
2K25..... 8.50	6J4WA..... 2.00	371B..... 2.50	ZB-3200..... 50.00	6101/6J6WA..... .85
2K26..... 35.00	6J6W..... .75	393A..... 5.00	5545..... 10.00	6111A..... 1.50
2K28..... 30.00	6L1..... 2.00	394A..... 3.00	5550..... 30.00	6112..... 1.50
2K29..... 25.00	6L6GAY..... .75	395A..... 3.00	5636..... 2.00	6115/QK-351..... 40.00
2K30..... 50.00	6L6WGA..... 1.50	396A/2C51..... 1.50	5641..... 1.75	6130/3C45..... 5.00
2K33A..... 200.00	6L6WGB..... 2.50	398A/5603..... 3.00	5642..... 2.00	6135..... 1.50
2K34..... 7.50	6Q5G..... 2.50	401A/5590..... 1.00	5643..... 3.00	6136/6AU6WA..... 1.25
2K35..... 250.00	6S7GT..... 1.00	403A/6AK5..... .65	5644..... 2.50	6137/6SK7WA..... 1.50
2K39..... 150.00	6S7WGT..... 1.25	403B/5591..... 3.00	5647..... 3.00	6146..... 3.00
2K41..... 25.00	6S7WGT..... 1.00	404A/5847..... 7.50	5651..... .75	6147..... 2.25
2K42..... 125.00	65N7W..... 50.00	407A..... 3.75	5654/6AK5W..... 1.25	6159..... 3.50
2K43..... 150.00	65N7WGT..... .85	408A/6028..... 3.25	5656..... 2.50	6161..... 50.00
2K44..... 125.00	65N7WGT..... 2.50	409A/6A56..... 1.00	5663..... .75	6186/6AG5WA..... 1.50
2K45..... 20.00	65U7GT..... .85	416B/6280..... 35.00	5665/C16J..... 35.00	6189/12AU7WA..... 1.50
2K47..... 125.00	6V6GT..... .90	WL-417A..... 2.50	5670..... 1.00	6197..... 1.50
2K48..... 50.00	6X4W..... .75	417A/5842..... 9.50	5672..... 1.75	6198..... 75.00
2K50..... 70.00	6X5WGT..... 1.25	418A..... 9.50	5675..... 8.50	6201/12AT7WA..... 1.85
2K54..... 10.00	7AK7..... 2.50	420A/5755..... 3.75	5678..... 1.25	6202/6X4WA..... 1.50
2K55..... 15.00	7BP7A..... 5.00	421A/5998..... 7.50	5686..... 1.75	6211..... .75
2K56..... 50.00	7MP7..... 22.50	429A..... 6.50	5687..... 1.50	6216..... 2.85
2P21..... 30.00	10KP7..... 15.00	GL-434A..... 10.00	5691..... 5.00	6233..... 100.00
2X2A..... .80	12AT7WA..... 1.50	450TH..... 40.00	5692..... 2.50	6236..... 150.00
3A5..... .75	12AY7..... 1.00	450TL..... 40.00	5693..... 3.50	6248..... 500.00
3AP1..... 2.00	12DP7..... 7.50	CK-503AX..... .75	5696..... .75	6252..... 15.00
3B24W..... 3.00	12PP7..... 12.50	CK-510AX..... 1.00	5702..... 1.50	6263..... 9.00
3B24WA..... 5.00	16F..... 10.00	575A..... 15.00	5703..... .85	6264..... 9.00
3B25..... 2.50	1C1J..... 25.00	576..... 12.50	5718..... .60	6265/6BH6W..... 2.75
3B26..... 2.25	FG-17..... 5.00	578..... 5.00	5719..... .60	6282/B-11..... 65.00
3B28..... 3.00	HK-24..... 2.00	KU-610..... 5.00	5721..... 100.00	6293..... 4.50
3B29..... 4.00	25T..... 10.00	NL-623..... 8.50	5725/6A56W..... 1.00	6299..... 37.50
3BP1..... 3.50	25Z6WGT..... 1.50	KU-627..... 6.00	5726/6AL5W..... .60	6316/BL800A..... 100.00
3C/4B24..... 4.00	26Z5W..... 1.50	631-P1..... 5.00	5727/2D21W..... 1.00	6322/BL-25..... 15.00
3C22..... 15.00	FG-27A..... 20.00	673..... 15.00	5749/6BA6W..... .75	6336..... 8.75
3C23..... 4.00	FG-32..... 6.50	676..... 25.00	5750/6BE6W..... 1.50	6336A..... 12.50
3C24/24G..... 5.00	FG-33..... 17.00	677..... 40.00	5751/12AX7W..... 1.35	6345..... 3.50
3C45..... 3.50	35T..... 10.00	701A..... 2.00	5751WA..... 1.50	6350..... 1.75
3CX100A5..... 20.00	35TG..... 1.25	707B..... 7.50	5763..... 1.75	6352..... 5.00
3D21A..... 2.50	FG-41..... 50.00	NL-710..... 10.00	5768..... 25.00	6385..... 7.50
3D22..... 8.00	FP-54..... 100.00	714AY..... 10.00	5777..... 150.00	6390..... 150.00
3DP1A..... 7.50	FG-57..... 6.00	715B..... 2.50	5778..... 150.00	6394..... 10.00
3E29..... 7.50	RK-60/1641..... 1.00	715C..... 12.50	5783..... 1.75	6438..... 5.00
3GP1..... 1.50	RK-61..... 2.35	719A..... 10.00	5787..... 2.00	6463..... 1.00
C3J..... 7.50	HY-67..... 3.85	720-AY-EY..... 20.00	5796..... 1.00	6517/QK358..... 250.00
3CJ/A..... 9.50	HY-69..... 3.00	721B..... 5.00	5799/VX-21..... 8.00	6533..... 5.00
3J21..... 35.00	BL-75..... 3.00	723A/B..... 2.85	5800/VX-41..... 5.00	6550..... 3.50
3J31..... 50.00	FG-81A..... 4.00	725A..... 10.00	5801/VX-33A..... 2.25	6807..... 20.00
3JP1..... 5.00	FG-95..... 17.50	726A..... 2.00	5802/VX-32B..... 2.25	6897..... 20.00
3K21..... 125.00	HF-100..... 10.00	726B..... 3.00	5803/VX-55..... 2.25	7044..... 2.00
3K22..... 125.00	100TH..... 12.00	726C..... 8.50	5814A..... 1.35	8005..... 7.50
3K23..... 250.00	FG-104..... 35.00	NL-760..... 20.00	5822A..... 55.00	8008..... 7.75
3K27..... 150.00	FG-105..... 15.00	802..... 5.00	5828..... 3.00	8013A..... 3.00
3K30..... 50.00	F-123A..... 4.00	803..... 3.50	5829..... .75	8014A..... 25.00
3KP1..... 9.75	HF-200..... 10.00	804..... 15.00	5836..... 60.00	8020..... 4.00
4-65A..... 10.00	211..... 2.50	805..... 5.00	5837..... 60.00	8025A..... 7.50
4-125A..... 20.00	212E..... 25.00	807..... 1.35	5839..... 3.00	9003..... 2.00
4-250A..... 32.50	231D..... .90	807W..... 1.50	5840..... 1.25	9005..... 3.00
4-400A..... 30.00	FG-235..... 40.00	808..... 1.00	5841..... 3.25	

ALL TUBES ARE NEW, INDIVIDUALLY CARTONED, FULLY GUARANTEED

western engineers

ELK GROVE, CALIFORNIA
SUPPLIERS OF ELECTRON TUBES SINCE 1932

Orders for less than \$10 cannot be processed

CIRCLE 462 ON READER SERVICE CARD

ANTENNA PEDESTAL SCR 584-MP 61B

Full azimuth and elevation sweeps 360 degrees in azimuth. 210 degrees in elevation. Accurate to 1 mil. or better over system. Complete for full tracking response. Angle acceleration rate: AZ, 9 degrees per second squared EL, 4 degrees per second squared. Angle slowing rate: AZ 20 degrees per sec. EL, 10 degrees per sec. Can mount up to a 20 ft. dish. Angle tracking rate: 10 degrees per sec. Includes pedestal drives, selsyns, potentiometers, drive motors, control amplifiers. Excellent condition. Quantity in stock for immediate shipment. Ideal for missile & satellite tracking, antenna pattern ranges, radar system, radio astronomy, any project requiring accurate response in elevation and azimuth.
Complete description in McGraw-Hill Radiation Laboratory Series, Volume 1, page 284 and page 209, and Volume 26, page 233.

MIT MODEL 9 PULSER 1 MEGAWATT - HARD TUBE

Output pulse power 25 KV at 40 amp. Max. duty ratio: 002. Uses 6C21 pulse tube. Pulse duration .25 to 2 microsec. Input 115 volts 60 cycles AC. Includes power supply in separate cabinet and driver. Fully guaranteed as new condition. Full Desc. MIT. Rad. Lab. Series "Pulse Generators."

500 KW PULSER

5C22 Hydrogen Thyration Modulator. 22KV at 28 Amps. W/HV & Fil Supplies. 3 pulse length rep rates: 2.25 usec 300 pps. 1.75 usec 550 pps. .4 usec 2500 pps. 115V 60 cy AC Input.

MIT MODEL 3 PULSER

Output: 144kw (12kv at 12 amp.). Duty ratio: 001 max. Pulse duration: .5 1 and 2 micro sec. Input: 115v 400 to 2000 cps and 24 vdc. \$325 ea. Full desc. Vol. 5 MIT Rad. Lab. series pg 140.

L BAND RF PKG.

20KW peak 990 to 1040MC. Pulse width .7 to 1.2 micro sec. Rep rate 180 to 420 pps. Input 115vac. Incl. Receiver \$1200.

225 KW X-BAND RF

4J50 Magnetron RF Generator with dummy load & Dir. Cpr. Variable rep rates. Variable power output 115V 60-cycle AC input. New. \$2400 complete.

SCR 584 RADARS AUTOMATIC TRACKING RADAR

Our 584s in like new condition, ready to go, and in stock for immediate delivery. Ideal for research and development, airway control, GCA, missile tracking, balloon tracking, weather forecasting, anti-aircraft defense tactical air support. Write us. Fully Desc. MIT Rad. Lab. Series, Vol. 1, pps 207-210, 228, 284-286.

AN/TPS - 1D RADAR

500 kw. 1220-1359 mcs. 160 nautical mile search range P.P.I. and A. Scopes, MTL. thratron mod. 5J26 magnetron. Like new. Complete system incl. spare parts and gas generator field supply.

AN/TPS - 10D HEIGHT FINDER

250 KW X-Band. 60 & 120 mile ranges to 60,000 feet. Complete.

AN/APS - 15B 3 CM RADAR

Airborne radar. 40kw output using 725A magnetron. Model 3 pulser. 30 in. parabola stabilized antenna. PPI scope. Complete system. \$1200 each. New.

10KW 3 CM. X BAND RADAR

Complete RF head including transmitter, receiver, modulator. Uses 2J42 magnetron. Fully described in MIT Rad. Lab. Series Vol. 1, pps. 616-625 and Vol. 11, pps. 171-185 \$375. Complete X Band Radar System also avail. incl. 360-deg. antenna, PPI. syn pwr supply. Similar to \$17,000 weather radar now in use by airlines, \$750 complete.

10 CM. WEATHER RADAR SYSTEM

US Navy Raytheon, 275 KW peak output S band. Rotating yoke Plan position Indicator. Magnetron supplied for any S band frequency specified, incl. Weather Band. 4, 20 and 80 mile range, 360 degree azimuth scan. Sensitive rcvr using 2K 28/707B and IN21B. Supplied brand new complete with instruction books and installation drawings. Can be supplied to operate from 32VDC or 115 volts. Price \$975. Ideal for weather work. Has picked up clouds at 50 miles. Weight 488 lbs.



**RADIO RESEARCH
INSTRUMENT CO.**
550 FIFTH AVE.,
NEW YORK
JUDSON 6-4691

CIRCLE 463 ON READER SERVICE CARD

FREE 32 PAGE CATALOG OF INDUSTRIAL ELECTRONIC EQUIPMENT "BUYS"

Test equipment, relays, tubes, capacitors, resistors, switches, rectifiers, transformers and hard to get items.

WE WANT TO BUY LARGE OR SMALL QUANTITIES, ESPECIALLY TEST EQUIPMENT, RELAYS, SWITCHES.

CAPITOL COMMODITIES CO., INC.

4757 N. Ravenswood Avenue
Chicago 40, Illinois

ALL PHONES : Longbeach 1 3355

CIRCLE 466 ON READER SERVICE CARD

GLASS TUBING

PYREX - NONEX - URANIUM

BULB & CYLINDERS

WRITE FOR FREE MONTHLY LIST

HOUE GLASS COMPANY

PHONE COLFAX 4-1800

P.O. Box 206

Keyport, N. J.

CIRCLE 467 ON READER SERVICE CARD

FREE...CATALOG TUBE & COMPONENT BARRY ELECTRONICS

512 BROADWAY
NEW YORK 12, N. Y.

Walker 5-7000
TWX- NY 1-3731

CIRCLE 468 ON READER SERVICE CARD

Warren Paley
of
**TALLYMASTER,
INC.**
calls . . .
UNIVERSAL

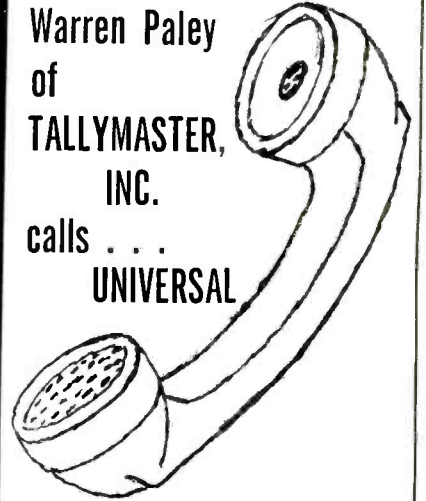

RELAYS



WARREN PALEY
President—E.E.

"If it's a relay—I call UNIVERSAL. I have always managed to get the relay I needed . . . regardless of brand name. Their tremendous inventory of current and hard-to-get relays has enabled me to get what I want — when I wanted it."

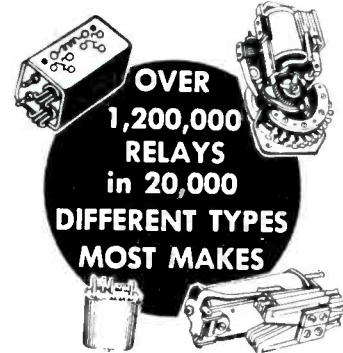

OVER
**1,200,000
RELAYS
in 20,000
DIFFERENT TYPES
MOST MAKES**

- PRODUCTION QUANTITIES IN STOCK
- DELIVERY ON OFF-THE-SHELF ITEMS WITHIN 48 HOURS. DELIVERY WITHIN ONE WEEK ON RELAYS REQUIRING ASSEMBLY AND/OR ADJUSTMENT.

**WE DELIVER RELAYS
NOT PROMISES**



FREE...

Send
for
**NEW
catalog
"E-2"**

Universal RELAY CORP.

42A White St., N. Y. 13, N. Y. Walker 5-9257
CIRCLE 469 ON READER SERVICE CARD

Wilgreen

can deliver **Amphenol
Bendix
Cannon
CONNECTORS
FITTINGS & CLAMPS**

We stock more than 5,000,000 MS/AN CONNECTORS of 50,000 variations! In PRODUCTION QUANTITIES we sell BELOW "O.E.M." PRICE and offer IMMEDIATE "OFF-THE-SHELF" DELIVERY!

FREE . . . Send for latest brochure and list price chart

WILGREEN INDUSTRIES, Inc.
102 Warren Street, New York 7, N. Y.
Worth 4-2490-1-2 Wire: FXK

CIRCLE 464 ON READER SERVICE CARD

SMALL AD but BIG STOCK

of choice test equipment
and surplus electronics

Higher Quality—Lower Costs
Get our advice on your problem

ENGINEERING ASSOCIATES

434 Patterson Road — Dayton 19, Ohio

CIRCLE 465 ON READER SERVICE CARD

INDEX TO ADVERTISERS



Audited Paid Circulation

Allegheny Ludlum Steel Corp.....	38, 39	• Kearfott Div. General Precision Inc....	97
Allen-Bradley Co.	41	Keithley Instruments, Inc.....	6
• American Lava Corporation.....	71	• Kyoritsu Electrical Instruments Works,	107
• Ampere Electronic Corp.....	34, 35	Ltd.	
Anelex Corporation	93		
• Associated Testing Laboratories Inc..	96		
		• Lapp Insulator Co., Inc.....	84
• Ballantine Laboratories, Inc.....	81	Litton Systems Inc., Data Systems	111
Barker & Williamson, Inc.....	105	Division	
• Beckman Instruments Inc.,	45	Litton Systems Inc., Guidance and	108
Berkley Division		Control System Div.....	
Behlman-Invar Electronics Corp.....	23	Lockheed California Co., Div. of	50
• Bendix Corporation		Lockheed Corp.	
Scintilla Division	37		
Semiconductor Division	73	• Marconi Instruments	111
• Bird Electronic Corporation.....	88	• Massa, A Div. of Cohn Electronics,	95
• Burnell & Co., Inc.....	3	Inc.	
• Bussmann Mfg. Div.,	20	• Mico Instrument Co.....	120
McGraw Edison Co.....		Minneapolis-Honeywell	16
		Precision Meter Division.....	
• Carborundum Company, The.....	19	• Moseley Co., F. L.....	12
• Celco-Constantine Engineering	110	Motorola Semiconductor Products Inc.	8
Laboratories		• Mycalex Electronics Corp.....	44
• Chart-Pak, Inc.	100		
Chomerics, Inc.	40	• Natvar Corporation	51
Clare & Co., C. P.....	46, 47	• North Atlantic Industries, Inc.....	98
• Constantine Engineering Laboratories.	110	• Northeastern Engineering, Inc.....	40
Continental-Diamond Fibre Subsidiary	24		
of the Budd Company.....		• Ohmite Mfg. Co.....	11
• Daven Company, The.....	3rd Cover	• Philco Corporation	52
Delta Design, Inc.....	40	Philips Gloeilampenfabrieken, N.V....	42, 43
		Plastoid Corp.	48
• Electronic Instrument Co., Inc. (EICO)	101		
Electronic Measurements Co., Inc.....	110	• Radio Corporation of America.....	7, 25
		4th Cover	
Federation Nationale Des Industries	90	• Raytheon Company	49, 83
Electroniques		Rosemount Engineering Co.....	96
• Fuji Tsushinki Seizo K.K.....	94	• Royal Electric Corp.....	99
Gamewell Co., The.....	109	Selenia	99
Garner Co., T. H.....	101	• Sola Electric Co.....	76, 77
General Electric Co.	26, 79	Sprague Electric Co.....	5, 22
Semiconductor Products Dept.....			
Capacitor Dept.	79	Taylor Fibre Co.....	80
• General Electrodynamics Corporation..	89	Texas Instruments Incorporated	87
• General Instrument Corp.....	21	Components Division	
General Precision Inc., Link Division..	92	• Tung-Sol Electric, Inc.....	13
Georgia Chamber of Commerce.....	75		
• Gould National Batteries, Inc.....	107	Uniform Tubes, Inc.....	111
• Grayhill, Inc.	107	United Transformer Corp.....	2nd Cover
Gries Reproducer Corp.....	120	• Utica Drop Forge & Tool Division,	36
		Kelsey-Hayes Co.	
Hansen Mfg. Co., Inc.....	102		
• Haydon Co., A. W.....	85	• Vernitron Corporation	109
Hollingsworth Co.	97		
Hughes Aircraft Co.	17, 18	Westinghouse Electric Corp.....	15
Space Systems Division.....		• Williams & Co., C. K.....	119
		• Wind Turbine Company.....	108
• Itek Electro-Products Co.....	31		
ITA Electronics Corp.....	2		
		• See Advertisement in the July 20, 1961	
• Japan Piezo Electric Co., Ltd.....	109	issue of Electronics Buyers' Guide for complete line of	
Jerrold Electronics Corp.....	14	products or services.	

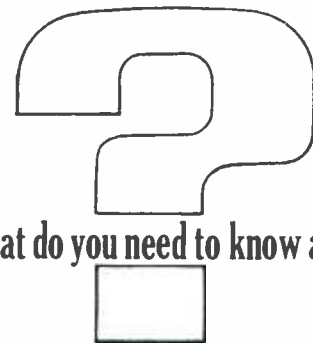

What do you need to know about

PURE FERRIC OXIDES MAGNETIC IRON OXIDES



Since the final quality of your production of ferrites and magnetic recording media depends on the proper use of specialized iron oxides—you'll find it mighty helpful to have the latest, authoritative technical data describing the physical and chemical characteristics of these materials. This information is available to you just for the asking. Meanwhile, here are the highlights.

PURE FERRIC OXIDES—For the production of ferrites, both hard and soft, we manufacture a complete range of iron oxides having the required chemical and physical properties. They are produced in both the spheroidal and acicular shapes with average particle diameters from 0.2 to 0.8 microns. Impurities such as soluble salts, silica, alumina and calcium are at a minimum while Fe_2O_3 assay is 99.5+%. A Tech Report tabulating complete chemical analysis, particle shape, particle size distribution, surface area, etc., of several types of ferric oxides, hydrated ferric oxide, and ferrous-ferric oxide is available.

MAGNETIC IRON OXIDES—For magnetic recording—audio, video, computer, and instrumentation tapes; memory drums; cinema film striping; magnetic inks; carbon transfers; etc.—we produce special magnetic iron oxides with a range of controlled magnetic properties. Both the black ferrous-ferric and brown gamma ferric oxides are described in a Data Sheet listing magnetic properties of six grades.

If you have problems involving any of these materials, please let us go to work for you. We maintain fully equipped laboratories for the development of new and better inorganic materials. Write, stating your problem, to C.K. Williams & Co., Dept. 25, 640 N. 13th St., Easton, Pa.

WILLIAMS
COLORS & PIGMENTS

Pigment Technology at its best

E. ST. LOUIS, ILL. • EASTON, PENNA. • EMERYVILLE, CALIF.

MICO

DESK AND DOOR PLATE ENGRAVER



FOR
Engraving most
sizes of Desk
and Door Plates
in a single set-
up.

FEATURES

1. Six Pantograph ratios—from 1.5:1 to 4:1.
2. Spindle has integral micrometer depth control of .250".
3. Uses standard tapered-shank engraving cutters.
4. New 19" Copy carriers hold 17" of master copy: Permits engraving about 11" line of characters in one set-up at the 1.5:1 ratio.
5. Three sizes of copy carriers available. Each positioned separately.
6. Work-holding fence speeds set-up and engraving time.

Send for illustrated Catalog

MICO INSTRUMENT CO.

77 Trowbridge St. Cambridge 38, Mass.
CIRCLE 213 ON READER SERVICE CARD

FASTENERS FROM GRC

DIE CAST ZINC ALLOY

- Wing Nuts
- Cap Nuts
- Thumb Nuts
- Thumb & Wing Screws

MOLDED NYLON & DELRIN

- Screws
- Hex Nuts
- Washers
- Screw Insulators

NYLON SCREWS AND NUTS

also available in Delrin

MACHINE SCREWS from miniature #0 thru 1/4" in wide range of lengths and head types.

Also SET SCREWS, NUTS from #2 thru 5/16"

GRC's exclusive methods—die casting zinc alloy or molding Nylon and Delrin fasteners in one high speed automatic operation—assure high quality at lowest possible cost.

Write, wire, phone TODAY for SAMPLES, prices, your copy of GRC's NEW INDUSTRIAL FASTENER CATALOG

GRIES REPRODUCER CORP.

World's Foremost Producer of Small Die Castings

151 Beechwood Ave. • New Rochelle, N. Y.
Phone: (914) NEW Rochelle 3-8600

MANUFACTURERS' REPRESENTATIVES
Mac Donald Inc, Samuel K..... 117

CLASSIFIED ADVERTISING
F. J. Eberle, Business Mgr.

EMPLOYMENT OPPORTUNITIES.113-117

EQUIPMENT
(Used or Surplus New)
For Sale117, 118

INDEX TO CLASSIFIED ADVERTISERS

- Barry Electronics Corp..... 118
- Capitol Commodities Co., Inc..... 118
Electro-Mechanical Research Inc..... 114
- Engineering Associates 118
Erie Electronics Division,
Erie Resistor Corporation..... 116

- Garrett Airesearch Manufacturing Div. 114
- General Dynamics/Electronics 116
- General Electric Company, Missile
& Space Vehicle Department..... 113
- Goodheart Co., R. E..... 117
- Houde Glass Co..... 118
- Lifschultz Fast Freight..... 117
- Radio Research Instrument Co..... 118
- Scientists, Engineers & Executives Inc. 116
- Universal Relay Corp..... 118
- Western Engineers 117
- Wilgreen Industries Inc..... 118

• See Advertisement in the July 20, 1961 issue of Electronics Buyers' Guide for complete line of products or services.

This index and our Reader Service Numbers are published as a service. Every precaution is taken to make them accurate, but ELECTRONICS assumes no responsibilities for errors or omissions.

electronics



Audit Bureau
of Circulations



Associated Business
Publications

Audited Paid Circulation

JAMES T. HAUPTLI

Advertising Sales Manager

R. S. QUINT:
Assistant Publisher Buyers' Guide and
Business Manager
FRED STEWART:
Promotion Manager
B. ANELLO:
Marketing Service Manager

RICHARD J. TOMLINSON:
Production Manager
GEORGE E. POMEROY:
Classified Manager
HUGH J. QUINN:
Circulation Manager

ADVERTISING REPRESENTATIVES

NEW YORK (36):
Donald H. Miller, Henry M. Shaw, George
F. Werner
500 Fifth Avenue, OXford 5-5959
BOSTON (16):
William S. Hodgkinson, Donald R. Furth
McGraw-Hill Building, Copley Square,
Congress 2-1160
PITTSBURGH (22):
David M. Watson
Four Gateway Center, Express 1-1314
PHILADELPHIA (3):
Warren H. Gardner, William J. Boyle
6 Penn Center Plaza, LOcust 8-4330
CHICAGO (11):
Harvey W. Wernecke, Robert M. Denmead
645 North Michigan Avenue, Mohawk 4-5800
CLEVELAND (13):
Paul T. Fegley
55 Public Square, Superior 1-7000
SAN FRANCISCO (11):
T. H. Carmody, R. C. Alcorn
255 California Street, Douglas 2-4600
LOS ANGELES (17):
Peter S. Carberry, Ashley P. Hartman
1125 W. 6th St., Huntley 2-5450

DENVER (2):
J. W. Patten
Tower Bldg., 1700 Broadway, Alpine 5-2981
ATLANTA (9):
Michael H. Miller
1375 Peachtree St. N.E., Trinity 5-0523
HOUSTON (25):
Joseph C. Page, Jr.
Prudential Bldg., Holcomb Blvd.,
Jackson 6-1281
DALLAS (1):
Frank Le Beau
The Vaughn Bldg., 1712 Commerce St.
Riverside 7-9721
LONDON W1:
Dennis McDonald
34 Dover St.
FRANKFURT/Main:
Stanley R. Kimes
85 Westendstrasse
GENEVA:
Michael R. Zeynel
2 Place du Port

DAVEN/GENERAL MILLS
...Blazing new trails in component reliability!



**DELIVERED
IN
24 HRS.**

Available Immediately from Distributors!

**87 adjustable stop switches
replace 2,001 standard types!**

Daven revolutionizes switch availability by putting the equivalent of 2,001 standard types on your local selected distributor's shelf, ready for immediate delivery. That's 97% of all your switch needs brought right to your door, usually within 24 hours.

Daven does it by designing the characteristics of 2,001 switches into 87 easy-to-stock, easy-to-use adjustable stop switches. The result: instant availability and **maximum flexibility** (you can change the number of switch positions at any time). The cost is the same, **or less**, than its standard counterpart.

Daven adjustable stop switches are built in **square** configuration, in 1 $\frac{1}{4}$ " and 2 $\frac{1}{4}$ " sizes. Like all Daven switches, their metal parts are fabricated from corrosion-resistant materials . . . plastics are heavily filled with non-organic fibres and are capable of withstanding high temperatures . . . switch contacts and rotor arms are solid silver alloy. Daven's patented knee action, tamper-proof rotor is standard. All applicable paragraphs of MIL-S-3786 and MIL-E-5272 are met and exceeded.

For your new switch catalog, with details on the new adjustable stop switches and a complete Replacement List, write today!

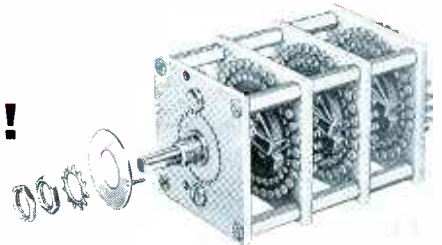

THE DAVEN COMPANY, Livingston, New Jersey

**General
Mills**

SWITCHES

TODAY, MORE THAN EVER, THE DAVEN © STANDS FOR DEPENDABILITY

...an outstanding example
of the *infrared* measurement
problems RCA photocells
can help you solve

Whatever your problems in sensing and measuring infrared radiation, you'll find that RCA has the experience and know-how to help you solve them. A pioneer and recognized authority in IR research, RCA can provide a wide variety of infrared photocells and cooling accessories. One RCA IR photocell, Developmental type C-70015, is so sensitive that under controlled conditions it can detect a difference in radiation resulting from a temperature change of one millionth of a degree.

INFRARED PHOTOCELLS

Developmental Photoconductive Types:

C72226A—A head-on, metal-Dewar type photocell. Detector: p-type gold-doped germanium. Spectral response: 2 to 9 microns. Coolant: liquid nitrogen. Detector temp.: 77°K.

C70015—A head-on metal-Dewar type photocell. Detector: p-type zinc-doped germanium silicon alloy. Spectral response: 2 to 14 microns. Unit employs cryostat. Coolant: pumped liquid nitrogen (for detector temperature of 50°K) or liquid neon (detector temperature of 27°K).

C70201—A head-on metal-Dewar type photocell. Detector: p-type gold-doped germanium silicon alloy. Spectral response: 2 to 14 microns. Unit employs cryostat. Coolant: pumped liquid nitrogen (for detector temperature of 50°K) or liquid neon (for detector temperature of 27°K).

Cells for your custom applications can be designed utilizing the special materials RCA has developed for IR detection, and our knowledge of the proper operating temperature for each material as well as the means by which this temperature is achieved and maintained. Windows of barium-fluoride or germanium suitably coated to be non-reflective at any desired wavelength can be supplied. For cells having response at wavelengths above 25 microns, cesium-iodide windows are used.

**DETERMINE
ΔT TO
0.000001° C!**

Basic Material	Doping Element	Carrier Type	Long Wavelength Cutoff Microns	Typical Detectivity (D) [*] cm cps) ^{1/2} watt ⁻¹ x 10 ⁹	Detector Temperature °K	Liquid Coolant (at atmosphere pressure)
In Sb	—	—	5.5	10	77	N ₂
Ge	Au	n	5	1	77	N ₂
Ge	Au	p	9	5	77	N ₂
Ge	Hg	p	14	20	20	H ₂
Ge Si	Au	p	14	5	50	N ₂ (at reduced pressure)
Ge Si	Au	p	14	5	27	N ₂
Ge Si	Au	p	14	5	21	H ₂
Ge Si	Zn	p	14	10	50	N ₂ (at reduced pressure)
Ge Si	Zn	p	14	10	27	N ₂
Ge Si	Zn	p	14	10	20	H ₂
Ge	Cu	p	30	50	4	H ₂
Ge	Au	p	25	—	4	H ₂
Ge	Zn	p	40	4	4	H ₂
Ge	Sb	n	120	—	Less than 4	H ₂ (at reduced pressure)

*Under following conditions: Bandwidth 1 cps; black-body source operated at a color temperature of 500°K interrupted at 900 pulses per second to produce incident-radiation pulses alternating between on and off.

RCA invites your specific questions and problems concerning IR. We are prepared to help you solve them either through products already developed—or by means of new products, materials and techniques developed especially for your application. For information, call your RCA Field Representative, or write directly to Phototube Products Marketing, Section L-19-Q-2, RCA Industrial Tube Products, Lancaster, Pa.

RCA Electron Tube Division Field Offices . . . INDUSTRIAL PRODUCT SALES:
NEWARK 2, N. J., 744 Broad St., Humboldt 5-3900 • CHICAGO 54, ILLINOIS,
Suite 1154, Merchandise Mart Plaza, Whitehall 4-2900 • LOS ANGELES 22,
CALIF., 6801 E. Washington Blvd., Raymond 3-8361 • BURLINGAME, CALIF.,
1838 El Camino Real, Oxford 7-1620 • GOVERNMENT SALES: HARRISON,
N. J., 415 South Fifth St., HU 5-3900 • DAYTON 2, OHIO, 224 N. Wilkinsou
St., BA 6-2366 • WASHINGTON 7, D. C., 1725 "K" St., N.W., FE 7-8509

RCA ELECTRON TUBE DIVISION



The Most Trusted Name in Electronics