

Electronics®

Cold-cathode tubes in beam switching: page 76

Special report: Experiments aboard Gemini, page 89

Production tips for engineers: page 113

April 5, 1965

75 cents

A McGraw-Hill Publication

Below: Astronauts Young and Grissom in the Gemini capsule, page 89

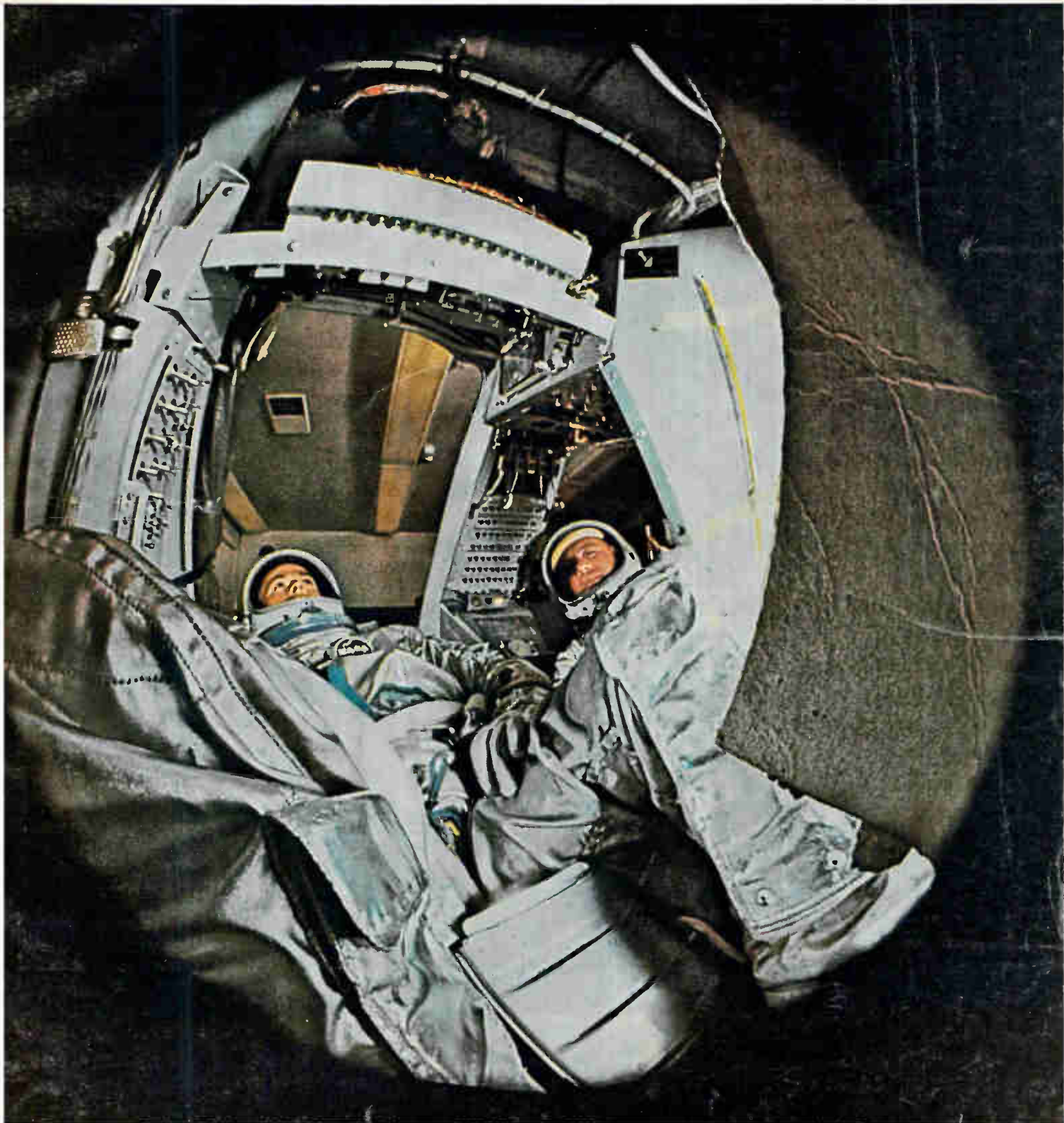

AUDIO TRANSFORMERS

DO-T No.	Pri. Imp.	D.C. Ma. in Pri.	Sec. Imp.	Pri. Res. DO-T	Pri. Res. DI-T	Mw Level	DI-T No.
DO-T44	80 CT 100 CT	12 10	32 split 40 split	9.8	11.5	500	DI-T44*
DO-T29	120 CT 150 CT	10 10	3.2 4	10		500	
DO-T12	150 CT 200 CT	10 10	12 16	11		500	
DO-T13	300 CT 400 CT	7 7	12 16	20		500	
DO-T19	300 CT	7	600	19	20	500	DI-T19
DO-T30	320 CT 400 CT	7 7	3.2 4	20		500	
DO-T43	400 CT 500 CT	8 6	40 split 50 split	46	50	500	DI-T43*
DO-T42	400 CT 500 CT	8 6	120 split 150 split	46		500	
DO-T41	400 CT 500 CT	8 6	400 split 500 split	46	50	500	DI-T41*
DO-T2	500 600	3 3	50 60	60	65	100	DI-T2
DO-T20	500 CT	5.5	600	31	32	500	DI-T20
DO-T4	600	3	3.2	60		100	
DO-T14	600 CT 800 CT	5 5	12 16	43		500	
DO-T31	640 CT 800 CT	5 5	3.2 4	43		500	
DO-T32	800 CT 1000 CT	4 4	3.2 4	51		500	
DO-T15	800 CT 1070 CT	4 4	12 16	51		500	
DO-T21	900 CT	4	600	53	53	500	DI-T21
DO-T3	1000 1200	3 3	50 60	115	110	100	DI-T3
DO-T45	1000 CT 1250 CT	3.5 3.5	16,000 split 20,000 split	120		100	
DO-T16	1000 CT 1330 CT	3.5 3.5	12 16	71		500	
DO-T33	1060 CT 1330 CT	3.5 3.5	3.2 4	71		500	
DO-T5	1200	2	3.2	105	110	100	DI-T5
DO-T17	1500 CT 2000 CT	3 3	12 16	108		500	
DO-T22	1500 CT	3	600	86	87	500	DI-T22
DO-T34	1600 CT 2000 CT	3 3	3.2 4	109		500	
DO-T51	2000 CT 2500 CT	3 3	2000 split 2500 split	195	180	100	DI-T51
DO-T37	2000 CT 2500 CT	3 3	8000 split 10,000 split	195	180	100	DI-T37*
DO-T52	4000 CT 5000 CT	2 2	8000 CT 10,000 CT	320	300	100	DI-T52
DO-T18	7500 CT 10,000 CT	1 1	12 16	505		100	
DO-T35	8000 CT 10,000 CT	1 1	3.2 4	505		100	
*DO-T48	8,000 CT 10,000 CT	1 1	1200 CT 1500 CT	640		100	
*DO-T47	9,000 CT 10,000 CT	1 1	9000 CT 10,000 CT	850		100	
DO-T6	10,000	1	3.2	790		100	
DO-T9	10,000 12,000	1 1	500 CT 600 CT	780	870	100	DI-T9
DO-T10	10,000 12,500	1 1	1200 CT 1500 CT	780	870	100	DI-T10
DO-T25	10,000 CT 12,000 CT	1 1	1500 CT 1800 CT	780	870	100	DI-T25
DO-T38	10,000 CT 12,000 CT	1 1	2000 split 2400 split	560	620	100	DI-T38*
DO-T11	10,000 12,500	1 1	2000 CT 2500 CT	780	870	100	DI-T11
DO-T36	10,000 CT 12,000 CT	1 1	10,000 CT 12,000 CT	975	970	100	DI-T36
DO-T1	20,000 30,000	.5 .5	800 1200	830	815	50	DI-T1
DO-T23	20,000 CT 30,000 CT	.5 .5	800 CT 1200 CT	830	815	50	DI-T23
DO-T39	20,000 CT 30,000 CT	.5 .5	1000 split 1500 split	800		50	
DO-T40	40,000 CT 50,000 CT	.25 .25	400 split 500 split	1700		50	
DO-T46	100,000 CT	0	500 CT	7900		25	
DO-T7	200,000	0	1000	8500		25	
DO-T24	200,000 CT	0	1000 CT	8500		25	
DO-TSH	Drawn Hipermalloy shield and cover 20/30 db						DI-TSH

DCMA shown is for single ended usage (under 5% distortion—100mw—1kc) . for push pull, DCMA can be any balanced value taken by .5W transistors (under 5% distortion—500mw—1kc) DO-T & DI-T units designed for transistor use only. U.S. Pat. No. 2,949,591; others pending. *Units newly added to series
§Series connected; §§Parallel connected

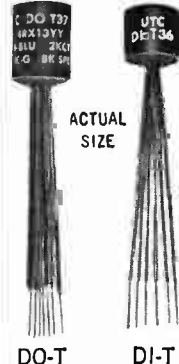

DO-T & DI-TTM

Transistor TRANSFORMERS and INDUCTORS

NOW! Hermetically Sealed to MIL-T-27B

*16 New Items Added to Stock Line
IMMEDIATE DELIVERY FROM STOCK

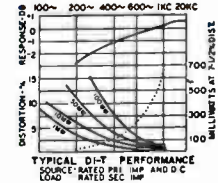
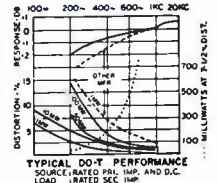

- High Power Rating up to 10 times greater
- Excellent Response twice as good at low end
- Low Distortion reduced 80%
- High Efficiency up to 30% better . . . compare DCR
- Moisture Proof hermetically sealed to MIL-T-27B
- Rugged Grade 4, completely metal cased
- Anchored Leads will withstand 10 pound pull test
- Printed Circuit Use (solder melting) nylon insulated leads
- Suited to Clip Mounting use Augat #6009-8A clip

INDUCTORS

DO-T No.	Inductance Hys @ ma	DO-T DCR Ω	DI-T DCR Ω	DI-T No.
*DO-T50 (2 wdg.)	\$.075 Hy/10 ma, .06 Hy/30 ma \$.018 Hy/20 ma, .015 Hy/60 ma	10.5 2.6		
DO-T28	.3 Hy/4 ma, .15 Hy/20 ma	25		
DO-T27	.1 Hy/4 ma, .08 Hy/10 ma		25	DI-T28
DO-T27	1.25 Hys/2 ma, .5 Hy/11 ma	100		
DO-T27	.9 Hy/2 ma, .5 Hy/6 ma		105	DI-T27
DO-T8	3.5 Hys/2 ma, 1 Hy/5 ma	560		
DO-T8	2.5 Hys/2 ma, .9 Hy/4 ma		630	DI-T8
DO-T26	6 Hys/2 ma, 1.5 Hys/5 ma	2100		
DO-T26	4.5 Hys/2 ma, 1.2 Hys/4 ma		2300	DI-T26
*DO-T49 (2 wdg.)	\$.20 Hys/1 ma, 8 Hys/3 ma \$.5 Hys/2 ma, 2 Hys/6 ma	5100 1275		

POWER TRANSFORMERS

*DO-T400	Pri 28V 380-1000 cycles, Sec 6.3V @ 60 ma
*DO-T410	Pri 28V 380-1000 cycles, 2-Sec 6.3 @ 30 ma each
*DO-T420	Pri 28V 380-1000 cycles, Sec 28V @ 20 ma (Isol. Electrostatic Shld.)

Write for catalog of over 1,200 UTC HIGH RELIABILITY STOCK ITEMS IMMEDIATELY AVAILABLE from your local distributor.



UNITED TRANSFORMER CORP.

150 VARICK STREET, NEW YORK 13, N. Y.
PACIFIC MFG. DIVISION: 3630 EASTHAM DRIVE, CULVER CITY, CALIF.
EXPORT DIVISION: 13 EAST 40th STREET, NEW YORK 16, N. Y. CABLE: "ARLAB"

Only with 175A Plug-ins:

1 mv/cm at 20 mc, dual channel

50 mc bandwidth at 10 mv/cm

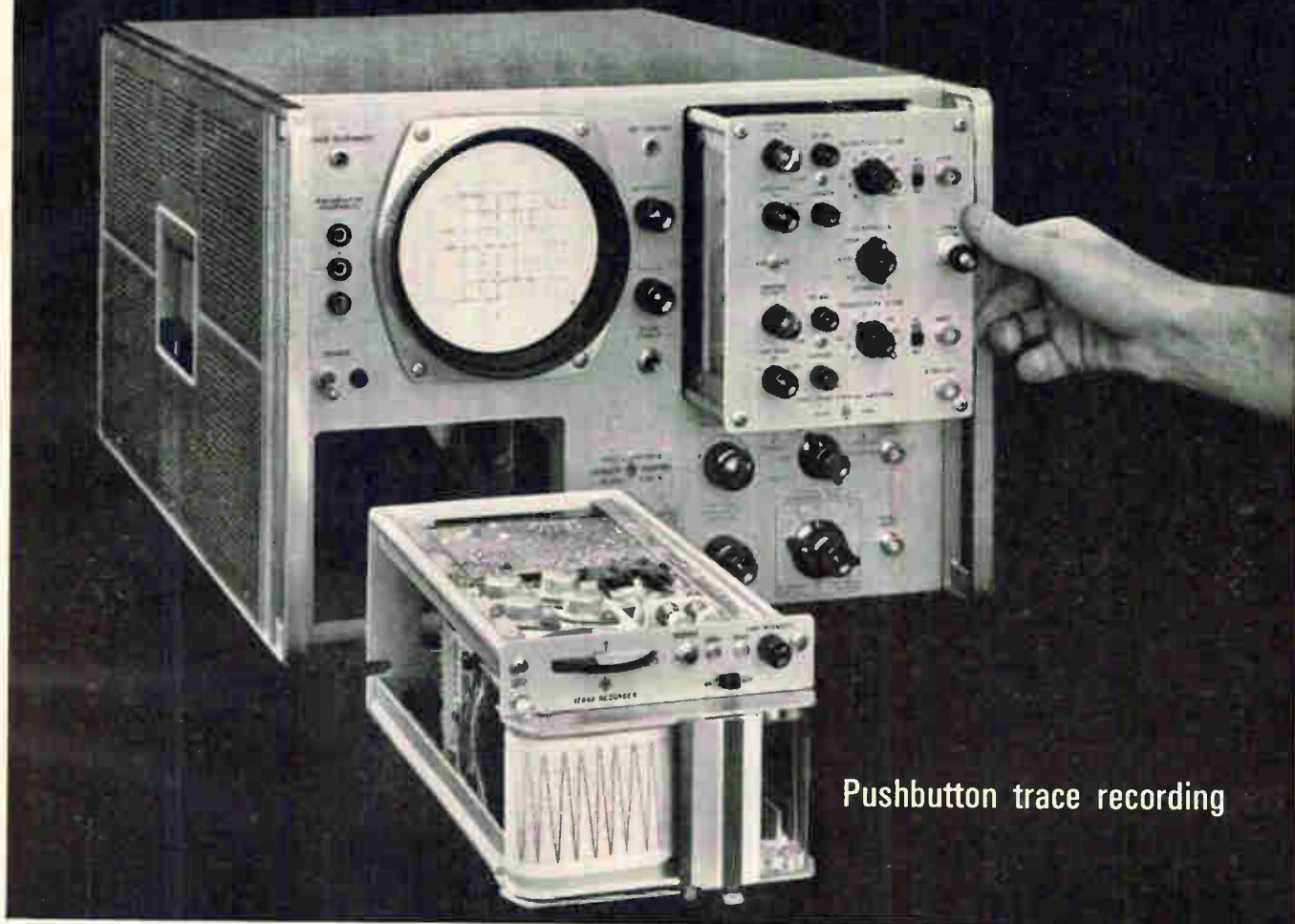

Pushbutton trace recording

comparison proves

the hp 175A is your best 50 mc scope buy! Unmatched measuring performance and value are yours with the 175A 50 MC Oscilloscope. First, many of its performance capabilities are exclusive and not available from any other scope manufacturer. Second, the 175A offers a dual plug-in versatility that means it can do more tasks for you than single plug-in scopes. Compare the 175A with other scopes, consider performance and versatility versus cost. You'll find your best all-around buy in the hp scope.

For example, the high-performance 1755A Dual-channel Vertical Amplifier, at only \$575, offers these sensitivities: 1 mv/cm at 20 mc bandwidth, 5 mv/cm at 40 mc or 10 mv/cm through 5 v/cm at 50 mc. Features include A + B operation, differential A - B use for common mode rejection, a sync amplifier for triggering on Channel B input. This unmatched performance for the price of the 1755B, plus the 175A main frame, \$1325.

Or for economy performance, the 1750B Dual-trace Amplifier, \$325, offers 50 mv/cm to 20 v/cm sensitivity, dc to 50 mc (7 nsec rise time). It lets you trigger on Channel B input, too.

Now compare the horizontal plug-in flexibility of the 175A: The 1784A Recorder plug-in permits permanent records of wave-

forms. It's easy to operate. Simply push a button to record. And it's economical, too. You can make 20 recordings for the cost of one photograph. Other horizontal plug-ins include a scanner for large trace recordings on an external recorder, sweep-delay operation, and time markers.

Other vertical plug-ins include a 50 mc single-channel unit, a 5 mv/cm differential amplifier, a high-gain amplifier and a four-channel plug-in with 40 mc bandwidth.

Compare performance versus cost of the 175A with any other available scope or combination of scopes. Then call your hp field engineer for a demonstration of the scope and plug-ins. Or write for complete information: Hewlett-Packard, Palo Alto, California 94304, Tel. (415) 326-7000; Europe: 54 Route des Acacias, Geneva; Canada: 8270 Mayrand Street, Montreal.

Data subject to change without notice. Prices f.o.b. factory.

**HEWLETT
PACKARD**



An extra measure of quality

Measure TRANSISTOR PARAMETERS

500 KC to 250 MC

Features:

Handles most popular TO packages
Convenient plug-in test circuits

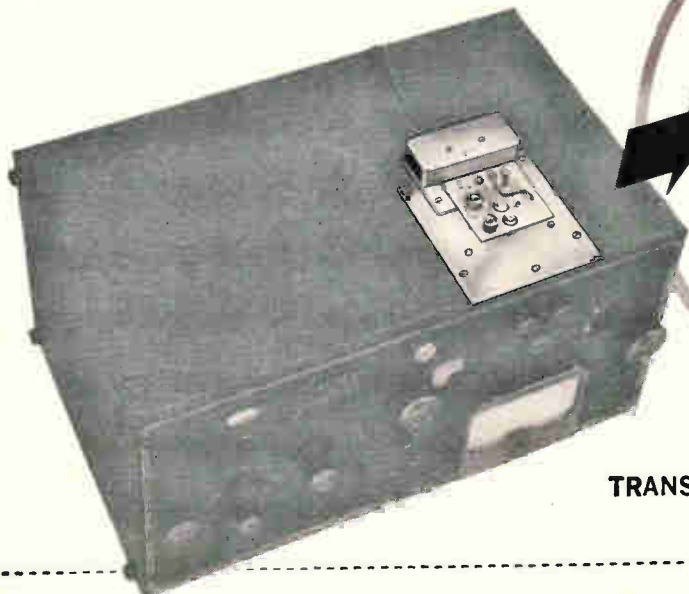

TRANSISTOR TEST JIG TYPE 13510A

The Transistor Test Jig, Type 13510A, is designed to provide a convenient means for measuring the Y parameters of transistors on the RX Meter, Type 250A, over the frequency range from 500 kc to 250 mc. The jig consists of four basic components: a Mounting Adapter and three separate plug-in test circuits for measuring Y_{11_b} , Y_{11_e} , and Y_{22_e} .

The Mounting Adapter mounts conveniently on the RX Meter and includes bias feed and bypassing for an external power supply (hp 721-A). Each of the test circuits is constructed on a printed circuit board for maximum stability and repeatability. Residual reactances have been minimized, providing maximum measurement accuracy.

Specifications:

RF RANGE: 500 kc to 250 mc

TEST CIRCUITS: Provide for readout of R_p and C_p on RX Meter to yield Y_{11_b} , Y_{11_e} and Y_{22_e} .

$$\boxed{Y_{()} = \frac{1}{R_p} + j\omega C_p}$$

EXTERNAL BIAS RANGE:

50 ma. dc maximum
30 volts dc maximum

TRANSISTOR MOUNTING:

Accommodates TO-1, 5, 9, 11, 18, 23, 24, 39 and similar packages.

PRICE: 13510A: \$195.00

F.O.B. Rockaway, New Jersey



BOONTON DIVISION

PRECISION ELECTRONIC INSTRUMENTS SINCE 1934
GREEN POND ROAD, ROCKAWAY, NEW JERSEY 07866



Hewlett-Packard
Company

TELEPHONE: (201) 627-6400 • TWX: (201) 627-3912 • CABLE ADDRESS: BOONRACO

Electronics

April 5, 1965
Volume 38, Number 7

Page 4	Readers Comment
8	People
10	Meetings
15	Editorial
17	Electronics Newsletter
55	Washington Newsletter
135	New Products
174	New Books
176	Technical Abstracts
183	New Literature

Electronics Review

Page 29	Color it faithful	34	Flight plan
30	Northern guard	34	Spray-on film
30	10-cent capacitors	36	Pinpoint navigation
31	Laser in chemistry	37	Interest high,
32	On the job		sales low

Electronics Abroad

185	Preferential treatment	188	Station automation
185	Patent pact	188	East meets West
186	Tv pipedream	189	Around the world
186	Royalty in jail		

Probing the News

119	Navy's all-purpose circuits
122	A million-dollar diversification plan
124	GAO pulls rank on Pentagon and industry

Technical articles

I. Design

Components	76	Cold-cathode tubes as triggers Subminiature tubes are inexpensive but reliable in low-speed logic and relay circuits Martin E. Bond, Mullard Ltd.
Circuit design	86	Designer's casebook FET circuit stretches 1-msec pulse to 30 hours; triangular waveforms have 1% linearity; scr switch turns off with reverse bias
Space electronics	89	Gemini: giant step to the moon First U.S. two-manned space flight carried some significant new instrumentation Joel A. Strasser and Peter Sigmund, space electronics editors

Just in case . . . 94

Sophisticated malfunction detection system is first to warn astronauts directly of trouble
S.I. Levine, Martin Co.

Physical exam in orbit 99

Bioinstrumentation has been sharpened to learn more about man's resistance to weightlessness
Herbert R. Seal, Spacelabs, Inc. and Gershon Weltman, University of California

Tv looks at the dark side 106

Television cameras that can photograph at low light levels record what the astronauts see
C. Beck, T.J. Shopple, and A.R. Prince, U.S. Naval Air Development Center

Rendezvous in space 110

Climax of project Gemini experiments is a rendezvous in space directed by special radar equipment
B.H. Vester and L. M. Zimmerman, Westinghouse Electric Corp.

III. Manufacturing

Production	113	Production tips Flat disks reduce the cost of making cathode-ray tubes; "sniffer" removes solder from board
-------------------	------------	---

Electronics

Editor: Lewis H. Young

Senior editors

Technical: Samuel Weber
News: Kemp Anderson, Jr.

Senior associate editors: John F. Mason, George Sideris

Department editors

Avionics: W.J. Evezia
Circuit design: Michael Elia
Communications: Alexander A. McKenzie
Components: Michael F. Tomaino
Consumer electronics: Richard Lipkin
Industrial electronics: Louis S. Gomolak
Instrumentation: Carl Moskowitz
Manufacturing: George Sideris
Military electronics: John F. Mason
New products: William P. O'Brien
Solid state: Jerome Eimbinder
Space electronics: Joel A. Strasser
Staff writers: Leon H. Dulberger, Stanley Zarowin

Regional editors

Boston: Thomas Maguire, editor; Robin Carlson
Los Angeles: William B. Wallace, editor; June Long
San Francisco: Laurence D. Shergalis, editor; Mary Jo Jadin
London: Derek Barlow, editor

Copy editors

Howard Rausch, Sally Powell, Walter Barney

Graphic design

Art director: Saul Sussman
Assistant art director: John C. Wright, Jr.
Editorial production: Ann Mella
Production editor: Arthur C. Miller

Editorial secretaries: Claire Benell, Mary D'Angelo, Lynn Emery, Kay Fontana, Carolyn Michnowicz, Lorraine Rossi, Lorraine Werner

McGraw-Hill news service

Director: John Wilhelm; **Atlanta:** Fran Ridgeway; **Chicago:** Bruce Cross;
Cleveland: Arthur Zimmerman; **Dallas:** Marvin Reid;
Detroit: Donald MacDonald; **Los Angeles:** Michael Murphy,
Ron Lovell; **San Francisco:** Margaret Raiston, Ed. Addeo;
Seattle: Ray Bloomberg; **Washington:** Arthur L. Moore, Glen Bayless,
Charles Gardner, Herbert W. Cheshire, Seth Payne

McGraw-Hill world news service

Bonn: Richard Mikton; **Brussels:** Arthur Erikson; **London:** John Shinn;
Mexico City: Wesley Perry; **Milan:** Bruce Bendow;
Moscow: Donald Winston; **Paris:** Dan Smith;
Rio de Janeiro: Leslie Warren; **Tokyo:** Marvin Petal, Charles Cohen

Circulation manager: Hugh J. Quinn

Reprints: T.M. Egan

Publisher: C.C. Randolph

Electronics: April 5, 1965, Vol. 38, No. 7

Printed at 99 North Broadway, Albany, N.Y.
Second class postage paid at Albany, N.Y.

Subscriptions are solicited only from those actively engaged in the field of the publication. Position and company connection must be indicated on orders. Subscription prices: United States and Possessions and Canada, \$6.00 one year, \$9.00 two years, \$12.00 three years. All other countries \$20.00 one year. Single copies, United States and Possessions and Canada 75¢. Single copies all other countries \$1.50.

Published every other Monday by McGraw-Hill Inc. 330 West 42nd Street, New York, N.Y. 10036. Founder: James H. McGraw, 1860-1948.

Subscribers: The Publisher, upon written request to our New York office from any subscriber, agrees to refund that part of the subscription price applying to copies not yet mailed. Please send change of address notices, subscription orders or complaints to Fulfillment Manager, Electronics, at the address below. Change of address notices should provide old as well as new address, including postal zone number if any. If possible, attach address label from recent issue. Allow one month for change to become effective.

Postmaster: Please send Form 3579 to Fulfillment Manager, Electronics, P.O. Box 430, Hightstown New Jersey 08520

Readers Comment

FCC blast

To the Editor:

The Federal Communications Commission policies of the past few years, which they claim "would widen tv reception" [March 8, 1965, p. 17], are really euphemisms for broadening the "wasteland" which one chairman created and legislated into life.

We "need" thousands of local trash outlets only after we are guaranteed access to network programming at the time it is taking place. If a local station cannot compete with network programming, then it should not be foisted on the public by limited area broadcasting (uhf) or by punitive regulation of cable companies.

Why is it that those who shout the loudest about "free enterprise" and "competition" are always the first in line seeking legislation that will keep them in business when competition comes their way?

Richard G. Devaney
Kingsport, Tenn.

Taking the shock

To the Editor:

Protection against shock can be achieved with a much smaller package than that described in the article "No more shock" [March 8, 1965, p. 42]. Instead of having enough iron and copper in a transformer to carry all of the power delivered to the load, a few turns of bifilar windings on a highly permeable core can be used.

The a-c flows from the power supply to the load in opposite directions through the two wires of the bifilar winding. Any leakage to ground shows as an imbalance of the currents in the bifilar winding. Because the maximum permitted leakage is small, and only the leakage current contributes to the magnetic field in the core, the core can be made of extremely high permeability material to permit fewer turns in the paired primary. The output of a sensing winding is easily amplified by conventional transistor circuitry, to triggers a unijunction or scr so a capacitor discharges through the

Sprague has what it takes to cope with any problem in electromagnetic interference or susceptibility control

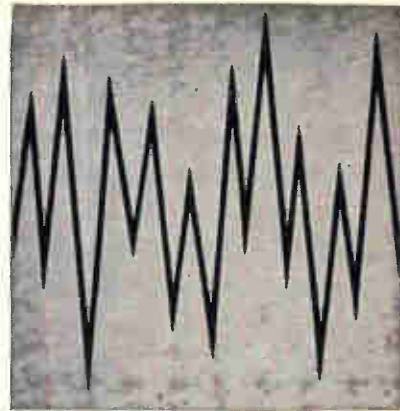

And we mean any problem . . . arising at any point in the development of any equipment or system!

Sprague's interference control facilities provide one of the most complete, fully integrated capabilities you can call on . . . embracing *every* aspect of interference and susceptibility control.

Design Assistance: Black boxes . . . subsystems . . . complete systems. Using advanced interference prediction techniques, Sprague engineers replace design by "hunch" with precise analysis of electrical schematics. Suppression and shielding can be designed into pre-prototype plans so accurately that little or no modification is required upon evaluation of the model. With today's more complex equipment and increasingly stringent EMI requirements, Sprague assistance in initial design can pay for itself in a dozen different ways by helping you be right the *first* time!

Measurement, Evaluation: Sprague can help you measure interference and susceptibility characteristics of your breadboard, prototype, or production equipment to the applicable interference specification. You know where you stand before investing in further development. We can also research such areas as shielding effectiveness, screen room integrity, transient susceptibility of digital equipment, and cable cross coupling.

Component Design: Sprague Filter Engineering Specialists can design, evaluate, and sample interference control devices to your particular requirements. These range from standard feed-thru capacitors and radio interference filters to the more sophisticated packages, such as frequency-controlling electric wave filters.

Component Production: Each of four Filter Development Centers maintains a well stocked model shop for the rapid fabrication of special

components in prototype quantities. Full scale production facilities are maintained in Visalia, Calif.; North Adams, Mass.; and Vandalia, Ohio.

Compliance Testing: Sprague can test your equipment or system and report on its compliance to the applicable specification: MIL-I-6181, MIL-I-26600, MIL-I-16910, MIL-E-6051 or to such other specialized interference documents as GM07-59-2617A, AFBSD Exhibit 62-87 (Minuteman WS133B), LSMC Specification ERS11897 (Polaris A3) or MIL-STD-449. If compliance is not indicated, a Sprague engineer will make concise recommendations and will, if you desire, give you every assistance in achieving that compliance.

Regional Service: Wherever you may be, this integrated EMI capability is readily available to you from strategically located Filter Development Centers in North Adams, Mass.; Annapolis Junction, Md.; Vandalia, Ohio; and Los Angeles, Calif. Each is fully equipped and staffed to evaluate, modify, or qualify your equipment.

In-plant Service: Sprague can put competent Interference Control Specialists at your service in your plant for consultation on, or supervision of, special projects.

Whether your work involves military or industrial electronic equipment or systems, Sprague Filter Development Center personnel can help assure substantial savings in dollars and hours at many points during development. Get complete information from the development center nearest you or by writing for a comprehensive brochure (FD-101) to Technical Literature Service, Sprague Electric Company, 35 Marshall Street, North Adams, Massachusetts.

FILTER DIVISION PRODUCTS AND SERVICES

INTERFERENCE FILTERS AND CAPACITORS
PRECISION TOROIDAL INDUCTORS
FREQUENCY SPECTRUM SIGNATURES
COMPONENT ENVIRONMENTAL TEST FACILITIES
45-F-134-83R1

ELECTRIC WAVE FILTERS
TELEMETRY FILTERS
EMI TEST FACILITIES
EMI SYSTEMS ENGINEERING



Sprague and ® are registered trademarks of the Sprague Electric Co.

Only from Sprague!

LABORATORY CAPACITANCE STANDARDS

100 μ F!



to a certified accuracy of



$\pm 0.1\%$

STYRACON[®] PRECISION CAPACITORS

Components for highly precise electronic equipment as well as laboratory standards of capacitance • Measurements are correlated with similar capacitors certified by National Bureau of Standards • Maximum capacitance stability possible in the state of the art • Capacitance values from .001 to 100 μ F • Specially-processed polystyrene dielectric • Hermetically-sealed.

STYRACON[®] DECADE CAPACITORS



Triple decade capacitors with direct in-line readout • Accurate to $\pm 0.5\%$ of nominal capacitance for any dial setting • Two basic ranges of capacitance — 0.0001 to 0.1099 μ F and 0.001 to 1.099 μ F • Available in bench or panel mounting styles.

For complete technical data, write for Engineering Bulletins 90,600 and 90,605 to Technical Literature Service, Sprague Electric Company, 35 Marshall St., North Adams, Mass.

SPRAGUE[®]

THE MARK OF RELIABILITY

'Sprague' and 'S' are registered trademarks of the Sprague Electric Co.
45C-160-6391

trip coil of a circuit breaker for fast opening.

Because a large transformer is replaced by a small sensing transformer, the equipment can be reduced in size and weight to a unit occupying about 6 cubic inches of volume more than that of the circuit breaker.

Because the transformer winding is bifilar, with the two a-c leads carrying current in opposite directions, the load does not see any effective inductive reactance due to the sensing transformer: only the unbalanced part of the current sees any inductance. No separate ground is needed for the unit; the generator or power line ground suffices.

Daniel J. Kantor
Frederick W. Kantor

Consultants
New York City

Thin film counter

To the Editor:

The article "X-rays to evaluate thin-film processes," [March 8, 1965 p. 90] says "recorded by a geiger counter and pulse-height analyzer." I think you mean proportional counter.

All information about energy level would be lost if a geiger counter were to be used. The advantage of a proportional counter is that the output pulse height bears relationship to the energy level; that is why it is used with a pulse height analyzer. A Geiger-Mueller tube is a broadband transducer.

A. Achtekk

Lionel Electronic Laboratories
Hillside, N. J.

▪ Reader Achtekk is mostly right. Still, the company that built the device is using a geiger counter, though its engineers agree that a scintillation counter or proportional counter would supply better accuracy.

Selecting diodes

To the Editor:

We congratulate you on publishing Robert Feket's excellent article on "Selecting the Right Diode for R-F Switching Circuits" March 22, p. 90, in which he gave a thorough treatment of the use of varactor

and P-I-N diodes in microwave switches.

The statement on page 69 that these diodes are designed and built to perform microwave switching "more reliably than high-speed computer diodes" is misleading. Fekete's statement that varactor and P-I-N diodes yield the "most predictable performance" applies to predicting microwave-circuit characteristics such as isolation, insertion loss, bandwidth, etc.—not to predicting longevity. The reliability of computer diodes used in microwave switches depends upon exactly the same parameters discussed in the article. The fact that computer diodes are ordinarily not specified for microwave service does not rule out their use for dependable operation at uhf and shf, especially if all the pertinent parameters are known or measured before installation in a microwave circuit.

The judgment that varactor and P-I-N diodes give the "best" performance is debatable.

K. Schomaker

Somerset Radiation Laboratory
Edison, Pa.

Big-dish tv

To the Editor:

In "Modernizing the missile range: part I" (Feb. 22, p. 94). I was intrigued by the photographs of the 85 foot TAA-2 antenna and its feed.

I wonder, whether anyone ever used this antenna in leisure moments to pick up broadcasts from Florida.

We have made some use of large fixed parabolic antennas (60 by 230 feet) for commercial television reception, and we wonder whether there was any informal experience at Grand Bahama on tv reception from Miami with an antenna of this size.

I. Switzer

Cablevision Lethbridge, Ltd.
Lethbridge, Alta., Canada

▪ Yes, engineers at Grand Bahama have received good tv signals from Florida using the big dish, but they don't need it. They get good, snow-free reception most of the time using one 11-element broadband antenna and a two-transistor pre-amplifier.

NEW TIME and FREQUENCY STANDARDS



Spectral purity is of the highest order . . . particularly important in microwave spectroscopy and, generally, in applications involving frequency multiplication.

Timing signals and time comparisons of unmatched precision... essential in such real-time applications as satellite telemetry and sequential decoding.

Minimum power consumption. Self-contained batteries provide at least 24-hour operation. Automatic changeover from line operation to batteries (and back to line) without transients make this equipment particularly useful in remote installations.



Standard-Frequency Oscillator, Type 1115-B

All solid-state, operates at 5 Mc/s using fifth-overtone-mode quartz crystal.

- 5Mc/s, 1Mc/s, and 100 kc/s low-distortion sine-wave outputs.
- Frequency Adjustment is 2700×10^{-10} (1×10^{-10} per dial division). Frequency can be controlled remotely with dc voltage.
- Short-Term Stability: Standard deviation (sigma) is $<50 \times 10^{-11}$ for 1 ms averaging time and $<10^{-11}$ for 1 sec.
- Aging $<5 \times 10^{-10}$ per day after 30 days, typically $<1 \times 10^{-10}$ per day after 1 year.
- Open-circuit to short-circuit load change causes $<\pm 2 \times 10^{-11}$ frequency deviation.
- $\pm 10\%$ ac line-voltage change causes $< \pm 10^{-11}$ deviation.
- Spectral line width is less than 0.25 c/s at 10 Gc/s.
- Noise Pedestal is less than -145 dB per $\sqrt{C/s}$ at 5Mc/s.
- 35-hour standby battery operation.
- Rugged: Meets MIL STD 167 for vibration and will withstand 30-g shocks of 11-ms duration.
- Uses ac or dc power: 90-130V or 180-260V, 40 to 2000 c/s, 8 watts at 115V, or 22-35V dc (4W at 24V).
- Price, \$2050.



NEW Digital Synchronometer® Time Comparator, Type 1123-A

A solid-state digital clock, uses standard-frequency-oscillator signal to produce precise, uninterrupted time-of-day information, both visual and electrical.

- Permits accurate comparisons between local standards and standard-time transmissions (WWV, Loran C, etc) Time comparisons possible to 20 ns.
- Generates timing pulses at 100, 10, 1 kc/s, 100, 10, 1, and 0.1 c/s with nanosecond jitter.
- Clock's time can be readily synchronized (to $10\mu s$) with standard time.
- Any number of clocks can be started simultaneously from one location; remote clocks can be started from and synchronized to a local clock (without interruption of local clock).
- Bright, 6-digit indication of hours/minutes/seconds. Any digit can be changed without disturbing timing.
- Manual start, fail-safe, regenerative circuits stop clock if input fails for even one cycle.
- BCD (1-2-4-2) output data, $10\mu s$ resolution (1-2-4-8 code available at extra cost).
- Price \$2950.



10, 100, and 1000 Mc.'s

produced by the Type 1121-AH Frequency Standard. Includes low-noise, phase-locked Frequency Multiplier Units, in addition to the Standard-Frequency Oscillator and Digital Synchronometer.

Complete with Rack \$8110.
Type 1121-AL (not shown) produces 10 and 1 kc/s, 400, 100, and 60 c/s from the Type 1114-A Frequency Divider.

Price \$6300.

Other Combinations Can Be Assembled —
Let Us Hear From You.

IN CANADA: Toronto 247-2171, Montreal (Mt. Royal) 737-3673
IN EUROPE: Zurich, Switzerland — London, England



GENERAL RADIO COMPANY

WEST CONCORD, MASSACHUSETTS

NEW YORK, N. Y., 964-2722
(Ridgefield, N. J.) 943-3140

CHICAGO
(Oak Park) 848-9400

PHILADELPHIA
(Ft. Washington) 646-8030

WASHINGTON, D. C.
(Rockville, Md.) 946-1600

SYRACUSE
454-9323

DALLAS
FL 7-4031

SAN FRANCISCO
(Los Altos) 948-8233

LOS ANGELES
469-6201

ORLANDO, FLA.
425-4671

CLEVELAND
886-0150

High-Power Electron Tubes For High Energy Physics

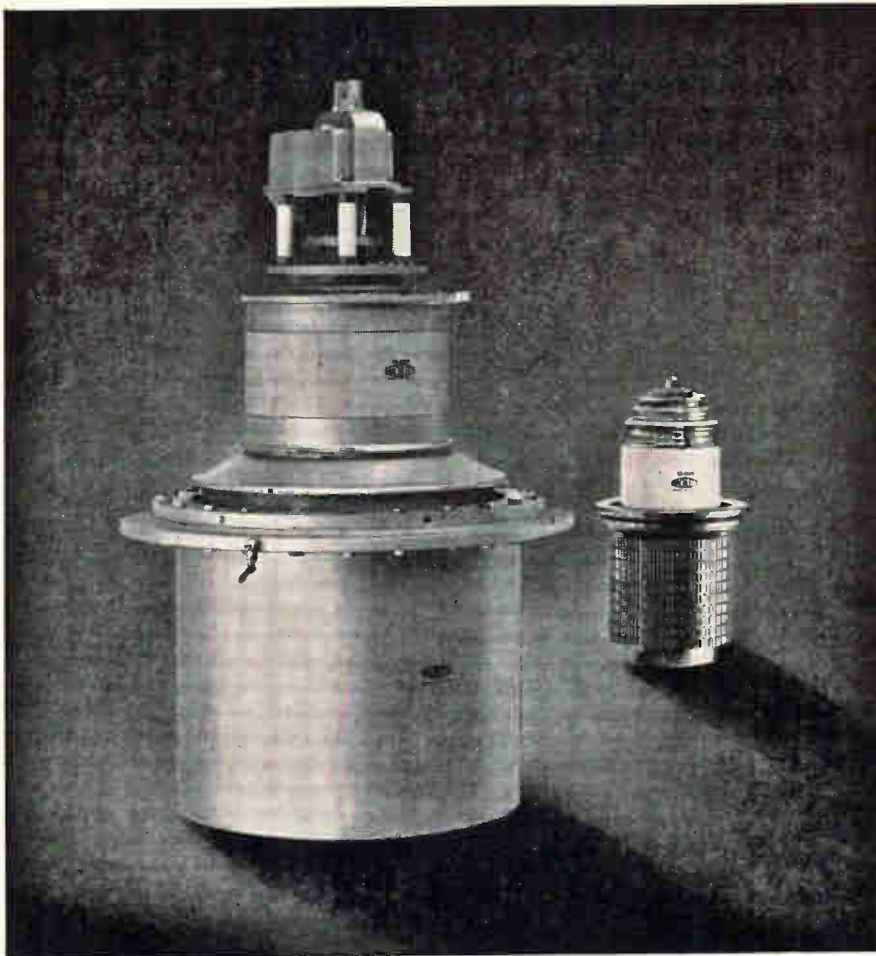

Machlett's power tubes have long served the advanced scientific community. Above are two of the latest developments adding to the expanding group of tubes especially suited for high-energy physics applications—The ML-8545, world's highest power tetrode, capable of 300 kw cw output at 50 Mc and 1.7 Mw pulsed rf power, and the ML-8549, magnetically-beamed triode, capable of 2.5 Mw cw output and 10 Mw pulsed rf power. Write for details: The Machlett Laboratories, Inc., Springdale, Conn. 06879. An Affiliate of Raytheon Company.

MACHLETT
ELECTRON TUBE SPECIALIST

People

Glen R. Madland was directly responsible for the research and development of integrated circuit processes, from design to packaging, at Motorola, Inc., and, until last year, he taught part of the Motorola course on integrated circuits.



Although Madland resigned from Motorola, he's still teaching engineers how to make the best use of integrated circuits. He is the president of a consulting firm called the Integrated Circuit Engineering Corp., in Phoenix, Ariz., which was formed by Madland and three other engineers who have formidable expertise in every area of integrated circuits.

Madland believes that few engineers have had the opportunity to acquire the broad technical background that's needed to put integrated circuits to effective use. He says many expensive mistakes are being made, often because the circuit manufacturer does not communicate effectively with the user. For example, he has found that \$100 circuits were used where \$20 circuits would have worked.

Maj. Gen. John W. O'Neill, boss of the Air Force's Electronic Systems Division at Hanscom Field, Mass., oversees a 10,000-man civilian-military team that designs equipment for surveillance, tracking, detection, communications and command and control—a half-billion dollar program.



The 46-year-old General's familiarity with military electronics dates back to 1946, when he was the Air Force liaison officer on guided missiles with the deputy chief of Naval operations. In 1961 he was assigned to the office of defense research and engineering at the Pentagon. He took over at Hanscom Field in mid-1964.

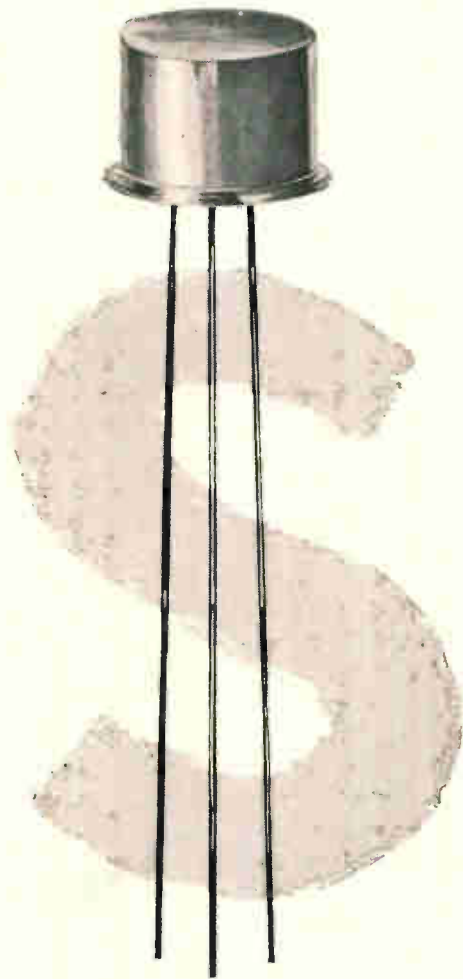

Prejudice can be a costly luxury!

Take device packages for example. Devices in metal packages are reliable, but costly. Plastic packages afford economies in production and are low in cost. But earlier molding plastics would distort, burn . . . some would contaminate device junctions . . . destroying device characteristics and reliability. Thermal limitations restricted device capability.

Result: the opinion that *all* molded devices are of questionable quality—not to be considered where long term reliability is required.

Fact? . . . opinion? . . . or prejudice? Facts lead to opinions . . . opinions that can be costly prejudice with the recent

development of devices packaged in silicone molding compound!

Unlike all other plastics, silicone molding compound is inherently non-burning, will not contaminate devices. Fact is, silicone resins have long been used on device junctions!

Molded devices packaged in silicone molding compound are now available from several leading manufacturers. Generally, these devices are lower in cost . . . lighter in weight . . . unaffected by heat aging . . . offers long term reliability . . . are non-burning . . . don't deform during soldering . . . pass moisture resistance tests.

Don't you owe it to yourself to evaluate these devices . . . and this new silicone packaging material?



Write for a list of manufacturers offering devices packaged in this unique material — and for more information on Dow Corning® molding compound. Address Dept. 3916, Electronic Products Division, Dow Corning Corporation, Midland, Michigan 48641.

DOW CORNING

Obviously from Sprague!

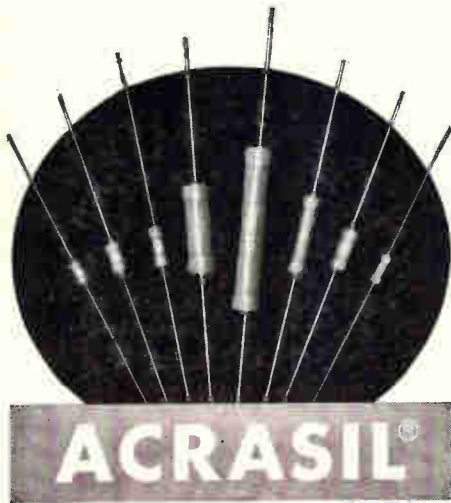

**... the precision/power
wirewound resistor
with more
PLUS features!**

Silicone Encapsulated—Seals resistance element. Provides exceptional protection against severe environmental conditions as well as physical damage.

Wide Application—Standard and non-inductive windings. Equally suited for printed wiring boards, custom packaging, and point-to-point wiring.

Close Resistance Tolerances—Standard tolerances to $\pm 0.05\%$.

Wide Range of Ratings— $\frac{1}{4}$ watt to 10 watts. Resistance values from $.05\Omega$ to $66K\Omega$.

Minified Sizes—Smaller than other conventional wirewound resistors.

Excellent Stability—Under extended load life and environmental operating parameters, Acrasil Resistors show exceptionally small change in resistance values.

Outstanding Reliability—Fully meet electrical performance requirements of MIL-R-26C, as well as individual customer high reliability specifications.

For complete technical data, write for Engineering Bulletin 7450 to Technical Literature Service, Sprague Electric Company, 35 Marshall St., North Adams, Mass.



'Sprague' and '®' are registered trademarks of the Sprague Electric Co.
45 R-186-62

Meetings

Protective Relay Engineers Conference, Texas A&M Univ.; College Station, Texas, Apr. 5-7.

National Packaging Exposition, AMA; McCormick Place, Chicago, Apr. 5-8.

IEEE Lectures on Microelectronics, IEEE; Chicago Lane Technical Institute, Chicago, Apr. 5, 12, 19, 26.

Cleveland Electronics Conference, IEEE, ISA, CPS, Western Reserve University, Case Institute of Technology; Cleveland Public Auditorium, Cleveland, Apr. 6-8.

Conference on Impact of Batch-Fabrication on Future Computers, PGEC/IEEE; Thunderbird Hotel, Los Angeles, Apr. 6-8.

Airlines Electronic Engineering Committee General Session, AEEC of ALCAC; Eden Roc Hotel, Miami Beach, Apr. 7-9.

Value Engineering Symposium, SAVE; Marriott Motor Hotel, Bala Cynwyd, Penn., Apr. 7.

IEEE Region 3 Meeting, Robert E. Lee Hotel, Winston-Salem, N.C., Apr. 7-9.

Electronic Components International Exhibition, FNIE, SDSA, Parc des Expositions (Fair Grounds), Paris, Apr. 8-13.

National Aeronautic Meeting and Production Forum, SAE; Sheraton-Park Hotel, Wash., Apr. 12-15.

IEEE Region 6 Annual Conference, Las Vegas Convention Center, Las Vegas, Apr. 13-15.

Telemetry National Conference, AIAA, IEEE, ISA; Shamrock-Hilton Hotel, Houston, Tex., Apr. 13-15.

Specialists Conference on Thin Film Action Devices, G-ED/IEEE, NASA; Johns Hopkins University, Baltimore, Apr. 14-15.

Marine Sciences Instrumentation Symposium, ISA; Dupont Plaza Hotel, Miami, Fla., Apr. 21-23.

Numerical Control Society Annual Meeting, NCS; La Salle Hotel, Chicago, Apr. 21-23.

Society of American Value Engineers National Convention, SAVE; Statler-Hilton Hotel, Boston, Apr. 21-23.

National Topical Meeting, ANS; Statler-Hilton Hotel, Detroit, Apr. 26-28.

American Physical Society Spring Meeting, APS; Sheraton-Park, Shoreham, Washington, D.C., Apr. 26-29.

Anti-Missile Research Advisory Council Meeting, IDA; Institute for Defense Analyses, Arlington, Va., Apr. 26-30.

Rocky Mountain Bioengineering Annual Symposium, IEEE, USAF Acad., Fitzsimmons Gen. Hospital, et al; Brown Palace Hotel, Denver, May 3-4.

Annual Technical Conference, ASQC; Biltmore Hotel, Los Angeles, Calif., May 3-5.

American Astronautical Society Annual Meeting, AAS, IIT Research Institute; Conrad Hilton Hotel, Chicago, May 4-6.

Packaging Industry Annual Conference, IEEE; Milwaukee Inn, Milwaukee, Wis., May 4-6.

"Post Apollo Missions" Meeting, AAS; The Conrad Hilton Hotel, Chicago, May 4-6.

ICA Annual Conference, ICA; Hilton Hotel, Pittsburgh, May 4-7.

Design Engineering Conference, ASME; New York Coliseum, New York, May 17-20.

Society of Photographic Scientists and Engineers Annual Conference, SPSE; Sheraton-Cleveland Hotel, Cleveland, May 17-21.

Aerospace Fluid Power Systems and Equipment Conference, SAE; Statler-Hilton Hotel, Los Angeles, May 18-20.

Digital Equipment Computer Users Society Spring Technical Meeting, DECUS; William James Hall, Harvard University, Cambridge, Mass., May 20-21.

Call for papers

UAIDE Annual Meeting, UAIDE; Holiday Inn, 57th Street, New York City, Oct. 11-14. **July 15** is deadline for submission of one-paragraph abstract to C. L. Bannister, Program Chairman, 1965 UAIDE Annual Meeting, R-COMP-RRL, NASA/Marshall Space Flight Center, Huntsville, Ala., 35812.

Nuclear Science Symposium, IEEE; San Francisco, Oct. 18-20. **July 1** is deadline for submitting 100 to 300 word abstract to J. M. Harrer, Argonne National Lab, Argonne, Ill.

Astrodata's New Astrolock*-loop FM Subcarrier Discriminator



Stability

Within $\pm 0.01\%$ of center frequency for 24-hours after a 5-minute warm-up.

Linearity

Better than $\pm 0.02\%$ of full bandwidth, best straight line.

The Astrodata Model 402-201, all solid-state FM subcarrier discriminator utilizes the new Astrolock phase-frequency detector, crystal-referenced, FET chopper-stabilized VCO, and current mode loop filter, which are proprietary developments of Astrodata, Inc.

This completely new and different type of locked-loop discriminator gives performance exceeding that of both conventional phase-locked-loop and pulse-averaging types of discriminators.

The new crystal-referenced, FET chopper-stabilized VCO provides state-of-the-art performance in stability and linearity, without a temperature controlled oven.

The Astrolock detector, with its composite phase-frequency characteristic, assures positive lock-in at any signal

level within the 66 db dynamic range. True locked-loop performance is provided for deviations up to $\pm 40\%$, with specified linearity. A quadrature detector mode of operation, selected by a switch on the front panel, provides correlation detection for extremely low S/N signals.

The Model 402-201 introduces a new method of tape-speed compensation in which the reference frequency is processed in the frequency domain. As a result, tape speed compensation is perfect at any fixed frequency from lower bandedge to upper bandedge, and is better than 30 db for intelligence frequencies up to a modulation index of 4. Deviations of more than $\pm 3\%$ anywhere in the band can be accommodated. No adjustments are necessary.

With this new Astrodata Tape Speed Compensation system, the over-all

stability for a given data channel is that of the data discriminator alone, whereas in a conventional system the over-all stability is the sum of the stabilities of both the data discriminator and the reference discriminator.

A complete line of accessories is available for use with the Model 402-201. Channel Selectors and Low Pass Filters are provided for all standard IRIG and Constant Bandwidth center frequencies up to 300 kc. Six discriminators and one common power supply mount in a rack adapter which occupies a panel space of 7-in. x 19-in.

For complete technical information on Astrodata's unique Astrolock-loop FM Subcarrier discriminator and full line of telemetry components, call your local Astrodata engineering sales representative or write to us directly.



ASTRODATA INC.

P. O. Box 3003 • 240 E. Palais Road • Anaheim, California 92803

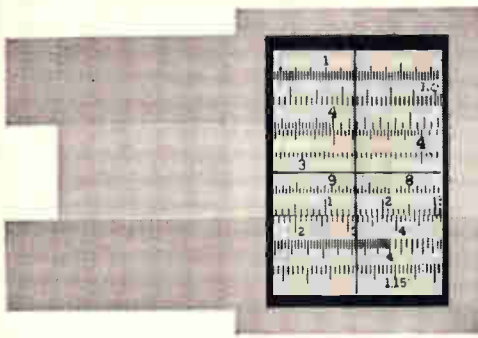

MALLORY

Snap-in mounting for printed circuit control

For use in printed circuits, Mallory can supply standard types of carbon value controls with a special mounting bracket which greatly simplifies production line handling.

The bracket has spring tabs pointing away from the front of the control. You simply press the tabs through the slots in the circuit board. The control locks in place. No need for twisting tabs. The spring tabs hold the control in correct position for soldering.

You can tilt the board, turn it over if you wish, without altering position of the control.

This is another example of the varied mounting methods which Mallory Controls can provide.

CIRCLE 240 ON READER SERVICE CARD

Need an encapsulated control?

For equipment manufacturers who need a wire-wound control that is sealed against dust and humidity, we have developed techniques of encapsulation that give protection against severe environments.

First, we use an epoxy encapsulation that surrounds the entire case of the control. Then, we build in a dual O-ring seal, one on the shaft and another between the control bushing and the mounting panel.



The picture above shows how this construction looks on our Type SC 5-watt control.

CIRCLE 241 ON READER SERVICE CARD

High-reliability aluminum electrolytics now in vertical-mount design

The new Type VPG is a single-end, vertical-mount version of the Type TPG high-reliability aluminum electrolytic capacitor. It is a miniaturized model of the Mallory Premium Grade capacitors which have long been the standard of reliability among aluminum electrolytics. The VPG is recommended for consideration as an economical equivalent for tantalum capacitors where all but extreme environmental requirements prevail.

The VPG has leads of 0.032" tinned copper, $\frac{3}{16}$ " long, spaced 0.200" apart. Case diameter is $\frac{1}{2}$ " nominal; lengths are $1\frac{1}{8}$ " and $1\frac{3}{8}$ ". Operating temperature is -40°C to $+85^{\circ}\text{C}$.

Life test data has been obtained beyond 20,000 hours. Indicated life expectancy, when operated within rated conditions is 10 years or better. DC leakage and equivalent series resistance are exceptionally low and stable. Ratings presently available



extend from 700 mfd, 3 VDC to 20 mfd, 150 VDC.

CIRCLE 242 ON READER SERVICE CARD

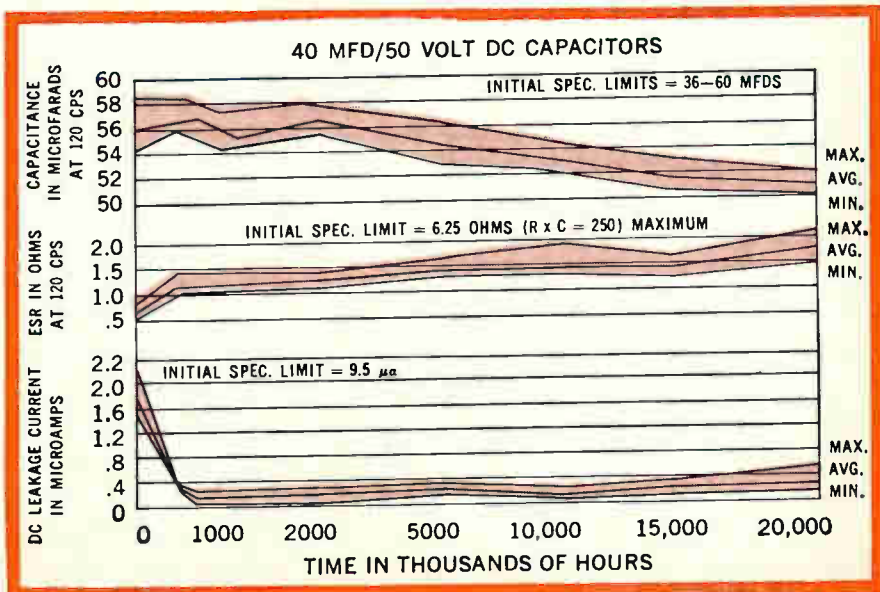

Typical 20,000-hour life test: 40 mfd, 50 volt DC capacitors.

DESIGNER'S FILE

P. R. MALLORY & CO. INC., INDIANAPOLIS, INDIANA 46206

Encapsulated capacitor modules have high mfd-volt ratings



Among the special capacitor packages which Mallory has been supplying is the TMB series of modules. These have exceptionally high capacitance per unit volume. They are as much as 60% smaller than standard MIL foil or wet slug tantalum capacitors of equivalent rating. The TMB packages come in three sizes: a 1" cube, $\frac{1}{2}$ " x 1" x 1", and $\frac{1}{2}$ " x 1" x 1.4". In the 1" cube, for instance, you can get a maximum rating of 1100 mfd at 45 volts, at 85°C.

These packages consist of sealed wet slug tantalum capacitors inside a molded epoxy case. Their temperature range is -55°C to +85°C; and with 33% voltage derating they can be used at +125°C. Inserts for mounting, tapped with 4-40 threads, are molded into the case. Standard capacitance tolerance is $\pm 20\%$. The following range of standard ratings is available:

Case size	Range of ratings (+85°C)
$\frac{1}{2}$ " x 1" x 1"	1200 mfd, 15V to 140 mfd, 110V
1" cube	2400 mfd, 15V to 360 mfd, 110V
$\frac{1}{2}$ " x 1" x 1.4"	2100 mfd, 15V to 220 mfd, 110V

Other ratings and sizes can be supplied to meet special needs.

CIRCLE 243 ON READER SERVICE CARD

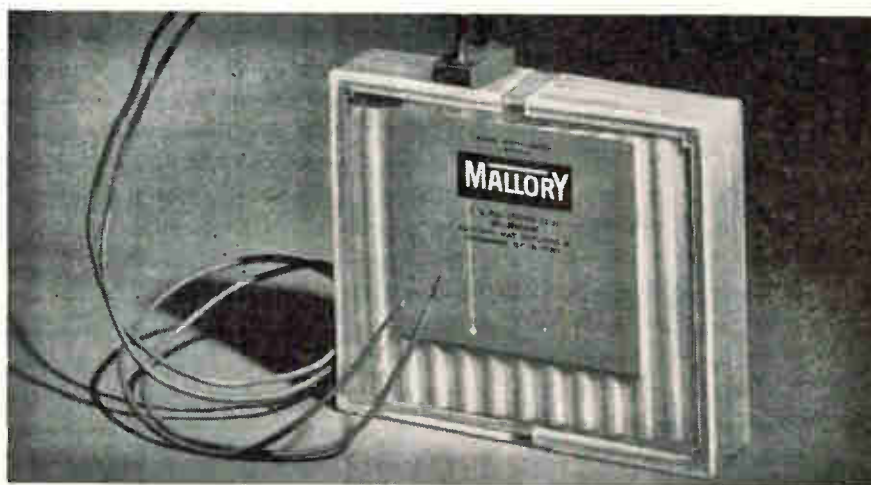

Water-activated battery for sonobuoys

Reserve type water-activated batteries with unusual power capabilities are available from Mallory Battery Company. They use a magnesium-silver chloride system which delivers 50 to 70 watt-hours per pound of dry weight, and $4\frac{1}{2}$ to 5 watt-hours per cubic inch. In the dry state, they can be stored for seven years with no appreciable loss of capacity.

The battery becomes activated upon immersion in water. Activation time in sea water is as little as 10 seconds; in fresh water, up to 90 seconds.

The system is most effective with relatively high load currents. Ratings of up to 50 hours can be provided, in series and parallel cell configurations to deliver the specified voltage and current output.

The Mallory design has compact, rugged construction, in which improved intercell isolation reduces losses due to spurious electrolytic action. Our engineers will custom-design the battery required by your particular electronic circuitry.

CIRCLE 244 ON READER SERVICE CARD

Broader resistance values added to MOL film resistors

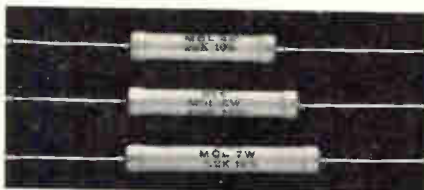

At both the high and low ends of the range, new resistance values have been added to the Type MOL metal oxide film resistor line. In the 2-watt size, for instance, you can get re-

sistances from 30 to 500,000 ohms. More values are also available in the 3, 4, 5, and 7 watt ratings.

This broadened range has been made possible by continuing Mallory developments in applying and controlling the metal oxide film. Current technical data is immediately available.

CIRCLE 245 ON READER SERVICE CARD

HIGH VOLTAGE PNP TRANSISTORS WITH PLANAR II STABILITY

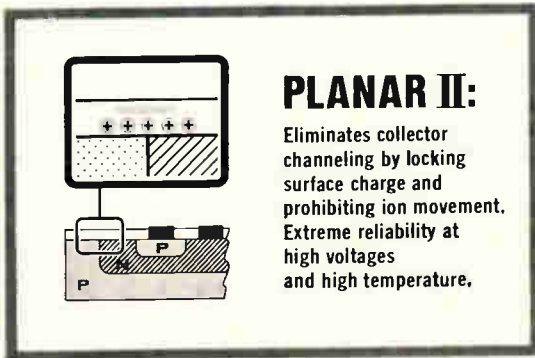

SWITCH: 2N3502 SERIES

- High Voltage — $V_{CE0} = 60V$ min
- High Uniform current gain — from $10\mu A$ to $500mA$
- Low Saturation Voltage — $V_{CE(sat)} = 0.4V$ max ($150mA$)
- Fast High Current Switching — $T_{on} + T_{off} = 140$ nsec max
- High Gain Bandwidth — $f_T = 200$ mc min ($150mA$)
- Complementary to Fairchild 2N3299 NPN Series. Package: TO-5, TO-18

AMPLIFIER: FT-0019 SERIES

- High Current Gain — from $1\mu A$ to $50mA$
- High Voltage — FT-0019H: $V_{CE0} = -80V$ min @ $I_C = 5mA$
FT-0019M: $V_{CE0} = -60V$ min @ $I_C = 5mA$
- Low Noise — 1KC spot noise figure = 2 db max
10KC spot noise figure = 2 db max
test conditions: $I_C = 20\mu A$, $V_{CE} = -5.0V$, $R_S = 10K\Omega$
- Low Saturation Voltage — $V_{CE(sat)} = 0.3V$ max; $I_C = 10mA$; $I_B = 0.5mA$
- Complementary to Fairchild 2N2484 NPN Series. Package: TO-18, TO-46

Available immediately from distributor stocks



EASTERN ALABAMA Huntsville: Schweber Electronics, 539-2756. **CONNECTICUT** Hamden: Cramer Electronics, 288-7771. **FLORIDA** Orlando: Crescent Electronics Sales, 423-8586; G. F. Bohman Associates, 425-8611. **MARYLAND** Baltimore: Valley Electronics, NO 8-4900/D. C. Area: Powell Electronics, 474-1030. **MASSACHUSETTS** Newton: Cramer Electronics, WO 9-7700/Watertown: L. L. Schley Co., WA 6-0235. **NEW JERSEY** Cherry Hill: Valley Electronics, NO 2-9337. **NEW YORK** Baldwin, L.I.: Taylor Electronics Corp., 223-8000/Buffalo: Dart Sales, 684-6250; Summit Distributors, 884-3450/Syracuse: Dart Sales, GL 4-9257; Eastern Semiconductor, 454-9247/Westbury, L.I.: Schweber Electronics, ED 4-7474. **PENNSYLVANIA** Philadelphia: Powell Electronics, 724-1900. **CENTRAL ILLINOIS** Chicago: Avnet Electronics, 678-8160; Semiconductor Specialists, 622-8860. **MICHIGAN** Detroit: Semiconductor Specialists, LU 4-5901. **MINNESOTA** Minneapolis: E. C. Electronics Sales, 888-4626; Semiconductor Specialists, UN 6-3435. **MISSOURI** St. Louis: Durbin-Hamilton Electro Corp., 966-3003. **OHIO** Cincinnati: Sheridan Associates, 761-5432. **TEXAS** Dallas: Norvell Associates, FL 7-6451/Houston: Norvell Associates, MO 5-0558. **WESTERN ARIZONA** Phoenix: Hamilton Electro, 272-2601; G. S. Marshall Co., 946-4276. **CALIFORNIA** Los Angeles: Hamilton Electro, 870-3300/Palo Alto: Hamilton Electro, 321-7541/Redwood City: G. S. Marshall Co., 365-2000/San Diego: Denny-Hamilton Electronics, 279-2421; G. S. Marshall Co., 278-6350/San Marino: G. S. Marshall Co., MU 1-3292. **COLORADO** Denver: Hyer Electronics, 771-5285. **NEW MEXICO** Albuquerque: Hyer Electronics, 268-6744. **WASHINGTON** Seattle: Hamilton Electro, 282-3886. **CANADA** Toronto, Ontario: Avnet, 789-2621; Montreal, Quebec: 697-1993.

FAIRCHILD SEMICONDUCTOR SALES OFFICES

EASTERN ALABAMA Huntsville 536-4428. **FLORIDA** Orlando CH 1-2596. **MARYLAND** College Park 779-6868. **MASSACHUSETTS** Bedford 275-8450. **NEW YORK** Endwell 754-2600; Long Island ED 4-8500; Poughkeepsie 454-7320; Syracuse GR 2-3391. **PENNSYLVANIA** Jenkintown TU 6-6623. **CENTRAL ILLINOIS** Elmwood Park 456-4200. **OHIO** Dayton 228-1111. **MINNESOTA** Minneapolis UN 6-3301. **TEXAS** Dallas FI 2-9523. **WESTERN ARIZONA** Phoenix 946-6583. **CALIFORNIA** Los Angeles HO 6-8393; Palo Alto 321-8780. **COLORADO** Denver 761-1735. **WASHINGTON** Seattle AT 2-5344. **CANADA OFFICE:** Ontario, Toronto 782-9230.

FAIRCHILD SEMICONDUCTOR/A DIVISION OF FAIRCHILD CAMERA AND INSTRUMENT CORPORATION/313 FAIRCHILD DR., MOUNTAIN VIEW, CALIF./962-5011/TWX: 910-379-6435

Editorial

Who's on first in space?

When Soviet cosmonaut Aleksei A. Leonov floated outside Voskhold 2 in March, a lot of people thought the ball game was over. The Russians seemed to have won it hands down. Then, a few days later, when U.S. astronaut Gus Grissom steered the first Gemini capsule in a near perfect three-orbit trip, the Soviet lead shrank like a cheap shirt.

It is easy when reading newspaper headlines and watching television specials to overlook some of the important fundamentals of space exploration that don't make such exciting copy.

For example, everybody has recognized that the Russians have had superior rocket boosters. Space-man Leonov's feat indicates they may be ahead on space suit design, too. It is hard to find out. The Russians won't share their space technology with anyone.

Still, the booster gap narrowed considerably with the successful firing of the Saturn last February. And we need reminding of how far ahead the U. S. stands in instrumentation and electronics. The fab-

ulous moon shots televised live last week from Ranger 9 did it dramatically. That lead is likely to increase even more.

One space scientist put it this way: "We've been in the rocket phase of space experimentation, developing bigger boosters. Now we are moving into the electronics phase."

In one aspect of the space race, the U. S. has far outdistanced the Soviet Union: that's in disseminating technical information to the world's scientific community.

The U. S. National Aeronautics and Space Agency is committed by law to disseminate technical information. Only from U. S. sources could you get such complete technical details as you'll find in the articles on pages 89 to 112. And you can be sure the silent Russians will be the most avid readers.

That the U. S. is willing to tell so much about the Gemini project is important to the scientific community because the experiments, tabulated on pages 90 to 94, are among the most significant so far in the exploration of space.

But even more important, some of the technology developed for the Gemini project is bound to have fallout on the civilian economy. For example, the bioinstrumentation (page 99) developed to check the astronaut's physiological reactions will be examined closely by medical researchers. And the low-light television work (page 106) will interest broadcasters and those using industrial television.

The space contest, if you want to call it that, has barely started. There are a lot more innings to be played before the game is over.

It's the volume

In the depression days of the thirties, burlesque comedians used to tell this joke:

A man came into a restaurant and ordered a steak dinner which was listed on the menu for 65 cents. When the meal came, the meat was fork-tender and delicious and was accompanied by a baked potato, two vegetables, salad, dessert and coffee.

"That's the finest meal I ever had," the diner told the owner. "How do you do it for 65 cents?"

"Well, I lose \$2 on every dinner," the sad-faced owner replied.

"Why do you do it then?"

"It's the volume!" came the reply.

That old joke might apply today to the integrated circuits business. The price cuts announced around the time of the IEEE show by almost all suppliers are aimed at increasing sales. But many of the producers are already losing so much money selling

integrated circuits that price cuts can only accelerate the flow of red ink.

Clearly, the problem is one of acceptance. But is price cutting the answer? A number of nonusers of integrated circuits complain that the manufacturers are not offering the right products. Analyzing why one sale had fallen through, the general manager of an integrated circuit firm admitted that his engineers had spent too much time talking to each other and not enough finding out what the customer wanted.

Even the volume buyers don't seem completely happy with the off-the-shelf products, which are the best hope for profits. Almost every computer maker (except IBM, which makes its own hybrid circuits) that has announced an integrated circuit machine has added that the circuits would be modified for its specific application.

If integrated circuit manufacturers were to concentrate on developing and offering products that are needed, instead of cutting prices on the items that aren't selling, they could speed the adoption of microcircuits by the rest of the industry—and, incidentally, make a profit.

NOW...P&B QUALITY IN A FULL LINE OF

SOLID STATE **time delay relays**

**FAST
ACCURATE
RELIABLE**

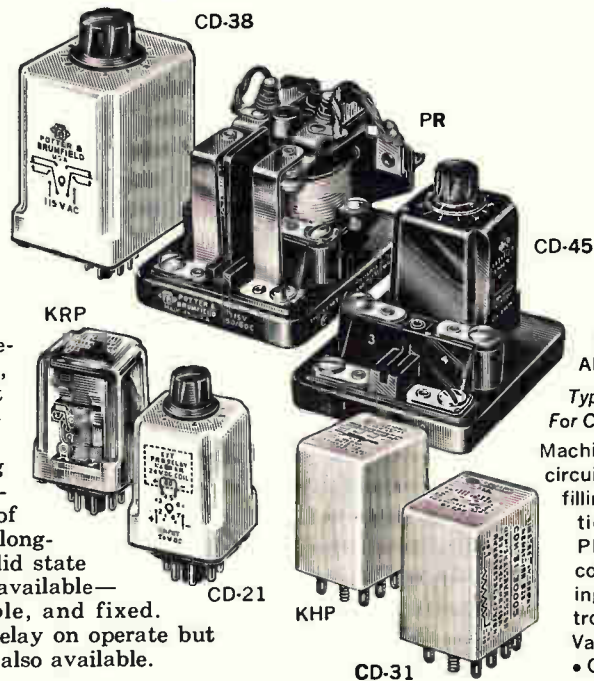

A wide range of time delay requirements can be met with these accurate, easy-to-use solid state relays. All built to P&B's exacting standards of reliability, this new series offers a multitude of advantages, including timing repeatability of $\pm 2\%$; nearly instantaneous (milliseconds) reset; a choice of sizes, mountings and terminations; long-life inherent with non-mechanical solid state switching. Three modes of timing are available—knob-adjustable, resistor-adjustable, and fixed. Most standard relays provide time delay on operate but relays with time delay on release are also available.

CD-38 HAS RELIABLE P&B DPDT RELAY MOUNTED INSIDE CASE
An internally mounted DPDT relay has contacts rated to 10 amps, 115V AC, resistive. Fixed time delay can be specified or relay can be adjusted with knob or external resistor.

CD-21 TIME DELAY PAIRS WITH POPULAR P&B KRP SERIES RELAYS
Compact AC or DC units available to time in increments from 0.1 to 180 seconds. For use with popular P&B KRP relay which provides up to 3PDT switching. Delay time may be fixed or adjusted with knob or external resistor.

USE CD-45 WITH PR RELAY FOR HEAVY DUTY APPLICATIONS
Designed for use with PR power relay in elevator controls, machine tools and other industrial applications. Contacts will switch up to 25 amps at 115V AC non-inductive, or 1 HP at 115/230V AC single phase. Heavy-duty screw terminals. Time delay: fixed or knob-adjustable.

CD-31 USED WITH KH RELAY PROVIDES 4PDT SWITCHING
Only slightly larger than one cubic inch. Available with fixed or resistor-adjustable time delay. Match with KHP relay for up to 4-pole switching capacity. Plug-in convenience when used with socket having solder or printed circuit terminals.

SOLID STATE TIME DELAY RELAYS ARE EASY TO APPLY IN ANY CIRCUIT

*Typical Applications
For CD Series Time Delay Relays*

- Machine tool sequencing • Motor starting circuits • Vending machines • Container-filling control • Data processing operations • Warm-up or turn-on delay • Photographic process control • Recorded message repeater • Heat sealing • Induction heating • Elevator controls • Die casting • Alarm circuits • Vacuum processing • Injection molding • Conveyor control

THESE STANDARD TIME DELAY RELAYS ARE AVAILABLE FROM ELECTRONIC PARTS DISTRIBUTORS

Type	Time Delay in Seconds	Input Voltage	Notes	Sugg. Resale Price
CDB-38-70003	0.1 to 10	115V AC	1	43.80
CDB-38-70004	0.6 to 60	115V AC	1	43.80
CDB-38-70005	1.8 to 180	115V AC	1	43.80
CDD-38-30003	0.1 to 10	24V DC	1	41.55
CDD-38-30005	1.8 to 180	24V DC	1	41.55
CDB-21-70003	0.1 to 10	115V AC	2	38.70
CDB-21-70001	1.8 to 180	115V AC	2	38.70
CDD-21-30003	0.1 to 10	24V DC	3	38.35
CDD-21-30001	1.8 to 180	24V DC	3	38.35
CDH-31-30005	180 (note 5)	24V DC	4 & 5	38.90
CDB-45-70002	0.6 to 60	115V AC	6	37.05
CDB-38-70012	0.6 to 60	115V AC	1 & 7	52.45
CDD-38-30012	0.6 to 60	24V DC	1 & 7	49.50

- NOTES**
1. Has internal relay with DPDT contacts rated at 10 amperes, 115V AC.
 2. Use with Potter & Brumfield relay KRP5AG—115V AC, KRP11AG—115V AC or KRP14AG—115V AC.
 3. Use with Potter & Brumfield KRP5DG—24V DC, KRP11DG—24V DC or KRP14DG—24V DC relay.
 4. Use with Potter & Brumfield KHP17D11—24V DC relay.
 5. Resistor-adjustable.
 6. Use with Potter & Brumfield PR11AY—115V AC relay.
 7. Provides delay on release; all others have delay on operate.

Now available at leading electronic parts distributors



POTTER & BRUMFIELD

Division of American Machine & Foundry Company, Princeton, Indiana
In Canada: Potter & Brumfield, Division of AMF Canada Ltd., Guelph, Ont.
Export: AMF International, 261 Madison Avenue, New York, N.Y.

Electronics Newsletter

April 5, 1965

Nuclear power to get space test

Direct thermal conversion of nuclear power in space is taking a long leap forward with the first launching of a nuclear reactor. The test of the Atomic Energy Commission's 500-watt SNAP 10-A conversion system aboard an Air Force Atlas-Agena rocket, scheduled for shortly after April 1, comes at a time when the turbine-conversion SNAP 8 program, capable of 35 kilowatts of power, is being cut back by a tight budget in the National Aeronautics and Space Administration.

Direct conversion systems can be built for greater output, but their efficiency—3%, compared with 10% to 12% for the turbo systems—still requires prohibitively large reactors.

SNAP 10-A is a 970-pound package being used to power an experimental Air Force ion engine and a variety of other space experiments being boosted into polar orbiting the Atlas-Agena. It uses a silicon germanium thermocouple and phosphorous arsenic dopants.

Color confusion for Europe's tv

Hope for a single color television system for Europe faded even before delegates opened a meeting designed to select one of the three contending systems. On March 22, two days before the meeting was to have begun, the Soviet Union announced support for France's Secam (sequence and memory) system.

Delegates are split between Secam, NTSC (National Television Systems Committee) used in the United States, and West Germany's PAL (phase alternation line). Britain has threatened to go it alone with NTSC if the countries of Europe fail to agree on a single system.

If Secam is adopted, the chief beneficiary would be the Compagnie Francaise de Television (CFT), the French developer of Secam. All companies selling sets in Europe would have to pay royalties to CFT. The Radio Corp. of America and other U.S. companies would also share in the benefits; Secam is basically a variation of NTSC, whose patents are held by U.S. concerns. The Raytheon Co.'s Italian affiliate has an agreement with CFT to develop and produce picture tubes for Secam receivers.

CBS Labs halting some IC output

An executive of CBS Laboratories, a division of Columbia Broadcasting System, Inc., has confirmed reports that the division is dropping commercial production of integrated circuits. Another official declined to amplify the report, other than to say, "It was simply a change in philosophy . . . CBS was reluctant to go into large manufacturing" of integrated circuits.

Only in January, CBS dedicated new microcircuit production facilities at its Stamford, Conn.

Raytheon reports 18-watt laser

In one laboratory last month, researchers produced a laser beam whose 18-watt continuous output overheated the mirrors. Meanwhile, another lab was developing a laser that uses no mirrors.

The 18 watts, a record for an experimental ionized argon laser, was recorded by the Waltham, Mass., research division of the Raytheon Co. The previously reported high for an argon laser was 4 watts. The mirrors became so hot during the test runs that the optical cavity had to be inter-

Electronics Newsletter

rupted by a chopper, which permitted lasing only in two millisecond bursts. The company is considering substituting prisms for the mirrors.

In the second development, H-Mu Systems, Inc., of Palo Alto, Calif., designed the first neon gas laser that uses coherence brightening. Instead of using mirrors to bounce the laser beam back and forth and build up energy, the "one-way" laser picks up energy from the inverted atoms as the beam goes down the tube. Elimination of the mirrors eliminates mode problems, says Harry Heard, H-Mu vice president. The pulsed laser, in a tube 20 centimeters long, has produced several watts of power in the visible and near infrared. Development on a continuously operated device has begun.

Aerospace group backs U. S. fair

After some hesitation, the Aerospace Industries Association is endorsing plans for a government-sponsored international aerospace and science exhibition, scheduled for next summer in Washington. The fair is designed to promote exports of electronics, aircraft and space equipment.

The Federal Aviation Agency originated the idea and quickly won assent from the Pentagon, the Commerce Department and the Civil Aeronautics Board. Now that industry has agreed to support the fair, President Johnson is expected to add his approval and seek funds from Congress to underwrite the exhibition.

Industry endorsement was slow in coming because manufacturers originally demanded that they be allowed to write off the expenses of their participation as allowable costs under government contracts, rather than paying for it out of profits. Government officials rejected the demand, and industry finally dropped it.

Gemini signals penetrated shield

One apparent technical success in the Gemini flight has received little public note. The National Aeronautics and Space Administration claims some success in receiving ultrahigh-frequency signals through the ion sheath that surrounds the spacecraft during reentry. The technique involves spraying water from the capsule, in effect washing the hot surface of the craft. The Air Force is understood to be testing the technique for its ballistic missiles.

Tape recordings of telemetered data from Gemini are being studied in an attempt to find out why the capsule, the Molly Brown, fell 58 miles short of her splash-down target near the Bahamas. Early indications are that garbled ground-to-air communication was a factor.

IBM tooling up its Tokyo plant

The International Business Machines Corp. is preparing to produce models 20 and 40 of its System 360 computer at its Tokyo plant, although production is being held up pending necessary Japanese government approval. Japan is worried that her own manufacturers aren't yet strong enough to compete against the American company. **IBM is anxious to reduce the time between approval and production, in case approval is given.**

Addenda

The National Science Foundation has awarded an \$11.3-million contract to Cornell University for a 10-million-electron-volt electron synchrotron, the largest in the world.

WANTED

 YOUR 

CIRCUIT DESIGN PROBLEMS

We can't solve all of them. But we can come a little closer than any other supplier.

From tubes to Triacs. From wet slug capacitors to SCR's. General Electric is your Number One Source for a full range of electronic components . . . for circuitry knowledge . . . for continuing innovation. Turn the page and see for yourself.

GENERAL  ELECTRIC

LATEST ROUNDUP

TO HELP SOLVE YOUR CIRCUIT PROBLEMS

CASH REWARD

TRIAC NOW CUTS 60~120 V STATIC CONTROL CIRCUIT COSTS

Now at even lower prices, Triac offers circuit economies in such a-c control applications as replacement of relays and contactors, manual switches, back-to-back SCR's, single SCR inside a diode bridge, and bi-directional diode switches with their associated transformer and circuitry. Triac simplifies control of full wave a-c power and is available in

both 6- and 10-amp ratings. Innovator: Semiconductor Products Department, Syracuse, N. Y.

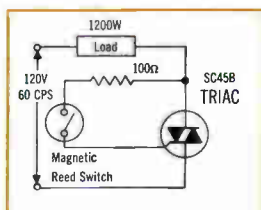

LIFE SENTENCE

20,000,000 operations. SPDT rounds out GE reed switch line

Advantages:

- 20,000,000 operation full load life.
- 150 milliohm max. contact resistance.
- 500-v breakdown (min. 60 cps, RMS).
- 3.100" max. length (with leads).
- 0.215" max. diameter.
- 15 volt-amp contact rating up to 1 amp or 250 volts.

Innovator: Tube Department, Owensboro, Kentucky.



WATCH FOR BLACK HAWK*

NEW SHAPE IN COMMERCIAL USE CAPACITORS

For test and measurement rigs, communications equipment, and consumer product applications, *Black Hawk* capacitors deliver unusual mechanical advantages . . . special features like molded encapsulation, welded leads, precise dimensions ($\pm .005"$), mounting feet, damage resistance, extended foil construction and modern design. Humidity and moisture resistance, efficient space utilization, and ease of handling are also well worth checking. *Black Hawk* capacitors will operate at temperatures up to $+125^{\circ}\text{C}$. Innovator: Capacitor Department, Hudson Falls, N. Y.

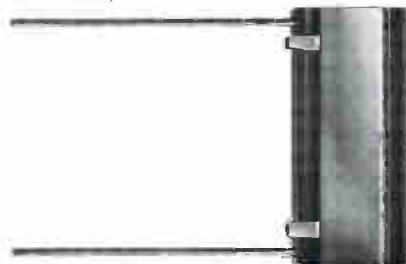

* Trademark of General Electric Co.

DANGER

VERY SENSITIVE

This electrostatic I.O. reduces power requirements of comparable, low-light-level systems 30 to 1, weight 20 to 1, and size 5 to 1. Measures just 13.125", weighs 11 oz. Focussing and deflection are self-contained. Available with S-10 or S-20 photocathodes. Innovator: Tube Department, Syracuse, N. Y.



ELECTRONIC COMPONENTS SALES OPERATION

GENERAL  ELECTRIC

SPACE STEALER

COMPACTRON REPLACES 2—
EVEN 3—IF AMPLIFIER TUBES

Lower cost, improved performance level, reduced space requirements—all are GE 9BJ11 COMPACTRON advantages.

Inside it—a double-pentode with dual-control input section and sharp cutoff output section. This new unit may be used in a 2-stage IF amplifier with performance level comparable to conventional 3-stage amplifiers in monochrome TV receivers. It reduces sockets required, associated circuitry, and labor costs; and eliminates need for an un-bypassed cathode resistor to utilize full gain capability. Innovator: Tube Department, Owensboro, Ky.

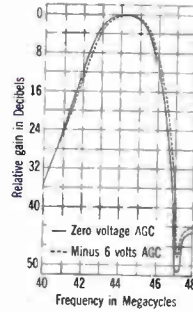

Response of 9BJ11 IF amplifier

QUICK ON THE TRIGGER

CADMIUM SULFIDE CELL WITH
5 MILLISEC. MAX. RISE TIME



Response speed of GE's A36M1 cadmium sulfide cell approaches that of cadmium selenide cells while retaining excellent temperature (see curve 1) and life test stability (curve 2). Notice how the GE A36M1's resistance changes rapidly with small changes in illumination (curve 3). Ideal for electronic shutter controls on cameras, computer readout cards, and similar applications requiring fast response times. Innovator: Tube Department, Owensboro, Ky.

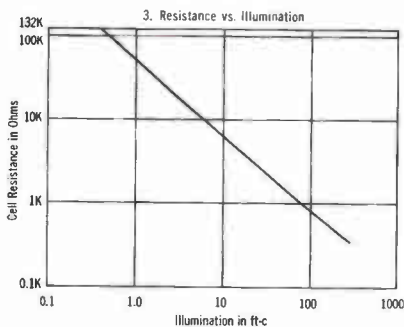
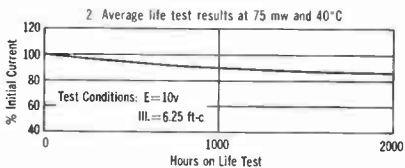
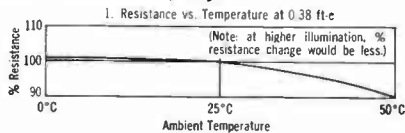

FOUND: SMALL PACKAGE

ZP-1061 TRIODE SIMPLIFIES CAVITY
DESIGN FOR OSCILLATOR SERVICE

This new high performance, metal-ceramic coaxial triode for NAVAID application features internal feedback that simplifies cavity design for oscillator service. Large cathode area offers long and reliable tube life. Grid-pulsed oscillator service simplifies modulator requirements, and small tube-cavity package size is ideal for miniaturization. Innovator: Tube Department, Sch'dy, N. Y.



JOINS WET SLUG GANG

NEW LOW IMPEDANCE CAPACITOR

The key is simplicity. GE has eliminated 75% of the internal connections found in packaged competitive Tantalum capacitors. This reduces chance for failure and helps eliminate high resistance contact—the primary cause of high impedance. High volt- μ f rating remains stable throughout life, and all capacitors in the line meet Mil-C-3965 requirements. Innovator: Capacitor Department, Irmo, S. C.



FEEDBACK

TEMPERATURE

SIZE

SHOCK

Radiation

VOLTAGE

Reliability

COST

FREQUENCY

WEIGHT

CURRENT

SPEED

VIBRATION

TIME

POWER

MIL

LIFE

RESISTANCE

MOUNTING

CIRCUIT-COST ROBBERS

AMPLIFIER—TRANSISTORS COST < \$1

Utilizing GE Economy transistors 2N2926 and 2N3391, the Darlington Amplifier below gains you excellent economics through high current gain at low collector circuits, low leakage currents, low collector capacitance and good f_t at low currents. These transistors provide an input impedance greater than 50 megohms up to 25 kc, with a circuit input capacitance of only 0.25 pf.

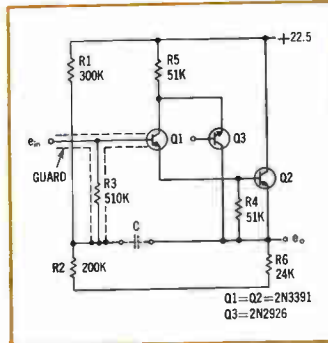

VERSATILE LOGIC—SEMICONDUCTORS COST < \$1

2-level gate in this circuit permits fan-in in excess of 10 into either the AND or the OR gate. Use of a gold-doped, GE Economy transistor 2N3605 with a f_t of 300 mcs. lowers the propagation delay to well under one microsecond under any combination of inputs and outputs. Innovator for both: Semiconductor Products Department, Syracuse, N. Y.

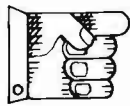
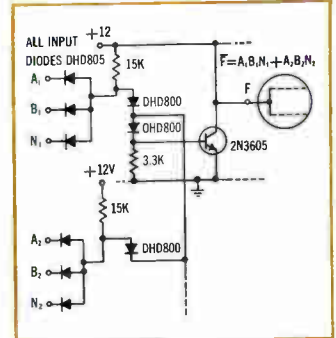

NOTICE

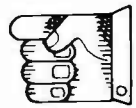

**WANT SPEC DETAILS?
PRICES? TEST SAMPLES?
APPLICATION HELP?**
We don't offer you everything
you want from one supplier.
We just come a little closer
than anyone else.

Call your nearest General Electric Regional or local Electronic Components Sales office for immediate assistance. Call collect now. Or ask your local distributor or write to us at 1 River Road, Schenectady, New York 12305.

NEW ENGLAND REGION—O. J. SCHOPP
Area Code 617, 482-1800
31 St. James Ave., Boston, Mass. 02117
Area Covered: Northeastern N. Y.; Me.; N. H.; Vt.; Mass.; R. I.; Conn.

EMPIRE REGION—BILL ROBUSTO
Area Code 315, 456-2062
Electronics Park, Syracuse, N. Y. 13201
Area Covered: Western N. Y.; Northeastern Pa.

EASTERN REGION—JOE UTTAL
Area Code 516, 921-8840
175 Jericho Turnpike, Syosset, N. Y. 11791
Area Covered: Long Island; Manhattan; Westchester; Fla.

GARDEN STATE REGION—JOHN NELSON
Area Code 201, 472-8100
200 Main Ave., Clifton, N. J. 07014
Area Covered: N. J.

ATLANTIC REGION—PAUL RYAN
Area Code 215, LO 8-1800
3 Penn Center, Philadelphia, Pa. 19102
Area Covered: Eastern Pa.; Baltimore; Washington, D. C.; Va.; N. and S. Carolina; Ga.; Ala.

EAST CENTRAL REGION—ED DRISCOLL
Area Code 216, 361-4464
4966 Woodland Ave., Cleveland, Ohio 44104
Area Covered: Ohio; Western Pa.; Ky.; Ind.; W. Va.

GREAT LAKES REGION—DON PUTNAM
Area Code 411, BR 1-5000
940 W. St. Paul Ave., Milwaukee, Wis. 53233
Area Covered: Mich.; Wis.; Minn.; N. and S. Dakota

CENTRAL REGION—JIM WALTON
Area Code 312, 777-1600

3880 N. Milwaukee Ave., Chicago, Ill. 60641
Area Covered: Ill.; Ia.; Okla.; Tex.; Miss.; La.; Ark.; Mo.; Neb.; Kan.; Western Tenn.

NORTHWESTERN REGION—HARRY PERLIS
Area Code 415, 434-2211
235 Montgomery St., San Francisco, Calif. 94106
Area Covered: Northern Calif.; Ore.; Wash.; Utah; Colo.; Northern N. M.; Ida.; Mont.; Wyo.; Nev.

PACIFIC SOUTHWESTERN REGION—GEORGE CURTISS
Area Code 213, BR 2-8566
11840 W. Olympic Blvd., Los Angeles, Calif. 90064
Area Covered: Peripheral Los Angeles, Southern Cal.; Ariz.; Southern N. M.

LOS ANGELES REGION—RAY KIDD
Area Code 213, 625-7381
212 No. Vignes St., Los Angeles, Calif. 90054
Area Covered: Los Angeles Proper

CONSUMER ELECTRONICS REGION—GEORGE CROSSLAND
Area Code 312, 777-1600
3800 N. Milwaukee Ave., Chicago, Ill. 60641
Area Covered: All major consumer electronics customer locations in the Midwest.

Innovations in Action

GENERAL  ELECTRIC

ELECTRONIC COMPONENTS SALES OPERATION

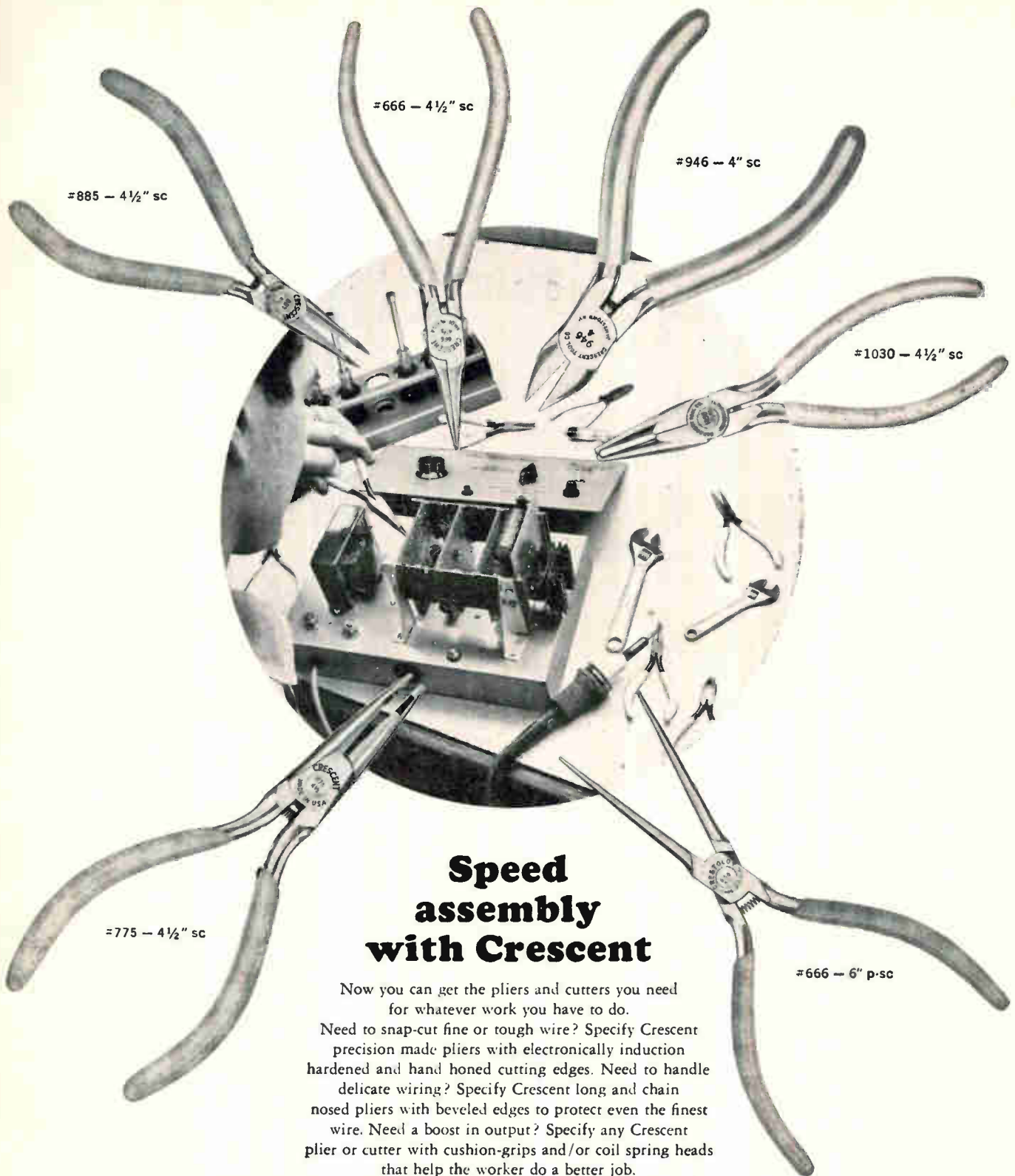

Speed assembly with Crescent

Now you can get the pliers and cutters you need for whatever work you have to do.

Need to snap-cut fine or tough wire? Specify Crescent precision made pliers with electronically induction hardened and hand honed cutting edges. Need to handle delicate wiring? Specify Crescent long and chain nosed pliers with beveled edges to protect even the finest wire. Need a boost in output? Specify any Crescent plier or cutter with cushion-grips and/or coil spring heads that help the worker do a better job.

These and more are standard features available with the full line of Crescent pliers and cutters for the electronic and industrial user.

Special designs available too . . . whatever you need to speed assembly. Call your Crescent Distributor, Sales Representative, or call the Crescent Tool Company, Jamestown, New York. All inquiries welcome.

CRESCENT®

CRESCENT TOOL COMPANY / DIVISION OF CRESCENT NIAGARA CORPORATION / JAMESTOWN, NEW YORK

CONSIDER YOUR HARNESSING OPERATION...

SURVEY of HARNESS
TYING OPERATION
for
YOUR COMPANY



Area Code 215, WA 2-1122 • TWX 215-568-8661
GUDEBROD BROS. SILK CO., INC.

FOUNDED IN 1870
Electronics Division

12 SOUTH 12TH STREET, PHILADELPHIA, PENNSYLVANIA 19107

• BRANCH OFFICES •

BOSTON, MASSACHUSETTS 02111
115 Chauncey Street, Area Code 617, MA 6-5347
CHICAGO, ILLINOIS 60654
1362 Merchandise Mart, Area Code 312, DE 7-3025

NEW YORK, NEW YORK 10001
225 West 34th Street, Area Code 212, LA 4-8888
BURBANK, CALIFORNIA 91504
2836 Ontario Street, Area Code 213, 848-3988
TWX 913-848-7891

PLANT: Pottstown, Pennsylvania 19464

Mr. Executive . . . Would you like to save money while improving the product?

(Take only a minute to read this unique, no cost offer of a survey and report)

There is available at Gudebrod a wealth of experience, gained in a specialized attention to the harnessing of wire cables since the earliest days of electronic equipment. Gudebrod has the latest information on tools and techniques, the latest information on materials and layout, the latest information on government requirements and industry trends. There is no comparable source for such information in the industry. Some companies, in the course of normal business have taken advantage of this Gudebrod experience and knowledge. You, too, can benefit from them. We can recommend ways in which to improve the operation of your harness room—and ways to save money at the same time. Here is what we propose—there are three parts.

First, we arrange, at your convenience, to have a Gudebrod representative make a

thorough survey of your harness operation—specifications, methods, materials.

Then, this survey is sent to the Gudebrod Home Office for review by an experienced consultant.

Finally (and most important), a Consultant's Report (as illustrated on the left hand page) is delivered to you. This will contain special, written, confidential recommendations on how *your* harnessing can be improved, how *you* can save money.

With self-interest, Gudebrod believes that by improving the state of the art throughout the industry, they will also improve their own business atmosphere. In your own concern for your company, why not talk to us about a survey of your harness operation—to improve it—to save money? To repeat—you will be involved in no cost or obligation.



UDEBROD BROS. SILK CO., INC.

FOUNDED IN 1870



Electronics Division

12 SOUTH 12th STREET, PHILADELPHIA, PENNSYLVANIA 19107

Area Code 215, WA 2-1122

COMPONENT COMMENTS *From Speer*

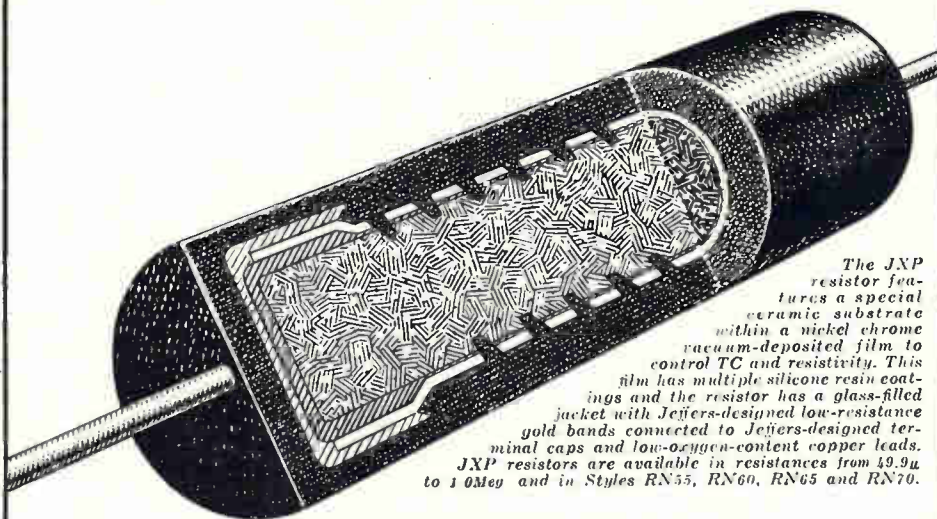

The JXP resistor features a special ceramic substrate with a nickel chrome vacuum-deposited film to control TC and resistivity. This film has multiple silicone resin coatings and the resistor has a glass-filled jacket with Jeffers-designed low-resistance gold bands connected to Jeffers-designed terminal caps and low-oxygen-content copper leads. JXP resistors are available in resistances from 49.9 Ω to 10Meg and in Styles RN55, RN60, RN65 and RN70.

Our new JXP resistor started people talking during the IEEE

When we announced that we'd be introducing our JXP resistor in New York during the IEEE Show, we assumed that this news would be of rather specialized interest. After all, most designers don't actually need a tolerance of 0.1% (or even less).

As the Show proceeded, however, surprisingly large crowds jammed into our modest Suite. (Our Vice President in Charge of Refreshments is still unnerved, just thinking about it.)

The cause of all the excitement? A new custom-made, temperature-stable metal film resistor manufactured to precise target values.

Unlike most special film resistors, the JXP isn't an "off the shelf" assembly line item that accidentally checked out to the desired values. We established a special task force within our Jeffers Electronics Division, and we developed

the JXP deliberately.

We might add that we engineer these new resistors with parental care, under conditions of hospital cleanliness. Thus they always achieve predictable performance parameters. Notable ones, too. For example, temperature coefficients are close to zero ppm over the common temperature ranges. Matching to within 0.02% is no difficult feat. Matched sets can track within 5 ppm/ $^{\circ}$ C of each other over the temperature range of -55° to $+175^{\circ}$ C. And JXP resistors meet all MIL-R-10509, Characteristic E, specs.

To learn more, use this coupon, and send for our JXP resistor brochure.

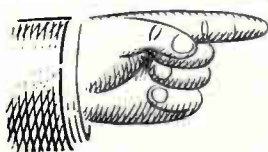

Be our Guest

If you'd like to receive reprints of these "Component Comments," mail the coupon. We'll place you on our mailing list.

JEFFERS ELECTRONICS DIVISION,

Speer Carbon Company
Du Bois, Penna.

Speer Carbon Co. is a Division of Air Reduction Company, Inc.

- Rush your JXP resistor brochure.
- Rush "Resistors for Precise Temperature Measurements of Cryogenic Environments."
- Arrange for me to receive reprints of "Component Comments."

Name _____

Title _____

Company _____

Address _____

City _____

State _____ Zip _____

Some chilling experiments in resistor capability

It has come to our attention that a rather intriguing application has been found for our regular carbon resistors.

During the past decade, a number of researchers have been studying the effects of cryogenic environments upon various metallic and nonmetallic materials used in military defense applications. In order to insure precise temperature measurements under conditions approaching absolute zero, many of these researchers decided upon using Speer resistors as resistance thermometers.

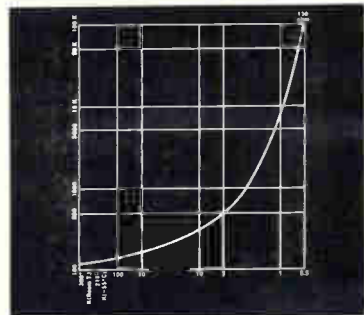

Log graph shows resistance-temperature characteristic of Speer 130-ohm carbon resistor between 300 $^{\circ}$ K and 3 $^{\circ}$ K.

Reports have been filtering in from Brown, RPI, Amherst—even from as far away as the National Physical Laboratory of New Delhi. And we're pleased to note that, invariably, our resistors have taken to this extreme cold like polar bears. Here, for example, is what one professor wrote about his studies: "The Speer resistors are generally most useful for accurate direct measurement in the temperature region 1 $^{\circ}$ K to 0.01 $^{\circ}$ K. The feature which makes them more desirable than other carbon resistors is their reproducibility (to within 1/4%) from run to run even with cycling to room temperature and back."

We've prepared an article on these various studies, entitled "Resistors for Precise Temperature Measurements of Cryogenic Environments." You can get a copy by merely using the coupon.

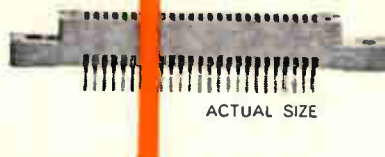
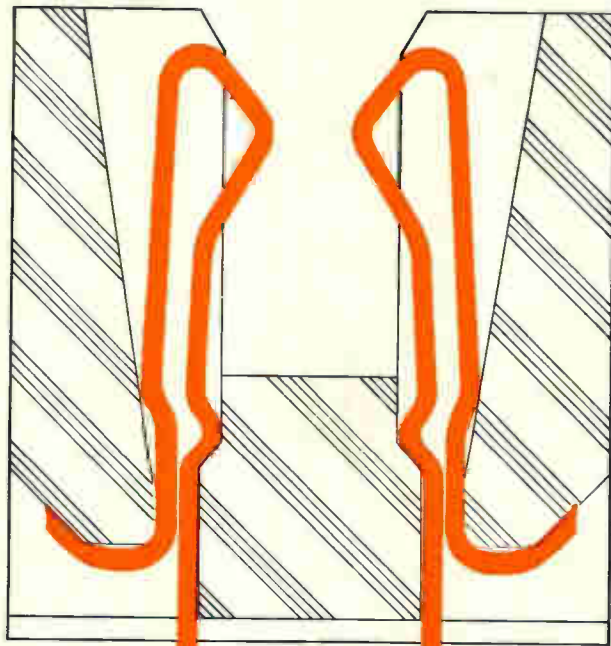

NEW SHORT-PATH CONTACTS FEATURED IN 0.050-INCH CENTERS MICROMINIATURE PC CONNECTORS

Ideal for use with integrated semiconductor or discrete component circuits, Winchester Electronics' rugged, economical PC connectors are industry's smallest.

Exclusive design wire contacts made of 50% IACS high-conductivity, beryllium copper, formed to offer exceptional resistance to vibration and shock loading, create a short, direct, low-resistance electrical path between board and backplane interconnection, rated at 1,400 volts RMS for contact-to-contact AC voltage breakdown value at sea level. This is just one of many outstanding reasons why Winchester Electronics' microminiature printed circuit connectors are more frequently being specified by space-conscious, performance-demanding microelectronics packagers.

Characteristics include: 0.050-inch centers. Flame-resistant, glass filled diallyl phthalate dielectric. Solder or weld-type terminations. Straight or offset tabs. Variety of mounting flanges. Choice of models

for 1/32 or 1/16-inch boards. Up to 50 positions. Conformance with applicable parts of MIL-C-21097B. High reliability. Precision construction.

The microminiature series is part of the most comprehensive line of standard printed circuit connectors available in the industry. It includes sizes, types and materials to meet nearly every military and industrial application. Winchester Electronics also offers complete lines of removable-crimp contact, miniature and subminiature rectangular, round, quick-disconnect/heavy duty, environmental and special-application connectors. Nationwide network of distributors, regional offices and representatives assures prompt delivery and engineering assistance. Write for new Catalog No. 364. Winchester Electronics, Main St. & Hillside Ave., Oakville, Conn.

WINCHESTER ELECTRONICS

A DIVISION OF LITTON INDUSTRIES



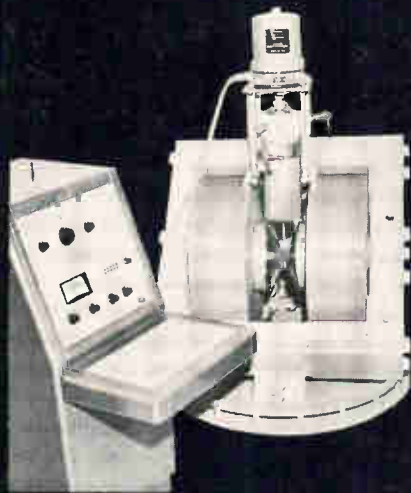

Magnetic Susceptibility Measurements
Vibrating Sample Magnetometer with high sensitivity and wide dynamic range for measuring magnetic moments of solids, gases and liquids. \$12,500. Write for Bulletin No. 110

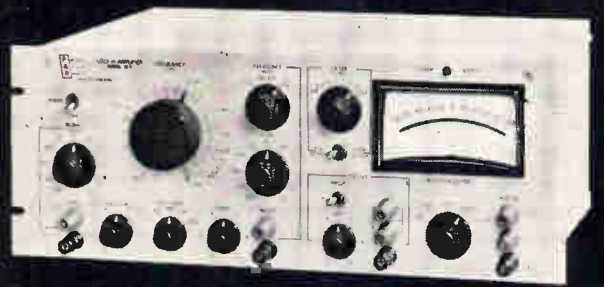

Low-Level Signal Recovery Instruments

Lock-in amplifiers (phase-sensitive detectors) continuously tunable 1.5 cps to 150 kc for the recovery of signal intensity information from noise. \$990 to \$1350. Write for Bulletin No. 111

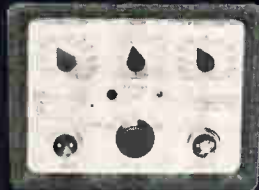

Low Noise, High Gain Amplifier

Extremely low-noise pre-amplifiers to greatly extend operating range of lock-in detectors and for general small signal applications. \$575 to \$680. Write for Bulletin No. 114

Precision Instruments for Research

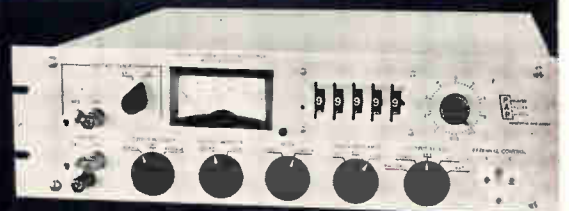

Voltage/Current Reference Sources

Completely solid state, voltage/current reference supplies with 0.001% stability, 0.01% absolute accuracy and up to 7 decades resolution. \$1185 to \$2200. Write for Bulletin No. 112

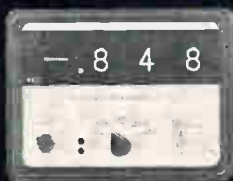

Digital Voltmeters

World's smallest transistorized digital panel meter with truly floating and guarded differential input circuit and other outstanding operating characteristics. \$995 to \$1070. Write for Bulletin No. 107



Plasma Diagnostics

Microwave Interferometers of the "zebra stripe" display type at discrete frequencies up to 140KMC (2mm) for measuring electron densities in plasmas. \$16,000 to \$48,500. Write for Bulletin No. 104



PRINCETON APPLIED RESEARCH CORP., Box 565, Princeton, N. J., Tel: 799-1222 (609)

Electronics Review

Volume 38
Number 7

Consumer electronics

Color it faithful

The models were pretty and their clothes were smart, but who cared about beauty or style? What interested the audience was the startlingly faithful picture on the color television set as the camera panned from one girl, under bright lights, to a second under dimmer lights, and then up to look directly at a 250-watt bulb.

There was no loss of color fidelity as the camera moved from the bright side of the stage to the dim; there was no color smear or bloom when the bulb appeared on the screen.

A few stunts. The competition stood by silently as North American Philips Co. put its new Norelco PC-60 Plumbicon camera through stunts that no other color tv camera maker would try. The showing, at last month's National Association of Broadcasters meeting in Washington, indicated that Philips, an affiliate of Philips Gloeilampenfabrieken N. V. of the Netherlands, was far ahead of any of the other United States tv camera makers.

Shadow line. The most spectacular demonstration was the use of key lighting to encourage shadows around the models. Ordinarily, shadows are verboten in a color tv studio. At low levels of illumination, the three color pickup tubes have different transient responses, and shadows take on a green hue. With the Plumbicon camera, however, shadows were reproduced without loss or change of color. Shadows, which add depth and texture to the picture, up to now have been possible only with color motion pictures, which is why owners of color receivers report that watching color movies is more pleasing than watching live color programing.



New Plumbicon color television camera shown off by North American Philips.

The Plumbicon cameras, which will be distributed by Visual Electronics Corp., are now in production, with the first deliveries scheduled for May. But independent stations may have to wait some time for delivery, because it is rumored that the Columbia Broadcasting System, Inc., has placed a substantial order for the first cameras.

The camera, the result of Dutch and American research, will be assembled in the United States; but certain parts, including the Plumbicon tube, will be manufactured in the Netherlands.

Like a vidicon. The Plumbicon and the standard one-inch vidicon work alike, although the light sensitive surface on the Plumbicon is lead monoxide. However, the two differ considerably in performance. The Plumbicon is more sensitive and retains a high signal-to-noise ratio even at low incident illumination. The Plumbicon has a shorter time lag, which means that a light-colored object moving rapidly

across the screen will not streak.

The Plumbicon, has a linear relationship between light level and signal current even at low light levels and its dark current (signal at zero illumination) is almost negligible. The vidicon, on the other hand, has high dark current and is nonlinear at low light levels. This causes the extraneous coloring of shadows. The linearity of the Plumbicon also allows for perfect matching of the cameras in a studio.

RCA entry. The Radio Corp. of America also introduced its version of a highly sensitive pickup tube, the Selenicon, in its new four-tube camera, the TK-42. The camera uses three Selenicons for red, blue and green pickup and a 4½-inch image orthicon for separate monochrome pickup. Because the monochrome picture comes from only one tube, rather than three, as in the Norelco camera, there is no black-and-white registration problem and color registration is supposed to be less

critical. However, the Norelco camera appeared to be in better color registration although both cameras produced equally sharp black-and-white pictures. Also, the RCA picture showed evidence of green fringing and the reflection of the clothing tinted the girls' faces.

The Norelco camera, plus control equipment, is priced at \$62,500, while the RCA camera, plus control gear, costs \$72,000. The Selenicon won't be in production until the first quarter of 1966. The TK-42 is now being produced, however, with three vidicon pickup tubes. To meet the competition, RCA will modify the camera to use the Selenicons when they are available. The company will change the optical system as well.

Flat lighting. The color camera display at the RCA exhibit could not take advantage of its higher sensitivity Selenicons because it contained the vidicon optics. The RCA mock studio was flat-lighted at 250 foot-candles. With flat lighting there are no shadows. The complete Selenicon camera will operate in lighting of 150 foot-candles.

The Norelco camera, which uses three Plumbicon pickup tubes, will operate faithfully down to 50 foot-candles. Also, the Norelco camera, which is no larger than a black-and-white camera, appears to be half the size of the RCA TK-42.

Military electronics

Northern guard

Communications links between radar sentries in Greenland and the air defense headquarters in Colorado Springs have long been considered marginal by military officials. One of the two existing operational routes runs under water via cable, and on occasion Russian trawlers have cut the lines. Next month, the most powerful troposcatter system in the world, and the longest frequency-modulated link to date, is expected to become

operational, completing the last leg of a third route that will strengthen the weak link in the United States' missile-defense chain.

The critical and final leg of the new route is a 590-mile jump from Thule, Greenland, to Fox Main, a lonely military station on the Melville Peninsula in the Canadian Northwest Territories, 140 miles north of the Arctic Circle. The 100-kilowatt Thule-Fox system is part of the military's 489L program, under which all the communications routes in the northern part of

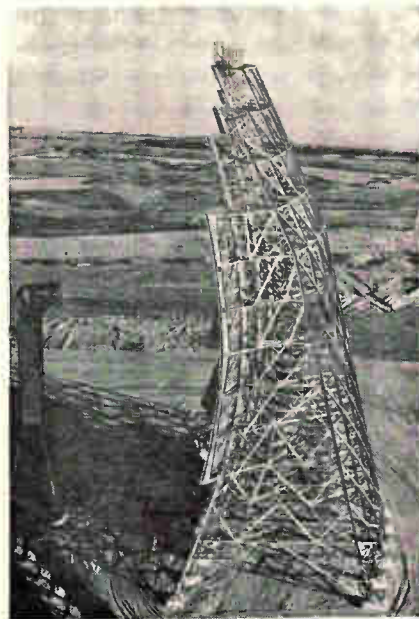

Listening post: Troposcatter antenna at Fox Main, a military base in the Canadian Northwest.

the hemisphere are being upgraded. The system broadcasts in the 345- to 455-megacycle range. It contains 12 communication channels; six are priority channels from radars of the Ballistic Missile Early Warning System (BMEWS).

The existing Distant Early Warning tropo link from Thule to Cape Dyer, called Dewdrop, is about 100 miles longer than the Thule-Fox link, but it's a single-sideband system.

Forging a route. The new \$18-million link will become part of the principle communications route for BMEWS. From Fox Main, the radar data is transmitted along

Dewline via existing military tropo links and commercial tropo to a station near the northern boundary of Alberta Province. From there, it's carried by commercial microwave to Colorado Springs.

Although the new link will be the principal route between Thule and Colorado, the existing paths will continue as alternates.

Upgrading the 489L communications program also includes installation of 22 60-foot troposcatter antennas along the Dewline to replace existing 30-foot antennas, a job about half done; improvement of communications in the Thule Air Base area, including installation of microwave links, which are now being tested; and upgrading of electronics switches and other communications equipment in Alaska.

A brute-force technique, using 100-kw continuous power to overcome signal fading along the 590-mile stretch, was adopted because the installation of repeaters along the way would have been economically impractical, a military spokesman explained. Quadruple diversity techniques are also being used to combat signal fading.

Northern billboards. The steel parabolic antennas in the Thule-Fox system look like billboards, 120 feet high and 120 feet wide. Two are at each location.

Four prime contractors are involved in the project: the Philco Corp., for system installations; Radio Engineering Laboratories, a division of the Dynamic Corp. of America, for radio subsystems; the Lenkurt Electric Co., for multiplex equipment; and the Blaw-Knox Co., for antenna subsystems.

Components

10-cent capacitors

The Mallory Capacitor Co. is betting that makers of radio and television sets will continue to turn to low input impedance transistors, rather than field effect transistors,

which have high input impedance. The company, a division of P.R. Mallory & Co., is investing several hundred thousand dollars on a molding process that will bring down the cost of aluminum wet electrolytic capacitors by permitting mass production. Had Mallory foreseen a trend to FET's, it would have bet on low-cost Mylar, mica, or multilayer ceramic capacitors.

Harry Nieders, marketing manager of the company, expects transistorization of black-and-white tv and small table radios to boost sales of aluminum electrolytics to 78 million units in 1966 from about 65 million this year. Low input impedance transistors can be bought for 25 cents each, while FET's cost about 80 cents each, even in million-unit lots, and aren't readily available, says Nieders.

Made in Japan. The market, however, isn't an easy one to crack. Wet electrolytic capacitors, hand-encapsulated in small plants in the United States, have been selling for as little as a dime each. Now Japanese manufacturers "have torn hell out of the market," says Nieders, by selling the capacitors for 6 to 12 cents each, depending on size.

Mallory and other large capacitor makers haven't been able to compete in that price range. The amount of hand labor needed to stuff the windings into plastic shells and pour in an encapsulant is too costly for large companies because of overhead and engineering.

Machine made. So Mallory devised a process that eliminates hand encapsulation. The windings are molded into plastic cases made of polypropylene. The company uses a special designed injection molder with a multicavity die. Mallory isn't disclosing how it keeps the electrolyte from escaping during the molding process, but probably the winding is coated with a thin plastic shell before molding.

Mallory showed the capacitors at the IEEE show in three case sizes with axial leads. One of these, the smallest, came out last year. The other two went into pro-

duction in February. Three more, in single-ended plug-in styles, will be introduced by July.

The tooling to produce each case size costs about \$20,000. Mallory is making the capacitors in rented space in Glasgow, Ky., while a new plant is being built in that city.

Buy American. Even with the molding process, Mallory will not be able to sell its capacitors as cheaply as the Japanese. Mallory will have to charge 10 to 15 cents each, in quantities of 25,000 to 50,000.

But Nieders doesn't expect Japan to maintain a competitive edge. Labor costs are going to rise there, he forecasts, and in the meantime the company expects to get most of its orders from U.S. companies that don't want to use Japanese capacitors.

Advanced technology

Laser in chemistry

When lasers were boring holes in razor blades and vaporizing bits of metal in laboratory demonstrations, it was frequently predicted that coherent light energy could also produce controlled chemical and physical reactions.

At Bell Telephone Laboratories, physicists have demonstrated one predicted phenomenon: they crea-

ted a specific chemical product, polystyrene, by irradiating a sample of distilled styrene monomer with a pulsed ruby laser beam. The simultaneous absorption of two photons by the monomer molecule caused polymerization—formation of large molecules from a combination of simple structures. The implications for future processing techniques are being examined closely by the chemical industry.

Kept cooler. Researchers Yo-Han Pao and Peter M. Rentzepis of The American Telephone and Telegraph Co.'s Bell Labs, fired a succession of 20 laser pulses at a sample of freshly distilled styrene monomer, which was kept at liquid nitrogen temperature to stabilize free radicals released during the two-photon process. After the irradiation, the sample was warmed to room temperature and the polymer was precipitated. An infrared spectrum analysis showed that the product was identical to the known polymer, polystyrene.

The chemical reaction was caused not by the thermal properties of the laser but by the electron energy of the photons of light. At the ruby laser wavelength of 6,940 angstroms, photons have an energy equivalent of 1.8 electron volts, insufficient to induce a chemical reaction. But in the Bell Labs experiment two photons were absorbed almost simultaneously, exciting the monomer by 3.6 ev. This formed free radicals and induced polymerization.



Laser beam created a predicted chemical reaction. Yo-Han Pao (left) and Peter Rentzepis polymerized a monomer molecule.

Computers

On the job

Busily whirring and clicking in offices, laboratories and factories across the country are about 18,000 general-purpose digital computers. They never take a coffee break or a vacation, are accurate and tireless and they can perform an incredible variety of jobs. But many computers are never asked to display their versatility and this raises the question of how management is using the machines.

800 answers. To get the answer, McGraw-Hill Publications put its department of economics to work on a survey of 800 companies in the United States. The responses from this cross-section of America's major industries are tabulated in the chart below.

Only 20% of the companies in the survey don't have a computer at their own facilities. Many of them, however, use computers at

universities or computer service centers for some special projects.

About 70% of the computers in operation are less than three years old, 26% are between three and six and the remaining 4% are over seven.

Only in the last few years have computer users gone beyond the obvious applications for the machines—accounting—and asked computers to do more complex jobs: business forecasting, data acquisition, process control and inventory control.

Although commercial establishments, such as banking, insurance and retail sales, are the biggest single group of computer users, aside from the government, they lag far behind all other industries in the use of the machines for sophisticated applications. For example, all the commercial companies that use computers apply them to accounting, but only 40% use them for inventory control, 15% for business forecasting, 2% for location selection, 11% for produc-

tion, planning and control and 10% for data acquisition.

In the aerospace industry, however, 100% of the companies use computers for inventory control, 54% for business forecasting, 31% for location selection, 100% for production, planning and control, 45% for process control and 69% for data acquisition.

But the commercial world isn't standing still; 93% of the concerns queried said they planned either to broaden current computer uses or seek new ones. Similar plans to expand computer use were recorded by 84% of all the concerns in the survey.

The labor picture. The survey produced information on how computers had affected employment. The report by the McGraw-Hill group says that were it not for computers, the number of employees at the 800 companies questioned would have been 3.1% higher. The producers of aerospace, ship and railway equipment, however, estimate that computers re-

HOW COMPANIES USE COMPUTERS

	Accounting	Inventory control	Business forecasting	Transportation	Location selection	Pert	Production, planning and control	Process control	Scientific and engineering applications	Data acquisition	Other
Iron and steel	100%	79%	37%	26%	5%	47%	84%	58%	63%	26%	16%
Nonferrous metals	100	93	20	13	0	7	67	13	27	13	7
Machinery	96	90	29	5	9	28	89	23	63	16	9
Electrical machinery	100	92	42	27	8	31	92	27	65	35	15
Autos, trucks and parts	100	100	38	15	8	23	92	15	54	23	31
Aerospace	100	100	54	0	31	92	100	46	92	69	31
Other transportation equipment	92	92	15	8	15	38	69	8	54	8	8
Fabricated metals and instruments	91	83	39	4	13	17	65	17	39	9	30
Chemicals	100	76	63	34	18	39	66	21	76	24	13
Paper and pulp	100	82	24	29	18	6	65	24	53	29	18
Rubber	100	100	75	50	25	25	75	25	75	25	25
Stone, clay and glass	100	38	44	25	6	38	50	6	50	6	38
Petroleum and coal products	100	85	70	60	35	55	75	50	85	45	20
Food and beverages	100	71	32	23	16	19	39	0	35	10	23
Textiles	100	89	28	28	0	6	72	28	11	17	17
Miscellaneous manufacturing	97	83	42	14	14	8	64	28	17	8	19
All Manufacturing	98	84	39	20	13	28	73	24	53	20	18
Mining	100	86	38	38	14	41	76	52	62	17	0
Railroads	100	63	31	56	6	6	25	0	44	31	25
Other transportation and communications	100	62	22	27	8	11	38	11	30	32	24
Electric utilities	100	71	24	37	5	44	34	17	90	27	17
Commercial	100	40	15	7	2	4	11	4	8	10	27
All Business	99	74	33	21	10	25	58	20	47	20	19

TRW EXHIBITS INCREDIBLE SHRUNKEN ZENER

TRW 1-watt zener
as seen by the naked eye!



Now, through the magic of TRW technology, you can have the finest 1-watt zener ever made! How do we do it? We just put fatter leads on our world-famous half-watt zener. You get the same low leakage, sharp knee, small size, high quality and low price—*plus full 1-watt performance* in this brand-new 1N4649 series!

Come one, come all!—to 14520 Aviation Boulevard, Lawndale, California. Or call 213-679-4561 (ext. 263).

TRW SEMICONDUCTORS

A SUBSIDIARY OF THOMPSON RAMO WOOLRIDGE INC.



MICROWAVE SWITCHES VARIABLE ATTENUATORS

- 500 mc to 12.4 gc frequency range
- High Isolation
- Extremely low insertion loss

The hpa 3500 Series of Microwave Switches is ideal for such applications as ECM receiver switching and low-power antenna switching in phased arrays. Completely solid state, this single-pole, single-throw switch features a switching speed of 300 nsec open to closed, 100 nsec closed to open. As variable attenuators the hpa 3500 Series can be used for power leveling and signal modulation applications. Size is 1 1/8" x 1" x 3/4". Price: \$275.

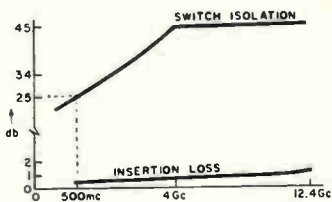

Write for more information.



hp associates
620 PAGE MILL ROAD,
PALO ALTO, CALIF. 94304,
(415) 321-8510

An Affiliate of Hewlett-Packard Co.

duced personnel by 8%.

In several industries, companies reported that computers had created new jobs. A quarter of the producers of automobiles, trucks and parts, for example, said that use of the computers had increased their personnel by 1% to 5%.

Several of the companies said they were unable to give an estimate because some products being made with computers couldn't be produced without them.

Flight plan

A new family of general-purpose airborne digital computers, built mostly with integrated circuits, is being hatched by the Air Force's Airborne Computer Standardization Committee. Contracts for the first system, for use aboard transport planes, will be awarded late this month or early May, according to John Mayer, director of computer development at Wright-Patterson Air Force Base, Ohio.

The system, called the AN/ASN-66(M), will be used first on the C-5, a behemoth being designed to carry 500 to 700 troops to any point in the world. The computer will replace the nine-year-old AN/ASN-24(V), a general-purpose navigational computer now used in the C-141 transport and for guidance in the Centaur space booster.

The ASN-24 is the only solid-state digital computer now in use on Air Force planes. All other operational computers are analog, Mayer says, except for the MA-1, a digital model built with vacuum tubes that is used on the F-106 fighter.

Airborne spares. The ASN-66 will be far more powerful than any existing airborne computer. It will process and display navigation data from star trackers, inertial systems, doppler radar, tactical air navigation (Tacan) and other navigation aids. It will also adjust the flight of the craft for minimum fuel consumption, check out other avionics equipment, assist in blind landings and calculate aircraft position, wind direction and velocity for paratroop drops.

The ASN-66 will be a serial,

single-address computer running synchronously at a clock rate of 500 kilocycles. Memory capacity will be 8,192 to 16,384 words of 28 to 32 bits, compared with 2,048 words in the ASN-24. The computer will occupy one-half cubic foot and weigh 40 pounds. Chief engineer on the project is Charles Marshall.

Because the plane may have to land at remote airports where there are no ground-support equipment or maintenance crews, the computers will have built-in warnings of malfunctions. If it isn't operating correctly, the flight crew will switch to a spare rather than attempt repairs.

Next projects. Plans are also being made, Mayer says, to develop a general purpose computer for tactical aircraft and fighter planes. It will handle navigational chores, as in the ASN-66, and fire control as well. The computer is slated for use in the Mark II integrated avionics system for new fighter planes. Mayer expects this to be a more expensive computer than the ASN-66. To keep weight down, it will use a solid-state memory. Integrated circuits may be used for the memory as well as the data processor section.

For high-speed analog data handling, a parallel digital data analyzer is being developed by Tele-dyne, Inc. This type of computer is now used on the ground for such chores as plotting and predicting missile trajectories. It will use digital circuitry to process analog data continuously at a clock rate of around 10 megacycles. Initially, the memory will be magnetic drum or disk. Later, the memory will be integrated.

Manufacturing

Spray-on film

The National Cash Register Co. has developed its spray process for making thin films to the point where it is ready to begin production of several types of optoelec-

tronic devices and instruments. NCR has had particularly good results using semiconductor compounds and phosphors in solution, according to S. H. Liebson, manager of physical research. The process has proved more economical than vacuum deposition or furnace firing.

Engineers at the NCR lab in Dayton, Ohio, have made cathodoluminescent displays with resolutions better than 2,000 lines an inch, field effect transistors, electro-luminescent films, photoconductors for ultraviolet recording, and more routine types of thin films, such as resistive and dielectric materials.

Hot process. The first step in the process is preparation of a clear water-based solution of an organic material, such as thiou-urea, and a metal salt, such as cadmium chloride. The ingredients depend on the film desired.

A fine mist of the solution is sprayed on a substrate heated to a few hundred degrees centigrade. When the spray hits the hot substrate, the water evaporates and the chemicals react to form a compound.

The sprayer makes up to 3,000 passes over the substrate, depositing a film only 10 to 100 angstroms thick on each pass. Liebson says this gives the final film excellent uniformity because variables average out. For mass production, substrates could be transported under a sequence of sprays. The production equipment will be inexpensive because vacuums and high temperatures aren't required. Post-deposition processes can make the films glassy or crystalline. There is no limit on the area of the films, he adds.

Flight power. NCR is currently making prototype solar cells that are four-inches square. Their efficiency, 2 percent to 4 percent is much lower than that of conventional photocells, but Liebson says they are expected to produce more power per pound. The cells are destined for an Air Force application that requires a large-area photocell made on flexible material so it can be unfurled in space like an umbrella.

On-the-wall tv? Liebson indi-

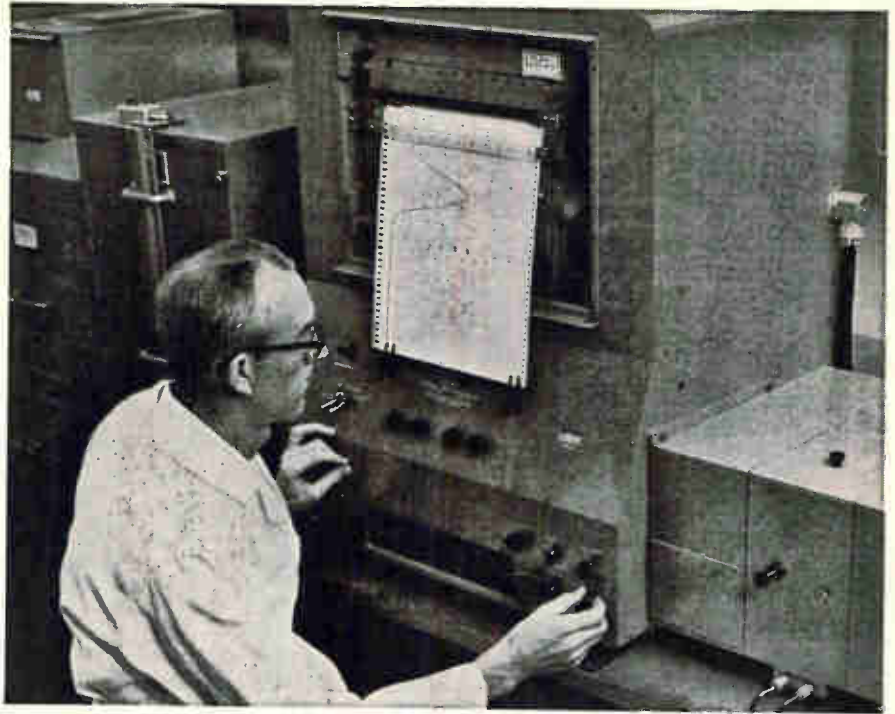

Du Pont Reagents assure you of optimum quality and uniformity while also fulfilling your needs for dependable service, safety and convenience in handling.

You Can Depend on Du Pont Reagents for QUALITY

Over 65 years' experience in manufacturing reagents (and the highest quality "crudes") has enabled Du Pont to identify and eliminate sources of contamination. Rigid quality tests are made on each lot — during manufacturing, in the analytical laboratory, and again before shipment — to meet Du Pont's

own strict standards and those of the ACS. In all, Du Pont Reagents receive 23 stringent quality checks to assure you of getting the highest possible quality and uniformity. Du Pont Reagents are available in 1 and 5 pint bottles and 6½ and 13 gallon carboys from your local Du Pont reagents distributor.

NITRIC ACID

Nitric Acid (HNO ₃)	Min. 70.0%, Max. 71.0%
Chlorides as Cl	Max. 0.000008%
Residue after Ignition	Max. 0.0002%
Heavy Metals as Pb	Max. 0.00001%
Sulfates as SO ₄	Max. 0.00008%
Iron (Fe)	Max. 0.00001%
Arsenic (As)	Max. 0.0000005%
Chromium (Cr)	Max. 0.00001%
Phosphates as PO ₄	Max. 0.00002%
Copper (Cu)	Max. 0.000005%
Nickel (Ni)	Max. 0.000005%



**You Can Depend on Du Pont Reagents
...for Quality, Service and Safety**

NITRIC ACID	GLACIAL ACETIC ACID
SULFURIC ACID	AMMONIUM HYDROXIDE
HYDROCHLORIC ACID	FORMIC ACID 90%

Du Pont Company, Room 2236
Wilmington, Delaware 19898

Send name of nearest Distributor Reagents Catalog Sheet
 prices.

Name _____

Title _____

Firm _____

Address _____

City _____ State _____ Zip _____



BETTER THINGS FOR BETTER LIVING
...through Chemistry

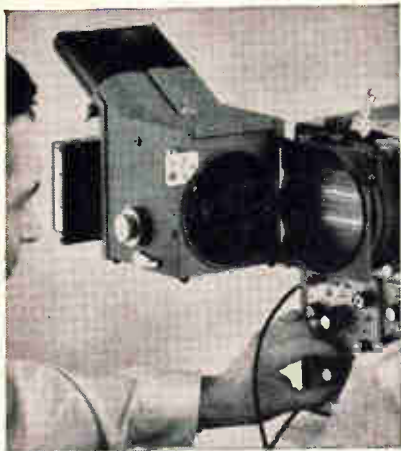

SEE IT...



SHOOT IT...

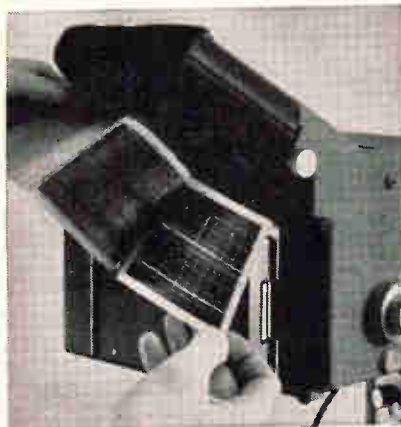

HAVE IT...

WITH SCOPE CAMERAS BUILT BY THE LEADER... FAIRCHILD

Available from the industry's most complete line of high precision scope cameras are models for high speed atomic research, radio astronomy, medical observations and general lab work. Prices start at \$350. Application assistance is available from your local Fairchild Field Engineer. Call him, or write for details, then compare design features. Fairchild Scientific Instruments, 750 Bloomfield Ave., Clifton, N. J.

FAIRCHILD

DU MONT LABORATORIES
SCIENTIFIC INSTRUMENT DEPARTMENT

cates that the lab is now ready to devise system applications for the process, but he has so far refused to disclose specific plans. NCR, however, has strong proprietary interests in data reading and display systems, some types of which require high-precision arrays of optoelectronic devices.

NCR demonstrated this capability more than a year ago by making a working television screen only $\frac{1}{8}$ -inch square—so small it has to be viewed through a lens. Resolution of 1,500 lines per inch is routinely obtained in deposited thin films of phosphors. Resolution well above 2,000 lines an inch has recently been achieved, according to Maclin S. Hall, project scientist.

Another possible application—which Liebson won't confirm or deny—is in a flat television picture tube, made without the usual electron gun and phosphors. Japanese researchers have proposed a system composed of photoconductive and electroluminescent materials activated by an electrode grid [Electronics, Sept. 10, 1963 p. 30]. Such a system has been used as an image intensifier, but response time of the photoconductor used was too slow for television. Tv field time is 16 milliseconds. NCR says it has deposited photoconductors with response time in the millisecond range.

Avionics

Pinpoint navigation

A transportable loran system tailored after the worldwide long range navigation network has been designed for tactical warfare, when a small error may result in a supply drop's falling into the hands of the enemy. The Sperry Gyro-scope Co., a subsidiary of the Sperry Rand Corp., is building the system for the Air Force under a \$3-million development contract.

Time the signal. Loran provides fixes by timing the arrival of signals from three or more stations. The worldwide network, known as loran C, uses transmitters at large,

fixed stations; its accuracy degrades by 1,000 feet for every 1,000 miles between a given station and the craft making a fix. Sperry's tactical system, known as loran D, operates with stations up to 500 miles apart, and up to 500 miles from the craft taking a fix. It will provide fixes accurate to within 600 feet at that maximum range.

Inside a craft, loran D's electronic equipment translates the signals from the master station and its two slaves into digital readings of altitude, latitude and longitude, as well as the deviations from a predetermined flight path known as track and cross-track errors. The unit also drives a stylus that traces position on a map.

Analog signals. In loran C, the receiving equipment reads out analog signals, which must be translated by the operator.

Loran D's transmitters, which are solid state, can be flown or trucked into a battle area. The stations broadcast pulses 16 times a second at 100 kilocycles, the loran C frequency.

IEEE show

Interest high, sales low

Everybody seems to be talking about integrated circuits but few makers of commercial and industrial instrumentation are using them. That consensus emerged at the New York show of the Institute of Electrical and Electronics Engineers.

A few companies are trying to incorporate them into their instrument lines, but they cite two basic problems: high price despite recent reductions, and complexity of working integrated circuits into designs.

Many executives agree with the wait-till-next-year approach of James S. Johnson, president of Datapulse, Inc. "We won't modify our existing equipment just for the sake of using integrated circuits," he declares. "But we are going to use integrated circuits in our new designs."

Too late. Recent price cuts seem

to have come too late for inclusion of integrated circuits in present equipment. Peter Dietz, sales manager of Datapulse's subsidiary, the Data Technology Corp., says: "The prices of integrated circuits dropped at a time when many companies had just completed the transition from germanium to silicon transistors. Some can't afford to change again so quickly."

Malcolm C. Holtje, group leader in developmental engineering at the General Radio Co., says prices are still too high. "Despite price-cutting talk," he declares, "the circuits you really want are not cheap, although improved production yield is changing the situation." He says General Radio is looking into the use of integrated circuits.

Thus few companies are taking as strong a stand as Johnson of Datapulse, whose company has introduced two units using integrated circuits—an integrating digital voltmeter and an integrated-circuit tester analyzer—and promised more next year.

Complexity a problem. Another factor working against the introduction of integrated circuitry is the complexity of designing it into equipment. The applications departments of integrated-circuit manufacturers are overloaded with requests for assistance, and many users are being forced to work largely on their own.

C. D. Simons, director of microelectronics operations for the Phileo Corp.'s Lansdale division, states: "The complexity of integrated-circuit design means that users are going to have to do their own applications work. This comes as a shock to those of us who have spent our lives in the transistor and diode business, but integrated-circuit manufacturers won't be able to support the gangs of applications engineers needed."

The Computer Control Co. and Data Technology Corp. say they hope to capitalize on this situation by selling logic cards and modules using integrated circuits. These are designed to simplify the designer's job. Computer Control introduced 24 circuit modules at the show, and Data Technology Corp. 18 logic cards.

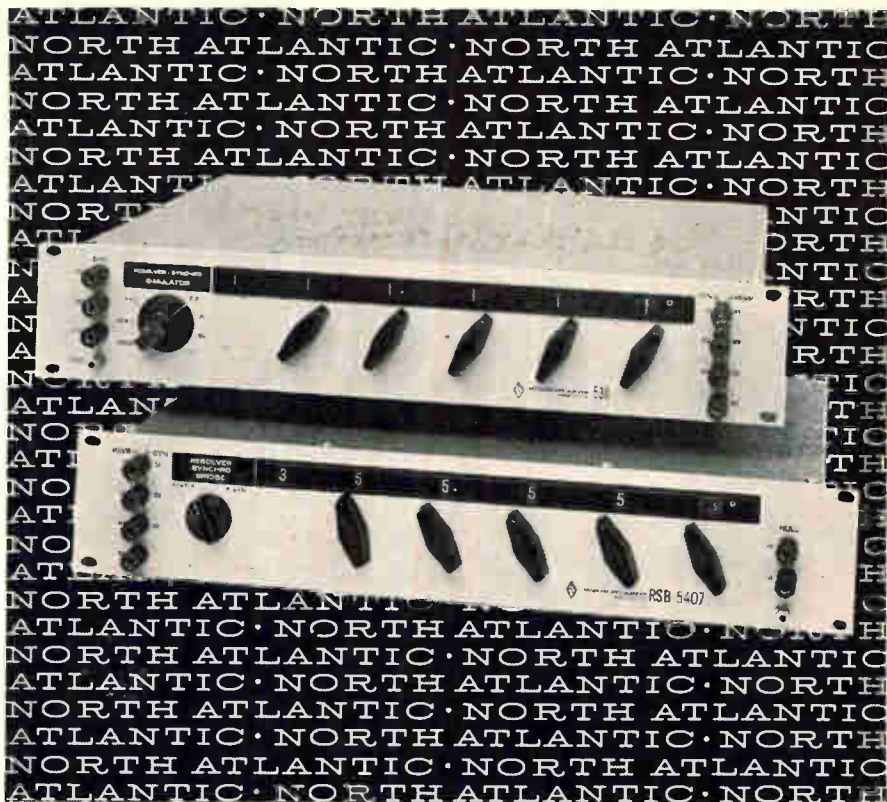

you are looking at the state-of-the-art in resolver/synchro testing

These two instruments provide the widest measurement capability available today for resolver/synchro testing. Each is a dual-mode unit, measuring both resolvers and synchros. Series 530 Simulators are ideal transmitters, and Series 540 Bridges are ideal receivers.

In addition to their dual-mode capability in 3½" of panel space, both series provide in-line decimal readout continuously switched through 360°, 2 second accuracy at any angle, and input/output isolation.

SERIES 530 SIMULATORS FEATURE

- Resolution 0.001°, 1°, or 5°
- Dual 26/115 volt excitation
- Switch selected line-line voltages 11.8, 26, 90, and 115 volts
- Low matched output impedance

SERIES 540 BRIDGES FEATURE

- Resolution 0.0001°, 1°, or 5°
- 500K input impedance
- Constant null-voltage gradient at all line-line voltages
- Unaffected by null detector loading

Prices range from \$1480.00 to \$2680.00

The flexibility of these instruments meets every need for rapid and accurate testing in the engineering laboratory, in production, and in ground support equipment. Used with a Phase Angle Voltmeter, they provide a complete facility for component or system test.

Programmable models with decade or binary input are also available. Your North

Atlantic representative will be glad to arrange a demonstration. Call or write him today.



NORTH ATLANTIC industries, inc.
TERMINAL DRIVE, PLAINVIEW, L. I., NEW YORK • Overbrook 1-8600

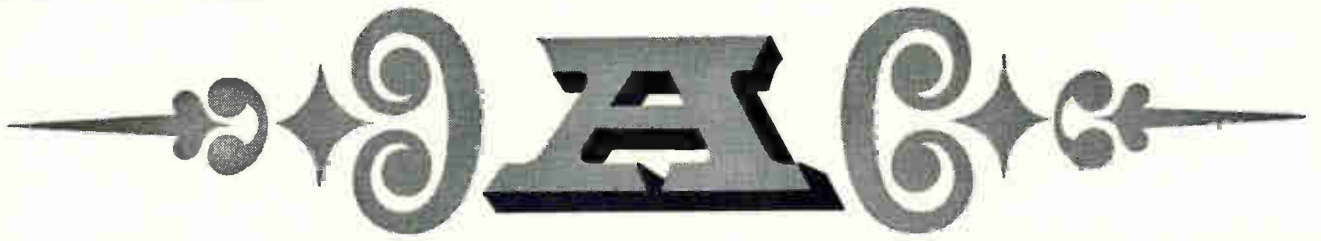

BLATANT APPEAL

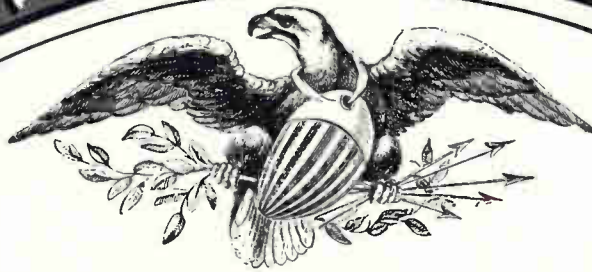

TO YOUR EMOTIONS and your wallet

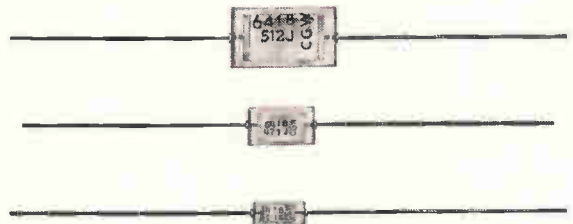
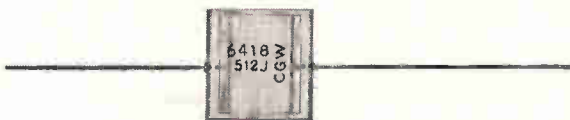

CORNING CYFM Capacitors: CYFM 10, 0.5—300 pf; CYFM 15, 220—1200 pf; CYFM 20, 560—5100 pf; CYFM 30, 3600—10,000 pf; VDCW, 300 and 500 volts.

Here's a chance to exercise your American sense of fair play and sportsmanship—and do a shrewd bit of capacitor-reliability buying at the same time.

Specify CORNING® CYFM Capacitors. Is it that simple? Yes.

Look at the rewards for you first. Our glass-dielectric CYFM capacitors give you *stability* that's invariable with time, temperature, and environment, and a TC that's always retraceable within 5 ppm on the curve.

You get *reliability* that's inherent from

the way they're made—in basically the same process that turns out our ultra-high-reliability CORNING CYFR Capacitor.

But you can save *dollars* on the CYFM because we don't put it through all the rigorous CYFR testing.

pf for pf, you can't buy more stability and reliability for fewer dollars than you get in the CORNING CYFM Capacitor.

Now, the emotional. Our CYFM lives constantly in the shadow of its glamorous Autonetics/Minuteman CYFR older brother. The CYFR has just successfully completed over 41 million unit test hours and 45 months of continuous testing!* You can well understand the

frustration, the second-best, underdog feelings of the CYFM.

Have a heart. Use your head. Specify CORNING CYFM Capacitors. You will make everybody happy—reliability engineers, comptrollers, and us.

For complete data and for parts, send to Corning Glass Works, 3913 Electronics Dr., Raleigh, N. C., or call your Corning distributor.

*Autonetics lot-acceptance testing program.

CORNING
ELECTRONICS

On March 1, Raytheon Computer dropped prices as much as 40% on the best germanium and silicon digital modules in the business. That includes a 5-year guarantee. And we also ship within 48 hours.

Component designation screened on board per MIL-E-16400E

High density (4 flip-flops on 3 1/4" x 4 1/4" board)

Color-coded test points on outputs for ease of system checkout

Decoupling on power input to reduce noise problems

Component leads and wire terminations clinched over runners per MIL-E-16400E

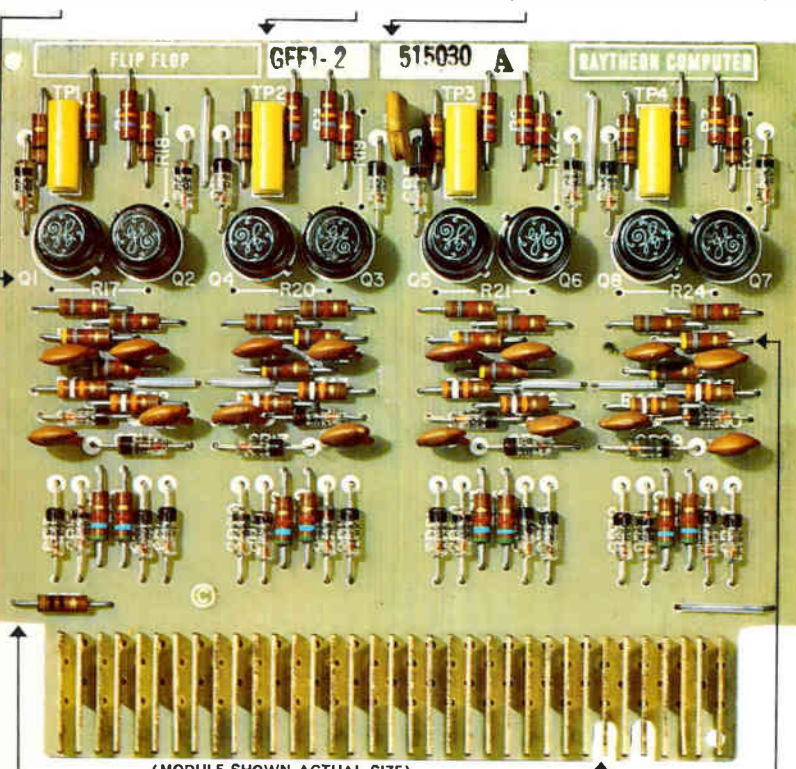

(MODULE SHOWN ACTUAL SIZE)

Epoxy fiberglass board NEMA grade G-10 per MIL-E-16400E

35 pin varicon connectors for density and reliability

2 oz copper clad single side etch — more reliable than eyelets

All boards keyed to insure proper installation

Bias network on ac coupled inputs for high noise rejection

Today, after cuts like this, you'd have to buy \$750,000 worth of competitive modules per year to get the cost per unit that we offer on a single module.

And, on top of this, we give quantity and volume discounts.

These low prices also apply to our nine new germanium modules, including half adders, shift registers, level converters, and a 20 MC flip-flop, plus several new silicon modules.

All modules in the Raytheon line are high-quality, high-density, high-reliability units with MTBF's as high as 4,000,000 hours.

Two outstanding examples: the GDG2 AND-gate with four 2-input gates and four 3-input gates, MTBF 4,000,000 hours per circuit; GFF2 flip-flop with four RS flip-flops, MTBF 472,000 hours per circuit.

Figures are based on MIL-HDBK-217, MIL-STD-756 and verified by life test.

Check the Raytheon Computer digital module price list on the reverse side, look at the new circuits offered, then call your nearest representative for a quotation on your next purchase.

Contact the factory for Data File M106 containing technical information.

24-hour shipment on many of our modules, 48 hours guaranteed on most.

Raytheon Computer, 2700 South Fairview Street, Santa Ana, California 92704



These new low prices for Raytheon Computer digital modules are effective March 1.

GERMANIUM MODULES		200 KC	1 MC	5 MC	SILICON MODULES		1 MC				
GAI2	Amplifier Inverter (12 circuits)	60.00	66.00	—	DD200	Lamp and Relay Driver 28V, 250 ma	171.00				
GBC1	Binary Counter (4 circuits)	42.00	63.00	82.00	DG200	Diode AND Gate (20 inputs, 8 outputs)	35.00				
GCG1	Clock Generator (free running)	60.00	85.00	95.00	DG201	Diode OR Gate (23 inputs, 9 outputs)	35.00				
GCG2	Clock Generator (crystal controlled)	80.00	105.00	115.00	*EF200	Emitter-Follower (12 circuits)	70.00				
GDA1	Digital-Analog Converter 8 Bits or 2-4 Bits Binary or BCD Bipolar or Unipolar	128.00	—	—	*IC202	Input Circuit AND-OR, High-Noise Reject	42.00				
*GDA2	Digital-Analog Converter, 10 Bit Binary	135.00	—	—	LC200	Level Converter (Positive to Negative) 10 circuits	80.00				
GDC1	Decade Counter (8-4-2-1 Code Out)	44.00	65.00	85.00	LC201	Level Converter (Negative to Positive) 10 circuits	80.00				
GDG2	Diode AND Gate (20 inputs, 6 outputs)	25.00	25.00	43.00	*MV200	Multivibrator Clock, Inhibit, 2 clock drivers	70.00				
GDG3	Diode OR Gate (21 inputs, 5 outputs, lev. rest.)	41.00	60.00	80.00	ND200	Nixie Driver (BCD Code In, 10 Lines Out)	57.00				
GDI1	Driver Inverter (10 circuits)	56.00	83.00	110.00	NE200	NOR Element (6 circuits, 2, 3 and 4 inputs)	50.00				
GDI2	Driver Inverter (10 circuits, cable driver)	54.00	80.00	100.00	ST200	Schmitt Trigger (2) Adjustable Threshold	80.00				
*GDL1	Delay Line, Magnetostrictive, to 1300 μ sec	—	425.00	—	*TF201	Flip-Flop (4) Gated, Test Points, Noise Reject	75.00				
GDM1	Decoder Matrix—Binary to octal or 16 line	64.00	64.00	75.00	*TF202	Flip-Flop (4) High-Noise Reject (Test Points)	75.00				
GDR1	Data Receiver (3 circuits)	100.00	—	—	TI200	Amplifier Inverter (12 circuits)	70.00				
GEF1	Emitter-Follower (12 circuits)	45.00	68.00	95.00	TO200	Dual One-Shot (2 circuits) Adjustable	80.00				
GFF1	Flip-Flop (4 circuits, universal)	46.00	65.00	85.00	XCG200	Crystal Clock Generator (1MC, 4 outputs)	100.00				
GFF2	Flip-Flop (4 circuits) RS	32.00†	52.00†	59.00†	SPECIAL GERMANIUM MODULES						
*GFF3	Flip-Flop, Gated, 4 circuits	50.00	69.00	90.00	GDD1	Display Driver (6 circuits, 1/2 B-to-D)	90.00				
*GFF4-20	Flip-Flop, 20 MC, Gated, 2 circuits	—	—	130.00**	GND1	Nixie Driver (8-4-2-1 and complement code input)	52.00				
*GHA1	Half Adder, Subt., Comp., 4 circuits	65.00	85.00	95.00	GPA1	Relay or Lamp Driver (8 circuits, 350 ma, —48V)	103.00				
GIG1	Input Gate (AC OR gate, 22 inp., 10 outp.)	38.00	38.00	57.00	*GPA2	Power Amplifier, 150 ma, 28V, 12 circuits	70.00				
*GLA1	Linear Amp., Gain 90, 20 cps to 1 MC (2)	—	60.00	—	*GRR1	Reed Relay, 4 relays with drivers	78.00				
GMV1	Multivibrator Clock (with 2 gated drivers)	50.00	82.00	—	*GRS1	Reference Voltage Supply Module, —5V	150.00				
GNA1	NAND gate (16 inputs, 6 outputs)	34.00	50.00	65.00	*GSS1	Silicon switch, 4 SCR's, 250 ma, 100V	100.00				
GOS3	One-Shot (3 circuits) adjustable width	54.00	80.00	95.00	<i>*New modules, recently introduced</i>						
GRG1	Reset Gate (4 circuits, 6 outp. per circuit)	38.00	38.00	57.00	<i>**GFF4-20 is a 20 MC unit</i>						
GSR2	Bidirectional Shift Register (2 circuits)	41.00	68.00	85.00	<i>†These prices represent typical reductions of 18%, 20%, and 33% respectively</i>						
GSR3	Bidirectional Shift Register (3 circuits)	54.00	80.00	100.00	DISCOUNT SCHEDULE						
*GSR4	Shift Register, Serial, Parallel (4 circuits)	46.00	65.00	85.00	Quantity	1-10	11-25	26-100	101-200	201-500	500+
GST1	Schmitt Trigger (4 circuits)	55.00	78.00	90.00	%	List	3%	6%	8%	10%	Contact Rep.
GST2	Schmitt Trigger (2 circuits, adj. thresh.)	57.00	70.00	80.00	Volume discounts allowed for purchases of \$50,000 and above. Contact representative for details.						
*GUL1	Universal Logic (18-gate inputs, 4 inverters)	27.00	37.00	49.00							

Technical representatives and company sales offices:

Alabama, Fact-Tronics, P.O. Box 1135, Huntsville, (205) 539-7193; Raytheon Computer, Holiday Office Center, Suite 47, Huntsville, (205) 881-2844; **Arizona**, Barnhill Assoc., 30 Pima Plaza, Office 20, Scottsdale, (602) 947-5493; **California**, Dynamic Assoc., Inc., 1011-D Industrial Way, Burlingame, (415) 344-2521; Raytheon Computer, 2700 South Fairview Street, Santa Ana, (714) 546-7160; Williams & Hedge, Inc., 4341 West Commonwealth, Fullerton, (714) 521-7410; **Colorado**, Barnhill Assoc., 1170 So. Sheridan Blvd., Denver, (303) 934-5505; **Connecticut**, Eltron Engr. Sales, 2341 Whitney Avenue, Hamden, (203) AT 8-9276; **Florida**, Fact-Tronics, P.O. Box 3202, Orlando, (305) GA 3-7069; **Georgia**, Fact-Tronics, 254 East Paces Ferry Road, Atlanta, (205) WX-4000; **Illinois**, Pivan Engineering, 3535 West Peterson Avenue, Chicago, (312) KE 9-4838; **Indiana**, Pivan Engineering, 10447 North College Avenue, Indianapolis, (317) VI 6-5805; **Iowa**, Pivan Engineering, P.O. Box 851, Cedar Rapids, (319) 365-6635; **Maryland**, L. G. White & Co., 880 Bonifant Street, Silver Spring, (301) JU 5-3141; **Massachusetts**, Eltron Engr. Sales, 246 Walnut Street, Newtonville, (617) DE 2-6975; **Michigan**, WKM Associates, Inc., 19430 Mount Elliott, Detroit, (313) 366-0840; **Minnesota**, Pivan Engineering, P.O. Box 387, Osseo, (612) 335-3333; **New Jersey & Met. New York**, Kenneth

E. Hughes Co., Inc., 4808 Bergenline Avenue, Union City, (201) UN 7-3204; **New York**, D. B. Associates, Inc., 3307 Erie Blvd. East, DeWitt, (315) 446-0220; D. B. Associates, Inc., 22 Byscayne Drive, Lancaster, (716) TF 5-6186; Raytheon Computer, 1501 Franklin Avenue, Mineola, L.I., (516) PI 7-3705; **New Mexico**, Barnhill Assoc., 319A Wyoming, N.E., Albuquerque, (505) 265-7786; **North Carolina**, L. G. White & Co., P.O. Box 2356, Winston-Salem, (919) 725-3612; **Ohio**, WKM Associates, Inc., 6741 Ridge Road, Cleveland, (216) 885-5616; WKM Associates, Inc., 6085 Far Hills Avenue, Dayton, (513) 298-7203; **Pennsylvania**, L. G. White & Co., 100 Essex Ave., North, Narberth, (215) MO 4-6505; WKM Associates, Inc., 90 Clariton Blvd., Pittsburgh, (412) 892-2953; **Texas**, Raytheon Computer, 204 East Main, Arlington, (817) CR 5-5361; J. Y. Schoonmaker Co., Inc., 5328 Redfield Avenue, Dallas, (214) ME 1-8480; **Washington**, The Thorson Co., 1767 15th Avenue, So., Seattle, (206) EA 5-5000; **Washington, D.C.** Raytheon Computer, 4217 Wheeler Ave., Alexandria, Virginia, (703) 836-7616; **Canada**, Radionics Limited, 8230 Mayrand Street, Montreal 9, Quebec, REgent 9-5517; Radionics Limited, 4938 Yonge Avenue, Willowdale, Ontario.



Raytheon Computer, 2700 South Fairview Street, Santa Ana, California 92704

Report from

**BELL
LABORATORIES**

D. L. Perry, who developed techniques for making high-reflectivity mirrors at Bell Laboratories, adjusts laser used for measuring thickness of dielectrics. The laser beam is split, and one part of the beam is compared with another part reflected from a monitor slide. High signal-to-noise ratio of laser system permits accurate measurement of quarter wavelength of layers.

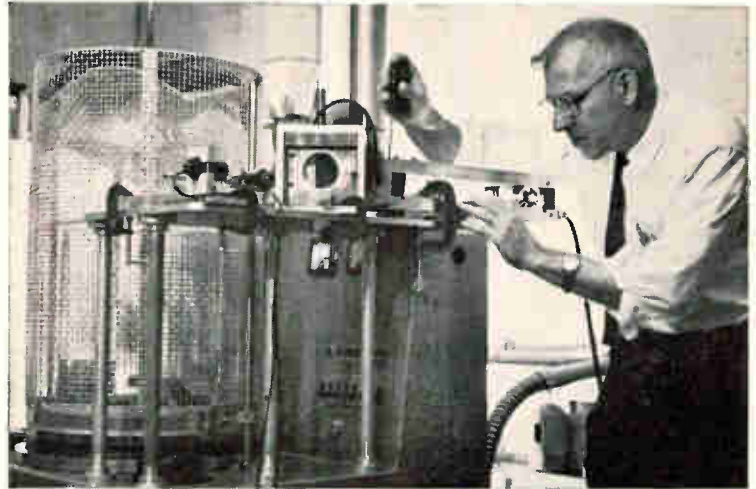

New techniques for making nearly perfect mirrors

Even the best mirrors scatter and absorb some of the light incident upon them. Because the power output of a laser depends importantly on this loss of light at mirrors, scientists at Bell Laboratories have sought to push the reflectivity of mirrors as nearly as possible to 100%. Preliminary measurements indicate that reflectivities of over 99.8% can be achieved at a given wavelength and that broad-band mirrors are also possible spanning the visible spectrum (4200 to 7400 Angstroms) with reflectivities greater than 99.5% for all wavelengths in the band.

The best mirrors are made by applying many layers of dielectric material of precisely controlled thickness to the mirror surface. In the past the number of such layers has been limited to about 15. One reason is that "large" (order of a wavelength of light) particles accumulate in the layers; these act as scattering centers, so that additional layers decrease rather than increase the reflectivity.

At Bell Laboratories a method has been developed to apply 27 or more layers successfully, with consequent increase in reflectivity. This method involves strict attention to the cleanliness of the substrate, careful control of evaporation temperature at a point just below the melting point of the dielectric material, and precise measurement of layer thickness. The thickness measurements are performed using a continuously operating gas laser. One of the most significant findings was that some dielectrics, when used in a powder form, were causing the large particles to appear in the layers. Apparently entrapped gases within the powders were suddenly released on heating, causing small showers of particles to be projected into the layer—a difficulty corrected by using a properly prepared "chunk" form of the material.



Bell Telephone Laboratories
Research and Development Unit of the Bell System

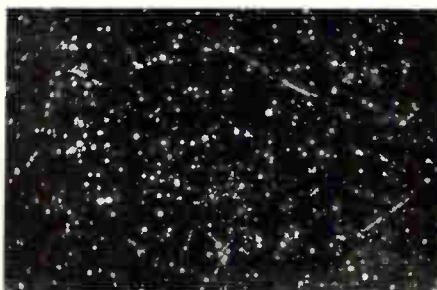

Microscope photos showing about $2\frac{1}{2}$ mm² each of three mirror surfaces. Oblique lighting causes each scattering particle to appear as a spot of light. The photos compare a poor mirror (left), an average mirror with 15 dielectric layers which, in addition to scattering loss, will have a few tenths of a percent transmission loss (center), and a mirror with 27 layers made at Bell Laboratories with refined coating technique (right). The additional layers plus a nearly total absence of large particles result in a greatly increased reflectivity.

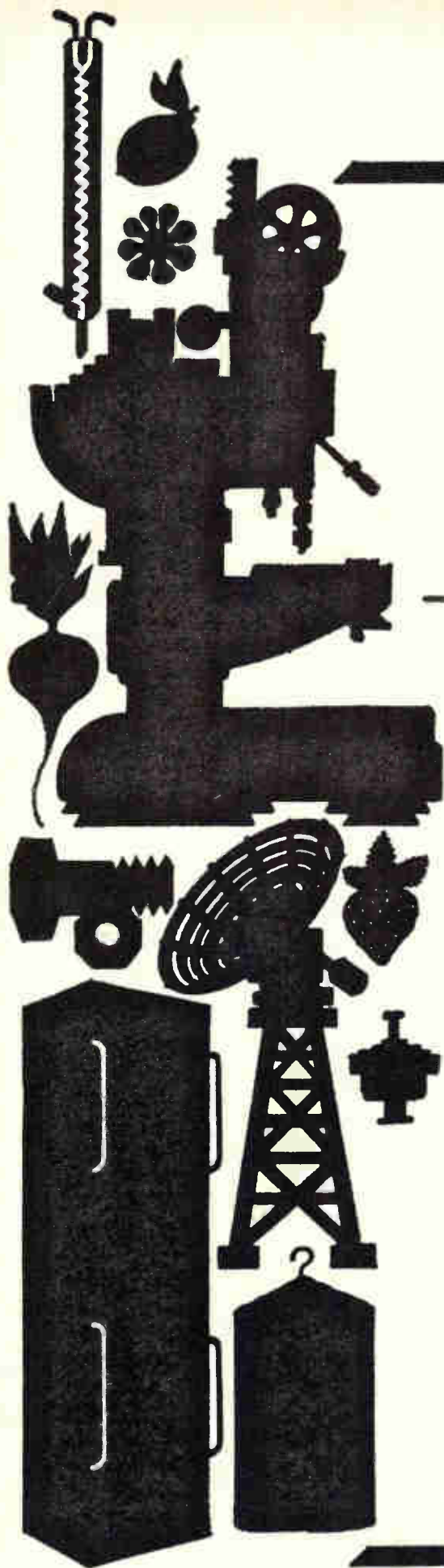

TIGER TALE #2

It Takes all Kinds...

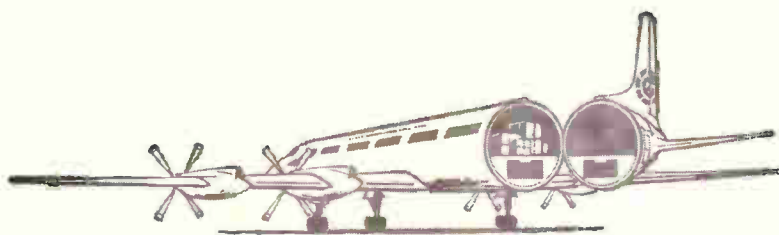

Put 'em in a Tiger's Tail!

Tigers handle all shapes and sizes of shipments. Little, delicate ones. Medium-size ones. Extra-big ones up to 84 feet long! Whatever you've got, we can carry in our straight-in-loading, coast-to-coast Swingtail CL-44s.

You get dependable door-to-door pickup and delivery. And your shipments get top priority on every flight because Tigers carry nothing *but* airfreight. Through our exclusive Advance Manifest Data System you can pinpoint your shipment, night or day, know exactly when it will arrive and when it will be delivered.

Let our airfreight specialists show you how our **wholesale** "Blocked Space" rates can save you up to 15%. Get your shipments off the ground the fastest, most economical way. Phone, or write to the Tiger office nearest you. Or call your local freight forwarder.

**FLYING
TIGER
LINE**

The Airfreight Specialist



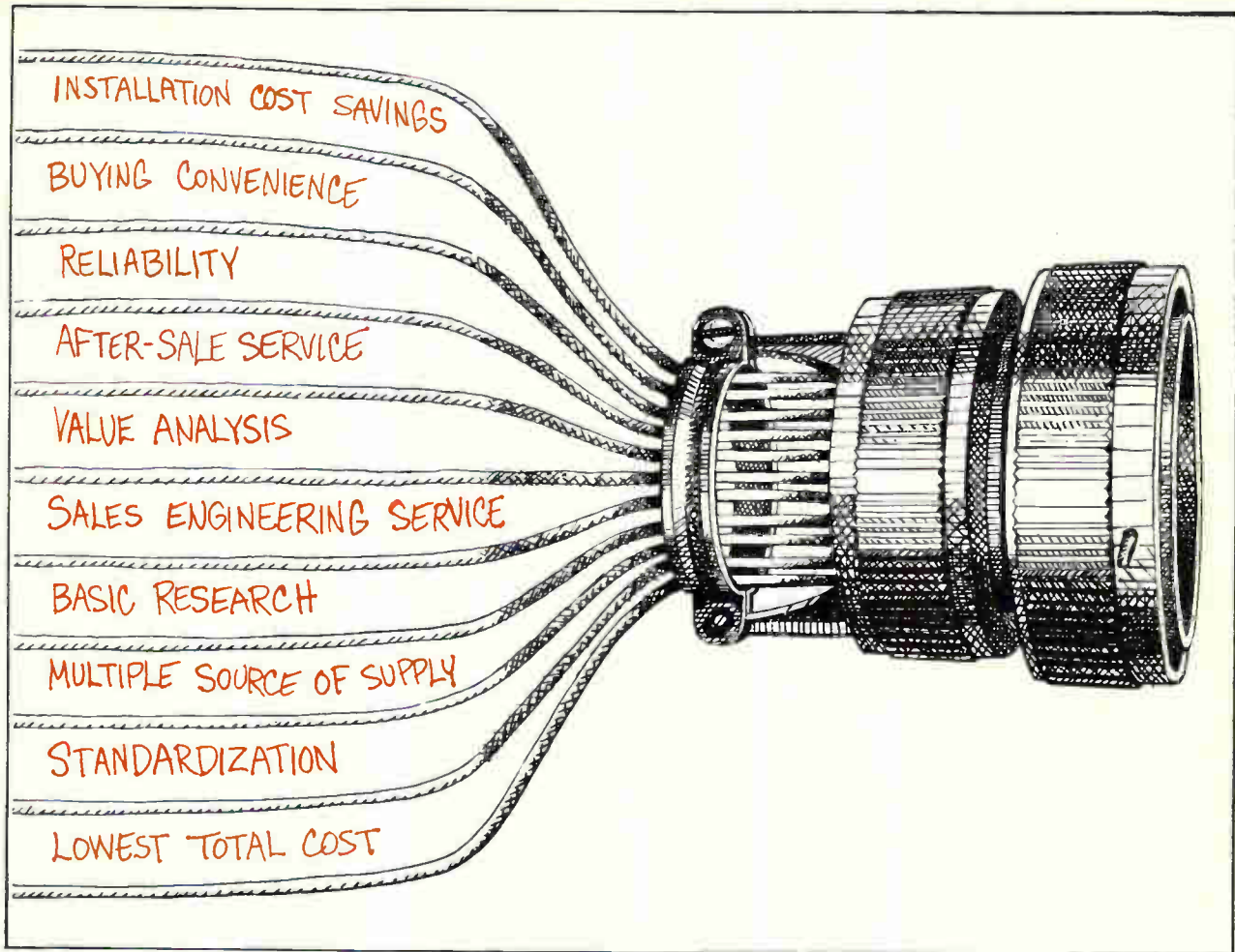

“Total Value” is designed into every Cannon connector

ITT Cannon's “Total Value” Program is designed to give you maximum value for all interconnection purchases *at the lowest total cost*. Whether you specify one connector or a thousand, this program has been developed to meet one specific objective . . . to provide TOTAL VALUE for your purchase through benefits and savings accrued not only in cost but in your time and effort.

Assurance of “Total Value” begins at the design stage and is methodically carried through every facet of manufacture, assembly, maintenance and logistics of supply. It is applied to routine purchases

as well as to meet specific “Value Engineering Clauses” under government contract or company sponsored programs and is backed by ITT Cannon's specialized knowledge and years of experience.

On all connector products, look to ITT Cannon for engineering excellence and “a dollar's value for every dollar spent!” For information, or our booklet “Assurance of Total Value,” write to: ITT Cannon Electric, 3208 Humboldt Street, Los Angeles, California. A division of International Telephone & Telegraph Corporation. © 1965 ITT CANNON ELECTRIC



Our 50th Year

ITT CANNON



FIELD INTENSITY METERS FROM 10 kHz to 2700 MHz

HIGH SENSITIVITY • BUILT-IN CALIBRATING GENERATOR

HIGHLY PORTABLE FIELD STRENGTH INDICATORS



VHF

TYPE HUZ
47-225 MHz

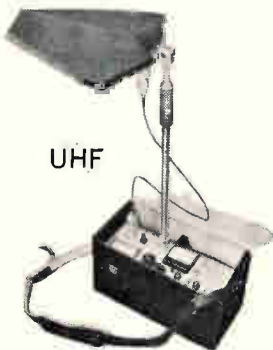

UHF

TYPE HUZU
470-850 MHz

HIGH PRECISION, HIGH SENSITIVITY FIELD STRENGTH METERS

RF-VLF

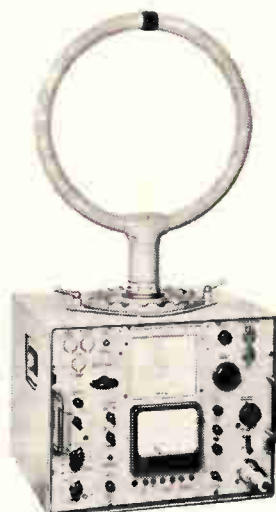

TYPE HFH
100 kHz - 30 MHz
(10 kHz - 30 MHz)

VHF-UHF



TYPE HFU
25-900 MHz

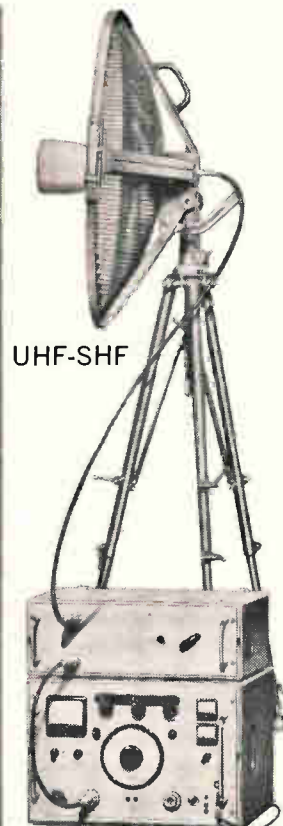

UHF-SHF

TYPE HFA
0.9 - 2.7 GHz

BUILT-IN TRACKING CALIBRATING GENERATOR
CALIBRATION UNAFFECTED BY COMPONENT AGING

Type HUZ, Type HUZU

Highly portable instruments for indication of field intensity. Built-in nickel-cadmium batteries. Separate charger unit included. Measuring range $5\mu\text{V/m}$ to 100 mV/m . Absolute accuracy $\pm 6\text{ db}$ ($\pm 3\text{ db}$ for relative measurements). Antennas: tunable dipole for Type HUZ, log-periodic for Type HUZU. Single range drum scale. Demodulation for AM and FM. Built-in loudspeaker; jack for headphone. Excellent as selective voltmeter.

Circle #225

Type HFH

Direct reading of field intensity values without correction. Measuring range 0 to 120 db referred to $1\mu\text{V/m}$ (full deflection). Accuracy $\pm 1.5\text{ db}$. Linear range (20 db) and two logarithmic ranges (40/60 db). Built-in 500 kHz crystal for frequency calibration. Frequency control by external synthesizer possible. IF bandwidth switchable: $\pm 100\text{ Hz}$, $\pm 500\text{ Hz}$, $\pm 4\text{ kHz}$. Operated from line or 12 V battery. Range can be extended down to 10 kHz by Type HFHL.

Circle #226

Type HFU

Consists of VHF/UHF measuring receiver Type ESU, and two wideband antennas. Three interchangeable plug-in sections cover frequency range. Measuring range 0 to 120 db referred to $1\mu\text{V/m}$ (full deflection). Accuracy $\pm 3\text{ db}$. Linear (20 db) and logarithmic (40 db) ranges. Indication of RMS and peak value. AM and FM demodulation. Operates from line or 12 V battery. Can be used as measuring receiver, selective voltmeter, or as complete transmission test set using built-in synchronous generator.

Circle #227

Type HFA

Consisting of measuring receiver Type USVU, parabolic antenna Type HA 262, and UHF bandpass Type PBA. Measuring range $50\mu\text{V/m}$ to 0.5 V/m , lower value at 7 db signal/noise. Accuracy $\pm 3\text{ db}$ without bandpass, $\pm 4\text{ db}$ with bandpass, $\pm 1\text{ db}$ for relative measurements. AFC. AM-detection. IF- and recorder outputs. Diameter of parabolic antenna is 900 mm.

Circle #228



ROHDE & SCHWARZ

ELECTRONIC MEASURING EQUIPMENT FOR THE UNCOMPROMISING

Inquiries from outside the U.S.A. should be directed to: Rohde & Schwarz, Muehldorfstrasse 15, 8 Munchen 8, West Germany.

111 Lexington Avenue
Passaic, New Jersey
201-773-8010

HOW TO FIT 100 TRANSISTORS IN A SPACE FOR ONLY 50

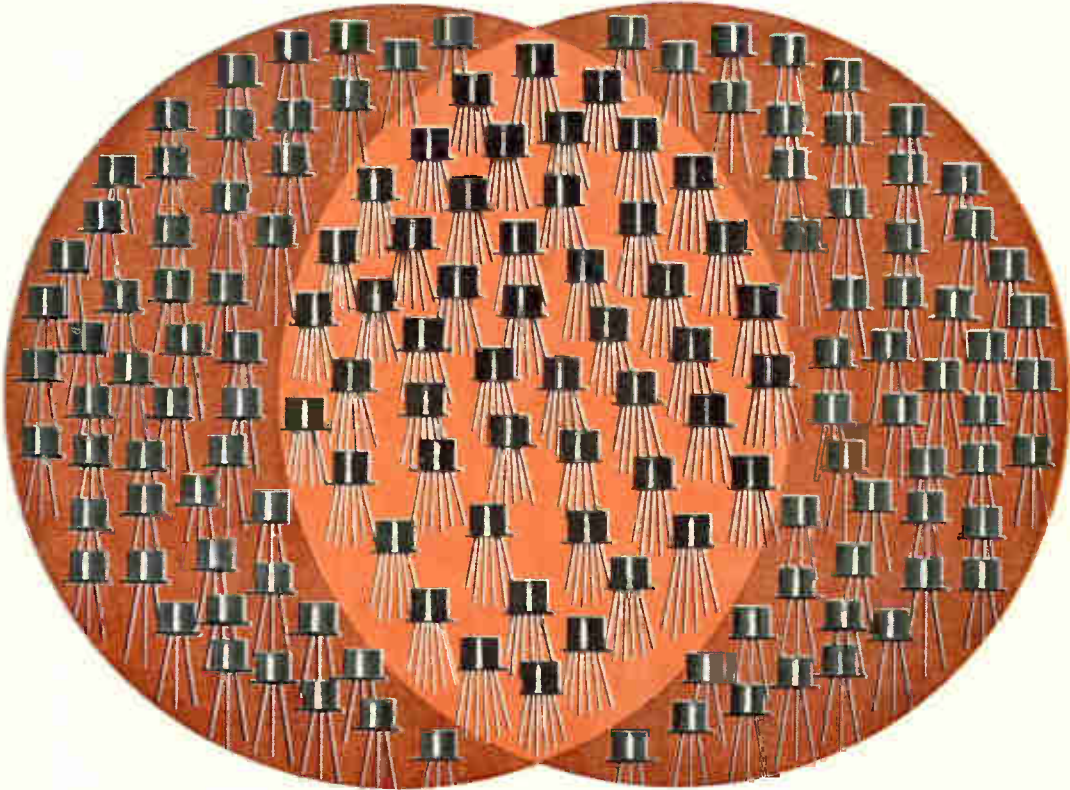

... Use Motorola Transistor TWINS!*

How many transistors are shown in the light area above? Fifty, you say? Look again. Notice that each transistor has six leads. Each is a Motorola multiple device with *two* transistors in each can . . . your answer to designs requiring maximum use of available space.

In each unit there are matching PNP or NPN transistors (or one of each) in a common environment to permit better parameter uniformity during wide temperature changes.

Virtually *any* combination of high-speed high-voltage transistors can be obtained in these two-in-one Motorola transistor "twins" . . . including differential amplifiers, complementary pairs, dual transistors, and Darlington amplifiers!

Immediate delivery can be made on all standard types. For Darlington amplifiers, which are supplied as "specials" only and are tailored to your specific requirements, consult your nearest Motorola representative. For data sheets, write to: Department TIC, Box 955, Phoenix, Arizona 85001.

*Trademark of Motorola Inc.

NOW AVAILABLE IN . . .

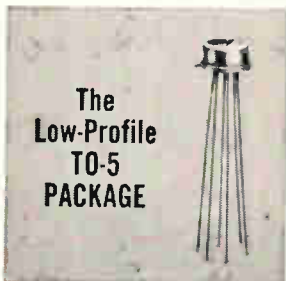

Try These

PNP SILICON EPITAXIAL DUAL TRANSISTORS

2N3800, 06 AND 2N3801, 07 — SIMILAR TO 2N3798 AND 2N3799 RESPECTIVELY Featuring V_{CE0} of 90V typ, h_{FE} specified from 10 μ A to 10mA, and NF of 0.8 db typ @ 1 KC and $I_C = 100 \mu$ A for low-level, low-noise applications.

NPN SILICON EPITAXIAL DUAL TRANSISTORS

MD1134 — SIMILAR TO 2N2369 Featuring f_T of 500 mc min, C_{00} and C_{10} of 4 pf, $V_{CE(sat)}$ of 0.25Vdc max @ $I_C = 10$ mA for high-speed, low-current switching.

PNP SILICON EPITAXIAL DIFFERENTIAL AMPLIFIERS

2N3802, 04, 06, 08, 10 AND 2N3803, 05, 07, 09, 11 — SIMILAR TO 2N3798 AND 2N3799 RESPECTIVELY Featuring $V_{BE1} - V_{BE2}$ as close as 5 mV max from $I_C = 10 \mu$ A to 10 mA, V_{CE0} of 90V typ, h_{FE} specified from 10 μ A to 10 mA, and NF of 0.8 db typ @ 1 KC and $I_C = 100 \mu$ A for low-level, low noise applications.

NPN SILICON EPITAXIAL DIFFERENTIAL AMPLIFIERS

MD1132 — SIMILAR TO 2N918 Featuring $V_{BE1} - V_{BE2}$ of 5m Vdc Δ ($V_{BE1} - V_{BE2}$) of 1.8 mV from -55 to $+125^\circ\text{C}$, h_{FE} match of 10%, and f_T of 600mc min for differential amplifier and other applications.

2N3409-11 AND MD1120-22 — SIMILAR TO 2N2218 Featuring an all aluminum bonding system, max $V_{BE1} - V_{BE2}$ as low as 5mVdc, current gain specified at four current levels, h_{FE} matched as close as 10% for differential amplifier and other applications.

NPN-PNP SILICON EPITAXIAL COMPLEMENTARY PAIRS

MD985-86 — SIMILAR TO 2N2218, 2N2904 & 2N834, 2N3250 RESPECTIVELY Featuring Monometallic construction, Beta specified at four current levels for high-speed logic, DC to UHF amplifiers.



MOTOROLA
Semiconductors

281-4

Announcing PMI's **NEW** **U SERIES** **PRINTED MOTORS**



Now at 50% lower cost!

Two years of engineering research and development now enable Printed Motors, Inc. to offer design engineers the new U SERIES — at less than half the cost of printed circuit armature motors previously available.

Models in the new U SERIES are priced as low as under \$40.00 in quantity — and give you every unique advantage of printed motors' superior electrical performance and reliable mechanical characteristics.

Practically, nothing is changed but the price. This means that the U SERIES brings printed motors within the reach of every manufacturer who needs the exceptional speed of response, smooth torque with no cogging, and the wide speed range these motors provide.

Four models in the new U SERIES are available. Possible applications include: tape capstans, reel drives, line printers, business machines, process controls, machine tools, packaging machinery, emulsion coating drives and printing equipment.

To find out how this printed motor advance can help solve your design problems, write or phone: Printed Motors, Inc., 33 Sea Cliff Avenue, Glen Cove, New York. Telephone: 516 OR 6-8000.



PRINTED MOTORS, INC.

GLEN COVE, NEW YORK

Engineering, Manufacturing and Sales by:

Photocircuits CORPORATION

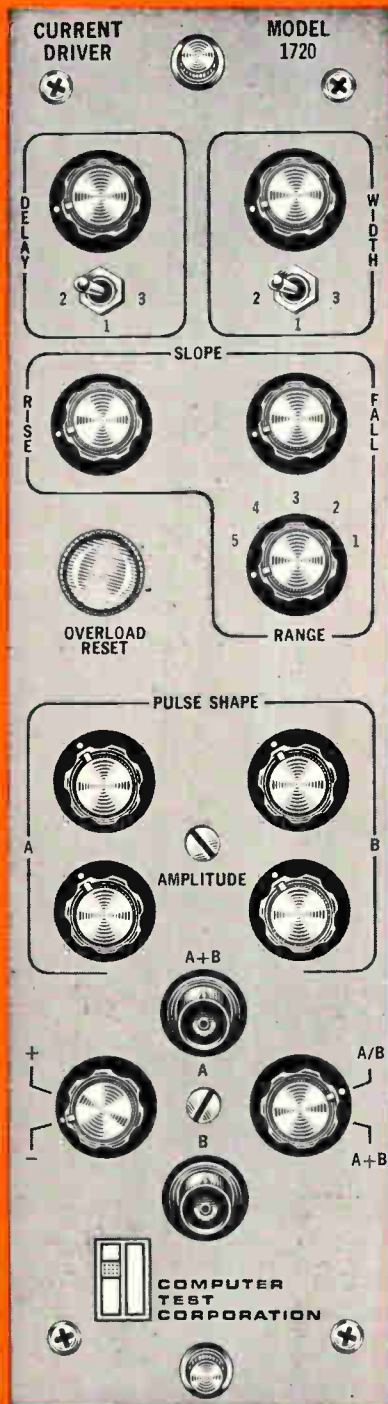

FAST, LINEAR RISE & FALL/independently variable from a comfortable 10ns to 500ns. Linearity $\pm 5\%$ at 10ns, worst case.

TWO OUTPUTS/provide precisely coincident current waves up to 600ma each output, or full ampere from single output.

LOW, LOW OUTPUT CAPACITANCE/15pf worst case each output, 5pf typical makes driving inductive loads a snap.

BI-POLAR OUTPUT/provides either positive or negative pulses (mirror images) dc referenced to ground.

HIGH VOLTAGE OUTPUT/develops 60V in direction of drive; withstands 60V in opposite direction.

SQUARE CORNERS/5% maximum deviation, all four corners of the waveform.

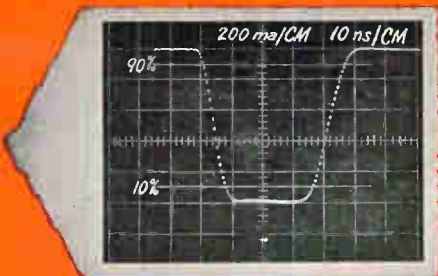

THIS NEW 10ns CURRENT DRIVER JUST MOVED THE MEMORY TEST FIELD AHEAD TWO YEARS

COMPUTER TEST CORPORATION
CHERRY HILL, N.J.



Your best choice is a Tektronix oscilloscope

Here's why

PERFORMANCE: Oscilloscopes and related accessory instruments are our sole product and, as a result, we have devoted every effort to bring you instruments capable of meeting practically any demand.

Whatever your oscilloscope application requirement, there is a Tektronix Oscilloscope to do the job—accurately and dependably.

Models range from a light-weight portable that operates from its own rechargeable internal batteries or from practically any common ac or dc source, to a semi-automated integrated circuit tester custom-built to meet individual needs.

You can choose from a selection of over 50 oscilloscopes. With some models you get additional adaptability of plug-in type vertical and horizontal amplifiers, thus enabling you to economically extend your oscilloscope's ability to meet new demands.

But whichever Tektronix instrument you choose, you can be certain it will perform as well—or better—than the specifications stated.



QUALITY: Modern science and industry require instruments capable of providing precise and reliable displays of changing phenomena. Tektronix Oscilloscopes meet this exacting demand by design—backed up by stringent quality control at every phase of manufacture.

Look inside a Tektronix Oscilloscope and note the clean layout and careful workmanship. The emphasis on quality appears in every component from the smallest bolt to the most complex switch.

When commercially available components do not meet our rigid specifications, or when components unique to a Tektronix instrument are needed, we manufacture our own. One good example is the split-screen storage crt—with independent storage and erase of upper and lower half of the screen.

Other special components include transformers, ceramic terminal strips and etched circuits—in addition to precision potentiometers, capacitors, inductors and solid-state devices.

Designed for reliability and efficiency, these Tektronix-manufactured components incorporate the highest standards of craftsmanship in meeting the special needs of particular instruments.

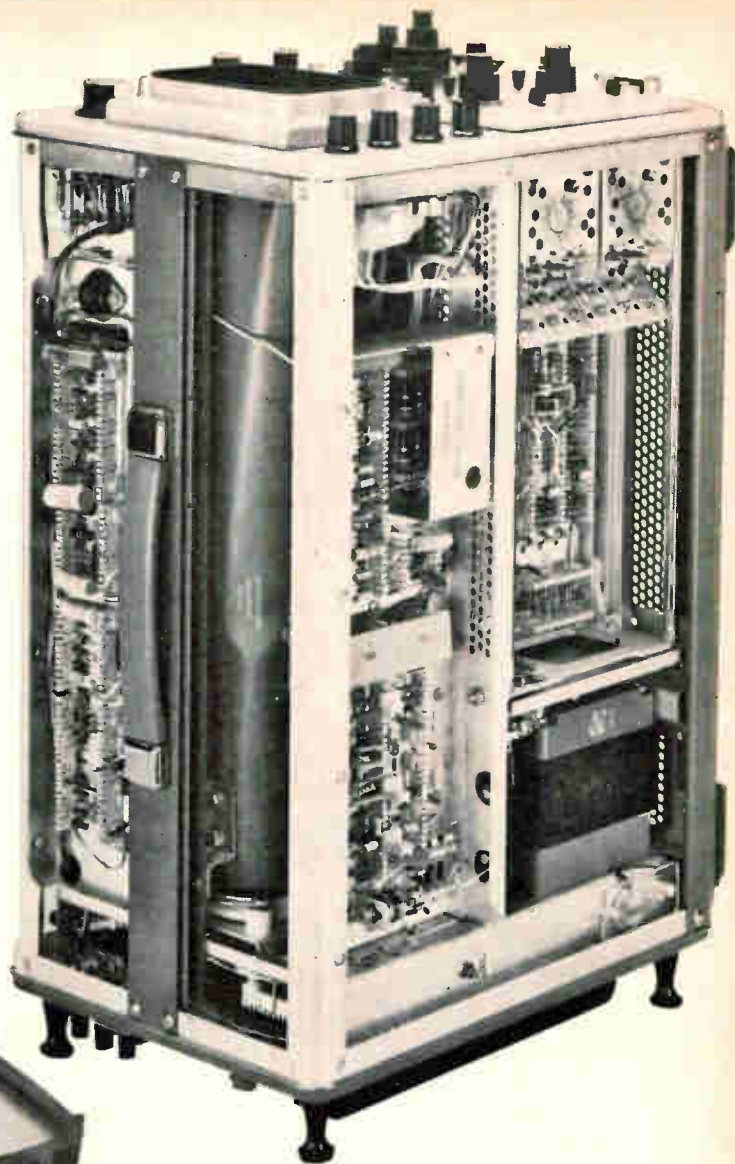

SERVICE: You can depend upon your Tektronix field engineer or representative to help you with any problem involving oscilloscopes. He is as near as your telephone and offers you comprehensive instrument-support services before, during, and after delivery of your Tektronix equipment.

Call him

- ... for guidance in selecting the proper instrument for a specific job.
- ... for instruction in instrument operation and in preventive-maintenance procedures.
- ... for demonstration on use of oscilloscopes and associated instrumentation.
- ... for counsel in relating the oscilloscope to specific problems or goals.

Tektronix, Inc.

P. O. BOX 500 • BEAVERTON, OREGON 97005
TEKTRONIX FIELD OFFICES in principal cities
in United States. Consult Telephone Directory.
OVERSEAS DISTRIBUTORS IN 30 COUNTRIES

**Last week,
you needed
a
switchlite.**



**Today,
you need a
pushbutton
switch.**



**Tomorrow, a
subminiature
toggle
switch.**



**Next Tuesday, a
hermetically-
sealed
switch.**



Good thing Control Switch is around to help.

We're unique among switch suppliers. No other manufacturer makes all the kinds of switches we make. And some don't make any of them.

When we're around to help, you can have your choice of:

- 3,150 toggle switches
- 4,200 pushbutton switches
- 1,240 hermetically-sealed switches
- 1,800 lighted pushbutton panel switches
- 460 basic precision switches
- 1,180 indicator lights.

... plus countless more standard variations.

These are quality switches and switchlites ... for computers, aircraft, missiles, controls, industrial and electrical equipment where performance standards demand the ultimate in reliability.

Keep your Control Switch distributor ... or us ... in mind. Today. Tomorrow. Next Tuesday.



**CONTROLS
COMPANY**
OF AMERICA
CONTROL SWITCH DIVISION
1420 Delmar Drive, Folcroft, Pennsylvania 19032

Get a record you can clearly read — even at 5 KC

...from the one system supplied complete with your choice of amplifier

Now you can have all the Sanborn advantages of a DC-5 KC optical oscillograph supplied as a complete, integrated package ready to record — plus clearer, higher resolution recordings made possible by improvements in optical system design and chart paper. Put eight traces on the 8" ultra-violet-sensitive chart of a standard "4500" system — with any trace across the full chart width and positioned by convenient front-panel controls. Or record up to 25 channels of high frequency information with optional versions. Save valuable time by recording all frequencies up to 5 kc with a single set of galvanometers driven by amplifiers incorporating frequency boost and compensating circuits, thus eliminating an "inventory" of different galvanometers and the time required to install and align a new set for each recording requirement. Make signal connections quickly and conveniently to front-panel or rear input connectors, and have complete operational control with amplifier front panel basic controls for each signal. Change system sensitivity from 2.5 mv/inch to 625 mv/inch by easily changing plug-in 8-channel amplifier modules (choice of four). Load paper in daylight . . . select any of 9 chart speeds by pushbutton or control them remotely . . . see fully developed traces a few seconds after recording . . . use system in mobile console, rack mount or portable cases.

Ask your local Sanborn Division/Hewlett-Packard sales office for technical data and expert application assistance. Offices in 47 U.S. and Canadian cities, and major areas overseas. Sanborn Division, Hewlett-Packard Company, Waltham, Mass.

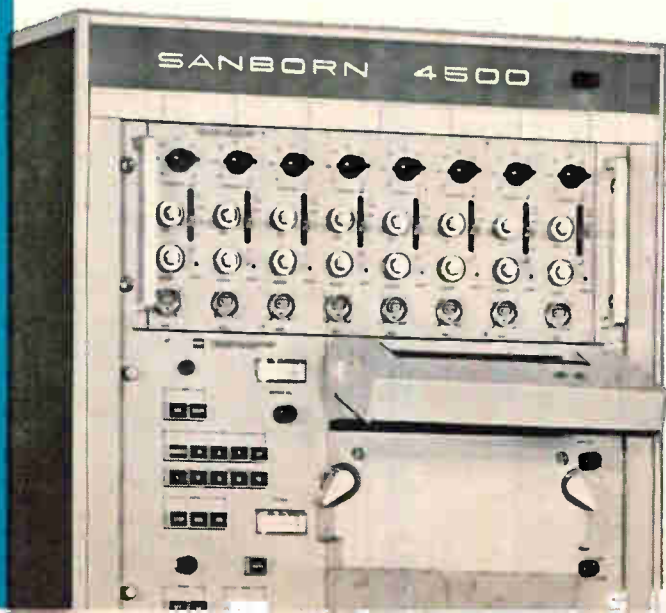
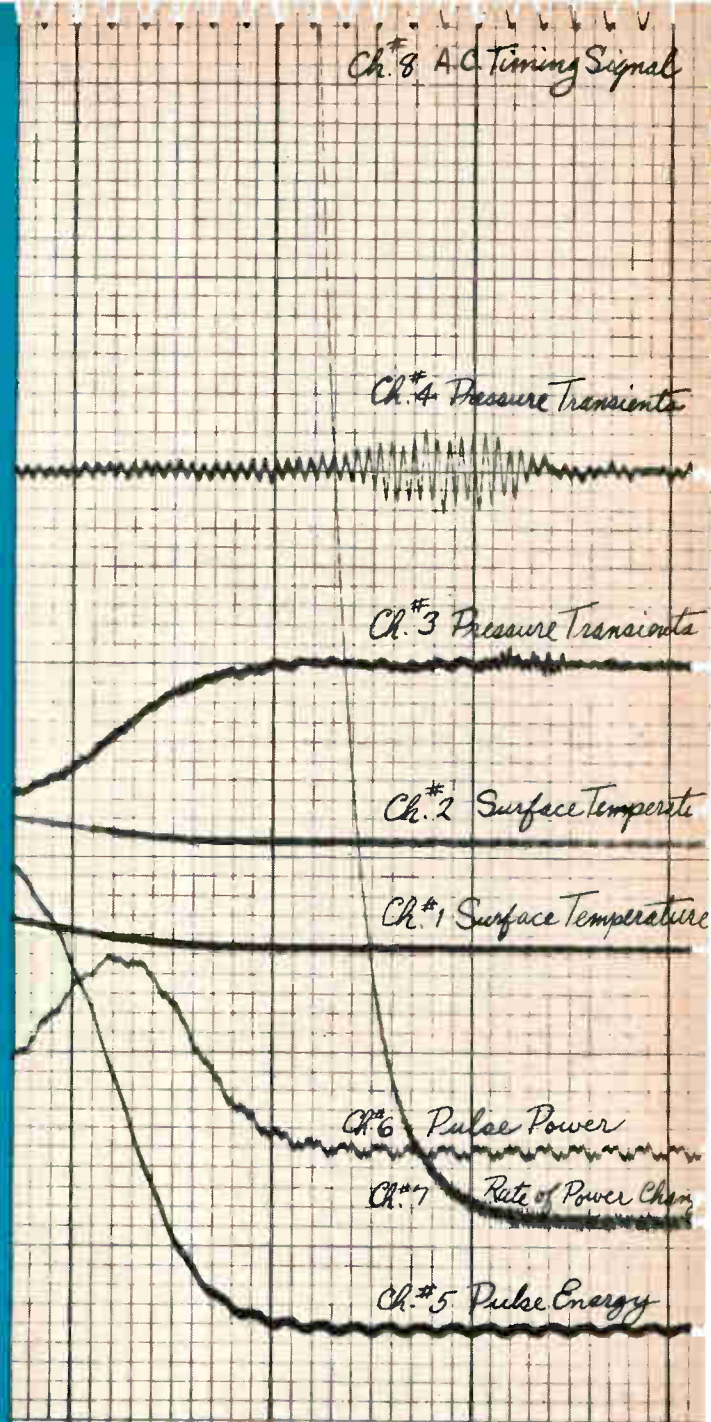

Specifications — 4500 Series Optical Oscillographs

Sensitivity	625 mv/1", 50 mv/1", or 2.5 mv/1", depending on amplifier chosen.
Frequency Response	DC to 5 KC (-3db) at 4" p-p
Common Mode Performance	Rejec. ratio at least 140 db at DC, max. c.m. voltage ± 500 v (with Medium Gain Amplifier)
Linearity	1½ % of full scale (8 inches)
Gain Stability	Better than 1%, 0° to 50°C, 103 to 127 (line) volts
Noise	0.02" p-p, max.
Chart Speeds	Nine, 0.25 to 100"/sec.
Prices	Complete 8-channel system in cabinet, with galvanometer driver amplifiers, \$6950; with medium gain amplifiers, \$8530 (F.O.B. Waltham, Mass.)

**HEWLETT
PACKARD**  **SANBORN
DIVISION**

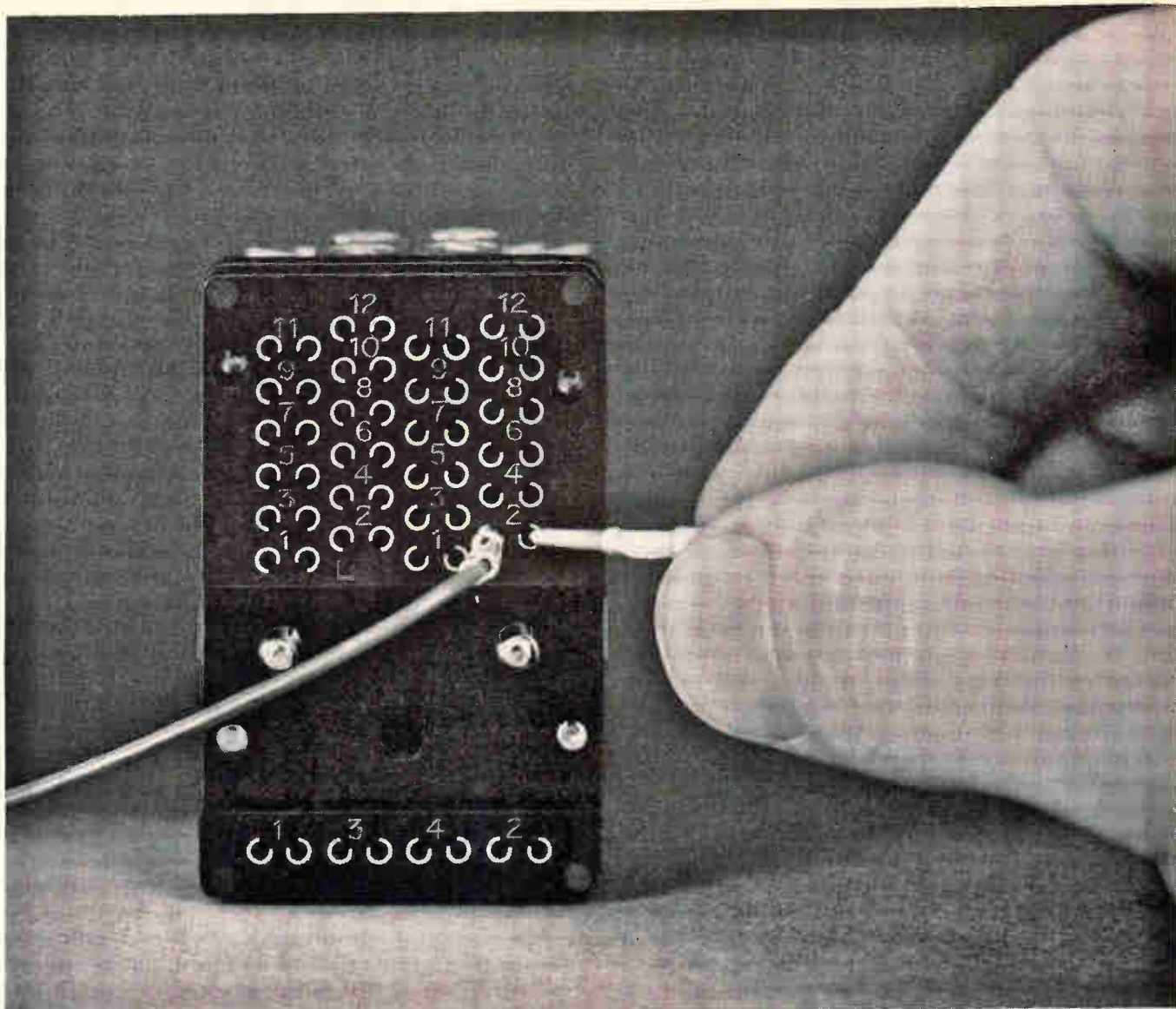

Now you can quick-connect two wires to each socket terminal of the Class E relay

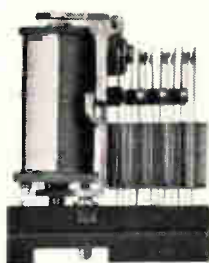

Here's new design flexibility—more than you've ever seen in plug-in Class E relays. The bottom view of our new ETP terminal* shows why.

For each terminal, the mating socket provides *two* taper pin receptacles. This is an AE exclusive, and it can *double* circuit capability: two wires on each contact terminal!

Connecting these wires is quick and easy. Just insert a taper pin—and get a connection that's even more secure than with conventional terminals.

And every time you make a circuit change, the connection is as good as the first one.

You can prewire the mating socket and later insert a standard Class E taper-tab relay. Add a plastic snap-on dust cover, and you've got a complete Series ETP assembly.

Sound interesting? Get some helpful details. Write for AE's Product News on the ETP socket.

Widest Mounting Choice

Besides this new ETP (taper pin) and the EIN (integral socket) versions, Class E relays are available with conventional solder, taper tabs, or wrapped-wire terminals, or pins for plug mounting. This is the widest selection of Class E relay connections in the industry—another good reason to check Automatic Electric for *all* your relay needs. Write the Director, Relay Control Equipment Sales, Automatic Electric, Northlake, Illinois 60164. *Patent applied for

AUTOMATIC ELECTRIC
SUBSIDIARY OF
GENERAL TELEPHONE & ELECTRONICS GTE

EXACTLY \$1950 AND 00 CTS

Fastest writing speed! More than 1,000,000 inches per second. ■ Extra long storage time! Retains stored traces until intentionally erased. ■ Higher brightness! 20 foot-lamberts—3-10 times brighter than others. ■ Guaranteed reliability! 1 year warranty on storage tube. ■ "Human-factored" controls! Color-coded, functionally grouped for easy, accurate operation. ■ Broad versatility! Conventional or storage operation. Plug-in preamps (\$150-\$300) expand utilization. ■ Wire, write or call today for complete data on the new Hughes MEMO-SCOPE® oscilloscope (Model 110): HUGHES INSTRUMENTS, 2020 Oceanside Blvd., Oceanside, Calif. 92057. For export information, contact: Hughes International, Culver City, Calif. 90232.

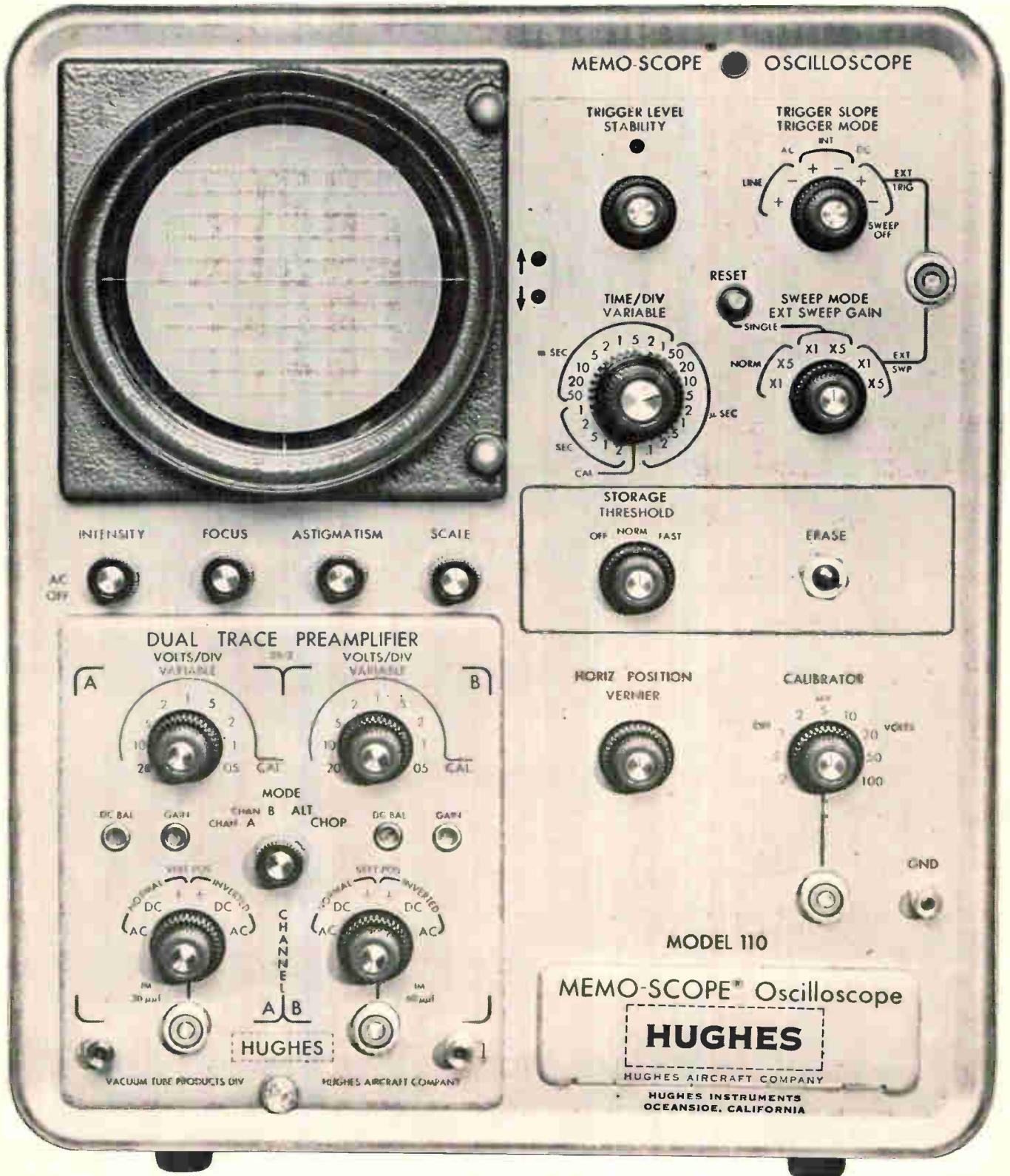

TWO GREAT NEW CHAMPS



NEW COAX

Recording 1.5 mc on as many as fourteen tracks, Mincom's new Portable Coaxial Recorder offers the industry's highest performance per cubic foot. Stands under two feet high. 14-inch NAB precision reels. $1\frac{7}{8}$ to 120 ips. Two playback channels. RFI-shielded, this new system is unequalled for van, shipboard and similar installations.

NEW PCM

Digital data in an improved parallel format at 120,000 bits per second per track — that's the story of Mincom's newest solid-state system. Sixteen channels for NRZ digital input, clock, timing and voice. Seven push-button speeds from $1\frac{7}{8}$ to 120 ips. Controls and adjustments front-accessible for CRT display and digital electronics.

Mincom Division **3M**
COMPANY

300 South Lewis Road, Camarillo, California

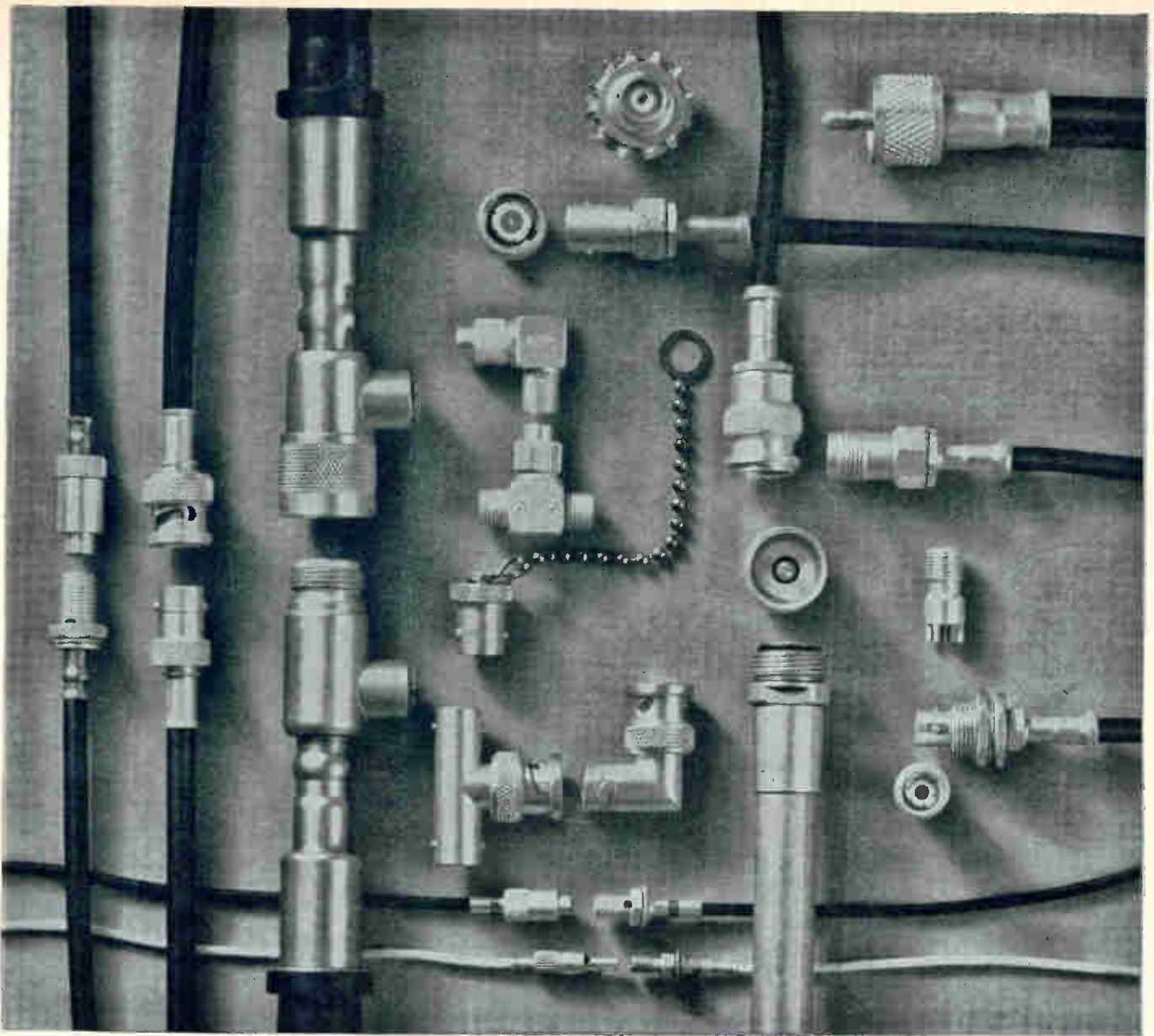

Meet the RF matchmakers

The A-MP★ COAXICON★ product line of coaxial connectors are RF matchmakers from the word "go." Why? Well, in case you haven't heard, there's a new specification—MIL-C-39012—which spells out the performance requirements for RF connectors. And our COAXICON Connectors have been designed, tested and modified to match this specification in every sense of the word. COAXICON Connectors have already exceeded the requirements of MIL-C-23329.

Why not? After all, one-crimp-terminated COAXICON Connectors are a product and design of their time. Their advanced design features provide high mechanical reliability. Take the special cable grip and support for example, or positive crimping of the center conductor, or really "anchoring" the braid so that values of 85 pounds are the norm for RG 58/U cable.

But more than merely meeting a design specification, these RF COAXICON Connectors meet *performance* specifications. They were "improved" at a time when MIL-C-23329 and MIL-C-39012 were being introduced and implemented by the military.

All A-MP COAXICON Connectors are applied with matching application tools that provide solderless, one-crimp termination of inner conductor, outer braid and cable support—*simultaneously*. This special technique assures you reliable, uniform terminations at lowest applied cost. And, the *complete* COAXICON Connector family includes threaded, miniature and subminiature, BNC and TNC Series, and UHF Connectors for every cable size, in addition to a full line of adaptors—right angle, "T" and feed-through—to match almost any panel installation. Try matching AMP's COAXICON Connectors spec for spec with other RF connectors on the market. Write today for complete information.

★Trademark of AMP INCORPORATED



A-MP★ products and engineering assistance are available through subsidiary companies in: Australia • Canada • England • France • Holland • Italy • Japan • Mexico • West Germany

IR EPITAXIAL CONTROLLED RECTIFIERS

PREMIUM PARAMETERS AT STANDARD PRICES

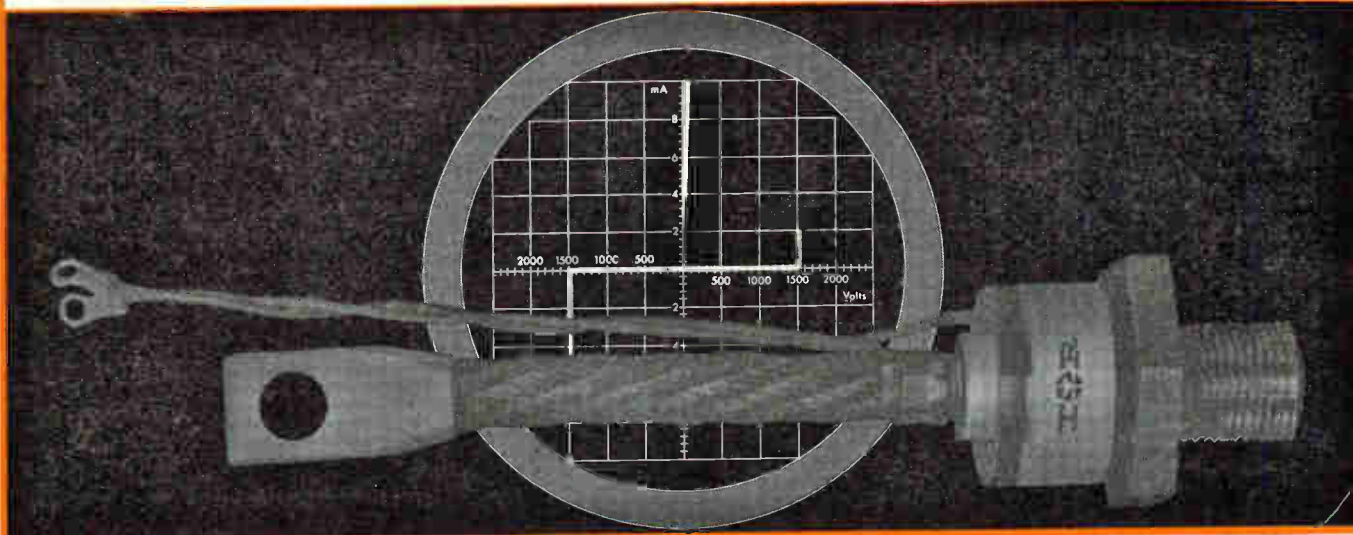

These Premium Parameters Now Available in Production Quantities in 35, 70, 100 and 150 Ampere Ratings through 1300 Volts

1. HIGHEST VOLTAGES The only complete line up to 1300 volts rated (1400 volts transient). Available with extremely high dV/dt (1000 ψ/μ sec.), short turn-off time, or 150°C. capability. Typical leakage currents: For the 70 ampere device, less than 100 microamperes at 25°C.

2. HIGHEST di/dt Repetitive turn-on tests to 300 amperes show rate of rise capability in excess of 1000 amperes per microsecond.

3. HIGHEST TRANSIENT ABSORPTION CAPABILITY No transient protection required when used within power ratings. Effective clamping by bulk avalanche characteristics.

4. UNLIMITED FORWARD BREAKOVER RELIABILITY IR's SCR's when subjected to any magnitude of transient forward voltage will turn on without any deterioration.

5. SHORTEST TURN-ON TIME Turn-on time is less than 2.0 microseconds to 100 ampere level.

6. HIGHEST TEMPERATURE CAPABILITY Operation at 150°C. without voltage derating. Devices also available with short turn-off time and dV/dt with voltage ratings through 1300 volts, at 150°C. Other characteristics: dV/dt , gate firing, holding current and turn-off are not sensitive to extreme temperature.

7. POSITIVE TEMPERATURE COEFFICIENT Both forward and reverse breakover voltages increase with increasing temperature, providing increased safety at higher temperatures.

New areas of application are virtually unlimited with IR's unmatched combination of epitaxial SCR parameters. For further information and application assistance, contact your local International Rectifier sales office or write to 233 Kansas Street, El Segundo, California.

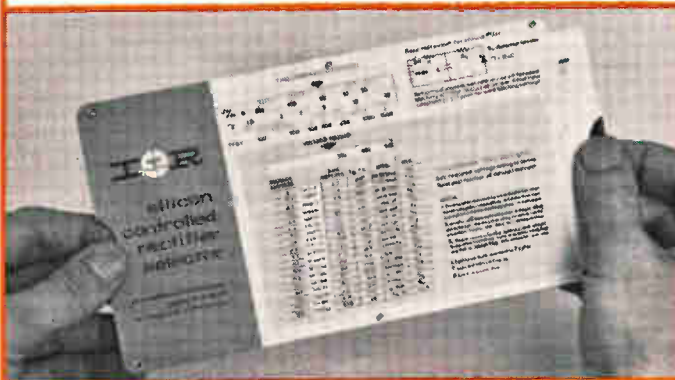

NEW TIME-SAVING SCR CALCULATOR NOW AVAILABLE FROM INTERNATIONAL RECTIFIER

This SCR Calculator provides a convenient compilation of common rectifier circuit design constants, and is a reference tool to help you determine quickly...

... what and how many controlled rectifiers are needed in a given piece of rectifier equipment.

... the dV/dt imposed by an R-C circuit on an SCR.

... the range of phase shift a gate triggering circuit should have for a given amount of voltage control in common rectifier circuits when feeding both resistive and inductive loads.

Price: \$1.00 postpaid

Send check or money order to International Rectifier Corporation, 233 Kansas Street, El Segundo, California.

WORLD'S LARGEST RECTIFIER SPECIALISTS



INTERNATIONAL RECTIFIER

INTERNATIONAL RECTIFIER CORP., EL SEGUNDO, CALIF., PHONE OR 8-6281 • CABLE RECTUSA • REGIONAL OFFICES IN NEW YORK CITY, CH 4-0748 • FORT LEE, N. J., WI 7-3311 • SYRACUSE, N. Y. HE 7-8495 • CAMBRIDGE, MASS., UN 4-6520 • ARDMORE, PA., MI 9-3667, GR 3-3932 • SILVER SPRING, MD., JU 9-3305 • MIAMI, FLA., 445-5201 • CHICAGO, ILL., OR 6-4090 • CLEVELAND, OHIO, 734-4100 • DAYTON, OHIO, 223-7691 • HUNTINGTON WOODS, MICH., LI 8-1144 • ST. LOUIS, MO., TE 8-6333 • MINNEAPOLIS, MINN., 920-1200 • RICHARDSON, TEX., AD 1-2504 • LOS ANGELES, CALIF., 750-0550 • IN CANADA: TORONTO, ONT., 421-5970 • MONTREAL, QUE., 861-0562

EUROPEAN GENERAL SALES OFFICE: 38 AVENUE DES ARTS, BRUSSELS 4, BELGIUM • TELEPHONE: 111774

Washington Newsletter

April 5, 1965

Civil Service bars Capehart workers

The question of whether government personnel or private employees should perform certain services for the military [Electronics, March 22, p. 63] was partially answered last month by an unexpected source—the Civil Service Commission.

At the request of the General Accounting Office (see page 124), the commission's general counsel looked into the hiring of 104 technicians by the Capehart Corp., Richmond Hill, N. Y., to work on design and installation of electronics and communications facilities at Fuchu Air Base, Japan. The commission's conclusion: the arrangement—"and all others like it"—violates the Civil Service Act. The ruling turned on a finding that there was no distinction between work done by Capehart employees and federal personnel, and that Capehart technicians are supervised by a federal official who has final say over hiring and firing.

The ruling is binding on the Pentagon. Therefore, all service contracts are now being reviewed to find out which ones must be revised or canceled. Some, at least, will simply be modified to avoid situations where the government has an employer relationship with contractor personnel.

But that won't end the matter. A high-level Pentagon group, which is studying the propriety and economics of using contractor employees in lieu of government personnel, will report to Defense Secretary Robert S. McNamara this month. Defense companies fear a substantial cutback.

House panel cuts R&D budget

The House Armed Services Committee is following through on its threat to "get tough" with McNamara. Already embroiled with the defense chief over military pay and the status of the reserves, the committee has now sharply cut the new spending authority McNamara wants for research and development in the coming fiscal year.

The reduction amounts to half a billion dollars, or about 7.6% of the \$6.6 billion McNamara had asked. It applies to the military authorization bill, which sets a ceiling on actual spending to be voted on later. The House nearly always supports the committee's decisions.

Committee sources indicate privately that the cut was made to remind McNamara that the House controls the pursestrings. The Senate probably will restore much of the slash, however, and the House in the end is likely to go along. McNamara had called his request "austere."

The committee also reduced proposed new spending authority for procurement of aircraft and missile, but only by \$150 million, or about 2%. But it demonstrated its independence in another way by increasing authority for ships by about the same amount. The increase would authorize construction of a new nuclear-powered guided missile frigate, which McNamara hadn't requested.

Pentagon urges stiffer patent rule

A clash between the Pentagon and defense contractors is building up over proposed regulations on reporting of patents. Under pressure from the General Accounting Office, the Defense Department has drawn up a draft of regulations that would increase financial penalties on contractors for failure to report inventions within the required time.

The Pentagon also proposes stretching that period somewhat. Present rules require that a company report an invention to the government

Washington Newsletter

within four months and provide for temporarily withholding 10% of the contract price until the contractor submits the required information. The proposal being circulated to industry for comment extends the reporting time to six months and reduces the withholding to 5%.

More avionics for the Army

The Army's long-range requirements for avionics equipment seem sure to rise. The extent of these increases will be determined in major decisions now shaping up in the Pentagon.

McNamara is expected to allow the Army to establish an air-mobile division, equipped with helicopters, within its present 16-division structure. The Joint Chiefs of Staff—with the Air Force dissenting—is understood to have recommended the move.

McNamara also has ordered a new study of the Army's over-all aviation requirements. The Army has authorization to build toward a total of 8,000 planes by mid-1966, compared with 5,500 in 1961. McNamara wants to determine, on a long-range basis, how far the Army should be allowed to go in procuring aircraft.

McNamara is allowing the Army to begin project definition for a new armed helicopter to be known as an advanced aerial fire-support system. The copter will have an advanced integrated avionics system. Harold Brown, director of defense research and engineering, has told Congress that the improved avionics package will be pushed to full development even if the aircraft is not.

Seek central file on performance

The House Government Operations Committee is pressuring the Pentagon to establish a centralized file containing performance records on every concern doing business with the military. The idea is to enable procurement officers to check the past performance and integrity of contractors before giving them new work.

The Pentagon already has a centralized data bank containing performance records of contractors engaged in advanced development and engineering work. It is studying the feasibility of extending this system to cover contractors engaged in production and supply activities.

The committee also wants the Defense Department to require that bidders certify the accuracy of information they provide on their capabilities and financial responsibility before a contract award. False certification would lead to criminal prosecution.

In addition, the committee suggests that the procurement officials check the past performance and integrity of affiliates which are to perform a substantial part of work awarded to a contractor.

Problems hinder Autec's array

Problems with water and equipment are plaguing efforts to install a unique oceanographic electronic array in mile-deep water at the Navy's \$130 million Atlantic Underwater Test and Evaluation Center (Autec) in the Bahamas.

The latest trouble came last week when two temperature sensors failed as the array was being installed. The next attempt was to be on April 2.

The project chief says, "The delays are beginning to threaten the September, 1966, target date" for getting the range in operation.

This is the array's second failure. The first came last summer, 23 days after the Bunker-Ramo Corp., made the first installation.

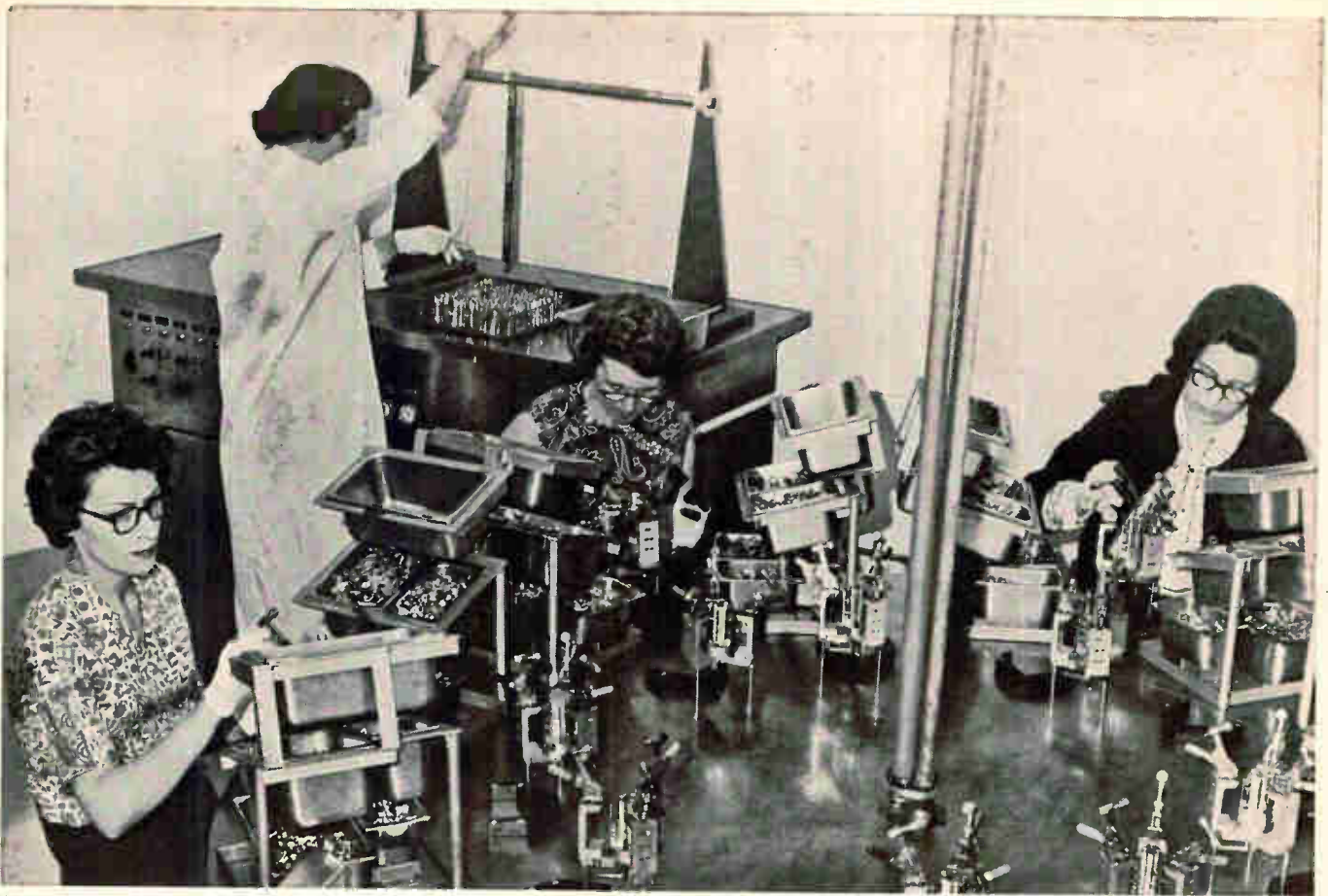

Because FREON solvents are nonflammable, relatively nontoxic and free from irritating odors, The Rauland Corp. can safely locate its cleaning equipment directly at the end of its assembly line for maximum efficiency.

Rauland "super-cleans" color-TV picture-tube subassemblies with Baron Blakeslee ultrasonics and FREON® TF

Cleaning of color-TV-tube gun subassemblies is a critical operation because of the extremely high voltages to which they will be subjected. Any particulate matter not removed could cause arcing and a blown tube... any leftover lubricants would seri-

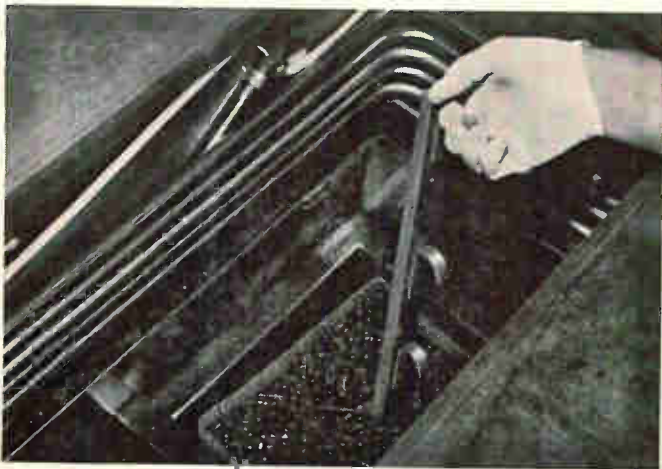

This combination cleaning system was engineered specifically for The Rauland Corporation by Baron Blakeslee, Inc., Chicago, Illinois. It is just another example of the complete cleaning-system engineering you can expect from your representative for Du Pont FREON.

ously affect the rise time and service life of the tube. For this critical cleaning operation, The Rauland Corporation, Chicago—a subsidiary of Zenith Radio Corporation—uses FREON TF and Baron Blakeslee ultrasonic equipment.

Now, cleaning of the subassemblies is a quick, simple, low-cost operation... thanks to a cleaning system engineered and installed by Baron Blakeslee, an authorized FREON solvent sales agent. This cleaning system uses FREON TF. The combined action of extremely low surface tension and high density enables FREON TF to penetrate minute crevices and effectively release and float away soils... even particulate matter. This results in complete, residue-free cleaning.

If you would like to investigate the many ways you can use FREON solvents in your cleaning operations, write Du Pont Company, "Freon" Products Div., Room 2637-A, Wilmington, Del. 19898.



Better Things for Better Living
... through Chemistry



AND ALL THIS TIME

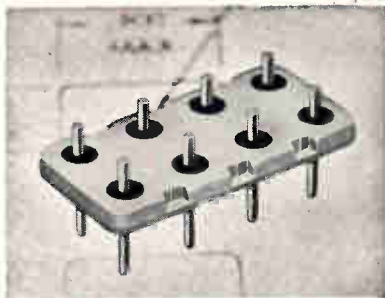

Care¹—Completely new design

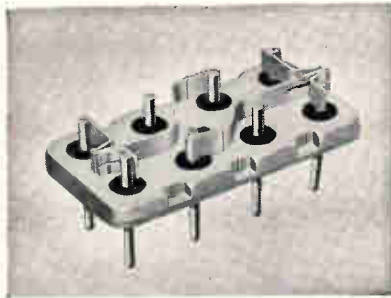

Care²—Bifurcated contacts

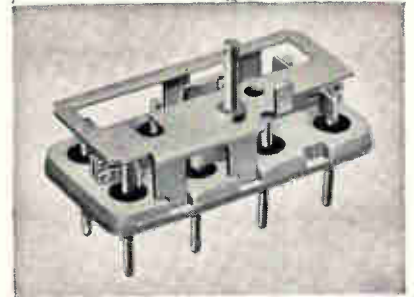

Care³—Shock resistant motor mount



Care⁴—Teflon insulated coil

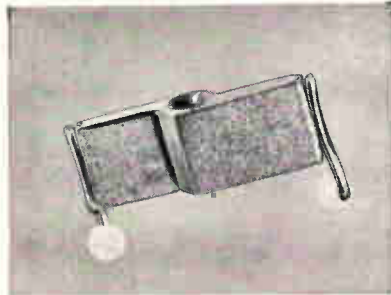

Care⁵—Balanced armature

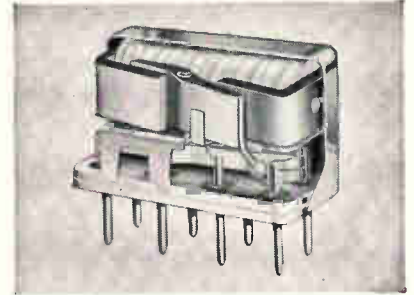

Care⁶—Rigid integral construction



Care⁷—Electron beam welded



Care^{...N}—Reliability control

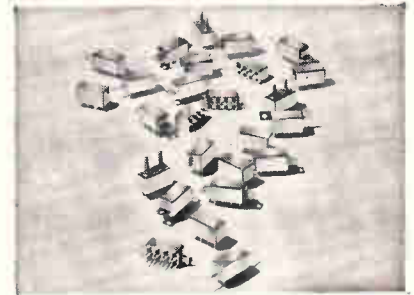

Care to relieve us of some?

LEACH

CORPORATION

RELAY DIVISION

5915 Avalon Blvd., Los Angeles 3, Calif.
Export: LEACH INTERNATIONAL S. A.

YOU THOUGHT WE DIDN'T CARE!

You kept saying you wanted true subminiature relays for difficult aerospace and printed circuit applications. You bugged us about environment, packaging density, contamination, and like that. And then you said, the problem really revolves more around reliability than mere size and weight. A really new solution, you said, don't just put old reliable in the shrink tank.

OK—so we did some soul searching. We figured if we could come up with real lilliputs that come on like standards, we'd still be your one and only.

I know—we've seen those scaled down kluges with the fine print specs. None of that for us. We started from scratch—Complete new design to assure highest technological development; Electron beam welding to eliminate solder flux contamination; "Balanced armature" design to deliver positive force to drive moving contacts; Bifurcated contacts to increase contact pressure and reduce contact bounce and resistance. We went all the way. We even made some. They worked pretty good. Now we're making them like there's no tomorrow—honest; dry circuit through 10 amps!

We use a remarkably sophisticated electron beam welder to seal the header to the can. This makes it impossible to introduce organic contaminants—like solder flux. But, we also weld the contacts and motor assembly right to the header so we don't have any internal wiring. No wires—no problems, we always say. Besides, it's stronger. Resists shock and vibration like you wouldn't believe (oh yeah? just look at those specs). Teflon we use to prevent outgassing—no kidding.

How does 100,000 cycles continuous duty at rated resistive load strike you? —65°C to +125°C temperature range? Eight series, dry circuit/low level to 10 amps, including magnetic latch and sensitive versions.

And you thought we didn't care! tsk tsk tsk...



Series E

Dry circuit through 2 amps 2PDT all welded, half size, subminiature relay ideal for PC; 6 mounting and 3 terminal types; 6, 12, 26.5 VDC operation 100-G shock, 30-G vibration 0.28 ounces—MIL-R-5757

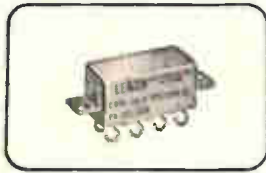

Series ES

Sensitive version of Series E 9 coils available from 104.0 to 14.5 milliamps DC all other specifications identical except vibration; 15-G—MIL-R-5757



Series M

Dry circuit / low level and 2 amp 2PDT all welded, subminiature relay 7 mounting and 3 terminal types 6, 12, 26.5 VDC operation 50-G shock, 30-G vibration 0.45 ounces—MIL-R-5757



Series CL

10 amp resistive contact rating @ 26.5 VDC 2PDT; all welded, magnetic latch subminiature relay; 5 mounting and 3 terminal types; 50-G shock, 30-G vibration; 1.6 ounces—MIL-R-5757 also available as 115 VAC, 400 cps

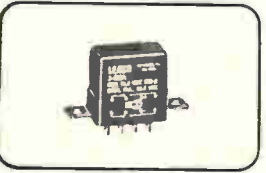

Series J

10 amp 2PDT all welded hermetically sealed subminiature relay; 6, 12, 26.5 VDC operation; 6 mounting and 4 terminal types; 100-G shock, 30-G vibration; 1.2 ounces—MIL-R-6160 also available as 115 VAC, 400 cps

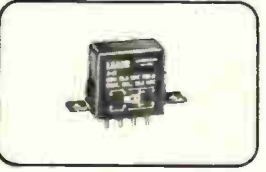

Series JH

10 amp polarized 2PDT all welded, special environment subminiature relay features increased contact pressure; 4 mounting and 3 terminal types; 500-G shock, 50-G vibration; 1.4 ounces—MIL-R-6160 also available as 115 VAC, 400 cps



Series KH

10 amp polarized 4PDT special environment subminiature relay four pole version of JH series; all other specifications identical



Series C-200

10 amp midget 2PDT all welded subminiature relay 6, 12, 26.5 VDC operation 4 mounting and 3 terminal types 50-G shock, 30-G vibration 1.1 ounce—MIL-R-5757 also available as 115 VAC, 400 cps

Ashamed of yourself? Now will you believe our heart's in the right place? Even if your problem's non-standard, we're for you. These multifarious achievements can be applied as readily to your own proprietary headache. Send for our subminiature relay design kit and we'll try to forgive you.

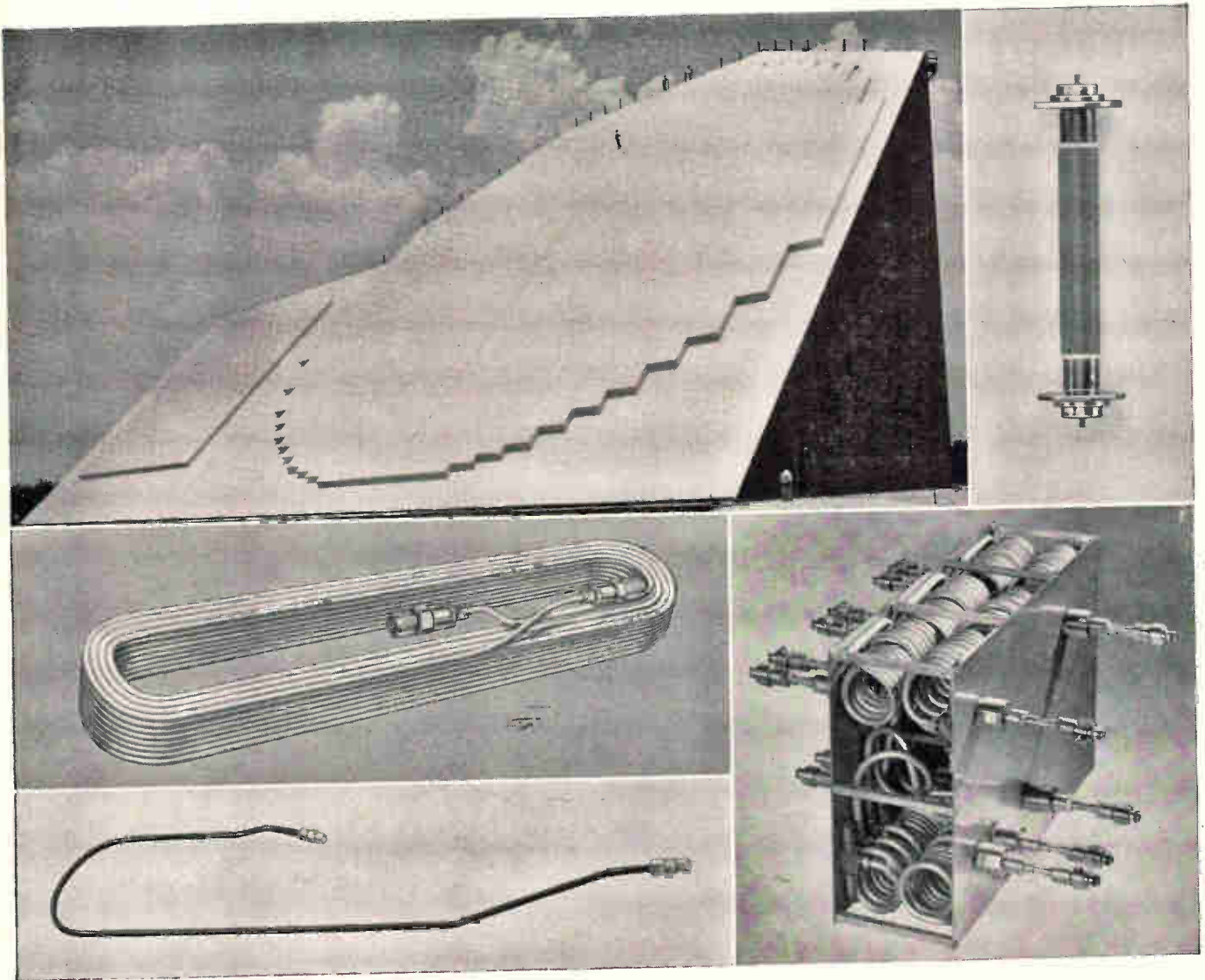

Coaxial cable. By the system. By the mile. By the electrical foot. Buy the answer to your particular transmission problems.

Here is complete and total capability in the sophisticated coaxial cable field. An extremely wide range of constructions, off-the-shelf, in a variety of impedances, with matching connectors, many offering exciting new parameters in phase stability. Custom cut lengths or special assemblies, tested and precisely measured to accuracies significantly extending the state-of-the-art. Development of entirely new cable designs to meet highly individual needs

And, think time and talent to assume responsibility in the origination of complete cable systems, from the definition of objectives through the formulation of plans and specifications, to construction, testing, installation and initial operation.

We suggest ourselves to you as a single source in any and all matters relating to coaxial cable. With good reason.

Ask for Bulletin SF-1. Or, write, outlining your particular needs.

PHELPS DODGE ELECTRONIC PRODUCTS
NORTH HAVEN, CONNECTICUT



There's a New Technique for Producing Thin Film Resistor Networks

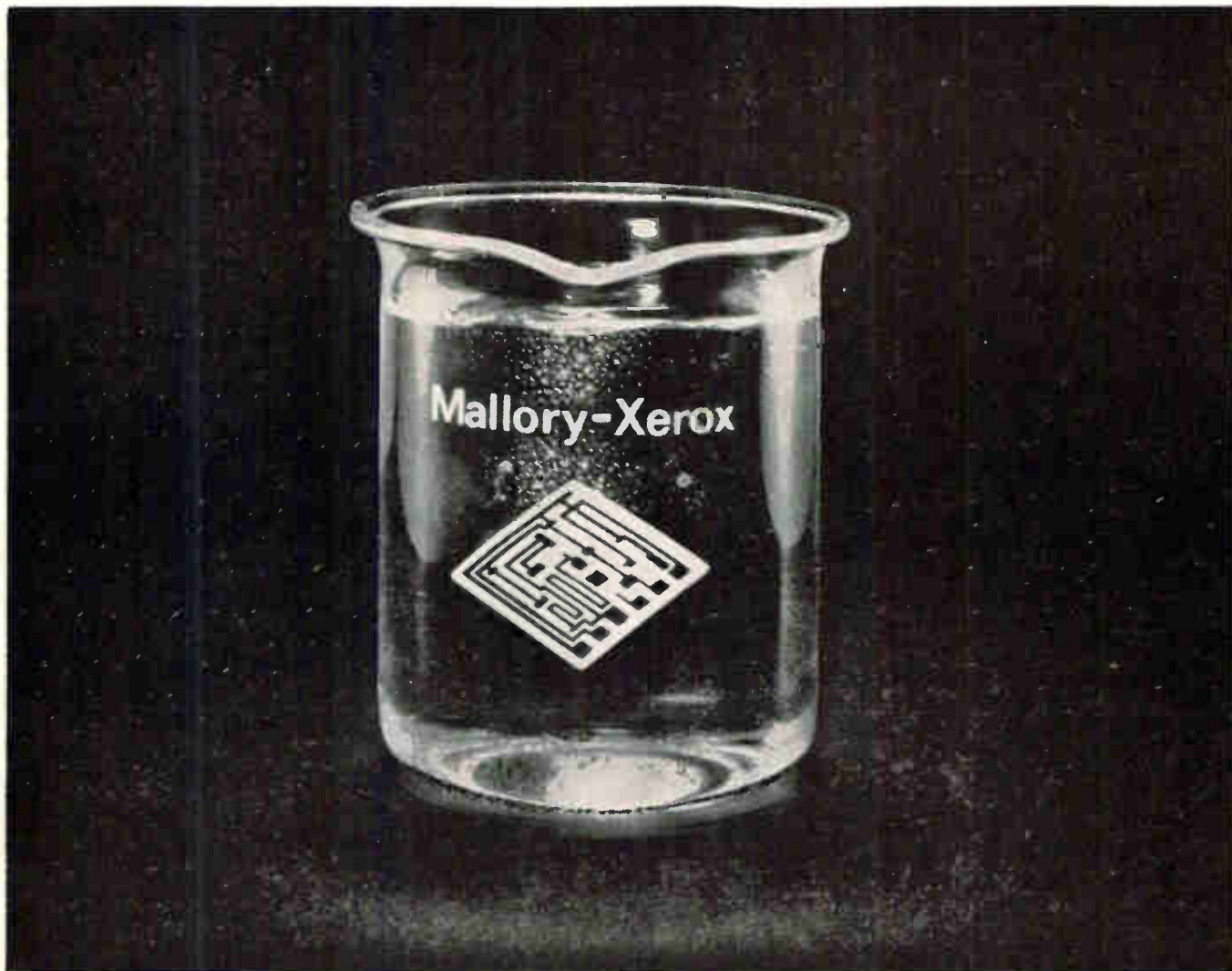

Now you can produce thin film resistor-conductor networks with Mallory-Xerox Resistor Boards. We deposit thin film resistance material and a conductive coating on a ceramic substrate. You produce thin film networks by etching the conductor and resistor layers.

- **Breadboard your microelectronic circuits quickly and economically.** Immediately determine actual effects of frequency and distributed capacitance on circuit performance.

- **No expensive vacuum equipment, masking techniques, or technical development program required.** For laboratory experiments or production quantities, the Mallory-Xerox process requires only the techniques used for making printed circuits.

- **In-house control from board layout to finished resistor.** Save days or weeks you would spend waiting for suppliers.

- **Great flexibility.** Infinite choice of resistance values. Ten resistors in an

area of 1/10 square inch. All ten cost no more than one.

Mallory-Xerox Corporation will show you how to make efficient design layouts and set up the processes required. A complete laboratory start-up facility is available in kit form for \$90.00. These kits, as well as quantities of resistor boards and chemicals are stocked by your local Compar Technical representative. Call him or write to Mallory-Xerox Corporation, Nine Third Avenue, Burlington, Massachusetts 01804.

Mallory-Xerox

A company jointly owned by P. R. Mallory & Co. Inc. and Xerox Corporation

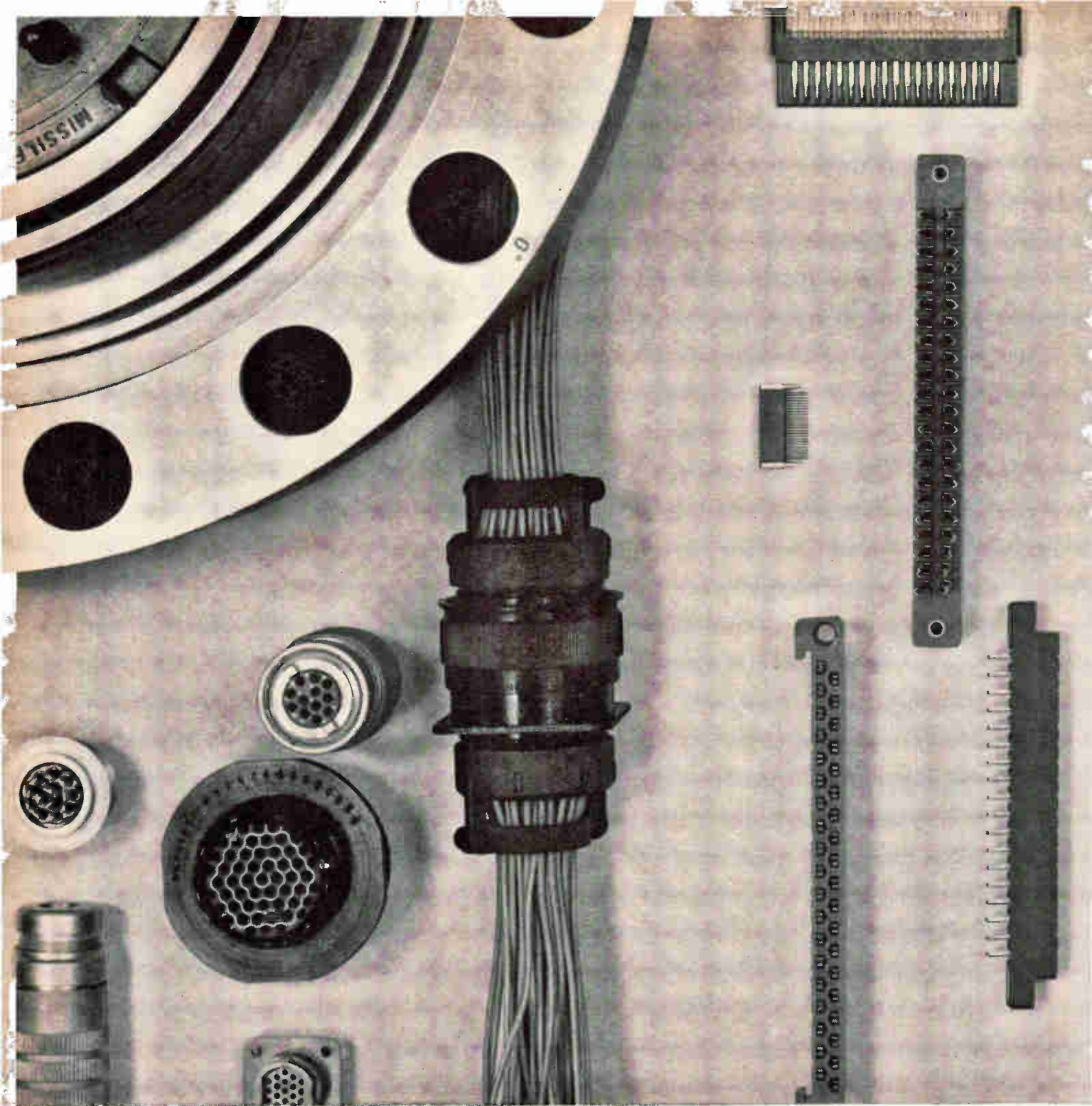

***Here are just 36
of the 36,000
Amphenol connectors***

Why so many? Because interconnection jobs have become so diverse and complex. On a Polaris, you may need a big aft umbilical connector that withstands 5000°F for 2½ minutes. But if you're miniaturizing a strip chart recorder, you can pack 50 contacts into a 1" connector. What else? **MILITARY CONNECTORS.** (Far left) We make all the standard AN/MS and other Mil-spec types, including

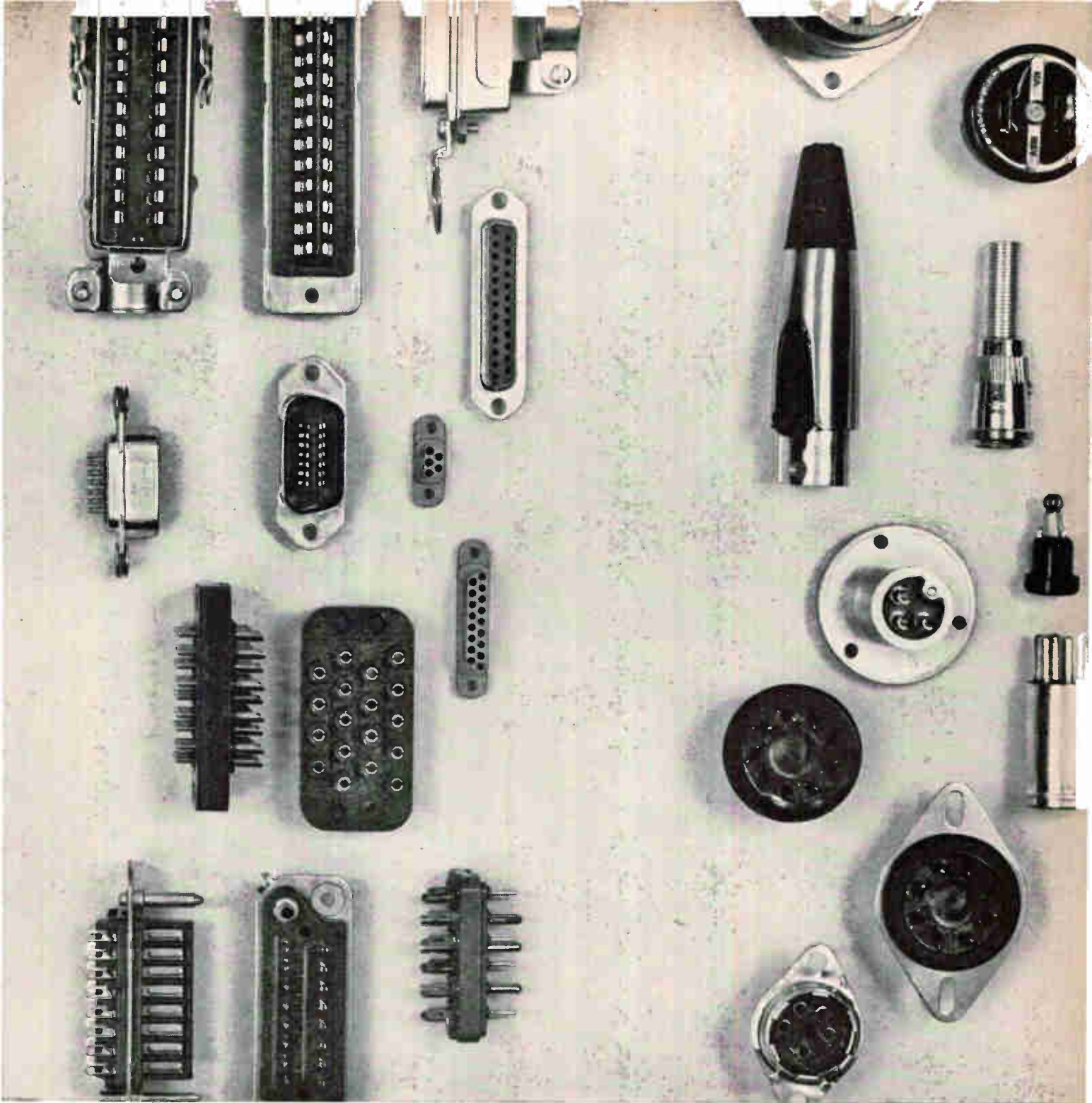

MIL-C-26500 and MIL-C-38300 circular environmental connectors. (Incidentally, we have a Space and Missile Systems facility just for specials.)

PRINTED CIRCUIT CONNECTORS. (Middle left) There are actually thousands. Everything from the micro-miniature 64 Series to the bellows-contact type 225 Series to the new Amphenol Flex-1 connector that welds directly to unstripped flat cable.

RACK AND PANEL CONNECTORS. (Middle right) There's the Min-Rac 17, with its extremely uniform body contacts. For the ultimate in mating reliability, consider our new Series 217. It is 99.99% reliable with three positive seals: around the contacts, at the rim, and at the lip. Or for easy blind mating, choose the Amphenol Blue Ribbon connector with sturdy, wedgelike contacts,

COMMERCIAL PLUGS AND SOCKETS. (Far right) Pick from a long list of tube sockets, microphone plugs, cable jacks, tip jacks, heavy duty industrial sockets—all you'll ever need.

Delivery? The fastest in the business. Ask your nearest distributor or Amphenol Sales Engineer. (Or write to us.) Amphenol Connector Division, 1830 South 54th Avenue, Chicago 50, Illinois.



CONNECTOR DIVISION

AMPHENOL-BORG ELECTRONICS CORPORATION

Specify Amphenol . . . the leading name in cable, connectors, rf switches, potentiometers, and microelectronics

You can ship 40 lbs. from New York to Boston on the ground for \$5.20. But why?



Air Express will do it for \$4.70

If you ship from 5 to 50 pounds anywhere in the U.S., you'll find Air Express is always fastest. And often lowest in cost.

Many times it costs less than even surface carrier. For example, note the rates above. They compare first class rail express with Air Express.

How is Air Express able to do it?

Air Express is a joint venture of all 39 scheduled airlines and R E A Express. As a result, Air Express gets first priority after air mail on every scheduled airline. On the ground, thousands of R E A Express trucks (many equipped with two-way radios) speed your pickups and deliveries.

It's no wonder Air Express can

answer your call within 2 hours. No wonder you get next-day delivery to any one of 21,000 U.S. cities, towns and communities.

So next time you want to ship from 5 to 50 pounds inexpensively and in a hurry, try Air Express. Call your local R E A Express office.

Air Express outdelivers them all ... anywhere in the U.S.A.

Air Express
Division of R E A Express



Regulate down to zero power factor with Sorensen's new silicon controlled rectifier ACR Voltage Regulators

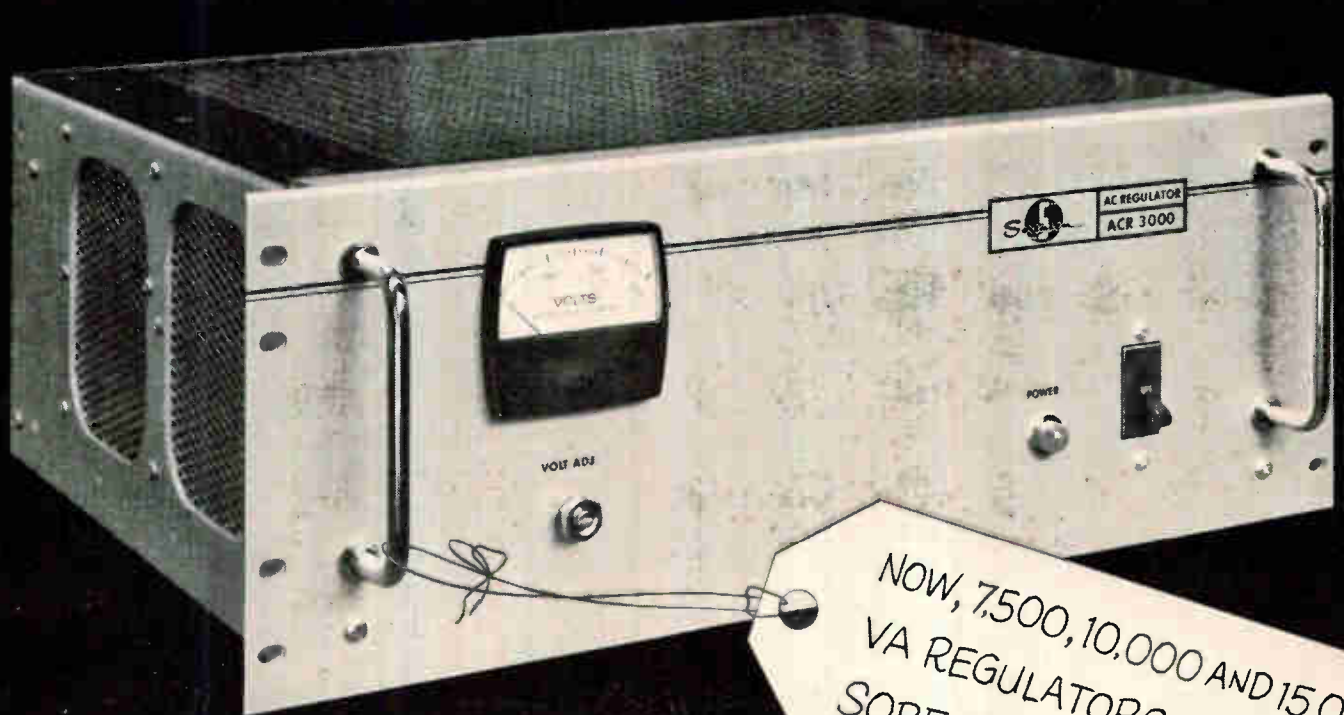

NOW, 7,500, 10,000 AND 15,000 VA REGULATORS ADDED TO SORENSEN'S ACR SERIES

Ideal for motor starting, lamp loads, tube filaments, x-ray applications, etc., ACR Series regulators are designed to control the RMS voltage to a variety of loads requiring precision regulation, fast response time, and low distortion.

- 1 8 MODELS AVAILABLE (500, 1000, 2000, 3000, 5000, 7500, 10000, 15000VA)
- 2 LOW PRICES (starting at \$290)
- 3 SMALL SIZE AND WEIGHT (about half the volume of competitive regulators)
- 4 FULL INPUT VOLTAGE RANGE 95-130 VAC; OUTPUT RANGE 110-120 VAC
- 5 FAST RESPONSE to line or load changes (30 ms)

- 6 LOW DISTORTION (3% max.)
- 7 STABILITY (.05% / 8 hours-after a 30-minute warm-up)
- 8 UP TO 95% EFFICIENCY
- 9 REGULATION $\pm 0.1\%$ RMS
- 10 PROGRAMMABLE
- 11 REMOTE SENSING
- 12 CONVECTION COOLED
- 13 EASY MAINTENANCE (removable "plug-in" printed circuit)

For complete data on the ACR Series and other Sorensen products, send for the new, 160-page book, "Controlled Power Catalog and Handbook." Write: Sorensen, Richards Avenue, South Norwalk, Connecticut. Or use reader service card number 200.

ACR ELECTRICAL AND MECHANICAL SPECIFICATIONS

MODEL NUMBER	OUTPUT VA RANGE	REGULATION ACCURACY		EFFICIENCY (FULL VA)	TYPICAL POWER FACTOR	TEMPERATURE AMBIENT COEFFICIENT		DIMENSIONS (INCHES)				PRICE**
		LINE	LOAD			(°C)	(°C)	WIDTH	HEIGHT	DEPTH	RACK HEIGHT	
ACR 500	0-500	$\pm 0.1\%$	$\pm 0.1\%$	88%	75%	0-50	.03%	15"	5	9	5 1/4	\$ 290
ACR 1000	0-1000	$\pm 0.1\%$	$\pm 0.1\%$	90%	75%	0-50	.03%	19	5 1/4	11	5 1/4	340
ACR 2000	0-2000	$\pm 0.1\%$	$\pm 0.1\%$	92%	75%	0-50	.03%	19	5 1/4	15	5 1/4	435
ACR 3000	0-3000	$\pm 0.1\%$	$\pm 0.1\%$	95%	75%	0-50	.03%	19	7	15	7	555
ACR 5000	0-5000	$\pm 0.15\%$	$\pm 0.15\%$	95%	75%	0-50	.03%	19	7	20	7	715
ACR 7500	0-7500	$\pm 0.15\%$	$\pm 0.15\%$	95%	75%	0-50	.03%	19	12 1/2	20	12 1/2	850
ACR 10000	0-10000	$\pm 0.15\%$	$\pm 0.15\%$	95%	75%	0-50	.03%	19	12 1/2	20	12 1/2	1,200
ACR 15000	0-10000	$\pm 0.15\%$	$\pm 0.15\%$	95%	75%	0-50	.03%	19	17 1/2	20	17 1/2	1,500

*A 19 inch adapter (rack) panel is available.

**Optional Meter \$22.



Circle 65 on reader service card

Your Comparative Reference Guide to CEC Analog and Digital Magnetic Tape Recorders and Accessories

CEC DataTape[®] Recorder/Reproducers— a proven instrument for every purpose

Type VR-3600—Considered the ideal "universal" recorder, and the ultimate choice for the most demanding pre- and post-detection use.

- ☐ 400 CPS to 1.5 MC direct frequency response, and DC to 500 KC FM frequency response.
- ☐ Multispeed electrically switchable direct and FM system.
- ☐ 7 or 14 channel systems available as standard.
- ☐ Available in "Universal" machine configurations for compatibility with lower bandwidth CEC recorders.
- ☐ Accessories include monitor meters for display of bias, input and output signals, RFI certification to MIL I 6181D.

Type VR-2600—Recognized as the finest, most versatile performer in its class.

- ☐ Available with any combination of four types of recording/reproducing electronics and configurations (direct, FM, PDM, PCM).
- ☐ All solid state electronics, pushbutton controlled for operation without readjustment at six (6) tape speeds.
- ☐ 600 KC direct, 80 KC FM, IRIG PDM, and 1000 bit per inch PCM capabilities.
- ☐ 7 and 14 track analog systems as well as 16 track PCM systems available as standard. Accessories include edge track

voice recording/reproducing, shuttle control and monitoring equipment, including both meter and oscilloscope presentation.

Type VR-3300—Unmatched for applications where portability must be combined with outstanding capability.

- ☐ High quality mobile recorder/reproducer providing laboratory performance in the DC to 200 kilocycle frequency range, using direct and FM electronics.
- ☐ Dual capstan drive system provides closed loop performance equal to standard laboratory tape record/reproduce systems.
- ☐ Interchangeable record and reproduce electronics and heads with CEC's Type VR-2800 laboratory recorder/reproducer.
- ☐ Six speed record/reproduce system.

Type VR-2800—A highly reliable wide-band system for use in laboratory environments with direct and FM electronics.

- ☐ Six speed record/reproduce operation.
- ☐ 100 CPS to 200 KC direct system and DC to 20 KC FM system.
- ☐ Up to 7 or 14 channels on ½" or 1" tape respectively on 14" reels provides extended record time.
- ☐ Uses all metal front surface magnetic heads, as do all CEC recorders, for long life and minimum tape wear.

Type PR-3300—Designed for portability at a modest cost.

- ☐ High quality mobile magnetic tape recorder/reproducer for standard 100 kilocycle work.
- ☐ 7 or 14 channel systems on ½" and 1" tape respectively; 10½" diameter reels.
- ☐ Handles information via direct, FM or PDM techniques in any combination or, like the VR-3300, this unit can be operated from AC or DC power sources using its accessory precision frequency power supply.
- ☐ Interchangeable electronics with CEC's GR-2800 magnetic tape recorder/reproducer system.

Type GR-2800—Commonly selected for general lab use in both industrial and military applications.

- ☐ General purpose laboratory recorder/reproducer system accommodating data in direct, FM or PDM recorded format in the frequency range from DC to 100 KC.
- ☐ Utilizes all solid state electronics.
- ☐ 7 or 14 channel operation on ½" and 1" tape respectively, with reel diameters to 14".
- ☐ Closed loop capstan drive system.
- ☐ Precision capstan drive electronics and tape speed control servo provide tape speed accuracies to within .02% of recorded speed.



VR-3600



VR-2600



VR-3300



VR-2800

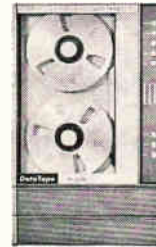

PR-3300

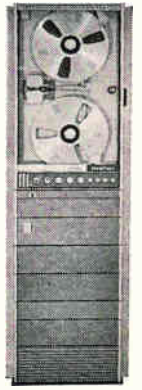

GR-2800

Type DR-2700—The ideal instrument for providing data storage in digital form.

☐ Most capable instrument for the storage of digital data at high speed for computer application.

☐ 7 or 8 channel configurations on ½" tape, or 16 channel configurations on 1" tape using 10½" NAB or IBM compatible reels as standard.

☐ Operates at tape speeds up to 150 IPS, and at command rates up to 200 per second without programming restriction.

☐ All solid state tape transport and read/write electronics. High reliability makes this unit extremely well-suited to on-line computer application.



DR-2700



GL-2810

Type GL-2810—Specifically designed for data reduction or data monitoring and storage where machine workload is heavy.

☐ Accommodates tape loop runs from 2 to 75 feet at six tape speeds from 1⅞ to 60 IPS.

☐ Handles data in the range from DC to 10 KC via FM techniques, and from 100 CPS to 100 KC employing direct techniques.

☐ Utilizes ½" tape for up to 7 channels, or 1" tape for up to 14 channels, using IRIG geometry.

☐ Accessories include selective erase equipment providing erasure of any combination of 7 or 14 tracks, without removal of the tape loop from the machine.

	VR-3600	VR-2600	VR-3300	VR-2800	PR-3300	GR-2800	GL-2810	DR-2700
TAPE SPEEDS	6 speeds to 120 ips	7 speeds to 120 ips (in two ranges)	6 speeds to 60 ips	6 speeds to 60 ips	6 speeds to 60 ips	6 speeds to 60 ips	6 speeds to 60 ips	up to 150 ips
DIRECT FREQUENCY RESPONSE	400 cps—1.5 mc	300 cps—600 kc	100 cps—200 kc	100 cps—200 kc	dc—100 kc	100 cps—100 kc	100 cps—100 kc	
FM FREQUENCY RESPONSE	dc—500kc	dc—80 kc	0—20 kc	0—20 kc	0—10 kc	0—10 kc	0—10 kc	
CHANNELS	up to 14	up to 14	up to 14	up to 14	up to 14	up to 14	up to 14	up to 16
RECORDING METHODS	Direct, FM	Direct, FM, PDM, PCM	Direct, FM, PDM	Direct, FM, PDM	Direct, FM, PDM	Direct, FM, PDM	Direct, FM, PDM	Digital—Densities to 555.5 Bits per Inch NRZ-1
ELECTRONICS	Solid State	Solid State	Solid State	Solid State	Solid State	Solid State	Solid State	Solid State

CEC DataTape® Accessories



The **Monitor Oscilloscope** is used with tape recorder/reproducers, or any multi-channel instrumentation system to provide visual display of electrical signals ranging in frequency from DC to 1,500,000 CPS.



The **Type TD-2903 Automatic Tape Degausser** is designed to erase data signals from magnetic tape wound on reels. A reel of 1"-wide instrumentation tape recorded at saturation level is erased to a nominal 90 db below normal level.

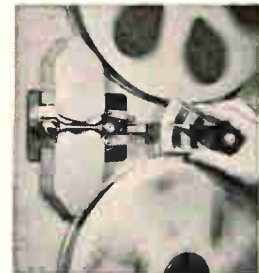

The **Dynamic Tape Tension Gage** permits accurate tension measurements directly in ounces while the recorder is in operation.

CEC Magnetic Instrumentation Recording Tape

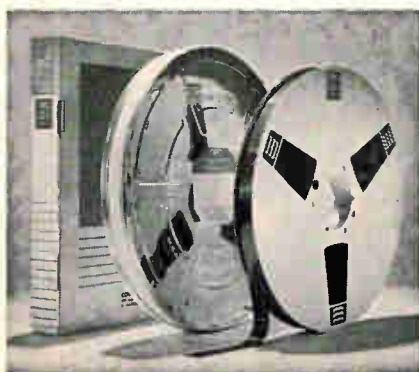

CEC Magnetic Instrumentation Tapes record at the highest applicable resolution and sensitivity—with the greatest uniformity and lowest tape and head wear obtainable today. Divided into four specific categories, CEC tapes have eliminated the time-consuming burden of performance evaluation.

And—all CEC tapes come shielded in moisture-proof metal containers—packed in cardboard filing boxes—sealed with dust-proof plastic sleeves.

For complete information on any CEC Tape Recorder/Reproducer or Magnetic Recording Instrumentation Tape, call or write CEC for bulletins in Kit #7001-X5.

Data Recorders Division
CEC
CONSOLIDATED
ELECTRODYNAMICS

A SUBSIDIARY OF BELL & HOWELL/PASADENA, CALIF. 91109
 INTERNATIONAL SUBSIDIARIES: WOKING, SURREY, ENGLAND
 AND FRIEDBERG (HESSER), W. GERMANY

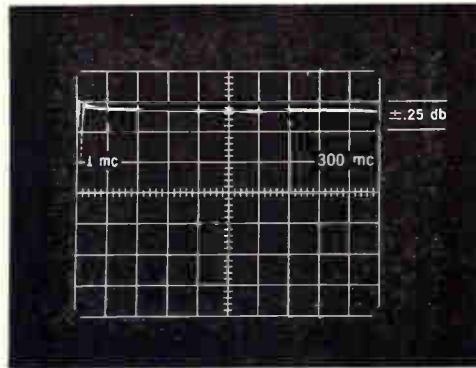

• Full 300 mc Wide Video Sweep

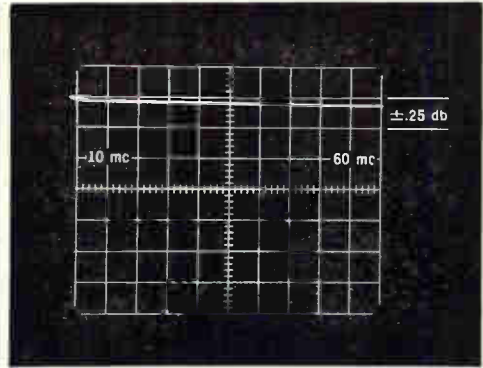

• Programmable, Voltage Controlled Oscillator

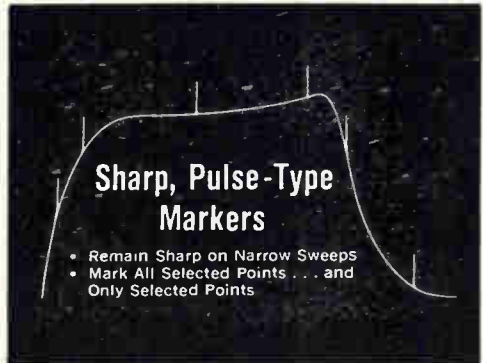

• Extremely Stable Narrow Sweeps

Wide 1 mc to 300 mc Sweeping Oscillator and Marker Generator:

KAY *Multi-Sweep* 159-B

A complete, all-solid-state sweeping oscillator and marker generator system, the 159-B covers the spectrum from 1 mc to 300 mc in a single sweep — and provides a continuously variable sweep display throughout its full range.

Performance characteristics include line-lock, cw, manual and variable sweep rates and external input for versatile modes of operation.

A complete selection of plug-in marker heads offers up to eight optional, individually switched crystal plug-in markers per head. Marked points stay sharp, clear, and precise even on the 159-B's narrow, extremely stable sweeps.

A variable birdie marker provision is included as standard equipment on the same display. To complement these, accurate, harmonic and cw birdie markers are also available. All plug-in marker heads may be changed or added as required.

The 159-B has provision for external modulation from dc up to more than 15 kc. A built-in detector and switched attenuator are supplied as standard features. Sweeps high-to-low or low-to-high.

SPECIFICATIONS

- Frequency Range: 1 mc — 300 mc.
- Sweep Width: Continuously variable from 200 kc to 300 mc.
- Operating Modes: Line-locked, variable from 5 to 60 cps, manual, cw, external input
- RF Out: 0.5 volt rms into 50 ohms (70 ohms on request), metered.
- Flatness: ± 0.25 db over widest sweep.
- Attenuator: Individually switched 20, 20, 20, 10, 6 and 3 db steps, plus 3 db variable.
- Sweep Output: Triangular wave synchronized with sweeping oscillator; approx. 10 v p-p.
- Markers: Up to 8 crystal controlled pulse or birdie type markers per marker head. Variable birdie marker developed from external oscillator.
- Power Supply: Approx. 20 watts input 117 v ($\pm 10\%$) 50-60 cps regulated.
- Weight: 28 lbs.
- Price: \$795.00
Marker plug-in: \$75.00
Plus markers

KAY ELECTRIC COMPANY
PINE BROOK, MORRIS COUNTY, N.J.

New IBM miniature dry reed switches give you low contact resistance —less than 100 milliohms throughout life

But that's not all.

These new reed switches are now double plated, rhodium over gold, to give you low noise as well.

And long life too—up to 125 million error-free operations (mean time to first error).



We dynamically set the air gap for each switch (shown here 2X actual size).

Whether you use IBM miniature dry reed switches in relays or magnet actuated applications you get highly consistent performance throughout life. Here's why.

First, we *dynamically* set the air gap between the reeds. This means a stable sensitivity of $\pm 7 \text{ NI}$ (maximum) in every reed switch. No need to select or grade them.

Then we check contact resistance of each switch (including leads) under low level conditions. Result: a mean of 50 milliohms.

To verify long switching life we conduct life tests on a regular basis. Here we monitor every switching operation to identify every error—all the way up to end of life.

Finally we test our reed switches to meet rigid standards of quality in 34 important areas, such as alignment,

leakage and voltage breakdown.

But perhaps the best proof of their life/performance is our own testimonial: We use them in practically all of our own computers, including the new System/360.

Why not put IBM miniature dry reed switches to the test in one of your applications. For complete specifications, life ratings and test criteria write to the IBM Industrial Products Division, 1000 Westchester Avenue,

White Plains, New York 10604.

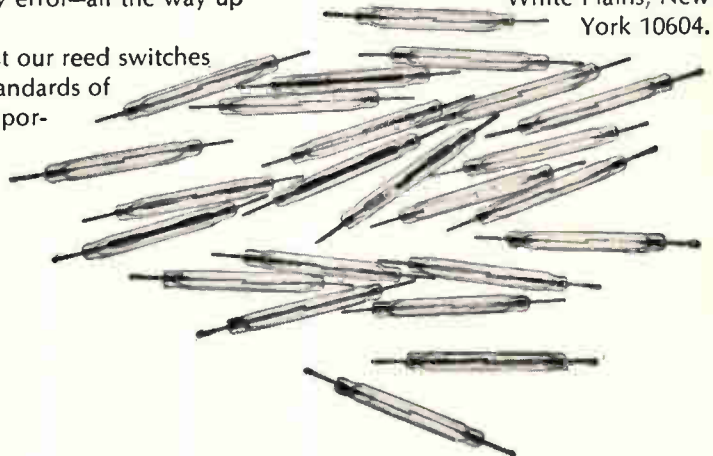

Sigma relay idea of the month

How to avoid short circuits when reversing polarity of inductive loads.

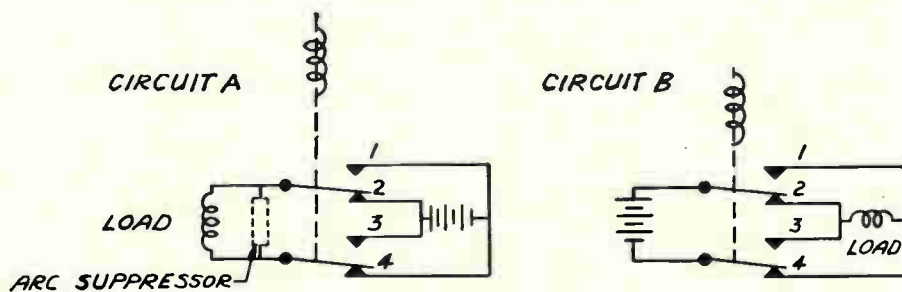

Circuits A and B are both commonly used for reversing polarity, but circuit A has an advantage not often recognized.

When reversing the polarity of a difficult load, such as a motor, a slight contact weld might delay the transfer of one pole while the other pole completes transfer. In circuit B this will short circuit the power supply resulting in catastrophic failure.

In circuit A a non-synchronous transfer would only short circuit the motor terminal. This is not harmful, and can be done deliberately with some relays, such as the

Sigma Series 42. Short circuiting the motor, known as "slugging," stops the motor more quickly, allowing faster reversals.

Neither circuit will prevent catastrophic failure if an arc is drawn across the contact gap, because this would short circuit the power supply.

Where arcing may be a problem, arc suppressors can be used.

If you have a relay idea or can show us how to improve this one, we'd like to hear from you. Your relay idea could be the next one we publish.

Sigma relay of the month

New, welded seal half-size crystal-can relay exceeds MIL-R-5757D/9.

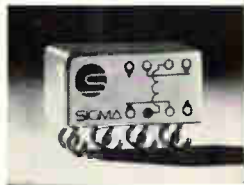

Actual Size

This new Sigma relay could have been introduced a year ago. It was every bit as good as competition, but our engineers weren't satisfied. They wanted something even better. They're satisfied now. You will be too.

Here's why:

The Series 36 is contamination-free. The cover is TIG welded to the header for complete flux-free cleanliness and a more dependable hermetic seal. Result: performance and reliability that exceed military and commercial requirements.

Design-centered for operation in the 100 ma to 400 ma range, the 36 is conservatively rated at 2 amps to dry circuit. Its small size and weight make it ideal for printed circuits and high-density packaging.

There are more advantages to the 36: 1. Extra durability—gold-plated silver-magnesium-nickel alloy contact *blades* minimize bounce, resist wear, and prolong life. 2. High efficiency—precise alignment of armature to pole pieces and reduced bobbin-wall thickness contribute to low operate power. 3. Outstanding environmental performance—balanced, low-inertia armature assures dependable, high-speed operation under severe conditions of shock and vibration.

Check out the distinctive features in the Sigma Series 36 for yourself—free of charge—against the types you may now be using. Just send for the new Sigma Series 36 bulletin and a free relay redemption certificate.



Tungsten Inert Gas welding of Series 36 relay prevents flux contamination.

SIGMA DIVISION  SIGMA INSTRUMENTS INC
Assured Reliability With Advanced Design/Braintree 85, Mass.

GRADUATE ELECTRICAL/ELECTRONIC ENGINEERS

BS MS PHD

**RADAR
ENGINEERS**

**COMPUTER DESIGN
ENGINEERS**

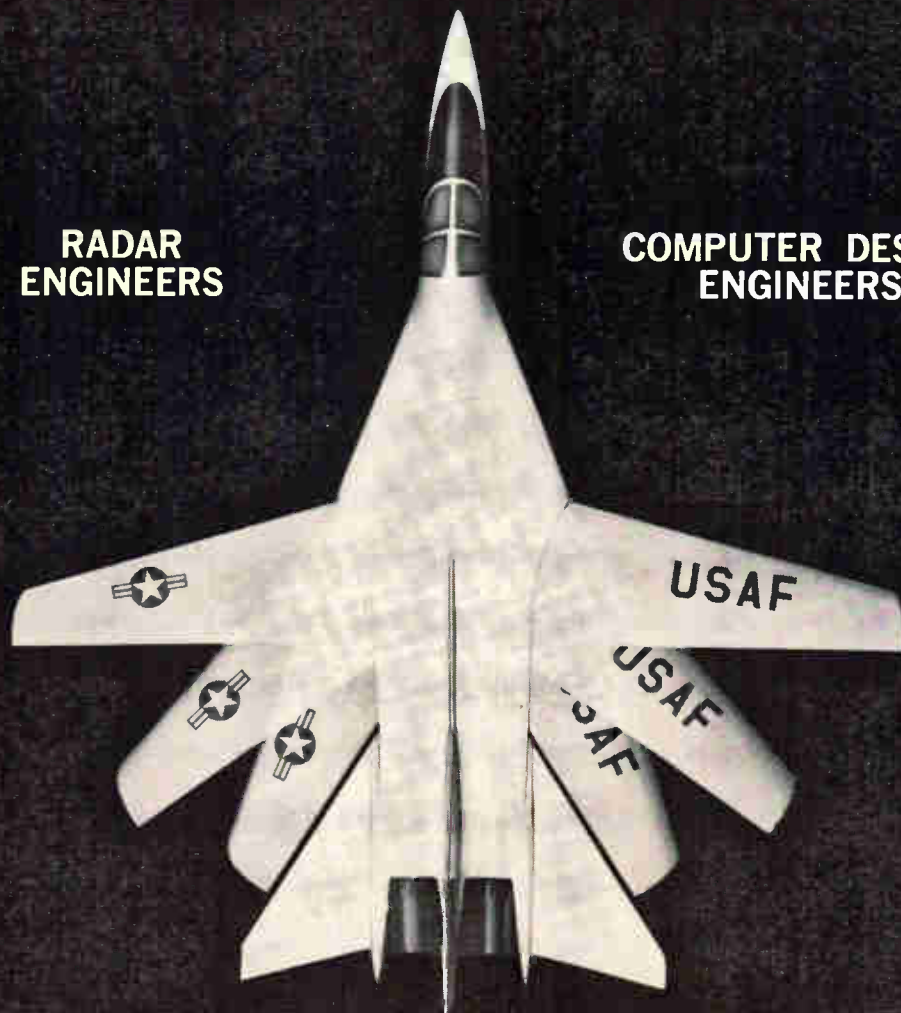

ADDITIONAL OPENINGS FOR WELL QUALIFIED ENGINEERS IN:

- STABILITY, GUIDANCE & CONTROLS
- CIRCUIT DESIGN
- ELECTRONICS SYSTEMS ANALYSIS
- FLIGHT TEST INSTRUMENTATION

THIS IS THE F111, the nation's new bi-service tactical fighter with a variable sweep wing and twin turbofan engines that contribute to multi-mission capabilities. General Dynamics/Fort Worth is the prime contractor on this and many other projects involving space vehicles and systems. Capable, qualified engineers and scientists are needed in our search for solutions to the problems encountered in our many and varied programs. We urge you to investigate the expanding opportunity to exercise your skills and knowledge in one of these projects by writing to Mr. J. B. Ellis, Industrial Relations Administrator-Engineering, General Dynamics/Fort Worth, P. O. Box 748-L, Fort Worth, Texas. An equal opportunity employer.



GENERAL DYNAMICS | FORT WORTH

Revolution in Resolution: 0.032% in a TRIMPOT® Package!

Seven inches of wirewound resistance element in a package just 5/16" square and one inch long—that's our new Model 3070! With resolution seven to ten times better than you normally get from wirewound units this small, Model 3070 TRIMPOT potentiometer gives you premium adjustability at no premium in space, weight, or temperature coefficient. Settings you make with this unit stay set, too; the exclusive rotor/wiper design, based on that of our precision potentiometers, is outstandingly stable under shock and vibration.

Model 3070 also offers slip-clutch action, the indestructible SILVERWELD® termination, and resistance wire with twice the normal cross-section area. Units are available immediately in a broad choice of terminal types and mounting styles, including two panel-mount versions.

Write today for free technical data.

Resolution:	0.032% to 0.15%
Standard resistances:	75Ω to 50K
Power rating at 70°C:	1.5W
Max. operating temp.:	175°C
Temp. Coeff. (entire unit):	70ppm/°C
Humidity:	Meets MIL-STD-202B, Method 106 (Cycling)
Size:	5/16" x 5/16" x 1 1/16"

If it's TRIMPOT®, it's BOURNS

TRIMPOT is a registered trademark of Bourns, Inc.

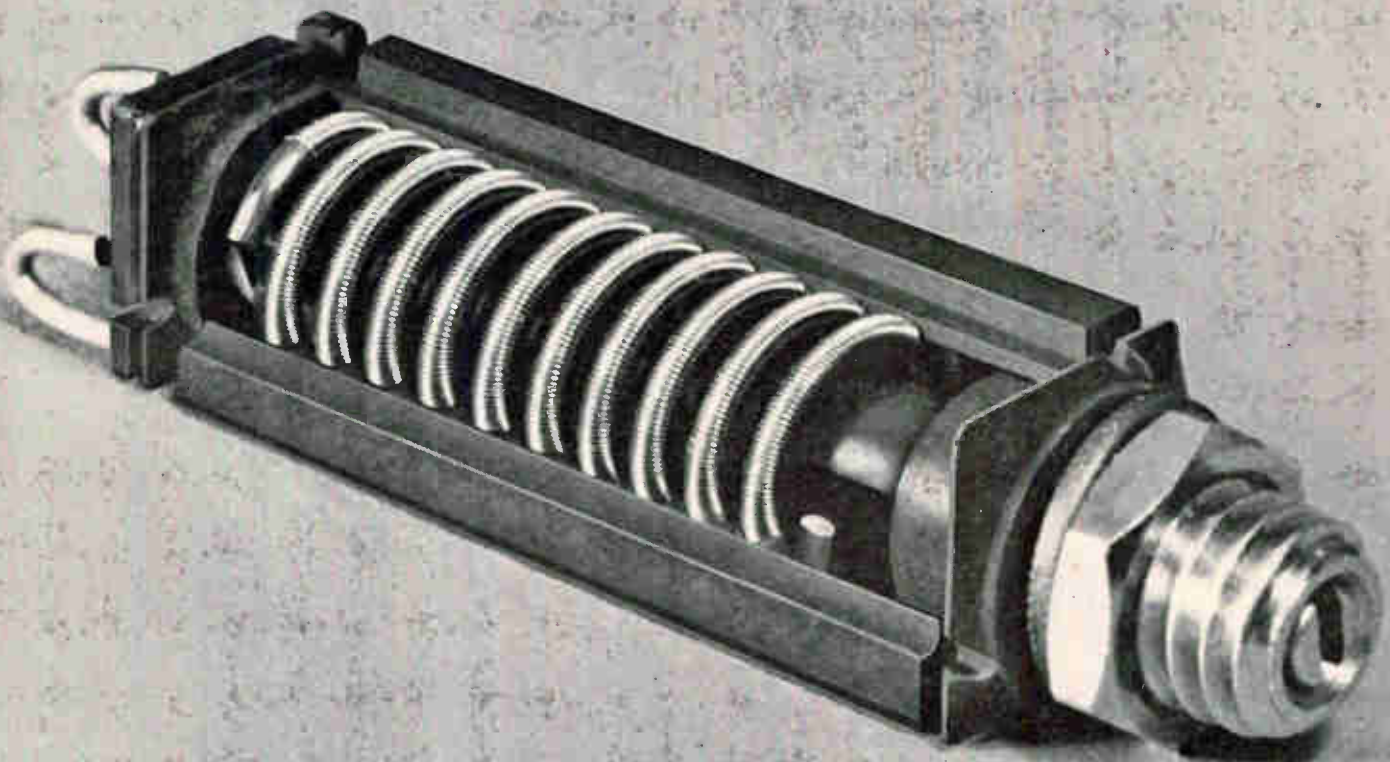
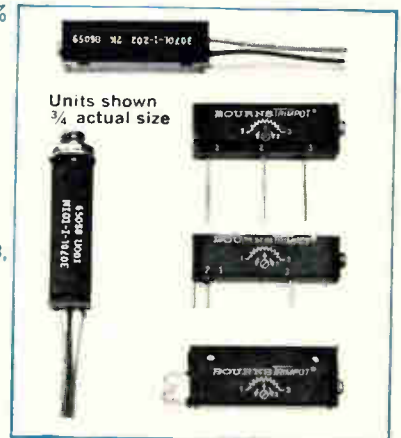

BOURNS

BOURNS, INC., TRIMPOT DIVISION
1200 COLUMBIA AVE., RIVERSIDE, CALIF.
PHONE 684-1700 · TWX: 714-682 9582
CABLE: BOURNSINC

MANUFACTURER: TRIMPOT® & PRECISION POTENTIOMETERS, RELAYS; TRANSDUCERS FOR PRESSURE, POSITION, ACCELERATION. PLANTS: RIVERSIDE, CALIFORNIA; AMES, IOWA; TORONTO, CANADA

Cinch capabilities in micro-electronic interconnection can solve your packaging problems

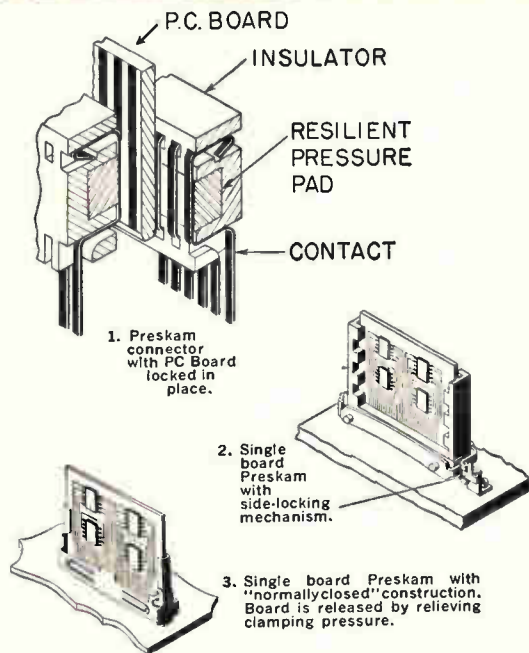
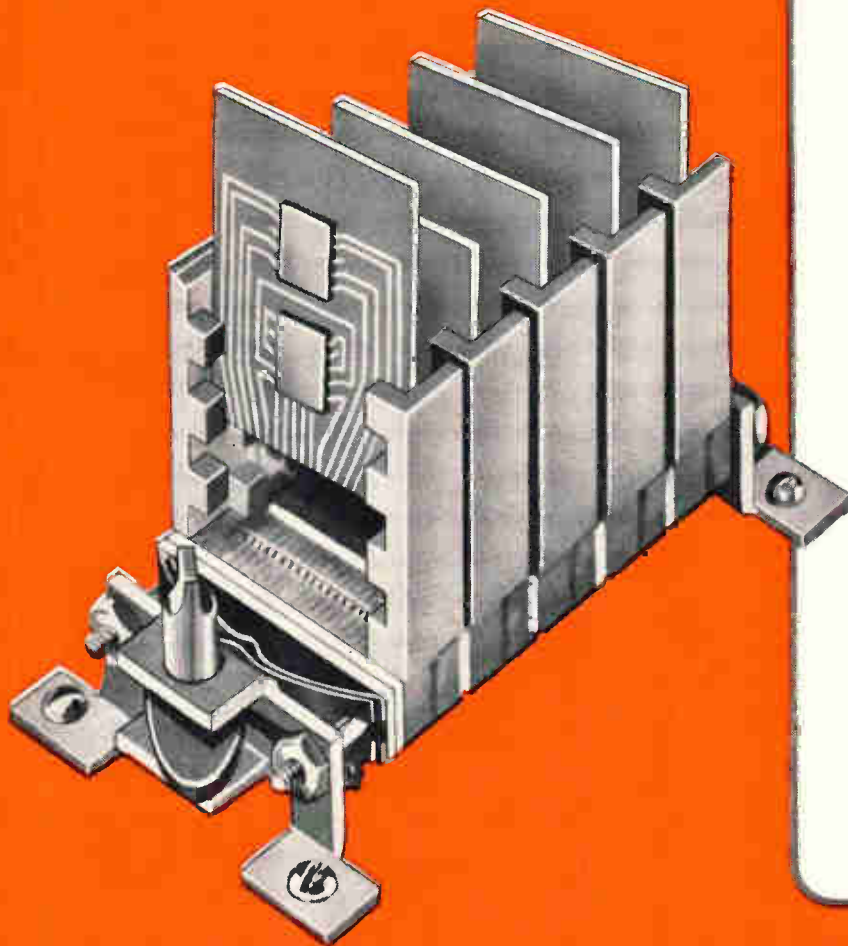

Ask Cinch about the new Preskam* System that permits connections that don't dwarf the circuits they join.

Either a board or male connector is dropped into place and then a cam actuated insulating bar clamps the board into the connector. High uniform contact pressure is maintained over an up to 70% greater contact area than in conventional connection means.

Contacts are on 25-mil centers and boards can be as little as 100-mils apart. Multiple boards may be controlled by the same locking device.

With contact disengagement before board insertion or withdrawal, the most fragile thin glass or ceramic substrate is undamaged even from repetitive insertions.

RELATE YOUR PRODUCT PLANNING TO THE STATE-OF-THE-ART INTERCONNECTION SYSTEMS WHICH ARE AVAILABLE FROM THE CINCH RESEARCH AND DEVELOPMENT PROGRAM. ASK CINCH FIRST: THEY MAY HAVE ALREADY SOLVED YOUR INTERCONNECTION PROBLEM.

Write Cinch Manufacturing Company, at 1026 South Homan Avenue, Chicago, Illinois 60624.

CM-6505

*Patent Pending



CINCH

DIVISION OF UNITED-CARR

Technical Articles

**Cold-cathode tubes
as triggers:
page 76**

Subminiature versions of these tubes are inexpensive yet highly reliable in low-speed logic and relay circuits. They can be used for counting, switching, voltage control, voltage stabilization and time delay.

**Experiments
on board Gemini:
page 89**



The United States' first two-manned spacecraft brought back a lot of information that will help astronauts reach the moon. In all, 10 manned Gemini trips will perform hundreds of experiments. The cover picture was taken by the National Aeronautics and Space Agency during a rehearsal for the launch in March. Astronauts Grisson and Young were strapped in for a test of environmental controls.

**Just in case . . .
page 94**

Gemini will carry a sophisticated malfunction-detection system, the first that directly warns the astronauts of any trouble. Previous systems alerted ground crews who passed the warning along to the astronaut.

**Physical exam in orbit:
page 99**

Bioinstrumentation has been sharpened and sophisticated to measure and telemeter physiological variables as the astronauts orbit. One key objective of the mission is to gather more information on the effects of weightlessness on man.

**Tv looks at
the dark side:
page 106**

Television cameras that can photograph at low light levels are aboard for trials and testing. They'll provide a filmed record of what the astronauts see during the trip.

**Rendezvous in space:
page 110**

Rendezvous in space is a main goal of Project Gemini. Early flights will test rendezvous radar that could make such a space meeting possible.

-
- A laser dosimeter for safety
 - More applications of the cold-cathode tube
 - Electronics Magazine's 35th anniversary issue features articles by

Dr. Daniel E. Noble
Dr. Gordon E. Moore
Dr. T.H. Maiman

Dr. Albert J. Kelley
Dr. Henri Busignies
Nathan Cohn

and predictions by

Dr. Charles H. Townes
Dr. James B. Fisk
Dr. C. Guy Suits

Dr. Eiichi Goto
Prof. H.M. Barlow

**Coming
April 19**

Cold-cathode tubes as triggers

Subminiature tubes are finding new uses in low-speed logic and relay circuits. Inexpensive but highly reliable, they have a wide technical application. Part 2 of a series

By Martin E. Bond

Mullard Radio Valve Co.

Cold-cathode tubes have a glowing future. Not only are their uses in display panels becoming more sophisticated [Electronics, March 22, page 78], but subminiature versions are finding increasing favor in low-speed relay and logic circuits. They are easy to maintain and require less-complicated circuitry; they also provide instant identification of malfunctioning circuits when the glow is off the tube. That's important in industrial controls, where circuit breakdown could cost time and money by holding up a production line.

The tubes also find a use in beam switching, an area that will be explored in the third and last article of this series. The present discussion concerns their application as trigger tubes where extended life and low power consumption are especially important, as in sequence switching, high-impedance switching, voltage monitoring, overvoltage protection, and information storage. Though voltage and speed considerations severely restrict trigger tubes' use in the more sophisticated fields of rocketry and large computer electronics, the tubes do provide the best and cheapest technical means for a wide range of industrial applications.

Trigger tubes designed for logic circuits are small and operate with low currents. Relay tubes are somewhat larger and have much larger current capacity. Characteristics of each type are given in the table on page 77. Logic capabilities are

discussed in three applications: in a small telephone exchange, in a desk calculator, and in an industrial shift register. Relay applications are described for voltage controls, timers and voltage stabilizers.

Logic tubes for counting and switching

Subminiature tubes like the Z700U and the Z700W are typical of those used in decade counting and switching circuits. They can count at rates up to about four kilocycles per second. An extra trigger in the Z700W simplifies the construction of reversible counters and or logic circuits. The Z701U is typical of tubes used for speech circuits in telephone exchanges; it has a very low internal noise level and a relatively small working anode voltage range, and also has two triggers.

The diagrams on page 77 show how trigger tubes supply logic functions with no need for additional active devices. The pulse-plus-bias AND gate, A, is the basis of most counting circuits. Bias must be applied some time before the pulse to allow time for the capacitor to discharge. This disadvantage is overcome by circuit B, where two pulses can be applied simultaneously. The OR gate in C uses a tube with two trigger electrodes. One signal is applied to each trigger. The two NOT gates in D and E are the inverse of the AND gates. Combinations of AND and NOT gates can be employed with OR gates.

Relay tubes are stable

Typical relay tubes, with more current capacity than logic tubes, have stable trigger-striking characteristics. The stability can be upset only if reverse conduction occurs in any gap, or if the tubes are stored at high temperatures for several months. A short conduction period usually restores their normal characteristics.

Tubes like the Z803U are used primarily for tim-

The author



Martin Bond is quality manager of thin-film devices, Mullard Radio Valve Co., a division of Mullard Ltd. in Mitcham, Surrey, England. He has had considerable experience with gas and photoelectric devices. He completed his engineering training at Borough College of Advanced Technology, London.

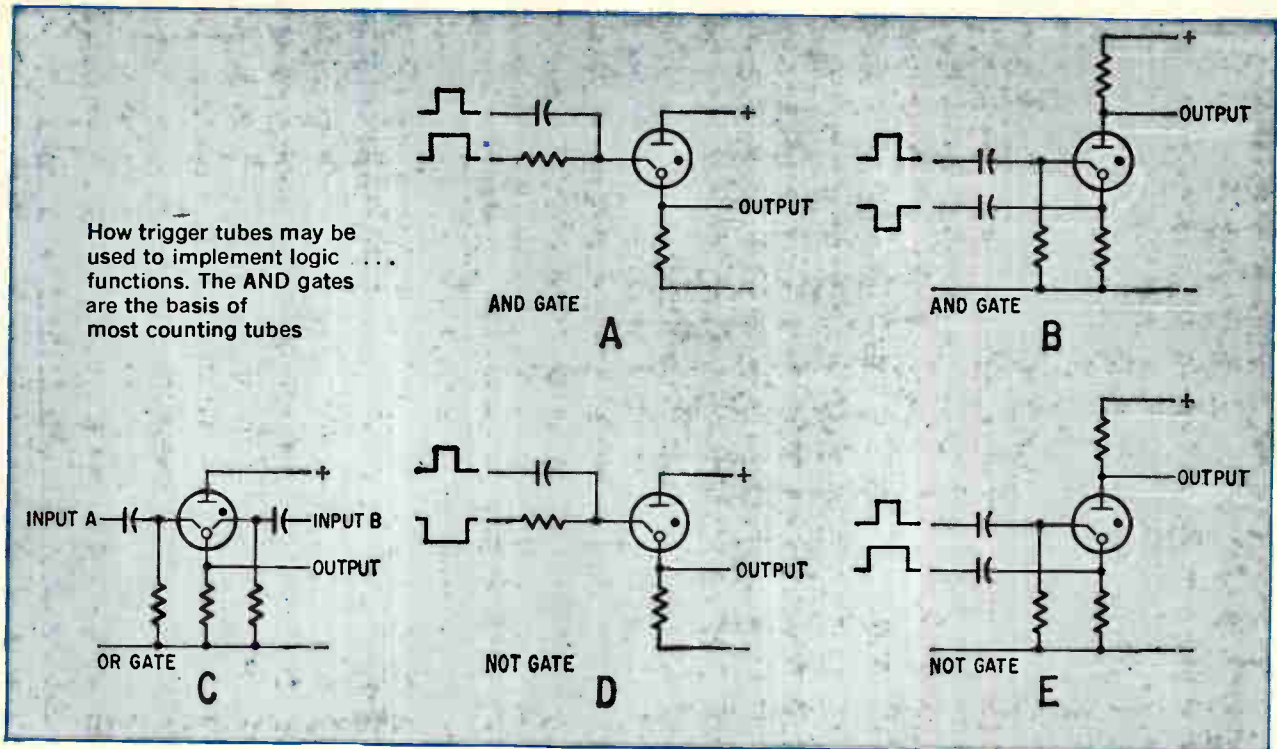

ers, voltage control and sensitive relay applications. Types like the Z900T (or 5823) are primarily for on-off relay applications, and should last for years in d-c circuits for passing currents of about 10 milliamperes. The maximum change in ignition voltage for tubes like the Z803U is about $\pm 2\%$. Temperature coefficient of ignition voltage is also very small—0.01% per degree centigrade.

A tube like the Z806W combines sharply defined trigger ignition with an ability to operate from a half-wave rectified a-c supply obtained directly from a 180-volt to 275-volt source [see the second diagram at the middle of p. 84]. The main anode-cathode gap is extinguished during each inverse half cycle, so that the trigger gap voltage is sampled on alternate half cycles.

Use in telephone switching

Trigger tubes can be used to supply logic gates and speech switching paths in small telephone exchanges containing up to 100 lines. The basic cir-

cuit, speech pulses and trigger connections for one such system are shown on page 79. A nonconducting tube has a high impedance, and is equivalent to an open switch. A conducting tube has a low impedance, and can be regarded as a short circuit. Each phone is connected to common channels, C_1 and C_2 , through a trigger tube. A connection is made, for instance, between phones A and B by firing tubes V_{1a} and V_{1b} . Speech signals pass from subscriber A via V_{1a} to C_1 , and on to subscriber B via V_{1b} .

A call can be made at the same time on another phone, using channel C_2 to ignite V_{2c} .

Speech tubes can be ignited only when the subscriber lifts the handset or when another subscriber calls. The tube cannot be ignited if the channel to which it is connected is occupied or if the called subscriber is engaged.

When a subscriber lifts his phone to make a call, a negative bias is applied to the common-cathode line of the tubes associated with the sub-

Characteristics of representative logic and relay tubes

Tube Type and Application	Size		Number of triggers	Anode working range (volts)	Nominal maintaining voltage	Maximum mean current (milliamps)	Nominal trigger ignition voltage
	Bulb length (millimeters)	Bulb Dia.					
Logic tubes							
Z700U.....	25	10	1	200-310	116	4	145
Z700W.....	25	10	2	200-310	116	4	145
Z701U.....	45	10	2	120-165	60	7	80
Relay tubes							
Z803U.....	38	22	1	170-290	105	40	132
Z806W.....	49	22	1	170-400	118	25	120
Z900T or 5823.....	47.5	19	1	140-200	62	35	80

scriber. This is insufficient to cause ignition [see waveform C on p. 79].

The number 2 triggers of all the tubes in a given channel are connected together [lines N and M is the basic telephone circuit, p. 79]. These triggers go to an allotter circuit, which feeds a pulse onto each line in rotation [see waveform A and B]. These pulses are also insufficient to cause ignition; but when a negative bias is also present at the cathode, the sum of the two voltages will cause ignition. Negative bias is supplied by an AND gate. A single call energizes a single tube and occupies one channel. The allotter pulses to the occupied channels are immediately inhibited for the duration of the call [see waveform A], so that another subscriber is prevented from entering the channel.

In a 100-line exchange, a caller dials two pulse trains—for example, 5 pulses and then 6. The pulses are counted and recorded in register circuits, where all the number 1 triggers of a particular channel are formed into a matrix [see diagram on page 79]. On completion of the first pulse train, all subscribers between 50 and 59 will receive a bias, and on completion of the second pulse, train subscribers 06, 16, 26, 36, etc. will receive a pulse. Only the speech tube of phone 56 will ignite, since it alone receives both bias and pulse.

The tube was selected by the AND gate. A NOT gate is employed to prevent another subscriber from breaking into an established call. For instance, if subscriber A is conversing with subscriber B on channel C_1 and subscriber C calls B on channel C_2 , the speech tube, V_{2b} , of subscriber B must be inhibited. This is achieved by allowing conduction in the channel 1 tube V_{1b} to place a positive bias at the common cathode point.

Desk calculator

Trigger tubes can count directly in decimal notation and can be coupled directly to gas numerical display tubes. The Anita desk calculator, manufac-

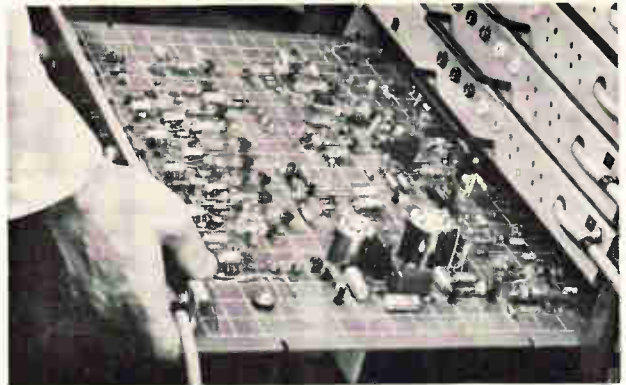
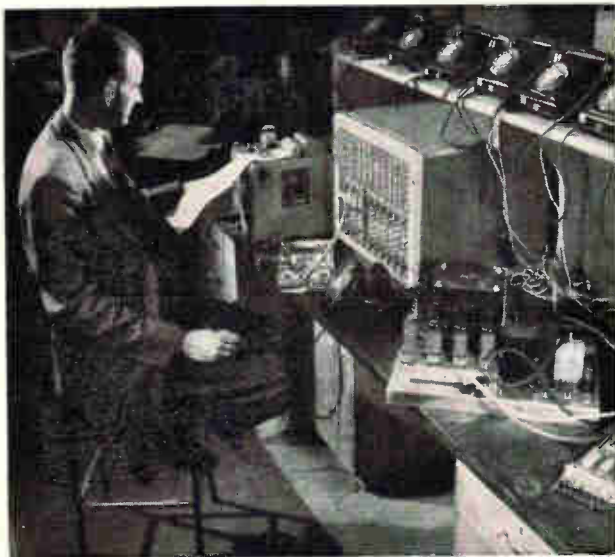

One of 13 switching boards in a commercial 25-line trigger tube telephone exchange made by Pye Ltd.

tured by the Bell Punch Co. in England, makes unique use of these features.

The pulse generator produces 4-kilocycle-per second pulses which are switched by the keyboard. Pulse trains are programed by the logic unit into a 12-stage register, which holds and displays the calculations.

The logic unit is directed by the command keys to multiply, divide, add or subtract.

Pressing a 5 key adds five pulses to the electronic counter associated with the key line used. If the 2 key is depressed, two pulses are accumulated—and so on. This is achieved by a trigger tube pulse-plus-bias counter that operates at one tenth of the pulse generator rate of 30 milliseconds. The counter has a tube for each of the 12 electronic stages in the register of the machine, and addresses the stages sequentially with a pulse corresponding to the value of the selected key. The addition of a number into the register requires only one complete revolution of the sequencing counter.

The counter circuit of one model is shown on page 82. All anodes of the trigger tubes are connected to a common register. A resistor in the cathode of each tube develops a voltage when the tube conducts. This voltage is coupled directly to bias the trigger of the next tube to a potential a little below the tube trigger ignition voltage. When the next drive pulse is applied to all triggers through their respective capacitors, only the tube which has its trigger biased will fire.

The capacitor in the cathode circuit of each tube stops the rise of the cathode potential, and the extra current through the anode resistor causes the common anode potential to fall. The capacitor in the cathode circuit of the tube which was previously ignited prevents the potential of this cathode from falling immediately, and this tube extinguishes. Square-wave pulses appear at the output of the circuit.

◀ Experimental electronic telephone exchange employs cold-cathode tubes to supply logic and speech paths. Small exchange is inexpensive and highly reliable.

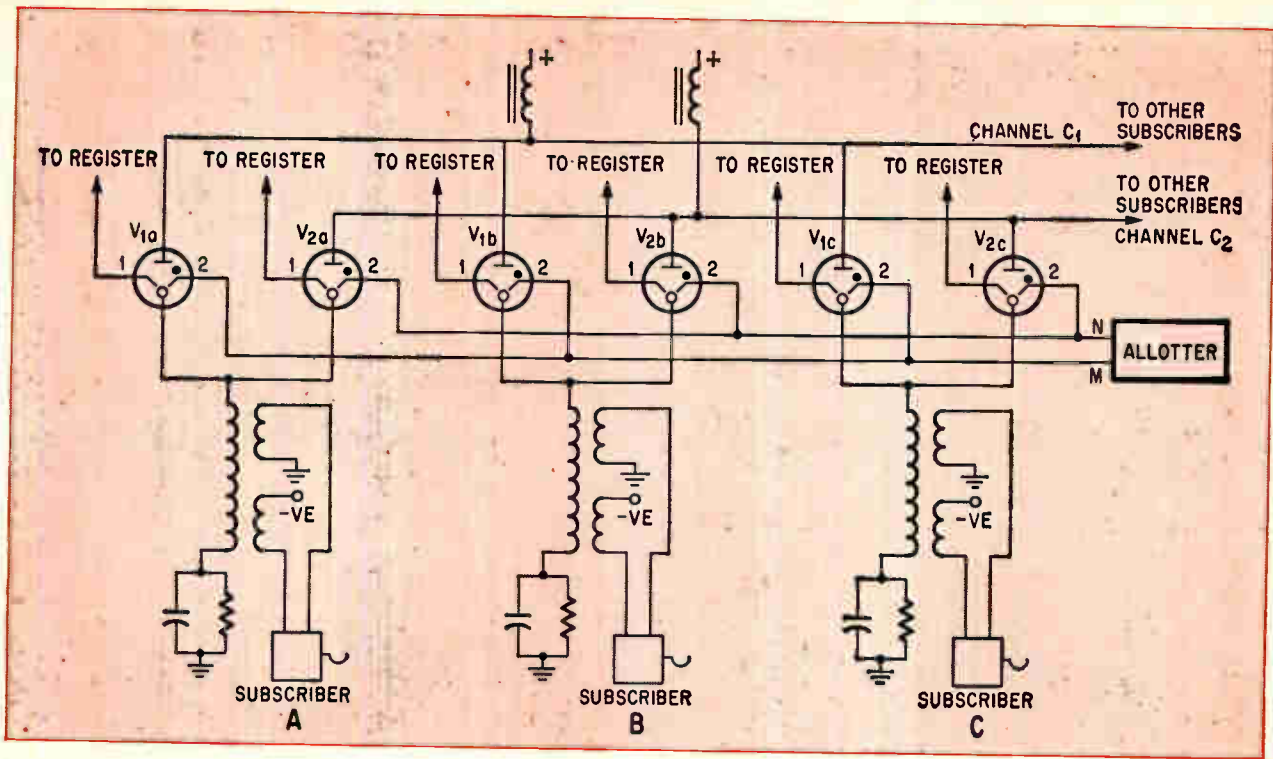

▲ Basic circuit of automatic telephone exchange. Each phone is connected to common channels through a trigger tube.

How pulse trains are fed into exchange circuit to select a particular connection, 56.

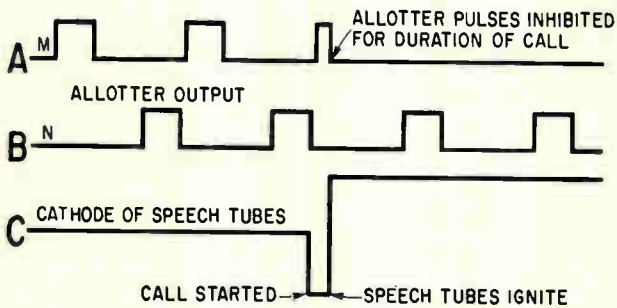

Waveforms of speech tubes in the telephone exchange. Pulses A and B are fed in rotation to allotter circuit. Tubes are ignited when channel is dialed (waveform C).

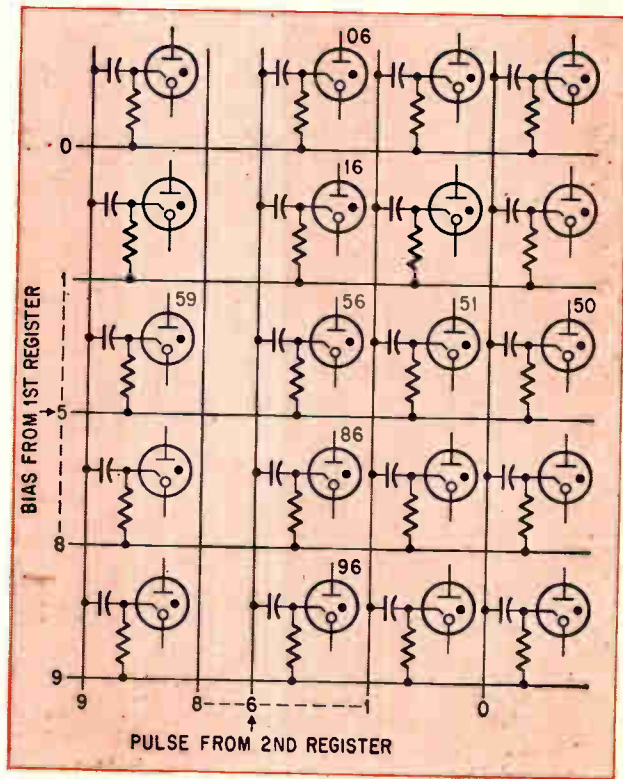

These sequencing counters operate at 400 pulses per second and have a voltage breakdown tolerance of about ± 100 volts. The extra cathode circuitry is to ensure a square-wave output, and the counting rate could be increased by a factor of ten without it.

The register circuit on page 83 counts the pulses received, displays the count, and if necessary, sets the carry store—so that when the sequencing counter moves to the next higher register

stage, a carry impulse can be added into that stage in addition to the pulses from the associated key line. An extinguishing pulse is applied to the circuit so that the tube following the previously conducting tube ignites when that pulse is removed.

The counter operation depends on the fact that the number tube takes longer to deionize than the trigger tube, and the capacitor connecting the conducting anode to the following trigger holds its charge for a period longer than the extinguishing

pulse. When the circuit is not counting, the same current flowing through one trigger tube and its number tube lights up the number associated with that trigger tube.

If a negative rectangular pulse of some 150 microseconds duration and 150-volt amplitude is injected into the number tube anode current from the drive tube anode, the two gas gaps are left with insufficient voltage to maintain conduction, and will extinguish. Deionization of the number tubes takes about 2.5 milliseconds. During the pulse, the trigger tube deionizes and the number tube remains heavily ionized.

During conduction, the anode of the trigger tube is at a lower potential than all the other trigger tube anodes. Hence the capacitor coupling the conducting anode to the subsequent trigger is charged to a lower voltage than the other trigger capacitors.

When the extinguishing pulse is removed, the anode of the previously conducting tube moves steply positive because of the number tube ion-

ization. The trigger of the next tube reaches its ignition voltage long before this could happen in any of the other tubes because of the retention of charge by the capacitor. The next tube then ignites. Using reliable mercury and neon number tubes and conventional trigger tubes, this circuit has counted at speeds up to 6 kilocycles per second with voltage breakdown margins of $\pm 50v$.

Industrial shift register

A memory chain of miniature logic tubes provides an extremely reliable counter for weighing and batching operations in a chemical plant. The circuit on page 82 shows three stages of the 60-stage shift register used in this system.

Crushed and screened rock is tipped into seven bunkers, each of which feeds a weighing machine. These machines weigh out batches of rock which are crushed and blown through a pipeline into a reaction vessel. The shift register produces a solids flow-rate signal for a ratio controller which controls the chemical flow into the vessel. The ratio con-

How the trigger tube works

In its simplest form, the trigger tube contains three electrodes in a gas envelope: a main anode, a triggering anode and a cathode.

The conduction path from main anode to cathode is designed to have the highest possible ignition voltage relative to the maintaining voltage, without sacrificing other operating features. The anode supply voltage is normally slightly lower than the main anode ignition voltage. In absence of a signal on the trigger, the main gap (main anode to cathode) does not conduct, and the tube input resistance may reach 10^{10} ohms.

The trigger ignition voltage is usually between one and two times the maintaining voltage. If the trigger-cathode voltage exceeds this value, the gap ignites and current flows. The graph on page 83 shows how the required voltage for main gap ignition falls as current increases. If the current increases sufficiently, the supply voltage becomes sufficient for ignition, and main-gap conduction occurs.

Trigger current is frequently obtained by discharging a capacitor through the trigger-cathode gap or with a pulse-plus-bias firing circuit.

After the tube has started conducting, the voltage across the main gap is the maintaining voltage, and is constant, whatever the current through the tube. The voltage across the load is therefore the different between the supply and the maintaining voltage, and the current through the tube will be determined by the value of the load.

The trigger tube can be extinguished only by reducing both trigger and main anode voltage below their maintaining voltages long enough to hold off the supply voltage. The time required for the tube to hold off the maximum anode voltage is known as the recovery time or deionization time.

Voltage and current restrictions

The cold-cathode tube fires spuriously if voltage and current levels are not held within defined limits. Circuit tolerances on supply voltage, maintaining voltage and resistor values can affect the range of current sharply. The simple gas diode circuit shown on page 83 illustrates the importance of maintaining proper

tolerances.

Here, a voltage source, V_s , supplies a maintaining voltage, V_m , through resistor R_1 . Current flowing equals

$$\frac{V_s - V_m}{R_1}$$

If V_s is not much greater than V_m , a small change in the source voltage can produce a proportionally greater change of current. The curve on page 81 shows the ratio of maximum currents that will flow for supply voltage tolerances of $\pm 5\%$ and $\pm 10\%$ as the function of the ratio V_s to V_m . If V_s is less than about 1.5 times V_m , the spread of current obtained for changes of V_s alone will be high. When V_s is slightly greater than V_m , the magnitude of change will be reduced slightly below that shown because of the incremental resistance of the gas tube. Normally, this reduction will be appreciable only in visual display tube and voltage stabilizer tube circuits—not in trigger tube or counting circuits. The graph makes no allowances for load resistor or maintaining voltage tolerances, but these also must be considered.

If the proportionate tolerances on V_s , V_m and R are $\pm p$, $\pm q$, and $\pm r$, respectively, the over-all ratio of maximum to minimum current will be:

$$\frac{I_{\max}}{I_{\min}} = \frac{\left[1 + p \frac{V_s}{V_s - V_m}\right] \left[1 + q \frac{V_m}{V_s - V_m}\right] (1+r)}{\left[1 - p \frac{V_s}{V_s - V_m}\right] \left[1 - q \frac{V_m}{V_s - V_m}\right] (1-r)}$$

Lower current means longer life

The minimum operating current for a tube is also important, for the life of many cold-cathode tubes is inversely proportional to a power of the operating current. Some tubes can operate 20 times longer when operating currents are cut in half. The operating current range of a circuit should be set for the lowest value consistent with tube characteristics and tolerances.

Voltage output of the gas diode circuit shown is not

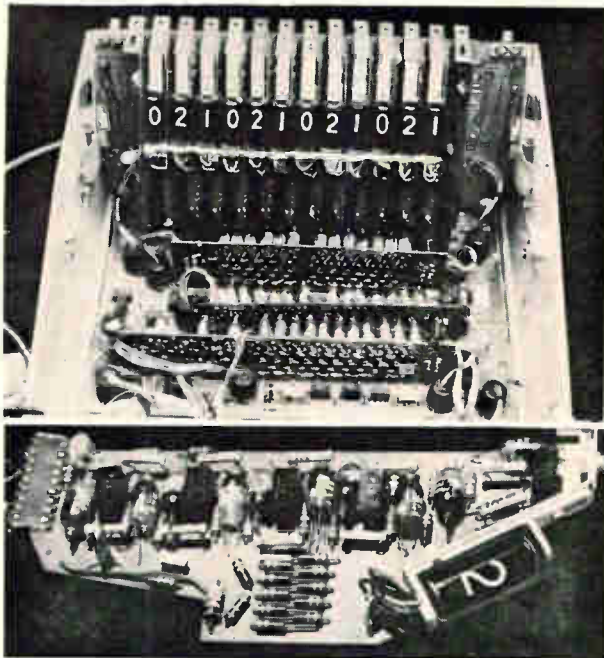

troller counts the tippings as they occur.

Each time the weighing machine operates, a signal is applied to the trigger of the first tube in the memory chain. A 20-millisecond pulse from the tipping mechanism ignites the first tube, and at 20-second intervals, this information is transferred tube by tube along the chain of 60 tubes. Thus the information is retained for 20 minutes. At any time, the total anode current taken by the chain of tubes is a measure of the number of tips made in the past 20 minutes.

The complete apparatus has seven channels. The trigger tubes are placed behind the holes in the panels so that the patterns of glow will show at a glance whether the plant is operating normally.

In this application, there were no failures among 420 tubes in 10,000 hours; the failure rate was less than 0.024% per 1,000 hours.

Internal construction of desk calculator (top). Circuits for each number tube are arranged on separate circuit boards (lower photo).

affected by the resistor tolerance. However, it can be affected by the tolerances of two resistors in series. This can be important when another cold-cathode tube is to be triggered by the output. It is also important in counting tube circuits, where the current passing is

mainly determined by the anode resistor, and the output voltage is developed across a much smaller cathode resistor. With counting-tube circuits it is essential for reliability to limit the voltage appearing across any cathode load resistors.

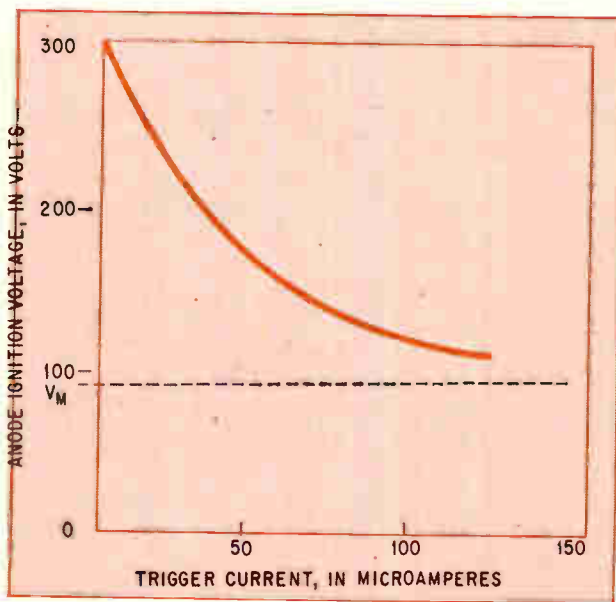

Curve shows how anode ignition voltage for the cold-cathode tube drops as trigger current increases. Ignition occurs when the main gap ignition voltage falls below the supply voltage.

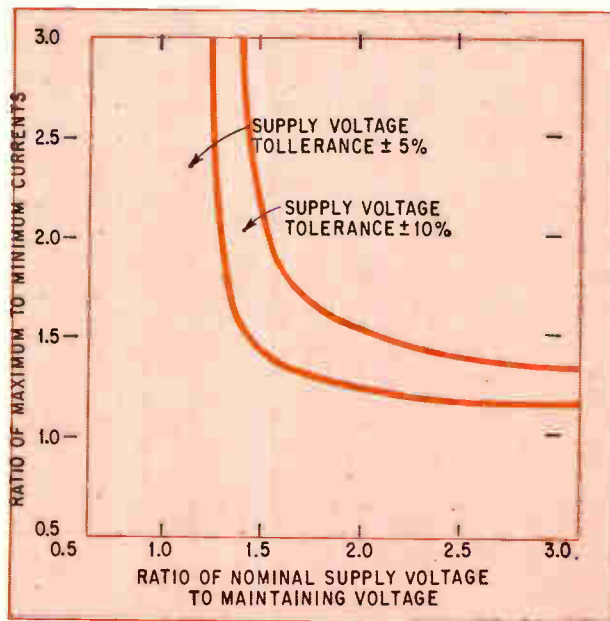

How supply voltage tolerances can affect the operating levels of the tube.

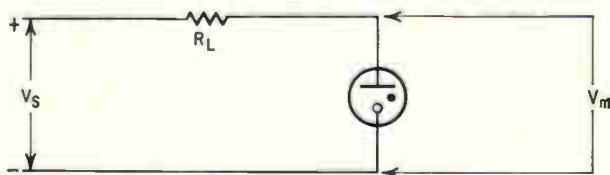

Simple gas diode circuit. If supply voltage V_s is only slightly greater than maintaining voltage V_m , a small change in V_s produces a proportionally greater change of current through the diode.

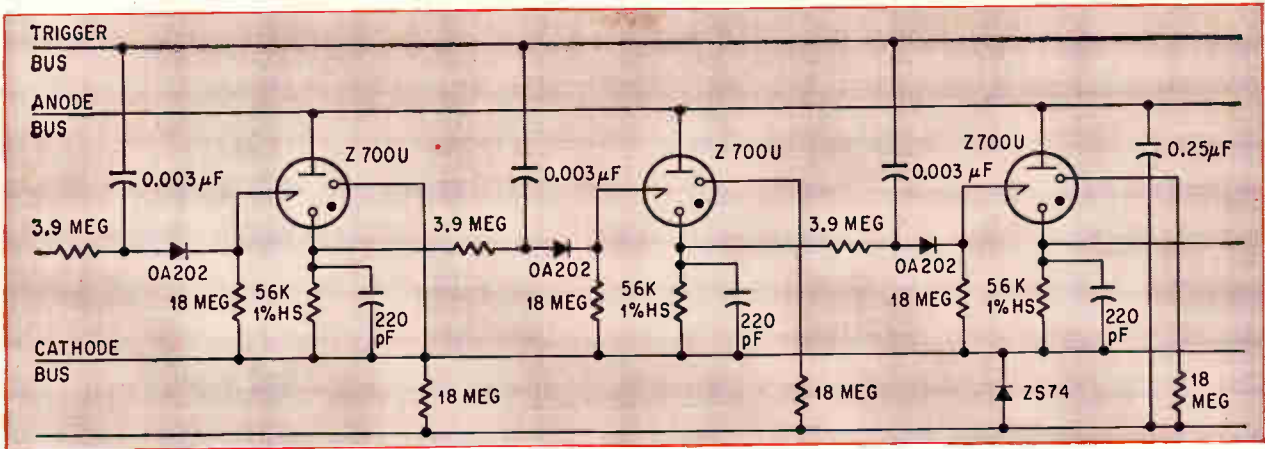

Memory chain of industrial shift register circuit counts weighing and batching operations in chemical plant. There were no failure rates among 420 tubes in 10,000 operating hours.

Voltage-control monitor

One ingenious method for voltage control uses a single trigger tube to monitor the output voltage from a supply transformer so that a correction can be applied by a motor-driven variable transformer, [see diagram on p. 83, top]. The anode of the tube is fed by two out-of-phase half-wave rectified a-c waveforms through separate load relays. The trigger is also fed by two out-of-phase waveforms derived from the transformer output voltage. One trigger waveform is set to a slightly larger amplitude. When the output from the supply transformer is normal, the larger waveform ignites the trigger tube. Thus, the trigger tube passes anode current

only from the anode supply in phase with this trigger signal—and the appropriate relay is held in.

If the supply transformer output rises above normal, the slightly smaller trigger voltage applied during the other phase also rises to ignite the tube. The tube then passes anode current during both phases—and the other relay pulls in. This completes a circuit to a motor that winds down the variable transformer coupled to a voltage supply transformer, which is reduced to its original voltage. If the supply transformer output voltage falls below normal, the first relay drops out and the motor is then operated in the reverse direction to increase the voltage to normal. Britain's Foster Transformer Co. developed the method.

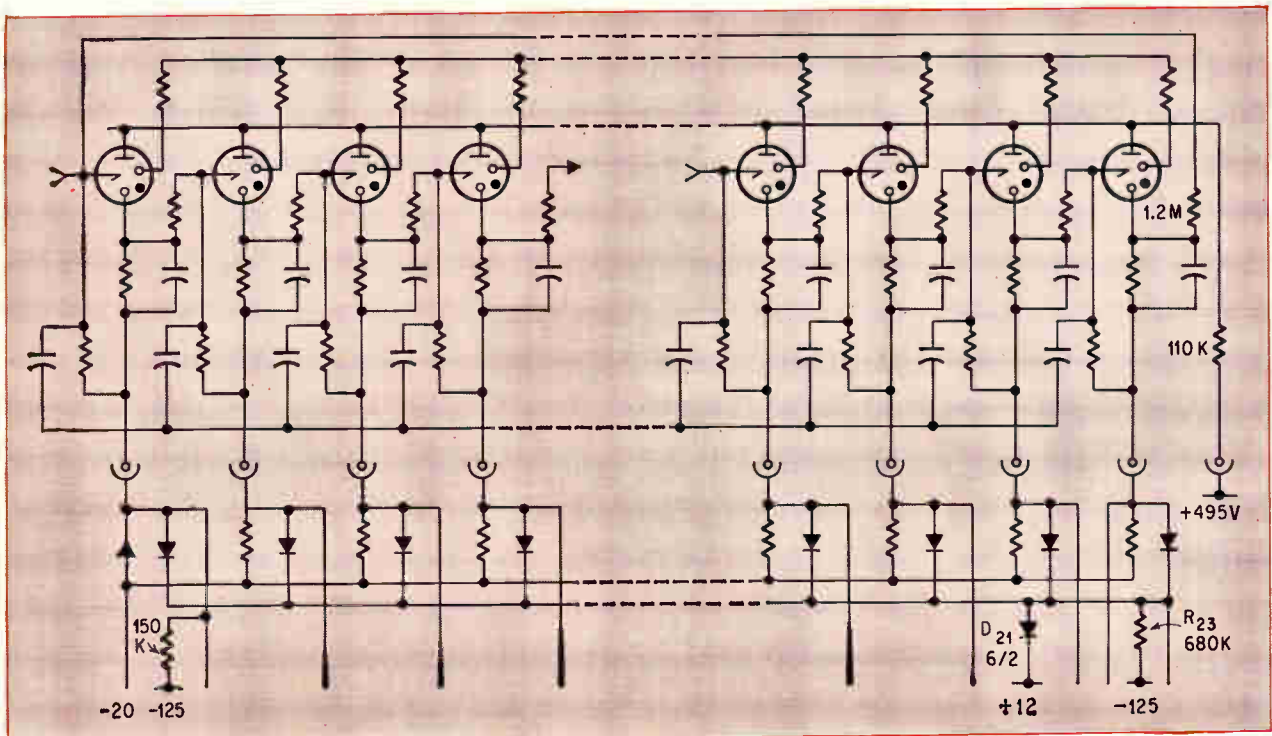

Sequencing counter of desk calculator is built up of pulse-plus-bias logic circuits which operate at 400 pulses per second. Square pulse output is fed to tubes in register stages.

A 500-kilowatt-ampere unit supplies a stabilized voltage to ships in port when their own generators are not operating. The output of this unit varies less than $\pm 1\%$.

Time-delay circuits

Three simple time-delay circuits are shown on page 84. The first obtains time delays of up to one hour. For delays of over a few minutes, the priming anode is disconnected to reduce the small trigger pre-ignition current. With the priming current flowing, the pre-ignition current is usually about 10^{-8} amps in a tube like the Z803U. If the primer is disconnected, the current is reduced to about 10^{-10} amps. The extra firing jitter due to the increased statistical delay will be negligible compared with the delay time itself.

The time is usually adjusted by varying the trigger supply voltage, because variable resistors with values high enough for the series position are not available.

The second circuit is used for short delay times. The time is proportional to the value of $R_x + R_t$.

The self-extinguishing circuit can be used in either case, and has the output pulse shown. Usually, the capacitor charge starts from the maintaining voltage and requires only a relatively small increase in voltage.

Accuracy is increased if the trigger capacitor is discharged to cathode potential just before the start of the timing interval.

If large capacitors are used in either the trigger or anode circuits, a resistor must be included in the discharge circuit to limit the peak current safely.

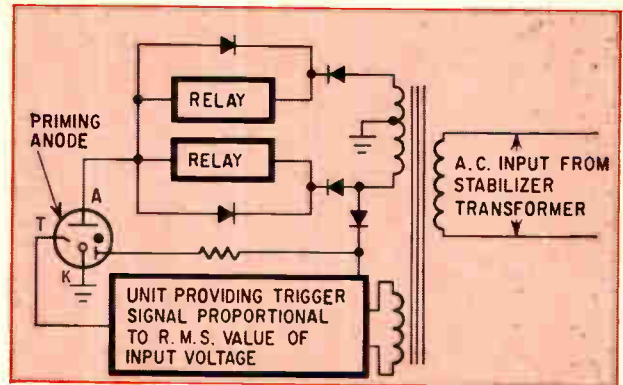

Single trigger tube monitors output of voltage supply, applies correction to a variable transformer.

Voltage stabilizers

Stable relay tubes can be used to control the output voltage of a small rectifier power supply, as shown on page 84. Changes in load current or input voltage are balanced by compensating changes in the tube current. The trigger tube circuit can be set to obtain a range of output voltage by a potentiometer.

In the voltage stabilizer, an alternating voltage applied to the input charges the reservoir capacitor C_1 through the dropping resistor R_1 and the diode D_2 . When the instantaneous value of the supply voltage drops below the level on the reservoir capacitor, diode D_2 blocks, and the capacitor discharges through the load—as in a normal R-C filtered supply. The trigger tube ensures that the voltage across the capacitor does not rise above the preset value during the charging period.

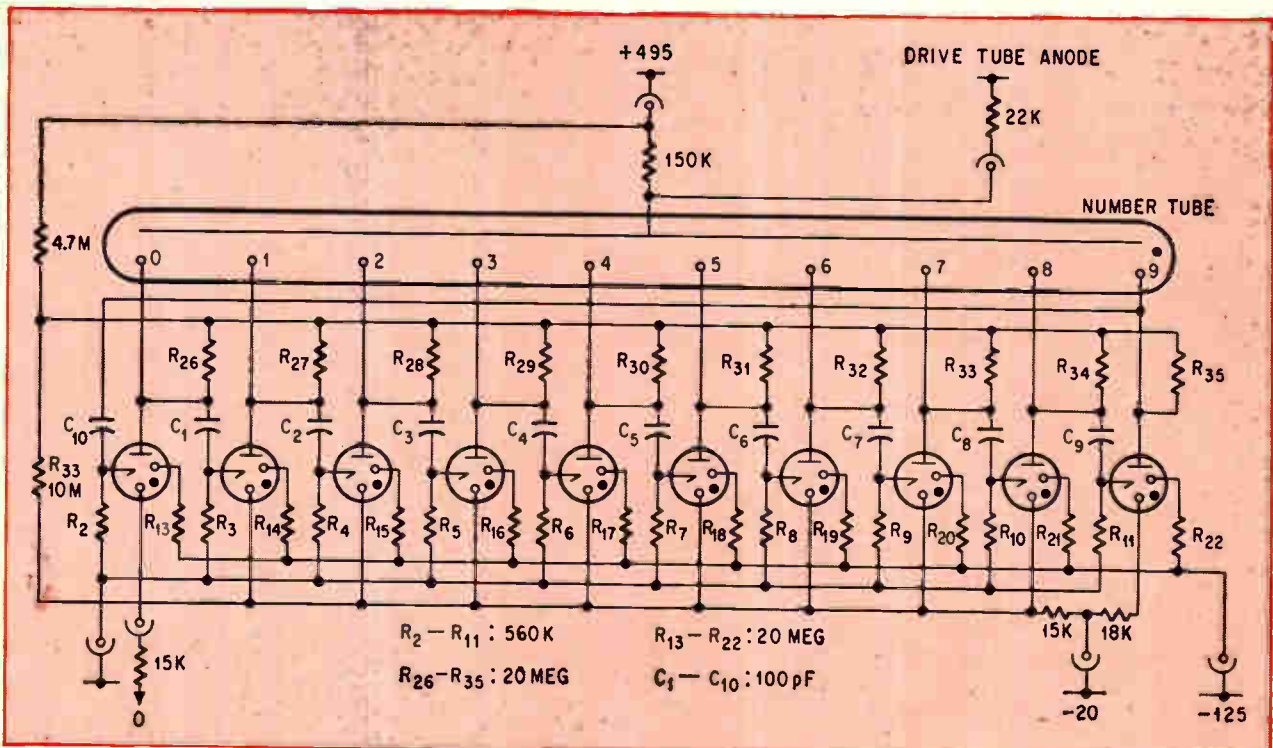

Register circuit of calculator counts and stores pulses received from sequencing counter. Number tube displays count and if necessary sets the carry store, so that a carry pulse can be added.

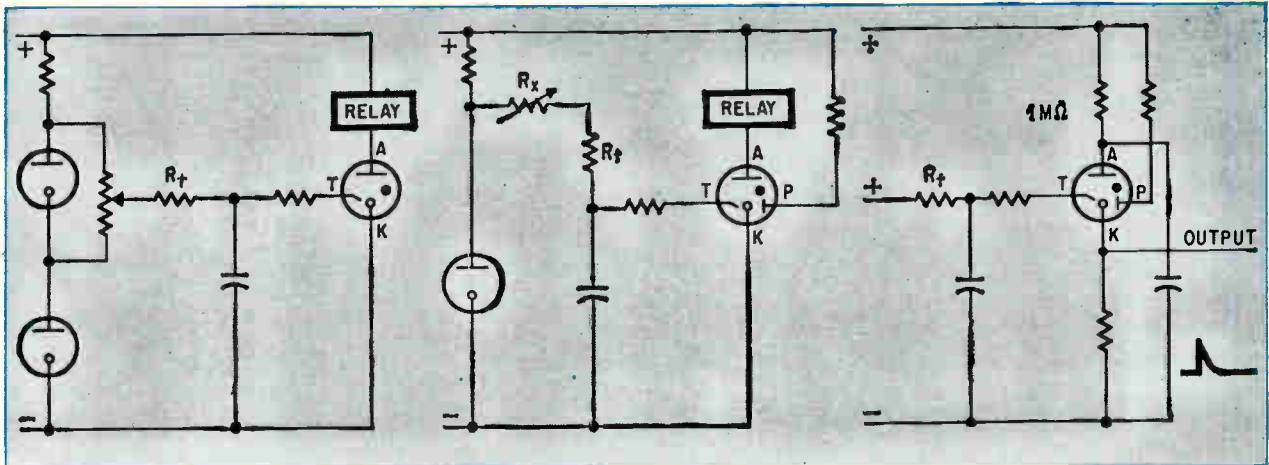

Three simple time delay circuits. First circuit provides delays of up to one hour. Second circuit is used for time delays of up to a few minutes. Self-extinguishing circuit, right, can be used in either case.

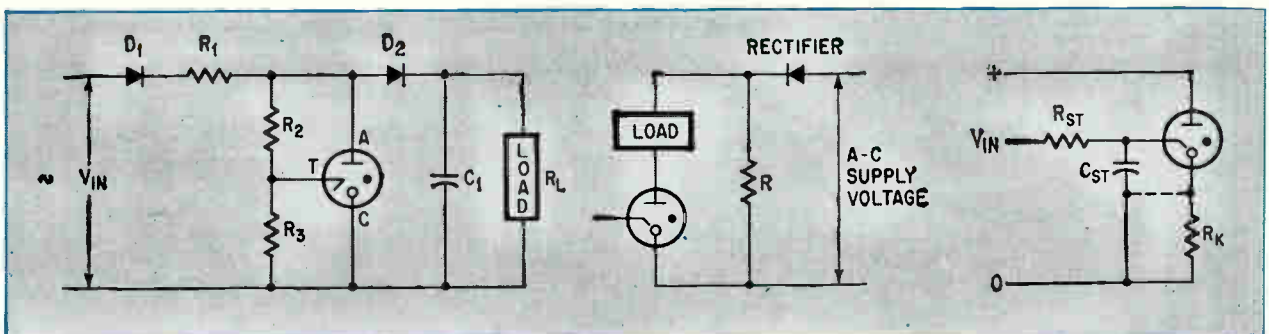

Stable relay tube, at left, controls voltage of a small power supply. In center diagram, inverse anode-cathode ignition is avoided in a-c circuits by using resistance and rectifier. In circuit at right, inverse trigger-cathode ignition is avoided by connecting lower end of capacitor to cathode (dashed line).

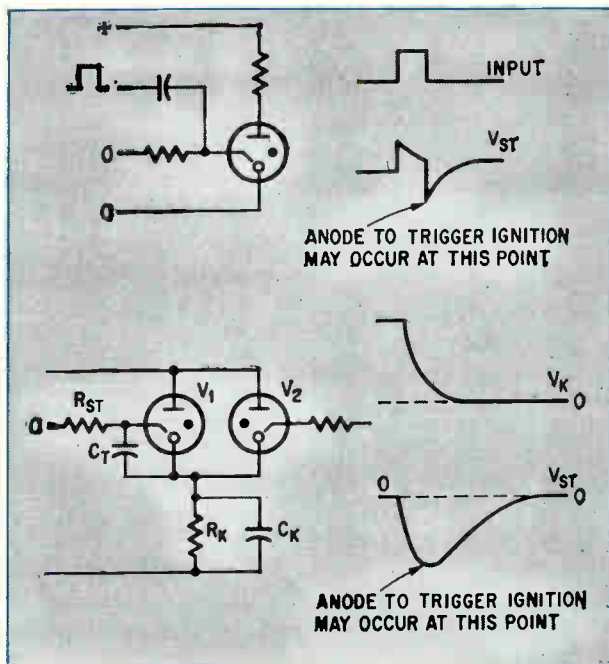

Diagrams show how anode-to-trigger ignition occurs in bias and pulse circuit, top, and in speech circuit, bottom. In both cases, spurious ignition can be avoided by the proper choice of component values.

During that period, the trigger anode is held at a preset proportion of the capacitor voltage by resistors R_2 and R_3 . When the capacitor voltage rises to the value at which the trigger voltage equals its ignition voltage, the tube fires. The anode voltage then falls to the maintaining voltage and the diode D_2 blocks so that no further charge can flow into the capacitor until the next a-c line cycle. The currents through the trigger tube depend on the value of R_1 and the supply voltage range. The trigger tube is extinguished when the instantaneous supply voltage falls below the maintaining voltage.

Preventing spurious ignition

Each type of logic or relay tube is designed so that the gaps between anode and cathode, and trigger and cathode conduct in a particular direction. When the tube conducts in its intended direction, the discharge tends to clean the cathode surface and purifies the gas in the tube. The more current the tube conducts, the greater the cleansing action, up to near the points where either the peak current is so high that the discharge changes from a glow to an arc, or the dissipation due to the mean current causes the temperature of the glass to rise so high it outgasses at a faster rate than the discharge can purify it.

Normally, the entire cathode could be fully covered by the glow, or the discharge—especially in

sputtered metal tubes. If this is not possible, then the circuit should pass a current pulse adequate for cleansing the cathode at frequent intervals. This can be arranged by discharging a capacitor through the tube when it ignites. The peak current rating for the tube should not be exceeded.

Voltage spreads between each pair of electrodes should be checked to determine that the tube ignites reliably, and does not fire spuriously.

Anode-cathode gap

If the voltage between anode and cathode exceeds the ignition voltage, the tube may fire spuriously. Anode-cathode ignition cannot be relied on to fire the tube, however, because the required voltage may change considerably after a period of conduction, because of heat. The upper limit for anode voltage is selected to account for variations in anode-cathode ignition, and should never be exceeded in normal use. For instance, care should be taken when a negative pulse is applied to the cathode that the sum of the anode voltage and the negative pulse does not exceed the ignition point.

The lower limit of the anode-cathode voltage is determined by the total energy in the trigger discharge and will vary from application to application. Information is usually supplied on the minimum anode-cathode voltage required for ignition as a function of both the trigger discharge current and the trigger discharge capacitor. In addition, a minimum anode voltage may be quoted; no damage would be caused by operating the tube below this minimum, but the circuit reliability achieved would be very poor.

The tube may fail to ignite when a resistance is inserted in series with the cathode and the tube is triggered by a positive pulse, fed to the trigger through a capacitor. Failure is caused by the rise in cathode potential due to the flow of trigger current. The anode-cathode voltage is reduced below its critical value. This failure can be overcome by bypassing the cathode resistor with a capacitor.

Inverse anode-cathode ignition can cause serious damage to the tube. This only arises in control circuits if the tube is connected to an alternating voltage. Unless a tube is specifically designed to operate at alternating voltage, a rectifier and resistance must be connected in the circuit [see second diagram, center, on p. 84]. The value of the parallel resistance R should be small compared with the diode reverse resistance, so that the anode does not go excessively negative with respect to the cathode.

The trigger-cathode gap

Reliable ignition of a trigger tube demands the satisfaction of two conditions. The trigger-ignition voltage must be exceeded, and discharge energy must exceed a minimum value. In any circuit, allowance should be made for any changes that occur in the tube itself.

Inverse ignition or spurious reignition can cause the trigger-cathode gap to conduct when it shouldn't. Inverse ignition can damage the tube.

Spurious reignition can occur in the timer circuit on page 84 (right diagram, center). During conduction, the trigger is at anode potential. When the tube is extinguished, the cathode potential falls rapidly to zero. However, because of the trigger capacitor C_{ST} , the trigger returns slowly to its zero potential, and the trigger-cathode ignition voltage may be exceeded.

The reignition is avoided by connecting the lower end of the capacitor to the cathode, as shown by the dashed line.

The trigger-anode gap

Breakdown across the trigger-anode gap can occur when the trigger goes excessively negative when the anode is positive, or vice versa. In either case spurious operation can damage the tube. Either the maximum voltage difference permitted across the trigger-anode gap, or the maximum negative trigger voltage, is given in published data for the tube. The maximum difference is met more often in practice, although the second can occur when an alternating voltage is fed directly to the anode without the series diode. The diagrams on page 84, bottom, illustrate two ways in which anode-to-trigger ignition can occur in logic circuits. In the bias-plus-pulse circuit, it is assumed that the bias is absent. The input pulse is differentiated by the trigger circuit components and the trigger may be made sufficiently negative by the trailing edge of the pulse to cause anode-to-trigger ignition.

The lower circuit on page 84, bottom, is a simplified speech circuit of the telephone exchange already described. Assume that V_2 has been conducting and that it has just been extinguished. The cathode voltage then falls with a time constant $R_k C_k$ toward zero. This fall in potential is fed through capacitor C_T to the trigger of V_1 and may result in anode-cathode ignition of V_1 . In both cases the difficulty can normally be overcome by proper choice of component values.

Continuous current cuts firing delay

A small discharge flowing continuously through the primer gap is necessary to reduce the time delay so that the tube will ignite immediately when the trigger ignition voltage is exceeded. Without the discharge, delay times of several seconds may occur.

An excessive priming discharge does not reduce the delay time below a certain minimum, but may reduce hold-off in the anode-cathode voltage as a trigger discharge.

Stray capacitance at the primer electrode is kept to a minimum by wiring the primer resistor as close to the tube as possible. Unless this precaution is taken, spurious anode-cathode ignition may occur when the primer gap ignites due to the energy stored in the stray capacitance.

Acknowledgment

The author acknowledges the assistance of his colleagues at Mullard Ltd., as well as at Bell Punch, Ltd., Foster Transformers, Ltd., Imperial Chemical Industries, and Pye, Ltd.

Designer's casebook

Designer's casebook is a regular feature in Electronics. Readers are invited to submit novel circuit ideas, packaging schemes, or other unusual solutions to design problems. Descriptions should be short. We'll pay \$50 for each item published.

Triangular waveforms have 1% linearity

By Jean F. Delpech

Institute d'Electronique, Orsay, France

The circuit shown below produces triangular waveshapes having less than 1% deviation from linearity at any frequency from 400 cycles per second to less than one cycle per hour.

The basic circuit consists of a Schmitt trigger, an integrator and a d-c amplifier. The rectangular waveshape of the Schmitt trigger is integrated by the R-C network and amplified. The amplifier's triangular output waveshape is fed back to the trigger, providing self-sustained (free-running) oscillation.

The sweep period is determined by the product of the integrator's R-C time constant and the gain of the d-c amplifier. Sweep linearity depends on the ratio of the output voltage amplitude to the amplitude of the Schmitt waveshape. This amplitude ratio is a function of the values of resistors

R_1 and R_2 . Output waveform symmetry can be adjusted by potentiometer R_3 .

The circuit operates as follows:

When a -22-volt supply voltage is applied, a voltage immediately appears across R_4 because capacitor C is initially uncharged and transistor Q_2 is cut off. The capacitor charges slowly through R_1 and R_2 , causing the output voltage across R_4 to decrease. Since the output voltage is directly fed-back to the input of the Schmitt trigger, Q_2 conducts when the turn-on threshold level is reached, and C discharges through R_4 , R_6 , Q_2 and R_2 . As C discharges, the output voltage increases, until the turn-off threshold of the Schmitt is reached. Q_2 turns off and the cycle repeats.

Design of this circuit is facilitated by the following equations:

Let v_2 represent the turn-on and v_1 the turn-off thresholds of the Schmitt, and v_A and v_B the lower and upper voltage amplitudes of the Schmitt's output square wave. Also, let V be the d-c voltage displacement and -K the gain of the d-c amplifier (for a d-c amplifier, $v_{out} = -Kv_{in} + V$).

A Miller integrator with a feedback capacitor C and an amplifier with a gain of -K is equivalent to a simple R-C integrator with a capacitor value $(1 + K)C$ followed by an amplifier, gain = -K.

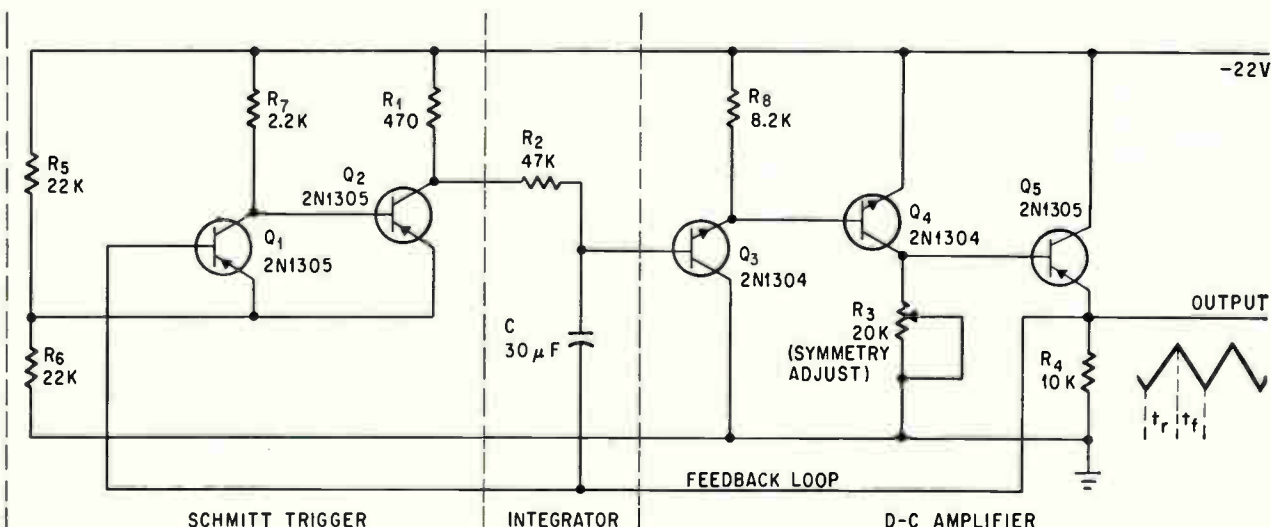

Linearity of triangular output frequency is better than 1%. Waveshape symmetry can be adjusted by potentiometer R_3 . Values of components in circuit give an output waveform having a period of 20 seconds; the frequency can be adjusted by changing the values of R_1 , R_2 , or capacitor C.

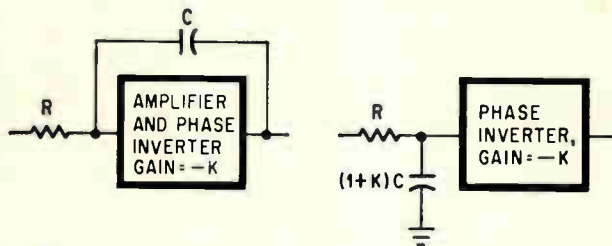

Basic Miller integrator diagram (left) and equivalent consisting of a resistor, a capacitor with a value $(1+K)C$, and an amplifier with a gain of $-K$.

The Schmitt trigger turns on when $v_2 = -K[v_B + v_A(1 - e^{-t_f/(K+1)RC})] + V$ and turns off when

$$v_1 = -K[v_A + v_B(1 - e^{-t_r/(K+1)RC})] + V$$

where t_f is the time occupied by the negative slope, and t_r , by the positive slope of the triangular wave.

These equations can be simplified by an expansion of the exponential form

$$e^x = 1 + x + \frac{x^2}{2!} + \frac{x^3}{3!} + \dots$$

where the $(1+x)$ term is a good approximation for the equation of the slope and the x^2 term is a measure of the deviation from linearity.

$$\text{Therefore } e^{-t/(K+1)RC} \cong 1 - \frac{t}{(K+1)RC}$$

Assuming that $K \gg 1$, then $(K+1) \cong K$, and solving for t_f and t_r from the preceding equations

$$t_f = \left[\frac{V - Kv_B - v_2}{v_A} \right] RC$$

$$t_r = \left[\frac{V - Kv_A - v_1}{v_B} \right] RC$$

The triangular wave will be symmetrical when $t_f = t_r$.

The deviation from linearity, λ , can be calculated from the second term of the expansion:

$$\lambda = \frac{t^2}{2[(K+1)RC]^2}$$

For a symmetrical waveshape

$$\lambda = \left[\frac{v - Kv_B - v_2}{(K+1)v_A} \right]^2$$

Note that neither the output waveshape symmetry nor linearity depend on the R-C time constant.

Resistor R_1 adjusts the output amplitudes v_A and v_B of the Schmitt trigger that control the amplitude and frequency of the triangular output waveshape. The value of R_2 affects only the R-C time constant, which determines the frequency. Potentiometer R_3 controls the waveshape symmetry by adjusting the value of V .

Low frequency performance is adjusted by first setting the generator frequency to about 100 cps, where symmetry and linearity can be conveniently observed on a scope. Then the generator is set to a very low frequency, where symmetry and linearity can be checked with a pen recorder, if required. The linearity and symmetry should be the same as at the higher frequency.

This generator was used to sweep the magnetic field across the air gap of an electromagnet in a nuclear magnetic resonance experiment. It could also be used in the design of servo systems or for testing very low frequency amplifiers.

The triangular wave generator can be followed by a diode function generator to obtain a very low frequency sinusoidal waveshape having a distortion of only a few percent.

FET circuit stretches 1-msec pulse to 30 hours

By M. E. McGee

Lawrence Radiation Laboratory,
University of California, Livermore

A one-millisecond input pulse is stretched to about 30 hours by the field effect transistor in the circuit shown on the next page.

The input and output transistor stages are emit-

ter followers that isolate the field effect transistor circuit. The input transistor Q_2 provides sufficient current gain to charge the capacitor, and also provides a reference for the diode D_1 . An input pulse causes Q_1 to conduct, turning on D_1 and providing a low impedance path to charge the capacitor. When the diode is turned off, it isolates the capacitor from the low-impedance emitter follower. The FET provides the impedance transformation. The input impedance of the FET is on the order of 10,000 megohms, and its output impedance is approximately 2,000 ohms. Transistor Q_1 reduces this output impedance further and also provides current gain to drive an external load.

Silicon diode D_1 has a leakage current of less

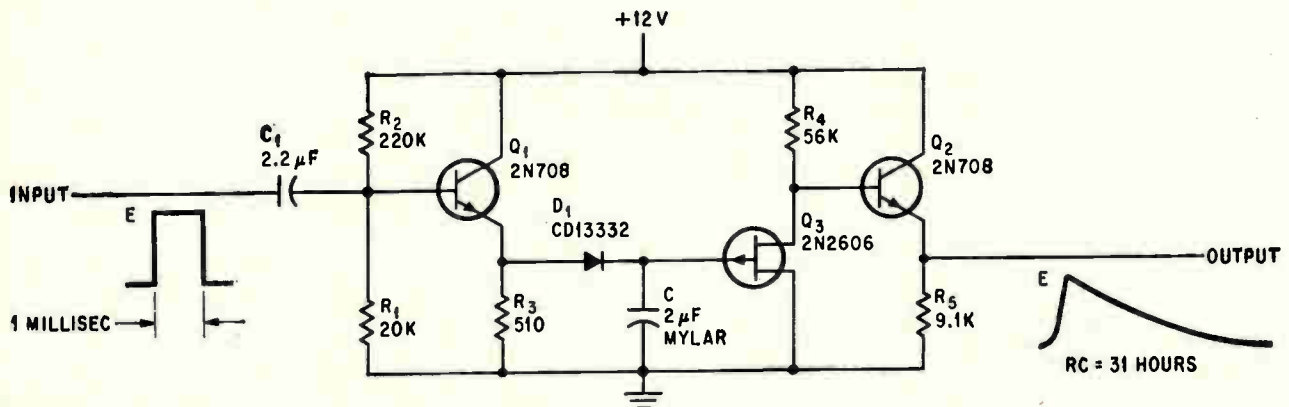

Extremely low leakage current through D_1 and the field effect transistor, Q_3 , gives this circuit its 30-hour time constant. Basically, Q_1 and Q_3 are emitter followers that isolate the FET circuit.

than 3 picoamperes with a peak inverse voltage of 10 volts at 25°C. The back resistance of D_1 , and the leakage currents through the FET and the 2- μf capacitor C make up the equivalent resistance of the circuit R-C time constant. The capacitor has a leakage resistance of 10,000 megohms per microfarad at rated voltage. The diode leakage resistance is on the order of 100,000 megohms at 10 volts. The FET leakage resistance is 1,000 megohms at 30 volts. These are given as minimum leakage resistances at specified voltages. The leakage resistances are in parallel and the equivalent resistance is about 5.6×10^{10} ohms at 25°C for the components and voltage shown in the circuit diagram at the top of this page.

Because each of these leakage resistances changes with voltage, the curve of the output voltage amplitude as a function of time, is not a true exponential decay. The departure from the ideal exponential decay characteristic was measured by observing the output voltage decay for more than 64 hours and recording the measurements with a digital voltmeter/printer. Applying the data to a curve fitting analysis gave an exponential time constant of 31 hours, accurate to 2½%. The exponential decay is accurate to 1% from two to five hours after the input pulse.

With this accuracy the output voltage may be measured at any time within the time constant period, and the initial pulse amplitude can be determined by interpolation.

The circuit can be used as a storage device that allows information to be retrieved after a specified period of time and can also be used as a compact long-period timer, where precise timing accuracy is not required.

Acknowledgment

The author acknowledges the assistance of Joe Wujek, Jack Matthews and Mary Lou Higuera.

Scr switch turns off with reverse bias

By Erwin L. Dosch

Technical Equipment Corp., Denver

A silicon controlled rectifier in series with a resistor can operate as an on-off switch when connected to a d-c supply. The resistor's value is selected to limit the anode current of the scr to less than the minimum holding current.

A reverse bias is applied to the gate of the scr at cutoff causing the switch to open rapidly. When the scr is conducting, a 2-volt drop exists across resistor R_4 in series with the scr cathode. A small positive input pulse causes Q_1 to conduct and switches the gate 2-volts negative with respect to the cathode. This bias voltage is adequate to interrupt anode currents of up to 30 ma in the scr.

Switching 10-ma anode current gives approximate rise and fall times of 10 and 5 microseconds respectively, and good pulse waveshapes at repetition rates up to 10 kilocycles per second.

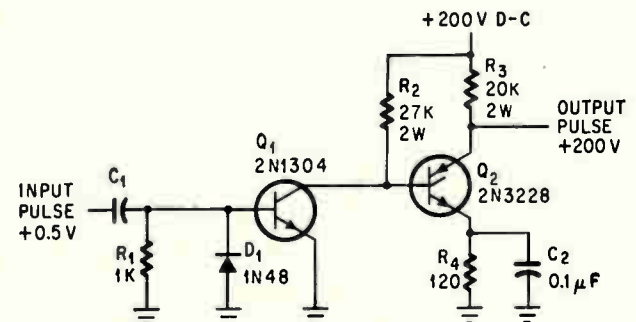

Low positive input pulse causes Q_1 to conduct and switches gate of scr 2 volts negative with respect to cathode.

Project Gemini: giant step on a stairway to the moon

Astronauts in orbit will test rendezvous techniques and the effects of weightlessness. They'll get plenty of electronic help. Part 1 of a 2-part report

By Joel A. Strasser and Peter Sigmund

Space Electronics Editors

Project Gemini has entered its most exciting phase: manned flights by pairs of astronauts, climaxed by the coupling of two vehicles in orbit. It's an important preliminary to Project Apollo, whose goal is to put two men on the moon by 1970 and bring them home safely.

At intervals of about 90 days, from now until well into 1967, pairs of astronauts will be placed in orbit for periods ranging from 4½ hours to 2 weeks. The space twins will study the earth via low-light-level television cameras, communicate by means of laser beams, and find out whether prolonged weightlessness impairs man's ability to maneuver a spaceship.

On the fourth manned flight, probably early in 1966, an astronaut will go outside his spaceship to perform mechanical chores. On this flight, the first space rendezvous will be attempted; the Gemini astronauts will try to link their spacecraft with an orbiting Agena rocket.

The manned part of the Gemini program began March 23 with the three-orbit flight of Maj. Virgil I. Grissom and Lt. Cmdr. John W. Young.

The second part of this report, on May 3, will discuss Gemini's telemetry and communications.

The first true spaceship

Gemini has the same bell-shape as the Mercury capsule that was used for the United States' first manned journeys into space. But it's a far more sophisticated craft.

Unlike Mercury, the 6,900-pound Gemini is a true spaceship. Grissom and Young actuated major systems, sharply altered the ship's altitude, shifted her orbital plane, and controlled the reentry path.

Gemini's maneuvers were ultra-precise. The pilots cranked attitude control commands into an

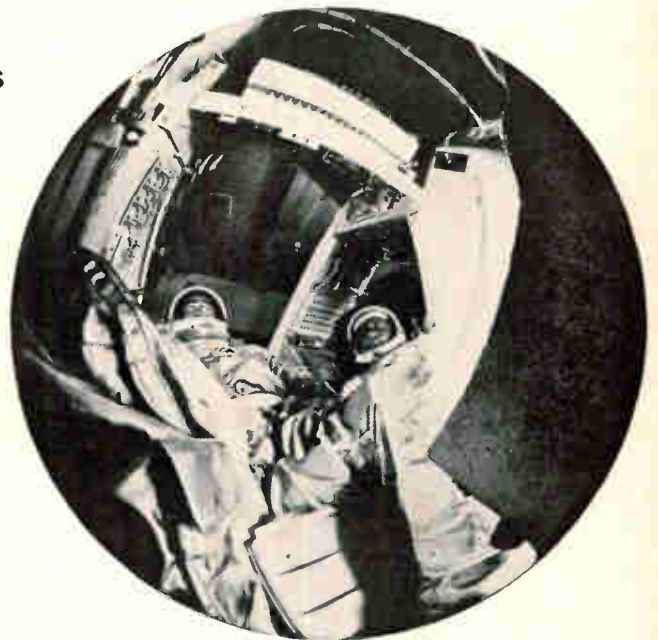

onboard computer which displayed on the control panel exactly how much pitch, roll, and yaw were needed. They changed reentry path by rolling their craft, again aided by the computer.

On future missions, such precise maneuvers will be essential to bringing spaceships together in orbits of the earth and later of the moon.

The spacecraft is attached to its two-stage Titan 2 launch vehicle by an adapter section that includes oxygen and attitude-control rockets. Starting with the third manned flight, two fuel cells—the first to be used on a manned U. S. spacecraft—will generate electricity through the chemical reaction of hydrogen with oxygen.

Unlike Mercury, Gemini has no escape tower for abort during launch. Instead, each astronaut sits in an ejection seat controlled by a new system for detecting any malfunction.

Rendezvous in orbit

Before attempting a rendezvous with the large Agena rocket, Project Gemini calls for a test approach to a 70-pound radar pod that will be ejected from the spacecraft. While one astronaut maneuvers the spaceship near the rendezvous evaluation pod, his crewmate will photograph the pod. If this preliminary meeting is successful, the astronauts will be ready to try for a rendezvous with the 1484-pound Agena rocket on the next flight.

The rendezvous operation will begin with the

launching of the Agena rocket; when Agena has completed one orbit, Gemini will be launched.

Two days later, Gemini is scheduled to meet the Agena target vehicle. For the rendezvous and docking, 100-pound jets will be used in the adapter.

The target and the spacecraft will be maneuvered onboard and by ground control. After Gemini and Agena are docked, it will be possible to start Agena's main engine and use it to alter Gemini's course.

The Gemini cabin will be depressurized on the first rendezvous mission with Agena. The program calls for one astronaut to climb out of the capsule, breathing oxygen supplied from a chestpack or from a tether connected to the spacecraft. This experiment will test the astronaut's mobility and ability to perform tasks in space without gravity.

On later rendezvous experiments, astronauts will go outside the spaceship to practice repair procedures, use electronic instruments on the outside of the craft for reconnaissance experiments, and study their own maneuverability in space. They'll wear rocket-powered backpacks, which they will don in space. Still later in the program, astronauts are slated to venture forth without any physical connection with the spacecraft.

On March 18, the Soviet Union announced that a cosmonaut had left a two-man spacecraft in orbit, and returned safely.

The payoff for the rendezvous experiments will come in Project Apollo. After exploring the moon, about the year 1970, two U.S. astronauts will launch

their craft into lunar orbit. Then they will rendezvous with the command module, which will bring them home.

Working while weightless

Gemini should set records for exposure to zero gravity. The U.S. spaceflight record is 33 hours, set by Astronaut Gordon Cooper on May 15, 1963. The Soviet record is Valery Bykovsky's 119-hour flight in Vostok 5 on June 14, 1963. The third manned Gemini, designated GT-5 (for Gemini-Titan-5), should eclipse them all later this year with a 168-hour flight—longer than the probable round-trip time for a moon flight. Gemini-Titan-7 may stay aloft 336 hours next year.

Experts in space medicine want to find out whether zero gravity will weaken an astronaut's ability to do his job. They also want to make sure the astronauts don't black out when they hit re-entry forces after long periods of weightlessness.

Zero-gravity experiments include fertilizing sea-urchin eggs before Gemini's launch and at intervals during the weightless part of the flight. Extensive medical tests also are planned.

Experiments for Project Gemini

A total of 23 scientific and technological experiments are planned in Project Gemini. These range from injecting water into the spacecraft's flow field, to the laser and low-light-level television tests. Gemini's experiments are described in the following chart.

Gemini experiments: goals and gear

Space environment

Type	Objective	Description	Equipment	Mission
Airglow horizon photography; zodiacal light photograph	Obtain color photographs of the zodiacal light and the airglow	Time exposures will be made on color film.	70-mm. general purpose camera for airglow; modified 35-mm. camera for zodiacal light	Airglow: GT-5, GTA-9, GTA-11, GTA-12 Zodiacal light: GT-5, GTA-8, GTA-9, GTA-10
Cloud-top altitude spectrophotograph	Supply basic data on new technique to be used by National Weather Satellite Center of U.S. Weather Bureau to determine altitudes of high cirrus and low stratus formations from satellites	By orienting spacecraft, astronaut will make vertically aligned spectrograms.	3.8-lb. spectrometer fitted with diffraction grating of 20 angstroms/mm dispersion in region of 7,550 to 7,750 angstroms	GT-5 and GTA-8
Electrostatic charge	Detect and measure any accumulated electrostatic charge on spacecraft caused by frequent use of spacecraft thrusters	Astronauts turn on electrometer protruding through adapter wall.	Sensor unit and electronics unit, power connections, one telemetry channel	GT-4
Proton-electron spectrometer; radiation measurements	Measure dose rates in trapped radiation at orbital altitudes	Spectrometer will measure proton flux in lower Van Allen belt, and electron flux in belt remaining from 1962 nuclear tests.	Proton-electron spectrometer	GT-4, GTA-6, GT-7

Magnetometer	Monitor direction and strength of earth's magnetic field to allow interpretation of radiation data	Magnetometer will be mounted in spacecraft adapter.	10-pound tri-axis flux gate unit	GT-4, GTA-6, GT-7, GTA-10, GTA-11, GTA-12
Nuclear emulsion	Study heavy particles in galactic cosmic radiation; study trapped proton flux of Van Allen belts near South Atlantic anomaly	Experiment package will be placed outside spacecraft and with drawn by astronaut using limited extra-vehicular activity.	10 lb. emulsion stack in insulated container	GT-7, GTA-8
Micrometeorite collection	Collect micrometeorites to study physical and chemical nature of interplanetary dust in primary form	Astronaut will place collection apparatus on outside of reentry module. He will later uncover collection surface by using switch.	8-pound collection box; cover is opened by actuating small electric motor	GT-6, GTA-9, GTA-10
Beta spectrometer	Measure velocity and intensity of beta particles	Apollo prototype spectrometer measures particles.	Beta spectrometer	GTA-10, GTA-11, GTA-12

Navigation and reconnaissance

Type	Objective	Description	Equipment	Mission
Wide-angle terrain photography	Obtain high-quality small scale photographs of selected parts of Earth's surface for research in geology, geophysics, oceanography, and other fields	Series of photos will be taken after Gemini is reoriented to angle between 45° and 90°	General-purpose 1-lb. 70 mm camera	GT-4, GT-5, GTA-6, GT-7, GTA-10
Manual sightings	Develop manual navigation system for Apollo spacecraft; investigate problems of window refraction	A hand-held sextant, accurate to within 10 seconds of arc, will be used to make celestial sightings through spacecraft window.	Manual sextant	One flight, late in program
Color patch photography	Determine influence of ultraviolet energy transmitted by camera lens, and the type of filters required to process and print color film exposed on lunar surface	Slate with four color patches will be photographed before the mission; in orbit, the slate will be attached to outside of spacecraft in maximum sunlight and rephotographed.	Gemini camera, Apollo lunar surface camera, color film	GTA-10
Two-color earth limb photography	To continue Project Mercury's horizon-definition experiments	Astronaut will take simultaneous photos with blue and red filters of Earth's limb (outer edge of brightness) from his sunrise to sunset	No. 12 Hasselblad magazine with filter mosaic between dark slide and film plate	GT-4
Landmark contrast	Measure difference of brightness of landmarks to find accuracy with which Apollo navigator can align them visually in Apollo sextant	Photometric measurements of landmarks to be used by Apollo crew.	Air Force D-5 equipment, MIT optical interference filters	GTA-10, GTA-11
Radiometric measurements	Gain data on spectral analysis of star fields, planets, earth and moon.	Intensity of radiation emanating from objects in space will be measured as a function of wavelength and compared with sky background measurements.	Three radiometers, two interferometer spectrometers	GT-5, GT-7

continued

Visual definition	Investigate problem areas associated with man's ability to observe, evaluate and photograph objects in space	Astronaut will photograph objects at specific intervals, including booster, rendezvous pod and Agena stage.	35-mm. photographic system	GT-5 and GTA-6
Astronaut visibility	Measure attenuation of spacecraft window due to effects of light scattering; test visual acuity	Astronaut will observe selected area and his comments will be recorded; photometer will measure scattering astronauts will use onboard vision tester five minutes every 24 hours.	Portable photometer, portable vision tester	GT-5 and GTA-7
Autonomous navigation	Develop manual space fixing techniques evaluating ability to determine orbital parameters without assistance from ground	Astronaut will measure horizon curvature, star-horizon angles, altitude at perigee (using analog computer), yaw attitude error (using ion detectors), and star occultation.	Stadimeter star-horizon sighting device	Later flights
Low-light-level TV	Astronaut will use tv to make test pictures of land, sea and cloud cover at night.	Astronaut will use tv camera to make pictures that will be recorded on film.	Image orthicon television camera with image intensifier	GTA-8, GTA-11

Biological

Type	Objective	Description	Equipment	Mission
Sea urchin eggs	Effect of zero gravity on growth of sea urchin eggs	Eggs are fertilized 30 minutes before spacecraft is launched and about 20 minutes after it is orbited	Eight chambers in 10-ounce flight container hold sperm, ova, and fixing agent.	GT-3
White blood cells	Study whether ionizing radiation in space causes chromosomal aberrations	Tissue culture containing white blood cells is exposed to radioactive phosphorus under zero gravity	Astronaut activates experiment by pulling plunger on small metal box	GT-3

Biomedical

Type	Objective	Description	Equipment	Mission
Cardiovascular reflex	Determine effectiveness of Graveline (pneumatic) cuffs to prevent cardiovascular deterioration	Cuffs on arms and legs inflated to about 50 mm for five minutes every one-half hour	Pneumatic cuff	GT-5, GTA-6, GT-7, GTA-8
Cardiovascular effect	Establish occurrence and degree of cardiovascular deterioration from prolonged weightlessness	Pulse rate and blood pressure measured before and after flights	Tilt tables used for 15-minutes period before and after flight	All flights
In-flight exerciser	Assess astronaut's capacity to work during spaceflight	Isotonic exercises during flight compared with exercises before flight	Bungee cord held between feet and stretched. Electroencephalogram and blood pressure bioinstrumentation	GT-4, GT-5, GTA-6, GT-7, GTA-11, GTA-12
Phonocardiogram	Indicate myocardial deterioration	Heart sounds detected by microphone at apex of heart, and recorded	Microphone biosensor on chest	All flights

Hormone analysis	Determine reactions to stresses of spaceflight	Plasma samples will be obtained before and after orbital flight	Urine collecting equipment	GTA-6 and following flights
Bone demineralization	Find occurrence and degree of bone demineralization	3 pre-flight and 3 post-flight x-rays will be taken of heel bone and of the end bone of 5th digit of right hand	Standard x-ray equipment	All flights
Calcium balance	Establish rate and amount of calcium loss during orbital flight	Astronauts will be kept on 0.8- to 1.0-gram calcium diet for two weeks prior to flight, during flight, and for two weeks postflight	Waste disposal system	GT-7, GTA-9, GTA-11, GTA-12
Electroencephalogram (EEG)	Assess alertness, levels of consciousness, and depth of sleep of astronauts in flight	Electrical activity of cerebral cortex will be monitored by two pairs of non-traumatic scalp electrodes	EEG electrodes, EEG signal conditioners, biomedical tape recorder	GT-5, GT-7, GTA-9, GTA-11, GTA-12
Vestibular effects	A. Measure changes in function of gravity sensors in inner ear during weightlessness. B. Determine astronauts' orientation capability in dark during weightlessness	A. Ocular counterrolling is measured photographically before and after flight. It is induced by tilting astronaut to one side. B. Egocentric visual location measured before, during and after mission	A. Highly sophisticated photographic equipment B. Lightproof goggles, one eye piece of which contains self-powered light source in form of movable white line. Astronaut positions white line to what he judges to be pitch axis of spacecraft.	GT-7, GTA-11, GTA-12

Miscellaneous

Type	Objective	Description	Equipment	Mission
Reentry communications	Neutralize reentry ionization by spraying water into slipstream	Thirty pounds of water squirted from two nozzles for about 10 seconds.	70-lb. unit	GT-3
Optical communications	Determine feasibility of using optically coherent beams for space-to-earth communications	Astronaut transmits three minutes of voice from hand-held gallium arsenide laser to ground receiver, and tracks another laser flashing next to receiver.	10-lb. transmitter; optical light collecting system used with FPS-16 radar	GTA-10
Spectral reflectance	Determine, ultraviolet spectral reflectance of lunar surface between 2,000 and 3,200 angstroms for values to be used in Apollo space suit visor design	Spacecraft hatch opened; astronaut guides spectrograph during exposures.	General purpose camera and UV lens	GTA-10
Visual rendezvous	Evaluate pilot's ability to control and maneuver spacecraft around a nearby object in space	Astronaut photographs rendezvous evaluation pod which has been ejected from spacecraft, and orients spacecraft.	70-lb. pod with L-band radar transponder and two high-intensity flashing lights	GT-5
Life support	Evaluate chest pack containing life support equipment and consumables; test backpack	Astronaut dons chest pack in cabin, gets backpack through extravehicular operation, and maneuvers in space with backpack propulsion.	Self-stabilizing maneuvering unit with five degrees of motion	Chest unit on GTA-8; chest and backpack on GTA-9 and GTA-12

Continued

Power tools	Test man's maintenance ability in space using minimum reaction power tool	Astronaut will step out of spacecraft, move via hand-holds to work panel, and use battery-operated hand power tool	Tool has output torque of 18 to 40 foot-pounds and comes with wrench, screwdriver thread tap, and drill attachments.	GTA-8
Mass determination	Evaluate technique for determining mass of small orbiting objects	Astronauts establish a known thrust for a fixed time while docked. By observing velocity buildup, they obtain data for measuring mass	Computer, and regular Gemini controls	GTA-6
Uhf, vhf polarization measurements	Precise measurements of electrons in ionosphere below spacecraft. Data to be used for improving spacecraft communications and control through ionosphere	Measure electrons' horizontal gradient as a function of time		GTA-8, GTA-9

Just in case . . .

In a 'first' for U. S. space flights, astronauts monitor launch vehicle's performance and can decide what to do if trouble develops during liftoff

By Sol Levine

Deputy Technical Director, Gemini Program
Martin Co., Baltimore

With the help of a built-in alarm system, astronauts do their own troubleshooting during the Gemini spacecraft's 5½-minute ride into orbit.

Unlike their predecessors in Project Mercury, they have an elaborate system for checking engine thrust, fuel-tank pressure and other variables in the Titan II rocket. If anything seems wrong, they are notified directly by lights and meters on the in-

strument panel. The chief astronaut then decides whether to continue the flight, switch over to a secondary guidance system, or abort the mission.

Project Mercury used an automatic abort system that allowed no decision-making by the astronauts during the launch phase of their flight.

In search of malfunctions

The Gemini Malfunction Detection System, built by the Martin Co.—a division of the Martin-Marietta Corp.—stresses reliability. It's not an advance in the state of the art; in fact it's not even particularly sophisticated. It employs redundancy in sensors and indicators, and in wiring between sensors and indicators.

To establish design criteria, Martin reviewed flight data and conducted failure analyses of Titan II. Although the Gemini launch vehicle contains 50,000 electronic and mechanical parts, it was concluded that advance warning of catastrophic failure was possible if three basic variables were moni-

The author



Sol Levine, deputy technical director for the Gemini program at the Martin Co., has held supervisory positions for other space projects, including Vanguard, Bullpup, Titan and Dyna-Soar. He holds several patents and is the author of two books: "Appointment in the Sky—the story of Project Gemini," and "Your Future in Electronic Engineering."

nauts to detect the malfunction and remedy it. So a redundant guidance and flight-control system has been designed into the Gemini system, together with a way to switch to it automatically.

Sensing tank pressures

To monitor propellant-tank pressure, two identical analog pressure sensors built by Servonic Instruments, Inc., a subsidiary of Gulton Industries, Inc., watch each of the four launch-vehicle propellant tanks. Pressure information from each aneroid-type sensor is transmitted to the spacecraft for display on a multimovement meter. Normal tank pressures during flight range from 70 down to 10 pounds per square inch absolute.

Each redundant transducer is energized by a separate d-c power supply and is individually wired to its pressure display in the spacecraft. The spacecraft's tank-pressure indicator, built by the instrument division of Lear-Siegler, Inc., has eight individual meter movements and eight pointers. Pointer movement is rapid, going from origin to 90% of full-scale indication within 0.65 second.

The pressure transducers are small and light. Including pressure-sensing element and circuitry, each transducer is 1 inch in diameter, 3 inches long, and weighs 8 ounces. The transducer output's signal accuracy is within $\pm 2\%$ of full voltage range and does not vary more than $\pm 0.1\%$ at any power-supply variation from 18 to 34 volts d-c. The transducer can withstand a sustained short circuit across its output without damage.

Because experience shows that most failures of components and wiring are caused by open circuits, the system is designed so that the voltage-output signal from the pressure transducer is the reverse of standard sensors. At maximum pressure, the transducer's output voltage is zero; at zero pressure, the output voltage is maximum—5 volts

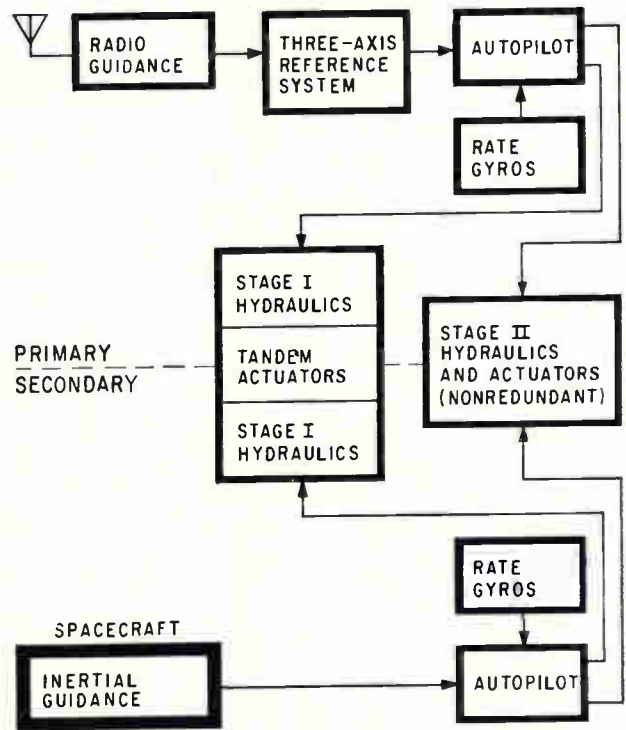

Redundant guidance and flight-control system. Switchover from primary to secondary system occurs if turning rate exceeds safe limit.

d-c. This fail-safe technique permits the astronaut to separate an actual tank-pressure loss from a measurement-system failure rapidly and positively. In addition, he can interpret a failure in the auxiliary power supply or the instrumentation power supply from the tank-pressure indications.

If one of the redundant pointers indicates normal pressure and the other is at full scale, it is obvious to the astronaut that one measurement channel has

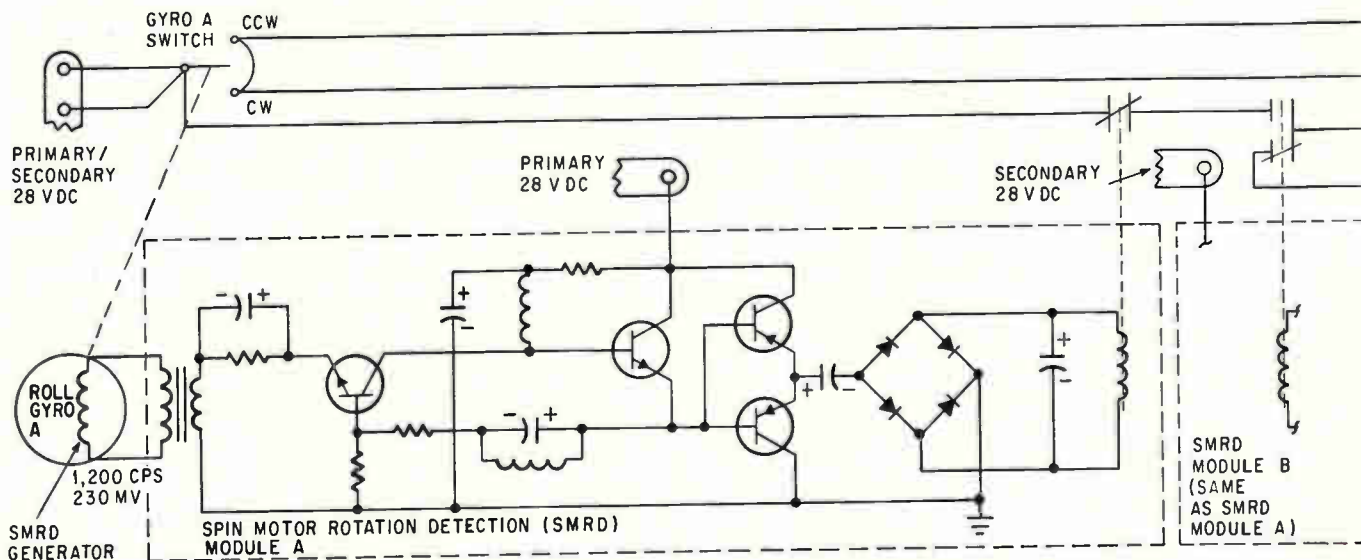

Gyroscope measures turning rate of launch vehicle. When turning rate exceeds safe value, contacts close and a 28-volt d-c signal

an open circuit or a power failure and should be ignored. Additional pressure information for the balance of the flight is obtained from the remaining circuit.

An indirect indication of failure of one of the two 28-volt d-c power supplies, primary or secondary, is available to the astronauts, too. Loss of power from the primary or secondary power supply causes one pointer from each of the four tank-pressure displays to indicate full scale.

Watching the engines

To observe engine performance, the Martin system uses redundant pressure switches in sensitive

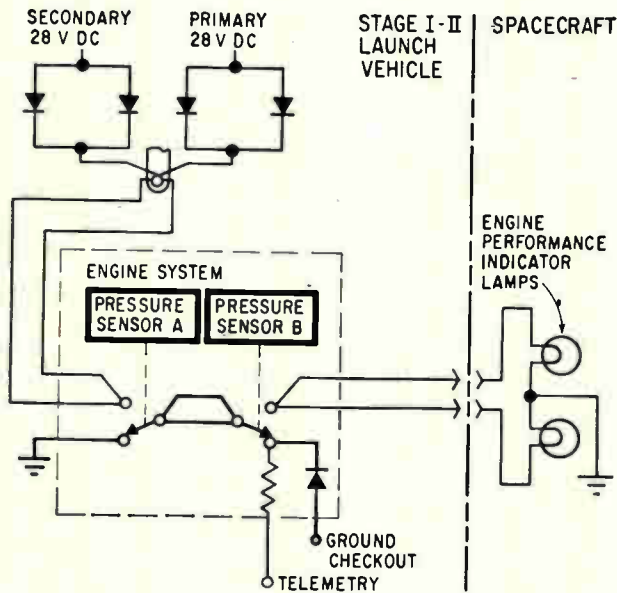

To monitor engine performance, series-connected pressure switches light a lamp in the spacecraft to indicate a loss of engine thrust.

locations on each of the two engines—in two sub-assemblies in the first stage and one in the second. If engine thrust drops 30% to 40% below normal, the pressure switches are triggered and a warning lamp in the cockpit is lit.

The redundant switches, built by the Frebank Co., are series-connected and are open when the engine is functioning properly. Both switches must be closed by loss of pressure and loss of engine thrust below a predetermined value before a 28-volt d-c signal is sent to the spacecraft. By using a redundant-pair series-connected technique, the chance of sending a false signal indicating engine failure is minimized. Tests show that pilot-reaction time to an engine-measurement signal is as short as 0.4 second.

Switches in the engine pressure-sensing system are single-pole, double-throw, snap action with a break-before-make feature. They are hermetically sealed and have stable switching characteristics from 0° to 160°F.

Engine failures are also detectable through cues, such as decrease in sound level and acceleration.

Avoiding the wrong turn

Finally, turning rates are monitored. Switches on rate gyros are closed when the vehicle pitches, yaws or rolls at a rate beyond preselected tolerances. A switch lights a warning lamp in the cockpit. Analyses indicate that the most likely cause of an excessive turning rate is a failure in guidance or flight controls so that automatic switchover from the primary to the secondary system occurs simultaneously with light actuation. Turning rates as low as 2.5° per second in the pitch and yaw planes are limiting values during some portions of flight. The Giannini Controls Corp. supplied the rate switch

Six rate gyros are used in the turning-rate sense-package.

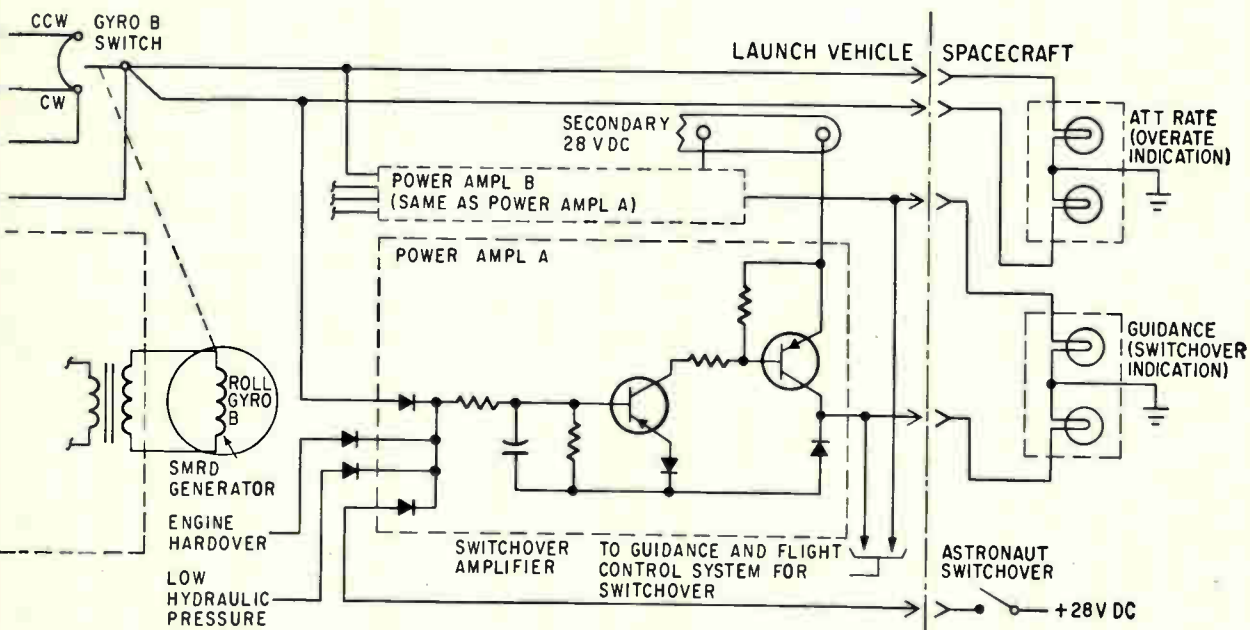

to the spacecraft. Switchover from primary to secondary guidance system occurs simultaneously.

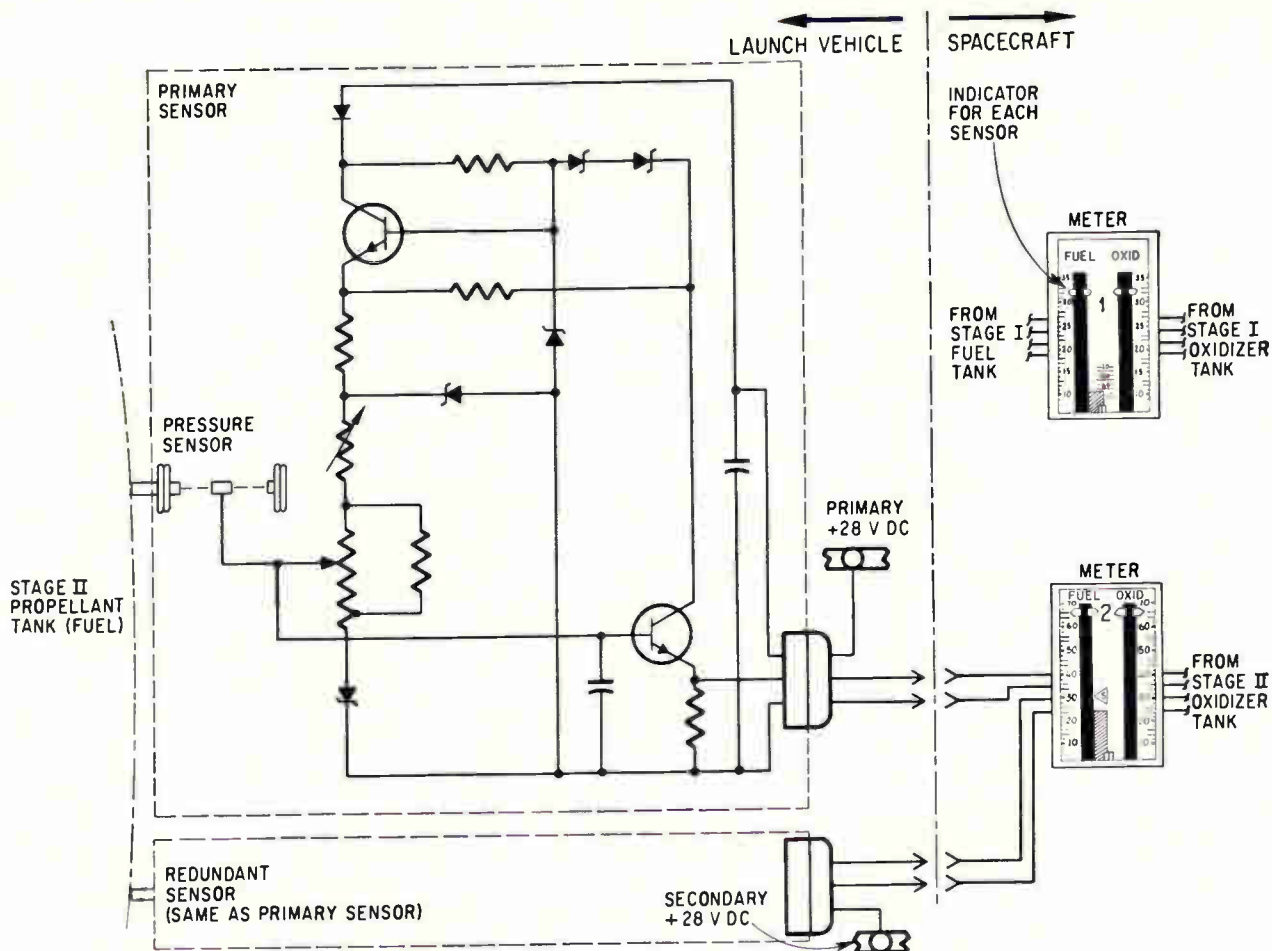

Propellant tank pressure is measured and indicated by system using redundant pressure sensors and dual pointer meters for each of the Gemini launch vehicle's four propellant tanks.

ing system, a redundant pair for each of the three vehicle-body axes of pitch, yaw and roll. With the exception of rate settings, which depend on the turning-rate limits of the launch vehicle, the gyro assemblies are identical.

"First pilot's spacecraft"

Gemini is the first true pilot's spacecraft. Although Mercury was handled a good deal by manual control, it was designed essentially as a fully automatic machine with manual control capability as backup to the automatic systems. The astronaut proved that he could contribute a great deal to the successful carrying out of the mission by controlling the capsule, but he had to override the automatic sequence to guide the craft himself. The original concept in manned Mercury flights was that the pilot would go along as an observer, not as the primary controller of the spacecraft.

Gemini, on the other hand, demands pilot response in all of its functions. The pilot must decide whether to abort a mission during the boost phase, he must steer the craft from one orbit to another to rendezvous with the Agena D engine . . . Gemini will be a pilot-controlled operational spacecraft—not just a research and development vehicle.

From a speech by Virgil I. Grissom, command astronaut of the first manned Gemini flight, at the U.S. Air Force Academy, Colorado Springs, Colo., January 25, 1963.

The rotor provides the rate-sensing capability it is a hysteresis type, 24,000-rpm synchronous motor, mounted with a spring-restrained gimbal. A switch mechanism linked to the gyro gimbal provides the switch output.

Commutator bars crossed by switch wipers drive two separate single-pole, double-throw (center-off) switches for each gyro. The double-throw switch permits sensing, both clockwise and counterclockwise, relative to the launch-vehicle's body axes.

Switches from a redundant pair of gyros are series-connected, requiring simultaneous closure of both switches before the pilot-warning or switch-over action is initiated.

The rate gyros fail when gyro motor-spin speed is lost. If one rate gyro is not running at synchronous speed, its rate switch does not close when the turning rate becomes excessive. To permit continued rate-sensing by the remaining gyro of the turning axis affected, a by-pass circuit for the defective rate gyro and switch is used.

Permanent magnets mounted in the gyro rotor, and a pickup coil within the gyro, provide an a-c voltage signal proportional to rotor speed. This signal is fed through an amplifier in a spin motor-rotation detection module. The signal passes through a narrow-band filter that provides an out-

put signal only when the rotor is running at synchronous speed. Lack of an output signal de-energizes a relay, closing a set of contacts to bypass the rate switch of a low-speed gyro; the remaining gyro and switch continue to be available for over-rate sensing.

As part of the Gemini test program, detection-system components were tested on five Titan II research-and-development launches and two un-manned Gemini flights. According to Martin, analyses verified the system's ability to operate in a boost space-flight environment that can produce vibrations as high as 95 g rms, acceleration of 12 g's, shock pulses of 120 g's and temperatures of 160°F.

Acknowledgments

The author thanks Lt. Col. Jay R. Brill, Air Force Space Systems division; Donald L. Jacobs, NASA Manned Spacecraft Center; Herbert Hecht and Henry Siesel, Aerospace Corp.; Ben Maglione, Servonic Instruments, Inc.; engineering staff of Giannini Controls Corp.; J. G. Tillery, Frebank Co.; and Robert C. Weaver, Tom Amacher and Conrad H. Cooke, Martin Co.

Bibliography

- Conrad H. Cooke, "Integrated abort program," Martin Co. document LV-97, December, 1963.
 Lt. Col. Robert J. Goebel, "Man-rating the Gemini," Aerospace Safety, April, 1964.
 Jerome B. Hammack and Walter J. Kapryan, "Gemini: Mercury experience applied," presented at AIAA Space Flight Testing Conference, Cocoa Beach, Fla., Mar. 18, 1963.
 Herbert Hecht, "Malfunction protection in the Gemini launch vehicle," Transaction of Eighth Symposium on Ballistic Missiles & Space Technology, San Diego, Calif., October, 1963.
 Bernhard A. Hohmann, "Pilot safety and Mercury/Atlas," Aeronautics and Aerospace Engineering, February, 1963.
 E. S. Joline, and R. L. Smith, "Optimization of malfunction sensing and decision systems for space vehicles," presented at IEEE Convention, Mar. 23, 1964.
 Christopher C. Kraft Jr., "A review of knowledge acquired for the first manned satellite program," presented at Virginia Polytechnic Institute, Aug. 13, 1963.
 J. U. LaFrance, Jr., "Gemini launch vehicle program," presented at AIAA 2nd Manned Space Flight Meeting, Apr. 22, 1963.
 Sol Levine, "Man-rating the Gemini Launch Vehicle", Aeronautics & Aeronautics, November, 1964.
 Charles W. Mathews, "The Gemini program," Aeronautics & Aeronautics, November, 1964.
 Warren J. North, "Gemini launch escape," presented at AIAA 2nd Manned Space Flight Meeting, Dallas, Texas, Apr. 23, 1963.
 Marvin Reid, "Manned Space Center combines glamor and complex equipment," Electronics Nov. 16.
 Scott H. Simpkinson, "Gemini test program," presented at AIAA/NASA, Third Manned Space Flight Meeting, Nov. 4, 1964.
 Robert Weaver, J. J. Miller, and J. C. Curlander, "Malfunction detection system configuration report," Martin Co. document LV-196, Feb. 1, 1963.

Physical exam in orbit

Bioinstrumentation system on Gemini relays heart, respiratory and temperature data of astronauts to ground-based medical team

Herbert R. Seal, Spacelabs, Inc., Van Nuys, Calif.

Gershon Weltman, University of California at Los Angeles

The authors



As chief project engineer at Spacelabs, Inc., Herbert Seal is responsible for the development of physiological instrumentation, data acquisition systems and life support systems. He designed the six-channel physiological telemetry system, currently in use at the School of Aviation Medicine, for remotely monitoring human subjects.



Gershon Weltman spent a year of study at the Weizman Institute of Israel as a recipient of a NATO post-doctorate fellowship. He is currently an assistant professor of engineering at UCLA. Associated with the Biotechnology Laboratory, he serves in both a research and teaching capacity.

The total time spent in space by John Glenn, Scott Carpenter and Walter Schirra adds up to about 16 hours. Gordon Cooper's Mercury mission, lasting 34 hours, was the first orbital flight of any real duration by a United States astronaut. When the GT-4 Gemini capsule circles the earth, astronauts James A. McDivitt and Edward H. White will live in space for days instead of hours.

The long orbit is being approached with confidence even though many questions remain unanswered concerning man's physiological reaction to an extended period of weightlessness.

The purpose of the Gemini bioinstrumentation system is to supply the medical monitoring team with information that will safeguard the men in flight and add to existing knowledge. Sensors placed on an astronaut's body will provide the raw information; other system components will amplify it, store it, and relay it to ground stations.

Each manned spaceflight is simultaneously a

unique operational mission and part of a continuing, complex research program. The medical monitors are interested both in the immediate safety of the astronaut, and in the effect of observed responses on the planning of subsequent flights. Since only a limited amount of bioinstrumentation can be carried on Gemini, the physiological measurements and the means of obtaining them had to be carefully selected in light of these two considerations.

To assist them in selecting what to measure and the means for doing so, the Gemini planners relied heavily on the results of the Mercury experiences. The measurements to be made are substantially the same as those taken on the last Mercury flight. But in the design and packaging of the system components, the Gemini program has attempted to advance frontiers whereas the Mercury program was forced by necessity to work strictly within the state-of-the-art.

Bioinstrumentation design for a spaceflight presents formidable problems. Equipment must be extremely small, lightweight and highly reliable in the face of severe environmental loads and variations. Good contact with the astronaut must be made and maintained far longer than in normal practice despite the restrictions imposed by his spacesuit. Recent testing indicates that the Gemini bioinstrumentation system not only meets the demands of the environment but also sets new standards of excellence for the physiological measurements involved.

System concept

The components of the Gemini bioinstrumentation system and their interconnections are shown schematically on the right. Each astronaut is fitted with an instrumentation package built around five signal conditioners:

- Two electrocardiograph amplifiers, to detect the electrical signals produced by the heart;
- An impedance pneumograph, which yields a waveform related to breathing rhythm and volume;
- A temperature unit, which indicates oral temperature;
- A blood pressure unit, which supplies the information for determining arterial blood pressure in the form of mixed signals representing arm cuff pressure and pulse sounds.

The outputs of the signal conditioner are fed directly into the on-board telemetry system, which is designed to operate on signal levels up to 5 volts. Ground monitoring stations receive the telemetered signals during flight. These signals are used to assess the physiological condition of the astronaut. A small tape recorder in the Gemini capsule makes a parallel record of the heart and respiratory signals at selected times during the flight. This recording eliminates the gaps in the data telemetered to the ground stations and is reviewed by the medical team after the mission.

The signal conditioners are worn in a belt around the astronaut's waist. Thin leads attach these units

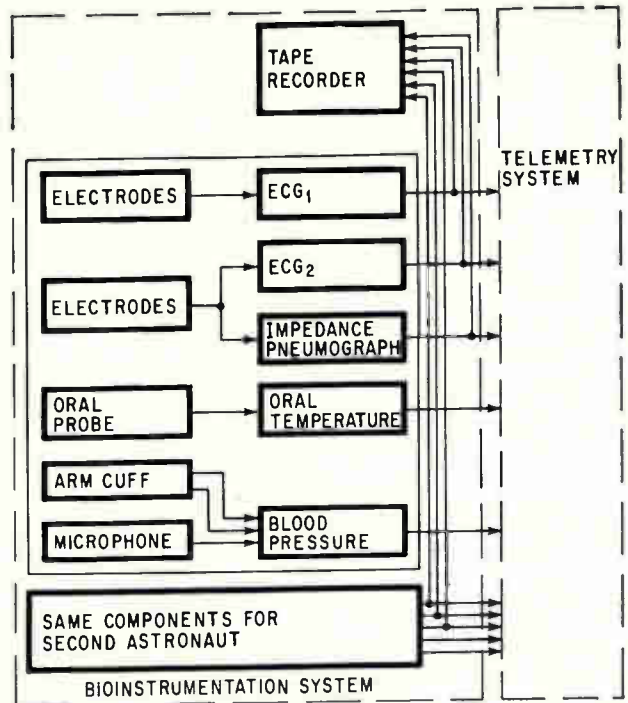

Measurements made by the bioinstrumentation system are fed into the on-board telemetry transmitter, then relayed to a ground station for observation by the medical monitoring team.

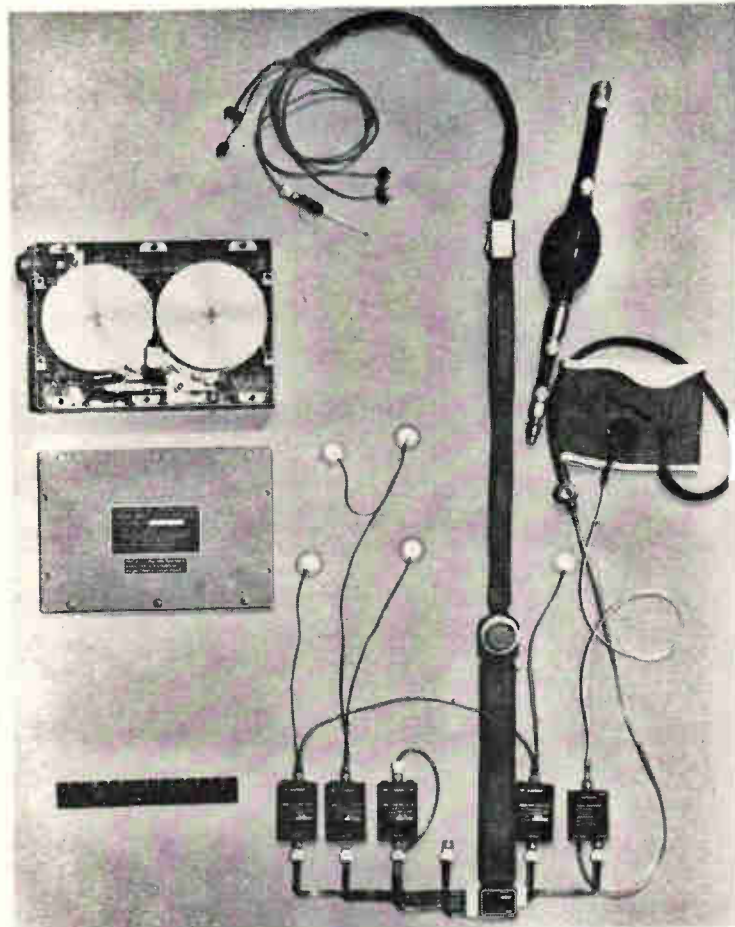

All sensors and signal conditioners are connected to a common trunk cable. The large connector in the center of the trunk provides a breakout point from the space suit. The miniature tape recorder, capable of recording for 100 hours, is in the top left corner.

to the sensors placed on his body and one large connector provides the means for bringing the signal leads out of his pressure suit. The photograph on the preceding page shows the various components of the bioinstrumentation system.

Each of the separate Gemini system components operates on a different aspect of physiological response, but they all share a common design factor; namely, an inseparable connection between the biological phenomenon measured and the electronic technique used to measure it. The bioinstrumentation designer must know biology almost as well as he knows circuit design and packaging or else his equipment will relay false information to the medical monitor.

ECG channels

In animals, life depends on oxygen carried to the tissues by the blood. The heart pumps the blood; if it falters in rate or amplitude, sensitive organs may be damaged. Furthermore, the heart responds rapidly to physiological and emotional stress, so that it is an excellent indicator of many types of trouble. In monitoring the condition of the heart, the most effective method is to concentrate on its

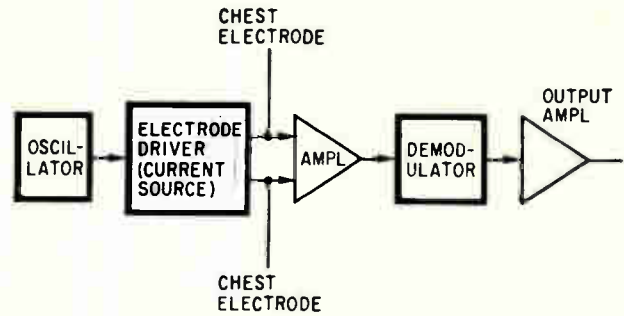

Changes in the output potential of the electrode driver are caused by variations in chest impedance as the astronaut inhales and exhales. The changes in potential are converted to a slowly varying signal.

electrical activity.

With each beat, electrical activity in the contracting heart muscle causes it to act like a dipole, producing a characteristically varying field. Since the whole body is a volume conductor, it is possible to detect the heart signal, or electrocardiogram (ECG) across two electrodes placed almost anywhere on the skin. The ECG wave complex repeats itself al-

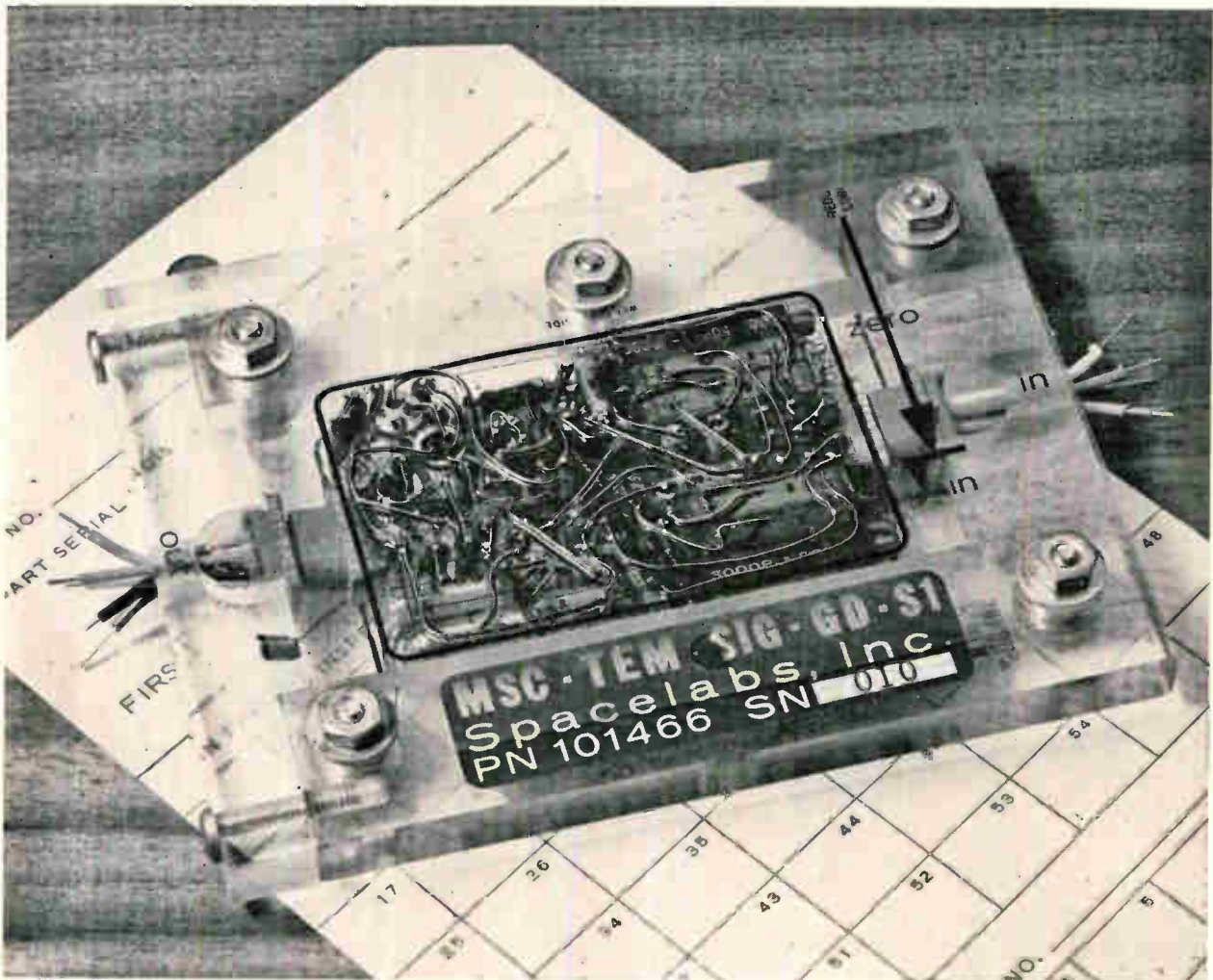

High-density packaging is the result of welded construction. The wire paths, printed on the films, serve as a road map and eliminate interconnection errors during assembly.

most exactly with each beat and has a peak amplitude of about 1 mv. Abnormalities can be detected by observing the heart rate (possibly the most useful indicator of stress) and waveform changes, a more subtle, qualitative indicator. Both of these are available from the ECG record.

Because of their highly informative nature, waveform changes must be transmitted without distortion. This creates a major problem in the design of the ECG electrode-amplifier.

The electrodes are a simple, yet highly critical, part of the bioinstrumentation system. If these relatively inexpensive units fail, much of the complex and expensive system immediately becomes useless. To attain the required degree of reliability, it is necessary that the electrode be mechanically secure to the skin, that skin-electrode resistance be low and held constant and that no extraneous voltages be generated by the electrode itself.

The Gemini electrodes incorporate a silver disk in a plastic housing. A strong, yet nontoxic, double-backed tape holds the housing to the skin. Reliable electrode contact is assured by use of a saline paste between the skin and the disk. The generation of extraneous voltages is avoided by a silver-chloride layer plated over the pure silver, so that the electrode does not polarize after exposure to the paste.

There are two sets of ECG electrodes in the Gemini system. One group, placed over the breastbone, contains three leads, two active and one common. Two other active leads across the chest are shared with the impedance pneumograph. The two sets provide an additional measure of reliability through redundancy and also, a chance to examine the heart field from two viewpoints. The two associated differential amplifiers compensate for possible adverse electrode conditions by providing a very high input impedance, in excess of 20 megohms each side to ground for each amplifier, and a common mode rejection ratio greater than 100 decibels even with a d-c offset at the amplifier input. These specifications hold over a bandwidth of 0.2 cycles per second to 100 cycles per second, more than adequate to obtain high-fidelity heart signals. In all, these ECG units perform far better than the conventional bioelectric amplifiers.

Impedance pneumograph

Medical researchers have known for some time that the a-c impedance across the chest varies regularly during the breathing cycle. Although the exact cause is unknown, this impedance change has proved very useful for monitoring respiration without constricting the chest or otherwise impeding the breathing function. With electrodes placed on the chest sides, as in the Gemini system, the rise and fall of impedance gives a clear indication of the breathing rate and some approximate measure of breath volume.

The impedance pneumograph developed by Spacelabs, Inc. is shown in block diagram form on page 101. The chest electrodes are excited from a 0.55 milliamper, 50 kilocycle per second, con-

stant-current source. They also form the input to circuits that measure small changes in the 50-kc potential caused by fluctuating chest impedance. Since the pneumograph excitation circuit is in parallel with an ECG amplifier, it is designed to present a shunt impedance of at least 10 megohms over the entire ECG signal bandwidth.

The change in 50-kc excitation voltage is amplified in several stages and demodulated by a peak detector. The slowly varying (0.02 cps to 10 cps) detector output is fed into an amplifier with a low output impedance. Full-scale output can occur for impedance changes as low as 2 ohms, and the pneumograph can accommodate a range of average chest impedances from 100 to over 3000 ohms without a change in calibration.

Oral temperature

Normally, the human body maintains so constant an internal temperature that any marked deviation indicates either a gross change in the external environment or a significant problem in some part of the body. This is why the physician measures body temperature and why it is monitored in space. The two most important factors in a temperature monitoring system are accuracy and response time.

For extended space missions, mouth temperature taken intermittently is the most comfortable and effective means of measurement. The oral probe used for Gemini contains a precision thermistor bead on the end of a thin, plastic-covered lead. The thermistor forms part of a bridge. The output of the bridge in turn feeds a low-noise temperature compensated d-c amplifier with differential input and single-ended output to the telemetry system.

Over-all accuracy of the signal conditioner and probe combination is 0.1°F over the temperature range of 95°F to 105°F. No in-flight adjustments are required. For reliability, an in-flight calibration check is provided by a standard resistor which can be switched into the bridge to produce an output signal equivalent to a temperature of 100°F. Accuracy of this order is essential if minute changes in body temperature, which may indicate a dangerous trend, are to be correctly interpreted. The over-all response time depends somewhat upon the position of the probe in the mouth, but at worst, an accurate reading may be obtained within 20 seconds.

Blood pressure

Arterial blood pressure is a physiological variable that summarizes many events and responses in the circulatory system. Because impaired response of blood pressure to stress after re-entry was one of the few adverse reactions that showed up on the longer Mercury flights, it is important that this variable be monitored accurately.

A simple and straightforward approach to blood pressure measurement has been adopted in the Gemini bioinstrumentation system; it essentially follows the method used by the physician in his office. An inflatable cuff is placed on the upper arm and pressurized until it occludes the underlying

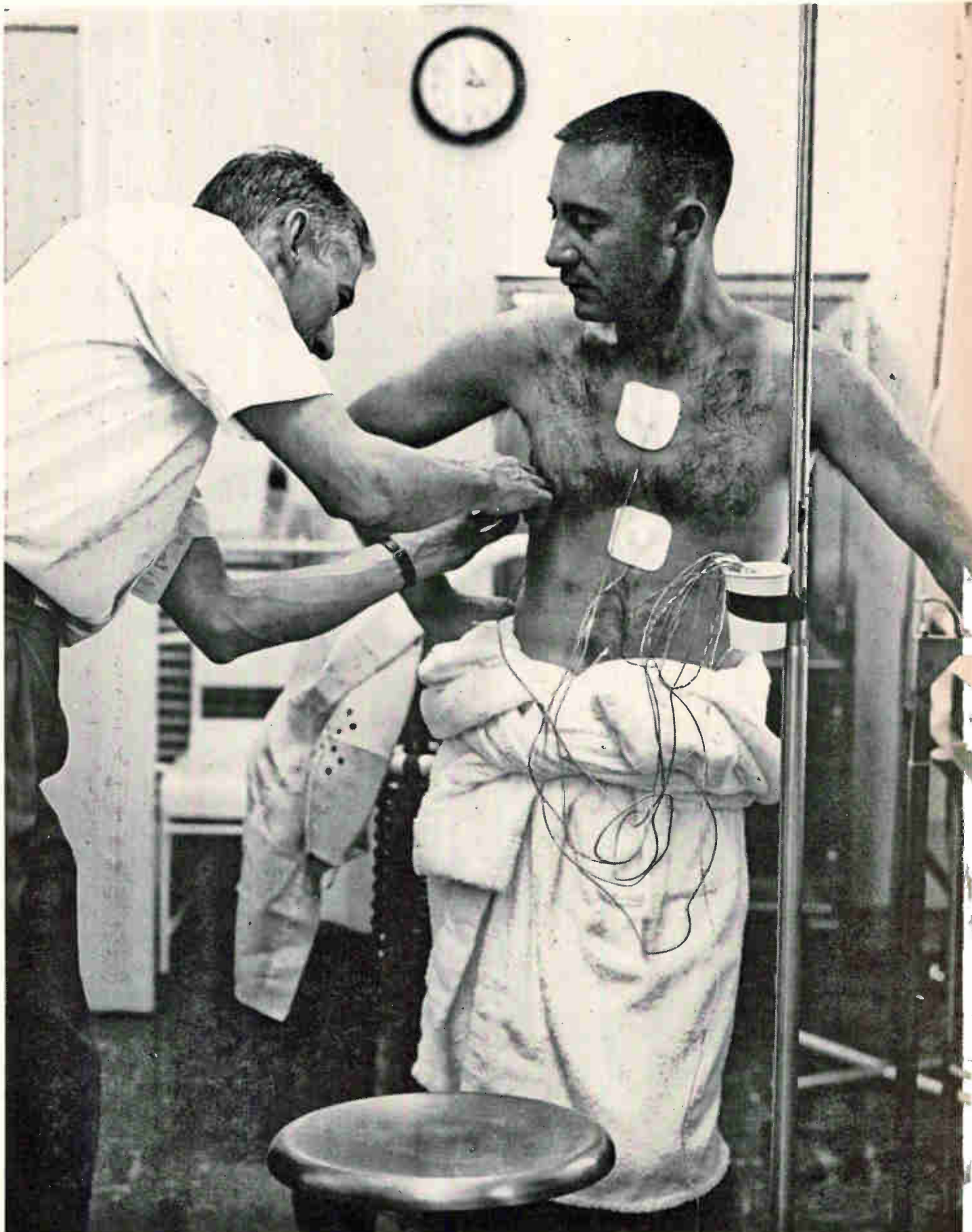

Electrodes are attached to astronaut Virgil I. (Gus) Grissom with special adhesive. Heart, respiratory and temperature data are relayed to ground-based medical monitors during the countdown and flight of Gemini.

brachial artery. A sound transducer is placed over the artery just downstream of the cuff. As cuff pressure is lowered and flow begins in the artery, this transducer picks up blood pulse sounds (called Korotkow sounds). The pressure in the cuff at the first appearance of the sound pulses represents systolic pressure, the highest point in the cyclic arterial pressure waveform; the pressure measured when the sounds completely disappear represents diastolic pressure, the waveform trough.

In the Gemini system, measurement is accomplished with the following components:

- An arm cuff specially designed to operate within the astronaut's pressure suit;
- A manually-operated squeeze bulb cuff inflator, incorporating a bleed valve to impose a constant deflation rate;
- A piezoelectric microphone with built-in pre-amplifier for detecting the Korotkow sounds;
- A signal conditioner module, containing the cuff pressure-transducer, additional amplifiers, and circuitry for mixing the d-c pressure signal with the a-c pulse sound signals.

After the mixed signal is telemetered to the ground, the systolic and diastolic values are extrac-

ted by determining points on the falling-pressure record that correspond with the beginning and end of the sound pulses.

In adopting the manual system, the Gemini team decided in favor of economy and reliability. Automatic cuff inflation devices had been planned for, but not actually installed, on Mercury. The present blood-pressure measurement system solves the difficult problem of obtaining clean signals under extremely poor conditions and does so in a very small total package size.

Bioinstrumentation tape recorder

The Gemini biomedical recording system is a miniature magnetic tape recorder containing seven data channels, one of which may be used for timing signals. Two channels provide a frequency range of d-c to 3 cps for slowly varying physiological signals. The other five channels cover a range from 0.1 cps to 100 cps for such signals as the ECG waveform.

Novel features of the unit include the application of direct recording at a tape speed of only 0.0293 inches per second to record data frequencies up to 100 cps, with a resultant total record time of 100

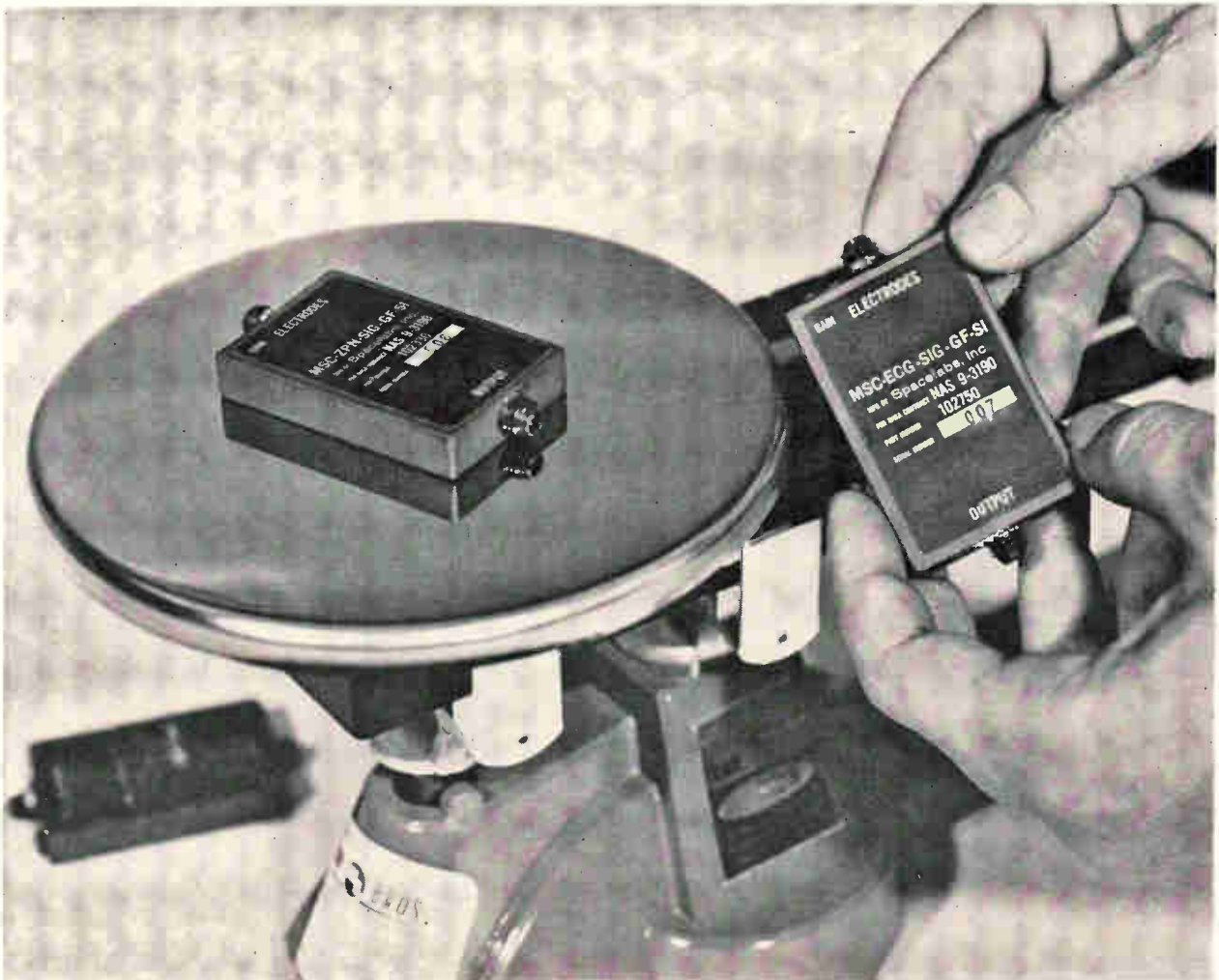

Finished signal conditioner is a small, lightweight package capable of withstanding extreme environmental conditions.

Component summary of Gemini bioinstrumentation system

Component	Supplier	Wt.	Vol.	Power	Principal features
ECG Sig. Cond.	Spacelabs, Inc.	1.8 oz.	1.35 cu. in.	0.10 watts	Output: 20 mv p/p differential Input Impedance: 40 megohms Common mode rejection: 100 db Noise equiv. at input: 20 μ V Bandwidth: 0.2 to 100 cps
Impedance Pneumograph Sig. Cond.	Spacelabs, Inc.	1.6 oz.	1.35 cu. in.	0.14 watts	Output: 20 mv p/p differential Electrode Excitation: 50 kcps, 0.5 ma Impedance range: 100-1000 Ω ΔZ sensitivity: 2 Ω for max. output Bandwidth: 0.02 to 10 cps
Oral Temp. Sig. Cond.	Spacelabs, Inc.	1.4 oz.	1.35 cu. in.	0.10 watts	Sensor: thermistor probe System accuracy: $\pm 0.1^\circ$ F System Response: 16 seconds (63%) Output: 5 volts for 95-105 $^\circ$ F range
Blood Pressure Sig. Cond.	AiResearch Division of Garrett Corp.	1.6 oz.	1.30 cu. in.	0.17 watts	Output: ± 20 mv differential sound and pressure signals mixed Pressure accuracy: 2% Pressure range: 25 to 250 mm Hg Sound bandwidth center frequency: 36 cycles/sec.
Instrumentation Tape Recorder	Cook Electric Co.	4 lbs.	100 cu. in.	1.2 watts	Capacity: 100 hours Channels: 6 plus timing Mode: direct (d. c. data chopped) Tape speed: .0293 inches/sec.
Wiring Harnesses	Cicoil Corp.				Flat tape Translucent silicone
Electrodes	NASA				Silver-silver chloride

hours. D-c response in the two low-frequency channels is achieved by chopping the signals at 20 cps prior to recording. The result is an amplitude-modulated 20-cps carrier which is easily recorded. After the mission the data signals are recovered by amplitude detection and filtering. A servo speed control system on the tape transport motor stabilizes tape speed through wide variations in the spacecraft power source. The motor is unique; rolling metal brushes minimize brush load and consume (with its speed control circuitry) only 0.3 watts of input power.

The highly compact tape recorder is designed to provide long recording periods over the biomedical data frequency range. Playback by conventional equipment at ground stations involves an initial speed-up to 7.5 ips to obtain a sufficiently large signal from the tape, re-recording the information in wideband f-m forms, and subsequent time-scaling to a convenient value.

Design, fabrication and testing

The electromechanical characteristics of the Gemini bioinstrumentation system components are summarized in the table above.

Cordwood component stacking and welded circuitry are used in the Gemini signal conditioners. This technique, illustrated in the photograph on page 101, yields high component densities and excellent reliability with proper lead preparation and welding control. In production of the Spacelabs' units, the welded modules are slipped carefully

into a dip-brazed, thin-wall aluminum box that has five sides. Then the box is potted with an opaque, glass-filled epoxy whose temperature coefficient of expansion matches the average coefficient of the components. The resultant signal conditioner is shown close-up in the photograph on the left.

During fabrication, a continuous and exacting quality control program ensures that the system components meet and surpass the severe reliability requirements of the National Aeronautics and Space Administration. This is a difficult task, for the qualification procedures alone are quite extensive. Perhaps one of the milder requirements is that the signal conditioner (with its connectors) must be soaked in human urine for two hours, dried in heat, alternately sprayed with urine and dried over a period of 40 hours, and then, without cleaning, operate normally in 100% oxygen at five pounds per square inch absolute and 160 $^\circ$ F at 95% relative humidity. Other tests simulate the various atmospheric, acoustic, thermal, and inertial loading extremes of the space environment. These requirements far exceed those of normal laboratory or hospital gear.

As the Gemini program advances further into the manned phase, there is a good reason for optimism as to the efficacy of the bioinstrumentation system. Although the physiological parameters to be monitored are few, they are significant. The equipment that will do the measuring combines the best in miniature, flight-rated packaging with superlative performance characteristics.

Tv looks at the dark side

Low light level television system may pierce the cover of night to allow earth surveillance by satellite

By Cyrus Beck, Thomas J. Shopple and Albert R. Prince.

U.S. Naval Air Development Center, Johnsville, Pa.

Among the most interesting experiments in Project Gemini is the one that the Department of Defense calls D-15. It is the attempt to provide astronauts with the ability to see in the dark by using a low light level television system, which is scheduled to be tested on Gemini flights in 1966 and 1967.

During an orbital flight, the transition from day to night occurs rapidly, with total darkness lasting for about 30 minutes. That's approximately the amount of time it takes for the eye to adapt itself completely to a low light condition. So, by the time the astronaut's vision is adapted to the dark, he has reached the light side of the earth. Should he use his time on the light side to become dark-adapted, he'll have to be satisfied with the limited visual information provided by his dark-adapted eye and to sacrifice valuable daylight viewing time as well.

It is hoped that the low light television system on Gemini will not only eliminate the need for dark adaptation but also provide viewing equipment superior to the dark-adapted eye. Nighttime surveillance by a man in a satellite would then be possible.

A television monitor will present views of the dark side of the earth. To amplify the little light available, an image intensifier (light amplifier) is placed in front of the image orthicon of the tele-

vision camera. A suitable objective lens completes the viewing chain.

Low light level television systems in general, and the Gemini system in particular, have some advantages over the unaided eye or optical devices such as telescopes and binoculars. Because the aperture of the television camera's lens is larger than that of the eye, it gathers more light; the image intensifier enhances what light is gathered, the image tube's photocathode is larger, and its efficiency is substantially higher than that of the retina of the eye; and because the astronaut is constantly looking at a bright monitor screen, his eyes will always be light adapted.

Sunlight to starlight

During the experiment a variety of land and ocean targets located on or near the spacecraft's ground track will be observed under ambient scene illumination, ranging from bright sunlight (10^4 foot candles), down to starlight (10^{-4} foot candles). The experiment is designed to determine the television system's static and dynamic resolution when viewing earth scenes under various light conditions, and to assess the ability of the astronauts to acquire and track targets on the earth's surface.

To perform the experimental tasks, the spacecraft must first be oriented so that its longitudinal axis is about normal to the earth's surface. The earth, captured by the television camera, will be observed by one of the astronauts on the viewing monitor, and simultaneously recorded photographically for a permanent record. A three-way comparison will be made of the scene; first, as observed by the astronaut looking at the viewing monitor; second, as observed by the second astronaut looking directly at the earth; and third, as recorded on photographic film. Oral descriptions of what is seen by both astronauts will be recorded. Following the flight, the photos will be compared with the descriptions.

For each task in the experiment, the astronauts will be required to orient the spacecraft to an attitude that will put a target of known location in the camera's field of view. The astronauts make these maneuvers, by using the direct command attitude rate or pulse attitude (orienting gas jet

The authors

Cyrus Beck is supervisor of the Equipment Development Branch of the Naval Air Development Center. He has a master's degree in electrical engineering from the University of Pennsylvania and holds six patents in the fields of automatic controls, automatic navigation computers, and antisubmarine warfare avionics.

Thomas J. Shopple, a physicist, has been at the Equipment Development Branch of the Naval Air Development Center for the past five years.

Before the inception of the Gemini experimental program he was involved in the development and evaluation of airborne submarine sensors.

Albert R. Prince, a mechanical engineer, dates his association with the Equipment Development Branch of the Naval Air Development Center from 1961.

Before his work with low light level television, he assisted in the design and development of airborne vehicle systems for housing sensors that detect submarines.

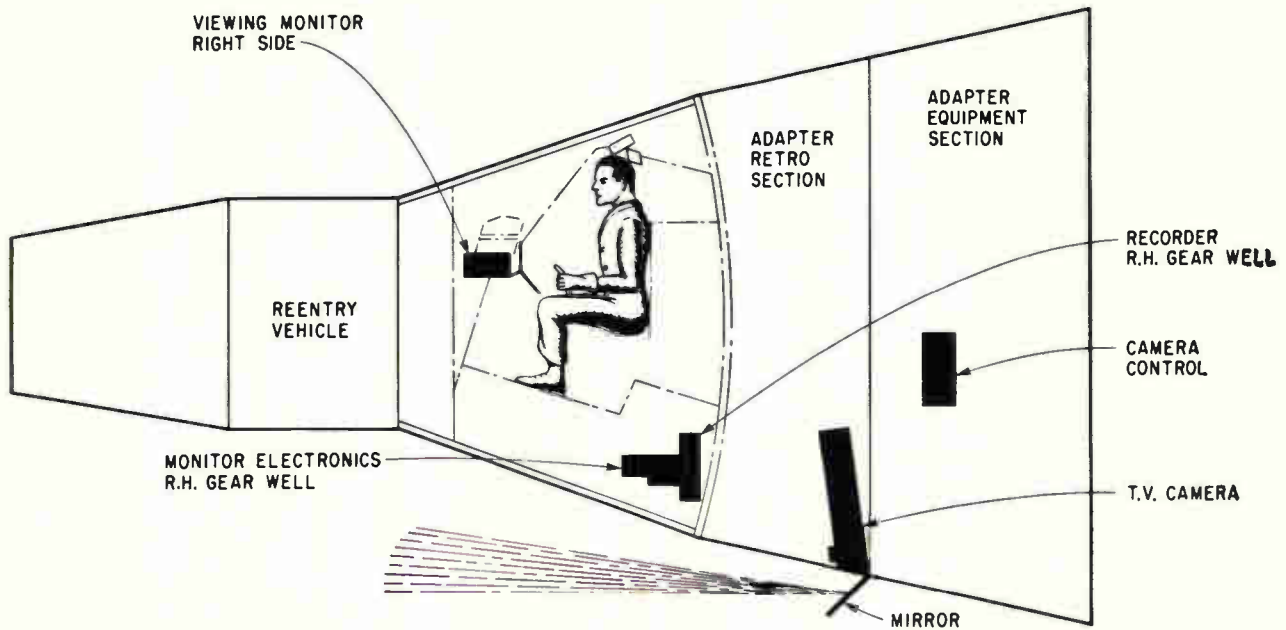

Approximate placement of electronic equipment for the Gemini low light level tv system. The television camera's line of sight is parallel to the lines of sight of the astronauts.

impulses) control modes; each of these has different orienting precision. To increase the probability of rapid target acquisition, a compromise was struck between field of view and ground resolution (in this case the smallest recognizable object that can be seen from the satellite). Upon acquisition, the astronauts will track the targets

to provide image motion compensations, making possible the determination of system static resolution (the smallest recognizable object, that would be recognized if there were no relative motion between the satellite and the object on the ground). The results of extensive Gemini attitude control simulations indicate that if a target can be seen on the monitor it can be adequately tracked. Gemini thus provides an ideal platform from which to determine the system resolution.

Operation problems

To allow for changes in launch times, flight plan modifications, or variations in local weather conditions, sequences in the experiment must be flexible. Plans are so organized that it will be possible to obtain useful data even if some portions of the experiment cannot be performed. Since the locations of the dark portions of the earth depend on the time of launch (subject to change), a large number of usable target areas, widely separated on the spacecraft ground track, will be needed so that the major portion of the experiment can be performed under low light conditions.

Image motion results in a reduction in television system resolution, particularly at low light levels. Any movement of the scene with respect to the camera which occurs during a tv frame time (1/30 sec), produces a smear in the display. If the camera's field of view is moved sufficiently to compensate for the movement of the scene, the smearing is eliminated. Since the V/H (velocity/altitude) rate for a circular orbit at an altitude of 160 nautical miles is approximately 1.4°/sec. The television camera's line of sight must be rotated at a rate equal to V/H, in order to reduce smear. The manual tracking ability of astronauts has been in-

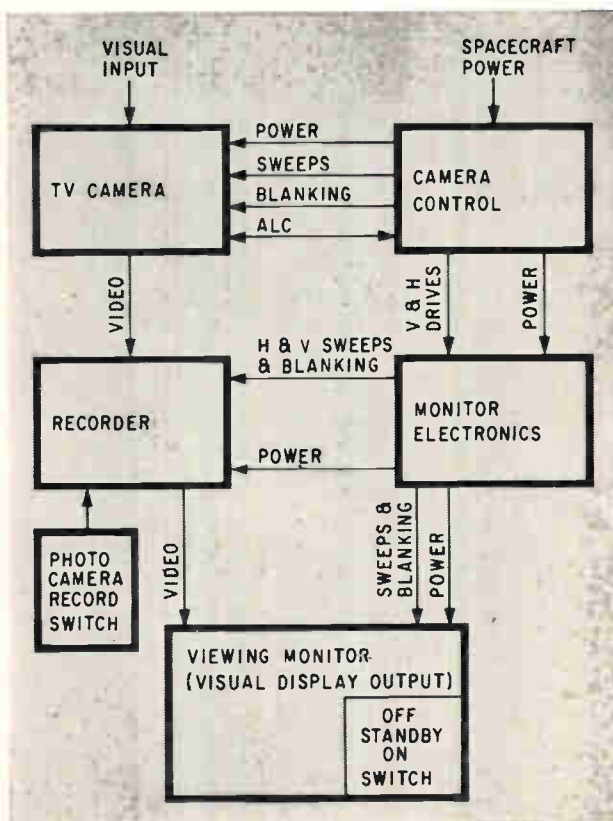

Gemini low light level television system

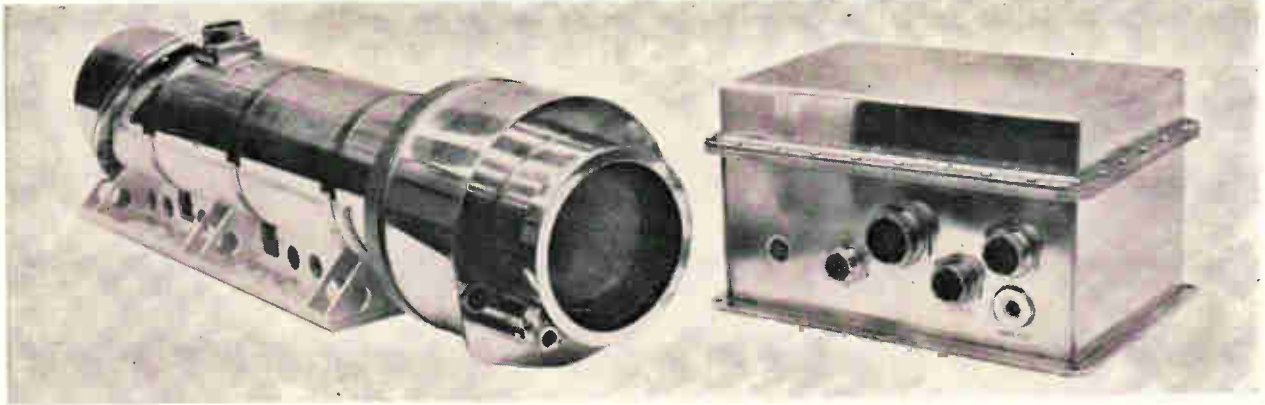

Gemini television camera and control unit. Use of fabricated aluminum to house equipment reduced weight.

investigated in Gemini simulators, and tracking errors can be kept to less than 0.25° . If this figure is valid in orbital flight, the tendency of the picture to smear can be reduced considerably.

Maximum resolution in the low light level television system depends upon the astronaut's ability to track ground targets. Under daylight conditions, techniques such as photocathode pulsing, which reduces integration time (period of light), could be employed to reduce smearing. When the photocathode is pulsed, it acts like a camera shutter; since the tv camera only takes a picture during the very short pulse period, less motion is captured and smearing is reduced. Under low light conditions the integration time cannot be decreased without reducing system sensitivity.

Airglow, resulting from the emission of light by gases in the upper atmosphere, may also degrade system performance.¹ The airglow layer, located between 40 and 55 nautical miles above the earth, will appear as a region of brightness between the spacecraft and the earth, radiating toward both. Airglow causes a reduction of target-to-background contrast, which results in decreased target resolution. The lower the ambient earth scene illumination, the more effective the airglow in reducing target-to-background contrast.

System design problems

In assigning experiments to specific flights, consideration was given to the probable availability of equipment at the time of launch, and to compliance with space, weight, and power consumption restrictions; as well as to passing equipment qualification tests. A study conducted by the McDonnell Aircraft Corp., the spacecraft manufacturer, resulted in prescribing subsystem's configuration and allowable weight distribution. Unit shapes and locations depended on the space available in various parts of the spacecraft.

In spite of the severe restrictions imposed, it was imperative to have a complete, flight-qualified system ready for installation to meet the construction schedule of the spacecraft to which it was assigned. System design and fabrication could include only readily available components able to meet the system performance requirements. To be accepted for

flight, the system had to comply with the same environmental qualification specifications as primary spacecraft equipment. All equipment had to be capable of withstanding launching acceleration and vibration. All units had to operate satisfactorily after experiencing random vibration of 8.8 g rms, and temperature variations, in a space vacuum, from -60°F to 160°F . Finally, the system had to be capable of compatible operation in an environment containing a variety of electronic equipment.

The system is fully automatic except for the "off-standby-on" switch, the photographic camera operate switch, and a monitor brightness control. System power consumption is nominally 145 watts at 24 volts d-c. The weight of equipment housing was reduced by using dip-brazed fabricated aluminum assemblies. All units contain dry nitrogen sealed at a pressure of one-half atmosphere. Except in the viewing monitor, heat is either dissipated by or supplied from standard spacecraft "cold plates." The cold plates, which are part of the environmental control system of the spacecraft, act as heat sinks or sources that maintain equipment temperature between 40°F and 100°F . Units exposed to thermal radiation are thus prevented from rising or falling to excessive temperatures.

A 32-pound modular-constructed tv camera is the heart of the low light level television system. The camera includes a ruggedized 3-inch image orthicon sensor tube coupled by fibre optics to a 40-mm image intensifier; a deflection and aluminum focus coil; an automatic light control system; an automatic beam control; power supplies; a pre-amplifier; alignment controls; a video processor; a focus current regulator and an objective lens.

System operation

At an orbital altitude of 160 nautical miles, the camera field of view is a square, 46 miles on a side. Selection of the field of view and the particular fixed focus lens is the result of a compromise influenced by ground resolution, elliptical orbit, orientation, and lens weight and complexity.

When the camera views the earth's scene, it focuses the optical image on a sensor which converts it to an electrical signal. This signal is processed and supplied as a video input to both the

Summary of system characteristics

Total weight	73.7 lbs
Total power	145 watts
Image orthicon	3 inch with fiber optics faceplate (GE Z7852)
Image intensifier	40 mm with fiber optics faceplate
System bandwidth	10 Mc \pm 1 db
Frame rate	30 frames/sec
Interlace	2:1
Aspect ratio	1:1
Scan lines	875
Objective lens	100 mm-f/1.2
Field of view	20° (across diagonal)
Photographic recording	3400 frames @ 3 frames/sec
Automatic light control and Automatic and beam control	(1) System operation over a range of average scene illumination from 10 ¹ to 10 ⁻⁴ ft-candles (2) Protection from excessive light (3) Prevention of blooming

local viewing and recording monitors. The picture on the monitor screen, representing approximately 2,000 square miles, will enable the second astronaut to observe much of the same earth area (via television) as the command astronaut sees through the spacecraft window.

The video signal which is sent to the recording monitor is displayed on a high resolution, electrostatic cathode-ray tube. A special photographic camera with a frame rate of 3 frames per second, will make a permanent record of selected views.

The television camera features a fully automatic light control (ALC) system. ALC serves two purposes: first, it provides a fast-acting shutter for protection from excessive light when average scene brightness exceeds 10⁴ ft-lamberts, and second, it allows the system to operate over a range of average scene illumination ranging from 10¹ to 10⁻⁴ ft-candles, corresponding to conditions of bright daylight to starlight with no moon. Satisfactory system operation over this wide range of scene illumination is achieved by automatic control of a continuous film neutral density filter, located between the optical lens and the image intensifier. Light hitting the optical lens is sensed before passing into the camera system and causes the filter to act like a light window. The filter attenuates all colors of the visible spectrum equally, regardless of the intensity of the incident light. The filter is formed from two film strips coated with a metallic (inconel) neutral density material and joined to form a continuous loop. The neutral density material is deposited on each film strip in a wedge pattern so that when the loop is driven the filters are moved relative to each other and present a continuous density variation without shading. Automatic beam control [Electronics, Feb. 22, 1965, p. 46] prevents blooming when large differences of

light level occur in continuous regions of the area being viewed.² This enables the camera to operate over a wide range of scene illumination without the need for manual adjustment.

In addition to the 5-inch high resolution cathode-ray tube and a deflection yoke, the viewing monitor contains a video amplifier, a horizontal deflection driver, sweep failure protection, an inverter, a regulator, and a high-voltage multiplier. Because of size restriction on the viewing monitor, not all monitor electronics could be made integral with it. The vertical sawtooth generator and vertical deflection driver and the horizontal driving pulse generator circuits are situated remotely in the monitor electronics unit, which weighs only 8.1 pounds.

The astronaut will view the earth on a 3½-inch square screen. He will also use a switch mounted on the viewing monitor panel to operate the photographic recorder equipment. The total weight of the viewing monitor is about nine pounds.

Permanent film records of the selected views are made by the recorder. In addition to the special camera, video amplifier, horizontal and vertical deflection drivers, recorder unblanking logic and gate generator, inverter, high voltage multiplier, and data display system of the recorder, it also has a high resolution electrostatic cathode ray tube. Here too, restrictions on unit size required situating some of the monitor electronic circuits (horizontal and vertical sawtooth generator circuits) remotely in the monitor electronics unit. The recorder weighs only 10.7 pounds.

The camera system was designed and developed by General Electric Co.'s light military electronics division in Utica, N. Y.

A 1.2 inch square screen in the recorder monitor displays the picture for the camera to record on 16-mm film. Simultaneously with the camera's activation, the time and the position of the neutral density filter, received from a data display system in the capsule, are recorded on each film frame. Filter position data enables average scene illumination to be determined. The photographic camera, built by the Giannini Scientific Corp., is of special design and features a film magazine which can be removed from the unit without disturbing the camera mechanism. To conserve space, the film magazine is of the displacement type, with film wound on cores rather than flanged spools. Film magazines need only be inserted into the unit; they are automatically aligned with the optical path and engaged by the drive mechanism of the camera. There are 3,400 usable frames per magazine.

The camera control unit includes the power converter, horizontal and vertical sweep, sync generator, and automatic light control programmer. It weighs 13.2 pounds.

References

1. Manned Spacecraft Center, NASA, "Mercury Project Summary, including results of the Fourth Manned Orbital Flight", NASA SP-45, May 15 and 16, 1963.
2. General Electric Technical Report "Automatic Beam Control for Latitude Improvement in TV Camera Systems", Nov., 1964.

Rendezvous: climax of Project Gemini

It will be made possible by radar that tracks down to zero range, measures target angles in two axes with only one receiver, and "talks with" its target

By B. H. Vester and L. M. Zimmerman

Westinghouse Electric Corp., Aerospace Division, Baltimore

Project Gemini, the meeting in orbit of a two-man spaceship with an unmanned satellite, will be made possible by a rendezvous radar that will enable the space capsule to "talk with" the target.

The radar system aboard Gemini will continuously measure the range and bearing of the target vehicle—an Agena rocket stage. From this information, Gemini's orbital velocity will be corrected until the vehicles dock. The radar system will provide automatic guidance at long range; at close range, it will allow the astronauts to steer their vehicle toward the target.

The Gemini radar is a transponder-aided pulse radar system that is light and simple and can operate with low power. Interferometer tracking with circularly polarized antennas will simplify angular measurements, yielding accuracies usually obtainable only from larger antenna systems. Two-way digital communications between Gemini and Agena has been added with little extra hardware.

The radar tracking phase of rendezvous will be tested initially using an evaluation pod instead of a full Agena target vehicle.

Rendezvous radar vs. tracking radar

The task of Gemini's rendezvous radar is not the same as that of a conventional missile- or fire-control radar system. In a missile-tracking radar, the return signal from a missile is weak and requires high power for long-range transmission. Agena, however, contains a transponder that will return a pulse when it receives an interrogation pulse from Gemini; this will allow long range to be attained with a low-power transmitter.

Also, in tracking radars the missile's velocity with respect to the target is very high; in the Gemini rendezvous, although both vehicles will be traveling at high velocities relative to the earth, their approach velocity relative to each other will be low.

With a transponder, rendezvous radar can obtain a 200- to 300-mile range without the usual signal-aiding techniques used in conventional radar. In tracking, or even search radars, conservation of the available signal power is usually the overriding design consideration; their antennas are designed with large surface area for high gain, but they result in narrow beamwidth. Since narrow-beam antennas cannot cover the entire search area for target acquisition, the target area is scanned mechanically with hardware such as gimbals and drive motors. The rendezvous radar, however, uses wide-angle, low-gain antennas that do not require gimbals. The transponder, therefore, makes possible a large reduction in weight.

Another advantage of the transponder system is the elimination of two sources of potential error in tracking. The amplitude of the target's transponder return signal is stable; it does not fluctuate like the reflected returns from irregularly shaped targets. Also, the transponder's return signal always emanates from a single point; in tracking radars this signal appears to wander over the target as it changes in aspect with respect to the transmitted signal.

These are the basic differences between the rendezvous radar and a missile-tracking system.

The authors



B.H. Vester Jr. is director of engineering for the Gemini radar program. He has worked at Westinghouse's Aerospace division since 1950.



L.M. Zimmerman joined the Westinghouse Electric Corp. in 1951. He was supervisor of mechanical design for Gemini rendezvous radar system.

Since the target won't be elusive, precision of the rendezvous is limited only by the accuracy of the guidance sensors and by the accuracy of the thrust rockets and their controls. The amount of fuel required to maneuver Gemini into position for the rendezvous is critical; it depends directly on the guidance sensor's accuracy.

Gemini's digital sensor and control systems are more accurate than analog systems. Agena's range and bearing will be measured periodically and are read out in digital form. From the digital data, the Gemini computer will calculate guidance information that is averaged rapidly from the data of many sets of readings; this system is more accurate than any single reading.

The digital computer also will combine the radar-angle output data with signals from the spacecraft's inertial platform allowing the angular rates of the line-of-sight to the target to be computed digitally in inertial coordinates. This eliminates the need for rate gyroscopes.

Gemini's interrogator radar transmits a pulse signal that is radiated over a continuous 70° conical angle. When Agena's transponder receives the interrogation pulse, it will transmit a reply signal that is delayed in time and shifted in frequency relative to the interrogation pulse.

The frequency offset permits the Gemini receiver to discriminate readily between the true transponder reply and any reflections of the interrogation pulse. These undesired signals can be reflected from earth or from Agena when it is close.

Close-range tracking is impossible with conventional pulse radar because at close ranges the reflected signal is overlapped by the transmitted pulse. To avoid this, Agena's transponder will delay the return signal for a period slightly longer than the interrogation pulsewidth. Gemini's radar can track Agena almost to the point of contact.

Gemini's radar will receive the transponder reply, measure the round-trip time, calculate the target range and read out the result in analog and

Gemini radar transmitter and receiver

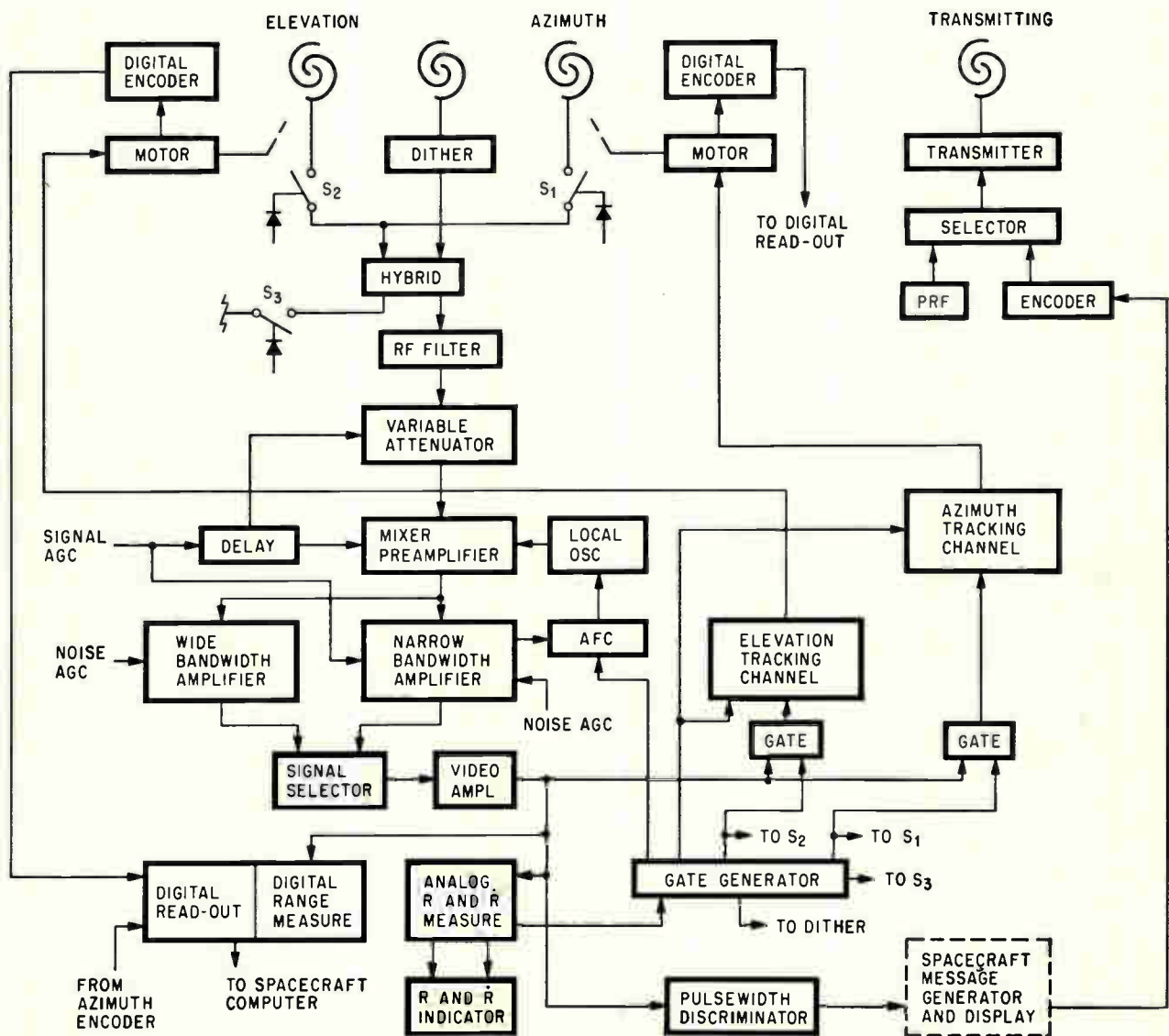

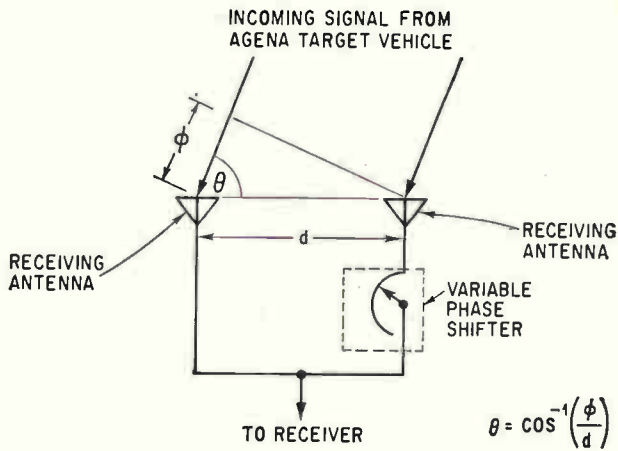

Interferometer principle is used to measure difference in arrival time of return signal at two different antennas to yield the target-angle displacement θ . Phase difference between received signals is ϕ , distance between antennas is d , both expressed in electrical degrees. Phase shifter is adjusted to nullify phase difference between received signals. Director cosine of the target angle is proportional to phase-shifter position.

digital form. At long ranges, where most of the fuel for maneuvering is consumed, the digital data will control the spacecraft with maximum accuracy and fuel economy. Closer to Agena, the astronaut will control Gemini for final slowdown and docking, using range and range-rate information that is read out in analog form.

Analog data is derived in a manner similar to conventional pulse radars. A voltage proportional to range is generated by a linear sweep that begins when the pulse is transmitted and terminates when the reply pulse is received. Ranges from 0 to 300,000 feet are displayed on a small meter whose scale is logarithmically compressed to accommodate this sweep. Precise range data is digitally read out from a high-speed counter and a 10-megacycle crystal-oscillator time standard. Target range is determined by counting the number of oscillator cycles between the transmitted interrogation pulse and the received transponder reply signal.

Measuring target angle

Target angles in two axes must be measured to provide basic guidance data for rendezvous.

Angle-measurement is a unique feature of the rendezvous radar. The measurement is based on the interferometer principle, in which the differences in arrival time of the return signal at two separate antennas is measured to determine target angle. This principle is illustrated in the diagram above. The time difference between received signals is ϕ , usually expressed as a phase difference in electrical degrees, and the antennas are separated by distance d , also expressed in electrical degrees. The target angle θ is the angle between the line of sight to the target and the line that connects the centers of the two antennas. Angle θ can be determined from $\cos \theta = \phi/d$.

In the conventional interferometer tracking sys-

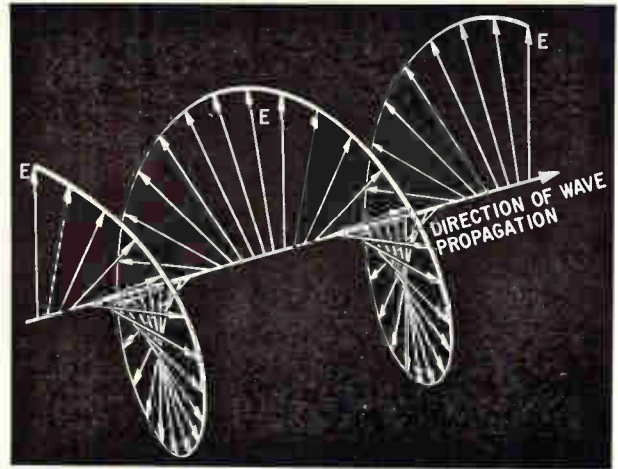

Field pattern, produced by circularly polarized antenna, has helical locus of voltage phasor in space. Locus advances in the direction of wave propagation.

tem, a servo-driven, r-f phase shifter is inserted into one antenna arm to maintain the phase difference between the two signals at zero. The position of the phase shifter is thereby proportional to the direction cosine of the received signal. Since the ratio of angular error to phase-measurement error is reduced by increasing the distance d , antennas are usually located many wavelengths



Antenna system consists of circularly polarized antennas in the form of Archimedean spirals, printed directly on epoxy boards. One transmitting antenna and three receiving antennas—azimuth and elevation measurements share a common antenna—shown by Westinghouse engineer, O. Lamar Bishop, are in the front of Gemini. Transmitter antenna and common receiver antenna are fixed, while the azimuth and elevation receiver antennas can be rotated.

apart. But another problem arises when the phase difference ϕ is equal to or greater than half a wavelength for small angles of deviation off the bore-sight. The same apparent phase delay occurs for several different angles. Relatively complicated schemes are required to resolve these ambiguities.

Circularly polarized antennas

Gemini's radar was designed to avoid ambiguity by keeping the antennas close together. One of the interferometer antennas itself is used as a highly linear phase shifter.

Linear phase-shift is accomplished with antennas that are circularly polarized.

The field pattern of a circularly polarized antenna is shown in the diagram on page 112. The locus of the voltage phasor in space instantaneously describes a helix in the direction of the wavefront. When the antenna is rotated, the helix rotates and the effect is equivalent to moving the antenna forward, much as a screw is linearly advanced by rotation. If the polarization is exactly circular, the wavefront's phase advance is a linear function of the antenna's rotation. The receiving elevation and azimuth antennas are rotated independently for their required phase shift. The reference antenna, common to both axes, does not rotate.

The circularly polarized antennas are in the form

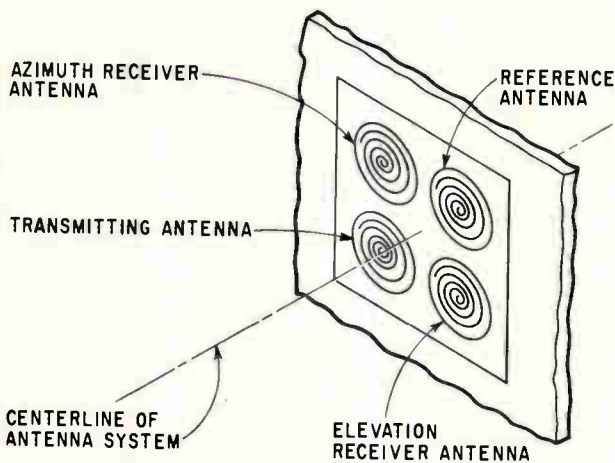

Azimuth and elevation receiver antennas share a common reference antenna to obtain two interferometers that measure target angles in two axes.

Angle error is converted to a-m signal so that only one receiver would be required for an antenna pair. Transmitting antenna radiates interrogation pulse.

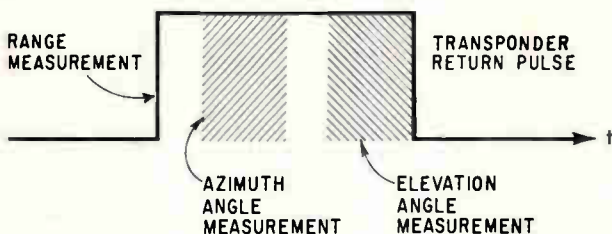

Transponder's return pulse is long enough to accommodate time sharing between both axes, so that both azimuth and elevation angles can be measured with a single receiver.

of Archimedean spirals printed directly on an epoxy board. Since the antenna is lightweight, a servo torque motor can rotate the antenna directly, without any gear-train mechanism. Direct motor drive minimizes the nonlinearity problems that occur in servo systems because of friction and backlash in gear trains.

One receiver for three antennas

To further simplify the angle-tracking instrumentation and to avoid the necessity for a pair of phase-matched receivers for each tracking axis, the phase-null error is converted into an amplitude-modulated signal. Most interferometer systems require for each tracking axis separate receivers for the fixed-phase reference antenna and the variable-phase antenna. In this system, the phase-error signal is converted to amplitude modulation by introducing a phase shift from an extra length of line that is synchronously switched in and out of one arm of the antenna pair. The target-angle error, in the form of an a-m signal, is measured by only one receiver. This technique also removes the requirements for receiver phase stability.

Angles in two orthogonal axes are measured with three receiving antennas, one of which is common to both axes [photo, p. 112]. The antennas are placed on Gemini so that their boresight axis is parallel to the spacecraft's roll axis; one pair of antennas lies in the pitch plane and determines target elevation; the other pair is in the yaw plane, determining target azimuth. A separate spiral antenna transmits independently to avoid the need for a transmit-receive duplexer for the radar. The antenna array is shown in the diagram at the left.

To measure both azimuth and elevation angles with a single receiver, the transponder's reply pulse has been made long enough to be time-shared between both axes [illustration below left]. The leading edge of the transponder's reply pulse will measure the target range; as soon as the leading edge is received, the angle-switching sequence will be triggered. First, the receiver input will be switched to monitor the azimuth antenna pair, and the receiver output will be switched to feed the azimuth antenna servo drive; then the switches will open and the receiver cleared and switched to the elevation channel. In this way, each pulse will provide tracking information for two axes. Solid-state microwave switches with high phase stability were developed to switch the r-f pulses in small fractions of a microsecond.

Astronaut's display

At long ranges, Gemini's radar computer will calculate major changes in velocity from the digital data, and control the spacecraft's flight. As Gemini approaches Agena, however, the astronauts will control the slowdown from an analog display.

Target-angle information will be read out of the radar in analog form, displaying to the astronaut the azimuth and elevation components of the angle between the line of sight to the target and the

spacecraft's roll axis. Angle and range data will define the target position relative to Gemini. Range will be displayed in analog form by an indicator that was designed especially for the rendezvous slowdown maneuver to simultaneously show range and range rate.

As the capsule approaches Agena, its deceleration must be such that the relative velocity will be zero at zero range. If the relative velocity is too high, the spacecraft will be unable to dock.

The relation between range R and range rate of approach dR/dt , defines a flight profile. An optimum flight profile exists (graph, below) that is limited by the deceleration capability. The forbidden zone—the region in the flight profile where the range to the target is too short to allow deceleration to zero velocity at zero range—is determined by the relationship $R = f\left(\frac{dR}{dt}\right)$, where the deceleration is a function of maximum thrust available from the retarding engine.

A safe profile that was determined for the Gemini mission is $R = \left(\frac{dR}{dt}\right)^2$. A method has to be provided for the astronaut to determine whether he is on the safe side of this profile. Therefore, both range and range-rate data are derived in logarithmic form and displayed on adjacent meter scales. The scales are arranged (photo at right) to satisfy the relationship $R = \left(\frac{dR}{dt}\right)^2$. The astronauts can maintain deceleration at a safe rate by keeping the range-rate needle below the range needle.

Logarithmic scale compression allows display of long-range data and of high closure rates and provides adequate resolution at the low end of both scales. A separate low-speed range-rate scale is included to provide the finer range-rate resolution required when the vehicles dock.

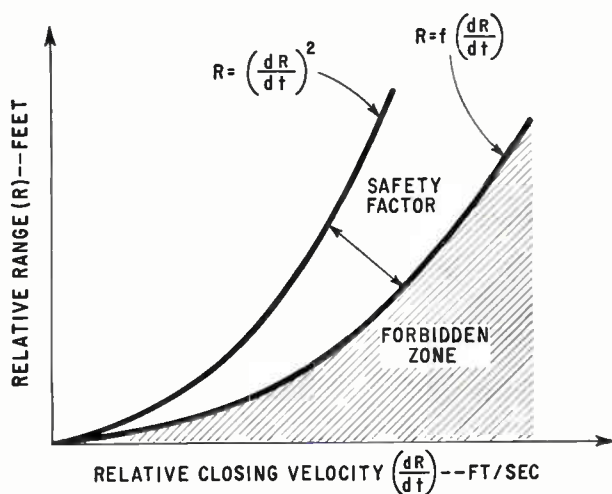

Flight profile is relation between range and range rate of approach of the two vehicles. Optimum profile would result from a deceleration that results in zero range at the instant the range rate of approach is also zero. Engine thrust determine the flight profile. Forbidden zone indicates a profile that would cause spacecraft to pass the target without docking.

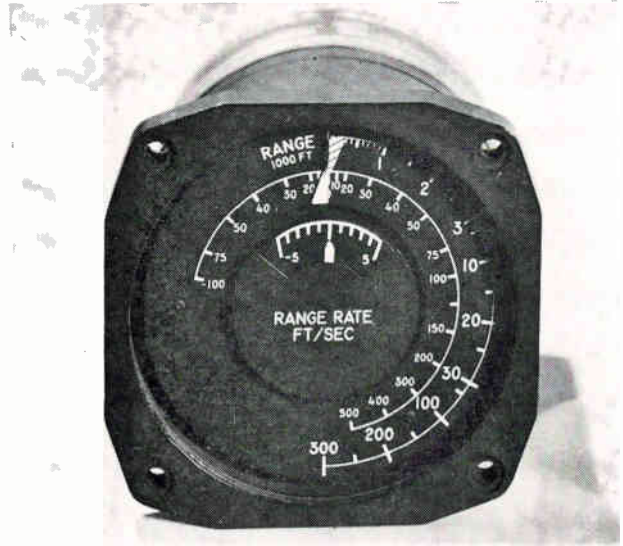

Range and range-rate indicator observed by astronaut who maintains a safe deceleration rate by keeping the range-rate pointer below the range pointer. When R and dR/dt pointers are aligned, the spacecraft is on an $R = (dR/dt)^2$ deceleration profile. Vernier scale provides finer range rate resolution required when the vehicles dock.

tion required when the vehicles dock.

The range voltage that feeds the indicator is generated as three contiguous linear segments, with each segment covering a decade of range. Since the slopes (volts per foot) of the three segments are in the ratio 100 to 10 to 1, the range-rate differentiator provides three different gains so that all segments have the same rate calibration. The different gains are achieved by using diode-balanced modulators to switch impedance ratios in the differentiator feedback circuit. The balanced modulator switch has high on-off impedance ratios and introduces minimum d-c shift and switching transients.

The command link

The rendezvous radar system contains a digital command link that will allow the astronauts in Gemini to transmit commands to Agena. Since Gemini will be "talking" to the Agena transponder to obtain radar tracking information, it is relatively simple to duplex binary digital commands on the same transmission. The command link and tracking radar will share the same transmitter, receiver and antenna on each vehicle. Only separate encoding and decoding circuits are on both vehicles.

Rendezvous evaluation pod

In preliminary rendezvous tests, Gemini will track and pursue an evaluation pod instead of the Agena target vehicle. The radar tracking phases of the rendezvous can be evaluated with this pod at minimal cost.

The evaluation pod will contain a radar transponder and associated antennas, batteries and other components; it will be carried aloft in Gemini's adapter module. After Gemini goes into orbit,

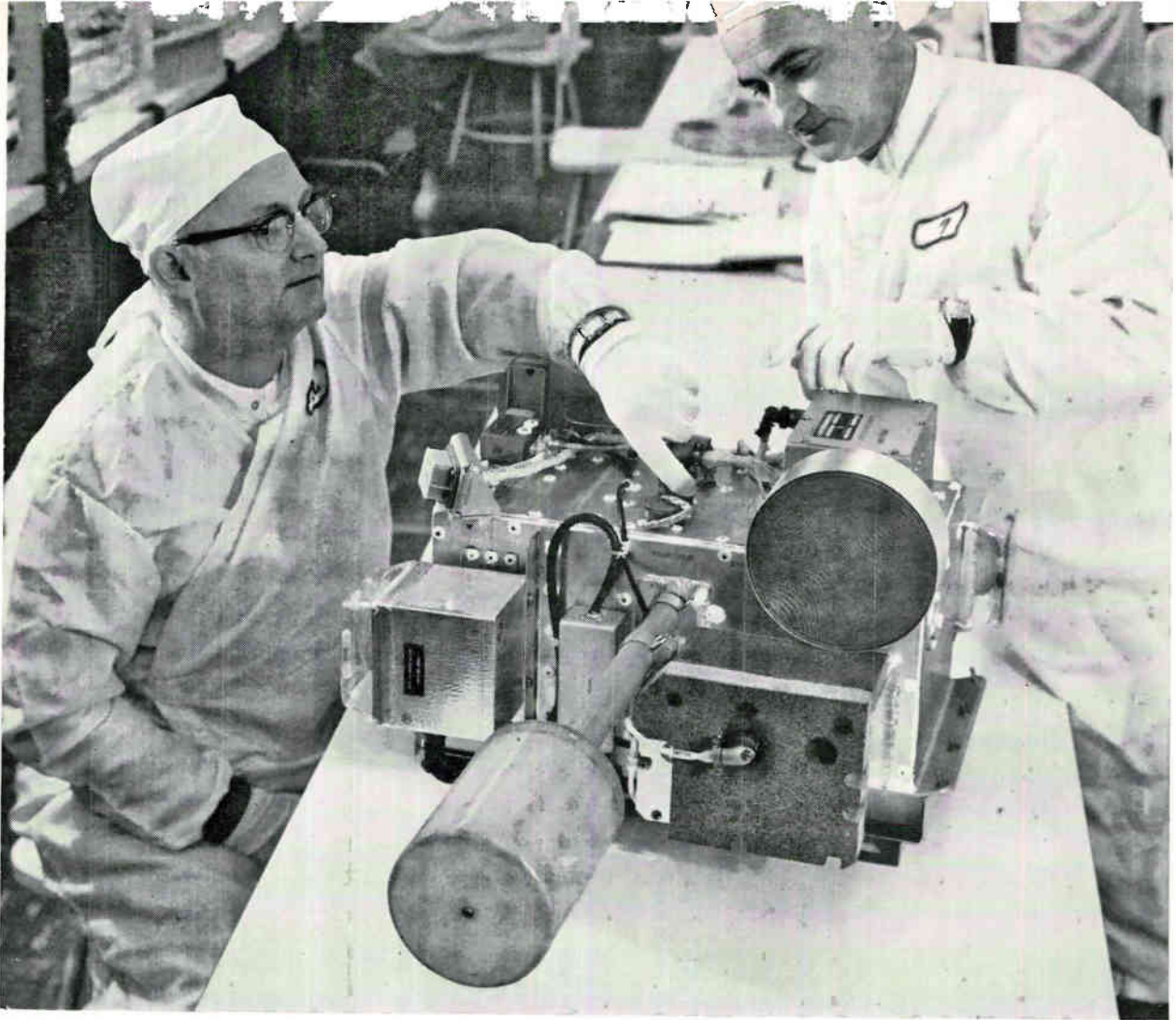

Rendezvous evaluation pod, unlike Agena, will tumble randomly. Pod provides complete spherical receiving antenna coverage with a dipole antenna (cylinder extending from test pod package) that covers one axis, and a spiral antenna at each end of the dipole axis. Ratio of signal level in the antenna systems determines which antenna will be automatically connected to the test pod receiver.

the evaluation pod will be ejected with a low differential velocity. When it separates from the spacecraft, it will be tracked by radar.

Unlike Agena, which will be stabilized, the evaluation pod will tumble randomly in space as it orbits. This creates additional design problems in the pod antenna's coverage and switching. However, the pod is designed so that a dipole antenna will give omnidirectional coverage around one axis, and a pair of spiral antennas will provide coverage at each end of the dipole axis. Only one of these antennas at a time will be connected to the receiver. Every few seconds a pulse will be sampled from the open antenna, and the antenna switch will connect the receiver to the antenna that produces the highest signal power. Smooth transition from one antenna to another at their pattern cross-over points is obtained without switching transients, because the switching decision is keyed to the ratio of the signals in each antenna. Thus the switching decision is independent of range—that is, signal strength. As a result, only the main lobes of the evaluation pod's antenna patterns will be involved in tracking, this should avoid the nulls

and distortions in the side lobes.

Solving thermal and reliability problems

Many other design problems had to be solved. One of the most severe was to establish a mean time between failures (mtbf) of 1,000 hours under launch and orbital environments. Studies of the history of previous radar-system failures indicated that the components that failed most frequently were relays, transmit-receive (TR) tubes and connectors. Therefore, the radar was designed without relays nor transmit-receive tubes and with almost no internal connectors, except a few microwave coaxial connections. All electronic circuits were designed with solid-state silicon components. The only tubes are the transmitter and local oscillator tubes.

A limited variety of semiconductors was permitted. This allowed considerable standardization of circuits. The system contains only components of the quality used on the Minuteman missile.

Although all parts are derated by 50% or more, derating is not a sufficient precaution. The villain that causes poor reliability is the components' high

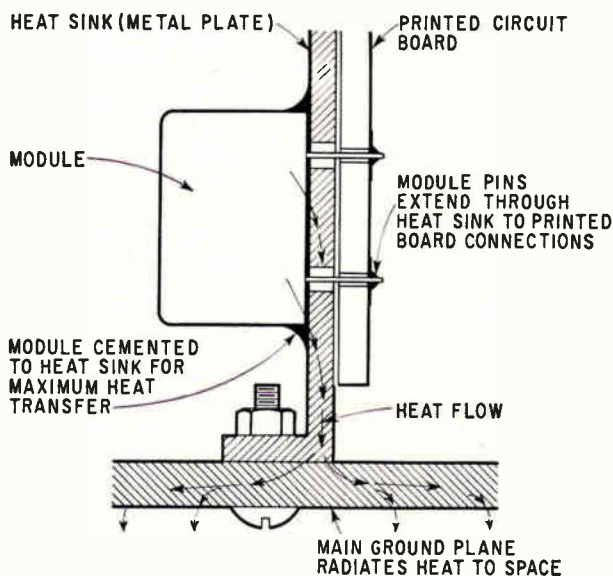

Modules are cemented to metal heat sink plate for maximum heat conduction to radiating surface. Orbital environment and Gemini's mechanical construction allows heat radiation as the only method of cooling components for maximum reliability. Electrical connections between module and printed circuit board are made by pins that extend through insulating holes in the metal heat sink.

operating temperature.

But the temperature-control problems were complicated by the installation requirements of the radar package and especially by the mission environment. Some of these problems were: the radar package is thermally isolated from the spacecraft itself; the radar must maintain its own heat balance by passive radiation; and only a limited area of the radar package is exposed for heat radiation. The mass available for use as a heat sink could not provide a thermal time lag long enough to limit the upper temperature of the hottest component to 75°C during the required mission time. The problems of designing and building a passive cooling system under these conditions involved transmitting the heat to the emission surface, selecting the surface finish for maximum heat emission, and analytically determining the thermal equilibrium.

The incident heat radiation—consisting of direct solar energy, earth-emitted energy and earth-reflected energy—was computed. The maximum incident heat radiation incurred when the spacecraft is directly in the path of the earth-sun line made it difficult for the radar's surface to transfer the heat to the atmosphere by radiation.

For maximum heat transfer, the radiating surface's finish must have high reflectivity and the thermal-radiation efficiency of a black body. The surface must have good adhesive properties, be noncorrosive and must not ignite during re-entry.

A cured epoxy, consisting of a titanium dioxide pigmented polyamide, fulfilled all requirements.

The difference between the allowable operating

temperature and the temperature of the radiating surface was so small that the temperature gradients among the various dissipating components' interfaces had to be minimized.

Several techniques were employed to provide the best conduction paths to dump the heat uniformly throughout the radiator. The highest-heat-producing components, such as the transmitter tube and power transistors, were mounted directly onto the radiating surface.

During design of the mechanical layout, the next-hottest components—based on power density—were mounted closest to the radiator. Since most of the electronic circuits were packaged into welded wire modules, many encapsulants were tested and evaluated before a thermally optimum encapsulant was selected. Still other extensive tests and evaluations were the basis for designing the best heat-flow network that would carry the heat from the modules to the ground plane radiator. A silica-filled epoxy was selected as the encapsulant for most modules; a few low-dissipation components are encapsulated in foam.

All the epoxy-filled modules are mounted on printed circuit boards that are assembled to perforated aluminum heat sinks. The modules and components are mounted directly into these heat sinks, and their leads extend through the perforations into the printed circuit boards. The heat sinks are attached to the ground plane and serve the dual function of structural-support elements and heat-flow paths. Gradients within the system are further reduced by bonding the components to the heat sinks with a resin-filled adhesive that provides a larger heat-transfer area.

Test data shows that all components maintain temperatures below the required 75°C under hottest conditions of orbit for the mission time.

Isolating radar from vibration

The vibration that occurs during launch poses another major design problem. These random-noise vibrations have frequency components up to 2,000 cycles per second. Since the resonances of most of the internal components are several hundred cycles per second or more, the supporting structure was designed to have a resonance between 100 and 150 cps—high enough to minimize structural excursions but low enough to avoid overlapping the component resonant frequencies. For the interrogator radar assembly, with its precision servo drives, an additional vibration safety margin is provided by mounting it on elastomer isolators. These isolators are designed to reduce the amplification occurring at the main structural resonance from 15-to-1 to 2-to-1.

The isolators resonate at 50 cps and act as a first-order filter above resonance, adding more high-frequency mechanical isolation for the electronics.

Reprints of this report are available. Use the reader service card at the back of this issue.

© copyright 1965, Electronics © A McGraw-Hill Publication

Production tips

Production tips is a regular feature in Electronics. Readers are invited to submit brief descriptions of new and practical processes, assembly or test methods, and unusual solutions to electronics manufacturing and packaging problems. We'll pay \$50 for each item published.

Flat disks reduce the cost of making cathode-ray tubes

By Brian Grayling

The M-O Valve Co., London

Problems of mechanical tolerance and alignment, which have limited the use of double guns in dual-trace cathode-ray tubes, can be overcome by making the guns with flat, apertured disks instead of the conventional cylindrical parts.

Double guns made the new way perform better than previous devices because of a 50% improvement in distortion corrections. Manufacturing costs are reduced about 20%. Designs can be changed faster and at less cost.

Despite the fact that double guns are the most direct way of making dual-trace crt's and can give the best performance, the design has fallen into disfavor because of manufacturing limitations. Beam switching and beam splitting—creating a dual trace from the beam of a single gun—have been adopted as alternate techniques.

Beam switching reduces the brightness of a display and transient information may be lost during a switching period. Split beams are less sensitive—typically 11 volts per centimeter compared to six volts for dual beams. Also, the double-gun design allows traces with contrasting brightness.

However, the use of two guns doubles the chance of error. With a single gun, trace distortion is the only significant variable; parallelism can also vary with double guns. As a result, the geometrical specifications must be halved if dual beams are to be as accurate as the dual traces of a single gun. With conventional double-gun construction it is difficult to obtain the accuracy required for modern oscilloscopes.

The conventional gun has forming and focusing electrodes composed of deep-drawn cylinders containing flat diaphragms that are perpendicular to the system's axis. The components must be parallel to within 0.0008 inch and coaxial to within 0.001 inch. These tolerances are difficult to achieve because errors in parts fabrication, tooling and jiggling are cumulative.

Each gun must be made separately and combined into a symmetrical assembly that will be matched

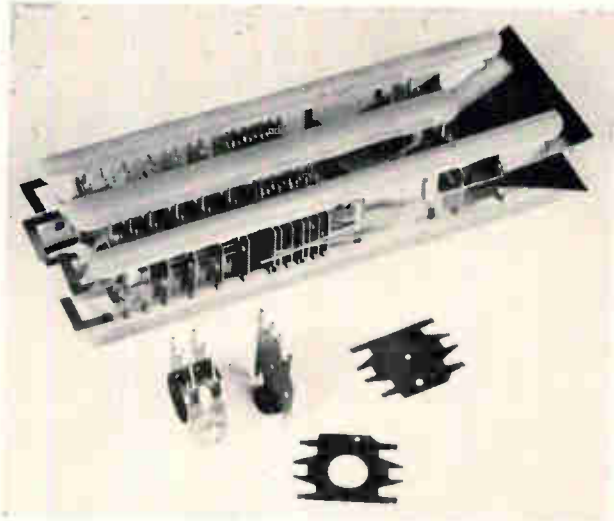

Lugs at corners of disks are inserted simultaneously into six glass rods to form the double-gun assembly.

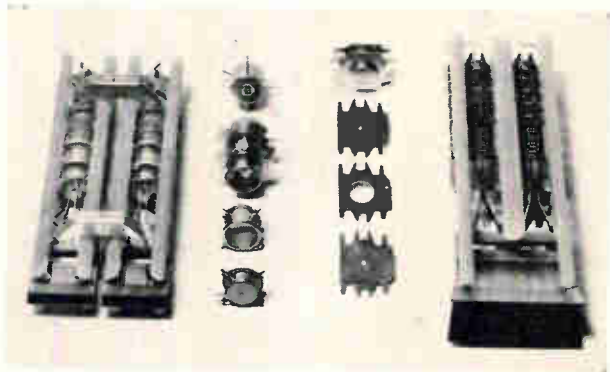

Flat-disk structure at right is easier to align than the conventional double-gun at left. Note how lugs on flat disks line up to form slot.

to the deflection system. This presents further complications. A post-deflection-acceleration system provides brightness and sensitivity, but usually forms a thick electron lens. Lens aberrations cause symmetrical pattern distortions in single-gun tubes and can be corrected. The distortions are not symmetrical in double guns, because each gun is displaced from the tube axis.

The new system solves these design and manufacturing problems. The ease with which design changes can be made is also important, because

the market for quality crt's is specialized and the obsolescence rate is high.

The flat disks, and the drawn cylindrical components they replace, are shown in the photo on page 113. Each disk blank has reference slots on its periphery. These slots provide high accuracy in locating the apertures, both at the time the apertures are pierced and during gun assembly.

The disks make the gun structure cartesian. The components can be positioned horizontally, vertically and axially with accuracy. Disk size and assymetry are designed so that the spacing between gun centers is small enough to minimize the effects of the post-deflection-acceleration system, yet large enough to permit alternate designs of the vertical deflector plates. Location of the deflector plates is made more positive by the cartesian nature of the assembly jig.

There are four glassing lugs on each disk, one lug at each corner. Making these integral with the disk avoids the customary welding of lugs to cylindrical parts after the parts are drawn.

The double gun is assembled by placing the parts

in a jig and inserting the lugs into six glass rods that have been heated until they are plastic. Conventionally, the pins around the circumference of the cylindrical components are dunked sequentially into the rods, one at a time. The lugs on the flat disks can be dunked into all six rods at once.

There are two advantages in this assembly method: the guns are assembled in a single operation, and they are less likely to become distorted by the cooling and contraction of the glass because cooling is not sequential either. The simplicity of this method makes it possible to automate the assembly process.

Design flexibility is achieved because the apertures pierced in the disk can vary in size, and disk spacing can be changed readily. Facilities for beam blanking and trace registration can be included in the structure. Beam blanking at a potential near ground eliminates the problem of supplying blanking signals at the high negative potential of the tube grid. Trace registration overcomes any displacement of the two beams that results from variations during manufacturing.

'Sniffer' removes solder from board

A "solder sniffer" is used by the Boeing Co. to unsolder components on Minuteman missile circuit boards. The sniffer does not damage the board and removes solder from a joint in seven seconds.

Instead of the standard pencil tip, the sniffer has a hollow adapter between heater and point. The adapter is connected to a rubber bulb by a stainless steel tube.

The hot tip is placed on the solder joint. It melts through the protective plastic coating and melts

the solder. Capillary action starts the solder flowing into the tip; the rest is removed by the suction of the bulb. Squeezing the bulb squirts the solder from the tip to clean it out.

The standard technique for unsoldering joints is to chip off the plastic coating, melt the solder with a soldering iron, and use wire braid to wick, or soak up, the metal. If the braid is not removed quickly enough, it becomes soldered to the board, requiring rework.

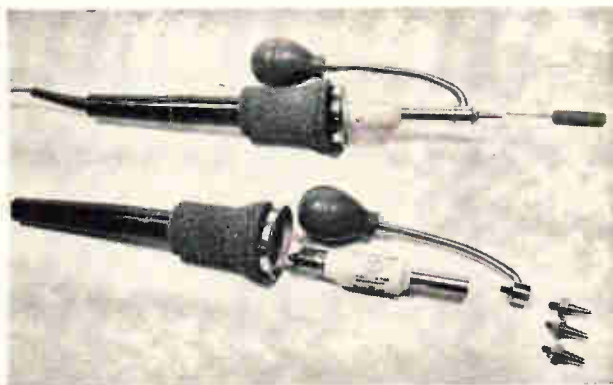

Sniffer is made by adding hollow adapter between heater and point. Disassembled view (below) shows three tip sizes.

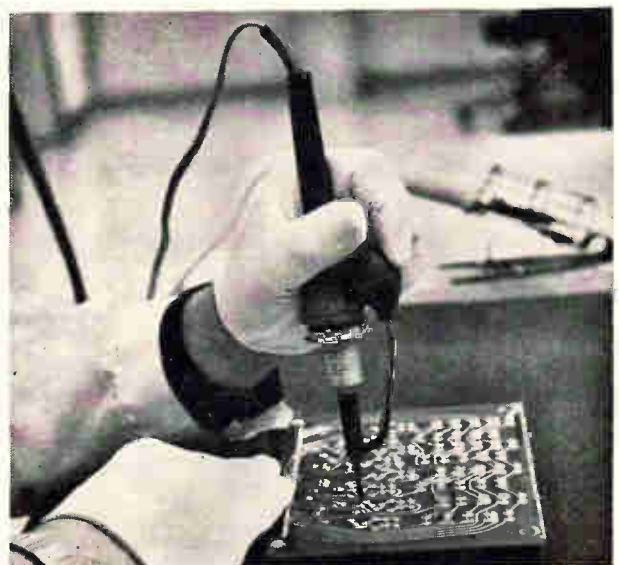

As hot iron melts solder, rubber bulb sucks it up into the hollow tip.

EIMAC

announces broad new line of reliable vacuum capacitors

Need a really reliable fixed or variable vacuum capacitor? Bothered because you can't find a capacitor conservatively rated to meet increased power and current ratings of today's advanced transmitters? Relax. Try a VacCap. New Eimac VacCaps feature a unique patented design which results in higher rf rms current ratings. All-copper-and-ceramic construction permits manufacture at higher bakeout temperatures, with improved vacuum and longer life. And

prices are competitive! VacCaps, fixed and variable, can deliver any value of capacitance up to 1500 picofarads at any voltage from 5 to 50 kV, and at current ratings up to 225 amperes. No special cooling is required. For details and technical data contact Applications Engineering, Power Grid Tube Division.

EITEL-McCULLOUGH, INC., San Carlos, Calif.

In Europe, contact Eitel-McCullough, S.A.,
15 rue du Jeu-de-l'Arc, Geneva, Switzerland



New products from TI to help you

New sub-miniature transistors simplify assembly, improve reliability over chips

TI silicon transistors are now available in the new TI "Chip-Pak"™ sub-miniature package shown in Figure 1. Designed to overcome problems encountered in using unencapsulated transistor chips, the new units offer device protection and ease of handling previously impossible with such small size.

Three types of "Chip-Pak" transistors are presently available — TIS22, TIS23 and TIS24. They are electrically equivalent to high-gain 2N929, 2N930 and 2N2484.

Little larger than unencapsulated chips, (0.060 x 0.060 x 0.035 in.), the new ceramic-plastic packages offer complete protection against surface degradation and mechanical damage. Round leads are weldable and solderable and may be bent to any configuration without damaging either bonds or element.

The new devices are recommended for thin films, chip circuits and some space-limited consumer circuits such as hearing aids and electronic watches. For data sheets, circle 103 on the Reader Service Card.

New silicon transistors usable to 2.5 Gc

Two new silicon transistors — designed to replace low-power klystrons, BWO's and vacuum-tube oscillators in microwave applications — are now available from TI.

Designated TIXS12 and TIXS13, the family offers a guaranteed power output of 250 mw at 1.5 Gc, and a typical gain-bandwidth product of 1.4 Gc (TIXS12). Usable power to 2.5 Gc is available. The oscillators are capable of driving harmonic generators to provide power at 12 Gc and beyond.

A new TI-designed coaxial package (shown in Figure 2) is used to allow maximum power output at high frequencies. Circle 104 on the Reader Service Card for data sheets.

New monolithic darlington silicon power circuit offers high gain, high speed, small size

Here is a complete silicon power circuit in a single dime-size unit. The new darlington devices, designated 2N2836-37, offer high gain (2000 min at 2 amps) and high speed ($t_{OFF} = 1.0 \mu\text{sec max @ 2 amps}$). Power dissipation is 25 w at 25°C case temperature. Collector current is 7 amps max. Collector-emitter voltage ($V_{(BR)CEO}$) ratings are 60 and 80 v.

The four-lead version of the THIN-PAC™ package is ideally adapted to systems that employ TI integrated circuits† in flat packages, and it offers a potential 10-to-1 size reduction.

Users benefit through reduced component count, simpler, more reliable circuitry, and optimized performance achieved by inherent matching of the two transistor elements. Circle 105 on the Reader Service Card for data sheets.

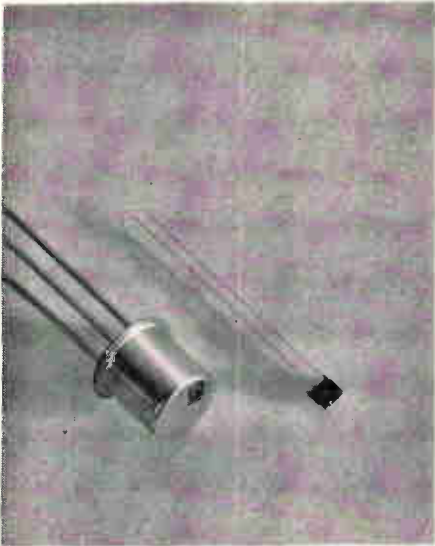

Figure 1. New TI "Chip-Pak" transistor package compared with TO-18 package (left) for size.



Figure 2. New TI-designed coaxial package for TIXS12-13 high-frequency transistors.

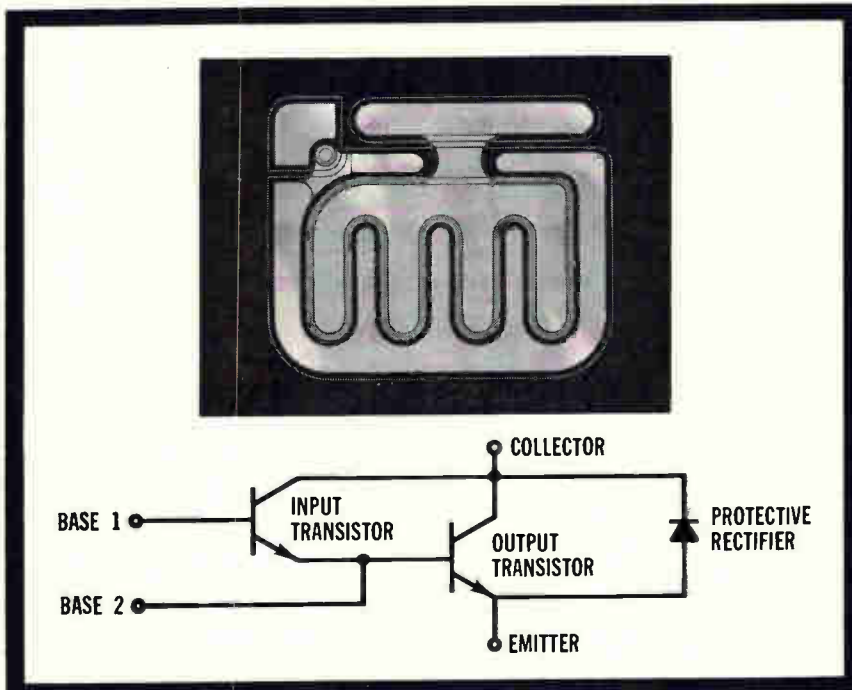

Figure 3. Structure and circuit of 2N2836-37 monolithic darlington silicon power circuit.

TI cannot assume any responsibility for any circuits shown or represent that they are free from patent infringement.

*Trademark of Texas Instruments †Patented by TI

improve performance and reduce costs

New planar epitaxial PNP silicon power transistors rated at 50 watts dissipation

The new TIXP07 transistor from TI is industry's highest power silicon PNP device and offers industry's lowest thermal impedance rating ($\theta_{J-C} = 1.5^\circ\text{C/W}$). The new unit was designed for use in complementary circuitry with the popular 2N1722, such as the 20-watt power amplifier shown in Figure 4. It can replace PNP germanium transistors where higher temperature capabilities are required.

Electrical characteristics include high voltage capability ($V_{(BR)CEO} = 80\text{ v}$), low leakage ($I_{CES} = 1\ \mu\text{a}$), low saturation voltage ($V_{CE(sat)} = 0.5\text{ v}$ at 2 amps), and high gain (20-90 at 2 amps, 20 min at 5 amps). Power dissipation is 50 w at 100°C case temperature, f_T is 10 mc min. The TIXP07 is supplied in a TO-53 package. Circle 106 on the Reader Service Card for data sheet.

New solid-state light source combines small size and high reliability

The new TIXL01 planar Gallium Arsenide light emitter gives users of silicon light sensors high efficiency, long life and freedom from catastrophic failures characteristic in incandescent lamps. The device resists vibration and high gravity forces which make filament-type sources unsuitable for some applications.

Housed in the package shown in Figure 5, the TIXL01 measures only $1/16$ in. diameter by $1/10$ in. high. Emitters may be mounted directly in $1/16$ in. printed circuit boards, simplifying circuit assembly. The narrow beam of near-infrared light (Figure 6) reduces optical cross-talk and minimizes light shielding problems.

Circle 107 on the Reader Service Card for data sheet.

4.5 db at one Gc is guaranteed noise figure for new germanium transistor

The new TIXM101 planar germanium transistor from TI offers low-noise and high-gain performance in industrial and military high-frequency amplifiers. Guaranteed noise figures are 2.6 db at 200 mc (2.0 db typical) and 4.5 db at one Gc. The gain-bandwidth product (f_T) is guaranteed 1.5 Gc — giving the circuit designer more gain per stage at high frequencies.

The planar construction allows the device to withstand more than 20,000 G's in the Y_1 plane and 1500 G's shock. This mechanical ruggedness, combined with the hermetically-sealed TO-18 package, makes the TIXM101 suitable for aerospace applications, as well as for high-frequency, low-noise circuitry.

Circle 108 on the Reader Service Card for data sheets.

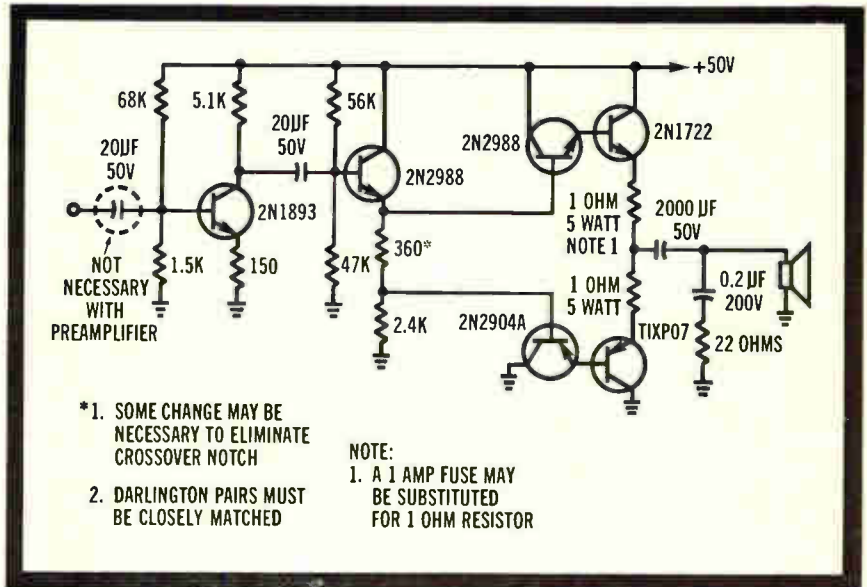

Figure 4. New 20-watt audio power amplifier employs TIXP07 in complementary output stage.



Figure 5. TIXL01 solid-state light source. Unit mounts directly in $1/16$ in. printed circuit board.

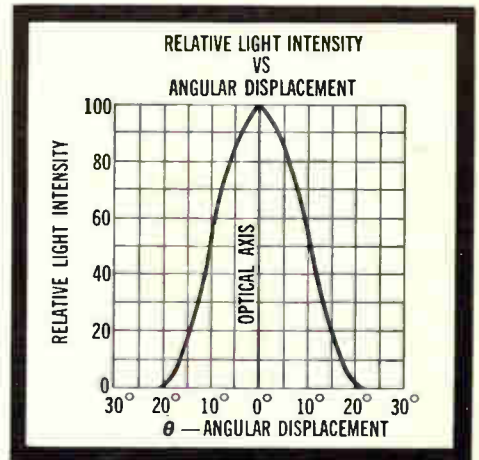
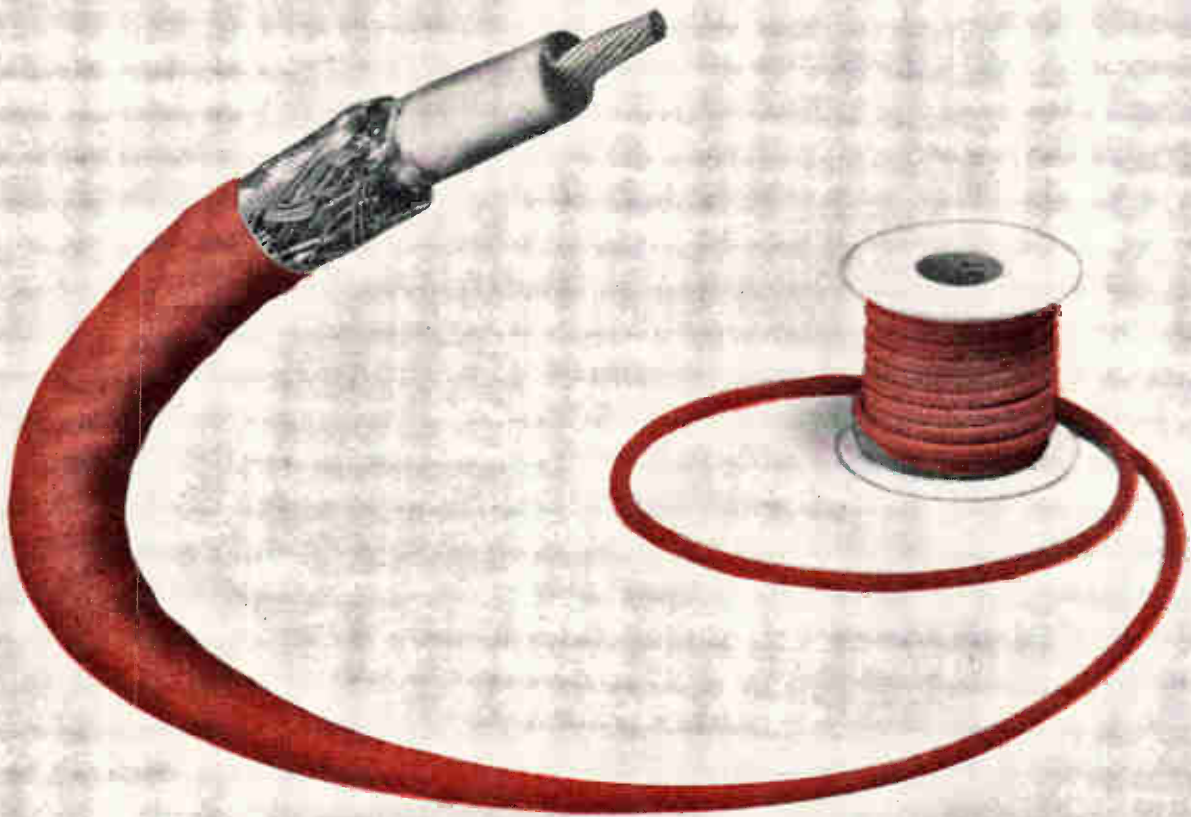

Figure 6. Narrow beam width from TIXL01 minimizes optical cross-talk and light shielding.



TEXAS INSTRUMENTS
INCORPORATED
13500 N. CENTRAL EXPRESSWAY
P. O. BOX 5012 • DALLAS 22, TEXAS

Now...a new step upward in performance for wire and cable jacketing for general purpose electronic and aerospace applications. It's made of irradiated KYNAR*—Pennsalt's polyvinylidene fluoride—combining superior mechanical toughness and excellent chemical resistance. Jacketing of irradiated KYNAR is free from outgassing, withstands gamma radiation. MIL-W-81044 wires operate at 135°C continuously, take 300°C for limited periods; are available in long lengths, and are smaller, weigh less and cost less than most alternative constructions.



Write for information and the names of leading manufacturers who supply wire and cable jacketed with irradiated Kynar to Plastics Department, Pennsalt Chemicals Corporation, 3 Penn Center, Philadelphia, Pa. 19102.

Kynar...a fluoroplastic that's tough!

*KYNAR is a registered trademark of Pennsalt Chemicals Corporation.



Probing the News

Military electronics

Navy's all-purpose circuits

Bureau of Weapons backs use of standardized modules to cut electronic design and maintenance costs

Navy supply officers have often wished that every man in the fleet wore the same size shoes, pants and shirts. Procurement would be simpler, and inventory would, relatively speaking, be a snap.

Supply officers and users of electronic equipment have wished even more ardently—and with more chance of realization—for an all-purpose circuit module that would plug into all electronic gear throughout the fleet. Besides simplifying procurement, it would assure continued availability of

components, and it would make maintenance aboard ship easier and cheaper than it is now.

Triumvirate. To harvest these benefits, three important agencies in the Navy's Bureau of Weapons have been busy for the past two years designing a family of general-purpose modules that they hope will one day be accepted by the entire Navy.

The effort, which is called the Standard Hardware Interface Program, is backed by the Special Projects Office's fire control and

guidance branch (SP-23), the industrial division (PID-23), whose job it is to foster technological advances in industry, and the components branch (REN-4), concerned with components research and engineering. The Naval Avionics Facility at Indianapolis (NAFI) is coordinating module engineering.

The first use of the standardized modules will be in new electronic control systems that the Special Projects Office is developing for the Navy's deep-submergence vessels (Electronics, Feb. 22, p. 123), and

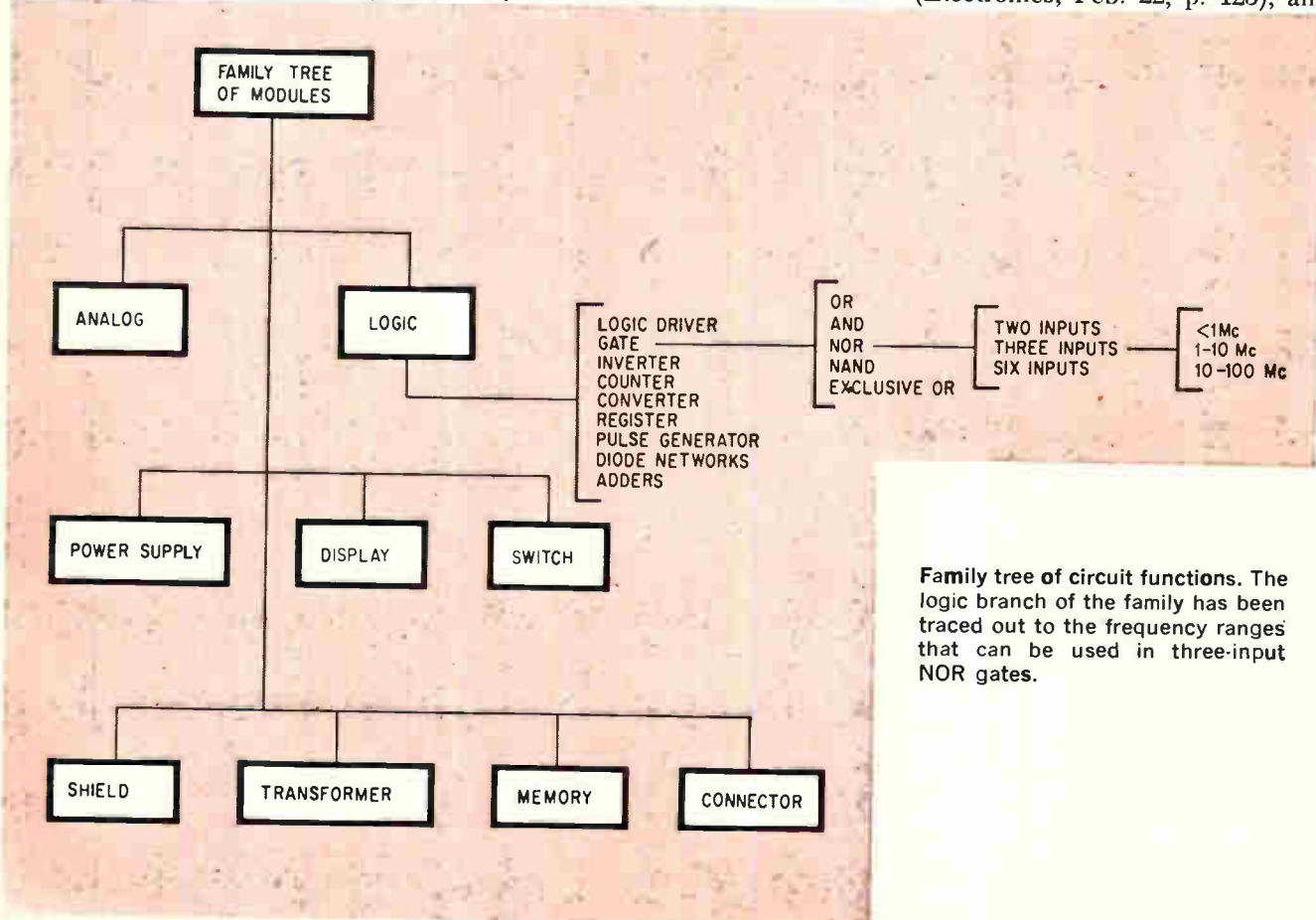

Family tree of circuit functions. The logic branch of the family has been traced out to the frequency ranges that can be used in three-input NOR gates.

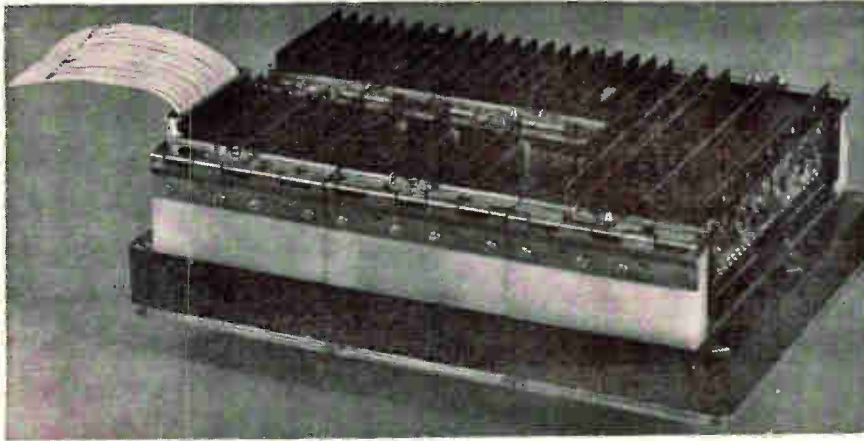

Type 2 assembly is used to interconnect Type 3 modules. Design is being changed so strips of metal, instead of the piano hinges, will hold modules in place.

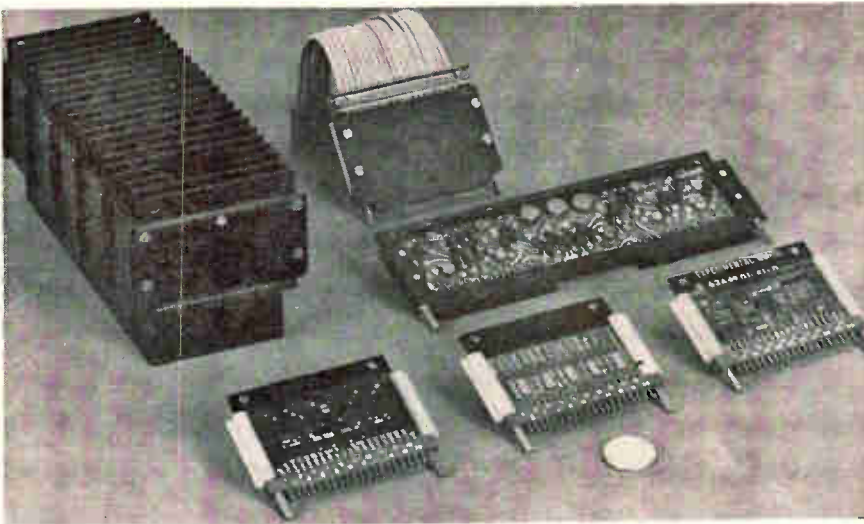

Basic Type 3 modules (foreground) can carry thin-film, integrated or hybrid circuits. Multiples of the basic dimensions are used in the power-supply, connector and discrete-component modules which plug into Type 2 frames.

in a digital data broadcasting system that NAFI is designing.

David Gold, head of SP-23, says that other naval agencies are interested but are waiting for his group to prove out the modules' merits.

If the modules are accepted by the Navy, contractors will be required to build systems, such as radar, sonar and navigation computers, from a standardized family of circuit functions and hardware designs. The modules could be made of any type of component—discrete, microcircuit or hybrid—but they would all look alike, plug in the same way, and work alike, no matter how different the specific circuit designs favored by individual Navy project engineers and contractors might be. The modules would cost \$50 or less each—cheap enough to throw away rather than repair.

I. Design guides

This month, NAFI is issuing a manual that defines the circuit functions of the basic plug-in modules. It standardizes the input-output characteristics, such as preferred operating voltages, and specifies the connector pin to be used for each input and output. The manual will be titled the "Type 3 Family Tree."

Type 3 is the identification number given the basic plug-in modules, shown in the photograph above. The structure that interconnects the modules, also illustrated, is called Type 2. Type 2 assemblies—equivalent to subsystems—are joined into systems by a framework identified as Type 1.

This month or next, NAFI will issue a second manual, the "Standard Interface Hardware Data

Book," that will spell out the details of construction and use of this hardware hierarchy. Initially, it will apply to ship-and shore-based systems. Avionics will be next.

Root of the tree. Even Gold, the program's chief proponent, doesn't expect overnight acceptance of the family-tree concept. Naval project engineers will be asked—not ordered—to specify use of the design guides when they write contracts for new systems.

Although some project engineers are waiting for proof of the benefits of the family-tree concept, Gold has seen it work successfully in the Mark 84 fire-control system for the Polaris missile. This system, developed by his group, was the genesis for the family-tree program. The Mark 84's 6,000 modules come in only 50 types, all with standard hardware. Besides being used in operational Mark 84's they are also used in support and training equipment. "An enormous gain in quality resulted," says Gold.

Contractors. Once several systems are using the standard modules, and a production base is established, Gold thinks the lower costs will cause contractors to use them in systems designed for other military services.

Standardized Type 3 connectors are already being produced on a pilot-line basis by the Methode

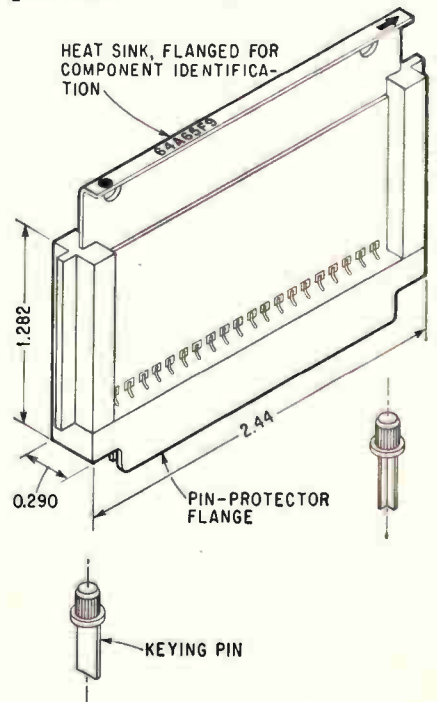

Plug-in mistakes are prevented by the use of half-round and three-quarter round keying pins.

Electronics Corp. for NAFI, which is making the module prototypes. The design is not proprietary, and can be made now by any manufacturer. The cost is less than \$3.

Helping hand. The new Chief of Naval Material, supervisor of \$10 billion a year in Navy procurement, is the former head of BuWeps' Special Projects Office, Vice Admiral I. J. (Pete) Galantin. As Gold's superior, he backed the family-tree program. Galantin considers modular construction one of the three most "attractive" solutions to maintainability problems in naval electronics—the other two are the use of solid state components and microcircuits, and automatic fault location in systems.

II. Freedom of design

Previous attempts to standardize circuit design and component usage have failed because of the restraints imposed on the use of new technology. Contractors want to use the most advanced circuits, not outmoded ones.

"We can't expect every manufacturer to use the same circuit design and fabrication," explains John Van Osdol, chief of the microelectronics engineering branch at NAFI, "but we can standardize module interfaces."

The price paid for all-purpose hardware is the sometimes oversized packaging it requires. Hardware that can carry conventional circuitry is larger than hardware needed for the latest thin-film or integrated circuitry. But the advantage, Van Osdol contends, is economy and the elimination of repair problems.

High density. Gold anticipates that designers may object to the family-tree concept because it doesn't make provision for further microminiaturization. Designers feel that combining several circuit functions in a small module represents a step forward in the use of microcircuits. They fear that failure to allow for such advances will restrict the state-of-the-art.

The present family tree, Gold replies, will probably be followed up with another, for modules with more complex circuit functions. Made with high-density packaging methods, these modules could contain a complete subassembly, such as a shift register.



This is PEMCO'S 17-pound Portable

It stands apart from the crowd of "portable" instrumentation recorders that weigh anywhere from 65 to 200 distressingly unportable pounds. It logs data from DC to 100 KC with laboratory precision* on only 20 to 45 watts (d-c or a-c). And it offers such large-instrumentation-recorder features as:

- Tape widths of ¼", ½", or 1"
- Standard speeds from 15/16 to 60 ips
- Record times from 3½ minutes to 3½ hours
- All-solid-state, plug-in Direct or FM electronics
- Up to 14 channels (I.R.I.G. compatible)
- Performs in any position to altitudes of 70,000 feet

It could be just what the doctor ordered. If the prescription fills your need, ask about the PEMCO Model 110 General-Purpose Data Recorder. You'll receive our 12-page product brochure forthwith.

*FOR EXAMPLE

- FM center carrier drift within 0.1% over a full reel of tape
- Signal-to-noise ratio of 40 db FM, 35 db Direct at 30 ips



**PACIFIC
ELECTRO
MAGNETICS**

942 Commercial Street, Palo Alto, Calif. 94303 / (415) 321-1177 / Cable: PEMCO

A million-dollar diversification plan

Britain's Hawker Siddeley Dynamics Ltd., followed four basic rules in switching successfully from military to industrial products

By Derek Barlow

London News Bureau

Though many military suppliers have switched to civilian operations and regretted it, Hawker Siddeley Dynamics Ltd., a subsidiary of the large Hawker Siddeley Group, is off to a fast start with its new industrial electronics operation. Started only 18 months ago, the operation will gross \$1 million in 1965 and sales are expected to climb 30 to 50% next year. After that, the company believes it will have a base of industrial products and know-how strong enough to hedge any further decline in military business.

Recipe for success. When Britain started canceling defense projects, Hawker Siddeley feared disaster. Fully 90% of its electronics work was in research and development for military projects. The company decided to diversify quickly into industrial electronics, despite no previous experience in the field.

Hawker Siddeley turned the job over to its chief engineer, J. E. Dick, and established a separate division. Dick took four basic steps, which may interest U. S. concerns caught in a similar squeeze:

- With other company officials, he chose a small area of specialization—telemetry and data transmissions—rather than trying to cover all of industrial electronics.

- He isolated the new area from military business by providing the new division with its own production facilities.

- He diluted the military attitude of the engineering department by hiring some engineers with industrial experience only.

- He determined to plan the product line years in advance.

I. Experience pays off

Dick was familiar with the prob-

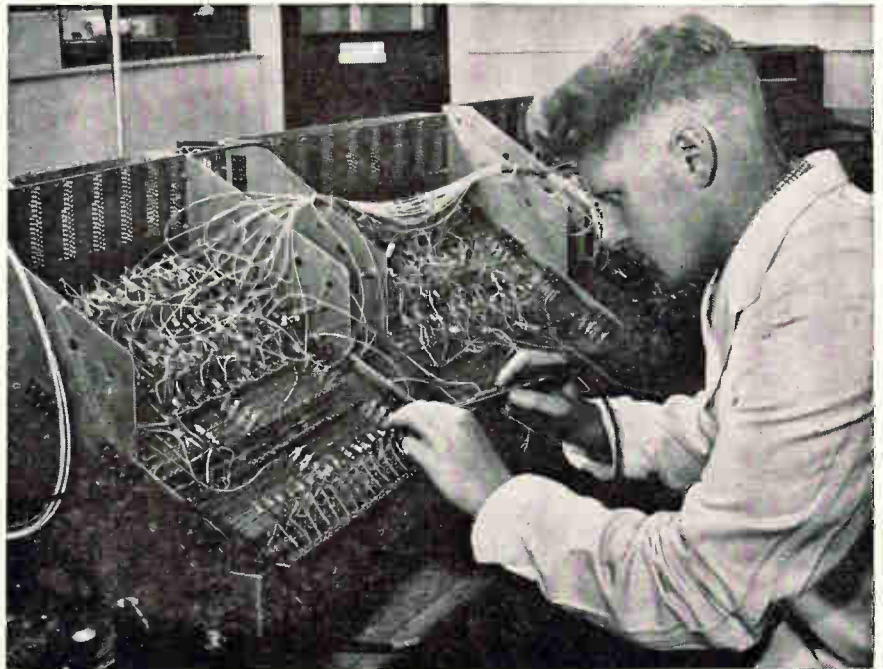

Hawker Siddeley technician breadboards a logic design. The company found that 'military' engineers changed easily to industrial projects.

lems of diversification. In 1959, he was the electronics manager of a primarily military electronics systems section at the Armstrong Whitworth Co., a member of the Hawker Siddeley Group.

Groundwork for diversification had been laid by a forward planning committee set up to investigate new growth areas. Its chairman was the company's purchasing officer ("because he had contacts in many of the places we wanted to visit," says Dick); other members included the commercial contracts officer, the electronics manager, a sales executive who was a specialist engineer for nuclear products, and a mechanical engineer.

"The work we did highlighted the first rule in diversification—set up a preliminary free-swinging small team to pinpoint potential

growth areas suitable for the company's background and resources, with little investigation into how to get into them," Dick says.

II. A new group, a fresh start

Shortly after that study, Dick went to the newly formed Hawker Siddeley Dynamics Ltd., made up from de Havilland Aircraft Ltd., A. V. Roe & Co. Ltd., and W. G. Armstrong Aircraft Co. Ltd.

The main emphasis of the new company was on space systems, missiles, and military electronics; nonmilitary activity accounted for less than 10% of sales. The company was also completely unbalanced Dick says, from the standpoint of production, sales, market research and engineering.

Dick organized the new firm so that production was separate from

design, thus making it difficult for engineers to tinker with the design during a production run. And he tried to protect his 30 engineers from being siphoned off to lend a hand when military crash programs came up.

Pilot production is now done in a small plant adjacent to the development teams, but mass production is carried out in northeast England, 100 miles from Hawker Siddeley Dynamics Ltd.

III. Switching sides

Dick rejects the hypothesis that an engineer with experience gained solely on military electronics cannot be easily switched to industrial electronics.

"We felt that an engineer worthy of being called an engineer is quite capable of switching readily to other fields. Often there is more motivation for them in the industrial field as they can see the social outcome of their work" he says.

Design was not the main problem in diversification; sales and production activities were far more important. Dick's approach was to hire a good cost estimating engineer. "We have been so successful that we are now able to compete in mass production of hi-fi amplifiers on sub-contract," he says. "This is a far cry from military production methods."

IV. Keeping it running

For new products, Hawker Siddeley Dynamics goes right to the customer to find out what he wants. For instance, a check with the parent company's engine division turned up a problem in the testing of engines. A modification of earlier work on a military checkout system solved it; and incorporating transducers in the engine simplified the test as well.

The company's specialties include electronic equipment for coal mines. One development now undergoing final trials is a simple data transmission system operating over a protecting wire ring main circuit around the mine. Data feed-in points can be coupled in to the system to provide the plant manager with below-ground production information.

Another area of inexpensive data recording is the manpower deployment system for coal mines.

to **20 KW** peak

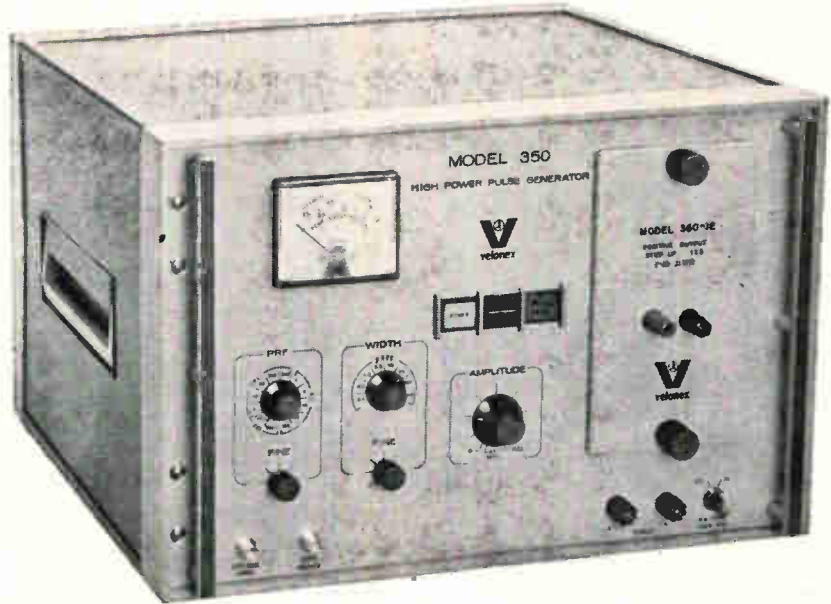

Model 350 High Power Pulse Generator

PRF:	3 to 100,000 cps
Pulse Width:	0.1 to 200 μ sec
Rise Time:	50 nanoseconds
Fall Time:	70 nanoseconds
Output:	to 2,000 volts neg. 10 Amps @ 200 Ω
Droop:	<0.05% per μ sec
Ripple:	Negligible
Duty Factor:	1% at 20 KW, greater for lower output levels.
Price:	\$3,990.00

Fast Rise Time: Complete Flexibility

VELONEX brings you a high power pulse generator capable of operating up to 20 KW output yet as easy to operate as an ordinary low-power lab pulse generator. In addition to **continuous** variability of all pulse parameters, VELONEX has added the dimension of **Impedance Matching**. Plug-ins match 0.5 Ω with **170 ampere** capability or 20,000 Ω with **19 KV**. You can match almost **any load** between. But even if you only need 300 W of peak power there is nothing like it on the market. The wide range of stocked plug-ins assure you the 350 will not be obsolete to do tomorrow's job as well as today's.



a division of Pulse Engineering, Inc.

velonex

560 Robert Avenue, Santa Clara, California. Area Code (408) 244-7370.

General Accounting pulls rank on Pentagon and industry

Comptroller general's agency widens its role from auditor of books to swayer of policies

all of them. This gives the agency time to concentrate on policy, management and on legal loopholes.

Contractors have become more frequent targets in recent years because of the increase in negotiated contracts.

Victims cry 'foul.' GAO's deeper probing in recent years has led to louder protests from industry and government agencies that have been under fire. The victims say much of GAO's criticism is unfair and that the accounting office makes judgments in areas in which it has no competence.

Deputy Defense Secretary Cyrus R. Vance accuses GAO of presenting its opinions as if they were facts. Its reports carry such titles as "waste and mismanagement in . . ." and "unnecessary procurement of . . ."

The Defense Department and

The electronics industry is girding itself for a new onslaught by the General Accounting Office. The agency is finishing a summary report on alleged transgressions committed by industry and government agencies last year, and will submit it to the House Appropriations Committee. The annual reports mention only cases that have already been publicized, but they are important because they analyze the alleged deficiencies.

The GAO's report last year prompted the committee to slash \$80.5 million from the Defense Department's request for funds to develop and buy electronic equipment.

Industry officials, unhappy about the prospect of a smaller military market, are equally concerned over GAO's expanding role in defense procurement.

I. Auditing the managers

When the accounting office was established in 1921, it functioned quietly as an auditor of the government's financial transactions, to see that they were handled correctly. Now, in addition to auditing figures, it "audits" management. It delves into matters of company policy that had always been considered internal affairs and then airs its findings publicly. It demands—and often allows to be published—cost data that companies hoped to keep confidential.

Why has the GAO changed its approach to its job? Why has this metamorphosis become increasingly intense in recent years? There are several reasons.

The government's transactions have become too numerous to monitor individually. The GAO now spot-checks accounting records rather than try to examine



Joseph Campbell the comptroller general heads GAO.

QUANTITATIVE
LIGHT
MEASUREMENT



\$375

**WITH THE EG&G
LITE-MIKE**

Nanosecond response. Wide spectral and dynamic range. Meter measures average power. Permits scope display of wave shape, rise and fall time, duration, amplitude, and integrated light pulse energy in the visible and near infrared range (0.35 to 1.13 microns). All for \$375.

Provides light source evaluation in CW and pulsed lasers; flash photolysis; flash tubes and equipment; exploding bridge wires; material fluorescence; gallium arsenide signals. Also provides standard for light instrumentation.

Ten inches high; light in weight; built-in controls for sensitivity and ambient light balancing; swivel-mounted head aligns with source. Order direct from Products Division, 160 Brookline Avenue, Boston, Massachusetts 02215.

 **EG&G** INC.

contractors often disagree with GAO's findings and rebut them. But the charge usually makes for a better newspaper story than does the rebuttal, and the net result is bad publicity.

Help is cited. Vance acknowledges that GAO reports are "an important management tool" and have been "of great help" in developing improved policies and procedures. But, he maintains, they should not be used as the basis for over-all evaluations of military procurement, supply management or other defense activities.

As for the charge of headline-hunting, GAO says the law requires public release of the report. It notes that it cannot control the use to which the reports are put after they become public.

II. Auditing the auditors

Karl Harr, president of the Aerospace Industries Association, asks: "Is GAO transcending its proper role and, if so, who's going to do anything about it?" Some companies have tried.

The Hewlett-Packard Co., for example, has a battle with GAO [Electronics, Jan. 25, p. 34]. The company was indicted when it refused to turn over cost-of-production records on a \$2-million sale of electronic gear to the Air Force in 1959. The company president, David Packard, said: "The electronics industry is a very competitive one and we consider cost data for specific instruments to be highly confidential." He noted that GAO reports are made public.

Austin G. Roe, an attorney for Melpar, Inc., objects to the way GAO handles contractors' replies to GAO charges.

The agency asks for a contractor's comments on a draft of its report. Then, when it publishes the final version, it carries the contractor's rebuttal but proceeds to rebut the rebuttal. GAO has been known to change its conclusions in the final report from those in the draft version, Roe charges. This makes the contractor's statement seem almost irrelevant.

Rx for industry. Roe advocates repeal of the GAO's statutory access to contractor records for checking to see whether the government came out on the short end of a deal. Congress granted

Ballantine True RMS VTVM

Model 320A

Price: \$485

Read voltages with the same high precision and accuracy over the entire five-inch logarithmic scale.

Accuracy specification of "2% of reading is far more accurate than for a linear meter rated at 1% of full scale."

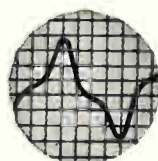
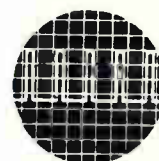
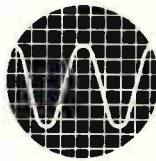

Measures 10 μ V to 330 V regardless of Waveform

Ballantine's Model 320A is a sensitive True RMS-responding VTVM with a frequency range of 5 Hz to 4 MHz and a voltage range of 10 μ V to 330 V. Its basic accuracy is better than 2%.

This accuracy, plus its wide band width and ability to measure signals with crest factors of 5 to 15, are the main features of the Model 320A. Thus it is ideal for accurate measurements of a wide variety of complex waveforms encountered in acoustical, vibrational, noise, pulse, and magnetic measurements. In addition to sinewaves, it measures distorted waveforms that include random noise and pulse trains with duty cycles as low as 0.04 and pulse widths as short as 0.3 μ sec.

The Model 320A can be used as a null detector with a sensitivity down to 10 μ V and as a wide band amplifier with floating, grounded or symmetrical output. Up to 50 V rms is obtained from the amplifier output. It can be used, too, with readout devices. And with Ballantine calibrated shunts, the Model 320A can be converted to a true rms-responding ammeter with a sensitivity down to 0.1 μ A.

Write for brochure giving many more details on both portable and relay rack versions

Member Scientific Apparatus Makers Association

— Since 1932 —



BALLANTINE LABORATORIES INC.

Boonton, New Jersey

CHECK WITH BALLANTINE FIRST FOR DC AND AC ELECTRONIC VOLTMETERS/AMMETERS/OHM METERS, REGARDLESS OF YOUR REQUIREMENTS. WE HAVE A LARGE LINE, WITH ADDITIONS EACH YEAR. ALSO AC/DC LINEAR CONVERTERS, AC/DC CALIBRATORS, WIDE BAND AMPLIFIERS, DIRECT-READING CAPACITANCE METERS, AND A LINE OF LABORATORY VOLTAGE STANDARDS FOR 0 TO 1,000 MHZ.

now
available:

high- power Trygon half racks!

Up to 300 watts — precision regulated power — constant voltage — constant current — remote sensing — remote programming! Models for every application, from \$149. For the lab: self-cased; for systems: single or dual in 5¼" panel. Write today for complete specs. Dept. E-28.



TRYGON®
POWER SUPPLIES
Roosevelt, L. I., N. Y. (516) FRreport 8-2800

this access more than 10 years ago, he explains, to protest the government's inexperienced negotiating team from being overwhelmed by the contractor's staff of high-paid engineers, lawyers and auditors.

"But today," he says, "it is the poor contractor who is at a disadvantage and needs help." He cites the vast increase in the complexity of procurement regulations, requirements for cost-data disclosures under penalty of criminal sanctions, increased emphasis on auditing by the contracting agency, and the heavy shift to competitive pricing, even in negotiated contracts.

III. GAO defends its role

The GAO's broadened role and tougher attitude reflect the policy of Joseph Campbell, the GAO's comptroller general. Through his second in command, Frank Weitzel—Campbell doesn't talk to the press himself—he gets his position across:

"We are no longer interested in merely adding columns of figures and making accounts balance," says Weitzel. "Congress author-

ized us to look not only at the receipt and disbursement of public funds, but also at their applications—whether they are being spent effectively, efficiently and economically. To do this, we must analyze and evaluate management decisions behind the figures."

GAO's power. GAO has the wherewithal to carry out these objectives. Its more than 2,000 auditors, investigators and lawyers can knock on the door of any contractor or walk into any United States military installation anywhere in the world and check into the way government funds are spent.

During fiscal 1964, which ended June 30, the agency made 480 examinations and audits at 273 plants of defense contractors, and 856 reviews at 780 military sites. It also made nearly 1,000 checks of nonmilitary work for the government.

GAO's limitations. Despite its independence, however, GAO does have limitations. It can only recommend corrective action; it has no power to force government agencies to adopt its recommendations. For this reason, agencies relegate

An aloof watchdog

The principal investigator and critic of the executive branch of government leads a personal life that's scrupulously aloof by Washington standards.

Comptroller General Joseph Campbell avoids fraternization with cabinet members or heads of the agencies whose activities he audits, or with contractors who do business with the government. He believes such conduct would compromise his position as an impartial judge of many aspects of their job performance.

Although an appointee of the President, the grey-haired, deep-voiced accountant is an agent of Congress. His job is to check whether executive agencies spend federal funds properly and efficiently.

Unlike most congressmen and their employees, Campbell has no business connections. When he was named comptroller general 10 years ago by President Eisenhower, he served all connections that he thought might raise conflicts of interest. "The government's interests are so pervasive they touch almost all aspects of life," he explains. "Though I once worked for a university, I wouldn't now serve as a university trustee because many colleges are contractors to the government."

Campbell was treasurer and vice president of Columbia University until 1953. He worked with Eisenhower when the general was president of Columbia.

Eisenhower named Campbell to the Atomic Energy Commission in 1953, and shifted him to his present post in December, 1954. The comptroller general holds office for 15 years and cannot be reappointed.

Campbell is the first certified public accountant to head the GAO. Of his three predecessors, two were lawyers and one had been a congressman.

From his spacious, paneled office in downtown Washington, the 65-year-old comptroller general performs an arduous job that requires broad knowledge of the workings of every government agency except the Federal Reserve System, Central Intelligence Agency and a few others. "Unlike other agencies, there are no neat boundary lines drawn around our area of operations," he says. "We have to be familiar with defense, postal service, housing, reclamation, agriculture, foreign aid, space—you name it."

Away from his desk, Campbell likes to fish and sail. His wife is a professional artist.

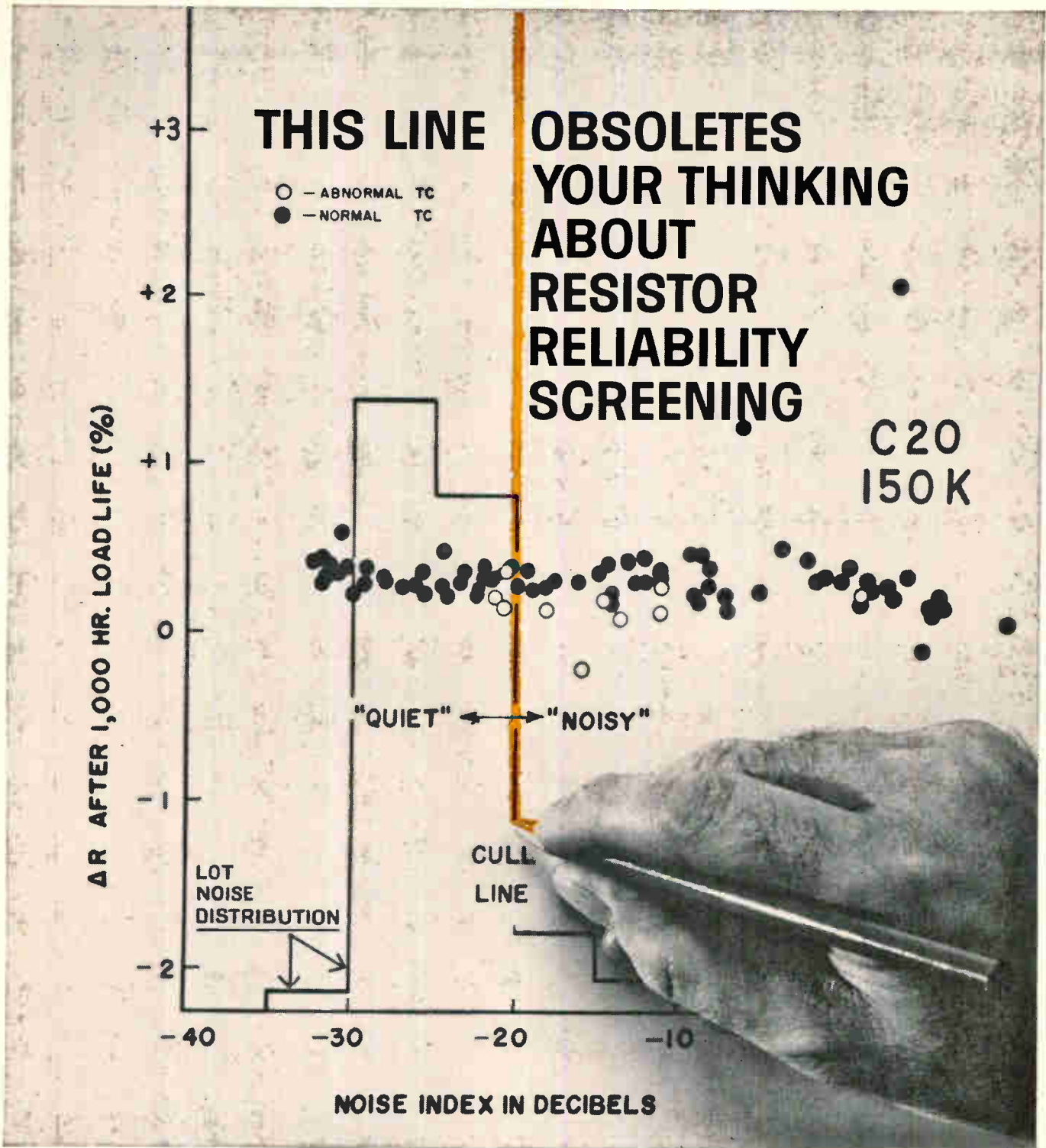

It's the reliability CULL* line we can draw on the basis of *current noise level* for any lot of CORNING® Metal Oxide Film Resistors.

The good guys are on the left. More than 230,000,000 unit test hours (many of them overstressed) have proven that all CORNING resistors passing current noise screening perform without failure.

The CULL line falls at different db levels for different styles and sizes

of CORNING resistors. But we can draw one for any of them that is practical in cost and unsmirched to date for reliability.

Resistors to the right of the line may be OK, but our findings indicate that all mavericks in TC and load life will be on the noisy side of the line.

Read all about this *non-destructive* reliability screening tool, and how we'll put it to work for you at modest cost. Write for our folder,

"Current Noise Level: New Reliability Screening Technique for CORNING Metal Oxide Resistors," to Corning Glass Works, 3913 Electronics Drive, Raleigh, N. C.

*Corning Uniformity Limit Level

CORNING
ELECTRONICS

TRYLON CONICAL MONOPOLE ANTENNA
Vertically-polarized, omnidirectional, for any
4:1 range from 2 to 30 mc. 4 db/iso gain.
50-ohm input. Power to 50 kw PEP

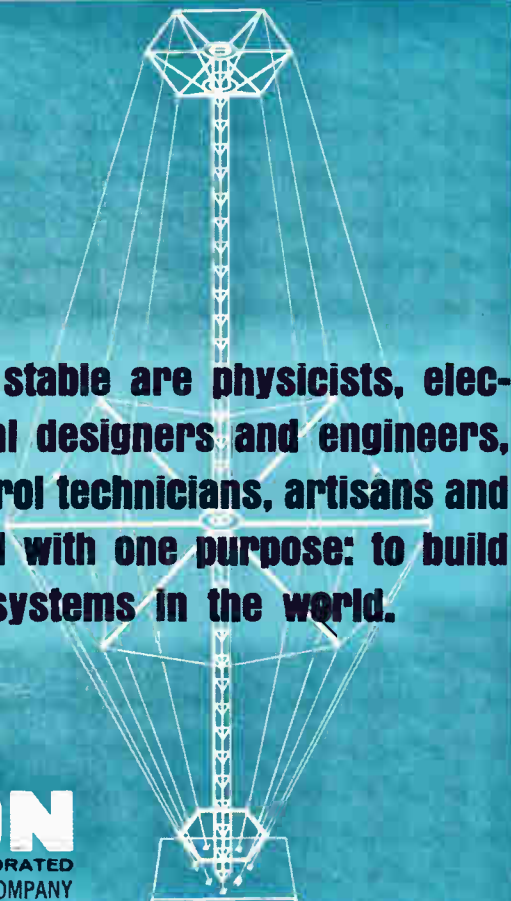

Here in one stable are physicists, electrical and structural designers and engineers, production and control technicians, artisans and expeditors—all fired with one purpose: to build the finest antenna systems in the world.



Elverson, Pa. 19520 (215) 942-2981 — International Division, 750 Third Ave., New York, N.Y. 10017, U.S.A.

Circle 203 on reader service card



CHRISTIE
SINCE 1929

XENON

& XENON MERCURY ARC LAMP
D-C POWER SUPPLIES



4.5 - 180 amp
11.5 - 65 vdc
1% Reg & Ripple

From Stock:
Various Ratings
and Styles

150 - 5000 watt
MIL & RFI Specs
Silicon

Igniters
Also
Available

Also 200 other Models of Power Supplies & Battery Charges • Write for Catalog

CHRISTIE ELECTRIC CORP. 3400 West 67th Street, Los Angeles 43, Calif.

many of its reports to inactive-file drawers and forget them.

Even so, GAO can wield considerable influence in bringing about changes, particularly in procurement practices. For one thing, it frequently seizes on an abuse and keeps issuing reports on it until the executive branch is goaded into taking action.

If GAO's recommendations are ignored long enough on shortcomings that appear to be serious enough, Congress can make the suggested change mandatory or use its budgetary power to accomplish the same end—as in the case of the \$80.5 million last year.

Accountants vs. generals. For the past year the GAO has been hitting particularly hard at the military's contracting and procurement procedures. Campbell has issued reports alleging that:

- The Army incurred unnecessary costs of more than \$2.2 million in the sole-source procurement of 500 AN/PPS-4 portable radar sets from Sperry Gyroscope Co., a division of the Sperry Rand Corp., without waiting until known deficiencies had been corrected. The Army's rebuttal pointed out that Sperry had met the terms of the contract satisfactorily. GAO had looked into the situation later, when problems had arisen for which Sperry was not responsible.

- An Air Force fixed-price contract with Avco Corp. for installing and testing radar systems was priced \$120,000 too high because Avco received an allowance for labor costs that was greater than it could reasonably expect to incur on the basis of prior experience.

- The Navy bought 333 aircraft receiver-transmitter units for \$2.3 million even though it had sufficient stock to meet its demands.

- The Navy bought 1,100 military-developed AN/WRT-2 radio transmitters knowing that a commercially developed radio transceiver with practically equal operational capability was available at less than half the cost.

Many of Campbell's goals are commendable from an accountant's viewpoint. But there are other considerations, not the least of which is national security. His critics complain that Campbell has extended his activities to fields outside his area of competence.

NEW EAGLE RELAYS

COMPARE
Better Life Characteristics

COMPARE
Higher Reliability

COMPARE
Fewer Parts

COMPARE
More Design Flexibility



Eagle 25AA
General Purpose
Relay (Actual Size)

COMPARE
Lower Pull-in Voltages

COMPARE THEM!

New Eagle relays... more than 3,000 types... are the best you can get anywhere. Be crafty. Check the specs and the product. Convince yourself.

One example: Gold-plated contacts are *standard* on every general purpose Eagle relay. And on medium power relays, silver cadmium oxide contacts are standard, since they deliver the best possible current-bearing characteristics in this power range.

Check some more. Note the sturdy designs... the ratings that exceed all other competitively-priced units... the precise engineering and inventive use of materials. They're all what you'd expect from Eagle—leaders in time/count control devices.

If you've ever dealt with Eagle you'll expect more, and you'll get it. We're talking about unequalled service... service that frankly has never before been available from any relay manufacturer.

Compare. You'll choose Eagle.

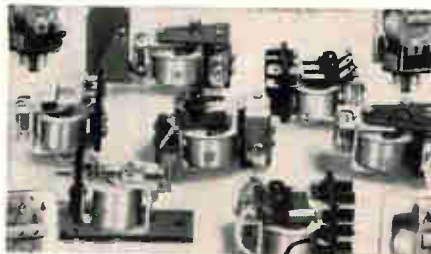

Part of the "big" picture... more than 3,000 types: plug-in with dust covers; dual latching; hermetically sealed; custom-engineered styles.

Get full details in our new, 16-page color catalog. Send for your free copy to Eagle Signal Division, E. W. Bliss Company, Federal Street, Davenport, Iowa.

BLISS  **EAGLE SIGNAL**

A DIVISION OF THE E W BLISS COMPANY

Electro-Mechanical, Electronic, Solid State Timing/Counting/Programming Controls General Purpose, Medium Power Relays

See us at The Design Show Booth 4439

AUGUST 27, 1962

Mariner II interplanetary probe launched from Cape Kennedy; successful midcourse correction of orbit brings it close to Venus.

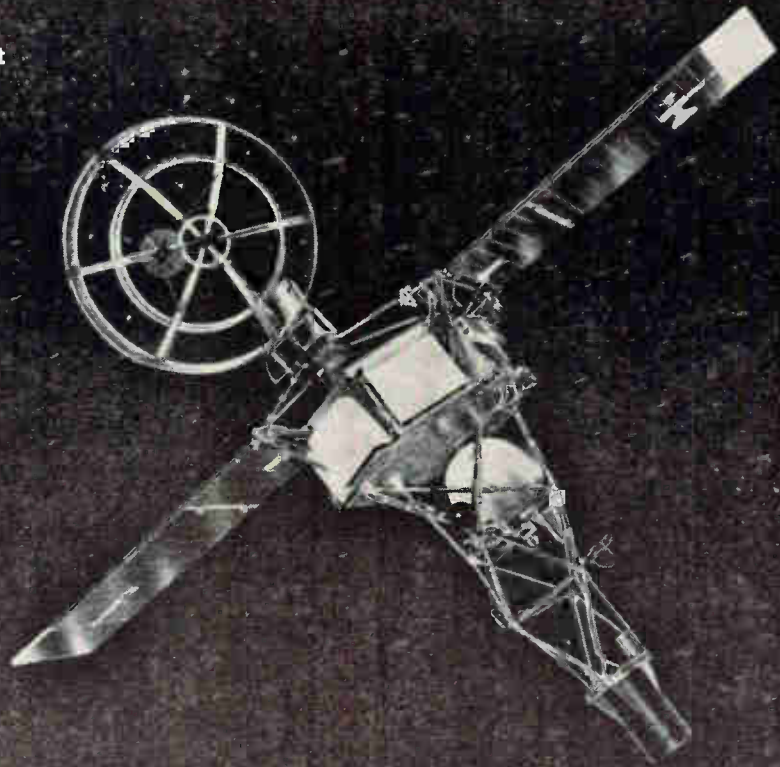

Many of the outstanding achievements in science and technology during the past 10 years have been recorded, analyzed and preserved on tapes of "Mylar." When reliability counts, count on "Mylar." *Du Pont registered trademark for its polyester film.



BETTER THINGS FOR BETTER LIVING... THROUGH CHEMISTRY

EAGLE ELECTRIC COUNTER

Batch count a predetermined number. Shut off or actuate a machine or machines.

Meter fluids by flowmeter. Control a shut-off or a mixing valve or valves.

Add-subtract count. Control of parking lot, hopper or conveyor section capacity.

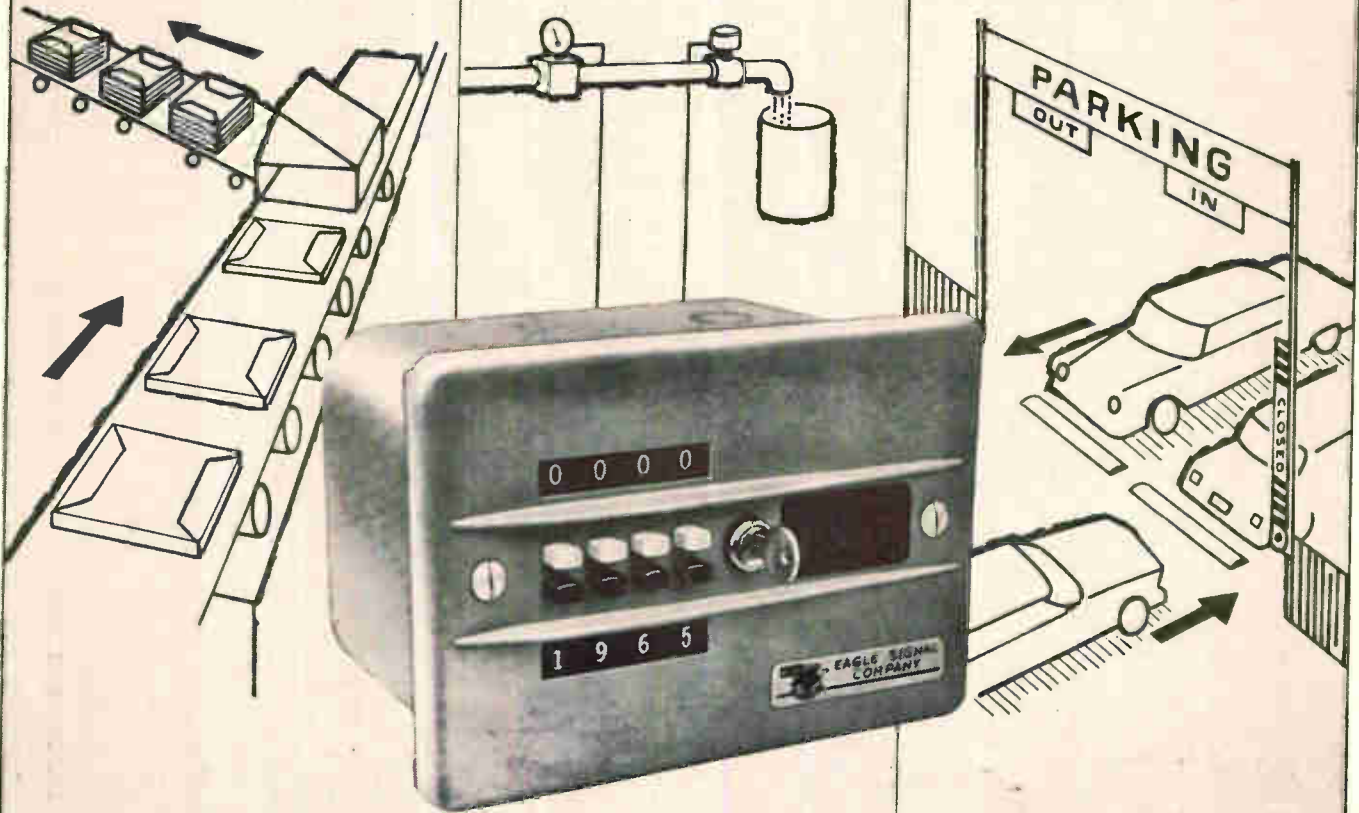

COUNTS...THEN CONTROLS

The HZ760 performs in three ways...as a batch counter...a continuous count counter...an add-subtract counter. Whether you count pills or automobile bodies, this is the unit for the job.

Functionally, the HZ760 registers counts by electric impulse from a limit switch, photo-electric cell, flow meter or similar device. At the preselected number of counts, *adjustable up to 9999*, the unit's control switch turns electronically or electrically controlled equipment on or off. **THERE IS NO RESET TIME.**

The HZ760 is a rugged counter designed for precise, industrial control. Among its outstanding features: pushbuttons to set count...keylock to prevent tampering...large, easy-to-read numerals...10 amp. load switches...counting speeds to 500 per minute...AC coils.

HZ762 shaft driven units for revolution counting also available. Compare. You'll choose Eagle.

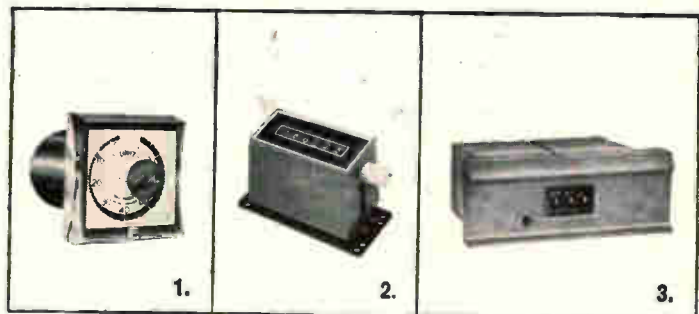

EAGLE's family of counters offers you a wide selection for your most exacting control problems: 1. 80 count plug-in automatic reset counter. 2. 6 digit electric count totalizer. 3. 3 digit electronic counter for high speed counting.

Contact Eagle Signal Division, E. W. Bliss Company, Federal Street, Davenport, Iowa.

BLISS  **EAGLE SIGNAL**

A DIVISION OF THE E. W. BLISS COMPANY

Electro-Mechanical, Electronic, Solid State Timing/Counting/Programming Controls General Purpose, Medium Power Relays

See us at the Design Show Booth 4439

Tung-Sol Read-Out Lamp Saves Customer Two Operations, Cuts Shrinkage

Our customer's problem stemmed from handling. The bulbs he bought went first to a wiring company to have lead wires attached. (Shrinkage here due to lead wire damage). After the leads were attached the bulbs went to a molder to have bases added. (More shrinkage due to bulb damage and lead wire breakage). Shrinkage in both operations ran as high as 15 per cent.

Now Tung-Sol does the whole job and the customer has benefitted 4 ways: (1) two processing steps eliminated. (2) valuable production time saved. (3) inventory reduced. (4) gets 1000 usable lamps for every 1000 purchased.

Tung-Sol can harness to any specifications and mold to any configuration. Describe your application to us for free suggestions about how Tung-Sol can solve your problem at a saving.



If your application requires only bulbs, ask for a quotation from Tung-Sol. The Tung-Sol line of miniature and subminiature lamps is extensive. Quality is the best that more than half a century of know-how can produce.

TUNG-SOL INSTRUMENT LAMPS

Tung-Sol Electric Inc., Newark, N. J. 07104

ACTUAL
SIZE



LIGHT FORCE Cherry Switch

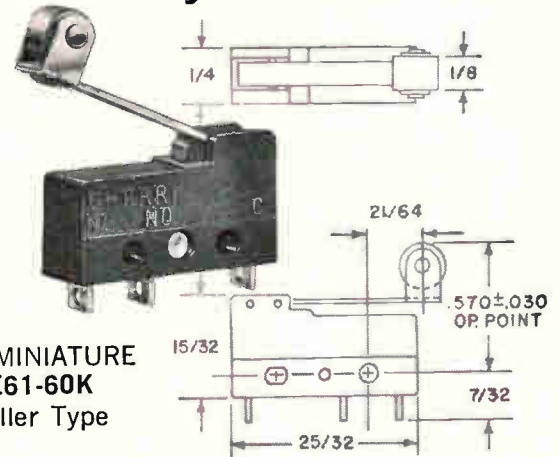

SUBMINIATURE
E61-60K
Roller Type

- Operating Force 9 grams Max.
- 5 amp, 125-250 V AC



The complete snap-action switch line!

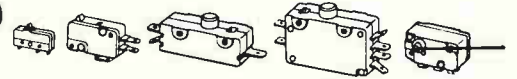

Cherry Electrical Products Corporation

P.O. Box 437-12 Highland Park, Ill.

In Canada: Barry Electric Ltd., Rexdale, Ontario
Circle 204 on reader service card

For any kind of MICROWAVE COMPONENT

try

RADAR DESIGN CORP.

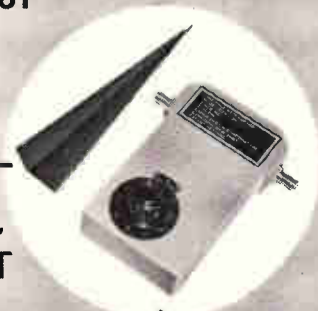

From broad-band waveguide terminating inserts, to continuously adjustable attenuators 0-10Gc/s, RDC maintains a perpetual inventory of more than 200 standard components ready for delivery. Modifications to your specifications promptly produced.

Special systems applications? An important segment of RDC is the Special Products Department regularly engaged in advanced design and development of microwave components for specific systems applications. Check our RFQ response capability.

ABSORBERS
ATTENUATORS
COUPLERS
DETECTORS
FILTERS
POWER DIVIDERS
SLOTTED LINES
TERMINATIONS
TUNERS
WAVEMETERS

Write for complete catalog #3A of standard microwave components. Information on custom "State of the Art" capabilities available on request.



RADAR
DESIGN
CORP

507 PICKARD DR., SYRACUSE, N. Y.

Soon all data tape recording will be “done by the numbers”

CEC Magnetic Tape, created and produced by Eastman Kodak, has virtually eliminated every tape problem in data recording.

The secret begins with traceability

All CEC tape is *numbered*—color-coded on the box, can, reel; even digitally numbered on the back of the *tape* itself for instant identification.

For example, on every 15 inches of tape there appears an internal Kodak reference number which immediately identifies the tape by type; and every 30 inches there is a numbered tape signature which provides an index to the coating and test records for that particular production block.

This provides several obvious advantages to the user. A specific run of tape may be immediately located and identified. No longer need a mixup in reels become a problem or delaying factor. So efficient is this coding method, it is possible—through the numbers on the tape, reel, can or box—to trace any roll of tape all the way back to the master web from which it came.

However, digital coding is only one of the significant reasons why CEC Magnetic Tape is rapidly changing the state-of-the-art.

CEC tapes are divided into *four* specific categories. Collectively, they meet the most advanced requirements of *every* data recorder. Yet each tape records at the highest applicable resolution and sensitivity—with the greatest uniformity and lowest tape and head wear obtainable today.



In addition . . .

- ☐ Only CEC tapes provide a standard nomenclature for simplified identification and ordering: S-1 standard, 100 kc; SX-1 standard extended, 300 kc; M-1 medium band, 600 kc; W-1 wide band, 1.5 mc.
- ☐ Only CEC tapes are so precisely differentiated that users are no longer subjected to the time-consuming burden of performance evaluation.
- ☐ Only CEC tapes come shielded in metal containers—packed in cardboard filing boxes covered with protective plastic sleeves.
- ☐ Only CEC tapes are protected from shipping and storage damage by means of a plastic waffle hub, thus preventing tape serration and flange deformation.

However, with all these advantages, CEC Instrumentation Tape costs *no more* than the tape you are now using.

Write now for your free CEC INSTRUMENTATION TAPE CHART. This special chart lists CEC tape categories, applications, and models of recorders for which each tape is recommended. Ask for CEC Chart DM-47-X13.

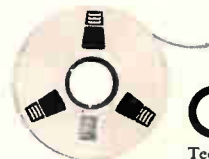

CEC

Technical Supplies Department

CONSOLIDATED ELECTRODYNAMICS

A SUBSIDIARY OF BELL & HOWELL/PASADENA, CALIF. 91109
INTERNATIONAL SUBSIDIARIES: WOKING, SURREY, ENGLAND
AND FRIEDBERG (HESSEN), W. GERMANY

Today — Raytheon Microwave Technology is Solving These Problems —

The quest for answers is leading industry into many new and more complex scientific disciplines. Here are some solutions from the field of electronics which may help to provide an insight into your problems. Today, Raytheon microwave technology is solving these problems. Tomorrow perhaps it can help you.

Problem: Improve the power/pound ratio in transportable radar systems.



Modern military radars go wherever the fighting man goes and consequently must be lightweight and readily transportable. Under battlefield conditions, the amount of gasoline required to generate primary power can be a critical logistical problem.

Working with major system manufacturers, Raytheon has developed microwave tubes that operate with high efficiency and low voltages to provide far more output power per input pound of gasoline. These crossed field amplifiers are so compact and lightweight that they also permit substantial reductions in system size. Raytheon has built more of them than any other manufacturer and has proven their long-term reliability in many field applications.

Crossed field amplifiers are a product of the Tube Operation of Raytheon's Microwave and Power Tube Division.

Problem: Develop a laser powerful enough to open up a vast array of new application possibilities.

In the laser field, one-watt output represents a tremendous amount of energy when generated under continuous-wave as opposed to pulse conditions. Raytheon's new LG12 argon laser, now in production, has this capability, making it suitable for a host of applications where insufficient power previously prohibited the use of lasers. Some of these are in laser reconnaissance systems, optical data processing systems, bright display work, underwater signalling, tracking and other oceanographic applications.

Operating in the single transverse mode, the LG12's one-watt output is over the range of 4545 to 5145 angstroms in the blue-green portion of the visible spectrum. Even more dramatic

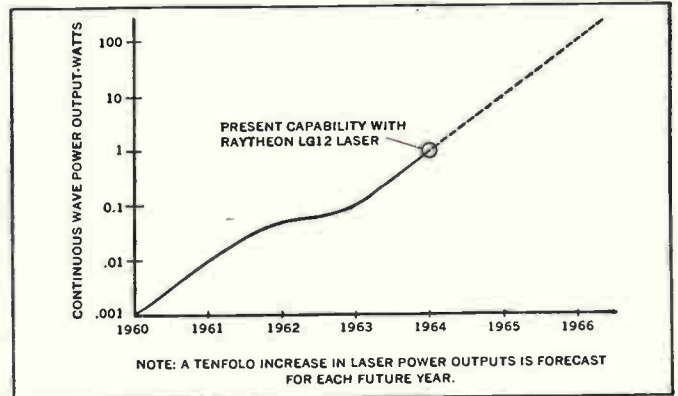

breakthroughs in laser continuous-wave power outputs are expected to be achieved by Raytheon in the months to come as illustrated by the graph above.

Lasers are a product of the Laser Advanced Development Center of Raytheon's Microwave and Power Tube Division.

Problem: How to prevent the rapid deterioration of flavor in preserved foods.

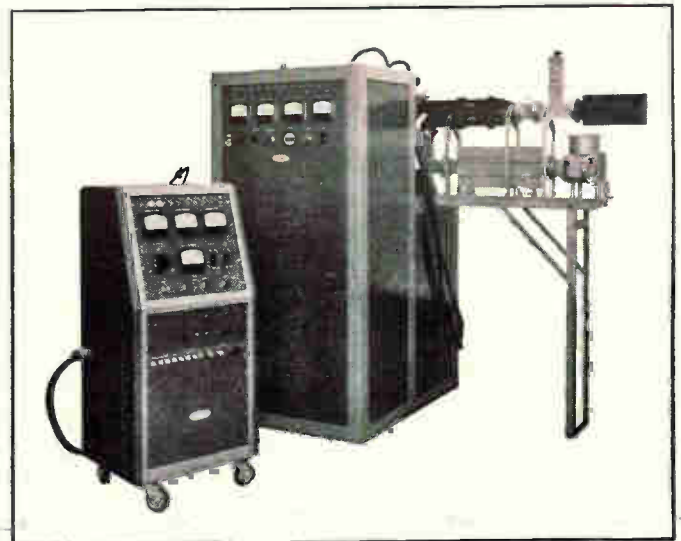

To help solve this problem in biological research, Raytheon recently developed for one of its customers a microwave generator that produces power of a precise, required frequency. By using the generator to permeate the food enzymes with microwave energy, it is hoped that the usual rapid deterioration of food flavor can be prevented. This will thereby extend the usable life of foods. Still another area where microwave generators by Raytheon are being utilized is gas plasma research. Additional application possibilities include pasteurization and sterilization, chemical synthesis, curing materials, polymerization of plastics, and setting up unusual chemical reactions.

Microwave generators are a product of the Special Electronic Equipment Operation of Raytheon's Microwave and Power Tube Division.

RAYTHEON

Write us in detail about your problem. Data on specific products is also available by contacting Raytheon Company, Microwave and Power Tube Division, Department 3036, Waltham, Massachusetts 02154

Operational amplifier offers 500-megohm input

Field-effect transistors in the input stage account for the unit's superior performance

Designed for computations and analog control functions, the model 131 differential operational amplifier furnishes input impedances 1,000 times higher than typical solid-state operational amplifiers (500 megohms compared with 5 to 500 kilohms). This improvement is made possible by field-effect transistors in the input stage, where conventional transistors were previously employed.

Unique compensation of temperature coefficients at the differential input stage maintains input-current change with temperature to 0.1 nanoampere per degree centigrade from 0° to 40°C, slightly higher over a greater range, without the need for a chopper. Drift is held low over a long period. Because stability is dependent on design rather than on matching—as is generally the case for transistors—the input balance-versus-temperature characteristic is not upset by aging.

Model 131 includes a balance potentiometer for adjustment of the input offset voltage to zero at any operating temperature. Typical change in offset voltage with temperature is only 20 μ v per degree; this stability is a result of careful selection of the FETs' bias points.

Open-loop gain of the model 131 is 100,000 with unity gain at 1 Mc. Output voltage is ± 10 v with a slewing rate of 5 v per μ sec. Common-mode rejection ratio is better than 60 db from d-c to 1 kc.

The input characteristics of an ideal operational amplifier call for infinite differential and common-mode impedances. In this respect, an FET stage is superior because its input has only the resistance introduced by leakage current; the conventional transistor, on the other hand, has relatively low resistance due to required base-conduction current.

The circuit (top left) is a typical differential operational amplifier connection for isolation between a transducer and another amplifier or similar buffering applications. The common-mode resistances, R_{CM1} and R_{CM2} , shunt the inputs to ground. For model 131 at d-c, R_{CM} is specified to be 500 megohms while some of the best conventional transistor amplifiers present an impedance of about 10 megohms to ground. The total input resistance is not R_{CM1} , however, but the parallel combination with the amplifier's differential input resistance. Differential input resistance equals the specification of R_{DIFF} multiplied by loop gain. Loop gain equals amplifier gain times the voltage divider $R_2/R_1 + R_2$. At d-c, model 131 has an R_{DIFF} of 500 megohms and, assuming the feedback divider equals 1/100, total differential input resistance is nearly infinity. For the conventional amplifier, R_{DIFF} is more likely to be in the order of 100 kilohms.

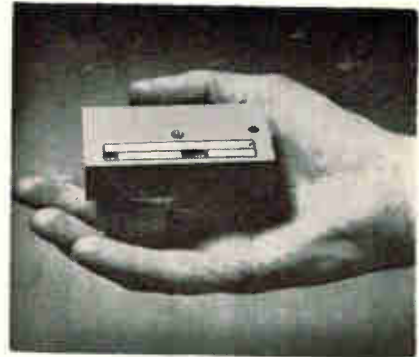

At d-c, the shunting effect of this resistance may not be excessively large, but it has considerable effect at high frequencies. At a frequency where gain has fallen to 100, for instance, the shunting resistance of the differential input is 100 kilohms for the conventional amplifier and 500 megohms for the FET amplifier.

A typical differential or difference amplifier connection is shown at the bottom left. With the FET model 131 resistances R_1 and R_2 may be larger because of higher input impedances. These higher resistances have the advantage of loading the source much less than standard resistances do. For example, if a closed-loop gain of 100 is desired, R_2 must be 100 times R_1 . Because of the low impedance of conventional transistors, R_1 and R_2 might be 1.0 and 100 kilohms respectively. But with the model 131, R_1 and R_2 can be 1.0 and 100 megohms respectively. Thus, with a FET input stage, low input current and high impedances are advantageous.

Model 131 is offered in a small encapsulated module, 1.6 by 3.0 by 0.7 in., with machined connecting pins to facilitate etched circuit-card mounting. Price is \$125 in quantities of 1 to 4, and delivery is immediate.

Zeltex, Inc., 2350 Willow Pass Rd., Concord, Calif.

Circle 350 on reader service card

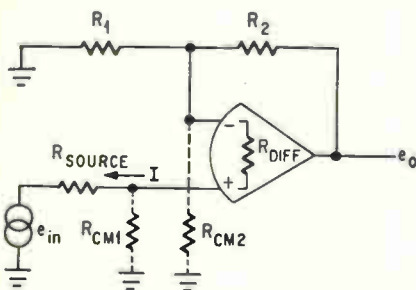

Buffer connection for differential operational amplifier

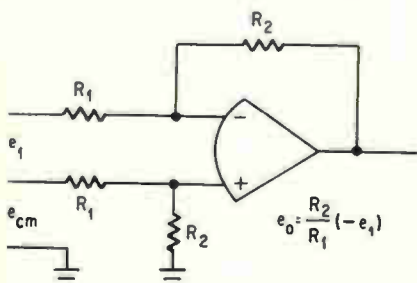

Differential or difference amplifier

Thin thermistor responds quickly

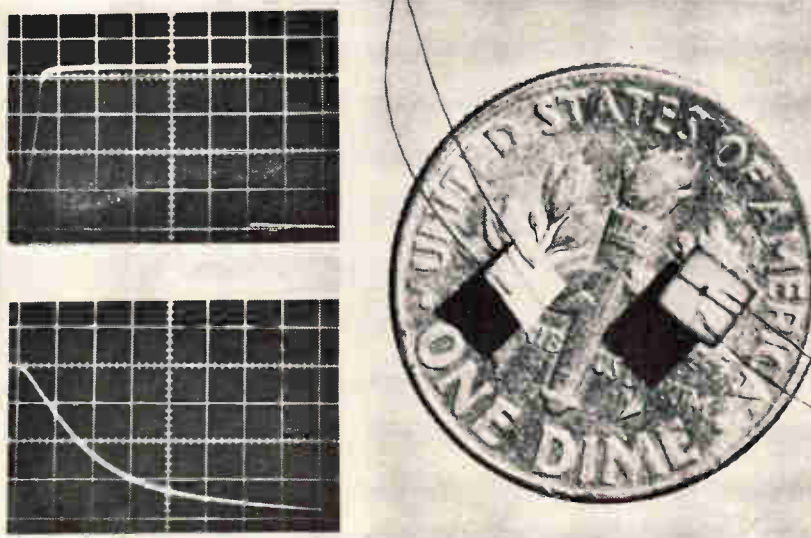

A new generation of ultrathin, highly sensitive and extremely rapid thin-film thermistors have been developed. The manufacturer calls them Thinistors. Two types have been developed: one, intended for surface mounting, consists of a metal oxide semiconductor film 5 microns (0.0002 in.) thick sintered to a variety of 0.010 in. thick substrate materials; the other, a free-standing unit intended for lead mounting, has no substrate and is 20 microns (0.0008 in.) thick. Both units are approximately 1/8 in. square and are provided with 1 mil diameter platinum-iridium leads. Thinistors have very high surface-to-mass ratios and extremely low heat capacities. The combination of these properties yields relatively high dissipation constants and produces thermal response times as fast as 150 μ sec. Illustrated at the upper left in the photo is the response of a typical Thinistor to pulse energy. Each division on the horizontal axis represents 50 msec. The figure at lower left shows the exponential cooling of a Thinistor after termination of pulse. Each division on the horizontal axis represents 100 μ sec. Some of the units listed as standard have a temperature coefficient of resistance of -4.4% per $^{\circ}$ C (at 25° C), which is claimed to be more than 10 times as high

as coefficients heretofore obtained from evaporated semiconductor films. Life tests indicate that suitably aged Thinistors will have a stability of better than 0.1%. Initially, Thinistors will be available in resistances ranging from 100 ohms to 1 megohm. They are expected to find applications in micro and pulse circuitry, gas chromatography, microcalorimetry, vacuum manometry, IR energy detection and medical electronics. Victory Engineering Corp., Springfield Ave., Springfield, N.J., 07081. [351]

Transistor sockets permit heavy-duty use



Molded-body sockets are available for TO-5, TO-22 and TO-18 circular and in-line 3- and 4-lead transistors. Units may be dip-soldered in a p-c board or locked in chassis by means of the heavy, broached inside diameter retaining ring furnished with them. Over-all height

Silicone Greases are available from these distributors

ARIZONA
ELECTRICAL SPECIALTY COMPANY
120 South 29th Street, Phoenix
R. V. WEATHERFORD COMPANY
9310 North Central Avenue, Phoenix

CALIFORNIA
ELECTRICAL SPECIALTY COMPANY
2820 East 12th Street, Los Angeles
158-168 11th Street, San Francisco
R. V. WEATHERFORD COMPANY
6921 San Fernando Road, Glendale 1
3240 Hillview Avenue, Palo Alto

COLORADO
ELECTRICAL SPECIALTY COMPANY
2026 Arapahoe Street, Denver 5

DISTRICT OF COLUMBIA
READ PLASTICS, INC.
317 Cedar Street, N.W., Washington 12

FLORIDA
GULF SEMICONDUCTORS, INC.
129 Almeria Avenue, Coral Gables 34

ILLINOIS
FEDERAL INSULATION
549 West Randolph Street, Chicago 7
J. J. GLENN & CO., INC.
605 West Washington Boulevard, Chicago 7

INDIANA
HYALINE PLASTICS CORP.
1019 North Capitol Street, Indianapolis

KENTUCKY
GENERAL RUBBER & SUPPLY COMPANY
3118 Prestan Highway, Louisville 40213

MASSACHUSETTS
NORTHEAST CHEMICAL COMPANY
581 Baylston Street, Boston 16

MICHIGAN
F. B. WRIGHT COMPANY, INC.
9999 Mercier Street, Dearborn

MINNESOTA
D. A. SCHULTZ COMPANY
801 S. E. 8th Street, Minneapolis

MISSOURI
D. A. JAMES COMPANY
911 St. Charles Street, St. Louis 1
REGAL PLASTIC SUPPLY COMPANY
1735 Main Street, Kansas City

NEW YORK
QUEEN CITY RUBBER COMPANY
825 E. Ferry Street, Buffalo, N. Y.
CHAMBERLIN RUBBER COMPANY
455 East Main Street, Rochester 14604
210 Marcellus Street, Syracuse 4
PUNT, INC.
160 Woodbine Court, Box 99, Floral Park

OHIO
THE PHILPOTT RUBBER COMPANY
2077 East 30th Street, Cleveland 15
PARKWAY PRODUCTS, INC.
1230 West Seventh Street, Cincinnati 45203

OREGON
ELECTRICAL SPECIALTY COMPANY
2360 N.W. Quimby Street, Portland 10

PENNSYLVANIA
SMITH OF PHILADELPHIA
Second and Somerset Street, Philadelphia 33
SPECK-MARSHALL COMPANY
P. O. Box 110, Nichol Avenue, McKees Rocks, 15136

TEXAS
HOUSTON INDUSTRIAL SUPPLY COMPANY, INC.
P. O. Box 52507, 1902 Bell Avenue, Houston 52
LAWRENCE ELECTRONIC COMPANY
P. O. Box 20676, 3422 Cridelle, Dallas 20

WASHINGTON
ELECTRICAL SPECIALTY COMPANY
2442 First Avenue, South, Seattle

WISCONSIN
R. J. WITTENBURG COMPANY
1338 West Atkinson Avenue, Milwaukee 53206

GENERAL  ELECTRIC

A HALF-TON OF SPECIAL FIELD COIL NEEDS A LOT OF HEAT DISSIPATION

(And G-E Silicone dielectric grease does
the job with half the volume of non-silicone
heat transfer agents)

This Klystron tube used for vital radar defense is over four feet in height and is supported by a special field coil weighing more than a half-ton. To protect the coil from its own heat, G-E Insulgrease® Dielectric Compound G-640 is applied to the coil windings to assure dissipation of the heat as rapidly and as efficiently as possible, even under the most adverse conditions. To attempt to duplicate this high level of effectiveness and reliability would take *more than twice the volume* of a non-silicone heat transfer agent!

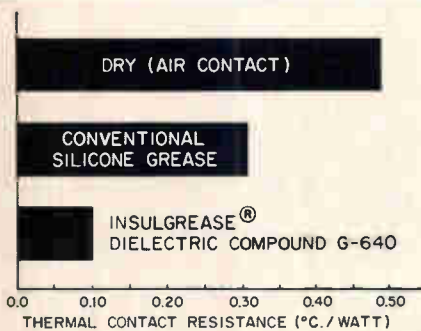

Data taken on a silicon power transistor mounted directly on an anodized aluminum plate. Mounting torque = 15 in.-lbs. Resistance measured as a function of the interface compounds between transistor case and mounting surface.

THERMAL CONTACT RESISTANCE.

The high thermal conductivity of G-E Insulgrease Dielectric Compound G-640 is reflected at left in its thermal contact resistance. Most conventional silicone greases offer improved thermal contact resistance over that of air. G-640 offers a still greater improvement with a value of 0.09°C/watt. G-E silicone greases are also water repellent and high temperature (over 400°F) resistant. Chemically inert, they are highly compatible, non-corrosive and will adhere to almost anything.

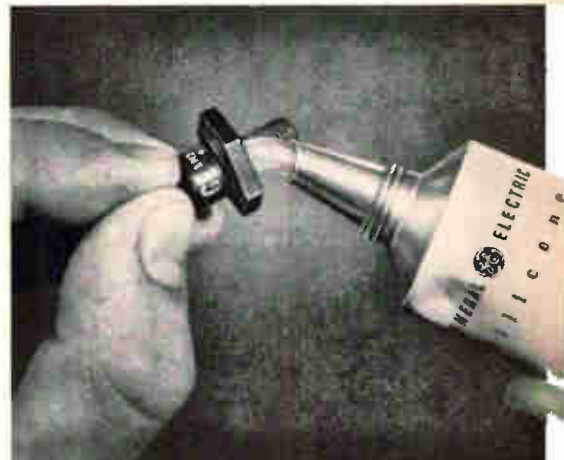

G-E silicone dielectric greases, available from the distributors shown on the opposite page, offer you countless ways to insulate and protect electric circuits and components. Get your free sample — and a copy of our informative new data book, S-21 — and see. There are greases compounded for insulation, and for lubrication, and for general purpose use. Write on your letterhead, mentioning your application, to Section N4142, Silicone Products Dept., General Electric Company, Waterford, New York.

GENERAL  ELECTRIC

Circle 137 on reader service card

New Components

of both TO-5 and TO-18 is $\frac{1}{4}$ in.; with lead length included, it is $\frac{1}{16}$ in. Diameter of TO-5 is 0.395 in.; TO-18, 0.312 in. Contact is precision machined beryllium copper silver/gold finish with 0.040-in. diameter terminations; the TO-18 series is also available with 0.020-in. diameter soft weldable termination. Body material is molded mica-filled phenolic. Terminations on TO-18 are off-set to TO-5 pattern, making wiring easier. The high quality heavy-duty transistor socket is good for the life of any equipment and particularly suitable for airborne equipment or equipment exposed to shock or vibration. Because of its mounting versatility, it may replace several specialized types of sockets in equipment, production, or stores inventory, according to the manufacturer.

Nugent Electronics Co., Inc., Box 486, New Albany, Ind. [352]

Metal-film resistors are ultra precise

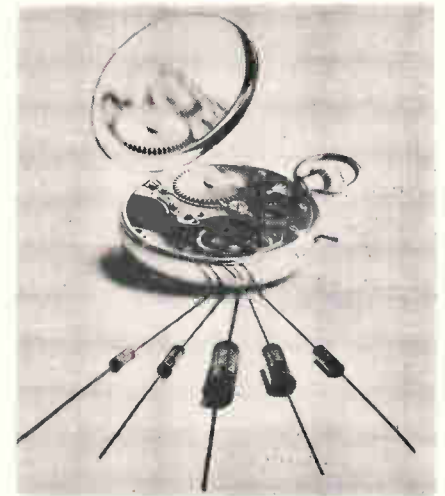

Type JXP metal film resistors are said to offer a high standard in precision, stability, reliability and long life. They are available in four styles, with wattage rating at 125°C ranging from $\frac{1}{10}$ w to $\frac{1}{2}$ w. Resistances range from 30 to 100,000 ohms and from 50 ohms to 1.5 megohms. Maximum voltage range is from 200 v to 350 v. Temperature coefficients are close to zero ppm over many of the common

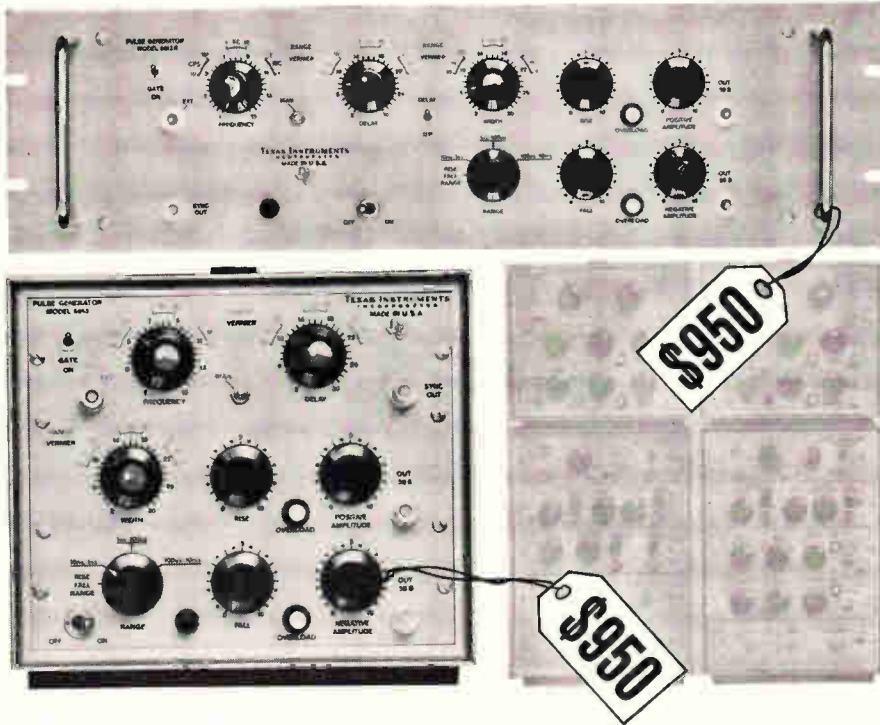

more general-purpose features, higher performance and quality with TI's 6613 pulse generator

The Model 6613 General Purpose Pulse Generator fills the need for a low-cost, high-quality test instrument with exceptional performance specifications. It is a general purpose instrument ideal for most pulse applications such as testing integrated circuits, digital circuit design, system design and checkout, testing of diodes and transistors.

The 6613 provides coincident positive and negative pulses determined by an internal clock generator or external source, with rep rate variable in 6 steps. Pulse width and delay are also variable in 6 steps. Amplitude is variable from near zero to 10 volts, with overload protection provided. Solid-state circuitry is utilized throughout. The compact unit measures 8½ in. high, 8½ in. wide, 12 in. deep and weighs only 10 lb.

SPECIFICATIONS

Clock Pulse Repetition Frequency

15 cps to 150 cps	15 to 150 kc
150 to 1500 cps	150 kc to 1.5 mc
1500 cps to 15 kc	1.5 mc to 15 mc

Delay

30 to 300 nano-secs	30 to 300 microsecs
300 nanosecs to 3 microsecs	300 microsecs to 3 millisecs
3 to 30 microsecs	3 to 30 millisecs

Width

30 to 300 nano-secs	30 to 300 micro-secs
300 nanosecs to 3 microsecs	300 microsecs to 3 millisecs
3 to 30 microsecs	3 to 30 millisecs

Pulse Amplitude—10 v into 50 ohms

Rise and Fall Times—variable: less than 10 nanosecs to 1 microsec, 1 microsec to 100 microsecs, 100 microsecs to 10 millisecs, minimum rise time typically 8 nanosecs

INDUSTRIAL
PRODUCTS
GROUP



TEXAS INSTRUMENTS

INCORPORATED

P. O. BOX 66027 HOUSTON, TEXAS 77006
7 RUE VERNONNEX GENEVA, SWITZERLAND

712

temperature ranges. Dimensions range from 0.260 in. max length by 0.110 in. max diameter to 0.720 in. max length by 0.250 in. max diameter. Leads are 1.5 in. long. JXP resistors meet all the requirements of MIL-R-10509, Characteristic E, with far less than allowable variations. They are available in tolerances from 1% to 0.05% as standard, and tighter tolerances are available on special order. They can be manufactured to track within 5 ppm per degree C of each other over a temperature range of -55°C to $+175^{\circ}\text{C}$.

Jefferis Electronics Division, Speer Carbon Co., DuBois, Pa. [353]

Slider switches save panel space

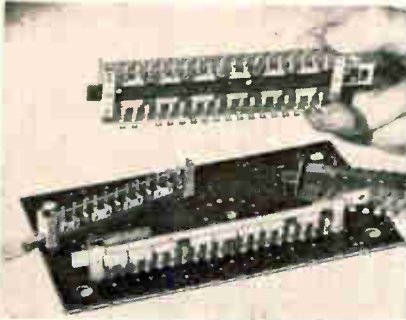

Two new series of slider switches have been introduced. The single-side 150 SL series and double-side 300SL series are available with 12 to 21 contacts per side, having either solder lug or printed-circuit terminals. All are double-throw switches with either manual or spring return. They are designed for such applications as test instruments, control systems, computers, communications equipment, tape recorders, tv sets, and radios. Primary advantages are that they require less panel space and simplify p-c board design, compared with equivalent rotary switches. All contacts are staked to the switch base with Wedgelock flat rivets, which prevent any possibility of contact rotation and misalignment. The p-c terminals are die cut after assembly to assure accurate alignment with holes in the p-c board. The p-c terminals may also be used for wire wrap connections. Contacts and slider blades are silver plated brass or silver alloy. Insulation may be best-grade XXXP phenolic (per

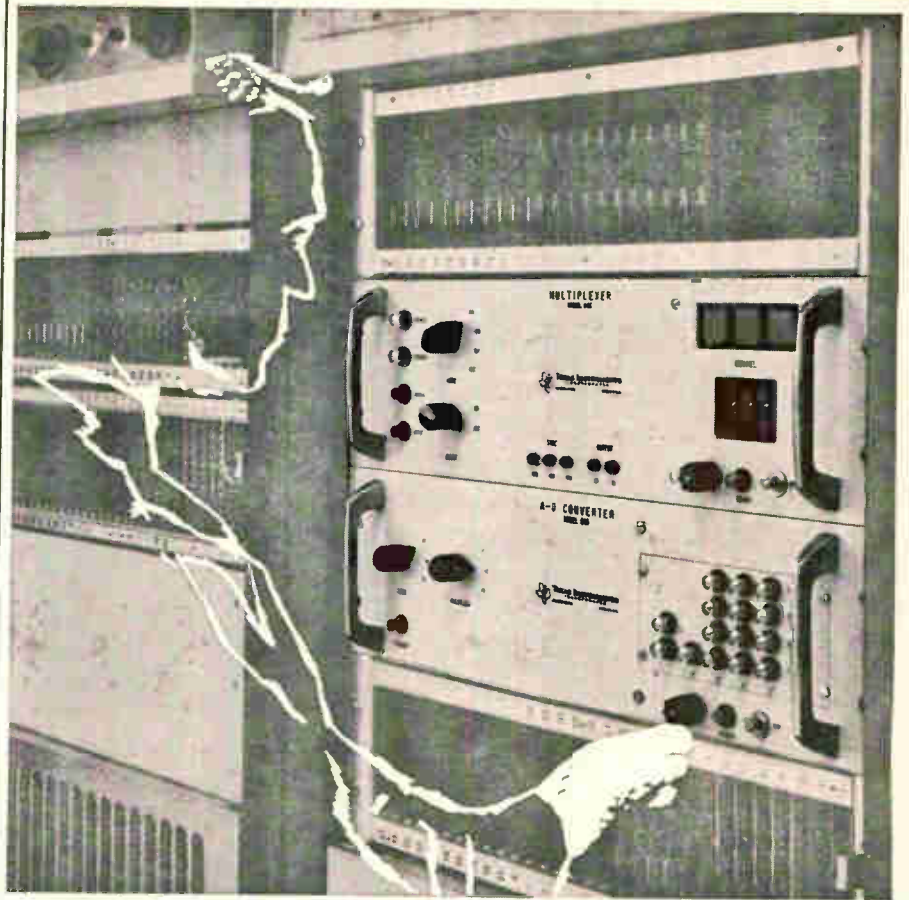

Accurate Data Sampling and Conversion at 50 KC plus

Model 846 A-D Converters, in straight binary or BCD code, include an integral sample and hold circuit with 100 nano-second aperture and automatic zero stabilization. Accuracy at 50 kc is 0.025% full scale . . . *sample and hold included!* Offered in a wide choice of input specifications, logic levels and output codes, plus D-A conversion option.

Model 844/845 Multiplexers feature 0.01% linearity with low dynamic crossfeed, fast settling time and variable sample duration. Choose from addressable, sequential, direct channel select, or combined addressable/sequential—all accommodate input levels to ± 10 volts. Basic capacities of 10 and 16 channels can be expanded tenfold with plug-in PC cards.

Ask a TI Application Engineer for further information on digital data handling equipment for your specific needs; one model must meet your requirements!

INDUSTRIAL
PRODUCTS
GROUP



TEXAS INSTRUMENTS

INCORPORATED

P. O. BOX 66027 HOUSTON, TEXAS 77006
7 RUE VERNONNEX GENEVA, SWITZERLAND

692

WHAT'S THE LATEST IN DISC CATHODES? ASK SUPERIOR.



Standard ED 1-2. (.121" OD shank, .490" ceramic). Most widely used cathode. Standard length, .312".

Narrow neck ED 1-5. (.121" OD shank, .365" ceramic). For 110° deflection tubes. Standard length, .312".

Miniature ED 1-33. (.100" OD shank, .365" ceramic). For 110° deflection tubes. Standard length, .280".



Miniature ED 1-11. (.090" OD shank, .365" ceramic). Save up to 50% heater power. Standard length, .280".

Shielded EX 271. Permits better temperature uniformity and control of grid-cathode spacing.

Shielded EX 270. Permits operation with small power consumption and hence low heat generation.

Widest choice of disc cathode designs

There are three basic types of Superior disc cathodes. Each has its own advantages. All feature close control of the E-dimension (distance between top of cap and top of ceramic), flare at the shank opening to facilitate assembly, shadow groove in the ceramic to inhibit electrical leakage and are available in wide choice of both cap and shank materials. Available in 0.121", 0.100" and 0.090" outside diameter shanks. Ceramic diameters can be either 0.490" or 0.365", with either round or triangular center hole.

New shielded disc cathodes—EX 271 and EX 270

In the EX 271 design, the emitter is shielded from the ceramic and isolated by an exceptionally long heat-conducting path. In the EX 270 design, the slender shank, thermal shield and thin ceramic permit low heater power consumption. The shield also acts to eliminate leakage if sublimation takes place.

Widest choice of disc cathode materials

Superior's disc cathodes feature separate nickel cap and shank alloys. Hence you may choose the most suitable material for each. The Cathaloy® series, developed and controlled by Superior Tube Co., offers alloys with high strength, high activity, low sublimation, freedom from interface impedance, or any desired combination.

Cathaloy A-31. Approximately twice as strong as tungsten-free alloys at high temperatures.

Cathaloy A-33. Combines the high emission of active alloys with freedom from sublimation and interface impedance.

Cathaloy P-51. More than 100% stronger than X-3014 at high temperatures.

X-3014. Powder metallurgy pure nickel for resistance to sublimation. Suggested for shanks.

X-3015. Special shank alloy for strength with resistance to sublimation and for non-emitting characteristics.

Nickel 220, Nickel 225, Nickel 230 and Nickel 233. Suggested for caps requiring normal emission with rapid activation.

Driver Harris 599 and 799. Provide rapid activation plus high level d-c emission. For caps only.

For your copy of our Catalog 51, write Superior Tube Company, 2500 Germantown Ave., Norristown, Pa.

Superior Tube

The big name in small tubing
NORRISTOWN, PA. 19404

West Coast: Pacific Tube Company, Los Angeles, California

Johnson & Hoffman Mfg. Corp., Carle Place, N.Y.—an affiliated company making precision metal stampings and deep-drawn parts

New Components

Mil-P-3115), linen base phenolic, or glass epoxy. Brackets and plunger are cold rolled steel or brass cadmium plated or unplated. The switches will carry 0.5 amp at 125 v. Maximum voltage rating is 450 v rms. Maximum current is 3.5 amps at 6 v rms. Life expectancy is 50,000 cycles, minimum. Series 150SL measures 3/4 in. high, above chassis by 1 1/2 in. deep by 5 3/4 in. to 6 1/2 in. long, depending upon number of contacts. The 300SL switches are 1 1/2 in. wide by 3/4 in. deep. Length is the same as the 150SL. Price of the 150SL switches ranges from 39 to 64 cents each; the 300SL, 44 to 88 cents each. Delivery of production quantities is four to six weeks.

Standard Grigsby Co., 920 Rathbone Ave., Aurora, Ill. [354]

Connector mounts microcircuit modules



A new connector, model F-816W, is announced for mounting standardized integrated circuit modules. Terminals on the connector are designed for mounting on single or multilayer p-c board, wire wrap, or termi-point termination. The integrated circuit module connector has been developed for use in computers, process control, data communications, telemetry, and microwave equipment. Model F-816W has 16 contacts, spaced at 0.150 in. intervals on a grid pattern. Provision is made for module keying. The connector body has surface standoffs that permit accessibility for a module-removing tool. The contacts are designed to retain securely integrated circuit modules

under shock and vibration conditions without any additional hold-down device. The connector has an insulator body of high-dielectric green diallyl phthalate. Contacts are gold plated beryllium copper. Over-all dimensions of the F-816W are 0.660 in. square by 1.04 in. high. Price is \$1.25 each in production quantities. Delivery is four weeks. Methode Electronics, Inc., 7447 W. Wilson Ave., Chicago, Ill., 60631. [355]

Trimming pot meets commercial needs



This low-cost, commercial $\frac{3}{8}$ in. square trimming potentiometer is said to be the first such unit to be offered by a major manufacturer. The series 212 Squaretrim potentiometer was developed to satisfy commercial and industrial applications where extreme military requirements are not imposed. However, it incorporates the identical wire-in-the-groove resistance element as that in the MIL Squaretrim. Also, it is housed in the same black anodized aluminum case. Series 212 covers a resistance range of 10 ohms to 20,000 ohms. Resistance tolerance is 10%. Power rating is 1 w at 50°C derated to 105°C. Operating temperature is from -55°C to $\pm 105^\circ\text{C}$. The $\frac{3}{8}$ in. unit has a 30:1 adjustment ratio. Weston Instruments, Inc., Archbald, Pa. [356]

Inductors available in 2 frequency ranges

A line of high and medium frequency inductors offer inductance values from 1.0 μh to 1.0 mH and from 50 μh to 0.1 henry. The higher frequency units provide Q values of

"THIS BETTER BE GOOD!"...

... I wouldn't have taken the time, if Standards hadn't sent you. As I understand it, you sold them an oscillator, which they think can help me! Did they fill you in?

Yes — they tell me the final test on your new line of amplifiers seems to be chewing up a lot more time than you'd like.

Time? Please! Every time the brass walks through here and sees those unshipped instruments, I get visions of my merit file being stuffed with nasty little notes! Big problem's been in checking for frequency response and harmonic distortion. Just too bloody long on each instrument!

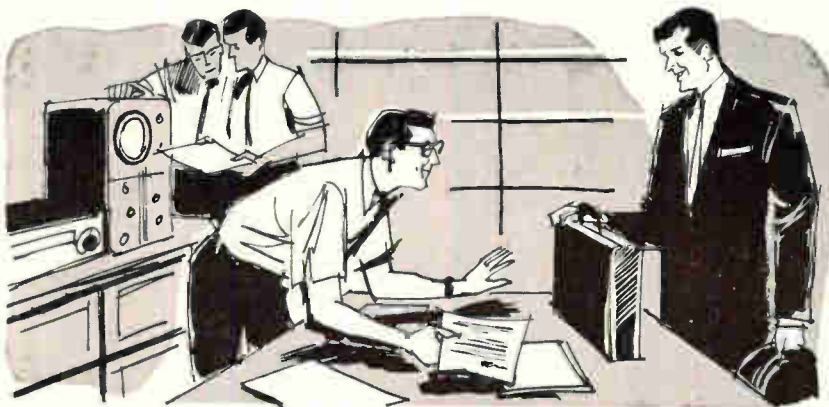

Take the tests one at a time. Frequency response. Been feeding preset amplitudes at frequency steps, reading amplifier output and comparing? Have to go back to the signal source each time to check and reset its output amplitude at every frequency?

Sure! Otherwise, I've got oscillator amplitude error in my gain figure.

OK. You don't have to. The frequency response of the Krohn-Hite 446 oscillator is within 0.01 db up to 20 kc, within 0.05 db all the way to 100 kc. And amplitude stability within 0.01% for a full hour! So, forget about resetting voltage every time you change frequency.

Beautiful! Eliminating rechecking the source and re-setting will really speed things up.

Now — what are you doing to the input signal when you measure harmonic distortion of the amplifier? Have to purify the oscillator output?

Naturally!

Not at all... use the 446 as your source and forget about harmonic distortion — it's less than 0.02% from 400 cps to 10 kc, 0.05% at 20 kc — 0.2% at 20 cps. Another thing — the 446 is available fully programmable for automatic check-out — including self-checking, "enable" and "completed" circuits.

Brother — you've just saved me 8 hours an instrument! I'm going upstairs right now and pinch a 446. We can ship some amplifiers tonight!

Hold it! They're right in the middle of DVM calibrations with their 446's. But I'll let you buy your own from me.

Dammit, progress always costs!



KROHN-HITE CORPORATION

580 Massachusetts Avenue, Cambridge 39, Mass.
Area Code 617 491-3211

Pioneering in Quality Electronic Instruments

PROBLEM IN FREQUENCY CONTROL?

Chances are **BULOVA**—the leader—has already solved it!

Bulova Electronics now offers the widest range of frequency control components of any company in the business! For example:

- Crystals of all types from 2 kc to over 125 Mc
- Ovens of every type: snap-action thermostat, proportional-controlled, or patented Transistat solid-state thermostat for extreme reliability
- Packaged crystal oscillators from 1 cps to 200 Mc with stabilities approaching frequency standards
- Tuning fork resonators and oscillators ranging from 1 cps to 25 kc with stabilities as high as .001%
- Crystal filters of all kinds from 7 kc to 30 Mc—SSB, symmetrical, band elimination and comb sets
- Servo amplifiers, both miniature and conventional, employing solid-state circuitry
- LC filters and coils from dc to 30 Mc

How does this help you? Well, in building this leading product line and developing this capacity, we have probably solved a problem just like yours. We have solved problems for such programs as Nimbus, Apollo, Polaris, Bullpup, TFX, Minuteman and Pershing. *No matter what your problem is—stability, reliability, precise control or price—call Bulova Electronics, the company with the widest product line! Or write us, at Dept. E-13.*



SPECIFY BULOVA LC FILTERS

Why Bulova? Because Bulova Electronics provides service as well as product! Service includes:

- Custom design—units built to solve your problems!
- Prototypes when you need them—in 2 weeks, or less!
- Production units to your schedule—ask our customers!

Product features include:

- Frequency range from DC to 30 Mc
- Low Pass, High Pass, Band Pass and Band Reject Filters
- Comb sets • Equalizers
- Discriminators •
- Sharpest shape factors... under all conditions

PLUS—Ask about "Mini-Comp", the new Bulova line of LC Filters that provide better or equal electronic performance in a smaller package at less cost to you.

Let us prove to you that you should specify Bulova LC Filters. Write us at Dept. E-13—or better, call us.

New Components

approximately 100 in the preferred frequency range from 1 Mc to 10 Mc. Q's of approximately 130 are offered in the medium frequency units in the preferred frequency range from 200 kc to 1 Mc. The new component is packaged in a hermetically-sealed tall TO-5 case and may be inserted either manually or by machine. The inductors meet MIL-T-27B, TF4RX09YY. Collins Radio Co., 19700 Jamboree Road, Newport Beach, Calif., [357]

Low-pass filter saves module space

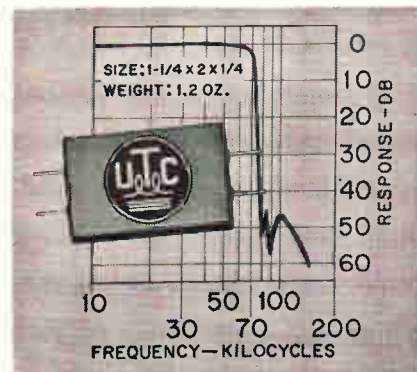

This filter's extremely flat physical configuration of only ¼ in. is said to afford module space-saving benefits unobtainable in filters presently having substantially less capabilities. The ultraminiature low-pass filter has a response which is flat from d-c to 40 kc within ± 0.1 db. It is within 1 db up to 60 kc and down less than 3 db at 70 kc, having an attenuation of at least 40 db above the 81 kc. Source and load impedance is 1,000 ohms. These units are manufactured and guaranteed to MIL-F-18327B. Pin terminals permit either easy soldering or welding. United Transformer Corp., 150 Varick St., New York, N.Y., 10013. [358]

Small resistor is fully insulated

Type BB 1/8-w resistors are suitable for use with transistors, diodes and other small components in miniaturized equipment. They may be used with encapsulating resin

BULOVA / ELECTRONICS DIVISION
WATCH COMPANY, INC. 61-20 WOODSIDE AVE., WOODSIDE 77, N.Y., 212 NE 9-5700

systems. The composition fixed resistors are fully insulated with a molded jacket. The lead wires are molded directly within the resistance material insuring permanent, reliable electrical contact. Leads are uniform in diameter and consistency, and are adaptable to substantial weld schedule latitude. The solder coating makes the lead wires readily solderable, even after long periods of storage. Resistance values—standard EIA and MIL-R-11—are 10 ohms to 100 megohms. Resistance tolerances are standard $\pm 5\%$, $\pm 10\%$ and $\pm 20\%$. Maximum continuous rated voltage is 150 v rms or d-c. Maximum continuous rated wattage at 70° C ambient is 0.125 w. They derate linearly to zero watts at +130° C max operating temperature.

Allen-Bradley Co., Milwaukee, Wisc. [359]

Tiny electronic battery is rugged and flexible

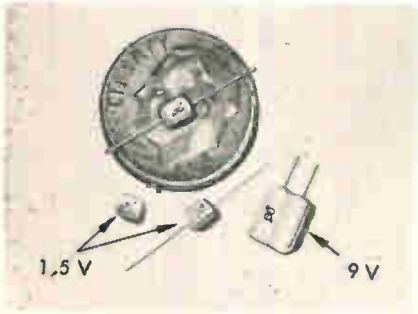

This microminiature electronic battery, composed of cells encased in a nonmetallic container, is lightweight, extremely rugged and flexible. It is useful in a variety of applications in the aerospace and medical fields. Any number of 1.5 v cells can be combined to produce miniature batteries to fit special shapes. Each will measure only $\frac{1}{8}$ in. thick and $\frac{1}{8}$ in. in diameter. The new Tiny Tiger battery is available as a basic design component for applications which require extremely small d-c power sources. A typical battery $\frac{1}{8}$ in. thick, $\frac{1}{4}$ in. wide and $\frac{1}{2}$ in. long will deliver 15 ma of current at 12 v. Any voltage multiple of 1.5 is available in a hermetically sealed configuration that can be custom engineered to meet requirements. Bionetics, Division of Tepper Research and Development Corp., 11633 San Vicente Blvd., Los Angeles, Calif. [360]

"SPECIALS"

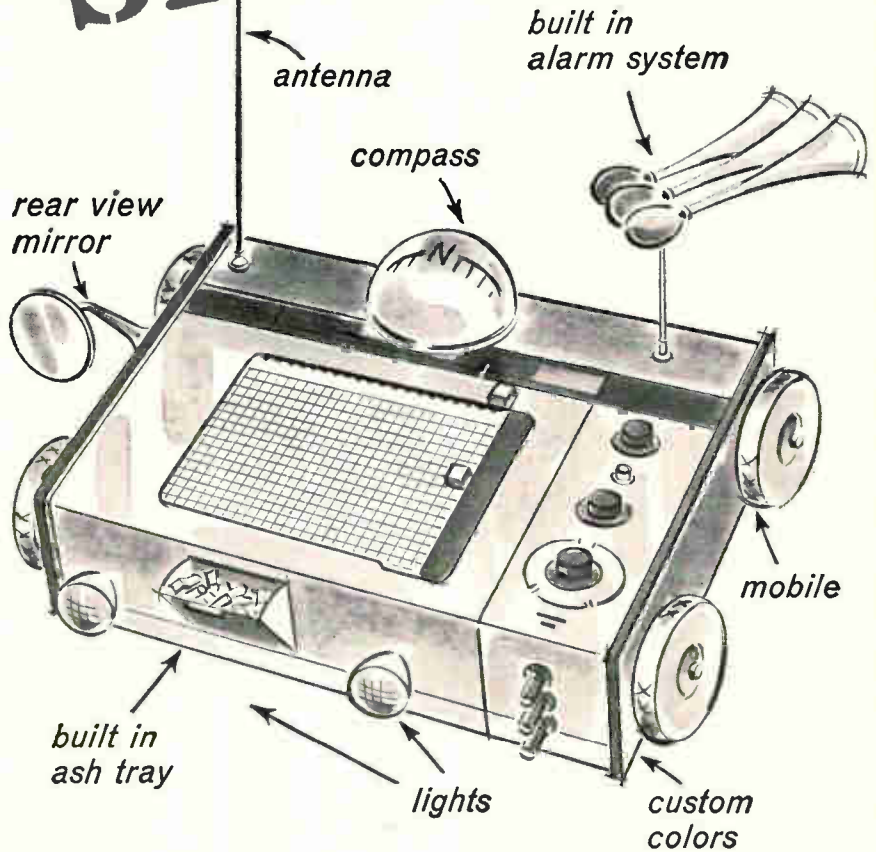

IN V.O.M. RECORDERS

Ever seen a Recorder that looks like this? Neither have we—yet! But we've made just about every other modification in the book for our customers—with 1 range, 2 ranges, with push-button zero, with different scales, and with special chart papers. We've painted them custom colors, put a variety of customer designations on them. You name it, we'll do it! Just let us know what, and the quantity. We'll work up a quote that'll be a pleasant surprise to you.

There are a goodly number of people who buy the standard instruments without modification, singly and in O.E.M. quantities. Boring, really, but we *do* fill these orders along with the specials. The standard Bausch & Lomb V.O.M. Recorder is a 5 inch Strip Chart Recorder that will record volts, ohms and milliamps directly. It has 5 built-in chart speeds, built-in event marker, built-in take-up reel, 5 voltage ranges, 6 linear ohms scales, 4 D.C. current ranges. Full scale sensitivity is 10mv, 2.5mv or 500 microvolts depending on the model selected. It has a number of other advantages, too. And, we have accessories, a variety of them, that make our recorders so versatile it hurts (other recorder manufacturers, that is!).

If you want further information on our standard recorders, so that you can tell us how you want them changed, write for Catalog 37-2068. Bausch & Lomb, 62316 Bausch Street, Rochester, New York 14602.

BAUSCH & LOMB

Leadership in Digital Measurement

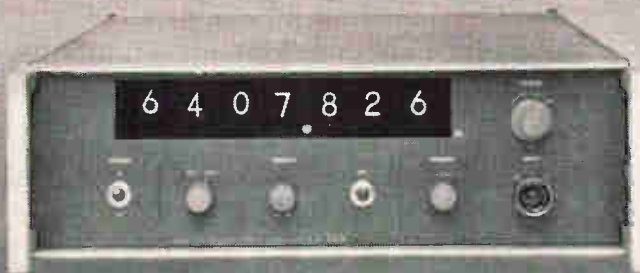

**MEASURE TO 6.4 Gc FASTER...
THAN DIALING YOUR PHONE!**



With the Eldorado Model 950 Frequency Counter, you can measure from 10 cps to 6.4 Gc direct, without time consuming calculations and adjustments. Absence of heterodyne or transfer oscillators, *plus* the 950's unique parity check (visual readout and printout signals are either the actual frequency or all zeros), means *total* elimination of operator error.

Combine these features with automatic trigger level and you have one-control frequency measurement. Just set the range switch...that's faster than dialing your nearest Eldorado representative. Make us prove it—call him. He's prepared to demonstrate what the 950 can do for you!



ELDORADO ELECTRONICS

601 Chalamar Road • Concord, California

Telephone (415) 686-4200



Find out about the Eldorado Model 950 firsthand! Call your nearest representative for a demonstration . . .

PACIFIC NORTHWEST

Ray Johnston Company, Inc.
Washington, Seattle • (206) 524-5170

ARIZONA - CALIFORNIA - NEVADA

T. Louis Snitzer Co.
Arizona, Phoenix • (602) 273-1673
California, Del Mar • (714) 454-2191
California, Los Angeles • (213) 938-2073
California, Palo Alto • (415) 968-8304

ROCKY MOUNTAIN STATES

Aztec Enterprises, Inc.
Colorado, Englewood • (303) 789-9592
New Mexico, Albuquerque • (505) 268-6421

IOWA - KANSAS - MISSOURI - NEBRASKA

Impala Inc.
Iowa, Cedar Rapids • (319) 362-2125
Kansas, Overland Park • (913) 648-6901
Kansas, Wichita • (316) 682-3593
Missouri, Hazelwood • (314) 522-1600

ARKANSAS - LOUISIANA - OKLAHOMA - TEXAS

Mitchell Speairs Co.
Texas, Fort Worth • (817) 923-4657
Texas, Houston • (713) 923-7616

ILLINOIS - INDIANA - MINNESOTA - WISCONSIN

R. Edward Stemm, Inc.
Illinois, Chicago • (312) 379-2700
Minnesota, Minneapolis • (612) 822-8404

NEW ENGLAND

Applied Measurements, Inc.
Connecticut, Milford • (203) 874-3338
Massachusetts, Acton • (617) 263-2766
(617) 646-7250

UPSTATE NEW YORK

KLM Associates
New York, Palmyra • (315) 597-9776
New York, Whitesboro • (315) 736-2450

METROPOLITAN NEW YORK

NEW JERSEY - PENNSYLVANIA

Associated Measurements and Controls, Inc.
New Jersey, Berkeley Heights • (201) 464-5100
(201) 464-5101

DELAWARE - MARYLAND - VIRGINIA (Northern)

WASHINGTON D. C. - WEST VIRGINIA

Brimberg Associates, Inc.
Maryland, Silver Spring • (301) 588-7790

SOUTHEAST

BCS Associates, Inc.
Alabama, Huntsville • (205) 534-1648
Florida, Orlando • (305) 425-2764
North Carolina, Greensboro • (919) 273-1918
(919) 292-1057

Circle 145 on reader service card

← Circle 144 on reader service card

New Instruments

Display recorder samples scopes

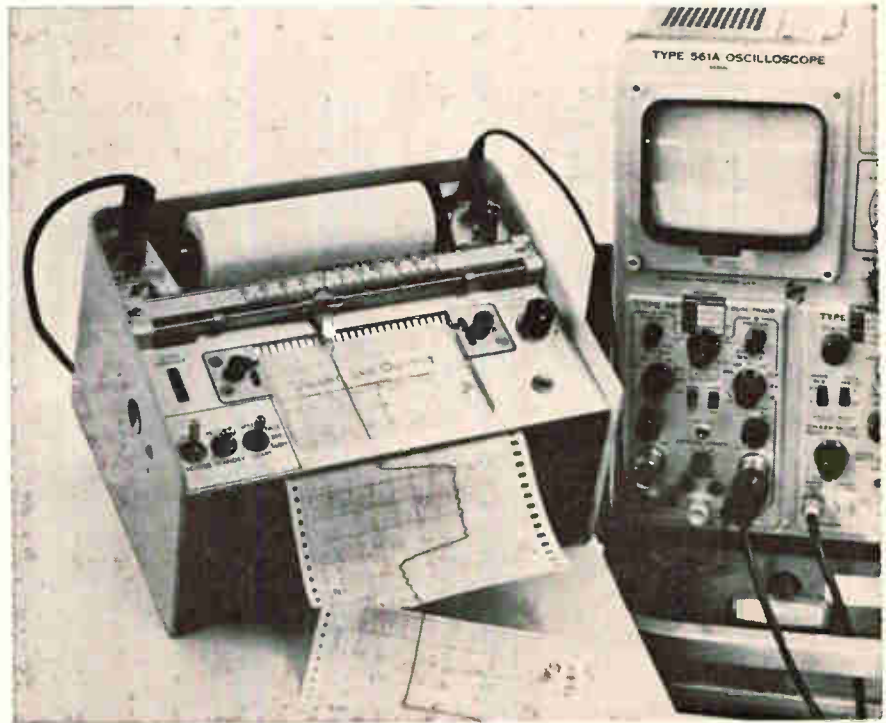

The SR100A sampling oscilloscope recorder can reproduce an oscilloscope display on a 5 in. by 5 in. chart paper facsimile of the scope graticule which may be torn off. The method is faster, more convenient, and less costly than conventional X-Y recorders and oscilloscope cameras; and one-time calibration eliminates time-consuming set-up operations. Recorded traces represent the actual presentation to within $\pm 1\%$. Reproductions can be made every 90 seconds or every 22 seconds, depending upon chart speed selected

by panel toggle switch. Chart paper is perforated between each grid, every six inches, and has space to record vertical and horizontal sensitivity, date, serial number, and other pertinent information. The paper used is suitable for Diazo process reproduction. Grid and trace are easily reproduced by xerographic or photographic methods. The SR100A is designed for use with most sampling oscilloscopes. Price is \$495.

Nesco Instruments, division of Data Pulse, Inglewood, Calif. [381]

Impedance analyzer uses low test voltage

Model 365 dynamic semiconductor impedance analyzer measures capacitances from 1 pf full scale to 1,000 pf full scale in seven direct reading ranges. The 100-ke test voltage applied to the device being measured is a constant 10 mv on all ranges. This low test voltage allows

the investigation of incremental impedances of many devices whose parameters are voltage sensitive. This is not possible with standard impedance measuring techniques, according to the manufacturer. An additional feature of model 365 is the ability to furnish a bias voltage variable from 0 to 100 v at currents up to 10 ma with full multirange voltage and current metering. Voltages as low as 0.01 v d-c can be set and measured with currents down

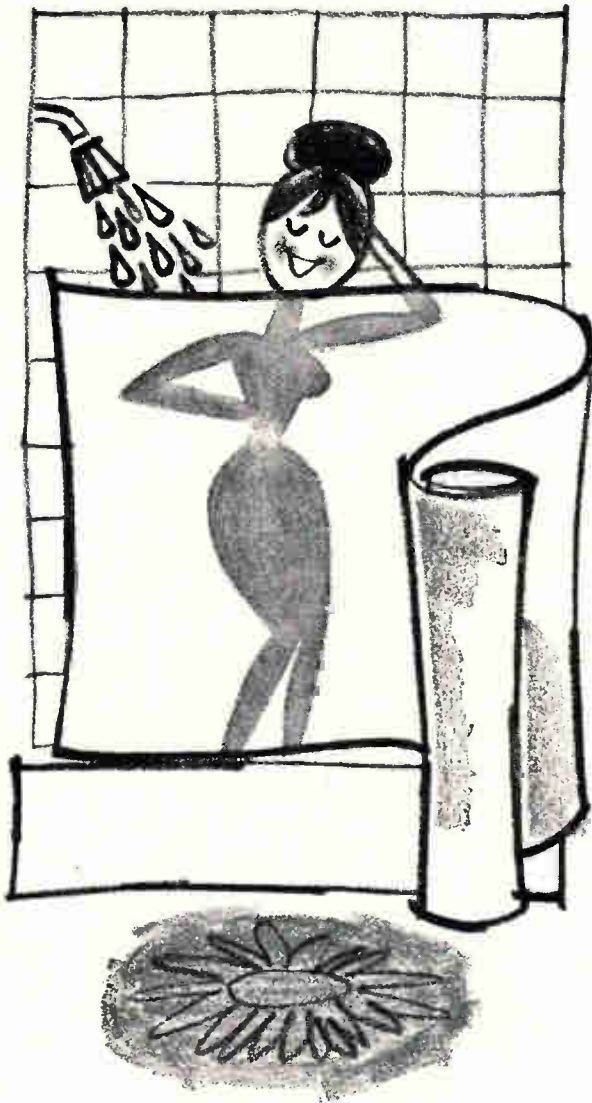

**Need a clear polyester film
for electrical grade labels?
"SCOTCHPAR"
is the answer to your needs**



Good taste prevents us from illustrating how completely transparent "Scotchpar" can be! The point we wish to make, however, is that this versatile electrical grade polyester film can be produced in various degrees of transparency . . . from sparkling clear to satin white. And our ability to customize "Scotchpar" goes below the surface . . . we can also make internal modifications of basic polyester to suit most of your specific electrical needs. Contact: 3M Co., Film & Allied Products Division, 2501 Hudson Rd., St. Paul, Minn., Dept. ICL-45.

Scotchpar[®] electrical grade
BRAND polyester film

"SCOTCHPAR" IS A REG. T.M. OF 3M CO.

3M
COMPANY

New Instruments

to 1 μ a. Model 365A includes an internal voltage sweep generator for continuous display of capacitance vs voltage characteristics for X-Y recorders and oscilloscopes. A guard circuit output is provided with this unit to facilitate the isolation of small capacitances from other capacitances and strays. The instrument measures 17 in. wide, 9 in. high, and 9 in. deep. Price is \$565; delivery two to three weeks. Denro Lab., 1643 Forest Drive, Annapolis, Md., 21403. [382]

**Null detector has
10-nanovolt resolution**



This electronic nanovoltmeter was designed as a null detector for use with six-dial potentiometers and other sensitive measuring equipment. Model 147 nanovolt null detector features 10-nv resolution with a 300-ohm source resistance, maximum sensitivity of 30 nv full scale, noise less than 3 nv peak-to-peak on the most sensitive range with low source resistance, line frequency rejection of better than 1,000 to 1 on the most sensitive range, and line or battery operation. The unit is immune to mechanical vibration and overload damage. It recovers within 10 seconds from overloads of one million times full scale, has three-second speed of response, and has a large, direct-reading meter. Model 147 eliminates ground-loop problems, since it may be operated by self-contained batteries and completely isolated from the a-c power line. High a-c and d-c isolation of input circuitry permits use of reversing keys in potentiometers regardless of unknown source isolation. The instrument has insignificant zero shift due to changing source resistances of a few hundred

ohms. Its output for driving a recorder or oscilloscope is accurate to within 1%. Price is \$1,275. Keithley Instruments, Inc., 12415 Euclid Ave., Cleveland, Ohio, 44106. [383]

Multi-probe cartridge for testing flatpacks

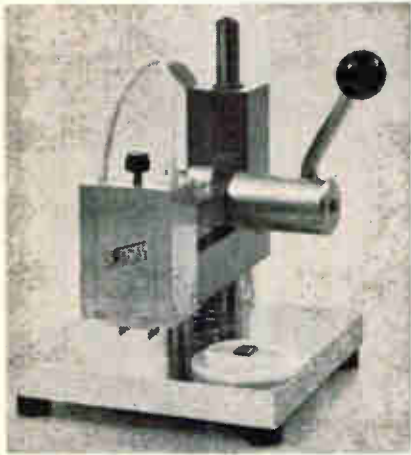

A new multiple-point probe head is designed to make a rapid electrical contact to the leads of flatpacks containing integrated or thin film circuits. This makes quick evaluation possible by both manufacturers and users. The head contains two rows of up to 20 probe points, spaced to match the pattern of the package leads. Loading can be varied between 20 and 200 grams on all probe points simultaneously by one single setscrew. The shape of the probe tips prevents possible deformation of package-leads. Dumas Instrument Co., 2950 Baker St., Costa Mesa, Calif., 92626. [384]

Digital counter offers large display



Model DRO-300 digital counter displays tuned frequencies from 30 to 300 Mc for quick reading and re-setting within an accuracy of one digit (1 kc). It is designed for use with vhf receivers employing a 21.4-Mc i-f. Similar units with ac-

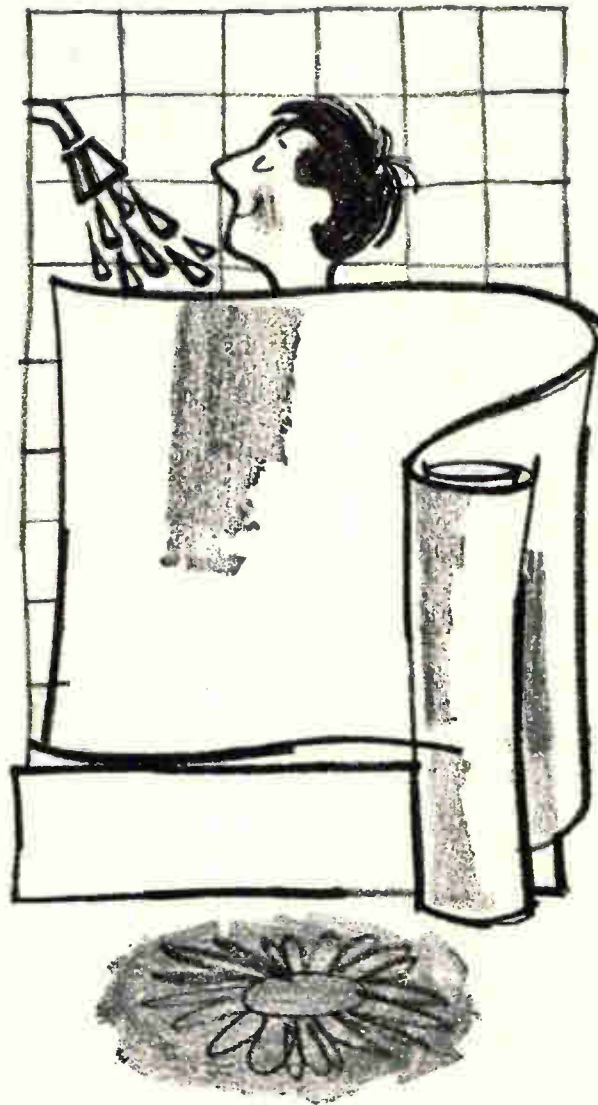

Need an opaque electrical grade polyester film? "SCOTCHPAR" is the answer to your needs

We've got nothing to hide! On the contrary the point we wish to make abundantly clear (or opaque) is that we can produce "Scotchpar" electrical grade polyester film in various degrees of opacity. Samples of our opaque "Scotchpar" are available at your request. But, of course, if you want to get down to "basics," good plain, high quality "Scotchpar" is still the industry's best buy. Either way — basic or customized — we'll be happy to serve you. Contact: 3M Co., Film & Allied Products Division, 2501 Hudson Rd., St. Paul, Minn., Dept. ICL-45.



Scotchpar[®] electrical grade
BRAND polyester film

"SCOTCHPAR" IS A REG. T.M. OF 3M CO.

3M
COMPANY

New Instruments



Need to say a lot
in a little space?

(or make markings
more **durable**...or
more **economical**...
or at **higher rates**?)

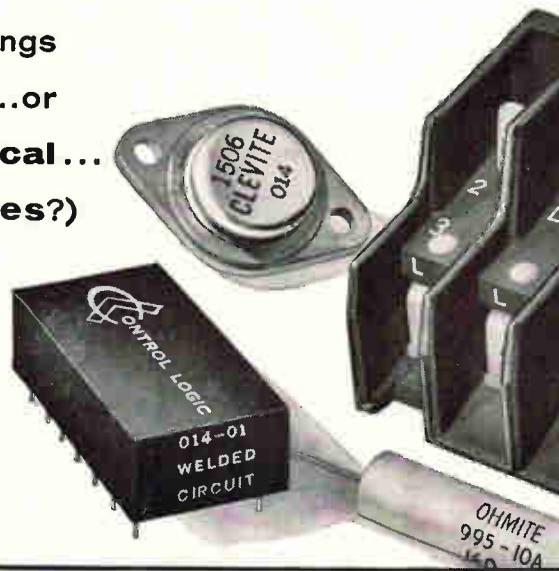

We can show you how

We can show you how to identify products so they will resist extreme amounts of handling, abrasion, many solvents and other atmospheric conditions . . . or how to sequentially number and identify components with savings of more than \$50 per 1000 . . . or how to print trademark, type number, value and date code on 90 units a minute . . . or how to produce an imprint that remains readable after 1000 hours at 200°C . . . or get 10 digits and 2 letters in a micro-circuit area of 0.090" — or 21 characters on a TO-5 case with interchangeable type number and date code . . . or save 75 cents of every dollar you now spend on buying, applying, inventorying and discarding obsolete preprinted labels.

The answers are in proven Markem machines, type and specialty inks, which daily produce better product or package identification by reducing costs, smoothing production control and increasing customer acceptance. And while Markem machines, type and inks are helping to produce better products through more complete and lasting identification, they frequently pay for themselves in the savings they make possible. Tell us what *you* make, what it must say, and for how long: we'll give you a specific recommendation and cost estimate right away. Write Electrical Division, Markem Machine Co., 305 Congress St., Keene, New Hampshire 03431.

MARKEM

curacies to ± 100 cps are available as companion pieces to h-f receivers having 455-kc, 500-kc or 3.9-Mc i-f's. The new counters determine receiver settings by automatically subtracting i-f from local oscillator frequencies. A big 6-digit Nixie display provides a continuous readout of the results. Information is updated every 20 milliseconds, but no flicker is apparent since only the final count is shown. The receiver may thus be tuned or switched to other bands with instantaneous readout. As a further dividend, any drift in the local oscillator can be detected immediately. The single manual control is a front panel on-off switch. Solid-state design throughout, except for the display tubes, eases servicing and maintenance and assures low power consumption. Drawing only 23 w, the DRO-300 can be used over a wide range of ambient temperatures without a cooling fan. Cost of the DRO-300 is \$2,800, with delivery in 45 days.

Communication Electronics Inc., 6006 Executive Blvd., Washington Science Center, Rockville, Md. 20852. [385]

Test set performs multiple functions

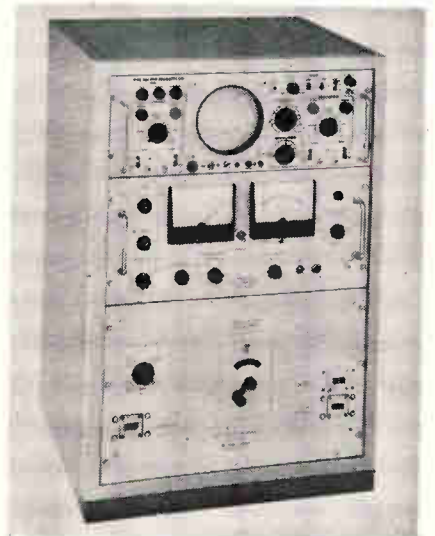

Model 310 series multifunction test set is said to provide unparalleled convenience and versatility at both microwave and radio frequencies. Phase and level transfer character-

istics are combined with complex reflection coefficient measurements for the frequency range of 25 Mc to 12.4 Gc. Oscilloscope display of swept frequency data, meter read-out, and analog outputs for data storage and processing are provided. Complex new system concepts including phased antenna arrays, multiplex f-m and pcm communications, chirp and interferometer techniques, and synthetic coherent arrays require precise control of transmission gain or loss and phase as well as matched terminal ports for all subsystems and networks. The homodyne measurement technique allows a wide dynamic range for testing and permits swept frequency operation with conventional sweep sources. Model 310 consists of a single versatile processing indicator that operates with a series of r-f resolver units. With the multifunction test set it is possible to measure: small signals down to -90 dbm, with 0.1° resolution to -60 dbm; fast changing phase with 0.17-msec rise time or 2-kc bandwidth; phase angle to 360° with 180° at a time on the meter face with no ambiguity; amplitude and impedance along with phase for true multifunction capability and no reconnections necessary in going from one test to another; amplitude over a 60-db range with an accuracy of 0.1 db per 10 db by i-f substitution techniques. Price of the model 310 phase amplitude and impedance indicator is \$4,200 plus cost of resolver.

Wiltron Co., 717 Loma Verde Ave., Palo Alto, Calif. [386]

Analyzer displays transfer function

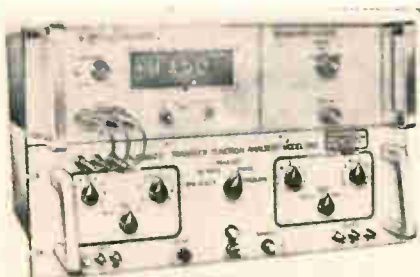

A new transfer function analyzer, designated Servodyne model 950, is specially designed for laboratory and production testing. The precision, solid-state instrument automa-

*burning the midnight oil
over a precision metal problem?*

*use the
theory of
probability
to solve your problems*



This is where experience counts! Chances are Hamilton has the answer for you . . . as we have for hundreds of others . . . whether it is ultra-thin foil, close-tolerance strip and wire or magnetic and high-temperature metals for computers, strain gages, delay lines, springs, diaphragms and an endless number of other applications. The Precision Metals Division of Hamilton Watch has the metallurgical "know-how" and the unique precision production facilities to do the almost "impossible!" What can you lose? Before you give up . . . ask us. Invest a postage stamp and ask for the brochure on Precision Metals. You will receive facts and information that you can use.

PRECISION METALS DIVISION
HAMILTON
WATCH COMPANY
LANCASTER, PA.

FILTERS...DC to 12Gc!

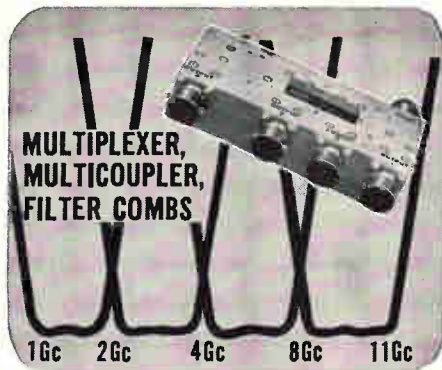

MULTIPLEXER,
MULTICOUPLER,
FILTER COMBS

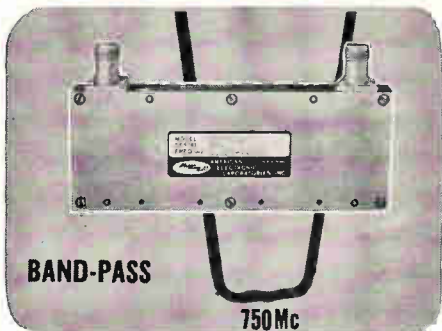

BAND-PASS

750 Mc

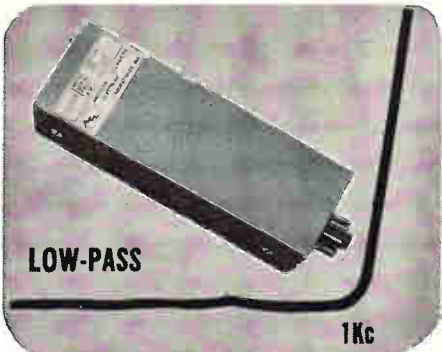

LOW-PASS

1Kc

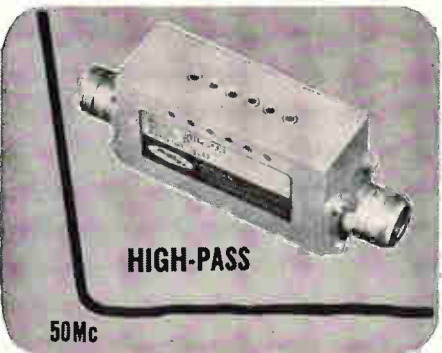

HIGH-PASS

50Mc

AVAILABLE IN LOW-PASS, HIGH-PASS
... BAND-PASS MULTIPLEXERS
MULTICOUPLERS and FILTER COMBS



from



*the most complete line of
commercial filters offered
anywhere*

NOW for the first time, you can order ALL your commercial filters (DC to 12 Gc) from a single source . . . AEL . . . with assurance of receiving high quality filters to meet your requirements. In both the very low and the higher frequency ranges, AEL commercial filters meet the highest standards of quality and performance—yet are competitively priced. Using newly developed core materials and computer derived tables, these high performance filters are offered in Butterworth, Tchebycheff, M-derived, and elliptic function configurations.

YOUR CUSTOM FILTER REQUIREMENTS SOLICITED

Our extensive experience in developing high-pass, low-pass, band-pass, and multiplexing filters is ideally suited in the custom designing of filters to meet your special requirements. Our custom filter designs are available in a variety of configurations including tubular, coaxial, interdigital, split-block, and many others. The development and testing of all custom filters is accomplished with the latest sweep frequency test equipment—your assurance that critical requirements are completely fulfilled. Let AEL tackle your next tough filter problem.

Write for NEW AEL FILTER CATALOG

**American Electronic
Laboratories, Inc.**

P. O. BOX 552, LANSDALE, PENNSYLVANIA 19446
PHONE: (215) 822-2929 • TWX: 510-661-4976

New Instruments

tically measures and supplies simultaneous phase and amplitude ratio information at any point in a system with respect to a generated input or reference signal. Ratio results are recorded in both digital and analog outputs—which allows flexibility in the use of recording devices (digital, x-y or strip chart). Other advantages include a high-speed readout, and elimination of errors due to d-c offset or harmonic effects. Model 950 may also be used for network analysis and precision phase measurement. Remanco, Inc., 1805 Colorado, Santa Monica, Calif. [387]

Solid state unit retains reading



An electronic memory unit that retains meter readings indefinitely is featured in the model 5201A memory voltmeter. The meter will continue to display maximum voltage applied to the instrument until reset. Having response from d-c to 20 Mc, the instrument will also measure one shot pulses down to 50 nsec in duration. The input voltage range is 0 to 1,000 v and is extended to 30 kv using optionally available h-v probes. Model 5201A voltmeter is accurate to $\pm 3\%$ of full scale and may be used as a conventional, wide band, peak reading voltmeter in addition to its storage mode of operation. The instrument has a recorder output for operating strip chart recorders in applications where unattended monitoring

is desirable. The all-solid-state unit is housed in a compact, portable carrying case. Models are available for a-c and/or battery operation. Price is \$695.

Micro Instrument Co., 13100 Crenshaw Blvd., Gardena, Calif. [388]

Small and ultrastable atomic timing device



Stability in parts per hundred billion is claimed for a new atomic timing device. Weighing less than 20 lb, the R-20 rubidium frequency standard is said to be the world's smallest atomic frequency standard and the lowest priced at \$9,800, considered a break-through for an instrument of such complexity. Its size and price open the way for the stability and accuracy inherent in atomic clocks as an electronic reference for jet-age navigation and for systems to prevent midair collisions in the supersonic age. Previously, these ultrastable frequency sources were of such size, complexity and cost as to limit use to national observatories and comparatively few top-level research institutions. The R-20 produces reference signals at precisely one hundred thousand, one million and five million cps. Within a small aluminum container an atomized vapor of the element rubidium (a soft, silvery metal) is excited electronically. The rubidium responds by emitting energy at a never-changing, ultrahigh frequency which is used to govern the output of a relatively unstable crystal oscillator to accuracies undreamed of a few years ago, according to the manufacturer. In already overburdened military and aviation communica-

RMC

HIGH STABILITY, TYPE JE

DISCAPS

are Practically Immune to Severe Temperature Change

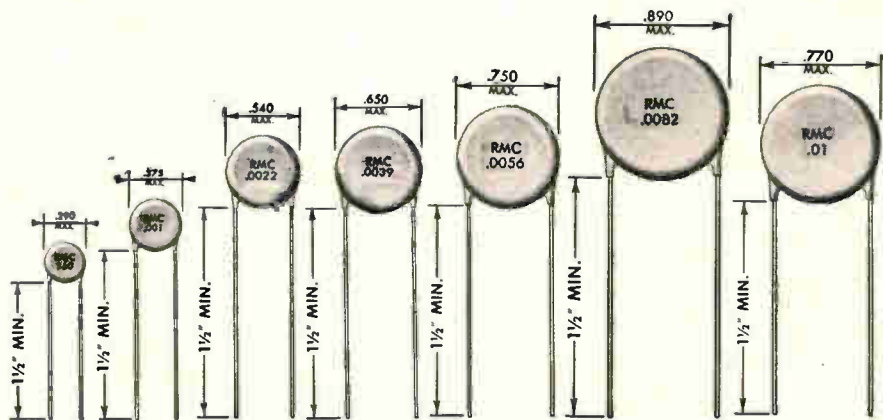

150	330	680	.0012	.0027	.0047	.0068	.01*
180	390	820	.0015	.0033	.0056	.0082	
220	470	.001	.0018	.0039			
270	560		.0022				

*Dual Disc construction—long leads only. Disc sizes under 1/2" diameter have lead spacing of .250". Disc 1/2" diameter and over have .375" spacing.

Specifications

CAPACITANCE: Within tolerance @ 1KC and 25°C.

CAPACITANCE TOLERANCES: +1.0%, +20% or +80 - 20%

WORKING VOLTAGE: 500 VDC

POWER FACTOR: 2.0% @ 1KC

INSULATION RESISTANCE: Greater than 7500 Megohms @ 500 VDC

TEMPERATURE COEFFICIENT: Z5E, Y5E

FLASH TEST: 1250 VDC for one second

LIFE TEST: Per EIA RS-198 Class II

POWER FACTOR AFTER HUMIDITY: 3.0% @ 1KC

INSULATION RESISTANCE AFTER HUMIDITY: Greater than 1000 Megohms @ 500 VDC

BODY INSULATION: Durez phenolic -- vacuum wax impregnated

LEAD STYLES AVAILABLE: Long lead - #22 tinned copper -, fin-lock kinked lead plug-in and pin type plug-in

RMC Type JE Discaps exhibit only $\pm 4.7\%$ capacitance change over the extended -30° to $+85^{\circ}\text{C}$ temperature range. These capacitors are especially suited for use in mobile communication and like equipment. Typical usage in R-C response shaping networks and feedback loops, in addition to conventional applications, is indicated.

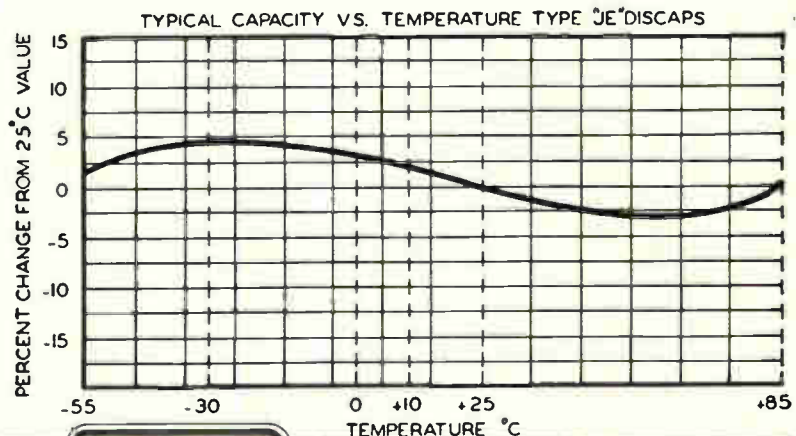

DISCAP CERAMIC CAPACITORS



RADIO MATERIALS COMPANY

A DIVISION OF P. R. MALLORY & CO., INC.

GENERAL OFFICE: 4242 W. Bryn Mawr Ave., Chicago 46, Ill.

Two RMC Plants Devoted Exclusively to Ceramic Capacitors

FACTORIES AT CHICAGO, ILL. AND ATTICA, IND.

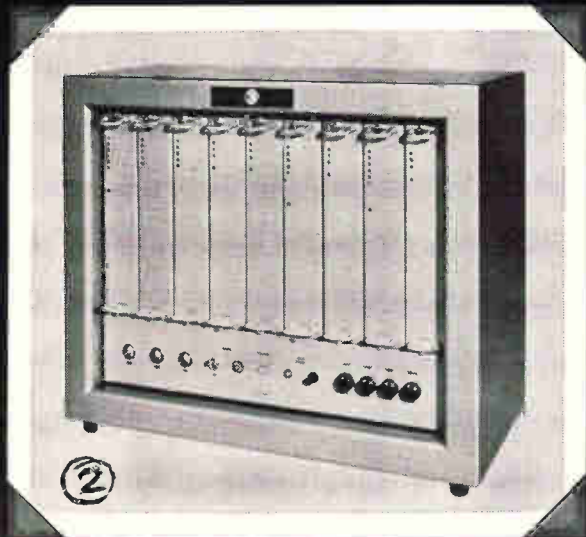
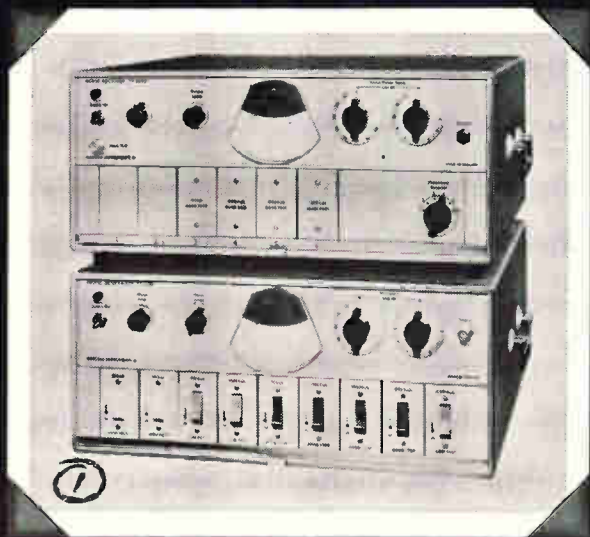

4 More from Marconi

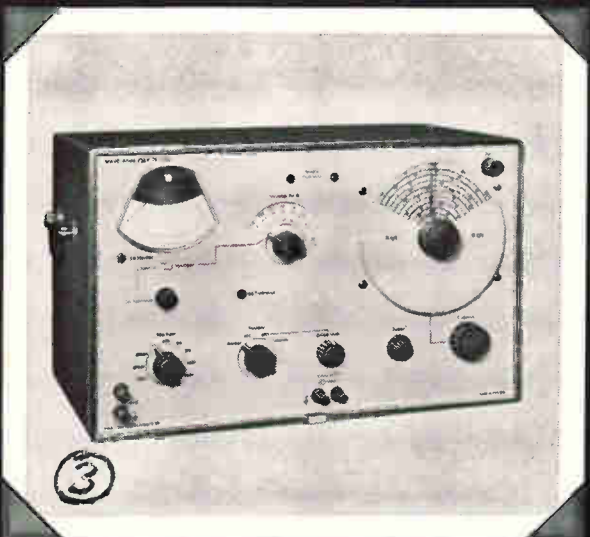

The **LEADERS** in Test Equipment for Multi-Channel Communications Systems

1 Transistorized Noise Loading Test Set
2700 Channels Model 2090

- Generates noise flat to ± 1 db from 12 kc to 12.388 mc
- Band limiting and Slot filters to 2700 channels for CCIR, CCITT and DCA recommendations.

READER SERVICE NUMBER 251

2 Autospec Automatic Single-Path Error-Correcting Telegraph Equipment

- Suitable for one-way or both-way circuits
- 1000:1 reduction of printed character error rate or more
- Alternative speeds include:
 - 45.45 Bauds 60 W.P.M.
 - 50 Bauds 66 W.P.M.
 - 75 Bauds 100 W.P.M.

READER SERVICE NUMBER 252

3 Transistorized Wave Analyzer Model 2330

- 20 cps to 50 kc with BFO output flat 0.05 db
- Measures down to $3\mu V$
- Relative amplitudes to -75 db

READER SERVICE NUMBER 253

4 Twelve Channel Noise Generator Model 7816

- Tests (and separates) multiplex cross talk and intermodulation
- Checks system line-in to line-out
- Provides 12 non-coherent independent channels 300 cps to 3400 cps.

READER SERVICE NUMBER 254

MARCONI INSTRUMENTS

Division of English Electric Corporation

111 CEDAR LANE • ENGLEWOOD, NEW JERSEY

MAIN PLANT: ST. ALBANS, ENGLAND



**WHERE
QUALITY
COMES
FIRST**

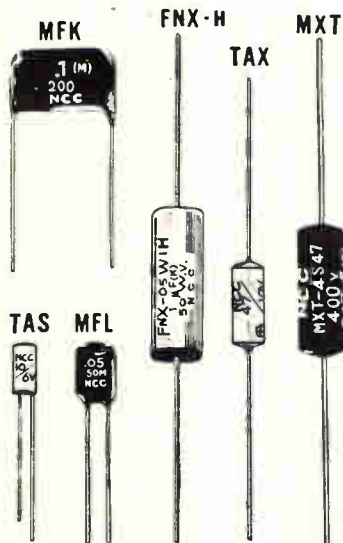

POLYESTER FILM CAPACITOR

	Capacitance Range	Voltages
TYPE MFL Dipped Flat Shape	.001 MFD to .47 MFD	35, 50, 100, 200v.DC
TYPE MFK Dipped Flat Shape Non-Inductive Construction	.01 MFD to .22 MFD	100, 200, 400, 600v.DC
TYPE MXT In Plastic Tube	.001 MFD to .22 MFD	100, 200, 400, 600v.DC

METALLIZED POLYESTER FILM CAPACITORS

TYPE FNX-H Mylar Wrapped Removable With Epoxy End Seal	1 MFD to 10 MFD	50v.DC
--	-----------------	--------

SOLID TANTALUM CAPACITORS

TYPE TAX MIL-C-26655A Hermetically Sealed	1 MFD to 220 MFD	3, 6, 10, 15, 20, 25, 35v.DC
TYPE TAS Sealed with Epoxy Resin	1 MFD to 220 MFD	3, 6, 10, 15, 20, 25, 35v.DC

**MATSUO
ELECTRIC
CO., LTD.**

HEAD OFFICE :

3-5, 3-CHOME, SENNARI-CHO, TOYONAKA-SHI
OSAKA, JAPAN.

TOKYO OFFICE :

25, 2-CHOME, KANDA AWAJI-CHO, CHIYODA-KU
TOKYO, JAPAN.

Cable Address "NCC MATSUO" OSAKA

New Instruments

tions, the R-20 provides a precise check on radio frequencies, providing the broadcast of signals on very narrow, unwavering frequency bands to squeeze much more message capability into each communications channel.

Varian Associates, 611 Hansen Way, Palo Alto, Calif. [389]

**Stable and accurate
temperature controls**



These stable, accurate, and inherently fail-safe temperature controls are designed for the majority of industrial applications. Series 700 offers a variety of choices in either control modes or temperature sensors to meet specific requirements. Even when stepless control action is specified, with scr output, any number of the new controls may be connected on a single line without scr interaction among units. Standard control modes include stepless (scr), on/off, time-proportioning, limit (alarm), and three-zone. Either nickel or platinum probes or thermocouples are used with series 700. Controls have electrical cold-junction compensation when thermocouples are used. A large number of standard temperature ranges are available, between -200°F and $3,000^{\circ}\text{F}$. Series 700 provides continuous temperature indication when this is desired. Control points may be set either with pointers or a digital set point. Both input and output connections are located just behind the front panel of the series 700 controls. API Instruments Co., Chesterland, Ohio. [390]

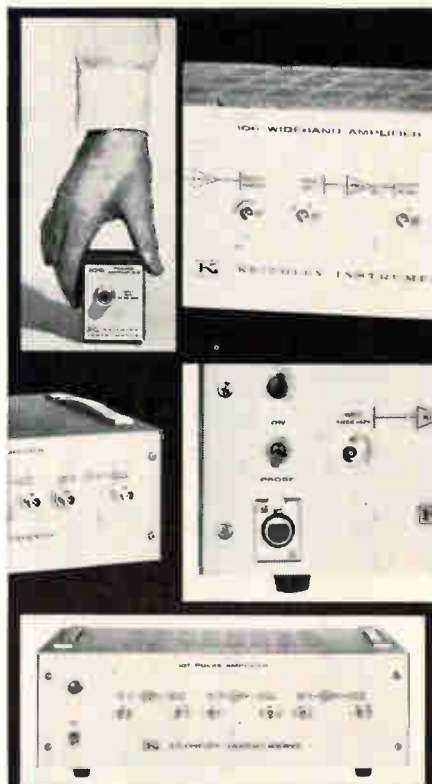

**AMPLIFYING WIDEBAND
SIGNALS?**

Here are six dependable ways from 15 cps to 180 mc

Wideband or pulse tuned Keithley amplifiers give you frequency response spanning 15 cps to 180 mc; midband flatness of 0.5 db; rise time under 3 nanoseconds and; overload recovery within 50 nanoseconds.

Use the Keithley 104 or 105 for their choice of input impedances (1 megohm at 10 pf or 50 ohms); choose high voltage gain and low noise ($35 \mu\text{v}$ with respect to the input) offered by the 106 or 107 models; select the bantam-sized 108 or 109 for carry-around convenience in general lab work.

Amplifying wideband signals? Choose the amplifier engineered to do your job:

Sine Wave Tuned	Gain	Price
Model 104	1, 10, 100	\$675
Model 106	10, 100, 1,000	\$675
Model 108	10	\$185
Pulse Tuned	Gain	Price
Model 105	1, 10, 100	\$675
Model 107	10, 100, 1,000	\$675
Model 109	10	\$185
Model 1081 Power Supply for Models 108 and 109 ... \$135		

Send for Engineering Note giving complete specifications



**KEITHLEY
INSTRUMENTS**
12415 Euclid Avenue • Cleveland 6, Ohio



4BT-2 Tiny-Stat Thermal Switch
Smallest, fastest!
Weighs 0.2 gram



Probe-Type Thermal Switch
Anticipates rapid temperature change.



3BT-2 Tiny-Stat Thermal Switch
Transistor-size. Shock & vibration resistant



4CT Solid State Controller
Stabilizes temperature at $\pm 0.05^{\circ}\text{C}$.



M1 High Capacity Thermal Switch
Up to 7 amps, 30 volts Extra High Reliability (EHR)



M2 Narrow Diff. Thermal Switch
 2° to 5°F differential in 0° to 250°F range.

RELY ON TI

FOR TEMPERATURE CONTROL

TI Precision Thermal Switches . . . identified by the trusted KLIXON® trademark . . . is the only line that brackets all these characteristics: control within $\pm 0.05^{\circ}\text{C}$; narrow differential; extremely fast response; large electrical capacity; subminiature size; open or close on temperature rise; single or double throw switching; automatic or manual reset; all-welded hermetic sealing; immersion probe sensing; tamperproof calibration; EHR (extra high reliability) series.

Wide-range application! KLIXON Precision Thermal Switches are now performing control or warning functions in thousands of industrial and military installations.

For complete information write today for a FREE copy of the KLIXON Thermal Switch Fact File.



METALS & CONTROLS INC.
5004 FOREST ST., ATTLEBORO, MASS.
A CORPORATE DIVISION OF
TEXAS INSTRUMENTS
INCORPORATED

New Semiconductors

Photon coupled circuit isolator

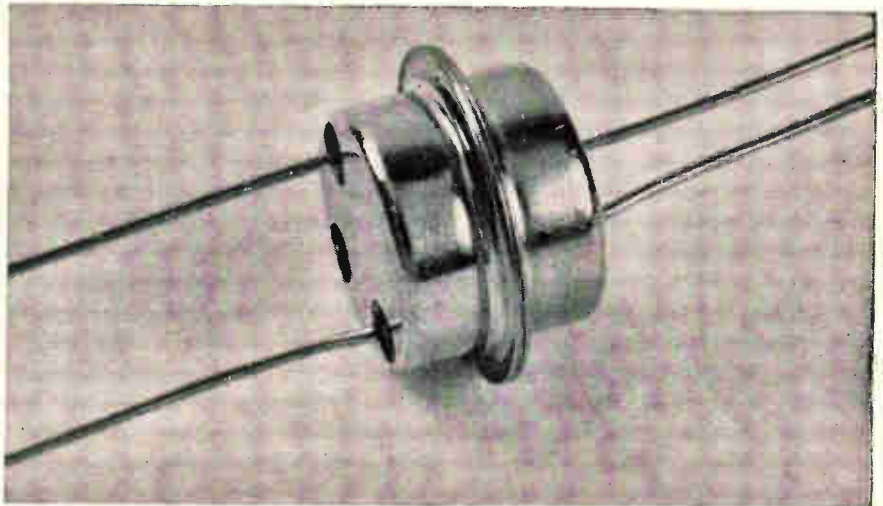

The L4450 photon coupled isolator is announced. It is a four-terminal, unilateral signal, coupling device consisting of a gallium arsenide infrared emitter diode coupled to a silicon photo detector over a short-shielded light path. The input and output leads are completely isolated, allowing maximum flexibility of circuit topology for circuits or systems requiring separate grounding configurations. Extremely high isolation is afforded by the L4450 since a photon stream provides the only signal coupling mechanism from input to output. Input-output package parasitics are virtually eliminated by a specially designed electrostatic shield reducing the coupling capacity to less than 0.0005 pf. Other characteristics in-

clude a signal cutoff frequency of 300 kc with optionally available units with up to 60-Mc cutoff frequency; output greater than 20 mv into a 20,000 ohm detector load with forward bias emitter drive currents in the 10- to 20-ma range; output-input isolation typically greater than 100 db (d-c to 1,000 Mc). Applications include photon coupled logic networks, isolation amplifiers and switches, high-voltage current/voltage sensing and other applications requiring extremely high circuit isolation. The isolators are priced at \$80 each in quantities of 1 to 9. Availability is 2 to 3 weeks.

Philco Corp., Solid-State Products Operation, Lansdale Division, Lansdale, Pa. [371]

Zener regulator kits aid circuit designers

A series of zener voltage regulator engineering kits have been designed for circuit designers as well as research and development personnel. The EKT series feature three kit type groups for use in transistor circuits where the lower voltages are normally used. Each kit is comprised of Powercomp TZ series zener regulators with voltages ranging from 6.8 to 200 v, and

6.8 to 30 v for the transistor circuit applications. Voltage tolerances are 10%, 5% and 1%. The TZ series zener regulators have a power rating of 1 w, a fully insulated hermetically sealed case molded under high temperature and pressure, solid silver leads 0.032 in. in diameter, and are rated for operation from -65°C to $+150^{\circ}\text{C}$. These zeners will withstand the standard Joy Bomb, humidity and thermal shock tests. Kit type EKTC101 consists of 1 each of 20 TZ zener regulators, with voltage range from

6.8 to 30 v, and voltage tolerance of 10%, and is priced at \$18, complete with metal cabinet having easy pull out plastic drawers. Power Components, Inc., P.O. Box 421, Scottsdale, Pa. [372]

Integrated quad gate immune to noise

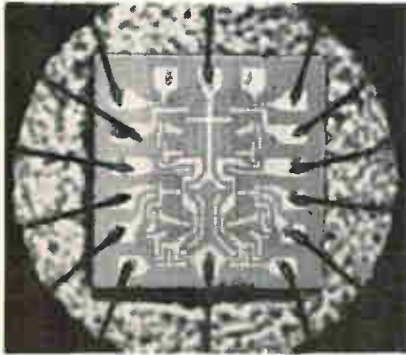

A quad two-input gate has been added to an advanced diode-transistor micrologic family. Called the DT μ L946, the new integrated microcircuit is said to provide for the first time the possibility of an exclusive OR function in a single package, through the presence of four dual gates. The device provides greater logic flexibility and allows equipment to be designed with fewer units. The DT μ L946, a monolithic silicon planar epitaxial circuit, is said to offer extremely high noise immunity, typically 1 volt at 25°C; propagation delay time of 25 nsec at 25°C; power dissipation of 5 mw per node; and a fan-out of 8. The circuit is guaranteed over the full military temperature range of -55°C to +125°C. It is available in the 14-lead Cerpak flat ceramic package and in the 14-lead TO-5 package.

Fairchild Semiconductor, 545 Whisman Rd., Mountain View, Calif. [373]

Glass-encapsulated silicon rectifiers

Glass-encapsulated, 1-amp silicon rectifiers have been developed with ratings from 100 to 1,000 v. Designated TIR01 through TIR10, the new rectifiers provide high current capability (1 amp continuous at 100°C, 50 amps surge) in a hermetically sealed glass package



When only the smallest, lightest, fastest thermal switch will do...

RELY ON T^I FOR TEMPERATURE CONTROL

New KLIXON 4BT Series Thermal Switch... only an eighth of an inch thick... is designed for such applications as this crystal oven warm-up heater.

Weighs only 0.4 gram! Low thermal mass explains why the KLIXON 4BT hermetically-sealed thermostat responds to temperature change five times faster than its nearest equivalent.

Consider these 'no space to spare' applications! As a replacement for thermistors and their electronic switching circuitry, these "Tiny-Stat"* switches combine temperature sensing and switching in a package no larger than the thermistor alone. Result? The smallest device on the market for limiting temperatures on computers, memory systems, printed circuit boards, crystal ovens, thermal batteries and electronic test equipment.

They are especially suited to airborne and missile applications.

Write today for bulletin DD-PRET-12

*PAT. PENDING



4BT SERIES "TINY-STAT"
ACTUAL SIZE

KLIXON
CONTROL PLANTS IN
Attleboro, Mass • Versailles, Ky.
Richmond Hill, Ontario
Holland • Italy • Australia
Argentina • Brazil • Mexico



METALS & CONTROLS INC.
5004 FOREST ST., ATTLEBORO, MASS.
A CORPORATE DIVISION OF
TEXAS INSTRUMENTS
INCORPORATED

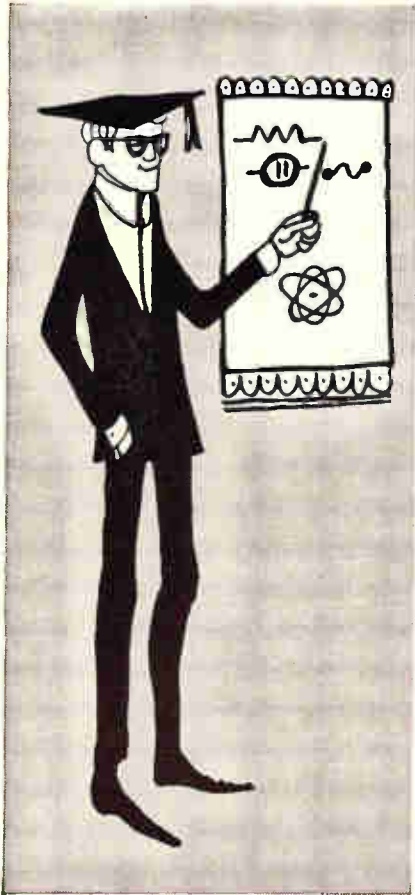

workability

(pre-production training)

WESTern PENNSylvania has a time-tested and proved-in-use plan by which adaptable, productive people with a variety of industrial aptitudes will be trained in advance in whatever skills are needed for YOUR particular operation, usually at no cost to you. For details—and information on 100% financing of industrial plants at low, low interest rates . . . financing of equipment and machinery . . . loans for working capital . . . and WESTern PENNSylvania's favorable tax climate—send coupon, wire or call collect.



WEST PENN POWER

an operating unit of ALLEGHENY POWER SYSTEM

Area Development Department, Room 560
WEST PENN POWER—Greensburg, Pa. 15602
Phone: 412—837-3000

In strict confidence, I'd like details about WESTern PENNSylvania's: Pre-Production Training Favorable Tax Climate Financing Plans Industrial Properties and Shell Buildings

Name _____
Title _____
Company _____
Address _____
City _____ State _____
Code _____ Phone _____

New Semiconductors

measuring only 0.150 in. by 0.360 in. This is one-tenth the volume of standard DO-4 top-hat stud rectifiers, making the new units well suited for space-limited applications. The glass package is cylindrical and fully insulated to permit high-density packaging for still further space savings. Construction features also include weldable leads and silver-disk contacts on both sides of the silicon wafer for protection against thermal shock. Prices range from 33 cents to \$1.80 in quantities of 100 to 999.

Texas Instruments Inc., 13500 North Central Expressway, Dallas, Texas. [374]

High-voltage scr's simplify circuitry



Three new, all-diffused silicon controlled rectifiers feature high voltage, high current and improved dynamic characteristics. Because of the combination of these properties, the new scr's simplify circuitry, increase reliability, reduce power losses, and increase circuit predictability. The semiconductors are designed for military and industrial applications, including primary phase control, a-c and d-c motor-speed control, high-voltage crowbars, temperature control, lamp dimmers and general switching applications. One model, the C145 (illustrated), is believed to have the highest available capacity in terms of kilowatts per cu in. Considerably smaller than compa-

HOW'S YOUR THERMISTOR IQ?

Want to learn more about these versatile, precision sensors? Here's FREE literature to help you.

CAPSULE THERMISTOR COURSE BOOK

Ten quick, painless lessons on precision thermistors, their characteristics, and how they are used. Illustrates basic thermistor circuits, compares thermistors with other sensors, gives typical circuit design calculations, etc.

Ask for F.E.I. CAPSULE THERMISTOR COURSE BOOK.



THERMISTOR FACT FOLDER



An illustrated booklet which describes various thermistor types, including F.E.I. ISO-CURVE* interchangeable thermistors, and how to apply them in measurement and control circuits.

Ask for F.E.I. THERMISTOR FACT FOLDER.

*MADE UNDER PAT. 3109227 AND OTHERS. ISO-CURVE IS A TRADEMARK OF F.E.I.

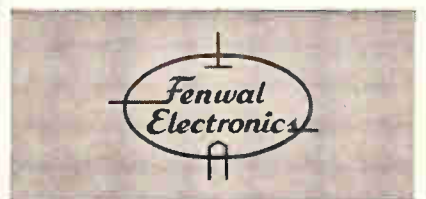

63 FOUNTAIN STREET, FRAMINGHAM, MASS.

rable high-power scr's, the device is rated at 1,300 v (V_{BO} and prv) and 55 amps rms. Type C150 is rated up to 1,300 v, 110 amps rms; the C180, up to 1,300 v, 235 amps. Because of the high voltage characteristic, the units can operate directly off 480-v lines. For instance, one 1,300-v scr can be used in place of two 500-v units in series and thereby reduce initial installation cost. One of the most important design features of these scr's is their ability to withstand fast rising forward voltage and high current surges. Minimum parameters include a dv/dt rating of 200 v per μsec and a minimum di/dt rating of 50-100 amps per μsec . The scr's range in price from \$16.50 for the C145B (200 prv in lots of 100-999) to \$62 for the C180B in similar quantities.

General Electric Co., Schenectady, N.Y. [375]

Pnp transistor offers high gain and voltage

A pnp transistor has been developed that combines excellent gain capability and high breakdown voltage with Planar II stability. The FT0019 is a double-diffused silicon planar epitaxial device. It is designed for use in high-performance low-level, low noise amplifiers from audio to high-frequency ranges. The Planar II process used in its manufacture eliminates the instability problems that have plagued earlier pnp devices by preventing ion migration in planar oxides, thereby inhibiting the formation of channels. The FT0019 also offers excellent uniform d-c current gain from 1 μa to 50 ma, and very low noise characteristics over a wide range of source impedances. It is packaged in the standard TO-18 can, and is guaranteed over the full military temperature range of -55°C to $+125^{\circ}\text{C}$. The transistor is available in two variations—the FT0019H with a voltage breakdown of 100 v; and the FT0019M with a voltage break-down of 80 v. Prices for the FT0019H are \$24 for 1-99 and \$16 for 100-999; for the FT0019M, \$18 for 1-99 and \$12 for 100-999.

Fairchild Semiconductor, 313 Fairchild Dr., Mountain View, Calif. [376]

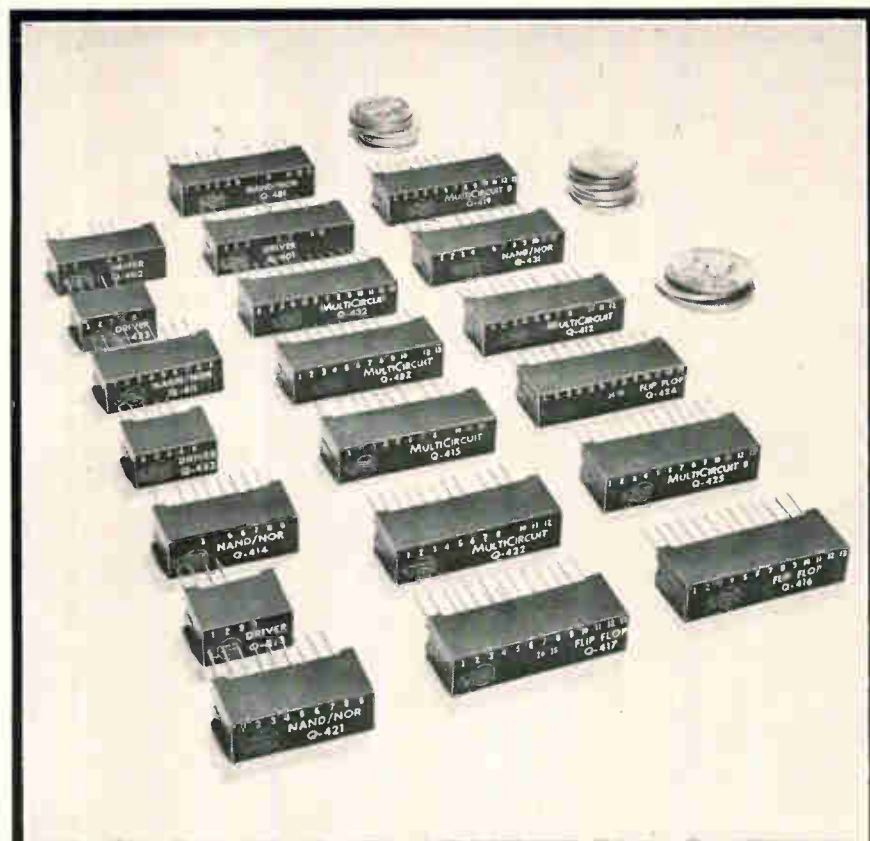

EECo's New Digital Logic Modules Control Anything...Including Costs

HERE IS THE MONEY-SAVING, TIME-SAVING APPROACH TO ANY LOGIC PROBLEM—EECo's new Q-Series welded and encapsulated digital circuit modules. A handful of compact Q's can replace a dozen conventional logic modules—or a barrelful of electromechanical devices. In fact, 99% of your digital needs can be answered with just four basic Q modules! And this new line includes:

- Five different flip-flops in one small package—25 kc or 100 kc—clamped or unclamped outputs.
- Four standard digital circuits can be made with one Q-Series MultiCircuit type.
- Special-purpose logic power driver modules for all Q-logic applications.
- 1-mc Q's that include a 3-input NAND/NOR module... a universal MultiCircuit that can be connected in pairs to form a variety of flip-flops or standard digital circuits... and a power driver capable of driving 25 ac or dc loads. Yes, we have silicon too.

Prices range from \$1.57 to \$7.05 in quantities of 100—your choice of applications. We'd be pleased to send complete information.

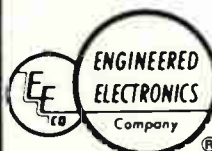

Write...wire...or phone

ENGINEERED ELECTRONICS Company

1441 East Chestnut Ave. • Santa Ana, Calif.

Phone: (714) 547-5651 Cable: ENGELEX

**THIS
SIGNAL
NEEDS
NO
AMPLIFYING...**

LEL
quality
receiver
products
now have
new
low prices

Call, write or
wire for
Short Form
Catalog 65
and revised
price list.



LEL DIVISION

VARIAN associates

AKRON ST., COPIAGUE, L. I., NEW YORK 11726
(516) AMityville 4-2200/(516) PYramid 9-8200
TWX Code 516-691-5085

New Subassemblies and Systems

D-c amplifier uses no choppers



Subminiature Teledyne series 215 d-c amplifier has wide application in airborne and ground support systems, low level signal conditioning systems, and analog computers. Designed as a completely welded solid-state unit, it uses no choppers and has differential and/or single-ended input and output. With four modes of operation thus provided, the new unit can be used with non-bridge sensors such as thermocouples, where grounds must be provided in order to insure proper system operation. Common mode rejection is greater than 60 db from d-c to 400 cps for 3.0 v peak-to-peak CM signal. Circuitry consists of two stages of amplification buffered by emitter followers with virtually 100% of d-c feedback. The manufacturer says this design provides a d-c amplifier with high input impedance, low output impedance, exceptional linearity and zero/gain stability with a minimum of components. All stages are in a balanced-differential / error-canceling configuration, utilizing dual chip silicon common heat sink devices. A signal conversion circuit is used to provide a versatile d-c amplifier capable of single-ended or differential output at low impedance. In the single-ended output mode, the amplifier is capable of driving load resistances as low as 1,000 ohms to the 5 v d-c level. The latest

welded circuitry and epoxy resin encapsulation techniques are employed to yield an increased degree of miniaturization and reliability. Measuring 1.067 in. by 0.817 in. by 0.50 in., the 215 weighs less than 15 grams.

Taber Instrument Corp., 107 Goundry St., N. Tonawanda, N.Y., 14120. [401]

Dc-amplifier features low drift



This d-c amplifier has a drift of 0.005% full scale/°C and noise of 30 μ v rms. It is a single-ended amplifier providing an output of ± 100 ma at ± 10 v d-c, with gains, of 1, 2, 5 and 10. Model G-10 features a maximum drift of 50 μ v/°C from 0 to 50°C; linearity, 0.005%; and an input impedance of 10 megohms. It uses silicon semiconductors throughout, does not use choppers, contains its own power supply, and is available with a 2.5

multiplying vernier. Other specifications are: gain accuracy of $\pm 0.1\%$, output impedance of 0.25 ohm, capacitive load to 0.25 μf , bandwidth of 40 kc, safe input of $\pm 100\text{ v}$, overload recovery of 120 μsec to 0.05% full scale, and settling time of 100 μsec to 0.05% full scale. Price is \$315.

Bay Laboratories, Inc., 20160 Center Ridge Road, Cleveland, Ohio. [402]

Bit synchronizer and signal conditioner

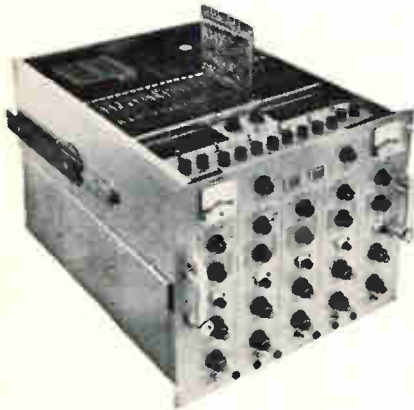

A new bit synchronizer and signal conditioner locks the clock to within $\pm 5^\circ$ for the entire tracking range. It operates on signal-to-noise ratios as high as -10 db and recovers data to within 1 db of the theoretical limit for any desired bit rate from 1 bps to 1,000,000 bps for all codes including NRZ-C, NRZ-M, NRZ-S, RZ, bi-polar and split phase. The low error rate obtained on split phase signals is identical to that obtained on NRZ data and phase determination is performed. Since no analog filtering is required, the unit is truly wide band. Code and bit rate can be programmed remotely. Simplified front-panel controls for selection of bit rate for any code include a decade control, a significant digit control, and 10-turn fine tuning control ($\pm 7.5\%$). Any bit rate can be set to within 2% without a counter. Simultaneous outputs include regenerated NRZ-C, split phase, NRZ-M, plus four phases of the bit rate clock. Output polarity may be either plus or minus, 6 to 12 v, and rise and fall times are less than 100 nsec into 1,000 μf and 1,000 ohms. Optional features include a

MAGSENSE®

COMPARATORS

Now—**PROVEN** comparators with laboratory sensitivity and military reliability for severe environments



Model 80—\$90. External Set Point



Model 82—\$170. Internal Adjustable Set Point

Dependable, low-level comparators with

- Proven performance to MIL E-5272 requirements
- 100 billion power gain
- 1 μa sensitivity
- 100 ms response
- Solid-state reliability
- Exceptional stability

Here are Magsense units designed for reliability and stability in military, aerospace and rugged industrial applications. Packaged for severe environments, they meet or exceed requirements of MIL E-5272. The magnetic sensing devices, which will detect and compare electrical currents less than 1 μa , can accept the output of thermocouples and strain gages directly *without amplifiers*. **PROVEN IN SERVICE**, Model 80 and 82 units are now orbiting in satellites.

BRIEF SPECIFICATIONS FOR 0-100 μa INPUT RANGE*

Input Resistance: 100 ± 10 ohms, electrically isolated.

Set Point Stability: $\pm 0.5\ \mu\text{a}$ max. for $\pm 10\%$ line voltage in range of 22 to 32 volts. $\pm 0.5\ \mu\text{a}$ typical in temperature range 0 to 40°C (± 1.0 typical -55° to $+85^\circ\text{C}$).

Hysteresis: Less than 3 μa , externally adjustable to 200%.

Output Load: Model 80—Non-latching 50 ma max., Latching 1 amp. max.; Model 82—Complementary 0.5 amp outputs, Latching or Non-Latching.

Size: 1.8" x 1.8" x 1.2" high.

Weight: Approx. 4 ounces.

Header: 8-pin solder type suitable for chassis or printed circuit card.

*DC, AC, polar and bi-polar voltage and current inputs available in Model 82 series.

CONTACT THESE DISTRIBUTORS FOR COMPLETE INFORMATION OR DELIVERY FROM STOCK . . .

Alabama (Florida Counties West of Jackson, Calhoun and Gulf)
The James Spader Co.
P.O. Box 6074
Birmingham, Ala. 35209
(205) 879-1366

S. California & Arizona
Perlmuth Electronics
5057 W. Washington Blvd.
Los Angeles, Calif. 90016
(213) 931-1041
TWX: 213 937-0629
8068 Engineers Road
San Diego, Calif. 92111
(714) 278-6230
TWX: 714 279-0272
2859 East Thomas Road
Phoenix, Arizona 85016
(602) 264-4934
TWX: 602 255-0584

N. California & Nevada
Held & Mollard, Inc.
1494 Oddstad Drive
Redwood City, California
(415) 365-1700
TWX: 415 364-9000
Meters, Inc.
1494 Oddstad Drive
Redwood City, California
(415) 365-1700
TWX: 415 364-9068

Colorado, Utah, Wyoming, Montana and South Idaho
Peterson Company
4949 Colorado Blvd.
Denver 16, Colorado
(303) 333-5434
TWX: 303 292-3277
Peterson Company
521 West 4th North
Salt Lake City, Utah
(801) 356-7464
TWX: 801 521-2536

Florida (Except Counties West of Gadsden, Liberty and Franklin)
The O. E. Grant Company
5206 St. Regis Place
Orlando, Florida
(305) 855-9220
Electro-Tech, Inc.
307 27th Street
Orlando, Florida
(305) 432-5589

Georgia
Electro-Tech, Inc.
690 Murphy Ave., S.W.
Atlanta, Georgia
(404) 753-4128
TWX: 404 527-0189

Northern Illinois, Northwest Indiana and Central Wisconsin

A & M Instrument, Inc.
4801 N. Ridgeway Ave.
Chicago, Illinois
(312) 539-4460
TWX: 312 222-9372

Maryland and Virginia
Thomas H. Closs Co.
21 W. Pennsylvania Ave.
Towson, Maryland 21204
(301) 825-4445

Michigan & Indiana (Except Counties Lake, La Porte and Porter)
The Satullo Company
4514 North Woodward
Royal Oak, Michigan
(313) 566-2375
618 Cincinnati-Batavia
Pike
Cincinnati, Ohio 45244
(513) 752-6683

Minnesota, Dakotas and Northwest Wisconsin
Pinkney and Assoc., Inc.
1925 Nicollet Avenue
Minneapolis, Minn. 55403
(612) 338-0523
TWX: 612 321-1345

Miss., Arkansas, Louisiana and Texas (Except Six West Counties)

Butler and Land, Inc.
5538 Oyer Street
Dallas, Texas
(214) 361-6631
217 Bermac Building
4101 San Jacinto Street
Houston, Texas 77004
(713) 523-8526

1034 Constance Street
New Orleans, La. 70130
(504) 524-0688

Nebraska, Iowa, Kansas, Missouri & S. Illinois

Impala, Inc.
7540 Lowell Street
Overland Park, Kansas
(913) 648-6901
TWX: 913 642-8371
7049 Laupher Street
Hazelwood, Mo. 63042
(314) 522-1600

247 South Pinecrest
Wichita, Kansas
(316) 682-3593
1011 Clifton Street, N.E.
Cedar Rapids, Iowa
(319) 362-2125

Six New England States
Alvin S. Mancib Company
363 Walden Street
Cambridge, Mass. 02138
(617) 864-2494
TWX: 203 346-1497

Randolph and Coe Roads
Middletown, Conn. 06458
(203) 347-5629

New Mexico, Six West Texas Counties
Electronic Enterprises
1900 Washington St., N.E.
Albuquerque, N.M. 87110
(505) 256-1585

Metropolitan New York, Long Island and Northern New Jersey
A & M Instrument, Inc.
48-01 31st Avenue
Long Island City 3, N.Y.
(212) 726-4343
TWX: 212 672-1329

Up-State New York
Ossmann Component
Sales Corp.
830 Linden Avenue
Rochester 25, New York
(716) 586-4940

5858 E. Mollay Rd.
Syracuse 11, New York
(315) 454-2461

P.O. Box 245
Vestal, New York
(607) 785-9947
TWX: 607 772-0209

North and South Carolina
Systems Service Corp.
3748 Monroe Road
Charlotte 7, N. Carolina
(703) 377-3407
TWX: 704 525-2558

Ohio, East Kentucky, Western Pennsylvania and West Virginia
Electro-Tech, Inc.
3107 Cullman Avenue
Charlotte, North Carolina
(704) 333-0326

Pioneer-Standard Electronics, Inc.
5403 Prospect Avenue
Cleveland, Ohio 44103
(216) 432-0010
TWX: 216 574-9725
2651 East Main Street
Columbus, Ohio
(614) 237-8615
TWX: 614 759-0034
Spreco Electronics
314 Leo Street
Oayton 4, Ohio
(513) 224-0871
TWX: 513 944-0430

Oklahoma
Riddle and Hubbell
302 S. Cheyenne Avenue
Tulsa, Oklahoma
(918) 585-5624
TWX: 918 923-3173

Eastern Pennsylvania, Delaware and Southern New Jersey

Robert K. Nye Associates
P.O. Box 611
Berwyn, Pennsylvania
(215) 644-8479
Electric Meter Service
1014 Vine Street
Philadelphia 7, Pa.
(215) 922-3422

Washington, Oregon and Northern Idaho
Eicher and Company
5 West Harrison Street
Seattle 99, Washington
(206) 284-1811

Southern Wisconsin
Taylor Electric Company
4080 N. Port Washington
Road
Milwaukee, Wis. 43212
(414) 964-4321
TWX: 414 964-4863

CONTROL DATA CORPORATION

CONTROL SYSTEMS DIVISION
4455 MIRAMAR ROAD, LA JOLLA, CALIFORNIA

FAMOUS ENCAPSULATING TECHNIQUES

with hull



...and by **HULL**



Now it's fashionable to claim *second* place. You can see we go a step further and show you *why* we're only second in encapsulating.

Hull encapsulating techniques are for components like diodes, resistors, delay lines, chokes, capacitors, pulse transformers. Our processes are direct encapsulation by transfer molding, by vacuum potting, and by continuous dispensing.

The "Hull Package"

We provide you a whole package (engineering, compound selection, design of molds and fixtures, Hull-developed encapsulating presses, and the working set-up).

And, we provide specific field-proved equipment: Vacuum units for potting and encapsulating with short pot life resins. The Blendmaster series of continuous metering, mixing and dispensing systems. And, of course, Hull transfer molding presses—standard or custom made.

Write for Bulletin P963, "Hull Direct Encapsulation Equipment." HULL CORPORATION, 5033 Davisville Road, Hatboro, Pa. 19040. Or, phone: (215) 675-5000.

H-3R2



New Subassemblies

10 cps to 500,000 cps 6-pole active Bessel filter for limiting wide band noise or matching premodulation filtering as well as remote selection of up to six preselected bit rates and codes. Illustrated on page 159 is a five-channel unit.

The Roback Corp., Huntingdon Valley, Pa. [403]

Metal film networks in epoxy molded case

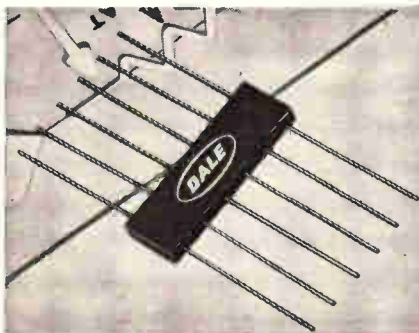

A series of microresistive networks uses metal film elements encapsulated in molded epoxy. The MN series is available with from two to six elements, each of which has a power rating of 50 mw at 125°C. The networks provide a major packaging and assembly advantage since they can be supplied with matched temperature coefficients and matched resistance ratios or with mixed high and low resistance values in the same package. All units in the series meet the applicable electrical and environmental requirements of MIL-R-10509E, Characteristic D, C or E (depending on temperature coefficient). Precision metal film elements within each network can be supplied with a resistance range of from 49.9 ohms to 75,000 ohms and with temperature coefficients of $\pm 25, 50, 100$ or 150 ppm/°C. Operating temperature range is from -55°C to $+175^{\circ}\text{C}$. Standard tolerances are $\pm 0.1\%, 0.25\%, 0.5\%, 1\%, 2\%$ and 5% . All elements have excellent high-frequency characteristics. Noise levels are rated at a maximum of $0.1 \mu\text{v}$ per v over a decade of frequencies. The epoxy molded case of each unit is 0.075 in. thick by 0.190 in.

Telrex

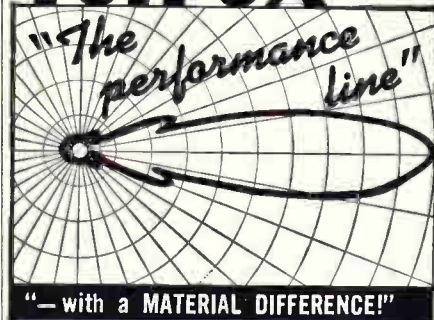

The Choice of the Discriminating Communication Engineer... the Man who Never Settles for Anything Less than THE-VERY-BEST!

telrex "BEAMED-POWER" ANTENNAS and ANTENNA SYSTEMS

Provide optimum performance and reliability per element, per dollar. Antennas from 500 Kc to 1500 Mc. Free PL88 condensed data and pricing catalog, describes military and commercial antennas, systems, accessories, Towers, Masts, Rotators, "Baluns" and transmission line data.



Asbury Park 41, New Jersey, U.S.A.
Circle 208 on reader service card

MICO

NEW SIX-RATIO STANDARD ENGRAVER

CAT. NO.
259

FOR LIGHT
AND MEDIUM
DUTY WORK

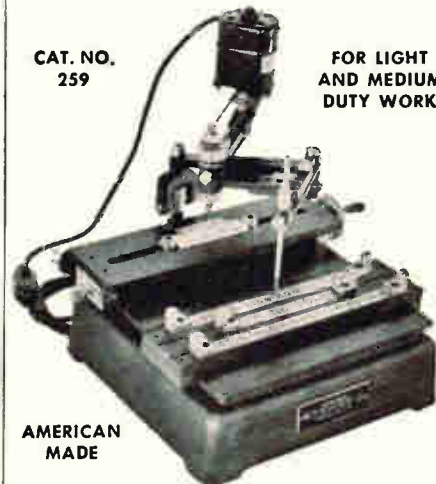

AMERICAN
MADE

- Engineered for ruggedness and simplicity.
- Six pantograph ratios—from 1.5:1 to 4:1.
- Ball-bearing spindle uses $\frac{1}{8}$ " shank cutters and has true .250" micrometer depth control.
- Sturdy one-piece ratio studs anchor in ESNA stop-nuts for quick locking of pantograph arms.
- Master copy and work right-side up—in full view of operator. Raising stylus raises cutter.
- Attachments available for increasing versatility.

Send for bulletins and prices

MICO INSTRUMENT CO.

77 Trowbridge St.

Cambridge 38, Mass.

wide. Lengths vary from 0.200 in. for the 2-element MN2 to 0.600 in. for the 6-element MN6. Standard leads are 0.016 in. tin-dipped copper, with weldable leads also available.

Dale Electronics, Inc., P.O. Box 488, Columbus, Neb. [404]

Antenna multicoupler and preamplifier



The wideband antenna multicoupler is a compact solid-state unit designed for use in precision h-f direction-finding systems. It uses a feedback design to reduce intermodulation products generated by large signals. Because of its advanced and unusual circuit design, it also outperforms conventional designs in both direction-finding and communication applications, according to the manufacturer. The multicoupler can be fed directly from any h-f antenna to drive up to eight receivers with extremely constant gain and phase match between channels and between units. To enhance over-all system sensitivity in the presence of high noise receiving equipment, the h-f preamplifier, a companion unit to the h-f multicoupler, can be inserted between the antenna and multicoupler to provide 10 db of stable low-noise gain ahead of the multicoupler. The design of the preamplifier is similar to that of the multicoupler. The multicoupler consists of a 7-pole band-pass filter, a broad-band feedback amplifier, and a regulated power supply. The feedback amplifier provides well-matched input and output impedances, an exceptionally large linear dynamic range, and stable, dependable performance independent of wide variations in terminating impedances, line voltage, and ambient temperature. The amplifier pass band is flat from 2 to 50 Mc, and the over-

This Mathatron digital computer needs one more significant digit

Your index finger. Some people use the third finger. That's all right.

Program the formula: $\frac{R_1 \times R_2}{R_1 + R_2} \times R_3$ for $R_1 = 6.2$
 $\frac{R_1 \times R_2}{R_1 + R_2} + R_3$ for $R_2 = 3.8$
 $R_3 = 9.1$

Switch to Learn:

Tap $S 1 \times S 2 \div (S 1 + S 2) \ominus 4$ $S 4 \times S 3 \div (S 4 + S 3) =$

Switch to Normal:

Tap $6 . 2 \ominus 1$ $3 . 8 \ominus 2$ $9 . 1 \ominus 3$

The printed tape reads 1.87147346

Four or eight independent storage registers, 24 or 48 step ferrite core memory, automatic printed output, 100 column number capacity, 8 to 9 significant digit accuracy, automatic decimal placement, electronic speeds, optional pre-wired programs, all solid state logic and circuitry. It won't solve everything, of course.

If you already have a large data processor, consider this: 80% of the Mathatron owners have big computers, too. But they can't stand the time lag, or the hourly cost, or the gaff. The Mathatron is twice the size of a typewriter and is accessible, immediately, to the whole department.

Write for further information.

MATHATRONICS, INC

257 Crescent St., Waltham, Mass. 02154 (617) 894-0835



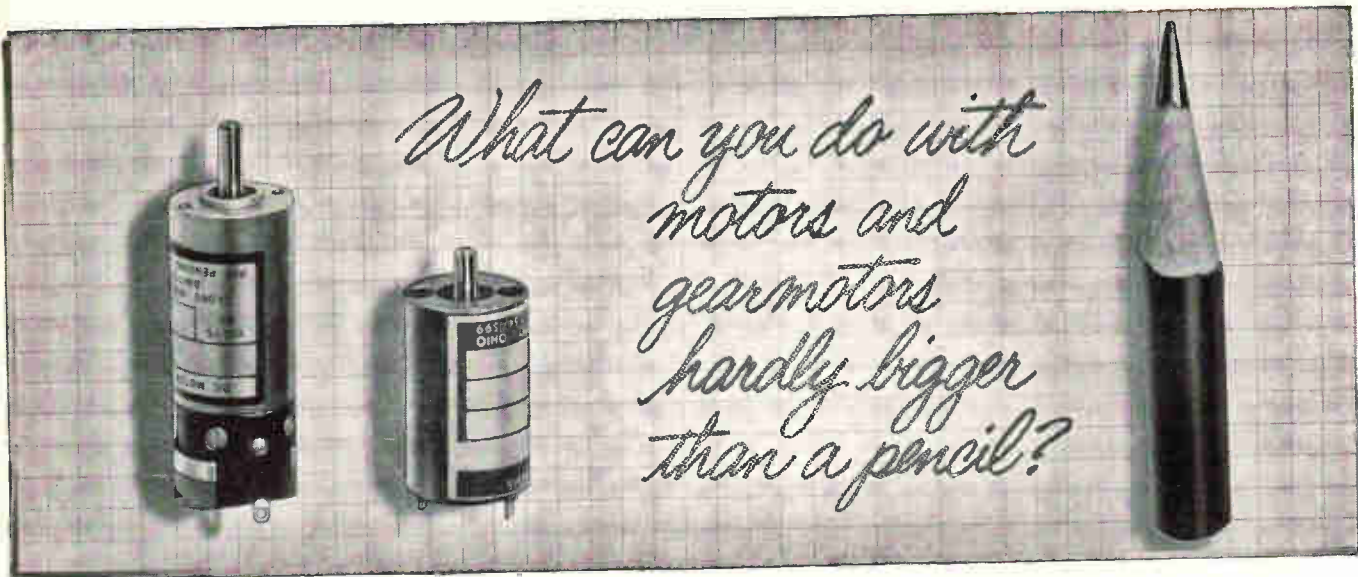

You can figure on designing more compact products. As a matter of fact Globe has developed 2 new MIL spec motors—one for a.c. called Type CC, and one for d.c. named VT. Motors are $\frac{5}{8}$ " and $2\frac{1}{2}$ " in diameter, weigh $1\frac{1}{2}$ and 2 ounces. Type VT uses a system of planetary gearing that multiplies torque up to 50 oz. in.

Choices for designers are fantastic; we have 83 standard gear ratios. Type VT can be wound for any voltage up to 50 v.d.c., and we can furnish them with speed governors. Type CC is a hysteresis synchronous motor. And if you need a smaller or larger power unit, come to the can-do manufacturer. Request Bn. 8906.

TYPE CC—Produces .08 oz. in. max. sync. torque. Size $2\frac{1}{32}$ " x $1\frac{11}{32}$ " long. 2 oz. 26 v.a.c. (115 v.a.c. with series capacitor), 2 or 4 poles, 400 cycles.

TYPE VT—Produces .0025 HP in the 8,000 to 17,000 rpm range. Size: $\frac{5}{8}$ " x $1\frac{5}{8}$ " long. 1.48 oz. To 50 v.d.c. Planetary gearing in 83 ratios.

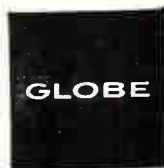

Globe Industries, Inc., 2275 Stanley Avenue
Dayton, Ohio 45404, U.S.A., Tel.: 513 222-3741

Circle 210 on reader service card

Solid State switches

(all you want, with mating drivers, too)



Constantly expanding its line of solid state switches, Sanders offers you the most significant advances in microwave switching techniques. Take a look at the complete line of solid state switches, drivers and switch/driver combinations available in quantity only from Sanders. These are all standard products off the shelf and span a wide range of frequencies from DC to 12 GC. Write for comprehensive data sheets. Sanders Associates, Inc., Microwave Products Dept., Nashua, New Hampshire. *T.M., Sanders Associates, Inc.

CREATING NEW DIRECTIONS IN ELECTRONICS
SANDERS ASSOCIATES, INC.



PRECISION CIRCUITS, INC.

Specialists in the art of producing **MULTI LAYER BOARDS** meeting customers requirements.

Inquiries invited.

Originators of the CIRLOC process (pat. app. for).

PRECISION CIRCUITS, INC.
93 Weyman Ave.,
New Rochelle, N. Y. 10802
Phone (914)—235-4300

"where performance is equal to promise."

New Subassemblies

all multicoupler pass band, which is set by the 7-pole input filter, can be selected to occupy all, or any fraction, of this frequency range. TRG, a subsidiary of Control Data Corp., Route 110, Melville, N.Y. [405]

Single-sideband transmitter exciter

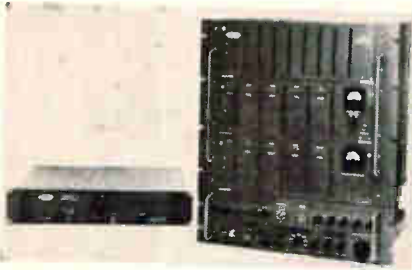

Fully transistorized, independent sideband transmitter exciters for linear amplifiers are announced. The units operate in the following modes: ssb, isb, frequency-shift keying, continuous-wave, and compatible ssb. The CSSB mode provides a narrowband version of the CSSB signal developed by the manufacturer for broadcasters. The units also allow the choice of up to 10 r-f frequencies which may be switched remotely. Module construction is used, simplifying maintenance.

Kahn Research Laboratories, Inc., 81 S. Bergen Place, Freeport, L.I., N.Y. [406]

Thumbwheel switch reduces errors

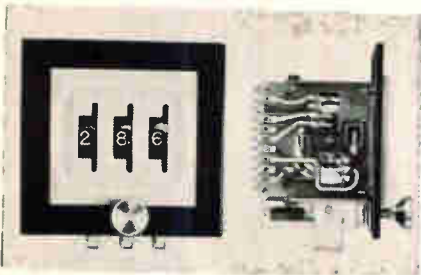

A space-saving modular tab-type binary or decimal thumbwheel switch offers push-button lock/release. Series LR is available in 8, 10, 12 or 16 positions and with up to 12 printed-circuit wafer mod-

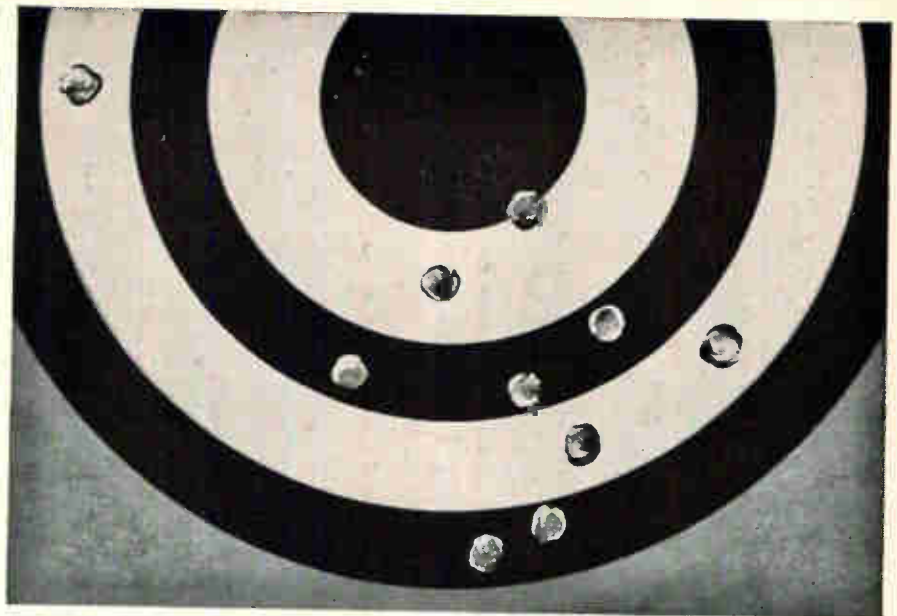

NO NEAR MISSES

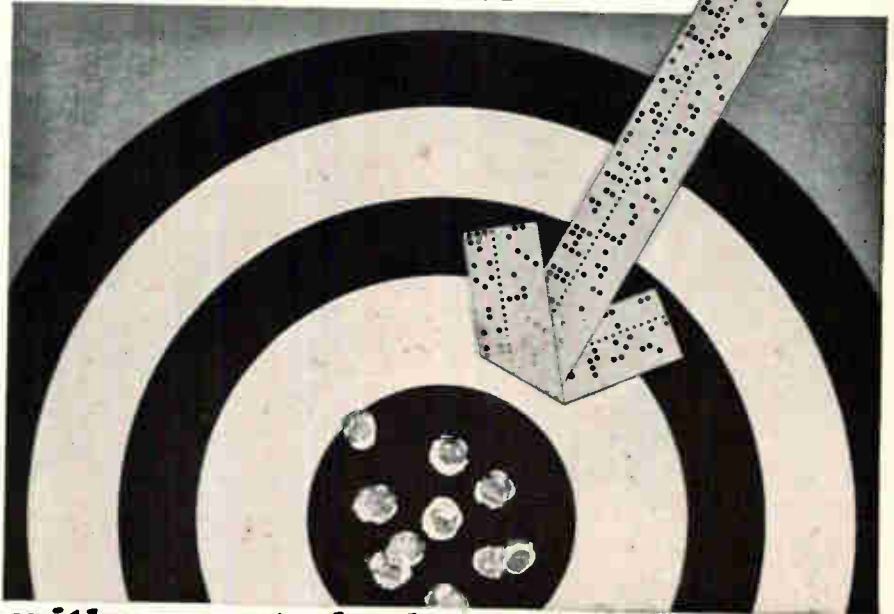

with computerized filter and transformer design

On-target design—with no false starts and no near misses—is one big advantage you get in Genisco filters and transformers designed with the help of computers.

You get faster solutions because computer designs are achieved in minutes instead of hours—and you get on-time delivery and lower shipping costs because Genisco plants are spotted in key market areas.

Computer design also means greater accuracy and the elimination of guesstimation. You never have to settle for the first solution when you're pressed for time because our computer method investigates several design approaches almost instantaneously.

Trial-and-error prototype costs are cut out because designs are automatically "performance tested" before production starts. And price quotations are fast and accurate. There's never any guessing about costs with Genisco computer design of filters and transformers.

Zero in on this new filter and transformer design capability. Write for complete information today.

COMPONENT DIVISIONS: Combined Sales and Application Engineering Departments

WESTERN UNITED STATES
6320 West Arizona Circle Los Angeles, Calif. 90045
Phone: (213) 776-1411 TWX: 213-670-4765

EASTERN UNITED STATES
111 Gateway Road Bensenville, Ill. 60106
Phone: (312) 766-6550 TWX 312-766-7048

Genisco

TECHNOLOGY CORPORATION



Couch

ROTARY RELAYS

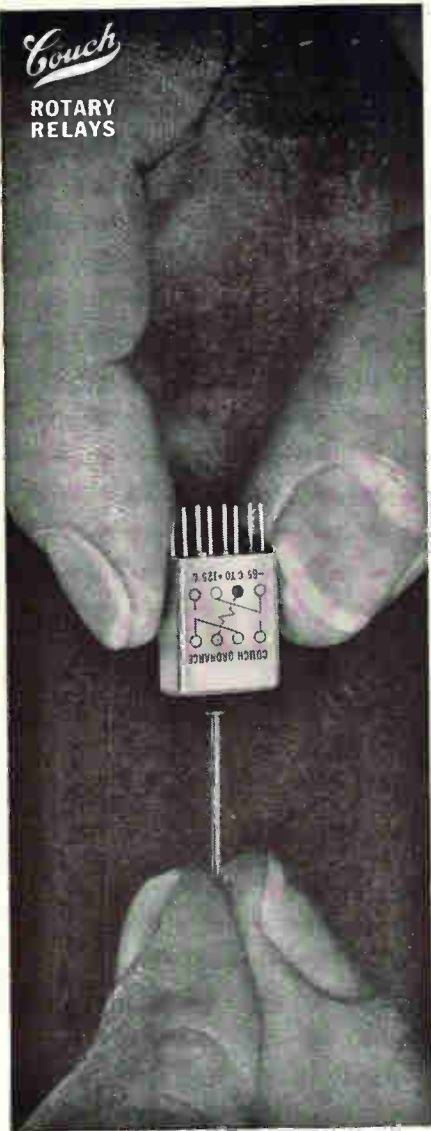

good and small

This new Couch rotary relay is surprisingly microminiature when you consider the rugged construction inside and the specifications

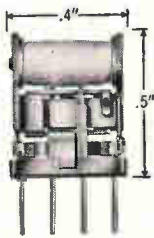

SIZE2" x .4" x .5"
TERMINAL SPACING	1/10" grid
RATING5 amp @ 30 VDC
COIL OPERATING POWER	150 mw
COIL RESISTANCE	60 ohms to 1,000 ohms
TEMPERATURE	-65°C to +125°C
VIBRATION	20 G
SHOCK	75 G

Write for Data Sheet No. 9

RUGGED ROTARY RELAYS  Dynamically and Statically Balanced

COUCH ORDNANCE INC.

3 Arlington Street, North Quincy 71, Mass., Area Code 617, CYPress 8-4147 • A subsidiary of S. H. COUCH COMPANY, INC.

New Subassemblies

ules. The devices are designed for military and industrial applications requiring high reliability, long life and error-proof operation. Bidirectional switch setting can be changed only while the button is being pressed. When finger pressure is removed, switch setting remains immobile in selected position. Casual tampering is prevented, safety is increased, and the operator is made more alert when changing switch position. The push-button can be supplied either above or below the switch assembly. Prices vary with number of modules, number of positions, circuit requirements, etc.

Chicago Dynamic Industries, Inc., 1725 Diversey Blvd., Chicago, Ill. [407]

Magnetic amplifiers offer high power gain

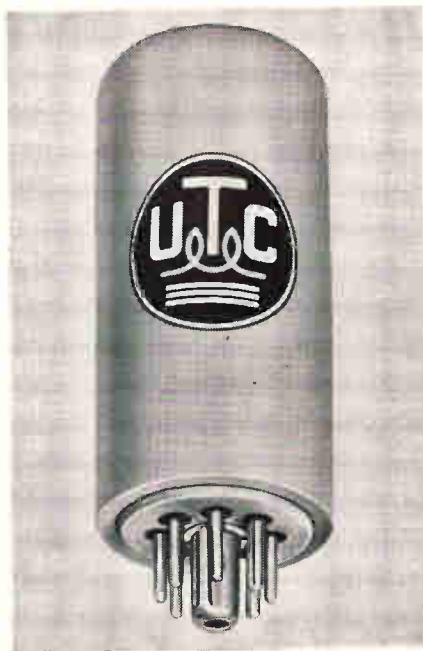

A new line of solid state, push-pull magnetic amplifiers is announced. They are iron core inductance devices affording high power gain. The MAS magamps operate on an input of 115 v 400 cps with an output of ± 7.5 v d-c, 1,000 ohm load and have two isolated control inputs. They afford a power gain of approximately 30,000. The power input and output are also completely and individually isolated.

CONSTANT VOLTAGE TRANSFORMER

Built-in Component Type

- * Completely automatic and continuous regulation within $\pm 1\%$ for input voltage fluctuation up to $\pm 15\%$
- * Regulated AC supply for semiconductor, filament, high voltage for rectifier tube, relay etc.
- * Compact, light weight and the most economical
- * Specialized in quantity production of built-in component type to your specifications. Write for new Bulletin

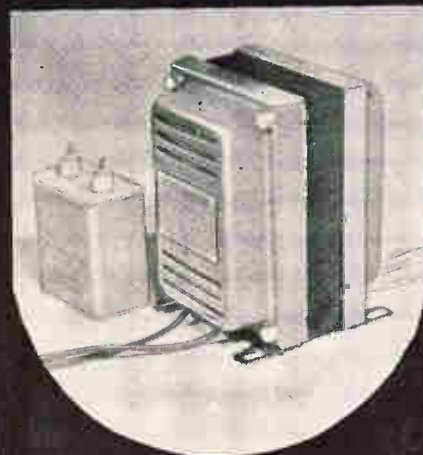

YEC

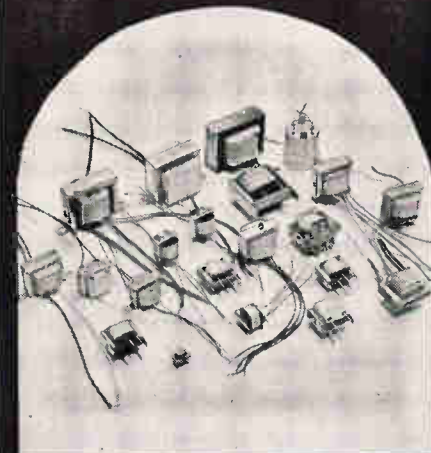

Specialist in

CUSTOM-BUILT TRANSFORMERS

TO YOUR SPECIFICATIONS

YUTAKA ELECTRIC invites you to submit your detailed specifications and quantity information to our engineering and production staff.

YUTAKA ELECTRIC MFG. CO., LTD.

1253, 1-chome, Yutaka-cho, Shinagawa-ku, Tokyo, Japan
Cable Address: "EDOYUTACO" Tokyo

The magamps are manufactured to MIL-T-27B standards. Units are housed in a hermetically sealed steel case with plug-in octal compressed glass terminals. They are 3 in. high with a 1½ in. diameter and weigh approximately ½ lb. The units feature long life and years of maintenance-free operation due to magnetic characteristics and solid state elements. They can withstand high shock, vibration, radiation, and moisture. The devices can also withstand 10 times overloads and operate into short without damage. Many possible applications include: control amplifier, photocell, scr controls, strain gage amplifier, meter preamps, and differential amplifier. United Transformer Corp., 150 Varick St., New York, N. Y. 10013. [408]

High-volume magnetic pickup



A low-priced, high-volume magnetic pickup has been developed for production-quantity requirements. Only 3/8 in. in diameter and 1¼ in. long, it is used in a wide variety of industrial measurement and control operations. Model 721962 magnetic pickup generates a-c voltage/frequency when an interrupting magnetic material moves in close proximity to its sensing face. It operates in a temperature range of -55°F to +225°F, and has a minimum peak-to-peak voltage of 34 v when tested at 1,000 in. per sec with a 20-pitch, 30-tooth gear at 0.005 in. clearance and load of 100,000 ohms. Coil resistance limits are 575 to 705 ohms; coil inductance limits, 165 to 250 mh. The shell is cadmium-plated steel and the pickup is supplied with two 6-in vinyl insulated flexible leads. Price is \$2.50 each in lots of 10,000. Electro Products Laboratories, 6123 Howard St., Chicago, Ill., 60648. [409]

LITTLE CHOPPER



Bristol Subminiature Chopper
Actual Size

BIG PERFORMER

Where component space is limited—Bristol's Subminiature Chopper offers:

- 0.1 cu. in. size
- complete shielding
- radiation resistance
- airborne environmental ratings
- lowest noise level

Write for detailed spec sheet. **The Bristol Company**, Aircraft Division, 152 Bristol Road, Waterbury, Conn. 06720.
A subsidiary of American Chain & Cable Company, Inc. 4.7

BRISTOL ... engineers for precision, builds for reliability



**BY
LAND**

ACL

**S-BAND TELEMETRY
RECEIVERS**



ACL Type TR-104

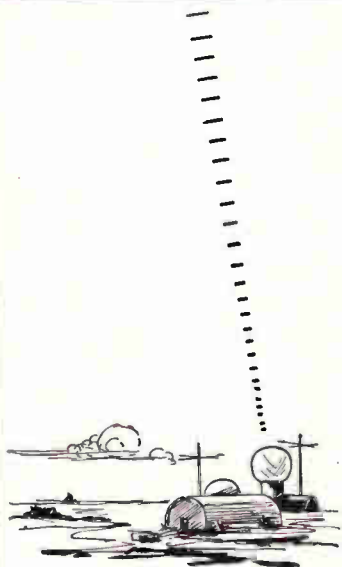

**MULTIBANDWIDTH SOLID STATE
TRACKING AND TELEMETRY
GROUND STATION RECEIVERS**

SEE THEM AT—

**NATIONAL TELEMETRY CONFERENCE
HOUSTON, TEXAS, APRIL 13, 14, 15, 1965**

**International Telemetry Conference
WASHINGTON, D. C. MAY 18, 19, 20, 1965**

ACL

**ASTRO
COMMUNICATION
LABORATORY**

DIVISION OF KELTEC INDUSTRIES, INC.
801 Gaither Road
Gaithersburg, Maryland
Phone: (301) 948-5210 TWX 710-828-9706
"RF Equipment for The Systems Engineer"

New Microwave

Millimeter klystron delivers high power

The 50BT/A is a versatile millimeter reflex klystron that delivers excellent power at a minimum price. Its broad tuning range of 46 to 54 Gc makes it a useful bench oscillator. Minimum power of 200 mw throughout this band assures adequate signal source capability, and peak power of over 600 mw makes the tube useful as a pump or low power transmitter. Optimum loading will usually double the minimum power output and will substantially increase power throughout the band. Developed for the use of electronic design engineers as well as research scientists, the new klystron has numerous applications in high altitude and space communications, high definition radar, microwave spectroscopy and plasma research. Warranted for 500 hours, the

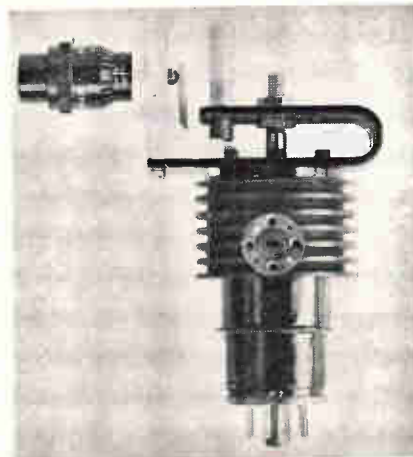

50BT/A will sell for \$1,040. Deliveries are expected to be made on a one month schedule.

Beam Tube Corp., 11 Beach St., Milford, Mass. [421]

**Very low leakage
X-band diode switch**



Model X417 switch/modulator/voltage-controlled attenuator has been developed for automatic radar testing systems. It features excellent shielding (leakage is 70 db below the waveguide power), isolation that is over 60 db and insertion loss that is less than 3.0 db from 8.5 Gc to 9.5 Gc. Over the broader band of 8.2 Gc to 11.0 Gc, at least 99% modulation is realized for modulation frequencies from audio to over 100 Mc. Model X417 is suitable also for service as a pulse modulator and for other ap-

plications where negligible leakage and radiation is mandatory for proper operation of a system in the presence of sensitive receivers. Price is \$420.

Somerset Radiation Laboratory, Inc., P.O. Box 201, Edison, Pa. [422]

**Microwave filters
need no calibration**

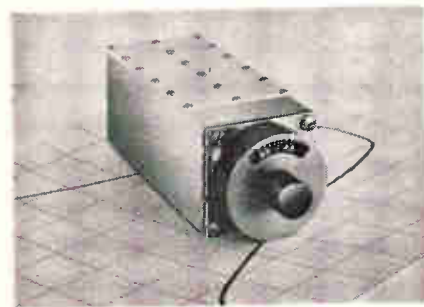

Two new tunable microwave filters cover the 2 Gc to 4 Gc frequency range. They are both direct dial reading, requiring no reference chart or external calibration. Accurate to within $\pm 1\%$ of the dial setting, the filters are supplied in 3 and 5-section versions under model

BY
SEA

ACL

**S-BAND TELEMETRY
RECEIVERS**



ACL Type TR-114

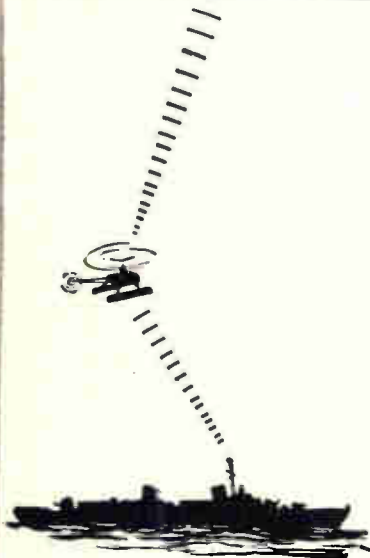

DESIGNED FOR ON-DECK SHIP-BOARD INSTALLATION. SOLID STATE MODULAR TELEMETRY RECEIVERS OPERATING -55°C to $+55^{\circ}\text{C}$.

SEE THEM AT—
NATIONAL TELEMETRY CONFERENCE
HOUSTON, TEXAS, APRIL 13, 14, 15, 1965

— — —
International Telemetry Conference
WASHINGTON, O. C. MAY 18, 19, 20, 1965

ACL ASTRO
COMMUNICATION
LABORATORY

DIVISION OF KELTEC INDUSTRIES, INC.
801 Gaither Road
Gaithersburg, Maryland
Phone: (301) 948-5210 TWX 710-828-9706
"RF Equipment for The Systems Engineer"

Circle 212 on reader service card

numbers TTA3000-5-3EE and TTA3000-5-5EE respectively. Insertion loss of the 3-section unit is typically 0.4 db, maximum 0.8 db; for the 5-section model these figures are 0.6 db and 1.0 db. Bandwidth at 3 db for both types is $5\% \pm 1\%$, maximum vswr at center frequency is 2:1 and nominal impedance is 50 ohms. The filter's performance is approximately that of a 0.01 db Chebishev type. Frequency is selected directly by the dial which is a 5:1 vernier type with a ball bearing movement and calibrated at 0.1 Gc intervals. The filter is housed in a one-piece aluminum case for maximum rigidity, and is equipped with type N female fittings as standard. The 3-section unit measures 2 in. by 2 in. by 4 in. and costs \$535; the 5-section unit is 2 in. by 2 in. by $5\frac{1}{2}$ in. and costs \$595.

Telonic Engineering Co., 480 Mermaid St., Laguna Beach, Calif. [423]

**Passive limiter
covers 8.5 to 9.6 Gc**

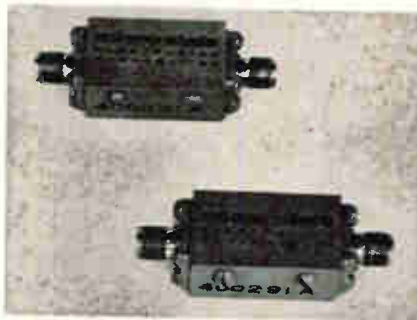

A new miniature passive limiter covers the X-band frequency range of 8.5 to 9.6 Gc. Model L-9102 limiter has a typical insertion loss for low level signals of 0.75 db and does not exceed 1 db over its operating range. This unit will protect receivers and tunnel diode amplifiers from powers up to 2 w with 0.4- μ sec pulse width and will offer, typically, 18 db of isolation for these high signals. The limiter's miniature size of 1 in. by $\frac{1}{2}$ in. by $\frac{1}{2}$ in., without connectors, makes it ideally suited for retrofitting systems where additional receiver protection is required. Model L-9102 is supplied with OSM type connectors.

The Micro State Electronics Corp., a subsidiary of Raytheon Co., 152 Floral Ave., Murray Hill, N.J. [424]

BY
AIR

ACL

**S-BAND TELEMETRY
RECEIVERS**



ACL Type TR-105

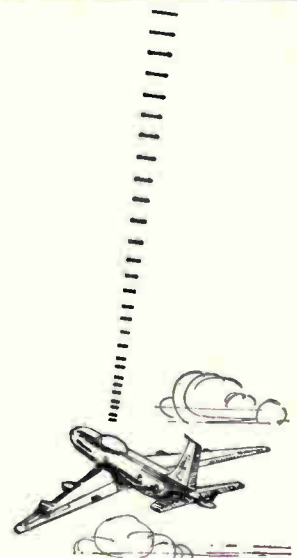

REDUCE MULTI-PATH EFFECT WITH HIGH CAPTURE RATIO, SOLID STATE MODULAR AIRBOURNE RECEIVING & DISPLAY SYSTEM

SEE THEM AT—
NATIONAL TELEMETRY CONFERENCE
HOUSTON, TEXAS, APRIL 13, 14, 15, 1965

— — —
International Telemetry Conference
WASHINGTON, O. C. MAY 18, 19, 20, 1965

ACL ASTRO
COMMUNICATION
LABORATORY

DIVISION OF KELTEC INDUSTRIES, INC.
801 Gaither Road
Gaithersburg, Maryland
Phone: (301) 948-5210 TWX 710-828-9706
"RF Equipment for The Systems Engineer"

Circle 167 on reader service card

Quick Reaction Capability that Counts



JANUS
Model B100-82
Forward-Backward
Counter Module with Display

HERE'S WHY:

These 1-mc Forward-Backward Decade Counters may be applied quickly and easily to systems and products requiring reliable high-speed bi-directional counting.

JANUS Model B100-80 Series Forward-Backward Counters Provide:

SPEED: Accept pulses to 1-mc in either direction.

QUICK REVERSING TIME: Less than two microseconds.

RELIABILITY: All transistorized, silicon circuitry throughout.

LOW COST:* \$115.00 (or less) for units with display, \$46.50 (or less) for units without display. Less costly than making them yourself.

FAST DELIVERY: From stock.

Available (with or without display) individually or in quantity for use in high speed counter applications where quality, low-cost and reliability are important.

Write for Technical Literature.

The Next Time You Need Counters Count on JANUS

*Price (FOB Newton, Mass.) even lower in large quantity.

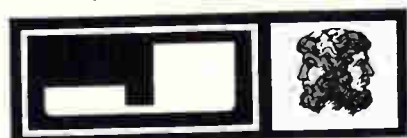

JANUS CONTROL CORPORATION
HUNT ST., NEWTON, MASS. TEL. 926-1037

New Production Equipment

Ultrasonic bonder fuses without heat

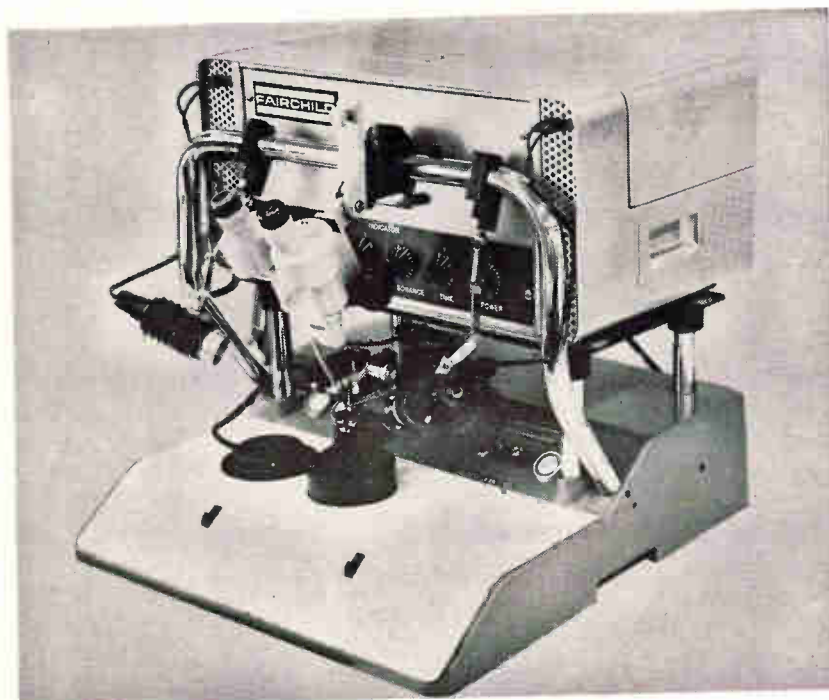

A major semiconductor production problem is eliminated by the model 1100 ultrasonic bonder, which produces reliable connections between transistor and integrated circuit parts and aluminum wires 1/1000th of an inch in diameter without using heat. After the semiconductor dice are fastened to bases, or headers, the aluminum wires must be connected from the dice to connection posts on the headers. Standard methods use heat to produce the fusion bonds, and sometimes cause a damaging discoloration called purple plague. Model 1100 uses ultrasonic energy instead of heat, eliminating any chance of purple plague, and speeding up the operation. The bond, which takes two-tenths of a second to produce, is the result of direct pressure and ultrasonic scrubbing. Oxides and impurities at the interface are pushed aside and the molecules of the two surfaces intermingle and grow into a firm bond. Target area of the bond can be as small as 1.5 mils by 3.0 mils. The tip which produces the bond is capable of up to 80,000 operations before refacing is required, and each tip can be refaced two or three times. Some important fea-

tures of the model 1100 are: simple tip replacement; adjustable power supply for different thicknesses of wire and header post; single control X and Y rotational motion; fast rethreading design and non-clogging capillary to feed the wire; use of hard-drawn aluminum wire with high tensile strength to eliminate breakage; and completely automatic wire feed. The unit is 20¼ in. wide, 20 in. deep and 19 in. high. It uses 115 v a-c electrical power and compressed air at 60 to 80 psi. Price is \$5,695.

Fairchild Semiconductors, 313 Fairchild Drive, Mountain View, Calif. [451]

Metallic comparator aids lead welding

A new, portable test instrument quickly and easily permits positive identification of materials for component lead welding. According to the manufacturer, the metallic comparator is the first component lead-testing instrument which makes it economically feasible to inspect completely all leads by providing a nondestructive, rapid and inexpensive method of determining lead material. The battery-operated,

completely portable unit permits positive identification of five diameters of eight materials most commonly used in welded construction techniques. Up to 6,000 leads can be checked by unskilled personnel in a normal eight-hour shift. Using color coded scale, the comparator provides both chemical and physical property readings, unlike methods presently in use which give chemical composition only. It was developed by Northrop's Nortronics Division for use on advanced missile and spacecraft navigation and guidance system welding. Apollo Instruments, Inc., Gardena, Calif. [452]

Sputtering unit deposits thin film



A new, low-energy sputtering unit is said to offer greater control and reproducibility in the deposition of thin-film materials. With this unit, called Plasma Vac AST-100, the deposition rate is constant throughout the cycle and the rate may be regulated by controlling voltage applied to a source material. Thickness uniformity can be held to within 2% over a 2 in. by 2 in. substrate. Film hardness and adherence are substantially improved as well, because metal atoms arrive at the substrate at a speed up to 40 times greater than that obtained by conventional evaporation processes. The system operates at 10^{-3} torr. PlasmaVac also has the capability of coating curved surfaces, depositing gold directly onto selected plastics, depositing resistor

You can reduce cost, save space and lower heat in transistorized circuits with General Electric's new #2158 indicator lamp.

Compare:

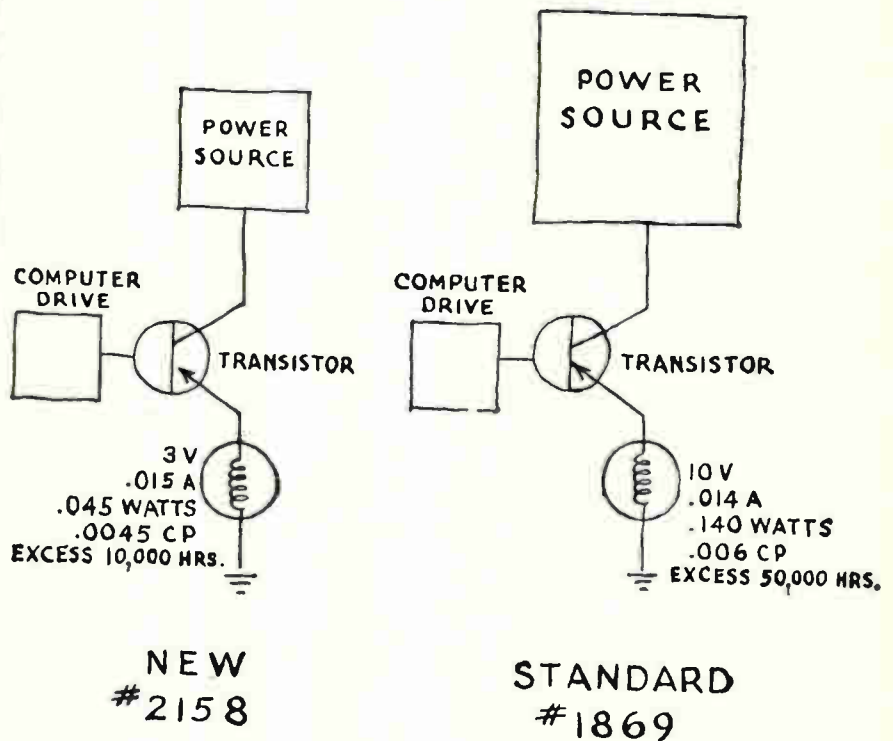

Gain immediate savings in cost and space requirements with General Electric's new #2158 low-wattage indicator:

THE #2158 REDUCES COST because its lower wattage permits a power source *smaller* than previously needed to drive G-E's #1869 indicator lamp. You also save by using a lower cost, high speed transistor.

THE #2158 CUTS SPACE REQUIREMENTS for the power source.

THE #2158 LOWERS HEAT by reducing wattage, so you may make further savings in reduced needs for heat-dissipating equipment. Chances are your transistors will operate better, too, in a cooler atmosphere.

The #2158 is available in both wire terminal and based versions. Wire terminals are cleaned and solderable.

You'll want all the details and specifications. Write for Bulletin #3-5097 from General Electric Co., Miniature Lamp Department M-15, Nela Park, Cleveland, Ohio 44112.

Progress Is Our Most Important Product

GENERAL  ELECTRIC

FIRST

we made
THERMISTORS
STABLE

SECOND

we made
THERMISTORS
INTERCHANGEABLE

THIRD

we made
THERMISTORS
LINEAR

NEW

YSI

THERMILINEAR®

THERMISTOR DEVICES

Now there are four new standard linear output thermistor devices covering ranges of 0 to 100°C, -5 to +45°C, -30 to +50°C and 30 to 100°F. Total linearity, interchangeability and absolute accuracy tolerance is as low as $\pm 0.2^\circ\text{C}$. Sensitivity is 20MV/°C and higher. This is 400 times more sensitive than an IC thermocouple (0.05MV/°C).

Price per single Thermilinear device, under \$20.00. Distributor quantities available from Newark Electronics.

Write for complete specifications



YELLOW SPRINGS INSTRUMENT CO., INC.

Yellow Springs, Ohio

New Production Equipment

materials on a flexible polyester film, and depositing two source materials simultaneously or sequentially.

Consolidated Vacuum Corp., 1775 Mt. Read Blvd., Rochester, New York, 14603. [453]

Precision drill press with 12-inch throat

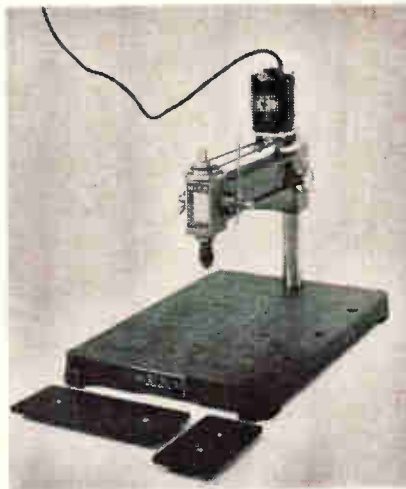

This precision drill press offers wide range and rugged design. It is especially suited for work on the larger sizes of p-c boards and other special items. The head casting, mounting post and base castings are all extra heavy and precision-machined to maintain stability during drilling operations. The drill head can swing radially and be adjusted vertically on the 12-in. high post. The head is locked in position with a built-in coordinate clamp on the 1½ in. diameter post. The spindle is equipped with dual, precision, pre-loaded and sealed ball-bearings for maximum life without adjustments. Dust protectors are incorporated to prevent entrance of abrasive dust to machined spindle areas. Maximum drilling depth is 1 inch; maximum throat capacity, 12½ in.; maximum operating distance between chuck end and base surface when using standard 12-in. post, 6½ in. Motor drive is a dynamically balanced 1½ h-p, 7500 rpm, 115 v universal motor. Catalog No. 926 deep-throat, precision drill-press assembly, consisting of No. 257 base with 12-in.

SIDE-LOOKING RADAR SYSTEMS ANALYSTS

New programs at HUGHES are generating opportunities for Systems Analysts experienced in high-resolution data gathering, data transfer and data processing systems. Openings exist for Systems Engineers, Mathematicians and Physicists qualified in synthetic array radars, optical, and other data collection systems (IR, Electro-Optical, SIGINT and others). Assignments include:

Senior Systems Scientist with 20 years' electronic systems experience—at least 10 years relevant to side-looking radar systems. Applicants will be considered for important program management responsibilities. M. S. or Ph. D. degree required.

Senior Systems Analysts with 10 years' electronic systems experience—at least 5 years relevant to high-resolution systems pre-design and evaluation. Applicants will be considered for assignments in concept formulation; single and multi-sensor applications; data transmission, processing and interpretation; systems integration and performance evaluation. M. S. or Ph. D. required.

Systems Analysts with 5 years' experience in: detection of signals in noise, optimum filter theory, non-linear signal processing, information theory, MTI and doppler systems analysis. B. S. or M. S. required.

Please airmail your resume to:

MR. ROBERT A. MARTIN
Head of Employment
Hughes Aerospace Divisions
11940 W. Jefferson Blvd.
Culver City 49, California

Creating a new world with electronics

HUGHES

HUGHES AIRCRAFT COMPANY
AEROSPACE DIVISIONS

U. S. CITIZENSHIP REQUIRED
An equal opportunity employer.



post, drill-press head assembly with 0-1/8 in. keyless chuck, motor drive and space belt, costs \$337.50. Mico Instrument Co., 80 Trowbridge St., Cambridge, Mass. [454]

New system automates schematics drafting

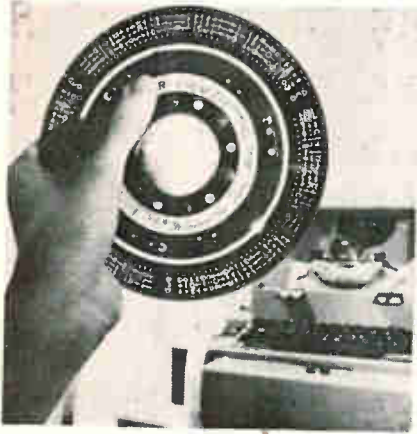

A design engineer's finished electrical or electronic circuit diagrams can now be "photodrafted" automatically at speeds up to 10 times as fast as they can be drawn manually. A trained typist can take an engineer's rough diagrammatical sketch and process it through the Photo-Draft system to obtain a finished schematic on drafting film within an hour's time. This schematic is then available for reproduction by standard processes such as diazo for similar-size copies, or microfilming for enlargement. The Photo-Draft equipment uses a light beam to make exposures on the drafting film through any combination of 168 different transparent schematic symbols, lines, letters or numbers contained on a revolving disk. The disk is positioned by commands from coded, 8-channel paper tape to make light exposures at the rate of approximately 200 a minute. The company says the use of Photo-Draft will not only free professional designers and skilled technical draftsmen from routine production drafting, but that the system also for the first time will permit use of either A-size (8 1/2 in. by 11 in.) or B-size (11 in. by 17 in.) drafting film for all finished schematics, instead of the larger C or D size schematics frequently used for many engineering drawings. Keuffel & Esser Co., Hoboken, N.J., 07030. [455]

YOKE SPECIALISTS

FOR INFORMATION DISPLAYS

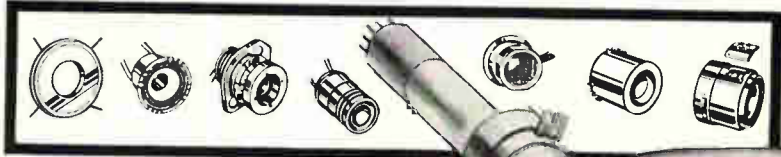

Syntronic's devotion to precision and attention to detail assure skillfully engineered deflection yokes in prototype or full production quantities. A complete line of value engineered yokes offer cost saving solutions to your CRT projects. Consult scientifically oriented Syntronic Yoke Specialists for the right yoke for your display.

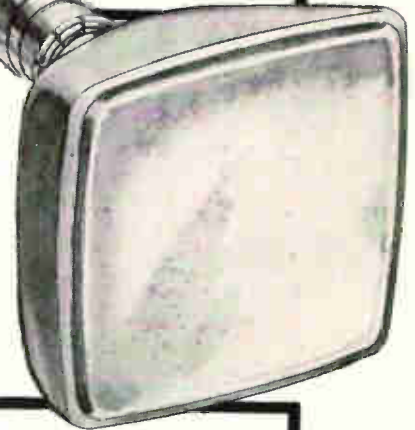

Syntronic INSTRUMENTS, INC.
100 Industrial Road, Addison, Ill.
Phone: Area 312, 543-6444

Circle 213 on reader service card

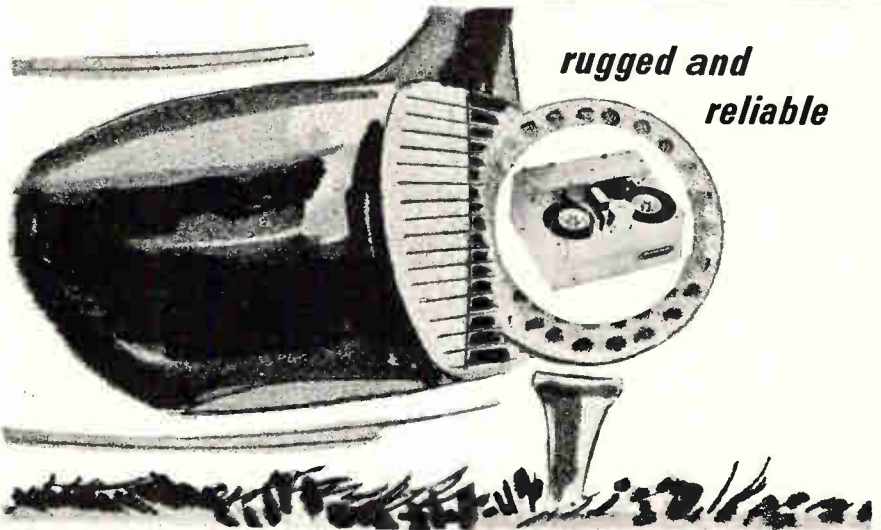

**rugged and
reliable**

For socko performance in severe environments, Genisco's 10-236 Miniature Tape Transport fits your needs to a tee. This ruggedized unit—ideal for "dummy" instrumentation, torpedo test and rocket probe applications—provides FM, direct or digital recording on up to 300 feet of 1 mil magnetic tape.

Model 10-236 offers the same tape speed and flutter characteristics as Genisco's larger-size family of tape transports: 1 1/2 to 120 ips in standard increments with low flutter even during peak environment period.

Write or call today for information on the right model to meet your requirements.

Genisco TECHNOLOGY CORPORATION
DATA DIVISION

18435 Susana Road, Compton, California (213) 774-1850

THE WORLD'S BEST AND MOST COMPLETE LINE OF MECHANICAL VACUUM PUMPS

REAL WORKHORSES

by **Kinney**

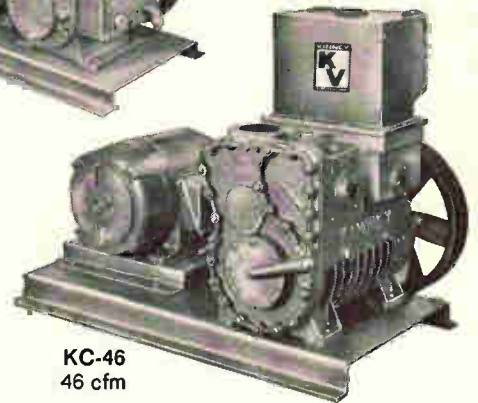
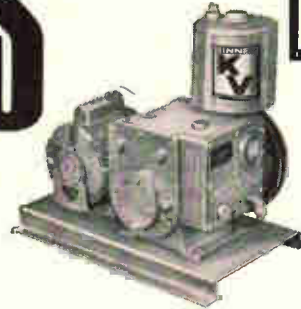

Time tested Kinney pumps are available in fifty different models and sizes ranging from 2 cfm to 850 cfm . . . with pressures ranging from 10 microns (0.01 torr). These long known and trusted pumps are immediately available. You get maximum performance at minimum cost. You know, Kinney leads the vacuum industry in vacuum pumps. Now is a good time to contact your local Kinney representative and find out how these reliable workhorses can help solve your vacuum problems.

KINNEY VACUUM DIVISION  3529 WASHINGTON STREET
THE NEW YORK AIR BRAKE COMPANY BOSTON, MASS. 02130

Circle 214 on reader service card

DRAMATIC REDUCTION

formerly 77" h. x 33" w. x 33" d.

now only

29" h x 17" w x 17" d

(5 KW Audio Power Amplifier)



All other models similarly reduced... (but in size only!) For instance, 10 KW Model, formerly 78" h. x 78" w. x 36" d., now only 48" h. x 34" w. x 24" d. CML Audio Power Amplifiers produce tremendous power in the smallest packages. Wide frequency range. Low distortion. Ideal for CW and pulsed operation,

acoustic testing, vibration testing, plasma tubes, ion propulsion engines. Perfect for marine installations. All units with wide range of output impedance taps. Air-cooled and vapor-cooled units. Full power available into low power factor loads. Call or write today for details.

CML, Inc.

A subsidiary of Tenney Engineering, Inc.
350 Leland Avenue • Plainfield, New Jersey
(201) 754-5502 • TWX: 201-756-2064



Planning to change your address?

Use the form below to indicate a change of address. Because our issues are addressed in advance, please try to allow at least 5 weeks for change of address to become effective. Attach the address label from your most recent issue in the space provided below.

[Please print the following information for proper service]

Title or position

Name

Chief job responsibility

Company and Div

Product or Service Approx. No. of employees

Address

City Zone State or Prov.

Mail to: Fulfillment Manager, Electronics
P.O. Box 430, Hightstown, N.J. 08520

***Paste present mailing label or address from wrapper or envelope here.**

New Materials

Kit provides circuits quickly

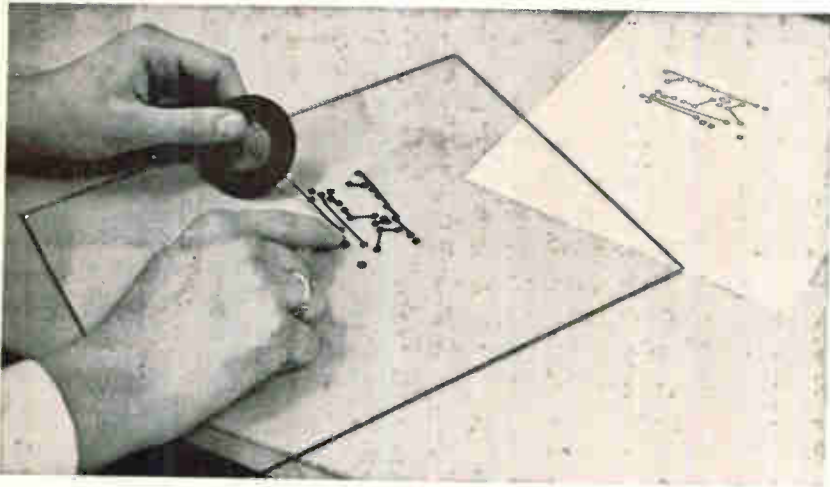

A self-contained flexible circuitry kit is now available. It is expected to save circuit designers considerable time because they will be able to design a circuit, make it and test it under operating conditions, all within the span of a few minutes. Heretofore circuit designers were obliged to wait a week or more for experimental circuits to be made from their drawings. The new kit utilizes the firm's photosensitive Schjel-Clad, a copper-Mylar lamination that has proved to have many applications in the field of flexible cabling. All the basic materials for making the circuits are contained in the kit, except for water and a light source. (Sunlight can be used as a light source.) The kit contains a 10-by 12-in. glass plate, a roll of black plastic adhesive tape, a quantity of small plastic washers, plastic gloves, developer, etchant, catalyst and trays. A circuit designer lays out his circuit on the plate glass, utilizing the black tape to create the image of the circuit and the plastic washers to provide rounded terminals for soldering. He places the Schjel-Clad beneath the glass—in direct contact with the taped circuit—and exposes it to a light source, then submerges the exposed Schjel-Clad in the developer for approximately two minutes. Next he washes it and immerses it in the etching solution, where all the copper except that protected by the taped circuit is

etched away. The result is the designed circuit—a copper pattern on an insulating sheet of Mylar. It can be immediately installed and tested under actual operating conditions. Etching time varies from six to 30 minutes, depending on the thickness of the copper in the Schjel-Clad. The kit sells for about \$35, and replacement components are available at nominal cost.

G.T. Schjeldahl Co., Northfield, Minn. [441]

Epoxy coating resists abrasion

HumiSeal type 2B13 is a modified, low viscosity, epoxy coating. The two-component system is said to have outstanding abrasion resistance and excellent flexibility. It is recommended for thin coating applications. The material has superior mechanical and electrical characteristics after a short bake cure. However, it will cure in 24 hours at room temperature. Four-to-six-hour pot life is one of its outstanding features. Type 2B13 has been specifically designed for printed-circuit board applications. It may be applied by dip, brush or spray, and it is impervious to all standard cleaning solutions. Columbia Technical Corp., Woodside, N.Y., 11377. [442]

MICROMINIATURE

PIN RECTIFIERS



50 to 2800 PIV

SERIES MM FEATURES:

- Extremely sharp breakdown characteristics
- High efficiency
- Very low capacitance
- Very low leakage
- Voltage and current ranges from 50 PIV — 500 ma (MM-0) to 2800 PIV — 125 ma (MM-28)

APPLICATIONS

Typical applications include — IR image intensifiers, voltage multipliers, RF diodes, coaxial switches, high voltage stacks for high frequency use.

CUSTOM DESIGNS

Solitron engineers would be happy to design special packages to your individual requirements.

Leader in Solid-State High Voltage Rectifiers, Temperature Compensated Zeners, Voltage Variable Capacitors, and Random/White Noise Components.

Solitron

DEVICES, INC.

256 Oak Tree Road, Tappan, New York 10983
Tel: 914-359-5050

At last — one comprehensive volume fully explains . . .

INTEGRATED CIRCUITS

Design Principles and Fabrication

450 pages, 334 illustrations, \$12.50

Edited by

RAYMOND M. WARNER, Jr.
JAMES N. FORDEMWALT

Here is an effective way to keep your knowledge and skills up to date in integrated-circuit manufacture and design. This book provides information and solutions you can apply in your own work. It covers the manufacture, design and applications of semiconductor and thin-film integrated microcircuits in all phases of modern engineering. This book discusses theory and processing from initial material processing, through device packaging and reliability testing. Compiled by Motorola's pioneering Semiconductor Products Division, this book brings you the accumulated experience of top engineers, scientists, and technicians — including much significant and useful data formerly unavailable in a single source.

Motorola Series
in Solid-State
Electronics



Buy this book
in your bookstore
or mail this coupon

McGraw-Hill Book Co., Dept. 23-L-45
330 West 42 Street, New York, N.Y. 10036

Send me Motorola's
INTEGRATED CIRCUITS for 10 days on approval.
In 10 days I will remit \$12.50 plus a few
cents for delivery costs, or return book post-
paid. **SAVE MONEY:** We pay delivery costs if
you remit with coupon; same examination and
return privilege.

NAME (print) _____

ADDRESS _____

CITY _____

STATE _____

ZIP CODE _____

For price outside U.S.,
write McGraw-Hill Int'l., N.Y. 36

23-L-45

New Books

Communications

Single Sideband Handbook
William P. Henneberry
The Technical Material Corp.
Mamaroneck, New York
210 pp., \$10.00

Of late, there has been considerable concern over the efficient use of the radio spectrum. At the IEEE 1965 convention in New York City one panel discussion was entitled "Radio Spectrum Utilization as a National Problem."

One answer to the problem of more efficient use of high-frequency is single sideband (ssb) transmission. By the use of ssb techniques, information can be transmitted utilizing only one-half of the bandwidth of a conventional a-m transmitter.

Single Sideband Handbook was prepared as an introduction to ssb techniques as well as a reference tool for those already acquainted with the field. Its publisher is a manufacturer of communications equipment and has used its factory training course as the basis of most of the material presented. This has disadvantages—mainly in overemphasis of the publishers own equipment—as well as advantages.

Since the handbook is written for technicians, it goes into great detail on many basic topics. Several chapters in the first portion of the book are devoted to the explanation of the fundamental theories of amplitude modulation, single sideband, and the generation of waveforms. This is accomplished through the use of clear definitions and detailed explanations.

Much of the text is supported by the use of known equations for percent modulation, power in the carrier, power in the sidebands, total bandwidth required, etc. These equations are supported by typical examples. This mathematical approach is not intended to show the reader how to design but to explain the function of circuits and systems. Only a basic understanding of mathematics is required to follow the greatly detailed text and equations. A very helpful feature is the review problems and solutions presented at the end of some of the chapters. This review is excellent

for the reader using the handbook for a self-study course.

Toward the latter portion of this book, many of the explanations make frequent reference to Technical Material Corp. (TMC) communication equipment. This should be useful mainly to the technicians servicing this particular equipment. But, to the casual reader, the last portion of the book is difficult to follow. The discussion reads like a maintenance manual.

The handbook is organized satisfactorily and is well illustrated with many tables and diagrams. It should be a invaluable text for the TMC training course or for the technician who does not understand ssb systems and has the responsibilities of calibration and maintenance of TMC equipment.

Gilbert R. Levy

General Instrument Corp.

Dubious reference

Transistor Reference Book
A Datadex Publication,
M.W. Lads Publishing Co.
Second Edition, 298 pp., \$3.95

This book tries to do too many things and as a result fails in each of its endeavors.

The publisher says it is the first transistor book to include price information as part of the technical comparison data. However, the price information it gives is of little value. Letters are used to denote price ranges (for example, C = \$2.01 to \$4.00, D = \$4.01 to \$8.00, E = \$8.01 to \$16.00, etc.). Not only are the ranges too wide, no indication is given as to quantity involved. That a 1-to-15 unit price can be considerably different from a 1,000-and-up price seems to be ignored. Since the letters denoting prices are assigned to type numbers, it apparently is assumed that all manufacturers' prices are approximately the same.

Price information is out of date. For example, the price range of the 2N1070 is listed as \$40.00 to \$79.99; however suppliers of this type were selling it for \$7.95 more than 18 months ago.

Much of the transistor informa-

High torque, Self-shielded



AI-2 (actual size)

moving coil mechanism

Versatile mechanisms for critical indicating and control systems have "On-off", "+, -", "Go-no go", null, left-right, or scale indicators. High torque, self-shielded core magnet design permits grouping of functions in small panel space. Moving coil weighs 100 mg less and provides at least 10% more torque than best previously available mechanism of this type. Wide choice of sensitivities; synchro or standard mounting.

AMMON

AMMON INSTRUMENTS, INC.
345 Kelley Street, Manchester, N. H. 03105

Circle 215 on reader service card

we are your best bet
for electronic materials

"What did you say?"
"WE SAID, WE ARE
YOUR BEST BET
FOR ELECTRONIC
MATERIALS!"

We are a primary fabricator and supplier of high purity metals and alloys, compound semiconductors and thermoelectric cooling materials.

PHONE AREA CODE 509 747-6111
TWX 509-328-1464 Telex 032 610

IMMEDIATE SHIPMENT BY AIR PRE-PAID

COMINCO PRODUCTS, INC.

electronic materials division

818 West Riverside Ave.,
Spokane, Washington 99201

5603

tion is inaccurate. Several of the manufacturers listed, such as Clark Semiconductor and Secoa, have been out of business for some time. Few of the newer manufacturers are listed. TRW Semiconductors is not listed although its predecessor company is shown. Many errors appear in the listing of company division names and addresses and the second source listings are incomplete.

The use of the book as an interchangeability guide should be conducted with care. Selections are based on data sheet ratings rather than actual testing. The authors have devised a coding system which they say allows logical and simple selection and substitution of thousands of transistor types. However material, current gain, and package are not included as comparison characteristics, and switching transistors are not distinguished from communications types. This information is available from the reference book with some page flipping. The authors use a special code number for field effect transistors but do not distinguish between metal oxide semiconductor and junction types.

The elementary introductory material on transistor theory and the section on transistor circuits are not treated in enough detail to be useful. A considerable number of transistor outlines are presented and should prove useful.

The authors plan similar books on diodes, vacuum tubes and other devices.

Recently published

Plasma Diagnostics with Microwaves, M.A. Heald and C.B. Wharton, John Wiley & Sons, Inc., 452 pp., \$13.50

Transistor Reference Book, Second Edition, M.W. Lads Publishing Co., 294 pp., \$3.95

Fundamentals of Data Processing, Allan Lytel, Howard W. Sams & Co., 320 pp., \$6.95

Mathematics for Electronics Engineers and Technicians, Norman H. Crowhurst, Howard W. Sams & Co., 256 pp., \$6.95

Microwave Measurements Manual, Robert Kellejian and Clifford L. Jones, McGraw-Hill, Inc., 152 pp., \$4.50

Satellite Environment Handbook, Francis S. Johnson, Stanford University Press, 194 pp., \$7.50

Microwave Circuits, Jerome L. Altman, D. Van Nostrand Co., 462 pp., \$15

Applied Combinatorial Mathematics, Edwin F. Beckenback, John Wiley & Sons, Inc., 608 pp., \$13.50

EE's for . . .
Operations Research
Systems Engineering

RAC

ADVANCED CAREER OPPORTUNITIES

Research Analysis Corporation, a principal operations research and systems engineering adviser to the U. S. Army, offers several exceptional career positions to experienced, creative engineers and scientists, as outlined below.

OPERATIONS RESEARCH

Combat Analysis—Participate in OR dealing with military consequences of major policy decisions. Requires Masters or PhD, Army research background, publications record.

Combat Analysis—Help develop criteria for measuring military systems effectiveness, esp. command control and communications. PhD in EE or physics, 5+ years in military OR with emphasis on information theory and interpreting fragmentary data; publications record.

Logistic Simulation—Analyze current and proposed logistic systems, reduce to model form, develop computer simulation, evaluate measures of logistic and cost effectiveness. MS (PhD pref.) with applicable experience, 7090 or equiv. programming familiarity, publications record.

SYSTEMS ENGINEERING

(Electromagnetic Technology)

Electro-Optics—Study problems related to night vision, surveillance systems, identification and fire-control techniques. MS or PhD, 10-15 years military electronic systems experience with electro-optical design emphasis.

Applications Engineering—Appraise weapons systems and advanced developments for likely contribution to military operations. MS or PhD, 10-15 years background (pref. industrial) in weapons systems analysis.

Please send your resume to: Mr. John G. Burke, Professional Staffing

Research Analysis Corporation

McLean, Va. 22101
(Suburb of Washington, D. C.)

An equal opportunity employer

PRECISION PRESSURE MEASUREMENT at low cost

CEC's Universal Electromanometer System is the proven method. Reason: cost-per-channel is now within the range of even modest budgets, yet it still provides the outstanding accuracy and long-term stability that have made CEC Electromanometers famous.

This "universal" electromanometer consists of a servo amplifier and a selection of force-balance transducers for pressure ranges from 15 to 60 psia and ± 5 psid through 0 to 10,000 psid.

Additional advantages:

- ▣ Accuracy equals or exceeds that of precision mercury manometers; and virtually no maintenance is required.
- ▣ Multiple-transducer setups can share a single servo amplifier through a multi-channel adapter, thus reducing per-channel cost even further.
- ▣ Full-scale output of 10 volts can be read out directly on digital voltmeters.
- ▣ The system is housed in a cabinet for bench use; yet is readily adaptable for rack mounting.
- ▣ Being completely versatile, it is ideal for all laboratory, field, and process control applications.

For complete information, call or write for CEC Bulletin #1164-X14.

CEC

Transducer Division

CONSOLIDATED ELECTRODYNAMICS

A SUBSIDIARY OF BELL & HOWELL/PASADENA, CALIF. 91109
INTERNATIONAL SUBSIDIARIES: WOKING, SURREY, ENGLAND
AND FRIEDBERG (HESSEN), W. GERMANY

Technical Abstracts

Integrated digital circuits

An integrated decade counter and a binary-to-decimal decoder

J.E. Price
Fairchild Semiconductor division,
Fairchild Camera & Instrument Corp.,
Palo Alto, Calif.

Two digital circuits have been built using monolithic integrated circuit technology in a silicon planar epitaxial structure. They are a decade counter and a binary-decimal decoder.

A fundamental principle of integrated circuit design is to minimize circuit area so as to maximize the number of circuits on a wafer and to increase the yield of good circuits. Circuit area may be reduced by minimizing the number and size of components, or by designing the circuit to maximize the number of components that have n- or p-type regions in common—thus keeping the number of areas that must be separated by isolation diffusions to a minimum. For example, two transistors with common collectors can be integrated in an area 30% smaller than that required to integrate the two transistors with isolated collectors.

The circuit is conventional in that it consists of four binary triggered flip-flops connected in cascade, with feedback loops so that the binary scale of 16 is permuted to a scale of 10. Binary triggering is achieved by application of the charge-control transistor concept.

The decoder comprises a diode matrix driving ten high-voltage output transistors. A biquinary decoding technique is used which reduces the number of diodes in the matrix from 40 to 12. The cross-conductors for the matrix are constructed by diffusing low-resistivity stripes to form the conductive paths in one direction, and depositing a conductive layer of aluminum for the other. The voltage drops along the resistive stripes are minimized by feeding them into bases of pnp transistors rather than diodes, so that the effective stripe resistance is reduced by the transistor betas.

Presented at the International Solid State Circuits Conference, Philadelphia, Feb. 17-19.

Brighter trace

High contrast display storage tubes
D.C. Brooke and F.N. Ingham
Westinghouse Electric Corp.,
Elmira, N.Y.

A high-contrast display storage tube has been designed for various radar applications and for studying electrical transients.

In conventional tubes, with a storage grid and a collector grid immediately behind the viewing screen, an erase pulse partially discharges the storage grid and reduces the brightness of the trace. Since the erase pulse is periodic and variable in amplitude and duty cycle it controls the persistence of the trace. Nominal erase pulse times are 10 to 25 milliseconds; nominal duty cycles are 0.5% to 5%. The erase pulse also causes a glow on the viewing screen, which reduces the contrast of the trace.

In the new tube, a suppressor grid is placed between the viewing screen and storage grid. Simultaneously with the operation of the erase pulse, a pulse equal or slightly greater in amplitude and duty cycle, but of opposite polarity, is applied to the suppressor grid. The erase pulse discharges the storage grid but no electrons can pass the suppressor grid during the erase time. All parts of the screen not carrying any part of the trace remain totally black.

Besides better legibility, especially for faint traces, the new tube displays up to 10 shades of gray as against 4 or 5 for others.

While all display tubes produce a halo around brightly written areas, in the new tube the high-contrast feature increases the halo effect. Also, the presence of the suppressor grid causes a slight decrease in resolution of the tube.

Presented at the 1964 Electron Devices Meeting, Washington, Oct. 29.

Broadside arrays

Frequency-independent amplitude difference patterns in broadside arrays
Mark H. Ronald
Airborne Instruments Laboratory,
division of Cutler-Hammer, Inc.,
Deer Park, N.Y.

A new method has been developed

Electronics

New subscriber order card

- Please start my one year subscription billing me later for \$6.
- Send me a three year subscription at \$12.
- I prefer to enclose my payment now
- Bill my company instead

Name _____ Title _____

Company _____

Company address _____

City _____ State _____ Zip code _____

Products manufactured _____ or, services performed _____

Please check your department or function below

- Research, design, development Production, operation, maintenance
- Other [please describe] _____

L—
M—

14-D15

Business reply mail

No postage stamp necessary if mailed in the United States

Postage will be paid by McGraw-Hill Inc.

Electronics
P.O. Box 514
Hightstown, N. J. 08520

Subscription department

First class
Permit number 42
Hightstown, N. J.

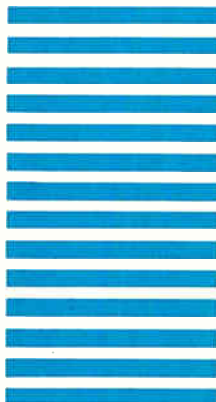

First class
Permit number 42
Hightstown, N. J.

Business reply mail

No postage stamp necessary if mailed in the United States

Postage will be paid by McGraw-Hill Inc.

Electronics
P.O. Box 514
Hightstown, N. J. 08520

Subscription department

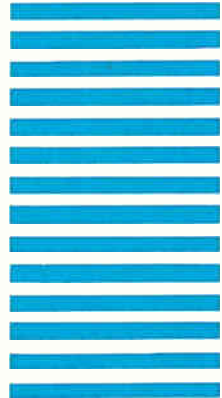

Electronics

New subscriber order card

- Please start my one year subscription billing me later for \$6.
- Send me a three year subscription at \$12.
- I prefer to enclose my payment now
- Bill my company instead

Name _____ Title _____

Company _____

Company address _____

City _____ State _____ Zip code _____

Products manufactured _____ or, services performed _____

Please check your department or function below

Research, design, development Production, operation, maintenance

Other [please describe] _____

L—
M—

14-D15

and demonstrated for achieving a frequency-independent amplitude-difference pattern in broadside antenna arrays. The technique is important in direction-finding systems, many of which use amplitude comparison as the basis of their operation.

In many such systems, two or more antennas that have beams pointing in different directions are used. Because of this difference in "look angle", the signal amplitude difference taken between the antennas varies as a function of the angle of arrival of the incoming signal. A plot of this function is called the amplitude-difference pattern. When it is desirable to use such an amplitude-comparison direction-finding system over a large frequency range, system accuracy can be preserved only if the amplitude-difference pattern is independent of frequency.

Two methods have been previously used to accomplish this. One method uses previously computed errors as the basis of corrections elsewhere in the system. The other approach is to make the frequency of each antenna independent—specifically, the antennas must be designed to have constant beamwidth and pointing accuracy. The adjustment of arrays of such antennas is critical, nonetheless, inefficient use of their apertures is inherent.

The authors describe a third method developed specifically for two-array systems. The beam-pointing characteristic of each array is made to vary in a frequency-dependent manner, and the variable beam-pointing compensates for variations in the pattern caused by frequency variations.

This is achieved by applying an arithmetically progressive frequency-independent phase shift to the antenna array elements. An additional degree of freedom can be gained by simultaneously applying a frequency-dependent phase shift to each array.

The technique was applied to an S-band antenna system consisting of two arrays of three cavity-backed planar spiral antennas. Antenna patterns were measured on



MAGNETICALLY SHIELD YOUR COMPONENT IN SECONDS

Versatile Netic and Co-Netic Foils cut to any size or outline with ordinary scissors—wrap easily

High attenuation to weight ratio possibilities; can dramatically enhance component performance. The shields stop degradation from unpredictable magnetic fields. When grounded, they also shield electrostatically. Co-Netic and Netic shielding foils are not significantly affected by dropping, vibration or shock, and do not require periodic annealing. Foils are available in thicknesses from .002" in rolls 4", 15", and 19-3/8" wide. Extensively used in experimental evaluation and production line operations for military, commercial and industrial applications.

MAGNETIC SHIELD DIVISION
 Perfection Mica Company
 1322 N. ELSTON AVENUE, CHICAGO 22, ILLINOIS
 ORIGINATORS OF PERMANENTLY EFFECTIVE NETIC CO-NETIC MAGNETIC SHIELDING
 Circle 217 on reader service card

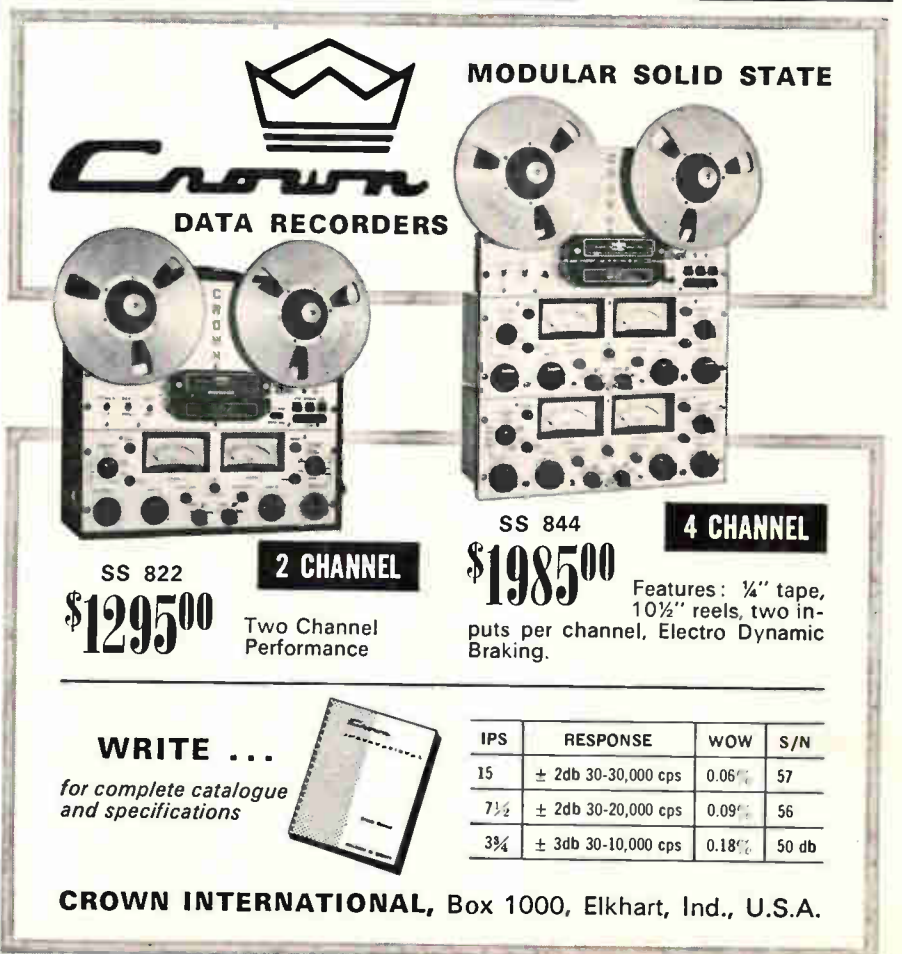

Crown
 DATA RECORDERS

MODULAR SOLID STATE

SS 822 2 CHANNEL
 Two Channel Performance
\$1295⁰⁰

SS 844 4 CHANNEL
\$1985⁰⁰
 Features: 1/4" tape, 10 1/2" reels, two inputs per channel, Electro Dynamic Braking.

WRITE ...
 for complete catalogue and specifications

IPS	RESPONSE	WOW	S/N
15	± 2db 30-30,000 cps	0.06%	57
7 1/2	± 2db 30-20,000 cps	0.09%	56
3 3/4	± 3db 30-10,000 cps	0.18%	50 db

CROWN INTERNATIONAL, Box 1000, Elkhart, Ind., U.S.A.

High-Protean Diet of Optical Devices

Photo-Coupled Transistors:

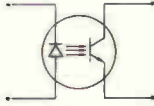

DC, AC, and pulsed signals • True electrical isolation (up to 25 kv in special packaging) • High current output • GaAs light source drives photosensitive multijunction device • Hermetically sealed TO-5 or TO-18 case; 4 leads

Phototransistor:

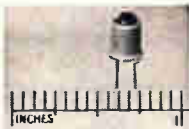

Quantum efficiency of photoconductive sensor >1000 • Spectral response, visible region to near infrared • Low unit cost • Applications for computer systems, industrial controls, optical tracking, optical relays • Standard enclosure, hermetically sealed TO-18 with lens • Special, line arrays and mosaics up to 100×100

Ultra-Low Capacitance Silicon Optical Detector:

Capacitance down to 3 pf/cm² • Peak response at 1.06 microns • Available in singles, arrays, quadrants

High D* Silicon Photovoltaic Sensor:

D* to 10^{13} • Peak at 9000A • Single chip and multiple chip mosaics up to 1000 detectors

Two-Color Detector:

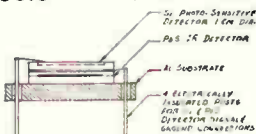

Antireflection-coated Si detects visible and transmits infrared to rear detector (PbS or other). Circular and quadrant assemblies. Special hemispherical Si acts as a 2 π front detector and as an IR lens.

GaAs Light Sources:

• High efficiency diodes for DC, AC, and pulsed operation • TO-5, TO-18, Varactor diode mount (0.050 dia. \times 0.125 L) • Peak emission $>10^{-3}$ watts/steradian DC at room temp. (TO-5 lens mount)

For a rich and varied diet of technical data, write or call ENL. You're also invited to ask for special servings in configurations designed to meet the requirements of specific applications.



**ELECTRO-NUCLEAR
LABORATORIES**

2433 Leghorn St., Mountain View, Calif. 94041

Technical Abstracts

the arrays at several frequencies, and showed a close approximation to the desired result.

Presented at the 1965 IEEE International Convention, New York, March 22-26.

Backward diode

Aluminum alloy junction backward diodes in microwave detection systems R.O. Wright and R.L. Goldman Philco Corp. Lansdale, Pa.

Germanium backward diodes that can operate at temperatures to 150°C are now available. The use of the backward diode as a doppler mixer and as a video detector has been described previously, but the premise of this paper is that improved performance can be obtained with high-temperature germanium backward diodes made by techniques using aluminum alloy junctions.

The aluminum-germanium junction, in conjunction with a highly preferential electrochemical etch, yields the low capacitance, (about 0.4 pf), and series resistance, (<2 ohms), necessary for efficient microwave operation of the new backward diode.

Diodes made with this new construction can be closely matched for parameters such as junction capacitance, peak current, and reverse voltage.

The high-temperature backward diode has been evaluated both as a mixer and a detector in such applications as the conventional superheterodyne mixer, low i-f frequency mixer, video detector, and power monitor.

As a superheterodyne mixer with a 30-Mc i-f frequency, the diode exhibits over-all receiver noise figures as low as 7 db at 9.375 Gc, with noise temperature ratios <1.15 .

As a video detector, the aluminum alloy junction diode exhibits a tangential sensitivity of -61 dbm at 9.375 Gc with a 2-Mc video bandwidth. The dynamic video resistance is about 5000 ohms, yielding a figure-of-merit in excess of 300 with typical R_{eq} values.

Presented at the International Solid State Circuits Conference, Philadelphia, Feb. 17-19.

STUCK for MAGNETS?



CALL PERMAG

We stock all sizes, all shapes, all grades, for all uses . . . all ready for 24-HOUR DELIVERY. Including soft magnetic materials — now available for the first time in small, less-than-mill-run quantities. Also, magnets engineered and fabricated to your needs. Write for catalog and data sheets.

PERMAG PACIFIC CORP. 6178 W. Jefferson Blvd., Los Angeles, Calif. 90016/ Phone: Area Code 213 VErmont 7-4479/TWX: 213 836-0445

PERMAG CENTRAL CORP. 5301 D Otto Ave. Rosemont, Des Plaines, Illinois 60018/ Phone: Area Code 312 678-1120

PERMAG CORP. 88-06 Van Wyck Expressway Jamaica, New York 11418/Phone: Area Code 212 OLYmpia 7-1818 / TWX: 212 479-3654

Circle 218 on reader service card

Reprint order form

Send to: Electronics Reprint Dept.
330 West 42nd Street
New York, N. Y. 10036

For listing of reprints available see the reader service card.

To help expedite mailing of your reprints please send cash, check or money order with your order.

For reprints of the latest special report:

Experiments on Gemini

Send me . . . reprints of key no R-70 at 50¢ each.

For reprints of previous special reports fill in below:

Send me . . . reprints of key no.(s) . . . at . . . ¢ each.

For prices see the reader service card.

Name

Number & Street

City, State

Zip code



EMPLOYMENT OPPORTUNITIES

PHYSICISTS OR ELECTRONIC ENG'RS

Opportunities for physicists (B.S. or M.S.) or electronic engineers in the stimulating field of Fundamental Particle Physics Research in the academic environment of one of the leading University laboratories of the world in beautiful Westchester surrounding. Benefits include tuition exemption plan.

Positions are open involving supervision of the maintenance, operation & development of large scale, automatic bubble chamber and spark chamber photograph analysis systems. Systems are on-line with modern digital computers.

Knowledge & experience required in digital electronics, optics & the engineering of high precision measuring machines. The most important requirement is a desire to assist in the exciting search for understanding of the world of elementary particles.

Please submit resume with salary requirements to

MR. A. E. STRAUSS

COLUMBIA UNIVERSITY
NEVIS LABORATORIES
P.O. BOX 137

IRVINGTON-ON-HUDSON, N. Y.

An Equal Opportunity Employer



E. E.'s

for FEE-PAID Positions
WRITE US FIRST!

Use our confidential application for professional, individualized service . . . a complete national technical employment agency.

ATOMIC PERSONNEL, INC.
Suite 1207L, 1518 Walnut St., Phila. 2, Pa.

ADDRESS BOX NO. REPLIES TO: Box No. Classified Adv. Div. of this publication. Send to office nearest you.
NEW YORK, N. Y. 10036: P. O. Box 12
CHICAGO, Ill. 60611: 645 N. Michigan Ave.
SAN FRANCISCO, Cal. 94111: 255 California St.

POSITION VACANT

Communications Engineer—FM Solid State
To locate in Miami, Florida. Require capable engineer with demonstrated experience in solid state FM two-way communications equipment. Must be able to independently launch projects and carry through to completion. Excellent working conditions, fringe benefits, advancement opportunity with leading national company. Send resume and salary requirements. P.O. Box 308, Riverside Station, Miami, Florida.

Need Engineers?

Contact them through this

EMPLOYMENT OPPORTUNITIES section

ELECTRONICS, SOLID STATE RESEARCH

New programs offer challenging new assignments in Monsanto's Central Research Department:

INTRUMENT ENGINEER

BS or MS in mechanical or electronic engineering with experience in development of electro-mechanical devices. Experience also desirable in device packaging for hazardous environments, magnetic circuits.

CIRCUIT DESIGN RESEARCH

BSEE or Physics with E.E. experience: experience essential in circuit and/or systems design. Digital circuitry and display devices preferred.

CIRCUIT DESIGN RESEARCH

BSEE or Physics with E.E. experience: experience essential in advanced circuitry particularly hi-speed and digital. Familiarity with integrated circuits advantageous.

ALSO

SEMICONDUCTOR DEVICE DEVELOPMENT

BS or MS in EE, Physics, or Metallurgy with five years experience in new device development. Some experience with compound semiconductors preferred.

DISPLAY RESEARCH

PhD in EE or Physics with experience in development of information display screens to investigate switching and scanning methods.

SEMICONDUCTOR MATERIALS RESEARCH

PhD in Physical or Inorganic Chemistry to explore new semiconductor compounds and then film semiconductors.

Attractive, well equipped research labs are located in suburban St. Louis. Excellent housing, schools, universities and cultural facilities are nearby.

Send resume in confidence to:

MANAGER, PROFESSIONAL RECRUITING

Department CL-201

MONSANTO

800 North Lindbergh Boulevard
St. Louis, Missouri 63166



An Equal Opportunity Employer

PROFESSIONAL SERVICES

GIBBS & HILL, Inc.

Consulting Engineers

Systems Engineering
Operations Research • Development
Field Studies • Design • Procurement
Power • Transportation • Communications
Water Supply • Waste Treatment

393 Seventh Avenue New York 1, N. Y.

ENGINEERING MANAGER ELECTRONICS

RESEARCH AND PRODUCT DEVELOPMENT

Responsible for Research, Design, Development & Production release of electronic products.

Space instrumentation background in stable frequency generation and digital and analog servos preferred. PHD or MSEE required.

CONTACT: Art Horle

THE BENDIX CORPORATION

Pioneer-Central Division
Hickory Grove Road
Davenport, Iowa

An Equal Opportunity Employer

EE's: Submarines = EE's: Space Stations

And that's pretty important.

When you consider that a nuclear submarine is, in effect, a manned "inner space" station, you get some idea of the great volume and variety of electrical and electronic equipment required.

For instance, it carries all of the electrical equipment necessary to generate light, heat and power 24 hours every day for months. It is equipped with ECM, and it is capable of firing Polaris missiles from upon or beneath the sea... involving almost every type of advanced electronic equipment and controls. Its nuclear power plant and its steering and diving devices are controlled by contributions from the electrical/electronic engineer.

The Engineers who work at Electric Boat enjoy this variety — and the opportunity of working closely with men from other disciplines.

Interested?

CHOOSE YOUR ASSIGNMENT AT ELECTRIC BOAT

1. EE's experienced in the installation, checkout testing, troubleshooting and/or test data analysis associated with complex weapons systems, preferably but not necessarily Polaris.
2. To work on power systems engineering and equipment specifications. Involves AC and/or DC power distribution system design and electric plant control equipment design.
3. To analyze electrical and electronic circuitry in systems such as radio, radar, ECM or sonar and to adapt these systems to government ship design specification requirements. Involves analysis of system interfaces for compatibility and design of necessary modifications.
4. For work in connection with the design and installation of interior communications, navigation ship control and/or fire control equipment and systems.
5. To develop control systems and to prepare component specifications for electric plant equipment. Involves power plant fluid system/electrical system design, AC/DC power distribution system design, motor and controller design and/or application.

For further details, send an outline of your background and salary requirements to Mr. Peter Carpenter. U.S. citizenship is required.

GD

GENERAL DYNAMICS | ELECTRIC BOAT

An Equal Opportunity Employer

128 Eastern Point Road, Groton, Connecticut

CHANGE JOBS PROFITABLY

Does one of these
demanding descriptions
fit you?

■ **SECTION MANAGER, TRANSMITTERS.** To direct aggressive development programs for state-of-the-art miniaturized RF transmitters. He should have ten years of experience in the design and engineering supervision of military communications equipment: it should have given him personal drive, demonstrated leadership ability, unusual technical understanding and keen administrative insight.

■ **SENIOR STAFF ENGINEERS, RECEIVERS.** Leadership capability sufficient for immediate assumption of key roles in vigorous development programs for solid-state micro-miniature receivers. Positions require six to eight years of experience and in-depth knowledge of receiver design fundamentals.

■ **PROJECT ENGINEERS, SPACE INSTRUMENTATION.** Technical ability of the very highest order is required. Six to eight years experience, preferably data handling, control, or analog instrumentation.

■ **DESIGN ENGINEERS, RF CIRCUITS.** With knowledge of state-of-the-art device and circuit technology. At least three years experience covering HF, VHF, UHF, or microwave applications.

If you qualify, your present job is not good enough. You can increase your personal satisfaction and professional rewards by contacting Electronic Communications, Inc., today.

ECI has built a solid, successful reputation in airborne communications, multiplexing and space instrumentation. The Company offers pleasant living conditions and unusual educational and cultural opportunities in St. Petersburg, Florida. And it offers you a chance to participate in further growth through technological contribution. Call collect Duane Meyer (813) 347-1121, or send him your resume at ECI, Box 12248B, St. Petersburg, Florida 33733. (An equal opportunity employer.)



**ELECTRONIC
COMMUNICATIONS, INC.**
St. Petersburg, Florida



SEARCHLIGHT SECTION

• CLASSIFIED ADVERTISING • BUSINESS OPPORTUNITIES
• USED OR SURPLUS EQUIPMENT

V.I.S* SERVICE

FASTEST TO BOTH COASTS

FOR YOUR VERY IMPORTANT SHIPMENTS

2nd DAY between Chicago—Milwaukee and Eastern Terminals

4th DAY between Chicago—Milwaukee and West Coast

LIFSCHULTZ FAST FREIGHT

NEW YORK — CHICAGO — PHILADELPHIA — BOSTON
HOLYOKE — BALTIMORE — BLOOMFIELD, N. J.
NEW HAVEN — PROVIDENCE — MILWAUKEE
LOS ANGELES — SAN FRANCISCO

CIRCLE 952 ON READER SERVICE CARD

SEMICONDUCTORS MAJOR BRANDS

INTERGRATED CIRCUITS • DIF. AMPS DARLINGTONS • POWER DIODES & TRANSISTORS • SPECIAL DEVICES

Write for Catalog S-1
SEMICONDUCTOR SALES OF CALIF.
1063 Perry Annex Whitier, Calif.
(213) 696-7544

CIRCLE 953 ON READER SERVICE CARD

TUBES & COMPONENT

FREE...CATALOG BARRY ELECTRONICS

512 BROADWAY 212-WALKER 5-7000
NEW YORK 12, N.Y. TWX-571-0484

CIRCLE 954 ON READER SERVICE CARD

ELECTRON TUBES

KLYSTRONS • ATR & TR • MAGNETRONS
SUBMINIATURES • C.R.T. • T.W.T. • 5000-6000 SERIES

• SEND FOR NEW CATALOG A2 •
A & A ELECTRONICS CORP.
1063 PERRY ANNEX
WHITTIER, CALIF.
696-7544

CIRCLE 955 ON READER SERVICE CARD

SMALL AD but BIG STOCK

of choice test equipment and surplus electronics

Higher Quality—Lower Costs
Get our advice on your problem

ENGINEERING ASSOCIATES
434 Patterson Road Doyton 19, Ohio

CIRCLE 956 ON READER SERVICE CARD

ROTRON COOLING FAN

Computer pullouts. Like new. "Muffin Fan. In-audibly cools amplifiers, tuners, power supplies, etc. Lengthens tube and equipment life—improves their performance. 4 1/16" sq. x 1 1/2" deep. 100 cfm. For 110-120 v. 60 cycle AC. 1 1/4 lbs. \$8.50 each.

MARS SALES P. O. Box 72832, Los Angeles, Calif. 90016

CIRCLE 957 ON READER SERVICE CARD

"Opportunity" Advertising
Think
"SEARCHLIGHT"
First

HEWLETT PACKARD

460 BR Wide Band Amp125.00	434 A Power Meter850.00
202 A Function Generator275.00	712 B Power Supply195.00
185 A Sampling Scope with	616 A Signal Gen 750.00
187 A Plug-In 1450.00	626 A Signal Gen1250.00
415 B VSWR Meter135.00	522 B Counter 500.00
430 CR Power-meter135.00	G-752-D Coupler 125.00
410 A VTVM 110.00	212 A Pulse Gen 225.00
380 A Attenuator 125.00	710 B Power Supply65.00

CONSOLIDATED ELECTRODYNAMICS

24-110 A Leak Detector2250.00
3294 B Autovac Gauge75.00

CALIBRATION STANDARDS

WB 100 A Wheelstone Bridge275.00
--

AD-YU ELECTRONICS

205 A (1-2) Phase Detector295.00
--

EPIC 100 D Pulser

.....225.00

KAY ELECTRIC

570 A Rada Pulser Sr.350.00
110 A Mega Sweep225.00
Radar Vari-Sweep275.00

BAIRD ATOMIC

GP-4 Transistor Tester250.00

FXR B-811 A

.....250.00

FARRAND OPTICAL

Grating Monochromator325.00

L&N OPTICAL PYROMETER

.....295.00

See previous issues for more equipment.
Send for Flyers.

All material in excellent condition. All prices F.O.B., San Francisco, Cal. subject to prior sale. Send for Listing and Flyers.

Marty's Mart

1236 Market St., San Francisco 3, California
Phone: Underhill 3-1215

CIRCLE 958 ON READER SERVICE CARD

An Investment!

Productive advertising is an **INVESTMENT** rather than an **EXPENDITURE**.

"Searchlight" advertisers almost invariably report prompt and satisfactory results.

BE CONVINCED—send us your advertisement TODAY.

Address Classified Advertising Division

ELECTRONICS

P. O. BOX 12, N. Y., N. Y. 10036

AUTOTRACK ANTENNA MOUNT

360 degree azimuth, 210 degree elevation sweep with better than 1 mil accuracy. Missile velocity acceleration and slewing rates. Amplifiers and servo control. Will handle up to 20 ft. dish. Supplied complete with control chassis. In stock—immediate delivery. Used world over by NASA, USAF. TYPE MP-61 B. SCR-584. NIKE AJAX mounts also in stock plus several airborne trackers.

SCR 584 AUTOMATIC TRACKING RADARS

Our 584s in like new condition, ready to go, and in stock for immediate delivery. Ideal for telemetry research and development, missile tracking, satellite tracking, balloon tracking. Used on Atlantic Missile Range, Pacific Missile Range, N.A.S.A. Wallops Island, A.B.M.A. Write us. Fully Desc. MIT Rad. Lab. Series, Vol. 1, pps. 207-210, 228, 284-286. Compl. Inst. Bk. avail. \$25.00 each.

PULSE MODULATORS

MIT MODEL 9 PULSER

1 MEGAWATT—HARD TUBE

Output 25 kv 40 amp. Duty cycle .002. Pulse lengths .25 to 2 microsec. Also .5 to 5 microsec, and 1 to 5 microsec. Uses 6C21. Input 115v 60 cycle AC. Mfr. GE. Complete with driver and high voltage power supply. Ref: MIT Rad. Lab. Series, Vol. 5, pps. 152-160.

500KW THYRATRON PULSER

Output 22kv at 28 amp. Rep. rates: 2.25 microsec. 300 pps. 1.75 msec 550 pps. 4 msec 2500 pps. Uses 5C22 hydrogen thyatron. Complete with driver and high voltage power supply. Input 115v 60 cy AC.

2 MEGAWATT PULSER

Output 30 kv at 70 amp. Duty cycle .001. Rep rates: 1 microsec 600 pps. 1 or 2 msec 300 pps. Uses 5948 hydrogen thyatron. Input 120/208 VAC 60 cycle. Mfr. GE. Complete with high voltage power supply.

15KW PULSER—DRIVER

Blased multivibrator type pulser gen. using 3E29. Output 3kv at 5 amp. Pulse lasts .5 to 5 microsec, easily adl. to 1 to 5 msec. Input 115v 60 cy AC. \$375. Ref: MIT Rad. Lab. Series, Vol. 5, pps. 157-160.

MIT MODEL 3 PULSER

Output 144 kw (12 kv at 12 amp.) Duty ratio: .001 max. Pulse duration: .5, 1 and 2 microsec. Input: 115 v 400 to 2000 cps and 24 vdc. \$325 ea. Full desc. Vol. 5, MIT Rad. Lab. series, pg. 140.

250KW HARD TUBE PULSER

Output 16 kv 16 amp, duty cycle .002. Pulses can be coded. Uses 5D21, 715C or 4PR60A. Input 115 v 60 cycle ac. Incl. H.V. pwr supply \$1200 ea.

5949 THYRATRON AGING RACK

Compl. Chatham Electronics Console incl. 15 kv power supply & PPN's. \$1800.

H.V. POWER SUPPLIES

1) 12 kv .75 amps nominal \$1400 ea. 2) 22 kv 100 ma nominal \$2200 ea. Std. 60 cycle inputs.

MICROWAVE SYSTEMS

E-4 FIRE CONTROL SYSTEM

Hughes Aircraft X Band. Complete. In stock.

C-BAND RADAR

250 KW output. C-band, PPI indicator, 5C22 thyatron modulator. Antenna, hi gain parabolic section. Input 115 volts 60 cycle AC, complete \$2750.00.

300 TO 2400MC RF PKG.

300 to 2400 MC CW. Tuneable. Transmitter 10 to 30 Watts. Output. As new \$475.

500KW "L" BAND RADAR

500 kw 1220-1359 mcs. 160 nautical mile search range P.P.I. and A Scopes. MTI. thyatron mod. 5J28 magnetron. Complete system.

PHILCO MICROWAVE LINKS

C Band Microwave Link terminal bays and repeater bays in stock. New \$1500 each or \$2500 per pr.

10KW 3 CM. X BAND RADAR

Complete RF head including transmitter, receiver, modulator. Uses 2J42 magnetron. Fully described in MIT Rad. Lab. Series Vol. 1, pps. 616-625 and Vol. II, pps. 171-185. \$375. Complete System \$750.

100—800MC. CW SOURCE

150 watts CW nominal output 115 V 60 Cy AC input. \$1000.

100KW 3CM. RADAR

Complete 100 kw output airborne system with AMTI, 5C22 thyr. mod. 4J52 magnetron, PPI. 360 deg az sweep. 60 deg. elev. sweep, gyro stabilizer, hi-gain revr. Complete with all plugs and cables.

M-33 AUTO-TRACK RADAR SYSTEM

X band with plotting board, automatic range tracking, etc. Complete with 1 megawatt acq. radar.

400 CYCLE SOURCE

Output: 115v 400 cycle 1 ph 21.7 amps cont. duty input: 208v 60 cycle 3 ph. req. 30r dc static exc. New. \$325 ea.

3KW RCA PHONE & TELEG XMTR

2—20 MC. 10 Autotone channels plus MO. Input 220 vac. 50/60 cycles.

Radio-Research Instrument Co.
550 5th Ave. New York 36, N.Y.
Tel. JUdson 6-4691

CIRCLE 951 ON READER SERVICE CARD

SEQUENCE RELAYS

UNIVERSAL 42-4039-1

SPST, 2 amp contacts; fibre-board mtg base 1x1 3/4" with two 5/32" d holes diagonally on 1 1/2" ctrs. Overall dimensions 2x1 1/8x1 5/8" h.

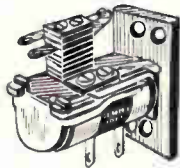

Stk. #s		Stk. #	
6VDC R4087	12VDC R4657	48VDC R4321	110VDC Each R4441 R4088
3.00	R4133	4.50	

*A-c operation thru diodes.

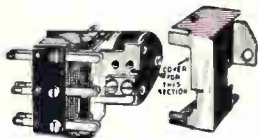

A sequence relay with three single pole normally open contacts. Starting with all three contacts open, the first pulse closes contact A. The second pulse closes B and opens A. Third pulse closes C and opens B. Fourth pulse returns relay to normal position with all contacts open. Contacts are of the crossbar type and are rated at 2 amp at 28VDC or 115VAC, non-inductive. Dimensions 1 3/4x1 7/8x2" h. Available in the following DC voltages.

Stock Nos.		Stk. #		Stk. #	
6VDC R2445	12VDC R2446	24VDC Each R2447	48VDC Each 6.00	110VDC Each R2448	6.25
				R2449	6.75

"Satisfaction is on the other end of your telephone"

RELAYS BY UNIVERSAL

Highlighted here are just a few of over 2,000,000 in 20,000 different types in stock . . . Most makes. This permits immediate delivery of production quantities. We are equipped to assemble, adjust and test any type of relay.

Average shipment made within 48 hours.

Orders requiring coil and frame assembly, special testing or adjustment are shipped within one week to ten days.

Send for latest 60-page free illustrated catalog #E which describes the largest inventory of relays in the world.

SEARCHLIGHT EQUIPMENT LOCATING SERVICE

No Cost or Obligation

This service is designed to help you, the reader of SEARCHLIGHT SECTION, to locate used or rebuilt equipment not currently advertised.

HOW TO USE: Check the ads in this SEARCHLIGHT SECTION to see if what you want is advertised. If not, print clearly the specifications of the equipment and/or components wanted on the coupon below, or on your own letterhead.

THIS IS A SERVICE TO OUR READERS. THIS PUBLICATION DOES NOT BUY, SELL OR STOCK EQUIPMENT OR MATERIALS OF ANY TYPE. Your requirements will be brought promptly to the attention of the used equipment dealers advertising in this section. You will receive replies directly from them.

Obviously, the list of such advertisers is limited by comparison with the over 63,000 subscribers to ELECTRONICS, all directly engaged in the electronics industry. A small "EQUIPMENT WANTED" advertisement in the SEARCHLIGHT SECTION will bring your needs to the attention of ALL who read ELECTRONICS. The cost is low.

SEARCHLIGHT EQUIPMENT LOCATING SERVICE

CLASSIFIED ADVERTISING

c/o Electronics

P. O. Box 12, N. Y., N. Y. 10036

Please help us to locate the following used equipment:

.....

.....

NAME

TITLE

COMPANY

STREET

CITY.....ZIP CODE.....

STATE..... 4/5/65

Universal RELAY CORP.

42 WHITE ST., NEW YORK 13, N. Y. • Walker 5-6900

CIRCLE 959 ON READER SERVICE CARD

New VACUUM PENCIL

for picking up miniature parts

PHILIP FISHMAN CO.
7 CAMERON ST., WELLESLEY, MASSACHUSETTS

CIRCLE 960 ON READER SERVICE CARD

3000 CYCLE MG SET

2KVA 115V. one phase, driven by 3HP 220/440V. 3 phase 60 cycle motor. Little used, mfd by Bogue Electric. What offered?

AINSWORTH LIGHTING

38-10 29th St., L. I. City, N. Y. 11101

CIRCLE 961 ON READER SERVICE CARD

FREE CATALOG! NEARLY 4,000 BUYS FOR INDUSTRY

OPTICS! SCIENCE! MATH! GIANT 148 PAGES

Many on-the-job helps . . . Quality Control Aids! Write for this completely new, 1965 Catalog. New items, new categories, new illustrations. 148 easy-to-read pages packed with hundreds of charts, diagrams, illustrations. A treasure-house of optical and scientific information . . . unusual bargains galore. Optics for industry, research labs, design engineers, experimenters, hobbyists! Instruments for checking, measuring—to speed work, improve quality, cut production costs. We give you facts: what it is—how it works—where it's used!

COMPARATORS, MAGNIFIERS, MICROSCOPES

Hard-to-get war surplus bargains—ingenious scientific tools—imported—domestic. Thousands of components: lenses, prisms, wedges, mirrors, mounts—accessories of all descriptions. Dozens of instruments: magnifiers, stereo microscopes, telescopes, binoculars, infra-red equipment, photo attachments. Shop by mail. No salesman will call. Use the Catalog of America's greatest Optics—Science—Math Mart. Known for reliability. Mail coupon below for catalog "EX". No obligation.

EDMUND SCIENTIFIC CO.
Barrington, N. J.

MAIL COUPON FOR FREE CATALOG "EX"

EDMUND SCIENTIFIC CO., Barrington, N. J.
Please send FREE Giant 148-page Catalog 'EX'

NAME

ADDRESS

CITY.....ZONE.....STATE.....

CIRCLE 962 ON READER SERVICE CARD

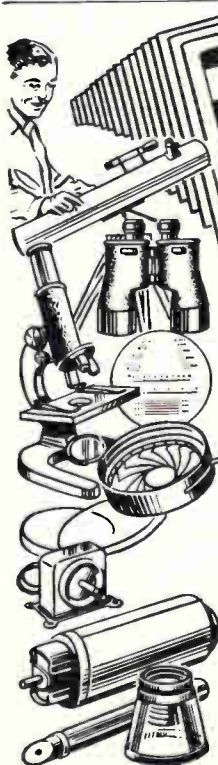

New Literature

Laboratory and test recorder. Honeywell Inc., Wayne & Windrim Aves., Philadelphia, Pa. 19144. A two-page specification sheet describes and illustrates the ElectroniK 15 laboratory and test recorder.

Circle 461 on reader service card

Digital voltmeter. Ballantine Laboratories, Inc., P.O. Box 97, Boonton, N.J., has published a bulletin describing the model 355 d-c/a-c dvm. [462]

Directional r-f wattmeters. Bird Electronic Corp., 30303 Aurora Road, Cleveland, Ohio, 44139. "Have Wave, Will Travel" is a six-page discussion of directional r-f wattmeters, why they work and how to use them. [463]

Thermoelectric power meter. General Microwave Corp., 155 Marine St., Farmingdale, L.I., N.Y., offers a brochure on models 454A and 454AR thermoelectric power meter with coaxial and waveguide thin-film thermoelectric power heads. [464]

Automatic soldering equipment. Hollis Engineering, Inc., Pine Street Extension, Nashua, N.H., has issued a catalog describing all three lines of its wave soldering equipment and discussing the advantages obtained from its oil/solder mix. [465]

Noise figure meter. General Microwave Corp., 155 Marine St., Farmingdale, L.I., N.Y. A four-page folder contains a complete description of model 551 solid-state, automatic noise figure meter with noise sources from 10 Mc to 18.0 Gc. [466]

Custom synthesis services. Melpar, Inc., 3000 Arlington Blvd., Falls Church, Va., 22046, has published a brochure describing its capability for the custom synthesis of organic, organometallic, and polymeric compounds. [467]

Automated production machines. Kahle Engineering Co., 3322 Hudson Ave., Union City, N.J., 07087, announces a brochure describing its facilities for designing and building of automated production machines. Copies may be obtained by writing on company letterhead.

D-c linear actuators. Globe Industries, Inc., 1784 Stanley Ave., Dayton, Ohio, 45404, offers a bulletin on type SS and GN linear actuators rated at 10 lb and 500 lb for strokes of 2 in. and 6 in., respectively, with power inputs of 12 v d-c and 28 v d-c. [468]

Metals and alloys. Materials Research Corp., Orangeburg, N.Y., 10962. A new brochure describes ultra-high-purity metal and alloy products and services available. [469]

Plug guide. ITT Cannon Electric, 3208

Humboldt St., Los Angeles, Calif., 90031. Numerous lines of multicontact electrical connectors are described in a new plug guide, catalog PG-7. [470]

Scr transformers. Aladdin Electronics, 703 Murfreesboro Road, Nashville, Tenn., 37210. An application note on scr transformers discusses how these may be used with a unijunction transistor, making the trigger circuit sensitive to specific frequencies. [471]

Synchro and resolver bridges. Theta Instrument Corp., Saddle Brook, N.J. Bulletin 3-20 is an eight-page design catalog giving complete data on a line of precision synchro and resolver bridges. [472]

Servomechanisms. McFadden Electronics Co., 8953 Atlantic Blvd., South Gate, Calif., has available a four-page condensed catalog of servomechanism systems and components. [473]

Products catalog. Ithaco Inc., 413 Taughannock Blvd., Ithaca, N.Y. A short form catalog contains specifications on the company's major electronic products including: low-noise preamplifiers, high-gain lab amplifiers, charge amplifiers, analog memories, data systems and accessories. [474]

Anechoic chambers. Emerson & Cuming, Inc., Canton, Mass. A four-page illustrated brochure describes several new, high performance Eccosorb anechoic chambers. [475]

Trimming potentiometers. Techno-Components Corp., 7803 Lemona Ave., Van Nuys, Calif., 91405. A six-page catalog covers a line of wirewound microminiature trimming potentiometers. [476]

Tunnel diodes. Kmc Semiconductor Corp., Parker Road, Long Valley, N.J., 07853, offers a new tunnel diode manual covering microwave, computer, detector and general purpose diodes. [477]

H-film insulation. Haveg Super-Temperature Wires, Inc., West Canal St., Winooski, Vt., 05404, has prepared an eight-page technical report on duPont H-film (Kapton) used as insulation for electronic wire and cable. [478]

Push-button switches. Cherry Electrical Products Corp., P.O. Box 439, Highland Park, Ill. A single-page bulletin illustrates and describes the E33-00G and E33-50G push-push (push-on, push-off) switches. [479]

Television recorders. Ampex Corp., Mail Stop 6-1, 401 Broadway, Redwood City, Calif. Models VR-660 and VR-1560 portable videotape television recorders are described and illustrated in a new product sheet. [480]

**YOU CAN SPLIT LOGS,
hairs, votes, and some
heat-shrinkable tubings,
BUT YOU CAN'T SPLIT**

**FLEXITE
SHRINKDOWN**



PLASTIC TUBING

when properly selected from these four grades and applied according to Markel recommendations:

1

HT-105, Flexible Class A (105°C) Shrinkdown
Extruded tubing similar to Flexite HT-105; outstanding dielectric properties; adaptable for many uses; it shrinks at less than 200°F.

2

SD-105, Semi-Rigid Class A Shrinkdown
For uses where greater mechanical strength and rigidity are needed, and over components sensitive to higher than 200°F temperatures.

3

PO-135, Flexible Class B (130°C) Shrinkdown
Thermally stable tubing of specially formulated polymers; excellent electrical, chemical and oil resistance. Shrinks at 235°F. Meets MIL-I-23053 (wep), Class I.

4

TE-250, Flexible Class C (250°C) Shrinkdown
Of modified polytetrafluoroethylene; offers exceptional electrical, thermal, and chemical-resistance properties. Shrinks at 621°F.

Markel customers are saving many dollars and much valuable time with these magic tubings that shrink 50% in diameter with the flash of a heat gun—adding a sheath of mechanical and electrical protection over terminals, connectors, cables, components, and other irregular shapes. Let's see how this idea could serve you; write for technical data and samples.

L. FRANK **MARKEL** & SONS
SINCE 1922

ONE SOURCE FOR EXCELLENCE
Insulating Tubings and Sleeveings
High Temperature Wire and Cable
NORRISTOWN, PENNSYLVANIA 19404

ROTRON

solves your cooling problems
a free service at our
aerodynamic laboratories

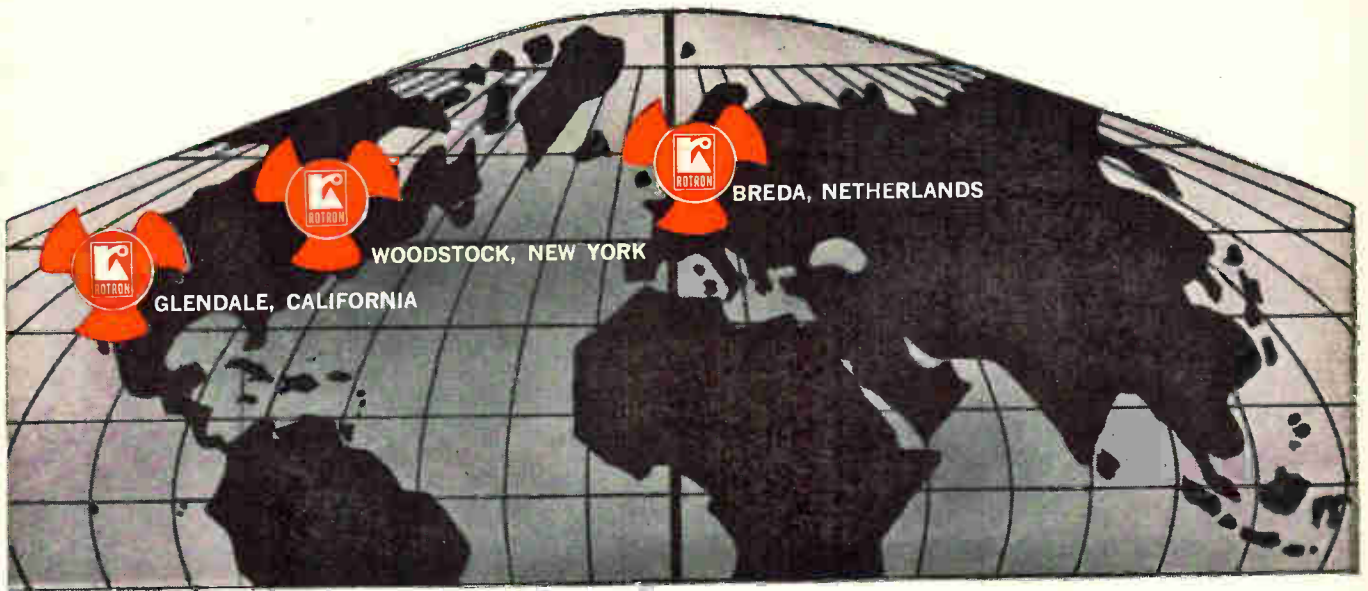

- Staffed by trained Rotron engineers
- Most up-to-date facilities
- To select most efficient cooling and protection for your equipment
- Assurance

Rotron has now expanded its laboratory facilities to readily service customers anywhere in Europe, or the Western Hemisphere.

In the European and two U.S. laboratories, Rotron offers the opportunity for the electronics engineer to determine cooling requirements for sub-assemblies or entire electronic and computer systems. The electronic package is placed in the AMCA test chamber and its characteristic impedance to airflow is measured and accurately plotted. This allows the engineer to determine in the prototype stage the optimum cooling or pneumatic requirement (air flow, physical size, acceptable noise level, power requirement, cost) necessary to maximum reliability in your product.

The recognized leader in the highly specialized and vital field of cooling electronic equipment, Rotron has extended their capability a step further with the opening of the newest laboratory in The Netherlands complementing the already existing facilities at Glendale, California and in Woodstock, New York. You are cordially invited to utilize these facilities as your projects require. There is no charge.

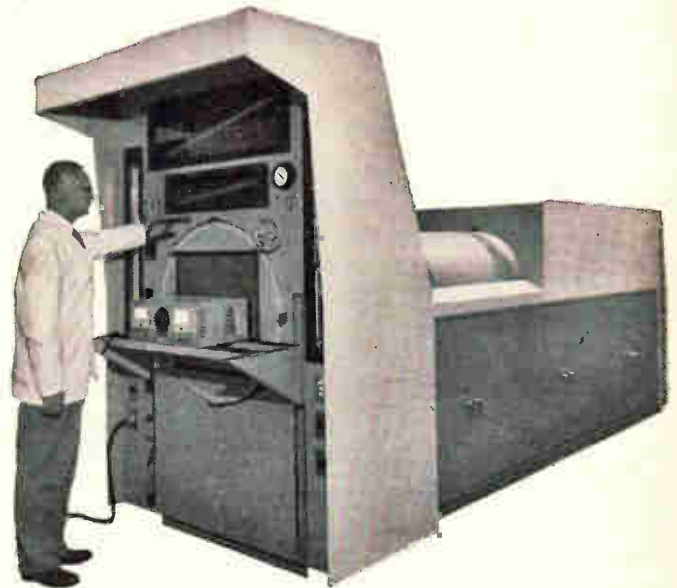

ROTRON MANUFACTURING COMPANY, INC.
WOODSTOCK, NEW YORK
West Coast: Rotron / Pacific, Glendale, Calif.
Canada: The Hoover Co., Ltd., Hamilton, Ont.
Rotron-Vactric Europa (N.V.) Breda, The Netherlands

Japan

Preferential treatment

Designers of integrated circuits and semiconductor devices may soon have available a process for growing silicon epitaxially on substrates, with no growth on regions masked by a layer of silicon dioxide. The preferential-growth process was developed by the Tokyo Shibaura Electric Co.

In conventional circuits made by the planar process, the impurity content is highest close to the surface. In making a single transistor this presents no serious problem because the impurity is lowest at the collector, highest at the emitter, and at an intermediate level at the base. But integrated circuits may require an isolation layer under the collector; obtaining the proper concentration in this layer is difficult with conventional techniques.

Independence. Toshiba deposits successive layers of the circuit epitaxially in windows—or holes—etched into the silicon dioxide on the substrate, and onto previously grown layers. Each layer's resistivity is independent of the layers above or below.

The Toshiba process can be combined with others to produce a variety of semiconductor devices. Anhydrous hydrogen chloride, which does not attack the oxide film, has been used to etch holes into the silicon wafers. Therefore, it's easy to create submerged as

well as planar and mesa structures. The new process already has been used to make all-epitaxial transistors, or with epitaxial bases or emitters, field effect transistors and silicon controlled rectifiers.

In diodes made with this technique, the p-n junction has reversed-bias characteristics; these indicate low leakage current and hard zener breakdown. One was fabricated on a 1.02- to 1.04-ohm-centimeter n substrate by epitaxially growing a p layer with an impurity of 10^{18} atoms per cubic centimeter of boron. The junction diameter is 0.7 millimeters.

Transistor. The sketch at the left below shows the structure of a transistor made with the Toshiba method. Epitaxial layers around the collector have no effect on its characteristics. Its typical cutoff frequency is higher than 130 megacycles; maximum collector voltage is 60 volts, and maximum collector current is 500 milliamperes. The current amplification factor at 100 ma is more than 20. Toshiba says its technique works most efficiently when the epitaxially grown region has maximum area.

Each transistor has three visible rings. The innermost is the emitter-base junction, the middle ring is the base-collector junction and the outer ring is where the collector region abuts the epitaxially grown region around the collector.

The sketch at the right below shows the first growth step in transistor fabrication. The circular p region is the transistor's base re-

gion. The shaded mask of silicon dioxide covers the collector region. The p region around the collector is the epitaxial region growth, which is permitted for improving the process. Because the transistor is n-p-n, Toshiba says no trouble is experienced with channels.

Soviet Union

Patent pact

One of the few mutual goals of the United States and the Soviet Union is increased East-West trade. Toward that end the Russians indicate willingness to remove a barrier to foreign businessmen. They say they'll sign an international agreement to protect patents and other industrial property rights.

The Paris Convention for the Protection of Industrial Property has 64 signatories, including several Communist countries in Eastern Europe.

Why the change? For all of its 48-year life, the Soviet government has helped itself to Western technology without respecting patents. It has entered into only a few licensing agreements.

Observers see two basic reasons for the shift.

- The Russians are convinced they now have products that can be sold in the West. These include computer controls for continuous casting of steel, and instruments for medical electronics.

- The Soviet government is acutely aware that Russian computer technology is several years behind the West's. It wants to increase its access to computers and electronic instruments through cross-licensing agreements.

What they offer. During 1964 the Soviet Union applied for 262 patents in the U. S.—more than in the entire previous history of the Communist regime. Rights to

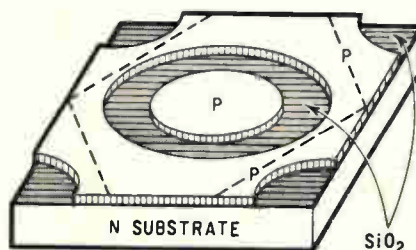
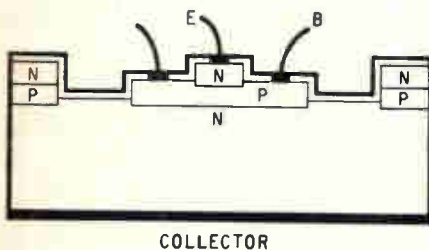

Complete mask-epitaxy transistor is at left. At right is the first junction made in the same transistor. Transistors are separated along dotted lines.

about 50 Soviet products and processes are controlled by the National Patent Development Corp.

Its president, Gerald Feldman, says 5,000 requests already have been received for an electronic sleep-inducing machine although the Food and Drug Administration has not yet authorized its use in this country. The machine operates on flashlight batteries. Feldman says a hospital model will sell for about \$200, with consumer models priced under \$100.

A steel-making system, recently installed in Novoi Lipetsk about 230 miles southeast of Moscow, is said to produce 300,000 tons a year with only three employees inside the mill. The Russians are expanding the facility tenfold, according to Martin M. Pollak, treasurer of National Patent, who recently visited the plant.

The only question is whether the Soviet process can produce rimming steel of high enough quality for use in the American automobile industry. The Russians say it can; now they're trying to prove it.

What they seek. A year ago, Soviet Academician V. N. Petrov wrote in Pravda, the Soviet Communist party newspaper, that Russian digital computers were "still bulky, expensive . . . and complicated in operation." This is similar to criticism leveled at U. S. digital computers in the late 1950's.

V. D. Lebedev, deputy chairman of the Soviet Union Economic Council, says about 10 million workers are now performing management tasks in Soviet industry, and calls for a reduction in this number. The only way to do this is to employ more electronic computers, which are in short supply, and specialists to operate them, who are even scarcer.

Last month the government announced that 119 major plants would begin using computers in the next two years to perform tasks in production management.

Besides computers, the Russians have expressed interest in buying, or building under license, sophisticated electronic instruments such as spectrometers and spectral analyzers.

Great Britain

Tv pipedream

A new type of waveguide, composed of copper tubing lined with polypropylene, is reviving hopes for transmitting television signals long distances through tubes.

Prof. H. M. Barlow of London's University College says the new waveguide can be bent into a circle with a radius of only four inches, with a loss of less than 0.20 decibel. In a recent demonstration, six right-angle bends were inserted in the circuit, adding only about 3.5 decibels of attenuation in a system operating at 30 to 40 gigacycles.

Tight fit. A layer of polypropylene 0.018 inch thick is bonded inside a copper tube 1.357 inches in outside diameter. The polypropylene acts as a dielectric and encourages propagation of the required wavemode by reducing the velocity of the unwanted modes.

The Barlow system is much cheaper to build than the traditional helical waveguide. In the older method, a fine enamel wire is helically wound on a polished steel mandrel, and the winding is covered with plastic to provide electrical attenuation between turns. The newer approach uses standard tubing. The polypropylene is extruded continuously and positioned onto the inner walls of the tube by a spreading technique.

The new system also uses flexible corrugated curvature sections, in which the wavefront is always radial with the tube. This is achieved automatically by the varied spacing of the corrugations. The tube is bent so that the inner section of the wavefront is slowed down and the outer section speeded up. Bends can be made without increasing losses.

Simple to make. With the simplicity of manufacture and of jointing—the copper sections are joined by an outside sleeve over the two sections—Barlow sees applications in urban areas where heavily loaded data transmission, closed-circuit tv and other circuits are required. By

working in the 8-millimeter band instead of at 4.5 millimeters as the Bell Telephone Laboratories did with the helical method, Barlow avoided close-tolerance difficulties.

"We could use standard terminal equipment," he explains. "The only difference is in the interconnection media between the terminals. As the system gives us a bandwidth of 12,000 megacycles, this is sufficient for some time to come. Probably later development will take it up to 4 millimeters and even into the optical range."

The new system is compatible with the helical system, whose filtering properties can be added by inserting 4- to 6-inch lengths of helical tube between sections of the lined copper tube.

Sweden

Loyalty in jail

As her loyal supporters crowded about and cheered, Sweden's renowned pirate queen, Britt Wadner, carrying a bouquet, boarded a train March 21 and headed for prison to start a one-month sentence for operating an offshore radio station.

A few hours earlier, in her last illegal broadcast over Radio Syd, Mrs. Wadner vowed to continue the fight against a 1962 law banning commercial radio transmission. Her defiant message was heralded and followed by a group called the Jailbird Singers. While Britt serves her prison term her son, Karl Gustav, 24 years old, is running the station.

Prison authorities say Britt will be allowed to work on company business in prison, but they have rejected her request to tape programs for Radio Syd.

Stormy seas. But the bravado of Radio Syd and its six counterparts off the shores of Britain and the Netherlands may not be enough for victory over an international armada heavily armed with laws and a treaty. It seems only a matter of time before the radio rebels are forced to strike their colors.

On Jan. 22 seven countries—Sweden, Denmark, France, Belgium, Greece, Luxembourg and Britain—signed a pact pledging to suppress any radio stations adjacent to their territorial waters.

The outlaw stations have been reaping handsome profits. The biggest, Radio Caroline off the British coast, is said to have paid off its \$1.5-million investment in a year and to be grossing \$42,000 a week.

Radio Syd broadcasts 21 hours a day, airing about 130 commercials by 40-odd advertisers. Before the antipirate law, her advertisers included the Swedish State Railways and the Scandinavian Airline System, which is partially government-owned. Last year the illegal radio grossed about \$300,000—without using any salesmen.

Suppliers' losses. Suppliers of radio equipment also have profited from the pirate operations. Equipment ranges from \$50,000 worth for a modest operation like Radio Syd to over \$1 million for Radio Caroline. But sales and service are forbidden by recent laws throughout Scandinavia.

Radio Syd is based on a ship called Cheetah II, flying the Honduran flag in the Oresund Strait between Sweden and Denmark. Her full-time staff of seven includes five engineers and two disk jockeys. For major repairs, technicians come out by boat from Malmö, Sweden's third-largest city.

Radio Syd uses a five-kilowatt transmitter made by Siemens & Halske AG in West Germany. An antenna and amplifier sometimes are used to boost the power to 20 kilowatts. Britt says her radio is beamed exclusively at Malmö.

Plans for tv. While mapping her legal defense, Britt disclosed plans to branch out into television. She said that Cheetah II was being fitted out for tv transmission and that test-sending might be started this spring. She refused to tell where she's getting equipment, but the transmitter and antennas are reported to be coming from United States companies.

Shortly before her arrest, Britt visited Radio Veronica, off the Dutch coast, to discuss cooperation



Demonstration for Mrs. Wadner, shown in left foreground. Signs say "Radio Syd does and gives," "Forward with Radio Syd" and "Down with injustice."

in the use of tv. She said she hoped to broadcast news, entertainment and films. Britt notes that the law forbidding pirate radios does not mention tv.

Europe's only pirate tv station, Tv North Sea, was a financial success before its demise. It is believed to have earned \$1 million in its 3½-month life before Dutch police raided it in December and dismantled its equipment. Tv North Sea operated from an artificial island, similar to an oil-drilling rig, five miles offshore.

The issue of commercial tv led to the resignation of the Dutch cabinet over that issue in February.

Commercials coming. Despite government opposition, commercial tv seems to have a future in Scandinavia. Swedish viewers already receive commercial telecasts from Finland, and Danish sets show West German hucksters. Several film studios in Sweden already are busy making tv commercial for West Germany or Britain.

Sweden already has one legal commercial station. It's a closed-circuit operation serving Sweden's biggest apartment building—about 770 apartments—in Malmö.

Launched in '58. Pirate radio operations started in 1958 in international water between Denmark

and Sweden. There were two floating stations in the beginning—Radio Mercur, broadcasting to Copenhagen, and Radio Syd, broadcasting from her original ship, Cheetah I. Radio Mercur was raided by Danish police last summer and put out of business.

Early in 1961 another Scandinavian pirate appeared, this one with American backing. Radio Nord, anchored in the Baltic Sea, broadcast to Stockholm and central Sweden. It was owned by Texas financiers including Robert F. Thompson of Dallas. The \$500,000 operation's light music and disk-jockey programs gained instant popularity; to compete, the Swedish Broadcasting Corp. added similar fare to its customarily intellectual programs. Radio Nord quit the pirate business in 1962.

Two British pirate stations, Radio Invicta and Radio City, broadcast from abandoned forts in the Thames estuary.

High rating. Radio Syd is popular in Malmö. One poll indicated that 87% of the area's radio listeners were tuned to the pirate station, compared with only 7% tuned to the Swedish Broadcasting Corp.

Blonde Mrs. Wadner is popular too. A former actress and advertising executive, she invariably re-

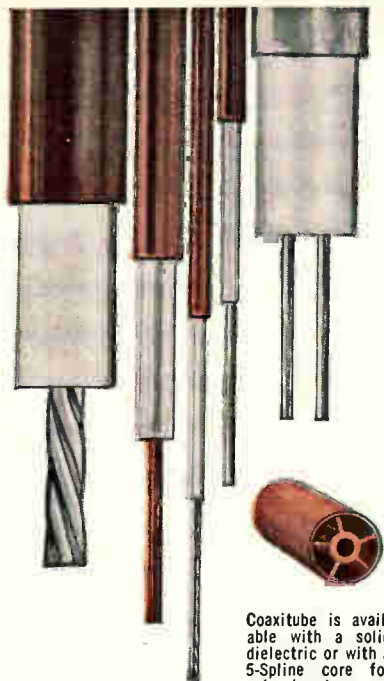

Coaxitube is available with a solid dielectric or with a 5-Spline core for extra low loss.

For Better RF Transmission

COAXITUBE

Tubular-Shielded Coaxial Cable

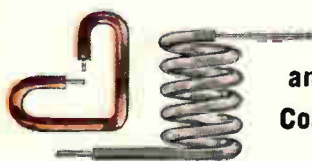

and Pre-Fab
Coax Shapes

For VHF and UHF transmission lines, where perfect RF shielding, excellent frequency response, and low attenuation are important considerations, Precision Coaxitube tubular-shielded coaxial cable is the ideal choice. It is comprised of a solid or stranded inner conductor, insulated with dielectric of Teflon or polyethylene, and covered with a seamless, non-ferrous metal jacket. The resulting coaxial cable construction is impervious to moisture, and has uniform electrical properties which surpass those of conventional braid-shielded cable. Coaxitube is offered in types equivalent to all the standard RG/U cables. Ask for more data.

Phone or write for prices
to your specifications

PRECISION
TUBE COMPANY, INC.
North Wales, Pa.

215-699-4806—Telex: 083-381

Electronics Abroad

ceives sympathetic treatment from the newspapers. One of her most popular programs is her own disk-jockey show.

Station automation

Self-service gasoline stations are nothing new in Sweden, but the one that the Nynas Oil Co. will open May 15 will incorporate a digital computer, using integrated circuits, that not only totals the bill and figures change but also keeps a running count of the gas left in the tanks. The only employee may be a cashier. It is one of the first commercial applications of integrated circuits.

The system was designed and produced by Retab, an electronics company whose maiden order was the contract signed with Nynas in October. Bertil Weyde, founder and president of Retab, credits integrated circuits with making the system possible. With them, he says, production is "fabulously simple;" and at about a dollar per circuit function, it is also economically feasible.

A system for five pumps costs about \$20,000, he says.

A customer for TI. The Retab system employs integrated circuits made by Texas Instruments, Inc. They're part of Series 73, a low-priced commercial counterpart of TI's Series 54 line, which was designed for the military and for more critical industrial applications.

Weyde says a self-service station that can accommodate up to 10 pumps requires 23 integrated circuits for each pump and 60 additional circuits in the office console. About 400 transistors are used. The system includes J-K flip-flops, two-input and five-input NAND gates, and transistor-driven Nixie tube readout stages.

Prototypes of another system using integrated circuits have been produced by Ljungmans Verkstader AB, a major supplier of service-station equipment. But that company says its system won't be offered commercially for several months.

West Germany

Hanover Fair

In 1947, British occupation authorities decided to help Germany's crippled economy by sponsoring a trade fair at Hanover. In 18 years, the fair has passed into German hands and become the world's biggest industrial exposition. When the 19th version opens April 24, it will also boast one of the biggest electronics displays.

Electronics had a hard time crashing the show. Although the German electronics market is now Europe's second-largest with annual sales of \$2.5 billion, it was a poor one in the early years of the fair. By the time foreign companies decided to exhibit, in the mid-1950's, the fair was booked solid.

New building. Last year a component show in Munich scored a big success [Electronics, Nov. 16, p. 175], and Hanover Fair officials decided the time had come to intensify their appeal to electronics companies. They put up a 75,000-square-foot exhibition hall exclusively for electronics exhibits. Within a few months, 150 concerns had reserved space there, in addition to the 350 firms previously signed up in the general area.

The new building increases the exhibition area, indoor and outdoor, to 6.5 million square feet. Over-all, about 5,800 companies and two million visitors will participate this year.

United States companies' participation has climbed to 80 from 12 last year.

Industrial electronics will have a prominent role, with a symposium to be conducted April 28 and 29 by eight German specialists.

Yugoslavia

East meets West

Yugoslavia will be able to receive telecasts from Western and Eastern Europe late this year when that country's broadband radio-link tele-

vision network is completed.

Eurovision, from the West, will enter at Trieste, where the Yugoslav system will tie in with the Italian networks. Programs from the Soviet bloc will enter at Vrsac, on the Rumanian border. Connections also are planned with the Austrian and Hungarian networks.

Italian suppliers. Two Italian companies won the international competition for the Yugoslav contracts. The biggest part, for \$1.1 million worth of equipment, will be supplied by Marelli-Lenkurt, a subsidiary of the General Telephone and Electronics Corp. It will include radio-link bays using solid-state demodulator units, and will operate at 4,000 megacycles per second.

The other supplier, V. C. Telettra of Rome, will supervise installation of the main north-south link through Croatia and a branch link running 240 miles down the Dalmatian coast to Split.

Around the world

France. The Hughes Aircraft Co. has won a \$20-million contract to supply data-processing equipment to West Germany, Belgium and the Netherlands. Hughes' international subsidiary in Paris says that payment will come from \$279 million earmarked for Nadge, the NATO air-defense ground-environment network [Electronics, Feb. 22, p. 188]. Officials at the North Atlantic Treaty Organization doubt that the award gives the Hughes-led consortium any competitive advantage over groups led by Litton Industries, Inc., and by the Westinghouse Electric Corp. More than one-half of the Nadge expenditures are expected to be for data-processing gear. Hughes thinks the new contract will enable it to set up production lines and to submit the low bid for the total project.

India. India's first plant for making television sets has begun pilot production. The government-owned facility in Rajasthan is expected to make 1,000 receivers a year by 1966.



For your vidicon, image orthicon and professional movie cameras, Cosmucar lenses are available in focal lengths from 12.5mm up to 1000mm.

New zoom lenses are now available.



ICHIZUKA OPTICAL CO., LTD.

2-56B, SHIMOOCHIAI, SHINJUKU-KU, TOKYO

CABLE ADDRESS: "MOVIEKINO TOKYO"

Circle 219 on reader service card

MITSUBISHI Photoconductive-Cells

CdS
PZC-7103



For the use of
Photoconductive
Cell-Operated Switches



CdS
PZC-3107

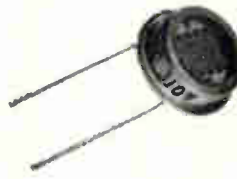

For the use of
Camera



CdSe
PZE-3101G

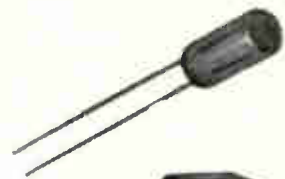

For the use of
Photoelectric-Chopper



Specifications

		PZC-7103	PZC-3107	PZE-3101G
Max. Rating	Voltage (V)	200	100	50
	Power (W)	0.3	0.03	0.01
	Temp. (°C)	75 ~ +60	75 ~ +60	-40 ~ +40
Max. Dimension	Thickness (in.)	0.32	0.12	0.52
	Diameter (in.)	1.10	0.37	0.26
Resistance (at 25°C)	100 lx.	1.6 kΩ	5 kΩ	70 kΩ
	10 lx.	8 kΩ	20 kΩ	--
	1 lx.	40 kΩ	80 kΩ	--
	Dark (after 30sec.)	5 MΩ	1 MΩ	1,000 MΩ

Electronics Division

MITSUBISHI ELECTRIC CORPORATION

Head Office: Mitsubishi Denki Bldg., Marunouchi, Tokyo. Cable Address: MELCO TOKYO



NEW!

Type "V" Miniature Air Variable Capacitors

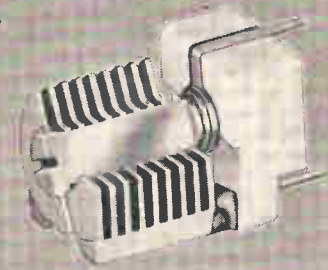

Available in Printed Circuit
and Panel Mount types

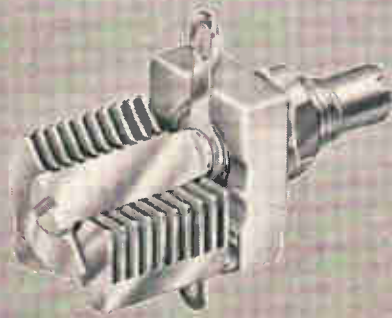
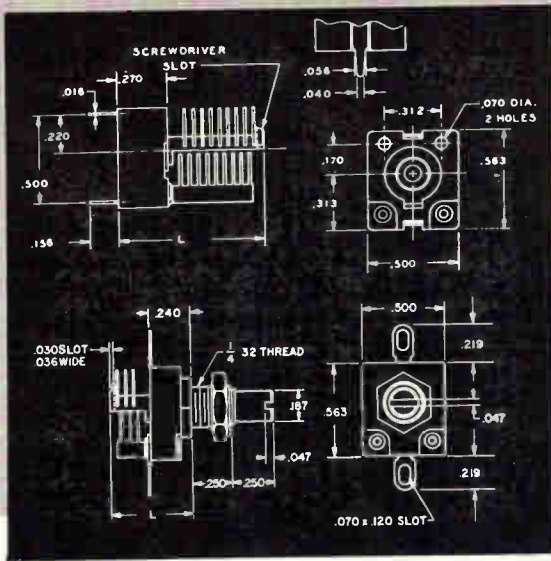

Precision machined for outstanding uniformity and electrical stability—low in cost!

The Type "V" Miniature delivers more capacity in less space — occupies less than 0.3 square inch for printed board or panel mounting. Rotors and stators are precision machined from one piece of solid brass — unique construction gives you high reliability and outstanding mechanical stability at modest cost! Series offers high "Q" (more than 1500 at 1 Mc.) . . . low temperature coefficient (plus 50 ± 20 PPM/°C) . . . and exceptionally uniform delta C and voltage characteristics. All metal parts silver-plated — ceramic is steatite grade L-423 or better. Voltage breakdown ratings to 650 Volts DC. Provides absolute freedom from moisture entrapment found in trimmers of the enclosed or solid dielectric type. Slotted rotor or shaft extension accommodates screwdriver or alignment tool for convenient adjustment.

Sub-Miniature Panel Mount "U" Variables and "U-LC" Tuners!

TYPE "U" Slightly smaller in size than the Type "V". Replaces costly glass piston capacitors — offers high reliability and excellent mechanical stability at a fraction of the cost.



"U-LC" TUNER Combines precision machined "U" capacitor with air-wound silver-plated inductor. Low cost, compact, tuneable "L-C" circuit with excellent "Q" and temperature stability.



WRITE FOR CATALOG 984!
Complete specification and
prices on all Johnson electronic
components.



E. F. JOHNSON COMPANY
3008 Tenth Ave. S.W. • Waseca, Minnesota 56093

Increase your skill and earning power as an ELECTRONICS TECHNICIAN



LIBRARY CONTAINS

Gillie's *Principles of Electron Devices*
Cooke's *Basic Mathematics for Electronics*
Gillie's *Electrical Principles of Electronics*

Whatever your past experience in electrical or electronics fields, you can easily master the skills and techniques that spell success in these areas today. Everything you need to know is in a unique 3-book Library that treats in detail basic fundamentals of electronics study. You gain a working knowledge of the mathematics required for solving everyday problems in modern electronics — including television, radio, and other fields. Arithmetical processes, logarithms, trigonometry, and algebra are explained in simple, non-technical language. Up-to-date concepts of *electron physics* . . . the nature and behavior of resistors, inductors, and capacitors . . . theories of magnetism . . . the characteristics of inductance and capacitance—and other subjects essential to a mastery of electronics are explained in detail. Finally, modern techniques for *designing new circuits* as well as analytical methods of correcting electronic problems of circuit design are presented.

BASIC ELECTRONICS LIBRARY

3 Volumes
1787 pages
1125 illus.
\$24.95

EASY TERMS:

\$6.95 in 10 days, then \$6.00 month for 3 months

Practical guidance on topics like these . . .

- Shows how to use the slide rule to simplify many mathematical operations
- Treats transistor multivibrator design and theory in detail
- Tells how to solve parallel circuits by the total circuit method
- Explains how to find the effective value of current or voltage
- Examines the circuit combinations with non-sinusoidal waveforms
- Shows how to apply Kirchhoff's Laws to analyze circuit conditions
- Considers the semiconductor diode and vacuum diode in terms of their operational similarities
- Analyzes tank circuits, using both vector algebra, and the principles of conductance, susceptance, and admittance
- And much, much more!

SAVE \$7.30! Purchased individually, the total price of these books would be \$32.25. Under this special offer, the complete Library is available for only \$24.95, a saving of \$7.30



10 DAYS' FREE EXAMINATION
Convenient Mail Service
Direct from MCGRAW-HILL

McGraw-Hill Book Co., Dept. 11-L-45
327 W. 41st St., N. Y. C. 10036

Send me the Basic Electronics Library for 10 days' examination on approval. In 10 days I will send \$6.95 then \$6.00 monthly until \$24.95 is paid. Otherwise I will return books postpaid. (If you remit in full with coupon, plus local tax, refund and return privileges still apply.)

Name

Address

City State Zip Code

Company

Position

For price and terms outside U. S. Write McGraw-Hill Int'l., N. W. C. 11-L-45

Electronics advertisers

April 5, 1965



Sanborn Co. A. Div. of Hewlett Packard Company Culver Advertising Inc.	49
Sanders Associates Inc. Chirurg & Cairns, Inc.	162
Sigma Instruments Inc. The McCann-Marschalk Company Inc.	70, 71
Solitrion Devices Inc. Armand Richards Advertising Agency	173
Sorensen Inc. Fuller & Smith & Ross Inc.	65
Sperr Carbon Company Hazard Advertising Company	26
Sprague Electric Company The Harry P. Bridge Co.	5, 6, 10
Superior Tube Company Gray & Rogers Inc.	140
Syntronic Instruments Inc. Burton Browne Advertising	171
TRW Electronics Fuller & Smith & Ross Inc.	33
Tektronix Inc. Hugh Dwight Adv. Inc.	46, 47
Telrex Laboratories George Homer Martin Associates	160
Texas Instruments Incorporated Industrial Products Group Robinson-Gerrard Inc.	138, 139
Texas Instruments Incorporated Metals & Controls Inc. Horton, Church & Goff Inc.	154, 155
TEXAS INSTRUMENTS INCORPORATED Semiconductor-Components Division	116, 117
Trygon Electronics Inc. Carpenter, Matthews & Stewart Inc.	126
Trylon Inc. George Moll Adv. Inc.	128
Tung-Sol Electric Inc. E. M. Freystadt Associates Inc.	132
United Transformer Corporation Philip Stogel Company Inc.	2nd Cover
West Penn Power Company Fuller & Smith & Ross Inc.	156
Winchester Electronics Div. of Litton Industries West, Weir & Bartel Inc.	27
Yellow Springs Instrument Company Odiorne Industrial Adv. Inc.	170
Yutaka Electric Mfg. Co., Ltd. Nichiden Adv. Ltd.	164

Classified advertising

F.J. Eberle, Business Mgr. Professional Services Employment Opportunities Equipment (Used or Surplus New) For Sale	179 179-180 181-182
---	---------------------------

Classified advertisers index

■ A & A Electronics Corp	181
Ainsworth Lighting	182
Atomic Personnel Inc.	179
■ Barry Electronics	180
Bendix Pioneer Central Div.	179
Columbia University Nevis Laboratories	179
Edmund Scientific	182
Electronic Communications, Inc.	180
Engineering Associates	181
■ Fishman, Co., Philip	182
General Dynamics Electric Boat	180
Lifschultz Fast Freight	181
Mars Sales	181
Marty's Mart	181
Monsanto	179
■ Radio Research Instrument Co.	181
Semiconductor Sales of Calif.	180
■ Universal Relay Corp.	182

Advertising sales staff

Gordon Jones [212] 971-2210
Advertising sales manager

Atlanta, Ga. 30309: Gus H. Krimser,
Michael H. Miller, 1375 Peachtree St. N.E.,
[404] TR 5-0523

Boston, Mass. 02116: William S. Hodgkinson
McGraw-Hill Building, Copley Square,
[617] CO 2-1160

Chicago, Ill. 60611: Robert M. Denmead,
645 North Michigan Avenue,
[312] MO 4-5800

Cleveland, Ohio 44113: Paul T. Fegley, 55
Public Square, [216] SU 1-7000

Dallas, Texas 75201: Richard P. Poole, The
Vaughn Building, 1712 Commerce Street,
[214] RI 7-9721

Denver, Colo. 80202: David M. Watson, Tower
Bldg., 1700 Broadway, [303] AL 5-2981

Houston, Texas 77025: Kenneth George,
Prudential Bldg., Halcombe Blvd.,
[713] RI 8-1280

Los Angeles, Calif. 90017: Ashley P.
Hartman, John G. Zisch, 1125 W. 6th St.,
[213] HU 2-5450

New York, N.Y. 10036:
Donald R. Furth [212] 971-3615
Frank LeBeau [212] 971-3615
George F. Werner [212] 971-3615
500 Fifth Avenue

Philadelphia, Pa. 19103: William J. Boyle,
Warren H. Gardner, 6 Penn Center Plaza,
[215] LO 8-6161

San Francisco, Calif. 94111:
James T. Hauptli, 255 California Street,
[415] DO 2-4600

London W1: John W. Patten, 34 Dover
Street, Hyde Park 1451

Frankfurt/Main: Gerd Hinske, 85
Westendstrasse Phone: 77 26 65 and
77 30 59

Geneva: Michael R. Zeynel,
2 Place du Port 244275

Paris VIII: Denis Jacob, 17 Avenue
Matignon ALMA-0452

Tokyo: Nobuyuki Sato
Shiba, Minato-ku (502) 0656

Osaka: Kazutaka, Miura, 163, Umegae-cho,
Kita-ku [362] 8771

Nagoya: International Media Representatives,
Yamagishi Bldg., 13, 2-Chome,
Oike-cho Naka-ku

Hugh J. Quinn: [212] 971-2335
Manager Electronics Buyers' Guide

David M. Tempest: [212] 971-3139
Promotion manager

Milton Drake: [212] 971-3485
Market research manager

Richard J. Tomlinson: [212] 971-3191
Business manager

Theodore R. Gelpel: [212] 971-2044
Production manager

■ For more information on complete product line see advertisement in the latest Electronics Buyers' Guide

Electronics reader service

Use these handy post cards for more detailed information on: products advertised, new products, new literature.

Circle the number on the Reader Service post card that corresponds to the number at the bottom of the advertisement, new product item, or new literature in which you are interested.

Please print clearly. All written information must be legible to be efficiently processed.

If someone has beaten you to the post cards, you may obtain the needed information by writing directly to the manufacturer, or by sending your name and address, plus the reader service number, to Electronics reader service department.

All foreign inquires that cannot reach Electronics before the expiration dates noted on the Reader Service post card, must be mailed directly to the manufacturer. The manufacturer assumes all responsibilities for responding to inquiries. Electronics merely provides and clears requests for information from inquirer to manufacturer.

Correct amount of postage must be affixed for all foreign mailings.

To subscribe to or to renew Electronics

Fill in the "For Subscriptions" area on the card if you desire to subscribe to or renew your present subscription to Electronics. Send no money. Electronics will bill you at the address indicated on the Reader Service post card.

Multi-product advertisements

For information on specific items in multi-product advertisements which do not have a specific Reader Service number indicated write directly to manufacturer for information on precise product in which you are interested.

7	April 5, 1965 Card Expires June 5, 1965	14
Name _____ title _____		For Subscriptions <input type="checkbox"/> new <input type="checkbox"/> renewal <input type="checkbox"/> 3 years \$12.00 <input type="checkbox"/> 1 year \$6.00
Company _____		
Address _____		
1 20 39 58 77 96 115 134 153 172 191 210 229 248 267 286 305 324 343 362 381 400 419 438 457 476 495 514 962 2 21 40 59 78 97 116 135 154 173 192 211 230 249 268 287 306 325 344 363 382 401 420 439 458 477 496 515 963 3 22 41 60 79 98 117 136 155 174 193 212 231 250 269 288 307 326 345 364 383 402 421 440 459 478 497 516 964 4 23 42 61 80 99 118 137 156 175 194 213 232 251 270 289 308 327 346 365 384 403 422 441 460 479 498 517 965 5 24 43 62 81 100 119 138 157 176 195 214 233 252 271 290 309 328 347 366 385 404 423 442 461 480 499 518 966 6 25 44 63 82 101 120 139 158 177 196 215 234 253 272 291 310 329 348 367 386 405 424 443 462 481 500 900 967 7 26 45 64 83 102 121 140 159 178 197 216 235 254 273 292 311 330 349 368 387 406 425 444 463 482 501 901 968 8 27 46 65 84 103 122 141 160 179 198 217 236 255 274 293 312 331 350 369 388 407 426 445 464 483 502 902 969 9 28 47 66 85 104 123 142 161 180 199 218 237 256 275 294 313 332 351 370 389 408 427 446 465 484 503 951 970 10 29 48 67 86 105 124 143 162 181 200 219 238 257 276 295 314 333 352 371 390 409 428 447 466 485 504 952 971 11 30 49 68 87 106 125 144 163 182 201 220 239 258 277 296 315 334 353 372 391 410 429 448 467 486 505 953 972 12 31 50 69 88 107 126 145 164 183 202 221 240 259 278 297 316 335 354 373 392 411 430 449 468 487 506 954 973 13 32 51 70 89 108 127 146 165 184 203 222 241 260 279 298 317 336 355 374 393 412 431 450 469 488 507 955 974 14 33 52 71 90 109 128 147 166 185 204 223 242 261 280 299 318 337 356 375 394 413 432 451 470 489 508 956 975 15 34 53 72 91 110 129 148 167 186 205 224 243 262 281 300 319 338 357 376 395 414 433 452 471 490 509 957 976 16 35 54 73 92 111 130 149 168 187 206 225 244 263 282 301 320 339 358 377 396 415 434 453 472 491 510 958 977 17 36 55 74 93 112 131 150 169 188 207 226 245 264 283 302 321 340 359 378 397 416 435 454 473 492 511 959 978 18 37 56 75 94 113 132 151 170 189 208 227 246 265 284 303 322 341 360 379 398 417 436 455 474 493 512 960 979 19 38 57 76 95 114 133 152 171 190 209 228 247 266 285 304 323 342 361 380 399 418 437 456 475 494 513 961 980		

Business reply mail
No postage stamp necessary if mailed in the United States

Postage will be paid by

**Electronics
Reader service department
Box 444
Hightstown, N.J. 08520**

First class
Permit no. 42
Hightstown, N. J.

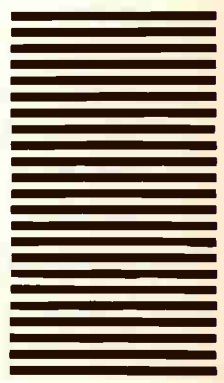

7	April 5, 1965 Card Expires June 5, 1965	14
Name _____ title _____		For Subscriptions <input type="checkbox"/> new <input type="checkbox"/> renewal <input type="checkbox"/> 3 years \$12.00 <input type="checkbox"/> 1 year \$6.00
Company _____		
Address _____		
1 20 39 58 77 96 115 134 153 172 191 210 229 248 267 286 305 324 343 362 381 400 419 438 457 476 495 514 962 2 21 40 59 78 97 116 135 154 173 192 211 230 249 268 287 306 325 344 363 382 401 420 439 458 477 496 515 963 3 22 41 60 79 98 117 136 155 174 193 212 231 250 269 288 307 326 345 364 383 402 421 440 459 478 497 516 964 4 23 42 61 80 99 118 137 156 175 194 213 232 251 270 289 308 327 346 365 384 403 422 441 460 479 498 517 965 5 24 43 62 81 100 119 138 157 176 195 214 233 252 271 290 309 328 347 366 385 404 423 442 461 480 499 518 966 6 25 44 63 82 101 120 139 158 177 196 215 234 253 272 291 310 329 348 367 386 405 424 443 462 481 500 900 967 7 26 45 64 83 102 121 140 159 178 197 216 235 254 273 292 311 330 349 368 387 406 425 444 463 482 501 901 968 8 27 46 65 84 103 122 141 160 179 198 217 236 255 274 293 312 331 350 369 388 407 426 445 464 483 502 902 969 9 28 47 66 85 104 123 142 161 180 199 218 237 256 275 294 313 332 351 370 389 408 427 446 465 484 503 951 970 10 29 48 67 86 105 124 143 162 181 200 219 238 257 276 295 314 333 352 371 390 409 428 447 466 485 504 952 971 11 30 49 68 87 106 125 144 163 182 201 220 239 258 277 296 315 334 353 372 391 410 429 448 467 486 505 953 972 12 31 50 69 88 107 126 145 164 183 202 221 240 259 278 297 316 335 354 373 392 411 430 449 468 487 506 954 973 13 32 51 70 89 108 127 146 165 184 203 222 241 260 279 298 317 336 355 374 393 412 431 450 469 488 507 955 974 14 33 52 71 90 109 128 147 166 185 204 223 242 261 280 299 318 337 356 375 394 413 432 451 470 489 508 956 975 15 34 53 72 91 110 129 148 167 186 205 224 243 262 281 300 319 338 357 376 395 414 433 452 471 490 509 957 976 16 35 54 73 92 111 130 149 168 187 206 225 244 263 282 301 320 339 358 377 396 415 434 453 472 491 510 958 977 17 36 55 74 93 112 131 150 169 188 207 226 245 264 283 302 321 340 359 378 397 416 435 454 473 492 511 959 978 18 37 56 75 94 113 132 151 170 189 208 227 246 265 284 303 322 341 360 379 398 417 436 455 474 493 512 960 979 19 38 57 76 95 114 133 152 171 190 209 228 247 266 285 304 323 342 361 380 399 418 437 456 475 494 513 961 980		

Reprint service

All Electronics editorial matter available in reprint form:

For reprints of special reports and feature articles see list on right side of this page. Send your order to Electronics Reprint Department at the address indicated. To expedite mailing of your order for single reprints please send cash, check or money order with your order.

Bulk reprints of editorial matter can be ordered from current or past issues. The minimum quantity is 100 copies. The higher the quantity ordered, the more economical the cost per copy. Prices quoted on request.

To order reprints or for further information, please write to: **Electronics Reprint Department, 330 West 42nd Street, New York, N.Y. 10036.** Telephone: Area code 212 971-3140.

You may order the following reprints by key number using order form on page 190.

Prices for the below listed reprints unless otherwise specified are 1-10 copies 50¢ each; 11-24 copies 35¢ each; 25-99 copies 25¢ each; price for 100 or more is 20¢ each.

Key No. **R-71 Experiments On Gemini**
24 pages.

Key No. **R-70 International Color Television**
12 pages.

Key no. **R-69 1964 Complete Electronics Index**
Catalogs all technical articles — newsletter items, Electronics Review, Electronics Abroad, and Probing the News stories, manufacturers mentioned in these articles plus a complete advertisers index.
40 pages. \$1.00

Key no. **R-68 Designing Against Space Radiation**, 18 pages.

Key no. **R-67 Electronics Markets 1965.**
24 page forecast report with 6 page foldout chart.

Key No. **R-66 Field Effect Transistors, Part III**
16 pages.

Key No. **R-65 Field Effect Transistors, Part II**
24 pages.

Key No. **R-64 Field Effect Transistors, Part I**
24 pages.

Key no. **R-62 Electronic Telephone Switching**, 16 pages.

Key no. **R-61 Direct Digital Control In Industry**, 24 pages.

Key no. **R-60 Transistor Heat Dissipators**
32 pages.

Key no. **R-58 Oceanography**, 15 pages.

Key no. **R-57 Magnetics**, 24 pages.

Key no. **R-53 Digital Instrumentation**, 16 pages.

Key no. **R-48 Modern Electronic Packaging**, 16 pages.

Key no. **R-40 Tunnel Diodes, [4 part series]**
26 pages.

Key no. **R-38 Family Tree of Semiconductors**, [22" x 11" foldout chart].

Key no. **R-31 1962 Electromagnetic Spectrum Chart**, [22" x 30" foldout chart].
\$1.00

Key no. **R-30 Graphical Symbols For Electronic Diagrams**, [29" x 11" foldout chart].

Key no. **R-26 Lasers Devices and Systems**, [1961 4 part series] 23 pages:
\$1.00

First class
Permit no. 42
Hightstown, N. J.

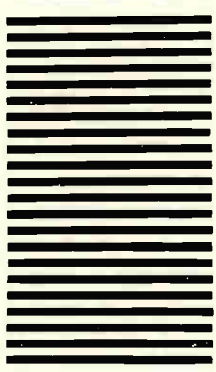

Business reply mail
No postage stamp necessary if mailed in the United States

Postage will be paid by

Electronics
Reader service department
Box 444
Hightstown, N. J. 08520

7 April 5, 1965 Card Expires June 5, 1965 14

Name _____	title _____	For Subscriptions
Company _____		<input type="checkbox"/> new <input type="checkbox"/> renewal
Address _____		<input type="checkbox"/> 3 years \$12.00
		<input type="checkbox"/> 1 year \$6.00

1 20 39 58 77 96 115 134 153 172 191 210 229 248 267 286 305 324 343 362 381 400 419 438 457 476 495 514 962
 2 21 40 59 78 97 116 135 154 173 192 211 230 249 268 287 306 325 344 363 382 401 420 439 458 477 496 515 963
 3 22 41 60 79 98 117 136 155 174 193 212 231 250 269 288 307 326 345 364 383 402 421 440 459 478 497 516 964
 4 23 42 61 80 99 118 137 156 175 194 213 232 251 270 289 308 327 346 365 384 403 422 441 460 479 498 517 965
 5 24 43 62 81 100 119 138 157 176 195 214 233 252 271 290 309 328 347 366 385 404 423 442 461 480 499 518 966
 6 25 44 63 82 101 120 139 158 177 196 215 234 253 272 291 310 329 348 367 386 405 424 443 462 481 500 900 967
 7 26 45 64 83 102 121 140 159 178 197 216 235 254 273 292 311 330 349 368 387 406 425 444 463 482 501 901 968
 8 27 46 65 84 103 122 141 160 179 198 217 236 255 274 293 312 331 350 369 388 407 426 445 464 483 502 902 969
 9 28 47 66 85 104 123 142 161 180 199 218 237 256 275 294 313 332 351 370 389 408 427 446 465 484 503 951 970
 10 29 48 67 86 105 124 143 162 181 200 219 238 257 276 295 314 333 352 371 390 409 428 447 466 485 504 952 971
 11 30 49 68 87 106 125 144 163 182 201 220 239 258 277 296 315 334 353 372 391 410 429 448 467 486 505 953 972
 12 31 50 69 88 107 126 145 164 183 202 221 240 259 278 297 316 335 354 373 392 411 430 449 468 487 506 954 973
 13 32 51 70 89 108 127 146 165 184 203 222 241 260 279 298 317 336 355 374 393 412 431 450 469 488 507 955 974
 14 33 52 71 90 109 128 147 166 185 204 223 242 261 280 299 318 337 356 375 394 413 432 451 470 489 508 956 975
 15 34 53 72 91 110 129 148 167 186 205 224 243 262 281 300 319 338 357 376 395 414 433 452 471 490 509 957 976
 16 35 54 73 92 111 130 149 168 187 206 225 244 263 282 301 320 339 358 377 396 415 434 453 472 491 510 958 977
 17 36 55 74 93 112 131 150 169 188 207 226 245 264 283 302 321 340 359 378 397 416 435 454 473 492 511 959 978
 18 37 56 75 94 113 132 151 170 189 208 227 246 265 284 303 322 341 360 379 398 417 436 455 474 493 512 960 979
 19 38 57 76 95 114 133 152 171 190 209 228 247 266 285 304 323 342 361 380 399 418 437 456 475 494 513 961 980

First class
Permit no. 42
Hightstown, N. J.



Business reply mail
No postage stamp necessary if mailed in the United States

Postage will be paid by

Electronics
Reader service department
Box 444
Hightstown, N.J. 08520

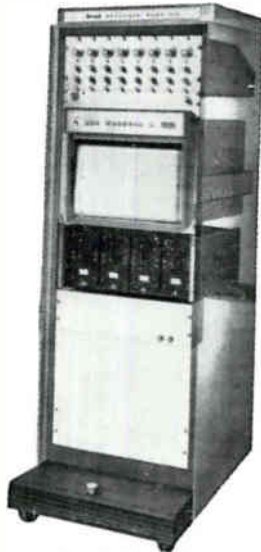

This is the Brush Mark 200, Series 1707

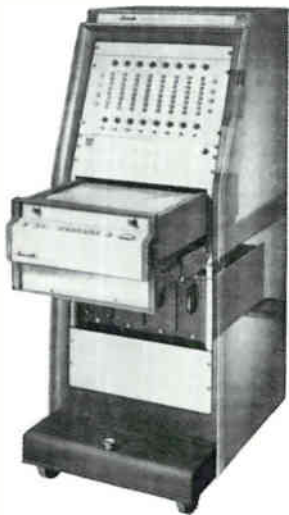

...and so is this



...and so is this

It's the only custom-built recorder that's standard

Your choice of combinations is almost infinite . . . with this new generation of the pace-setting Mark 200. Now you can eliminate "special" engineering time and costs. You specify your recording requirements. Then Brush quickly meets them with the perfect combination of off-the-shelf modular sub-systems. What's off-the-shelf at Brush . . . isn't even on the drawing board elsewhere. All the electronics are solid state.

Take your choice of penmotors: two channel 40 mm; high resolution 80 mm; eight channel "yes-no" event markers (all on one recorder . . . in any combination . . . on the same chart . . . on a common time base!)



Take your choice of oscillographs: vertical, pull-out horizontal or wide-view horizontal.

Take your choice of 32 different preamplifiers.

And you're way ahead with Brush innovations that set new standards in oscillography. A contactless super sensor called Metrisite . . . "polices" pen position to assure better than 1/2% accuracy. Useful frequency response to 200 cps. True rectilinear motion. Pressurized inking produces traces so crisp and accurate you can't misread the signal. All this with over 10,000 channels of field performance! A new booklet has the complete story on the Mark 200, Series 1707. Write for it. Brush Instruments, 37th & Perkins, Cleveland, Ohio 44114.

brush **CLEVITE**
INSTRUMENTS DIVISION

RCA-8072

Your Best Buy for New Equipment Mobile Transmitters

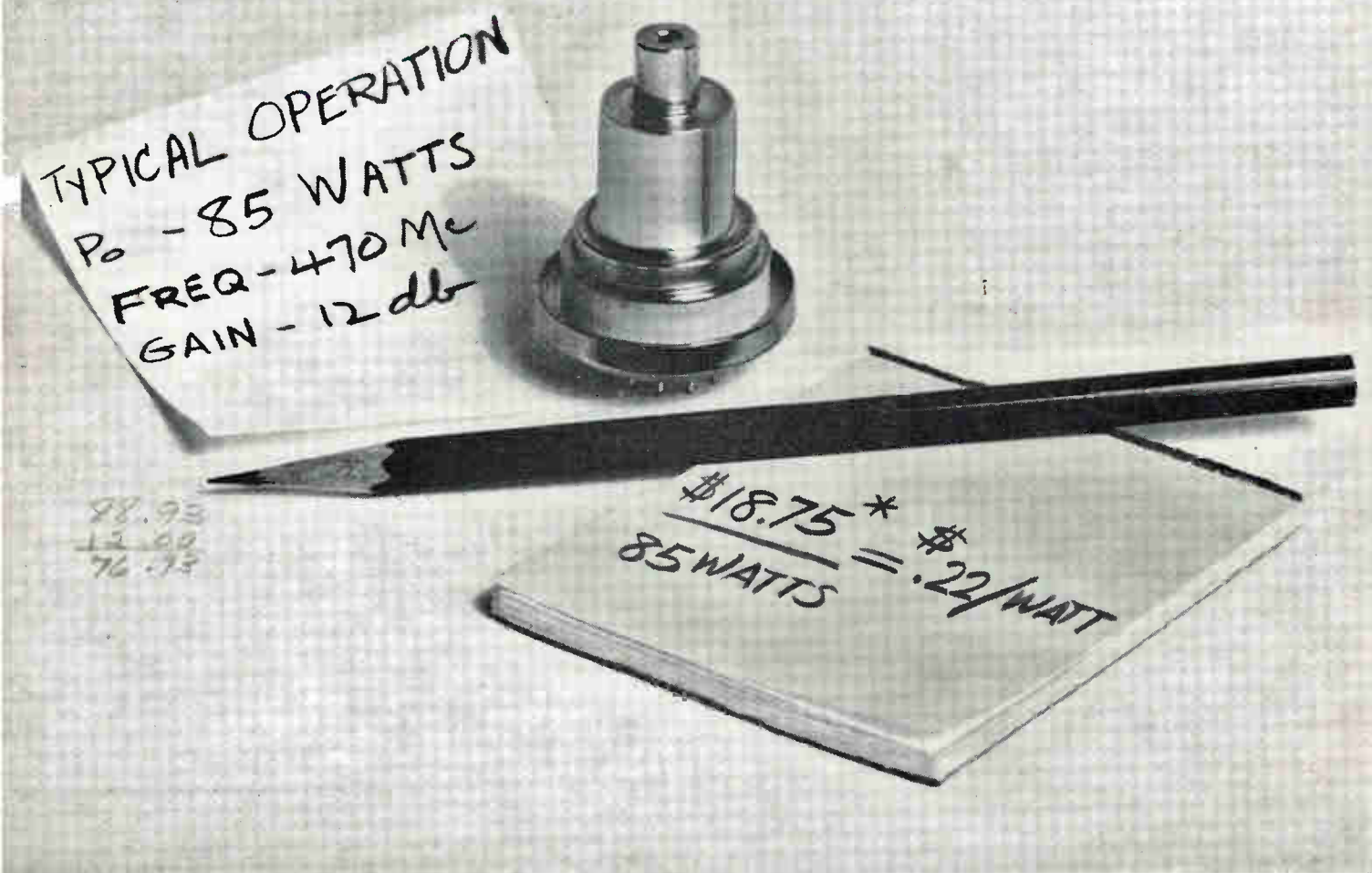

See your RCA Representative about RCA-8072 and other
RCA power tubes. For technical data, write:
RCA Commercial Engineering, Section D19Q-1 Harrison, N.J.

ALSO AVAILABLE FROM YOUR RCA INDUSTRIAL TUBE DISTRIBUTOR

*Optional Distributor Resale price. See your RCA Field Representative for Equipment price.



RCA Electronic Components and Devices, Harrison, N. J.

The Most Trusted Name in Electronics