

Electronics[®]

New uses for gallium arsenide: page 82

Read-only memories to perform logic: page 111

A maser designed for radar: page 115

June 12, 1967

\$1.00

A McGraw-Hill Publication

Below: First gallium arsenide field effect transistor, page 82

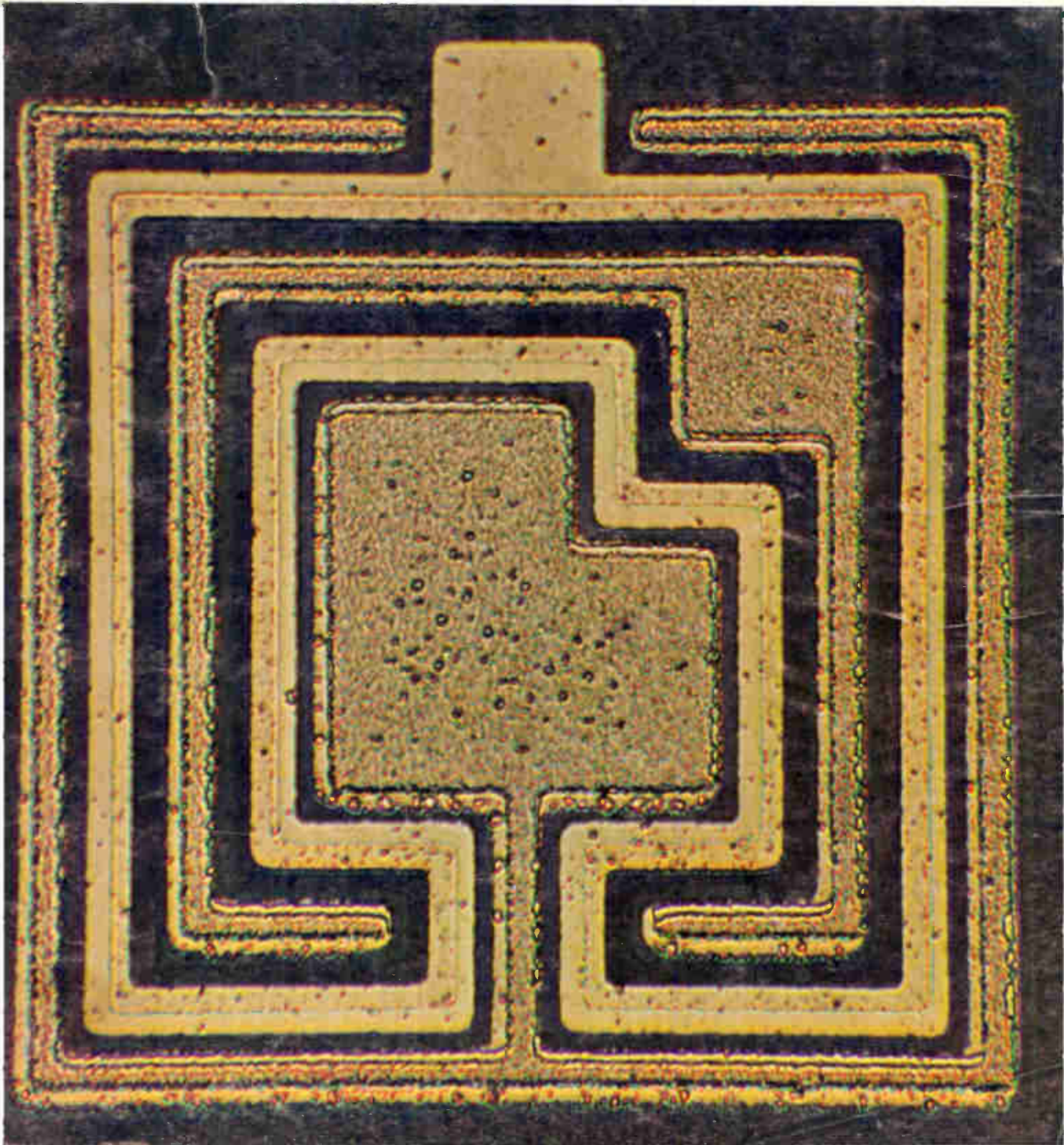



RF OUTPUT
 $Z_0 = 50 \text{ OHMS}$

1026 STANDARD-SIGNAL GENERATOR
GENERAL RADIO COMPANY
CONCORD MASSACHUSETTS USA
SERIAL 106

RF output: 1/2 watt

We've used an ordinary pilot lamp to prove a point: Our new Type 1026 Standard-Signal Generator puts out lots of power — $\frac{1}{2}$ watt into 50 ohms, 10 volts behind 50 ohms (5 volts when modulated). It also puts out as little as $0.1 \mu\text{V}$ and anything in between these limits.

The 1026 also has true single-dial tuning over its entire 9.5- to 500-MHz frequency range. There is no output trimmer control to adjust every time you change frequency. Output of the 1026 is *automatically* leveled; you can change frequency within a range or even switch ranges and maintain output level within ± 0.2 dB to 110 MHz and within ± 0.5 dB to 500 MHz. The carrier is leveled whether modulated or unmodulated. Amplitude modulation up to 95% can be imposed on the carrier from an internal, highly stable 1-kHz oscillator or from an external audio source. There are also provisions for external modulation to 1.5 MHz and for pulse modulation.

Other specifications are as much as an order of magnitude better than those of

any other signal generator you can buy. For example, envelope distortion is less than 1% for 1-kHz, 50% modulation; incidental fm accompanying this a-m is less than 1 ppm, peak; residual fm is less than 0.05 ppm, peak; residual a-m is at least 70 dB below carrier level in CW, internal 1 kHz, and external audio modes.

This instrument is made to order for a-m receiver testing, and its high-level output makes it most suitable for antenna-pattern and impedance measurements, receiver overload and cross-modulation tests, and measurements of large insertion losses. The ease of operation and outstanding performance of the 1026 in the most critical applications must be experienced to be appreciated.

For complete information or a demonstration of the 1026, write General Radio Company, W. Concord, Massachusetts 01781; telephone (617) 369-4400; TWX (710) 347-1051.



Type 1026 Standard-Signal Generator, \$6500 in U. S. A.

GENERAL RADIO

ADVANCE

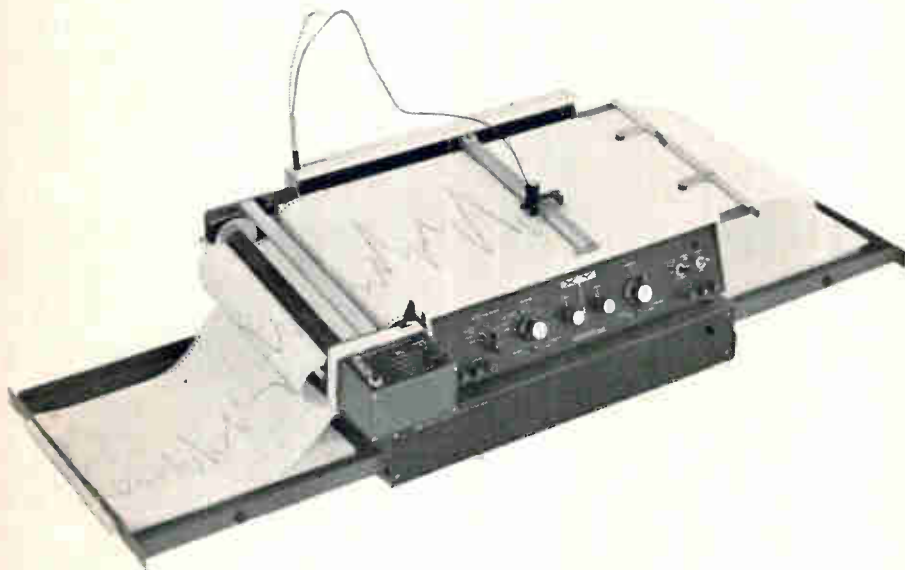

new X-Y
accessory
offers
unique
recorder
flexibility

The new 17005A Incremental Chart Advance turns your Moseley X-Y recorder into a more flexible lab and production tool. It provides this added versatility and high performance by converting your X-Y into a strip-chart recorder. It offers incremental advance for multi-channel pulse height analysis with resolution between channels—and accepts both positive- and negative-going signals to advance the appropriate increment in the advance mode.

Designed for remote control operation. Will adapt to most 11x17 Moseley Recorders. Powered by the recorder itself. Uses roll chart or Z-fold paper. Price: Model 17005A, \$895.

For complete information, contact your local HP field engineer, or write Hewlett-Packard, Palo Alto, California 94304; Europe: 54 Route des Acacias, Geneva.

SPECIFICATIONS:

Incremental advance mode

Plot density (plots/inch):
200, 100, 50, 20, 10

Increment size (in./advance):
0.005", 0.01", 0.02",
0.05", 0.10"

Frame advance mode

Advance distance: 24"
Accuracy:
 ± 0.005 " (non-accumulative)
Advance time: < 14 sec.

Time base mode

Chart speeds:
1, 5, 10, 50, 100 sec/in.
Accuracy: $\pm 2\%$

Major division advance mode

Advance distance:
Major divs. in 3" increments
Accuracy:
 ± 0.005 " (non-accumulative)
Advance time: 2 sec.
Other advance increments available

HEWLETT
PACKARD  MOSELEY
DIVISION

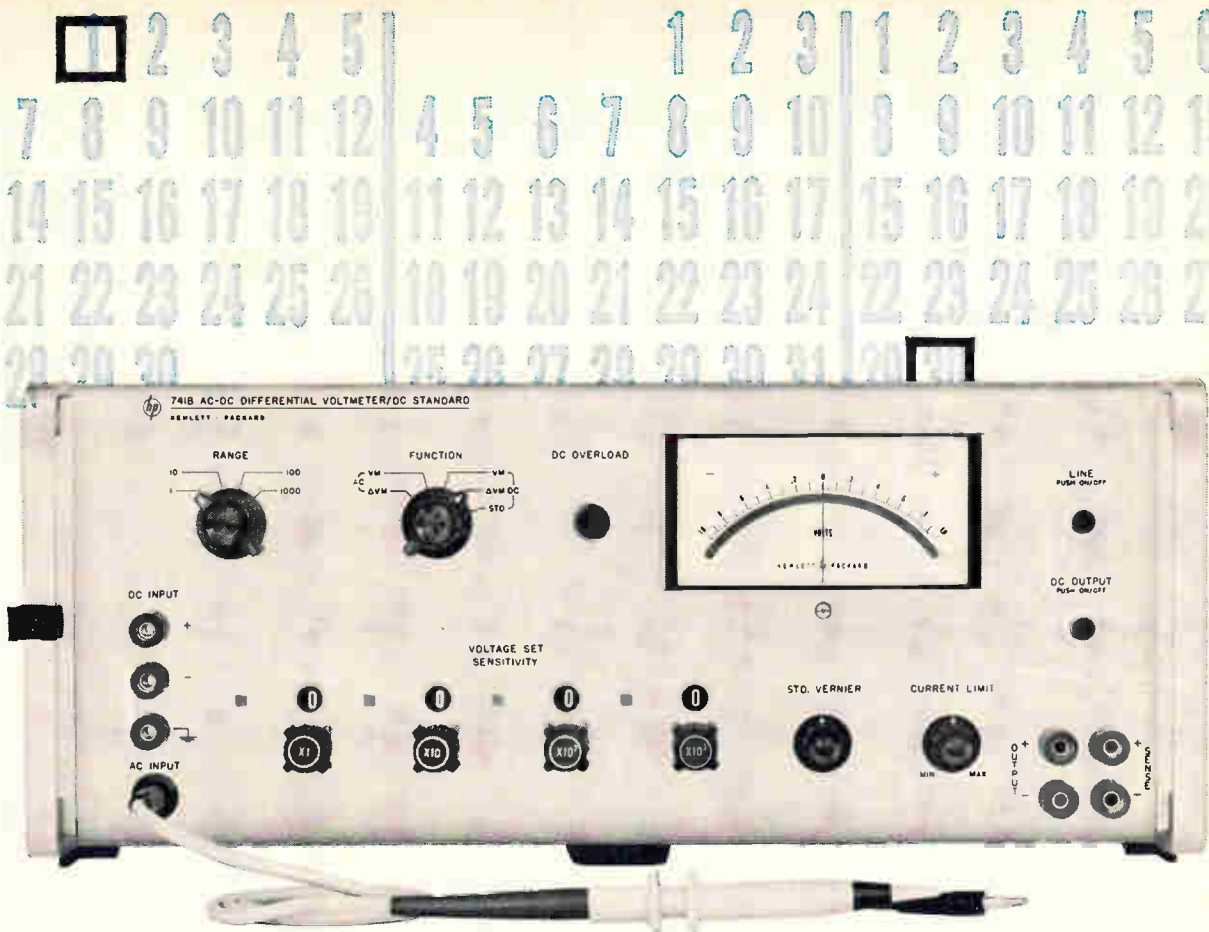

New Low-cost Δ VM / DC Standard Gives **0.01% FOR 90 DAYS**

... and five multi-purpose functions as well, for less than you normally pay for a single-function instrument! Reason for the superior stability of this all-solid-state calibrating tool: use of precision hp wire-wound resistors in the decade and range dividers, plus a temperature-compensated Zener diode reference supply. Other advantages include an input impedance greater than 10^9 ohms in DC Δ VM, and VM independent of null, 5-digit resolution, automatic decimal point, floating input, recorder output, plus overload and short-circuit protection. Calibration labs save high-cost time with 90-day calibration cycle, and **simple two-step calibration from DC to 20 kHz**. Compare price (\$1675) and specs:

DC STANDARD, 90-DAY CYCLE, $\pm 0.01\%$ or 0.001% FS (whichever is greater) from 0-1000 volts. Output resolution is 1 ppm on any range. Short-term stability typically better than 20 ppm/mo. Remote sensing permits output regulation at point of measurement. Temperature coefficient is less than 3 ppm/ $^{\circ}$ C from 0-50 $^{\circ}$ C.

AC DIFFERENTIAL VOLTMETER, 90-DAY CYCLE $\pm 0.02\% + 0.01\%$ of range from 400 Hz to 5 kHz (with reduced accuracy to 100 kHz). TC is less than 20 ppm/ $^{\circ}$ C, 20 Hz to 10 kHz, 5-40 $^{\circ}$ C. Input capacitance of less than 5 pf reduces loading errors and

circuit instabilities during measurement. Input impedance is 1 megohm.

DC DIFFERENTIAL VOLTMETER, 90-DAY CYCLE $\pm 0.02\%$ or $\pm 0.002\%$ FS (whichever is greater) from 0-1000 volts. Input impedance is greater than 10^9 ohms on all ranges independent of null — an ideal characteristic for drift measurements when null cannot be maintained. TC is less than 3 ppm/ $^{\circ}$ C from 0-50 $^{\circ}$ C.

AC-DC VOLTMETER/POWER AMPLIFIER provides greater than 10^9 ohms input on all DC ranges plus high AC input impedance (10^6 ohms shunted by less than 5 pf). In addition to the five functions shown, this calibration lab instrument provides a $\pm 0.02\%$ unity-gain amplifier from 0-1000 volts.

DC DIFFERENTIAL VOLTMETER OPTION 741B 01 provides $\pm 0.01\%$ DC Δ VM, and $\pm 0.02\%$ DC standard. Other specs identical. Ask for a demonstration or contact Hewlett-Packard, Palo Alto, California, 94304. Tel. (415) 326-7000. In Europe: 54 Route des Acacias, Geneva. 116A

HEWLETT  **PACKARD**
An extra measure of quality

News Features

Probing the News

- 145 Reception is loud and cool for subminiature antennas
- 153 Exchanging a viewpoint
- 155 Lending a hand to the Pentagon

Electronics Review

- 33 Advanced technology: Sliced laser
- 33 Communications: Out of the past
- 34 Military electronics: Lighter link
- 35 Circuit design: On line
- 36 Avionics: 3-D radar, continued
- 36 Components: Another Nixie challenger
- 38 Consumer electronics: The IC push; Back to tubes; Tuning in tv; Quiet playback
- 42 Solid state: Raising the noise barrier
- 44 For the record

Electronics Abroad

- 243 Great Britain: Jeep ground station; Stable mates
- 244 Soviet Union: Showmanship; Comparing computers
- 245 West Germany: Teutonic tutor; Tracking down defects
- 246 Japan: Sharp and flat; Current probe
- 247 Around the world

Departments

- 4 Readers Comment
- 8 People
- 14 Meetings
- 16 Meeting Preview
- 23 Editorial
- 25 Electronics Newsletter
- 47 Washington Newsletter
- 163 New Products
- 164 New Products Index
- 222 New Books
- 226 Technical Abstracts
- 232 New Literature
- 241 Newsletter from Abroad

Title R registered U.S. Patent Office; © copyright 1967 by McGraw-Hill Inc. All rights reserved, including the right to reproduce the contents of this publication, in whole or in part.

Technical Articles

I. Design

- Solid state 82 Gallium arsenide FET's outperform conventional silicon MOS devices (cover)**
Silicon nitride insulator makes possible families of new devices for higher frequencies
Hans W. Becke and Joseph P. White, Radio Corp. of America
- Advanced technology 91 GaAs bulk oscillators stir millimeter waves**
Diodes operating in the limited space charge accumulation mode should be able to handle watts of power in the millimeter-wave range
John A. Copeland, Bell Telephone Laboratories
- Solid state 97 R-f breakdown phenomenon improves the voltage capability of a transistor**
Cutoff is turned into an advantage when a device is operated above its frequency limits, because breakdown limits are nearly doubled
Peter Schiff, Radio Corp. of America
- Circuit design 102 Designer's casebook**
 - Single transistor protects power supply from overload
 - Current feedback enhances phototransistor sensitivity
 - R-f signals actuate transmit receiver switch
 - 100% amplitude modulation with two transistors
 - Two diodes remove pulse-width limitation
- Circuit design 106 One transistor sweeps clean**
Simple generator produces linear sweeps for timing or control subsystems
Sumner Weisman, Raytheon Co.

II. Application

- Computers 111 A logical next step for read-only memories**
Using memories to generate Boolean algebra changes conventional computer concepts
John L. Nichols, Fairchild Camera & Instrument Corp.
- Microwaves 115 A maser that works in radar by avoiding saturation**
A frequency-shifting technique prevents saturation of a maser so it can be used in radar systems
Simpson B. Adler, Radio Corp. of America

Electronics

Editor-in-Chief: Lewis H. Young

Associate managing editors

Design: Samuel Weber
Application: George Sideris
News: Robert Henkel
Copy: Sally Powell

Senior editor

Special projects: Donald Christiansen

Senior associate editors

John F. Mason, Joseph Mittleman, Stephen E. Scrupski

Department editors

Advanced technology: Stephen E. Scrupski
Avionics: W.J. Evanzia
Communications: Leonard Weller
Computers: Wallace B. Riley
Design theory: Joseph Mittleman
Industrial electronics: Alfred Rosenblatt
Instrumentation: Carl Moskowitz
Military electronics: John F. Mason
New products: William P. O'Brien
Staff writers: Paul Dickson, James Brinton, Kay Sloman

Section editors

Electronics abroad: Arthur Erikson
Electronics review: Stanley Zarowin
Probing the news: Eric Aiken

Regional bureaus

Domestic

Boston: H. Thomas Maguire, manager; Robin Carlson
Los Angeles: Lawrence Curran, manager; June Ranill
San Francisco: Walter Barney, manager; Mary Jo Jadin
Washington: William D. Hickman, Patricia C. Hoehling

Foreign

Bonn: John Gosch
London: Michael Payne
Tokyo: Charles Cohen

Copy editors

Albert Tannenbaum, James Chang, Frederick Corey

Graphic design

Art director: Saul Sussman
Assistant art directors: Ann Mella, Valerie Betz
Production editor: Arthur C. Miller

Editorial secretaries: Claire Benell, Lynn Emery, Lorraine Fabry,
Kay Fontana, Patricia Gardner, Lorraine Longo

McGraw-Hill News Service

Director: John Wilhelm; Atlanta: Fran Ridgway; Chicago: James Rubenstein;
Cleveland: Arthur Zimmerman; Dallas: Marvin Reid;
Detroit: N. Hunter; Houston: Robert E. Lee; Los Angeles: Michael Murphy, Gerald Parkinson
Pittsburgh: Louis Gomolak
San Francisco: William F. Arnold
Seattle: Ray Bloomberg; Washington: Arthur L. Moore, Charles Gardner,
Herbert W. Cheshire, Seth Payne, Warren Burkett, James Canan, William Small

McGraw-Hill World News Service

Bonn: John Johnsrud; London: John Shinn;
Mexico City: Bruce Cross; Milan: Ronald Taggiasco;
Moscow: Howard Rausch; Paris: Peter Kilborn;
Rio de Janeiro: Wes Perry; Tokyo: Marvin Petal

Reprints: Susan Nugent

Publisher: Gordon Jones

Electronics: June 12, 1967, Vol. 40, No. 12

Published every other Monday by McGraw-Hill, Inc. Founder: James H. McGraw 1860-1958.

Printed at 99 North Broadway, Albany, N.Y. 12207; second class postage paid at Albany, N.Y.

Executive, editorial, circulation and advertising addresses: McGraw-Hill Building, 330 W. 42nd Street,
New York, N.Y. 10036. Telephone (212) 971-3333. Teletype TWX N.Y. 212-640-4646. Cable address:
MCGRAWHILL N.Y.

Subscriptions are solicited only from those actively engaged in the field of the publication. Position and company connection must be indicated on orders. Subscription prices: United States and possessions and Canada, \$8.00 one year, \$12.00 two years, \$16.00 three years; all other countries, \$25.00 one year. Single copies: United States and possessions and Canada, \$1.00; all other countries, \$1.75.

Officers of McGraw-Hill Publications: Joseph H. Allen, President; Bayard E. Sawyer, Executive Vice President; Vice Presidents: J. Elton Tuohig, Operations; John R. Callahan, Editorial; John M. Holden, Marketing; Huber M. Gemmill, Circulation; Angelo R. Venezian, Production; Robert M. Wilhelmy, Controller.

Officers of the Corporation: Donald C. McGraw, Chairman of the Board; Shelton Fisher, President; L. Keith Goodrich, Donald C. McGraw, Jr. and Robert E. Slaughter, Executive Vice Presidents; John J. Cooke, Vice President and Secretary; John L. McGraw, Treasurer.

Title registered in U.S. Patent Office; © Copyright 1967 by McGraw-Hill, Inc. All rights reserved. The contents of this publication may not be reproduced either in whole or in part without the consent of copyright owner.

Subscribers: The publisher, upon written request to our New York office from any subscriber, agrees to refund that part of the subscription price applying to copies not yet mailed. Please send change of address notices or complaints to Fulfillment Manager; subscription orders to Circulation Manager, Electronics at address below. Change of address notices should provide old as well as new address, including postal zip code number. If possible, attach address label from recent issue. Allow one month for change to become effective.

Postmaster: Please send form 3579 to Fulfillment Manager, Electronics,
P.O. Box 430, Hightstown, New Jersey 08520

Readers Comment

Why they come

To the Editor:

As a "brain drain" engineer, I would like to comment on your editorial "Engineers abroad flee . . .", [March 20, p. 23; also Comment, April 17, p. 4].

You opine that the solution to this problem lies in remedying the lack of technical scope and the backward attitudes of management, etc., in brain-drain countries. But why does this sorry state of affairs exist? Might it not be that it is exactly the ideology which refuses to recognize the individual's right to his own life, liberty and the pursuit of happiness—and seeks the solution to every problem by means of force, by the wielding of a legislative club (and eventually a literal one)—that is responsible for the condition of which a brain drain is but one symptom?

The implication of these discussions is that engineers are the property of the governments of their respective countries of origin; and indeed, what those governments are in effect clamoring for is a Berlin Wall, to prevent their productive cattle from escaping. The issue here is none other than that of human slavery, camouflaged by euphemisms and equivocation.

What engineers come to America for is to live and function in a country founded on the ideals and principles of the American constitution and the political philosophy of such men as Thomas Jefferson, whether they are aware of this (the minority), or only of its effects (the majority) in the form of wider professional opportunity, a more courageous attitude toward progress, and a higher standard of living.

Bernard S. Super
Elmhurst, N.Y.

Skeptic

To the Editor:

The article "Back Talk" [May 15, p. 37] describes a marvelous invention. A machine that "accepts type-written, spoken, and hand-printed answers" for \$450? Your reporter should go back and get a feature-length article! Be sure to find out

Now from Sprague!



All the advantages of tantalum in one **LOW COST** capacitor!

EPOXY-DIPPED TANTALEX[®] CAPACITORS...

For industrial, commercial, and entertainment electronic applications where tantalum capacitors were previously too expensive!

⊖ Type 196D Solid-electrolyte Tantalum Capacitors have special epoxy-dip coating which keeps costs down without sacrifice in dependability. Positively seals capacitor section while providing excellent electrical insulation. Protects against mechanical damage in handling.

⊖ Radial lead design for plug-in mounting on printed wiring boards. The .250" lead spacing will fit standard .125" grids.



⊖ High stability—very little capacitance change, even at outer limits of operating temperature range.

⊖ Low dissipation factor of these capacitors permits higher ripple currents.

⊖ Meet environmental test conditions of Military Specification MIL-C-26655B.

⊖ Prime capacitance and voltage ratings. Based on rating popularity of other types of solid tantalum capacitors.

⊖ Designed for continuous operation at temperatures from -55 C to $+85\text{ C}$.

For complete technical data, write for Engineering Bulletin 3545 to Technical Literature Service, Sprague Electric Company, 35 Marshall Street, North Adams, Massachusetts 01247.

Now available for fast delivery from your Sprague Industrial Distributor

SPRAGUE COMPONENTS

CAPACITORS
TRANSISTORS
RESISTORS
INTEGRATED CIRCUITS
THIN-FILM MICROCIRCUITS
45C-4138K1

PULSE TRANSFORMERS
INTERFERENCE FILTERS
PULSE-FORMING NETWORKS
TOROIDAL INDUCTORS
ELECTRIC WAVE FILTERS

CERAMIC-BASE PRINTED NETWORKS
PACKAGED COMPONENT ASSEMBLIES
BOBBIN and TAPE WOUND MAGNETIC CORES
SILICON RECTIFIER GATE CONTROLS
FUNCTIONAL DIGITAL CIRCUITS



*Sprague' and '®' are registered trademarks of the Sprague Electric Co.

RCA CA3001 Video and Communications Differential Amplifier

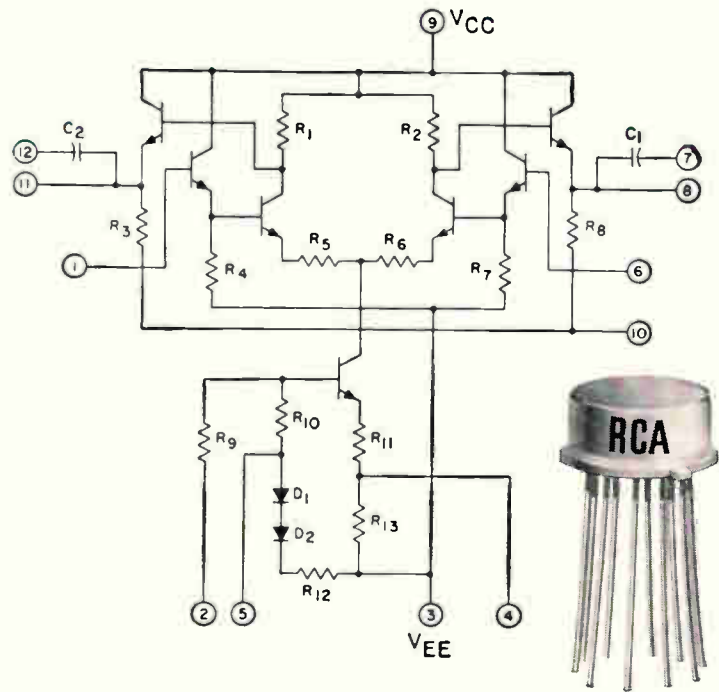

- DC, IF and Video Ampl
- Mixer

- Modulator
- Schmitt Trigger

PUSH-PULL IN AND OUT

VOLTAGE GAIN 19dB Typ.

AGC RANGE 60dB Typ.

INPUT OFFSET VOLTAGE 1.5mV Typ.

-3dB BANDWIDTH 16MHz

FULL TEMPERATURE RANGE

INPUT RESISTANCE 50K Ω Typ.

-55°C TO +125°C OPERATING

OUTPUT RESISTANCE 70 Ω Typ.

PRICE \$4.00 (1000+)

Versatility is the middle name of the RCA CA3001 — with wideband capabilities from DC to 16 MHz, ambient temperature operation range from -55° to 125° and ability to be gated or employ automatic gain control. Technical Bulletin is available from your nearest RCA Representative, or write to Commercial Engineering, Section ICN6-2, RCA Electronic Components and Devices, Harrison, N.J. 07029. **CHECK YOUR RCA DISTRIBUTOR FOR HIS PRICE AND DELIVERY**



RCA ELECTRONIC COMPONENTS AND DEVICES

The Most Trusted Name in Electronics

how "an indefinite number of words" are represented in an eight-bit code.

Steve Sells

Kansas City, Mo.

■ In the Dorsett machine, the number of words to which the eight-bit code responds is "indefinite" because the coding doesn't have to distinguish every word in the English language, but only among those that make sense as a response in the context of a given program. For example, the machine may respond in the same way to the words "potato" and "transformer". However, only one of these words is apt in a programmed course in electronics.

Dim view

To the Editor:

Your editorial on the "dim picture" for color television in Europe [May 29, p. 23] assumes that Europeans will disregard the problems which Americans uncovered during the early days of color receiver design and broadcasting in the States.

We Frenchmen have generally repudiated our famous M. Chauvin, who held that anything not French was not good and that what is done in France should be the model for other countries. There is a mistake from which Americans can profit. You seem to assume that foreigners will retrace the technical steps of their American counterparts, repeating the same flaws in the color fidelity of broadcasts and in the crude early methods of tuning television sets. However innocently arrived at, this assumption is offensive.

The American techniques and equipment, while first to reach com-

mercial success, are not the ultimate. May I remind you that the French Secam system is superior to the American NTSC system in that it avoids phase distortion problems during transmission of color signals. Another example of European improvement in television technology is the British color-television camera, reported on page 168 of your Dec. 26, 1966 issue.

Of course prices for the first European receivers will be high and the amount of color broadcasting will be low, since a large sales volume would take time to establish, but not enjoying a billion-dollar market at the outset is no tragedy.

The slim schedules of color programs may inhibit the general sale of sets, but Europeans, like Americans, who can afford this new status symbol will buy a color tv set and enjoy the programs that do come in color. Our black-and-white television broadcasting schedules, for example, are only a fraction of those in the United States but that hasn't kept Europeans from buying tv sets and enjoying what is available to them.

Paul Rion

Lille, France

Army aid

To the Editor:

In "Computer aided design: A model approach to ic's" [May 1, p. 56], I neglected to point out that the research reported was sponsored by the U.S. Army Picatinny Arsenal under contract number DA-28-017-AMC-3187(A).

Gerald J. Herskowitz
Associate Professor
of Electrical Engineering
Stevens Institute of Technology
Hoboken, N.J.

SUBSCRIPTION SERVICE

Please include an Electronics Magazine address label to insure prompt service whenever you write us about your subscription.

Mail to: Fulfillment Manager
Electronics
P.O. Box 430
Hightstown, N.J. 08520

To subscribe mail this form with your payment and check new subscription renew my present subscription

Subscription rates: in the U.S.: 1 year \$8; two years, \$12; three years, \$16. Subscription rates for foreign countries available on request

CHANGE OF ADDRESS

ATTACH LABEL HERE If you are moving, please let us know five weeks before changing your address. Place magazine address label here, print your new address below.

name _____

address _____

city _____

state _____

zip code _____

MEASURE

transient response

output impedance

loop stability

proper regulation

microvolt ripple

short and
long term drift

of your power supply

WITH ONE (1) INSTRUMENT

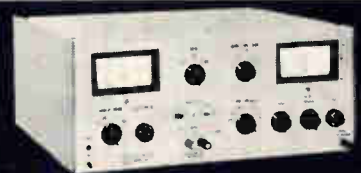

Now you can perform a complete check on all important parameters of your power supply . . . in a fraction of the time you used to take . . . with one small instrument instead of a bank of equipment.

PM's new Model 1004 Power Supply Test Set contains an electronic load capable of pulse loading a supply up to 20A and 70V. Operates in pulse or DC mode. Contains a regulation monitor for precise drift and regulation measurements. The meter is calibrated directly in % regulation. 10%, 1%, .1%, and .01% full scale. Accuracy is 3PPM/min. and 10-PPM/8 hrs.

PM 1004 — \$1100.00

PM 1003 (without regulation monitor) \$750.00



**PACIFIC
MEASUREMENTS
INCORPORATED**

940 INDUSTRIAL AVENUE,
PALO ALTO, CALIFORNIA
(415) 328-0300

People

Less than a week after winning the SAM-D missile contract from the Army, the Raytheon Co. appointed the program's project manager, 45-year-old **Floyd T. Wimberly**, to the post of vice president. It was Wimberly's design package for the missile that beat out the Hughes Aircraft Co. and the Radio Corp. of America for the advanced development order.



Floyd Wimberly

According to Wimberly, the new ground-to-air missile will take a new approach to guidance and make heavy use of integrated circuits. In fact, he adds, some degree of large-scale integration will be applied. By the time the SAM-D work gets into the engineering development stage, Wimberly explains, Raytheon will have had enough experience with LSI to use it in hardware prototypes.

Winning the contract could mean as much as \$2.5 billion to Raytheon if the decision is made to move into production. Raytheon's prime contract for the Hawk missile system has brought in more than \$1.5 billion over the past 13 years. The company also produces the Sparrow 3 for the Navy.

Other uses. While SAM-D is primarily intended for defense of field forces in the 1970's against high-performance aircraft and short-range missiles, it also has a potential application for continental air defense. Because some components of the system could also be used for air defense aboard ship, the Navy is participating in the development program.

Playing a significant role in Raytheon's victory, Wimberly says, was the company's development of ferrite arrays [Electronics, Jan. 9, p. 172]. The company-funded program was begun after Army studies indicated the need for multitarget multifunction arrays. SAM-D will be capable of simultaneously acquiring, tracking, identifying, and destroying multiple targets.

"What we learned in our ferrite

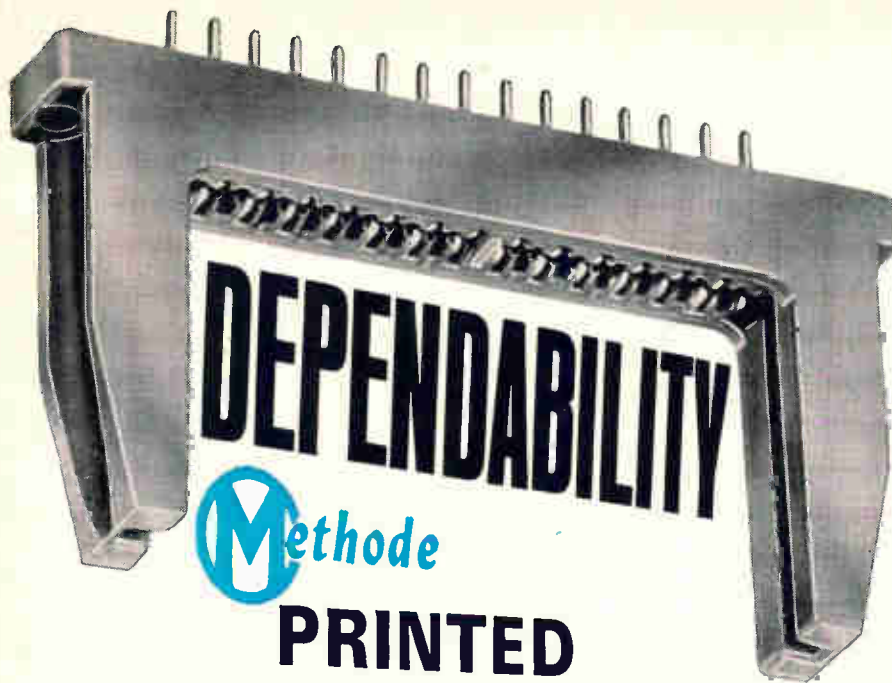

Methode

PRINTED CIRCUIT CONNECTORS

If your design requirements need printed circuit connectors of exceedingly high quality, but your design application is such that you do not need connectors made to military specifications ... talk to METHODE.

We stock a full line of dependable Reli-acon printed circuit connectors from the largest to the smallest sizes with a variety of contact designs. And all Reli-acon connectors are made to rigid quality standards that give you the reliability you need ... without paying the premium prices that mil spec. connectors command. However, Methode's MIL-C-21097B fully approved connectors are available to meet your military requirements.



Write for illustrated
catalog with full
engineering specifications.

Connector Division

Methode Electronics, Inc.
7447 W. Wilson Avenue
Chicago, Illinois 60656 • 312/867-9600





Check these Machlett planar triode advantages for microwave applications.

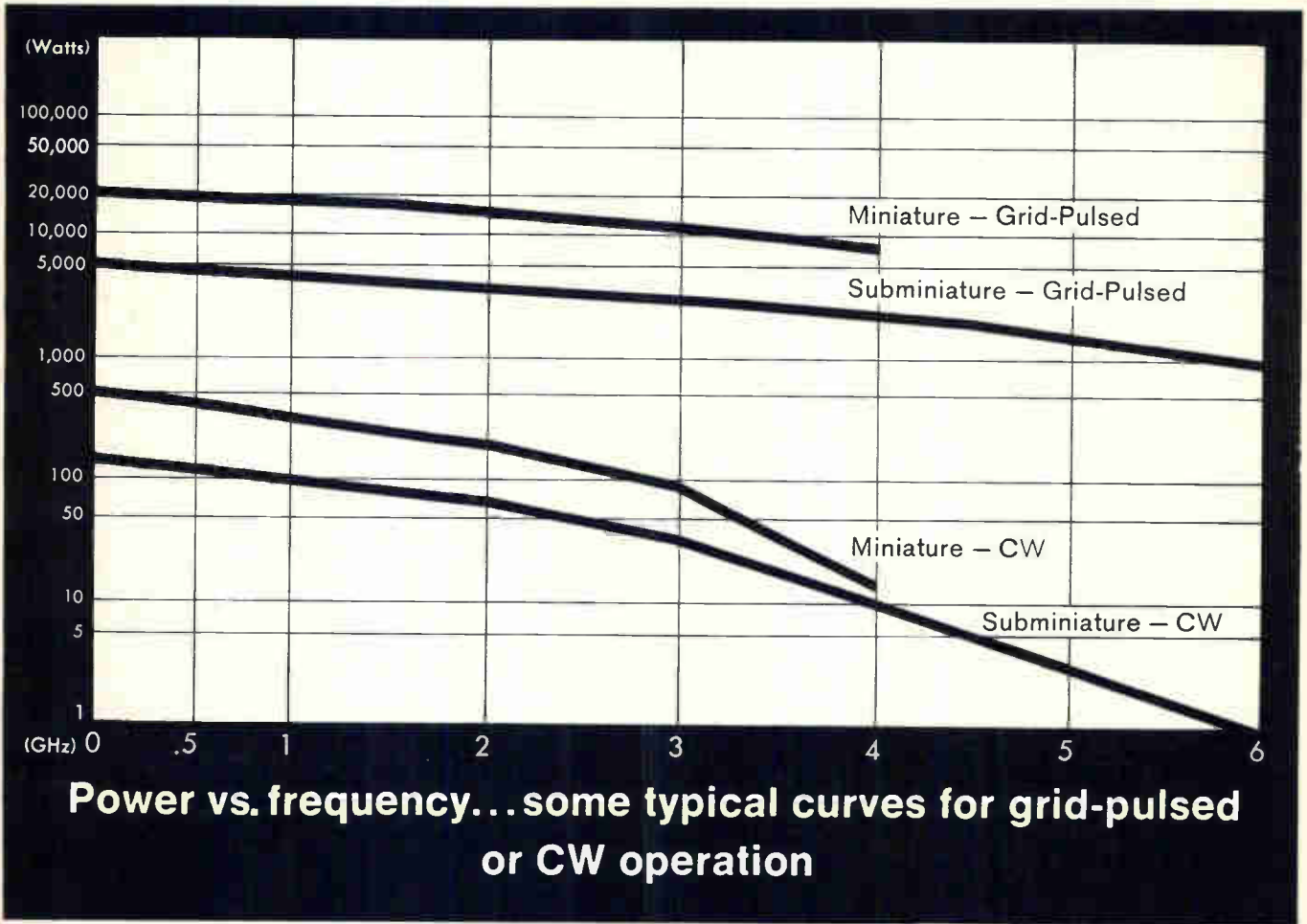

Electrical Advantages

- Superior frequency stability
- Negligible phasing problems
- Comparable or superior efficiency
- Low plate voltage
- Low noise
- Faster warm-up

Mechanical Advantages

- Small size
- Very low weight
- Greater ruggedness

Cost Advantages

- Lower initial cost
- Lower developmental cost
- Lower replacement cost

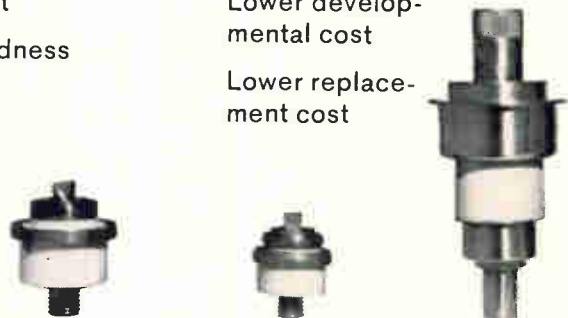

Write us now for application information on Machlett planar triodes: subminiature, miniature and standard. The Machlett Labs., Inc., 1063 Hope St., Stamford, Conn. 06907

The Machlett Laboratories, Inc., welcomes resumes from engineers and scientists.



THE MACHLETT LABORATORIES, INC.

A S U B S I D I A R Y O F R A Y T H E O N C O M P A N Y

You Can Get All These Microcircuits from Sprague Electric

SERIES SU300, LU300 UTILIGIC



K Package

For use in commercial, industrial, ground support applications. Available in two operating temperature ranges, -20 C to +85 C, and +10 C to +55 C. Propagation delay of 15 to 40 nanoseconds.

*Trademark of Signetics Corp.

Circle 504 on readers service card

*SERIES SE100, NE100, US700 (Signetics CS700) DTL INTEGRATED CIRCUITS

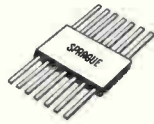

Two operating temperature ranges: -55 C to +125 C and 0 C to +70 C. NAND/NOR gates, clock and line drivers, gate expanders, RS/T and J-K binaries, one-shot multivibrator.

Circle 503 on readers service card

*SERIES 400 low-power TTL INTEGRATED CIRCUITS

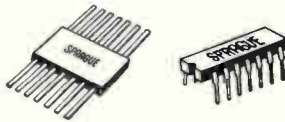

All dual or quad function devices... reduces can count and minimizes equipment size. Available in two package styles, three temperature ranges.

Circle 505 on readers service card

*SERIES SE500 LINEAR AMPLIFIERS



K Package

Operating temperature range: -55 C to +125 C. Two linear circuits available in 10-lead low silhouette TO-5 case. SE501K is a video amplifier, SE505K is a general purpose differential amplifier.

Circle 506 on readers service card

*SERIES SE800, NE800 TTL LOGIC

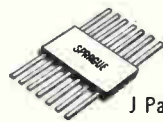

J Package

Designed for high-speed avionics systems. Eight high level circuits including four NAND Gates, Power Gate, Exclusive-OR Gate Input Expander, J-K Flip-Flop.

Circle 507 on readers service card

D to A CONVERTER CIRCUITS



Expandable to 12 bits with $\lt; \frac{1}{2}$ bit error

	4-BIT SERIES	5-BIT SERIES
Ladder Network	UT-1000	UT-1001
Ladder Switch	UD-4001	UD-4036
Buffer Amplifier	UD-4024	UD-4037

Circle 508 on readers service card

*Series SE100, NE100, CS700, SU300, LU300, SE400, NE400, SE500, SE800, NE800 are all available from Sprague Electric under technology interchange with Signetics Corp.

For data on the microcircuits in which you are interested, write Technical Literature Service, Sprague Electric Company, 35 Marshall St., North Adams, Massachusetts 01247

455-7100R1

SPRAGUE®

THE MARK OF RELIABILITY

*Sprague® and ® are registered trademarks of the Sprague Electric Co.

People

array work is being applied to SAM-D," Wimberly says. "The techniques have been proven, so they involve a low level of technical risk."

Wimberly joined Raytheon in 1946 after World War II service with the Army Signal Corps. He worked in radar altimetry and doppler navigation. Later he took part in initial design work on the Sparrow 3 missile guidance system and in production design of Hawk. He later served as Hawk program manager.

"To expand our role in electronic and antisubmarine-warfare systems, we'll investigate digital computation and electro-optical techniques," says **Simeon E. Watson**, new vice president for research and engineering at the Loral Corp.'s Electronic Systems division. Watson's position is a new one for Loral. Moving over from Teleadyne Inc., he brings to his new job a doctorate in electrical engineering and the experience gained from his previous associations with the McDonnell Aircraft Corp. [now the McDonnell Douglas Corp.] and the Collins Radio Co.



Simeon Watson

The 44-year-old Watson will push for large-scale integration to upgrade Loral's computer capabilities. His plans call for purchasing logic chips and then interconnecting and packaging them in-house to generate a hybrid LSI-circuit family. He envisions small special-purpose digital computers for use in signal-recognition and digital-control applications. First units could be operating in a year.

According to Watson, electro-optics research, although directed toward military-sensor applications, might eventually bolster the company's existing display capability. Loral now sells general-purpose and ASW situation display systems.

AC line regulation problems ?

—check
the
Sorensen
line.

✓	Precision Regulation Required? —Need $\pm 0.01\%$... maybe only $\pm 0.1\%$?—Sorensen's broad line of 'off-the-shelf' regulators can provide it.
✓	Size and Weight Important? —ACR units are less than half the size and weight of conventional units.
✓	Stringent Distortion Requirements? —FR models maintain less than 0.25% — even with an input line having 10% distortion.
✓	Need Quick Response? —All models of our FR Series respond to line and load changes within 50 μ s—less than 1 cycle.
✓	Delivery/Price a Factor? — Each standard model is available off-the-shelf.

However demanding your AC regulator checklist, the Sorensen line can bear a good hard look. Whatever your needs, chances are Sorensen has a unit for your application. We offer a broad range of off-the-shelf line regulators to choose from in the range 150VA to 15kVA. Our ACR Series, for example, feature silicon controlled rectifier regulation, printed circuit maintainability, and require minimal rack space. The .01 Series provides high precision regulation, $\pm 0.01\%$, for applications demanding the strictest accuracy and stability. Where fast response is an important consideration, the FR Series is unsurpassed. Sorensen's magnetic-amplifier S Series offers excellent low-cost regulation for a variety of applications.

Each Series is a carefully designed combination of power, performance and packaging,—to fill your specific requirements. Sorensen's AC regulation capability spans 25 years of experience in the design and production of regulators. Our standard product technology provides the firm basis for an outstanding custom design capability. Whatever your AC regulator problems, — check with Sorensen.

For details on Sorensen AC regulators, or for standard/custom DC power supplies or frequency changes, contact your local Sorensen rep. or: Raytheon Company, Sorensen Operation, Richards Ave., Norwalk, Conn. 06856.
Tel: 203-838-6571.





ONE POUND NET
TRANSISTORS
EN 2369A

FAIRCHILD
SEMICONDUCTOR

Get them by the pound.

There are 712 epoxy TO-5's to a pound; 1,516 epoxy TO-18's. Armed with this basic knowledge you are now ready to assimilate a few more facts about Fairchild epoxy devices.

Full line: We have epoxy PNP's, epoxy NPN's, epoxy FET's, epoxy anythings.

Metal-can performance: Our new EN epoxy transistors are equivalents of their metal-can counterparts, up to 70°C. (For example, an epoxy EN 2369A is the equivalent of a metal-can 2N 2369A.)

Fast delivery: We make more silicon epoxy devices than all the rest of the industry put together. (We can ship 2 to 3 tons per week — 5,000,000 devices to be exact.)

Low Prices: Our low epoxy prices are even lower now, while our special one pound discounts are in effect.

Call a Fairchild Distributor: Ask him to deliver a pound of your favorite transistors. And don't forget to redeem your coupon.

25¢

This coupon is good
for 25¢ at your neighborhood
Fairchild Distributor on purchase
of one pound of Fairchild
epoxy transistors.

25¢



FAIRCHILD
SEMICONDUCTOR

A Division of Fairchild Camera and
Instrument Corporation ■ 313 Fairchild Drive,
Mountain View, California 94040,
(415) 962-5011 ■ TWX: 910-379-6435

25¢

25¢

ERRORS make us angry!

that's why we
manufacture
variable
attenuators
with error of less
than 0.05 db*

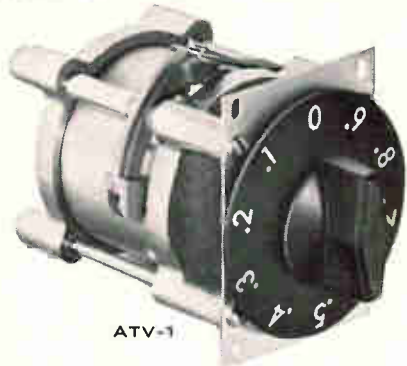

ATV-1

Think attenuators... say the words "Precision Performance"... and you must conclude Jerrold ATV-Series Turret Attenuators. Small, compact, they cost far less than you might expect.

Jerrold attenuators set the pace with intrinsic quality like coin-silver contacts for maximum conductivity, finest-quality deposited carbon disc and rod pad resistors for extreme accuracy, and positive spring-loaded detent mechanism for faultless resolution—in fact all the electrical features of "pull-and-turn" attenuators at one third the cost!

Model ATV-1,* 0-0.9 db in 0.1 db steps (Fixed Attenuation 3 db), Accuracy ± 0.05 db at max. attenuation. \$275.00

Model ATV-9, 0-9 db in 1 db steps, Accuracy ± 0.1 db at max. attenuation. \$250.00

Model ATV-50, 0-50 db in 10 db steps, Accuracy ± 0.5 db at max. attenuation. \$195.00

Group this with 50 ohm impedance, VSWR of 1.06:1 at 1000 MHz (1.1:1 at 1200 MHz), low insertion loss .1 db maximum, and you come up with THE BEST BUY IN THE INDUSTRY! If you're operating DC to 1200 MHz... send for complete specs today.



MEASUREMENT AND
TEST INSTRUMENTATION

JERROLD ELECTRONICS CORPORATION
Government and Industrial Division
Philadelphia, Pa. 19105

Meetings

Conference on Broadcast & Television Receivers, IEEE; O'Hare Inn, Des Plaines, Ill., June 12-13.

National Electronic Packaging Conference, Electronic Packaging Engineers; New York Coliseum, June 13-15.

Aerospace Instrumentation Symposium, Instrument Society of America; Hotel Del Coronado, San Diego, Calif., June 13-16.

International Science and Technology Exhibition, Geam Exports; Earls Court, London, June 14-24.

Seminar on Basic Research & Development Management; Pennsylvania State University, Nittany Lion Inn, Penn State University Park Campus, Penn., June 18-23.

Conference & Education Exhibit, American Society for Engineering Education; Michigan State University, East Lansing, Mich., June 19-22.

San Diego Biomedical Engineering Symposium, American Institute of Aeronautics and Astronautics; Hilton Inn, San Diego, Calif., June 19-21.

Symposium on Microelectronics, IEEE; Colony Motor Hotel, St. Louis, June 19-21.

International Scientific Congress on Electronics, Italy's Post & Telegraphs Ministry and Higher Posts & Telecommunications Inc.; Rome, June 19-23.

International Conference & Business Exposition, Data Processing Management Association; Boston, June 20-23.

International Symposium on Bioastronautics & the Exploration of Space, Southwest Research Institute; San Antonio, Texas, June 24-27.

American Society for Testing and Materials Meeting, American Society for Testing and Materials; Statler-Hilton Hotel, Boston, June 25-30.

Seminar on Computerized Imaging Techniques, Society of Photo-optical Instrumentation Engineers, Marriott Twin Bridges Motor Hotel, Washington, June 26-27.

Aerospace Systems Conference & Engineering Display, Society of Automotive Engineers, Statler Hilton Hotel, Los Angeles, Calif., June 27-29.

Symposium on Electromagnetic Compatibility, IEEE; Shoreham Hotel, Washington, July 18-20.*

Short Courses

Hybrid computation; University of Wisconsin's College of Engineering, Madison, Wis.; June 19-23; \$150 fee.

Modern theory of communications; Ohio State University's Department of Electrical Engineering, Columbus; July 10-21; \$275 fee.

Modeling of industrial processes for computer control; Purdue University's Schools of Engineering; Lafayette, Ind.; Oct. 16-25; \$250 fee.

Call for papers

International Electron Devices Meeting, IEEE; Sheraton-Park Hotel, Washington, Oct. 18-20. Aug. 1 is deadline for submission of abstracts to Burton McMurtry, technical program chairman, 1967 Electron Devices Meeting, Sylvania Electronic Systems, P.O. Box 205, Mountain View, Calif. 94040

Hybrid Microelectronics Symposium, International Society for Hybrid Microelectronics; Boston, Oct. 30-31. July 31 is deadline for submission of abstracts to Paper Selection Committee, International Society for Hybrid Microelectronics, P.O. Box 11091, Palo Alto, Calif. 94304

Asilomar Conference on Circuits & Systems, Naval Postgraduate School, University of Santa Clara; Asilomar Hotel, Pacific Grove, Calif., Nov. 1-3. Sept. 1 is deadline for submission of abstracts to S.R. Parker, Department of Electrical Engineering, Naval Postgraduate School, Monterey, Calif. 93940

* Meeting preview on page 16.

Even though Fluke differential voltmeters feature dc accuracies high as 0.0025%, ac accuracies of 0.05%, and 100 microvolts full scale sensitivity, they are so well designed that use is both simple and easy. Solid state bench top models are adaptable for half- or full-rack mounting... Many are offered in both line and rechargeable battery operated versions. Vacuum-tube models are available in cabinet or full-rack configurations. There are many accessories, too. All the fine features of Fluke differential voltmeters should surprise no one familiar with the Fluke line. For uncommon standards laboratory performance in portable instrumentation has always been and continues to be *standard*.

For particulars, write Fluke, Box 7248, Seattle, Washington 91833. Phone: (206) 774-2211. TWX: (910) 449-2850. In Europe address Fluke International Corporation, Sophialaan 2, The Hague, The Netherlands.

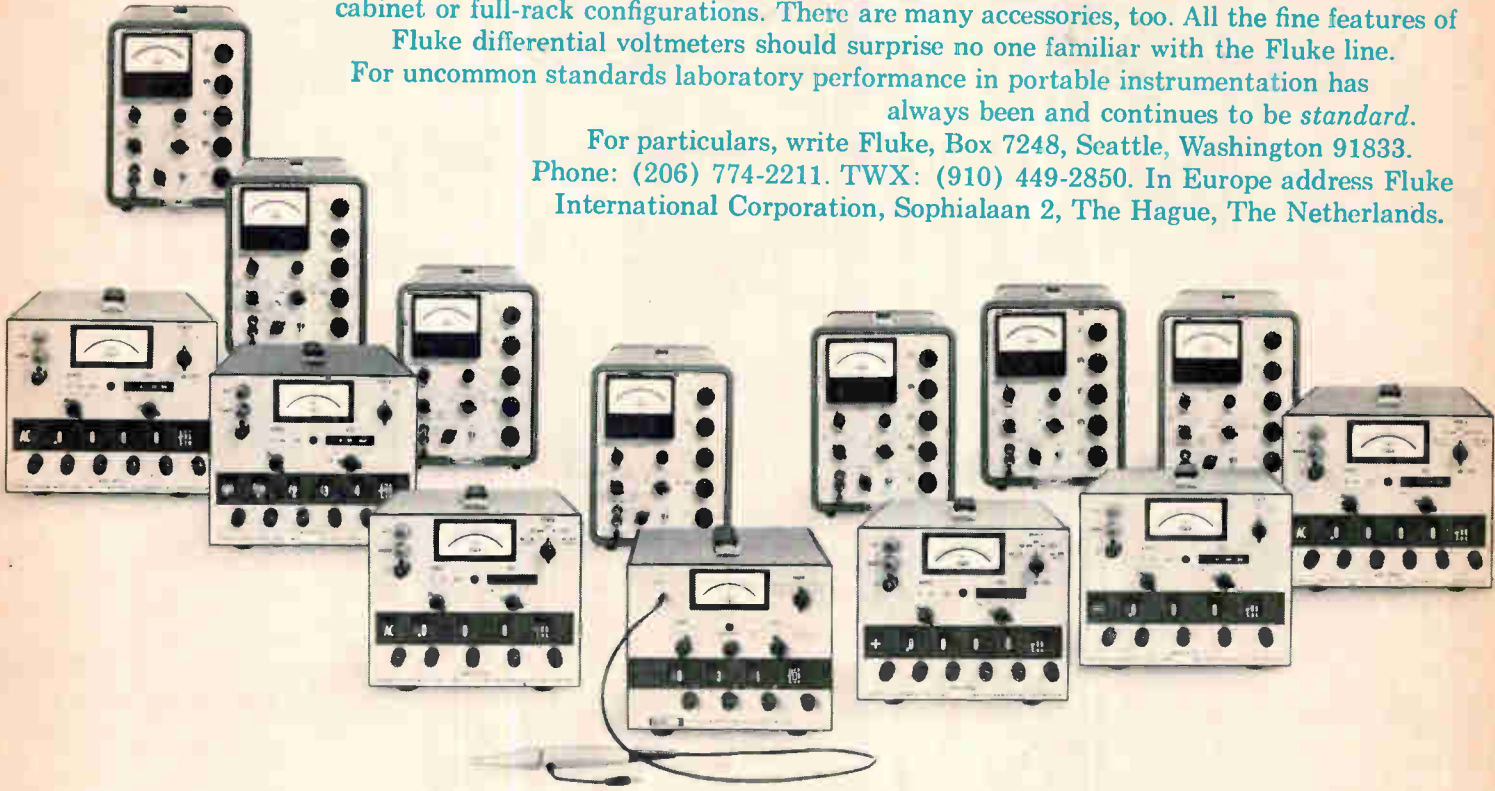

Count 'em. It's the world's largest, most sophisticated line of differential voltmeters. And what a line! You can buy a solid state dc, ac/dc, or true rms voltmeter. Or our vacuum tube version. You'd think Fluke invented the differential voltmeter. (Well, we did.)

DC DIFFERENTIAL VOLTMETERS						
MODEL	INPUT VOLTAGE	ACCURACY % OF INPUT	INPUT IMPEDANCE	MAX. METER RESOLUTION	PRICE	NOTES
801B	0-500 VDC	±0.05%	Infinite at null	50 uV	\$ 485.00	} +\$20 for rack models
825A	0-500 VDC	±0.02%		5 uV	\$ 590.00	
821A	0-500 VDC	±0.01%	Infinite at null	5 uV	\$ 795.00	} +\$130.00 for rechargeable battery pack
871A*	0-1100 VDC	±0.02%		10 uV	\$ 565.00	
881A*	0-1100 VDC	±0.005%	to ±11V 10 Meg	1 uV	\$ 825.00	}
885A*	0-1100 VDC	±0.0025%	above ± 14V	1 uV	\$ 965.00	
895A*	0-1100 VDC	±0.0025%	Infinite at null to ±1100V	1 uV	\$1,195.00	
AC/DC DIFFERENTIAL VOLTMETERS						
803B	0-500V AC or DC	±0.05% DC, ±0.2% AC	Infinite at null DC	50 uV	\$ 875.00	} +\$20 for rack models
803D	0-500V AC or DC	±0.02% DC, ±0.1% AC		5 uV	\$1,055.00	
823A	0-500V AC or DC	±0.01% DC, ±0.1% AC	{ 1 Meg, 35-50 pf AC	5 uV	\$1,215.00	} +\$160.00 for rechargeable battery pack
873A*	0-1100V AC or DC	±0.02% DC, ±0.2% AC	Infinite at null to 10 Meg	10 uV	\$ 875.00	
883A*	0-1100V AC or DC	±0.005% DC, ±0.1% AC	above 11 VDC	1 uV	\$1,215.00	}
887A*	0-1100V AC or DC	±0.0025% DC, ±0.05% AC	{ 1 Meg, 40 pf AC	1 uV	\$1,375.00	
TRUE RMS DIFFERENTIAL VOLTMETER						
931A*	0-1100V AC	±0.05% AC	1 Meg, 8 pf with BNC Input	20 ppm of dial setting	\$ 895.00	+ \$ 50.00 for permanent probe
			1 Meg, 5 pf with probe			+ \$100.00 for rechargeable battery pack

*Solid State



Circle 15 on reader service card

Low Cost 4 DIGIT

400 SERIES

INTEGRATING DC

DIGITAL VOLTMETER

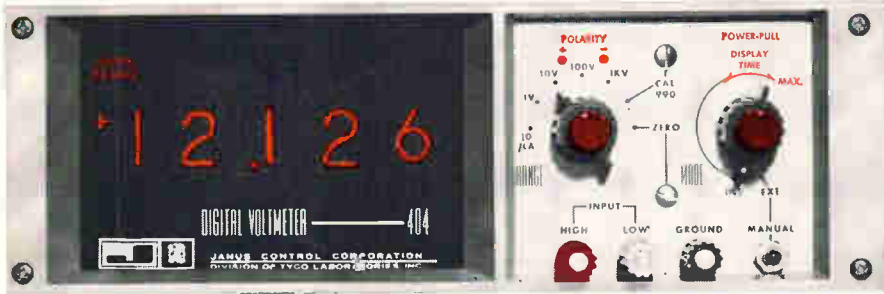

Extended Range Measurements: Fifth digit over-range.

Precise Measurements: With accuracies to 0.05%.

Input Flexibility: Four voltage ranges and a micro-current input for measuring in "Engineering Units" (psi, degrees, etc.)

System Compatibility: BCD Outputs and Remote Programming.

High Noise Rejection: Differential input and integration techniques provide common mode rejection greater than 120 db at 60 Hz.

Economical: 3 and 4 digit models range from \$349.50 to \$495.50.

These DVM's are not only **NEW**, they're **AVAILABLE** from Janus representatives from coast to coast!

CALL OR WRITE FOR A DEMONSTRATION.



296 NEWTON STREET • WALTHAM • MASSACHUSETTS 02154 • TEL: (617) 891-4700

Meeting preview

Noise and IC's

Although integrated circuits reduce the volume of electronic devices, they also compound electromagnetic compatibility (EMC) problems. Their small size make them more susceptible to external electromagnetic fields and increases the chance of interaction between circuits and elements within circuits. This aspect of IC's will be one of the major topics at this year's IEEE Symposium on Electromagnetic Compatibility at the Shoreham Hotel in Washington, July 18 to 20.

A paper on electromagnetic compatibility in IC's will be delivered by A.R. Valentino, research engineer with the ITR Research Institute in Chicago. He will outline his work with logic circuits, such as diode-transistor logic and transistor-transistor logic, describing how to predict the effect of spurious electromagnetic fields on the logic operations of modules and individual circuits.

Such data, Valentino says, is useful in the design and packaging of systems by helping the engineer to decide on the most effective wiring routes and methods for distribution of power.

Two of the symposium's 10 sessions will deal with the prediction and analysis of EMC. At one session, John Sell, an engineer with the institute's Electromagnetic Compatibility Analysis Center, Annapolis, Md., will describe his work to define and identify spurious response. In the second session, Maj. Anthony F. Albright, chief of the Army's data research branch of the frequency management directorate, will discuss an attempt to better utilize the overcrowded electromagnetic spectrum.

After the IEEE symposium, the Defense Department will hold its two-session electromagnetic compatibility conference. An unclassified meeting is scheduled for the afternoon of July 20, at which representatives from the Army, Navy, Air Force, and Electromagnetic Compatibility Analysis Center will discuss electromagnetic compatibility specifications required for equipment, and how they get these specifications.

These are some of the relatively unexciting components that make Trygon's new Liberator power supplies possible.

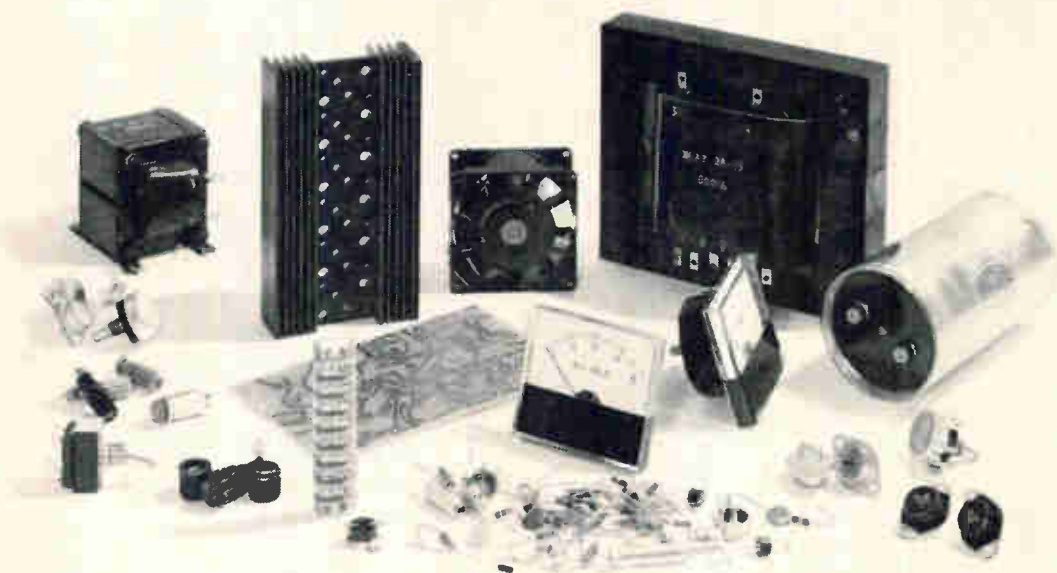

Here's the extraordinary, almost impossible system job it can do for you.

Trygon's Liberator Series is engineered to provide the ultimate in high power system performance, in a minimum size, at lowest possible cost.

Output current levels of 40 amperes (3½"), 70 amperes (5¼"). .005% regulation/.5mv ripple/3mv peak to peak noise/.01% stability/extremely low output impedance/MIL Spec. performance compliance/integral slide mounting/automatic load share paralleling/overvoltage protection/wide adjustable voltage range.

3½" units: 2.5-4.5V/40A; 4.8-6.8V/40A; 6.5-9.5V/25A; 8.5-11.5V/25A; 11-14V/25A; 13.5-19.5V/20A; 18.5-26.5V/15A; 24-32V/15A. Priced from \$420 to \$445. 0-8V/25A with overvoltage protection—\$525.

5¼" units: 2.5-4.5V/70A; 4.8-6.8V/70A; 6.5-9.5V/50A; 8.5-11.5V/50A; 11-14V/50A; 13.5-19.5V/40A; 18.5-26.5V/30A; 24-32V/30A. Priced from \$535 to \$550. 0-8V/50A with overvoltage protection; 0-15V/30A; 0-36V/15A; 0-60V/10A. Priced from \$550 to \$650.

LIBERATOR: the most precise system power supply available—at the highest possible power output—in the smallest possible package—at the lowest possible price. MAKE US PROVE IT!



TRYGON POWER SUPPLIES
PLEASANT AVE., ROOSEVELT, L.I., N.Y.

SEND ME PROOF OF LIBERATOR PERFORMANCE

NAME _____

COMPANY _____

ADDRESS _____

CITY _____ STATE _____ ZIP _____

TRYGON
ELECTRONICS, INC.,
Roosevelt, N.Y. 11575

Complementary Silicon Power— Direct-Couple Your Servo Drivers At Low Cost

(and in less time)!

Use these six new, 5-ampere Motorola complementary silicon power transistor pairs to achieve enormous economies in the push-push, push-pull driver portions of your medium-current, industrial/computer servo amplifier designs . . . you'll save two ways:

1. You get all the circuit-simplifying advantages of direct-coupled, complementary symmetry plus realize a higher degree of frequency stability in both ac and dc-driven loads WITHOUT the addition of expensive, impedance-matching driver transformers.
2. It's easier than ever to eliminate costly over-design by plugging in 87.5 watts of TO-3 power-handling capability — a "power gap" area up to now necessarily filled by higher-priced, higher-current units — for only a few cents more than the price for power-limited (25 W) TO-66 devices!

And you now have the choice of 5-ampere silicon NPN or PNP polarity for your power switching, series and shunt regulator driver and output stage, dc-to-dc converter, inverter and hammer driver designs.

Eighteen Motorola complementary silicon power transistor pairs ranging from 1 to 15-amperes and 5 to 150 watts are immediately available from your franchised Motorola distributor for the broadest range of cost-cutting PNP/NPN applications possibilities in the industry. Investigate them today!

Complement your Design Know-How . . . with a series of three informative Application Notes on complementary silicon power audio/servo amplifier circuits. How to reduce phase shift and accompanying problems plus easy conversion to transformerless operation are discussed at length. Send for them.

Type	Polarity	P _o @ 25°C	I _c (cont.)	V _{CEO} (sus)	h _{FE} (min @ I _c)	f _r (min)	Price (100-up, 40 V)
2N4913, 14, 15 2N4904, 05, 06	NPN PNP	87.5 W	5 A	40, 60, 80 V	25 @ 2.5 A	4 MHz	\$1.60
					20 @ 1 A		2.25
2N5067, 68, 69 2N4901, 02, 03	NPN PNP						1.20 1.84

— where the priceless ingredient is care!



How To Convert High-Frequency Power To DC in 100 Low-Cost nsec.

In no time at all you can accelerate the performance and efficiency of your high and low speed dc inverter, chopper, free wheeling and charging diode, sonar supply and ultrasonic system circuit components to outstanding levels. It takes just 100 ns for Motorola's new, 1N3879, -3889, -3899, -3909 and -4993, 3/4 to 30-ampere, fast recovery rectifiers to switch from a forward conducting to reverse blocking mode in all these applications.

This nimble new device line — now broadest in the industry — offers unequalled 50 to 600-volt V_{RM} capability and two speed ranges for maximum cost/performance flexibility: 200 ns max (100 ns typ) and 1 μ s max (0.5 μ s typ) recovery times for 250 to 500 kHz and 50 to 100 kHz applications, respectively. Besides agile switching and less power dissipated in the reverse mode, these diodes hold RFI and transient voltage generation to a minimum, reduce the size, cost and weight of power conversion and filter components in the output circuit and slim down the required input power source, since voltage drops are lower in the output circuitry.

Time-proven, reliable packaging is included: all 3 to 30-ampere fast recovery devices utilize the unique "basic cell" fabrication technique and 3/4 and 1-ampere units are cased in silicone-polymer Surmetic® packages — long-noted for high-temperature, high-humidity case integrity.

A quick point about price. You can design in Motorola fast recovery rectifiers for as little as \$.45 each (100-up) . . . little more than the moderate cost for similar, standard speed Motorola rectifiers.

Now's the time to see your franchised Motorola distributor about them.

Frequency Requirement	V_{RM}	I_o	T_{rr} (typ)	Motorola Preferred Rectifier Line
250 to 500 kHz	50 to 600 volts	3/4 to 30 amps	100 ns	58 High-Speed Units
50 to 100 kHz	50 to 600 volts	3/4 to 30 amps	0.5 μ s	30 Medium-Speed Units
10 to 15 kHz	50 to 1,000 volts	1 to 1,000 amps	5 μ s	284 Standard-Speed Units

MOTOROLA
Semiconductors

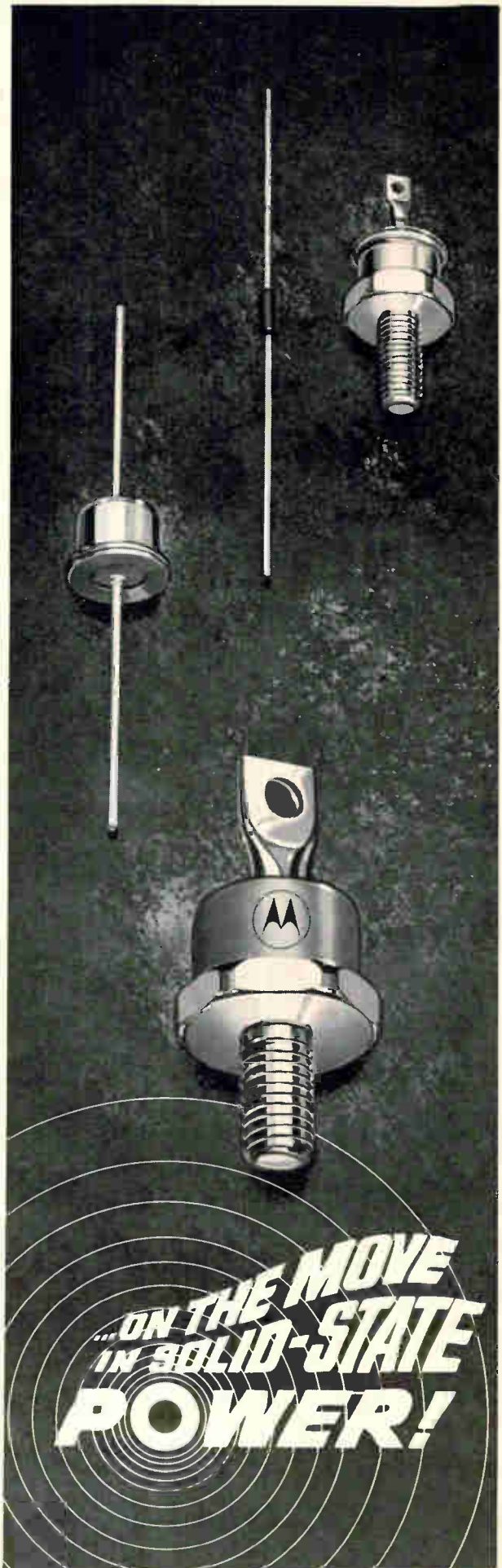

WHO'LL make the next breakthrough in EDP design?

Could be YOU: with Mosaic's Fiber Optics!

EDP systems design engineers are only beginning to tap the potential of fiber optics. Yet, after a brief acquaintance with this broad, new technology, they have made breakthroughs already . . . obsolescing "standard" EDP design solutions. Advances like greater speeds. Design freedom. New capabilities. Reliability and lower costs.

Did you hear about the oscillograph equipped with a fiber optic cathode ray tube? The CRT tube's electron beam is the writing device. Printout is nearly 100 times faster (1 million inches per sec.) than any direct-writing system in existence!

Do you know the story on Mosaic's Fiber Optic systems? In new EDP readers, printers, punched tape and card verifiers . . . in keypunch and teletype equipment, they're more dependable, less complicated, less costly and over 4 times faster than heat, wear and friction-prone mechanical systems!

Mosaic's fiber optics can help you make breakthroughs to advance the EDP state-of-the-art, too. Give those specific design problems of yours a hard look now. Then get going with the solution. Start by contacting Mosaic Fabrications, the people who know fiber optics inside-out . . . the largest single source of fiber optics technology, capability and productivity on earth!

Mosaic will work with you to solve your EDP design problems now . . . will help you design and develop,



from prototype to production, the specific EDP fiber optic hardware to put you way ahead!

Call or write for descriptive literature, today!

Bendix
Mosaic Fabrications, Inc

GALILEO PARK, STURBRIDGE, MASSACHUSETTS 01518 (617) 347-9191

How To Convert High-Frequency Power To DC in 100 Low-Cost nsec.

In no time at all you can accelerate the performance and efficiency of your high and low speed dc inverter, chopper, free wheeling and charging diode, sonar supply and ultrasonic system circuit components to outstanding levels. It takes just 100 ns for Motorola's new, 1N3879, -3889, -3899, -3909 and -4993, ¾ to 30-ampere, fast recovery rectifiers to switch from a forward conducting to reverse blocking mode in all these applications.

This nimble new device line — now broadest in the industry — offers unequalled 50 to 600-volt V_{RM} capability and two speed ranges for maximum cost/performance flexibility: 200 ns max (100 ns typ) and 1 μ s max (0.5 μ s typ) recovery times for 250 to 500 kHz and 50 to 100 kHz applications, respectively. Besides agile switching and less power dissipated in the reverse mode, these diodes hold RFI and transient voltage generation to a minimum, reduce the size, cost and weight of power conversion and filter components in the output circuit and slim down the required input power source, since voltage drops are lower in the output circuitry.

Time-proven, reliable packaging is included: all 3 to 30-ampere fast recovery devices utilize the unique "basic cell" fabrication technique and ¾ and 1-ampere units are cased in silicone-polymer Surmetic* packages — long-noted for high-temperature, high-humidity case integrity.

A quick point about price. You can design in Motorola fast recovery rectifiers for as little as \$.45 each (100-up) . . . little more than the moderate cost for similar, standard speed Motorola rectifiers.

Now's the time to see your franchised Motorola distributor about them.

Frequency Requirement	V_{RM}	I_o	T_{rr} (typ)	Motorola Preferred Rectifier Line
250 to 500 kHz	50 to 600 volts	¾ to 30 amps	100 ns	58 High-Speed Units
50 to 100 kHz	50 to 600 volts	¾ to 30 amps	0.5 μ s	30 Medium-Speed Units
10 to 15 kHz	50 to 1,000 volts	1 to 1,000 amps	5 μ s	284 Standard-Speed Units

MOTOROLA
Semiconductors

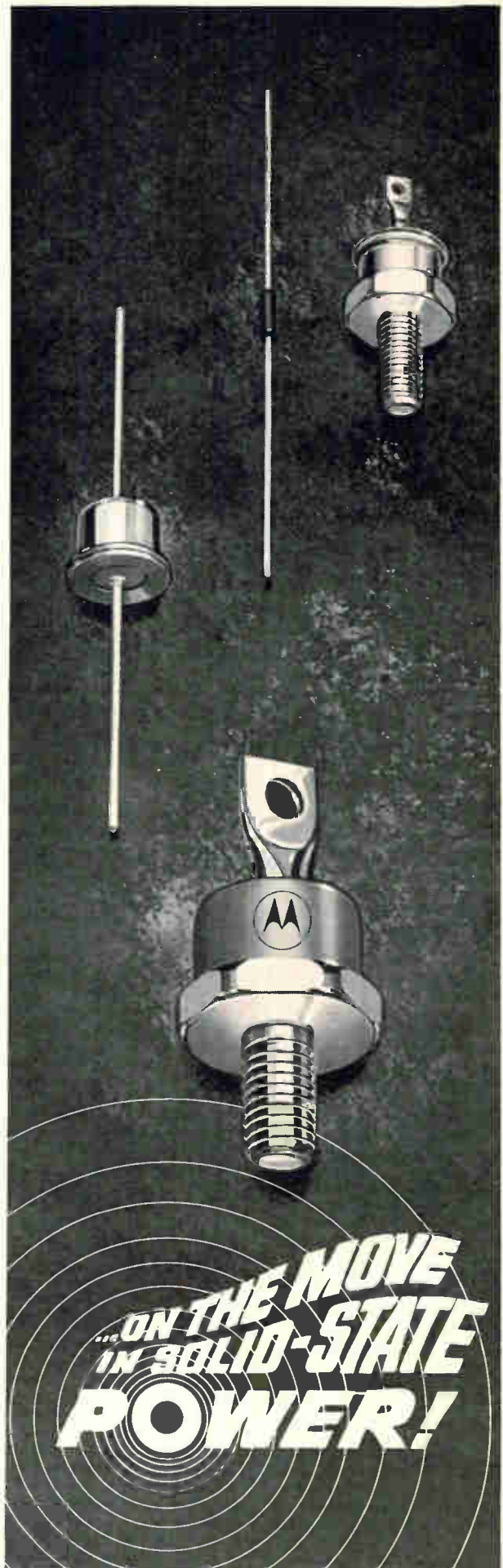

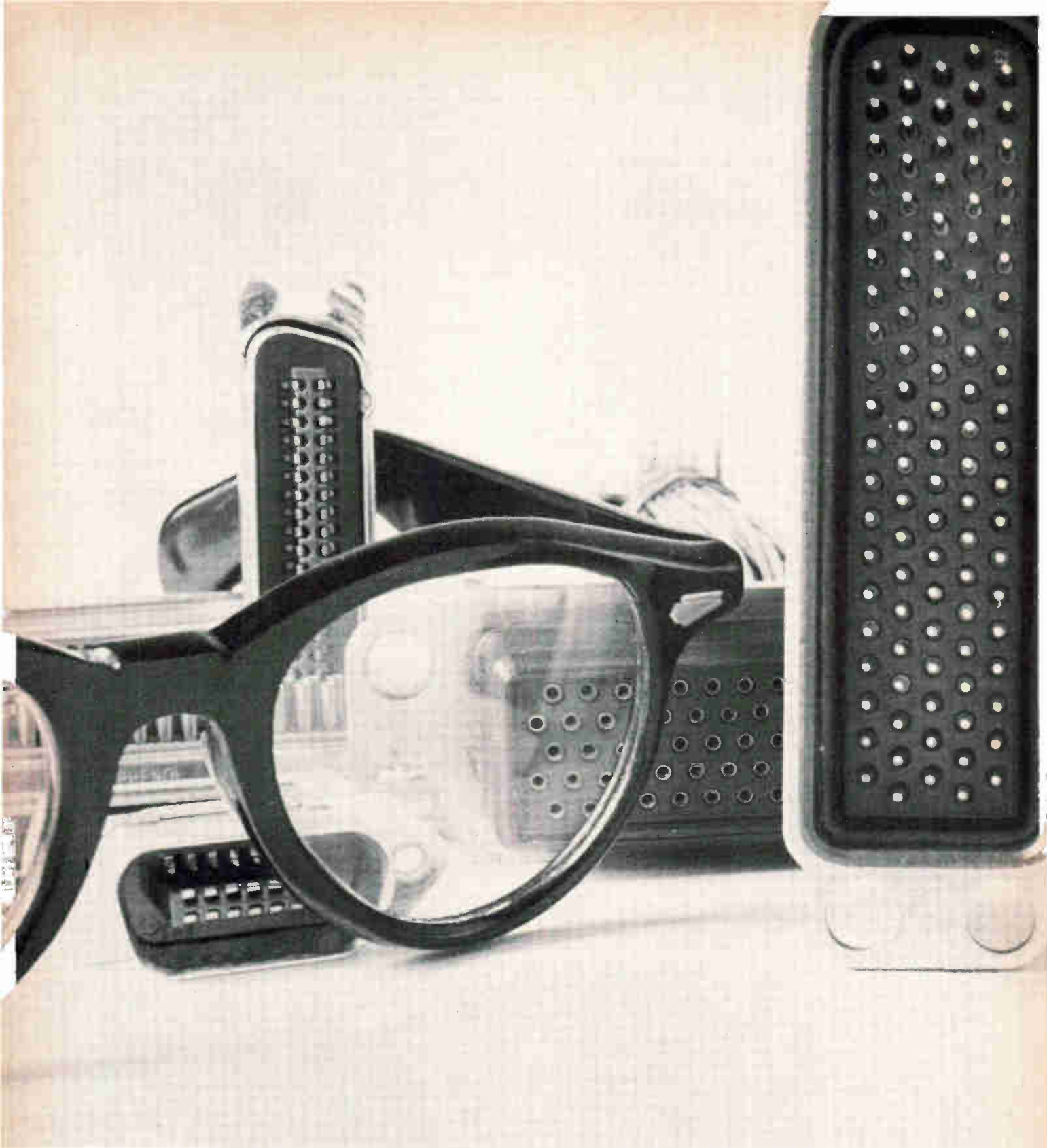

**What to look for
in a good miniature
rack and panel connector.**

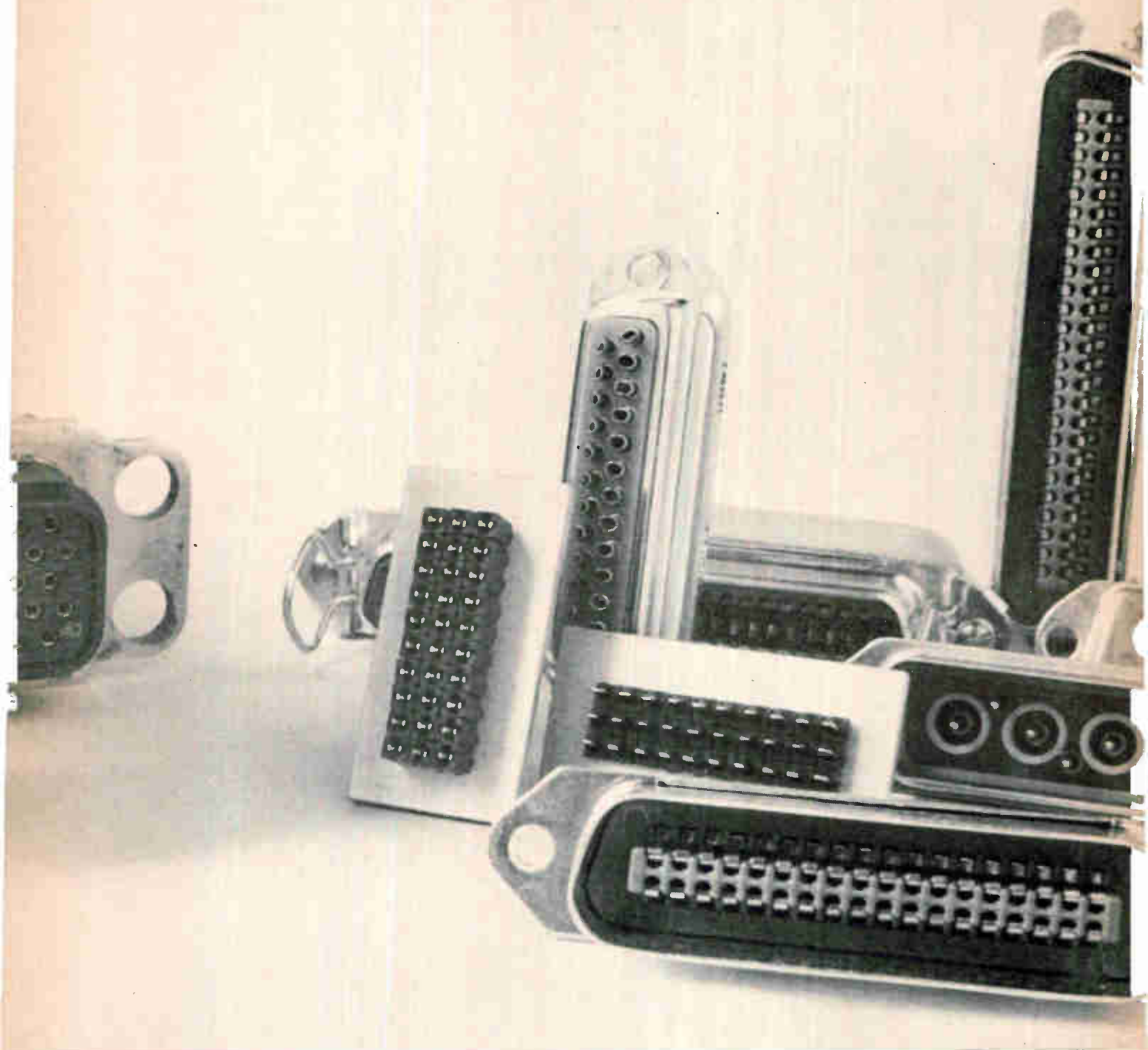

Miniaturization. Amphenol can give you rack and panel connectors with envelope dimensions of less than $2\frac{1}{2}$ " by $\frac{1}{2}$ ". With positive locking devices, too.

More Contact Density. .100" contact centers to .050" in standard lines for 24-, 26- or 28-gauge wire—with

no loss of dielectric strength. Environmental or non-environmental.

Greater Shielding Use. To provide protection through the connector, Amphenol gives you shielded contacts in key product lines.

Wide Selection—Fast Delivery. Chances are most distributors have

what you need in stock. If not, call your Amphenol Sales Engineer or write **Amphenol Connector Division**, 1830 S. 54th Ave., Chicago, Ill. 60650.



AMPHENOL

Specify Amphenol . . . the leading name in cable, connectors, assemblies, RF switches, potentiometers, motors, microelectronics
Circle 21 on reader service card

WHO'LL make the next breakthrough in EDP design?

Could be YOU: with Mosaic's Fiber Optics!

EDP systems design engineers are only beginning to tap the potential of fiber optics. Yet, after a brief acquaintance with this broad, new technology, they have made breakthroughs already . . . obsolescing "standard" EDP design solutions. Advances like greater speeds. Design freedom. New capabilities. Reliability and lower costs.

Did you hear about the oscillograph equipped with a fiber optic cathode ray tube? The CRT tube's electron beam is the writing device. Printout is nearly 100 times faster (1 million inches per sec.) than any direct-writing system in existence! Do you know the story on Mosaic's Fiber Optic systems? In new EDP readers, printers, punched tape and card verifiers . . . in keypunch and teletype equipment, they're more dependable, less complicated, less costly and over 4 times faster than heat, wear and friction-prone mechanical systems!

Mosaic's fiber optics can help you make breakthroughs to advance the EDP state-of-the-art, too. Give those specific design problems of yours a hard look now. Then get going with the solution. Start by contacting Mosaic Fabrications, the people who know fiber optics inside-out . . . the largest single source of fiber optics technology, capability and productivity on earth!

Mosaic will work with you to solve your EDP design problems now . . . will help you design and develop,



from prototype to production, the specific EDP fiber optic hardware to put you way ahead!

Call or write for descriptive literature, today!

Bendix
**Mosaic
Fabrications, Inc**

GALILEO PARK, STURBRIDGE, MASSACHUSETTS 01518 (617) 347-9191

Editorial

The near miss

There's a neat bit of irony connected with the development of the first practical gallium arsenide transistor [page 82]. The sponsor of the research gave up on it because it looked futile, only to see it achieved successfully a couple of months later.

Working under an Air Force contract to create a gallium arsenide transistor, engineers at the Radio Corp. of America's Princeton Research Laboratories built structure after structure in vain. During a routine review of the work, Air Force contract officers bluntly asked the engineers how chances for success looked. When the disheartened engineers replied, "not very good," the Air Force ended its support, to put its money on something that might prove more fruitful.

A few months later, working and thinking on their own, the same engineers hit on the idea of trying silicon nitride as an insulator instead of the traditional silicon dioxide. Bingo! Success. Now the RCA accomplishment promises to lead to families of new discrete devices and integrated circuits capable of handling higher power and higher frequencies than silicon ones can.

There may yet be a happy note for the Air Force, however. RCA engineers are telling Air Force contract officers about their work this week, and the Air Force may sponsor some of the next steps.

... and how to avoid it

But for many research and development projects there is no happy ending. Either they go on interminably and unsuccessfully, with good money following bad, or they are shut off too soon, and a competitor takes the next step and grabs the market.

With all their shiny new scientific management tools, executives still have not learned how to manage a research and development program efficiently. Nobody seems sure how to answer two fundamental questions: when do you shut off a project that looks as if it's headed nowhere? And how do you motivate researchers to reach into a new vein, out of the ordinary stream of technology?

Ten years ago company executives felt sure they would reap a harvest of exciting new products merely by pouring large sums into research and development programs. Unhappily, they found that R&D expenditure showed up only as expenses—few worthwhile products resulted—so today some large companies have cut back their spending. Their rationale is this: if R&D cannot be managed wisely and efficiently, with guaranteed successes, at least the company will waste fewer dollars if the effort is smaller.

A critical ingredient that has been missing in the management of many R&D programs has been serious

participation by top executives. The best advice that can be offered sounds like a cliché: successful management of R&D takes alert, imaginative executives prepared to learn the fundamentals of technology, the technical direction of the research effort, and how the company's efforts fit in with what has been done before.

Too few managers are willing or able to do this difficult homework. It is not easy for the average president of a corporation to wrestle with the logic organization of his company's computer product line or the details of dielectric isolation used in his semiconductor products or the design of an active filter his products should use. Most executives like to tell you that these are details to be worked out by the engineers, while the executives are concerned with policy and the big picture.

Yet top management's intimate understanding of the details can make or break an R&D program. It cannot be delegated, even though industry is full of bright young engineers who have risen to vice-presidential level because they can translate technology to the president and board of directors.

The average top executive doesn't feel comfortable in a meeting that delves deeply into technology. Rarely do company presidents expand their technical knowledge. Often they feel their role in the company demands a concentration on financial matters, organization, and occasional visits to the company's biggest customers.

Although the president of a large company may spend weeks working with accountants and lawyers to set the stock price for an acquisition, he'll give his vice president for research and development only 20 minutes to explain the company's technological plans for the coming year, even though these plans might involve two or three times the money spent on the acquisition.

J. Northcote Parkinson, the noted satirist, spotted this phenomena years ago. In his book "Parkinson's Law," he wrote that a board of directors will spend hours discussing whether to give the men an extra five minutes for tea time but will approve the purchase of a multimillion dollar nuclear reactor in five minutes.

In such an environment, technology has leaped far ahead of management's ability to cope with it.

This deficiency shows up in more ways than just poor management of R&D. It causes companies to lose markets they have dominated for years, to introduce the wrong new product, to misunderstand the servicing technically oriented customers require, and to suffer with problems within the company when the difficulties could be solved by the application of new technology.

Even in the electronics industry, where the stakes are greater because almost every move requires technical understanding, most top executives are only a little more willing to do their technical homework than their counterparts in less technically based fields.

New techniques in communications, integrated electronics, and computer-aided design are changing the structure of the industry. In this atmosphere, a thorough knowledge of technology is essential for top executives not only to evaluate R&D programs, but to assure the company's very continuance.

✓ Check CLIFTON for Servo Packages



ELECTRONIC COMPONENTS FOR COMPUTER USE
F-111 AIRCRAFT



BOOSTER AMPLIFIERS, COMPONENTS OF
THE NAVIGATION AND BOMBING COMPUTERS
F-111 AIRCRAFT



SERVO ASSEMBLY
F-111 AIRCRAFT



AUTO-PILOT SYNCHRONIZER
A7A AIRCRAFT



SERVO AMPLIFIERS USED
ON VARIOUS AIRCRAFT

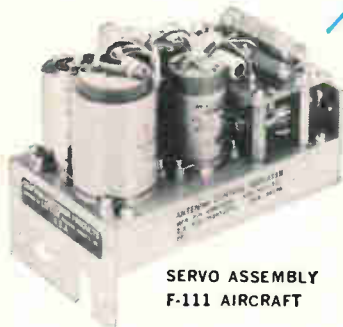

SERVO ASSEMBLY
F-111 AIRCRAFT

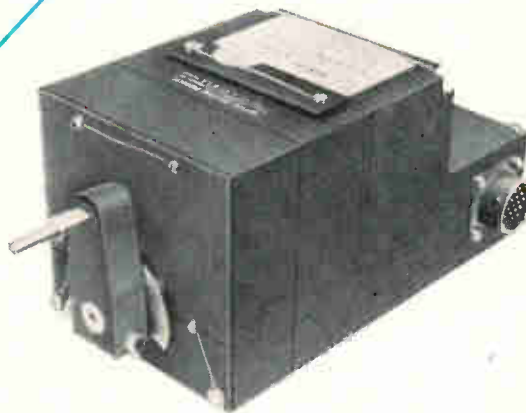

AUTOMATIC STABILIZATION ACTUATOR
CH47A HELICOPTER (SEA KNIGHT)



TACAN RANGE AND BEARING COUPLERS
NAVIGATIONAL USE ON VARIOUS AIRCRAFT

All units shown $\frac{1}{3}$ actual size.



We have been designers and manufacturers of flight controls and special aircraft devices for the past 10 years. A great many engineers and purchasing people think of Clifton only as a leader-manufacturer of rotating components, synchros, servo motors and resolvers. We would like to point out that we also develop, design and produce servo sub-assemblies, to the most exacting requirements. These precision-engineered modules are now flying, or will soon fly, in our coun-

try's most important aircraft.

These packages are built to Clifton synchro standards of reliability and accuracy . . . and in production quantities. While we can hand build models for you, we excel in "in-line" quantity and quality production.

Give us the opportunity to discuss your next servo package need! Do it now, today!

Call 215 622-1000 and ask for Mr. E. Fisher, or TWX 215 623-1183.

CLIFTON 
DIVISION OF LITTON INDUSTRIES

Electronics Newsletter

June 12, 1967

Surging microwave semiconductor sales forecast for 1970's

The over-all microwave semiconductor market should climb to \$25 million by 1970, more than 12 times the current sales level, says a Texas Instruments marketing forecast. And by 1977, TI adds privately, sales should reach \$410 million. Of this figure, \$300 million would go for integrated circuit assemblies, \$80 million for IC's, and \$30 million for discrete devices.

TI plans to be selling microwave IC's off the shelf by the end of 1967 and already has been marketing custom models for nearly a year.

Also gearing up for the expected sales spurt is Sylvania Electric Products, which is now developing a custom microwave IC capability at its Woburn, Mass., plant. Marvin Groll, product manager, says Sylvania expects to be selling an X-band (5.2 to 10.9 gigahertz) mixer by year's end. The concern will double its microwave device production space with the opening of a new plant in Woburn in August.

Air-traffic device snarled in traffic

The FAA's air-traffic control beacon system for commercial aircraft, which is just getting under way, has run into a traffic jam of its own. Ground transmitters, other than the agency's, are interrogating airplanes as they pass overhead, resulting in FAA control centers being overloaded with extraneous beacon responses. Aircraft beacon signals provide such information as a plane's identification, altitude, bearing, and heading.

A major violator is the Government itself, through its Nike missile installations, which use interrogators to identify friendly aircraft. Also creating problems are the manufacturers of interrogators because they test the gear at full power in open fields. Now the FAA is calling for limits on interrogator transmitting power.

Under the agency plan, enroute air-traffic centers and Air Defense Command radar would cut peak power to about 175,000 watts—enough to transmit for about 200 miles. Nike sites with shorter range radar would go lower than that, and airports would dip to 200 watts maximum for 50-mile-radius coverage.

Collins, RCA get Tacsat contracts

The Air Force and Army have awarded separate contracts for terminals in the nation's first tactical satellite communications system. Collins Radio will get \$7.2 million from the Air Force Electronic Systems Division for 43 ground, shipboard, and airborne terminals operating in ultrahigh-frequency bands, while RCA won the Army Electronics Command's \$3.4-million contract for 18 superhigh-frequency terminals. Both contracts call for first deliveries early next year.

U.S. seeks overseas site for seismic array

The U.S. is negotiating with an overseas nation for a site for a second LASA (large-aperture seismic array). The installation would be similar in concept to the 525-sensor array in Montana [Electronics, Sept. 19, 1966, p. 25]. Officials at the Defense Department's Advanced Research Projects Agency explain that LASA can't be used fully to distinguish between seismic events and man-made nuclear detonations until a second large array is available to provide corroborating data. Even detection of low-magnitude seismic and nuclear events by LASA can't be verified by any existing network of stations.

Electronics Newsletter

Cloudcroft project to make comeback

The Air Force will invest another \$2 million to \$3 million and two to three years in an electro-optical satellite tracking system that barely worked after \$5 million and five years was spent on development. The Electronic Systems Division has requested a proposal from RCA for revival of the FSR-2 program at Cloudcroft, N.M. RCA's Aerospace Systems division, Burlington, Mass., was prime contractor in the original effort to develop an optical sensor capable of operating beyond the range of radar. The Cloudcroft facility has been shut down for almost two years.

In addition to further development of image tubes for the system [Electronics, April 3, p. 168], the Air Force wants substantial advances in the fiber optics used to transmit light from the collecting telescope to the tubes. The design calls for 12 curved optical-fiber bundles, each nearly 1½ inches square and about 20 inches long. An attempt will be made to build flexible bundles so that they can be tuned to the telescope at one end and the image tubes at the other.

How to find a cop when you need one

New York City's Police Department is hot on the trail of a computerized command and control network [Electronics, May 1, p. 105] even though a major question has yet to be answered: How can patrol cars be monitored constantly for computer assignment? A scientific task force attached to the President's Commission on Law Enforcement and Criminal Justice, which urged highest priority for computerized networks, has dubbed four car-location schemes "technically feasible."

Most promising, says the task force, is a plan to equip each car with an acoustic or electromagnetic device emitting signals to receivers in police and fire call boxes, which would be linked to a control center via land lines. Inspector William Kanz, in charge of communications for the New York police, leans toward that scheme. In fact, he explains, "we're planning to extend our emergency call system by adapting 14,000 fire call boxes for police use. We might just be able to add a location system at the same time."

The three other plans include the use of radar transponders, radio direction-finding equipment, and a simplified inertial navigation system that would keep track of a car's location.

Solid state, 3-axis accelerometer planned for missile

A solid state, three-axis accelerometer is about to be delivered for a classified missile application by Conrac Corp. The device uses six diffused silicon strain gauges instead of conventional electromagnetic pickoffs and can measure accelerations as large as 500 G's with 0.25% to 1.0% accuracy.

All three axes pass through a single point, thus eliminating the need for compensating electronics. Three rods are drilled and passed through each other at right angles to form a cross with arms in x, y, and z axes; strain gauges support the ends of each rod.

The strain gauge device has no moving parts and requires no servo loops for operation. Most electromagnetic accelerometers detect acceleration by measuring the current needed to keep a captive pellet or pendulum in position. With the Conrac device, the resistance of the strain gauge changes under acceleration, giving an analog voltage proportional to the rate of change of velocity. The whole accelerometer package, including 12 integrated circuit amplifiers and one IC differential amplifier, is only 3 cubic inches.



We cross examine every IC at 14 points... and that's just the beginning.

Early in production, every Sylvania IC is 100% DC tested on our fully automated 14-point probe.

At the end, each Sylvania IC must pass final operational tests in four consecutive, temperature-controlled chambers from -55°C to 125°C .

And there's no let-up in testing in between. All bonds are air-blasted and mechanically tested prior to package sealing. All packages are baked at 300°C to insure absolute dryness before sealing.

After sealing, all units are aged at 300°C for

60 hours. Then all IC's are temperature cycled from -65° to 200°C , centrifuged at 20,000 Gs in the Y_1 plane, and all packages are 100% leak tested for hermetic seal.

These tests are far more comprehensive and thorough than any performed by our competitors. And we minimize errors in the first place with our fixed production process.

Sylvania Semiconductor Division, Electronic Components Group, Woburn, Mass. 01801.

SYLVANIA
SUBSIDIARY OF
GENERAL TELEPHONE & ELECTRONICS **GTE**

Circle 29 on reader service card

WE WILL PAY SUBSTANTIAL FINDER'S FEES TO YOU

**if you alert us to a private company for which we manage
a public offering of securities.**

***We are a 63-year-old Investment Banking Firm,
Member of the New York and American Stock Exchanges,
and we want to go to work on your suggestions.
Aside from our limitation of one fee per transaction,
the more fees we pay the happier we will be.***

D. H. Blair & Company is an aggressive, rapidly-expanding investment banking firm which combines the advantages of young management with 63 years of investment banking experience. We are ready to act quickly on your suggestions of firms interested in going public.

We are particularly interested in companies with several years of impressive growth in rapidly expanding industries. We are well-equipped to manage initial public offerings ranging in size from \$2 million to \$15 million. Further, if after examination we feel that a particular situation is not yet ready for a public offering, we will suggest and implement alternative methods of financing while working with the company to ready it for its objective of having a public issue. If we are enthusiastic enough about a situation, we may invest our own capital as an interim means of financing preparatory to a larger public offering.

We are looking especially for firms which have the potential for listing within 1-3 years on the American Stock Exchange and subsequently on the New York Stock Exchange. We are definitely not

interested in small Regulation A offerings.

What role can you play? You can alert us to a company which you believe meets our specifications and whose owners you think would like to see a public market for their stock. All you have to do to be eligible for a finder's fee is to be the first to write us in detail about a particular firm. Of course, your chances of getting us to give priority to your proposal will be enhanced if you do some advance spadework, e.g., sounding out the owners for a definite indication of interest, assembling and submitting to us product and financial data on the companies you propose, and indicating your ability and willingness to introduce us to the principals should we show interest in your submission.

We believe this offer is both unusual and generous. We hope you will find it intriguing enough to search your mind for companies you know which may meet our specifications. If you do, please submit information about these companies, in writing, to J. Morton Davis, Senior Partner, Investment Banking.

The financial rewards to you could be very substantial.

D. H. BLAIR & COMPANY

Serving investors since 1904

Members

New York Stock Exchange • American Stock Exchange

5 Hanover Square, New York, N. Y. 10004
10889 Wilshire Blvd.

212-WH 3-5800
Los Angeles, California 90024

ACQUISITIONS • MERGERS • UNDERWRITING
PRIVATE PLACEMENTS • SECURED LOANS • SHORT TERM FUNDS

CORPORATE PLANNING & DEVELOPMENT ADVISORY SERVICES

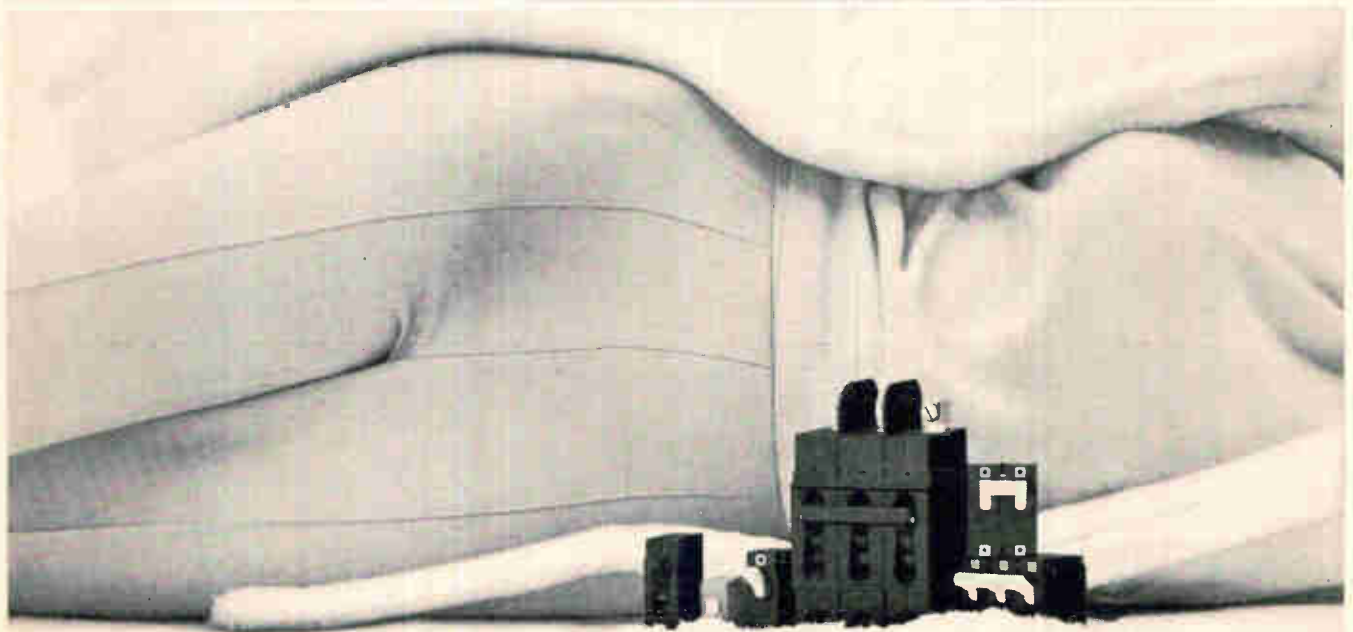
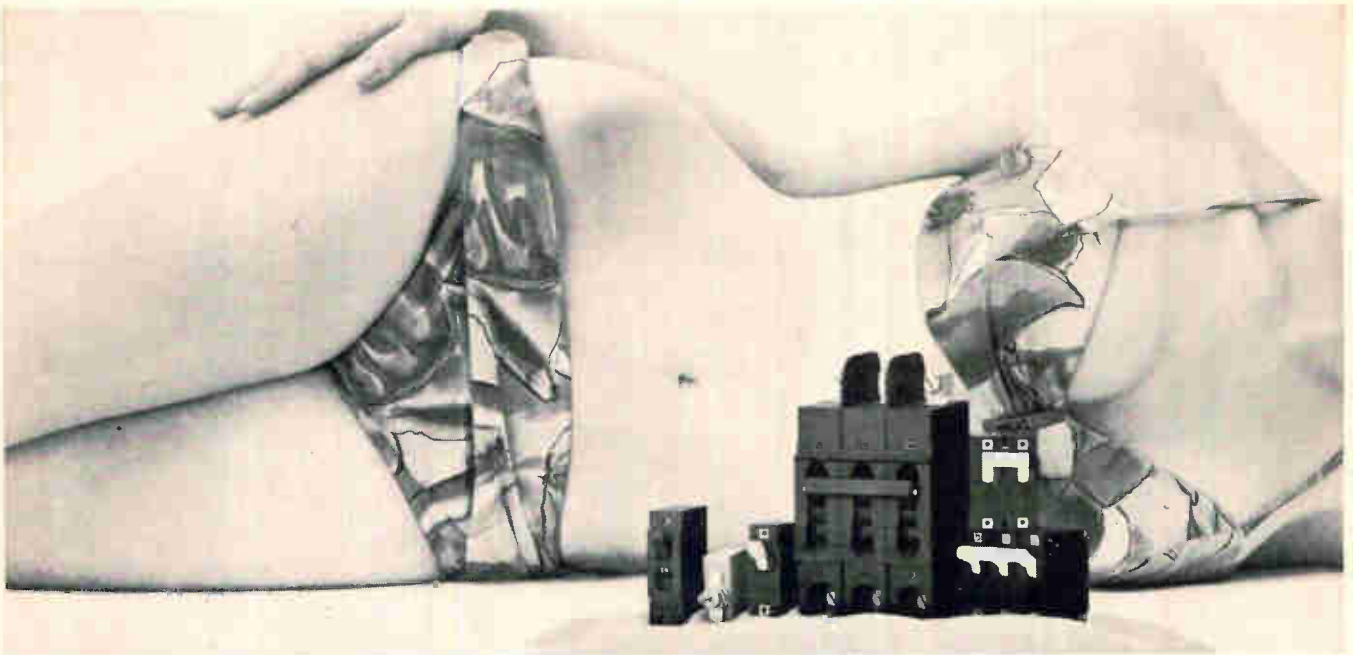

3267

No matter what the thermometer might read, Heinemann circuit breakers think for themselves.

They don't trip when the ambient temperature goes up, or fail to trip when the mercury drops. They're not affected by ambient extremes. Hot or cold. You get consistently predictable, temperature-stable overload protection.

The reason: magnetic actuation. A Heinemann breaker senses only the actual load current. Not current-produced heat. Calibrated trip-points don't shift with ambient temperature changes. The breaker can't be fooled.

Magnetic actuation also makes it practical to produce current ratings

precisely to customer specifications. We can give you the exact rating you need. Calibrated out to three significant figures, if you like. You can also choose a time delay response curve that closely matches the inrush characteristics of the protected equipment. And we can give you a non-time-delayed response for those applications where you can't tolerate any appreciable overcurrent.

Heinemann breakers are available in a broad range of models, from sub-miniature on up. Most can be had in current ratings as small as 0.010 amps

with voltage ratings comprising the most commonly used supply voltages, AC and DC.

Our Engineering Guide, Bulletin 202, will give you complete technical information, along with some interesting insights into ways circuit breakers can be used for control as well as protective functions. A copy is yours for the asking. Heinemann Electric Company, 2600 Brunswick Pike, Trenton, New Jersey 08602.



HEINEMANN



Just when we've solved your synchro problem, somebody comes up with a new one.

Designing and producing Autosyn® Synchros to fill the everyday needs of our customers isn't enough. We also specialize in meeting the unique need and solving your specific requirements.

Fact: engineers needed smaller, lighter-weight synchros for space-critical designs. Solution: the new series of 16 Size 08 Autosyn Synchros.

Fact: supersonic aircraft applications demanded synchros that could consistently operate at ultra-high

temperatures. Solution: eleven different Autosyn Synchros will perform accurately at temperatures up to 800°F.

Fact: we've built many of them to be corrosion- and radiation-resistant.

AUTOSYN® SYNCHROS

Size	Max. Diameter (In.)	Typical Weight (Oz.)	No. of Models
08	0.750	1.3	16
10	0.937	1.7	25
11	1.062	3.2	29
15	1.437	4.7	24
22	2.161	18	5

And we're able to provide synchros with tolerances as close as 50 millionths of an inch.

Meeting all needs has been our way of business since we began business in the 1920's. That's why the Bendix line of Autosyn Synchros (and Mil-Spec synchros) is the most extensive you can find. And it's why we're ready to solve your synchro problem. For complete details, write for our 42-page catalog. Flight & Engine Instruments Division, Montrose, Pa.

Bendix **Aerospace Products**

Advanced technology

Sliced laser

Most of today's high-powered crystal lasers are cooled by water flowing around the circumference of the laser rod, but even so the crystals often overheat before reaching their full potential output powers and repetition rates. At best, excess heat reduces laser efficiency; at worst, heat can destroy the laser rod.

But there's a better way, says Edwin Matovich, a researcher at the Autonetics division of North American Aviation Inc. Autonetics' trick is to slice the ruby or glass rod into several slices as small as 1/4 inch long and place them in a double-walled quartz tube. Teflon spacers separate the faces of the slices, allowing coolant to flow across the faces rather than around them. The inner quartz tube doubles as the plumbing needed to get coolant from face to face.

Since the slices are cooled on their faces rather than their rims, the temperature gradients no longer cause thermal distortions that can result in internal focusing. This can melt small areas within a solid slice or reduce efficiency by

defocusing the laser cavity.

Bit by bit. Use of small crystals to build large lasers is an advantage in the push toward higher output. Large solid crystals are nearly always flawed by bubbles, misaligned molecular lattices, or uneven dopant concentration. High optical quality is easier to attain in cheaper, smaller crystals. By stringing small slices together, laser builders can produce systems with lower thresholds and narrower output beams simply because each inch of the laser can be selected for optical quality.

Autonetics has found that for 5 inches of ruby, 5/8 inch in diameter, a 1/4-inch sliced laser required only 1 kilojoule of pump energy to reach threshold while a solid crystal required 1.5 kj. Beamwidth was only 1 milliradian for the sliced ruby, but 3 mrad for the solid crystal. Even the best commercially available lasers specify about 1.5 mrad beam divergence. Matovich attributes the boost to the better over-all optical characteristics achieved through slice-by-slice construction.

The ruby device has produced 100 megawatts peak power with no loss of efficiency due to heating and, according to Matovich, at 100 mw, it was nowhere near the limit

of its thermal dissipation capability. This laser will replace a standard type in a digital range finder at the Naval Ordnance Test Station, China Lake, Calif.

Autonetics has already begun working with neodymium doped glass and plans to start experiments with 1 5/8-inch thick slices of Nd-doped yttrium aluminum garnet. An experimental Nd glass laser is expected to develop 4.25-joule pulses at 20 pulses per second; average power should be about 90 watts. Matovich claims a solid Nd glass laser of the same active length would yield only 12 to 15 watts without rod damage.

Communications

Out of the past

Field-sequential color television is making a comeback. The CBS approach that in 1953 lost its place as the national standard to the compatible system has been applied by CBS Laboratories to the design of an 8-pound, low-light-level color camera. Ironically, the man who pushed the Columbia Broadcasting System to return to

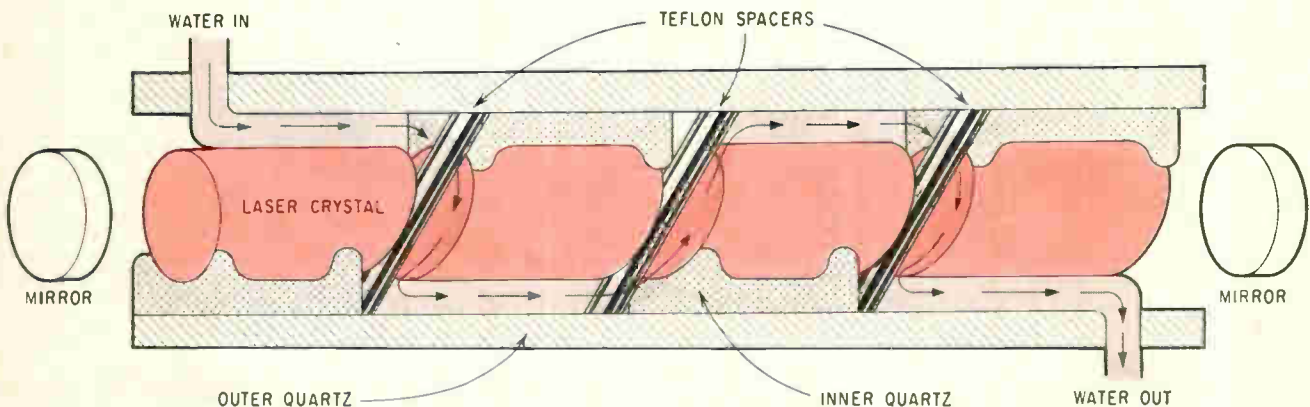

Cut up laser. Autonetics replaces the usual long laser rod with shorter sections allowing coolant to run over the rod's faces rather than around their circumference. The result is more efficiency and power. The inner quartz tube doubles as a crystal positioning jig and coolant pipeline.



Light and colorful. CBS's new miniature color television camera uses the same color-wheel-and-vidicon technique proposed for network tv in the early 50's. Its size, weight, and price suit it to applications in medicine, on the battlefield and in space.

field-sequential techniques and designed the new camera is one of the engineers who helped develop the National Broadcasting Co.'s version of the color compatible system.

With only one vidicon and a third as many components as a standard color camera, the new unit is inexpensive; there is no color registration problem and no need for beam splitters or prisms to feed separate vidicons in the lightweight camera.

The camera CBS proposed for network tv in the early 50's had a wheel with red, blue, and green fields that was spun before a vidicon. Color information was transmitted in sequence as the color filters passed in front of the tube. But because this setup required home sets to have color wheels too, the Federal Communications Commission opted for the three-vidicon compatible-color system, which

could transmit pictures to sets already in the home.

Full cycle. NBC's color system was partly designed by Renville McMann, who moved to CBS Laboratories in 1955. And now McMann, currently vice president and director of engineering at the CBS division, has dusted off the field-sequential approach.

Though developed with CBS funds, the camera was designed with a University of Pennsylvania medical program in mind. It will initially be used to view internal parts of the human body through fiber-optic probes. Other applications for the low-light unit could come in tactical command-and-control networks, night surveillance, and perhaps weather satellites.

The camera uses either a Plumbicon tube or a new secondary emission conduction (SEC) vidicon made by Westinghouse Electric Corp.—both highly sensitive, small tubes with aperture sizes of less than 1.5 inches.

The camera has been designed to deal with problems that plagued the original CBS system. One of these is color lag—faulty color information transmitted by the tube because slow decay time caused the retention of image data from scan to scan.

The fast decay times of the Plumbicon and SEC vidicon reduce this lag, but to minimize it, McMann uses noninterlaced scan. In this technique, the tube scans the same raster lines on each cycle, erasing any data that hasn't decayed.

To further clean up the signal, glass acoustic delay lines store the information in the raster lines adjacent to the one being scanned. Other circuits compare this data with the content of the line being scanned, and generate and amplify a difference signal that accentuates line-to-line variations. A threshold-sensitive amplifier sharpens contrast by responding only to signals above a given strength.

Low cost. The whole transistorized package, including synchronizer, costs about \$10,000. The only competition in this country would come from three-vidicon color

systems built by the Packard Bell Electronics Corp. and Cohu Electronics Inc. and costing \$18,000 to \$25,000 excluding sync and encoding equipment.

The CBS camera's price makes it a natural for closed-circuit color applications, but even more interesting are the jobs it might do for the military and the National Aeronautics and Space Administration. According to McMann, the system might be used to detect camouflaged soldiers at night. CBS has found it possible to tell the difference between live and dead foliage by noting the difference in absorption at red wavelengths; the same sort of detection technique could probably be applied to camouflage.

The space agency is interested in satellite applications for the camera, according to John Maniello, marketing vice president for CBS Laboratories. Aboard a weather satellite, the color camera could give a better representation of storm severity, ocean turbulence, or river pollution than black and white tv, he says.

With the little camera, field-sequential color might even find its way back into the national tv networks. CBS will probably use the camera as a "creepy-peepy" to cover the 1968 political conventions. The company has already developed a scan converter to change field-sequential signals to the national standard. With the scan converter and six "creepy-peepies," McMann says that on-the-spot floor coverage could be accomplished for only \$100,000. With standard three-vidicon cameras, the cost would double.

Military electronics

Lighter link

It takes two dozen huge vans, crammed with air-conditioning equipment and large power generators, to control batteries of surface-to-air missiles. In addition to tying up a considerable amount of heavy equipment, the control links

create maintenance and repair problems — qualified technicians and a large supply of spare parts are required in the field to support the system. In a move to streamline such an operation, the Army has awarded Litton Industries Inc. a \$10-million contract to build 128-pound digital processors to replace the 2-ton control units now in use.

The new unit, called AN/CSA-77 and commonly referred to as battery terminal equipment, is about the size of a small steamer trunk, consumes 170 watts, and employs integrated circuitry.

What makes the terminals particularly attractive to the military is their self-testing, fault-location, and quick-repair capability. Litton estimates that an unskilled operator in the field will be able, with a few instructions, to find and repair a fault in less than 15 minutes.

Whiz bang. The system automatically tests itself every three minutes by circulating loop test messages in parallel. Should a failure be detected, a horn alarm sounds, warning lights go on, and the unit shuts itself off. The operator opens the front panel of the processor to view 20 failure lights and a decal showing the circuit card numbers that correspond to the lights. After locating the failure, he checks the cards

with a pistol-grip tester; there are leads from each card so that they do not have to be removed for testing. Two blocking diodes on each card isolate the card from the rest of the system during fault location. Another array of lights indicates the status of the card being checked and signals, for example, if a microcircuit is faulty or if the operator has made a testing error. Spare circuit cards are stored in a tier at the rear of the control unit. Four standard digital cards make up 80% of the circuitry. Mean time between failure for the unit is rated in excess of 2,500 hours.

Self-healing. Hawk, Hercules, and Nike missile installations will be linked by the new control unit and, should certain batteries or the control center be knocked out, new communication routes for control of the system will be automatically established. Usually, the control center coordinates a group of batteries, but if it should be damaged, the new processors will automatically switch to establish communications with each other.

The contract for the processors came from the Army Missile Command in Huntsville, Ala. Prototypes from Litton and the Aerospace group of the Martin-Marietta Corp., the only other bidder for the con-

tract, were tested by the Army for more than a year. Litton's units bettered many of the Army specifications and that apparently was a factor in winning the order. For example, the Litton processor weighs 172 pounds less than specified, is more than 2 cubic feet smaller, consumes 330 fewer watts, and can be repaired more rapidly.

Circuit design

On line

Engineers at Autonetics have come up with the first practical, large-scale system for computer-aided design used by a major aerospace company. The system is based on a dual set of computer codes for circuit analysis developed at the division of North American Aviation Inc.

The two codes—SCAN (for system of codes for analysis of circuits and systems) and TRAC (for transient radiation analysis by computer)—stem from the firm's extensive commitments to microelectronics in such programs as the Mark 2 avionics system for the F-111 aircraft and the Minuteman 2 guidance computer. The advent of large-scale integration has provided further impetus for engineers to turn to computer methods of circuit analysis, according to Walter Hochwald, chief of the product analysis section in the division's advanced analysis and applications research department.

A year ahead. Hochwald believes the codes have put Autonetics as much as a year ahead of others in the industry in circuit analysis "not because we're any smarter, but because we've had Minuteman contracts that have given us both the money and the need" to predict the performance of microcircuits throughout their lifetime. Company officials claim the codes—developed by C. T. Kleiner, E. D. Johnson, and L. R. McMurray—give them design data in one-tenth the time of codes used elsewhere in industry.

Normal tolerance variations of circuit components through use of the digital computer codes are be-

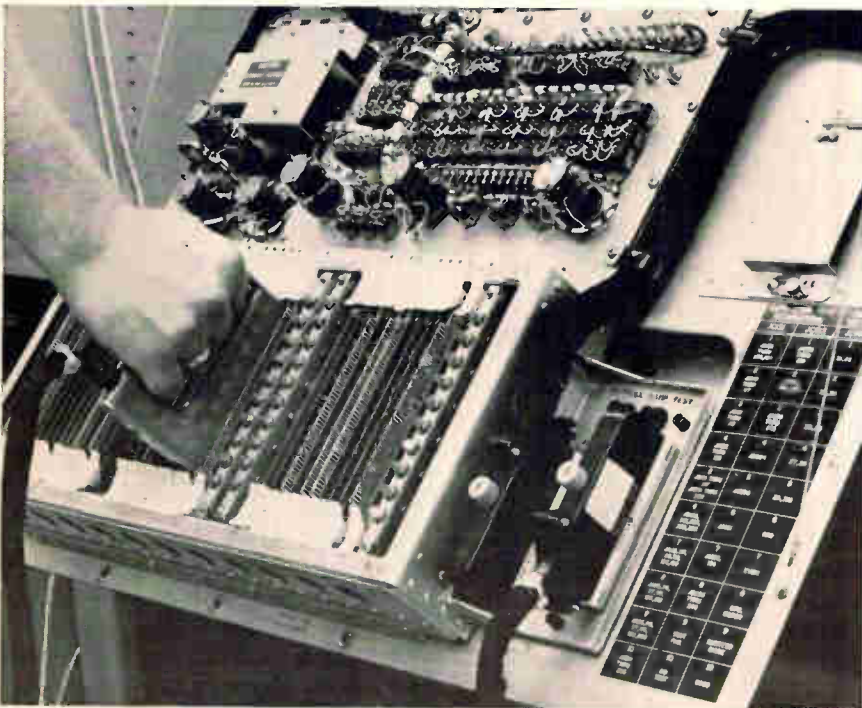

Quick repair. Malfunctions in the Army's new lightweight command link for surface-to-air missiles are quickly isolated by checking circuit cards with a pistol-grip tester.

ing sought. The capability ranges from an evaluation of a steady-state condition of an integrated circuit to an evaluation of an entire system subjected to transient phenomena. "For example," Hochwald says, "we can simulate fairly large portions of the Minuteman 2 guidance computer."

At each step, the conditions cranked into the computer are compared with behavior of circuit models stored in the computer's memory. The engineer gets both a printout and a graphic representation, on a cathode-ray tube, of the waveform he's analyzing.

He may, for example, want to find out what happens to the circuit he's studying if noise is introduced. He then tells the computer mathematically the value of the noise he's adding, and the computer compares the noise figure with the acceptable noise tolerance for the circuit model under investigation. The engineer has only to compare the waveform he gets back from the printout with the model to predict how the noise affects the circuit.

Quick services. The crt is situated at the central computer—an International Business Machines Corp. System 360 model 65. If the problem is urgent enough, the engineer can go to the computer and enter his data, and in a relatively short time get a display of the waveform that describes the conditions he's introduced. In practice, however, this is rare at Autonetics. Direct access is reserved only for those cases in which security might be compromised by sending the problem from a remote location. Standard procedure is for the computer to batch-process the problems.

The engineer generally feeds his problems to the computer at the end of the workday, and has the solutions—both computer printout and crt plot—the next morning. This turnaround time can be reduced to three or four hours during the workday if the problem is urgent enough. If the computer was used solely for circuit analysis, says Hochwald, the delay could be reduced even further.

The codes can accommodate nonlinear circuit models. For example, Hochwald picked a free-running flux oscillator with nonlinear transformer cores and nonlinear transistors. With such a model, he says, "you rule out all but about 10" computer programs in existence, including NET-1 (network analysis program) and ECAP (electronic circuit analysis program). Of the remaining programs, he says, the SCAN-TRAC family is the fastest by a ratio of between 3 and 10 to 1. Circuit analyses that would take between two and three hours with other programs have been run off in five to 10 minutes, Hochwald points out.

After receiving numerous queries about the codes from industry and Government, Autonetics toyed with the idea of developing a sales program. But the plan has apparently been dropped for now. At present, says W. H. Hafstrom, a company vice president and head of the commercial development office, there are no plans for any commercialization of the codes.

Avionics

3-D radar, continued

At the Government's sprawling avionics test facility at Atlantic City, N.J., stands a 165-foot-high monument to the frustrating search for an air traffic control system capable of keeping pace with the tremendous growth in air travel. It's an experimental three-dimensional radar built in 1961 at the behest of the Federal Aviation Administration; the project was subsequently dropped in favor of a system now becoming operational requiring commercial aircraft to carry transponders that signal the plane's identity, bearing, altitude, and other data to ground controllers. But the company that built the tower, the Maxson Electronics Corp. of Great River, N.Y., hasn't given up. It's now trying to sell the FAA on the idea of using improved 3-D radar to complement the beacon trans-

ponder system.

Not good enough? Maxson agrees the beacon transponder concept is good—but only when there is a lot of airspace around the craft being tracked; in crowded skies—like over busy airports—even the best computer-operated systems, which gather the beacon signals and process them, often confuse one plane with another nearby.

Whether this is a problem serious enough to warrant the use of 3-D radar in addition to the beacon technique is for the FAA to decide. But thus far the agency has maintained that the beacon system is sufficiently accurate for present needs.

Despite this apparent lack of interest by the FAA, Maxson is pushing the 3-D concept, claiming that it need operate only around the major airports. Maxson says the size and price would be sharply reduced by the application of solid state techniques developed since the first tower was designed. The company's engineers contend the size could be cut by a third, but they decline to speculate on the price.

Coarse and fine. Under the proposed system, the 3-D radar signals would provide coarse information on a plane's bearing and altitude; this data would then be used to direct the computer to lock onto the plane's beacon signal—eliminating the possibility of the computer's confusing signals of nearby planes.

Components

Another Nixie challenger

Two companies are now challenging the supremacy of gas-discharge digital readout tubes for small computers by turning to unique variations of the cathode-ray tube.

The Tung-Sol division of Wagner Electric Corp., Bloomfield, N.J., showed a pilot model of its new Digivac at the Society for Information Display meeting in San Francisco just as Japan's Ise Electronics Corp. was announcing its new in-

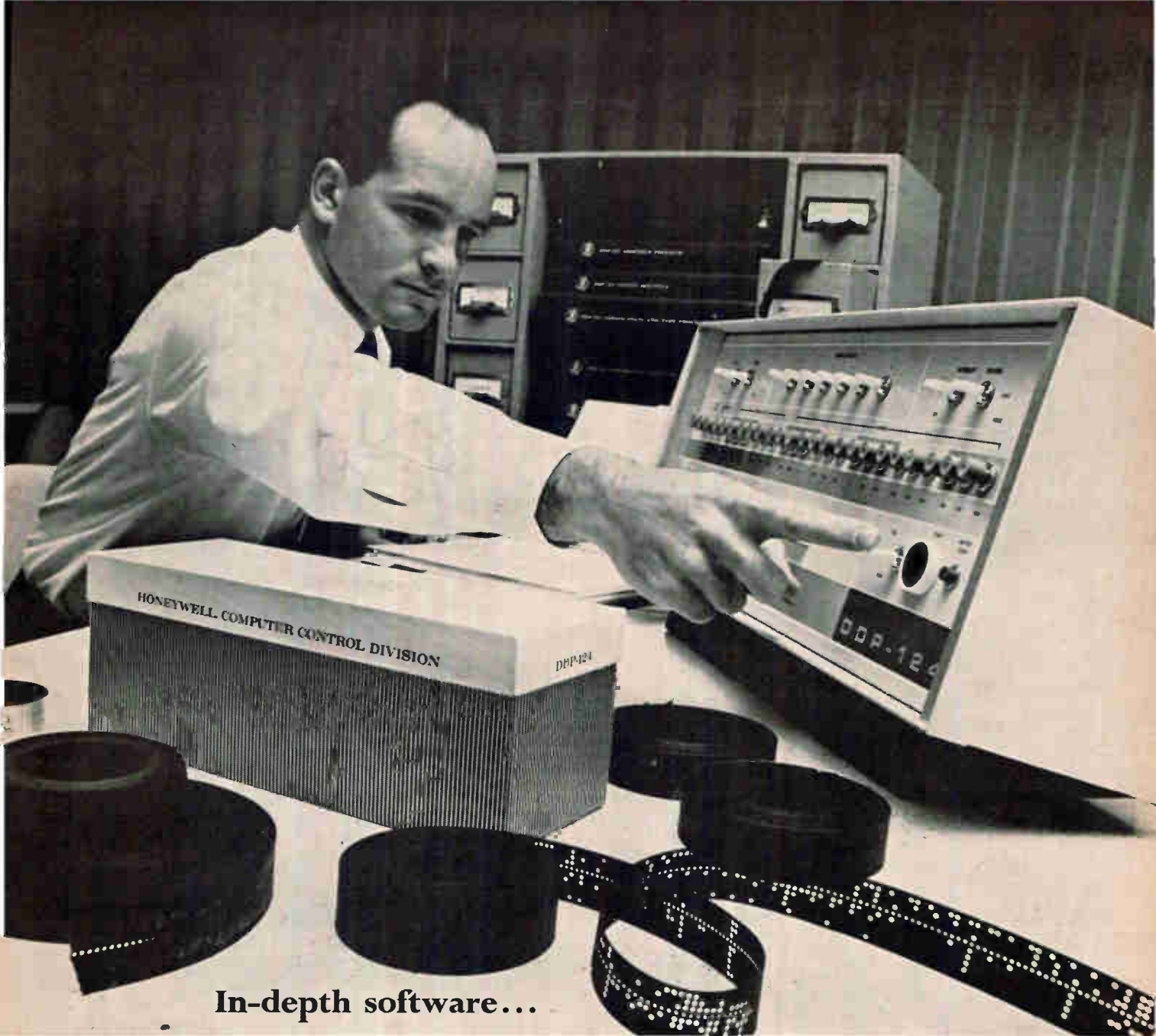

In-depth software...

...at your fingertips
for the finest 24-bit
I/C computer buy
...DDP-124

Every μ -COMP DDP-124 includes 253 field-proven software programs, FORTRAN IV compiler with Boolean capabilities, compatible symbolic assembler . . . *and more*. That's a lot of 24-bit software strength at your fingertips to help solve your programming problems.

Hardware? DDP-124 features I/C μ -PAC logic modules for high reliability, high performance, high speed at low cost . . . and its specs make it an ideal computer for flight simulation, message switching, physics research, radar tracking, data acquisition, scientific computation, missile tracking, impact prediction.

Interested in the finest 24-bit I/C computer? Write today for new DDP-124 brochures with complete software listing. Honeywell, Computer Control Division, Old Connecticut Path, Framingham, Massachusetts 01701.

Honeywell

 **COMPUTER CONTROL**
DIVISION

Circle 37 on reader service card

side-out Digitron [Electronics, May 29, p. 212].

Both tubes are small, cheap, require little power, and offer good contrast under high indoor lighting. Unlike gas-discharge tubes, the crt's provide single-plane character generation and their numbers don't "dance." Wagner's tube, measuring 1.125 by 0.5 inch, is smaller than Ise's 1.7 by 0.5 inch, and has alphanumeric capabilities (it can display 11 letters).

The two devices differ in the way they aim the electrons. Ise's Digitron turns the crt around so that the viewer looks through the front-mounted filamentary cathode to see the numbers on the rearward phosphor segments.

Back up front. Wagner's Digivac, however, puts the numbers up front in more conventional fashion. By using grid control, Wagner accelerates the electrons from the rear-mounted cathode through a nickel mesh anode. The electrons are slowed and then speeded back to the anode's front side, which has phosphor coating on discrete areas.

To prevent random electrons from lighting the wrong number segments, Wagner places a transparent conductive barrier electrode in front of the target area, which lets only the right electrons through. Basically, the device becomes two diodes with glowing anodes in which electron flow in the diodes is controlled by small grid control biasing signals.

Wagner is after part of the market held by the Burroughs Corp.'s Nixie gas-discharge tube. And Wagner spokesmen conceded they were dismayed and surprised by the announcement of the Ise device. Plans call for the Digivac to be marketed before year's end, at a price comparable with that of the Nixie tube.

The Digivac is a planar ceramic device of eight triodes with mesh targets (21 elements), eight control grids, and one anode. Each grid controls a separate segment or line to form part of a number or character. Ise's Digitron, which uses the older principle of anode switching, has multiple diodes, one grid, and eight anodes.

Turn to glass tubes. Wagner

houses the package in cheap and reliable glass tubes, a standard Compactron (12-pin) stem with a bottom-off configuration in a T-9 bulb.

The fixed anode voltage doesn't exceed 200 volts and grid-switching voltage is not more than -6 volts d-c.

Without ambiguity, the Digivac can generate the letters a, c, e, f, g, h, j, l, p, u, and y. By adding eight more grids the whole alphabet and about 64,000 characters more can be generated.

A company spokesman pointed out that the present glass package is a space waster; package height could be reduced to $\frac{3}{16}$ inch by using a windowed, rectangular metal case.

Consumer electronics

The IC push

Manufacturers of television receivers and other consumer electronics products will be buttonholed this week by representatives from the integrated circuit industry. The first major move to replace vacuum tube and discrete semiconductor stages with ic's is now under way. Independently, four ic makers, Texas Instruments, Motorola Semiconductor Products, Fairchild Semiconductor, and General Electric unveiled new linear ic's for consumer applications at the Chicago IEEE Spring Conference on Broadcast & Television Receivers, which runs from June 12 to 13.

TI is displaying five hybrid ic's—one for television f-m sound systems and four audio output circuits for driving speakers.

Motorola introduced a monolithic ic for video r-f and i-f stages, and Fairchild has come up with three monolithics—one for tv sound i-f systems and two general purpose high-frequency amplifying units.

GE is introducing five monolithic circuits for tv and radio applications.

Each ic firm claims the ic's are the first products of their kind

priced to compete with devices now occupying tv sockets and boards. Few ic's have found their way into tv receivers, primarily because of prohibitive prices. To accelerate the invasion, the new linear ic's will retail for a few dollars each in production quantities; some will sell for under \$2. None of the four vendors gave evidence that a large consumer electronics contract is in the wings.

The new TI tv hybrid contains monolithic active elements, thick-film resistors and conductors, and inverted discrete chips (flip chips). The inverted elements include bipolar small-signal and power units, field effect transistors and zener diodes. Designated the HC1001, the ic contains a wideband i-f amplifier, an f-m detector and an audio preamplifier. It accepts 4.5 Mhz i-f signals and directly drives vacuum tube or transistor audio power stages in tv sets.

The other four new hybrids are audio-output amplifiers with up to 1-watt capabilities for a-m radios and f-m radios and phonographs. Pricing of the five ic's is in the \$2 range. One of the chips is rated for direct operation in standard 130-volt lines.

Easily aligned. Motorola's ic will ease alignment problems in black-and-white and color-tv's at the assembly-test line, and will prevent detuning when the user switches channels. These benefits are traceable to the chip's high isolation and a built-in, modified automatic gain-control (agc) action.

Jerry Robertson, manager of Motorola's ic applications engineering, credits the chip's combination of cascoded input stage and Darlington configurations with higher isolation than discrete stages can offer. Agc is applied at the collector of an internal transistor instead of at its input—preventing the input impedance of tuned stages from changing with agc bias—a cause of detuning.

The linear ic contains multistage high-frequency amplifiers, an agc stage, biasing networks, and an output stage; tuning elements are outboarded. Other applications for the circuit include stagger-tuned amplifiers, wideband and narrow-

SPEER COMPONENT COMMENTS

How to get more satisfaction from your metal film resistors—without switching brands

It's easy. Just ask your supplier to incorporate his resistors into packaged networks or assemblies.

With pre-assembled networks, you can obtain packaging densities far greater than those obtainable with individual metal film resistors. In fact, volume savings of up to 80% can be achieved.

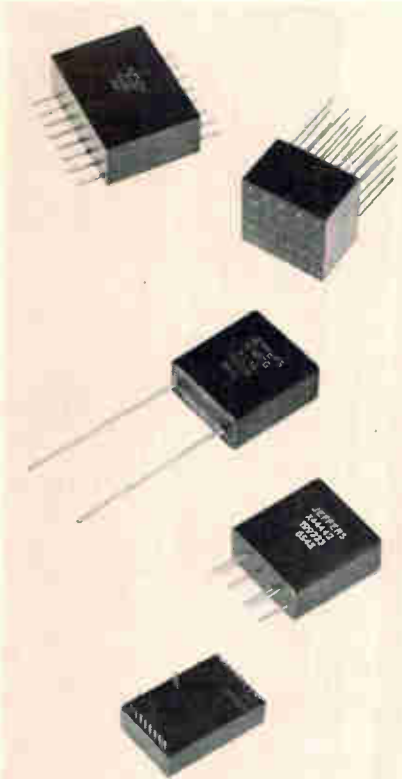

Pre-assembled and tested discrete resistor networks also offer reliability levels many magnitudes higher than those achievable with individual assemblies.

Another important advantage of networks is that manufacturing and performance cost factors can, in most cases, be surprisingly reduced.

As we noted above, these advantages (and others) will accrue no

matter what brand of metal film resistor you happen to be using. On the other hand, we would be remiss not to remind you that our Jeffers Electronics Division's JXP resistor has a definite edge over every other brand. Which means that networks incorporating this "white room" precision resistive element can really give you something extra in the way of increased satisfaction.

We therefore suggest that you don't just investigate metal film resistors networks, but that you investigate our JXP precision networks specifically. Mail us the coupon—and discover just how satisfying resistor satisfaction can be.

Please try to ignore the surplus performance that components sometimes deliver

You probably read the editorial on this subject that one of the industry magazines published not long ago. Nevertheless, the message is worth repeating:

A component designed to meet one set of specifications may also test out to more rigid specifications. And engineers have been known to cut costs by designing such a component into equipment for which it wasn't intended.

The only trouble is—they're putting themselves out on a limb (not to mention their supplier). Subsequent lots of the component may very well turn out to perform much closer to the claimed specifications—for a variety of reasons.

Speer components are among those that sometimes deliver this surplus performance. (The operative word here is "sometimes," incidentally. There are also areas in which our components always outperform their specifications. But that's another story—one we'll get into in a future issue.)

Your continued cooperation in this matter of under-specifying is much appreciated. We suspect that it's a little chilly out there on that limb.

Typical Error #8 in the testing of inductors

We're referring specifically to the testing procedures for measuring inductance and Q, as outlined in MIL-C-15305.

We heartily recommend these procedures for all commercial, industrial and military users of inductors (even users of our superb Jeffers inductors). But, as our headline suggests, there are more than a couple of commonly made test errors to watch out for.

There are eight.

Error #8, for example, consists of extreme variations in test area environment. Solution? Make sure that your measurements are made at room ambient temperature, relative humidity and pressure.

In future issues, we'll cover the other seven errors and indicate how to avoid them also.

So watch this space.



SPEER Speer Carbon Co.

Speer Carbon Co. is a Division of Air Reduction Company, Inc.

JEFFERS ELECTRONICS DIVISION
DuBois, Pennsylvania 15801

Rush complete information on your metal film resistor networks.

Name _____

Title _____

Company _____

Street _____

City _____ State _____ Zip _____

Tuning in tv

Tiny printed circuits may soon replace the bulkier wire-wound coils in tuner assemblies for television receivers. Developed by the Oak Manufacturing Co., Crystal Lake, Ill., a division of Oak Electronics Corp., the printed inductors are expected to be included in the firm's standard tuner line in the near future. Oak, a major supplier of tuners to the tv industry, expects the printed units to provide increased reliability without increased cost.

Printed inductors have long been possible, says Walter Meyer, an engineering section manager at Oak, but the precise dimensions necessary were difficult to achieve inexpensively. Oak has turned to a silk-screen process, however, to produce spiral-type inductors having a ± 0.001 -inch line-width tolerance.

The printed coils would control interstage coupling when the tuner is switched from channel to channel. The wire coils now used must be adjusted during final assembly. "With printed inductances," says Meyer, "more of the adjustments are built in." The technique also reduces the amount of hardware to about half that in wired assemblies.

Meanwhile, Motorola Inc.'s Motorola Semiconductor Products Inc. subsidiary unveiled a diode-tuning technique for a-m radios. Using voltage-variable-capacitance diodes, radios could be built without the large "butterfly capacitors" now found on most a-m chassis.

Quiet playback

Less than a year ago, Ray M. Dolby, an American engineer working in England, introduced a device for reducing noise in audio systems; he called it a signal-to-noise stretcher. Dolby designed it for professional recording studios, using attenuation and amplification circuitry to get rid of tape hiss, recording rumble, and other noise. The system has been redesigned by Dolby and is now being applied to home-entertainment devices by a 10-year-old U.S. company specializing in high-perform-

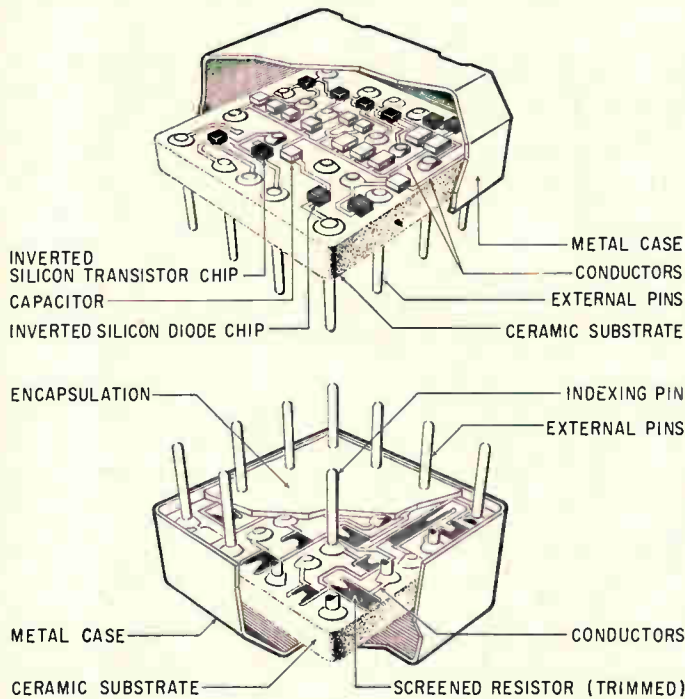

A hybrid IC built by Texas Instruments combines various semiconductor types for consumer products.

band tuned amplifiers, a-m systems and general-purpose radio and communications equipment.

Back to tubes

While television-set makers rely increasingly on solid state devices to pare their product prices, the General Electric Co. is suggesting a return to vacuum tubes. GE claims that a black-and-white 16-inch receiver designed around a new kit of its Compactron tubes can be priced below \$50, against the current low of about \$100 for such sets.

A demonstration GE television set will be shown at the IEEE's Conference on Broadcast and Television Receivers, June 12 and 13. Besides the customary tuner tubes, the set employs four Compactrons and a standard miniature tube to perform 12 circuit functions. The five tubes, in kit form, are being offered by the company to tv set makers.

New work. In fact, so optimistic is GE in the tube concept that it's investing a considerable sum in the development of a new kind of Compactron tube, called the Module-

tron, which should lower a tv's cost even more. According to James Holeman, a director of marketing at GE's Owensboro, Ky., facilities, the Moduletron will contain from 20 to 23 passive elements, reducing the number of external wiring connections.

Two of the tubes in the kit, the 33GY7A and 17BF11, have been in use for some time; the 33GY7A is employed in a self-oscillating circuit in the test receiver and serves as the horizontal output amplifier, while the 17BF11 functions as an f-m discriminator and audio output amplifier. Two other Compactrons are developmental models—the Y1607B acts as a combined video i-f amplifier and video output stage, and the Y1699B is used as the vertical output amplifier in a self-oscillating circuit, as the sync separator and amplifier, and as the keyed automatic gain control. The miniature tube, the 1BC2, is used as the high-voltage rectifier.

A GE spokesman says that except for a small deterioration in sensitivity due to the use of a single i-f amplifier stage, the pilot set is comparable in quality to similarly sized receivers containing twice as many tubes.

Everyone knows that to make a Triac to control 720 watts you have to use an expensive press-fit package

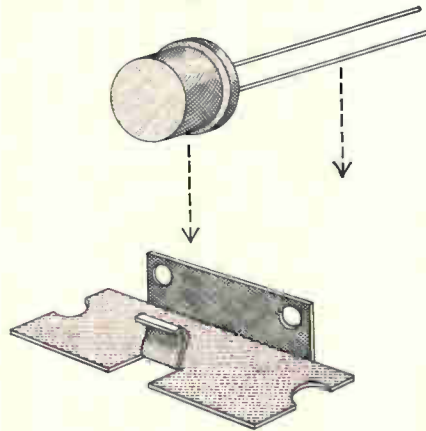

Well, everyone is wrong!

**RCA designed the low-cost two-lead 40485
TO-5 package to control 720 watts when used
with an associated heat spreader!**

The 40485 Triac is designed for 120V line operation for the phase control of ac loads in applications such as light dimming, universal and induction motor control, and heater control. *It sells for only \$1.50**. The 40486 Triac can control 1440 watts, 240V line operation, *and it sells for only \$1.98**.

Both new Triacs are delivered in hermetically sealed, all-welded, tin-plated modified TO-5 packages which offer the advantage of small size where space restrictions are a primary consideration. And because they are tin-plated, they can be soldered directly to a heat spreader as illustrated. This allows the use of mass produced, pre-

punched parts, and batch soldering techniques, and simplifies mechanical mounting and heat sinking. The process is a simple one. RCA salesmen are ready to demonstrate in your own office just how easy it is.

So save the money you'd spend for a comparable press fit unit, and take advantage of the small size and superior performance of RCA 40485 and 40486 Triacs. Your RCA Field Representative can give you all the information, including delivery. For additional technical data, write RCA Commercial Engineering, Section RN6-2, Harrison, N.J. 07029. See your RCA Distributor for his price and delivery. **Prices in quantities of 1,000 up*

RCA Electronic Components and Devices



The Most Trusted Name in Electronics

**LIGHT-WEIGHT
COMPACT
HIGH RESOLUTION
ACTIVE
BANDPASS
FILTER**

MODEL ABF 207



NEOTEC INTRODUCES a series of ACTIVE BANDPASS FILTERS in three models featuring:

- Extreme High Center Frequency Stability
- Very Low Bandwidth Variation
- Wide Operating Temperature Range

All these advantages available in a compact, light-weight component expressly engineered for systems use in close quartered printed circuit board applications. Unit prices range from \$140 to \$249 depending on type and quantity.



NEOTEC CORPORATION

640 Lofstrand Lane, Rockville, Md. 20850
Telephone (301) 762-8909

NEOTEC CORPORATION

640 Lofstrand Lane, Rockville, Maryland 20850

Specification sheet and detailed price list available immediately by mailing this coupon to the above address.

Name.....

Title.....

Company.....

Address.....

City.....

State..... Zip.....

ance stereo systems.

At the Consumer Electronics Show in New York this month, KLI Research and Development Corp. of Cambridge, Mass., will demonstrate a new tape recorder that incorporates the Dolby signal-to-noise stretcher.

Henry M. Morgan, KLI president, says the company also plans to market a "black box" that can be added to existing recorders and home audio systems. With Dolby's aid and by computer simulation methods, the Cambridge company was able to achieve a considerable price reduction of the original device.

Cost savings. The Dolby device that was developed for professional recorders costs about \$2,000. But for the consumer market, KLI plans to include it in a recorder that will sell for considerably less than \$500; less than \$100 represents the price of the Dolby device. As a black box that can be added to other recorders, it will retail for under \$200.

The Dolby unit boosts low-level audio signals in four separate frequency ranges during recording, and reduces them to their original levels during playback. Noise added by the recorder is reduced by the same amount as the boosted signals, thus effectively obliterating tape hiss, print-through echo, cross-talk, hum, and other forms of noise, according to KLI. The minimum amount of noise reduction claimed is 10 decibels.

Morgan says that the success of the Dolby system lies in the absolute symmetry of its operation and in its processing of only the lowest audio-signal levels. Symmetry is achieved by connecting networks, identical to those used for recording, in the feedback loop of the playback amplifier.

Low volume. The signal-to-noise stretcher operates only on signals of very low volume, those approaching the level of tape hiss or residual noise in the recorders. Signals of higher amplitude pass through the device untouched. Faint signals are boosted by 10 db as they pass through the system on the way to the recorder; on playback, these signals are reduced to their original relative volume.

But tape hiss and other unwanted noise in the recording are also reduced, giving the low volume signals a 10-db edge over the noise.

The device is connected between the microphone and tape machine for recording and between the tape head and amplifier on playback. Thus, only the noise added by recording electronics is affected, not the recorded matter. Also, by dividing the frequency spectrum into four sections, the Dolby device can operate on any section with a low-level input, high levels in any of the remaining three channels can't prevent noise reduction in a channel that needs it.

Solid state

Raising the noise barrier

Most integrated-circuit manufacturers are content to supply the industrial market with low-cost plastic-packaged versions of their standard military IC's. But Motorola Semiconductor Products Inc. isn't; it has evolved a family of industrial IC's with electrical characteristics tailored to the noisy environments prevailing in some industrial applications.

Called high threshold logic (HTL) circuits, the new IC's—dual four-input gates and two flip-flops—feature noise-immunity levels on the order of 6 volts. They also have a wide operating-temperature range (-30 to +75°C), high fan-out (10) and wide logic swing (12 volts).

Tradeoffs. Speed is modest (85 nanosecond propagation delay) and power needs (30 milliwatts per gate) are slightly higher than those of diode transistor logic (DTL) units, for example. However, Motorola engineers believe that in industrial applications the wide noise tolerance—six to seven times as high as DTL circuits—more than offsets the secondary speed and power characteristics.

The high noise immunity is achieved by using a zener diode instead of the offset diode DTL IC's employ. HTL, basically an offshoot of DTL, is an improvement over an

To monitor and control temperatures you need an **EMC** temperature control system

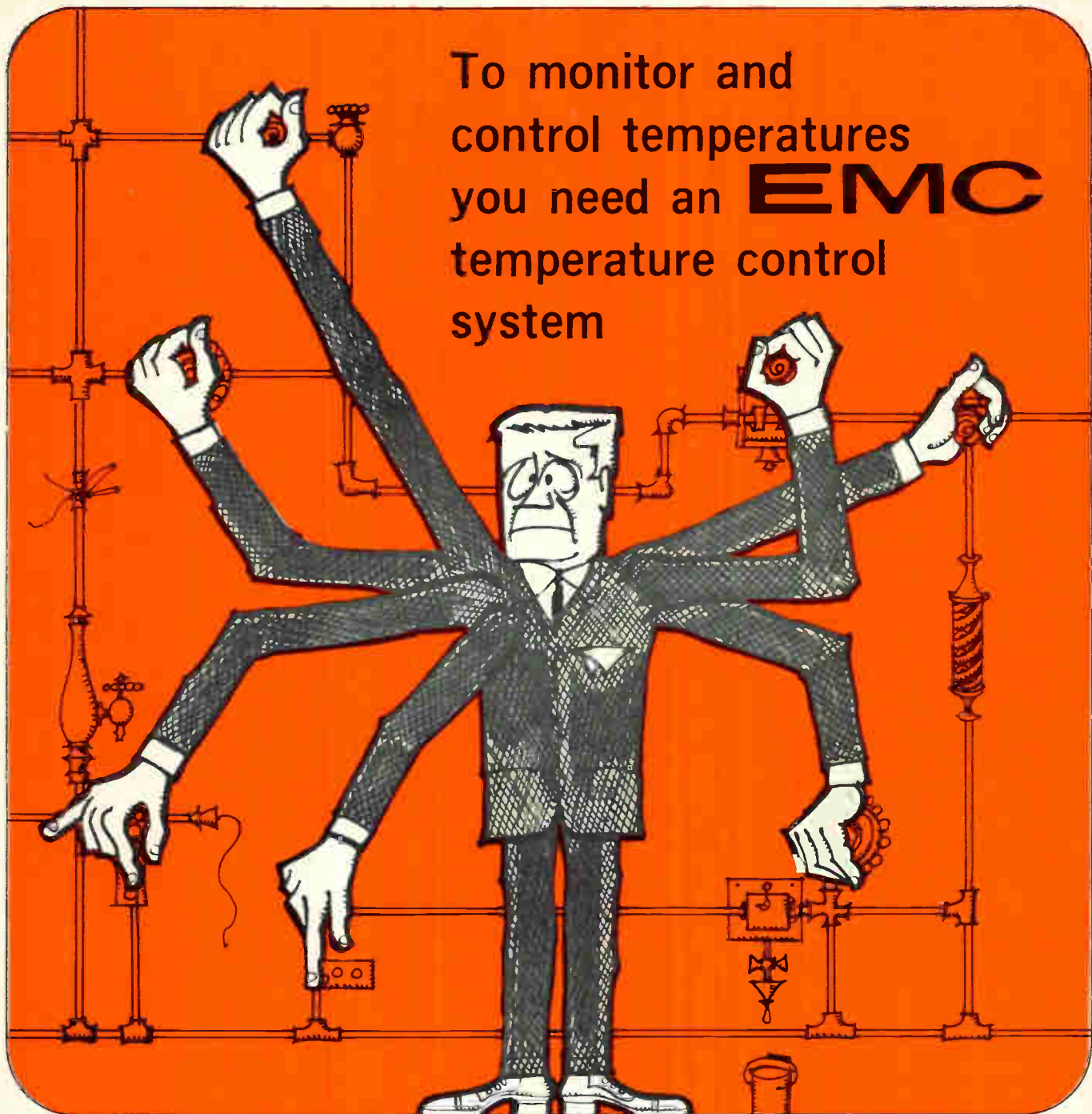

Proven EMC temperature scanning and control systems are now available for countless applications in a variety of industries. Temperatures are monitored at a rate of up to 50 points a second from -200°C to $+1000^{\circ}\text{C}$ with a demonstrated accuracy of 0.05% of full scale. Precision temperature control of remotely located processes is provided by EMC Series D6000 and D6100 Controllers, utilizing RTD, thermistor and/or thermocouple inputs and SCR drivers. Temperature response of the controllers is extremely rapid

with deviation less than 0.05°C . Automatic reset capability can be provided. These modularly-constructed systems are simple to install, operate and maintain. Modular units are interchangeable. The highly reliable systems are constructed from circuit modules with proven reliability of 4.5 million hours MTBF. This gives the typical system an MTBF in excess of 8,000 hours. Other scanning requirements (i.e., pressures, voltage levels, etc.) can be accomplished with the same basic techniques and systems components.

For additional information on how this and other EMC systems can meet your requirements for monitoring and control, write to:

VISIT OUR BOOTH 257



**ELECTRONIC
MODULES
CORPORATION**

Electronic Modules Corporation • SYSTEMS DIVISION

P.O. BOX 141 TIMONIUM, MARYLAND 21093 TWX-301-0723 301-666-3300

This new DVM from Trymetrics proves—



Eleven
(plug-in)
heads are better than one!



DELIVERY FROM STOCK ON MOST MODELS
Models 103—104—105
Single range plug-in heads
10V, 1V, 100MV

Models 300A—400A—500A
3, 4 and 5 automatic range
plug-ins; 10 μ V—1000VDC

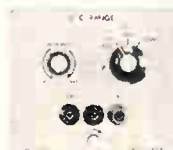

Models 300M—400M—500M
3, 4 and 5 manual
range plug-ins;
10 μ V—1000VDC

Check these Trymetrics features:

- Full 4 digit resolution. ■ Accuracy $\pm 0.01\%$ of reading ± 1 count. Automatic polarity and overscale indicator. ■ High common mode rejection. ■ Complete range of plug-in heads for optimum flexibility. All silicon solid state circuitry. ■ Operation up to 50°C. ■ Sampling speeds up to (10) samples/second. ■ Sensitivity to 10 μ V. ■ BCD printer output. ■ Crystal controlled oscillator guarantees ultra stable voltage-to-time conversion system.

Check this Trymetrics price:

Model 4000 DVM \$840 with Model 103 10V Range Plug-In. For complete information and prices, write to:

TRYMETRICS
Corporation
204 Babylon Tpke., Roosevelt, L.I., N.Y.
Phone 516-378-5020 Zip 11575

Electronics Review

earlier Motorola entry, variable-threshold-logic (VTL). Introduced in 1966, VTL was designed for industrial applications and situations requiring a variable logic swing. But the circuits require two power supplies, are relatively difficult to fabricate, and occupy a larger chip than HTL IC's. Noise immunity is 3 to 5 volts, depending on the bias used. VTL never quite caught on; it's now available only on demand and isn't a catalog item.

Predecessors. HTL is a late-comer of sorts; it closely resembles circuits introduced in 1966 by the Amelco Semiconductor division of Teledyne Inc. and Telefunken of Germany. Motorola's new IC's are 20% slower than Amelco's plastic-packaged devices, but have a slightly higher immunity to noise.

For the record

Doctoring the illness. A glass-fiber torso at the George Washington University Medical Center in Washington is helping medical students learn how to diagnose illnesses. Called Terry, the latex-covered dummy has eight small speakers from which recorded sounds of the heart and lungs are heard. The teaching aid is connected to a console that contains an eight-channel tape recorder and a transistorized printed-circuit card for each speaker.

Venus visit. Mariner 5, scheduled for launch this week, will pass within 2,000 miles of Venus and peer into the dense shroud covering the planet to gather environmental data. The 540-pound craft differs from Mariner 2, which passed Venus in 1962, in that it will carry a new high-gain antenna and a system to reduce experiment results to a common digital form.

Better red. A simple technique for achieving a truer red from electroluminescent displays has been developed by a team of engineers at North American Aviation Inc. Red phosphors—the usual red source—are dispensed with and replaced by a constant red generated from an outside source. Called chromatic biasing, the technique

balances the intensity of blue-green EL emission against a constant red light—much like biasing electric current.

On the move. As part of its master plan to become a major factor in the semiconductor business, ITT Semiconductors is wooing high-level engineering officials to its fold. Latest to sign on are Raymond Warner, Texas Instruments' metal oxide semiconductor operations manager, and Jack Belove, Fairchild Semiconductor's manager of proprietary integrated-circuit production. Warner becomes the firm's technical director for the U.S. and Belove becomes operations manager at the West Palm Beach, Fla., facilities.

Picking your spots. Most of the more than 200 process-control computers installed by IBM have been delivered within the last year. One IBM official ascribed the sales spurt to the growing practice of using computer control only to handle critical process variables. The difference is illustrated by a system at a Mobil Oil refinery where 250 variables are monitored but only analog loops in the catalytic cracker's reactor and kiln are computer-controlled. Even without total process control, Mobil spokesmen report an efficiency gain of more than 10%.

Business ahead. The Electronics Industries Association is predicting total 1967 electronic-equipment sales of \$22.4 billion, up 10% from the 1966 level and higher than Electronics magazine's 1967 forecast [Electronics, Jan. 9, p. 129] of \$21.5 billion. However, Robert Galvin, the EIA president, says the outlook for color television sales isn't so bright as it was in January. The official put 1967 volume at 6 million to 6.5 million sets, off from industry estimates six months ago of 7 million to 8 million, but still about 1 million above last year's total. Component sales are seen climbing 12% from a year before to \$6.3 billion, while replacement component volume is expected to edge up 1.6% to \$650 million. The EIA predicts an 11% gain in industrial electronics sales, and attributes this mainly to continued expansion of the market for computers.

TWO NEW FET IDEAS FROM MOTOROLA!

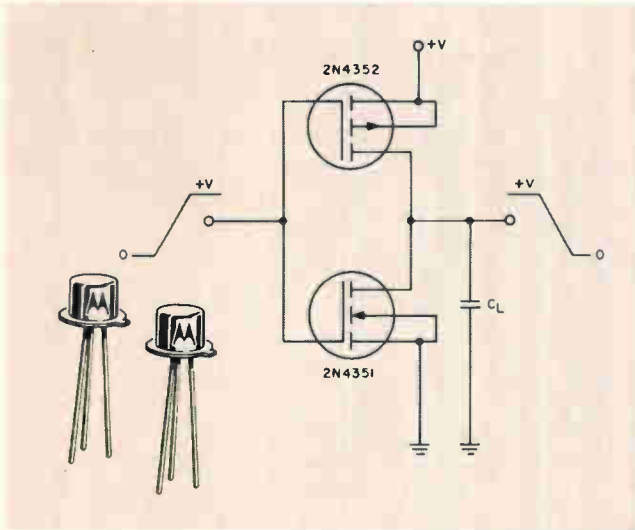

1 "Zero Power" Switching Complementary MOSFETs

Now, you can design ultra low-power complementary switching circuits, or circuits with switching times in the nanoseconds region using Motorola types 2N4351 (n-channel) and 2N4352 (p-channel) MOSFETs. In addition to exhibiting leakage currents of only 10 pA, they also show very low capacitance values. The combination provides a very high input impedance resulting in a large fan-out capability and almost no loading of the driving source. Both units are designed for enhancement-mode, or normally "off" operation.

Available in the standard TO-72 package, each device is 100-up priced at just \$4.50 (compared with prices in the \$7.00 range for most of today's MOSFETs). Here are more detailed specifications for these two new state-of-the-art devices:

CHARACTERISTICS (2N4351-2N4352)	SYMBOL	MIN	MAX	UNIT
Switching Time (Total)	t	—	270	ns
Forward Transfer Admittance	$ y_{fs} $	1000	—	μ mhos
Reverse Transfer Capacitance	C_{rss}	—	1.3	pF
Input Capacitance	C_{iss}	—	5.0	pF
"ON" Drain Current	$I_{D(on)}$	3.0	—	mAdc
Gate Leakage Current	I_{GSS}	—	± 10	pAdc
Zero-Gate-Voltage Drain Current	I_{DSS}	—	10	nAdc
Drain-Source "ON" Voltage	$V_{DS(on)}$	—	1.0	Vdc

*Trademark of Motorola Inc.

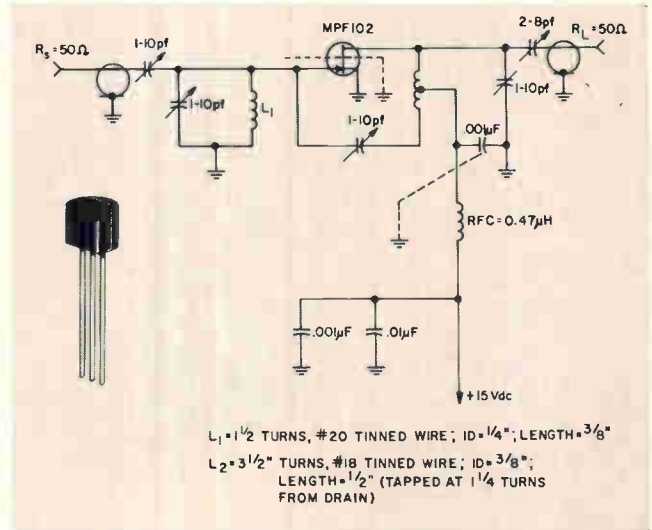

2 Low-Cost, Low-Noise Plastic RF FET

Here's a new low-cost junction FET (type MPF102) that's priced at just 45 cents each (1000-up), making it economical for FM-tuner front-ends, yet with such high quality performance it's also well suited for a variety of sockets in industrial communications equipment — for both mixer and amplifier applications! The MPF102, housed in Motorola's reliable Unibloc* plastic package, combines a low 200-MHz typical noise figure of only 2.5 dB with exceptionally high gain — prime qualities for *all* RF applications! Here are other top specs that show the all-around performance of the MPF102:

CHARACTERISTICS (MPF102)	SYMBOL	MIN	MAX	UNIT
Gate Reverse Current	I_{GSS}	—	2.0	nAdc
Zero-Gate-Voltage Drain Current	I_{DSS}	2.0	20	mAdc
Input Capacitance	C_{iss}	—	7.0	pF
Reverse Transfer Capacitance	C_{rss}	—	3.0	pF
Forward Transfer Admittance	$ y_{fs} $	2000	—	μ mhos
Noise Figure	NF	—	2.5 (typ)	dB

Write for complete data sheets on the MPF102 and 2N4351-52. We'll also send you our latest application notes on complementary FET switching and RF FET circuit design. Then, for sample devices you can try right now, contact your nearby franchised Motorola Semiconductor distributor or district sales office.

- where the priceless ingredient is care!



MOTOROLA
Semiconductors

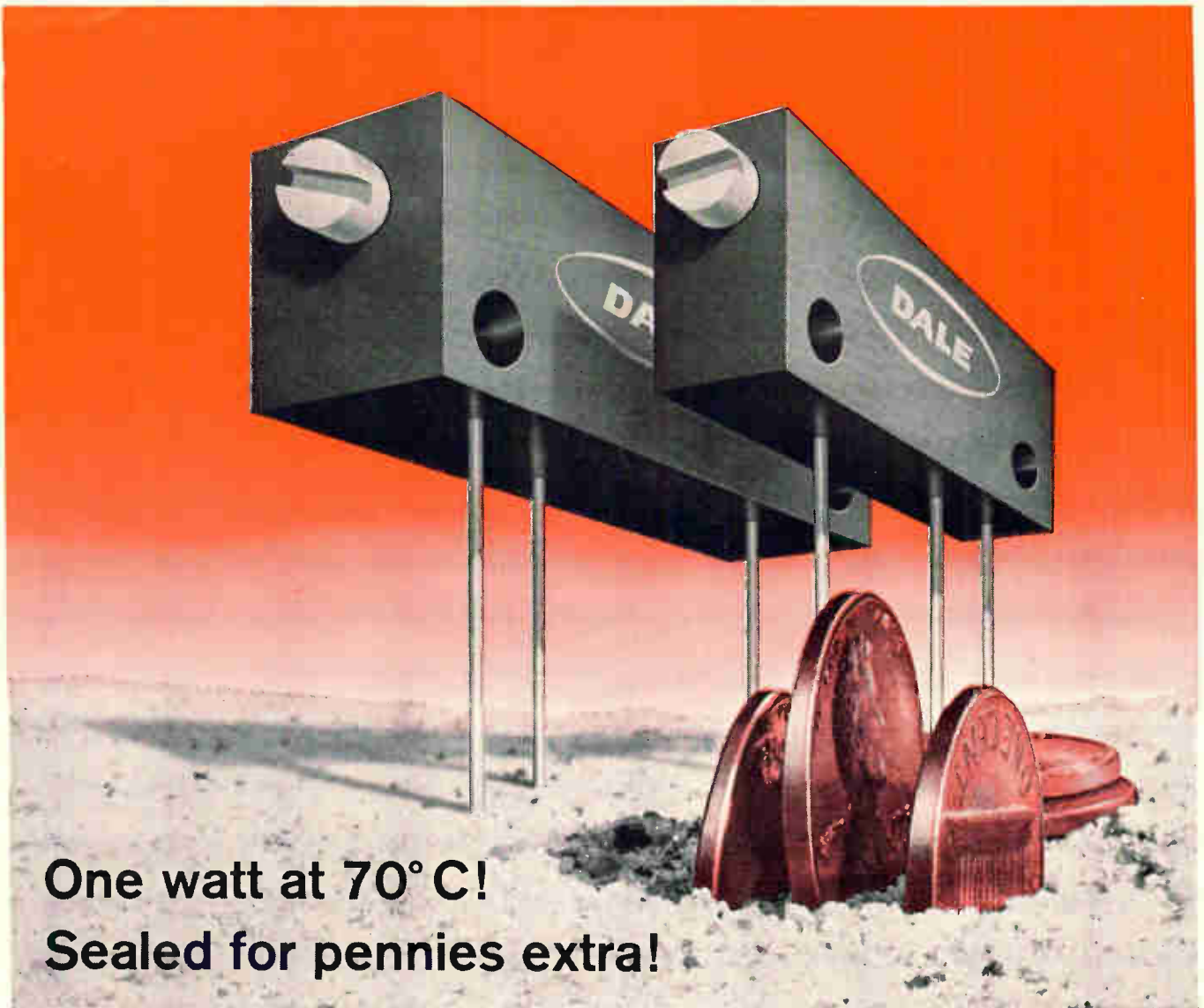

**One watt at 70° C!
Sealed for pennies extra!**

2 very good reasons why Dale sells so many Commercial Wirewound Trimmers

PERFORMANCE: Dale's 2100 and 2200 series are the commercial counterparts of RT-11 and RT-10 respectively. They can be sealed for just a few cents per unit, yielding mil-level performance in all areas except temperature.

PRICE: Competitive and then some! Check Dale's new lower commercial prices. They were made possible through an extensive value analysis program which actually improved overall unit quality.

DELIVERY: New automated production facilities plus a factory stocking program combine to put your order in your plant without delay.

*Simplify trimmer ordering — a call to Dale will do it.
Phone 564-3131, Area Code 402*

SPECIFICATIONS

	2100	2200
CASE DIMENSIONS	.28 high x .31 wide x 1.25 long	.18 wide x .32 high x 1.00 long
STANDARD MODELS	2187 — printed circuit pins, 21 AWG gold plated. 2188 — 28 AWG stranded vinyl leads. 2199 — solder lug, gold plated.	2280 — printed circuit pins, 22 AWG gold plated. 2292 — solid wire, 26 AWG gold plated. 2297 — 28 AWG stranded vinyl leads.
POWER RATING	1 watt at 70° C, derating to 0 at 125° C	
OPERATING TEMPERATURE RANGE	-65° C to + 125° C	
ADJUSTMENT TURNS	25 ± 2	15 ± 2
RESISTANCE RANGE	10 ohms to 100K ohms	10 ohms to 50K ohms
STANDARD TOLERANCE	± 10% standard (lower tolerances available)	

Write for Catalog B



DALE ELECTRONICS, INC.
1300 28th Avenue, Columbus, Nebraska
In Canada: Dale Electronics, Canada, Ltd.



Washington Newsletter

June 12, 1967

Systems approach knocked as panacea

Most everyone these days touts systems engineering as the answer to such complex nonmilitary problems as pollution, crime, and mass transportation. But a report to Congress from the National Academy of Science suggests that it won't pay off. The study was made by the academy's influential committee on science and public policy for the House Committee on Science and Astronautics, whose chairman, George Miller (D., Calif.), is a backer of the systems approach to civilian problems.

In the report—to be released next month—Hendrik W. Bode, a vice president of Bell Telephone Laboratories, says the “gap between military systems engineering and proposed civilian applications” is greater than most people realize. Systems engineering is “unlikely to contribute anything that wouldn't have been discovered anyway,” he adds, and—in the civilian sphere—perhaps amounts to “little more than a decision to do a careful and thorough engineering job.”

Minuteman scare: cheaper parts prove too costly

High reliability requirements were relaxed temporarily last year on Minuteman 2 components, and what happened cast doubt for a time on the reliability of the entire strategic missile system. Two test launchings failed—one due to a faulty resistor and the other because of a bad capacitor. A frantic search revealed that the faulty components hadn't gone through the normal high-reliability process—burn-in and lifetime tests, documentation, and strictly controlled production. The Air Force then started a crash program to replace all suspect components with units produced to original requirements.

The cheaper components were in a modification kit being installed to improve the Minuteman's guidance system. The problem came to light last October in the Long Life 2 project, an attempt to launch a firststage burn missile from an operational silo near Grand Forks, N.D.

Worldwide retrieval system proposed by Commerce aide

Plans for an ambitious, worldwide scientific and technical data retrieval system may be pushed if the top science job at the Department of Commerce goes to Chalmers W. Sherwin, deputy assistant secretary of commerce. Sherwin now seems the most likely candidate to succeed J. Herbert Hollomon as assistant secretary for science and technology. Hollomon, after an active and controversial tour of duty, goes to the University of Oklahoma in August as president.

Growing out of a yet-to-be-released study, Sherwin's plans call for a machine-language-compatible system capable of linking all independent information systems in the world. He says it would drastically cut the cost of local libraries and of extensive literature searches. Such a decentralized system, with 2,000 stations and a major international center, would cost about \$200 million annually, Sherwin estimates.

FCC okay seen near for over-air pay tv

FCC approval of over-the-air pay television is finally in sight. Indications are that the FCC's subscription television committee will send its recommendations to the full commission in 30 to 60 days, and Robert E. Lee, one of the three commissioners on the panel, sees a “good chance” for a go-ahead. Regarding pay tv by cable, it's doubtful that the FCC will press its claim of jurisdiction.

Zenith and two other firms petitioned 15 years ago for an amendment

Washington Newsletter

of FCC rules to include pay tv, but the commission declined to make a ruling until experiments had been carried out. Tests, using Zenith equipment, have been conducted over the air in Hartford, Conn., for six years by an RKO General subsidiary. With trial data in its hands, Zenith last year again petitioned the FCC.

ARPA sees system of billion elements drawing few watts

A system with a billion active elements and a power consumption of only a few watts is potentially attainable with techniques developed in work for the Advanced Research Projects Agency. The development came to light in recently released Congressional testimony by Charles M. Herzfeld, ARPA director. He said the nanowatt circuits, being designed for use in special sensor instrumentation, will have transistors with a collector area of 3 square microns each, resistors with a linewidth of less than 1 micron and length of less than 100 microns, and a sheet resistance as high as 100 megohms per 100 square microns.

Assault ship pact no guarantee of automated yard

A new U.S. automated shipyard doesn't seem to be in the cards for the Navy when it awards a "total package" contract to build five to 10 multi-purpose assault ships (LHA) next year. The Pentagon had expected to get an automated yard by contracting with one company for a substantial number of identical vessels. But Congress recently turned down the 30-ship Fast Deployment Logistics (FDL) program which would have been large enough to make this possible. The LHA program—expected to cost from \$300 million to \$600 million—is not a large enough order, although the winning company may be persuaded to modernize an existing yard.

The Navy will pick two or three bidders to compete in a contract definition beginning next month and running through January. The winner will be chosen in mid-1968.

U.S. renews effort for patent system

The Johnson Administration, determined to get a universal patent system for as many as 77 nations, this month unveiled a proposed international patent treaty. But the treaty will be academic unless Congress first goes along with U.S. patent reform. However, the reform bill appears dead for this session of Congress [Electronics, May 29, p. 60]. One of the stumbling blocks is a change from "first to invent" to "first to file" criteria for granting patents, something necessary for an international system since nearly all other nations have such a standard.

Addenda

First operational air communications centers for the Marine Corps Tactical Data System will be built by Philco-Ford's Western Development Laboratories. Cost of the four AN/TYQ-1 centers—one for each Marine air wing—will be around \$20 million . . . One of the four traveling-wave-tube amplifiers on Comsat's Intelsat-2 Pacific satellite has failed. That leaves the satellite without a backup tube. The tube failure, plus the fact that the communications satellite is operating at capacity, has prompted Comsat to spend \$7 million to put another Hughes-built Intelsat-2 satellite over the Pacific . . . Two new counter-infiltration systems are now being deployed in Vietnam. The AN/PSR-1, using four buried geophones and a control unit having an audio readout, has an 800-foot range; the AN/GSS-9 is a breakwire system. Expected later this year is a third system—the AN/PSS-5 pulse doppler radar, which has a three-mile range.

FET CHOPPERS ARE THE ONLY ANSWER

Part ELEVEN of a Series On The State of The Chopper Art.

MODEL 8000



Booze is the only answer at my house, but they frown down at the office when I suggest there is more than one way to solve problems. They should have my mother-in-law — they'd stick to booze, not electronics.

It turns out that an FET chopper is a distinct improvement over photo-choppers, what with 6 volts being enough drive instead of a couple hundred. Now the photo-chopper was better than the transistor choppers, because it looked like a resistor instead of a diode. So there ain't any voltage drops that have to cancel out. Mostly they don't. (Cancel, that is.)

As matters stand on noise and offset — and we sell choppers for only one purpose, which is to allow D.C. amplifiers with very little offset — the best of FET choppers are only two to three orders of magnitude worse than the best of mechanical choppers. Which is real progress. Last week it was three to four orders — before we invented this model 8000 FET chopper. The offset available is below 10 microvolts at 10,000 ohms, and would be lower if there weren't such wierd alloys inside the FET that have to come out eventually to copper.

So today's best mechanical choppers reach down below some 50 nanovolts, the FET chopper gets to about 5 microvolts. That's two orders of magnitude and crowding. Good thing we make solid-state choppers too.

Speaking only of offset, and anyway, what else is speakable about a chopper? I suppose you could say Mechanical Choppers << FET Choppers < Photo Choppers < Transistor Choppers.

AIRPAX ELECTRONICS
Cambridge, Maryland 21613

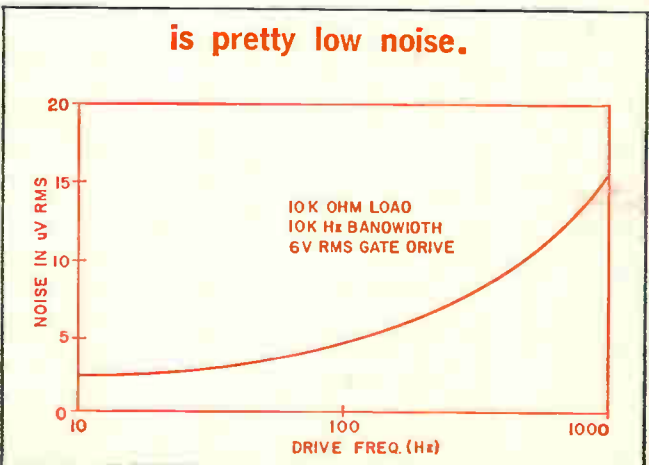
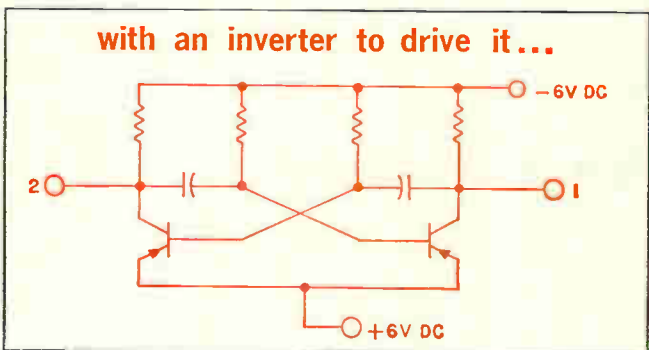
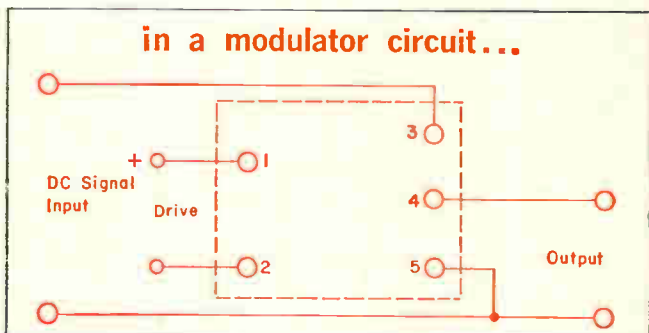
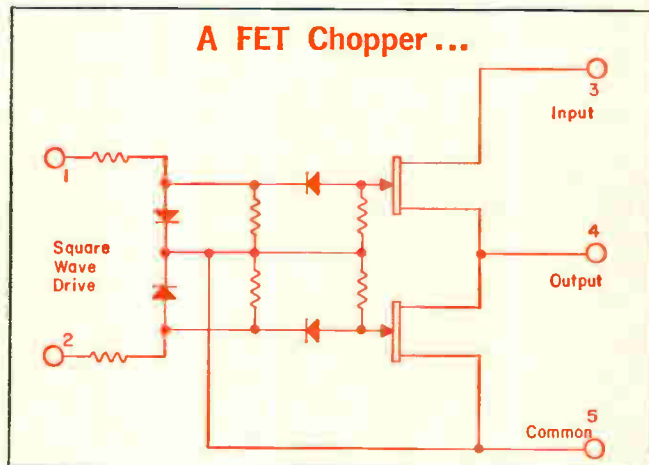

Leadership

15 ohms ON resistance with only 8.0 pf drain to gate capacitance solved critical FET switch applications



SPECIFICATIONS — TYPE 2N4977

- ON Resistance: 15 ohms max
- Drain to Gate Capacitance: 8.0 pf max
- Input Capacitance: 35 pf max
- Reverse Transfer Capacitance: 8.0 pf max
- Temperature Range:
Operating -55°C to 150°C
Storage -55°C to 200°C
- Breakdown Voltage Drain to Gate: 30v min
- Drain Current, Zero Gate Voltage: 50mA min
- Pinch-off Voltage: 10v max
- Gate Leakage Current: 0.5 nA max

Price:	1-99	100-999
	21.50	14.00

Available from stock in TO-18 package

AMELCO SEMICONDUCTOR

DIVISION OF TELEDYNE, INC. • 1300 TERRA BELLA AVENUE • MOUNTAIN VIEW, CALIFORNIA • Mail Address: P. O. Box 1030, Mountain View, California • Phone: (415) 968-9241 • REGIONAL OFFICES: East — Westwood, Mass., 805 High Street, (617) 326-6600; Melville, L. I., N. Y., (516) 692-4070; Syracuse, N. Y., (315) 437-8343; Paterson, N. J., (201) 696-4747; Glenside, Pa., (215) 887-0550; Towson, Md., (301) 825-3330; Orlando, Fla., (305) 423-5833 • Midwest — Des Plaines, Ill., 650 W. Algonquin Rd., (312) 439-3250; Cedar Rapids, Iowa, (319) 366-0635; St. Louis, Mo., (314) 427-7200; Farmington, Mich., (313) 474-0661; St. Paul, Minn., (612) 488-6634; Columbus, Ohio, (614) 299-4161; Dallas, Texas, (214) 631-6270 • Northwest — Home Office, Mountain View, Calif.; Los Altos, Calif., (415) 941-0336; Seattle, Washington, (206) 323-5100 • Southwest — Los Angeles, Calif., Suite 213, 8621 Bellanca Ave., (213) 678-3146; Los Angeles, Calif., (213) 870-9191; San Diego, Calif., (714) 298-4711; Phoenix, Ariz., (602) 277-9739; Albuquerque, N.M., (505) 268-0928; Littleton, Colo., (303) 798-8439 • Canada — Montreal, P.Q., (514) 384-1420.

Leadership

Power gain greater than 12 db @ 400 mc
from our FET RF Amplifier



SPECIFICATIONS—TYPE 2N5078

- Power Gain @ 400 mc: 12 db min
- Noise Figure @ 400 mc: 4.0 db max
- Input Capacitance: 6.0 pf max
- Reverse Transfer Capacitance: 2.0 pf max
- Breakdown Voltage Drain to Gate: 30v min
- Drain Current, Zero Gate Voltage: 4 to 25mA
- Pinch-off Voltage: 8.0v max
- Gate Leakage Current: 0.25nA max
- Temperature Range
Operating -55°C to 150°C
Storage -65°C to 200°C

Price:	1-99	100-999
	5.00	3.35

Available from stock in TO-72 package

AMELCO SEMICONDUCTOR

DIVISION OF TELEDYNE, INC. • 1300 TERRA BELLA AVENUE • MOUNTAIN VIEW, CALIFORNIA • Mail Address: P.O. Box 1030, Mountain View, California • Phone: (415) 968-9241 • REGIONAL OFFICES: East—Westwood, Mass., 805 High Street, (617) 326-6600; Melville, L. I., N.Y., (516) 692-4070; Syracuse, N.Y., (315) 437-8343; Paterson, N.J., (201) 696-4747; Glenside, Pa., (215) 887-0550; Towson, Md., (301) 825-3330; Orlando, Fla., (305) 423-5833 • Midwest—Des Plaines, Ill., 650 W. Algonquin Rd., (312) 439-3250; Cedar Rapids, Iowa, (319) 366-0635; St. Louis, Mo., (314) 427-7200; Farmington, Mich., (313) 474-0661; St. Paul, Minn., (612) 488-6634; Columbus, Ohio, (614) 299-4161; Dallas, Texas, (214) 631-6270 • Northwest—Home Office, Mountain View, Calif.; Los Altos, Calif., (415) 941-0336; Seattle, Washington, (206) 323-5100 • Southwest—Los Angeles, Calif., Suite 213, 8621 Bellanca Ave., (213) 678-3146; Los Angeles, Calif., (213) 870-9191; San Diego, Calif., (714) 298-4711; Phoenix, Ariz., (602) 277-9739; Albuquerque, N.M., (505) 268-0928; Littleton, Colo., (303) 798-8439 • Canada—Montreal, P.Q., (514) 384-1420

New FETs, UJTs and SCRs from TI to optimize your circuit designs

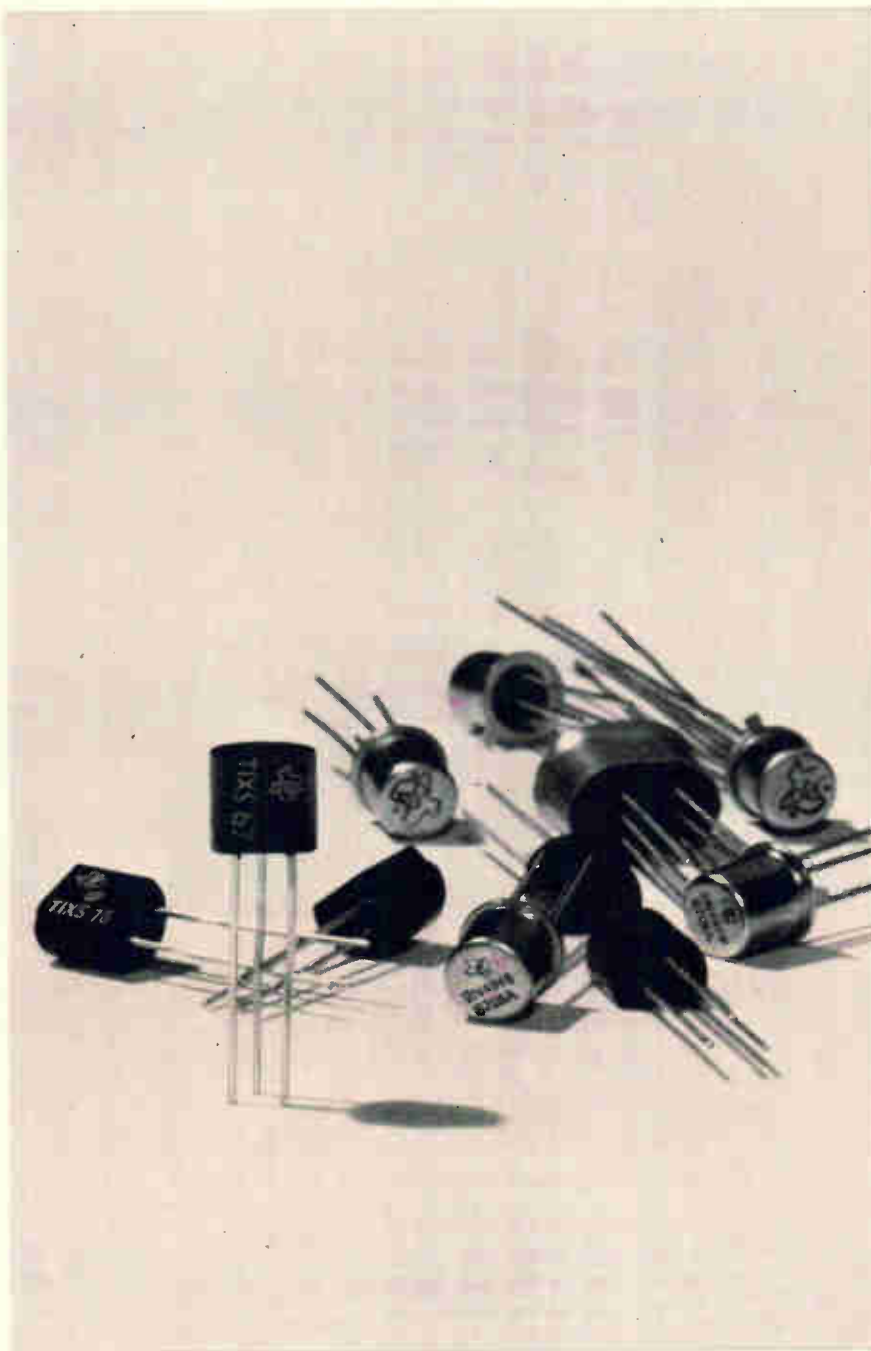

Improve your products, create new designs with these "firsts" from Texas Instruments: • six new families of FETs • six unijunctions • four low-cost SCRs.

Most of these devices are available in the exclusive SILECT™ package with TO-18 pin-circle lead configuration. SILECT transistors are backed up by more than 10,000,000 hours of testing. A preliminary report concludes that SILECT transistors are capable of meeting military specifications and are as reliable as metal can devices tested under the same conditions.

Circle 281 for Reliability Report.

New low-cost, high-voltage FET replaces vacuum tubes

The new TIXS78 silicon n-channel FET offers a 300-volt minimum breakdown voltage, making it a one-for-one replacement for vacuum tubes in such applications as high-voltage switching and large-signal amplification.

The new FET is priced for computer, industrial, communications and entertainment usage.

Circle 282 for data sheet.

New tetrode FET features industry's highest transconductance to capacitance ratio

The TIXS80 is a high-frequency metal-can tetrode FET that has a minimum transconductance of 5,000 μ mhos with a maximum reverse transfer capacitance of 0.8 pF. A second gate simplifies biasing, AGC, and oscillator injection circuitry. The TIXS80 is designed for

Leadership

Power gain greater than 12 db @ 400 mc
from our FET RF Amplifier



SPECIFICATIONS—TYPE 2N5078

- Power Gain @ 400 mc: 12 db min
- Noise Figure @ 400 mc: 4.0 db max
- Input Capacitance: 6.0 pf max
- Reverse Transfer Capacitance: 2.0 pf max
- Breakdown Voltage Drain to Gate: 30v min
- Drain Current, Zero Gate Voltage: 4 to 25mA
- Pinch-off Voltage: 8.0v max
- Gate Leakage Current: 0.25nA max
- Temperature Range
Operating -55°C to 150°C
Storage -65°C to 200°C

Price:	1-99	100-999
	5.00	3.35

Available from stock in TO-72 package

AMELCO SEMICONDUCTOR

DIVISION OF TELEDYNE, INC. • 1300 TERRA BELLA AVENUE • MOUNTAIN VIEW, CALIFORNIA • Mail Address: P.O. Box 1030, Mountain View, California • Phone: (415) 968-9241 • REGIONAL OFFICES: East—Westwood, Mass., 805 High Street, (617) 326-6600; Melville, L. I., N.Y., (516) 692-4070; Syracuse, N.Y., (315) 437-8343; Paterson, N.J., (201) 696-4747; Glenside, Pa., (215) 887-0550; Towson, Md., (301) 825-3330; Orlando, Fla., (305) 423-5833 • Midwest—Des Plaines, Ill., 650 W. Algonquin Rd., (312) 439-3250; Cedar Rapids, Iowa, (319) 366-0635; St. Louis, Mo., (314) 427-7200; Farmington, Mich., (313) 474-0661; St. Paul, Minn., (612) 488-6634; Columbus, Ohio, (614) 299-4161; Dallas, Texas, (214) 631-6270 • Northwest—Home Office, Mountain View, Calif.; Los Altos, Calif., (415) 941-0336; Seattle, Washington, (206) 323-5100 • Southwest—Los Angeles, Calif., Suite 213, 8621 Bellanca Ave., (213) 678-3146; Los Angeles, Calif., (213) 870-9191; San Diego, Calif., (714) 298-4711; Phoenix, Ariz., (602) 277-9739; Albuquerque, N.M., (505) 268-0928; Littleton, Colo., (303) 798-8439 • Canada—Montreal, P.Q., (514) 384-1420

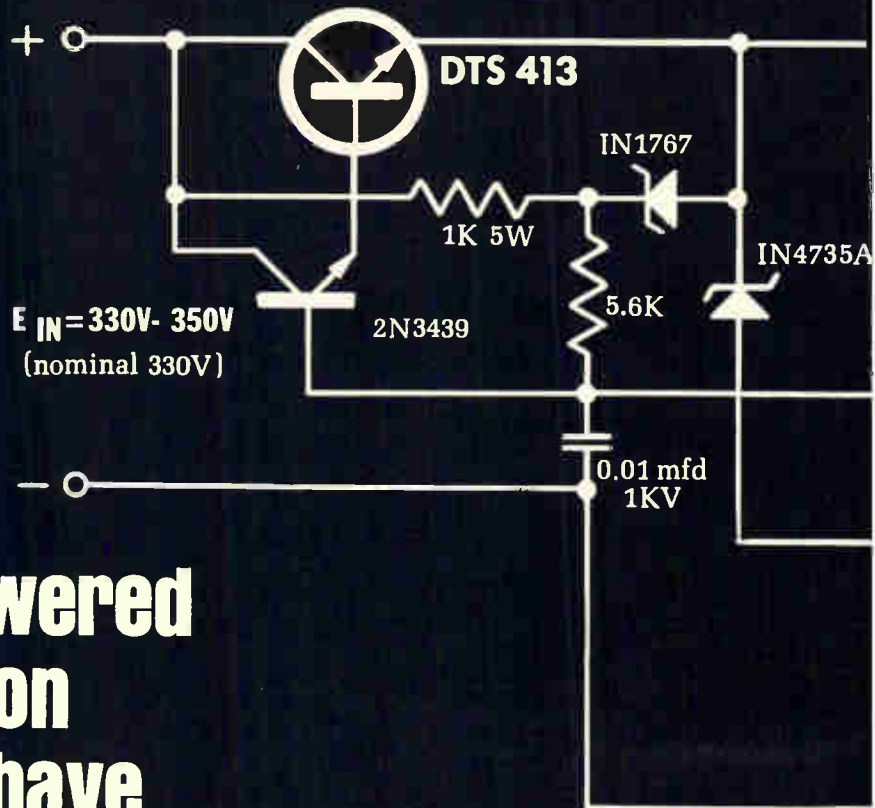

High-powered regulation doesn't have to carry a high-powered price!

The simple DC regulator shown supplies 290 volts to a load of 50 to 600 milliamperes. Regulation is better than $\pm .05$ percent with an input voltage variation of 15%. Delco high voltage silicon makes this possible with just one series transistor—the DTS-413—priced at just \$3.95 each in 1000-and-up quantities.

This circuit also can be scaled to the capabilities of any of the other cost saving Delco DTS transistors, including the new DTS-424 and DTS-425. And no matter which Delco high voltage transistor you use, reduction of weight, size, and component cost is part of the bargain. Circuit complexity and number of components are reduced and so assembly costs go down, too. And fewer components mean higher reliability.

Right now, Delco silicon power transistors are adding these benefits in such high energy circuits as: DC-DC converters, ultrasonic power supplies, VLF class C amplifiers, off-line class A audio output and magnetic CRT deflection (several major TV manufacturers use them in big screen horizontal and vertical sweep circuits).

How soon can you get Delco silicon power transistors? How soon do you need them? With our experience and new plant facilities, samples or production quantities can be shipped promptly. Call one of our distributors or a Delco sales office now.

For full details on the DC regulator circuit, ask for application note number 38.

Application of Delco high voltage silicon power transistors: a DC voltage regulator.

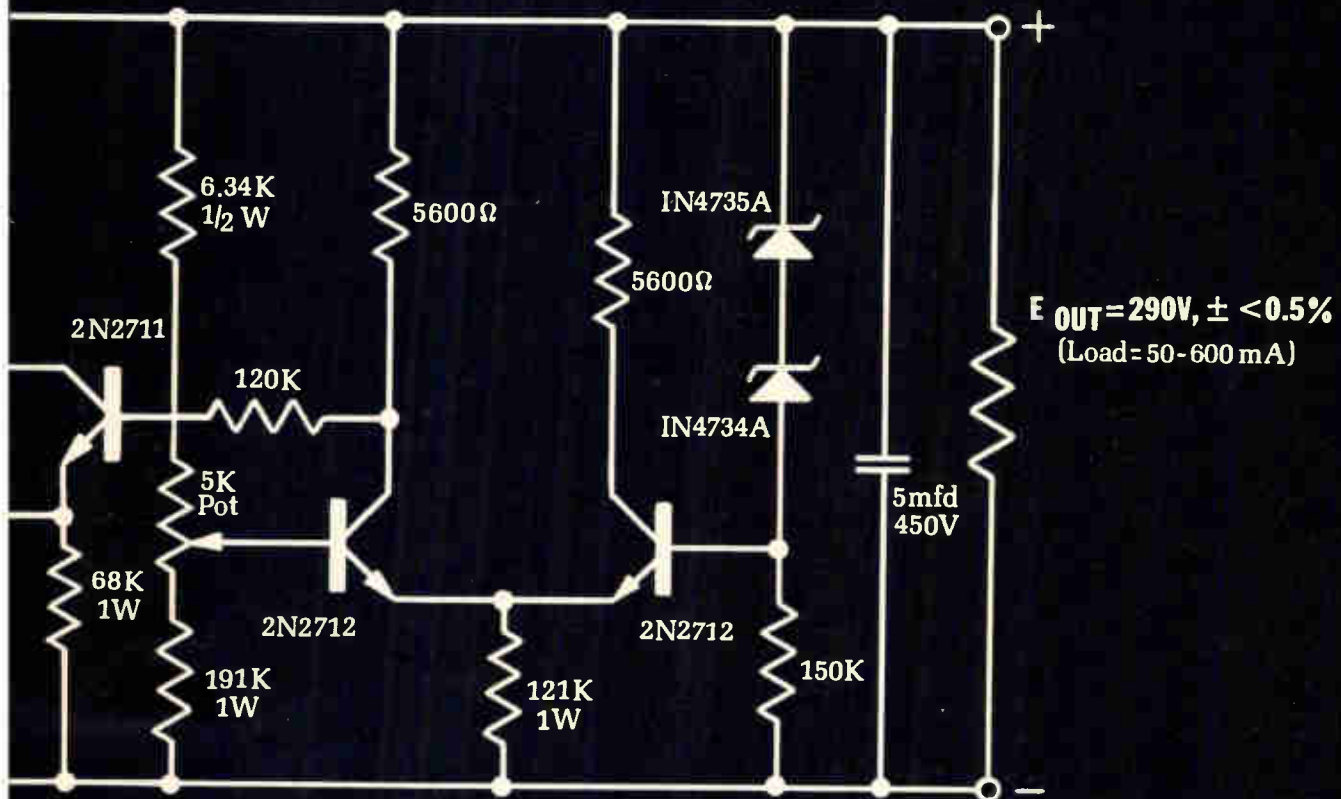

TYPE	V _{CEX}	V _{CEO} (sus) min.	I _C max.	h _{FE} min. V _{CE} =5 V @ I _C	P _D max.	PRICE 1000-and-up QUANTITIES
DTS-413	400V	325V	2.0A	15 @ 1.0A	75W	\$3.95
DTS-423	400V	325V	3.5A	10 @ 2.5A	100W	\$4.95
DTS-424	700V	350V	3.5A	10 @ 2.5A	100W	\$7.00
DTS-425	700V	400V	3.5A	10 @ 2.5A	100W	\$10.00
DTS-430	400V	300V	5.0A	10 @ 3.5A	125W	\$17.49
DTS-431	400V	325V	5.0A	10 @ 3.5A	125W	\$25.00

NPN silicon transistors packaged in solid copper TO-3 case.

Field Sales Offices

Union, New Jersey* 07083
Box 1018 Chestnut Station
(201) 687-3770

Detroit, Michigan 48202
57 Harper Avenue
(313) 873-6560

Santa Monica, Calif.* 90401
726 Santa Monica Blvd.
(213) 393-1465

Syracuse, New York 13203
1054 James Street
(315) 472-2668

Chicago, Illinois* 60656
5151 N. Harlem Avenue
(312) 775-5411

General Sales Office:
700 E. Firmin, Kokomo, Ind. 46901
(317) 459-2175

*Office includes field lab and resident engineer for applications assistance.

DELCO RADIO
DIVISION OF GENERAL MOTORS • KOKOMO, INDIANA

New FETs, UJTs and SCRs from TI to optimize your circuit designs

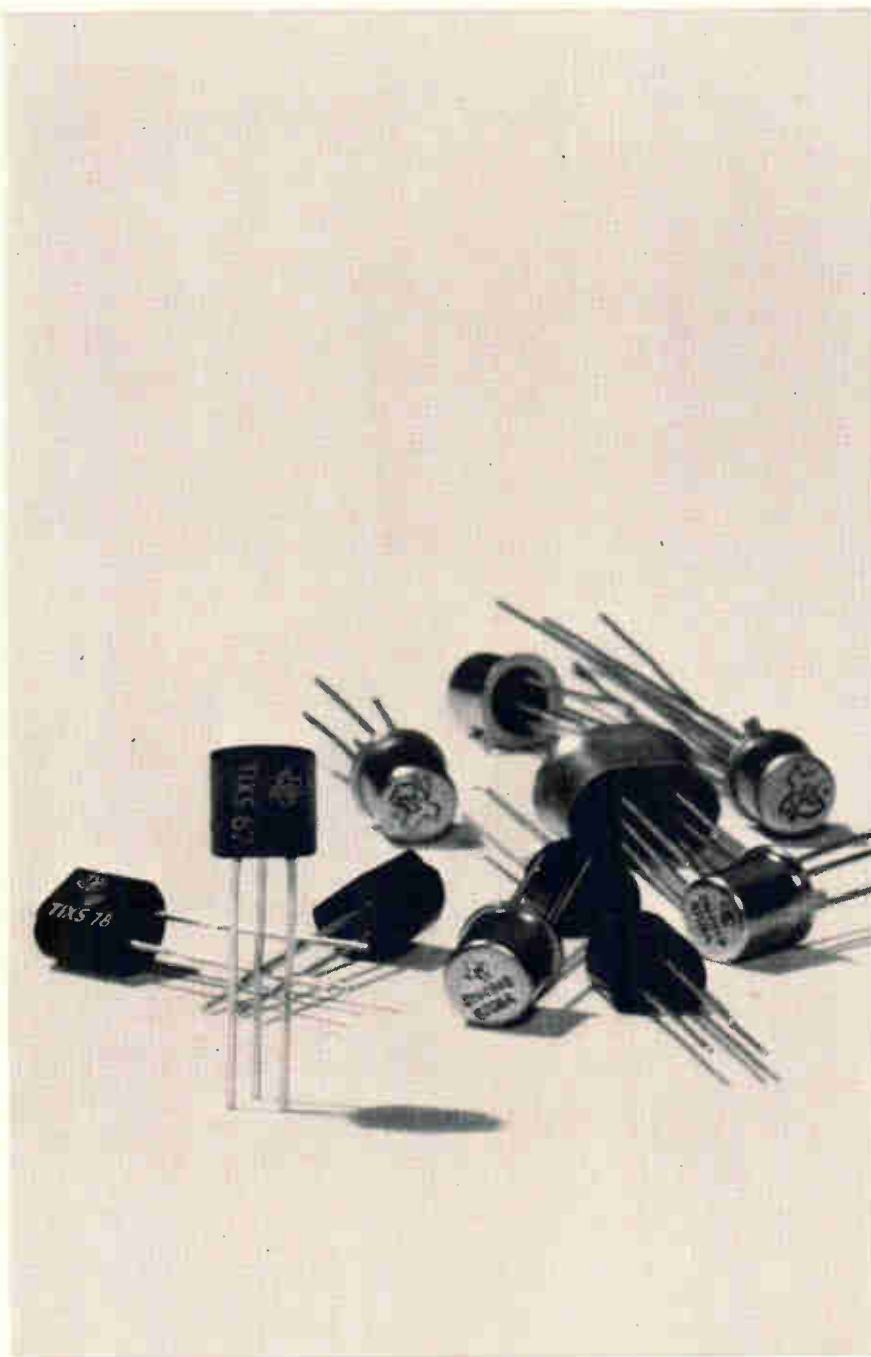

Improve your products, create new designs with these "firsts" from Texas Instruments: • six new families of FETs • six unijunctions • four low-cost SCRs.

Most of these devices are available in the exclusive SILECT™ package with TO-18 pin-circle lead configuration. SILECT transistors are backed up by more than 10,000,000 hours of testing. A preliminary report concludes that SILECT transistors are capable of meeting military specifications and are as reliable as metal can devices tested under the same conditions.

Circle 281 for Reliability Report.

New low-cost, high-voltage FET replaces vacuum tubes

The new TIXS78 silicon n-channel FET offers a 300-volt minimum breakdown voltage, making it a one-for-one replacement for vacuum tubes in such applications as high-voltage switching and large-signal amplification.

The new FET is priced for computer, industrial, communications and entertainment usage.

Circle 282 for data sheet.

New tetrode FET features industry's highest transconductance to capacitance ratio

The TIXS80 is a high-frequency metal-can tetrode FET that has a minimum transconductance of 5,000 μ mhos with a maximum reverse transfer capacitance of 0.8 pF. A second gate simplifies biasing, AGC, and oscillator injection circuitry. The TIXS80 is designed for

mixer and automatic gain-control applications.

In rf amplifiers, it provides high, stable gain at frequencies of 30 to 300 MHz without neutralizing.

Circle 283 for data sheet.

Industry's first plastic-encapsulated MOS FET



The TIXS67 is a p-channel silicon enhancement-mode field-effect transistor. It is the first such device to be encapsulated in plastic.

The unit features high transconductance (3500 to 6500 μ mhos), low feedback capacitance (4 pF), and the lowest leakage characteristic to be found in a plastic-encapsulated device (50 pA). These characteristics make it suitable for switching and high-input-impedance amplifier applications from dc through medium-frequencies.

Circle 284 for data sheet.

New economy matched-pair FETs

Here is a low-cost matched-pair FET assembly for analog computers, comparators, and differential amplifiers. The n-channel TIS68 pair, similar to the 2N3819, is matched for gate-leakage current and gate-source voltage. I_{DSS} and transconductance are matched within 5%. Minimum transconductance is 1000 μ mhos, maximum input capacitance is 8 pF, and reverse-transfer capacitance is 4 pF maximum.

A metal clip is furnished for banding devices together.

Circle 285 for data sheet.

Matched dual FETs have high common-mode rejection capability

This is the first dual FET having matched output admittances as well as matched transconductances for improved common-mode rejection capability. Designated 2N5045, this TO-18 type metal-can dual is ideal for general-purpose differential amplifier applications. Output admittance differential is within 1 μ mho; transconductance and I_{DSS} are matched within 5%. The 2N5045 is priced below comparable pairs which are matched to a lesser degree.

Circle 286 for data sheet.

Nine new FET switches feature lowest on-resistance

Here are industry's first low on-resistance switching FETs. The TIS73-75 series is offered in the SILECT package, while a metal-case TO-18 series is designated 2N4856-61.

Low on-resistance (25 to 60 ohms max.) and extremely low leakage (0.25 and 2.0 nA max.), make these devices unusually versatile.

Circle 287 for data sheet.

New planar UJTs offer optimized characteristics for specific applications

The 2N4892-94 series of planar silicon UJTs in SILECT packages and the 2N4947-49 family of metal-case equivalents are the first such devices on the market which are characterized for specific applications. They are designed for use as long-time-delays, SCR triggers, or high-frequency relaxation oscillators. Leakage is typically 0.1 nA...

one-thousand times lower than comparable alloy types. Other advantages are low base-emitter saturation voltage and high pulse-output voltage.

Circle 288 for data sheet.

Smallest, lowest-cost SCR

TI's new TIC44-47 SCRs are priced only one-third as much as the metal-can equivalents. They are also the smallest SCRs available. The series is rated for 600 mA continuous dc current at 30, 60, 100 and 200 volts. A maximum gate-triggering current of 200 μ A provides high turn-on gain.



Applications include motor speed controls, ignition systems, light flashers, light dimmers and a-c phase control systems.

Circle 289 for data sheet.

Call your nearest TI sales representatives or authorized distributor for more information. If you prefer, write us at P. O. Box 5012, Dallas, Texas 75222.



TEXAS INSTRUMENTS

INCORPORATED

NEW RELAY

+ 100,000 OPERATIONS



AT 5 AMPS

The completely **NEW** Hi-G BN series meets all applicable requirements of Mil-R-5757, weighs .95 oz. in a .875" x .800" x .400" crystal can. All standard configurations and header styles are available for fast delivery.

Write or call Hi-G for new bulletins which provide full details on this high quality line of 5 amp. crystal-can relays. Test data and performance capabilities are available on request. Tel: 203-623-2481

**Hi
G**

INCORPORATED

SPRING STREET & ROUTE 75 / WINDSOR LOCKS, CONNECTICUT 06096

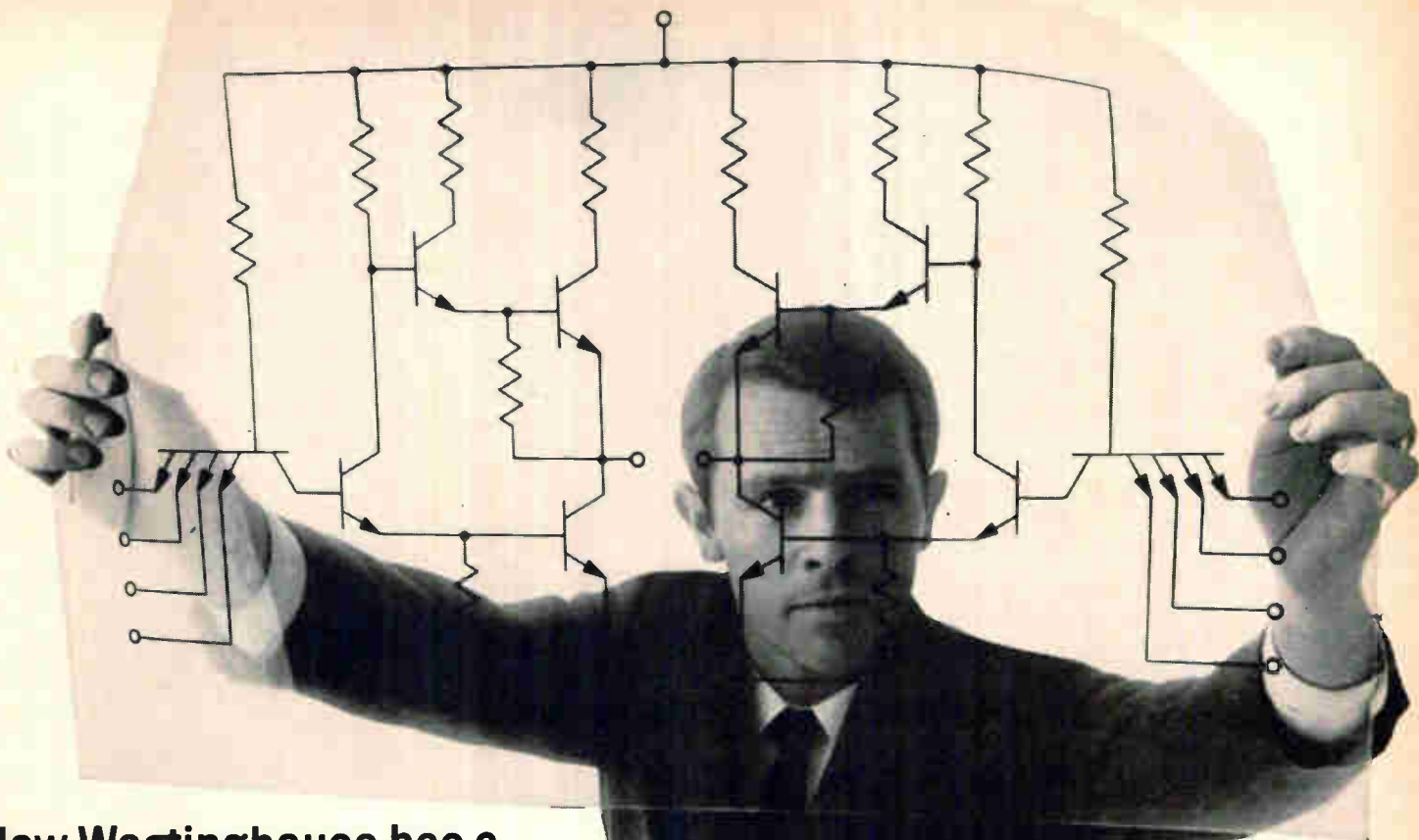

**Now Westinghouse has a
pin-for-pin replacement for
the industry-accepted TTL.**

**But don't think of us only
as a second source.**

There's a very good reason why you should make Westinghouse TTL your *first* source.

Because this is the TTL line that is available now.

It's a direct mechanical and electrical replacement for the industry-accepted SUHL II. And all circuits are available in industry-standard dual-in-line and flat packages.

They include: 6G260 Single 8-input NAND/NOR Gate, 6G241 Dual 4-input NAND/NOR Gate, 6G221 Quadruple 2-input NAND/NOR Gate, 6G210 Dual Expandable OR/NAND Gate, 6G250 Quadruple Expandable OR/NAND Gate, 6G130 Dual 4-input Driver, 6G270 Dual OR Expander, 6F251 AND input JK Flip-Flop, 6F261 OR input JK Flip-Flop.

In fact, it makes good sense to make Westinghouse first choice for all your IC's. Because our goal is to help keep your products competitive now and into the 1970's.

For evaluation quantities, contact your Westinghouse Electronic salesman. Or phone Westinghouse at (301) 796-3666. Or write Westinghouse Molecular Electronics Division, Box 7377, Elkridge, Maryland 21227.

You can be sure if it's Westinghouse

J-09142



Circle 57 on reader service card

New...

3 instruments in 1

for \$950

DIGITAL VOLTMETER
ELECTRONIC COUNTER
ANALOG INTEGRATOR

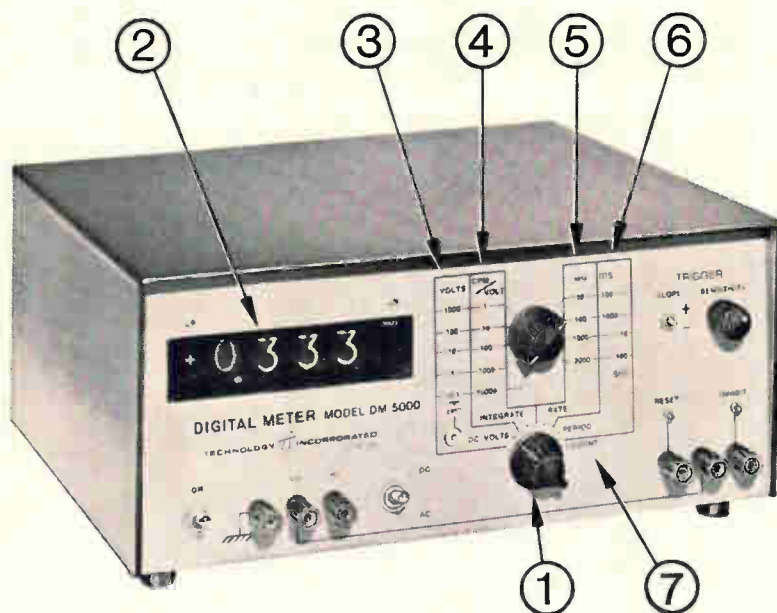

DIGITAL METER Model DM 5000

- 1. Five operating modes:** (1) 0.1% DC digital voltmeter; (2) analog integration; (3) rate and frequency measurement; (4) period and interval measurement; and (5) electronic counter.
 - 2. Four-digit buffered display:** with automatic polarity, 100 μ V resolution, no flicker, over-range and mode indications.
 - 3. DC voltages in five ranges:** ± 1000 V, ± 100.0 V, ± 10.00 V, ± 100.0 V, and ± 1000.0 V; calibrated over-range to 40%.
 - 4. Integration:** five full scale ranges—1, 10, 100, 1000, and 10,000 CPM/volt.
 - 5. Rate and frequency:** four full scale ranges—10, 100, 1000, and 10,000 kHz.
 - 6. Period:** four full scale ranges—99.99 ms, 999.9 ms, 9.999 sec., and 99.99 sec.
 - 7. Counter:** from 0 to greater than 250 kHz with 1 count in 10^4 resolution.
- Other features:** no adapters or plug-ins required . . . 10 megohm floating input.

Write today for free Bulletin 701-A.



TECHNOLOGY INCORPORATED

7400 Colonel Glenn Highway, Dayton, Ohio 45431

Phone: (513) 426-2405

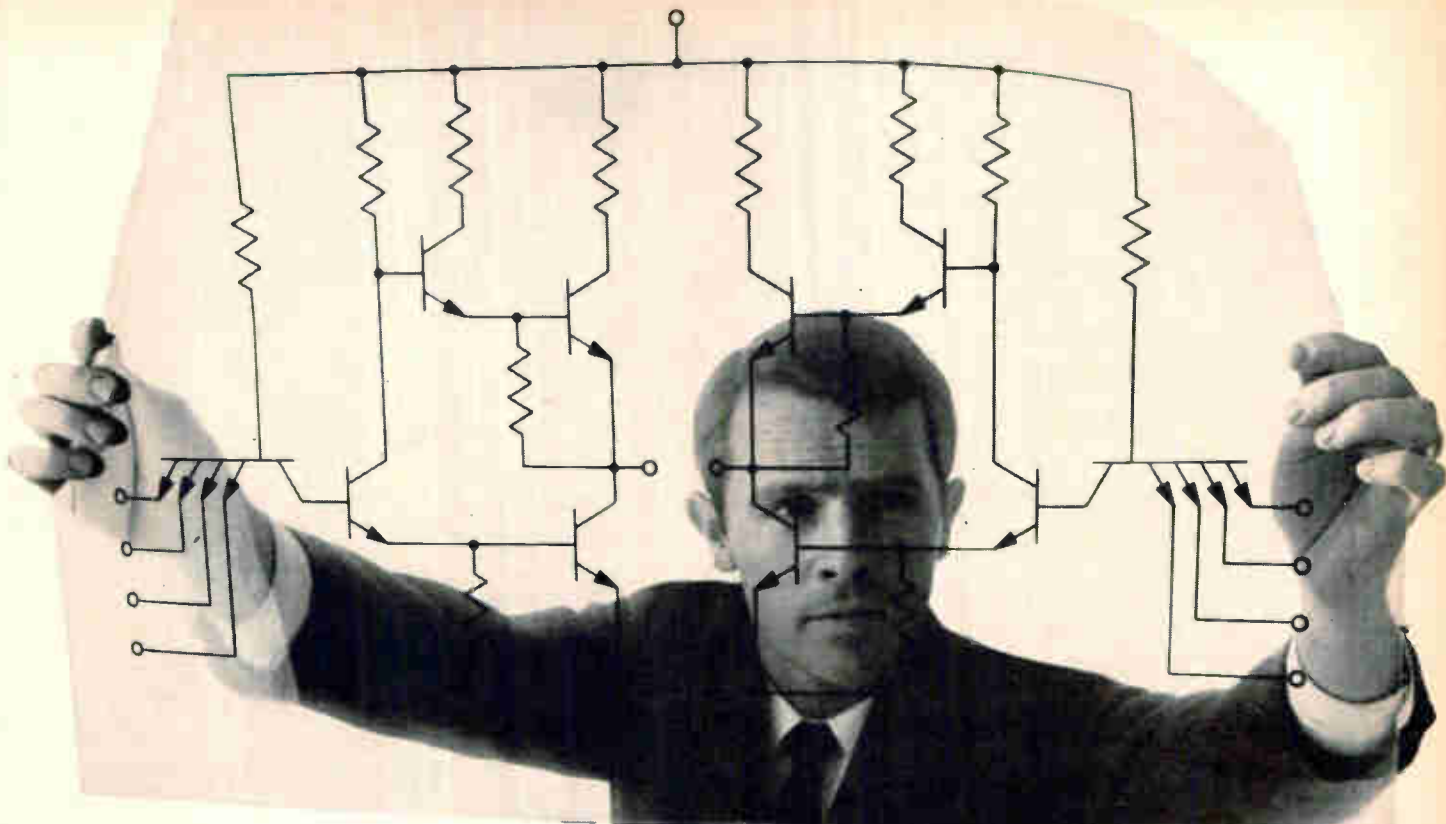

Now Westinghouse has a pin-for-pin replacement for the industry-accepted TTL.

But don't think of us only as a second source.

There's a very good reason why you should make Westinghouse TTL your *first* source.

Because this is the TTL line that is available now.

It's a direct mechanical and electrical replacement for the industry-accepted SUHL II. And all circuits are available in industry-standard dual-in-line and flat packages.

They include: 6G260 Single 8-input NAND/NOR Gate, 6G241 Dual 4-input NAND/NOR Gate, 6G221 Quadruple 2-input NAND/NOR Gate, 6G210 Dual Expandable OR/NAND Gate, 6G250 Quadruple Expandable OR/NAND Gate, 6G130 Dual 4-input Driver, 6G270 Dual OR Expander, 6F251 AND input JK Flip-Flop, 6F261 OR input JK Flip-Flop.

In fact, it makes good sense to make Westinghouse first choice for all your IC's. Because our goal is to help keep your products competitive now and into the 1970's.

For evaluation quantities, contact your Westinghouse Electronic salesman. Or phone Westinghouse at (301) 796-3666. Or write Westinghouse Molecular Electronics Division, Box 7377, Elkridge, Maryland 21227.

You can be sure if it's Westinghouse

J-09142



Circle 57 on reader service card

“Why do more and more executives say MICHIGAN has more of everything?”



“One reason is: year-around sports and recreation assure a full, rewarding life for all.”



For executives and their families who relocate in Michigan, the state offers a wonderland of enjoyment. The abundance of outdoor activities throughout the year enhances family living. Inland lakes and rivers and 3,000 miles of Great Lakes shoreline provide fishing, swimming and boating — besides assuring a wealth of fresh water for industrial use. For labor, as well, Michigan's superb sports and recreation facilities contribute to contentment.

Interested in moving to where the good life is? Contact Consumers Power for detailed, confidential information on plant sites in Michigan's Lower Peninsula.



216 West Michigan Ave. Jackson, Michigan 49201 Area Code 517 - 788-0502
W. N. McClelland, Director of Area Development

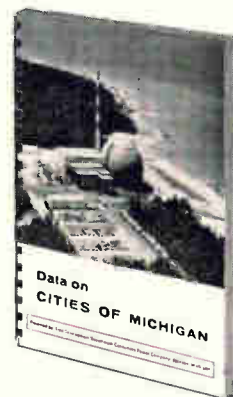

Ask for your copy

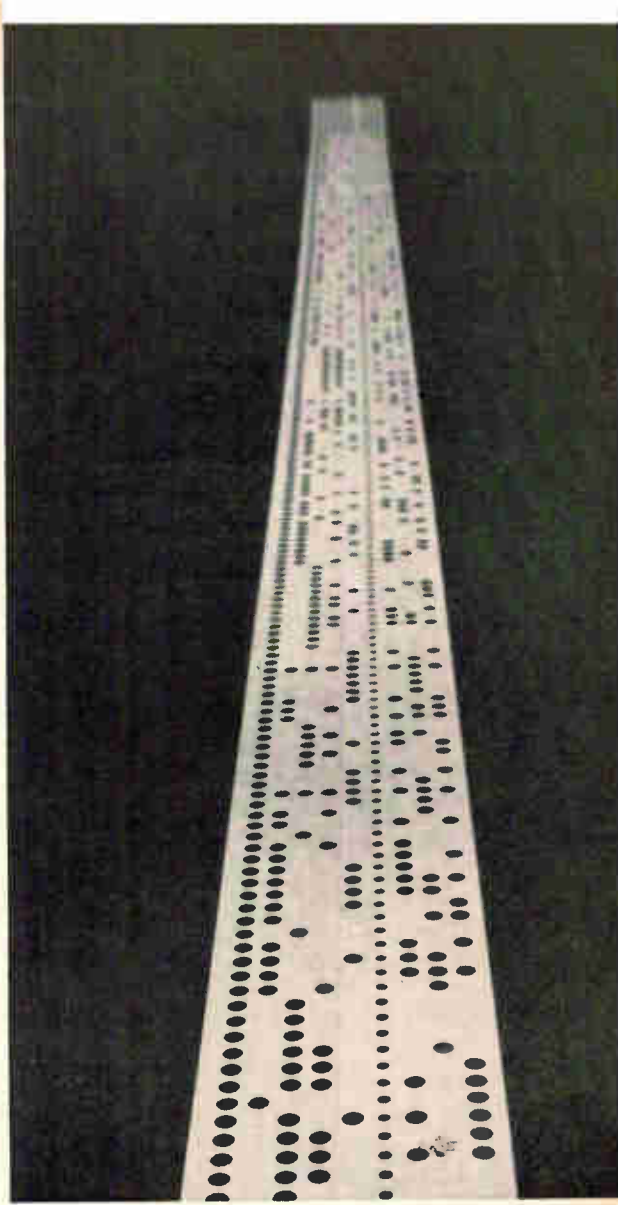
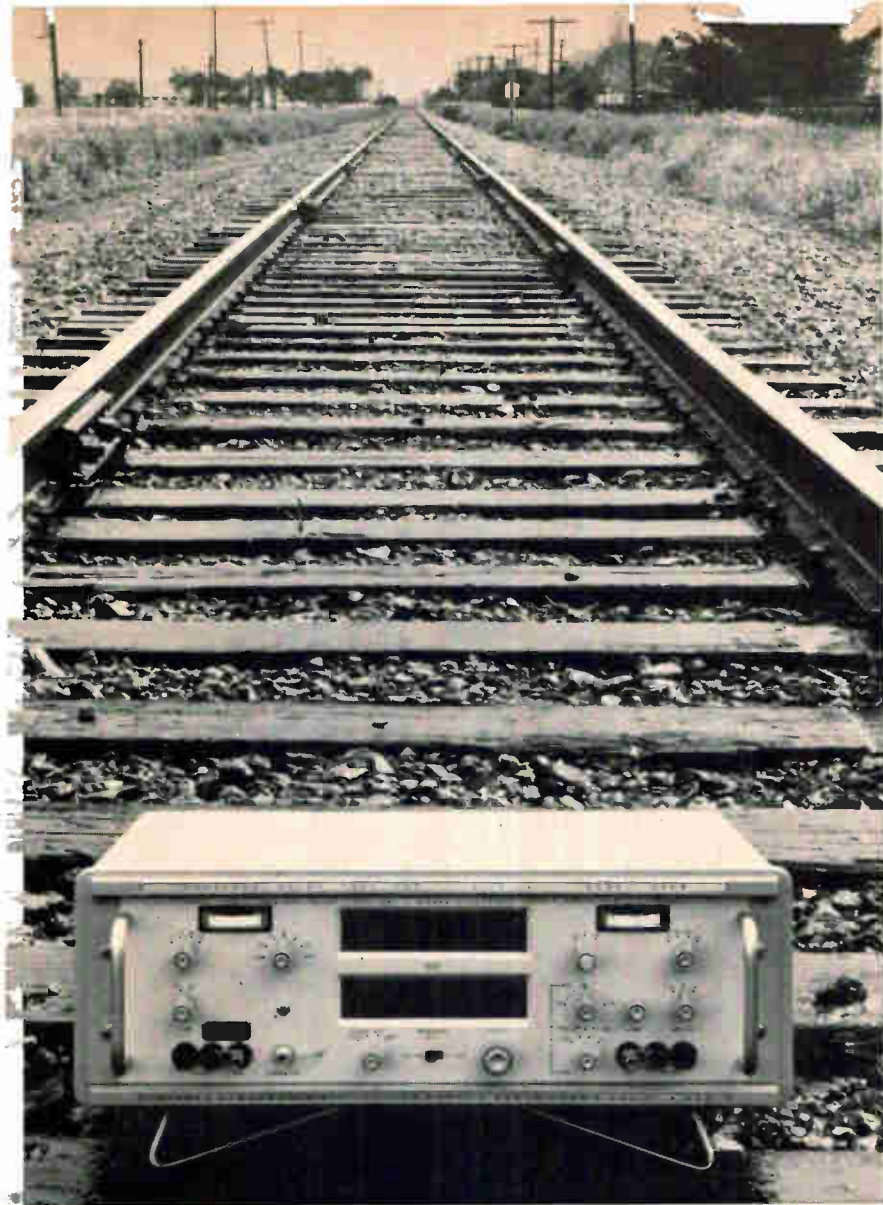

Tracks down envelope delay...

Undetected envelope (or group) delay can easily derail a digital data transmission. Bit-by-bit that pristine formation crumples. Down the line, someone ends up with a mess instead of a message. To keep the data train properly coupled, you need precise information about phase-shift-versus-frequency characteristics of your carrier. The kind of information you can get express from a Sierra Model 340B Envelope Delay Test Set.

Model 340B pinpoints relative delay to $\pm 20,000 \mu\text{sec}$ on a big, direct single-range digital counter. Resolves it to $1.0 \mu\text{sec}$. On a second digital counter, it displays frequency with 10-Hz resolution. Range of 300 Hz to 110 kHz spans voice channel through group frequencies. Measurement modes include end-to-end, loop-back, or end-to-end with return reference path.

Modulation frequency of 25 Hz, usable over full range, resolves fine-grain deviations separated by as little as 50 Hz. Alternative 250-Hz modulation resolves delay to $0.1 \mu\text{sec}$. Price, with one modulation frequency, \$4,750.

Ask for more data, and watch us pour on the coal. Write Sierra, 3885 Bohannon Drive, Menlo Park, California 94025.

clears the track for digital data wave trains



PHILCO-FORD CORPORATION
Sierra Electronic Operation
Menlo Park, California • 94025

Circle 59 on reader service card

New...

3 instruments in 1

for \$950

DIGITAL VOLTMETER
ELECTRONIC COUNTER
ANALOG INTEGRATOR

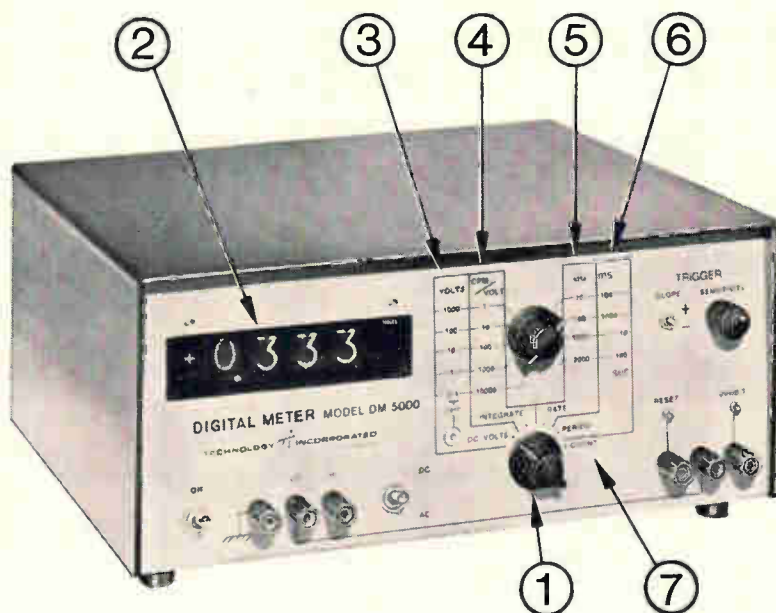

DIGITAL METER Model DM 5000

1. Five operating modes: (1) 0.1% DC digital voltmeter; (2) analog integration; (3) rate and frequency measurement; (4) period and interval measurement; and (5) electronic counter.

2. Four-digit buffered display: with automatic polarity, 100 μ V resolution, no flicker, over-range and mode indications.

3. DC voltages in five ranges: ± 1000 V, ± 100.0 V, ± 10.00 V, ± 100.0 V, and ± 1000.0 V; calibrated over-range to 40%.

4. Integration: five full scale ranges—1, 10, 100, 1000, and 10,000 CPM/volt.

5. Rate and frequency: four full scale ranges—10, 100, 1000, and 10,000 kHz.

6. Period: four full scale ranges—99.99 ms, 999.9 ms, 9.999 sec., and 99.99 sec.

7. Counter: from 0 to greater than 250 kHz with 1 count in 10^4 resolution.

Other features: no adapters or plug-ins required . . . 10 megohm floating input.

Write today for free Bulletin 701-A.



TECHNOLOGY INCORPORATED

7400 Colonel Glenn Highway, Dayton, Ohio 45431

Phone: (513) 426-2405

NEW LOWER PRICES

NEW TEST DATA FOR CTS INDESTRUCTIBLE CERMET SEMI-PRECISION RESISTOR NETWORKS

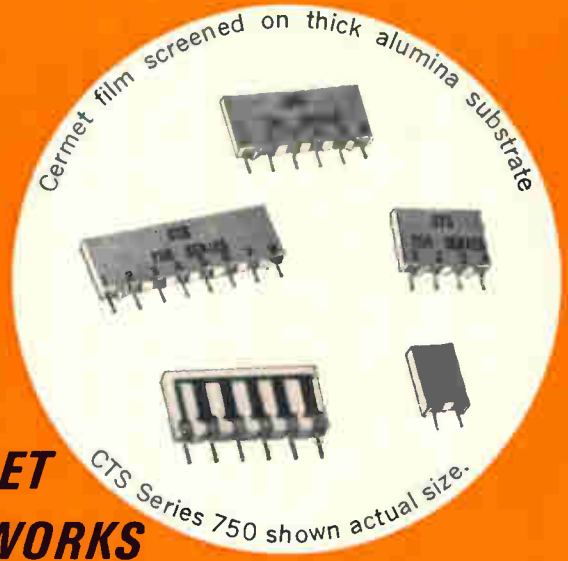

Series 750	2-Pin (1 Resistor)	4-Pin (3 Resistors)	6-Pin (5 Resistors)	8-Pin (7 Resistors)
Total Module Load	0.5 Watts	1.0 Watts	1.5 Watts	2.0 Watts
Approx. 10,000 cost	\$0.22 ea. 17¢	\$0.34 ea. 18¢	\$0.26 ea. 21¢	\$0.31 ea. 26¢

STANDARD MODULE SPECIFICATIONS FOR ALL SIZES	
Resistance Range	50 Ω to 100K Ω
Resistive Tolerance	$\pm 5.0\%$
TC	± 300 ppm/ $^{\circ}$ C
Load Life: 0.1 W per resistor at 70 $^{\circ}$ C, 1000 hrs. (Over 4,000,000 resistor hours)	$\pm 0.40\%$ Δ R max. $\pm 0.20\%$ Δ R av.
Moisture Resistance: .1 rated wattage at 70 $^{\circ}$ C, 90-98% humidity, 1000 hrs.	$\pm 0.50\%$ Δ R max. $\pm 0.20\%$ Δ R av.
Insulation Resistance: measured wet after moisture resistance test, 200 VDC	500 meg. Ω
Thermal Shock: 5 cycles, -63 $^{\circ}$ C to +125 $^{\circ}$ C, no load	$\pm 0.10\%$ Δ R max. $\pm 0.03\%$ Δ R av.
Short Time Overload: 2.5 times rated voltage, 5 sec.	$\pm 0.25\%$ Δ R max. $\pm 0.05\%$ Δ R av.
Low Temperature Exposure: -63 $^{\circ}$ C, 4 hrs.	$\pm 0.10\%$ Δ R max. $\pm 0.04\%$ Δ R av.
Terminal Strength: 5 lb. tensile & compression, 30 sec.	$\pm 0.10\%$ Δ R max. $\pm 0.03\%$ Δ R av.
Effect of Soldering: 63/37 solder, 246 $^{\circ}$ C, 2 sec.	$\pm 0.10\%$ Δ R max. $\pm 0.05\%$ Δ R av.

The data speaks for itself. Examine and judge its value for your application:

Extreme Stability and Reliability
High Power Capability: (Up to 1 watt per resistor)

- Space saving—a single module replaces up to 7 discrete resistors.
- Available in an infinite number of circuit combinations.
- Custom-built to your exact requirement.
- Ideally suited for cost-saving automatic handling.
- Cover coating unaffected by solvents.



founded 1896 Request Cermet Catalog

CTS
OF BERNE, INC.
BERNE, INDIANA

SUBSIDIARY OF
CTS CORPORATION • ELKHART, INDIANA

Extra cost options	
Resistance Range	10 to 49 Ω , 101K to 1 meg. Ω
Resistance Spread	Over 10 to 1
Resistive Tolerance	$\pm 0.5\%$, 1%, 2.5%
TC	± 150 ppm/ $^{\circ}$ C

Nobody but AE makes a Class E relay with all these terminals.

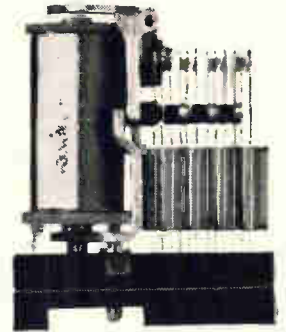

Take your pick:

1 *Solderless Wrap Terminals* eliminate the hazards of soldering. No splashes, heat or clippings. Faster, easier connections. And the technique is easy to learn.



2 *Taper Tab Terminals* accept solderless, slip-on connections which are crimped to each wire lead. Easy to connect or disconnect. Simplify circuit changes and relay substitutions.



3 *Solder Terminals*—the conventional way. For chassis and rack mounting where quick-connect methods aren't needed.



4 *Printed Circuit Terminals* can be inserted directly into PC cards or boards. All terminals are soldered at one time by "flowing." This process can be automated.

You can get AE Class E relay with several types of plug-in sockets, too—that further in-

crease the number of mounting options.

But don't select the Class E relay because of wiring convenience alone. This is a miniaturized version of the premium-quality Class B—with most of its best features. Perfect contact reliability exceeding 200 million operations is common. That's why, even with ordinary solder terminals, the Class E is the most popular *quality* relay of its size!

For helpful information on the full line, ask for Circular 1942. Just write the Director, Relay Control Equipment Sales, Automatic Electric Company, Northlake, Illinois 60164.

AUTOMATIC ELECTRIC

SUBSIDIARY OF
GENERAL TELEPHONE & ELECTRONICS **GTE**

Your 1967 Catalog Enclosed



DC Power Supply Modules
**GUARANTEED
FOREVER**
acdc electronics inc.

Name _____
Company _____
Address _____
City _____
State _____ Zip _____

acdc electronics inc.
222 North Eastern Blvd. • Burbank, California 91504

**If you'll circle Reader Service #25,
we'll send you one by return mail.**

DURANT'S NEWEST!

... in a growing line of count/control instruments



49600 UNISYSTEM®

New, single-level predetermining count/control system developed to meet the need for a small, inexpensive digital counter or timer. It provides direct digital reading, eliminating dial interpolation. Ideal for installation on control panels for machine tools, textile machinery, wire, machinery, metering and scaling equipment. This exceptionally compact unit is available as a standard unit equipped with 2, 3 or 4 Unipulser decades. Design permits it to be used equally well as a desk or panel mount without change. Important advantages include ease of presetting and resetting (panel or remote) . . . set-up and wiring simplicity . . . pre-determined visual setting is always retained. Count life and reset life proven for over 100 million counts. Count speed up to 30 cps. 115V — 230V, 50-60 cycles.

For more information circle No. 491 on Reader Service Card

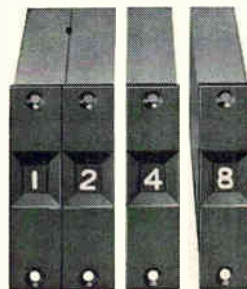

BCD UNIPULSER®

Durant Unipulsers are now compatible with count/control equipment using binary coded decimal systems. They are especially suited for use in data processing equipment, medical instrumentation, business machinery and more.

BCD Unipulsers use the 0-1-2-4-8 code and hook up easily with only 5 wires using standard connectors. Drive and visual readout is digital. Electrical readout is automatically encoded from digital to binary, eliminating the need and expense of code converters.

Important advantages include high count speed (40 cps), large readable figures, high current carrying capacity, and long life (proven for over 100 million counts). The BCD Unipulsers are the latest addition to the growing line of Durant decade modules, permitting you to count or control practically anything; hours, minutes, units, ounces, pounds, etc.

They are available in three models — 400 BCD non-polarized, 401 BCD with a common negative, 402 BCD with a common positive.

For more information circle No. 492 on Reader Service Card



6 YE SERIES ELECTRIC COUNTERS

These new 6 figure electric units have been developed for instrument or control systems, office machinery, data processing equipment where long life and high count speeds are required. Reset is optional, manual push-button or electric, with entire mechanism housed within the case. The 6 YE Series is available for base or panel mounting, providing permanent tamper-proof installation without extraneous hardware.

High accuracy and reliability are assured by an exclusive Durant drive feature: the power impulse cocks, power release counts, resulting in a uniform indexing force and smooth counting action.

Count speed is 2400 cpm DC — 1800 cpm AC (rectified). Models available for 115V, 230V AC or DC — other voltages on request.

For more information circle No. 493 on Reader Service Card



DIGITAL CLOCK — ELECTRICAL READOUT

Hours, minutes, seconds or decimal combinations of any time period can be readout visually and electrically by this highly dependable unit. It can be used in data reduction systems . . . for controlling batching where timed mixing is important . . . to aid in computing piece rate in all production processes . . . for use in all types of data or material handling where a time base is required.

Three, four, five and six digit models are available as shown or without cabinet for 9½" panel or 19" relay rack mounting. 115V or 230V AC, 50 or 60 cycle. Prices start at \$280.00.

For more information circle No. 494 on Reader Service Card

DURANT®
MANUFACTURING COMPANY

MILWAUKEE, WISCONSIN
In Europe: Durant (Europa) N.V. Barneveld, Netherlands

PROTECTION...a New England Tradition

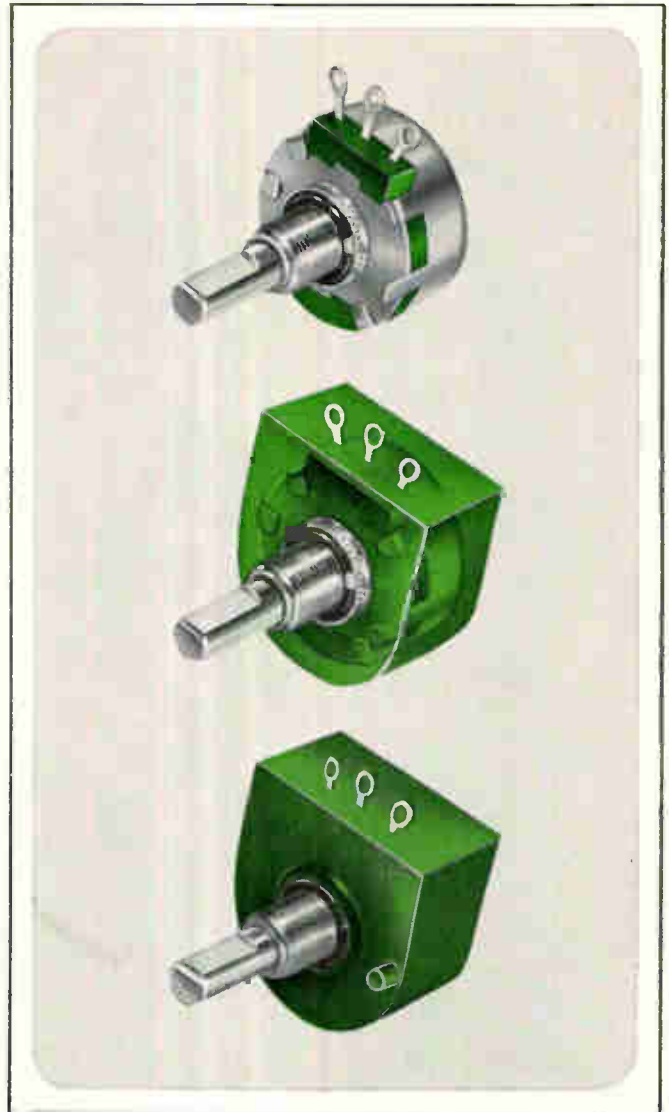
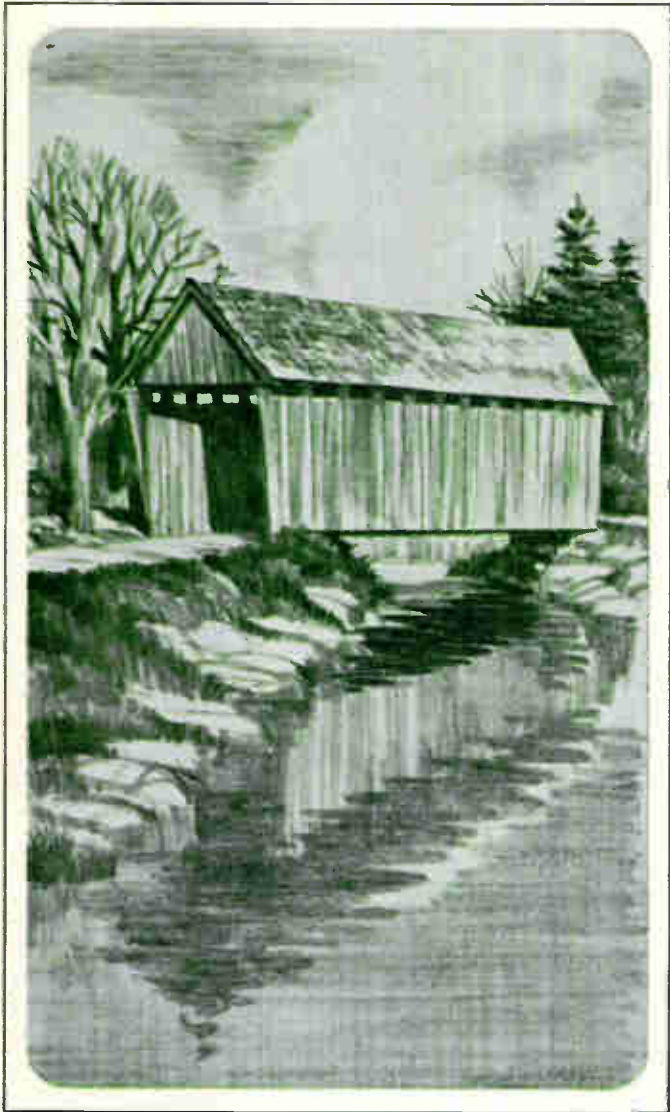

A TRADITION AT CLAROSTAT TOO is the engineering of components to withstand the harshest atmospheric conditions and variations in temperature. Today, the New England tradition of designing for protection against environmental hazards is expressed in Clarostat Potentiometers. No matter how critical your applications—computer—space—industrial—military—our molded potentiometers give complete protection—provide total immunity from moisture, shock, heat and other hostile, efficiency robbing elements. If the job calls for a potentiometer, resistor or switch, call for the component built to maintain a reputation in the craftsman tradition—call for...

CLAROSTAT

CLAROSTAT MFG. CO., INC., DOVER, NEW HAMPSHIRE 03820



10 VARIETIES
AVAILABLE
IN THE NEW
TW
LINE.

SPDT

DPDT

- Maintained ON, Momentary ON
- Maint. ON, Maint. ON
- Mom. ON, OFF, Mom. ON
- Maint. ON, OFF, Maint. ON
- Maint. ON, OFF, Mom. ON

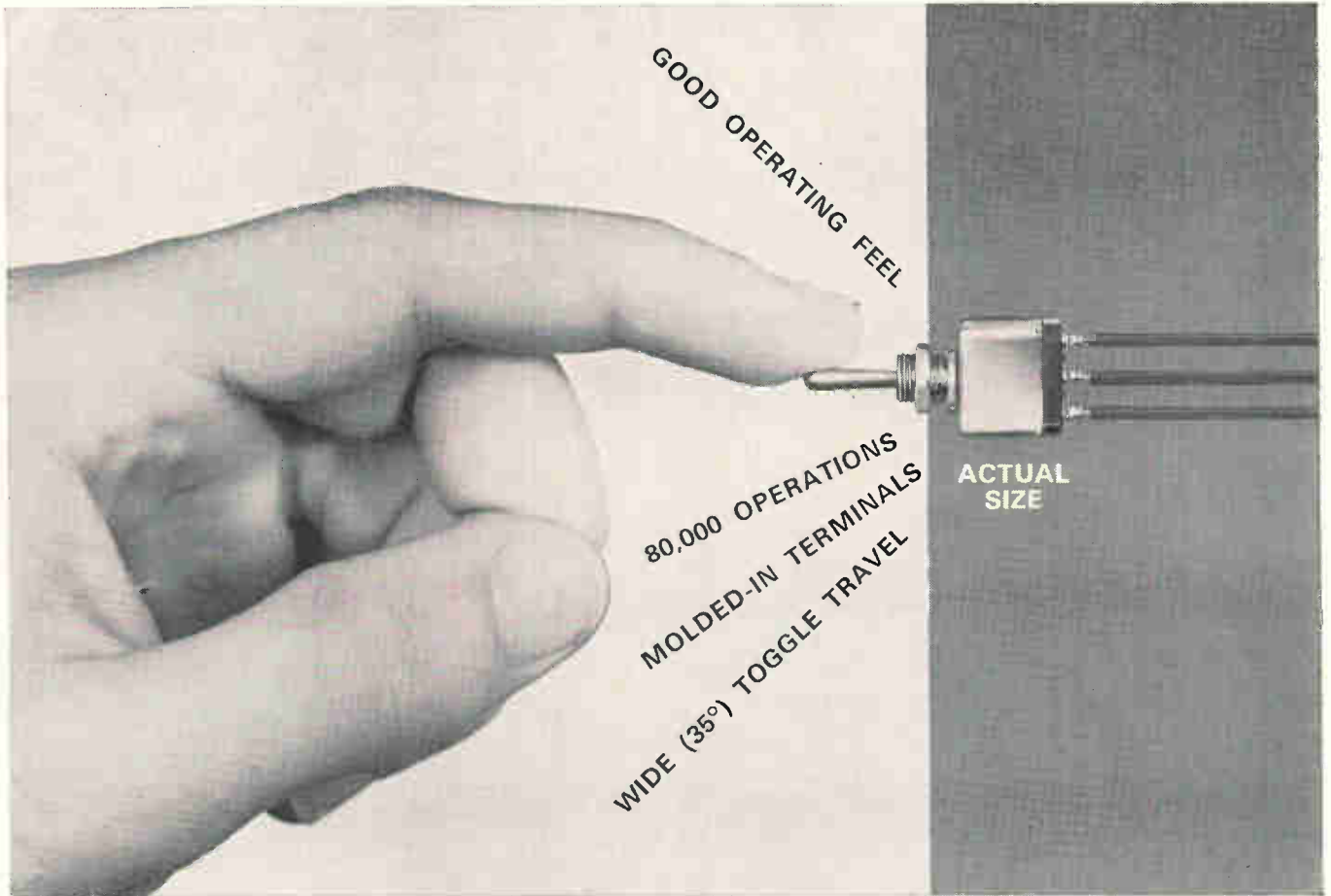

Biggest value yet in space-saving toggle switches

Here's the new little toggle that's big in the features you need. Space-saving size—only $\frac{5}{8}$ " behind the panel. Good operating feel—positive detents, optimum forces, positive return spring on momentary versions. Full versatility, too—ten versions offering SPDT or DPDT, 2 or 3 positions, maintained or momentary contact, 30 vdc or 115 vac, 5 amps resistive, 2 amps inductive.

Call a Branch Office or Distributor (Yellow Pages, "Switches, Electric"). Ask about TW switches. Or, write for Catalog 51.

MICRO SWITCH

FREEPORT, ILLINOIS 61032

A DIVISION OF HONEYWELL

HONEYWELL INTERNATIONAL—Sales and service offices in all principal cities of the world. Manufacturing in United States, United Kingdom, Canada, Netherlands, Germany, France, Japan.

0 ← **SCAN** → 25 MHz

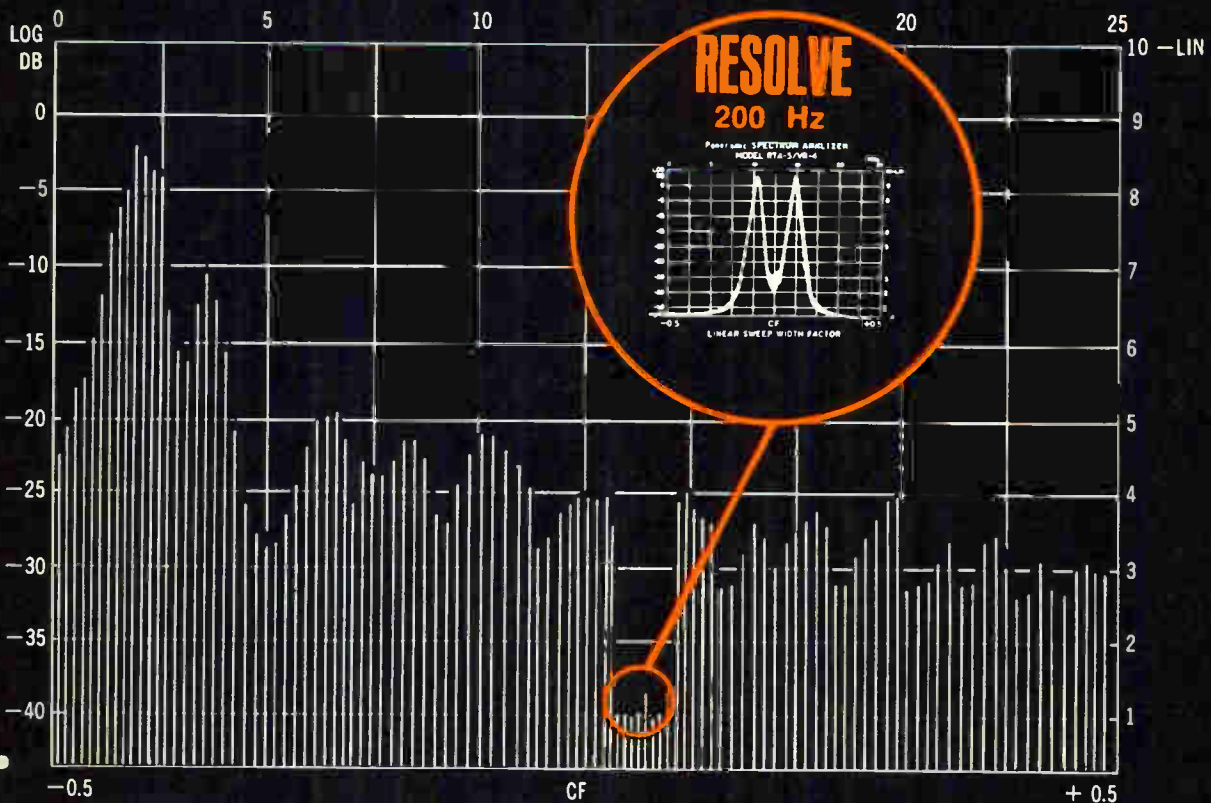

COMMUNICATIONS • SECURITY • TELEPHONY • TELEVISION

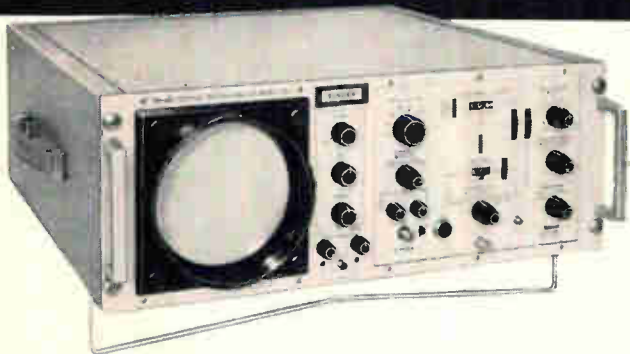

MONITOR & DIAGNOSE from 1 kHz to 27.5 MHz with the Panoramic VR-4/RTA-5 modular spectrum analyzer

SPECIFICATION HIGHLIGHTS

Frequency range: 1 kHz-27.5 MHz digital readout
Scan widths: 50 kHz-5 MHz, or 500 Hz-50 kHz phase
locked, digital readout; preset 0-25 MHz full dispersion
Resolution: 200 Hz
Sensitivity: 30 μ v linear full scale
Residual distortion: > 50 db down
Log display: 40 db calibrated
Display flatness: ± 1 db
Frequency calibration: $\pm 0.02\%$ internal crystal markers
Main frames: rack-mount or portable

At the flick of a switch the solid state VR-4/RTA-5 provides either the wide dispersion needed for *confidence level monitoring* or the high resolution needed for *precise problem diagnosis*. It's fully calibrated (and guaranteed) from its digital frequency controls to its CRT graticule. It has the ultra stability of internal phase lock and built-in crystal markers to check the frequency calibrations. It's compact, lightweight and designed for mounting in a standard 19" rack or in a convenient wrap around cabinet with carrying handles and tilt bar.

*Currently available modules, interchangeable within the Model RTA-5 main frame are: sonic (AR-1), log scan sonic (AL-2), ultrasonic (UR-3), and video (VR-4).

Write for complete technical data; better yet call for demonstration.



EMPIRE • EMC • GERTSCH • SENSITIVE RESEARCH

SINGER
INSTRUMENTATION

THE SINGER COMPANY, METRICS DIVISION • 915 Pembroke St., Bridgeport, Conn. 06608, U.S.A. • Phone (203) 366-3201 • TWX 710-453-3483

P-67-1A

for
sophisticated crystal filters
in
miniaturization



insist on M^CCoy

Sophisticated filters demand sophisticated design—
Miniaturization requires manufacturing know-how—
M^CCoy has both.

In ten years of manufacturing crystal filters—from 5 kc to 125 mc—M^CCoy has accumulated a wealth of filter manufacturing knowledge. Coupled with complete crystal manufacturing facilities, this background of filter know-how has established M^CCoy as a leader in the industry.

When sophisticated designs and miniaturization are required, practically everyone insists on M^CCoy, where sophisticated filters are routine.

Why not put your filter requirements in capable hands?

Contact M^CCoy for quotations on your specific requirements.



M^CCOY ELECTRONICS COMPANY

A SUBSIDIARY OF OAK ELECTRO/NETICS CORP.

MT. HOLLY SPRINGS, PA. 17065

TELEPHONE: 717-486-3411 • TWX 717-486-3400

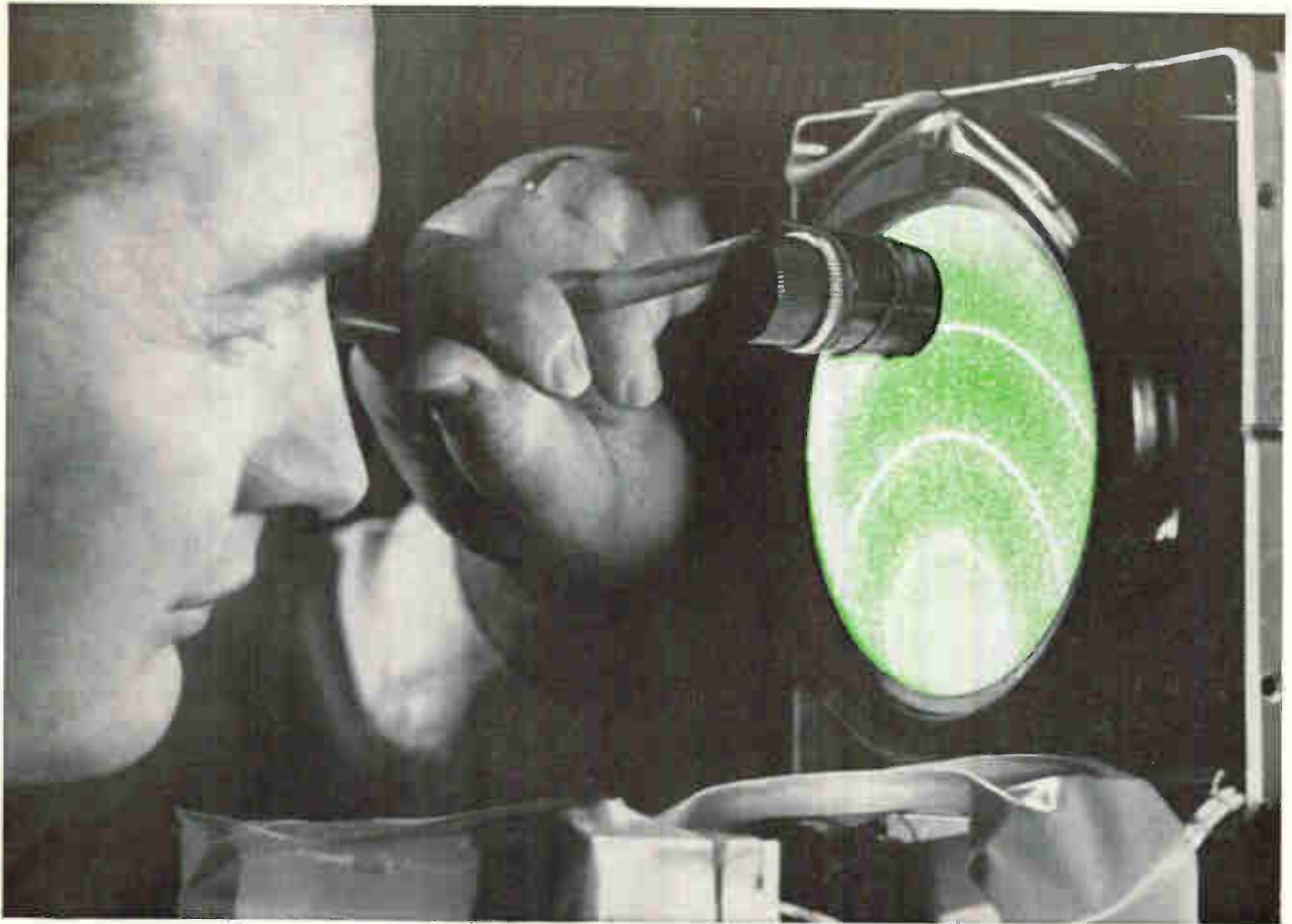

People who need uniformity, dual mode capability, and high resolution, focus on us.

That's why you'll find our direct view storage tubes in military avionics systems, terrain-following radar, in terminal guidance missile system display and commercial aircraft weather radar indicators.

We're specialists in meeting systems manufacturers' specs, which usually originate with MIL specs. All our tubes have a unique weld-ring construction that permits precise gun alignment not affected by sealing. This means you get unusual tube-to-tube uniformity.

Our capability shows up as soon as you flip the on switch. You get high resolution, up to 130 written lines per inch; writing speed up to one million ips. There are no halos to degrade the image. What's more, you have a tube with superior edge-to-edge lighting. Fast erase

speeds—as fast as 0.5 milliseconds without dunking. This allows TV displays at standard frame rates without smearing.

We're also specialists in getting involved in our customer's problems. We stick with the design engineer until he has the tube that meets his requirements. Whether it comes off the shelf or is a custom design.

So if you can't tolerate flaws and want a working partner who can't either, focus on us. Write: Dept. EI, ITT Electron Tube Division, International Telephone and Telegraph Corporation, P.O. Box 100, Easton, Penn. 18043.

ELECTRON TUBE DIVISION

ITT

How a TV maker boosted picture power 25%

**simply
by switching
insulation**



**Scotchpar[®] Polyester Film insulation permits
a smaller sweep transformer
that runs 30% cooler, lasts longer**



Elimination of the metal can saves money and permits better transformer location.

*SCOTCHPAR[®] IS A REG. T.M. OF THE 3M CO.

General Electric recently redesigned the sweep transformer for many of their TV models. They changed from a wax impregnated paper coil insulation to "Scotchpar" polyester film. They benefited by 25% more transformer power, greater reliability and cost savings.

The specific differences are: (1) Metal can around the transformer is no longer required. U.L. approved elimination of the can because "Scotchpar" polyester film won't burst into flames. (2) The coil is smaller because "Scotchpar" film has seven times more dielectric strength than paper. The transformer can now be mounted on the printed circuit board in some designs where it gets better air circulation so it runs cooler. (3) This contributes to a greater power output for color — 0.3 m.a. more at 25,000 volts. (4) Cost savings come from elimination of the can and six connecting wires, less assembly labor and greater reliability.

These were GE's benefits from switching to modern "Scotchpar" film insulation. What about your products? Better find out what "Scotchpar" film could do there, too. Write directly to Film & Allied Products Division, 3M Company, 2501 Hudson Road, St. Paul, Minnesota 55119, Department ICL-67.

3M
COMPANY

**TRW
TRANSISTORS
announces another
member of the
Gigahertz family**



1 Watt
2 GHz

B-32

1 Watt output ... 5dB gain!

TRW again breaks the Gigahertz barrier with this new 2 GHz addition to the TRW family of Ultra High Frequency transistors! They are the finest broadband transistors you can buy—the only power transistors capable of GHz operation in simple, straight through circuits.

As doublers or triplers these transistors will reach 3 GHz with cool efficiency. In the 600 to 700 MHz range their gain and efficiency are phenomenal!

And you get this remarkable performance from a 28 volt power source, 1 Watt output, 5 dB gain!

Contact any TRW distributor or TRW Semiconductors Inc., 14520 Aviation Blvd., Lawndale, Calif. 90260. Phone: 213-679-4561. TWX: 910-325-6206. *TRW Semiconductors is a subsidiary of TRW INC.*

TRW

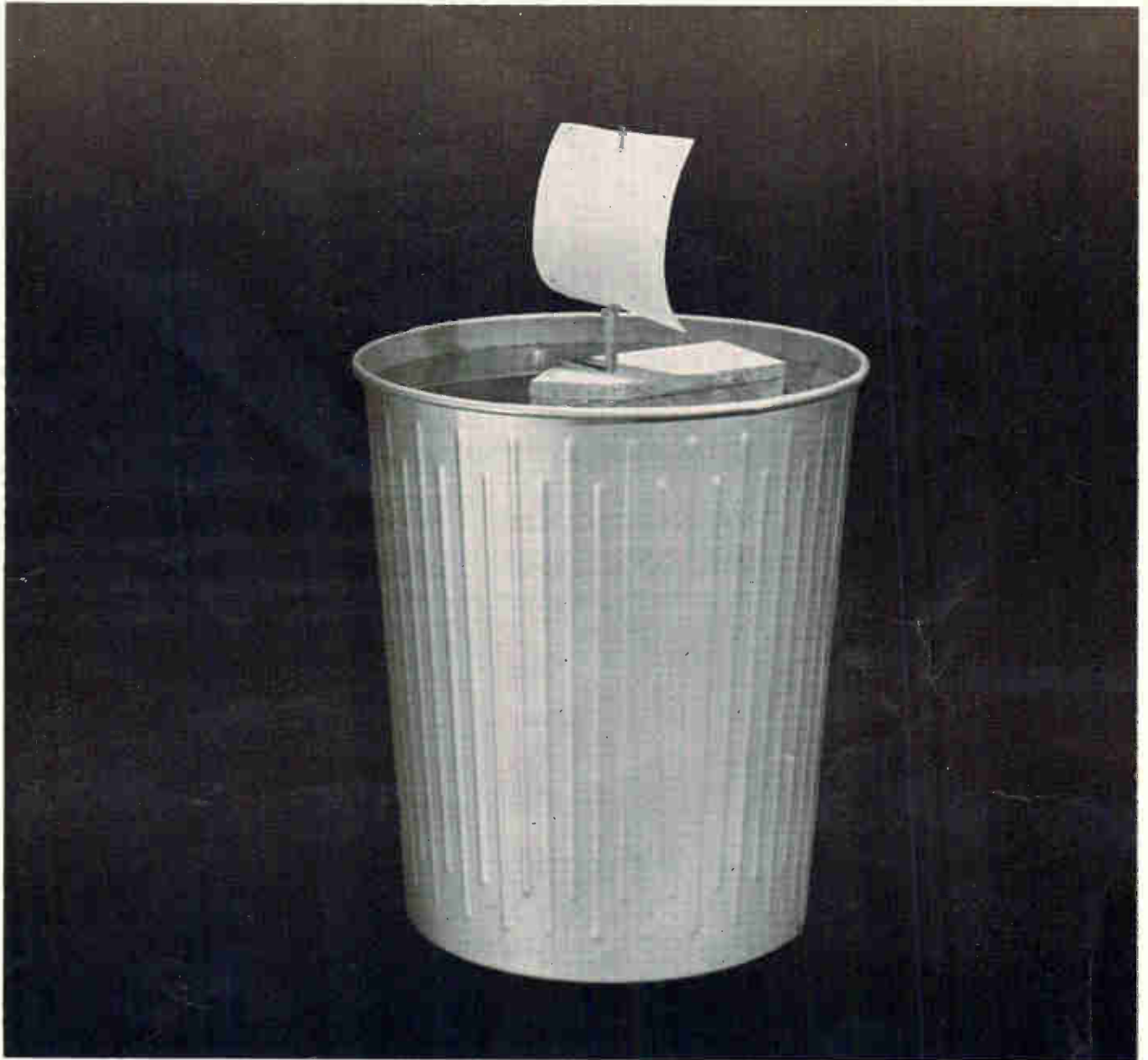

SUGGESTED APPLICATION

Telegraphy room wastebaskets can continue to be of service — but it takes a little imagination. They are of little practical use to companies who have found Codex TD-12 Telegraphy Error Correctors to be the least expensive, most efficient way to end garbled messages.

Unlike most message protecting systems, such as the ARQ, the TD-12 automatically detects *and corrects* virtually all transmission errors as they are received. Its forward-acting code needs no return path and overcomes channel error-rates that normally stop communication.

TD-12 units are fully compatible with standard VFTG equipment and operate in either start-stop or synchronous mode, with three or four basic transmission speeds. Reliable solid-state construction keeps maintenance to a minimum; no operator adjustment is needed.

We have a number of suggestions for using obsolete garble-baskets. Why don't you review the many advantages of "first-time-correct" copy. Write (or phone or Telex) for our brochure on the TD-12 . . . the best and least expensive telegraphy error corrector on the market.

**CODEX
CORPORATION**

• 222 ARSENAL STREET, WATERTOWN, MASSACHUSETTS •
ZIP CODE 02172 • (617) 926-3000 • TELEX 094-6332 •



Name your need in triggers, timers, ring counters, and oscillators

Whatever your problem, GE's very broad line of small signal, regenerative switching semi-conductors has at least one device that can solve it. Interested in developing a threshold voltage proportional to the supply voltage? Specify a GE unijunction transistor (UJT). Or do you need a device that gives you temperature and frequency stability with opposite polarity from a regular UJT? Our newest innovation, the Complementary UJT, gives you this. Silicon Unilateral Switches (SUS's) and Silicon Bilateral Switches (SBS's) serve as exceptionally stable low-voltage trigger diodes, compatible with integrated circuits. And GE Silicon Controlled Switches (SCS's) have achieved excellent results performing as 4-lead SCR's that feature high voltage capability and versatility.

All 5 of these GE types of devices are capable of generating an output current pulse in excess of 1 ampere from an input signal as low as $1\mu\text{A}$. Just name your triggering device need, then circle magazine inquiry card Number 90 for GE's full line information.

For aircraft and ground power applications: thin-sintered plate nickel-cadmium batteries



Meets military specifications

- Extremely reliable over a very wide temperature range.
 - Quick, full recharge within one hour.
 - Long life—with constant, dependable service.
 - Peak power at level voltage rate.
 - Constant voltage output 90% of the time.
 - Operational in temperatures from sub-zero to tropic.
 - Many years' storage life without harm.
 - Up to two-thirds lighter than conventional lead-acid batteries.
 - Extremely rugged—proved in tests up to 5,000 G's.
 - No modifications required with existing aircraft electrical systems.
 - Economical in operation through long life, little maintenance, and excellent performance.
- Circle Number 91 for all the facts.

Tiny 5-amp relay in 2-amp model price range

Weight: just 0.7 ounce maximum. Now, the proven magnetic motor design of GE's 3SAF microminiature relay, featuring all-welded construction, is combined with new, heavy-duty contacts and terminal leads. Result: 5-amp switching capability in a microminiature gridspace package. We call it the 3SBK. Electron-beam welding eliminates the need for solder flux, adding greater strength and delivering more trouble-free performance. Circle magazine inquiry card Number 92.

Actual Size



Highest power VTM's in industry



Electronically tunable at rates as high as 20,000 mc per microsecond.

GE Voltage Tunable Magnetrons—available at power levels of 100 watts and higher over electronically tuned bandwidths of 20% in L, S, and C bands—meet system requirements from 1,000 to 6,000 mc in:

- noise generators for electronic countermeasure systems.
- drivers for frequency diversity transmitters.
- other applications requiring high-efficiency, self-excited oscillators.

As developers of the VTM, GE engineers continually improve their uniformity and quality in quantity production. And GE integral isolator know-how helps alleviate tube-equipment interface problems. These VTM's feature electronic tuning, linear tuning characteristic, magnetic shielding, and rapid modulation. Conversion efficiencies exceed 60% in many high-powered types. Circle Number 93 for more details.

COMING YOUR WAY—GE's MICROWAVE TUBE VAN. CIRCLE NUMBER 94.

WE MAY NOT OFFER EVERYTHING YOU WANT FROM ONE COMPONENTS SUPPLIER. BUT WE DO COME A LITTLE CLOSER THAN ANYONE ELSE.

A LOW-COST 1 AMP SPDT RELAY MIGHT DO THE JOB BETTER THAN AN EXPENSIVE ONE.

If it's the new 75-cent Sigma Series 65.



New Sigma Series 65 miniature relays are specifically designed for low-level DC switching applications where economy is of major importance. Available in quantity for 75 cents, these general purpose relays include extra design benefits:

Superior Switching Performance: The precision knife-edge hinge design of the armature provides better magnetic coupling for full utilization of coil power. This results in heavier contact forces, lower contact resistance and better electrical stability.

Greater Mechanical Strength: Glass-filled nylon, not ordinary phenolic, is used to support contact members assuring long-term mechanical life and stability.

Better Thermal Stability: Use of high-grade, low-

temperature-coefficient materials assures excellent thermal stability over a wide temperature range up to 70°C.

We'd like to give you a new Sigma Series 65— or any of our other standard relays. Test and compare it against the brand you may now be using. It's the best way we know to prove what we say about Sigma relay performance. Just circle our reader service number on the reader service card. We'll send you the new Sigma relay catalog and a "free relay" request form. Return the form to us and your Sigma representative will see that you get the relay you need.

Need fast delivery? The Series 65 is available off-the-shelf from your Sigma distributor.

SIGMA DIVISION  SIGMA INSTRUMENTS INC
Assured Reliability With Advanced Design / Braintree, Mass. 02185
Sigma Instruments (Canada) Ltd., P.O. Box 43, Toronto 18

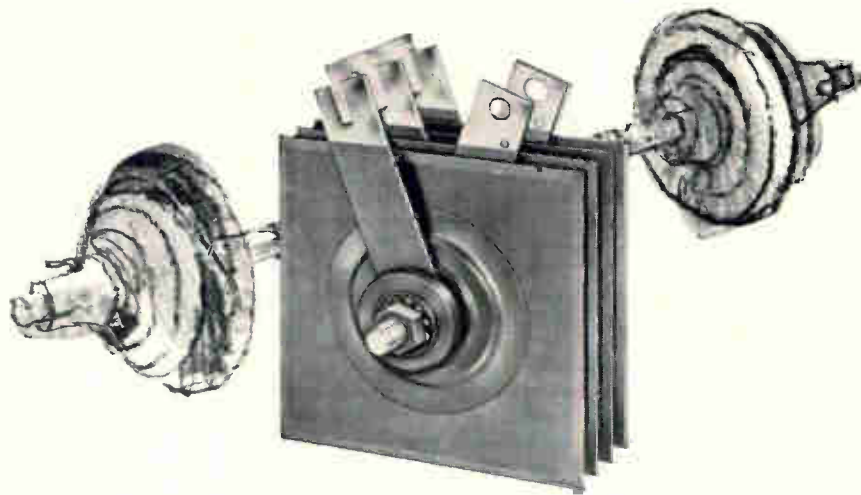

heavy weight!

small cell sizes reaches new capacity!

An extensive research and development program coupled with the industry's most complete selenium facility has produced the Uni-Sel — a high temperature, high density selenium cell, superior to all other types.

The current carrying capability of this new product makes possible reduction in cell sizes never before achieved.

Available in all cell sizes with voltage ratings as high as 45 volts.

Write For Literature



**SYNTRON
COMPANY**

241 LEXINGTON AVE. • HOMER CITY, PA. 15748
TELEPHONE 412-479-8011
Sales Representatives Coast-to-Coast

Please send details about Syntron's Complete Line of Rectifiers 241

Name & Title _____

Company _____

Street _____

City & State _____ Zip _____

67R11

Smaller, even, than our DHD silicon diodes

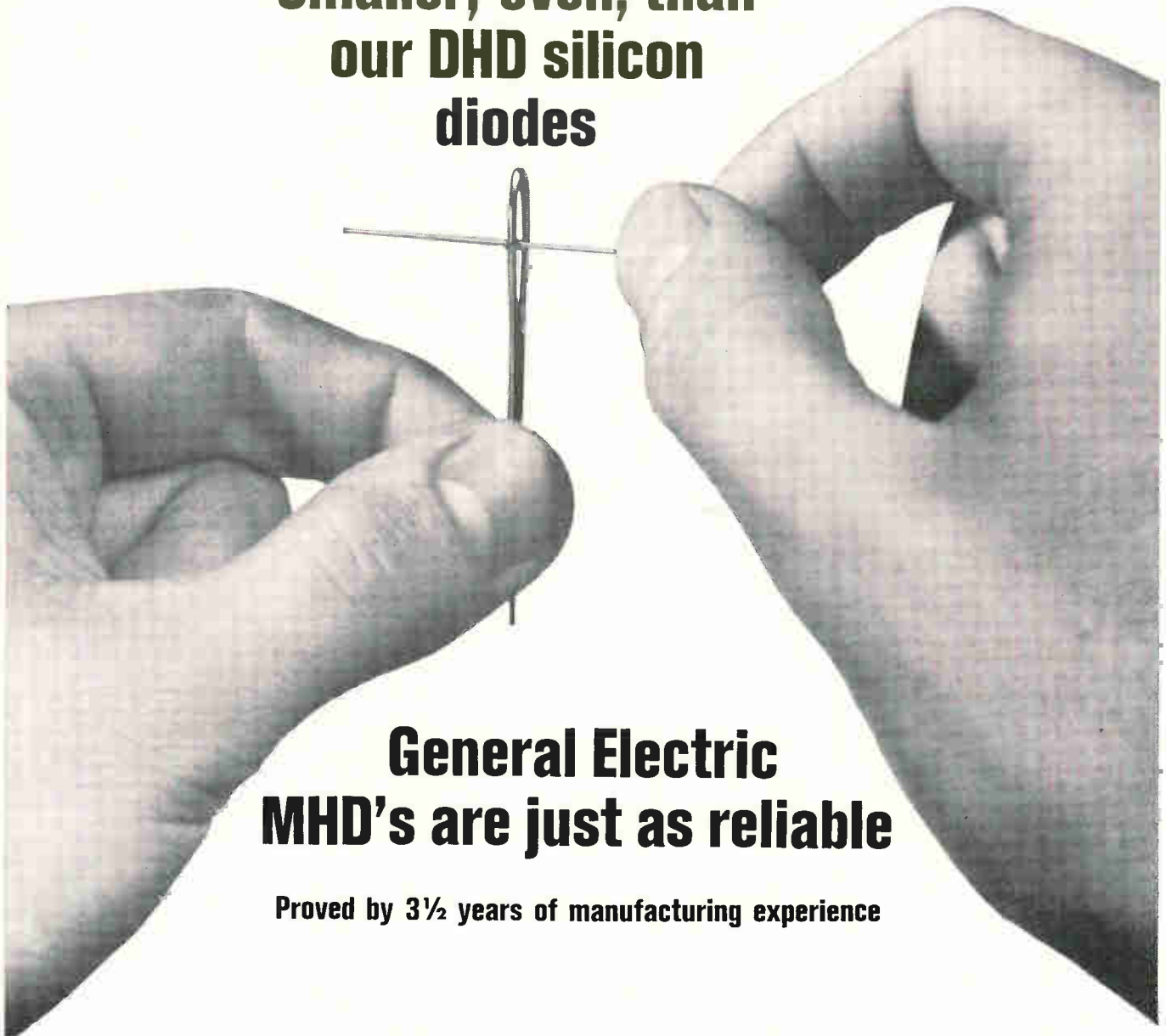

General Electric MHD's are just as reliable

Proved by 3½ years of manufacturing experience

■ They're the next logical step forward in GE signal diode innovations. Nearly 40% smaller than the DHD we introduced 5 years ago, tiny GE Milli-Heatsink diodes feature the same "springless" construction . . . the same proved, inherent reliability. MHD's are perfect for high-density circuit card and memory applications, and for "cordwood" construction. Each Milli-Heatsink diode features high conductance and nano-

second switching time. New General Electric MHD's are available in JEDEC types 1N4531-34 and 1N4536.

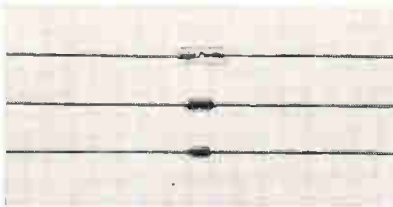

Signal diode packages shown actual size. From top to bottom: old DO-7 spring construction, General Electric DHD package, and General Electric MHD planar epitaxial silicon signal diode package.

MHD's are just one more example of the total electronic capability you get only from General Electric. For more information, call your GE engineer/salesman or authorized distributor. Or write: General Electric Company, Section 220-56, Schenectady, New York, 12305. In Canada: Canadian General Electric, 189 Dufferin St., Toronto, Ontario. Export: Electronic Component Sales, IGE Export Division, 159 Madison Ave., New York, N. Y., U.S.A.

SEMICONDUCTOR PRODUCTS DEPARTMENT

GENERAL  **ELECTRIC**



GET FAST SIX-WAY RELIEF.....

from irritation due to
circuit design problems

New NEXUS QFT capsules give "best-you-can-buy" op amp performance

1. FET input . . . 10^{11} ohms Z, differential and common-mode
2. High output in small package . . . $\pm 10\text{mA}$ @ $\pm 11.5\text{V}$
3. Low input bias current . . . 10pA , typical
4. High common-mode rejection — 86dB
5. Fast slewing . . . $10\text{V}/\mu\text{s}$ (gives full output to 200kHz)
6. Low temperature drift . . . $5\mu\text{V}/^\circ\text{C}$ max. (for the QFT-2B)

Here is a new FET op amp series guaranteed to relieve pains caused by typical marginal "general-purpose" operational amplifiers.

In addition to the unique combination of characteristics above, the three QFT models provide dc open-loop gain (full output) of 150,000 min., fast settling time ($5\mu\text{s}$ to 0.1%), extremely smooth

loop dynamics, and high tolerance to capacitive loads. The QFT-2, QFT-2A, and QFT-2B have maximum temperature coefficients of 35, 10, and $5\mu\text{V}/^\circ\text{C}$ respectively.

And best of all, prices for the QFT series are extremely soothing. Write today for complete specifications and price information on the QFT series.

The QFT-2 lists at only \$45 (1-9). The QFT-2A, \$70 (1-9) and QFT-2B, \$85 (1-9). Prices F. O. B. Canton, Mass. U.S.A.

NEXUS
RESEARCH LABORATORY, INC.
480 NEPONSET STREET, CANTON, MASS. 02021
TEL: (617) 828-9000 TWX (710) 348-1323

Circle 77 on reader service card

Let Honeywell extend your EMI measuring capabilities with these off-the-shelf products.

RG-3 INTERFERENCE RASTER GENERATOR – For determining sources of interference signals from computers, voice and digital communications, and telemetry.



\$1365

4856 WIDEBAND RASTER GENERATOR – Designed for the same applications as the RG-3, but with wideband (25MHz) capability, solid-state electronics, and 50 ohm input.



\$1645

AW-204 TRANSISTORIZED WIDEBAND AMPLIFIER – Used as a preamplifier with standard EMI meters and calibrated signal sources to provide rapid, remote measurement of extremely low level electric field signals in the 14kHz – 30MHz frequency range.



\$880

2854 WIDEBAND AMPLIFIER – A high gain, low noise, video amplifier used to detect low level wideband signals. Solid-state electronics; 1kHz – 10MHz frequency range.



\$1070

2855 ASSOCIATED PREAMPLIFIER – For matching rod antenna impedance to 50 ohm input of receivers or amplifiers (typically Honeywell 2854). Low noise solid-state electronics with self-contained battery; 300Hz – 10MHz frequency range.

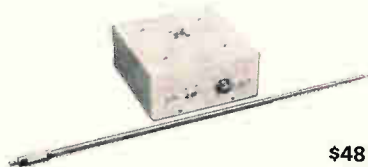

\$485

4857 LOW FREQUENCY IMPULSE GENERATOR – Provides flat spectrum of calibrated amplitude signals in 120Hz – 250kHz range for signal substitution or calibration of receivers and field intensity meters. Solid-state electronics.



\$550

PLT-1/PP REGULATED AC POWER SUPPLY – A solid-state, 60Hz, 115v rms supply for use in any application requiring extreme amplitude and phase stability. Low distortion; 1 KVA.

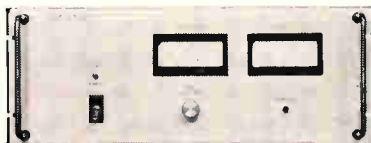

\$2450

3858 – 3861 LOW FREQUENCY POWER LINE IMPEDANCE STABILIZATION NETWORKS – Used for conducted interference testing of equipment requiring high level input power line current. Frequency range: 14kHz-5MHz; 50ohm line impedance.



\$230 – \$290

3862 HIGH FREQUENCY POWER LINE IMPEDANCE STABILIZATION NETWORK – Same as 3858 – 3861 networks, but for 4MHz – 1GHz frequency range; 80 amp capability.



\$220

Honeywell engineers sell solutions

The instruments shown here are more examples of how Honeywell's broad line, backed by local sales and service, can provide the *precise* solution to your instrumentation problems. For full details on any or all of these fine products, call your local Honeywell Representative, or write: Honeywell, Test Instruments Division, Annapolis Operation, Box 391, Annapolis, Md. 21404.

Honeywell

another Aerovox B-R-E-A-K-T-H-R-O-U-G-H in the state-of-the-art

1.0 MFD. 25 VDC molded case Ceralam in CK06 style

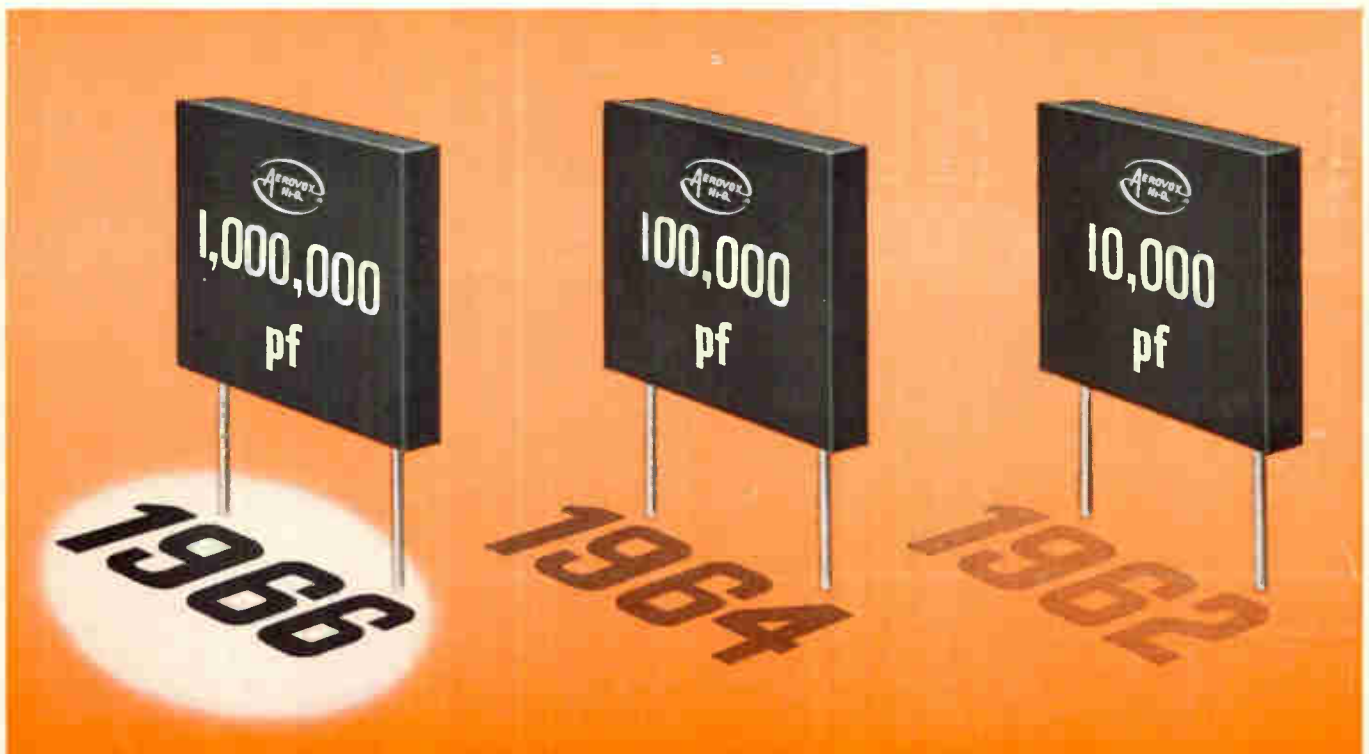

Just the ticket for those solid-state applications ... greatly increased capacitance ranges at a reduced voltage. This Aerovox breakthrough features a 1.0 mfd, CK06 made with Ceralam established reliability, semi-stable Characteristic "C" material ($\pm 15\%$ temperature coefficient).

In addition to the CK06, greater capacitance is made available in all Aerovox configurations and standard ceramic compositions. These include a 0.1 mfd CKR12, a 0.33 mfd CK05, and values up to 7.5 mfd in the Aerovox MC89 tubular series.

Aerovox's well established reliability has been a prime consideration in the development of these new units and careful adherence to conservative voltage stress limits has been maintained. Although rated at 25 volts, units are life

Selected commercial and military products are available off-the-shelf from Authorized Aerovox Distributors.

tested at twice rated voltage. Capacitors of similar low voltage rating such as electrolytics are tested only at rated voltage. Units may also be screened by "burning-in" at twice rated voltage for periods up to 250 hours without shortening the life of the capacitor and thereby bringing quality to the levels specified in MIL-C-39014.

For complete details contact your local Aerovox sales representative or write ...



AEROVOX
CORPORATION
OLEAN, N. Y.



Why buy price at any cost

To pay too little is to obviously speculate. To spend too much is to be foolishly extravagant. The real value of any purchase is determined in performance, not price. Resistors are like this also.

For years, Stackpole fixed composition resistors have been the standard of value for many leading manufacturers of electrical and electronic equipment. Engineers have become familiar with the testing and evaluation that go into each Stackpole resistor order. Purchasing people know they can expect prompt delivery. And management is assured of complete, in-depth service backed

It's for reasons like these that Stackpole resistors are selected to maintain top performance on so many established products and on a growing number of brand new ones. Such confidence and loyalty cannot be based on price alone, but instead come from the kind of dependability that builds a reputation for your product.

Uniformity is a known characteristic of Stackpole resistors. Unique production methods coupled with thorough testing assure you absolute performance. You can rest assured that the Stackpole resistors you order today will be identical in every way, order

Are you getting what you pay for in a resistor? Why not investigate the value Stackpole resistors can give you. Quality, economically priced and backed by the recognized name . . . Stackpole. There are four sizes to choose from: 2, 1, 1/2 and 1/4 watts.

For samples or a copy of our new booklet, "How to spot a quality resistor", write: Stackpole Carbon Company, Electronic Components Division, Kane, Pa. 17835. Phone: 814-837-7000. TWX: 510-695-8404.



STACKPOLE

ELECTRONIC COMPONENTS DIVISION

Technical Articles

New uses for gallium arsenide
page 82



For nearly 10 years engineers have been trying to improve the processing of gallium arsenide and design new devices that can use it. The long tedious work appears ready to pay off. At RCA, researchers have successfully built transistors on gallium arsenide by using a silicon nitride insulator instead of silicon dioxide [p. 82]. The FET's produced perform better than equivalent silicon metal oxide semiconductor devices. On the cover is a photograph of the first gallium arsenide MIS transistor. At Bell Telephone Laboratories, researchers are pushing ahead with the limited space accumulation mode of operation for bulk effect devices made of gallium arsenide, and the work appears to be more promising than that being done with any other kind of bulk phenomenon [p. 91].

R-f breakdown phenomenon can double the voltage capability of a transistor
page 97

Breakdown is turned into an advantage when the device is operated beyond its cutoff frequency. The breakdown limit rises above its static and low-frequency values so the device can withstand transient peaks up to twice the data sheet rating. The payoff is less expensive r-f amplifier circuitry.

A logical next step for read-only memories
page 111

Integrated electronics have made the read-only memory look more attractive by cutting its cost substantially. More and more computer users and makers are applying the read-only memory to control sequence or to provide a subroutine that doesn't have to change. Now the concept of large-scale integration, putting hundreds of elements on a slice of silicon, makes possible a radical change in computer organization: the use of read-only memories to generate Boolean logic to increase the arithmetic capability of computers.

A maser that works in radar: it avoids saturation
page 115

Masers aren't used often in radar systems because high-energy radar pulses can leak into the maser and damage it or saturate it so it doesn't amplify. A new technique of shifting the frequency keeps the maser from saturating and increases its use in radar systems.

**Coming
June 26**

- An examination of numerical control
- Designing systems with state variables
- A unique integrated circuit for telemetry applications
- Graphical processing for a computer

Gallium arsenide FET's outperform conventional silicon MOS devices

With silicon nitride as the insulator, transistors made of an epitaxial layer of GaAs are capable of better response at higher frequencies and temperatures, and could lead the way to gallium arsenide IC's

By Hans W. Becke and Joseph P. White

Radio Corp. of America, Electronic Components and Devices Division, Somerville, N.J.

The time, talent, and money lavished on gallium arsenide for more than a decade is on the verge of paying off in a field effect transistor that is far superior than counterparts made of silicon.

The transistor, which is a metal insulator semiconductor (MIS) device, outshines the silicon MOS (oxide insulator) device in power gain, frequency response, and temperature range. It is the offspring of a marriage of two new processes in materials technology—growing epitaxial GaAs from the vapor phase and using silicon nitride as an insulator. The result: high-quality devices that can be produced with high yields.

Better transistor performance at higher frequencies and temperatures calls for an extension of semiconductor materials technology beyond germanium

The authors



Hans W. Becke is a graduate of the Ohm Polytechnical Institute, Nuremberg, Germany, and has a master's degree from Newark College of Engineering. Now an engineering group leader in the advanced development section, he is working on silicon and GaAs devices.



Joseph P. White received his master's degree in physics from the Polytechnic Institute of Brooklyn in 1964. In the advanced development section, he has worked on silicon-diode arrays and high-frequency gallium arsenide bipolar and MOS transistors

and silicon into the area of Group III-V compounds. Of these, gallium arsenide now offers the most promise—it has high electron mobility, for high frequency response, and a wide-energy band gap, for high temperature operation.

The improvement that can be obtained with gallium arsenide was demonstrated by comparing the operation of two groups of insulated-gate FET's, one of GaAs and the other of silicon, with identical geometries. Measurements of the devices operating in the same circuit showed that GaAs has higher power gain ranging from a factor of 2 to a factor of 4. Improvement by as much as a factor of 10 appears possible. At high temperatures, GaAs MIS transistors performed far beyond the silicon devices. The GaAs devices fell off by only 3 decibels between 25° and 250°C, and showed a useful gain up to 350°C. Silicon devices were down 3 db at 130°C and dropped to 0 gain before 300°C was reached.

GaAs MIS epitaxial structures also lend themselves to integration and offer the advantages of an easy method of device isolation. In integrated form, isolation between devices could be achieved with a semi-insulating GaAs substrate, which is produced by doping GaAs with iron or chromium to yield resistivities in the 10⁸ ohm-centimeter range (resistivity of glass, for example, is in the 10⁹ ohm-cm range). Since GaAs is widely used in optical devices such as light-emitting diodes and lasers, integrated solid-state displays offer an attractive application.

Early attempts to develop GaAs bipolar transistors that could live up to the theoretical performance were frustrated by poor material quality and processing difficulties. However, in recent years,

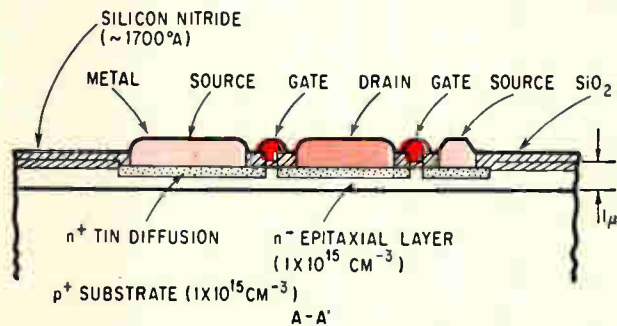
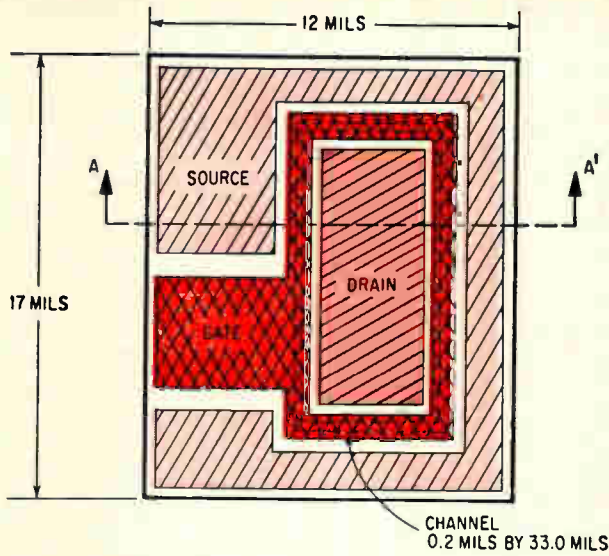

Structure of GaAs metal insulator semiconductor transistor.

much work has been done on two-terminal GaAs devices such as tunnel diodes, light emitters, junction lasers, and Gunn oscillators. Now that much more has been learned about GaAs processing, transistors can be built that take advantage of gallium arsenide's unusual properties.

FET vs. bipolar, GaAs vs. Silicon

The field effect transistor, as a majority-carrier device, has an intrinsic advantage over the bipolar transistor, which is a minority-carrier device. In the FET, the channel acts almost as a bulk resistor, and the crystal's defects and traps have little effect on the charge carriers. In the bipolar transistor, the carriers from the emitter are injected as minority carriers into the base, where they must avoid recombination to reach the collector.

The upper frequency limitation of the field effect transistor is set mainly by the ratio of transconductance, g_m , to the product of input and output admittances. With a fixed g_m , the input and output

capacitances limit the frequency performance. However, with a fixed geometry, increases in g_m improve the frequency response.

The g_m includes a carrier-mobility term and is substantially increased when gallium arsenide is used in place of silicon—GaAs has at least a 5-1 advantage in electron mobility over silicon. Gallium arsenide thus is ideally suited for an n-channel field effect transistor.

In the bipolar transistor, the maximum frequency depends on several time constants, with the transit time across the base width usually being the dominant one. Transit time depends on the diffusion constant and the base width. The diffusion constant is a function of carrier mobility, and the upper frequency limit is proportional to the square root of the product of minority and majority carrier mobilities. Again, gallium arsenide displays superiority over silicon—in this case, nearly a 4-1 improvement.

Insulated gate vs. junction gate

Insulated-gate field effect transistors—MIS type have several advantages over junction-gate types. They can be operated with negative and positive gate drive (depletion and enhancement modes); they can have narrower channels for higher gain; and they can have an input impedance essentially that of an insulator.

High-frequency junction-gate FET's still are feasible, however. Work on such devices is currently in progress at Britain's Plessey Co. and Switzerland's Battelle Memorial Institute.

Battelle researchers have reported on diffused-channel devices with an aspect ratio (channel width/channel length = W/L) of 15 to 1.¹ These devices exhibit a low frequency transconductance of about 1.0 millimho with an effective channel mobility of 3,000 cm^2 per volt-sec. An interesting effect was observed for transistors with saturation currents greater than about 25 milliamperes. Strong vhf oscillations occurred at threshold fields of the same magnitude necessary to induce the Gunn effect. Oscillations of this type have also been observed on insulated-gate devices fabricated at the Radio Corp. of America's Electronic Components and Devices division laboratory in Somerville, N.J.

Higher frequency devices with an aspect ratio of 50 to 1 were fabricated at Plessey using an epitaxial channel 5 to 7 microns thick.² These transistors had a transconductance as high as 6.8 millimhos and a cutoff frequency of 200 megahertz. A four-fold narrowing of the channel produced devices with cutoff frequencies up to 670 Mhz.

A prerequisite to the successful construction of

Gallium arsenide and silicon insulated-gate FET's

Characteristic	GaAs	Silicon
Drain current, I_D	5 to 30 ma	5 to 10 ma
Operating voltage, V_{DS}	5 to 9 v	8 to 12 v
Transconductance, g_m	10 to 25 mmhos	8 to 10 mmhos
Effective channel mobility, μ_{eff}	2,000 to 3,000 $\text{cm}^2/\text{v-sec}$	300 to 500 $\text{cm}^2/\text{v-sec}$
Power gain at 200 Mhz.....	17 to 22 db	14 to 16 db
Noise figure at 200 Mhz.....	4 to 5 db	3 to 4 db

Hydride vapor technique paved the way

The key that opened the door to RCA's gallium arsenide MIS transistor is the hydride vapor synthesis technique developed by James Tietjen and James Amick at the company's research laboratories in Princeton, N.J.

Arsenic and doping impurities in hydride vapor form—for example, AsH_3 , arsine gas or arsenic hydride—are introduced into the reaction chamber¹. Hydride vapors enable greater control of the concentration and reaction rate of the epitaxial layer. N-type layers have been grown with electron concentrations below $10^{15}/\text{cm}^3$ and electron mobilities above $7,000 \text{ cm}^2/\text{volt-second}$ at room temperature—ideal properties for fabrication of GaAs transistors. In comparison, bulk GaAs has carrier concentrations in the 10^{16} - $10^{17}/\text{cm}^3$ range; it is difficult to control transistor properties when starting with such high conductivity material.

The epitaxial material, unlike bulk GaAs, isn't appreciably compensated. Such impurities produce traps in the forbidden band and tend to make the conductivity low, which might suggest that a high-purity, low-conductivity material has been obtained. However, the material's conductivity may actually be high, and only appear low due to compensation effects.

Hall-effect measurements on the epitaxial material at liquid nitrogen temperature (77°K) show about an

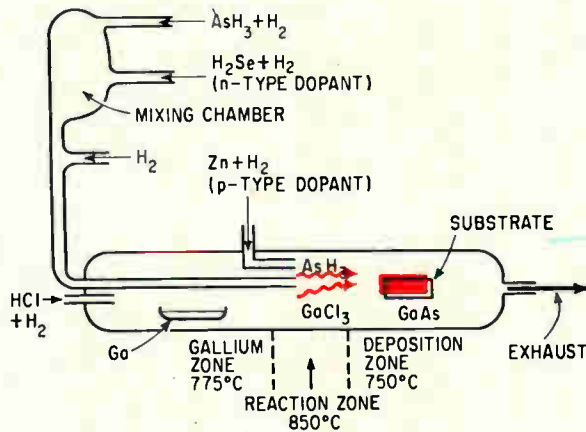

Vapor deposition apparatus for epitaxial growth of gallium arsenide.

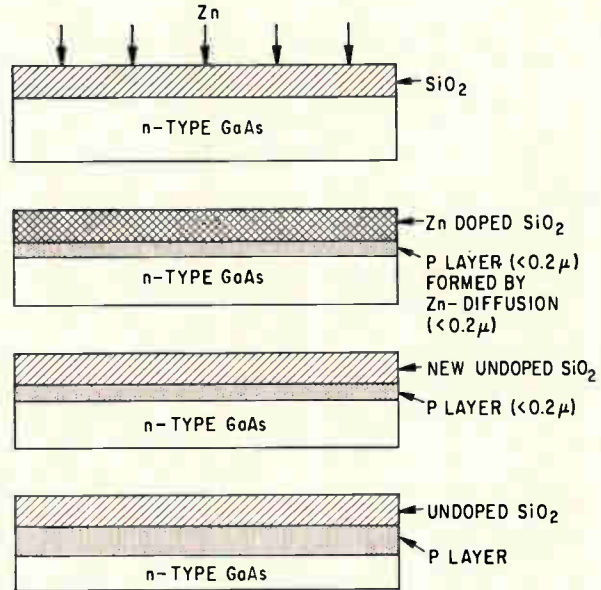

Solid-to-solid zinc diffusion process. The silicon dioxide layer serves as an interim source for zinc before the final diffusion of the p layer.

order of magnitude increase in mobility with little change in concentration, indicating low compensation. Thermal conversion (change in concentration or conductivity type during a heating cycle) has always been a problem during device processing with bulk material and has prohibited initial concentrations in the range employed with germanium and silicon transistors. If contamination from undesirable impurities, like copper, is prevented, thermal conversion is eliminated with these new epitaxial layers even for concentration below $10^{15}/\text{cm}^3$.

Several suitable acceptors and donors, listed below, are available.

Acceptors	Donors
Zinc	Tin
Manganese	Sulfur
Cadmium	Selenium
Mercury	Tellurium
Magnesium	Silicon
Copper	Germanium

an MIS transistor is an insulating material that makes intimate contact with the semiconductor crystal and produces an interface having a low density of electron states. Without such a material, most of the gate field will terminate on the interface states rather than penetrate the semiconductor to modulate the channel conductivity.

Silicon dioxide vs. silicon nitride

Initial work at RCA on gallium arsenide MOS devices showed that silicon dioxide had marginal results. Although intricate devices were constructed (aspect ratio of 200:1) the highest transconduc-

tances were 4.0 mmhos and the devices had only 10 db power gain at 100 Mhz.³

Analysis pointed up two factors restricting device performance: a high density of electron states at the SiO_2 -GaAs interface, and excessive drain-to-substrate capacitance associated with the high conductivity of the compensated bulk p-type material used as a substrate. The substrate conductivity could be reduced by using an epitaxial layer or semi-insulating GaAs.

An insulator with improved properties was sought using an MIS capacitor technique to study the surface states. In this technique, the capacitance

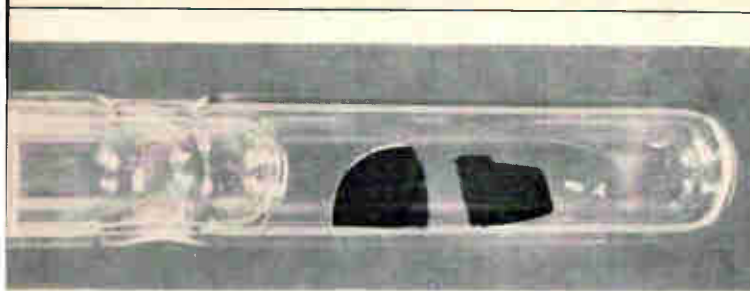

Gallium arsenide device wafer (right) and source wafer sealed in a quartz ampul for vapor-phase tin diffusion.

Tin is generally used as a donor because it doesn't readily produce undesirable surface compounds. Vapor-phase tin diffusions are normally employed. The dissociation of arsenic from the surface at high temperatures, resulting in severe surface erosion, is a problem common to all vapor-phase diffusions in GaAs. But this can be minimized by performing the diffusion in an arsenic atmosphere. The wafer to be diffused, the diffusant, and a sufficient amount of arsenic to maintain the vapor pressure at the diffusion temperature are sealed in an evacuated quartz ampul.

Zinc is the most widely used acceptor impurity. The acceptor levels it produces are sufficiently close to the valence band to be completely ionized at room temperature. Vapor-phase diffusion of zinc has been successfully used in several GaAs two-terminal devices where high surface concentrations were desired. Diffusing zinc into GaAs to yield low surface concentrations, however, is more difficult. Large changes in the vapor density produce only small changes in surface concentration.²

Relatively low surface concentrations are necessary, for example, when forming a transistor base layer to obtain an adequate emitter efficiency. The approach to zinc diffusion that has resulted in a reduction in surface concentration of several orders of magnitude is the introduction of the diffusant from a solid source rather than from a vapor source. One such technique³ employs a three-step diffusion cycle and yields base surface concentrations as low as $10^{17}/\text{cm}^3$.

Since zinc diffuses rapidly in silicon dioxide, pure SiO_2 cannot be used as the diffusion mask. By introducing phosphorous into the SiO_2 the diffusion is sufficiently slowed to produce satisfactory

is measured across the insulator separating the substrate from the metal-gate conductor. If the capacitance changes significantly, by 50% or more, as the d-c voltage between gate and substrate is varied, then the electric field is known to be penetrating the semiconductor. With a high density of surface states, the field doesn't penetrate as the voltage is changed, and the capacitance remains nearly constant.

Little improvement over SiO_2 was observed until a low-temperature deposition process for silicon nitride was developed.⁴ With SiN applied to GaAs, a low-state density interface is produced. Capacitance-voltage curves for SiO_2 and SiN on gallium arsenide show a large relative change of capacitance with voltage for silicon nitride and a significant improvement over silicon dioxide.

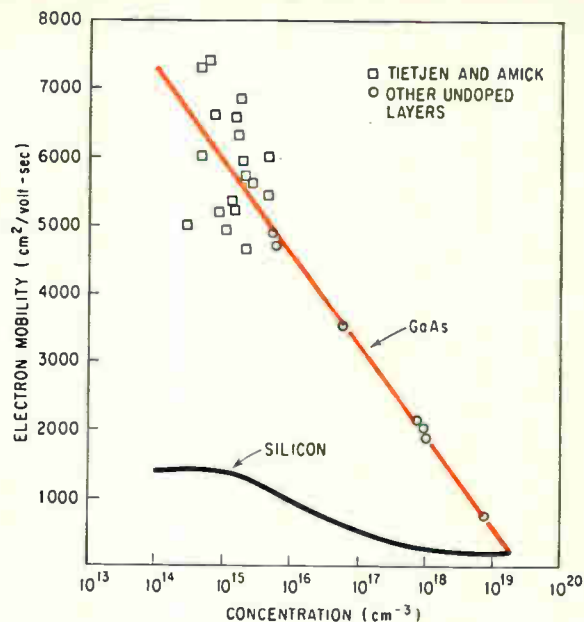

Electron mobility decreases with increases in electron concentration, but vapor-phase epitaxial layers of GaAs have much higher mobility than silicon.

masking for most applications.⁴ For deeper diffusions, the new techniques for depositing silicon nitride has given GaAs technology an insulator with excellent masking properties against both n- and p-type diffusants.

More important, SiN produces the lower surface-state density than SiO_2 that is needed for better insulated-gate field effect transistors. Also, silicon nitride does not contain oxygen, an element that produces deep donor levels in GaAs and can restrict the frequency performance of GaAs bipolar transistors.

References

1. J.J. Tietjen, J.A. Amick, "Preparation and Properties of Vapor Deposited Epitaxial $\text{GaAs}_{1-x}\text{P}_x$," *Journal of the Electrochemical Society*, July 1966, p. 724.
2. B. Goldstein, "Diffusion of Cadmium and Zinc in Gallium Arsenide," *Physical Review*, May 15, 1960, p. 1024.
3. H. Becke, D. Flatley, W. Kern and D. Stolnitz, "The Diffusion of Zinc into Gallium Arsenide to Achieve Low Surface Concentration," *Transactions of the Metallurgical Society*, March 1964, p. 307.
4. Scott, Flatley, Goldsmith, "A Zinc Diffusion Mask," *Electrochemical Society Meeting, Toronto, May 1963*.

An epitaxial channel-silicon nitride insulated-gate transistor was developed³ and more than 100 samples were investigated, tested, and compared with conventional silicon MOS transistors with identical surface geometry. Comparisons were made of d-c, high-frequency, and high-temperature characteristics.

Curve tracer characteristics (drain current versus

Continued on Page 88.

Traps—the pitfall of GaAs bipolar devices

The development of bipolar gallium arsenide transistors has generally followed the same course as silicon transistors: first, alloyed-emitter devices; then, double-diffused devices; and then, planar devices. The problem common to all has been the presence of traps in the structure that reduce the mobility of the carriers as they pass through the base region, thus limiting frequency.

Alloyed emitter. These mesa devices, with diffused bases, have been thoroughly investigated by Hans Strack of Texas Instruments Incorporated.¹ Describing the difficulties with this type transistor, Strack says: "Typically, transistors can be operated in the vhf range rather than at 1 to 5 Ghz as predicted from mobility data. Few devices have been reported to have gain-bandwidth products of 0.5 to 1.0 Ghz. No reliable process has been developed so far to produce these devices in large quantities. Furthermore, the advantages of higher band gap couldn't be utilized because low melting tin-alloyed emitters were employed."

The performance was limited because of deep traps within the forbidden band, possibly due to oxygen contamination. These traps reduce the average velocity of the electrons in traversing the base region. Electrons are captured and remain stationary at the trap site for a certain relaxation time before moving to the next site, and eventually on to the collector region. Thus, the effective electron mobility is reduced, limiting the high frequency performance.

Double diffused. Mesa structures of this type, delivering 2 watts at 50 Mhz, were developed at RCA in 1963.² These devices had a zinc-diffused base employing the three-cycle, low-concentration, solid-solid diffusion technique and tin-diffused emitters. Excellent control over junction planarity and penetration depths was achieved. With a zinc base of 0.8 microns, the tin emitter penetrated 0.5 microns, leaving a base width of only 0.3 microns.

The current gain of these transistors was generally low—less than 10. The current gain as a function of collector current is similar to that observed for silicon and germanium transistors. The reduction in current gain at low currents can be attributed to a high surface recombination velocity, and space charge recombination within the emitter junction depletion region. The fall-off at high current levels indicates the presence of base conductivity modulation and emitter edge injection as established for conventional transistors.

The beta-cutoff frequency (3 db down from the d-c value) occurs at about 40 Mhz. Beyond 200 Mhz, h_{re} falls off 6 db per octave and reaches unity at 300 Mhz. Thus, this transistor's f_T is 300 Mhz.

This value of f_T is significantly below that expected from mobility considerations and it is apparent that deep traps are also involved in the base transport processes of these devices.

For high-frequency amplifying devices, the power gain is normally more important than the voltage or current gain because of the finite input impedance. The power gain at 50 Mhz was as high as 11 db for several devices. In Class B operation, 1 watt r-f output was obtained from an input of

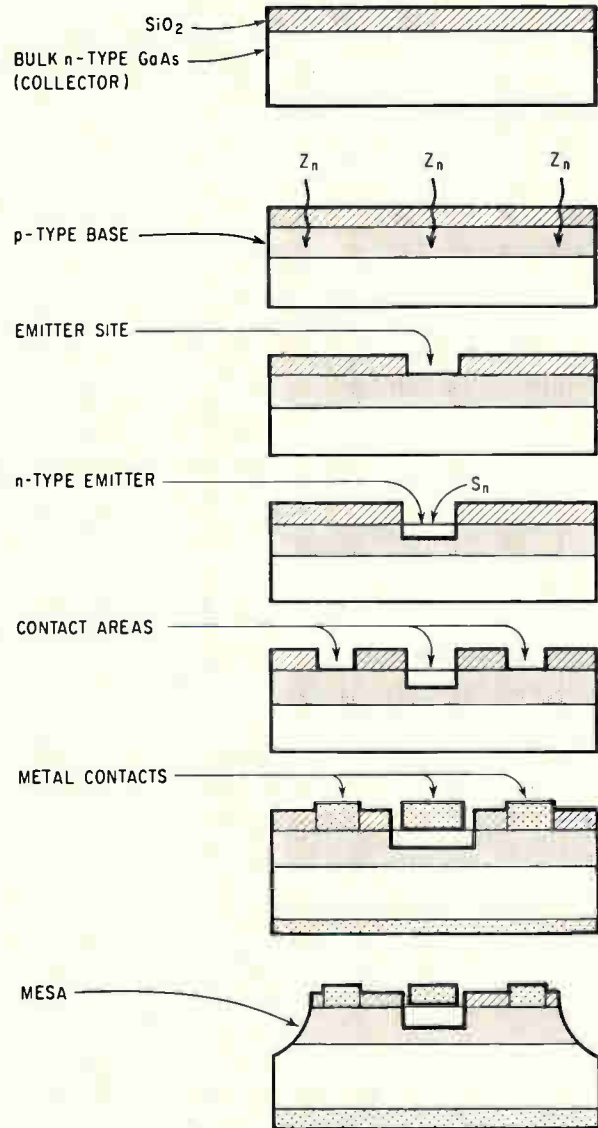

Process for GaAs double-diffused mesa transistor.

Comparison of iron-doped and iron-free transistors

	Iron-doped transistor	Iron-free transistor
Low frequency current gain.....	~15	>20
Gain bandwidth product.....	~150 Mhz	<5 Mhz
$f_T C_e$ product.....	~700 psec	>2,000 psec
Saturation resistance.....	~60 ohms	>200 ohms

typically 300 milliwatts, with a d-c dissipation of 1.6 w representing an efficiency of about 60%. A maximum r-f output of 2 w was observed on several units dissipating 3.5 w.

The temperature dependence of both the d-c current gain and the 50-Mhz small-signal power gain also were measured. Power gain decreases from 8.5 db at room temperature to approximately 5.5 db at 350° C. This excellent performance at high temperature can be expected for GaAs because of the high value of the band gap. Perhaps more striking was the device's unexpected behavior toward low temperatures.

There is no significant change in power gain down to liquid nitrogen temperatures and oscillators were built that worked well at liquid helium temperatures, -269° C. In contrast, conventional silicon and germanium transistors as well as GaAs devices having a diffused manganese base and an alloyed emitter exhibit a sharp drop in h_{fe} and power gain below about -60° C.

More recently, double-diffused mesa-type devices were investigated at Britain's Standard Telecommunication Laboratories Ltd.³ These devices also had zinc-diffused bases and tin-diffused emitters. The base was diffused from a zinc-doped sputtered silica layer. STL scientists reported a significant improvement in current gain by using an epitaxial rather than a boat-grown bulk substrate. Transistors having current gains up to 1,200 were built. However, the frequency response was again well below theoretical expectations. From pulsed breakdown tests and the measurement of frequency performance versus temperature, researchers were able to conclusively demonstrate the presence of deep traps, which are believed to be oxygen centers introduced by water vapor diffusing through the silica layer.

A possible solution to the problem of deep traps has been investigated by Strack. Mesa-type devices were fabricated with a magnesium-diffused base and a sulphur-diffused emitter. Iron, which produces a deep acceptor level, was introduced during the sulphur diffusion to compensate the deep donor level. The iron-doped devices showed higher gain bandwidth products, lower saturation resistance, lower τ_b/C_c time constant, and higher stability of the current gain at high temperatures.

Further improvement of the transistor characteristics was observed at TI when the silicon-dioxide diffusion mask was replaced by silicon nitride, eliminating a possible source of oxygen. For a base width of 1 micron, a gain-bandwidth product of 500 Mhz was obtained.

Planar. Devices of this type have been developed at the International Business Machines Corp. in Boeblingen, Germany⁴ and at RCA. The planar transistors suffer from the same deficiencies as the mesa types.

In reporting on his results, IBM's H. von Muench concludes: "It is possible to produce npn transistors with beta values in the range of 20 to 30 with reasonable yield. The devices, however, fall short with respect to high-frequency performance as compared to theoretical predictions from mobility data. Trapping effects are dominant with most of the GaAs material presently available; these pose formidable limitations to large-scale fabrication with GaAs."

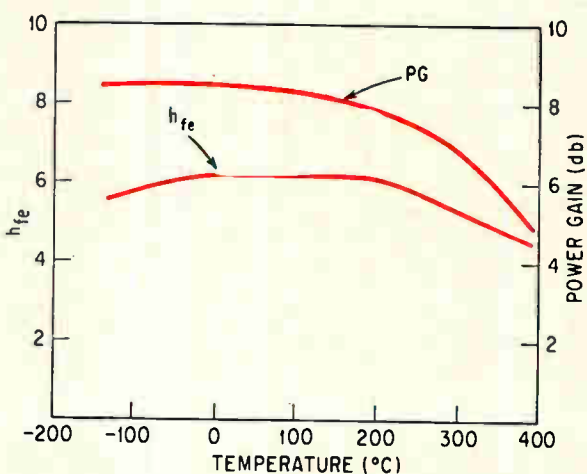
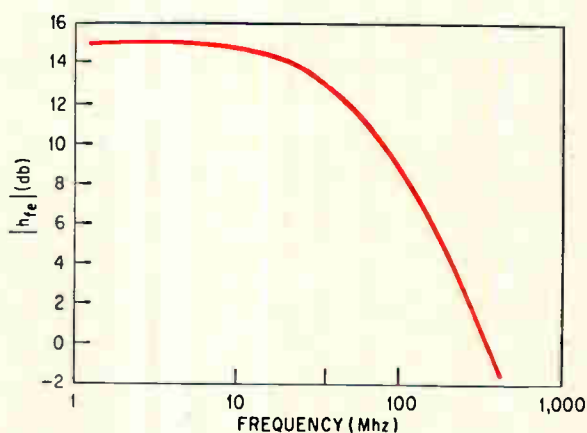
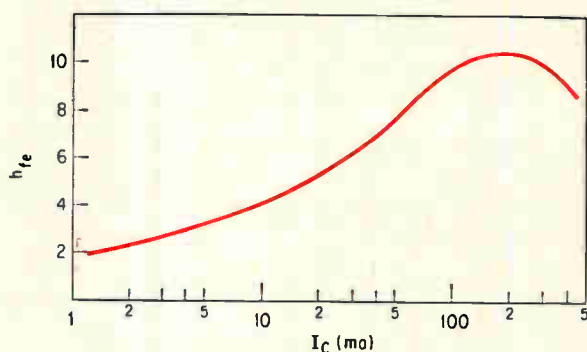

Performance of npn double-diffused gallium arsenide bipolar transistors.

It appears that further progress on bipolar GaAs transistors hinges on the elimination of the deep traps. The new hydride vapor synthesis technique for epitaxial growth, together with the use of silicon nitride as a diffusion mask, may offer a solution.

References

1. H. Strack, "Iron-Doped Gallium Arsenide Transistors," Gallium Arsenide—Institute of Physics and Physical Society (London) Conference Series No. 3, 1966, p. 206.
2. H. Becke, D. Flatley, D. Stolnitz, "Double-Diffused Gallium Arsenide Transistors," Solid-State Electronics, 1965, p. 255.
3. J. Antell, A. White, "Double-Diffused Gallium Arsenide Transistor," Gallium Arsenide—Institute of Physics and Physical Society (London) Conference Series No. 3, 1966, p. 201.
4. W. von Muench, H. Statz, A. Blakelee, Solid State Electronics, 1966, p. 826.

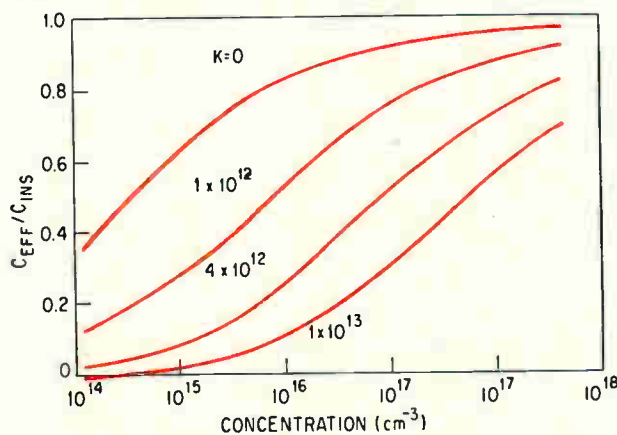
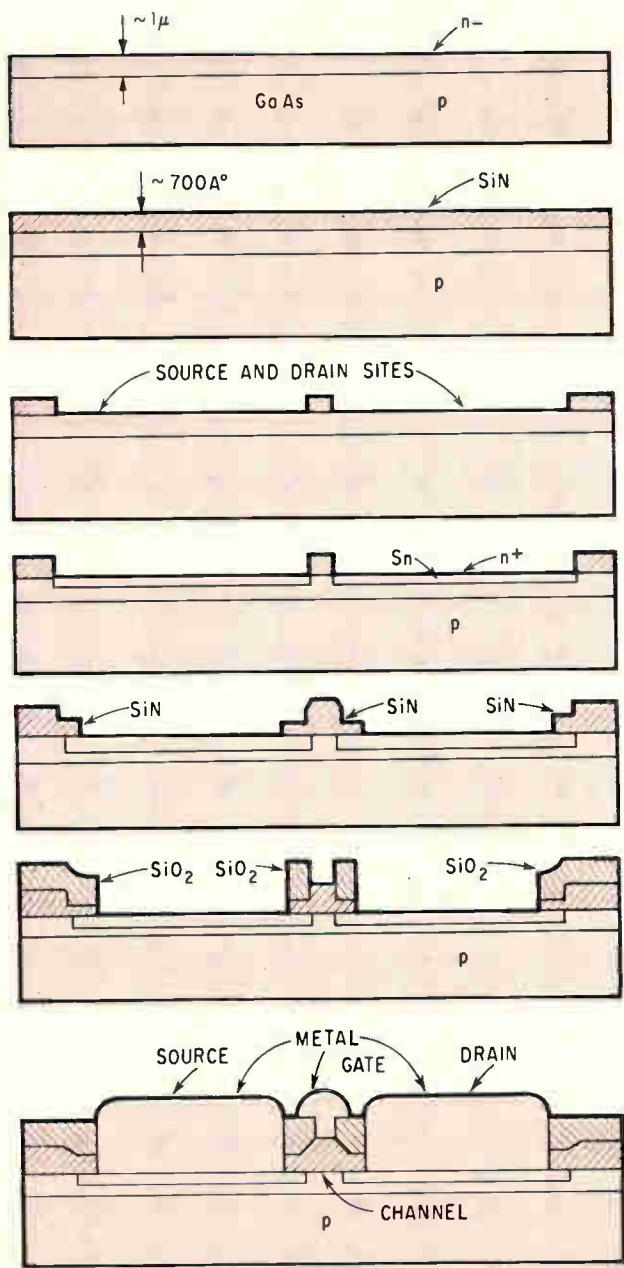

Effective capacitance as a function of channel concentration with interface state density as a parameter. The low values of K correspond to the high frequency case, since at high frequencies, fewer interface states can follow fast variations in gate signal.

Gallium arsenide metal insulator semiconductor process.

drain voltage with gate voltage as parameter) at 120 hertz for medium-current GaAs and silicon devices appear quite similar. The transconductances for both devices are about 8.0 millimhos around zero bias. Both transistors have saturation voltages of about 1.5 volts. The gate-cutoff voltage of the silicon device is -1.5 volts, equal to the saturation voltage, which agrees with first order theory. For the GaAs unit more gate voltage, -2.5 volts, is required for cutoff.

The increased cutoff voltage occurs because the GaAs device has a low-concentration epitaxial channel; depletion from the substrate junction is comparable to the depletion from the insulated gate. In earlier mos devices, the substrate depletion completely dominated the channel saturation because of high surface-state densities, and in general it was difficult to achieve cutoff from the gate at all.

GaAs vs. Silicon—frequency

A striking difference is observed when the transconductance for identical GaAs and silicon transistors is investigated as a function of frequency. The g_m of the silicon mos device is relatively constant while the g_m of the GaAs MIS transistor shows a marked increase with frequency.

GaAs MIS transistors have a very small g_m at zero frequency. At 100 hz the g_m is about the same as for silicon mos transistors, and at 400 Mhz the transconductance is two to three times higher than for silicon units, as expected on the basis of greater mobility in GaAs. This behavior is associated with the frequency response of interface states.

The active gate capacitance of an MIS device can be represented by a series-parallel combination of three capacitors: C_{ins} , the insulator (oxide) capacitance, is connected in series with the parallel combination of C_s , the semiconductor space-charge capacitance, and C_{ss} , the surface-state capacitance. C_{ins} is a constant, C_s is a function of bias and concentration, and C_{ss} is dependent on surface-state density.

The approximate high-frequency transconductance is⁵

$$g_m \cong \mu V_{do} \frac{W}{L} C_{ins}$$

$$\text{if } C_{ins} \ll C_s \\ C_{ss} = 0$$

where V_{do} is the source-to-drain saturation voltage, μ is majority-carrier mobility and W/L is the aspect ratio (channel width/channel length). With C_{ins} a constant, then based on this approximation, g_m should be a constant regardless of the frequency. At low frequencies, however, the surface-state effects become appreciable, and the insulator capacitance must be replaced by an effective gate capacitance

$$g_m \cong \mu V_{do} \frac{W}{L} C_{eff}(\omega)$$

No schedule for breakthroughs

The Government is finding it as difficult as ever to match development program planning with the timing of technological breakthroughs. The latest example is the Air Force's experience with RCA's gallium arsenide field effect transistors.

Toward the end of the contract last fall, representatives of the

advanced electronics branch, Electronic Technology division of the Avionics Laboratories at Wright-Patterson Air Force Base, which was underwriting RCA's efforts, asked how the project was coming along. RCA officials were not particularly optimistic about the prospects for success and told the Air Force so. As a result, the Avi-

onics Laboratories decided not to continue the program beyond its scheduled cutoff point.

However, just before Christmas, RCA's Hans Becke, Joseph White and their associates succeeded in applying silicon nitride as an insulator to epitaxial GaAs grown from the vapor phase and produced high quality MIS devices.

Now, slightly abashed contract officers in the Air Force are considering supporting the work again.

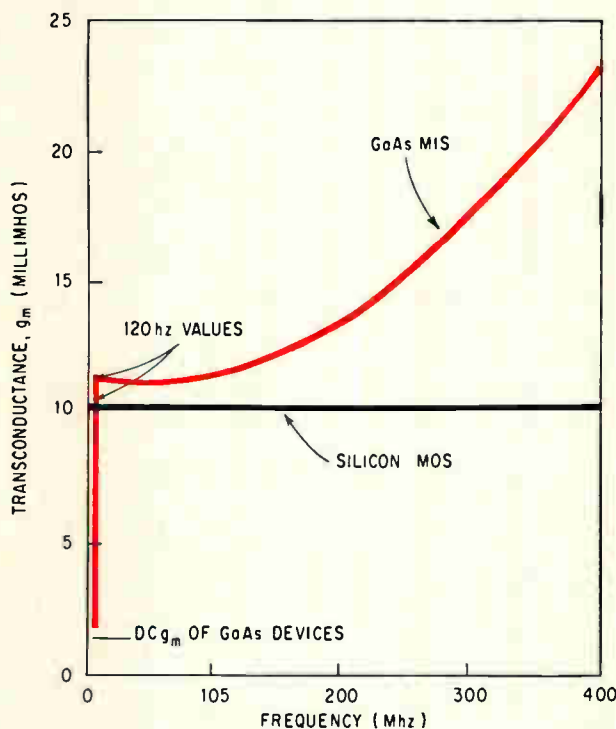

Comparison of transconductance variations with frequency for GaAs and silicon FET's. The GaAs transconductance rises with frequency because surface states have less effect at high frequencies. If it were not for the surface states, the gallium arsenide would have higher transconductance across the frequency range, in keeping with its higher mobility. The silicon MOS curve is flat across the frequency range because the surface-state density in silicon is low and changes in frequency have little effect.

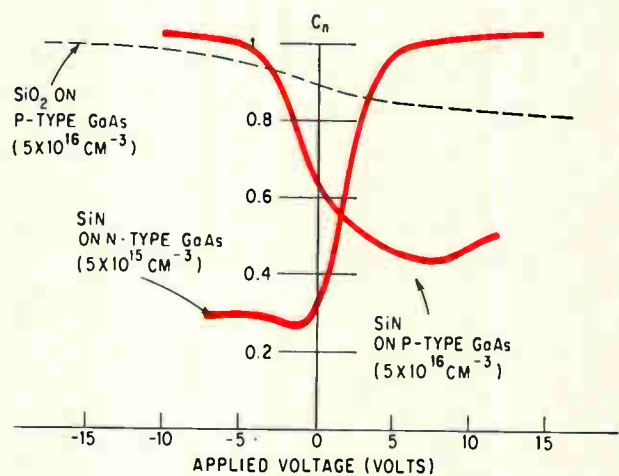

The large change in capacitance for silicon nitride on GaAs indicate the field is penetrating the semiconductor. The silicon dioxide curve is relatively flat, showing the field lines terminate at the interface of the insulator and substrate, and don't affect charges that are deeper.

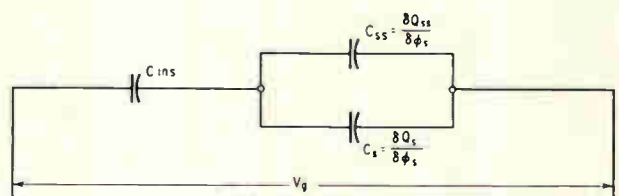

Equivalent circuit of gate capacitance for metal insulator semiconductor transistors. Ideally, the surface state capacitance, Q_{ss} , would be zero. Its effect, however, is to decrease the transconductance at low frequencies.

Semiconductor material properties

Material	Energy Gap (300° K) (eV)	Maximum operating temperature (° C)	Electron* mobility (300° K) (cm ² /v-sec)	Hole* mobility (300° K) (cm ² /v-sec)	Electron* mobility (300° K) (cm ² /v-sec)
Ge	0.78	100	2,100	800	4,000
Si	1.20	200	520	240	1,300
GaAs	1.52	400	5,300	350	11,000

* Mobility values in columns 4 and 5 correspond to the upper limit for a doping concentration of $10^{17}/\text{cm}^3$, the average concentration in the base of a bipolar transistor; the mobilities in column 6 are the corresponding values at $C = 10^{16}/\text{cm}^3$, a low-concentration channel of a field effect transistor.

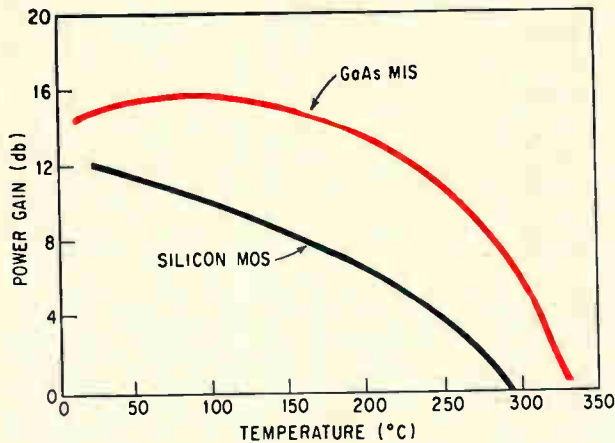

Comparison of temperature characteristics for GaAs and silicon FET's. The higher energy band gap for the GaAs provides the high temperature advantage over silicon.

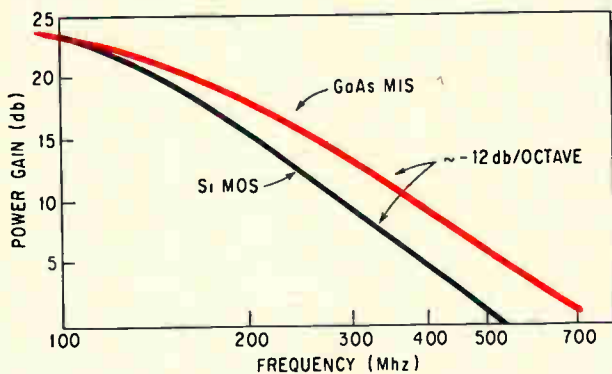

Power gain comparison of GaAs and silicon FET's. The GaAs shows higher gain at higher frequencies because of increased mobility.

where

$$C_{\text{eff}}(\omega) = \frac{\partial Q_s}{\partial V_g}$$

The effective gate capacitance is frequency dependent due to the frequency dependence of the interface states. The relationship between the net effective capacitance and the other capacities is given by

$$C_{\text{eff}}(\omega) = \frac{C_s C_{\text{ins}}}{C_s + C_{\text{ins}} + C_{\text{ss}}(\omega)}$$

The density, or number, of interface states that is able to follow the changing gate signal decreases as the frequency increases. At low frequencies, the field set up by the gate voltage terminates on those surface states that can follow the frequency, and thus can't affect mobile charges in the channel.

For silicon, the effect is negligible because the channel concentration is high and oxide technology has progressed to the point where K , the interface state density, is low—approximately $10^{11}/\text{cm}^2\text{V}$. For these GaAs devices, however, there is a large number ($10^{13}/\text{cm}^2\text{V}$) of a very slow states affecting the d-c response and a moderate density of fast states ($10^{12}/\text{cm}^2\text{V}$) that drop out with increasing frequency. Mis capacitor measurements have shown that the slow states can be eliminated with silicon

nitride, but the faster states remain.

The power gain for a transistor can be expressed in terms of the admittance parameters as

$$G = \frac{|Y_{21} - Y_{12}|^2}{4 \text{Re}(Y_{11} + Y_{12}) \text{Re}(Y_{22} + Y_{12})}$$

where Y_{21} is the transadmittance, Y_{12} the reverse transadmittance, and Y_{11} and Y_{22} are the input and output admittance, respectively.

The admittance parameters were measured on a transfer function bridge between 100 and 400 Mhz, and the corresponding power gain was calculated for both the silicon and GaAs transistors. Y_{11} and Y_{22} are essentially the same for the GaAs and silicon devices. They are related to the input and output capacitances, which are functions of the physical device geometry. Power gains are about equal at 100 Mhz. The GaAs devices have 3 db higher power gain at 200 Mhz and 5 db higher gain at 400 Mhz, at which point the devices become limited by the output time constant because they are medium-frequency structures. The projected cutoff frequency for the GaAs MIS transistors is 750 Mhz while that for the comparative silicon structures is 550 Mhz.

The improved performance of GaAs units at higher frequencies is a consequence of the increasing g_m , which is the dominant part of Y_{21} .

GaAs vs. Silicon—temperature

A 200-Mhz amplifier circuit was used to investigate the temperature performance of several GaAs and silicon transistors. A small resistance heater, insulated from both the test circuit and the surrounding ambient, supplied the heat. A thermocouple was included in the enclosure to measure the temperature. In general, the circuit didn't require retuning to deliver maximum power gain across the entire temperature range.

At high temperature, the GaAs MIS transistors far exceeded the performance of silicon MOS transistors, as expected because of the wider band gap of GaAs. As temperature rises, GaAs gain improves until it reaches a peak at about 100°C and drops. For silicon devices, gain falls off immediately. The temperature at which the power gain was 3 db below the gain at room temperature was about 150°C for silicon and 250°C for GaAs. At 300°C the silicon devices exhibited little or no power gain, while the GaAs devices had power gains as high as 9 db.

References

1. H. Winteler, A. Steinemann, "Gallium Arsenide Field Effect Transistors," Gallium Arsenide—Institute of Physics and Physical Society (London) Conference Series No. 3, 1966, p. 228.
2. J. Turner, "Gallium Arsenide Field Effect Transistors," Gallium Arsenide—Institute of Physics and Physical Society (London) Conference Series No. 3, 1966, p. 213.
3. H. Becke, J. White, "Gallium Arsenide Insulated-Gate Field Effect Transistors," Gallium Arsenide—Institute of Physics and Physical Society (London) Conference Series No. 3, 1966, p. 219.
4. J. Scott, L. Murray, "Optical Properties of Silicon Nitride," Electrochemical Society Meeting, Philadelphia, October 1966.
5. S. Hofstein, F. Heiman, "The Insulated-Gate Field Effect Transistor," Proceedings of the IEEE, September 1963, p. 1190.

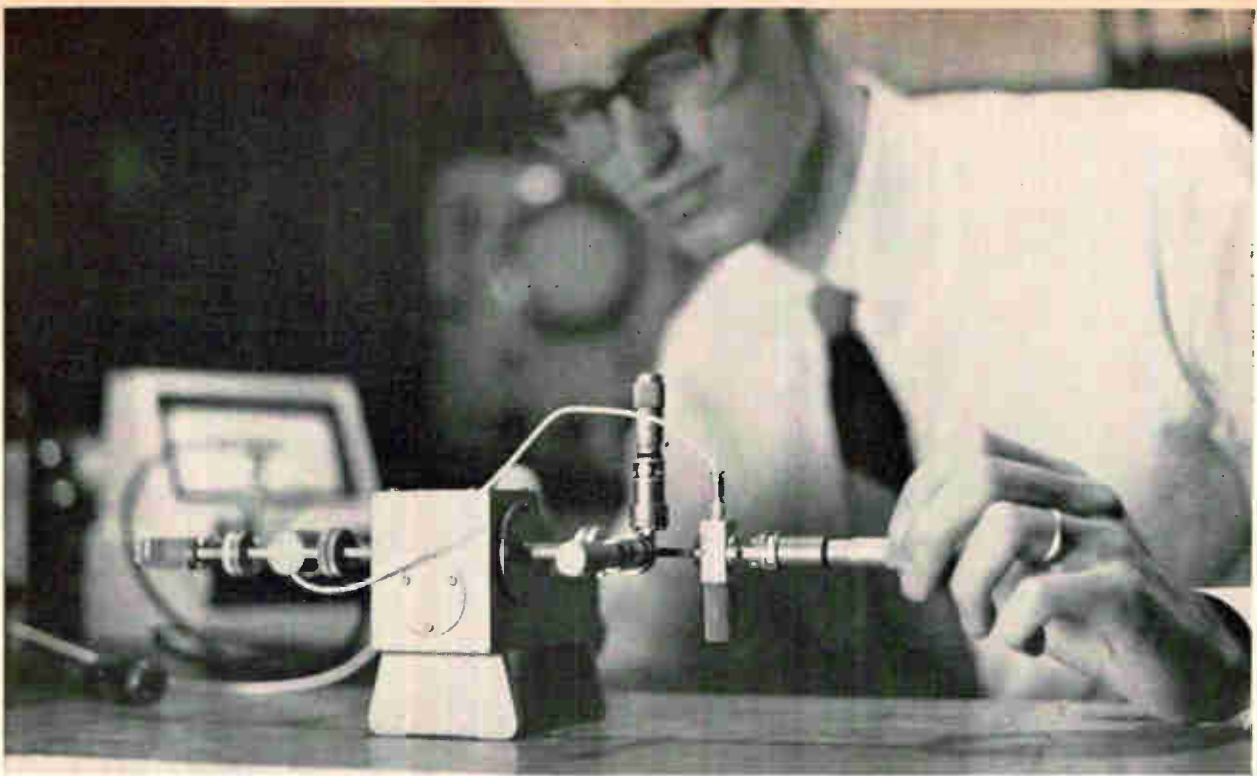

Oscillator mounted in a millimeter-wave system. The adjustable waveguide short-circuit being tuned by the author, and the E-H tuner to the left of the diode holder are used to optimize the load. The tuner is separated from the diode by a length of transmission line to provide a delay before the full load is applied to the diode.

Advanced technology

GaAs bulk oscillators stir millimeter waves

Watts of power in this unexploited frequency range are promised by diodes operating in the limited space charge accumulation mode

By John A. Copeland

Bell Telephone Laboratories, Murray Hill, N.J.

A new source of power may be the long-sought key to the exploitation of millimeter waves. Limited space charge accumulation (LSA) diodes promise to open the way to levels of power and frequency unattainable with any other active semiconductor device.

In the not-too-distant future, engineers should be able to use these diodes, energized by relatively low d-c voltages, to achieve:

- Watts of continuous millimeter-wave (30-300 Ghz) power with about 20% efficiency;
- Hundreds of kilowatts of pulsed microwave power.

The LSA diode performs well in the microwave range between 1 Ghz and 20 Ghz, but its prime contribution will probably come in the millimeter range, where it has a clear field; no currently available solid-state power source can do the job here,



Size advantage of the LSA oscillator is evident in this comparison of it with an air-cooled, low-power klystron and its power supply.

and vacuum tubes have many shortcomings.

The millimeter region, still almost unexplored territory, is attractive for the large bandwidth capabilities it can give communications systems. The small antenna needed makes millimeter systems a natural for communications between space vehicles and for high-resolution radar.

Vacuum tubes for this frequency range are expensive, have lifetimes of only a few thousand hours, and need high voltages. The LSA diode promises lower cost, longer life, and the ability to operate on the low d-c voltages normally available in airborne vehicles.

Transistors, avalanche diodes, and Gunn diodes are transit-time devices, and their theoretical limitations hold maximum power levels to about 1,000 watts at 1 GHz and 0.1 watt at 100 GHz.

But the realization of high power in the LSA mode demands the production of either high-quality n-type gallium arsenide or such other compound semiconductors as cadmium telluride and indium phosphide. The best results so far in the LSA mode have been achieved with a GaAs device designed primarily as a Gunn oscillator. The device—the first to operate continuously in this mode—consists of an epitaxially grown active layer sandwiched between two highly conductive layers acting as low-resistance contacts to the active material. It produced 20 milliwatts between 44 and 88 GHz with 2% efficiency. Operation of this diode was

recently extended to 160 GHz using a half-wave stub as part of the diode's package, a structure developed by Robert R. Spiwak at Bell Labs.

Other researchers, notably W.K. Kennedy Jr. and L.F. Eastman of Cornell University, have also reported LSA-mode high power at lower frequencies in the microwave region. The Cornell scientists measured a peak pulse power of 33 watts at X band with efficiencies as high as 3.4%.

Two paths

A block of n-type gallium arsenide can be used to generate high-frequency power either as a Gunn diode or an LSA diode, but the latter mode of operation produces the higher frequency oscillations. The LSA mode isn't a transit-time phenomenon; it generates power because of a negative resistance effect in a resonant circuit. Operating frequency in the Gunn mode depends on the time needed for a space charge layer to drift across the device. In the LSA mode, it depends primarily on the associated resonant circuit.

The property of n-type GaAs that is basic to both devices is a negative conductivity at electric fields exceeding about 3,000 volts per centimeter. Gallium arsenide is a "two-valley" semiconductor, having two electron-conduction band valleys at two different energy levels. The lower energy level band is the normal conduction band; electrons here have high mobility. The upper energy level band is normally not occupied, but when electrons are excited into this band, they have much less mobility. When the voltage across the diode is turned on, electrons generally remain in the lower band

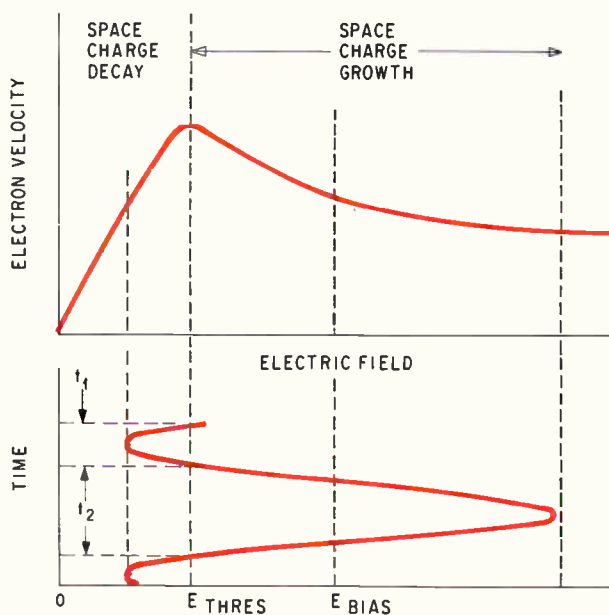

LSA diode must be biased on the negative resistance portion of its characteristic, but the r-f electric field must be high enough to swing below a critical voltage level for a fraction of each cycle to prevent space charge from building up. Interval t_1 should be greater than the domain relaxation time to allow the space charge to disappear, while interval t_2 should be less than the domain growth time.



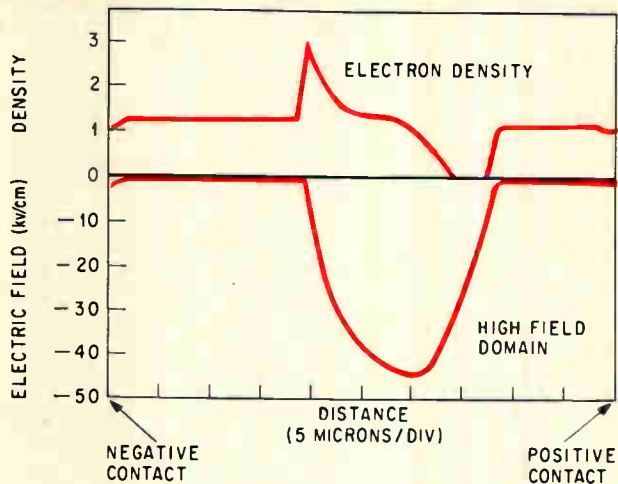

Movement of domains in the Gunn mode is shown in a frame from a computer-produced motion picture. The high-field domain moves completely across the diode. The narrow domain is the only region where the electric field is above the threshold for negative resistance.

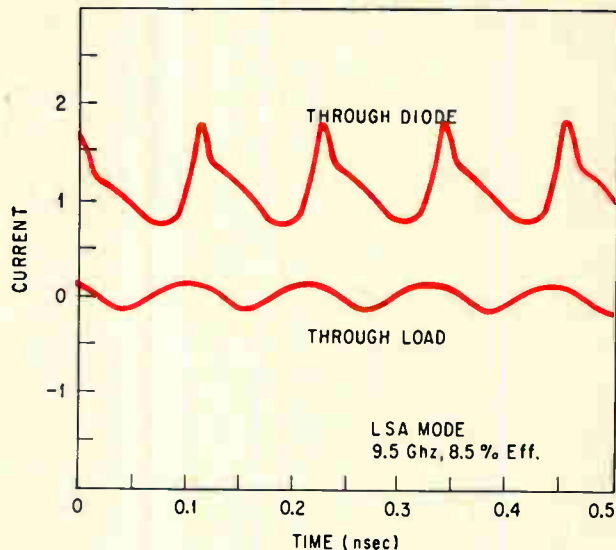

Computer-produced current waveform plot for a diode operating in the Gunn mode.

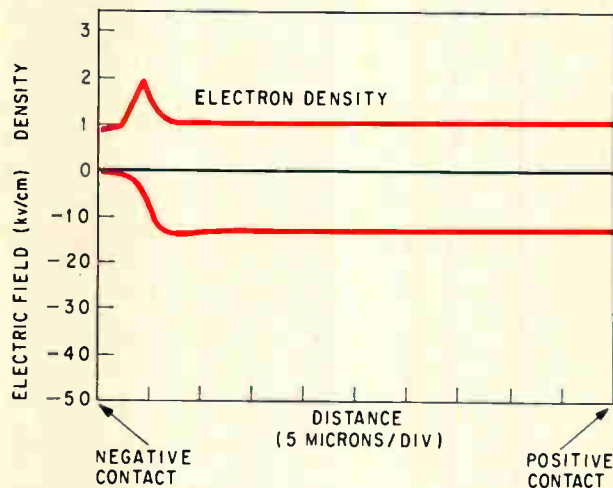

Excess electrons begin at the cathode in the LSA mode, but are squelched after going only a short distance. Most of the device is biased above the threshold for negative resistance and rf power is thus generated by essentially the entire volume of the diode.

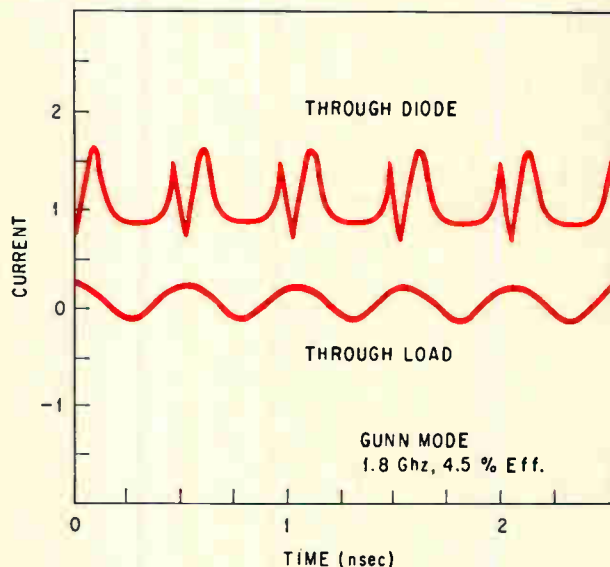

Current waveform plot for the same diode operating in the LSA mode.

and the diode acts as a positive-resistivity component. As the electric field is increased, however, electrons begin to pick up energy and some are excited into the lower-mobility band. As the field is boosted still further, the current begins to decrease as the effect of a greater number of slower-moving electrons in the upper energy band becomes dominant. The voltage at which this negative resistivity effect sets in is about 3,000 volts per centimeter.

Cadmium telluride and indium phosphide have also exhibited this negative resistance effect, and there probably are many other group III-V and II-VI semiconductors that can act in the same way, but gallium arsenide is the only material now available with sufficient purity to make successful devices consistently.

The magnitude of the negative resistance effect in any of these materials depends on the intervalley energy gap and on temperature. At high temperatures, enough electrons are excited into the upper energy band to cause a material to act as a normal resistive device. Cooling, however, may permit materials with a small intervalley gap and a high-threshold electric field to generate power at frequencies in the far infrared range—above 1,000 Ghz.

Although the critical electric field intensity is high, the actual voltage applied is only in the 6-to-28-volt range when the active region of the device is only about 10 to 50 microns thick. Because no transit-time requirement is involved, an LSA diode can be much longer than a Gunn device and thus deliver much higher power at a given

frequency; a Gunn diode has to be short to operate in the millimeter-wave range, and a larger voltage across it would cause avalanche breakdown. An analysis of the limitation on power imposed by the restriction that the length of the diode be inversely proportional to frequency, f , shows the Gunn-effect maximum power to be proportional to $f^{-2.5}$. The maximum power of other transit-time devices follows the same proportion.

Gunn effect

Gunn-effect oscillations stem from the behavior of space charge within the bulk semiconductor material. In normal ohmic material, space charge will decay exponentially with a time constant equal to the dielectric constant divided by the conductivity (the bulk counterpart to a resistance-capacitance time constant). When the conductivity is negative, however, space charge grows exponentially with time until, if unchecked, a narrow high-field domain forms. Inside the high-field domain, the critical field level of 3,000 volts per centimeter is exceeded and the region maintains its negative conductivity. The field outside the domain drops below the critical value, so this region—most of the diode—has a positive conductivity.

The high-field domain therefore destroys most of the negative conductance that might appear at the diode terminals. This domain isn't stationary, though; it drifts across the diode. As it disappears at the anode, another high-field domain forms at the cathode and begins its movement through the semiconductor. A cyclic current modulation is thus produced at microwave frequencies.

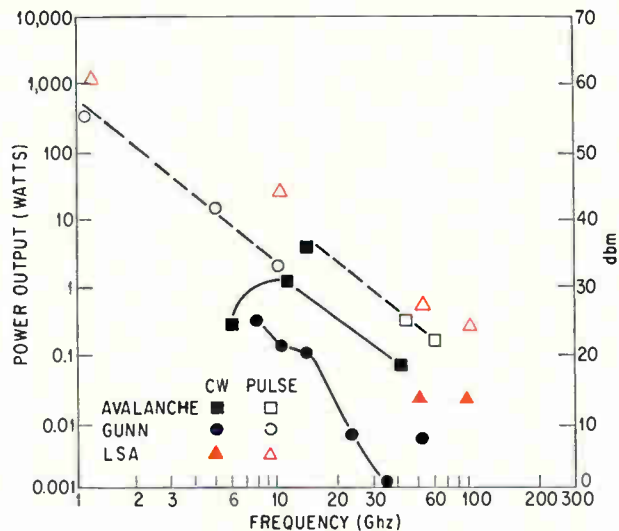

Maximum power available from three types of solid state oscillators. Because avalanche and Gunn diodes are transit-time devices, their maximum pulse power ultimately decreases with frequency in the proportion of $f^{-2.5}$. Much higher power is expected for the LSA diode.

The oscillation of the current caused by the modulation effect of the domains is the Gunn effect. The frequency is equal to the domain drift velocity—about 10^7 centimeters per second—divided by the diode's length. With an active region about 10 microns thick, for example, the Gunn frequency is 10 Ghz.

In the LSA diode, the buildup of space charge is suppressed and the diode exhibits a negative re-

Harnessing millimeter waves

When LSA diodes become commercially available, their principal job will be to give millimeter-wave systems the same high reliability now associated with solid state systems in use at lower frequencies. One can only speculate on the new communications systems and scientific instruments that will spring from the use of these diodes.

Millimeter-wave communications systems will have a larger bandwidth than present microwave setups, and, therefore, a much larger information capacity. A little-appreciated fact is that because of the limited capacity of today's base-band video circuitry, as much information as can currently be put on a laser beam can be put on a millimeter-wave carrier.

A 50-Ghz carrier wave with 1-Ghz bandwidth could carry about 100,000 voice communication channels or 100 television programs. Because of high attenuation in heavy rainstorms, however, long-range millimeter-wave surface communications signals will probably travel through buried waveguide rather than from tower to tower. An experimental guided-wave transmission system in this frequency range has been under study at Bell Telephone Laboratories for many years; LSA diodes recently made possible the first all-solid-state repeater for this system.

The use of millimeter waves can greatly increase the amount of communications carried by synchro-

nous satellites. Since these satellites must be placed in a circle around the equator, and since those operating on the same frequency have to be far enough apart to prevent interference, there is a limit to the number that can use the same frequency (about 30). This means that the maximum number of satellite channels is roughly proportional to the available frequency range. The range of usable frequencies between 30 and 300 Ghz is more than 20 times as wide as the range below 30 Ghz. Also, frequencies above 30 Ghz are almost unused, whereas the lower frequencies are becoming saturated.

The rainfall attenuation problem in satellite communications can be solved by locating ground stations at distances from each other that make it improbable that they would all experience heavy rainfall at the same time.

Among the many other possible uses for the millimeter-wave region are:

- Spectrometers. Many solids, liquids, and gases exhibit high absorption at specific characteristic frequencies in the millimeter-wave region.
- Compact and inexpensive low-power radar systems for industrial applications and automotive traffic control.
- Point-to-point communications and high-resolution radar in the vacuum of interplanetary space.

sistance across its two output terminals.

The growth and decay of the space charge takes a finite time that is inversely proportional to the doping, or carrier density. Fortunately, the decay time when the electrical field is below 3,000 volts per centimeter is much shorter than the growth time when the field is well above that level. Thus, by swinging the field below the critical level for a small portion of the cycle, the space charge accumulated during operation on the negative resistance portion of the curve can be made to decay before the field again exceeds the critical level, causing space charge to build again.

Therefore, space-charge buildup can be prevented by biasing the diode at 5,000 volts per centimeter or more, and using a lightly loaded resonant circuit to swing the electric field well below the 3,000-volt-per-centimeter level for a fraction of each cycle.

The criterion for LSA mode operation is that the ratio of diode carrier concentration to operating frequency, n/f , be in the range of 2×10^4 to 2×10^5 , with an optimum value of about 6×10^4 . To operate at 100 Ghz, for instance, diode doping should be about $6 \times 10^{15}/\text{cm}^3$. This narrow range of permissible doping levels and frequencies stems from the need to prevent the negative resistance effect from causing Gunn-mode oscillations.

Operation in the LSA mode requires that the resonant circuit be lightly loaded at first so oscillations can start. The starting push can come from the harmonic energy of the lower-frequency Gunn oscillations, or from the negative resistance of the diode when a Gunn domain is present. If the ratio of doping to frequency is in the proper range, Gunn domains can't form when the r-f amplitude is large enough to swing the voltage below the critical level during part of each cycle, and the carriers in the material can contribute directly to the conversion of d-c to r-f power.

Once LSA oscillation has started, the resonant circuit load and the output power and efficiency can be increased appreciably. A transmission line between the resonant circuit and the load can provide an automatic loading delay. Initially, the load across the diode is equal to the characteristic impedance of the transmission line. Only after the

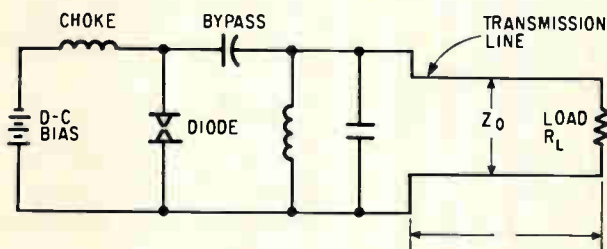

Circuit for LSA operation uses a length of transmission line to introduce a delay before the load is applied to the diode. The basic oscillator is a negative resistance type, and the output frequency depends only on the tuning of the circuit.

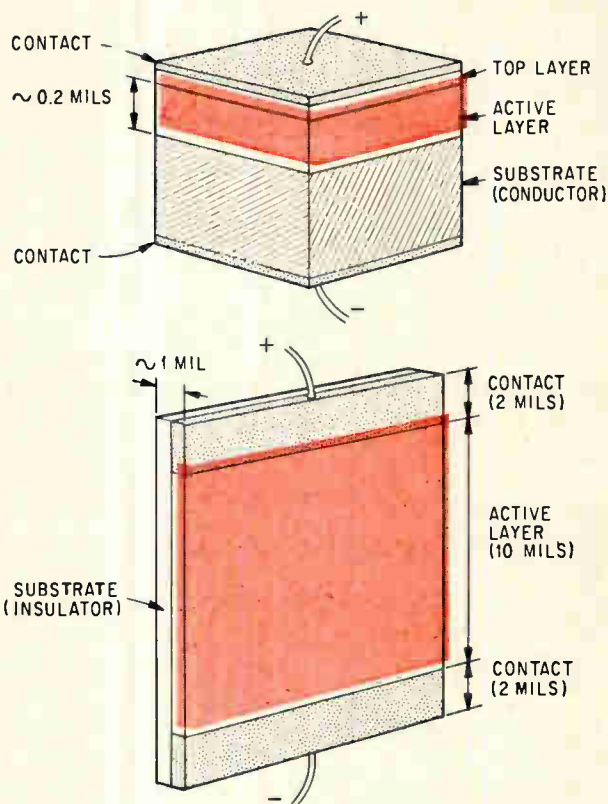

Two types of bulk n-type gallium arsenide diodes. The upper device is constructed from an epitaxial layer on a high-conductivity substrate. Developed for use as a Gunn diode, it has also been used as a LSA oscillator above 44 Ghz. The thin structure of the lower diode, not yet built, offers a better method of heat dissipation.

signal has traveled to the load and back to the resonant circuit does the diode see the steady-state load—the load resistance transformed by the length of mismatched transmission line.

Circuitry

In the actual waveguide circuit used for the LSA diode, the primary resonance is composed of the capacitance of the device and the inductance of a stub that is slightly less than a half-wavelength long at the LSA frequency, and half as wide as the waveguide. The coupling between the primary resonance and the waveguide can be varied by changing the angle between the stub and the bottom wall of the waveguide.

A waveguide short-circuit and an E-H tuner comprise the loading circuit, which is adjusted for maximum output; the short and E-H tuner are each about five wavelengths from the diode. The 9% efficiency obtained with 300-nanosecond pulses is quite good considering that the maximum theoretical efficiency for GaAs is 18.5%. A circuit in RG-99/U waveguide was used for operation to 94 Ghz.

The operating frequency is primarily determined by the length of the stub, and it can be varied over a 15% range by bending the stub up and down, about 0.2% by tuning the E-H tuner, or about 0.5% by inserting a dielectric near the free tip of

the stub. A 20% voltage change generally changes the frequency by about one part, in 1,000.

The structure of the diodes in this circuit is similar to that of the Gunn diodes used previously in the range of 6 Ghz to 20 Ghz. The LSA diodes are thermal-compression bonded—with the active layer down—to the top of a copper cylindrical mounting pellet that fits flush with the bottom surface of the waveguide. The diode is pressure-contacted from above by the bias pin, which also supports the stub. The doping level of the active region is typically from 6×10^{15} to 10^{16} cm^{-3} , and thickness runs from 5 to 20 microns. Heating has blocked the continuous operation of devices thicker than 10 microns.

Diode structure

Although the best results have been obtained with a diode in which the proper conductivity active layer is sandwiched between two highly conductive layers, this design isn't the optimum one for LSA operation. To achieve higher continuous power throughout the millimeter range, it will be necessary to make diodes that are thin in a dimension perpendicular to the current so that heat can be removed "sideways."

The diode's thickness is also determined by the variation of electric field across it when it's placed in a resonant cavity. The device should be placed at the center of the cavity. The diode, in order to hold the electric field within 10% of its maximum value, should be 0.12 wavelengths thick. However, since the wavelength in the diode is only about a third of the free-space wavelength, the diode should be $\frac{1}{3}$ times 0.12, or 0.04 free-space wavelengths thick. The other two dimensions can be made relatively large for high-power operation.

This type of diode can be fabricated from n-type GaAs grown on a semi-insulating GaAs substrate. Semi-insulating material, however, is just becoming available, and it's difficult to grow low-resistivity n-type GaAs on such a substrate because of problems with the diffusion of p-type impurities from the substrate into the n-type epitaxial layer. The first growing of high-quality material on semi-insulating substrates was done in England in 1966 at Standard Telecommunication Laboratories and at Plessey Co.

The generation of high-power pulses requires pieces of uniform GaAs much larger than have yet been produced. For example, a 150-kilowatt, 10-Ghz diode (10,000 volts, 80 amp d-c input) should be about 1 by 1 by 0.1 centimeter. Diodes of this size will probably be made from bulk-grown material where the crystals are grown from molten GaAs, or from solution-grown material formed from gallium and arsenide ions in solution. Until now, the largest bulk-grown diodes operated in the LSA mode have been about 0.1 by 0.1 by 0.02 centimeter.

For the next few years, system designers will have to choose between LSA, Gunn, and avalanche diodes if they want a solid-state source of 0.1 to 10 watts at frequencies between 5 and 30 Ghz. For

higher powers and frequencies, the LSA diode shows particular promise.

The avalanche diode is in the most complete state of development. Avalanche devices producing 0.01 watt at 10 Ghz have been put on the market by Microwave Associates Inc. and Sylvania Electric Products Inc.

Gunn diodes also turning out 0.01 watt at 10 Ghz have been made available for experimental purposes by Mullard Ltd. of Britain. At Bell Telephone Laboratories, experimental avalanche diodes have produced more than 1 watt at 10 Ghz and Gunn diodes have produced 0.1 watt of continuous power at that frequency.

Other considerations in choosing diodes will be noise and bias voltage. The LSA diode seems to be the quietest and the avalanche diode the noisiest.

At 10 Ghz, an avalanche diode requires from 50 to 100 volts, and a Gunn diode about 100 volts—100 volts divided by the frequency in gigahertz. An LSA diode can be designed to operate at any voltage from 25 volts to above 500 volts. The length and area can be adjusted to keep the same volume of GaAs, and therefore the same power (voltage \times current), to achieve different bias resistances (voltage/current) and r-f resistances (about 10 times bias resistance).

Bibliography

- B.K. Ridley and T.B. Watkins, "The Possibility of Negative Resistance in Solids," *Proceedings of the Physical Society (London)*, August 1961, pp. 293-304.
- C. Hilsum, "Transferred Electron Amplifiers and Oscillators," *Proceedings of the IRE*, February 1962, pp. 185-189.
- J.B. Gunn, "Microwave Oscillations of Current in III-V Semiconductors," *Solid State Communications*, September 1963, pp. 88-91.
- J.A. Copeland, "A New Mode of Operation for Bulk Negative Resistance Oscillators," *Proceedings of the IEEE (Letters)*, October 1966, pp. 1479-1480.
- M.P. Shaw and A.J. Shuskus, "Current Instability Above the Gunn Threshold," *Proceedings of the IEEE (Letters)*, November 1966, pp. 1580-1581.
- J. Whitaker and D.E. Bolger, "Shallow Donor Levels and High Mobility in Epitaxial Gallium Arsenide," *Solid State Communications*, 1966, pp. 181-184.
- D.P. Brady, S. Knight, K.L. Lawley, and M. Uenohara, "Recent Results with Epitaxial GaAs Gunn-Effect Oscillators," *Proceedings of the IEEE (Letters)*, October 1966, pp. 1497-1498.
- J.A. Copeland, "C-w Operation of LSA Diodes, 44-88 Ghz," *Bell System Technical Journal*, January 1967, pp. 284-287.
- J.A. Copeland and R.R. Spiwack, "LSA Operation of Bulk n-GaAs Diodes," *Digest of 1967 International Solid State Circuits Conference*, February 1967, pp. 26-27.
- W.K. Kennedy Jr. and L.F. Eastman, "High-Power Pulsed Microwave Generation in Gallium Arsenide," *Proceedings of the IEEE (Letters)*, March 1967, pp. 434-435.

The author



John A. Copeland joined Bell Labs two years ago after receiving his doctoral degree in physics from Georgia Institute of Technology. He has since been engaged in research on bulk-effect devices, and was the first to predict the possibility of LSA oscillations.

R-f breakdown phenomenon improves the voltage capability of a transistor

Operating a device beyond its alpha-cutoff frequency increases the dynamic breakdown limit; transient voltage capabilities can be raised to twice the static value, and the payoff is cheaper r-f amplifier circuitry

By Peter Schiff

Radio Corp. of America, Somerville, N.J.

Designers of transistorized radio-frequency amplifiers need not spend premium prices for devices with especially high breakdown ratings. Nor need they series-up two low-breakdown-rated devices, or turn to elaborate protective circuitry to accommodate high voltage peaks. All they need do is exploit a little-known phenomenon whereby a transistor's breakdown limit improves as the operating frequency extends into the r-f region.

When the device is operated above its specified alpha-cutoff frequency, f_{α} , its breakdown limit rises above its static or low-frequency value to a point where it can withstand transient peaks far above the data sheet breakdown rating, $V_{CEO(SUS)}$. Thus, engineers may select a relatively low-cost vhf/uhf transistor with a 60-volt breakdown and with correspondingly good current-handling capability, and see it perform as well as a more expensive r-f amplifier designed to withstand 120-volt transients.

High transient peaks common

The majority of today's transistorized r-f amplifiers, covering 10-megahertz to 2-gigahertz applications, typically operate with supply voltages ranging from 12 volts (for mobile equipment) to 28 volts (in airborne applications). With frequency,

pulse, and other forms of modulation, the peak collector excursions are typically at least twice the supply voltage. Peak voltages exceeding four times the supply voltage are sometimes encountered in high-level amplitude modulated systems, thus serving as a worst case example (High-level a-m refers to modulation of the output stage by variation of the effective supply voltage. In low-level a-m, modulation is effected by bias level changes at either the oscillator or buffer stages and usually produces less severe transients.)

Class B and C operation of an a-m amplifier presents more severe transient conditions than Class A operation. For example, peak collector excursions as great as 120 volts are conceivable with a 28-volt supply in either B or C operation. But the d-c collector-to-emitter breakdown rating, nominally equal to the low-frequency sustained breakdown voltage, $V_{CEO(SUS)}$, of a device suitable for such a system, need only be 60 volts. Such a transistor will easily withstand the 120-volt transients, providing that the operating frequency exceeds the cutoff value and circuit conditions permit a realization of the r-f phenomenon.

If a device with a higher breakdown—costing as much as 20% more—were selected instead, its peak current capabilities would be lower, because with higher resistivity (and the same geometry) the wattage ratings remain unchanged. Thus, if one were unwilling to sacrifice power capabilities, still another device—one with higher power ratings—would be required. This alternative would cost even more than the previous transistor. However, both devices would have a lower gain bandwidth product, f_T . Thus, dynamic range would be sacrificed. The remaining alternative, designing in protective

The author



Peter Schiff has been with the industrial power transistor applications department at RCA's Electronic Components and Devices division for the past four years. He has worked on second-breakdown effects and safe-operating areas of power devices. His present concern is electronic ballasts.

circuitry to reduce transient levels at the collector of the transistor, would require increased component expenditures and considerably more engineering time. It would also aggravate over-all space and power problems on the circuit board.

Taking advantage of the improved breakdown characteristic at r-f is virtually a must for the designer. The phenomenon itself is innate, related to the static characteristics and not induced at the expense of some other performance parameter.

Cause: avalanche multiplication

Under static conditions, the collector-to-base or avalanche breakdown of a transistor is the result of avalanche multiplication in its collector depletion layer. The charge carrier multiplication factor, M , is given by:

$$M = \frac{1}{1 - \left(\frac{V_{CB}}{V_A}\right)^n} \tag{1}$$

where V_A is the bulk-breakdown or punch-through voltage, and n the rate of multiplication (a constant with values ranging from 2.5 to 4 for most transistors).

In the open-base common-emitter mode, avalanche breakdown occurs at the collector-to-base junction and part of the emitter junction becomes forward biased. This results in infinite common-emitter current gain as the transistor snaps back into the sustaining mode. The prevailing gain, β , a function of M and the common-base current transfer ratio α , is given by:

$$\beta = \frac{\alpha M}{(1 - \alpha M)} \tag{2}$$

Since the base-to-emitter drop is negligible, V_{CE} can be substituted for V_{CB} in equation 1 and the

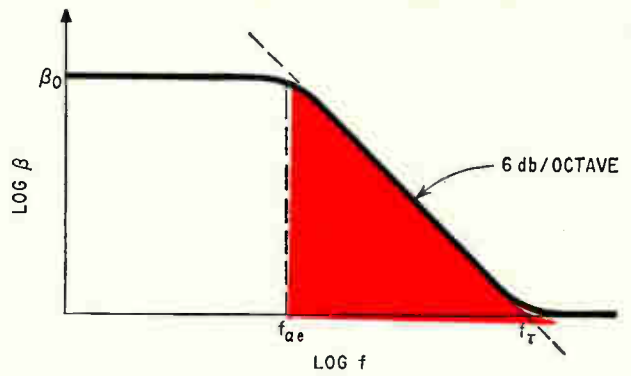

Gain versus frequency. Straight-line relationship prevails for frequencies between cutoff, f_a , and gain-bandwidth product, f_T . Breakdown value increases at r-f as β decreases.

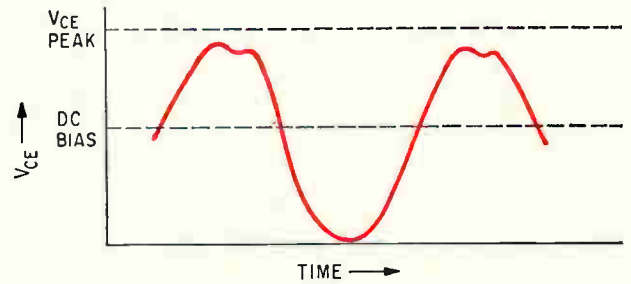

R-f collector voltage swing as a function of time for transistor under test. The dip in 90°-120° region is due to C_{cb} harmonics and a transistor snap-back effect.

expression can be carried to the sustaining state where β approaches infinity. As can be seen from equation 2, M approaches unity. Combining equations 1 and 2 for this condition yields:

$$V_{CE0(SUS)} = \frac{V_A}{\sqrt[n]{\beta + 1}} \tag{3}$$

This equation can be used to calculate the break-

ALL VARIABLE CAPACITORS: 7-100 pF

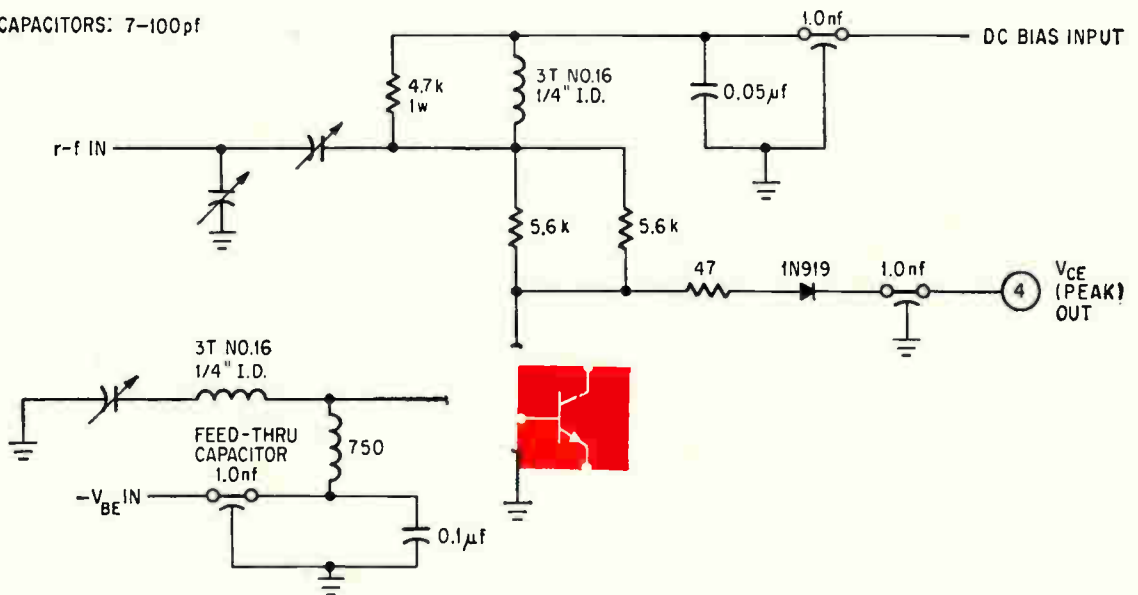

Continuous sine wave input to this circuit is used to measure breakdown; peak and average values are taken to approximate pulse behavior. A graph of average collector current values versus peak collector swings can be generated to portray the breakdown characteristics. T.U.T. stands for transistor under test.

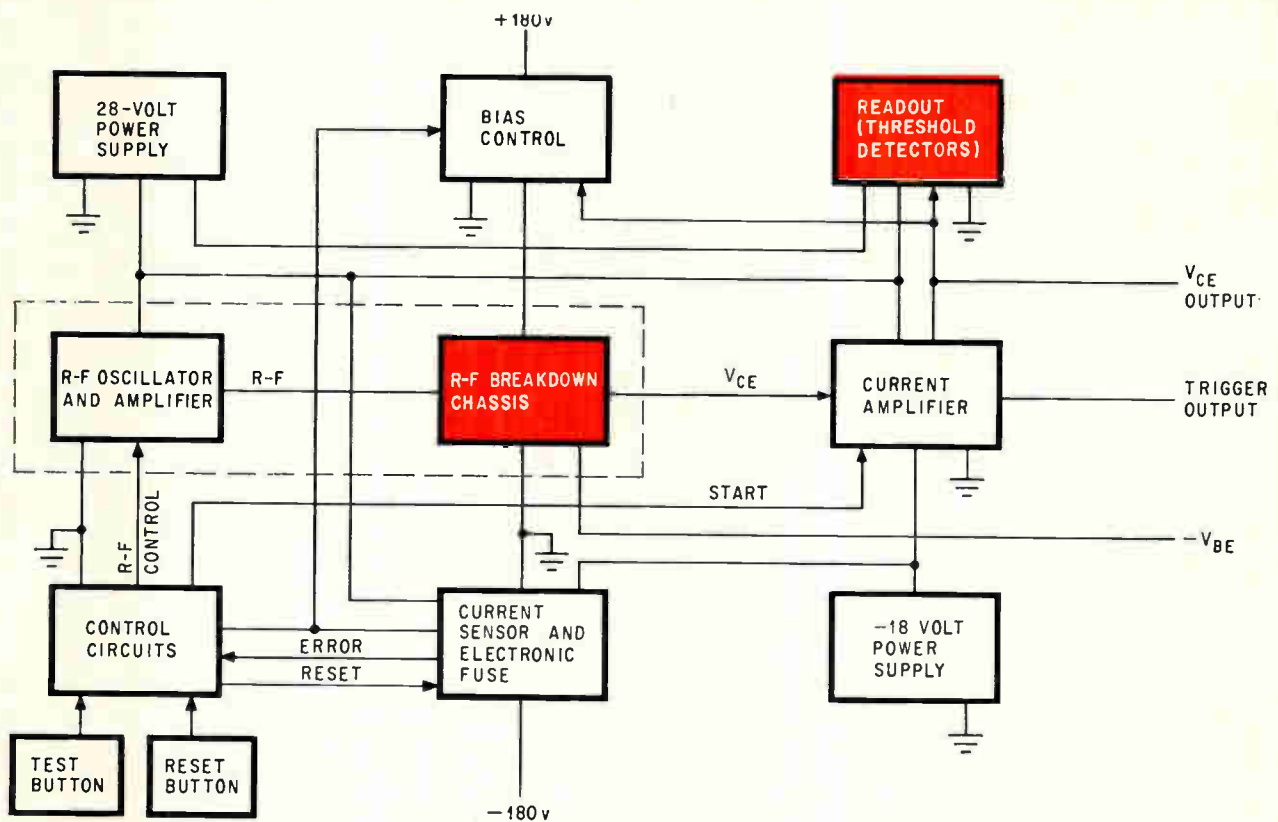

Automatic setup for rapid breakdown measurements. Replaceable modules accommodate different transistor types and a wide range of test frequencies. Threshold detectors (color) are for readout purposes.

down voltage behavior of a transistor as the effective β is altered by the base bias conditions that prevail at higher frequencies.

The beta-frequency relationship of the transistor shown at the top of page 98 is such that for frequencies above cutoff, the log-log plot of beta versus frequency follows a straight line.

Therefore, for $f > f_{\alpha}$,

$$\beta(f) = f_r/f \quad (4)$$

Combining equations 3 and 4 produces:

$$V_{CEO(SUS)} = \frac{V_A}{\sqrt{(f_r/f) + 1}} \quad (5)$$

Equation 5 indicates an increase in the breakdown characteristic from the $V_{CEO(SUS)}$ value at f_{α} to a value approaching V_A at $f = f_r$. To determine the breakdown values between these limits it is necessary to either calculate or measure the value of n . But other device conditions must be considered first. The improvement in breakdown isn't without circuit constraints, particularly in the base.

Although the base is open, the collector-to-base feedback capacitance, C_{OB} , is still connected to it. This impedance would tend to forward bias the base as the r-f collector voltage increases. To overcome this, a low impedance bypass must be created between base and emitter.

A second constraint involves the operating mode. The derivations of the equations describing the r-f breakdown phenomenon are based upon a static

relationship. They are valid only if the device is in the sustaining mode—when the emitter is injecting carriers where the beta mechanism comes into play.

Solving the measurement problem

Using pulse techniques to measure the r-f breakdown voltage is unsatisfactory. Because of the difficulty in separating the C_{OB} currents from routine leakage and in order to simplify current and voltage readout, a continuous sine wave is used for peak and average measurements. The simplicity of this approach is demonstrated by the circuitry for such a measuring setup, shown on page 98.

The transistor under test is placed in a common-emitter circuit where a series LC network shunts the C_{OB} currents between base and emitter. A reverse-biasing potential to the base to prevent Class A oscillations is supplied by the r-f choke. The device is driven at the desired frequency at its collector. Because the signal rides on a d-c voltage component, the collector base is not forward biased. Measurement is achieved by sampling both the average collector current from the d-c bias supply and the peak collector voltage swing, seen in the waveform on page 98. Here the voltage swing, V_{CE} , is rectified and filtered.

For high-volume testing, it is desirable to build the completely automated test set shown above. It can perform the r-f breakdown test in 30 milliseconds. The appropriate amplitude value and d-c bias (maintained at 60% of the peak voltage

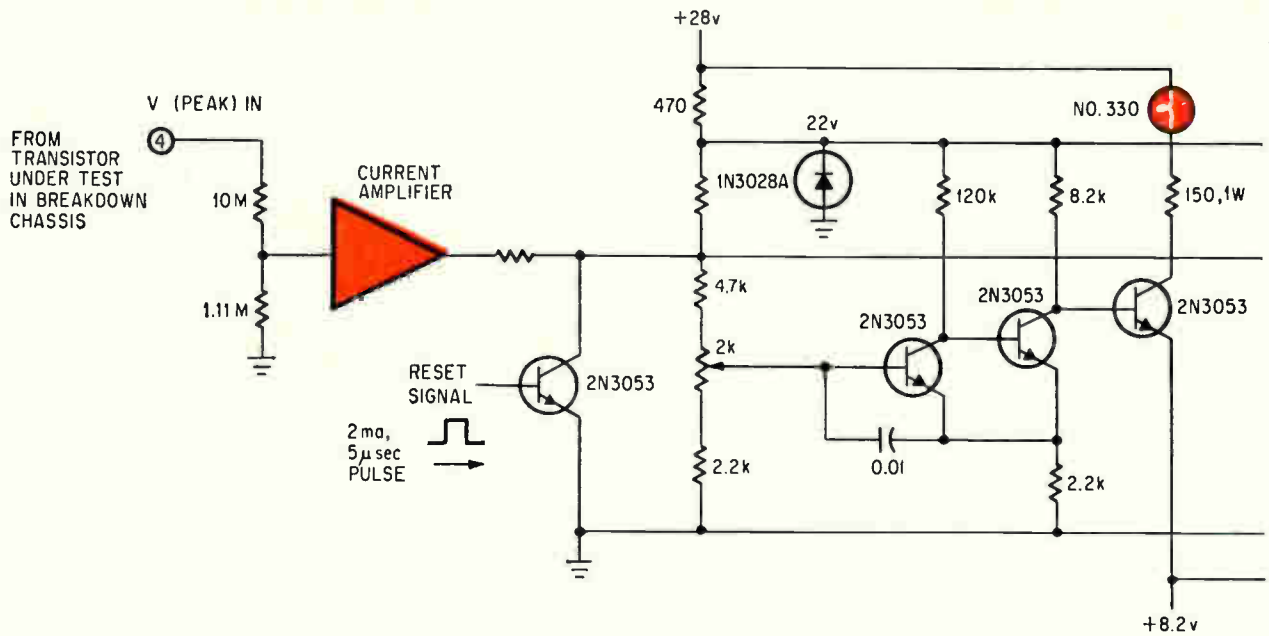

Threshold detectors measure V_{CE} and read out breakdown. Lamp is programmed for go, no-go device evaluation.

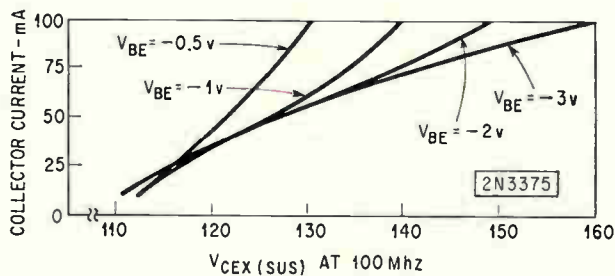

As base-to-emitter bias of the transistor increases, the breakdown voltage increases, because this bias limits C_{OB} feedback that lowers breakdown.

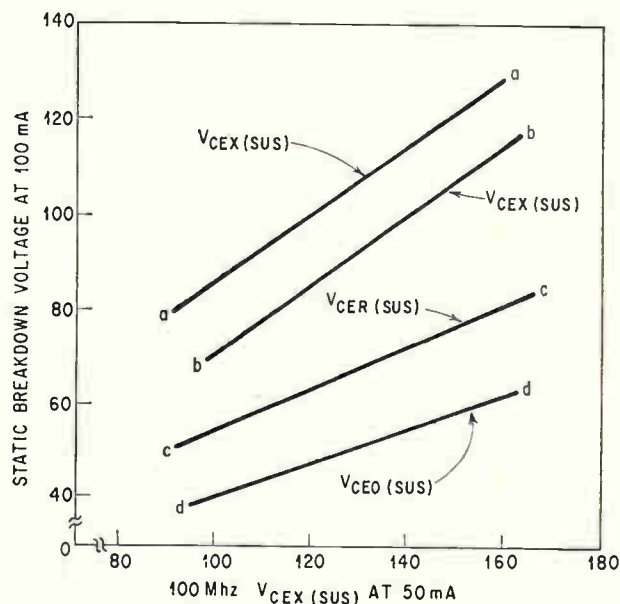

Comparison shows increase of r-f breakdown over static value. Curve a-a is $V_{CEX(SUS)}$ for a base-to-emitter drop of 1.5 volts and a load of 50 ohms; b-b depicts a 100-ohm case (same V_{BE}); c-c is for 100 ohms and 0 bias; d-d is with no load and 0 bias. Curves for a 2N3375.

swing) are automatically controlled for any breakdown current between 10 and 500 milliamperes. Readout is provided by five level detectors that indicate breakdown voltages between 90 and 135 volts. A typical threshold detector and its associated circuitry is shown above. Other generators and breakdown plug-in modules can be substituted to accommodate various transistor types and a wide range of r-f frequencies.

Confirming breakdown behavior

The instrumentation has been used to test two representative uhf power transistor types, the overlay 2N3375 and 2N3632. Sampling of 20 devices of each type was done at two r-f levels, 10 Mhz and 100 Mhz. Plots of average collector current versus peak r-f breakdown voltage show that low-current low-frequency operation tends to display better breakdown characteristics than high-frequency operation. This may be attributed to the high C_{OB} currents that forward bias the base-emitter junction at high frequencies.

As the transistor enters the sustaining mode of operation and clamps collector voltage excursions, the lower β at higher frequencies is evinced by the ensuing higher breakdown voltages. When the base reverse-bias voltage is altered as at left center, the r-f breakdown voltage will change. A comparison between static and r-f measurements at 100 Mhz for 20 2N3375's, shown at left, points out the higher breakdown capabilities at r-f. The graph also shows that the r-f breakdown locus closely follows the V_{CE0} characteristic of a transistor.

Relating static, r-f modes

The relation between the transistor's static characteristics and r-f breakdown can now be developed by solving for the value of n.

Examining the breakdown modes

Since r-f breakdown is a beta mechanism, it can be better understood by a study of the transistor equivalent circuit. The circuit shows how β decreases with increasing frequency. The key parameters are $r_{bb'}$, the base-spreading resistance; $C_{b'e}$, the emitter-base capacitance; $C_{b'c}$, the collector-base capacitance. Completing the transistor model, $V_{b'e}$ is the signal voltage, g_m the transconductance, and $r_{b'e}$ the a-c resistance between the active base and emitter.

At high frequencies, above $f_{\alpha e}$, the $r_{bb'}$ - $C_{b'e}$ network limits current and voltage swings and the magnitude of incremental base current at the b'-e junction. Base drive is further reduced by the negative feed-back action of $C_{b'c}$. Conduction is also retarded by the base width, which is insufficient to permit full transistor action of the finite-speed carriers. A base voltage gradient is induced by lateral currents in the base, flowing through $r_{bb'}$. In turn, this produces a pinch-out of emitter current to the emitter periphery. This pinch-out is enhanced by the $r_{bb'}$ - $C_{b'e}$ combination; subsequent current-crowding at the periphery reduces current gain.

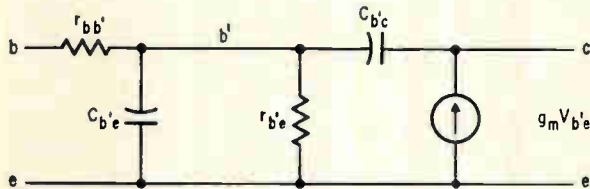

Equivalent transistor circuit (above) shows parameters that influence beta at high frequencies. Typical static breakdown characteristics (right) are shifted upward at high frequencies.

There are six static breakdown voltage modes, each relating to a specific collector current and base lead condition. In each case, a specified value of collector current is made to flow in the reverse direction. This is achieved by maintaining the collector negative with respect to the emitter. A vacuum-tube voltmeter or curve tracer may be used to measure the collector-emitter breakdown.

- BV_{CEO} is the collector-emitter breakdown when the base is left open (unconnected).
- BV_{CER} is the collector-emitter breakdown when a resistor of specified value, R , is connected between base and emitter.
- BV_{CES} is the collector-emitter breakdown when the base is shorted to the emitter.
- BV_{CEV} is the collector-emitter breakdown when the base is reverse biased with a voltage with respect to the emitter.
- BV_{CEX} is the collector-emitter breakdown voltage when the base is terminated through a specified circuit to the emitter.
- BV_{CBO} is the breakdown of the collector-base junction with the emitter open.

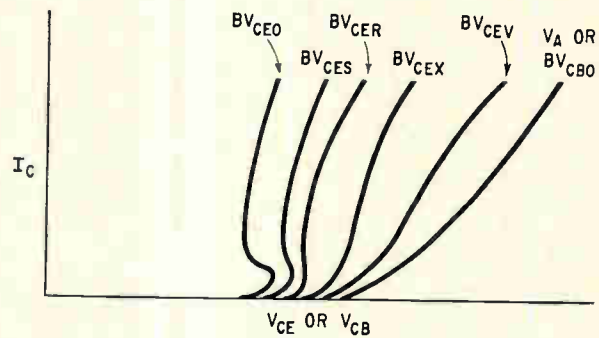

Equation 3 reveals that the collector-to-emitter breakdown varies directly with the punch-through voltage, V_A , and inversely with the n th root of beta. Referring to the static characteristics of the 2N3375 from the data sheet, $V_{CEO(SUS)}$ is 55 volts at a collector current of 100 ma. The device has a beta of 37 and a V_A of 165 volts.

Substituting in equation 3 yields:

$$55 = 165 / (\sqrt[n]{37 + 1})$$

$$(\text{Log } 37 + 1) / n = \text{Log } (165/55)$$

$$n = 3.3$$

For the general case, two factors—the β value and the resulting breakdown at a specific r-f condition—are needed because both the current distribution and operating mode differ from the static case. Therefore, the β term in equation 3 is now modified to $K\beta$, where K is a constant that modifies β for r-f:

$$V_{CEX(r-f)} = \frac{V_A}{\sqrt[n]{K\beta + 1}} \quad (6)$$

The value of K may now be calculated. At 10 Mhz, beta is 33 and $V_{CEX(r-f)}$ is 138. Using equation 6,

$$138 = 165 / 3.3 \sqrt{(K33 + 1)}$$

$$K = 2.4 \times 10^{-2}$$

With K known, any other r-f breakdown can be calculated merely by inserting the values of V_A and β for a specific frequency. For example, if at 100 Mhz β is 4.7, then equation 6 produces

$$V_{CEX(r-f)} = \frac{165}{3.3 \sqrt{(2.4 \times 10^{-2}) (4.7) + 1}}$$

$$= 158 \text{ volts}$$

To verify the accuracy of this computation, the r-f breakdown measurement equipment on page 98 was used. At 100 Mhz, with a V_{be} bias of 2.0 volts and a collector current of 100 ma, a breakdown of 156 volts is measured. This compares favorably with the value derived with equation 6.

Thus, for both r-f device evaluation and selection and r-f circuit design, engineers may use equation 6 or construct the instrumentation described and measure performance directly.

Bibliography

R. Minton, "Design of large-signal vhf transistor power amplifiers," RCA Application Note, SMA-36.

Designer's casebook

Designer's casebook is a regular feature in Electronics. Readers are invited to submit novel circuit ideas, packaging schemes, or other unusual solutions to design problems. Descriptions should be short. We'll pay \$50 for each item published.

Single transistor protects power supply from overload

By Szabolcs Walko

McCurdy Radio Industries Ltd., Toronto, Canada

Overload protection for a series regulator can be achieved with the addition of a single transistor. Usually, such protection requires a flip-flop or silicon controlled rectifier and another d-c supply.

When the input voltage is applied to the regulator, the charging current of capacitor C_1 increases the base current of transistor Q_1 . This, in turn, causes Q_2 to conduct, and a voltage, V_0 , appears at the output terminals.

The charging current of capacitor C_2 forward-biases protective transistor Q_5 , driving it into saturation. In the steady state of the regulator,

the R_3 - R_4 potential divider maintains Q_5 in saturation. The R_2C_2 time constant is much greater than R_1C_1 , so that V_0 is unaffected. Diode D_1 is back-biased under steady-state conditions, preventing the R_1C_1 time constant from influencing regulator operation. Transistors Q_3 and Q_4 form a differential amplifier that senses output voltage variations and supplies regulating signals to the base of Q_1 .

With increasing output current, the voltage across resistor R_5 increases. When the current reaches a predetermined maximum level (2 amperes), the voltage across R_5 cuts off Q_5 through resistor R_4 , turning off the regulator. The regulator is reset by depressing switch S_1 , which provides a discharge path for C_1 and C_2 .

Turning on the regulator under short circuit conditions may result in excessive output current. To limit this peak current, the value of R_1 is selected so that the R_1C_1 time constant is less than the thermal time constant of the series tran-

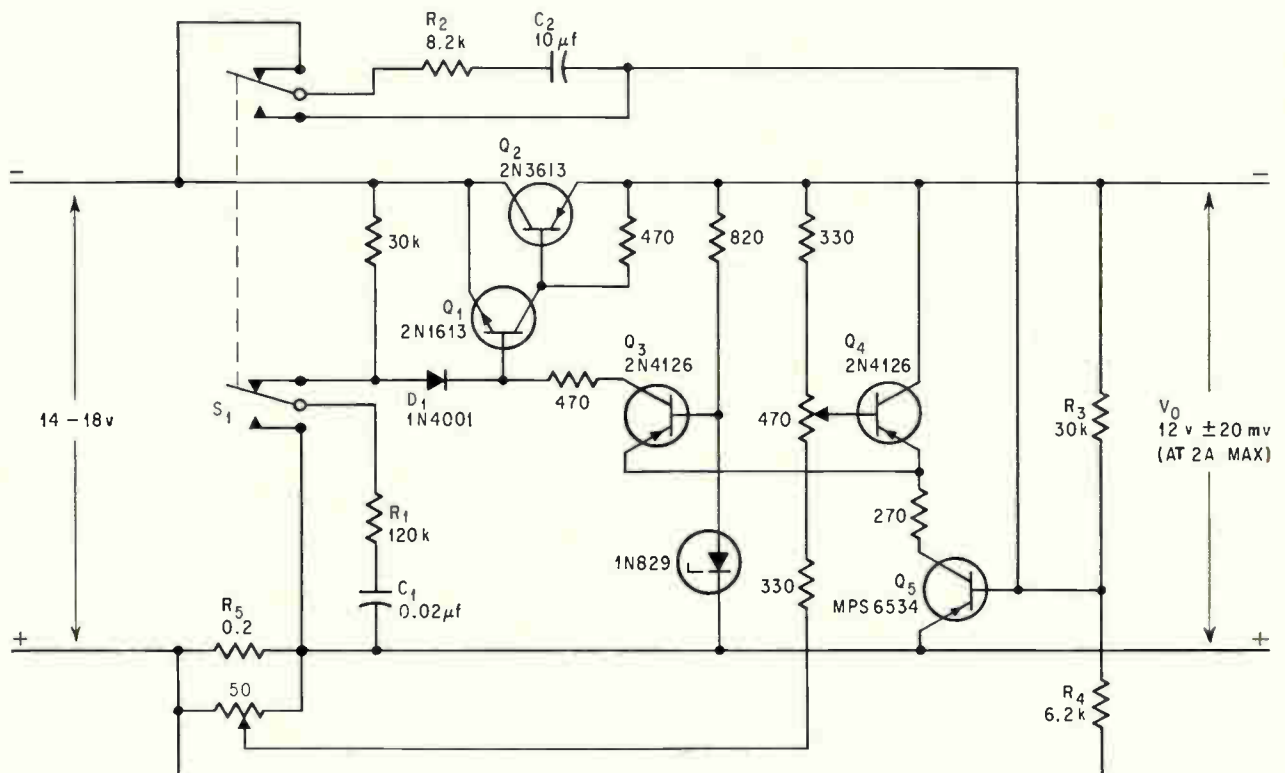

Under steady-state conditions, transistor Q_5 is held in saturation by potential divider R_3 - R_4 . When output current increases beyond a maximum value, the drop across R_5 cuts off Q_5 , turning off the regulator.

sistors. In addition, the value of R_1 is dependent on the unregulated input voltage waveform. A capacitor across the output improves stability.

By placing a diode in parallel with resistor R_4 , the regulator can also have a current-limited output characteristic.

The circuit has good temperature stability. For example, in the Q_3 - Q_4 differential amplifier, the two temperature-dependent base-emitter voltages compensate each other; the emitter follower, Q_4 , eliminates the effects of temperature on Q_5 's collector-emitter saturation voltage.

Current feedback enhances phototransistor sensitivity

By R. Sivaswamy

Defense Research & Development Organization,
Bangalore, India

Although phototransistors usually convert a light input into an electrical output, it isn't commonly known that they can simultaneously provide current gain for an electrical input. In the feedback amplifier shown, each phototransistor provides the other with an electrical signal that is a function of the illumination on the phototransistors.

With transistors Q_1 and Q_2 connected in cascade, light-induced electrical signals from Q_1 are amplified by Q_2 , added to Q_2 's light-generated signals, and then fed back to the base of Q_1 for further amplification; the regenerative feedback continues with the current from the collectors of both tran-

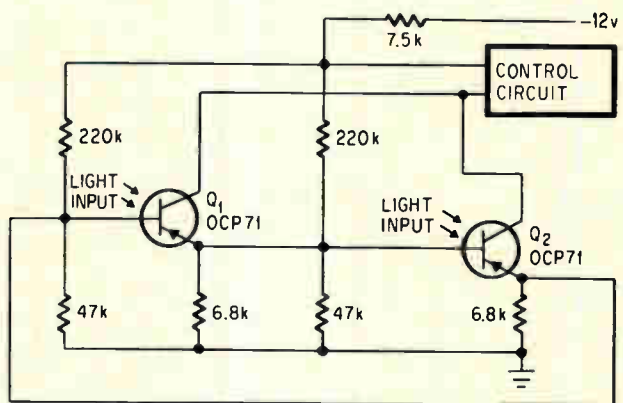

Light-induced signals from Q_1 are amplified by Q_2 , increased by Q_2 's light-generated signals and then fed back to the base of Q_1 for more amplification.

sistors driving the current-actuated control circuit.

The current gain of the circuit for signals induced by a typical illumination is 20 with these ocp 71 transistors. Without the feedback circuit and interconnection, the gain induced by the same illumination was about 4.

R-f signals actuate transmit-receive switch

By Keith C. Morton

Rome, N.Y.

Whenever an r-f signal at a predetermined frequency exceeds 1 volt, the transmit-receive switch protects a receiver's input stage by grounding the antenna's input terminals and terminating the antenna in its characteristic impedance. The protection circuit is energized solely by the input r-f signals at the desired frequency; this eliminates

expensive coaxial relays and associated disabling circuits which usually link the transmitter keying circuit to the receiver in conventional circuits.

Input radio-frequency signals pass through capacitor C_1 to the tank circuit, L , C_2 , and C_3 , which is tuned to a desired disabling frequency—7.3 megahertz for circuit values shown in the diagram. Capacitors C_2 and C_3 form a voltage divider that supplies detecting diodes D_1 and D_2 . When the transmitter is radiating, the diodes conduct and develop a negative bias on the base of Q_1 , turning Q_1 on. With Q_1 conducting, Q_2 turns on and energizes the relay. When the relay switches, it grounds the receiver antenna input and terminates the transmission line in impedance R_1 .

Capacitor C_4 maintains its charge for a few

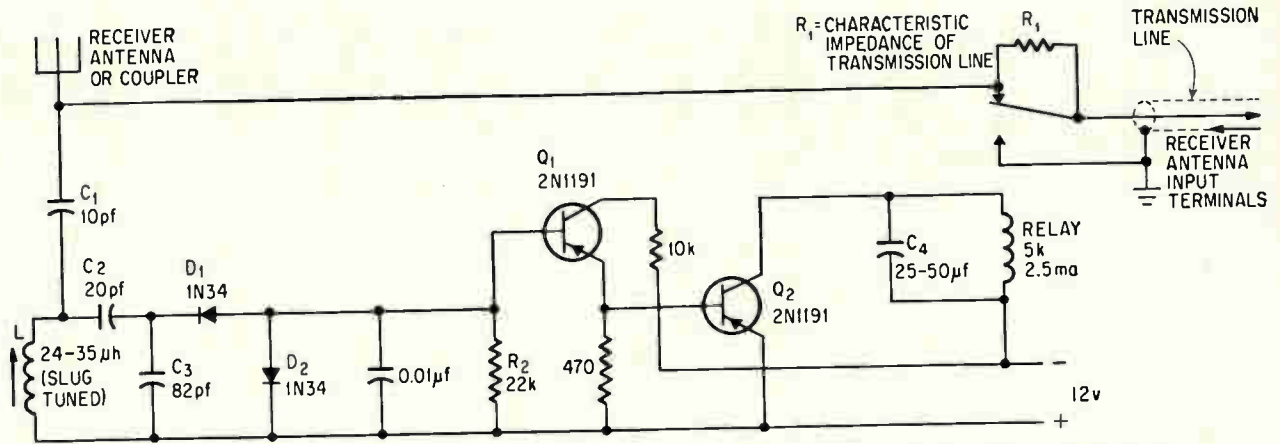

Radio-frequency signals greater than 1 volt at the disabling frequency determined by L, C₂, and C₃ activate the relay that grounds the receiver antenna input and terminates the antenna in its characteristic impedance.

moments after the transistors cut off, preventing chatter by slowing the relay's switching. When operating in the continuous-wave mode, C₄ should be selected to match the average operating speed and desired cut-in characteristics. For slower release times, a still larger capacitor may be used for C₄.

The circuit can be modified to operate at other

r-f signal levels by changing the ratio of C₂ to C₃ and R₂ to the emitter resistor, 470 ohms. Resistor R₂ can be eliminated by increasing the emitter resistor to approximately 5 kilohms. In high temperature environments, however, R₂ should be retained or even reduced; this may reduce the circuit sensitivity, which must be compensated for by adjusting the values of both capacitors C₂ and C₃.

100% amplitude modulation with two transistors

By Andre Pichard

Compagnie Francaise de Prospection Sismique, Paris

A simple circuit capable of 100% amplitude modulation can be built with two transistors. The first transistor separates the modulation signal into two signals that are 180° out of phase, to develop the supply voltage for the second transistor, which amplifies the carrier. Although the circuit was designed to modulate a 2-kilohertz subcarrier with a sub-audio signal, the circuit can be modified to operate at radio frequencies, as illustrated.

In the circuit, transistor Q₁ amplifies the modulation signals while providing isolation and 180° phase separation. The modulation signals appear intact at the emitter of Q₁, but show up 180° out of phase at the collector of Q₁ due to the normal inversion in an amplifier. Since the emitter and collector of transistors Q₁ and Q₂ are coupled,

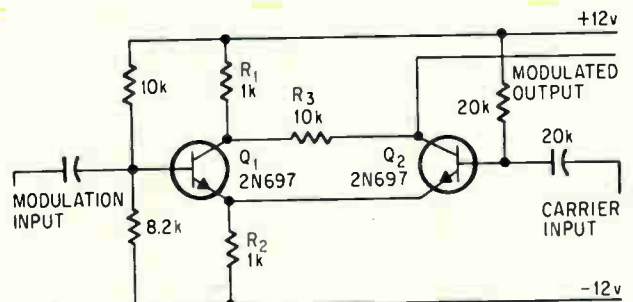

Modulation signals undergo a 180° phase separation in Q₁ and provide the supply voltage for Q₂.

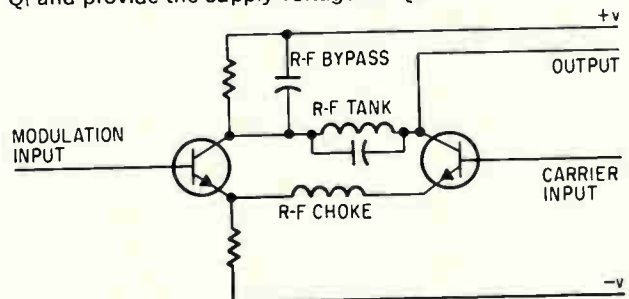

Modified circuit performs amplitude modulation at radio frequencies.

the phase-separated modulation signals form the supply voltage for Q_2 . The circuit differs from a differential amplifier as the load resistors of Q_1 and Q_2 are not connected to the same supply voltage.

The amplifier carrier signal has its amplitude directly modulated by the output voltages from

Q_1 —the amplified and phase-separated modulation signals; these signals determine the amount of current through Q_2 and hence the magnitude of the output voltage at load resistor R_3 . The values of resistors R_1 and R_2 are made small with respect to R_3 so that transistor Q_1 becomes a low-impedance supply source.

Two diodes remove pulse-width limitation

By Arthur J. Metz

Argonne National Laboratory, Argonne, Ill.

With two extra diodes, a multivibrator attains high noise immunity and fast recovery time without limiting its output pulse width. Usually, noise immunity requires heavy biasing of the switching transistors, while a small timing capacitance is needed for fast recovery times. These factors limit the output pulse width, which is directly proportional to timing capacitance and inversely proportional to the output transistor's base current.

With D_1 and D_2 added, the saturating bias current of Darlington combination Q_3 and Q_4 can be

set for maximum noise immunity, independent of timing considerations. Except for the diodes, the multivibrator is of conventional design. Transistor Q_2 provides a low-impedance recharging path for timing capacitor C_1 , resulting in a duty cycle of nearly 90%. Transistor Q_5 and its associated components form a variable current source.

When the circuit is in its stable state, Q_1 is off, and Q_3 and Q_4 conduct heavily. Base current I_2 is established by the combination of resistor R_1 and D_1 's zener voltage. When the circuit is triggered, the voltage across D_1 and D_2 falls below the zener voltage. The high resistance of D_1 under this condition effectively removes the diode path from the circuit, and the output pulse width is determined by the values of C_1 and I_1 . Diode D_2 maintains the high impedance of the diode branch as the voltage across it reverses near the end of the pulse. The voltage at the base of Q_3 must reach approximately 1.2 volts for regeneration.

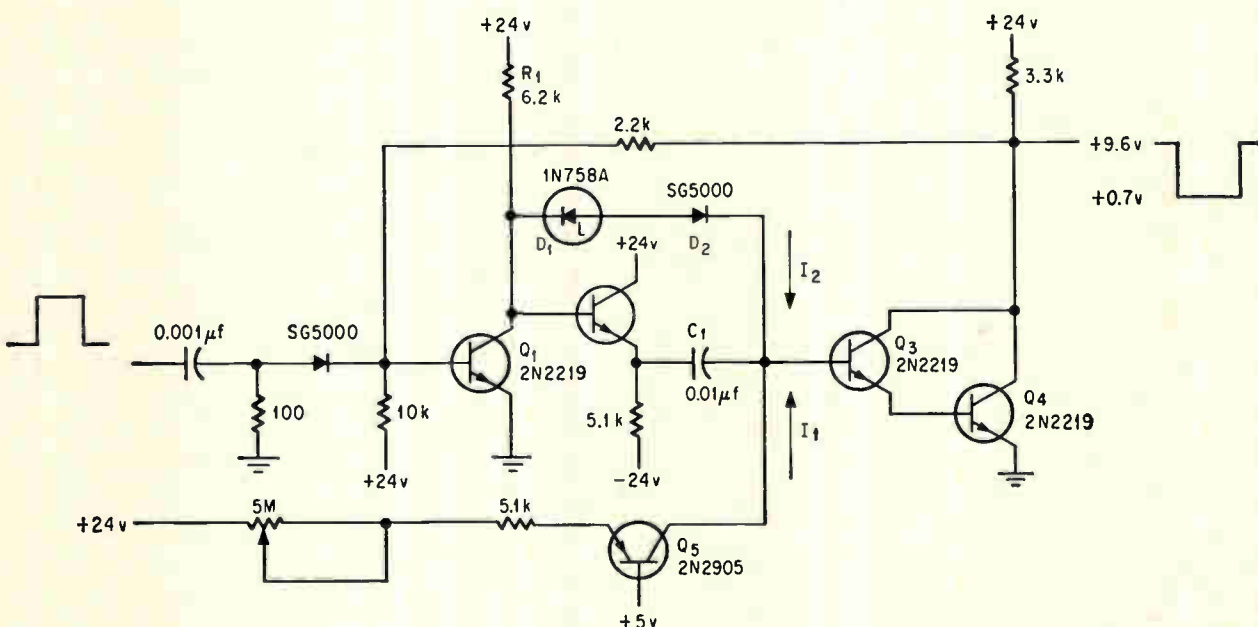

When Q_1 conducts, the voltage across diodes D_1 and D_2 falls below the zener level, making the output pulse width proportional to C_1/I_1 .

One transistor sweeps clean

Simple generator that produces linear sweeps can be transformed into a timing or control subsystem capable of producing pulses and complex signals by merely adding a few components and flip-flops

By Sumner Weisman*

Raytheon Co., Lexington, Mass.

In pursuit of sweep linearity, the designer often uses Miller sweeps, bootstrap circuits, phantastons and other configurations that employ feedback to obtain the desired waveform. Strangely enough, a circuit rarely chosen is the single-transistor constant-current sweep generator, which, with a minimum of components, provides an output that compares favorably with the more complex feedback-type generators.

Good linearity offers a means of precisely measuring time for synchronization, counting, or control purposes, and is often required in television, radar, pulse, and digital circuitry.

Add a garden-variety flip-flop and a few components to this remarkably versatile circuit and it is transformed into a useful timing or control subsystem. It will produce linear sweeps, digital pulses, or complex, digitally controlled signals.

With one extra transistor, a silicon controlled rectifier, and a potentiometer, the two basic circuits form a frequency divider that puts out jitter-free pulses whose rate can be adjusted. These basic circuits can also form a pulse generator in which the width of the output pulse can be adjusted. Add one more silicon controlled rectifier, and time-

delay relays can be controlled precisely.

By substituting digital input signals for the scrub and potentiometer, the sweep waveform as well as its timing can be controlled digitally. The slope of each sweep can be varied by increments. Add extra flip-flops and the waveforms will become complex signals suitable for control functions in many different kinds of systems.

Basic sweep circuit

The sweep generator, at the top left of page 107, is a common-base configuration with capacitor C_1 as the collector load. When the base of transistor Q_1 is grounded, the emitter end of resistor R_1 is at a negative potential, equal to Q_1 's base-emitter drop. The other end of R_1 is returned to a more negative voltage, $-V$. Since the base-emitter drop is small compared with the drop across R_1 , emitter current is established by the values of R_1 and $-V$. The grounded base holding the emitter voltage constant results in a constant-current generator.

If the small base current is neglected, the collector current equals the emitter current. The constant collector current develops a voltage across C_1 that is given by:

$$\frac{\Delta v}{\Delta t} = \frac{I}{C_1}$$

where

v = voltage across C_1 ($+V$ maximum)

I = collector current \approx emitter current ($-V/R_1$)

t = sweep time

Sweep action is controlled at the emitter of Q_1 by the voltage applied to diode D_1 . To turn on the sweep, a negative voltage is applied, reverse-biasing D_1 and allowing a constant collector current to flow. To turn off the sweep, a positive voltage is applied to D_1 , making the emitter of Q_1 more positive than its base, and stopping current

* Now with MKS Instruments Inc., Burlington, Mass.

The author



Sumner Weisman recently became manager of the electronic engineering department at MKS Instruments. At Raytheon's Wayland Laboratory, he was involved in the design of digital and analog circuits and systems.

Building blocks

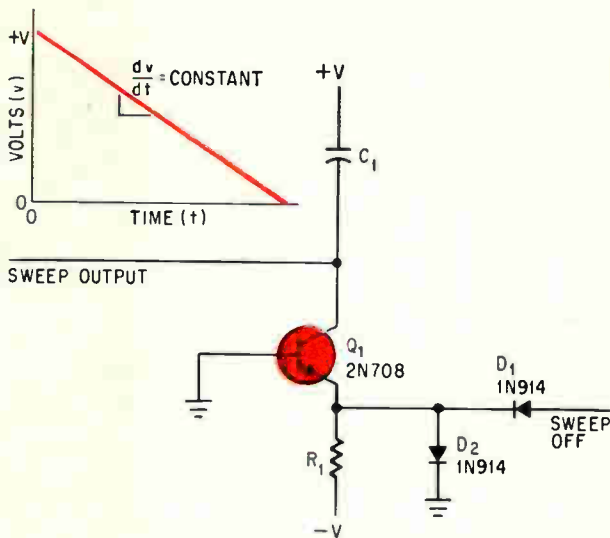

Linear sweeps are generated by charging capacitor C_1 with constant current flowing through the transistor.

flow. Diode D_2 protects Q_1 from being damaged by excessive reverse-bias during turn-off.

The sweep slope can be altered by changing R_1 . For adjustment, R_1 is a slope-controlling potentiometer in series with a fixed resistor (typically 1,000 ohms) that protects the transistor from damage when the potentiometer is completely shorted.

Pulse generators

The simple frequency divider, shown below, based on the generator and flip-flop, fills the need for synchronous generation of pulses in pulse or digital systems. The output pulses are always in time coincidence with the input pulse train. Because many applications require synchronous pulses at different frequencies, one variable frequency generator may be used to replace several fixed frequency dividers.

With the values shown and a 1-microfarad sweep capacitor, the output frequency can be varied from 10 to 1,000 hertz. The input frequency may typically

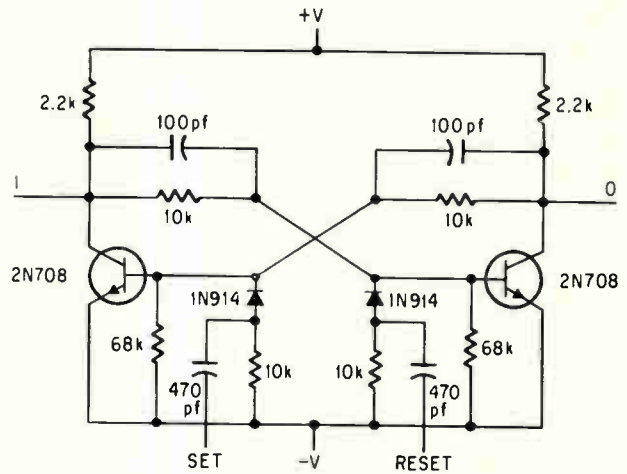

Flip-flop triggered by pulses at its set and reset inputs is used to control the charging of the sweep generator's capacitor. With a 1 at the set input, the flip-flop changes from the 0 state to the 1 state.

be 10 kilohertz. Input-to-output ratios of 1,000:1 can be achieved with variations of this circuit.

In contrast, monostable multivibrator-type dividers are limited to ratios of 10:1 or 20:1. Unlike the output of the new circuit, which remains jitter-free at the higher ratios, the output of multivibrators generally runs into jitter problems at ratios greater than 20:1. To obtain jitter-free pulses over a wide range of ratios, some designers turn to multistage counters. However, the number of stages becomes large when high ratios are needed. Unless the ratio is a power of 2, complex feedback paths may be needed.

The flip-flop that is used with the single-transistor generator has the conventional design shown above at the right. A positive trigger pulse applied to the set input changes its state from a binary 1 to 0. If a positive trigger is applied to the reset input, the state changes from 0 to 1.

Assume the flip-flop is in a 1 state, with the 1 output at 10 volts. The emitter of Q_1 holds off the

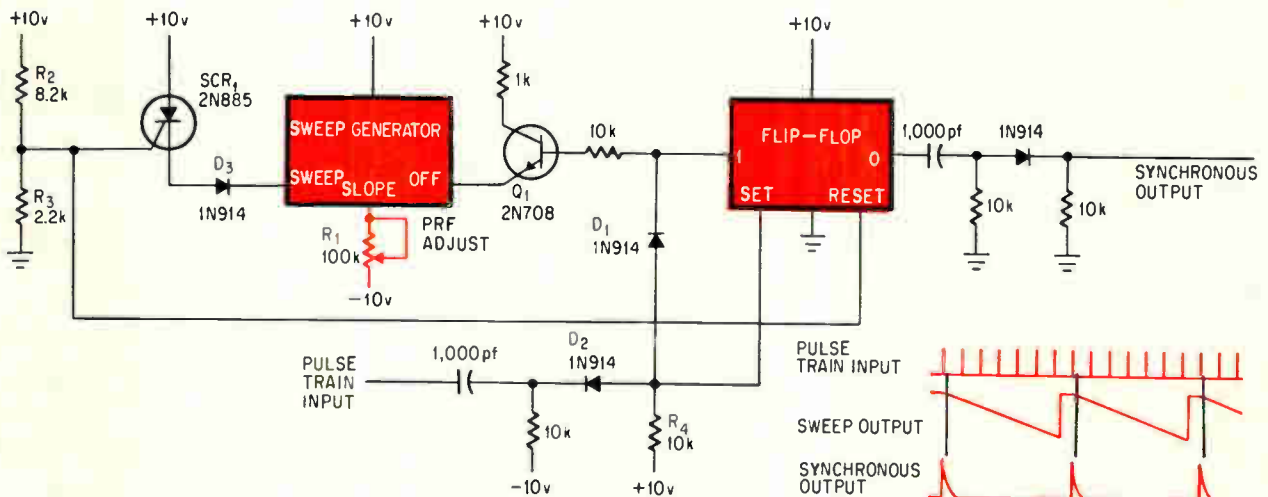

Frequency divider generates pulses synchronized to the pulse train input. The sweep begins when the flip-flop switches from a 1 to a 0 state, and ends when it switches back to the 1 state.

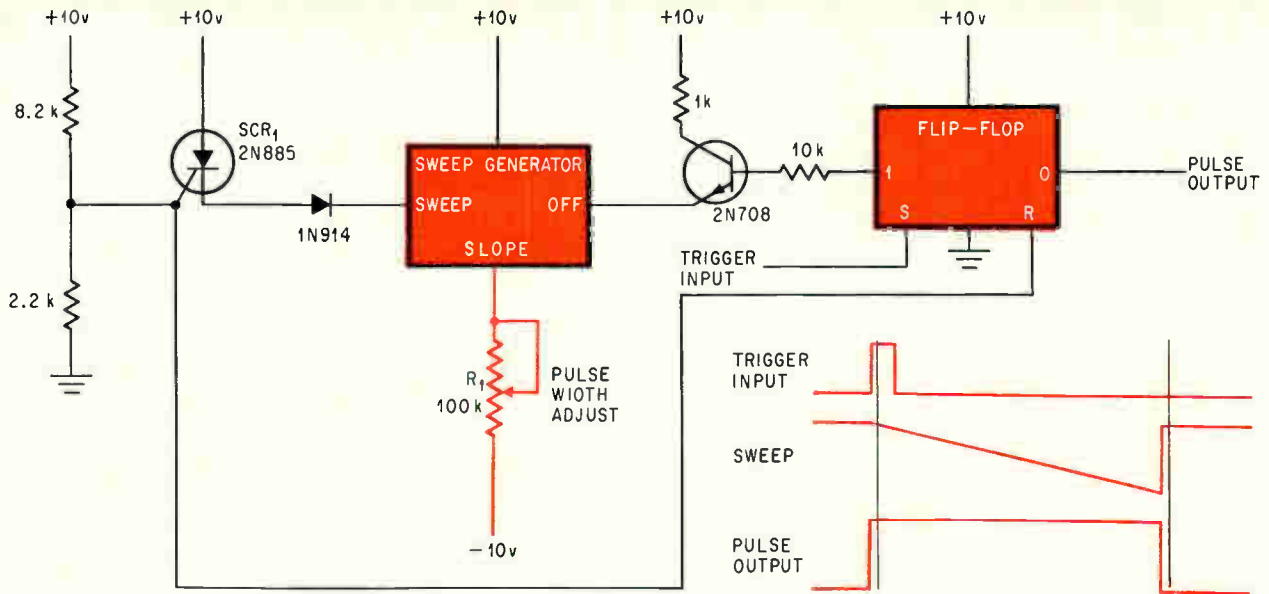

Pulses of variable width are produced at the O output of the flip-flop. Sweep length, which is controlled by R_1 , determines the pulse width.

sweep at 10 volts and SCR_1 is not conducting.

One pulse of the input train is applied to the set input of the flip-flop through the AND circuit formed by diode D_2 , resistor R_4 , and diode D_1 . Now, the flip-flop switches to the 0 state, and ground potential is applied to Q_1 's base. The voltage holding off the sweep is removed, initiating the sweep's negative excursion. The cathode of SCR_1 follows the negative sweep through forward-biased diode D_3 . Resistors R_2 and R_3 form a voltage divider that holds the gate of SCR_1 approximately 2 volts above ground.

As the sweep continues, a point is reached where the cathode of SCR_1 is more negative than its gate, and SCR_1 conducts. The conduction rapidly discharges the capacitor in the sweep generator, and the sweep output returns to 10 volts. The large

positive pulse at the gate of SCR_1 resets the flip-flop to a 1 state, turning off the sweep generator's transistor. Since the scr current flows through the sweep transistor, interruption of transistor current turns off SCR_1 . The cycle begins again with the next pulse of the train input.

The output is taken from the 0 side of the flip-flop, and is synchronous with the input pulse. Adjustment of potentiometer R_1 changes the sweep slope to obtain the desired output pulse repetition frequency (R_1 is part of the sweep generator circuit).

Changeable pulse width

The same basic components form a variable-width pulse generator, shown above. Every input trigger to the flip-flop generates a pulse whose

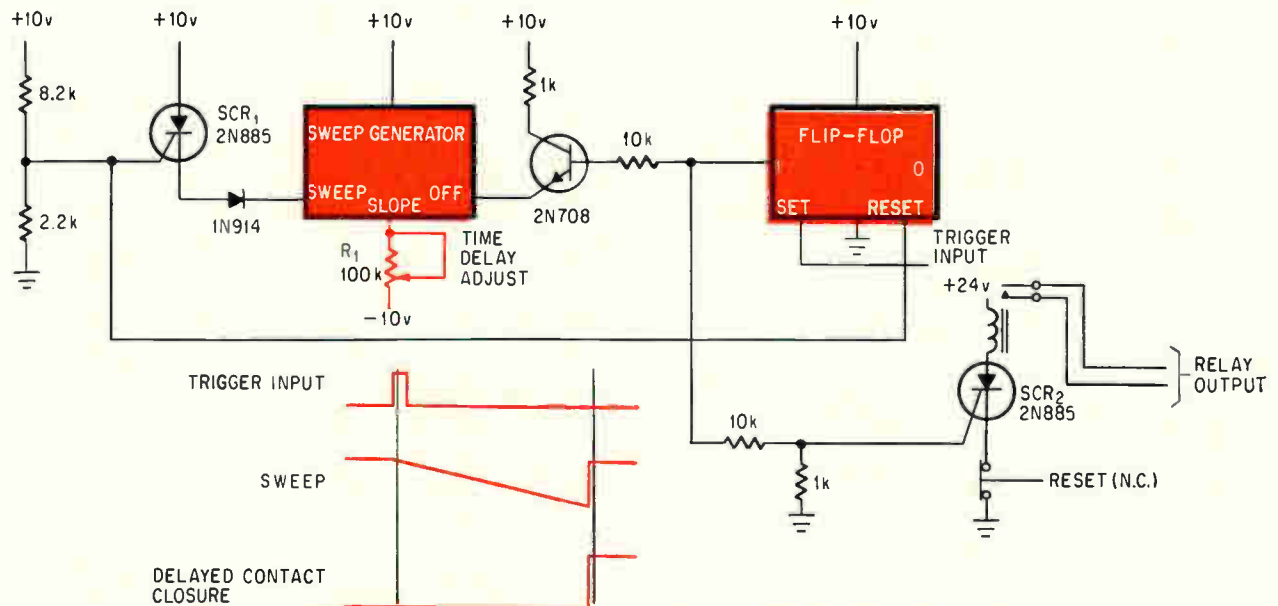

Turn-on time of relay is controlled by the length of the generated sweep. At the end of the sweep, the flip-flop switches to the 1 state and SCR_2 conducts.

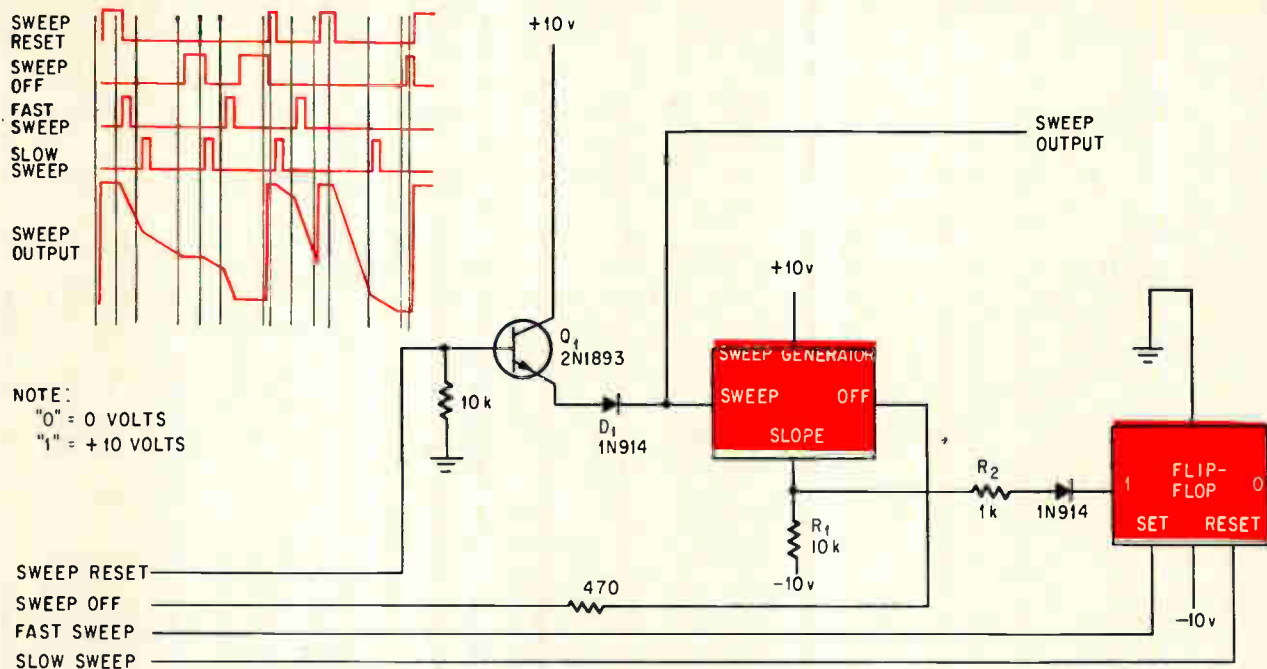

Digitally controlled outputs are generated when digital signals are applied to the sweep generator and the flip-flop. Sweep slopes can be changed to form complex control and timing signals.

width is controlled by the length of the sweep. The pulse width is a linear function of the control current—a function that's not available in a monostable multivibrator. With a calibrated, multi-turn linear potentiometer, R_1 , as the control, very high resolution and linearity are obtained. The values shown, together with a 1-microfarad capacitor in the sweep generator circuit, allow pulse width to be linearly controlled from 1 to 100 milliseconds.

With the addition of SCR_2 and its associated components, the pulse generator can accurately control the turn-on time of a time-delay relay. The circuit at the bottom of page 108 offers both linear control of the delay and repeatability—characteristics that aren't available from either a resistor-capacitor network or a thermal time-delay circuit.

The total turn-on time is the sum of the adjustable sweep time and the fixed turn-on time of the relay used. With the values shown and a 50-microfarad sweep capacitor, the relay delay can be varied from 50 milliseconds to 5 seconds, plus the fixed relay turn-on time.

Digitally controlled sweep

The versatility of the sweep generator and flip-flop combination is again demonstrated when provision is made for digital control of the sweep output. Digital signals can reset the sweep, turn it off at any level, or change its slope. In the configuration displayed above, the application of a 1 (positive level) to any of the four inputs actuates that input.

A 1 at the sweep reset input is amplified by transistor Q_1 and the sweep capacitor is discharged. A 1 at the sweep off input stops current flow in the sweep transistor, terminating the sweep at any desired d-c level. Sweep slope is determined by

the resistance in the sweep transistor's emitter circuit. With a 1 applied to the fast sweep input, the flip-flop is switched to a 0 state. This results in R_2 being connected in parallel with R_1 , which increases the sweep slope by drawing more sweep transistor current. For slow sweep, a 1 is applied at the slow sweep input, and the flip-flop is reset to the 1 state, eliminating R_2 from the circuit. Since the output is taken directly from the sweep capacitor, the load impedance should be high to preserve sweep linearity. A Darlington or field effect transistor amplifier, or an operational amplifier would satisfy the high-impedance requirement.

With a 1-microfarad sweep capacitor and the values shown, a slow sweep of 10 milliseconds and a fast sweep of 1 millisecond are obtained.

A series of typical digitally controlled sweeps are shown. With the addition of other flip-flops and more resistors in parallel with R_1 , greater variations in slope can be selected. The circuit can then be used to digitally simulate a wider variety of functions.

The sweep generator and flip-flop have been employed successfully in other configurations. One use was as a peak detector for low-duty-cycle pulse trains, where the sweep was turned off when its d-c level was equal to the pulse train peaks. The level was then measured by a digital voltmeter. This circuit performed better than a conventional capacitor peak detector, which is limited at low duty cycles because the capacitor won't hold its charge between input pulses. Another use for the combination was in automatic band sweeping of a communications receiver. A slow linear sweep controlled the bias of a voltage-variable capacitor that controlled receiver frequency. Thus, both rate and range of frequency were easily variable.

Extra Value Reed Relays

New Design provides Greater Reliability

PLUS Lowest Cost

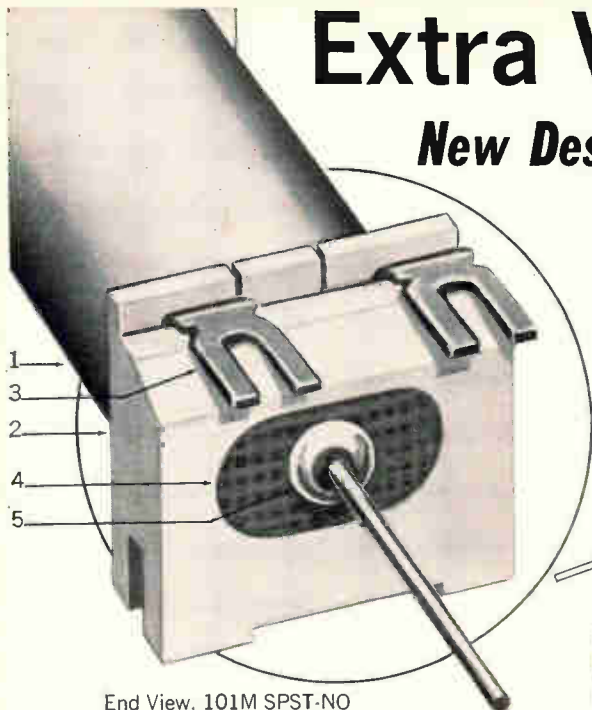

End View, 101M SPST-NO

Hermetically sealed reed capsules are completely enclosed and shielded by the bobbin.

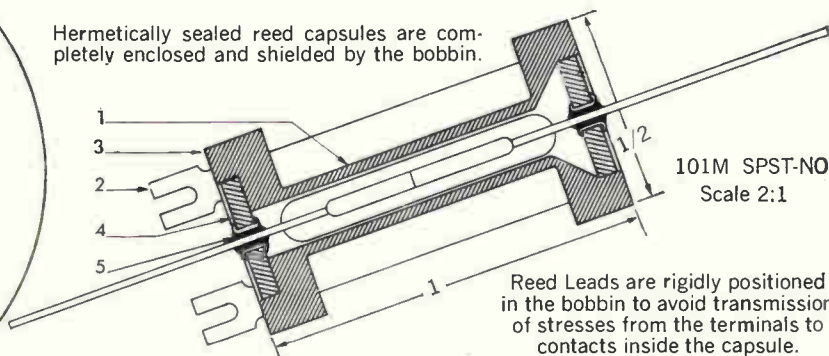

101M SPST-NO
Scale 2:1

Reed Leads are rigidly positioned in the bobbin to avoid transmission of stresses from the terminals to contacts inside the capsule.

The new Design has been developed to provide maximum reliability in Axial Lead Reed Relays

The coil bobbin (1) is integrally molded with square mounting supports (2) and tinned coil terminal inserts (3). With the reed capsule in place, ends of the bobbin are closed with insulating bushings (4). Rigid positioning of the contact leads in the insulating bushings (5) avoids transmission of stresses on the lead terminals to contacts inside the glass capsule and disturbance of relay adjustment.

This new design provides dust tight enclosure of the hermetically sealed glass capsule and increased protection against mechanical injury.

Configurations and contact combinations in which the new Axial Lead Relays are available are shown at the right.

The New EXTRA value Reed Relays with Axial Leads adaptable to printed circuits

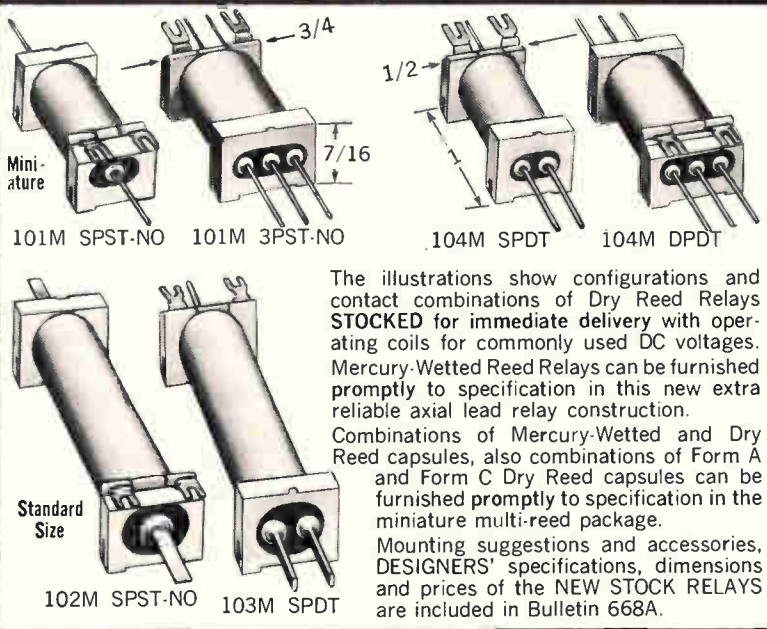

The illustrations show configurations and contact combinations of Dry Reed Relays STOCKED for immediate delivery with operating coils for commonly used DC voltages. Mercury-Wetted Reed Relays can be furnished promptly to specification in this new extra reliable axial lead relay construction. Combinations of Mercury-Wetted and Dry Reed capsules, also combinations of Form A and Form C Dry Reed capsules can be furnished promptly to specification in the miniature multi-reed package. Mounting suggestions and accessories, DESIGNERS' specifications, dimensions and prices of the NEW STOCK RELAYS are included in Bulletin 668A.

Do YOU need Reed Relays, NOW

160 Mercury-Wetted and Dry Reed Relays including— • Axial Lead • Bi-Stable • Encapsulated • Enclosed • High Speed • High Voltage • Latching • Low Capacitance • Magnetically Shielded • Microminiature • Miniature • Multiple Coil • Multiple Contact • Open Style • Plug-in • Printed Circuit—are STOCKED for immediate delivery.

All the above Reed Relays plus 248 Telephone, General Purpose, Coaxial, Time Delay and other types in STOCK for immediate delivery and available through authorized distributors at low factory prices are described and priced in STOCK RELAY CATALOG 267 and Bulletin 668A.

Complete Reed Relay information in one cover

Complete DESIGNERS' data on the extensive line of MAGNECRAFT Reed Relays is provided in the DESIGNERS' Handbook and Catalog.

The HANDBOOK also includes complete information on Reed Relays—Principles of Operation • Styles and Characteristics • Application Information • Testing Procedures • How to Specify.

The two publications illustrated plus Bul. 668A are mailed promptly on request.

For prompt action contact the MAGNECRAFT REPRESENTATIVE in YOUR area, write or phone us.

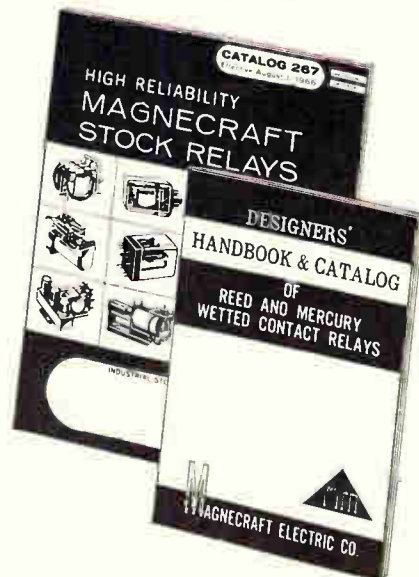

MAGNECRAFT Electric Co.

5575 North Lynch, Chicago, Ill. 60630
Phone 312-282-5500

A logical next step for read-only memories

One of the radical changes in computer concepts made possible by large-scale integration is the use of the memories to generate Boolean logic; with feedback, they can handle sequential operations

By John L. Nichols

Fairchild Semiconductor Division, Fairchild Camera & Instrument Corp., Mountain View, Calif.

Large-scale integration—the fabrication of hundreds or thousands of components in a single-chip silicon circuit—extends the applications of the read-only memory by making the cost of active devices inconsequential. One such extension—a major one—is the use of the memory as a Boolean logic generator.

In its conventional role in a computer, the read-only memory stores subroutines that calculate roots, powers, and logarithms, for example. These are faster than subroutines in core storage, and cheaper than wired-in routines. The memories can also convert codes—Teletype to Flexowriter, for instance. The incoming code word is the memory address, and the address produces the corresponding output code word.

In experiments with read-only memories in their new role, each bit stored corresponds to the product of several logic variables—what logic designers call a minterm. The 1's in the memory indicate the presence of a minterm, and 0's its absence. Thus, the address 1010 would be interpreted as a minterm $AB'CD'$, and in the word stored in location 1010, the 1's correspond to functions containing that minterm and the 0's to functions that don't.

The author



John L. Nichols is in the systems engineering section of Fairchild Semiconductor, where he works on the application of digital integrated circuits. Before coming to Fairchild two years ago, he was with the Western Development Laboratories of the Philco-Ford Corp.

Output is the same as it is in the memory's conventional applications except that here it's used as a logic expression rather than as a sequence control or instruction. Furthermore, by connecting the outputs back to the address inputs, the memory can be made into a sequential logic device—one whose output at any moment depends upon its past history as well as its immediate inputs.

This approach can result in improved performance and easier fabrication. Fast memories can manipulate logic at greater speeds than can conventional logic circuits. And the read-only memory is made with a much simpler mask layout than the one used to produce the flip-flops and gates of present logic configurations. Also, the memory can be tested before establishment of the internal connections that define the sequence of operations.

Sum of minterms

Any logic function can be represented in Boolean algebra as a sum of minterms. For example:

$$R = J'K'L'M + J'K'LM' + J'KL'M + JK'L'M' + JK'LM + JKL'M' + JKL'M + JKLM' + JKLM$$

Standard techniques of Boolean algebra can reduce this redundant expression to the minimized form:

$$R = JK + K'L + J'L'M.$$

Classic logic design demands this reduction to minimize the number of relay points or transistors. With the advent of large-scale integration, however, logic designers often find it convenient to work directly with a sum of minterms.

Suppose the function R is stored in a read-only memory that contains 16 words and that therefore

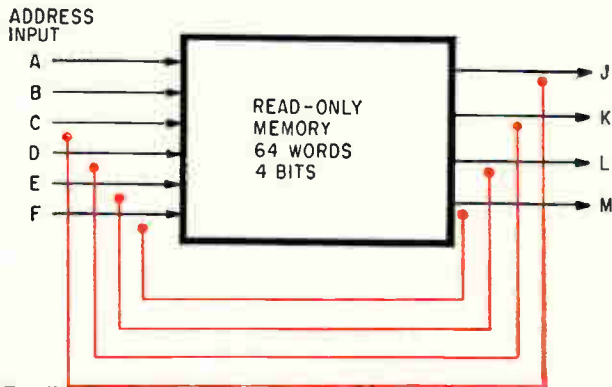

Feedback connections from output to input (color) enable read-only memory to perform sequential logic operations.

requires four-bit addresses. An address corresponding to one of the 10 minterms in R will generate a 1 on the output line corresponding to R. Other output lines corresponding to other functions containing the same minterm will also show a 1; lines for functions of other minterms will carry a 0.

In addition, read-only memories with the proper electrical characteristics can provide complex sequential circuits by the routing of some of the output lines back to the address inputs, as shown above. A sequential circuit can be created in a conventional logic design by connecting several combinational circuits—circuits whose outputs depend only on their inputs—and introducing feedback. The electrical characteristics needed to make a sequential circuit out of a read-only memory include an output signal of sufficient amplitude and free of glitches—transients of short duration that can affect other logic circuits.

The operation of such a sequential circuit depends on the relation between the number of bits in the words of the memory and the number of bits in the address, which in general equals the logarithm, base 2, of the number of words in the memory. If the word length is less than the address length, the additional address bits can provide the conditions for the operation of the sequential circuits. If the word length is greater than the address length, the output bits that aren't fed back to the input can provide additional outputs related to the various states of the sequential circuits.

Two-way counter

An example of a sequential circuit that can be based on a read-only memory is a dead-ending two-way counter. Such a device counts either up or down, depending on which of two inputs is pulsed, and counts only to a specific value in either direction, even if the corresponding input continues to pulse.

In the first step in designing the counter, the memory outputs are considered as arbitrary logic expressions that don't feed back to the inputs. Feedback is necessary in any sequential circuit, but it will be considered in the second design step.

In a read-only memory containing 64 words of four bits each, the address must contain at least $\log_2 64 = 6$ bits. In the diagram above left, the address bits are labeled A,B,C,D,E,F; the output bits are J,K,L,M. When all the address bits are 0, all the output bits are also 0; this combination is one of the 64 stored words. If address bit A becomes 1, the output from the word corresponding to address 10000 might be 0010. Likewise, for

JKLM	AB			
	00	01	10	11
0000	0000	0001	0010	0000
0001	0000	0001	0001	0000
0011	0011	0001	0111	0000
0010	0011	0010	0010	0000
0110	0110	0010	0100	0000
0111	0110	0111	0111	0000
0101	0101	0111	1101	0000
0100	0101	0100	0100	0000
1100	1100	0100	1110	0000
1101	1100	1101	1101	0000
1111	1111	1101	1011	0000
1110	1111	1110	1110	0000
1010	1010	1110	1000	0000
1011	1011	1011	1011	0000
1001	1001	1011	1001	0000
1000	1001	1000	1000	0000

Flow chart shows contents of read-only memory connected to operate as a two-way dead-ending counter. The colored arrows show some of the steps in the counting sequence.

JKLM	AB			
	00	01	10	11
0000	0000	0000	0010	0001
0001	0000	0001	0001	0011
0011	0011	0001	0111	0010
0010	0011	0010	0010	0110
0110	0110	0010	0100	0111
0111	0110	0111	0111	0101
0101	0101	0111	1101	0100
0100	0101	0100	0100	1100
1100	1100	0100	1110	1101
1101	1100	1101	1101	1111
1111	1111	1101	1011	1110
1110	1111	1110	1110	1010
1010	1010	1110	1000	1011
1011	1010	1011	1011	1001
1001	1001	1011	1001	1000
1000	1001	1000	1000	0000

Free-running counter results when words in last column of the memory are chosen so that every location addresses the adjacent location.

Bit A	0	1	0	1	0	1	0	1	0	1	0	1	0	1	0	1	0	...
Output	0000	0010	0011	0111	0110	0100	0101	1101	1100	1110	1111	1011	1010	1000	1001	1001	1001	...

the address 011001, the output might be 1001.

Thus, an address can generate a binary number that can be interpreted as an expression in Boolean algebra. The output can also be interpreted as a signal for routing data through a computer, or as an instruction in a subroutine.

Feedback connection

The dead-ending two-way counter is completed when feedback is provided by connecting the output lines to some of the input lines. For this example, output line J is connected to address input C, and K is connected to D, L to E, and M to F, as shown in color in the diagram. Address lines A and B are controlled externally, as before. As long as both A and B are 0's, the output of the memory is 0, and the remaining four address bits are therefore also 0. But, as before, if address bit A is made 1, the output becomes 0010, and feedback suddenly changes the address from 100000 to 100010. If the word in this location is also 0010, the output will remain stable.

If A and B are both 0 and the remaining address inputs are 1100, the memory location selected contains 1100. This output is fed back to the address inputs and maintains the selection of its own location. Now if B becomes 1, another location, containing 0100, is selected. The address becomes 010100 and selects a third location, which also contains 0100. The output feeds back to the input and maintains the selection of its own location. The locations that maintain themselves through the feedback to the address inputs are referred to as stable, the others as unstable.

The sequence of states taken by the memory depends on the way the outputs feed back to the inputs, and on the data stored in the memory. The table at far left is an example of what logic designers call a flow chart. It shows what the contents would be of all 64 words of the memory, which is connected in this example to create a dead-ending two-way counter. If the initial address is 000000, of which the last four bits are fed back from the output, and if address bit A is alternately set to 1 and to 0, the output states will advance, or count, through seven states until 1001 is reached. Further alternation of address bit A will cause no further changes. But if address bit B is alternated, the output states will count back to 0000 and then stop.

The table uses the standard logic-design convention of circled entries representing stable states of the sequential circuits. Whenever an address applied to the input causes the circuit to enter an unstable state, the feedback lines change the address to cause the circuit to go to another stable state, where it awaits a new input change.

In the design shown in the table, all address

bits are initially 0 and all output bits are 0. As described earlier, the output becomes 0010 if address bit A becomes 1; this forces the address to 100010, for which the output is 0010—a stable state. When A returns to 0, the address becomes 000010, for which the output is 0011; this forces the address to 000011, another stable state. As A continues to alternate between 0 and 1, the sequential circuit continues to step through stable states. The colored arrows at the top of the flow chart indicate the pattern followed. In the second row from the bottom, alternating input A causes the circuit to oscillate between the same pair of stable states; it dead-ends. The complete sequence of stable states is shown in the diagram above.

Likewise, as address bit B alternates, the sequential circuit steps through stable states that culminate in output 0000. Colored arrows at the bottom of the flow chart indicate the beginning of this sequence; in the first row they show how the sequence dead-ends. If the alternation of a single address bit stops during the progression and the other bit begins to alternate, the progression is reversed. If both A and B become 1 at the same time, the outputs go to 0000 and the sequence jumps back to the starting point, regardless of the circuit's prior state and regardless of which of the two bits returns to 0 first.

Variations

A slight change in the contents of the read-only memory can turn the circuit into a two-way modulo-8 counter. If the word in location 101001 were 0001 instead of the 1001 shown in the flow-chart, and the word in location 010000 were 1000 instead of 0000, both locations would be unstable. The circuit would retain its two-way operation but wouldn't dead-end. It would have eight stable states when both inputs were 0, and it would cycle indefinitely through all eight states. The rotation would go in one direction as one address bit was alternated, and in reverse order with the other bit.

A free-running counter is represented by the flow chart at right on the opposite page, which differs from the first flow-chart only in the last column. The chart represents a read-only memory with the same feedback connections as before, but with different data in the 16 words addressed 110000 through 111111. When both externally controlled address inputs are 1, the memory counts forward continuously at a speed determined by the circuit delays within the memory. It keeps going until one or both bits return to 0, at which point it stops at the nearest stable state.

Reference

1. Lee Boysel, "Memory on a chip: a step toward large-scale integration," *Electronics*, Feb. 6, 1967, p. 92.

After you've placed an important order for silicon power transistors, can you sit back and relax, confident that everything will proceed smoothly and on schedule?

Or is that when you have to haul out a big whip and start cracking it to keep your semiconductor supplier in line?

If you're like many others in our industry today, you've probably been wondering about what ever happened to the idea of a "buyer's market," where the supplier bends over backwards to satisfy your requirements. Instead, you've had to become a whip-wielder to defend yourself against broken delivery promises, unexplained delays, costly paperwork, phone calls, telegrams and constant expediting—not to mention spiraling prices and problems of technical service and quality control.

Well, get ready to put away that whip, because there is an easier way!

Our Semiconductor Division is now in production on a selection of the most popular types of silicon power transistors, with power ratings from 5 watts to 85 watts. We'll be adding other types soon, but here's the starting line-up:

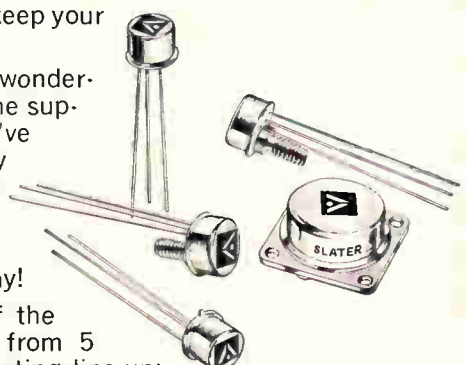

TYPE	POWER	PACKAGE	TYPE	POWER	PACKAGE	TYPE	POWER	PACKAGE	TYPE	POWER	PACKAGE
2N389	85 w	TO-53	2N1048	40 w	TO-57	2N1050A	40 w	TO-57	2N1769	40 w	TO-57
2N389A	85 w	TO-53	2N1048A	40 w	TO-57	2N1050B	40 w	TO-57	2N2032	85 w	TO-53
2N424	85 w	TO-53	2N1048B	40 w	TO-57	2N1116	5 w	TO-5	2N2033	8.75 w	TO-5
2N424A	85 w	TO-53	2N1049	40 w	TO-57	2N1117	5 w	TO-5	2N2034	8.75 w	TO-5
2N1047	40 w	TO-57	2N1049A	40 w	TO-57	2N1690	40 w	TO-57	2N2858	8.75 w	TO-5
2N1047A	40 w	TO-57	2N1049B	40 w	TO-57	2N1691	40 w	TO-57	2N2859	8.75 w	TO-5
2N1047B	40 w	TO-57	2N1050	40 w	TO-57	2N1768	40 w	TO-57	2N2911	8.75 w	TO-5

The next time you need any of these types, in any quantity, try the easy way—the Slater way. Delivery? Immediate, thanks to unique production break-throughs that give us the highest quality yield rates ever attained. Prices? Very, very competitive—which is a polite way of saying that we really mean business. Service? The kind you deserve, but haven't had in many years. As a starter, we invite you to lay down your whip and call us collect today for quotes, tech data or anything else that will help make your job easier.

SEMICONDUCTOR DIVISION, SLATER ELECTRIC INC., 45 SEA CLIFF AVE., GLEN COVE, N.Y., 516-671-7000



**There must be
an easier way to buy
silicon power transistors.**



A maser that works in radar by avoiding saturation

Frequency-shifting technique that uses an auxiliary coil to produce a magnetic field makes maser transmitter more attractive for applications in high-power radar

By Simpson B. Adler

Missile and Surface Radar Division, Radio Corp. of America, Moorestown, N.J.

Although masers—low-noise microwave amplifiers—could extend the range capabilities of high-power radars, they aren't used frequently. The reason: high-energy radar pulses leaking into the receiver can either damage the maser or cause it to saturate, blocking the reception of return pulses. Once saturated, the receiver can be ineffective for some 2 to 6 milliseconds, blocking the detection of targets up to 400 miles away.

Shifting the maser's frequency response while the radar pulse is transmitted overcomes the saturation problem and makes the maser considerably more attractive for applications in high-power radars. Interest in the amplifier, which operates on quantum-mechanical principles, is also increasing because of improved maser crystals and circuits. In addition, newly available superconducting magnets in small sizes can produce the large magnetic fields needed for maser operation, while reliable closed-cycle liquid helium cryogenic systems are available for the necessary cooling.

Magnetic pulsing

In the frequency-shifting technique, an auxiliary coil is pulsed to produce a magnetic field that adds to or subtracts from the maser's main d-c magnetic

field, causing a shift in the maser's frequency response. Input signals at the transmitter frequency can't couple to the maser during this period, thus a high degree of isolation is achieved, reducing the possibility of saturation. After the transmitted pulse ends, the auxiliary coil is deenergized and the maser can receive return pulses. The technique allows signals to be detected at ranges as close as from 3 to 5 miles.

In effect, the maser acts as an attenuator as in the oscilloscope pattern in the photo at the top of page 119. It is possible to get about 70 decibels of isolation in this manner. If, in addition, a low insertion loss isolator is included in the system, it is possible to attain 130-db isolation, enabling the maser to operate despite the presence of pulses with megawatt peak powers. A 60-db isolator having an insertion loss of about 0.5 db would degrade the system's noise temperature by only 35° Kelvin. Practically, a radar employing a maser and the frequency-shifting technique could be designed to have a system noise temperature of less than 100°K, rather than the 1,500 K that presently exists in mixer type receivers or the 900°K that exists with parametric amplifiers.

In monopulse radars, requiring three receivers, three traveling-wave masers can be packaged in one unit to achieve the desired frequency and phase stability, and maintain equal gains among the various receivers.¹ If the main d-c field is uniform, tuning can be accomplished with the main magnet. If not, separate trimmer coils may be needed to adjust the field for each channel.

The frequency-shifting technique also has possible applications in electronic countermeasure systems. When the maser's response is shifted, the

The author



Simpson B. Adler, a physicist at RCA, has been involved in radar and ballistic missile programs, and studies of electromagnetic scattering. Holder of a doctorate degree from Temple University, he headed development of the AN/FPS-16 precision monopulse radar.

A short course in maser operation

The maser referred to in the accompanying article is a solid state amplifier that finds wide use in satellite communications and radio astronomy. The reasons for interest in masers is their extremely low-noise operation. System-noise temperature — a measure of the noise power produced by amplifiers and transmission lines—can be less than 50° K compared to a few hundred degrees or thousands of degrees in systems employing conventional amplifiers as microwave frequencies.

In a solid state maser, radio frequency signals interact with a crystalline material that can absorb and release microwave energy. Energy pumped into the atomic structure of the crystal by a very high frequency source is released in such a way as to amplify a desired microwave signal that has a frequency lower than the pump source.

The crystal must be subjected to a high d-c magnetic field to produce paramagnetic energy levels—the so-called Zeeman levels. Maser operation depends on the transition of electrons (spins) between those energy levels. Energy is absorbed from the

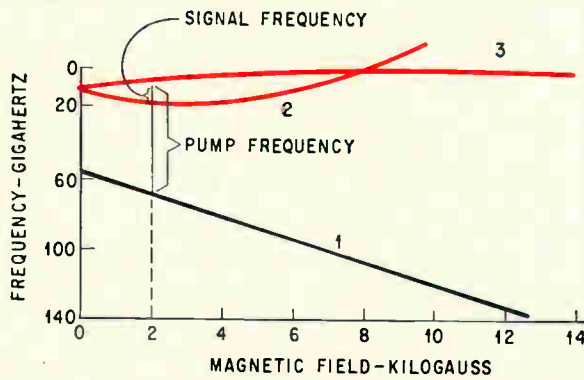

Energy levels, which determine maser's frequency of operation, vary with applied magnetic field. Amplification occurs when electrons in energy level 3 drop back to energy level 2 (curves in color).

signals can be received at the new center frequency, as in the lower scope trace on page 119. By controlling the magnitude of the auxiliary pulse, the frequency can be electronically shifted to receive signals in a frequency-jumping radar.

Saturation and recovery

Masers saturate because high energy pulses tend to equalize the difference in the number of electrons in the various energy levels needed to produce gains. In the maser discussed here, the population difference $n_3 - n_2$ between energy levels 2 and 3 approaches 0 [see "A short course in maser operation," above].

Saturation and recovery may be analyzed by first considering the rate-of-change of populations, given by²

$$\frac{d(n_1)}{dt} = - \left(\frac{\Delta n_{12} - \Delta N_{12}}{2 T_{12}} \right) - \left(\frac{\Delta n_{13} - \Delta N_{13}}{2 T_{13}} \right) + (1) - (W_P \Delta n_{13})$$

pump source when electrons are stimulated, or made to jump, from a low energy level to a higher level. In order for sufficient energy to be absorbed, the maser must operate at liquid helium temperatures. The energy for amplification is released when the stimulated electrons drop back to a lower level. This process accounts for the acronym maser, standing for microwave amplification by stimulated emission of radiation.

Three energy levels for iron-doped rutile crystal, TiO₂, are in the diagram at the left. The difference between the energy levels determines the frequencies of operation. For example, at a specified magnetic field, the frequency of the emitted energy caused by electrons dropping from level 3 to level 2 is given by

$$f_{32} = \frac{E_3 - E_2}{h} \quad (1)$$

where f_{32} = frequency of the energy

E_3 = the energy of level 3 at the specified magnetic field

E_2 = the energy of level 2 at the specified magnetic field

h = Planck's constant

The magnetic field is chosen so that f_{32} is the frequency at which amplification is desired. The pump source, which supplies energy to the crystal, would be at a higher frequency f_{13} , given by

$$f_{13} = \frac{E_3 - E_1}{h} \quad (2)$$

Without a pump source and with the crystal at thermal equilibrium, the number of electrons—the population—in each level decreases as the energy goes up. For example, the ratio of the population at level 3 to the population at level 2 is

$$\frac{N_3}{N_2} = e^{-(E_3 - E_2)/(kT)} = e^{-hf_{32}/kT} \quad (3)$$

$$\frac{d(n_2)}{dt} = - \left(\frac{\Delta n_{21} - \Delta N_{21}}{2 T_{12}} \right) - \left(\frac{\Delta n_{23} - \Delta N_{23}}{2 T_{23}} \right) + (2) - (W_S \Delta n_{23})$$

$$\frac{d(n_3)}{dt} = - \left(\frac{\Delta n_{31} - \Delta N_{31}}{2 T_{13}} \right) - \left(\frac{\Delta n_{32} - \Delta N_{32}}{2 T_{23}} \right) + (3) - W_P(\Delta n_{31}) - W_S \Delta n_{32}$$

where

$$\Delta n_{ij} = n_i - n_j$$

n_i = instantaneous population of level i

$$\Delta N_{ij} = N_i - N_j$$

N_i = population of level i at equilibrium

T_{ij} = spin-lattice relaxation time between levels i and j —the time in which the normal relaxation process in the atom will destroy population inversion between two levels

W_P = stimulated transition probability due to pump power

W_S = stimulated transition probability due to signal power.

Although the Δn_{ij} are interrelated by the rate

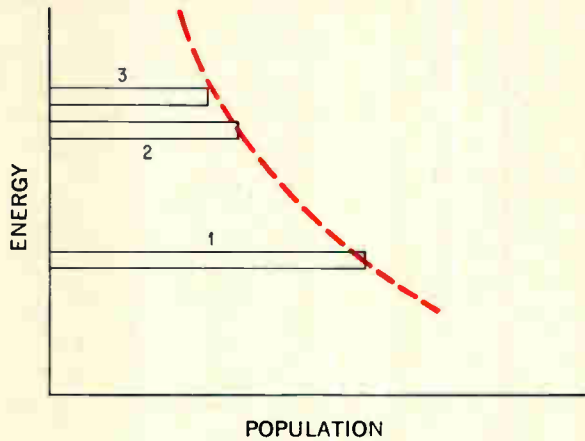

Maser's population—the number of electrons in each energy level—has an exponential distribution (in color) when the crystal is at equilibrium.

where N_3 = the population (number of atoms) in level 3 during equilibrium
 N_2 = the population in level 2
 k = Boltzmann's constant
 T = temperature in degrees K.

The relative size of the populations are indicated by the graph directly above. Equation 3 also indicates the reason for cooling the maser. If f_{32} is in the microwave region and T is at room temperature, the ratio N_3/N_2 is almost unity, indicating small population difference. This is indicative of low gain. At a lower temperature, the population difference will increase and provide the basis for higher gain in the maser.

When the pump source is applied, it excites the atoms reducing the population in level 1 and increases the population in level 3. This process results in higher population in level 3 than in level 2, as in the bar graph above at the right. In this condition the populations are said to be inverted.

The power absorbed by the crystal is

$$P_p = h f_{13} (W_{13} n_1 - W_{31} n_3) \quad (4)$$

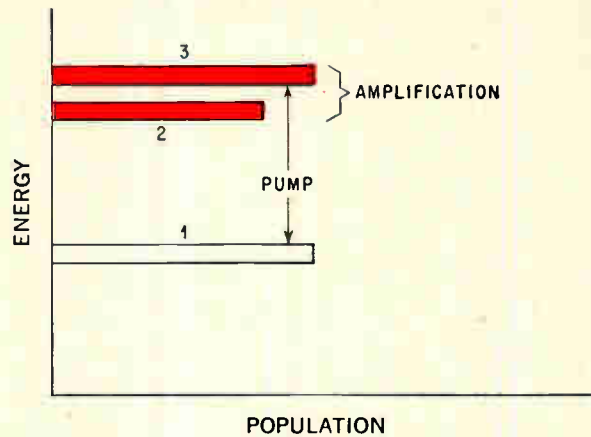

Population inversion occurs after crystal is pumped by an external source. Thus the input signal can be amplified by the difference in levels 2 and 3.

where

- n_1 = the instantaneous population of energy level 1
- n_3 = the instantaneous population of energy level 3
- W_{13} = the stimulated transition probability—the probability per unit time of stimulating electrons from level 1 to level 3
- W_{31} = the stimulated transition probability for electrons to jump from level 3 to level 1

Usually $W_{13} = W_{31} = W_p$ where W_p is the stimulated transition probability proportional to the pump power. As a result, equation 4 becomes

$$P_p = h f_{13} W_p (n_1 - n_3) \quad (5)$$

Similarly the power P_s available for signal amplification is

$$P_s = h f_{32} W_s (n_3 - n_2) \quad (6)$$

where n_2 is the instantaneous population of energy level 2 and W_s is the stimulated transition probability for the signal.

equations, it is possible to merely subtract equation 3 from equation 2 and solve for Δn_{32} . The reason is that the terms Δn_{31} and Δn_{21} remain fairly constant compared to Δn_{32} . Thus

$$\Delta n_{32} = \left(\frac{Z}{2W_s + \frac{1}{T_{23}}} \right) + \left\{ (\Delta n_{32})_0 - \frac{Z}{\left(2W_s + \frac{1}{T_{23}} \right)} \right\} e^{-\left(2W_s + \frac{1}{T_{23}} \right) t} \quad (4)$$

where

$$Z = -W_p \Delta N_{31} + \frac{\Delta N_{32}}{T_{23}} - \frac{\Delta n_{31} - \Delta N_{31}}{2T_{13}} + \frac{\Delta n_{21} - \Delta N_{21}}{2T_{12}}$$

$(\Delta n_{32})_0$ = the initial condition at $t = 0$.

The power gain of the maser is proportional to Δn_{32} . Because W_s in equation 4 is proportional to

power, any large increase in signal power—a pulse leaking into the receiver—will cause an exponential decrease in Δn_{32} , reducing the maser's gain.

Saturation

The saturation time constant τ_s in the exponential of equation 4 is

$$\tau_s = \frac{1}{\left(2W_s + \frac{1}{T_{23}} \right)} \quad (5)$$

The larger W_s , the shorter the time constant, and the faster the system saturates.

For high-level input signals, $W_s \gg 1/T_{23}$, the maser saturates at a rate governed by the stimulated transition probability W_s . For a given peak power, the wider the pulse the greater the saturation.

At small input levels, $W_s \ll 1/T_{23}$, the response is determined by the spin-lattice relaxation time, usually greater than a few milliseconds. At typical radar pulse widths in the order of a few microseconds, the maser's response to a low-level

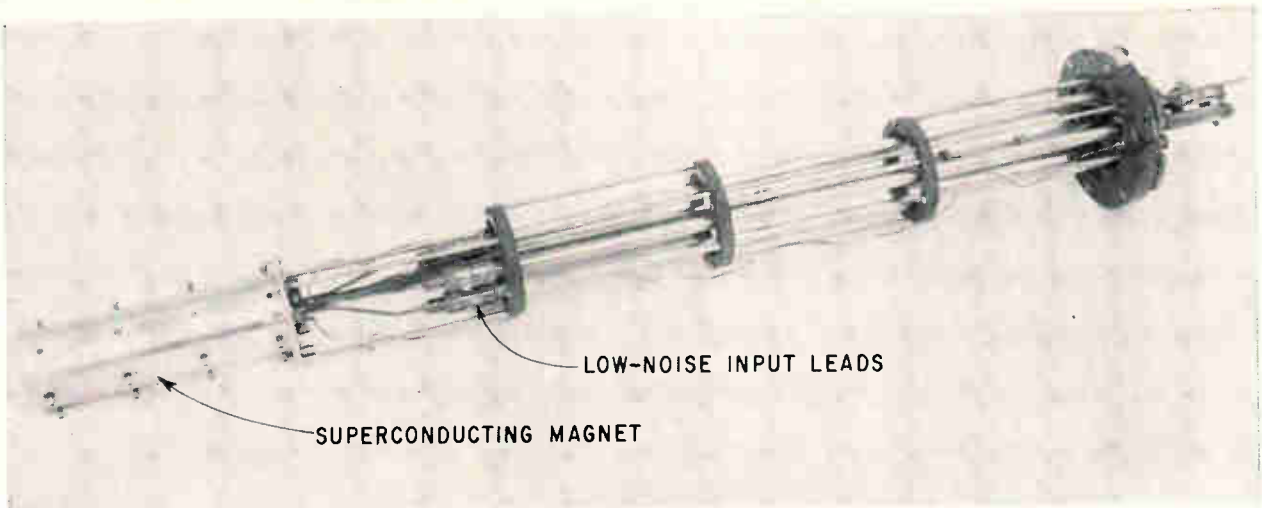

Amplifier operating at 5,528 Mhz was used in tests that verified frequency shifting by magnetic pulsing. Crystal is placed within the superconducting magnet, thus establishing proper magnetic field for gain at microwave frequencies.

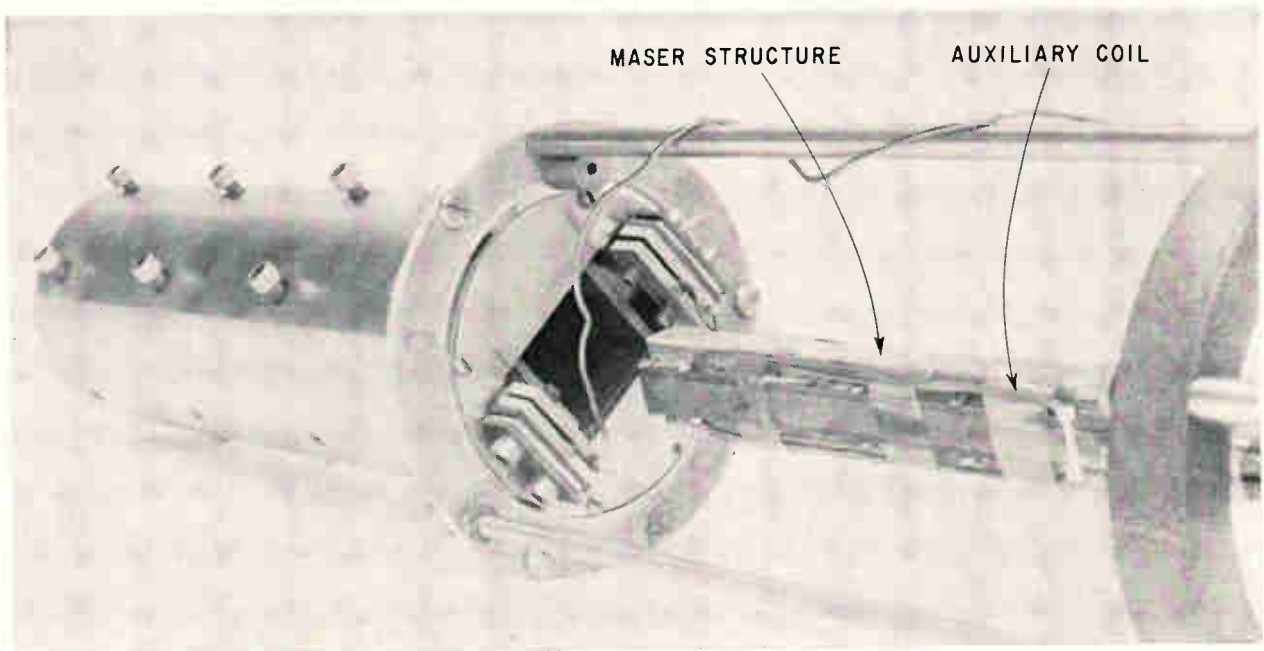

Auxiliary coil that shifts frequency is wound around maser structure so coil's field will add or subtract from the field produced by superconducting magnet. Two parallel coils form auxiliary coil.

pulse is essentially constant over the duration of the pulse.

Recovery

To determine how the maser recovers from a pulse, the value of W_s is set equal to 0. Thus

$$\Delta n_{32R} = T_{23} Z + \{(\Delta n_{32})'_0 - T_{23} Z\} e^{-t/T_{23}} \quad (6)$$

where Δn_{32R} = population difference during recovery and $(\Delta n_{32})'_0$ is difference $n_3 - n_2$ at the instant the pulse is removed.

Since $(\Delta n_{32})'_0$ is always smaller than $T_{23}Z$ the equation is written

$$\Delta n_{32R} = T_{23} Z - \{T_{23} Z - (\Delta n_{32})'_0\} e^{-t/T_{23}}$$

After the pulse is removed, the population difference increases exponentially to a finite positive value. The recovery time constant, τ_R , is equal to

the spin relaxation time, T_{23} , generally a few milliseconds.

A maser's saturation and recovery is indicated by the curves in the graph at the bottom of the next page. When the pulse is present, the population difference drops exponentially with the time constant, τ_s . After the pulse is removed, the gain increases with the time constant, τ_R , until it reaches the presaturation level.

Another way of showing the effects of saturation is a plot of peak output power as a function of peak input power for pulses of different widths. A graph plotting these effects for a maser with a 30-db gain at 5,600 megahertz is shown on page 120. The output power increases linearly until saturation starts. With the wider pulses, saturation begins at a lower input level. For radar pulses with widths up to

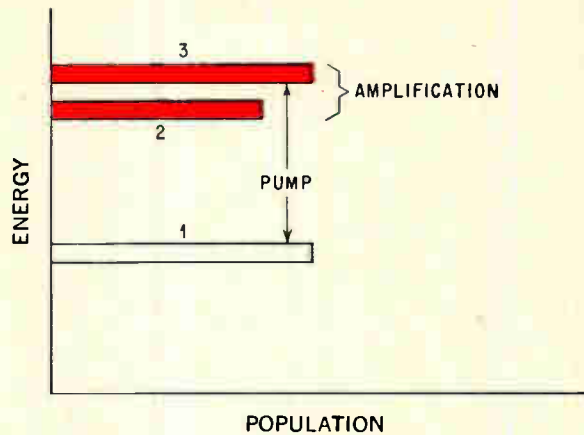
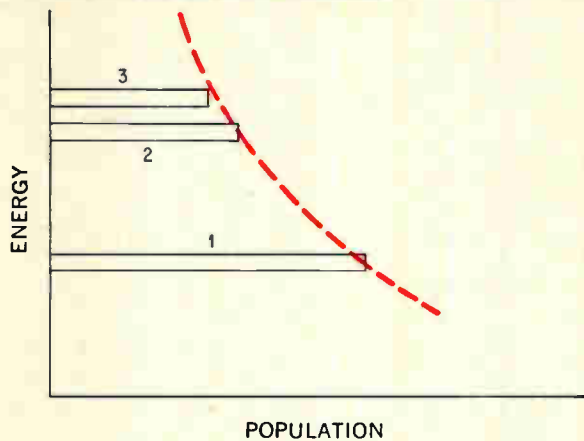

Maser's population—the number of electrons in each energy level—has an exponential distribution (in color) when the crystal is at equilibrium.

Population inversion occurs after crystal is pumped by an external source. Thus the input signal can be amplified by the difference in levels 2 and 3.

where N_3 = the population (number of atoms) in level 3 during equilibrium
 N_2 = the population in level 2
 k = Boltzmann's constant
 T = temperature in degrees K.

where

n_1 = the instantaneous population of energy level 1
 n_3 = the instantaneous population of energy level 3
 W_{13} = the stimulated transition probability—the probability per unit time of stimulating electrons from level 1 to level 3
 W_{31} = the stimulated transition probability for electrons to jump from level 3 to level 1

The relative size of the populations are indicated by the graph directly above. Equation 3 also indicates the reason for cooling the maser. If f_{32} is in the microwave region and T is at room temperature, the ratio N_3/N_2 is almost unity, indicating small population difference. This is indicative of low gain. At a lower temperature, the population difference will increase and provide the basis for higher gain in the maser.

Usually $W_{13} = W_{31} = W_P$ where W_P is the stimulated transition probability proportional to the pump power. As a result, equation 4 becomes

When the pump source is applied, it excites the atoms reducing the population in level 1 and increases the population in level 3. This process results in higher population in level 3 than in level 2, as in the bar graph above at the right. In this condition the populations are said to be inverted.

$$P_P = h f_{13} W_P (n_1 - n_3) \quad (5)$$

The power absorbed by the crystal is

Similarly the power P_s available for signal amplification is

$$P_s = h f_{32} W_s (n_3 - n_2) \quad (6)$$

$$P_p = h f_{13} (W_{13} n_1 - W_{31} n_3) \quad (4)$$

where n_2 is the instantaneous population of energy level 2 and W_s is the stimulated transition probability for the signal.

equations, it is possible to merely subtract equation 3 from equation 2 and solve for Δn_{32} . The reason is that the terms Δn_{31} and Δn_{21} remain fairly constant compared to Δn_{32} . Thus

$$\Delta n_{32} = \left(\frac{Z}{2W_s + \frac{1}{T_{23}}} \right) + \left\{ (\Delta n_{32})_0 - \frac{Z}{\left(2W_s + \frac{1}{T_{23}} \right)} \right\} e^{-\left(2W_s + \frac{1}{T_{23}} \right) t} \quad (4)$$

where

$$Z = -W_P \Delta N_{31} + \frac{\Delta N_{32}}{T_{23}} - \frac{\Delta n_{31} - \Delta N_{31}}{2T_{13}} + \frac{\Delta n_{21} - \Delta N_{21}}{2T_{12}}$$

$(\Delta n_{32})_0$ = the initial condition at $t = 0$.

The power gain of the maser is proportional to Δn_{32} . Because W_s in equation 4 is proportional to

power, any large increase in signal power—a pulse leaking into the receiver—will cause an exponential decrease in Δn_{32} , reducing the maser's gain.

Saturation

The saturation time constant τ_s in the exponential of equation 4 is

$$\tau_s = \frac{1}{\left(2W_s + \frac{1}{T_{23}} \right)} \quad (5)$$

The larger W_s , the shorter the time constant, and the faster the system saturates.

For high-level input signals, $W_s \gg 1/T_{23}$, the maser saturates at a rate governed by the stimulated transition probability W_s . For a given peak power, the wider the pulse the greater the saturation.

At small input levels, $W_s \ll 1/T_{23}$, the response is determined by the spin-lattice relaxation time, usually greater than a few milliseconds. At typical radar pulse widths in the order of a few microseconds, the maser's response to a low-level

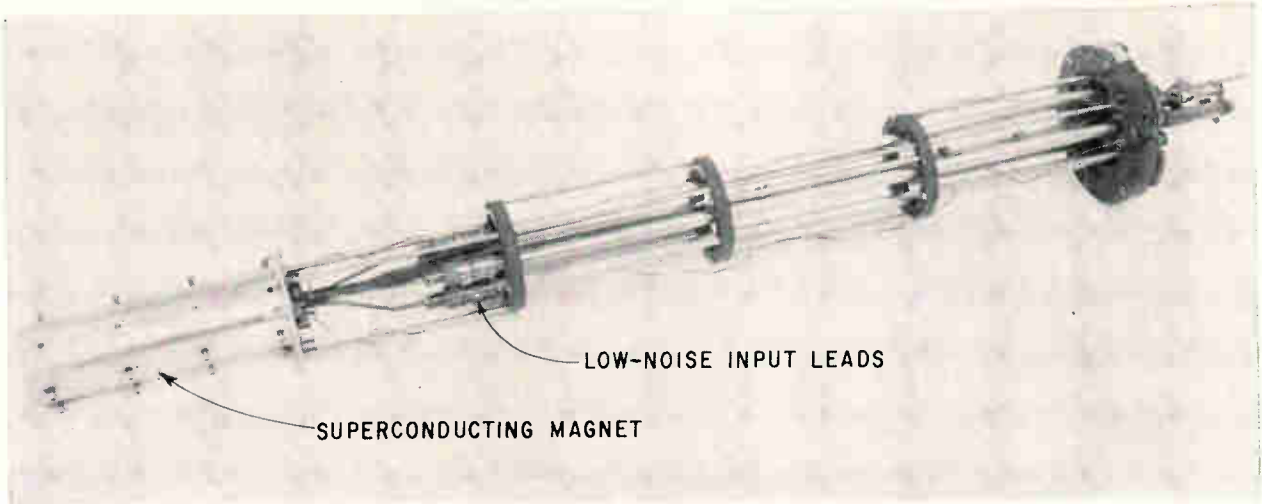

Amplifier operating at 5,528 Mhz was used in tests that verified frequency shifting by magnetic pulsing. Crystal is placed within the superconducting magnet, thus establishing proper magnetic field for gain at microwave frequencies.

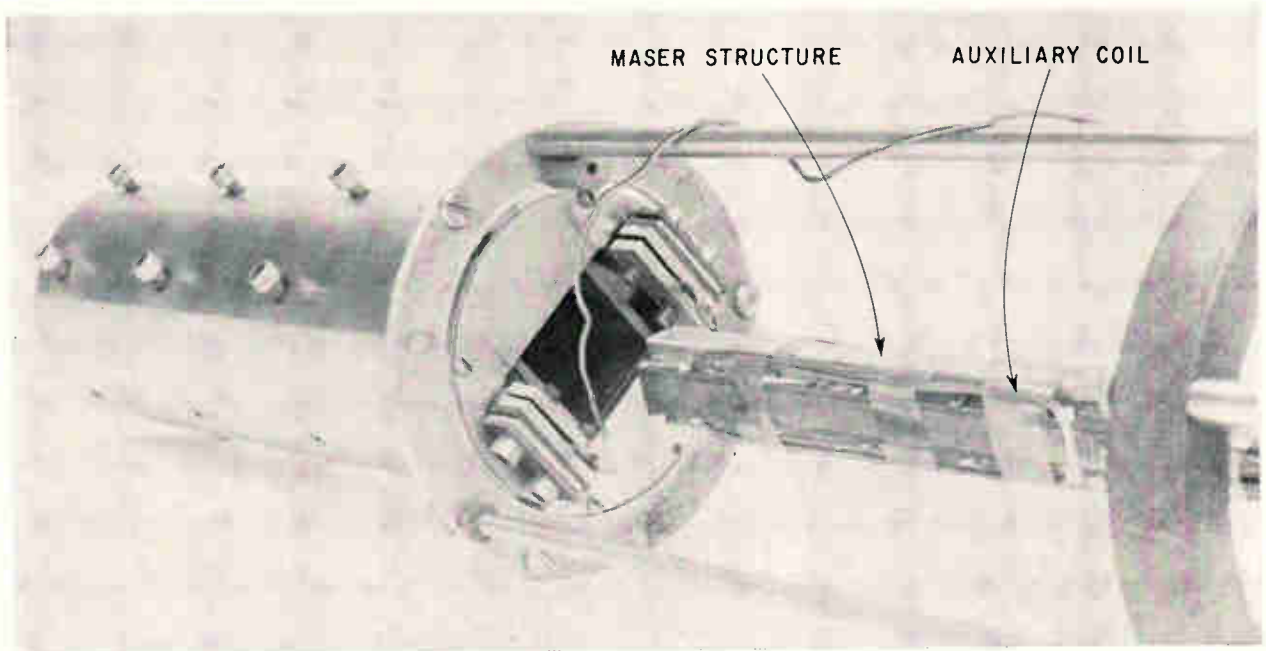

Auxiliary coil that shifts frequency is wound around maser structure so coil's field will add or subtract from the field produced by superconducting magnet. Two parallel coils form auxiliary coil.

pulse is essentially constant over the duration of the pulse.

Recovery

To determine how the maser recovers from a pulse, the value of W_s is set equal to 0. Thus

$$\Delta n_{32R} = T_{23} Z + \{(\Delta n_{32})'_0 - T_{23} Z\} e^{-t/T_{23}} \quad (6)$$

where Δn_{32R} = population difference during recovery and $(\Delta n_{32})'_0$ is difference $n_3 - n_2$ at the instant the pulse is removed.

Since $(\Delta n_{32})'_0$ is always smaller than $T_{23}Z$ the equation is written

$$\Delta n_{32R} = T_{23} Z - \{T_{23} Z - (\Delta n_{32})'_0\} e^{-t/T_{23}}$$

After the pulse is removed, the population difference increases exponentially to a finite positive value. The recovery time constant, τ_R , is equal to

the spin relaxation time, T_{23} , generally a few milliseconds.

A maser's saturation and recovery is indicated by the curves in the graph at the bottom of the next page. When the pulse is present, the population difference drops exponentially with the time constant, τ_s . After the pulse is removed, the gain increases with the time constant, τ_R , until it reaches the presaturation level.

Another way of showing the effects of saturation is a plot of peak output power as a function of peak input power for pulses of different widths. A graph plotting these effects for a maser with a 30-db gain at 5,600 megahertz is shown on page 120. The output power increases linearly until saturation starts. With the wider pulses, saturation begins at a lower input level. For radar pulses with widths up to

about 10 microseconds, the response is linear as long as the input level is less than -40 db referenced to a milliwatt.

Preventing saturation

To show that saturation could be prevented, laboratory tests were conducted with the traveling-wave maser in the top photo on the opposite page. The maser operates with a pump frequency of 60 gigahertz and amplifies signals at about 5.6 Ghz. A superconducting magnet used in the test produced a d-c magnetic field of about 2 kilogauss.

The iron-doped rutile crystal was placed along a meander line, a slow-wave circuit that increases the maser's gain per unit length and serves as the transmission line for the signal. The meander line-crystal unit was inserted within the superconducting magnet shown in the bottom photo on page 118.

Two parallel coils with about 10 turns produced frequency deviations of 25 Mhz in the maser's response. Since the maser's bandwidth, measured to the skirts of the frequency response curve, was 25 Mhz, the auxiliary coils were able to shift the maser almost completely out of the normal response band.

The shift occurs because the magnetic field produced by the auxiliary coil establishes a new set of energy levels within the crystal, affecting the maser's interaction with external signals. Under the shifted condition, the transmitter pulse can't interact with the crystal because the transmitter energy is decoupled from the crystal's electron spin system. When the auxiliary field is removed, the original energy levels are reestablished, allowing the maser to receive the radar pulses reflected from the target.

These effects can be demonstrated with an experimental apparatus. Two pulse generators—a transmitter pulse and a received signal pulse—are utilized. A transistor switch, actuated by a d-c pulse, allows current to pass through the auxiliary coils at the same time that a saturating transmitter pulse is applied to the maser. The saturating transmitter pulse is delayed so that it arrives at the maser when the auxiliary field is maximum. This results in maximum isolation between the maser and the transmit pulse.

When the auxiliary coil is pulsed, it detunes the maser. The magnetic field around the auxiliary magnet increases, thus shifting the maser's frequency response. This results in the maser's power output dropping about 40 db—the gain of this maser. Exponential curves in the photos above are due to the coil's time constant.

The exponential decay in the top photo can last 100 microseconds. However, in a radar the decay period would be at the end of the receiver's listening period, merely reducing the maximum range by about 8 nautical miles. The radar's pulse-repetition rate could be adjusted to compensate for this.

After the auxiliary coil is deenergized, the maser returns to its full gain in about 35 microseconds—a delay corresponding to a minimum radar range

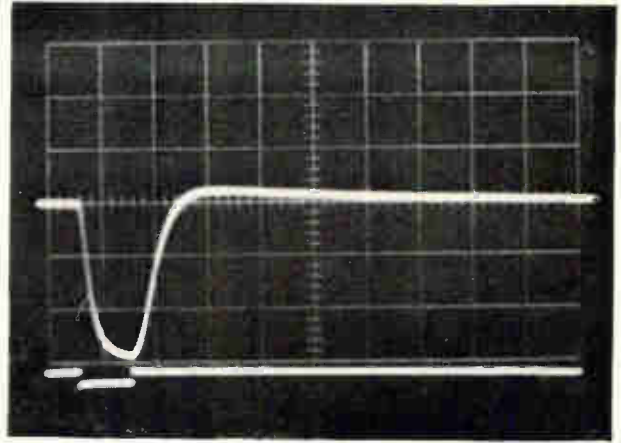

Output power (top trace) is affected by pulse (lower trace) applied to an auxiliary coil in the maser unit. At the operating frequency, 5,528 Mhz, the 100-microsecond-wide auxiliary pulse causes a drop in gain. This prevents transmitter pulse at same frequency from saturating maser.

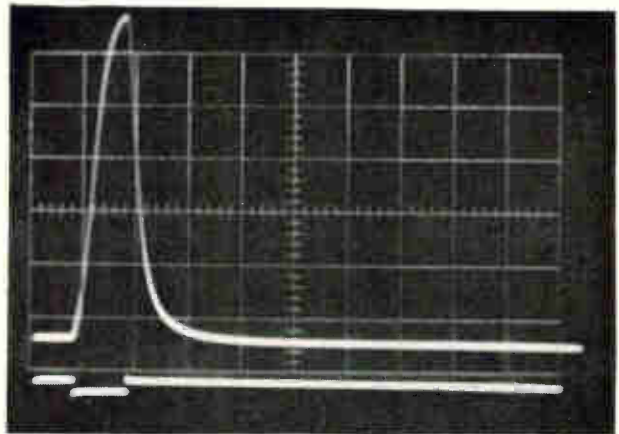

Gain can also increase in presence of auxiliary pulse. However, the input signal—5,528 Mhz—must be shifted to the new frequency of operation established by the new total magnetic field. The latter is produced by the auxiliary coil and superconducting magnet. Here, the input signal was at 5,505 Mhz to produce gain in presence of auxiliary pulse.

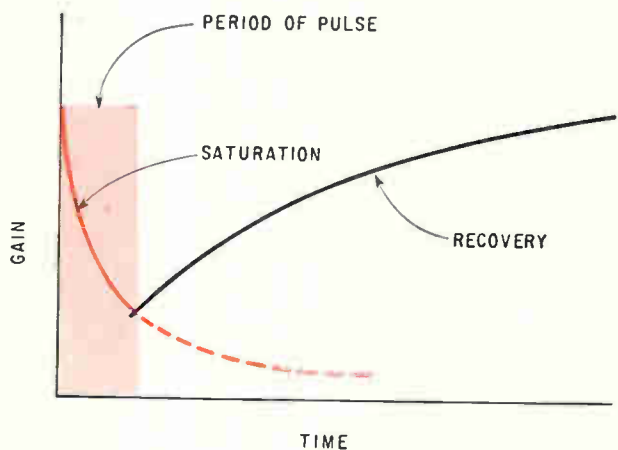

Exponential decrease in gain occurs when transmitted pulse (in color) saturates the maser. After the pulse is over, maser slowly recovers gain at rate determined by spin-lattice relaxation time. If maser is heavily saturated, recovery time lasts a few milliseconds.

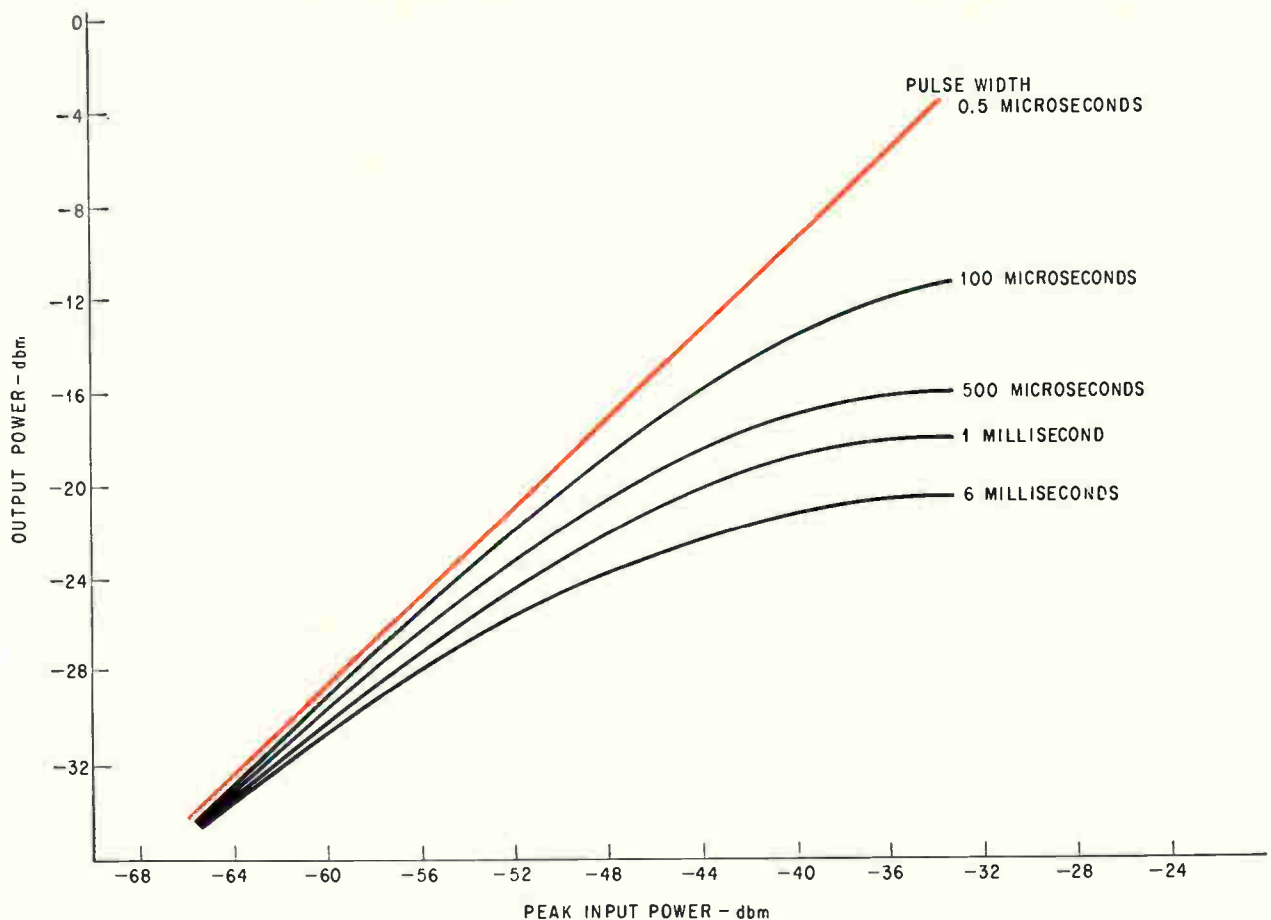

Higher input-power levels and longer pulse widths increase maser's tendency to saturate as shown by leveling off of the curves. For reference, most radar pulses are less than 10 microseconds in width. When pulse compression techniques are utilized at the receiver, transmitted pulses are as wide as 30 microseconds.

of about 3 nautical miles. Again, the delay is due to the coil's time constant and is independent of the maser's longer spin-lattice relaxation time.

Receiving at the shift

While this pulsing scheme protects the receiver from saturation, it also allows the maser to respond to signals at the new frequency to which the auxiliary coil has shifted operation. Thus, the maser can be electronically tuned to receive signals at different frequencies on a pulse-to-pulse basis—a useful technique for electronic countermeasure systems such as frequency-jumping radars.

Changing the pump frequency isn't necessary in this process. The function of the pump is to produce a population inversion in the maser spin system. Once the inversion has been accomplished, it will last for a few milliseconds corresponding to the maser's spin-lattice relaxation time. Therefore, if the magnetic field changes within microseconds, the inversion is still effective and the maser can amplify signals at the new frequency.

This operation is shown in the lower scope trace on page 119. The resonant frequency of the maser in the absence of auxiliary pulsing is 5,528 Mhz. If the maser's input frequency is decreased 23 Mhz while the auxiliary pulse is present the input signal

falls within the maser's new passband and the signal is amplified.

When the maser's frequency response is shifted, part of the incoming power is dissipated in the maser's cryogenic system and some stray power may affect low-level circuits. Isolation is therefore needed for protection.

As an example, consider a radar with a 1 megawatt peak power. Ordinarily, 130 db of external isolation would be required to hold the power input to the maser below -40 dbm, the maser's saturation level. When the frequency-shifting technique is employed, the maser can supply 70 db of the needed isolation.

The major limitation is the amount of heat that must be dissipated in the liquid helium cooling system. Excessive power dissipation would require a larger cooling system and additional weight. With 60-db external isolation, the dissipated power would be limited to 1 watt. The full 130-db isolation prevents burning out the maser.

References

1. S.B. Adler, "Performance of a Traveling Wave Maser for Monopulse Radars," 1966 Aerospace and Electronic Systems Convention Record, IEEE Publication 10 C 34.
2. A.E. Siegman, "Microwave Solid-State Masers," McGraw-Hill Book Co., 1964.

New *Linde* welding techniques solve most assembly problems.

Laser Welding: LINDE LWM-1—industry's first laser welder that makes precise reproducible welds on a production basis. Use it where the weld area may be smaller than a mil. The LWM-1 features low total heat input but high energy density. Since all this energy comes from the laser light beam, there is no physical contact with the work itself. All that is needed is a line of sight. The welder joins metals like copper, nickel, tantalum, stainless steel, molybdenum, titanium and others. It will join dissimilar metals of widely varying mass and thermal conductivity.



The LINDE LWM-1 is easy to use. The 25:1 ratio micro-manipulator makes precise positioning a simple operation. The binocular viewer in combination with a turret arrangement of three objective lenses gives a continuous view of the weld area at 20, 40 and 100 power of magnification. A shutter protects the operator at the moment the weld is made. LWM-1 adapts readily to automated welding and digital tape controls.



Cross weld between 0.005-in. diameter tungsten and 0.020-in. diameter nickel wires.

Plasma Needle Arc Welding: LINDE PWM-4—the practical, economical way to make high quality fusion welds on thin metals and miniature components. Plasma needle arc welding uses a constricted arc jet which extends more than 1/2 inch beyond the torch nozzle. The needle-like arc is extremely stable and easy to use: melting action remains constant despite great changes in arc length. Current values can be set so that burn-through is impossible. The angle of the torch and the long arc permit an unobstructed view while welding.

Plasma needle arc welding eliminates electrode contact and corrosive fluxes in the weld area; and these, combined with inert gas shielding and the highly stable arc, produce high quality welds without the limitations imposed by other commonly used processes.



LINDE PWM-4 plasma needle arc welder—a complete package, including power supply/control unit designed for bench mounting. Uses conventional power and water supplies. Foot switch provides on-off arc control; 10-ft. service line connects torch to control unit.



Repair welding of hermetically sealed relay case, using LINDE plasma needle arc torch.

For more information write Union Carbide Corporation, Linde Division, 270 Park Ave. New York, N. Y. 10017.

EIMAC

now has three new miniature planar triodes for airborne and space applications

EIMAC's new line of miniature planar triodes is specifically designed for use in advanced airborne and space applications. They are rugged and reliable, and feature larger contact areas for improved electrical paths. EIMAC 8755, 8756, and 8757 triodes are miniaturized versions of the well-known 8533, 7815, and 7698 tubes. You're assured of excellent tube-to-tube uniformity because of our more than 20 years experience with planar triode design and manufacture. Cooling is by forced air or heat sink. All tubes have arc-resistant cathodes, and provide good high-frequency efficiency through S-band. Write Power Grid Tube Marketing for more details, or contact your nearest EIMAC distributor.

TUBE TYPE Description	CHARACTERISTICS					
	8755 Miniature, high voltage pulse triode stable anode		8756 Miniature, high current, stable anode		8757 Miniature, high current, stable anode	
Anode dissipation (watts)	100		100		100	
Maximum Frequency (MHz)	3000		2500		2500	
Transconductance (micromhos)	30,000		25,000		30,000	
TYPICAL OPERATION	8755		8756		8757	
	grid pulsed	plate pulsed	CW	CW	grid pulsed	CW
Frequency (MHz)	1550	3000	500	2500	1100	500
Amplifier or Oscillator	AMP	OSC	AMP	OSC	AMP	AMP
Output Watts (minimum)	2000	2500	40	17	1500	65
						25

EIMAC
Division of Varian
San Carlos, California 94070



New *Linde* welding techniques solve most assembly problems.

Laser Welding: LINDE LWM-1—industry's first laser welder that makes precise reproducible welds on a production basis. Use it where the weld area may be smaller than a mil. The LWM-1 features low total heat input but high energy density. Since all this energy comes from the laser light beam, there is no physical contact with the work itself. All that is needed is a line of sight. The welder joins metals like copper, nickel, tantalum, stainless steel, molybdenum, titanium and others. It will join dissimilar metals of widely varying mass and thermal conductivity.

Plasma Needle Arc Welding: LINDE PWM-4—the practical, economical way to make high quality fusion welds on thin metals and miniature components. Plasma needle arc welding uses a constricted arc jet which extends more than 1/2 inch beyond the torch nozzle. The needle-like arc is extremely stable and easy to use: melting action remains constant despite great changes in arc length. Current values can be set so that burn-through is impossible. The angle of the torch and the long arc permit an unobstructed view while welding.

Plasma needle arc welding eliminates electrode contact and corrosive fluxes in the weld area; and these, combined with inert gas shielding and the highly stable arc, produce high quality welds without the limitations imposed by other commonly used processes.



The LINDE LWM-1 is easy to use. The 25:1 ratio micro-manipulator makes precise positioning a simple operation. The binocular viewer in combination with a turret arrangement of three objective lenses gives a continuous view of the weld area at 20, 40 and 100 power of magnification. A shutter protects the operator at the moment the weld is made. LWM-1 adapts readily to automated welding and digital tape controls.

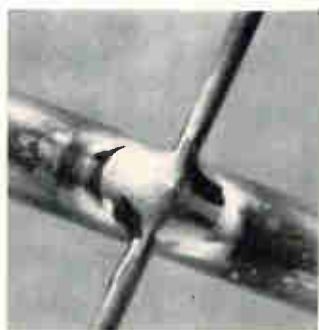

Cross weld between 0.005-in. diameter tungsten and 0.020-in. diameter nickel wires.



LINDE PWM-4 plasma needle arc welder—a complete package, including power supply/control unit designed for bench mounting. Uses conventional power and water supplies. Foot switch provides on-off arc control; 10-ft. service line connects torch to control unit.



Repair welding of hermetically sealed relay case, using LINDE plasma needle arc torch.

For more information write Union Carbide Corporation, Linde Division, 270 Park Ave., New York, N. Y. 10017.

LINDE is a registered trade mark of Union Carbide Corporation.



EIMAC

now has three new miniature planar triodes for airborne and space applications

EIMAC's new line of miniature planar triodes is specifically designed for use in advanced airborne and space applications. They are rugged and reliable, and feature larger contact areas for improved electrical paths. EIMAC 8755, 8756, and 8757 triodes are miniaturized versions of the well-known 8533, 7815, and 7698 tubes. You're assured of excellent tube-to-tube uniformity because of our more than 20 years experience with planar triode design and manufacture. Cooling is by forced air or heat sink. All tubes have arc-resistant cathodes, and provide good high-frequency efficiency through S-band. Write Power Grid Tube Marketing for more details, or contact your nearest EIMAC distributor.

TUBE TYPE Description	CHARACTERISTICS						
	8755 Miniature, high voltage pulse triode stable anode		8756 Miniature, high current, stable anode		8757 Miniature, high current, stable anode		
Anode dissipation (watts)	100		100		100		
Maximum Frequency (MHz)	3000		2500		2500		
Transconductance (micromhos)	30,000		25,000		30,000		
TYPICAL OPERATION	8755		8756			8757	
	grid pulsed	plate pulsed	CW	CW	grid pulsed	CW	CW
Frequency (MHz)	1550	3000	500	2500	1100	500	2500
Amplifier or Oscillator	AMP	OSC	AMP	OSC	AMP	AMP	OSC
Output Watts (minimum)	2000	2500	40	17	1500	65	25

EIMAC
Division of Varian
San Carlos, California 94070

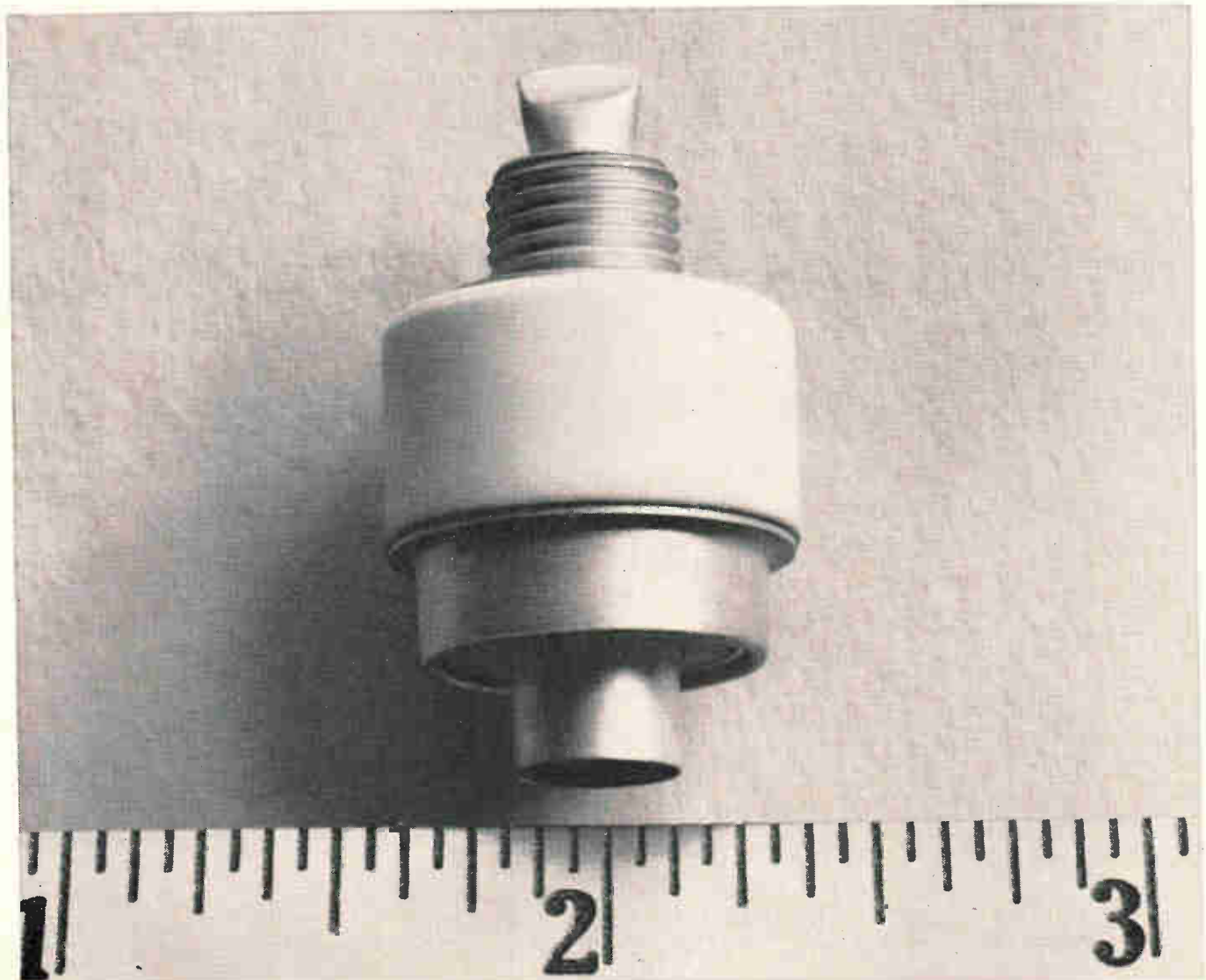

PROTECTS AGAINST • Bent Pointers • Burned-Out Resistors
 • Damaged Pivots • Overheated Springs • Burned-Out Meter
 • Changes in Accuracy Due to Overheating



Model 630-PLK

BURNOUT PROOF V-O-M

\$89.00
Suggested
U.S.A. User Net

USES UNLIMITED

School Classrooms • Field Engineers • Application Engineers
 • Electrical, Radio, TV, and Appliance Servicemen • Electrical
 Contractors • Factory Maintenance Men • Industrial Elec-
 tronic Maintenance Technicians • Home Owners, Hobbyists

FACTS MAKE FEATURES:

- 1** Comprehensive overload protection.
- 2** One selector switch minimizes chance of incorrect settings
- 3** Polarity reversing switch

Additional protection is provided by Model 630-PLK's new transistorized relay circuit. Transistorized overload sensing device does not load circuit under test, eliminating the possibility of damaging circuit components. A special meter shorting feature on "off" position offers high damping when moving tester. The exclusive patented Bar Ring Movement provides self-shielding and is not affected by stray magnetic fields. Wider spread scales, and unbreakable clear plastic window assure maximum readability. Diode network across meter protects against instantaneous transient voltage.

TRIPL'ET ELECTRICAL INSTRUMENT COMPANY, BLUFFTON, OHIO

RANGES

DC Volts:	0-2.5-10-50-250-1,000-5,000 at 20,000 ohms/volt. 0-0.25 at 100 microamperes.
AC Volts:	0-3-10-50-250-1,000-5,000 at 5,000 ohms/volt.
Decibels:	-20 to +11, +21, +35, +49, +61, +75; "0" DB at 1 MW on 600 ohm line.
DC Microamperes:	0-100 at 250 Mv.
DC Milliampers:	0-10-100-1,000 at 250 Mv.
DC Amperes:	0-10 at 250 Mv.
Ohms:	0-1,000-10,000 (4.4-44 at center scale).
Megohms:	0-1-100 (4,400-440,000 at center scale).

Output Volts (AC): 0-3-10-50-250-1,000 at 5,000 ohms/volt; jack with condenser in series with AC ranges.

CARRYING CASE

Model 639-OS black leather carrying case, built-in stand. Flaps open to permit use of tester in the case. Suggested U.S.A. User Net \$14.00



THE WORLD'S MOST COMPLETE LINE OF V O M'S AVAILABLE FROM YOUR TRIPL'ET DISTRIBUTOR'S STOCK

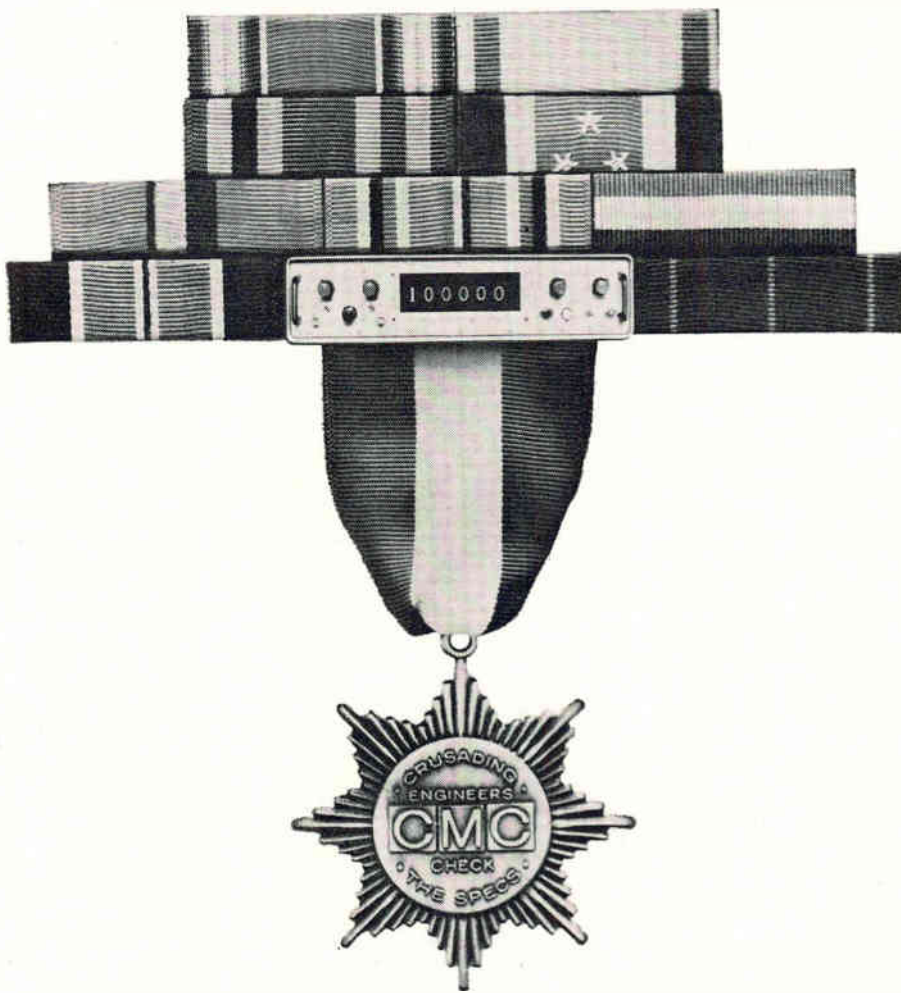

Unit Citation

We're honored! Not that we've won our crusade yet...just another battle ribbon. A while back we scored a military victory with our Model 880, the *first* solid state Mil Spec counter. This time it's a fully-militarized 5MHz all-silicon solid state universal counter-timer. Call it AN/USM-245, sir.

There's a good reason you should be interested. You see, the military model had its basic reliability well proved by our original commercial version, Model 607A. Now *there's* the one for you! It offers more features and capabilities than even the Admirals asked for. And it's available on-the-double.

Now hear this: Our lowest-bidder-type price is only \$1,575. (Check *that* saving against our competitor!) Then check these features: Model 607A is ideal for wide-range frequency measurements, frequency ratio determination, period and multiple period or time interval measurements, and pulse count totalizing. Time base is a 1 MHz crystal oscillator (for 1 microsec resolution). Display is six decade inline with display storage. BCD output transfers directly to CMC Model 410 tape printer, computer systems, etc. Automatically positioned illuminated decimal. Either ac or dc coupling of input signal. Front and rear A and B channel inputs. Rugged, compact (approx. 3½" high). Available for bench or rack.

THANKS

With all our pride and excitement over our AN/USM-245 award, and other new products, we haven't forgotten our fellow Crusaders who've made this success possible...YOU. A FREE Crusading Engineers medal is our fun-loving way of saying thanks. Get yours by writing for data so you can "Check the Specs" of our 607A. Your "chief" will be so proud of you at mail call!

12981 Bradley/San Fernando, California
Phone (213) 367-2161 / TWX 910-496-1487



Computer Measurements Company is a Leading Designer and Manufacturer of Electronic Instrumentation to Count, Measure, and Control.

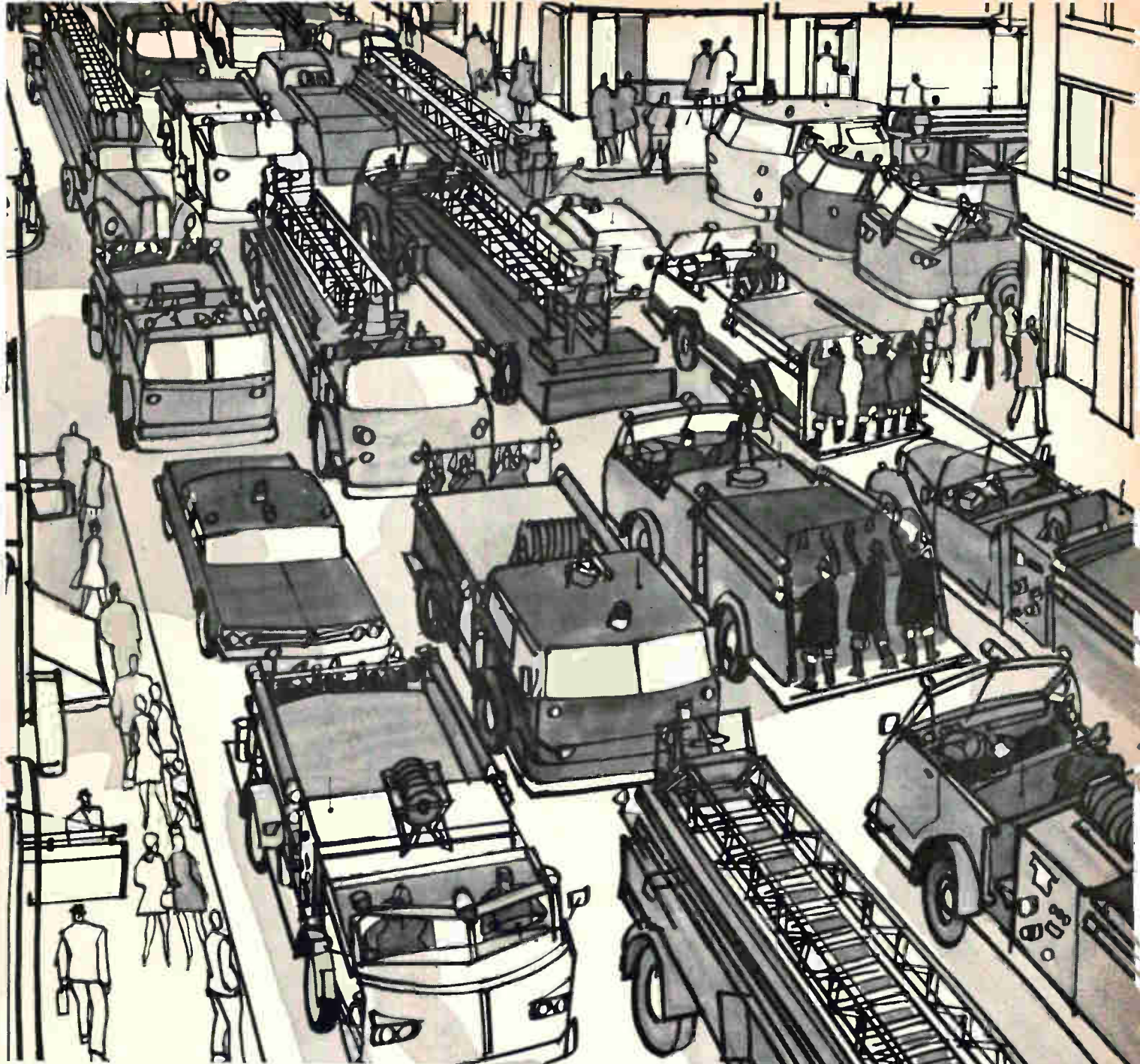

11,331 radio-dispatched fire-engines and only one tetrode rated for PTTS*

The fire fighter is rarely on the air for as long as 60 seconds and he is "otherwise occupied" for at least five minutes between calls. The same goes for most radio-dispatched vehicles.

PTTS* (Push-To-Talk-Service), with its duty cycle of ONE MINUTE ON and FOUR MINUTES OFF has been shown to be the most realistic, economical and practical rating system for vehicular communications systems.

For this reason, Amperex developed the 8637, the only twin tetrode ever designed and rated for PTTS. Featuring high thermal inertia anodes and

incorporating a wealth of twin-tetrode manufacturing experience, the 8637 offers the designer a new approach in creating a better vehicular radio. Fewer, and less costly components may be used. Some typical operating conditions which bear this out are shown on the chart at right . . . lower plate voltage, lower drive and higher efficiency at the VHF frequencies.

The 8637 is a 'small tube', (only 3 1/4" seated height), perfectly suited for today's low-profile designs. Its cost is lower than ICAS and CCS rated tube types of the same power.

For data, applications reports and engineering assistance, write: Amperex Electronic Corporation, Tube Division, Hicksville, L. I., N. Y. 11802.

ALL THIS—and AMPEREX QUALITY, TOO!			
ONE 8637—PUSH-PULL			
Internally Neutralized Throughout Entire Freq. Range	PLATE	OUTPUT	DRIVE
50 MHz			
CCS	375v.	25w.	0.67w.
ICAS	450v.	34w.	0.82w.
PTTS	600v.	84w.	0.86w.
175 MHz			
CCS	300v.	18w.	1.4w.
ICAS	350v.	26w.	1.6w.
PTTS	560v.	63w.	2.2w.



Circle 125 on reader service card

Amperex
TOMORROW'S THINKING IN TODAY'S PRODUCTS

TAKE ONE



If your work has anything to do with visual readout, there's something in this IEE Catalog for you. It contains the most complete, up-to-date information available on rear projection readouts. If you design, manufacture, market or use products requiring visual display, you should become familiar with current developments in rear projection display. It's in this catalog. The catalog explains the operating principles of rear projection readouts. It also describes the unique results you get with this product.

You will easily see why it is specified for applications requiring readability, appearance and versatility. One of these applications could be yours. In addition to specifications on the complete line of IEE projection readouts, the catalog includes information on displays, assemblies, accessories, lamps and prices. It's complete.

Ask us for a copy now.



The Rear Projection Readout: When one of the 12 lamps at the rear of the readout is lighted, it illuminates one of 12 film messages, focuses it through a lens system, and projects it onto the non-glare viewing screen at the front.

The displayed message is clearly and distinctly projected on a single plane, with no obstruction from unlighted filaments. There is a wide viewing angle and a minimum of interference from ambient light. It is extremely versatile, since anything that can be put on film can be displayed on an IEE readout. That includes any combination of colors, symbols, numbers, letters and words. A total of five different models offering character sizes ranging from $\frac{1}{8}$ " to $3\frac{3}{8}$ ".

"I double-E," the world's largest manufacturer of rear projection readouts.
Industrial Electronic Engineers, Inc., 7720 Lemona Ave., Van Nuys, Calif.



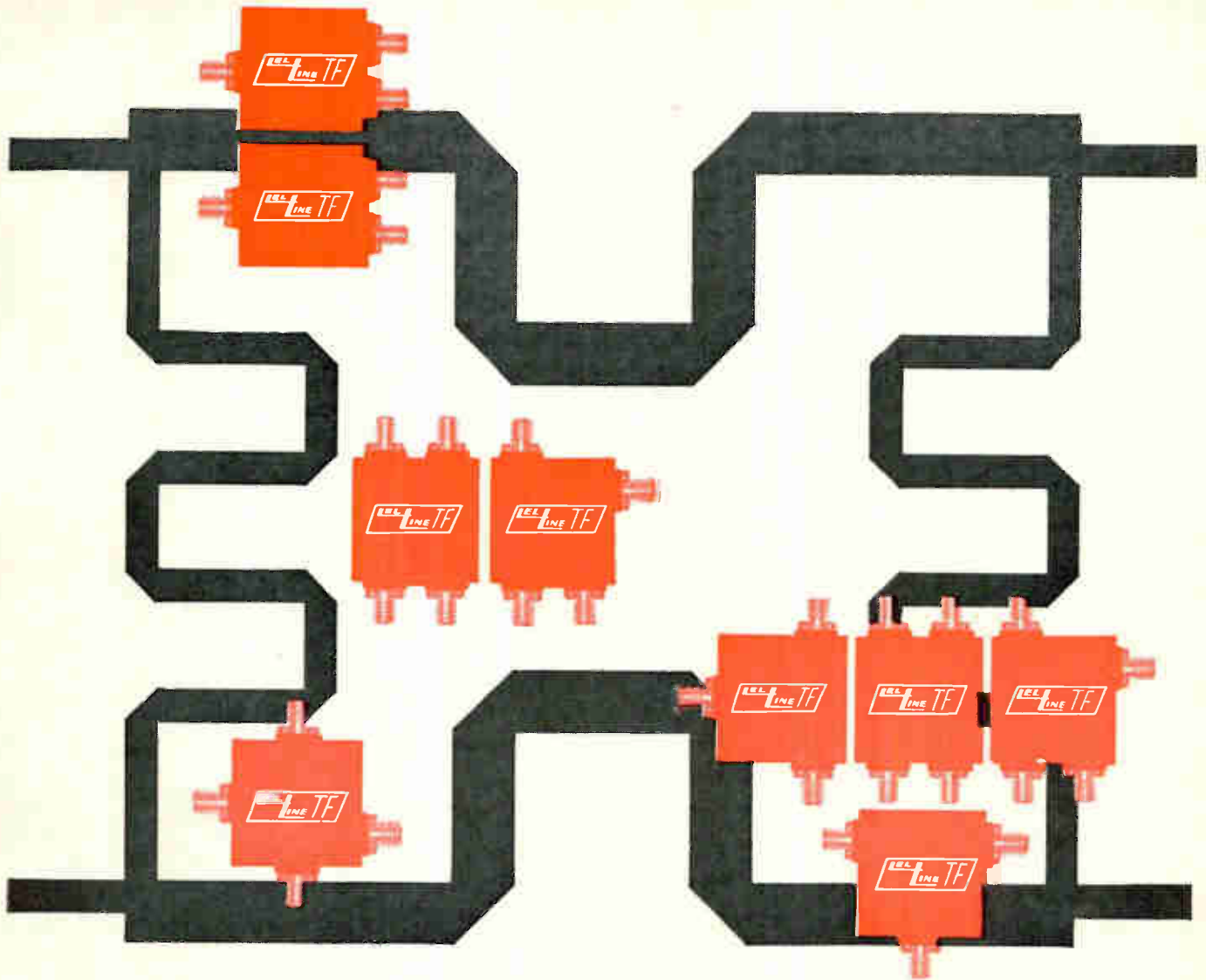

We're First in **Thin Film Microwave Components**

LEL-LINE TF . . . FIRST COMMERCIALY AVAILABLE MICROWAVE COMPONENTS USING THIN FILM HYBRID-INTEGRATED CIRCUIT TECHNIQUES

LEL can deliver them off-the-shelf. Just take a look at what LEL-LINE TF gives you: ultra small size . . . light weight . . . module interconnections (OSSM) . . . ceramic substrates for high temperature operations . . . over 37 standard module designs. How does LEL do it? It's the result of a complete in-house capability which makes for rapid delivery . . . uniformity of design permits low cost manufacture. If you're in any microwave endeavor involving sub-

miniature systems, investigate LEL-LINE TF components. They measure $1\frac{1}{8}'' \times 1\frac{1}{8}'' \times \frac{1}{32}''$ and weigh less than an ounce each. *Now ready are:* Balanced Mixers, (1-6 GHz) Quadrature Hybrids (1-4 GHz) and Magic-T Hybrids (2-6 GHz) reactive Power Dividers (1.5-6 GHz) and Directional Couplers (1.5-6 GHz). Naturally, they feature utmost economy and reliability . . . *they're created by LEL.*



LEL DIVISION

varian / akron street / copiaque / new york 11726 / 516 AM4-2200 / 516 PY9-8200 / TWX 510-224-6692

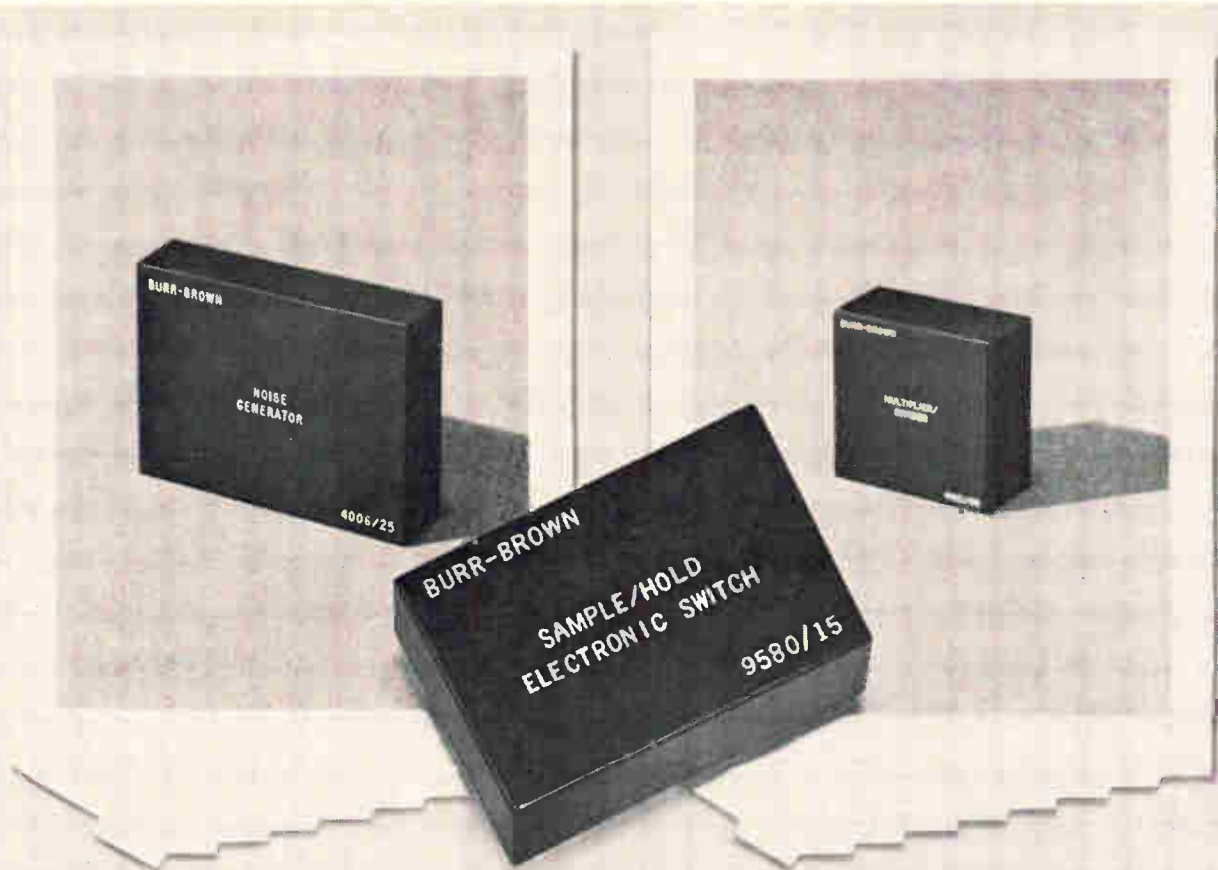

for Instant Analog Systems.

Burr-Brown Encapsulated Function Modules

Cut costs, simplify design, and achieve maximum performance from your analog and hybrid circuits by utilizing Burr-Brown encapsulated function modules. These compatible sub-systems are designed to mount and work side by side with operational amplifiers. You save money on component and assembly costs, design time is reduced to an absolute minimum, and you gain the performance advantage of Burr-Brown's specialized experience in analog applications.

Currently, Burr-Brown is supplying thirteen 10V, encapsulated function modules from stock. Each one provides the type of performance you'd expect from the company that "wrote the book" on operational amplifier applications. Available units include: Quarter Square Multiplier — Fast, $E_o = -E_i E_z / 10$. Squaring Modules —

Four separate units are offered. Noise Generator — Random digital output. Logarithmic Amplifiers — Both 40 db and 60 db log units. Adaptive Analog Comparator — Switched hysteresis. Electronic Switches — Including Fast Sample/Hold, Sample/Hold, Integrate/Hold, and Reset/Integrate/Hold units.

Rack Mounting Units — For your rack-mounting applications, Burr-Brown offers thirteen modules. These pre-engineered circuits are ready for you to plug in, wire together, and put to use immediately.

FOR COMPLETE INFORMATION on these maximum value units, contact your nearest Burr-Brown Engineering Representative and ask him for a copy of the new 16-page Burr-Brown catalog. He also has demonstrator units available for your immediate evaluation.

BURR-BROWN
RESEARCH CORPORATION

International Airport Industrial Park • Tucson, Arizona 85706
TELEPHONE: 602-294-1431 • TWX: 910-952-1111 • CABLE: BBRCORP



Operational Amplifiers
Instrumentation Amplifiers
Function Modules
Analog Simulators
Geophysical Instruments

ENGINEERING REPRESENTATIVES: ALABAMA, HUNTSVILLE (205) 534-1648 / ALASKA, ANCHORAGE (907) 272-5231 / ARIZONA, PHOENIX (602) 254-6085 / CALIF., LOS ANGELES (213) 665-5181, SAN FRANCISCO (408) 245-3321 / COLO., DENVER (303) 388-4391 / CONN., MILFORD (203) 874-9222 / D.C., WASHINGTON (SEE MARYLAND) / FLORIDA, ORLANDO (305) 425-2764 / ILLINOIS, CHICAGO (312) 286-6824 / LA., NEW ORLEANS (504) 834-6598 / MD., SILVER SPRING (301) 588-8134 / MASS., BOSTON (617) 245-4870 / MICH., DETROIT (313) 353-3822 / MINN., MINNEAPOLIS (612) 781-1611 / MO., ST. LOUIS (314) 524-4800 / N.C., GREENSBORO (919) 273-1918 / N.J., CAMDEN (609) 365-2450 / N.M., ALBUQUERQUE (505) 255-1638 / N.Y.,

ALBANY (518) 436-9649, BINGHAMTON (607) 723-9661, BUFFALO (716) 632-2727, MT. VERNON (914) 968-2200, NEW HARTFORD (315) 732-3775 / OHIO, CINCINNATI (513) 761-5432, CLEVELAND (216) 884-2001, DAYTON (513) 277-8911 / OKLA., TULSA (918) 835-2481 / OREGON, PORTLAND (503) 292-8762 / PENN., PHILADELPHIA (SEE CAMDEN, N.J.), PITTSBURGH (412) 243-6655 / TEXAS, DALLAS (214) 363-1671, HOUSTON (713) 928-5251 / UTAH, SALT LAKE CITY (801) 466-8709 / VIRGINIA, (SEE MARYLAND) / WASH., SEATTLE (206) 622-0177 / CANADA, TORONTO (416) 293-7011, VANCOUVER (604) 736-6377

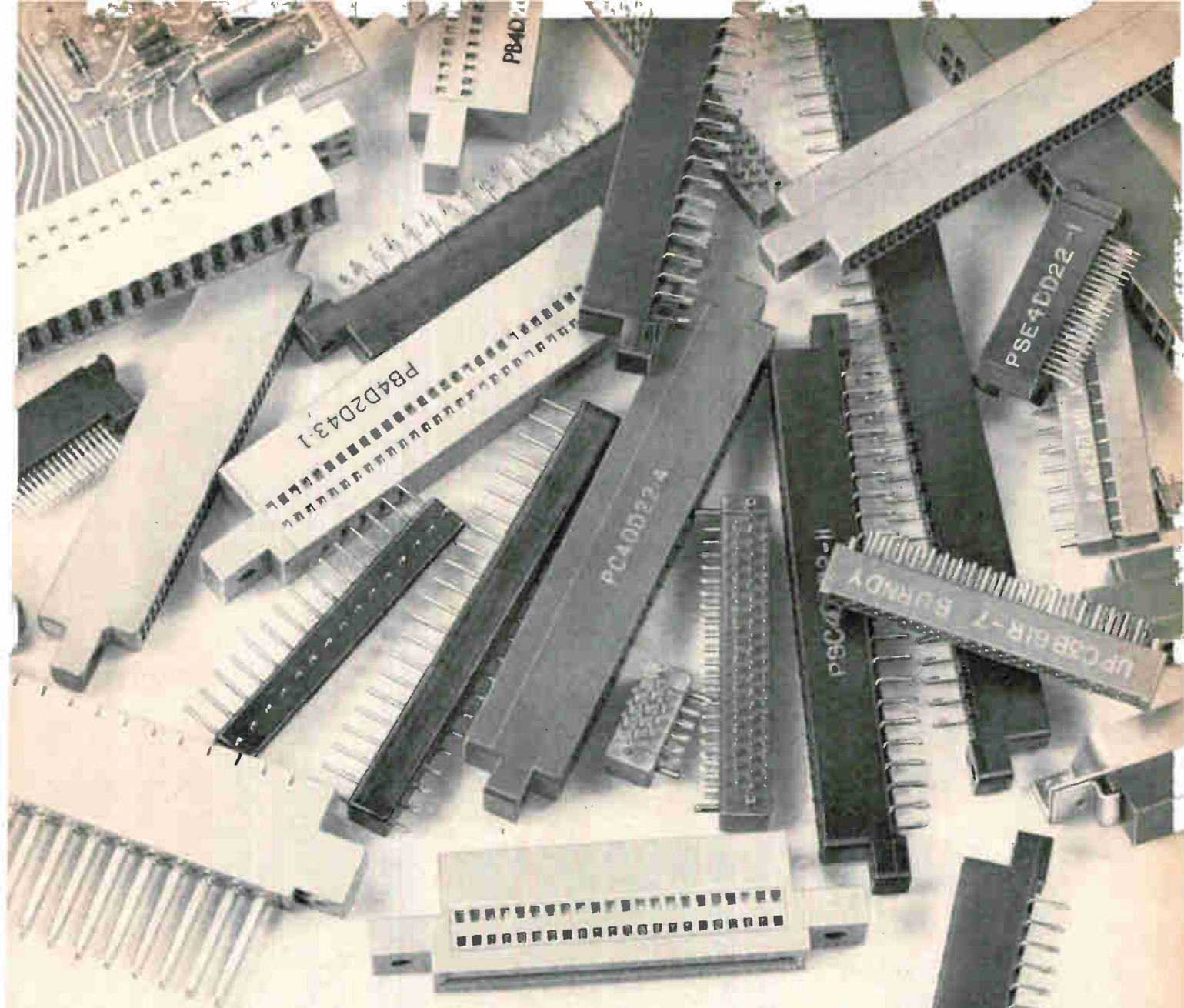

This is no line. This is a choice.

The way new uses for printed circuits are being found, it stands to reason that there should be enough different PC connectors available to insure that your application requirements are met squarely. Burndy gives you that choice.

In fact, we have more than 200 different PC connectors to choose from. And it's likely you'll find a connector that will meet the requirements of several projects. Individually, and as a group, the application potential is enormous. Call it choice . . . call it versatility. You're right on both counts.

This is part of what you have to choose from:

Card Receptacles

- Crimp removable contacts per MIL-C-

21097/B .156" spacing. Non-spec types for .078" .100" and .156" spacing. (The flexibility and convenience of crimp removable contacts often indicates new applications.)

- Solder or weld termination in spacings down to .050".
- Solderless wrap termination on .150" and .200" spacing.

Two-Piece Connectors

Crimp removable contacts on .100" and .150" centers meet the requirements of the most rugged environments. Round socket contacts support wires against severe vibration and shock.

- Solder dip types on .100" and .150" spacing. 11 sizes from 13 to 92 contacts conform to several NASA drawings and

Signal Corps specifications SCL6250B (MIL-C-55302).

Are they reliable?

Today, Burndy PC connectors are being used in everything from business machines and computers to telemetry systems. They wouldn't be if they weren't exactly that . . . reliable.

If you're involved with printed circuitry you'll want a copy of our PC connector catalog. Write now for catalog PC.

BURNDY
Norwalk, Connecticut

NICE TRY, GUYS

Man's first aerospace project, Babel I, utilized a straight-forward design concept: Travel into outer space would be effected by climbing a tower. However, it did not meet noise specifications, and the mission was aborted.

Now that Genisco offers a complete selection of power line filters and shielded enclosures you can avoid analogous difficulties.

Rated from 30 amps to 200 amps, 120 V to 250 V, single or three-phase power lines, the three series are designed for typical circuit breaker panelboards with or without requirements for power line filtering, and for use in shielded rooms and for installations requiring electrical distribution.

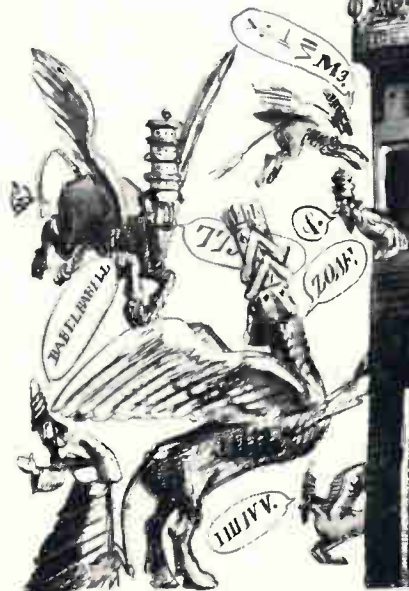

Although these power line filter assemblies meet MIL-F-15733, we do not recommend their use in towers extending beyond terrestrial limits. This application is not approved by The Chief Design Engineer.

Circle 308 Readers Service Card

DIDJA HEAR THE ONE ABOUT THE BI-PLANAR NAB 14" REELS?

Seems like there's this Model 10-276 magnetic tape recorder for aircraft, shipboard, or field portable use. Now, it has this low inertia capstan drive motor, and 6 speed selectable servo to eliminate belts, pulleys, and like that. And get this: no pinch rollers and solenoids to create flutter and skew! Well, these Genisco guys are making a mint on the thing, but they



figure they'll come out with a Model 10-286 with 14" instead of 8.5" reels for customers who need longer record time! Then they go and stack the reels in a bi-planar configuration to save space. The funny thing is it works great. Not much of a story maybe, but they sure are nice tape recorders.

Circle 309 Readers Service Card

EARN BIG \$\$\$\$ AS A TELEMETRY PERSON!!!

Now you can learn telemetry in the privacy of your own home! Take this free aptitude test NOW!

1. (T) (F) A telemeter is what they put on the back of the TV to find out what you watch.

2. (T) (F) A telemetering checkout station is where you sign out for a telemetering.

Congratulations! You've just won our free correspondence course! Naturally you'll now want a Model A-180 or A-186 completely portable ground station. The A-180 completely de-multiplexes any standard FM/FM Signal. Ideal for checkout of airborne or sledborne applications. The A-186 has fourteen stunning channels. Its receiver is continuously tunable over the 215MC to 260MC band. So get on the road to success! Buy some of our telemetry stuff.

Circle 310 Readers Service Card

WHEEP! WHEEP! WHEEP!

As your missile speeds downrange you are secure in the knowledge that its electro-explosive device can be armed only by the precise signal you alone can send.

Or, horror of horrors, by an unfiltered random burst of identical frequency and duration.

As perspiration beads your brow you feel a sudden fondness for Genisco, renowned experts in RF hazard testing. How nice of them, you think, to have in stock or to design just the filters for the RFI and EMI protection my firing circuits need.

By golly, you conclude, next one of their ads I see I think I'll just

Circle 311 Readers Service Card

IT JUST KEEPS ROLLIN', KEEPS ON ROLLIN' AROUND.

Going round and round is our new Model 1147 rate-of-turn table's main trick. It keeps at it no matter how much you abuse it.

Hydrostatic bearings give precise dimensional stability, excellent alignment, low runout and eccentricity, low mechanical noise, and long happy life. It rotates smoothly at less than sidereal rates (0.004°/sec.). And it's just as smooth up to 1500°/sec. Which is why particularly brilliant (and handsome) engineers picked it as the AGE gyro test table for the F-111 Aircraft System.

Great for the lab or just to tote around de field.

Circle 312 Readers Service Card



GENISCO TECHNOLOGY CORPORATION
18435 SUSANA ROAD
COMPTON, CALIFORNIA 90221

Control Switch announces

First and only pushbutton switches certifiable to MIL-S-8805

All 110 Versions of MIL-S-8805/3 – MS25089

● 7 mounting styles



● 5 circuit arrangements

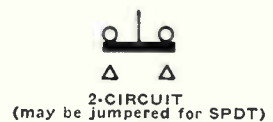

- 2 button colors.
- 2 button styles.
- Momentary or push-pull actions.
- Temperature range: —55°C to 85°C.
- Life: 25,000 operations minimum at rated load.
- Shock: High Impact, momentary types. 50G, all types.
- Vibration: 10 to 500 cps.

This new Series may include the pushbutton switch you need right now for extreme dependability in military or other equipment. Or the switch that breaks a design block, or sparks a new design idea. The specifications speak for themselves!

Series W190 pushbutton switches are another in a spectacular series of firsts from Control

Switch . . . source of the widest selection of high-reliability switches and indicator lights available anywhere. More firsts are coming. Soon! Order Series W190 from your Control Switch distributor, or direct from us.

DETAILED BULLETIN!

Check Number on Reader Service Card corresponding to number at left below for our Bulletin on new Series W190 pushbutton switches. While you're at it, get all the items listed below:

- ≠483 MIL-S-8805 Bulletin 64
- ≠484 Condensed Switch Catalog 100
- ≠485 Basic Snap-Action Switch Catalog 110
- ≠486 Toggle Catalog 180
- ≠487 Indicator Light Catalog 120
- ≠488 Hermetic Switch Catalog 130
- ≠489 Switchlite Catalog 220
- ≠490 Pushbutton Catalog 190

**CONTROLS
COMPANY**
OF AMERICA
CONTROL SWITCH DIVISION
1420 Delmar Drive, Folcroft, Pennsylvania 19032
A Subsidiary of
 General Precision Equipment Corp.

PIEZO ACCELEROMETER REPORT

CEC

REPORT NUMBER 2

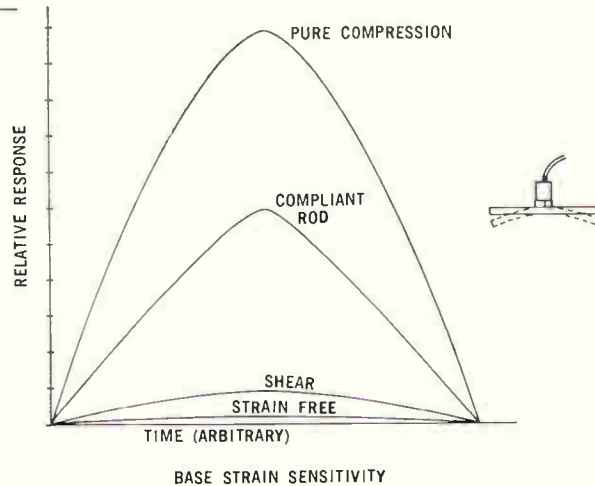

New CEC Accelerometers up to 30 times more resistant to base strain

Thanks to a unique application for CEC's Ceramicite[®], the compliant rod/mass assembly of CEC's new 4-250 Series Accelerometers is virtually isolated* from distortion of the base. This means that unwanted inputs from deformation of the accelerometer base are effectively eliminated. And—users are no longer plagued by temperature transients and acoustic loading.

As a result, CEC specifies a maximum base strain sensitivity guaranteed to .01 g/10⁻⁶ in/in. on each accelerometer.

The new series consists of four piezoelectric accelerometers—the 4-250, 4-251, 4-252 and 4-253. The extreme

flexibility of these instruments is evidenced by the fact that *only one* is needed for a given measurement requirement; whereas before, multiple units were used for various environmental conditions.

Price and Prospects

In spite of their advantages, these piezoelectrics sell for less than competitive accelerometers. Reason: more efficient construction techniques—something you might expect from the world's leading transducer manufacturer.

We predict that these units will soon be a "must" for aerospace, airlines and engine test stand applications.

The advent of the 4-250 Series Accelerometers provides the user with the ability to replace existing accelerometers and obtain much more accurate data. And the series also offers those interested in new vibration measurement applications the same advantages.

For complete information on CEC's new piezoelectric line, call your nearest CEC Field Office. Or write Consolidated Electroynamics, Pasadena, California 91109. A subsidiary of Bell & Howell. Bulletin Kit 326-X1.

CEC

TRANSDUCER PRODUCTS

*Patent Pending

TYPE	Sensitivity		Frequency Response	Dynamic Range		Cross-axis Sensitivity	Temp. Range	Temp. Response	Capacitance (Open Cir.)	Weight	FEATURES
	Voltage (open circuit)	Charge		Shock	Vibration						
4-250-0001	22 mv/g nom.	20 pcmb/g nom.	500 Hz ±5%	2000 pk-g	2000 pk-g	3% max.	-100°F to +500°F	Charge ±8% max. 0°F to +500°F	920 pf ±10%	32 grams	High charge output and flat charge vs. temperature sensitivity.
4-251-0001	20 mv/g nom.	15 pcmb/g nom.	2-5000 Hz ±5% ¹	2000 pk-g	2000 pk-g	3% max.	-320°F to +500°F	Voltage ±0% to -5% ² Typical	760 pf ±10%	32 grams	Flat voltage response over wide temperature range.
4-252-0001	12 mv/g nom.	8 pcmb/g nom.	5000 Hz ±5%	2000 pk-g	2000 pk-g	3% max.	-320°F to +300°F	Charge ±5% max.	640 pf ±10%	35 grams	Flat charge response at cryogenic and high temperatures.
4-253-0001	18 mv/g nom.	1.8 pcmb/g nom.	(Voltage) 5-5000 Hz ±5% ³ (Charge) up to 5000 Hz ±5%	1000 pk-g	1000 pk-g	3% max.	-320°F to +700°F	Charge or Voltage ³ ±5% max. -320°F to +500°F	100 pf nom. 90 pf min.	35 grams	Flat charge or voltage response at cryogenic and very high temperatures.

1. With a 500 megohm load
2. When shunted with 750 pf capacitance
3. With a 500 megohm load and 100 pf capacitance

BELL & HOWELL

Our I.C. digital modules reject more noise than anybody's.

Integrated flip-flops, inverters and buffer amplifiers in T Series modules are made to our proprietary design and hermetically sealed in TO-5 cans.

Full-width copper ground plane sandwiched between epoxy-glass boards minimizes circuit inductances and discourages noise spikes. Mounting cases also have full-width shield planes to retard noise coupling between logic wiring.

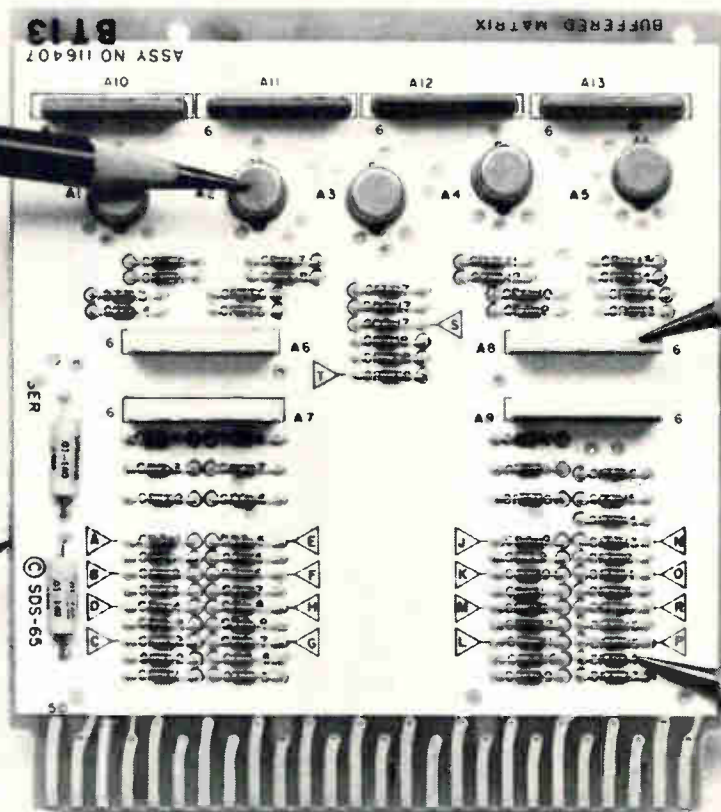

T Series input and load resistors, made to much tighter tolerances than can be attained with integrated components, are mounted outside the integrated circuit containers, eliminating power dissipation problems.

Discrete input diodes enable us to place the switching threshold right in the middle of the logic swing.

The payoff.

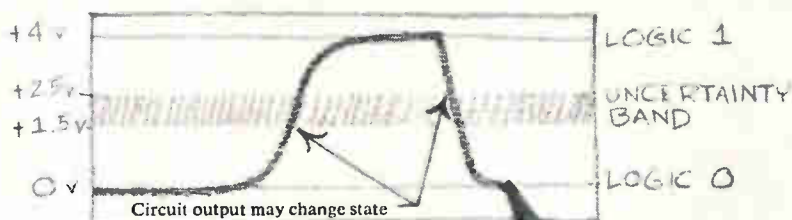

T Series logic levels are 0 and +4 volts, and noise rejection is 1.5 volts minimum, leaving a maximum uncertainty band only one volt wide within which noise can trigger the circuit output. This uncertainty band of 25% is far narrower than those of other I.C. modules on the market.

SDS
Scientific Data Systems,
Santa Monica, California

Plessey will design and make any memory stack

Whether you want single memory planes or stacks, Plessey can produce them. They can design them from basic applications data alone, or produce them direct from your own design. They can produce in quantity or as a special "one-off".

Performance-tested Plessey stacks are enabling large, high-speed systems to be developed for operation in the increasingly arduous environments imposed on modern computers, and the extensive facilities available for the design, manufacture and testing of stacks have been specially developed to cater for these stringent performance requirements.

This is one of the reasons why many leading international buyers come to Plessey.

If you have a memory problem or an unusual requirement involving stacks Plessey will solve it, write or telephone...

Plessey Components Group,
The Plessey Company Limited,
Matrix Division,
Wood Burcote Way,
Towcester, Northamptonshire, England
Tel: Towcester 312. Telex 31628.

PLESSEY
Components

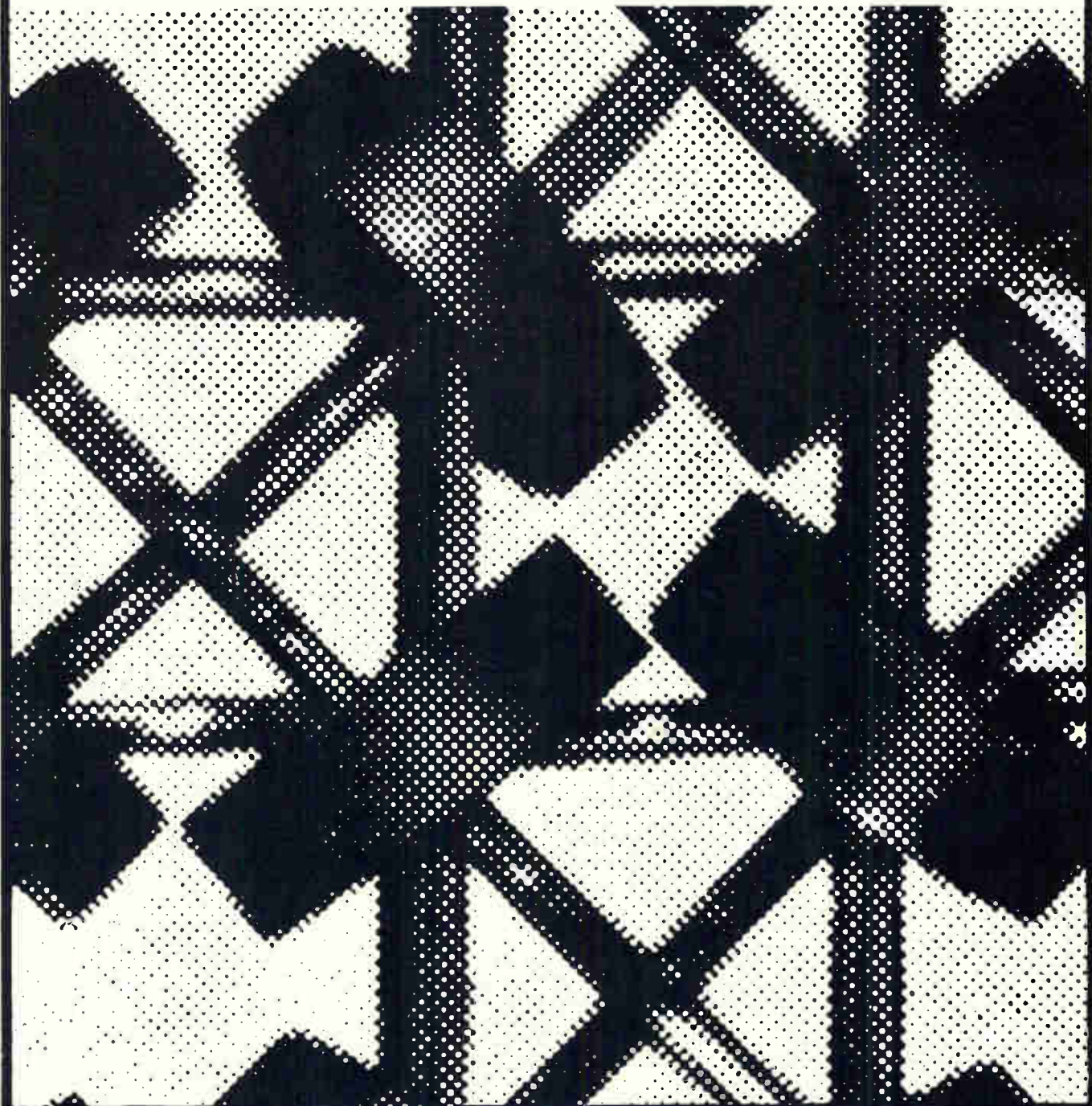

you've got it made

... when you
let **FANSTEEL** do it!

Let FANSTEEL make your electronic parts for you. What type of parts? For instance:

(1) FANTORK™ Chassis-Mounted Heat Sinks that give you up to 3-times greater shank torque and provide comparable heat dissipation of wrought copper alloys. With a complete FANTORK part . . . all you do is die-bond, attach leads and assemble. Or, we'll do any . . . or all . . . of these steps for you . . . braze the steel threaded shank into the sintered copper base . . . add pre-form backing discs (with or without coatings) . . . put on a steel weld ring . . . coin a projection into sintered copper base for direct ultrasonic welding of can . . . insert pins . . . or plate entire assembly. **(2) Lead Assemblies**—from refractory to conventional lead materials in close tolerance diameters from .025" to .125" . . . plated to your specifications. **(3) Semiconductor Backing Discs**—either pressed and sintered . . . punched . . . or cut . . . from tungsten or molybdenum. Fansteel coating technology assures positive wetting action. All sizes throughout the power ratings. Whatever your component parts need . . . LET FANSTEEL DO IT! Our diverse packaging technologies will help you reduce component assembly time and costs. For complete information on value engineered Fansteel parts, call your Fansteel representative . . . or write us.

1.



2.

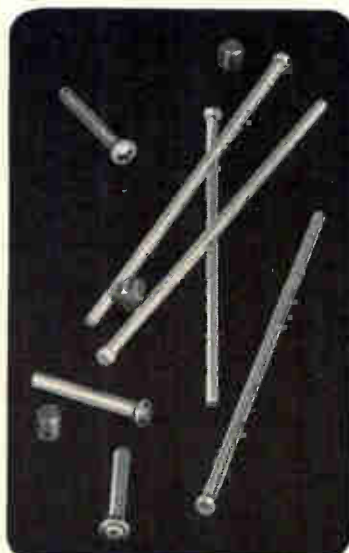

3.



See FANSTEEL at
NEP/CON EAST
BOOTH No. 711



FANSTEEL

METALLURGICAL CORPORATION

ELECTRONIC PARTS DIVISION
NUMBER ONE TANTALUM PLACE
NORTH CHICAGO, ILLINOIS 60064

This laser costs just \$195

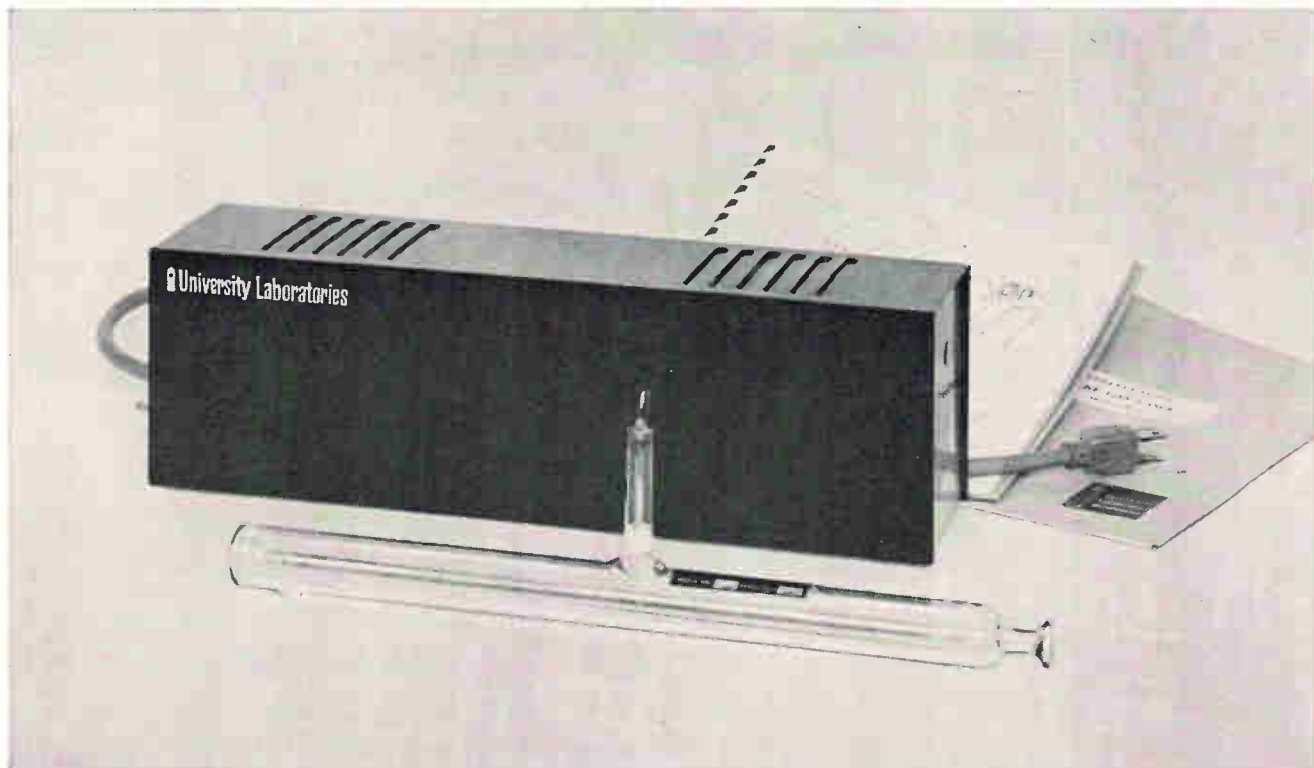

Can you afford not to have one in your science lab?

A good laser is vital today if students are to get a quick dramatic grasp of modern physical optics. That's why ULI has produced Model 200: a laboratory He-Ne continuous gas laser easily within the scope of any lab's budget.

The new ULI Model 200 is rugged, simple and safe. No mechanisms to get out of order—the only control is an on-off switch. Since its long-lived Lasertron™ plasma tube uses permanently aligned and sealed internal reflectors, no adjustments, alignments or maintenance of any kind are ever needed. The tube is so foolproof, it will operate even under water!

The solid-state power supply is simple and thoroughly reliable, assuring immediate, continuing output to specification. Output power: over 0.3 milliwatts. Output wavelength: 6328 Å (visible deep red). Operates in the uniphase TEM₀₀ wavefront mode. Alignment stability is guaranteed.

Ideal for group demonstrations or student use, Model 200 comes with a comprehensive manual that details simple procedures for many classic laboratory experiments, including diffraction and interference theory, holography, and laser quantum electronics.

MODEL 240 INDUSTRIAL LASER with laboratory-grade DC supply, \$295 complete. Over 0.5 milliwatts power output; built-in collimator; adjustable tripod mount; exceptionally strong mechanical design; same wavelength and wavefront as Model 200.



Send in the coupon now. Start today, at very low cost, to equip your laboratory with the exciting educational capability of laser experimentation. University Laboratories, Inc./1740 University Ave., Berkeley, California 94703/Telephone: (415) 848-0491.

UNIVERSITY LABORATORIES, INC., 1740 UNIVERSITY AVE.
BERKELEY, CALIFORNIA 94703

Please send technical data on ULI lasers.
 Please reserve a Model 200 a Model 240 from your current production. My official purchase order and shipping instructions will follow.

Name _____

Organization _____

Address _____

City _____ State _____ Zip _____

Terms: 2% discount 10 days, net 30 days. ULI products returned for any reason, prepaid and undamaged, within 30 days will receive full credit.

University Laboratories

Protects delicate electronic equipment in shipment.

PELASPAN-PAC® loose fill packing will absorb the shock. Unlike other loose fill, dunnage material, it doesn't settle or mat. It's resilient and highly shock absorbent. These curled strands of foamed polystyrene interlock to protect your product no matter how it's

bounced around.

And how PELASPAN-PAC can lighten your shipping problem! A cubic foot of it weighs only 8 oz., eight times lighter than other packing materials. What that does for shipping costs!

PELASPAN-PAC has other advan-



tages. It's clean and dust free. So easy to work with you'll get major savings in labor time and cost. Does your equipment get a boot out of shipping?

Get PELASPAN-PAC from your distributor. Write for his name.

The Dow Chemical Company, Plastics Sales, Department 71231, Midland, Michigan 48640.

PELASPAN-PAC is just for kicks.



it's proper to profit in Iowa

Take attitude for example . . . In Iowa, you'll find communities, state and local officials and existing industry all profit-minded. The labor picture is good for profitable electronic development and manufacturing. Readily trained men and women. Many educated by an area system of vocational schools and colleges. Space age scientists in state universities and private colleges provide technological training. No state indebtedness. Taxes are equitable. State revenue spending is directed toward projects that will further progress.

Send for the facts on the profit potential for you with an Iowa plant.

115 OF FORTUNE'S TOP 500 HAVE PROFITABLE IOWA LOCATIONS

CONFIDENTIAL		
IOWA DEVELOPMENT COMMISSION Dept. 567, 250 Jewett Building Des Moines, Iowa 50309		
		
Name _____		
Firm _____		
Address _____		
City _____	State _____	Zip _____

When it comes
to color-TV
receiving tubes



RCA
Engineers
never let
well-enough
alone!

TAKE DAMPER TUBES FOR EXAMPLE:

First...

THEY DESIGNED THE 6AU4GT. THEN THEY DEVELOPED THE 6DW4 WITH IMPROVED CHARACTERISTICS. THIS TUBE IS NOW PERFORMING IN MILLIONS OF COLOR-TV SETS.

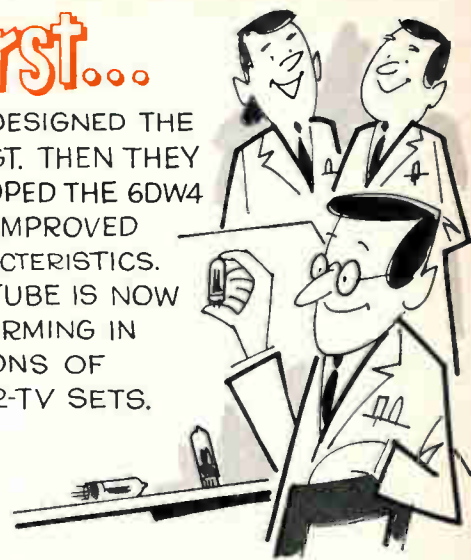

But...

THERE ARE STIMULATING CHALLENGES FOR THE ENGINEER TO STILL FURTHER IMPROVE DAMPER TUBES. FOREMOST IS TO REDUCE TUBE-VOLTAGE DROP.

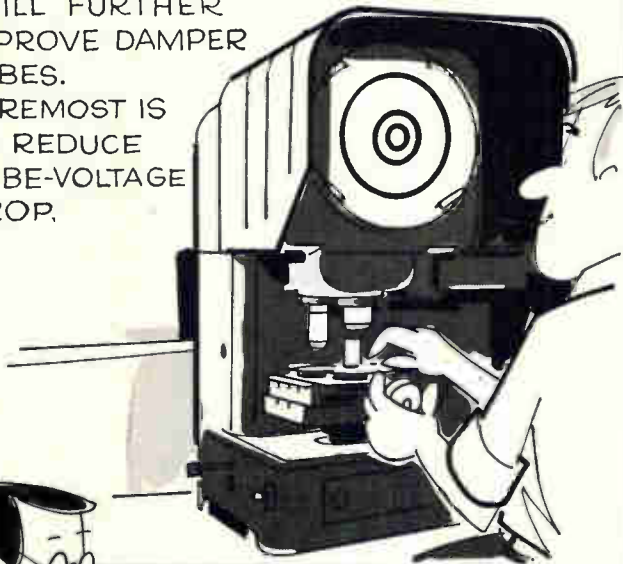

Now...

THEY HAVE A NEW CATHODE WITH A PRESSURE-WELDED COATING - THE BEST EVER FOR DAMPER TUBES. IT PERMITS TIGHTER SPACING WITH NO DANGER OF DAMAGE TO THE COATING RESULTING FROM ARC-OVER, SPUTTERING OR HOT SPOTS.

RESULT:

RCA'S NEW 6CL3 WITH LOWER TUBE-VOLTAGE DROP LESSENS THE LOAD ON THE HORIZONTAL-DEFLECTION OUTPUT TUBE.



CHECK THESE RCA-6CL3 FEATURES:

HEATER ... 6.3V @ 1.2 A
MAX. PEAK INVERSE PLATE VOLTAGE ... 5500 V
MAX. PEAK PLATE CURRENT... 1300mA
MAX. AVERAGE PLATE CURRENT.. 250mA
MAX. PEAK NEGATIVE HEATER-CATHODE VOLTAGE... 5500 V
TUBE VOLTAGE DROP ... 16V@350 mA (INSTANTANEOUS)
MAX. PLATE DISSIPATION 8.5 W

THE SAME PERFORMANCE PROFILE IS AVAILABLE IN BOTH 12CL3 (12.6V, 0.6A HEATER) AND 17CL3 (16.8V, 0.45A HEATER) TYPES.

RCA Engineers are quite excited about the pressure-welded coating of the new cathode. They see it as giving them new opportunities for still further improvements in damper tubes and other types as well. But RCA Engineers are always pursuing new ideas, working on new designs to bring color-TV circuit designers tubes that will provide even better performance at the lowest possible cost.

For news of the latest color-TV receiving tube developments, call your nearest RCA District Office. For specific data on the 6CL3, write to RCA Electronic Components and Devices, Commercial Engineering F19DE-2, Harrison, N. J. 07029.

RCA DISTRICT OFFICES—OEM SALES: EAST, 2075 Millburn Ave., Maplewood, N. J. 07040, (201) 485-3900 • MID-ATLANTIC, 605 Marlan Pike, Haddonfield, N. J. 08034, (609) 428-4802 • MID-CENTRAL, 2511 East 46th St., Bldg. G2, Atkinson Square, Indianapolis, Ind. 46205, (317) 546-4001 • CENTRAL, 446 East Howard Ave., Des Plaines, Ill. 60018, (312) 827-0033 • WEST, 6363 Sunset Blvd., Hollywood, Cal. 90028, (213) 461-9171 • INTERNATIONAL OPERATIONS, RCA International Division, Central and Terminal Aves., Clark, N. J. 07066, (201) 382-1000 • 118 Rue du Rhane, Geneva, Switzerland, 35 75 00.



The Most Trusted Name in Electronics

How goes the battle?

An odd question? Not today. For continuously observing the tides of struggle that ebb and flow throughout the world is vital to our nation. To help design the systems that provide this view, that secure the technological high ground from which command decisions can be made — this is one of MITRE's missions.

NATIONAL MILITARY COMMAND SYSTEM

Scientists and engineers are also needed in our Washington Office for systems analysis and feasibility studies, communications system analysis, systems design, integration and design verification of the NMCS. This "capping system" contains all the facilities, equipment, doctrine, procedures, and communications needed by national command authorities to give them strategic direction of the armed forces. MITRE's main concern is with the technical design and integration aspects of the NMCS and the communications between NMCS and various other command systems, including the World-Wide Military Command and Control System — a group of systems operated by the unified and specified commands.

COMMUNICATIONS SYSTEMS PLANNING AND DEVELOPMENT

Among MITRE's current communications activities are included: conceptual design of new communications systems and analysis of their performance analysis, investigation and development of advanced communication techniques; analysis and projection of Air Force tactical communications needs; and development of sophisticated simulation techniques for communications systems synthesis and evaluation.

Immediate staff and management level openings exist for: Communications Engineers and System Analysts experienced in the systems analysis and design of communications networks, modulation and signal processing techniques, switching systems and voice and data transmission; Operations Analysts with experience in simulation techniques and capable of establishing communications requirements and performing cost effectiveness trade-offs; Project Engineers for detailed engineering and specification of satellite communications systems; and specialists in airborne antenna and multiple access signal processing techniques.

SYSTEMS TESTING AND EVALUATION

Openings at MITRE's office at Elgin AFB, Florida are immediately available for engineers with experience in systems engineering and systems testing of command and control systems. Specific experience should include functional areas such as surveillance weapons control, tactical air operations, communications and system test planning. Skills should include radar, radio and wire communications, data processing and displays, computer program analysis and operations analysis.

If you have two or more years' experience and a degree in electronics, mathematics or physics, write in confidence to Vice President — Technical Operations, The MITRE Corporation, Box 208BC, Bedford, Mass. Persons interested in Washington openings should write directly to Mr. R.P. Knotts, P.O. Box 1202, Bailey's Crossroads, Va. 22041.



An Equal Opportunity Employer (M & F)

Pioneer in the design and development of command and control systems, MITRE was formed in 1958 to provide technical support to agencies of the United States Government. MITRE's major responsibilities include serving as technical advisor and systems engineer for the Electronic Systems Division of the Air Force Systems Command and providing technical assistance to the Federal Aviation Agency and the Department of Defense.

We go to great lengths to keep quantities of the finest quality flexible and semiflexible coaxial cable and connectors on our shelf. And every Friday we take stock so we can get out our weekly inventory report to 704 cable-using customers.

That way, engineers and P.A.'s know our stock at a glance with their Monday morning coffee. And a quick call to our home office or local Times representative can ease emergency situations. It's all part of Times' constant service as the No. 1 coaxial cable house in the country. No. 1 in quality and reliability. No. 1 in production. No. 1 in inventory. No. 1 in letting you know what and how much is available.

Join our Times' readers. The coupon offers you the Inventory Report — free, of course — every week for as long as you'd like to receive it.



Coaxial Cable—1) RG/U Over 50 Teflon insulated—and over 125 polyethylene insulated—to MIL-C-17. Over 120 types normally available from stock. **2)** RG/U Semiflexible (seamless aluminum tube sheath) coaxial cable in stock.
Connectors—3) Timatch® connectors for semiflexible coaxial cable.
Special Products: Miniaturized low capacitance, low attenuation cables; triaxial and turnaxial cables. Custom designed and engineered coaxial cables are a Times specialty. We have 10,000 of them.

Dept. E-76

Times Wire & Cable
 Hall Avenue
 Wallingford, Connecticut



- Yes, I am concerned with the purchase and/or specifications of coaxial cable and connectors. Please send me the Times Weekly Stock List.
 I can't wait for the mail. Please have your local representative contact me for discussion of a particular need.

 Name Title

 Company

 Address

 City State Zip

*Every Monday Our Inventory Report
 Proves to 704 Firms that
 Times is the No. 1 Coaxial Cable
 Manufacturer in the Country.
 Join Our Readers.*

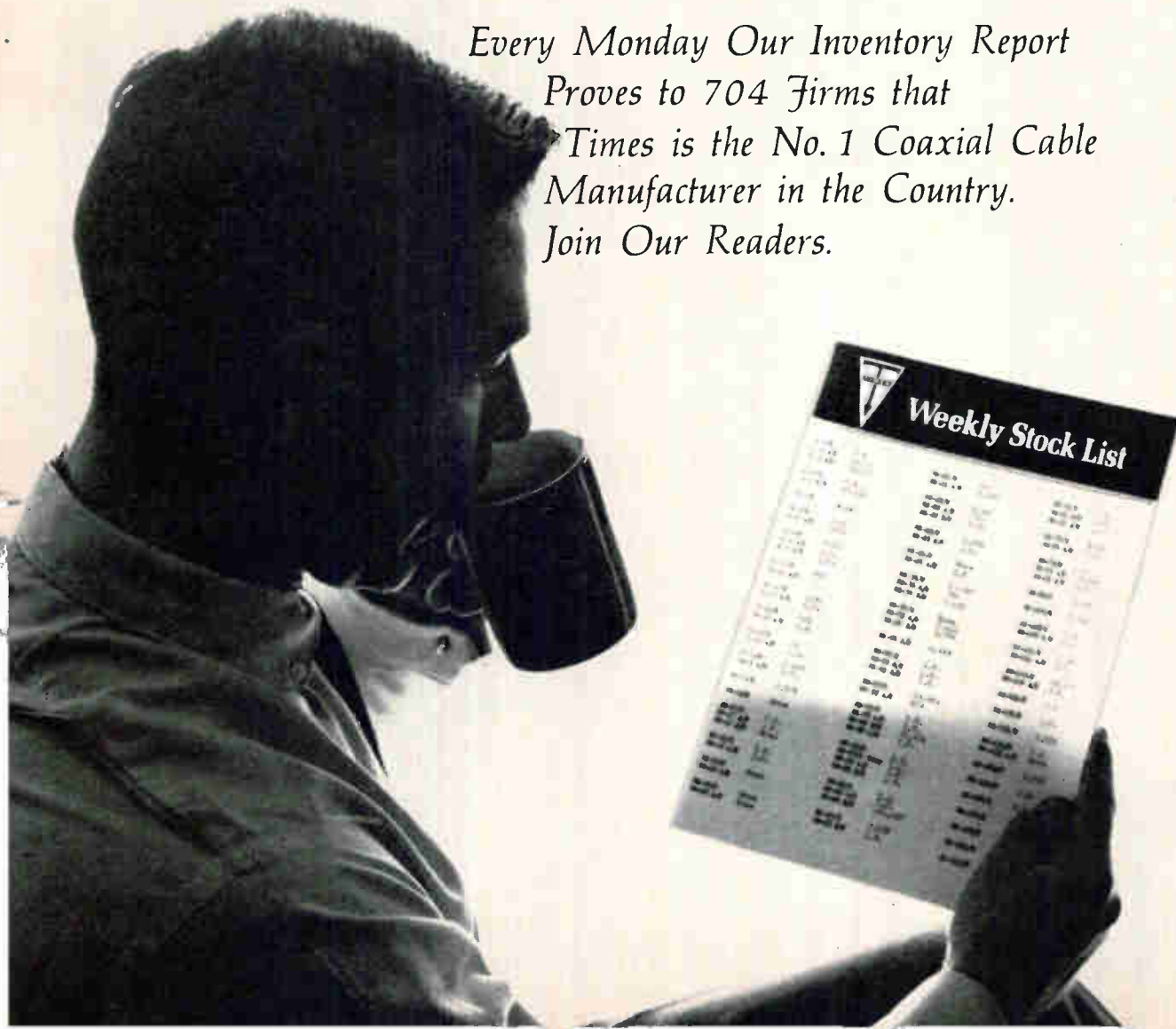

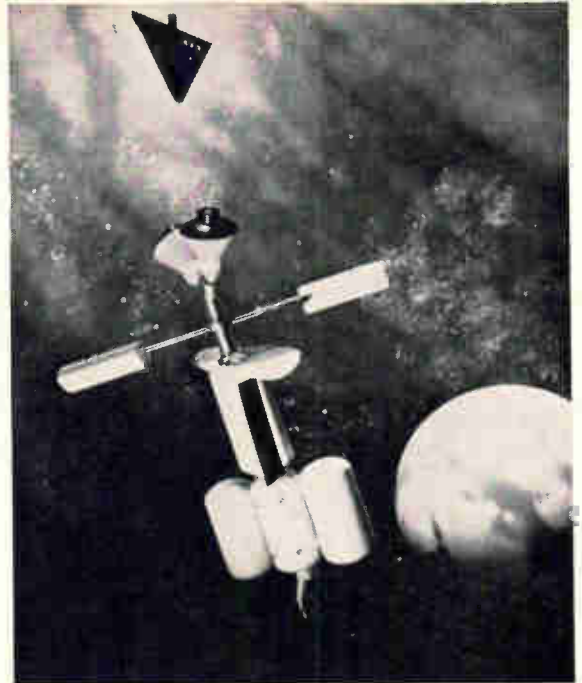

**LOOK
HERE
NOW**



FOR LEADERSHIP OPPORTUNITY

At the Fort Worth Division of General Dynamics, continuing research efforts are directed at further enhancing the pioneer F-111 swing-wing concept. This research encompasses many technologies and will have notable long range effects. Two outstanding examples of research products which are not confined to the field of aircraft geometry are boron filament structures and Mark II avionics. The Fort Worth Division has taken the lead in developing a lightweight composite skin built up of boron filaments reinforced with epoxy. Reports from experimental F-111 applications indicate that substituting this new boron-epoxy skin for aluminum can reduce component weight more than 30 percent, with a corresponding improvement in performance. Mark II avionics represent a significant advancement in the areas of navigation, control, and weapon delivery capabilities, and unique uses have been made of the air-data computer functions. Both of these research products will, during the next decade, result in improved performance and expanded capabilities for aerospace systems.

Achieve the professional status you need for career satisfaction in research, development, design, test or evaluation. The many advanced aerospace projects at the Fort Worth Division of General Dynamics represent a challenge in keeping with superior creative engineering or scientific capabilities. You'll enjoy working on advanced assignments in one of the nation's best-equipped plants . . . in an area where lower costs and higher opportunities contribute to rewarding living.

Fort Worth's uncongested freeways eliminate commuting problems between work and residential areas—which are superior. Cultural, recreational, and upper level educational facilities abound in mild-climate surroundings. Call Collect—817-732-4811, Extension 3551; or send a résumé of your training and experience to Mr. J. B. Ellis, Industrial Relations Administrator-Engineering, General Dynamics, Fort Worth Division, P. O. Box 748E, Fort Worth, Texas 76101. An equal opportunity employer.

GENERAL DYNAMICS
Fort Worth Division

Who says you need to clutter your system...

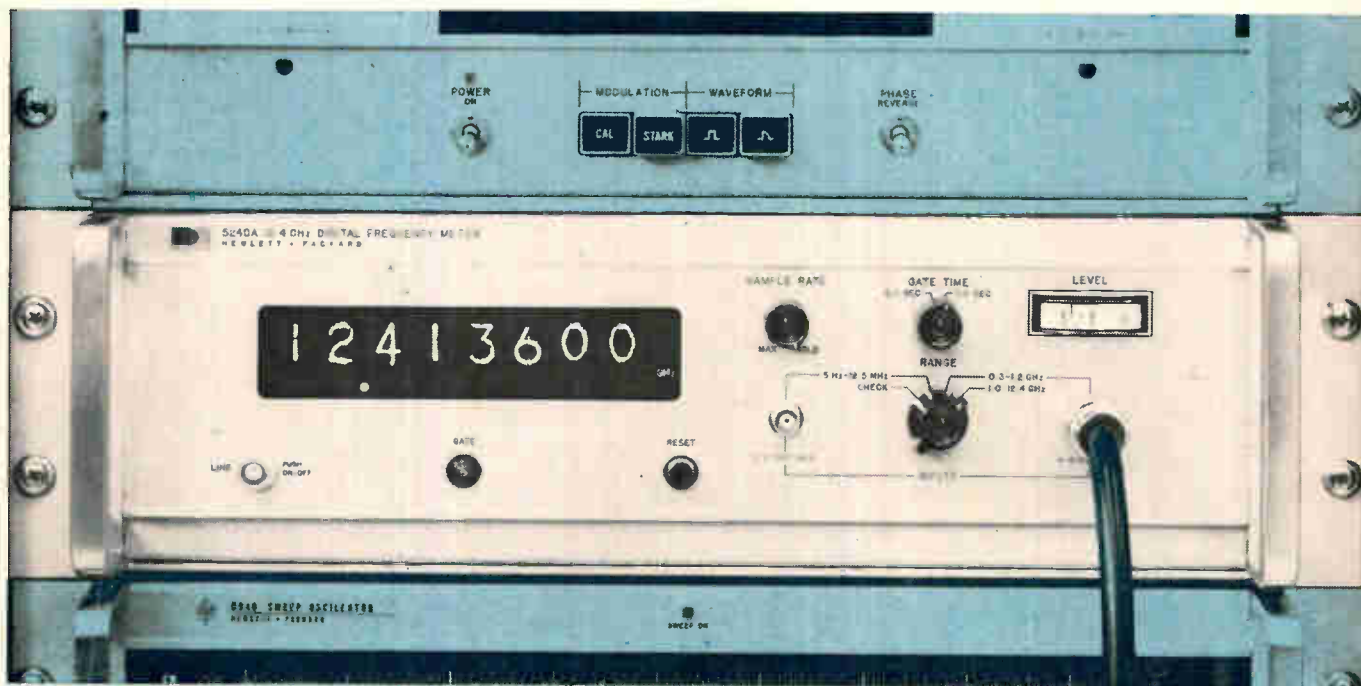

...to measure automatically 0.3 to 12.4 GHz?

He's wrong. Hewlett-Packard can supply an automatic, systems-oriented, single-package instrument to measure the widest microwave frequency range at the lowest price—\$4750.

The HP 5240A Digital Frequency Meter offers completely automatic tuning and direct readout from 0.3 to 12.4 GHz. No adjustments or calculations are necessary—just select the range desired (0.3 to 1.2 GHz or 1.0 to 12.4 GHz), connect the input signal, and read. Readout is inhibited until automatic phase lock is achieved. Therefore, the first reading made is automatically correct—no need to clutter your system with error-checking circuits. For extra usefulness, the internal counter

input is brought out so you can measure from 5 Hz to 12.5 MHz, too. This wide-range versatility makes it perfect for systems work and for rapid, error-free measurement for production and maintenance.

The 5240A uses special sampling techniques to maintain a low input VSWR (typically 1.2:1 to 1.8:1). The operator or system can measure from 0.3 to 12.4 GHz without adjusting for input sensitivity changes. More technical details are in the HP Journal, April, 1967.

Call your local HP field engineer for details on the 5240A. Or write Hewlett-Packard, Palo Alto, Calif. 94304; Europe: 54 Route des Acacias, Geneva.

HEWLETT  PACKARD

New! 100 MHz in a ruggedized oscilloscope with 3.5-ns risetime at the probe tip

DC-to-100-MHz bandwidth at 10 mV/cm
is NOW AVAILABLE
in a plug-in oscilloscope
with solid-state design . . .
the Tektronix Type 647A and R647A.

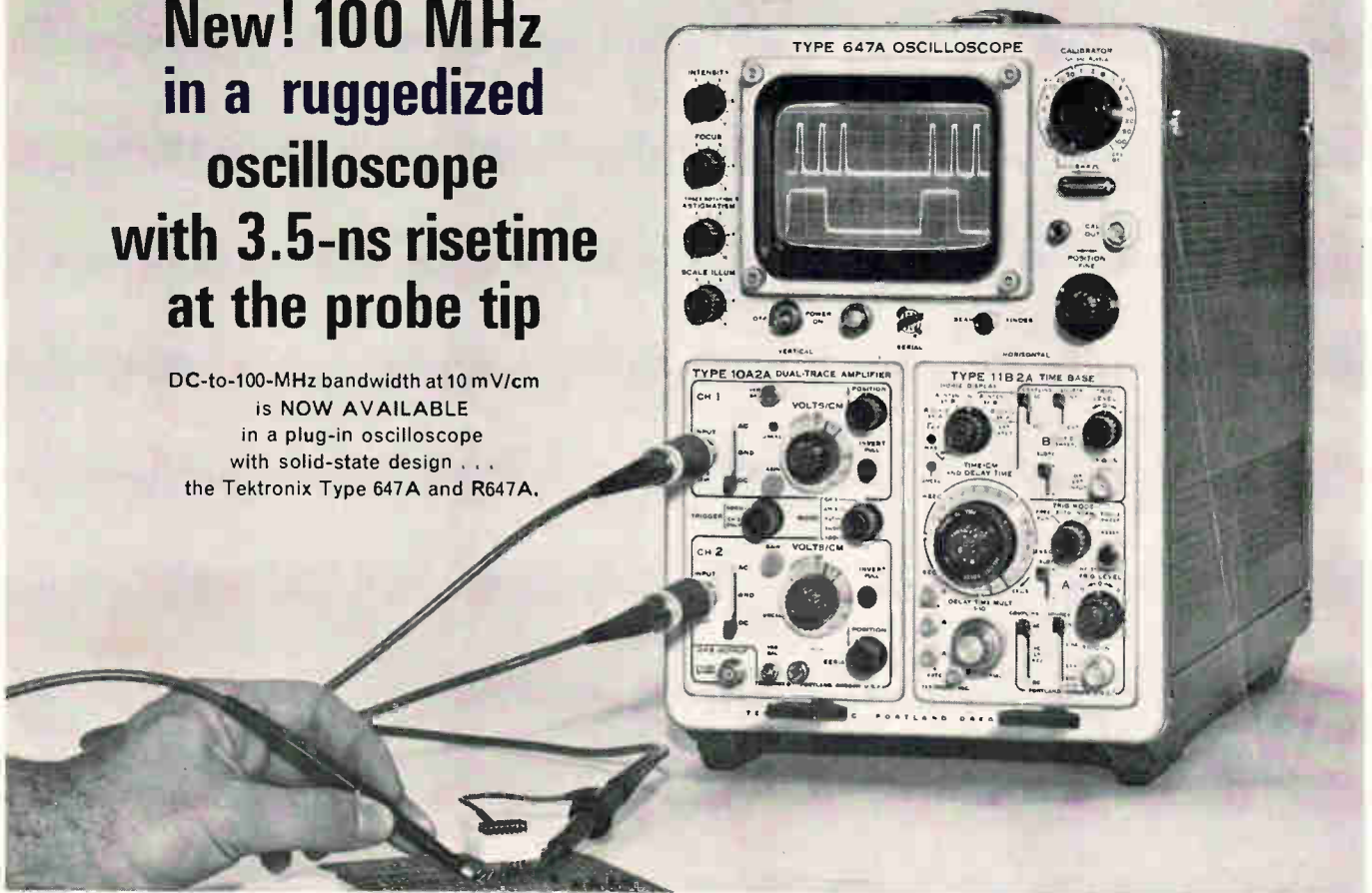

New Type 10A2A Dual Trace Amplifier. The risetime and bandwidth are specified where you use it — at the probe tip. The vertical system performance with or without the new miniature P6047 10X Attenuator Probe is DC-to-100 MHz bandwidth with 3.5-ns risetime at ambient temperatures of 0° C to +40° C (+32° F to +104° F). Bandwidth is DC-to-90 MHz with 4.1-ns risetime over its entire operating range, —30° C to +65° C. The calibrated vertical deflection range (without probe) is from 10 mV/cm to 20 V/cm.

Bright Displays. The Tektronix CRT provides bright displays with its advanced design and 14-kV accelerating potential. It has a 6-by-10 cm viewing area and a no-parallax, illuminated, internal graticule.

New Type 11B2A Delayed Sweep Time Base. The Type 11B2A triggers to above 100 MHz internally and provides a calibrated delayed sweep. Calibrated sweep range is from 100 ns/cm to 5 s/cm, extending to 10 ns/cm on both normal and delayed sweeps with X10 magnification. Calibrated sweep delay is from 1 μ s to 50 s and the plug-in also provides single sweep operation.

Rugged Environmental Capabilities. These instruments are capable of accurate measurements in severe environments and offer an extra margin of dependability and even greater accuracy in normal environments. Temperature: Operating —30° C to +65° C. Non-Operating —55° C to +75° C. Shock: Non-Operating 20 G's max, 2 shocks, each direction, along each of the 3 major axes. Vibration: Operating or Non-Operating 0.025" p-to-p, 10-55-10 Hz, (4 G's) 1 min cycles, 15 min each major axis. Humidity: Non-Operating meets MIL-STD-202B, Method 106A, except freezing and vibration, through 5 cycles (120 hours). Altitude: Operating 15,000 ft. Non-Operating 50,000 ft.

New Type R647A Rack Mount. The same DC-to-100 MHz performance also is available in a 7-inch-high rack mount oscilloscope, the Type R647A. Additional plug-ins include the Type 10A1 Differential Amplifier and the Type 11B1 Time Base.

Type 647A Oscilloscope (includes 2-P6047 Probes)	\$1500
Type R647A Oscilloscope (includes 2-P6047 Probes)	\$1625
Type 11B2A Time Base	\$ 850
Type 10A2A Dual Trace Amplifier	\$ 775

U. S. Sales Prices FOB Beaverton, Oregon

For complete information, contact your nearby Tektronix Field Engineer or write: Tektronix, Inc., P. O. Box 500, Beaverton, Ore. 97005.



Environmental testing



*. . . part of the Tektronix commitment
to technical excellence*

Probing the News

Communications

Reception is loud and cool for subminiature antennas

While developers test new versions and compile additional data, critics question whether such integrated devices can make it in tv

By Leonard Weller

Communications editor

and John Gosch

Electronics Bonn Bureau

While storms swirl about him, Edwin Turner—gadfly of the antenna establishment—is calmly conducting tests on a 4-inch-high omnidirectional subminiature integrated antenna (SIA) at Wright-Patterson Air Force Base in Dayton, Ohio. The device, which covers most of the very high frequency television broadcast spectrum, is an offshoot of Turner's controversial 2-inch-high assemblies incorporating transistors.



Hans Meinke who is doing the research work on SIA's in Munich shrugs off criticisms made against the antennas.

When he announced his mighty mites this April and received national publicity, Turner said such SIA's could be built into tv sets, and would outperform antennas many times their size. Not too surprisingly, a number of antenna experts—particularly those in the business of vending tv apparatus—took vigorous exception to the headier claims made for SIA's. "We're convinced that the subminiature integrated antenna is of no value for television reception," says Harry Greenberg, chief electronics engineer at the Channel Master Corp., Ellenville, N.Y., a leading producer of outdoor tv antennas. "In our opinion, it wouldn't even perform as well as the ordinary rabbit-ear type of antennas, let alone replace outdoor rooftop antennas."

Some observers dismiss the SIA development as essentially a technique for increasing bandwidth. Others question the SIA's ability to deal with problems of signal-to-noise ratio, intermodulation distortion, and directivity.

In the eye of this storm are Turner and Hans Meinke of the Institute for High-Frequency Research at the Technical University, Munich. Turner is contract manager for the development of small integrated antennas for military



"I've won my battles so far and I think I'll win this," asserts Edwin Turner, commenting on his controversial SIA's.

applications at Wright-Patterson; most of the actual work on the new SIA is being done in Munich under Meinke's direction.

Solo flyer. Apparently, Turner released his claims about the tiny antennas' potential commercial applications on the basis of a report from Meinke—without consulting his colleague. Shortly after the announcement, tv-antenna manufac-

Miniature Indicator and Panel Lamps

For better, more readable light

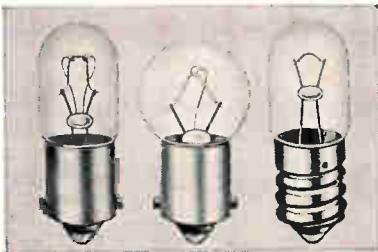

Superior bulbs for aircraft, automotive and other instrumentation, as well as commercial radio and television applications. Design volts from 2.0 to 28.0. Candlepower to 6.0.

For complete information, write: Hudson Lamp Company
526 Elm St., Kearny, N. J. 07032

Circle 500 on reader service card

Sub-Miniature Lamps

Space-savers for aircraft and indicator applications.



Sophisticated bulbs available in a wide range of base styles including the well-known "Tu-Pin" (originated by Hudson) for transistor and soldered connection sockets and fast plug-in on printed circuit boards.

For complete information, write: Hudson Lamp Company
526 Elm St., Kearny, N. J. 07032

Circle 501 on reader service card

Micro Miniature Lamps

Lives from 25,000 to in excess of 100,000 hours

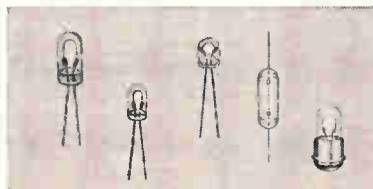

The ultimate in miniaturization in lamps for electronic applications, including transistorized circuitry, punch-card readers, computer tape readouts and photoelectric logic systems. Wire terminal or sub-midget flanged bases. Sizes from .093 dia., as short as .0145 in.

For complete information, write: Hudson Lamp Company
526 Elm St., Kearny, N. J. 07032

Circle 502 on reader service card

Short course on short antennas

A short antenna has a length of less than $1/8$ of a wavelength at the frequency it is designed to receive. Such antennas act like a very large reactance—usually capacitive—in series with a very low radiation resistance. Radiation resistance, which accounts for the power received or radiated by the antenna, can't be measured with a d-c resistance meter but can be calculated from antenna dimensions or experimentally determined by measurements.

To get maximum power from the antenna it's necessary to match its impedance to that of the cable or receiver connected to it. The capacitive reactance has to be tuned out with a coil, and the usually low radiation resistance has to be raised to match the input resistance of the desired circuit. A great deal of the power can then be dissipated in the matching circuit, and efficiency declines.

For an antenna of a given length, efficiency and bandwidth are interrelated: the wider the bandwidth the lower the efficiency of the antenna.

In general, the smaller the an-

tenna the lower the signal that can be picked up; thus the signal-to-noise ratio tends to go down as the antenna gets shorter. However, below 30 to 100 Mhz, atmospheric noise is so great that the signal-to-noise ratio is generally independent of the antenna-receiver combination. A smaller antenna still implies smaller received signal, but not necessarily a smaller signal-to-noise ratio.

According to Turner and Meinke, the controversial subminiature integrated antennas provide a wide-band impedance match at the antenna terminals without the use of tuning coils or transformers. Their SIA units have two or three small rods or coaxial cables built around a transistor circuit. One or more of the rods picks up the signal as in a conventional antenna. However, the characteristics of the antenna, as viewed by the load, depend on the manner in which the transistor is connected to the circuit as well as whether the sections of the antenna are operating like a vertical antenna, a loop, or both. Turner and Meinke have analyzed several versions of the SIA.

turers in both the U.S. and Germany began a concerted debunking campaign.

Meinke has also been under fire in Germany. To put the problems and potential of the antenna in perspective, he has prepared a special article and submitted it to the Association of German Engineers for publication.

Meinke shrugs off criticism of the antenna, saying that most of it is perfectly valid at this time. He contends he would probably have made the same kind of comments if someone had talked to him about such a device at this stage of its development. He says his report is not a description of an immediately practical device but simply a compendium of his findings.

I. Tune in

The hullabaloo focuses on an antenna that is structurally similar to the type found on most automobiles. The SIA is vertical but has a transistor and is very short.

According to Turner and Meinke, integrating a transistor circuit into the antenna permits operations

over a wide frequency band—usually in a ratio of at least 2 to 1, and possibly up to 50 to 1. In addition, the antenna can be connected directly to coaxial cables and tv transmission lines, unlike conventional short antennas. A tuning coil is required to resonate the conventional antenna's capacitance, and a matching transformer is needed to eliminate reflections that cause a loss of power.

Fraternal triplets. To complicate matters, Turner unveiled three SIA's, each with distinctly different characteristics. One version operates over a wide frequency band and, like any vertical antenna, has an omnidirectional beam pattern in the horizontal plane. A second assembly also has an omnidirectional beam but operates only over a narrow band. However, by controlling the transistor's d-c current, the band can be shifted over a wide frequency range. According to Turner, this opens up the possibility of combining an antenna and a tuner in one device—a useful assembly for either tv or military communications. The third

SIA, which is supposed to have tv applications, can operate only over a 2-to-1 band, but produces a directive beam. It can be grouped in arrays to electronically rotate the beam.

II. Turn off

Although Turner says Meinke has provided experimental evidence to back the claims made for these three SIA's, there is still considerable doubt as to whether the antennas in general and the tv unit in particular are ready for practical applications.

Harold Wheeler, an expert in the design of short antennas and president of Wheeler Laboratories, Inc., a subsidiary of the Hazeltine Corp., says: "Based on reports I've seen, a more objective evaluation is needed before we assume that the antenna is ready for useful applications in any frequency range."

Wheeler contends the transistor doesn't have to be integrated into the antenna at all. "You could get the same results with some type of active circuit at the output of the antenna," he says, citing the example of short antenna with wide bandwidth. In this case, a high resistance would be connected to the antenna to increase bandwidth—a procedure akin to adding a resistance to a tuned circuit to broaden response. Adding a transformer to the circuit matches the high resistance to the cable; finally, an amplifier is installed to compensate for the losses.

Out of focus. One of the faults of Meinke's initial report, Wheeler says, was that it never made a comparison between the bandwidth performance of the SIA and that of a comparable passive antenna with an active network at the output. He also considers the report hazy: "I'm sorry that it wasn't presented in a simpler way so we could see what it (the SIA) can or can't do. At no time have they presented their basic ideas stripped of all confusions."

He feels there isn't enough information about the noise level of the transistor, and he questions how easy it would be to operate the antenna at higher frequencies. The tests reported by Meinke were run at 2 to 32 Mhz. If used for tv, the antennas would have to operate from 54 to 174 Mhz for chan-

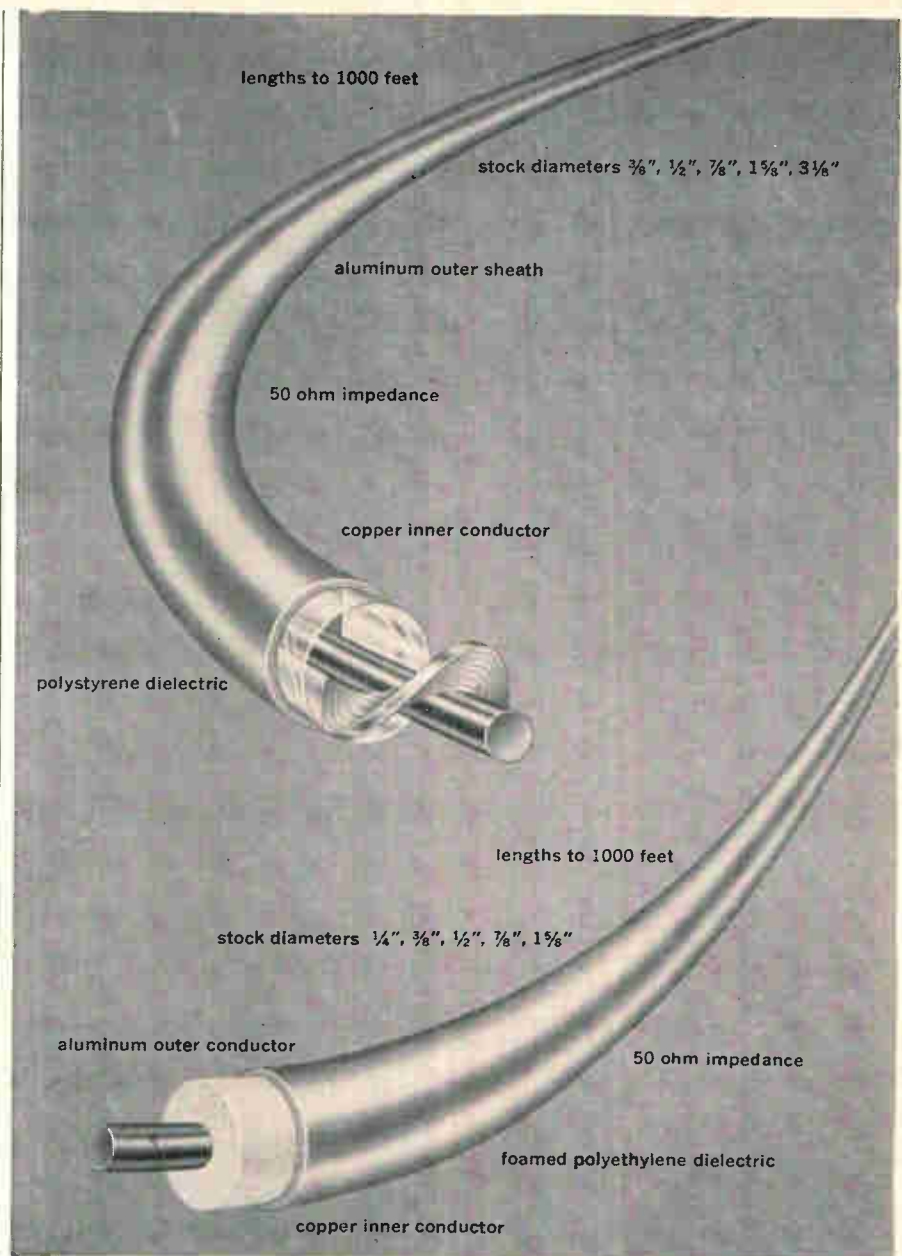

Coaxial cable to meet every need.

STYROFLEX® Here's a coaxial cable with an extraordinarily high degree of physical stability. Essentially an air dielectric cable, Styroflex inherently exhibits lower attenuation and higher velocity of propagation than solid dielectric types. Temperature cycling affects attenuation by less than 1% per 5°C of change. Continuous support assures perfect centering of the conductor during the load cycling.

If you're concerned with systems design in AM, FM, VHF and UHF transmission, microwave communications, radar, forward scatter systems and telemetering, multichannel long line telephone networks or general pulse work, we urge you to look into Styroflex coaxial cable.

A good start? Write for Bulletin PS, Issue 5.

FOAMFLEX If you're a pinch-penny when it comes to paying for coaxial cable, you'll go for Foamflex. Introduced back in 1955 as the first foam dielectric cable, Foamflex has been high on the list of cable bargain hunters ever since.

Foamflex is a semiflexible cable construction and a black pigmented polyethylene jacket can be supplied for added protection. Foamflex is the ideal low cost answer in extremely demanding applications in telemetry, missile guidance, microwave, delay lines and other airborne and GSE installations where high performance, light weight and absolute reliability are required.

May we tell you more about Foamflex? Write for Bulletin FF, Issue 4.

PHELPS DODGE ELECTRONIC PRODUCTS
NORTH HAVEN, CONNECTICUT



nels 2 through 13 and from 470 to 890 Mhz for channels 14 through 83. "Transistors aren't so good that you can take low-frequency behavior and scale to high frequencies," Wheeler declares.

III. Put down

Donald D. King, director of the electronics research laboratory at the Aerospace Corp., considers the antenna an interesting but not major development—essentially an improvement in the use of what is available. He describes the SIA as an extension of the work Turner did earlier with Ohio State University's solid-state antennafer in which amplifiers were combined with antennas [Electronics, Oct. 6, 1961, p. 68].

King believes the device's biggest problem is cross modulation. He doesn't believe a quantitative study has been made of how the SIA behaves in the high cross-modulation environment of television reception. "There's no simple way to filter it out with a device at the terminal itself," he asserts.

Turner says one answer to this difficulty is to use the omnidirectional-beam version of the SIA and reduce the bandwidth to the level needed to receive the signal. This version has a bandwidth of 10% to 20%, but it could be made narrower. It could then be electronically shifted to pick up signals at other frequencies.

Aye notes. There are observers who consider the antenna worthwhile, but they suggest that definitive tests be run. Raj Mitra, a professor of electrical engineering at the antenna laboratory of the University of Illinois, says: "The chief merit of the antenna seems to be the achievement of a match over a fairly wide bandwidth. I do feel that there should be more tests and evaluations made. The idea has potential and should be developed further."

Carlyle Sletten, chief of the electromagnetic radiation laboratory at the Air Force's Cambridge Research Laboratories, cautions that critical measurements haven't been made. The same kind of fanfare happened two or three years ago when the 'hula hoop' antenna [Electronics, Jan. 11, 1963, p. 44] was hailed as a panacea for antenna problems," he notes. "It was

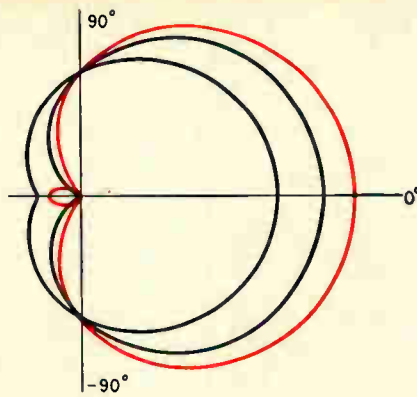

Antenna's directive beams are varied by controlling transistor's d-c current; pattern (color) is least sensitive to radiation from behind the assembly.

learned later that the device's efficiency was very low. Here, of course, there are compensating reactances. But still, the necessary measurements of efficiency and signal-to-noise ratios must be made."

However, Turner claims that the SIA's efficiency is high, arguing that the transistor raises the device's radiation resistance and thus prevents the resistance of the transistor and antenna leads from dissipating the bulk of the power. In a conventional antenna—one that doesn't have an amplifier—efficiency is the ratio of the radiation resistance to the sum of the radiation resistance and resistive losses. The higher the radiation resistance compared to the resistive losses, the higher the efficiency.

Neat trick. Turner alludes to high radiation resistance in a story in the May 19 issue of Time magazine in which he is quoted as saying: "We have in effect substituted a short antenna carrying a large current for a long antenna carrying a small current." A high radiation resistance often implies a higher current distribution.

Most sources agree that the transistor doesn't increase the SIA's efficiency. They characterize the transistor as an amplifier that boosts output signal level but not efficiency. Mitra says that there might be a slight increase in radiation resistance due to the transistor, but he attributes the big increase to the top-hat structure on the integrated antennas that have been built.

Lucio Vallese, a senior scientist at the ITT Federal Laboratories of the International Telephone & Tel-

graph Corp., says: "For a given antenna and a given ground plane, the losses are fixed. The transistor is only good for matching. As far as the efficiency is concerned, you don't gain anything."

Wheeler says, "You don't increase efficiency with an amplifier." Neither King nor Wheeler believe that radiation resistance is really defined for an antenna with a built-in transistor circuit. However, Wheeler's main point is that high radiation resistance is neither inherently good nor bad: "It's where the power goes and the signal-to-noise ratio that is important."

IV. Snow job

Television set manufacturers make much of the SIA's assumed problems with signal-to-noise ratios. They claim that with the tiny antenna described by Turner, the signal to the receiver would be very low. At the same time, the transistor would be adding noise—a situation that would lower the signal-to-noise ratio and produce "snow" on the picture.

In an interview in Munich, Meinke agrees that this is a problem. "If the antenna is made smaller, the received power is decreased while noise is added by the transistor. In principle then, miniaturization of the antennas is only possible for areas where high levels

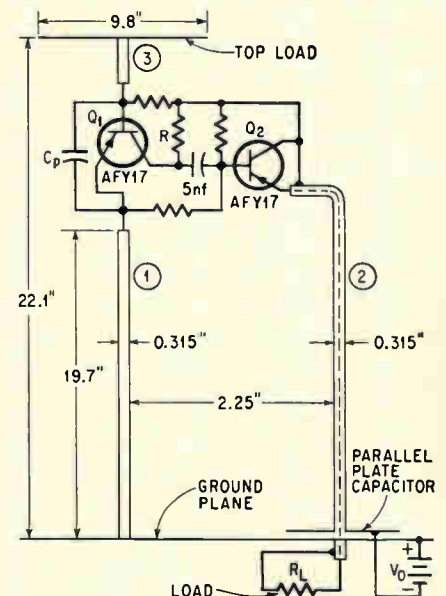

Wideband omnidirectional antenna for use at 3 to 30-Mhz has transistor Q_1 for amplification and Q_2 for matching to load R_L . Capacitor C_p prevents oscillations. Parallel plate capacitor provides an a-c ground.

you get a choice,



not a challenge

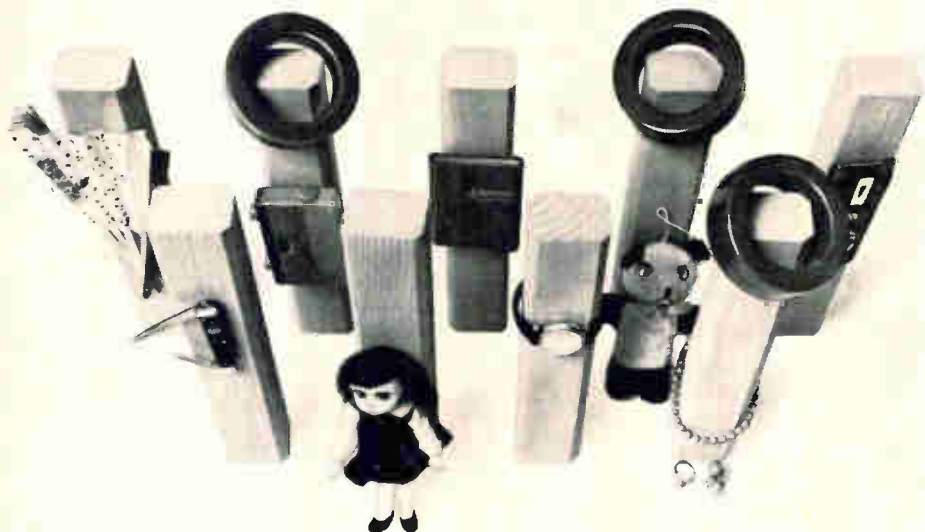

Industry's widest selection of powder cores gives you greater design flexibility

The trend toward smaller circuits and higher density packaging has posed a compaction problem for electrical design engineers—finding quality components small enough to do the job. Magnetics gives the designer more “elbow room” by providing the industry's most complete line of moly-permalloy powder cores—sizes as small

as 0.110" I.D. in the widest range of permeabilities and stabilizations.

We also give the designer involved with highly critical inductor stability factors more latitude with guaranteed temperature stabilization in miniature powder cores. All of these types are designed so they can be wound on present miniature toroidal winding equipment. The “M” type limits the change in inductance to $\pm 0.25\%$ from -65 to $+125^\circ\text{C}$. The “D” type limits the

change to $\pm 0.1\%$ from 0 to 55°C . The “W” type limits the change to $\pm 0.25\%$ from -55 to $+85^\circ\text{C}$. These stabilizations are available in all sizes and permeabilities.

If condensing a circuit design is your bugaboo, check Magnetics' powder core line—the one that gives you a choice, not a challenge. For the complete story, write Magnetics Inc., Butler, Pa. 16001

MAGNETICS inc.
®

FOR DESIGN ENGINEERS, MANUFACTURERS AND USERS OF CERAMIC CAPACITORS

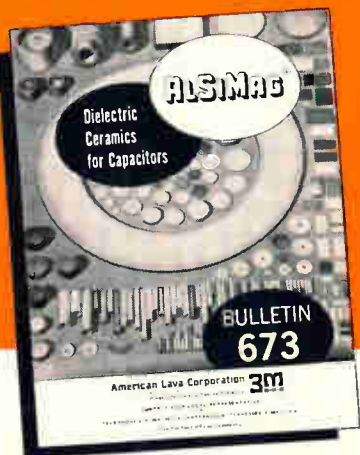

FREE to
technical personnel

... The latest edition of the only known publication on Ceramic Dielectrics for Capacitors. 36 pages of data, charts, graphs, specifications. Valuable to any producer or user of ceramic capacitors.

Please request Bulletin 673 on business letterhead, giving your title or work assignment.

American Lava Corporation pioneered the development and manufacture of special purpose ceramics for use as ceramic capacitors. Many of the major advances in the art resulted from its research.

This research over a period of years forms a strong background for further advances under our continuous research and development program.

American Lava Corporation **3M**
COMPANY

Titania Division
Chattanooga, Tennessee 37405
Sixty-Fifth Year of Ceramic Leadership

of field strength prevail."

Backing off. Turner willingly concedes this point. He says that he never meant to imply that integrated antennas only 2 inches long would be used for tv. "There's no percentage in making an antenna 2 inches long when you can use antenna, say, 18 inches long and improve the signal-to-noise ratio. You don't make an antenna shorter than you have to. You make it big as the television cabinet permits."

Tests on the 2-inch unit that got everyone excited in the first place have already been abandoned. "We ran a check at 400 Mhz." says Turner, "but it was inconclusive one way or the other. I don't even consider it a test." Turner's group is now working on 4-inch omnidirectional sias at 30 to 150 Mhz.

Turner points out that in military applications there are many cases where only very small antennas are practical. Mounting such miniature assemblies on an aircraft could save many thousands of dollars in installation costs, he says. "The installation of conventional flush-mounted very high frequency antennas on a fighter aircraft can cost several thousand dollars—especially when structural members or fuel lines have to be rerouted."

But signal-to-noise ratio isn't the only problem involved in television reception. Antennas must be directive to avoid interference from other stations and to eliminate ghosts caused by reflections. The antenna on which Meinke reports has only limited directivity, definitely no more than simple yagis.

V. Put to the test

On the basis of this drawback alone many manufacturers have decided against the sia. Robert Leitner, chief engineer of the Jerrold Corp.'s Technical Appliance Division, Sherburne, N.Y., says: "This device, I am sure, is limited for what we know is required for tv reception. It won't meet the need in fringe areas from the standpoint of interface-free and snow-free operation." Leitner also believes the sia would be relatively useless as a replacement for rabbit ears.

The JFD Electronics Co. has actually tested the antenna at its research and development labora-

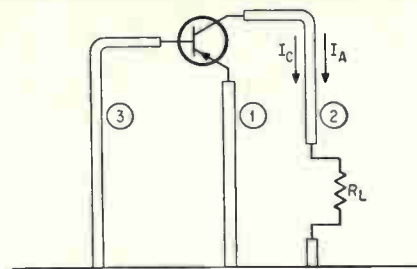

Directive antenna requires that arms 1 and 3 operate as a loop antenna while arm 2 acts as a vertical antenna. Peak of beam is in plane of the page.

tory in Champaign, Ill. The company's conclusion is that the very tiny antenna won't do the job. According to one company representative, the work has been going on since before mid-April when the antenna began receiving widespread publicity.

Loop capability. Both Wheeler and King question the sia's ability to operate as a loop—a capacity essential for directivity. "Every antenna has some directivity accidentally," Wheeler says. "The question is: is it a useful amount? In a small antenna, if you can't change the pattern appreciably, you gain nothing. The cardioid pattern that Meinke is talking about represents only a 3-db change over an omnidirectional version."

Wheeler also observes that the close spacings of the loop would produce a very low signal level in the receiver. Explaining the frequency dependence of this antenna, he says that the signal level depends on the width of the loop in wavelengths. For a given loop, the signal level drops off as the wavelength increases or as the frequency decreases. "The vertical arms should be one-sixth of a wavelength apart for optimum performance," he says. This would provide a phase relationship in the arms that would produce maximum voltage difference across the transistor.

VI. What's ahead

Applications for sia's in television aren't the dead issue some contend they are, says Meinke. Tests were run on the television-version sia early this year at frequencies from 40 to 100 Mhz. The antenna was an eight-wavelength assembly with omnidirectional pattern. In a few months, Meinke says,

the directive-type antennas will be checked out. He concedes that results to date have been poor, but points out that it's difficult to develop a high-performance device after only a few months of experimentation.

"The best opportunities for success are probably in the areas of indoor antennas and portable equipment," Meinke says, explaining that neither field enjoys optimum performance and progress could be made quite easily.

Nullifying echoes. One possibility is to develop sias with null points patterned to eliminate echoes. The design would have a simple control that could electronically adjust the null at any time.

Meinke says his institute has just designed a device that combines the function of a transmitter and receiver in a single antenna structure. The assembly, an antenna 1/16-wavelength long coiled inside a plastic tube, employs one transistor for receive functions and another for transmit. A button on the handle just below the tube is used for switching. Meinke says two companies are already considering it for walkie-talkie radios.

For the present, sias will be used only in systems operating at frequencies between 10 and 20 Mhz. For all practical purposes, such devices can be no smaller than 1/16 of a wavelength, says Meinke.

Happy warrior. Turner takes a philosophical view of the controversy surrounding his work. "I've gone through this four times already where almost the entire scientific community took exception to the work we've been doing," he says. "It will take three or four years for people to accept it. I've won my battles so far and I think I'll win this. I discovered the spiral antenna around 1953, and had a violent argument about what it could do. But it didn't matter what people said, the data stood on its own. I am now in a crash program to get experimental data on what he [Meinke] has done."

The acerbic controversy surrounding sias is clear proof that the antenna establishment has been shaken by their debut. Vindication of Turner's and Meinke's claims would cost it dearly in dollars and prestige.

storable tubular satellite antenna cold rolled to ± 0.00015 " tolerance

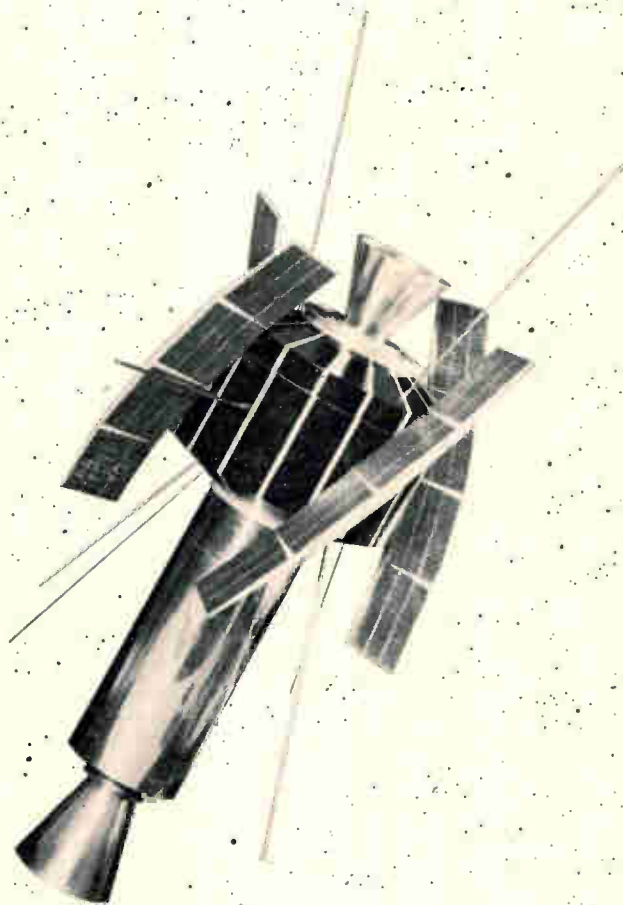

The Radio Astronomy Explorer (RAE) satellite is designed to give NASA an electronic map of the galaxy. Four reel-stored antennae of the RAE satellite consist of 2-in.-wide beryllium-copper strips over a tenth of a mile long. These antennae are made with furled metal strip produced by Hamilton Precision Metals, rolled to a thickness of 0.002" and held to a tolerance of ± 0.00015 ".

Hamilton Precision Metals is your prime source for ultra-precision-rolled metals in mass production quantities. 7 proprietary metals, 12 pure metals and 112 commercial alloys are available from Precision Metals. Write today for new 48-page data book.

HAMILTON PRECISION METALS

division of Hamilton Watch Company, Lancaster, Pa. 17604

How to build a Universal Measuring System



Push!

That's right. Eldorado's new Modular System Series of integrated circuit 10MHz counters slip together to provide nearly 100 different counting, totalizing, and control functions—more than any other counter system available today! And, infinitely more flexible to use than old-fashioned plug-in types. Lets you count and control anything, from beans to rpm to frequencies, and change easily as your requirements change.

Cost is as small as the size—less than \$600 buys one of the basic units, and less than \$1,700 covers almost any counting system requirement you can dream up.

Want to see one in action? Just push the button on your Eldorado representative. He'll slip one in his brief case and come right over.

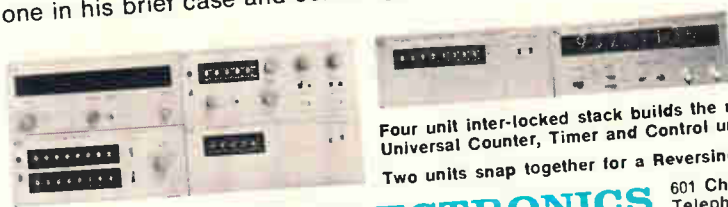

Four unit inter-locked stack builds the most complete Universal Counter, Timer and Control unit available.
Two units snap together for a Reversing Preset Controller.

ELDORADO ELECTRONICS

601 Chalomar Road, Concord, California 94520
Telephone: (415) 686-4200



Exchanging a viewpoint

After year at Stanford, Russian electronics engineer outlines a number of the differences that he notes between educational systems in the U.S. and USSR

By William Arnold

San Francisco News Bureau

A tall, bearded student strolls out of the electronics laboratories at Stanford University's campus in Palo Alto, Calif., chats with several classmates, turns and heads for the men's dormitory. In his wash-and-wear trousers and sports shirt, he looks like any other American graduate student—except that he isn't. He is Ants Koort, a 36-year-old exchange student from the Soviet Union.

Softspoken and easygoing, Koort is also a good-will ambassador to the U.S. "There are big differences between the two countries," he says. "I don't see anything wrong with differences."

While he doesn't fit into any convenient stereotype—"I'm Estonian, not Russian"—Koort's presence on an American campus belies a number of misconceptions about the Soviet Union. For one thing, it indicates that Russians may enjoy more freedom than most Americans give them credit for having. Although Soviet citizens can't study abroad without state approval, Koort maintains that the selection of Stanford was his own. He chose the West Coast school after reading an article in Time magazine last summer that gave it high marks in electrical engineering. And he says he was given the widest possible latitude in regard to his academic pursuits. "The only recommendation I received before leaving the Soviet Union was to work. How I do it is my option," he says.

The latitude given him by his government may have been wide, but the subject matter he studied was, at least compared to American standards, narrow: statistically optimizing the reliability of ohmmeter and voltmeter circuits. Koort is

considered a good student by his professors. His year in this country will be credited toward his technical science degree—equivalent to an American Ph.D.—at Tallinn Polytechnic Institute in Estonia.

Bruce B. Lusignan, Koort's faculty adviser at Stanford, says: "Specialized study in voltmeter reliability problems is a subject one level below that which is taught in the U.S. We teach students how to use them, but our students will have the same experience after two years in industry." He points out that while American universities have five basic engineering majors, Russian colleges have 140. However, U.S. schools do have 200 fields of concentration within this framework.

Koort's other special study at Stanford was comparative American education. "He's bucking for professor back there," Lusignan says.

Soviet vs. U.S. When he leaves for home later this month, he will take with him some opinions of American higher education, which he found somewhat lacking. "Soviet undergraduate departments are better because we are more specialized," he says. Unlike the U.S., freshmen in Russia are required to choose a major at once. "Early specialization is good," says Koort. "It allows you to go deeper into your field."

After a Russian student completes his engineering program—usually a five-year curriculum—he generally goes on to graduate school where he is expected to publish several papers and take three or four exams designed to aid his research project.

Like most of his Soviet engineer-



Visitor. Ants Koort, a Russian exchange student finishing up a year of graduate work in electronics at Stanford, has enjoyed his stay in the U.S. When not studying, he spends his time dining out with friends or traveling to national parks like Yosemite and the Grand Canyon.

ing colleagues Koort was dismayed by the number of students in the humanities. "Here, there is less emphasis on science and engineering," says the Russian. "In my country, young men prefer the engineering and scientific fields. In every university there are more students in science and mathematics than in the so-called 'social sciences' and humanities." Perhaps most startling to him is the fact that in the U.S. a great number of college students actually do prefer the humanities.

Freedom of choice. Admitting that the state places a newly graduated technocrat in a factory job for three years—"to repay the state for his tuition-free education"—Koort contends that rigid control over engineers has been relaxed. "They are free to change jobs and do so often," he says. But job-hopping Russian style isn't quite the same as in the U.S. Soviet engineers have one employer, the state, so the issue is purely academic.

Most Russian engineers are able to keep up with American technology. The large factories have libraries stocked with the latest Free World technical and popular periodicals—read and understood because Soviet engineering students are required to learn at least one Western language. At least in this respect, the Russians have a definite advantage over their free world counterparts.

new featherweight Tru-Touch 6120

A REAL SOFT TOUCH FOR A TOUGHIE.

The new Wil-Gard "Featherweight Tru-Touch 6120" disposable vinyl glove is so light it has bare hand tactile perception. So tough it can be used to protect products—or people. So thin you can read through it. It's ambidextrous and less expensive.



SOLD ONLY THROUGH DISTRIBUTORS

Write for special literature on the complete "Tru-Touch" glove line, Wil-Gard glove selector and name of Wil-Gard expert nearest you.

WIL-GARD®

Edmont-Wilson Canton, Ohio 44706

a division of Becton, Dickinson and Company



WR-467-60

Edmont, Wilson, Wil-Gard and Tru-Touch are Trade Marks

Lending a hand to the Pentagon

Nonprofit Institute for Defense Analyses furnishes technological and scientific services on strategic matters; Strat X report, due this summer, assesses U.S. missile posture into mid-1970's

By James Canan

Washington News Bureau

At the end of this summer, John S. Foster Jr., the Pentagon's director of defense research and engineering, will receive a classified document projecting the ballistic missile posture of the United States and that of its potential adversaries into the mid-1970's. Called Strat X, the report will culminate a nine-month study by the Institute for Defense Analyses (IDA), a systems-oriented, nonprofit consortium of 12 universities created 11 years ago as a Federal contract research center to furnish scientific and technological services beyond the reach of Department of Defense personnel. Similar IDA studies preceded development of the Polaris and Minuteman missile systems.

Among other matters, Strat X will recommend whether the missiles of the future should be based on railroad cars, in silos, on ships, or at other sites. The Pentagon may or may not accept IDA's conclusions completely, but the advice will certainly influence the military's final decisions on deploying the next generation of nuclear, intercontinental missiles.

Strat X illustrates the significance of the defense subjects handled by IDA. It does not, however, illuminate the scope of IDA's involvement in critical affairs over the years. An idea of IDA's wide-ranging mandate is apparent in the language of its contract with DOD, which specifies that the institute provide: "... personnel, facilities, and material required for surveys and analyses of the effectiveness of various weapons systems; evaluation of new equipment in the light of military requirements; evaluation and analyses of military problems to predict the operational behavior of new

material and equipment; development of new tactical doctrines to meet changing military requirements; studies and reports on the technical aspects of strategic planning; and analysis of combat reports, tactical and strategic plans, and field exercises in both the continental U.S. and elsewhere, with a view to determining how existing weapons and weapons systems could be more effectively employed."

In view of its responsibilities, it is no surprise that IDA's work is highly classified. Security is tight at the modern 10-story building which IDA occupies in Arlington, Va. near the Pentagon. Visitors make every step under escort, and in such an environment, details on specific projects are hard to come by as is an assessment of their impact on the electronics industry.

However, that impact is tersely

described by Norman L. Christler, IDA's vice president and general manager, as "considerable."

I. Rocky road

It hasn't all been clear sailing for IDA. Last year, the House Defense Appropriations Subcommittee accused it of sloppy administrative practices and of being over generous with its funds, particularly in the area of employee salaries and fringe benefits. And one of IDA's five divisions has been embroiled with a Pentagon weapons group. Throughout its existence, IDA has been criticized along with the other "think tanks," like the Air Force's Rand Corp., by those who question the wisdom of having tax-exempt, nonprofit corporations use public funds on public-policy matters in a decidedly nonpublic atmosphere.

But IDA seems to have weathered the storms. A spokesman for the House subcommittee says that IDA's administrative deficiencies have been corrected under the direction of retired Army Gen. Maxwell D. Taylor. The value of IDA's studies keeps its other critics mollified.

Champion. Taylor, chairman of the Joint Chiefs of Staff and ambassador to South Vietnam before taking over as IDA's president last September, says he has "a deep feeling of the essentiality" of IDA and the other nonprofit groups which serve the military services.

"I felt it as a military man, watching the development of weapons systems over the years," he says. "I've seen our weapons arsenal grow in both quality and quantity. We've gone down a long and difficult road since World War II. What has happened shows that the work of the study groups—not just



New broom. Gen. Maxwell D. Taylor has tightened IDA's administration since assuming presidency last fall.

Who's naive enough to let his customers move in and tell him how to schedule his slip-ring business?

Some company called Poly-Scientific.

Sometimes we feel like we're five different companies. We often have that many telling us what to do and how to do it. Because we set up our customers' own departments right here in our plant. We run the departments for them, or let them come down and establish priorities and schedule production personally.

Each customer gets a staff of supervisors, designers and engineers. Full time. Except for the few minutes they spend talking to the secretary we give him. To answer his phone. Type his reports. Bring him his coffee.

What can all this pampering mean to *your* short-lead-time projects? Precise follow up on every detail—from raw materials to final testing. Immediate assistance for getting the job done—fast. We even throw in weekly TWX progress reports to your home office when needed.

In short, you find something more than what's expected when you send your special requirements to Poly-Sci: Extra interest. Extra service. Extra satisfaction.

Care to tell us how to run our business?

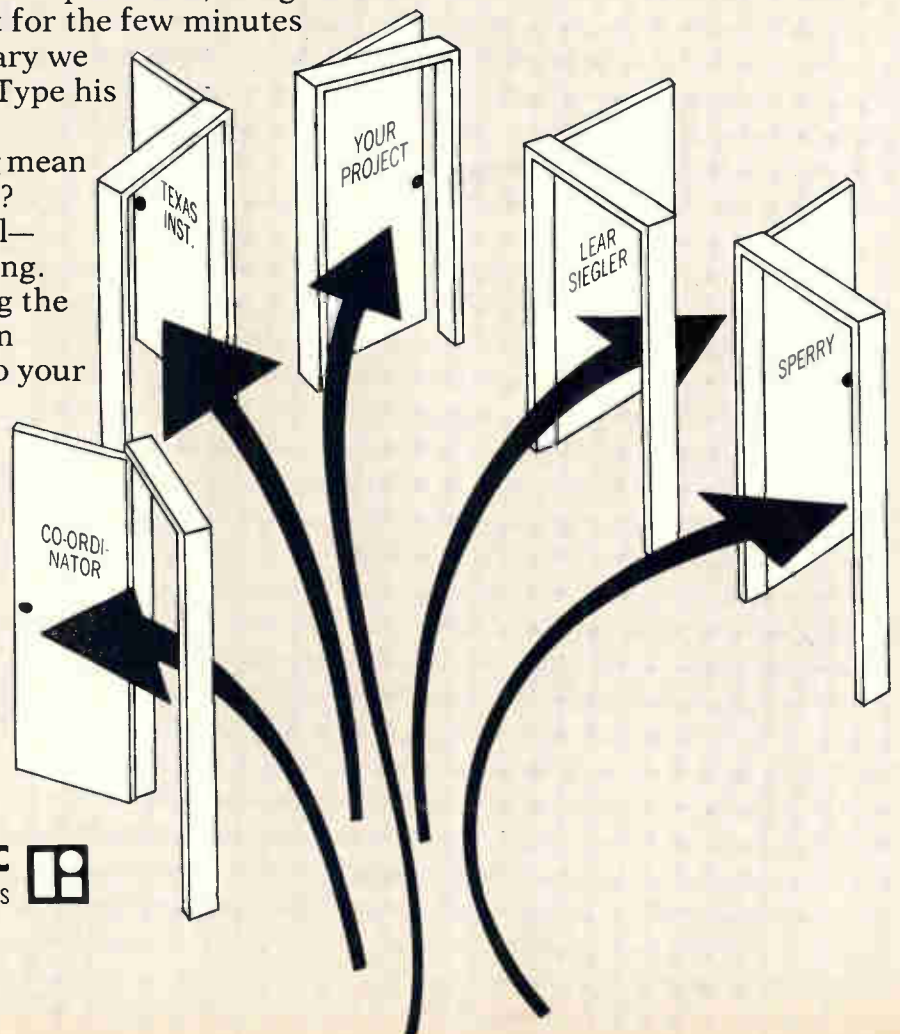

POLY-SCIENTIFIC 
A DIVISION OF LITTON INDUSTRIES

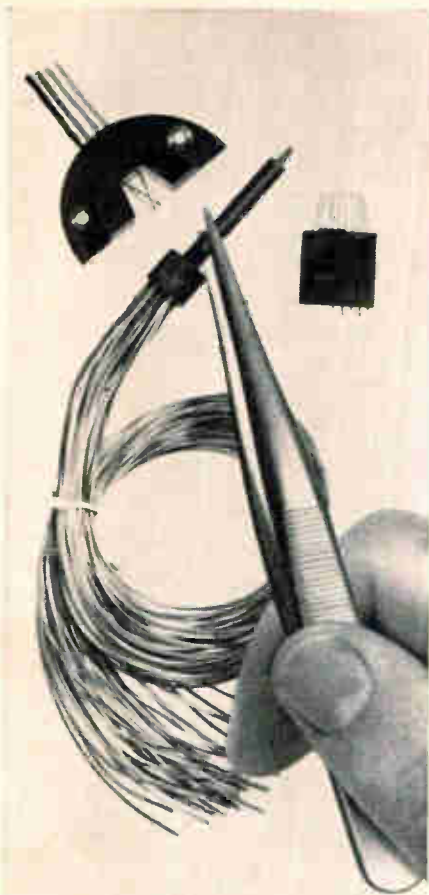

THE BIGGEST product line we offer includes slip rings, brush blocks and capsule assemblies of every size and shape—all tailored to meet your most stringent requirements. Whether it's over-all performance, long life, lot control, qualification testing, cost... or a little of all five.

We also place day-to-day emphasis on standard designs like our \$2.85 Delrin-insulated slip ring. And on developing new dielectric materials, new processes, and new products to improve circuit reliability—and to solve your slip-ring wear, contact noise, or size and weight problems.

So specify your problem to Poly-Sci. We'll specify your slip ring. Mail coupon or call Robert Gardner at 703/552-3011. Or TWX 710-875-3692. On the West Coast, call Jim Swallow, at 213/887-3361.

Poly-Scientific Division ★ ★
Litton Industries
1111 N. Main St., Blacksburg, Va.

I have a slip-ring problem. Tell me how Poly-Sci is qualified to solve it.

Name _____

Title _____

Company _____

Address _____

City _____ State _____ Zip _____

... over the years, IDA has ranged into broadening areas of study ...

IDA—has been fruitful.”

In 11 years, IDA's staff has grown from about 50, including 30 scientists and engineers, to 637, including 320 professionals in the scientific and engineering disciplines as well as in systems analysis. There are 31 electronics and electrical engineers in this group. The institute also uses consultants from universities and industries, and the Strat X study provides a case in point.

Requisition. Officials at IDA told the Pentagon they would undertake the study if they could get a particularly qualified man like Fred Payne, the Marquardt Corp.'s vice president of corporate development, to take charge of organizing the project. Among other credentials, Payne was deputy director of defense research on strategic weapons from 1961 to 1965, so Strat X was right up his alley. The Pentagon went to bat for IDA and landed Payne, persuading Marquardt to give him a leave of absence.

But assembling the Strat X team posed another problem. The study required a thorough knowledge of missile design. The institute has staffers who are knowledgeable in the design of fuel and control subsystems, but no experts in over-all design. Consequently, IDA turned to industry, picking off 20 men to work with 20 of its own.

II. Pedigree

IDA traces its history to the weapons systems evaluation group (WSEG) at the Pentagon, which was formed in 1949 at the behest of James L. Forrestal, the first secretary of defense. The group had both military men and civil-servant scientists. Six years later, Defense Secretary Charles Wilson asked for organized university support to back up WSEG in weapons development. Five universities—the Massachusetts Institute of Technology; the California Institute of Technology; Stanford University; Case Institute, and Tulane University—promptly set up IDA with the idea that they could, through cross-fertilization, serve themselves along with the defense establishment.

During its first two years, IDA had only a weapons systems evalua-

tion division (WSED) which had absorbed the civilians from WSEC. In 1958 the research and engineering support division (RESO) was organized to work with DOD's new advanced research projects agency (ARPA). Like WSED, RESO is accountable to the director of defense research and engineering, ARPA, and the joint chiefs.

In 1959, three more universities joined the IDA roster: Columbia University, Pennsylvania State University, and the University of Michigan. The University of Chicago joined up in 1961; Princeton University and the University of Illinois signed on in 1962; and the University of California came in during 1964.

New faces. In the meantime, IDA had spawned three more divisions—one for economic and political studies (EPS), one for communications research at Princeton, and the Jason division, which has 50 consulting physicists to analyze theoretical defense-science problems.

ARPA, which pays an estimated \$600,000 a year to IDA just to support the Jason group, also receives from IDA the Journal of Missile Defense Research, a highly classified compendium of scientific papers, which is issued quarterly.

Strat X illustrates how far IDA's weapons division has come since the early days, when its activities were largely confined to studies of radioactive fallout, nuclear stockpiling, and continental air defense. Over the years, it has ranged into the broad areas of command and control, ballistic-missile and other strategic offensive and defensive systems, antisubmarine warfare, logistics, tactical weapons systems, reconnaissance, and surveillance.

The research and engineering support division, for example, exerts great influence on such electronics fields as microwave technology, advanced avionics, radar propagation, laser technology, advanced sensors, optics, and advanced propulsion.

Last year, RESO completed the Pen-X study, analyzing the ability of ICBM's to penetrate ballistic-missile defense systems of the future. In addition, under a \$498,000 contract, it did the spade work for the



FREE SELECTOR CHART FOR REFRACTORIES

This Free New Selector Chart / Brochure describes a line of crystalline oxide refractory and insulating ware for use by industry and laboratories. These new products are designed for high resistance to heat, low reaction with metals and chemicals, low porosity and high thermal conductivity. The Selector Chart provides instant technical, mechanical and application data for apparatus made of Aluminous Porcelain, Recrystallized Alumina, Thoria, Zirconia and Magnesia. Write for your copy today.

57



... communications research work is kept under tight security ...

President's Commission on Law Enforcement and Administration of Criminal Justice on the use of science and technology in combating crime. If acted upon, its recommendations in this area should open up a substantial electronics market [Electronics, May 1, p. 105].

Meat-and-potatoes electronics studies undertaken by IDA include several by RESD, focusing on sonar technology and sonar signal processing, as well as on the potential of airborne low light level television for night reconnaissance.

Of all IDA's divisions, communications research keeps the tightest lid on information. That its work is largely theoretical is indicated by the fact that nearly all of its 30 professionals are mathematicians.

IDA also had a hand in Defense Secretary Robert S. McNamara's decision to ask Congress for money for fast deployment logistic ships—a project designed to interest aerospace companies in building automated shipyards. To gather material for reports on that subject, IDA men visited automated shipyards in Sweden and Japan.

Last year, IDA set up the defense systems analysis educational program, in cooperation with the University of Maryland, to inform military officers and non civilians of the knowledge being gained about analyzing defense problems.

III. New home

Two years ago, IDA moved from two locations in downtown Washington to a new building in Arlington, Va. The House subcommittee that probed IDA reported that it was paying \$991,000 a year, on a 10-year lease, for its 190,000 square feet of space in the building. The property is valued by Arlington County for tax purposes at \$7,342,780. It is owned by an organization called 400 Army-Navy Drive Associates, described as a group of local businessmen.

The House subcommittee wondered if the rental wasn't a little high. IDA countered by saying that it was less, per square foot, than the cost of quarters IDA had vacated downtown.

The subcommittee had much to

say about such items as apparently inflated expense accounts and it noted, pointedly, that IDA, as a non-profit organization, was not required to pay taxes on income from Government contracts.

New deal. The upshot was that the Pentagon cut by 20% the level of management fees which it pays IDA for performance of negotiated contracts, in which fees (or profits) are predetermined.

In its first decade, IDA received \$3.6 million in fees—a range of 5% to 6% of the total value of contracts. At the moment, it gets an average fee of only 4½% on contracts valued at some \$14.9 million.

Where the fee reduction hurts IDA most is in its inability to build up financial reserves to help maintain the backlog of personnel and flexibility of purpose that are the main reasons for its existence. Financial reserves are now growing at a significantly slower rate.

IDA and Pentagon officials contend that turning IDA's presidency over to Gen. Taylor was not related to the congressional investigation. Taylor succeeded J.P. Ruina, the only scientist ever to head the science-oriented institute. Ruina returned to MIT.

Before Ruina, Richard M. Bissell Jr., formerly deputy director of the Central Intelligence Agency, was IDA's chief executive. At IDA, Bissell brought to a head the long-smoldering antagonism between IDA's WSEG and the Pentagon's WSEG over prerogatives.

For nearly two years, the two groups had been at odds over whether WSEG could shape the contents of reports which IDA's WSEG prepared for it under Pentagon contract. The flag and general officers overseeing WSEG wanted to exert more influence than suited IDA's taste. Exactly what happened is a well-kept secret, but Bissell and the general in charge of WSEG left the scene at about the same time.

The issue seems to have been resolved in IDA's favor, and Taylor, when he took over, made it clear that he would not be a rubber stamp for the military. By all accounts, he has made this decision stick.

Look what's happened to the sweep generator. Telonic has designed the new 2003 "all-modular" for instant adaption to your swept frequency applications. The 2003 is essentially an

ULTIMATE SWEEP SYSTEM

consisting of a basic chassis and plug-in modules that permit selection of frequency range, attenuation, frequency marking, RF detection, and display processing.

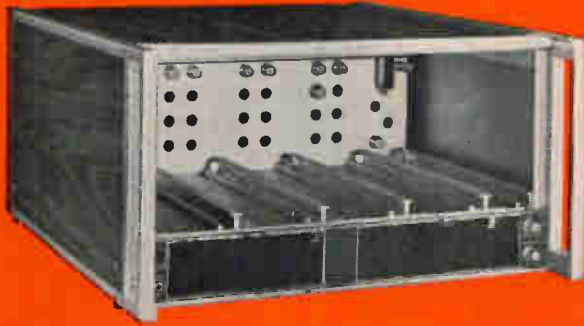

The sweep oscillator modules cover frequencies from

DC to MICROWAVE,

attenuation units range to 109 dB, markers are of both fixed, harmonic and variable types, passive and active detectors are available, and display outputs are provided for oscilloscope or X-Y recording. Useful power available ranges from .35 to .5 VRMS, and is frequency stable without additional isolation. The system may also be phase-locked externally.

Then consider bonus features such as marker tilt control, three sweeping modes, interference-free, time-shared markers, with center frequency and end-point tuning, and the 2003 Sweep System becomes the essential instrument for swept frequency measurement.

Write for Catalog 70, complete with descriptions, specifications, and Sweep Generator Applications.

Telonic INSTRUMENTS
A DIVISION OF TELONIC INDUSTRIES, INC.

60 N. First Avenue, Beech Grove, Indiana 46107
Tel. (317) 787-3231 TWX-610-341-3202

Representatives throughout the U.S., Canada, and overseas. Branch offices in Maidenhead, England; Frankfurt, Germany; and Milan, Italy.

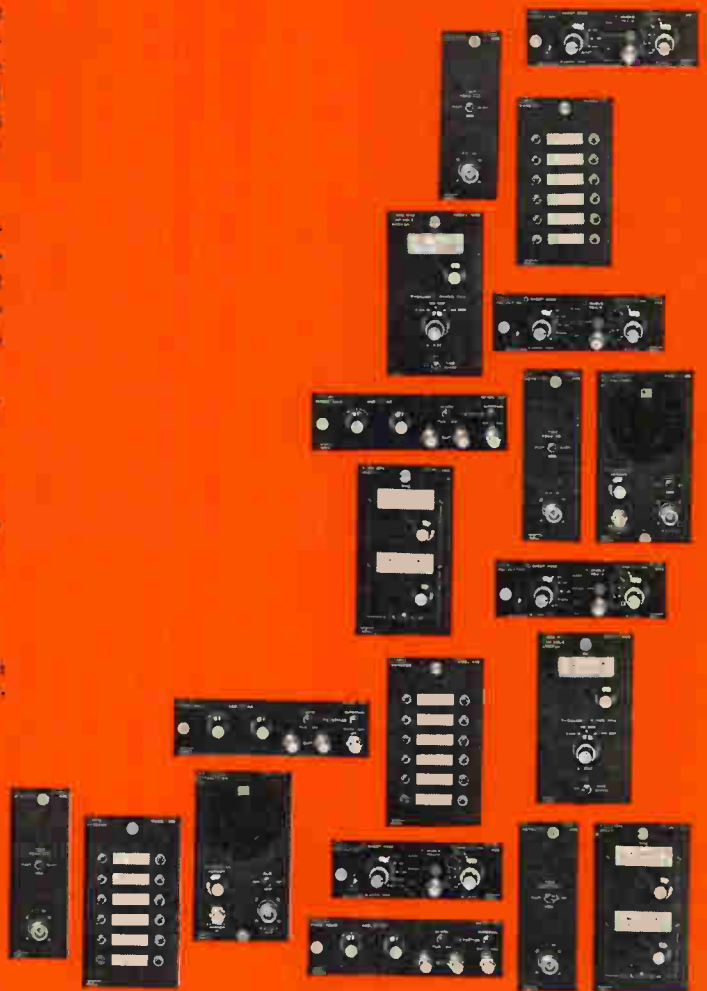

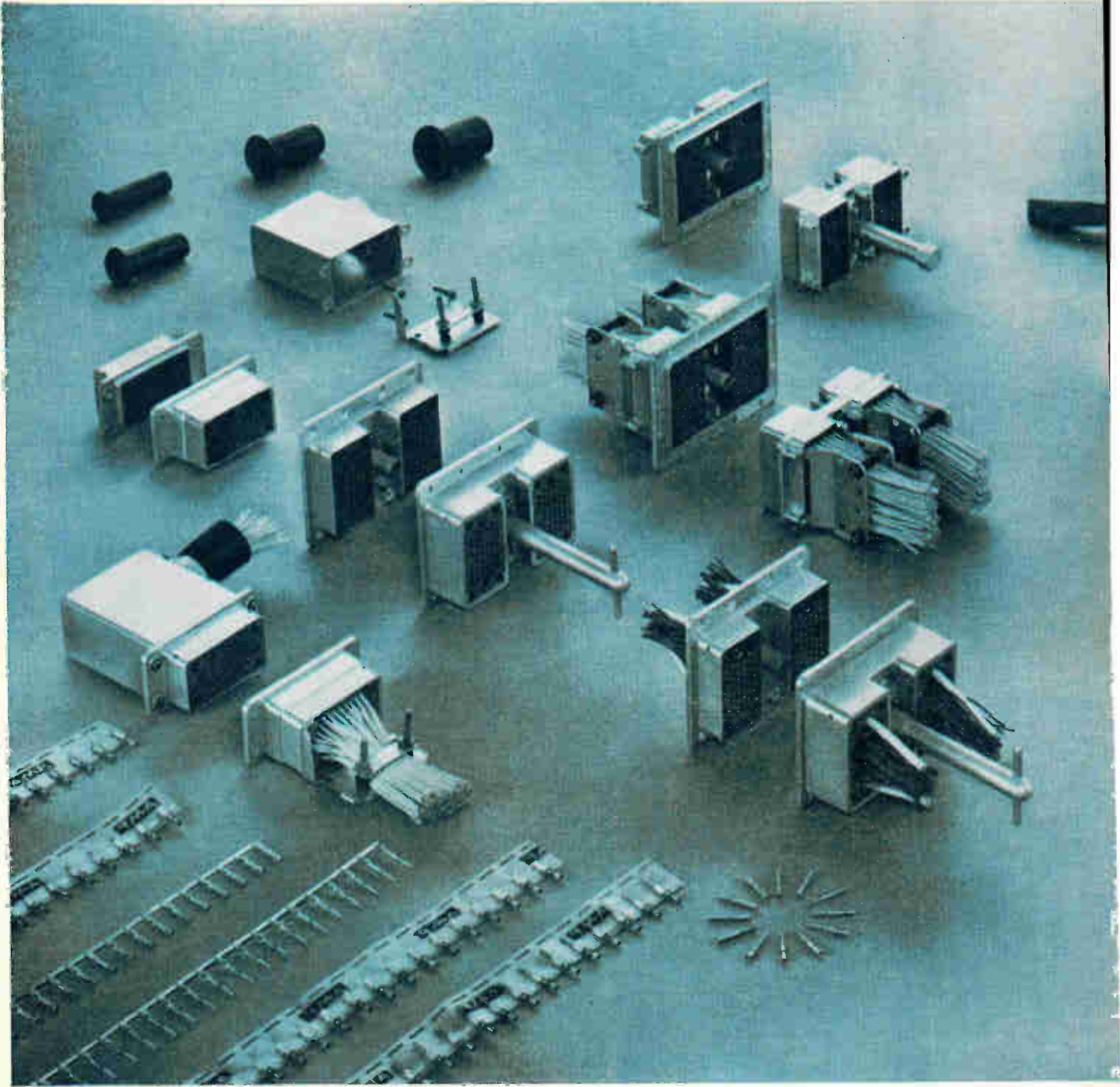

Hard-to-beat pin-and-socket connectors

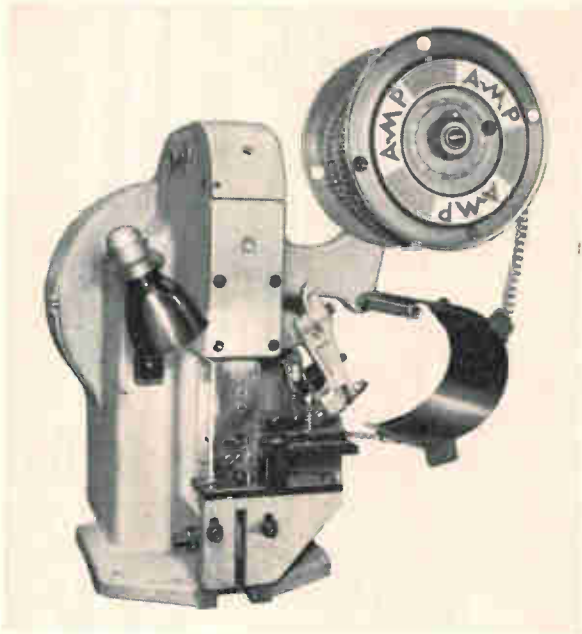
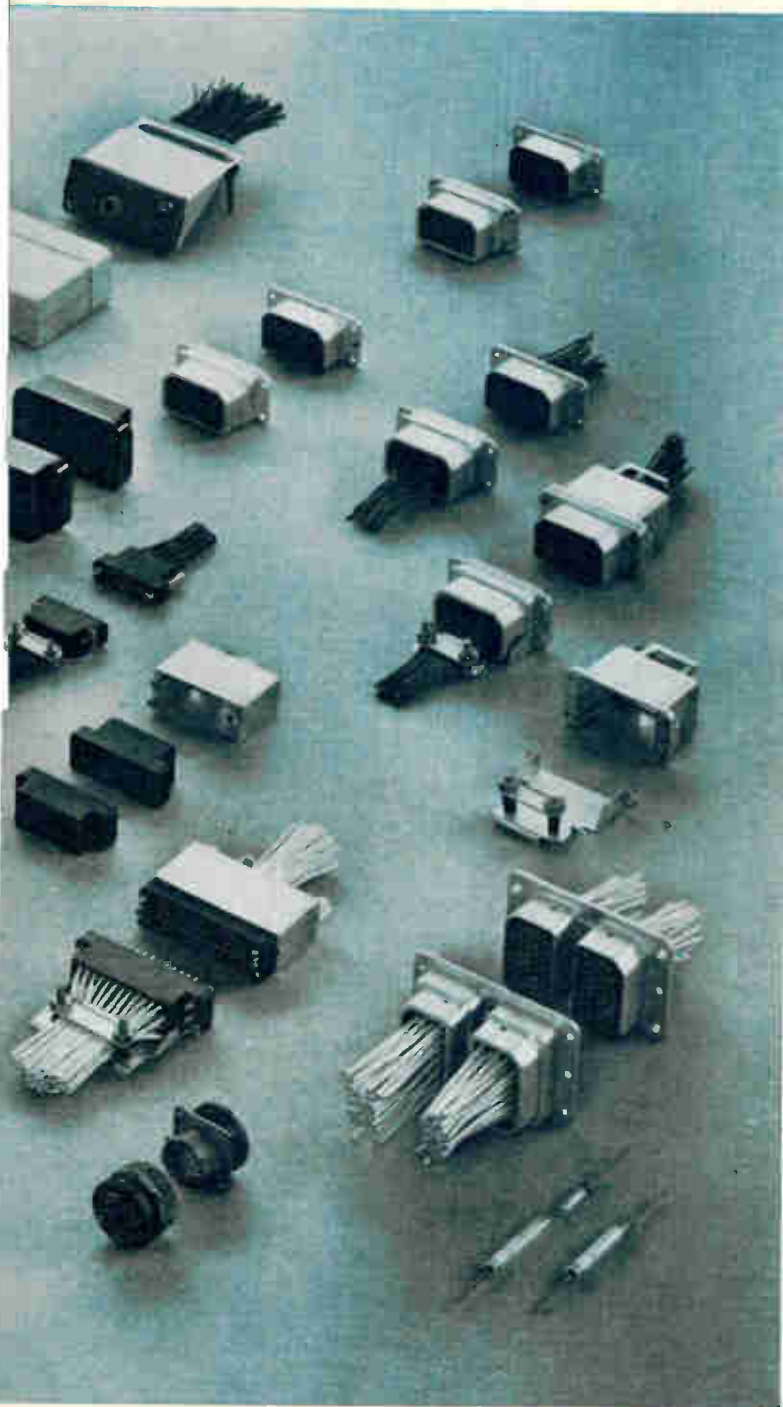

Some 4000 contacts an hour can be applied semi-automatically with this AMP-O-LECTRIC* automachine

The compact AMP-TAPETRONIC* Pneumatic bench machine applies tape-mounted contacts to wires from size 10 to 26 AWG.



Shake them, shock them, put everything from amperes to GHz into them. You'll see these pin-and-socket connectors really perform. Match them to the specifications and watch them go.

There's a connector for every requirement—military, commercial, or industrial. You won't find a more complete line. And if you want a special design we can custom engineer it for you.

Speedy automachine application and precision hand tools are an extra bonus and we provide regular instruction and technical seminars free. We're the leader in our field so we give you more than you'd expect. Send for more information today.

AMP
INCORPORATED
 Harrisburg, Pennsylvania

Put your ideas into action with the help of AMP Engineering . . . Worldwide

SCR'S



IRC can match your SCR needs

IRC silicon controlled rectifiers are value-engineered for optimum price and performance characteristics.

- Ratings from 25 to 700 volts, and 1.25 to 35 amps
- Mil types meet MIL-S-19500/108B (JAN)
- Choice of popular industrial types
- High-speed switching types
- Triggering types

All types are now immediately available from stock.

If you specify or buy silicon controlled rectifiers, you should know about IRC's SCR line. For new semiconductor catalog, price list and samples, write to: IRC, Inc., Semiconductor Division, 727 Lynnway, Lynn, Massachusetts 01905.



ZENER DIODES

MIL and industrial types, temperature-compensated types, 1-watt DO-7, and solid construction Poly-Sil packaging.



AXIAL LEAD RECTIFIERS

AR16 thru AR24 replaces 363 JEDEC devices for 50 to 1000V/.25 to 1A needs. Costs less than stud-mounted types.



RECTIFIERS

Complete choice, including sub-miniature, fast recovery and high power types. All popular configurations.

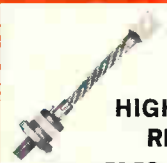

HIGH CURRENT RECTIFIERS

All JEDEC "1N" types available—in forward or reverse polarity. Ratings from 100 to 275 amps, to 1400 PIV.



Rewarding engineering opportunities are immediately available.

Amplifier swings its gain

Fluctuations of up to 100 decibels in signal levels are smoothed by raising or lowering gain in steps of 10 db

Signal fluctuations that can render an analog data recording useless are overcome by the automatic gain-changing loop in Ithaco Inc.'s instrumentation amplifier. It tones down signals or noise bursts that would swamp a data acquisition system and it beefs up signals too weak for recording or display. Then it records the gain changes for use when the signals are analyzed.

The model 441 amplifier holds the average output to a dynamic range adjustable from 10 to 20 decibels. Inputs that can swing between -10 db and 80 db are brought into range by gain switching in 10-db steps. The manufacturer claims that's seven more steps than other automatic gain-switching amplifiers provide.

Combinations of the amplifiers can eliminate the task of manually controlling gain when many channels are operating in a system. Each amplifier monitors and displays its gain status. The operator can also manually control gain.

The output is fed back through a gain-control loop as shown in the block diagram so the control amplifier will boost or attenuate the input signal. Low-frequency roll-off is manually set between 1 hertz and 10 khz; high-frequency roll-off is fixed at 100 khz. The frequency response is therefore compatible with very low frequency acoustic and vibration test systems. The averaging detector's time constant can be set up to 30 seconds to handle the lowest frequencies.

If the output signal level is too low, a threshold trigger produces gain-incrementing command pulses that tell the control amplifier to raise the gain in 10-db steps. If the output signal level is too high, the gain-decrement trigger reverses the process. The process ceases when the output reaches an adjustable threshold level, typically be-

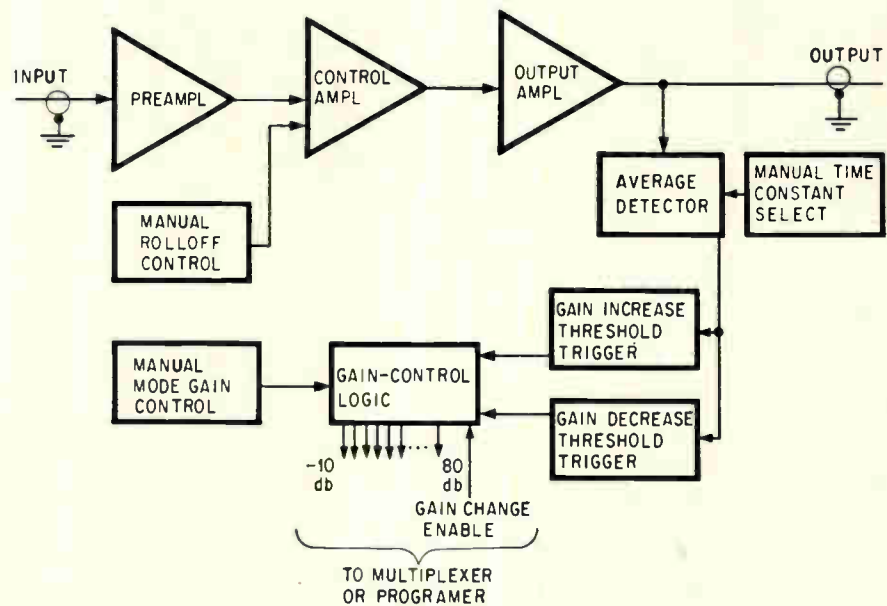

tween 0.25 and 1.0 volt rms, or when the -10- or 80-db gain limits are reached.

Gain switching may be controlled externally with a gain-change enable signal from a multiplexer or programmer. If enabling is sequential, up to 32 channels of gain-status information can be serially multiplexed on a single channel of an instrumentation tape recorder operating at d-c to 300 hz.

For manual adjustment, gain rises 10 db each time a toggle switch is pushed up; each time it is pushed down, gain falls 10 db. The gain-control logic continues operating automatically.

In either automatic or manual mode, gain status is monitored with solid state switches and panel lamps, and can be multiplexed with a standard IBC time code and recorded on one channel of magnetic tape. Or, it can be fed directly into analysis equipment.

Ithaco sells the model 441 for \$960. A rack adapter for eight amplifiers costs \$350. The amplifiers

operate with line power and contain a 60- to 400- hz power supply that is fully shielded.

Specifications

Gain	-10 to +80 db in 10-db steps
Gain accuracy	±0.1 db
Gain stability	±0.1 db long term
High-frequency roll-off	-3 db max. at 100 khz
Low-frequency roll-off	-3 db at 1, 10, 100, 1,000 hz, or 10 khz; approaches -6 db/octave below 3=db point
Low-frequency roll-off readout	Equivalent contact closure each setting
Input impedance	1 megohm min shunted by 500 pf max.
Maximum input	8 volts peak for linear operation, 75 v peak without damage
Average time constant	0.3, 1.0, 3.0, 10, and 30 sec.
Size	7x2x15 in.
Power	95 to 130 v, 60 hz; 5 w nominal

Ithaco Inc., 413 Taughannock Blvd., Ithaca, N.Y.

Circle 349 on reader service card

New Products

Dial-an-airport computer



Pilots and navigators will soon be able to simply dial their destination on a digital differential analyzer—and leave the navigating to the computer. A wired-in program actuated by a punched card will enable the computer to utilize data from other navigation subsystems to guide the plane.

Made by Britain's Marconi Co., the computer is designed to be a part of an avionics, air data analyzer or weapons fire-control system. In a navigation system, the computer—called the AD 670—would accept data from such inputs as very-high-frequency omnirange and distance-measuring equipment, doppler and inertial navigational aids, and altimeters.

A destination selector, at left in the photo, holds 12 cards on which the latitudes and longitudes of airports as well as flight data are represented by coded punched holes. The pilot dials the airport he wants by rotating the knob on the selector unit's front panel. Contacts inside the unit engage the holes and flight orders are relayed to the computer. An optical system built into the selector projects the information onto the front panel so the pilot sees the orders the computer receives. The letters on the dial, A to M, correspond to a list on the panel that indicates the latitude and longitude of the aircraft's destination and way points.

The computer has several out-

puts. One is used to drive the panel indicator, at right in photo, which continually displays either the aircraft's position or its distance from the correct ground track. Other outputs drive cockpit displays that indicate wind velocity, heading, drift, ground speed, and time between direction changes.

The computer's output can also be fed to an autopilot to guide the aircraft automatically. Another output is available for pictorial and tactical displays.

The complete AD 670 system consists of a computer, an analog-to-digital converter, control units, and displays. Because of the specialized design, the computer requires only 50% of the logic circuits and 18% of the memory capacity of a general-purpose machine. However, its arithmetic unit and ferrite memory are equal to those of most such machines. The memory has 1,536 15-bit words.

Power is provided internally for the computer's logic circuits, read-write amplifiers, and ferrite memory. If external power fails, the internal power initiates an automatic shut-down procedure that enables the computer to complete its iteration cycle. Restarting can be achieved automatically or manually, because the memory isn't destroyed. Built-in test equipment warns the pilot of computer failure. According to Marconi, production models of the AD 670 navigation system will be available next year. The Marconi Co., Essex, England [350]

New products in this issue

- 163 Amplifier swings its gain
- 164 Dial-an-airport computer

Components

- 166 IC-driven transistorized indicator
- 166 Fiber-optic faceplate for crt's
- 168 High-contrast display tube
- 168 Sealed industrial trimmer
- 170 Miniature connectors
- 172 Angular-surface dials
- 174 End-capped metal film resistor
- 176 Tiny 5-amp line filters
- 178 Mercury-wetted relays for IC's
- 180 Trimmer potentiometer
- 180 Thermal timing relays
- 182 Compact hybrid vidicons

Semiconductors

- 184 Hot current for coolant level
- 184 Monolithic 1-watt amplifier
- 186 Delay-type binary element
- 188 High-voltage silicon diodes

- 188 Silicon rectifier—no heat sinks

Instruments

- 190 Inexpensive X-Y recorder
- 190 Coherent amplifier ignores noise
- 191 Two-function graphic recorder
- 192 Temperature controller
- 193 Ultraflexible sweep generator
- 194 Phase-sensitive voltmeter
- 195 Recording oscillograph

Subassemblies

- 196 Versatile IC digital computer
- 196 Modular computer system
- 197 Data acquisition system
- 198 Wide-range digital integrator
- 199 Carbon dioxide laser
- 200 Plug-in servo for systems use
- 200 Analog multiplier
- 201 Amplifier modules
- 202 Water-cooled laser
- 203 Op amp uses FET input

- 204 Light-coupled telemetry system
- 204 Switching matrix
- 205 Air navigation indicator
- 205 Space telemetry delay line

Microwave

- 207 Acoustic delay line
- 207 Pulsed amplifier tube
- 207 Miniature balanced mixer
- 208 Stable local oscillator
- 209 Solenoid switches attenuator
- 209 Double-balanced mixer
- 210 Telemetry frequency converter
- 211 S-band dummy load

Production equipment

- 213 Trimmer-former handles IC leads
- 213 Copper-free coating system
- 214 Kiln fires films on substrates
- 216 Glass tip cuts bonding costs
- 219 Hand gun applies adhesives

Materials

- 220 Translucent silicone adhesive
- 220 Indium-tin alloy solders glass
- 220 Dielectric lacquer features high Q

In Making Masks for
Electronic Components...
...there's no
Margin for Error!

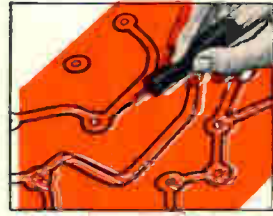

With sharp blade, outline the areas to be masked. Do not cut through the backing sheet. The Ulano Swivel Knife does the job quickly, easily.

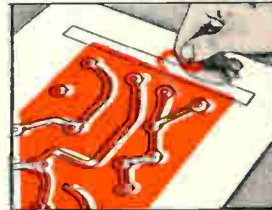

Now carefully peel off the film as outlined leaving a completed photo mask, positive or negative, that corresponds exactly to the desired pattern.

**THAT'S WHY EXPERIENCED DESIGNERS
AND ENGINEERS ALWAYS INSIST ON...**

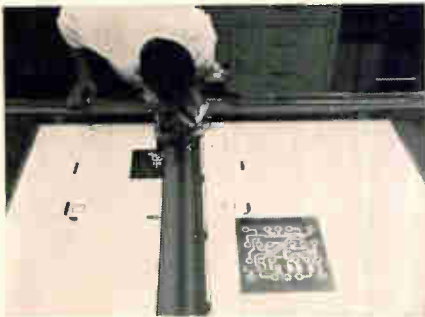

RUBYLITH™

HAND-CUT MASKING FILM FOR THE GRAPHIC ARTS

THE KNIFE-CUT, LIGHT-SAFE MASKING FILM
LAMINATED TO A STABLE POLYESTER BASE

The most versatile line of hand-cut masking films, including

.0075—RUBYLITH 75 DR* .005 RUBYLITH 5 DR
.005 AMBERLITH 5 DA

These new, thick Ulano films provide the positive answers
where exact register assumes a critical importance.

*Available in sheets only, cut to your specifications.

by

Ulano™

ulano™

610 DEAN STREET, BROOKLYN, N. Y. 11238

NEW YORK • CALIFORNIA • CHICAGO • ZURICH

In Europe: ULANO A. G., Untere Heslibachstrasse 22, Kusnacht 8700, Switzerland

Write on your letterhead for special electronic test kit (no charge) No. 4148

Bulova forks solve low frequency problems

Let the experience behind 300,000 forks per year help you!

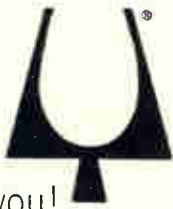

American Time Products forks are now available up to 25 kc, thanks to years of experience plus new design techniques developed by Bulova. (Including the tiny forks for Accutron® electronic timepieces, Bulova made 300,000 last year alone!)

Result: ATP units provide lower cost, smaller size, lighter weight and greater long term stability in such applications as Computers, Navigation Systems, Doppler Radar, Motor Drives, Encoders and Timers. Accuracies of up to 0.001% are available.

Bulova fork oscillators offer the added advantage of simplicity of design and circuitry. Fewer components mean greater reliability. Finally, Bulova fork products are uniquely capable of withstanding severe shock and vibration environments.

No wonder Bulova sold 300,000 last year!

FS-11 FORK FREQUENCY STANDARD

Standard Frequencies: Up to 10,000 cps

Accuracy: Up to $\pm 0.001\%$

Input: 28V DC (others on request)

Output: 5 volts p-to-p min. into 10K ohms

Temperature Range: As low as -55°C to as high as $+85^{\circ}\text{C}$

Size: $1\frac{1}{2}$ in. sq. x $\frac{3}{8}$ "



SUB-MINIATURE TF-500 TUNING FORK

Standard Frequencies: Up to 2400 cps

Accuracy: Up to $\pm 0.001\%$ at 25°C

Input: 28V DC (others on request)

Output: Up to 5V rms into 20K ohms

Temperature Range: As low as -55°C to as high as $+85^{\circ}\text{C}$

Size: $\frac{7}{8}$ " x $\frac{3}{4}$ " x $1\frac{1}{2}$ " max.

Write or call for specifications on Bulova's complete line of tuning fork products. Address: Dept. E-16.

BULOVA

AMERICAN TIME PRODUCTS

ELECTRONICS DIVISION OF BULOVA WATCH COMPANY, INC.

61-20 WOODSIDE AVENUE WOODSIDE, N.Y. 11377, (212) DE 5-6000

New Components and Hardware

Transistorized indicator is driven by IC's

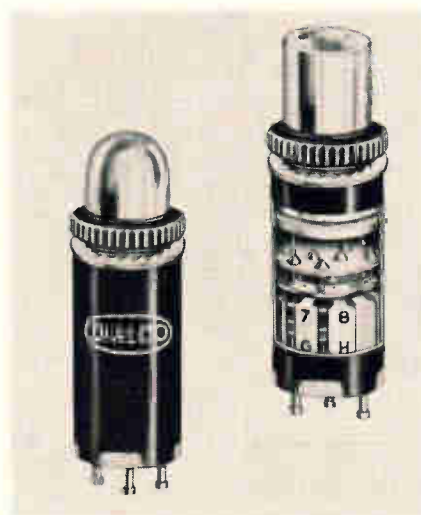

module, two loads of a transistor-transistor-logic module, or 10 loads of a resistor-transistor logic module.

The incandescent lamp is driven by a high-gain transistor with a diode AND gate input. The lamp operates from a 4.5 ± 1 volt d-c supply. When a logical 1 level input between 1 and 15 volts turns the lamp on, open-circuit current is less than 10 microamperes. When the lamp is off (logical 0 input, between 0 and 0.6 volt), the indicator represents a sink load of 2.8 milliamperes.

Specifications

Model	903-1458
Mounting	15/32-in. hole in $\frac{1}{8}$ -in.- or 3/16-in.-thick panel
Bulb	T-1 $\frac{3}{4}$ incandescent bulb with midget flanged base (GE 377)
Temperature range	-20°C to $+70^{\circ}\text{C}$
Lamp life	20,000 hours min. at 3.6 volts 5,000 hours min. at 5.0 volts
Off load On current	2.8 ma at 0 to 0.6 V less than 10 microamperes at 1 to 15 V
Cost	\$5.63 in lots of 1,000

Dialight Corp., 60 Stewart Ave., Brooklyn, N.Y. [351]

Conventional integrated circuits can operate a subminiature indicator light. All the circuitry needed to drive the lamp is contained in the indicator housing. Power-supply and logic requirements are compatible with IC's, eliminating the need for interface circuitry.

Indicator loading is minimal, and practically the full drive capability of the IC is available for other loads. Each indicator requires one load of a typical diode-transistor-logic

Fiber-optic faceplate for line-scan crt's

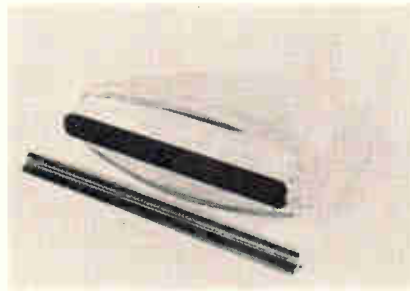

Parallax is eliminated by a fiber-optic faceplate that brings the intensity-modulated line display of a cathode-ray tube to the front surface. By moving photosensitive paper past the line scan, contact prints of photos, charts or other

information can be generated. Applications for the tube include copying equipment, automatic printing equipment, telemetering systems, and computer communications and read-out systems.

The faceplate is available up to $10\frac{1}{2}$ in. long x 2 in. wide. Any thickness can be supplied to meet voltage standoff or three-atmosphere pressure test requirements. The faceplate can be sealed to glass like KG-12, 0120, and others having equivalent coefficients of expansion. It can also be supplied sealed to a crt bottle.

The faceplate may have a numerical aperture from 0.3 to greater than 1.0; fiber size is available from 5 to 30 microns. Extramural-absorbing material may be incorporated within the matrix for contrast enhancement. The plate is

From RCA "overlay" ... 8 great RF-Power transistor advances!

new:



Industry's Best Performing
RF-Power Plastic Transistor

**RCA
2N5017**

$P_{out} = 15 \text{ W (Min.) @ 400 MHz}$

Low emitter and base inductances (0.1 nH and 0.2 nH respectively)... rugged "terminal block" structure permits choice of stripline, printed circuit, or lumped circuit mounting.

Circle 472 Reader Service Card

new:



Microwave Coaxial Package!

**RCA
TA 7003**

$P_{out} = 1 \text{ W (Min.)}, 5 \text{ dB Gain @ 2 GHz}$
 $P_{out} = 2 \text{ W (Min.)}, 10 \text{ dB Gain @ 1 GHz}$

New low-inductance package for UHF and microwave oscillator, frequency-multiplier, and rf-amplifier service.

Circle 476 Reader Service Card

new:



**RCA
2N5016**

$P_{out} = 15 \text{ W (Min.) @ 400 MHz}$

Formerly TA2675, this type uses the same chip as in RCA's new 2N5017 plastic-stud package, but in the popular hermetically sealed TO-60 case.

Circle 473 Reader Service Card

new:



High power version of
RCA's new 2N5016 transistor!

**RCA
TA 7036**

$P_{out} = 20 \text{ W (Min.) @ 400 MHz}$

For Class B or C VHF-UHF Military & Industrial Communications.

Circle 477 Reader Service Card

new:



For Class-A Wideband applications
in VHF Equipment!

**RCA
TA 2800**

$f_c = 1200 \text{ MHz (Min.) @ } I_c = 50 \text{ mA}$
Large dynamic range
 $NF = 3 \text{ db (Typ) @ 200 MHz}$

For top performance in CATV and MATV line amplifiers and low-noise linear amplifiers.

Circle 474 Reader Service Card

new:



High-gain Class-C amplifier
type for UHF service!

**RCA
TA 2710**

$P_{out} = 1 \text{ W (Min.) } 5 \text{ dB Gain @ 1 GHz}$
 $= 0.3 \text{ W (Typ) @ 1.68 GHz}$

Circle 478 Reader Service Card

new:



Class-B and -C amplifier type
for 24-V FM communications!

**RCA
2N5071**

As narrowband amplifier:
 $P_{out} = 24 \text{ W Min. @ 76 MHz with } P_{in} = 3 \text{ W}$
As broadband amplifier:
 $P_{out} = 15 \text{ W (Min.) @ 30-76 MHz with } P_{in} = 3 \text{ W}$

Circle 475 Reader Service Card

new:



Class-A and -B amplifier type for
Single-Sideband Transmitters!

**RCA
2N5070**

$P_{out} = 25 \text{ W (PEP) Min.}$
 $13 \text{ dB gain @ 30 MHz, } V_{cc} = 28 \text{ V}$
Intermodulation Distortion = 30 dB (Max.)

Circle 479 Reader Service Card

For information on these and other RCA "overlay" transistors, see your RCA Representative. For technical data on specific types, write: RCA Commercial Engineering, Section IN6-2, Harrison, N. J. 07029



RCA Electronic Components and Devices

The Most Trusted Name in Electronics

"How more rigid can quality control get?"



E-I GLASS-TO-METAL SEALS —

Specialized manufacture, with continual R & D pinpointed to absolute seal perfection

— PROVED IN CRITICAL AERO-SPACE PROJECTS!

Years of E-I specialized production, with research and development devoted exclusively to the ultimate in hermetic sealing, have resulted in electrical and mechanical characteristics compatible with today's highly sophisticated applications. Engineers and designers requiring high reliability in vacuum-tight sealing, should check these advantages:

- High dielectric strength, severe shock and vibration resistance
- Cushioned glass construction, maximum rigidity and durability
- Withstand wide fluctuations in temperature and humidity
- Miniaturization, design standardization

E-I sealed terminations include hundreds of stock items. Where custom seals or unusual lead configurations are required, E-I sales engineers will make recommendations from your blueprints, sketches or data.

Write for E-I Catalog — Complete data on standard types, custom seal components and sealing to your specifications. Address requests on company letterhead.



Electrical Industries

A Division of Philips Electronics and Pharmaceutical Industries Corp.
Murray Hill, N. J. 07971 — Tel. (201) 464-3200

Patented in U.S.A., No. 3,035,372; in Canada, No. 523,390; in United Kingdom, No. 734,583; other patents pending.

New Components

capable of repeated thermal cycling up to 850°F.

Chicago Aerial Industries Inc., 550 W. Northwest Highway, Barrington, Ill. 60010. [352]

Display storage tube provides sharp contrast



A patented design that permits high-contrast operation makes the background brightness of a new display storage tube independent of erase duty cycle and persistence. The tube is suitable for new dual-mode radar displays because it offers more halftones than conventional tubes.

Designated WX-31016, the new unit has a minimum erase time of 7 msec and can display nine shades of gray.

Other areas of application include navigation, search and fire-control radar displays, and air traffic control displays.

Two electrostatic focused and deflected writing guns in the WX-31016 give the systems designer a wide range of operating modes and offer an alternate tv display.

Westinghouse Electric Corp., Electronic Tube Division, Elmira, N.Y. [353]

Industrial trimmer is sealed for cleaning

A trimming potentiometer sealed for p-c board solvent cleaning is being offered at a price—\$1.95—competitive with the cost of unsealed units.

The ¾-in.-long rectangular model 77 has a cermet resistance element

How to flatten spikes precisely and for pennies

One look at this circuit and you recognize the answer to voltage transients.

But forget about paired diodes.

A single Carborundum® varistor gives you precise suppression for pennies. "VDR" marks the spot.

Our nonpolarized varistors flatten spikes from either direction, defy installation error. They're rugged enough to handle severe overloads, and they will do it with better reliability than diodes.

Aside from their low purchase price, Carborundum varistors can save you transistor dollars, too. Their precision damping performance means you can settle for lower breakdown ratings in transistors.

Send us your problems with transient suppression and voltage control and we'll send you precise technical and cost data.

Write to Mr. Harry Emes,
The Carborundum Company,
Refractories & Electronics Division,
Niagara Falls, N. Y. 14302.

Precisely yours . . .

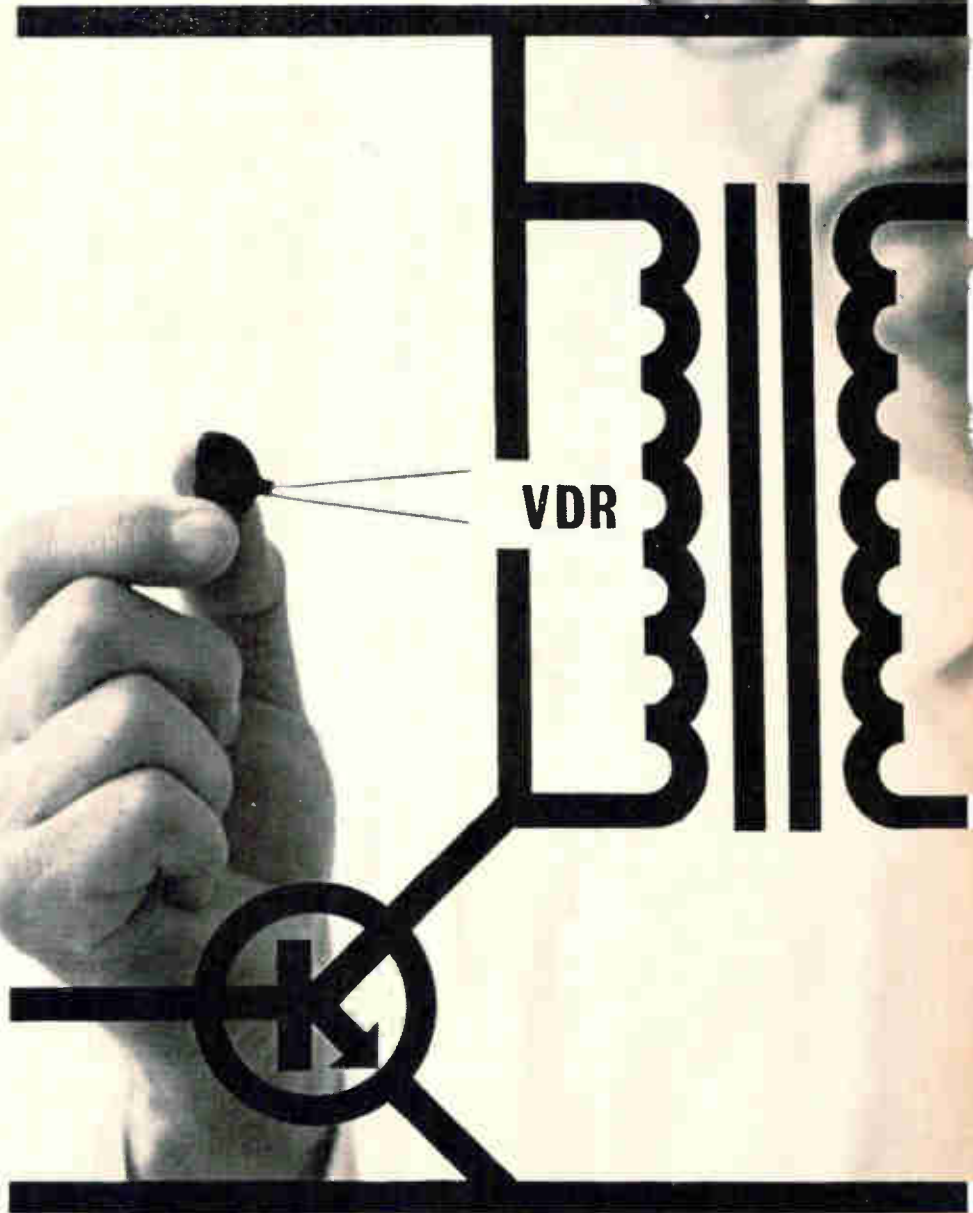

CARBORUNDUM



Automated tools like this Cintimatic[®] are a vital factor in producing

KAHLE automation for you!

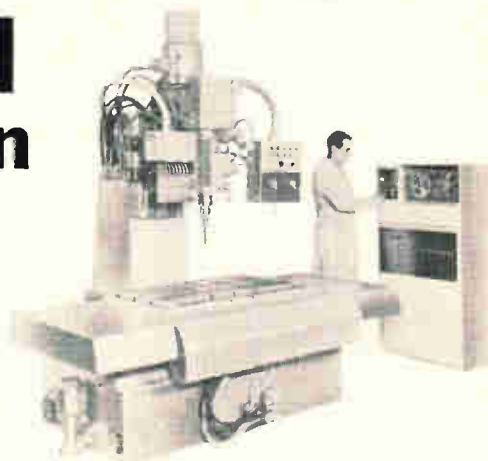

New multi-function equipment plus advanced engineering and technological know-how, assure—

- Constant Quality Control
- Uniformity and Precision

in the design, development and building of KAHLE Automatic and Semi-automatic machines!

This C.R.T. Sealing Machine for black-and-white or color gun sealing, is a 16-head, 16-index machine that takes tubes up to 27" dia. or diagonal, with all heads filled. Request Bulletin 2316 describing this unique KAHLE engineering achievement.

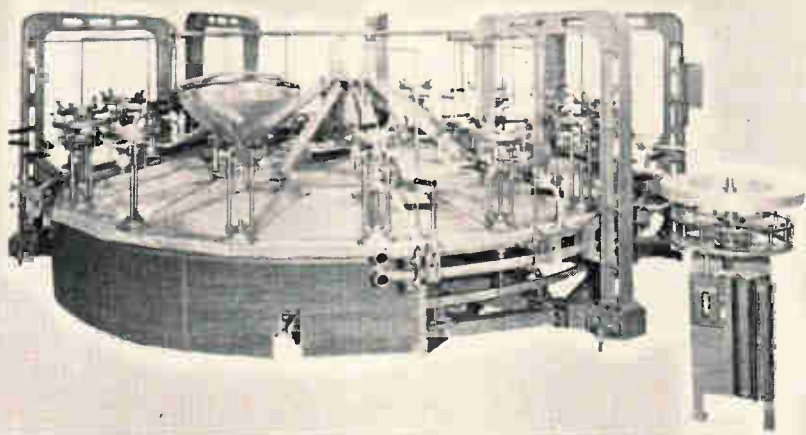

For Over 30 Years, Designers and Builders of Automatic and Semi-automatic Equipment for High Speed Production

Used worldwide, KAHLE assembly and production machines are effecting manufacturing efficiencies and economies in practically every type of industry — electronic, pharmaceutical, glassware, photographic and numerous other high-volume operations.

Constant KAHLE research and 'tooling-up' are keeping pace with today's demands for speed and accuracy, and the addition of the Cintimatic Vertical Machining Center, represents another step ahead. This machine mills, drills, taps or bores in one setting, with all the advantages of a single-function machine. Another example of automation at work for KAHLE, and for KAHLE customers.

©Cincinnati Milling Machine Co.

KAHLE ENGINEERING COMPANY

3324 Hudson Avenue, Union City, N. J. 07087

Telephone: (201) 867-6500

KAHLE EUROPEA—Via Spartaco 16, Caravaggio (Bergamo), Italy

New Components



and can be set to within $\pm 0.05\%$ of a required voltage. Standard resistances are available from 10 ohms to 2 megohms. Power rating is 0.75 watt at 25°C, derating to 0 at 105°C; operating temperature range is -55° to 105°C.

The manufacturer says the 15-turn adjustment unit is free from sudden failure and can withstand power surges five times its rated power. Clutching action at both ends of the adjustment screw prevents accidental damage during adjustment.

The units feature housings of glass-filled nylon and gold-plated terminal pins. Pin spacing makes the model 77 directly interchangeable with most low-cost commercial adjustment potentiometers.

Delivery is from stock.

Beckman Instruments Inc., 2500 Harbor Blvd., Fullerton, Calif. 92634. [354]

Miniature connector comes in four forms

A microminiature connector line only 19/32 in. in diameter is designed for coaxial and multipin (up to 14 pins) applications. With an over-all plug length of only 1 inch, the series C is available in four configurations: straight plug; panel-mounted receptacle; panel-mounted with back shell and clamp; and cable receptacle.

The multipin models have a 2-amp rating, a contact-to-contact test voltage of 1.2 kv, and a contact-to-ground test voltage of 1.4 kv. Wire size is 24 or 26. Coaxial models have 50 and 75 ohm impedance and Teflon inserts.

All series C connectors feature



CERMET

10Ω TO 1 MEG

POTENTIOMETERS

IMMEDIATE DELIVERY FROM FACTORY OR DISTRIBUTOR STOCKS!

Complete stocks are now available of TRIMPOT® cermet element potentiometers in the full range of 10Ω to 1 Megohm.

Models 3012 and 3052 are in the familiar rectangular configurations, while the Model 3282 is a 3/8" square unit available in five mounting configurations . . . all three units are rated at 1 watt. All PALIRIUM® cermet potentiometers are designed and built to the usual Bourns high quality standards. They meet all the requirements of MIL-R-22097 and are ideal for applications requiring top performance under the most stringent environmental conditions.

Remember, Bourns is your best single source for the industry's widest selection of wirewound, cermet and carbon potentiometers. For detailed technical data sheets on these cermet units, contact your nearest Bourns office, representative or write the factory direct.

These units are stocked in depth, in all resistances and mounting configurations at the factory and by your local Bourns authorized distributor!

SPECIFICATIONS

	3012	3052	3282
Size	1 1/4 x 3/2 x 3/16"	1 1/4 x 3/16 x 3/16"	3/8 x 3/8 x 1 3/4"
Mechanical Adjustment	22 Turns	22 Turns	25 Turns
Resistance Range		10Ω to 1 Megohm	
Resistance Tolerance		±10% Standard	
End Settings		10Ω to 200Ω, 0.5% 500Ω to 1 Megohm, 0.1%	
Temperature Range		-65°C to +175°C	
Power Rating		1.0 watt at 70°C	
Temperature Coefficient	+25°C to +175°C	{ 10Ω to 200Ω, 0 to +500 PPM/°C 500Ω to 1 Meg, ±100 PPM/°C	
	+25°C to -65°C	{ 10Ω to 200Ω, +500 to -100 PPM/°C 500Ω to 1 Meg, +100 to -250 PPM/°C	
Humidity		100 Megohms minimum insulation resistance after removal from chamber	



BOURNS, INC., TRIMPOT DIVISION • 1200 COLUMBIA AVE., RIVERSIDE, CALIF.
TELEPHONE 714 684-1700 • TWX: 910 332-1252 • CABLE: BOURNSINC.

TRIMPOT® and Precision Potentiometers - Miniature Relays - Electronic Modules - Microcomponents.

XEROX 2400 copier/duplicator relies on VICTORY THERMISTORS

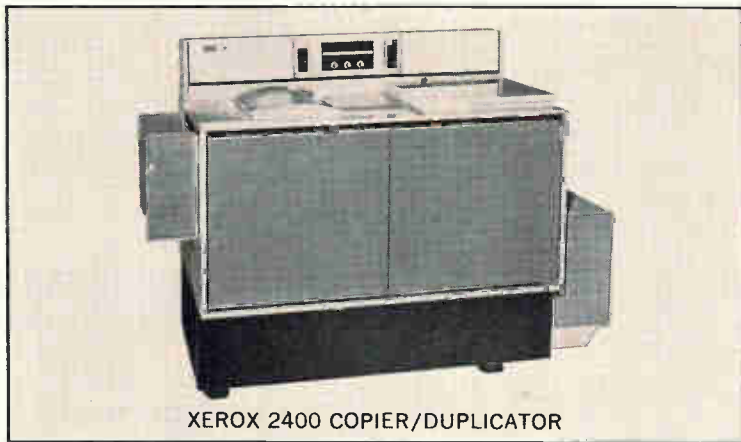

XEROX 2400 COPIER/DUPLICATOR

SO can you

When Xerox required a dependable, precise and fast-acting temperature sensing device, they brought a space age product "down to earth".

If your products require precise temperature measurement, control or compensation with FAST RESPONSE it will pay you to investigate VECO thermistors. VECO supplies a wide range of standard thermistors in various sizes, shapes, temperature coefficients and resistance values.

VECO's engineering staff is available to assist you in product application and circuit design.

Xerox and 2400 Reg. T.M. Xerox Corporation

Write for Catalog MGP681

VECO First in Progress • First in Service



VICTORY ENGINEERING CORP.

122 Springfield Ave., Springfield, N. J. 07801

Tel: 201-379-5900 TWX 710-983-440

New Components



a patented snap-latch device for positive self-locking, maximum holding power, and quick, one-hand disconnect.

Multipin insert material is Nylatron. Contact material for all models is phosphor bronze or beryllium copper depending on the application; contact plating is gold over nickel over copper.

Price ranges from \$2 to \$15 depending upon quantity and type. Delivery is three to five weeks for quantities of up to 5,000.

Lemo Division, Frazar & Hansen Ltd., 150 California St., San Francisco 94111, [355]

Angular-surface dials for multiturn pots

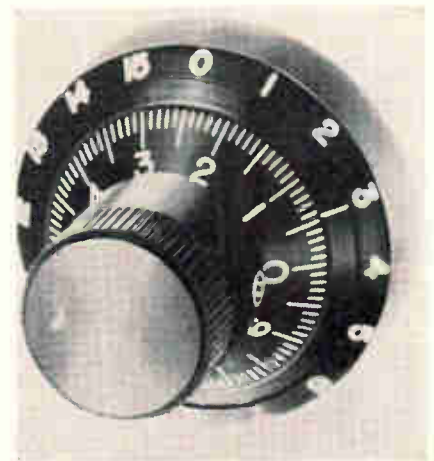

Two 15-turn dials are available for use with multiturn precision potentiometers. Although only 1 in. in diameter, the dials have an angular surface that enhances readout. Primary and secondary scale presentation is 000 to 1,499.

Set-screwed directly to a potentiometer shaft, there is no back-

RESOLVER/SYNCHRO DIGITAL CONVERSION

A very short course for engineers who are concerned with converting resolver or synchro data to digits and vice versa.

Engineers working in digital computer input/output interface systems for tactical airborne equipment, aircraft and space vehicle simulation, antenna positioning or programming, and similar systems are increasingly involved in solving the digital/analog interface problem for resolver and synchro data. Accomplishing this task becomes quite simple by taking advantage of North Atlantic's family of high accuracy resolver/synchro converters. Through the use of solid-state switching and precision transformer techniques, these converters provide single-speed accuracy and resolution from 10 to 17 bits, along with solid-state reliability and calibration-free operation.

Resolver/Synchro-To-Digital Conversion

One typical North Atlantic resolver/synchro interface is the Automatic Angle Position Indicator (Figure 1), which converts angular data from both 400Hz resolvers and synchros to digits.



Figure 1. Model 5450 Automatic Angle Position Indicator converts resolver and synchro angles to digital form.

This device uses all solid-state plug-in cards and trigonometric transformer elements (no motors, gears or relays), and operates at all line-to-line voltages from 9 to 115 volts. It can be supplied in a wide range of configurations for specific system requirements, for example, signal frequencies 60Hz to 10KHz, binary or BCD outputs, .001° resolution with 10 arc second

accuracy, and multi-speed and/or multiplexed inputs. Its five-digit Nixie readout can be integral or remote.

The unit illustrated has an accuracy of .01°, and two basic modes of operation. They are read-on command (rapid acquisition) and tracking (least significant bit update). Prices start at \$5900.

Digital-To-Resolver/Synchro Conversion

North Atlantic's all solid-state digital-to-resolver/synchro converters (Figure 2) accept digital input data at computer speeds in either binary angle or binary sine/cosine form and convert to either resolver or synchro data. Their high accuracy and resolution (up to 17 bits) and freedom from switching transients meets an important requirement in space-mission simulation and antenna positioning systems for smooth servo performance at low rates of data change. All models are usually supplied with input storage registers.

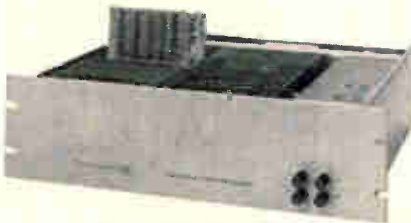

Figure 2. Series 536 Digital-To-Resolver Converters translate binary digital angle to four-wire resolver data.

Depending on the combination of features specified, prices are in the \$4500. to \$6000. range.

Modular D-R/S Converters For High-Density Systems

The plug-in converters pictured in Figure 3 were developed by North Atlantic specifically for airborne systems and for aircraft simulation systems requiring high-den-

sity multi-channel operation. The modules illustrated provide 11-bit digital-to-synchro conversion and are capable of driving up to four torque receivers. As with other North Atlantic resolver/synchro interfaces, conversion is achieved through solid-state switching and trigonometric transformers, so there are none of the stability or calibration problems associated with conventional resistor-chain/amplifier type converters. Prices, in production quantities, run about \$1100. per set. In prototype quantities about \$1500. a set.

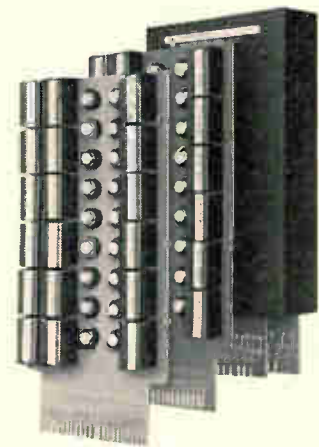
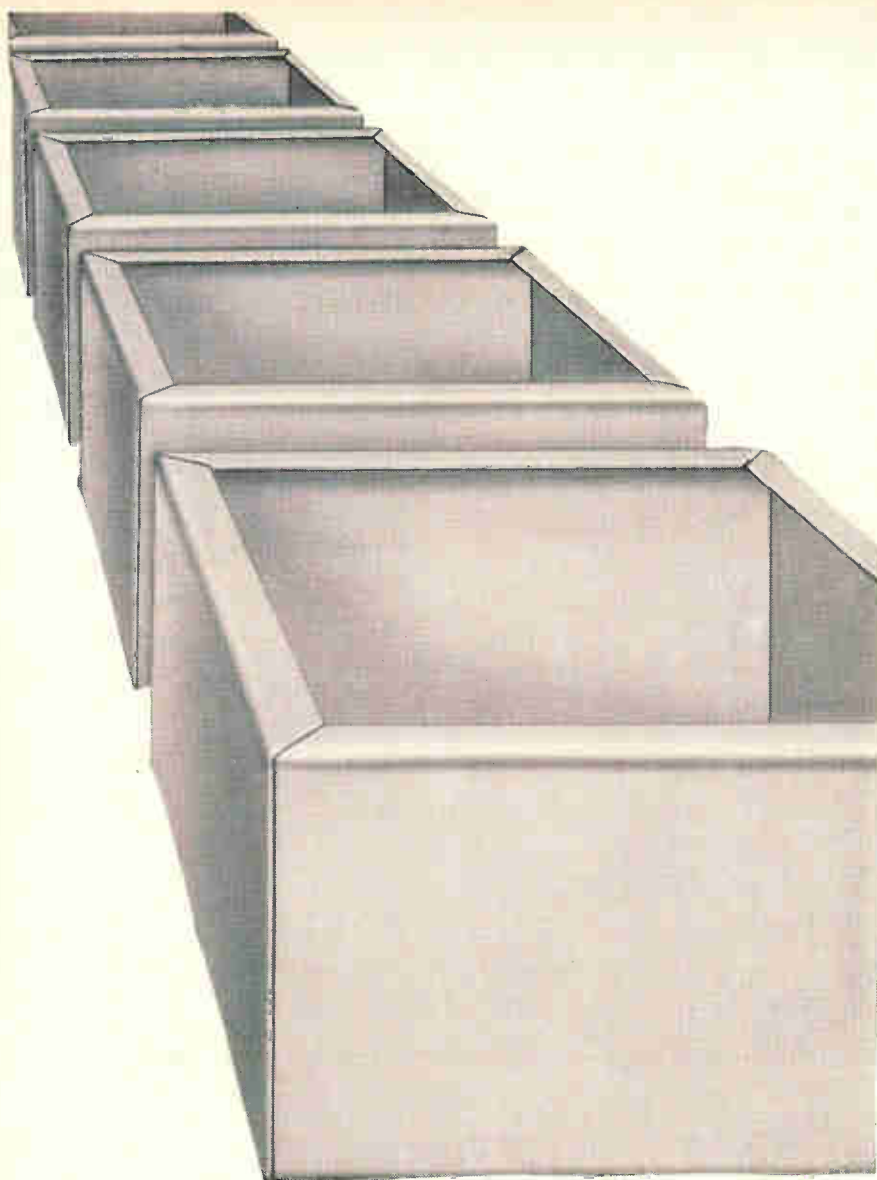

Figure 3. Series 537 D/S Converter Modules can drive multiple torque receivers from 11-bit digital data.

If you would like to take advantage of North Atlantic's state-of-art experience in resolver/synchro computer interface, we would be pleased to show you how these converters can meet your particular requirements. Or if you prefer, we will arrange a comprehensive technical seminar for your project group, without cost, in your own plant. Simply write: North Atlantic Industries, Inc., 200 Terminal Drive, Plainview, N. Y. 11803. TWX 510-221-1879. / Phone 516-681-8600.





THIS IS "DIE-LESS DUPLICATING"!

Produce short runs of simple parts quicker than an order can be processed to get them "outside." Use Di-Acro "Die-Less Duplicating" equipment to cut stock to size and to form it with die-accuracy — without costly dies. Get full information in our new "Die-Less Duplicating" catalog. See your distributor, or write us — naturally!



di-acro
DI-ACRO
division of
436 EIGHTH AVENUE
LAKE CITY, MINNESOTA 55041



New Components

lash and no necessity for extra panel holes. The units have been life tested to 250,000 cycles with no appreciable sign of wear.

Designated the RDK-411 (black with white figures) and RDK-461 (clear with black figures), the dials accept a 1/4-in. shaft.

Price is \$6.50 each in 100-lot quantities. Delivery time is 30 days. IRC Inc., 401 N. Broad St., Philadelphia 19108. [356]

Rugged end-capped metal film resistor

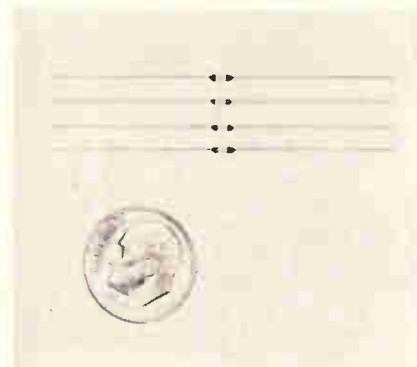

The end-cap construction of a new microminiature metal film resistor gives the unit the ability to withstand greater stresses during lead cutting, forming, and soldering than resistors of larger size, according to the manufacturer.

Conservatively rated at 1/20 watt (50 mw) at 100°C and 100 v, the RE-1/20 has nominal body dimensions of 0.040-in. diameter by 0.132-in. length. The 0.016-by-1-in. leads are available in tinned copper for soldering and gold-flashed dumet or nickel for welding.

Resistance range is 25 ohms to 25 kilohms in standard $\pm 1\%$ tolerance. The unit is also available in resistance tolerances of $\pm 0.5\%$, $\pm 2\%$, and $\pm 5\%$. Temperature coefficients are ± 50 , ± 100 , or ± 150 ppm/°C. Other features include low noise construction, low voltage coefficient, and multiple conformal coats of high-density epoxy for optimum protection from temperature and moisture.

Prices range from 59 cents to \$3.51 each, depending on tolerance,

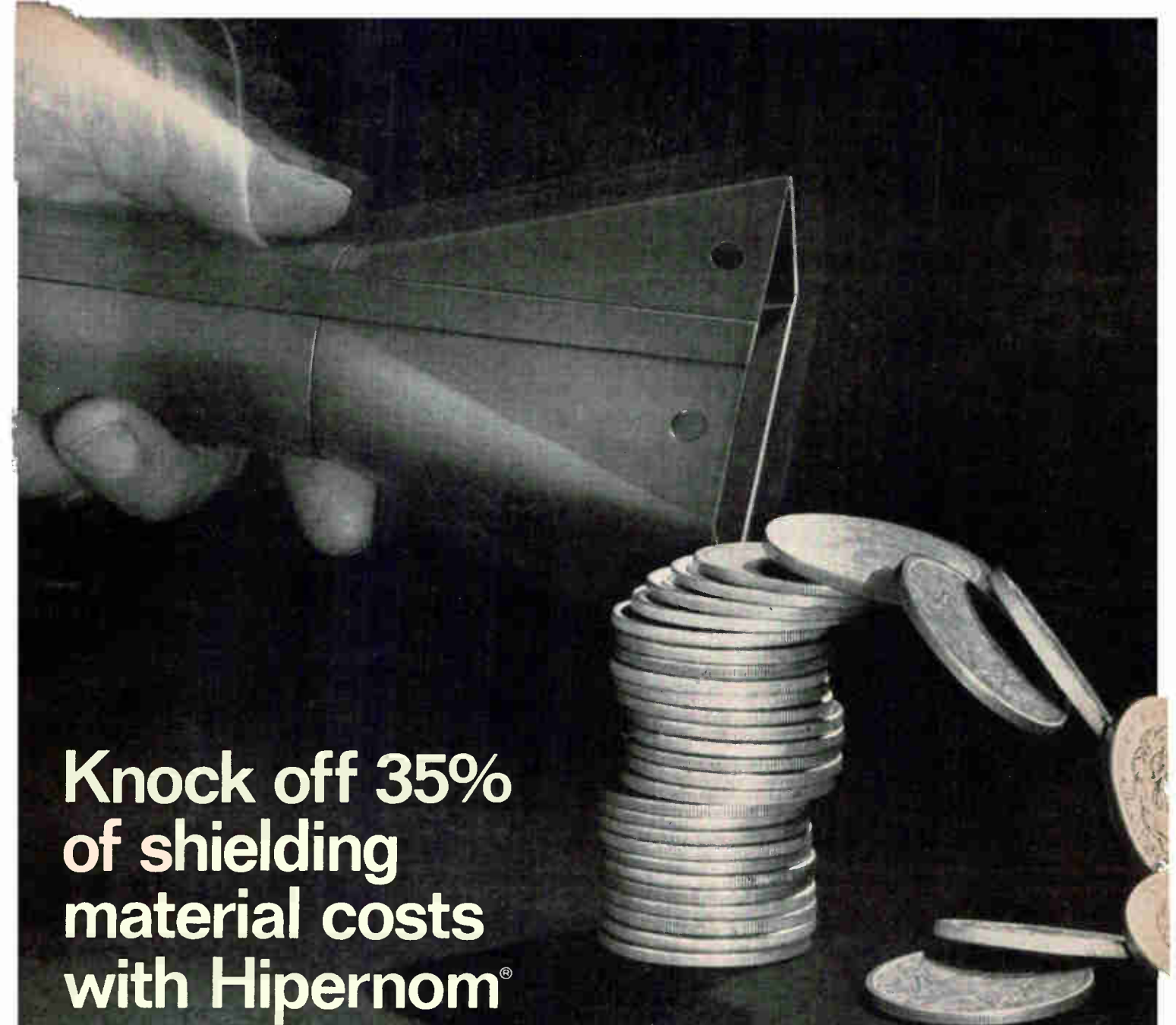

**Knock off 35%
of shielding
material costs
with Hipernom[®]**

**...and stay competitive
into the 1970's.**

Hipernom meets the requirements of Federal Standard No. 222.

Of course you want to pay less for magnetic shielding against DC to 10,000 Hz. fields. Solution: Get Westinghouse Hipernom alloy. Of all commonly used shielding alloys, Hipernom has the highest permeability. It lets you use thinner, lighter shields, allows easier, lower-cost fabrication. And you use less material per shield.

The 35% material cost saving per shield cited above is typical. Hipernom also brings you an important extra . . . the largest group of metallurgists specializing in magnetics. They'll put Westinghouse's 50 years of research leadership in magnetics at your service. Want specific details? Call Bob Carroll at 412-459-9400.

Free 36-page book on magnetic shielding
Any engineer who reads this book becomes one of America's foremost authorities on magnetic shielding. It is just that complete, practical and unique. For your free copy, write for "Shielding Book." Address Westinghouse Metals Division, Box 868, Pittsburgh, Pennsylvania 15230.

You can be sure if it's Westinghouse

J-05013

Circle 175 on reader service card



THE 104TH ELEMENT

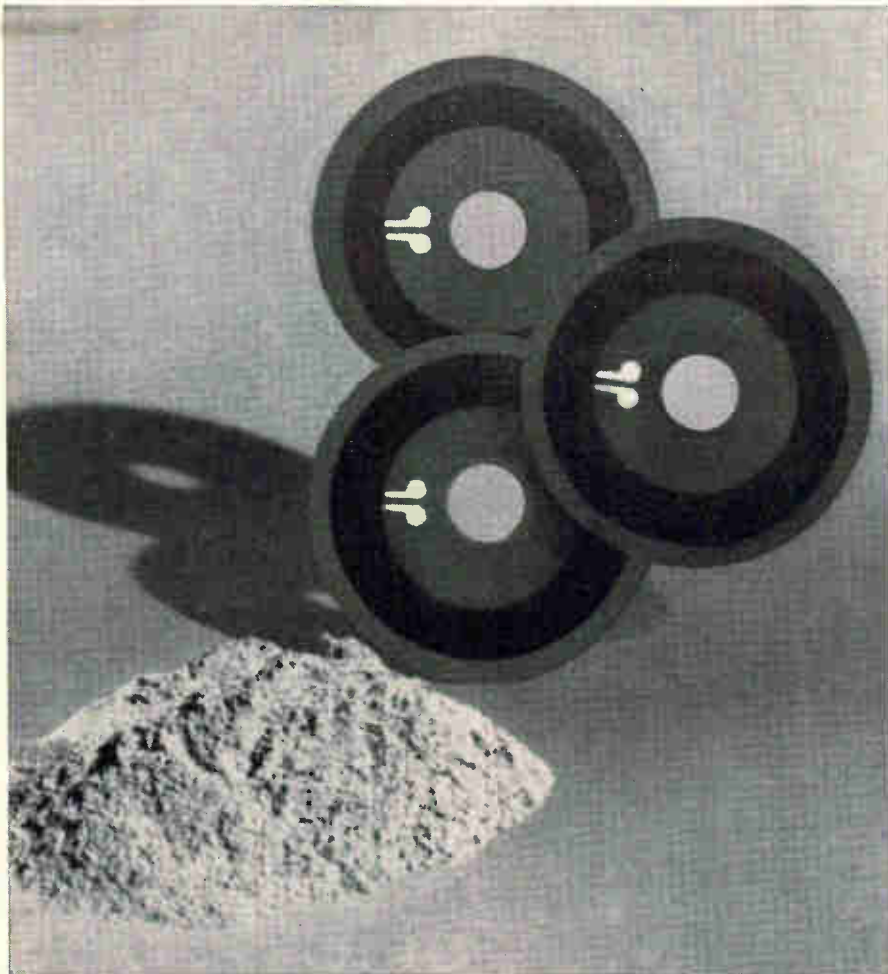

A BLISS-GAMEWELL DISCOVERY!

The book says there are only 103 elements . . . *not* so! At Bliss-Gamewell, the variety of available conductive plastic precision potentiometer elements is infinite. Be they round or simply a sector . . . you call the turns with us. Extremely tight accuracies for linearity or conformity are available . . . so are "wide open" economy styles. Bliss-Gamewell custom-engineered conductive plastic elements and potentiometers are quality controlled in our own facilities from powder to pot. We can fill the bill, no matter what your specs. Credentials? You'll find our CP pots in Phantom II aircraft navigational computers manufactured by Bendix. In Viet Nam, our pilots bet their lives on them every day. More interested in a wire wound? Our ultra-precision, half-moon-shaped, 1/2-inch wire wound precision resistance elements help the Shillelagh missile strike true. In translatory or rotary single and multi-turn styles — with linear or non-linear outputs — you can go 'round in the best circles with Bliss-Gamewell precision potentiometers. Write for information on how we can help you. Bliss-Gamewell, 1238 Chestnut Street, Newton, Massachusetts 02164.

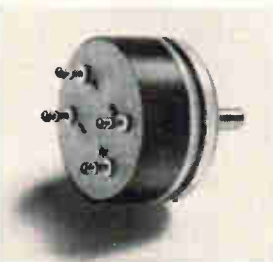

FIRST . . . WHEN PRECISION COUNTS!

BLISS  **GAMEWELL**

A DIVISION OF THE E. W. BLISS COMPANY

New Components

temperature coefficient, and quantity. The resistors are available from stock in small quantities; for production quantities, delivery time is three weeks.

American Components Inc., Conshohocken, Pa. 19428. [357]

Tiny line filters rated up to 5 amps



Hermetically sealed 115-v a-c line filters are said to be at least 20% smaller and lighter than the very smallest line filters now available.

The new units, designed for operation in 400-hz lines at 85°C and in 60-hz lines at 125°C, are available in L, T, and pi configurations with current ratings as high as 5 amps. Typical insertion loss is 30 db at 150 khz and 80 db from 1 Mhz through 2.75 Ghz.

Erie Technological Products Inc., Erie, Pa. [358]

Compact Kerr cells compatible with cameras

Small, cylindrical Kerr cells designed for compatibility with all standard makes of Kerr-cell cameras and laser Q switching equipment are offered with apertures from 0.24 in. to 0.6 in. Other sizes are available on special order.

Space charge is eliminated and the electric field is extremely uniform due to an improved method of nitrobenzene purification, according to the maker. The cells can be used to control high energies and light gains of more than 1,000 to 1.

Applications include laser Q spoiling and high-speed photographic studies of plasmas, lasers,

300 VOLTS

60 AMPS



350 W. @ 25° C 290 W. @ 25° C

Solitron, now in full production of the SDT 8950/SDT 8650 families, has reduced the price of these fast switching, high power silicon transistors. As shown on the comparison Volt-Amp chart, these transistors provide more power-handling capabilities per dollar than multiples of similar, limited-source devices. In order to meet various size and weight requirements, they are available in either 1/16" hex or TO-68 packages. A few of their many uses include visual display circuits, converters, inverters, voltage regulators and/or space flight applications.

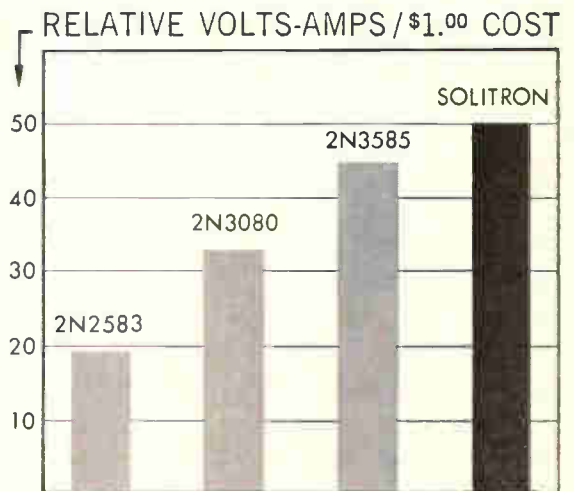

Type Number TO-68	Type Number HEX-CASE	DESIGN LIMITS			PERFORMANCE SPECIFICATIONS						
		$V_{(BR)CBO}$	V_{CE0} (SUS)	$V_{(BR)EBO}$	h_{FE}		V_{DC} (sat)	V_{CE} (sat)	I_{CBO}	f_T	
		Volts	Volts	Volts	$I_C = 40A$	$V_{CE} = 10V$	Volts	Volts	μA	MHz	
		$I_C = 1mA$	$I_C = 0.2A$	$I_E = 1mA$	Min.	Max.	$I_C = 40A$	$I_B = 6A$	$V_{CB} = 100V$	Max.	Typ.
SDT8651	SDT8951	200	200	8	10	40	2.0	2.0	10	20	
SDT8652	SDT8952	225	225	8	10	40	2.0	2.0	10	20	
SDT8653	SDT8953	250	250	8	10	40	2.0	2.0	10	20	
SDT8654	SDT8954	275	275	8	10	40	2.0	2.0	10	20	
SDT8655	SDT8955	300	300	8	10	40	2.0	2.0	10	20	

CONTACT US TODAY FOR COMPLETE INFORMATION

Solitron DEVICES, INC.

1177 BLUE HERON BLVD. / RIVIERA BEACH, FLORIDA / (305) 848-4311 / TWX: (510) 952-6676

Leader in Germanium and Silicon Transistors, Cryogenic Thermometers, High Voltage Rectifiers, Hot Carrier Diodes, Temperature Compensated Zeners, Voltage Variable Capacitors, Random, White Noise Components, Microelectronic Circuits, and Power-Sink Interconnection Systems.

**Would you believe
the new
"VY"
Thin Line
Porcelain Capacitors,
featuring a
-100 ppm/°C temperature
coefficient, have a
mean-time-between-
failure rate of
6,000,000 hours?**



■ Ten million unit hours of testing "VY" Thin Line Capacitors at accelerated conditions — equal to 50 million unit hours at rated conditions — bear this out. Their proven, low failure rate is .016% per 1000 hours, at a 90% confidence level.

Users of negative T.C. capacitors gain positive features: three space-saving case sizes and two lead configurations, ratings to 500 VDC, plus the stability and low-losses a porcelain dielectric guarantees.

Thinking more positively about these negative T.C. capacitors? Then write for Data Sheet P 18 — and be more sure.

"VY" Thin Line also available with 0 ± 25 ppm/°C T.C.)

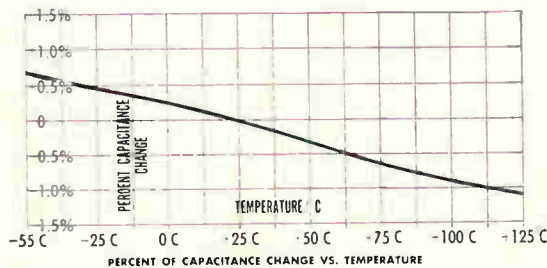

Vitramon

VITRAMON, INCORPORATED
BOX 544
BRIDGEPORT, CONN. 06601

In Greater Europe Contact:
VITRAMON EUROPE
Wooburn Green, Bucks, England



ballistics, and exploding wires.

With polarizers and cylindrical enclosure, the new Kerr cells are priced at \$1,600 each. They are also available in the standard box enclosure with polarizers at \$1,200 each. Delivery takes 90 days.

Beckman & Whitley Inc., 441 North Whisman Road, Mountain View, Calif. 94040. [359]

**Mercury-wetted
relays for IC's**

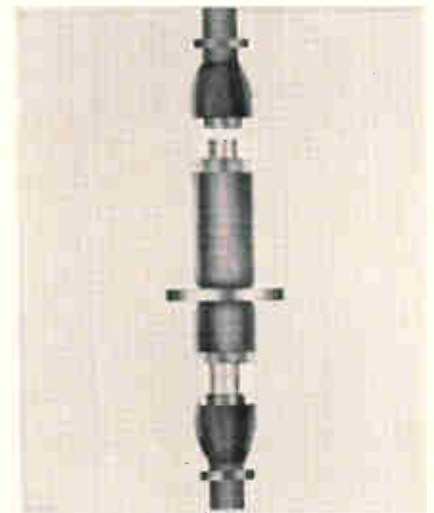

Small mercury-wetted relays featuring low noise, high speed, and long life can be used in integrated circuitry, peripheral input-output equipment, converters, and multiplex systems.

The bounce-free mercury film, hermetically sealed in a glass capsule, switches 2 amps up to 6 volts and 50 ma up to 100 volts at speeds of under 1 msec, and will operate

Coors Strate-Breaks



Speed Circuit Manufacturing

High quantity production of integrated circuits with uniform quality, increased precision tolerances, greater economy in the production of micro-ceramic components—all these are yours by gang printing your circuits on Coors *Strate-Breaks*. No cutting apart, no multiple handling before assembly. Just SNAP! . . . and there are your individual components with a straight, smooth, precision edge.

Coors *Strate-Breaks* are made to your specifications in sizes from $\frac{1}{2}$ " x $\frac{1}{2}$ " to 4" x 4". They are available unglazed for thick-film circuits, and glazed or unglazed for thin-film circuits. Get on-the-spot answers. Dial Coors—303/279-6565, Ext. 361. For complete design criteria, write for Coors Alumina and Beryllia Properties Handbook No. 952.

Patent
Pending

*consider
Coors
ceramics*

Coors

CERAMICS

ALUMINAS • BERYLLIAS • MAGNESIAS • SPECIAL OXIDES
Coors Porcelain Co., Golden, Colo.

Circle 179 on reader service card

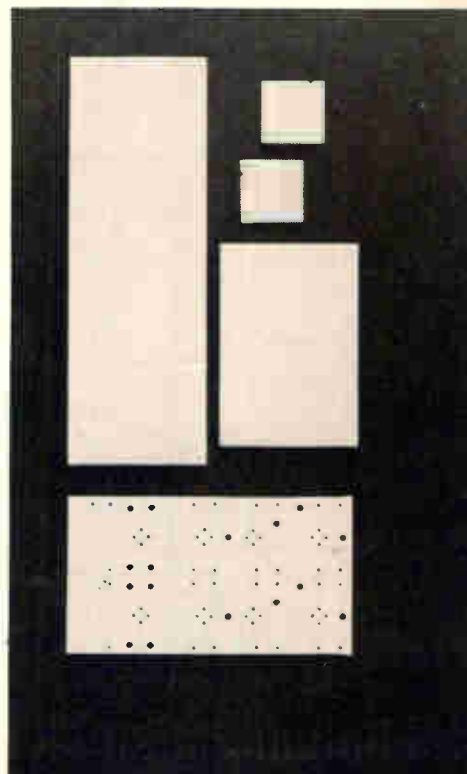

HOW CAN YOU USE THIS NEW WRINKLE IN PLASTIC TUBING?

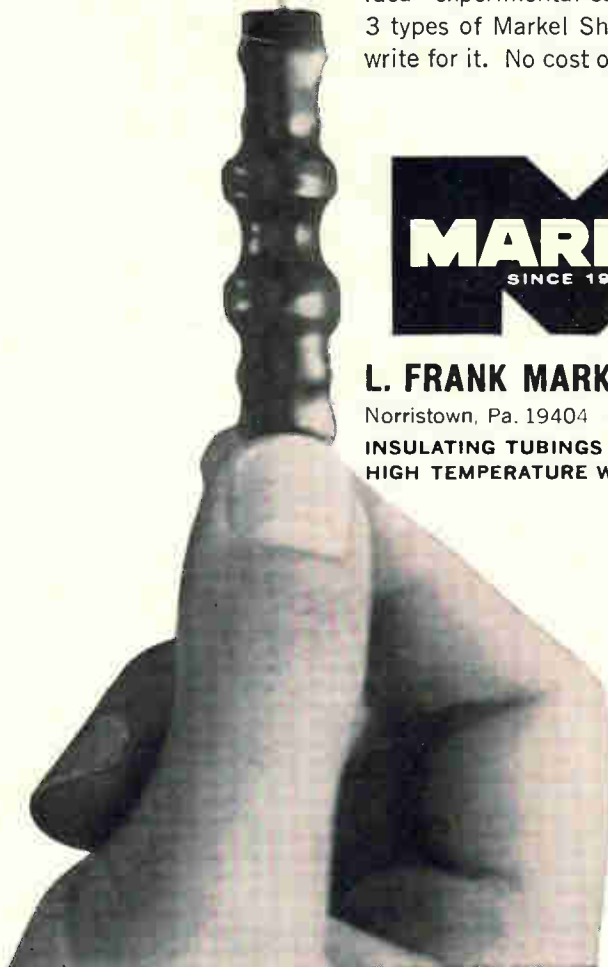

FLEXITE SHRINKDOWN TUBING is fast becoming an "indispensable" to design engineers. It shrinks 50% in diameter, upon application of moderate heat, to form a tough, tight-fitting sheath of plastic around objects of irregular shape. Primarily intended for insulation, it is also being used in many other ingenious ways. Like binding things together — adding strength and rigidity — protecting against abrasion, wear, breakage — resisting corrosion, heat, moisture — preventing vibration and noise — etc. How can you use it? We'll be glad to send you our "Hot Idea" experimental sample kit of all 3 types of Markel Shrinkdown. Just write for it. No cost or obligation.



L. FRANK MARKEL & SONS

Norristown, Pa. 19404 • 215-272-8960

**INSULATING TUBINGS AND SLEEVINGS
HIGH TEMPERATURE WIRE AND CABLE**

New Components

uniformly from -38° to $+100^{\circ}\text{C}$ at rates exceeding 250 hz.

The capsule is potted together with independent drive coils and a shielded magnetic latching circuit to withstand severe environmental conditions.

Fifth Dimension Inc., Box 483, Princeton, N.J. 08540. [360]

Trimmer potentiometer for panel mounting

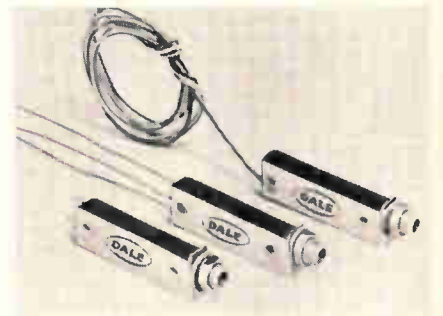

A panel mount configuration has been added to a line of humidity-proof trimmer potentiometers. Designated by model numbers 1684, 1685, and 1686, the pots meet or exceed the electrical and environmental characteristics of Military Style RT-12 of MIL-R-27208A.

The new pots have power ratings of 1 w at 70°C and an operating temperature range of -65° to 175°C . Resistance range is 10 ohms to 100,000 ohms with a standard tolerance of $\pm 5\%$.

Three-terminal configurations are available. Model 1684 has gold-plated, hook-type solder lugs; model 1685 has 22-Awg, gold-plated wire terminals; and model 1686 has 28-Awg, color-coded, Teflon-insulated leads.

Dale Electronics Inc., P.O. Box 488, Columbus, Neb. [361]

Thermal timing relays are easily installed

Only two mounting screws are used to install the Quick Connect series of thermal timing relays. Special brackets, sockets or retainers aren't needed. Push-on ter-

It comes clean out of our test bath

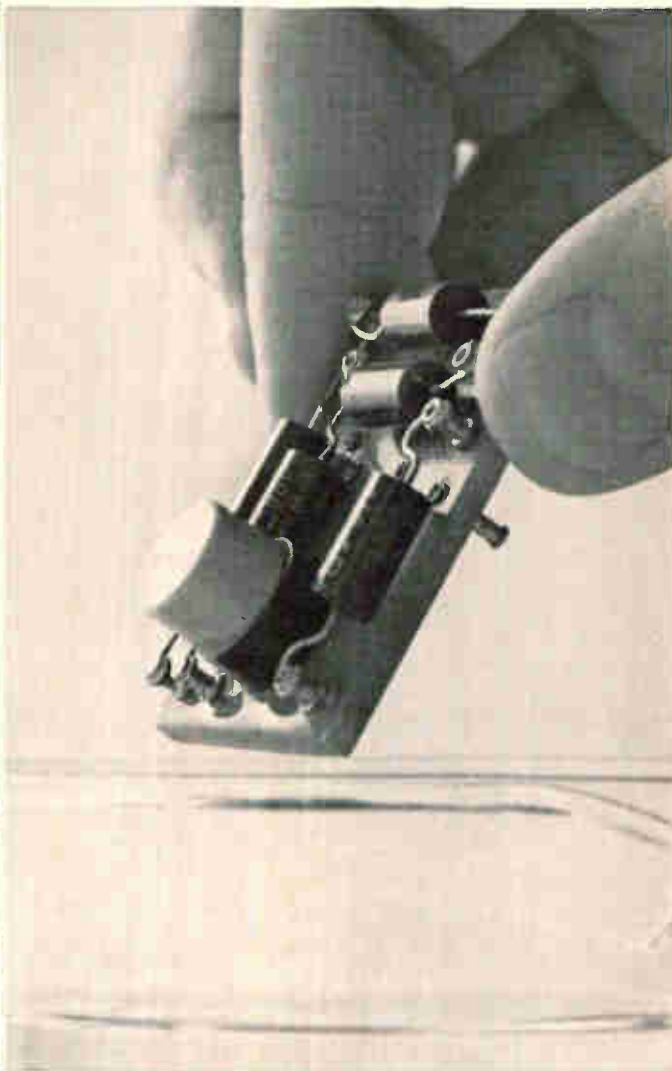
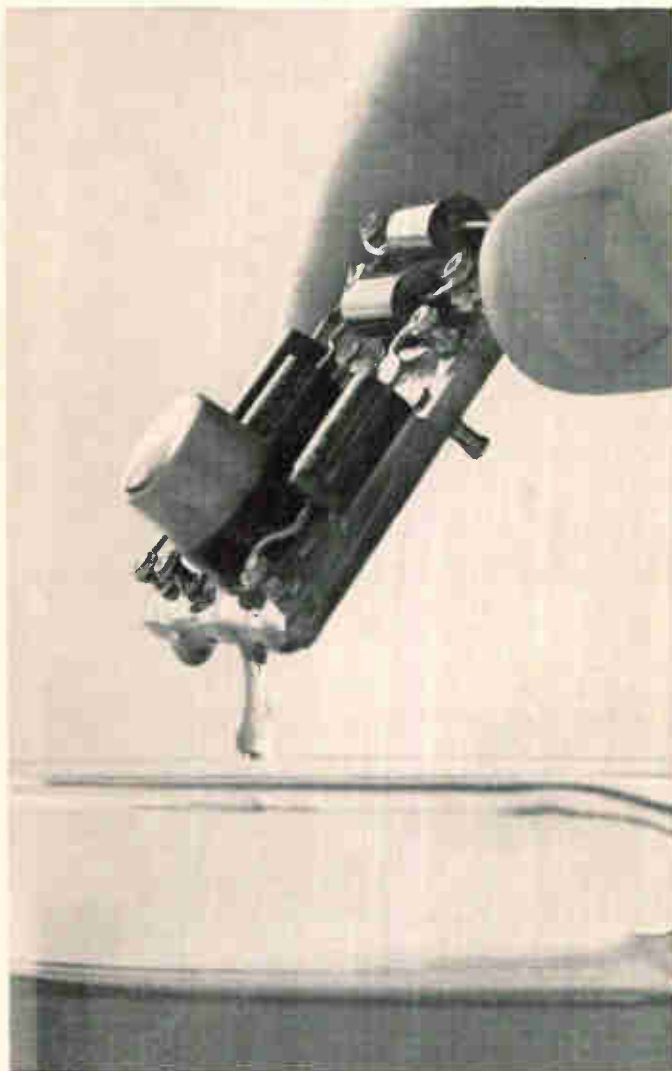

Temperature test your integrated or hybrid circuits in a 3M Brand Inert Fluorochemical Liquid and it'll drain clean, dry immediately and leave no residue.

Unlike conventional test bath fluids, with our Inert Liquids there's no costly cleaning stage to slow down production.

3M Brand Inert Liquids—FC-43, FC-75, FC-77, FC-78—also give you a wide liquid range so you can use them at both high and low temperatures, high dielectric strength for electrical insulation, compatibility to prevent adverse effects on sensitive materials, and non-flammability to make them safe.

With those properties and that kind of reliability—plus efficiency at removing heat—it's no wonder

our Inert Liquids work equally well as coolants. Test them for either application.

3M Chemical Division
Dept. KAX-67, St. Paul, Minn. 55119
Send me all the details about 3M Brand Inert Liquids.

Name _____

Company _____ Title _____

Address _____

City _____ State _____ Zip _____

Chemical Division **3M**
COMPANY

Now Silk City Offers Complete Ceramic Production Facilities From Development Through Volume Production

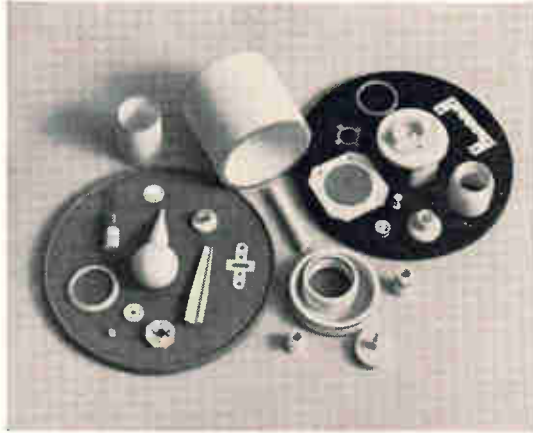

Major Ceramic Services Offered By Silk City

PROTOTYPE DEVELOPMENT

In the development of precision prototypes for the electronic industry, we are equipped to offer multi-shaped parts and varied-ceramic formulations to meet every possible design and economy requirement. We produce precision ceramics that are machined from alumina, die formed, isostatic pressed, extruded, molded or cast. Materials range from high-aluminas through forsterite.

PRECISION MACHINING

Where the tolerance or surface finish is extremely critical, we are skilled and equipped to provide the necessary ceramic machining. We offer a complete range of grinding, polishing, lapping and ultrasonic machining.

METALIZING AND PLATING

We offer prototype development or volume production of metalized and plated ceramics for use in hermetic seals and other sub assemblies. Both high and low temperature metalizing are available. We prepare surfaces for customer brazing or numerous other sealing requirements.

SUB ASSEMBLIES

We produce complete sub assemblies to customer specifications, as well as provide a capability to design parts to meet your requirements. Final assembly includes brazing of ceramic to ceramic and metal to ceramic for either mechanical or hermetic seals.

SHORT PRODUCTION RUNS

After prototypes have been developed and approved, we are staffed and equipped to carry the item through to a test production run or fill initial stock orders. You are assured precision products that meet the highest quality standards.

VOLUME PRODUCTION

With the addition of our new plant in Hendersonville, North Carolina, we are now prepared to handle your full production requirements. Our present equipment will produce ceramic parts with diameters ranging from a fraction of an inch up to 15 inches.

We invite your inquiry!

SILK CITY INDUSTRIAL CERAMICS INCORPORATED

Subsidiary of Basic Incorporated

221 Seventh Avenue • Hawthorne, New Jersey 07507
Phone 201-427-4211



OFFERING A COMPLETE CERAMIC SERVICE FROM PROTOTYPE THROUGH PRODUCTION

New Components

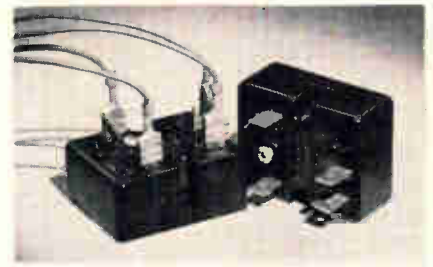

minals provide flexibility of wiring, part location, and equipment servicing. A Durex 11540 plastic case houses the stainless steel structure and nichrome heater windings.

The relays have a low profile and can be mounted in any position. Specifications include: single-pole single-throw contacts; 2-amp 115-v a-c or 1-amp 28 v d-c resistive ratings; 6.3-, 26-, 115-v a-c or d-c heater voltages; 5- to 180-sec time delays; $\pm 20\%$ time-delay tolerance.

G-V Controls Inc., Livingston, N.J.
07039. [362]

Hybrid vidicons focus on high resolution

Compact hybrid vidicons utilize magnetic and electrostatic fields in a focus-projection and scanning mode. Low in power consumption, the tubes provide very high resolution.

Both the magnetic focus and electrostatic deflection fields are superimposed on one another so that focus and scanning are accomplished simultaneously. The performance level for this combination of crossed fields is inherently higher than for similar devices using sequential, rather than simultaneous, focusing and deflection. Tube lengths are between 4½ and 6 in. Highest voltage required is typically only 300 v, allowing simplified circuitry to be used in the power supply section.

Applications include tv missile guidance, hand-held and space cameras.

Delivery is from two to four weeks.

General Electric Co., 1 River Rd., Schenectady, N.Y. 12305 [363]

DIAL DANA.... BEFORE YOU BUY A DVM

See for yourself why the Model 5400 is the fastest selling digital voltmeter in the 0.01% class . . . see (plug-in)² versatility, analog output, 80/second speed . . . dial your area code number for a demonstration today.

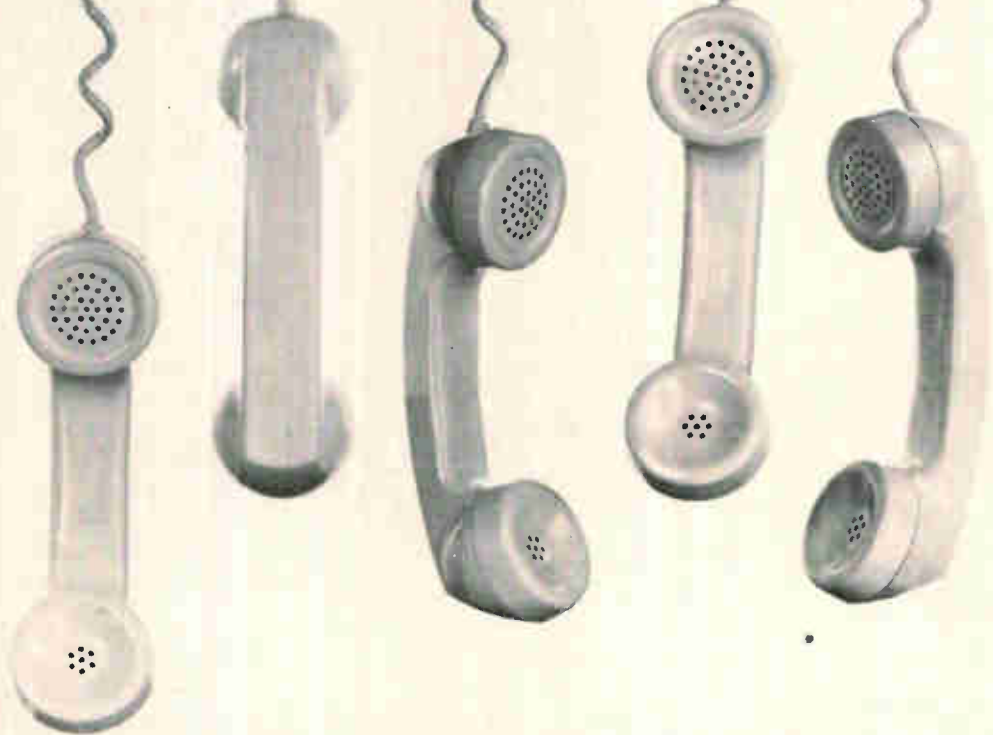

201 201: 687-8737	302 301: 946-0300	408 415: 968-7116	516 516: 433-1421	714 714: 297-4619	International Offices
201 201: 542-1441	303 303: 934-5505	412 412: 892-2953	517 313: 892-2500	714 213: 684-2840	
202 301: 946-0300	305 305: 723-6924	413 617: 648-2922	518 315: 454-9377	716 716: 271-7430	
203 203: 246-5686	309 312: 539-4838	414 414: 547-5131	602 602: 959-2115	717 717: 761-0577	
205 205: 881-3721	312 312: 539-4838	415 415: 968-7116	603 617: 648-2922	802 617: 648-2922	
206 206: 763-2755	313 313: 892-2500	417 913: 648-4173	606 513: 298-7203	805 213: 684-2840	
207 315: 454-9377	314 314: 837-0597	419 216: 885-5616	607 315: 454-9377	812 317: 253-1681	
212 201: 687-8737	315 315: 454-9377	501 214: 231-6541	609 215: 265-3250	814 412: 892-2953	
213 213: 684-2840	316 913: 648-4173	502 317: 253-1681	612 612: 537-4501	815 312: 539-4838	
214 214: 231-2573	317 317: 253-1681	503 206: 725-2700	614 216: 885-5616	816 913: 648-4173	
215 215: 265-3250	318 713: 528-6904	504 205: 881-3721	616 313: 892-2500	817 214: 231-6541	
216 216: 885-5616	319 319: 365-6635	505 505: 265-7766	617 617: 648-2922	904 305: 783-9407	
217 312: 539-4838	401 203: 246-5686	507 612: 537-4501	618 314: 837-0597	912 215: 881-3721	
218 612: 537-4501	402 913: 648-4173	512 713: 528-6904	703 301: 946-0300	913 913: 648-4173	
219 312: 539-4838	404 404: 261-5459	513 513: 298-7203	712 319: 365-6635	914 914: 769-1811	
301 301: 946-0300	405 214: 231-6541	515 319: 365-6635	713 713: 621-0040	916 415: 968-7116	
				Austria Wien: 82 46 732	
				Australia Victoria: 489-1911	
				Denmark Jyllinge: (03388) 150	
				England Dunstable: 65319	
				France Paris: 722 70 40	
				Germany Munich: 08 11 48 65 58	
				Greece Athens: 98 09 34	
				Israel Tel Aviv: 244 311-2	
				Italy Milano: 54 20 51	
				Japan Tokyo: 279-0771	
				Benelux Gennepe: 08851 1956	
				Norway Oslo: 28 26 24	
				Sweden Vallingby: 08/87 03 30	

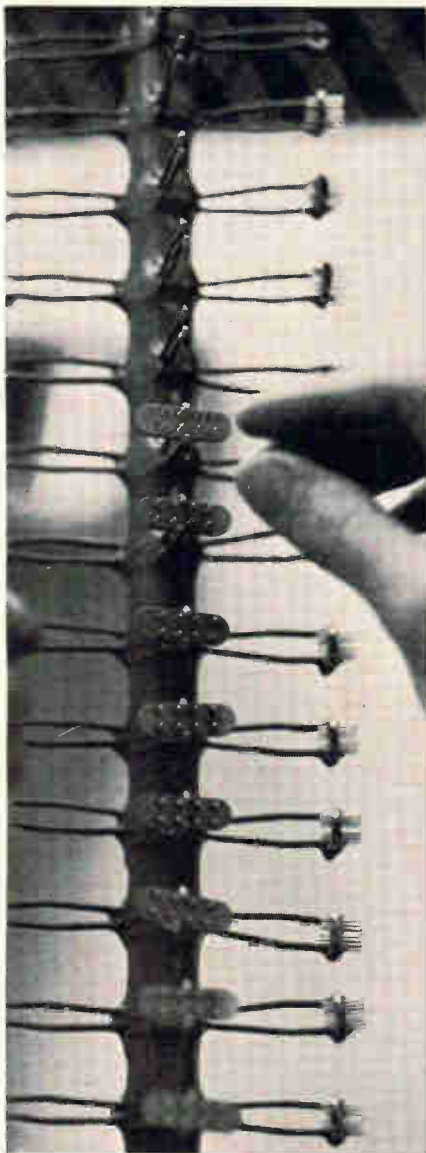

Pick a header... standard or custom

Then call Atlas—where reliability is a reality—whether you need custom headers to your drawings or any of more than 150 configurations of single-pin terminals for off-the-shelf delivery.

At Atlas a tape-programmed, six-head drilling machine reduces tooling time and total cost. An electron-beam welder bonds delicate parts with precision. And Helium Mass Spectrometers check for possible leakage.

In-house facilities such as these make it possible for us to manufacture and test to your specifications or MIL specs. For you that means unmatched quality and reliability. Challenge us today. Phone 215 666-0700. Or send for complete information.

ATLAS
CHEMICAL INDUSTRIES, INC.
Aerospace Components Division
Valley Forge, Pa. 19481

New Semiconductors

Hot current measures coolant level



Thermal runaway has ruined many a semiconductor device accidentally, but a similar phenomenon—tamed down—is used deliberately in a liquid-level sensor. In a liquid, the device runs cool. However, when the level falls and the sensor is exposed to air, the device heats up and produces a current surge.

All-o-Matic Manufacturing Corp. originally developed the device for automobile engine cooling systems, but says it can also be used in aerospace, electronics, and other industries where specific liquid levels must be maintained for equipment operation or safety. Depending upon the application, warning will occur within 14 to 18 seconds after the liquid level falls. The device operates at ambient and liquid temperatures ranging from -50°F to 300°F , without variation in performance.

Normally, a small, predictable current flows through the semiconductor when power is applied. This current tends to increase the device temperature. When the temperature reaches a critical value, the energy level of the electrons in the semiconductor increase sufficiently for them to break the energy bonds.

The current increases substantially, activating the warning mechanism.

In effect the sensor measures the thermal conductivity of the surrounding medium to determine the presence or absence of liquid around the metal housing of the semiconductor element. Thermal conductivity of a liquid prevents the semiconductor from reaching the critical temperature. The relatively poor thermal conductivity of the air enables the device's temperature to reach the critical level. If it's a liquid with good thermal conductivity, such as water, oil, glycol, etc., the unit will not conduct even if the temperature is as high as 350°F . Operation is not influenced by contaminants or by the liquid's electrical conductivity.

A typical application employs a 12-volt battery power source and an incandescent lamp or a buzzer for the warning signal, but the device works equally well on an alternating current source of equal voltage, which eliminates the need for polarity.

Custom-made samples are available within six weeks; production delivery is four months after the date of order. Cost will be based on specifications and the quantity ordered.

All-o-Matic Mfg. Corp., 2099 Jericho Turnpike, New Hyde Park, N.Y. 10017
[354]

Monolithic amplifier delivers full watt

An integrated circuit amplifier offers an audio output of 1 watt with a total harmonic distortion of less than 0.4% over a frequency range of 20 to 20,000 Hz. The monolithic unit, designated MC1554G, is also suitable as a general purpose amplifier for frequencies up to 300 kHz. The 1-watt output is delivered to either direct coupled or capacitively coupled loads.

Housed in a 10-pin, low-profile

Be a genius -dream up an application for our MIL-R-12934E single-turn pots-



(and win your very own certificate of genius).

Submit *any* design, simple or complex. Use one, two or any number of functions—including trigonometric, logarithmic, and non-linear empirical. And because all Litton single-turn pots are designed to meet or exceed MIL-R-12934E requirements—*especially* resolution—you can list your most stringent performance specs.

Producing single-turn pots *in production quantities* with .0004" wire is a speciality with us. So designs requiring a high degree of accuracy and superior resolution can also be submitted. These features alone make it easy for you to become a certified genius. But here are other points to enhance your design idea.

Litton pots are lined with dialyl phthalate to insure moisture resistance, dimensional and temperature stability—a unique plus that produces far greater reliability. What's more, we can easily reduce size and weight so make your design as compact as you like. And don't worry about shunts or slope changes. Our special butt welding results in a clean, even tap that prevents distortion in the functions.

Now let's see what you can come up with. Just jot down your application and we'll send your certificate by return mail. And if yours is one of the 50 best ideas we'll publish it in our next IDEA BOOK.

LITTON INDUSTRIES 
POTENTIOMETER DIVISION

If your present supplier can't solve your potentiometer problems, try us. For single-turn and multiturn, linear and functional, wirewound and conductive film, ganged or unitized with servo modules—Litton begins where others leave off.

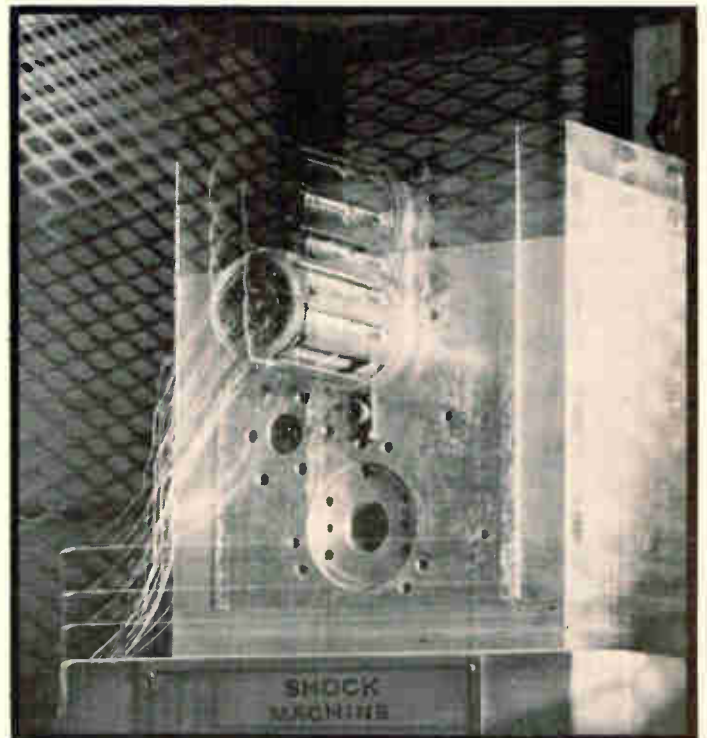

Certified testing equipment allows *simultaneous* measurement of Litton potentiometers under the extremes of environmental exposure.

Litton Industries, Potentiometer Division
226 East Third Street, Mt. Vernon, New York 10550
Tel.: (914) 667-6607 • TWX: 914/699-4687

- My idea for an application is attached. Send my certificate of genius.
- I have an idea, but need more data first. Send specs.

Name _____ Title _____

Company _____

Address _____

City _____ State _____ Zip _____

LAPP GAS FILLED CAPACITORS

ARE DESIGNED FOR

HIGH
VOLTAGE

HIGH
CURRENT

HIGH
CAPACITANCE

APPLICATIONS



These uniquely designed Lapp Gas-Filled Capacitors are completely unaffected by atmospheric or dust conditions. They are precision built and of extra strong construction to assure years of accurate, trouble-free operation. ■ Lapp Gas-Filled Capacitors are available in either fixed or variable models. All are equipped with an external safety gap to protect against internal flashover on excess voltage peaks. Capacitance available up to 30,000 mmf, safety gap settings up to 85 kv peak and current ratings up to 400 amps at 1 mc. ■ Write for Bulletin 302 . . . get our complete Gas-Filled Capacitor story. Lapp Insulator Co., Inc., Radio Specialties Division, 206 Sumner St., LeRoy, N.Y. 14482.

Lapp

New Semiconductors

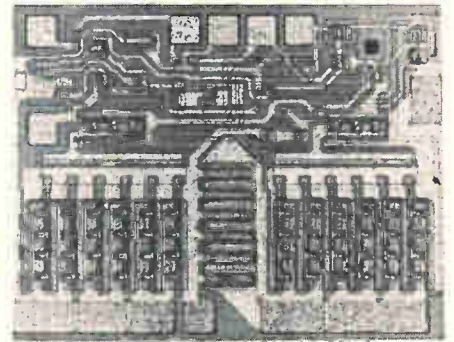

metal can, the MC1554G has an input impedance of 10 kilohms and an output impedance of 0.2 ohm. This low output impedance is optimized for driving a 16-ohm load (commonly encountered in audio or servo applications).

The voltage gain of the amplifier is adjustable by means of external connections to three gain-adjust pins. Gains of 9, 18, or 36 may be selected.

The output of the unit is relatively unaffected by temperature changes or variations in supply voltage. Typically, the output voltage changes less than 2 mv across the full -55° to $+125^{\circ}\text{C}$ operating temperature range. The output voltage sensitivity to power supply variations is 40 mv/v. For zero signal input, the drain current is 11 ma d-c with a 16-v power supply.

Price is \$15 each in quantities of 100 to 999, with immediate delivery.

Motorola Semiconductor Products Inc.,
Box 955, Phoenix, Ariz. 85001.[365]

Delay-type binary broadens IC line

A dual "D" or delay-type binary element has been added to the company's Series 8000 integrated-circuit line, which includes both high- and low-speed TTL and low-power DTL circuits. Incorporating the element broadens the uses of IC's. "D" type binaries are particularly suited for shift register, ripple counting, and divide-by-two applications.

Designated the S8828J, the dual binary—in a 14-lead glass-Kovar flatpack—operates over the full MIL



Where in the world... but Kansas

Beauties of nature witnessed by pioneers still stand in countless Kansas scenic locations. No fighting traffic to reach this point on the bluffs overlooking the Missouri River near Atchison. Surprised? Kansas has many pleasant surprises. We'll tell you more about Kansas, engineering opportunities at Boeing, Wichita, and send you Bill Post's recording of "Where In The World But Kansas" just for sending us the coupon on this page.

AVIONICS: Analysis and development of electro-optical sensor systems, long range airborne communications, forward looking infrared systems, ELINT/DF Systems, radar, navigation/guidance systems. Integration design and installation of aircraft electrical/electronic equipment.

ANTENNA SYSTEMS: Perform design, performance evaluation, and analysis of antennas, radomes and RF transmission systems, utilizing both digital computer and laboratory test evaluations.

FLIGHT TEST: Design airborne instrumentation. Test and analysis related to production or prototype aircraft systems.

OPERATIONS ANALYSIS: Develop conceptual missions for future military aircraft. Use advanced mathematical techniques and cost effectiveness methodology to define aircraft systems which satisfy the mission and cost requirements.

CONTROL DYNAMICS: Perform servo control analysis; involves analog and digital computer application in development of automatic flight controls. Analysis techniques include both classical and modern control theory

Inquiries are also invited in other areas of **Technical Competence**. Salaries are competitively commensurate with experience and educational background. Travel and moving allowances are paid to newly hired personnel. Boeing is an

equal opportunity employer and complies with the provisions of the Civil Rights Act of 1964.

TELEPHONE COLLECT

Area Code 316, MUrray 7-2239

Monday through Friday

8:00 AM to 4:30 PM, CDT

Details of a career with Boeing in your specific area of engineering interest will be promptly provided.

FREE RECORD OFFER:

45 RPM recording of "Where In The World But Kansas" by composer Bill Post and Chorus. Mail coupon below.

GERALD CAYWOOD, DEPT. A70
Boeing Professional Employment Office
Wichita, Kansas 67210

Name _____

Address _____

City _____

State _____ Zip _____

BOEING

Wichita (Kan.) Division 67210

OTHER DIVISIONS: Commercial Airplane • Missile and Information Systems • Space • Vertol • Also Boeing Scientific Research Laboratories

40% more light output

You get 40% more light output
from General Electric's new
D2A neon
indicator
Glow
Lamp.



40% more than
the C2A lamps
you're now using. And
25% more corona coverage. From
the same diameter bulb. Without
any decrease in life! Unbeatable
for legend illumination, display
panels, night lights, much more. More
information? Write for Glow
Bulletin 3-761. For complete Glow
lamp line, ask for Glow Bulletin
3-6254. General Electric Co.,
Miniature Lamp Department, M7-3,
Nela Park, Cleveland, Ohio 44112.

GENERAL  **ELECTRIC**

New Semiconductors

temperature range of -55° to $+125^{\circ}$ C. It is priced at \$8.40 each in lots of 100 and up.

Two other industrial package versions of the binary are offered for applications ranging from 0° to $+70^{\circ}$ C, and from $+15^{\circ}$ to $+55^{\circ}$ C.

Signetics Corp., 811 E. Arques Ave., Sunnyvale, Calif. [366]

Tiny silicon diodes handle high voltage

High-voltage silicon diodes, with peak inverse ratings from 1,000 v to 4,000 v, supply 10 ma maximum continuous forward current with only 10 na maximum reverse current at the rated peak inverse voltage. Maximum capacitance at 0 volt is 1 pf.

The microminiature units, series NV, are designed for high density packaging. Maximum dimensions are 0.85x 0.100 in. The lead diameter is 0.10 in. Units are designed to operate at a temperature range of -65° to $+100^{\circ}$ C.

Atlantic Semiconductor Inc., Division of Aerological Research Inc., 905 Mattison Ave., Asbury Park, N.J. [367]

Silicon rectifier eliminates heat sinks

A high current, axial lead silicon rectifier, suited for high density packaging, uses "tungstaloïd" pins that match the thermal expansion characteristics of the silicon junction to eliminate the need for heat sinks.

Basic internal structure consists of the tungstaloïd pins, metallurgically bonded above 900° C to solid silver leads (0.040 in.) at the silicon junctions.

Specifications include a peak inverse voltage rating from 50 to 600 v; average rectified current, 3 amps at 55° C, 6 amps when mounted per MIL-STD-750A; and static reverse current, 10 μ a at 25° C.

Semtech Corp., Newbury Park, Calif. [368]



Searching for electronic components that are hard to describe and even harder to find?

Stop.

Let the Northern Plains Industrial Catalog search for you.

Northern's Industrial Catalog can locate a source for most any part or assembly. It is a unique find-it-in-a-hurry service of Northern Natural Gas Company that will quickly locate reliable suppliers, sub-contractors and sources for parts, components and sub-assemblies made to your exact specifications. In technical terms, the Northern

Plains Industrial Catalog is a computerized compilation of all industrial fabricators in the Northern Plains area—Iowa, Kansas, Minnesota, Nebraska, South Dakota and western Wisconsin. It's the source of information that can tell you where to buy wisely, profitably and quickly. And the service is free. So if you're interested in electronic

components, plastics, short run stampings, motors, precision machined parts, instruments, die castings or whatever, fill out the coupon. You'll receive complete information. And if you attach a sketch or specifications of your required components, Northern Natural Gas will send you a specially compiled list of qualified producers.

INDUSTRIAL CATALOG
Area Development Dept. K-2

Northern Natural Gas Co., Omaha, Nebr. 68101

Dear Sirs: Please send Sources of Supply information on: _____

_____ Drawings enclosed.

NAME _____ TITLE _____

COMPANY _____

ADDRESS _____

CITY _____ STATE _____

MINIATURE TEST ACCESSORIES 1/3 smaller...

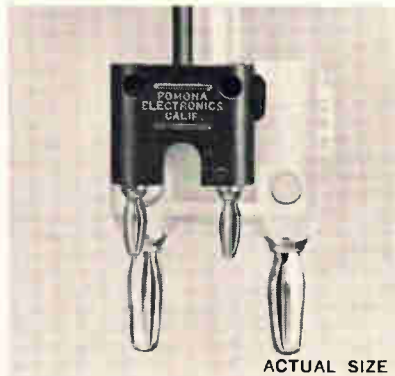

ACTUAL SIZE

1/2" SPACING for the new generation of miniaturized test equipment

Pomona created a complete line of 1/2-inch spaced Banana plugs, jacks, cable assemblies, patch cords, adapters, and binding posts to meet the industry's continuing demand for miniaturization.

Banana plug springs formed of one piece Beryllium copper (per QQ-C-533), heat treated for long service life and low contact resistance. Tough, molded thermoplastic bodies provide maximum strength and insulation. Available in a wide selection of colors.

WRITE FOR FREE CATALOG 11-66

Lists over 230 molded test accessories, all designed to meet rigid industrial and military specifications—and built by the quality leader...

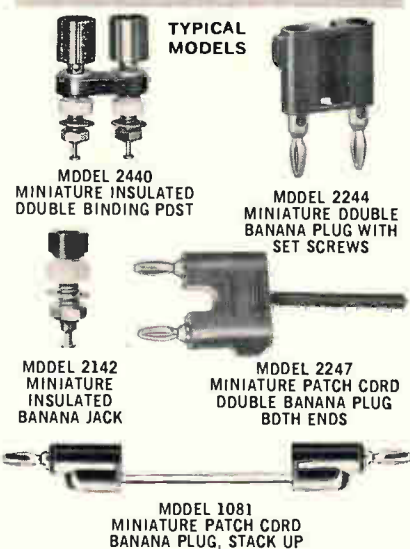

TYPICAL
MODELS

MODEL 2440
MINIATURE INSULATED
DOUBLE BINDING POST

MODEL 2244
MINIATURE DOUBLE
BANANA PLUG WITH
SET SCREWS

MODEL 2142
MINIATURE
INSULATED
BANANA JACK

MODEL 2247
MINIATURE PATCH CORD
DOUBLE BANANA PLUG
BOTH ENDS

MODEL 1081
MINIATURE PATCH CORD
BANANA PLUG, STACK UP

POMONA
ELECTRONICS CO., INC.
1500 East Ninth Street, Pomona, California 91769
Telephone (714) 623-3463

New Instruments

Permanent magnetism holds recorder paper



Chart paper held in place by permanent magnetism is a major feature of an inexpensive x-y recorder. The method of holding down the chart paper is unique with this recorder, according to the manufacturer. The platen is a magnet-impregnated hard rubber pad, and the paper is printed on one side with a magnetic ink pattern. Attraction between the two maintains paper alignment and eliminates electrostatic or vacuum hold-down devices commonly used on x-y recorders. Electronics are not used for paper hold-downs; thus it is fail-safe, requires no power, and is always on.

Designated the Series F-100, the rugged table-top recorders are highly accurate (0.25% of full scale) and have greater range sensitivity (100 $\mu\text{v}/\text{in.}$) than earlier models. Slewing speed (60 hz) is 15 in./sec, and repeatability is 0.2% of full scale.

Construction is modular, and electronic units are all solid state, with electronically-regulated (zener) reference circuits. Wide fluctuations in ambient temperature, relative humidity, and line voltage have little or no effect on performance. An electric pen-lifting mechanism is standard equipment.

Input circuits are independent, floating, and differential, offering true potentiometric operation. Input voltages range to 200 v d-c above or below ground. Rejection of 60 hz is at least 40 db for the transverse (normal) mode, and 120 db for the longitudinal (common) mode.

Input resistance is one megohm

at null. A patented circuit permits damping to be adjusted electrically without affecting calibration.

Series F-100 recorders weigh 30 lbs. They are 5 $\frac{5}{8}$ x 16 $\frac{7}{8}$ x 18 in. Power requirements are 105-125 or 210-240 v a-c, 60 or 50 hz, 100 w.

Price is \$1,395. Delivery takes 90 days.

Varian Associates, Recorder Division, 611 Hansen Way, Palo Alto, Calif. 94303. [371]

Coherent amplifier ignores high noise

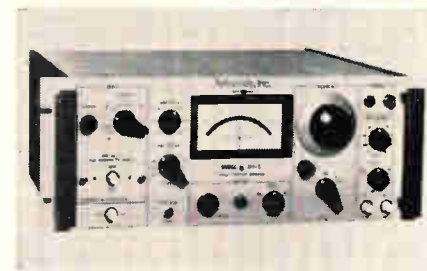

Ultralow-level signals can be measured in a high-noise environment with a coherent (lock-in) amplifier. It compares, amplifies, filters, synchronously detects, and integrates a low-level signal with virtually theoretical accuracy despite high noise.

The amplifier is continuously tunable over the range from 1.5 hz to 200 khz with a full-scale sensitivity of 100 nanovolts. It operates from broadband to a Q of 25 without gain change.

The instrument, called Model 300-A, measures the effects of biological stimuli, makes photometric measurements at low signal-to-noise ratios, converts a communications receiver to a sensitive radiometer, makes magnetic field effect studies, determines cross correlation of two periodic signals, and measures general amplification of low-level signals in presence of high noise.

The input configuration can be changed by using one of several plug-in preamplifiers. The preamps have single or differential inputs with high or low impedances. The

output is read from a built-in precision meter or from a digital voltmeter, high-impedance recorder or recording galvanometer connected directly to the amplifier. Reference voltage is obtained from an external source within a range of 0.5 to 300 v rms as well as from the internal tunable oscillator.

Supplied in a standard rack-panel mount, the 300-A sells for \$1,795 including the basic preamplifier.

Teltronics Inc., P.O. Box 466, Nashua, N.H. [372]

Graphic recorder combines 2 functions

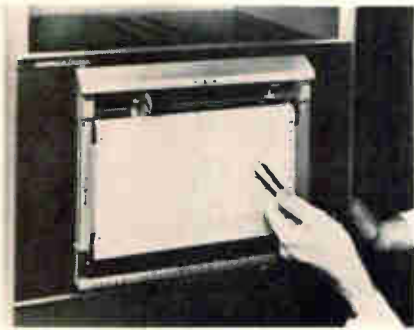

A recorder combines the functions of x-y and multipoint recorders into a single unit. This permits three-input x-y-z recording on a single chart. The manufacturer uses null-balancing potentiometric drives for the x and y axes, and a 24-position multipoint head for recording the z-axis inputs.

Initially intended for material flatness plotting, the recorder's other applications include automatic map plotting, recordings of such production information as sheet thickness and moisture content in paper manufacturing, temperature hardness and thickness in metal production, radiographic plots, as well as any other data which requires two or more separate recordings.

The recording of medical information is another area where the Contour/Riter recorder offers advantages. Plotting the path of radioactive tracers, or of r-f probes, is possible since the x and y axes can be synchronized easily to random scan patterns, and the z axis used to record measured intensity of the radiation. Contour electrocardio-

Ballantine Announces a New Solid State DC Digital Voltmeter



Model 353

Gives you fast, accurate readings to 0.02% ± 0.01% f.s. and at a low cost of just \$490

Ballantine's new Model 353 enables you to speed up dc measurements materially over those made on multi-knob differential voltmeters. And with laboratory accuracy from 0 to 1000 volts dc.

It requires just two steps: (1) Set knob to NORMAL mode and read voltage; (2) dial in the first digit in EXPAND mode and read voltage to four places with over-range to five; and, in addition, interpolate to another digit.

The NORMAL mode error becomes submerged by more than ten to one, and the operation is fast and accurate to 0.02% of reading ± 0.01% f.s. If the input signal is varying, the last digit may be followed visually, thus providing the advantage of analog display.

Note these other interesting features of the new 353: a left-to-right digital readout; an automatic display of "mV" or "V"; proper placement of the decimal point; 10 megohms input resistance; an automatic disabling of the motor during the "expand" dialing; a red light to indicate overrange or wrong polarity; and provision for a foot-operated switch for a "read" or "hold" function.

Write for brochure giving many more details



— Since 1932 —
BALLANTINE LABORATORIES INC.
Boonton, New Jersey

CHECK WITH BALLANTINE FIRST FOR DC AND AC ELECTRONIC VOLTMETERS/AMMETERS/OHM METERS, REGARDLESS OF YOUR REQUIREMENTS. WE HAVE A LARGE LINE, WITH ADDITIONS EACH YEAR. ALSO AC/DC LINEAR CONVERTERS, AC/DC CALIBRATORS, WIDE BAND AMPLIFIERS, DIRECT-READING CAPACITANCE METERS, AND A LINE OF LABORATORY VOLTAGE STANDARDS FOR 0 TO 1,000 MHz.

Step 1.
NORMAL
Mode
8.342 V



Step 2.
EXPAND
Mode
8.3420 V



Example of
"Overrange"
presentation
108.340 V



VIBRATION TESTING?

Get more engineers,
more equipment,
quicker action—
from Associated



Only Associated offers you so many advantages when you need vibration testing. You get the benefit of over a million man-hours of engineering experience! Twenty-four-hours-a-day, seven-days-a-week operation—enough capacity and support instrumentation for the most demanding tests! Quick reaction time—your test is in—and out—in far less time! And fully detailed and documented reports!

Equipment? Just one example: the 15,000 force-pound Vibration System shown above, including an 85-channel automatic equalizer/analyzer console. In fact, with its 16 systems, Associated has more vibration test systems and equipment than any other company on the East Coast!

Want more information? Call or write us today, outlining your needs. Address: Dept. E-2.



**ASSOCIATED TESTING
LABORATORIES, INC.**

200 Route 46, Wayne, New Jersey
(201) 256-2800

Northwest Industrial Park,
Burlington, Mass. • (617) 272-9050

New Instruments

grams, skin temperature, and circulatory records can also be plotted.

Span step response time of the x and y axes is 5, 10, and 24 seconds standard, with accuracy $\pm 0.5\%$ of full scale, and linearity $\pm 0.25\%$ of full scale (maximum deviation), while deadband is $\pm 0.25\%$ of full scale maximum. Standard chart frame size is 9.75 x 9.75 in. Print rate of the z axis is once per second, with digit change rate of one per second. Printing mode can be numbers only, points with numbers, or points only. Since the points are color coded, visual differentiation is simplified.

Price is in the \$3,000 range, dependent on options. Delivery is 90 days.

Texas Instruments Incorporated, 3609 Buffalo Speedway, Houston 77006. [373]

Temperature controller eliminates rfi



Radio-frequency interference and power line switching transients produced by standard scr temperature controllers can be a serious problem in industrial applications. This problem is overcome in the TC-720 series of indicating temperature controllers by circuitry that turns the heater on and off only when the a-c power line is passing through zero. Since there is no power the instant of switching, no switching transients are introduced and no rfi can be generated.

The TC-720 controllers have a time proportioning characteristic to ensure close temperature control. In addition, automatic reset elimi-

nates the temperature droop which occurs in simple proportioning controllers. Linearity is 0.25% standard. The dial is direct reading in temperature with a scale length of over 10 in., accommodating any temperature range between -200°C and $1,100^{\circ}\text{C}$.

A go-no-go indicator especially adapted for automated installations continuously monitors the actual temperature and provides a visual warning when it deviates from the set point.

TC-720 controllers are solid state, with no moving parts or contacts in the power control circuits. They are vibration resistant and may be mounted on the equipment to be controlled.

Operation may be from 115, 230, or 440 v, single phase or three phase. Standard power ranges are up to 300 kw.

Harrel Inc., 16 Fitch St., E. Norwalk, Conn. 06855. [374]

Ultraflexible design in a sweep generator



Instrument flexibility is said to be carried to its ultimate in a sweep generator, every discrete function of which is a separate package. The model 2003 comprises only a chassis, a power supply, and spaces for seven modular plug-in units.

The user can select plug-in oscillator units covering such ranges as 1 Mhz to 250 Mhz, 5 Mhz to 500 Mhz, 5 Mhz to 1,500 Mhz, and 1,000 Mhz to 2,000 Mhz, depending on application. The oscillators provide both start-stop and center-frequency - sweep - width control modes.

Another chassis space permits the user to select attenuators, again depending on requirements. These attenuators range from 0 to 1 db in 0.1-db steps, to 0 to 109 db in

HIGH VOLUME COMPONENT TESTING?

Only **Associated** gives you
so much capacity in a
chamber so low priced!

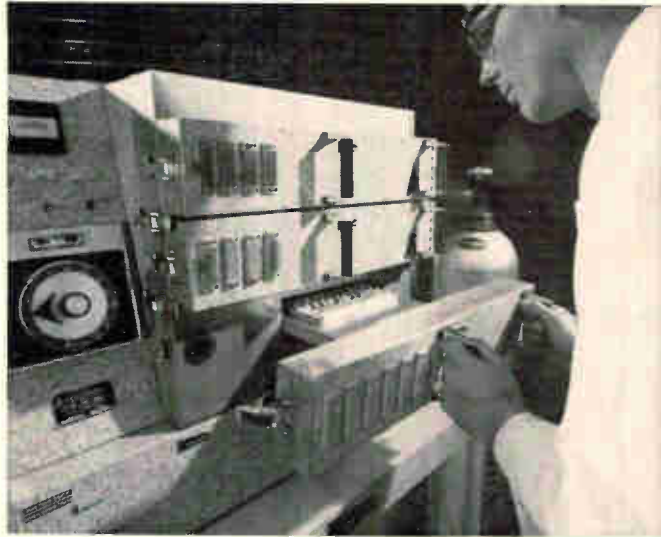

Dollar for dollar, Associated's complete line of component test tray chambers offers you versatility, efficiency and performance unavailable in any comparably-priced unit. Designed for rapid, accurate incoming and production testing of transistors, diodes and integrated circuits, these chambers provide features developed through years of actual test experience in Associated's own laboratories.

For example, you get:

- 225 axial lead component capacity!
- 10^{12} ohms insulation resistance, pin-to-pin!
- Low temperature gradients across tray!
- Widest variety of test trays available—2-wire, 4-wire, axial lead and transistor trays!
- All trays in stock!
- All Kelvin type wiring!
- Either $\pm 1/4^{\circ}\text{F}$ or $\pm 2^{\circ}\text{F}$ control!

Yet with all these features, prices start at just \$1765, complete. Options include solid-state and mechanical programmers; integral and remote scanners; and choice of CO_2 or cascade refrigeration. Write today for our complete catalog, showing the full range of Associated Environmental Test Chambers and Test Equipment. Circle the Reader Service Card or write us at Dept. E-5.

**ASSOCIATED TESTING
LABORATORIES, INC.**

200 Route 46, Wayne, New Jersey
(201) 256-2800



"All right, Jeff, we'll buy your system, but you'll have to specify a more advanced X/Y recorder. We need greater versatility and more reliable operation on the job. Any ideas?"

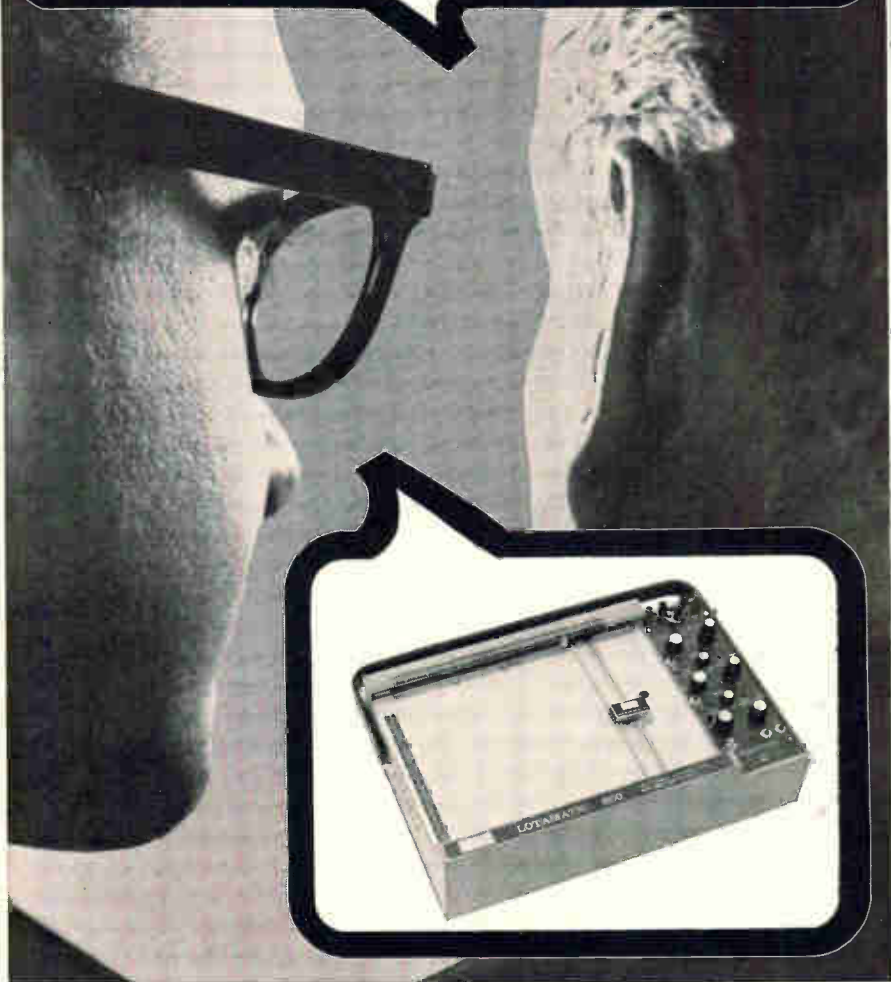

"If you like, Craig, I'll give you the system with the latest X/Y recorder on the market: The PLOTAMATIC[®] built by Bolt Beranek and Newman's Data Equipment Division. Other users swear by them. The PLOTAMATIC has a paper hold-down system that always works, never gets dirty, and yet allows you to adjust the paper for proper alignment after it's mounted. Input resistance is greater than one megohm, independent of gain setting. Accuracy and input versatility are as good as anything on the market, and you don't have to buy time base if you don't want it. No high voltages to produce RFI problems, either. Just between us, Craig, I think our people are in a rut with those X/Y recorders we've been using. They use them out of habit, and aren't up on the latest the market has to offer."

BBN's PLOTAMATIC line includes a variety of 8½" x 11" and 11" x 17" X/Y recorders for virtually every application. Keep up with the market—write us for a catalog.



BOLT BERANEK AND NEWMAN INC
 DATA EQUIPMENT DIVISION
 2126 SOUTH LYON ST., SANTA ANA, CALIF. 92705 (714) 546-5300

New Instruments

1-db steps, at 50- or 75-ohm impedances.

The r-f portion of the instrument's frequency marker system occupies two of the seven plug-in spaces, allowing the use of both variable and fixed markers in the measuring process. By means of a time-sharing circuit, closely spaced markers can be displayed simultaneously without interference.

Marker display processing is controlled in another plug-in unit. Markers may be vertical, tilted, horizontal, extra-intensity, birdy, pulse, or level-modulated, and may be processed for oscilloscope or x-y plotter presentation.

One space is allocated to plug-in r-f detector units of various frequency ranges, polarities, and impedances. This same space may be used for logarithmic amplifier-detectors and oscilloscope preamplifiers.

The last space accepts a master control unit that allows functional variations to be made, such as sweep rate regulation, single trace trigger for x-y recordings, and a-m and f-m modulation level control.

The instrument itself is a cabinet model measuring 19 in. wide by 9 in. high by 17 in. deep. It may be easily rack-mounted by the addition of two angle brackets that come with the instrument as standard equipment.

Telonic Instruments Division of Telonic Industries Inc., 60 No. First Ave., Beech Grove, Ind. 46107. [375]

Voltmeter conquers loading obstacles

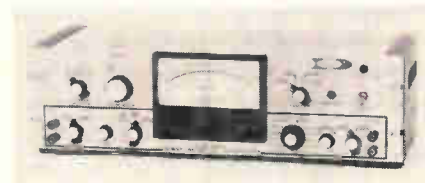

A phase-sensitive voltmeter overcomes the problem of circuit loading when using isolation transformers. The instrument incorporates transformers that provide an input impedance of 1.5 megohms.

This high impedance permits floating circuit measurements without appreciable loading.

Model 240SP will measure in-phase voltages, quadrature voltages, total and functional voltages, as well as phase angle.

Price is \$880. Delivery takes one week.

Dytronics Co., 4800 Evanswood Drive, Columbus, Ohio 43224. [376]

Recording oscillograph priced under \$1,000

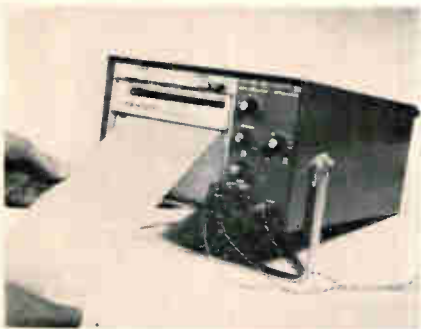

A two-to six-channel light-beam recording oscillograph is priced to compete with pen-and-ink recorders. The 460CPO (general purpose oscillograph) costs less than \$1,000 complete with two signal conditioners and two galvanometers ready to record.

Standard galvanometers for the CPO offer a flat frequency response to 2,000 hz and make it possible to record high-frequency events that mechanical recorders can't handle.

Plug-in signal conditioners make the CPO easier to use than most light-beam oscillographs. Several different types of attenuators, amplifiers, and differential amplifiers are available.

Operators may select paper speeds of 0.1 to 80 in. per sec, depending on the type of signal to be recorded. A xenon arc lamp provides high light intensity for fast recording.

Both grid and timing lines are standard equipment with CPO. Standard grid lines are 0.1-in. spacing with every fifth line accentuated. Full width timing lines every 1.0, 0.1 or 0.01 second may be selected automatically with chart speed or manually, as the operator requires.

Century Electronics & Instruments Inc., 6540 E. Apache St., Tulsa, Okla. 74115. [377]

NEED A 3000 VOLT ZENER DIODE?

Corotron actual size: Photo-multiplier power supply, showing Corotron location, 1/3 size.

You could string together several hundred zeners. Or you could specify *one* Victoreen Corotron. It is the gaseous equivalent of the zener with all the advantages of an *ideal* HV zener diode.

For space research and other rugged applications requiring absolute power supply stability, GV3S Series, shown, provide the ideal reference voltage anywhere in the range of 400 to 3000 volts. They enable circuitry to maintain constant high voltage regardless of battery source voltage or load current variations. Cubage and weight (GV3S Corotron weighs only 4 gm.) are important considerations. So is temperature variation (Corotrons operate from 200°C down to -65°C). Ruggedized versions withstand shock to 2000 G, vibration 10 to 2000 cps.

If you're trying to simplify circuits . . . to cut cost, size and weight . . . to upgrade performance—you need Corotron high voltage regulators. Models are available now from 400 to 30,000 volts. A consultation with our Applications Engineering Dept. will speed up the countdown.

8501-A



VICTOREEN INSTRUMENT DIVISION
10101 WOODLAND AVENUE • CLEVELAND, OHIO 44104
IN EUROPE: GROVE HOUSE, LONDON RD., ISLEWORTH, MIDDLESEX, ENGLAND

the
big

3

for
precision
high speed
circuit
board
production



1/8" shank
SOLID
CARBIDE
DRILLS

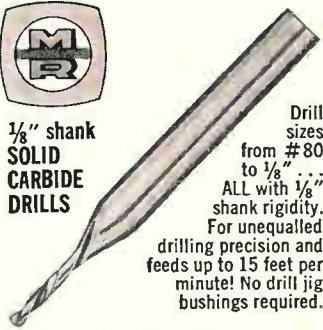

Drill
sizes
from #80
to 1/8" . . .
ALL with 1/8"
shank rigidity.
For unequalled
drilling precision and
feeds up to 15 feet per
minute! No drill jig
bushings required.

PCB-1
AIR
BEARING
SPINDLES



UP TO
150,000 RPM
SPINDLE SPEED

Absolutely vibration free . . .
spindle shaft literally "floats" on air
film . . . no ball bearings, no metal-
to-metal contact. Eliminates all har-
monics. Creates the truest running
drill spindle ever made. Air turbine or
electric high frequency driven.

SOLID CARBIDE
DIAMOND CUT
ROUTERS



For the
smoothest finish
in routing . . . any
material or plastic-
metal laminate.
Choice of end styles
including drill point.

Take the proved solid carbide advan-
tages of rigidity and wear resistance
. . . add the proved advantages of Metal
Removal tool design and precision . . .
to give you problem-free production in
circuit board drilling and routing.

Write for Catalogs.

THE METAL REMOVAL COMPANY
1859 W. Columbia Ave., Chicago 60626
Plants in Chicago • Los Angeles • San Juan

MASTER TOOL AND WHEEL
MAKERS FOR THE WORLD

New Subassemblies and Systems

IC digital computer has many uses

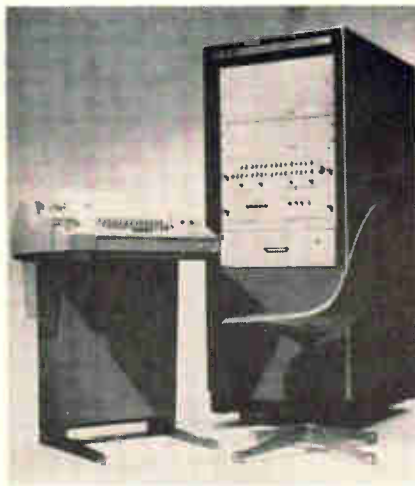

A 16-bit, integrated circuit digital computer gives the systems designer more versatility with which to handle changing requirements than is available with combinations of core buffers and special-purpose logic. Applications of the 703 computer include radar data processing, aircraft and helicopter check-out, and seismic data processing.

Besides a 16-bit word length, the machine provides 71 hardware instructions, direct and indexed addressing, byte addressing and manipulation, and memory expansion to 32,000 words. Memory cycle time is 2 μ sec.

Options include direct memory access channels, real-time clock, hardware multiply-divide, and additional interrupt lines. The company's multiverter family (multiplexer, sample and hold, and a-d converter) can be connected to the 703 by standard coupler to form data acquisition or logging systems.

Peripherals include paper tape reader and punch, magnetic tape, disk, and line printer. The M-Series ic logic system is compatible with the 703 and available from stock for special system assembly.

Software for the 703 will cover an assembler as well as executive, utility, and diagnostic routines.

The \$15,000 basic 703 contains a central processor with a register display and entry control panel, 4,000 words of core memory, a

priority interrupt system, and an ASR33 teleprinter. Initial deliveries are scheduled for August 1967.

Raytheon Co., Computer Division, 2700 S. Fairview St., Santa Ana, Calif. 92704. [381]

Modular, open-ended computer system

Through a modular approach to data system design, a broad line of black box elements has been developed. The elements may be directly interconnected in any combination for maximum data acquisition, reduction, logging and computing system applications. Called the 4000 series, it includes input and output devices and programming, processing, and memory units.

The new series of system and computer components includes on-line digital arithmetic units, keyboards, core storage assemblies, program input sources and accessories, as well as a variety of compatible instruments such as scanners, digital voltmeters, A-to-D converters, counters and encoders. Also available are digital clocks and output drivers and devices such as incremental tape recorders, paper tape or card punches, typewriters, teletypewriters, and column printers.

The resulting systems provide several advantages over conventional systems which normally are designed for specific applications, according to the manufacturer.

- Series 4000 systems are significantly lower in cost. Prices start at \$3,500 and typically a \$10,000 system compares in performance with conventional computers costing as much as \$25,000.

- Series 4000 systems are open-ended. A system can be expanded up to 32 modules, in any combination, without equipment modification. Alterations in system configuration and function can be accomplished at any time with plug-in ease.

- Series 4000 systems are easily programmed with algebraic statements by easily trained persons who

need not know any special computer language. Operation is simple and straightforward.

In operation, the parallel-connected system elements communicate both control instructions and data through interconnecting bus lines. One of the elements assumes control of the entire system, and other elements are assigned roles as input or output devices. The roles of input, output and control may be reassigned by control instructions issued through the bus by either operator or program. Although certain elements may be designed specifically to perform only input or output functions, any element may, theoretically, assume control, and it is possible for particular elements to assume multiple roles.

Wang Laboratories Inc., 836 North St., Tewksbury, Mass. [382]

Adaptable system for data acquisition



A stored-program data acquisition system samples a large number of analog and digital inputs, performs analog-to-digital conversion, formats data for computer compatibility, and records data on magnetic tape. The system is available in three models. Model 100 controls sampling sequence and tape block length. Model 200's expanded command list allows a more sophisticated approach to data acquisition. Model 300 has a general-purpose computer interface to handle on-line processing of the data collected.

Key to the flexibility of the sys-

"BLUE CHIP" TRANSFORMERS NOW AVAILABLE IN CASE SIZE #7

IN STOCK—is the latest addition to the versatile family of Blue Chip transformers for printed circuit applications. This still smaller size; (Height .340 inch maximum, volume .060 cubic inches), transformer offers design engineers more flexibility for electrical and mechanical transistor circuit applications. The size #7 Blue Chip transformers provide a response of ± 2 db from 300 to 100,000 Hz in a number of impedance ranges and are designed to meet Mil-T-27B, Grade 5, Class S. Write for your copy of complete electrical and mechanical specifications.

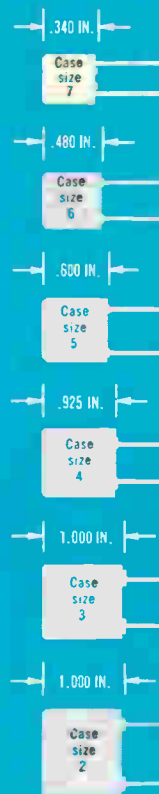
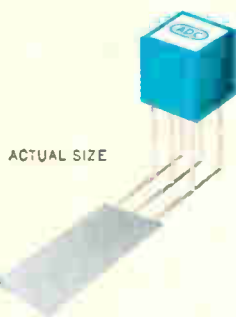

ADC

ADC PRODUCTS

A DIVISION OF MAGNETIC CONTROLS CO.

6405 Cambridge Street • Minneapolis, Minnesota 55426

How versatile is your leak detector



Can the complete instrument fit into spaces as small as 8 cu. ft.?

Does it have as many as 35 standard accessories available?

Is it available in models that sense for hydrogen, argon and neon, as well as helium?

CEC offers all of this and much more.

The following advantages explain why the 24-120B Leak Detector has become *the* instrument for virtually every aspect of commercial use, as well as for critical government programs. (*Federal stock number 6635-698-8086.*)

Compact size plus complete mobility assures access to difficult-to-reach locations.

Building block construction allows you to make substantial savings by buying *only* what is essential to the operation... then to add to it, if or when the need is called for, from the most complete line of accessories available.

Special models. Although the basic 24-120B is a helium detector, special models are available for monitoring argon, neon and hydrogen.

CEC backs you up with the most efficient sales, service and training organization in the field today.

For complete information, call your nearest CEC Field Office, or write Consolidated ElectroDynamics, Pasadena, Calif. 91109. A subsidiary of Bell & Howell. Bulletin 24120B-N6.

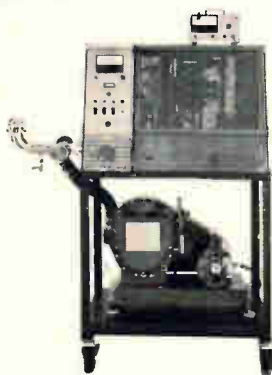

And be sure to ask for the free booklet:
LEAK DETECTION HINTS

CEC
ANALYTICAL INSTRUMENTS

 **BELL & HOWELL**

New Subassemblies

tem is a high-speed core memory that furnishes a data buffer as well as program steps—100 of which can be stored. Program steps, consisting of input channel identifiers and control functions, are entered via a 10-key keyboard as decimal digits. Nine commands, including unconditional transfer, store immediate, delete, recycle, and delay N cycles permit applications in which short cycling and variable sample rates, variable output tape formats, and other special data acquisition techniques are required.

The standard system includes a 16-channel multiplexer, expandable to 100 channels, an a-d converter, a 4,000-word eight-bit core memory and a digital tape transport.

Information Control Corp., 1320 E. Franklin Ave., El Segundo, Calif. 90245. [383]

Digital integrator offers wide range



A digital integrating recorder performs as an electronic integrator for linear signals (as from gas chromatographs), and also handles logarithmic conversion as required in amino acid analysis.

The model DIR-1 computes seven-digit integrals in real time, along with retention time to six digits, and reads out these values via a built-in printer. It is a wide-dynamic-range (1,000,000 to 1) autoranging analog-to-digital converter which records on paper tape, punched cards, or magnetic tape (or may feed digital values directly into an on-line computer).

For instruments other than chromatographs (spectrophotometers, fluorimeters, and slow-scanning

mass spectrometers), either the linear signal or its log conversion can be digitized and—if required—integrated. Independent controls insure optimum performance.

The DIR-1 makes extensive use of integrated circuits, and measures 17¼ x 17 x 5 in. Price, depending on options, ranges from \$6,400. Delivery takes 90 days.

Datex Division, The Conrac Corp., 1600 S. Mountain Ave., Duarte, Calif. 91010. [384]

Carbon dioxide laser rated at 40 w minimum

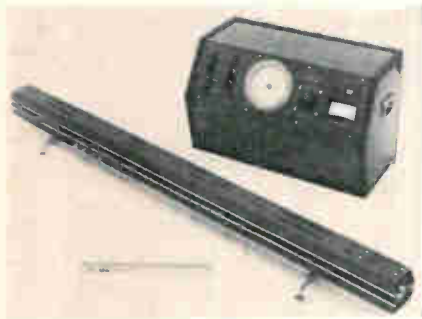

Developed for advanced scientific and industrial applications, a CO₂ laser is rated at 40 watts minimum and 50 watts typical output power at 10.6 microns, and has efficiency in excess of 10%. Spatial mode purity allows the infrared output beam to be collimated for high density transmission over great distances, and the 10.6-micron single frequency output is useful where wide bandwidth cannot be tolerated.

The system, designated Model 420, includes the laser head (7 ft long) and an associated power supply, with an optional self-contained coolant heat exchanger. Safety interlocks and warning lights caution users when high-power invisible radiation is emitted.

A unique optical system allows the beam to be focused to a point inside the laser housing itself. The sample chamber provides a convenient means of irradiating small samples for materials studies.

Applications include communications and optical ranging, metal-working functions such as milling, cutting, drilling, welding, brazing, soldering, gas chromatography, atmospheric and materials re-

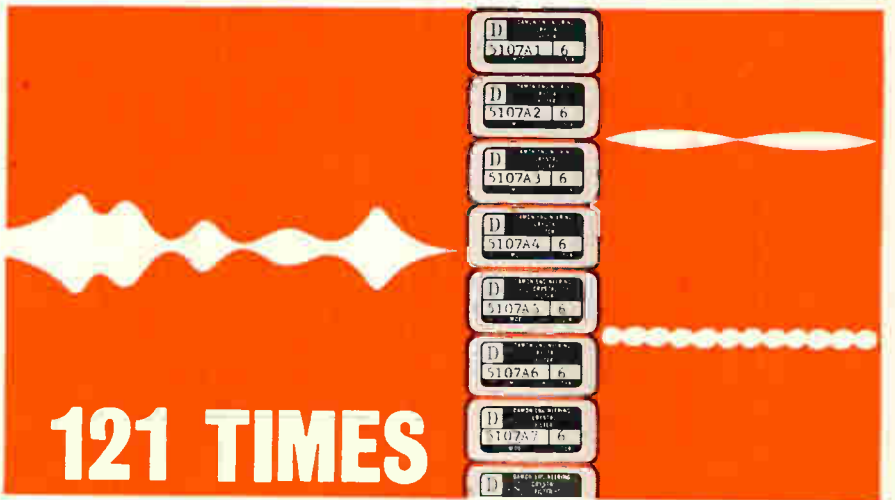
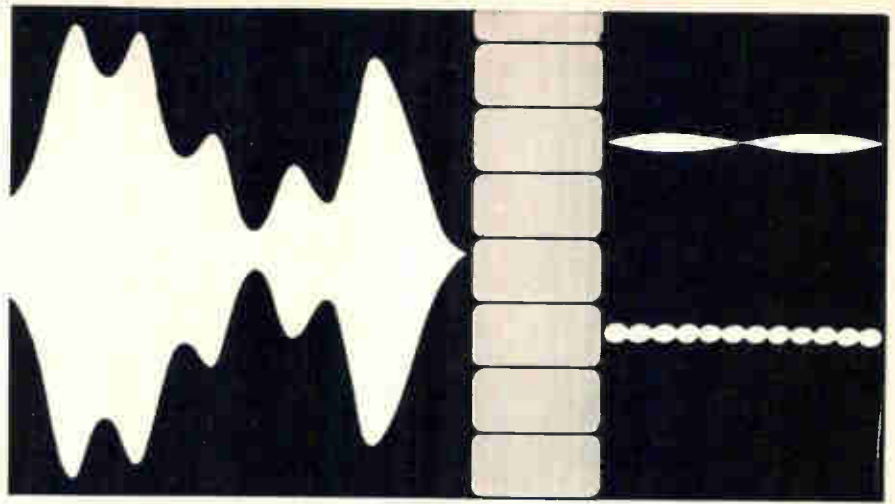

121 TIMES LESS DRIVE POWER

with Contiguous Comb
Filter Sets
by Damon



Typical Contiguous Comb Crystal Filter, Model 5107A is 1¼" L x ¼" W x ⅞" H.

Damon has produced a bank of 200 contiguous comb crystal filters that requires a total of 6.6 watts of drive power to obtain 10 milliwatts from each of the Gaussian (non-overshoot) response filters. This is only 1/121 of the 800 watts of drive power normally required to achieve the same output using conventional resistive padding techniques.

This significant achievement is the result of two advances in crystal filter technology: high efficiency contiguous comb crystal filters combined with new synthesis techniques. These advances permit the adherence to both frequency and time response specifications and offer a

new concept in the design of radar and other spectrum-based systems. Contiguous comb crystal filter banks are also the most reliable, efficient, compact and economical precision systems available for multichannel signal processing of all kinds.

Write for data on Gaussian Response Contiguous Comb Crystal Filters to Damon Engineering, Inc., Needham Heights, Mass. 02194, Tel. (617) 449-0800.

DAMON



Where Performance Comes

FIRST

With 22 years of achievement in space and defense programs, MELPAR continually expands horizons of R & D into broad new capabilities. Intimately associated with Mercury, Gemini and Apollo, we are now pioneering creative efforts on Voyager, Nimbus, Delta, and advanced Technical and Orbital Satellites.

Exciting opportunities exist in the following areas:

ASTRO SYSTEMS CENTER

Located at NASA Goddard Space Flight Center

The ASTRO Systems Center operates laboratories engaged in Astrochemistry, Astrophysics, Systems Integration, Monocrystalline Integrated Circuitry, Heat and Thermodynamics. Additionally, the Center has very attractive positions for Mechanical, Electrical and Chemical Engineers, as well as for Information Processing Specialists and Design personnel in its diversified operations at the Goddard Space Flight Center, Marshall Space Flight Center, Manned Space Flight Center, Wallops Station and Electronics Research Center of the National Aeronautics and Space Administration.

APPLIED ELECTRONICS DEPARTMENT

- RF circuit design for automatic and remotely controlled HF receivers, HF, VHF and UHF Frequency Synthesizers—Video Signal Processing
- Design of small special purpose digital computers and programming for real time and control applications, mathematical modelling.
- Theoretical and experimental design of missile and ground-based microwave antennas and microwave receivers and Microwave Components
- Advanced circuitry development and computer application related to information handling and processing.

SIMULATION & TRAINING DEPARTMENT

Computer systems design, programming, analysis and Human Factors for advanced weapon systems and tactics trainers.

THE AVIONICS DEPARTMENT

Radar, countermeasures and microminiature packaging techniques for aircraft avionics systems—video, HF transistor circuitry design

ELECTRONICS RESEARCH CENTER

- Data Compression Systems
- Redundancy Removal Coding Techniques
- Phonetic Pattern Recognition.
- Signal Enhancement Techniques.
- Wave Propagation-Acoustic-Electromagnetic.
- Underwater Systems Research.
- Thin Film Microelectronic Circuits
- Seismics

FIELD SERVICE ENGINEERS

- Flight Simulators
- Airborne Radar Countermeasures

CHEMISTRY & LIFE SCIENCES CENTER

Develop methodology for detecting low levels of microbial contamination in and on spacecraft and space hardware to include Apollo and other major space programs.

INSTRUMENTATION LABORATORY

Instrumentation and technology of physical and chemical properties to include gas chromatograph, aerosols, measurements and particle size determinations.

Write, in confidence, to: **Manager, Professional Placement**



A SUBSIDIARY OF WESTINGHOUSE AIR BRAKE COMPANY

7764 ARLINGTON BOULEVARD, FALLS CHURCH, VA. 22046

(Suburb of Washington, D. C.)

An Equal Opportunity Employer M/F

New Subassemblies

search, absorption spectroscopy, and biological and medical research.

Price for the laser and power supply is \$8,500, with delivery quoted at 60 days.

Varian Associates, Eimac Division, 301 Industrial Way, San Carlos, Calif. [385]

Plug-in servo aimed for use in systems

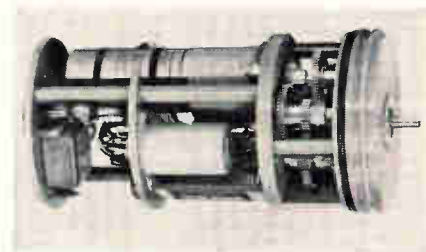

A versatile, plug-in servo can be used to position and actuate a variety of loads as part of an automatic control system. Mounting is achieved by three standard synchro clamps. The 0.18-in.-diameter output shaft of the CS-198 is positioned in response to a d-c command signal applied to the unit. Torque produced is 250 in.-oz and the following speed is 36° per second. Accuracy of positioning is 0.1%. All electrical connections are by means of plug-in connector.

The unit contains a servomotor-generator, clutch-protected multi-turn feedback potentiometer, stable silicon transistor amplifier, and associated gearing. Variations are available for a-c and synchro command signals as well as for higher torque outputs.

Control Technology Co., 41-16 29th St., Long Island City, N.Y. 11101. [386]

No nonlinear devices in analog multiplier

A four-quadrant d-c voltage multiplier also squares, divides, and extracts square roots without either special nonlinear or magnetic devices or external amplifiers. The solid state, encapsulated Model



M101 allows mode selection by shorting pins, has no critical supply regulation requirements, and no zero adjustments.

Specifications include ± 10 v differential inputs; 75,000 ohms minimum input impedance; output, ± 10 v at 5 ma maximum, short-circuit protection; output impedance, less than 1 ohm; full scale linearity better than 0.25%; offset error, ± 10 mv maximum; temperature stability of output offset, 1 mv/ $^{\circ}$ C; operating temperature, -25° C to $+85^{\circ}$ C; frequency response in multiplication mode, d-c to 1 khz; power requirements, ± 15 v d-c at 50 ma maximum; size, $3 \times 2 \times \frac{5}{8}$ in. The unit meets MIL standards.

Applications include electromechanical multiplier replacement, voltage-controlled linear attenuators, cross and auto correlation, power measurement, suppressed carrier modulation, servoanalyzers, and error correcting circuitry.

Price is under \$500; availability, 3 to 4 weeks.

Intronics Inc., 57 Chapel St., Newton, Mass. 02158. [387]

Amplifier modules in 10-db increments

Extremely wide bandwidth (1 khz to 500 Mhz) and a modular building-block design are provided by a series of multiple decade amplifiers. The devices are called Unit Amplifiers because each module furnishes a fixed unit of gain in a single stage. A unit of gain is 10 db, and the modules weigh $\frac{1}{2}$ oz. The concept makes it possible to cascade a series of modules with excellent impedance matching to achieve any amount of gain from 10 db to 60 or 70 db.

Unit Amplifiers have a flat gain

STEREO

THE ADDED DIMENSION OF DYNAZOOM® METALLOGRAPHS

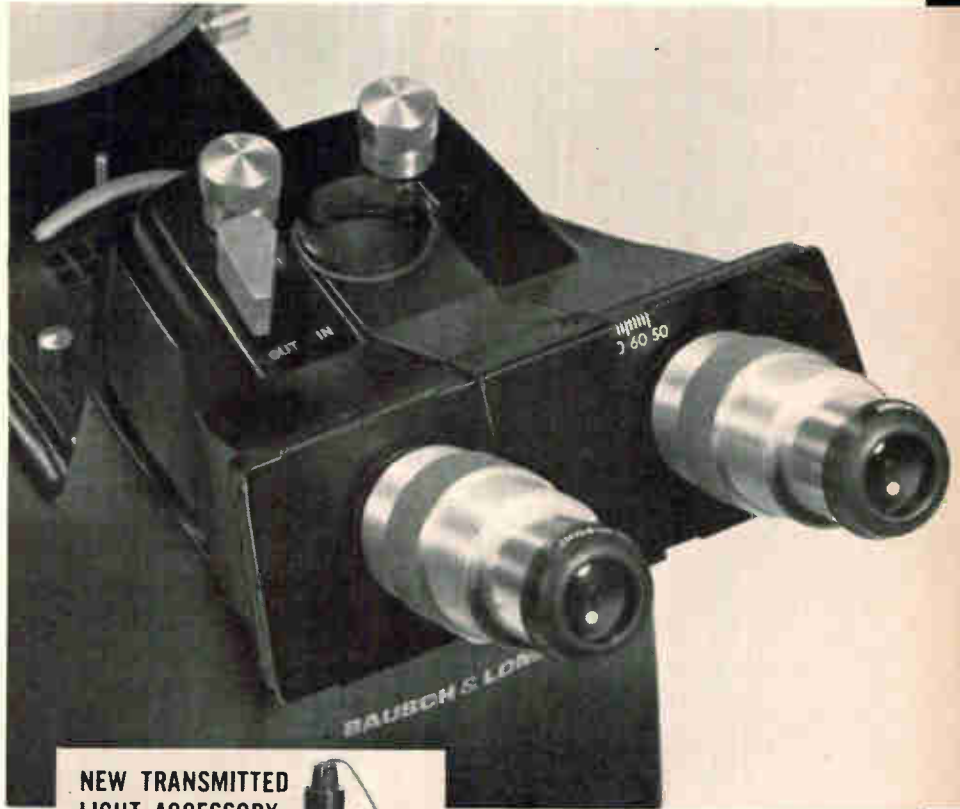

NEW TRANSMITTED
LIGHT ACCESSORY

Bausch & Lomb has added a new dimension to metallurgy. You get all the advantages of the Dynazoom II Bench Metallograph plus *full-range stereo viewing*. Simply flip a lever and you can differentiate between inclusions and holes, scan a surface for fractures or study various surface levels caused by polishing and etching. Avail-

able as a complete stereo model or convert existing Dynazoom Metallographs by adding the zoom-stereo body. Send for Brochure 42-2211. Also available, the free booklet, "High Power Stereo" by Harold E. Rosenberger, No. S-513.

Transmitted light available on all models

For the study of transparent and translucent specimens on your Dynazoom Metallograph, there is now a Transmitted Light Accessory. Adapts readily to all models, including stereo. Can even be used with high N.A. 75 \times oil immersion objectives. Plastics, glass, thin films, evaporated coatings, oils and other liquid specimens can be examined. Send for our Brochure 42-2212.

Ask for a no-obligation demonstration of this equipment. Write Bausch & Lomb, 62342 Bausch Street, Rochester, New York 14602.

BAUSCH & LOMB 

In Canada, Bausch & Lomb Optical Co., Ltd., 16 Grosvenor St., Toronto.

Circle 201 on reader service card

OPTO-METRIC Instruments for the world of precision measurement

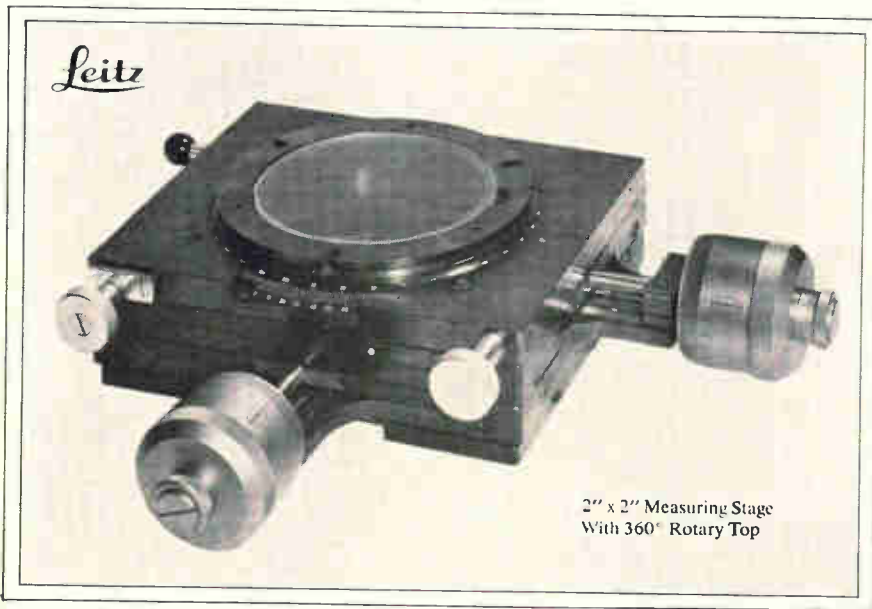

2'' x 2'' Measuring Stage
With 360° Rotary Top

COORDINATE MEASUREMENTS OR PRECISE POSITIONING

A full line of Leitz coordinate stages, with readings in .0001 inches, is available for use with microscopes for the critical scanning of small precision parts or delicate assembly work. Stages can be furnished with coordinate movements only, or in combination with graduated Rotary Top. Ball-bearing movements and precision machining insure smooth operation, unexcelled

accuracy and long-lasting service characteristic of Leitz equipment.

We would welcome the opportunity to help with your measurement problems. Whether for R & D or production control, Opto-Metric has an instrument to meet your exacting needs. Write for an Opto-Metric Catalog, c/o Technical Service Division.

01466

OPTO-METRIC TOOLS, INC. 
A SUBSIDIARY OF E. LEITZ, INC., 304 HUDSON ST., N.Y., N.Y. 10013

Circle 202 on reader service card

Not much of a plot, but a great cast of characters.

The characters are 6,000 manufacturers and more than 4,000 product listings. Even if you're not the literary type, you'll be interested in the unprecedented opportunity the Electronics Buyers' Guide affords you to reach readers. Over 445,000 engineer users go to EBG year round as a one-stop shopping center for all their electronic needs. Closing date: July 14th. Book some space now! First come, first served.

Electronics Buyers' Guide

A McGraw-Hill Market Directed Publication, 330 West 42nd Street, New York, N.Y. 10036

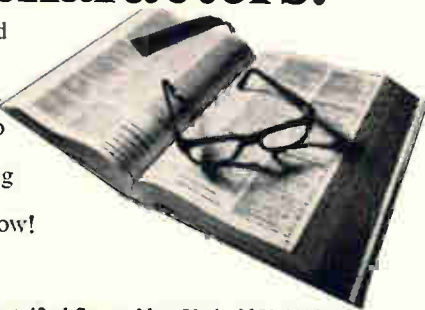

New Subassemblies

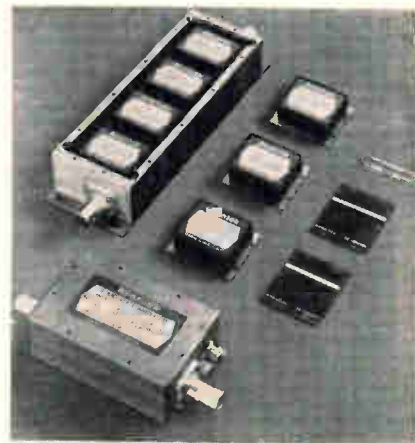

response from 1 kHz to 500 MHz in a single stage. The input and output 50-ohm impedance matching techniques provide a VSWR of 1.5 to 1 maximum and are typically 1.2 to 1. The bandpass flatness is less than the 1 dB over this multi-decade range. Input and output impedance levels are 50 ohms in all modules.

According to the manufacturer, the line is tailored for radar, electronic countermeasures, radiometry, communications, industrial electronics, computers, instruments, and the education equipment market.

Avantek Inc., 3001 Copper Road, Santa Clara, Calif. [388]

Water-cooled laser hits 300-Mw peak

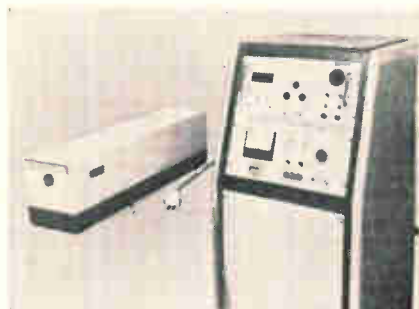

Q-switched laser systems that provide high peak powers and are water-cooled are available in the LHO1 series. They are solid state systems with a two-pulse-per-minute operation, using either ruby at 6,943 angstroms in the visible, or

neodymium-doped glass at 10,600 angstroms in the infrared. The lasing subsystem is packaged as the model LHS water-cooled laser head. A model LPS-28 power supply is used with the system.

Maximum peak pulse power of the series is 300 Mw. Typical pulse width is 9 to 10 nsec half height.

The LHOI series can be operated in the normal mode by removing the Q-switch, using the external mirror to complete the cavity, and modifying the flash-lamp pulse-forming network. Output in the normal mode is 35 joules with a pulse length of 1.5 msec.

With a Kerr cell, the model is designated LHO1A. The Pockels cell model is LHO1B. Raytheon Co., 130 Second Ave. Waltham, Mass. 02154. [389]

Operational amplifier uses FET input

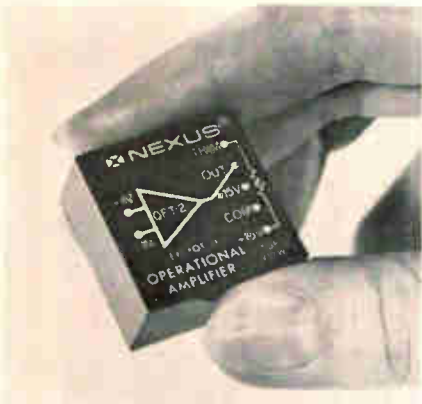

General-purpose operational amplifiers that employ a FET input stage provide 10^{11} ohms differential and common-mode impedances. Output characteristics (± 10 v at ± 10 ma) are high for the size of the package (1.12 x 1.12 x 0.58 in.). Typical input bias current is 10 picoamps. Common-mode rejection is 86 db.

Due to the amplifiers' loop dynamics, the settling time is less than that of many competitive operational amplifiers with higher frequency response, the manufacturer claims. A fast slewing rate of 10 v/ μ sec permits full output to 200 khz.

The QFT-2, QFT-2A and QFT-2B have maximum temperature coefficients of 35, 10 and 5 μ v/ $^{\circ}$ C, respectively. Prices are \$45, \$70, and \$85, respectively. Delivery

only the ALL-NEW 620 & 640 BELL GAUSSMETERS

offer
you these combined features
for Increased Versatility



**MODEL 620
GAUSSMETER**
All solid-state automatic battery take-over in case of line power failure. Available from stock.



**MODEL 640
GAUSSMETER**
All solid-state—1000X scale expansion—5V AUX output standard.

1

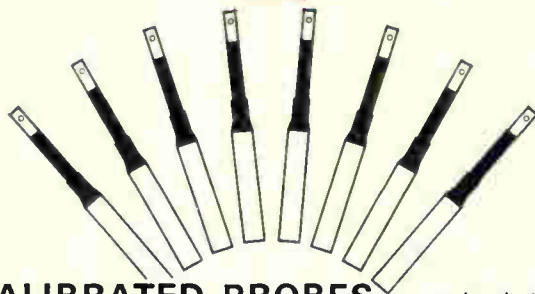

PRECALIBRATED PROBES — new imaginative design permits changing probes without recalibration (probe and instrument are preprogramed).

- 2** Temperature Compensated Probes — with $\pm 0.005\%$ / $^{\circ}$ C temperature dependence make possible a stability not formerly available in medium priced gaussmeters.
- 3** High Accuracy — 0.5% FS to 10 kG and 1.0% FS to 30 kG (possible without reference to cal magnet).
- 4** True Zero & Field Polarity — measure direction as well as magnitude.
- 5** Probe Versatility — 15 standard transverse, axial & multi-axis probes.
- 6** Direct & Independent meter readout of ac and dc fields.
- 7** 1 V Calibrated Output at front panel output jacks.
- 8** 1000X Scale Expansion with automatic zero center meter reading in incremental mode (640 only).



All this and a Gold Seal Probe Guarantee, too!

"BELL PRODUCTS for PLANNED PROGRESS"

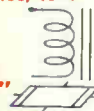

F. W. BELL
F. W. Bell, Inc.
1356 Norton Ave.
Columbus, O. 43212
Ph. 614-294-4906
TWX: 810-482-1716

Richard Bruce is a member of our technical staff. He's defining the atmospheric forces that act on earth satellites. (He calls it "the weather of outer space.") He's had to teach himself nearly everything he knows about the subject. There is no formal curriculum. Even basic facts are hard to get. Very few places have them. Aerospace is one.



The Aerospace Corporation performs systems engineering and provides technical direction for the U.S. Government on military space and missile programs. For information about technical positions, contact the Aerospace Corporation, an equal opportunity employer. Write to Stephen D. Robinson, P.O. Box 95085, Los Angeles, California 90045.

THE AEROSPACE CORPORATION

neodymium-doped glass at 10,600 angstroms in the infrared. The lasing subsystem is packaged as the model LHS water-cooled laser head. A model LPS-28 power supply is used with the system.

Maximum peak pulse power of the series is 300 Mw. Typical pulse width is 9 to 10 nsec half height.

The LHO1 series can be operated in the normal mode by removing the Q-switch, using the external mirror to complete the cavity, and modifying the flash-lamp pulse-forming network. Output in the normal mode is 35 joules with a pulse length of 1.5 msec.

With a Kerr cell, the model is designated LHO1A. The Pockels cell model is LHO1B. Raytheon Co., 130 Second Ave. Waltham, Mass. 02154. [389]

Operational amplifier uses FET input

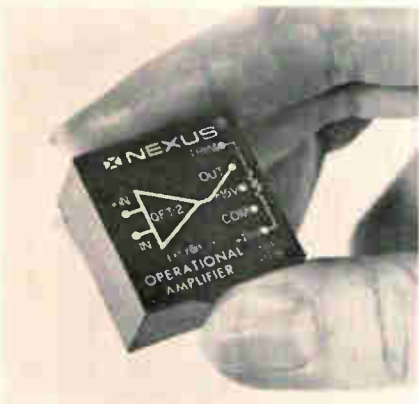

General-purpose operational amplifiers that employ a FET input stage provide 10^{11} ohms differential and common-mode impedances. Output characteristics (± 10 v at ± 10 ma) are high for the size of the package (1.12 x 1.12 x 0.58 in.). Typical input bias current is 10 picoamps. Common-mode rejection is 86 db.

Due to the amplifiers' loop dynamics, the settling time is less than that of many competitive operational amplifiers with higher frequency response, the manufacturer claims. A fast slewing rate of 10 v/ μ sec permits full output to 200 khz.

The QFT-2, QFT-2A and QFT-2B have maximum temperature coefficients of 35, 10 and 5 μ v/ $^{\circ}$ C, respectively. Prices are \$45, \$70, and \$85, respectively. Delivery

only the ALL-NEW 620 & 640 BELL GAUSSMETERS

offer
you these combined features
for Increased Versatility



**MODEL 620
GAUSSMETER**
All solid-state automatic battery take-over in case of line power failure. Available from stock.



**MODEL 640
GAUSSMETER**
All solid-state—1000X scale expansion—5V AUX output standard.

1

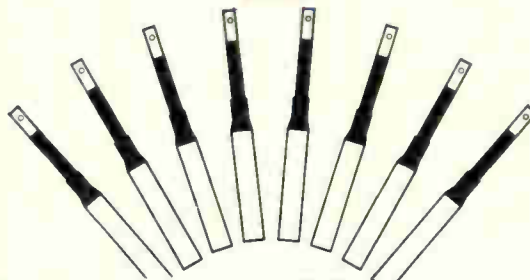

PRECALIBRATED PROBES — new imaginative design permits changing probes without recalibration (probe and instrument are programmed).

- 2** Temperature Compensated Probes — with $\pm 0.005\%$ / $^{\circ}$ C temperature dependence make possible a stability not formerly available in medium priced gaussmeters.
- 3** High Accuracy — 0.5% FS to 10 kG and 1.0% FS to 30 kG (possible without reference to cal magnet).
- 4** True Zero & Field Polarity — measure direction as well as magnitude.
- 5** Probe Versatility — 15 standard transverse, axial & multi-axis probes.
- 6** Direct & Independent meter readout of ac and dc fields.
- 7** 1 V Calibrated Output at front panel output jacks.
- 8** 1000X Scale Expansion with automatic zero center meter reading in incremental mode (640 only).



All this and a Gold Seal Probe Guarantee, too!

"BELL PRODUCTS for
PLANNED PROGRESS"

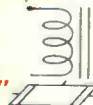

F. W. BELL
F. W. Bell, Inc.
1356 Norton Ave.
Columbus, O. 43212
Ph. 614-294-4906
TWX: 810-482-1716

New Subassemblies

takes three weeks for small quantities.

Nexus Research Laboratory Inc., 480 Neponset St., Canton, Mass. 02021. [390]

Light-coupled telemetry system

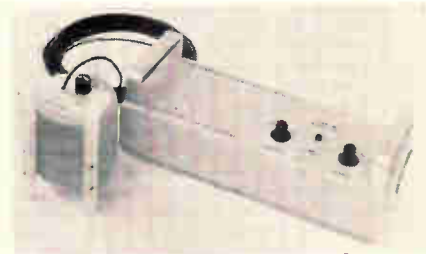

A telemetry system has been developed for use in environments where accurate measurements must be made and electrical isolation of the sensor is critical. Consisting of

sensor, light transmitter, fiber optics, light guide, and light receiver, it can measure electric and magnetic fields and current or voltage, and can transmit data from field probes, ion detectors, accelerometers, and strain gauges.

The portable, battery-operated system covers a frequency range from 10 khz to 30 Mhz, and can be supplied with up to 48 ft of fiber optics.

In operation, the sensor monitors a signal that is then passed through a gallium arsenide diode to appear as a modulated light output. This light output is transmitted through the fiber optics guide to the light receiver where it is demodulated and the original monitored signal is reconstituted.

Price of a single-ended version is \$2,250; a differential version costs \$2,450.

Develco Inc., 440 Pepper St., Palo Alto, Calif. 94306. [391]

Switching matrix has 200 crosspoints

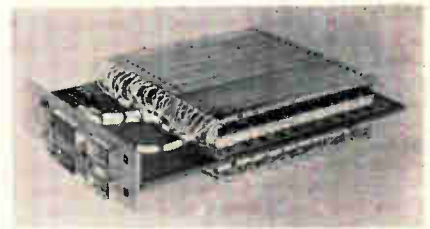

A video switching matrix can route any one of 10 video signals (telemetry receiver outputs) to one or more of 20 data distribution points; distribute closed circuit tv and wideband data signals; and provide nondestructive selection memory.

Major feature of the matrix is a network of 200 crosspoints, each of which incorporates its own magnetic latching Loc-Reed relay and has its own control address. Actuated by a 3-msec pulse, crosspoints require no holding power to remain operative or inoperative. In addi-

PROBLEM
SOLVED

Formica know-

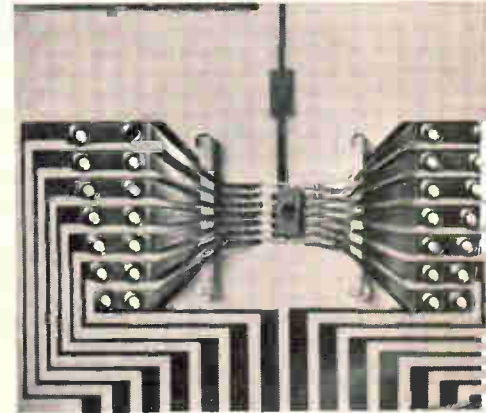

Case #1695-Problem: 4 different copper clad grades were purchased and inventoried, creating multiple paper work, record-keeping. Idea activated: One FORMICA® FR-45 laminate, created to meet NEMA G-10, G-11, FR-4, FR-5.

Case #6520-A-Problem: Pad slippage causing poor registration in production of multi-layer circuitry boards. Idea activated: FORMICA® laminate MLC system created a sandwich with better copper bond strength and registration control at elevated temperatures.

tion, a confirming signal insures that the selected source is routed to the correct output.

Integrity of signal is such that crosstalk is ordinarily held to 75 db or better.

Adaptable to rack or panel mounting, the switching matrix is less than 800 cu. in. in volume.

Price is approximately \$7,500 each. Delivery takes about 12 weeks.

McKee Automation Corp., 7315 Greenbush Ave., North Hollywood, Calif. 91605. [392]

Miniature indicator for air navigation

A small indicator, with flag display or pointer, is suitable for aircraft navigation instrumentation. The unit utilizes a microminiature moving coil, core magnet mechanism. Sealed against dust and dirt, it operates in a wide variety of electrical sensitivities and functions at temperatures from -55°C to 55°C .



The AI-21 is $\frac{7}{16}$ in. in diameter, $\frac{3}{4}$ in. in length and weighs 11.5 grams.

Ammon Instruments Inc., 346 Kelley St., Manchester, N.H. 03105. [393]

20-section delay line for space telemetry

An unpotted, cordwood-type delay line has been developed for use in space telemetry equipment where light weight, small size, and reliability are prime requirements. Com-

posed of 20 sections, the line is 2 in. long, $\frac{5}{8}$ in. high and 0.600 in. wide. Weight is approximately 10 grams.

With a delay time of 2 μsec , the



unit has a rise time of 250 nsec and an impedance of 1,000 ohms. Many of these parameters may be altered as required. A companion line, for example, fulfilling the same applications, with a delay of 0.5 μsec and a rise time of 165 nsec, is only 1 in. in length. When potted, it fulfills all applicable MIL specs.

Price is under \$50 each. Delivery takes approximately six weeks. Valor Electronics Inc., 13214 Crenshaw Blvd., Gardena, Calif. 90249. [394]

how activates ideas!

If your problem is printed circuit boards, call us. Continuing innovations at Formica Corporation have created a wide variety of copper clads. One of these could help you!

Small problems in copper clad circuit boards can become big problems in product dependability. Turn those problems into profit and reliability. Call Formica. No one offers as much experience in laminates... backed by the research resources of Cyanamid. We make a variety of copper clad grades to solve a variety of problems. Ideas solve problems. Formica know-how activates ideas.

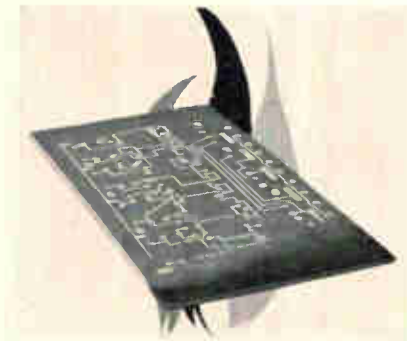

Case #5266-Problem: Flame retardant version of XXXPN-36 required, at no premium price. Idea activated: Flame retardant FORMICA® laminate FR-200 engineered to meet MIL specs, offers high flexural strength, excellent electrical properties.

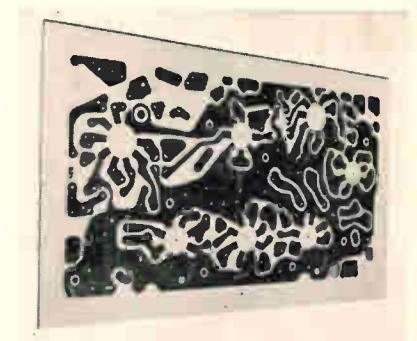

Case #J-9291-Problem: Utility-priced copper clad with quick local delivery required, due to limited inventory space. Idea activated: FORMICA® laminate FF-91 (meets G-10 specs) produced, maintained in Formica regional warehouses for phone-call delivery.

There are other brands of industrial plastics but only one

FORMICA CORPORATION • Cincinnati, Ohio 45232, Dept. EL 6-7 subsidiary of



Richard Bruce is a member of our technical staff. He's defining the atmospheric forces that act on earth satellites. (He calls it "the weather of outer space.") He's had to teach himself nearly everything he knows about the subject. There is no formal curriculum. Even basic facts are hard to get. Very few places have them. Aerospace is one.

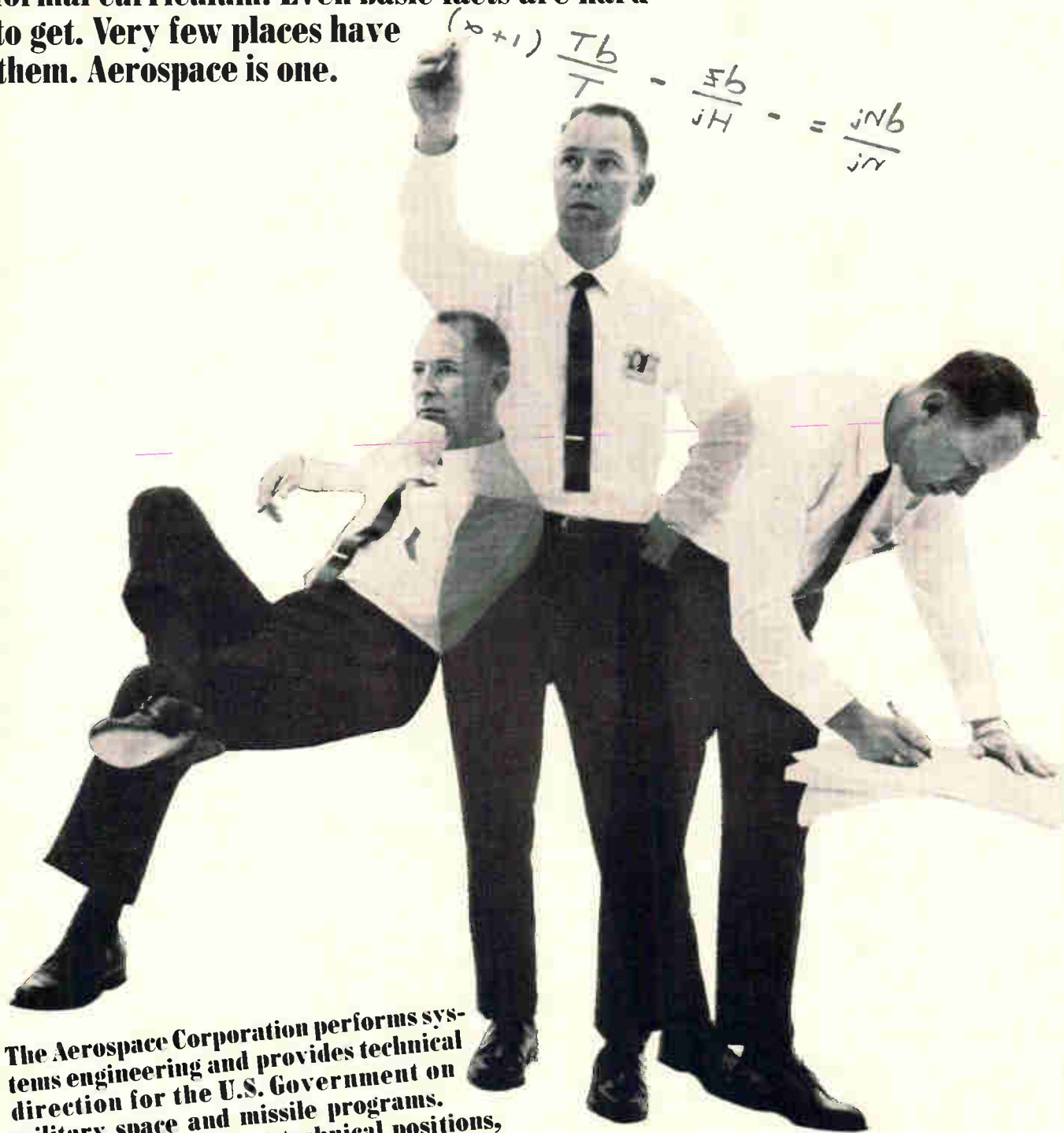

The Aerospace Corporation performs systems engineering and provides technical direction for the U.S. Government on military space and missile programs. For information about technical positions, contact the Aerospace Corporation, an equal opportunity employer. Write to Stephen D. Robinson, P.O. Box 95085, Los Angeles, California 90045.

THE AEROSPACE CORPORATION

New Microwave

Acoustic line gives 4- μ sec delay



A microwave acoustic delay line designed for operation at the 1.25 Ghz range can be used in moving-target indicators, electronic countermeasures and counter-countermeasures, altimeters, r-f checkout systems, and very-high-speed digital scratchpad memories. The unit is electrically matched into 50 ohms impedance.

At its center frequency, the delay line has a bandwidth of 600 Mhz and time delay of 4 μ sec. Other parameters include: insertion loss, 56 db; spurious, -15 db; and vswr, 2:1.

The device measures $\frac{1}{2}$ x $2\frac{1}{2}$ x $3\frac{1}{4}$ in. and weighs $4\frac{1}{2}$ oz. Andersen Laboratories Inc., 1280 Blue Hills Ave., Bloomfield, Conn. 06002. [395]

Pulsed amplifier tube delivers up to 3 Mw

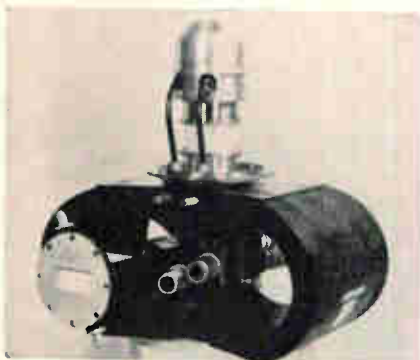

A pulsed-type Amplitron amplifier, a form of magnetron, is capable of power output levels from 0.5 to

3 megawatts over a frequency range of 5.4 to 5.9 Ghz. Called the QKS1343, the amplifier is an integral magnet tube with waveguide input and output. Modulators to be used with this tube can be designed to operate across the specified band without electrical or mechanical adjustment. Cooling is accomplished with forced liquids.

In a typical operation, peak power would be half a megawatt with average power output of 15 kw. With a duty cycle of 0.03, its pulse duration would be 200 μ sec. Peak anode voltage would be 48-53 kv; peak anode current, 16 amps; driver peak power, 40 kw.

The QKS1343 weighs 75 lbs. Raytheon Co., Waltham, Mass. [396]

Balanced mixer with high-density packaging

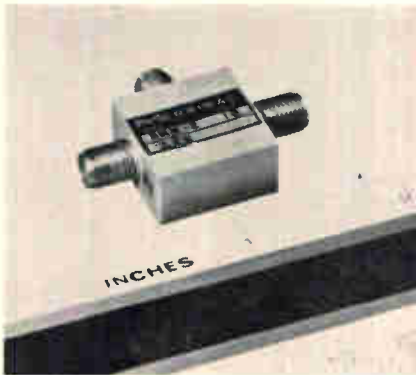

A miniature balanced mixer for microwave applications in the 1-to-5-Ghz range is said to be the smallest ever developed. The BMM-2 series mixers utilize the manufacturer's new ultraminiature quadrature (90°) hybrids, which permit drastic size reductions. Hot-carrier diodes are employed as active elements.

The mixers measure $\frac{3}{4}$ x $\frac{3}{4}$ x $\frac{3}{8}$ in. and weigh less than $\frac{1}{2}$ oz. Typical applications include spaceborne and aircraft systems and systems requiring high-density packaging, such as phased-array radars and portable military communications equipment.

Model BMM-2-2K was designed for telemetry applications in the



The Aerospace Corporation performs systems engineering and provides technical direction for the U.S. Government on military space and missile programs.

SPACE COMMUNICATIONS SYSTEMS ENGINEERS Responsible for manned and unmanned spacecraft communications and data handling systems engineering which includes coordination of subsystem and user requirements, interface definition, specifications preparation review and technical direction of manned and unmanned spacecraft contractors and subcontractors. Requires a sound communications background and familiarity with space systems. Space vehicle design, experience in tracking, telemetry, command, and voice communication systems is desirable. A balance between analytical and practical engineering experience is preferred.

SATELLITE SYSTEMS ENGINEERS Conduct systems analysis in support of advanced satellite programs. Must be capable of defining system performance requirements to establish ground and airborne systems specifications for contractor hardware fabrication. In addition to systems analysis background, depth required in some of following systems: electro-optical, communication, data processing and displays, attitude control.

COMPUTER - DISPLAY ENGINEERS Should be experienced in design, development and analysis of display generation and display presentation computer systems; experience in systems engineering and technical direction of large-scale digital and software systems development and testing programs. To participate in the advanced planning, systems engineering and technical direction of displays for both ground and spaceborne systems.

RADAR SYSTEMS ENGINEERS Perform analysis and program support on advanced radar systems. Analytical and hardware design experience required in phased array, pulse compression, receiver signal processing, current pulse, cw and pulse doppler techniques as applied to airborne and missile radar systems.

If you have an advanced degree and a minimum of five years experience, contact The Aerospace Corporation, an equal opportunity employer. Write to Stephen D. Robinson, P.O. Box 95085, Los Angeles, Calif. 90045.



THE AEROSPACE CORPORATION

DID YOU SAY INSIDE?

YES!

Delevan will put

MICRO*i*
Inductors & Transformers

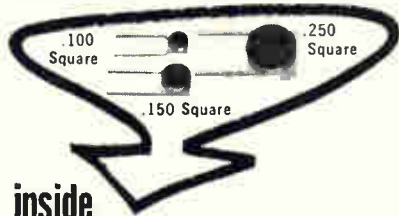

inside
IC's

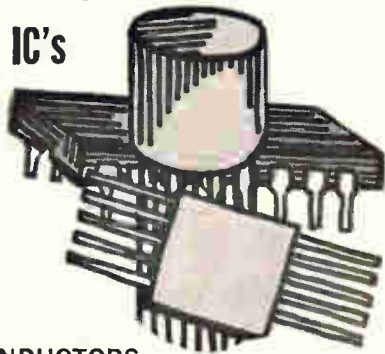

INDUCTORS

- Size .100, .150, .250 SQ x .065 HIGH
- L Range .015 uh to 1000 uh
- Shielded, Encapsulated, Excellent T.C.
- Meet MIL-C-15305C Grade & Class 5

TUNABLE INDUCTORS

- Size .150, .250 SQ x .125 HIGH
- L Range .10 uh to 1,300 uh
- Tuning Range 1.7 to 1
- Excellent Resolution, Non-Retractable Tuning

RF TRANSFORMERS (FIXED AND TUNABLE)

- Size .100, .150, .250 SQ x .125 HIGH MAX.
- Frequency Operation — 500 KHz to 50 MHz
- IF & Wideband Designs Available
- 30 MHz & 60 MHz IF Designs in stock

HI-Q COILS

- Size .250 SQ x .125 HIGH
- L Range .12 uh to 1000 uh
- Q values in area of 100
- Direct replacement for toroids
- L tolerances as low as $\pm 1\%$

Delevan Electronics Corporation / Division  **AMERICAN PRECISION INDUSTRIES, INC.**
270 QUAKER RD. / EAST AURORA, N. Y. 14052
TELEPHONE 716/652-3600 TELEX 091-293

OTHER DIVISIONS OF AMERICAN PRECISION INDUSTRIES, INC.:
BASCO, INC. • ELECTRO-MECHANICAL PRODUCTS DIVISION

New Microwave

2.2-to 2.3-GHz range. Other models covering frequencies down to 1 Ghz or up to 5 Ghz are available on special order.

Typical characteristics of the BMM-2-2.2K include: noise (at 1.5 db i-f), typically 6.3 db; isolation, 12 db; typical vswr for all three ports, 1.25:1; and an operating r-f bandwidth in excess of 10%.

Price is \$225 in small quantities, and delivery is from stock to 30 days.

Merrimac Research & Development Inc., West Caldwell, N.J. 07006. [397]

High stability offered by local oscillator

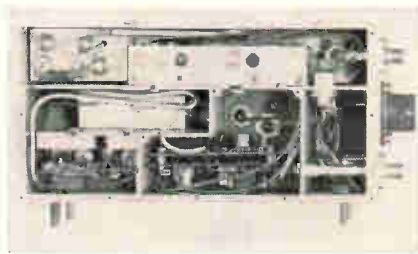

Microwave applications that demand exceptional operating stability and spectral purity are expected to benefit from a new solid-state local oscillator. Spurious outputs are down 75 db from 0 to 20 Ghz. Output spectral purity and frequency accuracy can be maintained even under high-load vswr for all phase angles. Output power varies smoothly over a supply range of 18 to 30 v without spectrum breakup.

The oscillator, called the LO-100, is available at any frequency between 7.5 and 14 Ghz. Minimum output power is 10 mw, with options as high as 50 mw. Provisions for an external input can be made that will enable a reference frequency at either 100 or 500 Mhz to produce the basic frequency within a fractional bandwidth of $\pm 1/2\%$. Operating temperature range is typically from 0° to +60°C; however, this range can be expanded.

The units can be ordered with electronic switching between the internal oscillator and an external

Need a mountain of data on, say, the rumblings of Vesuvius?

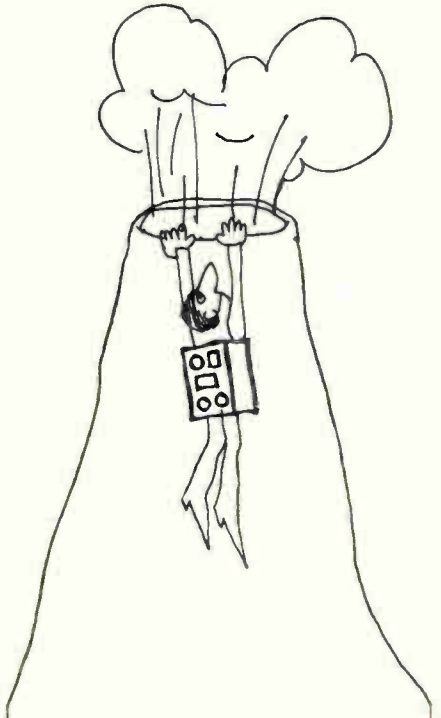

Lockheed's 28-lb. 417 recorder goes and gets it.

You can't top the 417's portability. Carry it almost anywhere with one hand. Any comparable recorder scales at least 50 lbs. more. And accuracy? The 417 matches even large rack machines.

Durability is another advantage. The 417's dual capstan transport provides precision operation under vibration and in any position.

The 417 operates from its internal battery or from 110/220 volts AC with power consumption as low as 10 watts. Frequency response is 100kc direct, 10kc FM. And it comes in a neat 14" x 15" x 6" package—small enough to fit under an airplane seat. The price is compact, too. Starting at \$7,000.

Next time you're smoking-out data, remember the lightweight 417. For information, write Boyd McKnight, Dept. E, 612 Edison, New Jersey.

LOCKHEED

LOCKHEED ELECTRONICS COMPANY
A Division of Lockheed Aircraft Corporation

input. They are also available with voltage control of frequency for phaselock operation.

The oscillator is packaged in a lightweight, 25-cu in. aluminum alloy housing. All circuits are etch wired and are encapsulated. Mean time between failures is in excess of 10,000 hours.

Applied Technology Inc., 3410 Hillview Ave., Palo Alto, Calif. [398]

Solenoid switches waveguide attenuator



A solenoid control designed for remote controlled equipment and systems applications switches an attenuator in and out of the circuit to produce an on-off fixed level of attenuation across the full frequency range of a waveguide.

Designated model M15SA, the unit has the following specifications: frequency range, 10 to 15 Ghz; attenuation, 40 db; accuracy, ± 2.0 db; insertion loss, 0.3 db maximum; vswr, 1.15 maximum; r-f power, 5 w c-w maximum; actuator power, 15 w at 28 v d-c (continuous duty); waveguide type, WR-75.

Price available on request. Delivery takes 45 days.

E&M Laboratories, 7419 Greenbush Ave., North Hollywood, Calif. [399]

Double-balanced mixer spans 0.20-500 Mhz

A double-balanced mixer for applications at frequencies ranging from 0.20 to 500 Mhz can be operated as a mixer, phase detector, current-controlled attenuator, frequency doubler, balanced modulator, amplitude modulator, or pulse modulator.

Called the DM-1-250, its performance characteristics vary

Whatever your display application,
Dialco has the right

SUB-MINIATURE INDICATOR LIGHTS!

Designed to Meet or Exceed Environmental and Operational Requirements of MIL-L-6723 and MIL-L-3661.

The chances are Dialco has the particular assembly you require... and off the shelf for prompt delivery. Sub-miniatures mount in 15/32" or 17/32" clearance hole—accommodate Incandescent lamps for 1.35 to 28V circuits—or Neon lamps for 105-125V AC-DC or 110-125V AC. In Dialco units, the current-limiting resistor is built-in (U.S. Pat. No. 2,421,321).

Other features available: water-tight construction; anti-rotation (locked) construction; dimming or non-dimming feature; and a wide array of lens shapes and colors with or without hot-stamped or engraved legends.

SAMPLES ON REQUEST—AT ONCE—NO CHARGE

For complete data—ask for our new 12 page catalog today!

(Illus. approx. actual size)



177-8430-0931-503



162-8430-0931-502



134-8430-0351-201



173-8836-0931-552

DIALCO

Foremost Manufacturer of Indicator Lights

DIALIGHT CORPORATION

60 STEWART AVE., BROOKLYN, N.Y. 11237

AREA CODE 212 497-7600

Circle 209 on reader service card



Write for
bulletin
describing

New CDS type 6C Photochopper Cells

- High Efficiency
- Low Temperature Coefficient
- Resistance Tolerance $\pm 50\%$
- Internal Electrostatic Shielding
- Dumet Leads

**CLAIREX
ELECTRONICS**

INC. ■ 1239 BROADWAY, NEW YORK, N.Y. 10001

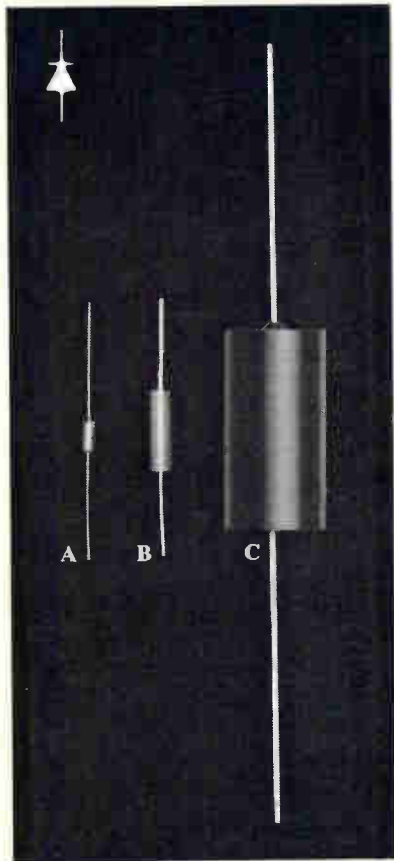

HV Rectifiers from .150 to 7 in. long

Diffused High Voltage silicon rectifiers available with 300 nanosecond recovery time (optional) and in custom designed assemblies.

A

.060 diameter.
.150 long.
1,000 to 3,500 volts PIV.
25 to 50 ma average rectified current.
Transfer molded epoxy package.

B

.100 diameter.
.400 long.
1,000 to 6,000 volts PIV.
50 to 100 ma average rectified current.
Transfer molded epoxy package.

C

.500 diameter.
1 to 7 inches long.
3,000 to 70,000 volts.
15 to 75 ma average rectified current.
Epoxy encapsulation.

For use in diode-capacitor voltage multipliers, cathode ray tube power supplies, RF power supplies (up to 200 KC), precipitator power supplies, and photo multipliers. Also available in diode-capacitor multiplier assemblies.



SPECIAL PRODUCTS DIVISION
2203 WALNUT STREET, GARLAND, TEXAS 75040
(214) 272-3561

New Microwave



across the range. In the band between 0.50 and 50 Mhz, conversion loss is a maximum of 7 db and the noise level is 7 db when referenced to a 1.5 db i-f noise figure. Across the full range, conversion loss is a maximum of 9 db and noise, referenced to a 1.5 db i-f noise figure, is 9 db. The local oscillator signal level is approximately 7 dbm.

Although BNC connectors are standard with the DM-1-250, other connectors and configurations are available. Miniaturized versions can also be ordered.

The unit is priced at \$95 in small quantities. Delivery takes 30 to 45 days.

Merrimac Research and Development Inc., 41 Fairfield Pl., West Caldwell, N.J. [400]

Frequency converter for telemetry systems

A frequency converter is available for use in S-band telemetry systems. Input signals of 2,200 to 2,300 Mhz are converted to signals of 215 to 265 Mhz. Called the SFC-2250, the converter is a wide-dynamic-range, self-contained, solid-state unit that includes bandpass filters, tunnel diode amplifier, local oscillator-frequency multiplier, amplifier mixer, amplifier detector, and power supply.

The unit has an 8.5-db max. noise figure and $\pm 0.001\%$ frequency stability for any 24-hr period. Phase modulation error at output does not increase more than $\pm 5^\circ$ from 1.5 khz to 1 Mhz. Phase linearity is $\pm 9^\circ$ over any 5-Mhz passband portion. Gain stability is ± 1 db at any given passband frequency spanning a minimum time of 24 hrs.

Motion carried!

Wives
are welcome.



**Western Electronic Show
& Convention
San Francisco
August 22-25**

Make your wife happy and make yourself a hero. Take her to the convention and we'll take $\frac{1}{3}$ off her Jet Coach fare. Ask about TWA Family Style travel — more wives are going to conventions than ever before. And we ought to know. We go to just about every big convention city in the U.S. and Europe. Call TWA and ask for our convention specialist, or see your travel agent.

Welcome to the world of **TWA**
Trans World Airlines*

*Service mark owned exclusively by Trans World Airlines, Inc.



Adjustment with a screwdriver enables the nominal 40-db gain to be varied ± 2.5 db minimum for input levels between -80 and 0 dbm. Automatic gain control maintains the output power within limits (0 dbm ± 2 db) for input power levels up to 0 dbm. Intermodulation distortion is 3% or less for input levels to 0 dbm max. Temperature range is $+20^\circ$ to $+150^\circ$ F.

LEL Division, Varian Associates, 1365 Akron St., Copiague, N.Y. 11726. [401]

Convection-cooled load handles 20 kw

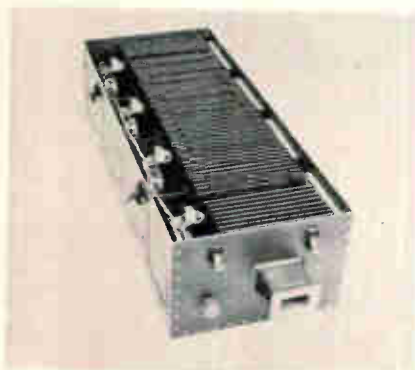

An S-band dummy load has been developed that handles fully rated peak power and 20-kw average power without the use of liquid cooling. Designed for a transportable radar system, the dummy load features a built-in forced air cooling system with an air flow safety interlock switch. It operates over a frequency of 2.7 to 3.3 Ghz, and has a maximum vswr of 1.20.

Designated model WI-A03, the high-power dummy load withstands internal gauge pressures of 45 psi and operates over a temperature range of -54° to $+65^\circ$ C in 100% relative humidity. The design techniques can be applied to other waveguide bands, according to the manufacturer.

Microlab/FXR, Ten Microlab Road, Livingston, N.J. [402]

Gen Res DIAL-A-SOURCE

(DIALABLE "ZERO IMPEDANCE" VOLTAGE SUPPLY)

- 1 PPM RESOLUTION
- SECONDARY STANDARD
- 25 M.A. (ZERO IMPEDANCE)
- 1 MICROVOLT TO 10 VOLT RANGE
- 5 PPM OUTPUT REGULATION (NO LOAD TO 25 M.A.)
- DIALABLE IN-LINE VOLTAGE READOUT
- ± 10 PPM STABILITY
- FLOATING OUTPUT; 1000 MEGS ISOLATION
- REMOTE SENSING SUPPLIES .0025% CALIBRATED VOLTAGE AT THE LOAD
- NOISE AND RIPPLE LESS THAN 3 PPM OF OUTPUT OR 20 MICROVOLTS PEAK

Also available Model DAS46 $\pm .005\%$, \$875.00. Write for Bulletin #512



Model DAS46L
.0025% Transportable Accuracy

Gen Res DIAL-A-VOLT

(DIALABLE VOLTAGE REFERENCE)

- D.C. VOLTAGE ACCURACY, 5 MODELS - .0015% TO .005%
- RANGE 1 MICROVOLT TO 10 VOLTS
- 6 DIAL, 1 PPM RESOLUTION
- 10 PPM STABILITY
- TEMPERATURE COEFFICIENT TO ± 1 PPM/ $^\circ$ C
- DESIGNED FOR D.C. CALIBRATION AND REFERENCE
- FINGERTIP DIALABLE CONTROL

Priced from \$399.00. Write for Bulletin #407



Gen Res

GENERAL RESISTANCE, INC

438 Southern Blvd. • Bronx, New York 10455 • Tel.: 312-262-1600 • TWX 212 824-4980

Circle 255 on reader service card

Your Best Reason

fore



Locating YOUR NEW PLANT
in West Palm Beach, Florida is its
EXTRA INDUSTRIAL ASSETS!!

ITT, Solitron, Pratt & Whitney, and R.C.A. have found them to be an important recruiting tool. Let us tell you more about how our EXTRA INDUSTRIAL ASSETS can become your most valuable asset.

For Color Brochure and information about our Extra Industrial Assets write in confidence to: E. Vincent Burkhardt, Chairman, West Palm Beach Industrial Commission, P.O. Box 1506, West Palm Beach, Florida 33402.

WEST PALM BEACH
INDUSTRIAL COMMISSION
an agency of the city government

IN COOPERATION WITH THE FLORIDA DEVELOPMENT COMMISSION

* The Jacobs Putter... the golf club with a hole in its head for retrieving balls, is manufactured by the Special Purpose Equipment Co., Inc. a Palm Beach County industry.

TRON SUB-MINIATURE PIGTAIL FUSES

BODY SIZE ONLY .145 x .300 INCHES

For use on miniaturized devices, or on gigantic space tight multi-circuit electronic devices.

Glass tube construction permits visual inspection of element.

Smallest fuses available with wide ampere range. Twenty-three ampere sizes from 1/100 thru 15-amps.

Hermetically sealed for potting without danger of sealing material affecting operation. Extremely high resistance to shock or vibration. Operate without exterior venting.

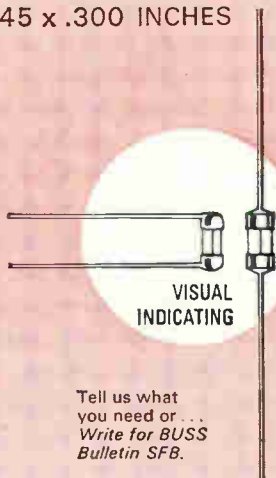

Tell us what you need or...
Write for BUSS
Bulletin SFB.

INSIST ON
BUSS QUALITY

BUSSMANN MFG. DIVISION, McGraw Edison Co., St. Louis, Mo. 63107

Circle 212 on reader service card



in Wet Locations with a

TRON

IN-THE-LINE WATERPROOF Fuseholder

FOR PROTECTION OF CIRCUITS OF 600 VOLTS OR LESS

FOR USE ON:

- Electronic Components at Missile Sites
- Marine Equipment
- Mobile Power Supply Units
- Yard Lights
- Military Field Applications
- Communications Equipment
- Any circuit operating in exposed locations.

Watertight construction; resistance to damage by weather, water, salt spray or corrosive fumes permit use of TRON fuseholders in exposed locations where safety and long life are of vital importance.

TRON fuseholders are available to take two sizes of fuses, 1 3/32" x 1 1/2" and 1 3/32" x 1 3/8"; and take many sizes of solid or stranded wire.

Write for BUSS Bulletin SFH-11

INSIST ON
BUSS QUALITY

BUSSMANN MFG. DIVISION, McGraw-Edison Co., ST. LOUIS, MO. 63107

Circle 212 on reader service card

BUSS: The Complete Line of Fuses and ...

3" dia. x 3 1/4" long, 16 ounces

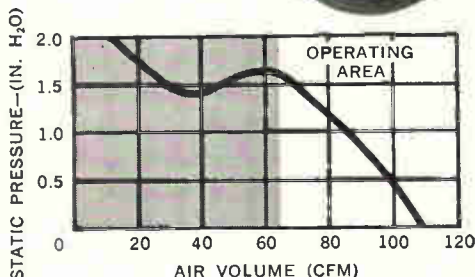

NEW VANEAXIAL

AC/DC

UNIVERSAL BLOWER

Globe's VAX-3-GN Universal Blower gives you 110 cfm. free air, with a design point of 68 cfm. at 1.5" H₂O—on either 115 v.d.c. or 115 v.a.c., 60 cycle power. Other voltages can be supplied. Nominal speed is 14,000 rpm.

You can standardize on this extremely versatile blower for ground support and commercial electronic cooling. It's designed to meet MIL specs, having passed shock and vibration per MIL-E-5272. Production tooling makes this blower economical. Prototypes can be in your hands tomorrow (telephone BA-2-3741 for part no. 19A908); production orders normally delivered in a short time.

Rugged mechanical protection is provided by the black anodized aluminum housing and propeller. Mount by clamping to servo ring at either end. Nominal life exceeds 1000 hours. Max. current is 0.47 amps at free air delivery. Request Bulletin GNB from Globe Industries, Inc., 2275 Stanley Avenue, Dayton 4, Ohio.

GLOBE





Adjustment with a screwdriver enables the nominal 40-db gain to be varied ± 2.5 db minimum for input levels between -80 and 0 dbm. Automatic gain control maintains the output power within limits (0 dbm ± 2 db) for input power levels up to 0 dbm. Intermodulation distortion is 3% or less for input levels to 0 dbm max. Temperature range is $+20^\circ$ to $+150^\circ$ F.

LEL Division, Varian Associates, 1365 Akron St., Copiague, N.Y. 11726. [401]

Convection-cooled load handles 20 kw

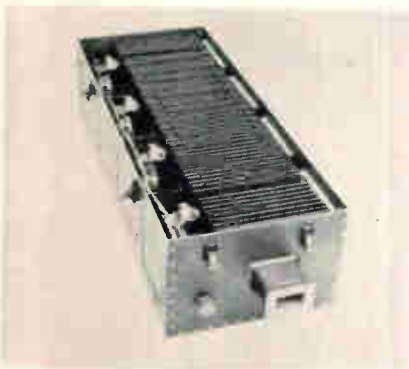

An S-band dummy load has been developed that handles fully rated peak power and 20-kw average power without the use of liquid cooling. Designed for a transportable radar system, the dummy load features a built-in forced air cooling system with an air flow safety interlock switch. It operates over a frequency of 2.7 to 3.3 Ghz, and has a maximum vswr of 1.20.

Designated model WI-A03, the high-power dummy load withstands internal gauge pressures of 45 psi and operates over a temperature range of -54° to $+65^\circ$ C in 100% relative humidity. The design techniques can be applied to other waveguide bands, according to the manufacturer.

Microlab/FXR, Ten Microlab Road, Livingston, N.J. [402]

Gen Res DIAL-A-SOURCE

(DIALABLE "ZERO IMPEDANCE" VOLTAGE SUPPLY)

- 1 PPM RESOLUTION
- SECONDARY STANDARD
- 25 M.A. (ZERO IMPEDANCE)
- 1 MICROVOLT TO 10 VOLT RANGE
- 5 PPM OUTPUT REGULATION (NO LOAD TO 25 M.A.)
- DIALABLE IN-LINE VOLTAGE READOUT
- ± 10 PPM STABILITY
- FLOATING OUTPUT; 1000 MEGS ISOLATION
- REMOTE SENSING SUPPLIES .0025% CALIBRATED VOLTAGE AT THE LOAD
- NOISE AND RIPPLE LESS THAN 3 PPM OF OUTPUT OR 20 MICROVOLTS PEAK

Also available Model DAS46 $\pm .005\%$, \$875.00. Write for Bulletin #512



Model DAS46L
.0025% Transportable Accuracy

Gen Res DIAL-A-VOLT

(DIALABLE VOLTAGE REFERENCE)

- D.C. VOLTAGE ACCURACY, 5 MODELS - .0015% TO .005%
- RANGE 1 MICROVOLT TO 10 VOLTS
- 6 DIAL, 1 PPM RESOLUTION
- 10 PPM STABILITY
- TEMPERATURE COEFFICIENT TO ± 1 PPM/ $^\circ$ C
- DESIGNED FOR D.C. CALIBRATION AND REFERENCE
- FINGERTIP DIALABLE CONTROL

Priced from \$399.00. Write for Bulletin #407



Gen Res

GENERAL RESISTANCE, INC

437 Southern Blvd. • Bronx, New York 10455 • Tel.: 212-292-1300 • TWX 212 824-4880

Circle 255 on reader service card

Your Best Reason

fore



Locating YOUR NEW PLANT
in West Palm Beach, Florida is its
EXTRA INDUSTRIAL ASSETS!!

ITT, Solitron, Pratt & Whitney, and R.C.A. have found them to be an important recruiting tool. Let us tell you more about how our EXTRA INDUSTRIAL ASSETS can become your most valuable asset.

For Color Brochure and information about our Extra Industrial Assets write in confidence to: E. Vincent Burkhardt, Chairman, West Palm Beach Industrial Commission, P.O. Box 1506, West Palm Beach, Florida 33402.

WEST PALM BEACH

INDUSTRIAL COMMISSION

an agency of the city government

IN COOPERATION WITH THE FLORIDA DEVELOPMENT COMMISSION

* The Jacobs Putter... the golf club with a hole in its head for retrieving balls, is manufactured by the Special Purpose Equipment Co., Inc. a Palm Beach County industry.

TRON SUB-MINIATURE PIGTAIL FUSES

BODY SIZE ONLY .145 x .300 INCHES

For use on miniaturized devices, or on gigantic space tight multi-circuit electronic devices.

Glass tube construction permits visual inspection of element.

Smallest fuses available with wide ampere range. Twenty-three ampere sizes from 1/100 thru 15-amps.

Hermetically sealed for potting without danger of sealing material affecting operation. Extremely high resistance to shock or vibration. Operate without exterior venting.

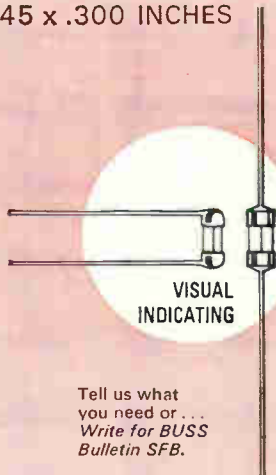

Tell us what you need or...
Write for BUSS
Bulletin SFB.

INSIST ON
BUSS QUALITY

BUSSMANN MFG. DIVISION, McGraw Edison Co., St. Louis, Mo. 63107

Circle 212 on reader service card



in Wet Locations with a

TRON

IN-THE-LINE WATERPROOF Fuseholder

FOR PROTECTION OF CIRCUITS OF 600 VOLTS OR LESS

FOR USE ON:

- Electronic Components at Missile Sites
- Marine Equipment
- Mobile Power Supply Units
- Yard Lights
- Military Field Applications
- Communications Equipment
- Any circuit operating in exposed locations.

Watertight construction; resistance to damage by weather, water, salt spray or corrosive fumes permit use of TRON fuseholders in exposed locations where safety and long life are of vital importance.

TRON fuseholders are available to take two sizes of fuses, $1\frac{1}{32}$ " x $1\frac{1}{2}$ " and $1\frac{1}{32}$ " x $1\frac{3}{8}$ "; and take many sizes of solid or stranded wire.

Write for BUSS Bulletin SFH-11

INSIST ON
BUSS QUALITY

BUSSMANN MFG. DIVISION, McGraw-Edison Co., ST. LOUIS, MO. 63107

Circle 212 on reader service card

BUSS: The Complete Line of Fuses and ...

3" dia. x 3 1/4" long, 16 ounces

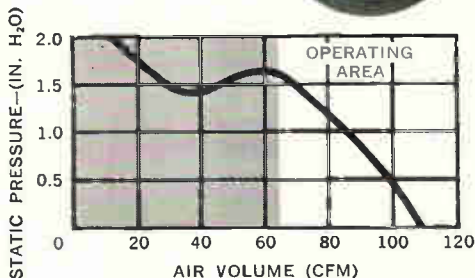

NEW VANEAXIAL

AC/DC

UNIVERSAL BLOWER

Globe's VAX-3-GN Universal Blower gives you 110 cfm. free air, with a design point of 68 cfm. at 1.5" H₂O—on either 115 v.d.c. or 115 v.a.c., 60 cycle power. Other voltages can be supplied. Nominal speed is 14,000 rpm.

You can standardize on this extremely versatile blower for ground support and commercial electronic cooling. It's designed to meet MIL specs, having passed shock and vibration per MIL-E-5272. Production tooling makes this blower economical. Prototypes can be in your hands tomorrow (telephone BA-2-3741 for part no. 19A908); production orders normally delivered in a short time.

Rugged mechanical protection is provided by the black anodized aluminum housing and propeller. Mount by clamping to servo ring at either end. Nominal life exceeds 1000 hours. Max. current is 0.47 amps at free air delivery. Request Bulletin GNB from Globe Industries, Inc., 2275 Stanley Avenue, Dayton 4, Ohio.



New Production Equipment

Trimmer-former handles IC leads

A new tool called the Versitron forms and trims the leads of TO-5 cans with a 90° turn of the operating lever. The leads are angled outward to the diameter of the TO-5 housing, directed downward, and then sheared to a predetermined length.

Because of the accurate forming, the can is easily mounted on p-c boards; it stands clear by 1/8 in. and doesn't need a spacer. The formed leads can be flow-soldered along with other components on the card without fear of the solder shorts that often occur with flush-mounted cans.

The Versitron processes 500 cans an hour. Its slotted and chamfered

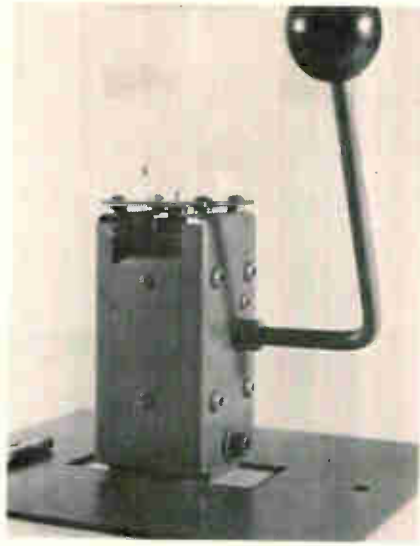

head makes for easy can insertion. The unit stands 9 in. high and weighs 4 lbs. Forming and shearing components and mechanical

linkages are of tool steel.

Basic price with one of several standard forming and shearing heads is \$275; additional heads are optional.

Versitron Inc., 6310 Chillum Place, N.W., Washington, D.C. 20011. [403]

Copper-free coating with vapor system

Phosphors for color tv tubes, coatings for optical devices, and other organic coating compounds can be applied with a copper-free vapor carrier system. The vapor-generating console and spray guns are built of steel, mostly stainless, and Teflon so there is no danger of copper contamination of the coatings. The unit also can be used to apply photoresist to IC substrates and p-c boards, as well as conformal coatings of epoxy and polyurethane to electronic assemblies.

In operation, Chemsine or Freon

Fuseholders of Unquestioned High Quality

BUSS SUB-MINIATURE FUSEHOLDER COMBINATION

For space-tight applications. Fuse has window for inspection of element. Fuse may be used with or without holder.

Fuse held tight in holder by beryllium copper contacts assuring low resistance.

Holder can be used with or without knob. Knob makes holder water-proof from front of panel.

Military type fuse FM01 meets all requirements of MIL-F-23419. Military type holder FHN42W meets all military requirements of MIL-F-19207B.

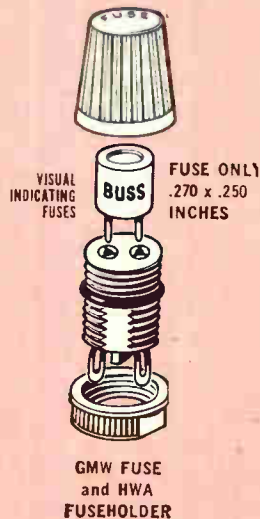

Write for BUSS Bulletin SFB

INSIST ON
BUSS QUALITY

BUSSMANN MFG. DIVISION, McGraw-Edison Co., ST. LOUIS, MO. 63107

BUSS



Write for BUSS Bulletin SFB.

QUICK-ACTING FUSES

"Quick-Acting" fuses for protection of sensitive instruments or delicate apparatus;—or normal acting fuses for protection where circuit is not subject to current transients or surges.

INSIST ON
BUSS QUALITY

BUSSMANN MFG. DIVISION, McGraw-Edison Co., St. Louis, Mo. 63107

Ceramic Capacitors

MOLDED CERAMIC TUBULARS

for computer applications. The ultimate in reliability (failure rate 0.001%/1000 hours at 85° C and twice rated voltage.)



DISC CERAMICS

for all commercial and military applications. New production techniques give Skottie a big edge in price, quality and delivery. Ask for a quote and find out if it's not so.

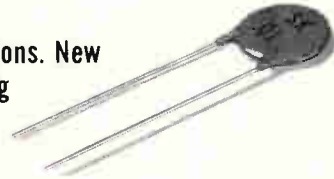

Do you have a problem in ceramic capacitors with special designs, quality, reliability, guaranteed delivery or price? If you do, it might pay you to look into Skottie Electronics. We specialize exclusively in the design and manufacture of ceramic dielectric capacitors. Skottie is a major supplier of ceramic capacitors to the largest computer and radio/TV manufacturers in the world.

Sure we do the military and commercial standards. But in ceramics, when you have special needs (particularly design or delivery) we think you'll find Skottie Electronics your best supplier. Representatives in major cities throughout the United States.

SKOTTIE ELECTRONICS, INC. / Archbald, Pennsylvania 18403
Phone 717-876-1686 TWX-510-656-2979

Circle 257 on reader service card

**EMPLOYEES
WANTED!**

INQUIRE INSIDE

**Is this sign
always on
your door?**

GET RID OF IT IN

South Dakota

INDUSTRY is finding a new and untapped personnel pool in SOUTH DAKOTA where a day's work for a day's pay is still a way of life. Alert, eager, trainable people with a literacy rate of 98.5 per cent . . . absenteeism is among the nation's lowest. You get into production fast and you maintain high quality standards when you have this kind of labor supply. Let us show you how SOUTH DAKOTA can fill your needs — and keep them filled.

- Free Port Law
- Abundant Water
- Available Power
- Low Corporate Tax Rates

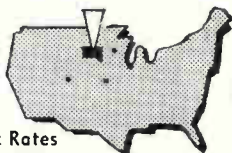

GET THE SOUTH DAKOTA STORY
CONTACT:
ROBERT H. MARTIN, DIRECTOR
Industrial Development Expansion Agency
Room 402 Pierre, South Dakota 57501
Phone 224-5911 Extension 307 AC 605

Production Equipment

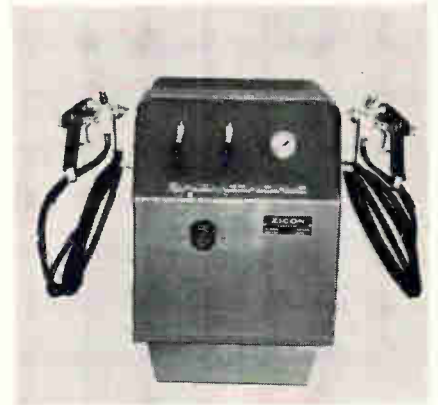

TF is vaporized and superheated to produce a warm, dry, absolutely pure atomizing agent. It is fed to the spray gun at low pressure and produces very fine atomization of the coating material.

Used with the manufacturer's automatic traverse machine and spray chamber, uniform pinhole-free coatings down to the angstrom range can be automatically applied.

Model 6003-S is approximately 29 x 22 x 25 in. and weighs 300 lbs.

Zicon Corp., 63 East Sandford Blvd., Mount Vernon, N.Y. 10550 [404]

Small kiln fires films on substrates



A small kiln fires conductive, resistive, and dielectric materials on ceramic substrates during experimentation and process development. The Explorer I has operating

MAGNETIC SHIELD REFERENCE GUIDE

SHEET STOCK

TO STOCKED NETIC & CO-NETIC
MAGNETIC SHIELDING FOIL AND
SHEETS FOR YOUR FABRICATION



THICKNESS	NETIC S3-6 SHEET WIDTH	CO-NETIC AA SHEET WIDTH	CO-NETIC AA FOIL IN COILS: (Specify length desired)	BLUE NETIC FOIL* IN COILS: (Specify length desired)	Both BLUE NETIC and CO-NETIC AA foils, plain and adhesive backed, can be furnished slit to any desired width, at additional cost—Ask for prices.
.014"	30"	30"	.004" thick x 15" wide	.004" thick x 19 ³ / ₈ " wide	Request Short Form Catalog No. 67.
.020"	30"	30"	.004" thick x 4" wide	.004" thick x 4" wide	
.025"	24"	30"	.002" thick x 4" wide	*BLUE NETIC foil not available in .002" thick	
.031"	26"	30"	All foil also available adhesive backed. Other widths available to maximum above.		
.049"	26"	30"			
.050"	26"	30"			
.062"	26"	30"			
.095"	26"	30"			

Maximum length is 120".
Also sold in 15", 30" and 60" lengths.
After fabrication, shields made from sheet must be heat treated for maximum shielding. No further annealing required.
Pre-annealed stock also available.

- Non-shock sensitive; requires no periodic annealing
- DELIVERY TIME—normal delivery time on stock widths is 1 to 2 days after receipt of order. For adhesive backed foils, approximately one week, and for foils slit to desired width, approximately 1 to 2 weeks.



MAGNETIC SHIELD DIVISION

Perfection Mica Company

1322 N. ELSTON AVENUE • CHICAGO, ILLINOIS 60622

Phone: 312, EV 4-2122 • TWX 910 221-0105.

Circle 258 on reader service card



All you need to solve most transformer design problems is a TRIAD catalog...

And your phone.

TRIAD distributors are practically everywhere, offering you over 1700 off-the-shelf transformers for immediate delivery. Chances are the unit you thought would have to be custom-made is at your TRIAD distributor's now. Of course, when you do need a custom job, turn to TRIAD too, for the best answer to your transformer, inductor and filter problems. Send for your catalog today. TRIAD Distributor Division, 305 North Briant St., Huntington, Indiana.

Triad Distributor Division
of Liltion Industries

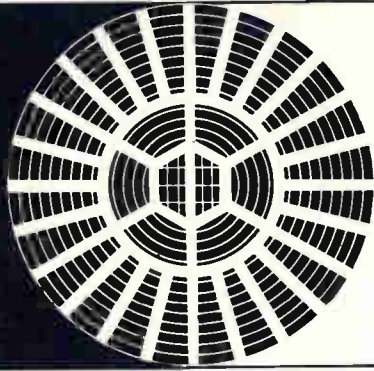

ANTENNA ENGINEERS

(Electrical and Mechanical)

Lockheed offers important assignments for experienced microwave antenna engineers. Work on large unfurlable reflector antennas and phased array systems for satellite and deep space vehicles. Design antennas for hostile reentry conditions of the new Poseidon Fleet Ballistic Missile and for tactical applications. BS or advanced degree in EE, ME or Physics, plus 5 years or more antenna design experience. A few positions are available for selected recent graduates. Reply to: R. C. Birdsall, Professional Placement Manager, Post Office Box 504, Sunnyvale, California 94088. Or call collect: (408) 743-2200 until midnight, Pacific Coast time. Lockheed is an equal opportunity employer.

LOCKHEED
MISSILES & SPACE COMPANY
A GROUP DIVISION OF LOCKHEED AIRCRAFT CORPORATION

Production Equipment

characteristics that allow easy conversion from pilot to volume production, according to the BTU Engineering Corp.

The kiln is inclined 2° from the horizontal to induce a laminar flow of muffle atmosphere over the product. Volatile contaminants released in the initial heat-up are quickly carried out.

Operating temperature range of the model EXP-I-2000 three-zone kiln is 400° C to 1,000° C, with accuracies better than ±2° C. Dimensions are 78 x 19 x 51 in.

Optional equipment includes an air preheater, radiant dryer, special speed controls, and overheat protection.

BTU Engineering Corp., Bear Hill, Waltham, Mass. 02154. [405]

Replaceable glass tip cuts bonding costs

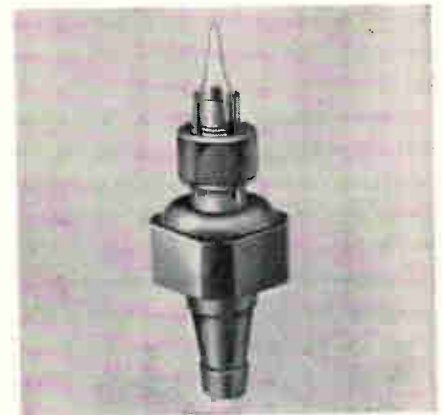

Easy-to-clean, replaceable glass tips for thermo-compression bonders are being marketed at prices only 1/6 to 1/10 as much as those for conventional metal tips. The manufacturer says the new tips also provide a better bond for IC's because of the natural smoothness of glass. Unlike metal, the surface of glass isn't granular and is completely inert. Because of this, the firm says, the bore doesn't deteriorate, a common defect of metal bonding tips. There is less buildup of gold floss within the tip bore and considerably less plugging.

When plugging does occur, the glass tip can be replaced in a mat-

BEST vacuum THERMOCOUPLES



Standard and UHF patterns; high output and square law types; matched pairs

Used by prominent instrument manufacturers in the U.S. and abroad for • true RMS measurement • transfer standards • sum and difference multipliers • low range UHF applications.

For example, by HEWLETT-PACKARD:

H-P's Model 3400A true RMS voltmeter uses a matched pair of Best UHF type thermocouples to give high accuracy, broad frequency response, DC calibration and long term stability.

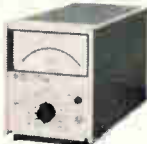

If you are designing or manufacturing an AC instrument, why not make it true RMS?

See Sec. 5300, '67 EEM. Catalog on request. For free application notes, write on company letterhead to

BEST ELECTRICS DIV. HARRY LEVINSON CO.

1211 E. Denny Way, Seattle, Wash. 98122
Tel. (206) 323-5100 TWX 910-444-2154

Specifically Engineered for RF Components!



A-27 Superfine Q-max EXTREMELY LOW-LOSS RF LACQUER

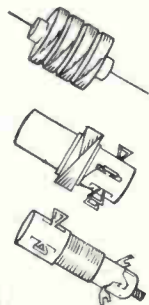

Q-MAX impregnating and coating composition penetrates deeply, seals out moisture, provides a surface finish. Q-MAX imparts rigidity and promotes stability of the electrical constants of high frequency circuits. Effect on the "Q" of RF windings is negligible.

Write for catalog today.

Q-max Corporation
MARLBORO, NEW JERSEY 07746
Telephone: (201) 462-3636

**General Technology's
Rubidium "atomic clock"
records over million hours
operational time.**

**Reliability now proven;
MTBF established at 22,000
hours per unit.**

Records kept since 1961 on every Rubidium Frequency Standard made by GTC show the average time between random component failures to be 87,000 hours — almost 10 years!



The Model 304-B shown here is but one in a complete family of all solid-state atomic frequency standards made by GTC for use in field and laboratory. Maximum deviation is ± 5 parts per 10^{11} in a year, or better. Special versions meet environmental and other requirements for tactical and missile/aircraft use.

For solutions to your stable-oscillator problems, write General Technology Corporation, subsidiary of TRACOR, Inc., 6500 Tracor Lane, Austin, Texas 78721. Phone 512-926-2800.

**Time & Frequency
Instruments by**



TFA - 1367

Circle 261 on reader service card

Air variables from JFD

**solve your high Q
high frequency
problems**

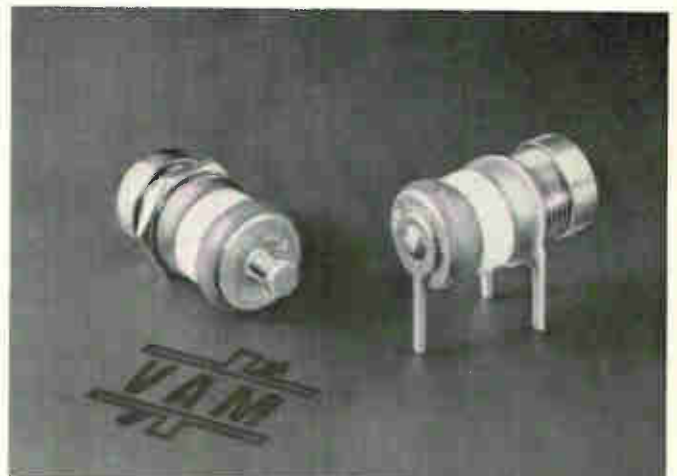

Capacitors shown enlarged 100%

These new JFD air variable capacitors are specially designed for high frequency applications that demand ultra stability, small size and high Q—greater than 2000 measured at 10 pf and 100 MC. These rugged, miniature units are offered in both printed circuit (VAM 010W) and panel mounting (VAM 010) models with capacitance ranges from 0.8 through 10.0 pf measured at 1 MC.

These units which measure less than $\frac{1}{2}$ " in length are completely interchangeable with competitive devices.

Internal air meshing shells are silver plated to provide good surface conductivity and to prevent corrosive effects. Internal contact springs assure positive electrical contact of rotor at all times. Leads on printed circuit model are tinned for ease in soldering . . . and these units are engineered to resist heat, won't come apart during soldering.

Bulletin VAM-65 gives more details. Write for your copy today.

JFD "TODAY'S COMPONENTS BUILT FOR TOMORROW'S CHALLENGES"

JFD ELECTRONICS CO. / COMPONENTS DIVISION 15th Avenue at 62nd Street
Brooklyn, N. Y. 11219 / Phone 212-331-1000 • Sales Offices—Arcadia, Calif.
Chi., Ill. / Balt., Md. / Saxonville, Mass. / Bklyn., N. Y. / New Hartford, N. Y.
Cinn., Ohio / Phila., Pa. / Pitts., Pa. / Paris, France / Azor, Israel

Circle 217 on reader service card

217

NEW

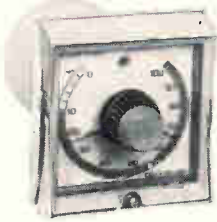

SOLID STATE TIMER

CA100

YOUR GREATEST CHOICE

NEW



ELECTROMECHANICAL DUAL-FUNCTION TIMER

HG100

The Man from E.A.G.L.E.* presents two samples that show the range in his bag of timing tricks. The CA100 solid state timer provides split-second control of continuous, high-speed, "on-off" cycles from 3 to 2000 times a minute. Housed in Eagle's famous Cycl-Flex case, the CA100 can be plugged in and taken out in seconds. Solid state circuitry eliminates moving parts, makes this timer great for dusty, dirty locations. At the other extreme the HG100 electromechanical dual-function timer does the job of two ordinary timers. With a single, easily-set dial it provides adjustable "on" and "off" time periods for cycles ranging from 30 seconds to 60 hours. It gives you unmatched ease of adjustment without setting cams or changing gears.

For detailed descriptions of one or both of these timers, get our CA Series Bulletin 322 and our HG Series Bulletin 320. Write Eagle Signal Division, E. W. Bliss Company, 736 Federal Street, Davenport, Iowa 52808; or call (319) 324-1361.

BLISS



EAGLE SIGNAL

A DIVISION OF THE E. W. BLISS COMPANY

*E.A.G.L.E.—Engineering Assistance Given Locally—Effectively.

For information on CA100 Timer circle reader service number 495.
For information on HG100 Timer circle reader service number 496.

Production Equipment

ter of seconds. Plugged tips are cleaned by a soaking in a solution of aqua regia; no poking or prodding is required. And because of the chemical inertness of the glass, cleaned tips are as good as new ones. Also, the natural transparency of glass permits easy visual inspection.

The new glass tips are designed for standard thermo-compression bonders. They are available in various sizes with bores as small as 0.0005 in. in diameter. Bores are accurate to ± 0.0001 . Outside diameters of the tips are held to ± 0.0005 in.

Specialty Glass Products Inc., 144 Terwood Rd., Willow Grove, Pa. 19090. [406]

Hand gun applies hot-melt adhesives

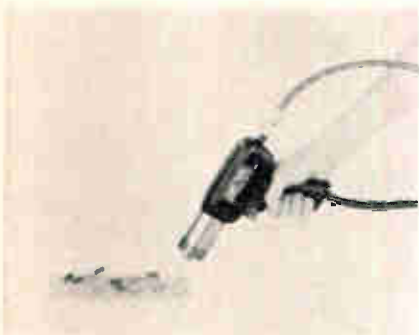

A hand gun for applying hot-melt adhesives has been designed to be used with the company's Thermo-pulse unit, which converts solid adhesives into liquid form. Its primary application is to apply the adhesive in cases where fully automatic equipment is not practical.

Called the X77300, the gun has a trigger that enables the operator to control the on and off functions. It can be used either to place small dots of adhesive or lay down continuous lines. When used with control equipment, the gun can lay down precisely measured lines or exact-sized dots.

Temperatures up to 500°F are maintained with built-in heaters, a solid state controller, and a thermistor.

Spraymation Inc., 52 Sindler Ave., Little Falls, N.J. 07424. [407]



INSTANT EAGLE RELAYS

Test Them Immediately...Get Production Quantities in Two Weeks!

That's right . . . Eagle challenges you to compare them with any relay on the market. NOW you can get immediate delivery on these general-purpose or medium-power relays. Test results prove they're the finest of their kind in the world. Eliminate your relay delivery problems. Call your "Man from E.A.G.L.E." . . . listed below. You'll find he has full details and specifications on Eagle relays.

YOUR "MAN FROM E.A.G.L.E."

Distributors

Burlingame, California
415-697-6244

Glendale, California
213-245-1172

Englewood, Colorado
303-781-0912

Hamden, Connecticut
203-288-9276

Orlando, Florida
305-855-3964

Baltimore, Maryland
301-484-5400

Newton Highlands, Mass.
617-969-7140

Minneapolis, Minnesota
612-922-7011

Clifton, New Jersey
201-471-6090

Haddonfield, New Jersey
609-429-1526

Albuquerque, New Mexico
505-265-1020

Albany, New York
518-436-8536

Depew, New York
716-684-5731

Endwell, New York
607-723-8743

Fairborn, Ohio
513-878-2631

Fairview Park, Ohio
216-333-4120

Dallas, Texas
214-363-1526

Houston, Texas
713-649-5756

Seattle, Washington
206-725-7800

Representatives

Scottsdale, Arizona
602-947-4336

Pasadena, California
213-681-4421

Jacksonville, Florida
305-388-7656

Orlando, Florida
305-422-4295

Roswell, Georgia
404-993-6498

Chicago, Illinois
312-775-5300

Chicago, Illinois
312-784-7314

Baltimore, Maryland
301-276-1505

Norwood, Massachusetts
617-769-3600

Minneapolis, Minnesota
612-922-0243

St. Louis, Missouri
314-428-5313

Hackensack, New Jersey
201-342-2602

Latham, New York
518-785-5032

Rochester, New York
716-436-4410

Skaneateles, New York
315-685-6172

Fairfield, Ohio
216-333-4120

Havertown, Pennsylvania
215-528-6640

Dallas, Texas
214-748-7788

Houston, Texas
713-224-9715

Bellevue, Washington
206-454-5200

Charleston, West Virginia
304-342-2211

BLISS



EAGLE SIGNAL

A DIVISION OF THE E. W. BLISS COMPANY

736 Federal Street, Davenport, Iowa

THE STANDARD T/M

"L" and "S" BAND FM SIGNAL GENERATORS



BY

ACL

Type SG-305

(1435-1540 MHz)

Type SG-307

(2200-2300 MHz)

HIGHLY STABLE RF
LOW RESIDUAL FM
WIDE BAND MODULATION

ACL INVITES YOUR INQUIRIES
SEND FOR SPECIFICATIONS

ACL

**ASTRO
COMMUNICATION
LABORATORY, INC.**

9125 GAITHER ROAD
GAITHERSBURG, MD. 20760

Phone: (301) 948-5210 TWX 710-828-9706

RF Equipment for The Systems Engineer

New Materials

Silicone adhesive adaptable and rapid



A translucent nonflowing silicone rubber that cures rapidly without addition of a curing agent is suitable for a variety of applications. Eccosil 1776 bonds to glass, ceramics, metals, and plastics. According to the manufacturer, no other adhesive product can match it for flexibility, extreme environment performance, long life, and ease of use.

Cartridges fit a standard caulking gun for use in the field or on the production line.

Cured properties are: hardness (Shore A), 35; tensile strength, 400 psi; elongation, above 350%; temperature range, -100° to $+450^{\circ}$ F; dielectric strength, 450 volts per mil; volume resistivity, 10^{16} ohm-cm; dielectric constant (1 khz), 2.8; dissipation factor (1 khz), 0.003.

Eccosil 1776 comes in a single cartridge (11 oz) or ten-cartridge packages. Price is about \$4 per cartridge.

Emerson & Cuming Inc., Canton, Mass. 02021. [408]

Indium-tin alloy solders glass

A low-melting-point alloy, composed of 50% indium and 50% tin, will adhere to glass, mica, quartz, thermosetting plastics, and many glazed ceramics. Cerroseal-35 is reported to be particularly suitable for fastening glass to glass and glass to metal joints. It can be used for sealing glass domes to metal bases, attaching metal fittings to the end of glass cylinders, soldering electrical conductors to

glass, and as a metal-to-metal solder in assembling electronic components.

Cerroseal-35 softens at approximately 240° F and is liquid above 260° F. Because of its low vapor pressure, it can be used in high vacuum apparatus. The alloy, its developer reports, will bond to any metal tinned with ordinary lead-tin solder, providing tinning is done at the same temperature (450° to 500° F) required for ordinary solders with flux.

Cerro Copper & Brass Co., Stamford, Conn. [409]

Dielectric lacquer features high Q

Extremely low loss and high Q characterize a radio-frequency dielectric lacquer. Called Q-Lac, the material is applied as a protective coating and an insulation for electronic components and circuits.

Q-Lac is composed of a cross polymer of iso-polystyrene, formulated in accordance with the Clausius-Masotti equation for a low-loss dielectric material. The absence of electrical dipoles assures a low loss factor.

The Lacquer is strongly adherent and resists moisture. It displays high surface resistivity because of the strong hydrophobic character of the Q-Lac films. Exposure to 98% relative humidity doesn't alter the surface conductivity. The product can be used as a dielectric coating for coils and other electronic components where circuit Q is important.

Properties of Q-Lac film include: volume resistivity of 1×10^{15} ohm-cm; surface resistivity, 5×10^{14} ohm; dielectric constant, 2.53 (1 Mhz) and 2.52 (50 Mhz); dielectric strength, 2,200 volts/mil; power factor, 0.001 (1 Mhz) and 0.0005 (50 Mhz); loss factor, 0.002 (1 Mhz) and 0.001 (50 Mhz); dissipation factor, 0.0001 (1,000 hz); H₂O absorption coefficient, less than 0.01; temperature range, -40° to $+100^{\circ}$ C.

Transene Co., Rt. 1, Turnpike, Rowley, Mass. 01969. [410]



**amerline
corporation
BOBBINS**

SEND FOR OUR
**NEW CATALOG
TODAY!**

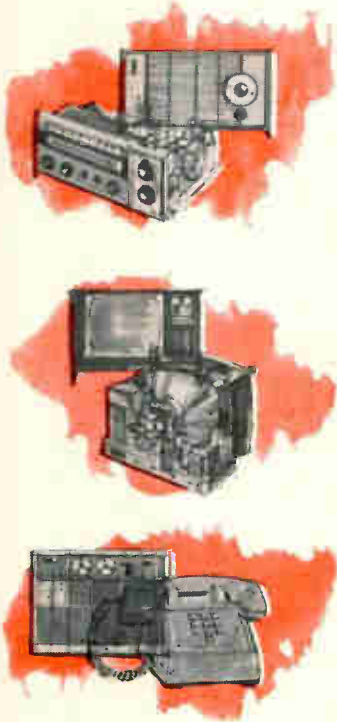

RADIO —

Moldcrafters of transformer bobbins oscillator I.F. and R.F. coil forms and stereo tape cartridges.

TELEVISION —

Producers of color yoke insulators, terminal boards, housing and convergence coil bobbins.

COMPUTER AND TELEPHONE —

Wide selection magnetic tape reels and containers, cartridges, disc packs, reed relay bobbins for computers, audio reels for tape recorders and players, bobbins for switching circuits and reed relays for telephone.

Complete line of patented Lead Slot bobbins.



AMERLINE CORPORATION
1800 FULLERTON AVENUE
CHICAGO, ILLINOIS 60614
(312) 348-4300 - TWX: 312-222-9410

Circle 260 on reader service card

**CARBON COMPOSITION AND
WIRE-WOUND POTENTIOMETERS**



FRACTIONAL HP ELECTRIC MOTORS
AC. AND D.C. OPERATED, WITH OR WITHOUT SPEED REGULATOR

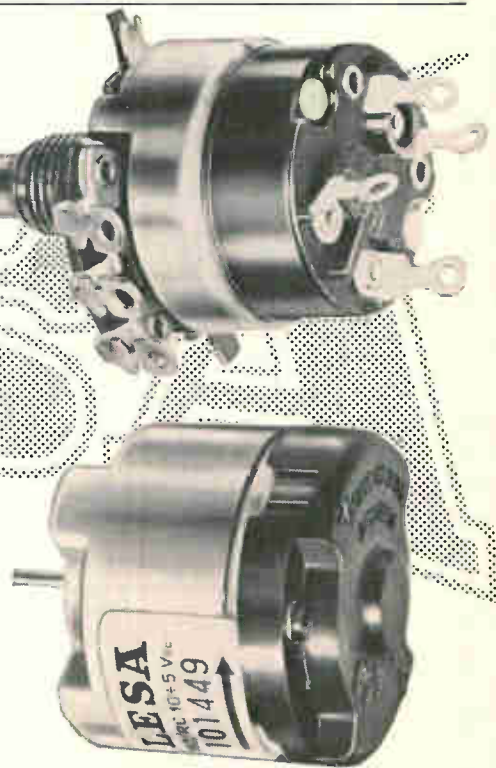

LESA
LESA
LESA
LESA
LESA

OF AMERICA CORP, 521 FIFTH AVENUE, NEW YORK, N.Y. 10017, TEL. 212 697.5838
COSTRUZIONI ELETTROMECCANICHE S.p.A., VIA BERGAMO, 21, MILANO, ITALY
DEUTSCHLAND GMBH, 1 WIESENTALSTRASSE, FREIBURG i/Br, WEST-GERMANY
ELECTRA, S.A., VIALE PORTONE 27, BELLINZONA, SWITZERLAND
FRANCE S.A.R.L., 19 RUE DUHAMEL, LYON, FRANCE

LESA
LESA
LESA
LESA
LESA

Circle 221 on reader service card

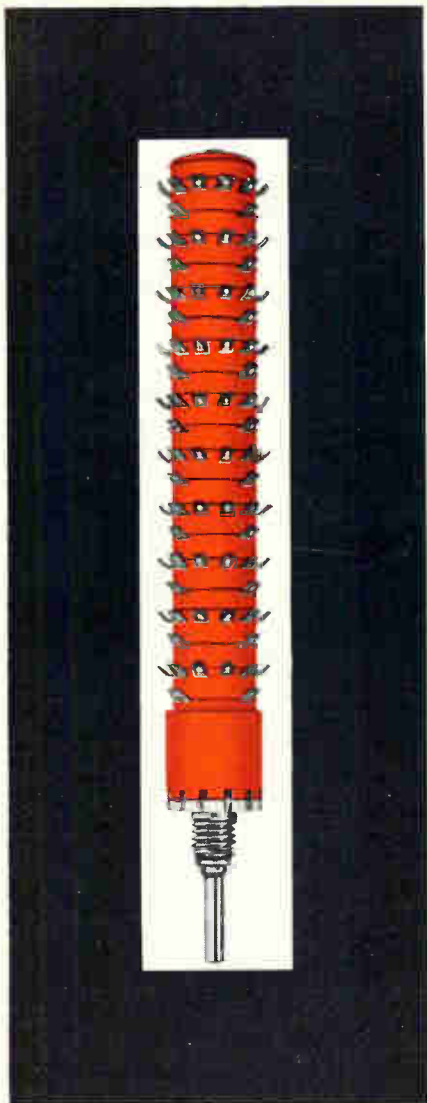

the red switch that keeps you in the black!

Daven has designed an entirely new sub-miniature rotary switch, capable of carrying up to 5 amps and switching up to 2 amps. This design has been tested for 50,000 cycles of rotational life with no failure, carrying a .500 amp load at 125°C. Available in 2 to 12 decks, 1 to 4 poles per deck, and up to 12 positions shorting. Daven offers the lowest price per circuit of any quality switch.

We build switches like no one else can!



DIVISION OF THOMAS A. EDISON INDUSTRIES
GRENIER FIELD, MANCHESTER, N.H. 03103
(603) 669-0940 • TWX 603-623-4938

New Books

Tracking the field

Phaselock Techniques
Floyd M. Gardner
John Wiley & Sons, 182 pp., \$8.95

Although the phase-lock principle has been known for quite some time, it has only been in the last decade that intensive work was directed toward engineering applications. This increased interest is a direct result of the requirements for modern communications, and for tracking and guidance of space vehicles at great distances.

The author has compiled the first comprehensive text to appear on phase-lock techniques. He has wisely allowed a certain settling period to take place after the initial flood of new knowledge on the subject before putting together his book. Currently, there is a great need among engineers for a focal point of information in this area, and this book meets that need. It offers an accurate and illuminating description of the important topics in theory and practice, and a wealth of references.

There are still unresolved problems in phase-lock techniques dealing with the more esoteric questions of loop threshold. However, at the engineering level the author utilizes experimental and analytical data to provide the reader with sound evaluations. In areas difficult to quantify, such as threshold performance, the author incorporates the theoretical knowledge and experimental evidence currently available into a logical, impartial discussion.

The book is directed to the engineer with a background in control systems and communications, and is particularly useful for those engaged in the analysis and design of phase-lock devices.

Jean A. Develet Jr.
TRW Systems
Redondo Beach, Calif.

On course

Range Instrumentation
Edited by Ernest H. Ehling
Prentice-Hall, 634 pp., \$16.75

Radar engineers interested in developing new systems for missile

test ranges should find this book helpful and instructive, but so should radio, computer, and optical-instrument designers. There's something here for everyone concerned with range instrumentation.

Each of the 10 chapters covers a specific area of the technology involved and is written by an expert in that field. The reader is first introduced to the objective of the technology and is then shown the design processes leading to the development of an instrumentation system. Actual range instruments are used as examples.

Range instrumentation and indirect measurements are generally discussed from the systems point of view, but the editor has included the mathematics of data reduction wherever it is helpful. The reader is thus offered a combination of engineering data and analytical and statistical solutions to instrumentation problems. Many of the problems and solutions are common to other areas of engineering.

The book assumes the reader has some knowledge of radar, optical systems, and so on. To develop theory, the reader must look elsewhere, but the practical solutions to problems are well documented.

After an introductory chapter, optical instrumentation, instrumentation radar, doppler systems, phase comparison systems, and radio telemetry systems are discussed. The remaining chapters describe instrumentation support systems, range ships, on-board measurements, and missile launch vehicles, while appendices review the mathematics of statistics and probability.

The chapter on instrument support systems is particularly useful. It defines the relationships between range instrumentation systems and is helpful for flight test work.

The editor explains the theory of normal equations, the techniques of least squares, the laws of the propagation of covariance, and interpolation. Naturally, the relation of these theories to the range tracking problem is stressed.

W.J. Evanzia
Avionics editor

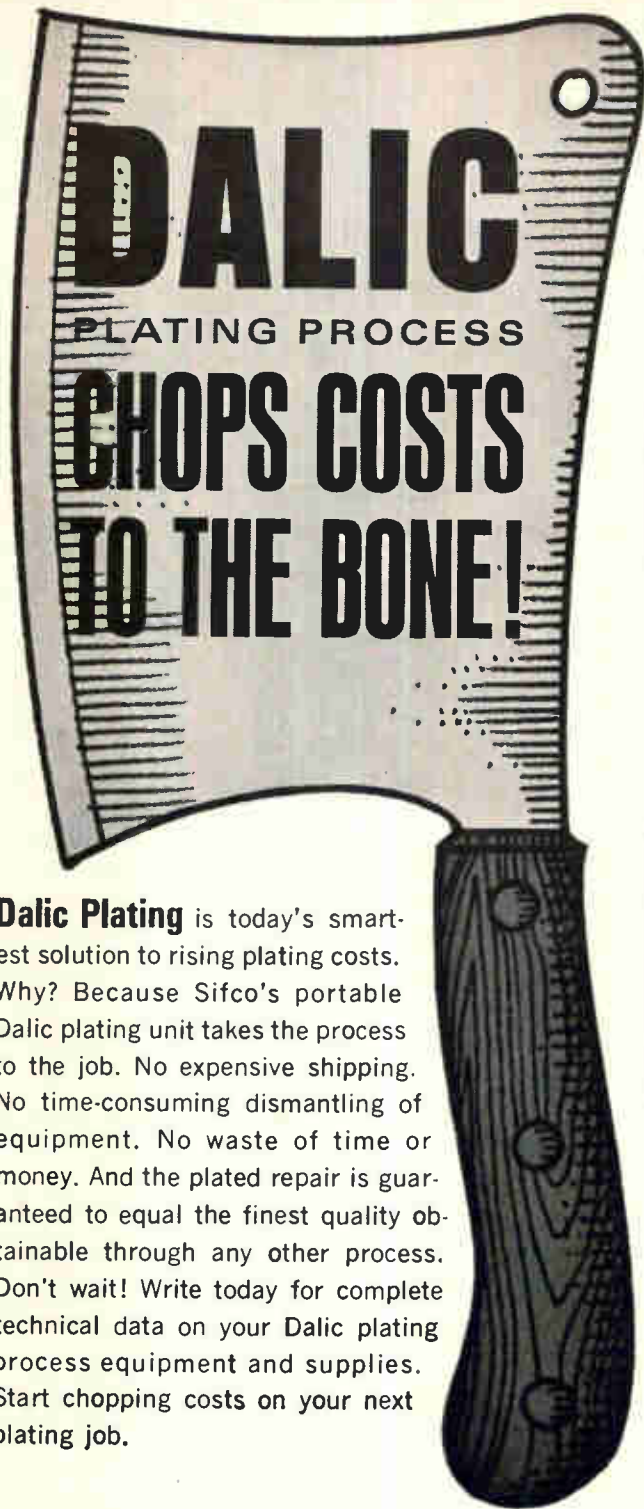

Dalic Plating is today's smartest solution to rising plating costs. Why? Because Sifco's portable Dalic plating unit takes the process to the job. No expensive shipping. No time-consuming dismantling of equipment. No waste of time or money. And the plated repair is guaranteed to equal the finest quality obtainable through any other process. Don't wait! Write today for complete technical data on your Dalic plating process equipment and supplies. Start chopping costs on your next plating job.

DALIC'S WIDE RANGE PLATING PROCESS

Complete line of PREPARATORY AND STRIPPING SOLUTIONS. NON-PRECIOUS METAL PLATING SOLUTIONS: Antimony, Bismuth, Cadmium, Chromium, Cobalt, Copper, Iron, Lead, Nickel, Tin and Zinc. PRECIOUS METAL PLATING SOLUTIONS: Gallium, Gold, Indium, Palladium, Platinum, Rhenium, Rhodium and Silver. ALLOY PLATING SOLUTIONS: Brass, Nickel-Cobalt, Tin-Indium and Gold-Antimony. SPECIAL COATINGS.



Dalic Plating Goes to the Job
SIFCO METACHEMICAL
 Division of Steel Improvement & Forge Co.
 935 EAST 63rd ST., CLEVELAND, OHIO 44103

Does this look like a digital design problem to you?

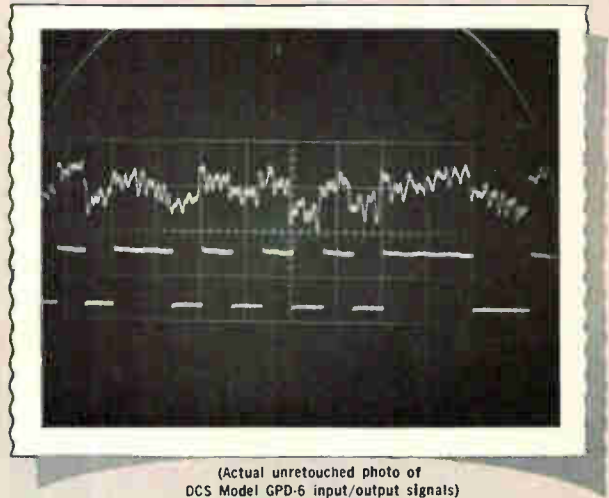

Trace A is Digital Data plus Noise at input.

Trace B is Digital Data at output.

Here's the problem: Design a bit synchronizer to remove noise and output a clean signal as in Trace B, plus clock (not shown).

Tough? Well it takes more than Schmitt triggers, axis crossing detectors, toggles or gates. It's an analog phase-locked loop design problem and we have the solution . . . DCS Models GPS-5 and GPS-6 Bit Synchronizers handle RZ, NRZ-L, NRZ-M, NRZ-S or Bi-Phase-L. The DCS Model GPD-6 handles Apollo and SGLS PSK, too.

We also make PCM Decoms, Synthesizers and data acquisition products. Complete systems specifically to meet your requirements are our specialty.

Interested? Call our office nearest you for information and data bulletins on DCS digital products.

Or write directly to:

Dept. E 6-7, East Liberty Street, Danbury, Conn. 06810
 Telephone: 203-743-9241 TWX 710-456-2596



DATA-CONTROL SYSTEMS INC.
Instrumentation for Research

Sales Offices
 Silver Spring, Md., Huntsville, Winter Park, Long Beach, Santa Clara,

Copenhagen London Rome Paris Munich Amsterdam

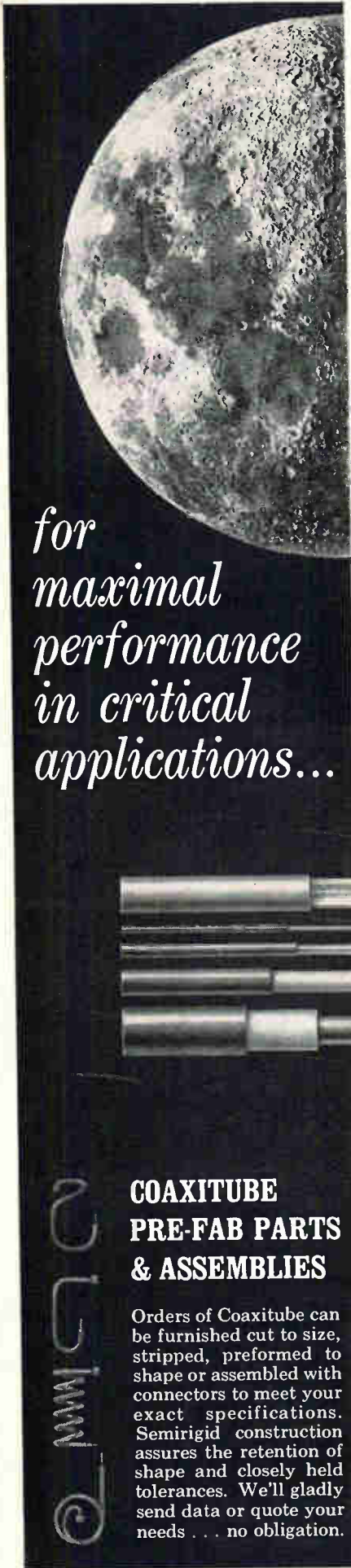

*for
maximal
performance
in critical
applications...*

COAXITUBE PRE-FAB PARTS & ASSEMBLIES

Orders of Coaxitube can be furnished cut to size, stripped, preformed to shape or assembled with connectors to meet your exact specifications. Semirigid construction assures the retention of shape and closely held tolerances. We'll gladly send data or quote your needs . . . no obligation.

New Books

Recently published

Modern Analytical Design of Instrument Servomechanisms, Bruce A. Chubb, Addison Wesley Publishing Co., 228 pp., \$11.95

In presenting the latest analytical techniques for designing instrument servomechanisms, the author considers all component tolerance effects. Specification techniques are discussed, with emphasis on obtaining design data from component specifications.

Handbook of the Engineering Sciences—Volume 1: The Basic Sciences, edited by James H. Potter, D. Van Nostrand Co., 1,347 pp., \$37.50

A mammoth volume dividing the basic sciences underlying engineering practice into seven sections—mathematics, physics, chemistry, graphics, statistics, experiment theory, and mechanics. Discussion of basic definitions and derivations in each of these areas is followed by examples of their use in engineering calculations.

MOSFET in Circuit Design, Robert H. Crawford, McGraw-Hill Book Co., 136 pp., \$10

Another in Texas Instruments Incorporated's Electronics Series, the book looks at the basic principles of the metal oxide semiconductor field effect transistor as they apply to circuit design. Included are discussions of the device's theory of operation, characteristics, and usage in both discrete and integrated-circuit form.

Threshold Logic, P.M. Lewis and G.L. Coates, John Wiley & Sons Inc., 483 pp., \$15

Directed at both the circuit designer and the engineering student, the book presents a complete exposition of the subject, with emphasis on synthesis for prescribed sensitivity constraints. The function tree is used as a unifying concept in this presentation.

High-Power Semiconductor-Magnetic Pulse Generators, Godfrey T. Coate and Laurence R. Swain Jr., M.I.T. Press, 136 pp., \$7.50

A monograph describing a solid state pulse generator configuration for high-power outputs. A detailed analysis of the basic circuit is presented as a starting point for adaptation to particular requirements. The design and construction of an experimental model illustrates the application of the analysis given.

Basic Switching Circuit Theory, Moshe Krieger, Macmillan Co., 256 pp., \$9.95

An introductory work on modern switching circuit theory aimed at the advanced undergraduate. Basic concepts of Boolean algebra are reviewed. A symbolic representation of switching devices as gates is developed and used in a presentation of the theory and design of combinational and sequential circuits.

Semiconductor Circuits: Worked Examples, J.R. Abrahams and G.J. Pridham, Pergamon Press, 208 pp., \$5

Basic circuits using semiconductor devices are analyzed in detail, along with discussions of the basic physical theory and principles of semiconductor devices.

RCA Receiving Tube Manual, Radio Corp. of America, Harrison, N.J., 608 pp., \$1.25

New tubes, old tubes, replacement tubes, revised circuit diagrams, and expanded applications are all described in the latest edition of this classic.



PRECISION Semi-rigid COAXITUBE

These high performance solid-jacketed cables offer broad frequency response, low attenuation, zero radiation and lowest possible VSWR. The splined, air-articulated types provide minimum attenuation and highest cutoff frequencies, eliminate periodicity phenomena, and insure phase stability in the order of 20 PPM/°C from 10°C to 40°C, and 35 PPM/°C from -40°C to +125°C. They also provide excellent external RF shielding. For critical applications in severe environments, your best decision is Precision.



PRECISION TUBE COMPANY, INC.
SPECIAL PRODUCTS DIVISION
North Wales, Pennsylvania 19454
Phone 215-699-4806 TWX 510-661-8427



Industrial Solid State Time Delay Relay

With this easily adjustable industrial time delay relay you have the added convenience of a standard octal plug-in unit. You can control either the time power is applied to a circuit, or the time power is removed.

This timer can be used to economically control all types of electrical or electronic equipment. Reset is instantaneous upon removal of power. The 10 amp load relay is DPDT for your further convenience. Three standard ranges are available from 0.1-400 seconds for AC or DC operation. Send for detailed information now.

AWH AYDON 232 North Elm Street
Waterbury, Conn. 06720
THE COMPANY 4060 Ince Boulevard
Culver City, Calif. 90231
Timing & Stepper Motors • Electromechanical & Electronic Timing Devices & Systems

Circle 263 on reader service card



*Quality and economy
in servo motors
and motor-tachs
depend on the
manufacturer's
experience*

...and CEDAR has it!

When it comes to sizes 8, 10 and 11 servo motors and motor-tachometers both with and without gear heads, Cedar is the leader, currently building at a higher rate than any other manufacturer in the country.

Because Cedar's volume is big and production techniques have been perfected and standardized, you are assured of the most economical price available. At the same time, the reliability testing and quality assurance programs built up on these units through years of experience guarantee you the finest quality and dependability.

When you need a servo motor or motor-tach, remember that the most advanced designs built with the most modern production techniques come from Cedar. Write or call us for complete information. You'll be glad you did.

CEDAR **CONTROL DATA**
ENGINEERING DIVISION CORPORATION

5806 W. 36th St., Minneapolis, Minn. 55416 Phone (612) 929-1681

Circle 264 on reader service card

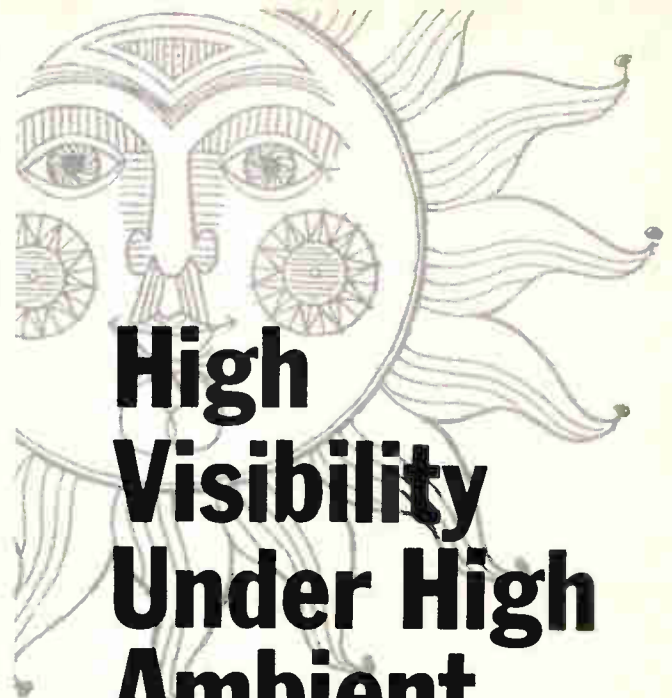

High Visibility Under High Ambient Light



Where digital readout recognition must be under high ambient light conditions, the Tung-Sol readout provides unmatched clarity and visibility. The Tung-Sol unit was designed for aircraft applications where ambient light reaches extremely high levels.

The Tung-Sol design embodies subminiature incandescent lamps combined with special light piping that achieves a bright, sharp character of unmistakable clarity.

Tung-Sol digital readouts are easy to install and require very little hardware. They are extremely rugged and long-lived. Nevertheless, they are designed to be easily replaced. More than half-a-century of experience in the manufacture of light source devices assures product reliability of the highest order.

For more information, write describing your application. Tung-Sol Division, Wagner Electric Corporation, One Summer Avenue, Newark, N.J. 07104. TWX: 710-995-4607.

TUNG-SOL®
HI-OPTICS
DIGITAL READOUT
The most thoroughly engineered
readout on the market

Circle 225 on reader service card

225

NEW! Modular Integrated Circuit Analog-Digital Converters

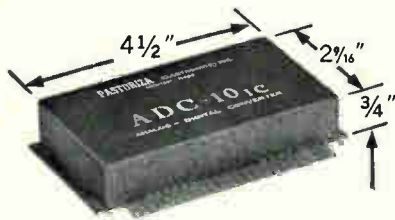

MODEL ADC-10_{iC} provides 10 bit binary parallel output in 10 micro-second conversion time . . . accepts a ten volt input range . . . contains a Clock, Reference Supply, Resistor Network and Comparison Amplifier . . . triggered by an external command signal and provides a "Status" output level to indicate completion of the conversion.

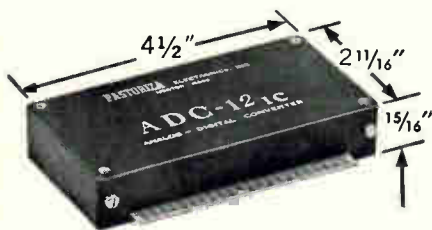

MODEL ADC-12_{iC} is a general purpose converter card which may be programmed to satisfy a wide range of specifications. For example, it will accept bipolar or unipolar input voltage ranges of varying amplitude and impedance requirements and will convert voltages into binary codes or various numbers of bits or into BCD code. This same basic card can therefore be supplied for a number of different system requirements without the usual expense and delays of "specials". MODEL ADC-12_{iC} utilizes TTL micrologic and is available in extended temperature ranges (-55°C to +100°C) for military applications.

PASTORIZA
ELECTRONICS, INC.
385 Elliot St., Newton Upper Falls, Mass. 02164
(617) 332-2131

Technical Abstracts

Small loss

A new class of low loss reactive wall waveguides
R.P. Larsen
Grumman Aircraft Engineering Corp.
Bethpage, N.Y.
A.A. Oliner, Polytechnic Institute of
Brooklyn, New York

Experiments and theoretical analysis have established the feasibility of achieving very low attenuation in a new class of waveguides employing reactive walls. Such waveguides would be of great value in millimeter wave or high-power microwave systems.

The reactive walls are designed as periodic structures formed by an array of parallel dielectric slabs. Initially, the analysis was made on the basis of an infinite parallel plate waveguide in which both conducting plates the replaced by identical one-dimensional, semi-infinite dielectric structures. Design parameters and excitation frequency are chosen so that operation lies well within the stop-band of the transverse, periodically-loaded transmission lines. Thus, the electromagnetic field is rapidly attenuated in the direction perpendicular to the direction of propagation. Under ideal conditions, this produces a purely reactive impedance in the direction of propagation, resulting in low loss.

The parallel plane configuration is capable of supporting two types of modes, one for which the field contains only magnetic field components perpendicular to the plane of the dielectric slabs (transverse

H-mode), and a second which contains only electric field components (transverse E-mode). Structures to support the transverse E and H modes can be combined to form a rectangular waveguide with four reactive walls. Theoretical analysis shows that such a waveguide has an attenuation constant almost one-third of an equivalent all-metal rectangular guide— 6.55×10^{-3} decibels per meter compared with 21.2×10^{-3} decibels per meter.

To verify the theory, a length of the reactive waveguide was built as a single-ended cavity, and resonant frequency and Q measurements were taken. The results, at a nominal frequency of 3,000 Mhz, showed rather good agreement with the theoretical analysis.

Preliminary studies by the authors indicate that circular reactive waveguides operating in the H_{01} mode would also exhibit smaller losses than all-metal circular guides of corresponding dimensions designed to carry the low-loss circular electric mode.

Presented at the 1967 G-MTT International Microwave Symposium, Boston, May 8-11.

Averaging capacitors

Multiple-Curie-point dielectrics
R.A. Delaney and H.D. Kaiser
International Business Machines Corp.,
Hopewell Junction, N.Y.

Designers of thick-film integrated circuits usually prefer to pay the extra cost of adding discrete capacitors to the circuit, rather than making a screen-printed and fired capacitor part of the circuit. One reason for this is that printed capacitors generally remain stable in value only within a limited temperature range—their dielectric constant goes haywire around the ferroelectric Curie point.

Now, the capacitance value of thick-film capacitors can be made fairly stable over a wide temperature range. Making the printing paste of several different dielectrics allows the temperature characteristics to be tailored and improves adherence to the substrate.

Barium titanate, a basic capacitor dielectric, has a Curie point of

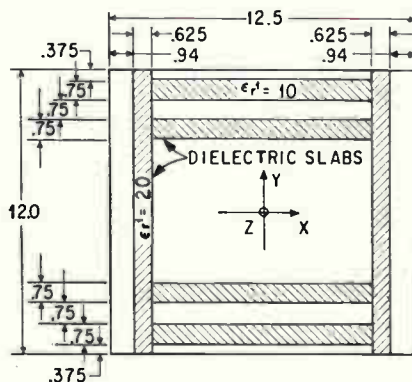

Cross section of reactive wall waveguide used to verify analysis which predicted low losses. Dimensions are given in centimeters.

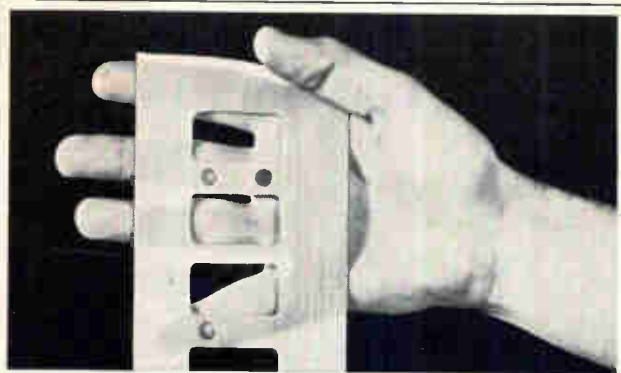

U.S. Patent No. 3,126,440

POLASHEET II

first truly effective pressure & RFI seal for connectors!

Polasheet II is oriented wire imbedded in silicone rubber sheets just .062" thick. Yields overall system attenuation of 125-135 db ... with sealing pressures up to 30 psi. Can be die cut into resilient, flexible gaskets of any shape. Compressible, too, so machined surfaces are not needed. About 12¢ per sq. in. Write for Free Samples, prices, literature!

METEX Corporation

970 New Durham Road, Edison, N.J. 08817
(201) 287-0800 • TWX 710-744-4530
West Coast: Cal-Metex Corp., 509 Hindry Ave., Inglewood, Calif.



4B

Circle 265 on reader service card

These two
heat-shrinkables
are hungry for
tough mil-spec
insulation problems.

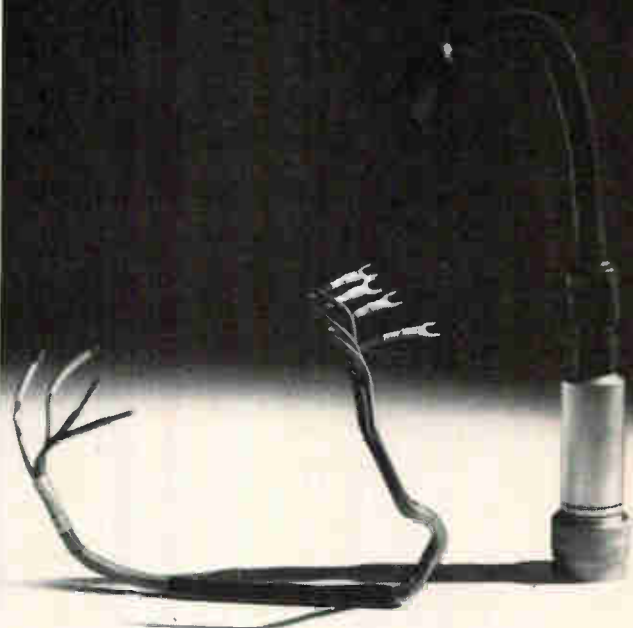

Feed them.

New Insultite® SR-350 eats up shock, strain and vibration like only a semi-rigid, irradiated polyolefin can. It combines superior dielectric characteristics with high structural strength. From 3/64" to 1" I.D.

Insultite FP-301, on the other hand, has a flexible polyolefin appetite that devours mil-spec applications. Quickly. Totally. From 3/64" to 4" I.D.

SR-350 meets classes 3 and 4 of MIL-I-23053A and NASA 276A. FP-301 meets classes 1 and 2.

Both are available in ten standard colors. Write today for free samples. (Specify diameters, please.)



ELECTRONIZED CHEMICALS CORPORATION

A subsidiary of High Voltage Engineering Corporation
Burlington, Mass. 01803, Area Code 617-272-2850

E.C.C. heat shrinkables are recognized under UL component file E39100

See us at NEPCON, June 13-15, Booth 706, New York Coliseum, New York



Packs a wide frequency range in small space

The Hewlett-Packard 3200B VHF Oscillator offers continuous coverage of frequencies from 10 to 500 MHz, yet takes up little space on the bench or in the rack. The 3200B provides $\pm 0.002\%$ frequency stability over a 5-minute period, a high RF output level, and an output attenuator. It is ideal as a general purpose source of CW signals and will also accept external pulse or amplitude modulation. The 3200B may be used with an accessory doubler probe to extend the frequency coverage to 1000 MHz. Size: 7 7/8" wide, 6 1/2" high and 13 1/8" deep. Price \$525. For more complete information, contact your local Hewlett-Packard field engineer or write: Hewlett-Packard, Green Pond Road, Rockaway, New Jersey 07866.

HEWLETT  PACKARD

1074

Circle 266 on reader service card

Circle 227 on reader service card

227

Solve Your Special Purpose Filter, Transformer, Inductor and other Wire Wound Component Problems at SIE!



Dresser SIE now offers a complete engineering and manufacturing service to fill all your needs for special purpose wire wound components for your ordnance, aircraft, aero space and seismic applications.

Send your specifications today to the address below for complete information.

DRESSER
SIE
INC.

INDUSTRIAL PRODUCTS GROUP
P.O. Box 2928/Houston, Texas 77001
one of the **DRESSER** Industries

Technical Abstracts

about 120°C. At about 80°C, its dielectric constant begins rising sharply from the normal value of about 2,000. At about 120°C the constant is nearly 5,000. When it is mixed with strontium titanate, the Curie point falls. Adding lead titanate or lead zirconate raises the Curie point.

Merely mixing such materials, however, doesn't solve the problem. When the mixture is fired—a necessary part of the circuit production process—the dielectrics combine and capacitance still varies widely with temperature. The way around this hurdle is to prepare the mixture so that discrete particles of each dielectric are separated from each other in an inert material. Then, the capacitor has several Curie points and its dielectric constant doesn't peak at any temperature. One such mixture has a dielectric constant between 380 and 400 over a temperature range of 0 to 100°C.

The dielectric constant is reduced from the bulk value of the barium titanate primarily because the particles are suspended in a glassy matrix with a relatively low dielectric constant. The composition is sintered at a temperature well above the firing temperature, so that the dielectric particles will remain separated after firing. After sintering, the composition is powdered and mixed with an organic binder to form the printing paste. The organic binder escapes when the circuit is fired. After firing, the capacitor is glazed.

Presented at the Electronic Components Conference, Washington, May 3-5

Old trick, new turns

Broadband cable chokes
Ernest T. Harper*
U.S. Army Electronics Command,
Ft. Monmouth, N.J.

Throw away those tuning slugs, a way has been found to make cable chokes broadband. They will isolate antennas from their feed cables over a band as wide as 10 megahertz, or more, without the necessity of tuning the choke to

* Now with Sylvania Electric Products Inc., Mountain View, Calif.

Why MARYLAND?

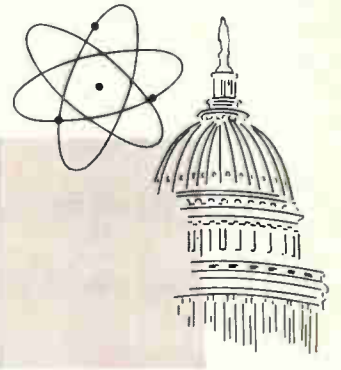

Proximity to federal agencies in Washington, D.C. affords the unique advantage of constant personal contact with government officials working with science-oriented industry. Such contact is an increasingly important locational criterion.

No other state is as convenient to as many Federal agencies as Maryland. For example, Maryland's major government scientific installations include NASA, AEC, NIH, the National Bureau of Standards, plus some 20 others.

Are there other reasons why R&D activities and science-oriented industries should consider locating in MARYLAND?

Yes... emphatically!

The availability of personnel, particularly engineers and scientists, is recognized as a chief criterion governing the location of any science-oriented industry.

There are almost 30,000 scientists and over 25,000 engineers living and working in Maryland and the District of Columbia.

There are 39 four-year colleges and universities in Maryland and the District of Columbia. Graduate and post-doctoral programs considered most significant to research and science industry are available.

Shouldn't you locate in MARYLAND?

Get All The Facts.

MARYLAND DEPARTMENT OF
ECONOMIC DEVELOPMENT
DIVISION E

State Office Bldg. • Annapolis, Md. 21404

Write, Wire Or Phone Collect



NEW from Cramer



ADJUST-A-LOK STOOLS

Adjust to every worker like fine tools!

Cramer Adjust-A-Lok is immediately adjustable to any workers height. Just release the safety stop, and lift or lower. It can be done just that quick. Since fatigue is a critical factor in efficiency of seated workers, it's just good economics to provide tools that minimize fatigue. With Adjust-A-Lok every worker can find his own most comfortable and efficient level. 6 seat styles and 5 base types provide 30 available models. For more information: write V. P. Sales, Cramer Industries, Inc., 625 Adams, Kansas City, Kansas 66105.

Industrial supplier
inquiries invited



Cramer—The leader in style and quality.

Circle 268 on reader service card



National NL-BEZ-84 Bezel Assembly

TTL IC Drivers for NATIONAL[®] Readout Tubes

From stock: Decoder/Driver, Decimal Counter/Driver and Decimal Counter/Driver with Latching Memory.

■ 15 MHz Counting Rate ■ For all side and end view National readout tubes.

NATIONAL REQUEST BULLETIN
ELECTRONICS, INC.
a varian subsidiary

PHONE: (312) 232-4300 • GENEVA, ILLINOIS, 60134

SO MANY OF EACH... FROM ONE SOURCE OF LAMINATED PLASTICS



SHEETS

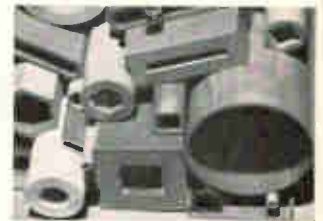

RODS, TUBES

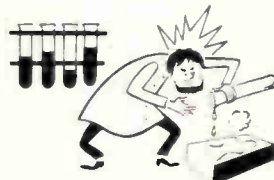

CHEMICAL RESISTANCE—

Synthane is immune to most oils and solvents as well as resistant to various acid concentrations and salts. It often has longer life per dollar, including replacement cost.



MOISTURE RESISTANCE—

Certain grades of Synthane are specifically designed to retain a high percentage of their electrical and mechanical properties under extremely humid conditions.



DIELECTRIC STRENGTH—

An excellent electrical insulator with low dissipation factor and low dielectric constant, Synthane is easily punched or machined into parts for radio and electrical equipment.



HIGH STRENGTH-TO-WEIGHT RATIO

Synthane weighs only half as much as aluminum, yet is one of the plastics highest in tensile, compressive, flexural, and impact strengths.

SYNTHANE GRADES

- | | |
|---|--|
| Kraft Paper Phenolic Grades | Asbestos Fabric Phenolic Resin Grades |
| Alpha Paper Phenolic Grades | Asbestos Fabric Melamine Resin Grades |
| Rag Paper Phenolic Grades | Asbestos Fabric Phenolic (High Temperature) Resin Grades |
| Paper Base Plasticized Resin Grades | Asbestos Fabric Phenolic Graphitized Grades |
| Paper Base Phenolic Flame Retardant Grades | Asbestos Fabric Phenolic Molycote Grades |
| Paper Base Epoxy Grades | Asbestos Mat Phenolic Grades |
| Paper Base Epoxy Flame Retardant Grades | Asbestos Mat Phenolic (High Temperature) Resin Grades |
| Coarse & Fine Weave Cotton Fabric Phenolic Grades | Nylon Fabric Phenolic Resin Grades |
| Coarse & Fine Weave Cotton Fabric Melamine Grades | Glass Fabric Staple Fibre Phenolic Resin Grades |
| Coarse & Fine Weave Cotton Fabric Phenolic Graphitized Grades | Glass Fabric Continuous Filament Phenolic Resin Grades |
| Coarse & Fine Weave Cotton Fabric Phenolic Molycote Grades | Glass Fabric Continuous Filament Melamine Resin Grades |
| Fine Weave Fabric Carbon Inclusion Phenolic Grades | Glass Mat Melamine Resin Grades |
| Cotton Mat Phenolic Resin Grades | Glass Fabric Epoxy Resin Grades |
| Asbestos Paper Phenolic Resin Grades | Glass Fabric Phenolic (High Temperature) Resin Grades |

SYNTHANE
CORPORATION **S** OAKS, PA. 19456

666-5011 Area Code 215, TWX 510-660-4750, Telex 084-5268

SYNTHANE-PACIFIC—518 W. Garfield Ave., Glendale, California 91204

Quick Answers to
Everyday Problems
in All Major
Engineering Fields



ENGINEERING MANUAL, 2nd Edition

A Practical Reference Book of
Data and Methods in Architectural,
Chemical, Civil, Electrical,
Mechanical, and Nuclear
Engineering.

Prepared by a Staff of Specialists.
ROBERT H. PERRY, Editor-in-Chief,
Professor of Chemical Engineering
University of Rochester.

Here's the one expert source to
check whenever you need quick
answers to everyday problems in
the major engineering fields. Now
fully revised, the second edition
of this valuable book makes vital
engineering information more ac-
cessible than ever . . . presented
in a manner that permits non-
detailed design in any engineer-
ing specialty even if the field is
not specifically your own.

An immensely useful supple-
ment to your professional library,
the Manual brings together in
one volume the most commonly
used data and methods in the
architectural, chemical, civil,
electrical, mechanical, and nu-
clear engineering fields. Every-
thing—from the basic principles
and fundamentals in each of the
engineering fields right down to
their applications—is instantly
available for quick, easy refer-
ence. **680 pp., \$11.75**

At Your Bookstore or
Send Coupon for

10 DAYS FREE EXAMINATION

McGraw-Hill Book Co., Dept. 23-L-612
330 West 42nd Street, New York, N. Y. 10036

Send me Perry's **ENGINEERING MANUAL** for
10 days on approval. In 10 days I will remit
\$11.75 plus a few cents for delivery costs,
or return book postpaid.

Name (print) _____

Address _____

City _____ State _____ Zip Code _____

For prices and terms outside U. S., write McGraw-Hill Int'l.
NYC

23-L-612

Technical Abstracts

resonance every time the operating
frequency of a radio set is changed.
Ordinary chokes require tuning
with either a slug in the inductor
or a variable capacitor.

To make a broadband choke,
miniature coaxial cable is wound
around a ferrite toroid; the ends
of the cable's outer conductor are
connected to metal plates that are
separated by an insulator. Prop-
erly wound, the chokes reduce
losses in the cable while providing
more than 5,000 ohms of radio-
frequency isolation in the outer
conductor.

The design stems from a trick
often used by amateur radio oper-
ators to protect themselves by re-
ducing the r-f energy leaking along
an antenna feed. The operators
slip an inductor on the feed, form-
ing a one-turn inductor. Winding
the feed around the inductor multi-
plies the isolation many times.

Isolation is essential when a co-
axial cable feeds the antenna. The
outer conductor acts as a radiating
antenna when currents from the
antenna flow into the conductor or
are created by radiation from the
antenna. This alters the antenna
systems radiating characteristics,
and causes antenna losses.

Simply winding a cable around
a toroid will not make the chokes
broadband. The dimensions of the
toroid and cable, the number of
turns, and the separation between
turns must be carefully chosen to
control electrical characteristics.
Bandwidth rises with susceptance,
for example, and falls with self-
capacitance of the winding.

Choke design theory and for-
mulas have been worked out, and
proven experimentally. For in-
stance, isolation is provided across
the high-frequency range of 2 to
30 Mhz by three chokes: one with
a bandwidth of 6.3 Mhz covers
frequencies from 2 to 8 Mhz; an-
other, 12.7 Mhz wide, isolates at
8 to 20 Mhz; and the third, with
a bandwidth of 11 Mhz, takes over
at 20 to 30 Mhz.

Similar groups of chokes can
cover the very high frequency
range of 30 to 80 Mhz.

Presented at the Electronic Components
Conference, Washington, May 3-4

Telrex

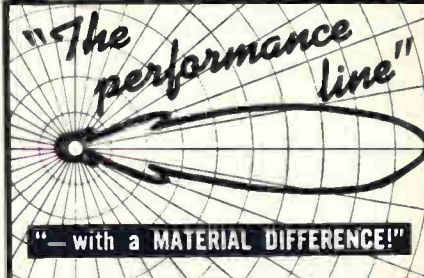

Telrex Communication Engineering Laboratories
provides the Most Technically-Perfect, Finest
Communication Arrays — Precision Engineered,
Manufactured, Tuned, Matched, Calibrated and
"Balun" Fed for "Balanced-Pattern" and Max-
imum S/N Ratio.

**Telrex "Beamed-Power"
"Balanced-Pattern"**

ANTENNAS AND ANTENNA SYSTEMS

The Standard of Comparison, and the Choice of
the Discriminating, Successful, Communication
Engineer.

Telrex Antennas and Antenna Systems provide
Optimum Performance and Reliability per ele-
ment, per dollar, from 500 Kc to 1500 Mc.

Send for free Military, Commercial Tech Cata-
log CMS67, illustrating Antennas and Systems,
Rotator-Selsyn-Indicator Systems, "Baluns,"
Towers, Masts and Accessories.



Circle 270 on reader service card



NEW **ECCOFOAM®** **FREE**

Plastics/Ceramics Foam Chart

Complete physical and electrical data
are displayed for eighteen foams

—liquids, powders, sheet stock—
plastics, ceramics and even artificial
dielectrics.

Fold-out chart in full color for note-
book or wall mounting is yours.

Write or Use Reader Service Card

Emerson & Cuming, Inc.



CANTON, MASS.
GARDENA, CALIF.
NORTHBROOK, ILL.
Sales Offices
in Principal Cities

EMERSON & CUMING EUROPE N.V., Oevel, Belgium

Circle 230 on reader service card

New HEAT-GRIP®

Irradiated Polyolefin Tubing

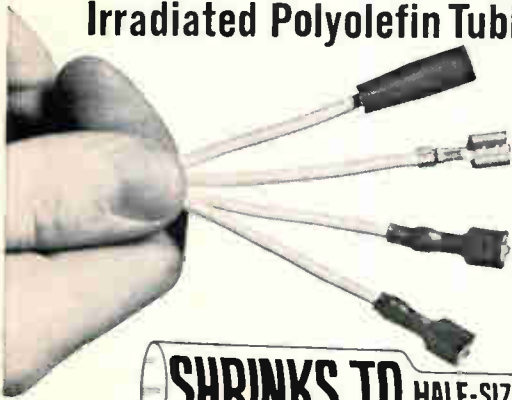

SHRINKS TO HALF-SIZE AT 250°F

Here's the fast, sure way to protect or insulate. Heat-Grip forms a strong, tight-fitting, flexible shield when moderate heat is applied. Won't melt or flow upon heating. Has longer heat life and greater resistance to solvents. Conforms to spec. MIL-I 23053.

Heat-Grip is available 1/8" to 1" I.D. in five colors and clear.

Excellent for mechanical protection, color identification, product encapsulation, insulation.

Send for Technical Data Sheet and FREE sample.

NATVAR CORPORATION
P. O. BOX 67 · RAHWAY, N. J. 07065

Circle 272 on reader service card

A New Waterproof Series MINIATURE TOGGLE SWITCHES

New case design with double high voltage barriers, and low-loss, high impact, high temperature materials. Wide silver contacts. Waterproof 'O' rings and sealed terminals. Available in One, Two, Three and Four Pole configurations all in compact unitized bodies. 6 Amps @ 125 VAC.



SPECIFY THE NEW "E" SERIES BY

FREE
PRODUCT
PLANNING
CATALOG

ALCOSWITCH

DIV. OF ALCO ELECTRONIC PRODUCTS INC., LAWRENCE, MASS.

A Unique Series MINIATURE ALCOSWITCHES

with the feel of a
standard toggle

Standard 15/32" hole mounting but with rear panel space requirements of a miniature switch. Case has high voltage barriers inside and out. Case material: high impact, high temperature, low loss. Wide silver contacts. Available in One, Two, Three, Four Pole configurations all in compact cases. 6 amps @ 125 VAC.



Mustang

FREE
12-PAGE
CATALOG
WRITE!

ALCOSWITCH

DIV. OF ALCO ELECTRONIC PRODUCTS INC., LAWRENCE, MASS.

Circle 274 on reader service card

NEW. Low Frequency Ceramic Band Pass Filter.

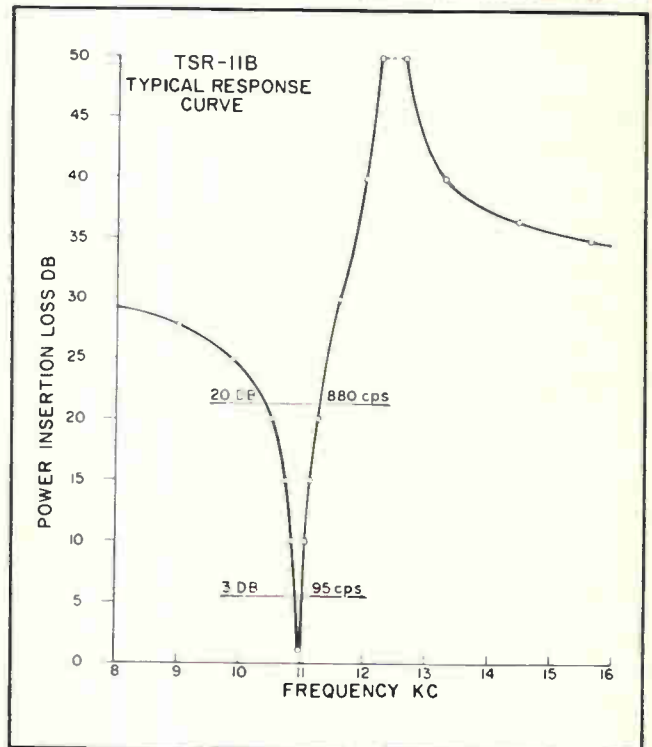

Big performance in a quarter ounce package.

Looking for something better in a low frequency filter? Look no more. Clevite's new generation of fixed-tuned ceramic band pass filters combine narrow bandwidths and high performance with surprisingly small size and low weight.

Check the specs and see for yourself:

Center Frequency — from 9kc to 50kc

Bandwidth (% fo) — @ 3db-1%; @ 20db-13%

Stability — Within 0.2% for 5 years

Within 0.2% from -40°C to +85°C

Dimensions—HC-6/U case 3/4" x 3/4" x .34" (hermetically sealed)

Shock — 20g any axis 20-2000 cps per mil std. 202B.

As we said, look no more for a high performance, low frequency filter. This new one from Clevite is the perfect choice. Write for free Technical Bulletin 94023. Clevite Corporation, Piezoelectric Division, 232 Forbes Road, Bedford, Ohio 44014.

CLEVITE

Circle 231 on reader service card

231



Polycarbafil housing for Dictograph speaker is injection molded by Waterbury Co., Randolph, Vt. Nylafil switch housing, push-buttons and volume control wheel are molded by Hinchman Mfg. Co., Inc., Roselle, N. J.

Polycarbafil[®] has toughness needed for new hospital speaker

Impact strength important in speaker for hospital patients

The pillow speaker for individual hospital patients made by Dictograph Products, Danbury, Conn., must be able to withstand accidental dropping on the floor. Dictograph looked for a material that would have the impact resistance and toughness for this, plus rigidity, dimensional stability and low coefficient of thermal expansion. They chose Polycarbafil, fiberglass reinforced polycarbonate. Fiberglass reinforcement increases all of these properties. In addition, Nylafil, fiberglass reinforced nylon, was chosen for push-buttons, volume control wheel and switch housing for its strength and wear resistance.

Compare Physical Properties

Property	Unit	Unreinforced Polycarbonate	Polycarbafil G-50/20
Tensile Strength @ 73°F	PSI	8,000	18,500
Flexural Strength @ 73°F	PSI	13,500	25,000
Coef. Linear Thermal Expansion / °F	In./In.	1.0x10 ⁻⁵	1.02x10 ⁻⁵
Heat Distortion Temp. @ 66 PSI	°F	285	308
Water Absorption 24 hrs.	%	0.15	0.11

Polycarbafil and Nylafil are only two of the full line of fiberglass reinforced thermoplastics pioneered and patented by Fiberfil. Only Fiberfil can give you complete technical data, practical experience and a full line of reinforced materials. Send for your free copy of the FRTP engineering manual, Fiberfil Div., Rexall Chemical Co., Evansville, Indiana 47717.



Fiberglass Reinforced Thermoplastics[®]

New Literature

Thermoplastic resin. General Electric Co., 1 Plastics Ave., Pittsfield, Mass. Bulletin CDX-41 describes the physical, mechanical, thermal, and electrical properties of Noryl, a thermoplastic resin for electrical and electronics applications. Circle 420 on reader service card.

Molding powders. Emerson & Cuming Inc., Canton, Mass. 02021. A foldout chart for notebook or wall mounting presents the Ecomold line of general purpose and specialty epoxy molding powders, and illustrates several applications. [421]

Variable attenuator. Weinschel Engineering, Gaithersburg, Md., has published a completely updated version of the series 905 variable attenuator data sheet. [422]

Welding power supplies. Hughes Welder Department, Hughes Aircraft Co., 2020 Oceanside Blvd., Oceanside, Calif. 92054. A 12-page catalog PS-3 covers new welding power supplies and accessories. [423]

Indicator lights. Dialight Corp., 60 Stewart Ave., Brooklyn, N.Y. 11237, has issued catalog L-160F on Datalites, ultra-miniature indicator lights suited for computer, data processing and automation applications. [424]

Microminiature chopper. Solid State Electronics Corp., 15321 Rayen St., Sepulveda, Calif. 91343, has available a bulletin on the model 30 Microchopper, a low-level spdt switch for operation from -55° C to -90° C. [425]

Reset timer. Eagle Signal Division of the E.W. Bliss Co., 736 Federal St., Davenport, Iowa. A two-page bulletin describes the model 88 reset timer with a meter-type dial. [426]

F-m subcarrier discriminator. Genisco Technology Corp., 18435 Susana Road, Compton, Calif. 90221. Specifications of an f-m subcarrier discriminator, designed for portable and mobile applications, are provided in a data sheet. [427]

High-temperature solders. Hi-Grade Alloy Corp., 17525 South Laflin St., East Hazelcrest, Ill. 60429, has published a brochure describing two high-temperature solder alloys, both containing pure silver and both of which will remain solid at up to more than 570° F. [428]

Traveling-wave tube. Microwave Associates Inc., Burlington, Mass. Bulletin 1826 describes the MA-2015 traveling-wave tube, said to be the smallest twt available within its power and frequency range. [429]

Digital plotting system. Milgo Electronic Corp., 7620 N.W. 36th Ave., Miami,

Fla. 33147. A 12-page brochure discusses the DPS-6 digital plotting system, a data display system that includes an x-y plotter, an input source, and supporting software. [430]

Programing switches. Sealectro Corp., 225 Hoyt St., Mamaroneck, N.Y. 10543. The use of Sealectroswitch programing switches for sequencing, timing, scanning, multiplexing, integrating, code generation, and general programing is described in a six-page illustrated catalog. [431]

Printed circuits. Circuitron Inc., Baldwin, Wis. 54002. A color brochure shows the facilities and standards used by the company for manufacturing printed circuits. [432]

Solvent-free resin. Isochem Resins Co., Cook St., Lincoln, R.I. 02865, has issued a technical bulletin on Isochem-Carb 163, a capacitor or electronic resin for use with polycarbonate films. [433]

Materials for multilayer circuitry. The Budd Co., 70 S. Chapel St., Newark, Del. 19711. Flame retardant grades of ultrathin materials for making multilayer printed circuits are described in technical bulletin No. 12,100. [434]

Electronic components. General Precision Inc., Kearfott Products Division, 1150 McBride Ave., Little Falls, N.J. 07424. A revised catalog on electronic components describes more than 100 different units. [435]

Crystals. Clark Crystal Corp., 344 Boston Post Road, Marlboro, Mass. 01752. A four-page brochure discusses crystals, ovens, and crystal oscillator circuits. [436]

Small motors. General Electric Co., 1635 Broadway, Fort Wayne, Ind. 46804. Publication GEA-8254 provides basic design, selection and application information for fractional horsepower a-c induction motors. [437]

Resistance-thermometer bridge. Leeds & Northrup Co., 4901 Stenton Ave., Philadelphia, Pa. 19144. Data sheet B1.2211 lists complete specifications for the 8064-1 panel-mounted Wheatstone bridge as well as a summary of its important applications. [438]

Hermetic seals. Greenfield Components Corp., 184 Shelburne Road, Greenfield, Mass. 01301, has issued a catalog showing its line of hermetic seals, and discussing its ability to supply industrial customers with molecular bonding of practically any similar or dissimilar materials. [439]

Power supplies. Sola Electric Division, Sola Basic Industries, Elk Grove Village, Ill. 60007. A complete line of regulated

TTL DTL

Monitor lets you choose

No restrictions when you choose MONILOGIC™ IC circuit cards. Select from TTL or DTL types in dual in-line configuration. All are electrically, logically, and physically compatible with each other.

Take your pick from more than 140 different cards, the widest selection in the field. You get important systems-oriented extras with every card. Features like high fan-in and fan-out capacity, built-in auxiliary functions, top-mounted test points and Elco Varicon connectors.

Full specs are in our latest bulletin, which is yours for the asking.



MONITOR
SYSTEMS INC.

Fort Washington, Pa. 19034 A Subsidiary of Epsco, Inc.

3713

Circle 275 on reader service card

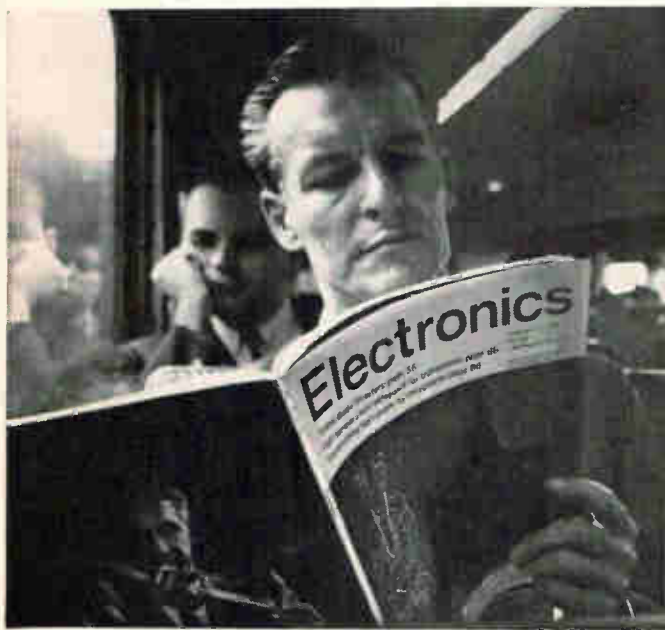

Great editorial is
something he takes to work
(What a climate for selling!)

Electronics

A McGraw-Hill Market-Directed Publication
390 West 32nd Street, New York, N.Y. 10001



TELEMETRY LEADERSHIP

with

8

S & L-BAND Transmitters!

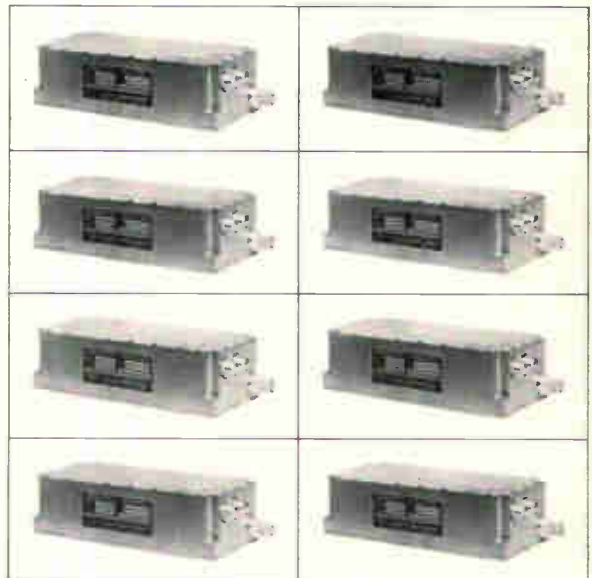

- 0.5, 2.0, 5.0, and 10 watt transmitters in both S and L-Band
- Linear wide-band modulation (better than 1% linearity to ± 10 MHz)
- Frequency response within ± 1 db from DC to over 7MHz
- Deviation sensitivities to 0.4mv/KHz peak
- Non-susceptibility to 70 volt transients or over-voltage conditions up to 36 volts continuous
- RF circulator and load built-in
- 1 1/4 x 3 x 6 inch airborne package

Send for our S-band and L-band transmitters brochure and choose the unit that will help you maintain leadership in your system.



TELEDYNE TELEMETRY

A TELEDYNE COMPANY

9320 Lincoln Boulevard • Los Angeles, California 90045
Phone (213) 670-7256 • TWX: 910 328 6529

TRW

MINUTEMAN

INVERTERS

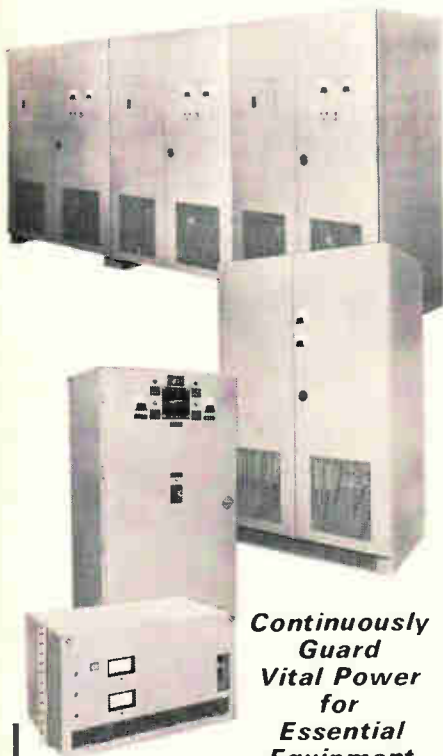

**Continuously
Guard
Vital Power
for
Essential
Equipment**

TRW Minuteman Inverter Systems include a broad range of models and equipment options from 100 VA to 100 KVA — single phase and three phase, with a variety of operational modes — including redundant and standby arrangements.

Guarding the continuous flow of power for communications equipment, process instrumentation, computers and other critical loads is the full time occupation of these Minutemen.

Other Minuteman Products

DC to DC Converters:
100 W to 20 KW.

Solid State AC Bus Transfer Switches:
from 25 amperes to 200 amperes.

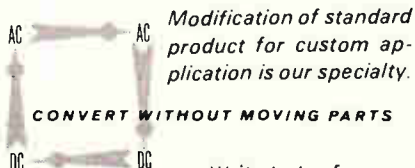

Modification of standard product for custom application is our specialty.

CONVERT WITHOUT MOVING PARTS

Write today for complete information.

**TRW EQUIPMENT
OPERATIONS**
Dept. 0855
23555 Euclid Avenue
Cleveland, Ohio 44117

TEL: (216) 383-3435

New Literature

d-c power supplies is described in brochure DC-100. [440]

Miniature decade counters. United Computer Co., 930 W. 23rd St., Unit 8, Tempe, Ariz. 85281, offers a bulletin on the model F1850 miniature decade counters that have many industrial applications and are suited for OEM applications as well as for one-time users. [441]

Electronic counter. The Rowan Controller Co., Oceanport, N.J. 07757, has available a brochure on its series EC electronic counter, which consists of 15 different models. Included are dimensions, technical specifications, design and construction features. [442]

A-c/d-c converters. Dana Laboratories Inc., 2401 Campus Drive, Irvine, Calif. Technical paper 724 details chief design considerations for high-speed, wideband a-c/d-c converters. [443]

FET chopper. Airpax Electronics Inc., Cambridge, Md. 21613. Bulletin C-125 provides complete information on the low-cost series 8000 field-effect-transistor chopper with series-shunt configuration. [444]

Cylindrical connectors. Elco Webster Corp., Watertown, Mass. 02172. A 20-page catalog describes and illustrates a complete line of cylindrical connectors that conform to MIL-C-26482. [445]

Voltage-temperature modules. Gulton Industries Inc., 212 Durham Ave., Metuchen, N.J. A line of voltage-temperature modules with over 200 times the sensitivity of chromel-alumel thermocouples is discussed in bulletin T110. [446]

Strobing voltmeter. E-H Research Laboratories Inc., 163 Adeline St., Oakland, Calif. 94607. A six-page brochure on the model 153 strobing voltmeter details design concepts of the unit, which is said to offer a unique approach to the problem of making voltage measurements on fast waveforms at precisely located points on the time axis. [447]

Video waveform monitor. Ball Brothers Research Corp., P.O. Box 1062, Boulder, Colo. 80302. A two-page bulletin covers the Mark 21 waveform monitor which provides an oscilloscope presentation of black-and-white or color tv signal information. [448]

R-f power measurement. Bird Electronic Corp., 30303 Aurora Blvd., Cleveland, Ohio 44139, has available a short form catalog (SF-67) of quality instruments for r-f power measurement. [449]

NEW!

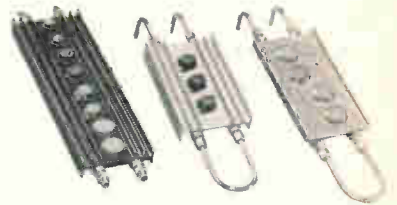

Fluid Cooled Heat Sinks for Power Transistors and Diodes

Compact, efficient. 1,000 watts dissipation in less than 45 cu. in. Replace bulky forced convection systems. Parallel or series flow; open or closed loop systems. Standard lengths to 4'. All semiconductor mounting hole patterns available. Send for data. IERC, 135 W. Magnolia Blvd., Burbank, Calif. 91502.

ierc 
SEMICONDUCTOR
HEAT DISSIPATORS

A corporate division of Dynamics Corp. of America

Circle 276 on reader service card

Well Known European

Sales and Service Organization

is looking for cooperation with manufacturing firms.

Representation - Sales - Import. Technical Service

Our dynamic enterprise also offers the possibility of a partnership or a common production.

TIG

**TECHNISCHE
INDUSTRIEPRODUKTE GMBH**

5 Köln-Lindenthal
Herder Str. 66-70
Postfach 1920
Germany

Professionalism at Grumman

...is our systems approach to maintainability

The design characteristics that lend themselves to ease of repair and maintenance are among the industry's newest fields of endeavor. Complex weapons systems and space vehicles have resulted in complex support systems. The maintainability engineer is the interface between the two. His efforts, whether structural, mechanical or electronic, are to make that support easier... to gain an optimum blend between the support system and the weapons system... to achieve total operational effectiveness.

Playing a critical role in advanced aircraft, and in the area of long-term space exploration (where in-flight maintainability is a necessity), the maintainability engineer at Grumman has to consider man-machine relationships and man's capability under severe environments. This means an expansion of the design capability to *all* aspects of the total system. No longer confined to just purely functional design considerations, he is thrust into design areas not previously forced to reckon with. The result, a degree of professionalism not usually obtainable elsewhere.

Grumman, in advanced programs ranging from inner to outer space, is an ideal career vehicle for the technical man who now has, or is seeking, true "systems" knowledgeability. If you count yourself one of them, why not investigate the following immediately available positions.

Maintainability Engineers—to establish maintainability goals, plan and direct maintainability programs, perform trade-off studies and participate in maintainability testing. Your experience in supportability, reparability or operational analysis will be put to good use. Degree required.

Reliability/Maintainability Data System Engineers—to apply the latest techniques in maintenance and malfunction data collection and processing to design, and implement feedback and corrective action programs. Experience should include general technical information of military and space vehicles and current Navy, NASA and Air Force data requirements.

Electronic Subsystems Reliability Engineers—for Electronic Subsystems and GSE Group with a wide-spectrum work load which permits genuine individual creativity in expanding programs of space vehicles, advanced aircraft, and ground support electronic systems. Collaborate with your professional peers to perform reliability disciplines such as: design reviews, prediction and trade-off studies, circuit analysis, reliability assessments, failure effect and mode analysis, failure analysis and corrective action.

Systems Reliability Engineers—to perform system reliability tasks such as: system/mission effectiveness studies, reliability assessments and development of advanced techniques for reliability control. Experience in operational analysis or related engineering disciplines desired. Degree Required.

Reliability Test Engineers—with experience in test planning, test equipment, reliability test procedures, overstress testing, and other related test disciplines essential in establishment of reliability testing requirements and evaluation of vendor generated documents. Engineering degree with several years work in a related field is desired.

Component Parts Reliability Engineers—to apply knowledge of part characteristics with respect to electrical, mechanical, and environmental loads. Experience preferred in specification review and failure analysis of semi-conductors, transformers, relays, connectors and rotating components. BS in EE or equivalent desired.

EMC Systems Engineers—BS in Engineering to perform systems analysis, state-of-the-art reviews & develop advanced EMC techniques. Will be responsible for generating design data, control plans, test plans, directing tests, analyzing results, generating fixes and preparing reports for conformance to MIL-E-6051C & 6181D. Should have specific experience & be familiar with all aspects of EMC. Familiarity with computer math modeling is desirable.

EMC Subsystems Engineers—BS with job related experience to generate MIL-I-6181D or equivalent design data, control plans, test plans, direct tests, analyze data, generate fixes & prepare reports for equipments being designed & produced.

EMC Test Engineers—BS or equivalent to supervise test technicians, subsystems & systems test in accordance with test plans of MIL-I-C181D. Responsibilities include correction, modification, & preparation of test plans data analysis & reduction & report writing. Specific experience in EMC instrumentation is essential.

Antenna/Radome Engineers—B.S. in Engineering & a minimum of 2 years job related experience in the design & development of aircraft antennas, radomes & microwave components. Experience should include design of antennas in all frequency bands.

ECM Engineers—BS in Engineering with a minimum of 3 years experience in RF systems performance testing, troubleshooting & evaluation. ECM experience should be extensive, encompassing antenna, receiver, encoder computer, display integration, and malfunction evaluation.

Communications Engineers—BS in Engineering or equivalent and a minimum of 3 years experience in design, development, and test of airborne, spaceborne & navigation equipment systems. Knowledge of communication & RF navigation requirements techniques, methods, and uses as well as knowledge of fabrication techniques, limitations & requirements, are essential.

Auxiliary Systems Engineers—BSEE with experience in the design or test of logic & switching circuitry for spacecraft pyrotechnic initiators & detonator devices.

BSEE with experience in fuel management, fire detection & extinguishing, environmental control, central air data computers; warning caution systems.

Armament Control Engineers—BSEE with a minimum of 3 years experience in the design of arming & releasing systems for airborne armament.

Aerospace Electrical Power Systems Engineers—B.S. in E.E. or Physics with a minimum of 2 years experience in design, development, or integration of aircraft or spacecraft electrical, power systems. Positions available in aircraft programs, manned & unmanned spacecraft programs; aircraft & spacecraft advanced systems.

Aircraft Electro-Mechanical Designers—Designers with experience in aircraft electrical/electronic circuit design, installation, liaison, packaging to military specifications.

Electronics Field Engineers—B.S. in Electronics or Physics with a minimum of 6 years experience desirable, but candidates demonstrating the equivalency will be considered. In-plant training will be provided. Must be experienced in one or more of the following areas: search & track radars, digital computers, inertial guidance systems & transistor theory & application.

Note: 1967 graduates looking to start a career in aerospace are invited to contact Grumman now!

To arrange an immediate interview, send comprehensive resume to: Mr. George E. Kwak, Manager, Engineering Employment, Dept. GR-76



GRUMMAN

AIRCRAFT ENGINEERING CORPORATION
Bethpage • Long Island • New York, 11714

An Equal Opportunity Employer (M/F)

engineers

Here is your opportunity to associate with a high calibre staff in its formative state. At our research center in Ithaca we are engaged in exploratory activities in aircraft and ocean instrumentation. Our job is to come up with new ideas and new designs for transducers, modules and sub-systems using the latest techniques and components. We seek the help of talented and resourceful engineers (E.E. & M.E.) having up to ten years applicable experience.

Technical domain of this work will range through... Solid-state applications • Servo-mechanisms • Transducer design • Circuit design • Electromechanical design • Subsystems design & testing • Analog and digital techniques.

This is a real ground floor opportunity. Your opportunity also to live and work in the stimulating atmosphere of Ithaca, the educational, recreational and scenic center of the Finger Lakes region.

Inquiries will be treated in confidence. Send resume to: Mr. R. G. Thrasher, Dept. E

THE BENDIX CORPORATION 
FLIGHT & ENGINE INSTRUMENTS DIVISION
 RESEARCH CENTER, CORNELL RESEARCH PARK, ITHACA, N.Y. 14850

An Equal Opportunity Employer

Today's brand new ocean opens your brand of engineering career opportunity.

Newport News, world's largest and most advanced shipbuilding company—involved with all today's revolutionary marine developments—has immediate career openings in all these engineering fields:

Mechanical Engineers	Civil Engineers
Electrical Engineers	Metallurgical Engineers
Marine Engineers	Data Programmers
Industrial Engineers	Systems Analysts
Naval Architects	Chemists
Nuclear Engineers	Laboratory Analysts

With an order backlog now over \$500,000,000, we're bidding for creative engineers who like challenges and personal responsibility. Write our employment manager, John J. Gaughan. You'll get fast action.



Newport News
 SHIPBUILDING AND DRY DOCK COMPANY, NEWPORT NEWS, VIRGINIA
 An Equal Opportunity Employer

JUNE OPENINGS

Cadillac Associates is the nation's largest executive and professional placement service. If you wish to find out your true worth in the electronics field, contact us. Our staff is versed in your particular discipline and can show you the openings now available—coast to coast. Our service is completely confidential and free to the applicant. Here are a few of the many positions now open:

ELECTRICAL CONTROLS . . . \$15,000
 Bkgd. in design and development

SR. OPTICAL ENGINEER . . . \$12,500
 Infra-red systems.

SUPERVISORY ENGINEER . . . \$17,000
 HF radios, SSB transmitters and solid state receivers.

STAFF ENGINEER . . . \$15,000
 Semi-conductor process and device devel.

ELECTRONICS CONTROLS . . . \$14,000
 For motor - generators, etc.

DEVELOPMENT ENGINEER . . \$15,000
 Electronics, optics, heat, sound mechanics and hydraulics.

E. W. MOORE

CADILLAC ASSOCIATES, Inc.
 29 E. Madison Bldg., Chicago, Ill. 60602
 Financial 6-9400

CIRCLE 966 ON READER SERVICE CARD

PROFESSIONAL SERVICES

Donald C. Harder., Inc.

Magnetic Component Engineers

Reactors—Transformers—Filters

Serving the Research Laboratory

2580 K Street, San Diego, Calif. 92102
 Phone (714) 239-8021

The Consulting Engineer

By reason of special training, wide experience and tested ability, coupled with professional integrity, brings to his client detached engineering and economic advice that rises above local limitations and encompasses the availability of all modern developments in the fields where he practices as an expert.



AGE engineering is the art of anticipation

Keeping ahead of this one requires a special sophistication

The F-111 places heavy demands on the foresight of an AGE engineer.

This—the most advanced combat aircraft in the U.S. arsenal—has already been extended to several versions. Ground- and carrier-based fighters. Attack bomber. Reconnaissance craft. Our AGE engineers, who pioneered and developed AGE for the original F-111, are now committed to a still more challenging task: developing equipment to test all aircraft configurations—present and future—so that as new avionics systems and aircraft missions are defined, the additional test needs can be met without major redesign. Necessarily, the equipment will require an expanded depth of testing capability, combined with a high degree of compactness and rugged construction for deployment and usage in all areas of the world.

The magnitude of the systems and design problems to be encountered really comes into focus when you consider the complexity of Aerospace Ground Equipment: it's a highly-automated test and fault-location system which includes a video station, radar/receiver/transmitter modulator station, indicator/controls station, central air data computer station, radar servo and indicator station, computer station, penetration aids station, attitude and rate station, UHF communications station, HF communications station, TACAN station, HF communications flight-line tester, IR station, UHF guidance station and digital station—each sophisticated enough to test state-of-the-art equipment.

And this is only one of the programs our AGE laboratory is "writing the book" on. Other programs include internal and external checkout systems for missiles such as Atlas, Nike-Zeus and Polaris . . . flight-line and depot systems for terrain-following radar . . . SSB equipment . . . automated vehicular trouble-shooting systems, and many more.

Obviously, if any of these areas dovetails with your interests, we have a lot to talk about. (You'll quickly see why so many engineers like the growth atmosphere of the Electronics Division.)

If you'd prefer to move in another direction, send us your resume anyway. We have rapidly expanding study and development programs going in ASW, radio communications, data equipment, navigational aids, tracking equipment and countermeasures. Opportunities are wide open. Direct your resume, in confidence, to Mr. L. A. Corwin, Dept.110.

GENERAL DYNAMICS
Electronics Division

1400 N. Goodman Street, Rochester, New York 14601
An Equal Opportunity Employer (M&F)

How Do You Spell **OPPORTUNITY?**

Start With A Major Aerospace Co.

ADD—The Establishing Of a New

MICROWAVE COMMUNICATIONS UNIT

And The Result Is Exceptional Openings For:

SENIOR LEVEL MICROWAVE ENGINEERS

In the Following Areas:

PASSIVE MICROWAVE DEVICES ENGINEERS

To analyze, design and develop passive microwave devices, strip-line, coax and wave guide filters, mixers, filter devices and attenuators. Requires minimum 5 years' experience in microwave equipment design and ferrite synthesis. Ferrite device design experience desired but not essential.

IF CIRCUITS DESIGN ENGINEERS

Will analyze, design and develop communications IF circuits, lumped constant filters, FM and Phase detectors, voltage controlled and crystal oscillators. RF semi-conductor circuit design and filter synthesis. Minimum 5 years' experience required.

ACTIVE MICROWAVE DEVICES ENGINEERS

Will work with advanced analysis design and development of active microwave devices which would include high power, solid state VHF amplifiers, veractor multipliers, parametric amplifiers, tunnel diode amplifiers and parametric up-convertors. Requires degree and minimum 5 years' experience in microwave equipment design with advanced RF semi-conductor circuit design.

Salary will be commensurate with your background and experience . . . the advancement potential is unlimited.

In Complete Confidence, Forward Details Of Education and Experience To:

BOX 3038

Electronics, Class. Adv. Div., P.O. Box 12, N.Y., N.Y. 10036

An Equal Opportunity Employer

"Put Yourself in the Other Fellow's Place"

TO EMPLOYERS TO EMPLOYEES

Letters written offering Employment or applying for same are written with the hope of satisfying a current need. An answer, regardless of whether it is favorable or not, is usually expected.

MR. EMPLOYER, won't you remove the mystery about the status of an employee's application by acknowledging all applicants and not just the promising candidates.

MR. EMPLOYEE you, too, can help by acknowledging applications and job offers. This would encourage more companies to answer position wanted ads in this section.

We make this suggestion in a spirit of helpful cooperation between employers and employees.

This section will be the more useful to all as a result of this consideration.

Classified Advertising Division

McGRAW-HILL, Inc.

330 West 42nd St.

New York, N. Y. 10036

In electronics it's Electronics magazine to sell used equipment!

Your advertisement will produce Results in Electronics. Engineers turn to Electronics magazine for the latest technical developments — and for the latest buying information. You can reach them inexpensively in Electronics Searchlight Section.

For information:
Searchlight Section
Classified Advertising Division
Post Office Box 12
New York 10036



SEARCHLIGHT SECTION

- CLASSIFIED ADVERTISING
- BUSINESS OPPORTUNITIES
- USED OR SURPLUS EQUIPMENT

For Sale

VACUUM METALIZER or COATING SYSTEM

N.R.C. Type 3143B-42301. Chamber size 36" dia. X 6' long complete with diffusion pumps, mechanical pumps, gauges and power supplies. Overall dimensions 19' long, 8' 6" high. Used 3 months.

Also 2 G.E. 5 KW dielectric heaters, .45 megacycles.

INSTRUMENTS & MACHINES, INC.

1200 Grove St. Irvington, N.J. 07111
Telephone: (201) 371-7900

CIRCLE 969 ON READER SERVICE CARD

WANTED

ELECTRONIC PRODUCT IDEAS

We are a well financed Electronic manufacturing plant with over 15 years experience as a major supplier to the electronics industry.

We are seeking patented or otherwise proprietary products to supplement our present services. Will consider outright purchase, license or manufacturing agreement.

Write Box BO-3033, Electronics
Classified Adv. Div., P.O. Box 12,
New York, N.Y. 10036

CIRCLE 970 ON READER SERVICE CARD

ELECTRONIC TEST EQUIPMENT

Oscilloscopes, Signal Generators, VTVM's Camera Chain, Regulated Power Supplies Pulse Generators, Varisweep, Video Amps. Manufactured by Tektronix, Dumont, Hewlett Packard, Ballantine, Lambda, Kepco, Sola. Many others. New & Used—Guaranteed Relays, Filters, Transformers—Other new Components. Send for complete List

NATIONAL INSTRUMENT COMPANY
Box 144 East Rockaway, N.Y. 11518

CIRCLE 971 ON READER SERVICE CARD

RECEIVE PICTURES FROM APT WEATHER SATELLITES

Limited supply of FACSIMILE MACHINES for receiving high quality (8x8") pictures. Like new, complete, fully guaranteed. Lowest price anywhere. For complete details, write:

NEWSOME ELECTRONICS
Dept. E, 2670 Pinetree, Trenton, Michigan 48183
Tel. 676-7460 (AC313)

CIRCLE 972 ON READER SERVICE CARD

For Lease

PRIME MFG. SPACE—HOLYOKE, MASS.

1st floor 41,000 sq. ft.
Basement 10,000 sq. ft.

Heated, sprinklered, clear open space, loading docks, vinyl tile parking.

CHARLES BELSKY & CO., INC.

Holyoke, Mass. 01040 Ph. 413-534-5797

CIRCLE 973 ON READER SERVICE CARD

ELECTRON TUBES

KLYSTRONS • ATR & TR • MAGNETRONS
SUBMINIATURES • C.R.T. • T.W.T. • 5000-
6000 SERIES

• SEND FOR NEW CATALOG A2 •

A & A ELECTRONICS CORP.
1063 PERRY ANNEX
WHITTIER, CALIF.
696-7544

CIRCLE 974 ON READER SERVICE CARD

AUTOTRACK ANTENNA MOUNT

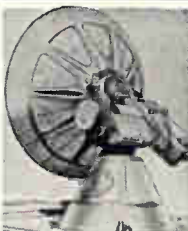

360 degree azimuth, 210 degree elevation sweep with better than 1 mil. accuracy. Missile velocity acceleration and slewing rates. Ampidyne and servo control. Will handle up to 20 ft. dish. Supplied complete with control chassis. In stock—immediate delivery. Used world over by NASA. USAF. MP-61-R. Type SCR-584. Nike Ajax mounts also in stock.

PULSE MODULATORS

MIT MODEL 9 PULSER 1 MW—HARD TUBE
Output 25kr 40 amp. Duty cycle, .002, pulse lengths .25 to 2 microsec. Also .5 to 5 microsec. and .1 to .5 microsec. Uses 6C21. Input 115V 60 cycle AC. Mfr. GE. Complete with driver and high voltage power supply. Ref: MIT Rad. Lab. Series, Vol. 5, p. 152.

2 MEGAWATT PULSER

Output 30 kv at 70 amp. Duty cycle .001. Rep rates. 1 microsec 600 pps. 1 or 2 macro 300 pps. Uses 5848 hydrogen thyratron. Input 120/208 VAC 60 cycle. Mfr. GE. Complete with high voltage power supply.

250 KW HARD TUBE PULSER

Output 16 kv 16 amp. Duty cycle .002. Pulses can be coded. Uses 5D21, 715C or 4PR60A. Input 115 v 60 cy. AC \$1200 ea.

18 MEGAWATT PULSER

Output 150KV at 120 amps. Rep rate: 50-500 PPS. Pulse length: 5 msec. 15KV 120 amp. into pulse transformer. Rise time 1.5 msec. Filament supply 5V 80 amp. incl. 17.5KV 1.5 amp DC power supply. Input: 220V 60 cy AC.

VARIAN KLYSTRONS

V-45: .15W output CW 9 to 10 KMC

VA-800: 10 KW output CW 1.7 to 2.4 KMC

VA-806H: 1KW output CW 7.5 to 8.5 KMC

T.W.T.

VA-157C: 5KW Peak, 350 W avg. .87 to 1.0 KMC

RCA-1154: 10 MW output 1.5 to 4.5 KMC

RCA-1161: 1 Watt output 1.0 to 4.1 KMC

SCR 584 AUTOTRACK RADARS

Our 584s in like new condition, ready to go, and in stock for immediate delivery. Ideal for telemetry research and development, missile tracking, satellite tracking. Fully Desc. MIT Rad. Lab. Series, Vol. 1, pgs. 207-210, 228, 284-286. Comp. Inst. Bk available \$29.00 each.

MICROWAVE SYSTEMS

L BAND RF PKG.

20 KW peak 990 to 1040 MC. Pulse width .7 to 1.2 micro sec. Rep. rate 180 to 420 pps. Input 115 vac incl. Receiver \$1200

200-225 mc RADAR SYSTEM

1 Megawatt output, 200 nautical mile range for long range detection of medium and high altitude jet aircraft as well as general search. Complete system in stock. Input 120/208 V. 60 cy. Type TPS 28.

C-BAND RADAR

250 KW output, C-band, PPI indicator, 5C22 thyratron modulator, Armonia hi gain parabolic section. Input 115 volts 60 cycle AC, complete \$2750.00

5 MEGAWATT C-BAND

Klystron RF package delivering nominal 5 megawatt pulse RF. Complete with pulser and power supply.

500 KW L BAND RADAR

500 kw 1220-1350 msec. 160 nautical mile search range P.P.I. and A scopes, MTFI thyratron mod 5426 magnetron. Complete system.

100 KW X BAND RADAR

Complete 100 kw output airborne system with AMTI, 5C22 thyr. mod. 4152 magnetron, 14FL 500 dec. as sweep, 60 cycle, elev. sweep, gyro stabilizer, hi-zain rev. Complete with all plus and cables.

AN/GPG-1 SKY- SWEEP TRACKER

3 cm. automatic tracking radar system. Complete package with indicator system. Full target acquisition and automatic tracking. Input 115 volts 60 cycle New. In stock for immediate delivery. Entire System 6' long, 3' wide, 10" high. Ideal for Infrared Tracker, Drone Tracker, Missile Tracker, R. & D.

500KW S BAND RADAR

250 miles search 115V 60 cy AC. Mfg. G.E.



RADAR AUTO-TRACK & TELEMETRY ANTENNA PEDESTALS 3 & 10 CM. SCR 584 AUTOTRACK RADARS, M-33 RADAR TPS-1D SEARCH, APS-45 TPS-10D HT. FINDERS, WX RADARS. FPN-32GCA, APS-10 APS-15B APS-27 (AMTI) SEARCH. ■ ■ APN-102 DOPPLER, DOZENS MORE. CARCINOTRONS. PFN'S. 25-51 23 G MEGAWATT PULSE MODULATORS. CAVITIES. PULSE TRANSFORMERS, IF STRIPS, WAVEGUIDE, BENDS 200 MC. 1 KMC. 3 KMC. 6 KMC. 9 KMC. 24 KMC. RF PKGS.

RADIO RESEARCH INSTRUMENT CO.
550 5TH AVE., NEW YORK 36, N. Y. JU 6-4691

CIRCLE 967 ON READER SERVICE CARD

WANTED

NO COMMERCIAL ONLY MILITARY EQUIPMENT

One of the leading Italian importers, supplying continuously the Italian Armed Forces with electronic equipment for a considerable value, extremely well introduced to all 3 Services, intends to expand even further its activities and seeks contact with:

- U.S. Manufacturers, not yet represented in Italy, working on Government contracts on most advanced equipment, which could be introduced to the Italian Armed Forces as future standard sets. Buying directly or, if the material is classified like Underwater Countermeasure Equipments, through the Service Attachés in Washington.
- Reliable dealers in electronic surplus equipment offering from own stock. The material should be either unused and warranted or OHC.

At this moment—besides hundreds of other items—we are interested in: Alford Antennas, B & C Band, Part of AS-470/FRN-12; Radar Training Simulators, AN/GPNT2A for Radar GCA, type AN/CPN-4; AN/APS-38 Radars, major parts and spares for same; Anti-mortar and artillery shell radars. Complete sets or major parts.

Also interested in aircraft or Bell and Sikorsky helicopter spares, hardware and electronic equipment.

Please contact urgently:

TELERADAR

Lungotevere Mellini 7,
Rome, Italy.

CIRCLE 968 ON READER SERVICE CARD

now in 9 sizes

HELIAX[®] elliptical waveguide covers the microwave spectrum



With the addition of two new sizes, flexible HELIAX elliptical waveguide is available for all microwave communication bands from 1.7 to 13.2 GHz. The continuous single lengths of HELIAX waveguide assure reliable system performance, with electrical characteristics better than conventional rigid

waveguides at less cost. ■ Investigate HELIAX Elliptical Waveguides for your next microwave system whether it be for a short haul installation or a long high density system. ■ Write for specifications—Andrew Corporation, P.O. Box 42807, Chicago, Illinois 60642.

2-67

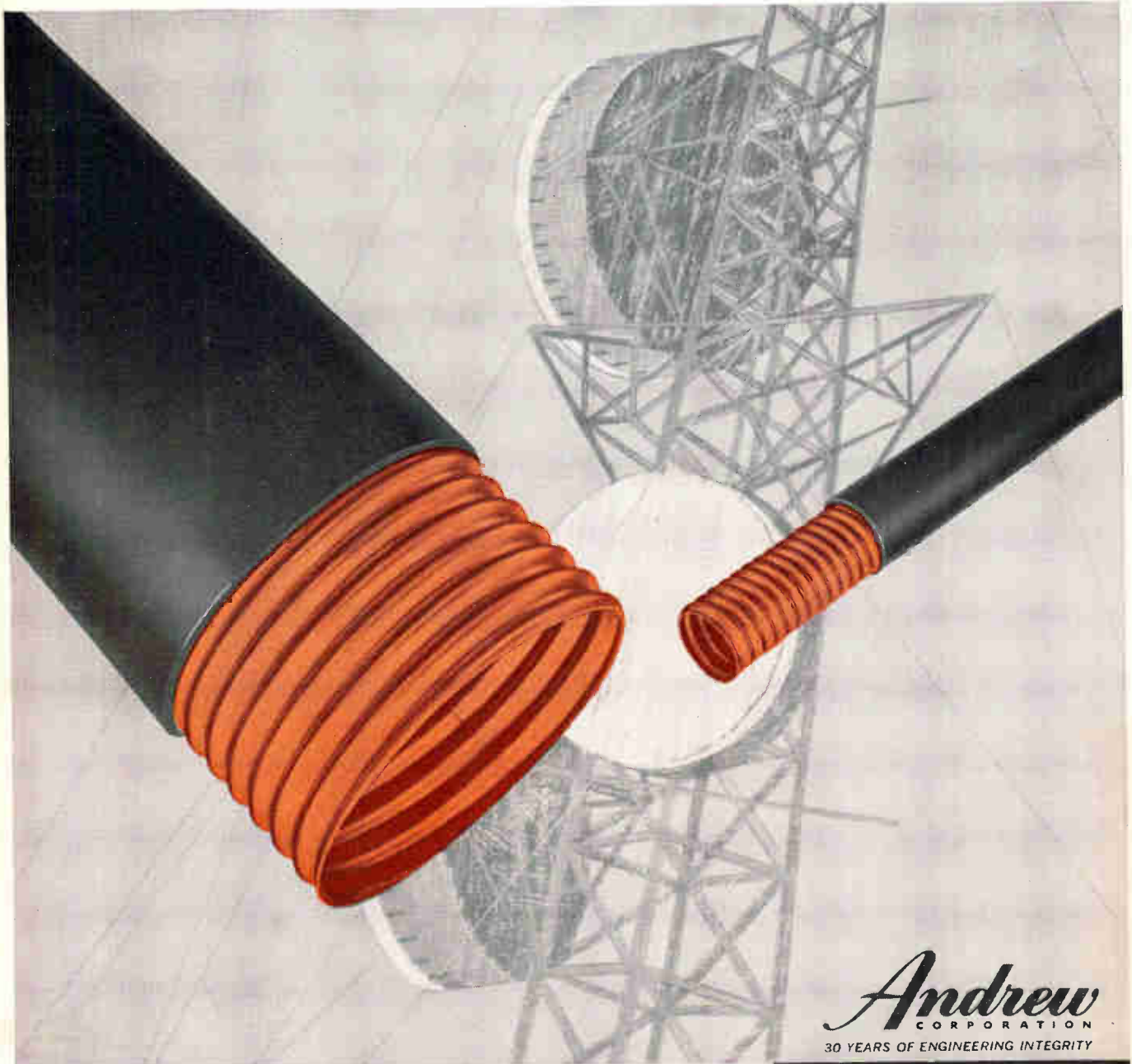

Andrew
CORPORATION
30 YEARS OF ENGINEERING INTEGRITY

9 SIZES OF ELLIPTICAL WAVEGUIDE



Standard or Tuned Connectors to Fit Standard Waveguide Flanges.

Newsletter from Abroad

June 12, 1967

East-West trade may be casualty of Mideast war

Fighting in the Middle East between Israel and the Arab nations will set back U.S. adherents of closer trade ties between the West and Soviet-bloc countries. Soviet backing of the Egyptian blockade of the Gulf of Aqaba, the incident that triggered the war, forced those urging more East-West trade to recognize that the Soviets still continue their policy of making mischief around the world. Moves by President Johnson to ease the technological embargo will run into stiffer resistance in the Congress as a result.

In the Middle East, the war has crystallized a change in the historic supplier pattern for electronic equipment. To further entrench themselves in the Arab market, Communist countries took advantage of the hostilities while Western countries embargoed shipments of military equipment. The Soviet Union has been building up the Arab war machine since 1956. Czechoslovakia signed an agreement to give military aid to the Arab states in March. And now the German Democratic Republic is eyeing the area for still another reason: East Germany would like the Arab states to recognize its sovereignty, something Western countries do not.

By the end of the first day's fighting, Israel's own infant electronics industry—hit by a mobilization callup that pulled up to 25% of the workers out of plants—met schedules by working overtime on a seven day week. French avionics producers who had supplied the electronics equipment for the Israeli Air Force's Mysteres were shut out of the replacement market. But just before hostilities broke out, three El Al commercial liners picked up full loads of spares in France and flew them to Israel. The U.S. was holding up processing of Israel's orders for Hawk Missiles and 24 Phantom fighter-bombers.

British companies that had supplied large quantities of electronics equipment to Arab nations ran into a similar embargo. But Associated Electrical Industries Ltd., which has a contract to supply an air-warning network to Saudi Arabia, expects no delay in delivery.

Bonn to bolster computer makers

A German equivalent of the French "Plan-Calcul" is fast taking shape. Anxious about the dominant position of U.S. computer companies in West Germany, the Kiesinger government has two schemes in the works that will sharply step up its support of native computer makers.

Under a five-year plan, the Ministry for Scientific Research intends to dole out about \$75 million for research and development of computers that will be put on the market by the early 1970's. The funds will underwrite up to half of manufacturers' R&D costs.

In addition, the Ministry of Economics wants to offer long-term, low-interest credits for computers already under development. The Ministry plans to earmark \$16 million for 1968 and then \$19 million annually through 1972.

The two schemes do not add up to the national concerted effort that the de Gaulle government set up with its Plan-Calcul [Electronics, Oct. 7, 1966, p. 224] but West German computer makers are hailing them. Siemens AG, the country's largest electronics firm, has been prodding the government for years to help the computer industry stand up to the competition of well-heeled U.S. data-processing giants, who have captured an estimated 85% of the German market.

After West Germany, Holland may be the next to follow de Gaulle's

Newsletter from Abroad

lead in bolstering native computer makers. The Dutch government is pondering a plan to aid its computer "industry"—for all practical purposes NV Philips' Gloeilampenfabrieken.

France and Germany push up launch date for joint satellite

France and West Germany made official their agreement to build a telecommunications satellite, and surprised some aerospace companies in the process. Plans now call for a launch from French Guiana in early 1970—pushed up from the late-1970 target talked about just a few weeks ago—and a circular 24-hour orbit at 23,000 miles. What particularly surprised some industry men was the announcement that the craft—to be called *Symphonie*—will be boosted by a Europa-2 rocket being developed by the European Launcher Development Organization. Use of the Europa would limit the weight of the satellite to about 400 pounds.

Some reports from West Germany had put the weight of the craft at 1,770 pounds—too heavy to be lifted by a Western European rocket—and this had led to speculation that Paris and Bonn would turn to the Soviet Union for a launch vehicle.

The new target date for the joint satellite is timed so that the French and Germans can make a case for a smaller U. S. share of the International Telecommunications Satellite Consortium when the agreement comes up for review in late 1969.

The French and West German aerospace industries are convinced they can build the hardware for the \$50 million satellite project. But some companies likely to get contracts have already sounded out U. S. firms about technical help in systems integration, assembly and testing.

Australian officials want IC consortium

The Australian government has started plumping for a single national effort in integrated circuits. Official planners are pushing for a government-led consortium grouping the country's major electronics firms. They say such a consortium is the most economic way to set up a production facility that could produce a wide range of IC's for the small Australian market. Outlook for IC use in the country is a climb from 40,000 devices last year to 1 million packages by 1970.

The IC consortium is being touted as the first step toward Australian self-sufficiency in defense electronics. It will probably be supported by Australian producers who long have claimed that the government imports military hardware that could be manufactured domestically.

Color-tv spurt seen for Germany

West German color-television set producers may be spared the doldrums that plagued U. S. receiver manufacturers for 10 years after color sets first went on the American market.

Market researchers at Deutsche Philips Industrie GmbH, who came up with remarkably accurate forecasts of black-and-white sales in 1955 and 1960, predict color-tv sales will bounce up 140% annually from this year's estimated 85,000 sets to hit a level of 575,000 sets by 1970.

Deutsche Philips' estimates are based on initial set prices of about \$625 and on the belief that West German network officials will fast add to the eight hours weekly now scheduled for the start-up of colorcasts in August. Deutsche Philips' parent company, NV Philips' Gloeilampenfabrieken of the Netherlands, has made heavy investments throughout Europe to prepare for the coming of color.

Electronics Abroad

Volume 40
Number 12

Great Britain

Jeep ground station

Convinced that military commanders will one day want a go-anywhere ground station to work through the U.S. Initial Defense Communications Satellite Project (IDCSP), Britain's Signals Research and Development Establishment has developed a jeep-hauled terminal that can be set up and put on the air in 45 minutes.

The terminal, with its 6-foot antenna dish and most of its electronics carried on a two-wheel trailer, had its first full-scale workout at the Paris Air Show which ended last week. During the show, the mobile station exchanged teletypewriter messages via IDCSP satellites between Paris and Fort Dix, N.J. and between Paris and Christchurch, England, the home base of the Signals Establishment, run by the Ministry of Technology.

With the exchange of messages through IDEX (for initial defense experiment), Britain became the first to work through a satellite with a truly peripatetic ground station. In the United States, the first mobile station for use with IDCSP will be delivered shortly by Radiation Inc. to the U.S. Army. Radiation's Mark V equipment (AN/TSC-34) is much heavier and larger; it weighs 12 tons and has a folding cloverleaf antenna array made up of four 10-foot-diameter reflectors.

Limited access. To get a small mobile terminal that can be hauled by a jeep or airlifted in by helicopter, the Signals Establishment limited its capacity to a single vocoded voice channel or 50 teletypewriter channels. The transmitter power is just 1 kilowatt, meaning the mobile terminal can't get into a frequency-division multiple-access satellite unless big fixed stations cut down their power. For

the demonstration at Paris, the U.S. Defense Communications Agency, which controls the IDCSP satellites, allocated an hour daily for IDEX. Up frequency was 8 gigahertz, down frequency 7 Ghz.

To hold down the terminal's weight, its designers dispensed with elaborate cooling systems. The transmitter's klystron is air cooled and the receiver's parametric amplifier is uncooled. Both transmitter and receiver are mounted on wings at the rear of the antenna dish, doing away with rotating microwave joints. The wings also serve to balance the equipment on the two-wheel trailer, as do the power supply packages, one at either end of the trailer.

On-vehicle. The jeep itself carries a gasoline-powered generator and five electronic modules: the transmitter module, satellite beacon receiver, information receiver, antenna controls, and transmitting-receiving controls.

Stable mates

The nuisance of compensating for temperature in quartz frequency-control oscillator crystals may soon be banished. The trick: pairs of crystals mounted in parallel but operating as one.

Two British researchers who hit on the double-crystal idea say it gives frequency-temperature curves flat to one part in 1 million over a range of about 80°C. What's more, they say the range could be extended to meet British military specifications of -40° to 80°C by mounting three or more crystals in parallel. Since the scheme works with relatively low-cost crystals that have parabolic frequency-temperature curves, the multicrystal oscillators figure to be competitive with compensated devices using AT-cut single crystals.

Good guess. Research engineers D.J. Fewings and C.R.S. Ince of the Marconi Co., a unit of the

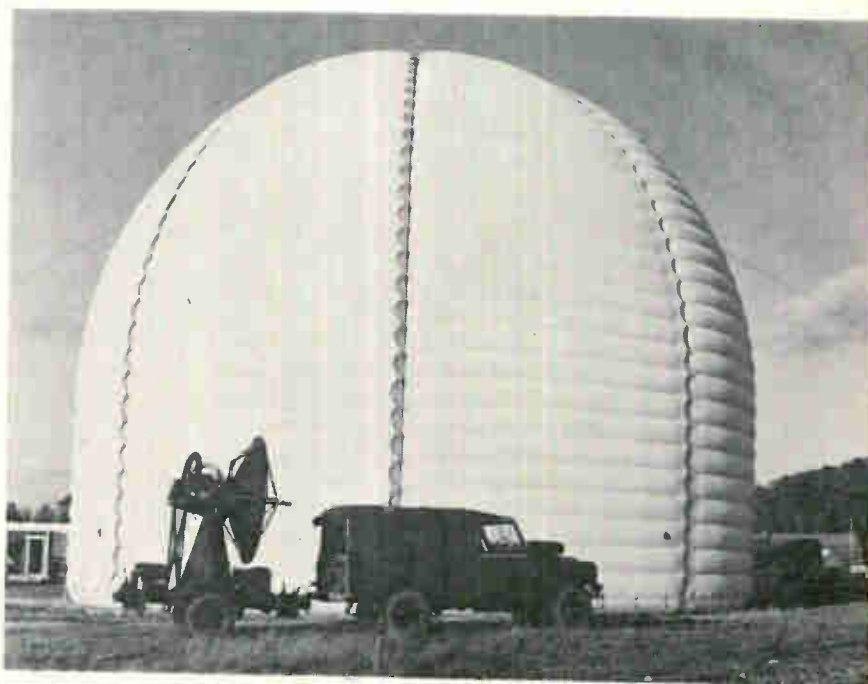

Itinerant. Radome of fixed station dwarfs Land Rover and two-wheel trailer that make up mobile ground station developed in Britain to work with IDCSP military communications satellites.

English Electric group, played a hunch to hit on the two-crystal arrangement. For their experimental oscillator they used parabolic-law crystals whose frequency-temperature curves centered at 5 megahertz. One crystal's center point was at 25°C, the other's at 75°C. The circuit also had a pair of capacitors in series with the crystal combination. The oscillator showed a flat output over a large part of the range between the two center points at a frequency slightly higher than 5 Mhz.

Reporting on the theory of two-crystal oscillators at a London conference last month, Fewings and Ince said the physics of the effect still aren't fully understood. But they've worked out the mathematical relationship between the frequencies of the individual crystals and the combined frequency, which is always slightly higher. The exact shape of the curve for the two-crystal combination depends on the value of the two capacitors in series.

Trio. The Marconi men also have calculated the values for a three-crystal combination to meet military requirements. Frequency at the center point would be 10.5 Mhz at -50°C for the first crystal 20°C for the second, and 90°C for the third. The only drawback with such a setup that Fewings and Ince can see is the problem of different aging rates for the three crystals. They might need rematching about once a year.

Soviet Union

Showmanship

Russian aerospace officials apparently have developed a knack for upstaging Western countries at the biennial Paris Air Show.

Two years ago, the Soviets stunned showgoers by flying a brand-new giant turboprop transport to Le Bourget. At this year's show, which wound up a 10-day run last week, the Soviets put themselves front and center again by displaying a Vostok launcher

and a pavilion full of mockups of their latest unmanned spacecraft, most of them never before displayed publicly.

Heavyweight. Most impressive of the spacecraft was the massive Proton research satellite. It weighs in at 12.2 tons and has panel-tip spread of 33 feet. An official manning the Russian exhibit at Le Bourget said three of the spacecraft had been launched to study cosmic particles in the energy range of 10^{11} to 10^{15} electron-volts. In addition, the missions included checks on solar radiation, the chemical composition of primary space particles, and interactions among high-energy particles.

In Proton, an on-board computer controls the electronics in the experiment package. Data collected by instruments is stored and transmitted to earth on command. Because of intense atmospheric braking on the massive satellites, their effective life was 100 days in orbits with perigees of 120 miles and apogees of 390 miles.

Queried on future Proton launches, the Russian official was non-committal. But some Western space experts think the vehicle may eventually be adapted for use as one module for an assembled-in-space manned vehicle.

Lightning. Space experts from the West also had their first look at the Soviets' Molnya 1 (for Lightning) communications satellite. Over the past 26 months the Russians have launched five of them, the fifth one late last month. It, apparently, is the only one still operating.

With the Molnya 1 satellites, which have 12-hour, highly elliptical orbits, the Russians are trying out long-range transmission of television, radio, telephone, and telegraph signals. The satellites also carry dosimeters to pick up data on radiation belts, say Soviet officials.

Power for the satellite comes from six foldout solar panels. Transmission power is 40 watts and the two antennas are parasols fitted with three-gun albedo sensors for earth acquisition. Antenna diameter is about 3.5 feet, indi-

cating a sensitive stabilization system for accurate pointing.

Weather watch. The Russians also had on view Cosmos 144, the weather satellite put up early this year. It covers the earth twice a day, picking up meteorological data like cloud cover, air-mass movements, temperatures, and wind speed. The on-board hardware includes a television camera, an infrared camera, and heat sensors.

A Soviet engineer at the Paris show said the Cosmos 144's camera was designed strictly for weather applications. But the satellite may well serve for reconnaissance. Among the display of photographs relayed back from Cosmos was a clear shot of the Sinai Peninsula, at whose tip lies the Gulf of Aqaba, focal point of the current Arab-Israeli crisis.

Comparing computers

It was an unlikely occasion for sizing up Russian computer capability; but technology watchers got a precise fix on the Soviet lag in data processing at the food and packaging machinery trade fair staged in Moscow last month.

At the U.S.-sponsored show, Scientific Data Systems Inc. sold the Soviets a \$400,000 SDS 930 computer that had been on display. Although SDS has been selling the

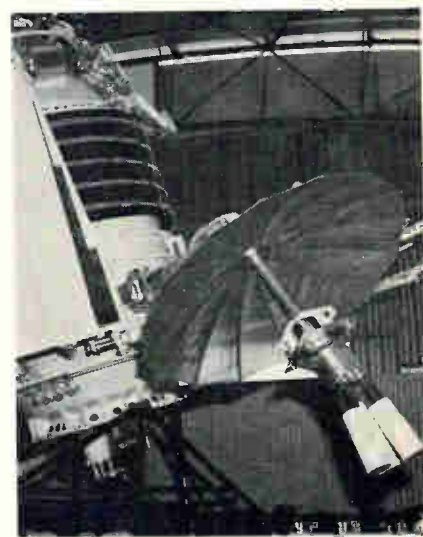

Pair of parasols. Umbrella-like antennas with triplets of albedo sensors distinguish Molnya 1 satellite.

machine in the U.S. for three years, it will be the fastest computer in the Soviet Union when it goes into service later this year, presumably at the Moscow Telemechanics Institute.

Bested. Although middle-aged by U.S. standards, the SDS 930 bests the BESM-6, the fastest known computer built so far by the Russians. The 930 has a cycle time of 1.75 microseconds, compared to about 2 μ sec for the BESM-6. The Russians claim their machine can perform 1 million operations per second. But a Western expert who has seen it points out the figure holds only for a few simple operations. The average speed, he says, is probably about 600,000 operations per second.

BESM-6 apparently is the only Soviet computer built so far with time-sharing in mind. And thus it has considerably more peripheral equipment than previous Russian computers. All the same, the peripherals the Russians will get with their SDS 930 will be vastly superior to those of BESM-6 according to Arthur Hyatt, who handles Eastern European sales for SDS.

Leader. SDS' sale of the 930 makes the company a U.S. leader in computer sales to the Soviets. Before the latest deal, SDS had pocketed Russian orders for two 910 and two 920 computers. The two 910's, worth \$380,000 between them, were installed last month at two Moscow research institutes.

West Germany

Teutonic tutor

Educators long have complained they spend too much classroom time teaching basic facts and definitions, a job that can be admirably handled by a computer-controlled teaching machine.

Trouble is, expensive computer-based systems are out of the question for most schools. And low-cost audio-visual teaching machines now on the market generally provide branched instruction—backtracking when a student hasn't

understood or skipping him ahead when he shows he knows—only in the visual channel.

For West German educators, the single-channel drawback is ending. Brown Boveri and Cie AG, a Heidelberg subsidiary of the Swiss company with the same name, will start series production this August of a \$370 machine that backtracks or skips forward in both audio and visual channels.

Peter Koehler, manager of Brown Boveri's teaching machine department, hopes to capture a 20% share of the country's teaching machine market with the low-cost entry, called the Probiton. Koehler expects the market will rise to between \$60 million and \$65 million by the early 1970's. Spending for software, he thinks, will run 10 times higher than that for the machines themselves.

Nine-track code. In the Probiton, visual instruction materials are presented on a paper strip 9 inches wide and up to 30 feet long. About 100 lesson segments can be put on each strip. The accompanying audio information comes from the machine's tape system, which plays through earphones. Each tape cassette can handle up to one hour of audio information.

The paper strip and tape drives are programed by a nine-track code punched into the paper strip. After completing a lesson segment, the student punches one of four buttons to answer a multiple-choice quiz. When he does, electrical connections are made through contact heads, actuated by the code holes, that feed relay logic. The signal of the logic circuits drives the strip and tape forward if the answer is correct, back if the answer is wrong. The nine-track code is flexible enough so that backtracking to the beginning of a lesson is possible should the student select a senseless answer.

Since the blocks of audio information on the tape vary in length, each block is separated by an unmodulated gap 3.5 inches long. By detecting the gaps, the tape drive control keeps the audio and visual blocks synchronized.

Portable. Although it most likely



Ready for more? Brown Boveri teaching machine moves on to a new lesson segment or backtracks in both audio and visual channels depending on student's pushbutton answer to quiz.

will be most used in the classroom, the Probiton was designed with homework in mind. The unit is about the size of a portable typewriter, weighs 18 pounds and is powered by rechargeable batteries.

And Koehler is convinced the market won't be limited to schools. He says that businesses and government agencies are considering the machine for their training operations. Eventually, Brown Boveri will try to move into export markets with the Probiton. The big problem, though, is finding companies abroad that can produce software—the programed visual strips and tapes—adapted to the peculiarities of foreign teaching methods.

Tracking down defects

Although the use of electronic gandy dancers to locate internal defects in tracks isn't new, West Germany has lurched ahead of the rest of Europe by placing ultrasonic test gear aboard a rail inspection train. The train is capable of checking both rails of a 20-mile section of track in one hour.

Developed for the Federal Railroads at Minden, the new system is a marked improvement over an

earlier inspection train. Internal fractures and fissures can be located accurately within 4 inches. Test and fault indications are displayed on scopes and recorded on film strips.

The ultrasonic equipment was built by the firm of J. & H. Krautkraemer, the same company that supplied the ultrasonic gear for the first U.S. rail inspection train.

By the bounce. The German detection system is based on principles used in some nondestructive methods of metal testing. Short pulses of ultrasonic energy sent into the rail are reflected at points where different propagation characteristics exist. Thus pulses penetrating faultless rail go through the metal before bouncing back. Pulses hitting a fracture in the metal are reflected sooner.

The pulses are picked up by transducers, disk-shaped piezoelectric crystals that resonate at a frequency between 2 and 4 megahertz. By damping, pulses about 5 microseconds long and 2 kilovolts in amplitude are produced. Pulse repetition rate is 3,000 hertz. The relatively weak echo pulses are boosted to a level of 120 decibels by broadband amplifiers before being applied to a scope.

Because of the high information content at the 3-kilohertz repetition rate and the 20-mph train speed, an evaluation of the test results by merely observing the scope is impossible. Photographing the pulses as they appear on the scope is impractical because a very high frame rate would be necessary, resulting in a large expenditure of film.

Reference points. To overcome the problem, the pulses are fed both to a regular scope and a cathode-ray tube that produces an intensity-modulated horizontal line. A pulse returning from a fault shows up as a bright spot on the line. An optical system projects the line onto a light-sensitive strip that moves under a lens at a rate proportional to the train speed but slower by a factor of 100. One-meter reference marks which facilitate fault location are also recorded on the strip.

The system uses eight test heads,

four under each side of the train. Six of the heads glide along the rail and beam the energy through the metal vertically and at angles of 35° and 70°. The remaining test heads are mounted about a foot above the rail. The pulses from these scan the rail surface to detect faults in the rail web and foot.

Japan

Sharp and flat

Television sets about the size of a book will be on the market in two or three years if the plans of the Hayakawa Electric Co. pan out.

Hayakawa this month demonstrated a development version of the flat cathode-ray tube around which its book-size set will be built, presumably with most of the electronics packed into integrated circuits. Images on the 8-inch screen were rated by viewers as fair. Hayakawa engineers claim that production versions will stand comparisons with the best conventional picture tubes.

Improved copy. Hayakawa admits that it is not the first to develop a flat tube. The General Electric Co., NV Philips' Gloeilampenfabrieken of the Netherlands, and others hold patents on flat crt's. Hayakawa, though, says it's carried the development to the point where it hopes to have the tube in production within two years. The company would like to persuade Hitachi Ltd., its principal tube supplier, to produce the flat version. If Hitachi balks, Hayakawa will try to line up a smaller tube producer and may even try making the flat tube in-house.

In the Hayakawa tube, the front-to-back dimension is just 2 inches. The neck with the electron gun extends straight down, parallel to the faceplate, rather than to the rear as in conventional crt's. Walls of the bulb are about 0.4-inch thick.

With a tube shaped like that, an ordinary electron gun can't be used because the electron path length varies with the vertical position of the faceplate and focus would be

poor. The Japanese flat tube has a gun that produces an almost-parallel beam. The spot size is less than 0.7 millimeter at all points on the faceplate.

Deflection. Hayakawa's kingly improvement over earlier experimental flat crt's apparently lies in its electrostatic vertical deflection system. Instead of a series of deflection plates switched on and off sequentially, Hayakawa uses just two plates. One is along the rear of the bulb, the other is formed by the aluminum backing on the faceplate phosphors. Hayakawa says the rear deflection plate could be made transparent so the image could be seen from either the front or the back of the tube.

The two-plate deflection makes possible almost constant voltage on the plates. Vertical sweep is obtained by changing the angle at which the gun injects electrons into the space between the plates. The electron-beam angle is varied by magnetic yokes. This arrangement does not give a truly linear sweep, but linearity is bettered by applying a dynamic correction voltage to the plates.

Current probe

Pioneer developers of the laser saw the device as a useful tool for physics measurements, but few expected it to find a place as a measurer of electrical power.

However, a laser current transformer to measure transient currents in extra-high-voltage (ehv) transmission lines is now being field-tested by the Central Research Institute of Japan's electric power industry.

Use of the instrument would eliminate the huge ceramic bushings required by conventional current transformers. The new setup electrically isolates the measuring apparatus from the power line. Test engineers also report that current waveforms of high fidelity can be produced with the new technique.

A helium-neon gas laser is used in the test project. It puts out one milliwatt of power and has a wavelength of 6,328 angstroms. The

Electronics Abroad

beam is directed into a flint-glass rod parallel to the ehv transmission line. The magnetic field set up by current in the ehv line also passes through the rod. The Faraday rotation—change in polarization—of the laser beam as it traverses the rod provides a measurement of the magnetic field, and this in turn gives a measurement of current.

The system's rise time, 200 nanoseconds, is limited by the bandwidth of the detectors and amplifiers. The dynamic range of the apparatus—30,000 amperes down to 30 amperes—is extended on the high end by choosing a high amplifier-saturation level, and on the low end by suppressing excess laser noise, accomplished by operating the laser in the fundamental mode. Induction interference is minimized by careful shielding and grounding, and by isolating the power source of the electronic apparatus from the high-voltage circuit.

Joji Hamasaki of the University of Tokyo reported on the project last week in Washington at the Conference on Laser Engineering and Applications.

Around the World

Great Britain. The first commercial test instrument based on a Gunn-effect oscillator has been put on the market by Flann Microwave Instruments Ltd. Flann's 8-16 gigahertz signal generator, which uses a solid-state diode signal source instead of the conventional klystron, will sell in the U.S. for about \$2,800. The company displayed the instrument at the Microwave Exposition held in New York last week.

France. The General Electric Co. will invest another \$30.2 million in Bull-GE, raising its interest in the joint venture to 66%. But GE's French partner, Compagnie des Machines Bull, retains the right to repay half the added investment within the next few years and thereby restore the 50-50 partnership.

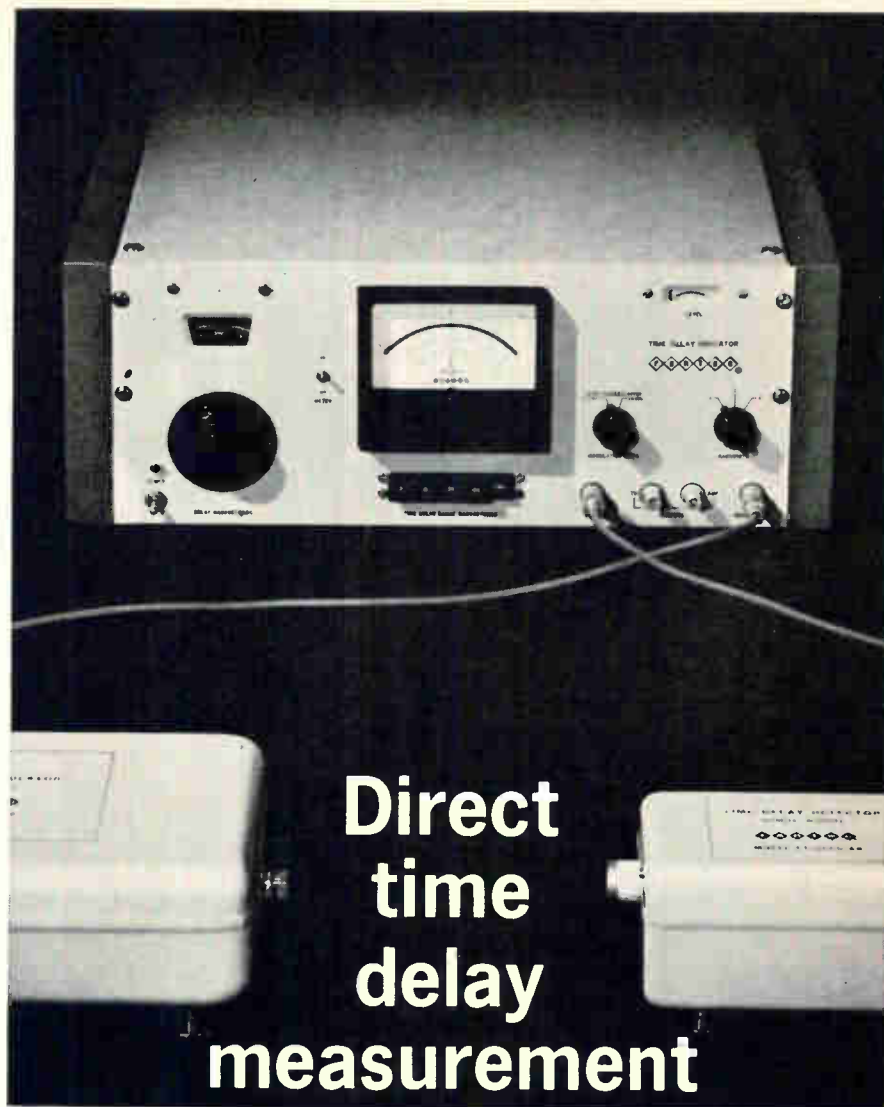

20 MHz to 18 GHz

The Rantec ET-300 is the first instrument to provide direct readout of time (group) delay from R-F through K_u-band. A new Rantec development (described in our Tech Memo TM-105) permits precise wide-band swept measurement of active and passive devices even when input and output frequencies of the devices differ. □ Features include: resolution to within 0.1 nsec; ten linear delay scales from 0.1 to 5000 nsec; selectable 200 kHz and 1 MHz modulation frequencies; simultaneous display of time delay and amplitude response as illustrated below. Accuracy is not affected by attenuation variations or signal source characteristics. □ Four interchangeable wide-band modulator units and three detectors cover the range 20 MHz to 18 GHz; these modules mate with the basic electronic unit, the ET-300E Time Delay Indicator. The cost is surprisingly low. □ Write for complete specifications and a copy of Rantec Memo TM-105.

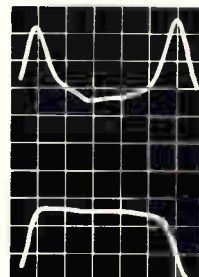

rantec
A DIVISION OF EMERSON ELECTRIC

Home Office: 24003 Ventura Boulevard, Calabasas, California 91302 • (213) 347-5446 • TWX 910-494-1218
□ Regional Offices: 910 Fox Chase Rd., Rockledge, Phila., Pa. 19111 • (215) 728-7500 • TWX 510-665-4176
1762 Massachusetts Avenue, Lexington, Massachusetts 02173 • (617) 861-0502 • TWX 710-320-0203



Advertising sales staff

Frank E. LeBeau [212] 971-6464

Advertising sales manager

Wallis Clarke [212] 971-2187

Assistant to sales manager

Donald J. Austermann [212] 971-3139

Promotion Manager

Atlanta, Ga. 30309: Michael H. Miller, 1375 Peachtree St., N.E. [404] TR 5-0523

Boston, Mass. 02116: William S. Hodgkinson McGraw-Hill Building, Copley Square [617] CO 2-1160

Chicago, Ill. 60611: Robert M. Denmead, J. Bradley MacKimm, Ralph Hanning, 645 North Michigan Avenue, [312] MO 4-5800

Cleveland, Ohio 44113: William J. Boyle, 55 Public Square, [216] JU 1-7000

Dallas, Texas 75201: Richard P. Poole, 1800 Republic National Bank Tower, [214] RI 7-9721

Denver, Colo. 80202: Joseph C. Page, David M. Watson, Tower Bldg., 1700 Broadway, [303] 255-5484

Detroit, Michigan 48226: Ralph Hanning 856 Penobscot Building [313] 962-1793

Houston, Texas 77002: Kenneth George, 2270 Humble Bldg., [713] CA 4-8381

Los Angeles, Calif. 90017: Ian C. Hill, John G. Zisch, 1125 W. 6th St., [213] HU 2-5450

Minneapolis, Minn. 55402: J. Bradley MacKimm, 1104 Northstar Center [612] 332-7425

New York, N.Y. 10036

500 Fifth Avenue

Donald R. Furth [212] 971-3615

James R. Pierce [212] 971-3616

Stanley J. Kail, Jr. [212] 971-3617

Philadelphia, Pa. 19103:

Warren H. Gardner, Jeffrey M. Preston, 6 Penn Center Plaza, [215] LO 8-6161

Pittsburgh, Pa. 15222: Warren H. Gardner, 4 Gateway Center, [412] 391-1314

Portland, Ore. 97204: James T. Hauptli, 218 Mohawk Building, 222 S.W. Morrison Street, Phone [503] 223-5118

Rochester, N.Y. 14534: William J. Boyle, 9 Greylock Ridge, Pittsford, N.Y. [716] 586-5040

St. Louis, Mo. 63105: Robert M. Denmead The Clayton Tower, 7751 Carondelet Ave. [314] PA 5-7285

San Francisco, Calif. 94111: James T. Hauptli, 255 California Street, [415] DO 2-4600

London W1: John W. Patten, Edwin S. Murphy Jr., 34 Dover Street, Hyde Park 1451

Milan: Robert M. Saidel 1 via Baracchini Phone: 86-90-656

Frankfurt Main: Gerd Hinske, Dieter Rothenbach, Elsa-Brandstroem Str. 2 Phone: 72 01 81

Geneva: Michael R. Zeynel, 1, rue du Temple Phone: 31 95 60

Paris VIII: Kenneth Davey, 17 Avenue Matignon Phone: 359 6637

Tokyo: Nobuyuki Sato, 1, Kotohiracho Shiba, Minato-Ku [502] 0656

Osaka: Ryoji Kobayashi 163, Umegae-cho Kita-ku [362] 8771

Business department

Wallace C. Carmichael, Manager

[212] 971-3191

Stephen R. Weiss, Production Manager

[212] 971-2044

Thomas M. Egan,

Assistant Production Manager [212] 971-3140

Dorothy Carmesin, Contracts and Billings

[212] 971-2908

Circulation and research

Milton Drake, Manager [212] 971-3485

Isaaca Siegel, Assistant Circulation Manager

[212] 971-6057

David Strasser, Assistant Research Manager

[212] 971-6058

Chloe D. Glover, Research Associate

[212] 971-6057

Electronics buyers' guide

George F. Werner, General Manager

[212] 971-2310

Ray Smyth, Eastern Regional Manager

[212] 971-6538

Regina Hera, Directory Manager

[212] 971-2544

Thomas M. Egan, Production Manager

[212] 971-3140

National Cash Register	28
Allen Dorsey & Hatfield	
National Electronics, Inc.	229
Connor-Sager, Assoc.	
Natvar Corp.	231
Sanger-Funnell, Inc.	
Neotec Corp.	42
Marken Adv., Inc.	
Nexus Research Laboratories	77
Larcom Randall Adv.	
North Atlantic Industries, Inc.	173
Murray Heyert Assoc.	
Northern Natural Gas Co.	189
Bozell & Jacobs, Inc.	
Oak Electro/Netics Corp.	27
Buchen Advertising, Inc.	
Opto-Metric Tools, Inc.	202
L.W. Frohlich & Co.	
Pacific Measurements, Inc.	7
Jack Herrick Adv., Inc.	
Pastoriza Electronics Co.	226
L.K. Frank Co., Inc.	
Phelps Dodge Electronics	
Products Corp.	147
Smith, Dorian & Burman, Inc.	
Philips Eindhoven, N.V.	OAS 1
T.A.G. De La Mar	
Plessey Electronics Co., Ltd.	
Matrix Div.	134
Roles & Parker Ltd.	
Plessey Electronics Co.,	
Radio Systems Div.	OAS 4, 5
Roles & Parker Ltd.	
Pomona Electronics Co.	190
Buxton Adv., Agcy.	
Precision Tube Co.	224
George Moll Adv., Inc.	
Q MAX Corporation	216
George Homer Martin Assoc.	
Radio Corporation of America	4th Cover, 6
Al Paul Lefton Co.	41, 139, 167
Rantec, Div. of Emerson Electric	247
Guerin, Johnstone, Gage, Inc.	
Schlumberger, A.C.B.	OAS 18
Hi-Fi Publicite	
Scientific Data Systems	133
Doyle, Dane, Bernbach, Inc.	
Sierra Electronics, Div. Philco Ford	59
Hal Lawrence, Inc.	
Sifco Metachemical, Div. of Steel	
Improvement & Forge Co.	223
Creative/3	
Sigma Instruments, Inc.	74
Marschalk Co., Inc.	
Singer Co., Metrics Div.	67
Hepler & Gibney, Inc.	
Skottie Electronics	214
Patrick J. Lahey, Inc.	
Slater Electric, Inc.	114
Industrial Marketing Associates	
Solartron Electronic Group, Ltd.	OAS 2, 3
Southern Adv., Ltd.	8, 9, 12, 13
Solitron Devices, Inc. Transistor Div.	177
Haselmire Pearson Adv.	
Sorensen Operation, Raytheon Co.	11
James Advertising, Inc.	
Souriau & Cie	OAS 14
Ariane Publicite	
South Dakota Industrial Development	
Expansion Agency	214
Maurice Paulsen Adv.	
S.P. Elettronica	OAS 15
Sprague Electric Co., The	5, 10
Harry P. Bridge Co.	
Stackpole Carbon Co.,	
Electronic Components Div.	80
Meek & Thomas, Inc.	
Sylvania Electric Products, Inc.,	
General Telephone & Electronics	29
Tatham-Laird & Kudner, Inc.	
Synthane Corp.	229
Arndt, Preston, Chapin, Lamb & Keen, Inc	
Syntron Co.	75
De Sales Adv., Inc.	
Technology, Inc.	60
Weber, Geiger & Kalat, Inc.	
Tektronix, Inc.	144
Hugh Dwight Adv., Inc.	
Teledyne Telemetry Co.,	
Div. of Teledyne, Inc.	233
S. Michelson Adv.	
Telonic Instruments	159
Jansen Associates	

Telrex Communications Engineering	230
Laboratories	
George Homer Martin Assoc.	
Texas Instruments Incorporated	
Semiconductor/Components	54, 55
Division	
Don L. Baxter, Incorporated	
Thermal American Fused Quartz	158
Kniep Associates	
TIG Cologne	234
Times Wire & Cable Div.	
International Silver Co.	141
Mohr & Co., Inc.	
Tracor, Inc.	217
Weekley & Valenti, Inc.	
Trans World Airlines, Inc.	210
Foote, Cone & Belding	
Triplett Electrical Instrument Co.	123
Burton Browne Adv.	
TRW, Equipment Operations	234
Ritchie & Sattler, Inc.	
TRW, Semiconductors	71
Fuller Smith & Ross, Inc.	
Trygon Electronics	17
Solow/Wexton Co., Inc.	
Trymetrics Corp.	44
Solow/Wexton Co., Inc.	
Tung Sol, Div. Wagner Electric Corp.	225
E.M. Freystadt Assoc.	
Ulano & Co., J.	165
Byrde, Richard & Pound, Inc.	
Union Carbide Corp., Linde Div.	121
J.M. Mathes, Inc.	
University Laboratories, Inc.	136
West Associates	
Varo, Inc.	210
Tracy-Locke Co., Inc.	
Victoreen Instrument Co., The	195
Palm & Peterson, Inc.	
Victory Engineering Corp.	172
BRM Black-Russell-Morris	
Vitramon, Inc.	178
Ted Sommers, Inc.	
West Palm Beach Industrial	211
Commission	
The Rachesky Co., Inc.	
Westinghouse/MED	57
McCann/ITSM	
Westinghouse/Metals Div.	175
McCann/ITSM	
Wilson Rubber Co., The	154
Norman Malone Assoc., Inc.	

Classified Advertising

F.J. Eberle, Business Mgr.

PROFESSIONAL SERVICES 236

EMPLOYMENT OPPORTUNITIES 235-238

EQUIPMENT (Used or Surplus New) For Sale 239

ADVERTISERS INDEX

A & A Electronics Corp.	239
Charles Belsky & Co., Inc.	239
The Bendix Corp., Flight & Engine Instr. Div.	236
Cadillac Assoc.	236
General Dynamics, Electronics Div.	237
Grumman Aircraft Corp.	235
Instruments & Machines, Inc.	239
National Instrument Co.	239
Newsome Electronics Sales	239
Newport News Shipbuilding & Dry Dock	236
Radio Research Instrument Corp.	239
Teleradar	239

For more information on complete product line see advertisement in the latest Electronics Buyers' Guide

Advertising in Overseas Advertising Section following Newsletter from Abroad

Every ITT 2N3375 gives you 66% more P_{OE} than EIA specs demand

28V CLASS B POWER OUTPUT VS FREQUENCY

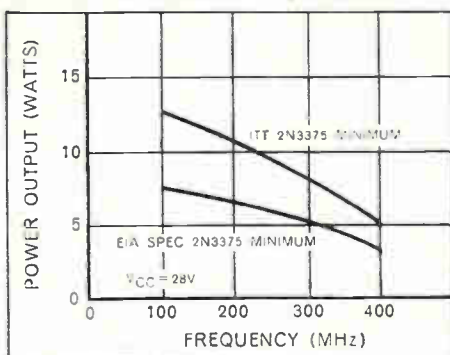

When you apply ITT 2N3375s, you get 5 watts minimum saturated power output at 400 MHz and $V_{CC} = 28V$, tested 100%.

The secret lies in ITT's unusually close control of resistivity, combined with interdigitated construction.

To find out more about the superior performance of the ITT 2N3375, write today for your free copy of "VHF/UHF Power Transistor Amplifier Design" and complete 2N3375 specs. Or see for yourself — order sample quantities off-the-shelf from your ITT distributor or factory representative. ITT Semiconductors is a division of International Telephone and Telegraph Corporation, 3301 Electronics Way, West Palm Beach, Florida.

ITT
SEMICONDUCTORS

FACTORIES IN WEST PALM BEACH, FLORIDA PALO ALTO, CALIFORNIA LAWRENCE, MASSACHUSETTS HARLOW AND FOOTSCRAY, ENGLAND, FREIBURG AND NUREMBURG, GERMANY

New hp 141A: Variable Persistence & Storage Make It...

THE SCOPE WITH AN ADJUSTABLE MEMORY

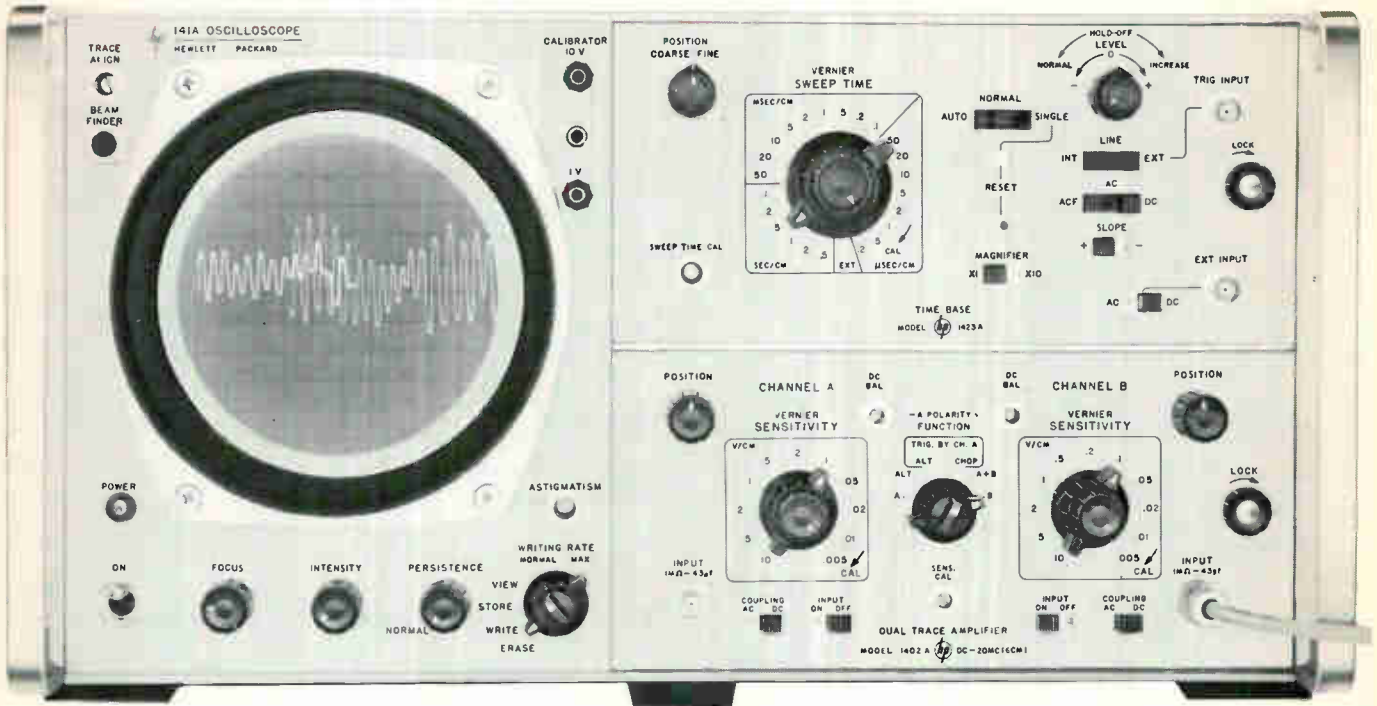

- Match the persistence of your screen to any signal for steady traces without annoying flicker
- Store waveforms for side-by-side comparison
- Cover the entire measurement spectrum to 12.4 GHz with 17 high-performance hp plug-ins

At the twist of a knob, you can adjust the 141A's memory span (trace persistence) from 0.2 sec to more than a minute. This adjustment is "variable persistence". It enables you to: (1) Get bright displays of fast, low rep rate pulses because each trace reinforces the previous one, (2) see signal trends while making circuit adjustments by simply making persistence long enough so that several traces appear on the screen simultaneously, (3) see slow signals such as EKG, transducer and sampling waveforms by adjusting persistence so that the old trace fades as the new one is being written, and, (4) get maximum resolution on swept frequency measurements by sweeping slowly and increasing persistence.

In addition to exclusive variable persistence, the 141A gives you storage for side-by-side comparison of waveforms. In this mode, traces can be held intact for more than an hour (overnight, in fact, with the scope turned off). Fast 1 cm/ μ sec storage writing rate enables you to capture single-shot transients.

The 141A also gives you conventional CRT persistence. So, the 141A gives you three scopes in one: variable persistence, conventional persistence, and storage. Further, you can choose from 17 high-performance hp plug-ins to make virtually any oscilloscope measurement. Price, 141A mainframe: \$1395.

Get the complete picture from your hp Field Engineer, or write for Data Sheet 140A and see for yourself how much more you can do with this radically advanced hp scope. Hewlett-Packard, Palo Alto, California, 94304. Tel. 415 326-7000. In Europe: 54 Route des Acacias, Geneva.

New hp 141A also gives you a choice of 17 high-performance plug-ins for clearly superior results in: 20 MHz Wideband • High-Sensitivity with no dc drift • 150 ps TDR • 12.4 GHz Sampling with delayed sweep —all with variable persistence and storage

New—fast writing rate CRT option for hp 141A, 5 cm/ μ s. Order Model C05-141A. Price \$1495.

HEWLETT  PACKARD
An extra measure of performance

087/16 RR

Circle 901 on reader service card

Here is power coverage for modern HF, VHF, and UHF communications. Look at the range covered by RCA Cermolox® and ceramic Beam Power Tubes. They're powerful, yet compact. Typical types outlined in the chart are just a few of the more than 25 tubes comprising a field-tested line that is immediately available—and priced to give your circuit extra value. Custom requirements can be filled on request. For applications assistance, contact your RCA EC&D Representative. For technical data on specific types, write: Commercial Engineering, RCA Electronic Components and Devices, Sect. F-19P-2, Harrison, N.J.

ALSO AVAILABLE FROM YOUR RCA INDUSTRIAL TUBE DISTRIBUTOR

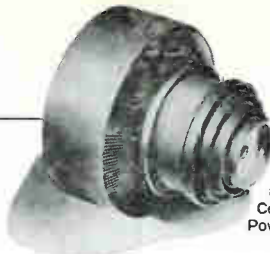

RCA POWER TUBES FOR HF, VHF, UHF

RCA-8501, a typical RCA Cermolox Beam Power Tube

RCA Type	Description	Cooling	Filament (F) or Heater Voltage	Max. DC Plate Ratings (Volts)	Frequency (MHz)	Typical CW Power Output (Watts)
7213	Cermolox	Forced Air	5.5	3000	600	1350
7650	Ruggedized Cermolox	Forced Air	6.3	2500	400	800
8072	Beam Power	Conduction	12-15	2200	50 470	110 85
8122	Beam Power	Forced Air	13.5	2200	50 470	375 300
8226	Cermolox	Forced Air	6.3	2500	1215 400	105 340
8501	Cermolox	Forced Air	8.5 (F)	7000	400	10000



The Most Trusted Name in Electronics

COMMUNICATION POWER

